



**HAL**  
open science

# Relation entre la propriété phytoprotectrice de synthèse de 2,4-diacétylphloroglucinol par les *Pseudomonas* fluorescents dans la rhizosphère, et la résistance des sols à la maladie de la pourriture noire des racines de tabac

Juliana Almario

## ► To cite this version:

Juliana Almario. Relation entre la propriété phytoprotectrice de synthèse de 2,4-diacétylphloroglucinol par les *Pseudomonas* fluorescents dans la rhizosphère, et la résistance des sols à la maladie de la pourriture noire des racines de tabac. Biologie végétale. Université Claude Bernard - Lyon I, 2012. Français. NNT : 2012LYO10337 . tel-01138517

**HAL Id: tel-01138517**

**<https://theses.hal.science/tel-01138517>**

Submitted on 2 Apr 2015

**HAL** is a multi-disciplinary open access archive for the deposit and dissemination of scientific research documents, whether they are published or not. The documents may come from teaching and research institutions in France or abroad, or from public or private research centers.

L'archive ouverte pluridisciplinaire **HAL**, est destinée au dépôt et à la diffusion de documents scientifiques de niveau recherche, publiés ou non, émanant des établissements d'enseignement et de recherche français ou étrangers, des laboratoires publics ou privés.

N° d'ordre 337-2012

Année 2012

THESE

présentée devant

L'UNIVERSITE CLAUDE BERNARD LYON 1

pour l'obtention du

DIPLOME DE DOCTORAT

(arrêté du 7 août 2006)

Par

**Juliana ALMARIO**

---

**Relation entre la propriété phytoprotectrice de synthèse de 2,4-diacétylphloroglucinol par les *Pseudomonas* fluorescents dans la rhizosphère, et la résistance des sols à la maladie de la pourriture noire des racines de tabac**

---

Directeur de thèse : Daniel MULLER

Co-directeur de thèse : Yvan MOËNNE-LOCCOZ

JURY :

M. Philippe LEMANCEAU  
M. Alain SARNIGUET  
Mme Monika MAURHOFER  
M. Yvan MOËNNE-LOCCOZ  
M. Daniel MULLER  
Mme Agnès RICHAUME

Rapporteur  
Rapporteur  
Examinatrice  
Examinateur  
Examinateur  
Examinatrice



---

## **Relation entre la propriété phytoprotectrice de synthèse de 2,4-diacétylphloroglucinol par les *Pseudomonas* fluorescents dans la rhizosphère, et la résistance des sols à la maladie de la pourriture noire des racines de tabac**

---

### RESUME :

Les bactéries du sol produisant des antifongiques comme le 2,4-diacétylphloroglucinol (DAPG) protègent les racines des plantes vis-à-vis des champignons phytopathogènes. Néanmoins, les conditions de fonctionnement de ces populations bactériennes dans le sol restent très mal connues. Dans certains sols, dits résistants aux maladies, ces bactéries phytoprotectrices sont présentes à des effectifs importants et leur activité est suffisante pour protéger la plante malgré la présence du pathogène. L'objectif de cette thèse a été de comprendre la relation entre la résistance des sols à la maladie de la pourriture noire des racines de tabac, et la fonction de synthèse du DAPG chez les bactéries du genre *Pseudomonas*. Dans la situation de référence de Morens (Suisse), les sols résistants diffèrent des sols sensibles par la présence de vermiculite, argile capable de relarguer du fer. On sait que la présence de vermiculite améliore la phytoprotection assurée par les *Pseudomonas* producteurs de DAPG, mais les mécanismes moléculaires sous-jacents restent inconnus. Dans un premier temps, la quantification de ces bactéries par une nouvelle méthode de PCR quantitative développée ici, a confirmé que leurs effectifs sont élevés dans les sols résistants, mais aussi dans les sols sensibles, suggérant que la résistance puisse plutôt dépendre d'une plus forte expression de la fonction de synthèse du DAPG. Dans un second temps, l'étude de l'expression des gènes de synthèse du DAPG en système de sol artificiel, à l'aide de la souche rapportrice *P. protegens phlA-gfp*, a montré que la présence de vermiculite dans le sol se traduit par une plus forte biodisponibilité du fer pour les *Pseudomonas*, induisant une plus forte expression des gènes de synthèse du DAPG et la protection du tabac. En conclusion, la résistance des sols de Morens à la maladie de la pourriture noire des racines est conditionnée par plusieurs facteurs abiotiques et biotiques, dont la biodisponibilité du fer qui régule l'expression des gènes de synthèse du DAPG chez *Pseudomonas*.



---

**Relation between the 2,4-diacetylphloroglucinol synthesis ability of fluorescent *Pseudomonas* in the rhizosphere, and soil suppressiveness to black root rot disease of tobacco**

---

**ABSTRACT :**

Soil bacteria producing antimicrobial compounds like 2,4-diacetylphloroglucinol (DAPG) protect plants from soil-borne phytopathogens. Nevertheless, the functioning of these bacterial populations in the soil is largely unknown. In certain soils, termed disease-suppressive soils, these bacteria are present at high numbers and their activity is sufficient to assure effective plant protection in the presence of the pathogen. The aim of this thesis was to understand the relation between soil suppressiveness towards black root rot of tobacco, and the 2,4-diacetylphloroglucinol synthesis ability of certain *Pseudomonas*. In Morens region (Switzerland), suppressive soils differ from conducive soil by the presence of vermiculite, an iron-releasing clay. It is known that DAPG-producing *Pseudomonas* provide better plant protection in the presence of vermiculite, but the molecular basis of this interaction is still unknown. First, the quantification of these bacteria, through a new real-time PCR method developed here, confirmed that high numbers of DAPG-producing *Pseudomonas* occur in suppressive soils, as well as in conducive ones, raising the possibility that suppressiveness depends rather on a higher expression of DAPG synthetic genes. Second, expression studies of DAPG synthetic genes using a *P. protegens phlA-gfp* reporter strain and artificial soil systems, confirmed that the presence of vermiculite in the soil can translate into higher iron bioavailability for *Pseudomonas*, triggering higher expression of DAPG synthetic genes and effective plant protection. In conclusion, black root rot suppressiveness of Morens soils is determined by several abiotic and biotic factors, among which iron bioavailability regulating the expression of DAPG synthetic genes in plant-protecting *Pseudomonas*.



## Remerciements

---

Ce travail de thèse a été réalisé au sein du laboratoire d'Écologie microbienne de l'Université Lyon1 dirigé par Monsieur René Bally, lorsque j'ai débuté ce travail, puis par Monsieur Yvan Moëgne-Loccoz, qui a pris sa succession. Je les remercie vivement de m'avoir accueilli au sein de leur unité.

J'adresse mes remerciements aux rapporteurs Philippe Lemanceau et Alain Sarniguet, ainsi qu'aux examinatrices Monika Maurhofer et Agnès Richaume d'avoir accepté d'évaluer ce travail. Je voudrais remercier également Christoph Keel, Claire Prigent-Combaret et Christian Steinberg d'avoir participé à mon comité de pilotage, et de m'avoir conseillée.

Je tiens à remercier spécialement mes directeurs de thèse Daniel Muller et Yvan Moëgne-Loccoz pour leur investissement dans cette thèse et pour tout le soutien qu'ils m'ont apporté. De manière plus générale je voudrais remercier tous les membres de l'équipe 'Rhizosphère' pour leur implication directe ou indirecte dans cette thèse, principalement Floriant Bellvert, Maxime Bruto, Gilles Comte, Jacqueline Haurat et Marie-Andrée Poirier.

Je voudrais remercier particulièrement Martina Kyselková et Karima Zouache, qui ont énormément participé à ma formation. Par ailleurs je voudrais remercier Benoît Drogue, Stéphanie Petit, Vincent Raquin et Arnaud Rondelet pour les nombreuses discussions scientifiques et pas scientifiques.

« *Une tête bien faite plutôt qu'une tête bien pleine.* » (Montaigne) ; je tiens donc à remercier tous les enseignants que j'ai eu le long de mon parcours scolaire au Lycée Français Paul Valéry de Cali et à l'Université Claude Bernard, qui ont participé à ma construction personnelle et surtout m'ont appris à penser. Spécialement, Xavier Mauron, Alain Corre, Alain Meschine, Marc Philippart, Amparo Viveros, Hernan Velez, Christophe Bruel, Emmanuel Desouhant, Dominique Mouchiroud, Marc Lemaire, Sabine Favre-Bonté, René Rohr et Yvan Moëgne-Loccoz.

Je remercie mes sœurs Nathalie et Tatiana, mes amis, et ma famille, et je leur dédie cette thèse. Je dois remercier particulièrement mes parents pour leur patience et leurs encouragements : « *Estudia y no serás cuando crecida, ni el juguete vulgar de las pasiones, ni el esclavo servil de los tiranos.* ».





# SOMMAIRE

INTRODUCTION GENERALE.....	13
La rhizosphère : interface plante-sol modulant l'activité des microorganismes.....	15
Les sols résistants aux maladies.....	17
<i>Pseudomonas</i> spp. protégeant les racines des plantes .....	19
<i>Pseudomonas</i> producteurs de DAPG et la résistance des sols à la maladie de la pourriture noire des racines.....	21
Hypothèses de la thèse .....	24
Objectifs et approches scientifiques.....	24
Plan de la thèse.....	26
SYNTHESE BIBLIOGRAPHIQUE .....	29
Introduction à la synthèse bibliographique .....	30
<b>Rhizosphere ecology and potential plant protection mechanisms in soils naturally suppressive to <i>Thielaviopsis basicola</i>-mediated black root rot of tobacco</b> .....	33
Abstract.....	34
Introduction.....	35
PART 1. Soil suppressiveness to black root rot.....	36
PART 2. Role of fluorescent <i>Pseudomonas</i> spp. in black root rot suppressiveness.....	42
PART 3. Rhizobacterial community and black root rot suppressiveness.....	45
Conclusion .....	48
Outlook .....	48
References.....	49
CHAPITRE 1 : Relation entre la densité des populations de <i>Pseudomonas</i> producteurs de DAPG et la résistance du sol à la maladie .....	59
Introduction au chapitre 1 .....	60
PARTIE 1.1 : Délimitation du groupe fonctionnel des <i>Pseudomonas</i> producteurs de DAPG : étude de la distribution de la fonction de synthèse du DAPG chez les <i>Pseudomonas</i> .....	67
<b>Distribution of 2,4-diacetylphloroglucinol biosynthetic genes among the <i>Pseudomonas</i> spp.</b> .....	69
Abstract.....	70
Introduction.....	71

Material and methods.....	72
Cultivation of <i>Pseudomonas</i> type strains and DNA extraction.....	72
PCR detection of <i>phlD</i> in <i>Pseudomonas</i> type strains .....	72
Phylogenetic analysis of <i>Pseudomonas</i> strains .....	72
Ancestral state reconstruction.....	73
Localization and genetic environment of the <i>phl</i> cluster in <i>Pseudomonas</i> genomes .....	73
Results.....	73
Distribution of <i>phlD</i> among <i>Pseudomonas</i> type strains .....	73
Position of <i>phl</i> <sup>+</sup> strains in the <i>Pseudomonas</i> phylogeny.....	74
Ancestral state reconstruction for the <i>phl</i> cluster .....	74
Genomic regions flanking the <i>phl</i> cluster in <i>Pseudomonas</i> .....	76
Discussion.....	78
Acknowledgements.....	81
References.....	81
PARTIE 1.2 : Quantification des <i>Pseudomonas</i> producteurs de DAPG dans les sols résistants et sensibles à la maladie de la pourriture noire des racines de tabac .....	87
<b>Monitoring of the relation between 2,4-diacetylphloroglucinol-producing <i>Pseudomonas</i> and <i>Thielaviopsis basicola</i> populations by real-time PCR in tobacco black root-rot suppressive and conducive soils .....</b>	<b>89</b>
Abstract.....	90
Introduction.....	91
Material and methods.....	93
Bacterial cultures, fungal cultures and genomic DNA extraction .....	93
Plant experiments and samplings .....	94
DNA extraction from plant roots and rhizosphere soil.....	94
Development of <i>phlD</i> primers .....	95
Generation of standard curves and <i>phlD</i> quantification in samples .....	97
Generation of standard curves from bulk soil inoculated with <i>phlD</i> <sup>+</sup> <i>Pseudomonas</i> F113 and CHA0.....	99
Method validation based on colony counts of ‘ <i>P. fluorescens</i> ’ F113Rif in the tobacco rhizosphere.....	99
Analysis of indigenous root-colonizing <i>phlD</i> <sup>+</sup> <i>Pseudomonas</i> in Morens soils .....	100
tRFLP analysis of <i>phlD</i> alleles .....	100

Real-time PCR quantification of <i>T. basicola</i> in Morens soils and suppressiveness test .....	101
Statistical analyses .....	102
Results .....	103
Development of <i>phlD</i> real-time PCR primers .....	103
Optimization and validation of <i>phlD</i> real-time PCR .....	103
Disease severity and soil suppressiveness .....	107
Prevalence of indigenous root-colonizing <i>phlD</i> <sup>+</sup> <i>Pseudomonas</i> in Morens soils.....	107
<i>phlD</i> polymorphism in Morens soils .....	109
Relation between <i>phlD</i> <sup>+</sup> <i>Pseudomonas</i> and <i>T. basicola</i> densities in Morens soils...	109
Relation between <i>T. basicola</i> density and disease severity in Morens soils .....	111
Discussion .....	112
Acknowledgement .....	116
References .....	116
CHAPITRE 2 : Relation entre le niveau d'expression des gènes de synthèse du DAPG par les <i>Pseudomonas</i> et la résistance du sol à la maladie .....	129
Introduction au chapitre 2 .....	130
<b>Effect of clay mineralogy on iron bioavailability and rhizosphere transcription of 2,4-diacetylphloroglucinol biosynthetic genes in biocontrol <i>Pseudomonas protegens</i></b> .....	135
Abstract .....	136
Introduction .....	137
Results .....	139
Effect of bioavailable iron on cell density and <i>phlA-gfp</i> expression of <i>P. protegens</i> <i>in vitro</i> .....	139
Effect of clay mineralogy on iron bioavailability for <i>P. protegens</i> on roots in artificial soil. ....	139
Effect of clay mineralogy on cell density and <i>phlA-gfp</i> expression of <i>P. protegens</i> on roots in artificial soil in absence of <i>T. basicola</i> . ....	141
Effect of iron addition on cell density and <i>phlA-gfp</i> expression of <i>P. protegens</i> on roots in artificial illitic soil. ....	141
Effect of clay mineralogy on cell density and <i>phlA-gfp</i> expression of <i>P. protegens</i> on roots in artificial soil in presence of <i>T. basicola</i> .....	144
Spatial patterns of <i>P. protegens</i> colonization and <i>phlA-gfp</i> expression on roots. ....	146
Discussion .....	147

Materials and Methods.....	150
Microbial cultures and tobacco growth. ....	150
Soil systems. ....	151
Biocontrol activity of <i>P. protegens</i> CHA0-mche(pME7100) in artificial soils. ....	152
Monitoring of <i>phlA-gfp</i> in vitro in response to iron or <i>T. basicola</i> . ....	152
Monitoring of <i>phlA-gfp</i> in the tobacco rhizosphere by confocal laser-scanning microscopy.....	153
RNA/DNA extraction and real-time PCR quantification of bacterial cells and <i>gfp</i> mRNA.....	153
Assessment of iron bioavailability <i>in vitro</i> and in the tobacco rhizosphere. ....	155
Image and statistical analyses.....	156
Acknowledgments.....	156
Literature Cited .....	157
DISCUSSION GÉNÉRALE.....	169
Méthodologie pour l'étude des populations bactériennes phytoprotectrices dans les sols résistants.....	171
Origine géologique du sol, minéralogie des argiles et résistance .....	174
Biodisponibilité du fer dans la rhizosphère et résistance.....	175
Rôles écologiques du DAPG et résistance des sols de Morens .....	178
Densité de population des <i>Pseudomonas phl<sup>+</sup></i> et prédiction de la résistance du sol ....	182
Interaction entre le pathogène et les <i>Pseudomonas phl<sup>+</sup></i> .....	184
Représentativité de <i>P. protegens</i> en tant que modèle des <i>Pseudomonas phl<sup>+</sup></i> de Morens .....	186
Conclusion .....	187
Perspectives.....	188
RÉFÉRENCES BIBLIOGRAPHIQUES.....	191
ANNEXES .....	209

# **INTRODUCTION GENERALE**



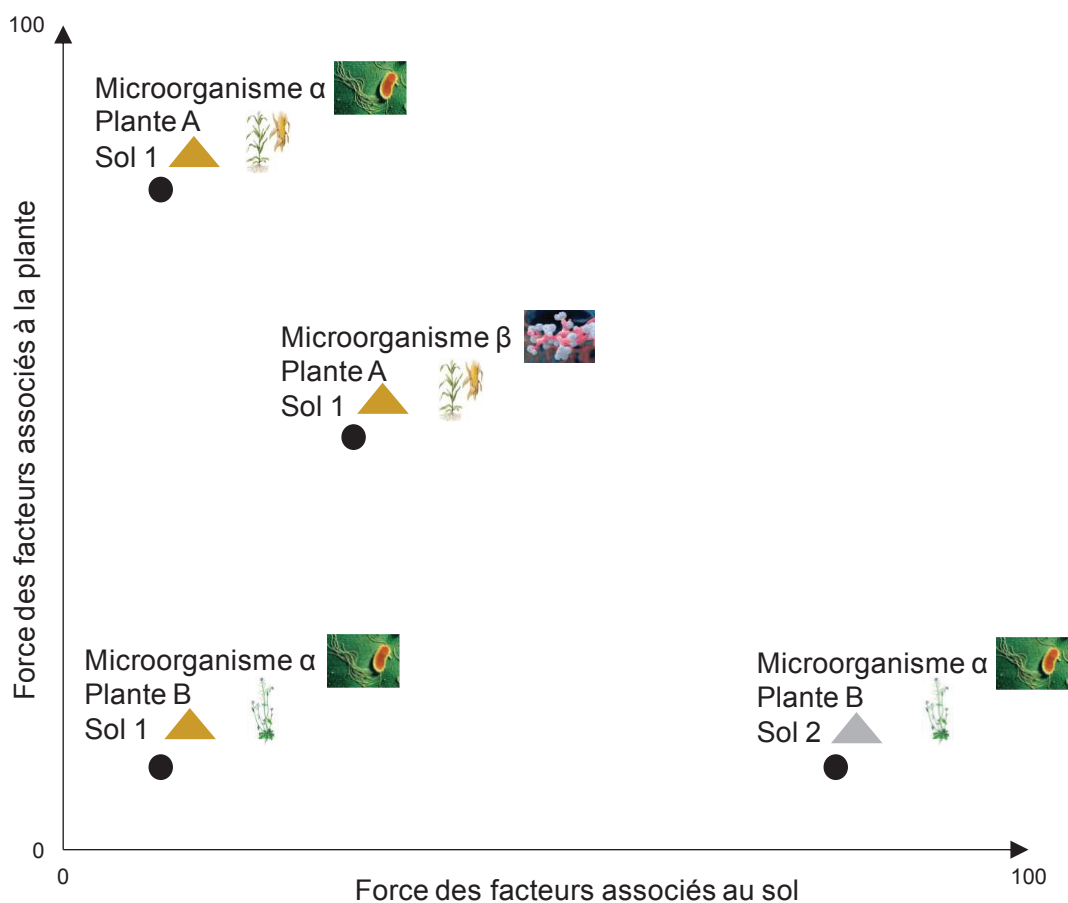
Le Sol est une construction géobiologique apparue il y a 400-500 millions d'années avec la colonisation de la surface terrestre par les premières plantes vasculaires (Gensel 2008). L'altération des roches et des minéraux par les processus abiotiques (érosion éolienne, hydrique, chimique...) a été accélérée par l'action synergique des racines et de microorganismes sécrétant des acides organiques, sidérophores et autres molécules; qui ont apporté la matière organique essentielle à la formation du Sol. En accélérant la colonisation de la surface terrestre par les plantes, la formation du Sol a accru la fixation de CO<sub>2</sub> et la production d'oxygène par ces dernières, et a donc été cruciale pour la construction de la Biosphère (Lambers et al. 2009). De nos jours les processus rhizosphériques i.e. se déroulant à l'interface entre le sol et les racines, et impliquant les microorganismes associés, influencent la nutrition (e.g. azotée et phosphatée) et la croissance des plantes, et ont donc un rôle pivot dans le fonctionnement des écosystèmes terrestres.

### **La rhizosphère : interface plante-sol modulant l'activité des microorganismes**

La rhizosphère, l'écosystème de transition entre les racines des plantes et le sol, représente un point-chaud de l'activité microbienne favorisant les interactions des microorganismes entre eux, avec la plante et avec le sol (Hinsinger et al. 2009). Les sucres, acides aminés, acides organiques et autres composés exsudés par la plante au niveau des racines, servent de substrat pour la croissance microbienne et participent aux cycles biogéochimiques du carbone, de l'azote et des autres éléments essentiels (Fe, Zn, Mo...) dans la rhizosphère et le sol. La plante produit aussi des composés signaux ayant comme rôles connus d'attirer les microorganismes symbiotiques (ex. flavonoïdes; Biais 2006), de stimuler l'activité de bactéries phytoprotectrices (ex. benzoxazinoides ; Neal et al. 2012) ou d'inhiber la croissance de phytopathogènes (acide rosmarinique; Biais 2006), entre autres. Ainsi, à travers la composition de leurs exsudats et autres rhizodépôts, mais aussi à travers d'autres facteurs comme l'architecture racinaire et l'acidification, les plantes influencent la communauté de microorganismes présents dans la rhizosphère et modulent son fonctionnement (Berg et Smalla 2009 ; Doornbos et al. 2012). En plus d'être sous l'influence de la plante, les microorganismes de la rhizosphère sont soumis aux facteurs physico-chimiques du sol. La texture et le pH du sol ont un fort impact sur ces microorganismes en agissant de façon directe sur leur habitat, et de façon indirecte en modulant l'activité racinaire de la plante (Garbeva et al. 2004a). Si on imagine le sol et la



plante comme des forces façonnant la communauté microbienne de la rhizosphère, on aboutit au schéma conceptuel de la Figure 1 illustrant la complexité des interactions plante-microorganismes. Les contraintes exercées par la plante et le sol sur les microorganismes dépendent du sol et de la plante considérée, et en outre, varient selon le microorganisme considéré. Ainsi ces contraintes ont des effets différents sur un microorganisme  $\alpha$  ou sur un microorganisme  $\beta$  plus résistant aux perturbations (Figure 1).



**Figure 1.** Schéma conceptuel illustrant les forces relatives des facteurs associés au sol (en abscisse) et à la plante (en ordonnée) sur deux microorganismes  $\alpha$  et  $\beta$ . Le microorganisme  $\alpha$  est fortement influencé par la plante dans la condition (Plante A  $\times$  Sol 1), alors qu'il est faiblement influencé par la plante dans la condition (Plante B  $\times$  Sol 2), où il est davantage influencé par le sol. Au contraire, le microorganisme  $\beta$  est plus résistant et peu influencé par le sol ou la plante. (Modifié à partir de Garbeva et al. 2004a).

L'importance des interactions plante-microorganismes-sol au niveau de la rhizosphère est évidente lorsque l'on considère les conséquences qu'elles peuvent avoir sur la croissance des plantes. Dans le cas de l'interaction plante-champignons, l'adaptation des plantes au sol a été rendue possible par la symbiose mycorhizienne à arbuscules établie entre les premières plantes vasculaires (ptéridophytes) et des champignons proches des *Glomeromycota*. Elle a amélioré leur capacité à acquérir des nutriments comme le phosphate (Rémy et al. 1994 ; Lambers et al. 2009) et est présente chez 80% des espèces d'angiospermes actuelles. Les symbioses entre les plantes et les bactéries fixatrices d'azote atmosphérique permettent aux plantes de pallier la carence azotée qui limite leur croissance. Elle concerne principalement les symbioses Fabaceae (plantes légumineuses) / *Rhizobium*, *Bradyrhizobium*, *Burkholderia*..., et plantes actinorhiziennes / actinobactéries du genre *Frankia*.

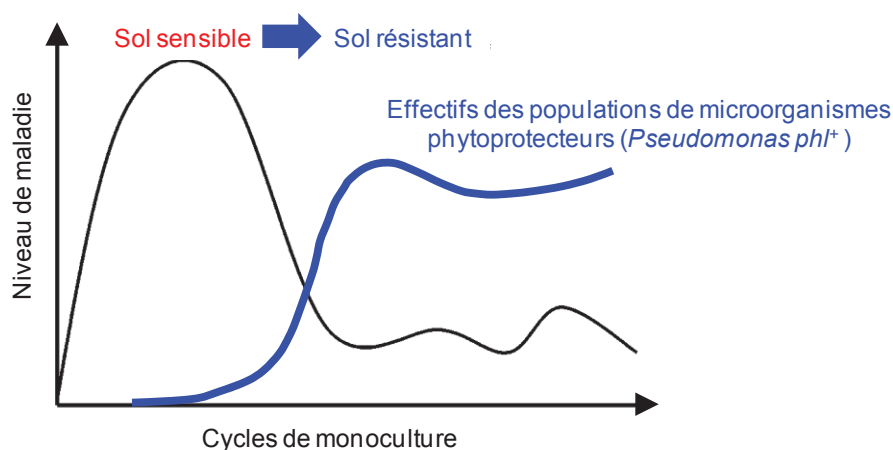
En plus des carences nutritives, la croissance des plantes est aussi limitée par les phytopathogènes. Dans la rhizosphère, microorganismes phytopathogènes et microorganismes capables de phyto-protection (souvent par inhibition du pathogène) coexistent et interagissent. La résultante de ces interactions conditionne le succès du pathogène et va donc aussi influencer la croissance végétale (Raaijmakers et al. 2009). Dans certains sols l'activité de ces microorganismes phytoprotecteurs dans la rhizosphère est suffisante pour limiter de manière significative le développement de la maladie, ces sols sont dits résistants aux maladies (Mazurier et al. 2009 ; Sanguin et al. 2009 ; Kyselková et Moënné-Loccoz 2012).

### **Les sols résistants aux maladies**

La résistance à la maladie est dans ce contexte, la capacité biologique des sols à limiter la sévérité de la maladie alors que le pathogène virulent est présent et que les conditions environnementales (dont les paramètres abiotiques du sol) sont favorables au développement de la maladie (Baker and Cook 1974). La communauté microbienne agit comme une première barrière limitant la prolifération du phytopathogène dans la rhizosphère. Elle assure un niveau basal de protection des racines avec un rôle similaire à celui du microbiote intestinal humain, et est responsable de la « résistance générale » (observée à des degrés différents dans tous les sols) reposant sur la compétition non spécifique entre le phytopathogène et les autres microorganismes. Plus efficace, la

« résistance spécifique » est attribuée à une (ou quelques) populations microbiennes (de champignons et/ou bactéries) qui inhibent spécifiquement le pathogène par compétition, antagonisme ou parasitisme. Par la suite, l'expression « résistance à la maladie » fera référence à ce type de résistance spécifique.

La résistance à la maladie est une propriété qui émerge des interactions complexes plante-microorganismes-sol dans la rhizosphère, et son origine n'est pas toujours comprise. La résistance peut être « induite » par la monoculture de la plante, qui favorise certaines populations de microorganismes phytoprotecteurs, enrichissant leurs effectifs à chaque cycle cultural (Sanguin et al. 2009). L'exemple le plus connu est le déclin de la maladie du piétin-échaudage causée par *Gaeumannomyces graminis* sur différentes céréales (Figure 2). La monoculture de la céréale en présence du pathogène se traduit par une première phase de maladie où le pathogène infecte les racines. L'infection conduit au relargage de composés favorisant l'accumulation de populations microbiennes phytoprotectrices (Chapon et al. 2002), qui finissent par atteindre des effectifs suffisants pour inhiber le pathogène (Sarniguet et Lucas 1992). Ceci conduit à la diminution progressive de la maladie et à l'établissement de la résistance (Figure 2). Ce type de résistance est perdu si la monoculture est arrêtée, et ne s'établit pas de manière systématique dans tous les sols, laissant supposer l'influence de certains facteurs du sol sur l'interaction (Raaijmakers et Weller 1998).



**Figure 2.** Etablissement de la résistance du sol à la maladie du piétin-échaudage induite par la monoculture du blé ou de l'orge (déclin du piétin-échaudage). Dans les premiers cycles de monoculture en présence du pathogène le niveau de maladie augmente (sol sensible) puis diminue (sol résistant) parallèlement à l'accumulation d'effectifs de populations microbiennes phytoprotectrices (ici des *Pseudomonas* produisant le composé antimicrobien 2,4-diacétylphloroglucinol; modifié à partir de Weller et al. 2002)

Au contraire, la résistance « naturelle » (ou « durable ») ne dépend pas du cycle cultural et est donc supposée être davantage associée à un effet du sol sur le microorganisme phytoprotecteur (Hornby 1983). Dans les sols de Châteaurenard (France) naturellement résistants à la Fusariose du melon causée par *Fusarium oxysporum*, la résistance a été attribuée à l'action conjointe de *Pseudomonas* et de *Fusarium oxysporum* non pathogènes inhibant le pathogène par compétition pour le fer (peu abondant dans la rhizosphère) et pour des ressources carbonées, et par antibiose (Lemanceau 1992 ; Mazurier et al. 2009). Un autre exemple sont les sols de la région de Morens (Suisse) résistant à la maladie de la pourriture noire des racines de tabac (et d'autres plantes) causée par *Thielaviopsis basicola*, où la résistance a été attribuée aux *Pseudomonas* produisant le composé antimicrobien 2,4-diacétylphloroglucinol (DAPG), mais pour lesquels les mécanismes de résistance ne sont pas encore bien compris même si on sait qu'ils impliquent une interaction entre ces bactéries et les argiles du sol qui sont différentes entre sols résistants et sensibles (Keel et al. 1989). Ainsi dans certains cas, la résistance est attribuée principalement à un effet de la plante sur les microorganismes de la rhizosphère (résistance induite par la monoculture), alors que dans d'autres cas elle est attribuée à un effet du sol sur ces derniers (résistance naturelle ; Kinkel et al. 2011).

L'étude des sols résistants a comme intérêt appliqué de permettre la découverte de plusieurs microorganismes intéressants pour la lutte biologique (Haas et Défago 2005). Plus important, ils sont des modèles permettant d'étudier l'activité des microorganismes phytoprotecteurs *in situ* et comprendre les facteurs favorisant leur activité, particulièrement dans ces sols.

### ***Pseudomonas* spp. protégeant les racines des plantes**

A différents endroits dans le monde, des bactéries du genre *Pseudomonas* sont impliquées dans la résistance des sols à différentes maladies (Haas et Défago 2005). Leur activité phytoprotectrice passe principalement par la production de métabolites secondaires impliqués dans l'inhibition du pathogène par compétition pour le fer, *via* la production de sidérophores comme les pyoverdines (inhibition de *F. oxysporum* dans les sols résistants à la fusariose ; Lemanceau et al. 1992), et/ou par antibiose *via* la production de composés antimicrobiens tels que les phénazines (inhibition de *G. graminis* dans le déclin du piétin-échaudage; Bull et al. 1991 et de *F. oxysporum* dans

les sols résistants à la fusariose ; Mazurier et al. 2009), le lipopeptide cyclique chloré thanamycine (inhibition de *Rhizoctonia solani* dans les sols résistants à la fonte des semis ; Mendes et al. 2011) ou le 2,4-diacétylphloroglucinol (DAPG, inhibition de *T. basicola* dans les sols résistants à la maladie de la pourriture noire des racines ; Haas et Défago 2005).

Des expériences au laboratoire ont par ailleurs montré que l'activité phytoprotectrice des *Pseudomonas* passe aussi par l'élicitation des défenses de la plante (Maurhofer et al. 1998) ce qui peut impliquer un métabolite comme le DAPG (Doornbos et al. 2012). En effet, plusieurs souches de *Pseudomonas* producteurs de DAPG sont capables d'induire une résistance systémique (ISR pour *Induced Systemic Resistance*) chez *Arabidopsis thaliana* vis-à-vis de *Pseudomonas syringae*; et cette capacité a été montrée comme dépendant des gènes de synthèse du DAPG chez *Pseudomonas fluorescens*' Q2-87 (Weller et al. 2012). De la même façon chez *Pseudomonas protegens* CHA0, les gènes de synthèse du DAPG (et non ceux pour la pyoverdine, la pyoluteorine, l'exoprotease AprA ou le cyanure d'hydrogène) sont essentiels pour activer une ISR chez *A. thaliana* vis-à-vis de *Peronospora parasitica* (Iavicoli et al. 2003). La voie d'action du DAPG dans l'ISR n'est pas encore connue mais elle nécessite un transporteur membranaire d'auxine (ER1) présent dans les cellules racinaires, et impliquerait donc des voies de signalisation de l'auxine (Iavicoli et al. 2003). Par ailleurs, d'autres effets signaux du DAPG sont la stimulation de l'exsudation racinaire (Phillips et al. 2004) et de la ramification du système racinaire, via la signalisation auxine-dépendante là aussi (Brazelton et al. 2008). Prises ensemble, ces observations suggèrent que le DAPG produit par *Pseudomonas* joue un rôle double dans le phytoprotection, en tant qu'antimicrobien et en tant que signal activateur d'ISR. Néanmoins, plusieurs facteurs biotiques et abiotiques influencent l'expression transcriptionnelle des gènes de synthèse (opéron *phlACBDE*) du DAPG (Duffy et Défago 1999 ; Notz et al. 2001 ; Roachat et al. 2010), qui sont en outre régulés à un niveau post-transcriptionnel (Haas et Keel 2003), et ceci se traduit par des quantités de DAPG produit par les *Pseudomonas* qui varient en fonction du génotype de la plante et de la souche considérée (Kwak et al. 2012). Il n'est donc pas clair si les quantités de DAPG produites en milieu naturel sont suffisantes pour induire une ISR ou inhiber le pathogène.

Des bactéries productrices de DAPG ont été isolées à travers le monde sur différents types de sols et plantes, avec une distribution cosmopolite (Keel et al. 1996). L'analyse phylogénétique des ces bactéries a montré qu'elles pouvaient être séparées en 6 groupes différents, qui correspondraient à au moins 6 espèces différentes appartenant toutes aux *Pseudomonas* (Frapolli et al. 2007). Cependant, la distribution et la phylogénie des gènes de synthèse du DAPG au sein des *Pseudomonas*, et de manière plus générale au sein des procaryotes, a été peu investiguée jusqu'à présent (Frapolli et al. 2012).

### ***Pseudomonas* producteurs de DAPG et la résistance des sols à la maladie de la pourriture noire des racines**

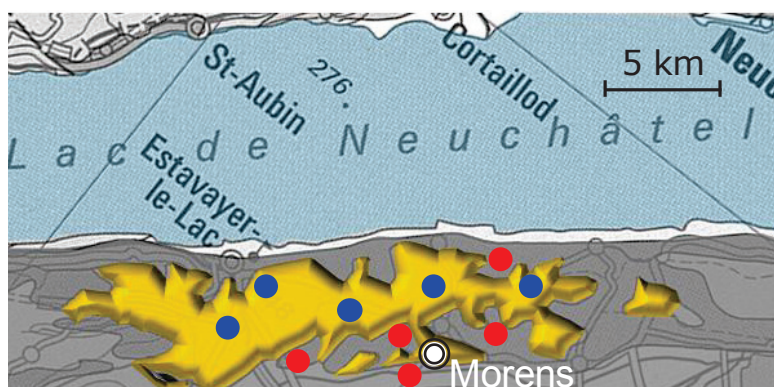
Dans les premières études sur les sols résistants, des populations de *Pseudomonas* ont souvent été identifiées comme responsables de la résistance (Scher et Baker 1982 ; Hornby 1983 ; Alabouvette et al. 1986), y compris dans le cas des sols de Morens (Suisse) résistants à la maladie de la pourriture noire des racines de tabac (et autres plantes) causée par le deutéromycète *Thielaviopsis basicola* (Stutz et al. 1986). Depuis, l'implication d'autres populations bactériennes et fongiques dans la résistance de plusieurs sols a été mise en évidence (Sanguin et al. 2009 ; Kyselková et Moëgne-Loccoz 2012). Dans les sols de Morens, des taxons bactériens incluant des souches capables de stimuler la croissance des plantes et/ou de phytoprotection, comme *Azospirillum*, *Burkholderia*, *Herbaspirillum*, les *Sphingomonadaceae*, *Comamonas*, *Gluconacetobacter* et *Pseudomonas*, ont été identifiées comme possibles bioindicateurs de la résistance, par une approche de puce taxonomique 16S (Kyselkova et al. 2009). Cependant, l'implication directe de ces taxons dans la résistance n'est pas claire, car sauf dans le cas des *Pseudomonas*, ils n'incluent pas des souches connues pour être antagonistes de *T. basicola* et cette question n'a pas été évaluée jusqu'à présent.

Stutz et al. (1986) et Keel et al. (1992) ont attribué un rôle majeur aux populations de *Pseudomonas* producteurs de DAPG (*Pseudomonas phl*<sup>+</sup>) dans la résistance des sols de Morens, et ont montré que dans les sols résistants ces populations étaient présentes à des effectifs suffisants pour contrôler la maladie. Cependant, par la suite Ramette et al. (2003) a montré que les effectifs de *Pseudomonas phl*<sup>+</sup> étaient hauts aussi dans les sols sensibles, rejetant l'hypothèse selon laquelle la résistance serait expliquée uniquement par des effectifs de *Pseudomonas phl*<sup>+</sup> plus hauts dans les sols résistants que dans les sols sensibles. Frapolli et al. (2010) a par ailleurs montré que la diversité (richesse et structure

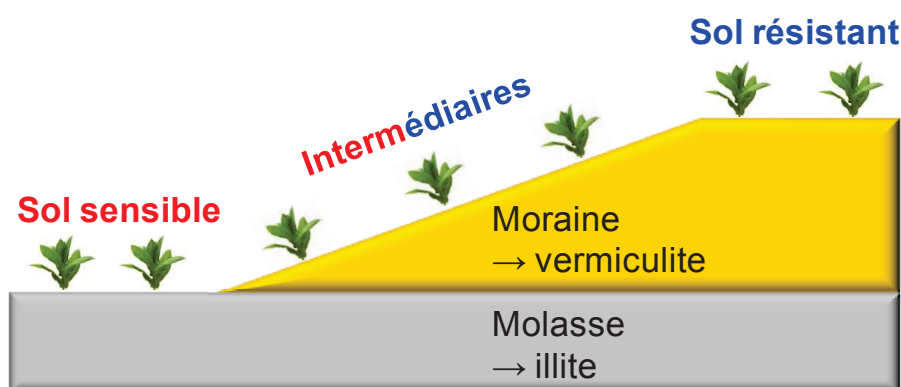
génétique) des *Pseudomonas phl*<sup>+</sup> dans les sols résistants et sensibles était comparable. La quantification des *Pseudomonas phl*<sup>+</sup> dans ces sols a été effectuée uniquement par des approches culturales, avec des résultats en contradiction avec ceux obtenus par l'approche (culture-indépendante) de puce taxonomique 16S (Kyselková et al. 2009). Or, dans la rhizosphère, les cellules de *Pseudomonas* sont souvent en condition de stress nutritionnel (Marschner et Crowley 1996) et des populations de cellules viables mais non cultivables peuvent se développer (Sorensen et al. 2001 ; Troxler et al. 2012), biaisant les estimations des approches culturales.

S'il reste pertinent de réévaluer les effectifs de *Pseudomonas phl*<sup>+</sup> par une approche culture indépendante, plusieurs observations pointent vers l'hypothèse que la résistance de ces sols ne dépend pas uniquement des effectifs de *Pseudomonas phl*<sup>+</sup>, et est liée à l'interaction entre les *Pseudomonas phl*<sup>+</sup> et les argiles du sol. Les sols résistants et sensibles de Morens ont une distribution particulière liée à leur origine géologique : les sols sensibles se sont formés à partir de roche de type molasse (grès) et les sols résistants à partir de dépôts de moraine (amenés par le glacier du Rhône) recouvrant cette molasse à certains endroits du paysage (sols morainiques ; Figure 3). Une étude conduite sur environ 100 sols de Morens a montré que sols résistants et sensibles sont pédologiquement comparables (brunisols), mais que plus la couche de moraine est épaisse, plus les sols ont tendance à être résistants (Stutz et al. 1989 ; Figure 4). Cependant, la résistance a été démontrée comme étant d'origine biologique car abolie par la stérilisation du sol, rejetant l'hypothèse d'une possible implication directe de facteurs abiotiques du sol dans la résistance (Stutz et al. 1986). La principale différence entre les deux types de sol est la minéralogie des argiles, avec des argiles de type illite prédominant dans les sols sensibles (molassiques) et des argiles de type vermiculite, capables de relarguer du fer, prédominant dans les sols résistants (morainiques ; Figure 4). En effet, la vermiculite est une argile contenant du fer et *Pseudomonas protegens* CHA0 est capable d'extraire ce fer en altérant les particules de vermiculite (Müller 2009). Le fer ayant un fort impact sur l'activité des *Pseudomonas* (Robin et al. 2007) et étant essentiel à la synthèse de DAPG (Duffy et Défago 1999) il a été proposé qu'une plus forte biodisponibilité du fer dans les sols résistants, liée à la présence de vermiculite, pourrait induire une plus forte expression des gènes de synthèse du DAPG et expliquer le niveau de phytoprotection assuré par les *Pseudomonas* producteurs de DAPG dans les sols résistants (Ramette et al. 2003 ; Frapolli et al. 2010). Bien que cette hypothèse soit étayée

par l'observation que ces bactéries assurent un niveau de phytoprotection plus fort en présence de vermiculite que d'illite dans des systèmes de sol artificiel (Ramette et al. 2006 ; Keel et al. 1989), l'expression des gènes de synthèse du DAPG n'a jamais été évaluée dans ces systèmes ou dans les sols naturels résistants et sensibles.



**Figure 3.** Illustration de la distribution de sols résistants (points bleus) et sensibles (points rouges) à la maladie de la pourriture du tabac causée par *T. basicola* dans la région de Morens (22 km<sup>2</sup> ; canton de Fribourg, Suisse). Les sols sensibles se forment sur la roche de type molasse (en gris) alors que les sols résistants se forment sur des dépôts de moraine (en jaune) recouvrant cette molasse.



**Figure 4.** Illustration de la relation entre la résistance du sol, l'épaisseur de la couche de moraine et la minéralogie des argiles à Morens. Les sols sensibles se développent à partir de roche de type molasse (en gris) alors que les sols résistants se forment à partir de dépôts de moraine (en jaune) recouvrant cette molasse. Il y a une relation positive entre le niveau de résistance du sol et l'épaisseur de la couche de moraine. La différence d'origine des sols se traduit par des différences dans la minéralogie des argiles, avec des argiles de type illite prédominant dans les sols sensibles (molassiques) et des argiles de type vermiculite prédominant dans les sols résistants (morainiques ; d'après Stutz et al. 1989).



## Hypothèses de la thèse

En se basant sur ces observations, l'hypothèse de travail de cette thèse est que la résistance des sols de Morens ne dépend pas uniquement des effectifs de *Pseudomonas phl*<sup>+</sup>, mais repose plutôt sur une plus forte expression de la fonction de synthèse du DAPG dans les sols résistants à la maladie de la pourriture noire des racines de tabac causée par *T. basicola*. Cette hypothèse générale comprend donc deux hypothèses spécifiques :

La première hypothèse est que les effectifs de *Pseudomonas phl*<sup>+</sup> sont élevés non seulement dans les sols résistants mais aussi dans les sols sensibles de Morens. Si c'est le cas, on peut conclure que la résistance de ces sols n'est pas expliquée uniquement par la densité des populations de *Pseudomonas phl*<sup>+</sup> mais qu'elle dépend d'autres facteurs, ce qui conduit à une deuxième hypothèse.

La deuxième hypothèse est que le niveau d'expression de la fonction de synthèse du DAPG est plus haut dans les sols résistants par rapport aux sols sensibles. Cette hypothèse correspond à un modèle de fonctionnement où la présence de vermiculite dans les sols résistants se traduit par une plus forte biodisponibilité du fer pour les *Pseudomonas* dans la rhizosphère, induisant une plus forte expression de la fonction de synthèse du DAPG, ce qui expliquerait le niveau de phytoprotection dans les sols résistants (vermiculitiques).

## Objectifs et approches scientifiques

Cette thèse s'inscrit dans le prolongement de questionnements sur les mécanismes et l'écologie de la résistance des sols de Morens à la maladie de la pourriture noire des racines de tabac causée par *T. basicola*. Si les premières études à l'ETH de Zurich ont établi l'importance des *Pseudomonas phl*<sup>+</sup> cultivables (Stutz et al. 1986 ; Keel et al. 1990), les études ultérieures ont mis en évidence que leurs effectifs étaient élevés non seulement dans les sols résistants mais aussi dans les sols sensibles, et suggéré une plus forte expression de la fonction de synthèse du DAPG dans les sols résistants par rapport aux sols sensibles (Ramette et al. 2003). Cette hypothèse est étayée par l'observation que les souches de *Pseudomonas phl*<sup>+</sup> sont capables d'assurer un niveau de phytoprotection, vis-à-vis de *T. basicola*, plus élevé en présence d'argile de type vermiculite (majoritaire

dans les sols résistants) que de type illite (majoritaire dans les sols sensibles ; Keel et al. 1989). Cependant, les mécanismes moléculaires sous-jacents restent mal compris, et donc l'objectif global de la thèse était d'éclaircir le lien entre la fonction de synthèse du DAPG chez les *Pseudomonas* et la résistance des sols à la maladie de la pourriture noire. Sur la base des hypothèses formulées plus haut, il s'agissait de vérifier, à l'aide d'une approche culture-indépendante, que la résistance de ces sols n'est pas expliquée par une plus forte densité des populations de *Pseudomonas phl*<sup>+</sup> (hypothèse 1), et déterminer si la résistance est liée au niveau d'expression de la fonction de synthèse de DAPG, appréhendée au niveau transcriptionnel (hypothèse 2).

Le premier objectif (correspondant à l'hypothèse 1) a été poursuivi en comparant la densité des populations de *Pseudomonas phl*<sup>+</sup> dans les sols résistants et sensibles à la maladie de la pourriture noire, en utilisant une approche culture-indépendante adaptée pour la quantification des populations naturelles de ces *Pseudomonas*. Cet objectif a été atteint en trois étapes, qui ont impliqué de (i) délimiter le groupe fonctionnel des *Pseudomonas phl*<sup>+</sup>, pour ensuite (ii) développer une méthode de PCR quantitative ciblant la totalité de ce groupe fonctionnel, et enfin (iii) implémenter cette méthode pour quantifier les effectifs des *Pseudomonas phl*<sup>+</sup> dans les sols résistants et les sols sensibles de Morens. Dans la première étape, la distribution de la fonction de synthèse du DAPG dans les lignées de *Pseudomonas* a été déterminée. Les espèces de *Pseudomonas* potentiellement capables de produire du DAPG ont été identifiées par criblage moléculaire de plusieurs souches type en utilisant le gène *phlD* (gène de l'opéron *phlACBDE* essentiel à la synthèse du DAPG) comme marqueur de la fonction de synthèse de DAPG. Dans la deuxième étape, une méthode de PCR quantitative en temps réel basée sur le gène *phlD* et ciblant tous les *Pseudomonas* producteurs de DAPG (identifiés dans l'étape 1) a été développée et optimisée pour les différents allèles du gène. Dans la troisième étape, cette méthode a été implémentée pour comparer les effectifs des *Pseudomonas phl*<sup>+</sup> colonisant la rhizosphère du tabac dans les sols résistants et sensibles de Morens.

Le deuxième objectif (correspondant à l'hypothèse 2), qui était de déterminer si la résistance du sol est liée au niveau d'expression de la fonction de synthèse de DAPG, a été poursuivi en évaluant le lien entre la minéralogie des argiles, la biodisponibilité du fer pour les *Pseudomonas* dans la rhizosphère, le niveau d'expression de la fonction de

synthèse du DAPG sur les racines, et le niveau de phytoprotection du tabac, en utilisant un sol résistant (vermiculitique) et un sol sensible (illitique). Ce point a été évalué en milieu simplifié, avec des sols artificiels (permettant de contrôler notamment la minéralogie des argiles), et des souches de *Pseudomonas protegens* rapportrices de la biodisponibilité du fer et de l'expression transcriptionnelle des gènes de synthèse du DAPG.

## **Plan de la thèse**

Le plan de la thèse est le suivant : une partie bibliographique, trois parties expérimentales et une discussion générale. La partie bibliographique intitulée « Rhizosphere ecology and potential plant protection mechanisms in soils naturally suppressive to *Thielaviopsis basicola*-mediated black root rot of tobacco » a été préparée comme un article de synthèse, et fait l'état de l'art et l'état des hypothèses actuelles concernant les mécanismes de phytoprotection potentiellement impliqués dans la résistance des sols à la maladie de la pourriture noire des racines de tabac causée par *T. basicola*.

Le premier chapitre intitulé « Relation entre la densité des populations de *Pseudomonas* producteurs de DAPG et la résistance du sol à la maladie » contient deux parties expérimentales.

La première partie, intitulée « Distribution of antimicrobial 2,4-diacetylphloroglucinol biosynthetic genes among *Pseudomonas* spp. » a été préparée comme une note scientifique et concerne la distribution de la fonction de synthèse de DAPG chez les *Pseudomonas*. Dans cette partie la distribution de cette fonction chez les *Pseudomonas* est vérifiée ainsi que la phylogénie des *Pseudomonas* produisant du DAPG. En outre, l'histoire évolutive des gènes de synthèse du DAPG est analysée.

La deuxième partie, intitulée « Monitoring of the relation between 2,4-diacetylphloroglucinol-producing *Pseudomonas* and *Thielaviopsis basicola* populations by real-time PCR in tobacco black root-rot suppressive and conducive soils » a été publiée comme article scientifique et concerne le développement d'une approche de PCR quantitative généraliste permettant de quantifier simultanément tous les *Pseudomonas*

*phI*<sup>+</sup> et d'analyser leur diversité par couplage avec une analyse de tRFLP (*terminal Restriction Fragment Length Polymorphism*). Cette technique a ensuite été implémentée pour comparer la densité et la diversité génétique des populations de *Pseudomonas phI*<sup>+</sup> dans la rhizosphère de quatre sols (de Morens) résistants ou sensibles à la maladie de la pourriture noire des racines de tabac. Cette partie évalue aussi la relation entre la densité de population du pathogène *T. basicola* et celle des *Pseudomonas phI*<sup>+</sup>, relation jamais étudiée jusqu'à présent.

Le deuxième chapitre, intitulé « Relation entre le niveau d'expression des gènes de synthèse du DAPG par les *Pseudomonas* et la résistance du sol à la maladie » contient une partie expérimentale intitulée « Effect of clay mineralogy on iron bioavailability and rhizosphere transcription of 2,4-diacetylphloroglucinol biosynthetic genes in biocontrol *Pseudomonas protegens* ». Cette partie a été préparée comme un article scientifique comparant la biodisponibilité du fer pour les *Pseudomonas*, leur densité de population, et l'expression transcriptionnelle de gènes de synthèse du DAPG sur les racines de tabac dans un sol vermiculitique (résistant) et un sol illitique (sensible).

Dans la discussion générale les résultats des trois parties sont discutés en fonction de leurs retombées concernant les mécanismes sous-jacents de la résistance des sols de Morens. Les limites du travail et des conclusions sont aussi discutées. Les perspectives concernant l'étude des sols résistants de manière plus globale sont présentées.



# **SYNTHESE BIBLIOGRAPHIQUE**

## Introduction à la synthèse bibliographique

---

Les sols de la région de Morens (canton de Fribourg, Suisse ; Stutz et al. 1986), résistants à la maladie de la pourriture noire des racines causée par le champignon deutéromycète *Thielaviopsis basicola* sont étudiés depuis 1981 (Gasser et Défago 1981). Leur résistance implique des *Pseudomonas* producteurs de l'antimicrobien 2,4 diacétylphloroglucinol (DAPG ; Stutz et al. 1986), et leurs interactions avec les argiles du sol (Stutz et al. 1989; Keel et al. 1989). Plus récemment, des études de densité (Ramette et al. 2003 ; Frapolli et al. 2010) et de diversité (Frapolli et al. 2008 et 2010) des populations de *Pseudomonas* producteurs de DAPG (*Pseudomonas phl*<sup>+</sup>) présents dans les sols résistants et sensibles, ont mis en évidence que leurs effectifs étaient comparables, mais que leur structure génétique était différente dans les deux types de sol. Ces observations suggèrent que la résistance des sols de Morens ne dépend pas uniquement de la densité des populations de *Pseudomonas phl*<sup>+</sup>, mais également de leur diversité et/ou de leur niveau de synthèse de DAPG, qui serait quant à lui régulé par les conditions physicochimiques des sols. La résistance pourrait aussi impliquer le rôle d'autres microorganismes.

D'autres microorganismes de la communauté rhizosphérique participant à la propriété de résistance des sols ont été recherchés en comparant les communautés bactériennes colonisant la rhizosphère du tabac dans les sols sensibles et résistants des régions de Morens (Suisse ; Kyselkova et al. 2009), de Seyssel et d'Albens (Savoie), régions voisines à l'échelle de l'arc Alpin (Almario et al. soumis; Annexe 1). Ces études ont permis d'identifier un certain nombre de bioindicateurs de la sensibilité et la résistance du sol à la maladie de la pourriture noire des racines de tabac, mais l'implication fonctionnelle de ces taxons n'a pas encore été évaluée.

Cette synthèse bibliographique intitulée « Rhizosphere ecology and potential plant protection mechanisms in soils naturally suppressive to *Thielaviopsis basicola*-mediated black root rot of tobacco » décrit l'état des connaissances au début de ce projet de thèse. Les premières observations qui ont

conduit à l'identification des sols résistants et sensibles de Morens, les études sur les populations de *Pseudomonas phl*<sup>+</sup>, et les études comparant plus largement les communautés rhizobactériennes de ces sols sont détaillées. Les premières recherches de l'ETH Zürich sur ces sols, et celles réalisées ultérieurement en collaboration avec l'Université de Lyon sont décrites. Nous énonçons également les hypothèses qui ont été émises au début de ce projet thèse, concernant les facteurs biotiques et abiotiques sous-jacents à la résistance.





**Rhizosphere ecology and potential plant protection mechanisms in soils naturally suppressive to *Thielaviopsis basicola*-mediated black root rot of tobacco**

Juliana Almario<sup>1,2,3</sup>, Daniel Muller<sup>1,2,3</sup>, Geneviève Défago<sup>4</sup>, Yvan Moëgne-Loccoz<sup>1,2,3</sup>

<sup>1</sup> Université de Lyon, F-69622, Lyon, France

<sup>2</sup> Université Lyon 1, Villeurbanne, France

<sup>3</sup> CNRS, UMR5557, Ecologie Microbienne, Villeurbanne, France

<sup>4</sup> Institute of Integrative Biology, ETH, CH-8092 Zürich, Switzerland

Corresponding author: Y. Moëgne-Loccoz; Telephone: +33 (0) 4 72 43 13 49;

Fax : +33 (0) 4 72 43 12 23; E-mail: [yvan.moenne-locco@univ-lyon1.fr](mailto:yvan.moenne-locco@univ-lyon1.fr)

## Abstract

Soil suppressiveness to disease is important to understand, because in disease-suppressive soils susceptible host plants are significantly protected from soil-borne disease. Unlike many soils where disease suppressiveness requires crop monoculture to establish, certain soils are naturally suppressive to disease, and this type of specific disease suppressiveness is maintained despite crop rotation. Soils naturally suppressive to *Thielaviopsis basicola*-mediated black root rot of tobacco and other crops occur in Morens region (western Switzerland) and have been studied for over 30 years. In Morens, vermiculite-rich suppressive soils formed on morainic deposits while illite-rich conducive soils developed on sandstone, but suppressiveness is of microbial origin. Antagonistic pseudomonads play a significant role in black root rot suppressiveness, and one of them (*Pseudomonas protegens* CHA0) has become a major model strain for research. However, other types of rhizobacterial taxa may differ in prevalence between suppressive and conducive soils, suggesting that the microbial basis of black root rot suppressiveness could be far more complex than solely a *Pseudomonas* property. This first review on black root rot suppressive soils covers the early findings on these soils, the significance of recent results, and compares them with other types of suppressive soils in terms of rhizosphere ecology and potential plant protection mechanisms.

## Introduction

Plant health is of prime importance for crop productivity, but crop plants are faced with a wide range of parasitic microorganisms in agroecosystems. Some of them infect shoots, whereas others colonize the rhizosphere and infect roots (Agrios 2005). The latter are particularly difficult to control because of the presence of the soil matrix (Lucas and Sarniguet 1998). However, saprophytic soil microorganisms may exert some level of control via competitive and other deleterious interactions, thereby limiting soil survival, root colonization and/or plant infection by soil-borne phytopathogens (Cook and Baker 1983). This type of disease suppression involves a large part of the total microbial community, is not pathogen-specific, and is termed general suppressiveness (Baker and Cook 1974). This natural barrier against root pathogens is a common soil attribute, but its efficacy varies according to soil composition, farming practices, and total microbial activity (Raaijmakers et al. 2009).

In addition to general suppressiveness, certain soils may also display specific disease suppressiveness, which enables effective control of one or a few phytopathogens. These soils are suppressive *sensu stricto*. Specific suppressiveness is thought to involve one or very few groups of plant-protecting microorganisms (Kyselková and Moënnelocoz 2012), and is primarily attributed to antagonistic interactions against the pathogen(s) (Weller 2007). Typically, it may be transferred to conducive soils by adding small amounts of suppressive soil. Soil suppressiveness to root disease is important to understand, because it represents an ideal model where plant protection is permanently implemented, in contrast to the more inconsistent efficacy of biocontrol agents in field inoculation experiments.

In many instances, specific disease suppressiveness is induced by monoculture. In the case of wheat take-all (caused by *Gaeumannomyces graminis* var. *tritici*), repeated cropping of the host plant leads to disease outbreak, but it can also cause progressive rhizosphere enrichment of antagonistic populations, resulting then in sustainable take-all decline (Weller 2007). Monoculture is also required for control of *Streptomyces scabiei*-mediated potato scab and the cereal-cyst nematode *Heterodera avenae* (Kerry 1982; Weller et al. 2002). In contrast, monoculture is not needed for natural (syn. long-lasting) specific suppressiveness to *Fusarium oxysporum*-mediated wilt of flax and other plants (Alabouvette et al. 1986; Janvier et al. 2007), and *Thielaviopsis basicola*-mediated black

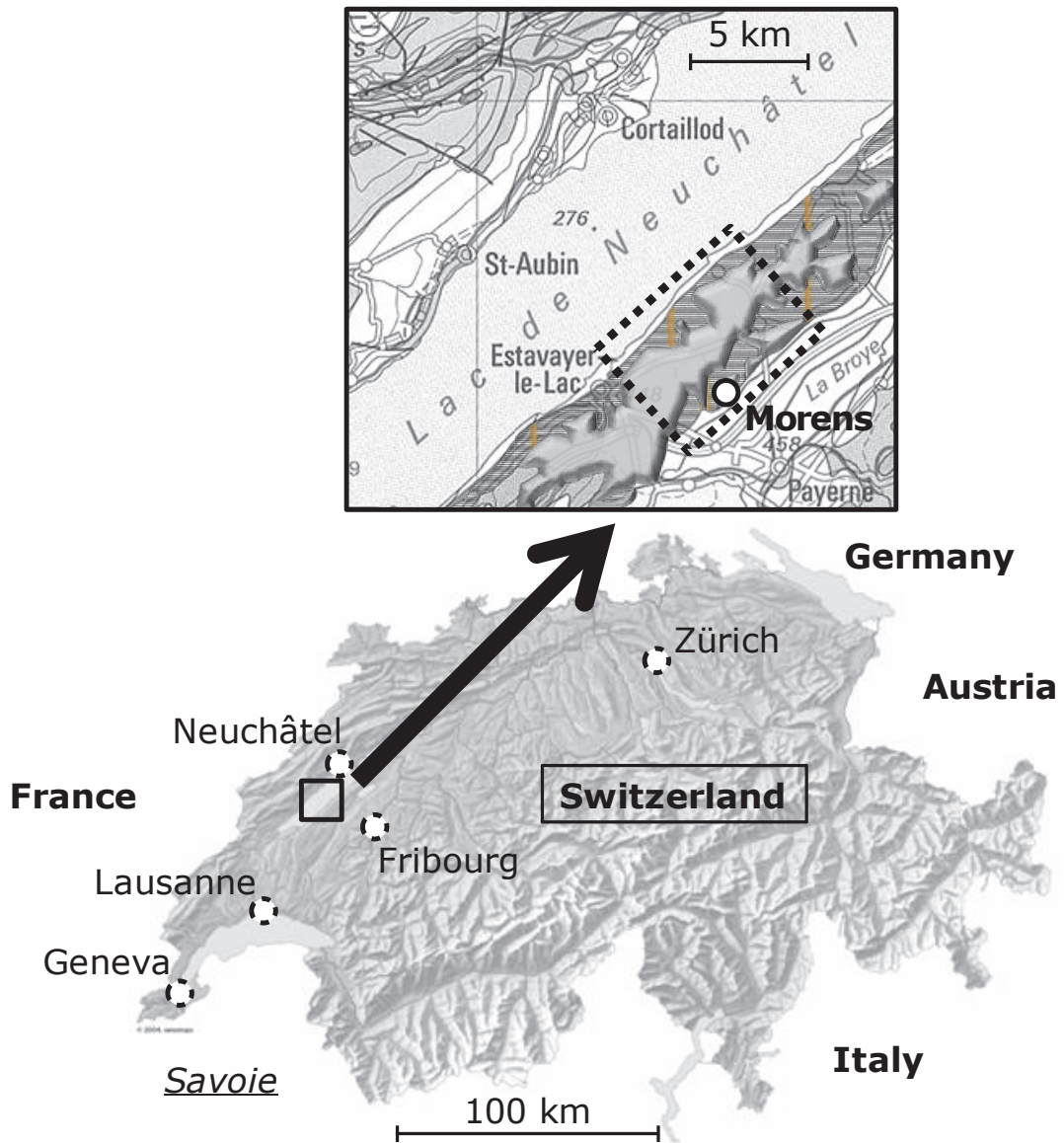
root rot of tobacco (Stutz et al. 1986), perhaps because soil composition plays a major role (Weller et al. 2002; Hornby 1983).

Swiss soils suppressive to tobacco black root rot have been studied for over 30 years, and arguably they represent the most extensively studied case of naturally-suppressive soils. In addition, they have enabled significant progress in our understanding of biological control, and one isolate from these soils (*Pseudomonas protegens* CHA0) has become a major model to assess rhizosphere ecology, bacterial secondary metabolism, and biocontrol of fungal root diseases (Haas and Défago 2005, Ramette et al. 2011). Against this background, there was however no literature review available on soil suppressiveness to black root rot. Therefore, the objective of this review is to cover the early findings on black root rot suppressive soils, to discuss the significance of recent results on these soils, and to compare them with other types of suppressive soils.

Black root rot disease of tobacco, which is caused by the parasitic Deuteromycete *Thielaviopsis basicola* (Berk. et Br.) Ferraris (syn. *Chalara elegans*), was first described in Italy (Peglion 1897). In Europe, black root rot became an important problem in the seventies with the development of blue mold (*Peronospora tabacina*) resistant varieties, which were more susceptible to *T. basicola* (Corbaz 1975; 1978). By 1987, black root rot was among the main fungal diseases of tobacco in Europe (Delon 1987). In the temperate regions of Europe and North America, where tobacco encounters cold periods after transplantation, this disease can cause up to 50-75% annual losses (Trojak-Goluch et al. 2005). *T. basicola* persists in soil as thick-walled, resistant chlamydospores and infects a large number of agronomic plants and weeds (137 genera; Huang 2010), which means crop rotation does not enable its eradication.

## **PART 1. Soil suppressiveness to black root rot**

**First observations.** Tobacco was introduced in the Swiss region of Morens (Figure 1), in the canton of Fribourg, at the beginning of the 18<sup>th</sup> century. Black root rot became a significant disease after 1965 (Corbaz 1978). However, during field surveys by the Tobacco Research Center (SOTA), it was noticed that certain fields from Morens were little affected by the disease. In 1981, Gasser and Défago conducted the first greenhouse experiment with two suppressive soils from Morens and a conducive soil from Vouvry (in canton Valais, 80 km, south-west of Morens), showing that indeed tobacco was little



**Figure 1.** Map showing the area of Morens, where soils suppressive to *T. basicola*-mediated black root rot have been identified and studied. The neighboring region of Savoie, where soils suppressive to black root rot have also been identified, is indicated. The upper part shows the area where the different fields are located; grey indicates where morainic deposits overlay the Aquitanian sandstone (shown with hatching).

affected by black root rot in the former two but displayed high disease level in the latter (Figure 2). At the time, other cases of disease suppressive soils had already been described, noticeably for *Fusarium oxysporum* (Louvet et al. 1976), *Phytophthora cinnamomi* (Broadbent and Baker 1974) and *Gaeumannomyces graminis* (Shipton et al. 1973).

Early work showed that the density of *T. basicola* propagules in soil (estimated using the carrot slice bioassay of Delon et al. 1977) at the start of the experiment was not higher in Vouvry conducive soil than in Morens suppressive soils, but it became so after 6 weeks of tobacco cultivation (Gasser and Défago 1981). Accordingly, persistence of a benomyl-resistant strain of *T. basicola* in bulk soil was not higher in Vouvry conducive soil than in a Morens suppressive soil (Berling et al. 1984), but its population size in the tobacco rhizosphere increased in the conducive soil while remaining low in the suppressive soil (Berling et al. 1984). This suggested that plant protection mechanisms were implemented in the rhizosphere rather than bulk soil, and on this basis Morens soil was disease suppressive rather than pathogen suppressive (Baker and Cook 1983). This was later confirmed by quantitative PCR (Almario et al. 2013).

All *T. basicola* isolates from Morens suppressive soils were pathogenic towards tobacco (Gasser and Défago 1981; Stutz et al. 1986), indicating that suppressiveness was not due to non-pathogenic *T. basicola* strains. This contrasts with the situation in Châteaurenard soil, where non-pathogenic strains of *Fusarium oxysporum* strains play an important role in suppressiveness to Fusarium wilt (Alabouvette et al. 1986), at least in part as a result of competition interactions (Lemanceau et al. 1988). In Morens, black root rot can affect different plants in addition to tobacco (e.g. beans, cherry trees), and these host plants are protected from the disease when grown in suppressive soils (Haas and Défago 2005).

**Analysis of black root rot suppressiveness.** The classical approach used with other suppressive soils (Weller 2007) was followed to characterize Morens soils. The biotic origin of suppressiveness was shown by abolishing tobacco protection in suppressive soils treated by autoclaving (Berling et al. 1984) or moist heat treatment (Stutz et al. 1986), thus excluding the possibility found in other soils (Meyer and Shew 1991) that plants were protected because soil abiotic properties prevented pathogen survival. In addition, suppressiveness was transferred to Vouvry conducive soil by amending it with



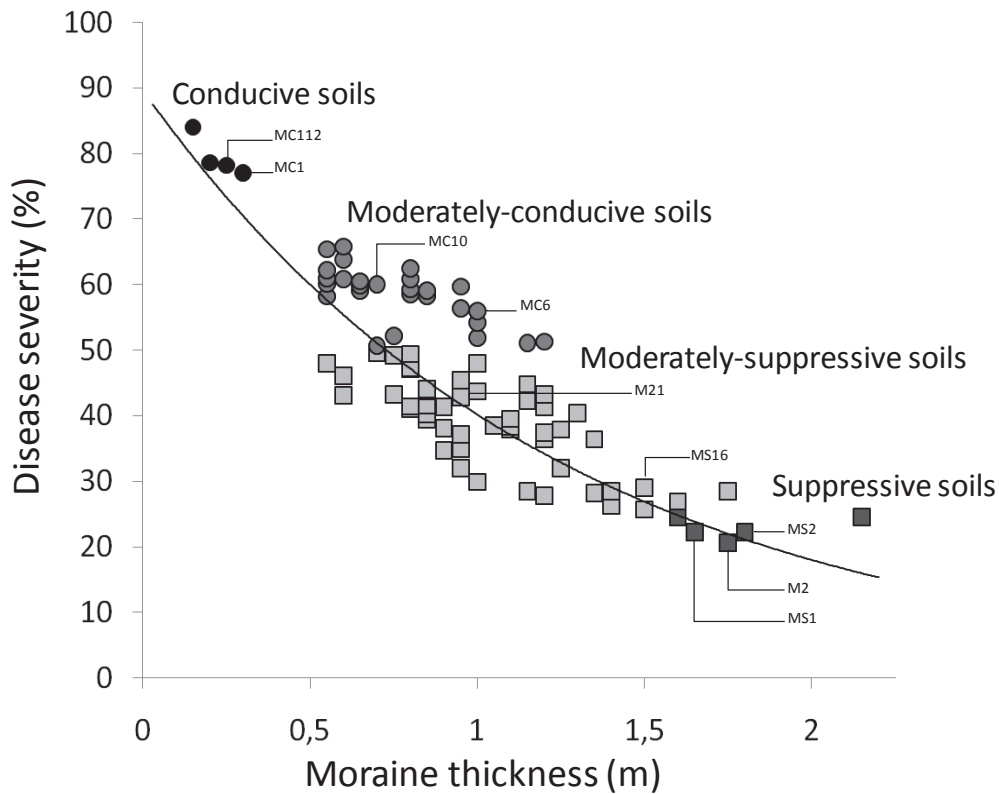
**Figure 2.** Greenhouse tobacco grown in sieved natural soil collected from Morens field suppressive or conducive to *T. basicola*-mediated black root rot and inoculated with  $10^4$  endoconidia of *T. basicola* strain ETH D127 per  $\text{cm}^3$  of soil. Tobacco is extensively diseased in the conducive soil (right) but remains healthy in the suppressive soil (left).



low amounts (5% w/w) of a suppressive soil from Morens (Stutz et al. 1986).

Only upper soil horizons colonized by roots (i.e. down to a depth of 1 m) were suppressive (Stutz et al. 1986). Specific farming practices were not required for tobacco protection, as this property was identified in soils under tobacco monoculture or crop rotation (Gasser and Défago 1981; Stutz et al. 1985). Therefore, suppressiveness was not induced by monocropping, as in the case of take-all decline (Weller 2007). Despite this, it is likely that cropping history, farming practices and weather conditions could influence tobacco susceptibility to *T. basicola* in Morens suppressive (and conducive) soils. Indeed, even though tobacco health was similar when plants were grown in suppressive soils collected one month apart (Gasser and Défago 1981), disease levels could vary when greenhouse experiments were conducted in different seasons or years (Ramette et al. 2003; Frapolli et al. 2010). In all cases, however, suppressive soils maintained the ability to limit further damage resulting from *T. basicola* inoculation (Ramette et al. 2003), meaning that they retained a suppressive status.

**Geomorphology and black root rot suppressiveness.** Soils naturally suppressive to black root rot (as well as conducive soils and soils of intermediate status) were identified in a 22-km<sup>2</sup> area around Morens (Stutz et al. 1985), which corresponds to a plateau between Lake Neuchâtel and La Broye valley in western Switzerland (Figure 1). Soils suppressive to black root rot are also documented in North Carolina, USA (Meyer and Shew 1991). In Morens, soils that developed from a freshwater molasse (sandstone) formed in the Swiss basin during the late Aquitanian are conducive to black root rot, whereas soils on morainic hill tops deposited by the Rhône glacier during the Würm ice age are suppressive and those on hill slopes are moderately suppressive or conducive (Stutz et al. 1985), as illustrated in Figure 3. Morens soils used for cropping correspond to cambisols (syn. brunisols) (Frapolli et al. 2010). Black root rot suppressiveness level did not correlate with soil pH in Morens, whereas it did with soil acidity and aluminum level in North Carolina soils suppressive to tobacco black root rot (Meyer and Shew 1991), and with soil acidification in New Mexico loamy soils suppressive to *T. basicola*-mediated fruit discoloration disease (i.e. blackhull) of peanut (Hsi 1978). Suppressiveness did not correlate either with contents in N, P, K and Mg, or texture (loamy sand, sandy loam or



**Figure 3.** Exponential relation between thickness of the morainic material deposited by the Rhône glacier and black root rot severity in greenhouse tests. Data were obtained in greenhouse tests performed with soil from 87 Morens fields (Stutz et al. 1985). Disease severity is expressed as the percentage of root surface covered by *T. basicola* chlamyospores recorded on 20 tobacco plants per soil. Soils were arbitrarily classified as conducive ( $\geq 75\%$  disease severity; black circles), moderately conducive (75% - 50%; dark-grey circles), moderately suppressive (50% - 25%; light-grey squares) or suppressive ( $\leq 25\%$ ; dark-grey squares). Main reference soils studied by Gasser and Défago (1981), Stutz et al. (1986 and 1989), Ramette et al. (2003) and Frapolli et al. (2010) are indicated.

loam) of the soil (Stutz et al. 1985). However, vermiculite predominates as clay mineral in suppressive soils and illite in conducive soils (Stutz et al. 1989). This may be of particular relevance, because clay minerals in morainic material are often highly weathered (Anderson et al. 1997) and can release micronutrients like iron and zinc, thereby promoting particular biocontrol functions (Duffy et al. 1999). Clay type can also play an important role in soil suppressiveness to Fusarium wilt (Stotzky and Martin 1963; Höper et al. 1995). The importance of vermiculite is strengthened by the observation that cambisols formed on other moraine deposits located in Savoie (125 km south-west of Morens) are neither vermiculitic nor suppressive to black root rot (Almario et al. submitted).

## **PART 2. Role of fluorescent *Pseudomonas* spp. in black root rot suppressiveness**

**Evidence for *Pseudomonas* importance in black root rot suppressiveness.** One approach to identify microorganisms potentially involved in disease suppressiveness is to search for taxa whose population densities correlate with suppressiveness level (Borneman 2007; Mazurier et al. 2009). Differences in suppressiveness level resulting from heat treatment of suppressive soil (temperatures from 20 to 120°C), adding various amounts of suppressive soil to a conducive soil (5 to 95% w/w), or comparison of different soils or different soil depths (20 to 160 cm) were used to show the prevalence of fast-growing (i.e. after 24 h incubation) fluorescent pseudomonads on tobacco roots in relation to suppressiveness (Stutz et al. 1986). In later investigations, this higher prevalence of fluorescent root-colonizing pseudomonads in Morens suppressive soils was confirmed by 16S rRNA microarray analysis (Kyselková et al. 2009) but was not found by colony counts after 48-h incubation (Ramette et al. 2003). Evidence is also available for a role of fluorescent pseudomonads in suppressiveness to Fusarium wilt (Mazurier et al. 2009) and Rhizoctonia potato rot (Garbeva et al., 2006), in apple replant disease control (Mazzola 2002), and especially in take-all decline (Weller 2007).

Work in Morens also resulted in the isolation of *Pseudomonas protegens* (previously *P. fluorescens*; Ramette et al. 2011) strain CHA0<sup>T</sup>, whose inoculation conferred effective tobacco protection in 36 of 39 conducive Morens soils, from which it was subsequently reisolated, thereby verifying Koch's postulates (Stutz et al. 1986). Beyond the issue of suppressiveness, this strain has become a main model to understand

secondary metabolism (Haas and Défago 2005) and rhizosphere ecology (Mascher et al. 2003) of soil bacteria.

***Pseudomonas* biocontrol mechanisms towards *T. basicola*.** Suppressiveness to black root rot is largely attributed to *Pseudomonas* antagonism (Stutz et al. 1986; Reddy and Patrick 1992), especially in relation to production of secondary metabolite 2,4-diacetylphloroglucinol (DAPG) (Ahl et al. 1986; Keel et al. 1990; 1992; Haas and Défago 2005). DAPG may impair mitochondrial function (Gleeson et al. 2010). DAPG at 128 µg/mL abolished *T. basicola* growth *in vitro*, while only 40 µg per g of artificial soil is sufficient to drastically reduce disease severity on tobacco (Keel et al. 1990; 1992). Even though DAPG levels as high as that have never been found in large rhizosphere samples (Keel et al. 1992; Raaijmakers et al. 1999; Bergsma-Vlami et al. 2005), they are likely to be attained at particular moments (Schnider-Keel et al. 2000) and/or in particular rhizosphere microsites, where bacterial microcolonies and soil compartmentalization limit DAPG diffusion on roots (Troxler et al. 1997; Raaijmakers et al. 2002; Haas and Keel 2003). Strain CHA0 and other DAPG<sup>+</sup> pseudomonads from Morens inhibit *T. basicola* *in vitro*, and most are effective at protecting tobacco from black root rot in vermiculitic but not (or less) in illitic artificial materials mimicking Morens suppressive and conducive soils, respectively (Stutz et al. 1989; Keel et al. 1989; Ramette et al. 2006).

Unlike in the case of take-all decline soils (Weller 2007), culturable DAPG<sup>+</sup> pseudomonads effectively colonized tobacco roots both in suppressive and conducive soils from Morens, at numbers that varied from one experiment to the next (Ramette et al. 2003; Frapolli et al. 2010) but that were sufficient (i.e. above 10<sup>4</sup> CFU g<sup>-1</sup> roots; Stutz et al. 1986) to protect tobacco plants from *T. basicola*. These findings were confirmed by quantitative PCR (Almario et al. 2013). The proportion of isolates from Morens suppressive soil capable of protecting tobacco from *T. basicola* was low for the total pseudomonads (Stutz et al. 1986) but very high when considering only DAPG<sup>+</sup> isolates (Ramette et al. 2006). Unlike in Morens, DAPG<sup>+</sup> bacteria were not prevalent in the rhizobacterial community in morainic soils (non suppressive) from Savoie (Almario et al. submitted). Numbers of root-colonizing DAPG<sup>+</sup> pseudomonads in Morens soils (Ramette et al. 2003; Frapolli et al. 2010) are comparable to those in take-all decline soils (Raaijmakers et al. 1997), where suppressiveness is induced by monoculture and involves rhizosphere enrichment of these bacteria.

Iron nutrition is important for production of antimicrobials and black root rot suppression by *P. protegens* CHA0 (Keel et al. 1989; Duffy et al. 1999), which fits the hypothesis that suppressiveness of Morens morainic soils could entail higher availability of iron released by vermiculite. Indeed, strain CHA0 adheres to vermiculite, contributes to vermiculite dissolution, and can use the clay as a source of iron and other micronutrients (Müller 2009). Yet, suppressiveness does not seem to involve competition for soluble iron, a scarce resource in the rhizosphere environment (Loper 1997), as a pyoverdine-negative mutant of strain CHA0 retained its capacity to protect tobacco from *T. basicola* in artificial and natural soils (Keel et al. 1989; 1992).

One particularity of *P. protegens* is the production of pyoluteorin, which helps strain CHA0 control Pythium damping-off of cress (Maurhofer et al. 1994). However, it probably plays a minor role in the case of black root rot, as non-producing pseudomonads and pyoluteorin-producing strains confer the same protection to tobacco (Ramette et al. 2006). Hydrogen cyanide (HCN) is an antimicrobial (Voisard et al. 1989) produced by almost all DAPG<sup>+</sup> strains, as well as many other pseudomonads (and non-*Pseudomonas* bacteria). HCN production ability contributes to tobacco protection from *T. basicola* by CHA0 (Voisard et al. 1989) but is often thought to be of less importance than DAPG (Rezzonico et al. 2007). Indeed, a DAPG-negative *Pseudomonas* mutant failed to protect tobacco from *T. basicola* although it could still produce HCN (Keel et al. 1992). The numbers of HCN<sup>+</sup> pseudomonads were not higher in the rhizosphere and on tobacco roots in Morens suppressive soils compared with conducive soils (Ramette et al. 2003), but little has been done to understand the contribution of this trait to Morens suppressiveness. Similarly, further research is needed to determine whether additional *Pseudomonas* properties, e.g. production of other antimicrobial secondary metabolites (Mazurier et al. 2009) or induction of systemic resistance (Bakker et al. 2007), which both are documented in *P. protegens* CHA0 (Haas and Keel 2003; Iavicoli et al. 2003) and other DAPG<sup>+</sup> *Pseudomonas* (Weller et al. 2012) could play a role in black root rot suppressiveness. Indeed, recent quantitative PCR monitoring of DAPG<sup>+</sup> *Pseudomonas* and *T. basicola* populations in Morens soil and rhizosphere raised the possibility of induced systemic resistance as a possible mechanism (Almario et al. 2013).

**Diversity of DAPG<sup>+</sup> *Pseudomonas* populations in black root rot suppressive soils.** DAPG<sup>+</sup> strains evidenced in Morens soils belong either to *P. protegens* (previously referred to as ARDRA-1 group), as expected, or more often to the species complex

termed the '*P. fluorescens*' group (Frapolli et al. 2012; Mulet et al. 2010). Differences in the composition of rhizosphere populations of DAPG<sup>+</sup> pseudomonads were found between Morens soils, based on molecular analysis of isolates (Ramette et al. 2003; Ramette et al. 2006), 16S rRNA microarray analysis (Kyselková et al. 2009), and especially DGGE of *phlD* alleles (Frapolli et al. 2008; Frapolli et al. 2010). Noticeably, 3 of 13 *phlD*-DGGE bands (including the one also found in strain Pf-5) and 12 of 31 *phlD* alleles were exclusively evidenced in suppressive soil(s), and 5 *phlD*-DGGE bands and 13 *phlD* alleles were only found in conducive soil(s) (Frapolli et al. 2010). In Morens, *phlD* alleles similar to those of Morens strain CHA0 or genotype-D strains Q8r1-96 (from take-all decline soil; Raaijmakers and Weller 2001) and MVP1-6 (from Fusarium wilt suppressive soil; Landa et al. 2002) were recovered from suppressive soil(s) as well as conducive soil(s).

Biogeography analysis identified that the main factor determining genetic diversity of DAPG<sup>+</sup> pseudomonads in Morens soils was soil location in the landscape (Ramette et al. 2006), followed by disease suppressiveness status (Frapolli et al. 2010). *phlD*-DGGE bands and alleles fluctuated also from one sampling to the next, whereas fluctuations were lower between neighboring plants or after *T. basicola* inoculation (Frapolli et al. 2010). Therefore, the possibility exists that genetic differences between DAPG<sup>+</sup> *Pseudomonas* populations could explain differences in suppressiveness status of Morens soils (Frapolli et al. 2010). Alternatively, since most DAPG<sup>+</sup> isolates (including those from conducive soils) protected tobacco in vermiculitic material mimicking Morens suppressive soil, it could be that Morens soils are suppressive if their chemical composition (presence of vermiculite conditioning iron availability) is favorable to DAPG production (Ramette et al. 2006).

### **PART 3. Rhizobacterial community and black root rot suppressiveness**

**Rhizobacterial community in Morens soils.** In recent years, bacterial communities have been compared in suppressive and conducive Morens soils to assess whether suppressiveness correlates with abundance of other taxa than pseudomonads. Indeed, 16S rRNA taxonomic microarray analysis showed that many bacterial taxa differed in prevalence level in the tobacco rhizosphere in suppressive versus conducive soil under greenhouse conditions (Kyselková et al. 2009). Whether iron availability would explain

such differences is unknown. Taxa more prevalent in suppressive soil included noticeably *Azospirillum*, *Burkholderia*, *Comamonas*, *Gluconacetobacter*, *Herbaspirillum* and *Sphingomonadaceae*, whereas *Bradyrhizobium*, *Mycobacterium*, *Rhodobacteraceae* and *Rhodospirillum* were among taxa that were less prevalent. Most of these differences were not found when comparing suppressive and conducive soils from Savoie, under the same conditions, in accordance with the hypothesis that it is a different type of black root rot suppressiveness in Savoie (Almario et al. submitted).

The tobacco rhizobacterial community was also investigated in farmers' fields from Morens. Even though experimental conditions were not the same as in the greenhouse experiments above, some of the same taxa were again more prevalent (*Azospirillum*, *Gluconacetobacter* and *Sphingomonadaceae*) or less prevalent (e.g. *Planctomycetes* and *Mycoplasma*) in samples from suppressive soils (Kyselková et al. in preparation). Overall, the composition of the rhizobacterial community depended largely on field location (determining soil properties resulting from geography and geology effects) and the year of the study, and the plant species (i.e. tobacco or wheat) and the experimental conditions (i.e. field survey versus greenhouse trial) were of less significance (Almario et al. submitted; Kyselková et al. in preparation).

Rhizobacterial communities also differed when comparing soils suppressive or conducive to ectoparasitic nematodes (Rimé et al. 2003), or after chitin amendment of clubroot suppressive soil (Hjort et al. 2007), but discriminating taxa were not sought. The 16S rRNA microarray approach identified certain *Acidobacteria*, *Alphaproteobacteria* (including *Azospirillum*), *Chloroflexi*, *Firmicutes*, *Nitrospira* and *Planctomycetes* as wheat rhizobacterial taxa prevalent in French take-all decline soil (Sanguin et al. 2009), and *Achromobacter*, *Agrobacterium*, *Burkholderia*, *Methylobacterium*, *Rhizobium*, and *Variovorax* as barley rhizobacterial taxa prevalent in German take-all decline soil (Schreiner et al. 2010). Therefore, it appears that the majority of rhizobacterial taxa indicative of soil suppressiveness status may differ when comparing different types of suppressive soils or even different soils suppressive to a same phytopathogen.

**Implications of rhizobacterial community differences.** Differences in tobacco rhizobacterial community composition between Morens suppressive and conducive soils may have several, non-mutually exclusive functional implications. One possibility is that some of these taxa might have deleterious effects on tobacco, which could be relevant for *Pantoea agglomerans* (ex *Erwinia herbicola*), *Pantoea toletana* (syn. *Erwinia toletana*)

and *Agrobacterium tumefaciens* (all three more prevalent in conducive soil), which include phytopathogenic strains. However, *Pantoea* is not documented as tobacco pathogen (Barash and Manulis-Sasson 2009). *Agrobacterium* is rarely pathogenic to tobacco (Furuya et al. 2004), and tobacco did not display crown-gall in our field surveys or the experiments performed to date (unpublished observations). Therefore, based on current knowledge, this possibility of deleterious effects is rather unlikely.

A second possibility is that some of the non-*Pseudomonas* taxa more prevalent in Morens suppressive soil could facilitate tobacco protection by DAPG<sup>+</sup> biocontrol pseudomonads (Couillerot et al. 2009; Kyselková and Moëgne-Loccoz 2012). Arguably, this might take place if these taxa have positive effects on rhizosphere colonization and/or the expression of biocontrol traits in root-associated *Pseudomonas* populations (de Boer et al. 2006; Garbeva and de Boer 2009). Some of these taxa can dissolve certain iron-containing minerals (e.g. biotite) (Uroz 2009) and it would be interesting to know if this could enhance iron bioavailability in soil. However, the possibility that non-*Pseudomonas* bacteria could enhance the biocontrol efficacy of pseudomonads remains to be assessed, regardless of whether soils suppressive to tobacco black root rot or other suppressive soils are concerned (McSpadden Gardener and Weller 2001).

A third possibility is that some of the discriminant taxa could have positive effects on tobacco health in Morens soils. This is substantiated by the fact that many of the taxa more prevalent in suppressive soil contain strains with biocontrol and/or plant growth promotion potential (Kyselková et al. 2009; Kyselková and Moëgne-Loccoz 2012). Indeed, microbial consortia consisting of representative strains from these taxa were effective at improving growth of rice (i.e. *Gluconacetobacter*, *Herbaspirillum*, *Azospirillum* and *Burkholderia*; Govindarajan et al. 2008) and tobacco (i.e. *Xanthomonadaceae* and *Stenotrophomonas* in combination with *Pseudomonas*; Mastretta et al. 2009). If this hypothesis were correct, it would mean that suppressiveness of Morens soils could involve joint contribution of pseudomonads and these other plant-beneficial bacteria. Indeed, certain *Azospirillum* strains are compatible with DAPG<sup>+</sup> *Pseudomonas* strains on roots (Couillerot et al. 2011) and may improve plant growth in presence of the latter (Combes-Meynet et al. 2011). In addition, some of the taxa cited above (e.g. *Stenotrophomonas* and *Burkholderia*) also harbor biocontrol strains, and combining microorganisms with different biocontrol mechanisms can result in improved plant protection (Mazzola 2002). Indeed, a consortium consisting of a DAPG<sup>+</sup> biocontrol pseudomonad and a proteolytic biocontrol *Stenotrophomonas* strain proved more



effective at protecting sugarbeet from *Pythium* damping-off than its individual components (Dunne et al. 1998). This possibility remains poorly documented in the case of these or other suppressive soils, but circumstantial evidence with *Pseudomonas* and chitinolytic *Actinobacteria* in cabbage clubroot suppressive soil suggests it could be the case (Hjort et al. 2007).

## Conclusion

Morens soils suppressive to *T. basicola*-mediated black root rot of tobacco have become a key model of long-standing specific suppressiveness. Their particularities include a relation between suppressiveness and soil geological origin, attributed to clay mineralogy and the resulting bioavailability of iron, as well as the extensive colonization of roots by DAPG<sup>+</sup> pseudomonads, including in conducive soils. Earlier results pointing to the importance of DAPG<sup>+</sup> *Pseudomonas* populations have been widened in recent years with the observations that differences in *Pseudomonas* populations were paralleled by differences in the prevalence of non-*Pseudomonas* rhizobacterial populations, as in the case of take-all decline soils.

## Outlook

Despite several decades of research on black root rot suppressiveness at Morens, this phenomenon remains poorly understood. Research is particularly needed in three directions. First, the main hypothesis so far is the ability of morainic soils to provide higher conditions for DAPG production by root-colonizing pseudomonads, either by stimulating DAPG synthesis or selecting more efficient *Pseudomonas* genotypes. However, this hypothesis remains to be assessed, as work so far has focused on diversity issues and neglected functional assessments. A similar comment can be made for almost all other types of suppressive soils.

Second, the recent identification of many non-*Pseudomonas* taxa associated with Morens suppressiveness raises questions on their ecological role, all the more as several of them are known for their plant-beneficial effects. This is for instance the case of

*Azospirillum*, which has also been identified in take-all decline soils. Whether the relation observed between taxa is only a correlation or has functional implications merits further research. For instance, DAPG was recently shown to enhance the expression of plant-growth promotion traits in *Azospirillum* (Combes-Meynet et al. 2011). Here again, this issue deserves similar attention in other types of suppressive soils.

Third, the focus so far in Morens suppressive soils has been put on rhizobacteria, following earlier reports that discounted the occurrence of non-pathogenic *T. basicola* (Gasser and Défago 1981; Stutz et al. 1986). However, it is known that biocontrol bacteria and fungi can interact positively (Lutz et al. 2004), for instance for protection of flax from Fusarium wilt (Duijff et al. 1999), and it would be worth assessing whether the microeukaryotic and faunal communities differ or not between Morens suppressive and conducive soils. This type of approach has already been initiated for fungi, but this was with other types of suppressiveness (Yin et al. 2003; Garbeva et al. 2006).

## References

- Agrios G. N. 2005. Plant Pathology (fifth edition), 952 p. Academic Press, San Diego, CA.
- Ahl P., Voisard C., Défago G. 1986. Iron bound-siderophores, cyanic acid, and antibiotics involved in suppression of *Thielaviopsis basicola* by a *Pseudomonas fluorescens* strain. Journal of Phytopathology 116:121-134.
- Alabouvette C. 1986. Fusarium-wilt suppressive soils from the Châteaurenard region: review of a 10-year study. Agronomie 6:273-284.
- Almario J., Kyselková M., Kopecký J., Ságová-Marečková M., Muller D., Grundmann G. L., Moëgne-Loccoz Y. Assessment of the relationship between geologic origin of soil, rhizobacterial community composition and tobacco black root rot suppressiveness in Savoie region (France). *Submitted to Plant and Soil*.
- Almario J., Moëgne-Loccoz Y., Muller D. 2013. Monitoring of the relation between 2,4-diacetylphloroglucinol-producing *Pseudomonas* and *Thielaviopsis basicola* populations by real-time PCR in tobacco black root-rot suppressive and conducive soils. Soil Biology and Biochemistry (in press).
- Anderson S. P., Drever J. I., Humphrey N. H. 1997. Chemical weathering in glacial environments. Geology 25:399-402.

- Baker K. F., Cook R. J. 1974. *Biological Control of Plant Pathogens*, 433 p. WH Freeman, San Francisco, CA.
- Bakker P. A. M., Pieterse C. M. J., Van Loon L. C. 2007. Induced systemic resistance by fluorescent *Pseudomonas* spp. *Phytopathology* 97:239-243.
- Barash I., Manulis-Sasson S. 2009. Recent evolution of bacterial pathogens: the gall-forming *Pantoea agglomerans* case. *Annual Review of Phytopathology* 47:133-152.
- Bergsma-Vlami M., Prins M. E., Raaijmakers J. M. 2005. Influence of plant species on population dynamics, genotypic diversity and antibiotic production in the rhizosphere by indigenous *Pseudomonas* spp. *FEMS Microbiology Ecology* 52:59-69.
- Berling C. H., Défago G., Kern H. 1984. Population-dynamics of *Thielaviopsis basicola* in soils conducive and suppressive to black root-rot disease. *Phytopathology* 74:867.
- Borneman J. and Becker J. O. 2007. Identifying microorganisms involved in specific pathogen suppression in soil. *Phytopathology* 45:153-172.
- Broadbent P. and Baker K. F. 1974. Behaviour of *Phytophthora cinnamomi* in soils suppressive and conducive to root rot. *Australian Journal of Agricultural Research* 25:121-137.
- Combes-Meynet E., Pothier J., Moëgne-Loccoz Y., Prigent-Combaret C. 2011. The *Pseudomonas* secondary metabolite 2,4-diacetylphloroglucinol is a signal inducing rhizoplane expression of *Azospirillum* genes involved in plant-growth promotion. *Molecular Plant-Microbe Interactions* 24:271-284.
- Cook R. J., Baker K. F. 1983. *The nature and practice of biological control of plant pathogens*, 539 p. American Phytopathological Society, St. Paul, MN.
- Corbaz R. 1975. Enquête 1975 sur les principales maladies et ravageurs du tabac. Pages 503-525, In: CORESTA Agronomy and Phytopathology Study Groups Reports. CORESTA, Torremolinos, Spain.
- Corbaz R. 1978. Les variétés de tabac cultivées en Suisse. *Revue Suisse d'Agriculture* 10:119-122.
- Couillerot O., Combes-Meynet E., Pothier J. F., Bellvert F., Challita E., Poirier M. A., Rohr R., Comte G., Moëgne-Loccoz Y., Prigent-Combaret C. 2011. The role of the antimicrobial compound 2,4-diacetylphloroglucinol in the impact of biocontrol *Pseudomonas fluorescens* F113 on *Azospirillum brasilense* phytostimulators. *Microbiology* 157:1694-705.

- Couillerot O., Prigent-Combaret C., Caballero-Mellado J., Moëgne-Loccoz Y. 2009. *Pseudomonas fluorescens* and closely related fluorescent pseudomonads as biocontrol agents of soil borne phytopathogens. *Letters in Applied Microbiology* 48:505-512.
- De Boer W., Wagenaar A. M., Klein Gunnewiek P. J., Van Veen, J. A. 2007. *In vitro* suppression of fungi caused by combinations of apparently non-antagonistic soil bacteria. *FEMS Microbiology Ecology* 59:177-185.
- Delon R. 1987. Survey of pests and diseases of tobacco and chemicals used. CORESTA, Paris, France.
- Delon R., Schiltz P., Genève R. 1977. Influence de l'assolement sur le taux d'infestation des sols en *Thielaviopsis basicola* (Berk. et Br.) Ferraris. *Annales du Tabac. Section 2* 14:152-157.
- Duffy B. K., Défago G. 1999. Environmental factors modulating antibiotic and siderophore biosynthesis by *Pseudomonas fluorescens* biocontrol strains. *Applied and Environmental Microbiology* 65:2429-2438.
- Duijff B. J., Recorbet G., Bakker P. A. H. M., Loper J. E., Lemanceau P. 1999. Microbial antagonism at the root level is involved in the suppression of Fusarium wilt by the combination of nonpathogenic *Fusarium oxysporum* Fo47 and *Pseudomonas putida* WCS358. *Phytopathology* 89:1073-1079.
- Dunne C., Moëgne-Loccoz Y., McCarthy J., Higgins P., Powell J., Dowling D. N., O'Gara F. 1998. Combining proteolytic and phloroglucinol producing bacteria for improved biocontrol of *Pythium*-mediated damping off of sugar beet. *Plant Pathology* 47:299-307.
- Frapolli M., Défago G., Moëgne-Loccoz Y. 2007. Multilocus sequence analysis of biocontrol fluorescent *Pseudomonas* spp. producing the antifungal compound 2,4-diacetylphloroglucinol. *Environmental Microbiology* 9:1939-1955.
- Frapolli M., Défago G., Moëgne-Loccoz Y. 2010. Denaturing gradient gel electrophoretic analysis of dominant 2,4-diacetylphloroglucinol biosynthetic *phlD* alleles in fluorescent *Pseudomonas* from soils suppressive or conducive to black root rot of tobacco. *Soil Biology and Biochemistry* 42:649-656.
- Frapolli M., Moëgne-Loccoz Y., Meyer J., Défago G. 2008. A new DGGE protocol targeting 2,4-diacetylphloroglucinol biosynthetic gene *phlD* from phylogenetically contrasted biocontrol pseudomonads for assessment of disease suppressive soils. *FEMS Microbiology Ecology* 64:468-481.
- Frapolli M., Pothier J. F., Défago G., Moëgne-Loccoz Y. 2012. Evolutionary history of synthesis pathway genes for phloroglucinol and cyanide antimicrobials in plant-

- associated fluorescent pseudomonads. *Molecular Phylogenetics and Evolution* 63:877-890.
- Furuya N., Shimokusuzono F., Nakamura Y., Nishimura K., Takeshita M., Matsuyama N., Manabe K., Takanami Y. 2004. Crown gall of tobacco caused by *Agrobacterium tumefaciens* biovar 1 in tobacco fields. *Journal of General Plant Pathology* 70:39-44.
- Garbeva P., de Boer W. 2009. Inter-specific interactions between carbon-limited soil bacteria affect behavior and gene expression. *Microbial Ecology* 58:36-46.
- Garbeva P., Postma P., Van Veen J. A., Van Elsas J. D. 2006. Effect of above ground plant species on soil microbial community structure and its impact on suppression of *Rhizoctonia solani* AG3. *Environmental Microbiology* 8:233-246.
- Gasser R., Défago G. 1981. Mise en évidence de la résistance de certaines terres à la pourriture noire des racines du tabac causée par le *Thielaviopsis basicola*. *Botanica Helvetica* 91:75-80.
- Gleeson O., O’Gara F., Morrissey J. P. 2010. The *Pseudomonas fluorescens* secondary metabolite 2,4-diacetylphloroglucinol impairs mitochondrial function in *Saccharomyces cerevisiae*. *Antonie van Leeuwenhoek* 97:261-273.
- Govindarajan M., Balandreau J., Kwon S. W., Weon H. Y., Lakshminarasimhan C. 2008. Effects of the inoculation of *Burkholderia vietnamensis* and related endophytic diazotrophic bacteria on grain yield of rice. *Microbial Ecology* 55:21-37.
- Haas D., Défago G. 2005. Biological control of soil-borne pathogens by fluorescent pseudomonads. *Nature Reviews Microbiology* 3:307-319.
- Haas D., Keel C. 2003. Regulation of antibiotic production in root-colonizing *Pseudomonas* spp. and relevance for biological control of plant disease. *Annual Review of Phytopathology* 41:117-153.
- Hjort K., Lembke A., Speksnijder A., Smalla K., Jansson J. K. 2007. Community structure of actively growing bacterial populations in plant pathogen suppressive soil. *Microbial Ecology* 53:399-413.
- Höper H., Steinberg C., Alabouvette C. 1995. Involvement of clay type and pH in the mechanisms of soil suppressiveness to fusarium wilt of flax. *Soil Biology and Biochemistry* 27:955-967.
- Hornby D. 1983. Suppressing soils. *Annual Review of Phytopathology* 21:65-85.
- Hsi D. C. H. 1978. Effect of crop sequence, previous peanut blackhull severity, and time of sampling on soil populations of *Thielaviopsis basicola*. *Phytopathology* 68:1442-1445.

- Huang J., Kang Z. 2010. Detection of *Thielaviopsis basicola* in soil with real-time quantitative PCR assays. *Microbiological Research* 165:411-417.
- Iavicoli A., Boutet E., Buchala A., Métraux J. P. 2003. Induced systemic resistance in *Arabidopsis thaliana* in response to root inoculation with *Pseudomonas fluorescens* CHA0. *Molecular Plant-Microbe Interactions* 16:851-858.
- Janvier C., Villeneuve F., Alabouvette C., Edel-Hermann V., Mateille T., Steinberg C. 2007. Soil health through soil disease suppression: Which strategy from descriptors to indicators? *Soil Biology and Biochemistry* 39:1-23.
- Keel C., Schnider U., Maurhofer M., Voisard C., Laville J., Burger U., Wirthner P., Haas D., Défago, G. 1992. Suppression of root diseases by *Pseudomonas fluorescens* CHA0: importance of the bacterial secondary metabolite 2,4-diacetylphloroglucinol. *Molecular Plant-Microbe Interactions* 5:4-13.
- Keel C., Voisard C., Berling C. H., Kahr G., Défago G. 1989. Iron sufficiency, a prerequisite for the suppression of tobacco black root rot by *Pseudomonas fluorescens* strain CHA0 under gnotobiotic conditions. *Phytopathology* 79:584-589.
- Keel C., Wirthner P. H., Oberhänsli T. H., Voisard C., Burger U., Haas D., Défago G. 1990. Pseudomonads as antagonists of plant pathogens in the rhizosphere: Role of the antibiotic 2,4-diacetylphloroglucinol in the suppression of black root rot of tobacco. *Symbiosis* 9:327-341.
- Kerry, B. R., Crump, D. H., Mullen L. A. 1982. Studies of the cereal cyst-nematode, *Heterodera avenae* under continuous cereals, 1975-1978. II. Fungal parasitism of nematode females and eggs. *Annals of Applied Biology* 100:489-499.
- Kyselková M., Almario J., Kopecký J., Ságová-Marečková M., Muller D., Grundmann G. L., Moëgne-Loccoz Y. Evaluation of rhizobacterial indicators of tobacco black root rot suppressiveness in farmers' fields. *In preparation*.
- Kyselková M., Kopecký J., Frapolli M., Défago G., Ságová-Marečková M., Grundmann G. L., Moëgne-Loccoz Y. 2009. Comparison of rhizobacterial community composition in soil suppressive or conducive to tobacco black root rot disease. *The ISME Journal* 3:1127-1138.
- Kyselková M., Moëgne-Loccoz Y. 2012. *Pseudomonas* and other microbes in disease-suppressive soils. Pages 93-140 in: *Sustainable Agriculture Reviews, Vol. 9: Organic Fertilisation, Soil Quality and Human Health*. E. Lichtfouse, ed. Springer, Dordrecht, The Netherlands.
- Landa B. B., Mavrodi O. V., Raaijmakers J. M., McSpadden Gardener B. B., Thomashow L. S., Weller D. M. 2002. Differential ability of genotypes of 2,4-

- diacetylphloroglucinol-producing *Pseudomonas fluorescens* strains to colonize the roots of pea plants. *Applied and Environmental Microbiology* 68:3226-3237.
- Lemanceau P., Alabouvette C., Couteaudier Y. 1988. Recherches sur la résistance des sols aux maladies. XIV: Modification du niveau de réceptivité d'un sol résistant et d'un sol sensible aux fusarioses vasculaires en réponse à des apports de fer ou de glucose. *Agronomie* 8:155-162.
- Loper J. E., Henkels M. D. 1997. Availability of iron to *Pseudomonas fluorescens* in rhizosphere and bulk soil evaluated with an ice nucleation reporter gene. *Applied and Environmental Microbiology* 63:99-105.
- Louvet J., Rouxel F., Alabouvette C. 1976. Recherches sur la résistance des sols aux maladies. I. Mise en évidence de la nature microbiologique de la résistance d'un sol au développement de la fusariose vasculaire du melon. *Annales de Phytopathologie* 8:425-436.
- Lucas P., Sarniguet A. 1998. Biological control of soil-borne pathogens with resident versus introduced antagonists: should diverging approaches become strategic convergence? Pages 351-370 In: *Conservation Biological Control* (Barbosa P., ed.). Academic Press, London.
- Lutz M. P., Wenger S., Maurhofer M., Défago G., Duffy B. K. 2004. Signaling between bacterial and fungal biocontrol agents in a strain mixture. *FEMS Microbiology Ecology* 48:447-455.
- Mascher F., Schnider-Keel U., Haas D., Défago G., Moëgne-Loccoz Y. 2003. Persistence and cell culturability of biocontrol strain *Pseudomonas fluorescens* CHA0 under plough pan conditions in soil and influence of the anaerobic regulator gene *anr*. *Environmental Microbiology* 5:103-115.
- Mastretta C., Taghavi S., van der Lelie D., Mengoni A., Galardi F., Gonnelli C., Barac T., Boulet J., Weyens N., Vangronsveld J. 2009. Endophytic bacteria from seeds of *Nicotiana tabacum* can reduce cadmium phytotoxicity. *International Journal of Phytoremediation* 11:251-267.
- Maurhofer M., Keel C., Haas D., Défago G. 1994. Pyoluteorin production by *Pseudomonas fluorescens* strain CHA0 is involved in the suppression of *Pythium* damping-off of cress but not of cucumber. *European Journal of Plant Pathology* 100:221-232.
- Mazurier S., Corberand T., Lemanceau P., Raaijmakers J. M. 2009. Phenazine antibiotics produced by fluorescent pseudomonads contribute to natural soil suppressiveness to *Fusarium* wilt. *The ISME Journal* 3:977-991.

- Mazzola M. 2002. Mechanisms of natural soil suppressiveness to soilborne diseases. *Antonie van Leeuwenhoek* 81:557-564.
- McSpadden Gardener B. B., Weller D. M. 2001. Changes in populations of rhizosphere bacteria associated with take-all disease of wheat. *Applied and Environmental Microbiology* 67:4414-4425.
- Meyer J. R., Shew H. D. 1991. Soils suppressive to black root rot of burley tobacco, caused by *Thielaviopsis basicola*. *Phytopathology* 81:946-954.
- Mulet M., Lalucat J., García-Valdés E. 2010. DNA sequence-based analysis of the *Pseudomonas* species. *Environmental Microbiology* 12:1513-1530.
- Müller B. 2009. Impact of the bacterium *Pseudomonas fluorescens* and its genetic derivatives on vermiculite: Effects on trace metals contents and clay mineralogical properties. *Geoderma* 153:94-103.
- Peglion V. 1897. Marciume radicale delle piantine di tabacco causato dalla *Thielavia basicola* Zopf. *Zentralblatt für Bakteriologie Abteilung II* 3:580-584.
- Raaijmakers J. M., Bonsall R. F., Weller D. M. 1999. Effect of population density of *Pseudomonas fluorescens* on production of 2,4-diacetylphloroglucinol in the rhizosphere of wheat. *Phytopathology* 89:470-475.
- Raaijmakers J. M., Paulitz T. C., Steinberg C., Alabouvette C., Moënne-Loccoz Y. 2009. The rhizosphere: a playground and battlefield for soilborne pathogens and beneficial microorganisms. *Plant and Soil* 321:341-361.
- Raaijmakers J. M., Vlami M., de Souza J. T. 2002. Antibiotic production by bacterial biocontrol agents. *Antonie van Leeuwenhoek* 81:537-547.
- Raaijmakers J. M., Weller D. M. 2001. Exploiting genotypic diversity of 2,4-diacetylphloroglucinol-producing *Pseudomonas* spp.: characterization of superior root-colonizing *P. fluorescens* strain Q8r1-96. *Applied and Environmental Microbiology* 67:2545-2554.
- Raaijmakers J. M., Weller D. M., Thomashow L. S. 1997. Frequency of antibiotic-producing *Pseudomonas* spp. in natural environments. *Applied and Environmental Microbiology* 63:881-887.
- Ramette A., Frapolli M., Fischer-Le Saux M., Gruffaz C., Meyer J. M., Défago G., Sutra L., Moënne-Loccoz Y. 2011. *Pseudomonas protegens* sp. nov., widespread plant-protecting bacteria producing the biocontrol compounds 2,4-diacetylphloroglucinol and pyoluteorin. *Systematic and Applied Microbiology* 34:180-188.
- Ramette A., Moënne-Loccoz Y., Défago G. 2003. Prevalence of fluorescent pseudomonads producing antifungal phloroglucinols and/or hydrogen cyanide in



- soils naturally suppressive or conducive to tobacco black root rot. FEMS Microbiology Ecology 44:35-43.
- Ramette A., Moënne-Loccoz Y., Défago G. 2006. Genetic diversity and biocontrol potential of fluorescent pseudomonads producing phloroglucinols and hydrogen cyanide from Swiss soils naturally suppressive or conducive to *Thielaviopsis basicola*-mediated black root rot of tobacco. FEMS Microbiology Ecology 55:369-381.
- Reddy M. S., Patrick Z. A. 1992. Colonization of tobacco seedling roots by fluorescent pseudomonad suppressive to black root rot caused by *Thielaviopsis basicola*. Crop Protection 11:148-154.
- Rezzonico F., Zala M., Keel C., Duffy B. K., Moënne-Loccoz Y., Défago G. 2007. Is the ability of biocontrol fluorescent pseudomonads to produce the antifungal metabolite 2,4-diacetylphloroglucinol really synonymous with higher plant protection? New Phytologist 173:861-872.
- Rimé D., Nazaret S., Gourbière F., Cadet P., Moënne-Loccoz Y. 2003. Comparison of sandy soils suppressive or conducive to ectoparasitic nematode damage on sugarcane. Phytopathology 93:1437-1444.
- Sanguin H., Sarniguet A., Gazengel K., Moënne-Loccoz Y., Grundmann G. L. 2009. Rhizosphere bacterial communities associated with disease suppressiveness stages of take all decline in wheat monoculture. New Phytologist 184:694-707.
- Schnider-Keel U., Seematter A., Maurhofer M., Blumer C., Duffy B. K., Gigot-Bonnefoy C., Reimann C., Notz R., Défago G., Haas D., Keel C. 2000. Autoinduction of 2,4-diacetylphloroglucinol biosynthesis in the biocontrol agent *Pseudomonas fluorescens* CHA0 and repression by the bacterial metabolites salicylate and pyoluteorin. Journal of Bacteriology 182:1215-1225.
- Schreiner K., Hagn A., Kyselková M., Moënne-Loccoz Y., Welzl G., Munch J. C., Schloter M. 2010. Comparison of barley succession and take-all disease as environmental factors shaping the rhizobacterial community during take-all decline. Applied and Environmental Microbiology 76:4703-4712.
- Shipton P. J., Cook R. J., Sitton J. W. 1973. Occurrence and transfer of a biological factor in soil that suppresses take-all of wheat in eastern Washington. Phytopathology 63:1-17.
- Stotzky G., Martin R. T. 1963. Soil mineralogy in relation to the spread of Fusarium wilt of banana in Central America. Plant and Soil 18:317-337.
- Stutz E., Défago G., Kern H. 1986. Naturally occurring fluorescent pseudomonads involved in suppression of black root rot of tobacco. Phytopathology 76:181-185.

- Stutz E., Défago G., Hantke R., Kern H. 1985. Effect of parent materials derived from different geological strata on suppressiveness of soils to black root rot of. Pages 215-217 In: Ecology and Management of Soilborne Plant Pathogens (Parker C.A., Rovira A. D., Moore K. J., Wong P. T. W., Kollmorgen J. F., ed.). American Phytopathological Society, St. Paul, MN.
- Stutz E., Kahr G., Défago G. 1989. Clays involved in suppression of tobacco black root rot by a strain of *Pseudomonas fluorescens*. Soil Biology and Biochemistry 21:361-366.
- Trojak-Goluch A., Berbeć A. 2005. Potential of *Nicotiana glauca* (Grah.) as a source of resistance to black root rot *Thielaviopsis basicola* (Berk. and Broome) Ferr. in tobacco improvement. Plant Breeding 124:507-510.
- Troxler J., Berling C. H., Moënne-Loccoz Y., Keel C., Défago G. 1997. Interactions between the biocontrol agent *Pseudomonas fluorescens* CHA0 and *Thielaviopsis basicola* in tobacco roots observed by immunofluorescence microscopy. Plant Pathology 46:62-71.
- Uroz S., Calvaruso C., Turpault M. P., Frey-Klett P. 2009. Mineral weathering by bacteria: ecology, actors and mechanisms. Trends in Microbiology 17:378-387.
- Voisard C., Keel C., Haas D., Défago G. 1989. Cyanide production by *Pseudomonas fluorescens* helps suppress black root rot of tobacco under gnotobiotic conditions. The EMBO Journal 8:351-358.
- Weller D. M., Landa B. B., Mavrodi O. V., Schroeder K. L., De La Fuente L., Blouin Bankhead S., Allende Molar R., Bonsall R. F., Mavrodi D. V., Thomashow L. S. 2007. Role of 2,4-diacetylphloroglucinol producing fluorescent *Pseudomonas* spp. in the defense of plant roots. Plant Biology 9:4-20.
- Weller D. M., Mavrodi D. V., van Pelt J. A., Pieterse C. M. J., van Loon L. C., Bakker P. A. H. M. 2012. Induced systemic resistance in *Arabidopsis thaliana* against *Pseudomonas syringae* pv. tomato by 2,4-diacetylphloroglucinol-producing *Pseudomonas fluorescens*. Phytopathology 102:403-412.
- Weller D. M., Raaijmakers J. M., McSpadden Gardener B. B., Thomashow L. S. 2002. Microbial populations responsible for specific soil suppressiveness to plant pathogens. Annual Review of Phytopathology 40:309-348.
- Yin B., Valinsky L., Gao X., Becker J. O., Borneman J. 2003. Identification of fungal rDNA associated with soil suppressiveness against *Heterodera schachtii* using oligonucleotide fingerprinting. Phytopathology 93:1006-1013.



# CHAPITRE 1

Relation entre la densité des populations de  
*Pseudomonas* producteurs de DAPG et la  
résistance du sol à la maladie

## Introduction au chapitre 1

---

Les *Pseudomonas* producteurs de 2,4-diacétylphloroglucinol (DAPG) sont un groupe fonctionnel souvent étudié en tant que bioindicateur de la qualité du sol (Janvier et al. 2007 ; Latz et al. 2012). Si la résistance des sols de Morens a été attribuée à ces bactéries, le lien direct entre la densité des populations de *Pseudomonas phl*<sup>+</sup> et la résistance des sols de Morens n'est pas clair. Ramette et al. (2003) et Frapolli et al. (2010) ont conclu que leurs effectifs étaient souvent comparables dans les deux types de sol, ce qui a conduit à l'hypothèse que la résistance des sols de Morens ne dépend pas entièrement de la densité des populations de *Pseudomonas phl*<sup>+</sup>. Il peut être argumenté que la quantification des *Pseudomonas phl*<sup>+</sup> dans ces sols a été effectuée uniquement par des approches culturales, avec des résultats qui semblent en contradiction avec ceux obtenus par une approche culture-indépendante de puce taxonomique ciblant l'ARNr 16S (Kyselková et al. 2009), même si dans cette étude les génotypes de *Pseudomonas* ciblés par les sondes ne correspondaient pas strictement aux *Pseudomonas phl*<sup>+</sup> (Sanguin et al. 2008). Dans la rhizosphère, les cellules de *Pseudomonas* sont souvent en condition de stress nutritionnel (Marschner et Crowley 1996) et des sous-populations de cellules viables mais non cultivables peuvent se développer (Sorensen et al. 2001 ; Troxler et al. 2012), biaisant les estimations des approches culturales. Le premier objectif de cette thèse a donc été de réévaluer la relation entre la densité des populations de *Pseudomonas phl*<sup>+</sup> dans la rhizosphère du tabac et la résistance des sols de Morens, en utilisant une approche culture indépendante.

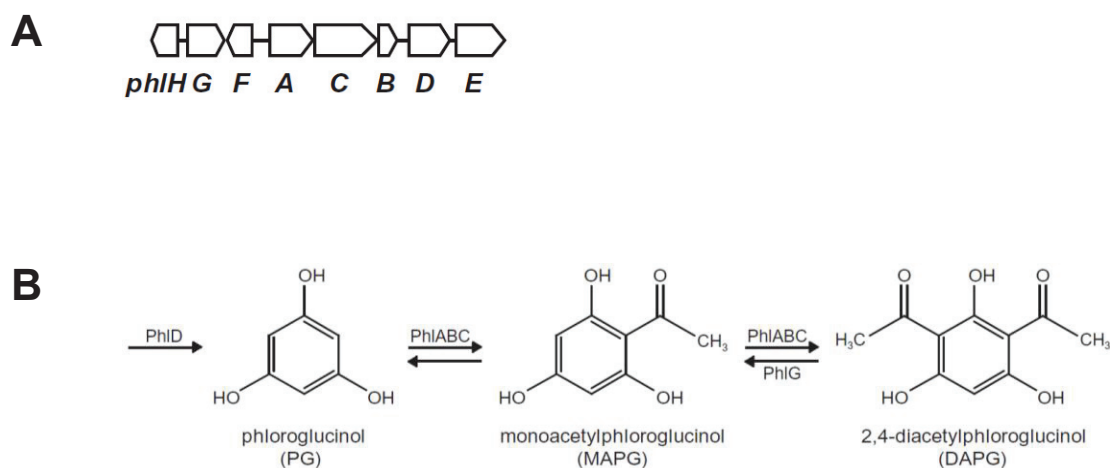
Les techniques disponibles pour étudier les effectifs du groupe fonctionnel des *Pseudomonas phl*<sup>+</sup> requièrent généralement une étape de culture car aucune technique de quantification culture-indépendante n'est à ce jour disponible, alors même que la PCR quantitative est une technique de plus en plus utilisée pour quantifier des groupes fonctionnels microbiens, par exemple celui des bactéries nitrifiantes (Le Roux et al. 2008). Pour l'instant, les approches de PCR quantitatives disponibles pour des *Pseudomonas phl*<sup>+</sup> ciblent uniquement quelques souches individuelles (Mavrodi et al. 2007 ; von Felten et al. 2010), mais pas le groupe fonctionnel dans sa totalité.

La PCR quantitative permet d'inférer le nombre de copies initiales du gène cible dans un échantillon d'ADN, à partir du nombre de copies synthétisées au bout d'un cycle seuil (*Ct*: *cycle threshold* ou cycle seuil) d'amplification par PCR. La détection de l'ADN synthétisé se fait à chaque cycle, en marquant l'ADN avec un fluorochrome (généralement le SYBR-green) ou une sonde marquée avec un fluorochrome (sondes TaqMan), et en mesurant la fluorescence émise. La quantification du nombre de copies initiales du gène cible dans l'échantillon d'ADN passe par la détermination du nombre *Ct* de cycles de PCR nécessaires pour que la fluorescence de l'ADN synthétisé dépasse un seuil arbitraire. Ainsi, plus le gène cible est abondant dans l'échantillon, plus faible sera le nombre de cycles PCR nécessaires pour que la fluorescence dépasse le seuil (= petit nombre *Ct*). La détermination du nombre de copies initiales du gène cible dans l'échantillon se fait en reportant le nombre *Ct* de l'échantillon, sur une courbe étalon construite à partir des nombres *Ct* obtenus sur des échantillons standard dont le nombre de copies initiales du gène cible est connu (courbe standard ; Bustin et al. 2009). Un important biais technique de la PCR, et donc de la PCR quantitative, est celui de l'écart entre le nombre de copies initiales du gène ( $N_i$ ) et le nombre de copies synthétisées au cycle  $n$  d'amplification par PCR ( $N_n$ ). En effet dans une réaction PCR 'parfaite' on devrait observer la correspondance :  $N_n = (2 \times N_i)^n$  ; mais la consommation des réactifs (amorces et nucléotides) et la diminution de l'activité de la polymérase à chaque cycle font que cette relation est rarement vérifiée en pratique. Une réaction de PCR vérifiant cette relation parfaitement est considérée comme étant 100% efficace. Ceci est rarement observé avec des échantillons complexes et donc pour limiter ce biais technique, le seuil minimum d'efficacité pour valider une méthode de PCR quantitative a été arbitrairement fixé à 80% d'efficacité (Zhang et Fang 2006).

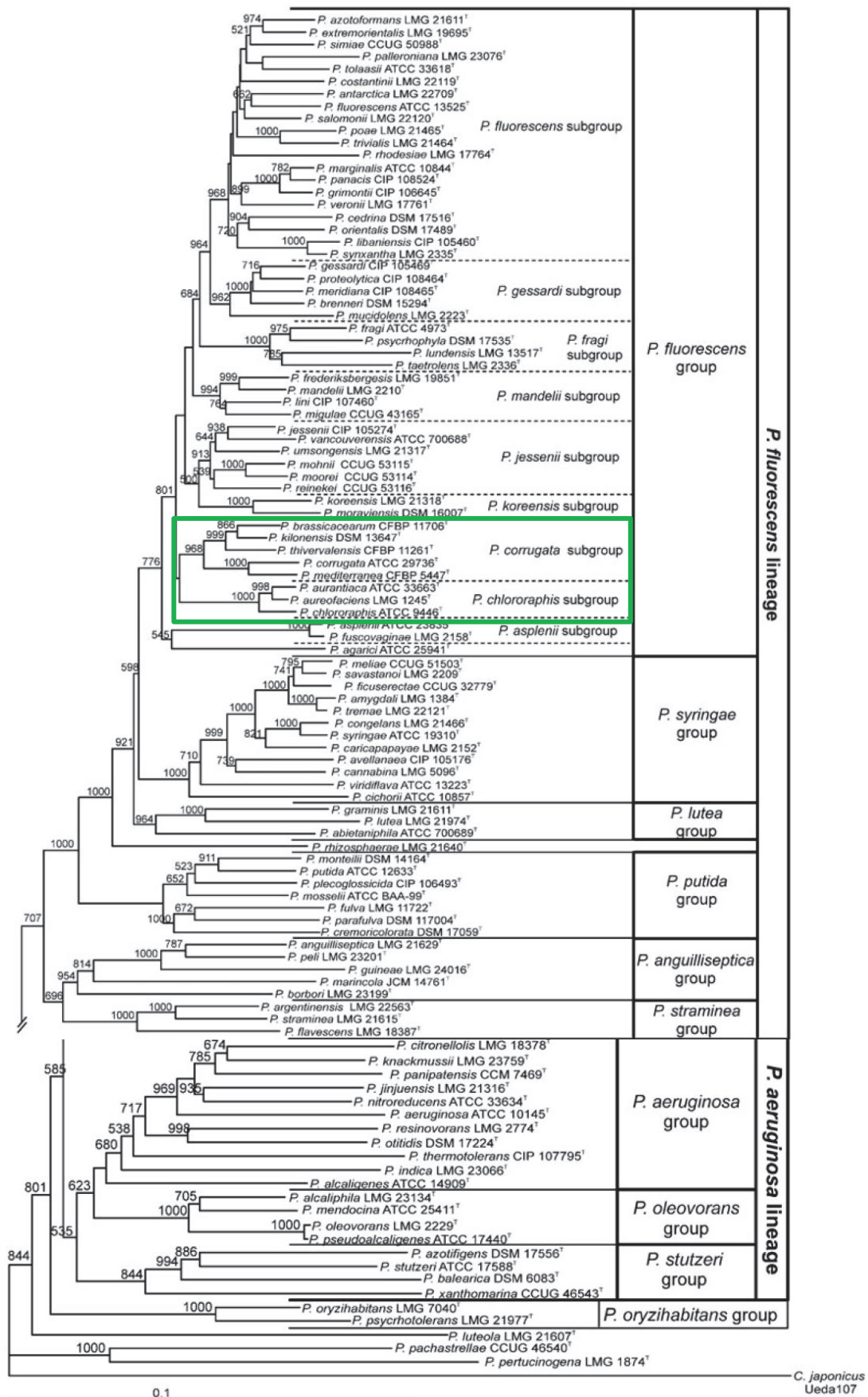
Pour quantifier un groupe fonctionnel microbien par PCR quantitative, une étape cruciale est la définition d'un marqueur génétique qui cible la globalité des membres du groupe. Il s'agit donc d'identifier un gène conservé chez tous les membres du groupe fonctionnel mais absent (ou peu conservé) chez les autres microorganismes. Pour les *Pseudomonas phl*<sup>+</sup>, le gène *phlD* codant une protéine essentielle à la synthèse du DAPG est généralement utilisé comme marqueur (McSpadden Gardener et al. 2001). La production de DAPG chez les *Pseudomonas* est sous contrôle du cluster de gènes *phl* (Moynihan et al. 2009). Ce cluster comprend l'opéron de synthèse du DAPG *phlACBDE*, le gène *phlG* codant une enzyme hydrolysant le DAPG, et les gènes *phlF* et *phlH* codant

des régulateurs de la transcription de l'opéron *phlACBDE* (Figure 1). La synthèse du composé impliquerait la condensation et cyclisation de trois molécules de manoyl-CoA par PhlD (polycétide synthase de type III) pour former du phloroglucinol (Zha et al. 2006), qui serait ensuite transformé en DAPG par les acétyl-tranfêrases (PhlA, C et B). Le composé serait ensuite transporté à travers la membrane par la perméase PhlE (Bangera et al. 1999).

Actuellement, l'opéron *phlACBDE* n'a été identifié que chez des *Pseudomonas* fluorescents. L'origine de cet opéron semble composite. En effet, les protéines PhlACB ont des homologues chez des archées alors que PhlD présente une homologie avec les polycétide synthases de type III de certaines actinobactéries, mais l'association des gènes dans l'opéron *phlACBDE* ne serait apparue que chez les *Pseudomonas* (Kidarsa et al. 2011). Moynihan et al. (2009) ont proposé que cet opéron se serait formé chez l'ancêtre commun des *Pseudomonas* fluorescents (groupe '*Pseudomonas fluorescens*' décrit par Mulet et al. 2010; Figure 2) puis aurait été perdu par la branche regroupant les *Pseudomonas phl* actuels (Figure 3).

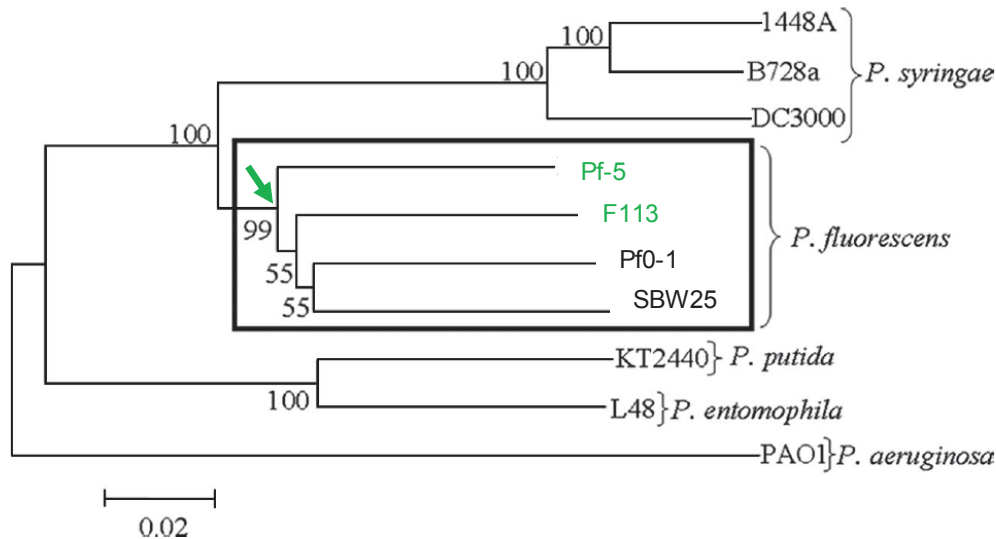


**Figure 1.** Synthèse du DAPG chez *Pseudomonas*. **A**, Organisation du cluster de gènes *phl* avec l'opéron de synthèse du DAPG *phlACBDE*, le gène *phlG* codant une enzyme hydrolysant le DAPG, et les gènes *phlF* et *phlH* codant des régulateurs de la transcription de l'opéron *phlACBDE*. **B**, Voie de synthèse du DAPG après la condensation et cyclisation de trois molécules d'acétyl-CoA par PhlD. Le phloroglucinol est transformé en DAPG par les acétyl-tranfêrases (PhlA, C et B). Il peut être dégradé en MAPG par l'hydrolase PhlG.



**Figure 2.** Arbre phylogénétique du genre *Pseudomonas* généré par concaténation de quatre gènes de ménage (*rpoB*, *rpoD*, *gyrB* et *rrs*) des 107 souches type représentant les espèces décrites. Les différentes lignées, groupes et sous-groupes sont indiqués. Les sous-groupes contenant des *Pseudomonas phl*<sup>+</sup> sont encadrés en vert (D'après Mulet et al. 2010).





**Figure 3.** Arbre du genre *Pseudomonas* montrant les relations phylogénétiques entre les espèces *phl*<sup>+</sup> (en vert) et *phl*<sup>-</sup> (en noir). L'apparition du cluster *phl* est indiquée par une flèche (D'après Moynihan et al. 2009). A noter que l'utilisation de l'espèce *P. fluorescens* par Moynihan et al. (2009) manque de rigueur. La souche CHA0 est très distante de *P. fluorescens* (Keel et al. 1996 ; Ramette et al. 2001 ; Frapolli et al. 2007) et appartient à l'espèce *P. protegens* (Ramette et al. 2011), ainsi que la souche F113 proche de *P. kilonensis* qui est elle-aussi distincte de *P. fluorescens* (Frapolli et al. 2012).

Cette théorie suppose qu'il y aurait eu divergence entre *Pseudomonas phl*<sup>-</sup> et *Pseudomonas phl*<sup>+</sup> qui formeraient actuellement deux groupes monophylétiques. Cependant, cette étude était basée sur les quelques souches du groupe '*Pseudomonas fluorescens*' dont le génome était disponible à l'époque, rendant l'analyse phylogénétique peu robuste. En 2007, Frapolli et al. mirent en évidence, par une analyse multi-locus sur dix gènes de ménage, que les souches de *Pseudomonas phl*<sup>+</sup> pouvaient être classées en six groupes représentant au moins six espèces différentes. Ces groupes multi-locus étaient proches des souches type de *P. brassicacearum*, *P. kilonensis*, *P. thivervalensis*, *P. mediterranea*, *P. corrugata* et *P. chlororaphis* (Frapolli et al. 2012). Parmi les 107 espèces du genre (Mulet et al. 2010), les souches de *Pseudomonas phl*<sup>+</sup> se situent dans le

groupe '*P. fluorescens*' et plus particulièrement dans les sous-groupes '*P. corrugata*' et '*P. chlororaphis*' (Figure 2; Frapolli et al. 2012).

Dans ce premier chapitre, notre objectif était de déterminer la relation entre la densité des populations de *Pseudomonas* producteurs de DAPG, et la résistance du sol à la maladie. Dans une première étape (Partie 1.1 « Délimitation du groupe fonctionnel des *Pseudomonas* producteurs de DAPG : étude de la distribution de la fonction de synthèse du DAPG chez les *Pseudomonas* »), on a d'abord délimité le groupe fonctionnel des *Pseudomonas* producteurs de DAPG et retracé l'histoire évolutive du cluster *phl* (*phlACBDE*, *phlF*, *phlG*, *phlH*). Pour cela, nous avons recherché la présence des gènes de synthèse du DAPG parmi les espèces de *Pseudomonas* fluorescents en se focalisant particulièrement sur les représentants séquencés des sous-groupes '*P. corrugata*' et '*P. chlororaphis*', qui comprennent tous les *Pseudomonas phl*<sup>+</sup> décrits actuellement. Cette approche nous a permis de montrer que les gènes de synthèse du DAPG ne se retrouvent pas chez toutes les espèces de ces deux sous-groupes ; ils ont été retrouvés chez les espèces *P. brassicacearum*, *P. kilonensis*, *P. thivervalensis* et *P. protegens*, et sont absents et/ou ont été perdus chez les espèces contenant des souches pathogènes *P. mediterranea* et *P. corrugata*. Cette étude est rédigée sous la forme d'un manuscrit préliminaire, intitulé « Distribution of 2,4-diacetylphloroglucinol biosynthetic genes among the *Pseudomonas* spp.»

Dans une deuxième étape (Partie 1.2 « Quantification des *Pseudomonas* producteurs de DAPG dans les sols résistants et sensibles à la maladie de la pourriture noire des racines de tabac »), on a mis au point une méthode de PCR quantitative ciblant le gène *phlD* des espèces de *Pseudomonas phl*<sup>+</sup> identifiées. On montre la bonne performance de la méthode et les conditions de son utilisation pour quantifier les effectifs de ce groupe fonctionnel dans les sols résistants et sensibles de Morens. Les résultats indiquent que la densité des populations des *Pseudomonas phl*<sup>+</sup> est comparable dans les sols sensibles et résistants, et que les effectifs atteignent des niveaux auxquels la souche *P. protegens* CHA0 peut assurer une activité phytoprotectrice. Cette étude a fait l'objet de l'article « Monitoring of the relation between 2,4-diacetylphloroglucinol-producing *Pseudomonas* and *Thielaviopsis basicola* populations by real-time PCR in tobacco black root-rot suppressive and conducive soils », publié en 2012 dans le journal *Soil biology and biochemistry*.



# **CHAPITRE 1**

## Partie 1.1

---

Délimitation du groupe fonctionnel des *Pseudomonas* producteurs de DAPG : étude de la distribution de la fonction de synthèse du DAPG chez les *Pseudomonas*

---



**Distribution of 2,4-diacetylphloroglucinol biosynthetic genes among the *Pseudomonas* spp.**

Juliana Almario<sup>1,2,3</sup>, Maxime Bruto<sup>1,2,3</sup>, Claire Prigent-Combaret<sup>1,2,3</sup>, Yvan Moënne-Loccoz<sup>1,2,3</sup>, Daniel Muller<sup>1,2,3</sup>

<sup>1</sup>Université de Lyon, F-69622, Lyon, France

<sup>2</sup>Université Lyon 1, Villeurbanne, France

<sup>3</sup>CNRS, UMR5557, Ecologie Microbienne, Villeurbanne, France

Corresponding author: Daniel Muller; Telephone: +33 (0) 4 72 43 27 14 ;

Fax: +33 (0) 4 72 43 12 23 ; E-mail: [daniel.muller@univ-lyon1.fr](mailto:daniel.muller@univ-lyon1.fr)

## Abstract

Many fluorescent pseudomonads can protect plant roots from phytopathogens by producing 2,4- diacetylphloroglucinol (DAPG). DAPG<sup>+</sup> *Pseudomonas* strains are documented in the '*P. corrugata*' and '*P. chlororaphis*' subgroups of the '*P. fluorescens*' group. However, DAPG production has not been investigated for all species of these subgroups, and whether or not the DAPG<sup>+</sup> *Pseudomonas* are monophyletic was unknown. Thus, the distribution of the DAPG synthetic gene cluster in the *Pseudomonas* spp. was investigated in sequenced genomes and type strains, using *phlD* as marker. Results showed that the DAPG<sup>+</sup> *Pseudomonas* include the species *P. protegens*, *P. brassicacearum*, *P. kilonensis* and *P. thivervalensis*, but not closely-related *P. chlororaphis* (all subspecies) and the pathogenic species *P. corrugata* and *P. mediterranea*. In the genomes studied, the *phl* cluster was found at different locations in highly variable regions, indicating it underwent horizontal transfer events or even more likely loss (for the phytopathogenic species *P. corrugata* and *P. mediterranea*, based on ancestral state reconstruction). In conclusion, the *phl*<sup>+</sup> *Pseudomonas* form a polyphyletic group within the '*P. fluorescens*' lineage, as *phl* was found only in certain but not all species of the '*P. corrugata*' and the '*P. chlororaphis*' subgroups.

## Introduction

*Pseudomonas* bacteria have developed diverse interactions with eukaryotic hosts, as the lineage includes human pathogens (e.g. in *P. aeruginosa*), phytopathogens (e.g. in *P. syringae*) and plant protecting strains (e.g. in *P. protegens*) (Ramette et al. 2011; Mithani et al. 2011). *Pseudomonas* producing the compound 2,4-diacetylphloroglucinol (DAPG) protect plants by inhibiting root pathogens (Almario et al. 2013) and/or eliciting plant defenses through induced systemic resistance (Weller et al. 2012). DAPG<sup>+</sup> *Pseudomonas* were isolated around the world and exhibited a cosmopolitan distribution (Wang et al. 2001). Multilocus sequence analysis based on housekeeping genes classified them into six main phylogenetic groups noted A to F (Frapolli et al. 2007 and 2012), belonging to the '*P. corrugata*' subgroup (multilocus phylogenetic groups A to E) and the '*P. chlororaphis*' subgroup (multilocus phylogenetic group F) of the '*P. fluorescens*' group defined by Mulet et al. (2010). DAPG production is thus documented in some species of the '*P. corrugata*' and '*P. chlororaphis*' subgroups, like *P. brassicacearum* and *P. protegens* (respectively), but it has not been investigated thoroughly in all the species of these subgroups. Consequently, it is unclear whether or not *phl*<sup>+</sup> *Pseudomonas* form a monophyletic group within the '*P. fluorescens*' group. Similarly, the ability to produce DAPG has been proposed as a highly conserved trait (Moynihan et al. 2009) but it was based on a rather limited number of species and genomes. Recent progress in the sequencing of additional *Pseudomonas* genomes, the phylogeny of *phl*<sup>+</sup> *Pseudomonas* (Frapolli et al. 2012) and the description of the *Pseudomonas* genus (including new species; Mulet et al. 2010) make it now possible to conduct a global assessment of these issues.

DAPG synthesis relies on the *phl* genetic cluster, which includes the DAPG synthetic operon *phlACBDE*, the DAPG hydrolase-encoding gene *phlG* and the regulatory genes *phlF* and *phlH* (Kidarsa et al. 2011). The aim of this study was to assess the distribution of the *phl* cluster among *Pseudomonas* type strains and sequenced genomes. Its occurrence in *Pseudomonas* spp. was determined, using the *phlD* gene as marker, and the phylogeny of *phl*<sup>+</sup> and *phl* *Pseudomonas* spp. was compared. In addition, the genomic context of the *phl* cluster in the available *phl*<sup>+</sup> *Pseudomonas* genomes was further explored.



## Material and methods

### *Cultivation of Pseudomonas type strains and DNA extraction*

The 12 *Pseudomonas* type strains (Table S1) from the '*P. corrugata*', '*P. chlororaphis*' and '*P. fluorescens*' subgroups were routinely grown on Luria-Bertani agar (Sambrook et al. 1989). For genomic DNA extraction, bacterial strains were grown overnight with shaking (150 rpm) in 20 mL of liquid LB medium, and DNA was extracted from 500  $\mu$ L of bacterial culture using the NucleoSpin Tissue kit (Macherey-Nagel, Hoerd, France), following the manufacturer's instructions. DNA was quantified spectrophotometrically and adjusted to 30 ng  $\mu$ L<sup>-1</sup>.

### *PCR detection of phlD in Pseudomonas type strains*

PCR detection of *phlD* was carried out using genomic DNA from the 12 *Pseudomonas* type strains (Table S1). PCRs were carried out in 50- $\mu$ L volumes containing 3% DMSO, 1 $\times$  buffer (Roche Applied Science, Meylan, France), 1.5 mM MgCl<sub>2</sub>, 100  $\mu$ M of each dNTP, 1  $\mu$ M of primers B2BF/BPR4 (Almario et al. 2013), 1.8 U of Taq Expand High Fidelity DNA polymerase (Roche Applied Science) and 1  $\mu$ L of template DNA. The cycling program included 3 min at 94 °C, 30 amplification cycles of 1 min at 94 °C, 1 min at 62°C and 1 min at 72 °C, and an elongation step of 3 min at 72 °C. In the absence of amplification, the *phlD* negative status of the strains was verified by conducting the PCR at lower primer hybridization temperatures (60, 58, 56 and 54 °C instead of 62 °C). PCR products were purified (MinElute PCR purification kit; Qiagen, Courtaboeuf, France) and both strands were sequenced (LGC Genomics, Berlin, Germany). The sequences (xxx) were checked, edited with BioEdit v.7.0 (Hall 1999), and their *phlD* identity was determined using the BlastN algorithm and the nr Nucleotide Sequence Database.

### *Phylogenetic analysis of Pseudomonas strains*

For phylogenetic analysis based on housekeeping genes, nucleotide sequences of *rpoB*, *rpoD*, *gyrB* and *rrs* were retrieved from the nucleotide database. For each gene, sequences were aligned using MUSCLE (Edgar 2004). Sequences from the four genes were then concatenated, the concatenates were realigned, most informative positions were selected using Gblocks (Castresana 2000) and phylogenetic distances were calculated

using the GTR model (Tavaré 1986). The maximum likelihood tree was inferred using PhyML (Guindon et al. 2010) and nodal robustness was assessed using 500 bootstrap replicates. All steps were performed using Seaview software (Gouy et al. 2010). The same procedure was followed for phylogenetic analysis of *phlD* (Table S1).

### ***Ancestral state reconstruction***

Ancestral state reconstruction was done using the *Pseudomonas* species tree based on concatenated housekeeping genes (described above), and a matrix of presence/absence of the *phl* cluster based on genome sequence analysis or *phlD* PCR detection. Analyses were done using Mesquite (Maddison and Maddison 2011) with Maximum Likelihood and Asymm2 models of rate variations (Pagel 1999).

### ***Localization and genetic environment of the phl cluster in Pseudomonas genomes***

Genomes of *phl*<sup>+</sup> strains *P. brassicacearum*<sup>T</sup>, *P. 'fluorescens'* F113, *P. 'fluorescens'* Q2-87 and *P. protegens* Pf-5 were recovered and aligned using progressiveMauve (Darling et al. 2010). Fluorescent *Pseudomonas* strains of uncertain taxonomic status but routinely referred to as *P. fluorescens* in the literature (i.e. strains Q2-87, F113, Pf-01) are hereafter designated *P. 'fluorescens'* in this report. 40-kb genomic regions including the *phl* cluster (*phlH*, *phlG*, *phlF*, *phlACBDE*) were obtained from the four strains and aligned using progressiveMauve (Darling et al. 2010). The 40-kb regions were screened for signs of genome instability based on G + C content analysis in Artemis (Rutherford et al. 2000), tRNA detection using tRNAscan-SE (Schattner et al. 2005), insertion sequence detection using ISfinder (Kichenaradja et al. 2010) and genomic island prediction using Island Viewer (Langille and Brinkman 2009). The entire genomes of *P. brassicacearum*<sup>T</sup> and *P. 'fluorescens'* F113 genomes were also compared, using the same procedures.

## **Results**

### ***Distribution of phlD among Pseudomonas type strains***

Among members of the '*P. corrugata*' subgroup, *phlD* was amplified in *P. brassicacearum*<sup>T</sup> (as expected; Ortet et al. 2011), in *P. kilonensis*<sup>T</sup> and *P. thivervalensis*<sup>T</sup> (not documented before; Table S1), but not in closely-related *P. mediterranea*<sup>T</sup> and *P.*

*corrugata*<sup>T</sup>. In the '*P. chlororaphis*' subgroup, *phlD* was detected in *P. protegens*<sup>T</sup> (as expected; Ramette et al. 2011), but not in the other subgroup members i.e. *P. chlororaphis* subsp. *aurantiaca*<sup>T</sup>, *P. chlororaphis* subsp. *aureofaciens*<sup>T</sup>, or *P. chlororaphis* subsp. *chlororaphis*<sup>T</sup>. The '*P. fluorescens*' group contains a third major subgroup containing plant-associated strains (designated the '*P. fluorescens*' subgroup), and *phlD* was not found in representatives of this '*P. fluorescens*' subgroup i.e. *P. tolaasii*<sup>T</sup>, *P. marginalis*<sup>T</sup> and *P. fluorescens*<sup>T</sup>.

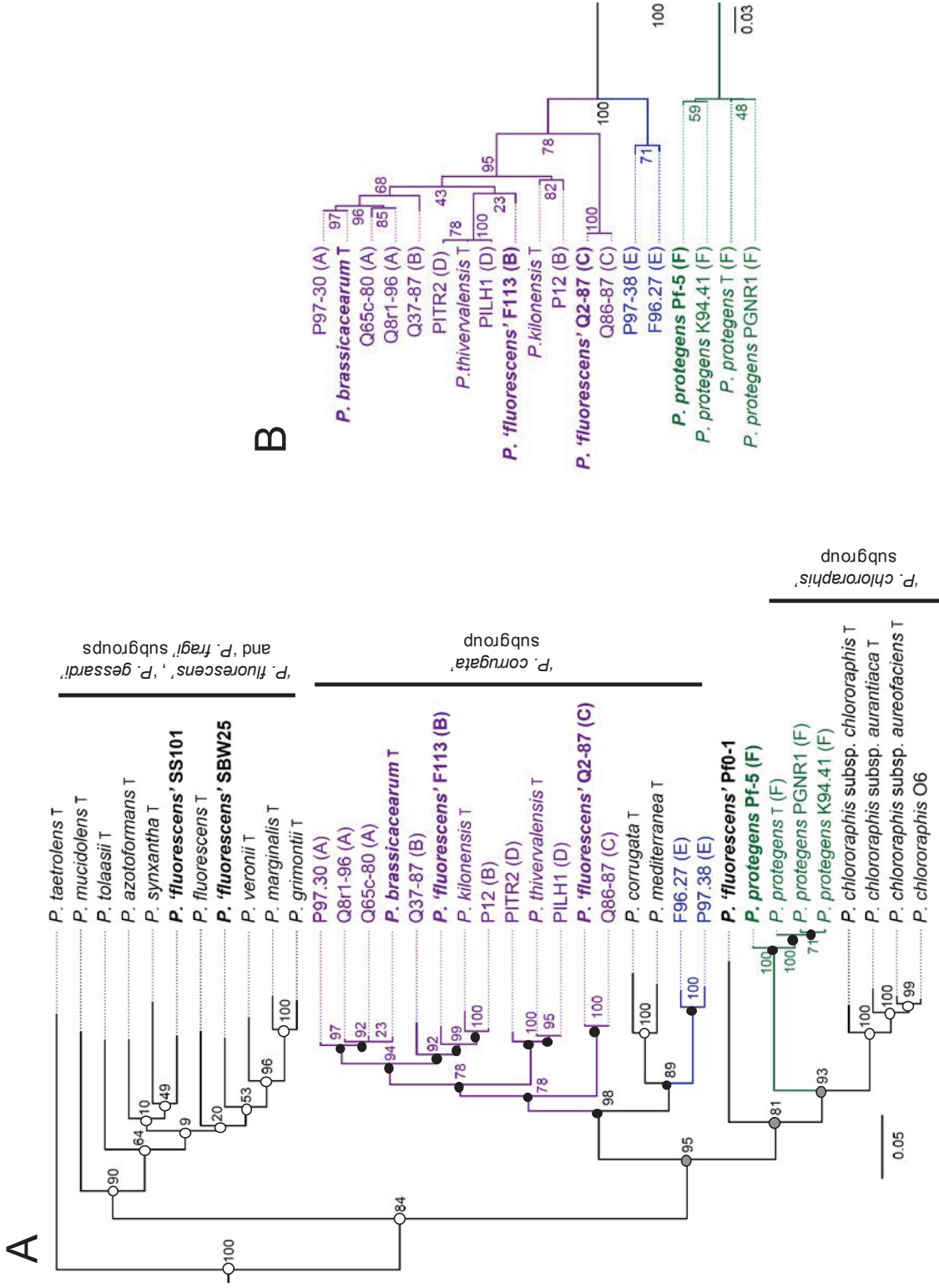
### ***Position of phl<sup>+</sup> strains in the Pseudomonas phylogeny***

As expected, *phl*<sup>+</sup> *Pseudomonas* strains clustered either in the '*P. corrugata*' or the '*P. chlororaphis*' subgroup of the '*P. fluorescens*' group defined by Mulet et al. (2010) in the phylogenetic tree based on housekeeping genes (Fig. 1). However, the *phl*<sup>+</sup> *Pseudomonas* did not group together in the '*P. corrugata*' subgroup, as they formed two distinct clades (Fig. 1A). The first clade gathered *phl*<sup>+</sup> strains from the multilocus phylogenetic groups A, B and C defined in Frapolli et al. (2007), as well as *phl*<sup>+</sup> type strains *P. brassicacearum*<sup>T</sup>, *P. kilonensis*<sup>T</sup> and *P. thivervalensis*<sup>T</sup>. The second clade gathered *phl*<sup>+</sup> strains from multilocus phylogenetic group E along with *phl*<sup>-</sup> *P. mediterranea*<sup>T</sup> and *P. corrugata*<sup>T</sup>. In the '*P. chlororaphis*' subgroup, *phl*<sup>+</sup> *P. protegens* strains (i.e. phylogenetic multilocus group F) clustered next to *phl*<sup>-</sup> *P. chlororaphis* (and close also to *phl*<sup>-</sup> *P. fluorescens*' Pf-01) (Fig. 1A). Taken together, this indicates that *phl*<sup>+</sup> *Pseudomonas* are not monophyletic within the '*P. corrugata*' subgroup or the '*P. chlororaphis*' subgroup. Their polyphyletic features suggest that the *phl* cluster could have undergone loss and/or horizontal transfer events.

The *phlD*-based phylogenetic tree was congruent with the one inferred from concatenated housekeeping genes *rpoD*, *rpoB*, *gyrB* and *rrs*, and the three clades of *phl*<sup>+</sup> *Pseudomonas* described above were clearly distinguished (Fig. 1B). Indeed, strains from multilocus phylogenetic groups A-C and type strains *P. brassicacearum*<sup>T</sup>, *P. kilonensis*<sup>T</sup> and *P. thivervalensis*<sup>T</sup> gathered together and were separated from group-E strains of the same the '*P. corrugata*' subgroup. Strains from multilocus phylogenetic group F ('*P. chlororaphis*' subgroup) clustered together and formed the outgroup.

### ***Ancestral state reconstruction for the phl cluster***

Ancestral state reconstruction for the *phl* cluster in the last common ancestor of the '*P. corrugata*' and '*P. chlororaphis*' subgroups was inconclusive, since the relative



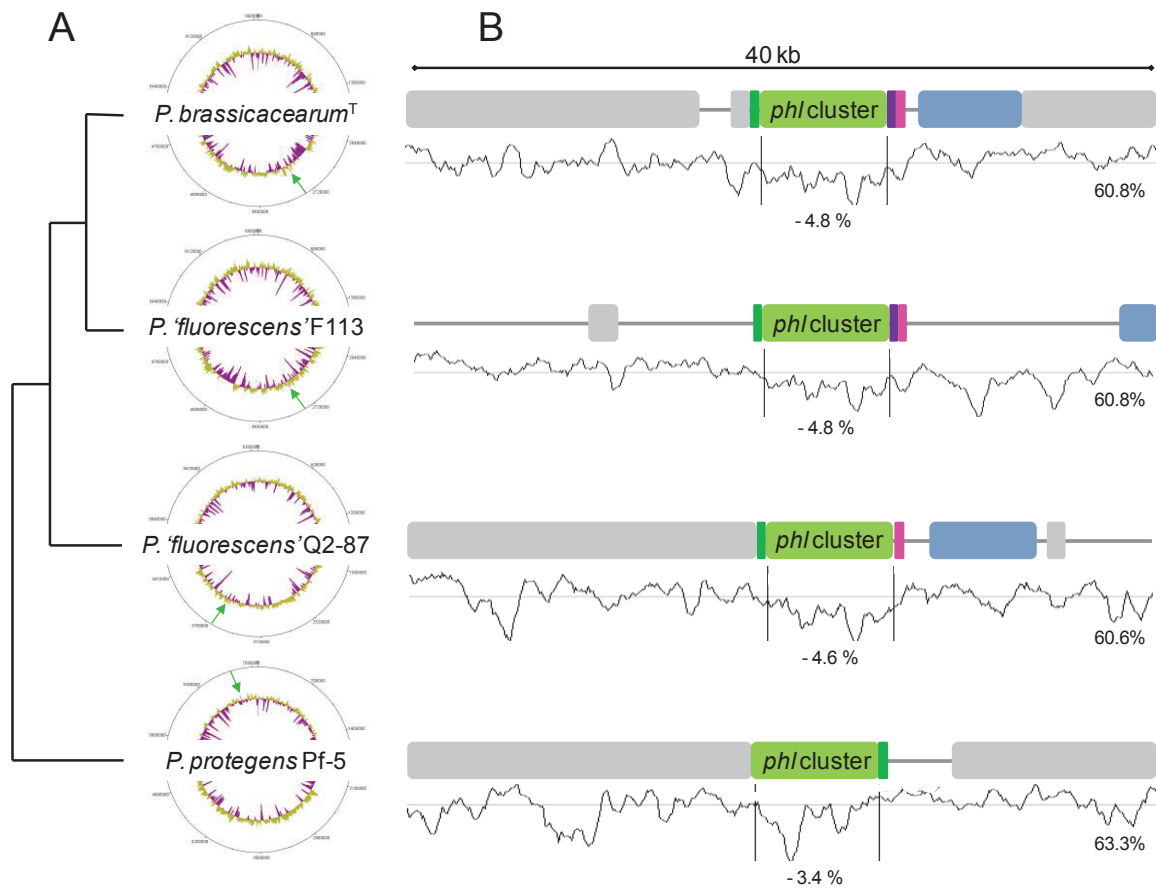
**Figure 1.** Comparison of species tree and *phlD* tree for the '*P. fluorescens*' group. **A**, Phylogenetic analysis based on concatenated housekeeping genes *rpoD*, *rpoB*, *gyrB* and *rrs* from 19 non-type strains and 18 type strains (T) and a clade of 7 *P. syringae* type strains (used for tree rooting). When available, membership to the multilocus phylogenetic groups defined in Frapolli et al. (2007) is given in parenthesis. *phl*<sup>+</sup> *Pseudomonas* strains are written in color and *phl*<sup>-</sup> *Pseudomonas* strains in black. The most likely ancestral state of the *phl* cluster at the node, based on Maximum Likelihood and AsymmK2 models of rate variations (Pagel 1999), is indicated by a black circle (if presence; relative likelihood ratio of presence/absence above 80/20), a white circle (if absence; relative likelihood ratio below 20/80), or a grey circle in the other cases (unclear). **B**, Phylogenetic analysis of *phl*<sup>+</sup> *Pseudomonas* based on *phlD* nucleotide sequences. In both panels, the maximum likelihood tree was inferred using PhyML and the GTR model, and nodal robustness was assessed using 500 replicates for bootstrap. Strains with sequenced genome and used for genomic analyses are shown in bold.

likelihood ratio of presence to absence in the node is 51/48, meaning that we cannot determine if the *phl* cluster was present or absent. Thus, we cannot conclude either on the alternative proposition of an independent acquisition of the *phl* cluster by the '*P. corrugata*' and the '*P. chlororaphis*' subgroups. Ancestral state reconstruction for the *phl* cluster in the '*P. corrugata*' subgroup pointed to an acquisition by the last common ancestor of *P. brassicacearum*, *P. kilonensis*, *P. thivervalensis*, *P. mediterranea* and *P. corrugata* (relative likelihood ratio of presence/absence was 94/6), followed by a subsequent loss of the *phl* cluster in the last common ancestor of *P. mediterranea* and *P. corrugata* (relative likelihood ratio of presence/absence was 13/86; Fig. 1). Ancestral state reconstruction for the *phl* cluster in the '*P. chlororaphis*' subgroup was not able to distinguish between two evolution scenarios, which were (i) the cluster was acquired by the last common ancestor of *P. protegens*, *P. chlororaphis* and *P. 'fluorescens'* Pf-01, and was subsequently lost in the *P. chlororaphis* and the *P. 'fluorescens'* Pf-01 branches independently, or (ii) the *phl* cluster was more recently acquired by the last common ancestor of the *P. protegens* clade (Fig. 1).

### **Genomic regions flanking the *phl* cluster in *Pseudomonas***

The *phl* cluster was found at three different positions in the *Pseudomonas* genomes studied. It was found near the replication terminus at position 2.87 Mb in *P. brassicacearum*<sup>T</sup> and *P. 'fluorescens'* F113, and 3.68 Mb in *P. 'fluorescens'* Q2-87. In *P. protegens* Pf-5, it was found near the origin of replication, at 6.76 Mb (Fig. 2A). The synteny was poorly conserved between *phl* flanking regions in the four genomes (Fig. 2B). The exceptions were genes coding (i) a hypothetical protein flanking the *phl* cluster at the 5' extremity in all four genomes, (ii) a tautomerase in the 3' region flanking the *phl* cluster, found at the same position in the three '*P. corrugata*' strains but absent in *P. protegens* Pf-5, and (iii) a DoxX family hypothetical protein flanking the *phl* cluster at the 3' extremity in *P. brassicacearum*<sup>T</sup> and *P. 'fluorescens'* F113. In the *phl* flanking regions, all the other genes in one strain were either located elsewhere or absent from the other strains (Fig. 2B).

Many of the genes found near *phl* in several of the four genomes were found at different genomic locations in different strains. For instance, among the 32 genes present in the 40 kb region surrounding *phl* in *P. brassicacearum*<sup>T</sup>, 4 genes were absent from the three other genomes, 13 were present in the *P. 'fluorescens'* F113 genome (but only 3 at the same location), 17 in *P. 'fluorescens'* Q2-87 genome (but only 8 at the same location)



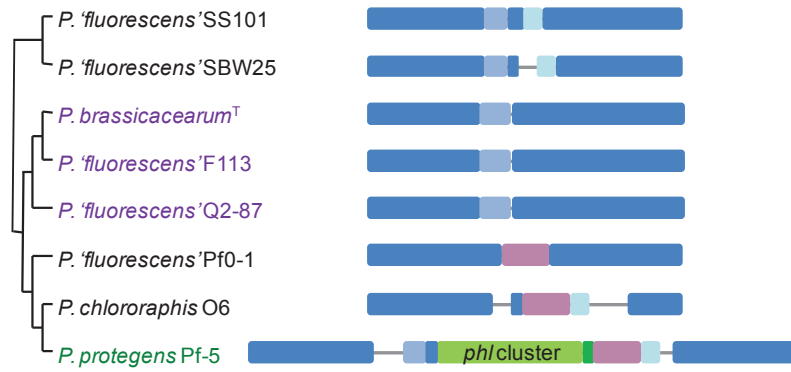
**Figure 2.** Location and genetic environment of the *phl* cluster in the four *phl*<sup>+</sup> *Pseudomonas* genomes. **A**, Cladogram (based on phylogeny in Fig. 1) indicating phylogenetic relations among *Pseudomonas* strains and their genome circular representation. The outer circles show chromosome architecture with the different positions of the *phl* cluster (green arrow), and the inner circle the variations in GC content indicated by purple (below average) and light-brown (above average) peaks. **B**, Synteny in progressiveMauve alignment of the 40-kb genomic region containing the *phl* cluster, using *P. brassicacearum*<sup>T</sup> as reference genome. The *phl* cluster (light green) and a gene coding for a hypothetical protein (dark green) are conserved among all strains while genes encoding a tautomerase (pink) and a DoxX family hypothetical protein (purple) are conserved only in certain strains. Grey blocks represent regions that have homology in at least one other strain but exhibit a different position with respect to the *phl* cluster. Empty (no blocks) regions have no homology in any of the other genomes (strain-specific regions). G + C deviation, computed for each 1-kb window as (G + C content of the window) – (G + C content of the whole genome) is indicated under each sequence, and the difference between the mean G + C content of the genome (indicated on the right) and that for the *phl* cluster is shown below the latter.

and 6 in the *P. protegens* Pf-5 genome (but only 1 at the same location). *P. fluorescens*' F113 was an interesting case, in that half the genes (i.e. 10 of 21) in the region flanking the *phl* cluster were specific to this strain, including genes encoding a cable pili-associated adhesin protein and an insecticidal toxin. Among the 35 genes of the 40-kb region flanking *phl* in *P. protegens* Pf-5, 4 were absent from the three other strains, and the 31 others were present at the same position near the replication origin in *phl*<sup>+</sup> *P. brassicacearum*<sup>T</sup>, *P. fluorescens*' F113 and *P. fluorescens*' Q2-87, but also in the genome of the *phl*<sup>-</sup> strains *P. fluorescens*' SS101, SBW25 and Pf-01, and *P. chlororaphis* O6 (Fig. 3), indicating that genes in this region (other than the *phl* cluster itself) are highly conserved in *Pseudomonas* species.

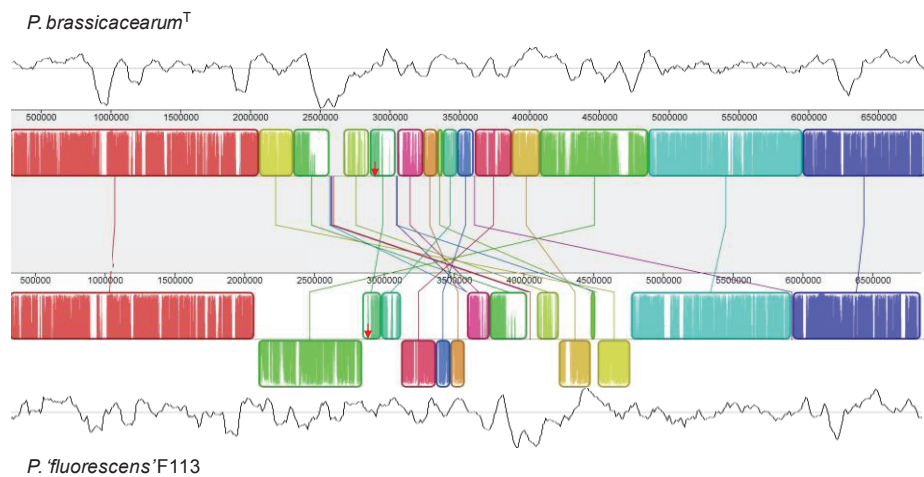
Neither genes coding for tRNA, integrases or transposases, nor insertion sequences or other genes associated with genome instability were found in the 40-kb region containing the *phl* cluster in either of the four *Pseudomonas* genomes studied. In addition, there was no marked difference in G + C content when comparing the *phl* cluster to the rest of the genome, despite a difference of 4.8 % for *P. brassicacearum*<sup>T</sup> and for *P. fluorescens*' F113, 4.6 % for *P. fluorescens*' Q2-87 and 3.4 % for *P. protegens* Pf-5 (Fig. 2B). Since the *phl* genomic context was very different in closely-related *P. brassicacearum*<sup>T</sup> and *P. fluorescens*' F113, their entire genomes were compared (Fig. 4). This confirmed that the replication terminus region (between positions 2 and 5 Mb) harboring the *phl* cluster differed between both strains, which was due mostly to large genome rearrangements than to the presence of strain-specific regions. Large genomic rearrangements became scarce near the origin of replication (positions 0 to 2 Mb and 5 to 6.6 Mb; Fig. 4).

## Discussion

So far, analysis of the evolutionary history of the *phl* cluster has focused mainly on the phylogenetic relations among established *phl*<sup>+</sup> pseudomonads, omitting closely-related *Pseudomonas* species of uncertain *phl* status. Here, we investigated the distribution of the *phl* cluster among a broader taxonomic range of *Pseudomonas* spp., established phylogenetic relations between *phl*<sup>+</sup> and *phl*<sup>-</sup> *Pseudomonas*, and explored the genomic context of the *phl* cluster.



**Figure 3.** Synteny of the genomic regions flanking the *phl* cluster of *P. protegens* Pf-5 in sequenced fluorescent *Pseudomonas* genomes. The cladogram (based on phylogeny in Fig. 1) indicates phylogenetic relations among *Pseudomonas* strains with *phl*<sup>+</sup> strains in color and *phl*<sup>-</sup> *Pseudomonas* in black. The progressiveMauve alignment was done using the 40-kb genomic region containing the *phl* cluster in *P. protegens* Pf-5 and the 18-kb homologous region found in all the other eight *Pseudomonas* strains at the same location near the origin of replication. Regions in dark blue are conserved among all strains while regions in other colors are conserved in only certain strains, and empty regions (no blocks) have no homology in any of the genomes.



**Figure 4.** progressiveMauve alignment of the *P. brassicacearum*<sup>T</sup> and *P. fluorescens* F113 genomes. The *phl* operon is indicated with a red arrow. Putative genomic rearrangements are shown using diagonal lines, homologous regions using color bars, and strain-specific regions using white bars. The G + C deviation plot, is shown above or below each sequence.



*phlD* detection indicated that besides *P. protegens* and *P. brassicacearum*, for which DAPG production has already been described (Ramette et al. 2011; Ortet et al. 2011), *phlD* was also found in *P. kilonensis* and *P. thivervalensis*, a possibility already suggested by the observation that pseudomonads closely related to the corresponding type strains displayed *phlD* (Frapolli et al. 2012). *phlD* is absent from the *P. fluorescens* species, which conflicts with the many literature reports indicating otherwise, and in which *P. fluorescens* was used as a convenient generic term for ill-defined fluorescent pseudomonads with biocontrol properties rather than an established taxonomic status per se (Couillerot et al. 2009). Overall, the *phl*<sup>+</sup> *Pseudomonas* did not form a monophyletic group, as *phlD* was found in some but not all species of the '*P. corrugata*' subgroup and of the '*P. chlororaphis*' subgroup.

Moynihan et al. (2009) proposed that the *phl* cluster was present in the last common ancestor of the '*Pseudomonas fluorescens*' group, but was only retained in one branch, giving rise to a divide between a *phl*<sup>-</sup> and a *phl*<sup>+</sup> group of fluorescent *Pseudomonas* and thus a paraphyletic distribution. Our results, based on a higher number of species (type strains) and related strains, do not support this hypothesis. First, ancestral state reconstruction (Fig. 1) indicated that the *phl* cluster was absent from the last common ancestor of the '*P. fluorescens*' group, and was probably assembled after the divide between the '*P. fluorescens*', '*P. gessardi*' and '*P. fragi*' clades on one side and the '*P. corrugata*' and '*P. chlororaphis*' clades on the other side. Second, *phl*<sup>+</sup> *Pseudomonas* form a polyphyletic group, in that the *phl* cluster is not present in all descendants of the last common ancestor of *phl*<sup>+</sup> *Pseudomonas*, and suggesting that the *phl* cluster could have undergone loss and/or horizontal transfer events. Indeed, in the four *Pseudomonas* genomes studied, the *phl* cluster was found at three different locations, two of them in highly-variable regions near the replication terminus, as already described (Moynihan et al. 2010). Regions near the replication terminus are more plastic than those near the replication origin (Silby et al. 2009), which was confirmed here when comparing *P. brassicacearum*<sup>T</sup> and *P. 'fluorescens'* F113 genomes (Fig. 4). Variability of the genetic environment around *phl* was mostly associated with genomic rearrangements, with no signs of recent horizontal gene transfer events (e.g. no genomic island or insertion sequences) corroborating observations by Moynihan et al. (2009). The congruence of species and *phlD* phylogenetic trees also undermines the possibility of recent *phl* transfer, but the possibility of an ancient (not detectable) transfer cannot be ruled out, all the more since the *phlACBDE* operon was formed in *Pseudomonas* through the acquisition of

*phlACB* from Archaea and *phlD* from another unclear origin, possibly *Streptomyces*, *Vibrio* (Kidarsa et al. 2011) or even plants (Cook et al. 1995; Ramette et al. 2001).

Different evolutionary scenarios could explain the observed distribution of the *phl* cluster among *Pseudomonas*. Ancestral state reconstruction indicates that the absence the *phl* cluster in the *P. corrugata* - *P. mediterranea* branch is due to gene loss. Interestingly, these species are the only ones in the '*P. corrugata*' and '*P. chlororaphis*' subgroups known to be plant pathogens, causing pith necrosis in tomato, eggplant, pepper and tobacco (Catara et al. 2002). Since DAPG is able to elicit plant defenses via ISR pathways (Iavicoli et al. 2003), it could be that the *phl* cluster was counter-selected and lost in these species during their adaptation to a phytopathogenic lifestyle. In the case of *P. syringae*, gene loss is a major mechanism of adaptation to pathogenicity (Mithani et al. 2011), but we could not assess this hypothesis since there is no *P. mediterranea* or *P. corrugata* genome available. Why the *phl* cluster is found in *P. protegens* but not in the '*P. chlororaphis*' subgroup relatives *P. chlororaphis* or *P. 'fluorescens'* Pf0-1 is unknown. Again, gene loss is a possibility (Fig. 1A), but a more parsimonious one would be transfer of the *phl* cluster between the last common ancestor of *P. protegens* and the last common ancestor of the '*P. corrugata*' subgroup.

## Acknowledgements

We thank Wafa Achouak (CEA, Cadarache, France) and Christelle Gruffaz (Université de Strasbourg, France) for gift of *Pseudomonas* type strains, Michele Frapolli (University Children's Hospital Zürich, Zürich, Switzerland) for help with phylogenetic analyses, Grégory Hoff from our laboratory for technical help and Audrey Chosson for iBio platform expertise.

## References

Almario, J., Moëgne-Loccoz, Y., and Muller, D. 2013. Monitoring of the relation between 2,4-diacetylphloroglucinol-producing *Pseudomonas* and *Thielaviopsis basicola* populations by real-time PCR in tobacco black root-rot suppressive and conducive soils. *Soil Biology and Biochemistry* (in press).

- Castresana, J. 2000. Selection of conserved blocks from multiple alignments for their use in phylogenetic analysis. *Molecular Biology and Evolution* 17:540-552.
- Catara, V., Sutra, L., Morineau, A., Achouak, W., Christen, R., and Gardan, L. 2002. Phenotypic and genomic evidence for the revision of *Pseudomonas corrugata* and proposal of *Pseudomonas mediterranea* sp. nov. *International Journal of Systematic and Evolutionary Microbiology* 52:1749-1758.
- Cook, R. J., Thomashow, L. S., Weller, D. M., Fujimoto, D., Mazzola, M., Banger, G., and Kim, D. 1995. Molecular mechanisms of defense by rhizobacteria against root disease. *Proceedings of the National Academy of Sciences of the USA* 92:4197-4201.
- Couillerot, O., Prigent-Combaret, C., Caballero-Mellado, J., and Moënne-Loccoz, Y. 2009. *Pseudomonas fluorescens* and closely-related fluorescent pseudomonads as biocontrol agents of soil-borne phytopathogens. *Letters in Applied Microbiology* 48:505-512.
- Darling, A. E., Mau, B., and Perna, N. T. 2010. progressiveMauve: multiple genome alignment with gene gain, loss and rearrangement. *PLoS One* 5:e11147.
- Edgar, R. C. 2004. MUSCLE: multiple sequence alignment with high accuracy and high throughput. *Nucleic Acids Research* 32:1792-1797.
- Frapolli M., Défago G., and Moënne-Loccoz Y. 2007. Multilocus sequence analysis of biocontrol fluorescent *Pseudomonas* spp. producing the antifungal compound 2,4-diacetylphloroglucinol. *Environmental Microbiology* 9:1939-1955.
- Frapolli, M., Pothier, J. F., Défago, G., and Moënne-Loccoz, Y. 2012. Evolutionary history of synthesis pathway genes for phloroglucinol and cyanide antimicrobials in plant-associated fluorescent pseudomonads. *Molecular Phylogenetics and Evolution* 63:877-890.
- Gouy, M., Guindon, S., and Gascuel, O. 2010. SeaView version 4: A multiplatform graphical user interface for sequence alignment and phylogenetic tree building. *Molecular Biology and Evolution* 27:221-224.
- Guindon, S., Dufayard, J. F., Lefort, V., Anisimova, M., Hordijk, W., and Gascuel, O. 2010. New algorithms and methods to estimate maximum-likelihood phylogenies: assessing the performance of PhyML 3.0. *Systematic Biology* 59:307-321.
- Hall, T. A. 1999. BioEdit: a user-friendly biological sequence alignment editor and analysis program for Windows 95/98/NT. *Nucleic Acids Symposium Series* 41:95-98.

- Iavicoli, A., Boutet, E., Buchala, A., and Métraux, J. -P. 2003. Induced systemic resistance in *Arabidopsis thaliana* in response to root inoculation with *Pseudomonas fluorescens* CHA0. *Molecular Plant-Microbe Interactions* 16:851-858.
- Kidarsa, T. A., Goebel, N. C., Zabriskie, T. M., and Loper, J. E. 2011. Phloroglucinol mediates cross-talk between the pyoluteorin and 2,4-diacetylphloroglucinol biosynthetic pathways in *Pseudomonas fluorescens* Pf-5. *Molecular Microbiology* 81:395-414.
- Kichenaradja, P., Siguier, P., Pérochon, J., and Chandler, M. 2010. ISbrowser: an extension of ISfinder for visualizing insertion sequences in prokaryotic genomes. *Nucleic Acids Research* 38:D62-D68.
- Langille, M. G. and Brinkman, F. S. 2009. IslandViewer: an integrated interface for computational identification and visualization of genomic islands. *Bioinformatics* 25:664-665.
- Maddison, W. P. and Maddison, D. R. 2011. Mesquite: a modular system for evolutionary analysis. Version 2.75 <http://mesquiteproject.org>.
- Mithani, A., Hein, J., and Preston, G. M. 2011. Comparative analysis of metabolic networks provides insight into the evolution of plant pathogenic and nonpathogenic lifestyles in *Pseudomonas*. *Molecular Biology and Evolution* 28:483-499.
- Moynihan, J. A., Morrissey, J. P., Coppoolse, E. R., Stiekema, W. J., O'Gara, F., and Boyd, E. F. 2009. Evolutionary history of the *phl* gene cluster in the plant-associated bacterium *Pseudomonas fluorescens*. *Applied and Environmental Microbiology* 75:2122-2131.
- Mulet, M., Lalucat, J., and García-Valdés, E. 2010. DNA sequence-based analysis of the *Pseudomonas* species. *Environmental Microbiology* 12:1513-1530.
- Ortet, P., Barakat, M., Lalaouna, D., Fochesato, S., Barbe, V., Vacherie, B., Santaella, C., Heulin, T., and Achouak, W. 2011. Complete genome sequence of a beneficial plant root-associated bacterium, *Pseudomonas brassicacearum*. *Journal of Bacteriology* 193:3146.
- Pagel, M. 1999. The maximum likelihood approach to reconstructing ancestral character states of discrete characters on phylogenies. *Systematic Biology* 48:612-622.
- Ramette, A., Moëgne-Loccoz, Y., Défago, G. 2001. Polymorphism of the polyketide synthase gene *phID* in biocontrol fluorescent pseudomonads producing 2,4-diacetylphloroglucinol and comparison of PhID with plant polyketide synthases. *Molecular Plant-Microbe Interactions* 14:639-652.

- Ramette, A., Frapolli, M., Fischer-Le Saux, M., Gruffaz, C., Meyer, J. M., Défago, G., Sutra, L., and Moëgne-Loccoz, Y. 2011. *Pseudomonas protegens* sp nov., widespread plant-protecting bacteria producing the biocontrol compounds 2,4-diacetylphloroglucinol and pyoluteorin. *Systematic and Applied Microbiology* 34:180-188.
- Rutherford, K., Parkhill, J., Crook, J., Horsnell, T., Rice, P., Rajandream, M. A., and Barrell, B. 2000. Artemis: sequence visualization and annotation. *Bioinformatics* 16:944-945.
- Schattner, P., Brooks, A. N., and Lowe, T. M. 2005. The tRNAscan-SE, snoscan and snoGPS web servers for the detection of tRNAs and snoRNAs. *Nucleic Acids Research* 33:W686-689.
- Kichenaradja, P., Siguier, P., Pérochon, J., and Chandler, M. 2010. ISbrowser: an extension of ISfinder for visualizing insertion sequences in prokaryotic genomes. *Nucleic Acids Research* 38:D62-D68.
- Sambrook, J., Fritsch, E. F., and Maniatis, T. 1989. *Molecular Cloning: A Laboratory Manual*, 2nd ed. Cold Spring Harbor Laboratory, Cold Spring Harbor, NY, U.S.A.
- Silby, M., Cerdano-Tarraga, A., Vernikos, G., Giddens, S., Jackson, R., Preston, G., Zhang, X. -X., Moon, C., Gehrig, S., Godfrey, S., Knight, C., Malone, J., Robinson, Z., Spiers, A., Harris, S., Challis, G., Yaxley, A., Harris, D., Seeger, K., Murphy, L., Rutter, S., Squares, R., Quail, M., Saunders, E., Mavromatis, K., Brettin, T., Bentley, S., Hothersall, J., Stephens, E., Thomas, C., Parkhill, J., Levy, S., Rainey, P., and Thomson, N. 2009. Genomic and genetic analyses of diversity and plant interactions of *Pseudomonas fluorescens*. *Genome Biology* 10:R51.
- Tavaré, S. 1986. Some probabilistic and statistical problems in the analysis of DNA sequences. *Lectures on Mathematics in the Life Sciences* 17:57-86.
- Wang, C. X., Ramette, A., Punjasamarnwong, P., Zala, M., Natsch, A., Moëgne-Loccoz, Y., and Défago, G. 2001. Cosmopolitan distribution of *phlD*-containing dicotyledonous crop-associated biocontrol pseudomonads of worldwide origin. *FEMS Microbiology Ecology* 37:105-116.
- Weller, D. M., Mavrodi, D. V., van Pelt, J. A., Pieterse, C. M. J., van Loon, L. C., and Bakker, P. A. H. M. 2012. Induced systemic resistance in *Arabidopsis thaliana* against *Pseudomonas syringae* pv. *tomato* by 2,4-diacetylphloroglucinol-producing *Pseudomonas fluorescens*. *Phytopathology* 102:403-412.

**Table S1.** *Pseudomonas* strains and nucleotide sequences used in this study

<i>Pseudomonas</i> strains	<i>phlD</i> <sup>b</sup>	Accession numbers <sup>a</sup>			
		<i>rpoB</i>	<i>rpoD</i>	<i>gyrB</i>	<i>rrs</i>
<b>'<i>P. corrugata</i>' subgroup</b>					
<i>P. brassicacearum</i> NFM421 <sup>T</sup>		CP002585			
<i>P. kilonensis</i> 520-20 <sup>T</sup>	xxx (in preparation ; this study)	AJ717472	AM084336	AM084677	AJ292426
<i>P. thivervalensis</i> SBK 26 <sup>T</sup>	xxx (in preparation ; this study)	AM084680	AM084338	AM084679	AF100323
<i>P. mediterranea</i> CFBP 5447 <sup>T</sup>	Absent (this study)	AJ717449	AM084337	AM084678	NR_028826
<i>P. corrugata</i> Slade 939/1 <sup>T</sup>	Absent (this study)	AJ717487	AB039566	AB039460	D84012
Q65c-80 (A) <sup>c</sup>	AJ278807	DQ458652	DQ458669	DQ458588	AJ417074
P97.30 (A)	EF424747	DQ458646	DQ458682	DQ458581	DQ453822
Q8r1-96 (A)		CM001512			
Q37-87 (B)	AY928641	DQ458651	DQ458671	DQ458587	AJ417069
F113 (B)		CP003150			
P12 (B)	EF424743	DQ458645	DQ458675	DQ458580	DQ453821
Q2-87 (C)		CM001558.1			
Q86-87 (C)	EF554356	EF044527	EF044553	EF044475	EF044361
PITR2 (D)	AJ278809	DQ458637	DQ458673	DQ458585	AJ417070
PILH1 (D)	AJ278810	DQ458649	DQ458674	DQ458584	DQ453824
F96.27 (E)	EF424744	DQ458641	DQ458679	DQ458576	DQ453817
P97.38 (E)	EF424749	DQ458647	DQ458684	DQ458582	DQ453823
<b>'<i>P. chlororaphis</i>' subgroup</b>					
<i>P. chlororaphis</i> subsp. <i>aurantiaca</i> INMI 473 c <sup>T</sup>	Absent (this study)	FN554452	FN554171	AJ717421	AB021412
<i>P. chlororaphis</i> subsp. <i>aureofaciens</i> L8 <sup>T</sup>	Absent (this study)	FN554453	FN554172	AJ717426	D84008
<i>P. chlororaphis</i> subsp. <i>chlororaphis</i> NRRL B-560 <sup>T</sup>	Absent (this study)	AJ717478	D86036	D86019	AF094723
<i>P. chlororaphis</i> O6	Absent		AHOT01000001		
<i>P. protegens</i> CHA0 <sup>T</sup> (F)	AJ278806	DQ458638	DQ458677	DQ458573	AJ278812
<b>'<i>P. protegens</i>' subgroup</b>					
<i>P. protegens</i> Pf-5 (F)		CP000076			
<i>P. protegens</i> K94.41 (F)	HQ395548	DQ458656	DQ458688	DQ458598	DQ453826
<i>P. protegens</i> PGNR1 (F)	HQ395550	DQ458654	DQ458686	DQ458590	AJ417071
<b>'<i>P. fluorescens</i>' subgroup</b>					
<i>P. marginalis</i> <sup>T</sup>	Absent (this study)	AJ717425	AB039569	AB039443	AB021401

<i>P. tolaasii</i> <sup>T</sup>	Absent (this study)	AB039561	AB039423	AJ717467	AF255336
<i>P. fluorescens</i> <sup>T</sup>	Absent (this study)	AJ717451	D86033	D86016	AF094725
<i>P. grimonitii</i> <sup>T</sup>	ND	AJ717439	FN554470	FN554188	AF268029
<i>P. veronii</i> <sup>T</sup>	ND	AJ717445	FN554518	FN554233	AF064460
<i>P. syzyxantha</i> <sup>T</sup>	ND	AJ717420	AB039550	AB039415	D84025
<i>P. azotoformans</i> <sup>T</sup>	ND	AJ717467	AB039561	AB039423	AB680322
<b>'P. gessardi' subgroup</b>					
<i>P. mucidolens</i> <sup>T</sup>	ND	AJ717427	AB039546	AB039409	D84017
<b>'P. fragi' subgroup</b>					
<i>P. taetrolens</i> <sup>T</sup>	ND	AJ717423	AB039523	AB039412	NR 036909
<b>Uncharacterized subgroups within the 'P. fluorescens' group</b>					
<i>P. 'fluorescens' SS101</i>	Absent		AHPN01000001		
<i>P. 'fluorescens' SBW25</i>	Absent		AM181176		
<i>P. 'fluorescens' Pf0-1</i>	Absent		CP000094		
<b>'P. syringae' group</b>					
<i>P. amygdali</i> <sup>T</sup>	ND	AB039509	AB039462	AJ717462	D84007
<i>P. savastanoi</i> <sup>T</sup>	ND	AJ717422	AB039514	AB039469	AB021402
<i>P. ficuserectae</i> <sup>T</sup>	ND	AJ717457	AB039501	AB039418	AB021378
<i>P. syringae</i> <sup>T</sup>	ND	AJ717484	AB039516	AB039428	D84026
<i>P. caricapapayae</i> <sup>T</sup>	ND	AJ717437	AB039507	AB039454	D84010
<i>P. tremae</i> <sup>T</sup>	ND	FN554761	FN554463	FN554229	AJ492826
<i>P. avellanae</i> <sup>T</sup>	ND	AJ717469	FN554454	FN554173	X95745

<sup>a</sup> Accession numbers for whole genomes are highlighted in gray.

<sup>b</sup> *phlD* absence (based on PCR detection or genome sequence analysis) is indicated when applicable. ND indicates strains for which *phlD* detection was not done.

<sup>c</sup> Membership to the multilocus phylogenetic groups A-F defined by Frapolli et al. (2007) is indicated in parenthesis.

# **CHAPITRE 1**

## Partie 1.2

---

Quantification des *Pseudomonas* producteurs de DAPG  
dans les sols résistants et sensibles à la maladie de la  
pourriture noire des racines de tabac

---





**Monitoring of the relation between 2,4-diacetylphloroglucinol-producing *Pseudomonas* and *Thielaviopsis basicola* populations by real-time PCR in tobacco black root-rot suppressive and conducive soils**

Juliana Almario<sup>1,2,3</sup>, Yvan Moënne-Loccoz<sup>1,2,3</sup>, Daniel Muller<sup>1,2,3</sup>

<sup>1</sup> Université de Lyon, F-69622, Lyon, France

<sup>2</sup> Université Lyon 1, Villeurbanne, France

<sup>3</sup> CNRS, UMR5557, Ecologie Microbienne, Villeurbanne, France

Corresponding author: Daniel Muller; Telephone: +33 (0) 4 72 43 27 14 ;

Fax: +33 (0) 4 72 43 12 23 ; E-mail: [daniel.muller@univ-lyon1.fr](mailto:daniel.muller@univ-lyon1.fr)

Journal : Soil Biology and Biochemistry (in press; Annexe 2)

## Abstract

Natural suppressiveness of Swiss soils to *Thielaviopsis basicola*-mediated tobacco black root rot is thought to depend mainly on fluorescent pseudomonads producing the antimicrobial compound 2,4-diacetylphloroglucinol. However, the relation between these *phl*<sup>+</sup> *Pseudomonas* populations and both the *T. basicola* population and disease suppressiveness in these soils is unknown, and real-time PCR tools were used to address this issue. Significant rhizosphere levels of *phl*<sup>+</sup> pseudomonads had been evidenced before in suppressive as well as conducive soils, but this was done using culture-based approaches only. Here, a *phlD*-based real-time PCR method targeting all *phlD*<sup>+</sup> genotypes, unlike the strain-specific real-time PCR methods available so far, was developed and validated (detection limit around 4 log cells g<sup>-1</sup> soil and amplification efficiency >80%). When implemented on Swiss soils suppressive or conducive to black root rot, it clarified the hypothesis that suppressiveness does not require higher levels of *phlD*<sup>+</sup> pseudomonads. The parallel assessment of *T. basicola* population by real-time PCR (method of Huang and Kang, 2010) suggested that suppressiveness was not due to the inability of the pathogen to colonize the rhizosphere and tobacco roots in suppressive soils, but rather that *phl*<sup>+</sup> pseudomonads might act by limiting root penetration by the pathogen in suppressive soils. In conclusion, an effective real-time PCR method was achieved for *phlD*<sup>+</sup> pseudomonads and can be used to monitor this key functional group in various environmental conditions, including here to better understand the ecology of suppressive soils.

## Introduction

Soil-borne plant pathogens can cause extensive damage to plants both in natural plant communities and crop stands. However, root infection by these phytopathogens may be controlled by competition or antagonistic effects of rhizosphere microorganisms (Raaijmakers et al., 2009). The latter include plant-protecting strains from the *Pseudomonas* spp., which can act by different mechanisms (Couillerot et al., 2009), particularly the production of antimicrobial compounds such as 2,4-diacetylphloroglucinol (DAPG) and others (Haas and Défago, 2005; Weller et al., 2007). DAPG inhibits various phytopathogens *in vitro* (Haas and Keel, 2003), may induce an ISR response in plant (Iavicoli et al., 2003; Weller et al., 2012), as well as modulating root development (Brazelton et al., 2008) and exudation (Phillips et al., 2004), or enhancing the expression of phytostimulation-relevant genes in neighboring *Azospirillum* bacteria (Combes-Meynet et al., 2011).

*Pseudomonads* harboring *phl* genes for DAPG production display world-wide distribution (Wang et al., 2001). However, their population size and diversity may fluctuate according to soil location (Meyer et al., 2010), soil geomorphology (Frapolli et al., 2010), crop species and variety (Picard and Bosco, 2006; von Felten et al., 2011), and soil management (Bergsma-Vlami et al., 2005; Rotenberg et al., 2007). In certain cases, the *phl*<sup>+</sup> *Pseudomonas* spp. reach rhizosphere numbers high enough for effective plant protection, as shown for soils suppressive to take-all of wheat and barley caused by *Gaeumannomyces graminis* var. *tritici* (Weller et al., 2007), Fusarium wilt of pea mediated by *Fusarium oxysporum* f. sp. *pisi* (Landa et al., 2002) and *Thielaviopsis basicola*-mediated black root rot of tobacco (Stutz et al., 1986; Keel et al., 1992). Suppressing soils are soils in which the extent of certain disease(s) on susceptible crop is significantly limited by one or several plant-protecting microbial populations, such as *phl*<sup>+</sup> *Pseudomonas* species or others (Raaijmakers et al., 1998; Weller et al., 2007; Kyselková and Moëgne-Loccoz, 2012).

The presence of root pathogens can lead to larger *phl*<sup>+</sup> populations, as observed for cucumber and maize infected by *Pythium ultimum* (Notz et al., 2001; Rotenberg et al., 2007), or bean by *Rhizoctonia solani* (Jamali et al., 2009). This is attributed to root leakage of nutrients as a result of disease, and participates to the build-up of *phl*<sup>+</sup>

*Pseudomonas* populations in relation to monoculture-induced decline of wheat take-all (Raaijmakers et al., 1998). Changes in the proportions of different genotypes of *G. graminis* var. *tritici* may also take place during take-all decline, and this might facilitate suppressiveness in that less aggressive genotypes become prevalent (Lebreton et al., 2007). It is unknown whether a similar interplay between pathogen and *phl*<sup>+</sup> *Pseudomonas* populations exists in black root rot suppressive soils (Gasser and Défago, 1981; Stutz et al., 1986; Frapolli et al., 2010), but very little has been done to monitor *T. basicola* in these soils.

The soils naturally suppressive to black root rot of tobacco (and other crops) occur mainly in the region of Morens (Switzerland), where both suppressive and conducive soils are present in the landscape. Conducive soils derive from weathered molasses (i.e. sandstone) and suppressive soils from shallow morainic material overlying the sandstone (Stutz et al., 1989). Yet, both types of soil (i.e. brunisols) are chemically similar, except for the predominance of iron-releasing vermiculite among clay minerals in suppressive soils (Stutz et al., 1989). Since *phl*<sup>+</sup> *Pseudomonas* were also present in significant numbers in Morens conducive soils (Ramette et al., 2003; Frapolli et al., 2010), the hypothesis was raised that soil suppressiveness status in the case of black root rot could be linked to the diversity of *phl*<sup>+</sup> *Pseudomonas* populations. Indeed, the latter differs between Morens suppressive and conducive soils (Frapolli et al., 2008, 2010), which can have a strong impact on plant protection efficacy (Becker et al., 2012). However, the monitoring of *phl*<sup>+</sup> pseudomonads at Morens has relied so far on (various) culture-dependent methods (needing PCR detection of the *phlD* gene essential for DAPG synthesis), whose results were not confirmed by a culture-independent approach based on 16S rDNA microarray analysis (Kyselková et al., 2009). Although active, *Pseudomonas* cells in the rhizosphere may be under starvation stress (Marschner and Crowley, 1996) and viable but non-culturable subpopulations can develop (Troxler et al., 2012; Sorensen et al., 2001), biasing culture-based estimates. Four *phlD*-based real-time PCR methods, each targeting a particular *phlD*<sup>+</sup> strain were developed by Mavrodi et al. (2007) but these methods poorly cover the diversity of *phl*<sup>+</sup> pseudomonads, for which 22 genotypic groups have been described worldwide. Thus, a general culture-independent method to quantify all 2,4-diacetylphloroglucinol-producing pseudomonads (and allowing analysis of their diversity) is still lacking.

Against the background of current hypotheses on the suppressiveness of Morens soils to Thielaviopsis black root rot, our understanding of this disease suppression is limited by (i) the fact that only culturable *phl*<sup>+</sup> pseudomonads have been studied until now, and (ii) the lack of knowledge on the relation between *phl*<sup>+</sup> *Pseudomonas* and *T. basicola* populations in these soils, and the consequences for suppressiveness. These issues were the targets of the current work. A real-time PCR protocol is available for quantification of the pathogen *T. basicola* (Huang and Kang, 2010) but not for *phl*<sup>+</sup> *Pseudomonas*, and thus a single *phlD*-based real-time PCR method was developed and validated for simultaneous quantification of all *phl*<sup>+</sup> *Pseudomonas*. This method was then implemented to assess the hypothesis that suppressiveness to black root rot does not require higher levels of *phlD*<sup>+</sup> pseudomonads in the rhizosphere. To this end, the size (and genetic structure by tRFLP analysis) of natural populations of *phl*<sup>+</sup> pseudomonads in disease suppressive and conducive soils from Morens was monitored, in parallel to the quantification of *T. basicola* using the real-time PCR method of Huang and Kang (2010).

## Material and methods

### *Bacterial cultures, fungal cultures and genomic DNA extraction*

The pseudomonads used belonged to *Pseudomonas protegens* (i.e. strain CHA0; Stutz et al., 1986; Ramette et al., 2011) or the ‘*Pseudomonas fluorescens*’ species complex defined by Anzai et al. (2000), i.e. strains Q2-87 (Vincent et al., 1991), F113 (Fenton et al., 1992) and its spontaneous rifampicin-resistant mutant F113Rif (Carroll et al., 1995), *P. thivervalensis* P1TR2, *P. kilonensis* P12 (Keel et al., 1996), K93.2, P87-38 and *P. brassicacearum* P97-30 (Wang et al., 2001). All strains were routinely grown at 27 °C in solid or liquid KB medium (King et al., 1954) supplemented with chloramphenicol (10 µg mL<sup>-1</sup>) and ampicillin (40 µg mL<sup>-1</sup>). For strain F113Rif, rifampicin was added to the medium at 50 µg mL<sup>-1</sup> (KB Rif). For genomic DNA extraction, bacterial strains were grown overnight in 150 mL of liquid medium with shaking (150 rpm), and DNA was extracted from 500 µL of bacterial culture using the NucleoSpin Tissue kit (Macherey-Nagel, Hoerd, France), following the manufacturer’s instructions. DNA was quantified spectrophotometrically and adjusted to 30 ng µL<sup>-1</sup>.

*T. basicola* Ferraris strain ETH D127 (Berk. and Br.) was grown 4 weeks in the dark on malt agar (Ramette et al., 2003). A suspension containing  $6 \times 10^4$  endoconidia  $\text{mL}^{-1}$  was prepared as described by Ramette et al. (2003) and used for tobacco inoculation or DNA extraction. Fungal DNA was extracted from 400  $\mu\text{L}$  of the suspension, following the protocol of Ward (2009) for spores in liquid medium. DNA concentration was adjusted to  $10 \text{ ng } \mu\text{L}^{-1}$ .

### ***Plant experiments and samplings***

Soil samples from two suppressive (MS8 and MS16) and two conducive (MC10 and MC112) fields from Morens (Frapolli et al., 2010; Kyselková et al., 2009) were taken from 8-30 cm depth in June 2010. Stones and roots were removed before sieving soil at 5 mm and filling 300  $\text{cm}^3$  plastic pots (350 g soil per pot). Tobacco (*Nicotiana glutinosa* L.) was grown for 4 weeks, as described previously (Ramette et al., 2003), before transplanting into soil. Soil water content was adjusted to 70% of the water retention capacity for each soil, and was maintained by watering the pots with distilled water every two days.

In the first plant experiment, carried out with soil MC10 alone (for method development), plant root systems with tightly-adhering soil were sampled 1 or 3 days after transplanting. Roots were washed in 1 mL of sterile 0.8% NaCl solution by vortexing (30 min at 1500 rpm), and rhizosphere soil was collected by centrifugation (20 min at 4 °C and 3500 g) prior to lyophilization (described below). In the second experiment, conducted with the four soils together (for comparison of suppressive and conducive soils), half the pots were inoculated with  $10^3$  *T. basicola* endoconidia  $\text{cm}^{-3}$  soil (as described in Ramette et al., 2003), and plant root systems with tightly-adhering soil were sampled at 7 and 21 days. They were lyophilized at -50 °C for two days (freeze-drier Christ Alpha 2-4, Martin Christ, Osterode, Germany) before delicately separating the roots from the rhizosphere soil using tweezers.

### ***DNA extraction from plant roots and rhizosphere soil***

DNA was extracted from soil or from roots, following a protocol modified from Griffiths et al. (2000), as follows. Lyophilized samples were ground in 2-mL tubes using a spatula and DNA was extracted from the totality of the sample for roots (33-264 mg) or 500 mg

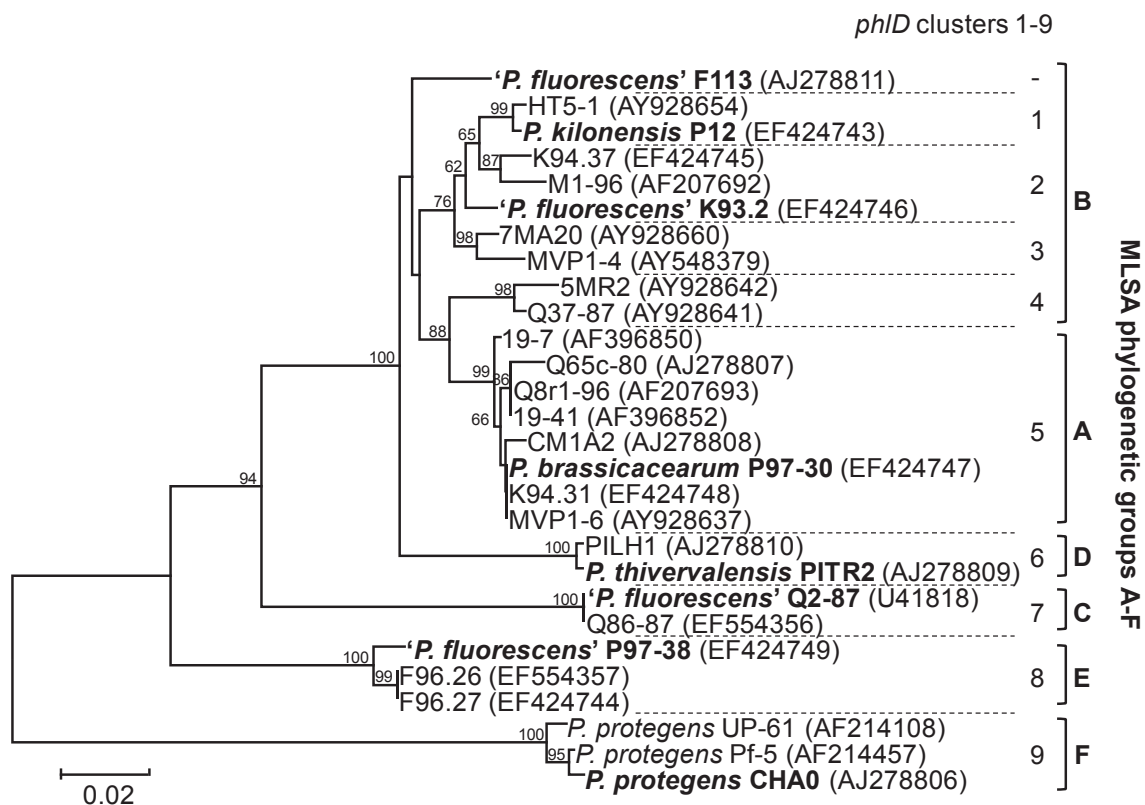
for rhizosphere soil. Samples were mixed with 0.5 g of 100  $\mu\text{m}$  zirconia/silica beads (BioSpec, Bartlesville, OK), 500  $\mu\text{L}$  of CTAB extraction solution (hexadecyltrimethylammonium bromide 5%, 1,4-dithio-DL-threitol 1 mM in 120 mM phosphate buffer, pH 8) and 500  $\mu\text{L}$  of phenol-chloroform-isoamyl alcohol (25:24:1), and were agitated in a bead-beater (TissueLyser II Retsch, Qiagen, Courtaboeuf, France) at 30 Hz for  $2 \times 45$  s with a 1 min cooling step in between. The tubes were then centrifuged for 10 min at 16 000 g and 4  $^{\circ}\text{C}$  and the aqueous phase containing the DNA was recovered. This extraction step was repeated once and the two supernatants were pooled, mixed with 1 volume of chloroform-isoamyl alcohol to eliminate phenol traces and centrifuged for 10 min at 16 000 g and 4  $^{\circ}\text{C}$ . For DNA precipitation, 75% of the aqueous phase was recovered and mixed with 40  $\mu\text{g}$  of glycogen and 0.1 volume of a 3M potassium acetate solution (pH 4.8). After addition of 2.5 volumes of absolute ethanol, DNA was precipitated for 2 h at -20  $^{\circ}\text{C}$  and was pelleted by centrifuging the tubes for 30 min at 16 000 g and 4  $^{\circ}\text{C}$ . The pellet was washed with 500  $\mu\text{L}$  of 70% ethanol, dried and suspended in 100  $\mu\text{L}$  of ultra-pure water. DNA was quantified using the PicoGreen assay (Molecular Probes, Invitrogen, Cergy Pontoise, France).

### ***Development of *phlD* primers***

The *phlD* sequences from 28 reference strains (Figure 1) representing the six phylogenetic groups of DAPG producers defined based on concatenated housekeeping gene sequences (Frapolli et al., 2007) were aligned using ClustalX (Thompson et al., 1997). The *phlD*-like sequence from the DAPG-negative strain *Streptomyces avermitilis* ATCC31267 (AB070948.1) was included in the alignment to serve as a non-target sequence. This alignment was used to perform a phylogenetic analysis on the 28 *phlD* sequences. The tree was inferred from 619 nucleotides using the Neighbor-Joining (NJ) method in MEGA4 (Tamura et al., 2007) with the Kimura two-parameter method for distance calculation (Kimura, 1980). Nodal robustness of the tree was assessed using 1000 bootstrap replicates.

Using the *phlD* alignment, new primers (25-30 bp in length) were visually selected in regions conserved among the *phlD* sequences and absent from the non-target sequence. The new primers, along with primers B2BF and BPR4 (McSpadden Gardener et al., 2001) known to amplify *phlD* in all DAPG-producing strains tested (De La Fuente et al., 2006; Frapolli et al., 2008), were then assessed based on the six following criteria:





**Figure 1.** Neighbor-Joining tree showing phylogenetic relationship between the 28 *phlD* sequences used for primer development and the correspondence with the MLSA phylogenetic groups A-F of *phl*<sup>+</sup> pseudomonads defined by Frapolli et al. (2007). Strains used for real-time PCR method validation are indicated in bold, and *phlD* accession numbers in parenthesis. Bootstrap values superior to 60% are shown. The scale bar represents the number of substitutions per site. The *phlD* clusters from Frapolli et al. (2008) are indicated.

(i) a melting temperature ( $T_m$ ) of 60 to 67 °C, (ii) an absence of predicted hairpin loops and primer-dimer formations (Couillerot et al., 2010), (iii) a  $T_m$  difference between primers not exceeding 1 °C, (iv) an amplification product not exceeding 400 bp, (v) a maximum of 3 mismatches between each primer and the 334 *phlD* sequences available (in February 2012) in the nr Nucleotide Sequence Database, and (vi) the ability to specifically amplify *phlD* in genomic DNA samples (using 6 ng of genomic DNA from the eight *phlD*<sup>+</sup> strains highlighted in Figure 1) and in a complex environmental DNA sample (using 6 ng of rhizosphere DNA from 21-days tobacco grown in soil MS8) by real-time PCR. Primer melting temperature, predicted hairpin loops and predicted primer-dimer formations were determined using Oligo 6 (Molecular Biology Insights, West Cascade, CO) and the nearest-neighbor method (Saitou and Nei, 1987). Amplification specificity was determined by checking the  $T_m$  and size of the amplification product through (i) melting curve analysis followed by  $T_m$  determination (described below) and (ii) gel electrophoresis analysis and the observation of a single band of the expected size. Following this, one *phlD*-specific primer-pair was used for *phlD* real-time PCR optimization.

### ***Generation of standard curves and *phlD* quantification in samples***

Standard curves were generated using genomic DNA of eight *phlD*<sup>+</sup> *Pseudomonas* strains (indicated in bold in Figure 1) belonging to distinct *phlD* genotypic clusters. Strain genomic DNA was serially diluted ten-fold in three separated series to obtain standards from  $3 \times 10^6$  to 30 fg DNA  $\mu\text{L}^{-1}$ . Two microliters of each standard dilution (i.e. from approximately  $8 \times 10^5$  to 8 *phlD* copies) were used for real-time PCR analysis. Real-time PCR assays were conducted using 96-well white microplates, LightCycler 480 SYBR Green I Master mix in a final volume of 20  $\mu\text{L}$ , and a LightCycler 480 (Roche Applied Science, Meylan, France). Cycle threshold (Ct) of individual samples was calculated using the second derivative maximum method in the LightCycler Software v.1.5 (Roche Applied Science). The standard curves were obtained by plotting the mean Ct value of the three replicates (per DNA concentration) against the log-transformed DNA concentration. Amplification efficiency (E), calculated as  $E = 10^{(-1/\text{slope})} - 1$ , and the error of the method (Mean Squared Error of the standard curve) were determined using the LightCycler Software v.1.5 (Roche Applied Science). The equivalence between DNA amount and *phlD* copy number was estimated based on (i) a *Pseudomonas* genome of approximately

7.26 fg DNA (derived from the 7.1 Mbp genome of *P. protegens* Pf-5; Paulsen et al., 2005) and (ii) the occurrence of *phlD* in one copy per genome (Moynihan et al., 2009). The detection limit was determined as the number of *phlD* copies at the last DNA concentration giving 3 positive results out of 3 replicates (Bustin et al., 2009). Amplification specificity was checked by melting curve analysis of the amplification product using a fusion program consisting of an initial denaturing step of 5 s at 95 °C, an annealing step of 1 min at 65 °C and a denaturing temperature ramp from 65 to 97 °C with a rate of 0.11 °C s<sup>-1</sup>. Melting curve calculation and T<sub>m</sub> determination were performed using the T<sub>m</sub> Calling Analysis module of LightCycler Software v.1.5 (Roche Applied Science).

Real-time PCR optimization was sought to improve *phlD* amplification efficiency (above 80%) and error (below 0.01; Zhang and Fang, 2006) for the eight *phlD*<sup>+</sup> *Pseudomonas* strains. Were tested: three primer concentrations (0.5, 0.75 and 1 μM), 2 DMSO concentrations (3% and 6%), the addition of T4g32 protein (0.5 μg per reaction mix; Roche Applied Science), 5 annealing temperatures (62, 63, 65, 67 and 69 °C), 5 annealing times (30, 15, 9, 7 and 5 s) and 2 elongation times (30 and 15 s).

The final reaction mix contained 10 μL of LightCycler 480 SYBR Green I Master Vial 1, 1.9 μL of Vial 2 (Roche Applied Science), 1 μM of primer B2BF, 1 μM of primer B2BR3, 0.5 μg of T4g32 protein, 3% DMSO and 2 μL of DNA. The final cycling program included a 10 min incubation at 95 °C, 50 amplification cycles of 30 s at 94 °C, 7 s at 67 °C and 15 s at 72 °C; and the fusion program for melting curve analysis described above. The standard curve thus generated from genomic DNA of '*P. fluorescens*' F113 was subsequently used as the external standard curve for determination of *phlD* copy number in uncharacterized DNA samples. Ten-time diluted DNA samples were analyzed by real-time PCR in triplicate (following the above protocol), and the mean Ct value was reported in the external standard curve to infer *phlD* copy number in the sample, using the Light Cycler 480 Software and the "external standard curve" option for absolute quantification. Two DNA standards from genomic DNA of '*P. fluorescens*' F113 (0.6 and 6 pg corresponding to approximately 80 and 800 *phlD* copies) were included as reference in each run to detect between-run variations.

### ***Generation of standard curves from bulk soil inoculated with *phlD*+ *Pseudomonas* F113 and CHA0***

Non-sterile bulk soil samples (500 mg) from fields MC10 or MS8 were inoculated with 100  $\mu\text{L}$  of ten-fold dilutions of bacterial cell suspension, reaching from  $4.6 \times 10^8$  to  $4.6 \times 10^2$  CFU  $\text{g}^{-1}$  soil for strain F113, and  $1.7 \times 10^8$  to  $1.7 \times 10^2$  CFU  $\text{g}^{-1}$  soil for strain CHA0. Three samples per strain and per CFU concentration were prepared, negative controls received 100  $\mu\text{L}$  of 0.8% NaCl solution, and the bacterial dilutions were plated onto KB medium to verify CFU levels. Soil samples were immediately lyophilized (at  $-50$  °C for two days) and DNA was extracted, as described above for rhizosphere soil. For each strain  $\times$  soil combination, a standard curve was obtained by plotting the mean Ct value of the three inoculation replicates against log-transformed CFU level. The amplification efficiency, the error and the detection limit of the method were also determined, as described above.

### ***Method validation based on colony counts of '*P. fluorescens*' F113Rif in the tobacco rhizosphere***

Before transplanting into soil MC10, tobacco roots were inoculated with 100  $\mu\text{L}$  of ten-fold dilutions of F113Rif cell suspension to obtain from  $2.6 \times 10^9$  to  $2.6 \times 10^3$  CFU per plant. Four plants per CFU concentration were prepared, negative controls received 100  $\mu\text{L}$  of 0.8% NaCl solution, and the bacterial dilutions were plated onto KB Rif medium to verify CFU levels. Two plants per CFU concentration were sampled at 1 day and the other two at 3 days. Plants were taken out of the soil, root systems (with tightly adhering soil) were placed each in 1 mL of 0.8% NaCl solution, the tubes were shaken for 30 min at 1500 rpm, roots were removed, and cell number of F113Rif in the remaining suspension was estimated by counting colonies on KB Rif plates (after a 2 day incubation). For DNA extraction, the suspensions were centrifuged for 20 min at 4 °C and 3500 g, the supernatant was discarded, the rhizosphere soil pellet lyophilized and its DNA extracted following the soil DNA extraction protocol described above. Ten times diluted DNA samples were analyzed by real-time PCR in triplicate and the mean Ct value was used to infer *phlD* copy number in each sample, as described above.

### ***Analysis of indigenous root-colonizing *phlD*<sup>+</sup> *Pseudomonas* in Morens soils***

Seven days (only for soils MS8 and MC112) and 21 days (for all soils) after tobacco transplanting, the root systems (roots and tightly adhering soil) of five tobacco plants inoculated with *T. basicola* and five non-inoculated tobacco plants (per soil and per date) were collected. After lyophilization, roots were separated from rhizosphere soil, as described above (section 2.2). *phlD* copy number in root and rhizosphere DNA samples was determined by real-time PCR, as described above (section 2.5).

When the real-time PCR method was implemented to monitor root-associated *phlD*<sup>+</sup> *Pseudomonas* in Morens soil, melting curve analysis and gel migration of the *phlD* amplicons showed the presence of a single peak (of expected  $T_m$ ) and band (of expected size), respectively. *phlD* identity was confirmed by sequencing four clones from one real-time PCR product from one root sample from soil MS8, as follows. Because real-time PCR products cannot be used directly for cloning, they were first re-amplified by conventional PCR using the same primers. PCRs were carried out in 50- $\mu$ L volumes containing 3% DMSO, 1 $\times$  buffer (Roche Applied Science), 1.5 mM MgCl<sub>2</sub>, 100  $\mu$ M of each dNTP, 1  $\mu$ M of each primer B2BF/B2BR3, 1.8 U of Taq Expand High Fidelity DNA polymerase (Roche Applied Science) and 1  $\mu$ L of template DNA. The cycling program included 3 min at 94 °C, 30 amplification cycles of 1 min at 94 °C, 1 min at 62 °C and 1 min at 72 °C, and an elongation step of 3 min at 72 °C. PCR products were purified (MinElute PCR purification kit; Qiagen), cloned (pGEMs-T Easy Vector System kit; Promega, Charbonnières, France) and both strands were sequenced (LGC Genomics, Berlin, Germany) for four clones. The sequences (EMBL accession numbers HE647865 to HE647868) were checked, edited with BioEdit v.7.0 (Hall, 1999), and their *phlD* identity was determined using the BlastN algorithm and the nr Nucleotide Sequence Database.

### ***tRFLP analysis of *phlD* alleles***

Following real-time PCR amplification of *phlD*, four amplification products (two from tobacco roots and two from the rhizosphere) per treatment were re-amplified by PCR, as indicated above, using primers B2BF and B2BR3 (the latter labelled in 5' with Carboxy-fluorescein; Invitrogen). PCR products were purified using the MinElute PCR purification kit (Qiagen), following the manufacturer's instructions. Product digestion and tRFLP

analysis were conducted as in von Felten et al. (2011), except that EcoO109I was replaced with MaeI to recognize a unique restriction site present only in *phlD* sequences from phylogenetic group D. Briefly, 500 ng of PCR product were digested for 4 h at 37°C with 0.5 U of each restriction enzyme (BspI, NspI, AseI, Kpn2I, PstI and MaeI; Fermentas, St. Leon Rot, Germany) in a 12 µL reaction containing 1× buffer (Fermentas). Terminal restriction fragments were analyzed on automated sequencer ABI 3730XL (Applied Biosystems, Foster City, CA), using 1 µL of digested product and 0.4 µL of GeneScan-600LIZ (Applied Biosystems), and data was analyzed using Gene Mapper Software 4.0 (Applied Biosystems) with a peak detection limit set to 50 relative fluorescence units. A sample consisting of a mix of genomic DNA (30 ng) from *P. brassicacearum* P97-30 (phylogenetic group A), '*P. fluorescens*' F113 (B), '*P. fluorescens*' Q2-87 (C), *P. thivervalensis* PITR2 (D), '*P. fluorescens*' P87-38 (E) and *P. protegens* CHA0 (F) was included to verify the size of terminal fragments. tRFLP chromatograms were converted into binary matrices (presence vs absence of peaks for each replicate) and results from the two replicates were combined and converted to frequency matrices (for each peak, frequency was 1 if present in both replicates, 0.5 if in one replicate, and 0 if absent), as done by von Felten et al. (2011). The frequency matrices were used for cluster analysis based on the Euclidean distances.

#### ***Real-time PCR quantification of T. basicola in Morens soils and suppressiveness test***

*T. basicola* was quantified by real-time PCR, using the protocol of Huang and Kang (2010). To generate the standard curve, *T. basicola* genomic DNA (obtained as described above) was serially diluted ten-fold in three separated series to obtain from  $1.3 \times 10^6$  to  $1.3 \text{ fg DNA } \mu\text{L}^{-1}$ , and 2 µL of each dilution were used for real-time PCR analysis. The assay was conducted using ITS primers Tb1/Tb2 (Huang and Kang, 2010). The reaction mix contained 10 µL of LightCycler 480 SYBR Green I Master Vial 1, 4 µL of Vial 2 (Roche Applied Science), 0.4 µM of primer Tb1, 0.4 µM of primer Tb2 and 2 µL of DNA. The cycling program included a 10 min incubation at 95 °C, 45 amplification cycles of 20 s at 94 °C, 20 s at 54 °C and 20 s at 72 °C; and the same fusion program for melting curve analysis described above for *phlD*. Ct values, standard curve, amplification efficiency and error, detection limit, melting curves and Tm values were determined, as indicated above for *phlD*.

For quantification of *T. basicola* in the rhizosphere of Morens soils (experiment described above), the standard curve generated with strain ETH D127 was used as external standard curve. Ten-time diluted DNA samples were analyzed by real-time PCR in triplicate and the mean Ct value was used to infer the amount of *T. basicola* DNA in the sample, using the external standard curve and two DNA standards ( $2 \times 10^4$  and  $2 \times 10^5$  fg of *T. basicola* DNA), as indicated for *phlD* quantification. To verify that amplicons did correspond to *T. basicola* ITS, real-time PCR products obtained with root samples from one non-inoculated plant (in soil MS8) and two inoculated plants (one in soil MS8 and the other in MC112), as well as with genomic DNA from strain ETH D127, were re-amplified by conventional PCR, as described above for *phlD*, except that no DMSO was added, primers Tb1/Tb2 were used and primer annealing was at 50 °C. PCR products were, purified, cloned and ten clones per sample were sequenced, as described above for *phlD*. *T. basicola* ITS sequences (EMBL accession numbers HE647869 to HE647899) were checked and edited with BioEdit v.7.0 (Hall, 1999) and their affiliation was determined using the BlastN algorithm and the nr Nucleotide Sequence Database.

In the same experiment, the suppressive/conducive status of each soil was verified. For this purpose, 8 *T. basicola* inoculated and 8 non-inoculated plants were collected per soil at 21 days, and the washed roots were used to score black root rot symptoms and determine disease severity (i.e. percentage of root surface covered by *T. basicola* chlamydospores) using a height-class disease scale (Stutz et al., 1986; Ramette et al., 2003).

### ***Statistical analyses***

All statistical analyses were performed in the R environment (v.2.12.0) using the Agricolae (de Mendiburu, 2007) and Car (Fox and Weisberg, 2011) packages, at  $P < 0.05$ . Normality was tested using Shapiro's test. Because real-time PCR data were not normally or log-normally distributed, (i) zero values were replaced by the detection limit (Kloepper and Beauchamp, 1992) of the real-time PCR method i.e. 8 *phlD* copies and 260 fg of *T. basicola* DNA, and (ii) data was power-transformed using the Box-Cox transformation method (Box and Cox, 1964) in the Car package. Means were compared by ANOVA performed both on power- and on rank-transformed data, followed by Fisher's LSD tests, obtaining nearly identical results with the two transformation procedures. Only statistical results from power-transformed data are shown. Disease

severity was compared between treatments by two-factor (i.e. soil  $\times$  *T. basicola* inoculation) ANOVA followed by Fisher's LSD tests at  $P < 0.05$ , based on rank-transformed data. Correlation analyses were performed on log-transformed data using Pearson's product-moment correlation coefficient ( $r$ ) and its associated  $P$  value.

## Results

### *Development of *phlD* real-time PCR primers*

Six primer pairs were assessed to fit the six phylogenetic groups of DAPG producers described by Frapolli et al. (2007). Primer pair B2BF-BPR4 (McSpadden Gardener et al., 2001) was discarded because of high  $T_m$  difference between primers and high product size. Two pairs were discarded as one of the primers displayed more than three mismatches with certain *phlD* sequences, and two others were dismissed since they failed to specifically amplify *phlD* from rhizosphere DNA by real-time PCR (Table S1). Only B2BF/B2BR3 (described in Table 1) fit all six assessment criteria, and this pair was chosen for real-time PCR optimization.

### *Optimization and validation of *phlD* real-time PCR*

Real-time PCR conditions were optimized to obtain an amplification efficiency of  $>80\%$  and an error below 0.1 with genomic DNA of all 8 *phlD*<sup>+</sup> strains tested, which exhibited the same detection limit of 60 fg DNA (equivalent to approximately 8 *phlD* copies; Table 2).

When tested in non-sterile bulk soil inoculated with strains F113 and CHA0, amplification efficiencies above 80% and errors below 0.1 were also obtained, for both soils tested (Figure 2; Table 2). Detection of indigenous *phlD*<sup>+</sup> *Pseudomonas* prevented estimation of detection limits in soil MS8, whereas in soil MC10 they were 4.4 log *phlD* copies g<sup>-1</sup> soil for strain F113 and 4.1 log *phlD* copies g<sup>-1</sup> soil for strain CHA0. In soil MC10, *phlD* copy numbers from real-time PCR were  $0.23 \pm 0.11$  log lower than that expected from CFU inoculation levels (Figure S1).



**Table 1.** Primers used for *phlD* real-time PCR optimization.

Primer	Sequence (5'-3')	Position <sup>a</sup> (+1)	Length (bp)	T <sub>m</sub> (°C)	Reference
B2BF	ACCCACCGCAGCAATCGTTTATGAGC	196	25	65.4	McSpadden Gardener et al., 2001
B2BR3	AGCAGCGCAGAGAACTCCAGGGA	514	25	64.6	This study

<sup>a</sup> Primer position on the 1050-bp *phlD* sequence from strain Pf-5 (genome accession number CP000076). The amplicon is 319 bp long.

**Table 2.** Standard curve parameters and real-time PCR amplification efficiencies for *phlD* *Pseudomonas* strains *in vitro* and in non-sterile bulk soil.

	MLSA phylogenetic group <sup>a</sup>	<i>phlD</i> cluster <sup>b</sup>	Slope	Amplification efficiency (%)	Error	Detection limit expressed as <i>phlD</i> copies ( <i>in vitro</i> ) or <i>phlD</i> copies g <sup>-1</sup> soil (in soil)
<b><i>Pseudomonas</i> strain <i>in vitro</i></b>						
' <i>P. fluorescens</i> ' F113	B	-	-3.35	98.7	0.03	8 <sup>c</sup>
<i>P. kilonensis</i> P12	B	1	-3.33	99.0	0.06	8
' <i>P. fluorescens</i> ' K93.2	B	2	-3.55	91.2	0.05	8
<i>P. brassicacearum</i> P97-30	A	5	-3.74	84.9	0.01	8
<i>P. thivervalensis</i> PITR2	D	6	-3.65	87.6	0.05	8
' <i>P. fluorescens</i> ' Q2-87	C	7	-3.67	87.3	0.02	8
' <i>P. fluorescens</i> ' P97-38	E	8	-3.62	88.7	0.01	8
<i>P. protegens</i> CHA0	F	9	-3.86	81.5	0.02	8
<b><i>Pseudomonas</i> strain<sup>d</sup> × soil</b>						
' <i>P. fluorescens</i> ' F113 × soil MC10	B	-	-3.48	93.8	0.05	4.4 log
' <i>P. fluorescens</i> ' F113 × soil MS8	B	-	-3.45	94.7	0.06	Not done <sup>e</sup>
<i>P. protegens</i> CHA0 × soil MC10	F	9	-3.85	81.9	0.02	4.1 log
<i>P. protegens</i> CHA0 × soil MS8	F	9	-3.88	80.8	0.02	Not done

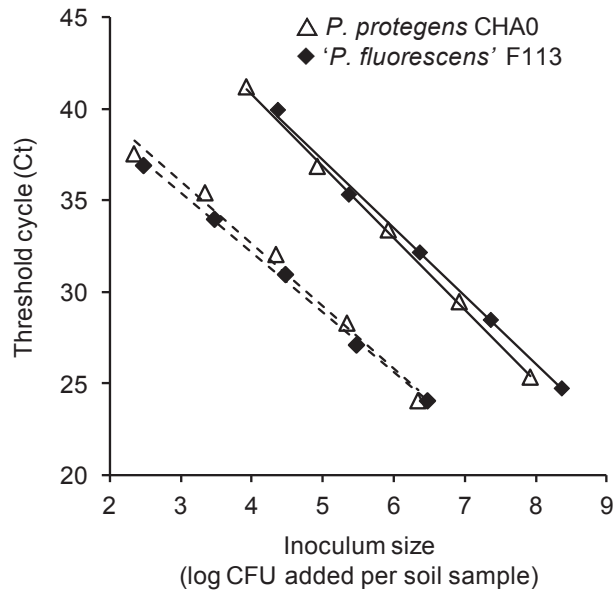
<sup>a</sup> MLST groups defined by Frapolli et al. (2007).

<sup>b</sup> Genotypic cluster of the different *phlD* alleles harbored by the strains. The *phlD* genotypic clusters were determined at a cut-off level of 99.1% sequence similarity by Frapolli et al. (2008). Strain F113 represented a *phlD* genotype on its own in that study.

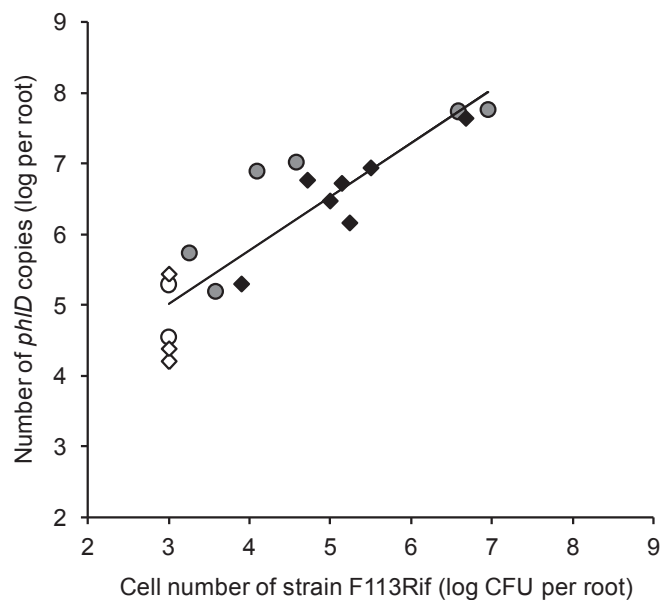
<sup>c</sup> Based on the experimental detection limit of 60 fg of genomic DNA, which corresponds to approximately 8 *phlD* copies.

<sup>d</sup> Obtained with an inoculum of 4.6 (for F113) or 4.2 (for CHA0) log CFU added g<sup>-1</sup> soil.

<sup>e</sup> No detection limit could be determined for soil MS8 because *phlD* was readily detected in uninoculated samples (i.e. due to the prevalence of indigenous *phlD*<sup>+</sup> *Pseudomonas*).



**Figure 2.** Real-time PCR standard curves for *P. protegens* CHA0 and '*P. fluorescens*' F113 inoculated in non-sterile bulk soils. Strains (CHA0 "△" or F113 "◆") were inoculated singly at different CFU levels in soil from fields MS8 (- - -) or MC10 (—). Mean Ct values from three replicates were used. Comparatively lower Ct values are observed for soil MS8 due to the presence of high numbers of indigenous *phlD*<sup>+</sup> *Pseudomonas*.



**Figure 3.** Relationship between colony counts and *phlD*-based real-time PCR for quantification of *phlD*<sup>+</sup> strain '*P. fluorescens*' F113Rif in the tobacco rhizosphere. Strain F113Rif was inoculated on roots and its population was determined 1 (◆) or 3 (●) days after planting in soil MC10. Empty symbols indicate data points where the zero value obtained for colony count was replaced by the detection limit of this method i.e. 3 log CFU per root system (Pearson's  $r = 0.90$ ,  $P = 5 \times 10^{-7}$ ,  $n = 18$ ).

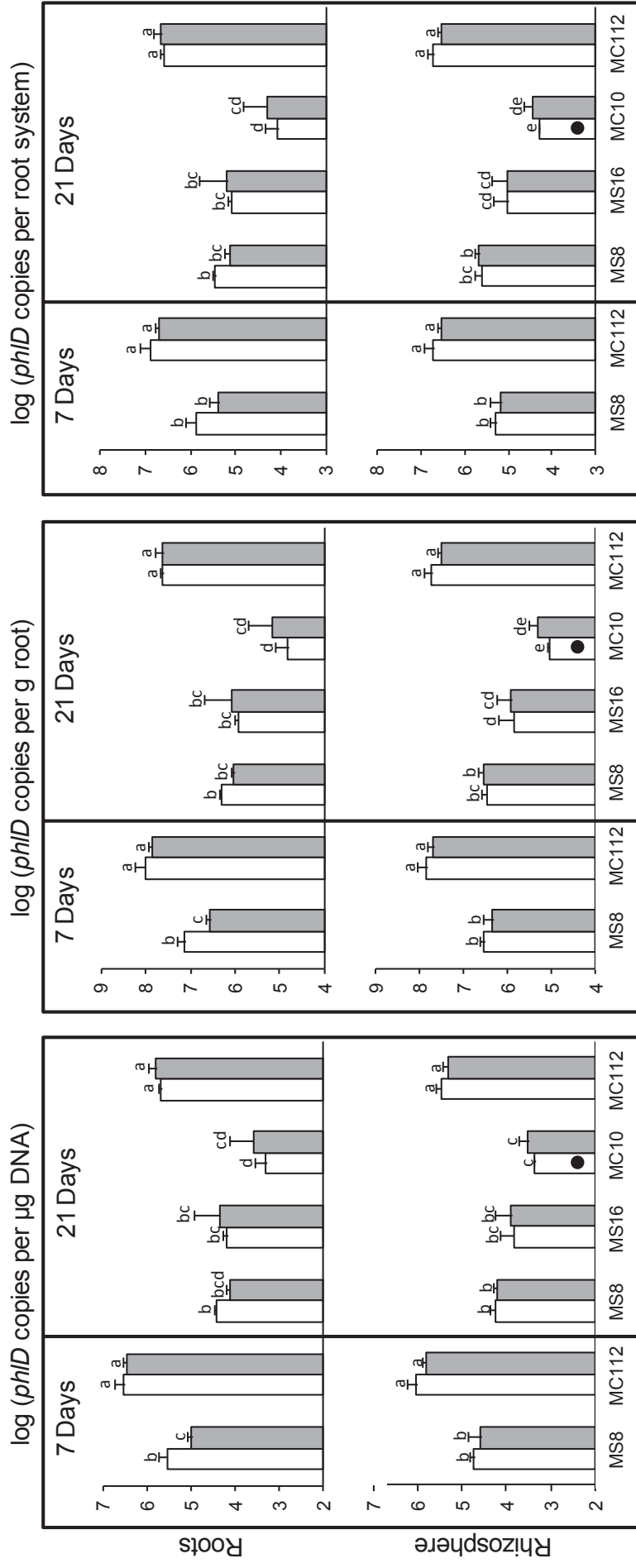
When the *phlD*<sup>+</sup> strain '*P. fluorescens*' F113Rif was monitored in the rhizosphere of tobacco grown in non-sterile soil MC10, a highly-significant, positive linear correlation ( $P \ll 0.01$ ) was observed between colony counts on KB Rif and *phlD* copies quantified by real-time PCR (Figure 3). The detection limit of the real-time PCR method in the tobacco rhizosphere was 3.7 log *phlD* copies per root system, but the corresponding CFU could not be determined since they were below the detection limit of approximately 3 log CFU per root system. For all samples, F113Rif levels quantified by *phlD* real-time PCR were  $1.66 \pm 0.50$  log higher than colony counts (Figure 3).

### ***Disease severity and soil suppressiveness***

Black root rot suppressiveness is the capacity of the soil (i) to limit disease severity due to natural *T. basicola* infestation and (ii) especially to buffer the increase in disease severity resulting from pathogen inoculation at high level ( $10^3$  or  $10^4$  endoconidia g<sup>-1</sup> soil), with final disease severity of tobacco typically less than 30%. Here, *T. basicola*-inoculated plants exhibited significantly higher disease severity than non-inoculated controls in conducive soils MC112 ( $47 \pm 10$  % vs  $15 \pm 8$  %) and MC10 ( $45 \pm 8$  % vs  $3 \pm 2$  %) (Figure S2). This was also the case in the moderately-suppressive soil MS16 ( $24 \pm 5$  % vs  $6 \pm 2$  %), but the increase in disease severity was only half as much. The difference was not significant in suppressive soil MS8 ( $23 \pm 8$  % vs  $19 \pm 8$  %).

### ***Prevalence of indigenous root-colonizing phlD<sup>+</sup> Pseudomonas in Morens soils***

At 7 days after transplanting of tobacco seedlings, the number of *phlD*<sup>+</sup> *Pseudomonas* quantified through real-time PCR was lower in soil MS8 than in soil MC112, regardless of whether (i) rhizosphere or roots were assessed and (ii) data were expressed per  $\mu\text{g}$  of DNA extracted, g of root, or root system (Figure 4). Inoculation with *T. basicola* had essentially no impact on *phlD* copies. Similar findings were also made in the two soils at 21 days, where the assessment was extended to soils MS16 and MC10. Compared with soil MS8 or MS16, *phlD* copies in soil MC10 were equivalent or lower, depending on sample type (rhizosphere or roots), *T. basicola* inoculation and/or data expression (per  $\mu\text{g}$  of DNA, g of root, or root system), whereas those in soil MC112 were always much higher. With soils MS8, MS16 and MC10 a positive correlation was found between the number of *phlD*<sup>+</sup> *Pseudomonas* and the ability of the soil to buffer disease severity



**Figure 4.** Real-time PCR quantification of *phlD*<sup>+</sup> *Pseudomonas* populations in tobacco roots and rhizosphere, based on the number of *phlD* copies detected per µg of extracted DNA, g of root or root system. Tobacco plants were grown for 7 or 21 days in two suppressive (MS8 and MS16) and two conducive (MC10 and MC112) soils inoculated (grey bars) or non-inoculated (white bars) with the pathogen *T. basicola*. Means and standard errors are shown for *phlD* copies per µg of extracted DNA (left), g of root (center) or root system (right). Black dots indicate treatments where *phlD*<sup>+</sup> pseudomonads were not detected and zero values were replaced by the detection limit. In each case, means were compared separately for roots and rhizosphere samples. Within each sampling time, different letters above bars indicate a significant difference between treatments ( $P < 0.05$ ).

increase resulting from pathogen inoculation, but it was not significant when including also soil MC112 (Figure S3).

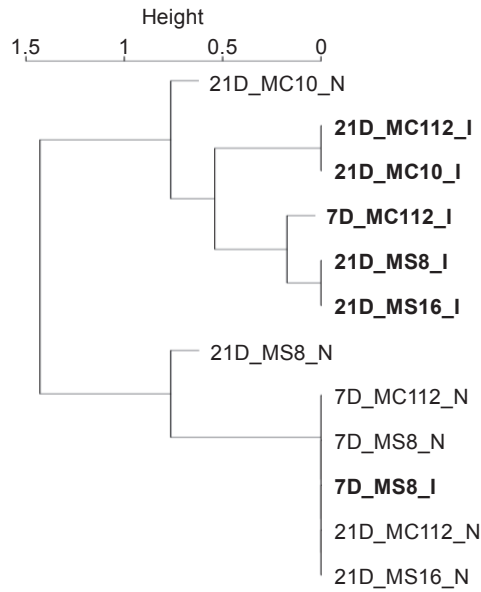
### ***phlD* polymorphism in Morens soils**

When tested on a mixture of genomic DNA from *Pseudomonas* strains belonging to the six phylogenetic groups of DAPG producers, tRFLP analysis of *phlD* allowed discrimination of the six expected terminal fragments, with sizes of 73 bp (phylogenetic group C), 142 bp (D), 212 bp (E), 222 bp (A), 229 bp (F) and 275 bp (B). In tobacco rhizosphere and root samples from Morens soils, only phylogenetic groups B (detected in 47 of 48 samples), D (41/48), A (11/48) and F (1/48) were found. In all soil × *T. basicola* inoculation combinations, the number of phylogenetic groups detected was higher for roots (2 or 3 per sample) than for rhizosphere (1 or 2 per sample), with all genotypes found detected in the rhizosphere also found with the root samples.

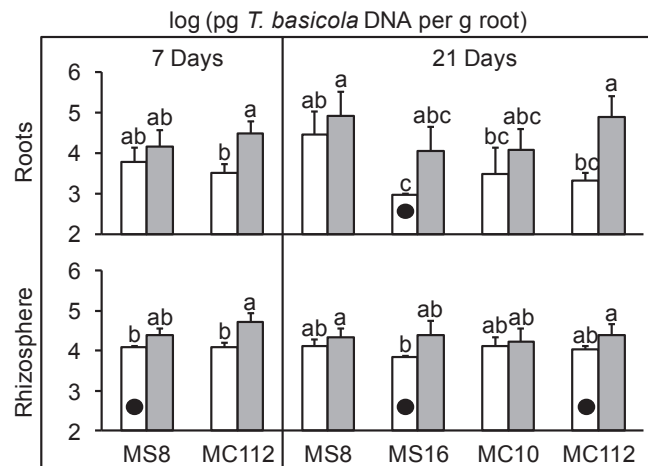
When all root samples were compared, two *phlD* tRFLP clusters were evidenced (Figure 5). One gathered 5 *T. basicola* inoculated treatments and 1 non-inoculated treatment, whereas the other was comprised of 1 inoculated and 5 non-inoculated treatments. This clustering of root samples was largely due to phylogenetic group A (i.e. *phlD* cluster 5), which was detected only with inoculated plants (but not all) in soils MS8, MS16 and MC112 and with both inoculated and non-inoculated plants in soil MC10, but was absent from 7-day-old inoculated plants in soil MS8 (and rarely found in the rhizosphere samples). Phylogenetic groups B and D were readily detected in all treatments (including in rhizosphere samples), while phylogenetic group F was found with roots from one 21-day-old plant grown in soil MS8.

### ***Relation between phlD<sup>+</sup> Pseudomonas and T. basicola densities in Morens soils***

No correlation was found overall between levels of *phlD<sup>+</sup> Pseudomonas* and *T. basicola*, regardless of whether the analysis was conducted (i) with roots, rhizosphere soil or both together, (ii) at either sampling time or with both combined, and (iii) on each soil separately or considering all soils together (not shown). Nevertheless, when considering only the roots of non-inoculated plants, a negative correlation was observed whether values were expressed per g of root ( $r = -0.69$ ,  $P = 0.012$ ),  $\mu\text{g}$  of DNA ( $r = -0.57$ ,  $P =$



**Figure 5.** Dendrogram based on *phlD*-tRFLP profiles obtained from tobacco roots grown in two suppressive (MS8 and MS16) and two conducive (MC112 and MC10) soils. *T. basicola* inoculated (I) and non-inoculated (N) plants were harvested 7 (7D) or 21 (21D) days after planting and two plants per treatment were analyzed (results pooled). Cluster analysis was based on Euclidean distances and constructed with the “complete” method in R environment. The “Height” axis represents the distances between nodes.



**Figure 6.** Real-time PCR quantification of *T. basicola* in tobacco roots and rhizosphere in Morens soils. Tobacco plants were grown for 7 or 21 days in two suppressive (MS8 and MS16) and two conducive (MC10 and MC112) soils inoculated (grey bars) or non-inoculated (white bars) with the pathogen *T. basicola*. Data shown are means and standard errors. Means were compared separately for roots and rhizosphere samples. Within each sampling time, different letters above bars indicate a significant difference between treatments ( $P < 0.05$ ). Black dots indicate treatments where *T. basicola* DNA was not detected and zero value were replaced by the detection limit.

0.039) or root system ( $r = -0.74$ ,  $P = 0.007$ ), whereas it was not significant when considering *T. basicola*-inoculated plants (not shown).

### ***Relation between T. basicola density and disease severity in Morens soils***

DNA amplification of *T. basicola* ETH D127 by real-time PCR generated a standard curve with a slope of -3.55 (corresponding to 91.1% amplification efficiency over 5 DNA concentrations), an error of 0.003 and a detection limit of 260 fg of *T. basicola* DNA per reaction. When the method was implemented to monitor root-associated *T. basicola* in Morens soil, cloning and sequencing revealed that the sequences amplified from non-inoculated and inoculated plants were highly similar (99.4%) or identical to that of *T. basicola* ETH D127 (not shown; 30 sequences assessed).

*T. basicola* DNA was detected in the roots of 34 plants but only in the rhizosphere of 18 of these plants. *T. basicola* inoculation did not result in a significant increase of *T. basicola* levels in the rhizosphere, except in soil MC112 at 7 days after planting (Figure 6). In all soils but MS16, *T. basicola* DNA was detected in roots of inoculated as well as non-inoculated plants. The roots of inoculated plants in soils MS8 (at 7 and 21 days), MC10 and MS16 (at 21 days) exhibited *T. basicola* levels comparable to those found in their non-inoculated counterparts. Conversely, *T. basicola* levels in roots were higher upon inoculation in soil MC112. The same differences were observed whether *T. basicola* level was expressed per  $\mu\text{g}$  of extracted DNA, g of root or root system (not shown).

The average disease severity rated at 21 days was positively correlated to the average pathogen level in roots measured at 7 days in soils MS8 and MC112 ( $n = 4$ ), regardless of whether pathogen level was expressed per  $\mu\text{g}$  of extracted DNA ( $r = 0.95$ ,  $P = 0.022$ ), g of root ( $r = 0.90$ ,  $P = 0.049$ ) or root system ( $r = 0.91$ ,  $P = 0.042$ ). However, no correlation was found when pathogen level was considered at 21 days (with all four soils available or only MS8 and MC112; not shown).



## Discussion

The enumeration of *phl*<sup>+</sup> *Pseudomonas* has often been done with culture-based methods that include (i) an enrichment step, (ii) the use of semi-selective medium and (iii) PCR identification of *phlD*<sup>+</sup> colonies (Ramette et al., 2003; Mavrodi et al., 2007; Frapolli et al., 2008). Although these methods enjoy low detection limits, the enrichment/selection step is likely to bias results by favoring certain types of *phlD*<sup>+</sup> strains (Mavrodi et al., 2007). Culture-independent real-time PCR methods, which have the potential to overcome this bias, have been developed for bacterial (Le Roux et al., 2008; Chen et al., 2008) and fungal populations (Lievens et al., 2006; Huang and Kang, 2010) in the soil and rhizosphere, including for a few types of *phl*<sup>+</sup> pseudomonads (Mavrodi et al., 2007).

The *phlD*-based real-time PCR method developed here to monitor natural populations of *phl*<sup>+</sup> pseudomonads in plant roots and rhizosphere targets the totality of the functional group and minimizes the differences in amplification efficiencies between *phlD* alleles, even though amplification efficiency was lower for *P. protegens* CHA0 (phylogenetic group F). Optimization of real-time PCR required a trade-off, as amplicon T<sub>m</sub> for *P. protegens* CHA0 was higher by more than 2 °C than those for the seven other *phlD*<sup>+</sup> pseudomonads tested. This was probably due to the higher GC content of the *phlD* sequence in strain CHA0 (65.7% vs 59.2-62.7% in the other strains), and is in accordance with the evolutionary divide between *P. protegens* (previously ARDRA group 1; Keel et al., 1996) and the '*P. fluorescens*' species complex (Frapolli et al., 2007; Ramette et al., 2011). Similar difficulties to amplify *phlD* (Mavrodi et al., 2007) and *phlA* (first gene from the *phl* operon; Rezzonico et al., 2003) in *P. protegens* have also been encountered when using strain-specific primers, and similar trade-off conditions were also necessary to develop a *phlD* DGGE protocol that could accommodate *phlD*<sup>+</sup> pseudomonads from both *P. protegens* and the '*P. fluorescens*' complex (Frapolli et al., 2008, 2010).

The primer annealing step is critical for the amplification of GC-rich templates, and final PCR conditions suitable for all *phlD*<sup>+</sup> pseudomonads were obtained here by simultaneously adjusting annealing time, annealing temperature and DMSO concentration (Mamedov et al., 2008), and by the addition of binding agent T4g32 protein (Jensen et al., 1976). Although amplification efficiencies varied among strains they were all above the 80% threshold (Zhang and Fang, 2006), and PCR optimization enabled to improve the

detection limit to 60 fg genomic DNA (i.e. approximately 8 *phlD* copies; Table 2) for each strain, which is comparable to 10 times lower than the limit of 60-600 fg (depending on strain) obtained by Mavrodi et al. (2007).

When the optimized PCR protocol was tested in non-sterile bulk soil (Figure 2), the detection limit (4.1-4.3 log *phlD* copies g<sup>-1</sup> soil for the two strains tested) was slightly better than that obtained after *Pseudomonas* enrichment (4.7 log cells g<sup>-1</sup> soil) in *phlD*-DGGE but much better than that of *phlD*-DGGE without prior enrichment (5 to 7 log cells g<sup>-1</sup> soil depending on strain) (Frapolli et al., 2008). Moreover, amplification efficiencies comparable to those found with genomic DNA were observed for both strains in both soils (Table 2). A strong correlation was found between added CFU and quantified *phlD* copies, with a mean difference of only 0.22 log (Figure S1). Results from real-time PCR and colony counts for '*P. fluorescens*' F113Rif in the tobacco rhizosphere were strongly correlated, but real-time PCR results were on average 1.7 log higher (Figure 3). This is probably due to the detection of DNA from non-culturable or dead cells, even though DNA from non-culturable *Pseudomonas* cells is not efficiently amplified (Rezzonico et al., 2003).

The number of rhizosphere *phlD*<sup>+</sup> pseudomonads was quantified by real-time PCR in four Morens soils (Ramette et al., 2003; Frapolli et al., 2010) of different suppressiveness status (which were again confirmed here) to clarify whether soil suppressiveness to black root rot of tobacco is linked to the former. Because in all soils, real-time PCR showed that *phlD*<sup>+</sup> pseudomonads were above the minimum threshold of 10<sup>4</sup> cells per g of root necessary for black root rot control (Stutz et al., 1986), it was unlikely that their abundance would determine soil suppressiveness. Indeed, no relation was found between soil suppressiveness level and the number of *phlD*<sup>+</sup> *Pseudomonas* with these four soils (Figure S3). Furthermore, the conducive soil MC112 displayed both the highest disease severity after pathogen inoculation and the highest number of *phlD*<sup>+</sup> pseudomonads colonizing tobacco roots and rhizosphere (Figure 4). This was not due to an enrichment of *phlD*<sup>+</sup> pseudomonads following necrosis-related leakage of organic root constituents (McSpadden Gardener and Weller, 2001; Chapon et al., 2002) by the more diseased plants in soil MC112, as numbers were already higher in MC112 than in MS8 at 7 days after planting, i.e. before root necrosis took place (Figure 4). Besides, *T. basicola* inoculation had little impact on *phlD*<sup>+</sup> *Pseudomonas* numbers (i.e. only a small decrease at 7 days on roots from soil MS8), and no correlation was found overall between real-time

PCR levels of *T. basicola* and *phl*<sup>+</sup> *Pseudomonas* (data not shown). These findings are in accordance with *T. basicola* infection not causing extensive root leakage (Hood and Shew, 1997). Higher numbers of *phlD*<sup>+</sup> pseudomonads for soil MC112 were found in some but not all experiments done previously on Morens soils (Frapolli et al., 2010). The current results, however, clarify the hypothesis that black root rot suppressiveness of Morens soils (unlike take all decline) does not entail higher populations of root-associated *phl*<sup>+</sup> pseudomonads, an assumption that so far was only substantiated by colony counts (Ramette et al., 2003) and MPN-PCR (Frapolli et al., 2010).

The genetic structure of the *phl*<sup>+</sup> *Pseudomonas* subcommunity can greatly affect its plant-protecting ability (Becker et al., 2012), and *phlD* DGGE on rhizosphere DNA showed that their genetic structure did differ between Morens suppressive and conducive soils (Frapolli et al., 2008). This difference was exploited here to confirm that our real-time PCR method could target *Pseudomonas* strains from different *phl*<sup>+</sup> phylogenetic groups. Indeed, the three phylogenetic groups A, B and D of DAPG producers already documented by *phlD*-DGGE (Frapolli et al., 2010) were also detected by *phlD*-tRFLP, in all four soils. In addition, phylogenetic group F, which had not been found by Frapolli et al. (2008, 2010), was also detected here but only in one sample (Table S2). Soil identity was not a major factor structuring *phlD*-tRFLP profiles (Figure 5), probably because the main differences between the soils concern the allelic composition within phylogenetic group A (Frapolli et al., 2008, 2010), which could not be accessed in this work since *phlD*-tRFLP is not resolutive enough. Interestingly, *T. basicola* inoculation had a stronger impact than soil on *phlD*-tRFLP profiles; phylogenetic group A was present in all MC10 samples, but for the other soils it was only detected in *T. basicola*-inoculated plants at 21 days (Table S2). Along these lines, Frapolli et al. (2010) found more *phlD* sequences from phylogenetic group A (i.e. *phlD* cluster 5) with inoculated (15 sequences) than with non-inoculated plants (6 sequences). Interestingly, when we reassessed data obtained by Ramette et al. (2006), we observed a trend for strains from phylogenetic group A to have a stronger biocontrol effect on black root rot than strains from other groups in vermiculitic gnotobiotic soil (mimicking Morens suppressive soils; Student's t-test,  $P = 0.08$ ) but not in illitic gnotobiotic soil (mimicking Morens conducive soils;  $P = 0.35$ ), suggesting a possible relation between soil clay type and biocontrol activity for group-A strains. This is consistent with the hypothesis that suppressiveness to *T. basicola*-

mediated black root-rot in Morens soils might entail root conditions more favorable for expression of DAPG synthesis ability by certain genotypes of *phl*<sup>+</sup> *Pseudomonas* strains.

The presence of an indigenous *T. basicola* population in these soils was evidenced by the detection of black root rot lesions and/or *T. basicola* DNA with non-inoculated plants from all soil, in agreement with Gasser and Défago (1981) who isolated only pathogenic *T. basicola* spores both in suppressive and conducive soils from Morens. Although inoculation of pathogenic *T. basicola* increased plant disease level in three of the four soils, the amounts of *T. basicola* DNA detected in the rhizosphere and roots were essentially the same in all soils. The amount of pathogen DNA in plant tissues may correlate with disease severity for certain shoot (Hogg et al., 2007) and root pathogens (Ippolito et al., 2004), but it is not always the case (Lievens et al., 2006). This is illustrated here by the absence of correlation between average disease severity and average pathogen level in roots. Perhaps PCR limitations, such as the detection of DNA from dead mycelia (Lievens et al., 2006), might also contribute to this lack of correlation.

Very few studies have targeted simultaneous monitoring of pathogen and biocontrol populations (Johnson and Dileone, 1999; Larkin and Fravel, 1999), and (to our knowledge) none of them in the context of soil suppressiveness. Inoculated *T. basicola* could colonize the tobacco rhizosphere in suppressive as well as in conducive Morens soils, but caused disease symptoms mainly in conducive soils. This suggests that suppressiveness to *T. basicola*-mediated black root rot is not due to hindering of pathogen survival and development in the rhizosphere, i.e. that it does not entail pathogen inhibition. In this context, the absence of correlation between *T. basicola* density in rhizosphere or roots and *phl*<sup>+</sup> *Pseudomonas* numbers has two implications. First, it suggests that *phl*<sup>+</sup> pseudomonads act mainly by reducing root penetration in suppressive soils. This could involve activation of ISR pathways in the plant (Maurhofer et al., 1994; Weller et al., 2012), as DAPG itself can induce such a response (Iavicoli et al., 2003), all the more as certain *phl*<sup>+</sup> pseudomonads behave also as root endophytes (Troxler et al., 1997). This possibility is also raised because direct contact between *P. protegens* CHA0 and *T. basicola* on tobacco roots did not affect physical integrity of the fungal hyphae (Troxler et al., 1997). Second, this lack of correlation also suggests that the fungal pathogen does not interfere significantly with *phl*<sup>+</sup> *Pseudomonas* ecology, unlike in other pathosystems (Fedi et al., 1997; Duffy et al., 2003).

In conclusion, a *phlD*-based real-time PCR method was developed to quantify genetically-contrasted *phl*<sup>+</sup> *Pseudomonas* populations in a single assay, and this new method will be useful to monitor *phl*<sup>+</sup> pseudomonads in various soil conditions. It was used here to show that suppressiveness to Thielaviopsis black root rot in Morens soils does not require (i) levels of *phl*<sup>+</sup> pseudomonads higher than those in conducive soils or (ii) *T. basicola* inhibition in the rhizosphere. Results also point to the hypothesis that rhizosphere conditions are more favorable for DAPG synthesis in suppressive than in conducive soils, and further work will target this issue.

## Acknowledgement

We are grateful to farmers in Morens region for field access and information. This work was supported by the Ministère Français de la Recherche. We thank Denis Desbouchages (IFR 41, Université Lyon 1) for technical help, and Christoph Keel (Université de Lausanne, Switzerland) and Monika Maurhofer (ETH Zurich, Switzerland) for useful discussions. We are also grateful to Yvan Rahbé (BF2I, INSA de Lyon) for access to greenhouse equipment. This work made use of the DTAMB and Serre technical platforms of FR41 at Université Lyon 1.

## References

- Anzai, Y., Kim, H., Park, J.Y., Wakabayashi, H., Oyaizu, H., 2000. Phylogenetic affiliation of the pseudomonads based on 16S rRNA sequence. *International Journal of Systematic and Evolutionary Microbiology* 50, 1563-1589.
- Becker, J., Eisenhauer, N., Scheu, S., Jousset, A., 2012. Increasing antagonistic interactions cause bacterial communities to collapse at high diversity. *Ecology Letters* 15, 468-474.
- Bergsma-Vlami, M., Prins, M.E., Raaijmakers, J.M., 2005. Influence of plant species on population dynamics, genotypic diversity and antibiotic production in the rhizosphere by indigenous *Pseudomonas* spp. *FEMS Microbiology Ecology* 52, 59-69.

- Box, G.E.P., Cox, D.R., 1964. An analysis of transformation. *Journal of the Royal Statistical Society: Series B* 26, 211-252.
- Brazelton, J.N., Pfeufer, E.E., Sweat, T.A., McSpadden Gardener, B.B., Coenen, C., 2008. 2,4-diacetylphloroglucinol alters plant root development. *Molecular Plant-Microbe Interactions* 21, 1349-1358.
- Bustin, S.A., Benes, V., Garson, J.A., Hellemans, J., Huggett, J., Kubista, M., Mueller, R., Nolan, T., Pfaffl, M.W., Shipley, G.L., Vandesompele, J., Wittwer, C.T., 2009. The MIQE Guidelines: Minimum information for publication of quantitative real-time PCR experiments. *Clinical Chemistry* 55, 611-622.
- Carroll, H., Moënne-Loccoz, Y., Dowling, D.N., O’Gara, F., 1995. Mutational disruption of the biosynthesis genes coding for the antifungal metabolite 2,4-diacetylphloroglucinol does not influence the ecological fitness of *Pseudomonas fluorescens* F113 in the rhizosphere of sugarbeets. *Applied and Environmental Microbiology* 61, 3002-3007.
- Chapon, A., Guillerm, A.Y., Delalande, L., Lebreton, L., Sarniguet, A., 2002. Dominant colonisation of wheat roots by *Pseudomonas fluorescens* Pf29A and selection of the indigenous microflora in the presence of the take-all fungus. *European Journal of Plant Pathology* 108, 449-459.
- Chen, X.P., Zhu, Y.G., Xia, Y., Shen, J.P., He, J.Z., 2008. Ammonia-oxidizing archaea: important players in paddy rhizosphere soil? *Environmental Microbiology* 10, 1978-1987.
- Combes-Meynet, E., Pothier, J.F., Moënne-Loccoz, Y., Prigent-Combaret, C., 2011. The *Pseudomonas* secondary metabolite 2,4-diacetylphloroglucinol is a signal inducing rhizoplane expression of *Azospirillum* genes involved in plant-growth promotion. *Molecular Plant-Microbe Interactions* 24, 271-284.
- Couillerot, O., Prigent-Combaret, C., Caballero-Mellado, J., Moënne-Loccoz, Y., 2009. *Pseudomonas fluorescens* and closely-related fluorescent pseudomonads as biocontrol agents of soil-borne phytopathogens. *Letters in Applied Microbiology* 48, 505-512.
- Couillerot, O., Bouffaud, M.L., Baudoin, E., Muller, D., Caballero-Mellado, J., Moënne-Loccoz, Y., 2010. Development of a real-time PCR method to quantify the PGPR strain *Azospirillum lipoferum* CRT1 on maize seedlings. *Soil Biology & Biochemistry* 42, 2298-2305.
- De La Fuente, L., Mavrodi, D.V., Landa, B.B., Thomashow, L.S., Weller, D.M., 2006. *phlD*-based genetic diversity and detection of genotypes of 2,4-diacetylphloroglucinol-producing *Pseudomonas fluorescens*. *FEMS Microbiology Ecology* 56, 64-78.

- De Mendiburu, F., 2007. *Agricolae*: statistical procedures for agricultural research, R package version 1.0–9. <http://tarwi.lamolina.edu.pe/~fmendiburu>.
- Duffy, B., Schouten, A., Raaijmakers, J.M., 2003. Pathogen self-defense: mechanisms to counteract microbial antagonism. *Annual Review of Phytopathology* 41, 501-38.
- Fedi, S., Tola, E., Moëgne-Loccoz, Y., Dowling, D.N., Smith, L.M., O'Gara, F., 1997. Evidence for signaling between the phytopathogenic fungus *Pythium ultimum* and *Pseudomonas fluorescens* F113: *P. ultimum* represses the expression of genes in *P. fluorescens* F113, resulting in altered ecological fitness. *Applied and Environmental Microbiology* 63, 4261-4266.
- Fenton, A.M., Stephens, P.M., Crowley, J., O'Callaghan, M., O'Gara, F., 1992. Exploitation of gene(s) involved in 2,4-diacetylphloroglucinol biosynthesis to confer a new biocontrol capability to a *Pseudomonas* strain. *Applied and Environmental Microbiology* 58, 3873-3878.
- Fox, J., Weisberg, S., 2011. *An R Companion to Applied Regression*, Second Edition. SAGE Publications Inc., Thousand Oaks (CA).
- Frapolli, M., Défago, G., Moëgne-Loccoz, Y., 2007. Multilocus sequence analysis of biocontrol fluorescent *Pseudomonas* spp. producing the antifungal compound 2,4-diacetylphloroglucinol. *Environmental Microbiology* 9, 1939-1955.
- Frapolli, M., Moëgne-Loccoz, Y., Meyer, J., Défago, G., 2008. A new DGGE protocol targeting 2,4-diacetylphloroglucinol biosynthetic gene *phlD* from phylogenetically contrasted biocontrol pseudomonads for assessment of disease-suppressive soils. *FEMS Microbiology Ecology* 64, 468-481.
- Frapolli, M., Défago, G., Moëgne-Loccoz, Y., 2010. Denaturing gradient gel electrophoretic analysis of dominant 2,4-diacetylphloroglucinol biosynthetic *phlD* alleles in fluorescent *Pseudomonas* from soils suppressive or conducive to black root rot of tobacco. *Soil Biology & Biochemistry* 42, 649-656.
- Gasser, R., Défago, G., 1981. Case of the certain soils which are suppressive to the black root-rot of tobacco caused by *Thielaviopsis basicola*. *Botanica Helvetica* 91, 75-80.
- Griffiths, R.I., Whiteley, A.S., O'Donnell, A.G., Bailey, M.J., 2000. Rapid method for coextraction of DNA and RNA from natural environments for analysis of ribosomal DNA- and rRNA-based microbial community composition. *Applied and Environmental Microbiology* 66, 5488-5491.
- Haas, D., Keel, C., 2003. Regulation of antibiotic production in root-colonizing *Pseudomonas* spp. and relevance for biological control of plant disease. *Annual Review of Phytopathology* 41, 117-153.

- Haas, D., Défago, G., 2005. Biological control of soil-borne pathogens by fluorescent pseudomonads. *Nature Reviews Microbiology* 3, 307-319.
- Hall, T.A., 1999. BioEdit: a user-friendly biological sequence alignment editor and analysis program for Windows 95/98/NT. *Nucleic Acids Symposium Series* 41, 95-98.
- Hogg, A.C., Johnston, R.H., Dyer, A.T., 2007. Applying real-time quantitative PCR to Fusarium crown rot of wheat. *Plant Disease* 91, 1021-1028.
- Hood, M.E., Shew, H.D., 1997. Reassessment of the role of saprophytic activity in the ecology of *Thielaviopsis basicola*. *Phytopathology* 87, 1214-1219.
- Huang, J., Kang, Z., 2010. Detection of *Thielaviopsis basicola* in soil with real-time quantitative PCR assays. *Microbiological Research* 165, 411-417.
- Iavicoli, A., Boutet, E., Buchala, A., Métraux, J.P., 2003. Induced systemic resistance in *Arabidopsis thaliana* in response to root inoculation with *Pseudomonas fluorescens* CHA0. *Molecular Plant-Microbe Interactions* 16, 851-858.
- Ippolito, A., Schena, L., Nigro, F., Ligorio, V.S., Yaseen, T., 2004. Real-time detection of *Phytophthora nicotianae* and *P. citrophthora* in citrus roots and soil. *European Journal of Plant Pathology* 110, 833-843.
- Jamali, F., Sharifi-Tehrani, A., Lutz, M., Maurhofer, M., 2009. Influence of host plant genotype, presence of a pathogen, and coinoculation with *Pseudomonas fluorescens* strains on the rhizosphere expression of hydrogen cyanide- and 2,4-diacetylphloroglucinol biosynthetic genes in *P. fluorescens* biocontrol strain CHA0. *Microbial Ecology* 57, 267-275.
- Jensen, D.E., Kelly, R.C., Vonhippel, P.H., 1976. DNA "melting" proteins. II. Effects of bacteriophage T4 gene 32-protein binding on the conformation and stability of nucleic acid structures. *Journal of Biological Chemistry* 251, 7215-7228.
- Johnson, K.B, Dileone J.A., 1999. Effect of antibiosis on antagonist dose-plant disease response relationships for the biological control of crown gall of tomato and cherry. *Phytopathology* 89, 974-980.
- Keel, C., Schnider, U., Maurhofer, M., Voisard, C., Laville, J., Burger, U., Wirthner, P., Haas, D., Défago, G., 1992. Suppression of root diseases by *Pseudomonas fluorescens* CHA0: importance of the bacterial secondary metabolite 2,4-diacetylphloroglucinol. *Molecular Plant-Microbe Interactions* 5, 4-13.
- Keel, C., Weller, D.M., Natsch, A., Défago, G., Cook, R.J., Thomashow, L.S., 1996. Conservation of the 2,4-diacetylphloroglucinol biosynthesis locus among



- fluorescent *Pseudomonas* strains from diverse geographic locations. *Applied and Environmental Microbiology* 62: 552-563.
- Kimura, M., 1980. A simple method for estimating evolutionary rate of base substitutions through comparative studies of nucleotide sequences. *Journal of Molecular Evolution* 16, 111-120.
- King, E.O., Ward, M.K., Raney, D.E., 1954. Two simple media for the demonstration of pyocyanin and fluorescein. *Journal of Laboratory and Clinical Medicine* 44, 301-307.
- Kloepper, J.W., Beauchamp, C.J., 1992. A review of issues related to measuring colonization of plant roots by bacteria. *Canadian Journal of Microbiology* 38, 1219-1232.
- Kyselková, M., Kopecký, J., Frapolli, M., Défago, G., Ságová-Marečková, M., Grundmann, G.L., Moëgne-Loccoz, Y., 2009. Comparison of rhizobacterial community composition in soil suppressive or conducive to tobacco black root rot disease. *The ISME Journal* 3, 1127-1138.
- Kyselková, M., Moëgne-Loccoz, Y., 2012. *Pseudomonas* and other microbes in disease-suppressive soils. In: Lichtfouse, E. (Eds.), *Organic Fertilisation, Soil Quality and Human Health - Sustainable Agriculture Reviews* vol. 9. Springer, Dordrecht, Netherlands, pp. 93-140.
- Landa, B.B., Mavrodi, O.V., Raaijmakers, J.M., McSpadden Gardener, B.B., Thomashow, L.S., Weller, D.M., 2002. Differential ability of genotypes of 2,4-diacetylphloroglucinol-producing *Pseudomonas fluorescens* strains to colonize the roots of pea plants. *Applied and Environmental Microbiology* 68, 3226-3237.
- Larkin, R.P., Fravel, D.R., 1999. Mechanisms of action and dose-response relationships governing biological control of *Fusarium* wilt of tomato by nonpathogenic *Fusarium* spp. *Phytopathology* 89, 1152-1161.
- Lebreton, L., Gosme, M., Lucas, P., Guillerm-Erckelboudt, A.Y., Sarniguet, A., 2007. Linear relationship between *Gaeumannomyces graminis* var. *tritici* (Ggt) genotypic frequencies and disease severity on wheat roots in the field. *Environmental Microbiology* 9, 492-499.
- Le Roux, X., Poly, F., Currey, P., Commeaux, C., Hai, B., Nicol, G.W., Prosser, J.I., Schloter, M., Attard, E., Klumpp, K., 2008. Effects of aboveground grazing on coupling among nitrifier activity, abundance and community structure. *The ISME Journal* 2, 221-232.

- Lievens, B., Brouwer, M., Vanachter, A.C.R.C., Cammue, B.P.A., Thomma, B.P.H.J., 2006. Real-time PCR for detection and quantification of fungal and oomycete tomato pathogens in plant and soil samples. *Plant Science* 171, 155-165.
- Marschner, P., Crowley, D.E., 1996. Physiological activity of a bioluminescent *Pseudomonas fluorescens* (strain 2-79) in the rhizosphere of mycorrhizal and non-mycorrhizal pepper (*Capsicum annuum* L.). *Soil Biology & Biochemistry* 28, 869-876.
- Mamedov, T.G., Pienaar, E., Whitney, S.E., TerMaat, J.R., Carvill, G., Goliath, R., Subramanian, A., Viljoen, H.J., 2008. A fundamental study of the PCR amplification of GC-rich DNA templates. *Computational Biology and Chemistry* 32, 452-457.
- Maurhofer, M., Hase, C., Meuwly, P., Métraux, J.P., Défago, G., 1994. Induction of systemic resistance of tobacco to tobacco necrosis virus by the root-colonizing *Pseudomonas fluorescens* strain CHA0: Influence of the *gacA* gene and of pyoverdine production. *Phytopathology* 84, 139-146.
- Mavrodi, O.V., Mavrodi, D.V., Thomashow, L.S., Weller, D.M., 2007. Quantification of 2,4-diacetylphloroglucinol-producing *Pseudomonas fluorescens* strains in the plant rhizosphere by real-time PCR. *Applied and Environmental Microbiology* 73, 5531-5538.
- McSpadden Gardener, B.B., Weller, D.M., 2001. Changes in populations of rhizosphere bacteria associated with take-all disease of wheat. *Applied and Environmental Microbiology* 67, 4414-4425.
- McSpadden Gardener, B.B., Mavrodi, D.V., Thomashow, L.S., Weller, D.M., 2001. A rapid polymerase chain reaction-based assay characterizing rhizosphere populations of 2,4-diacetylphloroglucinol-producing bacteria. *Phytopathology* 91, 44-54.
- Meyer, J.B., Lutz, M.P., Frapolli, M., Péchy-Tarr, M., Rochat, L., Keel, C., Défago, G., Maurhofer, M., 2010. Interplay between wheat cultivars, biocontrol pseudomonads, and soil. *Applied and Environmental Microbiology* 76, 6196-6204.
- Moynihan, J.A., Morrissey, J.P., Coppoolse, E.R., Stiekema, W.J., O'Gara, F., Boyd, E.F., 2009. Evolutionary history of the *phl* gene cluster in the plant-associated bacterium *Pseudomonas fluorescens*. *Applied and Environmental Microbiology* 75, 2122-2131.
- Notz, R., Maurhofer, M., Schnider-Keel, U., Duffy, B., Haas, D., Défago, G., 2001. Biotic factors affecting expression of the 2,4-diacetylphloroglucinol biosynthesis gene *phlA* in *Pseudomonas fluorescens* biocontrol strain CHA0 in the rhizosphere. *Phytopathology* 91, 873-881.

- Paulsen, I.T., Press, C.M., Ravel, J., Kobayashi, D.Y., Myers, G.S., Mavrodi, D.V., DeBoy, R.T., Seshadri, R., Ren, Q., Madupu, R., Dodson, R.J., Durkin, A.S., Brinkac, L.M., Daugherty, S.C., Sullivan, S.A., Rosovitz, M.J., Gwinn, M.L., Zhou, L., Schneider, D.J., Cartinhour, S.W., Nelson, W.C., Weidman, J., Watkins, K., Tran, K., Khouri, H., Pierson, E.A., Pierson, L.S. 3rd, Thomashow, L.S., Loper, J.E., 2005. Complete genome sequence of the plant commensal *Pseudomonas fluorescens* Pf-5. *Nature Biotechnology* 23, 873-878.
- Phillips, D.A., Fox, T.C., King, M.D., Bhuvanewari, T.V., Teuber, L.R., 2004. Microbial products trigger amino acid exudation from plant roots. *Plant Physiology* 136, 2887-2894.
- Picard, C., Bosco, M., 2006. Heterozygosity drives maize hybrids to select elite 2,4-diacetylphloroglucinol-producing *Pseudomonas* strains among resident soil populations. *FEMS Microbiology Ecology* 58, 193-204.
- Raaijmakers, J.M., Weller, D.M., 1998. Natural plant protection by 2,4-diacetylphloroglucinol -producing *Pseudomonas* spp. in take-all decline soils. *Molecular Plant-Microbe Interactions* 11, 144-152.
- Raaijmakers, J.M., Paulitz, T.C., Steinberg, C., Alabouvette, C., Moënne-Loccoz, Y., 2009. The rhizosphere: a playground and battlefield for soilborne pathogens and beneficial microorganisms. *Plant and Soil* 321, 341-361.
- Ramette, A., Moënne-Loccoz, Y., Défago, G., 2003. Prevalence of fluorescent pseudomonads producing antifungal phloroglucinols and/or hydrogen cyanide in soils naturally suppressive or conducive to tobacco black root rot. *FEMS Microbiology Ecology* 44, 35-43.
- Ramette, A., Moënne-Loccoz, Y., Défago, G., 2006. Genetic diversity and biocontrol potential of fluorescent pseudomonads producing phloroglucinols and hydrogen cyanide from Swiss soils naturally suppressive or conducive to *Thielaviopsis basicola*-mediated black root rot of tobacco. *FEMS Microbiology Ecology* 55, 369-381.
- Ramette, A., Frapolli, M., Fischer-Le Saux, M., Gruffaz, C., Meyer, J.M., Défago, G., Sutra, L., Moënne-Loccoz, Y., 2011. *Pseudomonas protegens* sp nov., widespread plant-protecting bacteria producing the biocontrol compounds 2,4-diacetylphloroglucinol and pyoluteorin. *Systematic and Applied Microbiology* 34, 180-188.
- Rezzonico, F., Moënne-Loccoz, Y., Défago, G., 2003. Effect of stress on the ability of a *phlA*-based quantitative competitive PCR assay to monitor biocontrol strain *Pseudomonas fluorescens* CHA0. *Applied and Environmental Microbiology* 69, 686-690.

- Rotenberg, D., Joshi, R., Benitez, M.S., Gutierrez Chapin, L., Camp, A., Zumpetta, C., Osborne, A., Dick, W.A., McSpadden Gardener, B.B., 2007. Farm management effects on rhizosphere colonization by native populations of 2,4-diacetylphloroglucinol-producing *Pseudomonas* spp. and their contributions to crop health. *Phytopathology* 97, 756-766.
- Saitou, N., Nei, M., 1987. The neighbor-joining method: a new method for reconstructing phylogenetic trees. *Molecular Biology and Evolution* 4, 406-425.
- Sørensen, J., Jensen, L.E., Nybroe, O., 2001. Soil and rhizosphere as habitats for *Pseudomonas* inoculants: new knowledge on distribution, activity and physiological state derived from micro-scale and single-cell studies. *Plant and Soil* 232, 97-108.
- Stutz, E.W., Défago, G., Kern, H., 1986. Naturally-occurring fluorescent *Pseudomonas* involved in suppression of black root-rot of tobacco. *Phytopathology* 76, 181-185.
- Stutz, E.W., Kahr, G., Défago, G., 1989. Clays involved in suppression of tobacco black root-rot by a strain of *Pseudomonas fluorescens*. *Soil Biology & Biochemistry* 21, 361-366.
- Tamura, K., Dudley, J., Nei, M., Kumar, S., 2007. MEGA4: Molecular evolutionary genetics analysis (MEGA) software version 4.0. *Molecular Biology and Evolution* 24, 1596-1599.
- Thompson, J.D., Gibson, T.J., Plewniak, F., Jeanmougin, F., Higgins, D.G., 1997. The CLUSTAL\_X windows interface: flexible strategies for multiple sequence alignment aided by quality analysis tools. *Nucleic Acids Research* 25, 4876-4882.
- Troxler, J., Berling, C.H., MoënneLoccoz, Y., Keel, C., Défago, G., 1997. Interactions between the biocontrol agent *Pseudomonas fluorescens* CHA0 and *Thielaviopsis basicola* in tobacco roots observed by immunofluorescence microscopy. *Plant Pathology* 46, 62-71.
- Troxler, J., Svercel, M., Natsch, A., Zala, M., Keel, C., Moënne-Loccoz, Y., Défago, G., 2012. Persistence of a biocontrol *Pseudomonas* inoculant as high populations of culturable and non-culturable cells in 200-cm-deep soil profiles. *Soil Biology & Biochemistry* 44, 122-129.
- Vincent, M.N., Harrison, L.A., Brackin, J.M., Kovacevich, P.A., Mukerji, P., Weller, D.M., Pierson, E.A., 1991. Genetic analysis of the antifungal activity of a soilborne *Pseudomonas aureofaciens* strain. *Applied and Environmental Microbiology* 57, 2928-2934.
- von Felten, A., Meyer, J.B., Défago, G., Maurhofer, M., 2011. Novel T-RFLP method to investigate six main groups of 2,4-diacetylphloroglucinol-producing pseudomonads in environmental samples. *Journal of Microbiological Methods* 84, 379-387.

- Wang, C.X., Ramette, A., Punjasamarnwong, P., Zala, M., Natsch, A., Moënne-Loccoz, Y., Défago, G., 2001. Cosmopolitan distribution of *phlD*-containing dicotyledonous crop-associated biocontrol pseudomonads of worldwide origin. *FEMS Microbiology Ecology* 37, 105-116.
- Ward, E., 2009. Use of Molecular Methods for the Detection of Fungal Spores. In: Burns, R. (Eds.), *Plant Pathology: Techniques and Protocols*. Humana Press, New York (NY), pp. 147-159.
- Weller, D.M., Landa, B.B., Mavrodi, O.V., Schroeder, K.L., De La Fuente, L., Blouin Bankhead, S., Allende Molar, R., Bonsall, R.F., Mavrodi, D.V., Thomashow, L.S., 2007. Role of 2,4-diacetylphloroglucinol-producing fluorescent *Pseudomonas* spp. in the defense of plant roots. *Plant Biology* 9, 4-20.
- Weller, D.M., Mavrodi, D.V., van Pelt, J.A., Pieterse, C.M.J., van Loon, L.C., Bakker, P.A.H.M., 2012. Induced systemic resistance in *Arabidopsis thaliana* against *Pseudomonas syringae* pv. *tomato* by 2,4-diacetylphloroglucinol-producing *Pseudomonas fluorescens*. *Phytopathology* 102, 403-412.
- Zhang, T., Fang, H.H.P., 2006. Applications of real-time polymerase chain reaction for quantification of microorganisms in environmental samples. *Applied Microbiology and Biotechnology* 70, 281-289.

**Table S1.** Features and performance of *phlD* primer pairs.

Primer pair	Primer size (nt)	Primer Tm <sup>a</sup> (C°)	Secondary structures	$\Delta$ Tm <sup>b</sup> (C°)	Product size (bp)	Mismatches with <i>phlD</i> sequences <sup>c</sup>	Specific real-time amplification of <i>phlD</i> <sup>d</sup>	
							Strain genomic DNA	Rhizosphere DNA
B2BF / BPR4 <sup>e</sup>	25 / 26	65.4 / 63.4	None	2	629	3 / 3	Yes	Yes
B2BF / B2BR1	25 / 21	65.4 / 64.8	None	0.6	186	3 / 5	Yes	No
B2BF / B2BR2	25 / 25	65.4 / 66.2	None	0.8	358	3 / 4	Yes	No
<b>B2BF / B2BR3<sup>f</sup></b>	<b>25 / 25</b>	<b>65.4 / 64.6</b>	<b>None</b>	<b>0.8</b>	<b>319</b>	<b>3 / 3</b>	<b>Yes</b>	<b>Yes</b>
BPF1 / BPR4	25 / 26	63.5 / 63.4	None	0.1	118	3 / 3	Yes	No
BPF2 / BPR4	26 / 26	62.8 / 63.4	None	0.6	134	3 / 3	Yes	No

<sup>a</sup> Primer melting temperature (Tm) and secondary structures were determined using Oligo 6 (Molecular Biology Insights, West Cascade, CO) and the nearest-neighbor method (Saitou and Nei, 1987).

<sup>b</sup> Tm difference between primers.

<sup>c</sup> Maximum number of mismatches between each primer and the 334 *phlD* sequences available on February 2012 in the nr Nucleotide Sequence Database. <sup>d</sup> The ability of the primers to specifically amplify *phlD* from genomic DNA samples (using 6 ng of genomic DNA from eight *phlD*<sup>+</sup> strains indicated in Figure 1) or a complex environmental DNA sample (using 6 ng of rhizosphere DNA from 21-days tobacco grown in soil MS8) was assessed by real-time PCR.

<sup>d</sup> Primer pair B2BF/BPR4 (McSpadden Gardener et al., 2001) was discarded because of high Tm difference and high product size.

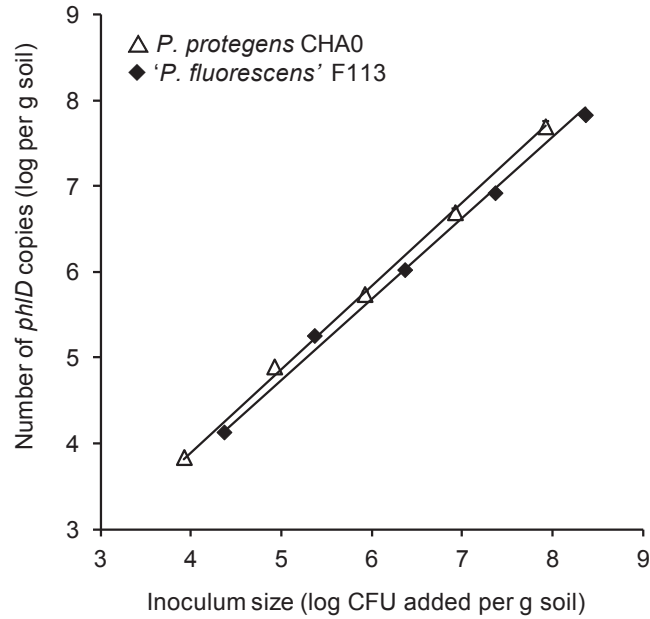
<sup>e</sup> Primer pair B2BF/B2BR3 was selected based on the six criteria (i) primer Tm between 60 - 67 °C, (ii) absence of secondary structures, (iii) Tm difference between primers ( $\Delta$  Tm) not exceeding 1 °C, (iv) an amplification product not exceeding 400 bp, (v) a maximum of 3 mismatches between each primer and the 334 *phlD* sequences available, and (vi) specific amplification of *phlD*. Primer pairs not meeting one or more of these criteria (grey boxes) were dismissed.

**Table S2.** Mean frequencies of the phylogenetic groups A-F of *phl*<sup>+</sup> pseudomonads (defined in Frapolli et al., 2007) detected by *phlD*-tRFLP in root and rhizosphere samples from *T. basicola*-inoculated (I) and non-inoculated (N) plants (2 per treatment) grown in the four soils for 7 (7D) or 21 days (21D).

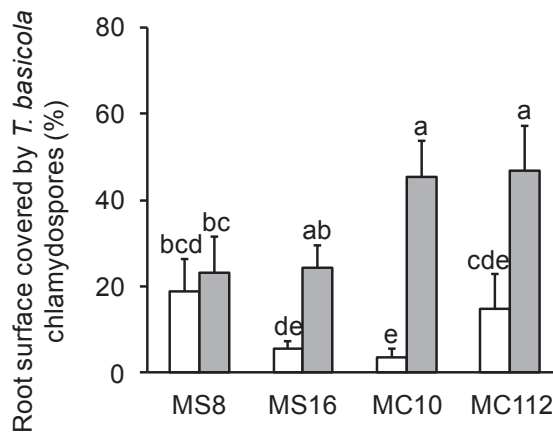
Phylogenetic group <sup>a</sup> and terminal fragment size	A (222 bp)	B (275 bp)	C (73 bp)	D (142 bp)	E (212 bp)	F (229 bp)
<b>Root samples</b>						
7D_MS8_N	0	1	0	1	0	0
7D_MS8_I	0	1	0	1	0	0
7D_MC112_N	0	1	0	1	0	0
7D_MC112_I	0.5	1	0	1	0	0
21D_MS8_N	0	1	0	0.5	0	0.5
21D_MS8_I	0.5	1	0	1	0	0
21D_MS16_N	0	1	0	1	0	0
21D_MS16_I	0.5	1	0	1	0	0
21D_MC10_N	1	0.5	0	1	0	0
21D_MC10_I	1	1	0	1	0	0
21D_MC112_N	0	1	0	1	0	0
21D_MC112_I	1	1	0	1	0	0
<b>Rhizosphere samples</b>						
7D_MS8_N	0	1	0	1	0	0
7D_MS8_I	0	1	0	0.5	0	0
7D_MC112_N	0	1	0	1	0	0
7D_MC112_I	0	1	0	1	0	0
21D_MS8_N	0	1	0	0	0	0
21D_MS8_I	0	1	0	0	0	0
21D_MS16_N	0	1	0	1	0	0
21D_MS16_I	0	1	0	1	0	0
21D_MC10_N <sup>b</sup>	0	0	0	0	0	0
21D_MC10_I	1	0	0	1	0	0
21D_MC112_N	0	1	0	1	0	0
21D_MC112_I	0	1	0	0.5	0	0

<sup>a</sup> Phylogenetic groups (Frapolli et al., 2007) associated to the terminal fragments detected. Phylogenetic group A corresponds to *phlD* genotypic cluster 5 (defined by Frapolli et al., 2008), B to clusters 1-4, C to cluster 7, D to cluster 6, E to cluster 8 and F to cluster 9.

<sup>b</sup> No *phlD* amplicon obtained in this treatment.

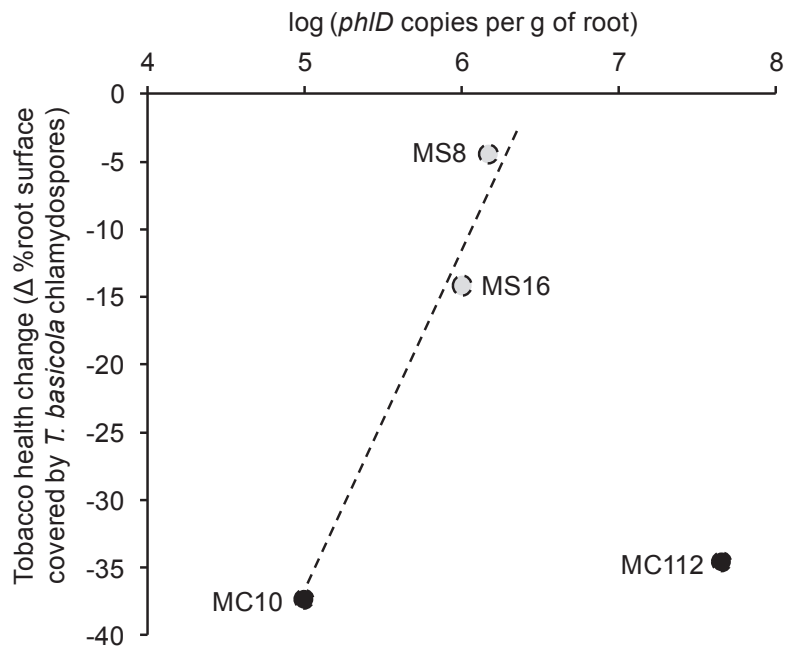


**Figure S1.** Relationship between numbers of inoculated *phlD*<sup>+</sup> *Pseudomonas* and *phlD* copies quantified by real-time PCR, in non-sterile bulk soil. Strains (CHA0 “△” or F113 “◆”) were inoculated singly at different CFU levels in soil from field MC10 and the mean *phlD* copy number from three replicates was plotted against added CFU level. Linear curves with slopes close to 1 were obtained for strain CHA0 ( $y = 0.95x + 0.13$ ,  $R^2 = 0.999$ ,  $P = 1.3 \times 10^{-5}$ ) and F113 ( $y = 0.91x + 0.27$ ,  $R^2 = 0.996$ ,  $P = 7.3 \times 10^{-5}$ ).



**Figure S2.** Impact of *T. basicola* inoculation on disease level of tobacco plants grown in the four suppressive/conducive soils. Disease level was recorded at 21 days after transplanting, using 8 plants inoculated with  $10^3$  *T. basicola* endoconidia per g of soil (grey bars) and 8 non-inoculated plants (white bars). Data shown are means and standard errors. Different letters above bars indicate a significant difference between treatments ( $P < 0.05$ ).





**Figure S3.** Relation between root density of *phl*<sup>+</sup> *Pseudomonas* and tobacco health change upon *T. basicola* inoculation. For each soil, disease level was recorded at 21 days after transplanting, using 8 plants inoculated with 10<sup>3</sup> *T. basicola* endoconidia per g of soil and 8 non-inoculated plants. Tobacco health change was then computed as % disease severity in non-inoculated plants - % disease severity in *T. basicola*-inoculated plants. A negative correlation ( $P < 0.05$ ) between tobacco health change and root density of *phl*<sup>+</sup> *Pseudomonas* is observed for soils MS8, MS16 and MC10 (dashed line), but this correlation is not significant when including soil MC112.

## CHAPITRE 2

Relation entre le niveau d'expression des  
gènes de synthèse du DAPG par les  
*Pseudomonas* et la résistance du sol à la  
maladie

## Introduction au chapitre 2

---

De manière conceptuelle, le phénomène de résistance du sol est attribuée à un effet microbien via la plante, (résistance induite par la monoculture), et/ou à un effet du sol sur la communauté microbienne (résistance naturelle) (Kinkel et al. 2011). Dans le deuxième cas, les argiles du sol ont parfois été identifiées comme contribuant au phénomène de résistance, sans que les mécanismes sous-jacents ne soient nécessairement compris (Stotzky et Torrence Martin 1963 ; Höper et al. 1995). La résistance des sols de Morens impliquerait une interaction entre les *Pseudomonas phl*<sup>+</sup> et les argiles du sol (Keel et al. 1989), qui sont différentes entre les sols résistants et sensibles (Stutz et al. 1989). Dans le chapitre 1 il a été conclu que la résistance de ces sols n'est pas expliquée uniquement par la densité des populations de *Pseudomonas phl*<sup>+</sup>, mais qu'elle dépendrait d'une plus forte expression de la fonction de synthèse du DAPG dans les sols résistants par rapport aux sols sensibles. Cette hypothèse correspond à un modèle de fonctionnement où la présence d'argile de type vermiculite dans les sols résistants se traduit par une plus forte biodisponibilité du fer pour les *Pseudomonas* dans la rhizosphère, induisant une plus forte expression de la fonction de synthèse du DAPG, ce qui expliquerait le niveau de phytoprotection dans les sols résistants (vermiculitiques).

Le fer est un élément essentiel pour la croissance des organismes principalement parce qu'il est utilisé en tant que cofacteur de plusieurs enzymes. Le fer disponible est présent généralement à de très basses concentrations (par exemple  $10^{-18}$  M dans un environnement aqueux à pH 7; Loper et Lindow 1994), l'écart entre cette concentration et la concentration nécessaire à la croissance des microorganismes ( $10^{-5}$  à  $10^{-7}$  M) augmentant avec le pH en raison de la précipitation d'oxydes de fer (Robin et al. 2008). Les organismes ont développé différentes stratégies pour pallier ce problème. Certaines plantes (principalement les dicotylédones) ont mis en place une stratégie visant à réduire le FeIII en FeII, pour ensuite internaliser le FeII. Une autre stratégie, observée chez les plantes (principalement les graminées) et les microorganismes, est la synthèse et sécrétion de composés chélateurs (sidérophores) piégeant le fer présent dans le milieu extracellulaire, et permettant ensuite l'internalisation du fer complexé (Lemanceau et al. 2009). Chez les *Pseudomonas*, cette fonction est assurée par plusieurs composés, comme l'acide salicylique (Maurhofer et al. 1998), les pyochelines et les pyoverdines (=

pseudobactines). Ces dernières sont un groupe de molécules fluorescentes avec une forte affinité pour le fer, partageant une structure chimique composée d'un chromophore (structure conservée) et d'un peptide à synthèse non ribosomique de composition variable (Ravel et Cornelis 2003 ; Visca et al. 2007). Leur constante de stabilité (environ  $10^{32}$ ) est supérieure à celle des chélateurs chimiques EDTA ( $10^{25}$ ) et EDDHA ( $10^{33}$ ) et de sidérophores fongiques comme la fusarine ( $10^{29}$ ) (Scher et Baker 1982). De plus, il a été montré que *P. protegens* CHA0 est capable d'extraire du fer soluble à partir de particules de vermiculite en les altérant (Müller 2009). Les gènes de synthèse des pyoverdines (*pvd*) sont régulés par le fer et leur expression a été proposée comme étant un bon indicateur de la biodisponibilité du fer dans le milieu pour les *Pseudomonas* (Loper et Henkel 1997). Le dosage chimique du fer total reste un indicateur insuffisant de la biodisponibilité du fer. La souche *P. protegens* Pf-5 *pvd-inaZ* a été développée pour être bioindicatrice de la biodisponibilité du fer pour les *Pseudomonas*. Elle a été construite en fusionnant le promoteur des gènes *pvd* et le gène rapporteur *inaZ* codant une protéine de nucléation de la glace de *P. syringae* (Loper et Lindow 1994).

En plus de son effet sur l'expression des gènes *pvd*, la carence fer diminue la croissance des *Pseudomonas* et a un effet général sur leur physiologie. Dans une étude récente, Lim et al. (2012a) ont employé une approche de transcriptomique combinée à de la protéomique afin d'étudier l'effet de la carence en fer en milieu liquide sur *P. protegens* (*Pseudomonas fluorescens* Pf-5). Les auteurs ont montré que la carence en fer régulait l'expression de 180 gènes, et réprimait la mobilité cellulaire, et particulièrement, réprimait la l'expression des gènes de synthèse du DAPG (*phl* ; Lim et al. 2012a). L'effet du fer sur l'expression des gènes *phl* n'a jamais été étudié dans un milieu complexe comme la rhizosphère, alors qu'il y a plusieurs publications sur l'expression des gènes *phl* sur les racines des plantes (de Werra et al. 2008 ; Jamali et al. 2009 ; Rochat et al. 2010). L'expression de ces gènes n'a jamais été étudiée chez des populations indigènes non plus, ce qui reflète probablement les contraintes techniques associées à ce milieu très complexe.

L'étude de l'expression des fonctions bactériennes dans la rhizosphère peut se faire en quantifiant le composé final, la protéine d'intérêt ou le niveau d'expression du gène d'intérêt (transcription). La quantification du composé est limitée par le seuil de détection; pour le DAPG environ 50 g de rhizosphère (soit de l'ordre de 50 plantes) sont

nécessaires pour que le composé soit détectable à une concentration de l'ordre de 50 ng/g (Bergsma-Vlami et al. 2005). La méthode la plus utilisée est la quantification du niveau d'expression du gène, qui peut se faire en quantifiant les transcrits du gène (ARNm), ou en utilisant une fusion transcriptionnelle du promoteur avec un gène rapporteur, c'est-à-dire codant une protéine avec une activité facilement détectable (système rapporteur). La quantification des transcrits bactériens dans la rhizosphère, et plus largement dans le sol, se fait généralement par PCR quantitative après rétro-transcription des ARNm (RT PCR quantitative), mais cette approche est limitée par les possibilités d'extraction des ARN du sol (on estime que seulement 3% sont extraits ; Nicolaisen et al. 2008), et par la présence de substances inhibant la rétro-transcriptase. Alternativement, les systèmes rapporteurs sont beaucoup utilisés pour étudier l'expression de gènes bactériens, et particulièrement, des gènes de synthèse d'antimicrobiens, dans la rhizosphère (de Werra et al. 2008 ; Jamali et al. 2009 ; Rochat et al. 2010). Parmi les protéines rapportrices les plus utilisées, il y a LacZ (activité  $\beta$ -galactosidase), InaZ (nucléation de la glace) et Gfp (fluorescence verte). Le système InaZ est très intéressant pour la limite de détection basse associée à l'activité de nucléation de la glace ( $10^5$  fois plus basse que celle de la  $\beta$ -galactosidase ; Lindow 1995). Le système Gfp nécessite quant à lui une détection par microscopie, mais présente l'avantage d'informer à la fois sur le niveau et sur la location de l'expression du gène. Ces deux approches pour étudier le niveau d'expression des gènes, c'est-à-dire les approches directe (quantification des ARNm) et indirecte (système rapporteur), ne donnent pas le même type d'information (Taniguchi et al. 2010). Les ARNm ont une durée de vie de quelques minutes alors qu'une protéine rapportrice comme la Gfp a une durée de vie d'au moins un jour (Andersen et al. 1998). Ceci veut dire que les systèmes rapporteurs nous informent sur l'expression cumulée pendant au moins un jour, tandis que les ARNm nous informent sur le niveau d'expression (presque) instantané.

L'étude de l'expression de gènes bactériens dans la rhizosphère peut être facilitée en simplifiant le système expérimental, notamment en éliminant les microorganismes indigènes ou les matières organiques notamment humiques. La complexité d'un système en sol naturel peut ainsi être diminuée en utilisant un sol stérilisé, ou en utilisant un sol artificiel dépourvu de matières organiques.

Notre objectif dans cette partie du projet de thèse était de déterminer si la résistance du sol est liée au niveau d'expression de la fonction de synthèse de DAPG. Cet objectif a été poursuivi en évaluant le lien entre la minéralogie des argiles, la biodisponibilité du fer pour les *Pseudomonas* dans la rhizosphère, le niveau d'expression des gènes *phl* sur les racines, et le niveau de phytoprotection du tabac, en utilisant des souches modèles ainsi qu'un sol résistant (vermiculitique) et un sol sensible (illitique). Cette étude supposait un contrôle total de la minéralogie des argiles dans les sols utilisés pour avoir des systèmes expérimentaux tranchés, avec les argiles prédominantes en concentrations équivalentes dans les deux sols et l'absence d'argiles minoritaires. Ceci étant impossible en sol naturel, on a utilisé des sols artificiels reproduisant la texture et les principales caractéristiques minéralogiques des argiles des sols de Morens.

L'étude des souches de *P. protegens* rapportrices de la biodisponibilité du fer et de l'expression des gènes *phl* dans la rhizosphère du tabac a montré une plus forte biodisponibilité du fer pour les *Pseudomonas* et une plus forte expression des gènes *phl* dans le sol résistant (vermiculitique) que dans le sol sensible (illitique). Cette étude a été poursuivie en sol naturel, avec les *Pseudomonas* indigènes, mais les limites techniques ont empêché la quantification de l'expression des gènes *phl* dans ces conditions.



**Effect of clay mineralogy on iron bioavailability and rhizosphere transcription of 2,4-diacetylphloroglucinol biosynthetic genes in biocontrol *Pseudomonas protegens***

Juliana Almario<sup>1,2,3</sup>, Claire Prigent-Combaret<sup>1,2,3</sup>, Daniel Muller<sup>1,2,3</sup>, Yvan Moënne-Loccoz<sup>1,2,3</sup>

<sup>1</sup>Université de Lyon, F-69622, Lyon, France

<sup>2</sup>Université Lyon 1, Villeurbanne, France

<sup>3</sup>CNRS, UMR5557, Ecologie Microbienne, Villeurbanne, France

Corresponding author: Y. Moënne-Loccoz; Telephone: +33 (0) 4 72 43 13 49;

Fax : +33 (0) 4 72 43 12 23; E-mail: [yvan.moenne-loccoz@univ-lyon1.fr](mailto:yvan.moenne-loccoz@univ-lyon1.fr)

Journal : Molecular Plant-Microbe Interactions (submitted)



## Abstract

*Pseudomonas* strains producing 2,4-diacetylphloroglucinol (DAPG) can protect plants from soil-borne phytopathogens and are considered the primary reason for suppressiveness of morainic Swiss soils to *Thielaviopsis basicola*-mediated black root-rot disease of tobacco, even though they also occur nearby in conducive sandstone soils. The underlying molecular mechanism(s) accounting for this discrepancy are not understood. In this study, we assessed the hypothesis that the presence of iron-rich vermiculite clay (dominant in suppressive soils) instead of illite (dominant in neighboring conducive soils) translates into higher levels of iron bioavailability and transcription of *Pseudomonas* DAPG synthetic genes in the tobacco rhizosphere. Rhizosphere monitoring of reporter gene systems *pvd-inaZ* and *phlA-gfp* in *Pseudomonas protegens* respectively indicated that the level of iron bioavailability and the number of cells expressing *phl* genes (DAPG synthesis) were higher in vermiculitic than in illitic artificial soils. This was in accordance with the effect of iron on *phlA-gfp* expression in vitro, and indeed iron addition to the illitic soil increased the number of cells expressing *phlA-gfp*. Similar findings were made in presence of the pathogen *T. basicola*. Altogether, results substantiate the hypothesis that iron-releasing minerals may confer disease suppressiveness by modulating iron bioavailability in the rhizosphere and expression of biocontrol-relevant genes in antagonistic *P. protegens*.

## Introduction

Many plant growth-promoting rhizobacteria have positive effects on plant health, which may take place via different modes of action noticeably induced systemic resistance and phytopathogen inhibition mediated by competition or antagonism mechanisms (Haas and Défago 2005; Raaijmakers et al. 2009). Antimicrobial secondary metabolites often play a key role in these plant-protection effects, especially the *Pseudomonas* compound 2,4-diacetylphloroglucinol (DAPG), which can both induce systemic resistance (Iavicoli et al. 2003; Weller et al. 2012) and inhibit various root pathogens (Couillerot et al. 2009; Haas and Défago 2005). DAPG can also trigger gene expression of phytobeneficial functions in neighboring plant-protecting bacteria and fungi (Baehler et al. 2005; Combes-Meynet et al. 2011; Lutz et al. 2004).

Soil-borne populations of DAPG-producing fluorescent *Pseudomonas* spp. are implicated in the natural suppressiveness of certain soils towards particular fungal phytopathogens (Kyselková and Moëne-Loccoz 2012), such as *Gaeumannomyces graminis* var. *tritici* (take-all of wheat; Weller et al. 2007), *Fusarium oxysporum* f. sp. *pisi* (Fusarium wilt of pea; Landa et al. 2002) and *Thielaviopsis basicola* (black root-rot of tobacco; Frapolli et al. 2010). Soils specifically suppressive to black root rot of tobacco (and other crops) are mainly documented in the region of Morens (Switzerland). At Morens, disease suppressiveness is a microbial property of the soil (Stutz et al. 1986) involving DAPG-producing pseudomonads (Haas and Défago 2005), and mutational inactivation of DAPG production ability in the Morens isolate *P. protegens* CHA0 abolished its ability to suppress black root rot (Keel et al. 1992).

Morens soils are of particular interest from a molecular plant-microbe interaction standpoint, because in that region conducive soils (formed from sandstone sediments) also occur, in the vicinity of suppressive soils formed from glacier's shallow morainic deposits overlying the sandstone (Stutz et al. 1985). Yet, both types of soil belong to the same brunisol category and are chemically similar, except for the predominance of iron-releasing vermiculite clay in suppressive soils versus illite clay in conducive soils (Stutz et al. 1989). This led to the hypothesis (Almario et al. 2013; Ramette et al. 2003) that iron released from vermiculite triggers transcription of *Pseudomonas* DAPG synthetic genes in suppressive soils to levels higher than those in conducive soils, where DAPG-producing *Pseudomonas* populations are also present at high levels (Frapolli et al. 2010;

Almario et al. 2013), but where iron availability is supposedly lower (Keel et al. 1989; Voisard et al. 1989). Indeed, *P. protegens* CHA0 can retrieve iron from vermiculite (Müller 2009). Earlier work with artificial soils mimicking texture and clay mineralogy of Morens suppressive (vermiculitic) and conducive (illitic) soils did show that (i) total and soluble iron contents (Keel et al. 1989) and (ii) plant protection by *P. protegens* CHA0 (Keel et al. 1989) and other DAPG-producing pseudomonads (Ramette et al. 2006) were higher in vermiculite-rich than in illite-rich soils, but whether or not iron bioavailability for pseudomonads and transcription of *Pseudomonas* DAPG synthetic genes in the rhizosphere were higher in presence of vermiculite has not been assessed so far.

Under soil-less laboratory conditions, root expression of *Pseudomonas* DAPG synthetic genes (*phlACBDE* operon) is influenced by biotic factors such as plant species, plant cultivar, pathogen presence and plant health (de Werra et al. 2008; Jamali et al. 2009; Jousset et al. 2011; Rochat et al. 2010). Abiotic factors such as Zn, Mo and Fe concentrations can also modulate DAPG production in *Pseudomonas* depending on culture medium conditions (Dowling et al. 1996; Duffy and Défago 1999). Recently, Lim et al. (2012) showed that iron had a strong impact on the transcriptome and proteome of the DAPG producer *P. protegens* Pf-5 in minimum medium, and in particular iron induced expression of DAPG synthetic genes *in vitro*.

The objective of this study was to assess the hypothesis that iron bioavailability for pseudomonads and transcription of *Pseudomonas* DAPG synthetic genes in the tobacco rhizosphere are higher in presence of vermiculite than illite, which are the dominant clay types in soils suppressive and conducive (respectively) to *Thielaviopsis* black root rot. To this end, the artificial vermiculitic and illitic soils of Keel et al. (1989) were used, along with a mechanistic approach based on expression analysis of reporter gene systems *pvd-inaZ* (iron availability) and *phlA-gfp* (transcription of DAPG synthetic genes) on rhizosphere-stable plasmids (e.g. Rochat et al. 2010), which was complemented by real-time RT PCR analysis of *phlA-gfp* transcription in DAPG-producing *P. protegens*.

## Results

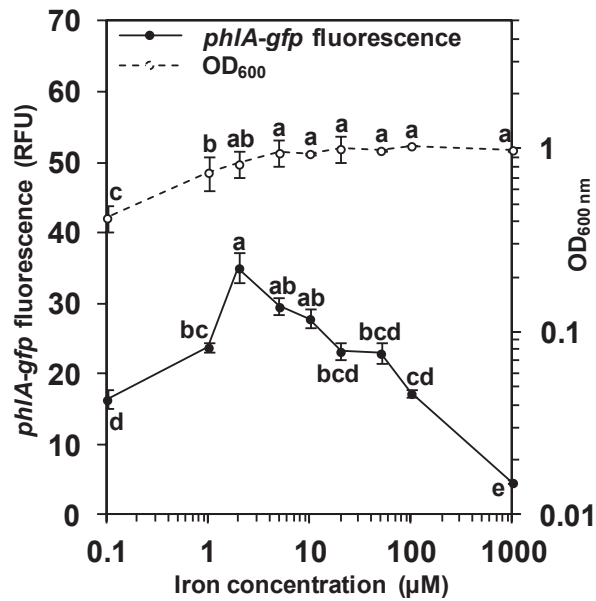
### ***Effect of bioavailable iron on cell density and *phlA-gfp* expression of *P. protegens* in vitro.***

Increasing the *in vitro* iron concentration up to 5  $\mu\text{M}$  FeEDDHA, a chelated iron form bioavailable to *Pseudomonas* (Keel et al. 1989), enhanced cell density (estimated by OD<sub>600</sub> values at 38 h; Fig. 1) of *P. protegens* CHA0(*attTn7::miniTn7-Gm-P<sub>tac</sub>-mcherry*; pME7100), in which a plasmid-borne copy of the DAPG synthesis promoter *phlA* is fused to the promoterless reporter gene *gfp* (Rochat et al. 2010). This strain is hereafter referred to as CHA0-*mche*(pME7100), based on Rochat et al. (2010). Additional increases of FeEDDHA concentration did not enhance cell density of the strain any further.

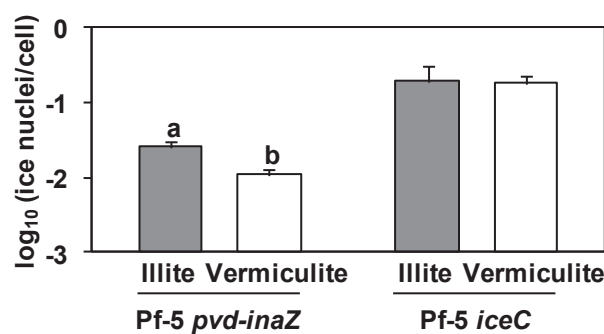
Bioavailable iron also modulated the number of GFP<sup>+</sup> cells (i.e. cells accumulating GFP following expression of the *phlA-gfp* fusion) *in vitro*, with a maximum relative green fluorescence (RFU) level at 2  $\mu\text{M}$  FeEDDHA (Fig. 1). Lower and higher iron concentrations resulted in lower RFU levels, indicating a maximal activity of the *phlA* promoter at 2  $\mu\text{M}$  FeEDDHA *in vitro*. Similar results were found at a later sampling (42 h) and/or when repeating the experiment (not shown).

### ***Effect of clay mineralogy on iron bioavailability for *P. protegens* on roots in artificial soil.***

Ice nucleation activity of the iron-biosensor strain *P. protegens* Pf-5 *pvd-inaZ*, in which the iron-regulated promoter *pvd* is fused to the promoterless ice nucleation reporter gene *inaZ* (Loper and Lindow 1994), was lower (- 57%;  $P = 0.008$ ) at 7 days in tobacco rhizosphere samples from vermiculitic than illitic artificial soil (Fig. 2). Similar findings were made at other samplings (3 and 21 days; Fig. S1). This means that rhizosphere bioavailability of iron for *P. protegens* was comparatively higher in the vermiculitic soil, and indeed it was estimated at 3.0  $\mu\text{M}$  Fe in the vermiculitic soil versus only 0.8  $\mu\text{M}$  in the illitic soil, based on data in Fig. 2 and an *in vitro* standard curve (Fig. S2). The ice nucleation activity of the positive control strain Pf-5 *iceC* was comparable in both types of soil (Fig. 2 and S1).



**Fig. 1.** Effect of iron concentration (from 0.1 to 1000  $\mu\text{M}$  FeEDDHA) on cell density and GFP fluorescence levels of *P. protegens* CHA0-*mche*(pME7100) at 38 h (early stationary phase) in OSGly liquid medium. Cell density ( $\text{OD}_{600}$ ) is shown with white symbols and dashed lines, and green fluorescence emission (RFU) with black symbols and solid lines. Means and standard errors are represented ( $n = 6$ ). For each type of measurement, statistical relations between iron concentrations are shown using letters a-e (ANOVA and Fisher's LSD tests;  $P < 0.05$ ). Similar results were obtained when measurements were taken at 42 h. The experiment was run on two other occasions, with measurements taken at 38 and 42 h, and similar results were obtained in all cases.



**Fig. 2.** Effect of clay mineralogy on ice nucleation activity of the iron biosensor strain *P. protegens* Pf-5 *pvd-inaZ* and the positive control strain Pf-5 *iceC* in the tobacco rhizosphere at 7 days after transplanting of bacteria-inoculated seedlings in artificial vermiculitic (white bars) or illitic soil (grey bars). Ice nucleation activity was computed as the number of ice nuclei per cell (means  $\pm$  standard errors;  $n = 6$  plants). Ice nucleation activity of the positive control strain Pf-5 *iceC* was the same in both soils, as expected. The experiment was done twice (each time with 3 plants per treatment) with similar results, and results were pooled. For each strain, statistical differences between soils are shown using letters a and b (Student's *t* tests;  $P < 0.05$ ).

***Effect of clay mineralogy on cell density and *phlA-gfp* expression of *P. protegens* on roots in artificial soil in absence of *T. basicola*.***

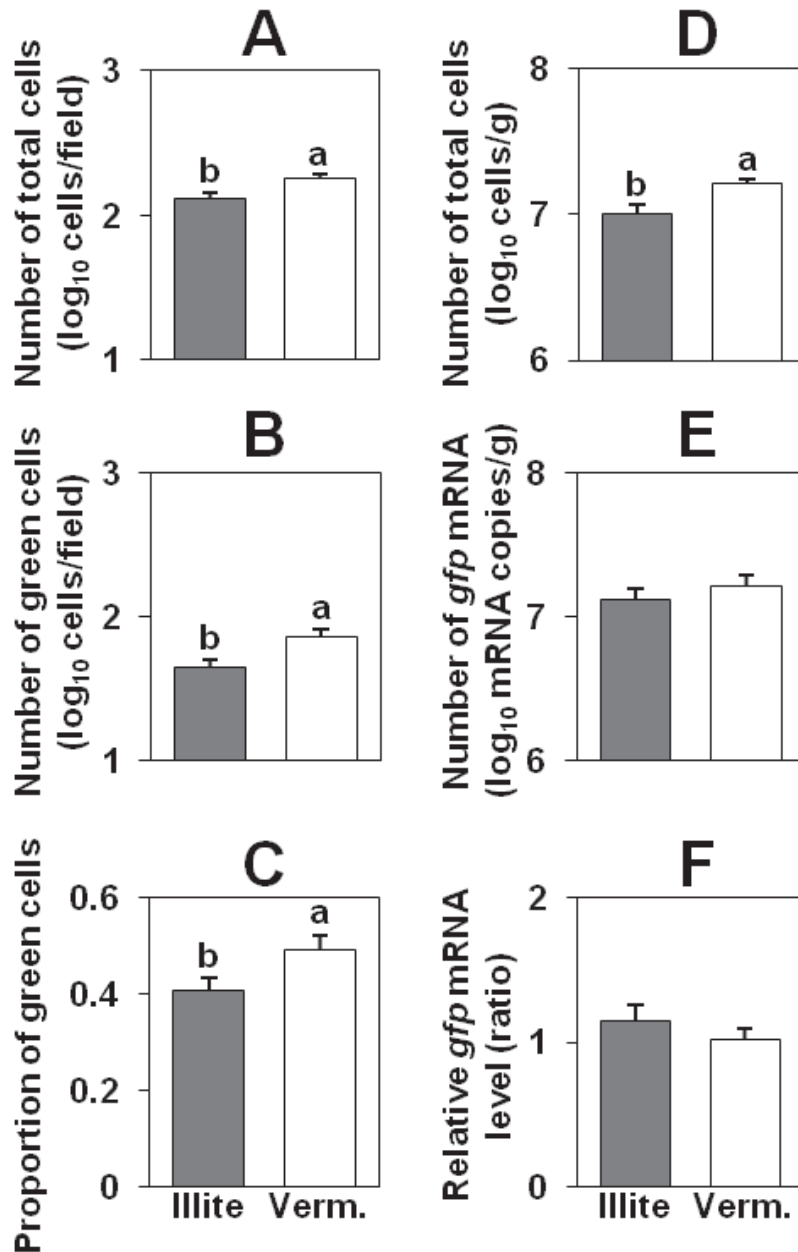
Seven days after root inoculation of *P. protegens* CHA0-*mche*(pME7100) in the absence of *T. basicola*, the number of inoculant cells on tobacco roots was higher in the vermiculitic than the illitic soil, both by microscopy analysis (+ 35% number of total cells/field,  $P = 0.007$ ; Fig. 3A) and real-time PCR analysis (+ 59%,  $P = 0.006$ ; Fig. 3D).

When expression of the *phlA-gfp* fusion was assessed at 7 days on tobacco roots in the absence of *T. basicola*, on one hand the number of GFP<sup>+</sup> inoculant cells (i.e. green cells) was higher (+ 63%,  $P = 0.002$ ) in the vermiculitic than the illitic soil (Fig 3B). This resulted from a higher number of root-colonizing cells (see above) as well as a higher proportion of GFP<sup>+</sup> cells in the vermiculitic soil (+ 21%,  $P = 0.036$ ; Fig 3C). On the other hand, real-time PCR analysis of *phlA-gfp* expression on tobacco roots gave comparable *gfp* mRNA (Fig. 3E) and relative *gfp* mRNA levels (i.e. *gfp* mRNA/cell ratio; Fig. 3F) in both soils.

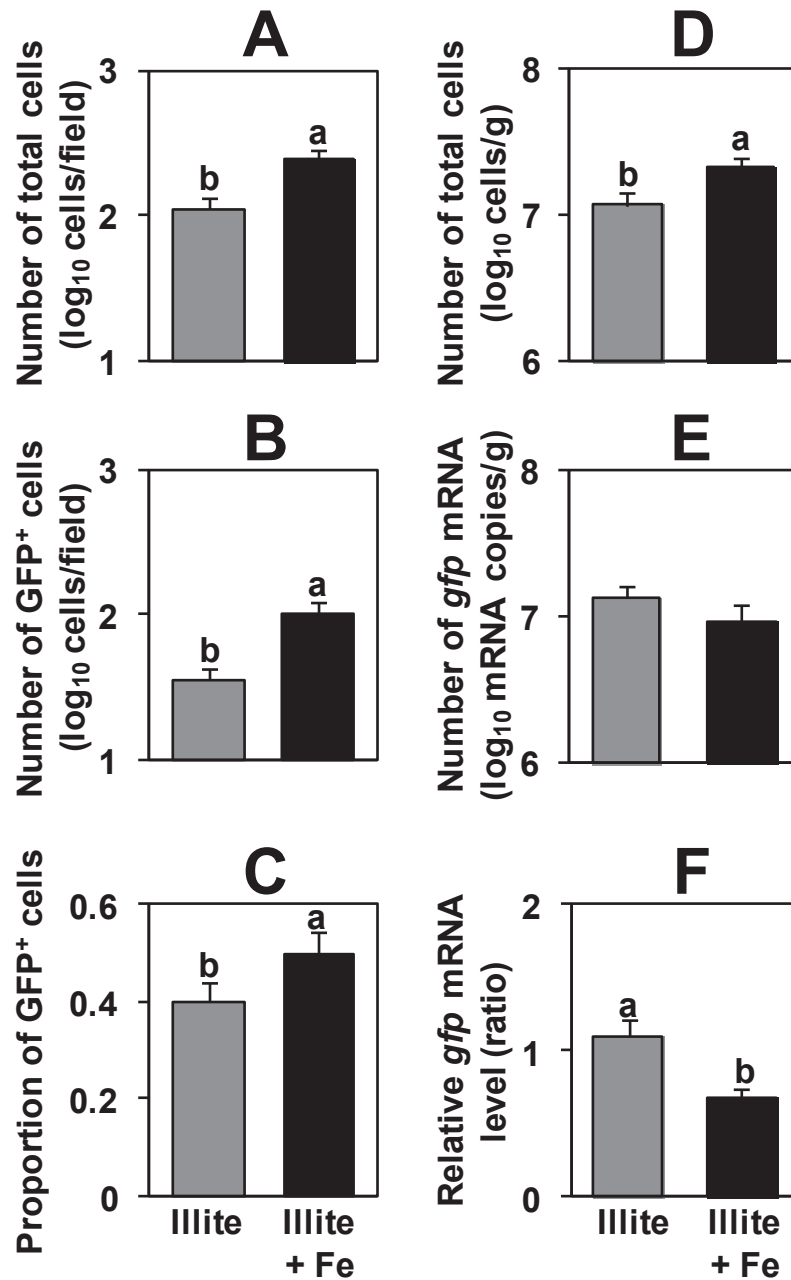
***Effect of iron addition on cell density and *phlA-gfp* expression of *P. protegens* on roots in artificial illitic soil.***

Whether, in illitic soil, low iron bioavailability in the tobacco rhizosphere was limiting for *phlA-gfp* expression in root-colonizing *P. protegens* was assessed using iron supplementation (2.4 mM FeEDDHA). As expected, this enhanced the level of bioavailable iron, as indicated by a lower ice nucleation activity ( $P < 0.001$ ) of the iron biosensor strain *P. protegens* Pf-5 *pvd-inaZ* at 7 days, i.e.  $-4.4 \pm 0.23$  log [ice nuclei/cell] versus only  $-1.6 \pm 0.09$  log [ice nuclei/cell] in the non-amended illitic soil (corresponding to respectively 8 and 0.8  $\mu$ M bioavailable Fe, estimated using an *in vitro* standard curve; Fig. S2). Iron supplementation resulted in enhanced root colonization of tobacco roots by *P. protegens* CHA0-*mche*(pME7100) at 7 days in illitic soil, based on higher total microscopy count of inoculant cells colonizing tobacco roots (+ 119%,  $P < 0.001$ ; Fig. 4A) and higher real-time PCR number of inoculant cells (+ 78%,  $P = 0.026$ ; Fig. 4D).

The number of GFP<sup>+</sup> cells of *P. protegens* CHA0-*mche*(pME7100) on tobacco roots (i.e. green cells/field) at 7 days was higher following iron supplementation (+ 190%,  $P < 0.001$ ; Fig. 4B). This resulted from a higher number of root-colonizing cells (see above) as well as a higher proportion (+ 25%,  $P = 0.003$ ; Fig 4C) of GFP<sup>+</sup> cells (i.e. proportion of green cells). Real-time PCR analysis of *phlA-gfp* expression on tobacco



**Fig. 3.** Effect of clay mineralogy on cell density and *phlA-gfp* expression of *P. protegens* CHA0-*mche*(pME7100) in the tobacco rhizosphere at 7 days after transplanting of bacteria-inoculated seedlings in artificial vermiculitic (verm.; white bars) or illitic soil (illite; grey bars), in the absence of *T. basicola* inoculation. **A, B, and C**, Confocal laser scanning microscopy analysis of tobacco roots. Two experiments were conducted (giving similar results), each consisting of 3 plants per treatment and 10 confocal fields ( $0.22 \times 0.22 \times 1 \mu\text{m}$ ) per plant. Pooled results from the two experiments are presented ( $n = 60$  fields). For each field, the proportion of green cells (GFP<sup>+</sup>) was calculated by dividing the number of green cells by the total number of fluorescent cells. **D, E, and F**, Real-time PCR analysis of tobacco roots. One of the experiments above was used, with 5 plants per treatment ( $n = 5$ ). For each plant, the relative *gfp* mRNA level was calculated by dividing the number of *gfp* mRNA copies by the number of cells. In each of the six panels, means and standard errors are shown. Statistical differences between soils are shown using letters a and b (Student's *t* tests;  $P < 0.05$ ).



**Fig. 4.** Effect of iron addition (2.4 mM FeEDDHA) on cell density and *phlA-gfp* expression of *P. protegens* CHA0-*mche*(pME7100) in the tobacco rhizosphere at 7 days after transplanting of bacteria-inoculated seedlings in artificial illitic soil. **A, B, and C**, Confocal laser scanning microscopy analysis of tobacco roots. Two experiments were conducted (giving similar results), each consisting of 3 plants per treatment and 10 confocal fields ( $0.22 \times 0.22 \times 1 \mu\text{m}$ ) per plant. Pooled results from the two experiments are presented ( $n = 60$  fields). For each field, the proportion of green cells (GFP<sup>+</sup>) was calculated by dividing the number of green cells by the total number of fluorescent cells. **D, E, and F**, Real-time PCR analysis of tobacco roots. One of the experiments above was used, with 5 plants per treatment ( $n = 5$ ). For each plant, the relative *gfp* mRNA level was calculated by dividing the number of *gfp* mRNA copies by the number of cells. In each of the six panels, means and standard errors are shown. Statistical differences between iron-amended (black bars) and non-amended soil (grey bars) are shown using letters a and b (Student's *t* tests;  $P < 0.05$ ).



roots showed that iron supplementation had no effect on *gfp* mRNA levels (Fig. 4E) but lowered relative *gfp* mRNA levels (*gfp* mRNA/cell ratio) (- 62%,  $P = 0.006$ ; Fig. 4F).

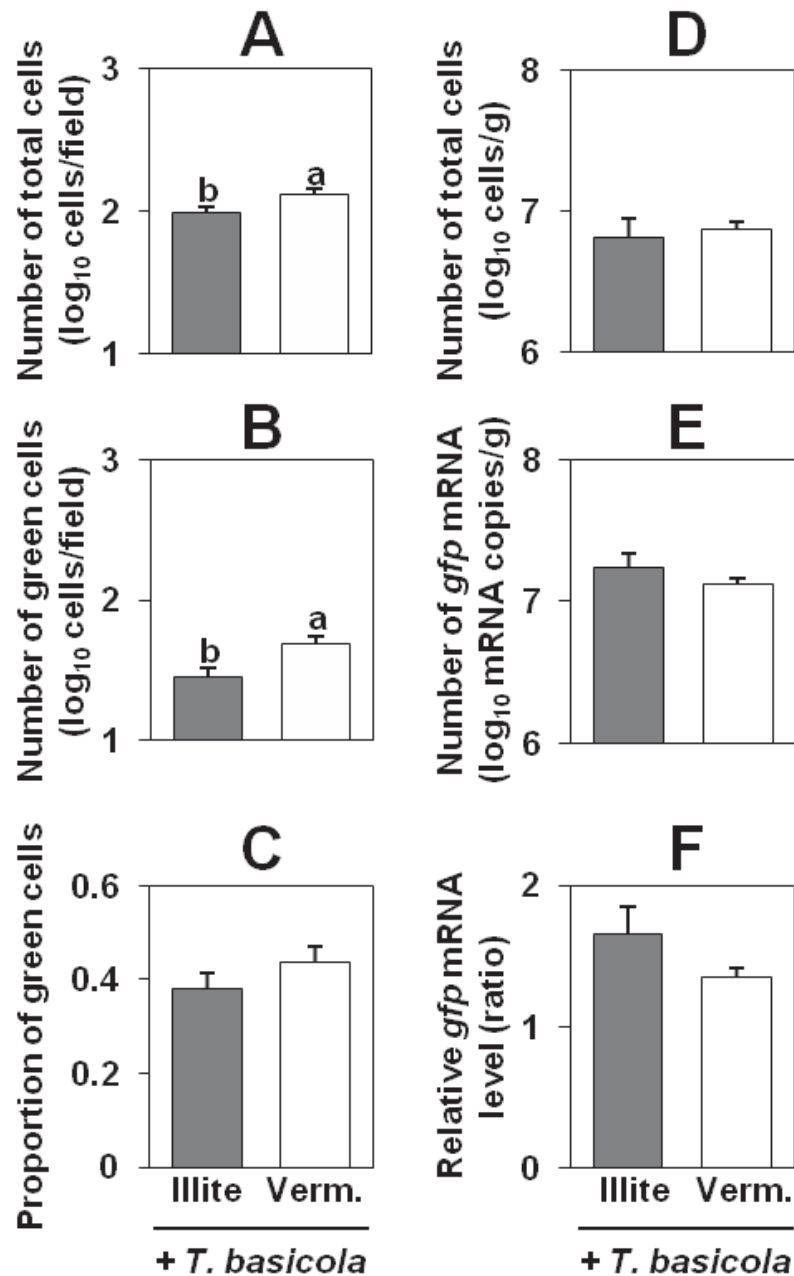
***Effect of clay mineralogy on cell density and *phlA-gfp* expression of *P. protegens* on roots in artificial soil in presence of *T. basicola*.***

When system complexity was increased by introducing the phytopathogenic partner, it was important to verify that the genetic modifications done to *P. protegens* CHA0 had not abolished its ability to control black root rot. In the absence of bacterial inoculation, comparable black-root rot severity (i.e. percentage of root surface covered by *T. basicola* chlamydospores) was observed at 27 days in the vermiculitic ( $23.9 \pm 9.1$  %) and the illitic ( $22.7 \pm 9.0$  %) artificial soil. In both soils, inoculation of *P. protegens* CHA0-*mche*(pME7100) resulted in lower black root-rot severity, but disease severity in the illitic soil ( $16.9 \pm 2.8$  %) remained two fold higher than in the vermiculitic soil ( $8.1 \pm 3.7$  %;  $P = 0.040$ ), as found with wild-type *P. protegens* CHA0 (Keel et al. 1989).

In OSGly minimal medium (Baehler et al. 2005), which contains 20  $\mu\text{M}$  FeEDDHA, *T. basicola* had no effect on cell density and *phlA-gfp* expression of *P. protegens* CHA0-*mche*(pME7100) (data not shown). This was observed irrespective of *T. basicola* inoculation level in the medium ( $10^2$  to  $10^4$  endoconidia/ml).

In both artificial soils, *T. basicola* inoculation affected cell density of *P. protegens* CHA0-*mche*(pME7100), as total microscopy cell numbers were 25% lower and real-time PCR counts were at least 35% lower (Fig. 5A and 5D) than in the absence of the pathogen (Fig. 3A and 3D). When the experiment with artificial soils was carried out with *T. basicola* inoculation, the number of GFP<sup>+</sup> cells of *P. protegens* CHA0-*mche*(pME7100) (Fig. 5B) were more than 30% lower than in the absence of the pathogen in both soils (Fig. 3B), but without any effect on the proportion of GFP<sup>+</sup> cells (Fig. 3C and 5C). Real-time PCR results evidenced comparable levels of *gfp* mRNA in *T. basicola* inoculated (Fig. 5E) and non-inoculated treatments (Fig. 3E), as well as a relative *gfp* mRNA level (*gfp* mRNA/cell ratio) at least 100% higher upon *T. basicola* inoculation (Fig. 3F and 5F).

In presence of *T. basicola*, cell density of *P. protegens* CHA0-*mche*(pME7100) on roots was higher in the vermiculitic than the illitic soil based on microscopy analysis (+ 33% number of total cells/field,  $P < 0.014$ ; Fig. 5A), but this trend was not significant with real-time PCR data (Fig. 5D). In presence of *T. basicola*, the number of GFP<sup>+</sup> cells on tobacco roots (i.e. green cells/field) was higher in the vermiculitic than the illitic soil ( $P = 0.003$ ; Fig. 5B), due to a higher cell density (see above) and a trend (not significant



**Fig. 5.** Effect of clay mineralogy on cell density and *phlA-gfp* expression of *P. protegens* CHA0-*mche*(pME7100) in the tobacco rhizosphere at 7 days after transplanting of bacteria-inoculated seedlings in artificial vermiculitic (verm.; white bars) or illitic soil (illite; grey bars) previously inoculated with *T. basicola* ( $10^3$  endoconidia/cm<sup>3</sup>). **A, B, and C**, Confocal laser scanning microscopy analysis of tobacco roots. Two experiments were conducted (giving similar results), each consisting of 3 plants per treatment and 10 confocal fields ( $0.22 \times 0.22 \times 1 \mu\text{m}$ ) per plant. Pooled results from the two experiments are presented ( $n = 60$  fields). For each field, the proportion of green cells (GFP<sup>+</sup>) was calculated by dividing the number of green cells by the total number of fluorescent cells. **D, E, and F**, Real-time PCR analysis of tobacco roots. One of the experiments above was used, with 5 plants per treatment ( $n = 5$ ). For each plant, the relative *gfp* mRNA level was calculated by dividing the number of *gfp* mRNA copies by the number of cells. In each of the six panels, means and standard errors are shown. Statistical differences between soils are shown using letters a and b (Student's *t* tests;  $P < 0.05$ ).

at  $P < 0.05$ ) for a higher proportion of GFP<sup>+</sup> cells (Fig 5C). *gfp* mRNA levels (Fig. 5E), as well as relative *gfp* mRNA levels (Fig. 5F), did not differ significantly between the two artificial soils.

### ***Spatial patterns of P. protegens colonization and phlA-gfp expression on roots.***

Confocal laser scanning microscopy analysis showed that *P. protegens* CHA0-*mche*(pME7100) colonized the three root zones (i.e. base, middle and root tips), including both the root surface and root hairs (the latter found mostly in the root tip zone). In the illitic soil, iron addition resulted in higher numbers of inoculant cells at the root surface (+ 143%) and on root hairs (+ 66%), higher numbers of GFP<sup>+</sup> cells at the root surface (+ 224%) and on root hairs (+ 193%), and a higher proportion of green cells on root hairs (+ 60%) but not at the root surface (Table S1). At the root surface, samples from the vermiculitic soil displayed higher numbers of inoculant cells (+ 62%) and of GFP<sup>+</sup> inoculant cells (+ 86%) than in the illitic soil, whereas there was no difference when considering root hairs. In presence of *T. basicola*, however, the numbers of inoculant cells (+ 46%) and of GFP<sup>+</sup> inoculant cells (+ 151%), as well as the proportion of green cells (+ 59%), were higher in the vermiculitic than the illitic soil for root hairs. These effects were not significant at the root surface.

Since root systems can be heterogeneous, cell distribution was also considered in more details. In all experiments, *P. protegens* CHA0-*mche*(pME7100) was found as a mixture of individual cells, cell clumps (comprised of 2-10 cells) and microcolonies (> 10 cells) (Fig. S3A). The resulting cell distribution pattern (Fig S3B) differed between root surface and root hairs (chi-squared test of independence;  $P = 10^{-17}$ ), as the proportion of individual cells was larger (20% versus 12%) and that of microcolony cells was smaller (44% versus 62%) on root hairs than at the root surface. In contrast, cell distribution pattern did not change significantly when comparing soil treatments (i.e. effect of clay mineral, iron addition, or *T. basicola* inoculation) or root zones (i.e. base, middle or root tips). Similar findings were made when considering GFP<sup>+</sup> cells of *P. protegens* CHA0-*mche*(pME7100) (not shown).

## Discussion

The aim of this study was to assess the hypothesis that iron bioavailability for *P. protegens* and expression of *P. protegens* DAPG synthetic genes in the tobacco rhizosphere are higher in presence of vermiculite than illite clay, thereby substantiating the hypothesis that (suppressive) vermiculitic soils in Morens should provide more favorable conditions for iron acquisition and *phl* transcription by *P. protegens* compared with (conductive) illitic soils. Indeed, biosensor analyses indicated that both iron bioavailability for *P. protegens* and *phlA* transcription (number of GFP<sup>+</sup> cells, following expression of *phlA-gfp*) were higher in the vermiculitic than the illitic soil. This resulted from both a higher cell density of *P. protegens* (especially at the root surface rather than on root hairs) and a higher proportion of GFP<sup>+</sup> cells in the vermiculitic soil. Soil parent material determines many soil characteristics including the type of clay mineral prevailing in the soil, yet the consequences for the functioning of rhizosphere microorganisms and plant-microbe interactions, which were important in the current case, are rarely studied (Almario et al. 2013; Ulrich and Becker 2006).

To determine the importance of iron bioavailability for *phlA-gfp* expression in *P. protegens*, iron addition was implemented *in vitro*, and it showed that the amount of bioavailable iron in vermiculitic soil (estimated at 3  $\mu$ M Fe) promoted *P. protegens* CHA0 growth *in vitro* and was close to the iron concentration inducing maximal *phlA-gfp* expression (i.e. 2  $\mu$ M; Fig. 1). Indeed, similar positive effects on both features (especially at the root surface rather than on root hairs) were observed when the illitic soil was amended with iron at 2.4 mM (thereby increasing iron bioavailability 10 times), a concentration raising plant-protecting activity of *P. protegens* CHA0 to levels found in vermiculitic soil (Keel et al. 1989; Voisard et al. 1989). These findings are compatible with the observation that iron deprivation affects *phl* transcription in *P. protegens in vitro* (Lim et al. 2012), and the hypothesis that higher iron availability in vermiculitic soils is required for disease suppression (Ramette et al. 2003).

The fact that *P. protegens* cells as well as GFP<sup>+</sup> cells at the root surface were much less abundant in the illitic soil than in high-iron soils (i.e. vermiculitic soil and iron-amended illitic soil) probably relates to the fact that iron deprivation affects several traits of importance for rhizosphere competence, besides *phl* transcription (Lim et al. 2012). Iron deprivation also limits cell motility (Lim et al. 2012), but this type of effect was not

apparent when considering spatial patterns of *P. protegens* root colonization and GFP accumulation. Localized antimicrobial production by rhizobacteria at pathogen entry-points is expected to underpin pathogen biocontrol (Fukui et al. 1994), but here *phl* transcription took place throughout the root system. This may be relevant for inhibition of *T. basicola*, as the latter does not display preferential sites of root penetration, e.g. it can infect root hairs as well as the root surface (Hood and Shew 1997). It has been suggested that *P. protegens* CHA0 could also act by inducing ISR pathways in tobacco (Almario et al. 2013; Troxler et al. 1997), because *P. protegens* CHA0 delays but does not alter *T. basicola* infection patterns, and physical interaction between both organisms is not necessary for black root rot suppression (Troxler et al. 1997). Indeed, DAPG triggers ISR pathways in *Arabidopsis* (Iavicoli et al. 2003; Weller et al. 2012). DAPG-triggered ISR requires a functional EIR1 gene (Iavicoli et al. 2003), which suggests that root tips, where this gene is expressed (Müller et al. 1998), might be a prime location to trigger ISR. However, cell distribution pattern of *P. protegens* on tobacco root tips did not differ in vermiculitic and illitic soils.

Cell density and *phlA-gfp* expression of root-colonizing *P. protegens* CHA0 reached lower values when *T. basicola* was added (Fig. 3A-F and 6A-F). Pathogen presence often increases cell density and expression of *phl* genes in *P. protegens* in other pathosystems, such as *Rhizoctonia solani*-bean (Jamali et al. 2008), *Pythium ultimum*-maize or *Pythium ultimum*-cucumber (Notz et al. 2001). Phytopathogens may also counteract antagonistic fluorescent pseudomonads using different mechanisms (Duffy et al. 2003), ranging from survival inhibition by *P. ultimum* (Fedi et al. 1997) to fusaric acid-mediated repression of DAPG synthesis by *Fusarium oxysporum* (Duffy and Défago 1997). Here, the negative effects of *T. basicola* on *P. protegens* did not take place *in vitro*, i.e. in the absence of roots. Using a split-root system, Jousset et al. (2011) showed that infection of barley roots by *P. ultimum* promoted expression of *phl* genes in root-colonizing *P. protegens* CHA0, through a systemic effect on the plant. It might be that the effect of *T. basicola* on tobacco was also systemic, and further work will be needed to address this issue.

In this work, microscopy analysis of GFP<sup>+</sup> cells, which reflects GFP accumulation (GFP protein exhibiting a half-life of days; Andersen et al. 1998) at the root microscale, was complemented by real-time RT PCR quantification of *gfp* mRNA, which reflects recent *phlA-gfp* transcriptional activity (prokaryotic mRNA exhibiting half-lives of minutes; Taniguchi et al. 2010) at the scale of the whole root system. Even though both

measurements may not correlate, combining both provides additional insights (Taniguchi et al. 2010). Here, real-time RT PCR quantification of *gfp* mRNA evidenced that *gfp* mRNA levels were comparable in all treatments, while green fluorescence levels varied. This could entail (i) *phlA-gfp* transcription levels that were not constant in space (i.e. with a number of transcripts that varied from one cell to the next) or in time, and/or (ii) the effect of post-transcriptional mechanisms (Taniguchi et al. 2010). Indeed, DAPG synthesis is subjected to Gac-mediated post-transcriptional up-regulation (Haas and Défago 2005) and DAPG production was even completely abolished in a *gacA* mutant of *P. protegens* Pf-5 despite *phl* transcription (Hassan et al. 2010). How differences in *phl* transcription translate in terms of DAPG synthesis under rhizosphere conditions remains to be quantified.

In the current work, differences in cell density of *P. protegens* CHA0 from one soil treatment to the next were of moderate magnitude (1.3 to 2.2 fold), as found when comparing root colonization of different cereal species (Rochat et al. 2010), and were lower than when comparing different plant species (Notz et al. 2001; de Werra et al. 2008). Similarly, the percentage of GFP<sup>+</sup> *P. protegens* cells varied little between soil treatments (from 36 to 50%), as found between cereal species (Rochat et al. 2010). The percentage of GFP<sup>+</sup> *P. protegens* cells on tobacco roots was rather low in comparison with cereals, where it may reach 86 to 97% (Rochat et al. 2010). This is in accordance with the lower ability of dicotyledonous plants (like tobacco) to promote expression of *phl* genes in comparison to monocots (Notz et al. 2001).

DAPG-producing pseudomonads correspond to at least seven *Pseudomonas* species from two main lineages, i.e. *P. protegens* and the '*P. fluorescens*' complex (Frapolli et al. 2007, 2012), which display differences in rhizosphere ecology (Sharifi-Tehrani et al. 1998; Wang et al. 2001). *P. protegens* is a well-established model for analysis of *Pseudomonas* secondary metabolism (Haas and Défago 2005; Kidarsa et al. 2011) and plant-protection mechanisms in Morens suppressive soils (Haas and Défago 2005), but species from the '*P. fluorescens*' complex are also present in the tobacco rhizosphere in Morens soils (Frapolli et al. 2008, 2010), and ecological approaches at the scale of all DAPG-producing pseudomonads will be necessary to assess whether the current findings apply to all members of the functional group in Morens field soils. We carried out a preliminary assessment under non-sterile soil conditions, but root colonization by *P. protegens* CHA0-*mche*(pME7100) was insufficient (about 5.5 log per g of root) for the current methodology, with often no more than a few GFP<sup>+</sup> cells per

microscopy field) and real-time PCR of *gfp* mRNA below detection limit. Future work will use real-time PCR assessment of *phl* transcripts in natural populations of DAPG-producing pseudomonads combined with chemical analysis of DAPG production. In addition, biocontrol is often multifactorial (Voisard et al. 1989; Haas and Défago 2005) and DAPG synthesis is not the only iron-regulated antagonistic function of *P. protegens* (Lim et al. 2012), which means a broader assessment of biocontrol functions in root-colonizing *Pseudomonas* guilds, and perhaps also in other plant-beneficial microbes (Kyselková et al. 2009), will be required to better understand black root rot suppressiveness of iron-rich vermiculitic Morens soil.

In conclusion, iron bioavailability for DAPG-producing *P. protegens* colonizing tobacco roots was higher in presence of vermiculite than illite clay, and it translated in higher cell density and GFP accumulation (pointing to enhanced PhIA levels) in the rhizosphere in vermiculitic compared with illitic soil. These results substantiate the hypothesis that higher iron availability in vermiculitic (suppressive) than illitic (conductive) Morens soils can promote transcription of DAPG synthetic genes and black root rot control by pseudomonads in the tobacco rhizosphere.

## Materials and Methods

### ***Microbial cultures and tobacco growth.***

The *attTn7::miniTn7-Gm-P<sub>tac</sub>-mcherry* strain *P. protegens* CHA0-*mche* carrying rhizosphere-stable plasmid pME7100 (which contains a *phlA-gfp* transcriptional fusion, Tc<sup>r</sup>) (Rochat et al. 2010) was cultured at 27 °C on King's B agar (King et al. 1954) supplemented with gentamycin (8 µg/ml) and tetracycline (125 µg/ml). For *phlA-gfp* expression experiments, the strain was grown in 50 ml Falcon tubes containing 20 ml of Luria-Bertani (LB; Duchefa Biochemie BV, Haarlem, The Netherlands) broth supplemented with the above mentioned antibiotics at 27 °C and 120 rpm. At 8 h, 1 ml was used to inoculate 100 ml of antibiotic-free LB broth in 500-ml Erlenmeyer flask and cells were grown at 27 °C and 180 rpm. At 4 h, log-phase cells were harvested and washed twice with ultra-pure sterile water, using 3500 g and 23 °C for 10 min. The pellet was resuspended in ultra-pure sterile water and the OD<sub>600</sub> was adjusted to 0.03 or 0.05 (i.e. respectively  $1.0 \times 10^7$  and  $1.6 \times 10^7$  cells/ml). The absence of fluorescence before

inoculation was checked under a Zeiss Axioskope epifluorescence microscope (Carl Zeiss, Le Pecq, France).

The iron-biosensor strain *P. protegens* Pf-5 *pvd-inaZ* i.e. strain Pf-5 carrying the *pvd-inaZ* construct composed of an iron-regulated promoter *pvd* fused to a promoterless ice nucleation reporter gene *inaZ* in the rhizosphere-stable plasmid pVSP61 (Rif<sup>r</sup> Km<sup>r</sup>; Loper and Lindow 1994), and the positive control *P. protegens* Pf-5 *iceC* i.e. strain Pf-5 carrying the *iceC* construct composed of an ice nucleation gene transcribed from its native iron-constitutive promoter (*iceC*) cloned into pVSP61 (Rif<sup>r</sup> Km<sup>r</sup>; Loper and Lindow 1994) were cultured at 27 °C on King's B agar supplemented with rifampicin (100 µg/ml) and kanamycin (50 µg/ml). For gene expression experiments, strains were grown in 500-ml Erlenmeyer flasks containing 100 ml of SM medium (Loper and Lindow 1987) supplemented with 10<sup>-4</sup> M FeCl<sub>3</sub> at 27 °C and 180 rpm. At 24 h, stationary-phase cells were harvested and washed, the pellet was resuspended and the OD<sub>600</sub> adjusted to 0.015 or 0.10 (i.e. respectively 1.0 × 10<sup>7</sup> and 6.7 × 10<sup>7</sup> cells/ml), as indicated above.

*T. basicola* Ferraris strain ETH D127 (Berk. and Br.) was grown 4 weeks in the dark on malt agar (Ramette et al. 2003). An endoconidial suspension was prepared as described by Ramette et al. (2003), adjusted to 10<sup>6</sup> endoconidia/ml and used for inoculation.

Tobacco (*Nicotiana glutinosa* L.) was grown in a growth chamber at 22 °C (day, 16 h) and 18 °C (night, 8 h) at 70% relative humidity. Seeds were surface disinfected in 70% ethanol for 1 min, 10% H<sub>2</sub>O<sub>2</sub> for 10 min and rinsed with ultra-pure sterile water. They were then germinated on 1.6% water agar for one week before transferring onto 0.6% Knop's agar (Keel et al. 1989). At four weeks, four-leaves plants were removed, roots were washed aseptically in ultra-pure sterile water before inoculation and transplanting into the soil systems.

### **Soil systems.**

Artificial soil systems were prepared as described by Keel et al. (1989). Briefly, quartz sand of different grain sizes (10% 1.5-2.0 mm, 9.3% 0.8-1.2 mm, 9.3% 0.5-0.75 mm, 28.6% 0.10-0.50 mm, and 42.8% 0.08-0.20 mm) was mixed with quartz powder (55% <40 µm) and clay (vermiculite or illite), in a 70:20:10 weight ratio. Vermiculite and illite clays were prepared as described in Keel et al. (1989). The artificial soils were autoclaved, moistened with ultra-pure sterile water (10% v/w for vermiculite and 5% v/w for illite), and 20 g filled in 42-cm<sup>3</sup> containers. When indicated, soil was amended with



2.4 mM FeEDDHA (9.9  $\mu\text{g Fe}^{3+}/\text{g}$  dry soil; Keel et al. 1989) or inoculated with  $10^3$  *T. basicola* endoconidia/cm<sup>3</sup>. After transplanting, 1.1 ml of Knop's plant nutrient solution (Keel et al. 1989) were added per container, water content was adjusted to 70% of the soil water-holding capacity (i.e. 20% w/w for vermiculitic soil and 15% w/w for illitic soil) with ultra-pure sterile water, and the containers were sealed with porous sterile adhesive tape (Micropore Surgical Tape; 3M, Borken, Germany). No further watering was necessary except for the longer (27 days) biocontrol experiment where soil water content was maintained by watering the pots every week.

#### ***Biocontrol activity of P. protegens CHA0-mche(pME7100) in artificial soils.***

To compare the biocontrol activity of *P. protegens* CHA0-mche(pME7100) in the vermiculitic and the illitic artificial soils, 10 plants per soil (each plant in a separate container) were either inoculated singly with *T. basicola* or co-inoculated with *T. basicola* and *P. protegens* CHA0-mche(pME7100), as indicated below. At 27 days, black root rot severity (i.e. percentage of root surface covered by *T. basicola* chlamydospores) was scored using a height-class disease scale (Stutz et al. 1986; Ramette et al. 2003).

#### ***Monitoring of phlA-gfp in vitro in response to iron or T. basicola.***

The experiment was carried out as described in Baehler et al. (2005). *P. protegens* CHA0-mche(pME7100) was inoculated (20  $\mu\text{l}$  containing  $3.3 \times 10^5$  cells) in 10 ml of OSGly medium (Baehler et al. 2005) containing either 0.1 to 1000  $\mu\text{M}$  FeEDDHA, or 20  $\mu\text{M}$  FeEDDHA and  $10^2$  to  $10^4$  *T. basicola* endoconidia/ml. For each FeEDDHA concentration, 200  $\mu\text{l}$  were placed (in six replicates) in a 96-well microtitration plate with flat transparent bottom (Greiner Bio-one, Frickenhausen, Germany) and the plate was incubated for 42 h at 30 °C with orbital shaking (500 rpm). The same procedure was followed for each *T. basicola* concentration. Green fluorescence (excitation 480 nm, emission 520 nm), red fluorescence (excitation 587 nm, emission 661 nm) and absorbance (at 600 nm) were measured every 2 h in a Xenius microplate reader spectrofluorometer (SAFAS, Monaco). For each individual measurement, fluorescence value was divided by the corresponding OD<sub>600</sub> value and the resulting specific fluorescence level expressed as relative fluorescence units (RFU). The experiment was done twice with similar results.

### ***Monitoring of *phlA-gfp* in the tobacco rhizosphere by confocal laser-scanning microscopy.***

Tobacco root systems were inoculated by dipping for 1 h in a cell suspension (OD<sub>600</sub> 0.03; approximately 10<sup>7</sup> cells/ml) of *P. protegens* CHA0-*mche*(pME7100), and seedlings were transplanted into artificial soil, as described above. At 7 days, plants were unearthed, roots were washed in ultra-pure sterile water, mounted in Aqua-Poly/Mount (Polysciences, Eppelheim, Germany) and examined immediately by confocal laser scanning microscopy using a 510 Meta microscope (Carl Zeiss S.A.S., Oberkochen, Germany) equipped with an argon-krypton laser, as well as detectors and filter sets for green (i.e. 488 nm for excitation and 505 to 550 nm for detection) and red (i.e. 543 nm for excitation and > 585 nm for detection) fluorescence. After acquisition of the transmitted image (in bright-field mode at ×400 magnification), the three single-color images were overlaid as a single image using LSM software (release 4.2; Carl Zeiss S.A.S.). Three root systems were analyzed per treatment, ten images per root system were taken, and the whole experiment was done twice.

### ***RNA/DNA extraction and real-time PCR quantification of bacterial cells and *gfp* mRNA.***

For real-time (RT) PCR, the roots of five plants inoculated with *P. protegens* CHA0-*mche*(pME7100) were collected in each treatment, washed in ultra-pure sterile water and immediately frozen in liquid nitrogen. Non-inoculated plants were used as negative controls. After grinding the roots in liquid nitrogen using a pestle, nucleic acids were extracted as described (Almario et al. 2013). Briefly, each root sample was mixed with 0.5 g of 100-µm zirconia/silica beads, 500 µl of CTAB extraction solution and 500 µl of phenol-chloroform-isoamyl alcohol (25:24:1), and was agitated twice in a bead-beater. The tubes were then centrifuged and the aqueous phase containing the nucleic acids was recovered. This extraction step was repeated once; the two supernatants were pooled, mixed with 1 volume of chloroform-isoamyl alcohol and centrifuged. For nucleic acid precipitation, 75% of the aqueous phase was recovered and mixed with 40 µg glycogen and 0.1 volume of a 3M potassium acetate solution (pH 4.8). After addition of 2.5 volumes of absolute ethanol, nucleic acids were precipitated for 2 h at -20 °C, pelleted, and the pellet was washed with 500 µl of 70% ethanol, dried and suspended in 100 µl of RNase-free water.

For quantification of cells of *P. protegens* CHA0, a 10 µl sample of nucleic acids was diluted 5 times and used directly in real-time PCR according to von Felten et al. (2010). Real-time PCR assays were conducted using 96-well white microplates and a LightCycler 480 (Roche Applied Science, Meylan, France), and analyzed using LightCycler Software v.1.5 (Roche Applied Science) and the second derivative maximum method for Ct determination. The reaction mix (20 µl) contained 0.5 µM of primers CHA0\_1\_for (5'-CGACACATGACCAACATCGTTTCGA-3') and CHA0\_1\_rev (5'-GGCTACAAGGTCATTACAAAATCCAGTGAT-3') targeting a strain-specific SCAR marker (von Felten et al. 2010), 10 µl and 4 µl of respectively LightCycler 480 SYBR Green I Master Vials 1 and 2 (Roche Applied Science), and 2 µl of DNA. The cycling program included 10 min × 95 °C, 50 amplification cycles of 3 s × 95 °C, 30 s × 67 °C, and a fusion program including an initial denaturing step of 5 s × 95 °C, an annealing step of 1 min × 65 °C and a denaturing temperature ramp from 65 to 97 °C with a rate of 0.11 °C/s. An external standard curve generated from genomic DNA of *P. protegens* CHA0 (obtained using the NucleoSpin Tissue kit; Macherey-Nagel, Hoerd, France) was used for estimation of cell number in uncharacterized DNA samples. Amplification specificity was checked by melting curve analysis and gel electrophoresis of the amplification product. DNA samples were analyzed in triplicate and the mean Ct value was reported in the external standard curve to infer cell number in the sample.

For *gfp* mRNA quantification, a 40 µl sample of nucleic acids was treated with DNase I (Invitrogen, Cergy Pontoise, France) according to the manufacturer's instructions, and RNA was purified and eluted in 100 µl of RNase-free water using the RNeasy kit (Qiagen, Courtaboeuf, France). Because one DNase I treatment was insufficient to eliminate all DNA contamination, a second treatment was performed on the purified RNA sample. Finally, RNA was precipitated for 30 min at room temperature using 1 volume of isopropanol, pelleted by centrifuging the tubes for 15 min at 16 000 g and 4 °C, and resuspended in 60 µl of RNase-free water. Reverse transcription for *gfp* cDNA synthesis was performed using 15 µl of RNA, primer RTgfpR (Baehler et al. 2005) at 0.1 µM and the Omniscript RT kit (Qiagen), following the manufacturer's instructions. *gfp* cDNA was subsequently purified using the MinElute purification kit (Qiagen) and used in real-time PCR. A negative control (i.e. the same but without reverse transcriptase) was also studied for each sample. Real-time PCR quantification of *gfp* cDNA was conducted following the protocol of Baehler et al. (2005) using *gfp* primers RTgfpF (5'-CCTGTCCTTTTACCAGACAACCA-3') and RTgfpR (5'-

CTCTTTTCGTTGGGATCTTTCG-3') at 0.5  $\mu$ M. The reaction mix, the cycling program, and the fusion program for melting curve analysis were the same as described above, except that 40 amplification cycles of 15 s  $\times$  95  $^{\circ}$ C, 30 s  $\times$  60  $^{\circ}$ C were conducted. An external *gfp* standard curve generated from plasmid pME7100 (obtained using the NucleoSpin Plasmid kit; Macherey-Nagel) was used for estimation of *gfp* copy number in uncharacterized cDNA samples. Amplification specificity was checked by melting curve analysis and gel electrophoresis of the amplification product. cDNA samples were analyzed in triplicate and the mean Ct value was reported in the external standard curve to infer *gfp* cDNA copy number in the sample.

#### ***Assessment of iron bioavailability in vitro and in the tobacco rhizosphere.***

The response of the iron-biosensor *P. protegens* Pf-5 *pvd-inaZ* to increasing iron concentrations *in vitro* was assessed as described by Loper and Henkels (1997). The strain (100  $\mu$ l containing  $6.6 \times 10^6$  cells) was inoculated into 20 ml of SM medium containing 0.1 to 1000  $\mu$ M FeEDDHA. Aliquots of 5 ml were placed into 15-ml Falcon tubes (3 replicates per concentration), which were incubated 48 h at 20  $^{\circ}$ C and 120 rpm before measuring ice nucleation activity. To this end, the number of ice nuclei was determined by the droplet freezing assay (Loper and Lindow 1997), after serially diluting samples and placing 40 droplets of 10  $\mu$ l from each dilution on a paraffin-coated aluminum foil floating on a -5  $^{\circ}$ C ethanol bath and recording the number of frozen droplets after 2 min. The number of ice nuclei was computed as  $\ln[1/(1 - \text{Fraction of frozen droplets})]/[\text{Droplet volume} \times \text{Dilution}]$ , as proposed by Vali (1971), and was divided by the number of cells (estimated via OD<sub>600</sub> measurement). A standard curve was generated by plotting the ice nucleation activity (ice nuclei/cell) against the FeEDDHA concentration.

To assess iron bioavailability in the tobacco rhizosphere, root systems were inoculated as indicated above, by dipping for 1 min in a cell suspension (OD<sub>600</sub> 0.015, approximately  $10^7$  cells/ml) of the iron biosensor *P. protegens* Pf-5 *pvd-inaZ* or the positive control strain Pf-5 *iceC*. The tobacco seedlings were then transplanted in the artificial soils or sterilized field soils described above. Seven days later, plants were unearthed. Each root system and adhering soil was placed in 1 ml of 10 mM potassium phosphate buffer (pH 7.0) and sonicated for 5 min. Samples were serially diluted, cell numbers were determined 2 days after plating onto King's B medium supplemented with rifampicin and kanamycin, and ice nucleation activity was determined (as indicated

above). Ice nucleation activity of the positive control strain Pf-5 *iceC* was constant in all treatments. Three plants were studied per soil × strain combination. The experiment was done twice.

### ***Image and statistical analyses.***

The cell counting option of BioImage\_L software v.2.1 (Chávez de Paz 2009) with a noise correction set to default, was used to quantify each type of fluorescent cells per confocal laser scanning microscopy image. The proportion of cells that expressed the *phlA-gfp* fusion and produced GFP (i.e. of GFP<sup>+</sup> cells) was calculated as the number of green cells divided by the total number of fluorescent cells in the image.

Root colonization pattern of bacteria was studied by recording for each confocal laser scanning microscopy image (i) the corresponding root zone i.e. the root base (first third), the middle part (second third) or the root tip (third third), (ii) the location of bacterial cells (root surface or root hair), and (iii) the size of each bacterial colony detected, using the particle size analysis option in ImageJ software (<http://imagej.nih.gov/ij/>).

Statistical analyses were performed after square root (for proportions), rank (for bacterial colony size) or log<sub>10</sub> (for all other variables) transformation. Means were compared by Student's *t* tests or by analysis of variance (ANOVA) followed with Fisher's LSD tests when more than two treatments were studied. Size distribution patterns of bacterial cells (i.e. the proportion of individual cells, cell clumps and microcolonies) were compared using a chi-squared test of independence. Analyses were carried out at  $P < 0.05$ , using the R environment.

### **Acknowledgments**

We are grateful to farmers in Morens region for field access and information. This work was supported by the Ministère Français de la Recherche. We thank Joyce Loper (USDA-ARS Horticultural Crops Research Laboratory and Department of Botany and Plant Pathology, Oregon State University, Corvallis, OR, USA), Christoph Keel (Université de Lausanne, Switzerland) and Alexandre Jousset (University of Goettingen, Germany) for gift of strains, Monika Maurhofer (ETH Zurich, Switzerland) for providing

artificial soils and useful discussions, Geneviève Défago (ETH Zurich, Switzerland) for useful discussions, and Denis Desbouchages (FR41, Université Lyon 1) for technical help. This work made use of the FR41 technical platforms DTAMB, Serre and Centre Technologique des Microstructures at Université Lyon 1.

## Literature Cited

- Almario, J., Moëgne-Loccoz, Y., and Muller, D. 2013. Monitoring of the relation between 2,4-diacetylphloroglucinol-producing *Pseudomonas* and *Thielaviopsis basicola* populations by real-time PCR in tobacco black root-rot suppressive and conducive soils. *Soil Biol. Biochem.* (in press).
- Andersen, J. B., Sternberg, C., Poulsen, L. K., Bjørn, S. P., Givskov, M., and Molin, S. 1998. New unstable variants of green fluorescent protein for studies of transient gene expression in bacteria. *Appl. Environ. Microbiol.* 64:2240-2246.
- Baehler, E., Bottiglieri, M., Péchy-Tarr, M., Maurhofer, M., and Keel, C. 2005. Use of green fluorescent protein-based reporters to monitor balanced production of antifungal compounds in the biocontrol agent *Pseudomonas fluorescens* CHA0. *J. Appl. Microbiol.* 99:24-38.
- Barahona, E., Navazo, A., Yousef-Coronado, F., Aguirre de Cárcer, D., Martínez-Granero, F., Espinosa-Urgel, M., Martín, M., and Rivilla, R. 2010. Efficient rhizosphere colonization by *Pseudomonas fluorescens* F113 mutants unable to form biofilms on abiotic surfaces. *Environ. Microbiol.* 12:3185-3195.
- Brazelton, J. N., Pfeufer, E. E., Sweat, T. A., Gardener, B. B., and Coenen, C. 2008. 2,4-diacetylphloroglucinol alters plant root development. *Mol. Plant-Microbe Interact.* 21:1349-58.
- Chávez de Paz, L. E. 2009. Image analysis software based on color segmentation for characterization of viability and physiological activity of biofilms. *Appl. Environ. Microbiol.* 75:1734-1739.
- Combes-Meynet, E., Pothier, J. F., Moëgne-Loccoz, Y., and Prigent-Combaret, C. 2011. The *Pseudomonas* secondary metabolite 2,4-diacetylphloroglucinol is a signal inducing rhizoplane expression of *Azospirillum* genes involved in plant-growth promotion. *Mol. Plant-Microbe Interact.* 24:271-284.
- Couillerot, O., Prigent-Combaret, C., Caballero-Mellado, J., and Moëgne-Loccoz, Y. 2009. *Pseudomonas fluorescens* and closely-related fluorescent pseudomonads as biocontrol agents of soil-borne phytopathogens. *Lett. Appl. Microbiol.* 48:505-512.

- de Werra, P., Baehler, E., Huser, A., Keel, C., and Maurhofer, M. 2008. Detection of plant-modulated alterations in antifungal gene expression in *Pseudomonas fluorescens* CHA0 on roots by flow cytometry. *Appl. Environ. Microbiol.* 74:1339-1349.
- Dowling, D. N., Sexton, R., Fenton, A., Delany, I., Fedi, S., McHugh, B., Callanan, M., Moëgne-Loccoz, Y., and O'Gara, F. 1996. Iron regulation in plant-associated *Pseudomonas fluorescens* M114: Implications for biological control. Pages 502-511 in: *Molecular Biology of Pseudomonads*, Chapter 44. T. Nakazawa, K. Furukawa, D. Haas, and S. Silver, eds. ASM Press, Washington, DC, USA.
- Duffy, B. K., and Défago, G. 1997. Zinc improves biocontrol of *Fusarium* crown and root rot of tomato by *Pseudomonas fluorescens* and represses the production of pathogen metabolites inhibitory to bacterial antibiotic biosynthesis. *Phytopathology* 87:1250-1257.
- Duffy, B. K., and Défago, G. 1999. Environmental factors modulating antibiotic and siderophore biosynthesis by *Pseudomonas fluorescens* biocontrol strains. *Appl. Environ. Microbiol.* 65:2429-2438.
- Duffy, B. K., Schouten, A., and Raaijmakers, J. M. 2003. Pathogen self defense: mechanisms to counteract microbial antagonism. *Annu. Rev. Phytopathol.* 41:501-538.
- Fedi, S., Tola, E., Moëgne-Loccoz, Y., Dowling, D. N., Smith, L. M., and O'Gara, F. 1997. Evidence for signaling between the phytopathogenic fungus *Pythium ultimum* and *Pseudomonas fluorescens* F113: *P. ultimum* represses the expression of genes in *P. fluorescens* F113, resulting in altered ecological fitness. *Appl. Environ. Microbiol.* 63:4261-4266.
- Frapolli, M., Défago, G., and Moëgne-Loccoz, Y. 2007. Multilocus sequence analysis of biocontrol fluorescent *Pseudomonas* spp. producing the antifungal compound 2,4-diacetylphloroglucinol. *Environ. Microbiol.* 9:1939-1955.
- Frapolli, M., Moëgne-Loccoz, Y., Meyer, J., Défago, G. 2008. A new DGGE protocol targeting 2,4-diacetylphloroglucinol biosynthetic gene *phlD* from phylogenetically contrasted biocontrol pseudomonads for assessment of disease-suppressive soils. *FEMS Microbiol. Ecol.* 64:468-481.
- Frapolli, M., Défago, G., and Moëgne-Loccoz, Y. 2010. Denaturing gradient gel electrophoretic analysis of dominant 2,4-diacetylphloroglucinol biosynthetic *phlD* alleles in fluorescent *Pseudomonas* from soils suppressive or conducive to black root rot of tobacco. *Soil Biol. Biochem.* 42:649-656.

- Frapolli, M., Pothier, J. F., Défago, G., and Moëgne-Loccoz, Y. 2012. Evolutionary history of synthesis pathway genes for phloroglucinol and cyanide antimicrobials in plant-associated fluorescent pseudomonads. *Mol. Phylogenet. Evol.* 63:877-890.
- Fukui, R., Schroth, M. N., Henderson, M., Hancock, J. G., and Firestone, M. K. 1994. Growth patterns and metabolic activity of pseudomonads in sugar beet spermospheres: Relationship to pericarp colonization by *Pythium ultimum*. *Phytopathology* 84:1331-1338.
- Haas D., and Défago, G. 2005. Biological control of soil-borne pathogens by fluorescent pseudomonads. *Nat. Rev. Microbiol.* 3:307-319.
- Hassan, K. A., Johnson, A., Shaffer, B. T., Ren, Q., Kidarsa, T. A., Elbourne, L. D. H., Hartney, S., Duboy, R., Goebel, N. C., Zabriskie, T. M., Paulsen, I. T., and Loper, J. E. 2010. Inactivation of the GacA response regulator in *Pseudomonas fluorescens* Pf-5 has far-reaching transcriptomic consequences. *Environ. Microbiol.* 12:899-915.
- Hood, M. E., and Shew, H. D. 1997. Initial cellular interactions between *Thielaviopsis basicola* and tobacco root hairs. *Phytopathology* 87:228-235.
- Iavicoli, A., Boutet, E., Buchala, A., and Métraux, J. P. 2003. Induced systemic resistance in *Arabidopsis thaliana* in response to root inoculation with *Pseudomonas fluorescens* CHA0. *Mol. Plant-Microbe Interact.* 16:851-858.
- Jamali, F., Sharifi-Tehrani, A., Lutz, M. P., and Maurhofer, M. 2009. Influence of host plant genotype, presence of a pathogen, and coinoculation with *Pseudomonas fluorescens* strains on the rhizosphere expression of hydrogen cyanide- and 2,4-diacetylphloroglucinol biosynthetic genes in *P. fluorescens* biocontrol strain CHA0. *Microbial Ecol.* 57:267-275.
- Jousset, A., Rochat, L., Lanoue, A., Bonkowski, M., Keel, C., and Scheu, S. 2011. Plants respond to pathogen infection by enhancing the antifungal gene expression of root-associated bacteria. *Mol. Plant-Microbe Interact.* 24:352-358.
- Keel, C., Voisard, C., Berling, C. H., Kahr, G., and Défago, G. 1989. Iron sufficiency, a prerequisite for the suppression of tobacco black root rot by *Pseudomonas fluorescens* strain CHA0 under gnotobiotic conditions. *Phytopathology* 79:584-589.
- Keel, C., Schnider, U., Maurhofer, M., Voisard, C., Laville, J., Burger, U., Wirthner, P., Haas, D., Défago, G. 1992. Suppression of root diseases by *Pseudomonas fluorescens* CHA0: importance of the bacterial secondary metabolite 2,4-diacetylphloroglucinol. *Mol. Plant-Microbe Interact.* 5:4-13.
- Kidarsa, T. A., Goebel, N. C., Zabriskie, T. M., and Loper, J. E. 2011. Phloroglucinol mediates cross-talk between the pyoluteorin and 2,4-diacetylphloroglucinol



- biosynthetic pathways in *Pseudomonas fluorescens* Pf-5. *Mol. Microbiol.* 81:395-414.
- King, E. O., Ward, M. K., and Raney, D. E. 1954. Two simple media for the demonstration of pyocyanin and fluorescein. *J. Lab. Clin. Med.* 44:301-307.
- Kyselková, M., Kopecký, J., Frapolli, M., Défago, G., Ságová-Marečková, M., Grundmann, G. L., and Moëgne-Loccoz, Y. 2009. Comparison of rhizobacterial community composition in soil suppressive or conducive to tobacco black root rot disease. *ISME J.* 3:1127-1138.
- Kyselková, M., and Moëgne-Loccoz, Y., 2012. *Pseudomonas* and other microbes in disease-suppressive soils. Pages 93-140 in: *Sustainable Agriculture Reviews, Vol. 9: Organic Fertilisation, Soil Quality and Human Health*. E. Lichtfouse, ed. Springer, Dordrecht, The Netherlands.
- Landa, B. B., Mavrodi, O. V., Raaijmakers, J. M., McSpadden Gardener, B. B., Thomashow, L. S., and Weller, D. M. 2002. Differential ability of genotypes of 2,4-diacetylphloroglucinol-producing *Pseudomonas fluorescens* strains to colonize the roots of pea plants. *Appl. Environ. Microbiol.* 68:3226-3237.
- Lim, C. K., Hassan, K. A., Tetu, S. G., Loper, J. E., and Paulsen, I. T. 2012. The effect of iron limitation on the transcriptome and proteome of *Pseudomonas fluorescens* Pf-5. *PLoS ONE* 7:e39139. doi:10.1371/journal.pone.0039139.
- Loper, J. E., and Henkels, M. D. 1997. Availability of iron to *Pseudomonas fluorescens* in rhizosphere and bulk soil evaluated with an ice nucleation reporter gene. *Appl. Environ. Microbiol.* 63:99-105.
- Loper, J. E., and Lindow, S. E. 1987. Lack of evidence for in situ fluorescent pigment production by *Pseudomonas syringae* pv. *syringae* on bean leaf surfaces. *Phytopathology* 77:1449-1454.
- Loper, J. E., and Lindow, S. E. 1994. A biological sensor for iron available to bacteria in their habitats on plant surfaces. *Appl. Environ. Microbiol.* 60:1934-1941.
- Loper, J. E., and Lindow, S. E. 1997. Reporter gene systems useful in evaluating in situ gene expression by soil- and plant-associated bacteria. Pages 482-492 in: *Manual of Environmental Microbiology*. C. J. Hurst, G. R. Knudsen, M. J. McInerney, L. D. Stetzenbach, and M. V. Walter, eds. ASM Press, Washington, DC.
- Lutz, M. P., Wenger, S., Maurhofer, M., Défago, G., and Duffy, B. 2004. Signaling between bacterial and fungal biocontrol agents in a strain mixture. *FEMS Microbiol. Ecol.* 48:447-455.

- Müller, B. 2009. Impact of the bacterium *Pseudomonas fluorescens* and its genetic derivatives on vermiculite: Effects on trace metals contents and clay mineralogical properties. *Geoderma* 153:94-103.
- Müller, A., Guan, C., Gälweiler, L., Tänzler, P., Huijser, P., Marchant, A., Parry, G., Bennett, M., Wisman, E., and Palme, K. 1998. *AtPIN2* defines a locus of *Arabidopsis* for root gravitropism control. *EMBO J.* 17:6903-6911.
- Notz, R., Maurhofer, M., Schnider-Keel, U., Duffy, B., Haas, D., and Défago, G. 2001. Biotic factors affecting expression of the 2,4-diacetylphloroglucinol biosynthesis gene *phlA* in *Pseudomonas fluorescens* biocontrol strain CHA0 in the rhizosphere. *Phytopathology* 91:873-881.
- Phillips, D. A., Fox, T. C., King, M. D., Bhuvaneswari, T. V., and Teuber, L. R. 2004. Microbial products trigger amino acid exudation from plant roots. *Plant Physiol.* 136:2887-2894.
- Raaijmakers, J. M., Paulitz, T. C., Steinberg, C., Alabouvette, C., and Moëgne-Loccoz, Y. 2009. The rhizosphere: a playground and battlefield for soilborne pathogens and beneficial microorganisms. *Plant Soil* 321:341-361.
- Ramette, A., Moëgne-Loccoz, Y., and Défago, G. 2003. Prevalence of fluorescent pseudomonads producing antifungal phloroglucinols and/or hydrogen cyanide in soils naturally suppressive or conducive to tobacco black root rot. *FEMS Microbiol. Ecol.* 44:35-43.
- Ramette, A., Moëgne-Loccoz, Y., and Défago, G. 2006. Genetic diversity and biocontrol potential of fluorescent pseudomonads producing phloroglucinols and hydrogen cyanide from Swiss soils naturally suppressive or conducive to *Thielaviopsis basicola*-mediated black root rot of tobacco. *FEMS Microbiol. Ecol.* 55:369-381.
- Rochat, L., Péchy-Tarr, M., Baehler, E., Maurhofer, M., and Keel, C. 2010. Combination of fluorescent reporters for simultaneous monitoring of root colonization and antifungal gene expression by a biocontrol pseudomonad on cereals with flow cytometry. *Mol. Plant-Microbe Interact.* 23:949-961.
- Sharifi-Tehrani, A., Zala, M., Natsch, A., Moëgne-Loccoz, Y., and Défago, G. 1998. Biocontrol of soil-borne fungal plant diseases by 2,4-diacetylphloroglucinol-producing fluorescent pseudomonads with different restriction profiles of amplified 16S rDNA. *Eur. J. Plant Pathol.* 104:631-643.
- Stutz, E., Défago, G., Hantke, R., and Kern, H. 1985. Effect of parent materials derived from different geological strata on suppressiveness of soils to black root rot of tobacco. Pages 215-217 in: *Ecology and Management of Soilborne Plant Pathogens*. C. A. Parker, A. D. Rovira, K. J. Moore, P. T. W. Wong, J. F. Kollmorgen, eds. American Phytopathological Society, St. Paul, MN.

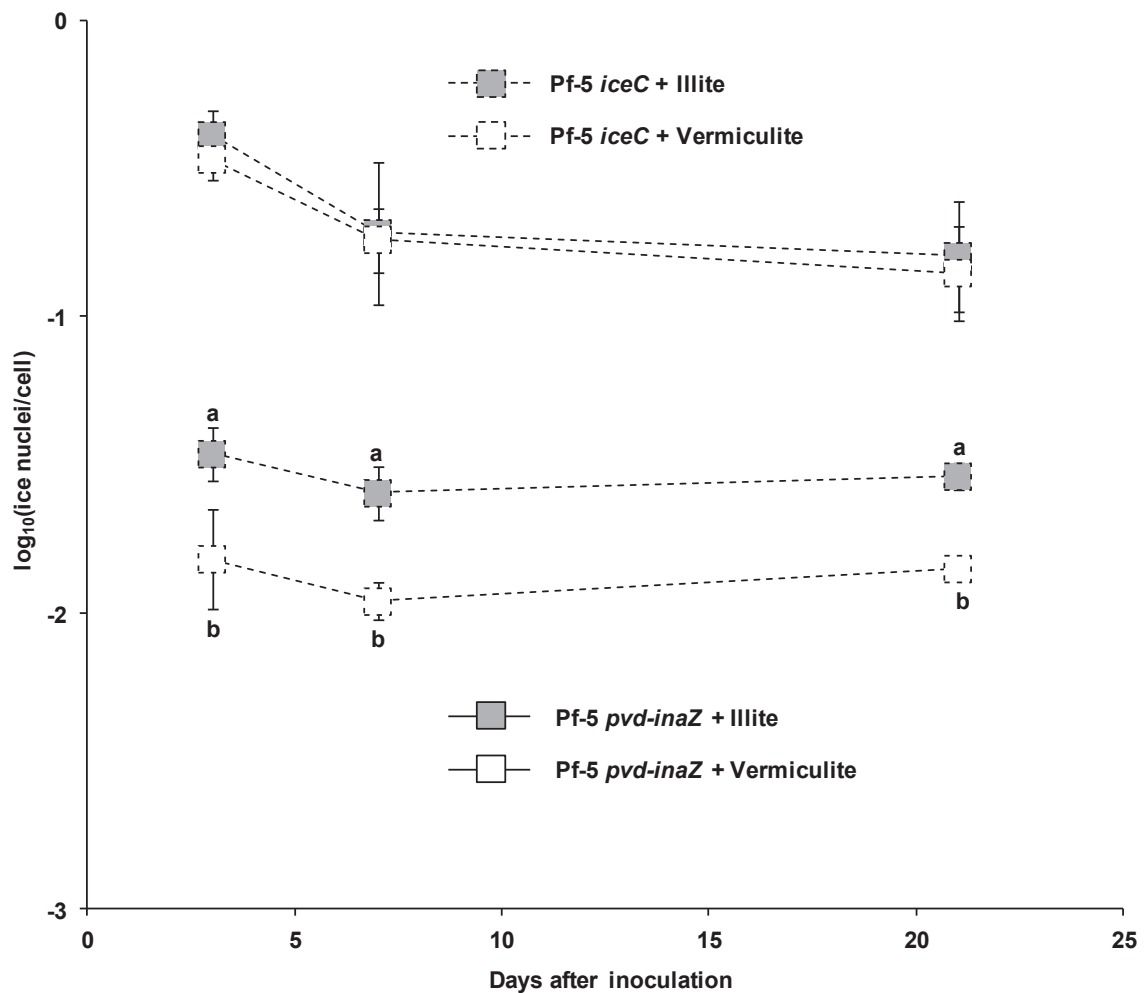
- Stutz, E. W., Défago, G., and Kern, H. 1986. Naturally-occurring fluorescent *Pseudomonas* involved in suppression of black root-rot of tobacco. *Phytopathology* 76:181-185.
- Stutz, E. W., Kahr, G., and Défago, G. 1989. Clays involved in suppression of tobacco black root-rot by a strain of *Pseudomonas fluorescens*. *Soil Biol. Biochem.* 21:361-366.
- Taniguchi, Y., Choi, P. J., Li, G. W., Chen, H., Babu, M., Hearn, J., Emili, A., and Xie, X. S. 2010. Quantifying *E. coli* proteome and transcriptome with single-molecule sensitivity in single cells. *Science* 329:533-538.
- Troxler, J., Berling, C. H., Moëgne-Loccoz, Y., Keel, C., and Défago, G. 1997. Interactions between the biocontrol agent *Pseudomonas fluorescens* CHA0 and *Thielaviopsis basicola* in tobacco roots observed by immunofluorescence microscopy. *Plant Pathol.* 46:62-71.
- Ulrich, A., Becker, R., 2006. Soil parent material is a key determinant of the bacterial community structure in arable soils. *FEMS Microbiol. Ecol.* 56:430-443.
- van Bruggen, A. H. C., Semenov, A. M., Zelenev, V. V., Semenov, A. V., Raaijmakers, J. M., Sayler, R. J., and de Vos, O. 2008. Wave-like distribution patterns of *gfp*-marked *Pseudomonas fluorescens* along roots of wheat plants grown in two soils. *Microbial Ecol.* 3:466-475.
- Vali, G. 1971. Quantitative evaluation of experimental results on heterogeneous freezing nucleation of supercooled liquids. *J. Atmos. Sci.* 28:402-409.
- Voisard, C., Keel, C., Haas, D., and Défago, G. 1989. Cyanide production by *Pseudomonas fluorescens* helps suppress black root rot of tobacco under gnotobiotic conditions. *EMBO J.* 8:351-358.
- von Felten, A., Défago, G., and Maurhofer, M. 2010. Quantification of *Pseudomonas fluorescens* strains F113, CHA0 and Pf153 in the rhizosphere of maize by strain-specific real-time PCR unaffected by the variability of DNA extraction efficiency. *J. Microbiol. Meth.* 81:108-115.
- Wang, C., Ramette, A., Punjasamarnwong, P., Zala, M., Natsch, A., Moëgne-Loccoz, Y., and Défago, G. 2001. Cosmopolitan distribution of *phlD*-containing dicotyledonous crop-associated biocontrol pseudomonads of worldwide origin. *FEMS Microbiol. Ecol.* 37:105-116.
- Weller, D. M. 2007. *Pseudomonas* biocontrol agents of soilborne pathogens: Looking back over 30 years. *Phytopathology* 97:250-256.

Weller, D. M., Mavrodi, D. V., van Pelt, J. A., Pieterse, C. M. J., van Loon, L. C., and Bakker, P. A. H. M. 2012. Induced systemic resistance in *Arabidopsis thaliana* against *Pseudomonas syringae* pv. *tomato* by 2,4-diacetylphloroglucinol-producing *Pseudomonas fluorescens*. *Phytopathology* 102:403-412.

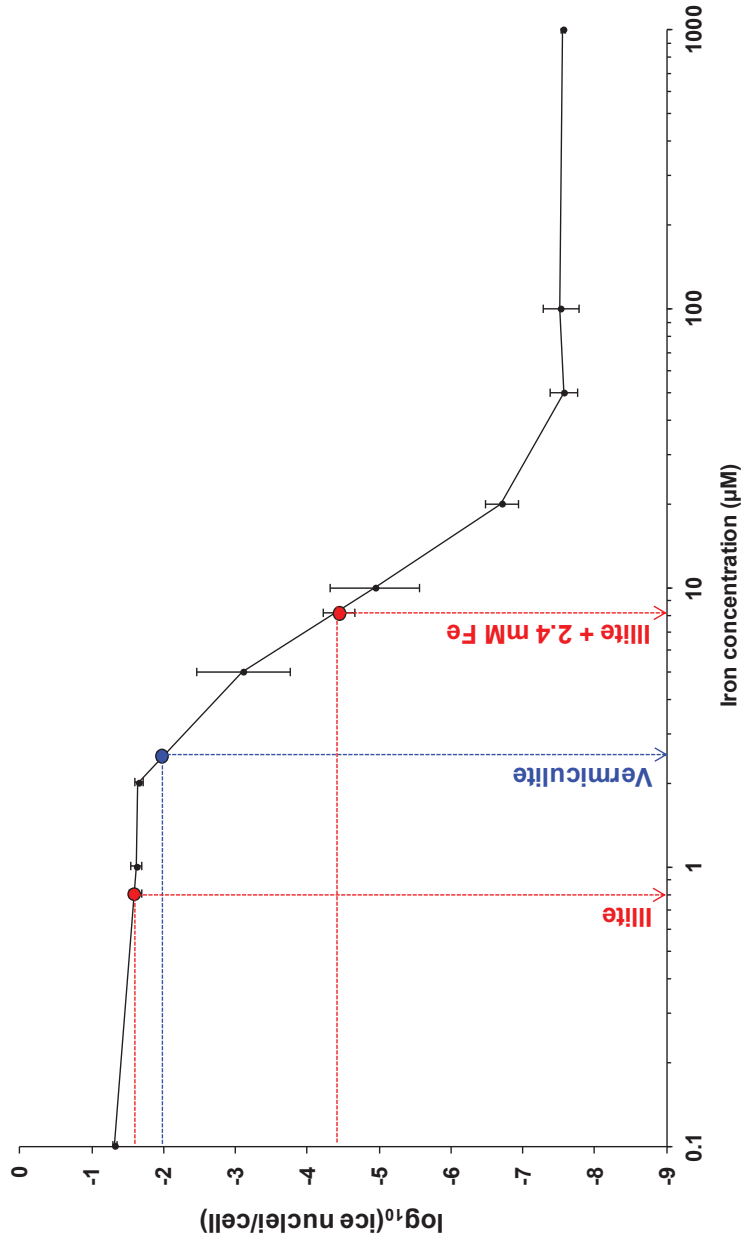
**Table S1.** Confocal laser scanning microscopy analysis of the numbers of total and GFP<sup>+</sup> cells (i.e. expressing *phlA-gfp*) of *P. protegens* CHA0-*mche*(pME7100) according to root zone and soil treatment, at 7 days after transplanting of bacteria-inoculated tobacco seedlings<sup>a</sup>.

	Root surface		Root hairs	
	Illite	Vermiculite	Illite	Vermiculite
<b>Illite versus vermiculite</b>				
Number of total cells (log <sub>10</sub> cells/field)	2.06 ± 0.04 b	2.27 ± 0.05 a	2.22 ± 0.06 a	2.22 ± 0.04 a
Number of green cells (log <sub>10</sub> cells/field)	1.62 ± 0.06 b	1.89 ± 0.09 a	1.69 ± 0.09 ab	1.84 ± 0.06 ab
Proportion of green cells	0.42 ± 0.03 ab	0.52 ± 0.05 a	0.36 ± 0.05 b	0.46 ± 0.03 ab
<b>Illite ± iron</b>				
	Illite	Illite + iron	Illite	Illite + iron
Number of total cells (log <sub>10</sub> cells/field)	2.01 ± 0.04 b	2.39 ± 0.05 a	2.15 ± 0.04 b	2.37 ± 0.06 a
Number of green cells (log <sub>10</sub> cells/field)	1.51 ± 0.06 b	2.02 ± 0.05 a	1.60 ± 0.09 b	2.07 ± 0.05 a
Proportion of green cells	0.39 ± 0.03 bc	0.49 ± 0.04 ab	0.35 ± 0.05 c	0.55 ± 0.06 a
<b>Illite versus vermiculite in presence of <i>T. basicola</i></b>				
	Illite	Vermiculite	Illite	Vermiculite
Number of total cells (log <sub>10</sub> cells/field)	1.97 ± 0.03 b	2.03 ± 0.07 ab	2.01 ± 0.06 b	2.18 ± 0.04 a
Number of green cells (log <sub>10</sub> cells/field)	1.48 ± 0.08 b	1.52 ± 0.09 b	1.41 ± 0.07 b	1.81 ± 0.05 a
Proportion of green cells	0.44 ± 0.05 ab	0.36 ± 0.04 ab	0.28 ± 0.03 b	0.49 ± 0.04 a

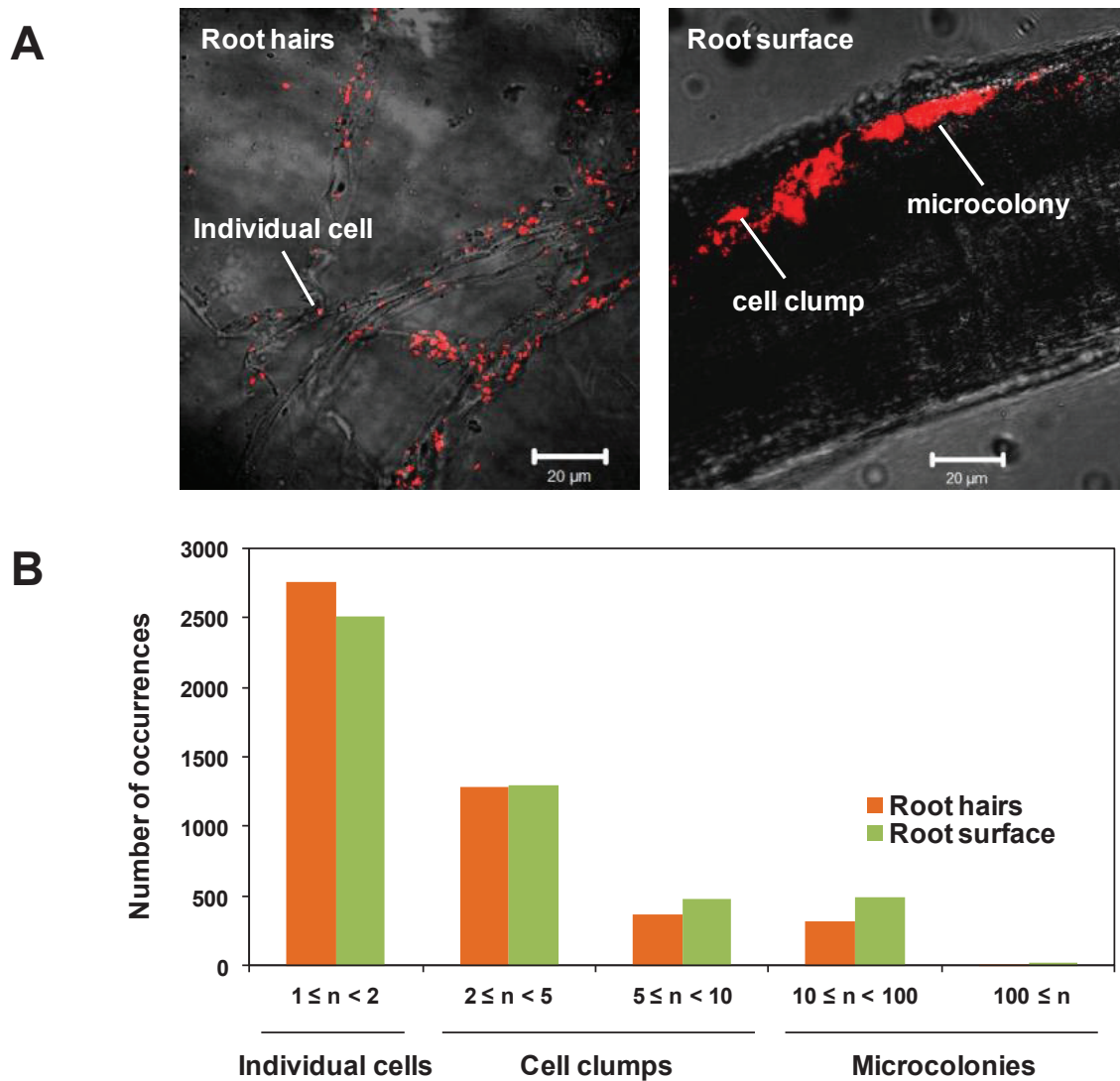
<sup>a</sup> Two runs were done for each experiment (giving similar results), each run consisting of 3 plants per treatment with 10 confocal fields (0.22 × 0.22 × 1 μm) assessed per plant. Means and standard errors are shown, after having pooled results from the two runs (*n* = 60 fields). Within each row, statistical differences between the four root zone × soil treatment combinations are indicated using letters a-c (ANOVA and Fisher's LSD tests; *P* < 0.05).



**Fig. S1.** Effect of clay mineralogy on ice nucleation activity of the iron biosensor strain *P. protegens* Pf-5 *pvd-inaZ* and the positive control strain Pf-5 *iceC* in the tobacco rhizosphere at 3, 7 and 21 days after transplanting of bacteria-inoculated seedlings in artificial vermiculitic (white bars) or illitic soil (grey bars). Ice nucleation activity was computed as the number of ice nuclei per cell (means  $\pm$  standard errors;  $n = 6$  plants). The experiment was done twice (each time with 3 plants per treatment) with similar results, and results were pooled. For each strain, statistical differences between soils, within each date, are shown using letters a and b (Student's *t* tests;  $P < 0.05$ ).



**Fig. S2.** Effect of iron concentration (from 0.1 to 1000  $\mu\text{M}$  FeEDDHA) on ice nucleation activity of *P. protegens* Pf-5 *pvd-inaZ* at 48 h in SM liquid medium. Ice nucleation activity (black symbols and black lines; means  $\pm$  standard errors) was computed as the number of ice nuclei divided by cell number (inferred from  $\text{OD}_{600}$  measurements). The experiment was done once, with  $n = 3$  replicates. The estimation of iron bioavailability for *P. protegens* Pf-5 in the tobacco rhizosphere is represented using data derived at 7 days from tobacco rhizosphere experiments in artificial soils, i.e. vermiculitic soil (blue symbol) and illitic soil amended or not with 2.4 mM Fe (red symbols). In the soil experiments, cell number of the inoculant was determined by colony counts. The experiment with artificial soils was run twice (giving similar results), each time with 3 plants per treatment, and pooled results from the two experiments are shown ( $n = 6$ ). Means and standard errors are shown for the soil experiments. For each soil treatment, the dashed line indicates the approximate iron concentration estimated from ice nucleation activity measured in the rhizosphere.



**Fig. S3.** Spatial distribution of *P. protegens* CHA0-*mche*(pME7100) on root hairs (orange bars) and at the root surface (green bars) at 7 days after transplanting of bacteria-inoculated tobacco seedlings in artificial soil. **A**, Images of root hairs and root surface showing individual cells, cell clumps and microcolonies of the inoculant. **B**, Cell distribution pattern of the inoculant on root hairs and at the root surface, which differed at  $P = 10^{-17}$  (Chi-squared test of independence). Pooled data from all experiments are presented ( $n = 3958$  occurrences).





# **DISCUSSION GÉNÉRALE**



Les sols résistants aux maladies sont des modèles permettant d'étudier les activités microbiennes rhizosphériques impliquées dans la phytoprotection, et de comprendre les facteurs biotiques et abiotiques les favorisant. Si on considère que « tout est partout: mais l'environnement sélectionne » (Beijerinck 1913), alors on peut supposer que les populations microbiennes impliquées dans la phytoprotection existent dans tous les sols. Les projets actuels de cartographie de la diversité microbienne permettront de mieux comprendre cet enjeu (Dequiedt et al. 2011 ; Gilbert et al. 2011). Ce serait donc l'ensemble des interactions biotiques et abiotiques que ces populations entretiennent avec l'environnement qui feraient (i) qu'elles s'établissent et (ii) qu'elles expriment leurs fonctions phytoprotectrices, dans certains sols (résistants) plutôt que d'autres (sensibles). La résistance du sol à la maladie peut être donc vue comme une propriété émergeant de ces interactions complexes dans la rhizosphère. D'un point de vue fondamental, mieux comprendre ces interactions permettrait de mieux cerner les facteurs modulant l'activité des communautés microbiennes et le fonctionnement de la rhizosphère. D'un point de vue appliqué, ceci nous permettrait de développer des stratégies agronomiques pouvant favoriser la phytoprotection des cultures, voire limiter l'utilisation de produits phytosanitaires souvent écotoxiques (Raaijmakers et al. 2009).

Beaucoup de connaissances sont maintenant disponibles sur les différentes populations microbiennes pouvant être impliquées dans les phénomènes de résistance, ainsi que sur leurs modes d'action potentiels (Kyselkova et Moëne-Loccoz 2012). Cependant, il y a encore clairement un manque de connaissance sur l'écologie rhizosphérique de ces populations et sur leurs activités *in situ*, d'où les nombreuses incertitudes quant à la réalité des mécanismes potentiels de phytoprotection dans les conditions écologiques qui sont celles de la rhizosphère. Par ailleurs, on manque de données expérimentales sur les facteurs biotiques et abiotiques modulant l'activité phytoprotectrice de ces microorganismes *in situ*. Ce projet de thèse avait pour objectif d'apporter de nouvelles connaissances dans ce contexte, en utilisant comme modèles les *Pseudomonas phl*<sup>+</sup> et les sols résistants de Morens.

## **Méthodologie pour l'étude des populations bactériennes phytoprotectrices dans les sols résistants**

Dans les premières études sur les sols résistants, la résistance a été attribuée à un seul type de microorganisme, voire un seul type d'isolat (Hornby 1983). Avec la

progression des connaissances sur la diversité microbienne dans les sols, et dans les sols résistants en particulier, il a été évident que la résistance du sol impliquait au minimum une population microbienne et, plus généralement, plusieurs populations appartenant à des groupes taxonomiques et fonctionnels différents, et pouvant agir par différents mécanismes (Kyselkova et Moëgne-Locco 2012). En conséquence, des approches culture indépendantes, permettant de suivre l'abondance de plusieurs taxons microbiens simultanément ont été davantage utilisées (Borneman et Becker 2007 ; Kyselková et al. 2009 ; Sanguin et al. 2009 ; Mendes et al. 2011). Ces approches sont très intéressantes pour étudier les populations bactériennes dans la rhizosphère, où des sous-populations viables mais non cultivables peuvent apparaître (Sorensen et al. 2001 ; Troxler et al. 2012). Cependant, elles utilisent souvent des marqueurs taxonomiques comme le gène *rrs* codant l'ARNr 16S, et présentent alors l'inconvénient de cibler des groupes phylogénétiques plutôt que des groupes fonctionnels. Or, la majorité des groupes fonctionnels antagonistes, e.g. les producteurs de phénazines (Mavrodi et al. 2010) ou de pyrrolnitrine (Garbeva et al. 2004b), ne correspondent pas à des groupes phylogénétiques monophylétiques. Un autre exemple est les *Pseudomonas phl*<sup>+</sup> qui, comme on le montre (Chapitre 1), ne constituent pas non plus un groupe monophylétique et il est donc difficile d'étudier leurs populations en utilisant un marqueur taxonomique comme *rrs* (Sanguin et al. 2008). Ici, on a développé une méthode (culture indépendante) de PCR quantitative reposant sur le gène *phlD* pour quantifier la densité de ce groupe fonctionnel, en permettant de cibler les différentes espèces de *Pseudomonas* (Chapitre 1; Almario et al. 2013). Cette méthode a été utilisée pour suivre ce groupe dans les sols de Morens (Almario et al. 2013) et dans d'autres sols résistants (Almario et al. soumis ; Annexe 1). Cet outil est précieux, car au-delà du cas des sols résistants, ce groupe fonctionnel est également utile en tant que bioindicateur de la qualité du sol (Janvier et al. 2007 ; Latz et al. 2012).

Les avancées sur la connaissance des sols résistants montrent qu'au-delà d'étudier la densité des populations responsables de la résistance, il est nécessaire de tenir compte aussi de leur activité *in situ*. L'objectif initial de cette étude était de quantifier simultanément la densité des populations des *Pseudomonas phl*<sup>+</sup> et l'expression de la fonction de synthèse de DAPG *in situ*, dans les sols résistants et sensibles de Morens. Dans le cas des populations produisant des antimicrobiens ceci peut se faire en mesurant les quantités du composé produites dans la rhizosphère (Okubara et Bonsall 2008), mais

cette tâche s'avère souvent difficile en raison de la grande quantité d'échantillon nécessaire (Raaijmakers et Mazzola 2012). La présence de DAPG dans la rhizosphère du tabac dans les sols résistants de Morens n'a pas pu être mise en évidence dans cette étude, même en utilisant une méthode robuste pour extraire le composé du sol (*Accelerated Solvent Extraction*) et une approche sensible de spectrométrie de masse. Ces tentatives, réalisées avec Florian Bellvert et Gilles Comte au Centre d'Etudes des Substances Naturelles (CESN ; UMR 5557 Ecologie microbienne) ne sont pas détaillées dans ce document de thèse. La détection du DAPG dans la rhizosphère nécessite de rassembler plusieurs plantes (50 au minimum dans Bergsma-Vlami et al. 2005). Cette limite technique rend la quantification du DAPG peu informative, car comme on ne peut pas mesurer la quantité de DAPG produite à l'échelle de la plante individuelle, on ne connaît pas la réalité des concentrations en DAPG nécessaires *in situ* pour une activité inhibitrice antimicrobienne ou pour l'ISR.

A défaut de détecter un composé dans la rhizosphère, il est généralement plus simple de quantifier l'expression des gènes associés à la synthèse du composé et ciblant leurs transcrits (Saleh-Lakha et al. 2005). Cette méthode suppose une extraction des ARN de la rhizosphère (sachant que seulement 3% des ARN du sol sont extraits ; Nicolaisen et al. 2008) et une quantification par RT-PCR quantitative (Nicolaisen et al. 2008). En suivant une procédure presque identique à celle utilisée par Baelum et al. (2008) permettant la quantification de l'expression du gène *tfdA* dans les populations indigènes du sol, il nous a été impossible de détecter de manière reproductible les transcrits du gène *phlD*, utilisé comme marqueur pour la synthèse de DAPG. On a cependant pu déterminer qu'au maximum ces transcrits atteignaient un niveau de  $3 \times 10^3$  transcrits par gramme de racine. Cette technique a été utilisée pour évaluer l'activité d'autres groupes fonctionnels dans la rhizosphère, y compris dans notre équipe (thèse de Marie-Lara Bouffaud en 2011), comme les bactéries fixatrices d'azote avec *nifH* (avec approximativement  $10^{10}$  transcrits par gramme de racine ; Hurek et al. 2002) ou la production de streptothricine par *Streptomyces rochei* (avec approximativement  $10^6$  transcrits par gramme de sol ; Anukool et al. 2004). Le principal atout de cette technique est la sensibilité mais elle est limitée par la faible efficacité d'extraction des ARN à partir de matrices complexes comme le sol, et la coextraction de composés inhibant les réactions enzymatiques ultérieures comme la dégradation de l'ADN par la DNase ou la rétrotranscription (Griffiths et al. 2000).

Pour contourner ces problèmes, on a utilisé une méthode de fusion transcriptionnelle entre le promoteur de l'opéron *phl* de *P. protegens* CHA0 (synthèse de DAPG) et un gène rapporteur codant la Gfp. La souche rapportrice *P. protegens* CHA0 *phlA-gfp* (Rochat et al. 2010), fournie par Christoph Keel (Université de Lausanne), nous a permis de vérifier que les gènes *phl* s'expriment dans la rhizosphère du tabac et d'étudier leur expression dans les systèmes de sol artificiel (Chapitre 2). Il est connu que le niveau d'expression des gènes *phl* dépend du génotype de la plante (Rochat et al. 2010). Notz et al. (2001) ont montré que de manière générale le niveau d'expression des gènes *phl* était plus bas sur les racines des plantes dicotylédones que des monocotylédones, alors que les effectifs de *Pseudomonas phl*<sup>+</sup> hébergés par les deux types de plantes sont comparables. Il est possible que le niveau d'expression de gènes *phl* dans la rhizosphère du tabac soit bas, et donc difficile à détecter compte tenu des difficultés techniques. Par ailleurs, il faut remarquer que deux publications décrivent des méthodes de RT-PCR quantitative pour les gènes *phl* (de Coste et al. 2011 ; Mishra et Arora 2012), mais aucune de ces méthodes n'a permis pour l'instant la quantification des transcrits *phl* dans des populations de *Pseudomonas* indigènes de la rhizosphère.

En conclusion sur la méthodologie, l'approche de PCR quantitative développée nous a permis de clarifier la relation entre densité des *Pseudomonas phl*<sup>+</sup> et résistance des sols de Morens. L'expression des gènes *phl* dans la rhizosphère du tabac a pu être caractérisée en utilisant la fusion *phlA-gfp*, et a permis de conclure sur la relation entre présence d'argile vermiculite, quantité de fer biodisponible pour *P. protegens*, expression des gènes *phl* de synthèse de DAPG, et contrôle de la maladie.

## **Origine géologique du sol, minéralogie des argiles et résistance**

L'origine géologique du sol a été montrée comme un facteur structurant la communauté bactérienne rhizosphérique (Ulrich et Becker 2006), probablement parce qu'elle détermine plusieurs caractéristiques importantes des horizons de surface du sol particulièrement la texture et la minéralogie des argiles présentes (Garbeva et al. 2004a). Mais les études ciblant cette question sont rares. C'est regrettable, car nos résultats suggèrent qu'en déterminant la minéralogie des argiles (et donc la biodisponibilité du fer), l'origine géologique du sol peut influencer l'activité de bactéries dans la rhizosphère (ici les *Pseudomonas phl*<sup>+</sup>) et peut donc potentiellement avoir un fort impact sur la

communauté rhizobactérienne. Ce type de questionnement a donc un intérêt scientifique qui va bien au-delà de la thématique des sols résistants.

Dans la région de Morens, les sols résistants se sont formés à partir de moraine, tandis que les sols sensibles sont développés sur la molasse (Stutz et al. 1985). À Morens, cette différence détermine la minéralogie des argiles dominantes (vermiculite ou illite ; Stutz et al. 1989); sols résistants et sensibles étant par ailleurs comparables aux niveaux pédologique et physicochimique. Nous avons d'ailleurs confirmé dans cette thèse qu'en système de sol artificiel, *P. protegens* CHA0 assure un niveau de phytoprotection plus fort en présence de vermiculite que d'illite, comme cela avait déjà été montré (Keel et al. 1989). Ce lien entre l'origine géologique du sol, la minéralogie des argiles et la résistance semble spécifique aux sols de la région de Morens, car il n'a pas été retrouvé dans d'autres sols résistants et sensibles à la maladie de la pourriture noire identifiés dans la région voisine de Savoie (Almario et al. submitted ; voir Annexe 1). À notre connaissance, une seule autre étude avait mis en évidence un lien entre la minéralogie des argiles et la résistance du sol. La résistance de certains sols à la fusariose de la banane est liée à la présence d'argiles de type montmorillonite (Stotzky et Torrence Martin 1963), qui induiraient (d'une façon inconnue) une plus forte activité antagoniste de *Serratia* (Rosenzweig et Stotzky 1979). À noter qu'il s'agit là d'une argile du même groupe dit groupe Montmorillonite-Vermiculite. Ces observations suggèrent que le type d'argile présent dans le sol est un facteur important car pouvant moduler l'activité des rhizobactéries, et donc qu'il devrait être étudié davantage pour comprendre le fonctionnement des communautés microbiennes rhizosphériques. Des différences dans la minéralogie des argiles du sol peuvent en effet se traduire par des différences de pH ou de concentration en fer (Höper et al. 1995) connues pour avoir un fort impact sur les microorganismes (Garbeva et al. 2004a).

### **Biodisponibilité du fer dans la rhizosphère et résistance**

La présence de vermiculite dans les sols résistants de Morens peut se traduire par une plus forte biodisponibilité du fer pour *Pseudomonas protegens*, induisant une plus forte expression des gènes *phl* et le contrôle de la maladie (Chapitre 2). Ceci contraste avec ce qui est observé dans certains sols résistants à la fusariose, où au contraire la résistance est liée à une plus faible disponibilité du fer. Dans ces sols, l'inhibition de



*Fusarium oxysporum* par *Pseudomonas* implique une compétition pour le fer (Scher et Baker 1982 ; Djuiff et al. 1999 ; Mazurier et al. 2009), plus rude lorsque le milieu est carencé (faible biodisponibilité du fer). Keel et al. (1989) a démontré que la compétition pour le fer n'était pas le mécanisme d'action principal de *P. protegens*; le mutant *P. protegens* CHA0 *pvd*- (incapable de produire de la pyoverdine) conservant son activité phytoprotectrice vis-à-vis de *T. basicola*. Cette différence concernant le mode d'action des *Pseudomonas* est probablement due au pathogène. *Fusarium* semble particulièrement sensible aux carences en fer (Robin et al. 2008) ; ses sidérophores ont une constante de stabilité très basse ( $10^{29}$ ) comparés à ceux de *Pseudomonas* ( $10^{32}$  ; Scher et Baker 1982) et ses chlamydospores contiennent peu de fer en réserve donc leur germination est limitée par le fer biodisponible dans le milieu (Elad et Baker 1985). *T. basicola* semble moins sensible aux carences en fer, car la faible biodisponibilité du fer dans le sol sensible (illitique) n'affecte pas sa croissance, ou sa capacité à infecter la plante (Keel et al. 1989 ; Chapitre 2), mais il y a peu d'études sur la physiologie de ce champignon. De plus, on peut argumenter que l'inhibition de *Fusarium* par compétition pour le fer s'établit généralement dans des sols avec un pH alcalin, où la biodisponibilité du fer est probablement très basse (Robin et al. 2008), et ce n'est probablement pas le cas des sols de Morens qui ont un pH presque neutre (Ramette et al. 2003). De manière plus générale, ceci montre que si la compétition pour le fer est un mécanisme d'action courant des *Pseudomonas* (Robin et al. 2008), il n'est peut-être pas efficace contre tous les pathogènes et dans tous les sols. Les champignons telluriques ont des stratégies différentes pour pallier la carence en fer et produisent différents sidérophores (Winkelmann 2007), et il est probable que certains se soient adaptés à la pression de compétition imposée par les *Pseudomonas* et les autres microorganismes saprophytes dans la rhizosphère, et soient plus performants dans la compétition pour le fer.

Par ailleurs, certains sidérophores produits par les *Pseudomonas* et autres bactéries en situation de carence en fer peuvent aussi éliciter des réactions de défense de la plante de type ISR, la rendant plus résistante à l'attaque de pathogènes (Maurhofer et al. 1998 ; Robin et al. 2008). Dans ce cas, on s'attendrait à ce que le niveau de protection soit plus élevé en condition de faible biodisponibilité du fer dans la rhizosphère, or on observe l'inverse dans le cas de la résistance des sols de Morens. Ceci peut s'expliquer parce qu'il y a une grande variété de sidérophores chez les *Pseudomonas* (Ravel et Cornelis 2003) et ils n'ont pas tous la capacité de déclencher une réponse de type ISR (Djavaheri et al.

2012). Par exemple dans le cas de *P. protegens* CHA0 la pyoverdine (principal sidérophore) n'est pas essentielle à l'activité phytoprotectrice de *P. protegens* vis à vis de *T. basicola* (Keel et al. 1989), ni pour une réponse ISR chez *Arabidopsis*, qui dépend de la synthèse de DAPG (Iavicoli et al. 2003 ; Weller et al. 2012).

L'induction de l'expression des gènes de synthèse du DAPG par le fer a été décrite récemment *in vitro* (Lim et al. 2012a) et a été confirmée ici (Chapitre 2), mais n'avait jamais été étudiée dans la rhizosphère. Le fer est donc le premier facteur abiotique décrit comme capable d'induire l'expression des gènes *phl* dans la rhizosphère, en plus des facteurs biotiques connus (de Werra et al. 2008 ; Jamali et al. 2009 ; Rochat et al. 2010). Le fer induit autres fonctions antimicrobiennes chez les *Pseudomonas phl*<sup>+</sup> par exemple la synthèse de cyanure d'hydrogène (HCN), un composé avec un effet antimicrobien sur *T. basicola* qui a été suggéré comme participant à la suppression de *T. basicola* par les *Pseudomonas phl*<sup>+</sup> (Voisard et al. 1989). Cependant, les études sont contradictoires concernant l'effet du fer sur la synthèse d'HCN (Voisard et al. 1989 ; Lim et al. 2012a). Toutes les *Pseudomonas phl*<sup>+</sup> sont aussi capables de produire de l'HCN (Svercel et al. 2007) et il est possible que cette fonction joue un rôle dans la résistance de sols de Morens.

D'une façon générale, le fer est connu pour influencer sur l'écologie des *Pseudomonas* que ce soit en modulant leur croissance, leur mobilité (Glick et al. 2010), la synthèse de composés antimicrobiens (Lim et al. 2012a), ou leur interaction avec l'hôte eucaryote fongique (comme dans cette étude), végétal (Robin et al. 2008 ; Djavaheiri et al. 2012) ou animal (Vasil et Ochsner 2002). Cet impact du fer n'est pas restreint aux *Pseudomonas*, mais est observé chez autres taxons bactériens plus abondants dans les sols résistants que dans les sols sensibles de Morens (Kyselková et al. 2009), comme les *Burkholderia* (Tuanyok et al. 2005) et les *Herbaspirillum* (Rosconi et al. 2006). Dans ce contexte, il semble possible qu'une plus forte biodisponibilité du fer dans les sols vermiculitiques puisse moduler l'expression d'autres fonctions (que la synthèse du DAPG) chez les *Pseudomonas phl*<sup>+</sup>, les autres *Pseudomonas* et les autres bactéries. Par ailleurs, il est aussi connu que le statut nutritionnel de la plante en fer influence la communauté bactérienne rhizosphérique (Maschner et Crowley 1998 ; Yang et Crowley 2000 ; Robin et al. 2007). On peut donc penser qu'une plus forte biodisponibilité du fer dans les sols vermiculitiques résistants peut potentiellement se traduire par des

changements multiples dans la communauté rhizosphérique (au-delà des *Pseudomonas phl*<sup>+</sup>) qui participeraient à la résistance du sol.

## **Rôles écologiques du DAPG et résistance des sols de Morens**

À forte concentration, le DAPG est un composé toxique avec des activités antibactériennes, antifongiques et phytotoxiques (Haas et Défago 2005 ; Brazelton et al. 2008), impliquant probablement une action sur la membrane cellulaire (Gleeson et al. 2010). Cependant, à faible concentration le DAPG agit comme molécule signal, c'est-à-dire une molécule émise par un organisme, et reconnue par un autre organisme chez qui il induit une réponse. Il agit comme molécule signal entre les *Pseudomonas phl*<sup>+</sup> en tant qu'auto-inducteur de sa propre synthèse (Schnider-Keel et al. 2000 ; Dubuis et Haas 2007). Il agit aussi en tant que molécule signal entre les *Pseudomonas phl*<sup>+</sup> et les bactéries rhizosphériques du genre *Azospirillum*, chez qui le DAPG induit l'expression de gènes impliqués dans des fonctions phytobénéfiques (production d'auxines), ainsi que dans la mobilité cellulaire et la colonisation racinaire (Combes-Meynet et al. 2011). Il agit aussi comme molécule signal sur les plantes en élicitant les défenses végétales (Iavicoli et al. 2003 ; Weller et al. 2012), et en modulant l'exsudation (Phillips et al. 2004) et l'architecture racinaire (Brazelton et al. 2008). L'étude des sols résistants de Morens a établi l'implication des *Pseudomonas phl*<sup>+</sup>. Cependant, le mode d'action du DAPG dans le phénomène de résistance reste à clarifier ; il pourrait impliquer l'inhibition du pathogène, l'élicitation des défenses de la plante, et/ou une action indirecte en modulant l'activité d'autres microorganismes phytobénéfiques.

L'implication du DAPG dans la résistance des sols de Morens a longtemps été attribuée à son activité antifongique (Keel et al. 1989 et 1992), ce qui est remis en question par plusieurs observations. Troxler et al. (1997) ont observé qu'une interaction physique entre *T. basicola* et *P. protegens* CHA0 n'était pas nécessaire pour la phytoprotection, et que la réduction de la maladie ne se traduisait pas par une inhibition de la croissance du pathogène mais par un retard de sa pénétration dans la racine. Les résultats de ce projet de thèse corroborent cette observation, car dans les sols résistants comme dans les sols sensibles le pathogène peut coloniser la surface racinaire et la rhizosphère du tabac (Almario et al. 2013). Ceci veut dire qu'il n'y a pas de phénomène

de 'suppression' du pathogène, mais plutôt une restriction de son entrée dans la racine (infection).

Une hypothèse alternative à l'effet antifongique direct du DAPG serait un effet phytoprotecteur par l'élicitation des défenses de la plante, à travers l'induction d'une résistance systémique de type ISR (Troxler et al. 1997 ; Almario et al. 2013). En plus des points énoncés ci-dessus, on peut argumenter que la concentration de DAPG nécessaire pour inhiber la croissance de *T. basicola in vitro* (128 µg/mL ; Keel et al. 1992) est environ 60 fois supérieure à celle requise pour induire une résistance systémique chez *Arabidopsis thaliana* (2,1 µg/mL ; Iavicoli et al. 2003) et que la concentration maximale de DAPG détectée dans la rhizosphère est de 150 ng/g de racine (Bergsma-Vlami et al. 2005). Même si ce raisonnement reste approximatif, les données n'ayant pas été obtenues sur le tabac, on peut spéculer que la concentration de DAPG dans la rhizosphère atteint plus facilement un niveau suffisant pour une ISR que pour l'inhibition de *T. basicola*. En conséquence, on propose que dans les sols de Morens la plus forte expression des gènes *phl* dans les sols vermiculitiques, se traduit par des concentrations plus élevées en DAPG dans la rhizosphère. Ces concentrations seraient suffisantes pour activer une ISR chez le tabac et peut-être aussi pour inhiber *T. basicola* dans certains microsites racinaires de synthèse préférentielle de DAPG. Au contraire, dans les sols sensibles les concentrations en DAPG ne sont peut-être pas suffisantes pour activer efficacement une ISR chez la plante. Il faut aussi prendre en compte que l'activation possible d'une ISR chez la plante dans les sols résistants pourrait se traduire par des modifications dans la structure de la communauté rhizobactérienne, comme observé chez *Arabidopsis* (Doornbos et al. 2011), ce qui pourrait expliquer en partie les différences entre les communautés rhizobactériennes dans les sols résistants et sensibles de Morens mises en évidence par Kyselkova et al. (2009). De plus, certains des taxons plus abondants dans les sols résistants de Morens (Kyselková et al. 2009) sont capables eux-aussi d'activer une ISR chez les plantes, comme *Azospirillum* (Russo et al. 2008), et pourraient agir en synergie avec le DAPG. Par ailleurs, le DAPG contribue vraisemblablement à structurer la communauté rhizobactérienne de façon indirecte, en modulant les exsudats racinaires (Phillips et al. 2004) ou en agissant comme pression de sélection sur certains groupes. Les relations entre DAPG, ISR et communauté rhizobactérienne sont donc complexes et restent encore à clarifier dans le cas des sols de Morens.

Le DAPG a une activité bactéricide à large spectre (Keel et al. 1992) et il a été montré que dans la rhizosphère du concombre seulement 42 % des isolats bactériens sont résistants au DAPG (à 50 µg/mL ; Natsch et al. 1998). Ceci suggère que ce composé pourrait affecter la composition la communauté bactérienne rhizosphérique et de ce fait le fonctionnement de la rhizosphère, d'autant qu'il est capable d'inhiber la croissance de bactéries pouvant avoir un rôle important dans le fonctionnement de la rhizosphère comme des *Bacillus* (Natsch et al. 1998), *Rhizobium* (Walsh et al. 2003) et *Cytophaga* (Johansen et al. 2002). De ces observations, il serait attendu que dans des écosystèmes où les *Pseudomonas phl<sup>+</sup>* sont *a priori* très actives, comme dans certains sols résistants, la synthèse de DAPG puisse avoir un impact sur l'écosystème rhizosphère. Or, les sols résistants ne présentent pas une diversité ou une biomasse microbienne plus faible que dans les sols sensibles malgré les effets antimicrobiens du DAPG (Landa et al. 2002 ; Kyselkova et al. 2009). Pour l'expliquer, Kinkel et al. (2011) proposent que dans les sols résistants les populations microbiennes rhizosphériques sont adaptées à la pression de sélection exercée par les *Pseudomonas phl<sup>+</sup>*, et que cette adaptation découle d'une coévolution avec les *Pseudomonas phl<sup>+</sup>*, qui passerait entre autres par le développement de mécanismes de résistance aux composés antimicrobiens. Par exemple, les bactéries du genre *Azospirillum* sont capables de résister à des fortes concentrations de DAPG (jusqu'à 210 µg/mL, soit 1000 µM), en produisant des granules de caroténoïdes leur permettant de résister au stress oxydatif (Couillerot et al. 2011). Par ailleurs, Kinkel et al. (2011) proposent que dans ces sols on devrait aussi observer une plus forte diversité de métabolites antimicrobiens. Cette diversité empêcherait la sélection de sous-populations du pathogène résistantes à certains antimicrobiens uniquement. En conclusion, selon cette théorie, il serait donc possible que le DAPG et les autres antimicrobiens produits dans la rhizosphère agissent comme pressions de sélection qui structureraient la communauté microbienne rhizosphérique en favorisant certains groupes plus résistants. Cette structuration pourrait expliquer en partie les différences entre les communautés rhizobactériennes dans les sols résistants et sensibles de Morens (Kyselkova et al. 2009) et d'ailleurs (Sanguin et al. 2009 ; Schreiner et al. 2010).

Le DAPG peut aussi moduler le développement du système racinaire en favorisant la formation de racines latérales *via* des voies auxine dépendantes (Brazelton et al. 2008).

Cet effet se traduirait par une augmentation du volume de sol exploité par les racines et donc une meilleure croissance des plants de tabac. Si on considère qu'une plante plus robuste résiste mieux à l'attaque d'un pathogène, il devient pertinent de considérer cet effet phytostimulateur pour comprendre la résistance des sols de Morens. Cependant, cet effet n'est probablement pas significatif dans les sols de Morens, car les plantes cultivées dans les sols résistants ne présentent pas une biomasse totale ou racinaire plus grande que celle des plantes dans les sols sensibles (Kyselková et al. 2009 ; Almario et al. 2013). Un autre processus lié au DAPG va dans le même sens, à savoir l'effet positif du DAPG sur l'expression de gènes d'*Azospirillum* impliqués dans la stimulation de la croissance de la plante (Combes-Meynet et al. 2011), d'autant que les *Azospirillum* sont plus abondants dans les sols résistants de Morens que dans les sols sensibles (Kyselkova et al. 2009). Cette interaction *Pseudomonas phl*<sup>+</sup> - *Azospirillum* pourrait ainsi contribuer à la santé du tabac dans les sols résistants de Morens.

L'effet du *DAPG* sur *Azospirillum* est intéressant, mais le rôle signal du DAPG n'est peut-être pas restreint à la communication avec *Azospirillum*, et donc ce type d'effet mériterait d'être étudié également au niveau des autres populations microbiennes de la rhizosphère, notamment lorsque l'on considère que de nombreuses populations bactériennes diffèrent en importance lorsque l'on compare sols résistants et sensibles, à Morens (Kyselkova et al. 2009) et dans d'autres sols résistants (Sanguin et al. 2009 ; Schreiner et al. 2010 ; Mendes et al. 2011). D'ailleurs, plusieurs types de microorganismes rhizosphériques plus abondants dans les sols résistants que dans les sols sensibles de Morens sont capables d'interagir avec les *Pseudomonas* (Kyselkova et Moëgne-Loccoz 2012). Un exemple est un consortium de souches de *Xanthomonadaceae*, *Stenotrophomonas* et *Pseudomonas* capable d'agir ensemble et d'améliorer la croissance du tabac (Mastretta et al. 2009). Un autre exemple est un consortium de *Pseudomonas phl*<sup>+</sup> et d'une souche de *Stenotrophomonas* protéolytique protégeant mieux la betterave des *Pythium* spp. (Dunne et al. 1998). Des interactions similaires pourraient contribuer à la résistance des sols, à Morens et ailleurs.

La résistance des sols de Morens est probablement multifactorielle et implique probablement plusieurs microorganismes et plusieurs mécanismes d'action. En conclusion, il serait possible que dans les sols résistants de Morens la plus forte expression des gènes *phl* se traduise par des concentrations en DAPG dans la rhizosphère

capables d'activer une ISR chez la plante et/ou d'induire l'expression d'autres fonctions microbiennes, antagonistes ou phytostimulatrices, dans la communauté rhizobactérienne. L'ensemble de ces interactions pourrait potentiellement participer au phénomène de résistance du sol. La complexité de ces interactions n'est probablement pas exclusive des sols de Morens et donc elles devraient être prises en compte dans l'étude des autres sols résistants.

## **Densité de population des *Pseudomonas phl*<sup>+</sup> et prédiction de la résistance du sol**

Les *Pseudomonas phl*<sup>+</sup> sont un groupe fonctionnel comprenant au moins six espèces (Chapitre 1), avec une distribution biogéographique cosmopolite (Keel et al. 1996 ; Wang et al. 2001). Cependant, leur activité phytoprotectrice n'est observée que dans certains sols (résistants) où leurs effectifs sont suffisamment hauts. Dans le premier chapitre de cette thèse, on a étayé l'hypothèse que dans les sols de Morens, la résistance ne dépend pas uniquement de la densité des populations de *Pseudomonas phl*<sup>+</sup>, ce qui se traduit par une absence de corrélation entre la densité de population des *Pseudomonas phl*<sup>+</sup> et le niveau de résistance du sol. Ceci contraste avec le postulat, décrit par Chen et al. (2012), selon lequel si un microorganisme est impliqué dans le phénomène de résistance d'un sol, alors « la densité de population du microorganisme bénéfique (antagoniste) doit covarier avec les niveaux de résistance » (Borneman et Becker 2007). Ce postulat est fort si l'objectif est de définir des populations microbiennes bioindicatrices de la résistance du sol, mais il est restrictif pour l'étude des populations responsables de la résistance avec des modes d'action autres que la compétition et où la fonction de protection n'est pas nécessairement proportionnelle à l'effectif.

D'une part, nous pensons que c'est l'activité des populations responsables de la résistance plutôt que leurs effectifs qui devrait corrélérer aux niveaux de résistance. Or, l'activité de protection d'une population bactérienne repose sur l'expression des fonctions correspondantes, qui peuvent selon les cas, être soumises à des régulations transcriptionnelles, traductionnelles et/ou post-traductionnelles. Dans le cas des gènes *phl*, la régulation s'effectue aux niveaux de la transcription (Haas et al. 2000) et de la post-transcription (Kay et al. 2005). Ces régulations ont certainement des effets importants dans la rhizosphère, et peuvent expliquer pourquoi l'expression de fonctions antagonistes chez par exemple *Pseudomonas*, *Burkholderia* ou *Bacillus* est modulée par le génotype de

plante (Bergsma-Vlami et al. 2005 ; Fan et al. 2012), des phénomènes de *quorum sensing* (Mavrodi et al. 2006 ; Schmidt et al. 2009), la concentration en Zn ou Fe (Lim et al. 2012a et 2012b) ou d'autres facteurs du milieu. Notre hypothèse est corroborée par l'observation que l'activité phytoprotectrice des microorganismes antagonistes varie significativement en fonction du génotype de la plante et de celui du pathogène (Kwak et al. 2012), du pathosystème (Rezzonico et al. 2007), et du type de sol (Ramette et al. 2006). Néanmoins, l'activité des populations antagonistes est rarement considérée dans l'étude des sols résistants (Bergsma-Vlami et al. 2005 ; Kwak et al. 2012), et dans cette thèse on a montré que la propriété de résistance, résultant de la présence de vermiculite, est liée à l'activité des *Pseudomonas phl*<sup>+</sup> (Chapitre 2), sur la base d'une corrélation entre l'expression des gènes *phl* chez *P. protegens* et le niveau de phytoprotection assuré par la bactérie.

D'autre part, le postulat développé par Borneman et Becker (2007) suggère une relation linéaire entre la densité des populations antagonistes et le niveau de résistance du sol, mais cette relation est rarement linéaire car il y a souvent un effet de seuil lié à un effectif minimal que la population antagoniste doit atteindre pour observer le phénomène de phytoprotection. Ceci est connu pour plusieurs sols résistants où les populations antagonistes doivent atteindre au moins 10<sup>4</sup> CFU/g de racine (*Pseudomonas phl*<sup>+</sup> dans les sols de Morens ; Almario et al. 2013), 10<sup>5</sup> CFU/g de racine (*Pseudomonas phl*<sup>+</sup> dans le déclin du piétin échaudage ; Raaijmakers et Weller 1998 ; Weller et al. 2007) ou 10<sup>3</sup> propagules/g de sol (*Fusarium oxysporum* dans les sols résistants à la fusariose ; Fravel et al. 2003). C'est donc le cas dans les sols de Morens, où la résistance implique un seuil de densité des *Pseudomonas phl*<sup>+</sup> (Stutz et al. 1986), mais pas une densité de population plus forte dans les sols résistants par rapport aux sols sensibles (Almario et al. 2013). Dans le cas de la résistance au piétin, une augmentation de l'effectif des *Pseudomonas phl*<sup>+</sup> n'entraîne pas un niveau de phytoprotection supplémentaire, pourvu que l'effectif soit déjà au-dessus du seuil en question (Raaijmakers et al. 1999).

En conclusion, on peut dire qu'à la différence d'autres sols résistants (Raaijmakers et al. 1999), la densité des populations de *Pseudomonas phl*<sup>+</sup> n'est pas un critère suffisant pour prédire le statut sensible ou résistant dans les sols de Morens, et que davantage d'attention devrait être portée à l'étude de l'activité de ces populations dans ces sols. La plupart des études sur les groupes fonctionnels dans la rhizosphère se concentre sur leur



densité et moins sur leur niveau d'activité (Chen et al. 2012). Or on pense que des approches fonctionnelles ciblant l'expression de gènes clef sont importantes pour comprendre l'écologie des communautés microbiennes en interaction avec les plantes (Saleh-Lakha et al. 2005 ; Delmont et al. 2012) ou d'autres eucaryotes (Poroyko et al. 2010).

### **Interaction entre le pathogène et les *Pseudomonas phl*<sup>+</sup>**

Dans les sols résistants à la fusariose, la résistance peut impliquer des *Fusarium oxysporum* non pathogènes, qui agissent par induction de résistance (Fuchs et al. 1997) et/ou par compétition pour la niche spatiale (Fravel et al. 2003), en interaction avec des *Pseudomonas* (Duijff et al. 1999 ; Mazurier et al. 2009). Il a aussi été observé que le déclin du piétin échaudage du blé peut impliquer le développement de génotypes du pathogène *Gaeumannomyces graminis* var. *tritici* (*Ggt*) moins agressifs (Lebreton et al. 2007). Cependant, la contribution de pathogènes peu ou pas virulents ne semble pas être pertinente pour expliquer la résistance des sols de Morens. Dans ces derniers, toutes les spores de *T. basicola* isolées par Gasser et al. (1981) étaient pathogènes sur tabac, indiquant que la résistance de ces sols n'impliquait probablement pas une sous-population de *T. basicola* non pathogènes. Cette hypothèse est renforcée ici, car les séquences ITS de *T. basicola* que nous avons détectées dans ces sols étaient toutes identiques (Almario et al. 2013) à celle de la souche pathogène ETH D127 (utilisée pour les expériences d'inoculation), y compris dans les sols non inoculés, et aucune ne correspondait à celles de souches non-pathogènes (Coumans et al. 2011) sur tabac.

En sol naturel, la présence du pathogène à forte densité (après avoir été inoculé) a modifié la structure génétique des populations de *Pseudomonas phl*<sup>+</sup> en favorisant la prévalence de l'espèce *P. brassicacearum*, sans effet clair sur l'espèce minoritaire *P. protegens* (Almario et al. 2013). Par contre, l'inoculation du pathogène a eu un effet négatif sur l'effectif de la souche de *P. protegens* dans le système de sol artificiel, et un effet neutre ou négatif sur l'expression des gènes *phl* (Chapitre 2). Ces observations indiquent que la présence de *T. basicola* peut moduler la composition voire aussi l'expression des gènes *phl* des populations de *Pseudomonas phl*<sup>+</sup>.

Le fait que *T. basicola* puisse modifier la composition du groupe fonctionnel des *Pseudomonas phl*<sup>+</sup> est important, car toutes les espèces et souches de *Pseudomonas phl*<sup>+</sup> n'ont pas la même activité phytoprotectrice envers les pathogènes fongiques (Sharifi-Tehrani et al. 1998 ; Rezzonico et al. 2007) y compris *T. basicola* (Ramette et al. 2006). De plus, la structure de communauté des *Pseudomonas phl*<sup>+</sup> (composition en nombre et types d'espèces) peut avoir un impact sur l'activité antagoniste résultante (Becker et al. 2012). *P. brassicacearum* était favorisé en présence de *T. basicola* (Almario et al. 2013), ce qui pourrait résulter d'effets directs ou indirects du champignon. *G. graminis* var. *tritici* favorise la croissance du *Pseudomonas 'fluorescens'* antagoniste Pf29Arp *in vitro* (Barret et al. 2009a), et l'infection des racines de blé par le pathogène module l'expression de plusieurs fonctions chez la bactérie, en induisant des gènes associés à l'antagonisme, comme ceux pour la synthèse d'HCN et un système de sécrétion de type IV (Barret et al. 2009b). Une interaction similaire entre *P. brassicacearum* et *T. basicola* existe peut-être, ce qui conduirait à émettre l'hypothèse que cette espèce joue un rôle particulier dans la résistance des sols de Morens.

L'effet négatif de *T. basicola* sur l'effectif de la souche de *P. protegens* et l'expression des gènes *phl* en sol artificiel (Chapitre 2), n'avait pas été décrit auparavant (Keel et al. 1989 ; Ramette et al. 2006). Cependant, il est connu que d'autres phytoparasites ont développé des mécanismes de défense pour contrecarrer l'activité des bactéries antagonistes (Raaijmakers et al. 2009). *P. ultimum* limite la capacité de colonisation du système racinaire de la betterave par *P. 'fluorescens'* F113 (Fedi et al. 1997), en interférant avec l'expression de gènes ribosomiques (Smith et al. 2001). La synthèse d'acide fusarique par *F. oxysporum* réprime l'expression des gènes *phl* chez *P. protegens* CHA0 (Notz et al. 2002). Des interactions similaires entre *P. protegens* et *T. basicola* ne sont pas documentées. Si elles existaient, elles correspondraient à une course à l'armement (van Valen 1973), dans laquelle les pathogènes développent des stratégies pour échapper à la pression antagoniste (Duffy et al. 2003), ce qui irait dans le sens d'une coévolution des phytopathogènes avec les populations antagonistes phytoprotectrices (hypothèse de la reine rouge), comme il a été suggéré ailleurs (Kinkel et al. 2011).

## Représentativité de *P. protegens* en tant que modèle des *Pseudomonas phl*<sup>+</sup> de Morens

Au vu de la diversité à l'intérieur du groupe fonctionnel des *Pseudomonas phl*<sup>+</sup>, comptant au moins six espèces différentes et peut-être beaucoup plus (Chapitre 1), il n'est pas surprenant qu'elles n'aient pas la même écologie (Sharifi-Tehrani et al. 1998 ; Wang et al. 2001) et donc qu'elles n'établissent pas les mêmes types d'interaction dans la rhizosphère. Deux observations faites dans notre étude illustrent ce point. La première concerne l'effet différent de l'inoculation de *T. basicola* sur *P. protegens* (effet négatif ; Chapitre 2) et sur *P. brassicacearum* (effet positif ; Chapitre 1) décrits plus haut. La deuxième est que les populations de *Pseudomonas phl*<sup>+</sup> ont une densité comparable dans les sols résistants et les sols sensibles de Morens (Chapitre 1), alors que dans l'étude en sol artificiel (Chapitre 2) on a observé un plus fort effectif de *P. protegens* CHA0 dans le sol vermiculitique (résistant) que dans le sol illitique (sensible). Bien que ces différents effets n'aient pas été observés dans les mêmes conditions expérimentales, ces observations suggèrent que la souche modèle *P. protegens* CHA0 n'est pas représentative de toutes les espèces de *Pseudomonas phl*<sup>+</sup>. En effet, même si cette espèce a été isolée dans un sol de Morens (Stutz et al. 1986), la plupart des *Pseudomonas phl*<sup>+</sup> identifiés actuellement dans ces sols, sur la base de méthodes moléculaires, appartiennent aux espèces *P. thivervalensis*, *P. kilonensis* et *P. brassicacearum* ou à des espèces très proches (Frapolli et al. 2010 ; Almario et al. 2013). Il est important de rappeler que le choix de *P. protegens* comme espèce modèle dans cette thèse a été motivé par son statut scientifique, les connaissances disponibles sur cette espèce, et l'existence de plusieurs outils techniques (e.g. les souches rapporteur) essentiels à notre étude (Keel et al. 1989; Iavicoli et al. 2003 ; Baehler et al. 2005; Lim et al. 2012a). Néanmoins, ce choix limite aussi la portée des résultats obtenus.

L'espèce *P. protegens* se différencie des autres espèces de *Pseudomonas phl*<sup>+</sup> appartenant au sous-groupe '*P. corrugata*' d'un point de vue taxonomique, car elle est plus proche de l'espèce *phl*- *P. chlororaphis* que des autres espèces *phl*<sup>+</sup> (Chapitre 1). L'hypothèse la plus parcimonieuse pour expliquer cela est que le cluster *phl* ait subi un événement de transfert entre l'ancêtre commun de *P. protegens* et l'ancêtre commun du sous-groupe '*P. corrugata*' (Chapitre 1). Cette dichotomie se traduit par des souches de *P. protegens* possédant, en plus de gènes de synthèse du DAPG et de l'HCN, des gènes de synthèse pour d'autres antimicrobiens capables d'inhiber certains phytoparasites tel la

pyolutéorine, la pyrrolnitrine, la rhizoxine et l'orfamide A (rôle antimicrobien supposé ; Loper et Gross 2007), gènes qui sont absents chez les autres souches *phl*<sup>+</sup> (Loper et al. 2012). Cependant, ces composés ne présentent pas d'effet antifongique connu sur *T. basicola*. *P. protegens* possède aussi les gènes pour la synthèse d'une plus grande diversité de sidérophores que les autres souches de *Pseudomonas phl*<sup>+</sup> (Loper et al. 2012). À l'inverse, les autres espèces de *Pseudomonas phl*<sup>+</sup> possèdent typiquement un système de sécrétion de type III (Rezzonico et al. 2004 ; Mazurier et al. 2004) avec un large panel d'effecteurs (Mavrodi et al. 2011 ; Loper et al. 2012). Chez *Pseudomonas*, le système de sécrétion de type III peut être impliqué dans la colonisation racinaire, l'inhibition de phytopathogènes, ou la résistance à la prédation (Rezzonico et al. 2005 ; Mavrodi et al. 2011 ; Loper et al. 2012). Ces autres espèces de *Pseudomonas phl*<sup>+</sup>, sauf celle(s) correspondant au groupe multilocus E (Frapolli et al. 2007), possèdent aussi une activité ACC désaminase (Wang et al. 2001), ce qui au-delà des effets sur la croissance du système racinaire peut moduler l'efficacité de la phytoprotection (Wang et al. 2000). La présence de ces propriétés chez les *Pseudomonas phl*<sup>+</sup> du sous-groupe '*P. corrugata*' favorise peut-être leur colonisation de la racine.

En conclusion, notre étude nous a permis de confirmer nos hypothèses sur *P. protegens*, mais la possibilité de généraliser ces résultats à l'ensemble du groupe fonctionnel des *Pseudomonas phl*<sup>+</sup> reste à vérifier. Il serait donc important de valider notre modèle de fonctionnement sur d'autres espèces représentatives de celles rencontrées à Morens, et idéalement sur des souches indigènes de ces *Pseudomonas phl*<sup>+</sup>.

## Conclusion

Dans cette thèse, la relation entre les *Pseudomonas phl*<sup>+</sup> et la résistance du sol a été analysée. L'étude en sol naturel (Chapitre 1) a montré que dans les sols résistants comme dans les sols sensibles, le pathogène peut coloniser la rhizosphère et la surface racinaire du tabac. Ceci indique que dans les sols résistants de Morens, il n'y a pas de phénomène de suppression du pathogène, mais plutôt une restriction de son entrée dans la racine (infection) se traduisant par une réduction des symptômes de la maladie. Ceci conduit à l'hypothèse que l'activité phytoprotectrice des *Pseudomonas phl*<sup>+</sup> dans les sols de Morens passerait davantage par l'élicitation des défenses de la plante, à travers

l'induction d'une résistance systémique, que par l'inhibition directe du pathogène. Grâce à une méthode de PCR quantitative développée dans ce projet, nous avons également étayé l'hypothèse déjà ancienne selon laquelle la résistance de ces sols n'implique pas des effectifs de *Pseudomonas phl*<sup>+</sup> plus élevés dans les sols résistants que dans les sols sensibles.

L'étude en système de sol artificiel (Chapitre 2) a permis de montrer que la présence d'argile vermiculite se traduit par une plus forte quantité de fer biodisponible pour *P. protegens*, induisant une plus forte expression de gènes de synthèse de DAPG (*phl*), et un niveau significatif de phytoprotection. Ceci suggère que dans les sols vermiculitiques de Morens, un phénomène similaire peut se produire, et pourrait être à l'origine de leur propriété de résistance à la maladie de la pourriture noire des racines de tabac.

De manière générale, nos résultats illustrent comment une propriété clef du sol liée à son origine géologique, à savoir la minéralogie des argiles, peut influencer sa qualité et sa productivité actuelle en modulant l'activité d'un groupe fonctionnel jouant un rôle important dans le fonctionnement de l'écosystème rhizosphérique et la santé de la plante. Par ailleurs, cette thèse illustre la complexité des interactions dans la rhizosphère, liée au fort nombre de partenaires en interaction, et aux multiples rôles écologiques qui peuvent être associés à une seule molécule produite par l'un des partenaires microbiens.

## **Perspectives**

Jusqu'à présent, les populations microbiennes associées à la résistance des sols aux maladies ont été étudiées principalement en termes d'effectif et de diversité (structure et richesse des populations) (Landa et al. 2002 ; Mazurier et al. 2009 ; Sanguin et al. 2009 ; Frapolli et al. 2010 ; Mendes et al. 2011), très rarement en termes d'activité (Bergsma-Vlami et al. 2005 ; Raaijmakers et al. 1999). Dans ce contexte, nos résultats montrent l'intérêt de prendre en compte l'activité transcriptionnelle des populations phytoprotectrices pour mieux comprendre la résistance des sols. Ce type de démarche mériterait d'être élargi pour prendre en compte l'ensemble des fonctions microbiennes associées à la résistance, même si ce type d'étude n'est pas facile en raison des

contraintes techniques limitant l'étude de l'expression des fonctions microbiennes dans la rhizosphère (Saleh-Lakha et al. 2005).

La principale limite de ce projet de thèse est que l'étude de la relation entre la minéralogie des argiles, la biodisponibilité du fer, l'expression des gènes *phl* chez *Pseudomonas*, et le niveau de phytoprotection, a été étudiée en système de sol artificiel en utilisant une souche modèle, et non pas en sol naturel et sur des populations indigènes. Les contraintes techniques liées à la détection des transcrits des gènes *phl* dans les populations indigènes de *Pseudomonas phl*<sup>+</sup> nous ont empêché de franchir cette étape, vraisemblablement en raison de niveaux d'expression insuffisants. Cet objectif nécessiterait une amélioration des méthodes d'extraction des ARN à partir du sol, en incluant par exemple une étape d'hybridation soustractive (Mettel et al. 2010) facilitant la détection d'ARNm cibles, ou une étape d'amplification des ARN (Gao et al. 2007). Ces avancées techniques sont prometteuses pour l'étude des bactéries dans les milieux complexes d'une manière plus générale.

L'amélioration de nos connaissances sur les composés (dits) antimicrobiens produits par les bactéries phytoprotectrices montre qu'ils ont des rôles écologiques divers (Raaijmakers et Mazzola 2012). Cependant, ces différents rôles ont été principalement décrits *in vitro* et ont rarement été démontrés en conditions naturelles. L'induction d'une résistance systémique chez la plante est proposée comme le mode d'action principal du DAPG dans la résistance des sols de Morens (Almario et al. 2013). Pour tester cette hypothèse, les approches utilisant du DAPG synthétique, des souches de *Pseudomonas phl*<sup>+</sup> et leurs mutants *phl*<sup>-</sup> ont montré leur utilité dans d'autres pathosystèmes (Iavicoli et al. 2003 ; Weller et al. 2012). Dans le cas du tabac, une des plantes modèles utilisées pour étudier l'ISR, des mutants au niveau de différentes étapes de voies de signalisation liées à l'ISR sont de plus disponibles (Elsharkawy et al. 2012). Finalement, il serait intéressant de comparer le niveau d'élicitation des défenses de la plante dans un sol résistant et dans un sol sensible de Morens. On s'attend à ce que le niveau d'infection racinaire par *T. basicola* soit limité dans les plantes en contact avec un sol résistant. Au-delà de la résistance des sols de Morens, ce type d'approche permettrait de démontrer que le DAPG produit par les *Pseudomonas* peut activer une ISR chez la plante en conditions naturelles de culture.

Dans le cas des sols de Morens, nos résultats suggèrent une plus forte synthèse de DAPG par les *Pseudomonas* dans la rhizosphère des sols résistants, ce qui reste encore à démontrer avec une méthode analytique plus performante. Le fait que de multiples rôles écologiques puissent être associés à une seule molécule microbienne, le DAPG, produite par un groupe microbien en interaction avec plusieurs autres groupes microbiens et la plante, montre à quel point les interactions dans la rhizosphère peuvent être complexes. L'une de ces interactions implique les *Azospirillum*, qui à Morens sont plus abondants dans les sols résistants que les sols sensibles (Kyselková et al. 2009), et dont l'expression des fonctions phytostimulatrices peut être stimulée par le DAPG (Combes-Meynet et al. 2011). Une interaction entre les *Pseudomonas phl<sup>+</sup>* et des populations d'*Azospirillum* phytostimulatrices et/ou élicitrices de l'ISR (Russo et al. 2008) pourrait contribuer à la résistance des sols de Morens, et cette possibilité mérite d'être évaluée. Cette interaction serait également un bon modèle pour tester la théorie proposée par Kinkel et al. (2011) selon laquelle la résistance du sol dépendrait de l'action synergique de plusieurs populations microbiennes ayant coévolué ensemble. Les *Pseudomonas phl<sup>+</sup>* et *Azospirillum* coexistent aussi dans la rhizosphère d'autres plantes, dans d'autres sols résistants (Sanguin et al. 2009), et la signification de leur interaction pourrait dépasser le cadre de la résistance du sol à la pourriture noire des racines de tabac.

# **RÉFÉRENCES BIBLIOGRAPHIQUES**





- Alabouvette, C. 1986. Fusarium-wilt suppressive soils from the Châteaurenard region: review of a 10-year study. *Agronomie* 6:273-284.
- Almario, J., Moëgne-Loccoz, Y., Muller, D. 2013. Monitoring of the relation between 2,4-diacetylphloroglucinol-producing *Pseudomonas* and *Thielaviopsis basicola* populations by real-time PCR in tobacco black root-rot suppressive and conducive soils. *Soil Biology and Biochemistry*. (in press).
- Almario, J., Kyselková, M., Kopecký, J., Ságová-Marečková, M., Muller, D., Grundmann, G. L., Moëgne-Loccoz, Y. Assessment of the relationship between geologic origin of soil, rhizobacterial community composition and tobacco black root rot suppressiveness in Savoie region (France). *Soumis à Plant and Soil*.
- Andersen, J. B., Sternberg, C., Poulsen, L. K., Bjørn, S. P., Givskov, M., Molin, S. 1998. New unstable variants of green fluorescent protein for studies of transient gene expression in bacteria. *Applied and Environmental Microbiology* 64:2240-2246.
- Anukool, U., Gaze, W.H., Wellington, E. M. H. 2004. *In situ* monitoring of streptothricin production by *Streptomyces rochei* F20 in soil and rhizosphere. *Applied and Environmental Microbiology* 70:5222-5228.
- Baehler, E., Bottiglieri, M., Péchy-Tarr, M., Maurhofer, M., Keel, C. 2005. Use of green fluorescent protein-based reporters to monitor balanced production of antifungal compounds in the biocontrol agent *Pseudomonas fluorescens* CHA0. *Journal of Applied Microbiology* 99:24-38.
- Baelum, J., Nicolaisen, M. H., Holben, W. E., Strobel, B. W., Sørensen, J., Jacobsen, C. S. 2008. Direct analysis of *tfdA* gene expression by indigenous bacteria in phenoxy acid amended agricultural soil. *The ISME Journal* 2:677-687.
- Bais, H. P., Weir, T. L., Perry, L. G., Gilroy, S., Vivanco, J. M. 2006. The role of root exudates in rhizosphere interactions with plants and other organisms. *Annual Review of Plant Biology* 57:233-66.
- Baker, K. F., Cook, R. J. 1974. Biological control of plant pathogens. The American Phytopathological Society, San Francisco, CA.
- Bangera, M. G., Thomashow, L. S. 1999. Identification and characterization of a gene cluster for synthesis of the polyketide antibiotic 2,4-diacetylphloroglucinol from *Pseudomonas fluorescens* Q2-87. *Journal of Bacteriology* 181:3155-3163.
- Barret, M., Frey-Klett, P., Boutin, M., Guillerm-Erckelboudt, A.-Y., Martin, F., Guillot, L., Sarniguet, A. 2009. The plant pathogenic fungus *Gaeumannomyces graminis* var. *tritici* improves bacterial growth and triggers early gene regulations in the biocontrol strain *Pseudomonas fluorescens* Pf29Arp. *New Phytologist* 181:435-447.

- Barret, M., Frey-Klett, P., Guillerm-Erckelboudt, A.-Y., Boutin, M., Guernec, G., Sarniguet, A. 2009. Effect of wheat roots infected with the pathogenic fungus *Gaeumannomyces graminis* var. *tritici* on gene expression of the biocontrol bacterium *Pseudomonas fluorescens* Pf29Arp. *Molecular Plant-Microbe Interactions* 22:1611-1623.
- Becker, J., Eisenhauer, N., Scheu, S., Jousset, A. 2012. Increasing antagonistic interactions cause bacterial communities to collapse at high diversity. *Ecology Letters* 15:468-474.
- Beijerinck, M. W. 1913. De infusies en de ontdekking der bacterien. *Jaarboek van de Koninklijke Akademie van Wetenschappen* 1-28.
- Berg, G., Smalla, K. 2009. Plant species and soil type cooperatively shape the structure and function of microbial communities in the rhizosphere. *FEMS Microbiology Ecology* 68:1-13.
- Bergsma-Vlami, M., Prins, M. E., Raaijmakers, J. M. 2005. Influence of plant species on population dynamics, genotypic diversity and antibiotic production in the rhizosphere by indigenous *Pseudomonas* spp. *FEMS Microbiology Ecology* 52:59-69.
- Borneman, J., Becker, J. O. 2007. Identifying microorganisms involved in specific pathogen suppression in soil. *Annual Review of Phytopathology* 45:153-172.
- Brazelton, J. N., Pfeufer, E. E., Sweat, T. A., McSpadden Gardener, B. B., Coenen, C. 2008. 2,4-diacetylphloroglucinol alters plant root development. *Molecular Plant-Microbe Interactions* 21:1349-58.
- Bustin, S. A., Benes, V., Garson, J. A., Hellems, J., Huggett, J., Kubista, M., Mueller, R., Nolan, T., Pfaffl, M. W., Shipley, G. L., Vandesompele, J., Wittwer, C. T. 2009. The MIQE Guidelines: Minimum information for publication of quantitative real-time PCR experiments. *Clinical Chemistry* 55:611-622.
- Chapon, A., Guillerm, A. Y., Delalande, L., Lebreton, L., Sarniguet, A. 2002. Dominant colonisation of wheat roots by *Pseudomonas fluorescens* Pf29A and selection of the indigenous microflora in the presence of the take-all fungus. *European Journal of Plant Pathology* 108:449-459.
- Combes-Meynet, E., Pothier, J. F., Moëgne-Loccoz, Y., Prigent-Combaret, C. 2011. The *Pseudomonas* secondary metabolite 2,4-diacetylphloroglucinol is a signal inducing rhizoplane expression of *Azospirillum* genes involved in plant-growth promotion. *Molecular Plant-Microbe Interactions* 24:271-284.
- Couillerot, O., Combes-Meynet, E., Pothier, J. F., Bellvert, F., Challita, E., Poirier, M. A., Rohr, R., Comte, G., Moëgne-Loccoz, Y., Prigent-Combaret, C. 2011. The role of

the antimicrobial compound 2,4-diacetylphloroglucinol in the impact of biocontrol *Pseudomonas fluorescens* F113 on *Azospirillum brasilense* phytostimulators. *Microbiology* 157:1694-705.

- Coumans, J. V. F., Harvey, J., Backhouse, D., Poljak, A., Raftery, M. J., Nehl, D., Katz, M. E., Pereg, L. 2011. Proteomic assessment of host-associated microevolution in the fungus *Thielaviopsis basicola*. *Environmental Microbiology* 13:576-588.
- de Werra, P., Baehler, E., Huser, A., Keel, C., Maurhofer, M. 2008. Detection of plant-modulated alterations in antifungal gene expression in *Pseudomonas fluorescens* CHA0 on roots by flow cytometry. *Applied Environmental Microbiology* 74:1339-1349.
- DeCoste, N. J., Gadkar, V. J., Filion, M. 2011. Relative and absolute quantitative real-time PCR-based quantifications of *hcnC* and *phlD* gene transcripts in natural soil spiked with *Pseudomonas* sp. strain LBUM300. *Applied and Environmental Microbiology* 77:41-47.
- Delmont, T. O., Prestat, E., Keegan, K. P., Faubladiere, M., Robe, P., Clark, I. M., Pelletier, E., Hirsch, P. R., Meyer, F., Gilbert, J. A., Paslier, D. L., Simonet, P., Vogel, T. M. 2012. Structure, fluctuation and magnitude of a natural grassland soil metagenome. *The ISME Journal* 6:1677-1687.
- Dequiedt, S., Saby, N. P. A., Lelievre, M., Jolivet, C., Thioulouse, J., Toutain, B., Arrouays, D., Bispo, A., Lemanceau, P., Ranjard, L. 2011. Biogeographical patterns of soil molecular microbial biomass as influenced by soil characteristics and management. *Global Ecology and Biogeography* 20:641-652.
- Djavaheri, M., Mercado-Blanco, J., Versluis, C., Meyer, J.- M., Van Loon, L. C., Bakker, P. A. H. M. 2012. Iron-regulated metabolites produced by *Pseudomonas fluorescens* WCS374r are not required for eliciting induced systemic resistance against *Pseudomonas syringae* pv. tomato in *Arabidopsis*. *Microbiology Open* 1:311-325.
- Doornbos, R. F., Geraats, B. P. J., Kuramae, E. E., Van Loon, L. C., Bakker, P. A. H. M. 2011. Effects of jasmonic acid, ethylene, and salicylic acid signaling on the rhizosphere bacterial community of *Arabidopsis thaliana*. *Molecular Plant-Microbe Interactions* 24:395-407.
- Doornbos, R. F., van Loon, L. C., Bakker, P. A. H. M. 2012. Impact of root exudates and plant defense signaling on bacterial communities in the rhizosphere. *Agronomy for Sustainable Development* 32:227-243.
- Dubuis, C., Haas, D. 2007. Cross-species GacA-controlled induction of antibiosis in pseudomonads. *Applied and Environmental Microbiology* 73:650-654.

- Duffy, B. K., Défago, G. 1999. Environmental factors modulating antibiotic and siderophore biosynthesis by *Pseudomonas fluorescens* biocontrol strains. *Applied and Environmental Microbiology* 65:2429-2438.
- Duffy, B. K., Schouten, A., Raaijmakers, J. M. 2003. Pathogen self defense: mechanisms to counteract microbial antagonism. *Annual Review of Phytopathology* 41:501-538.
- Duijff, B. J., Recorbet, G., Bakker, P. A. H. M., Loper, J. E., Lemanceau, P. 1999. Microbial antagonism at the root level is involved in the suppression of *Fusarium* wilt by the combination of nonpathogenic *Fusarium oxysporum* Fo47 and *Pseudomonas putida* WCS358. *Phytopathology* 89:1073-1079.
- Dunne, C., Moëgne-Loccoz, Y., McCarthy, J., Higgins, P., Powell, J., Dowling, D. N., O'Gara, F. 1998. Combining proteolytic and phloroglucinol producing bacteria for improved biocontrol of *Pythium*-mediated damping off of sugar beet. *Plant Pathology* 47:299-307.
- Elad, Y., Baker, R. 1985. The Role of competition for iron and carbon in suppression of chlamydospore germination of *Fusarium* spp. by *Pseudomonas* spp. *Phytopathology* 75:1053-1059.
- Fan, B., Carvalhais, L., Becker, A., Fedoseyenko, D., Wirén, N. von, Borriss, R. 2012. Transcriptomic profiling of *Bacillus amyloliquefaciens* FZB42 in response to maize root exudates. *BMC Microbiology* 12:116.
- Fedi, S., Tola, E., Moëgne-Loccoz, Y., Dowling, D. N., Smith, L. M., O'Gara, F. 1997. Evidence for signaling between the phytopathogenic fungus *Pythium ultimum* and *Pseudomonas fluorescens* F113: *P. ultimum* represses the expression of genes in *P. fluorescens* F113, resulting in altered ecological fitness. *Applied and Environmental Microbiology* 63:4261-4266.
- Frapolli, M., Défago, G., Moëgne-Loccoz, Y. 2007. Multilocus sequence analysis of biocontrol fluorescent *Pseudomonas* spp. producing the antifungal compound 2,4-diacetylphloroglucinol. *Environmental Microbiology* 9:1939-1955.
- Frapolli, M., Moëgne-Loccoz, Y., Meyer, J., Défago, G. 2008. A new DGGE protocol targeting 2,4-diacetylphloroglucinol biosynthetic gene *phlD* from phylogenetically contrasted biocontrol pseudomonads for assessment of disease suppressive soils. *FEMS Microbiology Ecology* 64:468-481.
- Frapolli, M., Défago, G., Moëgne-Loccoz, Y. 2010. Denaturing gradient gel electrophoretic analysis of dominant 2,4-diacetylphloroglucinol biosynthetic *phlD* alleles in fluorescent *Pseudomonas* from soils suppressive or conducive to black root rot of tobacco. *Soil Biology and Biochemistry* 42:649-656.

- Frapolli, M., Pothier, J. F., Défago, G., Moëgne-Loccoz, Y. 2012. Evolutionary history of synthesis pathway genes for phloroglucinol and cyanide antimicrobials in plant-associated fluorescent pseudomonads. *Molecular Phylogenetics and Evolution* 63:877-890.
- Fravel, D., Olivain, C., Alabouvette, C. 2003. *Fusarium oxysporum* and its biocontrol. *New Phytologist* 157:493-502.
- Fuchs, J.-G., Moëgne-Loccoz, Y., Défago, G. 1997. Nonpathogenic *Fusarium oxysporum* strain Fo47 induces resistance to Fusarium wilt in Tomato. *Plant Disease* 81:492-496.
- Gao, H., Yang, Z. K., Gentry, T. J., Wu, L., Schadt, C. W., Zhou, J. 2006. Microarray-based analysis of microbial community RNAs by whole-community RNA amplification. *Applied and Environmental Microbiology* 73:563-571.
- Garbeva, P., van Veen, J. A, van Elsas, J. D. 2004a. Microbial diversity in soil: selection microbial populations by plant and soil type and implications for disease suppressiveness. *Annual Review of Phytopathology* 42:243-270.
- Garbeva, P., Voesenek, K., van Elsas, J. D. 2004b. Quantitative detection and diversity of the pyrrolnitrin biosynthetic locus in soil under different treatments. *Soil Biology and Biochemistry* 36:1453-1463.
- Gasser, R., Défago, G. 1981. Case of the certain soils which are suppressive to the black root-rot of tobacco caused by *Thielaviopsis basicola*. *Botanica Helvetica* 91:75-80.
- Gensel, P. G. 2008. The earliest land plants. *Annual Review of Ecology, Evolution and Systematics* 39:459-477.
- Gilbert, J. A, O'Dor, R., King, N., Vogel, T. 2011. The importance of metagenomic surveys to microbial ecology: or why Darwin would have been a metagenomic scientist. *Microbial Informatics and Experimentation* 1:1-5.
- Gleeson, O., O'Gara, F., Morrissey, J. P. 2010. The *Pseudomonas fluorescens* secondary metabolite 2,4-diacetylphloroglucinol impairs mitochondrial function in *Saccharomyces cerevisiae*. *Antonie van Leeuwenhoek* 97:261-273.
- Glick, R., Gilmour, C., Tremblay, J., Satanower, S., Avidan, O., Déziel, E., Greenberg, E. P., Poole, K., Banin, E. 2010. Increase in rhamnolipid synthesis under iron-limiting conditions influences surface motility and biofilm formation in *Pseudomonas aeruginosa*. *Journal of Bacteriology* 192:2973-2980.
- Griffiths, R. I., Whiteley, A. S., O'Donnell, A. G., Bailey, M. J. 2000. Rapid method for coextraction of DNA and RNA from natural environments for analysis of ribosomal DNA- and rRNA-based microbial community composition. *Applied and*

- Environmental Microbiology 66:5488-5491.
- Haas, D., Blumer, C., Keel, C. 2000. Biocontrol ability of fluorescent pseudomonads genetically dissected: importance of positive feedback regulation. *Current Opinion in Biotechnology* 11:290-297.
- Haas, D., Keel, C. 2003. Regulation of antibiotic production in root-colonizing *Pseudomonas* spp. and relevance for biological control of plant disease. *Annual Review of Phytopathology* 41:117-153.
- Haas, D., Défago, G. 2005. Biological control of soil-borne pathogens by fluorescent pseudomonads. *Nature Reviews Microbiology* 3:307-319.
- Hurek, T., Handley, L. L., Reinhold-Hurek, B., Piché, Y. 2002. *Azoarcus* grass endophytes contribute fixed nitrogen to the plant in an unculturable state. *Molecular Plant-Microbe Interactions* 15:233-242.
- Hinsinger, P., Bengough, A. G., Vetterlein, D., Young, I. M. 2009. Rhizosphere: biophysics, biogeochemistry and ecological relevance. *Plant and Soil* 321:117-152.
- Höper, H., Steinberg, C., Alabouvette, C. 1995. Involvement of clay type and pH in the mechanisms of soil suppressiveness to *Fusarium* wilt of flax. *Soil Biology and Biochemistry* 27:955-967.
- Hornby, D. 1983. Suppressive soils. *Annual Review of Phytopathology* 21:65-85.
- Iavicoli, A., Boutet, E., Buchala, A., Métraux, J. P. 2003. Induced systemic resistance in *Arabidopsis thaliana* in response to root inoculation with *Pseudomonas fluorescens* CHA0. *Molecular Plant-Microbe Interactions* 16:851-858.
- Jamali, F., Sharifi-Tehrani, A., Lutz, M. P., Maurhofer, M. 2009. Influence of host plant genotype, presence of a pathogen, and coinoculation with *Pseudomonas fluorescens* strains on the rhizosphere expression of hydrogen cyanide- and 2,4-diacetylphloroglucinol biosynthetic genes in *P. fluorescens* biocontrol strain CHA0. *Microbial Ecology* 57:267-275.
- Janvier, C., Villeneuve, F., Alabouvette, C., Edel-Hermann, V., Mateille, T., Steinberg, C. 2007. Soil health through soil disease suppression: Which strategy from descriptors to indicators? *Soil Biology and Biochemistry* 39:1-23.
- Johansen, J. E., Binnerup, S. J., Lejbolle, K. B., Mascher, F., Sorensen, J., Keel, C. 2002. Impact of biocontrol strain *Pseudomonas fluorescens* CHA0 on rhizosphere bacteria isolated from barley (*Hordeum vulgare* L.) with special reference to *Cytophaga*-like bacteria. *Journal of Applied Microbiology* 93:1065-1074.
- Kay, E., Dubuis, C., Haas, D. 2005. Three small RNAs jointly ensure secondary metabolism and biocontrol in *Pseudomonas fluorescens* CHA0. *Proceedings of the*

National Academy of Sciences of the United States of America 102:17136-17141.

- Keel, C., Voisard, C., Berling, C. H., Kahr, G., Défago, G. 1989. Iron sufficiency, a prerequisite for the suppression of tobacco black root rot by *Pseudomonas fluorescens* strain CHA0 under gnotobiotic conditions. *Phytopathology* 79:584-589.
- Keel, C., Wirthner, P. H., Oberhänsli, T. H., Voisard, C., Burger, U., Haas, D., Défago, G. 1990. Pseudomonads as antagonists of plant pathogens in the rhizosphere: role of the antibiotic 2,4-diacetylphloroglucinol in the suppression of black root rot of tobacco. *Symbiosis* 9:327-341.
- Keel, C., Schnider, U., Maurhofer, M., Voisard, C., Laville, J., Burger, U., Wirthner, P., Haas, D., Défago, G. 1992. Suppression of root diseases by *Pseudomonas fluorescens* CHA0: importance of the bacterial secondary metabolite 2,4-diacetylphloroglucinol. *Molecular Plant-Microbe Interactions* 5:4-13.
- Keel, C., Weller, D. M., Natsch, A., Défago, G., Cook, R. J., Thomashow, L. S. 1996. Conservation of the 2,4-diacetylphloroglucinol biosynthesis locus among fluorescent *Pseudomonas* strains from diverse geographic locations. *Applied and Environmental Microbiology* 62:552-563.
- Kidarsa, T. A., Goebel, N. C., Zabriskie, T. M., Loper, J. E. 2011. Phloroglucinol mediates cross-talk between the pyoluteorin and 2,4-diacetylphloroglucinol biosynthetic pathways in *Pseudomonas fluorescens* Pf-5. *Molecular Microbiology* 81:395-414.
- Kinkel, L. L., Bakker, M. G., Schlatter, D. C. 2011. A coevolutionary framework for managing disease-suppressive soils. *Annual Review of Phytopathology* 49:47-67.
- Kwak, Y. S., Bonsall, R. F., Okubara, P. A., Paulitz T. C., Thomashow, L. S., Weller, D. M. 2012. Factors impacting the activity of 2,4-diacetylphloroglucinol-producing *Pseudomonas fluorescens* against take-all of wheat. *Soil Biology and Biochemistry* 54:48-56.
- Kyselková, M., Kopecký, J., Frapolli, M., Défago, G., Ságová-Marečková, M., Grundmann, G. L., Moëgne-Loccoz, Y. 2009. Comparison of rhizobacterial community composition in soil suppressive or conducive to tobacco black root rot disease. *The ISME Journal* 3:1127-1138.
- Kyselková, M., Moëgne-Loccoz, Y. 2012. *Pseudomonas* and other microbes in disease-suppressive soils. Pages 93-140 in: *Sustainable Agriculture Reviews, Vol. 9: Organic Fertilisation, Soil Quality and Human Health*. E. Lichtfouse, ed. Springer, Dordrecht, The Netherlands.
- Lambers, H., Mougél, C., Jaillard, B., Hinsinger, P. 2009. Plant-microbe-soil interactions in the rhizosphere: an evolutionary perspective. *Plant and Soil* 321:83-115.



- Landa, B. B., Mavrodi, O. V., Raaijmakers, J. M., McSpadden Gardener, B. B., Thomashow, L. S., Weller, D. M. 2002. Differential ability of genotypes of 2,4-diacetylphloroglucinol-producing *Pseudomonas fluorescens* strains to colonize the roots of pea plants. *Applied and Environmental Microbiology* 68:3226-3237.
- Latz, E., Eisenhauer, N., Rall, B. C., Allan, E., Roscher, C., Scheu, S., Jousset, A. 2012. Plant diversity improves protection against soil-borne pathogens by fostering antagonistic bacterial communities. *Journal of Ecology* 100:597-604.
- Lebreton, L., Gosme, M., Lucas, P., Guillerm-Erckelboudt, A. Y., Sarniguet, A. 2007. Linear relationship between *Gaeumannomyces graminis* var. *tritici* (Ggt) genotypic frequencies and disease severity on wheat roots in the field. *Environmental Microbiology* 9:492-499.
- Lemanceau, P., Bakker, P. A., De Kogel, W. J., Alabouvette, C., Schippers, B. 1992. Effect of pseudobactin 358 production by *Pseudomonas putida* WCS358 on suppression of Fusarium wilt of carnations by nonpathogenic *Fusarium oxysporum* Fo47. *Applied and Environmental Microbiology* 58:2978-2982.
- Lemanceau, P., Bauer, P., Kraemer, S., Briat, J.-F. 2009. Iron dynamics in the rhizosphere as a case study for analyzing interactions between soils, plants and microbes. *Plant and Soil* 321:513-535.
- Le Roux, X., Poly, F., Currey, P., Commeaux, C., Hai, B., Nicol, G. W., Prosser, J.I., Schlöter, M., Attard, E., Klumpp, K. 2008. Effects of aboveground grazing on coupling among nitrifier activity, abundance and community structure. *The ISME Journal* 2:221-232.
- Lim, C. K., Hassan, K. A., Tetu, S. G., Loper, J. E., Paulsen, I. T. 2012a. The effect of iron limitation on the transcriptome and proteome of *Pseudomonas fluorescens* Pf-5. *PLoS ONE* 7:e39139.
- Lim, C. K., Hassan, K. A., Penesyan, A., Loper, J. E., Paulsen, I. T. 2012b. The effect of zinc limitation on the transcriptome of *Pseudomonas protegens* Pf-5. *Environmental Microbiology*. (in press).
- Lindow, S. E. 1995. The use of reporter genes in the study of microbial ecology. *Molecular Ecology* 4:555-566.
- Loper, J. E., Lindow, S. E. 1994. A biological sensor for iron available to bacteria in their habitats on plant surfaces. *Applied and Environmental Microbiology* 60:1934-1941.
- Loper, J. E., Henkels, M. D. 1997. Availability of iron to *Pseudomonas fluorescens* in rhizosphere and bulk soil evaluated with an ice nucleation reporter gene. *Applied and Environmental Microbiology* 63:99-105.

- Loper, J. E., Gross, H. 2007. Genomic analysis of antifungal metabolite production by *Pseudomonas fluorescens* Pf-5. *European Journal of Plant Pathology* 119:265-278.
- Loper, J. E., Hassan, K. A., Mavrodi, D. V., Davis, E. W., Lim, C. K., Shaffer, B. T., Elbourne, L. D. H., Stockwell, V. O., Hartney, S. L., Breakwell, K., Henkels, M. D., Tetu, S. G., Rangel, L. I., Kidarsa, T. A., Wilson, N. L., van de Mortel, J. E., Song, C., Blumhagen, R., Radune, D., Hostetler, J. B., Brinkac, L. M., Durkin, A. S., Kluepfel, D. A., Wechter, W. P., Anderson, A. J., Kim, Y. C., Pierson, L. S., Pierson, E. A., Lindow, S. E., Kobayashi, D. Y., Raaijmakers, J. M., Weller, D. M., Thomashow, L. S., Allen, A. E., Paulsen, I. T. 2012. Comparative genomics of plant-associated *Pseudomonas* spp.: insights into diversity and inheritance of traits involved in multitrophic interactions. *PLoS Genetics* 8:e1002784.
- Marschner, P., Crowley, D. E. 1996. Physiological activity of a bioluminescent *Pseudomonas fluorescens* (strain 2-79) in the rhizosphere of mycorrhizal and non-mycorrhizal pepper (*Capsicum annuum* L.). *Soil Biology and Biochemistry* 28:869-876.
- Marschner, P., Crowley, D. E. 1998. Phytosiderophores decrease iron stress and pyoverdine production of *Pseudomonas fluorescens* PF-5 (*pvd-inaZ*). *Soil Biology and Biochemistry* 30:1275-1280.
- Mastretta, C., Taghavi, S., van der Lelie, D., Mengoni, A., Galardi, F., Gonnelli, C., Barac, T., Boulet, J., Weyens, N., Vangronsveld, J. 2009. Endophytic bacteria from seeds of *Nicotiana tabacum* can reduce cadmium phytotoxicity. *International Journal of Phytoremediation* 11:251-267.
- Mavrodi, D. V., Blankenfeldt, W., Thomashow, L. S. 2006. Phenazine compounds in fluorescent *Pseudomonas* spp. biosynthesis and regulation. *Annual Review of Phytopathology* 44:417-445.
- Mavrodi, D. V., Peever, T. L., Mavrodi, O. V., Parejko, J. A., Raaijmakers, J. M., Lemanceau, P., Mazurier, S., Heide, L., Blankenfeldt, W., Weller, D. M., Thomashow, L. S. 2010. Diversity and evolution of the phenazine biosynthesis pathway. *Applied and Environmental Microbiology* 76:866-879.
- Mavrodi, D. V., Joe, A., Mavrodi, O. V., Hassan, K. A., Weller, D. M., Paulsen, I. T., Loper, J. E., Alfano, J. R., Thomashow, L. S. 2011. Structural and functional analysis of the type III secretion system from *Pseudomonas fluorescens* Q8r1-96. *Journal of Bacteriology* 193:177-189.
- Mavrodi, O. V., Mavrodi, D. V., Thomashow, L. S., Weller, D. M. 2007. Quantification of 2,4-diacetylphloroglucinol-producing *Pseudomonas fluorescens* strains in the plant rhizosphere by real-time PCR. *Applied and Environmental Microbiology* 73:5531-5538.

- Maurhofer, M., Reimann, C., Schmidli-Sacherer, P., Heeb, S., Haas, D., Défago, G. 1998. Salicylic acid biosynthetic genes expressed in *Pseudomonas fluorescens* strain P3 improve the induction of systemic resistance in tobacco against tobacco necrosis virus. *Phytopathology* 88:678-684.
- Mazurier, S., Lemunier, M., Siblot, S., Mougel, C., Lemanceau, P. 2004. Distribution and diversity of type III secretion system-like genes in saprophytic and phytopathogenic fluorescent pseudomonads. *FEMS Microbiology Ecology* 49:455-467.
- Mazurier, S., Corberand, T., Lemanceau, P., Raaijmakers, J. M. 2009. Phenazine antibiotics produced by fluorescent pseudomonads contribute to natural soil suppressiveness to *Fusarium* wilt. *The ISME Journal* 3:977-991.
- McSpadden Gardener, B. B., Mavrodi, D. V., Thomashow, L. S., Weller, D. M. 2001. A rapid polymerase chain reaction-based assay characterizing rhizosphere populations of 2,4-diacetylphloroglucinol-producing bacteria. *Phytopathology* 91:44-54.
- Mendes, R., Kruijt, M., de Bruijn, I., Dekkers, E., van der Voort, M., Schneider, J. H., Piceno, Y. M., DeSantis, T. Z., Andersen, G. L., Bakker, P. A., Raaijmakers, J. M. 2011. Deciphering the rhizosphere microbiome for disease-suppressive bacteria. *Science* 332:1097-1100.
- Mettel, C., Kim, Y., Shrestha, P. M., Liesack, W. 2010. Extraction of mRNA from soil. *Applied and Environmental Microbiology* 76:5995-6000.
- Mishra, S., Arora, N. K. 2012. Management of black rot in cabbage by rhizospheric *Pseudomonas* species and analysis of 2,4-diacetylphloroglucinol by qRT-PCR. *Biological Control* 61:32-39.
- Moynihan, J. A., Morrissey, J. P., Coppoolse, E. R., Stiekema, W. J., O'Gara, F., Boyd, E. F. 2009. Evolutionary history of the *phl* gene cluster in the plant-associated bacterium *Pseudomonas fluorescens*. *Applied and Environmental Microbiology* 75:2122-2131.
- Mulet, M., Lalucat, J., García-Valdés, E. 2010. DNA sequence-based analysis of the *Pseudomonas* species. *Environmental Microbiology* 12:1513-1530.
- Müller, B. 2009. Impact of the bacterium *Pseudomonas fluorescens* and its genetic derivatives on vermiculite: Effects on trace metals contents and clay mineralogical properties. *Geoderma* 153:94-103.
- Natsch, A., Keel, C., Hebecker, N., Laasik, E., Défago, G. 1998. Impact of *Pseudomonas fluorescens* strain CHA0 and a derivative with improved biocontrol activity on the culturable resident bacterial community on cucumber roots. *FEMS Microbiology Ecology* 27:365-380.

- Neal, A. L., Ahmad, S., Gordon-Weeks, R., Ton, J. 2012. Benzoxazinoids in root exudates of maize attract *Pseudomonas putida* to the rhizosphere. PLoS One 7:e35498.
- Nicolaisen, M. H., Bælum, J., Jacobsen, C. S., Sørensen, J. 2008. Transcription dynamics of the functional *tfdA* gene during MCPA herbicide degradation by *Cupriavidus necator* AEO106 (pRO101) in agricultural soil. Environmental Microbiology 10:571-579.
- Notz, R., Maurhofer, M., Schnider-Keel, U., Duffy, B., Haas, D., Défago, G. 2001. Biotic factors affecting expression of the 2,4-diacetylphloroglucinol biosynthesis gene *phlA* in *Pseudomonas fluorescens* biocontrol strain CHA0 in the rhizosphere. Phytopathology 91:873-881.
- Notz, R., Maurhofer, M., Dubach, H., Haas, D., Défago, G. 2002. Fusaric acid-producing strains of *Fusarium oxysporum* alter 2,4-diacetylphloroglucinol biosynthetic gene expression in *Pseudomonas fluorescens* CHA0 *in vitro* and in the rhizosphere of wheat. Applied and Environmental Microbiology 68:2229-2235.
- Okubara, P. A., Bonsall, R. F. 2008. Accumulation of *Pseudomonas*-derived 2,4-diacetylphloroglucinol on wheat seedling roots is influenced by host cultivar. Biological Control 46:322-331.
- Phillips, D. A., Fox, T. C., King, M. D., Bhuvaneswari, T. V., Teuber, L. R. 2004. Microbial products trigger amino acid exudation from plant roots. Plant Physiology 136:2887-2894.
- Poroyko, V., White, J. R., Wang, M., Donovan, S., Alverdy, J., Liu, D. C., Morowitz, M. J. 2010. Gut microbial gene expression in mother-fed and formula-fed piglets. PLoS ONE 5:e12459.
- Raaijmakers, J. M., Weller, D. M., 1998. Natural plant protection by 2,4-diacetylphloroglucinol-producing *Pseudomonas* spp. in take-all decline soils. Molecular Plant-Microbe Interactions 11:144-152.
- Raaijmakers, J. M., Bonsall, R. F., Weller, D. M. 1999. Effect of Population density of *Pseudomonas fluorescens* on production of 2,4-diacetylphloroglucinol in the rhizosphere of wheat. Phytopathology 89:470-475.
- Raaijmakers, J. M., Paulitz, T. C., Steinberg, C., Alabouvette, C., Moënne-Loccoz, Y. 2009. The rhizosphere: a playground and battlefield for soilborne pathogens and beneficial microorganisms. Plant and Soil 321:341-361.
- Raaijmakers, J. M., Mazzola, M. 2012. Diversity and natural functions of antibiotics produced by beneficial and plant pathogenic bacteria. Annual Review of Phytopathology 50:403-424.

- Ramette, A., Moënne-Loccoz, Y., Défago, G. 2001. Polymorphism of the polyketide synthase gene *phID* in biocontrol fluorescent pseudomonads producing 2,4-diacetylphloroglucinol and comparison of PhID with plant polyketide synthases. *Molecular Plant-Microbe Interactions* 14:639-652.
- Ramette, A., Moënne-Loccoz, Y., Défago, G. 2003. Prevalence of fluorescent pseudomonads producing antifungal phloroglucinols and/or hydrogen cyanide in soils naturally suppressive or conducive to tobacco black root rot. *FEMS Microbiology Ecology* 44:35-43.
- Ramette, A., Moënne-Loccoz, Y., Défago, G. 2006. Genetic diversity and biocontrol potential of fluorescent pseudomonads producing phloroglucinols and hydrogen cyanide from Swiss soils naturally suppressive or conducive to *Thielaviopsis basicola*-mediated black root rot of tobacco. *FEMS Microbiology Ecology* 55:369-381.
- Ramette, A., Frapolli, M., Fischer-Le Saux, M., Gruffaz, C., Meyer, J. M., Défago, G., Sutra, L., Moënne-Loccoz, Y. 2011. *Pseudomonas protegens* sp nov., widespread plant-protecting bacteria producing the biocontrol compounds 2,4-diacetylphloroglucinol and pyoluteorin. *Systematic and Applied Microbiology* 34:180-188.
- Ravel, J., Cornelis, P. 2003. Genomics of pyoverdine-mediated iron uptake in pseudomonads. *Trends in Microbiology* 11:195-200.
- Remy, W., Taylor, T. N, Hass, H., Kerp, H. 1994. Four hundred-million-year-old vesicular arbuscular mycorrhizae. *Proceedings of the National Academy of Sciences of the United States of America* 91:11841-11843.
- Rezzonico, F., Défago, G., Moënne-Loccoz, Y. 2004. Comparison of ATPase-encoding type III secretion system *hrcN* Genes in biocontrol fluorescent pseudomonads and in phytopathogenic proteobacteria. *Applied and Environmental Microbiology* 70:5119-5131.
- Rezzonico, F., Binder, C., Défago, G., Moënne-Loccoz, Y., 2005. The type III secretion system of biocontrol *Pseudomonas fluorescens* KD targets the phytopathogenic Chromista *Pythium ultimum* and promotes cucumber protection. *Molecular Plant-Microbe interactions* 18:991-1001.
- Rezzonico, F., Zala, M., Keel, C., Duffy, B. K., Moënne-Loccoz, Y., Défago, G. 2007. Is the ability of biocontrol fluorescent pseudomonads to produce the antifungal metabolite 2,4-diacetylphloroglucinol really synonymous with higher plant protection? *New Phytologist* 173:861-872.
- Robin, A., Mazurier, S., Mougél, C., Vansuyt, G., Corberand, T., Meyer, J.-M., Lemanceau, P. 2007. Diversity of root-associated fluorescent pseudomonads as

- affected by ferritin overexpression in tobacco. *Environmental Microbiology* 9:1724-1737.
- Robin, A., Vansuyt, G., Hinsinger, P., Meyer, J. M., Briat, J. F., Lemanceau, P. 2008. Iron dynamics in the rhizosphere. Pages 183-225 in: *Advances in Agronomy*, Vol 99: *Advances in Agronomy*. D. Sparks, ed. Academic Press Inc, New York, NY.
- Rochat, L., Péchy-Tarr, M., Baehler, E., Maurhofer, M., Keel, C. 2010. Combination of fluorescent reporters for simultaneous monitoring of root colonization and antifungal gene expression by a biocontrol pseudomonad on cereals with flow cytometry. *Molecular Plant-Microbe Interactions* 23:949-961.
- Rosconi, F., Souza, E. M., Pedrosa, F. O., Platero, R. A., González, C., González, M., Batista, S., Gill, P. R., Fabiano, E. R. 2006. Iron depletion affects nitrogenase activity and expression of *nifH* and *nifA* genes in *Herbaspirillum seropedicae*. *FEMS Microbiology Letters* 258:214-219.
- Rosenzweig, W. D., Stotzky, G. 1979. Influence of environmental factors on antagonism of fungi by bacteria in soil: clay minerals and pH. *Applied and Environmental Microbiology* 38:1120-1126.
- Russo, A., Vettori, L., Felici, C., Fiaschi, G., Morini, S., Toffanin, A. 2008. Enhanced micropropagation response and biocontrol effect of *Azospirillum brasilense* Sp245 on *Prunus cerasifera* L. clone Mr.S 2/5 plants. *Journal of Biotechnology* 134:312-319.
- Saleh-Lakha, S., Miller, M., Campbell, R. G., Schneider, K., Elahimanesh, P., Hart, M. M., Trevors, J. T. 2005. Microbial gene expression in soil: methods, applications and challenges. *Journal of Microbiological Methods* 63:1-19.
- Sanguin, H., Kroneisen, L., Gazengel, K., Kyselková, M., Remenant, B., Prigent-Combaret, C., Grundmann, G. L., Sarniguet, A., Moëgne-Loccoz, Y. 2008. Development of a 16S rRNA microarray approach for the monitoring of rhizosphere *Pseudomonas* populations associated with the decline of take-all disease of wheat. *Soil Biology and Biochemistry* 40:1028-1039.
- Sanguin, H., Sarniguet, A., Gazengel, K., Moëgne-Loccoz, Y., Grundmann, G. L. 2009. Rhizosphere bacterial communities associated with disease suppressiveness stages of take-all decline in wheat monoculture. *New Phytologist* 184:694-707.
- Sarniguet, A., Lucas, P. 1992. Evaluation of populations of fluorescent pseudomonads related to decline of take-all patch on turfgrass. *Plant and Soil* 145:11-15.
- Scher, F. M., Baker, R. 1982. Effect of *Pseudomonas putida* and a synthetic iron chelator on induction of soil suppressiveness to Fusarium wilt pathogens. *Phytopathology* 72:1567-1573.

- Schmidt, S., Blom, J. F., Pernthaler, J., Berg, G., Baldwin, A., Mahenthalingam, E., Eberl, L. 2009. Production of the antifungal compound pyrrolnitrin is quorum sensing-regulated in members of the *Burkholderia cepacia* complex. *Environmental Microbiology* 11:1422-1437.
- Schnider-Keel, U., Seematter, A., Maurhofer, M., Blumer, C., Duffy, B., Gigot-Bonnefoy, C., Reimann, C., Notz, R., Défago, G., Haas, D., Keel, C. 2000. Autoinduction of 2,4-diacetylphloroglucinol biosynthesis in the biocontrol agent *Pseudomonas fluorescens* CHA0 and repression by the bacterial metabolites salicylate and pyoluteorin. *Journal of bacteriology* 182:1215-1225.
- Schreiner, K., Hagn, A., Kyselková, M., Moëne-Loccoz, Y., Welzl, G., Munch, J. C., Schloter, M. 2010. Comparison of barley succession and take-all disease as environmental factors shaping the rhizobacterial community during take-all decline. *Applied and Environmental Microbiology* 76:4703-4712.
- Sharifi-Tehrani, A., Zala, M., Natsch, A., Moëne-Loccoz, Y., Défago, G. 1998. Biocontrol of soil-borne fungal plant diseases by 2,4-diacetylphloroglucinol-producing fluorescent pseudomonads with different restriction profiles of amplified 16S rDNA. *European Journal of Plant Pathology* 104:631-643.
- Smith, L. M., Tola, E., DeBoer, P., O'Gara, F. 1999. Signalling by the fungus *Pythium ultimum* represses expression of two ribosomal RNA operons with key roles in the rhizosphere ecology of *Pseudomonas fluorescens* F113. *Environmental Microbiology* 1:495-502.
- Sørensen, J., Jensen, L. E., Nybroe, O. 2001. Soil and rhizosphere as habitats for *Pseudomonas* inoculants: new knowledge on distribution, activity and physiological state derived from micro-scale and single-cell studies. *Plant and Soil* 232:97-108.
- Stotzky, G., Torrence Martin, R. 1963. Soil mineralogy in relation to the spread of Fusarium wilt of banana in central America. *Plant and Soil* 18:317-337.
- Stutz, E., Défago, G., Hantke, R., Kern, H. 1985. Effect of parent materials derived from different geological strata on suppressiveness of soils to black root rot of tobacco. Pages 215-217 in: *Ecology and Management of Soilborne Plant Pathogens*. C. A. Parker, A. D. Rovira, K. J. Moore, P. T. W. Wong, J. F. Kollmorgen, eds. American Phytopathological Society, St. Paul, MN.
- Stutz, E., Défago G., Kern, H. 1986. Naturally occurring fluorescent pseudomonads involved in suppression of black root rot of tobacco. *Phytopathology* 76:181-185.
- Stutz, E., Kahr, G., Défago, G. 1989. Clays involved in suppression of tobacco black root rot by a strain of *Pseudomonas fluorescens*. *Soil Biology and Biochemistry* 21:361-366.

- Svercel, M., Duffy, B., Défago, G. 2007. PCR amplification of hydrogen cyanide biosynthetic locus *hcnAB* in *Pseudomonas* spp. *Journal of Microbiological Methods* 70:209-213.
- Taniguchi, Y., Choi, P. J., Li, G. W., Chen, H., Babu, M., Hearn, J., Emili, A., Xie, X. S. 2010. Quantifying *E. coli* proteome and transcriptome with single-molecule sensitivity in single cells. *Science* 329:533-538.
- Troxler, J., Berling, C. H., Moëgne-Loccoz, Y., Keel, C., Défago, G. 1997. Interactions between the biocontrol agent *Pseudomonas fluorescens* CHA0 and *Thielaviopsis basicola* in tobacco roots observed by immunofluorescence microscopy. *Plant Pathology* 46:62-71.
- Troxler, J., Svercel, M., Natsch, A., Zala, M., Keel, C., Moëgne-Loccoz, Y., Défago, G., 2012. Persistence of a biocontrol *Pseudomonas* inoculant as high populations of culturable and non-culturable cells in 200-cm-deep soil profiles. *Soil Biology and Biochemistry* 44:122-129.
- Tuanyok, A., Kim, H. S., Nierman, W. C., Yu, Y., Dunbar, J., Moore, R. A., Baker, P., Tom, M., Ling, J. M. L., Woods, D. E. 2005. Genome-wide expression analysis of iron regulation in *Burkholderia pseudomallei* and *Burkholderia mallei* using DNA microarrays. *FEMS Microbiology Letters* 252:327-335.
- Ulrich, A., Becker, R. 2006. Soil parent material is a key determinant of the bacterial community structure in arable soils. *FEMS Microbiology Ecology* 56:430-443.
- van Valen, L. 1973. A new evolutionary law. *Evolutionary theory* 1:1-30.
- Vasil, M. L., Ochsner, U. A. 1999. The response of *Pseudomonas aeruginosa* to iron: genetics, biochemistry and virulence. *Molecular Microbiology* 34:399-413.
- Voisard C., Keel C., Haas D., Défago G. 1989. Cyanide production by *Pseudomonas fluorescens* helps suppress black root rot of tobacco under gnotobiotic conditions. *The EMBO Journal* 8:351-358.
- Visca, P., Imperi, F., Lamont, I. L. 2007. Pyoverdine siderophores: from biogenesis to biosignificance. *Trends in Microbiology* 15:22-30.
- von Felten, A., Défago, G., Maurhofer, M. 2010. Quantification of *Pseudomonas fluorescens* strains F113, CHA0 and Pf153 in the rhizosphere of maize by strain-specific real-time PCR unaffected by the variability of DNA extraction efficiency. *Journal of Microbiological Methods* 81:108-115.
- Walsh, U. F., Moëgne-Loccoz, Y., Tichy, H.-V., Gardner, A., Corkery, D. M., Lorkhe, S., O’Gara, F. 2003. Residual impact of the biocontrol inoculant *Pseudomonas*



- fluorescens* F113 on the resident population of rhizobia nodulating a red clover rotation crop. *Microbial Ecology* 45:145-155.
- Wang, C., Knill, E., Glick, B. R., Défago, G. 2000. Effect of transferring 1-aminocyclopropane-1-carboxylic acid (ACC) deaminase genes into *Pseudomonas fluorescens* strain CHA0 and its *gacA* derivative CHA96 on their growth-promoting and disease-suppressive capacities. *Canadian Journal of Microbiology* 46:898-907.
- Wang, C., Ramette, A., Punjasamarnwong, P., Zala, M., Natsch, A., Moëgne-Loccoz, Y., Défago, G. 2001. Cosmopolitan distribution of *phlD*-containing dicotyledonous crop-associated biocontrol pseudomonads of worldwide origin. *FEMS Microbiology Ecology* 37:105-116.
- Weller, D. M., Raaijmakers, J. M., McSpadden-Gardener, B. B., Thomashow, L. S. 2002. Microbial populations responsible for specific soil suppressiveness to plant pathogens. *Annual Review of Phytopathology* 40:309-348.
- Weller, D. M., Landa, B. B., Mavrodi, O. V., Schroeder, K. L., De La Fuente, L., Blouin Bankhead, S., Allende Molar, R., Bonsall, R. F., Mavrodi, D. V., Thomashow, L. S. 2007. Role of 2,4-diacetylphloroglucinol-producing fluorescent *Pseudomonas* spp. in the defense of plant roots. *Plant Biology* 9:4-20.
- Weller, D. M., Mavrodi, D. V., van Pelt, J. A., Pieterse, C. M. J., van Loon, L. C., Bakker, P. A. H. M. 2012. Induced systemic resistance in *Arabidopsis thaliana* against *Pseudomonas syringae* pv. tomato by 2,4-diacetylphloroglucinol-producing *Pseudomonas fluorescens*. *Phytopathology* 102:403-412.
- Winkelmann, G. 2007. Ecology of siderophores with special reference to the fungi. *BioMetals* 20:379-392.
- Yang, C. H., Crowley, D. E. 2000. Rhizosphere microbial community structure in relation to root location and plant iron nutritional status. *Applied and Environmental Microbiology* 66:345-351.
- Zhang, T., Fang, H. H. P. 2006. Applications of real-time polymerase chain reaction for quantification of microorganisms in environmental samples. *Applied Microbiology and Biotechnology* 70:281-289
- Zha, W., Rubin-Pitel, S. B., Zhao, H. 2006. Characterization of the substrate specificity of PhlD, a type III polyketide synthase from *Pseudomonas fluorescens*. *Journal of Biological Chemistry* 281:32036-32047.

# **ANNEXES**



## Annexe 1.

### Assessment of the relationship between geologic origin of soil, rhizobacterial community composition and tobacco black root rot suppressiveness in Savoie region (France)

Juliana Almario<sup>a,b,c,\$</sup>, Martina Kyselková<sup>a,b,c,d,\$</sup>, Jan Kopecký<sup>e</sup>, Markéta Ságová-Marečková<sup>e</sup>, Daniel Muller<sup>a,b,c</sup>, Geneviève L. Grundmann<sup>a,b,c</sup>, Yvan Moëgne-Loccoz<sup>a,b,c,\*</sup>

<sup>a</sup> Université de Lyon, F-69622, Lyon, France

<sup>b</sup> Université Lyon 1, Villeurbanne, France

<sup>c</sup> CNRS, UMR5557, Ecologie Microbienne, Villeurbanne, France

<sup>d</sup> Biology Centre of the Academy of Sciences of the Czech Republic, Institute of Soil Biology, České Budějovice, Czech Republic

<sup>e</sup> Department of Plant Pathology, Crop Research Institute, Praha-Ruzyně, Czech Republic

Journal: Plant & Soil (submitted)

<sup>\$</sup>Both contributed equally to this work.

\*Corresponding author: Tel.: +33 4 72 43 13 49; fax: +33 472 43 12 23.

*E-mail address:* yvan.moenne-locoz@univ-lyon1.fr (Y. Moëgne-Loccoz)

---

#### Contribution de Juliana Almario:

Participation aux analyses de diversité par puce à ADN 16S lors d'un stage de M1, analyse des populations de *Pseudomonas* par PCR quantitative et tRFLP lors de la thèse, et contribution à la préparation du manuscrit. Ce manuscrit est présenté en annexe car il est extérieur au projet de thèse proprement dit.

## Abstract

*Background and aims* In Morens (Switzerland), soils formed on morainic deposits are naturally suppressive to *Thielaviopsis basicola*-mediated tobacco black root rot whereas nearby sandstone soils are conducive, but this model was never assessed elsewhere. Here, we tested this relation between geology and disease suppressiveness in neighboring Savoie (France).

*Methods* Two morainic and two sandstone soils from Savoie were compared based on disease suppressiveness status (*T. basicola* inoculation tests on tobacco), clay mineralogy (X-ray diffraction), tobacco rhizobacterial community composition (16S rRNA gene-based taxonomic microarray) and *phlD*<sup>+</sup> *Pseudomonas* populations involved in 2,4-diacetylphloroglucinol production (real-time PCR and tRFLP).

*Results* Unlike in Morens, the morainic soils were conducive and the sandstone soils putatively suppressive in Savoie, and vermiculite clay was not present in Savoie soils. The difference in rhizobacterial community composition between Savoie morainic and sandstone soils was significant but modest, and there was little agreement in bacterial taxa discriminating suppressive from conducive soils when comparing Morens versus Savoie soils. Finally, *phlD*<sup>+</sup> rhizosphere pseudomonads were present at levels comparable to those in Morens soils, but with different diversity patterns.

*Conclusions* The morainic model of black root rot suppressiveness might be restricted to the particular type of moraine occurring in the Morens region, as suppressive soils in neighboring Savoie presented different features and may rely on distinct plant-protection mechanisms.

## Introduction

Soil-borne phytopathogenic microorganisms cause extensive damage to crop plants worldwide (Agrios 1997), and most of them are difficult to control using genetic resistance or chemicals (Lucas and Sarniguet 1998). However, their actual effects on crops vary greatly from one site to the next. In certain soils, termed suppressive (Baker and Cook 1974), the extent of disease on susceptible crop is largely limited by a particular range of indigenous microbial populations that act against one or a few pathogens (specific disease suppressiveness). The occurrence of soils naturally suppressive towards phytoparasitic bacteria (Shiomi et al. 1999), oomycetes (Persson et al. 1999; Murakami et al. 2000), fungi (Stutz et al. 1986; Alabouvette et al. 1999) or nematodes (Rimé et al. 2003) has been reported worldwide, and with a few exceptions (noticeably take-all decline) each type of suppressive soil has mostly been studied within a small region only. This questions whether findings on suppressiveness mechanisms are generally applicable or restricted to the region studied.

Soils specifically suppressive to tobacco black root rot, a disease caused by the fungus *Thielaviopsis basicola*, have been extensively studied in the Swiss region of Morens (Stutz et al. 1986, 1989; Ramette et al. 2006; Frapolli et al. 2008, 2010). In that area of about 22 km<sup>2</sup>, located between lake Neuchâtel and Payerne (Broye valley) in canton Fribourg, suppressive soils developed on sandstone overlaid by morainic material (i.e. material brought by glaciers) while soils on sandstone sediments with no or very little morainic material are conducive (Stutz et al. 1989). On this basis, it seemed that natural soil suppressiveness to black root rot could be predicted if the geological origin of the fields is known. However, this principle has not been tested outside of Morens, despite the fact that moraines (as well as sandstones) occur also elsewhere in the vicinity of the Alpine arch, especially in neighboring Savoie (France) in a similar climatic context. Indeed, the general applicability of the Morens model cannot be taken for granted, because variations in both moraine and sandstone deposit compositions (Von Eynatten 2003; Föllmi et al. 2009) may lead to different soil conditions. This, in turn, might change microbial interaction patterns in the rhizosphere and perhaps also soil suppressiveness status.

In Morens, the morainic or sandstone nature of the substratum coincides with two properties of potential relevance to disease suppression. Firstly, the main physicochemical

difference between suppressive and conducive soils from Morens lies in their clay mineral composition (Stutz et al. 1986), which is related to the type of parental material (Johnson et al. 1970). The vermiculite to illite ratio is higher in suppressive soils (Stutz et al. 1986, 1989), and this prevalence of iron-releasing vermiculite has an impact on the expression of iron-regulated suppressive properties of biocontrol pseudomonads isolated from these soils (Keel et al. 1989; Voisard et al. 1989; Ramette et al. 2006). Secondly, differences between suppressive and conducive soils from Morens were shown in the abundance of several bacterial taxa colonizing the tobacco rhizosphere (Kyselková et al. 2009; Frapolli et al. 2010). This included particular types of antagonistic *Pseudomonas* spp. producing 2,4-diacetylphloroglucinol (Frapolli et al. 2008), which are thought to play a key role in suppressiveness of Morens soils (Haas and Défago 2005). In addition, other taxa known to include strains with biocontrol and/or plant-growth promoting properties, e.g. *Burkholderia*, *Azospirillum*, or *Commamonas* were prevalent in suppressive compared to conducive Morens soils (Kyselková et al. 2009), extending the list of bacteria putatively involved in black root rot suppression. However, whether the predominance of vermiculite and/or of these bacterial taxa is also of relevance outside the Morens region (and would be, therefore, of a more general prediction value) remains to be established.

The aim of this study was to assess the relationship between the morainic origin of soil and black root rot suppressiveness in the Savoie region (France). To this end, morainic and sandstone soils were selected in two areas of Savoie. All these soils are classified as cambisols, as in Morens. Black root rot suppressiveness of each Savoie soil was assessed under standardized greenhouse conditions, after exposure of tobacco to *T. basicola* (Ramette et al. 2003). Clay mineralogy and chemical soil composition were determined. Bacterial community composition in the tobacco rhizosphere was assessed using a 16S rRNA-based taxonomic microarray. Finally, real-time PCR and tRFLP of *phlD* genes (involved in 2,4-diacetylphloroglucinol production by antagonistic pseudomonads) was performed.

## Material and methods

### *Field sites and soil harvesting*

Four soils were selected in June 2007 in Savoie (France). Two soils i.e. Asa2 and Ysa5 originated from sandstone bedrock and two others i.e. Amo1 and Ymo4 from morainic material (Table S1). Soils Amo1 and Asa2 are located near Albens, and Ymo4 and Ysa5 near Seyssel. Albens is located 130 km and Seyssel 120 km south-west of Morens (Switzerland), and the distance between Albens and Seyssel is 22 km. Savoie soils are cultivated in a maize-based rotation, with occasional growth of wheat and of alfalfa or mixed pasture. Tobacco has been grown in these areas, but nowadays it seldom appears in the crop rotation, and maize (less common in Morens; Ramette et al. 2003) was growing at the time of sampling. In each field, soil samples were taken from 10-30 cm depth at three locations (approximately 5-10 m apart) and were mixed. Root residues and stones were removed, and soils were sieved (0.7 cm) where necessary.

### *Soil chemistry analyses*

Soil (10 g) for X-ray diffraction analysis of clay minerals was treated with sodium hypochlorite to remove organic carbon (Siregar et al. 2005), and clays were separated from other soil particles by sedimentation, according to Stokes' law (Day 1965). X-ray diffraction of oriented clays (including after saturation with glycerol, heating at 400°C and at 550°C) was assessed using Cu K $\alpha$  radiation (D8 Advance diffractometer, Bruker AXS, Karlsruhe, Germany) from 1 to 30 degrees  $2\theta$  at continuous stepscans (equivalent to scan step intervals of 0.0218 degrees  $2\theta$  at 2 s with scintillation computer) at room temperature (*Centre de diffractométrie Henri Longchambon*; University Lyon 1, Villeurbanne, France; <http://cdalpha.univ-lyon1.fr/>).

Soil composition was determined by SNC CESAR (Ceyzériat, France), following standard soil analysis procedures (see Table S1). Data were assessed by principal component analysis (PCA), using the correlation matrix and ADE-4 (Thioulouse et al. 1997) in R environment (<http://www.r-project.org>). Data were also subjected to Student's *t*-tests ( $P < 0.05$ ) to assess the effect of soil geology/suppressiveness status.



### ***Black root rot suppressiveness test***

Black root rot suppressiveness test was performed with the four Savoie soils. Preparation of tobacco seedlings (*Nicotiana glutinosa* L.) and endoconidial inoculum of the fungus *T. basicola* Ferraris strain ETH D127 were performed as described in Ramette et al. (2003). *T. basicola* endoconidia suspension was added to soil around the stems of 4-week-old tobacco plants on the same day of their transplantation in soils ( $10^3$  endoconidia  $\text{cm}^{-3}$  soil, with 150 g soil  $\text{pot}^{-1}$ ). The same volume of sterile distilled water was added to the non-inoculated controls. The number of pots was 8 per treatment (with one plant per 150- $\text{cm}^3$  pot). Soil water content was adjusted to 70% of their water retention capacity by watering pots every 1-2 days with sterile distilled water. Plants were cultivated in a growth chamber at 22°C (day, 16 h) and 18°C (night, 8 h) at 70% relative humidity.

Disease severity was recorded for each plant at 3 weeks after inoculation, as the percentage of root surface covered by *T. basicola* chlamydospores. Root disease level was rated visually using an eight-class disease scale (Stutz et al. 1986) based on midpoints of disease level intervals. Disease levels recorded in each soil were compared with Wilcoxon rank sum tests ( $P < 0.05$ ), using R (<http://www.r-project.org>). Between-soil differences in fresh plant biomass were tested with Kruskal-Wallis test ( $P < 0.05$ ). For correlation analysis, the impact of *T. basicola* inoculation on tobacco health was computed as  $(D_i - D_c)/D_c$ , with  $D_i$  and  $D_c$  representing disease level upon *T. basicola* inoculation and in the non-inoculated control, respectively. Correlation analyses between mean disease level and soil composition data were performed using Pearson's product-moment correlation coefficient ( $r$ ) and its associated  $P$  value ( $n = 4$ ).

### ***Rhizosphere DNA extraction and 16S rRNA taxonomic microarray analysis***

In the plant inoculation experiment, soil tightly adherent to roots (Frapolli et al. 2008) was sampled at 3 weeks from four inoculated plants and four non-inoculated plants from each soil. Total DNA was extracted from 250 mg of soil using PowerSoil DNA Isolation Kit (*MoBio Laboratories*, Carlsbad, CA).

The universal eubacterial primers *T7-pA* (forward; *TAATACGACTCACTATAGAGAGTTTGATCCTGGCTCAG*) and *pH* (reverse; *AAGGAGGTGATCCAGCCGCA*) were used to amplify 16S rRNA genes from total DNA extracts (Bruce et al. 1992). Primer *T7-pA* includes at the 5' end the sequence of T7 promoter (in italics), which enabled T7 RNA polymerase-mediated *in vitro* transcription using the purified PCR products as templates. PCR reactions were carried out using *Taq*

Expand High Fidelity (*Roche Applied Science*, Meylan, France) and cycling conditions described in Kyselková et al. (2009).

Purified DNA ( $50 \text{ ng } \mu\text{l}^{-1}$ ) was fluorescently labelled (Cy3) by *in vitro* transcription, according to Stralis-Pavese et al. (2004). Purified RNA was fragmented by incubation with  $\text{ZnSO}_4$ , as described (Stralis-Pavese et al. 2004), and 400 ng subjected to hybridization on a 16S rRNA gene-based taxonomic microarray containing 1033 probes (Kyselková et al. 2009). Each probe was present four times per slide, and two slides were hybridized per sample (i.e. each probe repeated 8 times). Hybridization was carried out according to Sanguin et al. (2006b).

The slides were scanned at 532 nm, images were analyzed with GenePix 4.01 (*Axon*, Union City, CA), and spot quality was checked visually, as described previously (Sanguin et al. 2006b). Data filtration was conducted using R 2.2.0 (<http://www.r-project.org>). Hybridization of a given spot was considered positive when 80% of the spot pixels had intensity higher than the median local background pixel intensity plus twice the standard deviation of the local background. The intensity signals (median of signal minus background) were replaced by their square root value and the intensity of each spot was then expressed as a fraction of the total intensity signal of the basic pattern it belongs to (Sanguin et al. 2006a). Finally, a given feature probe was considered as truly hybridized when (i) hybridization signals were superior to the mean signal of the negative controls and (ii) at least 3 of 4 replicate spots displayed positive hybridization (Kyselková et al. 2009).

### ***Analysis of microarray data***

Rhizobacterial communities (i.e. whole community and *Pseudomonas* subcommunity) were compared by PCA. The whole community PCA was done using 278 probes (from the total 1033 probes) that yielded signals with at least one soil. Sample positions along each PCA axis were statistically compared with ANOVA ( $P < 0.05$ ). The difference in rhizobacterial community composition between morainic and sandstone soils from Savoie was further evaluated with Between-Group Analysis (BGA) followed by a permutation test ( $n = 1000$ ), using package ADE-4 (Thioulouse et al. 1997) in R. In addition, individual probe signal intensity comparisons were done with Wilcoxon rank sum tests at  $P < 0.05$ . The *Pseudomonas* subcommunity PCA was done with the 7 *Pseudomonas* probes (out of 39 *Pseudomonas* probes included on the microarray) that yielded signals with at least one of the soils.

### ***Analysis of *phlD*<sup>+</sup> pseudomonads in the rhizosphere***

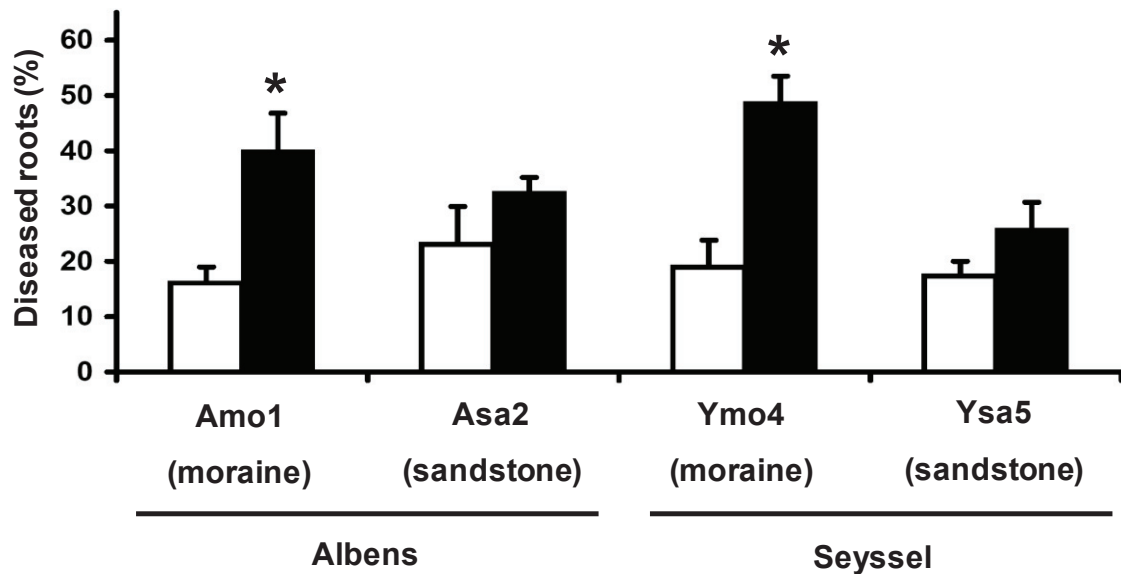
Rhizosphere DNA from the plant inoculation experiment was also used to quantify *phlD*<sup>+</sup> pseudomonads by real-time PCR, as described by Almario et al. (2013). As control, one real-time PCR product from Seyssel soil Ysa5 was re-amplified by conventional PCR and six clones were sequenced, as done by Almario et al. (2013). The sequences (EMBL accession numbers HE963007 to HE963012) were edited with BioEdit v.7.0 (Hall 1999), and *phlD* identity was confirmed after BlastN analysis. Log-numbers of gene copies were compared by three-factor ANOVA (soil geological origin × Savoie area field location × *T. basicola* inoculation) followed by Fisher's LSD tests ( $P < 0.05$ ). Correlation analyses between mean *phlD* copy log-number and soil composition data or disease data were performed using Pearson's  $r$  and its associated  $P$  value.

*phlD* polymorphism was assessed by tRFLP, as described by Almario et al. (2013), to identify the six phylogenetic groups of 2,4-diacetylphloroglucinol producers defined by Frapolli et al. (2007). tRFLP chromatograms were converted into binary matrices (presence vs absence of peaks for each replicate and each terminal fragment) and results from the four replicates were combined and converted to a frequency matrix used for cluster analysis based on the Euclidean distance, as in Almario et al. (2013).

## **Results**

### ***Relation between soil geological origin and suppressiveness***

Tobacco grown without pathogen inoculation in the four Savoie soils displayed disease level around 20% in all cases (Fig. 1) and fresh plant biomass did not differ significantly between the four soils (data not shown). *T. basicola* inoculation increased disease level significantly in morainic soils Amo1 and Ymo4 (to reach 40-50%), while for sandstone soils Asa2 and Ysa5 it did not differ significantly from that in the non-inoculated controls (Fig. 1). The disease had a negative effect on plant growth, and the correlation between disease level and fresh biomass for inoculated plants was significant (Pearson's  $r = -0.63$ ,  $n = 32$ ,  $P < 0.001$ ). Same findings were made when the disease suppressiveness experiment was repeated the following year, i.e. in September 2008 (not shown). Suppressive soils are expected to display a limited level of disease resulting from indigenous *T. basicola* (i.e. in non-inoculated treatments) and a controlled increase in



**Fig. 1** Disease suppressiveness experiment (July 2007) with four soils from Savoie (France). For each soil, the level of *T. basicola*-mediated black root rot of tobacco (shown as % of blackened root surface; mean  $\pm$  standard error, n = 8) is indicated for non-inoculated (white) and *T. basicola*-inoculated (black) plants. For each soil, an asterisk is used when the difference between inoculated and non-inoculated treatments was significant ( $P < 0.05$ ; Wilcoxon rank sum tests). The impact of *T. basicola* inoculation on tobacco health, which was computed as  $(D_i - D_c)/D_c$ , with  $D_i$  and  $D_c$  representing disease level upon *T. basicola* inoculation and in the non-inoculated control (respectively), was 1.48 (soil Amo1), 0.40 (Asa2), 1.58 (Ymo4) and 0.48 (Ysa5).

disease incidence under enhanced *T. basicola* pressure (i.e. in inoculated treatments). On this basis, the two morainic soils from Savoie were conducive while sandstone soils were potentially suppressive.

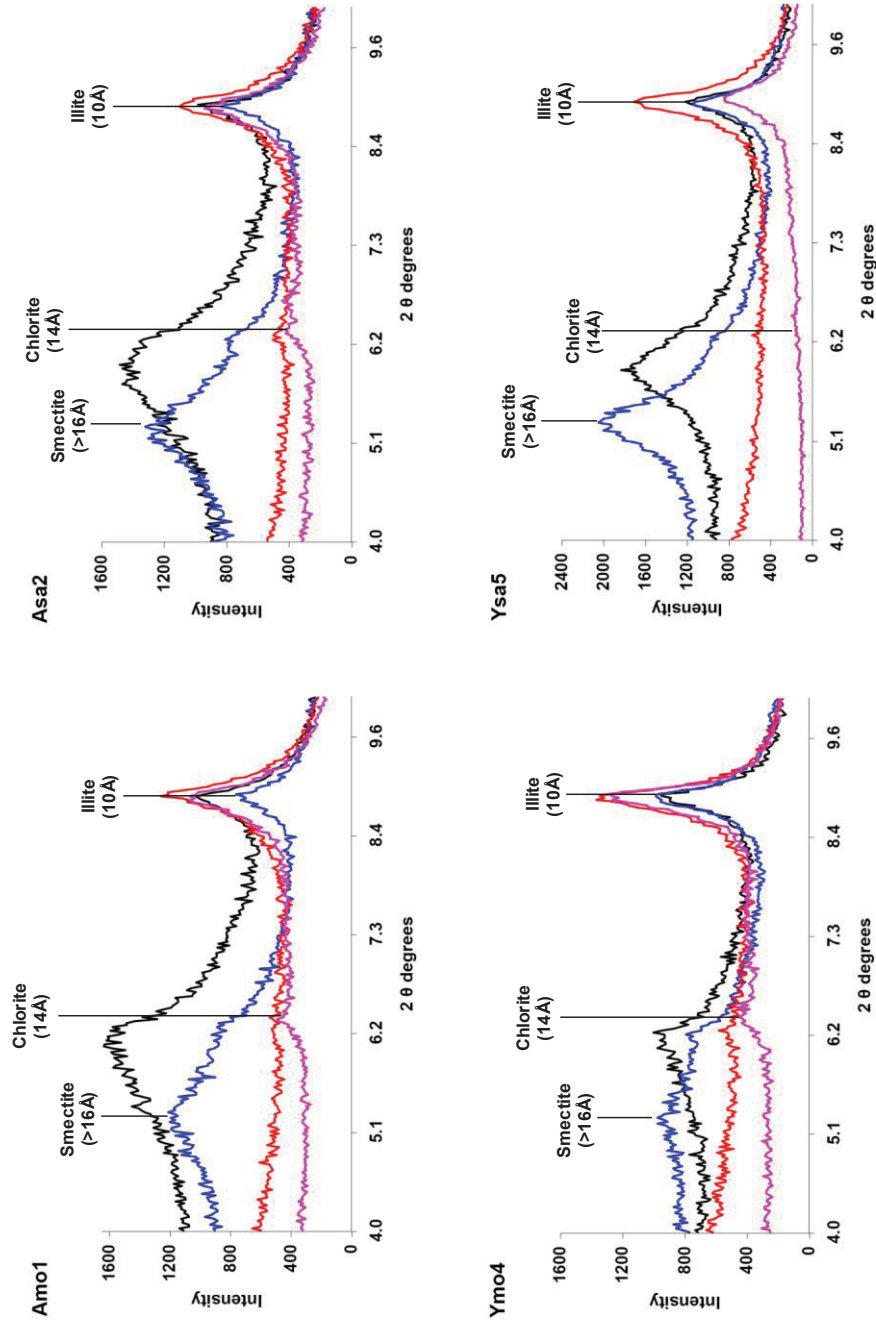
### ***Relation between soil geological origin, suppressiveness and soil chemistry***

When clay mineralogy was investigated, the four Savoie soils shared similar X-ray spectra (Fig. 2), which indicated presence of smectite (identified as the dominant clay mineral in all soils), as well as illite/smectite interstratified minerals, chlorite, illite and kaolinite. The soils differed slightly from one another in the proportions between interstratified minerals, chlorite and illite, the ratio between chlorite and interstratified minerals being higher in soils from Albens (morainic soil Amo1 and sandstone soil Asa2) than in soils from Seyssel (morainic soil Ymo4 and sandstone soil Ysa5). No vermiculite was detected. Therefore, (i) suppression of tobacco black root in the Savoie soils did not coincide with the presence of vermiculite, and (ii) there was no apparent relation between clay mineralogy and either soil geological origin or disease suppression.

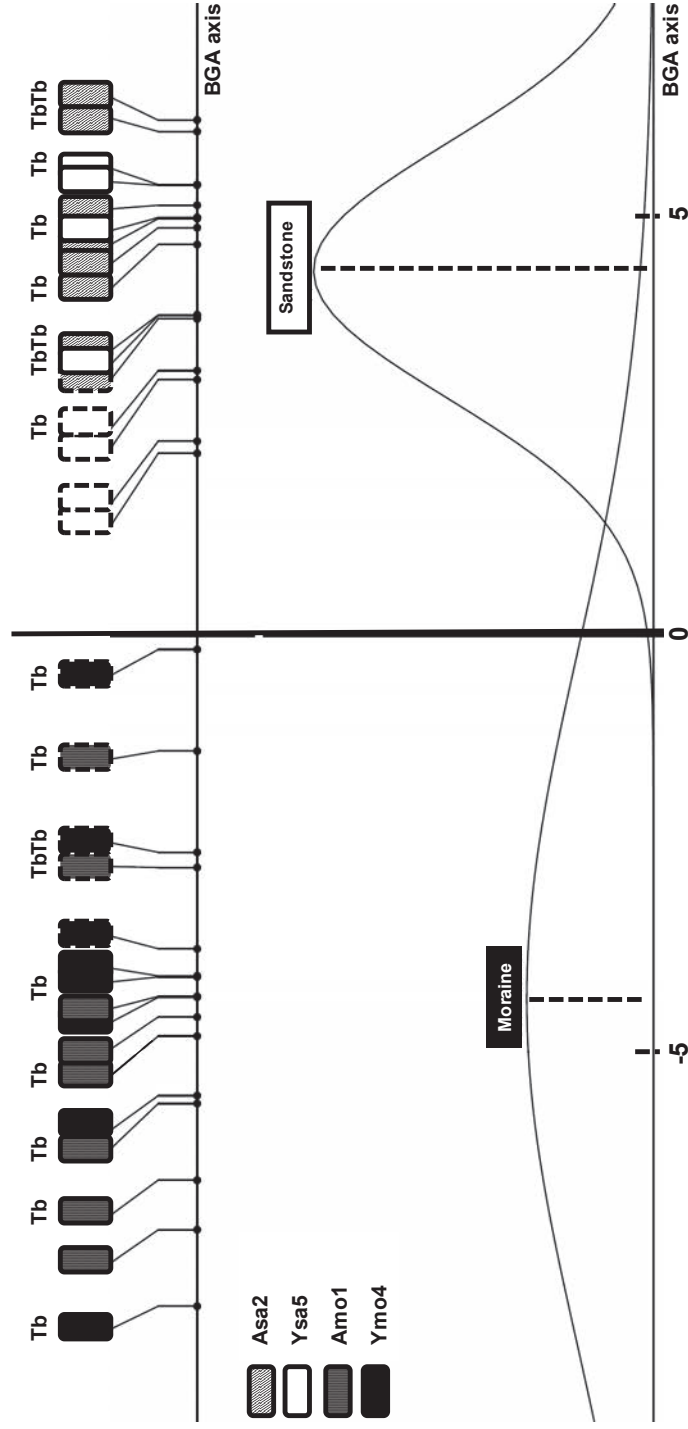
Morainic soils (Amo1 and Ymo5) exhibited statistically higher silt (+61%), nitrogen (+67%) and sodium (+117%) contents and lower sand content (-39%) compared with sandstone soils (Asa2 and Ysa5), based on Student's *t*-tests ( $n = 2$ ,  $P < 0.05$ ) on soil composition data (Table S1). In addition, the impact of *T. basicola* inoculation on tobacco health in the Savoie soils was significantly correlated ( $n = 4$ ) with soil content in silt ( $r = 0.90$ ,  $P = 0.047$ ), nitrogen ( $r = 0.91$ ,  $P = 0.044$ ), sodium ( $r = 0.99$ ,  $P = 0.005$ ) and sand ( $r = -0.94$ ,  $P = 0.031$ ).

### ***Relation between soil geological origin / suppressiveness and rhizobacterial community composition***

Tobacco rhizobacterial community composition at 3 weeks did not differ significantly among the individual Savoie soils, based on PCA of hybridization data from a previously-validated 16S rRNA microarray, regardless of whether *T. basicola*-inoculated and non-inoculated samples were analyzed separately or together (Fig. S1A). BGA, however, revealed a significant difference (permutation test;  $P < 0.01$ ) in rhizobacterial community composition between sandstone (suppressive) and morainic (conductive) Savoie soils, even though this difference corresponded to only 8% of data set variance (Fig. 3). The difference in signal intensity between sandstone and morainic Savoie soils was significant



**Fig. 2** X-ray diffractometry spectra of clay minerals from the four Savoie soils (Amo1 and Asa2 are from Albens, Ymo4 and Ysa5 from Seyssel). Blue, non-treated sample; green, saturated with glycerol; red, heated at 400°C; magenta, heated at 550°C. The main clay minerals identified (and approximate distances in Å) are indicated.



**Fig. 3** Between-Group Analysis (BGA) of tobacco rhizobacterial communities from sandstone soils Asa2 and Ysa5 (suppressive), and morainic soils Amo1 and Ymo4 (conductive) based on microarray probe signals. Upper part: Positions along the BGA axis of individual rhizosphere samples, half of them inoculated with *T. basicola* (Tb). Lower part: Distribution along the BGA axis of morainic (conductive, *left*) versus sandstone (suppressive, *right*) soil samples. The BGA mean was 4.4 for moraine and -4.4 for sandstone, and for each the variance (computed from the positions of individual samples above) is represented by a Gauss curve. The BGA axis explained 8% variance in the data set. The difference in rhizobacterial community composition between morainic and sandstone soils was statistically significant, based on permutation test ( $n = 1000$ ;  $P < 0.05$ ).

**Table 1** Most discriminant 16S rRNA probes for sandstone soils (suppressive) Asa2 and Ysa5 (20 probes) versus morainic soils (conductive) Amo1 and Ymo4 (20 probes), based on Between-Group Analysis (BGA) of rhizobacterial communities in *T. basicola*-inoculated and non-inoculated samples

Probe	Target	Correlation with BGA axis	Significance <sup>a</sup>
<b>Sandstone soils (suppressive)</b>			
Bkand	<i>Burkholderia andropogonis</i>	0.599	**
Eikcor2	<i>Eikenella corrodens</i> and <i>Neisseria meningitidis</i>	0.572	**
PalgiG3	<i>Paenibacillus alginoliticus</i> and relatives	0.563	**
Flavo2	<i>Flavobacterium columnare</i>	0.539	**
Paen5	<i>Paenibacillus</i>	0.508	*
Beta3	<i>Betaproteobacteria</i>	0.486	**
Neiselon	<i>Neisseria elongata</i>	0.481	*
Gludi	<i>Gluconacetobacter diazotrophicus</i>	0.461	*
Beta2	<i>Betaproteobacteria</i>	0.447	*
Bacpich2	<i>Bacillus pichinotii</i>	0.439	*
Burcep	<i>Burkholderia cepacia</i> , <i>B. mallei</i> , <i>B. pseudomallei</i> , <i>B. vietnamiensis</i> , <i>B. thailandensis</i> , <i>B. pyrrocinia</i>	0.436	**
Sphingo5B	<i>Sphingomonadaceae</i>	0.436	*
Rhizo157	<i>Rhizobiaceae</i> , <i>Bradyrhizobiaceae</i> , <i>Brucellaceae</i> and <i>Brevundimonas</i>	0.423	*
C58-128	<i>Agrobacterium</i>	0.402	
Paeni4-2	<i>Paenibacillus popolliae</i> and relatives	0.395	*
Aldef5	<i>Alcaligenes defragans</i>	0.385	
PalgiG1	<i>Paenibacillus alginoliticus</i> and relatives	0.379	*
B6-603	<i>Agrobacterium</i> , some <i>Rhizobium</i> and some <i>Brevundimonas</i>	0.358	*
Jant1	<i>Janthinobacterium</i>	0.353	
Pseu1	<i>Pseudomonas</i>	0.348	
<b>Morainic soils (conductive)</b>			
OP2-1	OP2	-0.821	**
Bacved_3	<i>Bacillus vedderi</i>	-0.798	**
Azo1	<i>Azospirillum</i> and relatives	-0.710	**



Pagg6	<i>Pantoea agglomerans</i>	-0.702	**
TDRNO1030	<i>Thermodesulforhabdus</i>	-0.674	**
Asia2	<i>Asaia</i>	-0.671	**
Azo5	<i>Azospirillum</i> and relatives	-0.663	**
Bkhcari1	<i>Burkholderia caribensis</i> and <i>B. hospita</i> )	-0.632	**
DSV820	<i>Desulfovibrio salexigens</i> , <i>D. zosterae</i> , <i>D. fairfieldensis</i> , <i>D. intestinalis</i> , <i>D. piger</i> , <i>D. desulfuricans</i>	-0.586	**
Acil	<i>Acidiphillum</i>	-0.579	**
Kisp9	<i>Kitasatospora griseola</i>	-0.568	**
Alvi2	Unidentified Epsilonproteobacteria affiliated to <i>Alvinella</i>	-0.542	**
Lipo1	<i>Azospirillum lipoferum</i> , <i>A. doebereineriae</i> and <i>A. largomobile</i>	-0.521	**
Mob4	<i>Mobiluncus</i>	-0.505	**
Ehrli1	<i>Ehrlichia</i> (excepted <i>Ehrlichia risticii</i> and <i>Cowdria</i> )	-0.481	*
Prochlo1	<i>Prochlorothrix</i>	-0.471	**
Methy1B	Some <i>Methylomonas</i>	-0.455	**
Sacchps10	<i>Saccharopolyspora</i>	-0.440	**
un43Chon8	Uncultured <i>Chondromyces</i>	-0.430	**
Myc011	<i>Mycoplasma</i>	-0.421	*

---

<sup>a</sup> Statistical evaluation of probe signals with Wilcoxon rank sum test, at  $P < 0.01$  (\*\*) or  $P < 0.05$  (\*).

(Wilcoxon tests) for 36 of the 40 probes that correlated best with the BGA axis (and thus contributed the most to the difference between sandstone and morainic soils) (Table 1).

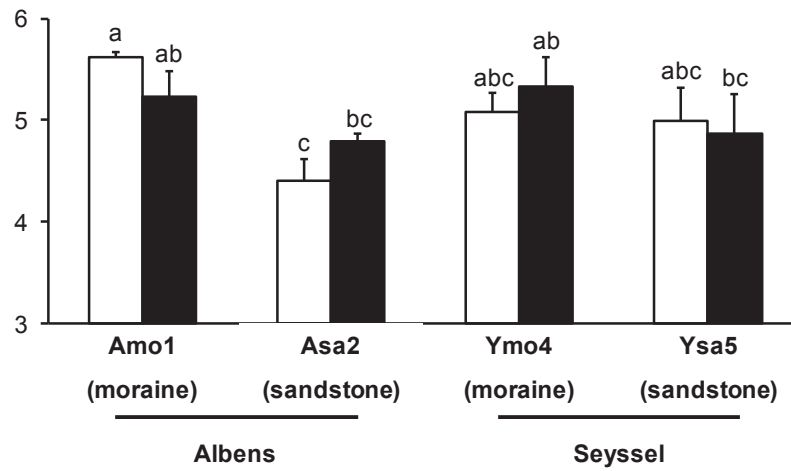
### ***Relation between soil geological origin / suppressiveness and taxonomic composition of Pseudomonas populations***

Six of the seven *Pseudomonas* 16S rRNA probes that hybridized with Savoie soils, i.e. Pseu1 and PseuD (targeting genus *Pseudomonas*), PseubC2BC3-2 and PseubC2-10 (*Pseudomonas* clusters C3-C5), PseubC4-6 (*P. corrugata*), and Pseu33 (*P. citronellolis/nitroreducens*), were positive with all four Savoie soils. The *Pseudomonas* probes did not differ in signal intensity between Savoie soils, based on Wilcoxon rank sum tests (comparison of suppressive versus conducive soils) or PCA (comparison of all four soils) (not shown). Here again, *T. basicola* inoculation did not have a significant impact on the results.

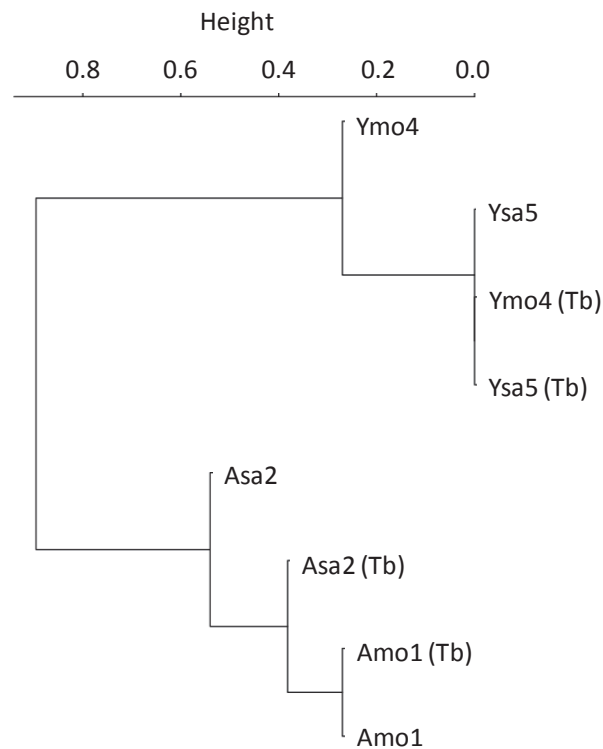
### ***Relation between soil geological origin / suppressiveness and *phlD*<sup>+</sup> Pseudomonas populations***

Real-time PCR gave *phlD*<sup>+</sup> *Pseudomonas* levels ranging from 4.4 to 5.6 log *phlD* copies/g rhizosphere (Fig. 4). Three-factor analysis of variance indicated that neither *T. basicola* inoculation nor Savoie area (i.e., Albens vs Seyssel) had an effect on rhizosphere numbers of *phlD*<sup>+</sup> pseudomonads, while these numbers were higher in morainic (conductive) soils than in sandstone (suppressive) soils ( $P = 0.0033$ ). Despite low sample number ( $n = 4$ ), significant correlations were found between the log-number of *phlD*<sup>+</sup> pseudomonads and soil content in silt ( $r = 0.99$ ,  $P = 0.0062$ ), nitrogen ( $r = 0.99$ ,  $P = 0.0011$ ) and sand ( $r = -0.96$ ,  $P = 0.042$ ).

tRFLP analysis of *phlD* amplicons evidenced pseudomonads from phylogenetic groups B (in 31 of 32 samples), D (30/32), A (13/32) and E (1/32) defined by Frapolli et al. (2007). *phlD*-tRFLP clustering separated Seyssel samples from those of Albens, regardless of soil geological origin and whether pathogen was inoculated or not (Fig. 5). This was mainly due to a higher frequency of phylogenetic group A and a lower frequency of group D in Albens samples than in Seyssel samples (Table S2).



**Fig. 4** Prevalence of *phlD*<sup>+</sup> *Pseudomonas* populations in the tobacco rhizosphere based on real-time PCR analysis (mean ± standard error, n = 4) of non-inoculated (white) and *T. basicola*-inoculated (black) tobacco. Relations between treatments are shown using letters a-c ( $P < 0.05$ ).



**Fig. 5** Dendrogram based on *phlD*-tRFLP profiles for *phlD*<sup>+</sup> pseudomonads in the tobacco rhizosphere. Four *T. basicola* inoculated (labeled Tb) and non-inoculated plants, grown in soils from Albens (Amo1 and Asa2) and Seysssel (Ymo4 and Ysa5), were analyzed. Cluster analysis was based on Euclidean distances and constructed with the ‘complete’ method in R environment. The ‘Height’ axis represents the distances between nodes.

## Discussion

Soil parent material indirectly modulates rhizobacterial community composition by determining most soil physicochemical properties (Ulrich and Becker 2006). In the Swiss region of Morens, the geological base rock determines whether soil will be suppressive or conducive to black root rot (Stutz et al. 1989), and the prevalence of iron-releasing vermiculite was identified as the functional link between soil geology and plant protecting conditions in the rhizosphere (Keel et al. 1989; Voisard et al. 1989). Whether the relation between morainic soil origin, vermiculite prevalence, specific rhizobacterial community, and black root rot suppressiveness is applicable outside this region was the purpose of this study.

Outside of Morens, comparable geomorphology and climate occur mainly in Savoie (France), which is located about 100 km away. Using cambisols from two areas of Savoie, we found that morainic soils there were neither suppressive nor vermiculitic, which indicates that the morainic suppressiveness model is unlikely to apply outside Morens. Furthermore, sandstone soils from Savoie appeared to be potentially suppressive, which was not due to vermiculite, as this clay mineral was not found in any of those soils. The results suggest that in the Savoie region, suppressiveness to *T. basicola* disease is independent of clay but is rather related to previously unidentified discriminant soil properties (sand, silt, nitrogen and sodium contents), which were not among those identified so far as black root rot suppressiveness determinants (Meyer and Shew 1991).

Based on PCA, rhizobacterial community composition did not differ between individual Savoie soils (Fig. S1A), which are at the most 22 km distant from one another, though Savoie soils could be distinguished from Morens soils (about 100 km distant) (Fig. S1B). On this basis, the total rhizobacterial community differed mainly by geography, as found elsewhere (Fulthorpe et al. 2008; Yergeau et al. 2010). Several regional factors that can vary at this scale might account for these findings. In addition to moraine and sandstone compositions (Von Eynatten 2003; Föllmi et al. 2009), they noticeably include microclimatic and farming conditions. Tobacco is grown regularly but maize is scarce in Morens, whereas in Savoie tobacco was not grown frequently in the last 20 years while maize has become an important crop. The two crops require different farming practices. Both soil management and cropping history can affect rhizobacterial communities (Marschner et al. 2003; Salles et al. 2004) and, consequently, certain types

of soil suppressiveness (van Elsas et al. 2002). On top of that, cultivated plants can also influence clay transformation in soil (Hinsinger and Jaillard 1993; Barré et al. 2007), which might influence soil suppressiveness in the long term. However, this was not considered of significant importance for black root rot suppressive soils in the current case, since (i) in Morens fields the suppressiveness persists for many years despite crop rotation, and (ii) the prevalence of maize cropping in these Savoie areas is relatively recent. Our results support previous findings that microorganisms display biogeographical patterns (Hughes Martiny et al. 2006), raising the possibility that soil suppressiveness to a particular root disease might involve different microorganisms in different regions, despite the possible contribution of cosmopolitan taxa (Ramette et al. 2006; Weller 2007).

Against this background, BGA did find an effect of soil geology on rhizobacterial community composition in Savoie soils (Figure 3), but it was minor in comparison with the effect of soil geographic origin. Suppressiveness sandstone soils from Savoie gave significantly higher signals with 16S rRNA probes targeting e.g. certain *Burkholderia*, *Eikenella/Neisseria*, *Paenibacillus* and *Flavobacterium*, and conducive morainic soils with e.g. OP2, *Bacillus vedderi*, *Azospirillum*, *Pantoea agglomerans* and *Thermodesulforhabdus* (Table 1). There was only little agreement between Savoie and Morens regions in the probes discriminating between morainic and sandstone soils, when comparing with the study of Kyselková et al. (2009) (Table S3). For instance, only probes targeting *Azospirillum*, *Methylomonas* and OP2 gave higher signals in morainic soils from both Savoie (conducive) and Morens (suppressiveness). However, probes PalgiG3 (for *Paenibacillus alginolyticus* and relatives), Spiro5 (for *Spirosoma*) and Inteur1 (for *Gluconacetobacter*) gave higher signal intensities in suppressiveness soils from both Morens (morainic) and Savoie (sandstone), which points to the likely importance of the corresponding taxa for suppressiveness, even though their role in tobacco black root rot suppression has not been studied.

In Morens soils, plant protection is (at least partially) attributed to 2,4-diacetylphloroglucinol-producing antagonistic pseudomonads (Stutz et al. 1986; Ramette et al. 2003, 2006; Frapolli et al. 2010), and *Pseudomonas* probes including those targeting particular types of 2,4-diacetylphloroglucinol-producing strains (Sanguin et al. 2008) were among the probes characteristic for suppressiveness in Morens (Kyselková et al. 2009). These probes hybridized also with Savoie soils, but without discriminating between morainic and sandstone soils (Table S3). However, *phlD* real-time PCR showed that the total amount of *phlD*<sup>+</sup> pseudomonads, which exceeded the threshold of 10<sup>4</sup> cells

per g of root required for soil suppressiveness (Stutz et al. 1986; Almario et al. 2013), was higher in morainic (conductive) soils, unlike in Morens. Diversity patterns of *phlD*<sup>+</sup> pseudomonads were also distinct between Savoie and Morens, as in Savoie (i) one additional phylogenetic group (i.e. group E) was identified and (ii) genotype distribution across the different phylogenetic groups was mostly due to the geographic origin (rather than geology) of the Savoie soils. Therefore, key ecological features of these bacteria differed in Savoie and Morens soils, raising the possibility of a different contribution to tobacco protection.

In conclusion, the generalization of black root rot suppressiveness results from one region to the next can be problematic due to local variations in factors influencing soil physicochemical and microbiological properties, such as soil matrix composition, microclimate and farming practices. Thus, the morainic model of black root rot suppressiveness might be geographically restricted to the Morens region, as it was insufficient to predict suppressiveness status in the neighboring Savoie region. In Savoie soils, *Thielaviopsis* black root rot suppressiveness displays new features in terms of its relation with the geologic origin of soil, soil chemical composition, and rhizobacterial community/populations. This new model of black root rot suppressiveness will require further work to understand its plant-protection mechanisms and the microbial populations involved.

## **Acknowledgement**

This work was supported by CORESTA (Paris, France), the ECO-NET network 10228TF (EGIDE, Paris, France), the Ministry of Education, Youth and Sports of the Czech Republic (project Kontakt ME09077), and the *Ministère Français de la Recherche*. We are grateful to G. Nicoud (Université de Savoie, Le Bourget du Lac, France) for help with geomorphology and L. Roger (UMR SeqBio, SupAgro, Montpellier, France) with clay analysis. We thank L. Jocteur-Monrozier, J. Haurat (UMR CNRS 5557 Ecologie Microbienne), D. Desbouchage (IFR 41), J. Bernillon (DTAMB) and C. Oger (DTAMB/PRABI) for technical help and/or discussion. This work made use of the IFR41 platforms Serre, DTAMB and PRABI.

## References

- Agrios GN (1997) Plant Pathology. Academic Press, San Diego, CA
- Alabouvette C (1999) Fusarium wilt suppressive soils: an example of disease-suppressive soils. *Austr Plant Pathol* 28:57-64
- Almario J, Moëgne-Loccoz Y, Muller D (2013) Monitoring of the relation between 2,4-diacetylphloroglucinol-producing *Pseudomonas* and *Thielaviopsis basicola* populations by real-time PCR in tobacco black root-rot suppressive and conducive soils. *Soil Biol Biochem* (available at <http://dx.doi.org/10.1016/j.soilbio.2012.09.003>)
- Baker KF, Cook RJ (1974) Biological Control of Plant Pathogens. The American Phytopathological Society, San Francisco, CA
- Barré P, Velde B, Catel N, Abbadie L (2007) Soil-plant potassium transfer: impact of plant activity on clay minerals as seen from X-ray diffraction. *Plant Soil* 292:137-146
- Bruce KD, Hiorns WD, Hobman JL, Osborn AM, Strike P, Ritchie DA (1992) Amplification of DNA from native populations of soil bacteria by using the polymerase chain reaction. *Appl Environ Microbiol* 58:3413-3416
- Day PR (1965) Particle fractionation and particle-size analysis. In: Black CA (ed) *Methods of Soil Analysis*. Academic Press Inc, New York, pp 545-567
- Föllmi KB, Arn K, Hosein R, Adatte T, Steinmann P (2009) Biogeochemical weathering in sedimentary chronosequences of the Rhône and Oberaar Glaciers (Swiss Alps): Rates and mechanisms of biotite weathering. *Geoderma* 151:270-281
- Frapolli M, Défago G, Moëgne-Loccoz Y (2007) Multilocus sequence analysis of biocontrol fluorescent *Pseudomonas* spp. producing the antifungal compound 2,4-diacetylphloroglucinol. *Environ Microbiol* 9:1939-1955
- Frapolli M, Moëgne-Loccoz Y, Meyer J, Défago G (2008) A new DGGE protocol targeting 2,4-diacetylphloroglucinol biosynthetic gene *phlD* from phylogenetically contrasted biocontrol pseudomonads for assessment of disease-suppressive soils. *FEMS Microbiol Ecol* 64:468-481
- Frapolli M, Défago G, Moëgne-Loccoz Y (2010) Denaturing gradient gel electrophoretic analysis of dominant 2,4-diacetylphloroglucinol biosynthetic *phlD* alleles in fluorescent *Pseudomonas* from soils suppressive or conducive to black root rot of tobacco. *Soil Biol Biochem* 42:649-656
- Fulthorpe RR, Roesch LFW, Riva A, Triplett EW (2008) Distantly sampled soils carry few species in common. *ISME J* 2:901-910

- Haas D, Défago G (2005) Biological control of soil-borne pathogens by fluorescent pseudomonads. *Nat Rev Microbiol* 3:307-319
- Hinsinger P, Jaillard B (1993) Root-induced release of interlayer potassium and vermiculitization of phlogopite as related to potassium depletion in the rhizosphere of ryegrass. *Eur J Soil Sci* 44:525-534
- Hughes Martiny JB, Bohannon BJM, Brown JH, Colwell RK, Fuhrman JA, Green JL, Horner-Devine MC, Kane M, Krumins JA, Kuske CR, Morin PJ, Naeem S, Ovreas L, Reysenbach AL, Smith VH, Staley JT (2006) Microbial biogeography: putting microorganisms on the map. *Nat Rev Microbiol* 4:102-112
- Johnson LJ (1970) Clay minerals in Pennsylvania soils. Relation to lithology of the parent rock and other factors-I. *Clays Clay Min* 18:247-260
- Keel C, Voisard C, Berling CH, Kahr G, Défago G (1989) Iron sufficiency, a prerequisite for the suppression of tobacco black root-rot by *Pseudomonas fluorescens* strain CHA0 under gnotobiotic conditions. *Phytopathology* 79:584-589
- Kyselková M, Kopecký J, Frapolli M, Défago G, Ságová-Marečková M, Grundmann GL, Moëgne-Loccoz Y (2009) Comparison of rhizobacterial community composition in soil suppressive or conducive to tobacco black root rot disease with a 16S rRNA gene-based taxonomic microarray. *ISME J* 3:1127-1138
- Lucas P, Sarniguet A (1998) Biological control of soilborne pathogens with resident versus introduced antagonists: should diverging approaches become strategic convergence? In: Barbosa P (ed) *Conservation Biological Control*. Academic Press, London, pp 351-370
- Marschner P, Kandeler E, Marschner B (2003) Structure and function of the soil microbial community in a long-term fertilizer experiment. *Soil Biol Biochem* 35:453-461
- Meyer JR, Shew HD (1991) Soils suppressive to black root rot of burley tobacco, caused by *Thielaviopsis basicola*. *Phytopathology* 81:946-954
- Murakami H, Tsushima S, Shishido Y (2000) Soil suppressiveness to clubroot disease of Chinese cabbage caused by *Plasmodiophora brassicae*. *Soil Biol Biochem* 32:1637-1642
- Persson L, Larsson-Wikstrom M, Gerhardson B (1999) Assessment of soil suppressiveness to *Aphanomyces* root rot of pea. *Plant Dis* 83:1108-1112
- Ramette A, Moëgne-Loccoz Y, Défago G (2003) Prevalence of fluorescent pseudomonads producing antifungal phloroglucinols and/or hydrogen cyanide in soils



- naturally suppressive or conducive to tobacco black root rot. *FEMS Microbiol Ecol* 44:35-43
- Ramette A, Moënne-Loccoz Y, Défago G (2006) Genetic diversity and biocontrol potential of fluorescent pseudomonads producing phloroglucinols and hydrogen cyanide from Swiss soils naturally suppressive or conducive to *Thielaviopsis basicola*-mediated black root rot of tobacco. *FEMS Microbiol Ecol* 55:369-381
- Rimé D, Nazaret S, Gourbière F, Cadet P, Moënne-Loccoz Y (2003) Comparison of sandy soils suppressive or conducive to ectoparasitic nematode damage on sugarcane. *Phytopathology* 93:1437-1444
- Salles JF, van Veen JA, van Elsas JD (2004) Multivariate analyses of *Burkholderia* species in soil: Effect of crop and land use history. *Appl Environ Microbiol* 70:4012-4020
- Sanguin H, Herrera A, Oger-Desfeux C, Dechesne A, Simonet P, Navarro E, Vogel TM, Moënne-Loccoz Y, Nesme X, Grundmann GL (2006b) Development and validation of a prototype 16S rRNA-based taxonomic microarray for *Alphaproteobacteria*. *Environ Microbiol* 8:289-307
- Sanguin H, Kroneisen L, Gazengel K, Kyselková M, Remenant B, Prigent-Combaret C, Grundmann GL, Sarniguet A, Moënne-Loccoz Y (2008) Development of a 16S rRNA microarray approach for the monitoring of rhizosphere *Pseudomonas* populations associated with the decline of take-all disease of wheat. *Soil Biol Biochem* 40:1028-1039
- Sanguin H, Remenant B, Dechesne A, Thioulouse J, Vogel TM, Nesme X, Moënne-Loccoz Y, Grundmann GL (2006) Potential of a 16S rRNA-based taxonomic microarray for analyzing the rhizosphere effects of maize on *Agrobacterium* spp. and bacterial communities. *Appl Environ Microbiol* 72:4302-4312
- Shiomi Y, Nishiyama M, Onizuka T, Marumoto T (1999) Comparison of bacterial community structures in the rhizoplane of tomato plants grown in soils suppressive and conducive towards bacterial wilt. *Appl Environ Microbiol* 65:3996-4001
- Siregar A, Kleber M, Mikutta R, Jahn R (2005) Sodium hypochlorite oxidation reduces soil organic matter concentrations without affecting inorganic soil constituents. *Eur J Soil Sci* 56:481-490
- Stralis-Pavese N, Sessitsch A, Weilharter A, Reichenauer T, Riesing J, Csontos J, Murrell JC, Bodrossy L (2004) Optimization of diagnostic microarray for application in analysing landfill methanotroph communities under different plant covers. *Environ Microbiol* 6:347-363

- Stutz E, Défago G, Kern H (1986) Naturally occurring fluorescent pseudomonads involved in suppression of black root rot of tobacco. *Phytopathology* 76:181-185
- Stutz E, Kahr G, Défago G (1989) Clays involved in suppression of tobacco black root rot by a strain of *Pseudomonas fluorescens*. *Soil Biol Biochem* 21:361-366
- Thioulouse J, Chessel D, Dolédec S, Olivier JM (1997) ADE-4: a multivariate analysis and graphical display software. *Stat Comput* 7:75-83
- Ulrich A, Becker R (2006) Soil parent material is a key determinant of the bacterial community structure in arable soils. *FEMS Microbiol Ecol* 56:430-443
- van Elsas JD, Garbeva P, Salles J (2002) Effects of agronomical measures on the microbial diversity of soils as related to the suppression of soil-borne plant pathogens. *Biodegradation* 13:29-40
- von Eynatten H (2003) Petrography and chemistry of sandstones from the Swiss Molasse Basin: an archive of the Oligocene to Miocene evolution of the Central Alps. *Sedimentology* 50:703-724
- Voisard C, Keel C, Haas D, Défago G (1989) Cyanide production by *Pseudomonas fluorescens* helps suppress black root-rot of tobacco under gnotobiotic conditions. *EMBO J* 8:351-358
- Weller DM (2007) *Pseudomonas* biocontrol agents of soilborne pathogens: Looking back over 30 years. *Phytopathology* 97:250-256
- Yergeau E, Bezemer TM, Hedlund K, Mortimer SR, Kowalchuk GA, van der Putten WH (2010) Influences of space, soil, nematodes and plants on microbial community composition of chalk grassland soils. *Environ Microbiol* 12:2096-2106

**Table S1** Soil composition

	Morens		Albens (Savoie)		Seysssel (Savoie)	
	MC112 Conducive (sandstone)	MS8 Suppressive (moraine)	Amo1 Conducive (moraine)	Asa2 Suppressive (sandstone)	Ymo4 Conducive (moraine)	Ysa5 Suppressive (sandstone)
Clay (%)	16.1	10.7	20.1	9.0	28.2	17.8
Silt (%)	29.9	29.6	39.8	19.7	33.5	25.9
Sand (%)	54.0	59.7	40.0	71.3	38.4	56.3
Texture	Sandy loam	Sandy loam	Loam	Sandy loam	Clay loam	Sandy loam
pH [water]	6.8	7.8	7.4	8.1	8.1	7.9
Organic matter (%)	2.2	1.3	3.7	2.1	2.6	2.2
CaCO <sub>3</sub> total (%)	0	6	0.7	4.1	19.5	2.8
N total (%)	0.13	0.13	0.24	0.11	0.21	0.16
P total (mg kg <sup>-1</sup> )	530	750	34	197	56	382
K total (mg kg <sup>-1</sup> )	111	150	116	153	276	223
Ca total (g kg <sup>-1</sup> )	2.26	8.47	4.41	6.32	9.84	6.86
Mg total (mg kg <sup>-1</sup> )	135	103	118	95	135	184
Na total (mg kg <sup>-1</sup> )	8	6	6	3	7	3
Cu [EDTA] (mg kg <sup>-1</sup> )	4.08	1.89	1.85	3.50	6.91	3.22
Zn [EDTA] (mg kg <sup>-1</sup> )	1.01	1.66	0.77	0.75	1.33	1.91
Mn [EDTA] (mg kg <sup>-1</sup> )	62.7	24.6	18.9	20.9	11.0	9.1
Fe [C <sub>2</sub> H <sub>4</sub> O <sub>2</sub> 1:10] (mg kg <sup>-1</sup> )	251	230	46	60	12	32

All soils displayed 100% CEC saturation.

**Table S2** Mean frequencies of the phylogenetic groups A-F of *phlD*<sup>+</sup> pseudomonads (defined in Frapolli et al., 2007) detected by *phlD*-tRFLP in rhizosphere samples from *T. basicola*-inoculated (I) and non-inoculated (N) plants (4 per treatment) grown in the four soils

Phylogenetic group <sup>a</sup> and terminal fragment size	A (222 bp)	B (275 bp)	C (73 bp)	D (142 bp)	E (212 bp)	F (229 bp)
Amo1_I	0.5	1	0	1	0	0
Amo1_N	0.5	1	0	0.75	0	0
Asa2_I	0.75	1	0	0.75	0	0
Asa2_N	0.75	0.75	0	1	0.25	0
Ymo4_I	0.25	1	0	1	0	0
Ymo4_N	0	1	0	1	0	0
Ysa5_I	0.25	1	0	1	0	0
Ysa5_N	0.25	1	0	1	0	0

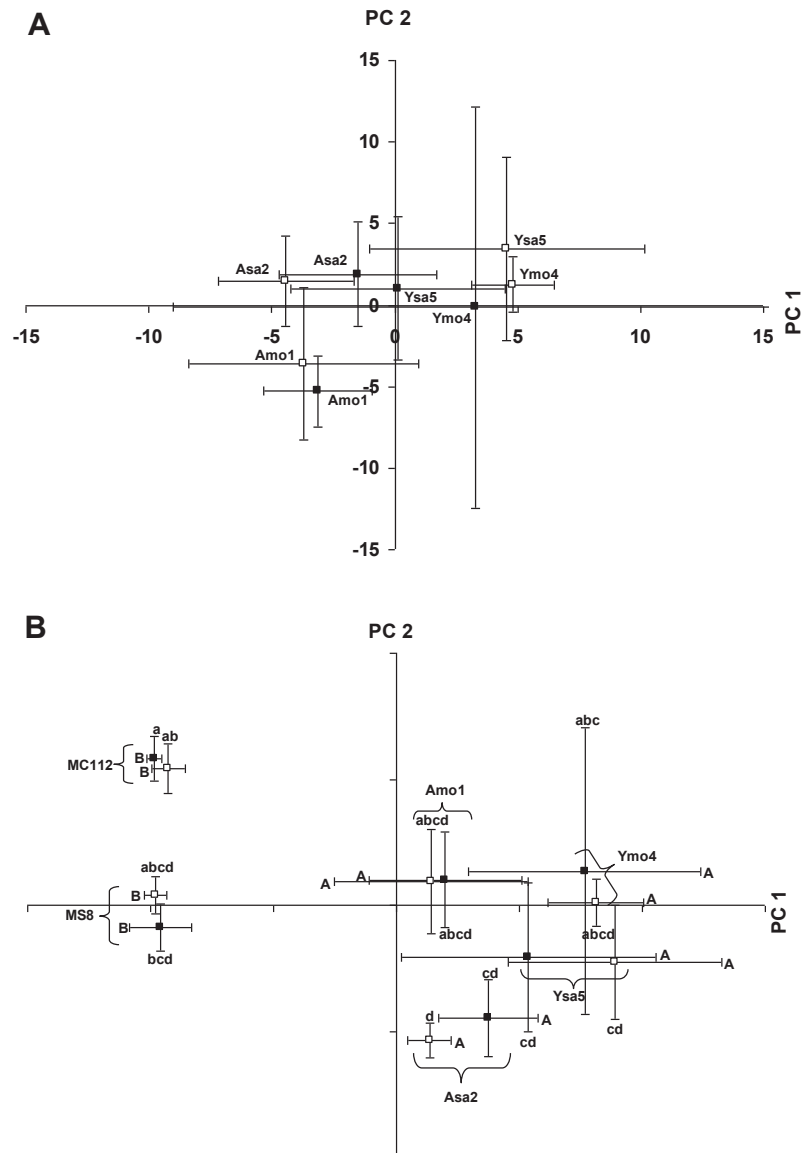
<sup>a</sup> Phylogenetic groups (Frapolli et al., 2007) associated to the terminal fragments detected. Phylogenetic group A corresponds to *phlD* genotypic cluster 5 (defined by Frapolli et al., 2008), B to clusters 1-4, C to cluster 7, D to cluster 6, E to cluster 8 and F to cluster 9.

**Table S3** 16S rRNA probes discriminating suppressive from conducive soils in Morens soils (Kyselková et al., 2009) and giving<sup>a</sup> statistically-different microarray hybridization signals in suppressive versus conducive Savoie soils, based on rhizosphere samples of tobacco at 3 weeks (n = 8; Wilcoxon rank sum test,  $P < 0.05$ )

Probe	Target	Savoie soils leading to higher signal intensity <sup>b</sup>
<b>Probes giving higher signals in Morens suppressive soil (moraine)</b>		
PalgiG3	<i>Paenibacillus alginolyticus</i> and relatives	Suppressive (sandstone) **
Spiro5	<i>Spirosoma</i>	Suppressive (sandstone) *
Inteur1	<i>Gluconacetobacter</i>	Suppressive (sandstone) *
Azo1 and Azo5	<i>Azospirillum</i> and relatives	Conductive (moraine) **
Methy1B	<i>Methylomonas</i>	Conductive (moraine) **
OP2-1	OP2	Conductive (moraine) **
<b>Probes giving higher signals in Morens conducive soil (sandstone)</b>		
Bacfor1	<i>Bacillus fortis</i> and relatives	Conductive (moraine) *
Bacved_3	<i>Bacillus vedderi</i>	Conductive (moraine) **
Lacto39	<i>Lactobacillus crispatus</i>	Conductive (moraine) *
ActORD1	<i>Actinomycetales</i>	Conductive (moraine) *
Pagg5	<i>Pantoea agglomerans</i>	Conductive (moraine) *
Ptol1	<i>Pantoea toletana</i>	Conductive (moraine) *
Aci1	<i>Acidiphilium</i>	Conductive (moraine) **
Ehrl1	<i>Ehrlichia</i>	Conductive (moraine) *
Mycol1	<i>Mycoplasma</i>	Conductive (moraine) *
TDRNO1030	<i>Thermodesulforhabdus</i>	Conductive (moraine) **

<sup>a</sup> These 17 probes were identified from 34 probes characteristic for Morens suppressive soil and 34 other probes characteristic for Morens conducive soil (Kyselková et al., 2009).

<sup>b</sup> The suppressiveness status (i.e. suppressive or conducive) and the geological origin of soils (i.e. moraine or sandstone) for which higher hybridization signals were obtained ( $*P < 0.05$  or  $**P < 0.01$ ) are indicated.



**Fig. S1** Principal component analysis (PCA) of rhizobacterial communities from *T. basicola*-inoculated (black symbols) and non-inoculated (white symbols) samples, based on microarray probe signals. Data are shown as means and standard errors of sample positions. **(A)** Comparison of Savoie sandstone (Asa2 and Ysa5) and morainic (Amo1 and Ymo4) soils. Principal components PC1 and PC2 corresponded to respectively 29% and 13% data variation. The treatments could not be statistically distinguished in the PCA ordination plot. **(B)** Comparison of Savoie sandstone (Asa2 and Ysa5) and morainic (Amo1 and Ymo4) soils, along with data obtained previously under the same conditions for two Morens soils (i.e. suppressive morainic soil MS8 and conducive sandstone soil MC112; Kyselková et al., 2009), which were cropped with wheat (MS8) and mixed pasture (MC112) at the time of sampling. Principal components PC1 and PC2 corresponded to respectively 30% and 10% data variation. Differences between treatments are shown using letters AB along axis PCA1 and a-d along axis PCA2.



## **Annexe 2.**





Contents lists available at SciVerse ScienceDirect

## Soil Biology &amp; Biochemistry

journal homepage: [www.elsevier.com/locate/soilbio](http://www.elsevier.com/locate/soilbio)

## Monitoring of the relation between 2,4-diacetylphloroglucinol-producing *Pseudomonas* and *Thielaviopsis basicola* populations by real-time PCR in tobacco black root-rot suppressive and conducive soils

Juliana Almario<sup>a,b,c</sup>, Yvan Moënne-Loccoz<sup>a,b,c</sup>, Daniel Muller<sup>a,b,c,\*</sup>

<sup>a</sup> Université de Lyon, F-69622 Lyon, France

<sup>b</sup> Université Lyon 1, Villeurbanne, France

<sup>c</sup> CNRS, UMR5557, Ecologie Microbienne, Villeurbanne, France

## ARTICLE INFO

## Article history:

Received 2 March 2012

Received in revised form

29 August 2012

Accepted 3 September 2012

Available online 17 September 2012

## Keywords:

Rhizosphere

Suppressive soil

Moens

Biocontrol

*Pseudomonas*

2,4-Diacetylphloroglucinol

*phlD*

*Thielaviopsis basicola*

## ABSTRACT

Natural suppressiveness of Swiss soils to *Thielaviopsis basicola*-mediated tobacco black root rot is thought to depend mainly on fluorescent pseudomonads producing the antimicrobial compound 2,4-diacetylphloroglucinol. However, the relation between these *phl*<sup>+</sup> *Pseudomonas* populations and both the *T. basicola* population and disease suppressiveness in these soils is unknown, and real-time PCR tools were used to address this issue. Significant rhizosphere levels of *phl*<sup>+</sup> pseudomonads had been evidenced before in suppressive as well as conducive soils, but this was done using culture-based approaches only. Here, a *phlD*-based real-time PCR method targeting all *phlD*<sup>+</sup> genotypes, unlike the strain-specific real-time PCR methods available so far, was developed and validated (detection limit around 4 log cells g<sup>-1</sup> soil and amplification efficiency >80%). When implemented on Swiss soils suppressive or conducive to black root rot, it clarified the hypothesis that suppressiveness does not require higher levels of *phlD*<sup>+</sup> pseudomonads. The parallel assessment of *T. basicola* population by real-time PCR (method of Huang and Kang, 2010) suggested that suppressiveness was not due to the inability of the pathogen to colonize the rhizosphere and tobacco roots in suppressive soils, but rather that *phl*<sup>+</sup> pseudomonads might act by limiting root penetration by the pathogen in suppressive soils. In conclusion, an effective real-time PCR method was achieved for *phlD*<sup>+</sup> pseudomonads and can be used to monitor this key functional group in various environmental conditions, including here to better understand the ecology of suppressive soils.

© 2012 Elsevier Ltd. All rights reserved.

### 1. Introduction

Soil-borne plant pathogens can cause extensive damage to plants both in natural plant communities and crop stands. However, root infection by these phytopathogens may be controlled by competition or antagonistic effects of rhizosphere microorganisms (Raaijmakers et al., 2009). The latter include plant-protecting strains from the *Pseudomonas* spp., which can act by different mechanisms (Couillerot et al., 2009), particularly the production of antimicrobial compounds such as 2,4-diacetylphloroglucinol (DAPG) and others (Haas and Défago, 2005; Weller et al., 2007). DAPG inhibits various phytopathogens *in vitro* (Haas and Keel, 2003), may induce an ISR response in plant (Iavicoli et al., 2003; Weller et al., 2012), as well as modulating root development (Brazelton et al., 2008) and exudation (Phillips et al., 2004), or enhancing the expression of

phytostimulation-relevant genes in neighboring *Azospirillum* bacteria (Combes-Meynet et al., 2011).

Pseudomonads harboring *phl* genes for DAPG production display world-wide distribution (Wang et al., 2001). However, their population size and diversity may fluctuate according to soil location (Meyer et al., 2010), soil geomorphology (Frapolli et al., 2010), crop species and variety (Picard and Bosco, 2006; von Felten et al., 2011), and soil management (Bergsma-Vlami et al., 2005; Rotenberg et al., 2007). In certain cases, the *phl*<sup>+</sup> *Pseudomonas* spp. reach rhizosphere numbers high enough for effective plant protection, as shown for soils suppressive to take-all of wheat and barley caused by *Gaeumannomyces graminis* var. *tritici* (Weller et al., 2007), Fusarium wilt of pea mediated by *Fusarium oxysporum* f. sp. *pisi* (Landa et al., 2002) and *Thielaviopsis basicola*-mediated black root rot of tobacco (Stutz et al., 1986; Keel et al., 1992). Suppressiveness is a soil property in which the extent of certain disease(s) on susceptible crop is significantly limited by one or several plant-protecting microbial populations, such as *phl*<sup>+</sup> *Pseudomonas* species or others (Raaijmakers and Weller, 1998; Weller et al., 2007; Kyselková and Moënne-Loccoz, 2012).

\* Corresponding author. Université de Lyon, F-69622 Lyon, France. Tel.: +33 4 72 43 27 14; fax: +33 4 72 43 12 23.

E-mail address: [daniel.muller@univ-lyon1.fr](mailto:daniel.muller@univ-lyon1.fr) (D. Muller).

The presence of root pathogens can lead to larger *phl*<sup>+</sup> populations, as observed for cucumber and maize infected by *Pythium ultimum* (Notz et al., 2001; Rotenberg et al., 2007), or bean by *Rhizoctonia solani* (Jamali et al., 2009). This is attributed to root leakage of nutrients as a result of disease, and participates to the build-up of *phl*<sup>+</sup> *Pseudomonas* populations in relation to monoculture-induced decline of wheat take-all (Raaijmakers and Weller, 1998). Changes in the proportions of different genotypes of *G. graminis* var. *tritici* may also take place during take-all decline, and this might facilitate suppressiveness in that less aggressive genotypes become prevalent (Lebreton et al., 2007). It is unknown whether a similar interplay between pathogen and *phl*<sup>+</sup> *Pseudomonas* populations exists in black root rot suppressive soils (Gasser and Défago, 1981; Stutz et al., 1986; Frapolli et al., 2010), but very little has been done to monitor *T. basicola* in these soils.

The soils naturally suppressive to black root rot of tobacco (and other crops) occur mainly in the region of Morens (Switzerland), where both suppressive and conducive soils are present in the landscape. Conducive soils derive from weathered molasses (i.e. sandstone) and suppressive soils from shallow morainic material overlying the sandstone (Stutz et al., 1989). Yet, both types of soil (i.e. brunisols) are chemically similar, except for the predominance of iron-releasing vermiculite among clay minerals in suppressive soils (Stutz et al., 1989). Since *phl*<sup>+</sup> *Pseudomonas* were also present in significant numbers in Morens conducive soils (Ramette et al., 2003; Frapolli et al., 2010), the hypothesis was raised that soil suppressiveness status in the case of black root rot could be linked to the diversity of *phl*<sup>+</sup> *Pseudomonas* populations. Indeed, the latter differs between Morens suppressive and conducive soils (Frapolli et al., 2008, 2010), which can have a strong impact on plant protection efficacy (Becker et al., 2012). However, the monitoring of *phl*<sup>+</sup> pseudomonads at Morens has relied so far on (various) culture-dependent methods (needing PCR detection of the *phlD* gene essential for DAPG synthesis), whose results were not confirmed by a culture-independent approach based on 16S rDNA microarray analysis (Kyselková et al., 2009). Although active, *Pseudomonas* cells in the rhizosphere may be under starvation stress (Marschner and Crowley, 1996) and viable but non-culturable subpopulations can develop (Troxler et al., 2012; Sørensen et al., 2001), biasing culture-based estimates. Four *phlD*-based real-time PCR methods, each targeting a particular *phlD*<sup>+</sup> strain were developed by Mavrodi et al. (2007) but these methods poorly cover the diversity of *phl*<sup>+</sup> pseudomonads, for which 22 genotypic groups have been described worldwide. Thus, a general culture-independent method to quantify all 2,4-diacetylphloroglucinol-producing pseudomonads (and allowing analysis of their diversity) is still lacking.

Against the background of current hypotheses on the suppressiveness of Morens soils to Thielaviopsis black root rot, our understanding of this disease suppression is limited by (i) the fact that only culturable *phl*<sup>+</sup> pseudomonads have been studied until now, and (ii) the lack of knowledge on the relation between *phl*<sup>+</sup> *Pseudomonas* and *T. basicola* populations in these soils, and the consequences for suppressiveness. These issues were the targets of the current work. A real-time PCR protocol is available for quantification of the pathogen *T. basicola* (Huang and Kang, 2010) but not for *phl*<sup>+</sup> *Pseudomonas*, and thus a single *phlD*-based real-time PCR method was developed and validated for simultaneous quantification of all *phl*<sup>+</sup> *Pseudomonas*. This method was then implemented to assess the hypothesis that suppressiveness to black root rot does not require higher levels of *phlD*<sup>+</sup> pseudomonads in the rhizosphere. To this end, the size (and genetic structure by tRFLP analysis) of natural populations of *phl*<sup>+</sup> pseudomonads in disease suppressive and conducive soils from Morens was monitored, in parallel to the quantification of *T. basicola* using the real-time PCR method of Huang and Kang (2010).

## 2. Material and methods

### 2.1. Bacterial cultures, fungal cultures and genomic DNA extraction

The pseudomonads used belonged to *Pseudomonas protegens* (i.e. strain CHA0; Stutz et al., 1986; Ramette et al., 2011) or the '*Pseudomonas fluorescens*' species complex defined by Anzai et al. (2000), i.e. strains Q2-87 (Vincent et al., 1991), F113 (Fenton et al., 1992) and its spontaneous rifampicin-resistant mutant F113Rif (Carroll et al., 1995), *Pseudomonas thivervalensis* PITR2, *Pseudomonas kilonensis* P12 (Keel et al., 1996), K93.2, P87-38 and *Pseudomonas brassicacearum* P97-30 (Wang et al., 2001). All strains were routinely grown at 27 °C in solid or liquid KB medium (King et al., 1954) supplemented with chloramphenicol (10 µg mL<sup>-1</sup>) and ampicillin (40 µg mL<sup>-1</sup>). For strain F113Rif, rifampicin was added to the medium at 50 µg mL<sup>-1</sup> (KB Rif). For genomic DNA extraction, bacterial strains were grown overnight in 150 mL of liquid medium with shaking (150 rpm), and DNA was extracted from 500 µL of bacterial culture using the NucleoSpin Tissue kit (Macherey–Nagel, Hoerdt, France), following the manufacturer's instructions. DNA was quantified spectrophotometrically and adjusted to 30 ng µL<sup>-1</sup>.

*T. basicola* Ferraris strain ETH D127 (Berk. and Br.) was grown 4 weeks in the dark on malt agar (Ramette et al., 2003). A suspension containing 6 × 10<sup>4</sup> endoconidia mL<sup>-1</sup> was prepared as described by Ramette et al. (2003) and used for tobacco inoculation or DNA extraction. Fungal DNA was extracted from 400 µL of the suspension, following the protocol of Ward (2009) for spores in liquid medium. DNA concentration was adjusted to 10 ng µL<sup>-1</sup>.

### 2.2. Plant experiments and samplings

Soil samples from two suppressive (MS8 and MS16) and two conducive (MC10 and MC112) fields from Morens (Frapolli et al., 2010; Kyselková et al., 2009) were taken from 8 to 30 cm depth in June 2010. Stones and roots were removed before sieving soil at 5 mm and filling 300 cm<sup>3</sup> plastic pots (350 g soil per pot). Tobacco (*Nicotiana glutinosa* L.) was grown for 4 weeks, as described previously (Ramette et al., 2003), before transplanting into soil. Soil water content was adjusted to 70% of the water retention capacity for each soil, and was maintained by watering the pots with distilled water every two days.

In the first plant experiment, carried out with soil MC10 alone (for method development), plant root systems with tightly adhering soil were sampled 1 or 3 days after transplanting. Roots were washed in 1 mL of sterile 0.8% NaCl solution by vortexing (30 min at 1500 rpm), and rhizosphere soil was collected by centrifugation (20 min at 4 °C and 3500 g) prior to lyophilization (described below). In the second experiment, conducted with the four soils together (for comparison of suppressive and conducive soils), half the pots were inoculated with 10<sup>3</sup> *T. basicola* endoconidia cm<sup>-3</sup> soil (as described in Ramette et al., 2003), and plant root systems with tightly adhering soil were sampled at 7 and 21 days. They were lyophilized at -50 °C for two days (freeze-drier Christ Alpha 2-4, Martin Christ, Osterode, Germany) before delicately separating the roots from the rhizosphere soil using tweezers.

### 2.3. DNA extraction from plant roots and rhizosphere soil

DNA was extracted from soil or from roots, following a protocol modified from Griffiths et al. (2000), as follows. Lyophilized samples were ground in 2-mL tubes using a spatula and DNA was extracted from the totality of the sample for roots (33–264 mg) or 500 mg for rhizosphere soil. Samples were mixed with 0.5 g of 100 µm zirconia/silica beads (BioSpec, Bartlesville, OK), 500 µL of CTAB extraction



the LightCycler Software v.1.5 (Roche Applied Science). The standard curves were obtained by plotting the mean  $C_t$  value of the three replicates (per DNA concentration) against the log-transformed DNA concentration. Amplification efficiency ( $E$ ), calculated as  $E = 10^{(-1/\text{slope})} - 1$ , and the error of the method (Mean Squared Error of the standard curve) were determined using the LightCycler Software v.1.5 (Roche Applied Science). The equivalence between DNA amount and *phlD* copy number was estimated based on (i) a *Pseudomonas* genome of approximately 7.26 fg DNA (derived from the 7.1 Mbp genome of *P. protegens* Pf-5; Paulsen et al., 2005) and (ii) the occurrence of *phlD* in one copy per genome (Moynihan et al., 2009). The detection limit was determined as the number of *phlD* copies at the last DNA concentration giving 3 positive results out of 3 replicates (Bustin et al., 2009). Amplification specificity was checked by melting curve analysis of the amplification product using a fusion program consisting of an initial denaturing step of 5 s at 95 °C, an annealing step of 1 min at 65 °C and a denaturing temperature ramp from 65 to 97 °C with a rate of 0.11 °C s<sup>-1</sup>. Melting curve calculation and  $T_m$  determination were performed using the  $T_m$  Calling Analysis module of LightCycler Software v.1.5 (Roche Applied Science).

Real-time PCR optimization was sought to improve *phlD* amplification efficiency (above 80%) and error (below 0.01; Zhang and Fang, 2006) for the eight *phlD*<sup>+</sup> *Pseudomonas* strains. Were tested: three primer concentrations (0.5, 0.75 and 1 μM), 2 DMSO concentrations (3% and 6%), the addition of T4g32 protein (0.5 μg per reaction mix; Roche Applied Science), 5 annealing temperatures (62, 63, 65, 67 and 69 °C), 5 annealing times (30, 15, 9, 7 and 5 s) and 2 elongation times (30 and 15 s).

The final reaction mix contained 10 μL of LightCycler 480 SYBR Green I Master Vial 1, 1.9 μL of Vial 2 (Roche Applied Science), 1 μM of primer B2BF, 1 μM of primer B2BR3, 0.5 μg of T4g32 protein, 3% DMSO and 2 μL of DNA. The final cycling program included a 10 min incubation at 95 °C, 50 amplification cycles of 30 s at 94 °C, 7 s at 67 °C and 15 s at 72 °C; and the fusion program for melting curve analysis described above. The standard curve thus generated from genomic DNA of '*P. fluorescens*' F113 was subsequently used as the external standard curve for determination of *phlD* copy number in uncharacterized DNA samples. Ten-time diluted DNA samples were analyzed by real-time PCR in triplicate (following the above protocol), and the mean  $C_t$  value was reported in the external standard curve to infer *phlD* copy number in the sample, using the LightCycler 480 Software and the "external standard curve" option for absolute quantification. Two DNA standards from genomic DNA of '*P. fluorescens*' F113 (0.6 and 6 pg corresponding to approximately 80 and 800 *phlD* copies) were included as reference in each run to detect between-run variations.

## 2.6. Generation of standard curves from bulk soil inoculated with *phlD*<sup>+</sup> *Pseudomonas* F113 and CHA0

Non-sterile bulk soil samples (500 mg) from fields MC10 or MS8 were inoculated with 100 μL of ten-fold dilutions of bacterial cell suspension, reaching from  $4.6 \times 10^8$  to  $4.6 \times 10^2$  CFU g<sup>-1</sup> soil for strain F113, and  $1.7 \times 10^8$  to  $1.7 \times 10^2$  CFU g<sup>-1</sup> soil for strain CHA0. Three samples per strain and per CFU concentration were prepared, negative controls received 100 μL of 0.8% NaCl solution, and the bacterial dilutions were plated onto KB medium to verify CFU levels. Soil samples were immediately lyophilized (at -50 °C for two days) and DNA was extracted, as described above for rhizosphere soil. For each strain × soil combination, a standard curve was obtained by plotting the mean  $C_t$  value of the three inoculation replicates against log-transformed CFU level. The amplification efficiency, the error and the detection limit of the method were also determined, as described above.

## 2.7. Method validation based on colony counts of '*P. fluorescens*' F113Rif in the tobacco rhizosphere

Before transplanting into soil MC10, tobacco roots were inoculated with 100 μL of ten-fold dilutions of F113Rif cell suspension to obtain from  $2.6 \times 10^9$  to  $2.6 \times 10^3$  CFU per plant. Four plants per CFU concentration were prepared, negative controls received 100 μL of 0.8% NaCl solution, and the bacterial dilutions were plated onto KB Rif medium to verify CFU levels. Two plants per CFU concentration were sampled at 1 day and the other two at 3 days. Plants were taken out of the soil, root systems (with tightly adhering soil) were placed each in 1 mL of 0.8% NaCl solution, the tubes were shaken for 30 min at 1500 rpm, roots were removed, and cell number of F113Rif in the remaining suspension was estimated by counting colonies on KB Rif plates (after a 2 day incubation). For DNA extraction, the suspensions were centrifuged for 20 min at 4 °C and 3500 g, the supernatant was discarded, the rhizosphere soil pellet lyophilized and its DNA extracted following the soil DNA extraction protocol described above. Ten times diluted DNA samples were analyzed by real-time PCR in triplicate and the mean  $C_t$  value was used to infer *phlD* copy number in each sample, as described above.

## 2.8. Analysis of indigenous root-colonizing *phlD*<sup>+</sup> *Pseudomonas* in Morens soils

Seven days (only for soils MS8 and MC112) and 21 days (for all soils) after tobacco transplanting, the root systems (roots and tightly adhering soil) of five tobacco plants inoculated with *T. basicola* and five non-inoculated tobacco plants (per soil and per date) were collected. After lyophilization, roots were separated from rhizosphere soil, as described above (Section 2.2). *phlD* copy number in root and rhizosphere DNA samples was determined by real-time PCR, as described above (Section 2.5).

When the real-time PCR method was implemented to monitor root-associated *phlD*<sup>+</sup> *Pseudomonas* in Morens soil, melting curve analysis and gel migration of the *phlD* amplicons showed the presence of a single peak (of expected  $T_m$ ) and band (of expected size), respectively. *phlD* identity was confirmed by sequencing four clones from one real-time PCR product from one root sample from soil MS8, as follows. Because real-time PCR products cannot be used directly for cloning, they were first re-amplified by conventional PCR using the same primers. PCRs were carried out in 50-μL volumes containing 3% DMSO, 1 × buffer (Roche Applied Science), 1.5 mM MgCl<sub>2</sub>, 100 μM of each dNTP, 1 μM of each primer B2BF/B2BR3, 1.8 U of Taq Expand High Fidelity DNA polymerase (Roche Applied Science) and 1 μL of template DNA. The cycling program included 3 min at 94 °C, 30 amplification cycles of 1 min at 94 °C, 1 min at 62 °C and 1 min at 72 °C, and an elongation step of 3 min at 72 °C. PCR products were purified (MinElute PCR purification kit; Qiagen), cloned (pGEMs-T Easy Vector System kit; Promega, Charbonnières, France) and both strands were sequenced (LGC Genomics, Berlin, Germany) for four clones. The sequences (EMBL accession numbers HE647865–HE647868) were checked, edited with BioEdit v.7.0 (Hall, 1999), and their *phlD* identity was determined using the BlastN algorithm and the nr Nucleotide Sequence Database.

## 2.9. *tRFLP* analysis of *phlD* alleles

Following real-time PCR amplification of *phlD*, four amplification products (two from tobacco roots and two from the rhizosphere) per treatment were re-amplified by PCR, as indicated above, using primers B2BF and B2BR3 (the latter labeled in 5' with Carboxy-fluorescein; Invitrogen). PCR products were purified using the MinElute PCR purification kit (Qiagen), following the

manufacturer's instructions. Product digestion and tRFLP analysis were conducted as in von Felten et al. (2011), except that EcoO109I was replaced with Mael to recognize a unique restriction site present only in *phlD* sequences from phylogenetic group D. Briefly, 500 ng of PCR product were digested for 4 h at 37 °C with 0.5 U of each restriction enzyme (BspI, NspI, AseI, Kpn2I, PstI and Mael; Fermentas, St. Leon Rot, Germany) in a 12 µL reaction containing 1 × buffer (Fermentas). Terminal restriction fragments were analyzed on automated sequencer ABI 3730XL (Applied Biosystems, Foster City, CA), using 1 µL of digested product and 0.4 µL of GeneScan-600LIZ (Applied Biosystems), and data was analyzed using Gene Mapper Software 4.0 (Applied Biosystems) with a peak detection limit set to 50 relative fluorescence units. A sample consisting of a mix of genomic DNA (30 ng) from *P. brassicacearum* P97-30 (phylogenetic group A), '*P. fluorescens*' F113 (B), '*P. fluorescens*' Q2-87 (C), *P. thivervalensis* PITR2 (D), '*P. fluorescens*' P87-38 (E) and *P. protegens* CHA0 (F) was included to verify the size of terminal fragments. tRFLP chromatograms were converted into binary matrices (presence vs absence of peaks for each replicate) and results from the two replicates were combined and converted to frequency matrices (for each peak, frequency was 1 if present in both replicates, 0.5 if in one replicate, and 0 if absent), as done by von Felten et al. (2011). The frequency matrices were used for cluster analysis based on the Euclidean distances.

#### 2.10. Real-time PCR quantification of *T. basicola* in Morens soils and suppressiveness test

*T. basicola* was quantified by real-time PCR, using the protocol of Huang and Kang (2010). To generate the standard curve, *T. basicola* genomic DNA (obtained as described above) was serially diluted ten-fold in three separated series to obtain from  $1.3 \times 10^6$  to 1.3 fg DNA µL<sup>-1</sup>, and 2 µL of each dilution were used for real-time PCR analysis. The assay was conducted using ITS primers Tb1/Tb2 (Huang and Kang, 2010). The reaction mix contained 10 µL of LightCycler 480 SYBR Green I Master Vial 1, 4 µL of Vial 2 (Roche Applied Science), 0.4 µM of primer Tb1, 0.4 µM of primer Tb2 and 2 µL of DNA. The cycling program included a 10 min incubation at 95 °C, 45 amplification cycles of 20 s at 94 °C, 20 s at 54 °C and 20 s at 72 °C; and the same fusion program for melting curve analysis described above for *phlD*.  $C_t$  values, standard curve, amplification efficiency and error, detection limit, melting curves and  $T_m$  values were determined, as indicated above for *phlD*.

For quantification of *T. basicola* in the rhizosphere of Morens soils (experiment described above), the standard curve generated with strain ETH D127 was used as external standard curve. Ten-time diluted DNA samples were analyzed by real-time PCR in triplicate and the mean  $C_t$  value was used to infer the amount of *T. basicola* DNA in the sample, using the external standard curve and two DNA standards ( $2 \times 10^4$  and  $2 \times 10^5$  fg of *T. basicola* DNA), as indicated for *phlD* quantification. To verify that amplicons did correspond to *T. basicola* ITS, real-time PCR products obtained with root samples from one non-inoculated plant (in soil MS8) and two inoculated plants (one in soil MS8 and the other in MC112), as well as with genomic DNA from strain ETH D127, were re-amplified by conventional PCR, as described above for *phlD*, expect that no DMSO was added, primers Tb1/Tb2 were used and primer annealing was at 50 °C. PCR products were purified, cloned and ten clones per sample were sequenced, as described above for *phlD*. *T. basicola* ITS sequences (EMBL accession numbers HE647869–HE647899) were checked and edited with BioEdit v.7.0 (Hall, 1999) and their affiliation was determined using the BlastN algorithm and the nr Nucleotide Sequence Database.

In the same experiment, the suppressive/conducive status of each soil was verified. For this purpose, 8 *T. basicola* inoculated and

8 non-inoculated plants were collected per soil at 21 days, and the washed roots were used to score black root rot symptoms and determine disease severity (i.e. percentage of root surface covered by *T. basicola* chlamydozoospores) using a height-class disease scale (Stutz et al., 1986; Ramette et al., 2003).

#### 2.11. Statistical analyses

All statistical analyses were performed in the R environment (v.2.12.0) using the Agricolae (De Mendiburu, 2007) and Car (Fox and Weisberg, 2011) packages, at  $P < 0.05$ . Normality was tested using Shapiro's test. Because real-time PCR data were not normally or log-normally distributed, (i) zero values were replaced by the detection limit (Klopper and Beauchamp, 1992) of the real-time PCR method i.e. 8 *phlD* copies and 260 fg of *T. basicola* DNA, and (ii) data was power-transformed using the Box–Cox transformation method (Box and Cox, 1964) in the Car package. Means were compared by ANOVA performed both on power- and on rank-transformed data, followed by Fisher's LSD tests, obtaining nearly identical results with the two transformation procedures. Only statistical results from power-transformed data are shown. Disease severity was compared between treatments by two-factor (i.e. soil × *T. basicola* inoculation) ANOVA followed by Fisher's LSD tests at  $P < 0.05$ , based on rank-transformed data. Correlation analyses were performed on log-transformed data using Pearson's product–moment correlation coefficient ( $r$ ) and its associated  $P$  value.

### 3. Results

#### 3.1. Development of *phlD* real-time PCR primers

Six primer pairs were assessed to fit the six phylogenetic groups of DAPG producers described by Frapolli et al. (2007). Primer pair B2BF–BPR4 (McSpadden Gardener et al., 2001) was discarded because of high  $T_m$  difference between primers and high product size. Two pairs were discarded as one of the primers displayed more than three mismatches with certain *phlD* sequences, and two others were dismissed since they failed to specifically amplify *phlD* from rhizosphere DNA by real-time PCR (Table S1). Only B2BF/B2BR3 (described in Table 1) fit all six assessment criteria, and this pair was chosen for real-time PCR optimization.

#### 3.2. Optimization and validation of *phlD* real-time PCR

Real-time PCR conditions were optimized to obtain an amplification efficiency of >80% and an error below 0.1 with genomic DNA of all 8 *phlD*<sup>+</sup> strains tested, which exhibited the same detection limit of 60 fg DNA (equivalent to approximately 8 *phlD* copies; Table 2).

When tested in non-sterile bulk soil inoculated with strains F113 and CHA0, amplification efficiencies above 80% and errors below 0.1 were also obtained, for both soils tested (Table 2). Detection of indigenous *phlD*<sup>+</sup> *Pseudomonas* prevented estimation of detection limits in soil MS8, whereas in soil MC10 they were 4.4 log *phlD* copies g<sup>-1</sup> soil for strain F113 and 4.1 log *phlD* copies g<sup>-1</sup> soil for strain CHA0. In soil MC10, *phlD* copy numbers from real-time PCR were  $0.23 \pm 0.11$  log lower than that expected from CFU inoculation levels (Figure S1).

When the *phlD*<sup>+</sup> strain '*P. fluorescens*' F113Rif was monitored in the rhizosphere of tobacco grown in non-sterile soil MC10, a highly significant, positive linear correlation ( $P \ll 0.01$ ) was observed between colony counts on KB Rif and *phlD* copies quantified by real-time PCR (Fig. 3). The detection limit of the real-time PCR method in the tobacco rhizosphere was 3.7 log *phlD* copies per root system, but the corresponding CFU could not be determined since they were below the detection limit of

**Table 1**  
Primers used for *phlD* real-time PCR optimization.

Primer	Sequence (5'–3')	Position <sup>a</sup> (+1)	Length (bp)	T <sub>m</sub> (°C)	Reference
B2BF	ACCCACCGCAGCATCGTTTATGAGC	196	25	65.4	McSpadden Gardener et al. (2001)
B2BR3	AGCAGAGCGACGAGAACTCCAGGGA	514	25	64.6	This study

<sup>a</sup> Primer position on the 1050-bp *phlD* sequence from strain Pf-5 (genome accession number CP000076). The amplicon is 319 bp long.

approximately 3 log CFU per root system. For all samples, F113Rif levels quantified by *phlD* real-time PCR were  $1.66 \pm 0.50$  log higher than colony counts (Fig. 3).

### 3.3. Disease severity and soil suppressiveness

Black root rot suppressiveness is the capacity of the soil (i) to limit disease severity due to natural *T. basicola* infestation and (ii) especially to buffer the increase in disease severity resulting from pathogen inoculation at high level ( $10^3$  or  $10^4$  endoconidia g<sup>-1</sup> soil), with final disease severity of tobacco typically less than 30%. Here, *T. basicola*-inoculated plants exhibited significantly higher disease severity than non-inoculated controls in conducive soils MC112 ( $47 \pm 10\%$  vs  $15 \pm 8\%$ ) and MC10 ( $45 \pm 8\%$  vs  $3 \pm 2\%$ ) (Figure S2). This was also the case in the moderately suppressive soil MS16 ( $24 \pm 5\%$  vs  $6 \pm 2\%$ ), but the increase in disease severity was only half as much. The difference was not significant in suppressive soil MS8 ( $23 \pm 8\%$  vs  $19 \pm 8\%$ ).

### 3.4. Prevalence of indigenous root-colonizing *phlD*<sup>+</sup> *Pseudomonas* in Morens soils

At 7 days after transplanting of tobacco seedlings, the number of *phlD*<sup>+</sup> *Pseudomonas* quantified through real-time PCR was lower in soil MS8 than in soil MC112, regardless of whether (i) rhizosphere or roots were assessed and (ii) data were expressed per µg of DNA extracted, g of root, or root system (Fig. 4). Inoculation with *T. basicola* had essentially no impact on *phlD* copies. Similar findings were also made in the two soils at 21 days, where the assessment was extended to soils MS16 and MC10. Compared with soil MS8 or MS16, *phlD* copies in soil MC10 were equivalent or lower, depending on sample type (rhizosphere or roots), *T. basicola* inoculation and/or data expression (per µg of DNA, g of root, or root system), whereas

those in soil MC112 were always much higher. With soils MS8, MS16 and MC10 a positive correlation was found between the number of *phlD*<sup>+</sup> *Pseudomonas* and the ability of the soil to buffer disease severity increase resulting from pathogen inoculation, but it was not significant when including also soil MC112 (Figure S3).

### 3.5. *phlD* polymorphism in Morens soils

When tested on a mixture of genomic DNA from *Pseudomonas* strains belonging to the six phylogenetic groups of DAPG producers, tFLP analysis of *phlD* allowed discrimination of the six expected terminal fragments, with sizes of 73 bp (phylogenetic group C), 142 bp (D), 212 bp (E), 222 bp (A), 229 bp (F) and 275 bp (B). In tobacco rhizosphere and root samples from Morens soils, only phylogenetic groups B (detected in 47 of 48 samples), D (41/48), A (11/48) and F (1/48) were found. In all soil × *T. basicola* inoculation combinations, the number of phylogenetic groups detected was higher for roots (2 or 3 per sample) than for rhizosphere (1 or 2 per sample), with all genotypes found detected in the rhizosphere also found with the root samples.

When all root samples were compared, two *phlD* tFLP clusters were evidenced (Fig. 5). One gathered 5 *T. basicola* inoculated treatments and 1 non-inoculated treatment, whereas the other was comprised of 1 inoculated and 5 non-inoculated treatments. This clustering of root samples was largely due to phylogenetic group A (i.e. *phlD* cluster 5), which was detected only with inoculated plants (but not all) in soils MS8, MS16 and MC112 and with both inoculated and non-inoculated plants in soil MC10, but was absent from 7-day-old inoculated plants in soil MS8 (and rarely found in the rhizosphere samples). Phylogenetic groups B and D were readily detected in all treatments (including in rhizosphere samples), while phylogenetic group F was found with roots from one 21-day-old plant grown in soil MS8.

**Table 2**  
Standard curve parameters and real-time PCR amplification efficiencies for *phlD* *Pseudomonas* strains *in vitro* and in non-sterile bulk soil.

	MLSA phylogenetic group <sup>a</sup>	<i>phlD</i> cluster <sup>b</sup>	Slope	Amplification efficiency (%)	Error	Detection limit expressed as <i>phlD</i> copies ( <i>in vitro</i> ) or <i>phlD</i> copies g <sup>-1</sup> soil (in soil)
<i>Pseudomonas</i> strain <i>in vitro</i>						
' <i>P. fluorescens</i> ' F113	B	—	−3.35	98.7	0.03	8 <sup>c</sup>
' <i>P. kilonensis</i> ' P12	B	1	−3.33	99.0	0.06	8
' <i>P. fluorescens</i> ' K93.2	B	2	−3.55	91.2	0.05	8
' <i>P. brassicacearum</i> ' P97-30	A	5	−3.74	84.9	0.01	8
' <i>P. thivervalensis</i> ' PITR2	D	6	−3.65	87.6	0.05	8
' <i>P. fluorescens</i> ' Q2-87	C	7	−3.67	87.3	0.02	8
' <i>P. fluorescens</i> ' P97-38	E	8	−3.62	88.7	0.01	8
' <i>P. protegens</i> ' CHAO	F	9	−3.86	81.5	0.02	8
<i>Pseudomonas</i> strain <sup>d</sup> × soil						
' <i>P. fluorescens</i> ' F113 × soil MC10	B	—	−3.48	93.8	0.05	4.4 log
' <i>P. fluorescens</i> ' F113 × soil MS8	B	—	−3.45	94.7	0.06	Not done <sup>e</sup>
' <i>P. protegens</i> ' CHAO × soil MC10	F	9	−3.85	81.9	0.02	4.1 log
' <i>P. protegens</i> ' CHAO × soil MS8	F	9	−3.88	80.8	0.02	Not done

<sup>a</sup> MLST groups defined by Frapolli et al. (2007).

<sup>b</sup> Genotypic cluster of the different *phlD* alleles harbored by the strains. The *phlD* genotypic clusters were determined at a cut-off level of 99.1% sequence similarity by Frapolli et al. (2008). Strain F113 represented a *phlD* genotype on its own in that study.

<sup>c</sup> Based on the experimental detection limit of 60 fg of genomic DNA, which corresponds to approximately 8 *phlD* copies.

<sup>d</sup> Obtained with an inoculum of 4.6 (for F113) or 4.2 (for CHAO) log CFU added g<sup>-1</sup> soil.

<sup>e</sup> No detection limit could be determined for soil MS8 because *phlD* was readily detected in uninoculated samples (i.e. due to the prevalence of indigenous *phlD*<sup>+</sup> *Pseudomonas*).

### 3.6. Relation between *phlD*<sup>+</sup> *Pseudomonas* and *T. basicola* densities in Morens soils

No correlation was found overall between levels of *phlD*<sup>+</sup> *Pseudomonas* and *T. basicola*, regardless of whether the analysis was conducted (i) with roots, rhizosphere soil or both together, (ii) at either sampling time or with both combined, and (iii) on each soil separately or considering all soils together (not shown). Nevertheless, when considering only the roots of non-inoculated plants, a negative correlation was observed whether values were expressed per g of root ( $r = -0.69$ ,  $P = 0.012$ ),  $\mu\text{g}$  of DNA ( $r = -0.57$ ,  $P = 0.039$ ) or root system ( $r = -0.74$ ,  $P = 0.007$ ), whereas it was not significant when considering *T. basicola*-inoculated plants (not shown).

### 3.7. Relation between *T. basicola* density and disease severity in Morens soils

DNA amplification of *T. basicola* ETH D127 by real-time PCR generated a standard curve with a slope of  $-3.55$  (corresponding to 91.1% amplification efficiency over 5 DNA concentrations), an error of 0.003 and a detection limit of 260 fg of *T. basicola* DNA per reaction. When the method was implemented to monitor root-associated *T. basicola* in Morens soil, cloning and sequencing revealed that the sequences amplified from non-inoculated and inoculated plants were highly similar (99.4%) or identical to that of *T. basicola* ETH D127 (not shown; 30 sequences assessed).

*T. basicola* DNA was detected in the roots of 34 plants but only in the rhizosphere of 18 of these plants. *T. basicola* inoculation did not result in a significant increase of *T. basicola* levels in the rhizosphere, except in soil MC112 at 7 days after planting (Fig. 6). In all soils but MS16, *T. basicola* DNA was detected in roots of inoculated as well as non-inoculated plants. The roots of inoculated plants in soils MS8 (at 7 and 21 days), MC10 and MS16 (at 21 days) exhibited *T. basicola* levels comparable to those found in their non-inoculated counterparts. Conversely, *T. basicola* levels in roots were higher upon inoculation in soil MC112. The same differences were observed whether *T. basicola* level was expressed per  $\mu\text{g}$  of extracted DNA, g of root or root system (not shown).

The average disease severity rated at 21 days was positively correlated to the average pathogen level in roots measured at 7 days in soils MS8 and MC112 ( $n = 4$ ), regardless of whether pathogen level was expressed per  $\mu\text{g}$  of extracted DNA ( $r = 0.95$ ,  $P = 0.022$ ), g of root ( $r = 0.90$ ,  $P = 0.049$ ) or root system ( $r = 0.91$ ,  $P = 0.042$ ). However, no correlation was found when pathogen level was considered at 21 days (with all four soils available or only MS8 and MC112; not shown).

## 4. Discussion

The enumeration of *phl*<sup>+</sup> *Pseudomonas* has often been done with culture-based methods that include (i) an enrichment step, (ii) the use of semi-selective medium and (iii) PCR identification of *phlD*<sup>+</sup> colonies (Ramette et al., 2003; Mavrodi et al., 2007; Frapolli et al., 2008). Although these methods enjoy low detection limits, the enrichment/selection step is likely to bias results by favoring certain types of *phlD*<sup>+</sup> strains (Mavrodi et al., 2007). Culture-independent real-time PCR methods, which have the potential to overcome this bias, have been developed for bacterial (Le Roux et al., 2008; Chen et al., 2008) and fungal populations (Lievens et al., 2006; Huang and Kang, 2010) in the soil and rhizosphere, including for a few types of *phl*<sup>+</sup> pseudomonads (Mavrodi et al., 2007).

The *phlD*-based real-time PCR method developed here to monitor natural populations of *phl*<sup>+</sup> pseudomonads in plant roots and rhizosphere targets the totality of the functional group and minimizes the differences in amplification efficiencies between *phlD* alleles, even though amplification efficiency was lower for

*P. protegens* CHA0 (phylogenetic group F). Optimization of real-time PCR required a trade-off, as amplicon  $T_m$  for *P. protegens* CHA0 was higher by more than 2 °C than those for the seven other *phlD*<sup>+</sup> pseudomonads tested. This was probably due to the higher GC content of the *phlD* sequence in strain CHA0 (65.7% vs 59.2–62.7% in the other strains), and is in accordance with the evolutionary divide between *P. protegens* (previously ARDRA group 1; Keel et al., 1996) and the '*P. fluorescens*' species complex (Frapolli et al., 2007; Ramette et al., 2011). Similar difficulties to amplify *phlD* (Mavrodi et al., 2007) and *phlA* (first gene from the *phl* operon; Rezzonico et al., 2003) in *P. protegens* have also been encountered when using strain-specific primers, and similar trade-off conditions were also necessary to develop a *phlD* DGGE protocol that could accommodate *phlD*<sup>+</sup> pseudomonads from both *P. protegens* and the '*P. fluorescens*' complex (Frapolli et al., 2008, 2010).

The primer annealing step is critical for the amplification of GC-rich templates, and final PCR conditions suitable for all *phlD*<sup>+</sup> pseudomonads were obtained here by simultaneously adjusting annealing time, annealing temperature and DMSO concentration (Mamedov et al., 2008), and by the addition of binding agent T4g32 protein (Jensen et al., 1976). Although amplification efficiencies varied among strains they were all above the 80% threshold (Zhang and Fang, 2006), and PCR optimization enabled to improve the detection limit to 60 fg genomic DNA (i.e. approximately 8 *phlD* copies; Table 2) for each strain, which is comparable to 10 times lower than the limit of 60–600 fg (depending on strain) obtained by Mavrodi et al. (2007).

When the optimized PCR protocol was tested in non-sterile bulk soil (Fig. 2), the detection limit (4.1–4.3 log *phlD* copies g<sup>-1</sup> soil for the two strains tested) was slightly better than that obtained after *Pseudomonas* enrichment (4.7 log cells g<sup>-1</sup> soil) in *phlD*-DGGE but much better than that of *phlD*-DGGE without prior enrichment (5–7 log cells g<sup>-1</sup> soil depending on strain) (Frapolli et al., 2008). Moreover, amplification efficiencies comparable to those found with genomic DNA were observed for both strains in both soils (Table 2). A strong correlation was found between added CFU and quantified *phlD* copies, with a mean difference of only 0.22 log (Figure S1). Results from real-time PCR and colony counts for '*P. fluorescens*' F113Rif in the tobacco rhizosphere were strongly correlated, but real-time PCR results were on average 1.7 log higher (Fig. 3). This is

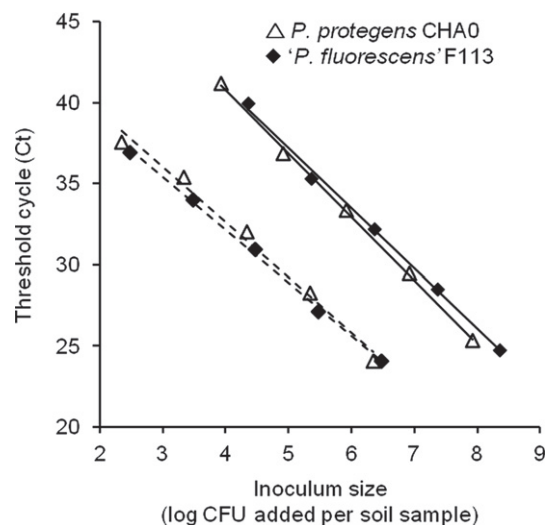
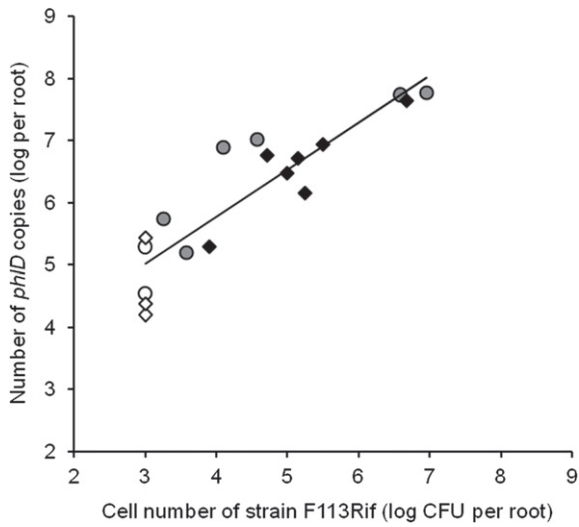


Fig. 2. Real-time PCR standard curves for *P. protegens* CHA0 and '*P. fluorescens*' F113 inoculated in non-sterile bulk soils. Strains (CHA0 "Δ" or F113 "◆") were inoculated singly at different CFU levels in soil from fields MS8 (---) or MC10 (—). Mean Ct values from three replicates were used. Comparatively lower Ct values are observed for soil MS8 due to the presence of high numbers of indigenous *phlD*<sup>+</sup> *Pseudomonas*.



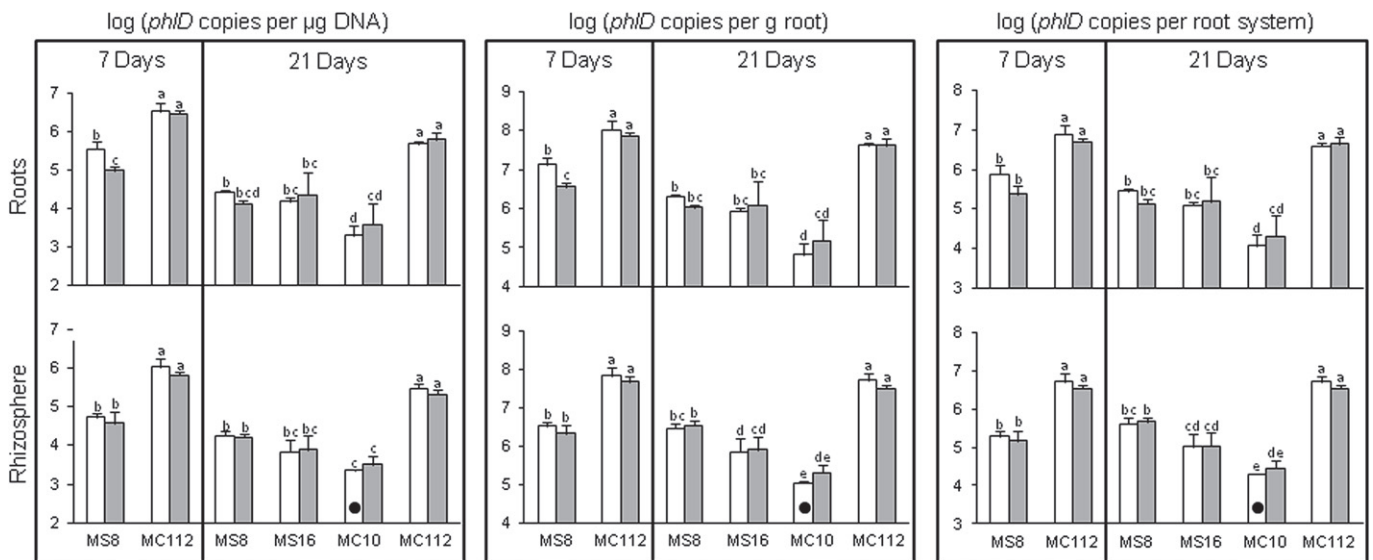
**Fig. 3.** Relationship between colony counts and *phlD*-based real-time PCR for quantification of *phlD*<sup>+</sup> strain '*P. fluorescens*' F113Rif in the tobacco rhizosphere. Strain F113Rif was inoculated on roots and its population was determined 1 (◆) or 3 (●) days after planting in soil MC10. Empty symbols indicate data points where the zero value obtained for colony count was replaced by the detection limit of this method i.e. 3 log CFU per root system (Pearson's  $r = 0.90$ ,  $P = 5 \times 10^{-7}$ ,  $n = 18$ ).

probably due to the detection of DNA from non-culturable or dead cells, even though DNA from non-culturable *Pseudomonas* cells is not efficiently amplified (Rezzonico et al., 2003).

The number of rhizosphere *phlD*<sup>+</sup> pseudomonads was quantified by real-time PCR in four Morens soils (Ramette et al., 2003; Frapolli et al., 2010) of different suppressiveness status (which were again confirmed here) to clarify whether soil suppressiveness to black root rot of tobacco is linked to the former. Because in all soils, real-time PCR showed that *phlD*<sup>+</sup> pseudomonads were above the minimum threshold of  $10^4$  cells per g of root necessary for black root rot control (Stutz et al., 1986), it was unlikely that their abundance would determine soil suppressiveness. Indeed, no relation was found between soil suppressiveness level and the number of *phlD*<sup>+</sup> *Pseudomonas* with these four soils (Figure S3).

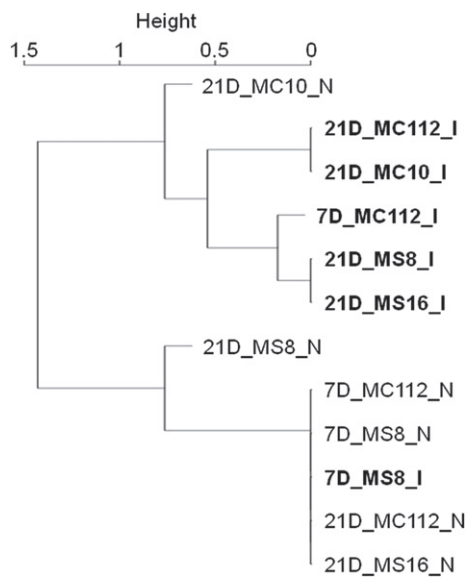
Furthermore, the conducive soil MC112 displayed both the highest disease severity after pathogen inoculation and the highest number of *phlD*<sup>+</sup> pseudomonads colonizing tobacco roots and rhizosphere (Fig. 4). This was not due to an enrichment of *phlD*<sup>+</sup> pseudomonads following necrosis-related leakage of organic root constituents (McSpadden Gardener and Weller, 2001; Chapon et al., 2002) by the more diseased plants in soil MC112, as numbers were already higher in MC112 than in MS8 at 7 days after planting, i.e. before root necrosis took place (Fig. 4). Besides, *T. basicola* inoculation had little impact on *phlD*<sup>+</sup> *Pseudomonas* numbers (i.e. only a small decrease at 7 days on roots from soil MS8), and no correlation was found overall between real-time PCR levels of *T. basicola* and *phlD*<sup>+</sup> *Pseudomonas* (data not shown). These findings are in accordance with *T. basicola* infection not causing extensive root leakage (Hood and Shew, 1997). Higher numbers of *phlD*<sup>+</sup> pseudomonads for soil MC112 were found in some but not all experiments done previously on Morens soils (Frapolli et al., 2010). The current results, however, clarify the hypothesis that black root rot suppressiveness of Morens soils (unlike take all decline) does not entail higher populations of root-associated *phlD*<sup>+</sup> pseudomonads, an assumption that so far was only substantiated by colony counts (Ramette et al., 2003) and MPN-PCR (Frapolli et al., 2010).

The genetic structure of the *phlD*<sup>+</sup> *Pseudomonas* subcommunity can greatly affect its plant-protecting ability (Becker et al., 2012), and *phlD* DGGE on rhizosphere DNA showed that their genetic structure did differ between Morens suppressive and conducive soils (Frapolli et al., 2008). This difference was exploited here to confirm that our real-time PCR method could target *Pseudomonas* strains from different *phlD*<sup>+</sup> phylogenetic groups. Indeed, the three phylogenetic groups A, B and D of DAPG producers already documented by *phlD*-DGGE (Frapolli et al., 2010) were also detected by *phlD*-tRFLP, in all four soils. In addition, phylogenetic group F, which had not been found by Frapolli et al. (2008, 2010), was also detected here but only in one sample (Table S2). Soil identity was not a major factor structuring *phlD*-tRFLP profiles (Fig. 5), probably because the main differences between the soils concern the allelic composition within phylogenetic group A (Frapolli et al., 2008, 2010), which could not be accessed in this work since *phlD*-tRFLP is not resolutive enough. Interestingly, *T. basicola* inoculation had a stronger impact than soil



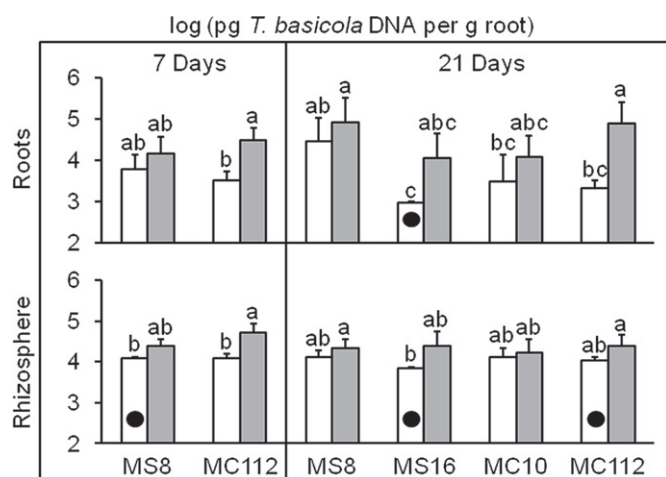
**Fig. 4.** Real-time PCR quantification of *phlD*<sup>+</sup> *Pseudomonas* populations in tobacco roots and rhizosphere, based on the number of *phlD* copies detected per µg of extracted DNA, g of root or root system. Tobacco plants were grown for 7 or 21 days in two suppressive (MS8 and MS16) and two conducive (MC10 and MC112) soils inoculated (gray bars) or non-inoculated (white bars) with the pathogen *T. basicola*. Means and standard errors are shown for *phlD* copies per µg of extracted DNA (left), g of root (center) or root system (right). Black dots indicate treatments where *phlD*<sup>+</sup> pseudomonads were not detected and zero values were replaced by the detection limit. In each case, means were compared separately for roots and rhizosphere samples. Within each sampling time, different letters above bars indicate a significant difference between treatments ( $P < 0.05$ ).





**Fig. 5.** Dendrogram based on *phlD*-tRFLP profiles obtained from tobacco roots grown in two suppressive (MS8 and MS16) and two conducive (MC112 and MC10) soils. *T. basicola* inoculated (I) and non-inoculated (N) plants were harvested 7 (7D) or 21 (21D) days after planting and two plants per treatment were analyzed (results pooled). Cluster analysis was based on Euclidean distances and constructed with the “complete” method in R environment. The “Height” axis represents the distances between nodes.

on *phlD*-tRFLP profiles; phylogenetic group A was present in all MC10 samples, but for the other soils it was only detected in *T. basicola*-inoculated plants at 21 days (Table S2). Along these lines, Frapolli et al. (2010) found more *phlD* sequences from phylogenetic group A (i.e. *phlD* cluster 5) with inoculated (15 sequences) than with non-inoculated plants (6 sequences). Interestingly, when we reassessed data obtained by Ramette et al. (2006), we observed a trend for strains from phylogenetic group A to have a stronger biocontrol effect on black root rot than strains from other groups in vermiculitic gnotobiotic soil (mimicking Morens suppressive soils; Student's *t*-test,  $P = 0.08$ ) but not in illitic gnotobiotic soil (mimicking Morens conducive soils;  $P = 0.35$ ), suggesting a possible relation between soil clay type and biocontrol activity for group-A



**Fig. 6.** Real-time PCR quantification of *T. basicola* in tobacco roots and rhizosphere in Morens soils. Tobacco plants were grown for 7 or 21 days in two suppressive (MS8 and MS16) and two conducive (MC10 and MC112) soils inoculated (gray bars) or non-inoculated (white bars) with the pathogen *T. basicola*. Data shown are means and standard errors. Means were compared separately for roots and rhizosphere samples. Within each sampling time, different letters above bars indicate a significant difference between treatments ( $P < 0.05$ ). Black dots indicate treatments where *T. basicola* DNA was not detected and zero value were replaced by the detection limit.

strains. This is consistent with the hypothesis that suppressiveness to *T. basicola*-mediated black root-rot in Morens soils might entail root conditions more favorable for expression of DAPG synthesis ability by certain genotypes of *phl*<sup>+</sup> *Pseudomonas* strains.

The presence of an indigenous *T. basicola* population in these soils was evidenced by the detection of black root rot lesions and/or *T. basicola* DNA with non-inoculated plants from all soil, in agreement with Gasser and Défago (1981) who isolated only pathogenic *T. basicola* spores both in suppressive and conducive soils from Morens. Although inoculation of pathogenic *T. basicola* increased plant disease level in three of the four soils, the amounts of *T. basicola* DNA detected in the rhizosphere and roots were essentially the same in all soils. The amount of pathogen DNA in plant tissues may correlate with disease severity for certain shoot (Hogg et al., 2007) and root pathogens (Ippolito et al., 2004), but it is not always the case (Lievens et al., 2006). This is illustrated here by the absence of correlation between average disease severity and average pathogen level in roots. Perhaps PCR limitations, such as the detection of DNA from dead mycelia (Lievens et al., 2006), might also contribute to this lack of correlation.

Very few studies have targeted simultaneous monitoring of pathogen and biocontrol populations (Johnson and Dileone, 1999; Larkin and Fravel, 1999), and (to our knowledge) none of them in the context of soil suppressiveness. Inoculated *T. basicola* could colonize the tobacco rhizosphere in suppressive as well as in conducive Morens soils, but caused disease symptoms mainly in conducive soils. This suggests that suppressiveness to *T. basicola*-mediated black root rot is not due to hindering of pathogen survival and development in the rhizosphere, i.e. that it does not entail pathogen inhibition. In this context, the absence of correlation between *T. basicola* density in rhizosphere or roots and *phl*<sup>+</sup> *Pseudomonas* numbers has two implications. First, it suggests that *phl*<sup>+</sup> pseudomonads act mainly by reducing root penetration in suppressive soils. This could involve activation of ISR pathways in the plant (Maurhofer et al., 1994; Weller et al., 2012), as DAPG itself can induce such a response (Iavicoli et al., 2003), all the more as certain *phl*<sup>+</sup> pseudomonads behave also as root endophytes (Troxler et al., 1997). This possibility is also raised because direct contact between *P. protegens* CHA0 and *T. basicola* on tobacco roots did not affect physical integrity of the fungal hyphae (Troxler et al., 1997). Second, this lack of correlation also suggests that the fungal pathogen does not interfere significantly with *phl*<sup>+</sup> *Pseudomonas* ecology, unlike in other pathosystems (Fedi et al., 1997; Duffy et al., 2003).

In conclusion, a *phlD*-based real-time PCR method was developed to quantify genetically contrasted *phl*<sup>+</sup> *Pseudomonas* populations in a single assay, and this new method will be useful to monitor *phl*<sup>+</sup> pseudomonads in various soil conditions. It was used here to show that suppressiveness to Thielaviopsis black root rot in Morens soils does not require (i) levels of *phl*<sup>+</sup> pseudomonads higher than those in conducive soils or (ii) *T. basicola* inhibition in the rhizosphere. Results also point to the hypothesis that rhizosphere conditions are more favorable for DAPG synthesis in suppressive than in conducive soils, and further work will target this issue.

#### Acknowledgment

We are grateful to farmers in Morens region for field access and information. This work was supported by the Ministère Français de la Recherche. We thank Denis Desbouchages (IFR 41, Université Lyon 1) for technical help, and Christoph Keel (Université de Lausanne, Switzerland) and Monika Maurhofer (ETH Zurich, Switzerland) for useful discussions. We are also grateful to Yvan Rahbé (BF21, INSA de Lyon) for access to greenhouse equipment. This work made use of the DTAMB and Serre technical platforms of FR41 at Université Lyon 1.

## Appendix A

Table S1

Features and performance of *phlD* primer pairs.

Primer pair	Primer size (nt)	Primer $T_m^a$ (°C)	Secondary structures	$\Delta T_m^b$ (°C)	Product size (bp)	Mismatches with <i>phlD</i> sequences <sup>c</sup>	Specific real-time amplification of <i>phlD</i> <sup>d</sup>	
							Strain genomic DNA	Rhizosphere DNA
B2BF/BPR4 <sup>e</sup>	25/26	65.4/63.4	None	2	629	3/3	Yes	Yes
B2BF/B2BR1	25/21	65.4/64.8	None	0.6	186	3/5	Yes	No
B2BF/B2BR2	25/25	65.4/66.2	None	0.8	358	3/4	Yes	No
<b>B2BF/B2BR3<sup>f</sup></b>	<b>25/25</b>	<b>65.4/64.6</b>	<b>None</b>	<b>0.8</b>	<b>319</b>	<b>3/3</b>	<b>Yes</b>	<b>Yes</b>
BPF1/BPR4	25/26	63.5/63.4	None	0.1	118	3/3	Yes	No
BPF2/BPR4	26/26	62.8/63.4	None	0.6	134	3/3	Yes	No

<sup>a</sup> Primer melting temperature ( $T_m$ ) and secondary structures were determined using Oligo 6 (Molecular Biology Insights, West Cascade, CO) and the nearest-neighbor method (Saitou and Nei, 1987).

<sup>b</sup>  $T_m$  difference between primers.

<sup>c</sup> Maximum number of mismatches between each primer and the 334 *phlD* sequences available on February 2012 in the nr Nucleotide Sequence Database.

<sup>d</sup> The ability of the primers to specifically amplify *phlD* from genomic DNA samples (using 6 ng of genomic DNA from eight *phlD*<sup>+</sup> strains indicated in Fig. 1) or a complex environmental DNA sample (using 6 ng of rhizosphere DNA from 21-days tobacco grown in soil MS8) was assessed by real-time PCR.

<sup>e</sup> Primer pair B2BF/BPR4 (McSpadden Gardener et al., 2001) was discarded because of high  $T_m$  difference and high product size.

<sup>f</sup> Primer pair B2BF/B2BR3 was selected based on the six criteria (i) primer  $T_m$  between 60 and 67 °C, (ii) absence of secondary structures, (iii)  $T_m$  difference between primers ( $\Delta T_m$ ) not exceeding 1 °C, (iv) an amplification product not exceeding 400 bp, (v) a maximum of 3 mismatches between each primer and the 334 *phlD* sequences available, and (vi) specific amplification of *phlD*. Primer pairs not meeting one or more of these criteria (gray boxes) were dismissed.

Table S2

Mean frequencies of the phylogenetic groups A–F of *phl*<sup>+</sup> pseudomonads (defined in Frapolli et al., 2007) detected by *phlD*-tRFLP in root and rhizosphere samples from *T. basicola*-inoculated (I) and non-inoculated (N) plants (2 per treatment) grown in the four soils for 7 (7D) or 21 days (21D).

Phylogenetic group <sup>a</sup> and terminal fragment size	A (222 bp)	B (275 bp)	C (73 bp)	D (142 bp)	E (212 bp)	F (229 bp)
<i>Root samples</i>						
7D_MS8_N	0	1	0	1	0	0
7D_MS8_I	0	1	0	1	0	0
7D_MC112_N	0	1	0	1	0	0
7D_MC112_I	0.5	1	0	1	0	0
21D_MS8_N	0	1	0	0.5	0	0.5
21D_MS8_I	0.5	1	0	1	0	0
21D_MS16_N	0	1	0	1	0	0
21D_MS16_I	0.5	1	0	1	0	0
21D_MC10_N	1	0.5	0	1	0	0
21D_MC10_I	1	1	0	1	0	0
21D_MC112_N	0	1	0	1	0	0
21D_MC112_I	1	1	0	1	0	0
<i>Rhizosphere samples</i>						
7D_MS8_N	0	1	0	1	0	0
7D_MS8_I	0	1	0	0.5	0	0
7D_MC112_N	0	1	0	1	0	0
7D_MC112_I	0	1	0	1	0	0
21D_MS8_N	0	1	0	0	0	0
21D_MS8_I	0	1	0	0	0	0
21D_MS16_N	0	1	0	1	0	0
21D_MS16_I	0	1	0	1	0	0
21D_MC10_N <sup>b</sup>	0	0	0	0	0	0
21D_MC10_I	1	0	0	1	0	0
21D_MC112_N	0	1	0	1	0	0
21D_MC112_I	0	1	0	0.5	0	0

<sup>a</sup> Phylogenetic groups (Frapolli et al., 2007) associated to the terminal fragments detected. Phylogenetic group A corresponds to *phlD* genotypic cluster 5 (defined by Frapolli et al., 2008), B to clusters 1–4, C to cluster 7, D to cluster 6, E to cluster 8 and F to cluster 9.

<sup>b</sup> No *phlD* amplicon obtained in this treatment.

## Appendix B. Supplementary material

Supplementary material associated with this article can be found, in the online version, at <http://dx.doi.org/10.1016/j.soilbio.2012.09.003>.

## References

- Anzai, Y., Kim, H., Park, J.Y., Wakabayashi, H., Oyaizu, H., 2000. Phylogenetic affiliation of the pseudomonads based on 16S rRNA sequence. *International Journal of Systematic and Evolutionary Microbiology* 50, 1563–1589.
- Becker, J., Eisenhauer, N., Scheu, S., Jousset, A., 2012. Increasing antagonistic interactions cause bacterial communities to collapse at high diversity. *Ecology Letters* 15, 468–474.
- Bergsma-Vlami, M., Prins, M.E., Raaijmakers, J.M., 2005. Influence of plant species on population dynamics, genotypic diversity and antibiotic production in the rhizosphere by indigenous *Pseudomonas* spp. *FEMS Microbiology Ecology* 52, 59–69.
- Box, G.E.P., Cox, D.R., 1964. An analysis of transformation. *Journal of the Royal Statistical Society: Series B* 26, 211–252.
- Brazelton, J.N., Pfeufer, E.E., Sweat, T.A., McSpadden Gardener, B.B., Coenen, C., 2008. 2,4-Diacetylphloroglucinol alters plant root development. *Molecular Plant–Microbe Interactions* 21, 1349–1358.
- Bustin, S.A., Benes, V., Garson, J.A., Hellems, J., Huggett, J., Kubista, M., Mueller, R., Nolan, T., Pfaffl, M.W., Shipley, G.L., Vandesompele, J., Wittwer, C.T., 2009. The MIQE guidelines: minimum information for publication of quantitative real-time PCR experiments. *Clinical Chemistry* 55, 611–622.
- Carroll, H., Moënne-Loccoz, Y., Dowling, D.N., O’Gara, F., 1995. Mutational disruption of the biosynthesis genes coding for the antifungal metabolite 2,4-diacetylphloroglucinol does not influence the ecological fitness of *Pseudomonas fluorescens* F113 in the rhizosphere of sugarbeets. *Applied and Environmental Microbiology* 61, 3002–3007.
- Chapon, A., Guillerme, A.Y., Delalande, L., Lebreton, L., Sarniguet, A., 2002. Dominant colonisation of wheat roots by *Pseudomonas fluorescens* Pf29A and selection of the indigenous microflora in the presence of the take-all fungus. *European Journal of Plant Pathology* 108, 449–459.
- Chen, X.P., Zhu, Y.G., Xia, Y., Shen, J.P., He, J.Z., 2008. Ammonia-oxidizing archaea: important players in paddy rhizosphere soil? *Environmental Microbiology* 10, 1978–1987.
- Combes-Meynet, E., Pothier, J.F., Moënne-Loccoz, Y., Prigent-Combaret, C., 2011. The *Pseudomonas* secondary metabolite 2,4-diacetylphloroglucinol is a signal inducing rhizoplane expression of *Azospirillum* genes involved in plant-growth promotion. *Molecular Plant–Microbe Interactions* 24, 271–284.
- Couillerot, O., Prigent-Combaret, C., Caballero-Mellado, J., Moënne-Loccoz, Y., 2009. *Pseudomonas fluorescens* and closely-related fluorescent pseudomonads as biocontrol agents of soil-borne phytopathogens. *Letters in Applied Microbiology* 48, 505–512.
- Couillerot, O., Bouffaud, M.L., Baudoin, E., Muller, D., Caballero-Mellado, J., Moënne-Loccoz, Y., 2010. Development of a real-time PCR method to quantify the PGPR strain *Azospirillum lipoferum* CRT1 on maize seedlings. *Soil Biology & Biochemistry* 42, 2298–2305.
- De La Fuente, L., Mavrodi, D.V., Landa, B.B., Thomashow, L.S., Weller, D.M., 2006. *phlD*-based genetic diversity and detection of genotypes of 2,4-diacetylphloroglucinol-producing *Pseudomonas fluorescens*. *FEMS Microbiology Ecology* 56, 64–78.
- De Mendiburu, F., 2007. *Agricolae: Statistical Procedures for Agricultural Research*, R Package Version 1.0–9. <http://tarwi.lamolina.edu.pe/~fmendiburu>.
- Duffy, B., Schouten, A., Raaijmakers, J.M., 2003. Pathogen self-defense: mechanisms to counteract microbial antagonism. *Annual Review of Phytopathology* 41, 501–538.
- Fedi, S., Tola, E., Moënne-Loccoz, Y., Dowling, D.N., Smith, L.M., O’Gara, F., 1997. Evidence for signaling between the phytopathogenic fungus *Pythium ultimum*

- and *Pseudomonas fluorescens* F113: *P. ultimum* represses the expression of genes in *P. fluorescens* F113, resulting in altered ecological fitness. *Applied and Environmental Microbiology* 63, 4261–4266.
- Fenton, A.M., Stephens, P.M., Crowley, J., O'Callaghan, M., O'Gara, F., 1992. Exploitation of gene(s) involved in 2,4-diacetylphloroglucinol biosynthesis to confer a new biocontrol capability to a *Pseudomonas* strain. *Applied and Environmental Microbiology* 58, 3873–3878.
- Fox, J., Weisberg, S., 2011. *An R Companion to Applied Regression*, second ed. SAGE Publications Inc., Thousand Oaks (CA).
- Frapolli, M., Défago, G., Moëgne-Loccoz, Y., 2007. Multilocus sequence analysis of biocontrol fluorescent *Pseudomonas* spp. producing the antifungal compound 2,4-diacetylphloroglucinol. *Environmental Microbiology* 9, 1939–1955.
- Frapolli, M., Moëgne-Loccoz, Y., Meyer, J., Défago, G., 2008. A new DGGE protocol targeting 2,4-diacetylphloroglucinol biosynthetic gene *phlD* from phylogenetically contrasted biocontrol pseudomonads for assessment of disease-suppressive soils. *FEMS Microbiology Ecology* 64, 468–481.
- Frapolli, M., Défago, G., Moëgne-Loccoz, Y., 2010. Denaturing gradient gel electrophoretic analysis of dominant 2,4-diacetylphloroglucinol biosynthetic *phlD* alleles in fluorescent *Pseudomonas* from soils suppressive or conducive to black root rot of tobacco. *Soil Biology & Biochemistry* 42, 649–656.
- Gasser, R., Défago, G., 1981. Case of the certain soils which are suppressive to the black root-rot of tobacco caused by *Thielaviopsis basicola*. *Botanica Helvetica* 91, 75–80.
- Griffiths, R.I., Whiteley, A.S., O'Donnell, A.G., Bailey, M.J., 2000. Rapid method for coextraction of DNA and RNA from natural environments for analysis of ribosomal DNA- and rRNA-based microbial community composition. *Applied and Environmental Microbiology* 66, 5488–5491.
- Haas, D., Défago, G., 2005. Biological control of soil-borne pathogens by fluorescent pseudomonads. *Nature Reviews Microbiology* 3, 307–319.
- Haas, D., Keel, C., 2003. Regulation of antibiotic production in root-colonizing *Pseudomonas* spp. and relevance for biological control of plant disease. *Annual Review of Phytopathology* 41, 117–153.
- Hall, T.A., 1999. BioEdit: a user-friendly biological sequence alignment editor and analysis program for Windows 95/98/NT. *Nucleic Acids Symposium Series* 41, 95–98.
- Hogg, A.C., Johnston, R.H., Dyer, A.T., 2007. Applying real-time quantitative PCR to Fusarium crown rot of wheat. *Plant Disease* 91, 1021–1028.
- Hood, M.E., Shew, H.D., 1997. Reassessment of the role of saprophytic activity in the ecology of *Thielaviopsis basicola*. *Phytopathology* 87, 1214–1219.
- Huang, J., Kang, Z., 2010. Detection of *Thielaviopsis basicola* in soil with real-time quantitative PCR assays. *Microbiological Research* 165, 411–417.
- Iavicoli, A., Boutet, E., Buchala, A., Métraux, J.P., 2003. Induced systemic resistance in *Arabidopsis thaliana* in response to root inoculation with *Pseudomonas fluorescens* CHA0. *Molecular Plant–Microbe Interactions* 16, 851–858.
- Ippolito, A., Schena, L., Nigro, F., Ligorio, V.S., Yaseen, T., 2004. Real-time detection of *Phytophthora nicotianae* and *P. citrophthora* in citrus roots and soil. *European Journal of Plant Pathology* 110, 833–843.
- Jamali, F., Sharifi-Tehrani, A., Lutz, M., Maurhofer, M., 2009. Influence of host plant genotype, presence of a pathogen, and coinoculation with *Pseudomonas fluorescens* strains on the rhizosphere expression of hydrogen cyanide- and 2,4-diacetylphloroglucinol biosynthetic genes in *P. fluorescens* biocontrol strain CHA0. *Microbial Ecology* 57, 267–275.
- Jensen, D.E., Kelly, R.C., Vonhippel, P.H., 1976. DNA “melting” proteins. II. Effects of bacteriophage T4 gene 32-protein binding on the conformation and stability of nucleic acid structures. *Journal of Biological Chemistry* 251, 7215–7228.
- Johnson, K.B., Dileone, J.A., 1999. Effect of antibiosis on antagonist dose–plant disease response relationships for the biological control of crown gall of tomato and cherry. *Phytopathology* 89, 974–980.
- Keel, C., Schnider, U., Maurhofer, M., Voisard, C., Laville, J., Burger, U., Wirthner, P., Haas, D., Défago, G., 1992. Suppression of root diseases by *Pseudomonas fluorescens* CHA0: importance of the bacterial secondary metabolite 2,4-diacetylphloroglucinol. *Molecular Plant–Microbe Interactions* 5, 4–13.
- Keel, C., Weller, D.M., Natsch, A., Défago, G., Cook, R.J., Thomashow, L.S., 1996. Conservation of the 2,4-diacetylphloroglucinol biosynthesis locus among fluorescent *Pseudomonas* strains from diverse geographic locations. *Applied and Environmental Microbiology* 62, 552–563.
- Kimura, M., 1980. A simple method for estimating evolutionary rate of base substitutions through comparative studies of nucleotide sequences. *Journal of Molecular Evolution* 16, 111–120.
- King, E.O., Ward, M.K., Raney, D.E., 1954. Two simple media for the demonstration of pyocyanin and fluorescein. *Journal of Laboratory and Clinical Medicine* 44, 301–307.
- Klopper, J.W., Beauchamp, C.J., 1992. A review of issues related to measuring colonization of plant roots by bacteria. *Canadian Journal of Microbiology* 38, 1219–1232.
- Kyselková, M., Moëgne-Loccoz, Y., 2012. *Pseudomonas* and other microbes in disease-suppressive soils. In: Lichtfouse, E. (Ed.), *Organic Fertilisation, Soil Quality and Human Health – Sustainable Agriculture Reviews*, vol. 9. Springer, Dordrecht, Netherlands, pp. 93–140.
- Kyselková, M., Kopecký, J., Frapolli, M., Défago, G., Ságová-Marečková, M., Grundmann, G.L., Moëgne-Loccoz, Y., 2009. Comparison of rhizobacterial community composition in soil suppressive or conducive to tobacco black root rot disease. *The ISME Journal* 3, 1127–1138.
- Landa, B.B., Mavrodi, O.V., Raaijmakers, J.M., McSpadden Gardener, B.B., Thomashow, L.S., Weller, D.M., 2002. Differential ability of genotypes of 2,4-diacetylphloroglucinol-producing *Pseudomonas fluorescens* strains to colonize the roots of pea plants. *Applied and Environmental Microbiology* 68, 3226–3237.
- Larkin, R.P., Fravel, D.R., 1999. Mechanisms of action and dose–response relationships governing biological control of Fusarium wilt of tomato by nonpathogenic *Fusarium* spp. *Phytopathology* 89, 1152–1161.
- Lebreton, L., Gosme, M., Lucas, P., Guillerme-Erckelboudt, A.Y., Sarniguet, A., 2007. Linear relationship between *Gaeumannomyces graminis* var. *tritici* (Ggt) genotypic frequencies and disease severity on wheat roots in the field. *Environmental Microbiology* 9, 492–499.
- Le Roux, X., Poly, F., Currey, P., Commeaux, C., Hai, B., Nicol, G.W., Prosser, J.I., Schlöter, M., Attard, E., Klumpp, K., 2008. Effects of aboveground grazing on coupling among nitrifier activity, abundance and community structure. *The ISME Journal* 2, 221–232.
- Lievens, B., Brouwer, M., Vanachter, A.C.R.C., Cammue, B.P.A., Thomma, B.P.H.J., 2006. Real-time PCR for detection and quantification of fungal and oomycete tomato pathogens in plant and soil samples. *Plant Science* 171, 155–165.
- Marschner, P., Crowley, D.E., 1996. Physiological activity of a bioluminescent *Pseudomonas fluorescens* (strain 2–79) in the rhizosphere of mycorrhizal and non-mycorrhizal pepper (*Capsicum annum* L.). *Soil Biology & Biochemistry* 28, 869–876.
- Mamedov, T.G., Pienaar, E., Whitney, S.E., TerMaat, J.R., Carvill, G., Goliath, R., Subramanian, A., Viljoen, H.J., 2008. A fundamental study of the PCR amplification of GC-rich DNA templates. *Computational Biology and Chemistry* 32, 452–457.
- Maurhofer, M., Hase, C., Meuwly, P., Métraux, J.P., Défago, G., 1994. Induction of systemic resistance of tobacco to tobacco necrosis virus by the root-colonizing *Pseudomonas fluorescens* strain CHA0: influence of the *gacA* gene and of pyoverdine production. *Phytopathology* 84, 139–146.
- Mavrodi, O.V., Mavrodi, D.V., Thomashow, L.S., Weller, D.M., 2007. Quantification of 2,4-diacetylphloroglucinol-producing *Pseudomonas fluorescens* strains in the plant rhizosphere by real-time PCR. *Applied and Environmental Microbiology* 73, 5531–5538.
- McSpadden Gardener, B.B., Weller, D.M., 2001. Changes in populations of rhizosphere bacteria associated with take-all disease of wheat. *Applied and Environmental Microbiology* 67, 4414–4425.
- McSpadden Gardener, B.B., Mavrodi, D.V., Thomashow, L.S., Weller, D.M., 2001. A rapid polymerase chain reaction-based assay characterizing rhizosphere populations of 2,4-diacetylphloroglucinol-producing bacteria. *Phytopathology* 91, 44–54.
- Meyer, J.B., Lutz, M.P., Frapolli, M., Péchy-Tarr, M., Rochat, L., Keel, C., Défago, G., Maurhofer, M., 2010. Interplay between wheat cultivars, biocontrol pseudomonads, and soil. *Applied and Environmental Microbiology* 76, 6196–6204.
- Moynihan, J.A., Morrissey, J.P., Coppoolse, E.R., Stiekema, W.J., O'Gara, F., Boyd, E.F., 2009. Evolutionary history of the *phl* gene cluster in the plant-associated bacterium *Pseudomonas fluorescens*. *Applied and Environmental Microbiology* 75, 2122–2131.
- Notz, R., Maurhofer, M., Schnider-Keel, U., Duffy, B., Haas, D., Défago, G., 2001. Biotic factors affecting expression of the 2,4-diacetylphloroglucinol biosynthesis gene *phlA* in *Pseudomonas fluorescens* biocontrol strain CHA0 in the rhizosphere. *Phytopathology* 91, 873–881.
- Paulsen, I.T., Press, C.M., Ravel, J., Kobayashi, D.Y., Myers, G.S., Mavrodi, D.V., DeBoy, R.T., Seshadri, R., Ren, Q., Madupu, R., Dodson, R.J., Durkin, A.S., Brinkac, L.M., Daugherty, S.C., Sullivan, S.A., Rosovitz, M.J., Gwinn, M.L., Zhou, L., Schneider, D.J., Cartinhour, S.W., Nelson, W.C., Weidman, J., Watkins, K., Tran, K., Khouri, H., Pierson, E.A., Pierson 3rd, L.S., Thomashow, L.S., Loper, J.E., 2005. Complete genome sequence of the plant commensal *Pseudomonas fluorescens* Pf-5. *Nature Biotechnology* 23, 873–878.
- Phillips, D.A., Fox, T.C., King, M.D., Bhuvanewari, T.V., Teuber, L.R., 2004. Microbial products trigger amino acid exudation from plant roots. *Plant Physiology* 136, 2887–2894.
- Picard, C., Bosco, M., 2006. Heterozygosity drives maize hybrids to select elite 2,4-diacetylphloroglucinol-producing *Pseudomonas* strains among resident soil populations. *FEMS Microbiology Ecology* 58, 193–204.
- Raaijmakers, J.M., Weller, D.M., 1998. Natural plant protection by 2,4-diacetylphloroglucinol-producing *Pseudomonas* spp. in take-all decline soils. *Molecular Plant–Microbe Interactions* 11, 144–152.
- Raaijmakers, J.M., Paulitz, T.C., Steinberg, C., Alabouvette, C., Moëgne-Loccoz, Y., 2009. The rhizosphere: a playground and battlefield for soilborne pathogens and beneficial microorganisms. *Plant and Soil* 321, 341–361.
- Ramette, A., Moëgne-Loccoz, Y., Défago, G., 2003. Prevalence of fluorescent pseudomonads producing antifungal phloroglucinols and/or hydrogen cyanide in soils naturally suppressive or conducive to tobacco black root rot. *FEMS Microbiology Ecology* 44, 35–43.
- Ramette, A., Moëgne-Loccoz, Y., Défago, G., 2006. Genetic diversity and biocontrol potential of fluorescent pseudomonads producing phloroglucinols and hydrogen cyanide from Swiss soils naturally suppressive or conducive to *Thielaviopsis basicola*-mediated black root rot of tobacco. *FEMS Microbiology Ecology* 55, 369–381.
- Ramette, A., Frapolli, M., Fischer-Le Saux, M., Gruffaz, C., Meyer, J.M., Défago, G., Sutra, L., Moëgne-Loccoz, Y., 2011. *Pseudomonas protegens* sp. nov., widespread plant-protecting bacteria producing the biocontrol compounds 2,4-diacetylphloroglucinol and pyoluteorin. *Systematic and Applied Microbiology* 34, 180–188.
- Rezzonico, F., Moëgne-Loccoz, Y., Défago, G., 2003. Effect of stress on the ability of a *phlA*-based quantitative competitive PCR assay to monitor biocontrol strain

- Pseudomonas fluorescens* CHA0. Applied and Environmental Microbiology 69, 686–690.
- Rotenberg, D., Joshi, R., Benitez, M.S., Gutierrez Chapin, L., Camp, A., Zumpetta, C., Osborne, A., Dick, W.A., McSpadden Gardener, B.B., 2007. Farm management effects on rhizosphere colonization by native populations of 2,4-diacetylphloroglucinol-producing *Pseudomonas* spp. and their contributions to crop health. Phytopathology 97, 756–766.
- Saitou, N., Nei, M., 1987. The neighbor-joining method: a new method for reconstructing phylogenetic trees. Molecular Biology and Evolution 4, 406–425.
- Sørensen, J., Jensen, L.E., Nybroe, O., 2001. Soil and rhizosphere as habitats for *Pseudomonas* inoculants: new knowledge on distribution, activity and physiological state derived from micro-scale and single-cell studies. Plant and Soil 232, 97–108.
- Stutz, E.W., Défago, G., Kern, H., 1986. Naturally-occurring fluorescent *Pseudomonas* involved in suppression of black root-rot of tobacco. Phytopathology 76, 181–185.
- Stutz, E.W., Kahr, G., Défago, G., 1989. Clays involved in suppression of tobacco black root-rot by a strain of *Pseudomonas fluorescens*. Soil Biology & Biochemistry 21, 361–366.
- Tamura, K., Dudley, J., Nei, M., Kumar, S., 2007. MEGA4: molecular evolutionary genetics analysis (MEGA) software version 4.0. Molecular Biology and Evolution 24, 1596–1599.
- Thompson, J.D., Gibson, T.J., Plewniak, F., Jeanmougin, F., Higgins, D.G., 1997. The CLUSTAL\_X windows interface: flexible strategies for multiple sequence alignment aided by quality analysis tools. Nucleic Acids Research 25, 4876–4882.
- Troxler, J., Berling, C.H., MoënneLoccoz, Y., Keel, C., Défago, G., 1997. Interactions between the biocontrol agent *Pseudomonas fluorescens* CHA0 and *Thielaviopsis basicola* in tobacco roots observed by immunofluorescence microscopy. Plant Pathology 46, 62–71.
- Troxler, J., Svercel, M., Natsch, A., Zala, M., Keel, C., Moënne-Loccoz, Y., Défago, G., 2012. Persistence of a biocontrol *Pseudomonas* inoculant as high populations of culturable and non-culturable cells in 200-cm-deep soil profiles. Soil Biology & Biochemistry 44, 122–129.
- Vincent, M.N., Harrison, L.A., Brackin, J.M., Kovacevich, P.A., Mukerji, P., Weller, D.M., Pierson, E.A., 1991. Genetic analysis of the antifungal activity of a soilborne *Pseudomonas aureofaciens* strain. Applied and Environmental Microbiology 57, 2928–2934.
- von Felten, A., Meyer, J.B., Défago, G., Maurhofer, M., 2011. Novel T-RFLP method to investigate six main groups of 2,4-diacetylphloroglucinol-producing pseudomonads in environmental samples. Journal of Microbiological Methods 84, 379–387.
- Wang, C.X., Ramette, A., Punjasamarnwong, P., Zala, M., Natsch, A., Moënne-Loccoz, Y., Défago, G., 2001. Cosmopolitan distribution of *phlD*-containing dicotyledonous crop-associated biocontrol pseudomonads of worldwide origin. FEMS Microbiology Ecology 37, 105–116.
- Ward, E., 2009. Use of molecular methods for the detection of fungal spores. In: Burns, R. (Ed.), Plant Pathology: Techniques and Protocols. Humana Press, New York (NY), pp. 147–159.
- Weller, D.M., Landa, B.B., Mavrodi, O.V., Schroeder, K.L., De La Fuente, L., Blouin Bankhead, S., Allende Molar, R., Bonsall, R.F., Mavrodi, D.V., Thomashow, L.S., 2007. Role of 2,4-diacetylphloroglucinol-producing fluorescent *Pseudomonas* spp. in the defense of plant roots. Plant Biology 9, 4–20.
- Weller, D.M., Mavrodi, D.V., van Pelt, J.A., Pieterse, C.M.J., van Loon, L.C., Bakker, P.A.H.M., 2012. Induced systemic resistance in *Arabidopsis thaliana* against *Pseudomonas syringae* pv. *tomato* by 2,4-diacetylphloroglucinol-producing *Pseudomonas fluorescens*. Phytopathology 102, 403–412.
- Zhang, T., Fang, H.H.P., 2006. Applications of real-time polymerase chain reaction for quantification of microorganisms in environmental samples. Applied Microbiology and Biotechnology 70, 281–289.