



HAL
open science

Sustainable design of oilseed-based biofuel supply chains: the case of Jatropha in Burkina Faso

Arnaud Chapuis

► **To cite this version:**

Arnaud Chapuis. Sustainable design of oilseed-based biofuel supply chains: the case of Jatropha in Burkina Faso. Chemical and Process Engineering. Ecole des Mines d'Albi-Carmaux; Institut international d'ingénierie de l'eau et de l'environnement, 2014. English. NNT: 2014EMAC0007. tel-01146790

HAL Id: tel-01146790

<https://theses.hal.science/tel-01146790>

Submitted on 29 Apr 2015

HAL is a multi-disciplinary open access archive for the deposit and dissemination of scientific research documents, whether they are published or not. The documents may come from teaching and research institutions in France or abroad, or from public or private research centers.

L'archive ouverte pluridisciplinaire **HAL**, est destinée au dépôt et à la diffusion de documents scientifiques de niveau recherche, publiés ou non, émanant des établissements d'enseignement et de recherche français ou étrangers, des laboratoires publics ou privés.



Université
de Toulouse

THESE



En vue de l'obtention du

DOCTORAT EN SCIENCES ET TECHNOLOGIES DE L'EAU, L'ENERGIE ET L'ENVIRONNEMENT

Délivré par :

Institut International d'Ingénierie de l'Eau et de l'Environnement (2iE), Ouagadougou, Burkina Faso

Discipline : ENERGIE

DOCTORAT DE L'UNIVERSITE DE TOULOUSE

Délivré par :

École Nationale Supérieure des Mines d'Albi-Carmaux conjointement avec l'INP Toulouse

Discipline : ED MEGEP, GENIE DES PROCEDES ET DE L'ENVIRONNEMENT

Présentée et soutenue, le 28/03/2014 à Albi, par :

Arnaud CHAPUIS

SUSTAINABLE DESIGN OF OILSEED-BASED BIOFUEL SUPPLY CHAINS – THE CASE OF JATROPHA IN BURKINA FASO –

Directeurs de thèse

Pr. Didier LECOMTE

Dr. Joël BLIN

Unités de recherche

Laboratoire Biomasse Energie et Biocarburants, CCREHD, 2iE-CIRAD, Burkina Faso

Centre Rapsodee, CNRS - UMR 5302, Ecole des Mines d'Albi-Carmaux, France

Jury

Pr. Daniel FROELICH – Arts et Métiers ParisTech

Pr. Gilles TRYSTRAM – AgroParisTech

Dr. Marie-Hélène DABAT – CIRAD

Dr. Gara VILLALBA MENDEZ – Université de Barcelone

Pr. Didier LECOMTE – Mines Albi

Dr. Joël BLIN – CIRAD-2iE

M. Patrick CARRE – CETIOM - CREOL

Rapporteur

Rapporteur, Président du Jury

Examineur

Examineur

Directeur

Co-directeur

Invité

Remerciements - Acknowledgement

Mes trois années et demi de thèse furent loin d'être monotones, en tout cas ! J'ai travaillé avec quatre équipes différentes, ce qui m'a donné l'occasion de beaucoup voyager et de faire de multiples rencontres au Burkina Faso, en France et en Suisse. Tout ceci s'est construit au fur et à mesure des rencontres et des opportunités, grâce à la bonne volonté et à la confiance de nombreuses personnes et, bien sûr, avec un petit peu de chance et d'heureuses coïncidences. Dans tous les endroits où je suis allé, on m'a accueilli chaleureusement et avec beaucoup d'enthousiasme. J'ai passé de très bons moments, j'ai créé de nombreux liens d'amitié et j'ai tissé un solide réseau autour du projet. J'ai énormément de gratitude pour toutes les personnes avec qui j'ai travaillé, qui sont d'ailleurs si nombreuses que je ne saurais toutes les citer.

Commençons donc par le début de l'histoire, fin 2010... Après plusieurs mois de voyages en Amérique latine, je me retrouvais à la case départ, en France, face à mon avenir. De multiples possibilités se présentaient, mais une chose était sûre, je voulais me sentir utile. Faire une thèse, ça faisait partie des options, oui, mais à condition de ne pas se transformer en « rat de laboratoire » ! Il fallait donc trouver Le sujet qui va bien. S'ensuivit donc une période de réseautage, cherchage sur le net, envoi et renvoi de mails... Et puis, par un heureux hasard, (comme il y en a eu beaucoup dans cette histoire), un de mes anciens profs, Didier Lecomte, parti récemment en Afrique, me contacte par l'entremise bienveillante de Bruno Ladevie. Ah, la fine équipe ! C'est donc depuis leur bateau ancré quelque part le long des rivages corses et à l'heure ô combien prolifique de l'apéritif qu'ils me concoctent un sujet de thèse « sur mesure ». Au départ, et même bien après d'ailleurs, le cadre administratif, académique et financier est plutôt flou, mais l'essentiel est là : un labo d'accueil, un financement de base...pour le reste, on trouvera, inch'allah ! Voilà comment l'aventure a commencé...et comme prévu, tout s'est bien passé.

J'atterris donc au Burkina Faso en Octobre 2010, accueilli par la chaleureuse et dynamique équipe du LBEB formée par Joël Blin, le « chef », « Jojo », qui deviendra par la suite mon co-directeur de thèse, Christel, Elo, Nath, FX, Madi, Wilfried, Micha, le grand Sayon et Parfait. Beaucoup plus que des collègues de travail, vous m'avez aussi fait découvrir Ouaga, le Burkina et bien d'autres pays de part vos nationalités variées ! J'ai été rapidement rejoint par trois autres compères thésards que j'attendais de pieds fermes puisque nous devons travailler sur le même projet mais dans des disciplines totalement différentes, dans l'ordre d'arrivée : Sarah, Salif et Charly. Nous avons passé beaucoup de temps tous les quatre à échanger sur nos problématiques et nos différentes approches et je pense que c'était vraiment indispensable pour rendre nos travaux pertinents. Je serai le premier de l'équipe à soutenir alors je vous souhaite beaucoup de courage pour terminer vos œuvres respectives ! Je voudrais aussi saluer l'implication de Marie-Hélène Dabat et Laurent Gazull, tous deux chercheurs du CIRAD, qui ont largement contribué à nos travaux pluridisciplinaires ainsi que Sophia Baumert, une doctorante allemande rencontrée à Ouaga avec qui nous avons partagé beaucoup d'infos.

Et puis l'équipe a évolué, s'est agrandie, certains sont partis, d'autres sont arrivés, mais le LBEB n'a pas perdu sa bonne humeur ! Une grande équipe, humaine et solidaire, issue des quatre coins du monde... enfin, surtout d'Afrique. Je ne suis pas près d'oublier les moments passés avec vous, le cadre de travail et l'ambiance exceptionnelle du LBEB, les grands débats qui ont animés nos repas du midi, le riz soubala sous les manguiers et bien sûr les Brakina du weekend. A ce propos, je ne saurais oublier de saluer le célèbre Club Choco, la crème de la crème du LBEB et des labos voisins à l'heure de la tournée des maquis du vendredi soir, qui

nous a valu des soirées mémorables. Je ne me risquerai pas à faire la liste car elle serait trop longue mais à tous, je vous dis un grand merci pour ces doux moments passés à Ouaga !

C'est aussi à Ouaga, lors d'une conférence, que j'ai rencontré Patrick Carré de la société CREOL qui prévoyait de lancer des activités de recherche sur l'extraction d'huile. Immédiatement, le courant est passé et moins d'un an plus tard, à l'automne 2012, j'ai été accueilli chez CREOL, à Bordeaux. Grâce à l'enthousiasme et l'expertise de Patrick, nous avons produit des résultats très fructueux en seulement 2 mois. Cela n'aurait pas été possible sans la participation active du personnel de CREOL, tout particulièrement Gaëlle, Jean-Yves et Fabrice qui étaient toujours là pour donner un coup de main lors des manips.

A l'été 2013, j'ai passé 4 mois à Lausanne à l'EPFL, dans l'équipe de François Maréchal, avec qui j'avais déjà travaillé par le passé. Malgré un certain nombre d'embûches et grâce à la bonne volonté et à l'optimisme de François, nous avons réussi à monter un partenariat, et à atteindre les objectifs fixés. Je remercie tout particulièrement Victor et Adriano, avec qui j'ai travaillé directement et qui m'ont permis d'être opérationnel très rapidement, et bien sûr tous les membres de la joyeuse équipe du LENI.

Les derniers mois de ma thèse se sont passés au centre RAPSODEE à l'Ecole des Mines Albi, en quelque sorte un retour aux sources pour moi qui suis sorti de cette école en 2009. Là encore, je vous épargne les épisodes du montage administratif mais croyez moi, c'était compliqué ! Un immense merci à Ange Nzihou pour tous les efforts réalisés et l'énergie dépensée pour m'accueillir, ainsi qu'à toutes les personnes du centre que j'ai côtoyées et qui m'ont aidées, en particulier Patricia Arlabosse. Dès mes premières missions à Albi et pendant ce long séjour final, les doctorants et post-docs du labo m'ont aussitôt intégré à l'équipe et ont pris soin de ne pas me laisser m'ennuyer durant les soirées et les week-ends. J'ai été sincèrement touché par cet accueil très chaleureux et j'aurais aimé passer plus de temps avec vous.

Pour finir, je remercie les institutions qui ont collaboré et soutenu la réalisation de ce projet. A commencer par 2iE et le CIRAD qui m'ont hébergé et financé tout au long de ma thèse, la Commission Européenne et l'UEMOA pour avoir financé le « projet biocarburants » dont cette thèse fait partie, l'EPFL qui m'a accueilli et appuyé techniquement, les sociétés CETIOM et CREOL qui ont permis la réalisation d'études expérimentales et enfin, l'Ecole des Mines d'Albi qui m'a accueilli et financé à plusieurs reprises.

Avant de terminer, j'aimerais adresser ma plus profonde gratitude à Séverine, pour son soutien inconditionnel, sa tendresse et sa compagnie quotidienne pendant ces 3 ans. Même mon état déplorable pendant ces deux derniers mois de rédaction, de nuits blanches et de caféine, n'a pas réussi à entamer ta bonne humeur !

Il y a encore de nombreuses personnes auxquelles je pense, qui m'ont soutenu d'une manière ou d'un autre, mais que je ne citerai pas ici. Mes proches, amis de longue date ou rencontrés durant ces années, ma famille, tous ceux qui font que la vie vaut la peine d'être vécue chaque jour... mais ceci n'a rien à voir avec le travail présenté dans ces pages.

Abstract

Sustainable design of oilseed-based biofuel supply chains – The case of Jatropha in Burkina Faso

The development of biofuel production in Burkina Faso, raises high expectations regarding the development of rural energy access and the substitution of imported fossil fuels. Several initiatives for biofuel production from Jatropha oilseeds were launched in recent years by NGOs and private operators. The government is planning to define a policy framework to support the development of this sector. To this end, the potential benefits from this activity need to be carefully investigated in regard to sustainable development objectives.

The goal of this work was to investigate these opportunities by determining the technical possibilities regarding the context and in what conditions and to what extent they can contribute to sustainable development objectives. The approach was based on the modelling and simulation of production processes coupled with environmental and economic assessment tools. Specific experiments were also led whenever data were not available, as for the determination of the oil yield of a screw press. Economic efficiency was assessed using value chain analysis, which consists in calculating the value added generated by the different activities involved in a supply chain, and the distribution of this value in the form of income to the employees, the supply chain players, the state and the banking institutions. Environmental impacts, including greenhouse gas emissions and fossil energy consumption, are evaluated using a partial life-cycle assessment.

The production of three different final products was investigated, i.e. straight vegetable oil (SVO), refined oil aimed to be used for stationary applications (power generation, shaft power, pumping...) and biodiesel dedicated to transportation. The analysis of individual processes allowed to identify the most sensitive parameters at a local level. As a general trend for all processes, the price of feedstock dramatically affects the production cost. For SVO production, the oil recovery and the seeds oil content are of paramount importance. The economic performances of the refining and transesterification processes are largely conditioned by the processing capacity, due to economies of scale, and to a lesser extent by the solution employed for energy supply. In the case of biodiesel production, the price of methanol is also a crucial factor.

The developed assessment method was applied to several prospective biofuel supply chains, all relying on the production of Jatropha seeds by smallholders. The results have shown that the method can bring crucial information to policy makers. Based on a seed market price of 100 FCFA/kg, any type of biofuel can be produced in a cost effective way. In some cases, the implementation of advanced technologies for energy supply and by-product valorisation is needed to reach the required production cost. This could also be a solution to increase the price of seeds so as to provide higher incomes to farmers. The production of refined oil for power generation appears to be rather expensive relatively to the target, which imposes large processing scales. Supply chains involving a biodiesel plant supplied by several decentralised SVO plants constitute a solution for addressing at the same time rural energy access and the substitution of fossil fuels. Then the income perceived by the State is directly determined by the value and the profits generated by biofuel producers.

Eventually, the environmental impacts related to seed processing, in terms of GHG emissions and fossil energy consumption, is relatively low especially when energy requirements are supplied from a renewable resource. By contrast, the impacts of biodiesel production are systematically impaired by the use of methanol of fossil origin in the process.

Keywords:

Sustainable development ; Biofuel ; Jatropha ; Industrial ecology ; Process engineering ; Modelling ; West Africa.

Résumé en français

Conception de filières durables de production de biocarburants oléagineux – Le cas des filières Jatropha au Burkina Faso

Au Burkina Faso, les biocarburants suscitent de nombreux espoirs quant au développement de l'accès à l'énergie en zone rurale et à la substitution des carburants fossiles importés. Plusieurs initiatives de production de biocarburants à partir de Jatropha ont été lancées au cours des dernières années par des ONG et des opérateurs privés. Le gouvernement envisage de définir une politique d'accompagnement pour le développement de ce secteur. Les bénéfices potentiels issus de cette activité, en terme de contribution au développement durable, doivent donc être soigneusement étudiés afin de prendre les décisions adéquates.

L'objectif de ce travail est d'évaluer les opportunités de développement des biocarburants, en définissant les possibilités techniques dans le contexte et en analysant à quelles conditions et dans quelle mesure elles peuvent contribuer au développement durable. L'approche repose sur la modélisation des procédés impliqués dans la production, couplée à des outils d'évaluation environnementale et économique. L'efficacité économique est évaluée par une analyse de la valeur ajoutée produite au sein des filières, ainsi que sa distribution sous forme de revenus, aux employés, aux agents de la filière, à l'état et aux banques. Les impacts environnementaux, notamment les émissions de GES et la consommation d'énergie fossile, sont évalués à l'aide d'une analyse de cycle de vie.

Trois produits finaux différents ont été envisagés: l'huile végétale brute (HVB) ou raffinée, destinée à des applications stationnaires et le biodiesel dédié aux transports. Une analyse individuelle de chaque procédé a permis d'identifier les paramètres les plus sensibles au niveau local. Pour tous les procédés, le prix de la matière première conditionne largement le coût de production. Pour la production d'HVB, le rendement en huile et la teneur en huile des graines ont une importance capitale. Les performances économiques du raffinage et de la transestérification de l'huile sont largement influencées par la capacité de transformation des procédés en raison d'économies d'échelle, et dans une moindre mesure, par la technologie et les ressources utilisées pour la fourniture énergétique. Dans le cas de la production de biodiesel, le prix du méthanol est également un facteur crucial.

La méthode d'évaluation développée a été appliquée à plusieurs scénarios de production de biocarburants à partir de graines de Jatropha produites par les petits exploitants. Les résultats montrent que la méthode permet d'apporter des informations essentielles pour la prise de décisions politiques. Sur la base d'un prix de marché des graines de 100 FCFA/kg, les trois types de biocarburants envisagés peuvent être produits de manière rentable. Dans certains cas, l'utilisation de technologies avancées pour l'approvisionnement en énergie et la valorisation des sous-produits est indispensable pour atteindre un coût de production compétitif. Cela pourrait aussi être une solution pour augmenter le prix des graines afin d'assurer des revenus plus élevés aux agriculteurs. La production d'huile raffinée pour la production d'électricité est particulièrement coûteuse et nécessite une production à grande échelle pour être rentable. Les filières impliquant une usine de biodiesel approvisionnées par plusieurs huileries décentralisées constituent une solution pour contribuer à la fois à l'amélioration de l'accès à l'énergie en zone rurale et à la substitution des combustibles fossiles. Les revenus perçus par l'Etat sont directement liés à la valeur ajoutée et aux bénéfices générés par les producteurs de biocarburants.

Enfin, les impacts environnementaux de la production d'huile sont relativement faibles, en termes d'émissions de GES et de consommation d'énergie fossile, en particulier si la fourniture énergétique est basée sur une ressource renouvelable. En revanche, les impacts de la production de biodiesel sont largement affectés par l'utilisation de méthanol.

Mots-clés :

Développement durable ; Biocarburant ; Jatropha ; Ecologie industrielle ; Génie des procédés ; Modélisation ; Afrique de l'Ouest.

Table of Contents

ABSTRACT	5
RESUME EN FRANÇAIS.....	7
INTRODUCTION.....	13
CHAPTER 1. OPPORTUNITIES AND CHALLENGES OF OILSEED-BASED BIOFUELS IN BURKINA FASO FOR SUSTAINABLE DEVELOPMENT: SCOPE OF THE STUDY	15
1. SOCIO-ECONOMIC, ENVIRONMENTAL AND MACRO ECONOMIC IMPLICATIONS: AN URGENT NEED FOR LOCAL ENERGY PRODUCTION MEANS	15
1.1. <i>Burkina Faso: a Sahelian land-locked country with very low living standards.....</i>	<i>15</i>
1.2. <i>Economic situation: a trade balance in deficit and a lack of manufacturing activities.....</i>	<i>16</i>
1.3. <i>Energy and environmental context: providing a viable access to modern energies is crucial to enable economic development</i>	<i>22</i>
1.4. <i>Energy as a prerequisite to economic development.....</i>	<i>26</i>
2. TECHNICAL OVERVIEW OF JATROPHA-BASED BIOFUELS AND POTENTIAL CONTRIBUTIONS TO DEVELOPMENT OBJECTIVES	28
2.1. <i>Jatropha production potential in Burkina Faso: integration in the current agricultural system</i>	<i>28</i>
2.2. <i>Biofuels from Jatropha seeds: products and uses.....</i>	<i>32</i>
2.3. <i>Seed transformation processes: key performance factors.....</i>	<i>35</i>
3. RESEARCH OBJECTIVES AND METHODOLOGY	41
3.1. <i>Providing decision support to identify the best production pathways: the questions raised by the development of a biofuel policy</i>	<i>41</i>
3.2. <i>Supply chains: from local small-scale to industrial biofuels.....</i>	<i>42</i>
3.3. <i>Analysing complex and multi-disciplinary issues using process modelling as a backbone.....</i>	<i>43</i>
3.4. <i>Boundaries of the study: technological options regarding the context.....</i>	<i>45</i>
4. REFERENCES	45
CHAPTER 2. SUSTAINABILITY ASSESSMENT OF BIOFUEL PRODUCTION SYSTEMS: RELEVANT CRITERIA AND AVAILABLE DATA	51
1. OVERVIEW OF SUSTAINABILITY CONCEPTS AND EVALUATION TOOLS.....	51
1.1. <i>Concepts of sustainable development.....</i>	<i>51</i>
1.2. <i>Current tools and framework of use.....</i>	<i>52</i>
1.3. <i>Ecological biofuel certification framework: a comprehensive tool for ex-post assessment</i>	<i>53</i>
2. ENSURING THE SOCIAL VIABILITY OF BIOFUEL SUPPLY CHAINS.....	58
2.1. <i>Food security and land rights.....</i>	<i>58</i>
2.2. <i>Rural development and access to energy.....</i>	<i>59</i>
2.3. <i>Underlying political position and ethics related to development questions.....</i>	<i>60</i>
3. ECONOMIC IMPLICATIONS OF BIOFUEL DEVELOPMENT AND VALUE CHAIN ANALYSIS	61
3.1. <i>The agricultural value chain: a concept first implemented for economic analysis..</i>	<i>62</i>
3.2. <i>Description of Jatropha biofuel supply chains.....</i>	<i>63</i>

3.3. <i>The creation and distribution of value added</i>	64
4. OPPORTUNITIES FOR REDUCING ENVIRONMENTAL IMPACTS.....	67
4.1. <i>Life-cycle assessment of biofuels</i>	67
4.2. <i>Conservation of biodiversity and ecosystem</i>	71
4.3. <i>Preserving soil quality</i>	72
4.4. <i>Protection of water resources and air</i>	72
5. SUMMARY OF THE ASSESSMENT FRAMEWORK USED IN THIS WORK	74
6. REFERENCES	75

CHAPTER 3. SEPARATION EFFICIENCY AND ENERGY CONSUMPTION OF OIL

EXPRESSION USING A SCREW-PRESS: THE CASE OF *JATROPHA CURCAS* L. SEEDS..... 78

1. INTRODUCTION	79
2. MATERIALS AND METHODS.....	82
2.1. <i>Input materials</i>	82
2.2. <i>Microwave continuous heating tunnel</i>	82
2.3. <i>Instrumented screw-press</i>	82
2.4. <i>Analytical methods</i>	83
2.5. <i>Experiments</i>	84
3. CALCULATIONS.....	87
3.1. <i>Calculation of shell mass fraction</i>	87
3.2. <i>Mass balance calculations</i>	87
3.3. <i>Pure oil mass flowrate determination</i>	88
3.4. <i>Performance indicators</i>	89
4. RESULTS AND DISCUSSIONS	89
4.1. <i>Influence of operational settings on process performance and behaviour</i>	89
4.2. <i>Mass balance assessment</i>	93
4.3. <i>Relation between oil recovery and specific energy consumption</i>	97
5. CONCLUSION	100
6. REFERENCES	100

CHAPTER 4. MODELLING OF THE *JATROPHA*-TO-BIOFUEL SYSTEM: ENERGY AND

MASS BALANCE 103

1. <i>JATROPHA</i> PRODUCTS PROPERTIES	103
1.1. <i>Fruits and seeds properties</i>	103
1.2. <i>Seedcake properties</i>	104
1.3. <i>Oil properties</i>	104
2. MODELLING OF TRANSFORMATION PROCESSES.....	104
2.1. <i>Jatropha cultivation model</i>	104
2.2. <i>Straight vegetable oil production model</i>	105
2.3. <i>Biogas production from the press cake</i>	108
2.4. <i>Refining operations: degumming and neutralization</i>	112
2.5. <i>Biodiesel production from refined oil</i>	121
3. ENERGY SUPPLY OF TRANSFORMATION PROCESSES.....	126
3.1. <i>Energy integration of chemical processes</i>	126
3.2. <i>Energy supply technologies</i>	126
4. REFERENCES.....	133

CHAPTER 5. ECONOMIC AND ENVIRONMENTAL ASSESSMENT OF THE JATROPHA BIOFUEL SUPPLY CHAINS.....	137
1. GEOGRAPHICAL ORGANISATION AND LOGISTICS	137
1.1. <i>Modelling transport distances</i>	137
1.2. <i>Cart transport cost</i>	138
1.3. <i>Truck transport cost</i>	139
2. FINANCIAL ANALYSIS OF PROCESSES	140
2.1. <i>Jatropha seed cultivation</i>	140
2.2. <i>Oil extraction plant using cold pressing</i>	143
2.3. <i>Biogas production from the seedcake</i>	148
2.4. <i>Chemical processes cost calculations</i>	149
2.5. <i>The cost of utility supply</i>	154
2.6. <i>Aggregation of process accounts and value chain calculation</i>	155
3. ENVIRONMENTAL IMPACT CALCULATIONS.....	157
3.1. <i>Fossil energy consumption and greenhouse gas emissions</i>	157
3.2. <i>Water requirements</i>	159
4. REFERENCES	160
CHAPTER 6. ANALYSIS OF PROCESS PERFORMANCE AND SUPPLY CHAIN ASSESSMENT.....	163
1. IMPLEMENTATION OF SUPPLY CHAIN ASSESSMENT	163
1.1. <i>The OSMOSE platform and the computing structure</i>	163
1.2. <i>Summary of model parameters</i>	164
1.3. <i>Supply chain structures and analysis strategy</i>	167
2. SENSITIVITY ANALYSES AT PROCESS-LEVEL.....	168
2.1. <i>Jatropha seeds production</i>	168
2.2. <i>Straight vegetable oil production</i>	170
2.3. <i>Straight vegetable oil refining</i>	177
2.4. <i>Biodiesel production from SVO</i>	183
3. INFLUENCE OF TERRITORIAL YIELD AND TRANSPORT COST.....	188
3.1. <i>Estimation of Jatropha production potential</i>	188
3.2. <i>Transport cost vs. economies of scale</i>	189
4. EXAMPLES OF JATROPHA BIOFUEL SUPPLY CHAINS	192
4.1. <i>Production of SVO: Local small- to medium scale</i>	192
4.2. <i>Production of refined oil for power generation</i>	199
4.3. <i>Production of biodiesel for transportation</i>	203
5. CONCLUSION	209
5.1. <i>Results from individual process analyses</i>	209
5.2. <i>Jatropha production potential and feedstock transport distance</i>	210
5.3. <i>Analysis of supply chain assessment results</i>	211
6. REFERENCES	214
CONCLUSION AND PERSPECTIVES.....	215

Introduction

Biofuels raise many questions about the place they should take in energy supply in the future and above all, the share of energy demand they can reasonably cover. They offer the advantage of replacing most liquid fuels of petroleum origin, without changing conventional conversion techniques (internal combustion engines in particular). However, in most cases, feedstock production requires large areas of arable land, a resource that becomes very scarce in some region of the world, because already in use for vital food production. Anyhow, the share of global energy demand that can be covered by biofuels is limited, due to land competition for food production.

Experience has already shown that the production of biofuels can have adverse socio-economic and environmental impacts, which earned them to be very controversial. Thus, there is now a real need for reframing this sector to exploit biomass resources in a sustainable way, i.e. by controlling societal impacts. Considering the economic interests at stake here, this reframing requires the implementation of regulations and safeguards. In order to define appropriate policy frameworks, it is necessary to determine the impacts of these sectors and to develop methods for the evaluation and for the design sustainable biofuel supply chains. This cannot be done without considering local context, including socio-economic situation, energy demand, and arable land availability.

The present thesis work contributes to address these issues through the development of a methodology for the design of sustainable biofuel supply chains. It was specifically elaborated in the context of Burkina Faso, a West African country where several biofuel production initiatives have started in recent years and the government wishes to evaluate the opportunities for the development of this sector. The country has very low living standard. The main economic activity is agriculture, which employs about 80% of the population. While the largest part (80%) of energy consumption is related to the use of firewood for cooking, modern energy supply mostly relies on expensive imports of fossil fuels. In this context, the development of a biofuel sector is expected to address a number of issues, including the development of energy access in rural area and the substitution of fossil fuels imported for power generation and transportation.

The goal of this work is to investigate these opportunities by determining the technical possibilities regarding the context and in what conditions and to what extent they can contribute to sustainable development objectives. The approach is based on the modelling and simulation of production processes coupled with environmental and economic assessment tools. This results in calculating a series of indicators that allow comparing several supply chains in regard to their contribution to development objectives, including environmental, micro- and macro-economic performances.

The analysis is focused on biofuel production from a specific feedstock, *Jatropha*, a shrub producing inedible oilseeds which raised high expectations for the production of biodiesel in tropical regions in recent years. This choice will not be discussed in details

here because it is beyond the scope of this work. Briefly, it was justified by the fact that using an edible oil as a fuel was not a popular idea in Burkina Faso and by the necessity to limit the scope of the study. Actually, as the country is a net importer of vegetable oils, developing the biofuel production from edible oils would probably start with increasing the production of oilseeds until the saturation of the domestic market. Only then, a part of the vegetable oil could be used for biofuel purposes. However, such a scenario would seriously postpone the question of the need for domestic energy production sources.

The document is constituted of 6 chapters. The first one is dedicated to the analysis of the local context, with specific emphasis on socio-economic situation and energy supply issues. On this basis the expected outcomes of *Jatropha* biofuel development are identified, and the boundaries of the study, in term of technological solution are defined. Chapter 2 is focused on the definition of a framework for the sustainability assessment of biofuel supply chains, based on existing methods and on the specificities of local context. Then, Chapter 3 presents an experimental analysis of *Jatropha* oil expression using a screw-press, which was realised to fill the lack of literature data on this process. The supply chain modelling is described in the two next chapters. Chapter 4 describes the models used for the unit operations in biofuel processing whereas Chapter 5 is dedicated to the implementation of economic and environmental assessment as defined in Chapter 2. Eventually in Chapter 6, some simulations results are presented and discussed. First, the economic performances of transformation processes are presented using sensitivity analyses. Then, several biofuel supply chains are proposed in regard to expected outcomes and assessed following the defined methodology. Based on the results, the opportunities for biofuel development in Burkina Faso are discussed. The conclusion is focused on the relevance of the proposed method with respect to the initial objective and on the perspectives for improvement.

Chapter 1. Opportunities and challenges of oilseed-based biofuels in Burkina Faso for sustainable development: scope of the study

The sustainable development of Burkina Faso involves developing rural areas, especially by providing affordable energy for the development of new economic activities (agricultural products transformation) and improving living standards of vulnerable people. It also includes improving industry performance by providing affordable energy and improving the benefits of investments in the energy sector in terms of independence and value added creation (contribution to economic growth).

1. Socio-economic, environmental and macro economic implications: an urgent need for local energy production means

1.1. Burkina Faso: a Sahelian land-locked country with very low living standards

Burkina Faso is a land-locked country located in West-Africa (see Figure 1) and is part of the least developed countries following the United Nations' classification. The climate is Sahelian with average annual rainfall ranging from 400 to 1200 mm north to south. The national population was estimated to 17 million in 2013, with around 25% urban population (World Bank, 2013). The Human Development Index was of 0,343 in 2012, ranking the country at 183th position over 186 countries globally (Malik, 2013). This low development level is characterized by very low average incomes with a gross domestic product (GDP) per capita of 670 \$ in 2012 and strong inequalities between rich and poor, and especially between urban and rural areas (Hanff et al., 2011).

The country has very few mineral resources, except gold that is being exploited by foreign companies due to the huge capital investments required for mining activities. Moreover, the low development of transport infrastructures still impedes many economic activities, together with high energy costs and low energy access (Legros et al., 2009). This situation is exacerbated by the economic crisis and the related high variability of prices for both food and energy products.



Figure 1. Location of Burkina Faso in West Africa.

Eventually, a large part of the economy of Burkina Faso depends on agriculture (food and non-food crops) which is rather extensive with very low yields. The country is in a climate area particularly affected by climate change that result in years with strong droughts or floods. These climatic hazards highly impact the agricultural production, which, some years, is not enough to feed the entire population.

1.2. Economic situation: a trade balance in deficit and a lack of manufacturing activities

1.2.1 The evolution of the trade balance

The trade balance of Burkina Faso is heavily in deficit. However, it has dramatically improved in recent years due to the rapid emergence of a new industrial activity, gold mining. This is well illustrated by the graph on Figure 2. While the exports were almost declining between 2006 and 2008, they suddenly increased by a factor of 4 between 2008 and 2011. On the other hand, imports have not known any recession in the past 10 years.

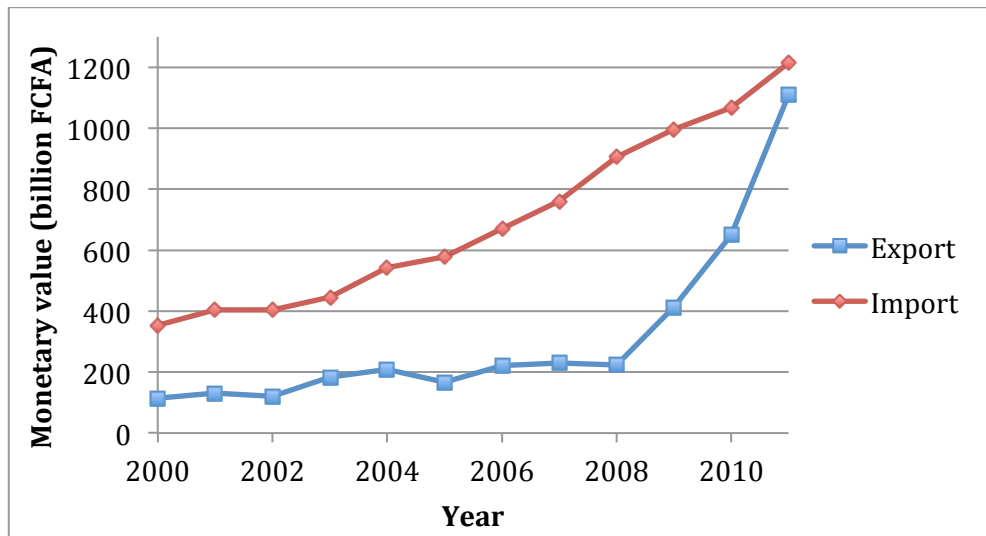

Figure 2. Evolution of overall imports and exports from 2000 until 2011. (Ministère de l'économie et des finances - Secrétariat Général, 2012)

1.2.2 Imports of manufactured products

Figure 3 illustrates the shares of imported products in 2011 sorted by economic categories. Food and petroleum products represent respectively 13% and 22% of total imports. The other categories concern industrial supplies, machinery (including power generation equipment) and transport equipment (cars, motorcycles, trucks), and consumer goods that include electronic and information devices among others.

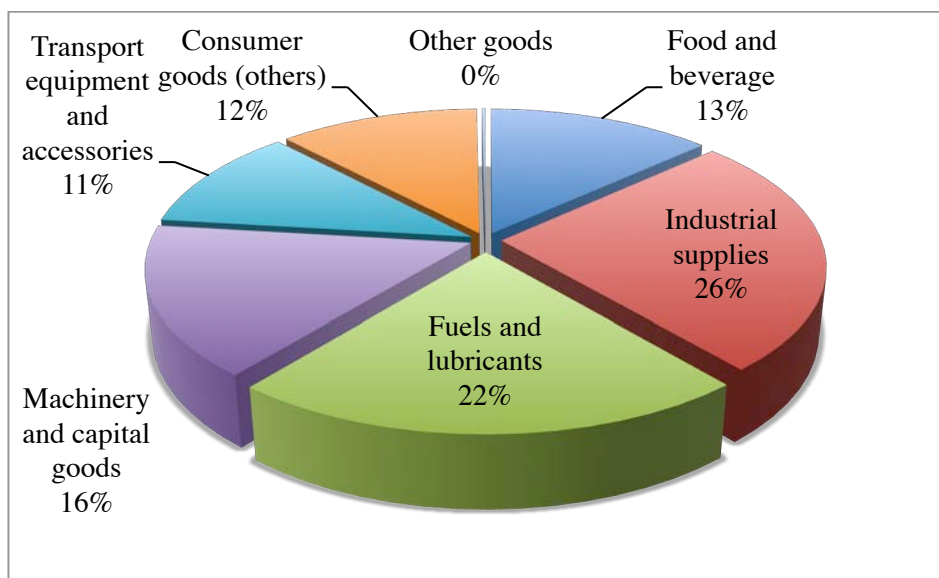

Figure 3. Main import products by categories in 2011. (Ministère de l'économie et des finances - Secrétariat Général, 2012)

1.2.3 Exports of raw material

For many years, cotton has been by far the first export product of Burkina, totalising around 60% (monetary) of total exports in 2008. The country is the largest African exporter of cotton. However, this trend was overturned by the launching of industrial gold mining in 2009-2010 to such an extent that in 2011, gold represented more than 75% of exports, the share of cotton being reduced to only 11 % (Ministère de l'économie et des finances - Secrétariat Général, 2012). The sharing out of main export products in 2011 is represented on Figure 4. Apart from gold and cotton, the main exports concern mainly raw agricultural production such as fruit and sesame seed.

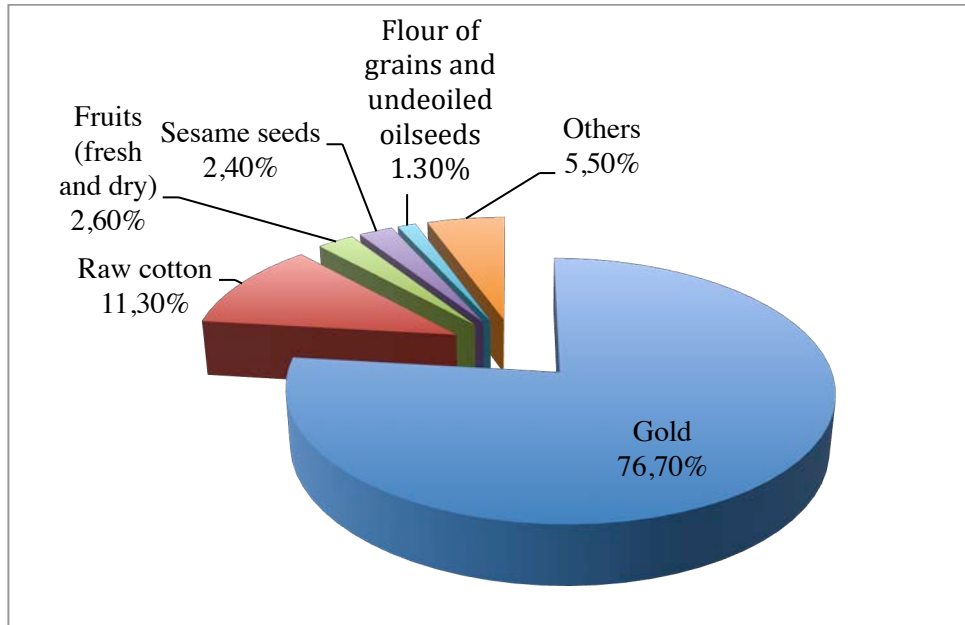

Figure 4. Shares of Burkina Faso's main export products in 2011. (Ministère de l'économie et des finances - Secrétariat Général, 2012)

This brief overview of import and export clearly reveals the lack of industrial development: besides having a negative trade balance, the country exports almost exclusively untransformed products and imports manufactured goods. Even cotton, which has been a leading agricultural production for decades, is still exported in bulk, where the development of a national textile industry would have enabled much more value creation.

1.2.4 Main economic activities and obstacles to industrial development

Despite the low development of industry, Burkina Faso displays an economic annual growth rate between 3% and 7% for the past 10 years. Following the National Institute for Demography and Statistics (INSD), about 75% of the Burkinabe population live in rural areas from farming and pastoral activities (Ministère de l'économie et des finances - Secrétariat Général, 2012). The contributions to GDP of primary, secondary and tertiary sectors are respectively of 32%, 16% and 42%. Among these contributions, the so-called informal sector, plays a major role, its contribution being estimated to about 50% of GDP. It includes smallholders and above all, trading activities in urban areas (small shops, retailers and street vendors).

This economic situation shows that the development scheme of Burkina Faso (like many other poor countries) is very different from that followed by occidental nations. While the agriculture is still not mechanised and involves the large majority of the population, and the industry is almost inexistent, trade and service activities are already widely developed. This is an effect of the globalization that brings on the national market a variety of highly competitive goods and services, from cars, motorcycles and appliance to information and telecommunication technologies. Thus, the population is subjected to very fast changes but with a serious gap between rural and urban areas.

Trading and retailing have become one of the main employment sectors in urban areas since it is an accessible activity even with a low education level. In contrast, the development of productive activities is much more demanding in terms of professional skills, and is subject to a stiff international competition. It is even more difficult to be competitive in a landlocked country where the infrastructure is lacking, the energy prices are very high and the education level is dramatically low (Malik, 2013).

In rural areas, agriculture is almost the only employment sector, but it is in most cases limited to subsistence farming. Smallholders do not have any mechanised cultivation means: the wealthiest use animal draft for heavy works, but motorised tractors and irrigation systems are almost inexistent. These facilities require capital investments that are not affordable to most smallholders and fuels are sometimes more expensive in remote areas because they are distributed through informal business. Moreover, the Sahelian climate is a harsh environment for farming and makes it even more difficult to cultivate large areas with hand tools.

Apart from gold extraction, the leading industry for many years has been the production of cotton, including fibres, oil and cake, a situation that dates back to the colonial period. However, the recent drop of cotton prices on the international market seriously affected the Burkinabe economy (Hanff et al., 2011). To face this situation, the government has initiated a strategy of diversification of industrial activities, starting with the valorisation of available products and by-products from agriculture and livestock. This includes mainly the transformation of dairy products, meat, cereals and fruits. The leather industry and the production of cosmetics and soap from local oilseed

resources are also identified as major opportunities to stimulate the national economy (Ministère de l'économie et des finances, 2012).

1.2.5 Development of new economic activities

As explained above, Burkina Faso's main economic activity is agriculture. However, this sector is not productive because of harsh climatic conditions and a lack of modern practices and production means. While the country is a net importer of food products, including cereals, large areas of arable land are still not cultivated (Blein et al., 2008). Moreover, it has been shown that a large part of the production (30% of vegetables and 50% of fruits) is lost because of a lack of conservation techniques. Then, developing and modernizing the agricultural sector and the transformation of its products appear to be priority for triggering the economic development of the country.

The transformation of agricultural products is a priority to avoid wastes and provide more elaborated, diversified and storable food products. The development of this sector may significantly increase the value added generated by the agricultural sector and thus increase the food sovereignty of the country.

Besides food production, Burkina Faso has very valuable and diverse bio-based resources like shea nuts, neem, balanites, morenga, baobab and so on. Most of these raw materials are exported, and only a small share is locally transformed into cosmetics and medicinal products by local populations and traditionally used for curative or preventive medicines. The elaboration of final products from the bio-resources follows traditional but not very productive processes. The introduction of technological innovations in these sectors could improve their economic viability, and increase production levels to generate exportation opportunities.

Eventually, the development of bio-products transformation activities, either for food or not, is closely linked to the availability of modern energies (electricity or liquid fuels). Indeed, many operations involved in the conditioning and transformation of bio-based resources are energy intensive, such as seed crushing, milling, drying, and chemical processes. However, the energy supply in Burkina Faso, including liquid fuels and electricity, are exclusively based on imports and so, are very expensive due the isolation of the country. Moreover, the use of wood as fuel for economic activities is no longer an option, given the pressure exerted on wood resources by the traditional use of firewood combined to the rapid demographic growth (Ozer, 2004).

1.3. Energy and environmental context: providing a viable access to modern energies is crucial to enable economic development

This section presents a detailed overview of the energy sector in Burkina Faso, including the main sources, their consumption levels and costs for the consumers and the state. Then, the challenges and stakes of improving rural energy access are developed. Eventually, we argue on the opportunities offered by the development of biofuel energy in this context.

1.3.1 Overall energy consumption and resources

Burkina Faso's primary energy consumption was estimated to 3,2 million TOE (tons oil equivalent) in 2008 (Tatsidjodoung et al., 2012), corresponding to an annual consumption per capita of 0.240 TOE. As a comparison the global average per capita energy consumption was estimated to 1.9 TOE in 2010 (International Energy Agency, 2012). 83% of the energy consumption in Burkina Faso is attributed to the firewood used in both rural and urban areas, emphasizing the energy poverty and the low economic development level. The 16% remaining is constituted of fossil fuels, and a negligible share (<1%) of renewable, hydro and imported electricity. This is illustrated in Figure 5.

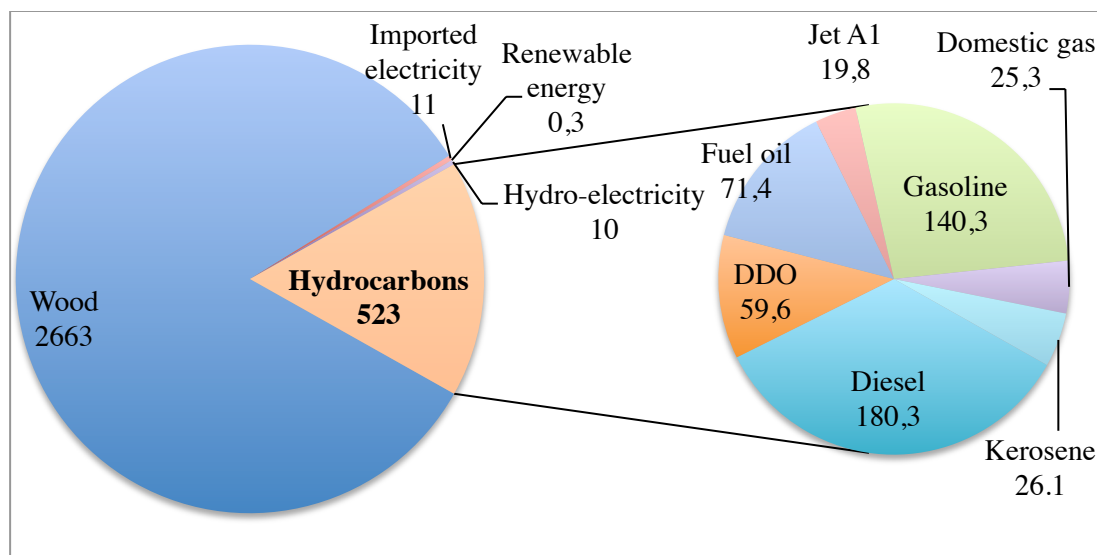

Figure 5. Breakdown of primary energy sources in 2008, in ktoe (Tatsidjodoung et al., 2012)

1.3.2 Imported fossil fuels

Different types of petroleum fuels are imported; they are listed and defined in Table 1. The largest share is represented by fuel oils, then gasoline, natural gas, kerosene, and jet fuel. Hydrocarbons are primarily used by the transport and power generation sectors, totalising 72% and 21% respectively, the remaining 10% being used for lighting and cooking purposes.

Table 1. Description of the different fossil fuels imported in Burkina Faso

Fuel type	General description
FUEL OILS	Diesel Standard diesel, mainly used for transportation. Corresponds to Fuel oil N°2 in ASTM classification.
	HFO Heavy fuel oil (HFO 180) is a heavy fuel used for marine application and power generation.
	DDO DDO (Distillate diesel oil) is a medium distillate fuel oil mainly used for power generation in West Africa.
Gasoline	Standard unleaded gasoline for transportation
Jet A1	Jet fuel used for gas-turbine aircrafts.
Domestic gas	Butane gas sold in cylinders, for cooking use
Kerosene	Kerosene used in lamps and cooking stoves

All fuels issued from the distillation of crude oil and for fuelling diesel-type engines are classified as fuel oils. In most fuel standards (ISO, ASTM), fuel oils are divided in several categories following their distillation temperature, and so, their viscosity level. The lightest fuel oil (highest quality) is the standard diesel fuel used for light vehicle and trucks. Other types of medium and low distillate fuel oils are used in large diesel engines employed for power generation and ships propulsion (Montagne, 2011). Heavy fuel oils can technically be substituted by oilseed-based biofuels, either straight vegetable oil or biodiesel (fatty acid methyl- or ethyl- esters).

In Burkina Faso, fuel oils concern two third of fossil fuel imports, divided in three categories which are standard diesel (58 %), distillate diesel oil (DDO, 19%) and heavy fuel oil 180 (HFO 180, 23%) (Tatsidjodoung et al., 2012). The two latter are exclusively used by thermal power plant employing high rated power diesel engine.

There is no oil refinery in Burkina Faso so all fuels are directly imported as refined products. They are shipped to the nearby ports of Cotonou, Abidjan or Lome and trucked over 1000 km to national fuel depots. This logistics induces an extra cost of 30% over CIF (cost insurance freight) prices (Hanff et al., 2011). Then, the government applies a tax on the fuels used for transport, amounting to about 90% and 57% of CIF

prices on gasoline and diesel respectively. The DDO and HFO used for power generation by the national electricity company are subsidized for about 30% and 68% of CIF prices respectively. The selling prices of fuels are listed in Table 2.

Table 2. Fuel prices in Ouagadougou in 2013. (source: www.sonabhy.bf)

Fuel	Price (FCFA/L)	
Gasoline	732	
Diesel	656	
DDO	392	Estimation: actualised based on Hanff et al. (2012) prices in 2008 and current diesel selling price.
FO 180	220	

1.3.3 Electricity: production means and costs

Energy prices are very high, especially electricity because of high production and distribution costs. Thermal power plants and small generators provide 46% of the electricity, 9% is hydropower and the last 45% is imported from Ghana and Côte d’Ivoire (SONABEL, 2012). Electricity supply is exclusively ensured by the national company SONABEL. As explained in the previous section, the government subsidizes a part of the fuel used for electricity production. However, even with this subsidy, the power production cost remains very high. In 2012, SONABEL displayed an overall cost price of 160 FCFA/kWh while the average selling price was of 138 FCFA/kWh and is thus largely in deficit. This situation is attributed to several factors, including the constant electricity price since 2006, the subcontracting of a part of thermal production and the increase of DDO and HFO prices (SONABEL, 2012).

Figure 6 illustrates the evolution of power generation in regard to production sources, from 1995 to 2012. First, it can be noticed that the demand is growing fast: by way of example, it has doubled between 2004 and 2012. To face this situation, the government has engaged a strategy based on the interconnection with neighbouring countries, mainly Côte d’Ivoire, Ghana and Togo, which can be seen in the rising share of imported electricity in the past few years (Figure 5). However, Ivorian power generation also relies on thermal power plants by more than 70%, so the production costs are also submitted to the increase of fossil fuel prices. The interconnection strategy should lead to 80% of imported power in the overall mix within a few years (Hanff et al., 2011). This policy will further increase the foreign dependence of the country for energy supply. Power shortages have already arisen in 2013 because the Ivorian electricity company was itself saturated by the demand.

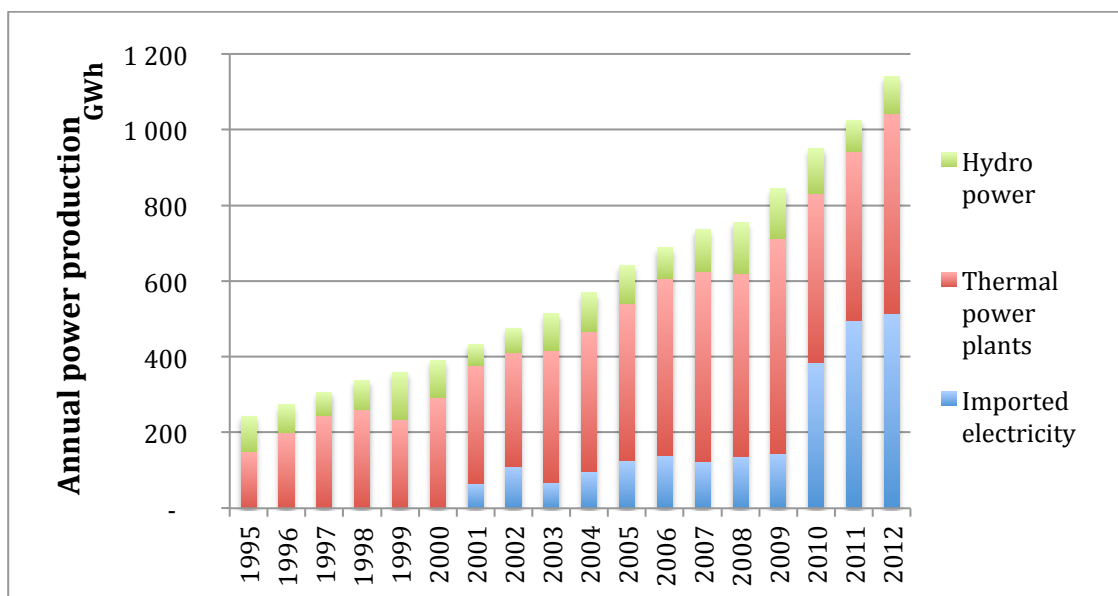

Figure 6. Evolution of power generation from 1995 to 2012, according to production source. (SONABEL, 2012)

1.3.4 A lack of energy access in rural areas

The gap is huge between rural and urban areas, in term of energy supply facilities in Burkina Faso. Following the international energy agency (IEA), the national electrification rate was of 14.6% in 2011 (International Energy Agency, 2011). It is estimated to 6.3% in rural areas vs. 25% in urban areas by the United Nation Development Program (Legros et al., 2009). The governmental policy for developing energy access is focused on the extension of the national grid. Considering the scatter and low level of the demand, it might take many years to provide electricity to a majority of the rural populations.

Besides the grid extension program, there is a decentralized electrification strategy for the most remote areas that are out of reach of the national grid. Funds have been raised to implement this strategy by financing small grids and generator sets in the villages. The grids are exploited by cooperatives and supervised by the SONABEL. However, electricity tariffs are much higher than on the national grid, and can reach 250 FCFA/kWh.

Concerning the access to liquid fuels, there are also large disparities between urban and rural areas. Very few gas stations are installed in remote areas, so the fuels are often distributed through informal business and sold by retailers in jerrycans or even glass bottles. Therefore, the price of diesel in some remote villages can reach 1000 FCFA/L, instead of 650 FCFA/L at the gas station. Moreover, the fuels distributed through these channels are often of poor quality because of contamination with dust and water due to inadequate handling and storage or because the retailers sometimes cheat on the purity.

1.3.5 Environmental issues: the depletion of wood resources and the risk of desertification

Burkina Faso is situated in a transitional area between the Sahara desert in the north and tropical wet regions to the south. Most of the territory is subject to a Sahelian or Sudano-Sahelian climate, characterized by a 9-months dry season and 3 months of rainy season, with rainfall varying from 400 mm in the north to 1100 mm south. The soils fertility is rather low and the vegetation is very sparse, especially in the north, which is semi-desert. Therefore, the biodiversity is very specific, making this ecosystem fragile and highly sensitive to perturbations. Some areas are regularly threatened of desertification and so far, human activities have worsened this phenomenon (Ozer et al., 2010).

The traditional use of firewood of natural origin, for cooking is no longer a sustainable practice due to increasing demography and urban areas development. As an example, the wood sold on the market in Ouagadougou is collected up to 150 km outside the city (Ouédraogo, 2007). This emphasizes the gravity of wood resource depletion around urban areas. In some villages, especially the big producers of traditional sorghum beer, wood supply has become a serious problem. Beyond energy supply issue, the wood depletion seriously increases the risk of desertification.

Then, another serious pollution issue is the deterioration of air quality in big cities, especially Ouagadougou, caused by the emission of sulphur dioxide SO₂ from all types of vehicles (Blin et al., 2008). The specifications applied for fuel quality are very permissive in terms of sulphur content limits. The limit for diesel fuel is 10 000 ppm and 1500 ppm for gasoline. Unfortunately, more than 80% of the vehicles run on diesel. The sulphur contained in the fuels leads to the emission of sulphur dioxide, a toxic gas that causes respiratory diseases. The SO₂ is transformed into sulphuric acid when put in contact with water and causes acidic rains, very harmful to fragile ecosystems.

However, the contribution of Burkina Faso to greenhouse gases emission and fossil resources depletion on a global level remains almost insignificant. Only a marginal part of the population can afford an occidental living standard, while the vast majority of the population consumes mostly local products and has no access to industrially elaborated goods. Thus, the consumption level brought to the number of inhabitants is very low.

1.4. Energy as a prerequisite to economic development

Burkina Faso, as many other least developed countries, is committed to reaching the Millennium Development Goals (MDGs) by 2015. The MDGs is list of 8 objectives defined by the United Nations in September 2000, related to food security, education, health, sanitary conditions, gender equity, etc. It has been shown that energy access is a key basis for reaching the MDGs (Hanff et al., 2011). Indeed, energy is a basic

requirement for any technological development, from education and health to industrial activities.

It is clear that the access to energy at an affordable price is a key factor for fostering economic, technological and human development. The relation of modern energy consumption to GNP per capita in Africa was clearly demonstrated by (Karekezi, 2002).

There is no international agreement on the definition of the term “modern energy” but it is commonly used by international institutions and scientists. The International Energy Agency uses this term to refer to household access to reliable electricity supply and to clean cooking facilities. In the present work, modern energy is given a slightly broader definition: it encompasses energy vectors and technologies able to provide mechanical power or electricity. Then, an energy service is considered accessible when it is physically available, affordable to the user and its use lies in the competence and abilities of the user.

Modern energy is useful to almost all sectors of social life to get developed, from agriculture to manufacturing, industry, education, health and administration. For example, electricity is vital for operating good health infrastructures, by ensuring the conservation of medicines, allowing the use of advanced medical equipment or even for light surgery intervention. The availability of electricity is also a must for education, providing lighting for the pupils to study in the evening.

Electricity access can also foster commercial activities, for example by enabling the use of fridges for fresh products conservations and cold drinks, television, radio and Internet, making shops more attractive. It is also a strong argument for touristic infrastructures. Eventually, energy access is necessary for most manufacturing activities or agricultural products transformation, such as welding, milling, oil extraction...

2. Technical overview of *Jatropha*-based biofuels and potential contributions to development objectives

In this part is presented an overview of the technical solutions for the production of biofuels from *Jatropha*, starting from cultivation to the end-use of straight vegetable oil and biodiesel in diesel engines. In each case, the most common technologies together with their economic and environmental constraints are highlighted.

2.1. *Jatropha* production potential in Burkina Faso: integration in the current agricultural system

*2.1.1 General agronomic characteristics of *Jatropha**

Jatropha Curcas Linnaeus is a shrub native to South-America that produces inedible oilseeds, and which has been identified as a good potential feedstock for biofuels production in subtropical regions.

The *Jatropha* tree reaches maturity and starts producing harvestable amount of seeds at around three years old and can live up to 50 years. It produces fruits of 20mm to 30mm in diameter, containing two or three seeds (see Figure 7). Fruits are ripe when their green colour turns to yellow/brown. When dried, the fruit husk represents around 35-40 % of the whole fruit. The fruits husks have lower heating value (LHV) ranging between 11 MJ/kg (Jongschaap et al., 2007) and 16 MJ/kg (Becker, 2009). They may be valorised through combustion, anaerobic digestion, or simply left on the field as mulch to the *Jatropha* crop. The seeds are ovoid, coated with a hard black shell that counts for about 37% of the whole seed weight. The whole seeds have an average oil content of 35% (d.b.) (Achten et al., 2008; Basha et al., 2009; Kaushik et al., 2007) but the values range from 28% to 40%. The kernels are white, rich in protein (25%) and oil (57%).



Figure 7. *Jatropha Curcas* L. (a): Young *Jatropha* trees in Padema, Burkina Faso. (b): Green and dry *Jatropha* fruits. (c): *Jatropha* seeds and fruit husks. (Source: (a) and (b): S. Audouin (2011) ; (c): Morad (2011))

Jatropha is still an undomesticated species and as such, presents highly variable properties, including seed yield and oil content (Achten et al., 2010). The literature reports a wide range of values for seed yield and oil fraction, respectively from 0 to 6 ton/ha and from 28% to 40% of oil (Achten et al., 2008; Basha et al., 2009). With the current knowledge on *Jatropha* cultivation, we are far from being able to predict production yields, but only to give some good agricultural practices (Jingura, 2011). Research is being conducted on domestication and breeding of *Jatropha* (Achten et al., 2010; Divakara et al., 2010; Kaushik et al., 2007). Under good conditions, in West Africa, the seeds yields are more likely to be about 1000 – 1500 kg/ha (Hanff et al., 2011; Tatsidjodoung et al., 2012). Even if *Jatropha* has good abilities to grow on poor soils and to withstand drought, reasonable seed yields cannot be achieved under too poor agro-climatic conditions and without good crop management.

Jatropha is technically an interesting feedstock for biofuel production. Its oil has a high energy content, relatively low viscosity and *Jatropha* seedcake has very good fertilising properties. Moreover, almost all parts of the tree have medicinal properties, which could be an additional valorisation pathway even if further investigations are still necessary (Heller, 1996; Kumar and Sharma, 2008). Eventually, its resistance makes it

suitable for fighting against desertification and reclaiming degraded land (Achten et al., 2008), a more and more pressing issue in West Africa.

*2.1.2 Brief history of *Jatropha* introduction in West Africa*

Jatropha was introduced in West Africa in the 16th century and then used for the production of soap during the colonisation (Heller, 1996). Since then, this practice continued and *Jatropha* soap is still produced traditionally in rural villages. *Jatropha* soap is white, which is an important marketing argument and is attributed therapeutic properties against skin problems. Before the current biofuel production initiatives, it was not cultivated as a crop but only planted as living fence. The seeds were collected by women and children and could be sold up to 200 FCFA/kg for soap production in some places.

The very first experiences of *Jatropha* cultivation for biofuel production in Burkina were conducted in the 1980's without real success because of many reasons such as difficulties in controlling seed yield, low oil prices and the lack of involvement of the government. More recently, with the rising biofuels production worldwide and the global craze for *Jatropha*, several project promoters have settled in Burkina since 2006.

It is not by chance that *Jatropha* attracted so much interest and expectations but because it presents many apparent advantages for biofuel production. First, it is inedible, so there is no direct concurrence with food market as for most other feedstock. Second, this shrub is capable of withstanding severe drought and to grow on degraded land. These two arguments make it, apparently, the perfect solution for solving the food biofuel competition issues. The media and the promoters have then presented it as a miracle plant without mentioning the agronomic uncertainties linked to the domestication of a wild species. Even if *Jatropha* is actually drought-resistant, the promised yields of 5 tons of seeds per hectare were never reached on the field (Achten et al., 2010; Rao et al., 2008).

While some promoters were counting on possible exportation to Europe and on carbon credit funding, the European commission has called for a moratorium on first generation biofuels import and the value of carbon credits dropped following the economic crisis. This combined to hard disillusion on production yields has led to serious conflicts between promoters and producers, causing the flop of the sector. Then, many of them left and those who stayed had to re-orient their business toward new local markets.

Today, there are about 12 active promoters in Burkina but many of them are just starting to harvest seeds (after difficulties to master the plant agronomy and as *Jatropha* it requires about 5 years growth for full production). Officially, around 97 000 ha of *Jatropha* are cultivated but this might be over-estimated because 90% of this surface is attributed to one promoter, whose data is probably skewed (Gatete Djerma and Dabat, 2013). After many difficulties with the management of *Jatropha* crops, some promoters

have started setting transformation units for the production of SVO in most cases and 2 promoters plan to produce biodiesel.

They are now facing several technical issues related to seeds and oil processing, with high uncertainties on production costs and potential demand. For its part, the government displays willingness for the development of a biofuel sector but, so far, no concrete measures were taken although a policy framework is under elaboration. Then, both promoters and decision-makers are seeking for technical information and support to development of the sector.

2.1.3 Land availability and food competition

As a non-edible product, *Jatropha* oil does not enter in direct competition with food, as it can be the case with other vegetable oil. However, the absence of competition on product uses does not prevent the competition on land uses, which is just as serious if not worse. In the field of biofuels, the land uses competition is a very polemic issue and has been widely discussed but it is also a complex question to which there is no universal solution and that has to be considered in a given context to be relevant. Basically, the preservation of food production and land rights on a national level can only be ensured by the implementation of an adequate policy framework.

In Burkina Faso, arable lands are unequally distributed over the territory: the southern part of the country benefits from well-watered and fertile lands while the northern part is a semi desert. This situation combined to the rapid demographic growth has led to massive migration of populations searching for new arable land, causing land conflicts (Drabo et al., 2003). Nevertheless, large surfaces of arable lands remain uncultivated and there is still a significant potential for *Jatropha* cultivation without compromising food production (Duba, 2013; Hanff et al., 2011).

Land grabbing often occurs along with the implementation of large-scale biofuel projects funded by private investors, who take advantage of the absence of a clear land law (Boons and Howard-Grenville, 2009). In Burkina Faso, land rights are still largely governed by traditional rules, so there could be some risks of land grabbing by the corruption of local chiefs. But, “fortunately” Burkina Faso’s lands are not so attractive for investors, so there is no immediate threat.

Finally, addressing land and food competition issues is not the primary goal of the present study, but it could not be ignored. As discussed in the next chapter, this point will be taken into account in the prospective analysis of biofuel production pathways, especially through the assumptions on feedstock production potential. In the present approach, the development of biofuel production is meant to be integrated in the current agricultural system, especially by the involvement of smallholders in the feedstock production. Then, the risk of land competition is considerably reduced, since the smallholders will most likely give the priority to food crops.

2.2. Biofuels from *Jatropha* seeds: products and uses

Mainly two types of biofuel can be produced from oilseeds: straight vegetable oil (termed SVO) and biodiesel. SVO refers to pure vegetable oil that is directly used to fuel a diesel engine: this is possible by blending it with diesel or by adapting the engine feeding system. Biodiesel is issued from a chemical transformation of vegetable oil: it has physicochemical properties very close to that of fossil diesel and can be used, without restriction, in all types of diesel engines.

2.2.1 SVO as fuel in diesel engines: blending and dual-fuel systems

Since their invention in 1892 by Rudolf Diesel, diesel engines have been improved to become highly efficient. Consequently, the current engines are optimised for the fuels they are designed for and are not flexible enough to enable optimum combustion of vegetable oils in the combustion chamber (Harwood, 1984).

In order to alleviate the problems of SVO injection and combustion in engines due to their high viscosity and low cetane number, it is necessary to proceed in the same way as when heavy fuels such as HFO 180 are used. It is necessary to (i) pre-heat the fuel to make it more fluid and (ii) pre-heat the engine with a light fuel (diesel) in order to increase the average temperature inside the combustion chamber (450 °C) and enable rapid and complete combustion (Sidibé et al., 2010). On average, this temperature is reached at 70% of the maximum engine load (Blin et al., 2013).

From a practical viewpoint, two options can be used to apply the principles described above to run stationary diesel engines on SVOs; it is necessary to either (i) blend SVOs with diesel at a low oil content, or (ii) adapt engines for dual-fuelling (Agarwal and Agarwal, 2007).

The blending solution overcomes SVO viscosity and injection problems, hence the combustion problem. However, in order for the blend to retain combustible properties close to those of diesel fuel, SVOs must not be used in proportions exceeding 30% (Sidibé et al., 2010). This blend solution is often chosen when only small quantities of vegetable oils are available. However, operators may be tempted to incorporate oil contents exceeding 30%, which would rapidly result in engine fouling and (often irreversible) mechanical breakdowns.

Dual-fuelling systems can be used to run a diesel engine, once hot, with 100% SVO. It consists in equipping the stationary engine with an extra fuel tank, for SVO, and a system of valves (electronically or manually controlled) making it possible to switch the feed from one fuel to the other. This dual-fuelling of stationary engines is commonly used in West African power stations that use diesel oil and DDO for the engine start-up and pre-heating phases, and then switch to 100% HFO 180.

Eventually, the use of SVO in diesel engine either pure or in blend yields energy conversion efficiency very close to fossil diesel. Moreover, the emissions of polluting

compounds such as carbon monoxide (CO), nitrogen oxides (NO_x) and unburnt hydrocarbons (HC) can be slightly reduced (Misra and Murthy, 2010).

2.2.2 SVO and biodiesel quality requirements

In order to guarantee optimum and durable diesel engine operation, manufacturers recommend using standardized fuels. To that end, the physicochemical properties of the fuel must correspond to the specifications set down by the standards. The quality of the fuel, either biodiesel or SVO, is closely linked to the feedstock quality and to the conditions of processing, handling and storage.

The purpose of the standards is to certify a set of characteristics and a composition for each fuel that (i) guarantee good performance when used in engines (efficiency, mechanical performance, endurance, atmospheric emissions, etc.) and (ii) make it possible to estimate and foresee the potential impacts of using, transporting and/or storing these fuels on health and the environment.

As the use of biodiesel in diesel fuel blends has become a widespread practice, biodiesel quality standards have been developed and set by international institutions, such as the International Standard Organisation (ISO, Geneva, Switzerland) or the American Society for Testing and Materials (ASTM). These standards include a list of 25 specifications that must be met for the fuel to be certified. It encompasses physicochemical properties such as density, viscosity and cetane number, and impurity content including unreacted glycerides, sulphur, calcium and magnesium, glycerol, phosphorus and so on.

In the case of straight vegetable oils, there is so far no official quality standard. The German institute for standardisation (Deutsche Institut für Normung, DIN) has issued a pre-standard for the quality of rapeseed oil as a fuel (DIN V 51605). However, this standard, in practice, shows some limitations of use because of its specificity to rapeseed and to test methods unsuitable to vegetable oils. Moreover, some test methods preconized by this standard require advanced and expensive laboratory equipment, which is not compatible with the production and use of SVO on small scales in African villages (Blin et al., 2013).

More recently, Blin et al. (2013) proposed a quality standard for the use of SVO in stationary diesel engines. As stationary engines are more robust and used at high stable loads, the proposed specifications are less restrictive than standard DIN V 51605. The authors gave special attention to propose test methods suitable to vegetable oils and that can be implemented with relatively simple laboratory equipment. The proposed standard includes 7 specifications presented in Table 3. Standard specifications for SVO as fuel in stationary diesel engines, as proposed by Blin et al. (2013) Two of them are optional: specific gravity and iodine value are to be measured if there is a doubt on the quality of SVO. These two parameters will help determining the origin of the oil (feedstock) and its purity.

Table 3. Standard specifications for SVO as fuel in stationary diesel engines, as proposed by Blin et al. (2013)

PARAMETER	UNIT	TEST METHOD	METHOD DESCRIPTION	LIMIT VALUE	
				MIN	MAX
Specific gravity at 15°C	kg/m ³	ISO 6883	Pycnometry	0.90	0.96
Kinematic viscosity at 40°C	Cst	ISO 3104	Falling ball viscometer	-	50
Iodine value	g I ₂ /100g	ISO 3961	Extraction - titrimetry	Report	
Phosphorus max	ppm	ISO 10540-1	Calcination-spectrocolorimetry	50	
Free fatty acid max	mg KOH/g	ISO 660	Extraction - titrimetry	3	
Total contamination (insolubles) max	ppm	ISO 663	Gravimetry	100	
Water content	ppm	ISO 8534	Coulometric titration (Karl Fischer)	750	

Among the parameters to be controlled, as presented in Table 3, four are related to impurities, i.e. phosphorus, free fatty acids, water and solid particles (contamination) content. Phosphorus content analysis is aimed at detecting the amount of phospholipids, which are undesirable constituents from the cell membranes of seeds and kernels. It is an essential concern in the quality of vegetable oil as a fuel, as using oil with a high level of phospholipids results in the formation of deposits, which coke in hot engine sections (combustion chamber and nozzle holes) (Sidibé et al., 2010). The phospholipid content of oilseeds varies among the species (Liu et al., 2012; Matthäus, 2012; Subramanian and Nakajima, 1997) and the amount that is dissolved in the oil largely depends on the extraction conditions: phospholipid mass fraction varies from 0.05% in palm oil up to 5% in soybean oil (Matthäus, 2012). The dissolution of phospholipid in the oil is very high in solvent extraction and in mechanical extraction, it rises with the pressing temperature and above all when cooking pre-treatment is employed.

Free fatty acid content is indicative of the degradation of the oil by hydrolysis of the triglycerides (Adeeko and Ajibola, 1990). Such hydrolysis reactions may take place in the seeds if they are stored under poor conditions (moisture), during pressing when high temperatures are reached, and during oil storage in the presence of water and light. Oil acidity is responsible for damage to engine feed circuits (hose, gasket, etc.), engine corrosion and SVO instability during storage (Blin et al., 2013).

Water present in oils comes directly from poorly dried biomass, or from condensation under poor oil storage conditions (Jiménez Espadafor et al., 2009). Water hydrolyses triglycerides to form free fatty acids. The presence of water in vegetable oil deteriorates fuel filter cartridges (Higelin, 1992). In addition, during combustion, water causes cavitation events, particularly at the piston head (Blin et al., 2013), which may cause

serious damage. In general, the presence of water in a fuel is detrimental, as it lowers the heating value, disrupts ignition and slows down flame propagation.

All these impurities can be removed by series of unit operations, called refining, as described in the next section.

2.3. Seed transformation processes: key performance factors

2.3.1 Oil extraction technologies

There are two great categories of oil extraction techniques: chemical extraction and mechanical extraction (termed oil expression).

Chemical extraction is only implemented for large-scale production. The vegetable oil is extracted using an organic solvent such as n-hexane allows high extraction yields (up to 99%) and is thus of special interest for seeds with low oil content such as soy and cotton (Matthäus, 2012). The seed meal obtained from chemical extraction contains 1% to 2% of oil. Most part of vegetable oil production globally, including in food industry, relies on this process or in a combination of mechanical and solvent extraction (Matthäus, 2012). This process however requires two to three times more energy than screw pressing, without considering the embedded energy of the solvent. Usually, refining operations follow the extraction. Moreover, n-hexane is a hazardous product and its massive use in this process generates high environmental impacts and health risk. Recent research works investigated the possibilities to displace the hexane by using enzymes or supercritical carbon dioxide, but further research is still needed to improve the economic viability of such solutions (Achten et al., 2008).

Mechanical oil extraction encompasses two types of processing equipment. The first, hydraulic press, has been used for centuries for pressing oilseeds. It is constituted of a plunger that exerts a pressure on a bed of seeds or seedcake. In the past, the plunger was driven by a lever or a worm, which now has been replaced by hydraulic cylinders. Most common presses provide pressures up to 30 MPa (Khan and Hanna, 1983) and have maximum processing capacities up to 200 kg of seeds /h. Operation is slow and breakdowns of hydraulic parts are frequent. Nowadays, these presses have been largely displaced by continuous screw-presses that allow for higher capacities and are more conveniently operated. However hydraulic presses are still in use for small productions and above all, for high-quality virgin oils, such as olive oil and cocoa butter. Frictions are indeed much lower in hydraulic than in continuous presses, allowing for oil expression at limited temperature thus preserving oil properties (Willems et al., 2008). Eventually, experiments on *Jatropha* seeds hydraulic pressing have shown that achieving acceptable oil yields required very high pressure on deshelled seeds; 70 MPa to extract 75% of the oil.

Screw press has become the most widespread equipment for extracting vegetable oils from dry oilseeds in small and medium-sized plants (Khan and Hanna, 1983). It is also

used for prepressing seeds with high oil contents prior to solvent extraction. Screw-presses are also widely used for high value vegetable oils (virgin), for small-scale processing in developing countries and for the production of straight vegetable oil (SVO) for fuel purposes.

A screw-press is composed of a barrel made of narrow spaced bars, in which a conical screw (worm shaft) rotates and presses the seeds (see Figure 8). The pressure increases along the screw due to reduced volume, and squeezes the oil through the seed mixture, termed cake, and out of the barrel through the spaces between the bars. The de-oiled press cake is discharged at the end of the screw. A mobile conical part, called choke, allows the adjustment of the outlet section of press cake. The mechanical strains inside the barrel are high, up to 50 to 100 MPa (Bredeson, 1977; Mrema and McNulty, 1985), and friction phenomena increase the temperature of the cake. The temperature build-up is crucial in the process since it lowers the oil viscosity and enables it to flow more readily through the pores of the cake (Khan and Hanna, 1983).

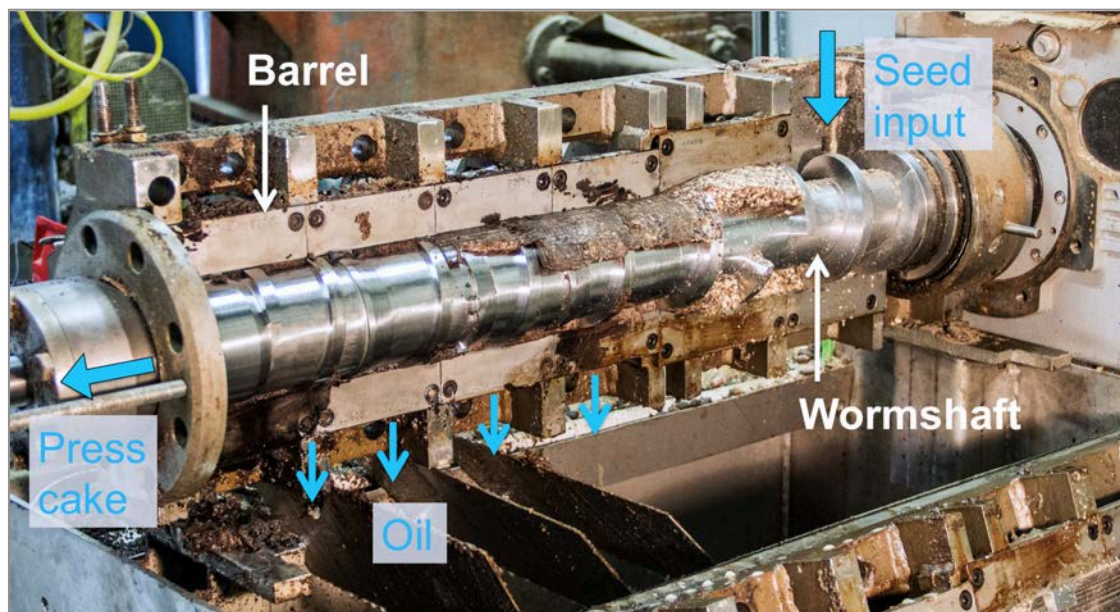

Figure 8. Screw-press with barrel open. (Source: A. Chapuis (2012))

Screw presses are usually driven by electrical motors and by. The energy requirement for pressing significantly varies with the type of seeds, their oil content and the achieved oil recovery (Karaj and Müller, 2011). It constitutes the main energy consumption of oilseeds processing and is an important consideration in the life cycle analysis of biofuels (Achten et al., 2008; Baumert, 2013; Ndong et al., 2009).

Prior to pressing, the seeds can undergo several preparation steps to facilitate oil expression and increase oil recovery. The most common pre-treatment operations are drying, dehulling, flaking, crushing and cooking. Thermal treatment (cooking) improves oil expression by thermally breaking oil cell walls but it results in higher contents of phospholipids and in some cases, higher contents of free fatty acids in the

oil (Matthäus, 2012; Veldsink et al., 1999). If such pre-treatments are applied for SVO production, the oil will have to undergo purification treatments such as neutralization and degumming to comply with quality needs for use as fuel in diesel engines (Blin et al., 2013). That is why cold pressing is usually preferred for SVO production, especially in small-sized installations.

After pressing, the crude oil contains solid particles called sediments up to about 5-10% (w/w), that have to be removed by filtration (Grimm, 1956). This operation can cause significant oil losses when sediment content is high (Ward, 1976). The losses also depend on the filtration equipment.

The most common equipment for small-scale processing is the plate and frame filter, also called filter press. It composed of a series of frames separated by filtering clothes and hold tight together by a binding system. The oil is injected at the centre of the frame, flows through the cloth and out at the bottom of the frame. The filtration support is constituted by the solid particles accumulated on the clothes, so when the filtration starts up, the filter has to be operated in closed-loop until it is loaded (Svarovsky, 2000). When the filter is full, the frames are loosened to get the filter cake off the clothes. Prior to discharging, the filter cake can be blown with pressurised air, which avoids significant losses by reducing filter cake oil content below 40% (Matthäus, 2012). It is thus a semi-continuous process, which can be automated in high-capacity oil plants.



Figure 9. Vertical pressure leaf filter. Highlighted area illustrates a sectional view of a leaf.
(Source: Filter MVDCD, © MAHLE Industrial Filtration, Alkmaar, The Netherlands)

However, for automated operations, the use of pressure leaf filters is usually preferred, because they are more compact, easily automated and can achieve high filtration rates. They are composed of a pressure vessel that encloses filtration surfaces called leaves. The leaves are made of a stainless-steel mesh covered on each side with a woven wire cloth stretched and sealed at the edges (see Figure 9). The crude oil is filtered from outside inwards through the cloth and the cake accumulated on the leaves constitutes the filtration medium (Bergstedt et al., 1957; Grimm, 1956; Svarovsky, 2000). Then, the filter is operated semi-continuously and the cake is blown with pressurized air before discharge. Pressure leaf filters are expensive but have relatively low operating costs.

2.3.2 *Jatropha* press cake valorisation

In the oilseed industry, the press cake is traditionally valorised as protein-rich animal feed. *Jatropha* press cake is highly rich in protein (58%) but contains toxic substances, mainly phorbol esters and curcumin, which prevents it from being directly used as fodder. Detoxification techniques are being investigated, but until now, no economically viable processes have been developed (Aregheore et al., 2003). Then, the three most likely options in the context are direct use as fertilizer, combustion and anaerobic digestion.

The properties of the press cake vary following its residual oil content. By way of example, press cake with an average oil content of 12% has a biochemical methane potential of 0.30 Nm³ CH₄.kg⁻¹ TS according to (Gunaseelan, 2009) and a lower heating value around 20 MJ.kg⁻¹ (Achten et al., 2008; Singh et al., 2008). Both methane potential and energy content increase with seedcake oil content. Chemically de-oiled seedcake has an average nutrient content of N: 3.5% - P: 1.7% - K: 0.8% (Achten et al., 2008), which is relatively high compared to other organic fertilizer such cow manure.

Local field experiments of *Jatropha* seedcake application as fertilizer on edible crops have shown very good results (Achten et al., 2008). Moreover, Devappa et al. have recently shown that the main toxic compounds of *Jatropha*, namely phorbol esters, are completely degraded in soil after 20 days or so (Devappa et al., 2010). This result removes most concerns on the safety of *Jatropha* seedcake application on edible crops. In addition, seedcake has pesticide properties (Achten et al., 2008). Therefore, seedcake appears to be a good substitute to chemical fertilizer, a scarce and expensive product. It requires transporting the seedcake back to the fields, which will probably be done using animal-driven carts, thus implying no extra energy costs.

Jatropha seedcake has proven to be a good feedstock for biogas production (Ali et al., 2010; Chandra et al., 2011; Gunaseelan, 2009; Prateek et al., 2009; Radhakrishna and Gollakota, 1989; Staubmann et al., 1997). This option would provide extra energy while keeping production of a good organic fertilizer via the fermentation slurry. Biogas can either be used to fuel internal combustion engines for electric or shaft power generation, or for heat generation for example for cooking needs or drying process. The first option requires clean biogas, with constant properties, which implies relatively sophisticated production equipment. The second option is technically simpler: it can be

accomplished using a basic bio-digester. However, due to the seasonal availability of humid biomass in Burkina Faso, it seems uneasy to stably run a biodigester all year long for domestic energy supply.

One of the main drawbacks is the water requirement of bio-digestion, especially since *Jatropha* seedcake is dry and water resource is already an important issue in Burkina. Then mixing seedcake with other fermentable wastes, such as wastewater, may be a good option (Mshandete and Parawira, 2010; Raheman and Mondal, 2012).

Eventually, the seedcake can be burnt for heat production needs. Its high energy content actually makes it an attractive solid fuel. However, experiments (Jongh and Putten, 2010) have shown that the combustion of seedcake in conventional cook stove releases a lot of smoke, due to oil content. It might be preferable to consider its use as fuel in an adapted industrial boiler.

2.3.3 Vegetable oil refining

For purposes of biodiesel production or when, right after extraction, the SVO does not match the quality standards, it has to be purified through a process called refining. Vegetable oil refining process derives from the food industry. For human consumption, oil refining consists in degumming (phospholipid removal), neutralization (free fatty acid removal), bleaching and deodorisation. The two latter are not required for use as fuel or further processing to biodiesel (Santori et al., 2012). Then, for biofuel purposes oil refining will consist in degumming, neutralization and drying.

In the vegetable oil industry, the most common techniques are the following: degumming is done by water washing with an optional acid pre-treatment; neutralization is realized by addition of an alkali followed by water washing; and drying is usually done at low pressure in a flash drum (Santori et al., 2012; Wiedermann, 1981). Depending on the oil properties (amount of phospholipids and free fatty acids), the operations may be intensified and the sequence swapped. This process is not very energy-intensive, but produces high amounts of wastewater contaminated with soap, sodium hydroxide and phosphoric acid (Pagès-Xatart-Parès, 2013).

Refining is usually implemented on large-scale, up to 100 000 tons/year (Landucci et al., 2013; Matthäus, 2012). Since it is a chemical process, the capital investment is high, so large-capacity implementation allows for faster amortisation. Nevertheless, refining process can be performed in batch mode, which limits the required capital and allow for lower capacity implementation. In occidental countries, batch refining is gradually displaced by continuous processes that are easier to control and thus more profitable. In contrast, in West African countries, where the infrastructure is expensive and the workforce is cheap and abundant, labour-intensive batch processes could remain a good option; especially for biofuels, for which the demand is still low.

Eventually, recent research works have proved that membrane filtration technologies allow dry degumming and neutralisation, at low temperature (20°C). This process

would be much more efficient, with lower operating costs, and thus available at smaller scale (Hafidi et al., 2005). However, research is still needed to fully control the operating conditions and no commercial process is yet available on the market.

2.3.4 Production of biodiesel from refined oil

The production of biodiesel from vegetable oil has been widely studied and is well documented in scientific literature. Biodiesel is produced from vegetable oil through a reaction of transesterification. During this reaction, triglycerides contained in the oil react with a short-chain alcohol, in practice ethanol or methanol, to form alkyl-esters (biodiesel) and glycerol, which is a by-product. This reaction is slow, so it has to be catalysed and conducted at high temperature (Knothe et al., 2005). The most common catalysts are alkali, such as sodium and potassium hydroxide, and acids such as sulphuric acid. Solid catalysts are also under development because they can be more easily recovered and reused after the process. Currently, the main alcohols used are methanol and ethanol.

Thus, from this variety of reactant and catalysts, many reaction procedures are possible and many proved to perform well in laboratory conditions. However, almost only one is implemented and is profitable on industrial scale that is the alkali-catalysed methanolic transesterification. This process offers many advantages such as high conversion rates with reasonable methanol excess, fast reaction and easy recycling of the methanol (Koh and Mohd. Ghazi, 2011; Santori et al., 2012). Its main shortcoming is its poor ecological performance. The methanol used as reactant is a by-product of the oil industry and its production requires large amounts of energy and generates greenhouse gas (GHG) emissions (Benoist, 2009). In comparison, all other processes present weaknesses hindering their economic viability, such as low conversion rates, expensive catalysts, expensive equipment or product separation issues (Koh and Mohd. Ghazi, 2011; Santori et al., 2012).

Commercially, biodiesel is produced in large-scale chemical plants, with an annual capacity ranging from 20 000 to more than 100 000 tons, in the case of continuous processes (Amigun et al., 2008). As for oil refining, the process can be operated in semi-batch mode and thus, implemented at smaller scale (Knothe et al., 2005; Santori et al., 2012). Nevertheless, the required capital investment is very high, nearly 10 M\$ for 30 000 t/yr. in 2005 (Amigun et al., 2008).

Transesterification is more energy intensive than refining, especially for the heat demand. This is mostly due to biodiesel drying and distillation of methanol that is used in excess in the reactor and recycled in the process. However, the main environmental impact, in terms of GHG emissions and fossil fuel depletion is due to the use of high amounts of methanol, which is a product from the oil industry (Achten et al., 2008; Banković-Ilić et al., 2012; Benoist, 2009).

3. Research objectives and methodology

This work is primarily aimed at developing a methodology to analyse the opportunities for the development of sustainable biofuel production chains, in view of providing decision makers with relevant elements to facilitate the elaboration of a biofuel policy framework. The approach is based on the analysis and the modelling of biofuel production processes, combined economic and environmental assessment methods.

3.1. Providing decision support to identify the best production pathways: the questions raised by the development of a biofuel policy

The present work was part of a project aimed at providing decision support to the West African Economic and Monetary Union (WAEMU) for the elaboration of a biofuel policy framework. The West African governments have clearly expressed their will to investigate the opportunities offered by the biofuels to address development issues, in a short to mid-term perspective, as presented in the first part of this chapter, encompassing rural to industrial development as well as environmental issues. Then, the scope was here limited to the case of *Jatropha* biofuels in Burkina Faso.

To provide a solid basis for political decision at this level, it is necessary to give the most comprehensive possible view of conceivable solutions. In particular, given the development disparities in geographical terms, the local to global effects of biofuel production should be considered. Moreover, special emphasis should be given to the social and economic aspects, including the creation of value added and its sharing out among the actors. Macro-economic effects are indeed a priority to policy makers, justified by the urgent need to raise the living standards.

So far, the environmental impacts of biofuels are given less importance, which is explained by many reasons. First, consumption levels are so low that the associated environmental impact of Burkina Faso, relatively to the number of inhabitants is negligible. The prime environmental concern in the country is the depletion of wood resources. Although this is a very serious question, it is not directly addressed by the development of biofuels, or only partially through the possible use of some by-products as firewood substitutes. But the reduction of firewood consumption is more likely to arise with the diffusion of dedicated technologies (improved and solar cookstoves, biogas...) in the short term or, over the long term, through the economic development of rural areas giving access to more advanced technologies.

3.2. Supply chains: from local small-scale to industrial biofuels

Based on the overview of the context and the available technologies, several scenarios can be envisioned to develop *Jatropha* biofuels in a sustainable way. Different production pathways exist, starting from local-small scale for providing access to energy in rural areas to the nationwide substitution of diesel fuels with biodiesel. In this section are presented three typical pathways for the production and use of biofuel from *Jatropha* (Hanff et al., 2011; Tatsidjodoung et al., 2012). These stereotypes are given as examples and to emphasize the opportunities and challenges of the development of biofuels on different levels. Of course, building scenarios assume that there is a willingness of the stakeholders to get involved in this sector, starting with the smallholders for the production of the feedstock.

3.2.1 Providing rural energy access

One of the main opportunities to directly tackle the issue of rural development would be to produce and distribute SVO locally to be used as a diesel substitute for power generation, motor-pumps or mills. This is an opportunity to improve the affordability of energy to rural populations, which might favour the development of new productive activities and more generally, improve the living standards. Actually, the production of SVO from *Jatropha* is in itself a new productive activity that could create employment and be a new source of income for the smallholders.

On the techno-economic side, this pathway would mostly involve small-sized SVO production units, relying on local seed production. The seedcake would be sold as organic fertiliser. Then, the economic viability will largely depend on the balance between the demand, the availability of the feedstock and the production capacity of the unit. Indeed, as the profitability is closely linked to the amortisation of the capital, a certain production capacity combined to a sufficient annual operating time is needed.

3.2.2 Producing SVO for national power generation

As mentioned previously, the electricity in Burkina Faso is mainly produced by thermal power plants equipped with high-power diesel engines fuelled with DDO or HFO 180. To work with heavy fuels, the engines are equipped with dual-fuelling systems just like those used with SVO. This end-use would allow substituting large amounts of imported and subsidized fossil fuels, which would have a very positive impact on the budget and on the national economy. Moreover, the centralisation of the end-use in a few power plants is likely to limit the distribution cost.

This pathway however requires the production of large amounts of SVO, which supposes the availability of the feedstock. SVO would be produced in large-scale installations, and thus benefit from important economies of scale and have possibilities for more advanced press cake valorisation. The main beneficiaries would be the State

for the reduction of subventions for power generation and the urban population for possible lower electricity cost. The seed production would provide a new source of income to the smallholders, but they would not benefit from a more affordable fuel.

3.2.3 Substituting diesel fuel on the national scale

Eventually, the most ambitious scenario consists in producing biodiesel to substitute fossil diesel fuel at the national level. Only a few full-scale biodiesel plants would be sufficient to displace the national diesel consumption, estimated to about 200 000 tons/year in 2008 (Tatsidjodoung et al., 2012). However, this solution is heavy to implement. It implies a high competitiveness since the fuels distributed for transport are taxed and it supposes to manage a large logistic system for the feedstock supply and the product distribution. Great areas of *Jatropha* are indeed required: for an average plant capacity of 20 000 tons of biodiesel per year, almost 100 000 ha with a seed yield of 1 ton/ha, would be necessary to supply the feedstock. On such a scale, logistics costs are likely to be significant, especially if the production is scattered. Then, it might difficult to only rely on the production from smallholders. Eventually, as a chemical process, biodiesel production requires good engineering skills and chemical input supply, which is scarce in Burkina Faso. Thus, this solution would be more suitable on a longer term, when *Jatropha* production will be more widespread.

3.3. Analysing complex and multi-disciplinary issues using process modelling as a backbone

The typical production pathways presented above give the outline of how a *Jatropha* biofuel sector could be developed in Burkina Faso. Among these stereotypes lies a range of different solutions, depending on the technologies, the implementation scales, the by-products valorisation, the energy supply options, the geographical configuration and so on. The impacts of biofuel production, in terms of sustainable development, will thus depend on many local factors and cannot be evaluated properly based only on stereotypes. It is necessary to consider well-defined technical pathways and to analyse all feasible solutions to identify the best ones and give a detailed picture of the opportunities and constraints.

To achieve these objectives, we developed in this work a methodology based on the techno-economic modelling of supply chains, combined to economic and environmental assessment methods. This approach, illustrated in Figure 10, is justified by the fact that economic and environmental performances are mostly a consequence of technical solutions. The outputs of technical models are thus used to feed the economic and environmental calculations.

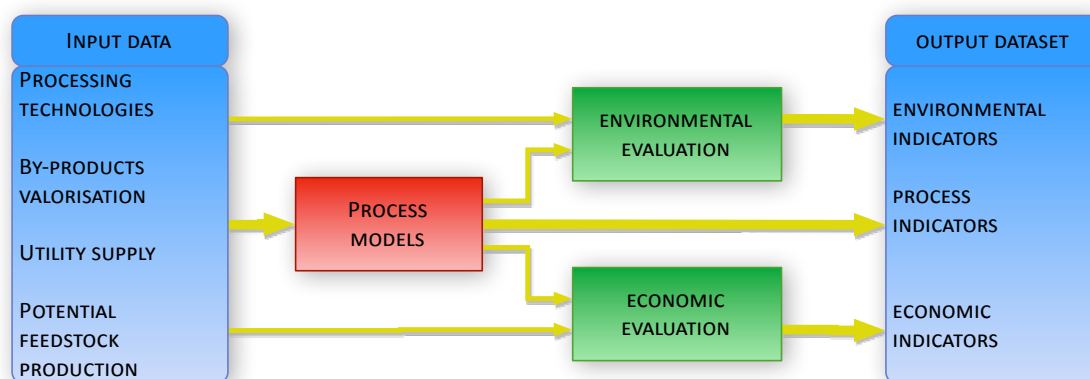

Figure 10. Diagram of the approach applied for evaluating prospective production pathways.

The goal of using models is to allow analysing the sensitivity of performances to a range of technical, economic and local variable parameters. This includes feedstock properties, process conversion efficiencies, energy supply, by-product valorisation for the technical part. Then, economic parameters are also included such as plant operating time, feedstock and product prices. Finally, based on logistics consideration in the local context, the different process models can be connected to form whole supply chains that are finally assessed for economic and environmental performance.

Then main asset of this methodology is to provide a very wide picture of the studied system, including all “points” within the range of variable parameters. The comparison of the sensitivity of parameters to their variability (the likeliness and the range of their variation in practice), provides very advanced information for the assessment of opportunities and risks. The relevancy of the results depends on both appropriate models and accurate context data on local parameters.

The completeness of the models depends on the availability of scientific and technical data. In this work, most process models are based on literature data, combined to specific software modelling in the case chemical processes (refining and transesterification). Also, for the extraction of vegetable oil by screw-pressing, experiments were conducted to fill the lack of available data and build an empiric model (Chapter 3). The description of process models is the object of Chapter 4.

Then, a sustainability assessment framework had to be defined, including a set of economic and environmental indicators as well as some basic principles for the definition of relevant scenarios in the present context. As described in Chapter 2, this framework was defined based on existing methods for economic, environmental and sustainability assessment and on the context analysis presented in this chapter. The equations related to economic and environmental assessment are presented in Chapter 5.

Eventually, the simulation and assessment of selected production pathways will be presented (Chapter 6). The results are first analysed in regard to the elements it brings

to support decision-making and of the biofuel development opportunities in Burkina Faso. Then the efficiency of the developed methodology and the perspectives of improvement will be discussed in the conclusion.

3.4. Boundaries of the study: technological options regarding the context

As the analysis of biofuel opportunities is here placed in a relatively short time horizon, the boundaries in terms of technology options were limited to commercial processes. This choice is also justified by the fact that the country has very few research and develop capacities. Moreover, it is almost impossible to have reliable cost data for technologies that are still under development and the simulation would then depend on very uncertain assumptions.

4. References

- Achten, W.M., Nielsen, L.R., Aerts, R., Lengkeek, A.G., Kjaer, E.D., Trabucco, A., Hansen, J.K., Maes, W.H., Graudal, L., Akinnifesi, F.K., others, 2010. Towards domestication of *Jatropha curcas*. *Biofuels* 1, 91–107.
- Achten, W.M.J., Verchot, L., Franken, Y.J., Mathijs, E., Singh, V.P., Aerts, R., Muys, B., 2008. *Jatropha* bio-diesel production and use. *Biomass Bioenergy* 32, 1063–1084.
- Adeeko, K.A., Ajibola, O.O., 1990. Processing factors affecting yield and quality of mechanically expressed groundnut oil. *J. Agric. Eng. Res.* 45, 31–43.
- Agarwal, D., Agarwal, A.K., 2007. Performance and emissions characteristics of *Jatropha* oil (preheated and blends) in a direct injection compression ignition engine. *Appl. Therm. Eng.* 27, 2314–2323.
- Ali, N., Kurchania, A.K., Babel, S., 2010. Bio-methanisation of *Jatropha curcas* defatted waste. *J. Eng. Technol. Res.* 2, 038–043.
- Amigun, B., Müller-Langer, F., Von Blottnitz, H., 2008. Predicting the costs of biodiesel production in Africa: learning from Germany. *Energy Sustain. Dev.* 12, 5–21.
- Aregheore, E.M., Becker, K., Makkar, H.P.S., 2003. Detoxification of a toxic variety of *Jatropha curcas* using heat and chemical treatments, and preliminary nutritional evaluation with rats. *S. Pac. J. Nat. Sci.* 21, 51–56.
- Banković-Ilić, I.B., Stamenković, O.S., Veljković, V.B., 2012. Biodiesel production from non-edible plant oils. *Renew. Sustain. Energy Rev.* 16, 3621–3647.
- Basha, S.D., Francis, G., Makkar, H.P.S., Becker, K., Sujatha, M., 2009. A comparative study of biochemical traits and molecular markers for assessment of genetic relationships between *Jatropha curcas* L. germplasm from different countries. *Plant Sci.* 176, 812–823.
- Baumert, S., 2013. Life cycle assessment of carbon and energy balances in *Jatropha* production systems of Burkina Faso (PhD). University of Bonn, Bonn, Germany.

- Becker, K., 2009. Biofuels from *Jatropha curcas* oil - perspectives for tropical regions. *OCL - Ol. Corps Gras Lipides* 16, 236–240.
- Benoist, A., 2009. Eléments d'adaptation de la méthodologie d'analyse de cycle de vie aux carburants végétaux : cas de la première génération.
- Bergstedt, D.C., Dahlstrom, D.A., Harms, V.D., 1957. Continuous Pressure Filtration Pilot Plant. Application to Vegetable Oils. *Ind. Eng. Chem.* 49, 1863–1870.
- Blein, R., Soulé, B.G., Dupaigne, B.F., Yérima, B., 2008. Les potentialités agricoles de l'Afrique de l'Ouest (CEDEAO). *FARM* Février.
- Blin, J., Brunschwig, C., Chapuis, A., Changotade, O., Sidibe, S.S., Noumi, E.S., Girard, P., 2013. Characteristics of vegetable oils for use as fuel in stationary diesel engines—Towards specifications for a standard in West Africa. *Renew. Sustain. Energy Rev.* 22, 580–597.
- Blin, J., Dabat, M.-H., Faugère, G., Hanff, E., Weisman, N., 2008. Opportunités de développement des biocarburants au Burkina Faso. KFW, GIZ, Ouagadougou.
- Boons, F., Howard-Grenville, J.A., 2009. *The Social Embeddedness of Industrial Ecology*. Edward Elgar Publishing.
- Bredeson, D.K., 1977. Mechanical pressing. *J. Am. Oil Chem. Soc.* 54, 489–490.
- Chandra, R., Vijay, V.K., Subbarao, P.M.V., Khura, T.K., 2011. Production of methane from anaerobic digestion of *jatropha* and *pongamia* oil cakes. *Appl. Energy*.
- Devappa, R.K., Makkar, H.P., Becker, K., 2010. Biodegradation of *Jatropha curcas* phorbol esters in soil. *J. Sci. Food Agric.* 90, 2090–2097.
- Divakara, B.N., Upadhyaya, H.D., Wani, S.P., Gowda, C.L., 2010. Biology and genetic improvement of *Jatropha curcas* L.: a review. *Appl. Energy* 87, 732–742.
- Drabo, I., Ilboudo, F., Tallet, B., 2003. Dynamique des populations, disponibilités en terres et adaptation des régimes fonciers: le Burkina Faso, une étude de cas. *CICRED/FAO*, Paris/Rome.
- Duba, G., 2013. Modélisation spatiale du potentiel de production de *Jatropha Curcas* L. au Mali, Burkina Faso et Bénin (Master thesis). Universités de Montpellier II et III, Montpellier.
- Gatete Djerma, C., Dabat, M.-H., 2013. Du vide institutionnel au partenariat multi-acteurs pour la définition de politiques en faveur des agrocarburants en Afrique de l'Ouest, in: *Quel Bilan et Quelles Voies D'avenir Pour Les Biocarburants et Les Bioénergies En Afrique?* Presented at the 4ème Conférence Biocarburants et Bioénergie, Éditions Sud Sciences et Technologies / Harmattan Burkina, Ouagadougou, pp. 164–175.
- Grimm, R.T., 1956. Leaf filter for foots removal from crude oil reduces labor and eliminates filter cloth and paper. *J. Am. Oil Chem. Soc.* 33, 437–439.
- Gunaseelan, N., 2009. Biomass estimates, characteristics, biochemical methane potential, kinetics and energy flow from *Jatropha curcus* on dry lands. *Biomass Bioenergy* 33, 589–596.
- Hafidi, A., Pioch, D., Ajana, H., 2005. Membrane-based simultaneous degumming and deacidification of vegetable oils. *Innov. Food Sci. Emerg. Technol.* 6, 203–212.

- Hanff, E., Dabat, M.-H., Blin, J., 2011. Are biofuels an efficient technology for generating sustainable development in oil-dependent African nations? A macroeconomic assessment of the opportunities and impacts in Burkina Faso. *Renew. Sustain. Energy Rev.* 15, 2199–2209.
- Harwood, H.J., 1984. Oleochemicals as a fuel: Mechanical and economic feasibility. *J. Am. Oil Chem. Soc.* 61, 315–324.
- Heller, J., 1996. Physic nut, *Jatropha curcas* L. Bioversity International.
- Higelin, P., 1992. Huiles végétales - biocombustible diesel: incidence des aspects thermiques liés au type de moteur sur la combustion. CIRAD-SAR.
- International Energy Agency, 2011. World energy outlook 2011. OECD Publishing, Paris.
- International Energy Agency, 2012. World Energy Outlook 2012. OECD Publishing, Paris.
- Jiménez Espadafor, F., Torres García, M., Becerra Villanueva, J., Moreno Gutiérrez, J., 2009. The viability of pure vegetable oil as an alternative fuel for large ships. *Transp. Res. Part Transp. Environ.* 14, 461–469.
- Jingura, R.M., 2011. Technical options for optimization of production of *Jatropha* as a biofuel feedstock in arid and semi-arid areas of Zimbabwe. *Biomass Bioenergy*.
- Jongh, J.A., Putten, E. van der, 2010. The *Jatropha* Handbook: From Cultivation to Application. FACT Foundation.
- Jongschaap, R.E.E., Corré, W.J., Bindraban, P.S., Brandenburg, W.A., 2007. Claims and Facts on *Jatropha curcas* L. Wageningen. *Plant Res. Int.*
- Karaj, S., Müller, J., 2011. Optimizing mechanical oil extraction of *Jatropha curcas* L. seeds with respect to press capacity, oil recovery and energy efficiency. *Ind. Crops Prod.* 34, 1010–1016.
- Karekezi, S., 2002. Poverty and energy in Africa—A brief review. *Energy Policy* 30, 915–919.
- Kaushik, N., Kumar, K., Kumar, S., Kaushik, N., Roy, S., 2007. Genetic variability and divergence studies in seed traits and oil content of *Jatropha* (*Jatropha curcas* L.) accessions. *Biomass Bioenergy* 31, 497–502.
- Khan, L.M., Hanna, M.A., 1983. Expression of oil from oilseeds—A review. *J. Agric. Eng. Res.* 28, 495–503.
- Knothe, G., Van Gerpen, J.H., Krahl, J., 2005. The biodiesel handbook. Amer Oil Chemists Society.
- Koh, M.Y., Mohd. Ghazi, T.I., 2011. A review of biodiesel production from *Jatropha curcas* L. oil. *Renew. Sustain. Energy Rev.* 15, 2240–2251.
- Kumar, A., Sharma, S., 2008. An evaluation of multipurpose oil seed crop for industrial uses (*Jatropha curcas* L.): A review. *Ind. Crops Prod.* 28, 1–10.
- Landucci, G., Pannocchia, G., Pelagagge, L., Nicoletta, C., 2013. Analysis and simulation of an industrial vegetable oil refining process. *J. Food Eng.* 116, 840–851.
- Legros, G., Ines, H., Nigel, B., Sophie, B., 2009. The energy access situation in

developing countries: a review focusing on the least developed countries and Sub-Saharan Africa. United Nations Development Programme.

Liu, K.-T., Gao, S., Chung, T.-W., Huang, C., Lin, Y.-S., 2012. Effect of process conditions on the removal of phospholipids from *Jatropha curcas* oil during the degumming process. *Chem. Eng. Res. Des.*

Malik, K., 2013. Human development report 2013: the rise of the South: human progress in a diverse world. United Nations Development Programme.

Matthäus, B., 2012. Oil Technology, in: Gupta, S.K. (Ed.), *Technological Innovations in Major World Oil Crops*, Volume 2. Springer New York, New York, NY, pp. 23–92.

Ministère de l'économie et des finances, 2012. Rapport général sur le secteur privé : Environnement des Affaires, Opportunités des Investissements et Partenariat Public et Privé. Presented at the 5ème Conférence de table ronde du Burkina Faso, Ministère de l'économie et des finances, Ouagadougou, p. 42.

Ministère de l'économie et des finances - Secrétariat Général, 2012. Situation du commerce extérieur du Burkina Faso en 2011. Institut National de la Statistique et de la Démographie, Ouagadougou.

Misra, R.D., Murthy, M.S., 2010. Straight vegetable oils usage in a compression ignition engine - A review. *Renew. Sustain. Energy Rev.* 14, 3005–3013.

Montagne, X., 2011. Carburants liquides Gazoles, jets fuels et autres distillats moyens. *Tech. Ing. Sources Dénergie Hors Nucl. base documentaire : TIB215DUO.*

Morad, A.F., 2011. *Jatropha curcas* L.

Mrema, G.C., McNulty, P.B., 1985. Mathematical model of mechanical oil expression from oilseeds. *J. Agric. Eng. Res.* 31, 361–370.

Mshandete, A.M., Parawira, W., 2010. Biogas technology research in selected sub-Saharan African countries—A review. *Afr. J. Biotechnol.* 8.

Ndong, R., Montrejaud-Vignoles, M., Saint Girons, O., Gabrielle, B., Pirot, R., Domergue, M., Sablayrolles, C., 2009. Life cycle assessment of biofuels from *Jatropha curcas* in West Africa: a field study. *GCB Bioenergy* 1, 197–210.

Ouédraogo, B., 2007. Filière bois d'énergie burkinabé: structuration des prix et analyse de la répartition des bénéfices. *Bois For. Trop.* 4.

Ozer, P., 2004. Bois de feu et déboisement au Sahel : mise au point. *Sci. Chang. Planétaires Sécher.* 15, 243–251.

Ozer, P., Hountondji, Y.-C., Niang, A.J., Karimoune, S., Manzo, O.L., Salmon, M., 2010. Désertification au Sahel: Historique et perspectives. *Bull. Société Géographie Liège* 54, 69–84.

Pagès-Xatart-Parès, X., 2013. Technologies des corps gras (huiles et graisses végétales). *Tech. Ing. Filière Prod. Prod. Orig. Végétale base documentaire : TIB433DUO.*

Prateek, S., Gopal, R., Mayur, S., Shilpkar, D., 2009. Biomethanation potential of *Jatropha* (*Jatropha curcas*) cake along with buffalo dung. *Afr. J. Agric. Res.* 4, 991–995.

- Radhakrishna, P., Gollakota, K.G., 1989. A pilot plant design and performance for biomethanation of non-edible oil cakes. *Energy* 14, 771–772.
- Raheman, H., Mondal, S., 2012. Biogas production potential of jatropha seed cake. *Biomass Bioenergy* In press.
- Rao, G.R., Korwar, G.R., Shanker, A.K., Ramakrishna, Y.S., 2008. Genetic associations, variability and diversity in seed characters, growth, reproductive phenology and yield in *Jatropha curcas* (L.) accessions. *Trees* 22, 697–709.
- Santori, G., Di Nicola, G., Moglie, M., Polonara, F., 2012. A review analyzing the industrial biodiesel production practice starting from vegetable oil refining. *Appl. Energy* 92, 109–132.
- Sidibé, S.S., Blin, J., Vaitilingom, G., Azoumah, Y., 2010. Use of crude filtered vegetable oil as a fuel in diesel engines state of the art: Literature review. *Renew. Sustain. Energy Rev.* 14, 2748–2759.
- Singh, R.N., Vyas, D.K., Srivastava, N.S.L., Narra, M., 2008. SPRERI experience on holistic approach to utilize all parts of *Jatropha curcas* fruit for energy. *Renew. Energy* 33, 1868–1873.
- SONABEL, 2012. Rapport d'activité 2012. Société nationale d'électricité du Burkina Faso, Ouagadougou.
- Staubmann, R., Foidl, G., Foidl, N., Gübitz, G.M., Lafferty, R.M., Valencia Arbizu, V.M., Steiner, W., 1997. Biogas production from *Jatropha curcas* press-cake. *Appl. Biochem. Biotechnol.* 63, 457–467.
- Subramanian, R., Nakajima, M., 1997. Membrane degumming of crude soybean and rapeseed oils. *J. Am. Oil Chem. Soc.* 74, 971–975.
- Svarovsky, L., 2000. *Solid-Liquid Separation*. Butterworth-Heinemann.
- Tatsidjodoung, P., Dabat, M.-H., Blin, J., 2012. Insights into biofuel development in Burkina Faso: Potential and strategies for sustainable energy policies. *Renew. Sustain. Energy Rev.* 16, 5319–5330.
- Veldsink, J.W., Muuse, B.G., Meijer, M.M.T., Cuperus, F.P., van de Sande, R.L.K.M., van Putte, K.P.A.M., 1999. Heat pretreatment of oilseeds: effect on oil quality. *Lipid/Fett* 101, 244–248.
- Ward, J., 1976. Processing high oil content seeds in continuous screw presses. *J. Am. Oil Chem. Soc.* 53, 261–264.
- Wiedermann, L.H., 1981. Degumming, refining and bleaching soybean oil. *J. Am. Oil Chem. Soc.* 58, 159–166.
- Willems, P., Kuipers, N.J.M., De Haan, A.B., 2008. Hydraulic pressing of oilseeds: experimental determination and modeling of yield and pressing rates. *J. Food Eng.* 89, 8–16.
- World Bank, 2013. *World development indicators 2013*. World Bank, Washington, D.C.,.

Chapter 2. Sustainability assessment of biofuel production systems: relevant criteria and available data

In this chapter is presented the method used for assessing the sustainability of biofuel production pathways. It starts with an overview of the concepts and tools related to sustainable development, showing that the most comprehensive tools are based on Criteria and Indicators methodology, which have been extensively used for biofuel ecological certification. As an example, we present the certification framework proposed by the Roundtable on Sustainable Biofuels (RSB). Then, each aspect of sustainable development of *Jatropha* biofuel is reviewed and analysed with regard to the present context and scope to identify the most suitable indicators, and those which can be considered in a prospective analysis. Eventually, we propose an assessment framework based on several sustainability indicators, most of them based on life cycle assessment and value chain analysis.

1. Overview of sustainability concepts and evaluation tools

1.1. Concepts of sustainable development

The assessment of production systems with regard to sustainable development is a complex problem involving multiple criteria, and raising both theoretical and practical questions. The first broadly-encompassing and widely accepted definition of sustainable development was proposed by the World Commission on Environment and Development in the Brundtland Report (WCED et al., 1987), i.e. '*Sustainable development is development that meets the needs of the present without compromising the ability of future generations to meet their own needs*'. This concept was further expanded to integrate society, environment and economy as the three target dimensions of sustainable development. In addition to these three 'pillars', implementing the concept of sustainable development implies determining temporal and spatial boundaries (Efroymsen et al., 2012). Defining objectives in terms of sustainable development necessarily involves setting a temporal horizon, in the same way that a geographical area determines a specific social, environmental and economic context.

Sustainability assessment constitutes an entire field of research in itself, one that involves a multitude of tools and techniques aimed at assessing - using a more or less integrated approach - the impact of projects, economic activities and regulations with regard to the three pillars of sustainable development (Ness et al., 2007). Devuyt et al. (2001) defined sustainability assessment as: '*a tool that can help decision-makers and policy-makers decide which actions they should or should not take in an attempt to make society more sustainable*' (Devuyt et al., 2001). Based on this definition as well as the work of Kates et al. (2005), Ness et al. (2007) suggested that the purpose of

sustainability assessment is *‘to provide decision-makers with an evaluation of global to local integrated nature–society systems in short and long term perspectives in order to assist them to determine which actions should or should not be taken in an attempt to make society sustainable.’* These two definitions show that sustainability assessment is clearly tied to private and political decision-making, with a prospective focus, and should involve multiple-scale consideration.

1.2. Current tools and framework of use

Several authors (Buytaert et al., 2011; Ness et al., 2007; Pope et al., 2004) have made an inventory of widely used tools and methods. Ness et al. (2007a) studied the use of these tools in the field of biomass energy. Tools were classified and constructive criticism was provided for each tool along with the object of focus of the tool (project, investment, product), temporal (ex-ante or ex-post) and/or spatial scale, and capacity to integrate and aggregate the different aspects of sustainable development.

Most of these tools are impact assessment tools - such as Life Cycle Assessment and Environmental Impact Assessment - or applied welfare economics tools, such as Cost Benefit Analysis, which assesses investment vs. gains in terms of social and environmental benefits. Environmental aspects are those most widely covered by these tools, at the expense of economic and social aspects. This may be explained by the fact that social impact is difficult to quantify, whereas economic assessment is often left to the competence of the private sector.

The tools which most effectively integrate the three dimensions of sustainable development are ‘Criteria and Indicators’ tools (Buytaert et al., 2011), mainly because they may include qualitative and quantitative criteria. Criteria and Indicators are used as decision-making tools in a wide number of fields, for example when assessing policies or in ecological certification. These tools consist in determining a number of indicators - for a given application - which measure as precisely as possible the sustainability of a system. The values measured by these indicators are then qualitatively assessed and aggregated in order to define an index (ex: Human Development Index), or weighed when used in the framework of participative decision-making.

Criteria and Indicators are particularly flexible since they can be used for ex-ante and ex-post assessment, as well as at different spatial scales depending on selected indicators (Buytaert et al., 2011; Pope et al., 2004). Using a spatial approach is particularly relevant when assessing sustainability, since different impacts do not apply on the same scale (Efroymsen et al., 2012): for example, greenhouse gas emissions have a global impact, the effect on economy can be measured on a local and national scale, whereas social impact is often measured on a local scale. Moreover, interpreting impacts strongly implies taking the social, environmental and economic context into consideration. As a consequence, assessing sustainability at different spatial scales is

crucial for facilitating decision-making with regard to development priorities such as rural development, macro-economic development or the creation of jobs in different sectors of activity (farming, services and industry).

In order to integrate these different dimensions in the case of the production of *Jatropha*-based biofuel in Burkina Faso, we chose to use criteria and indicators as tools for assessing *supply chains*. The concept of supply chain will then be linked to Value Chain Analysis (VCA) methodology (Dabat et al., 2010b; Fearne et al., 2012; Kaplinsky, 2000; Raikes et al., 2000). VCA, which will be further described, is an approach that provides a framework for a detailed analysis of economic impacts, with special emphasis on income creation and sharing out among the stakeholders. The notion of value chain makes it possible to compare the economic impact of different supply chains from the factory to the national level.

1.3. Ecological biofuel certification framework: a comprehensive tool for ex-post assessment

The ecological certification framework is taken as example for its comprehensiveness even if it is not directly applicable to the present case, since it is dedicated to ex-post assessment. However, analysing an ex-post assessment framework provides, besides the completeness, an idea of how impacts can be assessed for an existing supply chain. This section presents an example of biofuel certification framework. Then, based on the differences in viewpoints, its applicability to the present work is discussed.

1.3.1 The RSB certification framework

A large number of assessment frameworks have already been established for biomass energy, and more precisely biofuels. These assessment frameworks provide the principles and criteria to be met by projects in order to be deemed 'sustainable' (Buytaert et al., 2011). Most of the tools that are currently available are used for the ecological certification of biofuels and for assessing projects. This proliferation of frameworks stems from the controversial debate over biofuels (Dabat et al., 2010a; Dorin and Gitz, 2008; Lee et al., 2011; Walker, 2010), and the call from the European Union and member states to establish certification standards capable of guaranteeing that biofuels promote sustainable development and do not pose a threat for the environment.

These tools are all based on similar principles and criteria, even if some of them only apply to a specific product, for example, palm oil. Generally speaking, these tools are meant to be used for advanced projects or existing productions, and are therefore highly detailed tools. Moreover, assessment grids are very comprehensive in order to consider a majority of cases. In return, this comprehensive and unique nature confers to these assessment grids a poor ability to integrate local diversity, in spite of a substantial

documentation. In the present work, we analyse one of these grids and propose to apply its principles to the context of our study, as recommended by Pope and al (Pope et al., 2004). The grid we believe to be the most relevant in our case is that developed by the Roundtable on Sustainable Biofuels (RSB), an EU reference certification.

The RSB certification grid was established through a participative process involving all the players in the sector, governmental organizations, NGOs and civil society representatives, which gives it a certain level of legitimacy. The RSB certification grid features 12 principles, listed in Table 4, and each one of these principles determines a set of criteria which must be met by operators in order to obtain certification. This grid includes and itemizes most of the principles of sustainable development, as defined by Buytaert and al. (2011) for bioenergy. The assessment of criteria is detailed in methodological and instructions sheets.

Table 4. List of 12 principles and criteria as proposed by the Roundtable for Sustainable Biofuels (RSB, 2011)

Principles	Criteria
1. Legality: Biofuel operations shall follow all applicable laws and regulations.	1. Biofuel operations shall comply with all applicable laws and regulations of the country in which the operation occurs and with relevant international laws and agreements. (Operators who must comply: Feedstock Producer, Feedstock Processor, Biofuel Producer.)
2. Planning, Monitoring and Continuous Improvement: Sustainable biofuel operations shall be planned, implemented, and continuously improved through an open, transparent, and consultative impact assessment and management process and an economic viability analysis.	1. Biofuel operations shall undertake an impact assessment process to assess impacts and risks and ensure sustainability through the development of effective and efficient implementation, mitigation, monitoring and evaluation plans. 2. Free, Prior & Informed Consent (FPIC) shall form the basis for the process to be followed during all stakeholder consultation, which shall be gender sensitive and result in consensus-driven negotiated agreements 3. Biofuel operators shall implement a business plan that reflects a commitment to long-term economic viability.
3. Greenhouse Gas Emissions: Biofuels shall contribute to climate change mitigation by significantly reducing lifecycle GHG emissions as compared to fossil fuels.	1. In geographic areas with legislative biofuel policy or regulations in force, in which biofuel must meet GHG reduction requirements across its lifecycle to comply with such policy or regulations and/or to qualify for certain incentives, biofuel operations subject to such policy or regulations shall comply with such policy and regulations and/or qualify for the applicable incentives. 2. Lifecycle GHG emissions of biofuel shall be calculated using the RSB lifecycle GHG emission calculation methodology, which incorporates methodological elements and input data from authoritative sources; is based on sound and accepted science; is updated periodically as new data become available; has system boundaries from Well to Wheel; includes GHG emissions from land use change, including, but not limited to above- and below-ground carbon stock changes; and incentivizes the use of co-products, residues and waste in such a way that the lifecycle GHG emissions of the biofuel are reduced. (Operators: all) 3. Biofuel blends shall have on average 50% lower lifecycle greenhouse gas emissions relative to the fossil fuel baseline. Each biofuel in the blend shall have lower lifecycle GHG emissions than the fossil fuel baseline. (Operators: fuel blenders)

<p>4. Human and Labour Rights: Biofuel operations shall not violate human rights or labour rights, and shall promote decent work and the well-being of workers.</p>	<ol style="list-style-type: none"> 1. Workers shall enjoy freedom of association, the right to organize, and the right to collectively bargain 2. No slave labour or forced labour shall occur. 3. No child labour shall occur, except on family farms and then only when work does not interfere with the child's schooling and does not put his or her health at risk. . 4. Workers shall be free of discrimination of any kind, whether in employment or opportunity, with respect to gender, wages, working conditions, and social benefits. 5. Workers' wages and working conditions shall respect all applicable laws and international conventions, as well as all relevant collective agreements. Where a government-regulated minimum wage is in place in a given country and applies to the specific industry sector, this shall be observed. Where a minimum wage is absent, the wage paid for a particular activity shall be negotiated and agreed on an annual basis with the worker. Men and women shall receive equal remuneration for work of equal value. 6. Conditions of occupational safety and health for workers shall follow internationally-recognized standards. 7. Operators shall implement a mechanism to ensure the human rights and labour rights outlined in this principle apply equally when labour is contracted through third parties. <p>(Operators: all)</p>
<p>5. Rural and Social Development: In regions of poverty, biofuel operations shall contribute to the social and economic development of local, rural and indigenous people and communities.</p>	<ol style="list-style-type: none"> 1. In regions of poverty, the socioeconomic status of local stakeholders impacted by biofuel operations shall be improved. 2. In regions of poverty, special measures that benefit and encourage the participation of women, youth, indigenous communities and the vulnerable in biofuel operations shall be designed and implemented <p>(Operators: all)</p>
<p>6. Local Food Security: Biofuel operations shall ensure the human right to adequate food and improve food security in food insecure regions.</p>	<ol style="list-style-type: none"> 1. Biofuel operations shall assess risks to food security in the region and locality and shall mitigate any negative impacts that result from biofuel operations. (Operators: all) 2. In food insecure regions, biofuel operations shall enhance the local food security of the directly affected stakeholders. (Operators: all but smallholders)
<p>7. Conservation: Biofuel operations shall avoid negative impacts on biodiversity, ecosystems, and conservation values.</p>	<ol style="list-style-type: none"> 1. Conservation values of local, regional or global importance within the potential or existing area of operation shall be maintained or enhanced. 2. Ecosystem functions and services that are directly affected by biofuel operations shall be maintained or enhanced. 3. Biofuel operations shall protect, restore or create buffer zones. 4. Ecological corridors shall be protected, restored or created to minimize fragmentation of habitats. 5. Biofuel operations shall prevent invasive species from invading areas outside the operation site.
<p>8. Soil: Biofuel operations shall implement practices that seek to reverse soil degradation and/or maintain soil health.</p>	<ol style="list-style-type: none"> 1. Operators shall implement practices to maintain or enhance soil physical, chemical, and biological conditions.

<p>9. Water: Biofuel operations shall maintain or enhance the quality and quantity of surface and ground water resources, and respect prior formal or customary water rights.</p>	<ol style="list-style-type: none"> 1. Biofuel operations shall respect the existing water rights of local and indigenous communities. 2. Biofuel operations shall include a water management plan which aims to use water efficiently and to maintain or enhance the quality of the water resources that are used for biofuel operations. 3. Biofuel operations shall not contribute to the depletion of surface or groundwater resources beyond replenishment capacities. 4. Biofuel operations shall contribute to the enhancement or maintaining of the quality of the surface and groundwater resources..
<p>10. Air: Air pollution from biofuel operations shall be minimized along the supply chain.</p>	<ol style="list-style-type: none"> 1. Air pollution emission sources from biofuel operations shall be identified, and air pollutant emissions minimized through an air management plan. 2. Biofuel operations shall avoid and, where possible, eliminate open-air burning of residues, wastes or by-products, or open air burning to clear the land.
<p>11. Use of Technology, Inputs, and Management of Waste: The use of technologies in biofuel operations shall seek to maximize production efficiency and social and environmental performance, and minimize the risk of damages to the environment and people.</p>	<ol style="list-style-type: none"> 1. Information on the use of technologies in biofuel operations shall be fully available, unless limited by national law or international agreements on intellectual property. 2. The technologies used in biofuel operations including genetically modified: plants, micro--organisms, and algae, shall minimize the risk of damages to environment and people, and improve environmental and/or social performance over the long term. 3. Micro-organisms used in biofuel operations which may represent a risk to the environment or people shall be adequately contained to prevent release into the environment. 4. Good practices shall be implemented for the storage, handling, use, and disposal of biofuels and chemicals. 5. Residues, wastes and by-products from feedstock processing and biofuel production units shall be managed such that soil, water and air physical, chemical, and biological conditions are not damaged.
<p>12. Land rights: Biofuel operations shall respect land rights and land use rights.</p>	<ol style="list-style-type: none"> 1. Existing land rights and land use rights, both formal and informal, shall be assessed, documented, and established. The right to use land for biofuel operations shall be established only when these rights are determined. 2. Free, Prior, and Informed Consent shall form the basis for all negotiated agreements for any compensation, acquisition, or voluntary relinquishment of rights by land users or owners for biofuel operations.

1.3.2 Commonalities and differences with the present work

RSB, as other biofuel certifications, mainly applies to products made from raw materials produced in Southern Countries, and intended to satisfy a demand in developed countries. The commitment made by certain developed countries, mainly European countries, to use a certain share of biofuel in their energy mix, largely contributed to encouraging this system. This commitment ensured a huge and stable market to biofuel producers, who started to massively produce biofuel in Southern Countries, sometimes at the expense of food security and human rights (Cotula et al., 2008). For this reason, certifications such as RSB, were developed to provide importing

countries with a guarantee that imported biofuel is produced in socially and ecologically acceptable conditions in Southern Countries.

The main asset of this certification grid is to cover most of sustainability aspects, including all possible risks and threat to sustainability. The instructions sheets also provide the methods to be employed for assessing the criteria in practice, for a given project. The operators apply for certification on a voluntary basis. Then, if the application is retained, a screening exercise should help determine the investigation level required for each principle and the methods to be used. For qualitative principles, the validation depends on the ability of the operators to provide “objective evidence” of compliance with RSB criteria. The application of specific assessment methods can be required, which often relies on audit by experts and on local surveys. Then, the whole assessment is a heavy procedure and involves significant costs. Consequently, RSB is mainly turned towards large-scale production and processing, while smallholders are often left behind (Lee et al., 2011). However, in Burkina Faso for example, the most sustainable biofuel production schemes are likely to be those involving smallholders and dedicated to domestic market (Dabat et al., 2010a; Hanff et al., 2011).

As opposed to RSB, the assessment method applied in this work is primarily designed for producing countries. It can be used to assess and compare the benefits and the risks tied to different biofuel supply chains, namely with a view to providing a reliable and comprehensive support tool for political decision-making. As the RSB is dedicated to certifying biofuel producers, economic performance is not questioned in the assessment, neither the macro-economic implications, while they are crucial elements for local policy-making. They are also in close relation to principle 5 on rural and social development. To field this gap, value chain analysis (VCA) will be applied in order to give an insight of economic viability and income distribution. VCA will be described in the next section.

While RSB is dedicated to the assessment of on-going project (ex-post), the present work aims at assessing prospective scenarios. Thus, principles 1, 2, 4, and 11 are assumed to be met in a prospective analysis. Indeed, they are related either to the compliance with the existing legislation (1, 4), or to the environmental and risk management methods at the factory level (2, 11). The case of principles 8, 9 and 10, related to the protection of soil, water and air respectively, is similar in the sense that they are also submitted to environmental legislation. However, as they are also tied to technical parameters, they are further discussed in Section 0 and 4.4.

Then, all other principles are taken into account, in the limit of what can be predicted in a prospective analysis with the available data and within the time dedicated to this project. The application of principles 3, 5, 6, 7 and 12 is discussed in the following sections of this chapter. Principles 3, 5 and indicators related to economic impacts are analysed based on the results of supply chain modelling and simulation while principles 6, 7 and 12 are rather considered through the assumptions defined and the type of supply chain considered.

As our objective is to compare different supply chains, a special attention is given to defining discriminating indicators, i.e. which vary in a significant way between the different supply chains. Then, a specificity of certification is to provide indicator threshold value for the validation of criteria, which is not the case of this work. Then, no threshold was set for indicators, neither weighing factors, which would induce too much subjectivity in the assessment. The objective is rather to give a picture of the performances of several supply chains, each having its own assets and drawbacks regarding the context. The definition of development priorities is left to the competence of policy-makers.

2. Ensuring the social viability of biofuel supply chains

2.1. Food security and land rights

Food security is one of the most controversial issues tied to biofuels, and this is particularly true in the case of Africa (Cotula et al., 2008). Food security is an extremely complex concept, one that involves a number of different elements: availability, accessibility, utilization, beliefs and stability (FAO, 2008). Then, the development of biofuel activities in such a context represents both an opportunity and a threat to food security (Dabat et al., 2010a). On the one hand, biofuel production in rural areas is expected to provide affordable fuel access, thus facilitating mechanized operations including cultivation, harvest and product transformation. On the other hand, the uncontrolled development of *Jatropha* production for biofuels could lead to a reduction of local food production by the displacement of food crops with *Jatropha*.

This last risk is closely related to the respect of land rights, which is another burning issue tied to energy crops as there is a potential threat of land grabbing at the detriment of rural populations (Cotula et al., 2008). In West Africa, property rights consist in a complex layer of customary rights and duties, plus a land ownership legislation which is revised and amended on a regular basis. In Burkina Faso, the 034-2009 law on land ownership rights has not yet been promulgated, and officially acknowledges customary rights. As part of this law, negotiated frameworks (land ownership charters) will be defined for each district.

Then, the consequences of *Jatropha* biofuel development on both food security and land rights depend on a range of political and social factors that are far beyond the scope of this study. At the stage of a prospective analysis such as the present thesis work, these questions cannot be fully addressed. Nevertheless, some basic precautions can be taken by making realistic, or at least not over-optimistic, assumptions for feedstock production potential. In the present case, this will be possible relying on a detailed geographical work from Duba (2013) analysing the territorial potential for *Jatropha* seed production.

Using GIS, the author has conducted a spatial analysis bringing together pedoclimatic constraints, conservation areas and a model of space uses at the village level. First, accessible areas are defined based on areas with suitable pedoclimatic conditions to which are deduced protected areas (national parks, wildlife and cynegetic reserves, forests), urban areas, rainfed and irrigated croplands and buffer zones around watercourses. Then, using statistical demographic data of villages, the authors estimated the spaces needed by each village for common activities such as agriculture, wood collection, pasture and so on. This takes into account the expected demographic increase by 2015. Eventually, based on these data, the authors estimate the production potential following different scenarios, including agro-industrial crops of 10 000 ha in one piece or scattered in 100 ha pieces, and village-level production taking into account the capacity of households to invest in new productions. The results of the study show that a number of constraints seriously restrain the production potential on a national level. However, according to this study, some areas in the southern and eastern part of the country would be suitable for significant production of *Jatropha*.

2.2. Rural development and access to energy

The implementation of *Jatropha* biofuel production is expected to participate to the development of rural areas in two main ways: first by providing additional incomes to the stakeholders involved in the biofuel supply chain and second, by providing access to biofuels cheaper than fossil fuels (Hanff et al., 2011; Tatsidjodoung et al., 2012). The links between energy access and development were discussed in Chapter 1, Section 1.4. The concretisation of the emergence of new economic activities and the improvement of living standards following biofuel development should result from a series of expected/desirable effects, which are not systematic, since they involves broader socio-economic mechanisms. By way of example, the fact that a smallholder gets additional income does not systematically imply that he will improve his living conditions by spending more money in health services or education. Then, rural development cannot be simply considered as a systematic consequence of additional income and energy access, and thus cannot be fully assessed in a prospective analysis.

Nevertheless, even if the consequences are not systematic, providing new additional incomes and energy access constitutes favourable conditions for rural development (Dabat et al., 2010a). The creation of additional income for smallholders is studied through economic analysis of supply chains as described in Section 3.3. Then, energy access improvement and other economic benefits (tied to intermediaries involved in the supply chain and indirect effects) can be qualitatively analysed depending on the type of supply chain considered and how it targets rural populations. For example, in the frame of a large-scale production of biodiesel, rural population will benefit from additional incomes from *Jatropha* cultivation, but probably not from better energy access, since biodiesel production is centralised and distributed through the national

network. On the other hand, SVO produced on small-scale in rural areas is likely to be distributed locally, thus increasing the local impact of the supply chain.

2.3. Underlying political position and ethics related to development questions

Working on sustainability and development issues raises difficult questions of legitimacy and objectivity: what defines a sustainable development independently from any given culture? What share of politics and culture do we put in our reasoning? When does subjective judgement take the pace on scientific proof? It is necessary to take care of these questions before claiming scientific conclusions (Boons and Howard-Grenville, 2009). To give an example of the possible bias, we discuss here some points about the way international organisations promote development projects. This is directly linked to this work because of the omnipresence of development organisation on the field. (This work itself is funded by the European Commission)

The postulate that technological development is the base of any human development has been widespread by the globalization of the occidental model. Therefore, the good intention of helping poor rural population by fostering the access to so-called modern technologies is charged with this political/cultural position. This is exacerbated by the fact that most development projects are funded by international organisations (UNDP, World Bank, multi- and unilateral cooperation programs) that are promoting the same pre-defined development scheme all around the world. Practically, this is relayed by the prescriptions described in the call-for-project emitted by these organisations.

Then, inevitably, when promoting specific human development schemes through project funding, arises the need for defining, evaluating, judging development levels. International organisations tend to make uniform the evaluation criteria, thus fostering the cultural globalization trend. By way of example, gender approach and community-based projects are very recurrent and among the most controversial principles, especially because they are cultural and local-specific questions.

The trend of gender approach promotion became particularly popular after the success story of the Grameen Bank in Bangladesh, a social business created by Nobel peace prize M. Yunus, to provide women with micro-credit for business creation (Yunus, 2009). The success of this experience has been interpreted as the proof that the empowerment of women in business activities is a key success factor, confirming that the so-called emancipation of women as it occurred in the Occident is a necessary phase for development, and so that development programs should systematically promote it. However, it is sometimes a factor of failure of promising development projects (Sovacool et al., 2013). The ideal roles of men and women in the society is closely linked to cultural background and to familial schemes. And there are many social schemes, other than the occidental one, that are not contradictory with human development.

Another example is the difficulty to implement successful community-based projects. Community-based management of development projects is an approach that has been extensively promoted to increase the involvement and empowerment of local population in development projects. While this is in theory an ideal model from a social and human development view, in practice, successful examples of community-based management are scarce (Campbell and Vainio-Mattila, 2003; Stephen R. Kellert, Jai N. Mehta, S, 2000). By way of example, the results of UNDP project on multi-functional platforms in Burkina Faso and Mali is very mitigated. While thousands of agricultural platforms were effectively set out in villages, many management committees have failed in ensuring long-term operation of equipment, including maintenance and fuel purchase (Brew-Hammond, 2007; Nygaard, 2010; Sovacool et al., 2013). On the other hand, the platforms under private management (by a member of the community) tend to yield better results. However, this is not really a surprise, since there are only few examples in the western society, of successful community management of economic projects.

Therefore, the legitimacy and adequacy of the approaches promoted by development programs is questionable, even if they are based on humanistic values. Moreover, promoting the same schemes indifferently of local context may introduce cultural gaps that seriously impede the success of the projects.

In this work, the development of biofuel supply chains is considered as mostly based on private initiative, so as to ensure economic viability, which is, in the end, a prime condition for the success of self-sustained activities. In this framework, the social benefits could still be increased by implementing the principles of social business, also developed by M. Yunus, without necessarily trying to impose women empowerment.

3. Economic implications of biofuel development and value chain analysis

Regarding the context analysis developed in Chapter 1, the economics of biofuel development is of major importance, especially as it has large consequences including the reduction of energy cost, the contribution to economic growth and the creation of employment and of additional incomes for smallholders. Then, several levels of economic analysis are required to provide a comprehensive assessment, starting from the financial analysis of the activities involved in biofuel production, to the creation of income and its distribution.

While the financial aspects of biofuel processing are frequently addressed in the literature using accounting methods, the macro-economic implications are almost never considered. This issue is not either within the scope of ecological certification bodies. In this work a methodology inspired from Value Chain Analysis (VCA) is proposed. More precisely, the original methodology is typically francophone and is termed “*filière*” approach. It has been developed by socio-economists from INRA and CIRAD

to analyse the production of commodities from agriculture (Dabat et al., 2010b; Raikes et al., 2000). Further in this text, the “filière” approach will be referred to as VCA. As described in the next section, VCA is a very comprehensive analysis and only the part related to value added creation and sharing will be used here.

3.1. The agricultural value chain: a concept first implemented for economic analysis

Value chain assessment (VCA) is mainly used in the field of economy, and provides political decision-makers with key information for making strategic decisions. This meso-economic approach, which studies the aspects of economy on a level between that of a factory and that of an entire sector of activity, integrates macro- and micro-economic considerations, technical options for every function of the supply chain, the organization of economic players and the spatial dimension of activities. Given the considerable impact of these factors on sustainability, the supply chain is a particularly useful framework for identifying relevant factors, assessing their influence and providing essential elements for supporting decision-making.

Economists first used the term ‘value chain’ during the emergence of industrial farming to describe a meso-economic category consistent with the concept of national economic branch, one involving industrial-scale production, processing and trading. The term ‘value chain’ encompasses all of the different economic activities tied to the production and consumption of goods and services. Duruflé et al. (1988) were among the firsts to give a conceptual definition of the ‘value chain’ as referring to *‘all of the economic players (or fraction of these players) that contribute to bringing a raw material through the value chain (production, processing and shipping) so it can be sold on the market as a finished product (agricultural commodity). The term ‘supply chain’ covers the end-to-end value chain, from upstream activities tied to the production of raw material - or intermediate product - through to downstream activities, involving processing and adding value to raw material, in order to produce a finished product that is ready to be sold on the market.*

In this context, the supply chain is used as a means of describing the flow of commodities and financial assets (cash flow and material flow) between the players involved at every stage of the biofuel production: a series of processes, players and markets, mapped out in a simple way.

The sectorial delimitation of (agricultural) supply chains depends on the economist and the studied sector. Certain economists consider the agricultural supply chain to begin at the stage where inputs are supplied for intensive farming (companies supplying/manufacturing fertilizers and crop protection products, etc), whereas other economists consider it to begin at the stage of production, with some including and others excluding downstream consumption, which does not have a productive function.

Taking downstream consumption into consideration is particularly important in the case of bioenergy, since the end product is used as an input for production in other sectors of activity. Biofuel supply chains produce and process agricultural feedstock (*Jatropha*, sugar cane, oil palm tree, sweet sorghum, etc.) into agricultural and industrial commodities (straight vegetable oil, biodiesel, ethanol) that are sold to and used as intermediate products by industries operating in different sectors of activity (production of electricity, haulage, agro-industry, small businesses, etc.) or consumed by private households (electricity, consumer goods), locally (agricultural platforms, mills, water pumps, etc.) and nationwide (power plants, hydroelectric power plants, fuel distribution, etc.), and used in place of imported energy (diesel fuel, DDO, fuel oil, etc.), or to meet new demands (agricultural mechanization, irrigation, welding, etc.)' (Gatete Djerma and Dabat, 2014). The economic assessment of the bioenergy supply chain usually excludes downstream consumption by end-users (households) and supply in the form of an intermediate product to economic players. The end use of bioenergy by economic players is beyond the scope of VCA. Instead, it is taken into consideration when assessing the impact of the supply chain on its economic environment.

Then, the application of VCA to *Jatropha* biofuel supply chains will provide information concerning its economic efficiency, including its ability to create value and to equitably share it out among the stakeholders (operators, employees, banks and State). This information is highly useful to both macro-economic considerations, such as the cost and benefit of biofuels for the State, and also to socio-economic impacts, such as the remuneration of smallholders and the creation of employment (related to RSB Principle 5, "Social and rural development").

3.2. Description of *Jatropha* biofuel supply chains

In the present study, the supply chain is limited upstream to the consumption of input by the economic players and downstream by the sale of end-products on the market. The final use is not directly included in the boundaries, because for a given supply chain, there could be a range of different end-uses. However, it is still possible to qualitatively analyse the most likely end-uses, based on the final product (SVO or Biodiesel), on the volume produced and on the area of production.

To avoid any adverse impact on land rights and food security, and considering the need for rural development, we will assume that *Jatropha* cultivation is ensured by smallholders on their own land, whatever the type of supply chain. Then, the seeds are processed into biofuel, either SVO, refined oil or biodiesel. These operations can be realised on the same site by a unique player or in the case of refined oil and biodiesel, in a large –scale plant supplied by several SVO production plants. The functions of each player in the supply chain are presented in Figure 11. It can be noticed that this analysis, only the players involved in production and processing are considered.

Although the role of intermediaries and distributors can be very important, this is part of the aspects of a supply chain that cannot be planned in a prospective analysis.

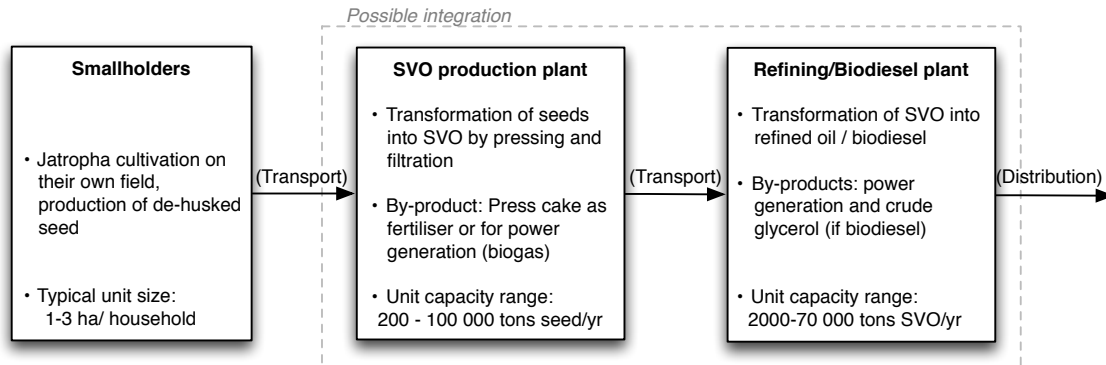

Figure 11. Description of supply chain players' functions

3.3. The creation and distribution of value added

3.3.1 Definition of value added

The concept of value added (VA) allows to measure the economic value created by a company, but only the additional value, which gives the gross domestic product, when summed up over the national territory. Concretely, this value is distributed in four main forms (see Figure 12), including wages to the employees, financial fees to the banks, taxes to the State and operating income to the players. It can also be calculated as the turnover minus intermediate consumption, which includes goods and services consumed by the company. The operating income and value-added can be calculated as gross or net value, i.e. including or excluding the amortisation.

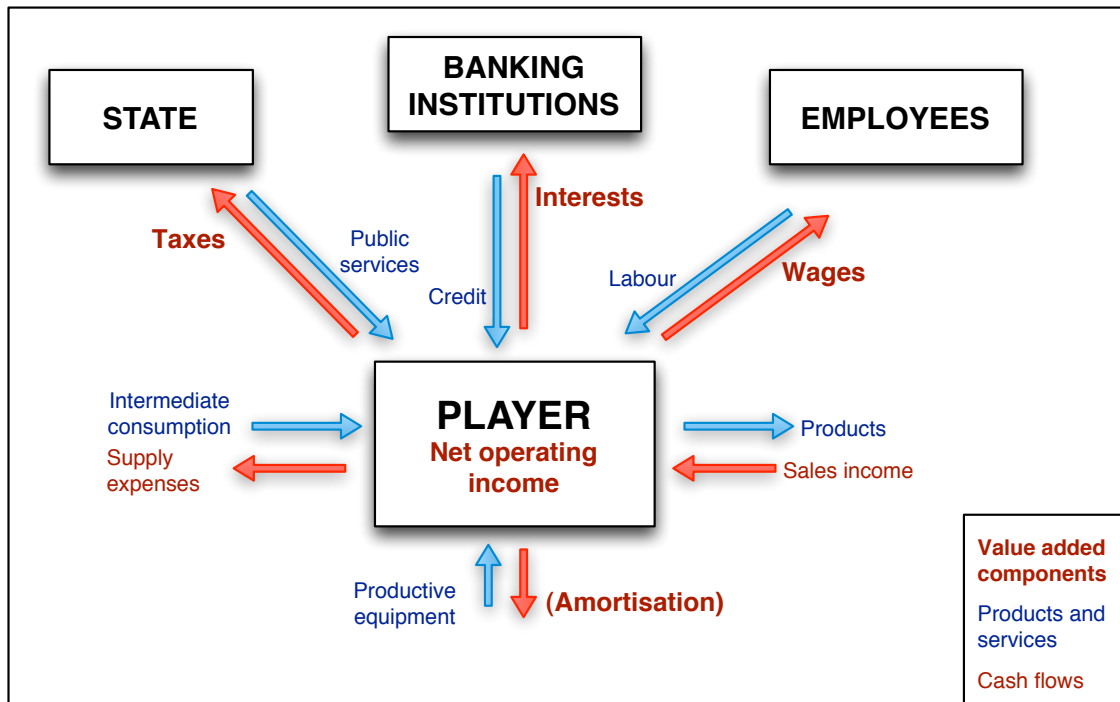

Figure 12. Value added creation by a supply chain economic player .

The overall value added of the supply chain can be calculated as the sum of the value created by each player, giving the direct contribution to domestic product. Then, the value added can be broken per type of player (smallholders, biofuel processors) who creates it, and per beneficiaries (employees, State, banks and supply chain players). This can typically be presented on two pie charts, the comparison of which gives indications on the distributive function of the supply chain. Eventually, according to the type of supply chain and location of the players, the geographical distribution of the value can also be analysed.

3.3.2 The effects of *Jatropha* supply chain on national economy

The use of biofuels can either constitute an additional energy consumption, or as a substitution of fossil fuels. In any case, the effect overall effect of the biofuel supply chain should be compared with the “business-as-usual” solution, consisting in relying on imported fossil fuels. In this study, only the direct effects are considered, by calculating the direct value added creation. However, the intermediate consumption may be divided as import (cost in foreign currencies = value leaving the country) and local consumption, which in turn, constituted of value added, import, and local consumption and so forth. This is the indirect effect of the supply chain, which determination requires a quantity of data.

While the consumption of imported fossil mostly induces costs in foreign currencies, the consumption of locally produced biofuels would allow to distribute most of the value within the country. Then, even if biofuel competitiveness in terms of production cost is limited, it might be more viable on a macro-economic level than imported fossil fuel (Nonyarma and Laude, 2010).

3.3.3 The state's income

The share of value added going to the state is mostly constituted of taxes on value added, on school, and on commercial and industrial profits. These taxes are paid by all supply chain players having a declared activity. A part of the supply chain is likely to rely on the informal sector, especially for commercial and transport activities relying on small businesses. Then, the amount of taxes depends on the legal status of the player: farmers, alone or within cooperative are exempted of all taxes. The tax on commercial and industrial benefits (CIB) is paid by all private companies and is calculated as 35% of operating income, with specific incentive measures applying to new companies. Eventually, the value added tax (VAT) at unique rate of 18% applies to all economic activities, having an annual turnover higher than 30 M FCFA (about 50 000 €). Several business sectors are exempted, including agricultural products, pesticide and fertilisers.

When analysing state's income, the substituted product should be taken into account. Indeed, as part of imported fossil fuels is subsidised, the substitution with locally produced biofuels would indirectly provide substantial benefit (Hanff et al., 2011; Nonyarma and Laude, 2010). However, this applies only to the fuels used for power generation, while significant taxes are levied on fuels intended for other uses.

3.3.4 Wages, job creation and benefits

The revenue generated by *Jatropha* and distributed in the form of wages may be used to pay for public and private services (health, education), living expenses and consumer goods, thus new jobs will contribute to improving living conditions. On the other hand, the net profits (or operating income) made by the players are rather dedicated to be spent for new productive investments and also for paying dividends and bonuses. In rural areas, this additional profit might contribute to the emergence of new economic activities (productive investments in farming machinery and livestock, and creation of new activities that are not linked to farming (trade, services)). In practice, a poorly structured and badly coordinated supply chain tends to increase the number of intermediaries, while failing to provide them with an adequate profit margin.

Direct job creation relates to declared workers directly employed by the players of the supply chain, a significant part of which may be related to intermediate functions (trading and transports). However, a significant share of workers involved in the supply chain, especially among farmers and intermediaries, might not be declared as salaried workers. In the following modelling of supply chains, labour is considered as paid in

the form of wages for all players including smallholders. In this way, a minimum wage can be applied, also providing for health care contribution, and the surplus is accounted as operated income.

Ultimately, what differentiates supply chains is the distribution of the revenue generated along the supply chain, up to the seed producers. Then, the impact of biofuel production on social and rural development is inevitably tied to the supply chain's economic efficiency. The distribution of income is likely to be greatly conditioned by product prices, the number of intermediaries and players' profit margins.

4. Opportunities for reducing environmental impacts

4.1. Life-cycle assessment of biofuels

4.1.1 General description of LCA methodology

Environmental impact is an important aspect of biofuel production in general, which can be observed at both local scale (process) or on the whole system. Life cycle assessment (LCA) is the most widespread methodology for assessing the environmental impact of biofuels, and has been standardized by the International Standards Organisation (ISO). It encompasses a range of impact categories, including climate change, abiotic resource depletion, human toxicity, acidification and eutrophication, etc.(Benoist, 2009). The assessment consists in inventorying all sources of impact throughout the life-cycle of a product, including indirect impacts. The inventory includes resources consumption, harmful emissions and qualitative information linked to local environment, agro-practices and land use.

If some impacts such as resource depletion and climate change apply on global scale, most others apply to the regional to local scale (Benoist, 2009). Then, even if impact assessment methods are consistent, the relevance of LCA results largely depends on input data, relating to both the life cycle inventory and the impact characterisation ("garbage in, garbage out"). In practice, LCA is employed in many different ways, depending on the objective; it can be limited to certain categories of impact and the boundaries can be restrained to a specific part of a process for comparison purposes.

Several LCA databases exist, identifying the life cycle inventories of the most common industrial processes and products, as well as impact data. The biggest and most renowned is the Swiss EcoInvent. However, most data is tied to environmental conditions of western countries and especially Europe (Huijbregts et al., 2003), and Africa-specific data is particularly scarce. Moreover, in the case of prospective scenarios, many assumptions would even increase the uncertainties of the results.

Then, in this work, LCA will only be employed to assess global-scale impact, including GHG emissions and fossil resources depletion. Other categories of impact are discussed in further sections.

4.1.2 *Jatropha* biofuels' LCA

Several LCAs on *Jatropha* biodiesel production are reported in the literature, most of these in the Asian context, with the exception of one study conducted in Mali (Ndong et al., 2009). These works show highly variable results both in terms of energy conversion performance and greenhouse gases emissions. The most sensitive parameters are tied to site characteristics, agricultural practices (use of fertilisers, pesticides and mechanical equipment), seed yield, and energy efficiency of the conversion processes (oil extraction and transesterification). Generally, the studies show that *Jatropha* has a good potential for biofuels production with high environmental performance.

In most studies (Achten et al., 2010; Ndong et al., 2009; Ou et al., 2009; Prueksakorn and Gheewala, 2008a), agriculture is the main contributor to greenhouse gas (GHG) emissions due to the use of nitrogen fertilisers which oxidation generates nitrous oxide (N₂O), a gas with a global warming potential 298 times higher than CO₂ (IPCC value, (Forster et al., 2007)). So, from the environmental point of view, there is a strong trade-off between the use of agricultural inputs and seed yield. In Burkina Faso, the cultivation is likely to be ensured by smallholders, thus with low environmental impact.

The integration of land use change effects in GHG emission calculation could significantly affect the results. Baumert (2013) studied, in Burkina Faso, the amount of carbon stocked by *Jatropha* trees, based on field measurements. The results have shown that even when cropland is converted to *Jatropha*, net carbon gains are observed. Then, land use change effects on GHG emissions should not be an issue, especially when the crop is implanted on marginal land. On this point, *Jatropha*, as a tree, has an advantage towards biofuel feedstock from annual oilseed crops.

In the biofuel transformation process, transesterification and oil extraction (pressing) are responsible for the major part of fossil fuel energy consumption. The impact of transesterification is mostly due to the consumption of methanol, which is a product of the oil industry with high embedded GHG emissions and fossil energy consumption (Achten et al., 2010). In the case of SVO production for electricity generation, oil expression is the main energy-consuming step, around 80% of the total production chain (Gmünder et al., 2010). In the case *Jatropha* biodiesel LCAs, the importance of the oil expression process is often underestimated, although it is actually a critical step in the production chain with possibilities of performance improvement. From field observations at village-scale, the energy used for pressing and filtering can represent up to 22% of the oil LHV produced.

The integration of the energy and emissions related to the construction and end-of-life of agricultural and process equipment is often considered as negligible in biofuel LCA.

Labouze et al., (2008) have estimated that, the amortisation of energy used for the manufacturing of agricultural machineries can represent about 10% of energy for feedstock production in intensely managed crops. On the other hand, the energy related to industrial equipment and buildings accounts for less than 1% in the production of rapeseed methyl esters.

Eventually, even if the results are variable according to the considered production pathways and calculation methods, most studies conclude to a positive impact in terms of fossil fuel consumption and greenhouse gas emissions, compared to standard fossil fuel scenarios (Achten et al., 2010, 2008; Ou et al., 2009).

4.1.3 The influence of by-product allocation method

Value-added by-products also impact GHG emissions. Supply chains rarely produce a single product, which means that by-products also need to be taken into consideration when calculating GHG emissions. Mainly two methods can be applied. The first one called 'allocation' consists in imputing the environmental impacts according to the different co-products used and according to a weighing factor (mass, energy content or monetary value of products). The second method 'substitution' consists in widening the boundaries of the system. For example, if electricity is a by-product, its production is considered as avoiding the consumption of grid electricity: then the GHG emissions tied to the consumption of the same amount of electricity from the grid is deduced from total GHG emissions.

Then, based on the method used for allocating emissions to by-products (proportionally to mass, energy and price), LCA may yield highly varying results. ISO 14040 recommends avoiding allocations wherever possible. Substitution is scientifically the most correct method but it can only be applied when the substituted products can be clearly identified all along the supply chain and when substitution is effective.

In the case of *Jatropha* biofuel supply chains, there are several uncertainties concerning the use of press cake (fuel, fertiliser...) and above all that of crude glycerol. Indeed, given the increased share of glycerol from biodiesel production on the market, the assumption of synthetic glycerol substitution is no longer relevant (Ayoub and Abdullah, 2012). Then, as by-products cannot be integrated as part of the production process, allocation method must be applied. Allocation based on the trade value of by-products will be used, as advised by RSB. The advantage of this method is that it reflects the socio-economic value of a product (Benoist, 2009).

*4.1.4 Application of LCA for GHG emissions and fossil fuel consumption of *Jatropha* biofuel supply chains*

(Calculation details are in Chapter 5, section 3)

Considering the results reported from *Jatropha* LCA, it can be considered that *Jatropha* biofuels, when produced in a “decent” way, contribute to mitigate climate change and fossil resources depletion when compared to fossil alternative. Also, the lack of data specific to the Sahelian environment and the prospective nature of the present study would induce high uncertainties to a comprehensive LCA of the studied supply chains. Then, as the main objective here is to compare different biofuel supply chains, it was decided to apply only a partial LCA, with an inventory limited to the main material and energy flows involved in the processes. This includes especially the features that can change depending on the scenarios, so that the different options can be compared.

In the present case, the functional unit is defined as 1 MJ thermal energy produced by the complete combustion of fuel. The reference scenario involves 1 MJ thermal energy produced by the combustion of fossil diesel fuel (Diesel, DDO or fuel oil). The LCA methodology consists in identifying all the sources of GHG emissions tied to biofuel production vs. the reference scenario. In the present approach, considering the lack of reliable region-specific data, the emissions of nitrous oxides from fertiliser application is not considered, neither the impact due to land-use change. Eventually the emissions and energy tied to the manufacturing of processing equipment is considered negligible (Labouze et al., 2008).

Life-cycle inventory data on input (chemicals and fuels) were taken from the Biograce GHG calculation tools version 4c. Biograce is a European project aimed at harmonising GHG emissions calculation from biofuel production. The data related to haulage were completed using values from EcoInvent v3. As mentioned in the previous sub-section, allocation to by-product is calculated based on their trade value.

Main factors for discriminating between supply chains are linked to the processing phase: (i) the type of energy that is used (crude vegetable oil used as a source of energy, public electricity network, decentralized electricity network, electricity produced from biogas, etc.), (ii) processing oil into biodiesel, this process requires using methanol, which according to different studies represents up to 80% of GHG emissions for biodiesel production (Prueksakorn and Gheewala, 2008b), (iii) options for valorising by-products. Haulage (iv) of raw materials is another significant source of GHG emissions, depending on the means of transport that is used and shipping distance.

Eventually, the importance given to environmental impact assessment highly depends on the scope and scale of *Jatropha* biofuel development. Indeed, in the frame of small-scale production aimed at improving rural living conditions by providing low cost energy access, environmental performance may not be the main concern. Moreover, the environmental impact is likely to be quite low in this case, considering the small quantities produced and the low-input agricultural practices – unless cultivation is

accompanied with deforestation. Conversely, the development of large-scale commercial production needs to be carefully assessed and regulated.

4.2. Conservation of biodiversity and ecosystem

The principle of conservation as defined by RSB encompasses the conservation of high biodiversity areas, the preservation of ecosystem services, the conservation and creation of buffer zones and ecological corridors around production sites, and the non proliferation of invasive species outside of farmland. The RSB has defined a protocol for identifying and assessing the value of different zones in terms of biodiversity and rendered services (ligneous and non-ligneous forest products, grazing land, sacred sites, etc.). Certain zones are therefore excluded as land for growing biofuel crops (protected areas, humid areas, habitats to endangered species). Biodiversity and ecosystem conservation is strongly tied to land use changes (Achten et al., 2009): measuring these changes is a complex task since it involves taking local parameters into consideration, as well as the history of past land uses. A simpler option might consist in defining areas that exclude *Jatropha* crops.

In Burkina Faso, the Forest Code distinguishes between: forests (protected natural sites designated by the state and local authorities), wildlife conservation areas (Ramsar sites, national parks, biosphere reserves, wildlife reserves, cynegetic zones) and areas providing pasture land and forest resources (wood-pasture reserves). This classification establishes land rights and controls access to these areas by users, and where required determines land use planning and management.

Other areas not to be used for *Jatropha* crops are those that have a rich biodiversity and/or high carbon reserves. The ecosystem in these areas generally renders vital services (wood used for heating, non-ligneous forest products). Using this land for growing biofuel crops would endanger both the ecosystem and the populations that rely on it for their subsistence. Available data in West Africa could be used in order to identify land that is unsuitable for growing *Jatropha* crops, such as the national land use database. The typology of areas to be excluded or included remains to be defined, along with exclusion thresholds (exclusion of dense forest land, humid areas, etc.).

In a prospective assessment, this issue cannot be fully addressed. However, as a precautionary measure, this should be taken into account in the assumption made on territorial *Jatropha* production potential, in order to avoid overestimations which would lead to excessively optimistic conclusions. The estimation of *Jatropha* production potential in Burkina Faso was exactly the objective of a recent geographical study by Duba (2013), which will then be used as a basis for building assumptions on available lands.

4.3. Preserving soil quality

One of the principles of RSB is that production should integrate farming practices aimed at reversing soil degradation and/or preserving soil fertility. As with most other crops, impact on soil health is measured by testing soil fertility, i.e. drawing up a balance sheet of mineral and nutrient uptake by plants vs. fertilizer input by farmers. Compensation for nutrient uptake once grains have been harvested is achieved by applying fertilizers, either chemical or organic. Fertilization practices, namely in terms of frequency and quantity, may vary from one farm to another, making it difficult to measure input.

Since there are no available agronomic studies on the subject in the literature, the influence of fertiliser application on seed yield cannot be predicted. Then, in the modelling of *Jatropha* cultivation, the minimum nutrient requirements will be calculated based on harvest nutrient uptake. As the prices of chemical fertilisers are very high in Burkina, it is very unlikely that smallholders use it for *Jatropha* crops. However, the cost of chemical fertilisation will be investigated. Alternatively, organic fertilisers can be applied and even have better properties, since they allow to increase soil organic carbon content. However, there is up to now, no specific market for organic fertilisers in Burkina, especially in rural areas, so the evaluation of its cost is very uncertain. Another possibility to ensure minimum fertilisation is to let graze animals in *Jatropha* fields.

Eventually, it can be noticed that there is a paradox in the impacts of fertiliser in overall environmental assessment. On the one hand, the application of fertilisers, especially of synthetic origin, has strong adverse effects on global warming and on the other hand, a minimum fertilisation is essential for preserving soil quality. This observation advocates the use of organic fertilisers.

4.4. Protection of water resources and air

Principle 9 on water protection implies that biofuel activities must not degrade the quality of surface and ground water or prevent local populations from having access to water. Quantities of water used for biofuel production and processing must allow for the renewal of water resources, and must not impact the quality of water. This is a crucial consideration in the context of Burkina Faso, given the scarcity of water resources.

In a prospective analysis of biofuel supply chain, this cannot be fully assessed, since the implantation of biofuel activities is unknown. Then, in the scenarios considered here, *Jatropha* crops are assumed to be rainfed, although it is known that some operators water their plants regularly the first year, to boost growth. Regarding biofuel processing, we propose inventorying the amount of water consumed in the processes (especially refining and biodiesel). The wastewater generated during the oil refining

and/or biofuel production process should be properly treated before it is returned to the environment: this is a condition for the activity to comply with applicable legislation. Practically, the requirement for wastewater treatment facilities will greatly restrain the sites eligible for implementing a refining/biodiesel plant.

Eventually, the protection of air through controlling the emission of pollutants is also part of the environmental legislation in Burkina Faso, which should ensure a limited impact. The processes involved in the production of SVO and biofuels mostly reject pollutant to the atmosphere due to fuel combustion for utility supply and possibly methanol vapour leakage. Anyway, these elements are related to technology implementation details and cannot be predicted using the process models developed here.

5. Summary of the assessment framework used in this work

Table 5 summarizes the principles of sustainability taken into account in the present assessment, with a short description of the method used and links specific sections. As mentioned in Chapter 1, one of the specificity of the sustainability assessment methodology developed in this work, is to be based on process models, so that the sensitivity of technical parameters can be analysed. In this way, key parameters can be identified and scale effects can be observed. The process models also provide data that are used as input of economic and environmental assessment.

Table 5. Summary of sustainability issues considered in the assessment of *Jatropha* supply chains.

Principle	Assessment method	Section
Economic		
Profitability	Financial analyses of all processes involved in the supply chain based	3.3
Economic efficiency	Value added creation vs. Distribution (farmers, processors, employees, banks, state)	3.3
Environmental		
Climate change	Partial life-cycle assessment of GHG emissions	4.1
Fossil resources	Partial life-cycle assessment of fossil energy requirement	4.1
Water resources protection	Inventory of water requirements from process mass balance	4.4
Social		
Land rights and food security	<i>Jatropha</i> seed production is assumed to be ensured by smallholders on their own land. Reasonable assumption on feedstock production potential.	2.1
Rural development	Qualitative appreciation based on the type of supply chain considered and on income distribution	2.2, 3.3

6. References

- Achten, W.M., Almeida, J., Fobelets, V., Bolle, E., Mathijs, E., Singh, V.P., Tewari, D.N., Verchot, L.V., Muys, B., 2010. Life cycle assessment of Jatropha biodiesel as transportation fuel in rural India. *Appl. Energy*.
- Achten, W.M., Mathijs, E., Muys, B., 2009. Proposing a life cycle land use impact calculation methodology, in: *Proceedings of the 6th International Conference on LCA in the Agri-Food Sector – Towards a Sustainable Management of the Food Chain*. Nemecek, T. & Gailard, G., Zürich, Switzerland, pp. 22–33.
- Achten, W.M.J., Verchot, L., Franken, Y.J., Mathijs, E., Singh, V.P., Aerts, R., Muys, B., 2008. Jatropha bio-diesel production and use. *Biomass Bioenergy* 32, 1063–1084.
- Ayoub, M., Abdullah, A.Z., 2012. Critical review on the current scenario and significance of crude glycerol resulting from biodiesel industry towards more sustainable renewable energy industry. *Renew. Sustain. Energy Rev.* 16, 2671–2686.
- Baumert, S., 2013. Life cycle assessment of carbon and energy balances in Jatropha production systems of Burkina Faso (PhD). University of Bonn, Bonn, Germany.
- Benoist, A., 2009. *Éléments d'adaptation de la méthodologie d'analyse de cycle de vie aux carburants végétaux : cas de la première génération*.
- Boons, F., Howard-Grenville, J.A., 2009. *The Social Embeddedness of Industrial Ecology*. Edward Elgar Publishing.
- Brew-Hammond, A., 2007. Challenges to increasing access to modern energy services in Africa, in: *Energy Security and Sustainability in Africa*, Kampala: Forum for Ministers of Energy in Africa (FEMA). pp. 1–21.
- Buytaert, V., Muys, B., Devriendt, N., Pelkmans, L., Kretschmar, J.G., Samson, R., 2011. Towards integrated sustainability assessment for energetic use of biomass: A state of the art evaluation of assessment tools. *Renew. Sustain. Energy Rev.* 15, 3918–3933.
- Campbell, L.M., Vainio-Mattila, A., 2003. Participatory Development and Community-Based Conservation: Opportunities Missed for Lessons Learned? *Hum. Ecol.* 31, 417–437.
- Cotula, L., Dyer, N., Vermeulen, S., 2008. *Fuelling Exclusion?: The Biofuels Boom and Poor People's Access to Land*. IIED.
- Dabat, M.-H., Blin, J., Rivier, M., 2010a. Affronter le défi énergétique et alimentaire au Burkina Faso, in: *Emilie COUDEL, H.D. (Ed.), Innovation and Sustainable Development in Agriculture and Food ISDA 2010*. Cirad-Inra-SupAgro, Montpellier France, p. 14 p.
- Dabat, M.-H., Lançon, F., Hanak, E., Fabre, P., 2010b. *Manuel d'analyse de filières agroalimentaires*. CIRAD, Paris.
- Devuyst, D., Hens, L., Lannoy, W. de, 2001. *How Green Is the City?: Sustainability Assessment and the Management of Urban Environments*. Columbia University Press.
- Dorin, B., Gitz, V., 2008. *Écobilans de biocarburants : une revue des controverses*. *Nat. Sci. Sociétés* Vol. 16, 337–347.

- Duba, G., 2013. Modélisation spatiale du potentiel de production de *Jatropha Curcas* L. au Mali, Burkina Faso et Bénin (Master thesis). Universités de Montpellier II et III, Montpellier.
- Durouflé, G., Fabre, P., Yung, J.M., 1988. Les effets sociaux et économiques des projets de développement. Manuel d'évaluation. Ministère de la coopération, Paris.
- Efroymson, R.A., Dale, V.H., Kline, K.L., McBride, A.C., Bielicki, J.M., Smith, R.L., Parish, E.S., Schweizer, P.E., Shaw, D.M., 2012. Environmental Indicators of Biofuel Sustainability: What About Context? *Environ. Manage.* 51, 291–306.
- FAO, 2008. An Introduction to the Basic Concepts of Food Security. EC - FAO Food Security Programme, Rome.
- Fearne, A., Martinez, M.G., Dent, B., 2012. Dimensions of sustainable value chains: implications for value chain analysis. *Supply Chain Manag. Int. J.* 17, 575–581.
- Forster, P., Ramaswamy, V., Artaxo, P., Bernsten, T., Betts, R., Fahey, D.W., Haywood, J., Lean, J., Lowe, D.C., Myhre, G., others, 2007. Changes in atmospheric constituents and in radiative forcing. *Clim. Change* 30, 2007.
- Gatete Djerma, C., Dabat, M.-H., 2014. Développement des agrocarburants en Afrique de l'Ouest. Une analyse institutionnelle comparative. Publ. Underway.
- Gmünder, S.M., Zah, R., Bhattacharjee, S., Classen, M., Mukherjee, P., Widmer, R., 2010. Life cycle assessment of village electrification based on straight *jatropha* oil in Chhattisgarh, India. *Biomass Bioenergy* 34, 347–355.
- Hanff, E., Dabat, M.-H., Blin, J., 2011. Are biofuels an efficient technology for generating sustainable development in oil-dependent African nations? A macroeconomic assessment of the opportunities and impacts in Burkina Faso. *Renew. Sustain. Energy Rev.* 15, 2199–2209.
- Huijbregts, M.A.J., Lundi, S., McKone, T.E., van de Meent, D., 2003. Geographical scenario uncertainty in generic fate and exposure factors of toxic pollutants for life-cycle impact assessment. *Chemosphere* 51, 501–508.
- Kaplinsky, R., 2000. Globalisation and Unequalisation: What Can Be Learned from Value Chain Analysis? *J. Dev. Stud.* 37, 117–146.
- Kates, R.W., Parris, T.M., Leiserowitz, A.A., 2005. What is Sustainable Development? Goals, Indicators, Values, and Practice. *Environ. Sci. Policy Sustain. Dev.* 47, 8–21.
- Labouze, E., Schultze, A., Gros, S., 2008. Elaboration d'un référentiel méthodologique pour la réalisation d'Analyses de Cycle de Vie appliquées aux biocarburants de première génération en France. *Bio Intell. Serv. Paris Fr.*
- Lee, J.S.H., Rist, L., Obidzinski, K., Ghazoul, J., Koh, L.P., 2011. No farmer left behind in sustainable biofuel production. *Biol. Conserv.* 144, 2512–2516.
- Ndong, R., Montrejaud-Vignoles, M., Saint Girons, O., Gabrielle, B., Pirot, R., Domergue, M., Sablayrolles, C., 2009. Life cycle assessment of biofuels from *Jatropha curcas* in West Africa: a field study. *GCB Bioenergy* 1, 197–210.
- Ness, B., Urbel-Piirsalu, E., Anderberg, S., Olsson, L., 2007. Categorising tools for sustainability assessment. *Ecol. Econ.* 60, 498–508.
- Nonyarma, E., Laude, J.P., 2010. Policy framework for the development of biofuels in

Burkina Faso. Presented at the Sud Sciences et Technologies, Institut International d'Ingénierie de l'Eau et de l'Environnement, pp. 119–127.

Nygaard, I., 2010. Institutional options for rural energy access: Exploring the concept of the multifunctional platform in West Africa. *Energy Policy* 38, 1192–1201.

Ou, X., Zhang, X., Chang, S., Guo, Q., 2009. Energy consumption and GHG emissions of six biofuel pathways by LCA in (the) People's Republic of China. *Appl. Energy* 86, S197–S208.

Pope, J., Annandale, D., Morrison-Saunders, A., 2004. Conceptualising sustainability assessment. *Environ. Impact Assess. Rev.* 24, 595–616.

Prueksakorn, K., Gheewala, S.H., 2008a. Full Chain Energy Analysis of Biodiesel from *Jatropha curcas* L. in Thailand. *Environ. Sci. Technol.* 42, 3388–3393.

Prueksakorn, K., Gheewala, S.H., 2008b. Full Chain Energy Analysis of Biodiesel from *Jatropha curcas* L. in Thailand. *Environ. Sci. Technol.* 42, 3388–3393.

Raikes, P., Friis Jensen, M., Ponte, S., 2000. Global commodity chain analysis and the French filière approach: comparison and critique. *Econ. Soc.* 29, 390–417.

RSB, 2011. Indicators of Compliance For the RSB Principles & Criteria, Ref. RSB-IND-01-001 (Version 2.0).

Sovacool, B.K., Clarke, S., Johnson, K., Crafton, M., Eidsness, J., Zoppo, D., 2013. The energy-enterprise-gender nexus: Lessons from the Multifunctional Platform (MFP) in Mali. *Renew. Energy* 50, 115–125.

Stephen R. Kellert, Jai N. Mehta, S., 2000. Community Natural Resource Management: Promise, Rhetoric, and Reality. *Soc. Nat. Resour.* 13, 705–715.

Tatsidjodoung, P., Dabat, M.-H., Blin, J., 2012. Insights into biofuel development in Burkina Faso: Potential and strategies for sustainable energy policies. *Renew. Sustain. Energy Rev.* 16, 5319–5330.

Walker, D.A., 2010. Biofuels - for better or worse? *Ann. Appl. Biol.* 156, 319–327.

WCED, Brundtland, G.H., World Commission on Environment and Development, 1987. *Our common future*. Oxford University Press, Oxford.

Yunus, M., 2009. *Creating a world without poverty: social business and the future of capitalism*. PublicAffairs ; Perseus Running [distributor], New York; London.

Chapter 3. Separation efficiency and energy consumption of oil expression using a screw-press: The case of *Jatropha curcas* L. seeds

As discussed in Chapter 1, the extraction of oil from *Jatropha* seeds is a central operation in biofuel supply chains. However, few data is available in the literature concerning its efficiency and the energy requirements. To bridge the gap, an experimental analysis of oil extraction was conducted using a pilot-scale screw press. This chapter is dedicated to the description of the protocol applied and the analysis of the results. It includes the analysis of material mass balance and energy requirements of pressing operation. A correlation between oil extraction efficiency, seeds oil content and energy requirement is identified. The results are further used in Chapter 4 as the basis for the elaboration of a process model.

1. Introduction

Screw pressing, also called oil expression, is the most widespread technique for extracting vegetable oils from dry oilseeds in small and medium-sized plants (Khan and Hanna 1983). Nowadays, most vegetable oil in the food industry is produced in large-scale industrial plant using solvent extraction, and screw-presses are mainly used for prepressing seeds with high oil contents (Matthäus 2012). Screw-presses are also widely used for high value vegetable oils (virgin), for small-scale processing in developing countries and for the production of straight vegetable oil (SVO) for fuel purposes. The latter application is the main scope of this study and more specifically the production of SVO from *Jatropha curcas* L. (*Jatropha*) seeds.

A screw-press is composed of a barrel made of narrow spaced bars, in which a conical screw (worm shaft) rotates and presses the seeds (see Figure 13). The pressure increases along the screw due to reduced volume, and squeezes the oil through the seed mixture, termed cake, and out of the barrel through the spaces between the bars. The de-oiled press cake is discharged at the end of the screw. A mobile conical part, called choke, allows the adjustment of the outlet section of press cake. The mechanical strains inside the barrel are high, up to 50 to 100 MPa (Mrema and McNulty 1985; Bredeson 1977), and friction phenomena increase the temperature of the cake. The temperature build-up is crucial in the process since it lowers the oil viscosity and enables it to flow more readily through the pores of the cake (Khan and Hanna 1983).

Prior to pressing, the seeds can undergo several preparation steps to facilitate oil expression and increase oil recovery. The most common pre-treatment operations are drying, dehulling, flaking, crushing and cooking. Thermal treatment (cooking) improves oil expression by thermally breaking oil cell walls but it results in higher contents of phospholipids and in some cases, higher contents of free fatty acids in the

oil (Veldsink et al. 1999; Matthäus 2012). If such pre-treatments are applied for SVO production, the oil will have to undergo purification treatments such as neutralization and degumming to comply with quality needs for use as fuel in Diesel engines (Blin et al. 2013). That is why cold pressing is usually preferred for SVO production, especially in small-sized installations.

Although screw expellers have been used for decades in the vegetable oil industry, no satisfactory mathematical models are available as is the case for most solid-liquid separation processes. The development and implementation of screw expellers are essentially based on the experience and know-how of manufacturers and operators. Several modelling attempts are reported in the scientific literature, most of them dating back to the 1980's and 1990's. If batch hydraulic oil expression can be satisfactorily simulated using Shirato-type models - based on soil consolidation theory (Willems, Kuipers, and De Haan 2008), it is not the case for continuous expression using screw-presses. Vadke et al. (1988) applied Shirato models to screw expeller with relatively good prediction results of seed throughput and press cake residual oil with a lab-scale equipment but only on a narrow range of processing conditions. Willems et al. (2009) improved Vadke's model and applied it to gas assisted mechanical expression (GAME), but the influence of temperature on pressure and residual oil was not satisfactorily predicted. Moreover, these models could not determine the presence of solid impurities in the oil, or the energy requirements. A theoretical model, based on the cellular structures of oilseeds, was developed by Lanoisellé et al. (1996) but was not applied to continuous oil expression.

Only few data are available in the scientific literature on the performance of screw-pressing for *Jatropha* oil expression and even fewer concerning energy requirements of vegetable oil expression in general. Karaj and Müller (2011) presented experimental results and analysed the links between oil recovery and energy consumption for *Jatropha* oil expression using a lab-scale cylinder-hole type screw-press. This type of press is commonly used for farm-scale oil production, but on industrial scale strainer presses are far more common. Thus, the work presented in this paper aims to bridge the gap by providing experimental results, including oil expression performance and energy requirements for a pilot scale strainer-type screw-press.

We present an experimental methodology to investigate the performances of continuous oil expression using screw expellers. The present case study deals with the pressing of *Jatropha* seeds but the methodology could be applied to any type of oil seeds. The main objectives are (i) to investigate the influence of seed preparation on the behaviour and performance of oil expression; (ii) to establish a mass balance of oil, solids and water and (iii) to identify useful relations between oil recovery, specific energy consumption and material throughput.

A series of experiments was conducted on a pilot scale screw press. The parameters studied included seed preparation, i.e. whole, crushed and deshelled seeds, as well as screw-press operational settings, i.e. screw rotational speed and press cake outlet

section. For each experimental setting, the mechanical energy consumption was measured and material flows (seeds, press cake and crude oil) were measured and analysed for oil, water and solids contents. The analysis of the results started with a thorough assessment of oil, solids and water mass balance over the press, including the reconciliation of measurement data, which constitutes the basis for determining the separation efficiency. Then, from the mass balance analysis, a systematic correlation between residual oil in the press cake and solids content of expressed oil will be proposed. Finally, the specific energy consumption will be studied with respect to separation efficiency.

Nomenclature

Variable	Unit	Description
E	$\text{Wh}\cdot\text{kg}^{-1}$	Mechanical energy spent per mass unit
$FOOT$	-	Foots mass fraction in crude oil
m	kg	Mass
\dot{m}	$\text{kg}\cdot\text{h}^{-1}$	Mass flowrate or throughput
M	-	Moisture content on wet basis
N	rpm	Shaft rotational speed
O	-	Oil mass fraction on wet basis
s	-	Shell mass fraction of seeds
SED	-	Sediment mass fraction in crude oil
SED_{vol}	$\text{mg}\cdot\text{L}^{-1}$	Sediment concentration in crude oil after foots removal
TS	-	Total solids fraction in crude oil
η	-	Oil recovery
ρ	$\text{kg}\cdot\text{m}^{-3}$	Density
Subscripts		
$batch$		Seed batch
co		Crude oil
$foot$		Foots in crude oil (solids larger than 0.8mm)
ker		Seed kernels
po		Pure oil
pc		Press cake
s		Seeds
sed		Sediment in crude oil (solids between 1 μm and 0.8mm diameter)
$shell$		Seed shells
vap		Water evaporated during pressing
Superscripts		
D		Direct calculation method
I		Indirect calculation method

2. Materials and methods

2.1. Input materials

The experiments were carried out in the fall of 2012 at the pilot oil plant of CREOL in Bordeaux, France. The seeds used originated from Jakarta, they had been harvested in 2008 and stored in France for 4 years. For these experiments, all seeds were dried in a hot air dryer to reduce the moisture content from 9.5% to about 6% wb. Then five batches were prepared: whole seeds, crushed seeds and deshelled seeds, including three different deshelling levels.

For crushing, an industrial cracking mill was used ($200 \text{ kg}\cdot\text{h}^{-1}$, Damman-Croes S. A. International, Belgium), made of two couples of corrugated cylinders with a spacing of 3 mm. For deshelling, the seeds first passed through the same cracking mill, but with a larger spacing between the rolls (5 mm) to break the shells. Large shell parts were removed by passing through an air grader (D50, Ets Denis S. A., France) and a specific gravity separator (Kipp Kelly, ArrowCorp Inc., Canada) allowed finer sorting of kernels. The specific gravity separator had 5 outputs with gradual shell mass fractions that were used to prepare deshelled seeds batches.

Whole seeds had an average shell mass fraction of 45%. Three levels of deshelling were used in the experiment, termed “deshelled – low”, “deshelled – medium” and “deshelled – high” corresponding to shell mass fractions of 39%, 33% and 26%, respectively (see section 3.1 for the calculation of shell mass fractions).

2.2. Microwave continuous heating tunnel

For some experimental settings, the seeds were preheated to a temperature of 35°C using a microwave continuous heating tunnel. This equipment is a prototype specially developed for oilseed materials, constituted of microwave applicators and a conveyor belt. It is similar to the one described in (Methlouthi, Rouaud, and Boillereaux 2010) and made by MES International Ltd, United Kingdom.

2.3. Instrumented screw-press

The experiments were conducted on a 101 mm diameter screw-press with a nominal throughput of $120 \text{ kg}\cdot\text{h}^{-1}$ (MBU20, La Mécanique Moderne S. A., France). The electrical motor of 7.5 kW was powered through a frequency converter set in a closed regulation loop with an RPM feedback from an incremental coder. This configuration allowed for torque, speed and power acquisition (2 Hz) from the frequency converter (Altivar 71, Schneider Electric S. A., France) with an accuracy of 5%. For temperature measurements, 9 K-type thermocouples of 1.5 mm diameter (Inconel 600® sheath ref. 405-050, TC Ltd, United Kingdom) were inserted in 25 mm depth holes in the 5 cm

thick steel bars along the barrel. They were connected to a temperature display. The seeds were fed by gravity through the hopper and a vat allowed for oil collection below the barrel.

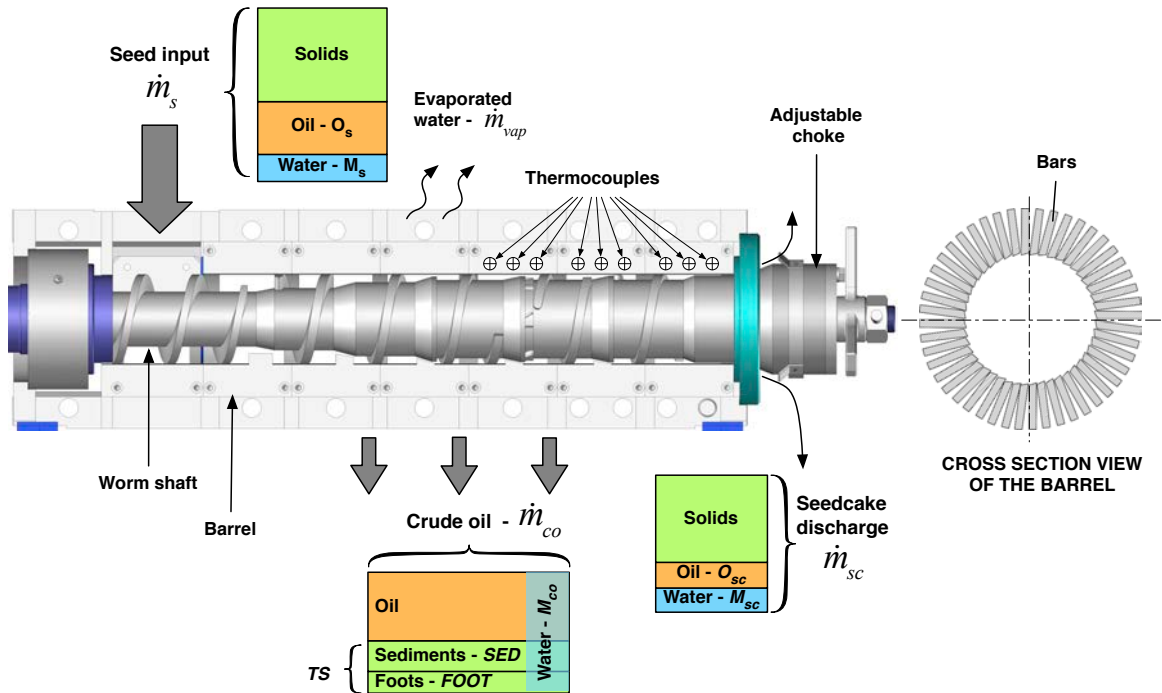

Figure 13. Side view of an oilseed screw-press and mass balance assessment terms. (with authorisation of La Mécanique Moderne)

2.4. Analytical methods

2.4.1 Oil content analysis using pulsed NMR spectroscopy

All measurements of oil contents in solid materials (seeds, press cake, kernels and shells) were made in triplicate using a pulsed nuclear magnetic resonance spectrometer (Minispeq MQ20/10, Bruker Corp., United States) following the standard method NF EN ISO 10565. Prior to measurements, the spectrometer had to be calibrated with *Jatropha* materials of known oil contents. This was done using two reference samples, one of seeds and one of press cake, that were previously analysed for oil contents using the Soxhlet extraction method NF V03-908. This method provides a measurement of pure oil mass fraction, excluding moisture, with a precision of about $\pm 0.1\%$ (m/m) (Krygsman et al. 2004).

2.4.2 Seeds and press cake moisture content measurements

The moisture content of seeds and press cake was determined by weighing samples before and after drying in an oven at 103°C for 24 hours, following the standard method NF V03-909. This method provides a precision of about $\pm 0.2\%$ (m/m).

2.4.3 Oil properties analyses

The water content of crude vegetable oil was measured using the Karl-Fischer titration method described by standard ISO 8534, with a precision of approximately $\pm 0.1\%$ (m/m).

Foots are gross solid particles contained in crude oil, larger than 0.8 mm. They are assumed to be free of oil and content moisture. The method to measure this solid content consisted in passing the crude oil through a 0.8mm sieve, and weighing it before and after the operation. This gives the mass of foots impregnated with oil, m_{foot} . Then, the mass fraction of foots free of oil, termed *FOOT* was deduced using equation (1), assuming they had an average oil content of 50% ($O_{foot} = 0.5$) (Beerens 2007).

$$FOOT = \frac{m_{foot} \cdot (1 - O_{foot})}{m_{co}} \quad (1)$$

After foot removal, the sediment content of crude oil was analysed by gravimetry following the standard NF E 48-652. This measurement provided a sediment mass concentration, termed SED_{vol} expressed in $mg \cdot L^{-1}$, that was further converted to a mass fraction *SED*, relative to crude oil mass, using equation (2). Sediments were assumed to be free of oil but they contain moisture.

$$SED = \frac{SED_{vol} \cdot 10^{-3}}{\rho_{co}} \cdot \frac{m_{co} - m_{foot}}{m_{co}} \quad (2)$$

where $\rho_{co} = 920 \text{ kg} \cdot \text{m}^{-3}$ (Akintayo 2004)

In further calculations, foots and sediments are grouped in a single term *TS*, for total solids expressed as $TS = SED + FOOT$.

2.5. Experiments

2.5.1 Experimental settings

The influence of four independent variables was investigated: screw rotational speed at 9, 18 and 26 rpm (when it was technically achievable), choke ring adjustment (i.e. open, medium and tight), seed crushing and seed deshelling. Due to the seed preparation process, deshelled seeds were necessarily coarsely crushed. By combining different values of these independent variables, 19 experimental settings were defined,

out of which three were in triplicate, giving 25 experiments. Two settings appeared technically undoable (see section 4.1.1), three other settings were added, and finally giving 26 experiments completed (see Table 1).

2.5.2 Experimental protocol

A complete measurement was made for each operational setting. Prior to pressing, three samples of 150 g were taken from the seed batch for oil and moisture content measurement, so that for each experiment, the oil and moisture contents of input material were known. Then the press was gradually brought to a stable operating regime. The process was considered in steady state when cage temperatures and electric power values were stable for 5 min.

Once the steady state was achieved, the measurements were taken on a 15 min run. At $t = 0$, the oil and press cake containers were set in place and the acquisition of mechanical power measurement was triggered. The 9 temperature values from thermocouples were recorded twice during the experiment.

After 15 minutes, produced press cake and crude oil were weighed. About 200 g of press cake were sampled for oil and moisture content analyses. The collected oil was passed through a 0.8 mm sieve to remove the foots. Afterward, 200 ml of oil was sampled and sent to laboratory for sediment and moisture content analyses.

Crushed and deshelled seeds were slightly preheated to a temperature between 30°C and 35°C prior to pressing, using a microwave continuous heating tunnel. This was necessary to achieve a proper temperature and pressure build-up during pressing (see section 4.1.1). Crushed and deshelled seeds are indeed more difficult to process and moreover the room temperature had dropped from 20°C to about 14°C between the period when the experiments with whole seeds were conducted and the period when crushed and deshelled seeds were processed. Table 6. Detailed results for all experiments. (Abbreviations: indir.: indirect calculation method ; dir. corr.: direct calculation method corrected with coefficient α , see section 3.3, 3.4 and 4.2.1 for details) gives the measurement results for each experimental setting.

Table 6. Detailed results for all experiments. (Abbreviations: indir.: indirect calculation method ; dir. corr.: direct calculation method corrected with coefficient α , see section 3.3, 3.4 and 4.2.1 for details)

Settings	N	Choke	Seed preparation	M_s	O_{sc}	\dot{m}_s	\dot{m}_{co}	M_{co}	TS'	\dot{m}_{po} (indir.)	\dot{m}_{po} (dir. corr.)	\dot{m}_{sc}	O_{sc}	M_{sc}	\dot{m}_{vap}	η (indir.)	η (dir. corr.)	E_s
Units	rpm	-	-	-	-	kg·h ⁻¹	kg·h ⁻¹	-	-	kg·h ⁻¹	kg·h ⁻¹	kg·h ⁻¹	-	-	kg·h ⁻¹	-	-	Wh·kg ⁻¹
1.1	9	Open	Whole	0.062	0.31	59.4	16.8	0.0040	0.13	14.31	14.57	41.8	0.10	0.068	0.786	0.77	0.79	56.4
1.2	26	Open	Whole	0.062	0.31	161.5	33.7	0.0075	0.28	24.97	24.15	126.6	0.20	0.067	1.217	0.50	0.48	47.3
1.3	9	Tight	Whole	0.062	0.31	57.0	16.2	0.0035	0.14	15.13	13.88	39.8	0.07	0.062	1.030	0.85	0.78	66.8
1.4	26	Tight	Whole	0.062	0.31	173.3	45.2	0.0075	0.24	35.15	33.89	125.9	0.15	0.065	2.253	0.65	0.63	51.7
1.5	9	Open	Crushed	0.056	0.32	68.1	21.0	0.0060	0.20	18.62	16.56	46.1	0.07	0.059	0.973	0.86	0.76	53.9
1.6	16	Open	Crushed	0.054	0.31	122.3	40.2	0.0065	0.25	32.35	29.94	80.3	0.06	0.057	1.765	0.86	0.80	51.4
1.7	9	Tight	Crushed	0.056	0.32	67.4	21.1	0.0050	0.18	19.05	17.16	45.1	0.06	0.053	1.257	0.88	0.80	66.0
1.8	16	Tight	Crushed	0.054	0.31	123.8	40.7	0.0070	0.25	33.10	30.20	80.4	0.06	0.047	2.645	0.87	0.80	64.0
1.9	18	Medium	Whole	0.059	0.32	115.8	35.1	0.0075	0.18	30.25	28.44	79.2	0.09	0.064	1.528	0.81	0.77	55.1
1.A	18	Medium	Whole	0.062	0.31	119.5	36.4	0.0055	0.19	30.09	29.46	81.1	0.09	0.063	2.075	0.81	0.79	53.0
1.B	18	Medium	Whole	0.062	0.31	121.0	37.0	0.0060	0.19	29.63	29.73	81.7	0.10	0.062	2.248	0.79	0.79	51.5
1.C	18	Medium	Crushed	0.056	0.32	139.5	42.2	0.0085	0.31	23.07	29.06	95.7	0.23	0.060	1.686	0.52	0.65	30.7
1.D	18	Medium	Crushed	0.055	0.31	144.0	46.3	0.0085	0.30	29.78	32.33	96.1	0.16	0.062	1.587	0.66	0.72	38.9
1.E	18	Medium	Crushed	0.054	0.31	143.2	46.0	0.0065	0.24	37.20	34.63	94.4	0.07	0.050	2.730	0.85	0.79	58.7
2.1	9	Open	Deshell. - L	0.058	0.34	73.4	26.0	0.0045	0.16	22.73	21.66	46.5	0.05	0.070	0.863	0.90	0.86	53.5
2.2	18	Open	Deshell. - L	0.058	0.34	136.4	48.9	0.0095	0.23	36.28	37.30	86.6	0.12	0.075	0.913	0.77	0.80	33.8
2.3	9	Tight	Deshell. - L	0.058	0.34	66.8	24.8	0.0085	0.27	18.26	17.94	41.2	0.11	0.072	0.674	0.80	0.78	44.3
2.4	18	Tight	Deshell. - L	0.058	0.34	135.4	50.3	0.0065	0.20	38.18	39.77	83.4	0.10	0.070	1.649	0.82	0.85	42.6
2.5	5	Open	Deshell. - H	0.056	0.42	43.0	16.5	0.0065	0.24	11.77	12.48	26.0	0.24	0.070	0.492	0.65	0.69	23.5
2.7	4	Tight	Deshell. - H	0.056	0.41	34.2	14.2	0.0055	0.22	11.85	10.99	19.6	0.12	0.073	0.404	0.84	0.78	35.1
2.9	13	Medium	Deshell. - M	0.057	0.37	99.1	32.1	0.0080	0.27	21.16	23.06	66.3	0.24	0.069	0.843	0.57	0.62	25.7
2.A	13	Medium	Deshell. - M	0.057	0.37	103.3	38.0	0.0065	0.24	26.81	28.65	64.3	0.18	0.073	0.948	0.70	0.74	28.5
2.B	13	Medium	Deshell. - M	0.057	0.37	98.6	36.1	0.0060	0.18	29.23	29.32	61.2	0.12	0.067	1.308	0.79	0.80	31.5
3.1	11	Open	Whole	0.059	0.32	76.0	24.3	0.0050	0.14	21.40	20.73	50.5	0.06	0.064	1.127	0.88	0.85	57.9
3.2	9	Medium	Deshell. - L	0.058	0.34	73.1	26.3	0.0080	0.22	19.00	20.34	46.2	0.13	0.075	0.569	0.76	0.81	37.5
3.3	18	Medium	Deshell. - L	0.058	0.34	135.8	43.8	0.0110	0.32	28.82	29.42	91.5	0.20	0.075	0.572	0.62	0.63	28.4

3. Calculations

3.1. Calculation of shell mass fraction

As mentioned above, the effect of seeds deshelling on the expression performance was investigated in the experiments. Therefore, the shell mass fraction of deshelled seeds batches had to be characterised. It was calculated from the oil content measurement of the seed batch, assuming that kernels and shells had constant oil contents. Reference values of oil contents in kernels and shells were determined by manually deshelling 20 entire seeds and measuring separately kernels and shells oil contents by pulsed NMR spectrometry (see section 2.4.1). Average oil contents of kernels and shells were 55.3 % and 1.4% on wet basis (at 6% moisture content) respectively.

Equation (3), established from the oil mass balance in a seed, allowed to calculate the shell mass fraction s of a given seed batch, provided its oil content was known.

$$s = \frac{O_{ker} - O_{batch}}{O_{ker} - O_{shell}} \quad (3)$$

with

$$O_{ker} = 0.553$$

$$O_{shell} = 0.014$$

3.2. Mass balance calculations

The calculation of mass balance was crucial for determining the separation efficiency of the process and it was also helpful in appreciating the quality of the measurements.

The different variables used for mass balance calculation are presented on Figure 13.

The following assumptions were made:

- Crude oil (co) is the mass flowrate coming directly from the press, which contains solids and water.
- Pure oil (po) is a fictive oil mass flowrate free of solids and water, as if the crude oil had undergone a perfect separation of solids and water.
- Crude oil moisture content is measured on supernatant oil and we assume it is representative of crude oil water content, including solids, as shown on Figure 13.

Four equations of mass conservation can be written, corresponding to overall matter, oil, water and solids, presented in equations (4) to (7) respectively.

The **overall mass balance** is expressed as:

$$\dot{m}_s = \dot{m}_{co} + \dot{m}_{pc} + \dot{m}_{vap} \quad (4)$$

The water mass balance is given by:

$$\dot{m}_s \cdot M_s = \dot{m}_{co} \cdot M_{co} + \dot{m}_{pc} \cdot M_{pc} + \dot{m}_{vap} \quad (5)$$

The **oil mass balance** comes as:

$$\dot{m}_s \cdot O_s = \dot{m}_{co} \cdot (1 - TS) \cdot (1 - M_{co}) + \dot{m}_{pc} \cdot O_{pc} \quad (6)$$

that can also be written as : $\dot{m}_s \cdot O_s = \dot{m}_{po} + \dot{m}_{pc} \cdot O_{pc}$, where \dot{m}_{po} is the pure oil mass flowrate.

Eventually, the **solids mass balance** is expressed as:

$$\dot{m}_s \cdot (1 - O_s - M_s) = \dot{m}_{pc} \cdot (1 - O_{pc} - M_{pc}) + \dot{m}_{co} \cdot TS \cdot (1 - M_{co}) \quad (7)$$

The **seed throughput** is calculated from equation (4) and (5). As the evaporated water mass flowrate is not measured, the calculation has to be iterated in order to converge to seed throughput and water mass flowrate values that verify both equation (4) and (5).

3.3. Pure oil mass flowrate determination

The pure oil mass flowrate may be derived from the following equation (direct calculation):

$$\dot{m}_{po}^D = \dot{m}_{co} \cdot (1 - TS) \cdot (1 - M_{co}) \quad (8)$$

Following oil mass balance equations, pure oil mass flowrate may also be determined indirectly:

$$\dot{m}_{po}^I = \dot{m}_s \cdot O_s - \dot{m}_{pc} \cdot O_{pc} \quad (9)$$

Important uncertainties arise from measurements with both methods of calculation. Among the quantities involved, i.e. seeds, raw oil and press cake mass flowrate, residual oil in press cake, water, foots and sediment content, sediment content appears as the most prone to measurement errors. Even if the analytical method is standardized, experience shows that the results are difficult to reproduce, especially for high sediment contents (Chirat 1996). Therefore, the indirect calculation equation was assumed more reliable and taken as a reference.

3.4. Performance indicators

The main indicator of separation efficiency is the oil recovery defined as the ratio of pure oil expressed to seeds oil content, which can be calculated either from directly or indirectly calculated pure oil mass flowrate, presented respectively in equations (10) and (11).

$$\eta^D = \frac{\dot{m}_{po}^D}{\dot{m}_s \cdot O_s} \quad (10)$$

$$\eta^I = \frac{\dot{m}_{po}^I}{\dot{m}_s \cdot O_s} \quad (11)$$

All calculation results are available in Table 6.

4. Results and discussions

In this section, the efficacy and reproducibility of oil expression using a screw-press is described in regard of operational parameters. Then, the consistency of the mass balance is thoroughly analysed and a relation between press cake residual oil content and solids content of crude oil is presented. Finally, a model linking the specific energy consumption of the process to the oil recovery is proposed.

4.1. Influence of operational settings on process performance and behaviour

4.1.1 Description of process operation and difficulties

During the experiment, it was observed that temperature and pressure build-up were closely linked and crucial in obtaining proper oil expression. While the press was gradually brought to a steady operation regime, the barrel temperature raised together with the mechanical power delivered by the motor. Maximum barrel temperatures varied between 75°C and 120°C, depending on the experimental setting. Below 75°C, no proper oil expression occurred. The choke adjustment appeared to have no significant effect on operating conditions and process performance.

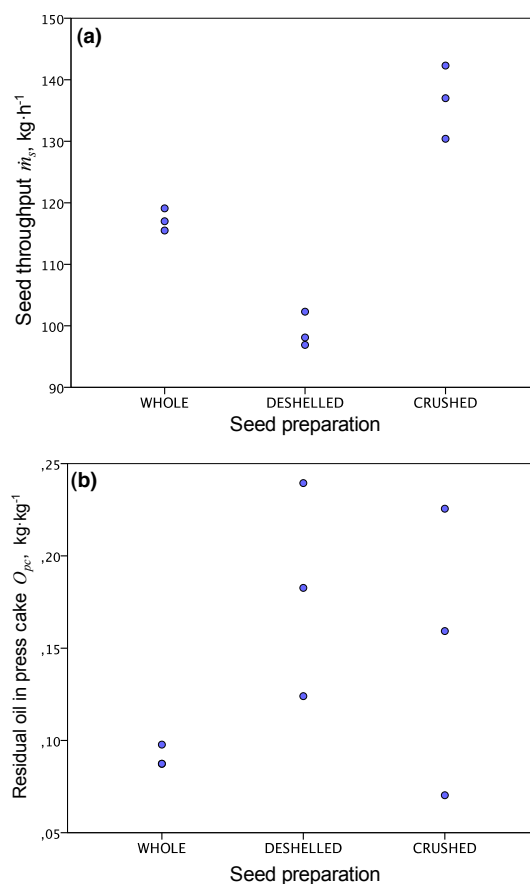

Figure 14. Graphical illustration of the results for triplicate experimental settings with respect to seed preparation. (a): seed throughput; (b): residual oil in press cake.

Several difficulties were encountered when pressing crushed and deshelled seeds. Instead of clean oil, a thick mixture of oil and fine solids was extracted. With deshelled seeds, it was difficult to obtain proper pressure and temperature build up, so that the seeds were merely extruded and no oil was expressed. This phenomenon is known to occur when pressing seed materials with an insufficient structure to allow a proper pressure build up, such as deshelled or over-cooked seeds (Boeck 2011). To overcome these issues, it was decided to preheat the seeds to a temperature close to 35°C , using a microwave continuous heating tunnel, to facilitate temperature build-up, which proved to be quite effective. However, even with this precaution, pressing 50% deshelled seeds was impossible at a shaft speed higher than 4 or 5 rpm.

The difficulty of pressing deshelled oilseeds was previously reported in literature by several authors. Zheng et al. (2003) observed that the screw pressing of dehulled flaxseed presented lower oil yields than whole seeds and required a special configuration of the worm shaft because of the softness of dehulled seeds. A Japanese research group reported the same observation for sunflower seeds and developed a twin-screw press for the oil extraction from dehulled seeds (Isobe et al. 1992). Finally, Xiao et al. (2005) compared the permeability of dehulled and undehulled rapeseeds

under various pressures and found greater permeability in undehulled material. Thus, the difficulties in pressing deshelled *Jatropha* seeds might be explained by the reduction of permeability and the lack of solid structure caused by the deshelling.

Then, it was observed during the pressing of crushed and deshelled seeds that the process is never totally in steady state, especially at high rotational speed. In particular, large fluctuations of mechanical power and temperature are observed. This is attributed to the lack of homogeneity of input material: shells and fines always tend to separate from kernel parts. At the best, a quasi-periodicity is observed and the regime is self-maintained.

In some other cases, the regime is not steady and starts drifting: either the temperature and power increase until the worm shaft gets stuck, or the temperature and power drop and oil expression turns to seed extrusion.

Thus, operation at 26 rpm was only possible with whole seeds. With deshelled seeds, such high speed systematically prevented pressure build up and with crushed seeds, pressure and temperature build up was too high and the shaft got stuck.

4.1.2 Reproducibility of the results

The reproducibility of the experiment is appreciated by analysing the results of triplicated experimental settings. Figure 14 shows the results of these three settings in terms of seed throughput and residual oil in press cake. The graph shows that seed throughput results are fairly reproduced with any type of seeds, the worst case being with crushed seeds with less than $\pm 10\%$ gap around average. In terms of residual oil in press cake, the results are well reproduced only with whole seeds. It is much more difficult to reproduce the performances when pressing crushed or deshelled seeds. This is attributed to the unsteady state phenomena described in section 4.1.1.

The lack of reproducibility observed reflects that, in some cases, the control of operational parameters (rotational speed, choke ring adjustment) of the present experimental apparatus is not sufficient to govern the process conditions. Parameters such as feed material homogeneity, cake porosity and temperature cannot be controlled. Consequently, the variable results of triplicated settings with deshelled and crushed seeds correspond to different process conditions, but under no circumstances are linked to measurement errors.

This means that any analysis of the links between controlled parameters and residual oil will present high uncertainty for crushed and deshelled seeds. However, the lack of reproducibility does not impede the analysis of the mass balance for each experiment and the relations between separation efficiency and energy consumption.

4.1.3 Relation between oil recovery and material throughput

Figure 15a presents the relation between oil recovery and seed throughput with respect to seed preparation: the oil recovery tends to decrease with increasing material throughput. This is physically meaningful, since the increase of material throughput corresponds to a lower residence time and thus a lower oil extraction. Moreover, it can be shown from the results presented in table 1 that the material throughput is strictly proportional to the screw rotational speed for a given seeds preparation.

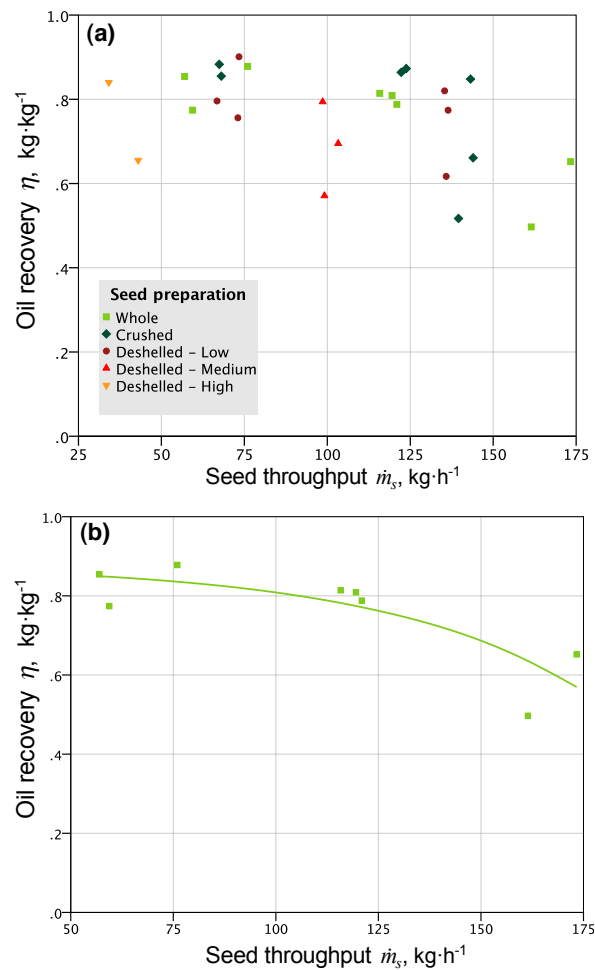

Figure 15. Relation between oil recovery and seed throughput. (a): all seed preparation. (b): Whole seeds only, line is the regression model (equation (12)).

Although the residence time is a crucial factor influencing oil recovery, the influence of processing conditions such as temperature and pressure cannot be ignored. Yet, we had observed and explained previously that the processing conditions cannot be reproduced for crushed and deshelled seeds with the present experimental apparatus. Then, no

model regression can be made on these data, apart for whole seeds results, which are fairly reproducible.

A non-linear regression was performed on whole seeds, following an asymptotic model defined as:

$$\eta = k_1 + k_2 \cdot \exp(k_3 \cdot \dot{m}_s) \quad (12)$$

The regression gives an $R^2 = 0.68$ and the curve corresponding to the model is presented on Figure 15b. The values of the coefficient k_1 , k_2 and k_3 are respectively 0.88, -0.01 and 0.02. Additional experiments with whole seeds at different screw rotational speeds would be required to improve this correlation. The same model was published by (Karaj and Müller 2011), but with an $R^2 = 0.78$.

4.2. Mass balance assessment

4.2.1 Interpretation of results and data reconciliation

According to equations (8) and (9), the direct and indirect calculation methods of the pure oil mass flowrate should give similar results. Figure 16a illustrates the indirect versus direct calculation of pure oil mass flowrate. Results from both methods are very close, but with random variations and a systematic error revealed by the linear regression that slightly deviates from equality. Indeed, the direct calculation method provides a result significantly higher than the indirect method at $p < 0.05$ (t-test).

The random variations can be attributed to unavoidable measurement and sampling errors. The systematic deviation is attributed to crude oil sampling for sediment content measurement. The mass flowrate calculated indirectly, taken as the reference (see section 3.3), is systematically lower than with the direct method, which means that the sediment content is always under-estimated. The under-estimation of sediment content measurement may be explained by the sampling method. For each experiment, 5 to 15 kg of raw oil is extracted, from which a raw oil sample of 200 mL is retrieved from the top of the bucket using a beaker while manually agitating the mixture. Thus, even with manual agitation, the sediment content of the sample is certainly lower than the overall sediment content.

This systematic error is corrected by applying a coefficient to the total solids content of crude oil, which is provided by the linear regression ($\alpha = 0.9324$).

$$\dot{m}_{po}^I = \alpha \cdot \dot{m}_{po}^D = \alpha \cdot \dot{m}_{co} \cdot (1 - TS) \cdot (1 - M_{co}) \quad (13)$$

We introduce a corrected value of total solids TS_α , such as: $1 - TS_\alpha = \alpha \cdot (1 - TS)$

This corrected value of total contamination content is set as reference for further analyses and the direct calculation of pure oil mass flow rate becomes:

$$\dot{m}_{po}^D = \dot{m}_{co} \cdot (1 - TS_\alpha) \cdot (1 - M_{co}) \quad (14)$$

The determination of oil recovery is crucial for appreciating the efficiency of the solid-liquid separation and directly depends on pure oil mass flowrate. Thus, two values can be calculated using direct and indirect pure oil mass flowrate calculation methods (see equations (10) and (11)). Figure 16b illustrates the matching between both methods. It is clear that the random error is exacerbated when pure oil mass flowrate is divided by input oil. However, the linear least squares regression exhibits a fair $R^2 = 0.78$ and the regression coefficient is very close to 1 (interception was forced to 0).

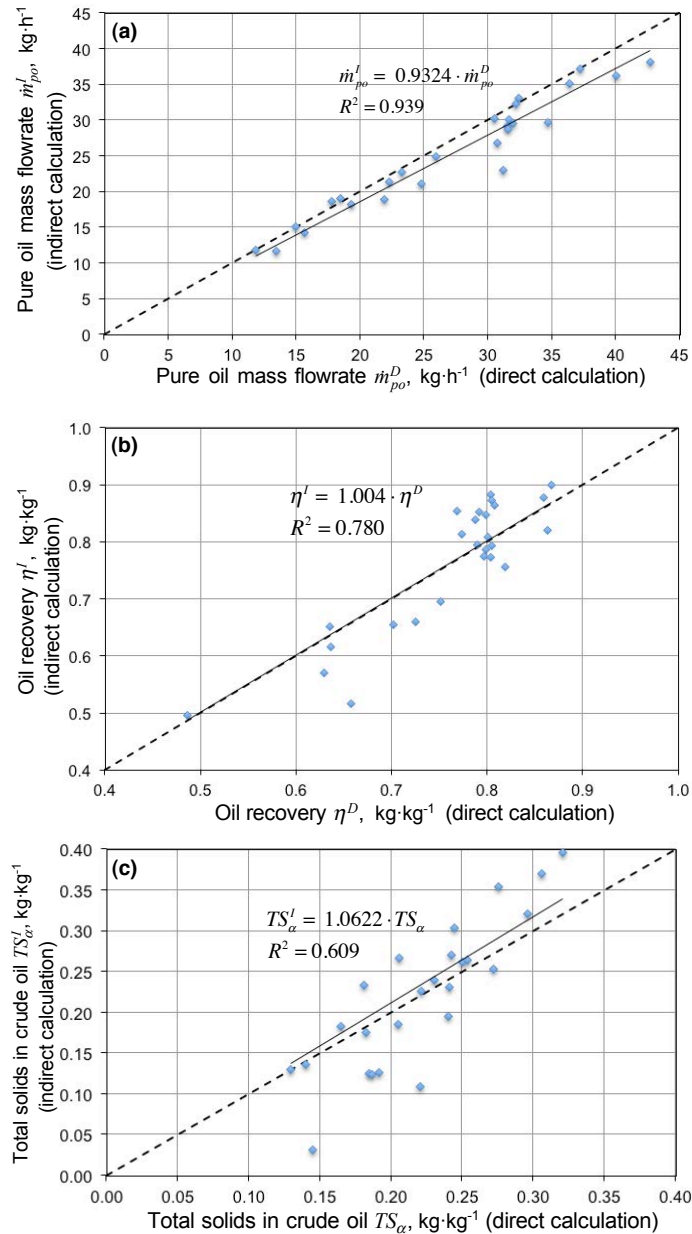

Figure 16. Validation graphs for the consistency direct and indirect calculation methods of pure oil mass flowrate (a), oil recovery (b) and total solids (c).

4.2.2 Correlation between seed, press cake and crude oil mass flowrates

A very well-correlated linear relation is observed between seed throughput and press cake output. The press cake throughput is always strictly proportional to the seed input. This result can also be observed in the results published by (Karaj and Müller 2011) on *Jatropha* oil expression experiments but was not highlighted by the authors. We call β the linear regression coefficient relating press cake throughput to seed throughput, as showed in equation (15). Figure 17 shows linear regressions between seeds and press cake throughput with respect to seed preparation grouped as entire seeds, crushed seeds and deshelled seeds.

$$\dot{m}_{pc} = \beta \cdot \dot{m}_s \quad (15)$$

The value of the coefficient β is mostly related to the design of the press, especially the volume generated by the profile of the worm shaft, which is the same for all experiments. However, it also depends on the seeds characteristics, in particular bulk density and oil content, which will influence the input mass flowrate conveyed by the screw and the proportion in which the material is divided between press cake and oil outlets. Indeed, β can be precisely evaluated with respect to seed preparation as shown on Figure 17. Table 7 summarizes the value of β for each seed preparation and for Karaj and Müller (2011) data. These values are specific to *Jatropha* seeds, and to the pressing equipment used in these experiments.

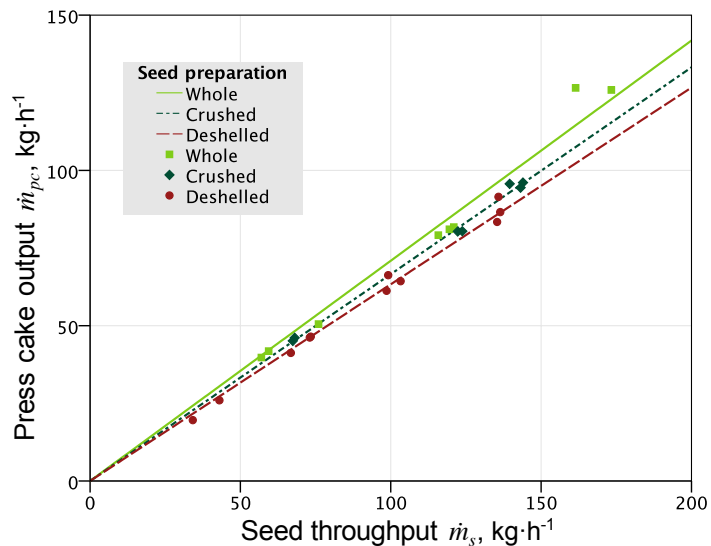

Figure 17. Relations between seed and press cake throughput with respect to seed preparation. Lines are linear least squares regression for each modality of seed preparation.

Crushed and entire seeds have approximately the same oil content; deshelled seeds have higher oil content and are only coarsely crushed compared to crushed seeds. The

highest value of β relates to whole seeds. For crushed seeds, the β value is slightly lower, which can be explained by a higher bulk density. Then the even lower β value for deshelled seeds might be explained by higher oil content, resulting in less press cake and more oil.

This important result shows that, whatever the operational parameters, the seed throughput is always divided in a stream of crude oil and a stream of press cake in the same proportion (β) for a given input material. Then, the residual oil in press cake and the amount of solids carried by the oil are directly related and determine the efficacy of the separation, i.e. the oil recovery. When the oil recovery is high, the press cake oil content is low, as well as the solids in crude oil, and conversely. This means that the separation efficacy of screw-pressing cannot be evaluated only by measuring crude oil mass flowrate, the knowledge of solids content or residual oil in press cake is required. This result allows writing the relations between oil recovery, press cake oil content and solids in crude oil using the coefficient β and the mass balance equations. This information could be very useful for choosing the screw-press design best suited to the type of seeds to process, especially given their oil contents.

Table 7. Values of coefficient β (linear regression coefficient relating seedcake to seed throughput in equation (15) and square residues of linear regressions.

Seed preparation	β (dimensionless)	R^2
<i>All types</i>	0.674	0.968
<i>Whole</i>	0.717	0.975
<i>Crushed</i>	0.666	0.995
<i>Deshelled</i>	0.637	0.990
<i>Karaj and Müller (2011) (whole seeds)</i>	0.762	0.969

4.2.3 Total solids prediction from oil recovery

Using β , oil recovery can be expressed as a simple function of seeds and press cake oil content:

$$\eta = 1 - \beta \cdot \frac{O_{pc}}{O_s} \quad (16)$$

Then, in the perspective of process modelling, provided that the value of β is known, the total solids in the extracted crude oil can be predicted. Combining equation (16) with the oil mass balance equation (6), total solids contamination can be expressed as a function of oil recovery as:

$$TS_{\alpha}^I = 1 - \frac{\eta \cdot O_s}{(1 - \beta) \cdot (1 - M_{co})}$$

Figure 16c illustrates the calculated solids content versus the measured one. Of course, here the random errors are strongly increased by the several ratios and multiplications.

In practice, the equation for total solids calculation can be simplified by ignoring oil moisture content. The water content of oil is indeed very low: in this case the maximum measured value is 1.1% and the average 0.7%. However, these moisture contents are actually high compared to usual values for vegetable oils, because this oil is degraded (high free fatty acid 9%) due to the poor storage conditions and the age of the seeds. Normally, even after being washed with water, vegetable oil has moisture content up to 0.5% wt/wt after phase separation (Lusas et al. 2012) . In comparison, following the standard DIN 51605, the moisture level required for using vegetable oil as a fuel is 0.075% maximum.

4.3. Relation between oil recovery and specific energy consumption

The oil expression is a solid-liquid separation process and as such, the specific energy consumption should be linked to the efficiency of the separation. This intuition is confirmed by observing Figure 18a, which shows a scatterplot of seed-specific energy consumption versus press cake residual oil content.

Using an exploratory data analysis methodology as described in (NIST/SEMATECH 2013), a model for seed-specific energy consumption was built stepwise. The basic procedure consists in identifying and fitting a first model including only the main explanatory variable — press cake residual oil in this case. The form of the equation should be determined according to the physics of the process. Then, the residues of this model are plotted against other potential explanatory variables and if there is a strong correlation, the variable is integrated in the model — seeds oil content in this case. In order to ensure that the model describes the data well enough and that there is no missing term, the residues were tested for normality using Shapiro-Wilk test (NIST/SEMATECH 2013).

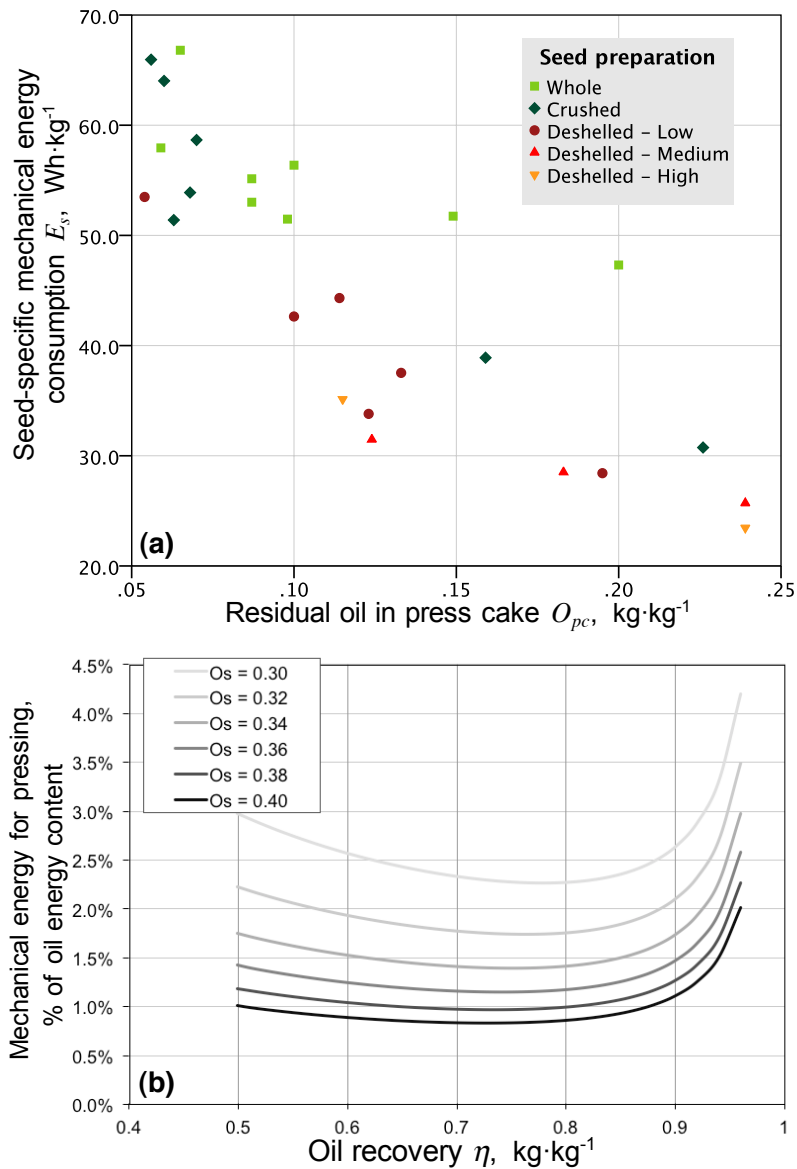

Figure 18. (a): Scatterplot of seed-specific energy consumption versus press cake residual oil content, with respect to seed preparation. **(b):** Graphical representation of the proposed energy model. Mechanical energy requirement for pressing, expressed as percentage of oil heating value, versus oil recovery, for different values of seeds oil content.

The final model is presented in equation (17); it explains 87% of seed-specific energy consumption variations — $R^2 = 0.87$. It includes two explanatory variables, oil recovery and seeds oil content and only three parameters, β_1 , β_2 and β_3 — press cake residual oil was replaced with oil recovery using equation (16). The values of β_1 , β_2 and β_3 are 1.075, -11.813 and -4.294 respectively. These parameters values are valid for *Jatropha* seeds and the pressing equipment used in these experiments. Additional experiments would be required, with other type of seeds and machinery to check if the same correlation is suitable to describe the process and to adapt the parameters values.

$$E_s = \frac{\beta_1}{O_s \cdot (1 - \eta)} + \frac{\beta_2}{1 + \beta_3 \cdot O_s} \quad (17)$$

Then, it is useful to observe oil-specific energy consumption, given by equation (18).

$$E_{po} = \frac{E_s}{\eta \cdot O_s} \quad (18)$$

This is also very well-correlated to experimental data with an $R^2 = 0.86$

It is relevant to compare the energy required to extract vegetable oil from the seeds with the oil heating value. Assuming an average heating value of 37 MJ·kg (Blin et al. 2013), we calculated the embodied energy of oil as a percentage of its energy content. This value is plotted against oil recovery on Figure 18b, for several values of seeds oil contents. The energy spent for oil expression is small (< 5%) compared to the heating value of the oil, which makes it an energy efficient separation process. Of course, the production of the mechanical energy and the energy required for seeds preparation, transport and production should also be estimated for a complete determination of the overall embodied primary energy.

The specific energy consumption is strongly sensitive to seeds oil content, especially at low oil content. A minimum energy requirement is generally observed at oil recoveries between 70% and 80%. Karaj and Müller (2011) presented similar results for cylinder-hole type screw-press but with significantly higher energy consumption levels, up to 400 Wh·kg⁻¹ of seeds. This shows that strainer-type screw-press is much more energy efficient than cylinder-hole type.

The relation of energy efficiency to oil recovery is an important consideration for optimising the processing strategy of oilseeds, depending on the final uses of the products, their economic values and energy prices. For instance, if the oil and the press cake are used for energy purposes, it might be beneficial to limit the oil recovery in order to minimise the oil expression cost and increase the energy value of the press cake. In this context, the approach applied in this work is particularly relevant and should be validated for other types of seeds and pressing equipment. Additional experiments would be necessary to determine if the correlation in equation (17) can be generalised to any type of mechanical oil expression process.

5. Conclusion

The oil expression from crushed and deshelled seeds appeared to be unstable due to a lack of homogeneity in input material, resulting in important discrepancies in the pressing efficiency. A high fraction of shells in the feed allows to build a solid permeable matrix which favours oil flow through the press cake. For a given feed material, the press cake mass flowrate is strictly proportional to the seed throughput, which enables to establish a direct relation between oil recovery and solids content in crude oil. A correlation between oil recovery and specific energy consumption was proposed. The results of this study are used to build a process model, as described in the next chapter.

6. References

- Akintayo, E. T. 2004. "Characteristics and Composition of Parkia Biglobbosa and Jatropha Curcas Oils and Cakes." *Bioresource Technology* 92 (3): 307–10.
- Beerens, P. 2007. "Screw-Pressing of Jatropha Seeds for Fuelling Purposes in Less Developed Countries." *Eindhoven University of Technology*.
- Blin, J., C. Brunshwig, A. Chapuis, O. Changotade, S.S. Sidibe, E.S. Noumi, and P. Girard. 2013. "Characteristics of Vegetable Oils for Use as Fuel in Stationary Diesel engines—Towards Specifications for a Standard in West Africa." *Renewable and Sustainable Energy Reviews* 22: 580–97. doi:10.1016/j.rser.2013.02.018.
- Boeck, Harald. 2011. "Edible Oil Processing and Production - Expanding and Expelling." *The AOCS Lipid Library*. <http://lipidlibrary.aocs.org/processing/expanding/index.htm>.
- Bredeson, D.K. 1977. "Mechanical Pressing." *Journal of the American Oil Chemists' Society* 54 (6): 489–90.
- Chirat, Nathalie. 1996. "Etude de la qualité de carburants dérivés des huiles végétales: approche méthodologique". Thèse de doctorat, France: ..
- Isobe, S., F. Zuber, K. Uemura, and A. Noguchi. 1992. "A New Twin-Screw Press Design for Oil Extraction of Dehulled Sunflower Seeds." *Journal of the American Oil Chemists Society* 69 (9): 884–89. doi:10.1007/BF02636338.
- Karaj, S., and J. Müller. 2011. "Optimizing Mechanical Oil Extraction of Jatropha Curcas L. Seeds with Respect to Press Capacity, Oil Recovery and Energy Efficiency." *Industrial Crops and Products* 34 (1): 1010–16. doi:10.1016/j.indcrop.2011.03.009.
- Khan, L.M., and M.A. Hanna. 1983. "Expression of Oil from oilseeds—A Review." *Journal of Agricultural Engineering Research* 28 (6): 495–503. doi:doi: 10.1016/0021-8634(83)90113-0.
- Krygsman, P, A Barrett, W Burk, and H Todt. 2004. "Simple Methods for Measuring Total Oil Content by Benchtop NMR." In *Oil Extraction and Analysis*, by D Luthria. AOCS Publishing. <http://www.crcnetbase.com/doi/abs/10.1201/9781439822340.ch9>.

- Lanoisellé, Jean-Louis, Eugène I. Vorobyov, Jean-Marie Bouvier, and Georges Pair. 1996. "Modeling of Solid/liquid Expression for Cellular Materials." *AIChE Journal* 42 (7): 2057–68. doi:10.1002/aic.690420726.
- Lusas, Edmund W., Mohammad S. Alam, Richard C. Clough, and Mian N. Riaz. 2012. "Animal and Vegetable Fats, Oils, and Waxes." In *Handbook of Industrial Chemistry and Biotechnology*, edited by James A. Kent, 1323–1402. Boston, MA: Springer US. http://www.springerlink.com/index/10.1007/978-1-4614-4259-2_34.
- Matthäus, Bertrand. 2012. "Oil Technology." In *Technological Innovations in Major World Oil Crops, Volume 2*, edited by S.K. Gupta, 23–92. New York, NY: Springer New York. http://www.springerlink.com/index/10.1007/978-1-4614-0827-7_2.
- Methlouthi, Abderraouf, Olivier Rouaud, and Lionel Boillereaux. 2010. "Microwave Applicator with Conveyor Belt System." In *Proceedings of the COMSOL Conference*. Paris. http://static1.comsol.dk/papers/8695/download/methlouthi_paper.pdf.
- Mrema, G.C., and P.B. McNulty. 1985. "Mathematical Model of Mechanical Oil Expression from Oilseeds." *Journal of Agricultural Engineering Research* 31 (4): 361–70. doi:doi: 10.1016/0021-8634(85)90111-8.
- NIST/SEMATECH. 2013. "E-Handbook of Statistical Methods." November 15. <http://www.itl.nist.gov/div898/handbook/>.
- Vadke, V.S., FW Sosulski, and CA Shook. 1988. "Mathematical Simulation of an Oilseed Press." *Journal of the American Oil Chemists' Society* 65 (10): 1610–16.
- Veldsink, J.W., B.G. Muuse, M.M.T. Meijer, F.P. Cuperus, R.L.K.M. van de Sande, and K.P.A.M. van Putte. 1999. "Heat Pretreatment of Oilseeds: Effect on Oil Quality." *Lipid/Fett* 101 (7): 244–48.
- Willems, P., N. J. M. Kuipers, and A. B. De Haan. 2008. "Hydraulic Pressing of Oilseeds: Experimental Determination and Modeling of Yield and Pressing Rates." *Journal of Food Engineering* 89 (1): 8–16.
- Willems, P., N.J.M. Kuipers, and A.B. de Haan. 2009. "A Consolidation Based Extruder Model to Explore GAME Process Configurations." *Journal of Food Engineering* 90 (2): 238–45. doi:10.1016/j.jfoodeng.2008.06.027.
- Xiao, Zheng, Lin Guoxiang, Li Zhi, and Wang Shaomei. 2005. "Inversion Algorithm for Permeability of Rapeseed Cake and Rapeseed Dehulled Cake." *Transactions of the Chinese Society of Agricultural Engineering* 21 (5): 20–24.
- Zheng, Yun-ling, Dennis P. Wiesenborn, Kristi Tostenson, and Nancy Kangas. 2003. "Screw Pressing of Whole and Dehulled Flaxseed for Organic Oil." *Journal of the American Oil Chemists' Society* 80 (10): 1039–45.

Chapter 4. Modelling of the Jatropha-to-biofuel system: energy and mass balance

This chapter is dedicated to the description of the processes involved in biofuel production pathways, the technologies employed and the associated models. The equations used for calculating the energy and material balance of each unit operation are presented. The process models are more or less sophisticated depending on the unit operation, its importance in the process and the available data. Then, equipment and operating cost functions are introduced in Chapter 5.

1. Jatropha products properties

As Jatropha has not been domesticated and is mostly a wild tree, its properties are highly variable, especially agronomic performance and products composition, as presented in chapter 1, section 2.1.1. In this section are presented the average values, which will be used as base case in the modelling of the production pathways. When available, field data from Burkina Faso were taken into account.

1.1. Fruits and seeds properties

Jatropha seeds oil content is highly variable depending on genetics and mostly on pedoclimatic conditions and agricultural practices (Kaushik et al. 2007). Table 8 summarizes the oil content values mentioned in 3 different literature review articles based on worldwide data. The average 35 % oil on dry basis is consistent with the oil content measured on seeds from Burkina Faso and is considered as the base case value. The typical moisture content of seeds dried with ambient air is fixed to 6%, giving a standard seeds oil content on wet basis of 33%.

Table 8. Summary of seeds oil content values from Jatropha review articles

Source	Seeds oil content (% d.b.)	Number of data	Standard deviation
Achten et al., 2008	34.4	38	3
Kaushik et al., 2007	33.1	24	2.93
Basha et al., 2009	36.0	72	3.9
Average	35.03	134	3.47

1.2. Seedcake properties

The cake is rich in NPK nutrient, in average 3.5% - 1.7% - 0.8% for de-oiled seedcake (Achten et al. 2008), which makes it a good organic fertilizer. In the absence of local field data, these values are set as base-case. They are then used to evaluate the price of seedcake as organic fertiliser.

Press cake also has a high calorific value, depending on its oil content. Dry de-oiled seed cake lower heating value is 18.7 MJ/kg (Achten et al. 2008). The press cake obtained from the processing of 6% moist seeds has an average moisture content of 7%.

1.3. Oil properties

The average lower heating value of Jatropha oil is considered of 37 MJ/kg based on several literature references (Achten et al., 2008; Blin et al., 2013; Demirbaş, 1998; Freedman and Bagby, 1989; Pramanik, 2003), and its density is 914 kg/m³.

2. Modelling of transformation processes

This section is dedicated to the presentation of the models used to describe the processes involved in Jatropha biofuel production. It includes Jatropha cultivation, SVO production using cold pressing, biogas production from press cake, oil refining using acid degumming and alkali-neutralisation, biodiesel production by methanolic transesterification and the technologies used for utility supply. Depending on energy requirements, the use of combined heat and power systems is considered employing either an internal combustion engine or steam turbine.

2.1. Jatropha cultivation model

(The economic model is developed in Chapter 5, Section 2.1)

As mentioned in Chapter 1, the current data about agronomy and cultivation does not allow to build an agronomic model able to predict seed and oil yield from soil and weather conditions and agricultural practices. Instead, an economic analysis of this activity will be conducted based on operational needs and realistic yield assumptions. Based on local field data from project promoters and agronomic studies (Domergue and Pirot 2008; Allard 2010), the base-case seed yield is set to 1000 kg/ha, assuming a seed moisture content of 6% w.b. Then, the yield is taken as variable parameter of the model.

As Jatropha cultivation by smallholders is supposed to be low-input, most of the production cost consists of labour for maintaining the crops and harvesting. The use of irrigation systems, which is already scarce for food crops in Burkina, will not be

considered for Jatropha, especially as it is a drought-resistant plant and considering that the effects of irrigation on the yield cannot be predicted. Moreover, if smallholders could afford irrigation systems, the priority would certainly not be given to Jatropha.

As a minimum fertilisation is vital to ensure the sustainability of the crop, the possibility of using chemical fertilisers is investigated, even if their prices in Burkina Faso are prohibitive. The minimum fertilisation needs, so as to compensate the nutrient export due to the harvest, can be calculated based on the products nutrient composition as proposed by several authors (Domergue and Pirot 2008; Borman et al. 2013; Allard 2010). The annual needs for nitrogen, phosphorus and potassium (NPK) per hectare are calculated using Equation (1). As vegetable oil is mainly composed of triglycerides (C, O, H), it is assumed that most nutrients present in the seeds are recovered in the cake after oil extraction. Then, the minimum nutrient requirement is calculated based on de-oiled cake nutrient content, assuming an average seed oil content of 35% d.b.

$$Fert_i = Y \cdot (1 - O_s) \cdot (1 - M_{sc}) \cdot [i]_{sc} \quad (1)$$

where i relates to the nutrient N, P or K, $Fert_i$ is the annual need for nutrient i in kg/ha, Y is the humid seed yield in kg/ha, O_s is the seed oil content on dry basis, M_{sc} is the base-case seed moisture content (6% w.b.) and $[i]_{sc}$ is the mass fraction of nutrient i in de-oiled seedcake.

2.2. Straight vegetable oil production model

(The economic model is developed in Chapter 5, Section 2.2)

2.2.1 Oil expression model using screw-press

The model used for the simulation of screw-pressing process was established from an experimental analysis conducted at pilot scale. The details of the experiments and modelling are presented in Chapter 2 and were also published in (Chapuis et al. 2014).

The oil recovery is defined as the ratio of oil extracted to the oil in the feed, and can be expressed in two different ways, as in Equation (2).

$$\eta = \frac{\dot{m}_{co} \cdot (1-TS)}{\dot{m}_s \cdot O_s} = \frac{\dot{m}_s \cdot O_s - \dot{m}_{pc} \cdot O_{pc}}{\dot{m}_s \cdot O_s} \quad (2)$$

where is \dot{m}_s the seed throughput, O_s is the seeds oil content, \dot{m}_{co} is crude oil mass flowrate, i.e. the oil mass flowrate directly coming out the press, TS is the solids content of crude oil, \dot{m}_{pc} is the press cake mass flowrate and O_{pc} is the residual oil content in the press cake .

For the purpose of the present study, the inputs of the model are the seed throughput to be treated \dot{m}_s and the desired oil recovery η . The standard oil recovery of an oil

expeller is about 80% but it can be operated at a lower oil recovery to achieve higher processing capacity with the same machine (Khan and Hanna 1983). In the experimental analysis described in chapter 3, two correlations were determined: the first one gives the oil recovery as a function of seed throughput; the second correlation gives seed-specific mechanical energy requirement as a function of oil recovery and seeds oil content.

The first correlation was defined for absolute seed throughput values, according to the capacity of the press used for the experiments. To use the same correlation whatever the press capacity, it has to be expressed as a function of loading rate that is the ratio of “actual throughput to nominal throughput”. The nominal throughput of the experimental equipment, i.e. the throughput at nominal screw speed (18 rpm @ 50Hz) was of 120 kg/h. As an indication the corresponding average oil recovery was 77%.

As a reminder, the initial correlation giving oil recovery as a function of seed throughput (for whole seeds) was:

$$\eta = k_1 - k_2 \cdot \exp(k_3 \cdot \dot{m}_s)$$

The values of the coefficient k_1 , k_2 and k_3 are respectively 0.88, 0.01 and 0.02. To transform it to a function of loading rate, \dot{m}_s was changed to $\frac{\dot{m}_s}{\dot{m}_s^{nom}}$ and coefficient k_3 changed to $k_3' = k_3 \cdot 120$, 120 kg/h being the nominal throughput of the experimental equipment.

Then, the adapted model is presented in equation (3), giving the press nominal throughput as a function of oil recovery and seed throughput. The nominal seed throughput will further be used to evaluate the investment costs. The nominal seed throughput is equal to the effective throughput, when the nominal oil recovery is chosen (77%).

$$\dot{m}_s^{nom} = \frac{k_3' \cdot \dot{m}_s}{\ln\left(\frac{k_1 - \eta}{k_2}\right)} \quad (3)$$

where $k_1 = 0.88$; $k_2 = 0.01$; $k_3' = 2.4$.

Then, the crude oil mass flowrate is calculated assuming a constant solids' content (TS) of 6%, whatever the oil recovery. This assumption supposes that the worm shaft profile of the screw press is adapted to achieve the desired oil recovery. Then the crude oil mass flowrate can be calculated as:

$$\dot{m}_{co} = \frac{\eta \cdot \dot{m}_s \cdot O_s}{1 - TS} \quad (4)$$

The seed-specific pressing energy consumption E_s (Wh.kg^{-1}) is determined by the oil recovery and seeds oil content using equation (5).

$$E_s = \frac{\beta_1}{O_s \cdot (1 - \eta)} + \frac{\beta_2}{1 + \beta_3 \cdot O_s} \quad (5)$$

where the values of the coefficient β_1 , β_2 and β_3 are 1.075, -11.813 and -4.294 respectively.

These equations reflect the general behaviour of an oil expeller. If the seed throughput increases, the residence time in the barrel decreases and the oil has less time to flow out, so the oil recovery decreases. The specific energy consumption increases exponentially with oil recovery and decreases within increasing seeds oil content. Thus, a low oil recovery implies a high seed throughput and low energy requirements, and inversely.

2.2.2 Filtration of crude oil

After extraction, the oil directly passes through a press filter to remove solid particles. We assume that unfiltered oil contains 6% of solid particles. The filtration process is assumed to remove all solids and the filter cake oil content, O_{fc} , is a variable of the model that reflects the efficiency of the filtration system. Typically, a simple press filter can achieve a filter cake oil content of 50% and a filter press (or a pressure leaf filter) equipped with a pressurized air system to dry the cake can achieve a filter cake oil content of 40% (Ferchau 2000; Matthäus 2012; Grimm 1956). Then, the SVO mass flowrate after filtration is given by equation (6).

$$\dot{m}_{svo} = \dot{m}_{co} \cdot \left(1 - \frac{TS}{1 - O_{fc}}\right) \quad (6)$$

Then the loss of oil through filtration can be expressed using Equation (7).

$$1 - \frac{\text{Filtered oil}}{\text{Oil in the feed}} = 1 - \frac{\dot{m}_{svo}}{\dot{m}_{co} \cdot (1 - TS)} = \frac{TS}{1 - TS} \cdot \frac{O_{fc}}{1 - O_{fc}} \quad (7)$$

For a total solids content of 6%, the loss of oil for $O_{fc} = 0.5$ and $O_{fc} = 0.3$ is of 6.4% and 2.7% respectively. This emphasises the importance of good filtration equipment.

2.2.3 Oil plant energy consumption

The main energy consumption of the oil production plant is for pressing, to which can be added a constant value of 5 Wh.kg⁻¹ of seeds to account for other process equipment, such as pumps, conveyers and air compressor used for filter cake blowing. This assumption is made from the observation of oil production business plans performed by CREOL (Carré 2010). To calculate the overall electricity consumption of the plant we consider that the press drive has an efficiency of 0.8. Then, total electricity consumption is given by:

$$E_{tot} = \frac{E_{sp}}{\eta_{drive}} + E_{other} \quad (8)$$

where $\eta_{drive} = 0.8$ and $E_{other} = 5 \text{ Wh.kg}^{-1}$ (pumps, lighting, air conditioning...);

2.3. Biogas production from the press cake

(The economic model is developed in Chapter 5, Section 2.3)

The production of biogas from press cake is investigated for medium-scale SVO production plants. In this section the assumptions used to evaluate this option are described, although no detailed mass balance of chemical components was performed.

2.3.1 Overview of anaerobic digestion process

Biogas can be produced from organic matter through a biological process called anaerobic digestion. This process involves four main steps: hydrolysis, acetogenesis, acidogenesis and methanogenesis. The gas produced is mostly a mixture of carbon dioxide (30 - 45%) and methane (55 - 70%), depending on the feedstock and processing conditions. The remaining substrate is termed digestate: it generally contains agro-nutrients and has good fertilising properties, especially due to the mineralisation of nitrogen during the fermentation, making it more easily assimilated by plants (Moletta 2011).

The control of biodigestion as a continuous process relies on a number of parameters. There are mostly two important physical parameters: temperature and contact conditions. Temperature has an effect on the kinetics of bacterial development and on the type of bacteria, i.e. mesophilic (25-35°C) or thermophilic (50-60°C). Then, contact conditions greatly influence the fermentation rate. On the biochemical part, the most important parameters include solid concentration, carbon to nitrogen ratio (C:N), pH and the concentration of toxic intermediate compounds produced by the bacteria (H₂S, NH₃) (Moletta 2011). C:N ratio should be in the range of 15-30 to avoid accumulation of ammonia in the digester (Weiland 2009).

The organic matter to digest can be solid (particles) or liquid and is introduced in the digester with inorganic matter and water. Each type of organic matter has an inherent methane production potential, which corresponds to the total amount of methane that would be produced if it were totally degraded through anaerobic digestion. This potential, called biochemical methane potential (BMP), can be measured through standardised analytical methods. Then, the effective transformation of the BMP through the digester depends on the employed technology and above all, on the proper management of operations. The load of organic matter applied must be carefully adjusted to the degradation rate in the digester: an organic matter overload can cause asphyxiation of bacteria, due to high concentration of intermediate compounds, such as volatile fatty acids (Weiland 2009; Braun 2012). This is why the homogeneity of the feed is crucial.

Eventually, anaerobic digestion can be conducted at different solid concentration level, classified as wet and dry fermentation. The most widespread mode is wet fermentation, where organic matter concentration is below 10%. Dry fermentation relates to substrates with solid contents in the range of 15% to 35%, which was developed for the treatment of municipal solid wastes. It would be an interesting option for the digestion Jatropha seedcake since it is a dry matter and water resources are limited in Burkina Faso. However, this process is more difficult to control and the technique still requires improvement (Weiland 2009). The high concentration of solid matter can induce frequent organic matter overloads and the handling of semi-solids requires specific equipment.

A range of digestion technologies is available depending on the feedstock. Jatropha seedcake can be assimilated to an agricultural residue and thus could be treated with common agricultural biogas production technologies. In Europe and especially in Germany, most on-farm digesters that treat manure together with crop residues use a vertical continuous stirred tank, with a gas-tight membrane roof (Moletta 2011). They are mostly operated under wet conditions but could also be used as dry digester with an adaptation of the stirring system (Weiland 2009). In wet conditions, these digesters commonly achieve volatile matter conversion in the range of 80 – 95%, for feedstock such as manure and agro-food waste (Kafle and Kim 2013; Braun 2012). The low-cost alternatives are the “chinese-type” fixed-dome and “indian-type” floating-dome systems. Their main advantage is that they are inexpensive as they can be built with local material but they have poor performances (volatile solids conversion of about 60%), especially due to the absence of a stirring system (Parawira 2009; Moletta 2011). Eventually, in the case of seasonal activities, biogas plants can be put in stand-by for several months while conserving bacterial population.

2.3.2 Biogas production from Jatropha press cake in Burkina Faso: model and assumptions

Several published works report the successful production of biogas from Jatropha press cake, alone (Staubmann et al. 1997; Grimsby, Fjørtoft, and Aune 2013) or with co-substrates (Raheman and Mondal 2012; Ali, Kurchania, and Babel 2010). The use of co-substrates is often necessary to adjust the composition so as to optimise biogas yield, since C:N ratio of Jatropha press cake can be rather low, between 8 and 15. In these works, biogas production is investigated with experimental digesters but so far, no full-scale biogas production from Jatropha seedcake was reported.

The biochemical methane potential of press cake significantly varies with its oil content, since oil and fat have very high methane potential. However, the fats are not readily available to bacteria and their degradation requires a longer lag time (Weiland 2009). Consequently, the possibility of using indian or chinese digesters was discarded, since they offer poor reaction conditions. Then, we considered the common vertical stirred tanks would be the most suitable technology for Jatropha press cake. Moreover, as it is the most widespread, economic data is available in the literature and based on field surveys (Moletta 2011; Amigun and von Blottnitz 2010; Walla and Schneeberger 2008). It is available from an equivalent methane thermal power of 150 kW (equivalent to about 50 kW_{el}), and up to more than 20 MW_{el} .

It was not possible to develop mass balance equations of the process based only on literature data. In practice, the press cake would need to be highly diluted in water, between 10 and 20 times, to reach proper conditions for anaerobic digestion. To avoid using clean water resources, which are scarce in Burkina Faso, press cake could be used as a co-substrate with more dilute effluent (wastewater, brewery effluents...). However, this type of solution was not considered in the present work, since it would bring considerable uncertainties (assumptions on co-substrate nature) and broadens the limits of the study. Eventually, the local hot climate would be particularly suitable for biogas production: with an annual average temperature of 27°C , biogas digester could probably run without heating system. By contrast, under European climate, heating the digesters can consume a significant amount of the biogas produced.

Then, in order to give an estimate of the opportunity of producing biogas and electricity from press cake, we considered a biogas plant based on a common vertical stirred tank technology, only fed with press cake with solid concentration of 10% (i.e. 90% water). The biochemical methane potential of the press cake is calculated as a function of its oil content, according to the data published by (Gunaseelan 2009). It is assumed that the digester achieves a conversion rate of 80% of volatile solids. The calculation of the seedcake BMP, expressed in $\text{Nm}^3 \text{ CH}_4/\text{kg}$ fresh matter for simplicity reasons, is as follows:

$$BMP_{pc} = BMP_{doc} \cdot (1 - O_{pc}) \cdot VS_{doc} \cdot TS_{doc} + BMP_{oil} \cdot O_{pc} \cdot VS_{oil} \cdot TS_{oil} \quad (9)$$

where BMP_{pc} is the press cake BMP in $\text{Nm}^3 \text{CH}_4/\text{kg}$; BMP_{doc} and BMP_{oil} are respectively the BMP of de-oiled cake and oil expressed in $\text{Nm}^3 \text{CH}_4/\text{kg}$; VS_{doc} and VS_{oil} are the volatile solid content of de-oiled cake and oil in $\text{kg VS}/\text{kg TS}$; TS_{doc} and TS_{oil} are the total solid content of de-oiled cake and oil in $\text{kg TS}/\text{kg}$; O_{pc} is the press cake oil content. The values of the parameters are detailed in Table 9.

Table 9. Properties of oil and de-oiled cake used for BMP calculations (Gunaseelan 2009).

	Total Solids [kg TS/kg fresh matter]	Volatile Solids [kg TS/kg VS]	BMP [Nm ³ CH ₄ / kg VS]
De-oiled cake	0.94	0.892	0.230
Oil	1	1	1.150

Then, the seedcake is digested with an efficiency of 80%. The power available at the output of the digester in the form of biogas can be calculated using the following equation:

$$P_{CH_4} = \dot{m}_{pc} \cdot BMP_{pc} \cdot LHV_{CH_4} \cdot \eta_{dig} \cdot 10^6 \quad (10)$$

where P_{CH_4} is the thermal-equivalent power available from the biogas (in W); \dot{m}_{pc} is the press cake mass flowrate entering the digester in kg/s ; $LHV_{CH_4} = 35.7 \text{ MJ}/\text{Nm}^3$ is the lower heating value of methane per unit volume; $\eta_{dig} = 0.8$ is the conversion efficiency of the digester.

Then, after purification, the biogas is used in an internal combustion engine for the production of power or combined heat and power. This part of the process will be treated further in section 3.2 dedicated to utility supply, since the power generated depends on the use of a CHP system.

Eventually, in the absence of a detailed mass balance model, it is not possible to precisely determine the composition of the digestate. However, during anaerobic fermentation, a small share of the macro-nutrients is used for bacteria growth and most of the nitrogen, phosphorus and potassium end up in the digestate. Moreover, it was shown that during the digestion of Jatropha press cake, (Grimsby, Fjørtoft, and Aune 2013) almost 80% of the organic nitrogen is converted to mineral nitrogen in the form of ammonium and nitrate, and all the phosphorus is recovered in the form of phosphate. As nutrients in mineral form can be directly assimilated by plants, Jatropha press cake digestate has a high fertiliser value. The nutrients are however much more diluted than in the dry press cake. Then, the digestate will be considered as a valuable by-product in the economic model, but with a depreciation compared to the press cake directly sold as fertiliser.

2.4. Refining operations: degumming and neutralization

The economic model is developed in Chapter 5, Section 2.4)

Vegetable oil refining process derives from the food industry. For human consumption, oil refining consists in degumming (phospholipid removal), neutralization (free fatty acid removal), bleaching and deodorisation. The two latter are not required for use as fuel or further processing to biodiesel (Santori et al. 2012). Then, for biofuel purposes, oil refining will consist in degumming, neutralization and drying. As argued in chapter 1, the technologies retained for this study are the most commonly used for commercial activities. Based on several review articles and process manufacturers' data, a generic refining process design was built and simulated using AspenPlus software. The Aspen model provides good estimations of energy requirements for heating and drying operations. This section explains the choices made for the modelling of the refining process based on scientific literature data, including process design and operating conditions. A batch version of the refining process is also presented.

2.4.1 Straight Jatropha oil average properties

In order to choose a suitable process design, assumptions had to be made on the average composition of the Jatropha oil to be treated. Following reports from several experimental results, Jatropha oil extracted in good conditions present a free fatty acid content in the range 0.5% to 2% (Kpoviessi et al. 2004; Sahoo and Das 2009; Rao et al. 2008). Higher values reflect high degradation level of the oil that can be due to improper seeds or oil handling and storage conditions. Phosphorus content of Jatropha oil is rarely reported in scientific literature. (Liu et al. 2012) mentioned phosphorus content in the range of 60-300 ppm in fresh Jatropha oil. (Rao et al. 2008) have shown that the overall phospholipid content of Jatropha seed lipids is 1.45%, which approximately corresponds to a phosphorus content of 480 ppm. This value is relatively low compared to other oilseeds such as rapeseed or soybean (Subramanian and Nakajima 1997; Wiedermann 1981). From several personal experiments, phosphorus content levels in Jatropha oil is around 50 ppm for cold-pressed oils and 100 to 150ppm when the seeds underwent a cooking treatment before pressing.

2.4.2 Water-degumming process using acid-conditioning

The degumming of vegetable oil aims at removing the phospholipids, large molecules constituting cell membranes, known to cause filter and injector clogging and carbon deposits on piston-heads when present in fuels, either SVO or biodiesel (Sidibé et al. 2010). Phospholipids may also neutralize alkali catalysers used in transesterification and reduce the yield of methyl ester (Lu et al. 2009). Acceptable phosphorus content in straight vegetable oils for use in stationary Diesel engines is below 50 ppm (Blin et al. 2013), whereas most biodiesel quality standards, such as ASTM D6751 and EN 14214, recommend a limit value of 10 ppm maximum.

The basic technique for removing phospholipids is to hydrate them by water washing, so that they precipitate into solid particles and can be removed by decantation. However, different forms of phospholipids are present in vegetable oils and not all are readily hydratable. The non-hydratable form appears when the phospholipids react with metal cations such as iron and magnesium. Phospholipids present in Jatropha oil include phosphatidylcholine (PC, ~60%), phosphatidylinositol (PI, ~25%) and phosphatidyl-ethanolamine (PE, ~15%). PC and PI are readily hydratable whereas PE is hydratable only at low pH (Dijkstra 2011). Then, in order to reach the phospholipid levels required for biodiesel production, i.e. below 10 ppm phosphorus, the oil is treated with a strong mineral acid, usually phosphoric acid, prior to water washing (Wiedermann 1981; Eichkoff 2004).

In some edible vegetable oil refining process, the hydrated phospholipids are separated before the oil undergoes neutralization, because lecithin can be recovered from the phospholipids. However, when there is no interest in recovering the lecithin, neutralization can be performed right after the acid treatment and the water washing and the separation of impurities are done at the end of the whole process.

Acid degumming conditions of Jatropha oil in industrial installations is not often reported in literature. (Liu et al. 2012) analysed the effect of process conditions on the efficacy of phospholipids removal from Jatropha during acid degumming in laboratory experiments. Commercial phospholipids were used to adjust the phosphorus content of the oil to 1200 ppm. The effect of temperature, acid amount and centrifugal speed were investigated and the best conditions were determined to be at 65°C, with 4% acid solution at 10% concentration and centrifugation at 1600 rpm. The phosphorus content dropped from 1200 ppm to 60 ppm after a washing with 4% water. (Wiedermann 1981) reported the industrial practices for the degumming of soy oil. Initial phosphorus content is approximately 700 ppm. In continuous process, the operation is generally realised at temperatures between 70°C and 90°C, highly concentrated phosphoric acid (75%) is added in a proportion from 0.05% to 0.2% and the mixture is stirred during 1 min. Then, 2% water is added at 60-70°C, the mixture is allowed to react for 10-15 min and centrifuged. In batch mode, Wiedermann (1981) recommends to add the phosphoric acid directly in the day tank and to allow it to react for 4 hours. Then, the water washing occurs in an agitated reactor for one hour at 60-70°C instead of 10 min. Finally, (Eichkoff 2004) presents the same type of processing conditions as Wiedermann, and specific acid amounts for soybean, sunflower, corn and rapeseed oils ranging from 0.05 to 0.15% (75% concentration). At the end of the process, the phosphorus content is reduced to 4 ppm (starting from 90-540 ppm).

Natural phospholipid content of Jatropha oil (from screw pressing) is relatively low compared to most common edible oils. Moreover, most phospholipids are encountered in hydratable form (PC and PI), so it was assumed that a light acid treatment would be adequate to remove most phospholipids in Jatropha oils. Thus, the temperature was set to 90°C and 0.05% phosphoric acid (75% concentration) is added. The mixture is

allowed to react for 10 min in a holding tank without stirring. The neutralisation is realised right after this acid treatment and water washing and centrifugation is done at the end of the process.

2.4.3 Alkali-neutralization of free fatty acids

Neutralisation is simpler than degumming. The conventional process consists in mixing the oil with a solution of lye, so that the free fatty acids react with sodium hydroxide to form soaps. The neutralisation reaction is the following: $\text{FFA} + \text{NaOH} \rightarrow \text{H}_2\text{O} + \text{SOAP}$. The soaps are then diluted and removed during water washing.

Then, the required amount of NaOH can be calculated from the free fatty acid content based on the stoichiometry of the reaction. Additional NaOH should be added to neutralise the phosphoric acid used for phospholipids conditioning. To ensure a good removal of phospholipid in the subsequent washing step, the NaOH should be added in the form of dilute lye (11-13% NaOH) (Wiedermann 1981; Eichkoff 2004). Then the saponification reaction takes 5-10 min. To avoid emulsion problems, it is recommended to conduct the reaction at a temperature of 30-50°C and then heat up to around 75°C to break the emulsion and enable the separation of soap. No specific information is available for batch processing.

Based on this information, in the process model, it was assumed considered that the oil flow is cooled to 50°C before lye addition. A solution of NaOH at 12% concentration is used. The amount of NaOH is calculated based on the stoichiometry of the reactions with FFA and phosphoric acid, to which a 10% excess is added. The reaction occurs in a stirred reactor during 10 min.

2.4.4 Water washing and centrifugation

After the phosphoric acid treatment and the alkali neutralisation, the soap and gums are separated by centrifugal or gravity sedimentation. Centrifugal sedimentation is commonly used in large-scale applications, since it can be operated continuously and provides high separation efficiency. Disk centrifuges, illustrated in Figure 19, allow for three-phase separation of oil water and solids (soap and gums). The removed solids have an oil content of 35-40% (Matthäus 2012). However, this type of equipment requires high capital investment. For smaller production units, gravity sedimentation may be more appropriate: equipment is far less expensive, although the losses are slightly higher.

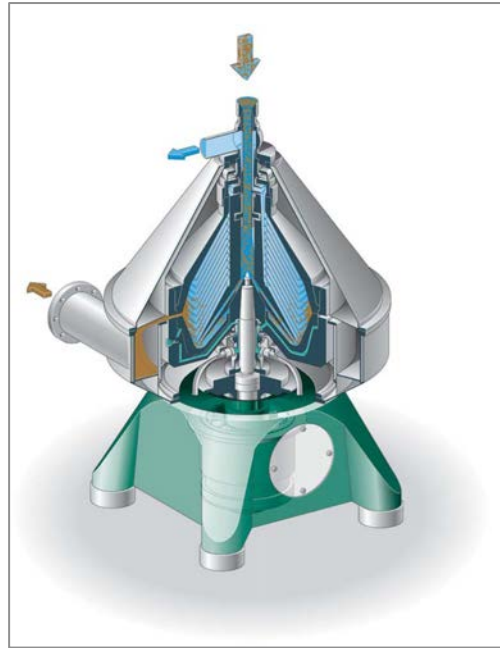

Figure 19. Sketch of disk centrifugal separator.
(Source: © GEA Westfalia Separator)

Table 10 gives water-washing conditions mentioned in literature for both water degumming and neutralisation. As mentioned before, in the food industry, these two operations are realised separately to allow for the recovery of lecithin (phospholipids). In the case of biofuel production from inedible vegetable oils, only one water-wash is realised at the end of the process (after neutralisation reaction). Based on the information in Table 10, we assume the oil is washed with 10% hot soft water at 90°C. In the case of continuous processing, this operation is realised in a washing tower allowing for 10 minutes contact time. The water-oil mixture is then separated in a centrifuge. In batch processing the washing takes place in an agitated tank, for about one hour, and the separation is achieved by gravity settling.

Table 10. Vegetable oil water washing conditions

Water washing conditions	Source	Temperature (°C)	Proportion to oil mass flowrate
Water-degumming			
	Wiedermann (1981)	60-70	2%
	Pagès-Xatart-Parès (2013)		2-4%
	Matthäus (2012)	80	2%
After neutralization			
	Wiedermann (1981)	95	15%
	Eichkoff (2004)		5-10%
	Pagès-Xatart-Parès (2013)	85	10-20%

2.4.5 Oil drying

The degummed and neutralised oil has to be dried before being used as fuel or processed to biodiesel. This is usually done in a flash dryer at low pressure, between 0.1 and 0.5 bar and a temperature of around 115°C. The simulation with Aspen allows to calculate the energy requirement and separation efficiency of this operation with respect to operating conditions.

2.4.6 Modelling of refining operations in semi-batch and continuous processes

While AspenPlus simulation provides a good estimate of thermal energy requirements, it does not easily handle the modelling of solid-liquid operations, especially with complex molecules such as phospholipids and free fatty acids. Then, the mass balance is calculated apart, using Matlab, in order to handle solid-liquid separation efficiencies. Figure 20 is a block flow diagram representing the whole refining process. The overall performances in terms of impurity reduction are presented in Table 11.

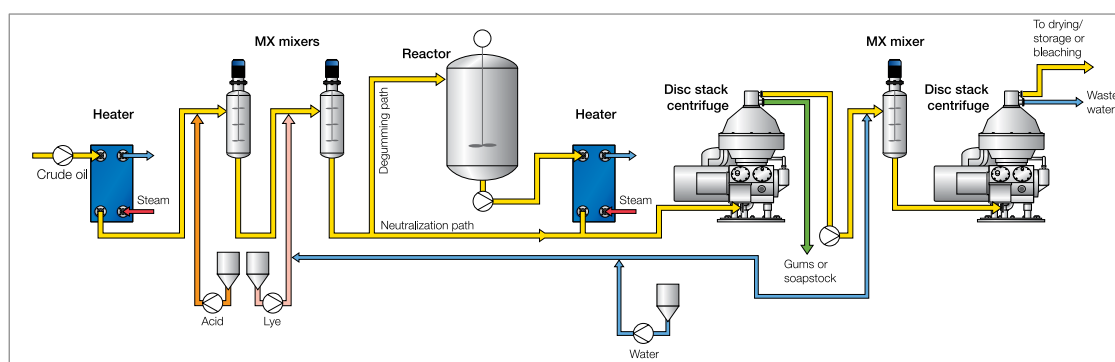

Figure 20. Two- stage alkali refining process

(Source: Alfa Laval degumming and neutralisation solutions, 2014, © Alfa Laval, Lund, Sweden)

Table 11. Residual impurities in refined oil (Wiedermann 1981; Eichkoff 2004)

	Initially	After centrifuge 1	After centrifuge 2	Units
Phosphorous	100	10	4	ppm
Phospholipid	3000	300	120	ppm
Water	0.5	0.5	0.5	%
Soap (Na₃PO₄ + FFASoap)	-	250	50	ppm
Free fatty acids (FFA)	2	0.04	0.04	%

The mass balance calculations are conducted as follows. First, the phosphoric acid mass flowrate is calculated from SVO mass flowrate:

$$\dot{m}_{acid} = p_{acid} \cdot \dot{m}_{svo} \quad (11)$$

where $p_{acid} = 5 \cdot 10^{-4}$, is the proportion of phosphoric acid (solution @75%) added.

Then, the sodium hydroxide mass flowrate is calculated from the stoichiometry of the following reactions:

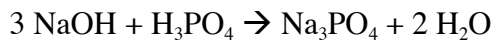
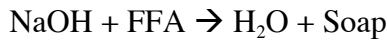

NaOH mass flowrate is calculated as:

$$\dot{m}_{NaOH} = \left(\dot{m}_{svo} \cdot \frac{X_{FFA}}{M_{FFA}} + \frac{3 \cdot \dot{m}_{acid} \cdot X_{H_3PO_4}}{M_{H_3PO_4}} \right) \cdot (1 + e) \cdot M_{NaOH} \quad (12)$$

where X_{FFA} is the mass fraction of free fatty acids in SVO; $X_{H_3PO_4} = 0.75$ is the H_3PO_4 mass fraction in the phosphoric acid solution, M_{FFA} , $M_{H_3PO_4}$ and M_{NaOH} are the average molecular weights of free fatty acids, H_3PO_4 and NaOH respectively; \dot{m}_{NaOH} , \dot{m}_{svo} and $\dot{m}_{H_3PO_4}$ are the mass flowrates of NaOH, SVO and H_3PO_4 respectively; $e = 0.10$ is the NaOH molar excess ratio.

The sodium hydroxide is used in the form of lye at 12% mass concentration. The mass flowrate of lye can be calculated as: $\dot{m}_{lye} = \frac{\dot{m}_{NaOH}}{X_{NaOH}}$, where $X_{NaOH} = 0.12$ is the NaOH concentration in the lye solution.

Now, it is possible to calculate the refined oil mass flowrate using the impurities content of input and output oil as presented in Table 11. The mass balance of triglycerides throughout the refining process can be written as:

$$\dot{m}_{refoil} \cdot (1 - X_{FFA}^f - X_{PL}^f - X_{H_2O}^f - X_{Soap}^f) = \dot{m}_{svo} \cdot (1 - X_{FFA}^i - X_{PL}^i - X_{H_2O}^i) - Losses \quad (13)$$

where $Losses = \text{Separation Loss} + \text{Drying Loss}$

The oil loss due to vaporisation during drying operation is calculated in Aspen model. Separation loss refers to the oil contained in the removed solids, called soapstock. It can be calculated from the mass of soapstock and the hypothetic oil content of these solids. For the sake of simplicity, we assume that most of gums, soaps and salts are removed in the first separation step (see Figure 21). The residual impurities after this separation,

which are removed during water washing and second separation, are considered negligible. Then, the separation losses can be estimated as follows:

$$\begin{aligned}
 \text{Separation Loss} = & ((\dot{m}_{svo} \cdot X_{FFA}^i - \dot{m}_{refoil} \cdot X_{FFA}^f) \cdot \frac{M_{FFAS}}{M_{FFA}} + \dot{m}_{svo} \cdot X_{PL}^i - \dot{m}_{refoil} \cdot X_{PL}^f \\
 & + \dot{m}_{acid} \cdot X_{H3PO4} \cdot \frac{M_{Na3PO4}}{M_{H3PO4}}) \cdot \frac{O_{SOAP}}{1 - O_{SOAP}}
 \end{aligned}
 \tag{14}$$

Separation Loss = (mass of FFA soap + mass of PL + mass of Na₃PO₄)*Oil content

with

$$M_{FFA} = 282 \text{ g / mol}; M_{H3PO4} = 98 \text{ g / mol}; M_{FFAS} = 300 \text{ g / mol}; M_{Na3PO4} = 164 \text{ g / mol}$$

The drying losses varies depending on drying conditions: drying the oil to 0.05% moisture content requires 115°C and 0.15 bar, which implies a loss fraction of 0.70 % of oil mass flowrate. To calculate refined oil mass flowrate based on equation (13) and (14), it can reasonably be assumed that the final concentration of free fatty acids and phospholipids are negligible compared to initial levels (see Table 11). This greatly simplifies the resolution of the equation. The mass balance of the continuous process in base-case conditions, i.e. with an initial phospholipid content of 3000 ppm and FFA content of 2%, is presented in Figure 21.

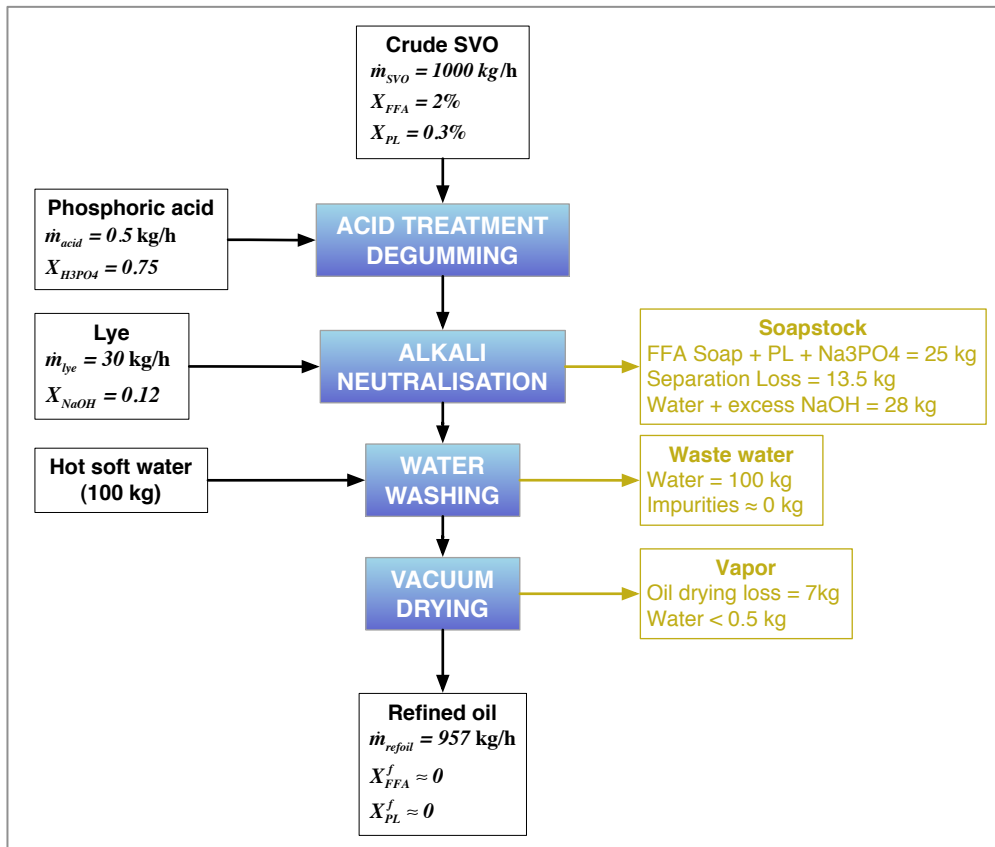

Figure 21. Continuous refining process mass balance for base-case conditions.

For a crude vegetable oil processing capacity of 1000 kg/h in base-case conditions, the energy requirements are calculated using AspenPlus software according to temperature levels (Table 12).

Table 12. Heat requirements of the SVO refining process in base-case conditions, at 1000 kg/h as calculated using AspenPlus software.

Operation	Heating (kW)	Cooling (kW)	Temperature °C	
			IN	OUT
Heating of SVO and acid	27		30	90
Cooling before neutralisation		-18	90	50
Heating after neutralisation	13		50	75
Refined oil cooling		-37	115	35
Wash water heating	7		30	90
Wastewater cooling		-5	90	35
Drying to 0.05% @0.15 bar; 115°C	21		90	115
TOTAL	68	-60		

2.4.7 About batch and continuous operation

In the industry, vegetable oil refining is achieved using semi-batch or continuous process, depending on the treatment capacity (Santori et al. 2012; Matthäus 2012). In the semi-batch process, degumming, neutralisation and washing operations are batch and drying is conducted continuously thanks to buffer tanks. The main advantage of batch process is that it requires lower capital costs because batch reactors are less expensive than continuous stirred tanks and separation operations are achieved by gravity sedimentation instead of centrifuge (Turton et al. 2012; Perry 1997; Ulrich and Vasudevan 2004). Batch production also has the advantage to be more flexible in terms of feedstock quality since each batch is treated separately so the reaction conditions can be adjusted to straight vegetable oil properties. Finally, the production schedule can be more easily adapted to supply intermittence.

However, batch refining also has disadvantages, in particular for processing large quantities of vegetable oil. First, it requires considerable labour for handling the products, loading the reactors and operating the process. This way of proceeding is even more tedious and expensive to apply than the size of the batches is large. Moreover, batch operation generally achieves lower refined oil yields because of poorer

contact conditions in the reactors (larger size) and lower separation efficiency if centrifugal separators are not used. Passed a certain size (around 10 000 tons/year), continuous processing performs much better and is more profitable. Finally, heat recovery and energy integration systems are not easily implemented on batch process because of energy demand variations.

Model assumptions for batch and continuous process

In order to calculate the size of the batch reactor and buffer tanks, it was necessary to define an operation cycle. We assume that neutralisation, washing and separation by gravity sedimentation are realised successively in the same reactor. The whole cycle take 6 hours, including 30 minutes loading, 1h for neutralisation reaction, 2h decantation, 1h washing, 1h decanting and 30 minutes unloading. Then, the size of the reactor tank can be calculated from the desired hourly capacity. A holding tank of 2 times the batch capacity serves as a buffer before drying in the flash drum which is operated continuously. Table 13 summarises the assumptions made for modelling batch and continuous refining.

Table 13. Summary of the assumptions made for modelling batch and continuous refining.

Operation	Batch	Continuous
Capacity range (kg/h)	200 – 2 000	1 000 – 10 000
Storage	20 days storage capacity in fixed roof tanks for SVO and refined oil.	20 days storage capacity in floating roof tanks for SVO and refined oil.
Day tank	2 day tanks of 12h capacity	2 day tanks of 12h capacity
Phosphoric acid conditioning	0.1% phosphoric acid @75% added in the day tank	0.1% phosphoric acid @75% 90°C in non agitated reactor 10 min residence time
Neutralisation	NaOH solution @12% 50°C in agitated batch reactor 1h reaction time	NaOH solution @12% 50°C in jacketed agitated reactor 10 min residence time
Separation 1 (gums and solid soaps)	Settling in the reactor	Disc centrifuge
Water washing	In the reactor 90 °C, 1h	In a mixer 90 °C
Separation 2 (aqueous phase)	Settling in the reactor	Disc centrifuge
Buffer tank	2 x reactor tank volume	-
Drying	Flash drum 115°C, 0.15 bar	Flash drum 115°C, 0.15 bar
Pumps	2 pumps	5 pumps

Separation by gravity decantation

The separation efficiency of the solids is considered lower for gravity decantation than for centrifuge due to higher liquid content in the solid phase. Thus, in the first separation, the oil content of the removed gums and soaps is assumed to be around 60% instead of 35% in continuous process.

Pumps

For the continuous process, pumping power is calculated in Aspen based on flowrates and pressure drop. As real pressure drops cannot be calculated without a precise definition of the process design (pipe length, heights, etc.), an average pressure of 4 bars abs. was considered in the Aspen process model. Then, the general rule for process design is to provide a pump between each unit operation, i.e. 5 pumps in the continuous process.

For batch operation, the sizing and number of pumps is different. As several operations are realised in the same reactor, only 2 pumps instead of five are included. The pumps are used intermittently for loading and unloading the reactors, so they should be more powerful than those required for continuous processing: it is assumed they are 10 times more powerful.

Utility supply

Energy use efficiency in batch operation is considered lower than for continuous operation. In batch mode, the demand is variable, so there are more energy losses at the boiler and heat network level. Moreover due to the intermittency of the demand, higher peak power is required. It is assumed that the heat consumption and the boiler heat duty are two times higher than for continuous processing. No heat network integration is considered in batch operation.

2.5. Biodiesel production from refined oil

(The economic model is developed in Chapter 5, section 2.4)

2.5.1 Transesterification reaction

As explained in chapter 1, the only biodiesel production process considered for the simulations is the alkali-catalysed methanolic transesterification; which is the most common an industrial scale. Transesterification is the reaction of a molecule of triglyceride with three of methanol that forms three molecules of fatty acids methyl-ester and one molecule of glycerol (see Figure 22). The reaction is reversible and needs to be catalysed.

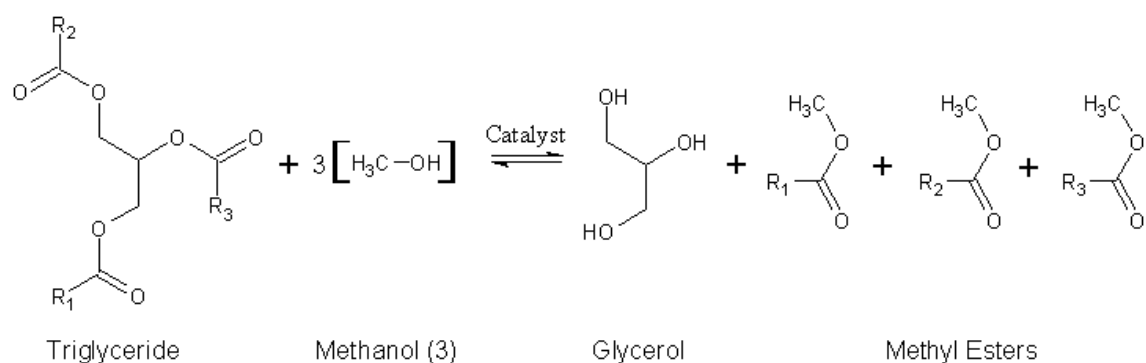

Figure 22. Methanolic transesterification reaction

2.5.2 Modeling of biodiesel production process

For the needs of this study, a continuous biodiesel production process was modelled using AspenPlus software. Most of the process design was adapted from Santori et al. (2012), who presented a very comprehensive review of current biodiesel production practices in the industry. In AspenPlus, the Unifac-Dortmund thermodynamic model was chosen for its capabilities in representing phase equilibrium of heterogeneous multi-component mixtures. It is the most suitable for the compounds and thermodynamic conditions considered in this study. A continuous 2-stage transesterification process is modelled with Aspen and then a semi-batch techno-economic model is derived. The oil is modelled as triolein and compounds derived from oleic acids, because they are the only compound in the AspenPlus database with sufficient thermodynamic properties. Since the reaction kinetics is not considered, this has little influence on the results. The overall process flowsheet is illustrated on Figure 23.

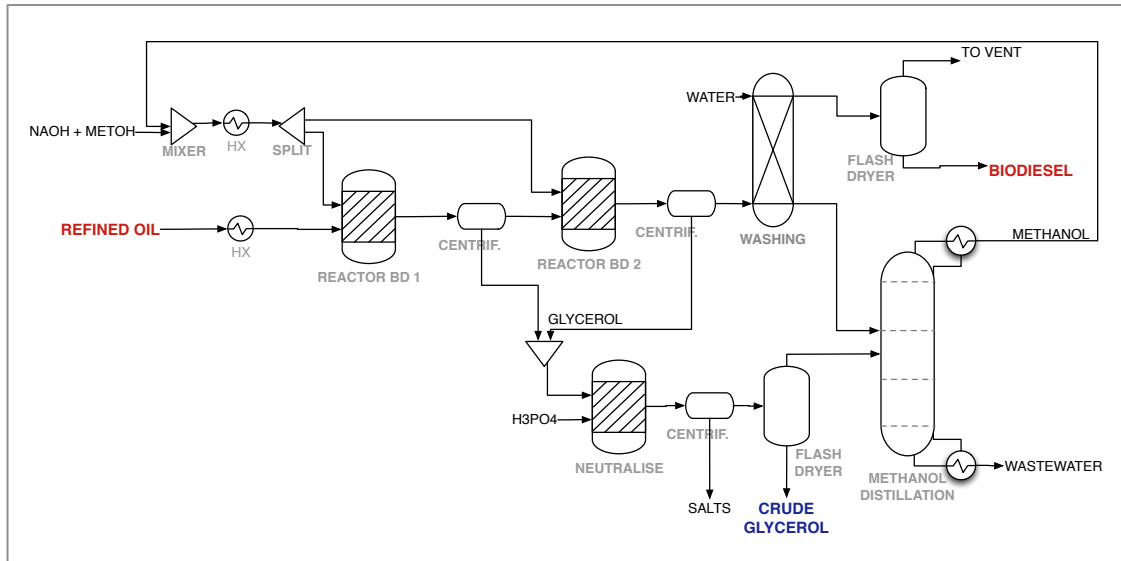

Figure 23. Transesterification process flowsheet (pumps and heat exchangers are not represented to preserve readability)

The vegetable oil is first heated to 60 °C and fed to a first continuous stirred tank reactor together with methanol and sodium hydroxide (NaOH) as a catalyst. The sodium hydroxide is previously mixed in the methanol tank in a proportion of 1.0% of the oil input. Then, the methanol is introduced in the first reactor with a molar ratio of 6:1. The residence time is about 10 min, thereby achieving a conversion rate of 85 % triglycerides. The reaction mixture then passes into a second reactor after a centrifugal separation of the heavy phase containing glycerol. Methanol is added to achieve a 20:1 molar ratio relatively to the remaining triglycerides, which allows to obtain an overall conversion rate of 99 % (Santori et al. 2012; Koh and Mohd. Ghazi 2011).

After the reaction stage, the biodiesel phase is cooled to 30°C and centrifuged to separate the glycerol phase. Centrifugation at low temperature gives a higher methyl-ester fraction in the biodiesel phase. Then, the biodiesel is washed with soft water at 30°C in a 6-tray tower. Washing at low temperature also gives better results in terms of biodiesel purity. A large amount of water is necessary to achieve an acceptable purity: one third of biodiesel mass flowrate gives good results. Finally, the biodiesel is dried in a flash drum at 120°C and 0.1 bar, which reduces the water mass fraction below 0.05%. The produced biodiesel has a purity of 99.4%.

The glycerol phase coming from the reactors has a glycerine content of about 50%. It also contains methanol, sodium hydroxide and soaps formed by the reaction of free fatty acids with NaOH. First, this phase is treated with phosphoric acid in order to neutralise sodium hydroxide and to convert the soaps into FFA and salts which are then removed by centrifugation. Then, the glycerol is separated from methanol and water in a flash drum at 90°C and 0.5 bar. The obtained glycerol has a purity of 89% and can be sold as crude glycerol.

The methanol/water phase from the flash dryer is condensed and sent to a 20-trays distillation tower together with the biodiesel wash water. This column allows to purify the methanol to 99.9% prior to recycling it in the process. The overall mass balance of the process, in the base-case conditions are presented in Figure 24.

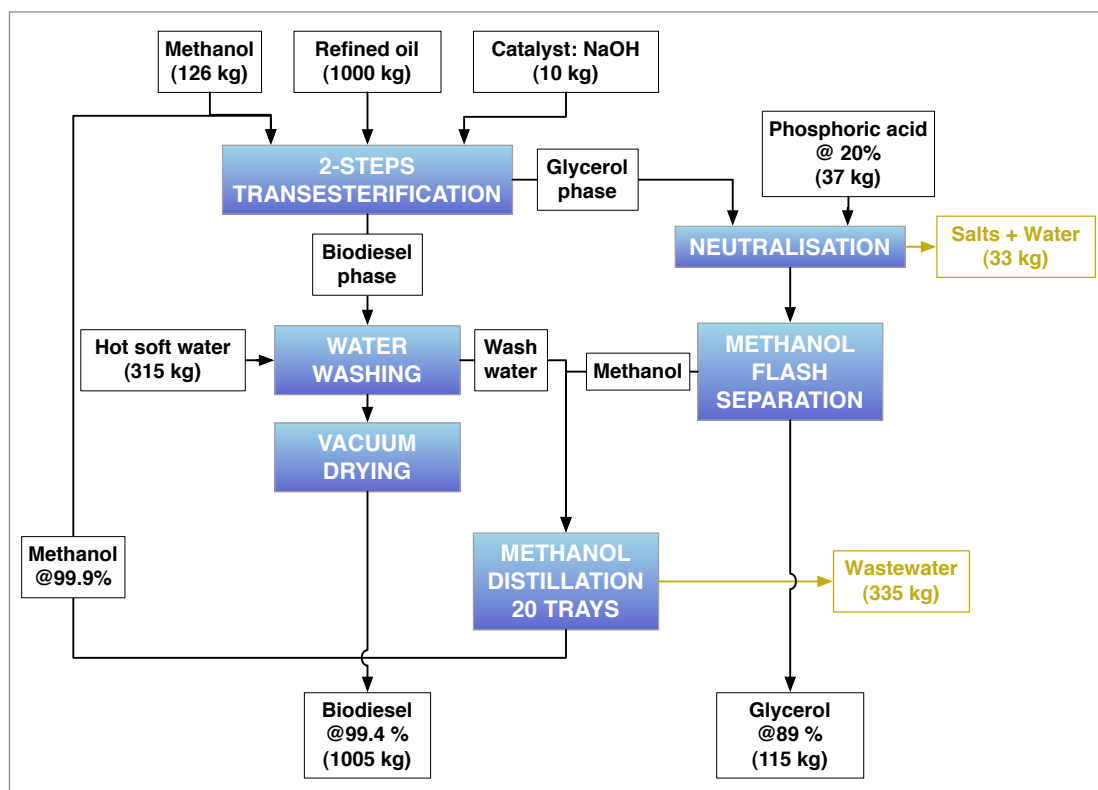

Figure 24. Overall mass balance of the transesterification of refined vegetable oil.

The heat requirements of the process are summarized in Table 14. The drying and distillation operations are, by far, the main consumers.

Table 14. Heat requirements of the biodiesel production process in base-case conditions as calculated using AspenPlus software.

Operation	Heating (kW)	Cooling (kW)
Input heating	16.4	
Products cooling		-246.0
Biodiesel drying	49.3	
Glycerol drying	46.3	
Methanol distillation	133.0	
TOTAL	245.0	-246.0

2.5.3 Batch and continuous operation

As for oil refining, biodiesel production can be semi-batch or continuous, depending on the implementation size and on the operating constraints such as the variability of feedstock quality. In the Aspen model, the process was modelled as continuous. In semi-batch operation, only the reactors are operated in batch, including transesterification and glycerol neutralisation, while the rest of the process (washing, drying and distillation) are operated on a continuous basis thanks to buffer tanks (Santori et al. 2012). The operating conditions of the main unit operations are summarized in Table 15.

Table 15. Summary of the assumptions made for modelling batch and continuous biodiesel production.

Operation	Batch	Continuous
Capacity range	200 – 2 000	1 000 – 10 000
Storage	20 days storage capacity in fixed roof tanks for refined oil and biodiesel.	20 days storage capacity in floating roof tanks for refined oil and biodiesel.
Transesterification	1 step of 1h reaction time (+30 min loading/unloading. MeOH : Oil = 6:1 Conversion rate: 99%	2 step of 10 min reaction time. Step 1: MeOH : Oil = 6:1 Step 2: MeOH : Oil = 20 :1 Conversion rate: 99%
Biodiesel buffer tank	Vertical vessel 3 times the batch capacity	-
Glycerol neutralisation	Vertical vessel 1 batch capacity	Jacketed agitated reactor 10 min residence time
Glycerol buffer tank	Vertical vessel 3 times the batch capacity	-
Separations	Settling in the reactors	Disc centrifuge
Glycerol drying	Flash drum 90°C, 0.5 bar	Flash drum 90°C, 0.5 bar
Biodiesel drying	Flash drum 120°C, 0.1 bar	Flash drum 120°C, 0.1 bar
Pumps	7 pumps	11 pumps

About storage: when refining process is set in the same plant as biodiesel, only two 20-days storage tanks are included (one for SVO and one for biodiesel).

The oil conversion rate of continuous and batch process are assumed to be equivalent (Koh and Mohd. Ghazi 2011; Santori et al. 2012). The batch process can be implemented for treatment capacity between 200 kg/h up to 2 000 kg/h, while continuous process is in the range of 1 000 kg/h up to more than 10 000 kg/h. It is also assumed that the continuous process can be effectively operated 8000 hours/year, while

batch process is limited to 7 000 hours annually due to higher operation hazards and maintenance (Ulrich and Vasudevan 2004).

3. Energy supply of transformation processes

3.1. Energy integration of chemical processes

The opportunity for reducing chemical processes heat consumption was investigated using heat network integration technique, especially the “pinch” method as described in (Gassner and Maréchal 2009; Maréchal 2008). It consists in inventorying all heat streams together with their temperature levels and then using a systematic method for optimizing the heat exchange between hot and cold streams. This calculation was performed using a code that was already available in the OSMOSE software used for the simulations.

This method provides an estimate of the achievable reduction in thermal power and the heat exchange area and number of heat exchangers required to achieve it. The results, for refining and biodiesel are given in Table 16.

Table 16. Refining and biodiesel process heat integration results.
(ST: standard heat supply; EI: Energy integration of heat network)

Process (1 000 kg/h)	Thermal power (kW)		Exchange area (m ²)		Number of heat exchangers	
	ST	EI	ST	EI	ST	EI
Refining	68	16	6	19	7	12
Biodiesel	245	153	19	45	11	17
Refining + Biodiesel	313	169	25	59	18	29

3.2. Energy supply technologies

(The economic models are developed in Chapter 5, section 2.5)

For each transformation process, several energy supply options are considered, including grid connection, power generation and combined heat and power from different types of fuel. The objective is to compare the opportunities for on-site energy production with the “business-as-usual” solution which consists in relying on grid connection for power supply and to a boiler (using biomass or SVO) for meeting the heat requirements. Onsite generation in Burkina Faso appears as a relevant solution with regard to both the grid access scarcity in remote areas and the high average price of grid power.

3.2.1 Fuels for utility supply

Only two different fuels were considered for utility supply. It is assumed that there is no interest in using fossil fuels for utility supply in a plant that produces biofuels, supposed to be cheaper. Then, energy requirements are satisfied using either SVO or biomass. As a reminder, SVO lower heating value is 37 MJ/kg. Its price depends on the considered context and will be discussed in Chapter 6.

Biomass corresponds to residues from agricultural activities, which are available in high amounts in Burkina Faso in some region of Burkina Faso. It includes paddy straw, cotton stalks and shells from peanuts, Shea kernels and a many others. These residues are rather dry due to the local climate, down to 8%. As an average a lower heating value of 12 MJ/kg was assumed. Then the price was calculated as half the wholesale price of firewood in Ouagadougou at equivalent energy content, i.e. 14 FCFA/kg.

3.2.2 Internal combustion engine for power generation and combined heat and power

A generator composed of internal combustion engine combined to an alternator can be used to supply electrical power and heat through a heat recovery system. It can be fuelled with different type of fuels, in this case SVO or biogas.

Power generation

Power generators are widely used throughout the world and particularly in developing countries. In Burkina Faso, they are used for both centralised and remote power generation. The average energy conversion efficiency from fuel to mechanical power varies from 30% for small engines to more than 45% for engines of several MW (Haupais 1992). In practice, load fluctuations can also impair the average efficiency. In the present case, generator efficiency is calculated as a function of rated-power following Equation (15) proposed by Walla and Schneeberger (2008), based on a statistical analysis of data from biogas plants, with power ranging from 50 kW to 2500 kW. The function is illustrated in Figure 25.

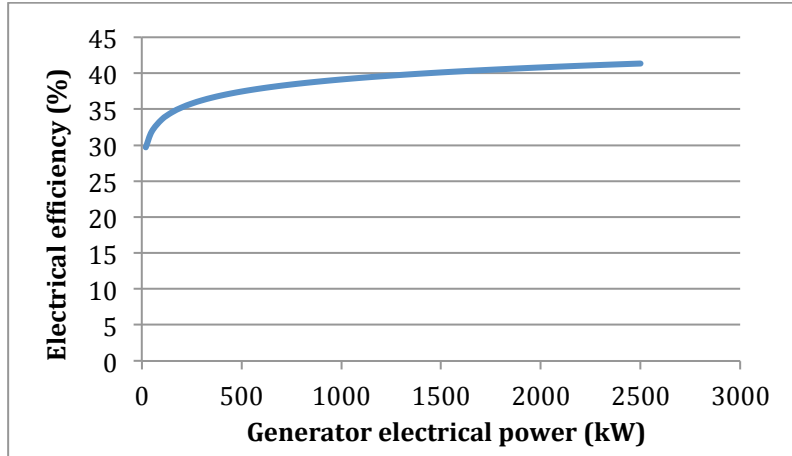

Figure 25. Electrical efficiency of generators as a function of rated-power (Equation (15), (Walla and Schneeberger 2008))

First, the generator rated-power is calculated based on process power requirement P_{elec} , augmented of 30% to ensure having a peak power higher than the average process requirement. This value is further used for equipment cost calculation. The electrical efficiency of the generator is calculated based on P_{elec} using Equation (15) and fuel power consumption is calculated using Equation (16).

$$\eta_{el} = a \cdot \log(P_{elec} \cdot 10^{-3}) + b \quad (15)$$

where η_{el} is the generator electrical efficiency, P_{elec} is the electrical power required for the process in W, $a = 0.2243$ and $b = 0.055$ are the model parameters (Walla and Schneeberger 2008).

$$P_{fuel} = \frac{P_{elec}}{\eta_{el}} \quad (16)$$

where P_{fuel} is the equivalent fuel power in W; η_{el} is the engine efficiency from Equation (15).

Combined heat and power

Power generators can be equipped with heat recovery system to supply both heat and electricity. The engine rejects heat in (i) the flue gas (30% of fuel energy) at temperatures between 450°C and 550°C, (ii) through the engine block cooling system (20%) at 80-90°C, (iii) in the combustion air cooling (intercooler) and through radiation to atmosphere, which is at low temperature and difficult to recover (Lévy 1996). This heat can be recovered to produced hot water, superheated water or low-pressure steam.

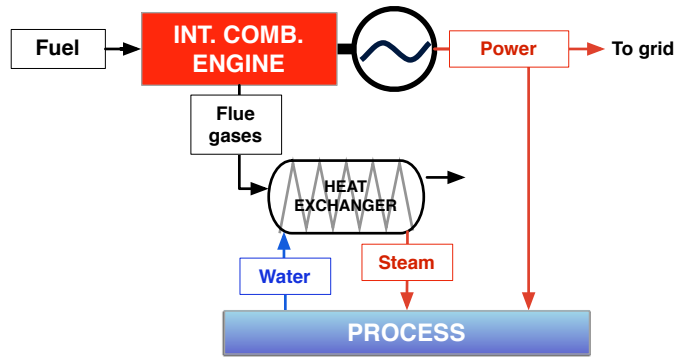

Figure 26. Diagram of combined heat and power using an internal combustion engine.

As the maximum temperature required by refining and biodiesel processes is below 125°C, it is assumed that the heat requirement can be met using an IC engine CHP system. Considering the process temperature levels (60 – 120°C), the return of the steam network will certainly be not below 80°C. Then, the heat from the engine cooling system cannot be recovered and only the flue gas heat is valorised (see Figure 26).

Following Lévy (1996), a typical 50 kW diesel engine rejects 30% of fuel energy in the flue gas at 670°C. Accordingly, assuming the flue gas is cooled down to 170°C, 75% of the flue gas heat can be recovered, i.e. 22% of fuel energy. On larger engines, flue gases are usually at a lower temperature (450°C), but can be equipped of high temperature cooling systems allowing to recover engine heat at temperature slightly higher than 100°C. The power and heat efficiencies considered are summarised in Table 17.

Table 17. Energy conversion efficiencies of engine generators and CHP system (Lévy 1996).

Type	Variable	Efficiency
Power generator (fuel to power)	η_{el}	Eq. (15)
CHP generator		
Fuel to power	η_{el}	Eq. (15)
Fuel to heat	η_{heat}	22 %

In practice, CHP systems are sized according to heat requirement (see Equation (17)) and the power generated is used to cover all or part of the electricity requirement. If the power generated is higher than electricity requirement, extra-power is sold on the grid (where available); in case it is lower, complementary power is bought from the grid.

$$P_{dim} = \frac{P_{heat}}{\eta_{heat}} \cdot \eta_{el} \quad (17)$$

IC engine lifetime

Industrial IC engines can usually have a lifetime of about 8 years when used 8000 hours a year; it can be shorter for small engines (<50kW) and much longer for heavy duty engines. However, in Burkina Faso and more generally in West Africa, the experience has shown that the local conditions seriously reduce engines lifetime. This is attributed to a range of factors including the poor quality of fuels, the ubiquitous airborne dust and the heat (in the range of 16 – 45°C with an annual average of about 27°C). Then, a lifetime of 4 years (32000 hours) was considered.

3.2.3 Boiler for heat and power supply

Boilers are used for the production of process steam, a part of which can be used for power generation through a steam turbine. Several technologies of boiler are in use depending on fuel type, steam pressure level and heat duty (Ulrich and Vasudevan 2004; Perry 1997). Solid-fuel boilers (coal or biomass) are slightly more complex and more expensive than liquid- and gaseous-fuel boilers, because they include solids- and ash-handling systems. Solid-fuel boilers also have lower efficiency. As a counterpart, solid fuels usually are cheaper than liquid fuels. Steam pressure and heat duty are also factors influencing the boiler design and its cost.

Boiler for steam supply

The model considered here for utility supply with a boiler simply consists in defining the thermal efficiency as a function of fuel type. The values used in the model were retrieved from (Lévy 1996) and are presented in Table 18. They are consistent with the value found in (Perry 1997; Ulrich and Vasudevan 2004). Then, fuel thermal power is directly calculated from process heat requirement, according to equation (18).

$$P_{fuel} = \frac{P_{heat}}{\eta_{boiler}} \quad (18)$$

where P_{heat} is the process heat power requirement in W, η_{boiler} is the boiler efficiency according to Table 18.

In the case of steam supply without power generation, it was assumed that the boiler produces saturated steam at 20 bars, which corresponds to a temperature of 220°C and is suitable to meet the heat requirements of refining and biodiesel processes, which maximum temperature levels are about 125 °C. Moreover, 20 bars is a standard value for packaged steam supply systems as provided by manufacturers (Ulrich and Vasudevan 2004).

Table 18. Efficiency of boilers and CHP system with respect to fuel type.

	Efficiency	
	<i>Liquid fuel</i>	<i>Solid fuel</i>
Boiler	88%	78%
Combined heat and power	86%	77%
Fuel to electricity	11%	10%
Fuel to heat	75%	67%

Combined heat and power using a steam turbine

As the process only requires low-temperature heat, there is an opportunity to produce electricity using a steam backpressure turbine. The technique consists in producing steam at a higher pressure and temperature than required, expanding it through a turbine and using the low-pressure steam at the output of the turbine for supplying the process (see Figure 27). The economic opportunity for this type of system may be investigated for power recovery from about 100 kW_{th} and higher (Ulrich and Vasudevan 2004).

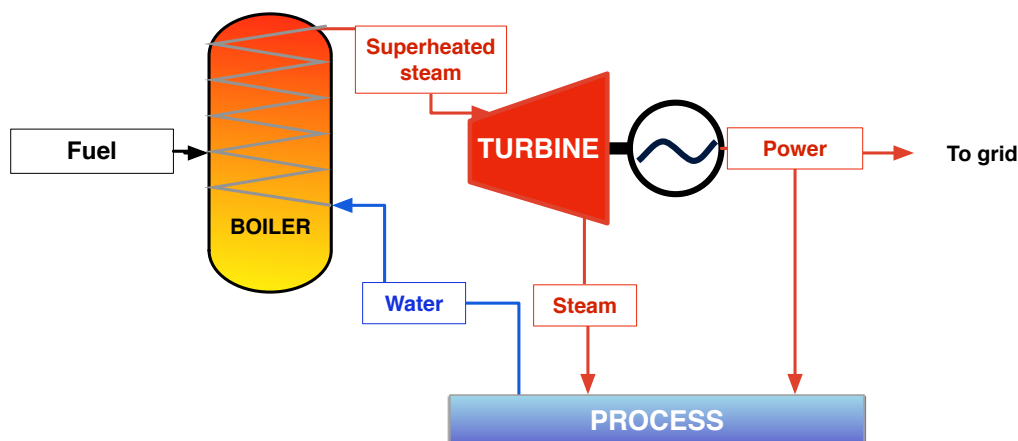
**Figure 27. CHP system using a boiler and a steam turbine.**

The method used here for sizing the steam turbine CHP system is described in (Ulrich and Vasudevan 2004). In the present case, the process requires heat up to about 120°C, which can be efficiently supplied by saturated steam at about 5 bars (saturation at 155°C). For this type of application with low pressure-drop, one-stage radial steam turbines are used, which have isentropic efficiencies in the range of 65-85%. Efficiencies are lower when the turbine is small and the pressure is low (Ulrich and Vasudevan 2004).

In the present case where the thermal power is in the range of 100 – 1000 kW, the isentropic efficiency is assumed to be of 65%. With inlet steam at 40 bars and 400°C (i.e. 150°C superheat) and an outlet at 5 bars, it is possible to meet the process heat requirements and to convert about 10% of fuel power to electricity (Ulrich and Vasudevan 2004; Lévy 1996). The assumptions made for thermal and electrical efficiencies are presented in Table 18. The advantage of CHP using a steam turbine is that the overall efficiency is always high, since the heat that is not converted to mechanical power in the through the turbine is recovered in the outlet steam.

3.2.4 Consistence between process energy demand and CHP characteristics

The advantages of using cogeneration systems depend on the match between power-to-heat ratios on demand and supply side. The power-to-heat ratio is a termed P/H . When sizing is based on heat demand (90% of the cases): if the CHP system's P/H (supply) is higher than that of the process, then CHP will cover the power demand and provide extra power (to be sold); if CHP P/H is lower than that of the process, the power supply will be lower than the demand. In this last case either power is bought from the grid to bridge the gap, or the CHP system can be oversized to fit the power demand, which causes heat losses. Then, this last option should only be considered when the gap between power demand and supply is small.

In this case, the power-to-heat ratios are of 0.15 for steam turbine and between 1.35 and 1.8 for IC engine depending on electrical efficiency. On the demand-side, the ratios are variable depending on the integration of processes on the same site, as listed in Table 19. In most cases, the demand-side P/H is below 1.35 or 0.15, which means that the energy demand can be met using either an engine or a steam turbine CHP, however with only two opportunities for steam turbine.

Table 19. Power-to-heat ratios for several process combinations. (P/H of CHP systems are 0.15 (steam turbine) and 1.35 (IC engine))

	Power (kW)	Heat (kW) without E.I.	P/H	Heat kW (with EI)	P/H
Refining	15	68	0.22	16	0.94
Biodiesel	30	245	0.12	153	0.20
Refining + Biodiesel	45	313	0.14	169	0.27
SVO* + Refining	235	68	3.46	16	14.69
SVO* + Ref. + Biodiesel	265	313	0.85	169	1.57

* SVO power demand for base-case conditions is considered, i.e. 220 kWh/ton SVO.

The figures in red font, related to oil extraction combined with refining unit, exhibit particularly high power-to-heat ratio, due to oil expression shaft power requirement. In these two cases, the investment in a CHP system would certainly not be viable. Only a slight share of the power demand could be met using an engine CHP system sized on heat demand: bridging the gap by purchasing power from the grid would seriously impair the return on investment, while sizing on power demand would cause huge heat losses.

In the case of a biodiesel plant starting from SVO production, and with an integration of process heat network, the ratio is 1.57, which can be in or close to the range offered by engine CHP. In this case, the opportunity for sizing the system on power demand should be investigated, since the corresponding heat losses would be limited and the self-produced power is likely to remain competitive with grid prices.

Eventually, when biogas is produced from the seedcake, the biogas engine is sized according to the biogas mass flowrate. If the refining or biodiesel process is installed on the same site as SVO production, the biogas engine can be used to supply the processes with power and steam. In this case, the size of the engine is always largely sufficient to meet the process heat demand. Indeed, in base-case conditions, for an SVO production of 1 ton/hour, the power produced from biogas is about 1600 kW, to be compared with the energy demand in Table 19.

4. References

- Achten, W.M.J., L. Verchot, Y.J. Franken, E. Mathijs, V.P. Singh, R. Aerts, and B. Muys. 2008. "Jatropha Bio-Diesel Production and Use." *Biomass and Bioenergy* 32 (12): 1063–84. doi:10.1016/j.biombioe.2008.03.003.
- Ali, N., A. K. Kurchania, and S. Babel. 2010. "Bio-Methanisation of Jatropha Curcas Defatted Waste." *Journal of Engineering and Technology Research* 2 (3): 038–043.
- Allard, Benoit. 2010. "Evaluation de La Rentabilité Économique de La Filière Jatropha Dans La Région de Teriya Bugu (Mali)". Master thesis, Montpellier: IRC Supagro.
- Amigun, B., and H. von Blottnitz. 2010. "Capacity-Cost and Location-Cost Analyses for Biogas Plants in Africa." *Resources, Conservation and Recycling* 55 (1): 63–73. doi:10.1016/j.resconrec.2010.07.004.
- Blin, J., C. Brunschwig, A. Chapuis, O. Changotade, S.S. Sidibe, E.S. Noumi, and P. Girard. 2013. "Characteristics of Vegetable Oils for Use as Fuel in Stationary Diesel engines—Towards Specifications for a Standard in West Africa." *Renewable and Sustainable Energy Reviews* 22: 580–97. doi:10.1016/j.rser.2013.02.018.
- Borman, Gareth D., Graham P. von Maltitz, Sunandan Tiwari, and Mary C. Scholes. 2013. "Modelling the Economic Returns to Labour for Jatropha Cultivation in Southern Africa and India at Different Local Fuel Prices." *Biomass and Bioenergy* 59: 70–83. doi:10.1016/j.biombioe.2012.06.020.

- Braun, Rudolf. 2012. "Anaerobic Digestion: A Multi-Faceted Process for Energy, Environmental Management and Rural Development." In *Improvement of Crop Plants for Industrial End Uses*, edited by P. Ranalli, 335–416. Dordrecht: Springer Netherlands. Accessed May 14. <http://www.springerlink.com/content/u227627564jtj26v/>.
- Carré, P. 2010. "Étude D'avant Projet Pour L'implantation D'une Unité de Trituration de Colza À Froid." *CREOL, Private Communication*.
- Chapuis, A., J. Blin, P. Carré, and D. Lecomte. 2014. "Separation Efficiency and Energy Consumption of Oil Expression Using a Screw-Press: The Case of Jatropha Curcas L. Seeds." *Industrial Crops and Products* 52: 752–61. doi:10.1016/j.indcrop.2013.11.046.
- Demirbaş, Ayhan. 1998. "Fuel Properties and Calculation of Higher Heating Values of Vegetable Oils." *Fuel* 77 (9–10): 1117–20. doi:10.1016/S0016-2361(97)00289-5.
- Dijkstra, Albert J. 2011. "Edible Oil Processing - Degumming, Introduction." *The AOCS Lipid Library*. <http://lipidlibrary.aocs.org/processing/degum-intro/index.htm>.
- Domergue, Marjorie, and Roland Piro. 2008. "Jatropha Curcas L." Rapport de synthèse bibliographique. Montpellier: CIRAD/AgroGeneration.
- Eichkoff, Klaus-Peter. 2004. "Basics of Alkali Refining of Vegetable Oils." In *Workshop on Fats, Oils and Oilseeds Analysis and Production*. Tunis, Tunisia: IUPAC-AOCS.
- Ferchau, Erik. 2000. *Equipment for Decentralised Cold-Pressing of Oilseeds*. Folkecenter for renewable energy. The Netherlands.
- Freedman, B., and M. O. Bagby. 1989. "Heats of Combustion of Fatty Esters and Triglycerides." *Journal of the American Oil Chemists Society* 66 (11): 1601–5. doi:10.1007/BF02636185.
- Gassner, Martin, and François Maréchal. 2009. "Methodology for the Optimal Thermo-Economic, Multi-Objective Design of Thermochemical Fuel Production from Biomass." *Computers & Chemical Engineering* 33 (3): 769–81.
- Grimm, R. T. 1956. "Leaf Filter for Fouts Removal from Crude Oil Reduces Labor and Eliminates Filter Cloth and Paper." *Journal of the American Oil Chemists' Society* 33 (10): 437–39.
- Grimsby, Lars Kåre, Kristian Fjørtoft, and Jens Bernt Aune. 2013. "Nitrogen Mineralization and Energy from Anaerobic Digestion of Jatropha Press Cake." *Energy for Sustainable Development* 17 (1): 35–39. doi:10.1016/j.esd.2012.10.009.
- Gunaseelan, N. 2009. "Biomass Estimates, Characteristics, Biochemical Methane Potential, Kinetics and Energy Flow from Jatropha Curcus on Dry Lands." *Biomass and Bioenergy* 33 (4): 589–96.
- Hauptais, A. 1992. *Combustion Dans Les Moteurs Diesel*. Ed. Techniques Ingénieur.
- Kafle, Gopi Krishna, and Sang Hun Kim. 2013. "Effects of Chemical Compositions and Ensiling on the Biogas Productivity and Degradation Rates of Agricultural and Food Processing by-Products." *Bioresource Technology* 142: 553–61. doi:10.1016/j.biortech.2013.05.018.

- Kaushik, N., K. Kumar, S. Kumar, N. Kaushik, and S. Roy. 2007. "Genetic Variability and Divergence Studies in Seed Traits and Oil Content of Jatropha (*Jatropha Curcas* L.) Accessions." *Biomass and Bioenergy* 31 (7): 497–502.
- Khan, L.M., and M.A. Hanna. 1983. "Expression of Oil from oilseeds—A Review." *Journal of Agricultural Engineering Research* 28 (6): 495–503. doi:doi: 10.1016/0021-8634(83)90113-0.
- Koh, May Ying, and Tinia Idaty Mohd. Ghazi. 2011. "A Review of Biodiesel Production from *Jatropha Curcas* L. Oil." *Renewable and Sustainable Energy Reviews* 15 (5): 2240–51. doi:10.1016/j.rser.2011.02.013.
- Kpoviessi, D. S.S, G. C Accrombessi, C. Kossouh, M. M Soumanou, and M. Moudachirou. 2004. "Propriétés Physico-Chimiques et Composition de L'huile Non Conventiionelle de Pourghère (*Jatropha Curcas*) de Différentes Régions Du Bénin." *Comptes Rendus Chimie* 7 (10-11): 1007–12.
- Lévy, Claude. 1996. "Les techniques de cogénération." *Techniques de l'ingénieur Sources d'énergie hors nucléaire* base documentaire: TIB215DUO (ref. article: b8910). <http://www.techniques-ingenieur.fr/base-documentaire/energies-th4/sources-d-energie-hors-nucleaire-42215210/les-techniques-de-cogeneration-b8910/>.
- Liu, Kuan-Ting, Shun Gao, Tsair-Wang Chung, Char-ming Huang, and Yung-Sen Lin. 2012. "Effect of Process Conditions on the Removal of Phospholipids from *Jatropha Curcas* Oil during the Degumming Process." *Chemical Engineering Research and Design*. doi:10.1016/j.cherd.2012.01.002. <http://linkinghub.elsevier.com/retrieve/pii/S0263876212000044>.
- Lu, Houfang, Yingying Liu, Hui Zhou, Ying Yang, Mingyan Chen, and Bin Liang. 2009. "Production of Biodiesel from *Jatropha Curcas* L. Oil." *Computers & Chemical Engineering* 33 (5): 1091–96. doi:10.1016/j.compchemeng.2008.09.012.
- Maréchal, François. 2008. "Pinch Analysis." In *UNESCO Encyclopedia of Life Support Systems*. EOLSS Publishers Co Ltd., Oxford, UK. <http://www.eolss.net/sample-chapters/c08/e3-19-01-07.pdf>.
- Matthäus, Bertrand. 2012. "Oil Technology." In *Technological Innovations in Major World Oil Crops, Volume 2*, edited by S.K. Gupta, 23–92. New York, NY: Springer New York. http://www.springerlink.com/index/10.1007/978-1-4614-0827-7_2.
- Moletta, René. 2011. *La méthanisation*. Lavoisier.
- Pagès-Xatart-Parès, Xavier. 2013. "Technologies Des Corps Gras (huiles et Graisses Végétales)." *Techniques de L'ingénieur Filière de Production: Produits D'origine Végétale* base documentaire: TIB433DUO. (ref. article: f6070). <http://www.techniques-ingenieur.fr/base-documentaire/procedes-chimie-bio-agro-th2/filiere-de-production-produits-d-origine-vegetale-42433210/technologies-des-corps-gras-huiles-et-graisses-vegetales-f6070/>.
- Parawira, Wilson. 2009. "Biogas Technology in Sub-Saharan Africa: Status, Prospects and Constraints." *Reviews in Environmental Science and Bio/Technology* 8 (2): 187–200. doi:10.1007/s11157-009-9148-0.
- Perry, Robert. 1997. *Perry's Chemical Engineers' Handbook*. 7th ed. /. New York: McGraw-Hill.

- Pramanik, K. 2003. "Properties and Use of Jatropha Curcas Oil and Diesel Fuel Blends in Compression Ignition Engine." *Renewable Energy* 28 (2): 239–48. doi:10.1016/S0960-1481(02)00027-7.
- Raheman, Hifjur, and Subhrajit Mondal. 2012. "Biogas Production Potential of Jatropha Seed Cake." *Biomass and Bioenergy* In press (0). doi:10.1016/j.biombioe.2011.12.042. <http://www.sciencedirect.com/science/article/pii/S0961953411006611>.
- Rao, Kotte Sagar, Pradosh Prasad Chakrabarti, B. V. S. K. Rao, and R. B. N. Prasad. 2008. "Phospholipid Composition of Jatropha Curcas Seed Lipids." *Journal of the American Oil Chemists' Society* 86: 197–200. doi:10.1007/s11746-008-1325-8.
- Sahoo, P.K., and L.M. Das. 2009. "Process Optimization for Biodiesel Production from Jatropha, Karanja and Polanga Oils." *Fuel* 88 (9): 1588–94. doi:10.1016/j.fuel.2009.02.016.
- Santori, Giulio, Giovanni Di Nicola, Matteo Moglie, and Fabio Polonara. 2012. "A Review Analyzing the Industrial Biodiesel Production Practice Starting from Vegetable Oil Refining." *Applied Energy* 92 (0): 109–32. doi:10.1016/j.apenergy.2011.10.031.
- Sidibé, S.S., J. Blin, G. Vaitilingom, and Y. Azoumah. 2010. "Use of Crude Filtered Vegetable Oil as a Fuel in Diesel Engines State of the Art: Literature Review." *Renewable and Sustainable Energy Reviews* 14 (9): 2748–59. doi:doi: DOI: 10.1016/j.rser.2010.06.018.
- Staubmann, R., G. Foidl, N. Foidl, G. M Gübitz, R. M Lafferty, V. M Valencia Arbizu, and W. Steiner. 1997. "Biogas Production from Jatropha Curcas Press-Cake." *Applied Biochemistry and Biotechnology* 63 (1): 457–67.
- Subramanian, R., and M. Nakajima. 1997. "Membrane Degumming of Crude Soybean and Rapeseed Oils." *Journal of the American Oil Chemists' Society* 74 (8): 971–75. doi:10.1007/s11746-997-0013-4.
- Turton, Richard, Richard C. Bailie, Wallace Whiting, Joseph A. Shaeiwitz, and Debangsu Bhattacharyya. 2012. *Analysis, Synthesis, and Design of Chemical Processes*. Prentice Hall.
- Ulrich, Gael D., and Palligarnai T. Vasudevan. 2004. *Chemical Engineering Process Design and Economics: A Practical Guide*. Process Pub. <http://www.lavoisier.fr/livre/notice.asp?ouvrage=1773789>.
- Walla, C., and W. Schneeberger. 2008. "The Optimal Size for Biogas Plants." *Biomass and Bioenergy* 32 (6): 551–57. doi:10.1016/j.biombioe.2007.11.009.
- Weiland, Peter. 2009. "Biogas Production: Current State and Perspectives." *Applied Microbiology and Biotechnology* 85 (4): 849–60. doi:10.1007/s00253-009-2246-7.
- Wiedermann, L. H. 1981. "Degumming, Refining and Bleaching Soybean Oil." *Journal of the American Oil Chemists' Society* 58 (3): 159–66. doi:10.1007/BF02582328.

Chapter 5. Economic and environmental assessment of the Jatropha biofuel supply chains

In Chapter 4, the models used to describe the different processes were presented. In this Chapter we describe first the assumptions made to evaluate seeds and SVO transport costs with respect to plant processing capacity. Then, the models and method applied for the financial analysis of transformation processes is presented followed by the calculation of economic efficiency indicators and environmental impacts.

1. Geographical organisation and logistics

The logistic operations cost of biomass can be significantly high compared to the value of the biomass itself. As an example, transport costs of cellulosic biomass for supplying a large-scale ethanol plant can be in the range of 35-60% of the cost of biomass (Ebadian et al., 2011; Fan et al., 2013).

The main logistic operations for Jatropha biofuels are harvesting, deshelling, and transporting the seeds to the oil plant. In this work, harvesting and deshelling are already accounted for in the cultivation part. Then, in this section, a model to estimate transport costs is presented.

In a prospective analysis, the mapping of production and transformation sites cannot be predicted. Moreover, as Jatropha cultivation is ensured by smallholders, the production is likely to be particularly scattered. Then, transport cost cannot be precisely determined, but it can be estimated. The model proposed here is relatively simple but it gives an idea of the influence of collecting radius on seeds transport cost.

Two means of transport are successively used: seeds are first collected using animal-driven carts to collection points of 100 tons capacity, and then transported by truck to the oil plant. Eventually, SVO is transported by tanker trucks to the refining/biodiesel unit.

1.1. Modelling transport distances

The Jatropha production is assumed to be homogeneously distributed over the area. Then, the collecting radius around a collect point can be calculated based on the “territorial yield” of Jatropha seeds as in Equation (1). Territorial yield is the apparent yield from the production of all smallholders in the collect area, as opposed to the agronomic yield expressed at field level.

$$R = \sqrt{\frac{Q}{Y_t \cdot \pi}} \quad (1)$$

where R is the collect radius in km, Q is the seed quantity to collect in ton, Y_t is the territorial yield of Jatropha seeds in t/km².

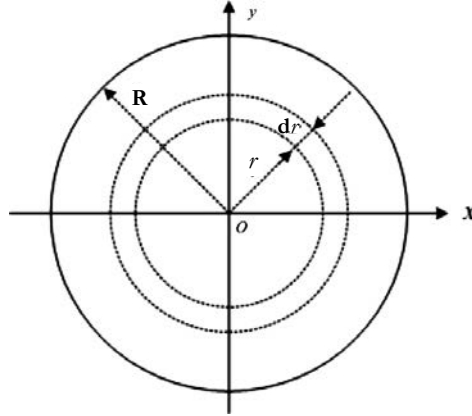

Figure 28. Model for integration of transport cost over the area (adapted from Fan et al., 2013).

Then, assuming a straight-line one-way transport to a central point, the transport cost can be calculated as a function of R , “territorial yield” and ton-kilometre price following Equation (2). The method is employed by (Fan et al., 2013) and illustrated in Figure 28.

$$C_{tr} = \int_0^R Pr_{tkm}(r,T) \cdot Y \cdot 2\pi r^2 dr \quad (2)$$

where $Pr_{tkm}(r,T)$ is the ton-kilometre price in FCFA/t.km as a function of distance r in km and tonnage T in tons.

It can be noticed here that if Pr_{tkm} is not dependent on the distance and T is constant, then the total cost can be expressed as: $C_{tr} = 2\pi \cdot Y \cdot Pr_{tkm} \cdot \frac{R^3}{3}$, that can also be expressed as $C_{tr} = Q \cdot Pr_{tkm} \cdot \frac{2}{3} \cdot R$, where Q is the total load to transport. This shows that in this case, the average transport distance to the central point is equivalent to $2/3R$.

1.2. Cart transport cost

In order to estimate the cost of collecting the seeds to local collection points, it was necessary to make an assumption on the ton-kilometre cost of cart transport. In the absence of reliable field data, this cost was estimated as follows. First the cost is considered independent on distance and load. The maximum load of a cart pulled by donkey is about 400 kg and the maximum distance covered in a day is 20km (Starkey et al., 2003). Then, the price paid to the carter for a day can be estimated to about 2000

FCFA, including his wage (minimum daily wage of 1600 FCFA) and a surplus for maintaining the cart and caring the donkey. This cost reduced to the kilometric ton is about 250 FCFA/t.km, which in the range of the value mentioned by (Starkey et al., 2003). Then, the cart transport cost per ton of seeds can be expressed as a function of collecting radius in equation (3).

$$C_{tr}^{cart} = \frac{2}{3} \cdot Pr_{tkm}^{cart} \cdot Q \cdot R \cdot s \quad (3)$$

where s is a tortuosity factor set to 1.5.

Tortuosity refers to the real distance compared to the straight-line distance. Without knowing the site implantation of the activity, its value can only be estimated through simple assumption. For example, a first assumption is to consider that the straight-line distance is the diagonal of a square, the sides of which represent the actual path: in this case the tortuosity is $\sqrt{2}$ (~ 1.4). Another possibility is to consider that the real path is the half-circle to which the straight line is the diameter: then the tortuosity would be $\pi/2$ (~ 1.6). Then an average value of 1.5 was chosen.

1.3. Truck transport cost

In Burkina Faso, it has been shown that truck transport prices are highly dependent on the distance and on the tonnage. This point was investigated by (Rizet and Gwét, 1998) who presented a statistical analysis of transport costs based on a survey. They proposed a correlation to calculate the ton-kilometre transport cost as a function of distance and tonnage ($R^2 = 0.72$). The random variation of the cost is due to a range of factor including the route, the availability of asphalt road and also the driver's mood and the negotiation skills of the customer!

$$Pr_{tkm}(r, T) = f_{act} \cdot r^{kd} \cdot T^{kt} \cdot 10^{k0} \quad (4)$$

where the model parameters are the tonnage factor $kt = -0.13$, the distance factor $kd = -0.42$, and a constant $k0 = 2.7$. Since this data dates back to 1998, an actualisation factor was applied $f_{act} = 1.51$. This value was established from the cost index published by the INSD.

Eventually, by introducing this in equation (2), the overall transport cost is calculated as:

$$C_{tr} = 2\pi \cdot Y \cdot f_{act} \cdot T^{kt} \cdot 10^{k0} \cdot \frac{R^{(kd+3)}}{kd+3} \quad (5)$$

Then, two adjustment factors are introduced. The first one, “ s ” traduces the tortuosity of the route compared to the straight-line distance assumed in the model. The transport price model has been established from data for transport of solid cargos but the transport cost for liquids by tanker trucks is higher. The tank equipment induces higher investment and higher fuel consumption due to extra-weight (Biograce, 2013).

Therefore, a cost increase of 30% was applied in the case of SVO transport. The typical truckload used in the model is of 10 tons. The transport cost per ton of seeds is illustrated in Figure 29 as a function of collecting radius. This is to be compared to the seed price, which is about 100 000 FCFA/ton.

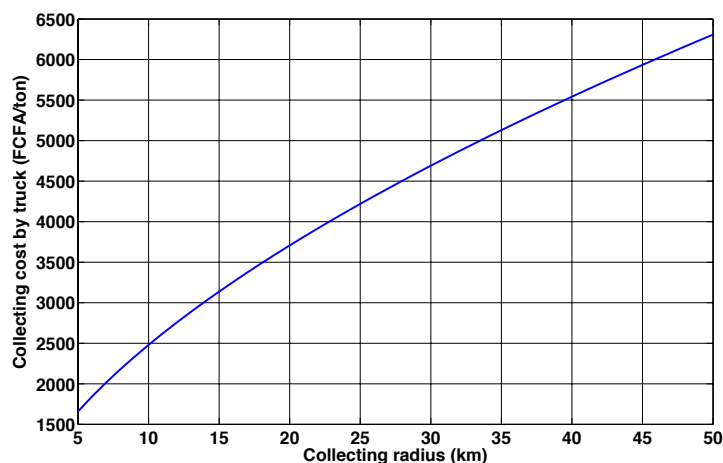

Figure 29. Seed collecting cost by truck with respect to collecting radius

In the evaluation of production pathways, the transport costs are directly incorporated to the feedstock purchase price of the plant operator. Then, the transporters are not considered as agent of the value chain; transport is rather a service contracted by the plant operator.

2. Financial analysis of processes

2.1. Jatropha seed cultivation

(Technical model is in Chapter 4, Section 2.1)

The economic model for Jatropha cultivation by smallholders is based on data from CIRAD experimental site in Mali (Allard, 2010; Domergue and Pirot, 2008): it provides empirical data on labour requirement for crop establishment and regular operations. Then the harvest labour was evaluated based on data from Borman et al. (2013).

As the production is realised by smallholders as an additional crop, it is assumed that the typical area planted with Jatropha is around 1 ha /smallholder. As Jatropha is a tree, the crop establishment represents a considerable amount of work. The trees are first grown in a nursery during two months, with regular irrigation until they are robust enough to be transplanted to the field. These tasks represent an investment, in term of labour especially. It is assumed that smallholders get the seeds for free as well as the plastic bags used to grow the seedlings. These materials are often supplied by project

promoters to get the smallholders involved in Jatropha production. The initial investment would most probably rely on familiar labour, since smallholders cannot afford the monetary payment of workers to do the job. Then the initial labour investment was assumed to be amortised on the plantation lifetime fixed to 20 years, as proposed by (Allard, 2010).

The possibility of using chemical fertilisers to meet the minimum nutrient requirements is investigated. Minimum nutrient requirements correspond to the compensation of nutrient export related to seed harvest and are calculated in Chapter 4, Section 2.1. The prices of each nutrient N, P and K were retrieved from a newsletter published by a local farmers' organisation (RECA Niger, 2011) and are presented in Table 20. They correspond to wholesale prices and thus constitute a minimum price. A survey in Burkina has indeed shown that retail prices are higher and highly variable from one retailer to another (Bassolé, 2007). The annual cost for chemical fertiliser purchase is calculated using Equation (6).

Table 20. Fertiliser prices in Burkina Faso, per nutrient element.

Nutrient	Price (FCFA/kg)
N	783
P	1859
K	966

$$C_{fert} = \sum_{i=N,P,K} Fert_i \cdot Pr_{fert,i} \quad (6)$$

where C_{fert} is the annual fertiliser purchase cost in FCFA/ha, $Fert_i$ is the minimum requirement of fertiliser i , and $Pr_{fert,i}$ is the price of fertiliser i in FCFA/kg.

Eventually, the labour requirement for harvest is evaluated as a function of yield, based on a model proposed by Borman et al. (2013). Based on field data, the authors proposed an equation to calculate the seed-picking rate of a harvester (in kg/man.day) as a function of fruit density. The model reflects the fact that picking is faster when the seed production is dense, i.e. when the seed yield is high. Picking rate is calculated using Equation (7).

$$R_{pick} = -55.05 \cdot \exp\left(\frac{-Y_{ha}}{N_{pick} \cdot 302.83}\right) + 60.28 \quad (7)$$

where R_{pick} is the seed picking rate in kg/man.day; Y_{ha} is the annual seed yield in kg/ha and $N_{pick} = 3$ is the number of picking events in a year.

Then, the annual labour for harvest is given by Equation (8).

$$W_{harv} = \frac{Y_{ha}}{R_{pick}} \quad (8)$$

The last operation ensured by smallholders is to remove fruit husks. While dehusking is a tedious operation when done manually on fresh fruits, it can be easy and fast when using a mechanical sheller (manually driven) on dry fruits. This can explain the huge disparities in the literature concerning dehusking labour requirements. Domergue (2008) mentions manual dehusking rate as low as 2 kg seeds/h, whereas Borman et al. (2010) considers 250 kg/h using hand-powered mechanical dehusker. Then, an average of 50 kg/h was considered in this study, assuming the use of a hand-powered dehusker. All labour requirements are summarized in Table 21.

Table 21. Labour requirements and cost for Jatropha cultivation

Variable	Description	Annual labour (man-day/ha)
W_{est}	Initial investment for crop establishment. Includes nursery, dead plants replacement and building of a storage and drying area.	103
W_{rop}	Regular operations includes: pruning and weeding once a year	15
W_{harv}	Harvest labour. See Equation (7) and (8). Value for base-case ($Y_{ha} = 1000$ kg/ha)	24
W_{dehu}	Labour for removing fruit husks using a manual mechanical sheller. $W_{dehu} = \frac{Y_{ha}}{R_{dehu}}$ with $R_{dehu} = 400$ kg/man.day	2.5

Eventually, the calculation of overall seed production cost is presented in Table 22. The main variable of the model is the seed yield and the use of chemical fertiliser, which is an option.

Table 22. Jatropha seed production annual cost calculation

Description		Equation	Unit
Operating costs			
C_{wages}	Labour cost	$C_{wages} = (W_{rop} + W_{harv} + W_{dehu}) \cdot Pr_{wf}$	FCFA/ha
C_{fert}	Fertilisers cost	Eq. (6)	FCFA/ha
Fixed costs			
C_{est}	Crop establishment cost	$C_{est} = \frac{W_{est} \cdot Pr_{wf}}{N_{year}}$	FCFA/ha
Production cost			
C_{seed}	Seed production cost	$C_{seed} = \frac{1}{Y_{ha}} \cdot (C_{est} + C_{wages} + C_{fert})$	FCFA/kg seed

2.2. Oil extraction plant using cold pressing

(Technical model is in Chapter 4, Section 2.2)

2.2.1 Screw press purchase price

An investment cost model for oil plants was built based on screw press purchase prices database published by Ferchau (2000) and on business plans from CETIOM (2005). The prices were actualised using the Chemical Engineering Plant Cost Index (CEPCI). The screw press is the main and most expensive equipment in an oil plant. Thus, the overall investment is extrapolated from the price of the pressing equipment.

To build the press purchase price function, the price data were analysed for consistency and consolidated with manufacturer data when needed. Then, a 2nd order linear regression model was calculated, between the logarithms of pressing capacity and prices, as illustrated by equation (9). This type of cost function is commonly used in the area of chemical engineering for all types of equipment.

$$\log(C_p) = k_1 + k_2 \cdot \log(A) + k_3 \cdot (\log(A))^2 \quad (9)$$

where C_p is the equipment purchase price and A , a capacity characteristic.

The prices database was composed of 30 oilseed screw presses from 9 manufacturers, mostly European and North-American, with nominal capacity ranging from 40 kg.h⁻¹ to 2500 kg.h⁻¹. When a range of processing capacity is provided by the manufacturer, the lower value is retained because it has been proven that Jatropha seeds give lower processing rates than common oilseeds such as rapeseeds (Jongh and Putten, 2010). Asian manufacturers were also referenced, providing small to medium capacity equipment at very low prices. However, several project promoters in Burkina Faso have

purchased this type of equipment to start with Jatropha oil production and reported it not to be flexible enough, to be prone to rapid wear and frequent breakdown, although the machines had not been used for so many hours. Thus, we did not consider the use of such equipment for fulltime operation in a commercial activity.

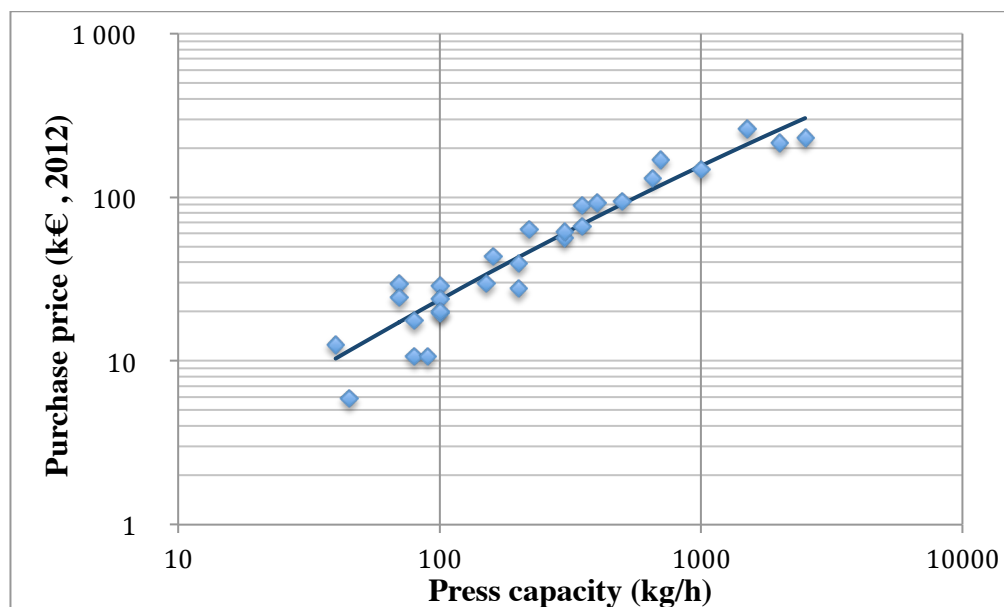

Figure 30. Screw-press purchase cost as a function of pressing capacity (solid line is the regression model according to equation (9)).

The values of coefficients for the purchase costs calculations are presented in Table 23 and the data and regression line are illustrated in Figure 30. The model is well correlated to the data with an $R^2 = 0.91$. It can be observed on Figure 30 that large price variations occur for high capacity equipment. This data was taken from complete oil plants quotations with varying overall capacities, some quotations included several screw presses: in this case the quoted price is usually lower than for a single machine.

Table 23. Coefficient values for screw-press purchase price according to model equation (9)

Coefficient	Value
k_1	2.3694
k_2	1.1247
k_3	-0.0613
R^2	0.91

Screw-presses of capacity higher than 2500 kg/h are rarely used. A plant design with several presses is generally preferred because it is much more versatile in terms of pressing rate and in case of breakdown or during maintenance.

Although the presented cost function was calculated for a single screw-press with a capacity between 40 and 2500 kg/h, we will assume it representative of the purchase cost for higher capacity oil plants, where several presses are required. This assumption was successfully validated by comparing the calculated price for a pressing capacity of 4000 kg/h and manufacturer quotations for the same capacity, including several presses (up to 4). The press purchase price is then calculated using Equation (9), with the coefficients in Table 23, applied to the nominal press capacity as calculated in Chapter 4, section 2.2.

2.2.2 Oil plant investment

The overall capital investment for the oil plant should also include side-equipment, including oil pumps, filters and storage. The cost of side-equipment is then mostly dependent on the oil mass flowrate to process. Based on the same database used for establishing the press cost function (Carré, 2010; Ferchau, 2000), it was possible to evaluate the price of these side-equipment as a function of oil treatment capacity.

Among the press cost data, 15 entries were included in a full oil plant quotation, from which the side-equipment cost was calculating by deducing the press cost. Then, a regression was performed to calculate a cost function according to Equation (9), and using the oil treatment mass flowrate as capacity variable. The model is plotted in Figure 31 and coefficients resulting from the regression are presented in Table 24. The oil mass flowrate should be in kg/h and the cost is calculated in euros. The change to FCFA is 656 FCFA/euro.

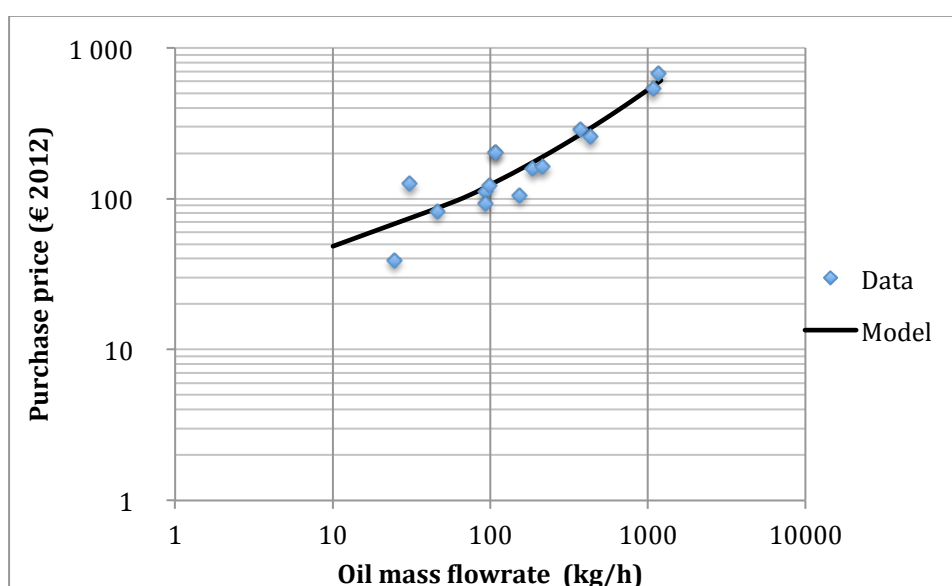

Figure 31. Oil plant side-equipment (excluding press) purchase price as a function of oil treatment capacity (Regression model is in equation (9) and parameters in Table 24).

Table 24. Coefficient values for oil plant side-equipment purchase cost according to model in equation (9)

Coefficient	Value
k_1	4.4967
k_2	0.0778
k_3	0.1103
R^2	0.82

The overall purchase cost of the oil plant process equipment Cap_{op-eq} is calculated as the sum of press purchase price Cap_{press} (function of nominal seed throughput) and side-equipment purchase price $Cap_{side-eq}$ (function of effective SVO mass flowrate).

2.2.3 Buildings and side process investments

In order to calculate the overall capital investment, including buildings, equipment installation and side process investment, such as offices, a factor is applied to the oil plant investment cost. The factor also accounts for the importation cost of pressing equipment from Europe to Burkina Faso. It is assumed that the importation generates an extra cost of about 20 %. Buildings and equipment installation are assumed to amount to 30% of process equipment purchase cost. This value is rather low considering the low workforce cost in Burkina Faso and the fact that installing oil expression equipment neither requires specific skills, nor much additional expensive facilities such as piping. Overall, an extra cost 50% is considered over the equipment cost.

2.2.4 Operational costs

Annual maintenance expenses are 3% of initial investment (Carré, 2010). The number of operators depends on the plant capacity. In Europe, oil plants are more and more automated to limit the need for operators, since the workforce is expensive: it is more profitable to invest in expensive automation systems. In contrast, workforce is cheap and abundant in Burkina Faso; then, this economic model relies on the involvement of operators for handling operations instead of automated systems. From field observations and data from (Carré, 2010), it was assumed that there should be a minimum of 4 operators, and then one more operator for each additional 500 kg/h capacity. Additionally, the numbers of supervisors and administrators are both taken as 20% of the workforce.

Financial cost C_{fin} is calculated based on an amortisation period of 15 years, and on an interest rate of 5%. Another important economic variable of the model is the annual operating time. Continuous operation is an important condition to avoid losses due to

process start-up and to ensure stable operating conditions, which ensure a homogeneous product quality. Then, it is considered here that the plant is operated on a continuous basis 24h hours per day. The annual operating time can vary from 2 000 hours to 8 000 hours. The base-case value is set to 4 000 hours, which corresponds to a 6-month continuous operation period; this is the scheme applied by cottonseed processors in Burkina Faso. Table 25 summarizes the capital investment, annual operating costs and income.

Table 25. Summary of capital investment annual costs and incomes of an oil plant.

	Description	Equation
Capital investment		
Cap_{op}	Oil plant total capital investment	$Cap_{op} = Cap_{op-eq} \cdot (f_{imp} + f_{build})$; $f_{imp} = 20\%$; $f_{build} = 30\%$
Operating costs		
C_{seed}	Seeds purchase cost	$C_{seed} = Q_{seed} \cdot Pr_{seed}$
C_{wages}	Wages payment	$C_{wages} = (N_{op} \cdot Pr_{op} + N_{sup} \cdot Pr_{sup} + \frac{1}{3} \cdot N_{admin} \cdot Pr_{admin}) \cdot H_{year}$
Other costs C_{other}		
C_{supp}	Various additional costs (supplies, packaging...)	$C_{supp} = f_{supp} \cdot Q_{seed}$; $f_{supp} = 0.5 \text{ FCFA} / \text{kg seed}$
C_{maint}	Maintenance of equipment (3% of equipment cost)	$C_{maint} = f_{maint} \cdot Cap_{op-eq}$; $f_{maint} = 3\%$
C_{ins}	Insurance (1% of equipment cost)	$C_{ins} = f_{ins} \cdot Cap_{op-eq}$; $f_{ins} = 1.0\%$
Fixed costs		
C_{amo}	Amortisation of the capital	$C_{amo} = \frac{Cap_{op}}{n}$; $n = 15 \text{ years}$
C_{fin}	Financial cost: interest for borrowing the capital	$C_{fin} = Cap_{op} \cdot \frac{i \cdot (i+1)^n}{(i+1)^n - 1} - C_{amo}$; $i = 5\%$ (interest rate)
Sales income		
Inc_{pc}	Income from press cake sales (unless valorised as biogas)	$Inc_{pc} = Q_{pc} \cdot Pr_{pc}$
Inc_{svo}	Income from SVO sales	$Inc_{svo} = Q_{svo} \cdot Pr_{svo}$

Note: the diversification of oil feedstock appears as a good opportunity to improve the economic performance, by extending the annual operation time. This would also provide more resilience towards feedstock and product prices fluctuations. To avoid too large storage capacity and too long storage period, synergies with other oilseed feedstock could be exploited (neem, balanites, sunflower). This option was not considered in this work since it is beyond the scope of the study. Specific investigations should help determine the overall economic performance and the share of the charges that can be imputed to Jatropha pressing activity.

2.3. Biogas production from the seedcake

(Technical model is in Chapter 4, Section 2.3)

The technology model and assumptions for biogas production is presented in Chapter 4, Section 2.3.2. The model used for capital investment was retrieved from (Amigun and von Blottnitz, 2010) who analysed the cost of 21 biogas plants in Africa. The authors proposed a correlation between cost and digester volume ranging from 20 to 5000 m³. The model was applied to the present case, considering the water mass fraction in the digester is 90% and the average retention time is of 70 days. It provides the capital cost for the biodigester including all biogas equipment and installation as a function of methane power, described in Equation (10). The calculated investment costs are consistent with the prices from manufacturer Zorg Biogas AG (Switzerland) and the model used in (Walla and Schneeberger, 2008).

$$\log(Cap_{dig}) = 5.77 + 0.79 \cdot \log(7.78 \cdot P_{CH_4}) \quad (10)$$

where Cap_{dig} is the capital investment in FCFA and P_{CH_4} is the methane thermal power in kW as calculated in Chapter 4 Section 2.3.2. The cost of power generation system is calculated separately, using the model described for utility supply. Thus, the biogas can be used for either power generation or combined heat and power. The lifetime of the biodigester is basically 15 years. This value is used for annualising capital cost, unless the lifetime of the oil plant to which it is attached is shorter. In such case, the oil plant lifetime is considered.

Then, the annual maintenance cost is calculated per unit of methane thermal energy, at 6 428 FCFA/MWh_{th}. Workforce requirement is low, estimated to 2 working hours per day in average for regular operations (Moletta, 2011; Walla and Schneeberger, 2008).

2.4. Chemical processes cost calculations

(Technical models are in Chapter 4, Section 2.4 and 2.5)

The method used here for the economic analyses of refining and biodiesel processes is commonly used in the field of chemical engineering. It is described in several books (Turton et al., 2012; Ulrich and Vasudevan, 2004), which provide the methodology for different level of analysis: here an “estimate study” is applied, for which the accuracy is estimated to -25% to +40%. Then, it is a “pessimistic estimate”.

2.4.1 Capital cost estimation

The estimate of process capital cost is based on the analysis of the process flowsheet, that can be performed using a chemical process simulation software, as already described in Chapter 4, Section 2.4 and 2.5. The main pieces of equipment are inventoried, with regard to their specifications and capacity. Then, equipment cost functions from several literature references are applied. The following method is applied to all pieces of equipment listed in Chapter 4.

The main data sources for cost functions were Turton et al. (2012) and Ulrich and Vasudevan (2004). In both books, capital cost estimate is structured on several levels and based on equipment *modules* cost.

First, the purchase cost of each equipment is calculated using an equation, typically of the form of Equation (11), which represents the base-conditions cost.

$$\log(C_p) = k_1 + k_2 \cdot \log(A) + k_3 \cdot (\log(A))^2 \quad (11)$$

where C_p is the equipment purchase cost (often in \$), A is a capacity parameter of the equipment (volume, flowrate, ...), and k_1 , k_2 and k_3 are the cost function coefficients. Since equipment cost data often dates back to several years, it is necessary to actualise the purchase cost, which is done using the Chemical Engineering Plant Cost Index published by the monthly journal Chemical Engineering (CEPCI 2012 = 584.6).

Then, the bare module cost is calculated using equation (12). The bare module cost factor depends on equipment type and on the operation pressure and construction materials. It accounts for the costs related to equipment purchase, shipping and installation as well engineering costs.

$$C_{BM} = C_p \cdot F_{BM} = C_p \cdot (b_1 + b_2 \cdot F_M \cdot F_P) \quad (12)$$

where C_{BM} is the bare module cost, F_{BM} is the bare module cost factor, F_M and F_P are the material and pressure factor respectively, and b_1 and b_2 the bare module factor parameters. The values of these parameters and factors are available in Turton et al. (2012) and in Ulrich et al. (2004) for a range of equipment.

Eventually, the total module cost $C_{TM,i}$, which represents the installation of process equipment as an expansion to an existing facility is calculated using Equation (13). The

grassroots cost of the module $C_{GR,i}$, which refers to the construction of the chemical plant “from scratch”, including land acquisition and all civil works, is calculated using Equation (14). The grassroots cost for the whole plant C_{GR} is calculated as the sum of grassroots cost of each piece of equipment (see Equation (15)).

$$C_{TM,i} = 1.18 \cdot C_{BM,i} \quad (13)$$

$$C_{GR,i} = C_{TM,i} + 0.5 \cdot C_{BM,i}^0 \quad (14)$$

$$C_{GR} = \sum_{i=1}^n C_{GR,i} \quad (15)$$

where i is the an index referring to the equipment, and the C_{BM}^0 refers to the bare module cost in base conditions. The base conditions are defined for each type of equipment; for instance, for process vessels it corresponds to carbon steel construction for atmospheric pressure operation.

As most of the available equipment cost data is based on North American surveys, a location factor $f_{loc} = 1.3$ was applied to account for the additional shipping cost, the lower infrastructure development level and the lack of local skilled human resources for building such chemical plants.

2.4.2 Evaluation of operating costs

The operating costs are basically evaluated based on raw material purchase, workforce and utility requirements, using the output of process mass and energy balance. Then, additional operating costs should be accounted for, including maintenance and diverse supplies as well as fixed costs. They are evaluated using several multiplication factors (Turton et al., 2012; Ulrich and Vasudevan, 2004) as described in Table 26.

Table 26. Annual costs considered in the economic analysis of chemical processes

	Description	Equation
Operating costs		
$C_{feedstock}$	Feedstock purchase cost	$C_{feedstock} = Q_{feedstock} \cdot Pr_{feedstock}$
C_{raw}	Other raw material input (chemicals)	$C_{raw} = \sum_{i=1}^n Q_i \cdot Pr_i$
C_{wages}	Wages payment: see Chapter 6, section 1.2.2	$C_{wages} = (N_{op} \cdot Pr_{op} + N_{sup} \cdot Pr_{sup} + \frac{1}{3} \cdot N_{admin} \cdot Pr_{admin}) \cdot H_{year}$
Other costs C_{other}		
C_{maint}	Maintenance and repairs (2 to 10% of fixed capital)	$C_{maint} = f_{maint} \cdot C_{GR} ; f_{maint} = 4\%$
C_{ins}	Local taxes and insurance (1.5-3% of fixed capital)	$C_{ins} = f_{ins} \cdot C_{GR} ; f_{ins} = 1.5\%$
C_{ov}	Overhead: packaging, storage etc. (50 to 70% of labour & maintenance)	$C_{ov} = f_{ov} \cdot (C_{wages} + C_{maint}) ; f_{ov} = 20\%$
C_{supp}	Operating supplies (10 to 20% of maintenance)	$C_{supp} = f_{supp} \cdot C_{maint} ; f_{supp} = 15\%$
C_{lab}	Laboratory charges (10 to 20% of operating labour)	$C_{lab} = f_{lab} \cdot C_{op-lab} ; f_{lab} = 15\%$
Fixed cost		
C_{amo}	Amortisation of the capital	$C_{amo} = \frac{Cap}{n} ; n = 20 \text{ years}$
C_{fin}	Financial cost: interest for borrowing the capital	$C_{fin} = Cap \cdot \frac{i \cdot (i+1)^n}{(i+1)^n - 1} - C_{amo} ; i = 5\% \text{ (interest rate)}$

Maintenance and repairs cost is likely to be moderate for refining and biodiesel that are relatively simple and robust processes (Santori et al., 2012; Wiedermann, 1981). Average values were used for operating supplies and laboratory charges. For local tax and insurance, the lowest value was considered, since taxes are calculated separately. Overhead is lower than the proposed range because storage tanks have already been accounted in the capital costs and packaging is rather limited for biofuels.

2.4.3 Operating labour requirement for biodiesel and refining

The operating labour requirements are particularly difficult to evaluate. Several methods are proposed in the chemical engineering literature (Perry, 1997; Silla, 2003; Turton et al., 2012; Ulrich and Vasudevan, 2004). However, some consider it is a function of capacity while others do not and when applied to the present case, the results are not consistent. Amigun et al. (2008) analysed workforce requirements based on data for 12 biodiesel plants using different technologies and with capacity ranging from 2000 to 200 000 t/year. The authors concluded that the operating labour could be described as a function of processing capacity as $N_{op} = \alpha \cdot Q^{0.5}$; N_{op} being the number of operators, Q a parameter reflecting the processing capacity and α the constant of the model. Thus, the influence of process capacity on workforce requirement cannot be ignored.

The model proposed here includes both process equipment considerations and processing capacity. It combines the method from Ulrich et al (2004) that is based on the equipment used in the process, with the capacity-factor model of Amigun et al. (2008). In this way, the workforce requirement will be consistent with the design of the present refining and transesterification process.

Table 27 presents the workforce requirements for biodiesel and refining processes, following process equipment as proposed by Ulrich et al. (2008). It gives a number of 5 operators for refining process and 6 for transesterification. The typical capacity of the refining and biodiesel processes considered in this work is about 20000 t/an @7500 h/year, i.e. about 2650 kg/h. Based on this assumption, the constant α of the capacity-factor model was determined for refining and biodiesel, using the hourly mass flowrate as capacity parameter.

Table 27. Determination of the number of operators following process equipment

Equipment	Operators / equipment	Number of equipment	
		Biodiesel	Refining
Boiler	0.6	1	1
Water demineralizer	0.3	1	1
Electric generation plants	2	1	1
Evaporators	0.4	1	1
Heat exchangers	0.05	10	5
Mixers	0.2	3	2
Towers	0.3	1	0
Drums	0	2	1
Reactor	0.3	3	2
Centrifuge/filter	0.1	3	2
TOTAL (rounded to the next integer)		6	5

The final model for calculating the required number of operators is presented in Equation (16). The advantage of this model is that it allows to account for both the equipment and the process capacity. However, the influence of batch or continuous operation is not considered, and the value of the model constant depends on the assumption made on the process typical capacity. In the absence of more accurate data, it will be considered that it provides a fair enough evaluation, especially as labour cost constitutes only a limited share of refining and biodiesel operations (Amigun et al., 2008; Haas et al., 2006).

$$N_{op} = \alpha_i \cdot \dot{m}^{0.5} \quad (16)$$

where \dot{m} is the output mass flowrate of the process and α_i is the constant related to the process (Refining: $\alpha = 0.0968$; Biodiesel: $\alpha = 0.1162$).

Eventually, supervising and administration personnel is estimated based on operating labour, as being each equivalent to 20% of the workforce. Supervisors are assumed to work on the same 3x8h basis as operators, while administrator work only 8 hours/day.

2.5. The cost of utility supply

The capital investment for utility systems is calculated using the same method as for chemical processes described in Section 2.4.1. Equipment cost functions for boilers, internal combustion engines and radial steam turbines were retrieved from Turton et al., (2012) and Ulrich and Vasudevan (2004).

2.5.1 National grid power price

The purchase price for grid power depends on the contract power and on the annual operating time, since several fees are paid on a monthly basis independently of the consumption. This was accounted for in the model according the national power company's tariffs. The contract power is calculated on the basis of process power demand increased of 30%, so that overload can be supported.

2.5.2 Internal combustion engine

IC engine purchase cost is calculated based on the rated-power P_{dim} as calculated in chapter 4, section 3.2.2. Then, 10% extra cost over the grassroots cost is considered to include the alternator and another 30% extra-cost in the case of a CHP system. The amortisation and financial cost are calculated over a lifespan equivalent to 32 000 hours of operations unless the related process lifetime is shorter; in this case the process lifetime is considered. The maintenance is taken as 10% of the capital investment (Ulrich and Vasudevan, 2004).

2.5.3 Boiler and steam turbines

The purchase cost of boiler is calculated based on heat duty, steam pressure, type of fuel (liquid or solid) and superheat (temperature gap above saturation), as described in the technical model. The steam turbine is of radial type and its cost is calculated based on electrical power. The lifetime of these equipment is set 20 years, assuming 8 000 hours a year. The maintenance costs are low, 2% of capital investment.

2.5.4 Fuel purchase price and power feed-in tariffs

If there is a surplus of power production from the utility system, or from the biogas plant, the electricity is assumed to be feed-in to the grid at an average tariff of 100 FCFA/kWh. As there is, so far, no legal framework around the conditions for electricity feed-in to the grid by private producers, the national electricity company is not obliged to buy it and no official feed-in tariff is defined. Then, this tariff is considered as a variable parameter.

The fuels considered for utility supply include only SVO and biomass. The cost of fuel purchase is calculated based on fuel power P_{fuel} . The purchase price for biomass was set

to 10 FCFA/kWh. When SVO is the fuel, there are different cases. First, for an SVO plant, the SVO required for power generation is deduced from the production amount, which increases the SVO production cost. In the case of a biodiesel/refining plant, the price of SVO used by the utility is the factory-gate price (purchase price + transport cost, see section 1.3). Finally, for an integrated biodiesel/refining plant, the SVO price is calculated as the production cost related to the SVO process only.

2.6. Aggregation of process accounts and value chain calculation

As mentioned at the beginning of this Chapter, the transformation processes may be installed all on the same site or with decentralised SVO production plants, supplying a large-scale refining or biodiesel production unit. The utility systems are sized according to the demand resulting from process grouping. Then, the production cost of the final product (SVO, refined oil or biodiesel) is calculated based on the aggregation of process accounts, together with utility and biogas production. In this section are described the rules applied to aggregate to costs and incomes of the different processes.

2.6.1 Costs aggregation at plant level

In biogas and utility models are calculated the following annual costs: capital amortisation, financial costs, wages (only for biogas) and maintenance. These figures are added to the corresponding cost categories of the related process. The overall plant production cost is calculated following Equation (17).

$$C_{prod} = (C_{feedstock} + C_{raw} + C_{ener} + C_{fin-tot} + C_{amo-tot} + C_{wages-tot} + C_{other-tot} - S_{by-p}) \quad (17)$$

where C_{prod} is the plant production cost FCFA/year,

S_{by-p} is the annual income from the sale of by-products (press cake, electricity, glycerol) and C refers to annual costs, subscripts referring to:

<i>feedstock:</i>	purchase cost for the feedstock entering the plant
<i>raw:</i>	raw materials other than feedstock (reactive, catalysts,..)
<i>ener:</i>	power from national grid and utility fuel.
<i>fin-tot:</i>	financial costs of all processes installed in the plant, as well as utility and biogas
<i>amo-tot:</i>	amortisation of the plant total capital investment
<i>wages-tot:</i>	sum of all wages involved by processes. When several processes are integrated on a same site, the workforce can be mutualised. Then, a reduction is applied to the total of the

wages required of 10% when 2 processes are grouped, 20% for all-integrated biodiesel plant.

other-tot: all process costs classified as other costs.

Then, the gross operating income, which is the annual profit before taxes, is calculated as:

$$OI = S - C_{prod} \quad (18)$$

where OI is the plant operating income in FCFA/yr, S the income from biofuel sales, tax free.

The net value added created by the economic player is calculated as:

$$VA = C_{wages-tot} + C_{fin-tot} + OI \quad (19)$$

Value added tax (VAT) is calculated as 18% of this basis.

VAT is applied only to main transformed products, i.e. SVO, refined oil and biodiesel. Seeds are not submitted to VAT because it is a product from agriculture. Press cake sold as fertiliser is also exonerated as agricultural input. Eventually, power fed-in to the grid is considered not to be submitted to VAT because there is so far no legislation on obligation and prices.

Then, taxes are deduced to operating income to calculate the net profit. It includes a tax on school and training Tax_{school} calculated as 4% of total wages, and the tax on Industrial and Commercial Profits (ICP), taken as 35% of the operating income.

Another tax is levied on Industrial and Commercial Profits (ICP), taken as 35% of the operating income. The net operating income is finally defined as:

$$NOI = OI - Tax_{ICP} - Tax_{school} \quad (20)$$

The breakdown of value added in wages, financial costs, taxes and benefits provides for the assessment of distribution between employees, banks, State and operators. When analysing a whole production pathway, the creation of value added can also be broken down following the operators (smallholders, processors) to emphasize the main contributions.

3. Environmental impact calculations

3.1. Fossil energy consumption and greenhouse gas emissions

As discussed in Chapter 2, a partial life-cycle analysis is applied to determine the fossil fuel consumption and greenhouse gas emissions (GHG) from Jatropha biofuel production. LCA basically consists in inventorying all environmental impacts associated with the production of a functional unit, within specific boundaries. Here, the functional unit is 1 MJ thermal energy in the form of liquid fuel (SVO, refined oil or biodiesel). The assessment starts from seeds collect and end at the final product at factory gate. Cultivation is not taken into account due to high uncertainties. The lifecycle inventory is based on the results of process mass and energy balance. Only the impacts associated to material and energy flows, and transport are considered, those related to building construction and process equipment manufacturing are ignored. Table 28 lists the impact factors considered here. Most were taken from Biograce standard values (Biograce, 2013).

Table 28. Figures used in life-cycle assessment

	Reference unit	CO ₂ _{eq} (g)	Fossil energy (MJ _f)	Source
Fuels				
Diesel	<i>MJ</i>	87.64	1.16	BioGrace 2013
Heavy fuel oil	<i>MJ</i>	84.98	1.088	BioGrace 2013
Biomass	<i>MJ</i>	0.4116	0.0063	See section
Grid power	<i>MJ</i>	197.84	2.75	See Table 11
Chemicals				
NaOH	<i>kg</i>	469.3	28.57	BioGrace 2013
H ₃ PO ₄	<i>kg</i>	3011.7	10.22	BioGrace 2013
MetOH	<i>kg</i>	599	33.02	BioGrace 2013
Transport				
Seeds (small truck 10 t load)	<i>t.km</i>	246.94	3.795	EcoInvent 3.0, lorry 7.5-16 t
SVO (tank trucks 20 t load)	<i>t.km</i>	192.44	2.979	EcoInvent 3.0, lorry 16-32t

The coefficient for grid electricity were calculated based on the Burkina Faso energy mix as detailed in Table 29. The factors for electricity from thermal power plants, where calculated using the specific consumption of 225 g/kWh reported by the national electricity company (SONABEL, 2012) and the factors for heavy fuel oil from Table 29. To calculate the factors for imported electricity, the same work was done using the energy mix of origin countries (91.2% from Côte d'Ivoire, 8.5% from Ghana and 0.3% from Togo). BioGrace 2013 database include GHG emission factors for grid power in these countries. The production is mostly based on hydro-power and natural gas power plant in Ghana and Côte d'Ivoire.

Table 29. Calculation of LCA factors for grid electricity

Production	Share	CO ₂ _{eq} (g)	Fossil energy (MJ _f)
Thermal power plant (HFO)	46.4%	215.06	2.92
Imported	45.2%	145.11	2.57
Hydro	8.5%	0.00	0.00
Line losses	16%		
Total		197.84	2.92

The biomass used as fuel for utility supply relates mostly to agricultural waste, but is not further defined. For the LCA, the biomass itself is considered as renewable and thus generates no GHG or fossil fuel consumption. However, it has to be trucked to the biofuel plant, which has an impact. The factors mentioned in Table 28 were calculated assuming the biomass is transported on 20km by truck (10 ton). The average LHV was set to 12 MJ/kg.

The general formula to calculate life cycle GHG emissions related to a final product at plant level is given in Equation (21). The method is exactly the same for the calculation of fossil energy, using fossil energy factors.

$$GHG_{plant} = Q_{feedstock} \cdot (f_{GHG}^{truck} \cdot D_{feedstock} \cdot 10^{-3} + f_{GHG}^{feedstock}) + E_{elec} \cdot f_{GHG}^{elec} + E_{fuel} \cdot f_{GHG}^{fuel} + \sum_i Q_{chem,i} \cdot f_{GHG}^{chem,i} \quad (21)$$

with:

- GHG_{plant} the life-cycle annual GHG emission in g CO₂-eq
- $Q_{feedstock}$ the annual feedstock consumption in kg
- f_{GHG}^{truck} the emission factor for truck transport in g CO₂-eq/t.km

$D_{feedstock}$	average transport distance of feedstock in km
$f_{GHG}^{feedstock}$	GHG emission factor of the feedstock, apart from transport (relates to the emissions due to feedstock production in g CO ₂ -eq/kg)
E_{elec}	annual grid electricity consumption in MJ
f_{GHG}^{elec}	grid electricity emission factor
E_{fuel}	annual fuel consumption for utilities in MJ
f_{GHG}^{fuel}	fuel emission factor
$Q_{chem, i}$	annual consumption of chemical i , kg
$f_{GHG}^{chem, i}$	emission factor of chemical i

Equation (21) gives the overall emissions related to the plant. These emissions are then allocated to the different products, following an economic allocation methodology. This consists in allocating the emissions to a product according to the share of income it generates, as in shown in Equation (22). Again, the method is exactly the same for fossil energy consumption.

$$GHG_{alloc}^i = \frac{1}{Q_i} \cdot GHG_{plant} \cdot \frac{S_i}{S_{tot}} \quad (22)$$

where GHG_{alloc}^i is the emission allocated to product i , Q_i is the annual amount of product i , S_i and S_{tot} are the sales income from product i and all products respectively.

3.2. Water requirements

As water is a scarce resource in Burkina, the water requirements for the different processes are reported. It includes only process water. The water used for cooling requirements, is highly pure water and is in a closed loop.

4. References

- Allard, B., 2010. Evaluation de la rentabilité économique de la filière Jatropha dans la région de Teriya Bugu (Mali) (Master thesis). IRC Supagro, Montpellier.
- Amigun, B., Müller-Langer, F., Von Blottnitz, H., 2008. Predicting the costs of biodiesel production in Africa: learning from Germany. *Energy Sustain. Dev.* 12, 5–21.
- Amigun, B., von Blottnitz, H., 2010. Capacity-cost and location-cost analyses for biogas plants in Africa. *Resour. Conserv. Recycl.* 55, 63–73.
- Bassolé, D., 2007. Etude sur la qualité des engrais vendus en détails dans 14 localités d'implantation des boutiques d'intrants et de location de matériels au Burkina. ADIPAC, IFDC, Ouagadougou.
- Borman, G.D., von Maltitz, G.P., Tiwari, S., Scholes, M.C., 2013. Modelling the economic returns to labour for Jatropha cultivation in southern Africa and India at different local fuel prices. *Biomass Bioenergy* 59, 70–83.
- Carré, P., 2010. Etude d'avant projet pour l'implantation d'une unité de trituration de colza à froid. CREOL Priv. Commun.
- Domergue, M., Pirot, R., 2008. Jatropha curcas L. (Rapport de synthèse bibliographique). CIRAD/AgroGeneration, Montpellier.
- Ebadian, M., Sowlati, T., Sokhansanj, S., Stumborg, M., Townley-Smith, L., 2011. A new simulation model for multi-agricultural biomass logistics system in bioenergy production. *Biosyst. Eng.* 110, 280–290.
- Fan, K.-Q., Zhang, P.-F., Pei, Z.J., 2013. An assessment model for collecting and transporting cellulosic biomass. *Renew. Energy* 50, 786–794.
- Ferchau, E., 2000. Equipment for decentralised cold-pressing of oilseeds, Folkecenter for renewable energy. ed. The Netherlands.
- Haas, M.J., McAloon, A.J., Yee, W.C., Foglia, T.A., 2006. A process model to estimate biodiesel production costs. *Bioresour. Technol.* 97, 671–678.
- Jongh, J.A., Putten, E. van der, 2010. The Jatropha Handbook: From Cultivation to Application. FACT Foundation.
- Moletta, R., 2011. La méthanisation. Lavoisier.
- Perry, R., 1997. Perry's chemical engineers' handbook., 7th ed. / ed. McGraw-Hill, New York.
- RECA Niger, 2011. Prix des engrais et tonnages prévus dans certains pays de la zone CFA pour la campagne 2011 - 2012 (Note d'information No. 16), Intrants. Réseau National des Chambres d'Agriculture du Niger, Niamey.
- Rizet, C., Gwét, H., 1998. Une comparaison internationale des prix du camionnage Afrique, Asie du sud-est, Amérique centrale. *Rech. - Transp. - Sécurité* 60, 69–85.
- Santori, G., Di Nicola, G., Moglie, M., Polonara, F., 2012. A review analyzing the industrial biodiesel production practice starting from vegetable oil refining. *Appl. Energy* 92, 109–132.
- Silla, H., 2003. Chemical Process Engineering: Design and Economics. CRC Press.

SONABEL, 2012. Rapport d'activité 2012. Société nationale d'électricité du Burkina Faso, Ouagadougou.

Starkey, P., Ellis, S., Hine, J., Ternell, A., 2003. Améliorer la mobilité rurale - Solutions pour développer les transports motorisés et non motorisés en milieu rural. World Bank, Washington, D.C.

Turton, R., Bailie, R.C., Whiting, W., Shaeiwitz, J.A., Bhattacharyya, D., 2012. Analysis, Synthesis, and Design of Chemical Processes. Prentice Hall.

Ulrich, G.D., Vasudevan, P.T., 2004. Chemical engineering process design and economics: a practical guide. Process Pub.

Walla, C., Schneeberger, W., 2008. The optimal size for biogas plants. Biomass Bioenergy 32, 551–557.

Wiedermann, L.H., 1981. Degumming, refining and bleaching soybean oil. J. Am. Oil Chem. Soc. 58, 159–166.

Chapter 6. Analysis of process performance and supply chain assessment

1. Implementation of supply chain assessment

1.1. The OSMOSE platform and the computing structure

The model is implemented using OSMOSE, a software platform developed under Matlab® by the Laboratory of energy engineering, EPFL. OSMOSE includes a framework for the simulation of energy conversion system and is able to communicate with flowsheeting software such as AspenPlus or Belsim. Several analysis and design tools are also accessible from the platform, including sensitivity analysis, multi-objective optimisation which are computed within Matlab and heat network optimisation which is computed using an external solver. Only some of these tools were used in this work.

In a first step, oil refining and biodiesel production processes were simulated using AspenPlus. Heat network integration was applied to these processes, (see Chapter 4, section 3.1) by transferring heat flows data from Aspen, through OSMOSE, to an external solver. The results of heat and mass balance of chemical processes and heat network integration are proportional to the process capacity, as there is no scale effect in the process performances as modelled in Aspen. Thus, in order to limit computing time, these results were integrated into technology models within Matlab, following the structure provided by OSMOSE. Each process model includes the calculation of capital and operating costs using equipment cost functions.

Then, Jatropha cultivation and SVO production are also coded using Matlab, as OSMOSE process models, while the models for utility supply technologies, biogas production and transport cost are coded as simple Matlab functions. Finally, a post-model function is used to compute the assessment of whole supply chains. An overview of this structure is given in Figure 32.

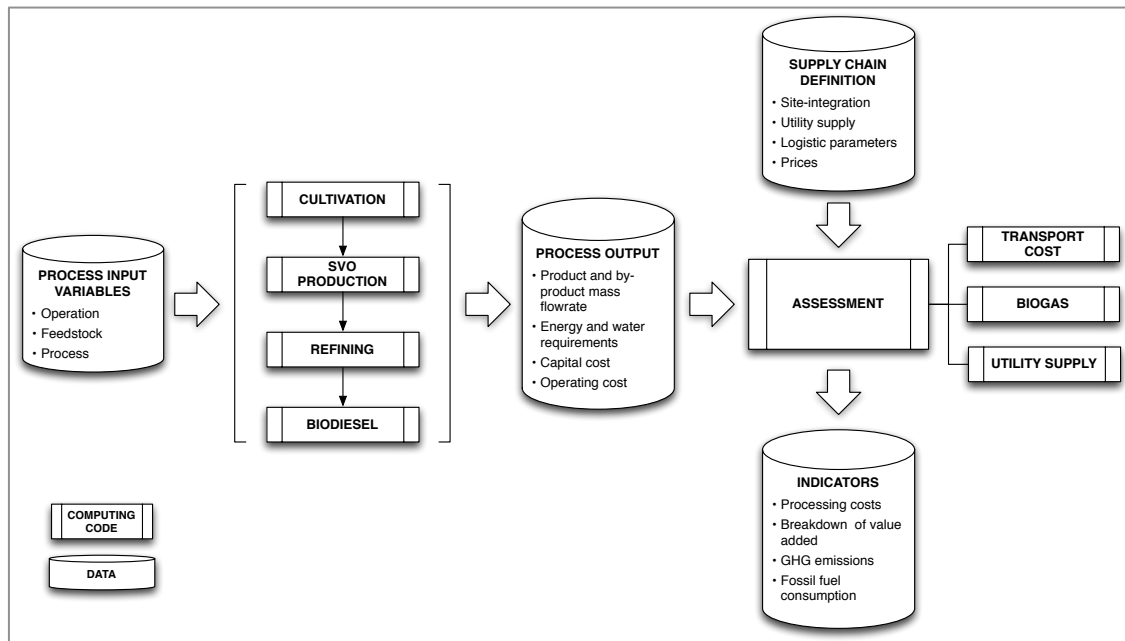

Figure 32. Diagram of the structure of the implementation of process models and assessment.
(Equipment cost functions are called within the process models but are not represented)

The overall supply chain structure is defined in the assessment function. This includes the choice of final product, site integration of transformation processes and utility supply options, as well as the definition of logistic parameters and product prices. Process input variables relates to local parameters that can be classified as *operation*, *feedstock* and *process*. This classification is used in section 2 to present the sensitivity analyses.

Eventually, sensitivity and “one-run” simulations can be conducted, one-run referring to a calculation with fixed settings. Simulation parameters are defined in a frontend sheet. Then, the process models involved are run successively, with a connexion linking the output to the input of the next one. The assessment model is run last, based on the output of process models.

1.2. Summary of model parameters

1.2.1 Technical input parameters

All technical variables used in the process models will be summarized in the next section dedicated to the sensitivity analyses of process economic performance. They are classified as operation-, process- and feedstock-related parameters and the variation range and base-case values are defined when possible. Base-case values were discussed in the description of the corresponding models in chapter 4 and 5.

1.2.2 Economic parameters

A certain number of economic parameters are constant, including energy and fertiliser prices, wages and financial parameters as presented in Table 30. The values given for wages correspond to gross salary, which includes health care and pension fees. According to Burkina Faso's Labour Code, these fees are calculated as 21.5% of salary basis, out of which 16% is charged to the employer and 5.5% to the employee. Further, in the calculation of value added distribution, gross salary values are accounted under the category *wages*.

Table 30. List of prices used in economic models, with variation range and base-case value, when applicable.

PRICES (FCFA)	Unit	Base-case	Description
Input			
N-fertiliser	kg	783	From field data (RECA Niger, 2011), see chapter 5, section 2.1
P-fertiliser	kg	1859	
K-fertiliser	kg	966	
Energy prices			
Biomass (12MJ/kg)	MJ	1.2	Half the wholesale price of wood in Ouagadougou at equivalent energy content, (Ouédraogo, 2007)
Grid electricity	kWh	115	Calculated using SONABEL's grid tariff (variable between 115 and 130 depending on contract power and annual operating time)
Gross wages			
Farm			
Worker	h	240	Minimum legal salary
SVO plant			
Operator	h	700	Assumed price for a qualified operator
Administrative	h	1250	
Supervisor	h	1500	A technician can supervise the oil plant
Refining/biodiesel			
Operator	h	1250	Assumed price for an operator qualified to work in a chemical plant (technician)
Administrative	h	1250	Same level as technician
Supervisor	h	4000	Assumed price for an engineer
Financial			
Interest rate	%	5	
Amortisation period			
Cultivation	yr	20	
Oil plant	yr	15	
Refining/Biodiesel	yr	20	

1.2.3 Fuel prices

There are several possibilities to consider the required competitiveness of biofuel with regard to the final use and the fossil fuel it replaces. Several reference prices are considered, calculated based on energy equivalent prices of fossil fuels as given in Table 31. First, when SVO is used by a small private operator to displace standard diesel, it can be assumed that the cost, to be advantageous for the user, should be about 20% lower than that of diesel (at equivalent energy content), which gives about 500 FCFA/L (vs. 656 FCFA/L for diesel). Then, SVO can also be used in place of DDO or HFO 180 for industrial shaft power or electricity production. The equivalent prices are respectively 465 and 362 FCFA/L, based on HFO and DDO without subsidy. The equivalent to subsidised prices, as paid by the national power company, are presented as an indication but will not be used further. From a macro-economic point of view, it would be much more profitable for the state to put this subsidies on locally produced fuel, since this will have an effect on national economy, while subsidising fossil fuel is mostly a foreign currency expense (Nonyarma and Laude, 2010). Finally, biodiesel price is considered equivalent to fossil diesel, i.e. 596 FCFA/L.

Table 31. Properties and prices of fuels.
(Achten et al., 2008; Blin et al., 2013; Demirbaş, 1998; Freedman and Bagby, 1989; Pramanik, 2003)

	LHV		Density	Price (incl. VAT)	
	MJ/kg	MJ/L	kg/m ³	FCFA/L	FCFA/MJ
Diesel	43.1	35.9	0.832	656	18.3
DDO	42.3	36.0	0.85		
w.o. subsidy				493	13.7
w. subsidy				392	10.9
HFO	40.5	38.5	0.95		
w.o. subsidy				412	10.7
w. subsidy				220	5.7
SVO	37.0	33.8	0.914		
eq. diesel -20%				495	14.6
eq. DDO w.o. subsidy				465	13.7
eq. DDO w. subsidy				369	10.9
eq. HFO w.o. subsidy				362	10.7
eq. HFO w. subsidy				193	5.7
Biodiesel					
eq. diesel	37.0	32.6	0.880	596	18.3

1.3. Supply chain structures and analysis strategy

Several supply chains can be built from the combination process models. Also, as there are many input variables and many indicators to observe, the analysis is decomposed in two main parts. First, the production cost of each process is analysed with respect to process variables and prices (section 2). In a second part (section 4), several types of supply chains are defined according to the different opportunities identified from the context analysis.

The different possible supply chain's configurations are illustrated in Figure 33. The final product can be either SVO, refined oil or biodiesel. Press cake can be valorised as biogas or as organic fertiliser; in the case of biogas, the digester is assumed to be on the SVO plant site. Then, SVO production and refining/biodiesel processes can be set in a unique plant or as one chemical plant (refining or biodiesel) supplied by several decentralised SVO production plants (number to be defined in the scenario). As a rule, biodiesel and refining are always considered grouped on the same site. The utility supply system is chosen once the site integration is defined.

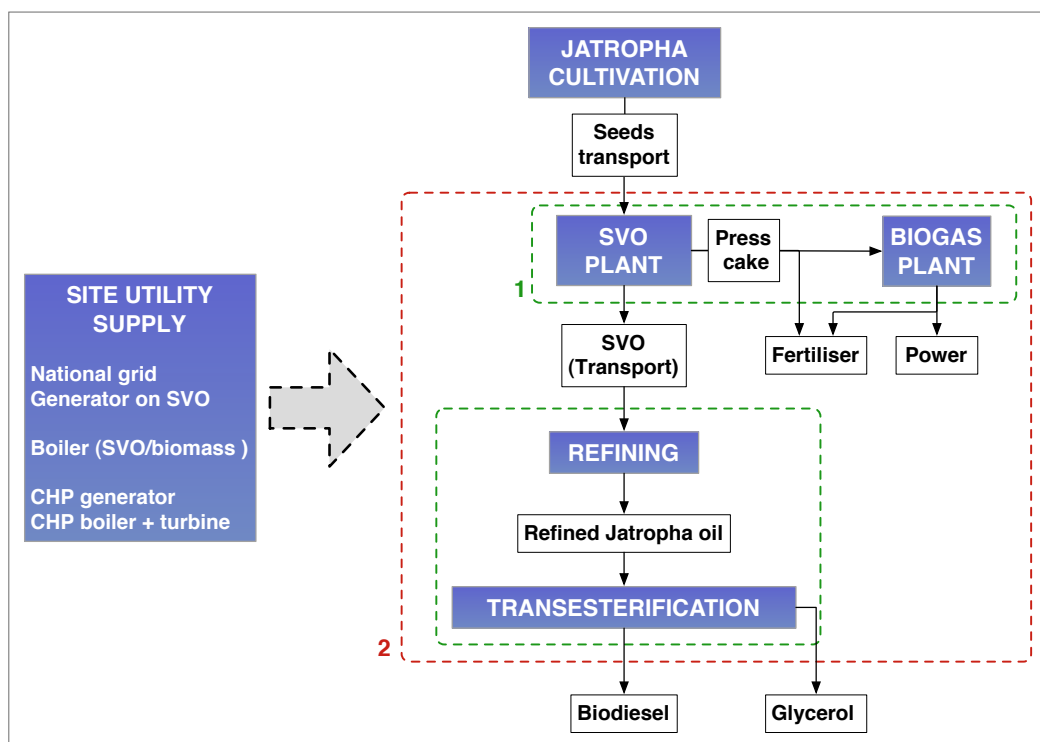

Figure 33. Supply chain structure including all possibilities. (Biogas, refining and transesterification are optional; Frame 1: Decentralised SVO production in several oil plants, Refined oil and/or biodiesel production on another site, Biogas is always on SVO plant site; Frame 2: all processes are centralised on unique site)

2. Sensitivity analyses at process-level

In this section, the sensitivities of process economic performances are analysed with respect to process and economic parameters variation. The results allow to identify the main factors influencing production costs.

2.1. Jatropha seeds production

Jatropha cultivation is expected to provide additional income to smallholders. Then, the main concern is to analyse the seed production cost, with regard to its market price. Following the model defined in Chapters 4 and 5, three variables can influence the production cost, i.e. seed yield, chemical fertilisers use and cultivation labour requirements. Variation range and base-case values are listed in Table 32.

Table 32. Summary of cultivation model parameters.

Process parameters	Unit	Value			Description
		Min	Max	Base-case	
<i>Process</i>					
Yield	kg/ha	300	3 000	1 000	Yield
Regular operation	man.day/ha	5	25	15	Regular operation
Chemical fertiliser		Yes	No	No	Chemical fertiliser

2.1.1 Seed yield and chemical fertilisers

The seed yield influences the production cost, since most cultivation labour is specific to the cultivated area, and not to the amount of seeds. Moreover, seed harvest is faster with increased seed yield. Then, another important factor is the use of chemical fertiliser. Here, the amount of chemical fertiliser is calculated to offset the nutrient export due to the seed harvest. The seed production cost is illustrated on Figure 34 as a function of the seed yield, with and without chemical fertiliser use.

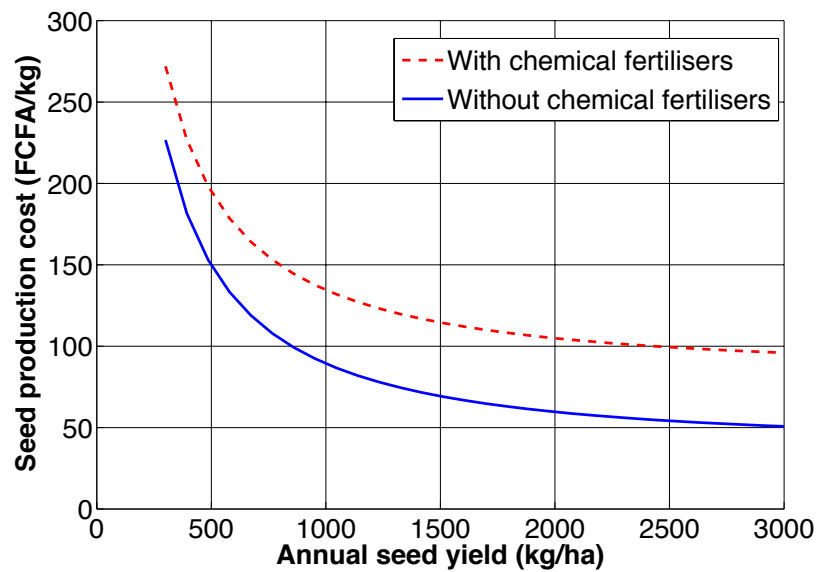

Figure 34. Variation of seed production cost with respect to annual seed yield. Chemical fertilisers are used to offset the nutrient export due to seed harvest

For the base-case yield of 1000 kg/ha, the seed production cost is of 89 FCFA/kg without fertiliser use and 135 FCFA/kg with fertiliser. The effect of yield is particularly pronounced up to 1500 kg/ha and tends to stabilise for higher yields. Since, the expected seed market value is about 100 FCFA/kg, 1000 kg/ha appears to be a minimum yield for a proper remuneration of smallholders.

The use of chemical fertilisers is however very expensive. The limit of 100 FCFA/kg is only reached for a yield of 2500 kg/ha and even for 3000 kg/h, the production cost is still 95 FCFA/kg. Moreover, as the amount of fertiliser considered here is the minimum requirement (harvest compensation), it is very unlikely that, this alone, allows to increasing the yield up to 3000 kg/ha. It might be possible if combined with irrigation, but this would involve substantial extra-costs. In contrast, it is much more likely that the yield reaches 1500 kg/ha with improved regular operations (Domergue and Pirot, 2008). Chemical fertilisers appear to be too expensive compared to the seed market value.

Then, further in this study, it will be considered that fertilisation is not achieved using chemical fertilisers but using organic fertilisers or simply by letting animals graze on *Jatropha* fields.

2.1.2 Sensitivity to labour requirements

Labour requirements were obtained from an experimental crop in Mali. However, they can vary depending on agricultural practices and on farmer's skills. Then, the production cost was analysed as a function of regular agricultural operations requirement, which is the main labour item after harvest. This is illustrated in Figure 35.

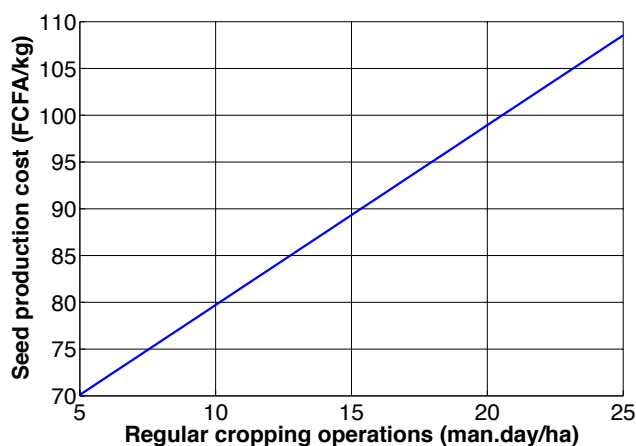

Figure 35. Seed production cost vs. regular agricultural operation requirements (base-case value is 15 man.day/ha).

It can be noticed that seed production is quite sensitive to labour requirement: a 30% increase in regular operation labour result in more than 10 % increase in production cost. This result emphasizes the importance of a proper training of smallholders willing to get involved in *Jatropha* production. A loss of time due to improper crop management would rapidly result in substantial shortfalls.

2.2. Straight vegetable oil production

The production of SVO from the seeds using cold pressing is a central and decisive process in *Jatropha* biofuel supply chains. In this section, the production cost of SVO is analysed with respects to several model parameters, including processing capacity, biogas production from the press cake, power supply options and also process variables and prices. All parameters investigated in sensitivity analyses are summarised in Table 33, including variation range. In terms of processing capacity, the range covered by the model is reduced in practice to emphasize the high sensitivity at low scale.

Table 33. List of variable parameters related to SVO production and biogas.

Process parameters	Unit	Value			Description
		Min	Max	Base-case	
Operation					
Annual seed processing capacity	tons	200	250000		
Annual operating time	hours	200 0	8000	4000	
Feedstock					
Seeds oil content (w.b.)	-	0.27	0.37	0.33	
Process					
Oil recovery	-	0.55	0.85	0.77	
Filter cake oil content	-	0.35	0.6	0.4	
Sediment content	-	0.02	0.1	0.06	
Prices (excl. VAT)					
Feedstock					
Seeds	kg	70	150	100	Seed price at farm level
By-products					
Press cake	kg	20	60	40	Based on equivalent fertilising value or solid fuel value compared to chemical fertiliser (60 FCFA/kg) and wood (47 FCFA/kg) prices
Digestion slurry					Half the value of seedcake before digestion
Power feed-in to the grid	kWh	70	150	110	No legislation. Assumption based on national company production cost (160FCFA/kWh)

2.2.1 Influence of processing capacity on capital investment and production costs

The first result concern the capital investment involved by the SVO production plant, with respect to the processing capacity and the energy supply options. Figure 36 illustrates the capital costs for seed processing capacity between 200 and 5 000 t/yr, for three energy supply options, i.e. national grid, power generator on SVO and power from biogas produced from the press cake.

Biogas production is not a simple energy supply solution but rather a power production plant: it implies huge capital investment, compared to the pressing plant. This is explained by the fact that the press cake is dry and should be diluted about 10-20 times with water or a co-substrate, for example. Combined to a retention time up to 100 days, it involves the use of large digesters. By contrast, operating costs are very low, especially as the feedstock comes directly from the pressing plant. It allows to produce

a great amount of electricity, of which, only about 10-15% is consumed by the pressing plant and the rest can be fed-in to the grid (assuming a legislation exists). The self-consumption share depends on the scale, due to variable engine efficiency.

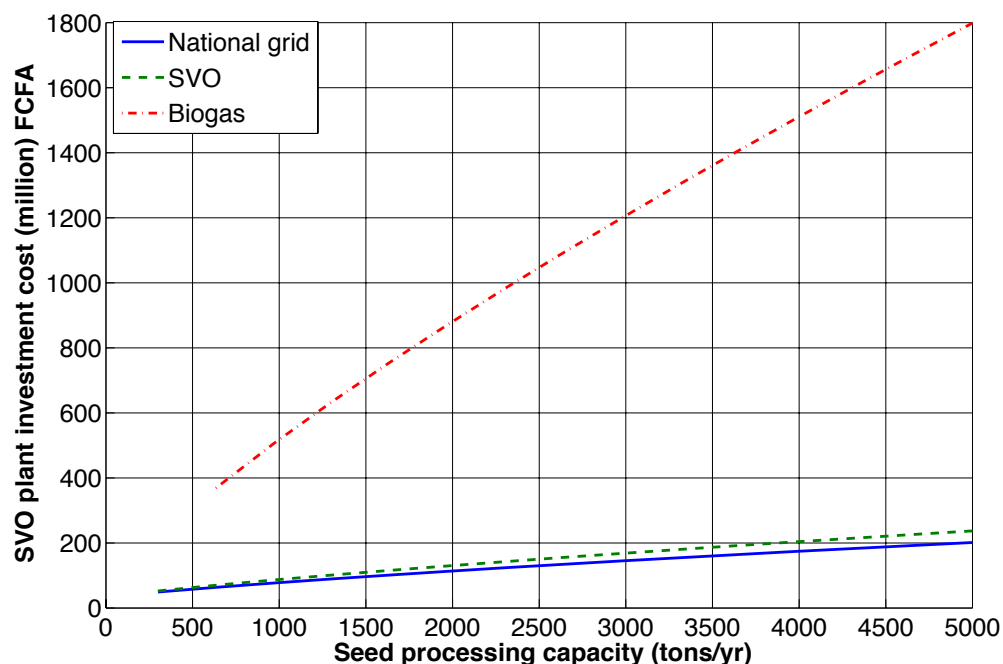

Figure 36. Capital investment for SVO production as function of processing capacity and for different energy supply options

Figure 36 also indicates that there are great economies when up-scaling the pressing process, which is not the case for biogas. The extra cost implied by a power generator is almost negligible relatively to SVO plant cost. As opposed to biogas, SVO production requires relatively low capital investment but involves high operating costs due to feedstock purchase and processing costs.

Figure 37 illustrates the production cost of SVO, for processing capacity ranging from 200 to 10 000 tons/yr. Important economies of scale are achieved with increased processing capacity. The production of power from SVO induces a slightly higher cost than grid connection, but the gap tends to decrease with increased capacity due to increased engine efficiency. This result shows that an SVO production plant could be set up in remote area, off power grid. While SVO production cost drops rapidly for capacity from 200 t/yr to 2000 t/yr, the decrease is more gradual for higher capacities, reaching about 325 FCFA/L at 10 000 t/yr.

The production of biogas and power from the seedcake provides significant cuts in production costs for high processing capacity, higher than 2000 t/yr. At 10 000 t/yr, the

production cost reaches 250 FCFA/L and keep decreasing for higher capacity, due better amortisation of capital investment and higher power generation efficiency.

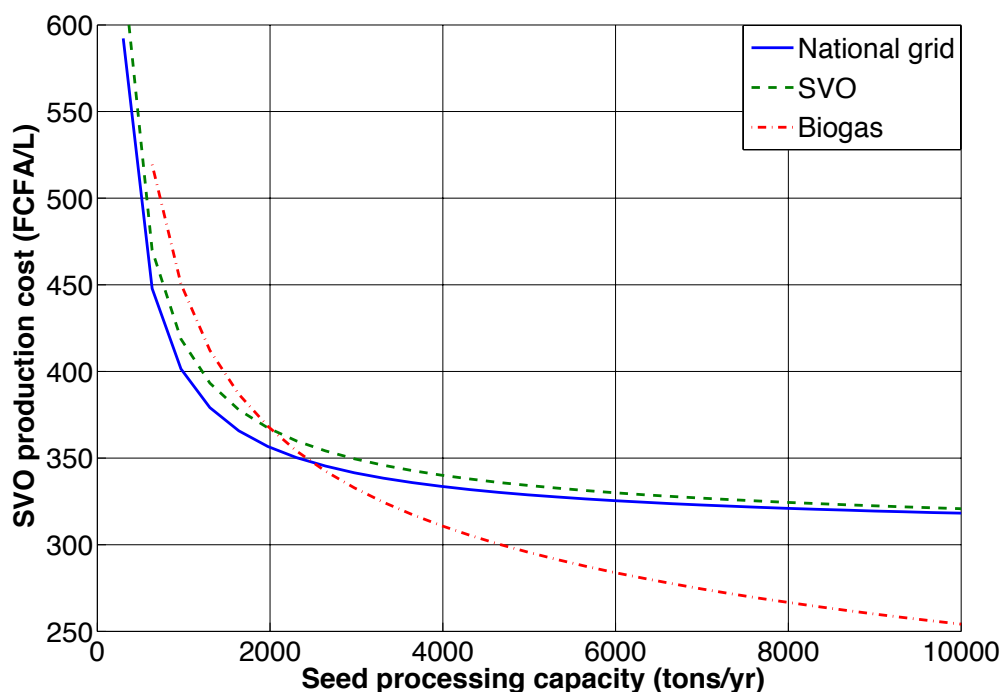

Figure 37. SVO production cost with respect to seed processing capacity and energy supply option.

2.2.2 Sensitivity to process parameters

Once the general influence of processing capacity and energy supply option is known, it is worth analysing the effects of the process parameters on production costs. In this section are presented the sensitivity analyses for 2 cases. The first case concerns a small SVO production plant processing 1000 t/yr and where the power is supplied using a generator fuelled with SVO. The second case concerns a larger scale plant, with 10 000 tons/year, with a production of biogas and power from the press cake. Each studied parameter is varied independently of the others that are fixed to base-case value. Then, the results are presented in Figure 38 on graphs giving the SVO production cost versus the parameter variation relatively to base-case value. In this way, the sensitivities to the different parameters are represented by the slopes of the curves and can be easily compared.

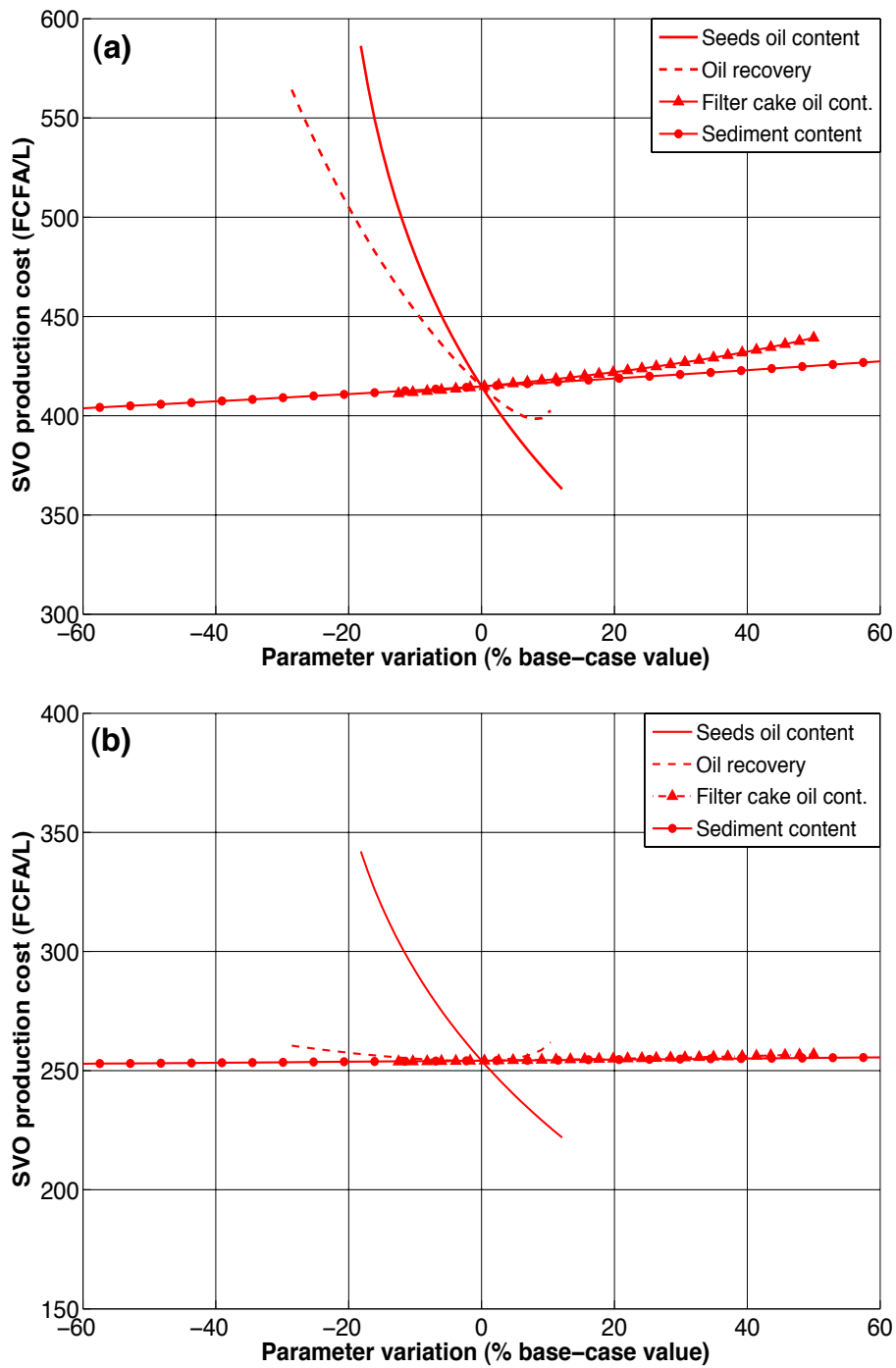

Figure 38. Sensitivity of SVO production cost to process parameters.
 ((a) capacity = 1 000 t/yr, power supply from SVO generator ; (b) capacity = 10 000 t/yr, power generation from biogas)

According to Figure 38, two parameters have a clear predominant influence on production cost, namely seeds oil content and oil recovery. Both are indeed directly related to the amount of oil that can be produced from a given amount of seeds: at 77% oil recovery, a seeds oil content of 27% implies a minimum of 4.4 kg of seeds per litre of SVO, where only 3.2 kg are necessary at 37% oil content. This corresponds to a difference of more than 120 FCFA/L only for feedstock purchase. The gap is even accentuated by the higher specific energy consumption for decreased seeds oil content. The same reasoning can be conducted for oil recovery. Then, the effect of sediment content and filtration efficiency cannot be ignored, although it is much lower than for the first two parameters.

When biogas is produced from the seedcake, the same predominant influence of seeds oil content is observed. However, the effect of all other parameters, which actually characterises the efficiency of oil extraction, is totally attenuated, since the part of the oil that is not properly separated in the process is transformed to biogas. This behaviour is a strong advantage since the biogas production from the press cake attenuates the eventual irregularities of pressing performances. However, in practice, too high oil content in the press cake can cause perturbations in the anaerobic digestion process.

2.2.3 Sensitivity to economic parameters

Economic parameters also strongly influences the production cost of SVO. They include feedstock and by product prices and annual operating time. The results of sensitivity analyses are illustrated in Figure 39 for the cases of small-scale SVO production and large-scale SVO and biogas.

In both cases, the most influent factor is the feedstock purchase price. Then come the by-product selling prices, i.e. press cake in the small-scale case and power feed-in to the grid and digestate in the case of biogas. Press cake price is influent because press cake is produced in great quantity relatively to SVO. Power feed-in tariff plays the same role in the case of biogas and is almost as influent as seed price. The income from digestate sales, calculated as half the value of seedcake also have a significant influence.

Eventually, the influence of annual operating time was investigated: the sensitivity is conducted at constant hourly capacity (variable annual capacity) in order to give a representative picture of equipment amortisation. The results show that an increase in operating time can reduce the production cost, particularly in the case of biogas since it involves high capital investment. However, this is not linear: the increase in production cost when operating time is reduced below the base case, is even more pronounced.

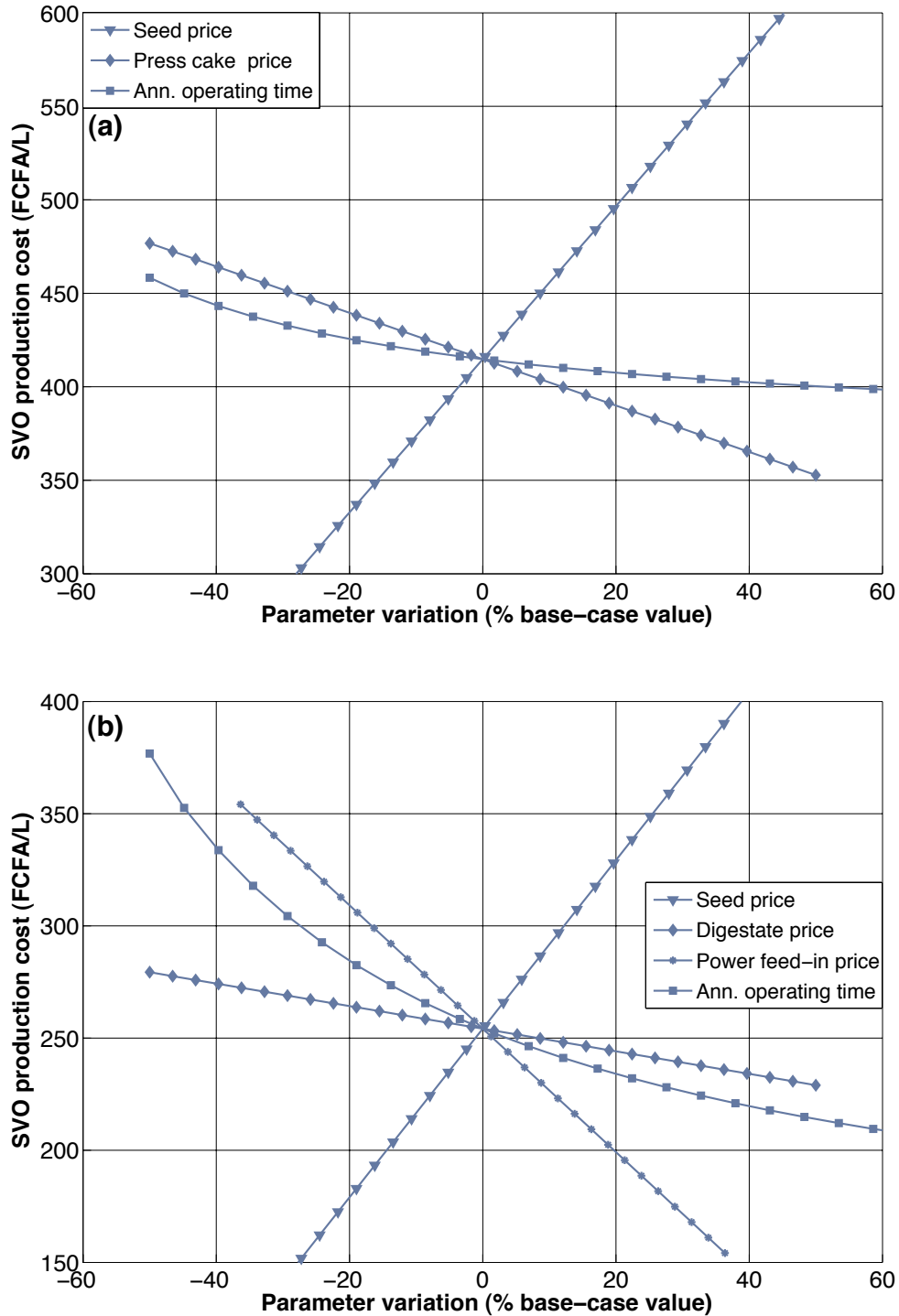

Figure 39. Sensitivity of SVO production cost to economic parameters.
 ((a) capacity = 1 000 t/yr, power supply from SVO generator ; (b) capacity = 10 000 t/yr, power generation from biogas)

2.3. Straight vegetable oil refining

This section is dedicated to the analysis of SVO refining costs. Refining is here analysed as a stand-alone process, without biodiesel production. The production of refined oil, in place of SVO, could be a valuable option when great amounts are used to substitute fuel oil for power generation. In this case, refining would ensure a homogeneous fuel quality, even if SVO originates from several pressing plant. The investigated parameters and options are presented in Table 34.

Table 34. List of variable parameters used in sensitivity analyses of refining cost.

Process parameters	Unit	Value			Description
		Min	Max	Base-case	
Operation					
Annual SVO processing capacity					
<i>Continuous</i>	<i>tons</i>	7 000	50 000	20000	
<i>Batch</i>	<i>tons</i>	1 000	10 000	5000	
Annual operating time					
<i>Continuous</i>	<i>hours</i>	5 000	8 000	7000	
<i>Batch</i>	<i>hours</i>	4 000	7 000	5000	
Feedstock					
FFA content	-	0.005	0.03	0.02	
Phosphorus content	<i>ppm</i>	50	200	100	
Process					
Batch/continuous	-	Batch	Cont.		
Energy integration	-	Yes	No	No	
Prices (FCFA, excl. VAT)					
Feedstock					
SVO	<i>L</i>	300	500	400	incl. VAT, given as an indication
	<i>L</i>	255	425	340	excl. VAT
By-products					
Power feed-in to the grid	<i>kWh</i>	70	150	110	No legislation. Assumption based on national company production cost (160FCFA/kWh)

2.3.1 Processing capacity and energy supply options: capital investment and production cost

Oil refining process can be implemented on a wide range of capacity, using batch processing for small capacity within 1 000 – 10 000 t/yr and continuous processing for higher capacities. Here, the upper limit is set to 50 000 t/yr, which is already very large scale in the present context. The best options for energy supply are investigated here.

As there are 3 technologies available for energy supply (Boiler + grid; CHP with IC Engine; CHP with steam turbine), two possible fuels (SVO and biomass) and the possibility of heat network integration, there are a number of possible combinations. For clarity and concision reasons, only the best and most relevant solutions are presented in the results. By way of example, the use of CHP with a steam turbine was not considered when energy integration is applied, since the power-to-heat ratio (0.94) is much higher than that of steam turbine CHP system (0.15).

Capital investment for batch and continuous processes are presented in Figure 40 as a function of processing capacity for different energy supply options. First, it can be observed that the capital cost for batch process is low compared to continuous, which is mostly explained by lighter equipment. Then, the investment for continuous process slightly varies depending on the energy supply options. The lowest investment corresponds to the use of a boiler and grid connection, while the highest correspond to combined-heat and power generation using a steam turbine. Anyway, the cost of the energy supply system is limited relatively to the whole investment. Energy integration also implies a slight over-cost.

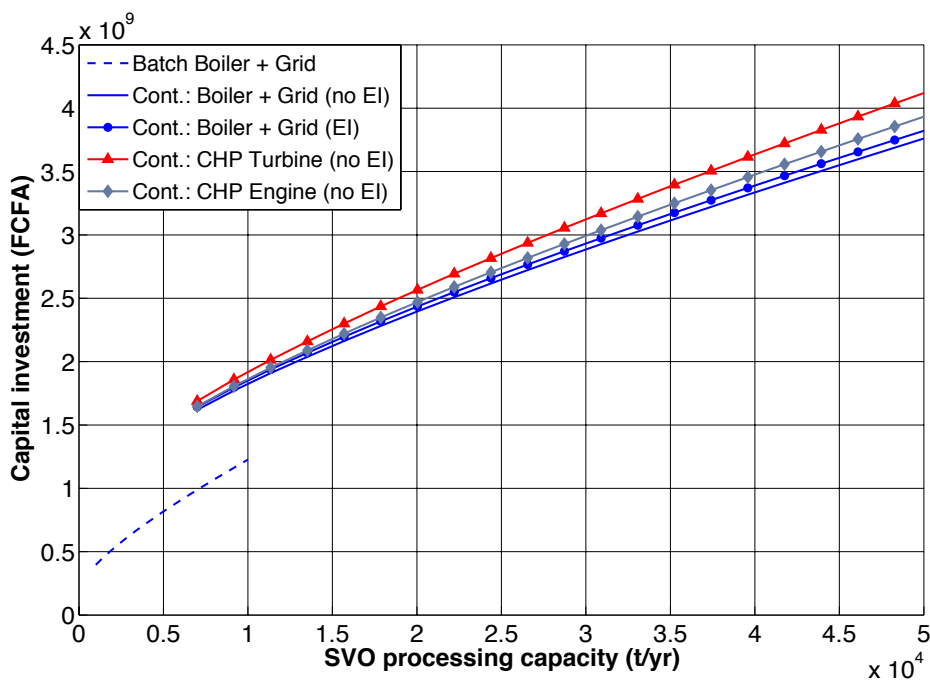

Figure 40. Capital investment for SVO refining plant as a function of processing capacity. (Cont.: continuous process; EI: energy integration)

Figure 41 illustrates the refined oil production cost versus processing capacity. In batch mode, the refined oil production cost varies between 450 and 390 FCFA/L for capacity from 1 000 t/yr to 10 000 t/yr respectively. With continuous process, it is significantly lower and varies between 395 FCFA/L at 7000 t/yr, down to 370 FCFA/L at 50 000

t/yr. In both cases, increased processing capacity provides significant economies of scale. Then, to a lesser extent, energy supply also influences the production cost. In base case conditions, the most profitable solutions are those using biomass as fuel, due to its low price. The use of SVO is more expensive, even when used in a CHP engine. CHP engines offers high fuel to power efficiency but the overall conversion efficiency is low. Then, with SVO at 340 FCFA/L, purchasing the power from the grid and using a boiler fuelled with biomass is more competitive. The use of a steam turbine is the most profitable option. Even if the fuel-to power efficiency is low, the overall energy conversion is very good and the fuel is cheap, which allows to produce very competitive electricity (compared to CHP engine).

Energy integration allows to reduce the production cost only when the utility fuel is expensive, e.g. SVO. In the case of a boiler fuelled with biomass, the reduction in production cost is negligible (not represented on the figure). Overall, the influence of energy supply options is very limited because the energy demand of refining process is rather low. Then, in practice, it might not be worth using a CHP system, which would require specific management, for only a limited gain on production cost.

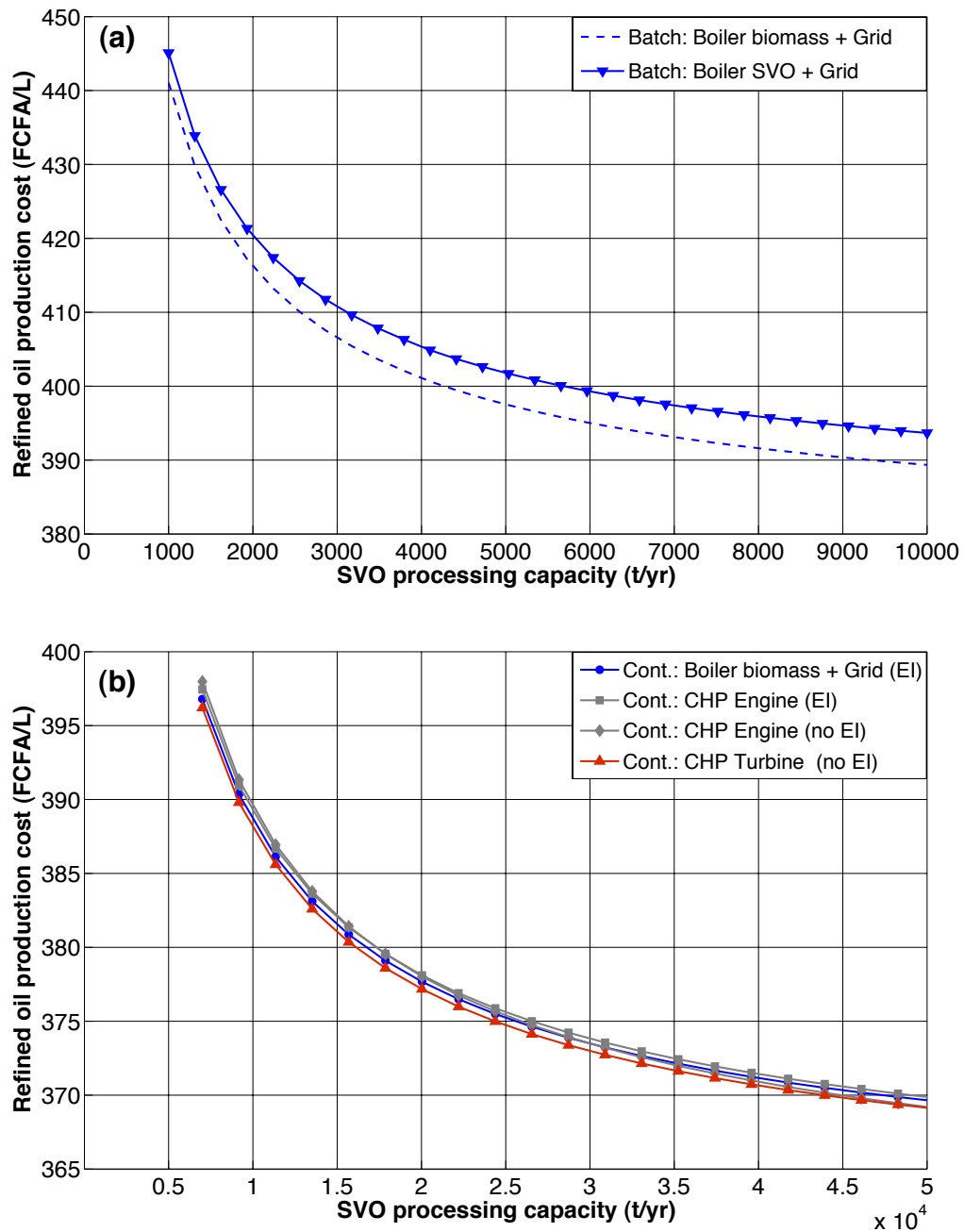

Figure 41. Refined oil production cost vs. processing capacity for several energy supply options. ((a) batch; (b) continuous. EI: energy integration)

2.3.2 Sensitivity to technical and economic parameters

In order to analyse the sensitivity of refining cost to several technical and economic parameters, 2 cases were considered. The first one is a batch process of 5 000 t/yr annual capacity, connected to the power grid and using a boiler fuelled with biomass for meeting heat demand. The second case is a 20 000 t/yr continuous process, with a CHP engine. The results of sensitivity analyses are illustrated in Figure 42.

As for SVO production, the most influent parameter is the feedstock purchase price. Increased annual operating time allows cutting production cost, especially in the case of batch processing, but in a much lesser extent than feedstock price. For the continuous process, the effect of power feed-in tariff was investigated: it appears to have very little influence, which is explained by the small amounts of power generated.

Eventually, two variables are related to SVO quality, i.e. phospholipid and free fatty acid content. Phospholipid has almost no effect on production cost since it is present in the oil in very small quantities (max 200 ppm of phosphorus, corresponding to 0.6% phospholipids). On the other hand, free fatty acid content, which mass fraction can be as high as 3%, have a significant influence, particularly in batch, where solid-liquid separations are less efficient.

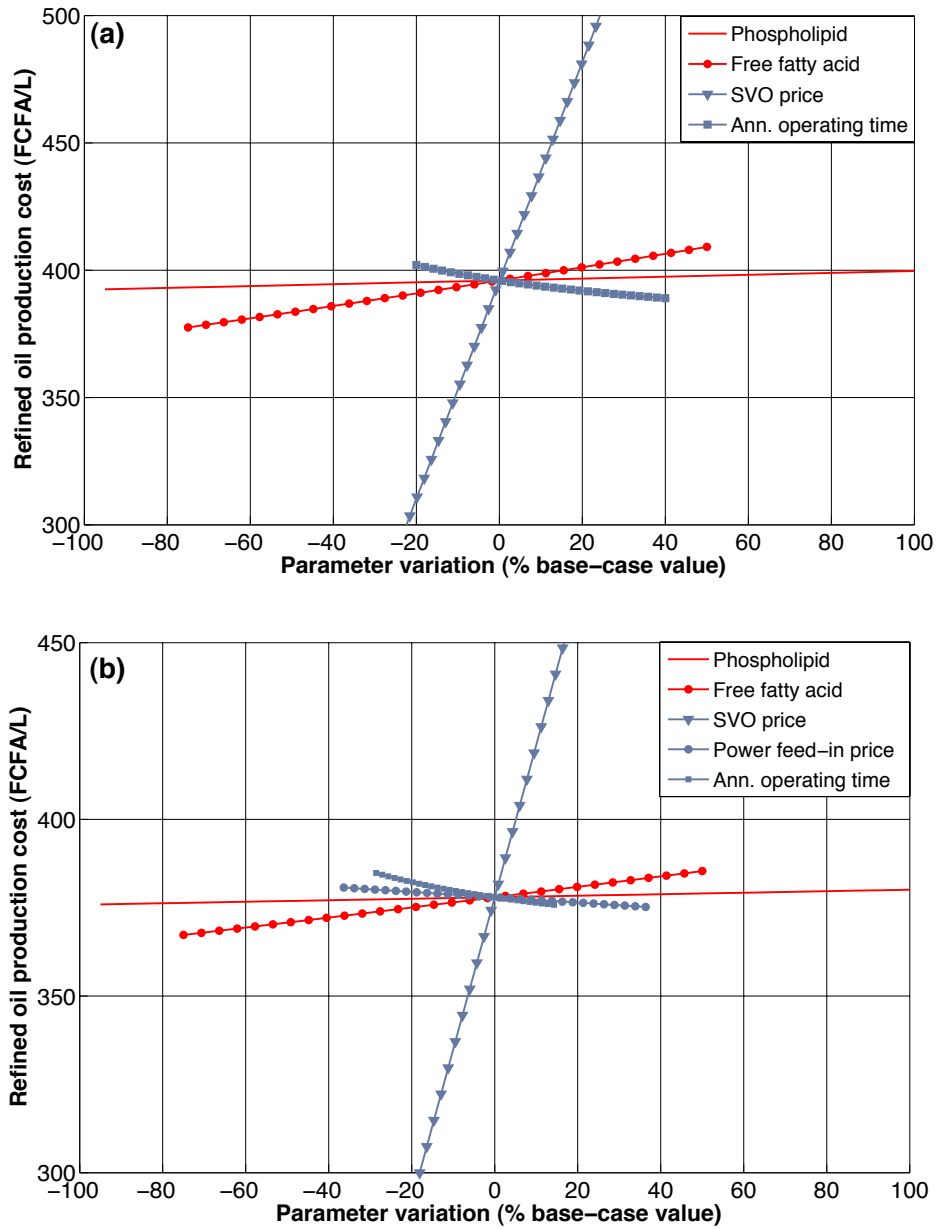

Figure 42. Sensitivity of refined oil production to process and economic parameters. ((a) batch, 5 000 t/yr, biomass boiler + grid; (b) continuous, 20 000 t/yr, CHP engine SVO)

2.4. Biodiesel production from SVO

The process considered here for biodiesel production includes both refining and transesterification, as there is no point, in practice, to have these processes separated. As for SVO and refining, the influence of processing capacity and energy supply options is analysed first. Then, the sensitivity of production cost to several technical and economic parameters is presented. All parameters are listed in Table 35. Those related to SVO quality, which were studied in the previous section dedicated to refining are not included.

Table 35. List of variable parameters used in sensitivity analysis of biodiesel production cost

Process parameters	Unit	Value			Description
		Min	Max	Base-case	
Operation					
Annual SVO processing capacity					
<i>Continuous</i>	<i>tons</i>	7 000	50 000	20 000	
<i>Batch</i>	<i>tons</i>	1 000	10 000	5 000	
Annual operating time					
<i>Continuous</i>	<i>hours</i>	5 000	8 000	7 000	
<i>Batch</i>	<i>hours</i>	4 000	7 000	5 000	
Process					
Batch/continuous	-	Batch	Cont.		
Energy integration	-	Yes	No	No	
Prices (FCFA)					
Feedstock					
SVO	<i>L</i>	300	500	400	incl. VAT, given as indication
	<i>L</i>	255	425	340	excl. VAT
Methanol	<i>kg</i>	200	500	325	
By-products					
Glycerol	<i>kg</i>	50	400	250	
Power feed-in to the grid	<i>kWh</i>	70	150	110	No legislation. Assumption based on national company production cost (160FCFA/kWh)

2.4.1 Processing capacity and energy supply options

The capital investment for a biodiesel production is very high, as illustrated in Figure 43. For a continuous process of 20 000 ton/yr, the initial investment is about 6 billions FCFA, i.e. 9 million euros. For a batch process, it is much lower, about 2 billion FCFA for a capacity of 5 000 t/yr. The additional investment for heat network integration and combined heat and power systems is relatively low compared to the overall cost. As for SVO refining, the most expensive option is the use of a steam turbine.

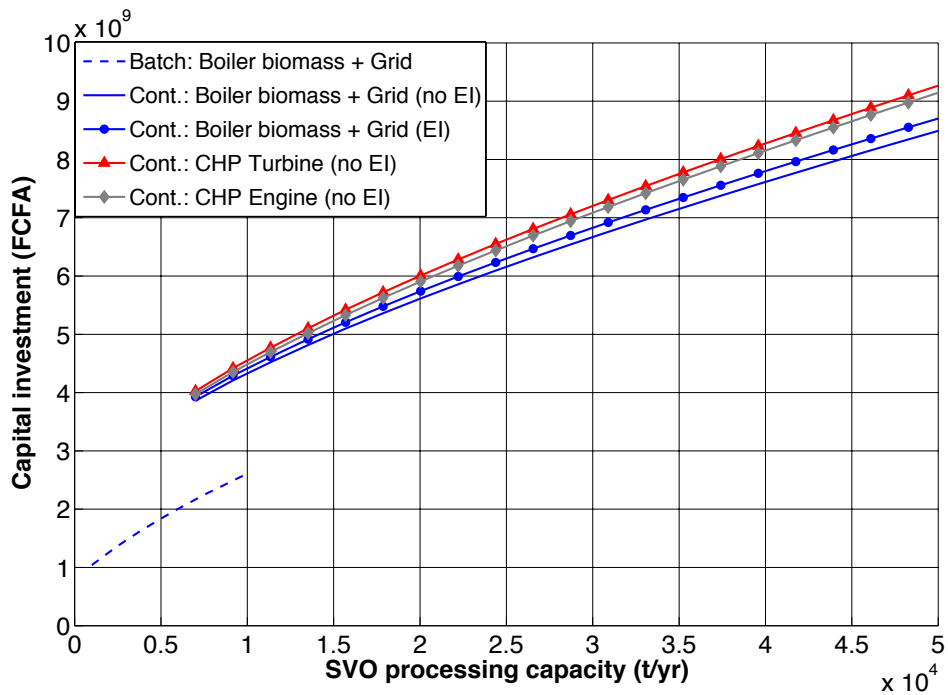

Figure 43 . Biodiesel plant capital investment as a function of processing capacity.

Under equivalent economic conditions, the production cost of batch process is substantially higher than with continuous process (see Figure 44). However, with an SVO price of 340 FCFA/L, a production cost below 500 FCFA/L can be achieved, meaning that a viable production is possible with this process. For both batch and continuous, the production capacity has a strong effect on production cost, which is linked to important economies of scale on equipment investment.

As opposed to refining process, the production cost is more affected by the energy supply option. The two cases where SVO is used as fuel in a boiler are by far the most expensive. They were however included in the simulation to emphasize the importance of having a low-cost utility fuel and to show the influence of energy integration, which is significant in this case. The gains of using a CHP engine increases with production capacity, due to increased engine efficiency at higher rated-power. The use of CHP engine without energy integration provides the lowest production cost at large capacity.

The effect of energy integration in this case is to limit the size of the engine, so that less extra-power is sold. Moreover, engine efficiency is lower.

The use of a steam turbine is also an efficient solution. In this case, energy integration has an adverse effect: by reducing heat demand, it increases the power-to-heat ratio from 0.14 to 0.27. As the ratio of steam turbine is 0.15, it fits perfectly the process without energy integration and yields the best result.

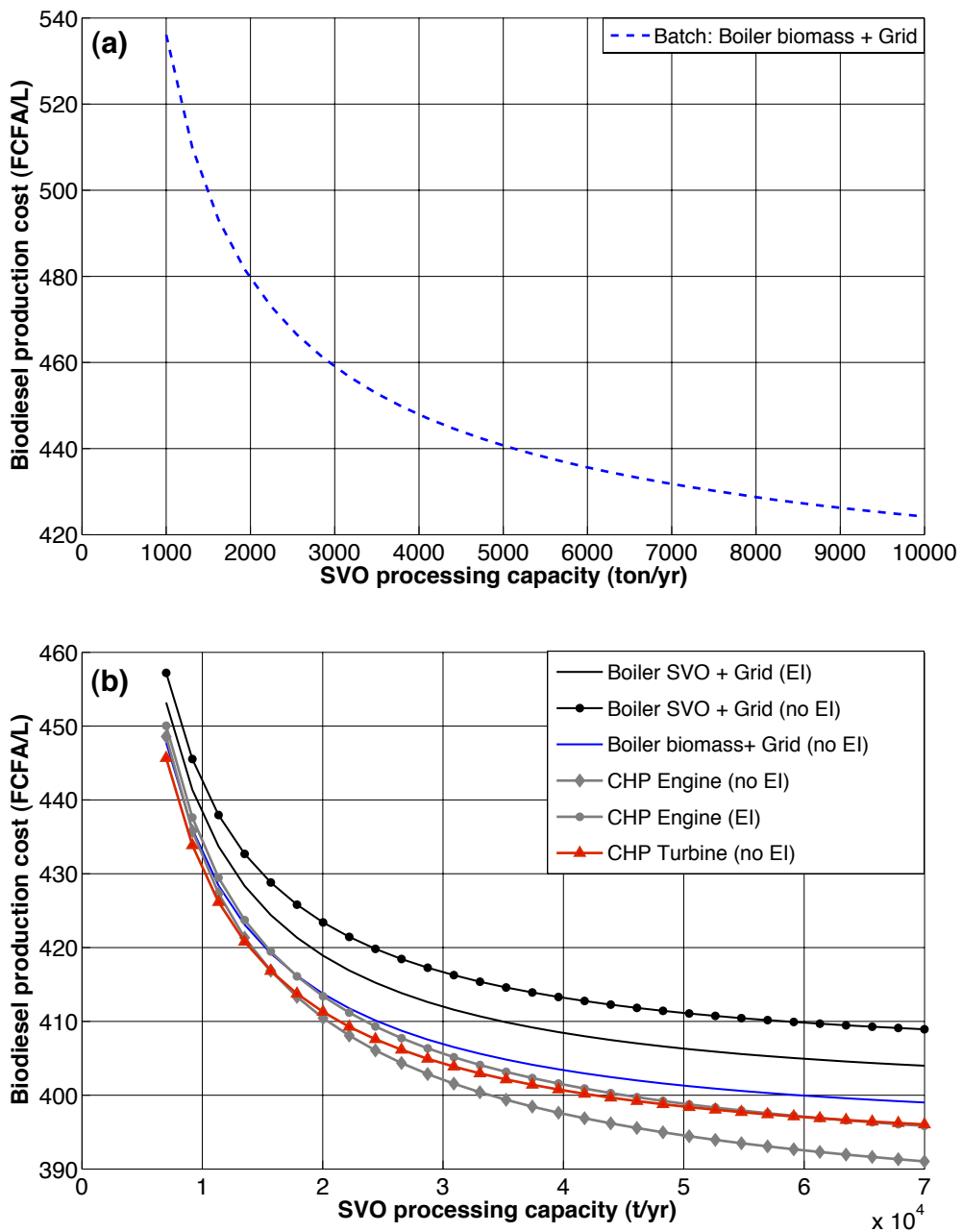

Figure 44. Biodiesel production cost vs. processing capacity for several energy supply options. ((a) batch, 5 000 t/yr ; (b) continuous, 20 000 t/yr. EI: energy integration)

2.4.2 Sensitivity of biodiesel production cost to economic parameters

As the biodiesel production process was modelled, there is no technical parameter to vary. The input of biodiesel process consists of refined oil, modelled as pure triolein, and then the conversion performances are considered constant. In a plant integrating refining and biodiesel, as considered, the quality of input SVO would have an influence on the production cost, as it was emphasized in the previous section dedicated to refining process. Then, these variables were not included in the sensitivity analyses of refining + biodiesel.

Nevertheless, the sensitivity to economic parameters, especially input and products prices, was investigated, for the same base-cases as refining, i.e. a 5000 t/yr batch process using a biomass boiler and grid and a 20 000 t/yr continuous process using a CHP engine system fuelled with SVO. The results are illustrated in Figure 45. The most sensitive parameter is by far, the feedstock price. Then, methanol price has a significant influence on production cost, which is an important consideration given the volatility of methanol price (a product from oil industry).

If glycerol cannot be sold at a good price, biodiesel production cost can be seriously affected. The same observation can be made on power feed-in price, which effect is even more pronounced, in the case of a continuous plant using a CHP system. As compared to refining process, power feed-in price is much more influent since the amount of electricity fed-in to the grid is about 5 times higher. Eventually, the utilization rate, represented by the annual operating time, has a noteworthy influence due to the importance of capital investment.

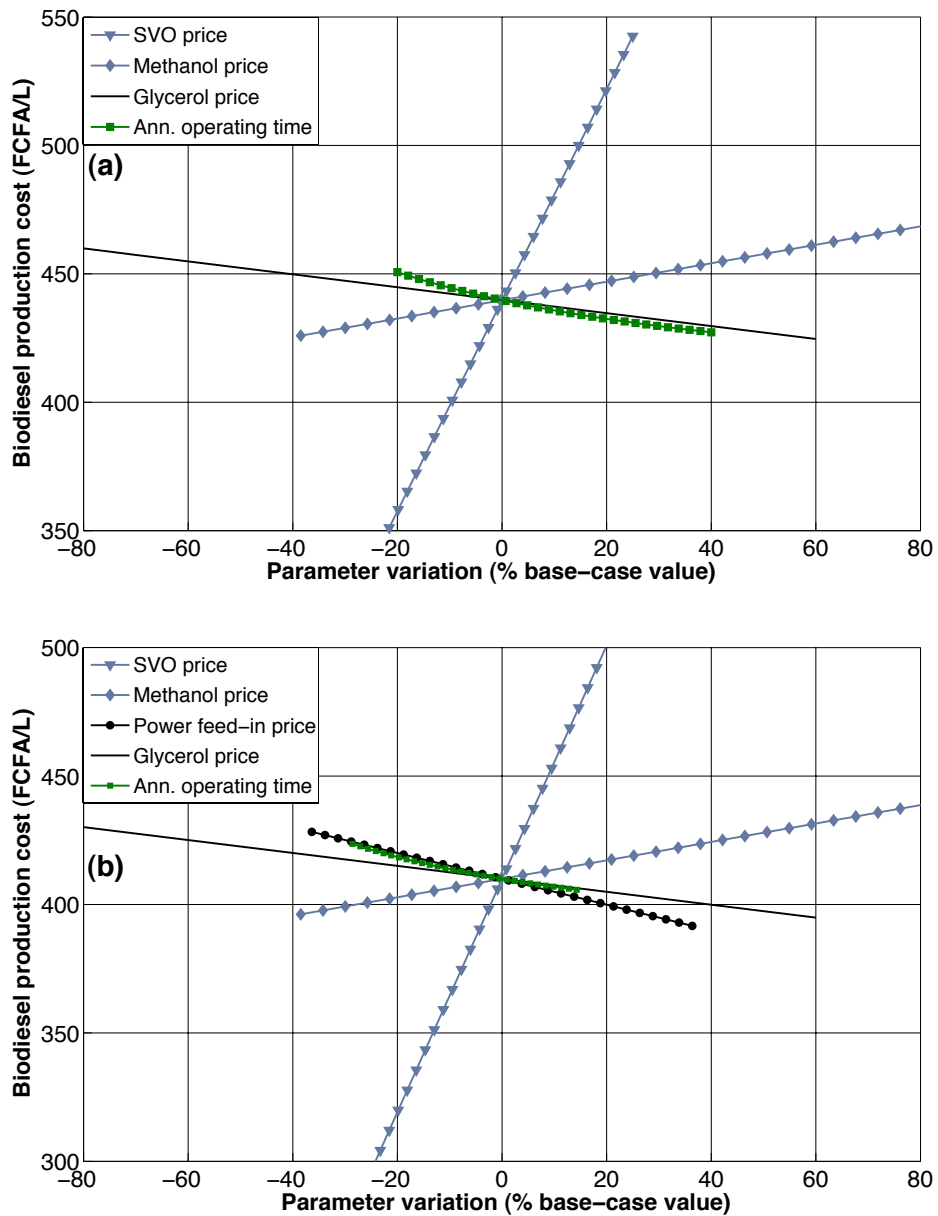

Figure 45. Sensitivity of biodiesel production to economic parameters.
 ((a) batch, 5 000 t/yr, biomass boiler + grid; (b) continuous, 20 000 t/yr, CHP engine SVO)

3. Influence of territorial yield and transport cost

This section is dedicated to the definition of assumptions related to *Jatropha* production potential in the local context. Based, on a study on *Jatropha* potential estimation at village level, the variation range of territorial seed yield is defined. The results are then used to calculate transport cost. Depending on *Jatropha* territorial yield, seed transport cost can significantly impact biofuel production cost.

3.1. Estimation of *Jatropha* production potential

As mentioned in Chapter 2, assumptions related to *Jatropha* production potential are based on a geographical study conducted by Duba (2013). The author proposed an estimate of the area potentially available for *Jatropha* cultivation. The study was based on a spatial analysis using map overlay technique combined to land use model at village level. First, several geographical data layers were overlaid to determine the suitable and unoccupied area. From the area with suitable soil and climate conditions are deduced urban areas, protected areas (national parks, wildlife and cynegetic reserves, forests), rainfed and irrigated croplands and buffer zones around watercourses. Then, a land use model at village level is applied to calculate the area needed by each village for agriculture, livestock farming and firewood collecting, based on demographical data. Available area is then defined as suitable and unoccupied lands that are not within a village area. The resulting map for Burkina Faso is presented in Figure 46.

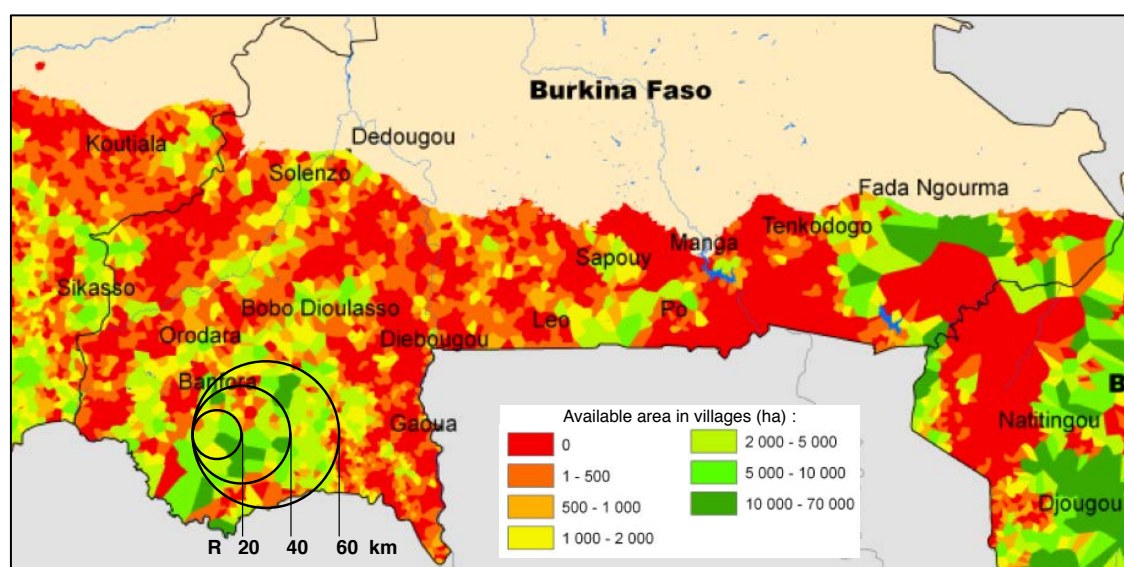

Figure 46. Map of estimated available areas at village level for *Jatropha* cultivation in Burkina Faso (adapted from Duba, 2013).

All the northern part of the country was considered to have too low rainfall for *Jatropha* cultivation (below 800 mm). Villages with available areas higher than 2 000 ha are mostly situated in the south-western and eastern parts of the country. Three circles of 20, 40 and 60 km radius were drawn on the map to help make an estimate of the possible value range of territorial yield. They correspond respectively to areas of 1 256 km² (125 600 ha), 5 024 km² (502 400 ha) and 11 304 km² (1 130 400 ha). As a reminder, territorial yield was defined as a parameter for transport distance calculations in Chapter 5, section 1: it represents the resulting yield on the overall area of collect, as opposed to the seed yield at field level.

Following the map, a 20 km radius area can encompass between a *Jatropha* cultivation potential between about 2 000 and 70 000 ha, depending if it is placed in yellow or green areas: this corresponds to a *Jatropha* crop density between 1.6% and 55%. This resulting territorial seed yield, assuming a seed yield of 1 t/ha at field level, is therefore, between 1.6 t/km² and 55 t/km². However, assuming *Jatropha* is cultivated by smallholders, 55% of the land covered with *Jatropha* crops appears to be a very high density. It would rather correspond to an intensive agro-industrial production. Then, in further analyses, the territorial yield will be assumed to vary between 1 t/km² and 20 t/km², i.e. 1% to 20% of land covered with *Jatropha*, for field-level yield of 1 t/ha.

As a general rule, it can be observed in Figure 46 that the size of collect area increases, the resulting territorial yield tends to decrease since low-potential areas (red to yellow) are necessarily within the area. Therefore, in the further definitions of supply chains, the territorial yield within the collect area of a biofuel plant will be assumed to decrease when the processing capacity increases.

3.2. Transport cost vs. economies of scale

The seed territorial yield within the collect area of a biofuel plant has a direct impact on the size of collect area and therefore on feedstock transport cost, which in turn, affects biofuel production cost. The model for transport cost presented in Chapter 5 is used here to investigate the possible trade-off between the reduction of production cost through biofuel plant up-scaling and transport costs due to increased collecting distance. The production cost of SVO was calculated for seed capacities up to 100 000 t/yr and for *Jatropha* territorial yield between 1 t/km² and 20 t/km². The power is assumed to be produced using an SVO generator. The result is illustrated in Figure 47. Transport cost includes cart transport to local collect point (100 tons) and trucking to the SVO plant.

For low *Jatropha* territorial yield up to 3 t/km², a minimum production cost (optimal plant size) can be clearly identified in the range of 20 000 – 40 000 t/yr. Beyond this value, the production cost raises with increased capacity, even faster than the territorial yield is low, due to a faster increase of transport cost. The lowest achievable production cost is also highly dependent on the territorial yield: at 1 t/km² it is slightly higher than

350 FCFA/L while it is below 330 FCFA/L at 9 t/km². The same analysis was conducted for the cases where power is supplied from grid and biogas is produced from press cake. For grid connection, the same trend was observed as for SVO generator, with a slightly sharper cost increase with capacity. When biogas is produced from the press cake, the SVO production keeps decreasing up to seed capacity of 200 000 t/yr, at 2 t/km² yield.

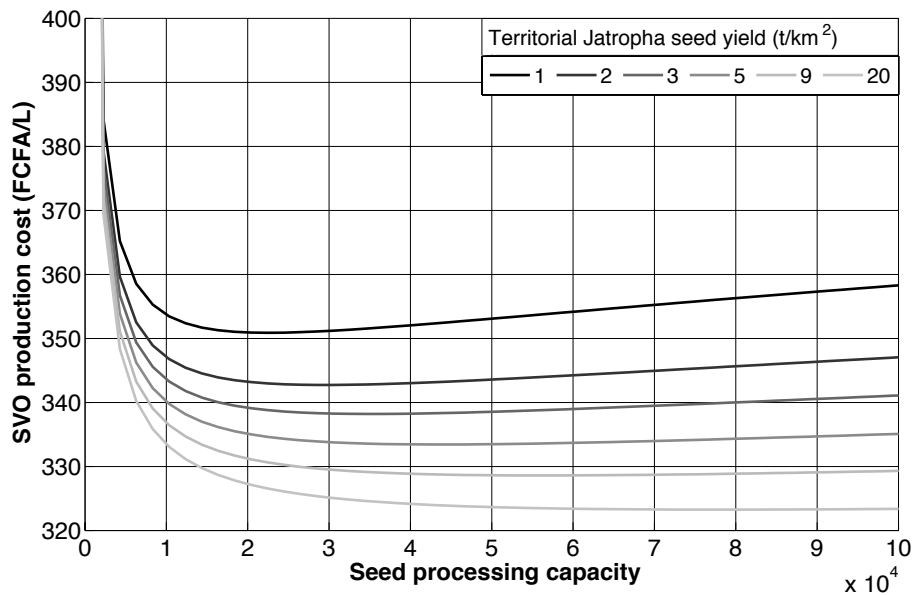

Figure 47. SVO production cost including seed transport, with respect to processing capacity and Jatropha territorial yield. (power supply from SVO generator)

Figure 48 gives the seeds average trucking distance as a function of plant capacity, with respect to territorial yield. The average trucking distance actually corresponds to the collecting radius, since the tortuosity was set to 1.5 and the straight-line equivalent distance is 2/3 of the collect radius (see Chapter 5, Section 1). Then, this distance is to be compared with the circles on the map in Figure 46.

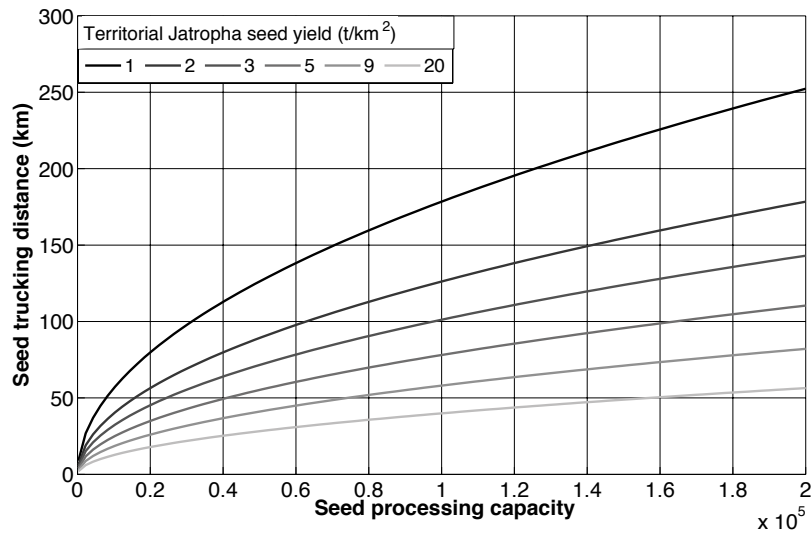

Figure 48. Seed trucking distance and seed price at factory (including transports) as a function of plant capacity and territorial seed yield.

The maximum size of 200 000 t was chosen because it is approximately the amount of seeds required to supply a 50 000 t biodiesel plant. Assuming a Jatropha seed yield of 1t /ha at field level and a territorial of 20 t/km² (i.e. 20 % of land covered with Jatropha), supplying such a plant would require an area of about 60 km radius. 20 % of land covered with Jatropha on such a large area seems very high, especially as it would encompass most of the high-potential southwestern area. Improving agronomic yield could seriously reduce the required area. Then, in the following analyses, the maximum capacity is set to 100 000 tons seed, which is still a high capacity but only requires 40 km radius in the same conditions.

In the case of large-scale biodiesel production, the seeds could probably not be entirely supplied by smallholders, as demonstrated by Duba (2013). The author shown that while there are large available areas in southwestern Burkina Faso, the capacity of smallholders, in this region, to invest in new crops is relatively limited. This evaluation was based on statistical geographical data related to the typology of households, which are classified as “wealthy”, “medium” and “poor”: then, for each category of household, the author defined a capacity to invest in Jatropha crops (from 0 ha for the poorest up to 2 ha for the wealthiest). By contrast, the results show that, in many villages, the Jatropha production capacity of smallholders would be suitable to supply decentralised power networks. A significant number of villages gather the three conditions of available surface, cultivation capacity and sufficient demand, to ensure local electrification based on Jatropha SVO.

4. Examples of Jatropha biofuel supply chains

In this section, several type supply chains are proposed and analysed in terms of economic efficiency and environmental impact. They are built regarding the expected outcomes of Jatropha biofuel development and presented according to final product. Depending on the end-use, the required competitiveness levels are different, as well as the volume of the demand. On this basis, each final product (SVO, refined oil or biodiesel), we propose conceptual supply chains, able to reach the required competitiveness level. According to the analysis of individual processes in section 2, lower production cost are achieved by increasing processing capacities and process technological sophistication (biogas production, CHP systems...). Moreover, processing capacity should also be defined regarding the biofuel potential demand. In each case, the creation and distribution of value added among the players is analysed (see Chapter 2, section 3.3), as well as the environmental impact. In all following simulations of supply chains, all parameters are set to base-case values unless otherwise stated.

4.1. Production of SVO: Local small- to medium scale

As mentioned in section 1.2.3, SVO can be used as a substitute to diesel, DDO and HFO, which determines its price competitiveness level. Non-subsidised prices were considered as reference level, so the values considered here are respectively 500, 470 and 360 FCFA/L including VAT (18%). To compare with biofuel production costs as presented in previous section, the prices excluding VAT should be considered, i.e. 424 FCFA/L, 398 FCFA/L and 305 FCFA/L respectively.

The use of SVO as a substitute to diesel concerns especially rural areas where it could be produced in small to medium capacity plants. This solution is primarily aimed at promoting rural development, by providing local access to an affordable diesel fuel substitute for private applications (mill, motorpump, generator...). Then, the related demand is likely to be low but is hard to evaluate precisely, especially as it encompasses substitution and new energy access creation.

By contrast, the substitution of DDO and HFO represents a large potential market for SVO. In 2008, the national power company consumed about 72 000 toe of HFO and 60 000 toe of DDO, which could be substituted with about 150 000 tons of SVO. This would constitute a large and secure market for Jatropha biofuel, but its implementation requires a decision from the government. Moreover, considering the organisational efforts from national power company tied to the substitution of these fuels, significant amounts of SVO would be required to even start the experimentations.

4.1.1 SVO supply chains definition

Based on the results of SVO production cost analyses in section 2.2, three supply chains were defined, as described in Table 36: supply chain 1 is aimed at the production of SVO as a local substitute to diesel in rural areas; the goal of supply chain 2 is to produce a substitute to DDO for power generation, especially in decentralised power networks; finally, supply chain 3 was designed to produce SVO at very low cost so that it can substitute HFO.

Supply chains 1 and 2 are both constituted of an SVO production plant set in rural area. As the goal of supply chain 1 is the production of SVO for local distribution and use in private applications (motor-pumps, mills...), the demand is likely to be relatively low and the processing scale should be limited to ensure the local availability of biofuel. Therefore, the processing capacity was set to 2 000 t/yr, which is also close to the minimum capacity for a profitable production. Then, the seed collecting area is relatively small, so we assume that the density of *Jatropha* crops can be relatively high within this area and the seed territorial yield is set to 10 t/km², i.e. a land cover of 10% of *Jatropha* crops assuming a field-level yield of 1 t/ha. Consequently, the seed transport distance by cart to local collect point is 1.8 km and trucking distance to oil plant is 8 km. The SVO production plant is assumed to be set in a remote area, so the power for the process is supplied using an SVO generator.

Supply chain 2 is similar since its objective is also to provide biofuel in rural area. However, as the fuel is aimed at power generation in decentralised networks, the selling price should be lower, to compete with DDO fuel, i.e. 470 FCFA/L (398 FCFA/L incl. VAT at 18%). To reach this production cost, it was chosen to increase the SVO plant processing capacity, while keeping the same configuration as supply chain 1. Then the processing capacity was set to 10 000 t/yr. With a territorial yield of 10 t/km², the seed trucking distance to SVO plant is 17.8 km. Regarding the production potential presented in section 3.1, this means that the plant is set in high-potential area (see Figure 46).

Eventually, supply chain 3, to compete with HFO (305 FCFA/L, excl. VAT), involves a more advanced process, including the production of biogas and power from the press cake. Moreover, as the potential demand for HFO substitution is high, the plant processing capacity is set to 20 000 t/yr, so that a significant amount of SVO can be produced. In order to improve the production cost, the annual operating time is set to 8 000 hours. In this case, the required amount of seeds is higher compared to supply chain 1 and 2, so the collect area should be larger. Then, a seed territorial yield to 5 t/km² is assumed, which gives a cart transport of 2.5 km and a truck transport distance of 35.7 km.

Table 36. Summary of SVO supply chains characteristics

SVO SUPPLY CHAIN	Unit	1. Small-scale	2. Medium-scale	3. Large-scale + biogas
Seed processing capacity	t/yr	2 000	10 000	20 000
SVO production	t/yr	450	2 269	4 866
Utility of SVO plant		SVO generator	SVO generator	Biogas
Power fed-in to the grid	kW	0	0	1750
Annual operating time	h	4000	4000	8000
Territorial yield	t/km ²	10	10	5
Seed transport distances				
- by cart to local collect point	km	1.8	1.8	2.5
- by truck to SVO plant	km	8	17.8	35.7
SVO selling price (incl. VAT)	FCFA/L	500	470	360

4.1.2 Economic efficiency of SVO supply chains

The economic efficiency of each supply chain was analysed and presented in Figure 49 in two charts: chart (a) describes the value added creation by supply chain players (farmers and SVO producers), which is calculated as the sum of wages, financial costs and gross operating income (see Chapter 5, section 2.6). In the VA created by the SVO producer, the VAT on SVO was included, while seed are exempted of VAT as an agricultural product. Then, this VA, is broken down according to beneficiaries in chart (b). The VA is shared between the employees (wages), the state (taxes: VAT and others), the banks (financial costs) and the profits of supply chain players (net operating income). In this first analysis only, the wages on chart (b) are decomposed as wages to farmers' employees and to SVO plant's employees (wages farmer and wages SVO plant in the caption). This emphasises that labour cost are mostly associated to *Jatropha* cultivation. In each case, values are expressed relatively to the quantity of SVO produced (FCFA/L).

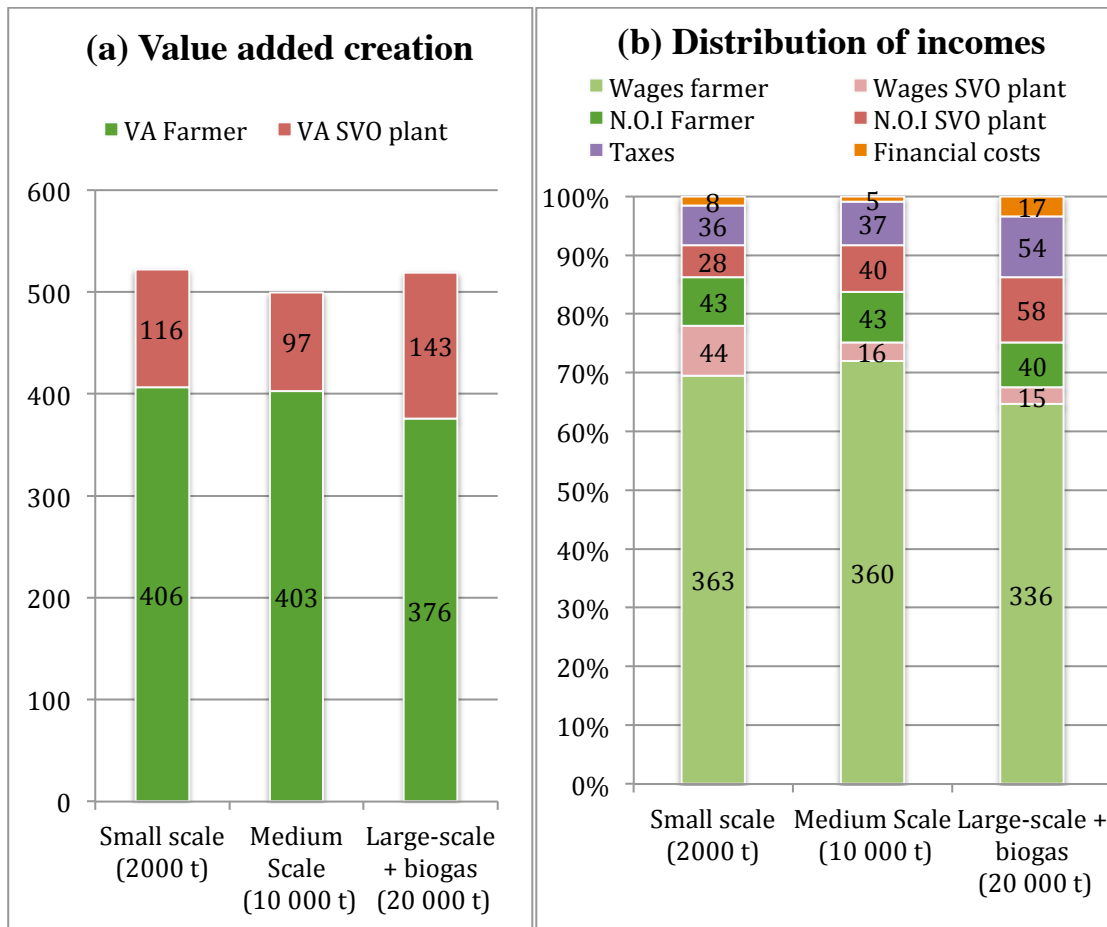

Figure 49. a) Value added creation by farmers (VA Farmer) and SVO plant (incl. VAT) (VA SVO plant). b) Distribution of this value added in the form of incomes to employees (wages farmer and wages SVO), to supply chain players (net operating incomes (N.O.I.) of farmers and SVO plant), to the state (Taxes, including VAT) and to the banks (Financial costs). This is declined for the three SVO supply chains. Figures in charts indicate the VA in FCFA/L of SVO (see Chapter 2, Section 3.3).

The overall VA created in the three scenarios is respectively of 522 FCFA/L, 500 FCFA/L and 519 FCFA/L. Despite the difference in selling prices, the value generated is similar in all three cases due higher profits at increased scale. Farmers produce 70% to 80% of VA. This share decreases with increased SVO plant conversion efficiency, i.e. seed-to-SVO ratio. Between supply chain 1 and 2 there is an increase in power generation efficiency and in supply chain 3, all SVO produced is sold since power is supplied from biogas plant.

Then, the value added is mostly distributed in the form of wages, especially to farmers. However, the share going to SVO plant employees is considerably reduced in supply chains 2 and 3 in favour of SVO producer's profit. With increased capacity, the SVO production plant has lower production costs and thus higher benefits. This is however compensated by the lower SVO selling price in case 2 and 3.

Actually, the prices of both seed and SVO are crucial in the sharing out of benefits between farmers and processors. In the three supply chains presented here, the seed price is constant, while the SVO price decreases with increased processing efficiency, which allows for a relatively fair distribution of profits. However, in supply chain 3, the SVO producer's NOI totalises 60% of overall supply chain benefits, while he is responsible for less than 30% of VA creation in this case.

This shows that improving the performance of SVO production process can allow either to decrease SVO selling price so as to compete with cheaper products, or increase seed price, so as to provide a higher income to farmers. This point is an important consideration when establishing a legal framework on product prices. On the one hand, the seed price should be high enough to provide a decent income to farmers, which is a basic condition for their involvement in *Jatropha* production. On the other hand, the viability of local small-scale supply chains is strongly dependent on affordable seed price.

Eventually, the share of VA going to the state is mostly determined by the selling price (for the VAT) and the operating income of SVO producer, 35% of which is recovered by the state. In all 3 cases, this share represents 5-10% of overall value added. Financial costs paid for borrowing capital represent 1% of VA in supply chain 1 and 2, while it is 3% in supply chain 3 due to the high capital investment for biogas plant.

Questions can be raised on the existence of a sufficient local biofuel demand. Evaluating energy demand is a very recurrent issue in the development of rural energy access, especially in rural electrification. Bouffaron et al. (2012) estimated basic electricity requirements of about 100 MWh for villages of 1 000 – 2 000 inhabitants. With an average power generation efficiency of about 25%, this corresponds to approximately 40 tons of SVO. Then, a plant processing 2 000 tons/yr of seeds and producing about 500 t of SVO could supply the demand of several small villages. A 10 000 t/yr SVO plant would then be more suitable to a small city.

4.1.3 Environmental impacts of SVO production

The environmental impacts of all three supply chains were analysed. As a reminder, a partial LCA was performed including only GHG emissions and fossil energy consumption related to feedstock transport, process energy consumption and process inputs (see Chapter 5, section 3). In Figure 50 are presented the impacts allocated to SVO (based on monetary value) for supply chains 1, 2 and 3. In all supply chains, the impacts are very low since energy is supplied from renewable resources (SVO or biogas). Therefore, impacts are caused only by seeds transport. Supply chain 1 generates the lowest impacts, then come supply chain 2 and 3. In supply chain 3, a lower share of impacts is allocated to SVO since the value of by-product (power and biogas effluent) is higher. In all cases, GHG emissions are below 0.5 g CO_{2-eq}/MJ of SVO and fossil energy content is below 0.01 MJ/MJ. As a comparison, life-cycle GHG emissions of fossil diesel is 88 g CO_{2-eq}/MJ and fossil energy content is 1.16 MJ/MJ.

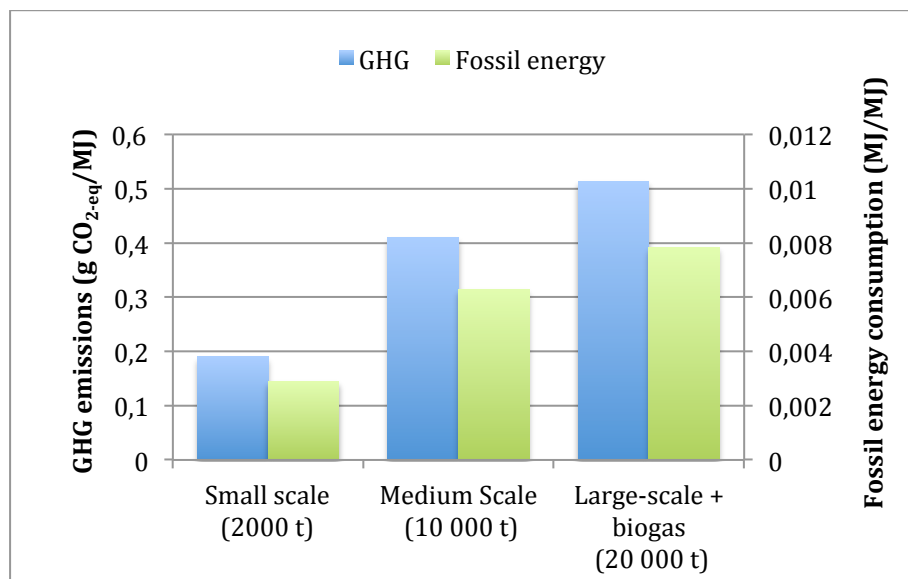

Figure 50. Greenhouse gas emissions and fossil energy consumption of SVO supply chains (By-product allocation is based on monetary value)

Then, another analysis was conducted to investigate the influence of transport distance and to compare the proposed supply chain with business-as-usual energy supply, i.e. grid power. Figure 51 presents SVO environmental impact as a function of processing capacity for two power supply options including grid connection and SVO generator: as for supply chain 1 and 2, seed territorial yield was set to 10 t/km². The result shows that the impacts are substantially higher when power is supplied from the grid: SVO fossil energy content reaches about 6% and the GHG emissions about 4 g CO_{2-eq}/MJ. In both cases, the impacts increase with increased production capacity, due to transports.

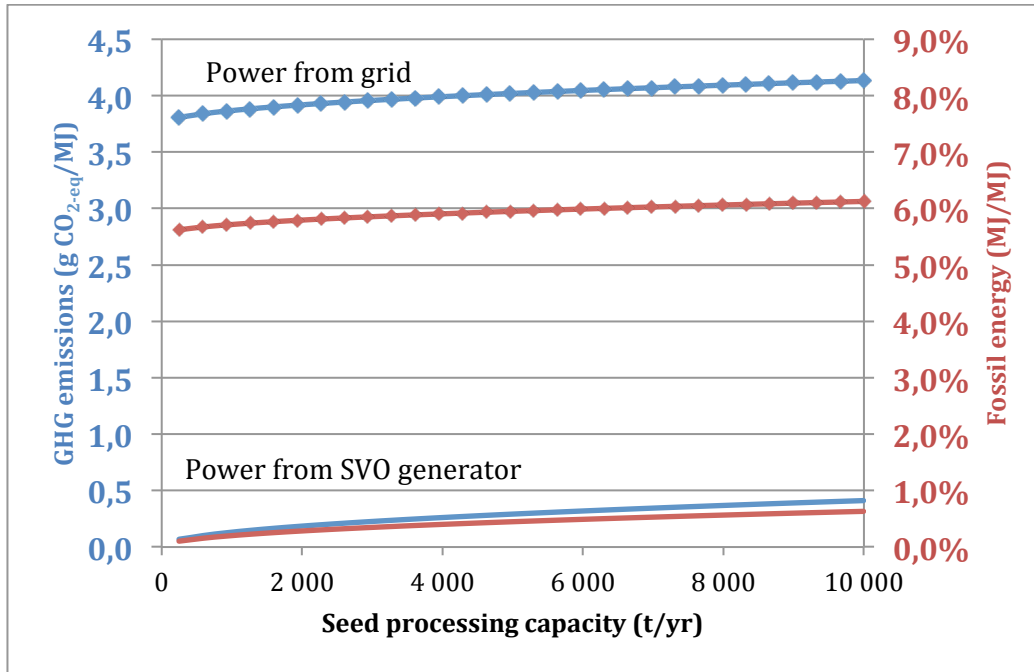

Figure 51. Environmental impacts of SVO production supply chain vs. processing capacity, for different energy supply options. (Territorial yield = 10 t/km²)

The installation of a biogas in Burkina Faso is submitted to several constraints, as discussed in previous chapters. High amounts of water are required, which can be natural water or a co-substrate from another industry. Based on a solid concentration of 10% in the digester, water requirements amount to 30 m³ by ton of SVO produced. Then, in supply chain 3, annual water requirements would amount to 150 000 m³. Biogas effluent is charged with NPK and could be used for irrigation. As a comparison, irrigation requirements for cereal amount to 4000 m³/ha and for 15 000 m³/yr for market-gardening (Durand, 1999). Then, there would be good opportunities to valorise biogas effluents, if the plant is set close to cropping areas.

Then, a power grid should also be available to absorb the power generated. Then, the installations of SVO plants with biogas production would be possible only close to small cities with water and grid available. Eventually, high capital investment is needed. However, this type of SVO plant combines economic and ecological assets, including the production of a biofuel competitive with FO 180, of power from biogas at 110 FCFA/kWh and the recycling of nutrient from press cake. For an annual seed capacity of 20 000 t, 4900 tons of SVO are produced at 360 FCFA/L, and 1750 kW of electricity is fed-in to the grid at a price of 110 FCFA/kWh.

4.2. Production of refined oil for power generation

As mentioned previously the potential demand of SVO (or refined oil) for power generation is estimated to 150 000 tons. For such amount of fuel, it might be useful to refine the oil, so as to ensure a stable oil quality and preserve the lifetime of power generation facilities. However, refining the SVO involves relatively large-scale processing and substantial additional production costs. Then, with the considered technologies, refined oil can compete with DDO price (470 FCFA/L, incl. VAT) but not with HFO.

4.2.1 Refined oil supply chains definition

Three supply chains are proposed here and presented in Table 37. Achieving a production cost below 470 FCFA requires a very efficient SVO production process: this can be achieved either by increasing the processing capacity, or by producing biogas and power from the press cake. Then, the three scenarios proposed here are aimed at investigating different supply chain organisations: (1) medium-scale centralised refining plant with biogas production, (2) large-scale centralised refining plant without biogas production and (3) large-scale refining plant with decentralised SVO production plants equipped of biogas production.

Then, the first supply chain consists of a medium-scale refining plant with integrated pressing process. The annual seed processing capacity is 20 550 tons, allowing to produce 5 000 tons of SVO which is refined through a batch process, giving 4 663 tons of refined oil. The press cake is valorised into biogas and power, which is essential to reach the required production cost. The plant operates 5 000 hours a year: in practice, the biogas plant is put in stand-by a part of the year.

Supply chain 2 and 3 include a continuous refining plant which processes 20 000 tons of SVO annually. In supply chain 2, the refining process and the production SVO are integrated on the same site: the annual seed processing capacity is of 82 200 tons. With such high capacity, the required production cost can be reached without producing biogas from the press cake, which is sold as organic fertiliser instead (base-case). The plant operates 7000 hours a year and uses a biomass boiler combined to a steam turbine CHP system for utility supply. This choice contributes to limiting the production cost, although a grid connection is necessary to provide the power required by the pressing process.

Eventually, in supply chain 3, the same refining process is used but SVO is produced in five medium-scale processing plants, which are equipped of biogas digesters. This configuration allows for very low SVO production cost: it is sold to the refining plant at 300 FCFA/L incl. VAT, i.e. 255 FCFA/L excl. VAT. Without biogas production, this decentralised scheme would not be economically viable.

Table 37. Summary of refined oil supply chains characteristics

REFINED OIL SUPPLY CHAIN	Unit	1. Batch centralised	2. Continuous centralised	3. Continuous decentralised
Seed processing capacity	t/yr	20 550	82 200	16 440 (x 5)
Utility SVO plant		-	-	Biogas
SVO price (incl. VAT)	FCFA/L	-	-	300
SVO processing capacity	t/yr	5 000	20 000	4 000 (x 5)
Refined oil production	t/yr	4 663	19 130	19 130
Utility for refining plant		Biogas	Steam turbine (biomass) + Grid	Steam turbine (biomass)
Power fed-in to the grid	kW	0	0	0
Annual operating time	h	5 000	7 000	8 000
Territorial yield	t/km ²	5	5	5
Seed transport distances				
- by cart to local collect point	km	2.5	2.5	2.5
- by truck to SVO plant	km	36.2	72.3	32.4
SVO transport distance	km	-	-	72.3
Refined oil selling price (incl. VAT)	FCFA/L	470	470	470

4.2.2 Economic efficiency of refined oil supply chains

The creation and distribution of value added is presented for all three cases in Figure 52. The overall value created is of 606 FCFA/L and 602 FCFA/L in supply chains 1 and 3, where biogas is produced from the press cake, while it is only 448 FCFA/L in supply chain 2. Among this value, about 400 FCFA/L is created by farmers.

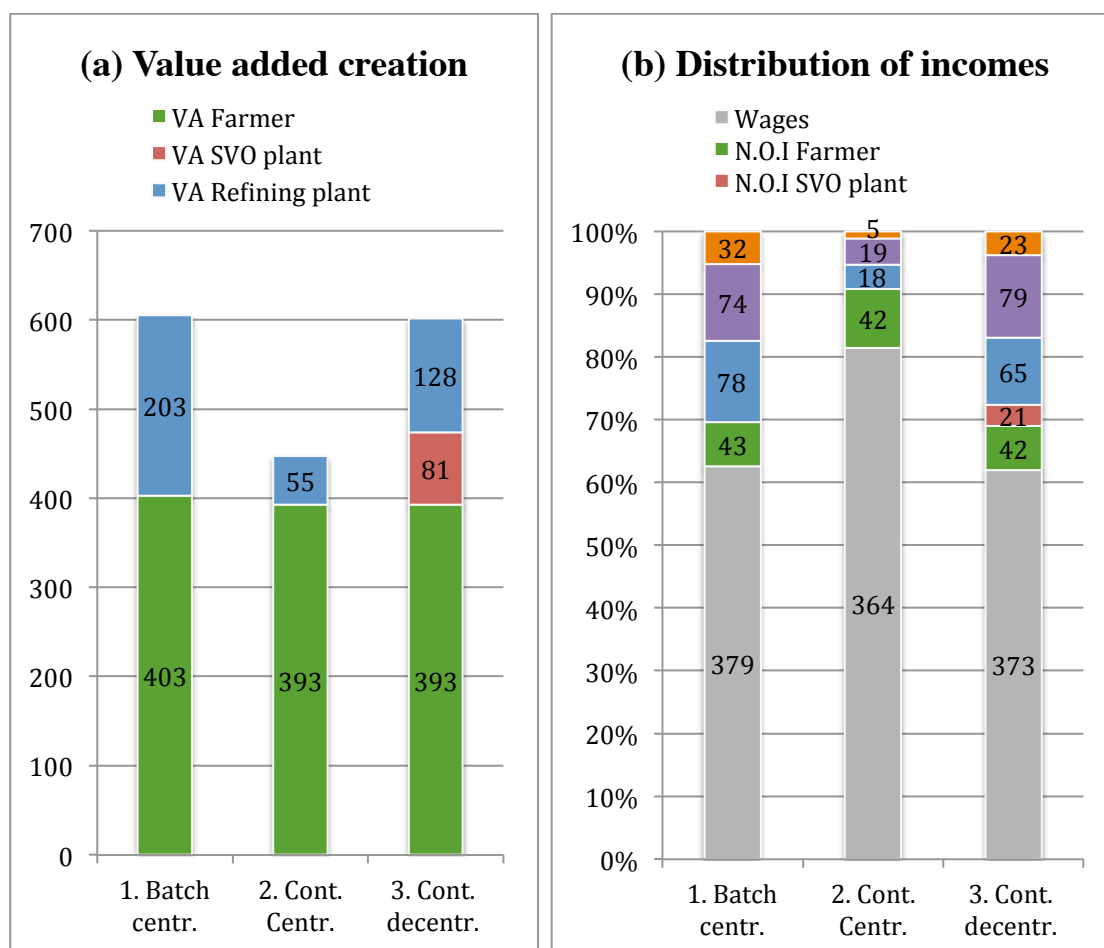

Figure 52. a) Value added creation by farmers (VA Farmer), SVO plant (incl. VAT) (VA SVO plant) and refining plant (incl.VAT) (VA Refining plant). b) Distribution of this value added in the form of incomes to employees (wages), to supply chain players (net operating incomes (N.O.I.) of farmers, SVO and refining plants), to the state (Taxes, including VAT) and to the banks (Financial costs). This is declined for the three refined oil supply chains. Figures in charts indicate the VA in FCFA/L of refined oil (see Chapter 2, Section 3.3).

The distribution of VA significantly varies in the different supply chains. To preserve the readability of the results, all wages were grouped together, independently of the player to which they belong. Wages constitute the major part of VA distribution: 60-65% for supply chains 1 and 3 and 80% in supply chain 2. This is closely linked to the profits generated by the supply chains.

In supply chains 1 and 3, profits are high due to the production of power from biogas, while it is much lower for supply chain 2. Respectively, overall operating incomes totalise 121 FCFA/L, 128 FCFA/L and 60 FCFA/L, which represents 20%, 21% and 13% of total VA. In cases 1 and 3, the share of operating income going to farmers is relatively low compared to their contribution in VA creation. In supply chain 1 and 3, biofuel producers grab 2/3 of overall income, while they generate only one third of value added. By contrast, in supply chain 2, the profit margin of the biofuel producer is limited, providing a more equitable distribution of incomes.

Eventually, the amount of taxes perceived by the state is directly determined by the value added and the operating income generated by biofuel processors. Farming activities are not submitted to any tax.

4.2.3 Environmental impacts of refined oil production

The greenhouse gas emissions and fossil energy consumption associated with the production of refined oil are presented in Figure 53. The figures presented here concern only the impact allocated to refined oil following monetary value. In the supply chains 1 and 3, process energy requirements are covered using renewable resources (biogas, biomass), so the impacts are mostly caused by raw material and transport. Impacts of supply chain 3 are slightly higher because of longer transport distances due to higher scale. Overall, in these cases, the impacts remain rather low, with greenhouse gas emissions below 1 g CO_{2-eq}/MJ and fossil energy consumption below 2% of biofuel energy content.

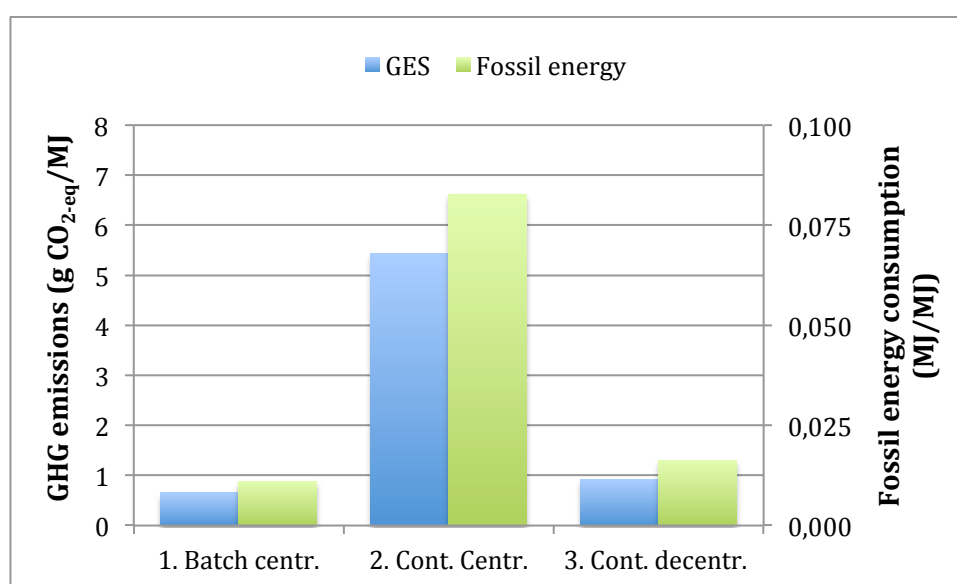

Figure 53. Greenhouse gas emissions and fossil energy consumption of refined oil supply chains (By-product allocation is based on monetary value)

On the other hand, supply chain 2 generates much higher impact. This is explained by the use of grid electricity. As, the steam turbine system is sized according to heat requirements, it provides sufficient power for the refining process but most power demand, which is used for pressing, is supplied from the grid. Grid electricity being generated from fossil resources, this results in GHG emissions of 5.5 g CO_{2-eq}/MJ and fossil energy consumption equivalent to 6.5% of biofuel energy content. This result emphasizes the importance of using renewable resources for meeting process energy requirements, especially as the final product is an energy carrier. Moreover, the financial analysis has shown that, in this context, grid connection was more expensive than other solutions.

Eventually, process water requirements amount to about 10% of the mass of SVO processed and it might be more for batch processing. The water is used to wash the oil at the end of refining process and is rejected in the form of wastewater containing soaps, gums, phosphoric acid and sodium hydroxide. This implies that SVO refining plants are set close to water treatment facilities or dispose of their own station. As discussed in previous section (4.1.3), water requirements are much higher for scenarios with biogas production, but the water is recovered in the digester effluents and can be valorised for fertilising irrigation.

4.3. Production of biodiesel for transportation

The production of biodiesel is achieved through a chemical process, which implementation involves substantial capital investment. Moreover, chemical industry is not developed in Burkina Faso and gathering skilled people could be an additional difficulty for the development of a biodiesel plant. However, as opposed to SVO and refined oil, there is a wide market for biodiesel distribution since it can be used in place of fossil diesel without constraints. In 2008, diesel fuel imports amounted to 180 ktoe, which ensures a market of more than 200 000 ton for biodiesel and the demand keeps raising with the development transport sector. Moreover, biodiesel could be sold at a price equivalent to diesel, i.e. 595 FCFA/L, which let some margin for profits, compared to other fuel oils, which low prices constitute a serious challenge.

4.3.1 Biodiesel supply chains definition

Three biodiesel supply chains are proposed here to investigate the different opportunities for biodiesel production in Burkina Faso. The first supply chain concerns a centralised biodiesel plant, using a batch process to produce 4 685 tons of biodiesel. SVO production is integrated on the same site. This is a solution to produce biodiesel with relatively low investment and in limited amounts, which could be a good start in the context of Burkina Faso, where the sector is still at very early development stage.

The second supply chain is also a centralised production of biodiesel, but with a continuous process with a production capacity of 10 000 t/yr. Process energy is

supplied from the grid and a boiler burning biomass. In this scenario, the influence of seed price is investigated.

Finally, supply chain 3 is a large-scale biodiesel plant relying on 10 SVO production plants. SVO plants produce their own power using SVO generators and the biodiesel plant is equipped with a steam turbine. In this case, two different values of territorial yield are considered: a local one related to the SVO plant collect area and a global one related to the biodiesel plant collect area. This assumption reflects that *Jatropha* crops are concentrated around the SVO plants. The local seed territorial yield is set to 10 t/km². Then, SVO plants are scattered over the territory and the biodiesel plant is set at the centre of the area encompassing all SVO plants. Then, the resulting territorial yield, brought to the biodiesel plant collect area is lower than around SVO plants: this overall territorial yield is set to 2 t/km². The local value is used to calculate seed transport distance to SVO plant while the global value is used to calculate SVO transport distance to biodiesel plant. This results in a short seed transport distance, 16.8 km in average, and a relatively long SVO transport distance to the biodiesel plant, 118.5 km in average. The description of the three supply chains is summarised in Table 38.

Table 38. Summary of biodiesel supply chains characteristics

BODIESEL SUPPLY CHAIN	Unit	1. Batch centralised	2. Continuous centralised	3. Continuous decentralised
Seed processing capacity	t/yr	20 550	41 100	8 823 (x 10)
Utility for SVO plant		-	-	SVO generator
Seed price	FCFA/kg	100	100 / 110 / 120	100
SVO price (incl. VAT)	FCFA/L	-	-	410
SVO processing capacity	t/yr	5 000 (Batch)	10 000	20 000
Biodiesel production	t/yr	4 685	9 610	19 220
Utility for biodiesel plant		Grid + Boiler (biomass)	Grid + Boiler (biomass)	Steam turbine (biomass)
Power fed-in to the grid	kW	0	0	4
Annual operating time	h	5 000	7 000	7 000
Territorial yield	t/km ²	5	2	10/2
Seed transport distances				
- by cart to local collect point	km	2.5	4	1.8
- by truck to SVO plant	km	36.2	80.9	16.8
SVO transport distance	km	-	-	118.5
Biodiesel price (incl. VAT)	FCFA/L	595	595	595

4.3.2 Economic efficiency of biodiesel supply chains

The first result presented is the effect of seed price variation on value added creation and distribution. Supply chain 2 was simulated for seed prices of 100, 110 and 120 FCFA/kg. The results are illustrated in Figure 54. The profitability of biodiesel production decreases dramatically with seed price increase. When the seed price is increased by 20%, the net operating income of biodiesel producer drops from 53 to 4 FCFA/L, while that of farmer rises from 40 to 115 FCFA/L. This emphasizes that the room for seed price increase is very limited in practice. At 120 FCFA/kg, the profit margin for the biodiesel producer is not worth the investment. Then, 110 FCFA/kg appears as a maximum in the present case. Moreover, the share perceived by the state is also very dependent on biodiesel plant profit margin.

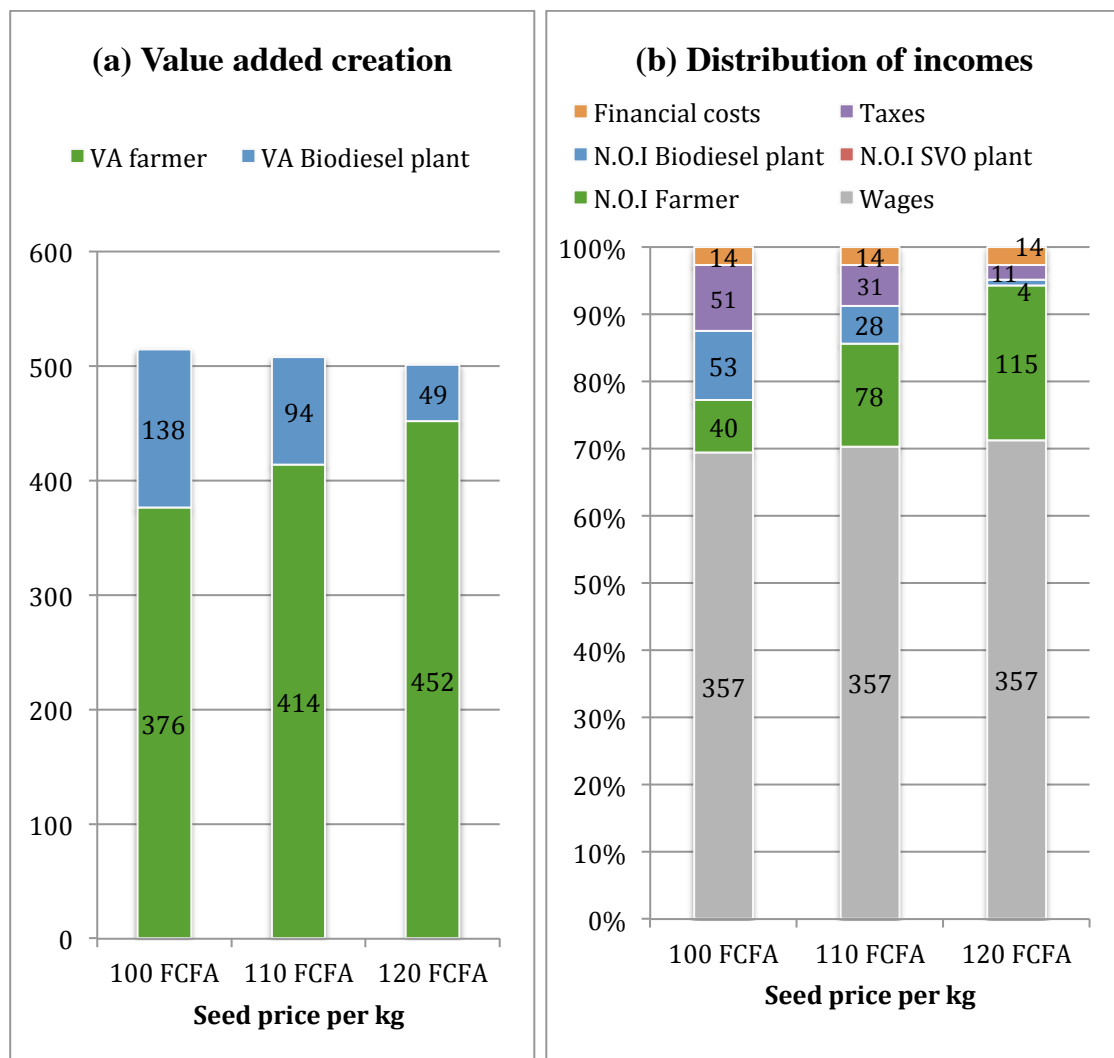

Figure 54. Value added creation and income distribution in biodiesel supply chain 2, for three different seed prices. a) Value added creation by farmers (VA Farmer), SVO and biodiesel plant (incl. VAT) (VA SVO plant and VA Biodiesel plant). b) Distribution of this value added in the form of incomes to employees (wages), to supply chain players (net operating incomes (N.O.I.) of

farmers and biodiesel plant), to the state (Taxes, including VAT) and to the banks (Financial costs). Figures in charts indicate the VA in FCFA/L of biodiesel (see Chapter 2, Section 3.3).

Figure 55 illustrates the comparison between the three supply chains at the same seed price (100 FCFA/kg). The overall VA generated is of 530 FCFA/L, 514 FCFA/L and 563 FCFA/L in supply chains 1, 2 and 3 respectively. Supply chain 1 and 2 approximately have the same production profitability, but the share of wages in the production cost is higher for batch than for continuous process, yielding higher VA. In supply chain 3, the higher VA is explained by the fact that processes energy demand is met using on-site generation. This is also why the seed-to-biodiesel ratio is lower in this case, allowing more income to farmers relatively to biodiesel produced.

The distribution of VA is very similar in all three cases. In supply chain 3, the operating incomes are fairly distributed to biodiesel producer, SVO producers and farmers, while in the two first cases, the biodiesel producer grabs most of the profit. The result of supply chain 3 is particularly important: it shows that a large-scale biodiesel plant could rely on a decentralised production of SVO by medium-capacity pressing plants. This solution is very relevant regarding the context. The SVO plant could also sell a part of their production locally, thus participating at the same time to rural development and national-scale biofuel production. The diversity of market output constitutes a security for SVO producers, while biodiesel producers can rely on several suppliers. Then, this type of supply chain is likely to be more robust and resilient than centralised ones.

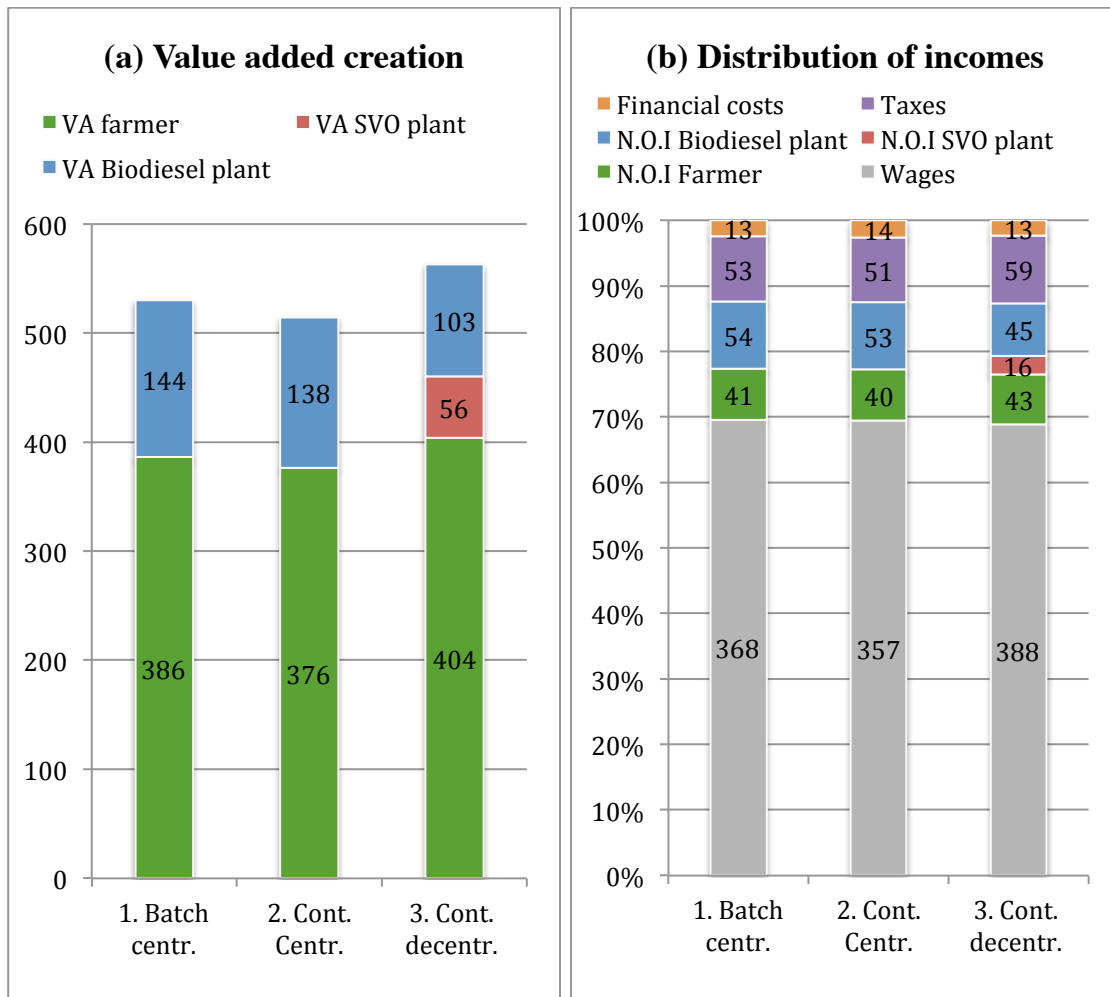

Figure 55. Value added creation and income distribution in biodiesel supply chain 1, 2 and 3. a) Value added creation by farmers (VA Farmer), SVO and biodiesel plant (incl. VAT) (VA SVO plant and VA Biodiesel plant). b) Distribution of this value added in the form of incomes to employees (wages), to supply chain players (net operating incomes (N.O.I.) of farmers, SVO and biodiesel plant), to the state (Taxes, including VAT) and to the banks (Financial costs). Figures in charts indicate the VA in FCFA/L of biodiesel.

4.3.3 Environmental impacts of biofuel production

Fossil energy consumption and greenhouse gases emissions associated with the production of biodiesel in the proposed supply chains are presented in Figure 56. Supply chain 3 generates significantly lower impacts because of all utility supply relies on renewable resources. GHG emissions are about two times lower compared to other supply chains. The gap between supply chains is smaller in terms of fossil energy consumptions, because most fossil energy consumption is due to the use of methanol in the process, which attenuates the differences due to energy supply. Even for supply chain 3 which generates the lowest impact, fossil energy consumption amounts to 13% of biodiesel energy content and it is close to 20 % in other cases. Eventually, GHG emissions can be compared to that of fossil diesel, i.e. 88 g CO_{2,eq}/MJ. For supply chain

2, emissions reach almost 10% of this value, while the scope of this LCA analysis is very restrained.

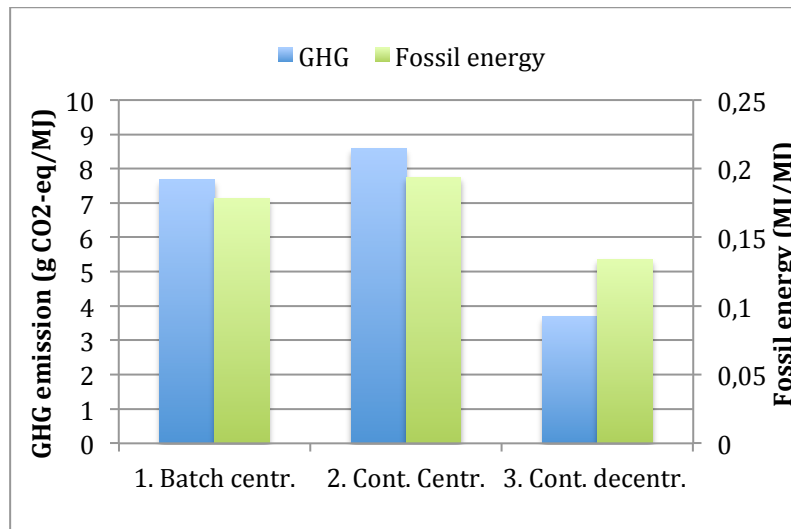

Figure 56. Greenhouse gas emissions and fossil energy consumption of biodiesel supply chains (By-product allocation is based on monetary value)

These results show that the environmental benefits of using biodiesel, compared to fossil diesel, could be rather limited if production supply chains are poorly organised (transport) and if energy supply is based on fossil fuels. Indeed, in the three supply chains studied here, energy requirements, at least for heat, are covered using renewable resources. Then, the LCA applied only accounts for the impact related to transport, energy and input chemicals, and the results show that the biodiesel produced already has a fossil energy content up to 20% and GHG emissions equivalent to 10% of that of fossil diesel. However, as often reported in the literature, most environmental impacts of biodiesel production are caused by the use of agricultural inputs and land use change. Therefore, a poorly managed biodiesel supply chain could rapidly results in very high environmental impacts, maybe even higher than fossil diesel. Fortunately, in the case of *Jatropha* which is a perennial crop, land use changes are likely to increase carbon stocks in many cases, and would improve the overall environmental performances (Achten et al., 2010a; Baumert, 2013).

Overall process water requirements for refining and biodiesel production amount to 425 kg per ton of SVO processed. As for refining process alone, it is rejected as wastewater but in this case, it is also contaminated with methanol which is very harmful to the environment and suppose and appropriate treatment. In supply chain 1, 2 and 3, annual water requirements amount to 2 125 t, 4 250 t and 8 500 t respectively. Water requirements for biogas were already discussed in section 4.1.3.

5. Conclusion

In the first part of this chapter, the transformation processes involved in the Jatropha biofuel supply chains were individually analysed in regard to economic performances. Capital investment and production costs were investigated with respect to process capacity and for several energy supply and press cake valorisation options. The influence of local parameters, including process and economic variables, was studied based on sensitivity analyses. Then, feedstock transport cost was analysed with regard to Jatropha production potential in Burkina Faso. The second part of the chapter was dedicated to the assessment of whole Jatropha biofuel supply chains following the framework developed in Chapter 2. Regarding, the opportunities identified in Chapter 1, nine production scenarios were presented, 3 for each final product considered, i.e. SVO, refined oil and biodiesel.

5.1. Results from individual process analyses

The result of individual processes allowed to identify the most sensitive parameters at a local level. As a general trend for all processes, the price of feedstock dramatically affects the production cost. For SVO production, the amount of oil that can be extracted from the seeds is essential: the oil recovery and the seeds oil content are of paramount importance, even more than seed price. In a lower extent but still with a significant influence, press cake selling price is essential. The production of biogas and power from the press cake requires much higher capital investment than the pressing plant itself, but it allows to considerably reduce SVO production cost, due to the sale of electricity which is assumed to be fed-into the national grid. In this case, oil recovery has less importance, since the oil left in the press cake is converted to biogas. Eventually, the power feed-in tariff is crucial, and an annual operating time of 4 000 hours should be observed due the importance of capital investment.

The purification of SVO using alkali refining can be conducted using a batch process for low processing capacity in the range of 200 – 2 000 kg/h, or a continuous process for capacity from 1 000 kg/h up to 10 000 kg/h. In both cases, increasing the capacity significantly reduces the production cost due to economies of scale. While the investment is much higher for a continuous process, it is generally more profitable than batch processing due to better conversion and energy use efficiency. Several energy supply options were investigated, including biomass and SVO boiler as well as CHP systems. However, this has a very limited influence on production cost, since process energy demand is relatively low. Then, free fatty acid content in SVO, which can be between 0.5% and 3%, directly affects the SVO-to-refined oil ratio, since they are eliminated in the process: as the mass fraction is low, it has a slight effect on production cost. The only very influent parameter in refining process is the SVO purchase price.

Eventually, the economic performance of biodiesel from SVO was analysed. In this case the process includes oil refining followed by transesterification. As for refining alone, the process can be batch or continuous according to the same capacity range. Capital investments are very high for this process which is more complex than refining and involves more advanced equipment (including a 20 trays distillation column for methanol recovery). Then, important economies arise when increasing the processing capacity. Energy supply solution has a noticeable importance in this case, because energy requirements are high, especially for heat. The best option is to use a CHP system, either with engine fuelled with SVO or a steam turbine. The former allows to produce more power and is more profitable at large scale: this is however highly dependent on power feed-in tariff and on SVO purchase price. By contrast, the steam turbine is less sensitive to these factors since it uses biomass as fuel and the power-to-heat ratio of the system closely fits the process demand, so that very little power is fed-in to the grid. In the end, the most sensitive economic factors are, in this order, SVO price, power feed-in tariff, methanol and glycerol prices. Consequently, the economic performance of this process in Burkina Faso is very uncertain. Indeed, the availability of methanol in industrial quantities and its price is questionable as well as a sufficient output market for glycerol, and there is, so far no legislation on the condition for power feed-in to the grid by private producers.

5.2. Jatropha production potential and feedstock transport distance

In order to define contextualised biofuel supply chains, it was necessary to make assumption on the territorial potential for Jatropha production. These assumptions were based on work from Duba (2013), who analysed Jatropha production potential at village level, with respect to soil and climate conditions, protected, cultivated and pasture areas and areas required for ecosystem services such as firewood collect. Overall, the results were mapped and show that villages with large available areas are mostly situated in southwestern and eastern part of the country. They were used to define the value range for Jatropha territorial yield, (i.e. the yield resulting from several crops in given (large) area), which was set to 1-20 t/km². As a general rule, it is more likely to have a high territorial yield on a small collect area than on a large one, due to the scattered nature of available areas.

Then, for the case of an SVO plant, the influence of territorial yield on transport distance and cost was analysed. The results highlighted that an optimal plant size can be identified due to the opposed effects of seed transport cost and economies of scale associated with increased capacity. This optimum is particularly marked for territorial seed yield below 5 t/km² and is situated at seed processing capacity between 20 000 t/yr and 40 000t/yr. However, for SVO plant with biogas production, economies of scale have more influence than transport costs and the production keeps decreasing with increased capacity.

5.3. Analysis of supply chain assessment results

Based on the results of previous analyses and on the expected outcomes of Jatropha biofuel development in Burkina Faso nine biofuel supply chains were built and analysed for economic efficiency and environmental impact. Three different end-uses were considered, including:

- (i) Private applications requiring shaft power in rural areas (motor-pumps, small power generators, mills and other agricultural product transformation); SVO comes as a substitute to fossil diesel or as a new energy consumption.
- (ii) Public power generation, which can concern small power stations and remote networks fuelled with DDO and large power plants fuelled with HFO; both fuels can be substituted with SVO; the possibility of producing refined oil to substitute DDO is also considered;
- (iii) Transportation; biodiesel is used as a substitute to fossil diesel in cars and trucks.

The end-use of the biofuel determines the consumption area and the population who benefits from the supply chain main product: the substitution of diesel for private applications is clearly oriented toward rural areas, power generation can concern both rural and urban, while biodiesel would be mostly distributed in urban areas. Moreover, independently of the final product users, the organisation of supply chains determines the area affected by this new economic activity. In the proposed scenarios, special attention was given to investigate both centralised and decentralised production schemes: indeed, while decentralised schemes can generate higher production costs, they also constitute a solution to distribute supply chains benefit over the territory through the local implementation of transformation processes and local distribution of by-products. On the other hand, the low processing costs achieved in centralised (large-scale) supply chains can provide more flexibility for feedstock price increase.

The production of SVO in rural areas for the substitution of fossil diesel is one of the most promoted development scheme, especially by NGOs and development organisations concerned with the development of energy access in rural areas. The results of supply chains simulation show that this scenario could be rather easily achieved from an economic viewpoint. In this case, it was assumed that SVO should be sold at a price equivalent to that of diesel reduce of 20% (at equivalent energy content), i.e. 500 FCFA/L incl. VAT. In these conditions and with a seed market price at 100 FCFA/kg, SVO can be produced cost effectively in small-scale processing plant for capacities from 2 000 t/yr and operated on a seasonal basis. For smaller plants, economic viability appears difficult to achieve, which can also be observed on field in the very small-scale projects promoted by some NGOs. Such processing units can even be autonomous for energy production using SVO generators and thus could be set in remote areas. The press cake is distributed locally as organic fertiliser. The value added

created in this type of supply chain would allow to properly remunerate all players of the supply chain. The possibility for increasing seed purchase price is however closely related to the SVO plant processing cost and to the profit margin accepted by the SVO producer. However, it was shown that a 10% increase in seed price would severely affect the SVO producer profit margin. The most effective way to reduce SVO production cost within small-scale processing plants is to increase processing capacity. Then, in order to preserve the possibilities for SVO production at local level (small-scale), the seed market price should not be set at a price higher than 100 FCFA/kg. Finally, a specific asset of these small-scale supply chains is that almost 80% of the VA created is distributed in the form of wages. Regarding the current on-going projects of this type in Burkina Faso, critical success factors can be highlighted. The first one is the equipment of SVO plants with robust pressing machinery, which requires higher investment than concurrent low-cost equipment but is also much more reliable and provides more stable performances. Another crucial factor in the intensive operation of SVO plant, so as to maximise annual operating time and avoid oil losses due to process start-up. Of course, this supposes to have sufficient seed supply and SVO demand. Eventually, the environmental impacts related to seed processing, in terms of GHG emissions and fossil energy consumption, is relatively low compared to fossil diesel. If the plant power requirements are met using a power generator on SVO, the impacts are negligible.

The production of SVO to substitute power generation fuels could be achieved in different ways. Based on fuel consumption of the national power company, the overall potential demand in this sector is estimated to 150 000 tons of SVO annually. Out of this, about 70 000 tons would concern the substitution of DDO while the rest would be dedicated to the substitution of HFO. However, the price of DDO is much higher than that of HFO. Then, the cost-effective production of SVO as a substitute to DDO is more easily achieved: the target selling price is 470 FCFA/L incl. VAT. Such production can be successfully reached with SVO plants of processing capacity in the order of 10 000 t/yr, with press cake sold as organic fertiliser. The amount of SVO produced in such medium scale supply chain would be suitable to supply the needs of small cities but is already high relatively to the potential demand of electrified rural villages. With a seed price of 100 FCFA/kg, the SVO producer can make substantial profits, provided that the seeds are produced within about 30 km around the plant to limit transport costs.

In the perspective of supplying the national power company with biofuel to substitute DDO in significant proportions, the production of refined oil could also be considered. The advantage of refined oil is to have a higher and constant quality compared to SVO, which constitutes a security in the context of a massive use. However, the refining of SVO requires the implementation of a chemical plant, which involves much higher capital investment and additional processing cost. Consequently, the cost effective production of refined oil requires to increase processing scale and/or to produce biogas

from the press cake so as to decrease SVO production cost. Without biogas production, the minimum scale for profitable production is in the range of 80 000 tons of seeds annually (i.e. about 20 000 tons of SVO) but the profit margin of the plant remains rather low in this case. The most profitable solution would be to have a batch refining process with integrated pressing process of 20 000 t/yr (seeds) capacity and biogas production. In all cases, the production of refined oil to substitute DDO is highly constrained by the selling price (470 FCFA/L) and requires the implementation of technologically advanced and large-scale production processes.

Supply chains simulations have also shown that SVO could be produced at a cost competitive with HFO, i.e. 360 FCFA/L incl. VAT. This is possible with SVO production plants including a production of biogas from the press cake and for seed processing capacity in the order of 20 000 t/yr. However, from a macro-economic perspective, it would be more profitable to start substituting DDO (with SVO), which price is higher. The producers would be less constrained by production costs and above all, the effect on trade balance would be higher at equivalent amount substituted.

Eventually, the production of biodiesel appears to be achievable and competitive with fossil diesel on tax included price basis. At an energy price equivalent to diesel, biodiesel could be sold at 595 FCFA/L. While the transesterification of vegetable oil is a relatively complex process, a profitable production can be achieved from rather low processing scale. Within a centralised supply chain, biodiesel can be produced below 595 FCFA/L using either a 5000 t/yr batch process or a 10 000 t/yr continuous process, with press cake sold as fertiliser. However, a biodiesel plant would most probably be set close to a urban area considering the need for infrastructure. This would impose to transport the seeds on long distances and to send the press cake back to rural areas. Moreover, the amounts of press cake are huge for such plants. Then, it might a better strategy to produce SVO in medium-size pressing plant in rural areas and to transport only the SVO to a centralised biodiesel plant. Simulation results show that this scenario is possible: the example of a 20 000 t/yr biodiesel plant supplied by 10 SVO plants was taken. Then, this kind of supply chains can address several objectives at once. SVO plants could distribute a part of their production in rural areas, and sell the rest to the biodiesel producer. However, the environmental impacts associated with the production of biodiesel are much higher than for SVO or refined, especially to the use of methanol of fossil origin in the production process. Then, even when energy supply is based on renewable resources, GHG emissions and fossil energy consumption are rather high.

From the state's viewpoint, the substitution of fossil diesel with biodiesel could constitute a shortfall in term of tax levy, since imported diesel is taxed, as opposed to DDO and HFO which are subsidised. Nevertheless, the positive effects on trade balance and economic growth would certainly compensate these shortfalls. Generally, the income perceived by the state on biofuel supply chains is directly related to the value added and the profits generated by the biofuel producers, since farmers are not submitted to taxes.

6. References

- Achten, W.M.J., Verchot, L., Franken, Y.J., Mathijs, E., Singh, V.P., Aerts, R., Muys, B., 2008. *Jatropha* bio-diesel production and use. *Biomass Bioenergy* 32, 1063–1084.
- Blin, J., Brunschwig, C., Chapuis, A., Changotade, O., Sidibe, S.S., Noumi, E.S., Girard, P., 2013. Characteristics of vegetable oils for use as fuel in stationary diesel engines—Towards specifications for a standard in West Africa. *Renew. Sustain. Energy Rev.* 22, 580–597.
- Bouffaron, P., Castagno, F., Herold, S., 2012. Straight vegetable oil from *Jatropha curcas* L. for rural electrification in Mali – A techno-economic assessment. *Biomass Bioenergy* 37, 298–308.
- Demirbaş, A., 1998. Fuel properties and calculation of higher heating values of vegetable oils. *Fuel* 77, 1117–1120.
- Domergue, M., Pirot, R., 2008. *Jatropha curcas* L. (Rapport de synthèse bibliographique). CIRAD/AgroGeneration, Montpellier.
- Duba, G., 2013. Modélisation spatiale du potentiel de production de *Jatropha Curcas* L. au Mali, Burkina Faso et Bénin (Master thesis). Universités de Montpellier II et III, Montpellier.
- Durand, J.-M., 1999. *Technique des petits barrages en Afrique sahéenne et équatoriale*. Editions Quae.
- Freedman, B., Bagby, M.O., 1989. Heats of combustion of fatty esters and triglycerides. *J. Am. Oil Chem. Soc.* 66, 1601–1605.
- Nonyarma, E., Laude, J.P., 2010. Policy framework for the development of biofuels in Burkina Faso. Presented at the Sud Sciences et Technologies, Institut International d'Ingénierie de l'Eau et de l'Environnement, pp. 119–127.
- Ouédraogo, B., 2007. Filière bois d'énergie burkinabé: structuration des prix et analyse de la répartition des bénéfices. *Bois For. Trop.* 4.
- Pramanik, K., 2003. Properties and use of *jatropha curcas* oil and diesel fuel blends in compression ignition engine. *Renew. Energy* 28, 239–248.
- RECA Niger, 2011. Prix des engrais et tonnages prévus dans certains pays de la zone CFA pour la campagne 2011 - 2012 (Note d'information No. 16), Intrants. Réseau National des Chambres d'Agriculture du Niger, Niamey.

Conclusion and perspectives

In this work, we developed a methodology to assess the opportunities for the development of biofuel supply chains with regard to sustainable development considerations. The method was applied to the question of *Jatropha* biofuel development in Burkina Faso. The assessment method allows to analyse the economic efficiency of supply chains based on value chain analysis and the environmental impacts using a partial life-cycle assessment. It relies on techno-economic models of biofuel production processes, so that a wide range of possibilities can be investigated as well as the sensitivity of performances to variable parameters (technical and economic).

The application of the method to the case *Jatropha* in Burkina Faso has shown that it can bring crucial information to policy makers and also biofuel producers. At process level, the most influent technical and economic parameters were identified. These results are essential to identify research and development needs within the sector.

*Highlighted research and development needs on *Jatropha* biofuels*

First, the importance of seed yield in *Jatropha* cultivation cost and of seeds oil content and prices in the performance of downstream transformation processes clearly shows that the improvement of *Jatropha* agronomic properties is a major stake. Then, researches on *Jatropha* breeding in view of improving oil yields should be a priority, even more than *Jatropha* crops have a lifetime of more than 20 years, so starting with good material is essential.

Then, the experiments conducted on *Jatropha* oil expression were crucial for the understanding of the process, the evaluation of its performances and the identification of influent parameters. This emphasizes the relevance of developing rigorous experimental protocols for the evaluation and the improvement of unit operations.

The production of biogas from the press cake could significantly increase the value created from *Jatropha* seeds. Moreover, it produces renewable electricity in significant quantities and allows to recycle agro-nutrients, which is a very important environmental concern given the low fertility of soils in Burkina Faso. The implementation of SVO plants with biogas production from the press cake would be an opportunity to exploit synergies between SVO and power production, and agriculture. However, further research is needed to identify the most suitable biogas technology and processing conditions, in regard to water resources constraints.

Finally, the economic and environmental performances of biodiesel production appear to be limited by the chosen technology, i.e. methanolic transesterification with homogeneous catalysis. The use of methanol is really binding: its price is high and variable and it induces high environmental impact due to its embedded fossil energy and to the energy expended to recycle it in the process. The development on new catalysts allowing for transesterification using bio-ethanol in place of methanol is then

particularly relevant, especially as ethanol could be produced from sugar cane in Burkina Faso.

Political decision elements provided by the method

The developed methodology proved to be very powerful for the assessment and comparison of prospective biofuel supply chains. The use of process models combined to economic and environmental assessment methodologies allows considering a very wide range of solutions. The output of supply chain assessment provides essential information for making strategic decision related to the development of the sector.

The analysis of value added creation and income distribution within biofuel supply chain allowed to understand the role of product prices and to identify critical values. Moreover, the state's incomes through tax levy can also be accounted: then several tax and subsidy systems could be compared. Eventually, the environmental impacts associated with biofuel processing were also evaluated.

Of course, the definition of the best strategy is highly tied to the political priorities and is far beyond the scope of this work since it involves very subjective positions. The assessment methodology was here applied to some example supply chains but an infinite number of other possibilities could be analysed.

For example, in supply chains dedicated to the production of SVO as a substitute to fossil diesel, SVO selling price is relatively high, which allows for cost effective production from very small processing scales using a simple cold pressing process. However, this high selling price could also be taken as an opportunity to increase the seed price so as to improve smallholders' incomes. Another strategy would be to reduce the SVO selling to increase the benefits to customers. Then, for end-uses in power generation, a lower SVO selling price is required to compete with fossil fuels, which can be achieved either by using more efficient technologies or by reducing the feedstock price. Then, all the challenge in the definition a policy framework consists in providing rules so that several types of supply chains can co-exist. Tax and subsidy systems could be applied to provide fair competition conditions between supply chain players.

A work in close collaboration with decision makers would be necessary to take into account the priorities fixed by the government and to have a more informed opinion on what solutions should be considered. In this context, the developed method could be fully exploited and help determining which solutions can be readily implemented and which one would be worth being developed in the future. Overall, the relevant analysis of assessment results requires a variety of knowledge and skills in the field of agriculture, process engineering, environment, economics and public policy.

Perspectives for the improvement of assessment method

As discussed above, an infinite number of possibilities can be assessed with the developed tool and in each case, an important quantity of output data is generated. On the one hand, this is an asset attesting of the capacity and flexibility of the method. On the other hand, the analysis of scenarios one by one implies to make a number of choices, is rather time-consuming and does not necessarily provide optimised solutions. Then, the use of a multi-objective optimisation tool, as provided in OSMOSE, might be helpful for the analysis of the models and the identification of the best solutions. This would require an important work due to the number of variable parameters and to the nature of economic efficiency indicators, which consists of a range of a vector rather than a simple scalar.

Then, a point that could be improved is the capacity of the tool in evaluating local environmental impacts, as for example, the impacts on biodiversity, water resources, the changes in carbon stocks due to land use change. This would require region-specific LCA data, which is not available so far. Given the specificity and the fragility of the Sahelian ecosystem, a deeper investigation of environmental impacts would be necessary to ensure long-term sustainability.

Eventually, this type of approach could be employed for the assessment of other productions than biofuels and in different contexts. This would imply to develop specific process models and possibly to generalise the definition of supply chains so that different structure can be considered.

Conception de filières durables de production de biocarburants oléagineux – Le cas des filières Jatropha au Burkina Faso

Au Burkina Faso, les biocarburants suscitent de nombreux espoirs quant au développement de l'accès à l'énergie en zone rurale et à la substitution des carburants fossiles importés. Plusieurs initiatives de production de biocarburants à partir de Jatropha ont été lancées au cours des dernières années par des ONG et des opérateurs privés. Le gouvernement envisage de définir une politique d'accompagnement pour le développement de ce secteur. Les bénéfices potentiels issus de cette activité, en terme de contribution au développement durable, doivent donc être soigneusement étudiés afin de prendre les décisions adéquates.

L'objectif de ce travail est d'évaluer les opportunités de développement des biocarburants, en définissant les possibilités techniques dans le contexte et en analysant à quelles conditions et dans quelle mesure elles peuvent contribuer au développement durable. L'approche repose sur la modélisation des procédés impliqués dans la production, couplée à des outils d'évaluation environnementale et économique. L'efficacité économique est évaluée par une analyse de la valeur ajoutée produite au sein des filières, ainsi que sa distribution sous forme de revenus, aux employés, aux agents de la filière, à l'état et aux banques. Les impacts environnementaux, notamment les émissions de GES et la consommation d'énergie fossile, sont évalués à l'aide d'une analyse de cycle de vie.

Trois produits finaux différents ont été envisagés: l'huile végétale brute (HVB) ou raffinée, destinée à des applications stationnaires et le biodiesel dédié aux transports. Une analyse individuelle de chaque procédé a permis d'identifier les paramètres les plus sensibles au niveau local. Pour tous les procédés, le prix de la matière première conditionne largement le coût de production. Pour la production d'HVB, le rendement en huile et la teneur en huile des graines ont une importance capitale. Les performances économiques du raffinage et de la transestérification de l'huile sont largement influencées par la capacité de transformation des procédés en raison d'économies d'échelle, et dans une moindre mesure, par la technologie et les ressources utilisées pour la fourniture énergétique. Dans le cas de la production de biodiesel, le prix du méthanol est également un facteur crucial.

La méthode d'évaluation développée a été appliquée à plusieurs scénarios de production de biocarburants à partir de graines de Jatropha produites par les petits exploitants. Les résultats montrent que la méthode permet d'apporter des informations essentielles pour la prise de décisions politiques. Sur la base d'un prix de marché des graines de 100 FCFA/kg, les trois types de biocarburants envisagés peuvent être produits de manière rentable. Dans certains cas, l'utilisation de technologies avancées pour l'approvisionnement en énergie et la valorisation des sous-produits est indispensable pour atteindre un coût de production compétitif. Cela pourrait aussi être une solution pour augmenter le prix des graines afin d'assurer des revenus plus élevés aux agriculteurs. La production d'huile raffinée pour la production d'électricité est particulièrement coûteuse et nécessite une production à grande échelle pour être rentable. Les filières impliquant une usine de biodiesel approvisionnées par plusieurs huileries décentralisées constituent une solution pour contribuer à la fois à l'amélioration de l'accès à l'énergie en zone rurale et à la substitution des combustibles fossiles. Les revenus perçus par l'Etat sont directement liés à la valeur ajoutée et aux bénéfices générés par les producteurs de biocarburants.

Enfin, les impacts environnementaux de la production d'huile sont relativement faibles, en termes d'émissions de GES et de consommation d'énergie fossile, en particulier si la fourniture énergétique est basée sur une ressource renouvelable. En revanche, les impacts de la production de biodiesel sont largement affectés par l'utilisation de méthanol.

Mots-clés :

Développement durable ; Biocarburant ; Jatropha ; Ecologie industrielle ; Génie des procédés ; Modélisation ; Afrique de l'Ouest.

Sustainable design of oilseed-based biofuel supply chains – The case of Jatropha in Burkina Faso

The development of biofuel production in Burkina Faso, raises high expectations regarding the development of rural energy access and the substitution of imported fossil fuels. Several initiatives for biofuel production from Jatropha oilseeds were launched in recent year by NGOs and private operators. The government is planning to define a policy framework to support the development of this sector. To this end, the potential benefits from this activity needs to be carefully investigated in regard to sustainable development objectives.

The goal of this work was to investigate these opportunities by determining the technical possibilities regarding the context and in what conditions and to what extent they can contribute to sustainable development objectives. The approach was based on the modelling and simulation of production processes coupled with environmental and economic assessment tools. Specific experiments were also led whenever data were not available, as for the determination of the oil yield of a screw press. Economic efficiency was assessed using value chain analysis, which consists in calculating the value added generated by the different activities involved in a supply chain, and the distribution of this value in the form of income to the employees, the supply chain players, the state and the banking institutions. Environmental impacts, including greenhouse gas emissions and fossil energy consumption, are evaluated using a partial life-cycle assessment.

The production of three different final products was investigated, i.e. straight vegetable oil (SVO), refined oil aimed to be used for stationary applications (power generation, shaft power, pumping...) and biodiesel dedicated to transportation. The analysis of individual processes allowed to identify the most sensitive parameters at a local level. As a general trend for all processes, the price of feedstock dramatically affects the production cost. For SVO production, the oil recovery and the seeds oil content are of paramount importance. The economic performances of the refining and transesterification processes are largely conditioned by the processing capacity, due to economies of scale, and to a lesser extent by the solution employed for energy supply. In the case of biodiesel production, the price of methanol is also a crucial factor.

The developed assessment method was applied to several prospective biofuel supply chains, all relying on the production of Jatropha seeds by smallholders. The results have shown that the method can bring crucial information to policy makers. Based on a seed market price of 100 FCFA/kg, any type of biofuel can be produced in a cost effective way. In some cases, the implementation of advanced technologies for energy supply and by-product valorisation is needed to reach the required production cost. This could also be a solution to increase the price of seeds so as to provide higher incomes to farmers. The production of refined oil for power generation appears to be rather expensive relatively to the target, which imposes large processing scales. Supply chains involving a biodiesel plant supplied by several decentralised SVO plants constitute a solution for addressing at the same time rural energy access and the substitution of fossil fuels. Then the income perceived by the State is directly determined by the value and the profits generated by biofuel producers.

Eventually, the environmental impacts related to seed processing, in terms of GHG emissions and fossil energy consumption, is relatively low especially when energy requirements are supplied from a renewable resource. By contrast, the impacts of biodiesel production are systematically impaired by the use of methanol of fossil origin in the process.

Keywords:

Sustainable development ; Biofuel ; Jatropha ; Industrial ecology ; Process engineering ;
Modelling ; West Africa.