



HAL
open science

Bandwidth allocation and energy efficiency solutions in optical access networks

Ozgur Can Turna

► **To cite this version:**

Ozgur Can Turna. Bandwidth allocation and energy efficiency solutions in optical access networks. Networking and Internet Architecture [cs.NI]. Institut National des Télécommunications, 2014. English. NNT : 2014TELE0005 . tel-01172614

HAL Id: tel-01172614

<https://theses.hal.science/tel-01172614>

Submitted on 7 Jul 2015

HAL is a multi-disciplinary open access archive for the deposit and dissemination of scientific research documents, whether they are published or not. The documents may come from teaching and research institutions in France or abroad, or from public or private research centers.

L'archive ouverte pluridisciplinaire **HAL**, est destinée au dépôt et à la diffusion de documents scientifiques de niveau recherche, publiés ou non, émanant des établissements d'enseignement et de recherche français ou étrangers, des laboratoires publics ou privés.



THESE DE DOCTORAT CONJOINT TELECOM SUDPARIS et L'UNIVERSITE PIERRE ET MARIE CURIE

Spécialité :

Informatique

Présentée par

Özgür Can TURNA

Pour obtenir le grade de

DOCTEUR DE TELECOM SUDPARIS

**Allocation des ressources et des solutions pour économiser de l'énergie
dans les réseaux optiques d'accès**

Soutenue le 30 Janvier 2014 devant le jury composé de :

Philippe GRAVEY
Dominique CHIARONI
Serge FDIDA
Nihal PEKERGIN
Catherine LEPERS
Hakima CHAOUCHI
Tülin ATMACA
Halim ZAİM

Rapporteur
Rapporteur
Examineur
Examineur
Examineur
Examineur
Directrice
Co-encadrant

Directeur d'étude à Telecom Bretagne
Chercheur Senior (Team Leader) à Alcatel-Lucent France
Professeur à l'université Pierre et Marie Curie
Professeur à l'université Paris Est Créteil Val de Marne
Professeur à Telecom SudParis
Professeur à Telecom SudParis
Professeur à Telecom SudParis
Professeur à l'université d'Istanbul

Thèse n° 2014 TELE0005



Doctor of Science Thesis Telecom & Management SudParis and Pierre & Marie Curie University

Specialization

Computer Science

Presented by

Özgür Can TURNA

Submitted in partial satisfaction of the requirements for the degree of

**Doctor of Science
TELECOM SUDPARIS**

Bandwidth Allocation and Energy Efficiency Solutions in Optical Access Networks

30 January 2014, committee in charge:

Philippe GRAVEY	Reviewer	Director of Studies at Telecom Bretagne
Dominique CHIARONI	Reviewer	Senior Researcher (Team Leader) at Alcatel-Lucent France
Serge FDIDA	Examiner	Professor at University Pierre & Marie Curie
Nihal PEKERGIN	Examiner	Professor at University Paris Est Créteil Val de Marne
Catherine LEPERS	Examiner	Professor at Telecom SudParis
Hakima CHAOUCHI	Examiner	Professor at Telecom SudParis
Tülin ATMACA	Director	Professor at Telecom SudParis
Halim ZAİM	Co-supervisor	Professor at Istanbul University

Thèse n° 2014 TELE0005

ACKNOWLEDGEMENTS

First and foremost I wish to thank my advisor Professor Tülin ATMACA for her patience, for being inspirational and supportive during this thesis. She gave me directions and ideas in all steps of my studies. Especially I would like to thank to her for accepting me as her student and giving me the opportunities to finish my thesis.

I would also like to thank to my co-supervisor Professor Halim ZAIM for his advices and supports for my studies in Turkey.

I am also grateful to Prof.Dr. Philippe GRAVEY and Mr. Dominique CHIARONI for accepting to be rapporteur of my thesis and for their promotive advices. I wish to express my sincere thanks to Prof.Dr. Serge FDIDA, Prof.Dr. Nihal PEKERGIN, Prof.Dr. Catherine LEPES and Prof.Dr. Hakima CHOUCHE to accepting being a jury member and attending to my defense.

I would like to thank all of my colleagues who have supported with collaborations and substantial ideas over our meetings. Especially I would like to thank to Prof.Dr. Hakima CHOUCHE, Tuan Dung NGUYEN and Glenda GONZALEZ for their contributions to my studies.

Without financial support from Telecom SudParis and Istanbul University, I would not be able to continue my studies in France. I gratefully appreciate their supports.

At last I want to give my best regards to Dr. Muhammed Ali AYDIN and Zeynep AYDIN for their endless support and friendship.

Özgür Can Turna
December 2013, Paris

Abstract

The advancements in information technologies have been progressed enormously. Improvements in telecommunication systems are one of the most important steps of the progress in information technologies. Although the telecommunication infrastructure has come into our lives for the first time with telephony networks, they have been diversified and enhanced by the discovery of Internet. Today, telecommunication technologies vary from satellite communication to communication over power lines at home. Considering the telecommunication infrastructures, Internet has the most importance. Internet is not only a telecommunication infrastructure but also a network of networks in which several independent telecommunication infrastructures operate as an overall system. From the commercial aspect, Internet invention brings new industry branches as network device manufactures, operators, service providers, etc. Service providers try to reach as much subscribers as they can with lower costs. Optical networks are distinguished as a solution to solve increasing bandwidth demand and error free data transmission over long haul.

The network architectures which constitute the Internet are handled as hierarchical three levels (backbone networks-WAN, metropolitan networks-MAN and access networks). The usage of optic fibers and optic based switching techniques in WAN and MAN networks are of long standing. In access networks, solutions can be grouped as wireless and fixed. For fixed access networks, twisted pair copper cables or coaxial links were used until the recent past. This property of access networks is a result of service providers' intention to use existing telephony or cable TV systems without laying down new links. The data transmission capacity of twisted pair copper links is limited with specific distances even if they use complex techniques. In Internet infrastructures, this property causes bottleneck for access networks. Using optical technologies in access networks provide solutions to overcome this bottleneck.

Optical access networks can be classified as three categories in terms of topology: point-to-point topology, star topology with intermediate active elements and tree topology with passive splitter "known as Passive Optical Network - PON". The first two topologies are not more cost-effective than tree topology with passive splitter in terms of operation expenditures or implementation

expenditures. By employing passive intermediate elements, tree structure has been used broadly due to its cost advantage.

PON consists of Optical Line Terminals-OLT at central office of service provider, Optical Network Unit-ONU at user side, passive combiners/splitters and optical fibers between them. PONs are named as; Time Division Multiplexing PON (TDM-PON) and Wavelength Division Multiplexing PON (WDM-PON) according to the used multiple access mechanism. Ethernet PON (EPON) and Gigabit-PON (GPON) are two main standard branches over TDM-PON structure. WDM-PON structure is not widely implemented since it is not still be a cost-effective solution. However, next generation PON (NG-PON) structure is thought to base on WDM-TDM hybrid PON solution. Two main problems (accessing more users over longer distances and increasing the bandwidth) are focused on for next generation PON standards. Also, one of the other popular research topics is the increasing number of mobile devices and mobile networks and design of optical-wireless convergence system to satisfy the bandwidth demands of these devices.

In this study, general overview about PON systems is presented and existing PON mechanisms and classifications are investigated. After the general overview of PONs, a novel dynamic bandwidth allocation algorithm for EPON is introduced. This proposed algorithm is named as “Half Cycling Dynamic Bandwidth Allocation-hcDBA” by the inspiration of its half cycling processing mode. Later, an improvement of hcDBA algorithm with early prediction mechanism is presented. The simulated traffic behavior of EPON’s upstream channel has been investigated in order to support the decision of traffic generator in further studies. The newly proposed algorithm have been implemented on NS2 simulation tool and compared to existing EPON dynamic bandwidth allocation algorithms. The comparison results and performance analysis are given for mono-service and multi-service cases for 1 Gbps and 10 Gbps link capacities. As a result statement of the study, hcDBA algorithm performs better than existing mechanism in terms of byte loss ratio and access delays.

Energy conservation is one of the hot topics in telecommunication networks. Access networks constitute a remarkable portion of the total energy consumption in telecommunication networks. ITU-T and IEEE organizations published recommendation for energy conservation in PONs. While, total energy consumption of ONUs is more than other equipment in fix access network the standards and most of the researches focused on saving energy at ONU side. As a result of researches XG-PON includes some improvements in energy-efficiency compared to GPON standard. In this thesis I focused on an energy efficiency method based on energy conservation on OLT side. The proposed method save energy by dynamically moving OLT cards to deep sleep mode according to the incoming and outgoing traffic loads.

Keywords: Energy Efficiency, Ethernet Passive Optical Network (EPON), Multipoint Control Protocol (MPCP), Network Simulation, Optical Access Network (OAN), Passive Optical Network (PON), Performance Evaluation, Resource Allocation, Quality of Service (QoS), Time Division Multiplexing (TDM), Wavelength Division Multiplexing (WDM)

Résumé

Les technologies de l'information ont connu un essor important ces dernières années. L'amélioration des systèmes de télécommunications est l'une des étapes les plus importantes de l'évolution des technologies de l'information. Bien que l'infrastructure de télécommunication a été adoptée d'abord pour les réseaux de téléphonie, celle-ci a bien évolué depuis pour embrasser la technologie de l'Internet. Aujourd'hui, les technologies de télécommunication varient depuis les communications par satellite aux communications sur les lignes électriques à domicile sans oublier les communications sans fil et les communications optiques. Compte tenu des infrastructures de télécommunication, le réseau Internet aujourd'hui a gagné la plus grande place. Internet n'est pas seulement une infrastructure de télécommunication, mais aussi un réseau de réseaux dans lesquels plusieurs infrastructures de télécommunication indépendantes fonctionnent comme un système global. Du point de vue commercial, l'invention de l'Internet apporte de nouvelles branches de l'industrie en tant que dispositif de réseau de produits manufacturés, les opérateurs, les fournisseurs de services, etc. Les fournisseurs de services cherchent à atteindre autant que possible l'abonné à moindre coût ; on parle d'une approche « user and service centric ». Les réseaux optiques se distinguent comme une solution pour résoudre la demande croissante de bande passante et sans erreur de transmission de données sur de longues distances.

Les architectures de réseaux qui constituent Internet sont traitées comme trois niveaux hiérarchiques (backbone réseaux WAN, les réseaux métropolitains ou réseaux MAN et les réseaux d'accès LAN). L'utilisation de fibres optiques et les techniques de commutation optique à base de WAN et MAN est très ancienne. Dans les réseaux d'accès, les solutions peuvent être regroupées comme fixe et sans fil. Pour les réseaux d'accès fixes, on peut citer la paire torsadée de câbles en cuivre ou les liaisons coaxiales qui ont été utilisés jusqu'à un passé récent. Cet établissement de réseaux d'accès est le résultat de l'intention des fournisseurs de services d'utiliser des systèmes de téléphonie ou la télévision par câble existantes sans poser de nouveaux liens. La capacité de transmission de données de liens torsadés paire de cuivre est limitée par des distances précises, même si elles utilisent des techniques complexes. Dans les infrastructures de l'Internet, cette propriété entraîne l'incidence des goulots d'étranglement pour les réseaux d'accès en plus de l'exploitation de WAN, MAN et des réseaux d'accès locaux. En utilisant des technologies optiques dans les réseaux d'accès pour fournir des solutions pour surmonter cet obstacle.

Les réseaux d'accès optiques peuvent être classés en trois catégories en termes de topologie: topologie point-à-point, topologie en étoile avec des éléments actifs intermédiaires et topologie arbre avec répartiteur passif connu sous le nom de « Passive Optical Network – PON ». Les deux premières topologies ne sont pas efficaces en termes de coût tel que topologie arbre avec répartiteur passif en termes de dépenses de fonctionnement ou des dépenses de mise en œuvre. En utilisant des éléments intermédiaires passifs, la structure de l'arbre a été largement utilisée en raison de son avantage de coût.

PON se compose des Optical Line Terminal - OLT au central de prestataire de services, et de Optical Network Unit -ONU du côté de l'utilisateur, des multiplexeurs passifs / répartiteurs et des fibres optiques entre eux. Les réseaux optiques PON sont nommés comme: Time Division Multiplexing PON (TDM-PON) et Wavelength Division Multiplexing PON (WDM-PON), selon le mécanisme d'accès multiple utilisé. Ethernet PON (EPON) et Gigabit PON (GPON) sont deux branches principales de la norme sur la structure TDM-PON. La structure WDM-PON est peu appliquée car il n'est pas toujours une solution rentable. Cependant, la prochaine génération PON (NG-PON) la structure est considérée basé sur la solution hybride WDM PON-TDM. Deux problèmes principaux sont considérés dans la future génération PON; il s'agit de multiplexage de plusieurs utilisateurs sur de longues distances et l'augmentation de la bande passante. En outre, l'un des autres sujets qui sont étudiés est le nombre croissant d'appareils mobiles et de réseaux mobiles et la conception du système de convergence optique sans fil pour satisfaire les besoins en bande passante de ces dispositifs.

Dans ce travail de thèse, un aperçu général sur les systèmes PON est présenté et sont étudiés les mécanismes et classification PON existants. Après la présentation générale de PONs, nous introduisons notre première contribution qui est un algorithme d'allocation dynamique de bande passante pour EPON. Cet algorithme proposé est désigné comme « Half cycling Dynamic Bandwidth Allocation – hcDBA ». Par la suite, une amélioration de l'algorithme de hcDBA avec mécanisme de prédiction précoce est présentée. Le comportement du trafic de simulation de canal en amont d'EPON a été étudié afin de soutenir la décision du générateur de trafic dans d'autres études. Pour évaluer notre nouvel algorithme proposé, nous avons procédé à son implémentation sous le simulateur NS2 et nous l'avons comparé par rapport aux algorithmes existants d'allocation de bande passante dynamique EPON. Les résultats de la comparaison et l'analyse des performances sont données pour les cas mono - services et multi-services pour 1 Gbps et 10 Gbps de capacités de liaison. Notre simulation montre bien que notre algorithme hcDBA est performant comparé aux mécanismes existants en termes de taux de perte de paquets et de délai d'accès.

Dans notre seconde contribution, nous sommes intéressés au problème de consommation d'énergie qui est un sujet d'actualité dans les réseaux de télécommunication. Les études montrent aujourd'hui que les réseaux d'accès constituent une partie remarquable de la consommation totale d'énergie dans les réseaux de télécommunication. Les organisations ITU-T et IEEE ont publié la recommandation pour la consommation de l'énergie pour les réseaux PONs. Bien que, la consommation totale d'énergie des nœuds ONU est plus importantes que d'autres équipements dans le réseau d'accès fixe, les normes et la plupart des travaux de recherches ont porté sur les économies d'énergie du côté de ONU. A la suite des travaux de recherches XG-PON comprend des améliorations dans l'efficacité énergétique par rapport à la norme GPON. En 2012 GreenTouch consortium a développé BiPON qui a obtenu un grand succès pour diminuer la

consommation d'énergie ONU. Dans cette thèse, nous nous sommes concentrés sur une méthode d'efficacité énergétique basée sur la conservation de l'énergie du côté de l'OLT. La méthode proposée permet d'économiser de l'énergie en déplaçant dynamiquement des cartes d'OLT en mode de sommeil profond en fonction des charges de trafic entrant et sortant.

Mots clés: Allocation des ressources, évaluation de la performance, l'efficacité énergétique, Ethernet Passive Optical Network (EPON), Protocole Multipoint contrôle, optique d'accès au réseau, réseau optique passif, réseau de simulation, la qualité de service, Time Division Multiplexing, Wavelength Division Multiplexing

Table of Contents

1	Introduction.....	1
1.1	Objective.....	3
1.2	Organization of the thesis	3
2	Passive Optical Networks Overview	5
2.1	Why to Pass Fiber Infrastructure in Access Networks?	5
2.2	Classification of Optical Access Networks	6
2.2.1	Classification by End-Point	6
2.2.2	Classification by Infrastructure.....	7
2.2.2.1	Point-to-Point Architecture.....	7
2.2.2.2	Active Star Architecture	8
2.2.2.3	Passive Tree Architecture	8
2.2.3	Comparison of Optical Access Network Topologies	9
2.3	Multiple Access Methods Used in PONs	10
2.3.1	Time Division Multiple Access (TDMA)	10
2.3.2	Subcarrier Multiple Access (SCMA)	10
2.3.3	Wavelength Division Multiple Access (WDMA).....	11
2.3.4	Optical Code Division Multiple Access (OCDMA).....	12
2.4	Evolution of Passive Optical Networks	12
2.5	PON Standards	15
2.5.1	Ethernet Passive Optical Network (EPON).....	15
2.5.1.1	Transmission in EPON.....	15
2.5.1.2	Dynamic Bandwidth Allocation in EPON.....	16

2.5.1.3	Multi Point Control Protocol (MPCP).....	16
2.5.2	Ten Gigabit Ethernet Passive Optical Network (10G-EPON)	17
2.5.3	Gigabit Passive Optical Network (GPON).....	19
2.5.3.1	Transmission in GPON.....	19
2.5.4	Next Generation PON (XG-PON1, NGPON2).....	20
3	Analysis of Dynamic Bandwidth Allocation Algorithms on EPON.....	22
3.1	Dynamic Bandwidth Allocation Algorithms.....	23
3.2	Online DBA.....	23
3.3	Offline DBA.....	24
3.4	Half Cycling DBA	26
3.5	Prediction Enhancement for hcDBA.....	31
3.6	Performance Evaluation.....	33
3.6.1	Simulation Environment and Parameters.....	33
3.6.2	Performance Evaluation.....	34
3.6.2.1	Comparison of hcDBA – IPACT – oDBA	35
3.6.2.1.1	Byte Loss Rate Comparison	35
3.6.2.1.2	Access Delays Comparison.....	36
3.6.2.1.3	Packet Delay Variation Comparison	38
3.6.2.2	Performance Analysis of Early Prediction Mechanisms	39
3.6.2.2.1	Access Delay Comparison	40
3.7	Conclusion.....	42
4	Traffic Characterization on EPON Upstream Channel	44
4.1	Dynamic Bandwidth Allocation in EPON	45
4.2	Traffic Models	46
4.2.1	Poisson Traffic Modeling.....	46
4.2.2	Self-Similar Traffic Modeling.....	47
4.3	Simulation Environment	48
4.4	Numerical Results.....	49
4.5	Conclusion.....	50
5	Energy Efficiency on Passive Optical Networks	54
5.1	ONU Oriented Solutions	56
5.1.1	Fast Sleep Power Saving Technique.....	57
5.1.2	Deep Sleep Power Saving Technique.....	57
5.1.3	Dozing Power Saving Technique.....	58

5.1.4	Power Shedding.....	58
5.1.5	Adaptive Link Rate.....	58
5.2	Aggregation Node Oriented Solutions	59
5.3	OLT Oriented Solutions.....	60
5.3.1	Wavelength Routing for Selective OLT Sleep	60
5.3.2	Elastic OLT.....	61
5.3.3	Selective Shutdown with Optical Switches.....	62
5.3.4	Hybrid Active/Passive Architecture Using Optical Switch	62
5.4	Our Dynamic Energy Efficiency Algorithm for OLT	62
5.4.1	Developed Architecture.....	63
5.4.2	Proposed Algorithm for Control Plane.....	64
5.4.3	Simulation Environment	67
5.4.4	Performance Evaluation.....	69
5.4.4.1	Access Delay Analysis	74
5.4.4.2	Buffer Occupancy	76
5.4.5	Conclusion.....	77
6	General Conclusion	79
6.1	Future Directions	81
7	Résumé en français de la thèse	83
7.1	Objectif.....	85
7.2	Organisation de la thèse.....	86
7.3	Contributions.....	87
7.4	Orientations futures	89
	List of Publications	91
	References	93

List of Figures

Figure 2.1: Evolution of bandwidth in access networks (Lee, et al., 2006)	6
Figure 2.2: Point-to-Point Connected Optical Access Network.....	7
Figure 2.3: Active Star Connected Optical Access Network	8
Figure 2.4: Passive Tree Connected Optical Network.....	9
Figure 2.5: Cost Comparison of Optical Access Network Types (Koonen, 2006)	9
Figure 2.6: Time Division Multiple Access	10
Figure 2.7: Subcarrier Multiple Access.....	11
Figure 2.8: Wavelength Division Multiple Access.....	12
Figure 2.9: Working Scheme of MPCP (Zheng & Mouftah, 2009).....	17
Figure 3.1: Bandwidth allocation for upstream channel in Online DBA Algorithm	24
Figure 3.2: Bandwidth allocation for upstream channel in Offline DBA Algorithm.....	25
Figure 3.3: Bandwidth allocation for upstream channel in offline part of hcDBA Algorithm.....	27
Figure 3.4: GATE Timer work flow in OLT	28
Figure 3.5: Byte Loss Ratio with Mono-Service	36
Figure 3.6: Byte Loss Ratio in Case1 and Case2 with Multi-Service.....	36
Figure 3.7: Mean Access Delay with Mono-Service.....	37
Figure 3.8: Mean Access Delay with Multi-Service	38
Figure 3.9: Packet Delay Variations (PDV) (1 Gbps)	39
Figure 3.10: Mean Access Delay with Mono-Service Traffic.....	40
Figure 3.11: Mean Access Delay with Multi-Service Traffic (1 Gbps)	41
Figure 3.12: Mean Access Delay with Multi-Service Traffic (10 Gbps).....	41
Figure 4.1: EPON Upstream Path (Nguyen, 2010)	45
Figure 4.2: IPACT Scheme	46
Figure 4.3: Comparison of the self-similar Internet traffic (measured) with Poisson (Fowler, 1999)	47
Figure 4.4: The histogram and log histogram of inter-arrival times of a Poisson process	47
Figure 4.5: Inter arrival time distribution a1-a4: Poisson traffic, b1-b4: EPON upstream traffic, c1-c4: Self-similar traffic.....	51

Figure 4.6: Packet arrivals in different time scales a1-a3: Poisson traffic, b1-b3: EPON upstream traffic, c1-c3: Self-similar (MMPP-2) traffic	52
Figure 5.1: World Energy Consumption 1990 -2040 (U.S. Energy Information Administration, 2013)	54
Figure 5.2: Energy consumption of a typical telecommunication network (Mukherjee, 2011)	55
Figure 5.3: An example of the estimation of power consumption (Otaka, 2008)	56
Figure 5.4: Fast Sleep Mode State Transitions (ITU-T, G.Sup45, 2009)	57
Figure 5.5: Link aggregation in (a) standard operation and (b) energy-aware operation (Imaizumi, et al., 2009)	59
Figure 5.6: Sleep control of EA. (a) Configuration. (b) State diagram (Shimazu, et al., 2010)	59
Figure 5.7: Energy-efficient optical access by WDM-TDMA PON and wavelength routing technologies, with wavelength assignment for (a) high-traffic condition and (b) low-traffic condition. (Kani, 2013a)	60
Figure 5.8: Concept of Elastic OLT (Iiyama, et al., 2010)	61
Figure 5.9: OLT with Optical Switches (Zhang, et al., 2011)	61
Figure 5.10: General Architectural Design of OLT Couple with switch-box	64
Figure 5.11: Finite State Machine of Transition between two modes in Control Plane	65
Figure 5.12: Control plane decision flow	66
Figure 5.13: Simulation environment	67
Figure 5.14: Generated traffic example (Average data send – Timeline) 1s intervals, Average Load: 0.18	68
Figure 5.15: Generated traffic example (Average data send – Timeline) 1s intervals, Average Load: 0.38	68
Figure 5.16: Generated traffic example (bitrate histogram) 1s intervals, Average Load: 0.18 (a), 0.38 (b)	69
Figure 5.17: Number of On-Off transition under different load experiments (S_t : 5 ms, R_t : 25 ms)	70
Figure 5.18: Sleep Duration of OLT couple (S_t : 5 ms, R_t : 25 ms)	71
Figure 5.19: Sleep Duration of OLT couple (S_t : 5 ns, R_t : 5 ms)	72
Figure 5.20: Average Access Delay Comparison (θ : 3 sec, S_t : 5 ms R_t : 25 ms)	73
Figure 5.21: Average Access Delay Comparison (θ : 10sec, S_t : 5ms R_t : 25ms)	73
Figure 5.22: Average Access Delay Comparison (θ : 3sec, S_t : 5ns R_t : 5ms)	74
Figure 5.23: Average Access Delay Comparison (θ : 10sec, S_t : 5ns R_t : 5ms)	74
Figure 5.24: Buffered packet behavior during switching	75

List of Tables

Table 2.1: Summary of EPON and 10G-EPON Protocols and Features (Gorshe & Mandin, 2009)	18
Table 3.1: Parameter Definitions for p-hcDBA Algorithm	32
Table 3.2: Traffic Distribution (Nguyen, et al., 2009)	33
Table 3.3: Simulation Parameters	34
Table 4.1: Simulation parameters for three different cases	49
Table 4.2: Correlation values of Poisson traffic and EPON upstream traffic	49
Table 5.1: Different types of sleep mode for a PON (Bokhari & Saengudomlert, 2013)	58
Table 5.2: Simulation Parameters	69

Abbreviations

AES	Advanced Encryption Standard
AON	Active Optical Network
APON	ATM Passive Optical Network
ATM	Asynchronous Transfer Mode
BMT	Burst Mode Transceiver
BPON	Broadband Passive Optical Network
CapEx	Capital Expenditures
CBR	Constant Bit Rates
CSMA/CD	Carrier Sense Multiple Access with Collision Detection
DBA	Dynamic Bandwidth Allocation
DSL	Digital Subscriber Line
EBD	Excess Bandwidth Distribution
EDFA	Erbium-Doped Fiber Amplifier
EFM	Ethernet in the First Mile
EoD	Education on Demand
EPON	Ethernet Passive Optical Network
FEC	Forward Error Correction
FSAN	The Full Service Access Network
FTTB	Fiber-to-the-Building
FTTC	Fiber-to-the-Curb
FTTH	Fiber-to-the-Home

FTTP	Fiber-to-the-Premise
GEM	Generic Encapsulation Method
GFP	Generic Framing Procedure
GPON	Gigabit Passive Optical Network
hcDBA	Half Cycling Dynamic Bandwidth Allocation
HDTV	High-Definition Television
IEEE	Institute of Electrical and Electronics Engineers
IPACT	Interleaved Polling with Adaptive Cycle Time
IPTV	Internet Protocol Television
ITU-T	International Telecommunications Union Telecommunication Standardization Sector
LAN	Local Area Network
MAC	Media Access Control
MAN	Metropolitan Area Network
MPCP	Multi Point Control Protocol
NS2	Network Simulator 2
OAM	Operation Administration and Maintenance
OCDMA	Optical Code Division Multiple Access
oDBA	Offline Dynamic Bandwidth Allocation
OLT	Optical Line Terminal
ONU	Optical Network Unit
OpEx	Operational Expenditures
p-hcDBA	Half Cycling Dynamic Bandwidth Allocation with Prediction
P2MP	Point-to-Multi-Point
P2P	Point-to-Point
PDV	Packet Delay Variation
PON	Passive Optical Network
PPBP	Poisson Pareto Burst Process
QoS	Quality of Service
RTT	Round Trip Time
SBA	Static Bandwidth Allocation
SCMA	Subcarrier Multiple Access

SLA	Service Level Agreement
SONET/SDH	Synchronous Optical Network and Synchronous Digital Hierarchy
T-CONT	Transmission Container
TCO	Total Cost Ownership
TDMA	Time Division Multiple Access
TDM-PON	Time Division Multiplexing – Passive Optical Network
VDSL	Very-High-Bit rate Digital Subscriber Line
VoD	Video on Demand
VoIP	Voice over IP
WAN	Wide Area Network
WDMA	Wavelength Division Multiple Access
WDM-PON	Wavelength Division Multiplexing – Passive Optical Network

1 Introduction

The advancements on information technology in recent 50 years have enormously increased. Telecommunication area covers pretty much of advancements on information technologies. Although the telecommunication infrastructure has been spread into our lives with telephony networks, they became diversified and enhanced by discovery of Internet, war and science oriented developments of countries. Nowadays, telecommunication technologies provide different services that vary from satellite technologies to data transfer via indoor electricity lines. Internet is the most important issue regarding current telecommunication infrastructures. Internet is a network of networks that acts as not only a single telecommunication infrastructure but also as a system that combines many independent telecommunication infrastructures. Internet has begun as a scientific study but now it has become a phenomenon that connects the world and has enormous affects such as even regime shifts. From a different point of view, internet has also caused revealing different areas such as service providers, operators, network hardware vendors etc. Internet's commercial aspects also caused these actors to search for more customers and market. All of these advancements are triggered to search solutions to fulfill the increasing bandwidth demands and meet more customers with low budgets. Here optical networks distinguish as an optimal solution for problems such as increasing bandwidth demand and error-free transmission over long haul.

Using optics in data communication is founded in 1965 and after in 80s it is used in long-haul communication systems. Today, optic fiber becomes indispensable for core and metropolitan network infrastructures. In 90s, bandwidth demand of end-users increased. This brings the idea of using optics in access networks as well. Today, most of the service provider infrastructures are based on optic solutions.

It is widely believed that a new video-centric world that will enable many new applications and opportunities is starting to be experienced. These opportunities will include services such as IPTV, video on demand (VoD), education on demand (EoD), HDTV, video conferencing, high-quality interactive-video gaming, and video surveillance. With the recent introduction of HD quality camcorders, it is becoming easier for consumers to generate high-bandwidth signals for upstream transmission (Lee, et al., 2006). These bandwidth hungry applications cause pressure on service providers to support more bandwidth in access networks.

Passive Optical Network (PON) seems to be the most promising solution for fix access network thanks to its cost-effective performance. PON gives the opportunity to serve more bandwidth to far distance compared to copper line access solutions (xDSL). Besides, PON is the economical solution among optical access solutions. PON needs fewer storage in central-office and less fiber planting compared to other optical fix access network solutions. Another point of interest for service providers is giving data, telephony and TV services on one medium (triple-play) where wavelength division multiplexing make it available to carry three services separately on single fiber to subscribers. As a result of these advantages of PON, it has been widely deployed to support broadband Internet, telephony and IPTV service.

PON uses a simple tree architecture where central-office unit (Optical Line Terminal – OLT) has one fiber interface to communicate with subscribers and other interfaces for control and backbone connections. The single fiber link from OLT connected with many subscribers unit (Optical Network Unit – ONU) by being divided with passive (no energy consuming) splitters. Owing to the tree architecture (by a result of passive splitter/couplers), data transmission in downstream accrues as broadcasting. In upstream direction, a multiple access technique has to run for sharing single fiber link to connect to central-office. PON performance is related to the link carry capacity and the bandwidth allocation scheme that is used to schedule each ONU. Today the released PON standard as Ethernet Passive Optical Network (EPON) and Gigabit Passive Optical Network (GPON) use Time Division Multiplexing (TDM) for scheduling downstream and Time Division Multiple Access (TDMA) for scheduling upstream usage. Both downstream and upstream schedule is controlled by OLT. A dynamic bandwidth allocation algorithm works on OLT for up/down channel bandwidth allocation. For a specific algorithm we cannot say that it is the perfect solution for channel utilization and performance. While some algorithms may perform a good channel utilization, they can suffer delay and fairness problems.

PON standards leave bandwidth allocation scheme as an open subject for implementers to make further developments available. The standards only figure out the messaging structure and general principles of bandwidth allocation scheme. For EPON, Multi Point Control Protocol (MPCP), which is placed in OLT, is responsible for the bandwidth allocation, signaling and new ONU registration. MPCP define two control packets GATE, and REPORT to negotiate with ONUs in scheduling the upstream bandwidth. Each upstream cycle OLT collects report messages and make bandwidth granting decisions for each ONU upstream. When and how long an ONU can use the upstream is informed by the gate message. OLT can send gate messages as soon as it receives a report (online scheme) or it can collect all the report messages before deciding and giving grants (offline scheme). Online scheme is an easy method to implement and has a good bandwidth utilization for efficient bandwidth allocation offline scheme where can be better to give fair allocation decisions.

Energy consumption is one of the crucial problems for future of globe. Global energy consumption is increasing day-by-day where fossil sources are diminishing. Thus, in the last decade, industry and academia tend to develop more energy effective products. Access networks consume 70 percentage of total energy used in telecommunication networks (Mukherjee, 2011). For the future projection, it seems that energy consumption in access networks still keeps its portion as a challenge. Besides being the most promising solution for future access networks, PON has a good manner in case of energy efficiency. An optical access network is not consist of just PON. It has

also other network equipment named as aggregation node (Ethernet Aggregation – EA) to connect multiple OLT cards to a single backbone connection. Thus, energy consumption in access network is handle from three different perspectives; (ONU side, OLT side, EA side). ONU side has the big portion of energy consumption because of the count of ONUs per PON. Thus, most of the energy efficiency methods in access networks are based on ONU enhancements. An ONU does not actively in use all the time under TDM scheme. Therefore, ONU can sleep in idle periods. ITU-T G.Sup45 recommendation describes four different power saving methods; power shedding, dozing, deep sleep, and fast/cyclic sleep for ONUs. To save energy on OLT side, some OLT can be powered off according to the traffic load. This process can cause data loss and derogation in service quality so can be acceptable only idle hours of the day (midnight). Also wavelength routing and some other techniques can be used to selectively close OLT cards. Similarly, EAs also can put into sleep when one EA can do the task of two or more EAs.

In the scope of this dissertation, we aim to provide an analysis of passive optical network standards. Classification, evolution and standardization procedures of optical access technologies are given. While bandwidth allocation has a major impact for PON performance the dynamic bandwidth allocation schemes for EPON are examined and a novel bandwidth allocation scheme based on combination of online and offline bandwidth allocation techniques is proposed. Afterwards, energy conservation in optical access networks are explored and an OLT based control plane proposed.

1.1 Objective

In the near future all fix access networks thought to be designed as sort of passive optical network (FttH, FttB, FttC, FttP ...). PON's performance and energy consumption is related to the development in optic and electronic components used in ONU, OLT, EA, and amongst them. Besides it is highly effected by the bandwidth allocation, scheduling, buffering and processing methodologies. In this dissertation, as mentioned before dynamic bandwidth allocation in EPON and energy efficient working techniques are examined. Service quality is the key point for operators while choosing novel techniques. In the view of access solutions the key quality issues can be thought as access delay and drop values. Increasing the service quality with better bandwidth allocation scheme is one of the objective of this dissertation. On the other hand, in last decade energy-efficient design of electronic devices gets more attention for decreasing the global energy consumption. While PON has a great portion in energy consumption of telecommunication networks we aim to propose a contribution to decrease energy consumption for TDM-PON implementations. Energy efficiency on ONU side is highly studied in literature thus, we focused on energy conservation on OLT side of PON.

1.2 Organization of the thesis

Chapter 2 presents the general information on optical access networks. First the situation in access networks and necessity for optic solutions have figured out. After classification and cost of different optical access solutions are given. Then the promising architecture (passive tree architecture known as PON) has been investigated. PON has to use a multiple medium access

protocol for sharing single connection to OLT. Possible multiple access connection types thought on PON given in the following section. As a historical summary, evolution of PON is given. At the end of the chapter, standardization studies are summarized.

Dynamic bandwidth allocation algorithms are examined in chapter 3. After giving online and offline DBA schemes a novel DBA method named as hcDBA is presented. HcDBA uses positive characteristic of online and offline DBA schemes and tries to eliminate the drawbacks. Performance evaluation of hcDBA is given in case of access delay, byte loss and packet delay variation. An enhancement based on prediction for hcDBA is proposed and performance evaluation of prediction enhancement is examined.

Chapter 4 presents an investigation about the traffic characterization study on upstream of EPON with IPACT algorithm. The output traffic pattern from PON is investigated to decide which traffic generator can be selected for MAN traffic simulations.

Chapter 5 includes the energy-efficiency studies about optical access networks. Standardization works and other propositions in literature are summarized. The energy efficiency techniques divided three sub groups as ONU oriented, OLT oriented, and EA oriented. Where the standards and most of the investigations are based on ONU side. We propose a novel OLT based energy conservation technique. Two OLTs joint as a couple with dedicate connection for control messaging. A detailed control plane is shown for dynamic energy conservation behavior. According to the traffic load change system can put to sleep one of the OLTs. Energy conservation is directly related to the sleeping period of OLT. The performance evaluation how much one OLT can be kept in sleep and the access delay is examined by comparing to classic working access delays. The advantages of dynamic sleep scheme for OLT is given in the conclusion.

Chapter 6 includes the overall summary of the thesis and gives ideas and topics for future directions.

2 Passive Optical Networks Overview

Nowadays, optical technologies are widely used in all kind of telecommunication networks. Day-by-day, the novel access network infrastructure implementations alter to fiber. Since, optics bring some sort of advantages that copper lines cannot supply as; long-haul reach, less effecting by environmental factors, this passing is proceeds fast.

There are different kinds of access network topologies which can be designed to serve subscribers. However, from the view of service provider, while making investments on new technologies one of the key point is to gain back as soon as possible. For a perfect service providing point-to-point fiber connection to each subscriber could be the best solution. However this is highly expensive in case of capital expenditures and operational expenditures. Passive Optical Network (PON) is accepted to be the promising solution for today and future needs. As it has used widely for today's broadband internet access solutions.

PON has a tree topology where a shared medium consists. This medium has to be shared among subscribers. Multiple access methods are used for shared medium scheduling. Time Division and Wavelength Division multiple access methods are deployed in today PON solutions. APON, BPON, GPON, EPON, 10GEPON, XGPON, NGPON, and so on are the standardizations.

In this chapter the optical technologies used in access networks and their classification are given. After, most promising optical access solution; Passive Optical Network (PON) is widely examined. Multiple access techniques, optical components and standards are summarized.

2.1 Why to Pass Fiber Infrastructure in Access Networks?

In all over fix network solutions, the fastest way to carry data is using the fiber technology, which is based on using light spectrum. Theoretically it is possible to carry data at 20Tbps rate over one single fiber. However the capacity of a system is determined by the slowest equipment. Although, the bit rate drops down dramatically in optical systems because of the electronic equipment at the start and end point of the fiber line, using fiber transmission infrastructure is faster than twisted pair or coaxial approaches. It is well known that the conventional access networks based on twisted-pair copper cable have very limited bandwidth-distance products. At data rates of 100

Mb/s, the transmission distance is limited to about 100m and requires the use of highly sophisticated transmission technologies (Chrissan, 2004). To overcome this limitation, it is essential to use a carrier medium as single-mode optical fiber as the transmission media in future access networks. Single-mode fiber provides essentially unlimited transmission bandwidth over extremely long-haul.

Network systems that constitutes internet are discussed as hierarchical three structures. Backbone networks (WAN), metropolitan networks (MAN) and access networks. The usage of optical fibers and optical switching techniques dates back to years ago. The connection on access networks can be classified as wireless and fixed solutions. Twisted pair copper cables or coaxial lines have been used until recent years as transmission medium for fixed networks. These types of solutions have been used due to demand of service providers to employ existing telephony or cable TV networks for providing internet service. Twister pair copper cables have limited transmission capacity up to specific distances even if complex techniques are used. This causes a bottleneck for access networks on Internet against the data rate of WAN, MAN and LANs. This bottleneck is solved by migrating to optical technologies in access network. Figure 2.1 shows the average data transmission rates of access networks in history and projection for future.

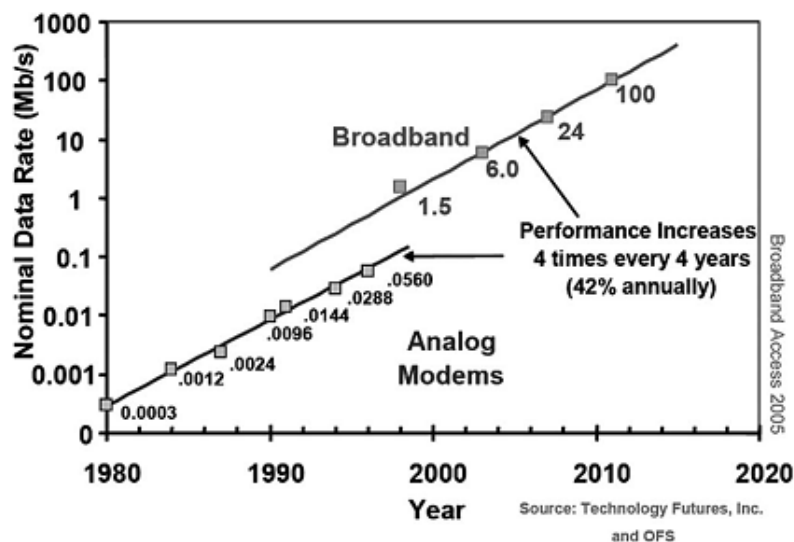

Figure 2.1: Evolution of bandwidth in access networks (Lee, et al., 2006)

2.2 Classification of Optical Access Networks

2.2.1 Classification by End-Point

Optical access networks are also named as Fiber-to-the-... (F^TX) solutions where X refers to the end point of the fiber line. F^TTH (Home), F^TTB (Building, Business), F^TTC (Curb, Cabinet), F^TTP (Premises) are mostly used. The last letter just give information about the end point and is not related to the underlying structure of the optical access solution. F^TTH means that the end point of the optical access network reach to the subscribers' home. In F^TTB, fiber line comes to a business location or building and subscribers are connected with LAN (mostly Ethernet) inside the building. Same for F^TTC, in which the end point of fiber line deployed in a cabinet for one or a

number of streets and subscriber connections done with DSL or Cable Modem solutions. The major expense to pass fiber infrastructure is digging and ducking of the fiber line. For FTTH solution, 85% of installation cost is digging and ducking expense where the equipment cost is just 3% (Koonen, 2006). Thus, service providers try to use existing access solutions as much as possible. For green networking, the desired solution is (FTTH/P) where there will be no active element on the access network. For economic considerations, FTTH proliferation is limited. However, the final goal is to provide a fiber connection to each customer premise or home.

2.2.2 Classification by Infrastructure

For implementation of fiber lines, we can classify infrastructure models into three types as Point-to-Point, Active Star, Passive Tree topologies. Some other topologies like ring and bus also can be used in optical access networks but they are not very common. Ring is mostly common in metropolitan networks and bus is common in local area networks.

2.2.2.1 Point-to-Point Architecture

Point-to-point working scheme is the idealist approach in terms of flexibility. All the connections are unshared by end-points like connection between backbone network routers. As shown in Figure 2.2, each subscriber unit is connected to the central office with a separate fiber line. Thus, users are completely isolated to each other and taking a service that is secure and insensitive to other's traffic. Contrary, it requires digging and ducking of separated fiber lines and termination point for each fiber line inside the central office cabinet. These two conditions increase the setup expense of the system drastically. Consequently, the overall cost and the overall income from subscribers cannot be balanced to compete with other approaches and system can be profitable over a couple of years. Besides, the amount of ending points in central office are excessive and it brings stock problems.

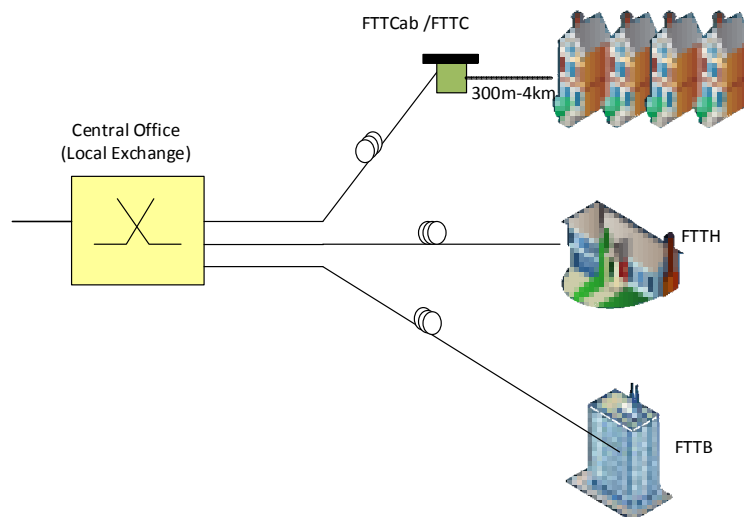

Figure 2.2: Point-to-Point Connected Optical Access Network

2.2.2.2 Active Star Architecture

In Figure 2.3, structure of Active Star Architecture is given. Contrary to point-to-point architecture, the network is connected to central office with a single fiber line. To reach each end point with a fiber, an active (power consuming) node is used between central office and end points. By the usage of active node the number of fiber line and termination points in central office are decreased by and the stock problem is solved. This approach decreases the setup cost of the system. Conversely, the active part of increase the operational cost of the system. On the whole lifetime the active node must be supplied with electricity, secured, and keep safe against natural disasters. Active star architecture is less flexible compared to point-to-point architecture. In active star the users have to share a single fiber after active node, so the bandwidth capacity is less than point-to-point architecture. Since, it is a better alternative in terms of expenses it can be preferred to point-to-point architecture. Networks have active star topology also named and known as Active Optical Networks (AON).

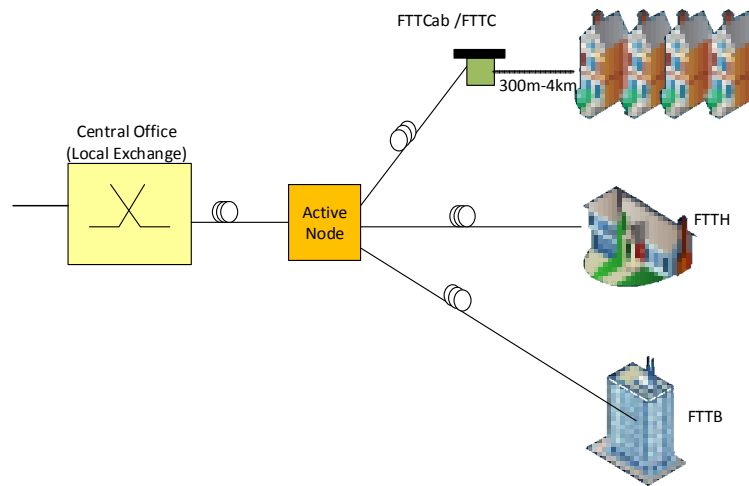

Figure 2.3: Active Star Connected Optical Access Network

2.2.2.3 Passive Tree Architecture

The aim on the development of passive tree connected network is to split up the light inside fiber without any active elements. By the development of passive optical splitters, necessity of active node in star architecture is eliminated. One fiber line starting from the central office is divided and shared with optical splitters among subscribers without any active element on the delivery line. This optical tree architecture is named as Passive Optical Network (PON). In Figure 2.4 a PON architecture is given. PONs have lower operational cost by eliminating the active part of AONs while having all the advantages that AON brings, compared to point-to-point architecture. The transmission on PON occurs purely in optical domain over the fiber and passive splitters. The beam goes through the shared medium and divided to all lines by passive splitters on the transmission from central office to the subscribers. End-point devices convert the beam signal to electronic domain and processed. The device filters the packets, which are destined to it, and forward them to the subscriber. In uplink, the packets are converted to beam signal and forwarded to the central office unit without any interrupt. The disadvantage of PON compared to AON is

just the number of users who can be connected. The reason is the going down of beam signal after passing through each splitter. The signal power must be over an energy level to be converted by the end-point device. This limitation is one of the main topics that researchers are studying on. Despite of this limitation, PON is the best solution regarding the expenses. Thus, PON becomes very popular in fix access solutions.

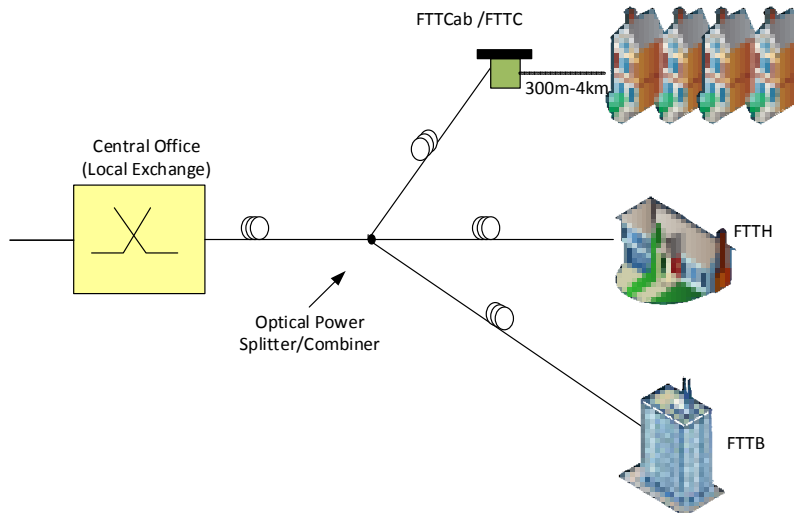

Figure 2.4: Passive Tree Connected Optical Network

2.2.3 Comparison of Optical Access Network Topologies

Point-to-Point architecture seems to be acceptable in case of giving best service opportunity. However the economic aspects are on contrary. Figure 2.5 gives comparison of point-to-point and point-to-multi-point architecture expenses with two different number of customers connected to the system. P2P refers to Point-to-Point connection, P2MP as Point-to-Multi-Point and N_1, N_2 are the customer numbers where $N_2 > N_1$. With less customer connections, P2P networks seems to be suitable but this scenario becomes reversed as the length of line and/or number of customer increases. Total cost of P2P can be lower with less user and for a short range where L_0 is the point the fiber length makes P2P undesirable compared to P2MP solutions. While the purpose of service providers is to access as much as customer and a long range cover, P2MP solutions perform better.

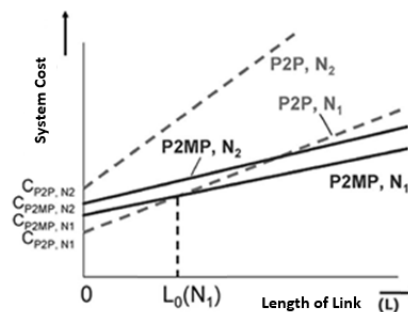

Figure 2.5: Cost Comparison of Optical Access Network Types (Koonen, 2006)

2.3 Multiple Access Methods Used in PONs

In PONs, it is requisite to use a multiple access method to share usage of one common fiber line among ONUs. While OLT is able to send the data as broadcast, ONUs have to be sure that the data packets they are sending not collide with others packets. The multiple access methods which are used for optical access solutions are given below and summarized after.

- Time Division Multiple Access (TDMA)
- Subcarrier Multiple Access (SCMA)
- Wavelength Division Multiple Access (WDMA)
- Optical Code Division Multiple Access (OCDMA)

2.3.1 Time Division Multiple Access (TDMA)

In TDMA systems, packets are scheduled by time slots on the upstream channel as seen in Figure 2.6. This can be achieved by packet transmission synchronization inside each ONU. Synchronization is done by sending grant information from OLT. These grant information tell each ONU the exact time to send packet. For each ONU, the correct time to send packet is calculated by distance discovery protocols according to the distance between OLT and ONU. Burst Mode Transceiver (BMT) is used in OLT to quickly synchronize packets form different ONUs and able to process different amplitude levels caused by the loss on the way. Since ONUs are sharing the common capacity given by OLT, if the number of ONUs increases the bandwidth amount of each ONU decreases.

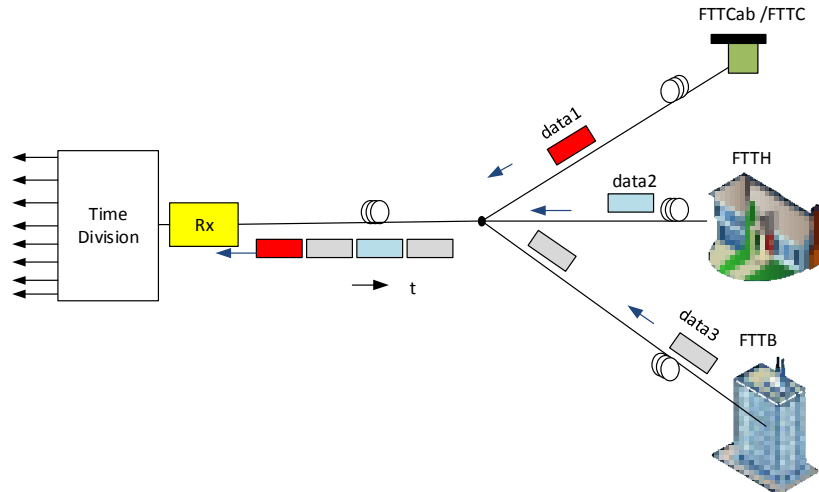

Figure 2.6: Time Division Multiple Access

2.3.2 Subcarrier Multiple Access (SCMA)

In SCMA, each ONU modulates its traffic flow to a different electrical carrier frequency as seen in Figure 2.7. After, these electronic frequencies are modulated to optical power by laser diodes. Thus, the packet flows are put in different frequency bands and forwarded from ONUs to OLT through

independent channels. Therefore, different kinds of signals can be carried over independent channels (i.e. broadband data connection on one channel and analog video streaming on some others). There is no necessity of time synchronization among channels. The wavelength used by each ONU has no impact. However, if the chosen wavelengths are closed to each other, the optical impulse of different frequencies can produce noise to each other. This noise can affect the packet data. Thus to eliminate the noise, the laser wavelengths are chosen with some gaps. This can be achieved by thermal tuning of the emission wavelength.

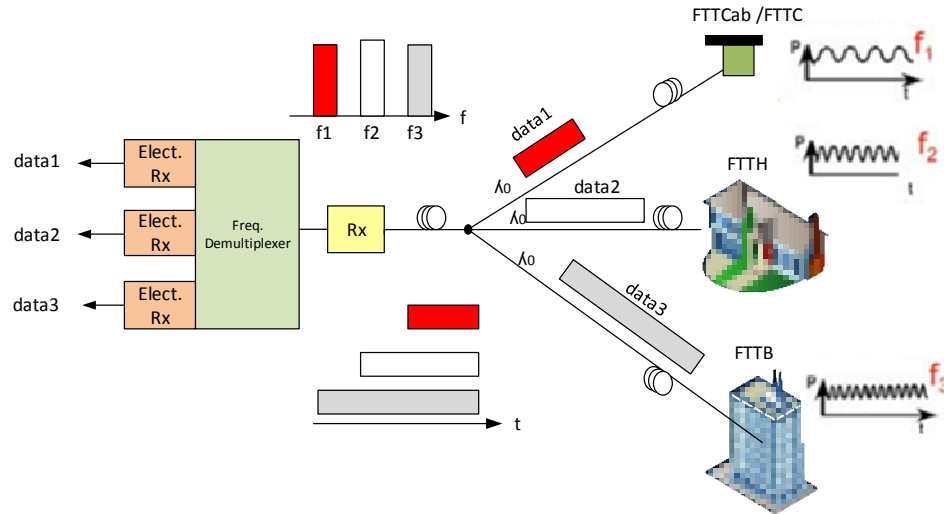

Figure 2.7: Subcarrier Multiple Access

2.3.3 Wavelength Division Multiple Access (WDMA)

WDMA is seen to be a promising solution in optical access networks and this kind of implementation is called as Wavelength Division Multiplexing PON (WDM-PON). A sample WDM-PON is shown in Figure 2.8. In WDMA, each ONU use different wavelengths to send packets to OLT. Wavelengths are separated at the splitting points of PON systems with multiplexers/de-multiplexers. Since each wavelength is isolated from others, different type of traffic can be carried on WDM-PONs. Time synchronization is not necessary either. Same wavelength can be used both in upstream and downstream simultaneously. The isolation at the wavelength de-multiplexer must be capable of not allowing crosstalk. Because of the de-multiplexer at the splitting point of PON, systems that need broadcasting such as cable TV services are prevented to serve.

Each ONU needs a laser diode that is capable of working on a particular wavelength. This necessity makes the system more expensive, difficult to maintain and cause more storage problems. As an alternative method universal colorless ONUs can be used. By so, storage and cost problems can be decreased. Implementation of colorless ONUs can be achieved with different approaches. For example, a light source (i.e. Super luminescent LED) can be used that has used spectral slicing to cut unnecessary large spectrum with multiplexer inside ONU (Frigo, et al., 1998). Another approach is using reflection modulation that reuse the light comes from OLT on a suitable channel

to carry data on upstream channel (Frigo, et al., 1995). Thus, the light source is not necessary in ONUs so the cost can be decreased. In both approaches, going down of the reach distance is the limitation. Optical amplifiers can be used to overcome these problems.

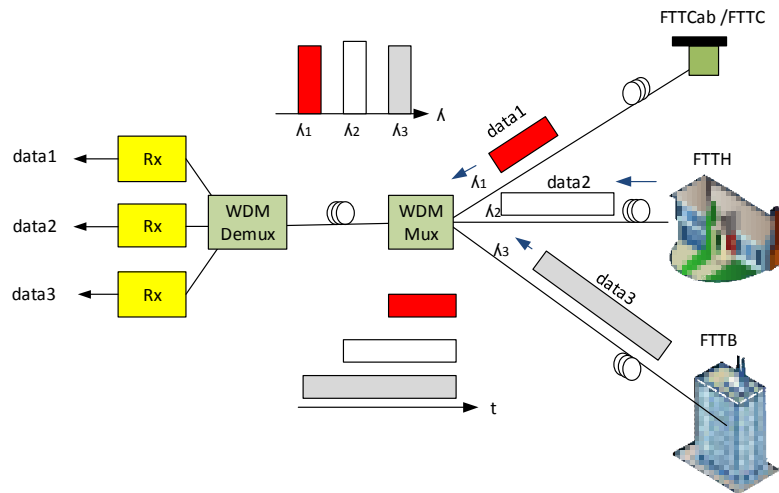

Figure 2.8: Wavelength Division Multiple Access

2.3.4 Optical Code Division Multiple Access (OCDMA)

In OCDMA, each ONU uses an optical code to separate itself from others. It can be categorized in two parts; time sliced code word using OCDMA and spectrum sliced code word using OCDMA. In time sliced OCDMA, each ONU uses a different signature array from short optic impulses and send this signature with data by on-off modulation. The array must be at least one bit length of data. Therefore, a very speedy signature array is needed for a moderate data flow rate. This situation degrade the reach range of system. OLT check the incoming signal with known signature arrays to recognize from which ONU it is coming. If the signature arrays are not orthogonal, crosstalk may occur.

In Spectrum Sliced OCDMA, each ONU takes a different spectrum slice combination from a wide band optical source (like LED) to modulate with data. If the spectral slices are not perfectly orthogonal, crosstalk may occur. A scenario where time and spectral slicing used can increase the number of reached ONUs (Adams, et al., 2005).

2.4 Evolution of Passive Optical Networks

In 1980, when the optic technologies is at the beginning of their evolution and just used in long haul communication systems, PON technology was introduced (Ballance, 1990) (Okada, et al., 1990). In this period, fiber has found lots of place in telecommunication companies' core, backbone and metro networks. In 90s, the increase of bandwidth demand of end-users paves the way for using optical fiber lines to be used as an access network solution. This opened the way for the standardization studies. One of the main events for development of PONs is the foundation of "Full Service Access Network" (FSAN) working group (Faulkner, et al., 1997). At the start of its

study, FSAN group has decided to use PON topology and “Time Division Multiplexing/Multiple Access – TDM/TDMA” in access solutions. In 1996, FSAN consortium decided Asynchronous Transfer Mode (ATM) is the best encapsulation method in multi-service networks. This decision has formed the first PON standard. This standard has accepted and presented by ITU-T as a full recommendation letter under (ITU-T Rec. G.983.1, 2005). This first standard is known as ATM-PON (APON).

Nippon Telegraph and Telephone (NTT) Company used APON to delivery broadband access on whole Japan. At this period, in USA some service providers perform limited experiments or deployments. Besides Verizon and Southwestern Bell Communications (SBC) (now part of AT&T) used APON in business approaches and improvements of cooper telephony systems. In this period APON seems to be expensive compared to novel SONET based platforms.

At the end of 90s, PON ripens as a mature technology to implement. However for the business especially in USA and Europe, PON applications were pushed back for reasons. First reason is that the capital expenditure is still too high for that day, second reason is the necessity of bandwidth supported by fiber lines is much higher than the demand, and third reason is the ambiguity in the industry as governments have not approved the standards. By this moment, cable TV systems are not capable to give three-play services. Thus service providers head towards to xDSL systems. There were a little exceptions like FTTC implementation for new buildings by Bellsouth Company (Effenberger, et al., 2007).

Since APON proved itself as an optimistic solution for access, its users (NTT and Bellsouth) have known that it is inadequate and has to be developed (Ueda, et al., 2001). As a result of that, Broadband PON (BPON) systems developed as an improvement to APON. BPON is developed by the requirement analysis of FSAN and written under ITU-T G.983 standards series. In this standard 622Mbps downlink and 155Mbps or 622Mbps uplink transmission speed. Each central office unit (Optical Line Terminal) has a reach up to 32 users at 20km. BPON also uses TDM mechanism and ATM packaging. Since, BPON seems an upgrade to APON and mostly call with the same name. BPON used by three companies (Bellsouth, SBC, and Verizon) in USA from 2003 to 2007.s

In March 2001, the working group 802.3 in IEEE consortium started 802.3ah “Ethernet in the First Mile” (EFM) project. The main aim is to use Ethernet frames in PON systems. IEEE adopted a technology based approach contrary to FSAN/ITU’s approach. The key idea is a PON system must use Ethernet frames from the connected local network with a small arrangement on packets. By this means EPON turns to the best access network solution to carry best-effort internet traffic. In June 2004, IEEE 802.3ah’s EPON standard is approved. EPON is standardized as capable to serve 16 ONU’s over 10-20km. EPON is commercialized by chance because of NTT’s need to struggle other service providers to give favorable bandwidth. Since, EPON gained much more interest in East Asia region (Shinohara & Manabe, 2006).

Meanwhile the EPON standard was developed, FSAN/ITU (ITU workgroup 15, SG15) were working on a novel PON standard (Next-Generation PON). First studies were on ATM structure, then Ethernet packaging was used. At last, physical layer packaging was adopted (like Generic Framing Procedure in SDH/SONET). This study was standardized under G.984 standard document and named as Gigabit-Capable PON (GPON). For transmission “Generic

Encapsulation Method” or “GPON Encapsulation Mode” (GEM) is used, and bandwidth capacity on downlink has increased 2,5Gbps and capacity on uplink to 1,25Gbps.

In 2007, IEEE 802.3av workgroup was founded to develop 10Gbps EPON (10G-EPON) systems. This work adopts two ideas such as; 10Gbps downlink with 10Gbps uplink capacity and 10Gbps downlink with 1Gbps uplink capacity working systems. They specify that asymmetric infrastructures are sufficient for near future needs. The desired use case is to support 10Gbps up/down symmetric capacity. 802.3av workgroup finalized their studies and published the standard in September 2009 (IEEE Standard For Information Technology 802.3av, 2009). In 10G-EPON wavelengths were selected to allow backward compatibility to allowing coexistence of 1G-EPON and RF Video transmission. Since 802.3av is working on 10G-EPON, FSAN group is working to develop their new standardization named as NG-PON (FSAN Group, 2009).

On the road of NG-PON, in 2010 ITU-T published next version of G-PON named as XG-PON (ITU-T Rec. G.987 series, 2010). XG-PON extends the G-PON standard as 10Gbps downstream and 2.5Gbps upstream capacities. It also allow coexistence with G-PON. XG-PON does not bring to much improvements in terms of split ratio and target distance. For these improvements, the next step is thought to include Wavelength Division Multiplexing (WDM) to go beyond XG-PON. This decision illustrates the NG-PON strategies. FSAN consortium is developing ideas on multiple enhancement systems. While XG-PON is suitable for backward compatibility, NG-PON seems to be unavailable for coexisting of old standards. In NG-PON,

Besides, ITU-T 15 and IEEE 802.3 working groups agreed to exchange the ideas for new PON standard development. This is expected to allow next generation products to work with less conformity problem (Effenberger & El-Bawab, 2009).

Wavelength Division Multiplexing Passive Optical Networks (WDM-PON) is seen to be solution for next generation access and backhaul networks. WDM-PONs have the advantages such as; scalable bandwidth, access to long-haul, ability to give different bandwidth capacity on different wavelength. These benefits make WDM-PON a suitable solution to use mutually for home, business access, and backhaul networks. Thus, WDM-PON is highly discussed in recent researches (Grobe & Elbers, 2009). Since home users do not need more than 1Gbps bandwidth capacity, WDM-PON systems are expensive solutions compared to EPON and GPON systems. Besides, wavelength division limits, obstruct the expansion. By sharing each wavelength among subscribers, the cost can be decreased and much more subscribers can be reached (as 1:500 division rates). These values can be available by using each wavelength by a number of subscribers (e.g. in a Dense-Wavelength Division Multiplexing PON – DWDM-PON 40th wavelength each is separated as 1:8 or 1:16). By keeping the separation ratio lower than EPON-GPON values, the bandwidth given per user can be increased (Grobe & Elbers, 2009).

In Korea, between 2003 and 2006, ETRI and Novera developed wavelength division multiplexing PON systems that have 16 wavelengths and 1.25Gbps up/down link capacity. In 2007, Korea Telecom (KT) used first Burst Mode Transceiver (BMT) and in March 2008 second one was achieved. Since April 2008, KT uses the WDM-PONs developed by ETRI to give broadband access service. Besides, in Korea hybrid solutions such as WDM-TDM-PON and long-reach WDM-PON are under development with government supported projects (Nikitin, et al., 2009).

In 2012, GreenTouch consortium released Bit-Interleaved PON (GreenTouch Consortium, 2012). While it has the same equipment with XG-PON, the running protocol has changed. Bi-PON protocol is constructed on the fact that over 90% of the traffic processed in ONUs are unnecessary.

2.5 PON Standards

In this part some standardizations and their general working schemes are summarized. Generally there are two ongoing standardization branches for PON architecture. One of these branches is carried on by IEEE Ethernet in the First Mile Group (EPON, 10G-EPON) and the other one is carried on by International Telecommunication Union (Telecommunication) Study Group 15 (APON, BPON, GPON, XG-PON, NG-PON).

2.5.1 Ethernet Passive Optical Network (EPON)

EPON is a classical implementation for TDM-PON. It is defined in (IEEE 802.3ah, 2004) standardization document. While developing EPON, Ethernet in the First Mile (EFM) group decided that it is better to use Ethernet framing instead of ATM cells, which is used in APON. Since, most of the carried data is IP based, carrying IP data on ATM cells consumes time and power and brings unnecessary overhead because of the 5byte header for each 48byte data in ATM cells. EPON uses variable-size packets up to 1518 bytes according to the IEEE 802.3 protocol for Ethernet. In standard, an OLT can handle connections up to 64 ONUs.

EPON uses VoIP to carry voice traffic and circuit emulation services (CES) to carry all other types of traffic. CES, as its name implies, allows synchronous circuit traffics over asynchronous packet-based networks. The primary benefits of CES over EPON are low cost and simplicity of deployment to support all types of legacy TDM applications across EPONs. While there is too much network equipment use legacy TDM and ATM based protocols, CES gives the opportunity to carry them over much more cost-effective packet-based networks.

2.5.1.1 *Transmission in EPON*

In EPON, upstream traffic from all ONUs share a fiber line to connect central office equipment (OLT). Thanks to the coupler behavior, traffic from the ONUs just forwarded to OLT. ONUs are unaware of upstream traffic of other ONUs, since other ONUs cannot listen upstream traffic. Conversely, classical collision resolution algorithms (i.e. Carrier Sense Multiple Access with Collision Detection CSMA/CD) cannot be used for multiple access. Because, when one ONU send data on upstream channel other ONUs cannot sense it and cannot predict the collisions at OLT. OLT can notify ONUs about the collisions with a control message. However such approach introduce to much delay to ONU-OLT transmission and that makes a huge derogation on system performance. Another solution may be using wavelength division multiplexing (WDM) to eliminate the collision of traffic form each ONU. This kind of EPON system is known as WDM-EPON. This approach needs tunable transmitter or a transmitter matrix capable to work with multi wavelengths in subscriber side. Tunable transmitter is an expensive solution and transmitter matrix has storage problems. Thus, WDM did not seem to be a promising solution (Zheng & Mouftah, 2009).

Compared to CSMA/CD and WDM approaches, time division multiplexing (TDM) that uses only one wavelength seemed to be a better solution for EPON development. In TDM, each ONU has to use the time slots arranged by OLT to send packets on upstream channel. Each time slot can carry one or more Ethernet packets. ONU collects the subscriber packets till a time slot has arrived. When the schedule comes to ONU it fill all the time slot with buffered client packets. Owing to the working principle of TDM, no collisions occur. Only one wavelength is used in OLT. So it is a favorable solution on the expenditure side (Zheng & Mouftah, 2009).

To make bandwidth allocation for each ONU, OLT needs a bandwidth allocation algorithm that collects bandwidth demands according to an allocation plan or service layer agreement (SLA). It is a challenge to find appropriate solution when and how much an ONU is going to use the upstream channel. This process generally named as bandwidth allocation and can be classified into two groups; static and dynamic. Static bandwidth allocation is simple and easy to implement. Each ONU uses a fix time slot for each cycle. However static allocation is not a good solution for bandwidth utilization for highly arbitrary internet traffic. The bandwidth requirement of an Internet user at time t is more than the request at t_i . In such a case static allocation cannot distribute the excess bandwidth. A smarter way is to allocate the bandwidth dynamically. Generally, the bandwidth allocation is done dynamically “Dynamic Bandwidth Allocation (DBA)”. DBA, gives the ability that OLT can grant different time slots for each ONU. In DBA, polling methods is often used for bandwidth allocation. By the use of polling OLT can dynamically allocate bandwidth to each ONU and can schedule many ONU communication properly. Thus, bandwidth utilization is highly increased and results increase in network performance (Zheng & Mouftah, 2009). Dynamic bandwidth allocation scheme for EPON is summarized in follows.

2.5.1.2 Dynamic Bandwidth Allocation in EPON

For EPON, lots of dynamic bandwidth allocation algorithms presented in recent studies are based on bandwidth utilization and QoS aware bandwidth sharing. When all the specifications are considered, a DBA algorithm cannot be perfect against others. Some algorithms can perform better in terms of QoS and fairness; while some others perform better in bandwidth utilization. Some algorithms can performs better but they may be complex for design and difficult to implement (Skubic, et al., 2009).

Interleaved Polling with Adaptive Cycle Time (IPACT) (Kramer, 2002a), is known as one of the best DBA algorithms in terms of the bandwidth utilization. In IPACT, while ONU_i is sending packets to upstream channel, OLT is sending channel usage information (including the allocated bandwidth and when to start) to other ONUs starting form ONU_{i+1} . ONU_{i+1} can be scheduled before ONU_i finishes sending packet. This time slots are scheduled in a cycle for each ONU. Such that the first bit of upstream traffic from ONU_{i+1} starts just the guard time after ONU_i time slots lasts (Skubic, et al., 2009). DBA algorithms are analyzed in detail in next chapter.

2.5.1.3 Multi Point Control Protocol (MPCP)

In EPON, Multi Point Control Protocol (MPCP) works as Media Access Control (MAC) layer and is responsible of bandwidth allocation control, auto discovery, and distance computation. IEEE 802.3ah [IEEE Std. 802.3ah 2004] defines MPCP for OLT-ONU communication. MPCP contains five control message types. *REGISTER REQ*, *REGISTER*, and *REGISTER ACK* are used in new

ONU registration process. *REPORT* and *GATE* messages are for medium access control. *REPORT* message is used to report the packet tail inside ONU buffers to OLT. OLT arrange the bandwidth amount for each ONU by examining the report messages. Report messages can carry different fullness threshold value instead of full queue length information. *GATE* messages are sent from OLT to ONUs to give them non-overlapped windows.

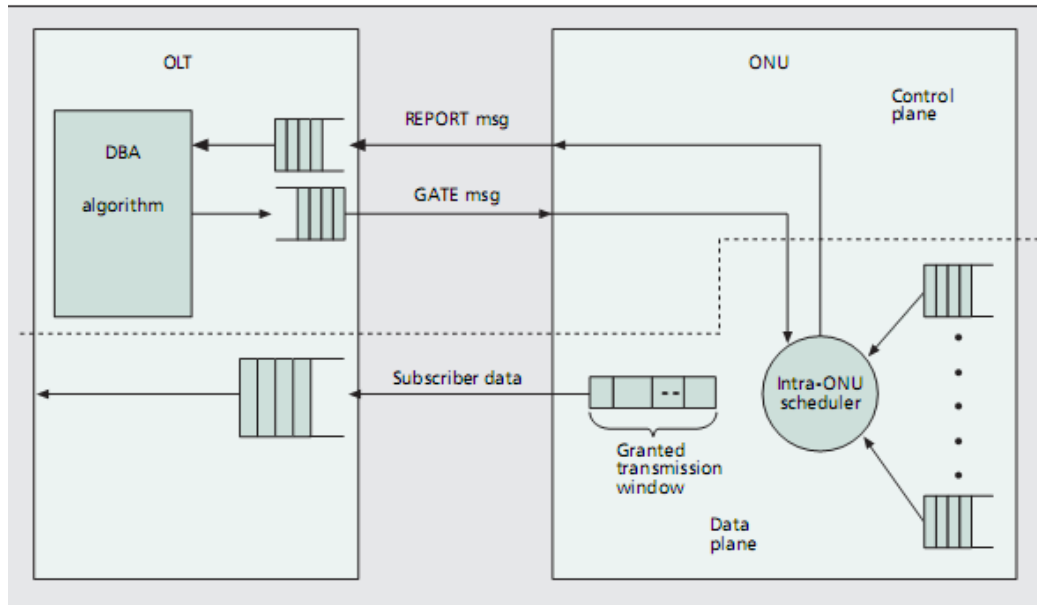

Figure 2.9: Working Scheme of MPCP (Zheng & Mouftah, 2009)

In Figure 2.9 general working scheme of MPCP is shown. *REPORT* messages that carry queue fill amount information are sent to upstream channel, and *GATE* messages that carry granted window size are sent to downstream channel. OLT collects the occupancy of user queues by *REPORT* messages. After that OLT use a Medium Access Control (MAC) algorithm to make a decision for next cycle how much bandwidth will be granted for which ONU. After, this information forwarded to ONUs with *GATE* message.

2.5.2 Ten Gigabit Ethernet Passive Optical Network (10G-EPON)

The IEEE 802.3av Task Force, formed in September 2006, was chartered to improve upon the 1G-EPON by defining a set of new physical layers for 10G-EPON. Today's new high bandwidth consuming applications such as IPTV, HDTV, 3DTV and Online video gaming need 50-100Mbps bandwidth per user which cannot be provided by EPON's 1Gbps capacity. 10G-EPON can provide much more bandwidth for FTTH, FTTB users and can fulfill the 1Gbps link capacity requirement for 4G wireless network access points. 10G-EPON uses most parts of the EPON protocol. For coexistence with EPON, combination of TDM and coarse wavelength division multiplexing (CWDM) is used. In the downstream direction the 1Gbps and 10Gbps channels are separated in wavelength domain. 1Gbps transmission limited to 1480-1500nm band and 10Gbps transmission using 1575-1580nm band. In the upstream direction, the 1Gbps and 10Gbps bands are overlapped. 1Gbps band spreads from 1260nm to 1360nm; 10 Gbps band uses 1260nm to 1280nm band. In 10G-EPON 10Gbps capacity is used in downstream; 1Gbps and 10Gbps capacities are available for upstream direction. For 10Gbps capable links 64B/66B block line code is used for 1Gbps it is same as EPON 6B/8B. 802.3av specification uses a split ratio as 1:16 or

1:32. In practice larger split ratios such as 1:64 or 1:128 when other optical losses are constrained to offset the additional 3dB loss that is incurred when the split ratio is doubled. To carrying traffic 10G-EPON uses VoIP for voice traffic and circuit emulation service (CES) for other TDM client signals as in EPON

Table 2.1: Summary of EPON and 10G-EPON Protocols and Features (Gorshe & Mandin, 2009)

Feature	EPON	10G-EPON
Responsible standards body	IEEE 802.3ah	IEEE 802.3av
Data Rate	1 Gbps	10Gbps down / 1Gbps or 10Gbps up
Split Ratio (ONUs / PON)	1:64	1:64
Line Code	8B/10B	Down: 64B/66B Up: 8B/10B (1Gbps) 64B/66B(10Gbps)
Number of Fibers	1	1
Wavelengths	1490 nm down & 1310 nm up	1577 nm down & 1310 nm up (1 Gbps) or 1270 nm up (10 Gbps)
Maximum OLT to ONU distance	10 and 20 km(1:16 split)	10 km with 1:16 split 20km with 1:16 split 20km with 1:32 split
Optics		
Protection switching	None	None
Data format (encapsulation)	None (uses Ethernet frames directly)	None (uses Ethernet frames directly)
TDM Support	CES	CES
Voice Support	VoIP	VoIP
Multiple QoS levels	Yes (802.1Q priority levels)	Yes (802.1Q priority levels)
FEC	RS(255, 239) - frame oriented	RS(255, 223) – stream oriented
Encryption	Defined by Regional standards	Not in the scope of 802.3av. Defined by regional standards
Operation Admission and Maintenance(OAM)	802.3ah Ethernet OAM frames	802.3ah Ethernet OAM frames

10G-EPON MAC-Layer control protocol is based on the protocol for EPON. It includes some enhancements for management Forward Error Correction (FEC) in 10G and inter-burst overhead. FEC allows a link capable to operate with a higher bit error rates at the receiver. FEC increase the optical link budget as directly related with reach distance and split ratio. When the bit rates increase, FEC becomes more important. For this reason FEC is mandatory for 10G-EPON. FEC in 10G-EPON differs from FEC in EPON in two ways. First, 10G-PON uses a more powerful Reed-Solomon (RS) (255, 223) code for error correction of 16 symbols instead of 8 symbols that can be corrected optionally with RS (255, 239) code specified for EPON. Second, 10G-EPON FEC is applied to fix-length sequence of streaming-data instead of Ethernet frames in EPON. 10G-EPON has the ability to overcome system bottlenecks by adjustments in EPON DBA algorithm. The cycle length and bandwidth allocation per ONU can be adjusted. By these adjustments, the OLT upstream transmission to the switch will be less bursty and will allow carriers to overcome blocking elements in their network topology. The features of EPON and 10G-EPON listed in Table 2.1.

2.5.3 Gigabit Passive Optical Network (GPON)

Development of GPON standard has been carried out by 15th study group of ITU-T. The standardization published under G984 series. GPON also uses TDM mechanism for controlling multiple access to shared medium. One of the key difference of GPON compared to EPON is the framing structure. In GPON, single mode fiber links takes place between central office unit (OLT) and subscriber units (ONUs). The link between OLT to ONUs is divided by passive splitters from factor 2 to 64. A GPON user can be up to 20 km away from central office. GPON standard defines different bit rates as 1244.16 Mbps and 2488.32 Mbps on downstream and 155.52 Mbps, 622.08 Mbps, 1244.12 Mbps, 2488.32 Mbps on upstream. All the combinations of up/down bit rates can be used except 2488.32 Mbps up and 1244.12 Mbps down selection.

GPON uses 1480-1500 nm band on downstream and 1260-1360 nm band on upstream. For RF video transmission 1550-1560 nm band is reserved. GPON uses FEC to increase the link budget approximately 3-4dB. GPON uses Transmission Containers (T-CONT) for managing of upstream bandwidth allocation. ONUs uses one or more T-CONTs to send data in upstream direction. T-CONTs enable QoS support in upstream. There are five types of T-CONT. T-CONT 1st guarantees fixed bandwidth allocation that can be useful for time sensitive applications as VoIP. 2nd for non-time sensitive fix bandwidth allocation, 3rd for mix of minimum guaranteed and non-guaranteed bandwidth, 4th is for best-effort and 5th is a mix of all types.

To determine how much bandwidth to assign an ONU, OLT needs to know the traffic flow of ONUs. OLT reads from T-CONTs the buffer occupy information of ONUs. If no packets are present in ONU, then ONU send an idle cell to OLT. In the downstream, OLT broadcast the data to all ONUs. Each user can access downstream data of others. Thus, GPON standard includes using an encryption method “Advanced Encryption Standard (AES)” for security. For connectivity protection, GPON includes different types of protection scenarios that are left to the implementers. There are two types of protection switching exists. First one is automatic switching triggered by fault detection such as loss of signal, loss of frame, signal derogate and so on. Second one is forced switching activated by administrative events, such as fiber rerouting or fiber replacement etc. (Cale, et al., 2007).

2.5.3.1 Transmission in GPON

GPON supports two encapsulation methods; ATM and GEM (GPON Encapsulation Method). Inside GEM all types of traffic can be carried. GEM provides connection-oriented communication. It is based on slightly modified version of ITU-T Recommendation G7041 “Generic framing procedure (specification for sending IP packets over SDH networks) (Cale, et al., 2007).

GPON uses TDM for downstream. The time slots is 125 μ s long for all the data rates and consists of physical control block downstream (PCBd) ATM partition and GEM partition. Even there is no packet waiting for an ONU, the downstream frame is sent for time synchronization.

GPON uses TDMA for upstream. ONUs have variable-length time slots which are controlled by OLT for time synchronization. Each upstream frame has multiple bursts. The upstream burst from an ONU consists of as a minimum PLOu (Physical Layer Overhead). That is followed by PLOAMu (Physical Layer Operations, Administration and Management upstream), PLSu (Power Leveling Sequence upstream), DBRu (Dynamic Bandwidth Report upstream) and payload.

2.5.4 Next Generation PON (XG-PON1, NGPON2)

After releasing GPON recommendations, FSAN group and ITU-T go on working to develop the successor of GPON standard as NG-PONs. There are lots of ideas discussed for novel PON standardization. Using WDM to increase bandwidth and split ratio is seen to be the future solution but it is not cost effective for short-term evolution. Besides, service providers looking for a cost effective mid-term solutions while giving more bandwidth, they want to use the same infrastructure. Thus, NG-PON studies divided into two sections as NG-PON1 and NG-PON2. NG-PON1 is a mid-term upgrade which is compatible with legacy GPON ODNs. NG-PON2 is a long-term solution in PONs and that can be deployed over new networks independent from GPON.

NG-PON1 must meet the bandwidth needs for novel services for a long time period and it is clear that downstream traffic will be in excess of upstream. Thus, NG-PON1 uses an asymmetric rate as 10Gbps for downstream and 2.5Gbps for upstream. The studies under NG-PON1 are concluded and named as XG-PON. XG-PON standard is released as a first step of NG-PON studies under (ITU-T G.987 Series, 2010).

XG-PON, as an enhancement, inherits framing and management from GPON. For co-existence, XG-PON uses WDM in downstream and WDMA in upstream to share the same infrastructure with existing GPON implementations. FSAN and ITU-T have proposed two evaluation scenarios to Greenfield and Brownfield. Greenfield implementations have no fiber infrastructure so novel system can directly implemented with new XG-PON devices. In Brownfield, operators can implement XG-PON with co-existing GPON ONUs and upgrade them one-by-one according to the bandwidth demands or directly exchange all system to XG-PON. For a successful upgrade where co-existence of GPON and XG-PON takes place, OLT and all ONUs must support (ITU-T Rec. G.984.5, 2007) Amd. 1 compliant wavelength plans. For XG-PON, FSAN selects 1575 – 1581 nm band for downstream and 1260-1280 nm band for upstream. Split ratio increase to 1:64 as normal and scalable to 1:128 or 1:256. Maximum physical reach is 20km and maximum logical reach is 60km.

In GPON development, power saving is not defined and left for future considerations. ITU-T published (ITU-T, G.Sup45, 2009) on saving powers with multiple modes at the chip level. XG-PON supports doze mode and cyclic sleep mode specification in (ITU-T, G.Sup45, 2009). It is also up to vendors to apply any other power saving techniques.

NG-PON2 is going to be a long-term evolution for PONs. The requirements analysis for NG-PON2 is released in (ITU-T Rec. G.989.1, 2013). TWDM-PON (Time and Wavelength Division Multiplexing Passive Optical Network), is accepted to be the base of NG-PON2. TWDM-PON is a multi-wavelength PON solution where each wavelength shared with time division to multiple ONUs. For downstream and upstream 4-8 TWDM channels must be supported with “pay as you grow” capability in the OLT. Each channel has nominal bit rates as “10Gbps downstream, 10Gbps upstream” or “10Gbps downstream, 2.5Gbps upstream” or “2.5Gbps downstream, 2.5Gbps upstream”. 1:256 split ratio can be supported. NG-PON2 also decided to give full legacy support for GPON, XG-PON, EPON and 10G-EPON for a full migration from the implemented infrastructures.

3 Analysis of Dynamic Bandwidth Allocation Algorithms on EPON

Bandwidth Allocation is one of the key aspects of speed (success) for network protocols. Even a network equipment is eligible to operate by the speed of light, there are two main factors that have drastic impact on capacity; the transmitter/receiver switching speed and bandwidth utilization. Generally, transmitter/receiver switching capacity is fixed for a network device from fabrication and can be increased with new physical equipment inventions. On the other side, bandwidth utilization is related to the underlying medium access algorithm and other internal or external parameters. The implemented medium access algorithm has a crucial effect on utilization. In shared mediums, such as radio channels or bus topology at fix networks, the shared medium must be sensed and/or planned to be ready for use. In EPON, the shared fiber line connected to OLT must be planed before usage for each direction. In EPON and generally in all kind of PON, OLT is responsible for bandwidth planning for both upstream and downstream. For downstream, it is easy to plan and share the line between subscribers since OLT stores the incoming packets for each ONU and is able to schedule the size of sending window according to the packet queues for each ONU and SLA (Service Level Agreement). For upstream direction, each ONU must sense the line to be idle before using. However, the structural design of PON obstruct ONUs to sense each other's upstream traffic. So, it is not possible to use a carrier sense multiple access methodology like the ones used in Wi-Fi or Ethernet networks. A better decision is using a centralized control mechanism for bandwidth assignment for each ONU in EPON system. This bandwidth allocation issue is one of the main research topics in EPON studies. Multi Point Control Protocol (MPCP) which is handled in OLT MAC layer is responsible of upstream bandwidth sharing among ONUs. MPCP perform this by sending two control messages between OLT and ONUs. The first one is GATE message and it is used to inform an ONU about the idle time and its window size (time to use uplink). OLT sends GATE messages to each ONU successively according to the window size for each ONU and the propagation delay (link range). The window size of the ONU is calculated according to its demand. The demand of ONUs are collected with REPORT messages which are sent from ONUs to OLT at the beginning or end of the upstream windows. The bandwidth necessity of the ONU is calculated according to the local buffer occupancy and current sending window. The simplest way to arrange bandwidth allocation is to give a static window size for each

ONU and schedule them successively. However this approach behaves very improper if only some ONUs are highly active and others are not. Highly active ONUs has to wait for cycles to clean up packets in their output queues. Thus arranging bandwidth allocation dynamically is better for maximizing the utilization.

In this chapter, Dynamic Bandwidth Allocation (DBA) algorithms for EPON upstream channel are examined and a novel bandwidth allocation algorithm is presented.

3.1 Dynamic Bandwidth Allocation Algorithms

There are many studies about dynamic bandwidth allocation which are summarized in (Zheng & Mouftah, 2009) and (McGarry, et al., 2008). For bandwidth allocation, there are some sort of parameters that must be considered to implement a cost-effective solution and support high quality-of-experience for subscribers, as delay, bandwidth utilization, QoS classification, delay variation, energy consumption etc. Therefore, researchers are focused on to find better bandwidth allocation algorithms that can perform better in sort of these parameters. For EPON standard, the bandwidth allocation control methods are defined (MPCP), but the way the algorithm behaves is left open for the implementers. Thus, it is open to academia and industry to find better solutions.

Even though there are considerably satisfactory solutions presented in recent researches, novel methods are going to be developed. Since, we cannot say there is a perfect method for bandwidth allocation which can handle every parameter ideally. Some can be better in terms of bandwidth utilization, while some others can be in access delay, and some can be in complexity. For recent years global warming gains much more attention. Researchers try to find better algorithms for lower power consumption. That brings a new aspect as “Energy Efficiency” for developing algorithms for electronic devices. For DBA algorithms, complexity is a key parameter for energy efficiency and hardware costs. Also, turning of idle devices in some periods or sleep paradigms, which is discussed in next chapter, used for energy efficiency.

3.2 Online DBA

There are many dynamic bandwidth allocation methods for EPONs. The first method is Interleaved Polling with Adaptive Cycle Time (IPACT) (Kramer, et al., 2002b). Five different modes are defined in this method. The best method among them is the applied maximum window approach. In IPACT, OLT sends GATE message to ONUs respectively before receiving a reply from all ONUs. This provides maximum usage in upstream channel for OLT. However, if one of the ONUs have a long packet tail in its queue, the upstream channel may be busy for a long time. In this case, other ONUs need bandwidth and they are treated unfairly. Therefore, maximum bandwidth to be used in a cycle for an ONU has been considered as maximum window size.

IPACT-like algorithms are named as online DBA methods. Since they have no stops or preventions during they operate, they are called online. In online mode, next ONU is always served regularly and while needed, the link is never left empty with these kind of methods. Figure 3.1 shows a sample of packet flow graph for online DBA method. ONUs forward their packets in order during the frame assigned to them according to the ordered grant information from OLT.

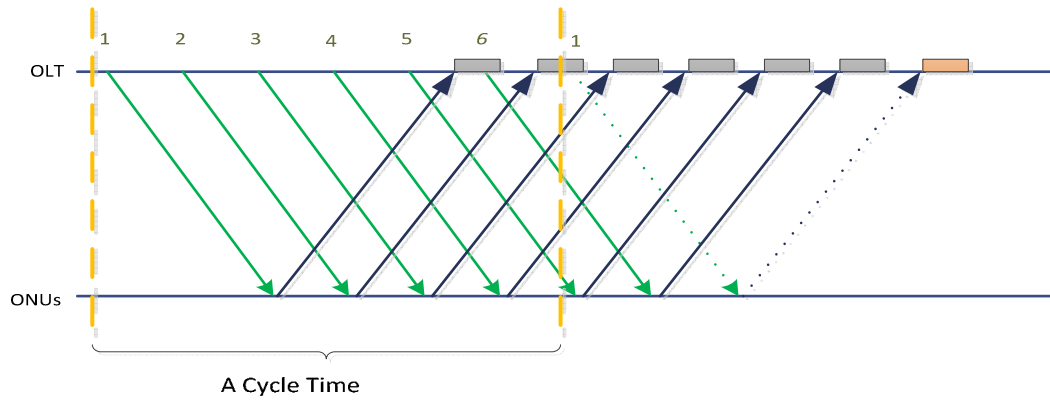

Figure 3.1: Bandwidth allocation for upstream channel in Online DBA Algorithm

When internet usages of the subscribers differ from each other, some ONUs can handle most of the traffic while some others are in idle position. In that case, bandwidth should dynamically passed to highly loaded ONUs with dynamic bandwidth allocation algorithms. The problem in IPACT (and so online DBA) algorithms is that they are incapable of sharing the free capacity in a cycle between high loaded ONUs. We can increase the maximum window sizes to let highly loaded ONUs to use much more of the bandwidth in one cycle. However, if the maximum window size is increased, the packets from other ONUs to be sent in the next cycle will wait longer in local buffers of ONUs. That brings unfairness among ONUs as one ONU can dominate the bandwidth usage. On the other side, if the maximum window size is decreased, more GATE and REPORT messages will be sent and extra overload will occur in the system.

3.3 Offline DBA

To distribute the bandwidth fairly among highly loaded ONUs, a different approach has been proposed. This approach is known as "Interleaved Polling with Stop" (also as offline DBA and will be referred as oDBA from now on). In oDBA method, OLT waits for all report messages from ONUs in a cycle. Then, OLT sends GATE messages to each ONU for the next cycle allocation. With this method, OLT obtains all bandwidth demands from ONUs before starting to serve. Thus, OLT can share the exceed bandwidth in a cycle fairly among high loaded ONUs. However, oDBA creates empty time periods in upstream channel. This time periods are equal to the sum of calculation time and Round Trip Time (RTT) between OLT and ONUs. (In our study same RTT values are assumed for all ONUs for simplicity).

$$T_{idle} = RTT + Computation Time \quad (3.1)$$

Figure 3.2 shows the general work flow of offline DBA methods. After OLT serves ONUs respectively, it cannot send service information (GATE) during time T_c to process all replies. Upstream channel will be able to use again after firstly served ONU's reply to OLT is received.

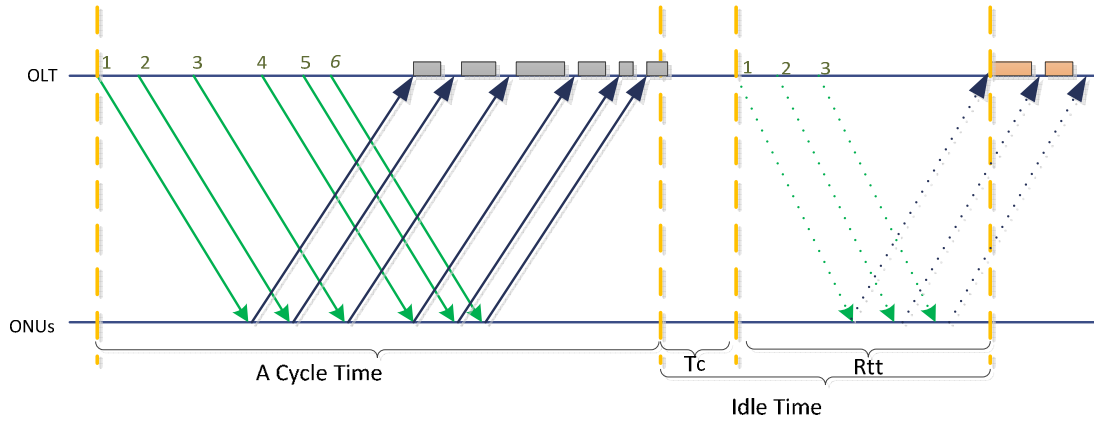

Figure 3.2: Bandwidth allocation for upstream channel in Offline DBA Algorithm

oDBA algorithm collects all bandwidth demands in a cycle. There may be low and high loaded ONUs in a cycle. Excess Bandwidth Distribution (EBD) mechanism distributes the exceed bandwidth of low loaded ONUs to high loaded ONUs. The minimum bandwidth value (in Bytes/s) that will be allocated for an ONU, among N ONUs, by EBD is shown in Equation 3.2.

$$B_i^{MIN} = \frac{(T_{cycle} - N \times T_g)}{8 \times N} \times R \quad (3.2)$$

While T_{cycle} shows the cycle time, T_g shows the guard time, bandwidth (B_i^g) that will be allocated to ONU_i is calculated as follows:

$$B_i^g = \begin{cases} R_i & \text{if } R_i < B_i^{MIN} \\ B_i^{MIN} & \text{if } R_i \geq B_i^{MIN} \end{cases} \quad (3.3)$$

While R_i shows the bandwidth demand of ONU_i , the fair allocation of excess bandwidth in a cycle between high loaded ONUs is done according to following Equations 3.4 and 3.5, B_i^{excess} indicates the excess bandwidth allocated to ONU_i and K is the number of high loaded ONUs.

$$B_i^{excess} = \frac{B_{total}^{excess} \times R_i}{\sum_{k \in K} R_k} \quad (3.4)$$

$$B_i^g = B_i^{MIN} + B_i^{excess} \quad (3.5)$$

There are some previous studies that aimed to use the free time period. In (Assi, et al., 2003), an algorithm has been proposed in order to use the free time period by scheduling them to low loaded ONUs before receiving the report messages from all ONUs. By this way, there is no need to calculate the excess bandwidth distribution of low loaded ONU. These ONU can be directly

scheduled to free time period and the excess bandwidth of them can be collected for high loaded ONUs to be distributed. The advantage of this approach is to increase the processing capacity on low loads. However, if all ONUs are high loaded, free time period will be again wasted. In (Zheng & Mouftah, 2005), an extended version of the same algorithm has been presented. According to this version, if there are no low loaded ONUs in a cycle, one of the high loaded ONUs use the free time period. Also, another method to use the free time period in high loaded cases is proposed in (Nguyen, et al., 2009) in which does not offer an early reservation method as in the former two methods. On the contrary, OLT makes extra bandwidth allocation to let them use free time period according to bandwidth demands.

All approaches that mentioned above are proposed in order to solve the idle time period problem in offline DBA algorithm. Since these algorithms change the service order, they cause packet delay variation (PDV). The proposals in (Nguyen, et al., 2009) and (Zheng, 2006) need to use extra GATE and REPORT messaging and thus this causes extra traffic on downstream and upstream.

Queue size prediction approach is another method for decreasing the access delay of packets in buffers of ONUs. By this method, an ONU predicts the number of packets in its buffer for next cycle, accordingly declare its bandwidth demand in advance and prevent the waiting time of arriving packets for the next cycle (Byun, et al., 2003) (Luo & Ansari, 2005b). Unfortunately, due to the irregular nature of local network traffic, if early prediction method fails, the allocated unneeded bandwidth cause the packet of other ONUs to be delayed more and accordingly to increase the total delay in the system.

The study in (Mcgarry, et al., 2004) summarizes the DBA algorithms on EPON in detail. The algorithms can be classified into two categories according to the bandwidth allocation: Online DBA (Interleaved Polling with Adaptive Cycle Time approaches) and offline DBA (Interleaved Polling with Stop). Since online DBA algorithms can use the entire bandwidth without leaving free time periods, they perform good results in terms of bandwidth usage. However, under an unbalanced traffic, gated Online DBA method does not distribute the bandwidth fairly among ONUs. A high loaded ONU can monopolize the upstream channel that can cause unfair waiting times for low loaded ONUs. Limited approach in (Kramer, 2002a) aims to solve this monopolization problem by using maximum window size limit. Maximum window size limits the maximum bandwidth that can be granted to an ONU in a cycle. In this case, the excess bandwidth demand of high loaded ONUs should wait for the next cycle. On the other hand, fair allocation among high loaded ONUs is provided with offline DBA approaches. However, this method brings free period problem that reduces the total bandwidth usage. To solve the free period problem, several studies have been done which both increase bandwidth usage on the upstream channel and also have some disadvantages mentioned above.

3.4 Half Cycling DBA

Our novel DBA algorithm has been inspired from the fact that there has not been proposed any intermediate solution between online and offline DBA algorithms. This algorithm aims to provide an intermediate solution between online and offline DBA algorithms while inheriting the advantages of both of them. Also, it aims to distribute the bandwidth fairly and maximizes the bandwidth utilization. Thus, a grant size approach in which a dynamic switching between online

and offline modes has been proposed. In offline mode, instead of calculating at the end of full cycle, calculation in half cycle approach is adopted. By this way, the idle time period problem, which occurs during calculations of sending GATE messages by OLT, is overcome. This proposed algorithm is called as “Half Cycling Dynamic Bandwidth Allocation Algorithm” and the abbreviation “hcDBA” will be used from now on.

hcDBA algorithm operates in two modes depending on the load on upstream channel. In low loads, like IPACT, the algorithm switches to offline DBA mode and in high loads it switches to online DBA mode. Operating mode is executed automatically according to bandwidth demands for upstream channel.

In online DBA method, if OLT knows the bandwidth demands before the free time period starting at time plus RTT ($t+RTT$), it can send GATE messages on upstream channel without causing free time periods. In hcDBA method, if OLT received REPORT messages from more than half of the ONUs, it can allocate the bandwidth for the half of the ONUs without receiving all REPORT messages. If OLT did not received REPORT messages from half of the ONUs, OLT send the GATE message for the next ONU in schedule order. In this case, OLT acts like on online DBA mode and this continues until the receipt of REPORT messages exceed half of the ONU count. After half of the ONUs send their REPORT messages, OLT switches to offline DBA mode and allocated the bandwidth during half cycles. OLT switches to online DBA mode whether it cannot collect the sufficient number of REPORT messages. Too short time slots of ONUs show the low loaded nature of upstream channel. Thus, fair bandwidth allocation should not be considered on low loads since one cycle time will be lower than the desired cycle time limit on low loads. Due to this, maximum window size limit may be chosen a larger value than the one in IPACT (limited). If the cycle time becomes longer, algorithm switches to offline DBA mode and performs the bandwidth allocation fairly. By the switching paradigm of hcDBA, under a low loaded system high loaded ONUs have ability to use much more bandwidth while eliminating the dominating problem of high loaded ONU in IPACT.

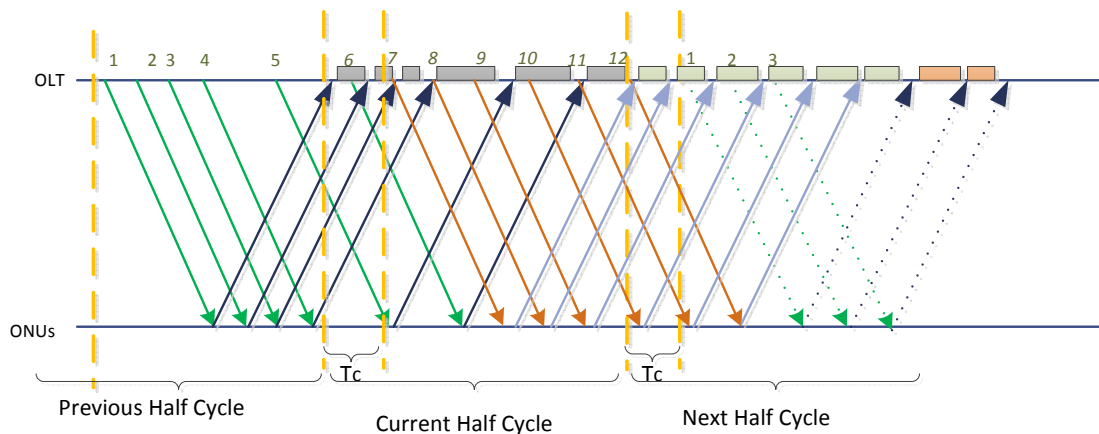

Figure 3.3: Bandwidth allocation for upstream channel in offline part of hcDBA Algorithm

The offline part of hcDBA algorithm on a system with 12 ONUs is shown in Figure 3.3. Here, each half cycle time is equal to service time that can serve half of the total active ONUs. As well as being changeable, sum of two subsequent half cycles cannot exceed the maximum cycle time. As seen in the figure, at the end of each half cycle, the system does not remain free during sum of

calculation time and next RTT. While a number of ONUs are granted in a half cycle, normal scheduling process can continue for other ONUs. Due to alternately subsequent half cycles, a scheduling without any free waiting time is provided.

hcDBA does not require any changes on MPCP messaging method on EPON standard and any configuration at ONU side. hcDBA method only changes the queuing mechanism of OLT. The algorithm can be explained in two main parts: principles of expire function of GATE scheduler and excess bandwidth distribution (EBD) method. GATE scheduler is the unit which is responsible for generating GATE messages at the OLT. It calculates the parameters for GATE messages whenever the GATE scheduler expires. The work flow of GATE Timer is given in Figure 3.4 and explained step by step below.

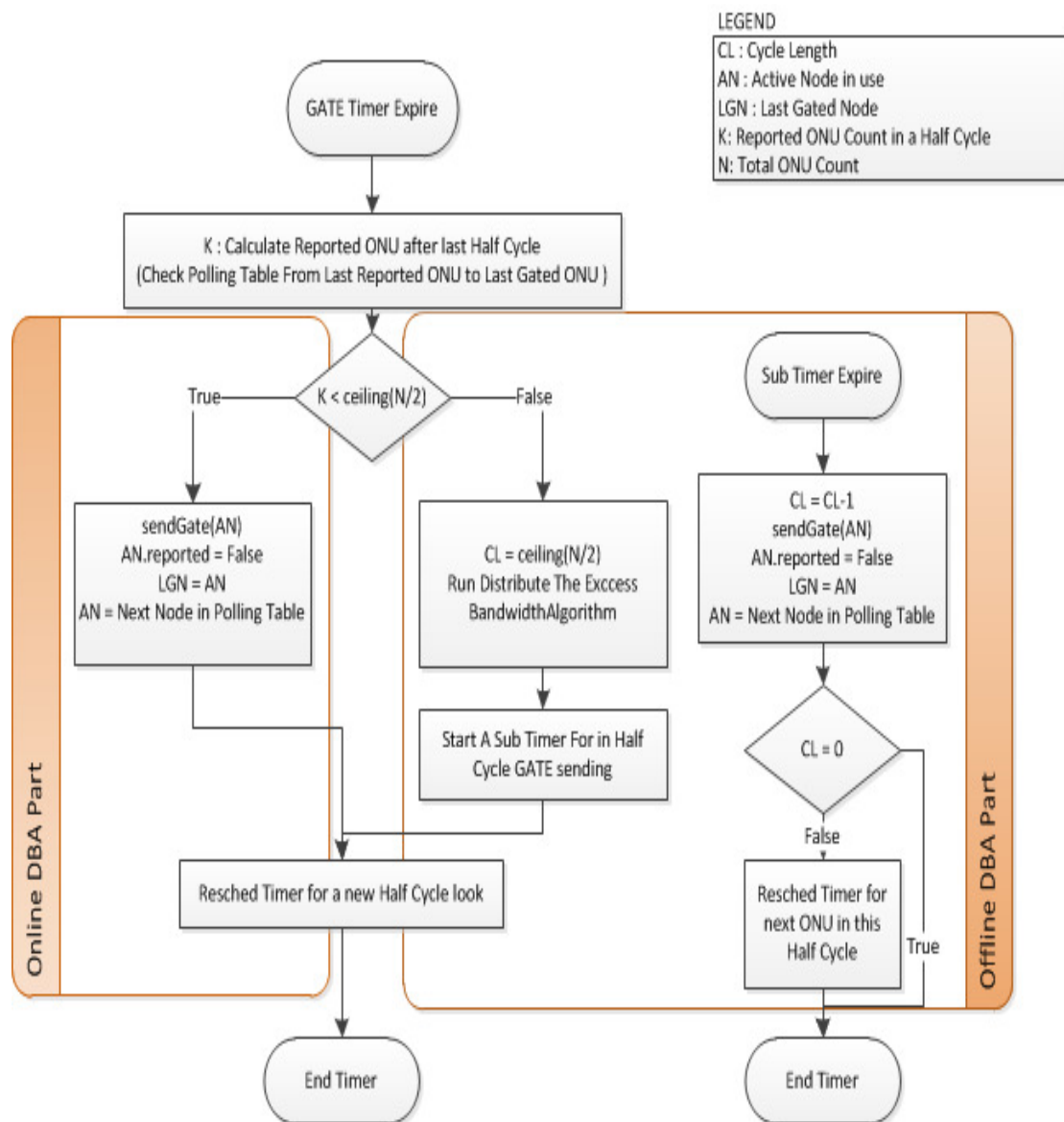

Figure 3.4: GATE Timer work flow in OLT

- N is the number of ONUs in PON structure. First, GATE Timer checks the polling table and calculates the number of reported ONUs (K). K value is calculated based on reported value on the polling table. If K is greater than half of the ONUs, then timer switches to

offline DBA mode and performs the EBD algorithm for next ONUs. Otherwise, hcDBA algorithm runs in online mode like IPACT.

- In offline DBA mode, timer should arrange the half cycle parameters and should schedule the next expire time to about free time length before from free time starting point. **CL** (Cycle Length) keeps the number of ONUs in current half cycle. **CL** is set to $N/2$ at the begging of offline DBA mode and then EBD algorithm (will be explained later) is performed. A sub timer to send GATE messages to ONUs during half cycle is triggered and main timer is scheduled to T_{idle} time before the end of half cycle.
- **CL** is decreased at each trigger of sub timer, GATE message is sent for the next ONU in the polling table and report received information is omitted for this ONU in the polling records. This information is marked again whenever the REPORT message from the ONU is received again. **LGN** (Last Gated ONU) is set to Active Node (**AN**) value in the polling table. **AN** value is set to next ONU in the polling table. Then, **CL** value is checked. If **CL** is zero it shows the half cycle is over and then the sub timer expires. Otherwise, sub timer is rescheduled in order to send GATE message to next ONU in the half cycle.
- In online DBA mode, GATE message is sent to next ONU on the polling table and reported information is left unchecked. **LGN** value is updated and timer is rescheduled to control whether a new half cycle occurs. At this point, if the allocated time will be shorter than the calculation time, then the timer is scheduled to perform immediately for the next step.

hcDBA algorithm needs requested and given bandwidth values in the previous cycle in addition to information in offline DBA algorithms. The last gated ONU and last reported ONU information is also should be followed instantaneously in hcDBA algorithm. The order of gated ONUs does not change in hcDBA and thereby last gated ONU and last reported ONU can be followed easily from the polling table. Online DBA part acts like IPACT's limited window approach and window limit can be chosen larger than in IPACT because the upstream channel tends to be low loaded in online mode. Since larger window size can be given for the next ONU to be gated. While the channel is low loaded, larger window size for an ONU will not cause any unfairness among other ONUs because other ONUs will also be able to use their requested bandwidth in the related cycle. But, if the number of high loaded ONUs arises too much, then distributing large bandwidth values to ONUs may cause unfairness. In this case, OLT should switch to offline mode and distribute the excess bandwidth to high loaded ONUs fairly.

The algorithm switches between online and offline modes by considering the total number of reported ONUs between time of last gated (GATE message sent) ONU and expire time of GATE timer. This parameter is related to cycle time, requested window sizes by ONUs and RTT values. If the requested window sizes of half of the ONUs are very few, these can be even served during a period below RTT value. Therefore, when the GATE Timer expires, if the gated window size is not greater than RTT value, OLT cannot collect enough REPORT messages for half cycle calculation.

EBD in offline mode is the most important part of our hcDBA algorithm. hcDBA employs a similar approach to EBD in offline DBA algorithms. Unlike them, in hcDBA, OLT implements the EBD procedure for reported (**K**) ONUs, not for whole list. For ($N-K$) nodes, OLT still does not have the bandwidth demands. If OLT distributes the excess bandwidth throughout **K** reported

ONUs, bandwidth distribution decision may be wrong and thus may cause unfair distribution of bandwidth to ONUs in a full cycle. In this case, differences may occur between two different ONU groups which are granted in two different half cycles. Therefore, excess bandwidth distribution in hcDBA is performed for $N/2$ nodes, algorithm makes the decisions not only using K reports (always using $K \geq \lceil N/2 \rceil$). Besides, demanded and served values for $(N-K)$ nodes (nodes whose REPORT messages have not been received) from previous cycle are examined. If the requested bandwidth in previous cycle is larger than excess bandwidth, then more bandwidth can be used in this half cycle. Otherwise, excess bandwidth distribution is done while considering the status of the current half cycle in order to be fair in the next half cycle.

In EBD algorithm, ONUs are classified into two categories: reported and unreported. Algorithm needs all ONUs information to distribute the bandwidth fairly. For unreported ONUs, the information on previous cycle is taken into account. Excess bandwidth distribution algorithm and its principles are given in detail by the following equations. Minimum bandwidth calculation is done similar to oDBA as in Equation 3.6.

$$B_i^{MIN} = \frac{(T_{cycle} - N \times T_g)}{8 \times N} \times R \quad (3.6)$$

The calculation of excess bandwidth is somehow different from oDBA approach. Excess bandwidth distribution in a half cycle is not performed by considering only the ONU demands in current half cycle. OLT should take into account the bandwidth demand of ONUs in previous cycle to fairly distribute the excess bandwidth to all ONUs in PON system. Since all excess bandwidth cannot be used in a half cycle, B^{USABLE} value is calculated with regard to B^{EXCESS} . B^{EXCESS} is calculated as the sum of excess bandwidth of K reported ONUs and excess bandwidth of $(O:N-K)$ unreported ONUs from previous cycle. Excess bandwidth for K ONUs and O ONUs are calculated separately as follows:

$$B^{EXCESS} = B_K^{EXCESS} + B_O^{EXCESS} \quad (3.7)$$

$$B_k^{EXCESS} = \sum_{i=1}^K [B_i^{MIN} - B_i^{REQ}] \quad (B_i^{MIN} > B_i^{REQ}) \quad (3.8)$$

Unused bandwidth for K ONUs is calculated by Equation 3.8.

$$B_o^{EXCESS} = \sum_{j=K+1}^N [B_j^{MIN} - B_j^{REQ}] \quad (B_j^{MIN} > B_j^{REQ}) \quad (3.9)$$

Unused bandwidth for O ONUs is calculated by Equation 3.9.

B_K^{USABLE} indicates the total maximum excess bandwidth of K ONUs. Bandwidth allocation in a half cycle is only done for $\lceil N/2 \rceil$ ONUs. In a half cycle, without considering excess bandwidth distribution for K ONUs, only distribution for $\lceil N/2 \rceil$ is taken into account. B_K^{USABLE} is calculated as follow:

$$B_K^{USABLE} = \begin{cases} B_K^{EXCESS} + B_L^{UNUSED} & \text{if } \frac{R_K^H}{R_K^H + R_O^H} \times B^{EXCESS} \geq B_K^{EXCESS} \\ \frac{R_K^H}{R_K^H + R_O^H} \times B^{EXCESS} + B_L^{UNUSED} & \text{if } \frac{R_K^H}{R_K^H + R_O^H} \times B^{EXCESS} < B_K^{EXCESS} \end{cases} \quad (3.10)$$

B_L^{UNUSED} is the unused excess bandwidth with regard to demanded extra bandwidth and excess bandwidth values previously. (This calculation should be performed every time by controlling the polling table, since dynamic switching between online and offline DBA modes occur. Some ONUs may have served on online DBA mode between previous half cycle and current half cycle. If the bandwidth need exceeds the excess bandwidth, it will be assumed as zero.) R_K^H represents the total bandwidth of high loaded ONUs among K ONUs and R_O^H represent total bandwidth demand of high loaded ONUs among O ONUs in previous cycle. If excess bandwidth for K nodes is smaller than its portion in total excess bandwidth for K nodes (this shows the high loaded ONUs in the current half cycle), algorithm marks all excess bandwidth usable for K ONUs. If it results in other way, it means that ONUs in the previous half cycle is highly loaded. In this case, while the algorithm allocates the excess bandwidth to current half cycle, it considers all needs of ONUs in the PON system. Besides, if there is any unused excess bandwidth for $N/2$ ONUs in previous half cycle, this unused amount is added to total excess bandwidth. In consequence of all these calculations, hcDBA algorithm tries to guarantee a fair distribution among subsequent half cycles.

Bandwidth allocation for each half cycle is calculated as follows after B_K^{USABLE} is calculated.

$$B_i^g = \begin{cases} R_i & \text{if } R_i \leq B_i^{MIN} \\ R_i & \text{if } R_i > B_i^{MIN} \wedge B_K^{USABLE} \geq (R_K^H - B_i^{MIN} \times K) \\ B_i^{MIN} + \frac{R_i}{R_K^H} \times B_K^{USABLE} & \text{if } R_i > B_i^{MIN} \wedge B_K^{USABLE} < (R_K^H - B_i^{MIN} \times K) \end{cases} \quad (3.11)$$

3.5 Prediction Enhancement for hcDBA

This section introduces an enhancement to hcDBA algorithm by early prediction mechanism. hcDBA algorithm completely runs on OLT and does not require any modifications on processing and packet sending procedures of ONUs. This new algorithm is named as p-hcDBA due to its "prediction (p)" property (Turna, et al., 2011b) (Turna, et al., 2012). Early prediction mechanism is also designed without modification on the current architecture and process of ONUs. Thus, update cost of ONUs and performance problems due to differences between old and updated ONU in the system, will be prevented. On the other hand, an algorithmic update for an OLT can be done by a firmware update easily.

Early prediction mechanism for hcDBA algorithm is an extension for just online mode. As it is known, traffic of ONUs is relatively low and the system is not overloaded in online mode. So if it is needed, extra bandwidth can be granted to next ONU without treating unfairly among ONUs.

Table 3.1 is a list of parameters used in p-hcDBA approach. The calculated early prediction amount is added to its demanded bandwidth amount and sent to the ONU by GATE messages to inform

its next grant size. If demanded total bandwidth with early prediction exceeds the B_{max} , only B_{max} size will be granted for this ONU.

Table 3.1: Parameter Definitions for p-hcDBA Algorithm

Parameter	Definition
G	Grant Size – granted window size to ONUs with GATE messages from OLT.
R	Request Size – requested window size of ONUs by report messages.
P	Prediction Size – extra prediction size that will be added to demanded amounts
B_{max}	Maximum window size – maximum bandwidth amount for an ONU in a cycle (15 KB for 1Gbps)
H	Average value for last 10(j) windows size granted to ONUs
α	prediction weight ratio for history (set to 0.5)
k	Weight coefficient for early prediction ratio, set to k=3 at the beginning (means that the early prediction amount will be 33% of the demand)

In p-hcDBA algorithm, grant amount is calculated as in Equation 3.12 for i^{th} ONU.

$$G_i = \begin{cases} R_i + P_i & \text{if } (R_i + P_i < B_{max}) \\ B_{max} & \text{if } (R_i + P_i \geq B_{max}) \end{cases} \quad (3.12)$$

The prediction size for an ONU is calculated while considering the grant sizes in previous cycles. Last m (set to 10 in simulations) grants to related ONU are taken into account in the algorithm. The history information of i^{th} ONU at j^{th} cycle is calculated as below;

$$H_i = \frac{\sum_{n=1}^m G_i^{j-n}}{m} \quad (3.13)$$

The prediction size is affected from past grants by α and last grant size by $(1-\alpha)$. Early prediction amount will be calculated as k ratio of this sum. k is the coefficient variable used to rearrange the prediction size dues to false predictions in previous demands.

Early prediction amount is calculated by;

$$P_i = \frac{(1-\alpha) \cdot R_i + \alpha \cdot H_i}{k} \quad (3.14)$$

The probability of wrong predictions about the queue length in ONU's buffer is considerably high. Therefore, due to inconsistent traffic behaviors, early prediction mechanism may calculate wrong predictions. In this case, if the early prediction amount is equal to or more than ONU's queue length, next demand amount will be reported as "0". Otherwise, ONU will send the amount of

packets in its queue to OLT as a request higher than zero. Thus, k value can be recalculated in order to define the early prediction ratio in next cycle.

$$k_i^{j+1} = \begin{cases} k_i^j - \frac{R_i^{j+1}}{G_i^j} & \text{if } R_i^{j+1} > 0 \wedge G_i^j > 0 \wedge G_i^j > R_i^{j+1} \\ k_i^j - 1 & \text{if } R_i^{j+1} > 0 \wedge G_i^j > 0 \wedge G_i^j < R_i^{j+1} \\ k_i^j + 1 & \text{if } R_i^{j+1} = 0 \end{cases} \quad (3.15)$$

k_i^{j+1} value is rounded up to 1, if it is below 1. Similarly, it is rounded down to 100, if it is over 100. This limitation is done to keep the k value in an acceptable range. The early prediction value is ignored if the calculated value is smaller than acceptable size of an Ethernet packet (smaller than 64 KB). This is to decrease the length of unused slot size. If any grant demand is received from an ONU for next cycle and any packet is delivered to OLT in previous cycle, there will be no need to make early prediction calculation for this ONU.

3.6 Performance Evaluation

In this section, simulation parameters and comparison results are given to figure out the performance of the hcDBA algorithm.

3.6.1 Simulation Environment and Parameters

In simulations, an EPON which contains 16 ONUs connected to one OLT with passive splitters is taken. For each ONU, propagation delay is selected as 0.05 ms according to the distance from passive splitter to OLT and ONUs which is taken as 10km. The comparisons are made over 1 Gbps upstream (EPON) and 10 Gbps upstream (10G-EPON) variations, under mono-service and multi-service scenarios. Table 3.2 shows traffic distribution for each service class in multi-service scenario.

For high priority class (Premium, Silver), CBR (Constant Bit Rate) traffic generator is used and for best-effort traffic it is modeled with self-similar traffic generators. To create self-similar traffic, Poison Pareto Burst Process (PPBP) is used (Willinger, et al., 1997). In hcDBA development, main aim is to increase the bandwidth utilization while keeping fairness between ONUs. For better understanding of the impact of algorithm, mono-class results are evaluated. PPBP generators are used to create mono-service traffic flows.

Table 3.2: Traffic Distribution (Nguyen, et al., 2009)

	<i>CoS1 Premium</i>	<i>CoS2 Silver</i>	<i>CoS3 Bronze</i>	<i>CoS4 BE</i>
<i>Traffic Ratio</i>	10%	10%	30%	50%
<i>Packet size(in Bytes)</i>	70	70	50,500,1500	50,500,1500
<i>Source and Burstiness</i>	CBR	CBR	PPBR/ $\mu=1.4$	PPBP/ $\mu=1.4$
<i>Burst Length (# of Packets)</i>	CBR	CBR	10	20

In simulations, a double-stage buffer approach is used for traffic class scheduling. Each class uses a separate buffer in first stage. Packets from all traffic classes, which are waiting for a slot in next cycle, are collected together on a second level buffer. When a new GATE message arrives to ONU, packets in second level buffer are sent. After that, if there is space in current slot, according to the priority packets from first level buffers are scheduled. After filling the slot all of the packets left in first level buffers are taken to the second level buffer in order from higher to lower priority. At the end, new REPORT message will be created according to the new fill size of the second level buffer. By using double-stage buffers high priority packets are prevented to dominate the upstream channel.

We use NS2.34 network simulation tool to implement the simulations. In Table 3.3, simulation parameters for each algorithm are given.

Table 3.3: Simulation Parameters

<i>Parameters</i>	<i>Values(Case1)</i>	<i>Values(Case2)</i>
<i>No. of ONUs</i>	16	16
<i>Upstream Bandwidth, R</i>	1Gbit/s	10Gbit/s
<i>Maximum cycle time for hcDBA and oDBA</i>	2ms	2ms
<i>Maximum transfer window size for IPACT and hcDBA</i>	15 KB (IPACT) 30 KB (hcDBA)	150 KB (IPACT) 300 KB (hcDBA)
<i>Guard Time</i>	5 μ s	5 μ s

3.6.2 Performance Evaluation

In first section, comparison of hcDBA algorithm with online (IPACT) and offline (oDBA) algorithms is given. In second section, comparison results of hcDBA algorithm with early prediction (p-hcDBA) with hcDBA and IPACT is examined. We show the comparison results of byte loss rate, access delay and packet delay variation (PDV).

In simulations, both 1 Gbps and 10 Gbps upstream cases are examined. In our opinion, it is also an important criterion to see the performance change of the algorithms while the bandwidth increases. This should help choosing correct approaches to get advance for future network designs.

3.6.2.1 Comparison of hcDBA – IPACT – oDBA

In hcDBA algorithm, main aim is to combine advantages of online and offline DBA methodologies. Those are the bandwidth utilization success of online DBA and fair bandwidth distribution of offline DBA on an unbalanced network. For PONs, main performance evaluation criteria should be taken as data loss and packet delay on queues. Since the distance that the packets are travelling is same for all ONUs, end-to-end delay is not examined. Access delay values seem to be appropriate to evaluate the performance in delay classification. End-to-end delay is directly related to the traveled distance of packets and waiting time in ONUs output queues. Besides, in PON, the distance and speed of the line is fixed.

Another performance parameter that has a remarkable impact on high priority traffic such as interactive entertainment, multi-player online games, is packet delay variation (PDV). In these kind of applications, data packets should arrive in a smooth timely fashion. Otherwise, undesired corruptions or bounces may occur, since PDV is not desired in high priority applications.

3.6.2.1.1 Byte Loss Rate Comparison

While each time slot in TDM is destined to carry an amount of data “not packets” and the carried packets sizes differ, packet loss rate can be deceptive. At this point, an algorithm which gives priority for small packets can be seen better in performance, however evaluating an algorithm by the overall bearing capacity should be a better criteria. The loss of data shows an undesired transmission. In TCP, unsuccessful packed transmission end up with retransmission of some packets and that will cause extra delay in applications.

In PON, there will be no data loss because of the collision. Thanks to the structure of PON, it does not allow collisions. The loss of data occurs because of the buffer overflows in the output buffers “for downstream in OLT and for upstream in ONU”. The data flow in downstream accrues as broadcasting. Therefore, OLT can manipulate the packets easily in downstream queues. If the packets that come to the OLT are overloaded, data loss will be accrued. In this study, especially the data loss on ONU side is examined. The overflows in ONUs are occurred when the incoming packets are much more than the given slot size. The packets which cannot fit into the given slot have to wait in buffer for next cycle. If the arrival rate of packets is higher than the bearing capacity of usable bandwidth, packet loss is inevitable. Thus, in oDBA data loss occurs much more than other algorithms due to the lack of full bandwidth utilization.

Figure 3.5 shows byte loss rate of algorithms under mono-service traffic flow. Both in 1Gbps and 10Gbps cases only oDBA algorithm has data loss under 0.9 load. On the other side, since IPACT and hcDBA have full bandwidth utilization there is no loss has been observed. Also we can figure out that increase in bandwidth end up with a decrease of data loss. EPON does not allow packet segmentation among slots. Thus under low bandwidths, there is a higher possibility of unused percentage of slots.

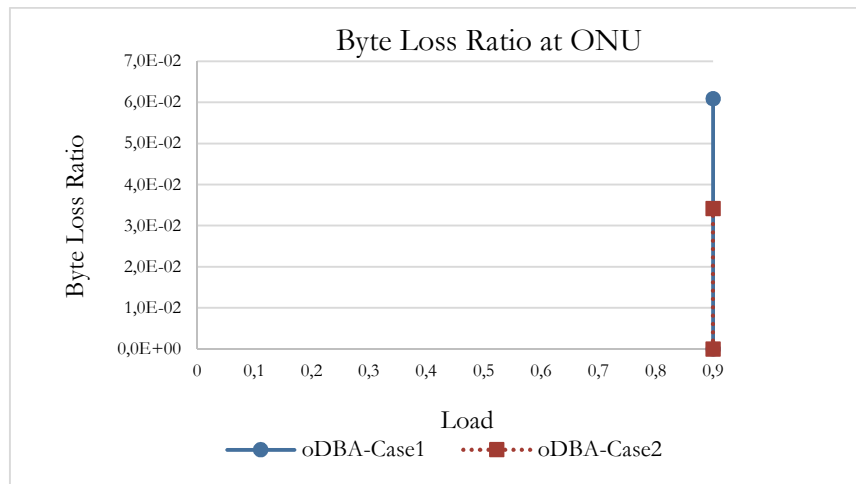

Figure 3.5: Byte Loss Ratio with Mono-Service

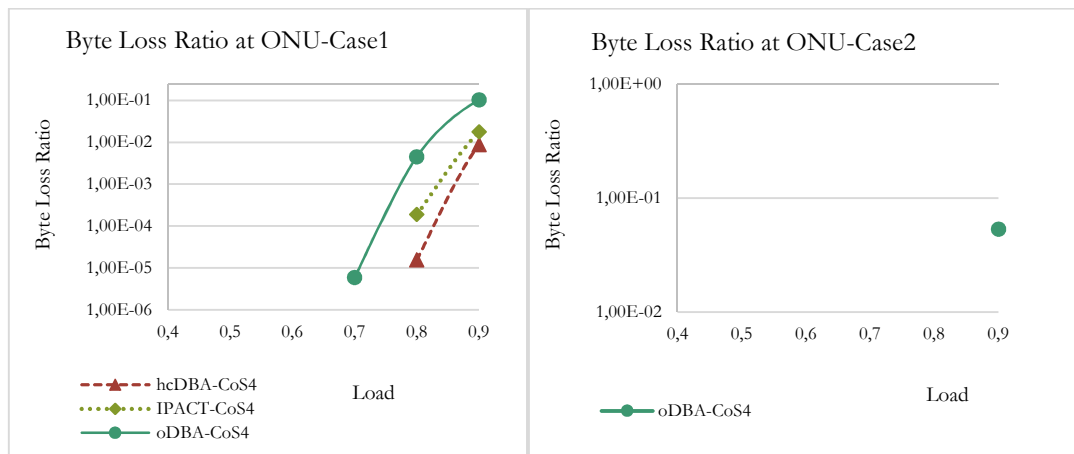

Figure 3.6: Byte Loss Ratio in Case1 and Case2 with Multi-Service

Multi-service results for 1 Gbps and 10 Gbps cases results are given in Figure 3.6. As seen in the figures, byte loss accrues only in the lowest priority traffic class (named as CoS4). For 1 Gbps case, data loss occurs over 0.7 loads. If we compare the success of algorithms, we see that hcDBA gives better results. Byte loss for hcDBA only occurs over 0.8 load and stays under of IPACT values in each result set.

For 10 Gbps case again we should say hcDBA performs better than other algorithms. In hcDBA, only 7% loss occurs under full load. In multi-service results, again we observe that 10 Gbps results are lower than 1Gbps's. In real life, 7% is a huge amount for data loss. In such case, TCP protocol slow down the traffic flow and prevent this loss. So in simulations, it should be pointed that there is no TCP implantation and the results are obtained under salt load values.

3.6.2.1.2 Access Delays Comparison

In this section, comparison of access delays, which is formed from waiting time of packets in ONU output buffers, for hcDBA, IPACT and oDBA are given. In Figure 3.7 and Figure 3.8 these values are presented as an average of values from all ONU's. For better understanding of the difference between algorithms, firstly mono-service results are examined and shown in Figure 3.7.

One of the causes of access delay variation is the length of a cycle time. Since OLT gives grants to each ONU simultaneously, an ONU can send its packets after a cycle period. Another point related to access delay is the distance between OLT and ONU. ONU's have to wait respond to own report message, before sending the packets. Even if PON has only one ONU, this messaging time lasts for RTT duration. When the number of packets in ONU's output queues increases, the cycle time for ONU to take grants is increased as well. The maximum length of a cycle time is limited to 2 ms in each algorithm. In other words, it is guaranteed for an ONU to take grant in 2 ms periods. However, the queue length of an ONU can be greater than the given slot size in one cycle. In such case, according to the queue scheduling algorithm used in ONUs (double-stage buffers are used in this study), some packets are delayed for the next cycle. As a result, some packets may have access delay values over 2 ms.

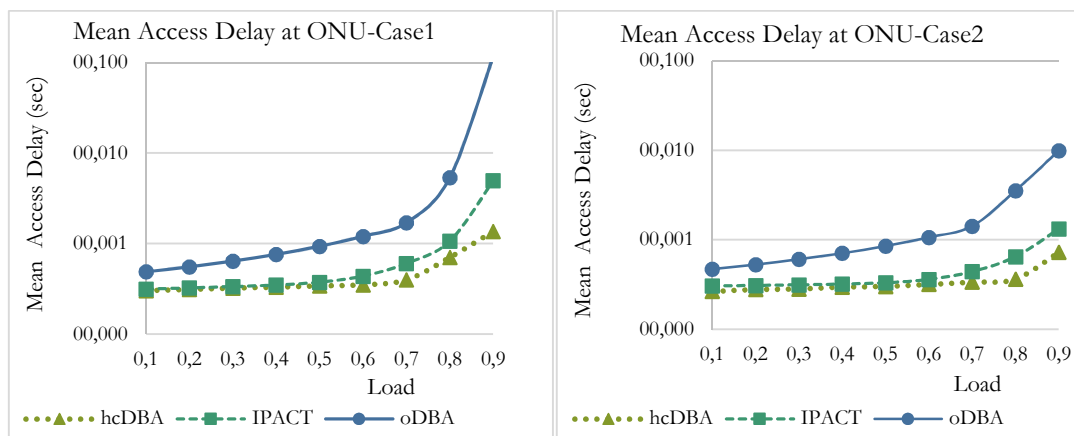

Figure 3.7: Mean Access Delay with Mono-Service

In Figure 3.7, it is clear that each algorithm has access delay values below 1 ms under 0.5 load for 1Gbps. For higher load values, oDBA increase rapidly while hcDBA and IPACT show a slight increase. Main reason of this situation, which is mentioned in data loss comparison, is lack of full bandwidth utilization in oDBA algorithm. As seen in the graphics, hcDBA performs better than other algorithms. Additionally at 0.8 load, hcDBA has an average access delay of under 1 ms. Even the load is very low, the access delay values cannot be under a certain value. The RTT time is responsible for this limit and it is equal for all algorithms. Access delay of each algorithm is lower in 10 Gbps case compared to 1 Gbps case. In 10 Gbps case, hcDBA has a visible success when compared to IPACT under all loads. In Figure 3.9, mean access delay of hcDBA, IPACT and oDBA for 1 Gbps and 10 Gbps cases are presented for multi-service traffic. In an ONU, a double-stage buffer mechanism is used. By using double-stage buffers, it is aimed to prevent high priority class to take all resources in a HoL fashion. In EPON, each packet has to wait a cycle time before it is assigned into a slot while ONU is waiting for the response from report message. Meanwhile, the packets from users are collected at the ONU for the next cycle. In mono-service class, scenario the packets can be scheduled in the incoming order (except some offline DBA algorithms because they try to increase the overall performance by reordering packet schedule).

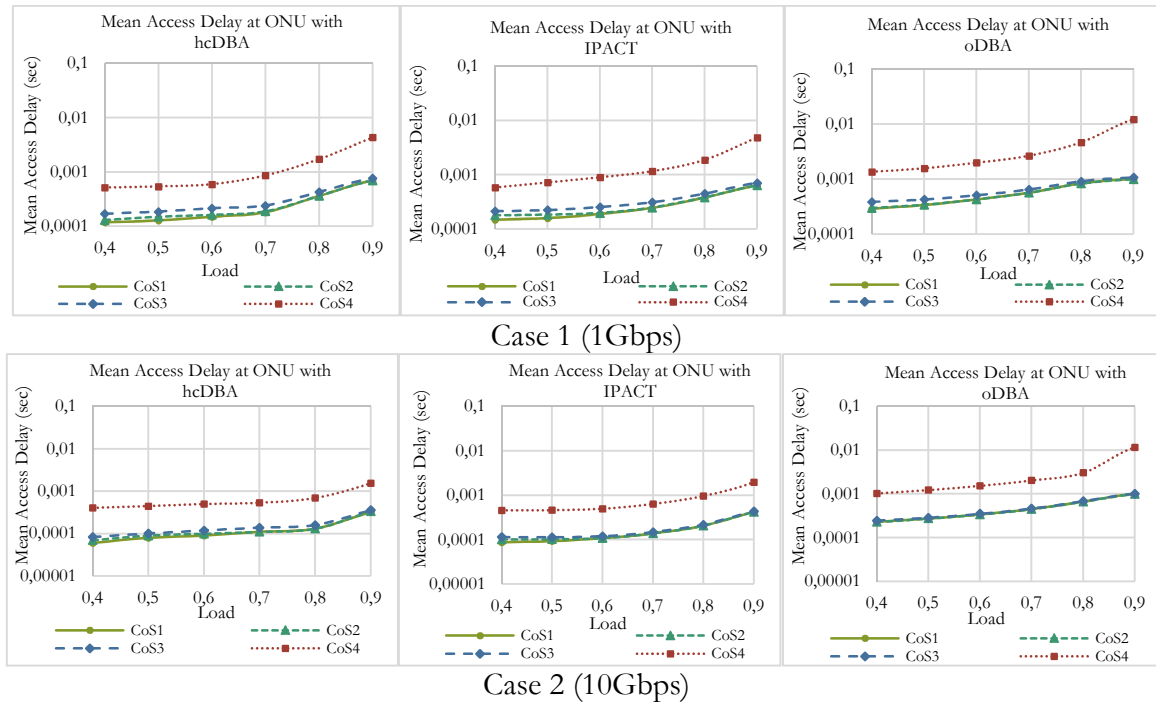

Figure 3.8: Mean Access Delay with Multi-Service

On the contrary, in multi-service if we use HoL fashion then high priority packets take first place even they come later. Thus, high priority packets possibly use time slots that are reserved for lower priority ones. Then, lower priority packets are rescheduled for next cycle. When the number of high priority packets is huge, it is possible that lower priority ones cannot be served at all. Double-stage buffering is used to eliminate this problem in HoL approach. In this approach, each packet is tried to be sent in the slot that is reserved. If the slot size granted by OLT is smaller than the queue length, starting from the lowest priority, packets are left in buffer for next cycle.

In simulation studies, only CoS4 packets remain for next cycle. This is a desired situation for traffic service classes while CoS4 stands for best effort traffic. Under all load values, hcDBA is able to hold the access delay values below 1 ms for high priority classes. Also it performs better than the other two algorithms in all traffic classes. Thanks to the buffer scheduling mechanism, the waiting time for high priority packets can be below than the minimum waiting time. Thus for high priority packets, access delay values near to 0.1 ms can be seen.

Besides, in 10 Gbps case and under 0.4 offered load, service time for high priority class accrues below 0.1 ms. According to the increase in bandwidth, slot size and buffer memory size are also increased. Consequently, possibility to be served for high priority packets increase. The size of the slots in 10 Gbps case is 10 times bigger than 1 Gbps case. The possibility to find low priority packets that are scheduled for next cycle increases in 10 Gbps data rate. The gaps in the slots are not related to this issue because the slot size is given by the OLT according to the bandwidth demands in previous report. Using available bandwidth in a cycle is examined in early prediction part.

3.6.2.1.3 Packet Delay Variation Comparison

In this section, the effect of algorithms on packet delay variation is examined. In Figure 3.9, the packet access delay of three algorithms with 1 Gbps data rate under offered load from 0 to 1 is

given. The variation in access time decreases while the load increases. All of the algorithms give similar results under the same load. In all load values, PDV for IPACT and hcDBA has very little difference. oDBA is just a little lower than others. From the results, we can say that for PDV the traffic load is much more related than the bandwidth allocation algorithm.

PDV is important especially for some applications that need high priority traffic such as IPTV, VoIP, real-time gaming, video conference etc. For best-effort traffic, PDV is not a drastic problem. Figure 3.9 shows the results are for mono-service traffic pattern. For all scenarios, the PDV results are similar and it is not really related with the bandwidth allocation algorithms, so other PDV results are omitted.

The decrease of PDV due to the increase in load and not being related to bandwidth allocation algorithm is related to the issues below. First of all in each algorithm, packets are scheduled in the incoming order. In a highly loaded link, each packet will take service nearly after a cycle time, since previous cycle is fully loaded because of heavy traffic load. When the load decreases, the packet count in the queues varies in time. The service time for packets in an ONU's output buffer is directly related to the queue length and cycle time. Under low load, the cycle time varies according to the queue lengths. The alteration of queue length in each ONU is rapid. This is reflected to the results that under low loads, PDV is higher and goes down with the increase of traffic load. In simulated algorithms, the same buffering mechanism is used and the packet order is not changed. That is why each algorithm gives similar PDV. PDV is slightly higher in hcDBA than oDBA. hcDBA has smaller queue lengths that will be result an increase in PDV as described above. The increase of PDV in hcDBA is a reasonable negation besides its advantage in access delay and byte loss metrics.

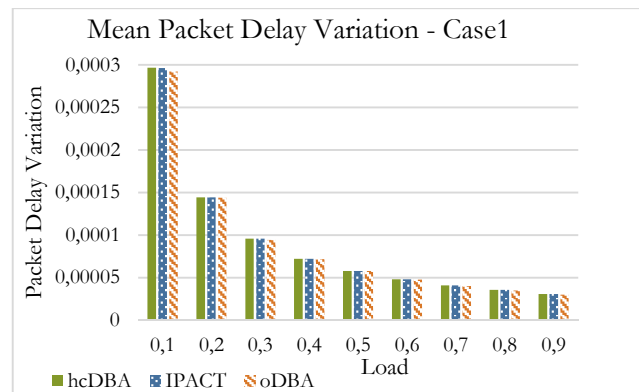

Figure 3.9: Packet Delay Variations (PDV) (1 Gbps)

3.6.2.2 Performance Analysis of Early Prediction Mechanisms

In this section, the extended version of hcDBA algorithm with early prediction is examined. For performance comparison, IPACT and hcDBA results are taken as a reference. For PON upstream scheduling, there are quite prediction algorithms presented in recent researches. These prediction algorithms are generally designed to distribute all of the bandwidth among ONUs according to the prediction results. In fact, for very variable traffic as Internet, because of the irregularity of user behavior, correct prediction of the incoming data flow is not mostly possible. However, in synthetic simulations it is known that some better results can be obtained. The prediction scheme developed in p-hcDBA differs from classical prediction algorithms by way of using predictions. p-hcDBA use

prediction on bandwidth allocation just in online part, in other words while system is not highly loaded. p-hcDBA is an extension for hcDBA algorithm. It is not a complete prediction based bandwidth allocation algorithm. So the results are not compared with other prediction based approaches. Since data loss rates and PDV differences are very small in simulated algorithms, they have been omitted in p-hcDBA comparisons.

3.6.2.2.1 Access Delay Comparison

To figure out the performance of the algorithm as whole, firstly mono-service results are examined. In Figure 3.10 access delay values of three algorithms are compared for 1 Gbps and 10 Gbps and under mono-service. Early prediction extension provides a reduction in access delay of p-hcDBA compared to hcDBA algorithm. The prediction mechanism is active when hcDBA works in online mode. It means that prediction mechanism only can be in use when the traffic load is low. Prediction under heavy loaded networks may be thought to perform better, however there is also a possibility of false predictions. In a heavy loaded situation, false prediction causes postpones for other ONUs to take service. This can degrade overall system performance. Therefore, early prediction in hcDBA algorithm only applied to online mode. While the system is in online mode, the total bandwidth demand is not too much and giving extra bandwidth to some ONUs does not cause bad performance of other ONUs. Even if prediction is a false drop, the system can tolerate all of the demands in a cycle time since the system is lowly loaded. Contrary in offline mode, if we use prediction mechanism and the prediction is a false drop then it unnecessarily causes to some ONUs to postpone their packets for next cycle. In addition, if we have ONUs demanding bandwidth at the maximum slot size, the algorithm cannot increase the bandwidth amount for them. Prediction is applied to some other ONU's which bandwidth demands under the maximum bandwidth limit. This would be a mistake because the demanding ONU cannot take the advantage of prediction scheme in case it has to wait more than classical approach.

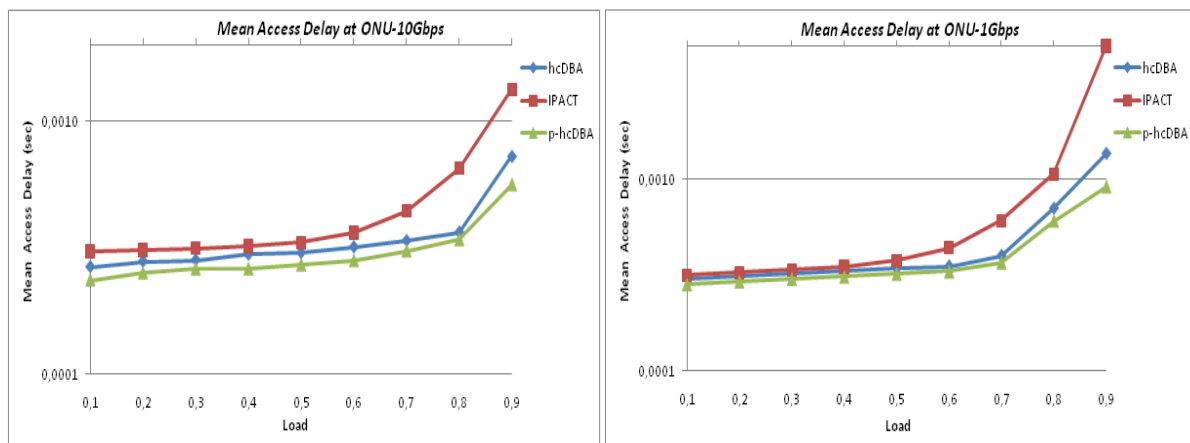

Figure 3.10: Mean Access Delay with Mono-Service Traffic

In comparison of 1 Gbps and 10 Gbps cases, p-hcDBA performs much better under 10 Gbps case. While the bandwidth amount is higher the slot sizes and packet queues are also bigger according to the bandwidth. As a result, the predicted amount possible matches with extra bandwidth demand. This improves access delay performance.

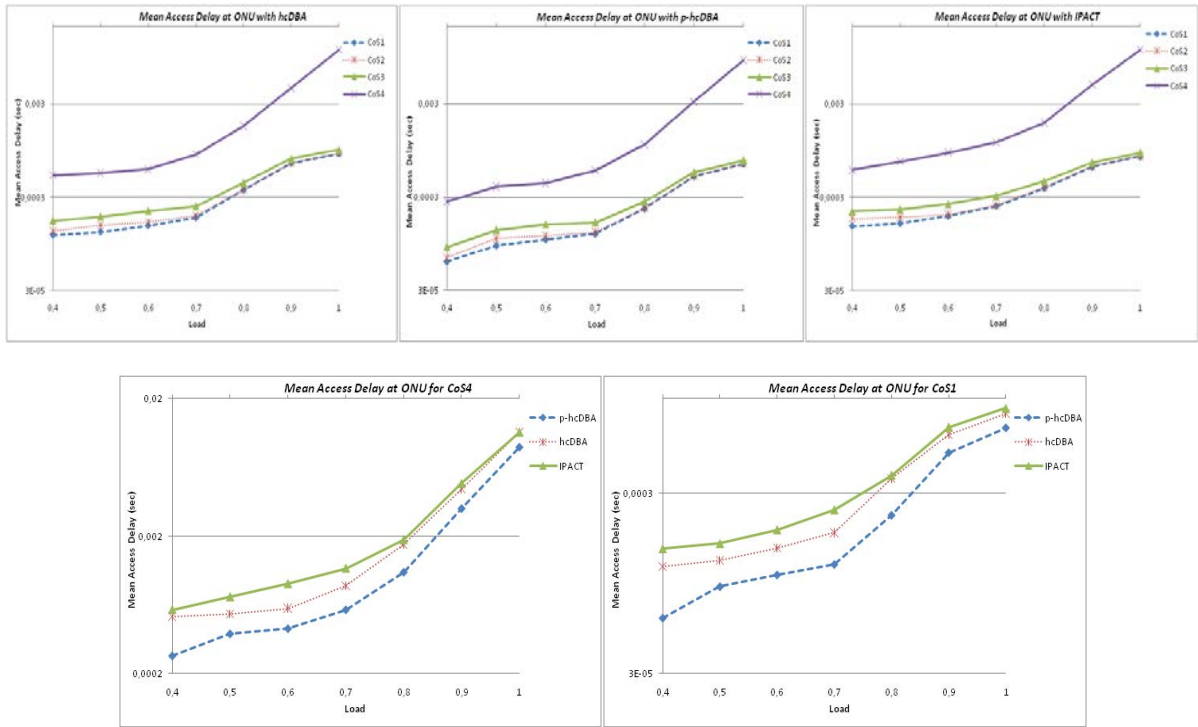

Figure 3.11: Mean Access Delay with Multi-Service Traffic (1 Gbps)

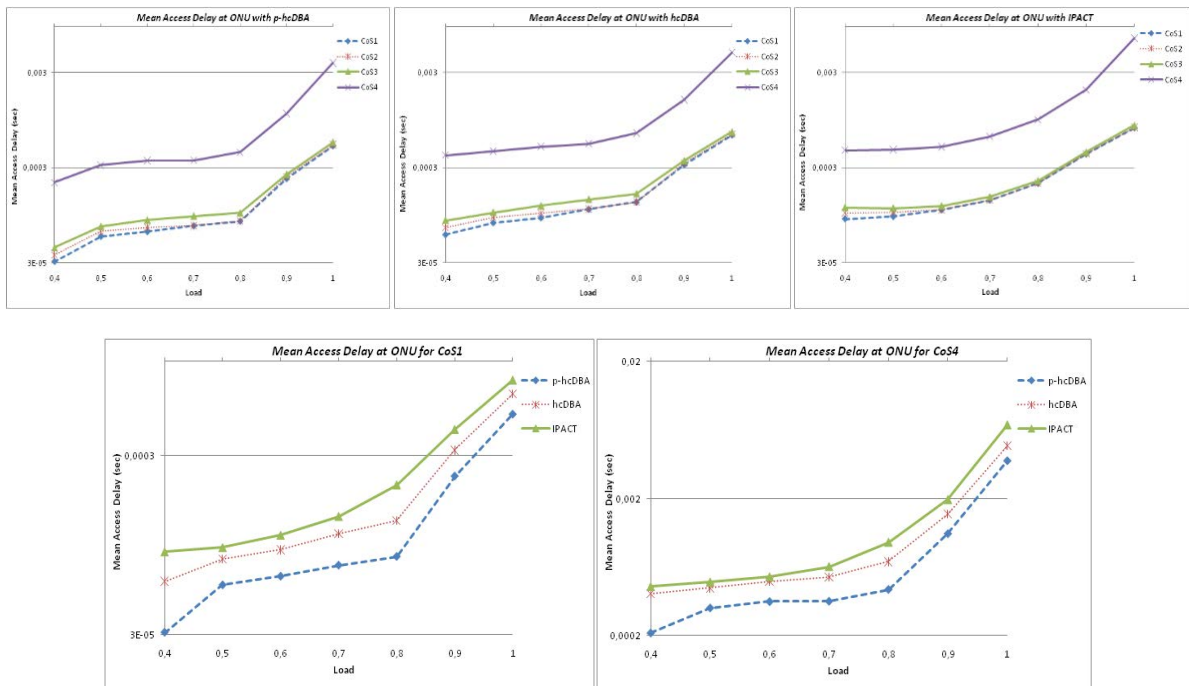

Figure 3.12: Mean Access Delay with Multi-Service Traffic (10 Gbps)

In Figure 3.11 mean access delay results of hcDBA, IPACT and p-hcDBA are given under 1 Gbps case with multi-service traffic. Early prediction provides performance improvement also in multi-service condition. Performance improvement mostly occurs for high priority traffic, since the buffer mechanism for multi-service firstly give available bandwidth for high priority. The predicted amount is generally used by high priority traffic which has to wait for next cycle in normal

scheduling paradigm. Figure 3.12 shows the results of mean access delay for hcDBA, IPACT, p-hcDBA with multi-service under 10 Gbps case where we can see the performance of p-hcDBA is better.

3.7 Conclusion

In this study, a novel dynamic bandwidth allocation algorithm for EPON, which is named as hcDBA is presented (Turna, et al., 2010). Also, a prediction extension (p-hcDBA) for the algorithm is studied (Turna, et al., 2011b). The developed methods are compared with classical DBA approaches as IPACT and oDBA with NS2 network simulation tool. In simulations, two different conditions “1 Gbps, and 10 Gbps upstream capacity” are examined over 16 ONUs connected PON architecture (These cases are taken in reply to EPON first “1 Gbps” and second “10 Gbps” standards). In these two conditions, the algorithms run in single and multiple “four” service class scenarios. For traffic generation, CBR packet generators are used for high priority service class and self-similar generators are used for other service classes. “Poisson Pareto Burst Process” PPBP (Willinger, et al., 1997) traffic generators are used to generate self-similar traffic. In ONUs, double-stage buffer approach is used for managing output queues. By the use of double-stage buffer, overwhelming of high priority traffic to other traffic classes is prevented and a fair queue scheduling grant for all traffic classes. Consequently, while high priority class delay and loss values kept in desired conditions, lower classes also have acceptable delay values.

The algorithms are compared in terms of data loss, access delays and packet delay variation under same conditions and traffic loads. Firstly, hcDBA algorithm is compared to IPACT and oDBA for data loss. For both single and multiple class conditions, hcDBA gives lower data loss results. In single traffic class condition the data loss is only seen in oDBA under 0.9 offered load. By the use of online mode working scheme, other algorithms do not waste bandwidth and prevent causing data loss. In multi-service, data loss only occurs in lowest class. Also in multi-service case, hcDBA performs better than bandwidth allocation algorithms. PONs do not allow collisions on the line because of their design principals. Hence, all of the data loss occurs because of buffer overflows in ONUs’ outgoing queues. If the buffer size increased, the data loss would be decreased. However this will result as a cost increase in ONU implementation and increase in access delays. In simulation experiments, buffer sizes are selected according to the maximum window sizes.

hcDBA performs the best results in terms of access delay as well. In mono class case, especially over 0.5 load, the success of hcDBA compared to IPACT is better in terms of access delay values. The main reason of this result is IPACT algorithms working paradigm doesn’t sent packets from an ONU over the maximum window limit even if the bandwidth is suitable to support desired cycle timing. IPACT make the incoming packets to wait for next cycle, which results an extra cycle delay for this ONU and also for overall system performance. In fact, if we think about the Internet traffic, end-users traffic generation is irregular and bursty. So momentarily, while one ONU is heavily loaded, others could have limited packets in their upstream queues. hcDBA algorithm tries to take advantage of this situation by using half cycled offline mode. If the traffic load on the line is higher than one half cycle time, ONUs are treated fairly with half cycling controls. If the traffic demand cannot fill a half cycle amount, then a highly loaded ONU can use the bandwidth in online mode with a bigger window limit than which is given in IPACT algorithm. Thus, both in low load

and high load conditions ONUs can take more bandwidth in a cycle while keeping fairness issue among them.

In terms of packet delay variation, all of the algorithms perform similar results. It is clear that load values are much more related to the packet delay variation than the running DBA algorithm. In each three algorithms, there is no packet order change or ONU scheduling, so no extra PDV occurs.

If the results taken from 1 Gbps and 10 Gbps cases are compared, hcDBA is more successful under 10 Gbps bandwidth capacity. That gives a viewpoint such as, in higher bandwidth capacities this kind of algorithmic approaches can perform better.

Besides, hcDBA can outperform other offline DBA approaches with its advantages listed below. These advantages of hcDBA are based on not being offline logic at all, but using half cycle stops and working without waiting all node responses.

The advantages of hcDBA compared to other offline approaches:

- There is no long wait problem under low loads. Offline methods have to wait all responses even if the line is idle.
- By giving higher maximum window limit compared to IPACT, if only some of the ONUs are highly loaded the bandwidth can be distributed more effectively.
- hcDBA does not need any implementation change in ONU side and also using the standard control message structure.
- Can be combined with other QoS algorithms.
- Does not change packet or ONU scheduling order, so no extra PDV occurs. Therefore, it is a good alternative for PDV sensitive high priority applications as real time video.
- Most of the offline DB algorithms try to solve idle time period problem by giving additional schedule slots for ONUs. This means sending additional control messages. hcDBA uses minimum amount of control message, thus has less overhead in upstream and downstream.

The only disadvantage of hcDBA compared to IPACT is the complexity of the algorithm. On the contrary the complexity is not higher than most of the offline DBA algorithms.

The performance improvement over hcDBA with early prediction, which is called p-hcDBA, is analyzed by simulation studies. In p-hcDBA, the prediction mechanism is not the core of the algorithm as in the classical prediction approaches. The early prediction is only done in online working mode which means while the load is lower. Accordingly, algorithm tries to prevent the decrease at system performance by false predictions in highly loaded case.

4 Traffic Characterization on EPON Upstream Channel

The optical fiber has appeared to be the most appropriate transmission medium that meets the new network requirements: higher transmission rates, lower attenuation and small error levels over long haul. Hence, the optical fiber has been widely deployed in telecommunication networks over the last few years. The required optical architecture to construct an efficient transport plane has evolved differently in the backbone, metro, and access levels (Alanqar & Jukan, 2004).

In this study, we focused on the access part of the overall network architecture. Access networks interconnect end users to Central Offices (CO). In novel access approaches, access networks are optical networks that do not contain active elements between source and destination, so-called Passive Optical Network (PON). PON has gained a great amount of interest both in industry and academia as a promising cost-effective solution to the 'last mile' problem in the broadband access network (Kramer & Pesavento, 2002d) (Lam, 2007) (Effenberger & El-Bawab, 2009).

In order to simulate an end-to-end network (access network/ metro access/ metro core), we need to know the traffic coming from passive coupler to OLT. Since there are many EPON networks connected to the metro network, we cannot directly simulate all of them in order to obtain a complete simulation. Indeed, for high number of EPONs (i.e. 60), we rapidly reach a complexity level that is impossible to integrate directly into the simulation. So, one of open questions is how to generate this traffic from a well-known source without implementing a real EPON implementation.

The study on generated traffic characterization is important to help us to find a traffic source which is the most similar to arrival traffic at OLT. Classical sources such as CBR (Constant Bit Rate) or Poisson (Ross, 1983) and their superposition are candidate traffic sources for modeling. However, in many real-world cases, it has been found that, the traffic pattern is self-similar (Paxon & Floyd, 1995) for some environments. So in each ONU, the best-effort traffic is generated by a self-similar generator and CBR for high priority traffic sources. We will examine the superposition of this self-similar and CBR sources at the entrance point of the OLT to analyze the overall traffic behavior of the outgoing traffic from ONUs.

This chapter is organized as follows. We first describe a well-known dynamic bandwidth allocation – IPACT (Interleaved Polling with Adaptive Cycle Time). Next, we present two traffic models; Poisson and Self-similar. From their characteristics, we look into the similarity of traffic pattern. The obtained results are compared to EPON network implementing IPACT. Finally, we present some conclusions and discussions of future works.

4.1 Dynamic Bandwidth Allocation in EPON

Since EPON merges the inexpensive Ethernet equipment and the high-bandwidth capable optical fiber, it has been considered as an attractive solution and the best choice for the next generation broadband access networks. In EPON, a passive splitter connects several ONUs with only one OLT and all data transmitted in the network are encapsulated in Ethernet frames (Zheng & Mouftah, 2005). The upstream flow uses TDMA shown in Figure 4.1. As mentioned before, since all ONUs share the same transmission medium, EPON system must include a medium access control (MAC) mechanism to arbitrate access to the shared medium.

Bandwidth allocation scheme can be implemented either in static or in dynamic way. In static allocation, a fixed-size transmission window is allocated from OLT regardless of the instantaneous ONU's requirement collected by the OLT. On the other hand, in the dynamic allocation, a variable-size transmission window is dynamically allocated from OLT for each ONU based on its instantaneous requirement. The experiments are done on a well-known DBA algorithm called as IPACT.

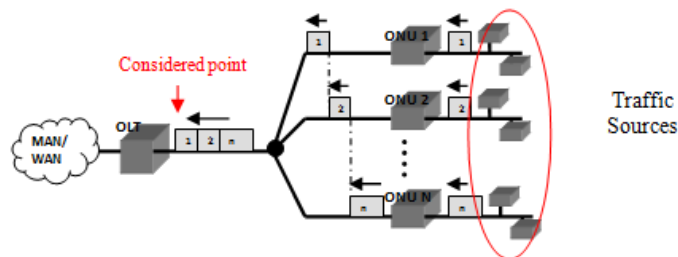

Figure 4.1: EPON Upstream Path (Nguyen, 2010)

In IPACT, OLT polls ONUs individually and issues the granted transmission window to them in a round-robin cycle. A polling message is scheduled in an interleaved way that reduces the bandwidth overhead and thus increases the bandwidth utilization rate of the upstream channel. Figure 4.2 presents an example of IPACT implemented in the EPON network with 3 ONUs. In this figure, “G” refers to GATE message and “R” refers to REPORT message. By GATE messages OLT grant a window in upstream channel for the corresponding ONU. By REPORT messages, each ONU informs its window demand for next cycle. Notice that the guard time exists between two consecutive data transmissions from different ONUs for purpose of the global synchronization.

In this study, we chose the Limited Service Approach (LSA) of IPACT. Since LSA is the best algorithm among the IPACT approach (Kramer, et al., 2002b). LSA grants the requested transmission bandwidth, but it is limited by the maximum transmission window (MTW).

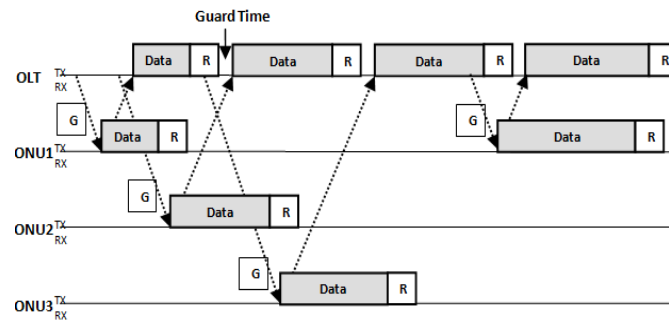

Figure 4.2: IPACT Scheme

4.2 Traffic Models

A traffic model is a stochastic process which can be used to simulate the behavior of a real traffic stream. Ideally, the traffic model should accurately represent all of the relevant statistical properties of the original traffic. However, there is a conflict between the accuracy and complexity of the model (such as the number of parameters involved). A model can be too simple to provide accurate results or too complex to be used in practice. The conflicting requirements of an ideal model can be listed as follows: The model should be easy and amenable for performance analysis. At the same time, the model should be accurate.

For a long time, classical sources like Constant Bit Rate (CBR), Poisson or their superposition were used for network analysis. Over last decade, several researches have shown that traditional traffic models may be inadequate for modeling real traffic to be carried by the future transport infrastructure. Studies have reported that LAN traffic, WAN traffic and variable bit rate (VBR) video traffic often display long range dependence (LRD) and can be better modeled by self-similar processes.

A stochastic process exhibits LRD when it has a non-summable autocorrelation function. Traditional traffic models, on the other hand, typically possess some form of Markovian structure and display short range dependence (SRD) structure only.

It is necessary to mention the differences between traditional sources and self-similar sources. The major difference is illustrated in Figure 4.3. Essentially, a SRD process loses the burstiness of process under long time-scales; the variance of the process describing client arrivals decays rapidly when the time closes to infinity. A self-similar process exhibits same burstiness overall observed scales. Here, the variance of process of client arrivals is slowly decaying as the time is going to infinity (Popa, 2005).

4.2.1 Poisson Traffic Modeling

Poisson traffic modeling presents a SRD. In this model, the packet arrival is modeled by a Poisson process. This model relies on the assumption that the number of packet arrivals has a Poisson distribution with α parameter. Accordingly, the mean number of packets arriving in a duration of T sec is αT . The Poisson distribution implies that packet inter-arrival times are exponentially distributed with $1/\alpha$ mean value. Besides being based on a valid assumption, Poisson model includes useful properties which make it analytically tractable. (For example, the multiplexing of n

Poisson arrival processes with parameters $\alpha_1, \alpha_2 \dots \alpha_n$ is a Poisson arrival process with parameter $\alpha = \sum_{i=1}^n \alpha_i$). The Poisson model is considered to be insufficient to represent today's current packet network traffic. Briefly in this model, the inter-arrival times have the following characteristics:

- They are independent
- They are exponentially distributed

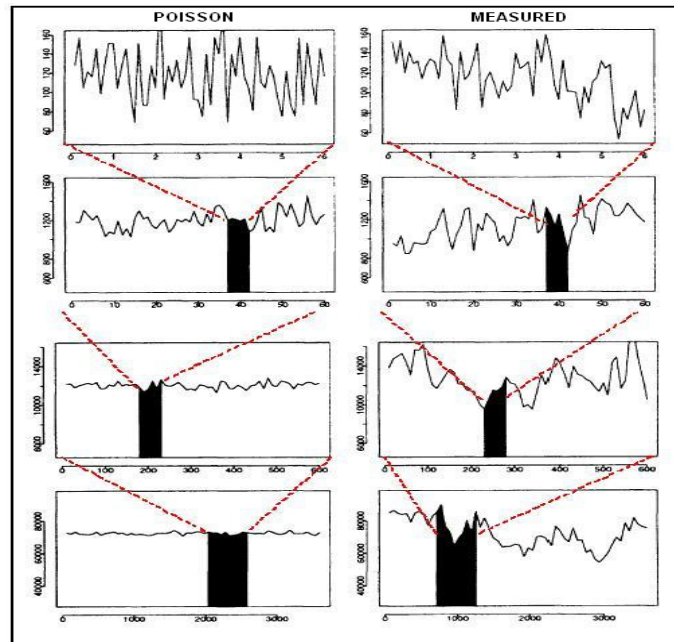

Figure 4.3: Comparison of the self-similar Internet traffic (measured) with Poisson (Fowler, 1999)

If we plot a histogram of the inter-arrival times, it would be an exponentially decreasing function, as shown in Figure 4.4(a). There are many statistical techniques to verify if a particular arrival process is Poisson. One simple way to visually verify whether the inter-arrival times are exponentially distributed (the second condition above) is to plot a log histogram, as is shown in Figure 4.4(b). Since the probability is an exponential function, the logarithm of the probabilities would be a linear function (Jain & Routhier, 1986).

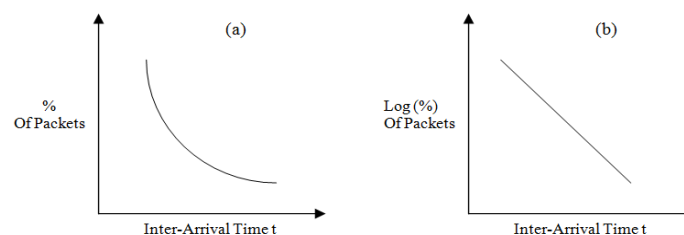

Figure 4.4: The histogram and log histogram of inter-arrival times of a Poisson process

4.2.2 Self-Similar Traffic Modeling

Self-similarity is a concept related to two other concepts that have received much publicity: fractals and chaos theory. The major difference is that if we observe a Poisson process in different time scales, it is bursty at one scale, but loses its burstiness under larger scales. On the other hand, a self-

similar process holds its burstiness over all observed scales. Most of the novel traffic models focus on capturing the first-order and second-order statistics of arrival counts which, in general, are known to be insufficient when attempting to predict queuing behavior (Elbiaze, et al., 2003). In this paper, we consider a Markovian approach for modeling packet traffic with Long Range Dependence (LRD) proposed in (Andersen & Nielsen, 1998). It suggests a superposition of two-state Markovian sources as a very versatile tool for modeling variable packet traffic with LRD. The benefits of using a Markov model are obvious, since a whole array of tools for calculating performance measures is already available. The authors of (Andersen & Nielsen, 1998) illustrate that appropriately constructed Markov models appear to be a viable modeling tool also in the context of modeling LRD traffic over several time scales. They show how a Markovian model can be adapted to a given set of the traffic descriptors, e.g., rate and variance time curve, rather than looking into the fragile issue of obtaining these descriptors from real traffic traces. By construction, these Markovian-based models are well suited for modeling the aggregate behavior of a stochastic process which presents variability over a number of time scales. In our study, we shall consider the modeling framework given in (Andersen & Nielsen, 1998) for the application of superposition of two-state Markovian sources to the modeling of LRD over various times scales. We construct our model for the packet traffic as a superposition of two-state Markov Modulated Poisson Process (MMPP) also known as Switched Poisson Process (SPP). Let our source model be a superposition of two-state Markovian model, each process may be at one of the two states. The superposition is an MMPP which is a special case of the Markovian Arrival Process (MAP) (Lucantoni, 1991) (Lucantoni, et al., 1990).

4.3 Simulation Environment

We used discrete event network simulation tool (ns2.34) for our simulations. To examine the upstream traffic in EPON, we collect traffic flow at the entrance of OLT. For IPACT case, we consider an EPON access network consisting of 16 ONUs connected to an OLT through a passive coupler. In EPON, since the collision resolution mechanism (IPACT) exists for upstream channel, packet collisions are disallowed. The upstream bit rates are taken 1 Gbps, guard time is taken 5 μ s, and maximum transfer window limit for IPACT algorithm is taken as 15 KB. We have used CBR and MMPP-2 traffic sources at each ONU. CBR source is used for high priority service class with 70 byte packet size and MMPP-2 traffic source is used for other lower priority service classes with 50 byte, 500 byte, 1500byte packet sizes. In this simulation, four different sized packets are used with proportion over total generated traffic as: 50 byte – 8 %, 70 byte – 13 %, 500 byte – 35 %, 1500 byte – 44 % (Ross, 1983). Four different Class of Services (CoS) are used as shown in Table 4.1. MMPP-2 State traffic generator is used to create access traffic which shows Self-Similar property in ONUs for Bronze and Best-Effort CoS while CBR traffic generator is used for Premium and Silver CoS.

In order to analyze the collected traffic above, we consider other simulations described as follows. We replace the passive coupler by a node in which one buffer is used. Traffic generator is connected directly to the node with a simple buffer to simulate the same behavior as EPON's upstream channel. Two different traffic generators behavior is alternatively implemented and examined: Poisson and MMPP-2 sources; so-called respectively case 1 and case 2 in Table 4.1. In order to give the same properties as the upstream channel brings in, the used buffer at the entrance of traffic

stream has unlimited size. In each case, the simulations have been done with the same load and same packet related properties.

Table 4.1: Simulation parameters for three different cases

		Cos1 Premium	Cos2 Silver	Cos3 Bronze	Cos4 Best-Effort
Case with IPACT	Packet Size (in Bytes)	70	70	50, 500, 1500	50, 500, 1500
	Source	CBR	CBR	MMPP-2	MMPP-2
	Local Buffer Size (in KB) at ONU	100	250	250	500
Case 1	Packet Size (in Bytes)	70	70	50, 500, 1500	50, 500, 1500
	Source	MMPP-2	MMPP-2	MMPP-2	MMPP-2
Case 2	Packet Size (in Bytes)	70	70	50, 500, 1500	50, 500, 1500
	Source	Poisson	Poisson	Poisson	Poisson

4.4 Numerical Results

At the end of the simulation studies we observed that the traffic characteristic of the upstream channel in EPON shows Poisson property in simulation conditions. It is interesting to see that all different packet sized traffic sources show similar property as Poisson at the entrance of OLT. This can be seen in Figure 4.5 where column (a) shows Poisson traffic generator output as a comparison case and column (b) shows the collected traffic information at the entrance of OLT in the IPACT algorithms which are used in simulation. The MAC algorithm schedules the upstream channel in EPON and flatten the packet arrivals at OLT. When all the packets have to use a shared link, they are scheduled one after another. A packet batch comes from each ONU and after a gap takes place because of guard time or unused bandwidth. This behavior of MAC mechanism in EPON regulates the traffic arrivals to the OLT in upstream channel. So the collected traffic behavior as seen in Figure 4.5(b) is different from the original self-similar behavior seen in Figure 4.5(c). Instead the traffic distribution at the entrance point of OLT is similar to the Poisson process traffic generator output for the same traffic load conditions as seen in Figure 4.5(a) (Turna, et al., 2011a), (Turna, et al., 2011c).

In Figure 4.5, the packet arrival intervals are given for each case under 0.5 load. In other load conditions, the results are similar, so, not all of them are presented. A Poisson traffic generator is expected to give a graphic such like Figure 4.5 for packet arrival intervals. In our simulations, both the collected traffic stream from a Poisson generator and traffic stream from EPON upstream gives similar curves close to the expected Poisson distribution. The correlation values of Poisson traffic and EPON upstream traffic shown in Figure 4.5, are given in Table 4.2 and it can be seen that all values are over 0.7. These values show that the graphics reveal similar slopes to each other.

Table 4.2: Correlation values of Poisson traffic and EPON upstream traffic

Packet Types	50 Byte	70 Byte	500 Byte	1500 Byte
Correlation Values	0.73	0.88	0.93	0.91

For comparison, we also simulate the traffic distribution behavior of MMPP and Poisson generators over a single node. The traffic distribution results of generators and the EPON upstream channel for different intervals are shown and compared in Figure 4.6. From the figures, it can be seen that the behavior of EPON upstream traffic shows a distribution similar to Poisson process in the given simulation conditions. The behavior of the traffic can differ according to the environmental parameters such as packet distribution rates, guard times, bandwidth, and so on. In Figure 4.6, column (a) stands for Poisson traffic, column (b) for EPON upstream and column (c) for MMPP-2, which is used in simulations to generate self-similar traffic. For Poisson and MMPP-2 traffic generators, the mean traffic amount of each class from EPON upstream channel is calculated and the same conditions for all traffic generators are used. So each figure is taken under the same packet load values.

4.5 Conclusion

In this chapter, traffic distribution of upstream that arrive to the OLT in EPONs with IPACT algorithm is examined. MMPP-2 traffic generator is used to create access traffic which shows Self-Similar property in ONUs. For comparison of the collected traffic from the upstream channel of EPON, two different traffic generators' behavior is examined on a node-to-node architecture where no collision occurs and any allocation algorithms are used.

Though a traffic generator which shows Self-Similar property is used in ONUs, the collected upstream traffic in OLT shows mostly Poisson property. These results can be helpful for modeling the traffic behavior of metro access networks connected to EPONs as access structures. Besides to figure out that the upstream shows Poisson property can be handful in decision of buffer sizes, packet scheduling and routing algorithms for outgoing traffic to metro access network of OLTs. After we can assume that the traffic can be modeled with a Poisson generator for upstream traffic after OLTs in metro-access simulations. This work projects a light to use Poisson traffic generator for our future studies on metro-access simulations.

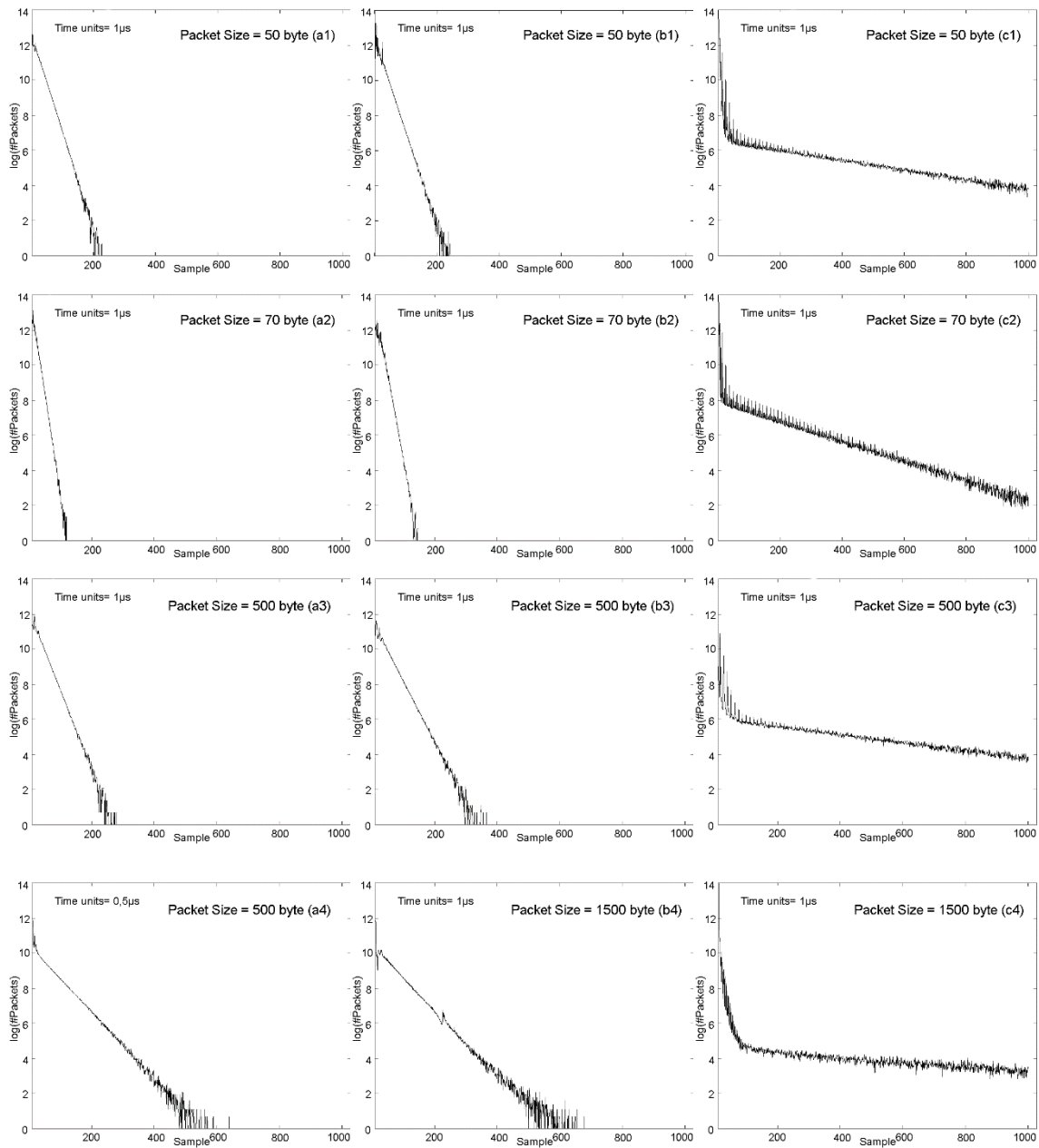

Figure 4.5: Inter arrival time distribution a1-a4: Poisson traffic, b1-b4: EPON upstream traffic, c1-c4: Self-similar traffic

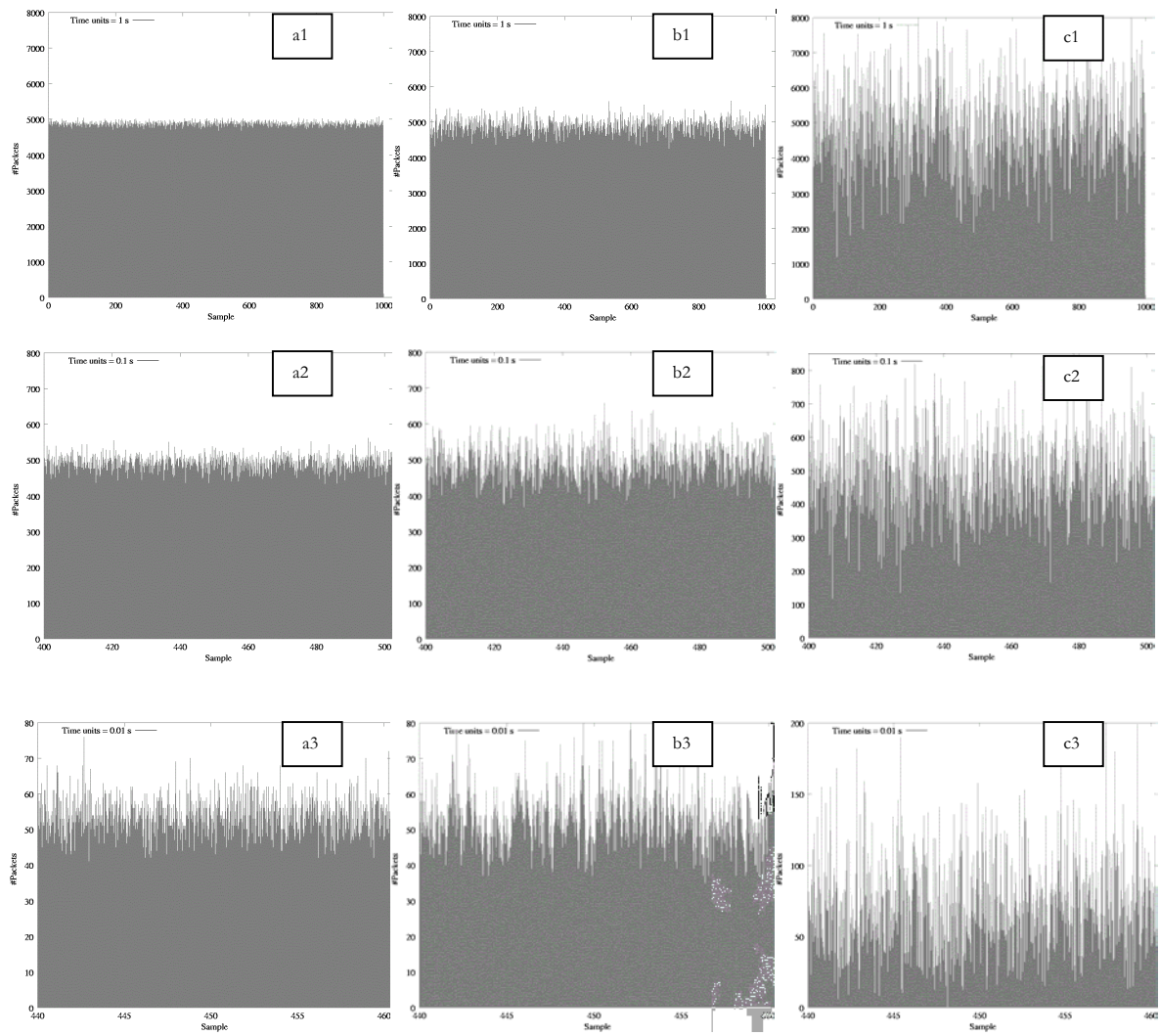

Figure 4.6: Packet arrivals in different time scales a1-a3: Poisson traffic, b1-b3: EPON upstream traffic, c1-c3: Self-similar (MMPP-2) traffic

5 Energy Efficiency on Passive Optical Networks

Energy consumption is one of the crucial problems for future of our world. In (U.S. Energy Information Administration, 2013), the energy consumption projection is given for 2040 as shown in Figure 5.1. It is foreseen that energy consumption in world grow by 56% from 2010 to 2040. Thus, in last decade industry and academia trend to develop more energy effective products. According to the study of M.Picavet from Ghent University in 2009, the Information and Computing Technology (ICT) percentage of energy consumption in overall electronics is 8%, which corresponds to a power consumption of 156 GW. In case of ICT, one of the considerable energy consumer is network devices which are distributed all over the world for Internet coverage (22 GW according to the study of M.Picavet, 2009). In (Mukherjee, 2011), it is mentioned that access networks consume 70% of total energy consumption of network devices in 2009. According to the projection of the energy consumption distribution in telecommunications network which is given in Figure 5.2, the energy consumption of access network is considerably high for today and seem to be keeps its volume for future.

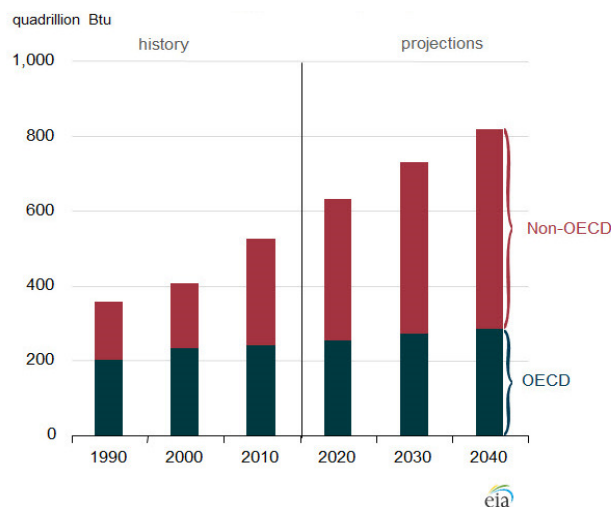

Figure 5.1: World Energy Consumption 1990 -2040
(U.S. Energy Information Administration, 2013)

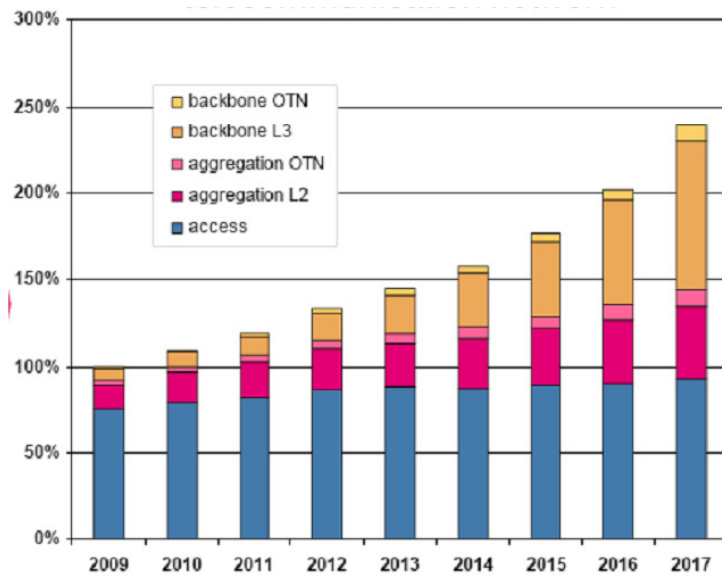

Figure 5.2: Energy consumption of a typical telecommunication network (Mukherjee, 2011)

Passive Optical Network (PON) is the most promising solution for future access networks. Since, using optical technology in fix networks brings advantages as; reaching long-haul, less corruption on carried data, and far less being affected from environmental factors. Besides these advantages PON also gives the most favorable solution for energy efficiency. While PON is the best solution for energy efficiency in access networks, the consumed energy can be reduced more by effective techniques, and/or devices.

An Optical Access Network (OAN) doesn't just consist of PON. Each PON's OLT card must be connected to the core network over a point-to-point connection. While, each OLT card cannot have a dedicated connection to core routers OAN has a second part that collects traffic from OLTs. Ethernet Aggregators (EAs) are used for this purpose. In (Otaka, 2008) an estimation of power consumption in OAN is given. Figure 5.3 shows the estimated power consumption as total and as per user. ONU has the big slice %60 of overall energy consumption in OAN. Therefore proposed solutions are mostly related to decrease the energy consumption in ONUs. According to the study in (Nishihara, et al., 2012), EPON systems around the world consumes 2.37TWh energy annually, which is approximately equals to 300,000 house energy necessity.

FSAN and ITU-T made three surveys from 2006 to 2007 to gather requirement analysis for power-saving. According to the surveys power saving has lesser priority compared to service quality, availability, and interface variability. Two revealed foci in surveys are improving power consumption characteristic and improving performance in mains outage situations presented in (ITU-T, G.Sup45, 2009).

In 2009, power conservation recommendations for GPON (ITU-T, G.Sup45, 2009), and EPON (Mandin, 2008) are released to cover sort of energy conservation methods in PON systems. For power consumption, G.Sup45 recommendation describes four different power saving methods; power shedding, dozing, deep sleep, and fast/cyclic sleep.

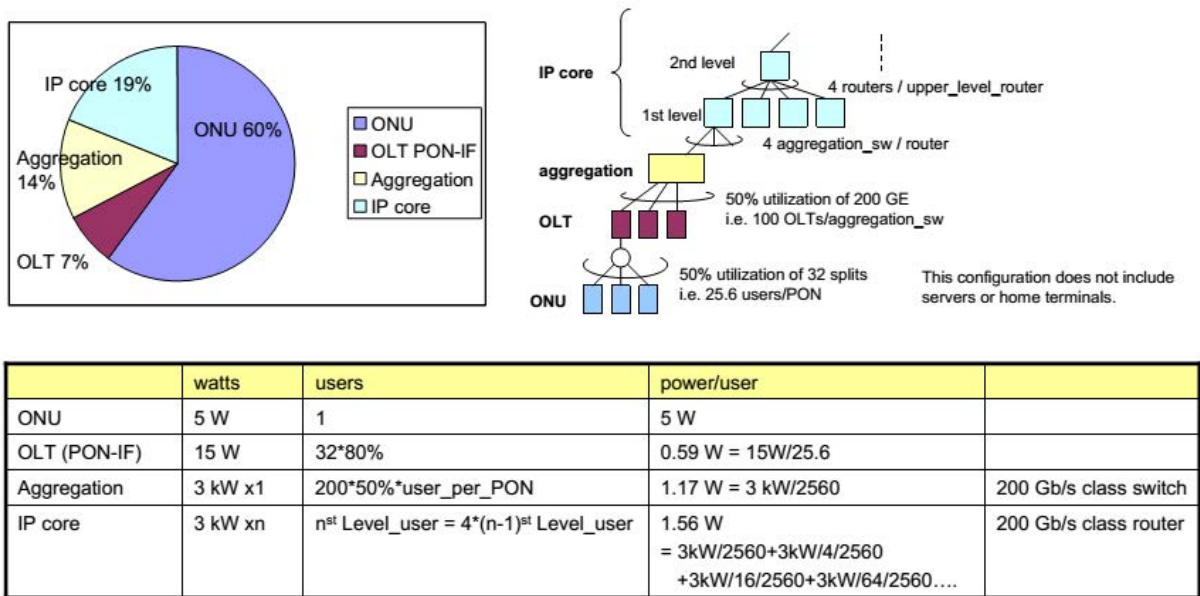

Figure 5.3: An example of the estimation of power consumption (Otaka, 2008)

After releasing GPON recommendations, FSAN group and ITU-T go on working to develop the successor of GPON standard as NG-PONs. There are lots of ideas discussed for novel PON standardization. As a mid-term solution to meet service providers' demands, XG-PON (ITU-T Rec. G.987 series, 2010) released. XG-PON, as an enhancement, inherits framing and management from GPON. For co-existence, XG-PON uses WDM in downstream and WDMA in upstream to share the same infrastructure with existing GPON implementations. XG-PON supports doze mode and cyclic sleep mode specifications in (ITU-T, G.Sup45, 2009). Applying any other power saving techniques left for the vendors' choice.

In 2012, a novel approach Bit-Interleaving PON (Bi-PON) released by GreenTouch consortium (GreenTouch Consortium, 2012). GreenTouch is founded by a group of network companies and academic institutes to accomplish the purpose that ICT energy consumption in 2010 will be decreased factor of 1000 in 2015. Bi-PON aims to reduce the power consumption on end user devices (ONU) and reveal a success that energy consumption of ONU reduced from 3.5W (XG-PON) to 0.5W (Bi-PON) in average.

In the rest of this chapter, summary of the recommendations and some other existing techniques for energy saving are given. The studies are classified in three sections according to their point of interest in energy conservation. Besides, a novel OLT based energy saving proposition is presented (Turna, et al., 2013).

5.1 ONU Oriented Solutions

For energy conservation in PON, the general applied approach is sleeping ONUs for a period of time. In upstream or downstream cycle, an ONU receive packets less than 10% that are dedicated to itself. Thus, near 90% of a cycle time, an ONU can stay in sleep state (consume less energy by closing some of its services and functions). A summary of approaches for energy conservation at ONU side can be find in (Dhaini, et al., 2011) and (Kani, 2013a).

Legacy standard ONU implementations for EPON and GPON do not include energy saving properties. In (Wong, et al., 2009), a different novel ONU design are given for energy saving and compared with legacy standard EPON ONU implementation. In the following section, a list of different power saving techniques based on saving energy at ONU are summarized.

5.1.1 Fast Sleep Power Saving Technique

In fast sleep mode, the ONU alternates between sleep periods. In sleeping periods, optical transceiver is completely powered off along with non-essential functions. Only timing and activity detection function remain active. In fast sleep mode, all the ONUs are synchronized and managed by OLT with Sleep PLOAM message. Each active period followed by a sleep period and it is called a “sleep cycle”.

When an ONU is in fast sleep mode, it starts sleep period by receiving a Sleep PLOAM message. In sleep period, the ONU maintains a free-running clock that generates a wake up signal powering the receiver in advance of scheduled wake-up frame. The transitions of Fast Sleep mode are shown in Figure 5.4. OLT buffers the incoming packets for sleeping ONUs. The structure of OLT buffer left as an open issue. Sleep PLOAM messages sent to all ONUs even they are awake or sleep to keep out mismatched states. The performance of fast sleep technique is highly related the length of the sleep periods and DBA algorithms that control packets in active state (ITU-T, G.Sup45, 2009).

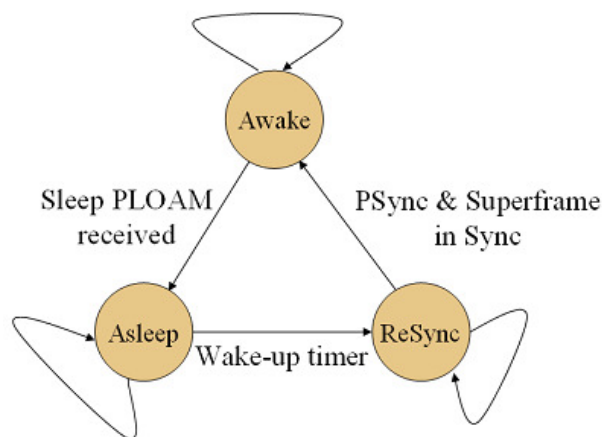

Figure 5.4: Fast Sleep Mode State Transitions (ITU-T, G.Sup45, 2009)

5.1.2 Deep Sleep Power Saving Technique

In deep sleep technique, ONU shuts down all of its functions and services and exceptionally keeps the activity detection. This technique has the ability to conserve maximum energy. On the contrary, it is not performance effective. While the ONU is off, it misses the signal for synchronization and may miss incoming downstream data. ONU is switched-on by an inside timer or from the off-hook condition. This technique is preferable when the ONU is shut down by the user and/or the given service can tolerate data loss. The OLT may continue or optionally discard sending downstream traffic to sleeping ONU. In order to timely wake-up, OLT must allocate regular targeted ranging windows to the sleeping ONUs (ITU-T, G.Sup45, 2009).

5.1.3 Dozing Power Saving Technique

Dozing mode is introduced as an alternative for fast sleep mode. In dozing, ONU turns off the transmitter for a substantial amount of time. Transmitter remains closed as long as there is no upstream traffic to send. On the other side, receiver stays on all the time. ONU turns back to normal mode by a signal from OLT or buy local stimulus. As an alternate IEEE MPCP allows an ONU to ignore grant messages in case it has nothing to send in upstream. Besides OLT can send a “force report” grant message, which requires a response.

5.1.4 Power Shedding

With power shedding, the ONU simply turns off some of its devices and reduces power usage by engaging in a different mode of services and functions, while leaving the optical link at full function. The (ITU-T Rec. G.984.4, 2008) series recommendations allows the ONU to perform controlled power shedding, when the ONU operates under battery power. Power shading can give the best performance compared to power saving techniques in (ITU-T, G.Sup45, 2009), but achieved energy saving is lower. It is a feasible technique to use in case of AC power loss to increase battery life.

In (Bokhari & Saengudomlert, 2013), a comparison of these four techniques is given as in Table 5.1.

Table 5.1: Different types of sleep mode for a PON (Bokhari & Saengudomlert, 2013)

Sleep Mode	Fast Sleep	Deep Sleep	Shedding	Dozing
Transmitter	Alternate on-off	Off	On	Alternate on-off
Receiver	Alternate off-on	Off	On	On
Functions during sleeping	Only timing and detection functions on	All functions off	Non-essential functions powered off or in low power mode	Only optical transmitter powered off
Need of resynchronization	Yes	Yes	No	No
Power consumption	0.8-1 W	≤ 0.7 W	2.78 W	1.7 W
Time of execution	Light traffic load	Idle	Failure of main power supply	No upstream

5.1.5 Adaptive Link Rate

Adaptive Link Rate (ALR) is a method where the transmission rate can be dynamically selected. For energy efficiency, ALR has been widely deployed in wireless networks (e.g. Wi-Fi, WiMAX). In this wireless technologies, multiple transmission rates are available to be used. Naturally, the higher transmission rate brings out the higher power consumption. On the other side, lower transmission rates result in derogation in network performance. In GPON, where multiple transmission rates are present (1Gbps, 2.5Gbps, 10Gbps), ALR can be used. However for EPON implementation ALR is unavailable and for NG-PON, ALR has not been explored. In (Kubo, et al., 2010), using ALR in 10G-EPON is examined with a multi-rate ONU to set the optical link rate adaptively based on the monitored traffic load. By this approach it is said that the ONU active time can be minimized and by extending the sleep period more energy can be saved.

5.2 Aggregation Node Oriented Solutions

Ethernet Aggregators (EAs) are the connection points of OLT cards to backbone as seen in Figure 5.3. For energy conservation some EAs can be shutdown according to the low traffic load. For energy conservation some EAs can be shutdown according to the diminution in traffic load. For the electronic links, Energy-Efficient Ethernet (EEE) of (IEEE P802.3az, 2010) can be used both in OLT-EA and EA-backbone connections. EEE only covers energy conservation on electronic links. As an alternative method, link aggregation can be used which is defined in (IEEE P802.3ad, 2000). The study (Imaizumi, et al., 2009) has an additional protocol and an algorithm definition for realizing power saving. In Figure 5.5 standard operation and energy-aware operation of link aggregation are illustrated.

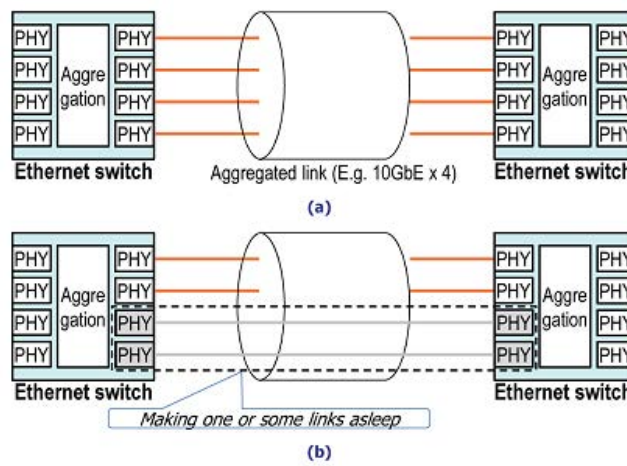

Figure 5.5: Link aggregation in (a) standard operation and (b) energy-aware operation (Imaizumi, et al., 2009)

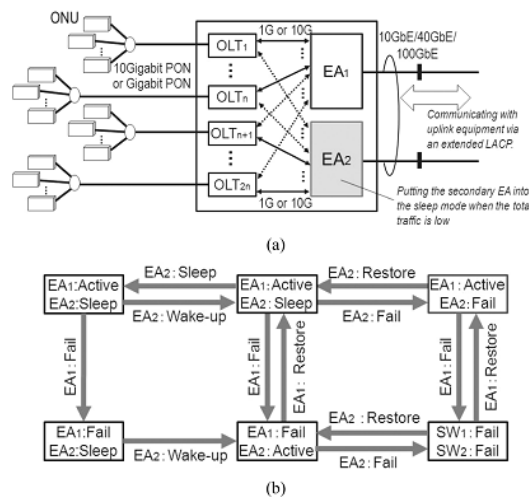

Figure 5.6: Sleep control of EA. (a) Configuration. (b) State diagram (Shimazu, et al., 2010)

In (Shimazu, et al., 2010) authors proposed an extension to this idea by dividing the EAs into two parts. According to the traffic load, the secondary EA sleeps. Apart from energy efficiency, this approach also brings reliability with redundant devices for break downs.

In Figure 5.6 the configuration of the architecture and state diagram are given for transitions in case of sleep and fail. To recover a sleeping EA does not need a fast wake-up process. Since, by the statistical multiplexing the load on an EA does not change very quickly. In (Kani, et al., 2013b), author shows that by using EEE in OLT-EA links as well as selective EA sleep, energy consumption of EA and OLT can be reduced to around %60 when the traffic is low.

5.3 OLT Oriented Solutions

Central office equipment (OLT) consumes approximately 10W-100W energy according to the manufacturers (Grobe, 2010) (Ghazisaidi & Maier, 2010) (Chowdhury, 2011) (Aleksic, et al., 2013). There are a lot of ONU based studies for energy efficiency, where just a few propositions presented for energy conservation in OLT. Solutions for OLT regarding wavelength division are presented in (Tokuhashi, et al., 2011), grouping OLTs are presented in (Saliou, et al., 2011) and summary of some related studies are presented in (Kani, 2013a). When these solutions are examined, it is observed that these methods are mostly based on a major device renovation with novel technical devices or closing the device during some time period of day.

Another approach that was argued in literature is energy-efficient design for Long Reach PON. Long Reach PON (LR-PON) is one of the studies carried on to develop next generation PON solutions by extending split ratio and reach distance. In (Saliou, et al., 2011), energy conservation of central offices is examined with six scenarios. By the use of Extender Boxes the reach of PON increased and some central offices are replaced by extender boxes. This approach said to decrease the energy consumption of central offices. It is useful in some case of OpEx derogation for operators.

In this section the presented propositions are summarized and our motivation to develop a novel OLT base energy efficiency algorithm is given.

5.3.1 Wavelength Routing for Selective OLT Sleep

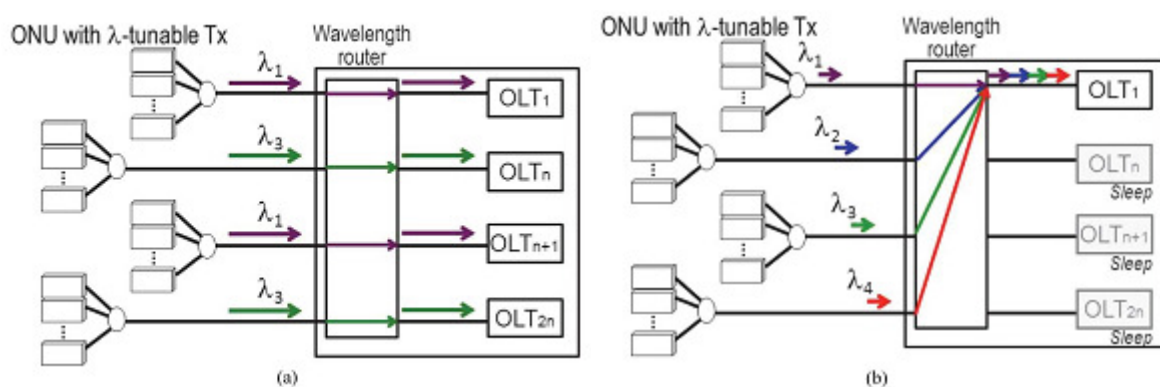

Figure 5.7: Energy-efficient optical access by WDM-TDMA PON and wavelength routing technologies, with wavelength assignment for (a) high-traffic condition and (b) low-traffic condition. (Kani, 2013a)

In WDM-TDM PON, power consumption of OLT can be decreased with dynamic wavelength division multiplexing. In (Kani, et al., 2013b) and (Kani, 2010), “selective OLT sleep” method was proposed to use dynamic wavelength routing to save energy under low traffic load. Each OLT

works on a different wavelength and wavelength-tunable ONU selects the OLT port to access by changing the transmitter wavelength. Figure 5.7 illustrates the energy-efficient PON structure based on WDM-TDM PON and wavelength routing. In Figure 5.7, (a) is the high traffic situation and (b) is the low traffic situation of wavelength routing assignments. Dynamic wavelength routing is useful for a rapid wavelength control to avoid loss/delay in wavelength reassignment. Using this technique allows bandwidth balancing among several PON branches by sharing bandwidth over different wavelengths to ONUs. This is said to be effective for network performance since active ONUs under each PON branch are not necessarily the same in practice.

5.3.2 Elastic OLT

While the power budget of upstream signal is derogated because of travelled distance and passed through splitters, some of the OLTs can obtain unnecessary power values. That is waste of energy when the power of optic signal is not used. For a full power budget utilization, in (Iiyama, et al., 2010) “elastic OLT” model was proposed to increase the efficiency of power budget by increasing the split ratio and extending the transmission distance. In Figure 5.8 the concept of “Elastic OLT” is compared with classic implementation. In the concept description, the power budget symbolized as fuel barrels. First scenario shows the architecture without modification, where some of the power is wasted in service 2. In Elastic OLT, the excess power should be used in split ratio or distance extension. The scenario is only described for upstream and authors implied that it can also be applied for downstream.

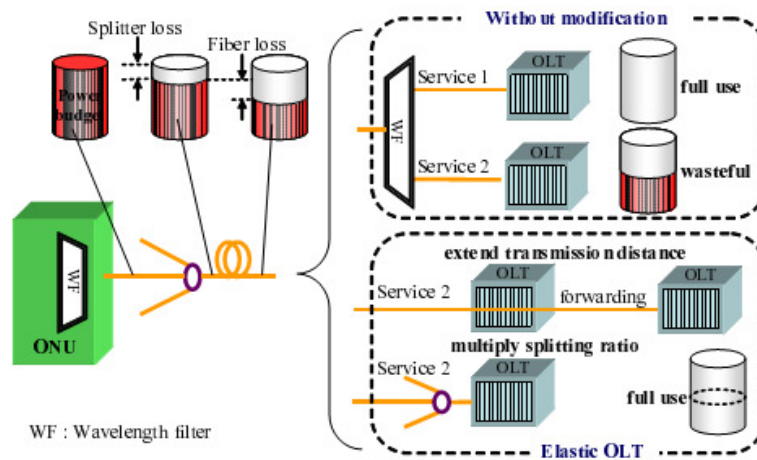

Figure 5.8: Concept of Elastic OLT (Iiyama, et al., 2010)

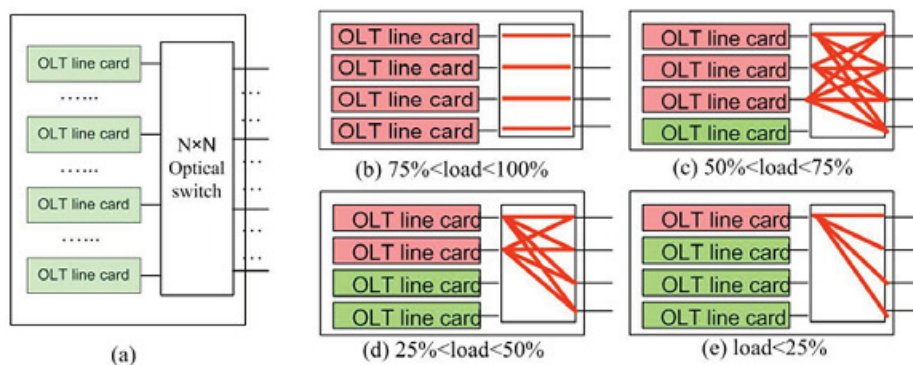

Figure 5.9: OLT with Optical Switches (Zhang, et al., 2011)

5.3.3 Selective Shutdown with Optical Switches

Legacy OLT cards as in EPON and GPON have to be active all over the time. Otherwise, ONUs can be out of service. In (Zhang, et al., 2011), authors represent a take-off scheme for OLT cards with a 4x4 optical switch. When the traffic load is low, ONUs from other PONs can be switch to another OLT in order to close some OLT cards. The handicap of this algorithm is data loss during the switching time. Thus, this technique can be used for example on a timeline of day (Idle period, peek time normal usage etc.). According to the traffic load some OLT cards can be turned-off. However it is ineffective for a day time idle situation cannot be handled or a peek in the middle of night will result as a bad service quality.

5.3.4 Hybrid Active/Passive Architecture Using Optical Switch

In (Tokuhashi, et al., 2011) uses a $n \times n$ or $m \times n$ optical switch between OLT and passive splitter to switch different PON branches to other OLT cards as the method described in 5.3.3. In this work the system thought to work dynamically where one OLT card is selected as master and manage the energy-efficiency algorithm and controls the switch functions. This is a better approach than 5.3.3. Since, system can handle arbitrary user behaviors by dynamic decision making. In this work, authors used a very high speed optical switch that makes switching in nanoseconds however consumes a considerable amount of energy (9.8 W for a 4x4 switch use in two way communication which is nearly equals to an OLT card energy consumption). For the developed model, the optical switches are active all the time. This means that if the system is highly loaded, it will result more energy consumption than classical approach. The authors relied on that most of the time the overall PON usage is approximately 25%. Besides, the control plane for the communication among OLT cards is not defined. When the master OLT decide to move some OLTs into sleep mode, how the process moves on and if there is any data loss, are open questions.

In the next section, we describe a novel OLT based energy saving approach that uses optical switches. In our scenario an amplifier is used to equilibrate the optic power budget in energy saving mode. A control plane is also defined for moving the states of PON branches between OLT cards.

5.4 Our Dynamic Energy Efficiency Algorithm for OLT

In a PON system, OLT consumes considerable amount of energy, which is a challenge for green networking and causes operational expenditure for service providers. In course of time, network equipment generally are not fully utilized especially while servicing home subscribers. Because home devices can be switched off, be idle or in usage with a quite light traffic (i.e. web surfing traffic). In such cases, by the use of different techniques some network equipment can be switched off or sent to sleep / deep sleep modes. In PON, there is no intermediate equipment that can be removed, and OLTs and ONUs must always be online for providing service. However, owing to TDM /TDMA aspects, ONUs are actively in use less than %10 of the timeline. Though, ONUs can be put into sleep mode while the ONU is not actively in use. On the contrary, OLT has to be active all the time to schedule and serve each ONU simultaneously. If we want to put an OLT into sleep, the subscribers must be served by another network element.

Our contribution provides an energy efficiency approach with a diminutive modification on central office systems and no modification reflected to the ONU part. In our approach, two OLT cards are combined as a couple to handle each other traffic flows under low load. Thus, one OLT can be kept in deep sleep mode till a heavy traffic volume occurs on uplink or downlink. Operating mode is switched dynamically according to the traffic pattern.

Optical amplifiers are used to elevate optical power to reach long-hauls with fiber lines. Also they are used to recover the decay of passive splitter on divided optical power by two or more fraction. A summary of amplifiers used in PON systems are; xDFA (...-doped fiber amplifier), Raman amplifier, and SOA (semiconductor optical amplifier) is given in (Trojer, et al., 2008). According to this study, a Raman amplifier consumes 0.5W energy. Besides, decreasing the energy consumption of amplifiers is aimed by novel methods. Optical switches are used in re-configurable optical add/drop multiplexer, optical cross-connect systems, and network switching for fault and restoration applications. In our proposition, optical switches are used for forwarding one OLT's subscribers (ONUs) to other one in power saving mode.

The proposed approach uses a switch-box that is electronically connected with OLTs for control plane and consists of 1×2 optical switches and an optical amplifier. The switch-box implementation is assumed to use far less power compared to an OLT. On standard process, switch-box shuts down the amplifier and consumes energy just for the electronic control unit. In energy saving mode consumes as $\sim 0.6W$ energy. The amplifier is only in use when one OLT is put into sleep mode, in another words when it is in energy saving mode to satisfy the power budget for doubled fiber line split.

5.4.1 Developed Architecture

The developed architecture comprises two OLTs (*OLT-A* for sleeping one, *OLT-B* for master one) and a switch-box consists of five 1×2 optical switches and one amplifier. OLTs and switch-box are directly connected by dedicated communication line. System works in two modes; Normal and Energy Saving. The transition between these two modes is decided according to the traffic load over the OLTs. If one of the OLTs (*A*) has a low traffic volume on both uplink and downlink, it requests *OLT-B* for passing to the energy saving mode. If *OLT-B*'s traffic volume is under a reasonable limit, it responds with a positive response and starts processes to put *OLT-A* into deep sleep mode (OLT is completely shut down except wake on by signal feature). Therefore, *OLT-B* must be able to take all responsibilities of *OLT-A*, and serves without any unsatisfactory delays. If *OLT-B* encounter a heavy traffic volume in uplink or downlink, than *OLT-B* wakes up and prepares *OLT-A* to serve as in usual way.

The following issues have to be considered in system implementation.

- OLTs have to be capable of exchanging their synchronization and route table information with each other over a dedicated connection. It can be over an Ethernet, an USB or a BUS interface.
- A switch-box that consists of optical switches and an amplifier must be implemented. Energy consumption of the switch must be at a very low level.
- OLTs can be capable of controlling the switch-box and buffering the traffic of backbone connection while other OLT is not ready for switching process.

The general structure and switch-box design are shown in Figure 5.10. Each OLT connects to the switch-box with a single fiber. The fiber coming from OLT is connected to a 1×2 optical switch. The fiber coming from the ONUs side also connected to another 1×2 switch at the entrance of switch-box. On normal mode, through input switches OLTs directly connected to its ONUs, on energy saving mode both ONU set directed to middle line in switch-box and it is directed to the active OLT (*OLT-B*) by another 1×2 optical switch.

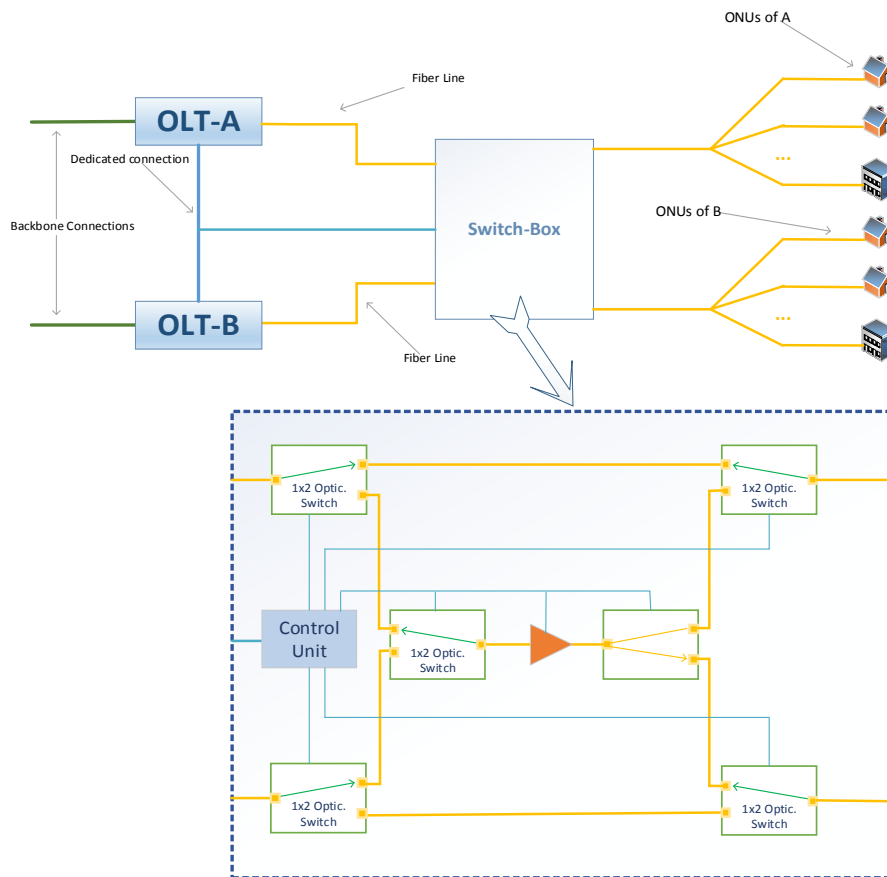

Figure 5.10: General Architectural Design of OLT Couple with switch-box

5.4.2 Proposed Algorithm for Control Plane

The proposed system works in two modes as; Normal mode and Energy Saving mode. In normal mode, the switch-box always waits on stand-by. The amplifier is not powered and optical switches are locked in their states. The system performs as usual such as two separate OLTs. To switch between these two modes, a control plane is used to schedule and share information between OLTs. The control plane of the algorithm is proposed as a finite state machine in Figure 5.11 and summarized below. The first part of Figure 5.11 shows the states of sleeping node and second one shows states of active (master) pair. The decision flow of the control plane is shown in Figure 5.12. In following example the two OLT pairs named as *A* and *B*. When *OLT-A* has less traffic than a particular lower bound in both uplink and downlink, it informs *OLT-B* with *ENERGY_SAVE_REQUEST* from the dedicated link. If *OLT-B*'s traffic volume is under the

predefined threshold, *OLT-B* responds with *ENERGY_SAVE_OK* message otherwise *ENERGY_SAVE_NO* from the dedicated link. If *OLT-B* responds OK then *OLT-A* starts the preparations for deep-sleep mode. Otherwise, *OLT-A* waits next load check interval for next query.

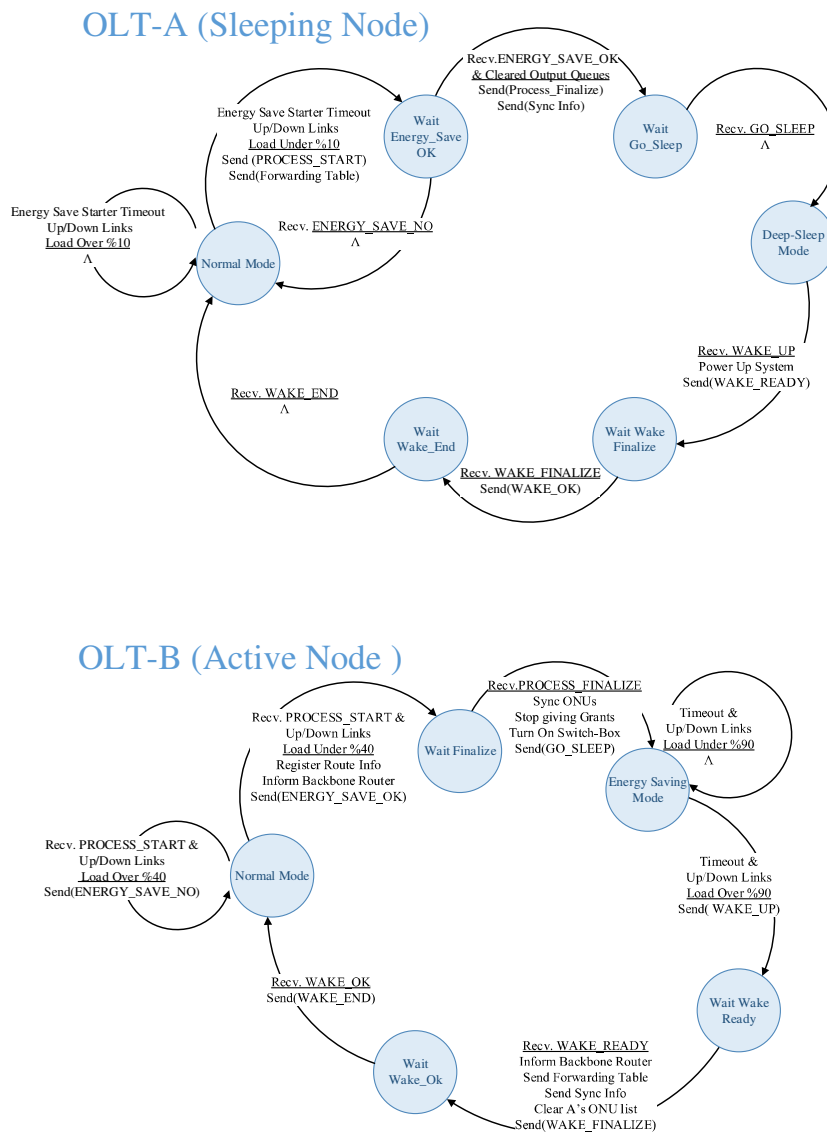

Figure 5.11: Finite State Machine of Transition between two modes in Control Plane

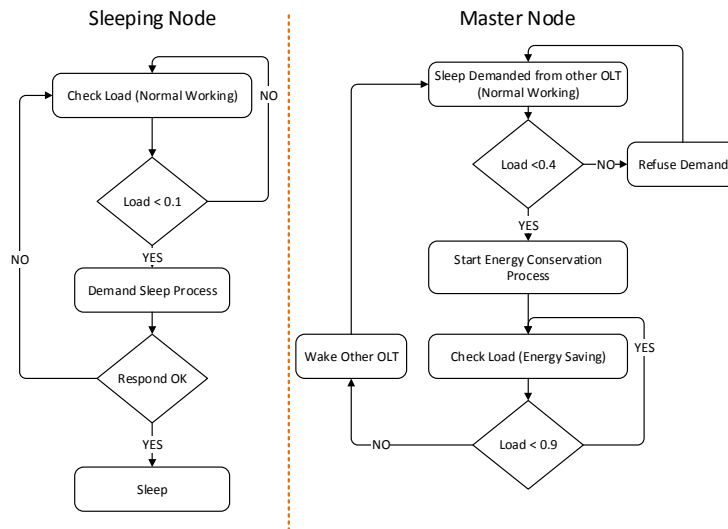

Figure 5.12: Control plane decision flow

OLT-A executes the processes below to prepare itself for deep-sleep mode;

1. *OLT-A* must lead all connection (routing information) to transmit over itself to *OLT-B*. Thus, *OLT-A* activates *OLT-B* from the direct connection link by sending *PROCESS_START* control message and its forwarding table.
2. Till the connection is established over *OLT-B* (the time is about refreshing Forwarding Table of connected router), *OLT-A* receives incoming packets from backbone and schedule them for its ONUs. After a while, the forwarding table is refreshed (can be assumed or strictly checked from the backbone device). After sending all queued packets, *OLT-A* sends *PROCESS_FINALIZE* message to *OLT-B* to inform that it is ready for deep sleep.
3. Just before sending *PROCESS_FINALIZE* message, *OLT-A* clears all the grant information for its ONUs and give the sync information to *OLT-B*. By doing so, while switching process is on, ONUs belongs to *OLT-A* have no packets in transmission.
4. After finishing all the operations *OLT-A* waits to get *GO_SLEEP* message from *OLT-B*. If no response returns from *OLT-B*, *OLT-A* cancel the energy saving process and wait for new commands and packets in active state.

OLT-B performs the processes below before switching to energy saving mode;

1. After receiving *PROCESS_START* message, *OLT-B* waits for *OLT-A*'s forwarding table, then update its forwarding table and inform the backbone router for new routes. Prepare itself to communicate with ONUs of *OLT-A*, and waits for *PROCESS-FINALIZE* message form *OLT-A*.
2. Before *PROCESS_FINALIZE* message, *OLT-B* gets sync information for ONU's of *OLT-A* and schedules bandwidth allocation for all ONUs including network A and network B.
3. With *PROCESS_FINALIZE* message, *OLT-B* arranges a time interval for switching, stops giving grants and stops downstream traffic for this interval, and turns the switch-box for forwarding packets to itself.

4. While switching to energy saving mode, *OLT-B* stores any arrived packets that belongs to ONUs of *OLT-A*. After the switching procedure, these packets are scheduled with appropriate grant (*GATE*) information.

When *OLT-B* reaches to upper load limit, then it demands *OLT-A* to wake up to share the ONUs again and work in normal mode by sending *WAKE_UP* message from dedicated link. After *OLT-A* receives *WAKE_UP* signal, it powers up and sets its parameters (buffers, schedulers, counters etc.) and responses to *OLT-B* with *WAKE_READY* message. After *OLT-B* receives *WAKE_READY* message, it knows that *OLT-A* can handle the incoming messages. *OLT-B* sends sync information to *OLT-A* and sets forwarding table of backbone router, itself, and *OLT-A*. After all updates, *OLT-B* sends *WAKE_FINALIZE* message to *OLT-A*. If preparations are finished as expected, *OLT-A* responds with *WAKE_OK* and *OLT-B* turns the switch-box in normal working mode. After that, *OLT-B* triggers *OLT-A* to start processing in normal mode with *WAKE_END* control message.

5.4.3 Simulation Environment

To evaluate the performance of our proposed design, we compared with standard OLT implementation with OMNET++ 4.3 tool. We simulated a simple scenario where two OLT cards connected with aggregation node and a switch-box. Figure 5.13 shows the simulation environment where OLTs are connected to an Ethernet Aggregation node supplied with sources for downstream traffic. For the subscriber side, ONUs are connected to subscriber nodes and follows sink points for generated traffic. In simulations, just downstream traffic is taken into consideration for simplicity. Since upstream traffic has generally much less or same as downstream traffic volume.

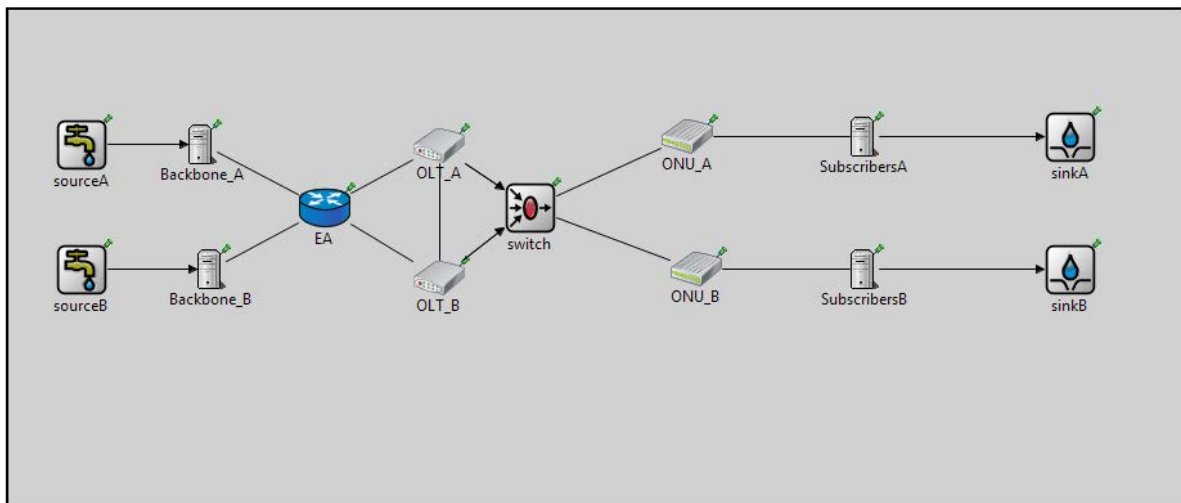

Figure 5.13: Simulation environment

Energy saving mode is able to be activated under low loads. When the load increases, system switches back to normal mode. Classic traffic generation is not effective to observe the performance of the algorithm, since it creates approximately same load during overall execution. Thus, traffic sources are configured to produce different loads in successive time intervals to easily analyze the performance of energy efficiency algorithm. The time intervals and load are exponentially random distributed. For a given time, the traffic load is arbitrarily change between zero and one. Traffic generator creates different loads in exponentially distributed time intervals.

For the experimental results different traffic patterns were performed by changing the load and variation intervals. In figures the average calculated offered load is given for reference. The generated traffic for average load equals to 0.18 is given in Figure 5.14 and same graphics for 0.38 load is given in Figure 5.15. Histogram of the packet distribution is given in Figure 5.16. The simulation has many transitions between low and high load situations.

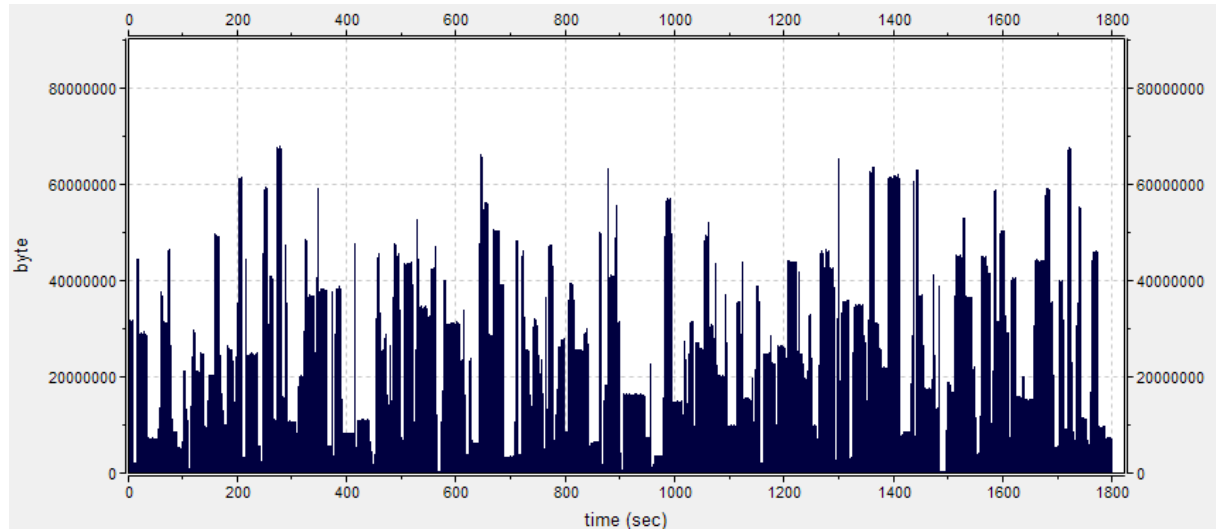

Figure 5.14: Generated traffic example (Average data send – Timeline)
1s intervals, Average Load: 0.18

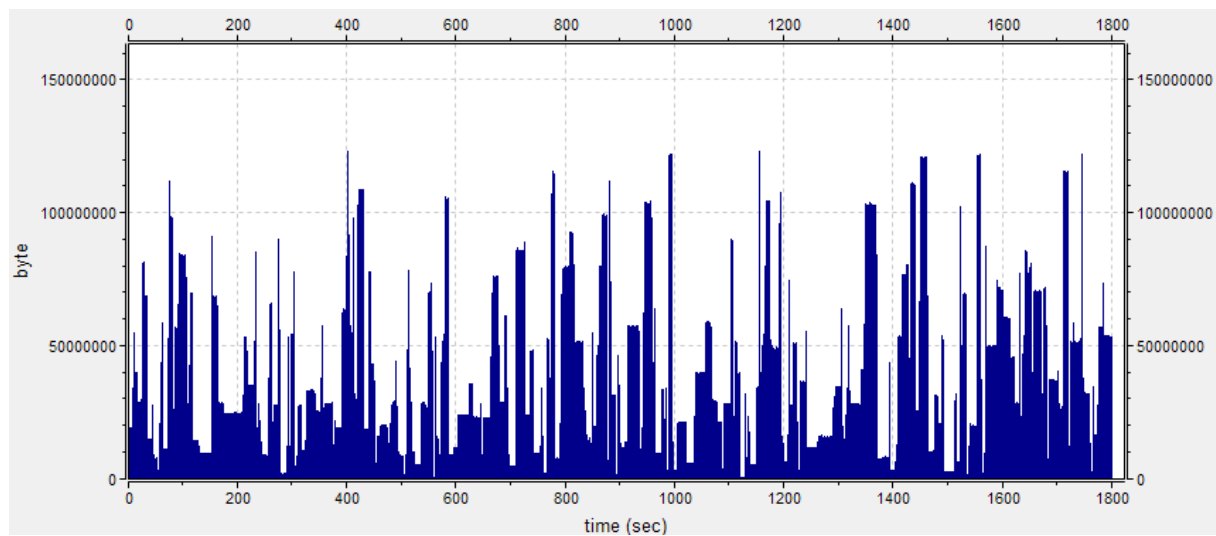

Figure 5.15: Generated traffic example (Average data send – Timeline)
1s intervals, Average Load: 0.38

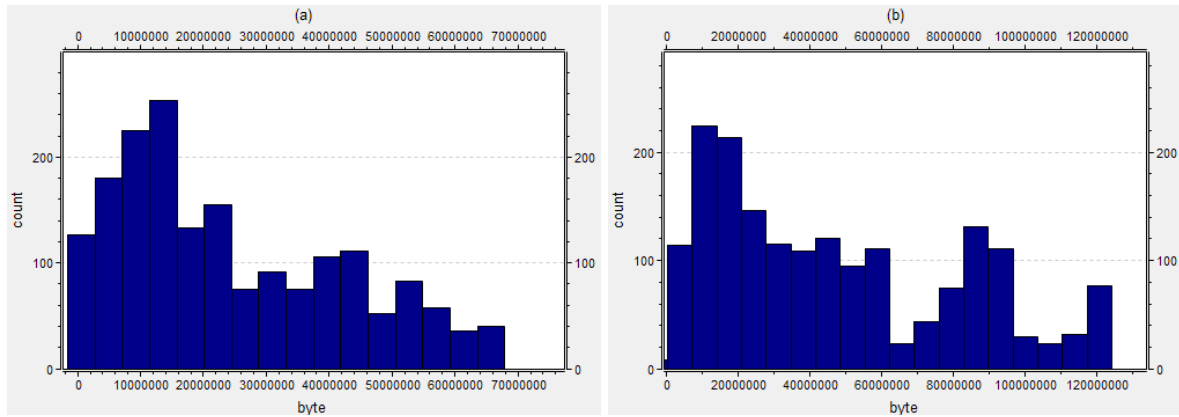

Figure 5.16: Generated traffic example (bitrate histogram)
1s intervals, Average Load: 0.18 (a), 0.38 (b)

5.4.4 Performance Evaluation

The performance of the dynamic energy efficiency algorithm is quite related to the incoming traffic pattern. Transition between normal and energy saving modes occurs when the incoming traffic load varies. Therefore, classic traffic generators given in OMNET simulation environment are inadequate for our evaluation. Distribution algorithms as Poisson or exponential are based on a fix load parameter and the generated packet distribution heaps up the given load value. To figure out the effects of dynamic transitions between normal and energy saving modes a traffic generator creates variable load, which explained above, is used. Parameters of the simulation environment are summarized in Table 5.2.

Table 5.2: Simulation Parameters

Parameter	Symbol	Values
Bandwidth	β	1 Gbps
OLT buffer sizes		20 MB
Simulation Times	t	10000 sec
Load Check Interval	LCI	10 ms
Packet Sizes		1500 Byte
Load Change Interval	θ	3 s , 10 s
Optic Switch-Switching Time	St	5 ms , 5 ns
Route Table Update Time	Rt	25 ms , 5 ms
Load Limits - Percentages (Wake Up, Accept Sleep Request, Demand Sleep Request)	<i>Case 1</i> <i>Case 2</i> <i>Case 3</i>	(90 , 40 , 10) (80 , 40 , 10) (90 , 40 , 20)

The performance of energy-efficiency algorithm has been investigated under different traffic pattern and bounds. Load change interval (θ) shows how long the traffic is generated based on the same load. In our simulations we examine two different θ value as 3 sec and 10 sec. θ equals to

three seconds means that the load is very variable. Thus, incoming traffic is changed between low and high bounds of energy-efficiency algorithm. Low bound is the limit where an OLT can send sleep demand. High bound stands for when the master OLT sends wake up demand. The low and high bounds can affect the buffer fill and access delay. For performance evaluation we present three cases. *Case1*: 90% for high bound and 10% for low bound, *Case2*: 80% for high bound and 10% for low bound, *Case3*: 90% for high bound and 20% for low bound. In each scenario, upper bound to accept the sleep demand is selected as 40%. Firstly, the number of On-Off transitions, where S_t is 5 ms and R_t is 25 ms, is given in Figure 5.17. θ has greater impact on the On-Off transitions in each scenario.

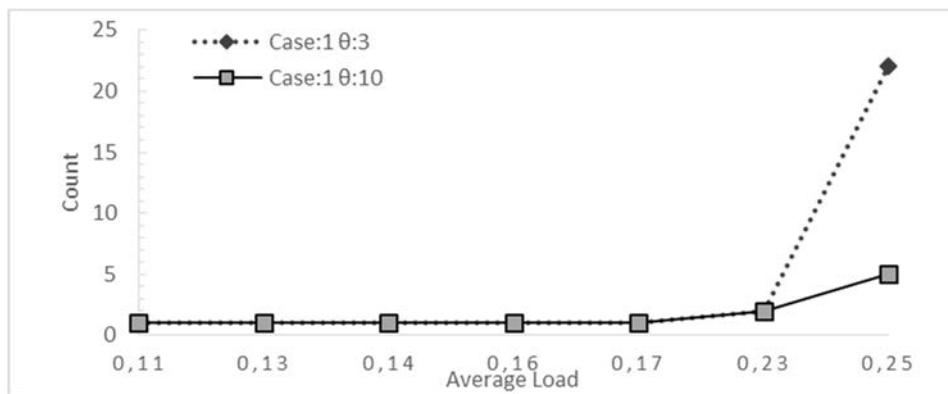

(a)

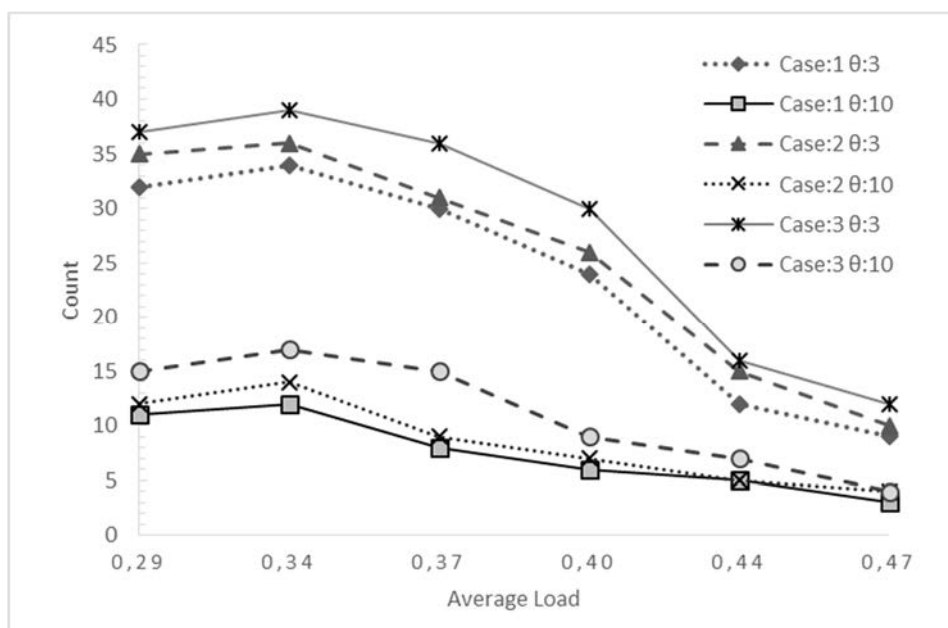

(b)

Figure 5.17: Number of On-Off transition under different load experiments (S_t : 5 ms, R_t : 25 ms)

For the average load under 0.25, only *Case1* is investigated, since under low load values OLT couple stays in energy saving mode where one of the OLT's always stays in sleep mode. Under 0.17 average load, one OLT is always in sleep state. Same situation also occurs at high average load values. Thus, over 0.50 average load is not investigated. Also, the other conditions are not given since they are

comparably same. The number of On-Off transitions means more switching and route table update delays and results with an increase of access delay. When θ equals to 3 sec, the maximum average of On-Off transition is resulted as 55 times in 10000sec simulation duration.

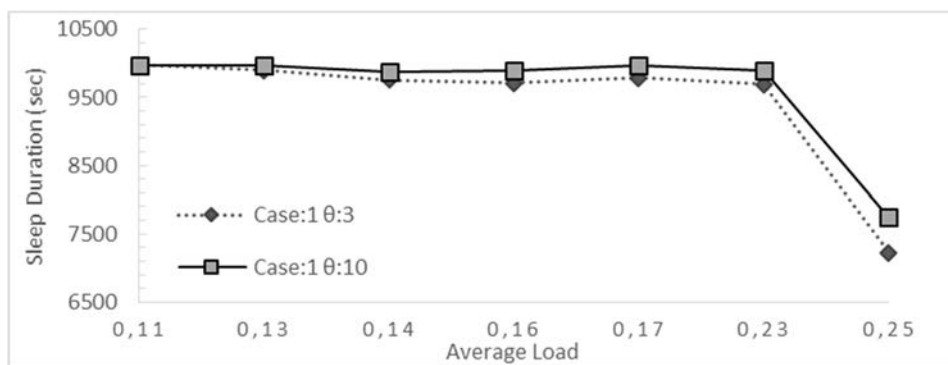

(a)

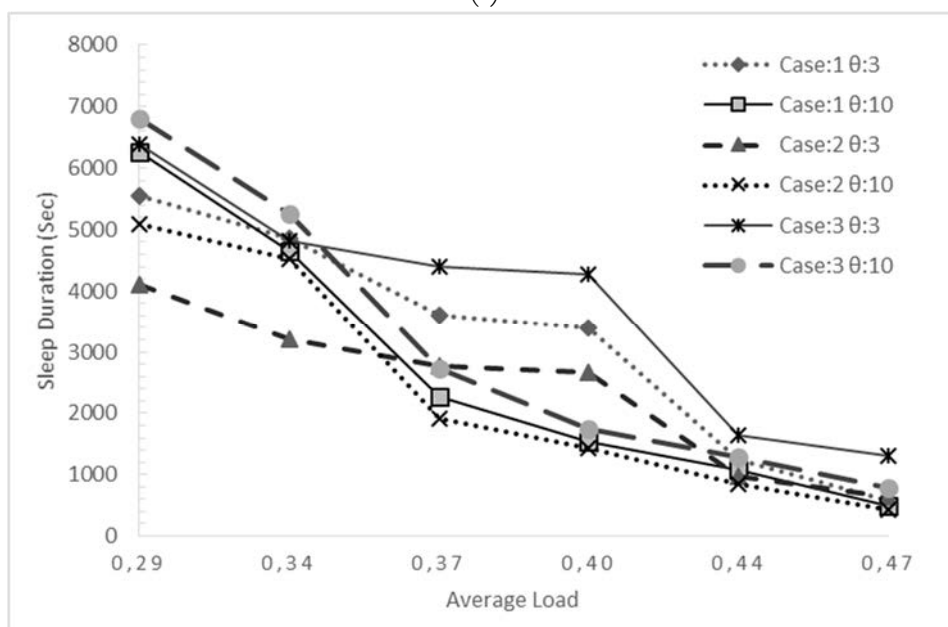

(b)

Figure 5.18: Sleep Duration of OLT couple (S_t : 5 ms, R_t : 25 ms)

In Figure 5.18 and Figure 5.19, total sleep duration of OLT couple is shown. These values are sum of both OLT's sleep durations in 10000 sec simulation time. The average load values under 0.23, one OLT stays 99% in sleep mode. Thanks to dynamic scheme one OLT can be kept in sleep mode till the average load increase to 50%. Load change interval of the traffic affects the algorithm performance in load values between 0.30 and 0.45. Arbitrary traffic means more transitions between sleep and active states. That seems to increase the sleep performance of OLT couple, however it also increases the access delay. For different case studies the results are very similar where θ taken as 10 sec. *Case2* shows the lowest sleep performance and *Case3* shows the highest sleep performance, as expected, since the sleep decision bounds have great impact when the traffic load varies. The bounds of sleep algorithm has direct impact on sleep performance and access delay. During day time, internet usage has peak (work hours) and idle (night) periods. So, it is better to select *Case2* (80-40-10) in peak periods, *Case3* (90-40-20) in idle periods, and *Case1* (90-40-10) in other periods. Though, the energy efficiency can be maximized while access delay values kept under

1ms. The amount of sleep times shown in Figure 5.19, are similar to the values in Figure 5.18. The switching delay does not have much impact on sleep durations but has more impact on access delay. This is because some packets are kept in OLT buffers during switching process.

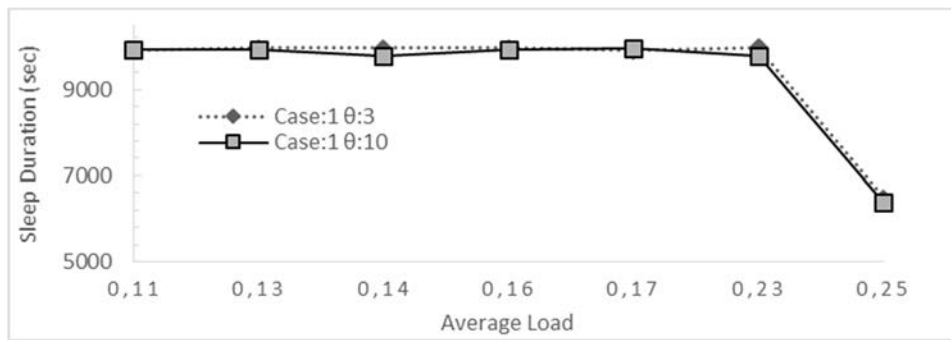

(a)

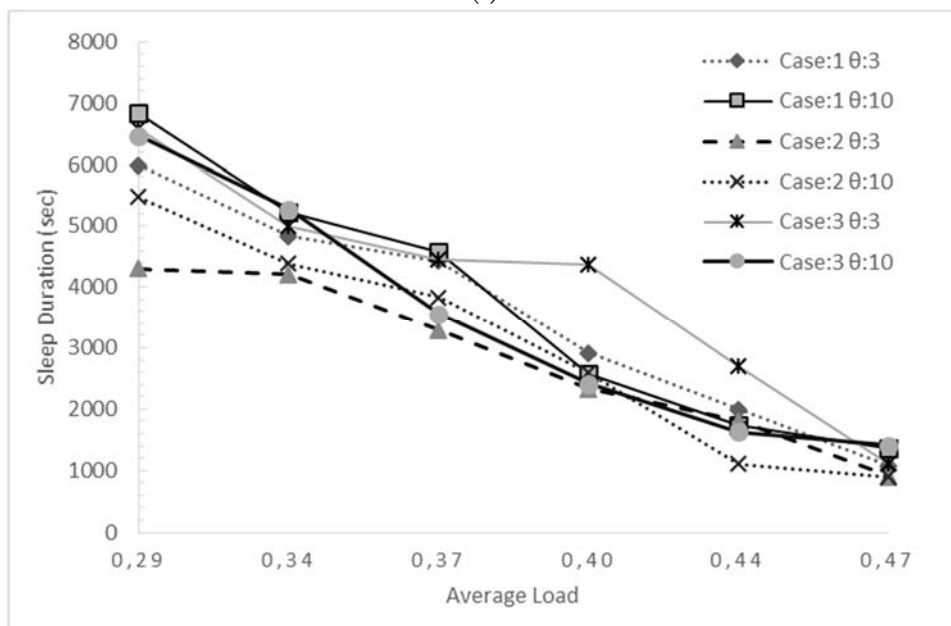

(b)

Figure 5.19: Sleep Duration of OLT couple (S_t : 5 ns, R_t : 5 ms)

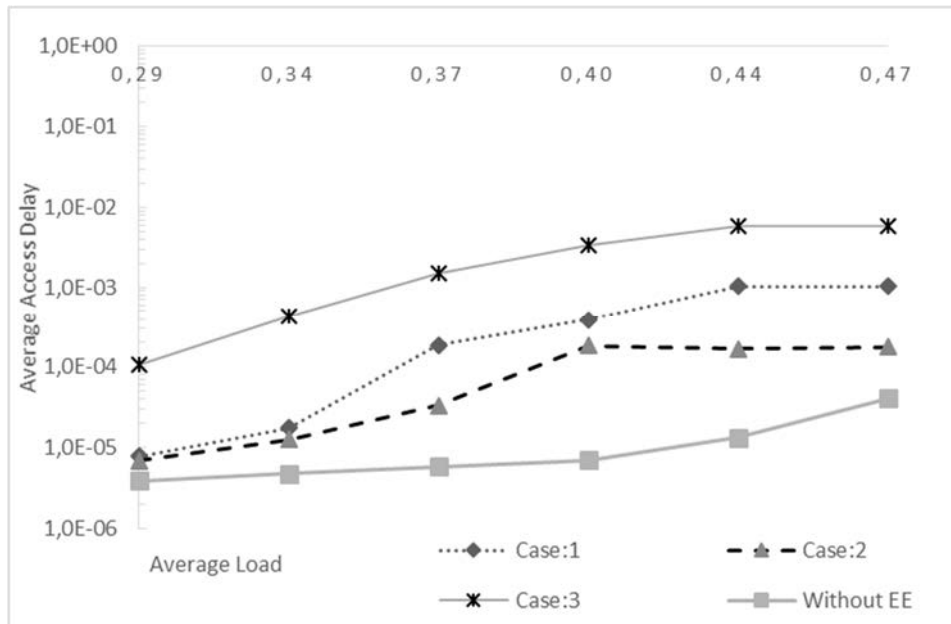

Figure 5.20: Average Access Delay Comparison (θ : 3 sec, St : 5 ms Rt : 25 ms)

Figure 5.20, Figure 5.21, Figure 5.22, and Figure 5.23 present average access delay performance of our algorithm compared to the system without energy-efficiency algorithm. The access delays are related to the time spent in energy saving mode, the number of On-Off transitions and the switching time. Thus, while $\theta = 3$ sec, $St=5$ ms, and $Rt= 25ms$ in Figure 5.20 system has the maximum access delay results. The number of On-Off transitions is the critical parameter for the access delay increment. When the load is not highly variable, the energy-efficiency algorithm performs better. *Case2* has the lowest access delay performance. On the contrary, it is not as much energy-efficient as other cases. These results shows that changeable bounds according to the predicted traffic pattern can maximize the access delay versus energy-efficiency performance.

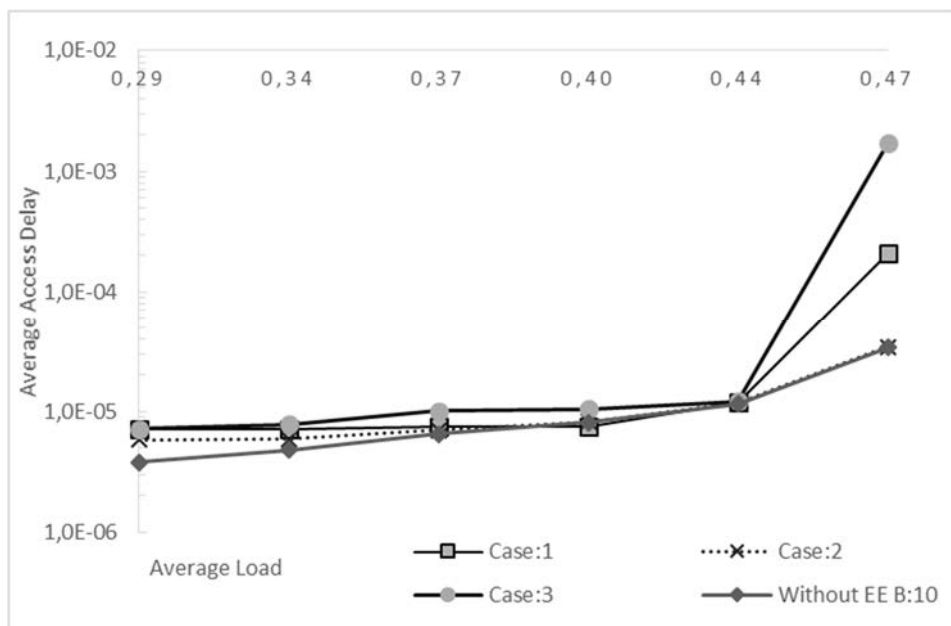
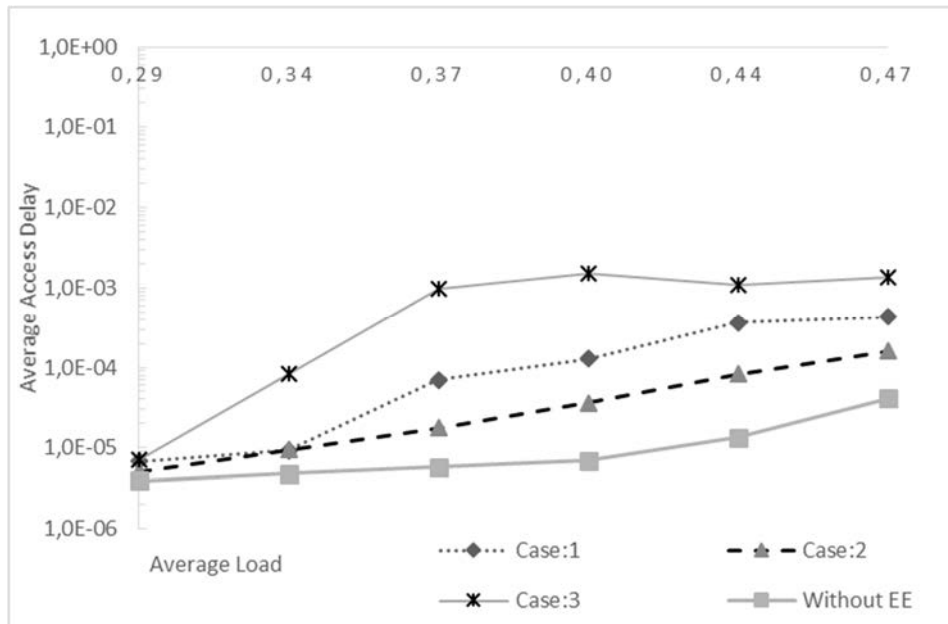
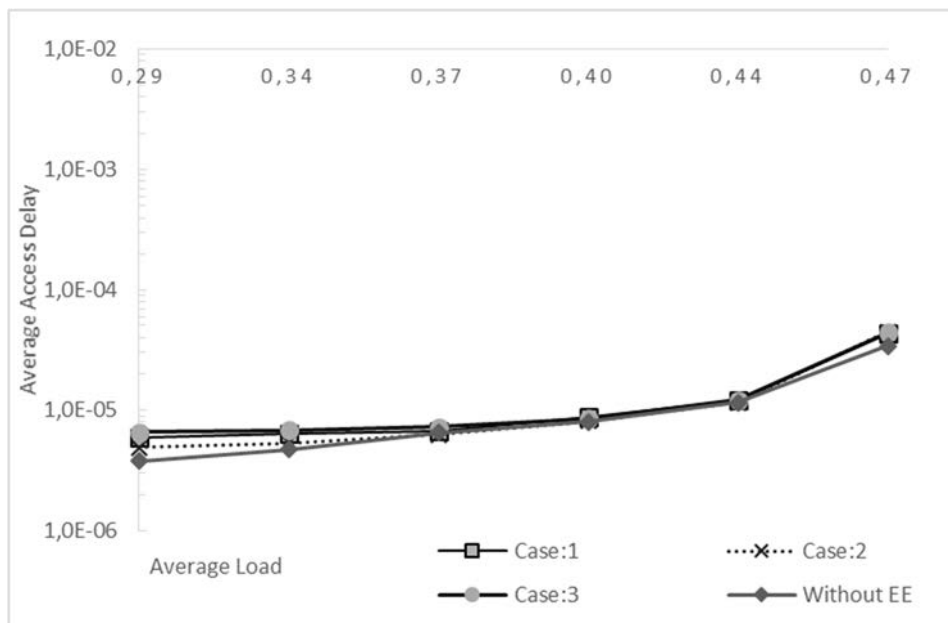

Figure 5.21: Average Access Delay Comparison (θ : 10sec, St : 5ms Rt : 25ms)

Figure 5.22: Average Access Delay Comparison ($\theta: 3\text{sec}, St: 5\text{ns}, Rt: 5\text{ms}$)Figure 5.23: Average Access Delay Comparison ($\theta: 10\text{sec}, St: 5\text{ns}, Rt: 5\text{ms}$)

5.4.4.1 Access Delay Analysis

It is obvious that traffic load variation results in more transitions between normal and energy-saving mode. According to the Optic Switch Switching Time (S_t), access delays of incoming packets are increased by the number of transitions.

For classical model of access waiting time, we can figure out the access delay (W) of a node in terms of arrival rates (λ) and service rate (μ).

$$W = \frac{\lambda}{\mu(\mu-\lambda)} \quad \text{Equation 5.1}$$

In our energy-efficient design, there are four different cases that has to be modeled separately for an OLT to calculate average waiting time of the system. These cases are;

- 1) W_{en} : Normal state: OLT process its own PON's packets
- 2) T_{es} : Switching State: Total delay in switching time
- 3) W_{ee} : Energy-Saving state: OLT process both PONs' packet
- 4) W_{ex} : Sleeping state: OLT in sleep mode, no waiting packets

Total waiting time in energy-efficient OLT (W_{et}) is the total average of the first three waiting time values. If C_{en} and C_{es} are packet counts of normal state in energy-efficient OLT, and energy-saving state in energy-efficient OLT respectively.

$$W_{et} = \frac{W_{en}C_{en} + T_{es} + W_{ee}C_{ee}}{C_{en} + C_{ee}} \quad \text{Equation 5.2}$$

We can easily model W_{en} and W_{ee} according to the arrival rates of OLTs' (λ_A, λ_B) and bandwidth capacity of OLT as service rate (μ). Here the waiting times for OLT-A can be modeled as;

$$W_{en} = \frac{\lambda_{An}}{\mu(\mu-\lambda_{An})} \quad \text{Equation 5.3}$$

$$W_{ee} = \frac{\lambda_{Ae} + \lambda_{Be}}{\mu(\mu - (\lambda_{Ae} + \lambda_{Be}))} \quad \text{Equation 5.4}$$

Where λ_{An} is arrival rate of OLT-A for normal state, λ_{Ae} is arrival rate of OLT-A for energy-saving state and λ_{Be} is arrival rate of OLT-B for energy-saving state.

In energy-saving state, both of PONs' packets pass through one OLT. Since, the arrival rate is sum of both traffic where the service rate stays the same.

Total waiting time for switching (T_{es}) consists because of the packet arrivals of both OLTs stored till switching time (S_t) and the arrivals while they are served. Packets from two OLTs' are stored in active OLT's buffer. In Figure 5.24 the buffer filling and release of the packets during switching is symbolized. In region one, arrived packets are buffered, since the OLT is waiting for switch process. After, packets in buffer are served. While the buffered packets are served, it is obvious that OLT receives new packets. Region two symbolize the releasing of buffered packets. To compute T_{es} , we need to look at the delay of the packets in two separate parts.

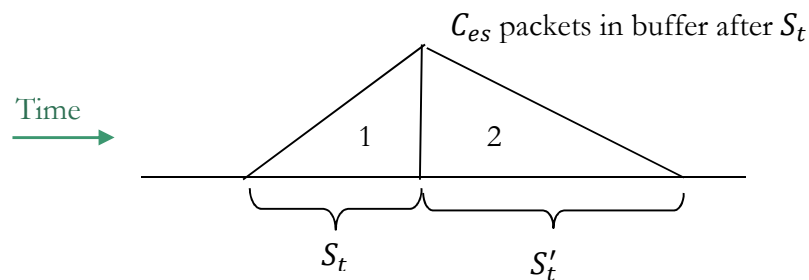

Figure 5.24: Buffered packet behavior during switching

Packets stored in the buffer while switching process (C_{es}) is;

$$C_{es} = (\lambda_{Ae} + \lambda_{Be})S_t \quad \text{Equation 5.5}$$

The time pass to serve the packets stored while switching (S'_t) can be calculated as;

$$S'_t = \frac{(\lambda_{Ae} + \lambda_{Be})(S_t + S'_t)}{\mu} \quad \text{Equation 5.6}$$

$$S'_t = \frac{(\lambda_{Ae} + \lambda_{Be})S_t}{\mu - (\lambda_{Ae} + \lambda_{Be})} \quad \text{Equation 5.7}$$

Let C'_{es} shows the arrived packet count during S'_t .

$$C'_{es} = (\lambda_{Ae} + \lambda_{Be})S'_t + C_{es} \quad \text{Equation 5.8}$$

$$C'_{es} = (\lambda_{Ae} + \lambda_{Be}) \frac{(\lambda_{Ae} + \lambda_{Be})S_t}{\mu - (\lambda_{Ae} + \lambda_{Be})} + (\lambda_{Ae} + \lambda_{Be})S_t \quad \text{Equation 5.9}$$

$$C'_{es} = \frac{S_t(\lambda_{Ae} + \lambda_{Be})\mu}{\mu - (\lambda_{Ae} + \lambda_{Be})} \quad \text{Equation 5.10}$$

If we consider the packet arrivals as uniformly distributed during switching process, the extra waiting time caused by switching can be formulated as the arithmetic sum of the packets delay in two regions.

$$T_{es} = N \left(\frac{C_{es} \left(\frac{S_t + S_t}{2} \right) + \frac{C'_{es} \left(\frac{S'_t + S'_t}{2} \right)}{2} \right) \quad \text{Equation 5.11}$$

$$T_{es} = N \left(\frac{(1 + C_{es})S_t}{2} + \frac{(1 + C'_{es})S'_t}{2} \right) \quad \text{Equation 5.12}$$

If we define T_{es} in terms of S_t , arrival rates and service rate;

$$T_{es} = N \left(\frac{((1 + (\lambda_{Ae} + \lambda_{Be})S_t)S_t) + \left(1 + \frac{S_t(\lambda_{Ae} + \lambda_{Be})\mu}{\mu - (\lambda_{Ae} + \lambda_{Be})}\right) \frac{(\lambda_{Ae} + \lambda_{Be})S_t}{\mu - (\lambda_{Ae} + \lambda_{Be})}}{2} \right) \quad \text{Equation 5.13}$$

Here S_t is the key parameter to indicate total waiting time of packets. The energy-saving algorithm's performance is highly related to system parameters such as the switching duration, and router table update duration. Switching and route table update durations can decrease by invention of novel devices. Besides optical switch that responds in nanoseconds already present and in use at backbone networks where the study in 5.3.4 admit to use these type of optical switches.

5.4.4.2 Buffer Occupancy

One of the critical issue in using energy efficiency methods is the capability of system to give same service quality in energy saving mode compared to normal state. In our dynamic switching concept, the buffer occupancy in OLT is a key metric for service quality. While saving energy, system should not drop or excessively wait data transmission. In PON, while collision does not occur in OLT-ONU communication, only buffer overflows cause data loss. In switching process, the OLT stops

serving packets. Since, the packets are filled in buffer, buffer capacity has to adapt the worst case buffering demand. While the system goes into the switching process, the buffer fullness of active node can be computed as;

$$N_{es} = \lambda_{An} W_{en} \quad \text{Equation 5.14}$$

Total buffer necessity at the end of the switching process is;

$$BufferOccupancy = PacketSize \times (C_{es} + N_{es}) \quad \text{Equation 5.15}$$

$$BufferOccupancy = PacketSize \times \left((\lambda_{Ae} + \lambda_{Be}) S_t + \frac{\lambda_{An}^2}{\mu(\mu - \lambda_{An})} \right) \quad \text{Equation 5.16}$$

If we examine the worst condition for *Case1*, OLT-A has 40% traffic load and OLT-B has 10% traffic load while passing to energy saving mode. When the other parameters are taken as S_t : 5 ms, bandwidth: 1 Gbps and packet size: 1500 byte, the buffer occupancy caused by the energy efficiency switching process is approximately 312 KB. Since, the buffer size of OLT is 20 MB for 1 Gbps link scheduling 312 KB additional utilization is manageable.

5.4.5 Conclusion

In this chapter, a novel OLT based energy efficiency technique in optical access network is presented. A control plane of OLT is designed to manage communications between OLT pairs and switch-box. Our strategy is simply putting one of the OLTs into deep-sleep mode as much as possible while using standard TDM messaging procedure in PON. The architecture is evaluated with OMNET++4.3 simulation tool for performance analysis. Our energy-efficiency algorithm's performance is compared with normal processing in case of access delay. Energy-efficiency algorithm can save 90% of one OLTs energy consumption if the system average load is not high. When mostly 25% of users are simultaneously using Internet, energy can be conserved whole day with our dynamic scheme. When compared to selective shutdown algorithm, our algorithm has the ability to conserve energy at peak hours of the daytime if any gap occurs between high loads, and excludes the performance problem caused by arbitrary increased traffic in idle hours (night). This approach can reduce the OLT's energy consumption under low loads. It does not bring too much structural changes and can be performed by a service provider without changing standard implementation of PON. Besides, our structure has no limitations on using ONU-based energy conservation approaches. Besides, this approach seems to be promising for implementation expenditures compared to WDM based solutions.

As the negative aspects of our proposition, it requires a switch-box implementation and use of dedicated communication line between OLT pairs and switch-box. While the system is on the switching process the packets are delayed in OLT and ONU buffers. This waiting time is necessary because of switching time and aggregation node updates (i.e. less than 30ms).

The switching mechanism can be triggered dynamically at any time or a weighted approach can be used for day-night, weekdays-weekend pairs for a better performance and energy conservation.

6 General Conclusion

Internet became irrevocable for daily use. From education to entertainment, sanitation to government services most of the information transmission is done over Internet with web oriented applications. Increasing demand of end-users because of the bandwidth consuming applications like online video gaming, online education, video conference, online video and music services, lead the service providers to find better solutions to reach more user within a longer range. Besides Internet coverage, service providers also aim to give telephone and IPTV services, which is known as triple play service, on same access network solution for cost-effectiveness. Optical access networks comes front for the promising solution for the needs of service providers to give cost-effective high bandwidth available alternative.

Optics started to be used in access networks in nineties and becomes the most popular fix access technology in last decade. Passive optical access network technology has shown great progress. The standards of PONs has been released from ITU-T and IEEE under EPON and GPON branches currently reach 10 Gbps up/down rates. These standards use TDM in downstream and TDMA in upstream directions. By TDM, a PON can reach 32 or 64 users up to 20 km range with a single fiber leaving from central office and divided by passive splitters. Novel standard developments are focused on increasing the reach and split ratio of PON. NG-PON is going to be next standard for PON which aims to have at least 40 Gbps downstream capacity, 1:256 split ratio and legacy support for co-existence with implemented PON standards.

In this thesis, the passive optical access solutions have been examined. In Chapter 2, types of optical access networks and evaluation of PONs are summarized from the beginning to today's standardization studies.

The standardization process branches into two separate areas where one of them is developed by IEEE and another one is developed by ITU-T. IEEE 802.3xx work groups developed EPON and its successor standard 10G-EPON. Ethernet in the First Mile Task Force of IEEE decided to create a TDM-PON based on Ethernet framing. EPON and 10G-EPON use Ethernet frames like LANs to carry packets over PON. Packets are broadcasted in downstream and variable-sized time slots are used for upstream. The time slots are carried on a single fiber without collision and under

control of MPCP in OLT. EPON standard figures out the wave band, power threshold, signaling, registration, packet type and such system parameters for concurrency of products from various vendors. On the other side, bandwidth allocation, security and link failure tolerance left to the vendors as an open issue for further development. While EPON performs as a good solution for service quality and bandwidth availability, the bandwidth allocation algorithm in use has a direct impact on bandwidth utilization and service quality. Online DBA algorithms like IPACT, can have full bandwidth utilization while the bandwidth demand of each node is not carefully compared. Since, some highly loaded ONU starved bandwidth IPACT schedule some packets from these ONUs to next cycle. Offline DBA algorithms have been proposed to find solution for fair bandwidth allocation to highly loaded ONUs in same cycle, if the overall usage of bandwidth is suitable. However, offline methods have to collect all the reports and they have utilization problem to solve.

In Chapter 3, a novel DBA algorithm (hcDBA) for EPON has been proposed. hcDBA takes the advantage of both online and offline DBA methods by half cycle stops. hcDBA includes two working modes as; online and offline mode. According to the calculated traffic load for every half of the ONUs reports, if the traffic load is low hcDBA decides to work in online mode and gives more bandwidth to demanding ONUs. Otherwise, if the traffic load is high hcDBA works in offline mode with half stops and calculate excess bandwidth distribution on each half and full cycles for fairly distributed excess bandwidth among highly loaded ONUs.

hcDBA algorithm is compared to IPACT and classical offline DBA approach for access delay, drop and packet delay variation performances. The comparisons are made on NS2 (Network Simulation Tool 2.34) on a 1:16 EPON simulation set. NS2 does not include EPON implementation in the framework, therefore at first EPON is modeled on NS2 with OLT, ONU, splitter, and packet format implementations. With comprehensive simulation studies, the performance of hcDBA exposed in graphics.

Early prediction is a method used in network design to decrease waiting time of packets in queues. In EPON, while each ONU has to report its buffer fill size to OLT before getting grants, every packet in EPON has to wait at least one cycle period before served. Thus prediction algorithms are widely studied in literature for decreasing access delay in EPON upstream. While OLT is calculating the grant size of an ONU, prediction algorithm can add extra grant space for newly arrived packets to ONU from local network. Besides, prediction is a good way to decrease packet waiting duration, in case of false predictions more bandwidth can be wasted unnecessarily. False predictions are inevitable in the nature of Internet user traffic. Therefore, in our approach we decided to use prediction case when the system is not highly loaded. By doing so, in case of false prediction the system does not perform worse than the worst case of without prediction. The extended algorithm is named as p-hcDBA and compared to hcDBA and IPACT to investigate their performances. The simulations done by adding prediction extensions on NS2 platform developed before. When only 25 percent of user are active at a given time on Internet, prediction under low loads can increase the user experience without behaving unfair for highly loaded situations.

In Chapter 4, the traffic characterization of OLT backbone connection is studied by collecting the upstream traffic traces of PON. While doing MAN simulations, we have to simulate PONs at all to give a coherent traffic pattern. For today's computers, making such kind a huge simulation is impossible to accomplish. Thus, we looked at the behavior of EPON upstream traffic to figure out

how the traffic output from OLT behaves. It is clear that a composition of self-similar and constant bit rate traffic pattern from subscriber nodes show Poisson distribution at OLT entrance. Thus, we concluded to use classical traffic generators which are suitable as traffic source for MAN simulations.

Fossil energy reserves of our planet are going to run out in near future and day-by-day the global energy consumption is increasing. Telecommunication networks have a considerable portion in global energy consumption where access networks constitutes 70% of the energy consumption in telecommunication networks. Thus, industry and academic institutes tend to develop more energy effective products and algorithms. In Chapter 5, the energy efficiency solutions proposed for access networks are examined in three categories. The standardization organizations have released energy conservation techniques as recommendations. In general, most of the energy conservation researches are based on ONU enhancements, since saving energy at ONU side has major impact for overall energy consumption. On the other hand, energy can be saved from central office equipment and inside connections. In Chapter 5, Ethernet Aggregation node and OLT oriented solutions are also summarized. A novel OLT based energy-efficiency method is proposed. In proposed design, two OLTs are connected with a dedicated control link. A switch-box controls the connections between OLT and ONUs. When energy-efficiency algorithm is in use, one PON's traffic is directed to other OLT. Each OLT has its own energy-efficiency decision algorithm. When one of them has low traffic load, it informs other one if there is availability to carry its traffic. If the negotiation from the dedicated control channel responded with OK message, one of the OLTs moves to sleep mode. In this procedure, the OLT gives all the backbone and PON connection information to the other OLT and clean up the packets in its local buffers. At the end of the processes, active OLT sends sleep signal to the other and let it into a deep sleep where just wake up function is left open. In energy saving mode, if the active OLT gets too much traffic load in downstream or upstream direction, it wakes up sleeping OLT and gives its own information back.

A simple simulation environment is prepared on OMNET++4.3. Our energy-efficiency algorithm's performance is compared to normal processing in case of access delay and byte loss. Energy-efficiency algorithm can save 90% of one OLT's energy consumption if the system's average load is not high. When mostly 25% of users are simultaneously use Internet, with our dynamic scheme, energy can be conserved during whole day. Compared to selective shutdown algorithm, our algorithm has the ability to conserve energy at peak hours of the daytime if any gap occurs in user traffic and removes the performance problem in idle hours (night) arbitrary increased traffic.

6.1 Future Directions

Wavelength Division Multiplexing is considered as the ideal solution for future of PONs. Reaching far distance, isolating user traffic from each other's and giving different type of services are advantages of WDM. However, using necessary optical equipment like wavelength splitters etc. is not cost-effective to serve end-user with WDM today. Besides, the unshared bandwidth that WDM provides is far more over the needs of end-users. Regarding economic considerations, WDM is not very common in PONs, for the near future, it is expected that it will be used more. Meanwhile,

ITU-T is working on NGPON2 standard. In NGPON2 recommendations using TDM-WDM hybrid PON structure is accepted for novel standard.

As a future development dynamic bandwidth allocation with half cycle stops can be implemented on TDM-WDM PON architecture. The performance of bandwidth allocation can be improved with WDM implementations. WDM introduce more occasions to find available bandwidth thanks to statistical multiplexing.

Another hot topic for future access networks is the convergence of wireless and fix (optic) networks. By pervade of mobile devices, the amount of wireless communication data is growing up. PON is one of the most used fixed connection type to connect these wireless users to backbone. With the developments in wireless technologies (i.e. 4G, LTE, WiMAX), optimization of wireless traffic data flow is getting much more importance. Since PONs are an intermediate layer for wireless end-points, the convergence of two access network is seen as one of the key points for future access networks. In convergence of wireless-optic; bandwidth allocation, cross control plane, shared packet format, radio over fiber are some of the topics that are open for further research. For next step, we also decided to enhance our dynamic bandwidth allocation algorithm in case of better wireless-optic convergence.

Energy-efficiency is going to keep its importance in future product development. Generally energy-efficiency context stays opposite to performance. While conserving energy, the system may compromise from the performance. In such cases, more effective algorithms can improve the energy conservation by losing negligible performance. As a future study, for our energy-efficiency proposition, the performance of energy saving scheme will be presented with different traffic patterns. Dynamic vs. time-based schedule working modes will be compared. And also, QoS aware decision making is going to be investigated. Afterwards, we aim to figure out 1xN OLT switch-box design and evaluate its performance.

7 Résumé en français de la thèse

Les progrès en matière de technologie de l'information au cours de ces 50 dernières années ont accéléré de façon considérablement afin d'augmenter la capacité de transmission en terme de la bande-passante imposés par l'émergence des applications de données et en terme des revenus attractifs. L'infrastructure de télécommunication est développée de plus en plus et est arrivée jusqu'à nos vies. La découverte de l'Internet a beaucoup changé la vie d'humaine et la science pour le développement du pays. Aujourd'hui, les technologies de la télécommunication offrent de différents services qui varient de technologies satellitaires au transfert de données via les lignes électriques. L'Internet est actuellement la plus importante des infrastructures de télécommunication. Il peut être vu comme un ensemble de réseaux qui agit non seulement comme une infrastructure de télécommunication unique, mais aussi comme un système qui combine de nombreuses infrastructures de télécommunication indépendantes. L'Internet a été lancé au début comme une étude scientifique, mais aujourd'hui il est devenu un phénomène qui relie le monde entier et a un énorme impact tel que même les changements de régime. D'un point de vue différent, l'Internet a également révélé différents domaines tels que les fournisseurs de services, les opérateurs, les fournisseurs de matériel de réseau. Les aspects commerciaux de l'Internet sont également l'origine de la recherche de clients et du marché. Tous ces progrès ont poussé à chercher des solutions pour répondre aux exigences des demandes des usagers en termes de bande passante et de la Qualité de Service (QoS) et de la faible erreur sur la transmission et à attirer plus de clients qui ont un faible budget. Ici les réseaux optiques se distinguent comme une solution optimale face aux demandes croissante de bande passante et de la transmission sans erreur sur long terme.

L'Utilisation de l'optique pour le transfert des données est fondée en 1965 et dans les années 80, il est utilisé dans les réseaux de communication à longue distance. Aujourd'hui, la technologie optique devient indispensable pour le réseau cœur et métropolitain. Puisque elle offre une énorme capacité de transmission. En 1990, la demande de bande passante des utilisateurs finaux a augmentée, ceci a porté l'idée d'utiliser l'optique dans les réseaux d'accès. Aujourd'hui, la plupart des infrastructures de fournisseur de service sont basées sur des solutions optiques.

Les nouvelles applications orientées vers le monde vidéo-centrique ont engendrées de nouveaux service tels que IPTV, le vidéo à la demande (VoD), l'éducation à la demande (EoD), la haute définition TV (HDTV), la vidéo conférence, Les jeux vidéo-interactive de haute qualité, et la

surveillance vidéo. Avec l'introduction récente de caméscopes HD de qualité, il devient plus facile pour les consommateurs de générer des signaux à large bande passante pour la transmission en amont (Lee, et al., 2006). Ces applications gourmandes en bande passante provoquent une pression sur les fournisseurs de services pour offrir plus de bande passante dans les réseaux d'accès.

Le Réseau optique passif (PON) semble être la solution la plus prometteuse parmi les réseaux d'accès fixe grâce à ses performances économiques. Le PON donne l'occasion d'offrir plus de bande passante à grande distance par rapport aux solutions d'accès existantes comme xDSL. En outre, le PON est une solution plus économique parmi les solutions d'accès optique. Le PON a besoin moins de stockage dans l'Unité centrale (CO, central Office) et de moins de fibres à implémenter par rapport à d'autres solutions de réseau d'accès fixe optique. Un autre point d'intérêt pour les fournisseurs de services est de fournir multiples services tels que des services de données, de téléphonie et de télévision sur un support triple-play où le multiplexage de longueur d'onde (WDM) rend possible à effectuer trois services séparément sur une seule fibre pour les abonnés. En raison de ces avantages du PON, il a été largement déployé pour soutenir l'Internet haut débit, la téléphonie et le service IPTV.

Le PON utilise une architecture en arbre simple où l'unité de central (Optical Line Terminal - OLT) a une interface de fibre permettant de communiquer avec les abonnés et les autres interfaces pour le contrôle et pour les connexions avec le réseau cœur. Le lien fibre unique de l'OLT est connecté aux unités de nombreux abonnés (Optical Network- ONU) via le répartiteur passif (pas de consommation d'énergie) qui diffuse le trafic vers les ONU. En raison de l'architecture de l'arbre (par suite de passifs répartiteurs / coupleurs), la transmission de données en aval n'est que la radiodiffusion. En amont, une technique d'accès multiple doit être utilisée pour le partage de lien fibre unique pour relier le centre-office (OLT). Les performances du PON sont liées à la capacité du lien de transport et le mécanisme d'allocation de bande passante à utiliser pour planifier la transmission des données de chaque ONU. Aujourd'hui la norme PON standardisée comme Ethernet Passive Optical Network (EPON) et Gigabit Passive Optical Network (GPON). Ils utilisent Time Division Multiplexing (TDM) pour la transmission en aval et Time Division Multiple Access (TDMA) pour la transmission en amont. La transmission de données en aval et en amont est contrôlée par l'OLT. Un algorithme d'allocation dynamique de bande passante fonctionne au niveau l'OLT pour l'allocation (en amont / en aval) de la bande passante du canal. Pour un algorithme spécifique, nous ne pouvons pas dire que c'est la solution idéale pour l'utilisation et les performances de l'utilisation du canal. Alors que certains algorithmes peuvent faire une bonne utilisation du canal, ils peuvent causer des délais et des problèmes d'équité.

Les Normes PON laissent ouvert le sujet de l'allocation de la bande passante, aux constructeurs pour de nouveaux développements. Les normes n'indiquent rien sur la structure d'échange de message et des principes des méthodes d'allocation de bande passante. Pour l'EPON, Multi Protocol Control Point (MPCP), qui est implémenté dans l'OLT, est responsable de l'allocation de bande passante, la signalisation et l'enregistrement du nouvel ONU. MPCP utilise deux paquets de contrôle ; GATE et REPORT, pour négocier avec les ONUs sur leur besoin en bande passante en amont. Chaque cycle, pour l'allocation de bande-passante en amont, l'OLT recueille des messages de REPORT et alloue la bande-passante à chaque ONU pour la transmission des données en amont. Quand et combien de temps une ONU peut utiliser le canal en amont sont informés par le message GATE. L'OLT peut envoyer des messages GATE dès qu'elle reçoit un rapport (mode en

ligne) ou il peut recueillir tous les messages de REPORT avant de décider et accorder des allocations (mode hors ligne). Le fonctionnement en ligne est une méthode facile à mettre en œuvre et fournit une bonne utilisation efficace de la bande-passante mais l'utilisation en mode hors ligne peut donner des allocations équitables.

La consommation d'énergie est l'un des problèmes cruciaux pour l'avenir du monde. La consommation mondiale d'énergie augmente de jour en jour où les sources fossiles diminuent. Ainsi, dans la dernière décennie les industriels et des institutions universitaires tentent de développer des produits énergétiquement efficaces. Les réseaux d'accès consomment 70% de l'énergie totale utilisée dans les réseaux de télécommunication (Mukherjee, 2011). Dans l'avenir, il semble que la consommation d'énergie dans les réseaux d'accès conserve sa part. En plus d'être la solution la plus prometteuse pour l'avenir des réseaux d'accès, le PON promet une solution pour l'économie de l'énergie. Un réseau d'accès optique ne se compose pas uniquement de PON, il a également d'autres équipements de réseau nommé comme nœud d'agrégation (agrégation Ethernet - EA) qui connecte plusieurs cartes d'OLT à une connexion principale du réseau cœur. Ainsi, la consommation d'énergie dans le réseau d'accès doit être traitée en trois points de vue différents : côté ONU, côté OLT, côté EA. Le côté ONU consomme plus d'énergie à cause de la numérotation du nombre des ONUs par PON. En conséquence, la plupart des méthodes développées pour économiser de l'énergie dans les réseaux d'accès sont basées sur les améliorations des unités ONU. Une ONU n'est pas active tout le temps sous régime TDM. Par conséquent, une ONU peut dormir dans les périodes d'inactivité. La Recommandation ITU-T G.Sup45 décrit quatre méthodes différentes d'économie d'énergie : délestage, somnoler, sommeil profond et sommeil rapide / sommeil cyclique pour les ONUs. Pour économiser de l'énergie du côté de l'OLT, certains OLT peuvent être mis hors tension en fonction de la charge de trafic. Ce processus peut entraîner la perte de données et dégradation de la qualité des services, et ceci peut donc être acceptable seulement dans les heures de repos de la journée (minuit). Le routage par longueur d'onde, et d'autres techniques peuvent être utilisés pour mettre en dehors d'utilisation (fermer) sélectivement des cartes d'OLT. De même, les EAs peuvent également être mis en sommeil quand un EA peut faire la tâche de deux ou plusieurs EAs.

Dans le cadre de cette thèse, nous visons à fournir une analyse des normes de réseau optique passif. Des procédures de classement, d'évolution et de normalisation des technologies d'accès optique sont présentées. L'allocation de bande passante a un impact majeur sur les performances de PON, les systèmes de répartition de la bande passante dynamique pour l'EPON sont étudiés et un schéma d'allocation de bande passante basé sur une combinaison des techniques d'allocation de bande passante en ligne et hors ligne est proposé. Ensuite, la conservation de l'énergie dans les réseaux d'accès optiques est explorée et un plan de contrôle basé OLT est proposé.

7.1 Objectif

Dans un proche avenir, tous les réseaux d'accès fixe seront conçus comme des réseaux optiques passifs (FttH, FttB, FttC, FttP, ...). Les performances et la consommation d'énergie du PON sont liées au développement de composants optiques et électroniques utilisés dans ONU, OLT, EA, et parmi eux. D'ailleurs il est très affecté par l'allocation de la bande passante, la planification, les files d'attente et les méthodologies de traitement. Dans cette thèse, comme mentionné précédemment

L'allocation dynamique de la bande passante dans l'EPON et les techniques efficaces de l'économie de l'énergie sont étudiées. La qualité de service est le point clé pour les opérateurs tout en choisissant de nouvelles techniques. Pour les solutions d'accès, les clés de qualité des solutions peuvent être considérées comme le délai d'accès et la perte. Pour améliorer la qualité de service avec le choix du meilleur mécanisme de l'allocation de la bande passante est l'un des objectifs de cette thèse. D'ailleurs, dans ces dernières années, la conception éco-énergétique des équipements électroniques reçoit plus d'attention pour diminuer la consommation mondiale d'énergie. Comme on sait que le PON consomme une grande portion de l'énergie consommée par des réseaux de télécommunication, nous visons à proposer une contribution pour réduire la consommation d'énergie pour les implémentations TDM-PON. L'efficacité énergétique du côté ONU est très étudiée dans la littérature, ainsi, nous nous sommes concentrés sur la conservation de l'énergie sur le côté de l'OLT du PON.

7.2 Organisation de la thèse

Au chapitre 2 nous présentons les principaux éléments sur les réseaux d'accès optiques. Tout d'abord nous faisons le point sur les réseaux d'accès et la nécessité de solutions optiques, puis la classification et le coût des différentes solutions d'accès optique sont abordés, ensuite, l'architecture prometteuse (architecture de l'arbre passive appelée PON) a été étudiée. Le PON doit utiliser un protocole d'accès multiple au support pour le partage de connexion unique vers l'OLT. Par la suite, les types de connexion d'accès multiples possibles sur le PON sont également présentés dans le chapitre. En résumé, l'historique et l'évolution du PON sont donnés à la fin de ce chapitre pour des études de la normalisation.

Les algorithmes d'allocation dynamique de bande passante (DBA) sont présentés dans le chapitre 3. Après avoir donné les mécanismes de DBA en ligne et hors ligne, une nouvelle méthode de DBA nommé hcDBA est élaborée. L'hcDBA utilise les principaux avantages de DBA en mode en ligne et hors ligne et tente d'éliminer les inconvénients. L'évaluation des performances de hcDBA est montrées en terme de délai d'accès, de perte d'octets et de la variation du délai des paquets. Une amélioration basée sur la prévision pour hcDBA est proposée et l'évaluation des performances de la mise en valeur de prédiction est examinée.

Dans le chapitre 4, on se focalise sur l'aspect de trafic et la caractérisation du trafic en amont en utilisant l'algorithme IPACT. La caractérisation du trafic à la sortie du PON est étudiée afin de décider quel générateur de trafic peut être sélectionné pour les simulations du trafic de MAN.

Le chapitre 5 comprend les études d'efficacité énergétique sur les réseaux d'accès optique. Des Travaux de normalisation et d'autres propositions dans la littérature sont rappelés. Les études d'efficacité énergétique sont divisées en trois sous-groupes comme côté ONU, côté OLT, et côté EA. Bien que les normes et la plupart des enquêtes soient basées sur le côté ONU, de notre côté, nous nous sommes propose de travailler sur des techniques de conservation de l'énergie du côté OLT. Notre proposition consiste à utiliser deux OLTs. Un plan de contrôle détaillé montre le fonctionnement dynamique de la conservation de l'énergie. Selon le changement de la charge de trafic, l'une des OLT peut être mise en sommeil. La conservation d'énergie est directement liée à des périodes de sommeil de l'OLT. L'évaluation des performances, afin de savoir jusqu'où une OLT peut rester dans le sommeil et le délai d'accès sont abordés en comparant le délai d'accès avec

celui obtenu dans les réseaux d'accès classiques. Les avantages de mode de sommeil dynamique pour l'OLT ont été donnés dans la conclusion.

Le Chapitre 6 résume globalement la thèse et évoque les problèmes qui restent à surmonter ainsi que les perspectives pour les réseaux d'accès.

7.3 Contributions

Dans le chapitre 3 un nouvel algorithme de DBA nommé hcDBA pour l'EPON a été proposé. L'hcDBA prend l'avantage des deux méthodes de DBA en ligne et hors ligne par l'arrêt à demi-cycle. L'hcDBA comprend deux modes de fonctionnement ; en ligne et hors ligne. Selon la charge de trafic et des REPORT reçu des ONUs, le mode de fonctionnement en ligne ou hors ligne est décidé à chaque demi-cycle. Si la charge de trafic est faible hcDBA décide de travailler en mode en ligne et alloue plus de bande passante demandée par des ONU. Sinon, si la charge de trafic est élevée l'hcDBA fonctionne en mode hors ligne (déconnecté) avec des arrêts à demi-cycle et calcule l'attribution de la bande passante en excès sur chaque demi-cycles et répartit équitablement la bande passante excédentaire entre ONUs très chargé.

L'algorithme l'hcDBA est comparé avec celui de l'IPACT et avec l'approche classique hors ligne de DBA pour le délai d'accès, la perte et la variation de délai de paquet. Les comparaisons sont faites en utilisant NS2 (Network Simulator 2.34) sur un ensemble de simulations pour l'EPON 1:16. Comme sur NS2, l'EPON n'est pas implémenté d'abord il fallait modéliser l'EPON puis l'ONU, l'OLT, coupleur/séparateur et le format de paquet sont implémentés. Les études complètes et les performances de l'hcDBA par simulation ont été exposées sous forme de graphe.

La prédiction précoce est une méthode utilisée dans la conception de réseau pour réduire le temps d'attente des paquets dans les files d'attente. En EPON, tandis que chaque ONU doit envoyer les REPORTs sur sa taille de remplissage du tampon à l'OLT avant d'obtenir des crédits (allocation), chaque paquet dans l'EPON doit attendre au moins une période de cycle avant être servi. Les algorithmes de prédiction sont largement étudiés dans la littérature pour diminuer le délai d'accès en amont dans l'EPON. Alors que l'OLT calcule la taille de l'allocation de bande-passante (crédit). L'algorithme de prédiction peut permettre d'allouer les crédits supplémentaires pour les paquets nouvellement arrivés à l'ONU à partir du réseau local. En outre, la prévision est une bonne façon de diminuer le délai d'attente des paquets, en cas de mauvaises, prédictions plus de bande passante peut être gaspillée inutilement. Néanmoins les mauvaises prédictions sont inévitables dans la nature du trafic des utilisateurs d'Internet. Par conséquent, dans notre approche pour utiliser la prédiction, nous avons décidé d'utiliser le cas de prédiction lorsque le système n'est pas très chargé. En faisant ainsi, en cas de mauvaise prédiction, le système n'effectue pas le pire cas que le pire des cas de sans prédiction. L'algorithme étendu est nommé p- hcDBA et est comparé avec hcDBA et IPACT pour les études des performances. Les simulations sont effectuées sur la plate-forme NS2 et développées avant d'ajouter les extensions de prédiction. Selon les études sur des comportements des utilisateurs d'Internet, seulement 25 % des utilisateurs sont actifs à un moment donné, la prédiction sous faible charge peut augmenter l'expérience d'utilisateur sans créer des situations à charge élevée.

Dans le chapitre 4, la caractérisation du trafic de la connexion de l'OLT au réseau MAN (Metropolitan Area Network) est étudiée par la collecte des traces de trafic MAN en amont de

l'PON. En simulant du MAN, nous devrions simuler aussi le PON connecté au MAN afin d'utiliser un modèle de trafic cohérent. Avec les ordinateurs d'aujourd'hui ne sont pas assez puissant pour faire des simulations de grande échelle. Ainsi, nous avons examiné le comportement du trafic en amont de l'EAPON pour comprendre comment le trafic à la sortie de l'OLT se comporte. On voit que la composition du trafic auto-similaire et du débit constante à partir des nœuds d'abonnés correspondants possèdent les caractéristiques du processus de Poisson à l'entrée de l'OLT. Ainsi nous avons conclu d'utiliser les générateurs de trafic classiques (Poisson) qui sont adéquats comme des sources de trafic pour les simulations de MAN.

Les Réserves d'énergie fossile de la planète vont disparaître dans un avenir proche et de jour en jour la consommation mondiale d'énergie augmente. Les réseaux de télécommunications ont une portion considérable de la consommation mondiale d'énergie où les réseaux d'accès constituent 70 % de la consommation d'énergie des réseaux de télécommunication en 2009. Pour cela, les industriels et les institutions universitaires sont en train de développer plus de produits énergétiquement efficaces et des algorithmes qui permettent d'économiser de l'énergie dans les réseaux.

Dans le chapitre 5, les solutions de conservation de l'énergie proposées pour les réseaux d'accès ont été présentées dans les trois catégories. Les organismes de normalisation ont publié les techniques de conservation de l'énergie sous forme de recommandations. En général, la plupart des recherches de conservation de l'énergie sont basées sur l'amélioration du fonctionnement de l'ONU. L'économie d'énergie du côté ONU a un impact majeur pour la consommation globale d'énergie. L'énergie peut être sauvée du côté de l'équipement du Central Office et du côté de connexions internes.

Dans le chapitre 5, les propositions sur la base d'agrégation Ethernet (EA) et OLT sont résumées. Nous avons aussi proposé une nouvelle architecture d'OLT basée sur la conception de l'efficacité énergétique. Cette nouvelle architecture proposée compose de deux OLTs et un routeur-commutateur qui contrôle les connexions entre l'OLT et les ONU. Les deux OLT sont connectés avec un lien de contrôle dédié. L'algorithme de l'efficacité énergétique est exécuté pour le choix de fonctionnement des OLT et le routage du trafic des OLTs vers les ONU. Chaque OLT a son propre algorithme de décision à l'efficacité énergétique. Lorsque l'un d'eux présente une faible charge de trafic, il informe l'autre s'il est disponible pour récupérer et exécuter son trafic. Si la négociation entre OLTs est positive dans ce là, la réponse est envoyé via canal de commande dédié avec le message OK, L'OLT ayant la faible charge se met en mode sommeil. Dans cette procédure, l'OLT à dormir donne toute les informations concernant les connexions avec le PON et avec les réseaux cœur à l'autre OLT et nettoie les paquets dans ses tampons locales. A la fin du processus, l'OLT actif envoie un signal de sommeil à l'autre et le laisse dans un sommeil profond, seulement la fonction de réveil est laissé ouverte que l'on appelle « en mode d'économie d'énergie ». Pendant que l'un des OLT est dans ce mode si l'OLT actif devient trop fortement chargé dans le sens en aval ou en amont, il réveille l'OLT dormi et il lui donne ses propres informations concernant toutes les connexions.

Afin d'étudier le fonctionnement de ces modes dans les OLTs, un environnement de simulation est préparé sur OMNET ++ 4.3. Les performances de notre algorithme d'efficacité énergétique sont comparées avec le fonctionnement sans mode d'économie de l'énergie (normal) en termes de délai d'accès et de perte d'octets. L'Algorithme d'efficacité énergétique permet d'économiser 90

% cent de la consommation d'énergie sur un OLT si la charge moyenne du système n'est pas élevée où la plupart du temps, 25 % des utilisateurs utilisent simultanément l'Internet. En Conséquent, notre algorithme dynamique proposé sur l'économie de l'énergie dans les OLTs peut être fonctionné toute la journée. Par rapport à l'algorithme d'arrêt sélectif, notre algorithme a la capacité de conserver l'énergie aux heures de pointe de la journée. Si un écart se produit dans le trafic des utilisateurs, on supprime le problème des performances en heures creuses (la nuit) où le trafic a augmenté de façon arbitraire.

7.4 Orientations futures

Le multiplexage de longueur d'onde (WDM, Wavelength Division Multiplexing) est considéré comme la solution idéale pour l'avenir de PONs. L'atteinte de longue distance, isolement du trafic des utilisateurs des uns des autres et l'offre de service de différents types de services sont les avantages de le WDM. Cependant, aujourd'hui, l'utilisation d'un équipement optique nécessaire comme séparateurs de longueurs d'onde, etc... n'est pas rentable pour servir les utilisateurs finaux avec l'WDM. En outre, la bande passante non-partagée que WDM fournit est loin de satisfaire les besoins d'aujourd'hui, des utilisateurs finaux. Alors que pour des raisons des coûts le WDM n'est pas trop présent dans les PONs, mais pour le proche avenir, il sera beaucoup plus utilisé. Pendant ce temps de l'ITU-T travaille sur la norme NGPON2. Dans les recommandations NGPON2 utilisant TDM-WDM la structure hybride de PON est acceptée pour nouveau standard.

La future allocation dynamique de bande passante avec l'arrêt à la moitié de cycle peut être mis en œuvre sur l'architecture TDM-WDM PON. Les performances de l'allocation de la bande-passante peuvent être changées avec les implémentations de WDM. Le WDM permet d'offrir plus de possibilités pour trouver la bande-passante disponible grâce au multiplexage statistique.

Un autre sujet prometteur pour les réseaux d'accès futurs est la convergence des réseaux sans fil et fixes (optique). Avec le développement rapide des appareils mobiles, le volume de trafic de données sans fil augment considérablement. Le PON est un réseau fixe d'accès le plus utilisé pour relier les utilisateurs sans fil au réseau cœur. Avec le développement dans les réseaux sans fil (4G, LTE, WiMAX) l'optimisation de trafic de données sans fil montre l'importance de ce domaine et attire plus d'attention des fournisseurs. Le PON s'est situé comme un segmente intermédiaire des réseaux entre les équipements finaux sans fils de points d'extrémité, la convergence de deux réseaux d'accès est considérée comme l'un des points clés pour les réseaux d'accès futures. Dans la convergence des réseaux sans fil et optique; l'allocation de bande passante, le plan de contrôle, le format de paquet commun, et la radio sur fibre sont quelques sujets qui sont ouverts à de nouvelles recherches. Pour la suite, nous avons proposé également d'améliorer notre algorithme d'allocation dynamique de bande passante en cas de meilleure convergence sans fil et optique.

L'efficacité énergétique va continuer à garder son importance dans le développement futur des produits. Généralement les méthodes développées pour l'efficacité énergétique restent opposée aux critères de performances. En conservant l'énergie, les performances peuvent se dégrader, dans tels cas, les algorithmes plus efficaces peuvent améliorer la conservation de l'énergie par dégradation négligeables des performances. Comme des perspectives, nous voulons nous focaliser sur des propositions de l'économie de l'énergie et sur les performances avec différents modèles de trafic. Le modèle dynamique et le modèle en mode d'arrêt à cycle fixe seront comparés. Et aussi,

la qualité de service, la prise de décision pour passer en mode de sommeil et en mode de réveil vont être examinée. Ensuite, nous nous proposerons d'étudier la conception d'un commutateur-routeur de 1xN de l'OLT et d'examiner l'évaluation des performances et le gain de l'énergie.

List of Publications

INTERNATIONAL JOURNALS

1. Özgür Can Turna, Muhammed Ali Aydın, Abdül Halim Zaim, Tülin Atmaca, “A new dynamic bandwidth allocation algorithm based on online-offline mode for EPON”, *Optical Switching and Networking*, (Under Review)

INTERNATIONAL CONFERENCES

1. O.C. Turna, M.A. Aydın, T. Atmaca, “A Novel OLT Based Energy Efficiency Algorithm in TDM Passive Optical Networks”, *Performance and Security Modelling & Evaluation of Cooperative Heterogeneous Networks (HET-NETs)*, 11-13 Nov. 2013, West Yorkshire, England, UK (Selected for Journal Submission)
2. Ozgur Can Turna, M. Ali Aydın, A. Halim Zaim, Tulin Atmaca, "Half cycling dynamic bandwidth allocation with prediction on EPON," 2012 IEEE Symposium on Computers and Communications (ISCC), pp. 898-902, 2012, Istanbul, Turkey.
3. Turna, O.C. Aydın, M.A. Atmaca, T. Zaim, A.H. Tuan-Dung Nguyen , "Traffic Characterization Study on EPON Upstream Channel" *Wireless Communications and Mobile Computing Conference (IWCMC)*, 2011 7th International, pp.1601-1606, 4-8 JULY 2011, Istanbul, Turkey
4. Özgür Can TURNA, M.Ali AYDIN, Tülin ATMACA, A.Halim ZAİM, “What is the Traffic Characterization on EPON’s Upstream Channel?”, *The First International Conference on Networking and Future Internet(ICNFI 2011)*, April 5-8 2011, Paris France.
5. Özgür Can TURNA, M.Ali AYDIN, Tülin ATMACA, A.Halim ZAİM, “A Prediction Extension for Half Cycling Dynamic Bandwidth Allocation on EPON” , *Euro-NF International Workshop on Traffic and Congestion Control for the Future Internet (Euro-NF TCCFI 2011)*, March 31 –April 1 2011, Volos, Greece.

-
6. O.C. Turna, M.A. Aydin, T. Atmaca, H. Zaim, "A Novel Dynamic Bandwidth Allocation Algorithm Based on Half Cycling for EPON", EMERGING 2010, Florence, Italy.

References

- Adams, R. et al., 2005. Demonstration of encoding/decoding 2-D wavelength-time bipolar codes for optical CDMA. *Photonics Technology Letters*, 24 Nov, 17(11), pp. 2490-2492.
- Alanqar, E. & Jukan, A., 2004. Extending End-to-End Optical Service Provisioning and Restoration in Carrier Networks: Opportunities, Issues, and Challenges. *IEEE Communications Magazine*, January, 42(1), pp. 52-60.
- Aleksic, S. et al., 2013. Energy efficiency of femtocell deployment in combined wireless/optical access networks. *Computer Networks* 57, p. 1217–1233.
- Andersen, A. T. & Nielsen, B. F., 1998. A Markovian approach for modeling packet traffic with long-range dependence. *Selected Areas in Communications*, 16(5), pp. 719-732.
- Assi, C. M., Ye, Y., Dixit, S. & Ali, M. A., 2003. Dynamic Bandwidth Allocation for Quality-of-Service Over Ethernet PONs. *IEEE Journal on Selected Areas in Communications*, Nov, 21(9), pp. 1467-1476.
- Ballance, J., 1990. *Optical communication network*. US, Patent No. 4977593.
- Bokhari, M. & Saengudomlert, P., 2013. Analysis of mean packet delay for upstream transmissions in passive optical networks with sleep mode. *Optical Switching and Networking*, July, 10(3), pp. 195-210.
- Byun, H. J., Nho, J. M. & Lim, J. T., 2003. Dynamic Bandwidth Allocation Algorithm in Ethernet Passive Optical Networks. *Electronics Letters*, 39(13), p. 1001–1002.
- Cale, I., Salihovic, A. & Ivekovic, M., 2007. *Gigabit Passive Optical Network - GPON*. Cavtat, ITI 2007. 29th International Conference on Information Technology Interfaces, pp. 679 - 684.
- Chowdhury, P., 2011. *Energy-Efficient Next-Generation Networks (E2NGN) [Thesis (Ph.D.)]*. Davis: University of California.
- Chrissan, D., 2004. *Uni-DSL: One DSL for universal service*, : Texas Instruments White Paper.

- Dhaini, A., Ho, P.-H. & Gangxiang, S., 2011. Toward green next-generation passive optical networks. *Communications Magazine*, Nov., 49(11), pp. 94-101.
- Effenberger, F. & El-Bawab, T. S., 2009. Passive Optical Networks (PONs): Past, present, and future. *Optical Switching and Networking* 6, pp. 143-150.
- Effenberger, F. J., Mccammon, K. & O'byrne, V., 2007. Passive optical network deployment in North America. *Journal Optical Communications and Networking*, Volume 6, pp. 808-818.
- Elbiaze, H., Chahed, T. & Atmaca, T., 2003. Shaping Self-similar Traffic at Access of Optical Networks. *Performance Evaluation*, August, 53(3-4), pp. 187-208.
- Faulkner, D. et al., 1997. The full service access network initiative. *IEEE Communications Magazine*, 35(4), pp. 58, 63-68.
- Fowler, T. B., 1999. A Short Tutorial on Fractals and Internet Traffic. *The Telecommunications Review*, Volume 10, pp. 1-15.
- Frigo, N., Iannone, P. & Rei, K., 1995. *Demonstration of Performance-tiered Modulators in a WDM PON With a Single Shared Source*. s.l., 21st European conference on Optical Communication, pp. 441-444.
- Frigo, N., Iannone, P. & Reichmann, K., 1998. *Spectral slicing in WDM passive optical networks for local access*. Madrid, 24th European Conference on Optical Communication, pp. 119-120.
- FSAN Group, 2009. *Full Service Access Network*. [Online]
Available at: <http://www.fsan.org/>
[Accessed 1 Nov. 2013].
- Ghazisaidi, N. & Maier, M., 2010. Techno-economic analysis of EPON and WiMAX for future Fiber-Wireless (FiWi) networks. *Computer Networks* 54, p. 2640–2650.
- Gorshe, S. & Mandin, J., 2009. Introduction to IEEE 802.3av 10Gbit/s Ethernet Passive Optical Networks (10G EPON). *China Communications*, 6(4), pp. 136-147.
- GreenTouch Consortium, 2012. *BIPON: Bit-Interleaved Passive Optical Network Technology*. [Online]
Available at: <http://www.greentouch.org/index.php?page=Bi-PON>
[Accessed 25 Sept. 2013].
- Grobe, K., 2010. *Performance, Cost, and Energy Consumption in Next-Generation WDM-based Access*. Athens, BROADNETS.
- Grobe, K. & Elbers, J.-P., 2009. A Total-Cost-of-Ownership Analysis of L2-Enabled WDM-PONs. *Topics in Optical Communications, IEEE Communications Magazine*, March, 47(3), pp. 24-29.
- IEEE 802.3ah, 2004. *Ethernet in the First Mile Task Force*. [Online]
Available at: <http://www.ieee802.org/3/ah/>
[Accessed 19 2011].
- IEEE P802.3ad, 2000. *Link Aggregation*. [Online]
Available at: <http://www.ieee802.org/3/ad/>
[Accessed 20 Nov. 2013].

- IEEE P802.3az, 2010. *Energy Efficient Ethernet*. [Online]
Available at: <http://grouper.ieee.org/groups/802/3/az/>
[Accessed 20 Nov. 2013].
- IEEE Standard For Information Technology 802.3av, 2009. *Physical Layer Specifications and Management Parameters for 10Gb/s Passive Optical Networks*. [Online]
Available at: <http://www.ieee802.org/3/av/>
[Accessed 01 Sept. 2011].
- Iiyama, N., Kimura, H. & Hadama, H., 2010. *A novel WDM-based optical access network with high energy efficiency using Elastic OLT*. Kyoto, 14th Conference on Optical Network Design and Modeling, ONDM, pp. 1-6.
- Imaizumi, H. et al., 2009. *Power saving mechanism based on simple moving average for 802.3ad link aggregation*. Honolulu, HI, 2nd IEEE Global Commun. Conf., pp. 1-6.
- ITU-T G.987 Series, 2010. *10-Gigabit-capable passive optical network (XG-PON)*. [Online]
Available at: <http://www.itu.int/rec/T-REC-G.987/en>
- ITU-T Rec. G.983.1, 2005. *Broadband optical access systems based on Passive Optical Networks (PON)*. [Online]
Available at: <http://www.itu.int/rec/T-REC-G.983.1-200501-I/en>
[Accessed 01 Sept. 2011].
- ITU-T Rec. G.984.4, 2008. *Gigabit-capable passive optical networks (G-PON): ONT management and control interface specification*. [Online]
Available at: <http://www.itu.int/rec/T-REC-G.984.4/en>
[Accessed 01 Sept. 2011].
- ITU-T Rec. G.984.5, 2007. *Gigabit-capable Passive Optical Networks (G-PON): Enhancement band*. [Online]
Available at: <http://www.itu.int/rec/T-REC-G.984.5/en>
[Accessed 01 Sept. 2011].
- ITU-T Rec. G.987 series, 2010. *10-Gigabit-capable passive optical networks (XG-PON)*. [Online]
Available at: <http://www.itu.int/rec/T-REC-G.987/en>
[Accessed 1 Nov. 2013].
- ITU-T Rec. G.989.1, 2013. *40-Gigabit-capable passive optical networks (NG-PON2): General requirements*. [Online]
Available at: <http://www.itu.int/rec/T-REC-G.989.1>
[Accessed 1 Nov. 2013].
- ITU-T, G.Sup45, 2009. *GPON power conservation*. [Online]
Available at: <http://www.itu.int/rec/T-REC-G.Sup45/en>
[Accessed 1 Nov 2013].
- Jain, R. & Routhier, S. A., 1986. Packet trains-measurement and a new model for computer network traffic. *IEEE Journal on Selected Areas in Communications*, Sept, 4(6), pp. 986-995.

- Kani, J., 2010. Enabling technologies for future scalable and flexible WDM-PON and WDM/TDM-PON systems. *J. Sel. Topics Quantum Electron.*, Sep.-Nov., 16(5), p. 1290–1297.
- Kani, J., 2013a. Power Saving Techniques and Mechanisms for Optical Access Networks Systems. *Journal of Lightwave Technology*, Feb., 31(4), pp. 563-570.
- Kani, J., Shimazu, S., Yoshimoto, N. & Hadama, H., 2013b. Energy-efficient optical access networks: issues and technologies. *Communications Magazine*, Feb., 51(2), pp. 22-26.
- Koonen, T., 2006. Fiber to the Home/Fiber to the Premises: What, Where, and When?. *Proceedings of the IEEE*, 94(5), pp. 911-934.
- Kramer, G., 2002a. Interleaved Polling with Adaptive Cycle Time (IPACT): A Dynamic Bandwidth Distribution Scheme in an Optical Access Network. *Photonic Net. Commun.*, 4(1), p. 89–107.
- Kramer, G., Mukherjee, B. & Pesavento, G., 2002b. IPACT: a dynamic protocol for an Ethernet PON (EPON). *IEEE Commun. Mag.*, 40(2), p. 74–80.
- Kramer, G. & Pesavento, G., 2002d. Ethernet passive optical network (EPON): building a next-generation optical access network. *IEEE Communications Magazine*, 40(2), pp. 66-73.
- Kubo, R. et al., 2010. Study and Demonstration of Sleep and Adaptive Link Rate Control Mechanisms for Energy Efficient 10G-EPON. *Journal of Optical Communications and Networking*, Sep., 2(9), pp. 716-729.
- Lam, C. F., 2007. *Passive Optical Networks: Principles and Practice*. 1 ed. Burlington, MA: Academic Press.
- Lee, C.-H., Sorin, W. V. & Kim, B. Y., 2006. Fiber to the Home Using a PON Infrastructure. *Journal of Lightwave Technology*, 24(12), pp. 4568-4583.
- Lucantoni, D. M., 1991. New results on the single server queue with a batch markovian arrival process. *Communications in Statistics. Stochastic Models*, 7(1), pp. 1-46.
- Lucantoni, D., Meier-Hellstern, K. & Neuts, M., 1990. A single server queue with server vacations and a class of nonrenewal arrival processes. *Advances in Applied Probability*, 22(3), pp. 676-705.
- Luo, Y. & Ansari, N., 2005b. Limited Sharing with Traffic Prediction for Dynamic Bandwidth Allocation and QoS Provisioning over Ethernet Passive Optical Networks. *OSA J. Opt. Net.*, 4(9), p. 561–72.
- Mandin, J., 2008. *EPON Powersaving via Sleep Mode*. [Online]
Available at: http://www.ieee802.org/3/av/public/2008_09/3av_0809_mandin_4.pdf
[Accessed 1 Nov. 2013].
- McGarry, M. P., Maier, M. & Reisslein, M., 2004. Ethernet PONs: A Survey of Dynamic Bandwidth Allocation (DBA) Algorithms. *IEEE Communications Magazine*, Aug, 42(8), pp. 8-15.

- McGarry, M. P., Reisslein, M. & Maier, M., 2008. Ethernet Passive Optical Network Architectures and Dynamic Bandwidth Allocation Algorithms. *IEEE Communications Surveys & Tutorials - 3rd Quarter*, 10(3), pp. 46 - 60.
- Mukherjee, B., 2011. *Energy Savings in Telecom Networks Energy Savings in Telecom Network*. [Online] Available at: <http://www.ict.kth.se/MAP/FMI/Negonet/tgn-ons/documents/Energy%20efficiency%20in%20Access%20networks/bm-sbr11-tutorial-1june11.pdf> [Accessed 10 Nov. 2013].
- Nguyen, T., 2010. *Architecture, QoS et Performances dans les réseaux optiques métropolitains*. Paris, France: Ph.D. Thesis, de l'Université de Paris VI & Telecom SudParis.
- Nguyen, T. D., Eido, T. & Atmaca, T., 2009. *An Enhanced QoS-enabled Dynamic Bandwidth Allocation Mechanism for Ethernet PON*. Sliema, Malta, Fifth European Conference on Universal Multiservice Networks.
- Nikitin, A., Pyattaev, V. & Kim, B., 2009. *Technological aspects of the triple play service on fixed access networks*. Phoenix Park, ICACT 2009. 11th International Conference on Advanced Communication Technology, pp. 1890 - 1893.
- Nishihara, S. et al., 2012. Power-saving methods with guaranteed service interoperability in Ethernet passive optical networks. *Communications Magazine, IEEE*, Sept, 50(9), pp. 110,117.
- Okada, K., Mano, F. & Miki, T., 1990. *Passive double star architecture and subscriber network evolution*. , 2nd IEEE Workshop on Local Optical Networks for the Local Loop.
- Otaka, A., 2008. *Power saving ad-hoc Report*, Seoul: IEEE 802.3av.
- Paxon, V. & Floyd, S., 1995. Wide-area traffic: the failure of poisson modeling. *IEEE/ACM Transactions on Networking (TON)*, Aug, 3(3), pp. 257-268.
- Popa, D., 2005. *Performance Issues in Metropolitan Optical Networks: Packet format, MAC protocol and QoS (Ph.D.Thesis)*. France: Institute National des Telecommunications INT Evry & Université d'Evry-Val-d'Essonne.
- Ross, S. M., 1983. *Stochastic Simulation*. s.l.: John Wiley & Sons.
- Saliou, F., Chanclou, P., Genay, N. & Laurent, F., 2011. *Energy efficiency scenarios for long reach PON Central Offices*. s.l., Optical Fiber Communication Conference and Exposition (OFC/NFOEC), 2011 and the National Fiber Optic Engineers Conference, pp. 1-3.
- Shimazu, S., Kani, J., Yoshimoto, N. & Hadama, H., 2010. *Novel sleep control for EPON optical line terminal employing layer-2 switch functions*. Miami, FL, IEEE Global Commun. Conf., pp. 1-5.
- Shinohara, H. & Manabe, T., 2006. Broadband optical access technologies and FTTH deployment in NTT, in: C. Lin (Ed.). *Optical Access Networks and Fiber-to-the-Home*, p. 1-16.
- Skubic, B. et al., 2009. A Comparison of Dynamic Bandwidth Allocation for EPON, GPON, and Next-Generation TDM PON. *IEEE Communications Magazine*, March, 47(3), pp. 40-48.

- Tokuhashi, K., Ishii, D., Okamoto, S. & Yamanaka, N., 2011. *Energy Saving Optical Access Network based on Hybrid Passive/Active Architecture*, s.l.: IEICE.
- Trojer, E., Dahlfort, S., Hood, D. & Mickelsson, H., 2008. Current and Next-Generation PONs: A Technical Overview of Present and Future PON Technology. *Ericsson Rev.*, Issue 2, pp. 64-69.
- Turna, O., Aydin, M. & Atmaca, T., 2013. *A Novel OLT Based Energy Efficiency Algorithm in TDM Passive Optical Networks*. West Yorkshire, England, UK, Performance and Security Modelling & Evaluation of Cooperative Heterogeneous Networks (HET-NETs).
- Turna, Ö. et al., 2011c. *Traffic Characterization Study On Epon Upstream Channel*, Istanbul, Turkey, 7th International Wireless Communications And Mobile Computing Conference (IWCMC), pp. 1601-1606.
- Turna, Ö. C., Aydın, M. A., Atmaca, T. & Zaim, A. H., 2010. *A Novel Dynamic Bandwidth Allocation Algorithm Based on Half Cycling for EPON*. Florence, Italy, EMERGING 2010.
- Turna, Ö. C., Aydın, M. A., Atmaca, T. & Zaim, A. H., 2011a. *What is the Traffic Characterization On Epon's Upstream Channel?*. Paris France, The First International Conference on Networking And Future Internet(ICNFI 2011).
- Turna, Ö. C., Aydın, M. A., Atmaca, T. & Zaim, A. H., 2011b. *A Prediction Extension for Half Cycling Dynamic Bandwidth Allocation on EPON*. Volos, Greece, Euro-NF International Workshop on Traffic and Congestion Control for the Future Internet (Euro-NF TCCFI 2011).
- Turna, Ö. C., Aydın, M. A., Zaim, A. H. & Atmaca, T., 2012. *Half Cycling Dynamic Bandwidth Allocation with Prediction on EPON*. Cappadocia, Türkiye, 4th IEEE PEDISWESA Workshop.
- U.S. Energy Information Administration, 2013. *INTERNATIONAL ENERGY OUTLOOK 2013*. [Online]
Available at: <http://www.eia.gov/forecasts/ieo/index.cfm>
[Accessed 1 Nov 2013].
- Ueda, H. et al., 2001. Deployment status and common technical specifications for a B-PON system. *IEEE Communications Magazine*, 39(12), p. 134-141.
- Willinger, W., Taqqu, M., Sherman, R. & Wilson, D., 1997. Self-Similarity through High-Variability: Statistical Analysis of Ethernet LAN Traffic at the Source Level. *IEEE/ACM Transactions on Networking*, Feb., 5(1), pp. 71-86.
- Wong, S.-W. et al., 2009. *Sleep Mode for Energy Saving PONs: Advantages and Drawbacks*. Honolulu, HI, GLOBECOM Workshops, IEEE, pp. 1-6.
- Zhang, J., Wang, T. & Ansari, N., 2011. *Designing energy-efficient optical line terminal for TDM passive optical networks*. Princeton, NJ, IEEE 34th Sarnoff Symposium, pp. 1-5.
- Zheng, J., 2006. Efficient bandwidth allocation algorithm for Ethernet Passive Optical Networks. *IEE Proceedings - Communications*, 153(3), pp. 464-468.
- Zheng, J. & Mouftah, H. T., 2005. Media Access Control for Ethernet Passive Optical Networks: An Overview. *IEEE Commun. Mag.*, Feb, 43(2), p. 145-50.

Zheng, J. & Mouftah, H. T., 2009. A survey of dynamic bandwidth allocation algorithms for Ethernet Passive Optical Networks. *Optical Switching and Networking* 6, p. 151–162.