



**HAL**  
open science

## Voice capacity over LTE in PMR context : challenges and solutions

Manh Cuong Nguyen

► **To cite this version:**

Manh Cuong Nguyen. Voice capacity over LTE in PMR context : challenges and solutions. Networking and Internet Architecture [cs.NI]. Institut National des Télécommunications, 2015. English. NNT : 2015TELE0015 . tel-01186322

**HAL Id: tel-01186322**

**<https://theses.hal.science/tel-01186322>**

Submitted on 24 Aug 2015

**HAL** is a multi-disciplinary open access archive for the deposit and dissemination of scientific research documents, whether they are published or not. The documents may come from teaching and research institutions in France or abroad, or from public or private research centers.

L'archive ouverte pluridisciplinaire **HAL**, est destinée au dépôt et à la diffusion de documents scientifiques de niveau recherche, publiés ou non, émanant des établissements d'enseignement et de recherche français ou étrangers, des laboratoires publics ou privés.



DOCTORAT EN CO-ACCREDITATION  
TÉLÉCOM SUDPARIS - INSTITUT MINES-TÉLÉCOM  
ET L'UNIVERSITÉ PIERRE ET MARIE CURIE - PARIS 6

Spécialité: Informatique

École doctorale EDITE

Présentée par

Manh Cuong NGUYEN

Voice capacity over LTE in PMR context:  
Challenges and Solutions

Soutenue le 15/06/2015 devant le jury composé de:

Michel KIEFFER	Professeur, Université Paris-Sud	Rapporteur
Steven MARTIN	Professeur, Université Paris-Sud	Rapporteur
Samir TOHMÉ	Professeur, Université de Versailles Saint-Quentin-en-Yvelines	Rapporteur
Philippe MÈGE	Directeur, Airbus Defense & Security	Examineur
Véronique VEQUE	Professeur, Université Paris-Sud	Examineur
Anne WEI	Professeur, Laboratoire Cédric du CNAM	Examineur
Hang NGUYEN	Professeur, Télécom SudParis	Encadrante de thèse
Eric RENAULT	Professeur, Télécom SudParis	Directeur de thèse



# Abstract

The Professional Mobile Radio (PMR) network, which is used for public safety operation, has to evolve to the broadband solutions to satisfy the user demands in the future. In the current broadband technologies Long Term Evolution (LTE) standard, developed by the 3rd Generation Partnership Project (3GPP), is considered as one of the potential candidates for the next generation of PMR. Despite the fact that LTE supports high-speed data transmission and supports different packet sizes by using Adaptive Modulation and Coding (AMC), LTE is not yet optimized for low bit rate voice communication, especially in case of using LTE in Professional Mobile Radio (PMR) context. Therefore, in this dissertation, we present several new proposed solutions for enhancing the voice capacity of LTE in the PMR context for both uplink and downlink transmission. The new proposed solutions, based on existent LTE standards with minor modifications, allow reducing both control and data overhead of Voice over LTE (VoLTE) in PMR context.

After a general introduction, we introduce the Long Term Evolution (LTE) standard in the perspective of PMR network and present the two biggest issues that affect the voice capacity of LTE in the PMR context: data and control overhead in chapter 2.

In chapter 3, we introduce our new proposed architecture and our new proposed scheduling method for multiplexing voice packets from different users into one same LTE packet in the downlink transmission to reduce the difference between the LTE packet size and PMR voice payload. In this new proposed architecture, the multiplexing size can be modified according to the Modulation and Coding Scheme (MCS), the payload of users and the LTE bandwidth. The new proposed scheduling method is used to transmit the multiplexed packets to corresponding users. This new proposed scheduling method is implemented by negligible modifications in MAC layer. Therefore, this new multicast does not require additional components in LTE architecture. The average voice data capacity gain of the proposed method is about 242.4%. In the best case the proposed method can multiply the voice data capacity by a factor of 7.5.

Chapter 4 concentrates on the solutions to reduce the control overhead issue in the multiplexing scheme. In this chapter, two new approaches are developed: RNTI aggregation method and Group\_RNTI method. The new proposed RNTI aggregation method uses Physical Downlink Control Channel (PDCCH) channels with high format, created by the aggregation of PDCCH channels with low format, to transmit several RNTIs of different UEs in a same multiplexing group. In the new proposed Group\_RNTI method, UEs having the same Modulation and Coding Scheme (MCS) will be clustered in one or more groups. Each group is assigned a common Group RNTI. Control information is sent for groups rather than for each UE. The new proposed RNTI aggregation method can increase the voice control capacity of the multiplexing scheme up to 170%; while the new proposed Group\_RNTI reduces the control overhead up to 77%. We also evaluate and compare the two new proposed methods for different scenarios in order to offer recommendations.

In chapter 5, we propose another method for enhancing voice capacity of LTE in the PMR context: CDMA-OFDM combination method. In this chapter, we present a new architecture, a novel algorithm for determining the spreading factor, code assignment and resource allocation for the new proposed CDMA-OFDM combination method. In addition, a new design for DMRS for the CDMA-OFDM combination method for the uplink transmission

is also discussed in this chapter. The new proposed CDMA-OFDM combination method can be applied for both uplink and downlink. The CDMA-OFDM combination method significantly increases the capacity of VoLTE over PMR context. On average, the proposed CDMA-OFDM combination method can double the voice data capacity in comparison with the LTE standard.

While the purpose of the proposed Multi-users Multiplexing method and the proposed CDMA-OFDM combination method is to increase the size of payload, the new proposed Adaptive Physical Resource Block method, presented in chapter 6, is to design a more efficient and more consistent User Assignment Resource Unit for the LTE in the PMR Context. In this proposed method, we reorganize the structure of the Physical Resource Block (PRB) to optimize the voice capacity of LTE downlink in the PMR Context. Available PRBs in each subframe are reorganized into a number of Sub Physical Resource Blocks (subPRBs). The number of control symbols can be selected with more flexibility. The proposed method allows reducing both data overhead and control overhead for Voice over LTE downlink in PMR context. On average, the voice capacity gain is shown to have about 144.5% in comparison with the LTE standard.

We compare the advantages and disadvantages of these three new proposed methods for enhancing Voice Capacity over Long-Term Evolution (LTE) in PMR Context: the proposed Multi-users Multiplexing Method, the proposed CDMA-OFDM Combination Method and the proposed Adaptive Physical Resource Block Method in chapter 7. We offer suggestions and recommendations for the use of each method.

We conclude and discuss perspectives in chapter 8. In this PhD thesis, we have presented the main challenges affecting the capacity of the voice over LTE in the PMR context. We proposed several new solutions for enhancing capacity of voice over LTE in the PMR context for both uplink and downlink, for both data plan and control plan. Even of these new proposed methods are implemented by negligible modifications of existent LTE standards, the efficiency obtained from these methods is very impressive. On average, the proposed methods can double the voice capacity. These results reaffirm that the existent broadband solutions are not entirely suitable for low data rate applications. Therefore, the service providers need to forecast and take into account the different services when building new standards for the next generation networks (e.g. 5G, 6G) to ensure the efficient use of radio resources. On the basis of analyzing the advantages and disadvantages of three methods, we also recommend of using CDMA-OFDM Combination Method method as the main method for enhancing Voice Capacity over LTE in PMR Context. The CDMA-OFDM Combination method can reduce both control and data overhead and apply to both uplink and downlink without requiring new additional components to the system.

# Résumé

Le réseau de radiocommunications mobiles professionnelles (PMR), qui est utilisé pour le fonctionnement de la sécurité publique, doit évoluer pour les solutions à large bande pour satisfaire les demandes des utilisateurs à l'avenir. Dans les technologies à large bande actuels, Long Term Evolution (LTE), développé par le 3GPP (3rd Generation Partnership Project), est considéré comme l'un des candidats potentiels pour la prochaine génération de PMR. Malgré le fait que la technologie LTE en charge la transmission de données à haute vitesse et prend en charge différentes tailles de paquets en utilisant la modulation et le codage adaptatifs (AMC), le LTE n'est pas encore optimisée pour la communication vocale de bas taux de code, en particulier en cas d'utilisation LTE de radiocommunications mobiles professionnelles (PMR) contexte. Par conséquent, dans cette thèse, nous présentons des solutions pour renforcer la capacité de la voix de la technologie LTE dans le cadre PMR à la fois la liaison montante et la transmission de liaison descendante. Les nouvelles propositions, basées sur la technologie de norme LTE existant avec des adaptations, permettent la réduction des frais généraux de données et frais généraux de contrôles sur LTE (VoLTE) dans le contexte PMR.

Le chapitre 2 présente Long Term Evolution (LTE) dans la perspective de réseau PMR et présente les deux principaux facteurs qui affectent la capacité de la voix de la technologie LTE dans le cadre PMR: les frais généraux de données et les frais généraux de contrôles. Ce est l'un des principaux obstacles à surmonter pour appliquer LTE au système Professional Mobile Radio (PMR) parce que la capacité de la voix est l'une des principales exigences du réseau de la sécurité publique.

Dans le chapitre 3 nous présentons notre nouvelle architecture et de notre nouvelle méthode de planification pour le multiplexage des paquets de voix provenant de différents utilisateurs en un même paquet LTE en liaison descendante pour réduire la différence entre la taille des paquets de LTE et PMR voix charge utile. Dans cette architecture, la taille de multiplexage peut être modifiée en fonction de la modulation et de codage Scheme (MCS), la charge utile des utilisateurs et la bande passante de la technologie LTE. Le procédé de programmation est utilisé pour transmettre les paquets multiplexés aux utilisateurs correspondants. Le procédé de programmation proposée est mise en œuvre par des modifications négligeables de couche MAC. Par conséquent, cette nouvelle multidiffusion ne nécessite pas de composants supplémentaires dans l'architecture LTE. Le gain de la méthode proposée de capacité de données vocale moyenne est d'environ 242.4% et dans le meilleur des cas la méthode proposée peut se multiplier la capacité de données vocales par un facteur de 7.5.

Chapitre 4 se concentre sur les solutions pour réduire le problème de surcharge de contrôle dans le multiplexage régime. Dans ce chapitre, deux nouvelles approches sont développées: méthode d'agrégation RNTI et la méthode Group\_RNTI. Procédé d'agrégation RNTI canal de commande physique utilise en liaison descendante (PDCCH) canal à haute format, créé par l'agrégation de canaux PDCCH à bas format de transmettre plusieurs RNTIs de différents UEs dans un même groupe de multiplexage.

Dans le procédé Group\_RNTI, UEs ayant le même schéma de modulation et de codage (MCS) sont regroupés dans un ou plusieurs groupes. Chaque groupe est affecté un groupe commun RNTI. Contrôle de l'information est envoyée pour les groupes plutôt que pour chaque UE. La méthode d'agrégation RNTI peut augmenter la capacité de contrôle de

la voix du schéma de multiplexage jusqu'à 170 % et en moyenne, le gain de capacité de commande vocale est d'environ 150 % tandis que le Groupe\_RNTI réduit considérablement le problème de surcharge de contrôle. Nous évaluons et comparons également les deux méthodes pour différents scénarios afin de proposer des recommandations.

Dans le chapitre 5, nous proposons une autre méthode pour améliorer la capacité de la voix de la technologie LTE dans le cadre PMR: méthode de combinaison CDMA-OFDM. En cela, nous présentons une nouvelle architecture, un nouvel algorithme pour déterminer le facteur d'étalement, l'affectation de code et l'allocation des ressources pour la méthode de combinaison CDMA-OFDM. En outre, un nouveau design pour DMRS pour la méthode de combinaison CDMA-OFDM dans la transmission Uplink est également abordée dans ce chapitre. La méthode de combinaison CDMA-OFDM peut être appliquée à la fois pour la liaison montante et descendante. Procédé de combinaison CDMA-OFDM donne une augmentation significative de la capacité de liaison montante sur VoLTE contexte PMR. En moyenne, le gain du procédé de combinaison CDMA-OFDM capacité de données voix est d'environ 215.3%.

Si le but de la Multi-utilisateurs méthode de multiplexage et de méthode de combinaison CDMA-OFDM est d'augmenter la taille de la charge utile, l'approche de la méthode Adaptive physique Resource Block, présenté dans le chapitre 6 est de concevoir une unité Affectation utilisateur de ressources plus efficace et cohérente pour la LTE dans le contexte PMR. Dans cette méthode, nous réorganisons la structure du bloc de ressource physique (PRB) pour optimiser la capacité de voix de liaison descendante LTE dans le contexte PMR. Le PRBs disponibles dans chaque sous-trame sont réorganisés dans un certain nombre de blocs Sous Ressource Bloc physique. Le nombre de symboles de commande peut être sélectionné flexibilité. La méthode proposée permet de réduire les frais généraux des données et les frais généraux des contrôles pour la voix sur LTE pour la liaison descendante dans le contexte PMR. En moyenne, le gain de capacité vocale ont été montré pour avoir environ 144.5% en comparaison avec la LTE standard.

Nous comparons les avantages et les inconvénients de trois méthodes pour améliorer la capacité de voix sur Long Term Evolution (LTE) en radiocommunications mobiles professionnelles (PMR) Contexte: Multi-utilisateurs multiplexage Méthode, Combinaison CDMA-OFDM Méthode, Adaptive physique Bloc de ressource méthode au chapitre 7. Sur la base de l'évaluation des avantages et inconvénients de chaque méthode, nous offrons des suggestions et des recommandations pour l'utilisation de chaque méthode.

Nous conclure et proposer des perspectives dans le chapitre 8. Dans cette thèse, nous avons présenté une vision relativement complète des défis et des solutions pour améliorer la capacité de la voix sur LTE dans le cadre PMR pour les liaisons montantes et descendantes, à la fois pour le plan des données et plan de contrôle.

# Acknowledgments

I would like to express my special appreciation and thanks to my teachers, Professor Hang NGUYEN and Professor Eric RENAULT for their academic advices and the PhD opportunity that they provided to me.

I am also using this opportunity to express my gratitude to Eric Georgeaux, Philippe Mege and Laurent Martinod, experts from EADS Cassidian who gave me many important technical insights.

I would also like to thank all of my friends from Telecom SudParis who supported me in writing, and encouraged me to strive towards my goal.

And, of course, special thanks to my family: my parents, my wife, my children who always beside and support me in my carrier and my studies.



# List of abbreviations

<b>2G</b>	Second Generation Technology
<b>3G</b>	Third Generation Technology
<b>3GPP</b>	Third Generation Partnership Project
<b>4G</b>	Fourth Generation Technology
<b>ACELP</b>	Algebraic Code Excited Linear Prediction
<b>AMBE</b>	Advanced MultiBand Excitation
<b>APCO</b>	Association of Public Safety Communications Officials International
<b>ARQ</b>	Automatic Repeat Request
<b>BER</b>	Bit Error Rates
<b>BW</b>	Bandwidth
<b>CA</b>	Carrier Aggregation
<b>CDMA</b>	Code Division Multiple Access
<b>CP</b>	Cyclic Prefix
<b>CQI</b>	Channel Quality Information
<b>CRC</b>	Cyclic Redundancy Checked
<b>DCI</b>	Downlink Control Indicator
<b>DL</b>	Downlink
<b>DMRS</b>	Demodulation Reference Signal
<b>EADS</b>	European Aeronautic Defence and Space
<b>eMBMS</b>	Evolved Multimedia Broadcast and Multicast Service
<b>EPC</b>	Evolved Packet Core
<b>HARQ</b>	Hybrid ARQ
<b>IEEE</b>	Institute of Electrical and Electronics Engineers
<b>IMBE</b>	Improved MultiBand Excitation
<b>IMS</b>	IP Multimedia Sub-system
<b>LTE</b>	Long Term Evolution

**LTE-A** LTE-Advanced

**LMR** Land Mobile Radio

**MAC** Medium Access Layer

**MCS** Modulation and Coding Scheme

**MIMO** Multiple-Input Multiple-Output

**OFDM** Orthogonal Frequency Division Multiplexing

**P25** Project 25

**PAPR** Peak Average Power Ratio

**PAS** Tetrapol Publicly Available Specification

**PDCCH** Physical Downlink Control Channel

**PDCP** Packet Data Convergence Protocol

**PDSCH** Physical Downlink Shared Channel

**PDU** Packet Data Unit

**PMR** Private/Professional Mobile Radio

**PUCCH** Physical Uplink Control Channel

**PUSCH** Physical Uplink Shared Channel

**QCI** QoS Class Identifier

**QoS** Quality of Service

**QPSK** Quadrature Phase Shift Keying

**RE** Resource Element

**RLC** Radio Link Control

**RNTI** Radio Network Temporary Identifier

**ROHC** Robust Header Compression

**RTP** Real-time Transport Protocol

**SC-FDMA** Single Carrier FDMA

**SDU** Service Data Unit

**TBS** Transport Block Sizes

**TCP** Transport Control Protocol

**TETRA** Terrestrial Trunked Radio

**TETRAPOL** Proprietary solution of the EADS company

**TTI** Time Transmission Interval

**UDP** User Datagram Protocol

**UE** User Element

**UEP** Unequal Error Protection

**UL** Uplink

**WIMAX** Worldwide Interoperability for Microwave Access

# List of Publications

- [1] Manh-Cuong Nguyen, Hang Nguyen, Alina Florea, Philippe Mege, Laurent Martinod and Eric Georgeaux. *Architecture for Multi-users Multiplexing Radio Voice Transmission for Enhancing Voice Capacity over LTE in PMR Context*. In IEEE 25<sup>th</sup> Annual International Symposium on Personal, Indoor and Mobile Radio Communications (PIMRC), 2-5 September 2014, Washington, USA. (Published)
- [2] Manh-Cuong Nguyen, Hang Nguyen, Alina Florea, Philippe Mege, Laurent Martinod and Eric Georgeaux. *Scheduling for Multi-users Multiplexing Radio Voice Transmission for Enhancing Voice Capacity over LTE in PMR Context*. In IEEE Wireless Communications and Networking Conference (WCNC), 9-12 March 2015, New Orleans, USA. (Published)
- [3] Manh-Cuong Nguyen, Hang Nguyen, Eric Georgeaux, Philippe Mege and Laurent Martinod. *CDMA-OFDM Combination Method for Enhancing Capacity of Voice over LTE Uplink in PMR context*. In IEEE Wireless Communications and Networking Conference (WCNC), 9-12 March 2015, New Orleans, USA. (Published)
- [4] Manh-Cuong Nguyen, Hang Nguyen, Eric Georgeaux, Philippe Mege and Laurent Martinod. *Group-RNTI for Multi-users Multiplexing Radio Voice Transmission for Enhancing Voice Capacity over LTE in PMR Context*. In IEEE 81<sup>st</sup> Vehicular Technology Conference: VTC2015-Spring 11–14 May 2015, Glasgow, Scotland. (Accepted)
- [5] Manh-Cuong Nguyen, Hang Nguyen, Eric Georgeaux, Philippe Mege and Laurent Martinod. *RNTI Aggregation for Multi-users Multiplexing Radio Voice Transmission for Enhancing Voice Capacity over LTE in PMR Context*. In First International Workshop on Intelligent Design and performance evaluation of LTE-Advanced Networks in conjoint with IEEE 81<sup>st</sup> Vehicular Technology Conference: VTC2015-Spring 11–14 May 2015, Glasgow, Scotland. (Accepted)
- [6] Tien-Anh Le, Hang Nguyen, Manh-Cuong Nguyen. *Application-Network Cross Layer Multi-variable Cost Function for Application Layer Multicast of Multimedia Delivery over Convergent Networks*. In Journal on Wireless Networks, Springer 2015. (Published)
- [7] Manh-Cuong Nguyen, Hang Nguyen, Eric Georgeaux, Philippe Mege and Laurent Martinod. *Adaptive Physical Resource Block Design for Enhancing Voice Capacity over LTE in PMR Context*. In IEEE Global Communication Conference (Globecom) 6-10 December 2015, San Diego, USA. (Submitted)

- [8] Manh-Cuong Nguyen, Hang Nguyen, Eric Georgeaux, Philippe Mege and Laurent Martinod. *Multi-users Multiplexing Radio Voice Transmission For Enhancing Voice Capacity over LTE in PMR Context*. In Journal on Wireless Networks, Springer. (Submitted)
- [9] Manh-Cuong Nguyen, Hang Nguyen, Eric Georgeaux, Philippe Mege and Laurent Martinod. *Control overhead issue in the Multi-users Multiplexing Radio Voice Transmission : Challenges and Solutions*. In Annals of Telecommunications, Springer . (Submitted)
- [10] Manh-Cuong Nguyen, Hang Nguyen, Eric Georgeaux, Philippe Mege and Laurent Martinod. *CDMA-OFDM Combination Method for Enhancing Capacity of Voice over LTE in PMR context*. (To be submitted)
- [11] Manh-Cuong Nguyen, Hang Nguyen, Eric Georgeaux, Philippe Mege and Laurent Martinod. *Voice over LTE in PMR Context: Challenges and Solutions*. (To be submitted)

# Liste of Credits

1. Réussir un article de recherche (23, 24 janvier 2014): 2 points
2. Réussir une communication scientifique orale (9, 10, 12 décembre 2013): 3 points
3. Se préparer à l'embauche et réussir les entretiens de sélection (9, 10 avril 2015): 2 points



# Table of contents

<b>1</b>	<b>Introduction</b>	<b>7</b>
<b>2</b>	<b>LTE in the perspective of PMR broadband context</b>	<b>9</b>
2.1	LTE in the perspective of PMR broadband context . . . . .	9
2.1.1	Voice communication in the perspective of PMR broadband era . . . .	9
2.1.2	Overview of data flow transmission in LTE . . . . .	11
2.2	Data and control overhead issues of Voice over LTE and Voice over LTE in PMR context . . . . .	14
<b>3</b>	<b>New proposed Multi-users Multiplexing Radio Voice Transmission Method for Enhancing Voice over LTE in PMR context</b>	<b>19</b>
3.1	New proposed Multi-users Multiplexing Radio Voice Transmission Method . .	20
3.1.1	General Idea and Challenges . . . . .	20
3.1.2	Proposed Multi-users Multiplexing Architecture . . . . .	21
3.1.3	Proposed Multi-users Multiplexing Scheduling . . . . .	23
3.1.4	Proposed multiplexing size determination algorithm . . . . .	26
3.1.5	Different MCS values issue and proposed algorithm for grouping UEs with different MCS values . . . . .	28
3.2	Performance evaluation . . . . .	31
3.2.1	System Parameters . . . . .	31
3.2.2	LTE Voice Data Capacity Evaluation . . . . .	32
3.3	Conclusion . . . . .	37
<b>4</b>	<b>Control overhead issue in Multi-user Multiplexing radio voice transmission: Challenges and New Proposed Solutions</b>	<b>39</b>
4.1	Control overhead issue in Multi-user Multiplexing radio voice transmission . .	40
4.2	New proposed RNTI aggregation for the Multi-user multiplexing Voice radio transmission method . . . . .	42
4.2.1	General Idea . . . . .	42
4.2.2	Proposed RNTI aggregation size determination function and definition of the control capacity gain . . . . .	42
4.2.3	Proposed CCE indexes determination method . . . . .	45
4.2.4	Performance evaluation . . . . .	46



4.3	New proposed Group_RNTI for the Multi-user multiplexing Voice radio transmission method . . . . .	48
4.3.1	General idea of the new proposed Group_RNTI . . . . .	48
4.3.2	New proposed Group - Change management method . . . . .	49
4.3.3	Numerical analysis . . . . .	49
4.3.4	Performance evaluation . . . . .	52
4.4	Comparison of the new proposed RNTI Aggregation method and the new proposed Group_RNTI method: Recommendations . . . . .	55
4.5	Conclusion . . . . .	55
<b>5</b>	<b>New proposed CDMA-OFDM combination method for enhancing voice capacity over LTE in PMR context</b>	<b>59</b>
5.1	New proposed CDMA-OFDM Combination Method . . . . .	59
5.1.1	Proposed CDMA-OFDM Combination Architecture . . . . .	59
5.1.2	Proposed spreading factor determination, resource allocation and code assignment algorithm in the CDMA-OFDM combination method . . . . .	61
5.1.3	New proposed algorithm for grouping UEs with different MCS values . . . . .	62
5.1.4	DMRS issue in the Uplink transmission and proposed DMRS Design for CDMA-OFDM Combination . . . . .	62
5.1.5	Proposed CDMA-OFDM Combination Scheduling . . . . .	66
5.2	Performance Evaluation . . . . .	67
5.3	Conclusion . . . . .	70
<b>6</b>	<b>New Proposed Adaptive Physical Resource Block Design for Enhancing Voice Capacity over LTE in PMR context</b>	<b>73</b>
6.1	Introduction . . . . .	73
6.2	Proposed Adaptive Physical Resource Design . . . . .	73
6.2.1	Proposed Sub Physical Resource structure . . . . .	73
6.2.2	Proposed System Evaluation Model . . . . .	75
6.3	Performance evaluation . . . . .	77
6.3.1	System Parameters . . . . .	77
6.3.2	LTE Voice Capacity Evaluation . . . . .	77
6.4	Conclusion . . . . .	77
<b>7</b>	<b>Comparison of the new Proposed Methods for Enhancing Capacity of Voice over LTE in PMR context: Evaluation and Recommendations</b>	<b>81</b>
7.1	Evaluation . . . . .	81
7.2	Recommendations . . . . .	85
<b>8</b>	<b>Conclusion and Perspectives</b>	<b>87</b>
8.1	Conclusion . . . . .	87
8.2	Perspectives . . . . .	88
	<b>Complementary Results</b>	<b>89</b>
	<b>Bibliography</b>	<b>92</b>

# List of Figures

2.1	LTE frame structure type 1 . . . . .	11
2.2	Resource block structure in LTE . . . . .	12
2.3	Data flow transmission in LTE . . . . .	13
2.4	LTE frame structure type 2 . . . . .	14
2.5	Data overhead of VoLTE in PMR context . . . . .	15
2.6	Control overhead of VoLTE in PMR context . . . . .	16
2.7	Packet bundling [36] . . . . .	16
2.8	Semi-persistent packet scheduling . . . . .	17
3.1	Multi-users Multiplexing Radio Voice Transmission architecture at the sender side . . . . .	22
3.2	AES Encryption architecture . . . . .	23
3.3	Deciphering at the receiver side . . . . .	23
3.4	Multicast issue in the proposed method . . . . .	24
3.5	Broadcast and Multicast in LTE . . . . .	24
3.6	Scheduling in the proposed method . . . . .	24
3.7	Multi-users Multiplexing Radio Voice Transmission Scheduling . . . . .	26
3.8	Downlink transmission in LTE . . . . .	27
3.9	Different MCS values issue and the general idea for grouping UEs . . . . .	31
3.10	Algorithm for classifying and selecting UEs for scheduling . . . . .	32
3.11	Voice data capacity gain (%) of the proposed method for the first scenario . . . . .	35
3.12	Voice data capacity of the proposed method in terms of number of users in 20 ms for 1.4 MHz bandwidth . . . . .	35
3.13	Voice data capacity of the proposed method in terms of number of users in 20 ms for 3 MHz bandwidth . . . . .	36
3.14	Voice data capacity of the proposed method in terms of number of users in 20 ms for 5 MHz bandwidth . . . . .	36
3.15	Voice data capacity gain of the proposed method for the second scenario . . . . .	37
3.16	Used resource blocks of the proposed method for the second scenario . . . . .	38
4.1	Control region in each Sub-frame . . . . .	41
4.2	Control overhead issue of VoLTE in PMR context in the multiplexing scheme . . . . .	41
4.3	RNTI aggregation general idea . . . . .	43
4.4	Control region search space in LTE . . . . .	45

4.5	PDCCH blind detection procedure of the proposed method . . . . .	46
4.6	Control capacity gain of the proposed method for the first scenario . . . . .	47
4.7	Control capacity gain of the proposed method for the second scenario . . . . .	48
4.8	Group_RNTI scheduling . . . . .	50
4.9	Group - Change management . . . . .	50
4.10	Comparison of number of required PDCCH channels between Fully Dynamic scheduling and the proposed method in one TTI for 1.4 MHz bandwidth . . . . .	53
4.11	Comparison of blocking rate between Fully Dynamic scheduling and the proposed method for 1.4 MHz bandwidth . . . . .	53
4.12	Comparison of blocking rate between Fully Dynamic scheduling and the proposed method for 3 MHz bandwidth . . . . .	54
4.13	Comparison of blocking rate between Fully Dynamic scheduling and the proposed method for 5 MHz bandwidth . . . . .	54
4.14	Comparison of voice control capacity of two methods in 1.4MHz bandwidth for 20ms . . . . .	56
4.15	Comparison of voice control capacity of two methods in 3MHz bandwidth for 20ms . . . . .	56
4.16	Comparison of voice control capacity of two methods in 5MHz bandwidth for 20ms . . . . .	57
5.1	Architecture of using CDMA-OFDM combination in LTE . . . . .	60
5.2	OVSF code tree for CDMA-OFDM method . . . . .	61
5.3	CDMA-OFDM architecture at eNodeB . . . . .	61
5.4	Algorithm for choosing UEs with different MCS values . . . . .	64
5.5	DMRS for uplink . . . . .	64
5.6	DMRS design for CDMA-OFDM method with CS+OCC . . . . .	65
5.7	PDCCH structure in the proposed method . . . . .	67
5.8	Determination of Code position in new PDCCH structure . . . . .	67
5.9	CDMA-OFDM scheduling . . . . .	68
5.10	Downlink voice data capacity gain of the proposed method for the 1.4 MHz bandwidth for 20 ms . . . . .	70
5.11	Uplink voice data capacity gain of the proposed method for the 1.4 MHz bandwidth for 20 ms . . . . .	70
5.12	Downlink voice data capacity gain of the proposed method for the 3 MHz bandwidth for 20 ms . . . . .	71
5.13	Uplink Voice data capacity gain of the proposed method for the 3 MHz bandwidth for 20 ms . . . . .	71
5.14	Downlink voice data capacity gain of the proposed method for the 5 MHz bandwidth for 20 ms . . . . .	72
5.15	Uplink voice data capacity gain of the proposed method for the 5 MHz bandwidth for 20 ms . . . . .	72
6.1	REG structure . . . . .	74
6.2	Adaptive Physical Resource Block . . . . .	74
6.3	SubPRB mapping . . . . .	76
6.4	Control capacity of the proposed method (1.4 MHz bandwidth and 20ms) . . . . .	78
6.5	Control capacity of the proposed method (3 MHz bandwidth and 20ms) . . . . .	78

---

6.6	Control capacity of the proposed method (5 MHz bandwidth and 20ms) . . .	79
7.1	Comparison of voice data capacity gain for the 1.4 MHz bandwidth for 20 ms	82
7.2	Comparison of voice data capacity gain for the 3MHz bandwidth for 20 ms .	83
7.3	Comparison of voice data capacity gain for the 5MHz bandwidth for 20 ms .	83
8.1	Comparison of voice data capacity gain for the 1.4 MHz bandwidth for 20 ms for code rate 4.57 kbits/s . . . . .	89
8.2	Comparison of voice data capacity gain for the 3 MHz bandwidth for 20 ms for code rate 4.57 kbits/s . . . . .	89
8.3	Comparison of voice data capacity gain for the 5 MHz bandwidth for 20 ms for code rate 4.57 kbits/s . . . . .	90
8.4	Comparison of voice data capacity gain for the 1.4 MHz bandwidth for 20 ms for code rate 6 kbits/s . . . . .	90
8.5	Comparison of voice data capacity gain for the 3 MHz bandwidth for 20 ms for code rate 6 kbits/s . . . . .	91
8.6	Comparison of voice data capacity gain for the 5 MHz bandwidth for 20 ms for code rate 6 kbits/s . . . . .	91



# List of Tables

2.1	Target voice code rate for PMR networks . . . . .	11
2.2	Number of symbols per slot . . . . .	12
2.3	Channel bandwidths specified in LTE . . . . .	12
3.1	DCI format for the Multi-users Multiplexing Radio Voice Transmission . . . .	26
3.2	voice data capacity gain of the proposed method for 1ms for the first scenario	34
3.3	Average voice data capacity gain of the proposed method for the second scenario	37
4.1	System Parameters . . . . .	47
4.2	Control capacity gain of the proposed method for 1 ms for the first scenario .	47
4.3	setup_group_DCI structure . . . . .	49
4.4	GroupMultiplexing_DCI structure . . . . .	49
4.5	System parameters . . . . .	52
5.1	Uplink DCI format for the CDMA-OFDM combination system . . . . .	66
5.2	Downlink DCI format for the CDMA-OFDM combination system . . . . .	66
5.3	System parameters . . . . .	68
5.4	Average voice capacity gain of the CDMA-OFDM combination method for the second scenario . . . . .	69
5.5	Average voice control capacity gain of the proposed method for 20 ms . . . .	69
5.6	Average voice data capacity gain of the proposed method for 20 ms . . . . .	69
6.1	Adaptive DCI structure . . . . .	76
6.2	System Parameters . . . . .	77
6.3	Voice capacity gain of the proposed method for 1.4 MHz in 20 ms (k=1) . . .	79
7.1	System parameters . . . . .	82
7.2	Voice data capacity gain of three methods for the second scenario . . . . .	84
7.3	Use case of three methods . . . . .	84
7.4	Voice capacity of PMR NarrowBand Technologies . . . . .	85
7.5	Voice capacity of PMR BroadBand Technologies . . . . .	85



# Chapter 1

## Introduction

Private Mobile Radio - sometimes called Professional Mobile Radio (PMR) or Land Mobile Radio (LMR) in North America address the public safety operations (e.g. radio systems used by police forces, fire brigades) and not only. The current deployed PMR technologies are still based on standards of over 25 years. On the contrary, in the public field, the broadband technologies have evolved rapidly in recent years. There is a big gap between the proposed PMR solutions and those of public operators. Thus, the public safety industry has reached a crossroad where the future products of PMR need to be considered. This raises the need of building an evolved PMR standard that upgrades to broadband technologies in order to satisfy the target user demands.

In the current broadband technologies, Long Term Evolution (LTE), developed by the 3rd Generation Partnership Project (3GPP), becomes a potential candidate for the next generation of PMR. But LTE physical layer technologies are not convincing for PMR context because of the difference between public LTE and PMR missions. While LTE is designed for large payloads of voice and video communication, PMR is used mainly for low data rate voice communication because PMR must privilege the network capacity in term of number of users in the critical issues. Therefore, the current LTE standards are not suitable for PMR context because the current LTE standards do not have a significant increase of voice capacity in terms of number of users in comparison to existing 2G and 3G PMR networks. In order to fulfill the PMR requirements, many challenges must be overcome.

In this thesis, we present the key factors that affect the voice capacity over LTE in PMR context and our three new proposed methods for enhancing the voice capacity of LTE in the PMR context: Multi-users Multiplexing method, CDMA-OFDM Combination method and Adaptive Physical Resource Block method. After evaluating the advantages and disadvantages of each method, we will offer suggestions and recommendations for the use of each method.

This dissertation is organized as follows. After a general introduction, we will give an overview about the PMR network as well as the LTE in the perspective of PMR broadband context in chapter 2. In this chapter, we also present two major issues that affect the voice capacity of LTE in the PMR context: data overhead and control overhead. Chapter 3 presents our new proposed Multi-users Multiplexing Radio Voice Transmission method. In this new method, voice packets from different users are multiplexed into one LTE packet in the downlink transmission for reducing the data overhead caused by the difference between the PMR voice payload and LTE packet size. Chapter 4 introduces two new proposed meth-



ods for reducing the control overhead issue in the multiplexing scheme: RNTI Aggregation method and Group RNTI method. The efficiency and the cost of the two new proposed methods are also evaluated in different contexts to draw assessments and recommendations. In chapter 5, we propose another new method for enhancing capacity of Voice over LTE (VoLTE) in PMR context: the Code Division Multiple Access - Orthogonal Frequency- Division Multiplexing (CDMA-OFDM) combination method. In this new proposed method, voice payloads of different User Equipments (UEs) having the same Modulation and Coding Scheme (MCS) can be spread by different orthogonal codes and mapped to the same set of resource elements. This new proposed method allows reducing both data and control overhead and can be applied for both uplink and downlink transmission. While the purpose of the proposed Multi-users Multiplexing method and CDMA-OFDM combination method is to increase the size of payload, the approach of the new proposed Adaptive Physical Resource Block method is to design a more efficient and more consistent User Assignment Resource Unit for the LTE in the PMR Context. In this new proposed method, we reorganize the structure of the Physical Resource Block (PRB) to optimize the voice capacity of LTE downlink in the PMR Context. Available PRBs in each subframe are reorganized into a number Sub Physical Resource Blocks (subPRBs). The number of control symbols can be selected with more flexibility. The details of this new proposed method is presented in chapter 6. We compare the advantages and disadvantages of the three new proposed methods and offer suggestions and recommendations for each method in chapter 7. We conclude and discuss perspectives in chapter 8.

# Chapter 2

## LTE in the perspective of PMR broadband context

### Contents

---

<b>2.1</b>	<b>LTE in the perspective of PMR broadband context . . . . .</b>	<b>9</b>
2.1.1	Voice communication in the perspective of PMR broadband era . . . . .	9
2.1.2	Overview of data flow transmission in LTE . . . . .	11
<b>2.2</b>	<b>Data and control overhead issues of Voice over LTE and Voice over LTE in PMR context . . . . .</b>	<b>14</b>

---

### 2.1 LTE in the perspective of PMR broadband context

This chapter presents an overview of Long Term Evolution (LTE) in the perspectives of Professional Mobile Radio (PMR) broadband evolution. While analyzing the spectral efficiency of voice transmission over LTE, we found that LTE is not yet optimized for low bit rate voice communication, especially in case of using LTE in PMR context. In this chapter, we will highlight the key factors that affect the spectral efficiency of LTE voice communication in the PMR context.

#### 2.1.1 Voice communication in the perspective of PMR broadband era

Private Mobile Radio - sometimes called Professional Mobile Radio (PMR), or Land Mobile Radio (LMR) in North America address the public safety operations (e.g. radio systems used by police forces and fire brigades) and not only [1, 2]. The current deployment PMR technologies such as Association of Public Safety Communications Officials Project 25 (APCO25) [3], Terrestrial Trunked Radio (TETRA) [4, 5], TETRAPOL are still based on standards more than ten years. APCO's Project 25 is a digital trunking standard for the US public safety market. APCO25-phase 1 based on FDMA technology, 12.5 kHz. In APCO 25 - phase 2, it used TDMA technology in addition to the narrow band FDMA  $6\frac{1}{4}$  kHz version. TETRA uses time division multiple access (TDMA), RF carrier spacing 25 KHz, cross channel rate 36.6 kb/s. The Tetrapol technology uses FDMA with RF carrier spacing 12.5 kHz and 10 kHz [6]. On the contrary, in the public field, the broadband technologies have evolved rapidly in recent years. There is a big gap between the PMR proposed solutions and

those of public operators. Thus, the public safety industry has reached a crossroad where the future products of PMR need to be considered [7]. This raises the need of building an evolved PMR standard that upgrades to broadband technologies in order to satisfy the target user demands.

There are several solutions envisaged for the broadband PMR technologies. First, construction of a new PMR standard which uses broadband technologies. Second, adaptation of existent broadband technologies to the new PMR networks. The construction of a new standard, if successful, will bring high performance but construction costs are very large and high risk. In the framework of our collaborative project SOAPS.2, labeled by the Systematic PARIS-REGION Cluster, the second solution is chosen because of its cheap cost and its small time consuming. In the current broadband technologies, WIMAX and LTE standards are considered as the potential candidates for the next generation of broadband PMR. Worldwide Interoperability for Microwave Access (WIMAX) is created by Intel and Alvarion companies in 2002. WiMAX is the commercial label issued by the WiMAX Forum. IEEE 802.16d (2004), IEEE 802.16e (2005) and The IEEE 802.16m (2009) are the most famous releases of WIMAX standard [8–10]. Standard LTE and LTE-Advanced have been developed by the The 3rd Generation Partnership Project (3GPP). Release 8 (2008) introduced a completely new radio interface and core network for LTE standard. Release 9(2009) included some new features such as self organizing network (SON), evolved multimedia broadcast and multicast service (eMBMS). LTE-Advanced was standardized by the 3GPP in March 2011 as 3GPP Release 10 that provided notable features like carrier aggregation (CA), higher order MIMO antenna configurations. Even of LTE and WIMAX have many common features (e.g. all IP architecture, MIMO, OFDM and/or SCFDMA, intelligent base stations). Recently LTE seems to become the preferred candidate for the broadband PMR evolution [2, 11]. However, some specific techniques of LTE have to be adapted in order to fulfill the PMR requirements.

It is interesting to note that in the PMR networks, the capacity in term of number of voice communications is the key factor. The number of users can vary from several hundreds to several thousands people in case of large scale disasters. Imagine that a disaster happens in the stadium or a train derails. In these situations, there are many forces participating in rescue such as: fire fighters, polices, ambulances, helicopters for observation and victims. All users require available and reliable channels. Therefore, PMR network does not require high bit-rate voice coders, concise and short but intelligible speech are good enough. The low bit-rate voice coders are commonly used.

In Association of Public Safety Communications Officials International (APCO) 25 project, the Improved MultiBand Excitation (IMBE) voice coder with bit rate of 4.4 kbps is used for the first Phase (APCO 25 Phase 1) and the Advanced MultiBand Excitation (AMBE) with very low bit rate of 2.45 kbits/s is used for second Phase (APCO 25 Phase 2). TETRAPOL, defined by the Tetrapol Publicly Available Specification (PAS), uses Regular Pulse Code-Excited Linear Prediction (RPCELP) voice coder with target bit rate of 6 kbits/s. Terrestrial Trunked Radio (TETRA) uses Algebraic Code Excited Linear Prediction (ACELP) voice coder [12] with bit rate of 4.57 kbits/s. The target bit-rate voice coder of PMR networks is briefly presented in Table 2.1. The most interesting finding was that the target bit-rate voice coder of PMR networks is very low. Therefore the design of architecture and methods for PMR future network must take into account the characteristics of the low bit-rate voice coders. In the next sub-sections, we will discuss the data flow transmission in LTE as well as obstacles to be overcome in order to apply the LTE standard

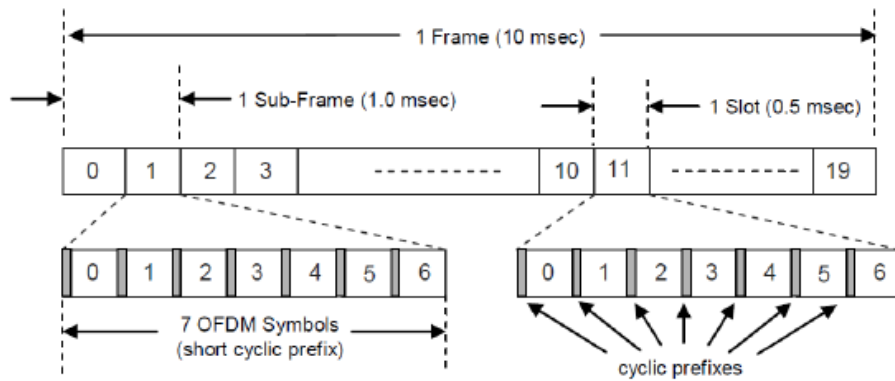

Figure 2.1: LTE frame structure type 1

for the next generation of broadband PMR.

Table 2.1: Target voice code rate for PMR networks

PMR technology	Target speed code rate
APCO 25 Phase 1	Improved MultiBand Excitation (IMBE) 4.4 kbits/s
APCO 25 Phase 2	Advanced MultiBand Excitation (AMBE) 2.45 kbits/s
TETRAPOL	Regular Pulse Code-Excited Linear Prediction (RPELTP) 6 kbits/s
TETRA	Algebraic Code Excited Linear Prediction (ACELP) 4.57 kbits/s;

### 2.1.2 Overview of data flow transmission in LTE

LTE (Long Term Evolution) and LTE-Advanced have been developed by the 3rd Generation Partnership Project (3GPP) [13–16] to respond to the requirements of the era of a mobile data revolution. Base on novel key technologies such as MIMO (Multiple Input, Multiple Output), OFDMA (Orthogonal Frequency Division Multiplexing Access) and an optimized system architecture evolution (SAE), LTE and LTE-Advanced provide high user data rate, improve system capacity and coverage, reduce the cost per bit, reduce the latency [17]. The LTE standard (3GPP release 8) supports a peak data rate of 300 Mbps and the LTE-Advanced (3GPP version 10) can provide a peak data rate of 1 Gbps.

LTE organizes Physical resources into radio frames. LTE supports two types of frame structure: type 1 applicable to FDD and half duplex FDD, and type 2 applicable to TDD.

Radio frame structure type 1 is 10 ms long. Each radio frame consists of 10 sub-frames, each 1 ms. Each sub-frame is divided in 2 slots of 0,5 ms. The details of frame structure type 1 is presented in Figure 2.1.

The transmitted signal in each slot is described by as a resource grid that consists of a set of OFDM subcarriers along several OFDM symbol intervals. The number of symbols per slot and the number of sub-carriers depends on the LTE configuration (see Table 2.2). The number of resource block depends on the channel bandwidth (Table 2.3).

Radio frame structure type 2 consists of two half frames of 5 ms length each. The LTE half-frames are split into five subframes of 1ms long. The subframes can be standard subframes or special subframes. The special subframes consist of three fields: Downlink

Table 2.2: Number of symbols per slot

Configuration	Number of sub- carriers	Number of symbols per slot
Normal CP (15kHz)	12	7
Extended CP (15kHz)	12	6
Extended CP (7.5kHz)	24	3

Table 2.3: Channel bandwidths specified in LTE

Channel Bandwidth (MHz)	Number of resource blocks
1.4	6
3	15
5	25
10	50
20	100

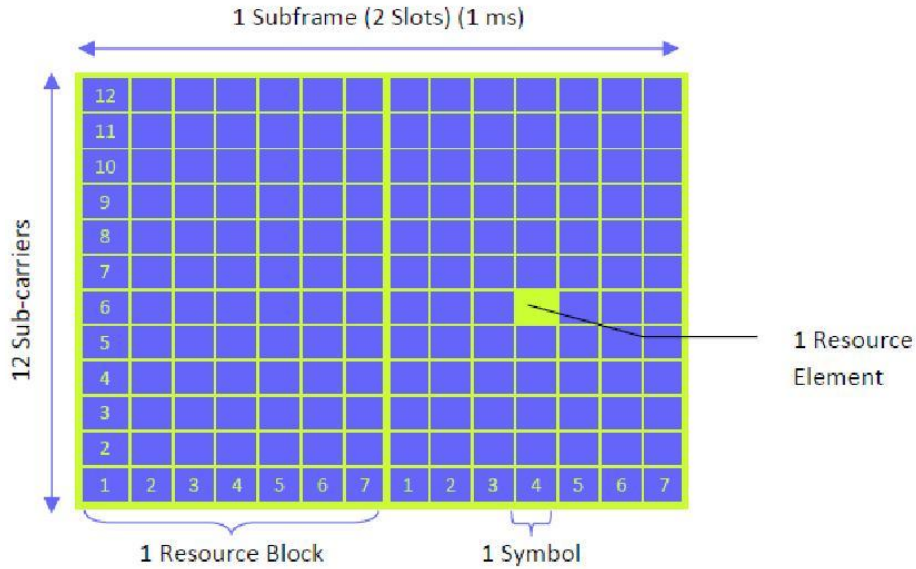

Figure 2.2: Resource block structure in LTE

Pilot Time Slot (DwPTS), Guard Period (GP), Uplink Pilot Time Slot (UpPTS) [18] (see Figure 2.4). In this dissertation, we use mainly the radio frame structure type 1 because this structure is the one selected for the Broadband PMR.

LTE uses radio resource management (RRM) to improve the efficient use of radio resources. RRM includes the procedures such as the Hybrid ARQ (HARQ), Link Adaptation (LA) and Channel Quality Indication (CQI) reporting. User Equipment (UE) provides the CQI reports in uplink to eNodeB [19]. The eNodeB uses CQI reports to estimate modulation and coding schemes (MCS) that is used for link adaptation purposes. In LTE, the base scheduler is Fully Dynamic (FD) scheduler [19]. In Dynamic Scheduling, the UE can get scheduling assignments (resource allocation information such as Resource Block assignment, MCS) for the downlink and the grant for the uplink in every subframe. Fully Dynamic scheduling provides good frequency domain and multi-user gain for best effort type traffic [20,21]. FD Scheduler uses Physical Downlink Control Channels (PDCCHs) to inform UEs about radio resource allocated for Physical Downlink Shared Channel (PDSCH)

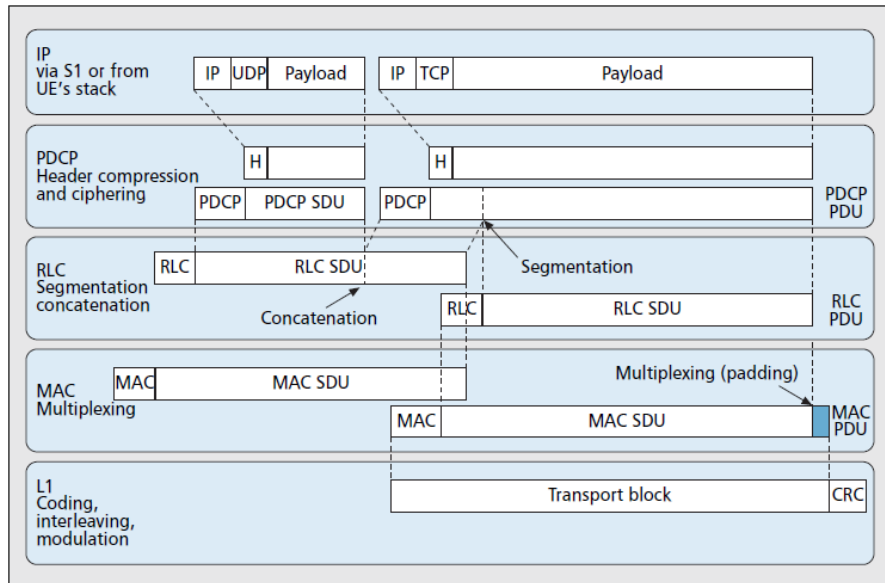

Figure 2.3: Data flow transmission in LTE

in the downlink and dedicated radio resources for Physical Uplink Shared Channel PUSCH. Details of the FD scheduling are introduced in Figure 2.8. In FD scheduling, one pair of Physical Resource Blocks (PRBs) is the smallest User Assignment Resource Unit [22–24]. A PRB contains twelve consecutive subcarriers in frequency domain and six or seven symbols in the time domain. The number of symbols depends on the type of Cyclic Prefix (CP). If normal CP is used, the number of symbols is seven. Otherwise, the number of symbols is six. One PRB contains 84 (normal CP) or 72 (extended CP) Resource Elements (RE). A RE is the smallest modulation structure in LTE. A RE is one subcarrier in frequency domain and one symbol in time domain (see Figure 2.2). The process of encapsulating and scheduling VoIP packets of UEs is presented in Figure 2.3. The data bits from application layer are placed in an RTP/UDP/IP packet to prepare for transmission (adding RTP, UDP, IP header). Next, at the PDCP layer, the robust header compression performs the compression of higher layer headers. Next, the PDCP and Radio Link Control (RLC), MAC headers are included to create the MAC SDU. At the MAC layer, the system will calculate the transport block size depending on the MAC SDU size and the Modulation and Coding Scheme (MCS). Padding is added if necessary. The output packet of MAC (MAC PDU) enters in the physical layer for CRC attachment, turbo encoding, rate matching, code block concatenation, scrambling, modulation, layer mapping/precoding, symbol mapping to the OFDM (DL) or SC-FDMA (UL) before transmitting.

Based on the evaluation results of LTE considering PMR specific applications, the study of [7] has found that the radio allocations are inefficient for low data rate voice communication in the PMR context. In this article, the authors have compared the performance of LTE with current deployment narrow band PMR networks and GSM network. The results show that number of possible communications in current LTE standards is not much greater than those in PMR if take into account the reuse factor. The high data and control overhead are two mains factors that affect the voice capacity over LTE in PMR context. In the next sub-section, we will discuss in details these two issues.

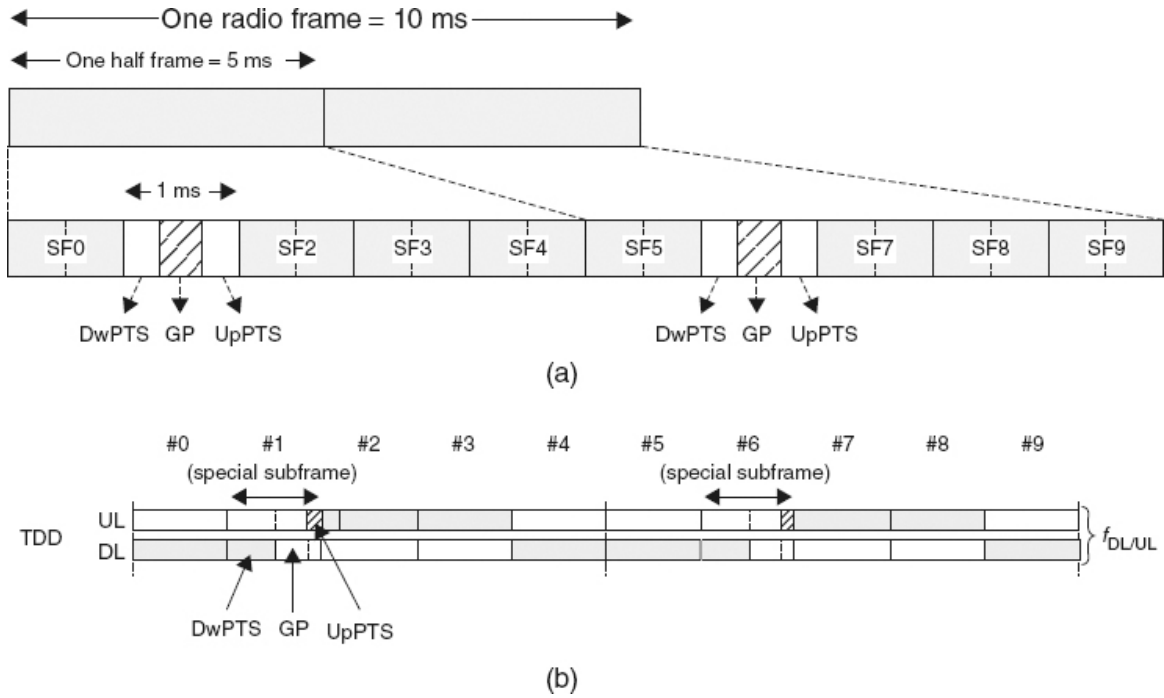

Figure 2.4: LTE frame structure type 2

## 2.2 Data and control overhead issues of Voice over LTE and Voice over LTE in PMR context

Since LTE was seen as a completely IP cellular system, the voice over LTE is considered to be voice over IP (VoIP). Therefore, there are factors affecting the capacity of VoLTE [25].

**Strict delay requirements:** to ensure the quality of voice perceived by user, the tolerable delay for MAC scheduling and buffering is recommended to be less than 80 ms [26]. This implies that the data should be scheduled early enough for the retransmission if necessary.

**Data overhead:** As the voice over LTE is now VoIP, there are many components needed in adding to the voice payload for transmission. These components cause the data overhead issue [27]:

- The common overhead shared by all users such as: reference signals, synchronization information and broadcast information.
- The cyclic prefix overhead used to avoid inter-symbol interference and inter-carrier interference.
- The protocol overhead (the protocol header (including the compression of (RTP/UDP/IP/)) by ROHC, PDCP, RLC, MAC headers and CRC).
- The Fully Dynamic (FD) scheduling overhead (padding in MAC layer).
- HARQ overhead used for re-transmission.

The level of overhead will become more and more significant as the size of voice payload is reduced. In the PMR context, we found that the data overhead caused by the Fully

Figure 2.5: Data overhead of VoLTE in PMR context

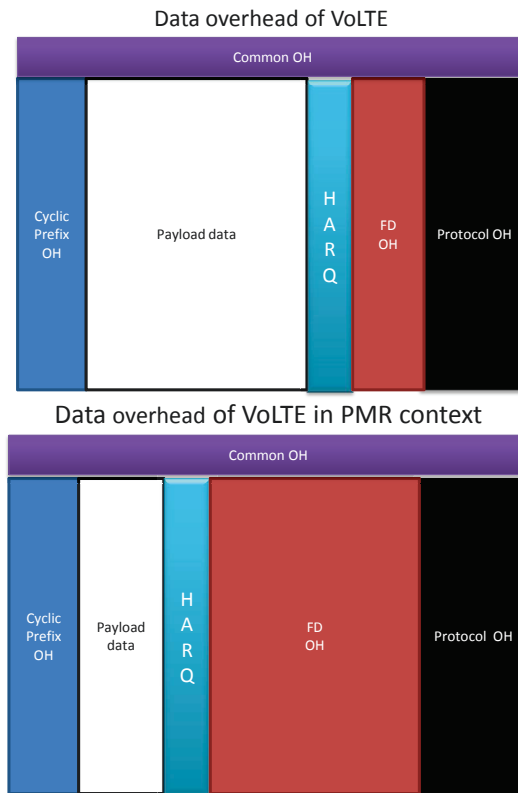

FDOH: Fully Dynamic Scheduling Overhead

Dynamic scheduling overhead becomes a major factor affecting the voice capacity of LTE (see Figure 2.5). The smallest LTE packet size is still too large in case that low bit rate voice communication is transmitted in high quality channel. In one general scenario, LTE uses 3MHz bandwidth, two transmission antennas, 3 symbols for Physical Downlink Control Channel (PDCCH), Advanced Multiband Excitation (AMBE) voice coder 2450 bps, Modulation and Coding Scheme (MCS) index 16 in PMR context, the size of smallest LTE packet is about 280 bits, three times bigger than the size of voice payload with size of 97 bits. This padding reduces significantly the voice capacity of the system. In the PMR context, we found that if we could eliminate this padding, we can improve the voice capacity essentially.

Control overhead: Since Voice over LTE uses the low data bit rate, the number of scheduled users per Transmission Time Interval (TTI) can become quite large. When each of these users is scheduled by L1 control signaling, the control channel overhead can become the bottleneck of VoIP system performance. In that case the dynamic packet scheduler is unable to fully exploit the PDSCH air interface capacity, and some of the PDSCH resources remain unused while the control channel capacity is already exhausted [28,29] (Figure 2.6).

There are several studies for increasing voice capacity over LTE. We can classify these studies into two main categories: Reduction of overhead for data transfer denoted by data over-head and Decrease of L1/L2 control signaling for scheduling and Hybrid Automatic Repeat Request (HARQ) feedback denoted by signal overhead.

First, in order to reduce the data overhead, in [30–32], a Robust Header Compression



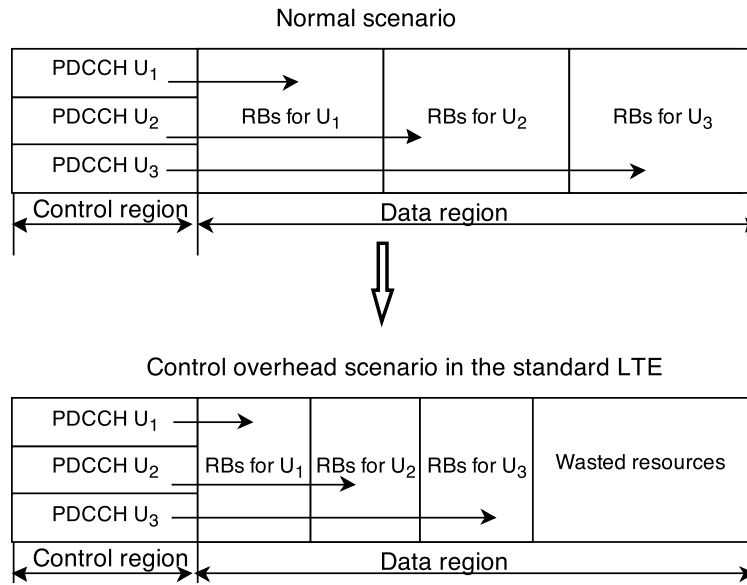

Figure 2.6: Control overhead of VoLTE in PMR context

Wasted Resources: resources blocks remain unused because the control channel capacity is already exhausted

$U_i$ : Resource Blocks allocated for User  $i^{th}$

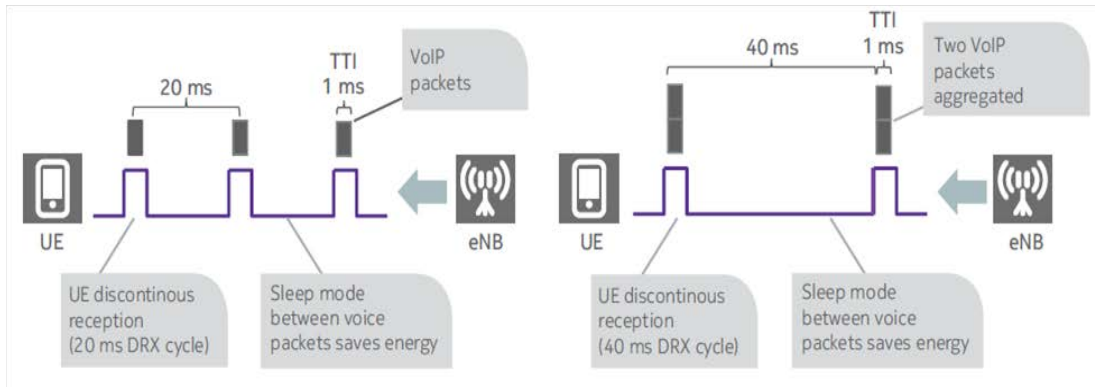

Figure 2.7: Packet bundling [36]

(ROHC) method used to compress the higher protocol headers (Internet Protocol (IP), User Datagram Protocol (UDP) and Real-time Transport Protocol (RTP)) is presented. With ROHC the IP/UDP/RTP header is compressed from 46 bytes for IPv4 and 66 bytes for IPv6 down to 1-3 bytes. The authors of [33] proposed a mechanism that reduces the Cyclic Redundancy Check (CRC) size from two to one byte without impacting the performance of system. Florea and al. [34, 35] have presented methods for reducing the redundancy for the errors correction section. In these articles, different code rates of turbo code are used for bits having different protected levels. Packet bundling [21, 26, 36] is used for increasing the payload of voice. In packet bundling, two or more voice packets of one user are bundled into one L1 Protocol Data Unit (PDU). Packet bundling adds delays in step of 20 ms. The number of voice packets in a bundle depends on channel quality and delay budget (see Figure 2.7).

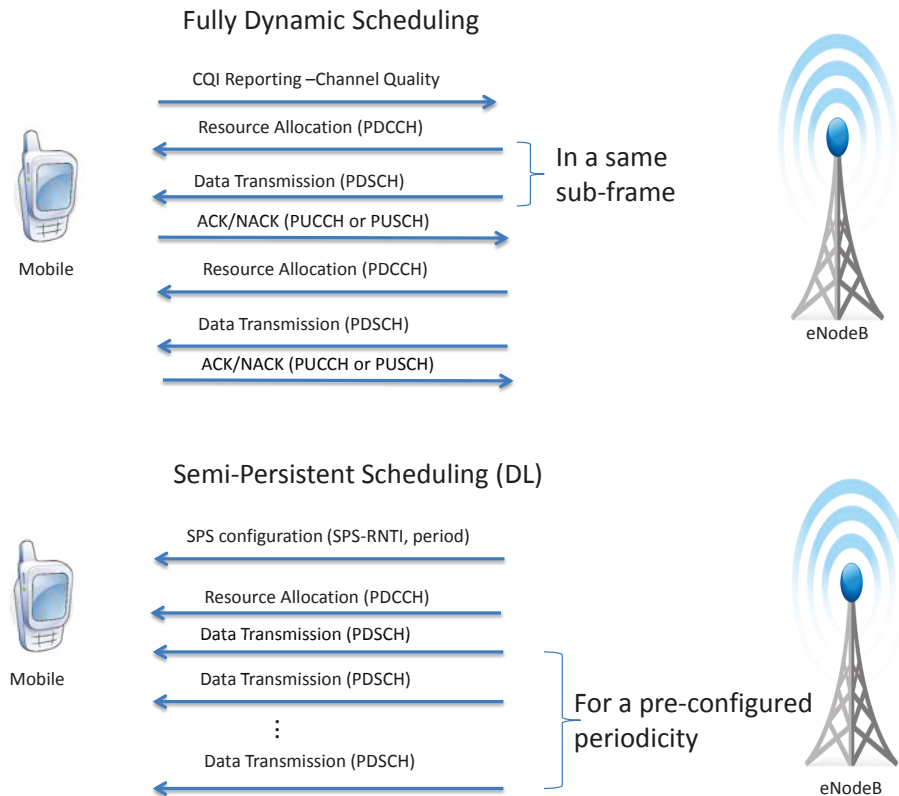

Figure 2.8: Semi-persistent packet scheduling

Second, to avoid control channel limitations of fully dynamic (FD) scheduling semi-persistent packet scheduling, group scheduling, TTI bundling can be used. In semi-persistent packet scheduling (SPS) [37–39], the UE is preconfigured by the eNB for a periodicity. During this period, certain resource allocation information such as RB assignments, Modulation and Coding Scheme remain fixed. A new control channel (PDCCH) will have to be sent if radio link conditions change. The difference between FD scheduling and SPS scheduling is presented in Figure 2.8 [40].

Transmission Time Interval (TTI) bundling [41–43] and group scheduling [44, 45] can also be used efficiently to reduce the signal overhead. In TTI bundling [41–43, 46] a few consecutive TTIs are bundled together and a single transport block is coded and transmitted by using a consecutive TTIs instead of being segmented in case of over-payload. TTI bundling reduces the L1/L2 grant and the number of HARQ feedbacks. In group scheduling [44, 45], the mobile stations are clustered into group and the resource allocations are scheduled for each group instead of scheduling for each mobile station.

However, state-of-the-art methods expose many difficulties to obtain the improvement of the Voice over LTE (VoLTE) capacity. The solutions for reducing data overhead do not take into account the signal overhead whenever evaluating the system performance. Imagine a scenario in which we can reduce the data overhead for payload allocation but there is no more control signal for allocating others UEs. In this scenario, these methods may not increase the voice capacity. On the other hand, the solutions for control overhead such

as group scheduling, semi-persistent scheduling do not examine the data overhead. These methods can economize the control signaling whereas in several cases, these methods are unable to reduce the data overhead. Consecutively, it becomes a bottleneck of the voice capacity. Some other mechanism such as TTI-bundling and packet bundling can reduce both overheads while they increase significantly the delay.

In addition, existent methods pay attention mainly for the data overhead or signal overhead for large or medium voice payload. The difference between the LTE packet size and the very small voice payload of PMR draws less attention so that the existent methods can not provide a significant voice capacity gain in PMR context. Therefore, in this thesis, we present and compare three new proposed methods for enhancing the voice capacity of LTE in the PMR context: Multi-users Multiplexing method, CDMA-OFDM Combination method, and Adaptive Physical Resource Block method. On the basis of evaluating the advantages and disadvantages of each method, we offer suggestions and recommendations for the use of each method. Details of these new proposed methods are discussed in the following sections.

# Chapter 3

## New proposed Multi-users Multiplexing Radio Voice Transmission Method for Enhancing Voice over LTE in PMR context

### Contents

---

<b>3.1</b>	<b>New proposed Multi-users Multiplexing Radio Voice Transmission Method</b>	<b>20</b>
3.1.1	General Idea and Challenges	20
3.1.2	Proposed Multi-users Multiplexing Architecture	21
3.1.2.1	Architecture at the sender side	21
3.1.2.2	Architecture at the receiver side	22
3.1.3	Proposed Multi-users Multiplexing Scheduling	23
3.1.3.1	Limitation of evolved Multi-media Broadcast/Multicast Service (eMBMS)	23
3.1.3.2	Proposed Multi-users Multiplexing Radio Voice Transmission Scheduling for transmitting multiplexed packets	25
3.1.4	Proposed multiplexing size determination algorithm	26
3.1.5	Different MCS values issue and proposed algorithm for grouping UEs with different MCS values	28
3.1.5.1	Different MCS values issue	30
3.1.5.2	Algorithm for grouping UEs with different MCS values	30
<b>3.2</b>	<b>Performance evaluation</b>	<b>31</b>
3.2.1	System Parameters	31
3.2.2	LTE Voice Data Capacity Evaluation	32
3.2.2.1	First scenario of same MCS results	32
3.2.2.2	Second scenario of different MCS results	34
<b>3.3</b>	<b>Conclusion</b>	<b>37</b>

---

In the PMR context, the difference between PMR voice payload and LTE packet size is the major factor affecting the data overhead. Therefore, in order to reduce data overhead of voice over LTE in PMR context, the first approach considered is to use the multiplexing

method to increase the size of voice payload. In this chapter, we propose a new Multi-users Multiplexing Radio Voice Transmission method for enhancing voice data capacity over LTE in PMR context. In this method, we build a new architecture for multiplexing voice packets from different users into one same LTE packet in the downlink transmission. In addition, a new scheduling method, which is used to transmit the multiplexed packets to corresponding users, is introduced. This chapter gives also a novel algorithm for calculating the multiplexing size based on the MCS, voice payload and LTE bandwidth and gives a new algorithm for selecting and grouping mobile users which are assigned different Modulation and Coding Scheme (MCS) values. The results show that the average voice data capacity gain of the proposed method is about 242.4% and in the best case, the proposed method can multiply the voice data capacity by 7.5.

### 3.1 New proposed Multi-users Multiplexing Radio Voice Transmission Method

#### 3.1.1 General Idea and Challenges

In PMR context, voice packets from different User Equipments (UEs) are emitted by the Application Layer every  $T_{voice}$  ms with size  $s_{voice}$ . To transmit these voice packets, eNodeB has to choose a LTE packet from a set of available LTE packet sizes. In LTE, eNodeB receives the CQI feedback from UEs as an indication to select modulation and coding scheme (MCS), code rate and LTE packet size ( $s_{LTE}$ ) for downlink transmission. We define  $MCS_i$  as the assigned MCS for  $UE_i$ . For each MCS value, eNodeB has a set of LTE packet size  $s_i$  corresponding to the number of resource blocks  $R_i | i \in 1..N_{BW}$  with  $N_{BW}$  is the number of allowed resource blocks of a defined bandwidth.

Assume that  $n$  UEs scheduled in one Transmission Time Interval (TTI) in standard LTE. The total of resource blocks that are used for scheduling

$$R^{total} = \sum_{i=1}^n R_i \quad (3.1)$$

with:

$$\sum_{i=1}^n R_i \leq N_{BW} \quad (3.2)$$

We consider  $s_{LTE}$  of  $UE_i$  as a function of  $MCS_i$ , payload, and number of used resource blocks  $R_i$

$$s_{LTE} = f(MCS_i, s_{voice}, R_i) \quad (3.3)$$

We define  $\delta$  is the difference between voice packet size and LTE packet size

$$\delta = s_{LTE} - s_{voice} \quad (3.4)$$

In PMR context, the  $\delta$  is large especially in case of high MCS. This reduces the voice data capacity of LTE because in this case, the main part of LTE packet transmits useless additional redundancy and it wastes the resource blocks.

In our case, the general idea is to put voice packets from different UEs into one LTE packet. This allows to reduce  $\delta$  so that we can reduce the average of resource blocks which are used to transmit voice payload of one UE. Assume that, we classify and group  $n$  UEs into  $k$  group. Each group uses  $RG_j$  resource blocks to transmit multiplexed payload of group.

The total of resource blocks that are used for scheduling in the proposed method

$$RG^{total} = \sum_{j=1}^k RG_j \quad (3.5)$$

with:

$$\sum_{j=1}^k RG_j \leq N_{BW} \quad (3.6)$$

In this case, we have to find out a strategy for grouping so that

$$RG^{total} \leq R^{total} \quad (3.7)$$

However, to cluster voice packets from different UEs we have to solve several issues. The first issue is how to send multiplexed packets to the corresponding UEs. The second issue is how to determine the number of voice packets that can be put in one LTE packet. The third issue is to find out the criteria for choosing voice packets for scheduling in case that UEs have different MCS values. We will discuss these issues in the next subsections.

### 3.1.2 Proposed Multi-users Multiplexing Architecture

#### 3.1.2.1 Architecture at the sender side

The architecture for Multi-users Multiplexing Radio Voice Transmission over LTE downlink is presented in Figure 3.1. This architecture consists of a classifier, a Serial to Parallel (S/P) and a Selector and Scheduler components. First, the Packet Data Convergence Protocol Service Data Units (PDCP SDUs) from different User Equipments (UEs) are classified into VoIP packets and data packets. Then the voice packets are put into the voice packets queue of each user by S/P component. Next these voice packets are encrypted at the PDCP layer. After encryption step, the Classifier and Scheduler uses MCS values of UEs to select, schedule and cluster the encrypted voice packets to create the MAC protocol data units (MAC PDUs). The way to classify and select voice UEs to send to MAC layer is realized by a new scheduling method. The detail of our scheduling method will be discussed in sub-section 3.1.3.

Our method clusters voice packets from different UEs, for security reasons, we need to ensure that each UE has the right to read only the part that is intended for it and not have the right to read the parts of the other UEs in the received multiplexed packets. For this reason, we propose to use a ciphering mechanism. In our method, we propose of using supported mechanisms in LTE for ciphering data at DPCP layer. LTE supports three EPS encryption algorithms [47, 48]. There are SNOW 3G [49], Advanced Encryption Standard (AES) [50] and ZUC [51]. We can use any of these three encryption algorithms.

We recommend to use AES. AES is a symmetric key block cipher which encrypts and decrypts a data block of 128 bits. AES use 10, 12, 14 rounds for encryption and decryption with key size of 128, 192, 256 bits [52]. The size of key depends on the numbers of rounds

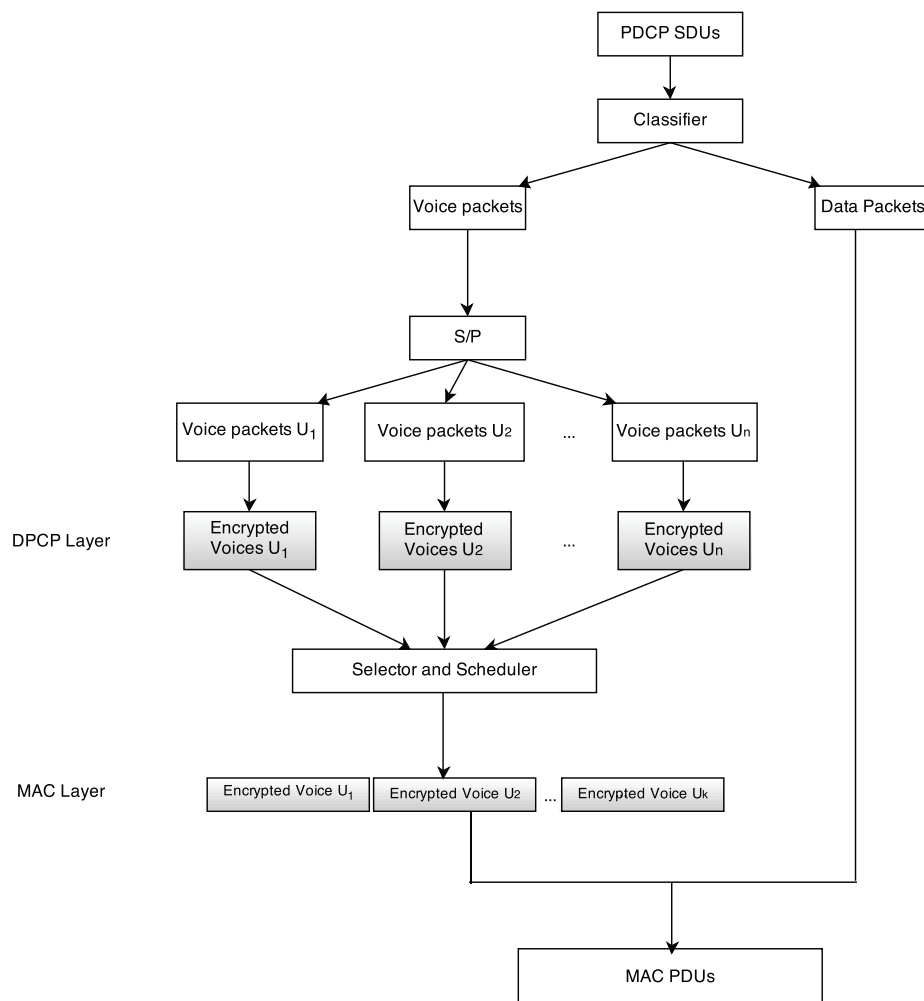

Figure 3.1: Multi-users Multiplexing Radio Voice Transmission architecture at the sender side

(see Figure 3.2). The AES is used because it is a well-known encryption algorithm and the AES block size is convenient with the LTE packet size in PMR context.

### 3.1.2.2 Architecture at the receiver side

At the receiver side, UEs receive signal from the antennas, read the Physical Downlink Control Channel (PDCCH) to find out the DCI information about resource allocation, MCS and packet position in the multiplexing packet. Next, the UEs make the demodulation, decoding. In the next step, UEs check the CRC for errors and request for retransmission if necessary. Figure 3.3 shows steps for decryption at the receiver side. Each UE of the group will receive the packet, which contains the data of all UEs in the group.  $UE_i$  will use its position  $p_i$  in the DCI (see Table 3.1) to take out its part in the multiplexing packets. Then, UEs prepare for deciphering with key  $k_i$  and Header Decompression.

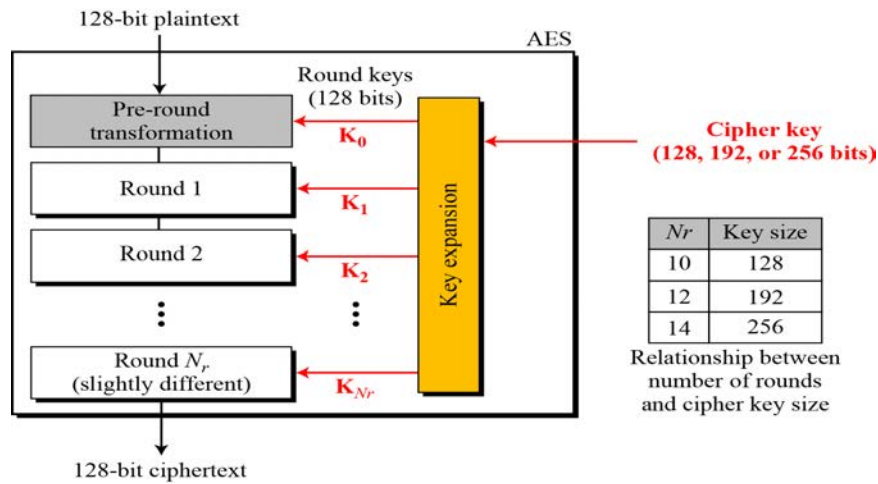

Figure 3.2: AES Encryption architecture

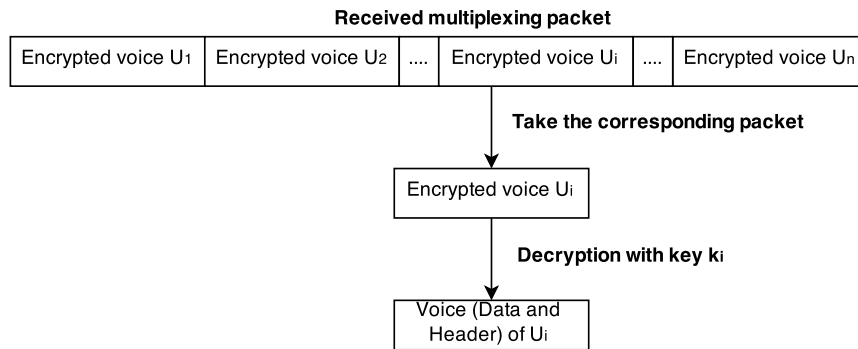

Figure 3.3: Deciphering at the receiver side

### 3.1.3 Proposed Multi-users Multiplexing Scheduling

The second issue to solve is how to transmit multiplexed packets to the corresponding UEs (see Figure 3.4). In LTE, the communication between UE and eNodeB is mainly unicast and broadcast. The unicast is used for carrying the user data or control information (resource allocation). Broadcast is used to send essential parameters for initial access (e.g. downlink system bandwidth, system frame number). In our case, we need a multicast mechanism. In this subsection, we will discuss about the limitation of the evolved Multi-media Broadcast/Multicast Service for sending multiplexed packets and propose our new scheduling based solution.

#### 3.1.3.1 Limitation of evolved Multi-media Broadcast/Multicast Service (eMBMS)

For transmission of the multiplexed packets to the corresponding UEs in the downlink, a multicast mechanism is needed. In LTE, multicast is realized by concept of evolved Multi-media Broadcast/Multicast Service (eMBMS) [53, 54]. However, eMBMS is used mainly for live video, audio streaming [55, 56]. Solution for voice packets is still a challenge.



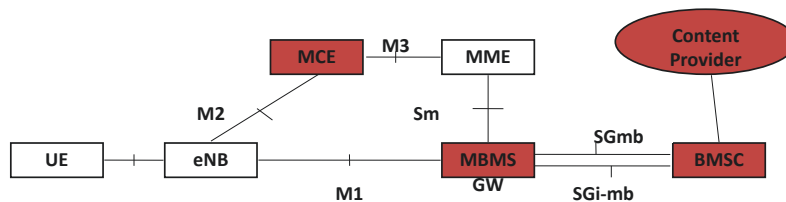
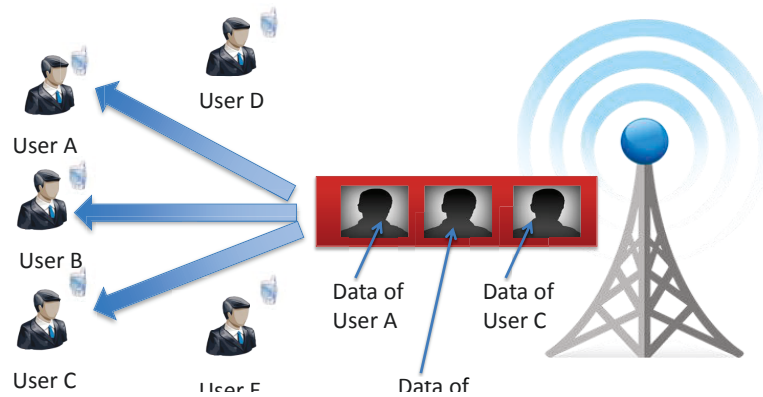

Figure 3.5: Broadcast and Multicast in LTE

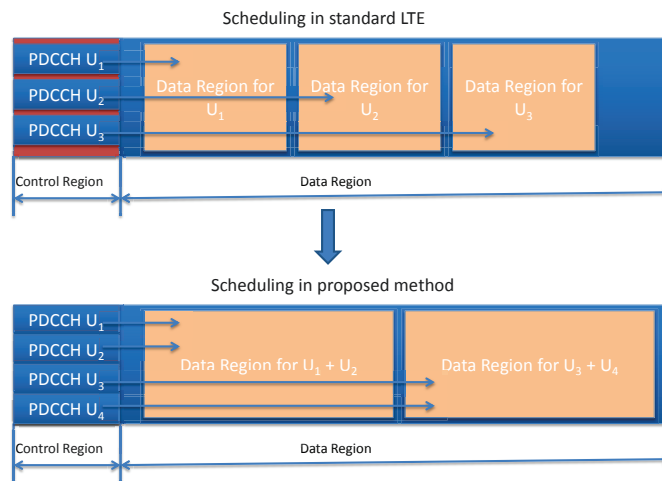

Figure 3.6: Scheduling in the proposed method

On the other hand, to apply eMBMS there are some new entities that must be added in the LTE infrastructure. eMBMS needs a Broadcast Multicast Service Center (BM-SC), eMBMS Gateway (MBMS GW), Multi-cell/Multicast Coordination Entity (MCE) (see Figure 3.5). BM-SC provides membership, session and transmission, service announcement, security and content synchronization. MBMS GW distributes user plane data to eNodeB and performs the control signaling session. MCE provides admission control. In the Broad-

cast and Multicast in eMBMS, all Mobile Users have the same content to receive. However, in our case, each UE has different content to receive and each UE must take out the corresponding part in LTE packet. Therefore, we proposed a new mechanism for multicast voice packet. This new multicast mechanism is realized by a new group scheduling method. In our scheduling method, we make modifications of standard scheduling in LTE to realize the multicast for multiplexed packets.

### 3.1.3.2 Proposed Multi-users Multiplexing Radio Voice Transmission Scheduling for transmitting multiplexed packets

In standard LTE, the resource allocation is realized at each TTI. The information of the allocated resource elements for UEs in the downlink is found in the Physical Downlink Control Channel (PDCCH). The PDCCH uses the first 1, 2, 3 (1, 2, 3, 4 in the case of 1.4MHz bandwidth) OFDM symbols at the beginning of each sub-frame. The number of OFDM symbols in a sub-frame is indicated by the Physical Control Format Indicator Channel (PCFICH). The PCFICH is located at the first OFDM symbol of each sub-frame. Each PDCCH carries one Downlink Control Information (DCI) and the information about the identity of each UE by a Radio Network Temporary ID, or RNTI. The DCI carries the detailed information about allocated resource blocks for each user, the modulation and coding scheme and the other additional information (e.g. HARQ process number, CQI request, and Transmit Power Control (TPC) command). There are 8 DCI formats can be configured in PDCCH: DCI Format 0, DCI Format 1, DCI Format 1A, DCI Format 1B, DCI Format 1C, DCI Format 1D, DCI Format 2 and DCI Format 3. DCI format depends on the purpose of control message.

DCI undergoes channel coding to form PDCCH. In standard LTE, each UE will search space that carries control information, finds out corresponding PDCCH by compare its RNTI with RNTI in PDCCH [57]. Next, UEs read information in PDCCH to find out their allocated resources and modulation and coding scheme.

In our case, the group classifier and group selector will classify and select voice UEs to send to MAC scheduler (see Figure 3.7). The criterion for classifying the UEs is MCS values of UEs. UEs having the same MCS values will be put in a same group. The group Selector will select UEs in a same group or groups with adjacent MCS values to create a list of UEs, choose MCS for group and send it to the MAC Scheduler. MAC Scheduler will calculate resources to be used and assigns the same resource allocation and the same MCS for all users in the list.  $n$  UEs in the 'multiplexing' group will receive  $n$  different PDCCH channels having the same Resource Block Assignment (RBA) and MCS values. To do that, we define a new DCI format for the Multi-users Multiplexing Radio Voice Transmission. This format contains information about the Resource Block Assignment (RBA), MCS and position of UE in the group (see table 3.1). The position field is used for the demultiplexing step at the receiver side.

We can find out the difference between our scheduling and the scheduling in standard LTE. In standard LTE, each PDCCH contains different resource allocation information for each UE. In our scheduling, PDCCHs of a multiplexed group contain the same information about resource allocation for group (see Figure 3.7).

Table 3.1: DCI format for the Multi-users Multiplexing Radio Voice Transmission

field Name	Length (bits)	Comment
RBA	3 (1.4 Mhz)	Same for all UEs in the group
	5 (3 Mhz)	
	7 (5 Mhz)	
MCS	5	Same for all UEs in the group
Position in group	6 (1.4 Mhz)	Different for each UE
	7 (3 Mhz)	
	8 (5 Mhz)	

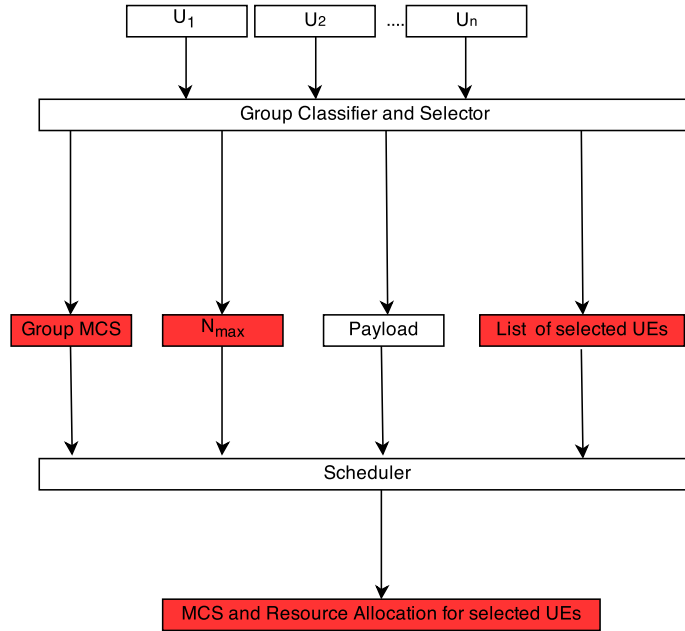

Figure 3.7: Multi-users Multiplexing Radio Voice Transmission Scheduling

### 3.1.4 Proposed multiplexing size determination algorithm

Another issue to consider while applying the Multi-users Multiplexing Radio Voice Transmission Method is to determine the number of voice packets that can be clustered into one LTE packet. The idea is that for each MCS, we calculate the largest LTE packet size. Based on the largest LTE packet size and voice payload, we can determine the multiplexing size.

Figure 3.8 shows the communication between Mobile Equipment with eNodeB for Downlink Transmission in LTE. In the first step, UE measures the power of the reference signal (RS) from eNodeB. Next, UE calculates the Channel Quality Indicator (CQI) based on RS and the signal-to-noise ratio (SNR) and sends CQI report to eNodeB. CQI report can be sent in one of two types: periodic and aperiodic. The periodic CQI report is carried by Physical Uplink Control Channel (PUCCH) and the aperiodic CQI is sent by Physical Uplink Shared Channel (PUSCH). eNodeB receives CQI report from UE, assigns the MCS and the number of Resource Blocks for UEs and sends these information on the Physical Downlink Control Channel (PDCCH) before sending data to UEs. UEs receive the PDCCH, read the resource allocation information in PDCCH and detect data in corresponding Re-

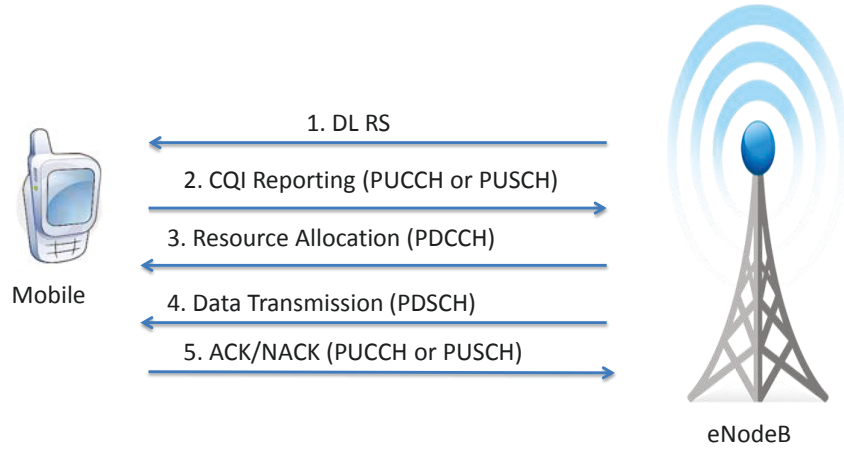

Figure 3.8: Downlink transmission in LTE

source Blocks and send ACK/NACK to eNodeB. In the downlink transmission, the number of resource blocks which are used for transmission depends on the MCS, payload and bandwidth. Consecutively, the number of resource blocks affects the voice data capacity of LTE downlink. For this reason, we present our proposed algorithm (algorithm 1) to determine the number of voice packets that can be clustered into one LTE packet for a defined LTE bandwidth for Downlink Transmission. This algorithm uses assigned MCS, payload of UEs and the bandwidth as parameters to determine the multiplexing size. This subsection gives also the definition of voice data capacity and voice data capacity gain.

**Definition 3.1.1.** *Standard LTE voice data capacity of a defined LTE bandwidth at a defined Modulation and Coding Scheme(MCS) is maximum number of voice UEs that can be transmitted in 1 ms over this bandwidth at this MCS.*

$$\text{Standcapacity} = \frac{N_{BW}}{RB_{UE}} \quad (3.8)$$

In which:

- $N_{BW}$ : Number of allowed resource blocks of a defined bandwidth
- $RB_{UE}$ : Number of resource blocks which is used to transmit a defined voice payload at a defined MCS

**Definition 3.1.2.** *Multiplexing method voice data capacity of a defined LTE bandwidth at a defined MCS value is maximum number of voice UEs that can be transmitted in 1 ms over this bandwidth at this MCS by using the proposed method.*

$$\text{Multicapacity} = \frac{N_{BW} * N_{max}}{RB_{group}} \quad (3.9)$$

In which:

- $N_{BW}$ : The number of allowed resource Blocks of a defined bandwidth
- $RB_{group}$ : Number of resource blocks which is used to transmit the multiplexed packet at a defined MCS
- $N_{max}$ : Maximum number of voice packets that can be put into one group.

**Definition 3.1.3.** Voice data capacity gain is fraction of the proposed method voice data capacity and standard LTE voice data capacity

$$Capacitygain = \frac{Multicapacity - Standcapacity}{Standcapacity} * 100\% \quad (3.10)$$

In which:

- *Multicapacity*: Multiplexing method voice data capacity
- *Standcapacity*: Standard LTE voice data capacity

Algorithm 1 can be described as follow: Voice packets are emitted by the Application Layer every  $T_{voice}ms$  with code rate  $R_{vocoder}$ . These packets are added headers each time passing Real-time Transport Protocol (RTP), User Datagram Protocol (UDP) and Internet Protocol (IP) for transmission. Then, these voice packets are compressed at Packet Data Convergence Protocol (DPCP) layer by Robust Header Compression (ROHC). In the next step, voice payload is encrypted at PDCP and PDCP header, RLC header and MAC header are added to create voice transport block  $TBS_{necessary} = P_{voice} + H_{overhead}$ .

eNodeB receives Channel Quality Indicator (CQI) values from UEs, assigns corresponding MCS index for UEs. In the next step, the biggest LTE packet size ( $TBS_{max}$ ) for the corresponding MCS of a defined bandwidth is determined by using table 7.1.7.2.1 of TS 36.213 [16] at Transport Block Size Index row and the number of allowed resource blocks  $N_{BW}$  column. Then, the number of voice packets that can be clustered into one LTE packet  $N_{max}$  is quotient of  $TBS_{max}$  and  $TBS_{necessary}$ .

For calculating the voice data capacity gain, firstly we have to calculate number of required PRBs to transmit voice payload of one UE in the standard LTE ( $RB_{UE}$ ) by refer to the Table 7.1.7.2.1-1 at TBS index which verifies :  $RB_{UE} = N_{PRB}(index(min(TBS_i - TBS_{necessary}))$ . Next, we have to calculate the number of required PRBs for multiplexed voice  $RB_{group}$ , which verifies :  $RB_{group} = N_{PRB}(index(min(TBS_i - TBS_{group}))$  with  $TBS_{group}$  is multiplication of  $TBS_{necessary}$  and  $N_{max}$ . The voice data capacity of standard LTE is defined as quotient of  $N_{BW}$  and  $RB_{UE}$ . The voice data capacity of the proposed method is defined as  $\frac{N_{BW} * N_{max}}{RB_{group}}$ .

### 3.1.5 Different MCS values issue and proposed algorithm for grouping UEs with different MCS values

Algorithm 1 is used to estimate the multiplexing size and the voice data capacity gain for the different MCS values. However, this algorithm clusters only UEs having exactly the same MCS value. If there are few UEs having the same MCS, this algorithm is not optimal. It would be interesting to have a flexible algorithm that can cluster UEs having different MCS values. This subsection introduces a new algorithm for grouping UEs having different MCS values.

**Algorithm 1:** Proposed multiplexing size determination algorithm

Step 1) Set parameters :

- $MCS$ , Modulation and Coding Scheme of user equipment
- $N_{BW}$ , number of allowed resource blocks of a defined bandwidth
- $R_{vocoder}$ , data rate of speech codec

Step 2) Compute voice packet length,  $P_{voice}$  bases on the voice coder bit rate,  $R_{vocoder}$ , and the voice frame time length,  $T_{voice}$

$$P_{voice} = R_{vocoder} * T_{voice}$$

Step 3) Calculate size of header from IP, UDP, RTP, PDCP, RLC, MAC denoted by  $H_{overhead}$

Step 4) Calculate payload for a voice UE

$$TBS_{necessary} = P_{voice} + H_{overhead}$$

Step 5) Load Modulation and TBS index table for PDSCH (table 7.1.7.1-1) and transport block size table (table 7.1.7.2.1-1) from 3GPP TS 36.213 V9.0.1 [23]

Step 6) Refer to the table 7.1.7.1-1 of 3GPP TS 36.213 V9.0.1 to find corresponding TBS index of MCS index.

Step 7) Refer to table 7.1.7.2.1-1 to find the value of  $TBS_{max}$  for TBS index of step 5 and  $N_{PRB} = N_{BW}$  .

Step 8) Calculate number of voice packets that can be clustered into one LTE packet  $N_{max} = TBS_{max} / TBS_{necessary}$

Step 9) For all possible values of  $i$  from 1 to  $N_{BW}$  at the TBS index row, find number of resource blocks to be used to transmit the voice payload  $RB_{UE}$  which verifies:

$$RB_{UE} = N_{PRB}(\text{index}(\min(TBS_i - TBS_{necessary})))$$

Step 10) Calculate voice data capacity of standard LTE

$$Standcapacity = \frac{N_{BW}}{RB_{UE}}$$

Step 11) Calculate group Transport Block Size  $TBS_{group}$

$$TBS_{group} = N_{max} * TBS_{necessary}$$

Step 12) For all possible values of  $i$  from 1 to  $N_{BW}$  at TBS index row, find number of resource blocks which is used to transmit the multiplexed packet  $RB_{group}$  which verifies:

$$RB_{group} = N_{PRB}(\text{index}(\min(TBS_i - TBS_{group})))$$

Step 13) Calculate voice data capacity of the proposed Multi-user Multiplexing Radio Voice Transmission method

$$Multicapacity = \frac{N_{BW} * N_{max}}{RB_{group}}$$

Step 14) Calculate voice data capacity gain

$$Capacitygain = \frac{Multicapacity - Standcapacity}{Standcapacity} * 100\%$$

**3.1.5.1 Different MCS values issue**

In LTE, CQI values are measured by the UEs and are sent to eNodeB. There are several factors that affect the CQI value. The CQI value depends on the noise and interference level of the channel and the quality of receiver. eNodeB receives the CQI values from the UEs and assigns the corresponding MCS values for UEs. For UEs that are assigned low MCS values, the number of RBs that must be used to transmit the same voice packet is larger than in the case of higher MCS values. Since with low MCS value, LTE needs more resources for detecting and correcting the errors.

In fact, in a cell, the channels usually have different CQI values. Therefore, UEs may be assigned different MCS values. One of the issues to be solved is how to group UEs that are assigned different MCS values. It means what MCS should be chosen as the common MCS of the group. This is the trade off between the Bit Error Rate (BER) and the system performance. If in a group the lowest MCS value is used, LTE will use more Resource Blocks for detecting and correcting errors. This allows a better error protection but the additional resource blocks will reduce the gain of the proposed method. On the contrary, if a higher MCS value is used as common MCS of the group, the error protection level will not be as good as expected for UEs that should have low MCS value.

**3.1.5.2 Algorithm for grouping UEs with different MCS values**

To ensure the error protection and system performance, we propose a new algorithm for grouping and selecting UEs when UEs have different MCS values. The main idea is that UEs which have the same MCS value or adjacent MCS values will be selected for the same group.

In each group, the lowest MCS value is chosen for calculating the group size. This value is considered as the common MCS value for the same group. This can affect the voice data capacity gain. However, in this case, the BER will be reduced because a higher error protection level is used.

In addition, this algorithm does not use the same size of group for all UEs. The size of group is changeable. It depends on the channel quality of each group. For UEs that have good channel quality (concentrate mostly in the center of the cell), this algorithm will assign a high value size of group. In contrast, for UEs with low channel quality (situated mostly at border of the cell), the size of the group is small (see Figure 3.9). This allows to enhance the system performance. Since for channels with high quality (high CQI values), LTE will assign high corresponding MCS values for UEs. In this case, the LTE packet size will be much larger than voice payload of UEs. Therefore, a bigger size of group will reduce the difference between the LTE packet size and the voice payload of group. In addition, this also increases the number of voice payload that can be clustered into one same LTE packet to enhance the voice data capacity gain.

Algorithm for choosing UEs for scheduling is presented in Figure 3.10. In this algorithm, UEs will be sorted according to MCS values from low to high. The classification and arrangement before implementing scheduling allows increasing efficiency of resource allocation because this reduces the dispersion of MCS in a group.

The scheduling will be done according to ascending values of MCS. In each group, the smallest MCS value will be selected for calculating the multiplexing size. This is to ensure the best error protection for the group. In this algorithm, with the low MCS value, the

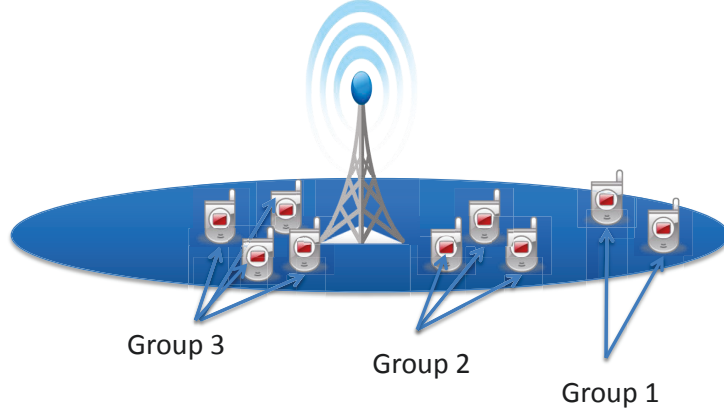

Figure 3.9: Different MCS values issue and the general idea for grouping UEs

number of UEs in a group is small and vice versa. This increases the efficiency of resource allocation.

To estimate the gain in this case, we first calculate the total number of resource blocks for all UEs in standard LTE. Assume that there are  $n$  UEs.  $UE_i$  needs  $RB_i$  resource blocks to transmit its voice payload. The total using resource blocks in standard LTE :  $R^{total} = \sum_{i=1}^n RB_i$

Assume that, we cluster  $n$  UEs into  $k$  group. Each group uses  $RG_j$  resource blocks to transmit multiplexed packet of group. The total of resource blocks that are used for scheduling in our case:  $RG^{total} = \sum_{j=1}^k RG_j$ .

In this case, the gain of the proposed method is the fraction between  $RG^{total}$  and  $R^{total}$ .

$$gain = \frac{(R^{total} - RG^{total}) * 100\%}{R^{total}} \quad (3.11)$$

## 3.2 Performance evaluation

In this section, we describe the performance evaluation of our proposed method.

### 3.2.1 System Parameters

In our context, we study and evaluate LTE as a candidate for future PMR. In PMR, the voice communications are typically short. Voice capacity and robust channel protection are important aspects of PMR. Therefore, the AMBE codec with low bit rate (2450 bps) and the low bandwidths of LTE (1.4 MHz, 3 MHz, 5 MHz), 24 bits CRC and Normal Cyclic Prefix are used for our evaluation.

In the first scenario, we cluster UEs having the same MCS values for evaluating the efficiency of the proposed method when the number of UEs in a cell is high. In the second scenario, UEs that have different MCS values can be grouped together. This scenario is used for evaluating the efficiency of the proposed method in case of low and medium number of UEs. In this scenario 50, 100, 200, 500, 1000 and 2000 UEs with random MCS values (Uniform distribution) are used for 1000 tests. We compare the average of used resource blocks in standard LTE and in our proposed method.



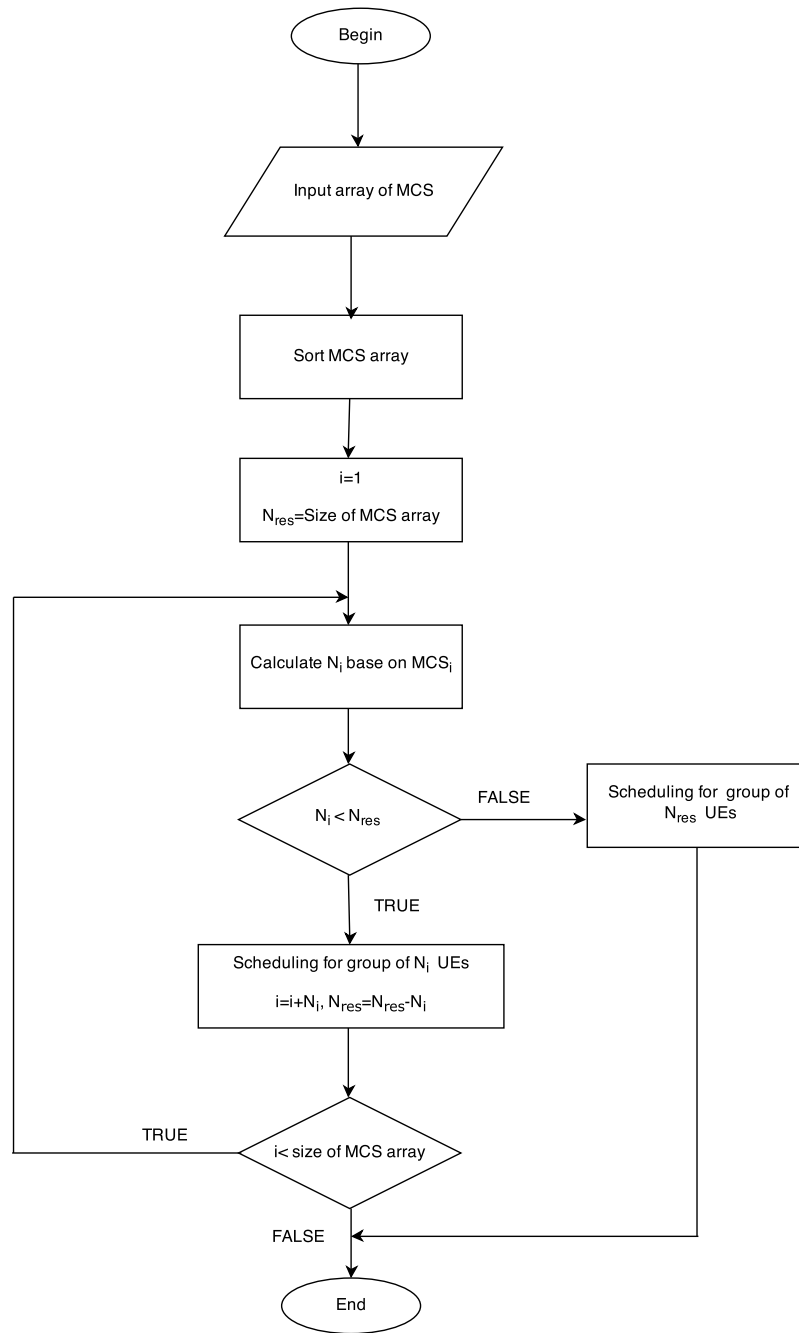

Figure 3.10: Algorithm for classifying and selecting UEs for scheduling

### 3.2.2 LTE Voice Data Capacity Evaluation

#### 3.2.2.1 First scenario of same MCS results

Table 3.2 presents voice data capacity comparison between our proposed method with the standard LTE for the first scenario. From this table, we can find that the voice data capacity gain is low for the small value of MCS and the voice data capacity gain increases with the augmentation of MCS. When modulation is QPSK and MCS from 0 to 9, the average of

voice data capacity gain is about 35%(1.4 MHz), 51%(3 MHz), 53%(5 MHz) . With the 16-QAM modulation and MCS from 10 to 16, the voice data capacity gain reaches the average of 125%(1.4 MHz), 133.33%(3 MHz), 137%(5 MHz). The best value of voice data capacity corresponds to the value of MCS from 17 to 28 with the average of 394%(1.4 MHz), 401%(3 MHz), 403%. Even in poor channel condition, Mobile Users concentrate at border of the cell , our method gives positive results. Our method's performance is very high in case that the Mobile Users concentrate at the center of cell with high channel quality.

Another point we can get from this table is that voice data capacity is not increased steadily with the augmentation MCS. There are points at which the value of voice data capacity is not changed or is increased not much (MCS 0, 2, 3, 6 in 1.4 MHz bandwidth). At these points, the difference between the size of standard LTE packet and the voice payload is not considerable so that the gain is not high when eliminating this difference. In fact, the voice data capacity gain depends on the difference between voice payload and LTE packet size. If the difference is high, it means the LTE packet size is much bigger than the voice payload, the voice data capacity gain is high because our method can reduce this difference by multiplexing voice packets. In the best case, the voice data capacity can be multiplied by factor of 7.5 (MCS 28 in 5 MHz, the voice capacity of standard LTE is 500 and the voice capacity of the proposed method is 3780 (see Figure 3.14).

Figure 3.11 is the graph presentation of voice data capacity gain of our proposed method in percent unit for evaluation over one millisecond period. Figures 3.12, 3.13, 3.14 show voice data capacity gains for 1.4 MHz, 3 MHz and 5 MHz bandwidths for evaluations of 20 milliseconds period. We use the 20 milliseconds for evaluations of voice data capacity because standard voice is packetized in 20 ms intervals. In addition, this ensures the consistency with our previous assessment of the voice capacity [7].

From these figures we can find that in the standard LTE, along with the increasing of MCS, the voice data capacity is increased to its maximum value (called saturate MCS). In these figures, the saturate MCS is equal to 6 in 1.4 MHz bandwidth, equal to 7 in 3 MHz and 5 MHz bandwidth. When the MCS is greater than the corresponding saturate MCS, the voice data capacity of standard LTE cannot be enhanced. We also found that the graph of voice data capacity in standard LTE has parts in which the voice data capacity is not changed.

However, the graph of voice data capacity in our method is increased steadily with the increasing of MCS. This is because of the scheduling mechanism in LTE. In LTE, the smallest User Assignment Resource Unit is a pair of PRBs. When MCS is increased the LTE packet size is larger, but the size of voice payload is not changed so that one pair of PRBs can transmit maximum one voice payload from one UE. In addition, in standard LTE, it is difficult to choose a LTE packet size that is close to the size of voice payload. In our case, when the LTE packet size is expanded, we can transmit voice payloads from several UEs by a flexible multiplexing size therefore we can get high voice data capacity gain. With the same MCS, the voice data capacity gain of larger bandwidth is higher because in the larger bandwidth, more voice packets can be multiplexed in one LTE packet. This shows the potential of the method with larger LTE bandwidth. In LTE-Advanced from Release 10, there are a set of new features. One of these features is carrier aggregation. LTE-Advanced allows the aggregation of carriers to create very large bandwidths (up to 100 MHz). Therefore, in the case that LTE-Advanced is used for PMR context, the performance of our method is more interesting. Our method is efficient in PMR context because PMR uses mainly the small voice payload for transmission.

Table 3.2: voice data capacity gain of the proposed method for 1ms for the first scenario

MCS	Modulation	Code rate	TC <sup>1</sup>	Standard LTE <sup>2</sup>			Proposed Method <sup>3</sup>			Gain <sup>4</sup>		
				1.4 <sup>5</sup>	3	5	1.4	3	5	1.4	3	5
0	QPSK	0.159	1/3	1	3	5	1	4	7	0%	33.00%	40.00%
1	QPSK	0.19	1/3	1	3	6	2	5	9	100.00%	66%	50.00%
2	QPSK	0.22	1/3	2	5	8	2	6	11	0%	20.00%	37.50%
3	QPSK	0.254	1/3	3	7	12	3	8	14	0%	14.28%	16.67%
4	QPSK	0.317	1/3	3	7	12	4	10	18	33.33%	42.81%	50.00%
5	QPSK	0.381	1/3	3	7	12	5	13	22	66.66%	85.71%	83.33%
6	QPSK	0.435	1/3	3	7	12	6	16	26	100.00%	128.57%	116.67%
7	QPSK	0.508	1/3	6	15	25	7	18	32	16.66%	20.00%	28.00%
8	QPSK	0.571	1/3	6	15	25	8	21	36	33.33%	40.00%	44.00%
9	QPSK	0.635	1/3	6	15	25	9	24	41	50%	60.00%	64.00%
10	16-QAM	0.317	3/4	6	15	25	9	24	41	50.00%	60.00%	64.00%
11	16-QAM	0.333	3/4	6	15	25	10	27	45	66.66%	80.00%	80.00%
12	16-QAM	0.379	3/4	6	15	25	12	30	51	100.00%	100.00%	104.00%
13	16-QAM	0.46	3/4	6	15	25	13	34	59	116.67%	126.66%	136.00%
14	16-QAM	0.492	3/4	6	15	25	15	40	66	150.00%	166.67%	164.00%
15	16-QAM	0.556	3/4	6	15	25	17	43	74	183.33%	186.67%	196.00%
16	16-QAM	0.603	3/4	6	15	25	18	47	79	200%	213.33%	216.00%
17	64-QAM	0.402	5/6	6	15	25	18	47	79	200%	213.33%	216.00%
18	64-QAM	0.466	5/6	6	15	25	19	51	82	216.66%	240.00%	228.00%
19	64-QAM	0.476	5/6	6	15	25	22	55	94	266.66%	266.67%	276.00%
20	64-QAM	0.529	5/6	6	15	25	24	61	102	300%	306.67%	308.00%
21	64-QAM	0.571	5/6	6	15	25	26	66	110	333.33%	340.00%	340.00%
22	64-QAM	0.614	5/6	6	15	25	28	71	118	366.66%	373.33%	372.00%
23	64-QAM	0.677	5/6	6	15	25	30	77	129	400.00%	413.33%	416.00%
24	64-QAM	0.72	5/6	6	15	25	33	82	139	450%	446.66%	456.00%
25	64-QAM	0.762	5/6	6	15	25	36	87	145	500%	480.00%	480.00%
26	64-QAM	0.804	5/6	6	15	25	37	94	157	516.66%	526.66%	528.00%
27	64-QAM	0.847	5/6	6	15	25	38	98	163	533.33%	553.33%	552.00%
28	64-QAM	0.974	5/6	6	15	25	45	114	189	650.00%	660.00%	656.00%

### 3.2.2.2 Second scenario of different MCS results

Table 3.3 presents the efficiency of the proposed method in the 1.4 MHz, 3 MHz and 5 MHz LTE bandwidth for the second scenario. We found that the efficiency of the proposed algorithm depends on the number of UEs in one cell. The more UEs in one cell, the higher voice data capacity gain.

The average voice data capacity gain of the proposed method for the second scenario is represented in figure 3.15. Figure 3.16 shows a comparison between our proposed method with the standard LTE in the efficiency of using resource. Our proposed method uses resource blocks more efficiently than the standard LTE.

The results show that when the number of UEs is low, our method works more effectively at low bandwidth and less effectively at high bandwidth. As the number of UEs is increased,

<sup>1</sup>Turbo code rate

<sup>2</sup>Maximum number of UEs can be scheduled in 1 ms for standard LTE

<sup>3</sup>Maximum number of UEs can be scheduled in 1 ms for the proposed method

<sup>4</sup>Voice data capacity gain of the proposed method

<sup>5</sup>MHz unit

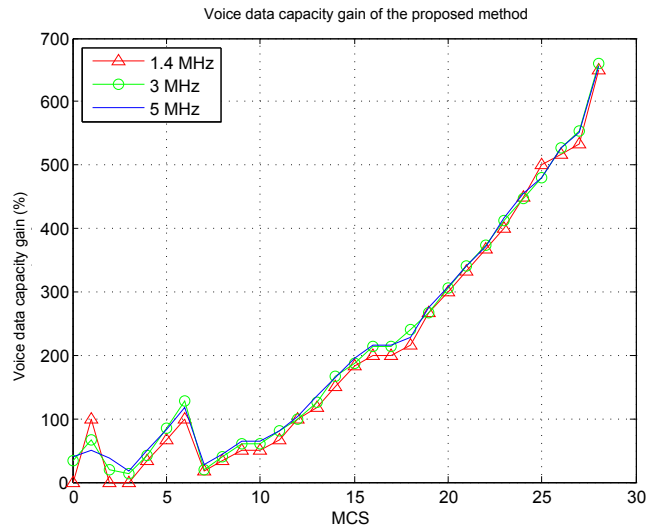

Figure 3.11: Voice data capacity gain (%) of the proposed method for the first scenario

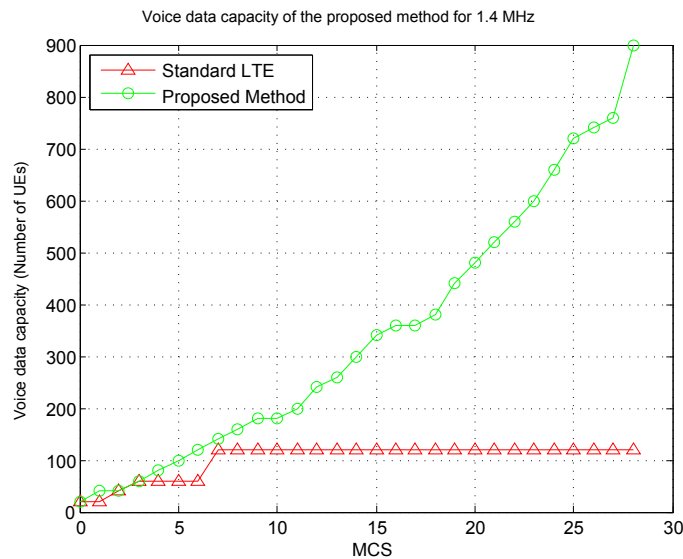

Figure 3.12: Voice data capacity of the proposed method in terms of number of users in 20 ms for 1.4 MHz bandwidth

our method is more efficient at high bandwidth. The reason is that our method uses the minimum MCS value to group the UEs for error protection and uses the biggest LTE packet for multiplexing the packets. Therefore, when the number of UEs is low, the dispersion of MCS values in a group is high when the packet size is large, this reduces the efficiency of resource utilization in our method. When the number of UEs is high, the dispersion of MCS values in a group is low, so with the bigger LTE packet size, the efficiency of resource utilization is enhanced.

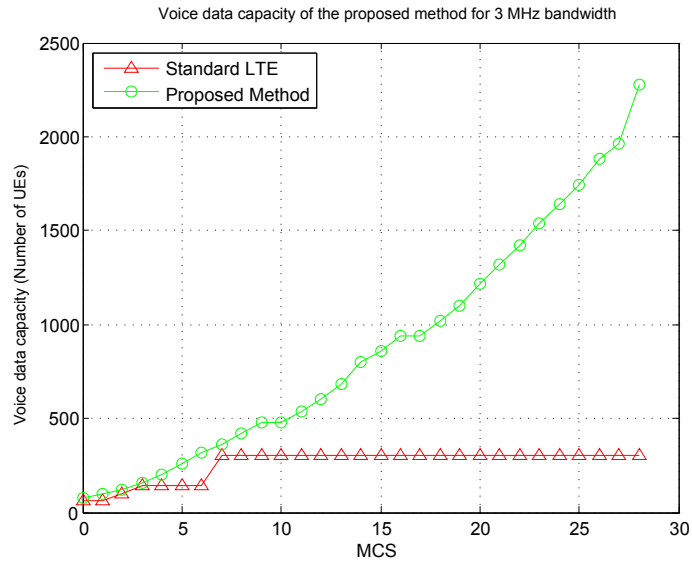

Figure 3.13: Voice data capacity of the proposed method in terms of number of users in 20 ms for 3 MHz bandwidth

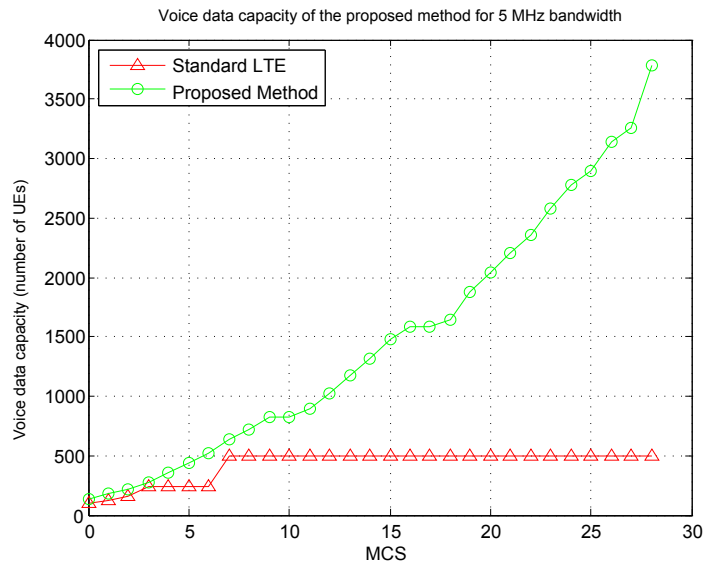

Figure 3.14: Voice data capacity of the proposed method in terms of number of users in 20 ms for 5 MHz bandwidth

<sup>6</sup> Average number of used resource blocks in standard LTE for 1.4MHz bandwidth  
<sup>7</sup> Average number of used resource blocks in the proposed method for 1.4MHz bandwidth  
<sup>8</sup> Average number of used resource blocks in standard LTE for 3 MHz bandwidth  
<sup>9</sup> Average number of used resource blocks in the proposed method for 3MHz bandwidth  
<sup>10</sup> Average number of used resource blocks in standard LTE for 5 MHz bandwidth  
<sup>11</sup> Average number of used resource blocks in the proposed method for 5MHz bandwidth

Table 3.3: Average voice data capacity gain of the proposed method for the second scenario

Bandwidth	50 UEs	100 UEs	200 UEs	500 UEs	1000 UEs	2000 UEs
$R^{total}$ 1.4MHz <sup>6</sup>	72	144	289	724	1450	2891
$RG^{total}$ 1.4MHz <sup>7</sup>	50	92	177	428	851	1693
Gain 1.4 MHz	44%	56.5%	63.2%	69.1%	70.3%	70.7%
$R^{total}$ 3MHz <sup>8</sup>	72	145	290	724	1448	2891
$RG^{total}$ 3 MHz <sup>9</sup>	60	101	175	402	782	1539
Gain 3 MHz	20 %	43.5%	65.7%	80.1%	85.1%	87.8%
$R^{total}$ 5MHz <sup>10</sup>	72	144	289	723	1446	2896
$RG^{total}$ 5 MHz <sup>11</sup>	75	111	187	412	782	1527
Gain 5 MHz	0%	29.7%	54.4%	75.4%	84.9%	89.6%

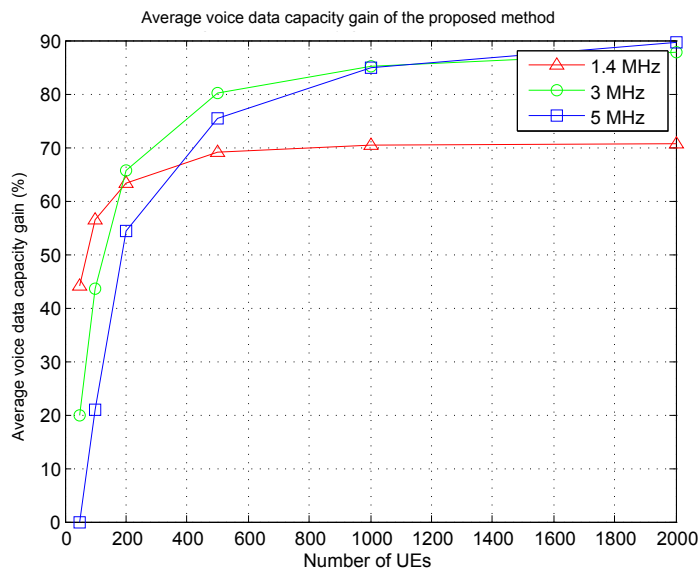

Figure 3.15: Voice data capacity gain of the proposed method for the second scenario

### 3.3 Conclusion

In this chapter, a new Multi-users Multiplexing Radio Voice Transmission Method is introduced. In this method, we propose a new architecture for multiplexing different voice packets from different Mobile Users for enhancing the voice data capacity of LTE in the PMR context. We also proposed a new scheduling method to transmit multiplexed voice packets to the corresponding Mobile Users. This scheduling is implemented by software changes in MAC layer in which different UEs in a multiplexing group can be scheduled for a same resource allocation. Therefore, this new Multicast does not require additional investment components in LTE architecture. Two scenarios are used for evaluating the efficiency of our method. In the first scenario, UEs with the same MCS and all UEs are assumed to have the same MCS value are grouped together to evaluate the efficiency of the proposed method in case that the number of UEs in a cell is high.

In this scenario, we found that the higher MCS, the higher voice data capacity gain we can obtain. Our method gives positive results even in poor channel condition. Our method's

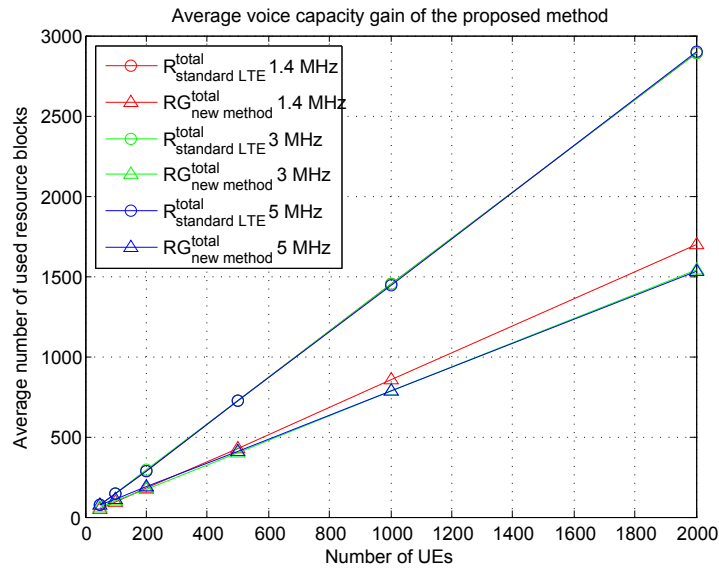

Figure 3.16: Used resource blocks of the proposed method for the second scenario

performance is very high in case that the mobile users are grouped at the center of cell with high channel quality. In the best case, the proposed method can multiply the voice data capacity by the factor of 7.5.

In the second scenario, UEs that have different MCS values can be grouped together by our flexible algorithm. This scenario is used for evaluating the efficiency of the proposed method in case of low and medium number of UEs. The results show that the average voice data capacity gain of the proposed method can raise up to 80%. In this scenario, we found that the more number of UEs, the higher the voice data capacity gain. The efficiency of our method depends on the dispersion of MCS values, the LTE bandwidth and the number of UEs. Our method is efficient in PMR context. PMR is suitable for emergency services where there is burst communication from UEs in a short period. However, in this chapter, the Multi-users Multiplexing method is only implemented for downlink transmission. The solution for uplink transmission may require one or more additional components in the system. In addition, the limitation of the control plan is not yet considered. The control overhead issue of the multiplexing scheme will be discussed in the next chapter.

# Chapter 4

## Control overhead issue in Multi-user Multiplexing radio voice transmission: Challenges and New Proposed Solutions

### Contents

<b>4.1</b>	<b>Control overhead issue in Multi-user Multiplexing radio voice transmission . . . . .</b>	<b>40</b>
<b>4.2</b>	<b>New proposed RNTI aggregation for the Multi-user multiplexing Voice radio transmission method . . . . .</b>	<b>42</b>
4.2.1	General Idea . . . . .	42
4.2.2	Proposed RNTI aggregation size determination function and definition of the control capacity gain . . . . .	42
4.2.3	Proposed CCE indexes determination method . . . . .	45
4.2.4	Performance evaluation . . . . .	46
4.2.4.1	System Parameters . . . . .	46
4.2.4.2	LTE Voice Control Capacity Evaluation . . . . .	47
<b>4.3</b>	<b>New proposed Group_RNTI for the Multi-user multiplexing Voice radio transmission method . . . . .</b>	<b>48</b>
4.3.1	General idea of the new proposed Group_RNTI . . . . .	48
4.3.2	New proposed Group - Change management method . . . . .	49
4.3.3	Numerical analysis . . . . .	49
4.3.4	Performance evaluation . . . . .	52
4.3.4.1	System Parameters . . . . .	52
4.3.4.2	LTE Voice Capacity Evaluation . . . . .	53
<b>4.4</b>	<b>Comparison of the new proposed RNTI Aggregation method and the new proposed Group_RNTI method: Recommendations . . . . .</b>	<b>55</b>
<b>4.5</b>	<b>Conclusion . . . . .</b>	<b>55</b>

In the last chapter, we proposed a Multi-users Multiplexing Radio Voice Transmission method for enhancing voice capacity over LTE in PMR context. In the Multi-users Multiplexing Radio Voice Transmission method, voice packets from different users having the same Modulation and Coding Scheme (MCS) can be clustered into one LTE packet in the



downlink transmission for reducing the data overhead caused by the difference between the LTE packet size and the PMR voice payload. However, in the last chapter, the control overhead issue is not yet considered. Therefore, in this chapter, we introduce two new methods for reducing the control overhead issue in the multiplexing scheme: RNTI Aggregation method and Group\_RNTI method. The main objective of the two methods, RNTI Aggregation method and Group\_RNTI method, is to reduce the control overhead issue in the multiplexing scheme. The main idea is to reduce the transmission of PDCCHs channels having the same content multiple times. However, two methods are used with different approaches. RNTI Aggregation method uses PDCCH channel with high format, created by the aggregation of PDCCH channels with low format, to transmit several RNTIs of different UEs in a same multiplexing group. This method allows increasing significantly the control capacity, but does not affect the Bit Error Rate (BER) in the transmission of PDCCH channel. The Group RNTI method clusters UEs having the same Modulation and Coding Scheme (MCS) into one or more groups. Each group is assigned a common Group\_RNTI. Control information is sent for groups rather than for each UE. The efficiency and the cost of the two methods are also evaluated in different contexts to draw assessments and recommendations. The use of the two methods for the Multi-users Multiplexing Radio Voice Transmission allows reducing both data overhead and control overhead issues for VoLTE in PMR context.

## 4.1 Control overhead issue in Multi-user Multiplexing radio voice transmission

In LTE for the transmission of Downlink (DL) and Uplink (UL) transport channels, certain associated control signaling have to be used. LTE uses Physical Downlink Control Channel (PDCCH) to carry all allocation information for both downlink and uplink shared channels. PDCCH can only use first one to three (one to four in case of in the 1.4MHz bandwidth) OFDM symbols in each subframe to carry Downlink Control Information (DCI) (see Figure 4.1). These symbols are organized in Resource Elements (RE), Resource Element Group and Control Channel Element (CCE). One RE corresponds to one OFDM symbol in time domain and one subcarrier in frequency domain. One REG consists of four consecutive REs or four REs separated by one Reference Signal. One CCE comprises nine REGs. To build the PDCCH, LTE uses a number of consecutive CCEs called CCE aggregation level. The CCE aggregation level can be one, two, four or eight. The aggregation level depends on the DCI size and the effective coding rate. There are four PDCCH formats (PDCCH format 0, PDCCH format 1, PDCCH format 2, PDCCH format 3) corresponding to four aggregation levels. In LTE, the base scheduler is Fully Dynamic (FD) scheduler. In the FD scheduler, each data packet needs to associate with a Layer 1 (L1) control signaling (a PDCCH channel). As the voice packet is small so that the number of scheduled packets in one TTI (Transmission Time Interval) can become quite large. Consequently, the number of required control channels is increased significantly. However, the number of PDCCHs is limited because the PDCCHs can only use first one to three OFDM symbols in each subframe. This can in-turn limit the number of simultaneous voice calls. This is defined as control overhead in LTE. To solve the control overhead of FD scheduling, Semi-persistent scheduling (SPS) [37],[58] proposed to remain certain information (Resource block assignments, Modulation and Coding Scheme...) for a pre-configured period. During this

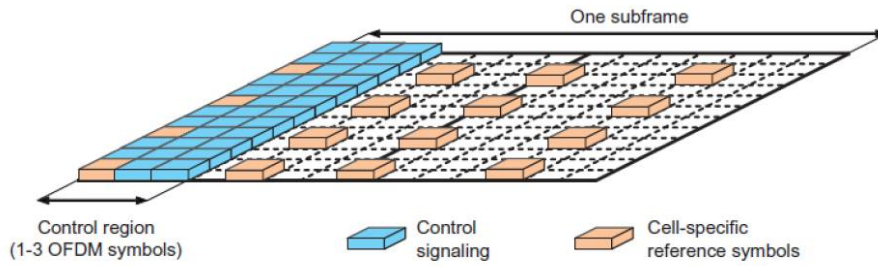

Figure 4.1: Control region in each Sub-frame

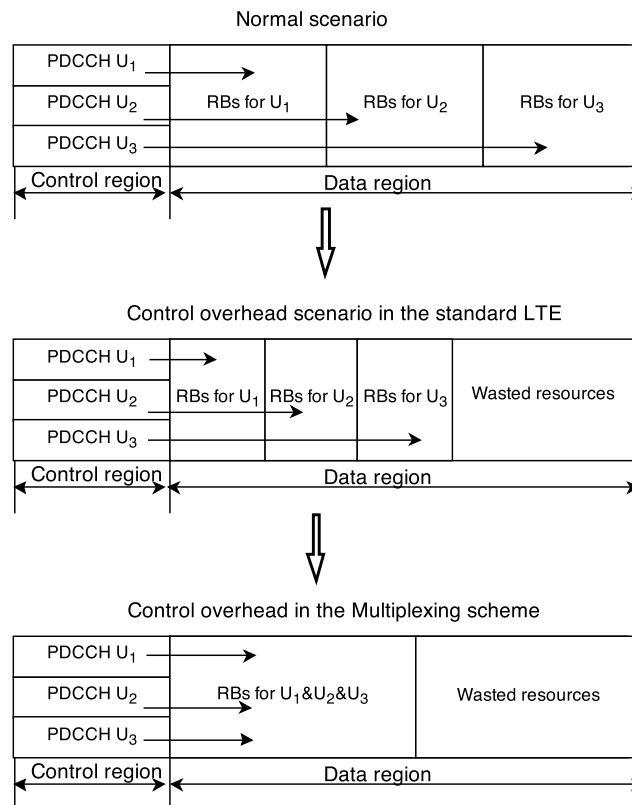

Figure 4.2: Control overhead issue of VoLTE in PMR context in the multiplexing scheme

period, if the link condition changes, SPS scheduler will send a new PDCCH. In group scheduling [44], the mobile stations are clustered into groups and the resource allocations are scheduled for each group instead of scheduling for each UE (User Equipment). In our Multi-users Multiplexing Radio Voice Transmission method, different UEs in a multiplexing group can be scheduled for a same resource allocation (see Figure 4.2) so that an adequate method to reduce the control overhead for this situation needs to be considered.

This chapter investigates two alternatives to reduce the control overhead in the multiplexing scheme, namely RNTI Aggregation method and Group RNTI method. Two methods are used with different approaches. The RNTI Aggregation method is used for increasing the amount of control information that can be transmitted by a finite amount of control

resource while the Group\_RNTI method is used to reduce the number of required control channels. RNTI Aggregation method uses PDCCH channel with high format, created by the aggregation of PDCCH channels with low format, to transmit several RNTIs of different UEs in a same multiplexing group. This method allows increasing significantly the control capacity, but does not affect the Bit Error Rate (BER) in the transmission of PDCCH channel. The details of this method is presented in section 4.2. The Group\_RNTI method clusters UEs having the same Modulation and Coding Scheme (MCS) into one or more groups. Each group is assigned a common Group\_RNTI. Control information is sent for groups rather than for each UE. We introduce the Group\_RNTI method in section 4.3. We then provide a comparison between the two methods focusing on the control overhead gain, the complexity and the cost in section 4.4. The final section 4.5 draws some conclusions.

## 4.2 New proposed RNTI aggregation for the Multi-user multiplexing Voice radio transmission method

### 4.2.1 General Idea

Figure 4.3 shows the general idea of RNTI aggregation method. Assume that there are  $n$  UEs that will be scheduled in one TTI by our multiplexing algorithm. In our proposed method, instead of transmitting  $n$  different PDCCHs, which contain only a same DCI information and a different RNTI for each UE in the group, we can transmit  $m$  new aggregation PDCCH channels. This is done by a negligible modification in the structure of PDCCH. One PDCCH channel now can transmit one DCI value and one or several RNTIs. The number of RNTIs ( $\delta_i$ ) transmitted in one PDCCH depends on the DCI size, the PDCCH format that UEs required and the PDCCH which will be used for transmitting the aggregation RNTIs.

The major issues to be considered is how to determine the number of RNTIs ( $\delta_i$ ) that can be put in one PDCCH and how to ensure that the new method does not increase the bit error rate of PDCCH. In the next section, we will describe our proposed mechanism for determining the RNTI aggregation level.

### 4.2.2 Proposed RNTI aggregation size determination function and definition of the control capacity gain

As LTE supports different PDCCH formats (depending on the DCI size and the code rate) and to ensure the Bit Error Rate (BER) of PDCCH, we propose to use PDCCH channels with high format, created by the aggregation of PDCCH channels with low format, to transmit more than one RNTIs in one PDCCH. This allows increasing the control capacity, but does not affect the BER in the transmission of PDCCH channel if we constrain a constant code rate for the DCI.

Assume that we have  $n_i$  PDCCH channels with format  $i$ , in the Fully Dynamic Scheduling in LTE, with  $n_i$  PDCCH channels with format  $i$  we can only transmit the allocation information (DCI) for  $n_i$  UEs with  $n_i$  different RNTI values. Therefore, numberl of UEs that can be scheduled in one TTI with the FD scheduler is:

$$n_{totalFD} = \sum_{i=0}^3 n_i \tag{4.1}$$

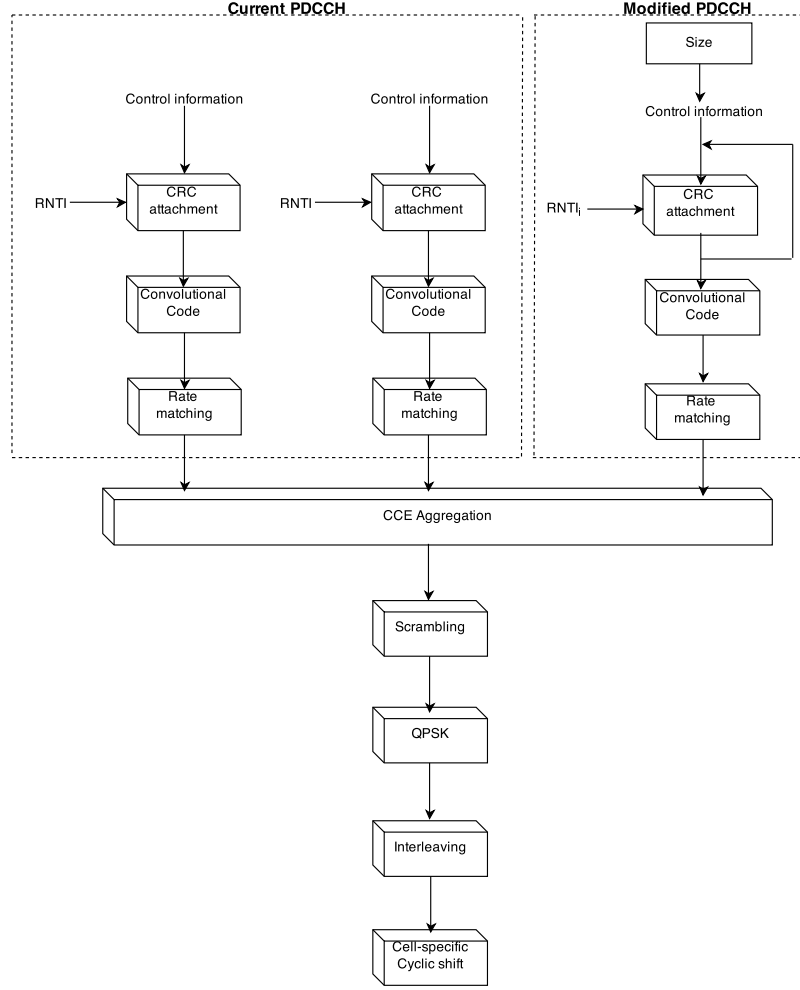

Figure 4.3: RNTI aggregation general idea

In the proposed method, we aggregate  $n_i$  PDCCH channels with format  $i$  to create  $n_{ij}$  PDCCH channels with format  $j$  with  $j \in \{i..3\}$ . Assume that one PDCCH channel with format  $j$  can transmit  $\delta_{ij}$  RNTIs of UEs that require PDCCH format  $i$ . So in our method the total of UEs that can be total scheduled in one TTI can be estimated by equation 4.2:

$$n_{totalofProposedMethod} = \sum_{i=0}^3 \sum_{j=i}^3 n_{ij} * \delta_{ij} \quad (4.2)$$

The control capacity gain is given by:

$$gain = \frac{n_{totalofProposedMethod} - n_{totalFD}}{n_{totalFD}} * 100\% \quad (4.3)$$

To ensure that the proposed method does not affect the BER in the transmission, the number of RNTI of UEs with PDCCH level  $i$  that can be put in one PDCCH with format  $j$  denoted by  $\delta_{ij}$  can be calculated by formula 4.8.

Assume that in standard LTE, the FD scheduler uses one PDCCH channel with format  $i$  with size  $s_i$  to transmit DCI with size  $DCIsize$  at code rate  $r$ . So we have:

$$(DCIsize + 16) * r = s_i \quad (4.4)$$

Where: 16 is the size of CRC xor RNTI.

In our case, we aggregate PDCCH channels of lower format  $i$  to create PDCCH with higher format  $j$  to transmit DCI with size  $DCIsize$  at code rate  $r$  of  $\delta_{ij}$  RNTI values so we have:

$$(DCIsize + 16 * \delta_{ij}) * r = s_j \quad (4.5)$$

From Formula 4.4 and Formula 4.5 we have:

$$\frac{DCIsize + 16 * \delta_{ij}}{DCIsize + 16} = \frac{s_j}{s_i} \quad (4.6)$$

We have:

$$s_k = 2^k * s_0 \quad (4.7)$$

So:

$$\frac{DCIsize + 16 * \delta_{ij}}{DCIsize + 16} = 2^{j-i} \quad (4.8)$$

In the standard LTE, the choice of aggregation level depends on the DCI size and the radio condition. In our case, PDCCH with high format is used not only to support multiple DCI formats and to accommodate the radio condition, but also is used to transmit several RNTIs in one PDCCH. In order to maximize the control capacity, the aggregation levels will be created in high to low order priority. This is suitable for the multiplexing scheme because in the multiplexing scheme, the number of multiplexed voice packets in one LTE packet is higher in case that quality of channels are good and vice versa. At the  $i^{th}$  TTI, assume that we use  $n$  CCEs to transmit  $n_i$  PDCCH of format  $i$ . To increase the number of RNTIs that can be transmitted in one PDCCH, in our proposed method, we try to create more PDCCH in high format to transmit RNTIs of UEs that require low format PDCCHs.

$$n_{ij} = \begin{cases} \lfloor \frac{n_i}{2^{j-i}} \rfloor & j = 3 \\ \lfloor \frac{n_i - \sum_{k=j+1}^3 n_{ik} * 2^k}{2^{j-i}} \rfloor & i \leq j < 3 \end{cases} \quad (4.9)$$

Where

- $n_{ij}$  is the number of PDCCHs of format  $j$  that are created by the aggregation of PDCCH format  $i$
- $n_i$  is the number of PDCCHs of format  $i$

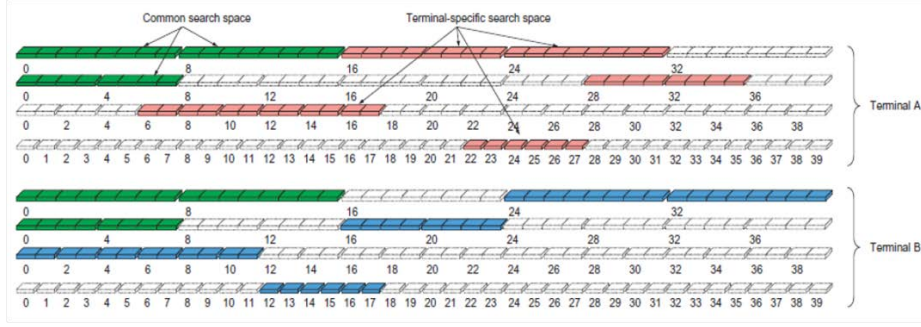

Figure 4.4: Control region search space in LTE

### 4.2.3 Proposed CCE indexes determination method

LTE can define a default value A\_RNTI (Aggregation RNTI) to calculate the CCE index of PDCCHs having more than one RNTIs. The PDCCH created by RNTIs aggregation ( $\delta_{ij} > 1$ ) will be considered a PDCCH of UE having A\_RNTI. In standard LTE, UE will find CCE indexes on 2 areas: common search space (RNTI = 0) and the specific search space (C\_RNTI) [59] (see Figure 4.4).

In our proposed method, UE will search on 3 areas: common search space (RNTI = 0), the aggregation search space (A\_RNTI) and the specific search space (C\_RNTI) (see figure 4.5). We can also put the aggregation search space into the common search space by assigning A\_RNTI=0.

To find the allocation in the aggregation search space, UEs will first calculate the indexes CCEs by using the A\_RNTI and apply the formulas in spec 36.213 [23] as:

$$Y_k = (A.Y_{k-1}) \bmod D \quad (4.10)$$

Where

- $i = 0$  to (Aggregation Level - 1)
- $N_{CCE}$ : Number of CCE's available for PDCCH
- if  $k = 0$ ,  $Y_{k-1} = A\_RNTI$

$$CCEindex = L((Y_k + m') \bmod (\lfloor N_{CCE}/L \rfloor)) + i \quad (4.11)$$

Where

- $L$ : Aggregation level,  $L \in \{1,2,4,8\}$
- $A=39827$
- $D= 65537$
- $k$ : Subframe number
- $m' = 0$  to (Number of PDCCH candidates -1)

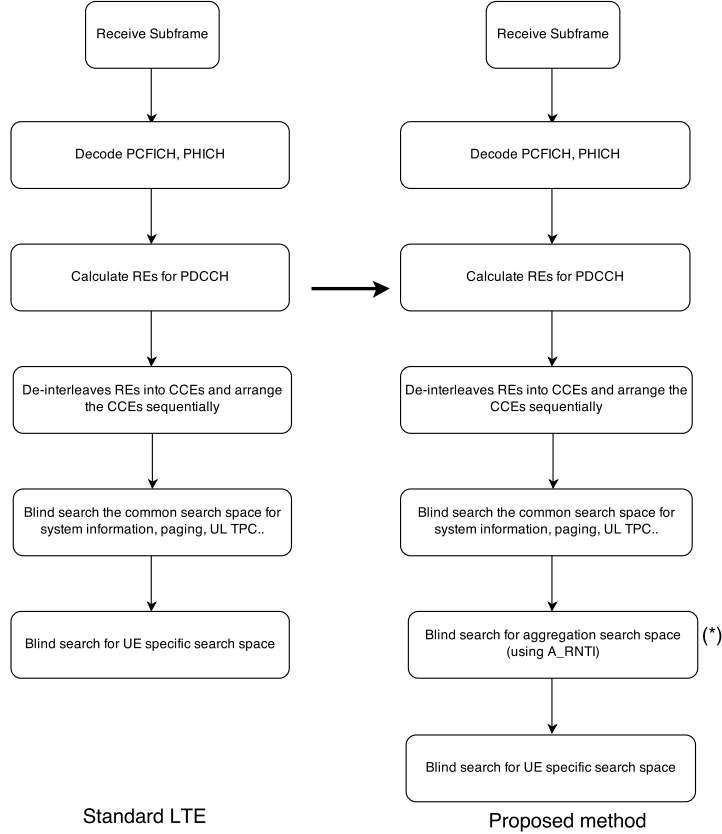

Figure 4.5: PDCCH blind detection procedure of the proposed method

For each CCE index in the aggregation search space, UE will calculate all the available aggregation size values corresponding to the size of each DCI format by using the formula 4.8. For each aggregation size value, UEs will use its RNTI value to compare with RNTI values located in PDCCH to find out if there is the corresponding RNTI.

## 4.2.4 Performance evaluation

### 4.2.4.1 System Parameters

In this section we will present the performance evaluation of our RNTI aggregation method. Two scenarios are used for our evaluation. In the first scenario, we assume that all UEs use CCE with aggregation level 1 (PDCCH format 0) for transmission of downlink allocation information (ideal scenario). This scenario is used to estimate the maximal control capacity of the system. In the second scenario we use the model of [60]. In this model, the probability that UEs chose CCE aggregation level  $i$  is  $p_i$ . With  $p_1 = 0.35$ ,  $p_2 = 0.25$ ,  $p_3 = 0.30$ ,  $p_4 = 0.1$ . This model is used to estimate the control capacity gain in a more reality case. The other parameters are presented in table 4.1.

Table 4.1: System Parameters

Parameter	Value
Bandwidth	1.4 MHz, 3MHz, 5 MHz, 10 MHz, 20 MHz
Symbols for PDCCH	3 symbols
Ng	1
Cyclic Prefix	Normal
Number of antenna	2

Table 4.2: Control capacity gain of the proposed method for 1 ms for the first scenario

Bandwidth	1.4 MHz	3 MHz	5 MHz	10 MHz	20 MHz
Maximum number of CCEs	4	12	20	41	84
$N_{totalFD}$ of the Fully Dynamic Scheduling	4	12	20	41	84
$N_{totalofProposedMethod}$ of the proposed method	9	29	51	109	227
Control capacity gain	125%	141.66%	155%	165.8%	170.23%

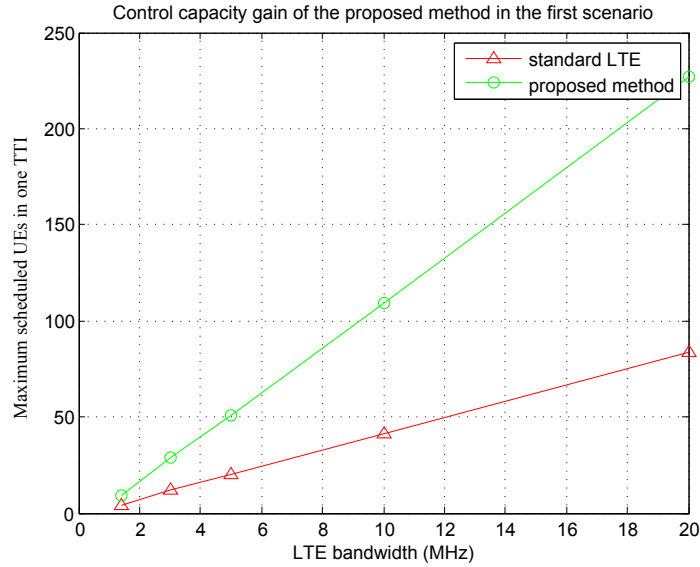

Figure 4.6: Control capacity gain of the proposed method for the first scenario

#### 4.2.4.2 LTE Voice Control Capacity Evaluation

The maximal number of UEs that can be scheduled in one TTI between the Dynamic Scheduling and our proposed method for the first scenario are compared in Table 4.2 and Figure 4.6 . It can be seen from the data in Table 4.2 that the proposed method reported a significant increase in the maximal number of UEs that can be scheduled in one TTI in comparison with the FD scheduling. In addition, it is apparent that the efficiency of the proposed method increases along with the increase of LTE bandwidths. In the best case, the proposed method can increase the maximal number of UEs that can be scheduled in one TTI from 84 UEs if using FD in LTE to 227 UEs (at 20 MHz) (170.23%). The control capacity gain of the proposed method for the second scenario is shown in Figure 4.7. In case that the UEs are dispersed in the cell (scenario 2), the control capacity gain of the



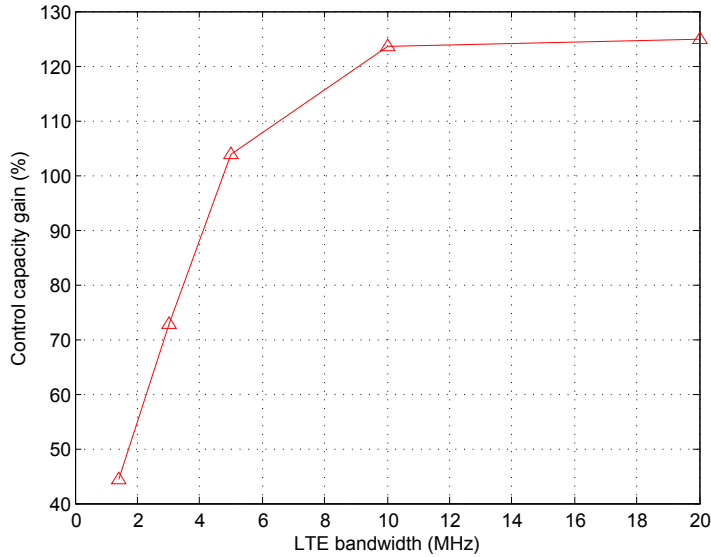

Figure 4.7: Control capacity gain of the proposed method for the second scenario

proposed method can also rise up to 124.79 % (at 20 MHz). From the results of scenario 1 and 2, we found that our RNTI Aggregation method gives better results for better channel quality conditions.

### 4.3 New proposed Group\_RNTI for the Multi-user multiplexing Voice radio transmission method

#### 4.3.1 General idea of the new proposed Group\_RNTI

The idea of Group\_RNTI bases on the Group Scheduling method [61] and [62] with adaptations. The principle of group\_RNTI includes two steps: (1) initialization of Group\_RNTI and (2) using of Group\_RNTI for resource allocation.

In the first step, UEs having the same MCS values can be classified in one or more groups. Each group is assigned a common Group\_RNTI. We assume that in the PMR context, the number of UEs in a cell is high so that we can cluster only UEs having the same MCS value. The initialization of group is done by a new Setup\_Group\_RNTI PDCCH. Setup\_group\_DCI combines with its CRC bits scrambled by the C\_RNTI value of UE to create Setup\_Group\_RNTI PDCCH. The structure of Setup\_group\_DCI is presented in table 4.3. The Setup\_Group\_RNTI PDCCH is used for the first time resource allocation or when UE changes the group (changing of MCS value of UE).

In the second step, assume that at the  $i^{th}$  TTI, there are  $n$  voice payload of  $n$  UEs that can be multiplexed into one LTE subframe. In this case, instead of sending  $n$  different PDCCH channels for  $n$  UEs having the same DCI value, eNodeB will send  $k$  different Group\_RNTI PDCCH channels for  $k$  groups. The scheduler will try to cluster maximum possible number of UEs in the same Group\_RNTI. GroupMultiplexing\_DCI combines with its CRC bits scrambled by the Group\_RNTI value to create Group\_RNTI PDCCH. The

Table 4.3: setup\_group\_DCI structure

Field Name	Length (bits)	Comment
RBA	5 (1.4 MHz) 7(3 MHz) 9 (5 MHz)	Resource block assignment
MCS	5	Modulation and Coding Scheme
Group_RNTI	16	Identification of group
Group_Position	4	Position of UE in the group

Table 4.4: GroupMultiplexing\_DCI structure

Field Name	Length (bits)	Comment
RBA	5 (1.4 MHz) 7(3 MHz) 9 (5 MHz)	Resource block assignment
MCS	5	Modulation and Coding Scheme
Group Bitmap	16	Group information for UEs

structure of GroupMultiplexing\_DCI is presented in table 4.4.

After having received a setup\_group\_DCI message, the UE starts monitoring DCI messages sent over the PDCCH scrambled by the Group\_RNTI value. When a valid message is found, the bit at position Group\_Position in the bitmap is checked: a '1' indicates that the RB(s) contain some data for that UE (see Figure 4.8). In our case, UE keeps both C\_RNTI and Group\_RNTI values. Group\_RNTI is a temporary value. Group\_RNTI can be changed if UE changes the group (changing of MCS). The Group\_RNTI value in this case is assigned by eNodeB.

### 4.3.2 New proposed Group - Change management method

Assume that at  $i^{th}$  TTI, the quality of channel for an  $UE_i$  is changed (the value of MCS for  $UE_i$  is changed) and the  $UE_i$  belongs to a multiplexing group at  $i^{th}$  TTI. In this case, eNodeB will send a new setup-group PDCCH that indicates the new Group\_RNTI for this UE (see Figure 4.9).

### 4.3.3 Numerical analysis

To estimate the performance of our method, we compare the number of required PDCCH channels of the FD scheduling and the number of required PDCCH channels of the proposed method.

According to [37], the average of data packets and PDCCH channels that  $n$  active UEs require in one  $ms$  can be calculated by formula as follows:

$$Av.RqLTE = \lambda \left[ \frac{nv}{I_1} + \frac{n(1-v)}{I_2} \right] \quad (4.12)$$

In which:

- $n$ : number of active users
- $\lambda$ : average transmission number

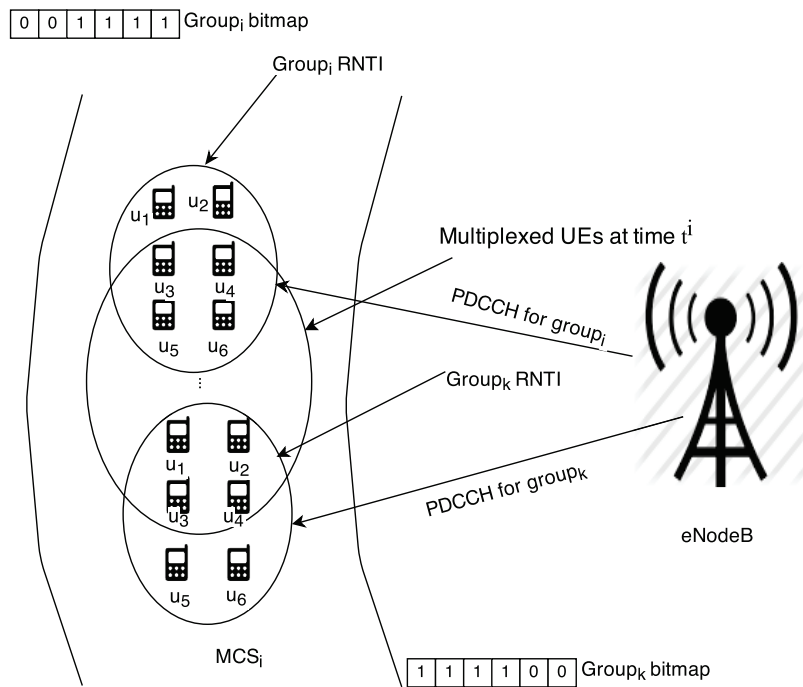

Figure 4.8: Group\_RNTI scheduling

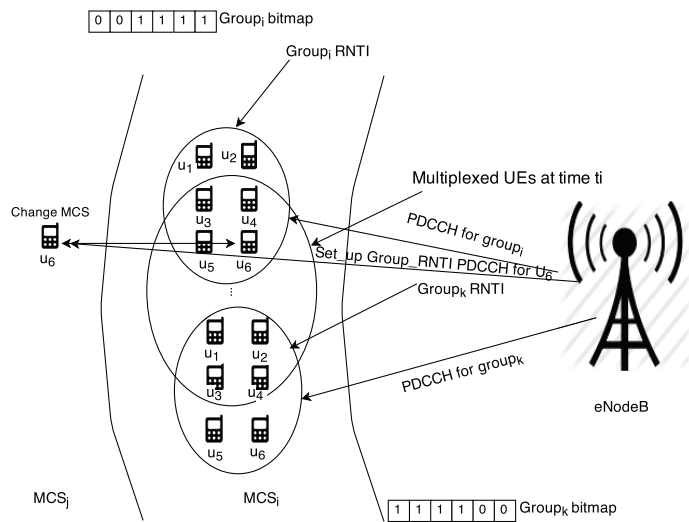

Figure 4.9: Group - Change management

- $I_1$ : the inter-arrival time of voice packets
- $I_2$ : the inter-arrival time of Silence Insertion Descriptor (SID) packets
- $v$  : voice activity factor

Assume that  $t$  ms is the average of call time so the average required data packets and PDCCH channels of FD scheduling is:

$$Av.RqFD = t.Av.RqLTE \quad (4.13)$$

Suppose that the Multi-users Multiplexing Radio Voice Transmission method can classify the  $Av.RqFD$  required packets into  $l$  multiplexing groups. UEs of  $i^{th}$  multiplexing group belong to  $k_i$  group RNTI. So the number of required PDCCH channels in  $t$  ms of the proposed scheduling is:

$$No.GroupRNTI\_CCH = n + \sum_{k=1}^l k_i p_i + \epsilon \quad (4.14)$$

Where:

- $n$ : number of required PDCCH channels for the initialization of group
- $\epsilon$ : number of PDCCH for UEs that change group RNTI during  $t$  ms
- $p_i$ : coefficient variation size of PDCCH caused by the new adding fields

Therefore, the average of PDCCH channels that  $n$  UEs require in one  $ms$  is:

$$Av.RqGroupRNTI = \frac{n + \sum_{k=1}^l k_i p_i + \epsilon}{t} \quad (4.15)$$

The control capacity gain is given by:

$$controlgain = \frac{Av.RqLTE - Av.RqGroupRNTI}{Av.RqLTE} * 100\% \quad (4.16)$$

The term blocking rate refers to the number of VoIP that can not be served due to the lack of data or control resources. Assume that  $n_{BW}$  is number of allowed Resource Block (RB),  $u_{FDRB}$  is the average number of used RBs for transmitting one voice payload in the standard LTE,  $u_{NewRB}$  is the average number of used RBs for transmitting one voice payload in the proposed method. The average number of data packets that can be transmitted in one TTI in the standard LTE  $Av.SpLTE$  is:

$$Av.SpLTE = \frac{n_{BW}}{u_{FDRB}} \quad (4.17)$$

The average number of data packets that can be transmitted in one TTI in the proposed method  $Av.SpGroupRNTI$  is:

$$Av.SpGroupRNTI = \frac{n_{BW}}{u_{NewRB}} \quad (4.18)$$

The data blocking rate of the standard LTE ( $dblock_{LTE}$ ) is:

$$dblock_{LTE} = \begin{cases} 0 & \text{if } Av.RqLTE \leq Av.SpLTE \\ \frac{Av.RqLTE - Av.SpLTE}{Av.RqLTE} & \text{else} \end{cases} \quad (4.19)$$

Assume that in one TTI, the average number of supported PDCCH channels is  $Av.SpPDCCH$ . The control blocking rate of the standard LTE ( $cblock_{LTE}$ ) is:

$$cblock_{LTE} = \begin{cases} 0 & \text{if } Av.RqLTE \leq Av.SpPDCCH \\ \frac{Av.RqLTE - Av.SpPDCCH}{Av.RqLTE} & \text{else} \end{cases} \quad (4.20)$$

The blocking rate of the standard LTE ( $\delta_{LTE}$ ) is:

$$\delta_{LTE} = Max(dblock_{LTE}, cblock_{LTE}) \quad (4.21)$$

The data blocking rate of the proposed method ( $dblock_{GroupRNTI}$ ) is:

$$dblock_{GroupRNTI} = \begin{cases} 0 & \text{if } Av.RqLTE \leq Av.SpGroupRNTI \\ \frac{Av.RqLTE - Av.SpGroupRNTI}{Av.RqLTE} & \text{else} \end{cases} \quad (4.22)$$

The control blocking rate of the proposed method ( $cblock_{GroupRNTI}$ ) is:

$$cblock_{GroupRNTI} = \begin{cases} 0 & \text{if } Av.RqGroupRNTI \leq Av.SpPDCCH \\ \frac{Av.RqGroupRNTI - Av.SpPDCCH}{Av.RqGroupRNTI} & \text{else} \end{cases} \quad (4.23)$$

The blocking rate of the proposed method ( $\delta_{GroupRNTI}$ ) is:

$$\delta_{GroupRNTI} = Max(dblock_{GroupRNTI}, cblock_{GroupRNTI}) \quad (4.24)$$

### 4.3.4 Performance evaluation

#### 4.3.4.1 System Parameters

For the performance evaluation of Group\_RNTI method, we use the AMBE codec with low bit rate (2450 bps), the low bandwidths of LTE (1.4 MHz, 3 MHz, 5 MHz), 24 bits CRC and Normal Cyclic Prefix. We compare the blocking rate of the Fully Dynamic Scheduling and the proposed method for different number of active users (50, 100, 200, 500, 1000, 2000) having random MCS values. The main system parameters are presented in Table 4.5.

Table 4.5: System parameters

Parameter	Value
Voice codec	AMBE 2450 bps
Frame structure	Type 1 FDD
Bandwidth	1.4 MHz, 3MHz, 5 MHz
Symbols for PDCCH	3 symbols
CRC	24 bits
Number of active UEs	50, 100, 200, 500, 1000, 2000
Cyclic Prefix	Normal
Number of antenna	2
Average time call	60s
$\lambda$	1.2
$I_1$	20
$I_2$	160
$v$	50%
CCEs for Downlink	50% of total CCEs

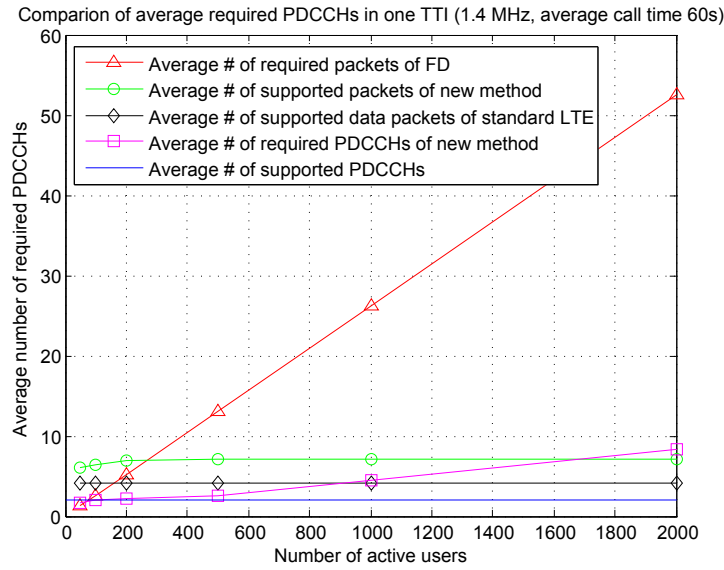

Figure 4.10: Comparison of number of required PDCCH channels between Fully Dynamic scheduling and the proposed method in one TTI for 1.4 MHz bandwidth

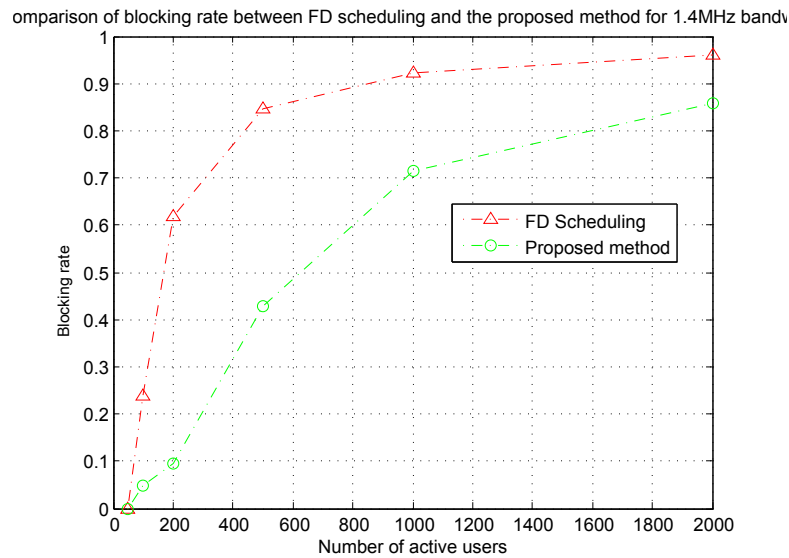

Figure 4.11: Comparison of blocking rate between Fully Dynamic scheduling and the proposed method for 1.4 MHz bandwidth

#### 4.3.4.2 LTE Voice Capacity Evaluation

Figure 4.10 shows the comparison of required number of PDCCH channels in one TTI between Fully Dynamic scheduling and the proposed method for different number active users in case of 1.4 MHz bandwidth. It is apparent that there was a significant reduction of the required number of PDCCH channels of the proposed method in comparison to the Fully Dynamic scheduling especially in case of the high number of active users. In the best case, the proposed method can reduce the control overhead up to 77%.

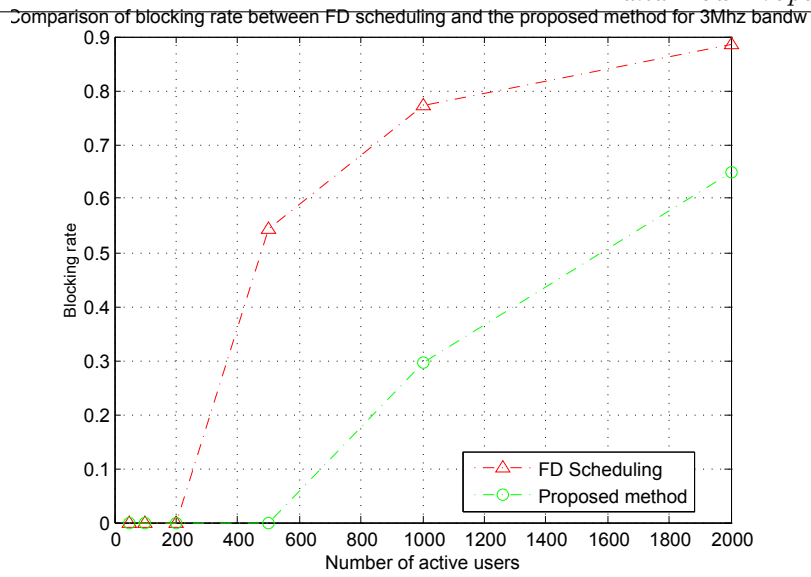

Figure 4.12: Comparison of blocking rate between Fully Dynamic scheduling and the proposed method for 3 MHz bandwidth

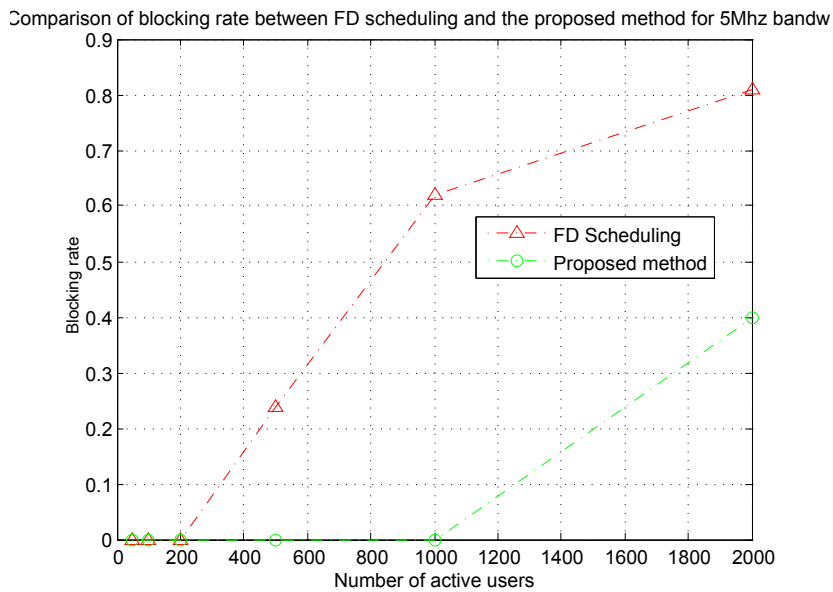

Figure 4.13: Comparison of blocking rate between Fully Dynamic scheduling and the proposed method for 5 MHz bandwidth

Figures 4.11, 4.12 and 4.13 compare the blocking rate of the Fully Dynamic scheduling and the proposed method for the corresponding 1.4 MHz bandwidth, 3 MHz bandwidth and 5 MHz bandwidth. The results show that the higher the bandwidth is, the higher efficiency the proposed method gains. In addition, with each bandwidth, the higher number of active UEs in the cell, the higher voice capacity gain our method can obtain.

## **4.4 Comparison of the new proposed RNTI Aggregation method and the new proposed Group\_RNTI method: Recommendations**

Figures 4.14, 4.15 and 4.16 compare the effectiveness of the two methods with the Fully Dynamic Scheduling. From the above results, we can see that both proposed methods give better results than the FD scheduling method. Even though it is still very difficult to assess which method is more effective. The main objective of the two methods, RNTI Aggregation method and Group\_RNTI method, is to reduce the control overhead issue in the multiplexing scheme. However, two methods are used with different approaches. RNTI Aggregation method uses PDCCH channel with high format, created by the aggregation of PDCCH channels with low format, to transmit several RNTIs of different UEs in a same multiplexing group. This method allows increasing significantly the control capacity, but does not affect the Bit Error Rate (BER) in the transmission of PDCCH channel. The Group RNTI method clusters UEs having the same Modulation and Coding Scheme (MCS) into one or more groups. Each group is assigned a common Group\_RNTI. Control information is sent for groups rather than for each UE.

Each method has its own strengths and weaknesses. RNTI Aggregation method is relatively easy to install and gives positive results even in poor channel condition. However, the efficiency of this method is not very high, particularly in the case of low bandwidth and low quality channels. In reserve, evaluation of the energy consumption at the receiver side needs to be considered because in this method, there is an increase in the size of the search space. This will increase the energy consumption of the mobile station although in the case of an emergency this is not a big problem. In the case of the Group\_RNTI method, we found that its performance heavily depends on the call duration, channel stability and the number of UEs in one cell. The longer call duration, the higher number of UEs and the higher stability of the channel quality, the higher control voice capacity the Group\_RNTI method gains.

## **4.5 Conclusion**

This chapter investigated two solutions to reduce the control overhead issue in the Multi-users Multiplexing Radio Voice Transmission for enhancing voice capacity over LTE in PMR context. The RNTI aggregation method uses PDCCH channel with high format, created by the aggregation of PDCCH channels with low format, to transmit several RNTIs of different UEs in a same multiplexing group. The number of RNTIs transmitted in one PDCCH is calculated to ensure that there is no increase of BER for receiving PDCCH channel. The results show that the RNTI aggregation method can improve the control capacity gain up to 170%.

The Group\_RNTI method clusters UEs having the same MCS into one or more groups. Each group is assigned a common Group\_RNTI value. The Group\_RNTI values are used for the scheduling to reduce the number of required PDCCH channels, used in the multiplexing scheme. In the best case, the proposed method can reduce the control overhead up to 77%.

The use of the two methods for the Multi-users Multiplexing Radio Voice Transmission allows reducing both data overhead and control overhead issues for VoLTE in PMR context. Therefore, the proposed methods allow enhancing the voice capacity for VoLTE in PMR



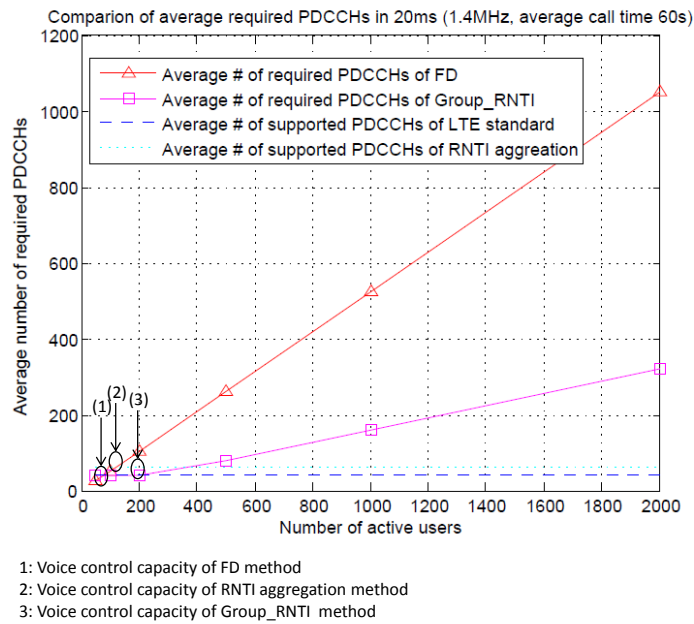

Figure 4.14: Comparison of voice control capacity of two methods in 1.4MHz bandwidth for 20ms

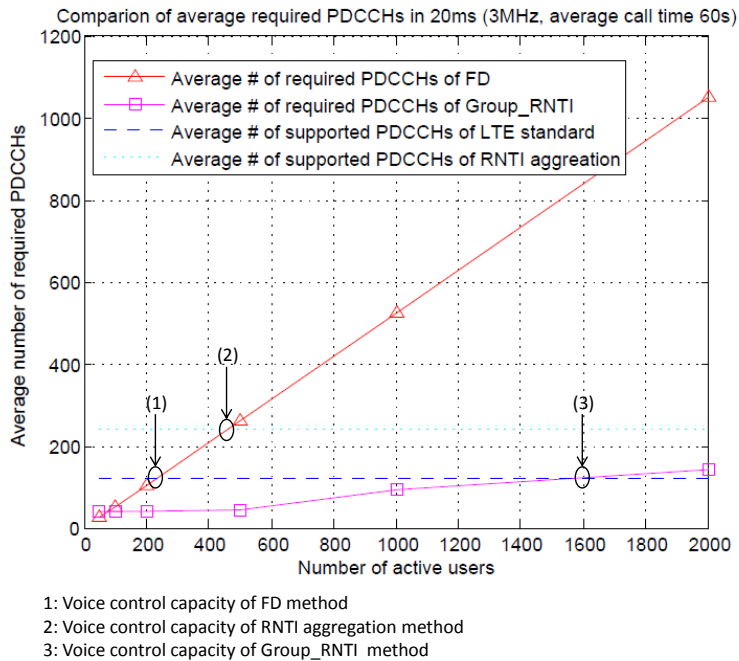

Figure 4.15: Comparison of voice control capacity of two methods in 3MHz bandwidth for 20ms

context.

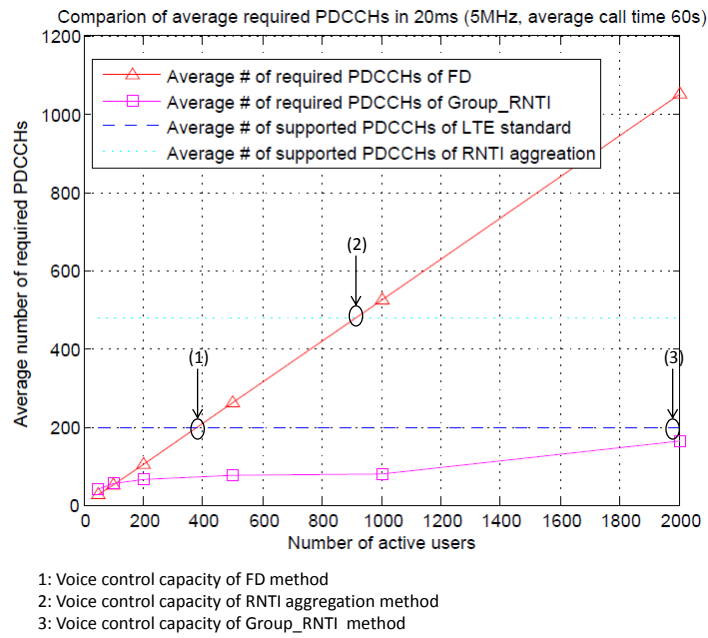

Figure 4.16: Comparison of voice control capacity of two methods in 5MHz bandwidth for 20ms



# Chapter 5

## New proposed CDMA-OFDM combination method for enhancing voice capacity over LTE in PMR context

### Contents

<b>5.1</b>	<b>New proposed CDMA-OFDM Combination Method . . . . .</b>	<b>59</b>
5.1.1	Proposed CDMA-OFDM Combination Architecture . . . . .	59
5.1.1.1	Sender side . . . . .	59
5.1.1.2	Receiver side . . . . .	60
5.1.2	Proposed spreading factor determination, resource allocation and code assignment algorithm in the CDMA-OFDM combination method . . . . .	61
5.1.3	New proposed algorithm for grouping UEs with different MCS values . . . . .	62
5.1.4	DMRS issue in the Uplink transmission and proposed DMRS Design for CDMA-OFDM Combination . . . . .	62
5.1.5	Proposed CDMA-OFDM Combination Scheduling . . . . .	66
<b>5.2</b>	<b>Performance Evaluation . . . . .</b>	<b>67</b>
<b>5.3</b>	<b>Conclusion . . . . .</b>	<b>70</b>

To increase the size of the voice payload, another technique can be also used : Code division multiple access (CDMA). In this chapter, we propose a new CDMA-OFDM combination method for enhancing voice capacity over LTE in PMR context. In this method, voice packets from different users having the same MCS values can be spread by different orthogonal codes before being mapped to the same set of resource elements. The selection of spreading factor allows a maximum reduction of the difference between the LTE packet size and PMR voice payload.

## 5.1 New proposed CDMA-OFDM Combination Method

### 5.1.1 Proposed CDMA-OFDM Combination Architecture

#### 5.1.1.1 Sender side

The proposed architecture for spreading VoLTE is presented in Figure 5.1. In this architecture, data bits from MAC layer (MAC PDUs) of Voice UE after adding the Cyclic

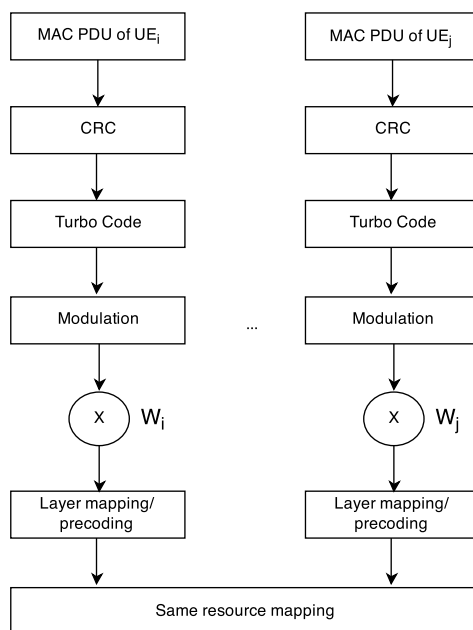

Figure 5.1: Architecture of using CDMA-OFDM combination in LTE

redundancy check (CRC), channel coding, will be modulated and spread by an orthogonal sequence. Then, the OFDM symbols undergo layer mapping. In our method, packets of UEs in a spreading group will be code-multiplexed and mapped into the same set of resource elements (REs).

The spreading code, which is used for the voice packets, is the Orthogonal Variable Spreading Factor (OVSF) codes [63–65]. The using of OVSF allows from 4 to 512 different terminals in the same cell transmitting simultaneously (see Figure 5.2). The spreading factor will be chosen based on the bandwidth of LTE, Modulation and Coding Scheme of UE, and the voice payload of UE. Algorithm for scheduling and assigning the Spreading Code for each UE will be discussed in sub section 5.1.2.

The idea of combining OFDM and CDMA, which is called multi-carrier code division multiple access (MC-CDMA) has been presented in several articles [66–68]. The researches showed that this combination has several advantages. In MC-CDMA, signal can be easily transmitted and received using FFT device without increasing the transmitter and receiver complexities [69]. MC-CDMA retains the frequency-diversity of CDMA but robust to channel frequency selectivity. MC-CDMA allows using the available spectrum efficiently. We apply the MC-CDMA in case of VoLTE to increase the voice capacity in the PMR context.

### 5.1.1.2 Receiver side

The receiver processes the received signal as follows. First, it removes the cyclic prefix, performs the DFT/FFT, equalization and despreading. Second, the receiver demodulate the PDSCH in case of downlink or PUSCH in case of uplink (In case of uplink transmission, eNodeB uses the Demodulation reference signals (DMRS) to demodulate the Physical Uplink Shared Channel (PUSCH). In this case, we have to modify the DMRS design to adapt the

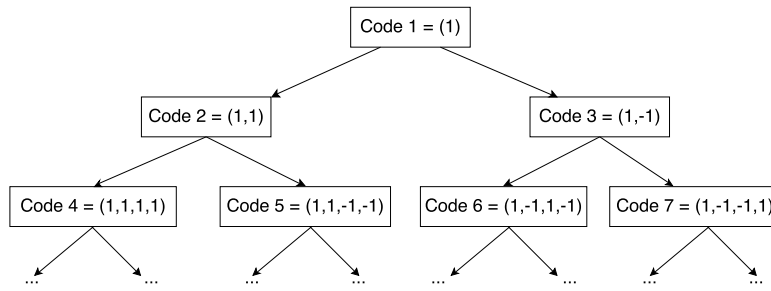

Figure 5.2: OVSF code tree for CDMA-OFDM method

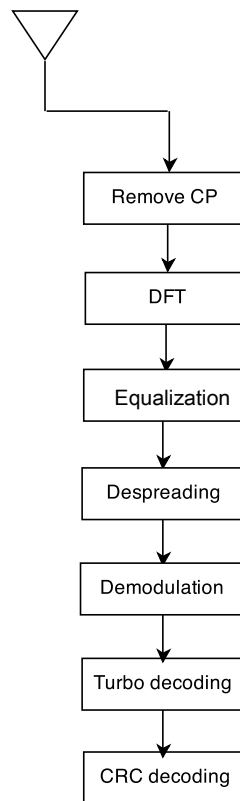

Figure 5.3: CDMA-OFDM architecture at eNodeB

CDMA-OFDM method. The details of adaptation for DMRS design will be presented in section 5.1.4). Finally, the receiver processes the channel decoding, CRC decoding to reconstruct the MAC PDUs.

### 5.1.2 Proposed spreading factor determination, resource allocation and code assignment algorithm in the CDMA-OFDM combination method

For the calculation of the spreading factor and the voice data capacity, we made some adaptations of the algorithm presented in articles [7] and [70].

Voice packets is emitted by the Application Layer with size of  $T_{voice}$ . These packets are added the header each time passing the real-time transport protocol (RTP), user datagram

protocol (UDP) and IP for transmission. Next the voice packet headers are compressed at the Packet Data Convergence Protocol (DPCP) layer by the Robust Header Compression (ROHC). Then the PDPCP header, RLC header and Mac header are added to create their payload,  $TBS_{temp} = P_{voice} + H_{overhead}$ . The output packets of MAC layer will undergo the Cyclic Redundancy Check, channel coding and be modulated. The output symbols of modulation component will be spread by an orthogonal code. In our method, eNodeB determines the spreading factor  $SF$  based on the  $TBS_{temp}$ , the number of allowed resource blocks of the defined bandwidth ( $N_{BW}$ ) and the MCS. Then, eNodeB will perform the scheduling and send resource allocation information and the code assignment information for UE Uplink in the Physical Downlink Control Channel (PDCCH) channel. The details of the steps for calculating the spreading factor are presented in Algorithm 2.

### 5.1.3 New proposed algorithm for grouping UEs with different MCS values

Algorithm 2 is used to estimate the spreading factor in case that we clusters only UEs having exactly the same MCS value. This is suitable for the case that the number of UEs in a cell is very high. In case of low and medium number of UEs, we need to give a flexible algorithm that can cluster UEs having different MCS values. To ensure the error protection and system performance, we propose a new algorithm for grouping and selecting UEs in case that UEs have different MCS values. The main idea is that UEs which have the same MCS value or adjacent MCS values will be selected for the same group. Algorithm for choosing UEs for scheduling is presented in Figure 5.4. In each group, the lowest MCS value is chosen for calculating the available spreading factors. This value is considered as the common MCS value for all UEs in the same spreading group. The spreading factor is chosen based on a set of available spreading factors such that the efficiency of resource allocation is maximal.

### 5.1.4 DMRS issue in the Uplink transmission and proposed DMRS Design for CDMA-OFDM Combination

Demodulation reference signals (DMRS) is used by the base station for channel estimation for coherent demodulation of the uplink channels. DMRS uses the 4<sup>th</sup> SC-FDMA symbols in each slot (LTE frame type 1). DMRS is sent once every 0.5 ms. In the frequency domain, DMRS is mapped to the same set of PRBs used for PUSCH channel [71] (see Figure 5.5).

Each UE uses different DMRS sequences. In LTE standard, each DMRS sequence  $r_{\alpha}^{u,v}(n)$  is defined by a cyclic shift (CS)  $\alpha$  of a base sequence  $\bar{r}_{u,v}(n)$  according to:

$$r_{\alpha}^{u,v}(n) = e^{j\alpha n} \bar{r}_{u,v}(n), 0 \leq n < M_{RS}^{sc} \quad (5.1)$$

where:

- $\alpha$ : cyclic shift (CS) value
- $M_{RS}^{sc}$ : length of DMRS sequence
- $\bar{r}_{u,v}(n)$ : base sequence

In order to support the demodulation of packets from several UEs that are spread in one LTE packet, the DMRS design must be adapted to support the CDMA-OFDM combination method. In our method, we apply and make some adaptations of methods presented in [71]

---

**Algorithm 2:** Proposed spreading factor determination, resource allocation and code assignment algorithm
 

---

Step 1) Set parameters :

- $MCS$ , Modulation and Coding Scheme of user equipment
- $N_{BW}$ , number of allowed resource blocks of a defined bandwidth
- $R_{vocoder}$ , data rate of speech codec
- Initialization of CDMAOFDMcapacity value. Set CDMAOFDMcapacity=0

Step 2) Compute voice packet length,  $P_{voice}$  based on the voice coder bit rate,  $R_{vocoder}$ , and the voice frame time length,  $T_{voice}$

$$P_{voice} = R_{vocoder} * T_{voice}$$

Step 3) Calculate size of PDCP ROHC size, PDCP header, RLC header, MAC header denoted by  $H_{overhead}$

Step 4) Calculate payload for a voice UE

$$TBS_{necessary} = P_{voice} + H_{overhead}$$

Step 5) Load Modulation and TBS index table for PDSCH (table 7.1.7.1-1) and transport block size table (table 7.1.7.2.1-1) from 3GPP TS 36.213 V9.0.1 [23]

Step 6) Refer to the table 7.1.7.1-1 of 3GPP TS 36.213 V9.0.1 to find corresponding TBS index of MCS index.

Step 7) For all possible values of  $i$  from 1 to  $N_{BW}$  at the TBS index row, find number of resource blocks which is used to transmit the voice payload  $RB_{UE}$  which verifies:

$$RB_{UE} = N_{PRB}(\text{index}(\min(TBS_i - TBS_{necessary}) \geq 0))$$

Step 8) Refer to table 7.1.7.2.1-1 to find the value of  $TBS_{max}$  for TBS index of step 6 and  $N_{PRB} = N_{BW}$

Step 9) Calculate number of voice packet that can be multiplexed in one LTE packet  $N_{max} = TBS_{max} / TBS_{necessary}$ . In case of Uplink, we have to calculate  $N_{max}$  in conjoint with number of supported DMRS (In our design, the number of supported DMRS is 24). If  $N_{max} > 24$  Set  $N_{max} = 24$

Step 10) Calculate the spreading factor (SF) with  $t = \lfloor \log_2 N_{max} \rfloor$ . For  $i \in \{1..i\}$  chose  $\max(i) | (2^i * TBS_{necessary} + 24 * (2^i - 1)) < TBS_{max}$  and  $SF = 2^i$

Step 11) Set  $TBS_{necessaryCDMAOFDM} = SF * TBS_{necessary} + 24 * (SF - 1)$

Step 12) For all possible allocation values, with  $i$  from 1 to  $N_{BW}$ , find  $TBS(i)$  which verifies

$$\text{Min}(TBS(i) - TBS_{necessaryCDMAOFDM}) > 0$$

Where  $TBS(i)$  spans column  $i$  in TBS\_table

Assign the same  $i$  resource block for  $SF$  UEs.

Assign  $SF$  orthogonal codes in the code tree for  $SF$  UEs.

Step 13) Calculate the voice data capacity of CDMA-OFDM method

CDMAOFDMcapacity=CDMAOFDMcapacity+SF Set  $N_{PRB} = N_{PRB} - i$

Repeat step 7 to step 13 until  $N_{BW} = 0$  or  $N_{BW} < RB_{UE}$

Step 14) Calculate voice data capacity of standard LTE

$$\text{Standcapacity} = \frac{N_{BW}}{RB_{UE}}$$

Step 15) Calculate voice data capacity gain

$$\text{Capacitygain} = \frac{\text{CDMAOFDMcapacity} - \text{Standcapacity}}{\text{Standcapacity}} * 100\%$$

---



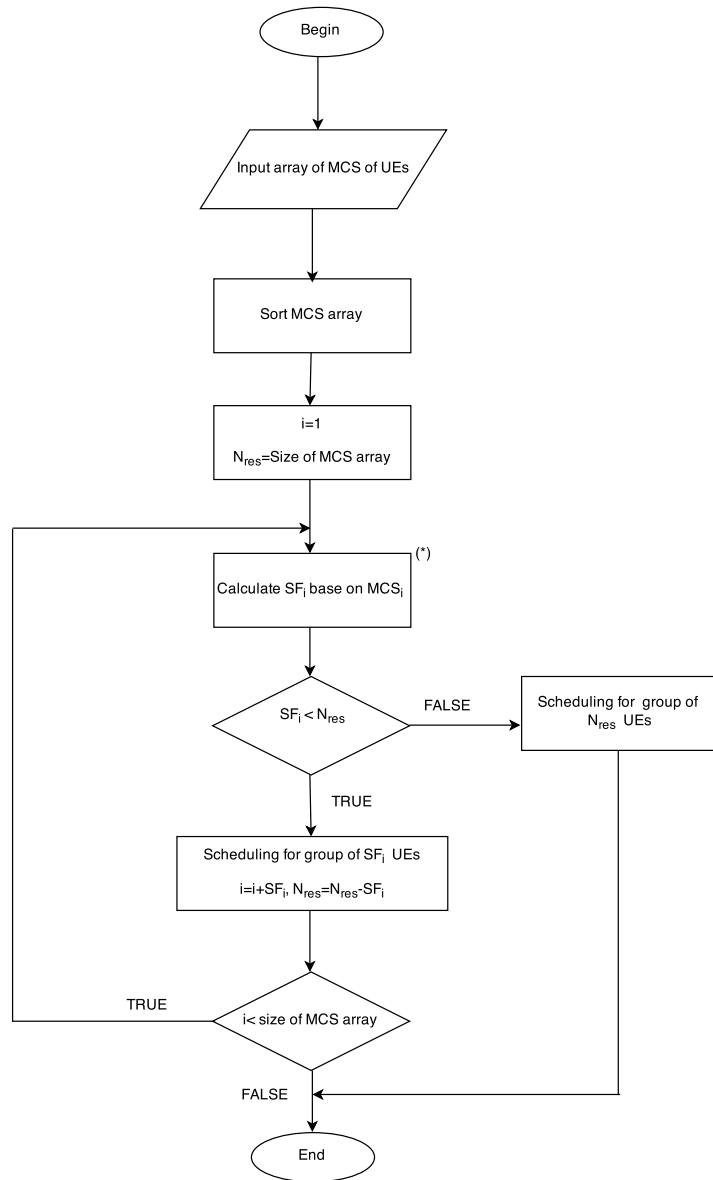

Figure 5.4: Algorithm for choosing UEs with different MCS values

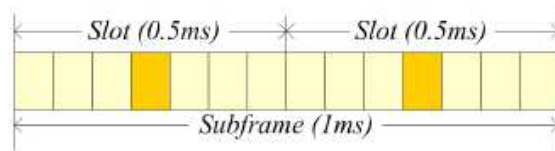

Figure 5.5: DMRS for uplink

and [72]. We propose to combine Cyclic Shift (CS) with orthogonal cover code (OCC) in time domain. In addition, the number bits for CS of DMRS can be increased from 3 bits

to 4 bits. In our case, the DMRS is distinguished by two values: the CS value  $\alpha$  and the OCC code position. The spreading of DMRS is realized in time domain and Cyclic Shift in frequency domain (see Figure 5.6) like the DMRS design of [72] but in our case, instead of being used to support MIMO, this design can be applied to UEs in a same spreading group. This allows increasing the number of supported DMRS for the CDMA-OFDM combination method.

In our method, UEs in a same spreading group will use the same base sequence  $\bar{r}_{u,v}(n)$ .

We propose of using the method of [71] to calculate the CS value. The CS value of DMRS for  $i^{th}$  UE in the multiplexing group will be calculated by formula 5.2:

$$\alpha_i = 2\pi n_{cs,i}/12 \quad (5.2)$$

where

$$n_{cs,i} = (n_{cs,0} + \frac{2 * C}{n_{SF}} * i) \bmod(C), i = 0, 1, \dots, n_{SF}/2 - 1 \quad (5.3)$$

and:

- $n_{cs,i}$ : CS value of DMRS for  $i^{th}$  UE
- $n_{cs,0}$ : CS value for the first UE in the group.
- $C$ : constant value 12
- $n_{SF}$ : spreading factor

The DMRS received from Cyclic Shift will be spread by an OCC. In this case the OCC size equals 2. Therefore, the maximum number of supported DMRS can be  $n_{DMRS} = 12 * 2 = 24$  and the maximum value of spreading factor ( $n_{SF}$ ) is 16. In our method, the DMRS sequences of the UEs in the same spreading group are orthogonal. This allows the eNodeB to separate from each other the received demodulation signals of the different UEs in the same spreading group.

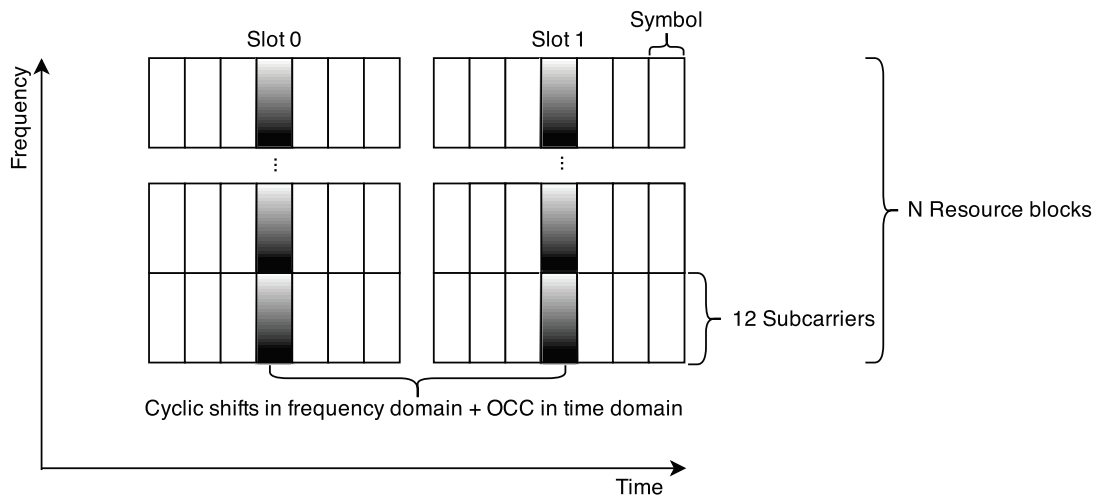

Figure 5.6: DMRS design for CDMA-OFDM method with CS+OCC

### 5.1.5 Proposed CDMA-OFDM Combination Scheduling

Scheduling mechanism of the proposed CDMA-OFDM Combination method is similar to the case of Multi users Multiplexing method. In this case, the group classifier and group selector will classify and select voice UEs to send to MAC scheduler. The criteria for classifying the UEs are the MCS values of UEs. UEs having the same MCS values will be put in a same group. In our scheduling, PDCCHs of a spreading group contains the same information about Resource Block Assignment (RBA) and MCS for the group. UEs in a same group are distinguished by the code position field in the DCI (see Table 5.1 for Uplink DCI and Table 5.2 for Downlink DCI).

Table 5.1: Uplink DCI format for the CDMA-OFDM combination system

Field Name	Length (bits)	Comment
RBA	3 (1.4 Mhz)	Same for all UEs in the group
	5 (3 Mhz)	
	7 (5 Mhz)	
MCS	5	Same for all UEs in the group
Code position	4 (1.4 Mhz)	Different for each UE (new field)
	6 (3 Mhz)	
	8 (5 Mhz)	
TPC for PUSCH	2	Power control
CS for DMRS	4	See Table 5.5.2.1.1-1 in 36.211
OCC position for DMRS	1	For DMRS

Table 5.2: Downlink DCI format for the CDMA-OFDM combination system

Field Name	Length (bits)	Comment
RBA	3 (1.4 Mhz)	Same for all UEs in the group
	5 (3 Mhz)	
	7 (5 Mhz)	
MCS	5	Same for all UEs in the group
Code position	4 (1.4 Mhz)	Different for each UE (new field)
	6 (3 Mhz)	
	8 (5 Mhz)	

In order to reduce the control overhead issue that occurs when there is not enough PDCCH channels for the resource allocation for the CDMA-OFDM combination method, we proposed of using the RNTI aggregation method that is presented in chapter 4. This method uses PDCCH channel with high format, created by the aggregation of PDCCH with low format, to transmit several RNTIs of different UEs in a same group (see Fig.5.9). The number of RNTI in one PDCCH is calculated to ensure that there is no increase of Bit Error Rate (BER) for receiving PDCCH channel. The value of code position in the DCI is the base value for determining the code position of each UE in the PDCCH. Assume that there are  $k$  RNTIs aggregated in one PDCCH channel and the value of code position in the DCI is  $p$ . So the code position of UE having the  $i^{th}$  RNTI in the PDCCH is  $p + k - i$  (Figures 5.7 and 5.8).

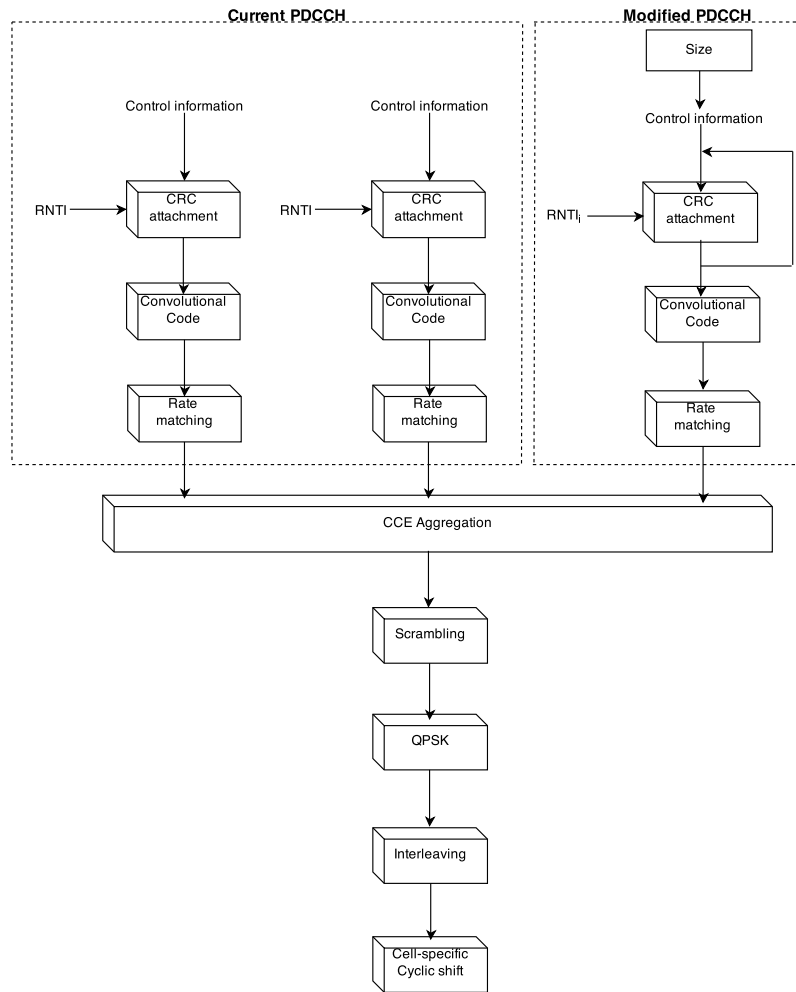

Figure 5.7: PDCCH structure in the proposed method

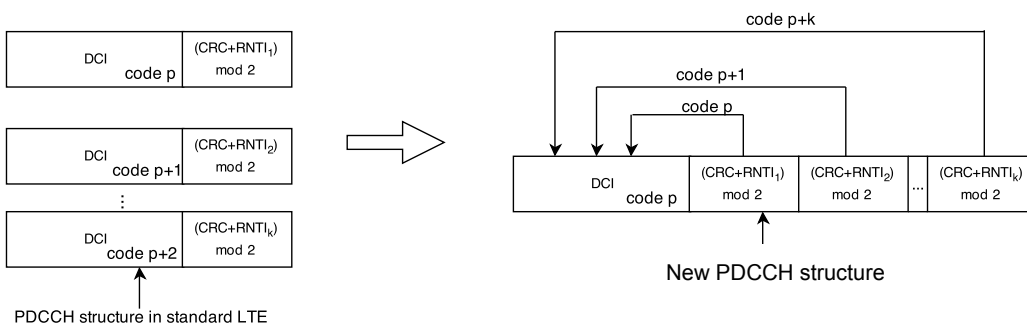

Figure 5.8: Determination of Code position in new PDCCH structure

## 5.2 Performance Evaluation

In our context, the voice capacity of LTE is evaluated with PMR constraints so that we use a very low bit rate voice coder (Advanced Multiband Excitation 2450 bps codec). The evaluation is computed for three deployment bandwidths (1.4 MHz, 3 MHz, 5 MHz). Table

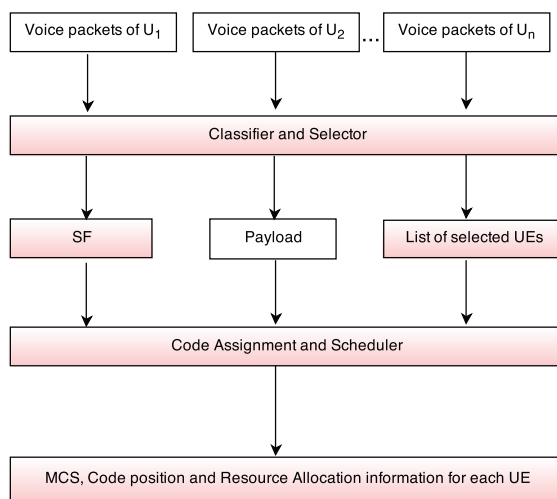

Figure 5.9: CDMA-OFDM scheduling

5.3 provides the main system parameters. We used two scenarios for the performance evaluation. In the first scenario, only UEs having the same MCS values can be clustered in a spreading group. This scenario is used for evaluating the efficiency of the proposed method when the number of UEs in a cell is high. In the second scenario, UEs having different MCS values can be grouped together. This scenario is used for evaluating the efficiency of the proposed method in case of low and medium number of UEs. In this scenario 100, 200, 500, 1000 and 2000 UEs with random MCS values are used for 1000 tests. We compare the average of used resource blocks in standard LTE and in our proposed method.

Table 5.3: System parameters

Parameter	Value
Bandwidth	1.4 MHz, 3MHz, 5 MHz
LTE	Type 1 FDD
Codec	AMBE 2450 bps
Symbols for PDCCH	3 symbols
Ng	1
CRC	24 bits
Cyclic Prefix	Normal
Number of antenna	2

A comparison of the voice data capacity between the proposed method and the standard LTE for the first scenario is presented in Figures 5.10, 5.11, 5.12, 5.13, 5.14 and 5.15. As shown in these figures, the proposed method reported significantly more voice data capacity than the standard LTE for both downlink and uplink transmission. We can find that the efficiency of the algorithm increases with MCS. This is because the scheduling mechanism

<sup>1</sup> Average number of used resource blocks in standard LTE for 1.4MHz bandwidth  
<sup>2</sup> Average number of used resource blocks in the proposed method for 1.4MHz bandwidth  
<sup>3</sup> Average number of used resource blocks in standard LTE for 3 MHz bandwidth  
<sup>4</sup> Average number of used resource blocks in the proposed method for 3MHz bandwidth  
<sup>5</sup> Average number of used resource blocks in standard LTE for 5 MHz bandwidth  
<sup>6</sup> Average number of used resource blocks in the proposed method for 5MHz bandwidth

Table 5.4: Average voice capacity gain of the CDMA-OFDM combination method for the second scenario

Bandwidth	100 UEs	200 UEs	500 UEs	1000 UEs	2000 UEs
$R^{total}$ 1.4MHz <sup>1</sup>	145	290	724	1452	2897
$RG^{total}$ 1.4MHz <sup>2</sup>	106	211	506	1009	2007
Gain 1.4 MHz	26,89%	27,24%	30,11%	30,50%	30,72%
$R^{total}$ 3MHz <sup>3</sup>	145	290	724	1448	2891
$RG^{total}$ 3 MHz <sup>4</sup>	112	223	512	1014	2021
Gain 3 MHz	21,67%	23,10%	29,37%	30,02%	30,14%
$R^{total}$ 5MHz <sup>5</sup>	144	290	725	1450	2898
$RG^{total}$ 5 MHz <sup>6</sup>	143	238	559	1075	2117
Gain 5 MHz	0,69%	17,93%	22,89%	25,86%	26,94%

in LTE is not optimized for small voice payload and the standard does not offer a reasonable choice for a very small voice payload. When the channel quality is high (higher MCS), the number of bits transmitted in a PRB can increase rapidly due to the selection of higher-order modulation and high turbo code rate. However, one pair of PRBs can transmit maximum one voice payload from one UE. In our case, when the LTE packet size is expanded, we can transmit voice payloads from several UEs by a flexible spreading size therefore we can get higher voice data capacity gain. In the best case (MCS value equal to 28 and LTE downlink bandwidth equal 5 MHz), the proposed method can multiply the voice data capacity by the factor of 7.

Table 5.4 presents the voice data capacity gain of the proposed method for the second scenario. We found that the efficiency of the proposed algorithm depends on the number of UEs in one cell. The more UEs is in one cell, the higher voice capacity gain.

Table 5.5 illustrates the average voice control capacity gain of the proposed method. From the data in Table 5.5, it is apparent that the proposed method also allows a significant reduction of the control overhead. The proposed method allows reducing both data overhead and control overhead issues for VoLTE in PMR context. Table 5.6 shows the average voice data capacity gain of the proposed method. On average, the proposed method can increase about two times the voice data capacity.

Table 5.5: Average voice control capacity gain of the proposed method for 20 *ms*

Bandwidth	1.4 MHz	3 MHz	5 MHz
PDCCH capacity of FD	80	240	400
PDCCH capacity of new method	180	580	1020
Average control capacity gain	125%	141.66%	155%

Table 5.6: Average voice data capacity gain of the proposed method for 20 *ms*

Bandwidth	1.4 MHz	3 MHz	5 MHz
Downlink	195.94%	219.24%	230.96%
Uplink	190.54%	198.64%	196.92%

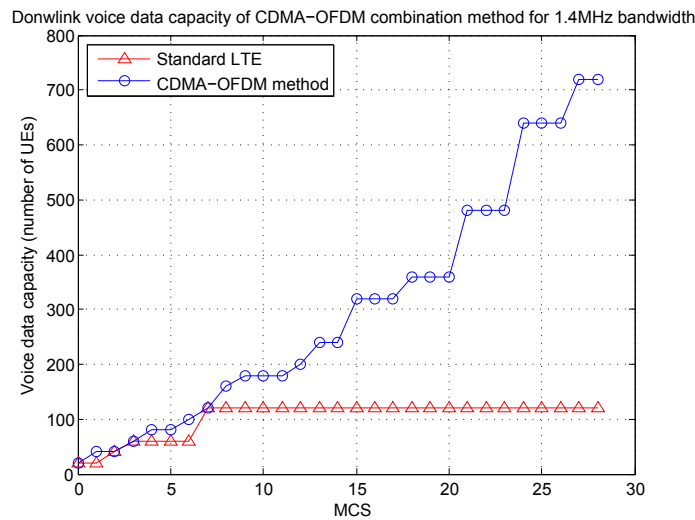

Figure 5.10: Downlink voice data capacity gain of the proposed method for the 1.4 MHz bandwidth for 20 ms

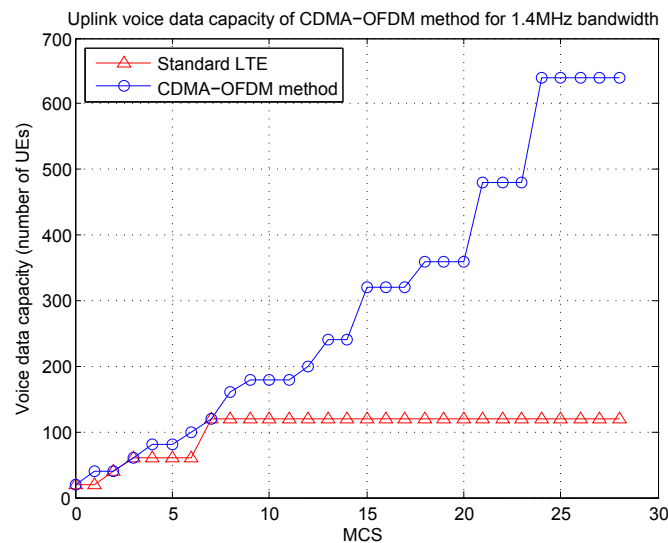

Figure 5.11: Uplink voice data capacity gain of the proposed method for the 1.4 MHz bandwidth for 20 ms

### 5.3 Conclusion

In this chapter, we discussed and evaluated a new CDMA-OFDM combination method that aims to improve the voice capacity of VoLTE in PMR context. In this method, the voice payload of different UEs having the same MCS can be spread by different orthogonal codes and mapped to the same set of resource elements. The spreading factor is chosen for maximum reduction of the difference between the LTE packet size and PMR voice payload. The lack of control signaling is solved by a RNTI aggregation mechanism. In addition, we

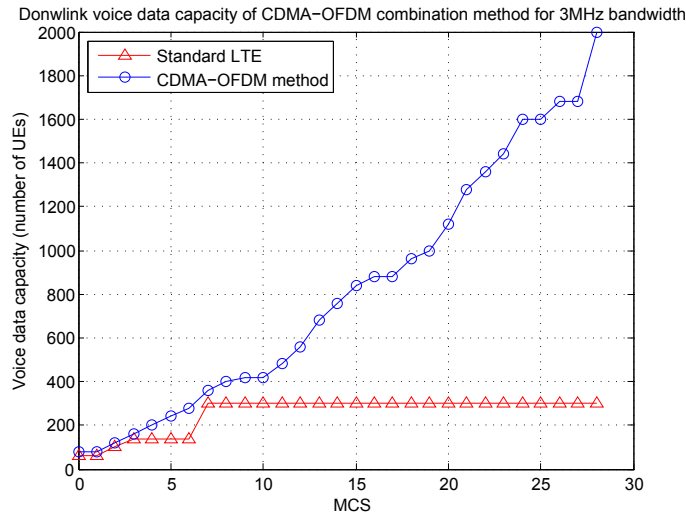

Figure 5.12: Downlink voice data capacity gain of the proposed method for the 3 MHz bandwidth for 20 ms

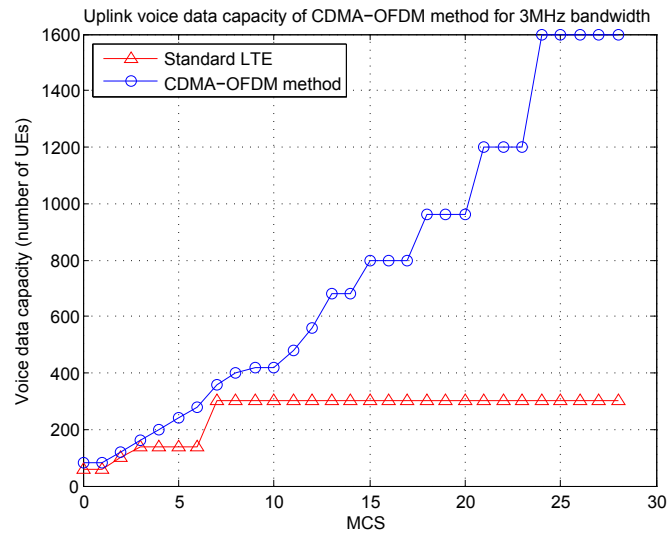

Figure 5.13: Uplink Voice data capacity gain of the proposed method for the 3 MHz bandwidth for 20 ms

also proposed a new scheduling scheme for the CDMA-OFDM combination method. The results indicate that our proposition gives a significant increase in capacity of VoLTE uplink in the PMR context. In the best case, the proposed method can multiply the voice data capacity by the factor of 7 and increase voice control capacity up to 155% in comparison with the standard LTE. However, this research has raised up many questions in need of further investigation. Firstly, power control issue needs to be considered. Secondly, phase and frequency synchronization issue has to be addressed.



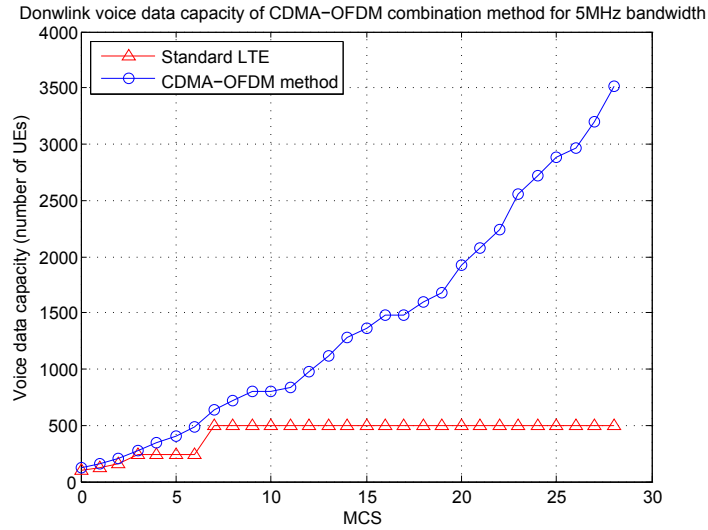

Figure 5.14: Downlink voice data capacity gain of the proposed method for the 5 MHz bandwidth for 20 ms

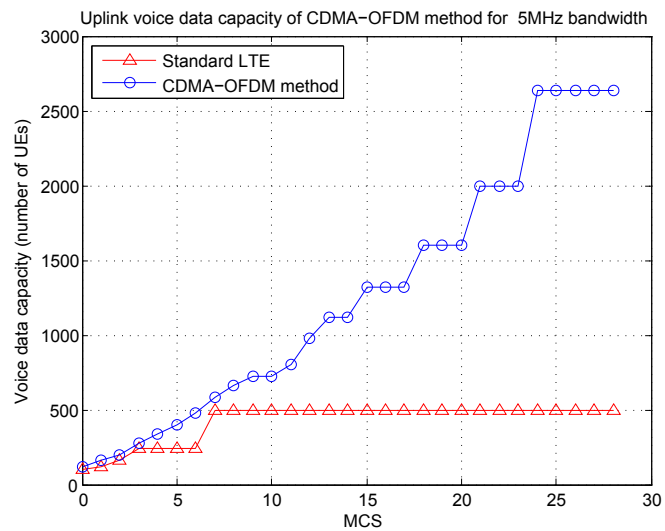

Figure 5.15: Uplink voice data capacity gain of the proposed method for the 5 MHz bandwidth for 20 ms

# Chapter 6

## New Proposed Adaptive Physical Resource Block Design for Enhancing Voice Capacity over LTE in PMR context

### Contents

<b>6.1</b>	<b>Introduction</b>	<b>73</b>
<b>6.2</b>	<b>Proposed Adaptive Physical Resource Design</b>	<b>73</b>
6.2.1	Proposed Sub Physical Resource structure	73
6.2.2	Proposed System Evaluation Model	75
<b>6.3</b>	<b>Performance evaluation</b>	<b>77</b>
6.3.1	System Parameters	77
6.3.2	LTE Voice Capacity Evaluation	77
<b>6.4</b>	<b>Conclusion</b>	<b>77</b>

### 6.1 Introduction

In this chapter, we propose a new Adaptive Physical Resource Block Design for Enhancing Voice Capacity over Long-Term Evolution (LTE) Downlink in Private Mobile Radio (PMR) Context. In this method, we reorganize the structure of the Physical Resource Block (PRB) to optimize the voice capacity of LTE downlink in PMR Context. The available PRBs in each subframe is reorganized into a number of Sub Physical Resource Blocks (subPRBs). The number of control symbols can be selected flexibly. The proposed method allows reducing both data overhead and control overhead issues for VoLTE downlink in PMR context. The details of this method is presented in section 6.2. The performance of our method is evaluated in section 6.3. Section 6.4 will give the conclusion and some perspectives.

### 6.2 Proposed Adaptive Physical Resource Design

#### 6.2.1 Proposed Sub Physical Resource structure

In LTE, one pair of Physical Resource Blocks (PRBs) is the smallest User Assignment Unit. However, the smallest LTE packet size is still too large in case of low bit rate voice

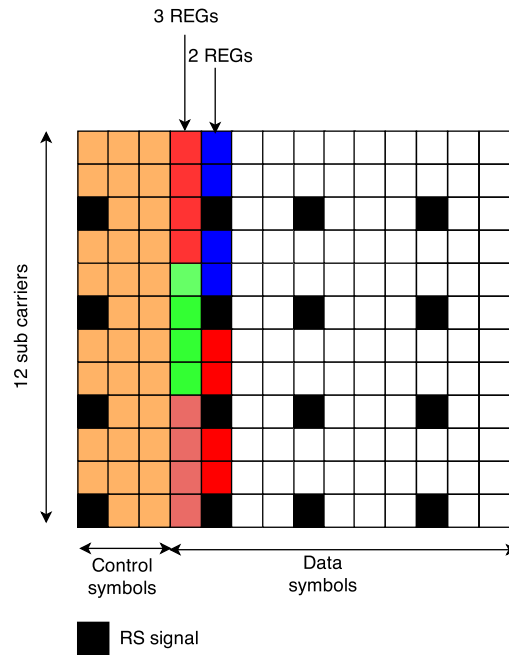

Figure 6.1: REG structure

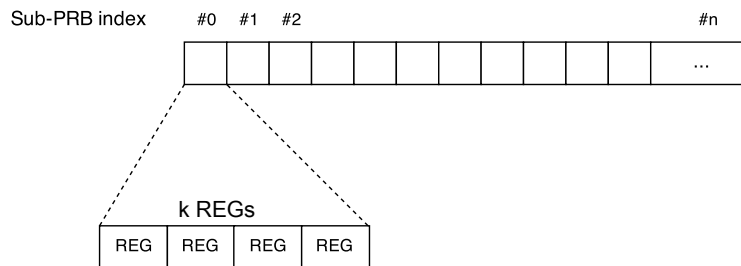

Figure 6.2: Adaptive Physical Resource Block

communication transmitted in high Modulation and Coding Scheme (MCS). This is the main factor that affects the data overhead of VoLTE in PMR context. Therefore, the main idea of the proposed method is to reorganize the structure of the PRB of LTE to optimize the voice capacity of VoLTE in case of PMR context but not affect the operations of the system.

In order to ensure the integrity of processing for control signals (e.g. Reference Signal (RS), Primary Synchronization Channel (PSS), Secondary Synchronization Channel (SSS)) these control signals are organized in the same way with LTE standards. The difference is that in the new design, the available REs for data in each subframe is reorganized into a number of Sub Physical Resource Blocks (SubPRBs). Each SubPRB consists of four Resource Element Group (REG). Each Resource Element Group (REG) contains four consecutive Resource Elements (RE) or four REs separated by a cell-specific Reference Signal (RS). The structure of SubPRB is similar to the structure of Control Channel Element

(CCE) for the control channel with adaptations. SubPRB structure is illustrated in Figure 6.1 and 6.2.

In addition, in the new design, instead of limiting the number of symbols for control channels from 1 to 3 symbols, the new design allows a flexible choice of the number of symbols so that the system can obtain the maximum voice capacity. Figure 6.3 illustrates the model of our proposed system. There is a slight change in the last step. The symbols after passing the Layer mapping/precoding are mapped into subPRBs instead of PRBs. Therefore, the major issues to be considered is how to determine the size of SubPRB and the number of symbols used for control channel to maximize the voice capacity. In LTE, the base scheduler is Fully Dynamic (FD) scheduler. In the FD scheduler, each data packet needs to associate with a Layer 1 (L1) control signaling (a Physical Downlink Control Channel). LTE uses Physical Downlink Control Channel (PDCCH) to carry all allocation information for both downlink and uplink shared channels. These symbols for control channels are organized in Resource Element Group and Control Channel Element (CCE). One REG consists of four consecutive REs or four REs separated by one Reference Signal. One CCE comprises nine REGs. To build the PDCCH, LTE uses a number of consecutive CCEs called CCE aggregation level. The CCE aggregation level can be one, two, four or eight. The aggregation level depends on the DCI size and the effective coding rate. There are four PDCCH formats (PDCCH format 0, PDCCH format 1, PDCCH format 2, PDCCH format 3) that correspond to four aggregation levels. PDCCH carries Downlink Control Information (DCI). We know that the number of control channels depends on the size of the DCI and the code rate. The size of DCI in turn depends on the number of available PRBs (in case of LTE) or available SubPRB (in our case). Therefore, the choice of size Sub\_PRB influences the number of available control channels. If the size of Sub\_PRB is too small, the number of bits need to be used for resource allocation in the corresponding DCI is increased. However, if the size of Sub\_PRB is too big, the gap between LTE packet size and the PMR voice payload will be increased. In the proposed SubPRB design, we propose that the one SubPRB can consist of four REGs (see Figure 6.2). The number of symbols for control channel are chosen to optimize the voice capacity of VoLTE in PMR context.

### 6.2.2 Proposed System Evaluation Model

We consider the number of available control channel ( $N_C$ ) is a function of the number of allowed resource blocks of a defined bandwidth  $N_{BW}$ , the number of symbols used for PDCCH channels  $n_c$ , number of active UEs in the cell with the aggregation level  $A_{ij}$  that is need to be used to transmit PDCCH for  $UE_i$  at  $j^{th}$  TTI, voice payload of UE  $S_p$ .

$$N_C = f(N_{BW}, n_c, S_p, [A_{ij}]) \quad (6.1)$$

We consider the number of available data channels ( $N_D$ ) is a function of  $N_{BW}$ ,  $n_c$ ,  $S_p$  number of active UEs in the cell with Modulation and Coding Scheme assigned  $MCS_{ij}$

$$N_D = f(N_{BW}, n_c, S_p, CP, [MCS_{ij}]) \quad (6.2)$$

The voice capacity  $N_V$  at the  $j^{th}$  TTI is defined as:

$$N_V = \min(N_C, N_D) \quad (6.3)$$

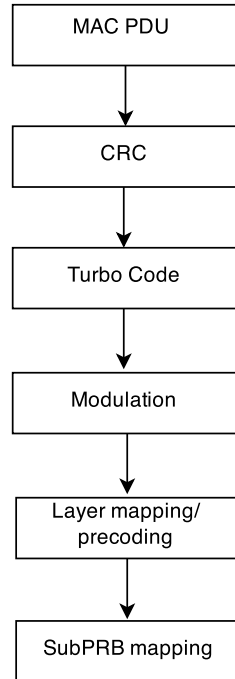

Figure 6.3: SubPRB mapping

At the  $j^{th}$  TTI, choose  $n_c$  so that:

$$\operatorname{argmax}_{n_c, n_k} f(n_c) = \{n_c | \forall x : f(x) \leq f(n_c)\} \quad (6.4)$$

The voice capacity in a period  $\{t_1, t_2\}$  is defined as:

$$\text{Voicecapacity} = \sum_{t_1}^{t_2} N_V \quad (6.5)$$

The number of OFDM symbols in a sub-frame is indicated by the Physical Control Format Indicator Channel (PCFICH) like in case of LTE standard. In order to determine the size of subPRB, the UEs have to read the field SRBS (Size of SubPRB) in new Adaptive DCI structure. The structure of Adaptive DCI structure is presented in table 6.1. In this case, the field SRBA (Sub Physical Resource Block assignment) is used instead of RBA (Physical Resource Block assignment) in LTE standard.

Table 6.1: Adaptive DCI structure

Field Name	Length (bits)	Comment
SRBA	8 (1.4 MHz) 10 (3 MHz) 12 (5 MHz)	SubPRB assignment
MCS	5	Modulation and Coding Scheme

Table 6.2: System Parameters

Parameter	Value
Bandwidth	1.4 MHz, 3MHz, 5 MHz
LTE	Type 1 FDD
Codec	AMBE 2450 bps
Ng	1
CRC	24 bits
Cyclic Prefix	Normal
Number of antenna	2

## 6.3 Performance evaluation

### 6.3.1 System Parameters

For the performance evaluation, we use the target codec of PMR context AMBE with code rate 2450 bps for three lower bandwidths 1.4 MHz, 3MHz, 5 MHz. UEs take random values of MCS and Aggregation level for PDCCH channel. The other parameters for the evaluation are presented in table 6.2.

### 6.3.2 LTE Voice Capacity Evaluation

Figures 6.4, 6.5 and 6.6 show the relation between the number of symbols for control channel with the number of average supported data packets, average supported control packets and the voice capacity.

Table 6.3 compares the average voice capacity obtained from Physical Resource Block design (standard LTE) and from Adaptive Physical Resource Block design (our method) for 1.4 MHz bandwidth in 20 *ms*. In this case, the optimal number of symbols for control channel is about 6 symbols. As Table 6.3 shows, there is a significant voice capacity gain (54 for standard LTE and 91 for the proposed method) between the two methods. Comparing the two results, it can be seen that the proposed method allows a more flexible and optimal LTE packet size than the existent standard LTE. The existent LTE standards do not optimize the packet size in case of PMR context. This leads to a decreased number of available data packets and control packets. Meanwhile, the proposed method allows a choice packet size and the number of symbols for control channel more flexible so that the proposed method can choose an optimal value for improving voice capacity.

## 6.4 Conclusion

In this chapter, we proposed a new Adaptive Physical Resource Design for improving control capacity of LTE Downlink in the PMR context. In this design, the available PRBs in each subframe is reorganized into a number of subPRBs. In addition, the number of symbols for control channel are chosen flexibly to maximize the voice capacity. The results show that on average, the voice capacity gain of proposed method is about 83.5%. Finally, a number of important limitations need to be considered. First, the complexity assessment and the energy consumption issue of the new design has not been studied. Second, an assessment of the Bit Error Rate (BER) should also be considered because the interference between the adjacent channels may be increased when the number of supported voice calls is increased and the size of Sub PRB is smaller than the size of PRB.

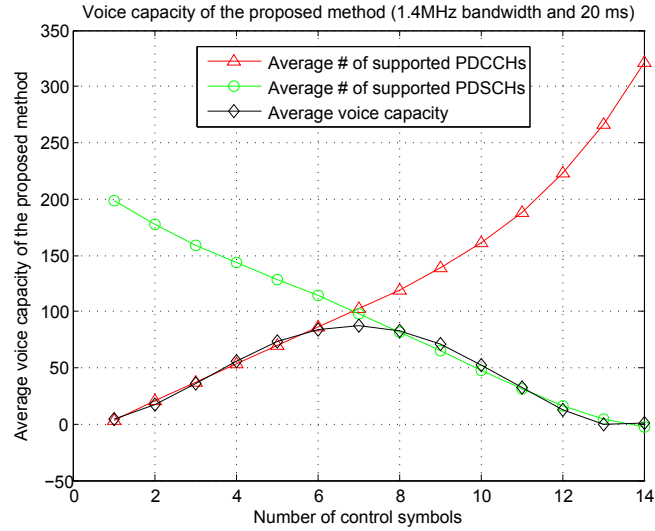

Figure 6.4: Control capacity of the proposed method (1.4 MHz bandwidth and 20ms)

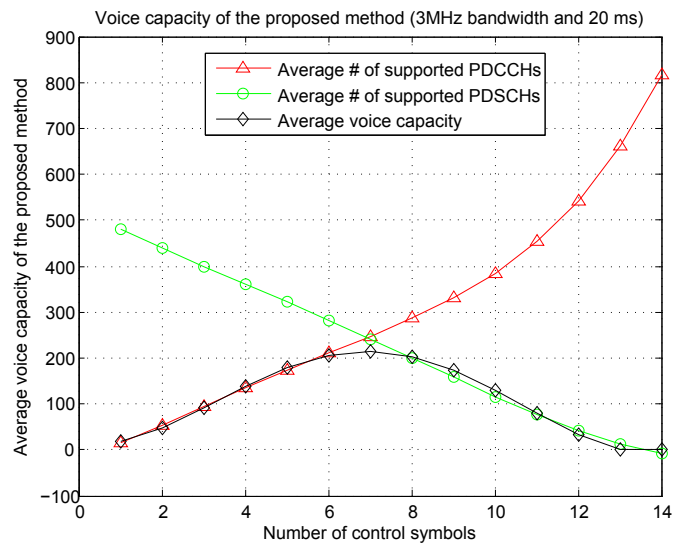

Figure 6.5: Control capacity of the proposed method (3 MHz bandwidth and 20ms)

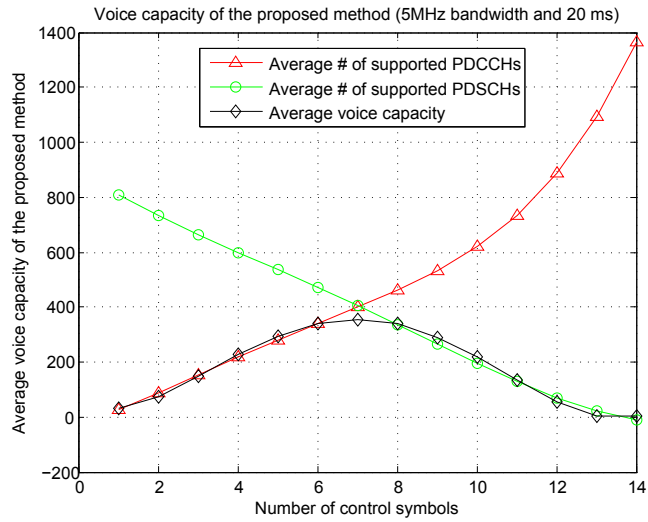

Figure 6.6: Control capacity of the proposed method (5 MHz bandwidth and 20ms)

Table 6.3: Voice capacity gain of the proposed method for 1.4 MHz in 20 ms (k=1)

Number of control symbols	1	2	3	4	5	6	7	8	9	10	11	12	13	14
$A_2$ Average scp of FD	7	31	54	X	X	X	X	X	X	X	X	X	X	X
$A_1$ of FD	84	84	84	X	X	X	X	X	X	X	X	X	X	X
$A_2$ of new method	6	26	46	67	87	107	127	148	168	188	208	229	249	269
$A_1$ of new method	169	157	140	129	115	99	86	72	57	44	28	14	7	0
$A_3$ of FD	54													
$A_3$ of new method	99													
Gain	83.5%													

X: Standard LTE does not support

$A_1$ : Average supported voice data packets

$A_2$ : Average supported voice control packets

$A_3$ : Average supported voice capacity





# Chapter 7

## Comparison of the new Proposed Methods for Enhancing Capacity of Voice over LTE in PMR context: Evaluation and Recommendations

### Contents

<b>7.1</b>	<b>Evaluation . . . . .</b>	<b>81</b>
<b>7.2</b>	<b>Recommendations . . . . .</b>	<b>85</b>

### 7.1 Evaluation

In this chapter, we will compare the performance of our three proposed methods. In our context, the voice capacity of LTE is evaluated with PMR constraints so that we use a very low bit rate voice coder (Advanced Multiband Excitation 2450 bps codec). The evaluation is computed for three deployment bandwidths (1.4 MHz, 3 MHz, 5 MHz) for downlink transmission. Table 7.1 provides the main system parameters.

For the performance evaluation, we will compare the effectiveness of three methods in two main scenarios. In the first scenario, we cluster UEs having the same MCS values for evaluating the efficiency of Multi-users Multiplexing method and CDMA-OFDM combination method when the number of UEs in a cell is high. In the second scenario, UEs having different MCS values can be grouped together. This scenario is used for evaluating the efficiency of the proposed methods in case of low and medium number of UEs. In this scenario 100, 200, 500, 1000 and 2000 UEs with random MCS values are used for 1000 tests. We compare the average of used resource blocks of three methods and the LTE standard. The evaluation on both scenarios allows determining the advantages and the disadvantages of each method in the different contexts.

Figures 7.1, 7.2, 7.3 show the comparison of voice data capacity gains for 1.4 MHz, 3 MHz and 5 MHz bandwidths for evaluations of 20 milliseconds period of three methods and the LTE standard for the first scenario. From these figures we can find that all three methods can reduce the data overhead of VoLTE in the PMR context. In terms of efficiency, the results from these figures show that the Multi-user Multiplexing method gives the best efficiency in all three bandwidths.

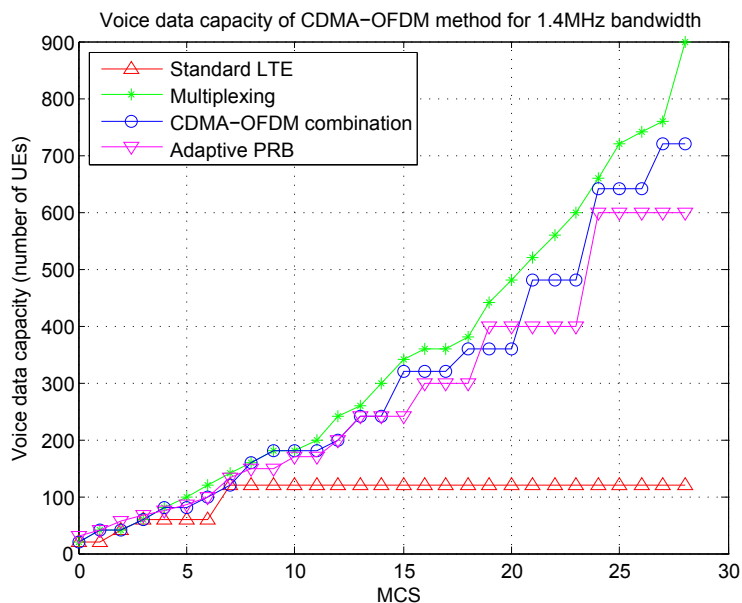

Figure 7.1: Comparison of voice data capacity gain for the 1.4 MHz bandwidth for 20 ms

Table 7.2 presents the efficiency of three methods for the second scenario. It can be seen from the data in Table 7.2 that in case of low and medium number of UEs in a cell, the Adaptive Physical Resource Block method give the best value of voice data capacity gain. The efficiency of two method Multi-users Multiplexing method and CDMA-OFDM depend on the number of UEs and the bandwidth. Along with the increasing number of UEs, the efficiency of these methods is increased.

Table 7.1: System parameters

Parameter	Value
Bandwidth	1.4 MHz, 3MHz, 5 MHz
LTE	Type 1 FDD
Codec	AMBE 2450 bps
Symbols for PDCCH	3 symbols
Ng	1
CRC	24 bits
Cyclic Prefix	Normal
Number of antenna	2

All three methods can reduce the data overhead of VoLTE in the PMR context. Nevertheless the applicability and effectiveness of each method is different. In terms of efficiency, in case that the number of UEs in a cell is not limited, the Multi-user Multiplexing method gives highest efficiency. However, the CDMA-OFDM combination method is more appreciated because of its usability for both channels: uplink and downlink (See table 7.3). The biggest advantage of the Adaptive PRB method is the simplicity. The Adaptive PRB method can reduce only the data overhead. In fact, it also increases the control overhead because in this method, the DCI size is increased by the number of SubPRBs is much larger than the number of PRBs. To reduce the control overhead in case of Adaptive PRB method, it is necessary to make a trade-off between the voice data capacity and the voice control

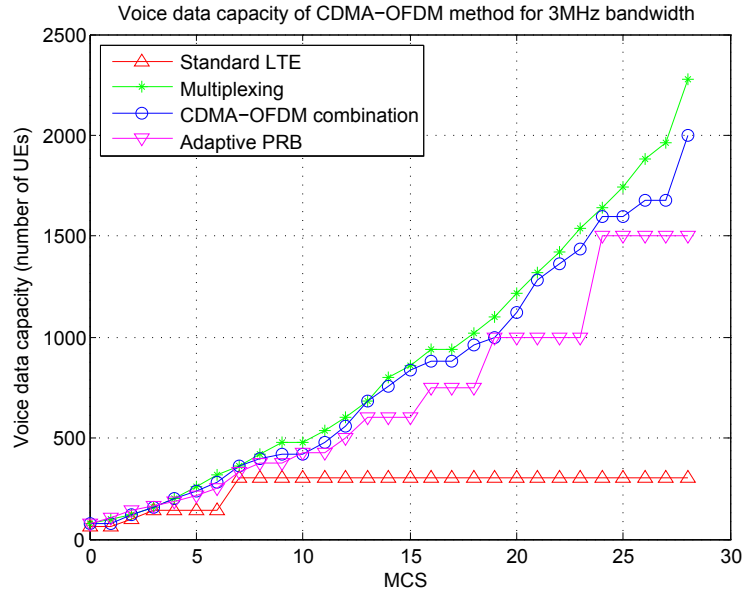

Figure 7.2: Comparison of voice data capacity gain for the 3MHz bandwidth for 20 ms

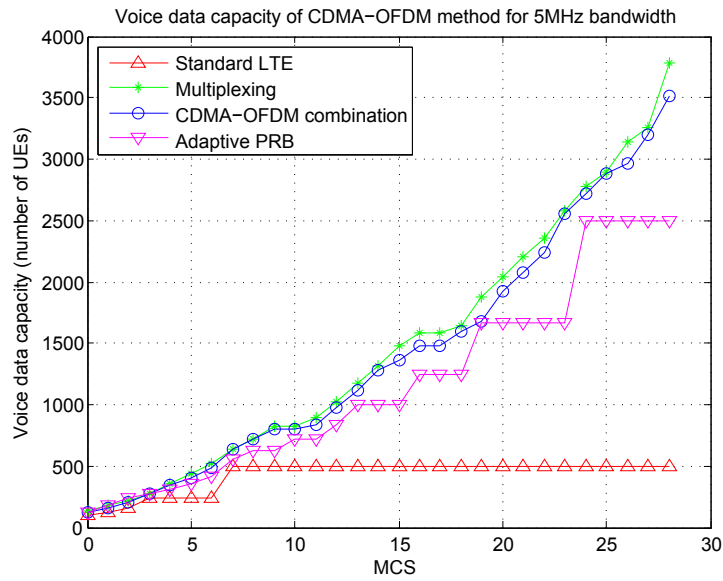

Figure 7.3: Comparison of voice data capacity gain for the 5MHz bandwidth for 20 ms

capacity by changing the amount of symbols for control channel. In this method, we have proposed a flexible choice of the number of symbols for control channel.

The control overhead issue in case of Multi-users Multiplexing Method and CDMA-OFDM combination method can be solved by using one of two methods: RNTI Aggregation method and Group\_RNTI method. The use of RNTI aggregation method and the Group\_RNTI method for the Multi-users Multiplexing Radio Voice Transmission method and CDMA-OFDM combination method allows reducing both data overhead and control

Table 7.2: Voice data capacity gain of three methods for the second scenario

Bandwidth	Method	Number of UEs				
		100	200	500	1000	2000
1,4 MHz	Multi-users Multiplexing method <sup>1</sup>	93	177	429	853	1692
	CDMA-OFDM combination method <sup>2</sup>	106	211	506	1009	2007
	Adaptive PRB method <sup>3</sup>	85	170	424	847	1698
	LTE standard <sup>4</sup>	145	290	724	1452	2897
3MHz	Multi-user Multiplexing method <sup>1</sup>	101	176	404	783	1539
	CDMA-OFDM method <sup>2</sup>	112	223	512	1014	2021
	Adaptive PRB method <sup>3</sup>	85	170	424	847	1698
	LTE standard <sup>4</sup>	143	290	725	1449	2893
5MHz	Multi-user Multiplexing method <sup>1</sup>	111	188	413	786	1529
	CDMA-OFDMcombination method <sup>2</sup>	143	238	559	1075	2117
	Adaptive PRB method <sup>3</sup>	85	170	424	847	1698
	LTE standard <sup>4</sup>	144	290	725	1450	2898

<sup>1</sup> Average number of used resource blocks in Multi-users Multiplexing method

<sup>2</sup> Average number of used resource blocks in CDMA-OFDM combination method

<sup>3</sup> Average number of used resource blocks in Adaptive Physical Resource Block method

<sup>4</sup> Average number of used resource blocks in LTE standard

Table 7.3: Use case of three methods

Method	Downlink	Uplink	Reducing of data overhead	Reducing of control overhead
Multi-user Multiplexing method	Yes	? <sup>1</sup>	Yes	Yes
CDMA and OFDM method	Yes	Yes	Yes	Yes
Adaptive PRB method	Yes	? <sup>2</sup>	Yes	? <sup>3</sup>

<sup>1</sup> Solution for uplink in case of Multi-user Multiplexing method is still an issue to solve. It may need one or more new additional components in the system.

<sup>2</sup> In order to apply Adaptive Physical Resource Block method for the downlink. It is necessary to consider a new design for DMRS in this case to ensure the integrity of system

<sup>3</sup> In order to reduce the control overhead in Adaptive Physical Resource Block method. It need to make a trade-off between the voice control capacity and voice data capacity.

overhead issues for VoLTE in PMR context. This allows enhancing the voice capacity for VoLTE in PMR context for both methods.

We also compared the number of possible communications of existent PMR narrowband networks to those of our proposed methods. Table 7.4 and Table 7.5 show the comparison of number of possible communication between the technologies for narrowband PMR networks presented in [7] and our proposed methods for broadband PMR networks using LTE technology in the 1.4 MHz bandwidth. The results show that in term of number of possible communications for a determined bandwidth, all of three proposed methods give better results in comparison with solutions of existent narrowband PMR networks. This

Table 7.4: Voice capacity of PMR NarrowBand Technologies

<b>Technology</b>	<b>TETRA</b>	<b>TETRAPOL 10 kHz</b>	<b>TETRAPOL 12.5kHz</b>
Channel bandwidth	25 kHz	10 kHz	12.5 kHz
Number slots/ channel	4	1	1
Reuse factor/1.4 MHz	16	12	12
Number communications/1.4 MHz	224	140	112
Number of communications/1.4 MHz/cell	14	11.66	9.33

Table 7.5: Voice capacity of PMR BroadBand Technologies

<b>Technology</b>	<b>LTE</b>	<b>Multiplexing</b>	<b>CDMA-OFDM</b>	<b>Adaptive PRB</b>
Channel bandwidth	1.4 MHz	1.4 MHz	1.4 MHz	1.4 MHz
Average number communications/1.4 MHz	105	355	312	258
Average number of communications/1.4 MHz/cell	105	355	312	258

demonstrates the effectiveness of our proposed methods and the feasibility of applying LTE for the broadband PMR networks.

## 7.2 Recommendations

In this chapter, we compared three methods for enhancing Voice Capacity over Long-Term Evolution (LTE) in Professional Mobile Radio (PMR) Context: Multi-users Multiplexing Method, CDMA-OFDM Combination Method, Adaptive Physical Resource Block Method. Each method has its advantages and its disadvantages. We recommend using CDMA-OFDM Combination Method. Although, the effectiveness of this method is not greater than the two remaining methods, the CDMA-OFDM Combination method can reduce both signal and data overhead. In addition, it can be applied for both uplink and downlink without requiring new additional components to the system. However, the combined solutions (different solutions for uplink and downlink) may also be considered.



# Chapter 8

## Conclusion and Perspectives

### Contents

---

8.1 Conclusion . . . . .	87
8.2 Perspectives . . . . .	88

---

### 8.1 Conclusion

In this dissertation, we have studied issues affecting the capacity of voice over LTE in the PMR context and we have proposed several new solutions for enhancing the voice capacity over LTE in case of applying LTE for the next generation of PMR technology. The data overhead and the control overhead are two main factors affecting the voice capacity of LTE in the PMR context. These two issues come from the difference between the design philosophies of the PMR standard and the LTE standard. While LTE is designed for high data rate communication, PMR is used mainly for low data rate communication because PMR must privilege the network capacity in term of number of users in the critical issues. Therefore, an all IP architecture of LTE standard is not dimensioned for low rate data transmission. The radio allocation mechanism is not effective for low data rate voice communication in PMR context therefore the use of radio resources is inefficient and wasteful.

Our solutions focus on solving the above two issues. For the data overhead issue, we have proposed three new methods: Multi-users Multiplexing method, CDMA-OFDM Combination method, Adaptive Physical Resource Block method. The purpose of the proposed Multi-users Multiplexing method and the CDMA-OFDM Combination method is to increase the voice payload size while the purpose of the proposed Adaptive Physical Resource Block method is to provide a more flexible LTE packet size design.

The theoretical results implemented by matlab show that all of these new proposed methods can reduce significantly the gap between the PMR voice payload and the LTE packet size, which is the major part of data overhead of Voice over LTE in PMR context. We also analyzed the advantages and disadvantages of each method. This analysis is essential in making the choice of a solution to install in the future. In terms of efficiency, the results from the performance evaluations show that the Multi-user Multiplexing method gives the best efficiency. However, the ability of using this method for uplink channel remains a challenge. The solutions for Multi-user Multiplexing for uplink may require the



construction of additional subsystems. The CDMA-OFDM combination method is more appreciated because of its usability for both channels: uplink and downlink channels and this method does not require additional components.

The Multi-users Multiplexing Method method and the CDMA-OFDM Combination can be used simultaneously with the RNTI aggregation method or Group\_RNTI method to reduce both the data overhead and control overhead.

The biggest advantage of the Adaptive PRB method is the simplicity. However, the Adaptive PRB method can reduce only the data overhead. The solution for uplink transmission and solution for control overhead are still issues to be solved.

Even these new proposed methods are implemented by negligible modifications of the existent LTE standards, the efficiency obtained from these methods is very impressive. On average, the proposed methods can double the voice capacity. These results reaffirm that the existent LTE standards are not entirely suitable for low data rate applications. Therefore, if the service providers want to apply LTE or other broadband standards for PMR evolution, they need to take into account these low throughput communications services when building new standards (e.g. 5G, 6G) to ensure the efficient use of radio resources.

On the basis of analyzing the advantages and disadvantages of three methods, we recommend of using CDMA-OFDM Combination Method method as the main method for enhancing Voice Capacity over LTE in PMR Context. The CDMA-OFDM Combination method can reduce both signal and data overhead. In addition, it can be applied for both uplink and downlink without requiring new additional components to the system. However the combined solutions (different solutions for uplink and downlink) may also be considered.

## 8.2 Perspectives

In this thesis, we have presented several new solutions to solve the two main issues that affect the voice capacity of LTE in the PMR context: data overhead and control overhead for both uplink and downlink. These proposed methods are relatively complete. For each issue, we have proposed several new methods and have given assessments of each method as the basis for the selection of the solution to implement for future PMR network. However, there are also many interesting directions to continue for optimizing the efficiency of resource allocation in LTE for the PMR context:

1. The Multi-users Multiplexing method is implemented for downlink transmission. The solution for uplink transmission can be considered for the future works. This could be expected to build one or more additional components in the system.
2. For the Group\_RNTI method, we need to find out a more accurate model for estimate MCS change rate as this affects the evaluation of the proposed method.
3. For CDMA-OFDM combination method, further work would need to be done in to solve the power control and phase and frequency synchronization issue.
4. For the Adaptive Physical Resource Block method, solutions for uplink transmission can be investigated.
5. The optimal solutions for source coding, channel coding and joint source/channel coding may also be considered.
6. The performance evaluations of the proposed methods are only theoretical results implemented by matlab with assumptions of static characteristics. Realistic simulations with more dynamic characteristics such as ROHC size, variability of channel quality can be implemented.

## Complementary Results

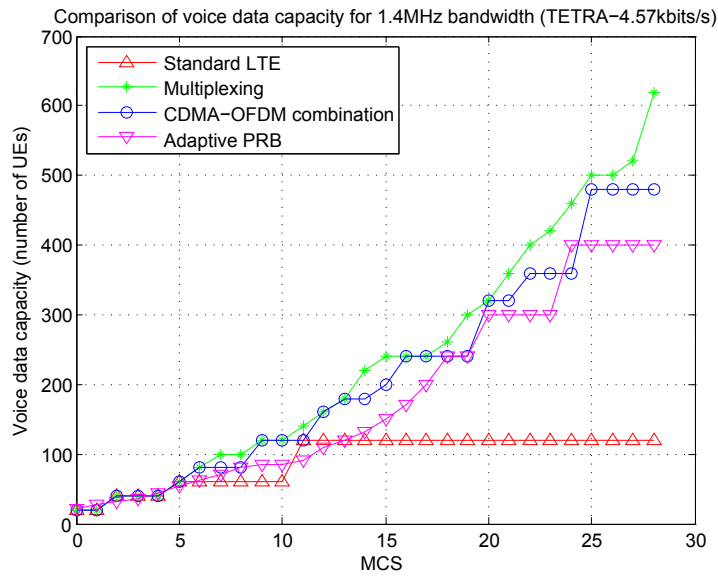

Figure 8.1: Comparison of voice data capacity gain for the 1.4 MHz bandwidth for 20 ms for code rate 4.57 kbits/s

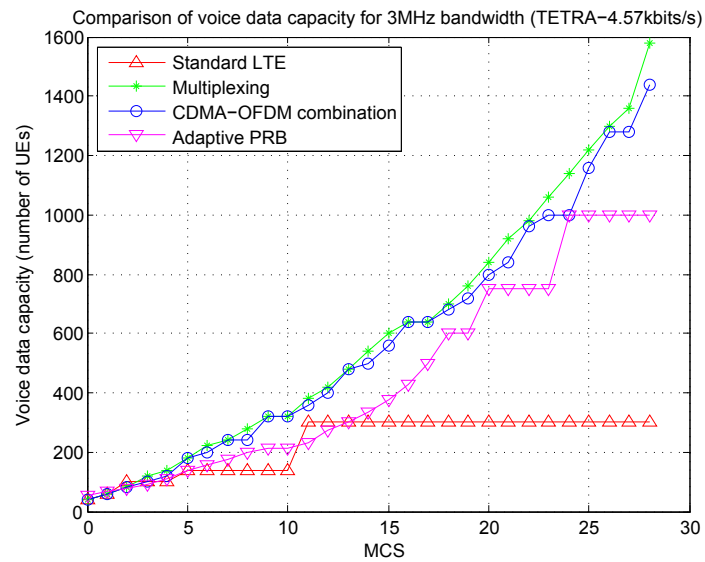

Figure 8.2: Comparison of voice data capacity gain for the 3 MHz bandwidth for 20 ms for code rate 4.57 kbits/s

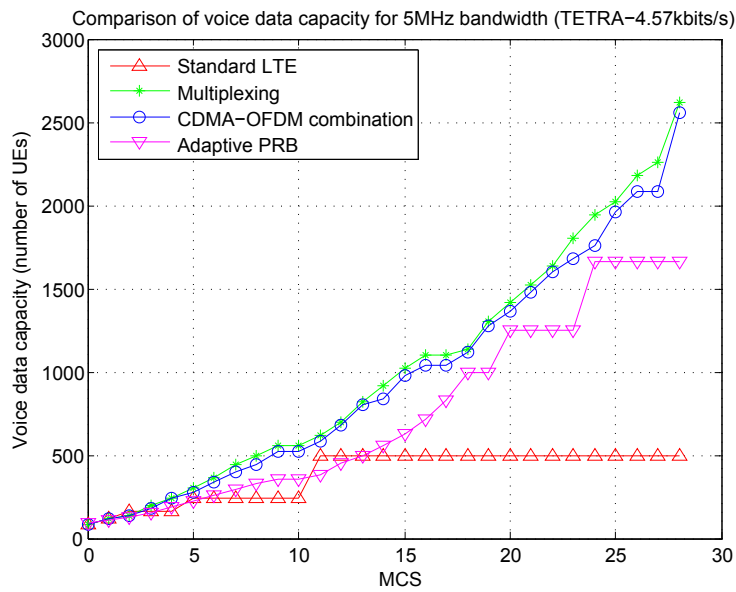

Figure 8.3: Comparison of voice data capacity gain for the 5 MHz bandwidth for 20 ms for code rate 4.57 kbits/s

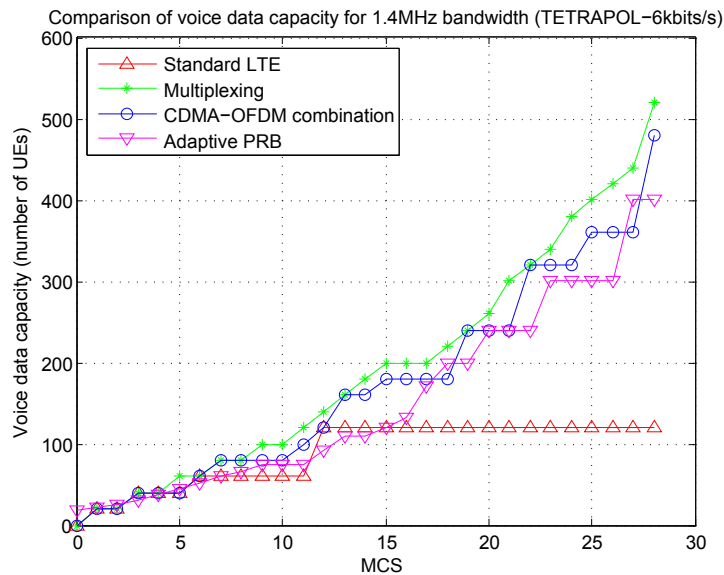

Figure 8.4: Comparison of voice data capacity gain for the 1.4 MHz bandwidth for 20 ms for code rate 6 kbits/s

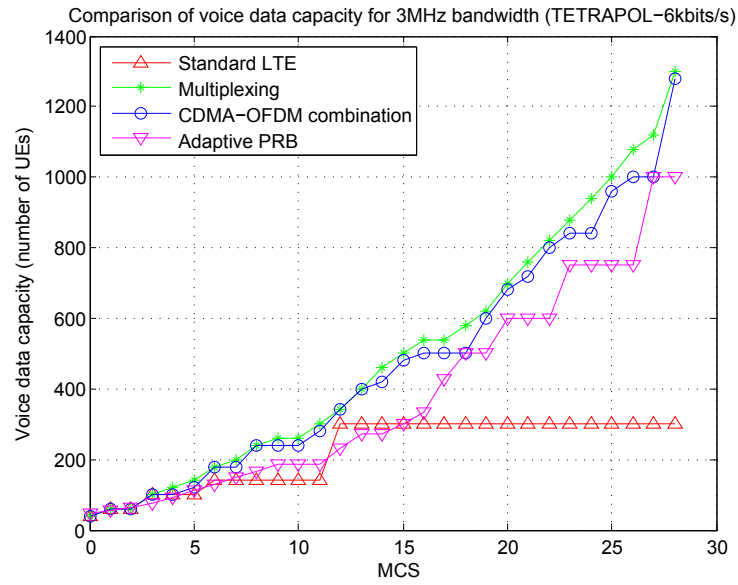

Figure 8.5: Comparison of voice data capacity gain for the 3 MHz bandwidth for 20 ms for code rate 6 kbits/s

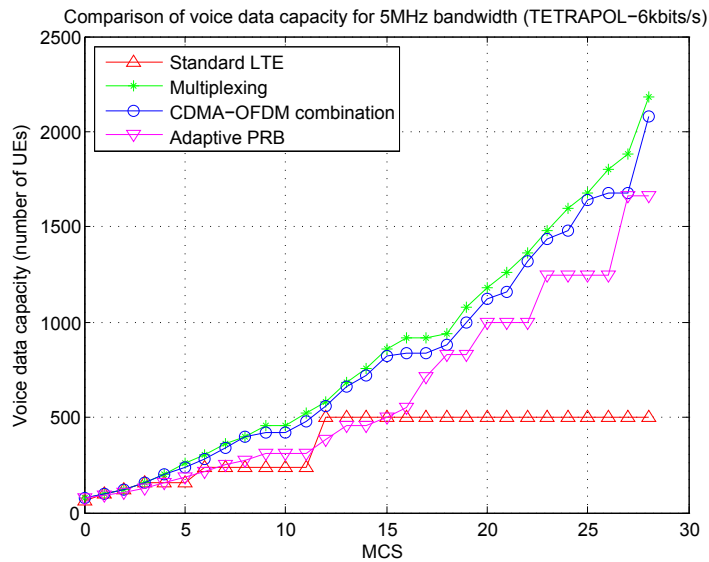

Figure 8.6: Comparison of voice data capacity gain for the 5 MHz bandwidth for 20 ms for code rate 6 kbits/s



# Bibliography

- [1] Hans-Peter Ketterling. *Introduction to digital professional mobile radio*. Artech House, 2003.
- [2] Alina Alexandra Florea. *Optimisation de la transmission de phonie et vidéophonie sur les réseaux à larges bandes PMR*. PhD thesis, Evry, Institut national des télécommunications, 2013.
- [3] Mathieu Simon. Standard apco25 physical layer of the radio transmission chain. 2014.
- [4] Peter Stavroulakis. *Terrestrial trunked radio-TETRA: a global security tool*. Springer Science & Business Media, 2007.
- [5] Shiga BakariC, Mario Borzic, Darko BratkoviC, and Vinko Grga. Tetra (terrestrial trunked radio)-technical features and application of professional communication technologies in mobile digital radio networks for special purpose services. In *ELMAR, 2005. 47th International Symposium*, pages 307–310. IEEE, 2005.
- [6] Adrian Boukalov. Cross standard system for future public safety and emergency communications. In *Vehicular Technology Conference, 2004. VTC2004-Fall. 2004 IEEE 60th*, volume 7, pages 5224–5229. IEEE, 2004.
- [7] AA Florea, L Martinod, P Mege, and H Nguyen. Multi-layer Realistic Voice Capacity Evaluation in LTE Rel. 9 and Performance Comparison with PMR and GSM. In *World Telecommunications Congress (WTC), 2012*.
- [8] Daan Pareit, Bart Lannoo, Ingrid Moerman, and Piet Demeester. The history of wimax: A complete survey of the evolution in certification and standardization for ieee 802.16 and wimax. *Communications Surveys & Tutorials, IEEE*, 14(4):1183–1211, 2012.
- [9] Dusit Niyato, Ekram Hossain, and Jeffrey Diamond. Ieee 802.16/wimax-based broadband wireless access and its application for telemedicine/e-health services. *Wireless Communications, IEEE*, 14(1):72–83, 2007.
- [10] Steven J Vaughan-Nichols. Achieving wireless broadband with wimax. *Computer*, 37(6):10–13, 2004.
- [11] Tewfik Doumi, Mike F Dolan, Said Tatesh, Alessio Casati, George Tsirtsis, Kiran Anchan, and Dino Flore. Lte for public safety networks. *Communications Magazine, IEEE*, 51(2):106–112, 2013.

- [12] TJ Mousley and I Wells. Speech transmission in tetra [private mobile radio]. In *Low Bit-Rate Speech Coding for Future Applications, IEE Colloquium on*, pages 2–1. IET, 1993.
- [13] 3GPP. Evolved Universal Terrestrial Radio Access (E-UTRA); LTE physical layer; General description. TS 36.201, 3rd Generation Partnership Project (3GPP), 03 2010.
- [14] 3GPP. Evolved Universal Terrestrial Radio Access (E-UTRA); Physical channels and modulation. TS 36.211, 3rd Generation Partnership Project (3GPP), 03 2010.
- [15] 3GPP. Evolved Universal Terrestrial Radio Access (E-UTRA); Multiplexing and channel coding. TS 36.212, 3rd Generation Partnership Project (3GPP), 10 2010.
- [16] 3GPP. Evolved Universal Terrestrial Radio Access (E-UTRA); Physical layer procedures. TS 36.213, 3rd Generation Partnership Project (3GPP), 10 2010.
- [17] Stefania Sesia, Issam Toufik, and Matthew Baker. *LTE: the UMTS long term evolution*. Wiley Online Library, 2009.
- [18] Abd-Elhamid M Taha, Najah Abu Ali, and Hossam S Hassanein. *LTE, LTE-advanced and WiMAX: Towards IMT-advanced Networks*. John Wiley & Sons, 2011.
- [19] Petteri Kela, Jani Puttonen, Niko Kolehmainen, Tapani Ristaniemi, Tero Henttonen, and Martti Moisio. Dynamic packet scheduling performance in ultra long term evolution downlink. In *Wireless Pervasive Computing, 2008. ISWPC 2008. 3rd International Symposium on*, pages 308–313. IEEE, 2008.
- [20] Akhilesh Pokhariyal, Troels E Kolding, and Preben E Mogensen. Performance of downlink frequency domain packet scheduling for the utran long term evolution. In *Personal, Indoor and Mobile Radio Communications, 2006 IEEE 17th International Symposium on*, pages 1–5. IEEE, 2006.
- [21] J Puttonen, T Henttonen, N Kolehmainen, K Aschan, M Moisio, and P Kela. Voice-over-IP performance in UTRA Long Term Evolution downlink. In *Vehicular Technology Conference (VTC), 2008*.
- [22] Telesystem Innovations Inc. *LTE in a Nutshell: The Physical Layer*. 2010.
- [23] Evolved Universal Terrestrial Radio Access (E-UTRA); Physical layer procedures, 3GPP TS. 36.213 V9.0.1, Dec. 2009.
- [24] Sunggu Choi, Kyungkoo Jun, Yeonseung Shin, Seokhoon Kang, and Byoungjo Choi. Mac scheduling scheme for voip traffic service in 3g lte. In *Vehicular Technology Conference, 2007. VTC-2007 Fall. 2007 IEEE 66th*, pages 1441–1445. IEEE, 2007.
- [25] B Furht and SA Ahson. *Long Term Evolution: 3GPP LTE radio and cellular technology*. Crc Press, 2009.
- [26] Yong Fan, Markku Kuusela, Petteri Lunden, and Mikko Valkama. Downlink voip support for evolved utra. In *Wireless Communications and Networking Conference, 2008. WCNC 2008. IEEE*, pages 1933–1938. IEEE, 2008.
- [27] Petter Edström. Overhead impacts on long-term evolution radio networks. 2007.

- [28] Robert Love, Ravi Kuchibhotla, Amitava Ghosh, Rapeepat Ratasuk, B Classon, and Y Blankenship. Downlink control channel design for 3gpp lte. In *Wireless Communications and Networking Conference, 2008. WCNC 2008. IEEE*, pages 813–818. IEEE, 2008.
- [29] Jani Puttonen, H-H Puupponen, Kari Aho, Tero Henttonen, and Martti Moisio. Impact of control channel limitations on the lte voip capacity. In *Networks (ICN), 2010 Ninth International Conference on*, pages 77–82. IEEE, 2010.
- [30] C Bormann, C Burmeister, M Degermark, H Fukushima, H Hannu, LE Jonsson, R Hakenberg, T Koren, K Le, Z Liu, et al. RObust Header Compression (ROHC): Framework and four profiles: RTP, UDP, ESP, and uncompressed. Technical report, RFC 3095, July, 2001.
- [31] Carsten Bormann and Mikael Degermark. Robust header compression (rohc): Framework and four profiles: Rtp, udp, esp, and uncompressed. 2001.
- [32] David E Taylor, Andreas Herkersdorf, Andreas Doering, and Gero Dittmann. Robust header compression (rohc) in next-generation network processors. *IEEE/ACM Transactions on Networking (TON)*, 13(4):755–768, 2005.
- [33] ER Vale, MA Grivet, and JC Brandao. Reducing the VoIP packet overhead in UMTS air interface. In *Adaptive Science & Technology (ICAST), 2009*.
- [34] AA Florea, H Nguyen, L Martinod, and C Molko. Serial Progressive Hierarchical Turbo Codes. In *Global Telecommunications Conference (GLOBECOM), 2011*.
- [35] AA Florea, H Nguyen, L Martinod, and C Molko. Parallel progressive hierarchical turbo codes,. In *Wireless and Mobile Computing, Networking and Communications (WiMob), 2011*.
- [36] NSN White paper of Nokia. From voice over ip to voice over lte. 2013.
- [37] D Jiang, H Wang, E Malkamaki, and E Tuomaala. Principle and performance of semi-persistent scheduling for VoIP in LTE system. In *Wireless Communications, Networking and Mobile Computing (WiCom), 2007*.
- [38] Haiming Wang, Dajie Jiang, and Esa Tuomaala. Uplink capacity of voip on lte system. In *Communications, 2007. APCC 2007. Asia-Pacific Conference on*, pages 397–400. IEEE, 2007.
- [39] Yong Fan, Petteri Lundén, Markku Kuusela, and Mikko Valkama. Efficient semi-persistent scheduling for voip on eutra downlink. In *Vehicular Technology Conference, 2008. VTC 2008-Fall. IEEE 68th*, pages 1–5. IEEE, 2008.
- [40] Micheal. Semi-persistent scheduling (sps). [http://lteuniversity.com/get\\_trained/expert\\_opinion1/b/mccarthy/archive/2013/12/04/semi-persistent-scheduling-sps.aspx](http://lteuniversity.com/get_trained/expert_opinion1/b/mccarthy/archive/2013/12/04/semi-persistent-scheduling-sps.aspx), 2013.
- [41] R Susitaival and M Meyer. LTE coverage improvement by TTI bundling. In *Vehicular Technology Conference (VTC), 2009*.



- [42] J Han and H Wang. Principle and performance of TTI bundling for VoIP in LTE FDD mode. In *Wireless Communications and Networking Conference (WCNC), 2009*.
- [43] H Wang, J Han, and S Xu. Performance of TTI bundling for VoIP in EUTRAN TDD mode. In *Vehicular Technology Conference (VTC), 2009*.
- [44] S McBeath, J Smith, D Reed, H Bi, D Pinckley, A Rodriguez-Herrera, and J O'Connor. Efficient signaling for VoIP in OFDMA. In *Wireless Communications and Networking Conference (WCNC), 2007*.
- [45] Shweta Shrivastava, Mohammad M Rashid, and Rath Vannithamby. Group resource allocation for increasing voip capacity over wimax. In *Communications (ICC), 2010 IEEE International Conference on*, pages 1–5. IEEE, 2010.
- [46] Fan Yang and Xi Zhang. Adaptive transmission of voip packets using tti bundling in lte uplink. In *Information Sciences and Systems (CISS), 2014 48th Annual Conference on*, pages 1–5. IEEE, 2014.
- [47] Anastasios N Bikos and Nicolas Sklavos. Lte/sae security issues on 4g wireless networks. *Security & Privacy, IEEE*, 11(2):55–62, 2013.
- [48] Dan Forsberg, Günther Horn, Wolf-Dietrich Moeller, and Valtteri Niemi. *LTE security*. John Wiley & Sons, 2012.
- [49] Ghizlane Orhanou, Said El Hajji, and Youssef Bentaleb. Snow 3g stream cipher operation and complexity study. *Contemporary Engineering Sciences-Hikari Ltd*, 3(3):97–111, 2010.
- [50] Joan Daemen and Vincent Rijmen. *The design of Rijndael: AES-the advanced encryption standard*. Springer Science & Business Media, 2002.
- [51] Shadi Traboulsi, Nils Pohl, Josef Hausner, Attila Bilgic, and Valerio Frascolla. Power analysis and optimization of the zuc stream cipher for lte-advanced mobile terminals. In *Circuits and Systems (LASCAS), 2012 IEEE Third Latin American Symposium on*, pages 1–4. IEEE, 2012.
- [52] Frederic P Miller, Agnes F Vandome, and John McBrewhster. Advanced encryption standard. 2009.
- [53] David Lecompte and Frederic Gabin. Evolved multimedia broadcast/multicast service (eMBMS) in LTE-advanced: overview and Rel-11 enhancements. *Communications Magazine, IEEE*, 50(11):68–74, 2012.
- [54] Jose F Monserrat, Jorge Calabuig, Ana Fernandez-Aguilella, and David Gomez-Barquero. Joint delivery of unicast and e-mbms services in lte networks. *Broadcasting, IEEE Transactions on*, 58(2):157–167, 2012.
- [55] Li Zhang, Yi Cai, Zhiqiang He, Chunye Wang, and Peter Skov. Performance evaluation of lte mbms baseline. In *Wireless Communications, Networking and Mobile Computing, 2009. WiCom'09. 5th International Conference on*, pages 1–4. IEEE, 2009.
- [56] Contact Person. Performance evaluation of lte for mbsfn transmissions.

- 
- [57] Evolved Universal Terrestrial Radio Access (E-UTRA); Multiplexing and channel coding, 3GPP TS. 36.212 V11.4.0, Dec. 2013.
- [58] Francesco Capozzi, Giuseppe Piro, Luigi Alfredo Grieco, Gennaro Boggia, and Pietro Camarda. Downlink packet scheduling in lte cellular networks: Key design issues and a survey. *Communications Surveys & Tutorials, IEEE*, 15(2):678–700, 2013.
- [59] Tayal Nitin. All about PDCCH and CCE allocation. <http://www.test.org/doi/>.
- [60] Patrick Hosein. Resource allocation for the lte physical downlink control channel. In *GLOBECOM Workshops, 2009 IEEE*, pages 1–5. IEEE, 2009.
- [61] S Shrivastava and R Vannithamby. Group scheduling for improving voip capacity in iee 802.16 e networks. In *Vehicular Technology Conference, 2009. VTC Spring 2009. IEEE 69th*.
- [62] H Wang and D Jiang. Performance comparison of control-less scheduling policies for voip in lte ul. In *Wireless Communications and Networking Conference, 2008. WCNC 2008. IEEE*.
- [63] Hiroyuki Atarashi, Sadayuki Abeta, and Mamoru Sawahashi. Variable spreading factor-orthogonal frequency and code division multiplexing (vsf-ofcdm) for broadband packet wireless access. *IEICE transactions on communications*, 86(1):291–299, 2003.
- [64] Thit Minn and K-Y Siu. Dynamic assignment of orthogonal variable-spreading-factor codes in w-cdma. *Selected Areas in Communications, IEEE Journal on*, 18(8):1429–1440, 2000.
- [65] Yang Yang and T-SP Yum. Maximally flexible assignment of orthogonal variable spreading factor codes for multirate traffic. *Wireless Communications, IEEE Transactions on*, 3(3):781–792, 2004.
- [66] S Hara and R Prasad. Design and performance of multicarrier CDMA system in frequency-selective Rayleigh fading channels. *Vehicular Technology, 1999*.
- [67] S Tomoki and F Adachi. Comparative study of various frequency equalization techniques for downlink of a wireless OFDM-CDMA system. *IEICE transactions on communications*, 86(1):352–364, 2003.
- [68] Lajos L Hanzo, Matthias Münster, Byungcho Choi, and Thomas Keller. *OFDM and MC-CDMA for broadband multi-user communications, WLANs and broadcasting*. John Wiley & Sons, 2005.
- [69] Shinsuke Hara and Ramjee Prasad. Overview of multicarrier cdma. *IEEE communications Magazine*, 35(12):126–133, 1997.
- [70] MC Nguyen, H Nguyen, E Georgeaux, P Mege, L Martinot, and A Florea. Architecture for Multi-users Multiplexing Radio Voice Transmission for Enhancing Voice Capacity over LTE in PMR Context. *Personal, Indoor and Mobile Radio Communications (PIMRC), 2014*.

- [71] Xiaolin Hou, Zhan Zhang, and Hidetoshi Kayama. Dmrs design and channel estimation for lte-advanced mimo uplink. In *Vehicular Technology Conference Fall (VTC 2009-Fall), 2009 IEEE 70th*, pages 1–5. IEEE, 2009.
- [72] Xincheng Zhang and Xiaojin Zhou. *LTE-Advanced air interface technology*. CRC Press, 2012.