



HAL
open science

A qualitative spatio-temporal modelling and reasoning approach for the representation of moving entities

Jing Wu

► **To cite this version:**

Jing Wu. A qualitative spatio-temporal modelling and reasoning approach for the representation of moving entities. Geography. Université de Bretagne occidentale - Brest, 2015. English. NNT : 2015BRES0036 . tel-01199257v2

HAL Id: tel-01199257

<https://theses.hal.science/tel-01199257v2>

Submitted on 8 Jan 2019

HAL is a multi-disciplinary open access archive for the deposit and dissemination of scientific research documents, whether they are published or not. The documents may come from teaching and research institutions in France or abroad, or from public or private research centers.

L'archive ouverte pluridisciplinaire **HAL**, est destinée au dépôt et à la diffusion de documents scientifiques de niveau recherche, publiés ou non, émanant des établissements d'enseignement et de recherche français ou étrangers, des laboratoires publics ou privés.



THESE / UNIVERSITE DE BREST
sous le sceau de l'Université européenne de Bretagne
pour obtenir le titre de
DOCTEUR DE L'UNIVERSITE DE BREST
Spécialité : Géomatique
Ecole Doctorale des Sciences de la Mer

présentée par

Jing WU

Préparée à l'Unité Mixte de recherche (n° 3634)
Institut de Recherche de l'École Navale

A Qualitative Spatio-Temporal Modelling and Reasoning Approach for the Representation of Moving Entities

Thèse soutenue le 14 Septembre 2015
devant le jury composé de :

Jean-Philippe BBAU

Professeur des universités, Université de Bretagne Occidentale / *Examineur*

Thérèse LIBOUREL

Professeur des universités, LIRRM / *Rapporteuse*

Sébastien MUSTIÈRE

Docteur ès sciences (HDR), COGIT / *Rapporteur*

Lamia BELOUAER

Docteur ès sciences, IRENAV / *Examinatrice*

Min DENG

Professeur, Central South University, CHINA / *Co-directeur de thèse*

Christophe CLARAMUNT

Professeur des universités, IRENAV / *Co-directeur de thèse*



N° d'ordre :

THÈSE

présentée à

L'UNIVERSITÉ DE BRETAGNE OCCIDENTALE

pour obtenir le titre de

DOCTEUR DE L'UNIVERSITÉ DE BRETAGNE OCCIDENTALE

Mention Géomatique

par

Jing WU

A Qualitative Spatio-Temporal Modelling and Reasoning
Approach for the Representation of Moving Entities

soutenue le 14 Septembre 2015 devant la commission d'examen :

Composition du Jury

Rapporteurs : Pr. Thérèse LIBOUREL – LIRRM

Dr. Sébastien MUSTIÈRE – COGIT

Examineurs : Pr. Jean-Philippe BABAU – Université de Bretagne Occidentale

Dr Lamia BELOUAER – IRENav

Co-Directeur : Pr. Christophe CLARAMUNT – IRENav

Pr. Min DENG – Central South University, CHINA

ACKNOWLEDGMENTS

Pursuing a PhD degree has been a long journey. So much has happened and changed in my life during the last four years. Although the sorrow in my heart was so great that it almost crushed me, I am now rising from the ashes like a phoenix. I could by no means have carried out this work without the ongoing guidance, support, and friendship of many individuals. Whereas it would lead me too far to mention each name exhaustively, I would like to express my sincere gratitude to all the people that have helped me in any respect. Let me explicitly mention some of them.

I have to start by appreciating my parents, **Mr. Jiping WU** and **Ms. Chunlan YAO**, because their role is far greater than my Doctoral degree. I am indebted to them for raising me as an independent and hopeful individual; always trusting my decisions and having faith in me. More importantly, I am thankful to them for showing me by example that will and faith are the essentials to make life better.

I wish to thank my supervisor **Prof. Min DENG** for his openness to discuss and explore fresh ideas and his courage to face novel research challenges. I deeply appreciate giving me the opportunity to conduct my research in France at the IRENav.

I also owe my utmost gratitude to my supervisor **Prof. Christophe CLARAMUNT** for his admirable academic guidance and for his willingness to be always available for me. I highly commend his great enthusiasm and diligence, and also his excellent research skills and abundant sense of humour which have made working with him a great pleasure.

I gratefully recognize the Research Foundation – China Scholarship Council for funding my research in France.

Moreover, I want to extend my heartfelt thanks to all my friends – in China and in France – for their unwavering support throughout the years. Especially for those far away, it hasn't always been easy to keep in touch, but I still appreciate them being there for me.

Finally, special thanks to Buddha. Words cannot express how grateful I am to experience your guidance to explore the spirit world and to be a wise and happy woman.

*To see a world in a grain of sand,
And a heaven in a wild flower,
Hold infinity in the palm of your hand,
And eternity in an hour.*
---- *William Blake*

TABLE OF CONTENTS

Table of Contents.....	i
List of Figures	v
List of Tables.....	viii
INTRODUCTION	1
1 Problem Statement	2
2 Aim and Objectives.....	3
3 Approach Overview	4
4 Contributions	5
5 Thesis Structure	6
CHAPTER I: Related Work.....	9
I.1 Introduction	10
I.2 Qualitative Spatial and Temporal Representations	10
2.1 Qualitative Topological Relations.....	11
2.2 Qualitative Orientation Relations	15
2.3 Qualitative Distance Relations	18
2.4 Qualitative Temporal Relations	20
I.3 Qualitative Spatio-Temporal Reasoning	21
3.1 Conceptual Neighbourhoods.....	22
3.2 Composition Tables.....	23
I.4 Qualitative Movement Modelling	25
4.1 Space + Time Approaches	26
4.2 Integrated Space-Time Approaches	28
I.5 Movement Semantics.....	30

I.6 Discussion	32
CHAPTER II: Movement Patterns	35
II.1 Introduction	36
II.2 Modelling Principles	37
2.1 Primitive DL-RE Topological Relations	38
2.2 Dimensionality and Cardinality	39
2.3 Dimension Sequence of an Ordered Set of Spatial Entities	40
2.4 Neighbouring Discs on Intersection Points	40
II.3 Boundary-based Movement Pattern between One Directed Line and a Region.....	43
3.1 No Intersection	44
3.2 One 0-dimensional Intersection Point	44
3.3 One 1-dimensional Intersection Line	46
3.4 More than One Intersection	49
II.4 Orientation-based Movement Pattern between Two Directed Lines	52
II.5 Conclusion	57
CHAPTER III: Qualitative Representation of Moving Entities.....	59
III.1 Introduction	60
III.2 Spatio-Temporal Primitives.....	61
2.1 Temporal Primitives.....	61
2.2 Topological Primitives	63
2.3 Distance Primitives	64
III.3 Towards a Region-Region Movement Representation	66
3.1 Movement outside a Reference Entity	66
3.2 Movement on the Boundary of a Reference Entity	67
3.3 Movement inside a Reference Entity	68
III.4 Towards a Trajectory-Region Movement Representation	71
4.1 No Intersection	71
4.2 One 0-dimensional Intersection Point	73
4.3 One 1-dimensional Intersection line	75
III.5 Discussion.....	78

CHAPTER IV: Qualitative Reasoning on Moving Entities.....	81
IV.1 Introduction	82
IV.2 Continuous Transitions of Movements	82
2.1 CND for Region-Region Movements	83
2.1.1 Interpreting the CND.....	84
2.1.2 Similarity between Region-Region Movements	86
2.2 CND for Trajectory-Region Movements	88
IV.3 Composition Tables	89
3.1 A Composition Table for Region-Region Movements	90
3.2 Case Studies	91
3.2.1 Case study 1	91
3.2.2 Case study 2.....	92
3.2.3 Case study 3.....	94
IV.4 Conclusion.....	95
CHAPTER V: Experimental Applications	97
V.1 Introduction.....	98
V.2 Application to Air Transportation.....	98
2.1 Analysis of Flight Trajectories	99
2.2 Flight Trajectory Reasoning	105
V.3 Application to Maritime Transportation.....	107
3.1 Maritime Trajectory Patterns.....	107
3.2 Maritime Trajectory Reasoning	109
V.4 Conclusion	110
CHAPTER VI: Conclusions & Perspectives	113
VI.1 Outline.....	114
VI.2 Main Research Findings.....	114
VI.3 Perspectives	117
APPENDIX A: Résumé étendu de la thèse.....	121
A.1 Introduction.....	122

A.2 Patrons de Mouvements	123
2.1 Principes de Modélisation	124
2.2 Patrons de Mouvements Orientés Frontière entre une Ligne Orientée et une Région	124
2.3 Patrons de Mouvements Basés sur des Relations d’Orientations entre deux Lignes Orientées	125
A.3 Représentation Qualitative de Mouvement d’Entités.....	126
3.1 Primitives Spatio-temporelles.....	126
3.2 Vers une Représentation de Mouvements Région-Région.....	127
3.3 Vers une Représentation d’une Trajectoire-Région.....	127
A.4 Raisonnement Qualitatif sur des Entités Mobiles	129
4.1 Transitions Continues de Mouvements	129
4.2 Tables de Composition.....	130
A.5 Applications Expérimentales	130
5.1 Application au Transport Aérien	130
5.2 Application au Transport Maritime	131
A.6 Conclusion	132
APPENDIX B: List of Publications	135
APPENDIX C: Short Curriculum Vitae	137
REFERENCES	141

LIST OF FIGURES

Figure 1 Research domains covered by the research.....	3
Figure 2 General outline of the thesis	7
Figure I.1 Graphic representation of the RCC calculus	13
Figure I.2 Cardinal directions between two points in 2D space: (a) cone-based model; (b) projection-based model; (c) projection-based model with neutral zone.....	16
Figure I.3 LR relations	17
Figure I.4 DRA relations.....	17
Figure I.5 OPRA ₂ relations	18
Figure I.6 Qualitative absolute distances	19
Figure I.7 Distance-based relations between δ_i s	20
Figure I.8 Thirteen temporal relations between two temporal intervals I_1 and I_2	21
Figure I.9 CND of RCC8 (Randell et al. 1992).....	23
Figure I.10 Illustration of QTC	27
Figure I.11 Trajectory configurations example $A(v^+ p^+)B$ (Noyon et al. 2007).....	28
Figure I.12 A region in space-time which is not continuous	29
Figure I.13 Two men walking along a street.....	33
Figure II.1 Representing movement by a directed line.....	37
Figure II.2 Topological configurations of two endpoints of \vec{L} and a region.	39
Figure II.3 Dimensional intersections.....	40
Figure II.4 A neighbouring disc $\text{neigh}(p)$	41
Figure II.5 Local characteristics of the intersections of neighbouring discs	43

Figure II.6 Classification of DL-RE topological relations.....	49
Figure II.7 Movement patterns representation: (a) several vessels towards or from one region; (b) one vessel moves across different regions.....	52
Figure II.8 The named primitives defined by the HBT model.....	53
Figure II.9 Some Disjoint relations cannot be distinguished by HBT model.....	54
Figure II.10 Some Cross/touch relations cannot be distinguished by HBT model.....	54
Figure II.11 Reference system of the DOR model.....	54
Figure II.12 Body-body intersections between directed lines.....	55
Figure II.13 Examples of configurations between directed lines.....	56
Figure III.1 Temporal primitives.....	62
Figure III.2 Distance between two moving entities at continuous time instant.....	65
Figure III.3 Movement outside a reference entity.....	67
Figure III.4 Movement on the boundary of a reference entity.....	68
Figure III.5 Movement inside a reference entity.....	70
Figure III.6 Movement semantics of a man that enters a room.....	70
Figure III.7 Trajectory configurations outside a reference entity.....	72
Figure III.8 Trajectory configurations inside a reference entity with no intersection.....	73
Figure III.9 Trajectory configurations with one 0-dimensional intersection point.....	75
Figure III.10 Movement configurations with one 1-dimensional intersection line.....	78
Figure III.11 Movement with respect to a region with a broad boundary.....	79
Figure III.12 Degenerated cases for region-region movement.....	80
Figure IV.1 CND for region-region movements.....	83
Figure IV.2 Continuous transitions of moving A over a larger region B.....	84
Figure IV.3 Continuous transitions of A moving over a smaller region B.....	85
Figure IV.4 Continuous transitions of A moving over a region B of equal size and shape.....	86
Figure IV.5 An example of region-region movements' similarity.....	87

Figure IV.6. CND for trajectory-region movements	89
Figure IV.7. Relative movements between a man A, a car B and a parking lot C	92
Figure IV.8. Relative movements between a storm A, a boat B and a fishing area C	93
Figure IV.9. Relative movements between two men and the room	94
Figure V.1. Flight trajectory configurations	99
Figure V.2. Primitive trajectory configurations over the example of Ireland	101
Figure V.3. The sequence of motion event “PassThrough”	102
Figure V.4. Comparison of trajectory events	105
Figure V.5. Possible evolution of a flight trajectory	106
Figure V.6. Maritime trajectory patterns	109
Figure V.7. Forward trajectory patterns.....	110
Figure VI.1. Primitive movement patterns: (a) between a directed line and a region; (b) between two directed lines.....	116
Figure A.1. Mouvements élémentaires entre une ligne orientée et une région.....	125
Figure A.2. Mouvements élémentaires entre deux lignes orientées	126
Figure A.3. Configurations de mouvement Région-Région: (a) extérieur d’une entité de référence; (b) frontière d’une entité de référence; (c) à l’intérieur d’une entité de référence	128

LIST OF TABLES

Table I.1 Topological relations defined from the connection C relation (Cohn et al. 1997)	12
Table I.2 Composition table for RCC8	25
Table II.1 Orientation-based movement patterns	56
Table IV.1 Conceptual distances between region-region movements.....	88
Table IV.2 Composition table of region-region movements	91
Table IV.3 Composition table between a man A, a bus B and a parking lot C	92
Table IV.4 Composition table between a storm A, a boat B and a fishing area C	93
Table IV.5 Composition table between two men and a room.....	94
Table V.1. The number of different primitive configurations in various time intervals ..	100
Table V.2. The number of flights regarding different motion events.....	104
Table VI.1. Summary of the proposed modelling contributions	115



The research developed by this Ph.D. thesis (doctorat mention géomatique) is centered on the representation of moving entities in a qualitative way that should reflect as much as possible human cognitive capabilities. The motivation behind this research originates from the necessity to find formal and computational solutions for describing and reasoning on objects' movements in geographical spaces. We formalize an approach that represents qualitative movements based on several spatio-temporal relations, and provides a series of reasoning methods to derive, describe and analyse possible movements.

This introductory chapter develops the main motivations and results of our research. Section 1 provides a brief introduction to qualitative spatio-temporal models and natural language approaches closely related to our work. The aim and objectives of our research are set out in Section 2. An overview of the approach developed is given in Section 3, while Section 4 describes our main contributions. Finally, Section 5 summarizes the structure of the thesis.

1 Problem Statement

Nowadays, many environmental and urban sciences require novel approaches for a better integration of the time dimension within Geographical Information Systems (GIS). Although current GISs have been largely applied over the past forty years (Goodchild 2009; Bhatt et al. 2011), the world cannot be represented and reproduced objectively if its representation is limited to static objects and spatial relationships. A series of spatio-temporal formalisms have been developed over the past few years for the representation of geographical data, even when only partial or imprecise information is available (Harmelen et al. 2008; Ligozat 2012; Claramunt and Stewart 2015). Such modelling approaches have contributed to the development of many contributions such as spatio-temporal representation of evolving spatial entities (Claramunt et al. 1997a; Hornsby and Egenhofer 2000; Erwig and Schneider 2002), spatio-temporal reasoning frameworks (Galton 2004; Wallgrün, 2010; Delafontaine et al. 2011; Stell et al. 2011; Chen et al. 2013), models oriented to the representation of trajectories and activity patterns (Van de Weghe 2004, 2005; Delafontaine et al. 2008), as well as formal models close to human cognition and natural language (Álvarez-Bravo et al. 2006; Pustejovsky and Moszkowicz 2011). It clearly appears from these works that qualitative spatial reasoning provides valuable representation and reasoning capabilities for the manipulation of geographical data.

A qualitative spatio-temporal model should have the capability to represent and manipulate spatial, temporal and semantic information. Such a model should also track changes at the local level in order to not only observe them at the local level, but also derive patterns at a more global level. This implies to represent the spatio-temporal semantics closely associated to these entities in space and time, and the static and dynamic properties associated to them (i.e., events, processes), changes and the spatio-temporal relationships that emerge. This leads us to examine how a given dynamic environment is perceived and interpreted by humans, and how such interpretations can be formally described. The advantage of such an approach is that it will have the advantage of being close to the way human beings perceive and reason about change, this providing a necessary step towards a better formal and system representation in a computerized system.

Natural language is naturally used to express moving entities' status and movement patterns as those are perceived. Although humans have excellent cognitive and efficient capabilities to interpret natural language expression, the formal description of motion as

denoted by language expressions still poses a challenge to the qualitative spatio-temporal reasoning community. The problem here is to find out an appropriate framework to characterize those language expressions, and to model them using an appropriate reasoning language. We believe that a formal characterization of motion and changes as interpreted by natural language will give new insights to the development of temporal GISs. Such an approach is very likely to take into account the semantics that emerge from dynamic systems, and then generate a formal language that will later favour development of manipulation languages required for a successful application of temporal GIS to many environmental and urban systems.

Overall, this research is oriented towards the qualitative representation and manipulation of moving entities. The research is grounded on three research domains including knowledge representation and reasoning, natural language processing, and GIS as illustrated in Figure 1. Knowledge representation and reasoning brings the principles and approaches on which our model will be built. Natural language processing provides a series of concepts to enhance human-computer intersection, while GIS is the preferred domain context of our modelling approach.

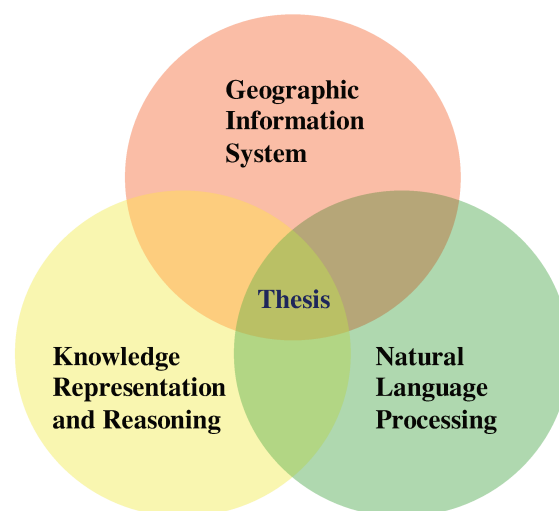

Figure 1 Research domains covered by the research

2 Aim and Objectives

From the problem statement, the aim of this thesis is to investigate the development of a qualitative spatio-temporal representation and reasoning approach for moving entities. To carry out our investigation, we set out the following research objectives:

- to identify and model the basic movement patterns derived from qualitative spatio-temporal relations that qualify moving entities;
- to develop a formalism that models and describes the qualitative spatio-temporal relations of moving entities embedded in a 2-dimensional space;
- to propose some reasoning mechanisms to deal with incomplete movement knowledge;
- to apply the formal and qualitative movement representation to experimental real-world applications.

3 Approach Overview

By taking into account the complementary properties of spatial and temporal data, the approach proposed in this thesis is based on a fundamental principle: space constitutes in itself a trace of time. The concept of movement clearly denotes the successive spatial locations of a moving entity. Our approach explores a modelling representation of movement based on an integration of qualitative topological, distance, and temporal relations. The approach is complemented by a systematic representation of possible configurations, and a tentative qualification of possible natural language expressions of the different cases identified. The conceptual transitions can be applied to evaluate the possible changes of a configuration or to measure the similarity between different configurations, as well as composition tables can generate new relations when two existing relations share a common entity. The advantage of such derivation mechanisms is that it offers additional reasoning capabilities over or the analysis of qualitative movements.

The major constraints taken into consideration by our approach for representing and reasoning over moving entities in a qualitative way are as follows:

(1) **Representing a moving entity**

A moving entity can be abstracted as a point, line, or region, as well as spatially related to a collection of entities among which networks and partitions have been often used as background spatial structures (Güting and Schneider 2005). As moving lines can be found in geographical spaces but are not the most common objects in daily life, we focus on the following types of moving entities:

- **Moving point:** the basic abstraction of a physical entity (0-dimensional entity) moving around in the plane or a higher-dimensional space, for which only the position, but not the extent, is relevant. In many real-world contexts, entities can be represented as moving points when this is sufficient from an application point of view. Examples are people, animals, aircrafts, ships, cars, and so on.
- **Moving region:** an entity in the plane that changes its position as well as its extent and shape (i.e., a moving region may not only move but also grow and shrink). Examples are hurricane, oil spills, forest fires and so on.

(2) **Relative view of two moving entities**

Moving entities may behave differently whether they are moving alone, or in relation with another entity. Our approach describes not only the movement characteristics of an observed entity, but also in relation with a reference entity.

(3) **Movement context**

Movements can occur in a free space (e.g., a bird flying through the sky) or can be spatially restricted by certain factors (e.g., a robot moving in an indoor space). We study the representation of movement under both contexts, and restrict our attention to a two-dimensional space, which is commonly used as a projection of the three-dimensional physical space.

4 Contributions

The research presented in this thesis makes several contributions to the field of spatio-temporal modelling and the representation of qualitative movement. The major contributions of this work are as follows:

- Movement patterns are formally described and derived from a systematic study of the spatial relations that qualify two moving entities. As the reference entity can be either a region or a line, we introduce two formal models for deriving movement patterns based on topological relations between the trajectory of a moving entity and a reference region, and orientation relations between two trajectories. These formal models integrate topological relations with qualitative distances over a spatial and temporal framework in order to represent the qualitative movement of moving regions and moving points, respectively. Movement semantics are also given for each primitive movement, and all configurations of movement patterns identified are qualified by natural language expressions.

- The modelling framework supports reasoning capabilities over movement patterns. Conceptual neighborhood diagrams and composition tables are introduced and allow for a derivation of possible movements in cases of incomplete knowledge.

5 Thesis Structure

The remainder of this thesis is organized as follows:

Chapter I discusses the relevant literature background for the subsequent approaches. Current formalisms and spatial models oriented to the representation of spatial and temporal relations, theoretical supports and formal modelling and reasoning approaches developed for a representation of qualitative movement, as well as current spatial models for the representation of topological relations under uncertainty are studied.

Chapter II introduces a series of topological properties that describe the spatial configuration of a directed line with respect to a region in a two-dimensional space. The movement patterns of moving entities are modelled based on boundary of the reference region and the orientation relations, respectively.

Chapter III introduces two formal models for a qualitative movement representation of a moving entity which is characterized either as spatially extended or as a point.

Chapter IV develops some reasoning mechanisms for the manipulation of entity movements in case of incomplete knowledge. We apply the notion of conceptual neighborhood diagram and composition tables. A series of case studies illustrate the whole approach.

Chapter V presents an application of the modelling approach to the aviation and maritime domains. The trajectories of either a plane or a vessel are modelled, analyzed, this offering several reasoning opportunities based on our approach.

Chapter VI. While each chapter contains a summary of its results, this concluding chapter lists the contributions of the thesis as a whole and provides a series of possible extension and application of our research.

Figure 2 presents and illustrate the overall structure of this thesis.

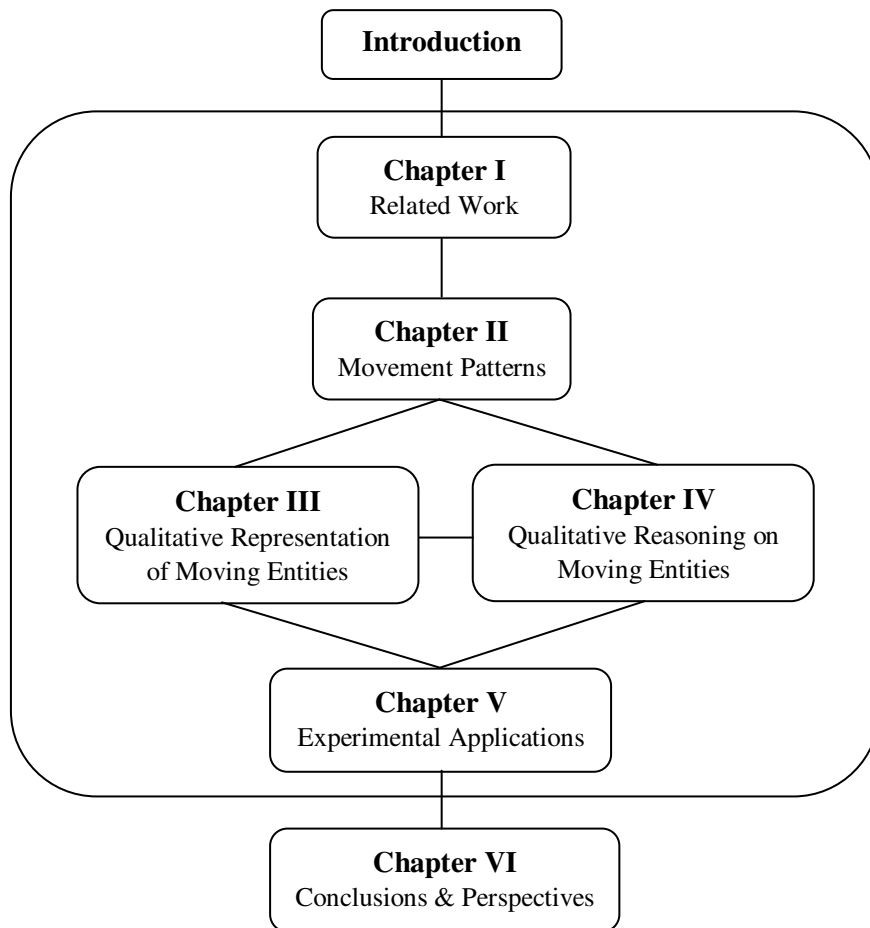

Figure 2 General outline of the thesis



Related Work

I.1	INTRODUCTION.....	10
I.2	QUALITATIVE SPATIAL AND TEMPORAL REPRESENTATIONS.....	10
2.1	QUALITATIVE TOPOLOGICAL RELATIONS	11
2.2	QUALITATIVE ORIENTATION RELATIONS	15
2.3	QUALITATIVE DISTANCE RELATIONS.....	18
2.4	QUALITATIVE TEMPORAL RELATIONS	20
I.3	QUALITATIVE SPATIO-TEMPORAL REASONING	21
3.1	CONCEPTUAL NEIGHBOURHOODS.....	22
3.2	COMPOSITION TABLES.....	23
I.4	QUALITATIVE MOVEMENT MODELLING	25
4.1	SPACE + TIME APPROACHES	26
4.2	INTEGRATED SPACE-TIME APPROACHES.....	28
I.5	MOVEMENT SEMANTICS.....	30
I.6	DISCUSSION	32

I.1 Introduction

This chapter presents a brief review of a series of research contributions closely related to our research. The chapter successively introduces recent work on the development of qualitative spatial and temporal representations, spatio-temporal reasoning mechanisms, qualitative representations of movement and semantic-based movement approaches. This chapter is by no means an exhaustive overview but merely points out some of the most noteworthy approaches that have influenced our work. The whole contributions are summarized in the conclusion of the chapter.

I.2 Qualitative Spatial and Temporal Representations

Qualitative calculi usually deal with elementary spatial entities (e.g., points, regions) and qualitative relations between them (e.g., “touch”, “to the right of”). This is one the reasons why qualitative representations are generally well understood by humans. However, it appears that the modelling of spatial qualitative relations, when combined with the temporal dimension, is not a straightforward task (Peuquet and Duan 1995). This stresses a need for the development of knowledge representations that should support humans’ knowledge representations of spatial, temporal and spatio-temporal information. By imposing discrete and symbolic frameworks on real-world phenomena, qualitative spatio-temporal representations are likely to provide a bridge between the perceptual and conceptual levels, and then a formal and computational support for qualitative spatio-temporal reasoning.

Within GIS, real-world phenomena are usually represented by two sorts of conceptual realms: continuous and discrete. While continuous approaches generally provide structural representations based on either regular or irregular tessellations and the distribution of a continuous variable that can be mathematically modelled or approximated in some specific cases, discrete approaches represent spatial entities by appropriate geometrical primitives (e.g., points, lines, polygons) and some structural properties and relations (e.g., topological and orientation relations) (Latecki 1998). In fact, and due to a certain degree of variability and uncertainty in the perception and abstraction of many real-world phenomena, the spatial entities that emerge according to a given domain of study can be considered as either well-defined (i.e., crisps) or fuzzy entities (Leung and Yan, 1997). In

the context of our research, the focus is on well-defined and precisely defined spatial entities.

2.1 Qualitative Topological Relations

One of the most foundational qualitative representations of space has been based on topology. Topology, also known as rubber sheet geometry (Vieu 1997), is mainly concerned with the properties of geometric objects (such as dimensionality, boundaries, and number of holes) that are invariant under some homeomorphisms such as translation, rotation and scaling. Several properties, so-called invariants, are preserved by topological transformations such as dimension, connectivity, separation and intersection. For instance, if there is a drawing on a rubber sheet, the topological properties of the drawing remain unchanged when the rubber sheet is distorted by stretching, twisting, or bending. However, other transformations such as tearing, puncturing, or inducing self-intersection do affect topological properties and relations (Mortensen 1997).

Over the last three decades, a large variety of formal approaches oriented to the representation of topological relations have been proposed by many scholars from a variety of fields and extensively applied to the representation of topological information within spatio-temporal databases (Güting and Schneider 2005; Tossebro 2011), spatial reasoning in artificial intelligence (Li and Cohn 2012), and representation of natural-language relations (Xu 2007; Praing and Schneider 2009) to mention a few examples. Most of these approaches can be classified into two categories, i.e., region-based and point set approaches. In the former approaches a spatial entity is considered as a whole, while in the latter approaches a spatial entity is represented in terms of the set of its components. According to the dimension of the spatial entities considered in a two-dimensional vector space (\mathbb{R}^2), six types of spatial configuration can be distinguished, including point-point, point-line, point-region, line-line, line-region and region-region. As the configurations involving point objects (i.e. point-point, point-line and point-region) are relatively straightforward, most of the efforts have been oriented to the cases involving lines or regions.

2.1.1 Region-based Approaches

The region-based approaches take spatial regions as the basic modelling primitives. A spatial region is an atomic and non-null unit that cannot be subdivided into an interior and a boundary as permitted by point set topology. The best known approach is the Region

Connection Calculus (RCC) (Randell et al. 1992) which is developed on the spatial counterpart of the Interval Calculus applied to spatio-temporal reasoning (Clarke 1981; Clarke 1985) and based on the connection of entities. Connectivity is a fundamental relation in this context when determining whether and how two entities might interact. The primitive relation in RCC is $C(x,y)$, defined as region x connects with region y , which holds when the regions x and y share a common point. Based on the primitive relation $C(x,y)$, a set of basic topological relations are defined (Table I.1) and has led to a rich calculus of spatial predicates and relations.

Relation	Interpretation	Definition of $R(x,y)$
$DC(x,y)$	x is disconnected from y	$\neg C(x, y)$
$P(x,y)$	x is a part of y	$\forall z[C(z, x) \rightarrow C(z, y)]$
$PP(x,y)$	x is a proper part of y	$P(x, y) \wedge \neg P(y, x)$
$EQ(x,y)$	x is identical with y	$P(x, y) \wedge P(y, x)$
$O(x,y)$	x overlaps y	$\exists z[P(z, x) \wedge P(z, y)]$
$DR(x,y)$	x is discrete from y	$\neg O(x, y)$
$PO(x,y)$	x partially overlaps y	$O(x, y) \wedge \neg P(x, y) \wedge \neg P(y, x)$
$EC(x,y)$	x is externally connected to y	$C(x, y) \wedge \neg O(x, y)$
$TPP(x,y)$	x is a tangential proper part of y	$PP(x, y) \wedge \exists z[EC(z, x) \wedge EC(z, y)]$
$NTPP(x,y)$	x is a nontangential proper part of y	$PP(x, y) \wedge \neg \exists z[EC(z, x) \wedge EC(z, y)]$

Table I. 1 Topological relations defined from the connection C relation (Cohn et al. 1997)

The RCC calculus provides a powerful algebra to represent and make a difference between complex entities such as doughnuts or loops (Gotts et al. 1996), as well as it has been extended to the integration of uncertainty (Schockaert et al. 2009). By removing redundant relations and using the converse relation of TPP and NTPP, the RCC8 calculus is composed of eight mutually exclusive and jointly exhaustive relationships: DC, EC, PO, EQ, TPP, NTPP, TPPI, NTPPI. If the boundary of the region is not considered, some of the RCC8 relations are grouped and overall reduced to five relations, which is known as RCC5. Figure I.1 presents the graphic representation of the RCC8 and RCC5 relations.

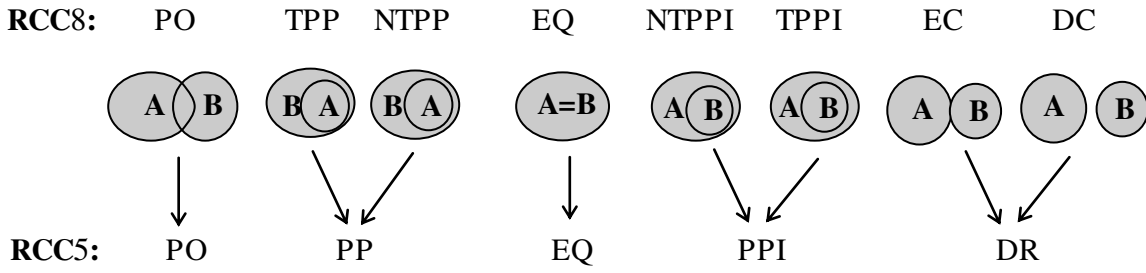

Figure I.1 Graphic representation of the RCC calculus

2.1.2 Point-Set Approaches

Point-set approaches consider a set of points as the basic modelling primitive and define topological relations from point-set topology (Alexandroff 1961). A series of formal models of topological relations have been suggested, and where the main properties of the regions are the interior, boundary, exterior and the dimension of a set of points.

The 4-Intersection Model (4IM) (Egenhofer and Franzosa 1991) formally models topological relations between two spatial entities through the intersection sets of interiors and boundaries of two point sets. Considering empty and non-empty as the values of the intersections, the 4IM model can distinguish 2 cases of topological relations for the point-point group, 3 cases for the point-line group, 3 cases for the point-region group, 16 cases for the line-line group, 13 cases for the line-region group, and 8 cases for two simple regions (i.e., 2-dimensional connected regions with connected boundaries).

Egenhofer and Herring (1991) extended the 4IM to a 9-Intersection Model (9IM) taking into consideration exterior intersections. The 9IM can be regarded as a refinement of 4IM. Moreover, this binary topological relation model is also based on the concepts of point-set topology with open and closed sets. The binary topological relations between two spatial entities, A and B , in \mathbb{R}^2 are based upon the intersection of A 's interior (A°), boundary (∂A), and exterior (A^-) with B 's interior (B°), boundary (∂B), and exterior (B^-). The nine intersections between the respective entity's parts are used for describing a topological relation and can be concisely represented by a 3×3 matrix, i.e.,

$$M_{91}(A, B) = \begin{bmatrix} A^\circ \cap B^\circ & A^\circ \cap \partial B & A^\circ \cap B^- \\ \partial A \cap B^\circ & \partial A \cap \partial B & \partial A \cap B^- \\ A^- \cap B^\circ & A^- \cap \partial B & A^- \cap B^- \end{bmatrix} \quad (I.1)$$

The 9IM can distinguish $2^9=512$ types of binary topological relations. However, only a small subset of them is plausible for spatial entities embedded in \mathbb{R}^2 (Egenhofer and Herring 1991; Clementini et al. 1993). For example, the 9IM can identify 2 cases for the

point-point group, 3 cases for the point-line group, 3 cases for the point-region group, 33 cases for line-line group, 19 cases for the line-region group, and 8 cases for region-region group. The 8 topological relations between regions are: disjoint, overlaps, meets, equals, inside, contains, covers, and covered-by. These correspond once more to the RCC relations (Cohn 1996), with: disjoint = DC, overlaps = PO, meets = EC, equals = EQ, inside = NTPP, contains = NTPPI, covers = TPP, and covered-by = TPPI.

Due to the fact that either 4IM or 9IM cannot identify the resulting dimension of the intersections, Clementini et al. (1993) developed the Dimension Extended Model (DEM) by deriving the dimension of the intersection set. This model may be represented by:

$$M_D(A, B) = \begin{bmatrix} \text{Dim}(A^\circ \cap B^\circ) & \text{Dim}(A^\circ \cap \partial B) \\ \text{Dim}(\partial A \cap B^\circ) & \text{Dim}(\partial A \cap \partial B) \end{bmatrix} \quad (\text{I.2})$$

In Equation I.2, the dimension of intersections is defined by the following function, i.e.

$$\text{Dim}(\cdot) = \begin{cases} -1, & \text{If the intersection set is empty} \\ 0, & \text{If the intersection set contains at least a point and no lines or areas} \\ 1, & \text{If the intersection set contains at least a line and no areas} \\ 2, & \text{If the intersection set contains at least an area} \end{cases}$$

Theoretically, there are $4^4=256$ different topological cases that can be distinguished by the DEM. However, geometric constraints for specific groups of relations can be applied to reduce the number of cases due to the fact that the dimension of the intersection cannot be higher than the lowest dimension of the two operands of the intersection. Taking the line-line group as an example, the dimension of the intersection of the interiors of two entities only possibly assumes the values: -1 and 0 due to the limit of the dimension of the entity itself. Regarding the DEM, 2 cases for the point-point group, 3 cases for the point-line group, 3 cases for the point-region group, 18 cases for the line-line group, 17 cases for the line-region group, and 9 cases for the region-region group can be identified. In order to provide a more user-oriented modelling method, the Calculus Based Method (CBM) (Clementini et al. 1993) identified five topological relations under the condition that only boundary operators are available: touch, in, cross, overlap, and disjoint. Clementini and Di Felice (1994) proved that the CBM is more expressive than the 9IM or DEM and could be regarded as the minimal set to represent all 9IM and DEM relations.

Apart from these generic models that are nowadays considered as the main spatial reasoning references within GIS, other efforts have been made on the development of models dedicated to specific types of features, e.g. line-line relations (Clementini and Di

Felice 1998; Li and Deng 2006) and line-region relation models (Egenhofer and Franzosa 1995; Kurata and Egenhofer 2007; Deng 2008).

2.2 Qualitative Orientation Relations

Qualitative orientation relations describe how two spatial entities are placed one relative to the other. They can be defined in terms of three basic concepts: the primary object, reference object and frame of reference (Clementini et al. 1997). Orientation relations are important complementary qualitative relations because topological relations alone are insufficient in many situations as they cannot encompass all the semantics of a given spatial configuration.

Orientation relations can be defined as absolute orientations (e.g., cardinal) or relative orientations. By applying directional abstractions (e.g., North, Northeast, East, Southeast, South, Southwest, West, and Northwest), Frank (1991, 1992) divides the 2D space around a reference object into cone-shaped areas (Figure I.2a) or 4 partitions using a projection-based approach (Figure I.2b). Moreover a neutral zone, which is an area around the reference object where no direction is defined, can be added to divide the neighboring space into 9 areas (Figure I.2c). Then Frank (1996) compared the three representations and showed that the projection-based representation with a neutral zone was more efficient than the others in terms of spatial reasoning capabilities. Similar to the projection-based approach with a neutral zone, the direction-relation matrix (Goyal and Egenhofer, 2001) approximates the reference object by its minimum bounding rectangle and defines 9 regions around it. A 3×3 matrix (Equation I.3) is used to calculate the intersection of the primary region with the 9 regions.

$$\text{Dir}(A, B) = \begin{bmatrix} \frac{\text{Area}(NW_A \cap B)}{\text{Area}(B)} & \frac{\text{Area}(N_A \cap B)}{\text{Area}(B)} & \frac{\text{Area}(NE_A \cap B)}{\text{Area}(B)} \\ \frac{\text{Area}(W_A \cap B)}{\text{Area}(B)} & \frac{\text{Area}(O_A \cap B)}{\text{Area}(B)} & \frac{\text{Area}(E_A \cap B)}{\text{Area}(B)} \\ \frac{\text{Area}(SW_A \cap B)}{\text{Area}(B)} & \frac{\text{Area}(S_A \cap B)}{\text{Area}(B)} & \frac{\text{Area}(SE_A \cap B)}{\text{Area}(B)} \end{bmatrix} \quad (\text{I.3})$$

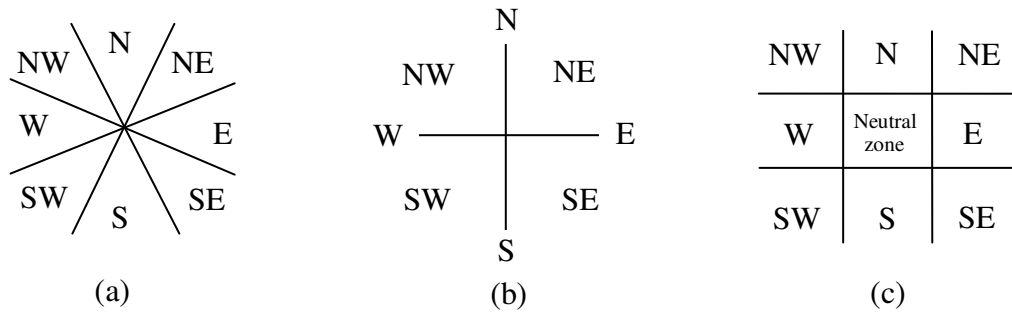

Figure I.2 Cardinal directions between two points in 2D space: (a) cone-based model; (b) projection-based model; (c) projection-based model with neutral zone

The calculi describing relative orientations are mainly based on three different kinds of primitive entities that are closely related: a tuple of points, directed line segment and oriented point. A tuple of points can be regarded as a line segment, a directed line segment L can be represented by its start point s_L and end point e_L , while an oriented point can be modelled as a directed line segment of infinitesimally small length.

An example of calculi based on point tuples is the Flip-Flop calculus (Ligozat 1993) which has been later refined to the LR calculus by Scivos and Nebel (2004). Further examples of calculi of this kind are single- and double-cross calculus (Freksa 1992b). The Ternary Point Configuration Calculus (TPCC) (Moratz et al. 2003; Dylla and Moratz 2004) is calculus based on ternary relations complemented by qualitative distance measurements based on two of the three points. A reference frame for the LR calculus is given by a tuple of points $\langle A, B \rangle$. For $A \neq B$, the frame is a directed line segment from A to B written as \overline{AB} as shown in Figure I.3. A ray being collinear to \overline{AB} and having the same direction divides the Euclidean plane into three sections: the half-plane to the left of the ray (l); the half-plane to the right of the ray (r); and the ray itself. The ray itself is divided into segments by points A and B : The segment behind A (b); the start point A (s); the segment in-between A and B (i); the end point B (e) and the segment in front of B (f). Given a third point C , the orientation relation R use the symbols introduced above can be written as

$$(A B R C) \quad (I.4)$$

For example, in Figure I.3, C lies to the right of the ray, expressed as $(A B r C)$. The seven relations are defined by Flip-Flop calculus, in which the case of $A = B$ are lacking. In that case, dou for $A = B \neq C$ and tri for $A = B = C$ has been introduced in the LR calculus.

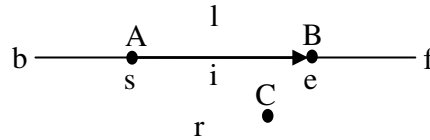

Figure I.3 LR relations

The arrangement of the intervals can be horizontal or vertical, and it is possible to change their orientations within a range of 360° in the two-dimensional plane. Gottfried (2004) provides a set of relations based on line segments to represent both positional and orientation information. Schlieder (1995) developed the Line Segment Calculus but without the possibility to express polylines. Further refinements by Moratz et al. (2000) lead to the Dipole Relation Algebra (DRA) with the ability to express relations and qualitative angles between line segments in any position. The reference frame of these calculi is a directed line segment (also called a dipole) in the Euclidean plane with non-zero length. A dipole A is formed by a tuple of its start point and end point $\langle s_A, e_A \rangle$. The set of 7 different dipole-point relations are used to distinguish the location and orientation of different dipoles. Take the DRA_f (f stands for fine grained) in Figure I.4 as an example, the relations between two dipoles may be specified according to the following four relationships:

$$AR_1 s_B \wedge AR_2 e_B \wedge BR_3 s_A \wedge BR_4 e_A \quad (I.5)$$

where $R_i \in \{l, r, b, s, i, e, f\}$ with $1 \leq i \leq 4$. Theoretically this leads to 2401 relations, out of which 72 relations are geometrically possible. DRA_{fp} is an extension of DRA_f with additional qualitative angle information due to “parallelism”.

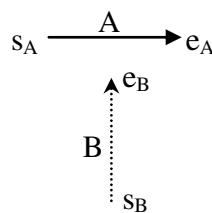
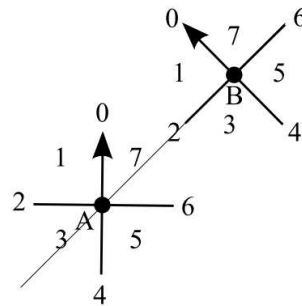

Figure I.4 DRA relations

The calculus that considers oriented points is the Oriented Point Relation Algebra (Moratz 2006) which is abbreviated as OPRA or $OPRA_m$, where $m \in \mathbb{N}$ is a parameter that determines the granularity of the reference frames. The oriented point is based on the perception of a spatial entity (e.g., a car) moving in space with a certain direction. The

motivation for this abstraction is quite the same as for the dipole calculi introduced above but it disregards any possible lengths of the entities. The oriented point is defined as a tuple $\langle p, \varphi \rangle$, where p is a coordinate in \mathbb{IR}^2 and φ an angle to an arbitrary but fixed axis. The plane around each oriented point is sectioned by m lines with one of them having the same orientation as the oriented point itself. The angles between all lines are equal. The linear sectors (on the lines) and planar sectors (between two lines) are numbered from 0 to $4m-1$ counterclockwise. The label 0 is assigned to the orientation of the oriented point. Given an oriented point A , an OPRA_2 reference frame is constructed as the line through the point A being collinear to its direction and a line through A being perpendicular to the previous one as shown in Figure I.5. The plane is segmented into 4 linear and 4 planar sectors which are assigned numbers from 0 to 7 counterclockwise. For another oriented point B , the same reference frame is also constructed. If A disjoint B , the OPRA_2 relation $A_2 \angle_i^j B$ is defined according to the sector in which the oriented point lies: i is the sector of the reference frame of A in which B lies and j is the sector of the reference frame of B in which A lies. The relation in Figure I.5 is $A_2 \angle_7^2 B$. If A meet B , then i is set to s , and j is the sector of the reference frame of A which B points into.

Figure I.5 OPRA_2 relations

2.3 Qualitative Distance Relations

The perception of the concept of distance, which is a fundamental concept in everyday life, is closely dependent upon both culture and experience (Lowe and Moryadas 1975). On the one hand quantitative approaches avoid these contextual issues by reducing all distance information to an absolute metric scale. On the other hand, qualitative distance relations can be modelled by relative distances or by a combination of absolute and relative distances. An absolute distance between two spatial entities can be directly computed

based on their positions, while a relative distance can be obtained by comparing the distance to a third entity, i.e. closer than, equidistant, or further than.

For the former approaches, Hernandez et al. (1995) introduces a relative set of distance distinctions at different levels of granularity. This model makes a difference between close, medium, and far, or a another level of granularity between five distinctions very close, close, commensurate, far, and very far as illustrated in Figure I.6. Distance-based reasoning frameworks can be further refined by additional spatial relations. For instance, Hernandez's work has been extended by Clementini et al. (1997) to include orientation relations. This model is made up of an ordered sequence of distance relations and a set of orientation relations. Each distance relation is defined under an acceptance area which can be uniquely identified with consecutive spatial intervals $(\delta_0, \delta_1, \dots, \delta_n)$ surrounding a reference entity. The relations between δ_i s are defined according to the distance-based relations, which can be used to specify a monotonicity property (δ_i are increasing) (Figure I.7a), or the order of magnitude relationships ($\delta_i + \delta_j \sim \delta_i$ for $j < i$) (Figure I.7b). So far several calculi have been suggested based on a primitive which combines both distance and orientation information. Zimmermann and Freksa (1993) introduced a primitive which defines the relative position of a point with respect to a directed line segment. Liu (1998) explicitly defined the semantics of qualitative distance and qualitative orientation angles to suggest a representation of qualitative trigonometry. Moratz and Wallgrün (2012) extended a point-based orientation calculi with a local reference distance which is referred to as elevation and express relative distance relations by comparing these elevations.

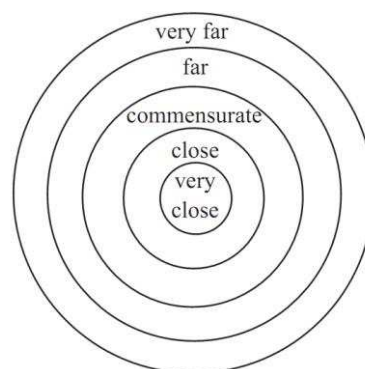
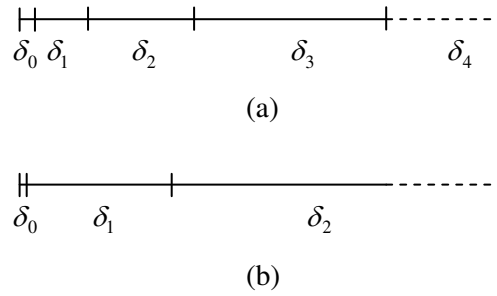

Figure I.6 Qualitative absolute distances

Figure I.7 Distance-based relations between δ_i s

2.4 Qualitative Temporal Relations

Time can be regarded as a projection of events that occur and properties that hold. Any sort of event or happening can be described by a corresponding time (Allen and Hayes 1989). Approaches oriented to the representation of temporal knowledge are mainly either point-based or interval-based. A time instant is a single, atomic time point in the time domain (Jensen et al. 2009). The qualitative relations between time instants are (Vilain and Kautz 1989): “ $<$ ” (precedes), “ $=$ ” (equals), and “ $>$ ” (follows). Let us consider for example two flight events as an example: “The aircraft AF1821 took off at CDG airport at 9:45 and landed in Rome at 11:55” and “The aircraft EI527 took off at CDG airport at 16:00 and landed in London at 17:10”. These events are associated with the following temporal intervals [9:45, 11:55] and [16:00, 17:10], respectively. Time instants t_1 (9:45) and t_2 (16:00) denote the “beginning of the flight” for each flight, respectively. This denotes a transition from a motionless state to the flight being in progress, that is, a motion state.

Many temporal representation frameworks such as the Situation Calculus (McCarthy and Hayes 1969) and the Time Specialist (Kahn and Gorry 1977) are based on time instants. On the other hand, taking intervals as a primitive for representing and reasoning has been also considered in temporal reasoning (Hamblin 1971; Humberstone 1979). The Interval Calculus (Allen 1983) provides a rich formalism to express qualitative relations between temporal intervals. Allen’s algebra has strongly influenced research in temporal, and even spatial and spatio-temporal reasoning.

Allen introduces a calculus based on binary relations between temporal intervals without gaps plus a set of operations defined over these relations. A temporal interval I is represented as a pair (I, I^+) of real numbers with $I < I^+$, which denote the beginning and end points of the temporal interval, respectively. According to all possible relations

between two temporal intervals based on the relative orderings of their beginning and end points, 13 temporal relations which are so-called Allen's basic relations are derived. As shown in Figure I.8, these relations are composed of six temporal relations (before, meets, overlaps, starts, during, finishes) and their inverse relations (after, met-by, overlapped-by, started-by, contains, finished-by), and a self-inverse relation (equal).

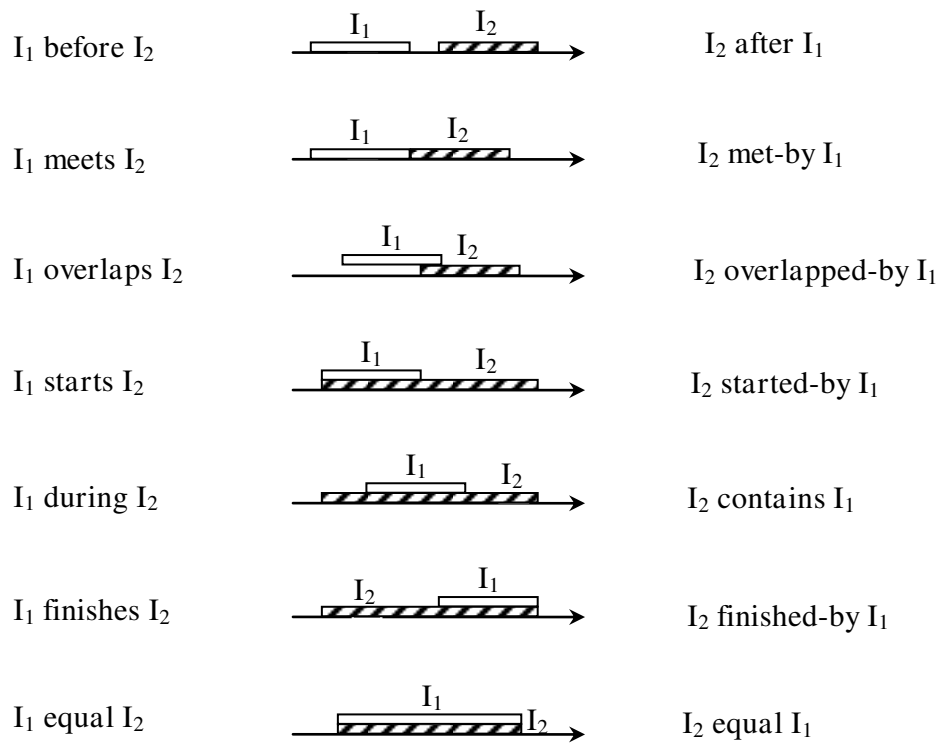

Figure I.8 Thirteen temporal relations between two temporal intervals I_1 and I_2

I.3 Qualitative Spatio-Temporal Reasoning

One of the main objectives of Qualitative Spatio-Temporal Reasoning (QSTR) is to match as much as possible humans' common activities of their daily life, and more generally real-world phenomena that deal with objects located in space and that change over time. Although formal models of spatial and temporal relations introduced in the previous subsections represent some basic spatial and temporal relations, the ability to reason on a given spatio-temporal system is a much more complicated task. The range of reasoning tasks related to humans' activities or to the representation of real world phenomena is very large, this generating a need for the development of generic and domain-oriented algebra that can support modelling and reasoning tasks. Recent years have witnessed the developments of several QSTR frameworks oriented to the representation of spatio-

temporal dynamics (Hazarika 2005; Bhatt 2010; Bhatt and Wallgrün 2014) or integration of different levels of abstractions (Hornsby 2001; Mau et al. 2006). Those frameworks cover and have been applied to a large range of applications such as robotics (Bedkowski 2013), risk events detection (Ligozat et al. 2009, 2011), archeology (Jeansoulin and Papini 2007), scene analysis (Bhatt and Dylla 2009), automatic surveillance (Dee et al. 2009) and so on. Several practical software tools providing general consistency and constraint satisfaction tasks have been developed, prime examples are the generic toolkit QAT for n-ary calculi (Condotta et al. 2006), SparQ (Dylla et al. 2006), and GQR (Gantner et al. 2008).

Two main perspectives can be considered when reasoning with qualitative spatial data over time: one is to take a snapshot viewpoint and describe a dynamic behaviour as a set of temporal states, while another one represents a given phenomenon as spatio-temporal histories. Whatever the point of view (i.e., snapshot or histories), an important preliminary requirement of any QSTR is to first model things that happen with appropriate spatial and temporal information. Secondly, and by providing additional reasoning mechanisms, novel information can be derived from elementary configurations. In this section, the most frequently used approaches for qualitative reasoning, i.e. conceptual neighbourhoods and composition tables, are briefly introduced.

3.1 Conceptual Neighbourhoods

Under the assumption of continuous change, the term of conceptual neighbourhood is defined as: “A set of relations between pairs of events forms a conceptual neighbourhood if its elements are path-connected through conceptual neighbor relations” (Freksa 1992a). A Conceptual neighborhood diagram (CND), whose alternative names are conceptual neighbourhood graphs, transition graphs, and continuity network, is a diagram in which spatial or temporal relations (or potentially any set of concepts in a certain domain) are “networked” according to their conceptual closeness, like the one shown in Figure I.9 for the set of RCC8 relations between regions. Each node corresponds to a relation and each link connects a pair of conceptual neighbors in a CND. If one relation holds at a particular time, then there are some continuous changes possible to lead to another relation in its neighborhood. All the intermediate relations must be passed through while changing from any relation to another one in the CND. Taking the quantity space $\{-, 0, +\}$ as an example, a variable cannot transit from ‘+’ to ‘-’ without passing through the intermediate value 0.

Research on qualitative spatial and temporal reasoning often considers the construction and utilization of various kinds of CNDs. Most of the qualitative spatial and temporal calculi introduced in this chapter have also derived CNDs. To the best of our knowledge, the FROB program introduced in (Forbus 1982) was the first program to use a transition graph that combines spatial continuity constraints with dynamic constraints for reasoning about the movement of point objects in space. A well-known CND is the one applied by Freksa (1991) to interval relations as defined in (Allen 1983). Further examples of conceptual neighborhood diagrams applied to spatio-temporal relations have been applied to cyclic temporal interval relations (Hornsby et al. 1999), topological relations between regions (Egenhofer and Al-Taha 1992), lines and regions (Egenhofer and Mark 1995), and directed lines (Kurata and Egenhofer 2006).

The novel knowledge that can be derived from conceptual neighbourhoods of some given JEPD relations can be used to evaluate the possible changes of a relation or to measure the similarity among some relations (Schwering 2007). CNDs have also been applied to build a qualitative spatial simulator (Cui et al. 1992) and to movement-based reasoning (Egenhofer and Al-Taha 1992; Rajagopalan 1994; Van de Weghe 2004; Noyon et al. 2007; Glez-Cabrera et al. 2013).

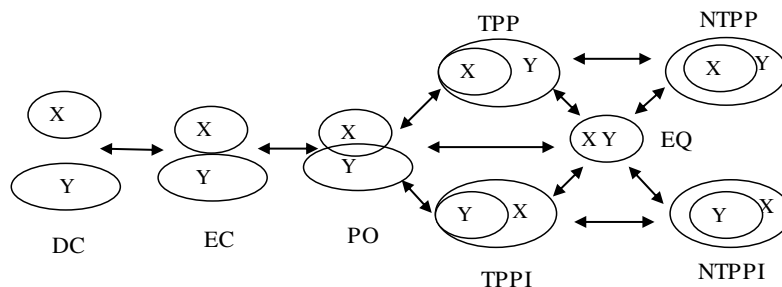

Figure I.9 CND of RCC8 (Randell et al. 1992)

3.2 Composition Tables

Given a set of n jointly exhaustive and pairwise disjoint (JEPD) basic relations, the algebraic operations union, intersection, complement, and converse of relations can be computed. Taking the 13 basic temporal relations of Allen (1983) for example, these operations are defined as follows (R_1 and R_2 being subsets of the 13 Allen relations):

- The union ($R_1 + R_2$) of two sets R_1 and R_2 is the set-theoretic intersection of the two relations; it is the relation composed of all basic relations that are in either R_1 or R_2 .

Eg: If $R_1 = \{\text{before, meets}\}$, $R_2 = \{\text{contains, finished-by}\}$,
 then $R_1 + R_2 = \{\text{before, meets, contains, finished-by}\}$.

- The intersection ($R_1 \wedge R_2$) of two sets R_1 and R_2 is the set-theoretic intersection of the two relations; it is the relation composed of all basic relations that are in both R_1 and R_2 .

Eg: If $R_1 = \{\text{before, starts, during, finished-by}\}$, $R_2 = \{\text{before, overlaps, contains}\}$,
 then $R_1 \wedge R_2 = \{\text{before}\}$.

- The complement ($\sim R$) of a set R is the relation consisting of all basic relations not in R . For every relation R , $\sim(\sim R) = R$.

Eg: If $R = \{\text{before, overlaps, during, started-by, contains}\}$,
 then $\sim R = \{\text{meets, starts, finishes, after, met-by, overlapped-by, finished-by}\}$.

- The converse ($!R$) of a set R is the relation consisting of the converses of all basic relations in R . For every relation R , $!(!R) = R$.

Eg: If $R = \{\text{overlaps, contains}\}$,
 then $!R = \{\text{overlapped-by, during}\}$.

The composition of binary relations, also called relative product (Tarski, 1941), is the most prevalent operator used for QSTR to generate new relations, i.e., if two existing relations R and S share a common entity, a composition can be derived and is denoted by:

$$R \circ S = \{(x, y) \mid \exists z: (x, z) \in R \text{ and } (z, y) \in S\} \quad (\text{I.6})$$

If there are no constraints imposed on the composition, this gives a universal disjunction U , which is the disjunction of all relations of the JEPD set. By constructing a $n \times n$ composition table (also denoted as transitivity table), where the set of possible new relations are stored, the inference result can be preliminary evaluated instead of computing the possible resulting configurations. The composition tables have been precomputed for many different qualitative spatial and temporal calculus, e.g., temporal calculus (Allen 1983; Freksa 1992a), topological calculi (Cui et al. 1993; Egenhofer 1994), directional calculi (Frank 1991; Freksa 1992b), distance calculi (Hernandez et al. 1995), and spatio-temporal calculi (Van de Weghe 2004). Although the composition tables of the calculi based on ordered or well-structured domains are easy to construct, such as the Directed Interval Algebra (Renz 2001) or the Rectangle Algebra (Balbiani et al. 1999), it is generally difficult to compute the compositions effectively in many other cases especially for domains with arbitrary spatial regions such as those internally disconnected. In some domains, the operation of composition could lead to an infinite number of relations,

whereas the basic idea of qualitative reasoning is to deal with a finite number of relations (Renz and Ligozat 2005). Many researchers have pointed out that composition tables do not necessarily correspond to the formal definition of composition (Bennett 1994; Grigni et al. 1995; Ligozat 2001). It can be resorted to a weaker form of composition in order to apply constraint-based reasoning mechanisms (Cohn and Renz 2008). The weak composition table for RCC8 (Düntsch et al. 2001) is shown as Table I. 2. Further composition tables can be found for topological relations (Hernandez 1994; Kurata and Egenhofer 2006), orientation relations (Frank 1992; Freksa 1992b; Hernandez 1994; Papadias and Egenhofer 1997), distance relations (Hernandez et al. 1995) and temporal relations (Allen 1983; Freksa 1992a).

o	DC	EC	PO	TPP	NTPP	TPPI	NTPPI	EQ
DC	No info	DR,PO, PP	DR, PO, PP	DR, PO, PP	DR, PO, PP	DC	DC	DC
EC	DR,PO, PPI	DR, PO, TPP,TPPI	DR, PO, PP	EC, PO, PP	PO, PP	DR	DC	EC
PO	DR,PO, PPI	DR, PO, PPI	No info	PO,PP	PO, PP	DR, PO, PPI	DR, PO, PPI	PO
TPP	DC	DR	DR, PO, PP	PP	NTPP	DR, PO, TPP ,TPI	DR, PO, PPI	TPP
NTPP	DC	DC	DR, PO, PPI	NTPP	NTPP	DR, PO, PP	No info	NTPP
TPPI	DR, PO, PPI	EC, PO, PPI	PO, PPI	PO, TPP TPPI	PO,PP	PPI	NTPPI	TPPI
NTPPI	DR, PO, PPI	PO, PPI	PO, PPI	PO, PPI	PO	NTPPI	NTPPI	NTPPI
EQ	DC	EC	PO	TPP	NTPP	TPPI	NTPPI	EQ

Table I.2 Composition table for RCC8

I.4 Qualitative Movement Modelling

Instead of describing how objects are moving quantitatively, i.e. by lists of many precise positions, modelling movement in a qualitative way can formalize our common-sense view of the world. As topological, orientation, and distance relations between some spatial entities are likely to change over time, the formal models of spatial relations introduced above are not sufficient as such to represent the spatio-temporal behaviour of these spatial entities. The notion of movement closely associated to a given spatial entity is a

fundamental concept that can model and embed its behaviour in space and time. This can also denote the notion of spatial change associated to a given spatial entity. Such changes intuitively perceived by humans as qualitative processes and have been elsewhere studied by Naive Physics in an absolute space to formalize common sense human beings knowledge of physical world (Hayes 1979). Several formal approaches have been then developed such as the Qualitative Process Theory (Forbus 1982, 1983), Qualitative Kinematics (Forbus et al. 1987; Faltings 1990), and Region-Based Geometry (Bennett et al. 2000). Most of these qualitative models focus on how entities move one in relation to the others. This section reviews current approaches oriented to qualitative and relative movement descriptions, those being translation-, rotation- and scale-invariant. A few key factors that differentiate those modelling approaches are as follows:

- Whether they consider dimensionless points or regions as primitive objects, either in time, space or in space and time.
- Whether they are based on discrete or continuous times.
- Whether they represent the space and time domains separately or homogeneously.

We classified those modelling approaches into two groups: one denotes approaches which represent two separated domains for space and time, and the other approaches which integrate a primitive and integrated space-time domain.

4.1 Space + Time Approaches

Let us first consider formal models that consider space and time as separate domains. Those approaches model movement as a sequence of locations. A movement is either modelled as a change associated to time instants (i.e., that denotes an instance or a state) (Gottfried 2004; Noyon et al. 2007; Gottfried 2011; Glez-Cabrera et al., 2013) or to pairs of adjacent time intervals (Van de Weghe 2004).

The Qualitative Trajectory Calculus (QTC) (Van de Weghe 2004) is in fact a set of calculi that represents the relative movement of some spatial objects. The QTC-Basic (QTC_B) considers a notion of a qualitative distance between a pair of moving points, such as moving towards or moving away from (Van de Weghe et al. 2005, 2006). The more general QTC-Double-Cross calculus (QTC_C) takes into account the relative orientation of the entity movements in a 2-dimensional space, and represents the relative movement of two entities by a four-component label. The first two components describe a distance change trend of an entity with respect to the current position of another entity, while the other two components describe the relative orientation of the entity movements with

respect to the reference line that connects them. The QTC on Networks (Delafontaine et al. 2008), i.e. QTC_N and QTC_{DN} , represent the qualitative relation between two moving entities in a static and dynamic network, respectively. More precisely, one or more of the following parameters are applied to describe the situation of two moving points A and B at two successive time instants t and $t+1$.

- the relative distance: one of the points approaches (-), moves away from (+), or keeps the same distance from the other (0);
- the relative speed: the speed of A is smaller (-), larger (+), or equal (0) to that of B;
- the orientation relation: each point moves towards the left half-plane (-), towards the right half-plane (+), or moves while staying on the line (0).

Take Figure I.10 as an example, the relations between A and B can be denoted as A (-, +, +, -, -) B according to the QTC_C calculus (A approaches B, B moves away from A, A moves toward the right half-plane, B toward the left half-plane, and the speed of A is less than that of B).

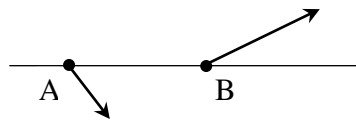

Figure I.10 Illustration of QTC

When considering the start point and the end point as the boundary of a directed line segment, the 9IM (Egenhofer and Herring 1991) is extended to 9^+IM (Kurata and Egenhofer 2007), in which 26 topological relations are defined between a directed line and a region for characterizing movement patterns. In order to describe the properties of these topological relations, they denote by I, B, E the entity's positions in the region's interior, boundary, and exterior, respectively.

To qualify the movement of a former entity with reference to a latter one as perceived by an observer acting in the environment, Noyon et al. (2007) proposed a formal trajectory model based on two elementary primitives: relative velocity and relative position. The trajectory configurations illustrated in Figure I.11 are an example of the configuration $A(v^+ p^+)B$ when B is either a point (Figure I.11a), a line (Figure I.11b), or a polygon (Figure I.11c) where the relative velocity is positive (the reference object A is faster than the target object B), and B disjoint A. The formal identification of elementary

trajectory configurations and their relationships with reference regions favor the understanding of local trajectory patterns.

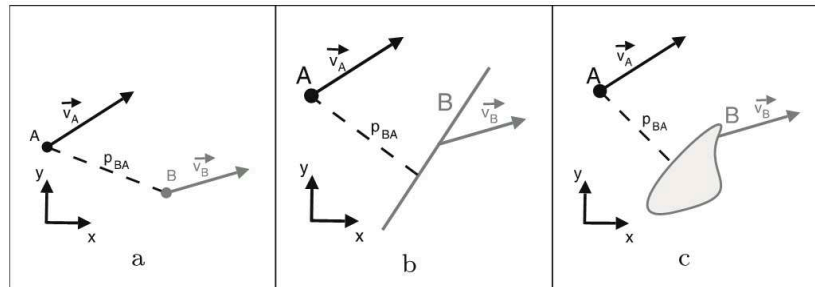

Figure I.11 Trajectory configurations example $A(v^+ p^+)B$ (Noyon et al. 2007)

Gottfried (2011) modelled the relative movement of pairs of moving entities by taking into account directional information to take into account the influence of direction changes.

By considering the oriented rectilinear projection of entities' trajectories, the Qualitative Rectilinear Projection Calculus (QRPC) (Glez-Cabrera et al. 2013) models a movement by an n-tuple composed by an ordered set of symbols associated to qualitative features and by taking into account the front-back and left-right dichotomies.

Muñoz-Velasco et al. (2014) presented a logic-based approach to deal with moving entities under fuzzy qualitative representation based on Propositional Dynamic Logic (PDL). The movement of an entity with respect to another one is modelled by a tuple whose components include information about objects, velocity, orientation, relative movement, allowed movements, qualitative latitude (North-South position and distance) and longitude (East-West position and distance).

4.2 Integrated Space-Time Approaches

Movements happen in space, but also in time – they have a “where” as well as a “when” dimension. Moving entities have a position and shape for a given time or interval, which may differ at other times (Hayes 1985). Starting with Russell (1914), a few researchers (Carnap 1958; Quine 1960) and more recently (Hayes 1985; Galton 1995; Muller 1998b) interpret entities in space-time rather than in space alone.

Galton (1995, 2000) interpreted motion primarily as a change in position and modelled a movement as an event in terms of the conditions for its occurrence, this generating the concept of state for a given time. Time is modelled using either instants or intervals with an ordering relation, while the representation of space is based on regions and RCC8 (Randell et al. 1992), while moving entities can be rigid or non-rigid. Holds-at(S,t) and

Holds(S,i) denotes that a state S holds at time instant t or throughout a time interval i, respectively. The two notions are connected by the following rule

$$\text{Holds}(S,i) \leftrightarrow \forall t \in i \text{ Holds-at}(S,t) \quad (\text{I.7})$$

which says that a state S holds throughout a time interval t if and only if it holds at every time instant of the time interval i.

Based on the notion of spatio-temporal histories (Hayes 1985), Muller (1998a) introduced a mereo-topological model for representing movement. Two connected primitive entities (i.e., spatio-temporal regions) are assumed to be also time-connected, this providing a formal gateway to combine topological and temporal relations. Topological concepts are enriched based on a theory introduced by Asher and Vieu (1995) which has more or less the same expressive power as the one of RCC8 (Randell et al. 1992). Besides a temporal precedence relation $<_t$, a primitive temporal connection \approx (a connection which can be interpreted in the similar way as a temporal $C(x, y)$) is introduced to maintain the valid topological relations between some spatio-temporal entities. A definition of the continuity of a spatio-temporal region is informally stated as: “A spatio-temporal region w is continuous if, and only if, for any temporal slice x of w and any part u of w, if x and u are contemporary, then x and u are connected.” Figure I.12 illustrates a situation where the continuity property is not verified (Muller 1998a). The temporal slice x (i.e., the regularization of the part of the region preceding time instant t_1) and the sub-region u are contemporary as their projections share the same time instant t_1 , but they are not connected to each other. In that case, the spatio-temporal region w which contains x and u is not continuous.

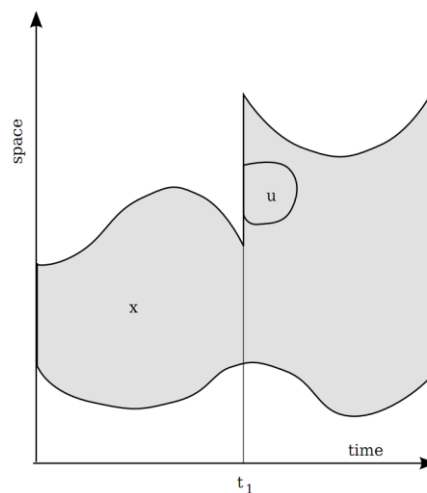

Figure I.12 A region in space-time which is not continuous

I.5 Movement Semantics

Mappable objects such as roads, buildings, rivers and even people can be observed by human beings. Day-to-day actions and phenomena associated to these objects, such as cars driving on the road, people entering a building, horses crossing a river, denote an interaction among the livings and the real world. Language descriptions, either formal or natural, enable and constrain what can be expressed from the semantics of a given movement within a given context (Wittgenstein 1953). Fundamental concepts oriented to the formal representation of movement semantics can be provided by linguistic approaches. Research in natural language studies, especially developed by cognitive linguists (Herskovits 1986; Lakoff and Johnson 1980; Talmy 1983) has been notably influential to the development of spatio-temporal theories in the early 1990s (Mark and Frank 1991).

Our experience and perception of motion have given every language on earth plentiful means to verbally express many different aspects and semantics of movement, and this at different levels of granularity. Talmy (1985) classified primitive languages broadly into two distinct strategies for expressing the concepts of motion: path constructions and manner-of-motion constructions. According to this linguistic distinction, semantic movement representations can involve two categories of predicates: location-based predicates (such as arrive, depart, etc.) and action-based predicates (such as drive, fly, etc.). Location-based predicates pay attention to points on a trajectory and make an explicit reference to locations, while the focus of action-based predicates is on the action semantics, the location being a property of the action.

Motivated by the fact that natural language is a gateway to understand how people conceptualize space (Mark 1988), building a bridge between natural language descriptions of movement and qualitative spatio-temporal representation and reasoning can provide a valuable step towards the development of more effective modelling frameworks. Mani and Pustejovsky (2012) introduced a broader formal perspective on several aspects related to movement that combine several linguistics, modelling and computational dimensions. They provide a semantic-oriented theory of movement expressions as defined in natural language, and closely associated to a qualitative model of space and time. The formal model integrates inference mechanisms for tracking moving objects' changes.

By interpreting time and space (including topological, orientation, and distance relations), most of the qualitative spatial and temporal models developed give a set of

movement primitives whose objective is to favor human-computer interactions. Asher and Sablayrolles (1995) offered a number of motion verbs and spatial prepositional phrases in French. They proposed ten groups of motion verbs as follows: *s'approcher* (to approach), *arriver* (to arrive), *entrer* (to enter), *se poser* (to alight), *s'éloigner* (to distance oneself from), *partir* (to leave), *sortir* (to go out), *décoller* (to take off), *passer par* (to go through), and *dévier* (to deviate). Muller's (1998a) introduced a set of six motion classes: leave, hit, reach, external, internal and cross. Erwig and Schneider (2002) formally described how to handle topological relations between moving objects in a spatio-temporal database. They defined a series of spatio-temporal predicates which are used to describe developments of spatial topological relationships. For example, a moving point P Enters a region R if P starts outside the region R, then meets it and in the end P is inside R. In (Wang et al. 2004), a Segment Operator Model (SOM) for representing topological line-region relations has been introduced. Movement patterns are classified into seven categories: across, stabsin, along, bowsto, sticksto, inside and disjoint. Howarth and Couclelis (2005) presented a linguistics-based approach based on Force Dynamics theory (Talmy 2000) in language by means of the Aristotelian distinction between constitutive, agentive, and telic dimensions in things to model spatio-temporal change with different scales and granularities. Kurata and Egenhofer (2007) developed a formal model of topological relations between a directed line and a region for characterizing movement patterns. The 26 DLine-region relations are derived from the 9+-intersection model. In order to describe DLine-region relations, the moving point location is characterized according to its location in the region's interior, boundary, and exterior. Shi and Kurata (2008) explored the modelling of motion concepts with different configurations between a directed line and a region. Stewart Hornsby and Li (2009) suggested that textual documents that contain movement verbs and terms can be mapped to elementary abstractions that include source, destination, route, direction, distance, start time, end time, and duration properties. Pustejovsky and Moszkowicz (2011) developed a computational semantics for motion as expressed in natural languages, based on a temporal logic. Klippel (2011) characterized movement patterns from the perceptual and cognitive dimensions. Primitive movements are identified as movement choremes. These choremes are based on the 9IM (Egenhofer and Herring 1991) when the moving point is either in the exterior, in the boundary, or in the exterior.

I.6 Discussion

This chapter reviews related work in qualitative spatio-temporal representation and reasoning approaches oriented to the representation of movement. It appears that qualitative formalisms have a long standing tradition as methods to bridge the gap between formal and linguistic descriptions of movement. This section comments on the works that have most influenced our work, highlighting some of the limitations that motivate our own approach towards a qualitative representation of movement.

The movement of an entity with respect to any region of interest, such as a man entering a room or a flight closing to a given zone, can be modelled as spatial configuration between a trajectory (directed line) and a region in 2-dimensional spatial scenes. The peculiarity of this approach is that the directed line embeds the trajectory behaviour. As such movement is materialized by two spatial entities, spatial reasoning mechanisms can be applied. Topological relations can implicitly reflect the entity movements inside or outside the region of interest, how the entity touches or crosses the boundary of the region of interest, those being primary information when people conceptualize the movement. Many topological models (such as 4IM, 9IM and CBM) have been primarily designed for static spatial configurations. An open research question is as to whether they can adequately represent all the possible configurations between a line and a region in a 2-dimensional space. For example, 4IM, 9IM and CBM can only distinguish 11, 19 and 31 line-region topological relations, respectively, this being a limitation in many situations. Among those line-region topological relation models, 9^+IM (Kurata and Egenhofer 2007) is the most related and appropriate approach to represent topological relations between a directed line (i.e., the trajectory of a moving point) and a region. However, 9^+IM cannot easily deal with complex configurations, and the primitives identified do not take into account clockwise directions, nor the dimensions of the intersections, those being useful when qualifying the specific configurations that emerge when a directed line crosses the boundary of a given region.

As a movement can be regarded as some continuous changes of location, it occurs mostly on spatial entities materialized as points or regions. Some of the models considered represent moving entities as points (Van de Weghe 2004; Noyon et al. 2007), while others as spatially extended for studying changes of spatial configurations (Shi and Kurata 2008; Gottfried 2011). As space and time are inextricably linked, it is natural to consider space-time as a homogeneous domain. Therefore, the works of Galton (1995) and Muller (1998a)

have been the ones inspiring our movement theory. However, the formal models identified mainly deal with moving regions as primitive entities, and are mainly oriented towards the representation of topological relations. Furthermore, a complete model of movement should not be limited to topological relations, as other properties are important, for instance orientation and distance relations. Let us consider the example shown in Figure I.13, there are two men walking along a street. When considering topological relation alone, one can say that man A and man B are disjoint in Figure I.13a, but the same would be true in Figure I.13b. So the question is: How can we reflect the differences between these two figures? In fact, by taking into account distance relations, one can say that man B is walking towards man A in Figure I.13a, while man B is leaving man A in Figure I.13b. Moreover, a similar configuration might also be enriched by orientation relations in order to qualify the direction taken by the man B leaving man A.

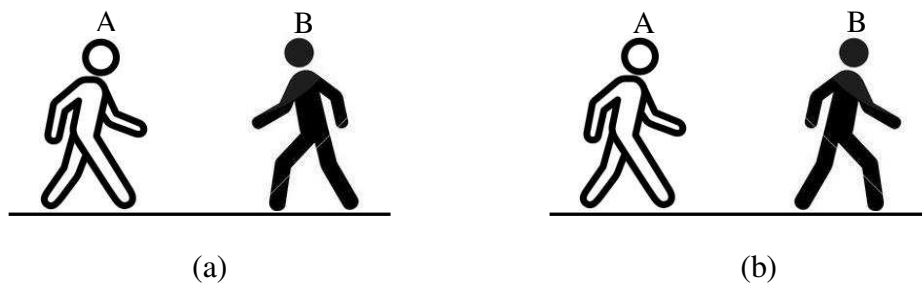

Figure I.13 Two men walking along a street

While most of current formal approaches have been essentially oriented towards topological relations, the objective of our modelling framework will be to not only integrate topological relations as a support for a representation of movement semantics, but also to integrate additional properties such as orientation and distance.

Another important motivation of our work is that, while most of current approaches have been oriented towards conceptual representation of moving entities, none of them has taken both the boundary of the reference entity and the changing of qualitative distance into consideration. We take a relative point of view of the movement of two given entities, movement being considered by giving a particular importance on the boundary of the one that might be considered as predominant or as a reference. This specific property is relevant for example in indoor spaces, when analyzing the trajectory of a moving entity with respect to a given bounded room or place, or when analyzing in a large-scale space the movement of an entity with respect to a region. A moving human has for example to

pass through a door when moving from one room to another. When modelling such activities, the relativity of these processes is a factor that matters, for instance the qualitative location of a human with respect to a given room (is he inside or outside?), and when integrating time his overall behaviour with respect to this room (is he leaving or approaching this room?). These two examples illustrate the motivation behind our approach that will be more formally developed in the next chapters.



Movement Patterns

II.1 INTRODUCTION.....	36
II.2 MODELLING PRINCIPLES.....	37
2.1 PRIMITIVE DL-RE TOPOLOGICAL RELATIONS.....	38
2.2 DIMENSIONALITY AND CARDINALITY	39
2.3 DIMENSION SEQUENCE OF AN ORDERED SET OF SPATIAL ENTITIES.....	40
2.4 NEIGHBOURING DISCS ON INTERSECTION POINTS.....	40
II.3 BOUNDARY-BASED MOVEMENT PATTERN BETWEEN ONE DIRECTED LINE AND A REGION.....	43
3.1 NO INTERSECTION	44
3.2 ONE 0-DIMENSIONAL INTERSECTION POINT	44
3.3 ONE 1-DIMENSIONAL INTERSECTION LINE	46
3.4 MORE THAN ONE INTERSECTION	49
II.4 ORIENTATION-BASED MOVEMENT PATTERN BETWEEN TWO DIRECTED LINES...	52
II.5 CONCLUSION	57

II.1 Introduction

With the proliferation of GPS (Global Positioning System), WiFi (Wireless Fidelity), RFID (Radio Frequency Identification) and other sensor-based tracking techniques, there is an increasing amount of data available and recording the movement of objects in both outdoor and indoor spaces. This favours the generation of large data sets that usually contain implicit information on the movement patterns of moving objects thus offering many opportunities for analysis and interpretation. Over the past few years this has generated several emerging researches in the areas of human mobility (Song et al. 2010; Hawelka et al. 2014; Gao 2015), transportation studies (Song and Miller 2014), weather forecast (Beard et al. 2007; Dodge et al. 2012), and health and epidemiology studies (Bian 2013; Pindolia et al. 2014) to mention a few examples.

Not only the availability of these large data sets offers novel opportunities for many application domains, they also trigger several research questions for the representation, storage and manipulation of the large datasets generated in computerized systems. For example, Dodge et al. (2008) identified a taxonomy of movement behaviours that categorizes different movement patterns. This taxonomy distinguishes between two types of movement patterns: generic patterns and behaviour patterns. Generic patterns, such as symmetry, constancy, convergence, and divergence can be found in many movement behaviours. But still, the authors mentioned that there is so far little agreement on the categorization of the various types of movement patterns. Other authors have been studying, extracting and interpreting the behaviour of individual objects (Andrienko and Andrienko 2007; González et al. 2008), interactions between objects (Eftimie et al. 2007), or particular types of collective phenomena such as crowd of pedestrian patterns (Bandini et al. 2014) or animal collectives (Vicsek and Zafeiris 2012).

Our research objective is not to provide a quantitative evaluation of movement by a sort of metrics, but rather to identify the emerging qualitative properties of movement patterns, and particularly the semantics that qualify the different configurations of a given entity with respect to a reference entity. These entities denote real world objects (i.e., people, animals, vehicles etc.) in dynamic interaction in space and time. For example, this denotes whether a given object moves towards or away from another one, or whether their trajectories cross, to mention just some of the most basic cases.

Intuitively, these spatio-temporal processes can be explicitly and qualitatively represented by the concept of directed line. For instance, Figure II.1 illustrates a simplified

case of a girl entering a church on the right, which can be abstracted as a directed line that starts from outside and ends inside the region of the church over a given a period of time. Although directed lines offers an intuitive support for the representation of trajectories at the abstract level, there are few formal models, such as 9⁺IM (Kurata and Egenhofer 2007), oriented to the representation of movement patterns. An important motivation for this work is to provide the foundations of a spatio-temporal model oriented to the representation of directed lines. Such a framework will act as a representation solution necessary for extracting movement patterns in a Geographic Information System (GIS) although the principles of the model can be applied to other domains.

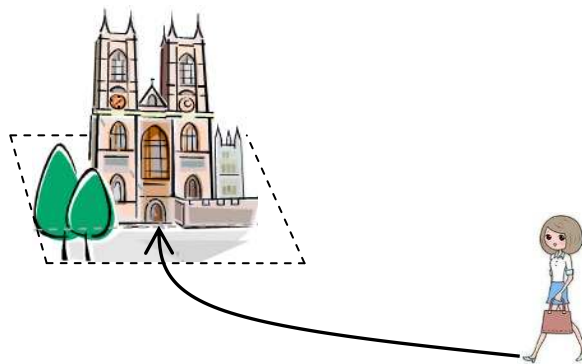

Figure II.1 Representing movement by a directed line

The remainder of this chapter is structured as follows. Firstly, topological properties including dimensionality, cardinality, dimension sequence, and intersection type, are introduced in Section II.2. Section II.3 introduces a formal model of topological relations for deriving movement pattern, which is based on the topological properties of intersections between a directed line and a region in a two-dimensional space. Furthermore, an orientation relation model between two directed lines, in which the detailed topological relations can be distinguished, is proposed in Section II.4. Finally, this chapter ends with some conclusions in Section II.5.

II.2 Modelling Principles

In order to model the spatio-temporal relations that qualify moving entities, let us introduce several general topological invariants. A directed line (\vec{L}) is defined as a non-branching simple line without cycle and with a direction, which is obtained through a continuous one-to-one mapping from $[0, 1]$. A region of interest is a simple region which

is a bounded regular closed subset in 2-dimensional space with a connected interior and exterior (Clementini and Di Felice 1998). The following sections characterize the relations between a directed line and a region of interest according to these topological invariants.

2.1 Primitive DL-RE Topological Relations

Topological invariants qualify the spatial relations that emerge from a set of regions distributed in a given scene (Deng et al. 2007). The completeness of primitive Directed Line REgion (DL-RE) topological relations can be illustrated according to the distribution of the boundary of \vec{L} , that is, the two endpoints of \vec{L} with respect to a region. A point has three possible topological relations with respect to a region: either in the exterior, boundary, or interior of a region. Overall, there are six cases regarding the topological relations of the two endpoints of \vec{L} and a region:

- both of the endpoints of \vec{L} are either in the exterior (Figure II.2a);
- in the interior of the region (Figure II.2b);
- one endpoint of \vec{L} is in the boundary of the region and the other is in the exterior of the region (Figure II.2c);
- one endpoint of \vec{L} is in the boundary of the region and the other is in the interior of the region (Figure II.2d);
- one endpoint of \vec{L} is in the interior of the region and the other is in the exterior of the region (Figure II.2e);
- both of the endpoints of \vec{L} are in the boundary of the region (Figure II.2f).

At the coarse level, the line-region topological relations corresponding to each case in Figure II.2 are: disjoint, contained-by, meet, covered-by, cross and on-boundary (Deng 2008). When considering the direction of \vec{L} : reverse configurations are valid for cases 1c, 1d and 1e (i.e., meet, covered-by, and cross), this leading to 9 primitives.

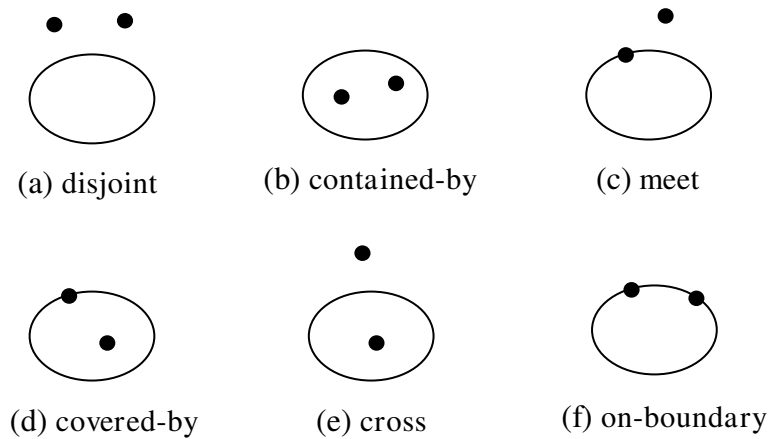
Figure II.2 Topological configurations of two endpoints of \vec{L} and a region

2.2 Dimensionality and Cardinality

The result of an intersection set between a directed line and a region can be described by its dimensionality and the number of resulting disjoint entities if any.

Definition II.1. The **dimensionality** of a set S of spatial entities (e.g., regions, lines, points), denoted as $H\text{-dim}(S)$, is defined as the highest dimension of the entities of the set S . The **cardinality** of the set S is denoted as $\#(S)$.

The intersection between a directed line \vec{L} and the boundary of a region A gives a set O of non-connected spatial entities, or the empty set. An ordered set ΔO is defined according to the order being given by the direction of the spatial entities of O in \vec{L} . The dimensionality of the set O is used to distinguish whether the intersection of \vec{L} and the boundary of A gives either one-to-many points ($\dim(O)=0$), or one to many lines and zero-to-many points ($\dim(O)=1$) (Figure II.3). The dimension of ΔO is given by $d = H - \dim(S) = \max(\dim(\vec{L} \cap \partial A))$. The cardinality is given by $m = \#(\Delta O) = \#(\vec{L} \cap \partial A)$. When the intersection between \vec{L} and the boundary of A is empty, we note per convention $m=0$. In the example shown in Figure II.3, there are one 0-dimensional intersection in ΔO_1 ($m=1$; $d=0$), one 1-dimensional intersection in ΔO_2 ($m=1$; $d=1$), and two successive 0-dimensional intersections and followed by one 1-dimensional intersection in ΔO_3 ($m=3$; $d=1$).

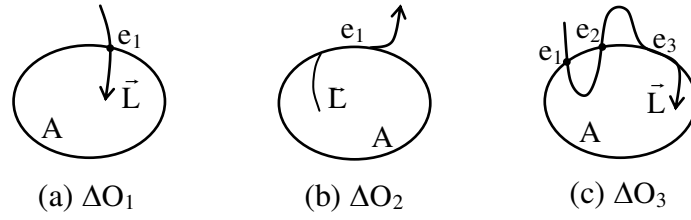

Figure II.3 Dimensional intersections

2.3 Dimension Sequence of an Ordered Set of Spatial Entities

Following a directed line from its start point until its end point, ordered numeric labels can be assigned to the successive entities that result from the intersections between the directed line and a region. Under a topological transformation, the sequence of various components in the intersection set must be preserved.

Definition II.2. The dimension sequence of an ordered set ΔO of spatial entities (e_1, e_2, \dots, e_n) denotes the respective dimensions of these spatial entities, it is given by

$$\text{SeqDim}(\Delta O) = \langle \dim(e_1), \dim(e_2), \dots, \dim(e_n) \rangle \quad (\text{II.1})$$

For example, the dimension sequences of the configurations presented in Figure 2 are as follows:

- (a) $\text{SeqDim}(\Delta O_1) = \langle \dim(\vec{L} \cap \partial A) \rangle = \langle 0 \rangle$
- (b) $\text{SeqDim}(\Delta O_2) = \langle \dim(\vec{L} \cap \partial A) \rangle = \langle 1 \rangle$
- (c) $\text{SeqDim}(\Delta O_3) = \langle \dim(\vec{L} \cap \partial A) \rangle = \langle 0, 0, 1 \rangle$

2.4 Neighbouring Discs on Intersection Points

As the spatial entities of ΔO are non-connected, the boundary of ΔO is the union of the boundaries of the spatial entities of ΔO . This boundary, denoted as $\partial(\vec{L} \cap \partial A)$, is a set of points as the boundary of a point is a point, and the boundary of a line is the starting and ending points of that line.

Definition II.3. An intersection point of ΔO is one of the points of the boundary of ΔO .

The intersection points of ΔO are ordered by the ordering of these points in the directed line \vec{L} of ΔO , the resulting ordered set is denoted as $\Delta(\partial(O))$. For each spatial entity e_i of ΔO there is either an intersection point when $\dim(e_i)=0$, or two intersection points when $\dim(e_i)=1$, that is, the starting and the ending points of e_i . In order to study the different local configurations of these intersection points, let us introduce the concept of small neighbouring disc.

Definition II.4. A small neighbouring disc $\text{neigh}(p)$ is defined for each intersection point p of $\partial(O)$. The intersection of $\text{neigh}(p)$ with the region A of O gives at most two points, as well as for its intersection with the directed line \vec{L} of O , in order to avoid multiple intersections for regions and lines with complex shapes.

Four intersections at most can be defined between a small neighbouring disc $\text{neigh}(p)$ and the region A and \vec{L} of O , which are respectively denoted as $V_{\text{back}}(\text{neigh}(p))$, $V_{\text{left}}(\text{neigh}(p))$, $V_{\text{front}}(\text{neigh}(p))$, $V_{\text{right}}(\text{neigh}(p))$ from the back to the front, and clockwise according to the direction of \vec{L} (Figure II.4). Let $n(p)$ denote the number of intersections of a neighbouring disc $\text{neigh}(p)$ of $\partial(O)$ with a region A and a directed line \vec{L} of O , $n(p)=\#((\text{neigh}(p)\cap\vec{L}),(\text{neigh}(p)\cap\partial A))$ with $1\leq n\leq 4$. Figure II.4 illustrates the intersections of an example of neighbouring disc $\text{neigh}(p)$ with a directed line \vec{L} and a region A of O with $n(p)=3$.

The local characteristics of the intersections of a neighbouring disc $\text{neigh}(p)$ with a region A and a directed line \vec{L} of O are refined according to the locations of these intersections (where ∂A denotes the boundary of A , A° the interior of A and A^- the exterior of A):

- If such an intersection lies in \vec{L} , it is either in A^- (\vec{L}_+), in ∂A (\vec{L}_0), or in A° (\vec{L}_-).
- If such an intersection lies in ∂A , it is either in the right part of \vec{L} (A_R) or in the left part of \vec{L} (A_L).

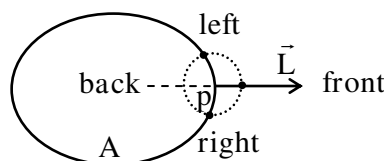

Figure II.4 A neighbouring disc $\text{neigh}(p)$

As illustrated in Figure II.5, let us first consider I_1 as the intersection point of \vec{L}_1 with a region A , $\Delta(\vec{L}_1 \cap \partial A) = (I_1)$. For I_1 we have:

- $n(I_1) = \#((\text{neigh}(I_1) \cap \vec{L}_1), (\text{neigh}(I_1) \cap \partial A)) = 4$
- $V_{\text{back}}(\text{neigh}(I_1)) = \vec{L}_-$ intersection is in \vec{L}_1 and in A°
- $V_{\text{left}}(\text{neigh}(I_1)) = A_L$ intersection is in ∂A and in the right part of \vec{L}_1
- $V_{\text{front}}(\text{neigh}(I_1)) = \vec{L}_+$ intersection is in \vec{L}_1 and in A^-
- $V_{\text{right}}(\text{neigh}(I_1)) = A_R$ intersection is in ∂A and in the right part of \vec{L}_1

while for I_2 and I_3 , intersection points of \vec{L}_2 with A , $\Delta(\vec{L}_2 \cap \partial A) = (I_2, I_3)$, we have:

- $n(I_2) = \#((\text{neigh}(I_2) \cap \vec{L}_2), (\text{neigh}(I_2) \cap \partial A)) = 2$
- $V_{\text{back}}(\text{neigh}(I_2)) = A_R$ intersection is in ∂A and in the right part of \vec{L}_2
- $V_{\text{left}}(\text{neigh}(I_2)) = \phi$ intersection is empty
- $V_{\text{front}}(\text{neigh}(I_2)) = \vec{L}_0$ intersection is in \vec{L}_2 and in ∂A
- $V_{\text{right}}(\text{neigh}(I_2)) = \phi$ intersection is empty

and

- $n(I_3) = \#((\text{neigh}(I_3) \cap \vec{L}_2), (\text{neigh}(I_3) \cap \partial A)) = 2$
- $V_{\text{back}}(\text{neigh}(I_3)) = \vec{L}_0$ intersection is in \vec{L}_2 and in ∂A
- $V_{\text{left}}(\text{neigh}(I_3)) = \phi$ intersection is empty
- $V_{\text{front}}(\text{neigh}(I_3)) = A_L$ intersection is in ∂A and in the left part of \vec{L}_2
- $V_{\text{right}}(\text{neigh}(I_3)) = \phi$ intersection is empty

Definition II.5. Establishing a clockwise orientation on the boundary of $\text{neigh}(p)$, the **intersection type** of a neighbouring disc $\text{neigh}(p)$ is modelled as a 4-value tuple:

$$S(\text{neigh}(p)) = [V_{\text{back}}, V_{\text{left}}, V_{\text{front}}, V_{\text{right}}] \quad (\text{II.2})$$

with $V_i \in (\vec{L}_+, \vec{L}_0, \vec{L}_-, A_R, A_L, \phi)$.

The intersection types of the three neighbouring discs in Figure II.5 are as follows:

- $S(\text{neigh}(I_1)) = [\vec{L}_-, A_L, \vec{L}_+, A_R]$
- $S(\text{neigh}(I_2)) = [A_R, \phi, \vec{L}_0, \phi]$
- $S(\text{neigh}(I_3)) = [\vec{L}_0, \phi, A_L, \phi]$

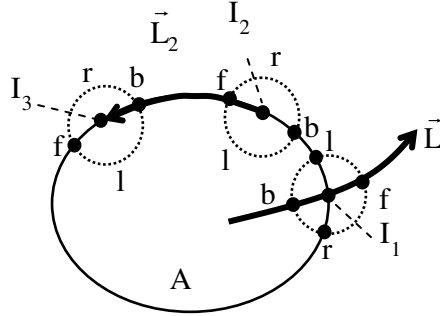

Figure II.5 Local characteristics of the intersections of neighbouring discs

II.3 Boundary-based Movement Pattern between one Directed

Line and a Region

The movement of an object with respect to any area of interest can be modelled as a spatial relation between a directed line and a region. Topological relations can reveal how an object crosses the border or moves between inside and outside a given region. These cases are important when people conceptualize the phenomenology of a movement. In order to derive the movement patterns that emerge between a directed line and a region from topological relations, let us make a difference between the configurations that emerge from a point that moves inside the region, across the boundary or the exterior of that region.

More formally the intersection between the directed line \vec{L} and the boundary of a region A gives a set O of non-connected spatial entities with the properties of cardinality and dimension, which also characterize the possible configurations. The DL-RE topological relations are classified according to the properties: $m = \#(\Delta O) = \#(\vec{L} \cap \partial A)$, $d = H - \dim(\Delta O) = \max(\dim(\vec{L} \cap \partial A))$, and the values of the intersections of the neighbouring discs $[V_{\text{back}}, V_{\text{left}}, V_{\text{front}}, V_{\text{right}}]$ of ΔO .

The 30 DL-RE movements are the ones derived from either one 0-dimensional or one 1-dimensional DL-RE intersections (one can remark in Figure II.6 that purely atomic movements are (a), (b), (c₁), (c₂), (d₁), (d₂), (h₁), (h₂), respectively). Under the same principles the approach can be extended to configurations with n 0-dimensional or n 1-dimensional DL-RE intersections.

- When there is no intersection between \vec{L} and the boundary of A, that is, $m=0$, then the coarse topological relationship between them is disjoint or contained-by, and these two cases are distinguished by the intersection type of the neighbouring disc;
- When the intersection between \vec{L} and the boundary of A is one 0-dimensional point, there are three or four intersections on the neighbouring discs of this intersection point, corresponding to coarse line-region topological relationships such as meet, cross and covered-by;
- When the intersection between \vec{L} and the boundary of A is one 1-dimensional line, we then consider the neighbouring discs of the two endpoints of the line, so there are two or three intersections on each of the boundary of neighbourhood corresponding to coarse line-region topological relationships such as on-boundary.

Each DL-RE topological relation is closely related to a primitive movement, and describes a particular part of motion of the directed line with respect to the region, and can be composed to describe complex movement patterns. The following cases develop movement patterns where a directed line represents the trajectory of a moving spatial object materialized by a moving point with respect to a given region.

3.1 No Intersection

When there is no intersection ($m = 0$) between \vec{L} and the boundary of A, a neighbouring disc is defined on the endpoint \vec{L}_e of \vec{L} (Figure II.6a and II.6b). There are two possible configurations either \vec{L} is in the interior or the exterior of A:

- $S_1(\text{neigh}(\vec{L}_e)) = [\vec{L}_+, \phi, \phi, \phi]$, denoted as MoveOutside (MO) (Figure II.6a);
- $S_2(\text{neigh}(\vec{L}_e)) = [\vec{L}_-, \phi, \phi, \phi]$, denoted as MoveInside (MIS) (Figure II.6b).

3.2 One 0-dimensional Intersection Point

Let us consider the configurations where the intersection between \vec{L} and the boundary of A is one 0-dimensional point I_1 ($m = 1, d = 0$).

1. $n(I_1) = 3$

When the endpoint of \vec{L} meets the boundary of A from the exterior of A, the topological relation between \vec{L} and A is meet, and can be refined by two primitive DL-RE topological relations as follows:

- $S_3(\text{neigh}(I_1)) = [\vec{L}_+, A_L, \phi, A_R]$, denoted as Arrive (AR) (Figure II.6c₁);
- $S_4(\text{neigh}(I_1)) = [\phi, A_L, \vec{L}_+, A_R]$, denoted as Depart (DE) (Figure II.6c₂).

When the endpoint of \vec{L} meets the boundary of A from the interior of A, the topological relation between \vec{L} and A is coveredby, and can be refined by two primitive DL-RE topological relations:

- $S_5(\text{neigh}(I_1)) = [\vec{L}_-, A_L, \phi, A_R]$, denoted as MovetoBoundary(MB) (Figure II.6d₁);
- $S_6(\text{neigh}(I_1)) = [\phi, A_L, \vec{L}_-, A_R]$, denoted as MovetoInterior(MI) (Figure II.6d₂).

2. $n(I_1) = 4$

When the coarse topological relation between \vec{L} and A is cross, there are four intersections on the neighbouring disc. According to the direction of \vec{L} , two movement primitives can be refined as follows:

- $S_7(\text{neigh}(I_1)) = [\vec{L}_+, A_L, \vec{L}_-, A_R]$, denoted as CrossIn (CI) (Figure II.6e₁);
- $S_8(\text{neigh}(I_1)) = [\vec{L}_-, A_L, \vec{L}_+, A_R]$, denoted as CrossOut (CO) (Figure II.6e₂);

When the interior of \vec{L} meets the boundary of A from the exterior of A, the topological relation between \vec{L} and A is meet. According to the direction of \vec{L} , two movement primitives can be refined as follows:

- $S_9(\text{neigh}(I_1)) = [\vec{L}_+, A_L, A_L, \vec{L}_+]$, denoted as TouchOutside_r (TO_r) (Figure II.6f₁);
- $S_{10}(\text{neigh}(I_1)) = [\vec{L}_+, \vec{L}_+, A_R, A_R]$, denoted as TouchOutside_l (TO_l) (Figure II.6f₂).

When the interior of \vec{L} meets the boundary of A from the interior of A, the topological relation between \vec{L} and A is coveredby. According to the direction of \vec{L} , two movement primitives can be refined as follows:

- $S_{11}(\text{neigh}(I_1)) = [\vec{L}_-, A_L, A_L, \vec{L}_-]$, denoted as TouchInside_r (TI_r) (Figure II.6g₁);
- $S_{12}(\text{neigh}(I_1)) = [\vec{L}_-, \vec{L}_-, A_R, A_R]$, denoted as TouchInside_l (TI_l) (Figure II.6g₂).

3.3 One 1-dimensional Intersection Line

When the intersection between \vec{L} and the boundary of A is one 1-dimensional line ($m = 1$, $d = 1$), the two start and end points of the line, respectively denoted as I_1 and I_2 , are taken into consideration. Accordingly, both of the intersection types of $\text{neigh}(I_1)$ and $\text{neigh}(I_2)$ should be considered. The number of intersections of each neighbouring discs are respectively given by:

$$n(I_1) = \# \left(\left(\text{neigh}(I_1) \cap \vec{L} \right), \left(\text{neigh}(I_1) \cap \partial A \right) \right) \quad (\text{II.3})$$

$$n(I_2) = \# \left(\left(\text{neigh}(I_2) \cap \vec{L} \right), \left(\text{neigh}(I_2) \cap \partial A \right) \right) \quad (\text{II.4})$$

1. $n(I_1) = n(I_2) = 2$

When the topological relation between \vec{L} and A is on-boundary, both of the end points of \vec{L} lie in the boundary of A. According to the direction and the clockwise or anticlockwise orientations of \vec{L} (clockwise or anticlockwise orientations being implicitly taken into account), two movement primitives can be refined as follows:

- $S_{13}(\text{neigh}(I_1)) = [A_L, \phi, \vec{L}_0, \phi]$ and $S_{13}(\text{neigh}(I_2)) = [\vec{L}_0, \phi, A_R, \phi]$, that is, a clockwise movement denoted as $\text{Along}_{cl}(\text{AL}_{cl})$ (Figure II.6h₁);
- $S_{14}(\text{neigh}(I_1)) = [A_R, \phi, \vec{L}_0, \phi]$ and $S_{14}(\text{neigh}(I_2)) = [\vec{L}_0, \phi, A_L, \phi]$, that is, an anticlockwise movement denoted as $\text{Along}_{acl}(\text{AL}_{acl})$ (Figure II.6h₂).

2. $n(I_1) = 3, n(I_2) = 2$

This is the case when \vec{L} starts from either the exterior or interior of A and ends in the boundary of A. When \vec{L} ends in the boundary of the region from the exterior of A, and according to the direction and the clockwise or anticlockwise orientations of \vec{L} , two movement primitives can be refined as follows:

- $S_{15}(\text{neigh}(I_1)) = [\vec{L}_+, A_L, \phi, \vec{L}_0]$ and $S_{15}(\text{neigh}(I_2)) = [\vec{L}_0, \phi, A_L, \phi]$, denoted as $\text{Arrive}_r\text{-Along}(\text{AR}_r\text{-AL})$ (Figure II.6i₁);
- $S_{16}(\text{neigh}(I_1)) = [\vec{L}_+, \vec{L}_0, \phi, A_R]$ and $S_{16}(\text{neigh}(I_2)) = [\vec{L}_0, \phi, A_R, \phi]$, denoted as $\text{Arrive}_l\text{-Along}(\text{AR}_l\text{-AL})$ (Figure II.6i₂).

When \vec{L} ends in the boundary of A from the interior of A, and according to the direction and the clockwise or anticlockwise orientations of \vec{L} , two movement primitives can be refined as follows:

- $S_{17}(\text{neigh}(I_1)) = [\vec{L}_-, A_L, \phi, \vec{L}_0]$ and $S_{17}(\text{neigh}(I_2)) = [\vec{L}_0, \phi, A_R, \phi]$, denoted as MovetoBoundary_r-Along (MB_r-AL) (Figure II.6j₁);

- $S_{18}(\text{neigh}(I_1)) = [\vec{L}_-, \vec{L}_0, \phi, A_R]$ and $S_{18}(\text{neigh}(I_2)) = [\vec{L}_0, \phi, A_L, \phi]$, denoted as MovetoBoundary_l-Along (MB_l-AL) (Figure II.6j₂).

3. $n(I_1) = 2, n(I_2) = 3$

This is the case when \vec{L} starts in the boundary of A and ends in the exterior or interior of A. When \vec{L} ends in the exterior of A, and according to the direction and the right or left orientations of \vec{L} , two movement primitives can be refined as follows:

- $S_{19}(\text{neigh}(I_1)) = [A_R, \phi, \vec{L}_0, \phi]$ and $S_{19}(\text{neigh}(I_2)) = [\phi, A_L, \vec{L}_+, \vec{L}_0]$, denoted as Along_r-Depart (AL_r-DE) (Figure II.6k₁);

- $S_{20}(\text{neigh}(I_1)) = [A_L, \phi, \vec{L}_0, \phi]$ and $S_{20}(\text{neigh}(I_2)) = [\phi, \vec{L}_0, \vec{L}_+, A_R]$, denoted as Along_l-Depart (AL_l-DE) (Figure II.6k₂).

When \vec{L} starts in the boundary of A and ends in the interior of A, and according to the direction and the right or left orientations of \vec{L} , two movement primitives can be refined as follows:

- $S_{21}(\text{neigh}(I_1)) = [A_L, \phi, \vec{L}_0, \phi]$ and $S_{21}(\text{neigh}(I_2)) = [\phi, A_L, \vec{L}_-, \vec{L}_0]$, denoted as Along_r-MovetoInterior (AL_r-MI) (Figure II.6l₁);

- $S_{22}(\text{neigh}(I_1)) = [A_R, \phi, \vec{L}_0, \phi]$ and $S_{22}(\text{neigh}(I_2)) = [\phi, \vec{L}_0, \vec{L}_-, A_R]$, denoted as Along_l-MovetoInterior (AL_l-MI) (Figure II.6l₂).

4. $n(I_1) = n(I_2) = 3$

When \vec{L} first starts in the interior of A, then lies in the boundary of A, to finally ends in the exterior of A, and according to the direction and the clockwise or anticlockwise orientations of \vec{L} , two movement primitives can be refined as follows:

- $S_{23}(\text{neigh}(I_1)) = [\vec{L}_-, A_L, \phi, \vec{L}_0]$ and $S_{23}(\text{neigh}(I_2)) = [\phi, \vec{L}_0, \vec{L}_+, A_R]$, denoted as MovetoBoundary_r-Along_l-Depart (MB_r-AL_l-DE) (Figure II.6m₁);

- $S_{24}(\text{neigh}(I_1)) = [\vec{L}_-, \vec{L}_0, \phi, A_R]$ and $S_{24}(\text{neigh}(I_2)) = [\phi, A_L, \vec{L}_+, \vec{L}_0]$, denoted as MovetoBoundary_l-Along_r-Depart (MB_l-AL_r-DE) (Figure II.6m₂).

When \vec{L} first starts in the exterior of A, then lies in the boundary of A, to finally ends in the interior of A, and according to the direction and the clockwise or anticlockwise orientations of \vec{L} , two movement primitives can be refined as follows:

- $S_{25}(\text{neigh}(I_1)) = [\vec{L}_+, A_L, \phi, \vec{L}_0]$ and $S_{25}(\text{neigh}(I_2)) = [\phi, \vec{L}_0, \vec{L}_-, A_R]$, denoted as Arrive_r-Along_l-MovetoInterior (AR_r-AL_l-MI) (Figure II.6n₁);
- $S_{26}(\text{neigh}(I_1)) = [\vec{L}_+, \vec{L}_0, \phi, A_R]$ and $S_{26}(\text{neigh}(I_2)) = [\phi, A_L, \vec{L}_-, \vec{L}_0]$, denoted as Arrive_l-Along_r-MovetoInterior (AR_l-AL_r-MI) (Figure II.6n₂).

When \vec{L} first starts in the exterior of A, then lies in the boundary of A, to finally ends in the exterior of A, and according to the direction and the clockwise or anticlockwise orientations of \vec{L} , two movement primitives can be refined as follows:

- $S_{27}(\text{neigh}(I_1)) = [\vec{L}_+, A_L, \phi, \vec{L}_0]$ and $S_{27}(\text{neigh}(I_2)) = [\phi, A_L, \vec{L}_+, \vec{L}_0]$, denoted as Arrive_r-Along_r-Depart (AR_r-AL_r-DE) (Figure II.6o₁);
- $S_{28}(\text{neigh}(I_1)) = [\vec{L}_+, \vec{L}_0, \phi, A_R]$ and $S_{28}(\text{neigh}(I_2)) = [\phi, \vec{L}_0, \vec{L}_+, A_R]$, denoted as Arrive_l-Along_l-Depart (AR_l-AL_l-DE) (Figure II.6o₂).

When \vec{L} first starts in the interior of A, then lies in the boundary of A, to finally ends in the interior of A, and according to the direction and the clockwise or anticlockwise orientations of \vec{L} , two movement primitives can be refined as follows:

- $S_{29}(\text{neigh}(I_1)) = [\vec{L}_-, A_L, \phi, \vec{L}_0]$ and $S_{29}(\text{neigh}(I_2)) = [\phi, A_L, \vec{L}_-, \vec{L}_0]$, denoted as MovetoBoundary_r-Along_r-MovetoInterior (MB_r-AL_r-MI) (Figure II.6p₁);
- $S_{30}(\text{neigh}(I_1)) = [\vec{L}_-, \vec{L}_0, \phi, A_R]$ and $S_{30}(\text{neigh}(I_2)) = [\phi, \vec{L}_0, \vec{L}_-, A_R]$, denoted as MovetoBoundary_l-Along_l-MovetoInterior (MB_l-AL_l-MI) (Figure II.6p₂).

Overall, a set of 30 DL-RE topological relations are identified with respect to the cardinality and dimensionality of the intersections. Each DL-RE topological relation is related to a movement primitive, thanks to the concepts of intersection points and neighbouring discs. Because of the particular importance of directional information when navigating, the movement direction is also considered to distinguish different movement primitives. Take S_{11} and S_{12} in Figure II.6 as an example, when the trajectory of the moving point meets the boundary of the region and still moves inside the region, we need to know whether they choose the right or left directions.

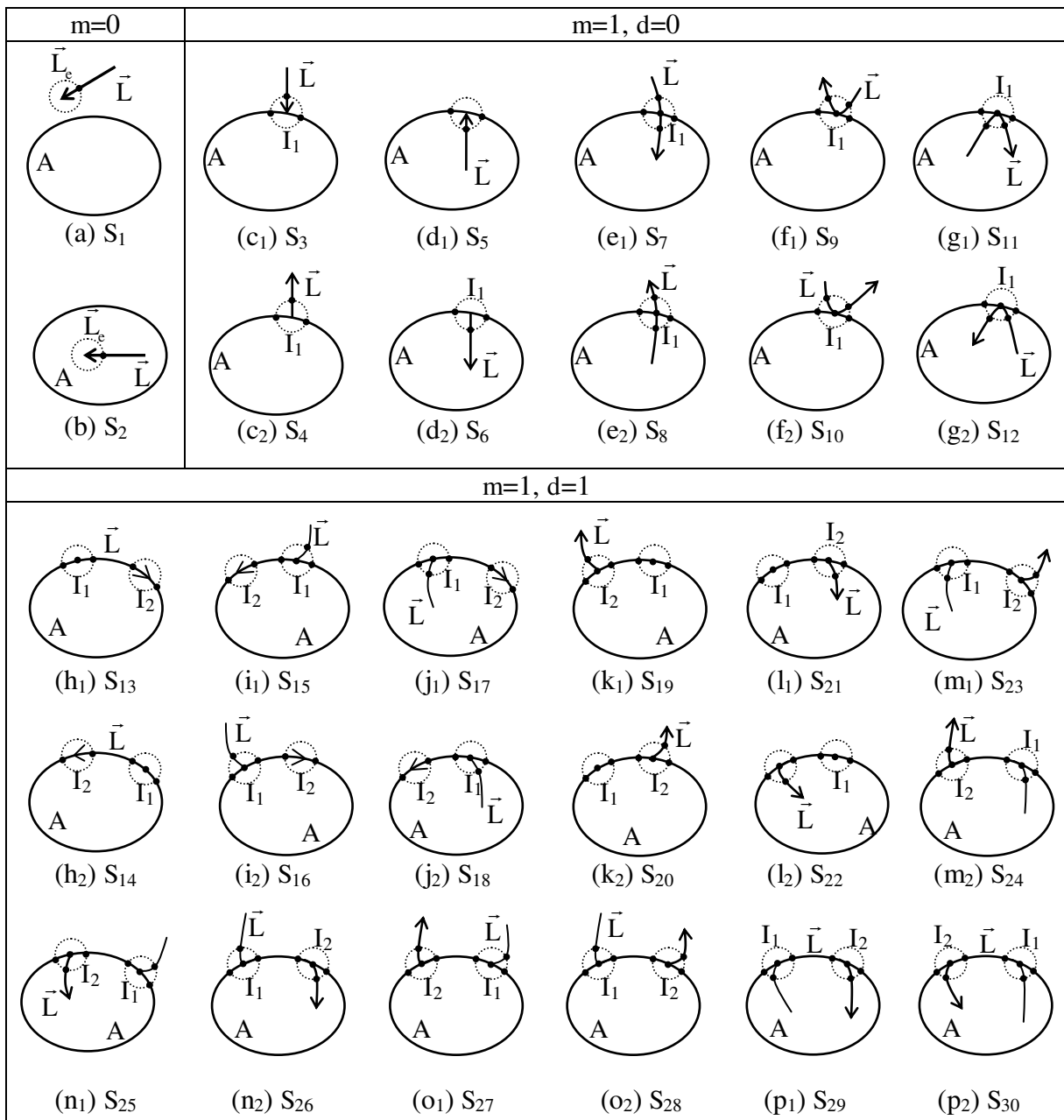

Figure II.6 Classification of DL-RE topological relations

3.4 More than One Intersection

The approach is flexible enough to generate different sets of configurations depending on the chosen criteria. One can for example restrict the configurations to $m=1$ and $d=1$ and find the complete configurations shown in Figure II.6. Several of these configurations can be derived from other configurations. For example, S_{15} can be composed by S_3 and S_{14} , S_{23} is made up of S_5 , S_{13} and S_4 . If there are more than one intersections ($m>1$), the DL-RE topological relations can be composed according to the dimension sequence of ΔO .

The possible topological configurations and movements that emerge from the topological configurations between a directed line and a region can be relative large. As a matter of fact, there should be an infinite number of possible DL-RE topological relations in a 2-dimensional Euclidean space when not limiting the number of 0- or 1-dimensional intersections. Although the model developed can potentially represent a high number of intersection points and then complex movements, a composition of DL-RE movements can be also applied.

Definition II.6. A composite movement of a directed line over a given region

models a sequence of DL-RE movements over a given region, which generally represents a complex trajectory of a spatial entity materialized by the configuration of a directed line \vec{L} over a region A, denoted as $DTR(\vec{L}, A)$, and given as follows:

$$DTR(\vec{L}, A) = \langle s_1, \dots, s_n \rangle \quad (\text{II.5})$$

with $s_i \in (S_1, \dots, S_{30}) \forall i = 1, \dots, n$

In order to model a given trajectory by a composite movement, we say that the sequence of primitive movements generated is the one modelled by the minimum number of primitive movements. This allows for example to not decompose a primitive movement S_8 by a sequence of $\langle S_5, S_4 \rangle$. Let us illustrate the potential of the approach using a simplified case study. Fishing Restricted Areas (FRA) are delimited areas at sea, within which fishing is temporarily or permanently prohibited to protect local marine resources as well as certain species. The region in Figure II.7a denotes a FRA in North West France where fishing sea bass is forbidden every year from March the 1st to May the 31th. The main idea behind the trajectories of vessels presented in that sketch example is to show some typical fishing ship behaviours and how the modelling approach can represent them. For example, the directed line \vec{L}_1 shows a trajectory of a local fisherman that sails out the FRA and then return to its origin. The DL-RE topological relation between \vec{L}_1 and the FRA A is given as $DTR(\vec{L}_1, A) = \langle S_8, S_7 \rangle$, with corresponding movement pattern $\langle CO_r, CI \rangle$ (i.e., CrossOut, CrossIn). The directed lines \vec{L}_2, \vec{L}_3 and \vec{L}_4 demonstrate several trajectories of vessels from the exterior to the FRA. \vec{L}_2 illustrates the trajectory of a vessel

moving towards the FRA and then moving away from it after touching the boundary of FRA. A fishing ship that crosses the FRA is the example of \vec{L}_3 . \vec{L}_4 denotes the trajectory of another fishing vessel that moves towards the FRA, sails along its boundary, then fishes inside the FRA, and finally sails out of the area. The DL-RE topological relations of these three trajectories can be modelled as follows:

- DTR (\vec{L}_2 , A) = $\langle S_{10} \rangle$, with corresponding movement pattern $\langle TO_1 \rangle$
- DTR (\vec{L}_3 , A) = $\langle S_7, S_8 \rangle$, with corresponding movement pattern $\langle CI_f, CO \rangle$
- DTR (\vec{L}_4 , A) = $\langle S_{26}, S_8 \rangle$, with corresponding movement pattern $\langle AR_1-AL_r-MI_1, CO \rangle$

Let us introduce an example of incomplete trajectory in Figure II.7a where two sample points are known and recorded, and that potentially materialize such trajectory, that is, S_{16} (the start and ending points of \vec{L}_5), with corresponding movement pattern $\langle AR_1-AL \rangle$. The intermediate trajectory derived from these two points is illustrated in the figure, as well as the potential forward conceptual trajectories when this trajectory will terminate. These can be either S_{16} , S_{28} or S_{26} . Likewise, if another two sample points (the start and ending points of \vec{L}_6) of the end part of the trajectory are recorded and form a trajectory of S_{21} which corresponds to movement pattern $\langle AL_r-MI \rangle$, the potential backward conceptual trajectories when this trajectory started can be either S_{21} , S_{26} or S_{29} .

Besides modelling movement patterns between a directed line and a region, the DL-RE topological relations model can also be applied to represent the trajectory of a directed line over several regions.

Definition II.7. A composite movement of a directed line over several regions

models a sequence of DL-RE movements over several regions. It is denoted as $DTR(\vec{L}, (A_1, \dots, A_m))$, where m denotes the number of regions considered, and given as follows:

$$DTR(\vec{L}, (A_1, \dots, A_m)) = \langle A_1 \langle s_{11}, \dots, s_{1n} \rangle, \dots, A_m \langle s_{m1}, \dots, s_{mp} \rangle \rangle \quad (II.6)$$

with $s_i \in (S_1, \dots, S_{30}) \forall i = 1, \dots, n$ and $\forall j = 1, \dots, m$.

Figure II.7b denotes a vessel moving across four continuous regions, which are two state marine reserves (A_1 and A_3) and two state marine conservation areas (A_2 and A_4) in California. The topological relations of the trajectory \bar{L} with respect to these four regions can be composed by a sequence of DL-RE movements over several regions:

$$DTR(\bar{L}, (A_1, A_2, A_3, A_4)) = \langle A_1 \langle S_7, S_{17} \rangle, A_2 \langle S_{22}, S_8 \rangle, A_3 \langle S_7, S_5 \rangle, A_4 \langle S_6, S_8 \rangle \rangle$$

The movement pattern is $\langle A_1 \langle CI_f, MB_r \rangle \text{-} AL \rangle, A_2 \langle AL \text{-} MI_f, CO_r \rangle, A_3 \langle CI_f, MB_f \rangle, A_4 \langle MI_f, CO \rangle \rangle$

These examples illustrate the capabilities of the modelling approach. Its main advantage is to formally define and categorize basic movements, and to provide a composition language to express complex behaviours.

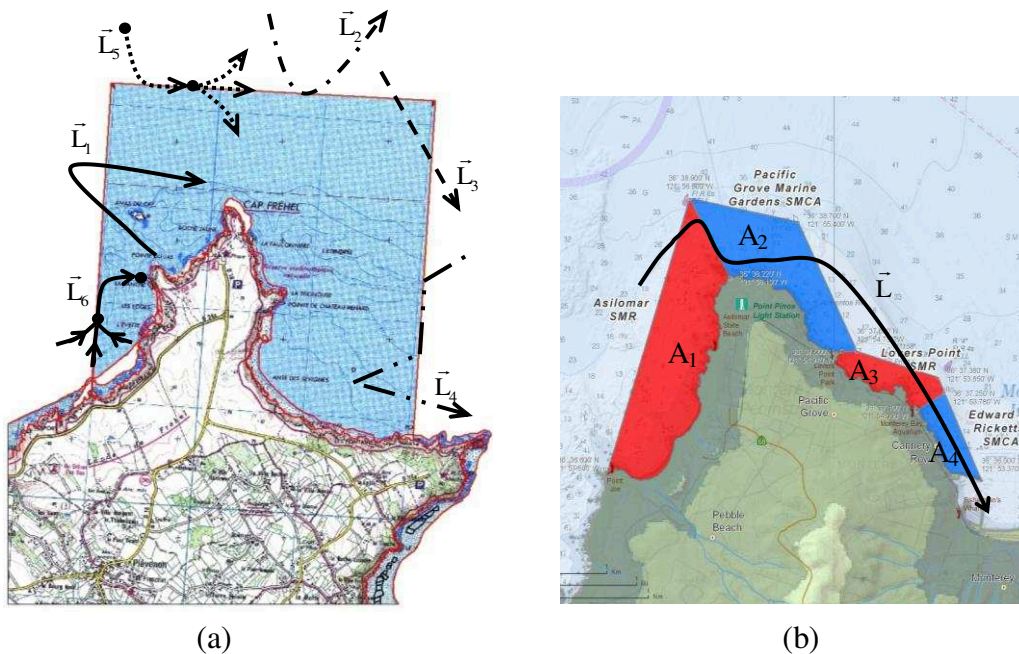

Figure II.7 Movement patterns representation: (a) several vessels towards or from one region; (b) one vessel moves across different regions

II.4 Orientation-based Movement Pattern between two Directed Lines

The topological relations between two directed lines can also be used to represent the movement pattern of a pair of objects. Taking the start and end point of a directed line X as its boundary (head: $\partial_{\text{head}} X$ and tail: $\partial_{\text{tail}} X$), and the connection between the points as

its interior (X°), Kurata and Egenhofer (2006) extended the 9IM with the head-body-tail (HBT) intersection matrix between two directed line segments (Eqn. II.4).

$$M_{\text{HBT}}(A, B) = \begin{bmatrix} \partial_{\text{tail}}A \cap \partial_{\text{tail}}B & \partial_{\text{tail}}A \cap B^\circ & \partial_{\text{tail}}A \cap \partial_{\text{head}}B \\ A^\circ \cap \partial_{\text{tail}}B & A^\circ \cap B^\circ & A^\circ \cap \partial_{\text{head}}B \\ \partial_{\text{head}}A \cap \partial_{\text{tail}}B & \partial_{\text{head}}A \cap B^\circ & \partial_{\text{head}}A \cap \partial_{\text{head}}B \end{bmatrix} \quad (\text{II.7})$$

Because the head or tail of a directed line is a point which cannot intersect with more than one part of another directed line, only 68 out of $2^9 = 512$ configurations satisfy the constraint. In that case, the HBT model classifies 68 topological relations between two directed lines, each of which is given a compound name by a set of named primitives as shown in Figure II.8.

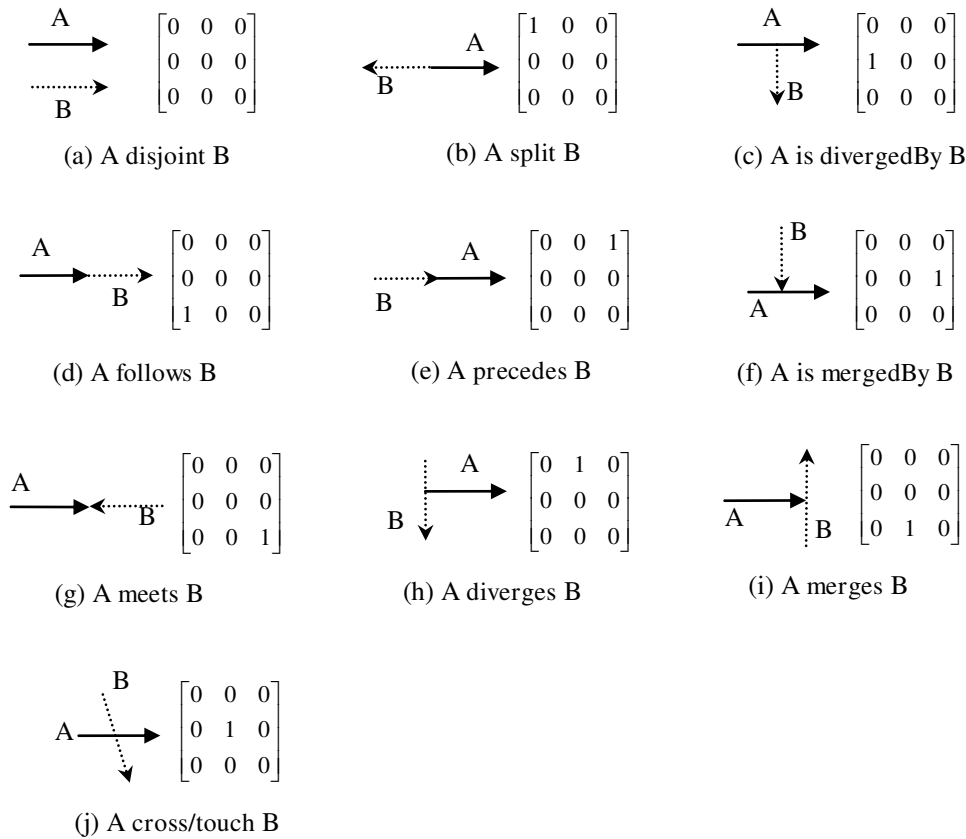

Figure II.8 The named primitives defined by the HBT model

However, some critical topological relations cannot be distinguished because of the expressive power of the matrix empty and non-empty intersections. For instance, the topological relations of three different configurations in Figure II.9 are disjoint, and those in Figure II.10 belong to cross/touch.

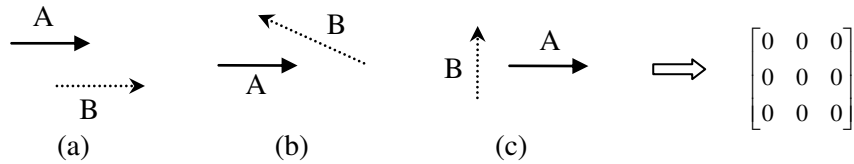

Figure II.9 Some Disjoint relations that cannot be distinguished by the HBT model

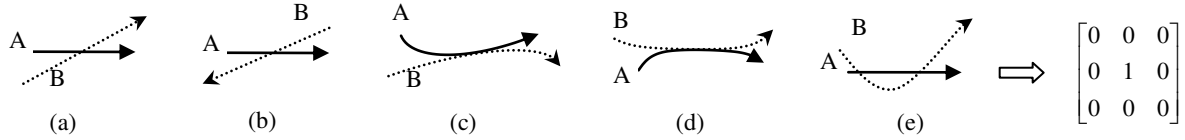

Figure II.10 Some Cross/touch relations that cannot be distinguished by the HBT model

In order to represent the detailed relations between two directed lines, orientation relations should be taken into consideration. An orientation-based model is proposed with one arbitrary directed line as the reference object and the other one as the target object.

$$DOR(A, B) = (AR_1 \partial_{tail} B, AR_2 B^\circ, AR_3 \partial_{head} B) \quad (II.8)$$

where A is the reference object; R_1, R_2 and R_3 represent the orientation relations of the start point, interior and end point of B with respect to A, respectively; The start point, interior and end point of A are denoted as s, i and e, respectively; The plane is divided into several regions by A and two perpendicular lines across the start and end point of A: frontleft (fl), front (f), frontright (fr), left (l), right (r), backleft (bl), back (b) and backright (br), i.e., $R_i \in \{s, i, e, fl, f, fr, l, r, bl, b, br\}, 1 \leq i \leq 3$, as shown in Figure II.11.

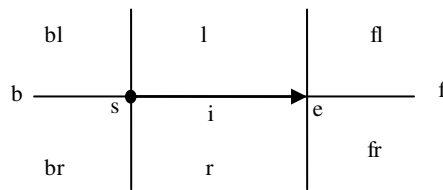

Figure II.11 Reference system of the DOR model

The spatial relation between two directed lines can be classified into two categories according to whether the interior parts of them are intersected.

1. The interior part of B is disconnected with the reference object A

When the interior part of B is disconnected with A, i.e., $R_2 \neq i$, the basic topological relations corresponding to DOR model are defined as follows:

- When neither of the start point and end point of B intersect with A, i.e., $R_1, R_3 \notin \{s, e, i\}$, the corresponding topological relation is disjoint (Figure II.8a)
- When the start point of B is coincident with the start point of A, i.e., $R_1 = s$, the corresponding topological relation is split (Figure II.8b)
- When the start point of B lies in the interior part of A, i.e., $R_1 = i$, the corresponding topological relation is divergedBy (Figure II.8c)
- When the start point of B is coincident with the end point of A, i.e., $R_1 = e$, the corresponding topological relation is follow (Figure II.8d)
- When the end point of B is coincident with the start point of A, i.e., $R_3 = s$, the corresponding topological relation is precede (Figure II.8e)
- When the end point of B lies in the interior part of A, i.e., $R_3 = i$, the corresponding topological relation is mergedBy (Figure II.8f)
- When the end point of B is coincident with the end point of A, i.e., $R_3 = e$, the corresponding topological relation is meet (Figure II.8g)

2. The interior part of B is intersected with the reference object A

When the interior part of B intersects with A, i.e., $i \in R_2$, the interior part of B is divided into several segments by the intersections. In that case, one needs to consider the detailed topological relations of each segment of B with respect to A:

$$R_2 = (Ar_0 B_0^\circ, Ar_1 B_1^\circ, \dots, Ar_n B_n^\circ) \tag{II.9}$$

where r_j represents the detailed topological relation of the interior part between the j intersection and the $j+1$ intersection of B with respect to A, $r_j \in \{l, i, r\}$, $0 \leq j \leq n$. The inverse relation of r_j is denoted as \check{r}_j . When $r_j = l$, $\check{r}_j = r$, and vice versa. If the intersection is a point, the detailed topological relation can be subdivided into cross (Figure II.12a) and touch (Figure II.12b). If the intersection is a line, the corresponding detailed topological relation is overlap (Figure II.12c).

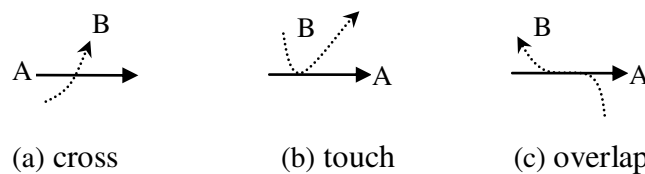

Figure II.12 Body-body intersections between directed lines

Although the movement pattern between two directed lines defined by the DOR model demonstrates only the orientation relation, ten primitive topological relations can be mapped towards their corresponding orientation relations, as shown in Table II.1. A composition of primitive topological relations is modelled according to the intersection sequence following the target directed line from head to tail. For example, for Figure II.13a, $DOR(A, B) = (i, l, e)$, which corresponds to topological relation *divergedBy-meet*; for Figure II.13b, $DOR(A, B) = (s, (r, l), i)$, which corresponds to topological relation *split-cross-mergedBy*; for Figure II.13c, $DOR(A, B) = (fr, (r, l, i, l), bl)$, which corresponds to topological relation *cross-overlap*.

Intersect inside	Orientation relation	Topological relation
$R_2 \neq i$	$R_1, R_3 \notin \{s, e, i\}$ $R_1 = s$ $R_1 = i$ $R_1 = e$ $R_3 = s$ $R_3 = i$ $R_3 = e$	disjoint split divergedBy follow precede mergedBy meet
$i \in R_2$	$r_j = i$ $r_j = r_{j+1}$ $r_j = \tilde{r}_{j+1}$	overlap touch cross

Table II.1 Orientation-based movement patterns

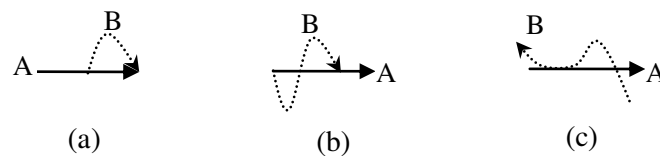

Figure II.13 Examples of configurations between directed lines

Compared to the HBT models, spatial relations between two directed lines can be represented effectively by the DOR model. For example, three different disjoint relations in Figure II.9 can be modelled as follows:

- (a) $DOR(A, B) = (r, fr, fr)$
- (b) $DOR(A, B) = (f, fl, l)$
- (c) $DOR(A, B) = (br, b, bl)$

Five different configurations in Figure II.10 can be represented as follows:

- (a) $DOR(A, B) = (br, (r, l), fl)$, with topological relation *cross*

- (b) $\text{DOR}(A, B) = (\text{fl}, (\text{l}, \text{r}), \text{br})$, with topological relation cross
- (c) $\text{DOR}(A, B) = (\text{br}, (\text{r}, \text{r}), \text{fr})$, with topological relation touch
- (d) $\text{DOR}(A, B) = (\text{bl}, (\text{l}, \text{i}, \text{l}), \text{fl})$, with topological relation overlap
- (e) $\text{DOR}(A, B) = (\text{bl}, (\text{l}, \text{r}, \text{l}), \text{fl})$, with topological relation cross

II.5 Conclusion

This chapter introduces two formal models to represent movement patterns in a 2-dimensional space. In order to describe how an object moves in relation to other objects, we introduce two models that consider either a region or a directed line segment as the reference entity, respectively. The former can be a stable region of interest or an area occupied by a group of moving objects, while the latter is derived from the trajectory of the reference moving object over a time interval. The first modelling approach is based on the study of the configuration between a directed line with respect to the boundary of a reference region. This supports derivation of movement patterns from DL-RE topological relations classified by several topological properties. Movement predicates are defined to map movement patterns toward verbs (such as move, depart), directional prepositions (such as to, along), particles (such as outside, inside), and other adjuncts. The second modelling approach favours an interpretation of movement patterns with orientation relations. This second approach enhances the semantics of the spatial relations that characterize two directed lines.

Overall the two methods complement each other. The first model is oriented to the analysis of the behaviour of a given trajectory in the neighbourhood and boundary of a given region of reference, and by making a difference between the patterns that emerge inside or outside that region. On the other hand, the second approach models the relative behaviour of either two crossing trajectories, or one trajectory with respect to a polyline or the boundary of a given region. The two modelling approaches can be also considered as complementary when analyzing some trajectories' behaviours at different levels of abstraction. For example, by aggregating the trajectories of several birds, a generalized reference region can be derived thus allowing the study of the movements of the flock of birds. One of the interesting patterns to analyze will be the analysis of such movements at the local and aggregated scale.



Qualitative Representation of Moving Entities

III.1 INTRODUCTION.....	60
III.2 SPATIO-TEMPORAL PRIMITIVES.....	61
2.1 TEMPORAL PRIMITIVES	61
2.2 TOPOLOGICAL PRIMITIVES	63
2.3 DISTANCE PRIMITIVES	64
III.3 TOWARDS A REGION-REGION MOVEMENT REPRESENTATION	66
3.1 MOVEMENT OUTSIDE A REFERENCE ENTITY	66
3.2 MOVEMENT ON THE BOUNDARY OF A REFERENCE ENTITY	67
3.3 MOVEMENT INSIDE A REFERENCE ENTITY	68
III.4 TOWARDS A TRAJECTORY-REGION MOVEMENT REPRESENTATION.....	71
4.1 NO INTERSECTION	71
4.2 ONE 0-DIMENSIONAL INTERSECTION POINT	73
4.3 ONE 1-DIMENSIONAL INTERSECTION LINE.....	75
III.5 DISCUSSION.....	78

III.1 Introduction

Qualitative representations of movement patterns have proven to be particularly appropriate for the representation of dynamic spatial data as not only they provide formal framework, but as they can be also used in many contexts, especially when only partial or imprecise information are available (Gottfried and Witte 2007; Lücke et al. 2011). Moving entities in geographical spaces can be classified into two categories: (1) entities without area represented as moving points, and (2) entities with area represented as moving regions and whose extent may also change with time. So far, most of real-world applications considered as background applications (e.g., trajectories of cars, pedestrians, or animals) have conceptualized a moving entity as a point. Hence, several qualitative models have been developed in these contexts (Delafontaine et al. 2008; Dylla et al. 2007; Glez-Cabrera et al. 2013; Van de Weghe 2004). Trajectories are usually defined as being composed of three distinct parts: a source, a destination, and locations in-between. The importance of the source-path-goal structure has been reflected in recent formal spatial reasoning developments (Kurata and Egenhofer 2006; Noyon et al. 2007), natural language-based representations (Hornsby and Li 2009), as well as in connection with time geography principles (Zhou et al. 2015).

The second category of approach, surely more complex from a modelling point of view although notably important as this might cover many application contexts, models qualitative movements of some regions as moving regions. But to the best of our knowledge, this case has attracted less attention. In fact most of current works have considered moving regions as relatively independent entities, and where changes are detected as either a sequence of snapshots as in most GIS approaches, or as transitions between different states (Claramunt et al. 1997a; Galton 1995; Liu and Schneider 2010; Muller 1998). The later can further support additional manipulations using the concepts of spatio-temporal graphs (Del Mondo et al. 2013). However, the modelling of moving regions considered as such at the abstract level still deserves a complete reasoning framework that will take into account a large range of properties. Amongst the ones considered, topological relations and their evolution over time usually provide the modelling abstractions behind the first category considered, but the next sections will show that additional relations, particularly the notion of distance considered from a qualitative point of view, provide useful additional parameters that enrich the extent of the modelling support and then reasoning capabilities.

When interpreting movement in natural language, appropriate constructs such as verbs as well as additional prepositions can reveal some mental cognitive representations (Sablayrolles 1995). As natural languages organize verbs and prepositions together in sentences, we qualify movement predicates with either a single semantic (i.e., one verb or preposition) or composite semantic (i.e., composition of verbs and prepositions).

This chapter develops a qualitative and formal modelling approach to qualify the main movements between two entities in space and time, these movements being related to a set of movement predicates expressed in natural language. The main assumptions of the modelling approach are as follows. Firstly, we take a relative point of view when representing the movement of two given entities. Secondly, a movement is considered by giving a particular importance on the boundary of the region considered as predominant or as a reference. Thirdly, the other entity, denoted as target entity, is abstracted as a directed line or a region. This specific property is relevant for example in indoor spaces when analyzing the trajectory of a man with respect to a given room, or to some specific places in a large-scale space.

The rest of this chapter is organized as follows. The temporal, topological and distance primitives for a qualitative representation of movement are defined in Section III.2. Based on these spatio-temporal primitives, a modelling approach for moving regions is presented in Section III.3, the primitive movements of a trajectory with respect to a region are developed in Section III.4. Conclusions and discussions are summarized in Section III.5.

III.2 Spatio-Temporal Primitives

A core objective in this chapter is to set up the principles of the formalism applied to the representation of the movement of two moving entities over a given period of time in 2-dimensional space. To reach this goal, let us introduce the spatio-temporal primitives needed for the conceptual framework.

2.1 Temporal Primitives

One of the primary components of a spatio-temporal model is its fundamental temporal structure. This first implies to retain several amongst the different temporal principles and primitives usually considered for temporal reasoning, that is, points or intervals, temporal domain for these primitives (i.e., continuous or discrete), the ordering imposed on these primitives (i.e., linear or branching), and whether time is bounded or unbounded

(Goralwalla et al. 1997). The moving entities we are dealing with denote some dynamic real world objects that change continuously over linear sequences of time. In this thesis, the temporal primitives taken into consideration are time intervals which are assumed to be continuous and linear.

Definition III.1. The time line $TL = \langle t, < \rangle$ is a point structure which is a total (linear) order without endpoints (Galton 1995).

Each element of TL corresponds to a time instant t and is endowed with a temporal succession relation $<$ (Galton 1995):

$$t_1 < t_2 < t_3 \Leftrightarrow t_1 < t_2 \wedge t_2 < t_3 \quad (III.1)$$

Definition III.2. A time interval, denoted as T , is any connected subset of TL composed of its start time instant (t_s) and end time instant (t_e), i.e., $T = [t_s, t_e]$, where $t_s \in TL$, $t_e \in TL$ and $t_s < t_e$.

An open time interval, left-closed, and right-closed time intervals (denoted as (t_s, t_e) , $[t_s, t_e)$, and $(t_s, t_e]$, respectively) can be defined analogously. By an application of the Interval Calculus (Allen 1983), a time interval sequence is defined as follows.

Definition III.3. Given a sequence of time intervals, if

$$\forall T_i, T_j, i < j : T_i \text{ before or meets } T_j \text{ hold,} \quad (III.2)$$

we say (T_1, T_2, \dots, T_n) is a time interval sequence.

Figure III.1 illustrates the time line and the temporal primitives defined over it. The lower bounds (t_{1s}, t_{2s}) and upper bounds (t_{1e}, t_{2e}) of the time intervals T_1 and T_2 are points which are members of the time line, and T_1 before T_2 , which makes (T_1, T_2) a time interval sequence.

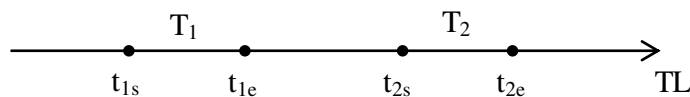

Figure III. 1 Temporal primitives

According to these temporal primitives, the state of a moving entity can be defined as follows (Claramunt et al. 1997a):

- The state of a moving entity, denoted as S_i , represents a stable value (without trend change) of this entity within a time interval T_i as:

$$\text{Holds}(S_i, T_i) \Leftrightarrow \forall t \in T_i, \text{Holds-at}(S_i, t) \quad (\text{III.3})$$

- and an entity state holds throughout every sub-interval included in its own time interval:

$$\text{Holds}(S_i, T_i) \wedge J \subseteq T_i \Rightarrow \text{Holds}(S_i, J) \quad (\text{III.4})$$

2.2 Topological Primitives

Topological primitives should help to materialize the evolution of some moving entities by studying the evolution of the topological relationships that relate them. Let us consider two given entities and their evolution over time, and study the behaviour of a first observed entity with respect to a second entity considered as the reference region entity. The objective is to reflect how a given entity evolves outside, inside or on the boundary of the reference region.

The movement of a single moving entity can be conceptualized as a region that occurs in relation to a reference region, such as a tornado passing through a city. Multiple entities moving collectively, for example, a herd of zebra, flocks of birds, can be simplified to one region entity. In order to describe the topological relations between these two regions, several region-region topological models can be considered, such as the 9IM (Egenhofer and Herring 1991), the CBM (Clementini and Di Felice 1994) and the RCC model (Randell et al. 1992). While the two other models derive topological relations by comparing the intersection of the interior, the exterior and the boundary of different planar regions, the RCC model is based on a single primitive relation between spatial regions, the “connectedness” relation. One variant of the RCC model, RCC8, uses eight mutually exhaustive and pairwise disjoint relations to describe the topological relations between two spatial regions as follows: disconnected (DC), externally connected (EC), partial overlap (PO), equal (EQ), tangential proper part (TPP) and tangential proper part inverse (TPPI), and non-tangential proper part (NTPP) and nontangential proper part inverse (NTPPI). RCC8 can be used in spaces of arbitrary dimensions, especially for two- and three-dimensional Euclidean spaces (Renz 2002). This makes RCC8 very general and widely applicable. In that case, the representation framework for region-region movement

developed retained the RCC model although the other models mentioned above will produce some relatively equivalent reasoning formalisms.

If the target entity is assimilated to a point, such as a vehicle, a person, or an animal, its movement over time can be abstracted as a directed line. Although several models (Egenhofer and Franzosa 1995; Deng 2008; Kurata and Egenhofer 2007) have been developed to describe line-region topological relations, whether they can cover all possible configurations in a 2-dimensional space is still an open research question. As the DL-RE topological relations proposed in Chapter II.3 are flexible enough to qualify possible movements according to several topological properties such as the dimension and cardinality of the intersections between a directed line and a region, they can act as line-region topological primitives.

2.3 Distance Primitives

Distance is another important property of space, as stated in Zimmermann and Freksa (1993): “Time and space are related through physical movement, since a certain amount of time is required for achieving motion over a certain distance.” While quantitative distances are based on pure metrics, qualitative distances often use adverbs such as close, near and far-away. For instance, the modelling framework of Qualitative Trajectory Calculus (QTC) introduced by Van de Weghe (2004) retains qualitative distances as defined by comparing distances between the positions of the two moving points at different time instants. Since the topological relations between them are always disjoint in QTC, the changes of distance happen outside of each other.

In order to derive the qualitative distance relations between an entity A and an entity B, let us introduce the following notation by assuming that the location of the entity B is stable over time, while the position of the entity A varies over a given time interval.

- d_t denotes the distance between the entity A and the entity B at a time instant t , which is modelled as the minimum distance between the boundary of A and the boundary of B, as shown in Figure III.2.
- R_t denotes the RCC8 topological relations between the entity A and the entity B at a time instant t .

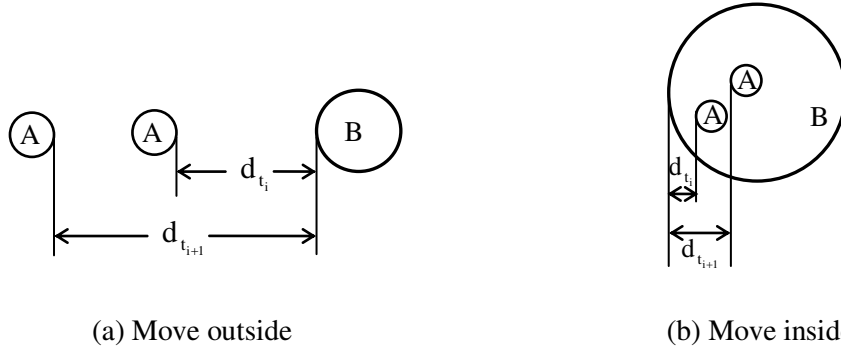

Figure III.2 Distance between two moving entities at continuous time instant

In order to represent whatever the relative location for moving regions A and B, i.e., whether A is outside, on the boundary or inside B, the distance primitives are studied with the RCC calculus, which appear to be semi-quantitative as opposed to purely qualitative in nature, the dynamic distance between two given entities are defined as follows:

Definition III.4. The dynamic distance between a target entity A and a reference entity B, denoted as d , denotes the variation trend of the distance between A and B over a time interval T.

The basic dynamic distance configurations of two given entities A and B over a given interval of time T are modelled as follows:

- $d_{\text{ext}+}$ denotes that d is continuously increasing outside B over a given temporal interval T:

$$\forall t_i \in T, (d_{t_{i+1}} > d_{t_i}) \wedge (R_{t_i} = DC) \quad (\text{III.5})$$

- $d_{\text{ext}-}$ denotes that d is continuously decreasing outside B over a given temporal interval T:

$$\forall t_i \in T, (d_{t_{i+1}} < d_{t_i}) \wedge (R_{t_i} = DC) \quad (\text{III.6})$$

- $d_{\text{ext}=\}$ denotes that d is constant outside B over a given temporal interval T:

$$\forall t_i \in T, (d_{t_{i+1}} = d_{t_i}) \wedge (R_{t_i} = DC) \quad (\text{III.7})$$

- d_0 denotes that d is null over a given temporal interval T:

$$\forall t_i \in T, (d_{t_{i+1}} = d_{t_i} = 0) \wedge R_{t_i} \in \{EC, PO, TPP, TPPI, EQ\} \quad (\text{III.8})$$

- $d_{\text{int}+}$ denotes that d is continuously increasing inside B over a given temporal interval T:

$$\forall t_i \in T, (d_{t_{i+1}} > d_{t_i}) \wedge R_{t_i} \in \{NTPP, NTPPI\} \quad (III.9)$$

- d_{int-} denotes that d is continuously decreasing inside B over a given temporal interval T :

$$\forall t_i \in T, (d_{t_{i+1}} < d_{t_i}) \wedge R_{t_i} \in \{NTPP, NTPPI\} \quad (III.10)$$

- $d_{int=}$ denotes that d is constant inside B over a given temporal interval T :

$$\forall t_i \in T, (d_{t_{i+1}} = d_{t_i}) \wedge R_{t_i} \in \{NTPP, NTPPI\} \quad (III.11)$$

III.3 Towards a Region-Region Movement Representation

Let us first consider the case in which both the moving entity and the reference entity are conceptualized as being spatially extended. Based on region-region topological primitives (TOP_{RCC}) and distance primitives (d), a set of movement primitives of moving regions ($PriM_{V_r}$) which support the qualitative representation of movement between a moving region A and a reference region B over a time interval T is formally defined as follows:

$$PriM_{V_r}(A, B) \equiv Holds(TOP_{RCC}, d, T) \quad (III.12)$$

where $TOP_{RCC} \in \{DC, EC, PO, EQ, TPP, TPPI, NTPP, NTPPI\}$, $d \in \{d_{ext+}, d_{ext-}, d_{ext=}, d_0, d_{int+}, d_{int-}, d_{int=}\}$.

The movement primitives are classified into three categories according to the relative location of the moving entity with respect to the reference entity over a given temporal interval T , that is, outside, on the boundary, or inside a reference entity.

3.1 Movement outside a Reference Entity

When a moving entity A is disconnected from a reference entity B over a given temporal interval T , three categories of movements can be distinguished: Approach (AP), Leave (LV) and AroundOutside (AO). More formally the movement primitives identified are as follows:

- Approach: A moving entity A is approaching a reference entity B over a time interval T , as shown in Figure III.3a. For all $t \in T$, DC holds and the dynamic distance d is decreasing outside B over T :

$$Approach(A, B) \equiv Holds(DC, d_{ext-}, T) \quad (III.13)$$

- Leave: A moving entity A is leaving a reference entity B over a time interval T, as shown in Figure III.3b. For all $t \in T$, DC holds and the dynamic distance d is increasing outside B over T:

$$\text{Leave}(A, B) \equiv \text{Holds}(\text{DC}, d_{\text{ext}+}, T) \quad (\text{III.14})$$

- AroundOutside: A moving entity A is either moving around or static outside a reference entity B over a time interval T, as shown in Figure III.3c. For all $t \in T$, DC holds and the dynamic distance d is constant outside B over T:

$$\text{AroundOutside}(A, B) \equiv \text{Holds}(\text{DC}, d_{\text{ext}=?}, T) \quad (\text{III.15})$$

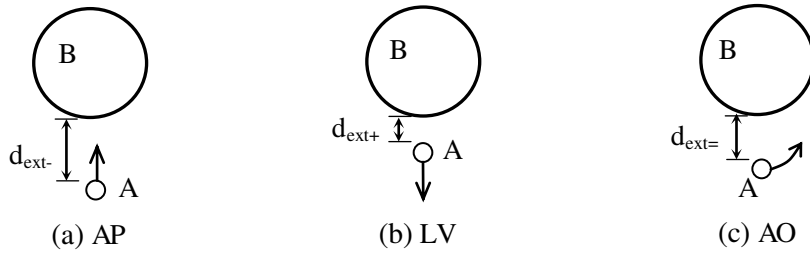

Figure III.3 Movement outside a reference entity

3.2 Movement on the Boundary of a Reference Entity

When an entity A is moving on the boundary of a reference entity B over a time interval T, five different categories of movements are identified: Touching (TI), Overlapping (OI), CoveringBy (CB), Covering (CI) and Equaling (EI), in which CB and CI are a pair of inverse movements. More formally the movement primitives identified are as follows:

- Touching: A moving entity A is touching outside the boundary of a reference entity B over a time interval T, as shown in Figure III.4a. For all $t \in T$, EC holds and the dynamic distance d is d_0 over T:

$$\text{Touching}(A, B) \equiv \text{Holds}(\text{EC}, d_0, T) \quad (\text{III.16})$$

- Overlapping: A moving entity A is overlapping the boundary of a reference entity B over a time interval T, as shown in Figure III.4b. For all $t \in T$, PO holds and the dynamic distance d is d_0 over T:

$$\text{Overlapping}(A, B) \equiv \text{Holds}(\text{PO}, d_0, T) \quad (\text{III.17})$$

- **CoveringBy:** A moving entity A is touching inside the boundary of a reference entity B over a time interval T, as shown in Figure III.4c. For all $t \in T$, TPP holds and the dynamic distance d is d_0 over T:

$$\text{CoveringBy}(A, B) \equiv \text{Holds}(\text{TPP}, d_0, T) \quad (\text{III.18})$$

- **Covering:** A moving entity A is touching outside the boundary of a reference entity B over a time interval T, as shown in Figure III.4d. For all $t \in T$, TPPI(A, B) holds and the dynamic distance d is d_0 over T:

$$\text{Covering}(A, B) \equiv \text{Holds}(\text{TPPI}, d_0, T) \quad (\text{III.19})$$

- **Equaling:** A moving entity A equals a reference entity B over a time interval T, as shown in Figure III.4e. For all $t \in T$, EQ holds and the dynamic distance d is d_0 over T:

$$\text{Equaling}(A, B) \equiv \text{Holds}(\text{EQ}, d_0, T) \quad (\text{III.20})$$

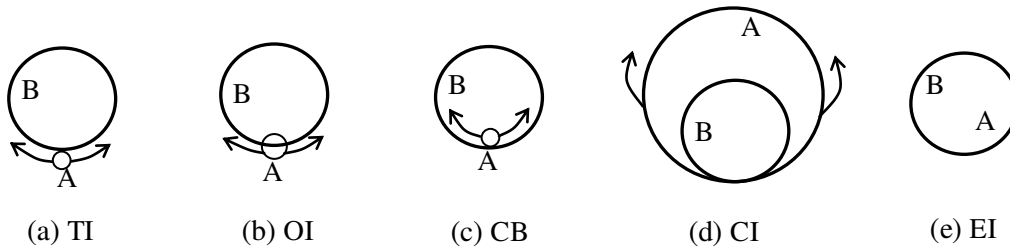

Figure III.4 Movement on the boundary of a reference entity

3.3 Movement inside a Reference Entity

When an entity A moves inside a reference entity B over a time interval T, there are six categories of movements: *MovetoInterior* (MI), *MovetoBoundary* (MB), *AroundInside* (AI), *EmbracingMoveOutside* (EMO), *EmbracingMovetoBoundary* (EMB), and *EmbracingAroundOutside* (EAO), in which MI and EMO, MB and EMB, AI and EAO are three pairs of inverse movements, respectively. Those disjoint configurations are derived from six relative distance behaviours over a given temporal of time: d_{int+} , d_{int-} , $d_{int=}$, d_{ext+} , d_{ext-} , and $d_{ext=}$. Similarly the spatial configurations valid are NTPP or NTPPI when respectively an entity A is either inside a reference entity B, and conversely. More formally the movement primitives identified are as follows:

- **MovetoInterior:** When a moving entity A is NTPP to a reference entity B and leaving the boundary of B over a time interval T, we say that A is moving to the interior of B, as shown in Figure III.5a. For all $t \in T$, NTPP holds and the dynamic distance d is increasing inside B over T:

$$\text{MovetoInterior}(A, B) \equiv \text{Holds}(\text{NTPP}, d_{\text{int+}}, T) \quad (\text{III.21})$$

- **MovetoBoundary:** When a moving entity A is NTPP to a reference entity B, and A is moving to the boundary of B over a time interval T, we say that A is moving to the boundary of B, as shown in Figure III.5b. For all $t \in T$, NTPP holds and the dynamic distance d is decreasing inside B over T:

$$\text{MovetoBoundary}(A, B) \equiv \text{Holds}(\text{NTPP}, d_{\text{int-}}, T) \quad (\text{III.22})$$

- **AroundInside:** When a moving entity A is NTPP to a reference entity B, and A is either moving around the boundary of B or static relative to B over a time interval T, we say that A is around inside B, as shown in Figure III.5c. For all $t \in T$, NTPP holds and the dynamic distance d is constant inside B over T:

$$\text{AroundInside}(A, B) \equiv \text{Holds}(\text{NTPP}, d_{\text{int=}}, T) \quad (\text{III.23})$$

- **EmbracingMoveOutside:** When a moving entity A is NTPPI to a reference entity B, and A is moving outside B over a time interval T, we say that A is embracing B and moving outside B, as shown in Figure III.5d. For all $t \in T$, NTPPI holds and the dynamic distance d is increasing outside B over T:

$$\text{EmbracingMoveOutside}(A, B) \equiv \text{Holds}(\text{NTPPI}, d_{\text{ext+}}, T) \quad (\text{III.24})$$

- **EmbracingMovetoBoundary:** When a moving entity A is NTPPI to a reference entity B, and A is moving to the boundary of B over a time interval T, we say that A is embracing B and moving to the boundary of B, as shown in Figure III.5e. For all $t \in T$, NTPPI(A, B) holds and the dynamic distance d is decreasing outside B over T:

$$\text{EmbracingMovetoBoundary}(A, B) \equiv \text{Holds}(\text{NTPPI}, d_{\text{ext-}}, T) \quad (\text{III.25})$$

- **EmbracingAroundOutside:** When a moving entity A is NTPPI to a reference entity B, and A is either moving around or static outside of B over a time interval T, we say that A is embracing B and moving around outside B, as shown in Figure III.5f.

For all $t \in T$, $NTPPI(A, B)$ holds and the dynamic distance d is constant outside B over T :

$$\text{EmbracingAroundOutside}(A, B) \equiv \text{Holds}(NTPPI, d_{\text{ext}=\}, T) \quad (\text{III.26})$$

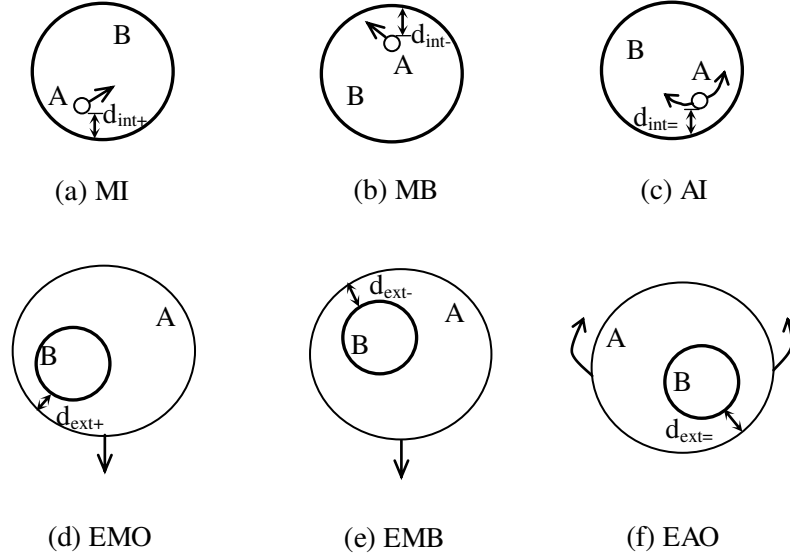

Figure III.5 Movement inside a reference entity

A sequence of movement can be decomposed by the movement primitives defined above. Taking the movement sequence of a man A (a moving region taken up a certain space) enters a room B (a reference region) as an example, when that man enters that room, he firstly approaches the door of the room over a time interval T_1 , then arrives and stands outside the door over a time interval T_2 , passes through the doorway over a time interval T_3 , goes into the room over a time interval T_4 , and moves inside the room over a time interval T_5 . The sequence of movements is shown in Figure III.6. The semantic of man A enters a room B over a time interval sequence $(T_1, T_2, T_3, T_4, T_5)$, denoted as $\text{Enter}(A, B)$, can be described using the following semantics:

$$\text{Enter}(A, B) \equiv \text{events}((\text{Approach}(A, B), T_1) \wedge (\text{Touching}(A, B), T_2) \wedge (\text{Overlapping}(A, B), T_3) \wedge (\text{CoveringBy}(A, B), T_4) \wedge (\text{MovetoInterior}(A, B), T_5))$$

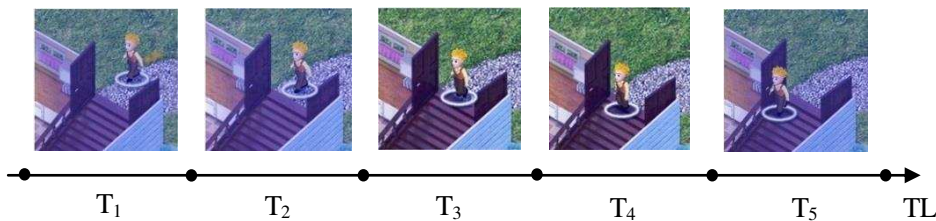

Figure III.6 Movement semantics of a man that enters a room

III.4 Towards a Trajectory-Region Movement Representation

A trajectory, modelled as a semantic abstraction, should be represented by spatial, temporal and semantic domain knowledge this being denoted as a semantic enrichment process (Bogorny et al. 2014). Regarding the spatial dimension, a trajectory can be modelled as a series of episodes as suggested in (Mountain and Raper 2001), an episode being defined as a maximal homogeneous sub-sequence of a trajectory. This allows us to map a given trajectory to a series of spatial predicates whose semantics can be also enriched by additional application dependent criteria.

To analyze the case in which the movement of a moving entity is conceptualized as a trajectory while the reference entity is spatially extended, a set of movement primitives of the trajectory (PriM_{V_t}) is formally defined based on DL-RE topological relations ($\text{TOP}_{\text{DL-RE}}$) and dynamic distance (d) over a time interval T .

$$\text{PriM}_{V_t}(A, B) \equiv \text{Holds}(\text{TOP}_{\text{DL-RE}}, d, T) \quad (\text{III.27})$$

where $\text{TOP}_{\text{DL-RE}} \in \{S_1, \dots, S_{30}\}$, $d \in \{d_{\text{ext}+}, d_{\text{ext}-}, d_{\text{ext}=?}, d_0, d_{\text{int}+}, d_{\text{int}-}, d_{\text{int}=?}\}$.

The intersection type of the neighbouring disc of either endpoints (the starting point L_s or the destination point L_e) or the intersection (I) on the trajectory is used to derive $\text{TOP}_{\text{DL-RE}}$. If there is no intersection between the trajectory and the boundary of the reference entity, the intersection type of $\text{neigh}(L_e)$ should be considered. Otherwise, the intersection type of $\text{neigh}(I)$ is applied. The primitive movement semantics are classified into the following categories according to the number and dimension of the intersection.

4.1 No Intersection

Let us first consider the configuration where a trajectory A is outside a reference entity B . Over a given temporal interval T , three categories of primitive movement predicates can be distinguished: Approach (AP), Leave (LV) and AroundOutside (AO). During that time interval T , the DL-RE relation is S_1 and the relative distance can be either decreasing, increasing or constant ($d_{\text{ext}-}$, $d_{\text{ext}+}$ and $d_{\text{ext}=?}$, respectively). More formally:

- Approach(A, B) denotes the case of a trajectory A is approaching a reference entity B over a time interval T , as shown in Figure III.7a. For all $t \in T$, S_1 holds and the dynamic distance d is decreasing outside B :

$$\text{Approach}(A, B) \equiv \text{Holds}(S_1, d_{\text{ext}-}, T) \quad (\text{III.28})$$

- Leave(A, B) denotes the case of a trajectory A is leaving the reference entity B over a time interval T, as shown in Figure III.7b. For all $t \in T$, S_1 holds and the dynamic distance d is increasing outside B:

$$\text{Leave}(A, B) \equiv \text{Holds}(S_1, d_{\text{ext}+}, T) \quad (\text{III.29})$$

- AroundOutside(A, B) denotes the case of a trajectory A is either moving around or static outside the reference entity B over a time interval T, as shown in Figure III.7c. For all $t \in T$, S_1 holds and the dynamic distance d is constant outside B:

$$\text{AroundOutside}(A, B) \equiv \text{Holds}(S_1, d_{\text{ext}=\}, T) \quad (\text{III.30})$$

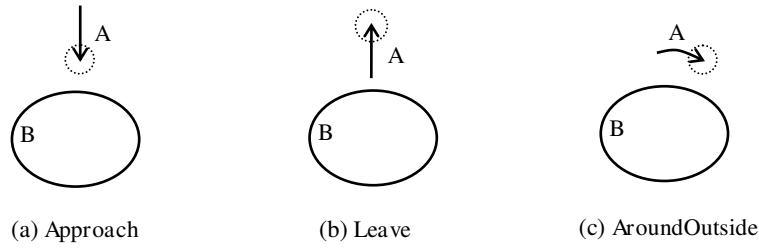

Figure III.7 Trajectory configurations outside a reference entity

When a trajectory A is inside a reference entity B over a time interval T, there are three categories of movements: MovetoBoundary (MB), MovetoInterior (MI) and AroundInside (AI). During that time interval T, the DL-RE relation is S_2 and the relative distance can be either decreasing, increasing or constant ($d_{\text{int}-}$, $d_{\text{int}+}$ and $d_{\text{int}=\}$, respectively). More formally:

- MovetoInterior(A, B) denotes the case of a trajectory A is inside B and leaving the boundary of B over a time interval T, as shown in Figure III.8a. For all $t \in T$, S_2 holds and the dynamic distance d between A and B is increasing inside B over T:

$$\text{MovetoInterior}(A, B) \equiv \text{Holds}(S_2, d_{\text{int}+}, T) \quad (\text{III.31})$$

- MovetoBoundary(A, B) denotes the case of a trajectory A is inside B and moving to the boundary of B over a time interval T, as shown in Figure III.8b. For all $t \in T$, S_2 holds and the dynamic distance d between A and B is decreasing inside B over T:

$$\text{MovetoBoundary}(A, B) \equiv \text{Holds}(S_2, d_{\text{int}-}, T) \quad (\text{III.32})$$

- AroundInside(A, B) denotes the case of a trajectory A is inside B and moving around the boundary of B over a time interval T, as shown in Figure III.8c. For all

$t \in T$, S_2 holds and the dynamic distance d between A and B is constant inside B over T :

$$\text{AroundInside}(A, B) \equiv \text{Holds}(S_2, d_{\text{int=}}, T) \quad (\text{III.33})$$

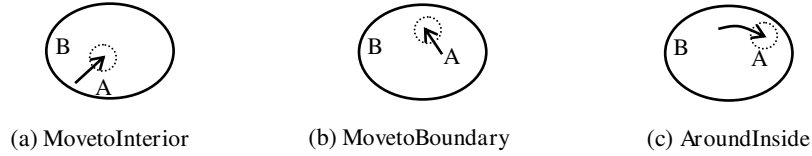

Figure III.8 Trajectory configurations inside a reference entity with no intersection

4.2 One 0-Dimensional Intersection Point

When there is one intersection point between a trajectory and the boundary of a reference region, the movement predicate is composed by one or two movement states that hold over a left-closed or right-closed time interval and another one meets the boundary of the region at certain time instant, such as the start time (t_s), the end time (t_e) or the time instant when the trajectory intersect the boundary (t_l), respectively. More formally:

- $\text{Arrive}(A, B)$ denotes the case of the end point of the trajectory A meets outside B , as shown in Figure III.9a. The trajectory A Approach B during the time interval $T = [t_s, t_e)$ before it meets the boundary of B . More formally:

$$\text{Arrive}(A, B) \equiv \text{Holds}(S_1, d_{\text{ext-}}, T) \wedge \text{Holds-at}(S_3, d_0, t_e) \quad (\text{III.34})$$

- $\text{Depart}(A, B)$ denotes the case of the start point of the trajectory A meets outside B , as shown in Figure III.9b. The trajectory A starts on the boundary of B then Leave it during the time interval $T = (t_s, t_e]$. More formally:

$$\text{Depart}(A, B) \equiv \text{Holds-at}(S_4, d_0, t_s) \wedge \text{Holds}(S_1, d_{\text{ext-}}, T) \quad (\text{III.35})$$

- $\text{Exit}(A, B)$ denotes the case of the end point of the trajectory A meets inside B , as shown in Figure III.9c. The trajectory A MovetoBoundary of B during the time interval $T = [t_s, t_e)$ then ends on the boundary of it. More formally:

$$\text{Exit}(A, B) \equiv \text{Holds}(S_2, d_{\text{int-}}, T) \wedge \text{Holds-at}(S_5, d_0, t_e) \quad (\text{III.36})$$

- $\text{Enter}(A, B)$ denotes the case of the start point of the trajectory A meets inside B , as shown in Figure III.9d. The trajectory A starts on the boundary of B then MovetoInterior of it during the time interval $T = (t_s, t_e]$. More formally:

$$\text{Enter}(A, B) \equiv \text{Holds-at}(S_6, d_0, t_s) \wedge \text{Holds}(S_2, d_{\text{int+}}, T) \quad (\text{III.37})$$

- $\text{CrossIn}(A, B)$ denotes the case of the start point of the trajectory A is outside B then crosses the boundary of B and ends inside B, as shown in Figure III.9e. The time interval T is divided by the time instant when A meets the boundary of B, i.e., $T = T_1 \wedge t_I \wedge T_2$, where $T_1 = [t_s, t_I)$ and $T_2 = (t_I, t_e]$. More formally:

$$\text{CrossIn}(A, B) \equiv \text{Holds}(S_1, d_{\text{ext-}}, T_1) \wedge \text{Holds-at}(S_7, d_0, t_I) \wedge \text{Holds}(S_2, d_{\text{int+}}, T_2) \quad (\text{III.38})$$

- $\text{CrossOut}(A, B)$ denotes the case of the start point of the trajectory A is inside B then crosses the boundary of B and ends outside B over a time interval, as shown in Figure III.9f. The time interval T is divided by the time instant when A meets the boundary of B, i.e., $T = T_1 \wedge t_I \wedge T_2$, where $T_1 = [t_s, t_I)$ and $T_2 = (t_I, t_e]$. More formally:

$$\text{CrossOut}(A, B) \equiv \text{Holds}(S_2, d_{\text{int-}}, T_1) \wedge \text{Holds-at}(S_8, d_0, t_I) \wedge \text{Holds}(S_1, d_{\text{ext+}}, T_2) \quad (\text{III.39})$$

- $\text{TouchOutside}(A, B)$ denotes the case of the start and end points of the trajectory A both lie in the exterior part of B and the interior of A meets the boundary of B with either clockwise (Figure III.9g) or anticlockwise orientations. The time interval T is divided by the time instant when A meets the boundary of B, i.e., $T = T_1 \wedge t_I \wedge T_2$, where $T_1 = [t_s, t_I)$ and $T_2 = (t_I, t_e]$. More formally:

$$\begin{aligned} \text{TouchOutside}(A, B) \equiv & \text{Holds}(S_1, d_{\text{ext-}}, T_1) \wedge (\text{Holds-at}(S_9 \vee S_{10}), d_0, t_I) \wedge \\ & \text{Holds}(S_1, d_{\text{ext+}}, T_2) \end{aligned} \quad (\text{III.40})$$

- $\text{TouchInside}(A, B)$ denotes the case of the start and end points of the trajectory A that both lie in the interior part of B and the interior of A meets the boundary of B with either clockwise (Figure III.9h) or anticlockwise orientations. The time interval T is divided by the time instant when A meets the boundary of B, i.e., $T = T_1 \wedge t_I \wedge T_2$, where $T_1 = [t_s, t_I)$ and $T_2 = (t_I, t_e]$. More formally:

$$\begin{aligned} \text{TouchInside}(A, B) \equiv & \text{Holds}(S_2, d_{\text{int-}}, T_1) \wedge (\text{Holds-at}(S_{11} \vee S_{12}), d_0, t_I) \wedge \\ & \text{Holds}(S_2, d_{\text{int+}}, T_2) \end{aligned} \quad (\text{III.41})$$

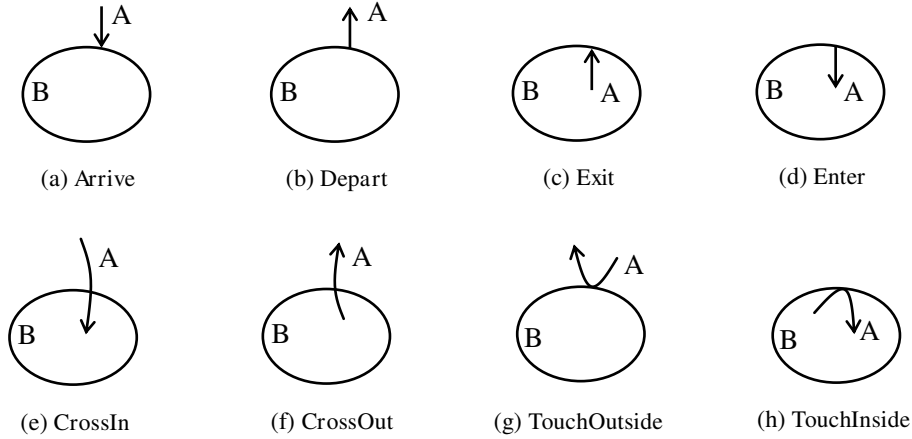

Figure III.9 Trajectory configurations with one 0-dimensional intersection point

4.3 One 1-Dimensional Intersection Line

When part of the trajectory of a moving point A is on the boundary of a reference entity B during a time interval T, the different configurations of the neighbouring discs of the start point (I_1) and the end point (I_2) of the 1-Dimensional intersection line, should be considered.

- $\text{Along}(A, B)$ denotes the case of the start and end points of the trajectory A that both lie in the interior part of B over a time interval T. More formally, for all $t \in T$, S_{13} or S_{14} holds according to the clockwise or anticlockwise orientations of the trajectory and the relative distance is null:

$$\text{Along}(A, B) \equiv \text{Holds}((S_{13} \vee S_{14}), d_0, T) \quad (\text{III.42})$$

- $\text{Arrive-Along}(A, B)$ denotes the case of the start point of the trajectory A that lies in the exterior part of B and ends on its boundary with either clockwise or anticlockwise (Figure III.10a) orientations. The time interval T is divided by the time instant occurred on the endpoint of the intersection line, i.e., $T = T_1 \wedge t_l \wedge T_2$, where $T_1 = [t_s, t_l]$ and $T_2 = (t_l, t_e]$. More formally:

$$\begin{aligned} \text{Arrive-Along}(A, B) \equiv & \text{Holds}(S_1, d_{\text{ext-}}, T_1) \wedge ((\text{Holds-at}(S_{15}(I_1), t_l) \wedge \text{Holds}(S_{14}, d_0, T_2)) \\ & \vee (\text{Holds-at}(S_{16}(I_1), t_l) \wedge \text{Holds}(S_{13}, d_0, T_2))) \end{aligned} \quad (\text{III.43})$$

- $\text{Exit-Along}(A, B)$ denotes the case of the start point of the trajectory A that lies in the interior part of B and ends on its boundary with either clockwise (Figure III.10b) or anticlockwise orientations. The time interval T is divided by the time

instant occurred on the endpoint of the intersection line, i.e., $T = T_1 \wedge t_I \wedge T_2$, where $T_1 = [t_s, t_I]$ and $T_2 = (t_I, t_e]$. More formally:

$$\begin{aligned} \text{Exit-Along}(A, B) \equiv & \text{Holds}(S_2, d_{\text{int-}}, T_1) \wedge ((\text{Holds-at}(S_{17}(I_1), t_I) \wedge \text{Holds}(S_{13}, d_0, T_2)) \\ & \vee (\text{Holds-at}(S_{18}(I_1), t_I) \wedge \text{Holds}(S_{14}, d_0, T_2))) \end{aligned} \quad (\text{III.44})$$

- **Along-Depart(A, B)** denotes the case of the start point of the trajectory A that lies on the boundary of B and ends in its exterior part with either clockwise or anticlockwise (Figure III.10c) orientations. The time interval T is divided by the time instant occurred on the endpoint of the intersection line, i.e., $T = T_1 \wedge t_I \wedge T_2$, where $T_1 = [t_s, t_I]$ and $T_2 = (t_I, t_e]$. More formally:

$$\begin{aligned} \text{Along-Depart}(A, B) \equiv & (((\text{Holds}(S_{14}, d_0, T_1) \wedge \text{Holds-at}(S_{19}(I_2), t_I)) \vee (\text{Holds}(S_{13}, d_0, T_1) \\ & \wedge \text{Holds-at}(S_{20}(I_2), t_I))) \wedge \text{Holds}(S_1, d_{\text{ext+}}, T_2) \end{aligned} \quad (\text{III.45})$$

- **Along-Enter(A, B)** denotes the case of the start point of the trajectory A that lies on the boundary of B and ends in its interior part with either clockwise or anticlockwise (Figure III.10d) orientations. The time interval T is divided by the time instant occurred on the endpoint of the intersection line, i.e., $T = T_1 \wedge t_I \wedge T_2$, where $T_1 = [t_s, t_I]$ and $T_2 = (t_I, t_e]$. More formally:

$$\begin{aligned} \text{Along-Enter}(A, B) \equiv & (((\text{Holds}(S_{13}, d_0, T_1) \wedge \text{Holds-at}(S_{21}(I_2), t_I)) \vee (\text{Holds}(S_{14}, d_0, T_1) \\ & \wedge \text{Holds-at}(S_{22}(I_2), t_I))) \wedge \text{Holds}(S_2, d_{\text{int+}}, T_2) \end{aligned} \quad (\text{III.46})$$

- **Exit-Along-Depart(A, B)** denotes the case of the start point of the trajectory A that lies in the interior part of B, then moves along its boundary with either clockwise (Figure III.10e) or anticlockwise orientations and ends in its exterior part. The time interval T is separated into three sub-sections by the time instants occurred on two endpoints of the intersection line, i.e., $T = T_1 \wedge t_{I1} \wedge T_2 \wedge t_{I2} \wedge T_3$, where $T_1 = [t_s, t_{I1}]$, $T_2 = (t_{I1}, t_{I2})$, and $T_3 = (t_{I2}, t_e]$. More formally:

$$\begin{aligned} \text{Exit-Along-Depart}(A, B) \equiv & \text{Holds}(S_2, d_{\text{int-}}, T_1) \wedge ((\text{Holds-at}(S_{17}(I_1), t_{I1}) \wedge \\ & \text{Holds}(S_{13}(I_2), d_0, T_2) \wedge \text{Holds-at}(S_{20}(I_2), t_{I2})) \vee \\ & (\text{Holds-at}(S_{18}(I_1), t_{I1}) \wedge \text{Holds}(S_{14}(I_2), d_0, T_2) \wedge \\ & \text{Holds-at}(S_{19}(I_2), t_{I2}))) \wedge \text{Holds}(S_1, d_{\text{ext+}}, T_3) \end{aligned} \quad (\text{III.47})$$

- **Arrive-Along-Enter(A, B)** denotes the case of the start point of the trajectory A that lies in the exterior part of B, then move along its boundary with either clockwise or

anticlockwise (Figure III.10f) orientations and ends in its interior part. The time interval T is separated into three sub-sections by the time instants occurred on two endpoints of the intersection line, i.e., $T = T_1 \wedge t_{11} \wedge T_2 \wedge t_{12} \wedge T_3$, where $T_1 = [t_s, t_{11})$, $T_2 = (t_{11}, t_{12})$, and $T_3 = (t_{12}, t_e]$. More formally:

$$\begin{aligned} \text{Arrive-Along-Enter}(A, B) \equiv & \text{Holds}(S_1, d_{\text{ext-}}, T_1) \wedge ((\text{Holds-at}(S_{15}(I_1), t_{11}) \wedge \\ & \text{Holds}(S_{14}(I_2), d_0, T_2) \wedge \text{Holds-at}(S_{22}(I_2), t_{12})) \vee \\ & (\text{Holds-at}(S_{16}(I_1), t_{11}) \wedge \text{Holds}(S_{13}(I_2), d_0, T_2) \wedge \\ & \text{Holds-at}(S_{21}(I_2), t_{12}))) \wedge \text{Holds}(S_2, d_{\text{int+}}, T_3) \quad (\text{III.48}) \end{aligned}$$

- **Arrive-Along-Depart**(A, B) denotes the case of the start point of the trajectory A that lies in the exterior part of B, then move along its boundary with either clockwise (Figure III.10g) or anticlockwise orientations and ends in its exterior part. The time interval T is separated into three sub-sections by the time instants occurred on two endpoints of the intersection line, i.e., $T = T_1 \wedge t_{11} \wedge T_2 \wedge t_{12} \wedge T_3$, where $T_1 = [t_s, t_{11})$, $T_2 = (t_{11}, t_{12})$, and $T_3 = (t_{12}, t_e]$. More formally:

$$\begin{aligned} \text{Arrive-Along-Depart}(A, B) \equiv & \text{Holds}(S_1, d_{\text{ext-}}, T_1) \wedge ((\text{Holds-at}(S_{15}(I_1), t_{11}) \wedge \\ & \text{Holds}(S_{14}(I_2), d_0, T_2) \wedge \text{Holds-at}(S_{19}(I_2), t_{12})) \vee \\ & (\text{Holds-at}(S_{16}(I_1), t_{11}) \wedge \text{Holds}(S_{13}(I_2), d_0, T_2) \wedge \\ & \text{Holds-at}(S_{20}(I_2), t_{12}))) \wedge \text{Holds}(S_1, d_{\text{ext+}}, T_3) \quad (\text{III.49}) \end{aligned}$$

- **Exit-Along-Enter**(A, B) denotes the case of the start point of the trajectory A that lies in the interior part of B, then move along its boundary with either clockwise (Figure III.10h) or anticlockwise orientations and ends in its interior part. The time interval T is separated into three sub-sections by the time instants occurred on two endpoints of the intersection line, i.e., $T = T_1 \wedge t_{11} \wedge T_2 \wedge t_{12} \wedge T_3$, where $T_1 = [t_s, t_{11})$, $T_2 = (t_{11}, t_{12})$, and $T_3 = (t_{12}, t_e]$. More formally:

$$\begin{aligned} \text{Exit-Along-Enter}(A, B) \equiv & \text{Holds}(S_2, d_{\text{int-}}, T_1) \wedge ((\text{Holds-at}(S_{17}(I_1), t_{11}) \wedge \\ & \text{Holds}(S_{13}(I_2), d_0, T_2) \wedge \text{Holds-at}(S_{21}(I_2), t_{12})) \vee \\ & (\text{Holds-at}(S_{18}(I_1), t_{11}) \wedge \text{Holds}(S_{14}(I_2), d_0, T_2) \wedge \\ & \text{Holds-at}(S_{22}(I_2), t_{12}))) \wedge \text{Holds}(S_2, d_{\text{int+}}, T_3) \quad (\text{III.50}) \end{aligned}$$

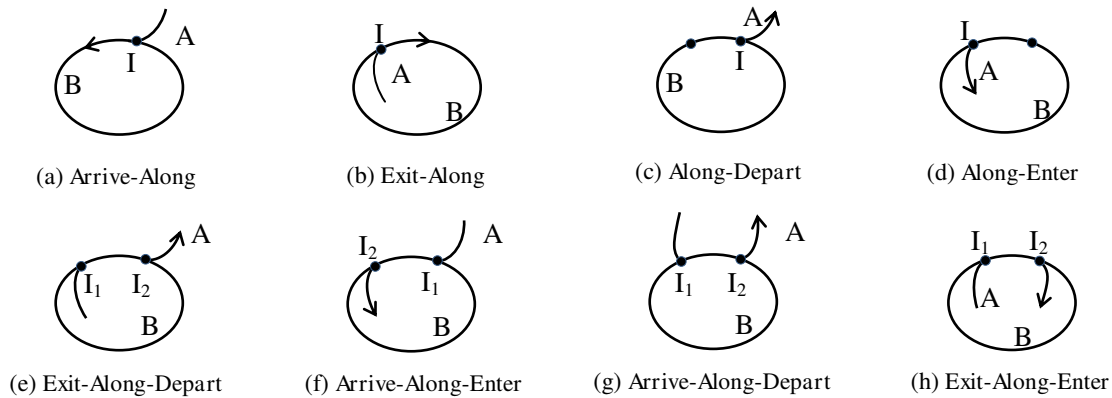

Figure III.10 Movement configurations with one 1-dimensional intersection line

As there should be an infinite number of possible DL-RE configurations in a 2-dimensional Euclidean space, the possible movement semantics that emerge from those configurations can be relative large. A composition of the primitive movement predicates defined above can be applied to reconstruct the trajectory as a sequence of highly-correlated episodes.

III.5 Discussion

The research developed in this chapter introduces several modelling approaches for a qualitative movement representation of a moving entity which is characterized as either a region or as a point with respect to a reference region. These models are based on several complementary spatio-temporal primitives:

- continuous and linear time intervals as temporal primitives;
- RCC8 algebra for the representation of topological relations between moving regions, and DL-RE topological relations;
- dynamic distance as distance primitives.

These approaches are complemented by a semantic qualification of the possible natural language expressions of the primitive movements identified. The movements between a moving region and a reference region are classified into three categories according to the relative location which are movements outside, on the boundary, and inside the reference entity, while the primitive movements of a trajectory with respect to a region are classified according to the number and dimension of the intersection on the boundary of the

reference region. By using the above conceptual modelling framework, it is possible to describe the characteristics of movements in a way that is likely to be understandable.

Although the framework developed favours the identification of a series of movement primitives with respect to a crisp reference region, it can also be used in the case of a reference region with a broad boundary. Take for example the configuration in Figure III.11 as an example, region B is made up of two regions B_1 and B_2 with $B_1 \subseteq B_2$, where ∂B_1 is the inner boundary of B and ∂B_2 is the outer boundary of B. The qualitative movement of region A with respect to B can be represented by $[\text{PriMv}_r(A, B_1), \text{PriMv}_r(A, B_2)]$, if both of the relations holds throughout the time interval T. In that case, the movement of A in Figure III.11 can be represented as [Approach, Overlapping].

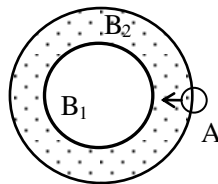

Figure III.11 Movement with respect to a region with a broad boundary

It appears clearly that the modelling approach heavily relies on the relative distance between the moving entity and the reference entity. However, there are more issues to be studied, and the approach may not be suitable in all cases. As the moving regions considered are simple regions, some degenerated cases will take place when the movement is still monotonic and continuous under some specific configurations. As shown in Figure III.12a, a moving entity A can be considered from a cognitive point of view as “approaching” a reference entity B over a time interval T. However, the relative distance between A and B is constant during that period, which should be described as *AroundOutside* according to the model. Another case refers to a region with a hole. For example, a ship A is moving along an island C that lies in the lake B, whose behaviour can be regarded as a movement touching the inner boundary of B as shown in Figure III.12b. However, this behaviour can be also perceived as either a movement towards the external boundary of the lake this resulting in two possible movement semantics: *CoveringBy* and *MovetoBoundary*. This clearly shows that despite its generality the region-region movement framework should be adapted to deal with some specific configuration contexts, especially when dealing with complex regions. If the moving region is generalized to a moving point, similar configurations might hold for the trajectory-region trajectory

framework when the shape of the region of reference is specific enough to generate some tricky situations.

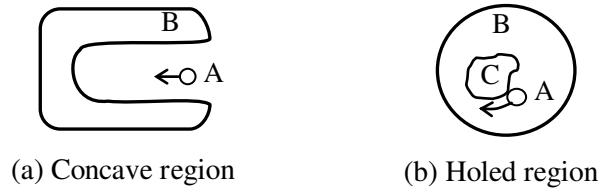

Figure III.12 Degenerated cases for region-region movement



Qualitative Reasoning on Moving Entities

IV.1 INTRODUCTION.....	82
IV.2 CONTINUOUS TRANSITIONS OF MOVEMENTS.....	82
2.1 CND FOR REGION-REGION MOVEMENTS.....	83
2.2 CND FOR TRAJECTORY-REGION MOVEMENTS.....	88
IV.3 COMPOSITION TABLES	89
3.1 A COMPOSITION TABLE FOR REGION-REGION MOVEMENTS	90
3.2 CASE STUDIES	91
IV.4 CONCLUSION	95

IV.1 Introduction

Representing continuous properties by discrete schemes of symbols and providing formal calculi for reasoning over spatial entities is the essence of qualitative reasoning (Cohn and Hazarika 2001). As current qualitative spatial relations identified in related work provide limited opportunities for reasoning beyond an exact matching (Egenhofer 2010), two methods have shown relevant support for qualitative reasoning: (1) conceptual neighbours that qualify gradual and continuous changes, and (2) composition of relations to infer a third relation from two relations that share a common entity. Conceptual neighbourhood diagrams (CND), which originates with Freksa's (1992a) analysis of temporal intervals (Allen 1983), provide valuable support for qualitative reasoning. By replacing temporal relations by spatial relations, CND can be applied to the spatial domain, which has already been fairly well developed:

- topological relations in RCC (Randell et al. 1992) (Figure I.9) and the 9-Intersection Model (Egenhofer and Al-Taha 1992; Egenhofer et al. 1993; Egenhofer and Mark 1995) ;
- orientation relations (Freksa 1992b; Egenhofer 1997; Pacheco et al. 2002).

Originating in Allen's analysis of temporal relations, the utilization of a composition table has become another important technique in providing an efficient inference mechanism. By simply inferring composition relations in such a table, one can answer the general query: what are the possible relations between a and c, if the relations between a and b, and b and c are known.

This chapter introduces the notion of conceptual transitions of movements and CNDs according to two types of moving entities as defined in Section IV.2. One focuses on continuous transitions and the similarity of region-region movements, while the other one favours the exploration of possible trajectories in the case of incomplete knowledge configurations. A composition table for region-region movements is studied and illustrated by three examples in Section IV.3. Finally, Section IV.4 concludes the chapter and draws some conclusions.

IV.2 Continuous Transitions of Movements

The movement of an entity can be qualitatively modelled as a sequence of neighbouring spatial configurations which hold for consecutive time intervals. As noted in Chapter I,

changes modelled by qualitative spatial and temporal calculi such as RCC8 have been analyzed through conceptual neighbourhood diagrams (Randell et al. 1992). A CND provides additional reasoning capabilities to anticipate future movements and to develop reasoning mechanisms in case of incomplete knowledge (Van de Weghe 2004; Noyon et al. 2007; Glez-Cabrera et al. 2013).

2.1 CND for Region-Region Movements

Based on Freksa's definition of conceptual neighbourhood (Freksa 1992a), we define:

Definition IV.1. Two movements between two region entities are **conceptual neighbours**, if they can be directly path-connected by a continuous movement.

The conceptual transitions of region-region movements which can be derived from primitive movements identified in Chapter III.3 are shown in Figure IV.1. The boundary of the reference region not only plays an important role in the representation of qualitative region-region movements, but also constrains continuous transitions among them, yielding a directed rather than undirected transition graph. A bidirectional arrow indicates that the movements on each side can be directly transformed into the other by a continuous transition. A one-way arrow shows the direction of the transition. The CND can be divided into four sub-graphs, that is, move outside, move on the boundary, move inside, and move while englobing.

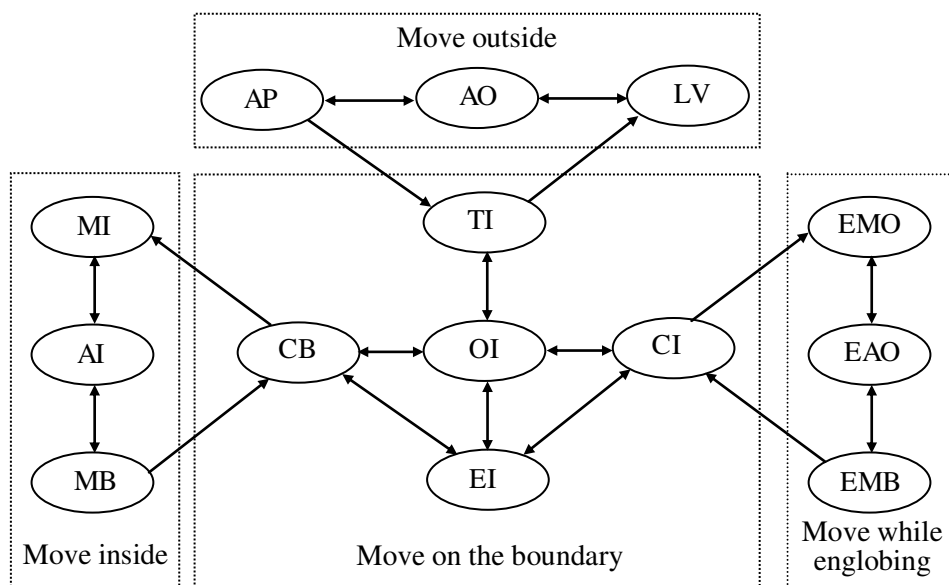

Figure IV.1 CND for region-region movements

2.1.1 Interpreting the CND

Let us interpret the CND according to the relative size of the moving entities, which gives rise to three different scenarios: (1) A is smaller than B, (2) A is larger than B, and (3) A is equal to B. The movement of one region with respect to the other is illustrated by a continuous sequence of temporal snapshots that denote a series of consecutive views of a given 2-dimensional space. Each temporal snapshot is assumed to denote a valid primitive movement during a given time interval.

Scenario 1. A is smaller than B and A is moving over B (Figure IV. 2a)

The continuous transitions of movements of A with respect to B are: Approach (AP), Touching (TI), Overlapping (OI), CoveringBy (CB), MovetoInterior (MI), AroundInside (AI), MovetoBoundary (MB), CoveringBy (CB), Overlapping (OI), Touching (TI), Leaving (LV), which correspond to a top-down-bottom-up traverse along the left-most branch of the CND, as shown in Figure IV. 2b.

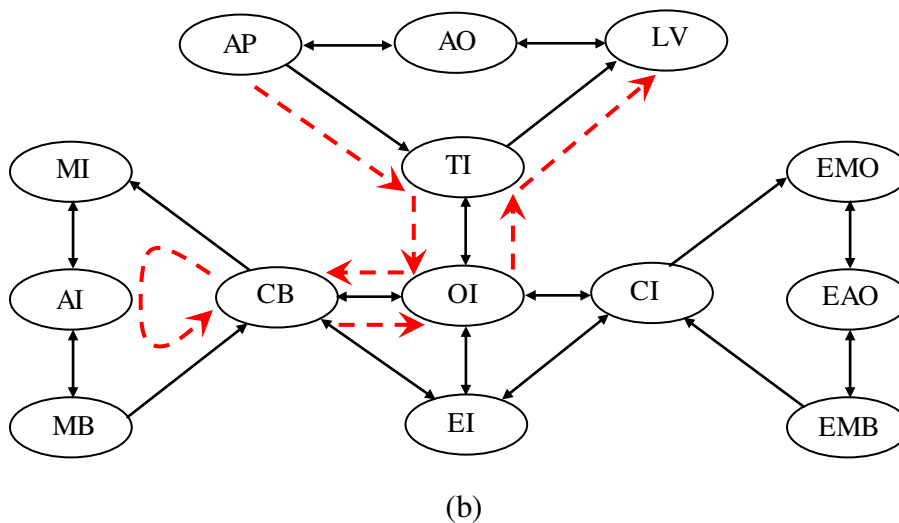
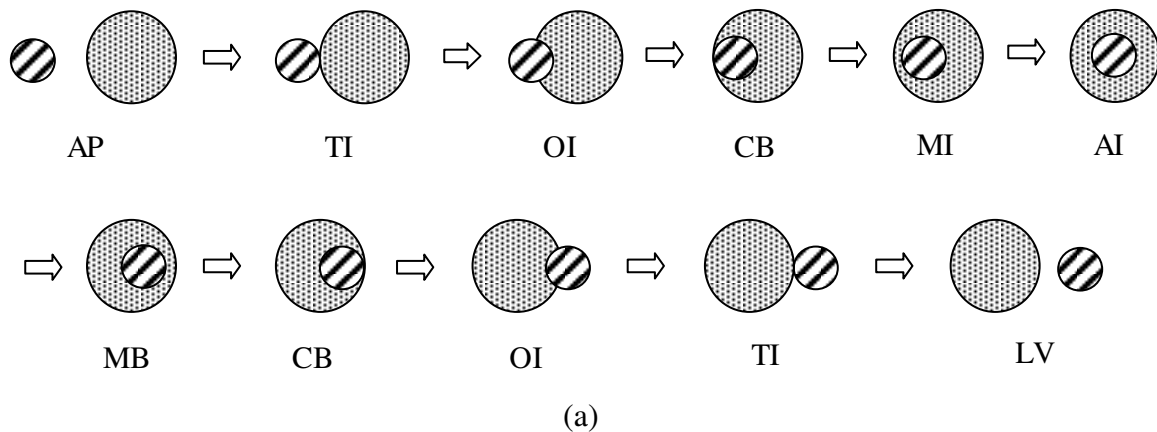
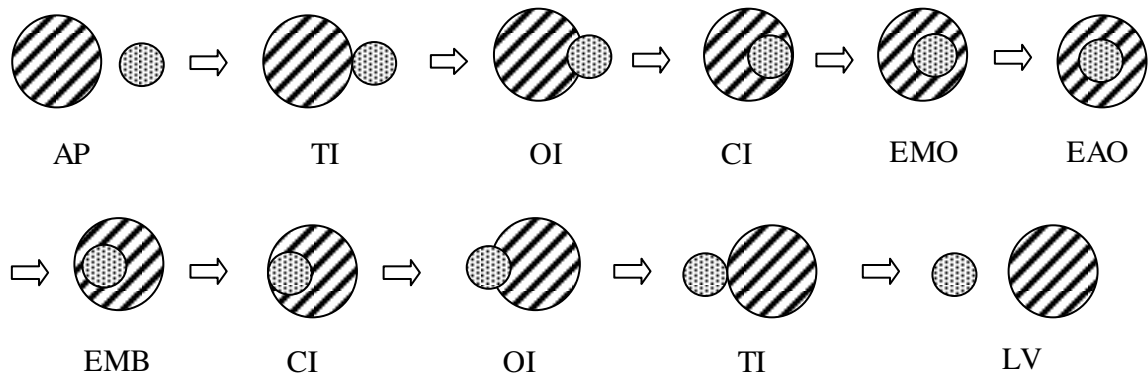

Figure IV.2 Continuous transitions of moving A over a larger region B

Scenario 2. A is larger than B and A is moving over B (Figure IV. 3a)

The continuous transitions of the movements of A with respect to B are: Approach (AP), Touching (TI), Overlapping (OI), Covering (CI), EmbracingMoveOutside (EMO), EmbracingAroundOutside (EAO), EmbracingMovetoBoundary (EMB), Covering (CI), Overlapping (OI), Touching (TI), Leaving (LV), which correspond to a top-down-bottom-up traverse along the right-most branch of the CND, as shown in Figure IV. 3b.



(a)

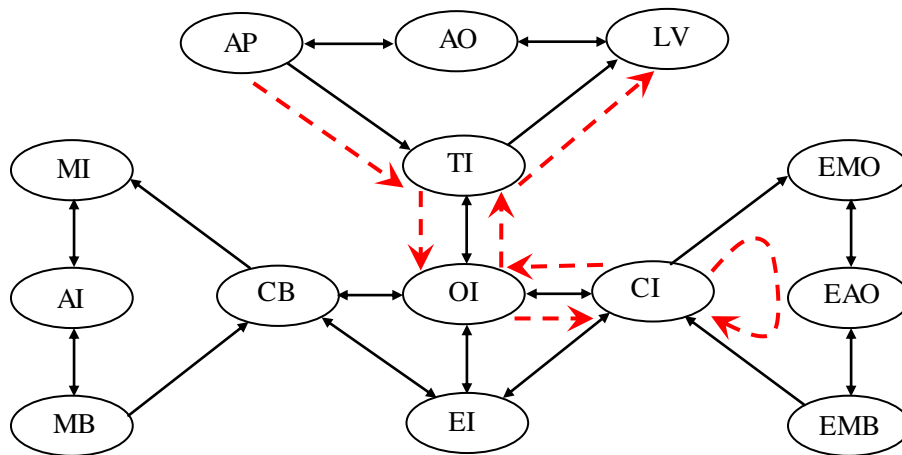

(b)

Figure IV.3 Continuous transitions of A moving over a smaller region B

Scenario 3. A is equal to B and A is moving over B (Figure IV. 4a)

The continuous transitions of the movements of A with respect to B are: Approach (AP), Touching (TI), Overlapping (OI), Equaling (EI), Overlapping (OI), Touching (TI), Leaving (LV), which correspond to a top-down-bottom-up traverse in the center of the CND, as shown in Figure IV. 4b.

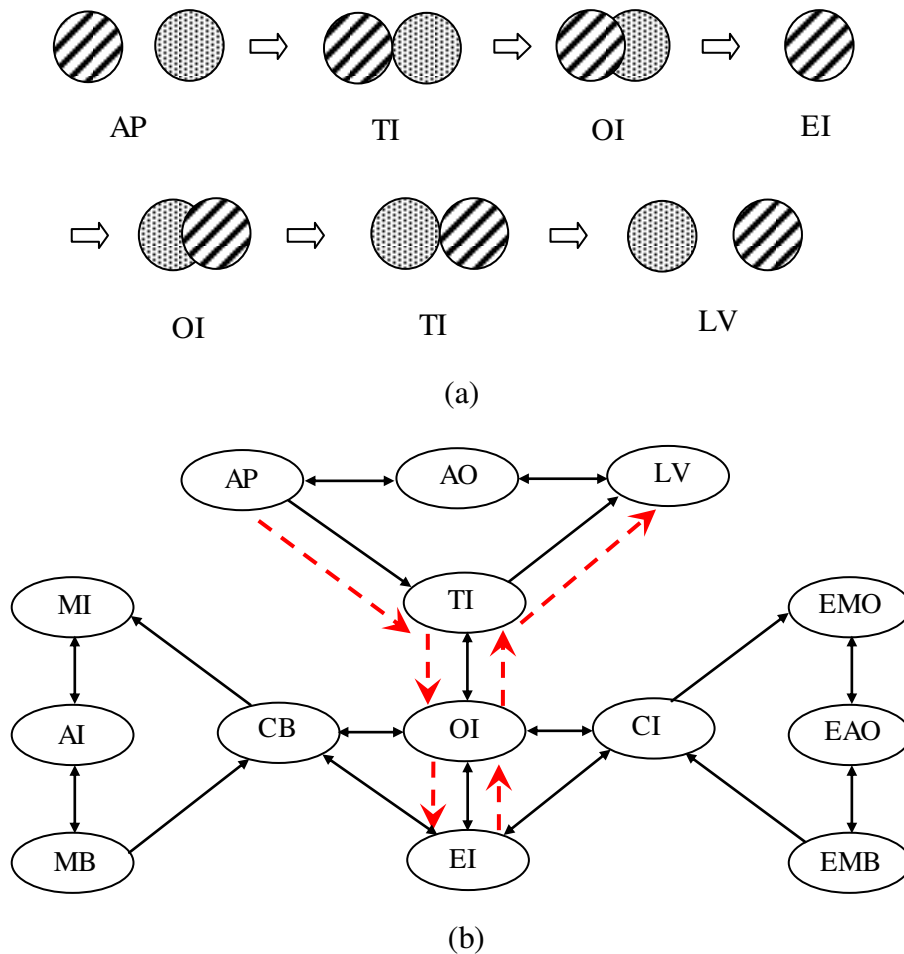

Figure IV.4 Continuous transitions of A moving over a region B of equal size and shape

2.1.2 Similarity between Region-Region Movements

Moving entities exhibit differences but also share some similarities while in movements. For instance, homing pigeons often have similar flight patterns when they are close to their home (Laube et al. 2007). Extracting such similarities can contribute to the modelling, reasoning, and simulation of the behaviour of moving entities. In the qualitative reasoning literature, similarity between two relations has been often measured by the inverse of dissimilarity, which is quantified as the distance of transforming from one relation to another. A conceptual neighbourhood diagram has been often acting as a basis for computing distances in a set of JEPD relations, such as interval relations (Freksa 1992a), topological relations (Egenhofer and Al-Taha 1992), and cardinal direction relations (Goyal 2000).

In order to determine the similarity of movement patterns between two moving regions, we define:

Definition IV.2. The conceptual distance between two region-region movements in the CND, denoted as CD, is derived from the shortest path distance between them in the CND, a one-step distance in the CND being equal to one.

The similarity between region-region movements is evaluated according to the value of the conceptual distance between these region-region movements:

If $CD(M_1, M_2) < CD(M_1, M_3)$, then M_1 is more similar to M_2 than M_1 to M_3 .

Example:

Suppose $M_1 = AP$ ($\text{Holds}(\text{DC}, d_{\text{ext-}}, T)$) and $M_2 = LV$ ($\text{Holds}(\text{DC}, d_{\text{ext+}}, T)$), i.e., the topological primitive keeps unchanged (DC), and the distance primitive changes from $d_{\text{ext-}}$ to $d_{\text{ext+}}$ passing $d_{\text{ext=}}$, then the movement pattern cannot change from AP to LV without passing AO, Thus, $CD(M_1, M_2) = 2$.

If there is another movement pattern $M_3 = CB$ ($\text{Holds}(\text{TPP}, d_0, T)$), then the movement pattern has to change from AP to CB passing TI and OI, Thus, $CD(M_1, M_3) = 3$.

So we have: AP is more similar to LV than to CB (Figure IV.5).

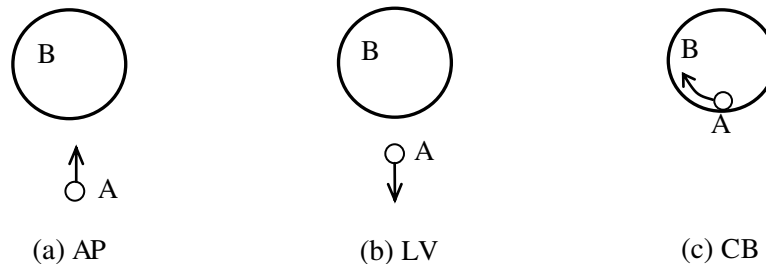

Figure IV.5 An example of region-region movements' similarity

The resulting conceptual distances between region-region movements are listed in Table IV.1. The distance between two identical movements is given a null value. The maximum distance is eight, which is from the top to the left or right bottom in the CND and vice versa.

	LV	AO	AP	TI	OI	CB	MI	AI	MB	EI	CI	EMO	EAO	EMB
LV	0	1	2	3	4	5	6	7	8	5	5	6	7	8
AO	1	0	1	2	3	4	5	6	7	4	4	5	6	7
AP	2	1	0	1	2	3	4	5	6	3	3	4	5	6
TI	1	2	3	0	1	2	3	4	5	2	2	3	4	5
OI	2	3	4	1	0	1	2	3	4	1	1	2	3	4
CB	3	4	5	2	1	0	1	2	3	1	2	3	4	5
MI	6	7	8	5	4	3	0	1	2	4	5	6	7	8
AI	5	6	7	4	3	2	1	0	1	3	4	5	6	7
MB	4	5	6	3	2	1	2	1	0	2	3	4	5	6
EI	3	4	5	2	1	1	2	3	4	0	1	2	3	4
CI	3	4	5	2	1	2	3	4	5	1	0	1	2	3
EMO	6	7	8	5	4	5	6	7	8	4	3	0	1	2
EAO	5	6	7	4	3	4	5	6	7	3	2	1	0	1
EMB	4	5	6	3	2	3	4	5	6	2	1	2	1	0

Table IV.1 Conceptual distances between region-region movements

2.2 CND for Trajectory-Region Movements

Regarding the case of a moving point conceptualized as a directed line trajectory, we adopt a slightly different definition in order to model possible movements when we know either a starting part of trajectory but not the end part of it, or the end part of trajectory but not its starting part. The starting part of the trajectory is defined as a directed line segment that starts at its start point, and the ending part of trajectory as a directed line segment that ends at its endpoint. These possible movements are denoted as conceptual transitions.

The conceptual transitions that emerge from the 30 DL-RE movement patterns (illustrated in Figure II.6) are shown in Figure IV.6 where each node denotes a DL-RE movement. Two categories of conceptual transitions are represented in cases of incomplete knowledge:

- When a first DL-RE movement From is linked by a directed plain arrow to a second DL-RE movement To this means that To is a forward conceptual transition of From (i.e., a movement starting as From but not finished can terminate as a movement To);
- When a first DL-RE movement From is linked by a directed dotted arrow to a second DL-RE movement To this means that To is a backward conceptual

compose a set of new facts from existing ones. A composition table provides valuable manipulation capabilities in qualitative reasoning, and derives a finite set of new relations from existing ones. That is, if two existing relations ($R_1(A, B)$ and $R_2(B, C)$) share a common reference object B, they can be composed into a new relation set $R_3(A, C)$.

In this section, we focus on the composition table for region-region movements, and potential application is illustrated by several case studies.

3.1 A Composition Table for Region-Region Movements

In order to reason efficiently on spatio-temporal movements, composition tables can be used to identify a disjunction of possible transitive relations. As stated in Chapter III.3, there are 14 JEPD relations in region-region movements. This implies that to construct a composition table, 196 (14×14) combinations of relations need to be examined. The composition table presented in Table IV.2 provides the possible movements that can hold between an entity A and an entity C, given some movements given between an entity A and an entity B, and between an entity B and an entity C over a given time interval T. “ALL” is used when all movement primitives apply.

Table IV.2 clearly shows that the number of possible compositions largely depends on the nature of the compositions, but in some cases resulting transitions can be studied and even constrained by some additional properties and application constraints.

	LV	AO	AP	TI	OI	CB	MI	AI	MB	EI	CI	EMO	EAO	EMB
LV	ALL	ALL	ALL	LV, AO, AP, TI, OI, CB, MI, AI, MB	LV, AO, AP, TI, OI, CB, MI, AI, MB	LV, AO, AP, TI, OI, CB, MI, AI, MB	LV, AO, AP, TI, OI, CB, MI, AI, MB	LV, AO, AP, TI, OI, CB, MI, AI, MB	LV, AO, AP, TI, OI, CB, MI, AI, MB	LV	LV, AO, AP	LV, AO, AP	LV, AO, AP	LV, AO, AP
AO	ALL	ALL	ALL	LV, AO, AP, TI, OI, CB, MI, AI, MB	LV, AO, AP, TI, OI, CB, MI, AI, MB	LV, AO, AP, TI, OI, CB, MI, AI, MB	LV, AO, AP, TI, OI, CB, MI, AI, MB	LV, AO, AP, TI, OI, CB, MI, AI, MB	LV, AO, AP, TI, OI, CB, MI, AI, MB	AO	LV, AO, AP	LV, AO, AP	LV, AO, AP	LV, AO, AP
AP	ALL	ALL	ALL	LV, AO, AP, TI, OI, CB, MI, AI, MB	LV, AO, AP, TI, OI, CB, MI, AI, MB	LV, AO, AP, TI, OI, CB, MI, AI, MB	LV, AO, AP, TI, OI, CB, MI, AI, MB	LV, AO, AP, TI, OI, CB, MI, AI, MB	LV, AO, AP, TI, OI, CB, MI, AI, MB	AP	LV, AO, AP	LV, AO, AP	LV, AO, AP	LV, AO, AP
TI	LV, AO, AP, TI, OI, CI, EMO, EAO, EMB	LV, AO, AP, TI, OI, CI, EMO, EAO, EMB	LV, AO, AP, TI, OI, CI, EMO, EAO, EMB	LV, AO, AP, TI, OI, CB, CI	LV, AO, AP, TI, OI, CB, CI	LV, AO, AP, TI, OI, CB, MI, AI, MB	LV, AO, AP, TI, OI, CB, MI, AI, MB	LV, AO, AP, TI, OI, CB, MI, AI, MB	LV, AO, AP, TI, OI, CB, MI, AI, MB	TI	TI, LV, AO, AP	LV, AO, AP	LV, AO, AP	LV, AO, AP
OI	LV, AO, AP, TI, OI, CI, EMO, EAO, EMB	LV, AO, AP, TI, OI, CI, EMO, EAO, EMB	LV, AO, AP, TI, OI, CI, EMO, EAO, EMB	LV, AO, AP, TI, OI, CI, EMO, EAO, EMB	ALL	OI, CB, MI, AI, MB	OI, CB, MI, AI, MB	OI, CB, MI, AI, MB	OI, CB, MI, AI, MB	OI	LV, AO, AP, TI, OI, CI, EMO, EAO, EMB	LV, AO, AP, TI, OI, CI, EMO, EAO, EMB	LV, AO, AP, TI, OI, CI, EMO, EAO, EMB	LV, AO, AP, TI, OI, CI, EMO, EAO, EMB
CB	LV, AO, AP	LV, AO, AP	LV, AO, AP	LV, AO, AP, TI	LV, AO, AP, TI, OI, CB, MI, AI, MB	CB, MI, AI, MB	MI, AI, MB	MI, AI, MB	MI, AI, MB	CB	LV, AO, AP, TI, OI, CB, CI	LV, AO, AP, TI, OI, CI, EMO, EAO, EMB	LV, AO, AP, TI, OI, CI, EMO, EAO, EMB	LV, AO, AP, TI, OI, CI, EMO, EAO, EMB
MI	LV, AO, AP	LV, AO, AP	LV, AO, AP	LV, AO, AP	LV, AO, AP, TI, OI, CB, MI, AI, MB	MI, AI, MB	MI, AI, MB	MI, AI, MB	MI, AI, MB	MI	LV, AO, AP, TI, OI, CB, MI, AI, MB	ALL	ALL	ALL
AI	LV, AO, AP	LV, AO, AP	LV, AO, AP	LV, AO, AP	LV, AO, AP, TI, OI, CB, MI, AI, MB	MI, AI, MB	MI, AI, MB	MI, AI, MB	MI, AI, MB	AI	LV, AO, AP, TI, OI, CB, MI, AI, MB	ALL	ALL	ALL
MB	LV, AO, AP	LV, AO, AP	LV, AO, AP	LV, AO, AP	LV, AO, AP, TI, OI, CB, MI, AI, MB	MI, AI, MB	MI, AI, MB	MI, AI, MB	MI, AI, MB	MB	LV, AO, AP, TI, OI, CB, MI, AI, MB	ALL	ALL	ALL
EI	LV	AO	AP	TI	OI	CI	MI	AI	MB	EI	CB	EMO	EAO	EMB
CI	LV, AO, AP, TI, OI, CI, EMO, EAO, EMB	LV, AO, AP, TI, OI, CI, EMO, EAO, EMB	LV, AO, AP, TI, OI, CI, EMO, EAO, EMB	TI, OI, CI, EMO, EAO, EMB	OI, CI, EMO, EAO, EMB	OI, CB, CI	OI, CB, MI, AI, MB	OI, CB, MI, AI, MB	OI, CB, MI, AI, MB	CI	CI, EMO, EAO, EMB	EMO, EAO, EMB	EMO, EAO, EMB	EMO, EAO, EMB
EMO	LV, AO, AP, TI, OI, CI, EMO, EAO, EMB	LV, AO, AP, TI, OI, CI, EMO, EAO, EMB	LV, AO, AP, TI, OI, CI, EMO, EAO, EMB	OI, CI, EMO, EAO, EMB	OI, CI, EMO, EAO, EMB	OI, CI, EMO, EAO, EMB	OI, CB, MI, AI, MB, CB, EMO, EAO, EMB	OI, CB, MI, AI, MB, CB, EMO, EAO, EMB	OI, CB, MI, AI, MB, CB, EMO, EAO, EMB	EMO	EMO, EAO, EMB	EMO, EAO, EMB	EMO, EAO, EMB	EMO, EAO, EMB
EAO	LV, AO, AP, TI, OI, CI, EMO, EAO, EMB	LV, AO, AP, TI, OI, CI, EMO, EAO, EMB	LV, AO, AP, TI, OI, CI, EMO, EAO, EMB	OI, CI, EMO, EAO, EMB	OI, CI, EMO, EAO, EMB	OI, CI, EMO, EAO, EMB	OI, CB, MI, AI, MB, CI, EMO, EAO, EMB	OI, CB, MI, AI, MB, CI, EMO, EAO, EMB	OI, CB, MI, AI, MB, CI, EMO, EAO, EMB	EAO	EMO, EAO, EMB	EMO, EAO, EMB	EMO, EAO, EMB	EMO, EAO, EMB
EMB	LV, AO, AP, TI, OI, CI, EMO, EAO, EMB	LV, AO, AP, TI, OI, CI, EMO, EAO, EMB	LV, AO, AP, TI, OI, CI, EMO, EAO, EMB	OI, CI, EMO, EAO, EMB	OI, CI, EMO, EAO, EMB	OI, CI, EMO, EAO, EMB	OI, CB, MI, AI, MB, CI, EMO, EAO, EMB	OI, CB, MI, AI, MB, CI, EMO, EAO, EMB	OI, CB, MI, AI, MB, CI, EMO, EAO, EMB	EMB	EMO, EAO, EMB	EMO, EAO, EMB	EMO, EAO, EMB	EMO, EAO, EMB

Table IV.2 Composition table of region-region movements

3.2 Case Studies

This section presents three case studies for the potential application of the composition table given above.

3.2.1 Case study 1

Let us first take an example of a movement between a man A, a bus B and a parking lot C. We can get a few additional constraints by common sense constraints: the size of the man A is smaller than the size of the bus B, and both size of man A and bus B are smaller than the size of parking lot C. This restricts the set of possible topological relations between those entities, as well as the evolution of relative distances. The composition table presented in Table IV.3 derives the possible composition movements between the man A and the parking slot C according to the movements between the man A with respect to the bus B, and between the bus B with respect to the parking slot C.

For example, when the man A moves around outside (AO) the bus B, or gets onto the bus B (touching (TI) or overlapping (OI)), the bus B has to be static. In that case, the bus B has only one movement semantics AO related to the parking lot C. When the man A leaves or approaches the bus B, there are several possible movements between the man A and the

parking lot C. However, when the man A moves inside the bus B, the movement semantic between the man A and the parking lot C is the same than the movement between the bus B and the parking lot C.

	LV	AO	AP	TI	OI	CB	MI	AI	MB
LV	LV, AO, AP, TI, OI, CB, MI, AI, MB	LV, AO, AP, TI, OI, CB, MI, AI, MB	LV, AO, AP, TI, OI, CB, MI, AI, MB	LV, AO, AP, TI, OI, CB, MI, AI, MB	LV, AO, AP, TI, OI, CB, MI, AI, MB	LV, AO, AP, TI, OI, CB, MI, AI, MB	LV, AO, AP, TI, OI, CB, MI, AI, MB	LV, AO, AP, TI, OI, CB, MI, AI, MB	LV, AO, AP, TI, OI, CB, MI, AI, MB
AO	/	AO	/	/	/	/	/	/	/
AP	LV, AO, AP, TI, OI, CB, MI, AI, MB	LV, AO, AP, TI, OI, CB, MI, AI, MB	LV, AO, AP, TI, OI, CB, MI, AI, MB	LV, AO, AP, TI, OI, CB, MI, AI, MB	LV, AO, AP, TI, OI, CB, MI, AI, MB	LV, AO, AP, TI, OI, CB, MI, AI, MB	LV, AO, AP, TI, OI, CB, MI, AI, MB	LV, AO, AP, TI, OI, CB, MI, AI, MB	LV, AO, AP, TI, OI, CB, MI, AI, MB
TI	/	AO	/	/	/	/	/	/	/
OI	/	AO	/	/	/	/	/	/	/
CB	LV	AO	AP	TI	OI	CB	MI	AI	MB
MI	LV	AO	AP	TI	OI	CB	MI	AI	MB
AI	LV	AO	AP	TI	OI	CB	MI	AI	MB
MB	LV	AO	AP	TI	OI	CB	MI	AI	MB

Table IV.3 Composition table between a man A, a bus B and a parking lot C

Take the example shown in Figure IV.7 as an example, the man A is changing a seat to the middle of the bus B (MI) and the bus B is driving to the parking lot C (AP) during a time interval T. Then we have $\text{MovetoInterior}(A, B) \equiv \text{Holds}(\text{NTPP}, d_{\text{int+}}, T)$, $\text{Approach}(B, C) \equiv \text{Holds}(\text{DC}, d_{\text{ext-}}, T)$. The result of the composition of these two movement configurations is $MI \circ AP = AP$, which means that over the time interval T, the man A is approaching the parking lot C.

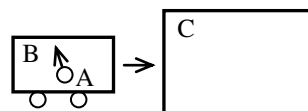

Figure IV.7. Relative movements between a man A, a car B and a parking lot C

3.2.2 Case study 2

Let us take another example of the movement between a storm A, a boat B and a fishing area C, where the size of the storm A is larger than the size of the boat B and fishing area C. The movements between the storm A and boat B, and between the boat B and the fishing area C can be modelled. From the composition table (Table IV.4), we can derive the possible movements between the storm A and the fishing area C, from the configurations identified.

	LV	AO	AP	TI	OI	CB	MI	AI	MB
LV	LV, AO, AP, TI, OI, CI, EMO, EAO, EMB	LV, AO, AP, TI, OI, CI, EMO, EAO, EMB	LV, AO, AP, TI, OI, CI, EMO, EAO, EMB	LV, TI, OI	LV, TI, OI	LV, TI, OI	LV, TI, OI	LV, TI, OI	LV, TI, OI
AO	LV, AO, AP, TI, OI, CI, EMO, EAO, EMB	LV, AO, AP, TI, OI, CI, EMO, EAO, EMB	LV, AO, AP, TI, OI, CI, EMO, EAO, EMB	AO, TI, OI	AO, TI, OI	AO, TI, OI	AO, TI, OI	AO, TI, OI	AO, TI, OI
AP	LV, AO, AP, TI, OI, CI, EMO, EAO, EMB	LV, AO, AP, TI, OI, CI, EMO, EAO, EMB	LV, AO, AP, TI, OI, CI, EMO, EAO, EMB	AP, TI, OI	AP, TI, OI	AP, TI, OI	AP, TI, OI	AP, TI, OI	AP, TI, OI
TI	LV, AO, AP, TI, OI, CI, EMO, EAO, EMB	LV, AO, AP, TI, OI, CI, EMO, EAO, EMB	LV, AO, AP, TI, OI, CI, EMO, EAO, EMB	LV, AO, AP, TI, OI, CI	LV, AO, AP, TI, OI, CI	TI, OI	OI	OI	OI
OI	LV, AO, AP, TI, OI, CI, EMO, EAO, EMB	LV, AO, AP, TI, OI, CI, EMO, EAO, EMB	LV, AO, AP, TI, OI, CI, EMO, EAO, EMB	LV, AO, AP, TI, OI, CI, EMO, EAO, EMB	LV, AO, AP, TI, OI, CI, EMO, EAO, EMB	OI	OI	OI	OI
CI	LV, AO, AP, TI, OI, CI, EMO, EAO, EMB	LV, AO, AP, TI, OI, CI, EMO, EAO, EMB	LV, AO, AP, TI, OI, CI, EMO, EAO, EMB	TI, OI, CI, EMO, EAO, EMB	OI, CI, EMO, EAO, EMB	OI, CI	OI	OI	OI
EMO	LV, AO, AP, TI, OI, CI, EMO, EAO, EMB	LV, AO, AP, TI, OI, CI, EMO, EAO, EMB	LV, AO, AP, TI, OI, CI, EMO, EAO, EMB	OI, CI, EMO, EAO, EMB	OI, CI, EMO, EAO, EMB	OI, CI, EMO, EAO, EMB	OI, CI, EMO, EAO, EMB	OI, CI, EMO, EAO, EMB	OI, CI, EMO, EAO, EMB
EAO	LV, AO, AP, TI, OI, CI, EMO, EAO, EMB	LV, AO, AP, TI, OI, CI, EMO, EAO, EMB	LV, AO, AP, TI, OI, CI, EMO, EAO, EMB	OI, CI, EMO, EAO, EMB	OI, CI, EMO, EAO, EMB	OI, CI, EMO, EAO, EMB	OI, CI, EMO, EAO, EMB	OI, CI, EMO, EAO, EMB	OI, CI, EMO, EAO, EMB
EMB	LV, AO, AP, TI, OI, CI, EMO, EAO, EMB	LV, AO, AP, TI, OI, CI, EMO, EAO, EMB	LV, AO, AP, TI, OI, CI, EMO, EAO, EMB	OI, CI, EMO, EAO, EMB	OI, CI, EMO, EAO, EMB	OI, CI, EMO, EAO, EMB	OI, CI, EMO, EAO, EMB	OI, CI, EMO, EAO, EMB	OI, CI, EMO, EAO, EMB

Table IV.4 Composition table between a storm A, a boat B and a fishing area C

Let us consider the example where the storm A is approaching the boat B (AP) and boat B is touching the boundary of fishing area C (TI) over a time interval T. We have $\text{Approach}(A, B) \equiv \text{Holds}(\text{DC}, d_{\text{ext-}}, T)$, $\text{Touching}(B, C) \equiv \text{Holds}(\text{EC}, d_0, T)$. The results of the composition give three possibilities: (1) Approach, which means that the storm A is approaching the fishing area C over the time interval T (Figure IV.8a); (2) Touching, which means that the storm A is touching the fishing area C over the time interval T (Figure IV.8b); (3) Overlapping, which means that the storm A is overlapping the fishing area C over the time interval T (Figure IV.8c).

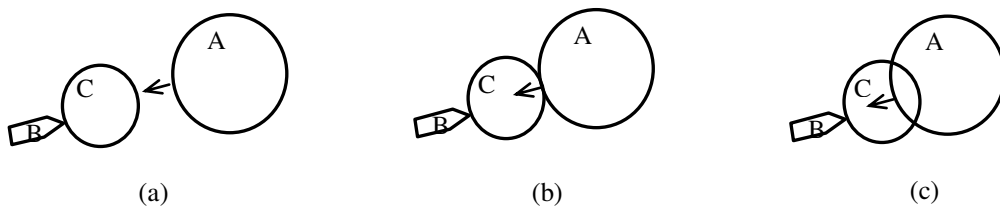

Figure IV.8. Relative movements between a storm A, a boat B and a fishing area C

3.2.3 Case study 3

Let us consider two rigid moving entities (man A and man C), whose sizes are smaller than that of the reference entity (room B). The movements between the man A and room B, and the movement semantic between the man C and room B can be modelled. Compared to the above examples, the reference entity in this example is always the room B and the size of the space where two men occupied are equal.

As illustrated by the composition table derived from the constraints given in this case (Table IV.5), one can derive the movements between man A and man C. Because they cannot intersect with each other, the topological relationship between them can only be DC or EC. When the man moves in the indoor space, we consider that he can't move freely on the boundary of the room because of some obstacles. He can only enter or leave the room through the open door.

	LV	AO	AP	TI	OI	CB	MI	AI	MB
LV	LV, AP, TI	LV, AP, TI	LV, AP, TI	LV	LV	LV	LV	LV	LV
AO	LV, AP, TI	LV, AP, TI	LV, AP, TI	LV, AP, AO	LV, AP, AO	LV, AP	LV, AP	LV, AP	LV, AP
AP	LV, AP, TI	LV, AP, TI	LV, AP, TI	AP	AP	AP	LV, AP	LV, AP	LV, AP
TI	LV	LV, AP, AO	AP	LV, AP, TI	LV, AP, TI	LV, AP, TI	LV, AP	LV, AP	LV, AP
OI	LV	LV, AP, AO	AP	LV, AP, TI	LV, AP, TI	LV, AP, TI	LV, AP	LV, AP	LV, AP
CB	LV	LV, AP	AP	LV, AP, TI	LV, AP, TI	LV, AP, TI	LV, AP	LV, AP, TI	LV, AP, TI
MI	LV	LV, AP	LV, AP	LV, AP	LV, AP	LV, AP	LV, AP, TI	LV, AP, TI	LV, AP, TI
AI	LV	LV, AP	LV, AP	LV, AP	LV, AP	LV, AP, TI	LV, AP, TI	LV, AP, TI	LV, AP, TI
MB	LV	LV, AP	LV, AP	LV, AP	LV, AP	LV, AP, TI	LV, AP, TI	LV, AP, TI	LV, AP, TI

Table IV.5 Composition table between two men and a room

As shown in Figure IV.9, man A is leaving the room B and man C is moving to the interior of room B over the time interval T. We have: $Leave(A, B) \equiv Holds(DC, d_{ext+}, T)$, $MovetoInterior(C, B) \equiv Holds(NTPP, d_{int+}, T)$. The result of the composition of these movement configurations is then $Leave(A, C) \equiv Holds(DC, d_{ext+}, T)$, which means that over the time interval T, the man A is leaving man C.

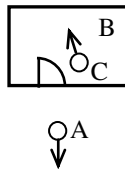

Figure IV.9. Relative movements between two men and the room

IV.4 Conclusion

In this chapter, continuous transitions as well as composition tables are studied for qualitative reasoning over entity movements. The conceptual neighbourhood diagrams for both region-region movements and trajectory-region movements are introduced, and allow for a derivation of possible movements in cases of incomplete knowledge. The boundary of the reference region constrains the continuous transitions among those primitive movements, yielding directed rather than undirected conceptual neighbourhood diagrams. The conceptual transitions between trajectory-region movements are classified according to either the starting part or the end part of a trajectory, which is slightly different from region-region movements. The similarity between region-region movements is evaluated, which can contribute to the modelling, reasoning, and simulation of the behaviour of moving entities.

To provide additional reasoning capabilities, the composition table for region-region movements is studied, this providing a practical support for an implementation in computerized systems. The fourteen region-region primitive movements generate a matrix composed of 196 entries, resulting in a relatively complete look-up table. The implementation of the lookup table can reduce the composition complexity of primitive movements. A few potential applications for the composition tables are discussed. The results obtained in the case studies suggest that the number of possible compositions largely depends on the domain of possible regions. By inferring with additional properties, such as orientation relations, the results can be constrained to a smaller range. This is a perspective we plan to explore in further work.



Experimental Applications

V.1 INTRODUCTION.....	98
V.2 APPLICATION TO AIR TRANSPORTATION	98
2.1 ANALYSIS OF FLIGHT TRAJECTORIES.....	99
2.2 FLIGHT TRAJECTORY REASONING	105
V.3 APPLICATION TO MARITIME TRANSPORTATION.....	107
3.1 MARITIME TRAJECTORY PATTERNS.....	107
3.2 MARITIME TRAJECTORY REASONING	109
V.4 CONCLUSION	110

V.1 Introduction

Having presented the building blocks of our qualitative modelling approaches in the previous chapters, the objective of this chapter is to show the potential of an implementation experiment designed and developed on top of the representation and manipulation models developed so far. As discussed in the previous chapters, the modelling approach provides a representation of movement based on an integration of qualitative topological and distance relationships. It gives a set of modelling primitives that support the qualitative representation and reasoning over movements, and that can be applied to a large extent of applications.

In this chapter, the potential applications in the aviation and maritime domains are introduced. Section V.2 introduces a series of flight trajectories modelled and analyzed at different levels of granularity. In Section V.3, a prototype is developed and applied to a maritime trajectory database in order to derive the possible movement patterns of a vessel trajectory with respect to some preselected restricted areas. The final section finally draws some conclusions and possible extensions of the case studies.

V.2 Application to Air Transportation

Let us consider for example the case of flight trajectories, a representative example of the air transport domain, and where thousands of trajectories are achieved on a daily basis worldwide. With the systematic development of GPS positioning system in all aircrafts, and the real-time broadcast of flight trajectories to specialised services thanks to the Automatic Dependent Surveillance-Broadcast transponder system (ADS-B), Multilateration systems (MLAT) and data provided by the Federal aviation Administration (FAA) in the United States for instance, a lot of flight real-time tracking systems are nowadays available. The availability of flight trajectory data provides a lot of opportunities for reasoning, searching for trends and some specific behaviours over flight trajectories. Our modelling approach is applied to a series of flight trajectories at the regional level in order to derive some significant patterns in space and time, the objective being to provide a global view of the flights related to some selected countries of interest. The different cases identified will be qualified by primitive movement configurations, the case of missing data is also taken into account in order to show the applicability of the conceptual neighbourhood reasoning mechanisms.

2.1 Analysis of Flight Trajectories

The modelling approach is applied on top of the aircraft tracking system Flightradar24 that provides real-time information of flights trajectories at the worldwide level (<http://www.flightradar24.com/48.86,2.35/7>). Let us consider the flight trajectories related to Ireland, a series of primitive movement configurations identified at a given time instant can be illustrated as follows (Figure V.1):

- The flight KLM644 is flying close to Ireland, this illustrates the movement configuration Approach (AP)
- The flight EIN84L is leaving Ireland, this illustrates the movement configuration Leave (LV)
- The flight PI103 is flying along the boundary of Ireland, this illustrates the movement configuration Touching (TI)
- The flight STK22GL is overlapping the boundary of Ireland, this illustrates the movement configuration Overlapping (OI)
- The flight EZY29CN is touching inside the boundary of Ireland, this illustrates the movement configuration CoveringBy (CB)
- The flight ROU1909 is flying to the centre of Ireland from the Dublin airport, this illustrates the movement configuration MovetoInterior (MI)
- The flight RYR606E is flying to the southeast boundary of Ireland from the Dublin airport, this illustrates the movement configuration MovetoBoundary (MB)

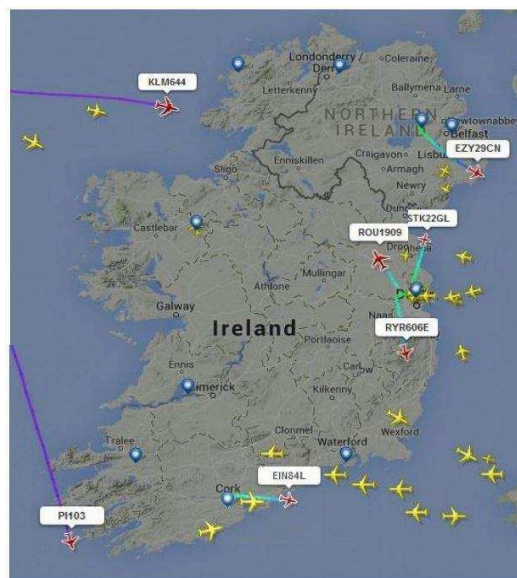

Figure V.1. Flight trajectory configurations

Although the information on the flight origins and destinations surely provide some useful data for transportation planning, the analyses of the spatio-temporal trends that emerge for a given country are likely to produce some information of interest. We analyse these patterns by taking into account the way the airspace is occupied by a series of flight at different times of the day and the week. The different primitive trajectory configurations related to Ireland are analyzed every half an hour in the morning, afternoon, evening and midnight on a week day and a Saturday (Table V.1). For instance Figure V.2 shows some noticeable differences in the specific example of Ireland. A general trend is that air traffic within and close to Ireland decreases from high values in the mornings to lower values in the evenings. Air traffic is also higher in the week-end. The number of flights either closing or leaving Ireland (AP and LV) is overall relatively high as well as the number of flights close to the boundaries of Ireland (TI, OI and CB). Other primitive or aggregated motion patterns can be similarly explored as well as some uncommon behaviours.

Day	Time	Qualitative Movement						
		AP	LV	TI	OI	CB	MI	MB
Monday	9:00-9:30	32	19	22	18	23	13	16
	14:00-14:30	21	13	8	17	13	9	7
	19:00-19:30	8	7	6	13	10	7	9
	23:00-23:30	11	5	16	14	16	6	7
Saturday	9:00-9:30	26	19	10	17	19	11	15
	14:00-14:30	16	15	5	18	13	7	8
	19:00-19:30	13	10	6	10	12	7	9
	23:00-23:30	9	3	12	10	11	4	6

Table V.1. The number of different primitive configurations in various time intervals

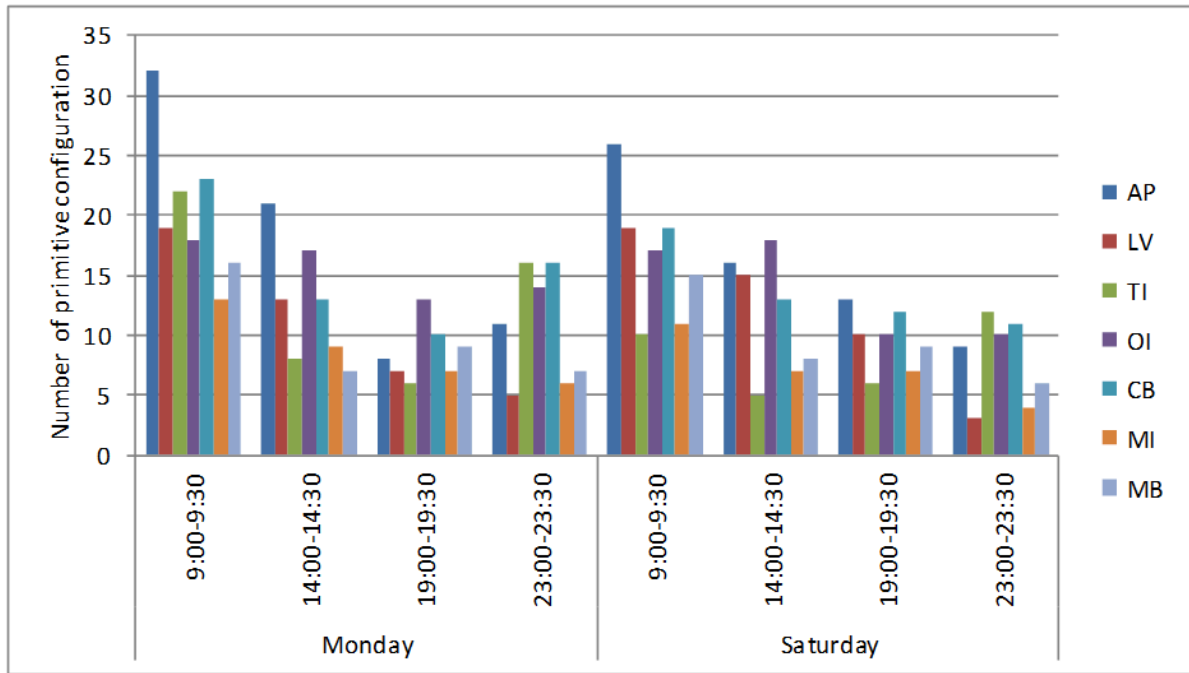

Figure V.2. Primitive trajectory configurations over the example of Ireland

A flight trajectory can be regarded as a motion process, and represented as a sequence of trajectory primitives which act as the basic units for the modelling approach. Therefore, a trajectory can be modelled as a string of predicates where each predicate represents a trajectory primitive. Let us consider for example the flight AFR77 which is flying from Los Angeles to Paris, and whose trajectory passes through Ireland. This flight trajectory can be decomposed into the following movement primitives (Figure V.3). The semantics of the motion event “PassThrough” can be modelled as:

$$\text{PassThrough}(t_1) \equiv \text{events}(\text{AP}_{t_1 t_2} \wedge \text{TI}_{t_2 t_3} \wedge \text{OI}_{t_3 t_4} \wedge \text{CB}_{t_4 t_5} \wedge \text{MI}_{t_5 t_6} \\ \wedge \text{MB}_{t_6 t_7} \wedge \text{CB}_{t_7 t_8} \wedge \text{OI}_{t_8 t_9} \wedge \text{TI}_{t_9 t_{10}} \wedge \text{LV}_{t_{10}})$$

where t_i ($i \in [1, 10]$) are the start time when the primitive movements AP, TI, OI, CB, MI, MB, CB, OI, TI and LV take place respectively, with $t_1 < t_2 < \dots < t_{10}$.

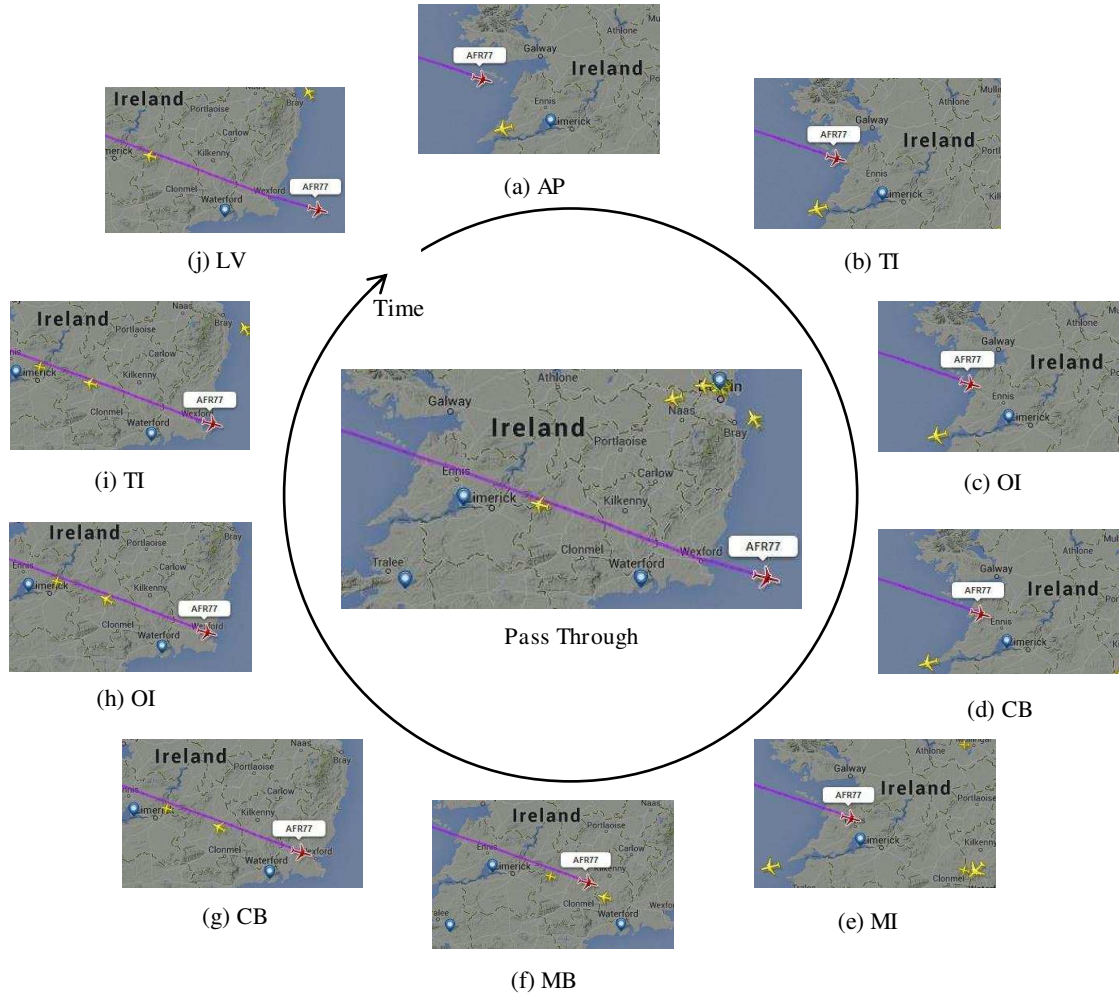

Figure V.3. The sequence of motion event “PassThrough”

For instance, the semantics of the flight trajectories Arrive and Depart can be described as follows:

$$\text{Arrive}(t_A) \equiv \text{events}(\text{AP}_{t_1 t_2} \wedge \text{TI}_{t_2 t_3} \wedge \text{OI}_{t_3 t_4} \wedge \text{CB}_{t_4 t_5} \wedge \text{MI}_{t_5 t_A} \wedge \text{AI}_{t_A t_{A+\delta}})$$

where t_A is the arrival time of the flight, t_1, t_2, t_3, t_4, t_5 are the start times when the primitive movements AP, TI, OI, CB, MI take place, respectively, with $t_1 < t_2 < t_3 < t_4 < t_5 < t_A$, δ is the time interval when the flight stays in the airport before the next take off, this being approximated as a AI primitive movement.

$$\text{Depart}(t_D) \equiv \text{events}(\text{AI}_{t_D - \delta t_D} \wedge \text{MB}_{t_D t_1} \wedge \text{CB}_{t_1 t_2} \wedge \text{OI}_{t_2 t_3} \wedge \text{TI}_{t_3 t_4} \wedge \text{LV}_{t_4 t_5})$$

where t_D is the departure time of the flight, t_1, t_2, t_3, t_4, t_5 are the end times when the primitive movements MB, CB, OI, TI and LV take place, respectively, with $t_D < t_1 < t_2 < t_3 < t_4 < t_5$, δ is the time interval when the flight stay in the airport before it takes off, this being again approximated as a AI primitive movement.

The trajectory events above illustrate the potential of the modelling approach as applied to some illustrative examples in the case of Ireland. Indeed, a frequency table of flight departure and arrival times can identify some movement patterns at the airport levels (i.e., departures and arrivals) but our approach also provides a slightly different information on flights approaching and leaving a given country, and also the ones that pass through (i.e., aggregated process PassThrough), this providing complementary information on trajectory patterns. Let us compare the number of flights (Table V.2) that Arrive at the airports of Ireland and Iceland, Depart from their airports, and PassThrough the two countries during four different time intervals in a day from Monday to Sunday, as shown in Figure V.4. It appears that the numbers of trajectory events are a little higher on weekdays than on weekends. Friday is also the busiest day in a week which has more flights Arrive and Depart in both countries. Not surprisingly, Ireland has an air traffic much more important than the one of Iceland. Compared with the three above trajectory events, the number of flights which PassThrough is inconstant. The busiest time above Ireland is from 7:00 to 9:00 in the morning with around 60% flights PassThrough its airspace, except on Thursday where the number decreases to 47%. However, in Iceland there are few flights that PassThrough from 7:00 to 9:00, while the peak time is from 12:00 to 14:00, especially on Wednesday with 90% of the flights above Iceland passing through the country. Overall it also appears that the motion process PassThrough is much more important in Ireland than in Iceland.

Day	Time	Motion Event					
		Arrive		Depart		PassThrough	
		Ireland	Iceland	Ireland	Iceland	Ireland	Iceland
MON	7:00-9:00	19	2	26	13	66	1
	12:00-14:00	24	2	25	2	42	24
	16:00-18:00	20	4	40	10	21	10
	20:00-22:00	25	2	11	0	13	2
TUE	7:00-9:00	19	2	26	9	64	1
	12:00-14:00	23	2	24	1	26	15
	16:00-18:00	18	2	40	9	12	13
	20:00-22:00	24	0	11	1	7	3
WED	7:00-9:00	19	2	26	11	66	2
	12:00-14:00	26	0	27	0	27	9
	16:00-18:00	23	2	42	8	11	14
	20:00-22:00	27	1	11	1	8	3
THU	7:00-9:00	19	2	26	13	42	2
	12:00-14:00	28	0	26	0	23	16
	16:00-18:00	20	3	41	8	14	14
	20:00-22:00	25	2	11	1	8	5
FRI	7:00-9:00	21	2	30	13	66	4
	12:00-14:00	33	0	30	1	28	7
	16:00-18:00	26	2	44	9	14	7
	20:00-22:00	27	1	11	0	8	6
SAT	7:00-9:00	18	1	25	8	64	2
	12:00-14:00	30	0	25	1	19	15
	16:00-18:00	16	2	22	6	14	8
	20:00-22:00	15	1	7	0	13	2
SUN	7:00-9:00	12	0	23	13	66	5
	12:00-14:00	30	1	28	1	24	15
	16:00-18:00	26	4	43	10	21	4
	20:00-22:00	25	1	14	1	11	2

Table V.2. The number of flights regarding different motion events

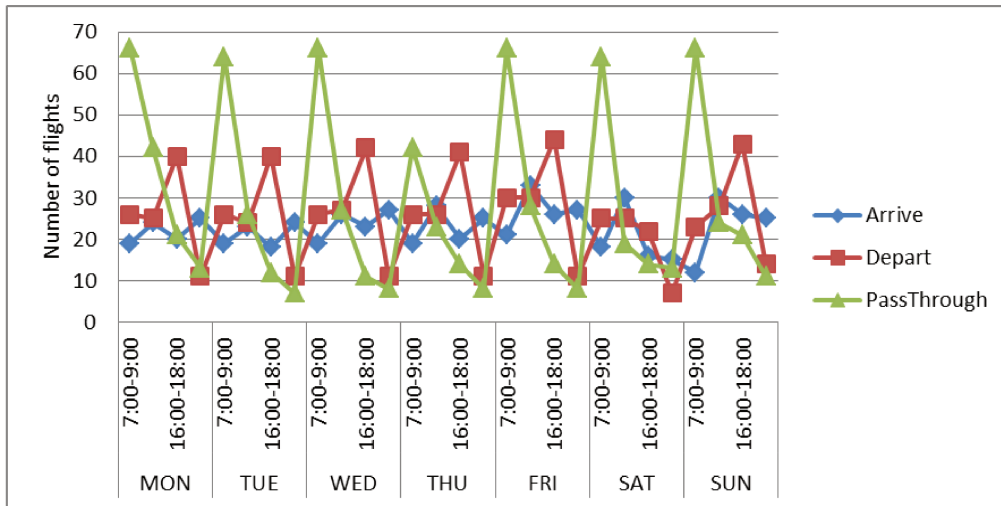

(a) Ireland

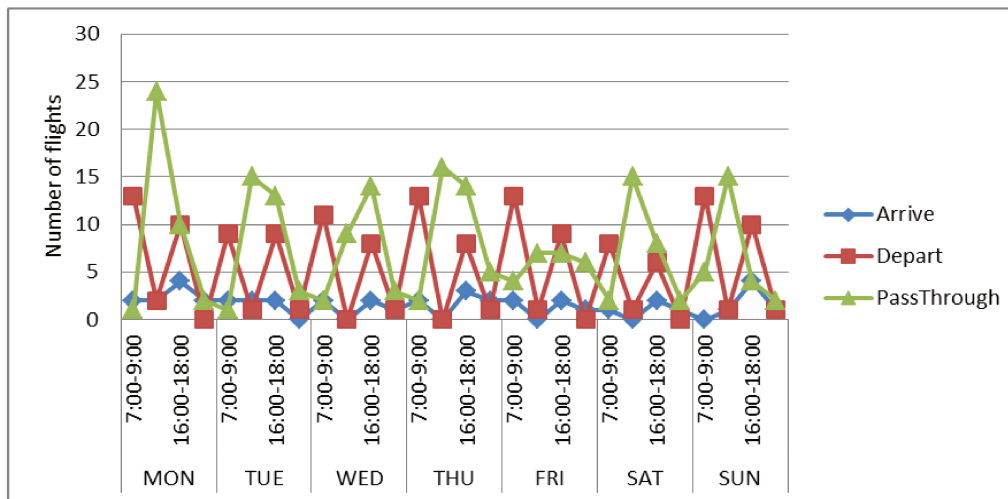

(b) Iceland

Figure V.4. Comparison of trajectory events

2.2 Flight Trajectory Reasoning

The modelling approach can be also applied to the prediction of the possible trajectory of a flight when for example the geo-location signal is missing due to some technical or emergency circumstances. Let us consider the case illustrated in Figure V.5, L_0 is an incomplete flight trajectory with P_0 as its last recorded sample point. Let us also assume that the positioning signal is lost when the flight is in the airspace of Iceland. Only one additional sample point P_1 outside the airspace is known and recorded. Because the movement patterns at P_0 and P_1 are MI and LV respectively, four possible trajectories can be derived according to the conceptual neighbourhood diagram:

- Trajectory P_0P_1 : The flight PassThrough Iceland directly without any stop, that is, a sequence of trajectory primitives: $MI \wedge MB \wedge CB \wedge OI \wedge TI \wedge LV$.
- Trajectory $P_0A_1P_1$: The flight stopped at Akureyri airport (A_1) then took off again leaving Iceland, that is, a sequence of trajectory primitives: $MI \wedge MB \wedge AI \wedge MI \wedge MB \wedge CB \wedge OI \wedge TI \wedge LV$.
- Trajectory $P_0A_2P_1$: The flight stopped at Egilsstadir airport (A_2) then took off again leaving Iceland, that is, a sequence of trajectory primitives: $MI \wedge MB \wedge AI \wedge MB \wedge CB \wedge OI \wedge TI \wedge LV$.
- Trajectory $P_0A_1A_2P_1$: The flight stopped at Akureyri airport firstly and then Egilsstadir airport, that is, a sequence of trajectory primitives: $MI \wedge MB \wedge AI \wedge MI \wedge MB \wedge AI \wedge MB \wedge CB \wedge OI \wedge TI \wedge LV$.

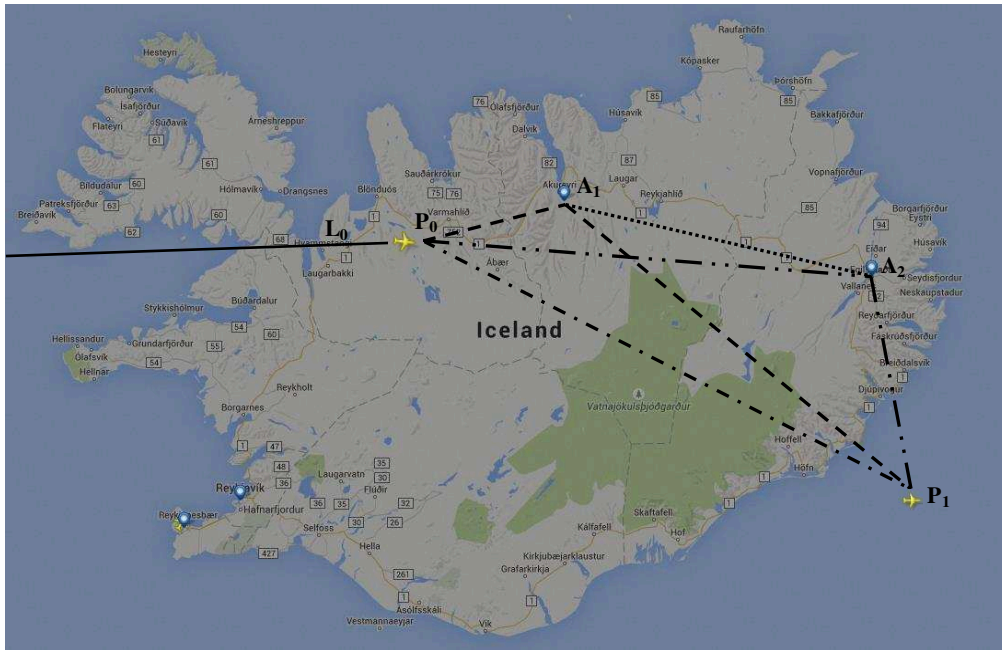

Figure V.5. Possible evolution of a flight trajectory

This illustrative example shows how the conceptual neighbourhood diagram principles can be applied to predict the possible trajectories of a given flight. Other applications of the CND are still to be explored such as the suggestion of trajectory options to a flight in an emergency situation.

V.3 Application to Maritime Transportation

Coastal seas play a fundamental role in human societies where many diverse activities take place, such as maritime transportation of passengers, commercial fishing, and water sports (sailing, windsurfing, scuba-diving, rowing) (Schwartz 2005). Allocating and analysing the spatial and temporal distribution of human activities in marine areas have been regulated for years. For instance, marine transportation is often managed with some specific zones especially in intensively used areas. For example, fisheries can be constrained to some specific functions such as “open” or “close” in particular areas (Katsanevakis et al. 2011). Note that the objective of this experimental case study is to act as a proof of concept where specific trajectories related to some given regions of interest can be retrieved on demand. Trajectory patterns can be retrieved and matched to the primitive movements identified as well as the evolution of these trajectories can be explored in case of incomplete knowledge.

3.1 Maritime Trajectory Patterns

The modelling approach is supported by a prototype development that has been applied to a maritime database in North West France where real-time ship locations are broadcasted by Automatic Identification Systems (AIS) and stored in a PostgreSQL database management system (Ray et al. 2013). The AIS is an automatic VHF tracking system that regularly broadcasts ship locations to neighboring ships and receivers on the coast. It is a solution comparable to aeronautic transponders. The application developed allows for a real-time integration and analysis of maritime trajectories. Incoming data are stored and manipulated by the PostGIS spatial database extension of the PostgreSQL object-relational database. The objective is to analyze some typical maritime trajectories patterns with respect to some specific and restricted areas. When considering a given restricted area defined as a region, a PostGIS embedded query selects and displays all the trajectories close to that region given a distance threshold. The temporal extent of the content is parameterized by the user (typically 5 to 30 minutes). A rule-based engine has been implemented and supports the matching of some observed trajectories with some pre-conditions. A graphic user interface presents the selected trajectories at the interface level (Figure V.6). At the data manipulation level, a difference is made between static objects (user-defined regions of interest) and maritime trajectories. All queries have been implemented using the Java Topology Suite library (JTS). Let us illustrate the potential of

the approach using a few examples of ship trajectories crossing some restricted areas. The regions in Figure V.6 denote several forbidden areas denoted A_1 and A_2 in the bay of Brest (Brittany, France). An example of embedded spatial operation that retrieves the trajectories that intersect those two regions A_1 and A_2 is given below:

Embedded spatial operation - Example

Rule "Example"

```

when
  $region1 : region1()
  $region2 : region2()
  &trajectory : AISTrajectory()
  eval($trajectory.getGeo()
intersects(&region1.getWkb_geometry())
intersects(&region2.getWkb_geometry()))
then
  logger.logMessage("")
end

```

The resulting trajectory in the left of Figure V.6 denotes the route of a ship (\vec{L}_1) from the sample point WP0 to WP7, that crosses these two restricted areas A_1 and A_2 (for the purpose of clarity other trajectories in the neighborhood of the regions A_1 and A_2 are not displayed in Figure V.6). The values of the four intersections [$V_{back}, V_{left}, V_{front}, V_{right}$] on the boundary of the neighboring disc are derived according to the rules previously defined, this giving the corresponding movement patterns. Overall, the topological relations of the trajectory \vec{L}_1 with respect to these regions A_1 and A_2 are composed by a sequence of DL-RE movements as follows:

$$DTR(\vec{L}_1, (A_1, A_2)) = \langle A_1 \langle S_7, S_8 \rangle, A_2 \langle S_7 \rangle \rangle$$

And the corresponding movement pattern is $\langle A_1 \langle CI_f, CO \rangle, A_2 \langle CI \rangle \rangle$.

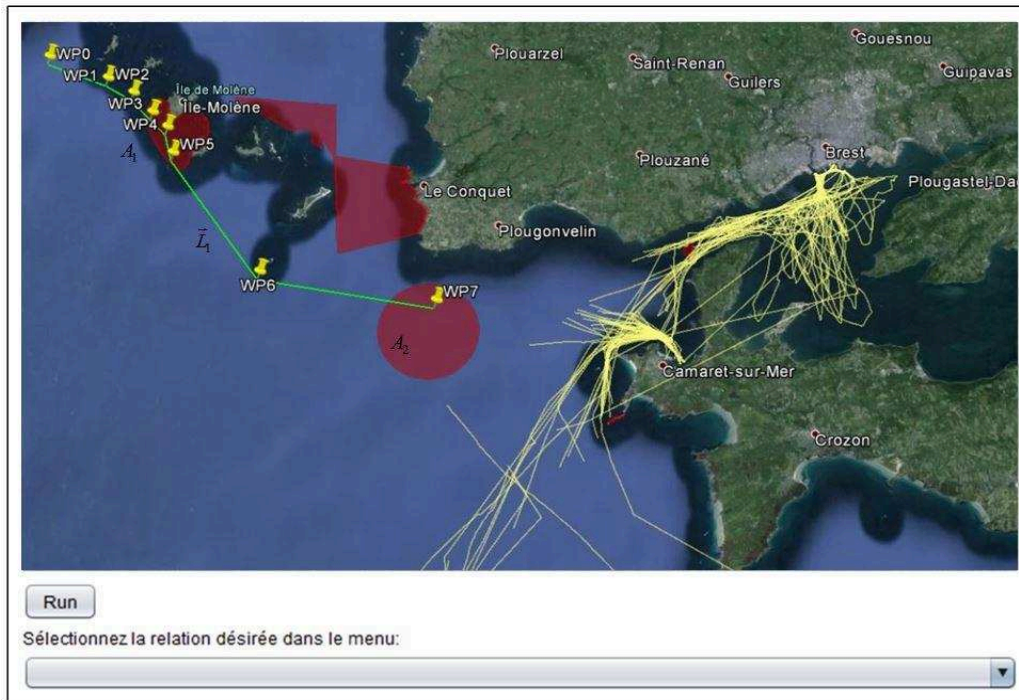

Figure V.6. Maritime trajectory patterns

3.2 Maritime Trajectory Reasoning

The combination of a data integration process based on real AIS data, PostGIS and a rule-based engine supports the filtering of trajectory data, this favouring further reasoning. For the region A_2 and trajectory \vec{L}_1 the interface illustrated in Figure V.7 returns the corresponding movement pattern S_8 . Let us consider \vec{L}_1 as an incomplete trajectory where an additional sample point WP8 is known and recorded, and that potentially materializes a movement pattern $MovetoBoundary$ S_5 . The possible trajectory derived from these two points is illustrated in Figure V.7, as well as the potential forward conceptual trajectories derived from S_8 , and that anticipate the evolution of that trajectory. These can be either S_8 , S_{11} , S_{12} , S_{17} or S_{18} . For instance, if the potential trajectory pattern is $CrossOut$ (S_8), the neighboring disc of its endpoint $neigh(\vec{L}_{2e})$ can also be used to detect whether it will have a potential intersection with another trajectory and neighboring disc such as $neigh(\vec{L}_{3e})$.

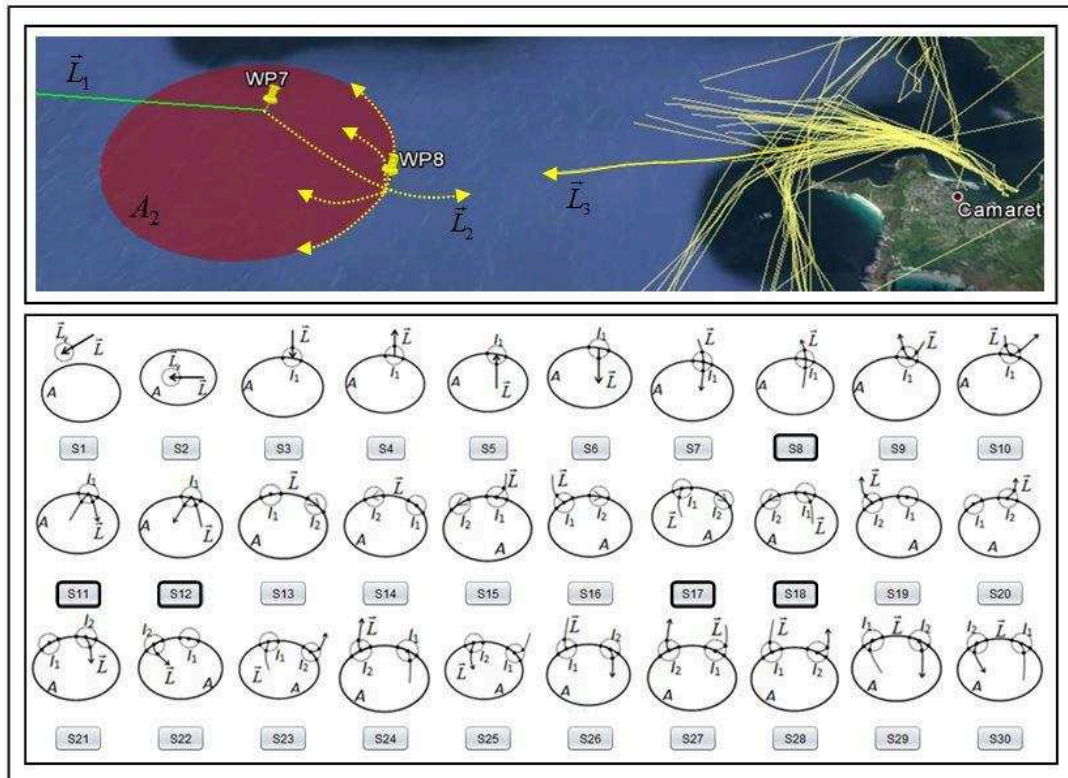

Figure V.7. Forward trajectory patterns

V.4 Conclusion

In this chapter, the capabilities of the modelling approach are illustrated by two case studies in the air and maritime transportation domains. In particular, we showed that flight trajectories can be analyzed at different levels of granularity. The model can either track a given trajectory and even simulate the possible next states of a given flight, or at the aggregated level, characterize the air trajectory patterns for a given region of interest. The example of the maritime context is also particularly relevant, the trajectory patterns of a vessel are retrieved and matched to the primitive movements identified, and the evolution of these trajectories are explored in case of incomplete knowledge. It can be used for anticipating any collision risk in overcrowded maritime locations. Its main advantage is to formally define and categorize basic movements, to provide a composition language to express complex behaviours, and to give a sound support for a further integration of the algebra within existing spatial query languages.

The approach can also be applied to many other domains, such as video retrieval and robotics. The movement patterns of moving objects can be categorized from the video

images that are observed by a static camera during a certain period of time, e.g., to recognize specific patterns in sports activities, or to find all animals moving similarly to a sample trajectory. The movement predicates defined in our model can provide a taxonomy to represent and describe such movement patterns. In order for a robot to understand human movements and act accordingly, a cognitive system should be implemented within its processing engine in order to interpret semantically the data collected by its sensors. Such artificial reasoning mechanisms can be associated with some predefined movement patterns such as walking towards someone or something, entering a room, standing still, etc. The automatic interpretation of such movement is important for mobile robots designed to provide services to human beings. For instance, a coffee serving robot should be able to detect the movement of a potential customer, and infer whether he/she is interested in having a cup of coffee or not from his/her behaviour.



Conclusions & Perspectives

VI.1 OUTLINE	114
VI.2 MAIN RESEARCH FINDINGS.....	114
VI.3 PERSPECTIVES	117

VI.1 Outline

This dissertation proposes a qualitative spatio-temporal modelling and reasoning approach for the representation of moving entities. Movement patterns are formally described and derived based on complementary spatial relations: (1) topological relations between a trajectory of a moving entity and a reference region, and (2) orientation relations between a trajectory and another one. Qualitative movements are derived from the spatio-temporal relations that characterize moving entities conceptualized as either regions or points. The approach is complemented by a tentative qualification of the possible natural language expressions of the primitive movements identified. Complex movements can be also represented by a composition of these primitive movements. The modeling framework supports several reasoning capabilities over movement patterns thanks to the concepts of conceptual neighbors, conceptual transitions and composition tables. The main results of our research are presented in Section VI.2 while an overview of future research is developed in Section VI.3.

VI.2 Main Research Findings

Three major contributions are elaborated in this thesis: (i) A categorization of movement patterns, (ii) A framework for the formal representation of qualitative movements and (iii) qualitative reasoning methods for deriving possible movements.

The proposed categorization of movement patterns (Chapter II) provides a basis for the definition and formalization of qualitative movements. Spatial relations, such as topological orientation relations, give the first component of the modelling approach. Thanks to the topological properties identified from the intersections of a given moving entity on the boundary of reference region, such as dimensionality, cardinality, dimension sequence, and intersection type, as well as clockwise/anticlockwise orientations, 30 primitive movements are derived. These configurations represent the possible configurations of the trajectory of a moving point with respect to a reference region. Orientation relations are applied to identify the movement patterns between the trajectories of two moving points, this allowing us to derive and classify 10 primitive topological relations. These primitive movement patterns identified are summarized in Figure VI.1.

The framework developed for the formal representation of qualitative movements in Chapter III integrates topological and distance relations and their evolution over time. The idea behind this approach is to take into account both the boundary of the reference entity in the analysis of the spatial configurations, as well as the evolution of the relative distance. The RCC8 algebra and DL-RE topological relations are chosen as the topological primitives for moving regions and moving points, respectively. The framework developed favours the identification of a series of movement predicates and natural language expressions. These conceptual models can be extended by composition mechanisms depending on the application semantics. The proposed modelling contributions are summarized in Table VI.1.

The qualitative reasoning methods developed in Chapter IV for deriving possible movements are based on the conceptual neighbors of primitive movements and composition tables. The conceptual neighborhood diagrams for both region-region movements and trajectory-region movements are studied and allow for a derivation of possible movements in cases of incomplete knowledge. The composition table for region-region movements provides additional reasoning capabilities.

The application of the approach developed in Chapter V experiments the feasibility of the modelling framework and how it can be used practically in real-life situations. A few possible application areas have been discussed: air and maritime transportations. These application scenarios show that the applied methodology provide some promising capabilities to analyse trajectory patterns at the local and regional levels, as well as it provides a formal and sound support to the generation of a movement taxonomy.

Model Type	Type of target object	Type of reference object	Spatial and temporal relations				Number of predicates	Section in the thesis	
			Topological		Orientation	Distance			Temporal
			RCC8	DL-RE					
Movement Pattern	A directed line	A region		×				30	II.3
	A directed line	A directed line			×			10	II.4
Qualitative Movement	A region	A region	×			×	×	14	III.3
	A directed line	A region		×		×	×	23	III.4

Table VI.1 Summary of the proposed modelling contributions

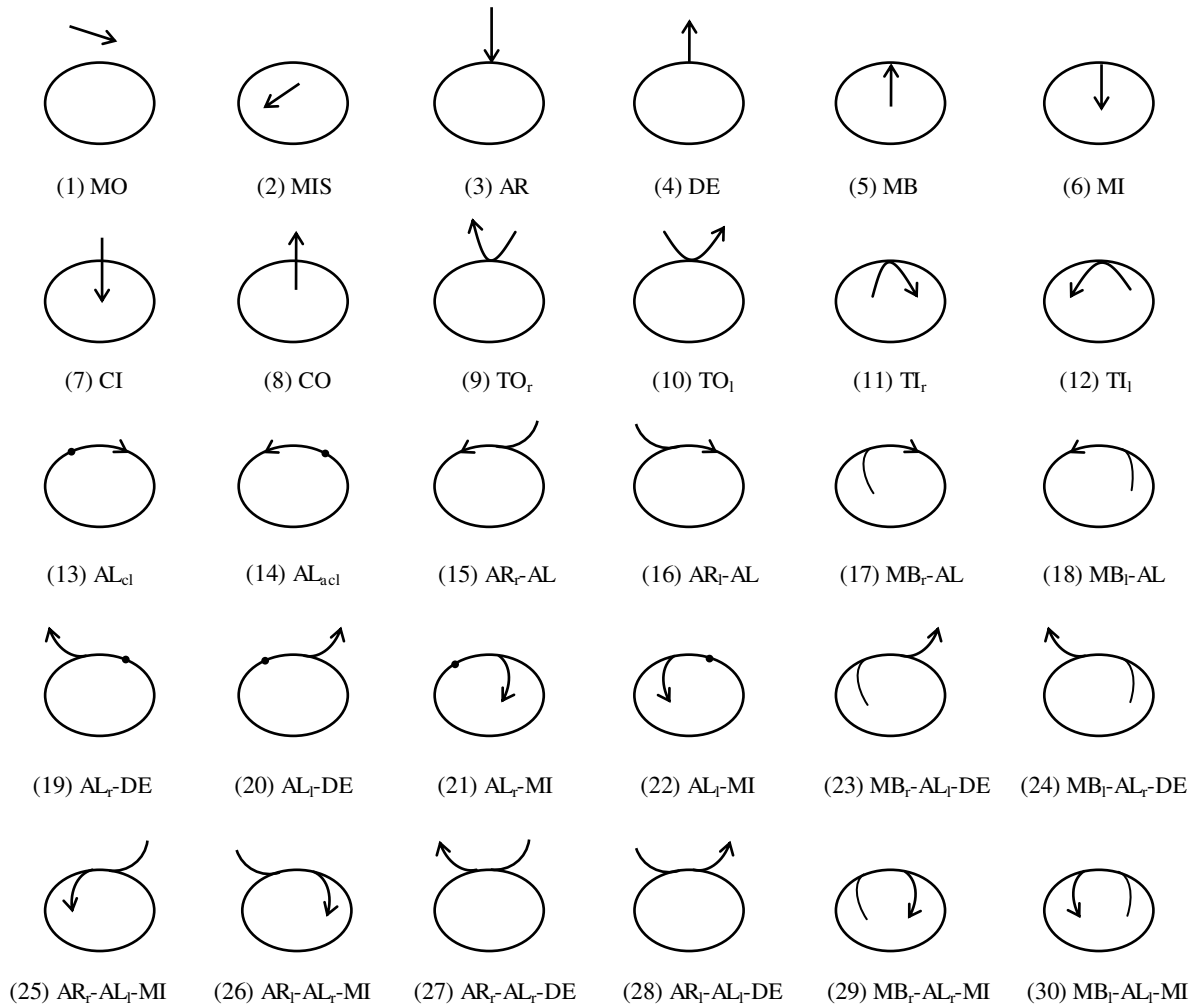

(a)

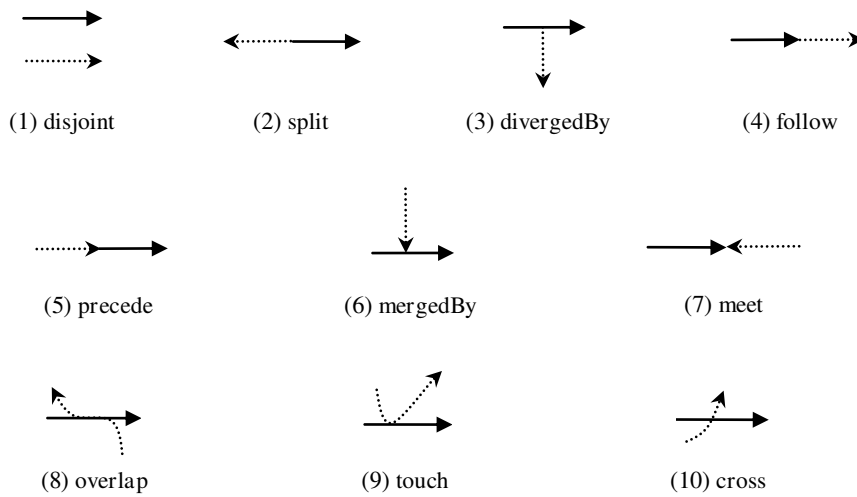

(b)

Figure VI.1. Primitive movement patterns (a) between a directed line and a region;

(b) between two directed lines

VI.3 Perspectives

Although the present study has contributed to the development of formal approaches for the qualitative representation of moving entities, there are several aspects to be further investigated in future research.

(1) Modelling extensions: orientations, velocities and accelerations

Moving objects are influenced by various factors which constrain their movements. Examples are intrinsic properties (e.g., speed or acceleration), environment constraints (e.g., network), and influences of other moving objects (e.g., competition or disturbances). Currently, topological relations and relative distance relations are taken into consideration. The model is preliminary and still should be extended by the integration of additional properties, such as additional orientation relations and relative velocities and accelerations, in order to enrich the semantics associated to the movements identified. In particular, orientation relations can demonstrate the direction of the movement, e.g., whether the object moves to the left or right from an observer's viewpoint. By describing the way a dynamic object moves either faster or slower, than the other one, or while accelerating or decelerating with respect to the other one, relative velocities and relative accelerations can tell us more insights on the movement patterns and then enrich reasoning capabilities.

(2) Towards a three-dimensional representation

It is worth noting that in many applications an object's movement actually takes place in a three-dimensional space. Additional information can be drawn from the original 3D trajectory instead of its 2D projection. For example, it is not possible to identify if the moving objects are on the same surface or above each other in a 2D plane. Since the 2D relations used for representing the projected 2D trajectory are viewpoint-dependent and inferred from a plane, the relations that characterize these moving objects can be in fact inconsistent. By extending the spatial primitives of our modelling approach to a three-dimensional space, a broader range of movement patterns can be captured, and a view-invariant representation of qualitative movement can be constructed to provide spatial descriptions appropriate to a three-dimensional space.

(3) Integration of the fuzziness dimension

It appears that the models developed for the description of qualitative movement in this study are particularly appropriate for simple moving entities, especially for those with

clear boundary. However, moving objects do not always have a clear boundary in the real world, such as dunes, forest fires, and hurricanes. Fuzzy moving entities are a valuable concept for representing many spatio-temporal phenomena when crisp representations are not appropriate. Consequently, the development of modelling and reasoning approaches dealing with fuzzy moving entities might be appropriate and further investigated in cases of either fuzzy boundaries or uncertain positional knowledge. In fact, our model might be extended to take into account uncertain boundaries. For instance a given boundary might be represented as a region that denotes its possible locations, this generating the fact two boundaries whose configurations might be studied under similar principles.

(4) Reasoning extensions

This framework developed a series of reasoning techniques, i.e., conceptual neighborhood diagrams and composition tables, in order to reason over incomplete knowledge of movements for moving entities either as points or regions. Further work will be oriented to the study of the similarities between trajectory-region movements through CND diagrams and movement sequences, and by an application of another reasoning methodology known as the constraint satisfaction problem (CSP) that can be applied to search for a solution that satisfies a set of constraints given by an application context.

(5) Conceptual modelling

The movement predicates identified can be integrated in conceptual modelling approaches, that is, case tools oriented to the modelling of a specific application domain. When modelling and representing a given application context of some real-world phenomena, an important preliminary step is to identify the objects and relations that characterize the domain of study. While the first generation of conceptual tools developed at the conceptual level were very much oriented to the representation of static properties, many current conceptual models and approaches now integrate the dynamic dimension. Therefore, the different algebra introduced by our approach can act as a series of modelling abstractions that can be used when representing the semantics of a given application.

(6) Cognitive evaluation of the movement configurations

Natural language is a powerful tool for efficient human-computer interactions. The modelling approach developed provides some natural language expressions to qualify the different movement predicates identified. Therefore, it is part of further work to

investigate their adequacy and appropriateness. An experimental framework to be developed with a panel of representative human users that will extensively assess the predicates should be set up to evaluate if the movement configurations identified match the natural expression defined.

(7) Implementation perspectives

At the implementation level the interfaces illustrated so far by our modelling approach gives a few directions to explore. First, the algebra developed at the formal level provides a sound support for the integration of the basic movement identified within a spatial query language. This can be done and implemented either on top of a spatial query language, or as specific routines and geometrical algorithms closely integrated in a GIS software. Secondly, all movement identifies are expressed as natural language expressions, this also providing some possibilities to develop some user-oriented interfaces that will favour the tracking and manipulation of trajectory patterns.

(8) Application validations

So far, the application of the whole modelling framework has been considered in the context of GIS, such as tracking air flights or vessels. However, many other domains of interest such as medicine and biology surely provide some application perspectives to explore. For example, one might apply our algebras to discover some displacement mistakes of a blind person to reduce the risk of injury, or identify the movement patterns of a cell to analyze the spread of bacteria.

Certainly, it cannot be expected that these extensions will directly lead to practical utility in the near future, but we hope that they will contribute to the development of valuable computerized systems to reason in space and time.



Résumé étendu de la thèse

A.1	INTRODUCTION	122
A.2	PATRONS DE MOUVEMENTS	123
2.1	PRINCIPES DE MODELISATION	124
2.2	PATRONS DE MOUVEMENTS ORIENTES FRONTIERE ENTRE UNE LIGNE ORIENTEE ET UNE REGION .	124
2.3	PATRONS DE MOUVEMENTS BASES SUR DES RELATIONS D'ORIENTATIONS ENTRE DEUX LIGNES ORIENTEES	125
A.3	REPRESENTATION QUALITATIVE DE MOUVEMENT D'ENTITES	126
3.1	PRIMITIVES SPATIO-TEMPORELLES	126
3.2	VERS UNE REPRESENTATION DE MOUVEMENTS REGION-REGION	127
3.3	VERS UNE REPRESENTATION D'UNE TRAJECTOIRE-REGION	127
A.4	RAISONNEMENT QUALITATIF SUR DES ENTITES MOBILES.....	129
4.1	TRANSITIONS CONTINUES DE MOUVEMENTS	129
4.2	TABLES DE COMPOSITION	130
A.5	APPLICATIONS EXPERIMENTALES.....	130
5.1	APPLICATION AU TRANSPORT AÉRIEN	130
5.2	APPLICATION AU TRANSPORT MARITIME.....	131
A.6	CONCLUSION.....	132

A.1 Introduction

Une part importante des objets du monde réel est en mouvement plus ou moins continu que les humains perçoivent et observent à travers le concept de changement. Dans le domaine de la représentation de l'information spatiale, ces dernières années ont vu le développement d'une série de contributions formelles et sémantiques orientées vers la modélisation et la représentation des propriétés spatiales et temporelles d'entités mobiles. Ces approches ouvrent la voie à de nouveaux champs de raisonnement mais demandent encore l'identification de techniques de représentation formelles qui prendraient mieux en compte toute la complexité spatiale, temporelle et sémantique de la dynamique de ces entités mobiles dans un espace géographique.

La recherche développée par cette thèse est orientée vers la représentation d'entités mobiles du monde réel à partir d'une approche de modélisation qualitative spatiale et temporelle le plus proche possible des capacités cognitives des humains. Notre approche est construite à partir de plusieurs domaines de compétence de recherche à savoir la représentation des connaissances et le raisonnement, le traitement du langage naturel et les Systèmes d'Informations Géographiques (SIG). La motivation de cette recherche provient de la nécessité de développer des modèles formels et informatiques de description de la dynamique d'entités mobiles, et des mécanismes appropriés de raisonnement qui puissent manipuler utilement les mouvements de ces entités dans des espaces géographiques.

Les principaux objectifs de notre recherche sont les suivants :

- Identifier et modéliser les mouvements élémentaires d'entités mobiles dérivées à partir de configurations spatiales et temporelles telles que caractérisées par des relations spatio-temporelles;
- Développer un formalisme qui modélise et décrit les relations spatio-temporelles de mouvement d'entités mobiles dans un espace à deux dimensions;
- Proposer des mécanismes de raisonnement qui puissent manipuler des configurations à données incomplètes ou incertaines;
- Expérimenter le potentiel de notre approche qualitative et formelle de la dynamique d'entités mobiles dans le contexte d'applications maritimes et aériennes.

Ce manuscrit est organisé en plusieurs sections qui reflètent autant de contributions formelles et méthodologiques qui sont résumées dans ce chapitre résumé étendu en français. Le premier chapitre de cette thèse, qui est résumé dans la section suivante A.2,

présente une approche de modélisation d'entités mobiles à partir d'un point de vue centré vers la notion de frontière d'une entité de référence. Les mouvements d'une entité observée sont caractérisés par rapport à cette première entité de référence, en prenant en compte les relations topologiques et d'orientation entre une entité spatiale observée et une entité spatiale de référence.

La Section A.3 développe deux modèles formels de représentation de la dynamique d'une entité considérée comme une région ou un point. La Section A.4 présente les principes de raisonnement appliqués à la manipulation d'entités en mouvement dans des contextes de données incomplètes. Une application expérimentale et illustrative appliquée à la manipulation de données de trajectoires aériennes et maritime est résumée dans la section A.5. La section A.6 conclut la thèse et dresse quelques perspectives de recherche et d'applications.

A.2 Patrons de Mouvements

Le récent et important développement, voire la prolifération, de nombreuses techniques d'intégration de données géographiques en temps réel à partir de senseurs issus de techniques GPS, WIFI et RFID, pour citer quelques exemples représentatifs, ouvrent de nombreuses perspectives pour la génération massive de données de trajectoires, que ce soit dans des espaces à grande ou à petite échelles géographiques. Cette évolution technologique favorise la génération de larges bases de données qui le plus souvent ne contiennent que des informations implicites sur la nature intrinsèque des mouvements des entités sous-jacentes observées. Si les possibilités d'analyse offertes par les bases de données générées sont satisfaisantes pour de nombreux domaines applicatifs, de la modélisation en transport à la simulation de dynamiques urbaines à différents niveaux d'abstraction, la sémantique associée à ces dynamiques d'entités mobiles demande encore le développement de mécanismes de raisonnement dans l'espace et dans le temps. Notre objectif de recherche consiste à développer une approche qualitative de représentation de la sémantique spatio-temporelle associée au mouvement d'une entité observée par rapport à une entité de référence, plus qu'une approche quantitative de mesure de ces mouvements comme dans la plupart des approches actuelles.

Notre approche formelle a donc pour objectif d'identifier et de modéliser ces propriétés qualitatives à partir de techniques de raisonnement spatial qualitatif.

2.1 Principes de Modélisation

Intuitivement, des processus spatio-temporels qui caractérisent le mouvement d'une entité dynamique de type région ou ponctuel peut être modélisé qualitativement par le concept de ligne orienté. Une ligne orientée est définie comme un segment de ligne non-branché sans cycle et avec une direction. Nous considérons des régions simples et bien définies dans un espace à deux dimensions, avec un intérieur, une frontière et un extérieur comme définies par les approches topologiques.

Afin de modéliser les relations spatio-temporelles qui qualifient des entités mobiles, plusieurs invariants topologiques sont considérés à partir d'une ligne orientée et d'une région comme la dimensionnalité, la cardinalité, la séquence de dimensions et les types *d'intersection* (Chapitre II.2).

2.2 Patrons de Mouvements Orientés Frontière entre une Ligne Orientée et une Région

Le mouvement d'une entité observée par rapport à une région d'intérêt peut être modélisé à partir de la caractérisation de la relation spatiale entre une ligne orientée et une région. Les relations topologiques peuvent préciser comment une entité en mouvement par exemple croise la frontière ou entre à l'intérieur d'une région de référence. Ces cas illustrent dans une certaine mesure comment les humains conceptualisent des mouvements élémentaires à partir d'abstractions liées à la localisation relative de ces entités dans l'espace. Les configurations identifiables entre une ligne orientée et une région permettent de caractériser des mouvements élémentaires. Les 20 Ligne Orientée - Région "Directed Line Region" (DL-RE) relations topologiques identifiées par notre approche sont dérivées à partir d'intersection à 0-dimension ou 1-dimension. Chaque relation topologique DL-RE est associée à une primitive de mouvement (Figure A.1), et représente un mouvement particulier matérialisé par une relation topologique entre cette ligne orientée et une région de référence. Notre approche caractérise ces mouvements élémentaires et développe des mécanismes de composition de ces relations et donc de ces mouvements.

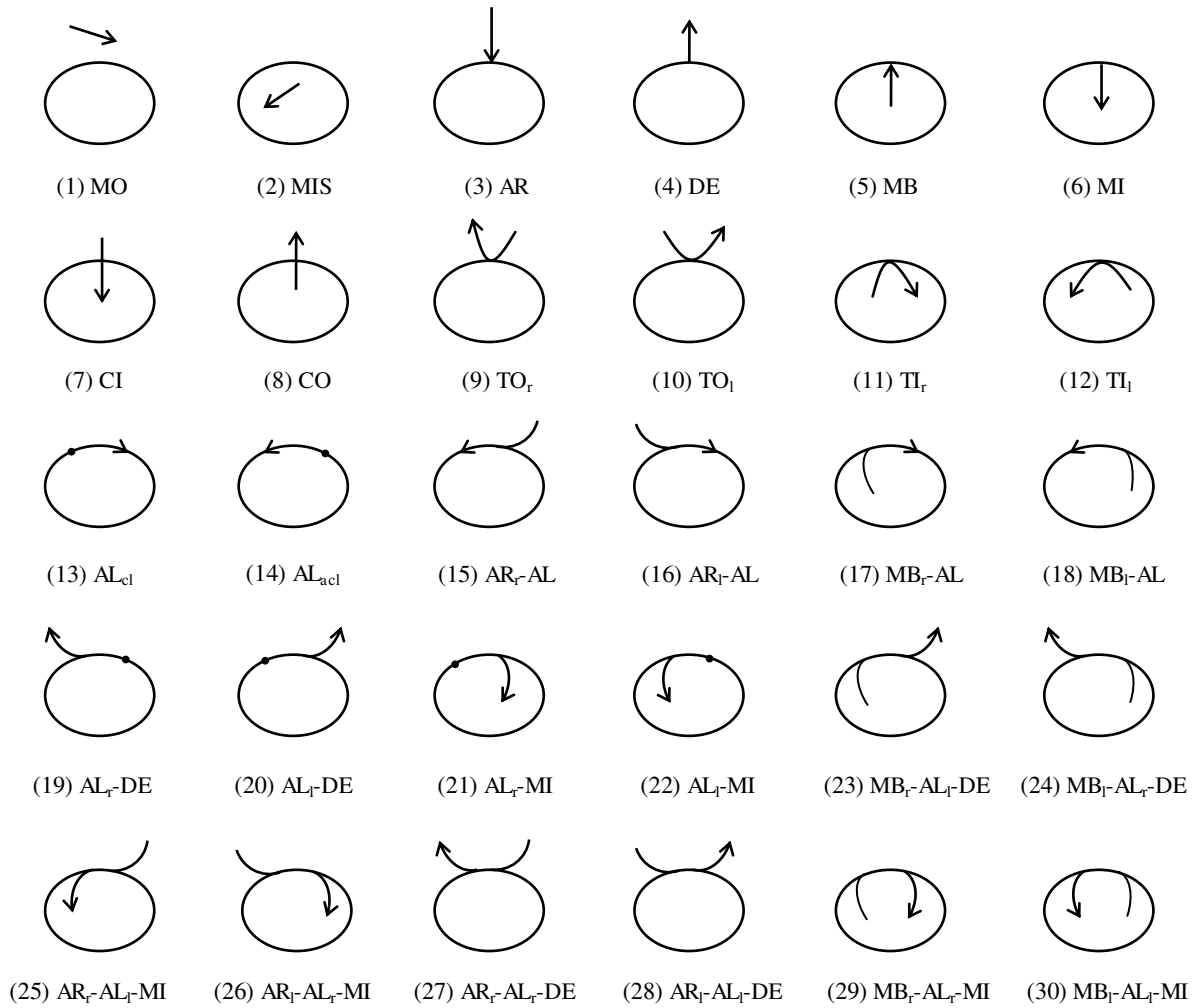

Figure A.1. Mouvements élémentaires entre une ligne orientée et une région

2.3 Patrons de Mouvements Basés sur des Relations d’Orientations entre deux Lignes Orientées

Les relations topologiques entre deux lignes orientées peuvent donc modéliser la dynamique de deux entités en mouvement relatif. En considérant le point de départ et d’arrivée d’une ligne orientée comme les frontières de cette ligne, et les intersections possibles de deux lignes orientées considérées, un modèle de classification identifiant 10 relations topologiques élémentaires est identifié (Figure A.2). Une composition de ces relations topologiques primitives est modélisable à partir des types d’intersections de ces lignes orientées.

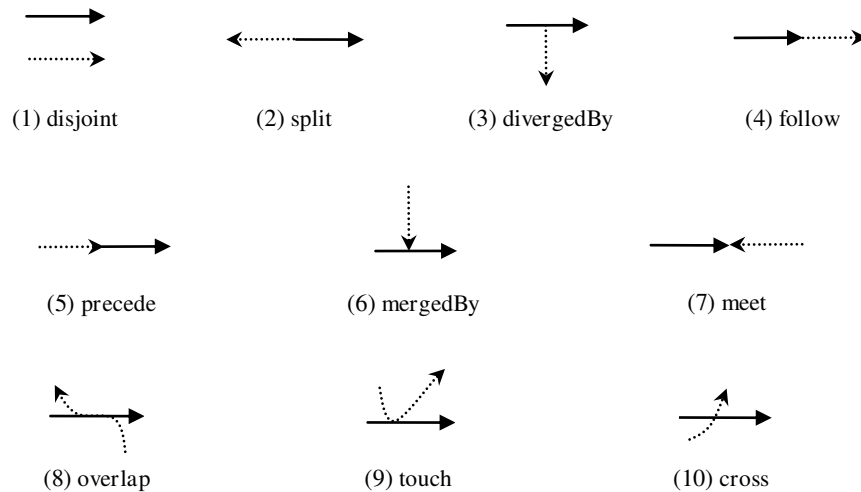

Figure A.2. Mouvements élémentaires entre deux lignes orientées

A.3 Représentation Qualitative de Mouvement d'Entités

Les entités mobiles dans un espace géographique à deux dimensions peuvent être classifiées en deux catégories : (1) entités modélisées comme ponctuelles et (2) entités matérialisant des régions mobiles. Nous proposons une approche de modélisation qualitative et formelle de caractérisation des mouvements de deux entités dans l'espace et dans le temps, les prédicats identifiés sont exprimés en langage naturel afin de se rapprocher d'une conceptualisation relativement intuitive. Les mouvements plus complexes seront identifiés à partir de mécanismes de composition.

3.1 Primitives Spatio-temporelles

Afin de construire un formalisme de représentation et de raisonnement pour deux entités mobiles dans un intervalle de temps, nous utilisons les primitives spatio-temporelles suivantes (Chapitre III.2):

- Primitives temporelles : intervalles temporels convexes;
- Primitives topologiques : RCC8 pour modéliser des relations région-région et DL-RE pour des relations ligne-région;
- Primitives de distance : une représentation qualitative de ces distances est modélisée.

3.2 Vers une Représentation de Mouvements Région-Région

A partir de primitives topologiques région-région (TOP_{RCC}), de primitives de distance (d), et d'un ensemble de primitives de régions mobiles ($PriMv_r$), nous développons une approche qualitative de représentation des mouvements d'une entité observée A et d'une région de référence B sur un intervalle de temps T , plus formellement définie comme :

$$PriMv_r(A, B) \equiv Holds(TOP_{RCC}, d, T) \quad (A.1)$$

où $TOP_{RCC} \in \{DC, EC, PO, EQ, TPP, TPPI, NTPP, NTPPI\}$, $d \in \{d_{ext+}, d_{ext-}, d_{ext=}, d_0, d_{int+}, d_{int-}, d_{int=}\}$.

Ces primitives de mouvement sont classifiées en trois catégories qui distinguent la localisation de l'entité mobile observée par rapport à l'entité de référence sur un intervalle de temps T :

- Mouvement à l'extérieur d'une entité de référence : Approach (AP), Leave (LV) et AroundOutside (AO), comme illustré dans la Figure A.3(a);
- Mouvement sur la frontière d'une entité de référence : Touching (TI), Overlapping (OI), CoveringBy (CB), Covering (CI) and Equaling (EI), comme illustré dans la Figure A.3(b);
- Mouvement à l'intérieur d'une entité de référence : MovetoInterior (MI), MovetoBoundary (MB), AroundInside (AI), EmbracingMoveOutside (EMO), EmbracingMovetoBoundary (EMB), and EmbracingAroundOutside (EAO), comme illustré dans la Figure A.3(c).

3.3 Vers une Représentation d'une Trajectoire-Région

Afin d'analyser le cas du mouvement d'une entité mobile conceptualisée comme une trajectoire par rapport à une entité de référence région, nous identifions un ensemble de mouvements élémentaires ($PriMv_t$) formellement définis à partir de relations topologiques DL-RE (TOP_{DL-RE}) et de distances qualitatives d sur un intervalle de temps T .

$$PriMv_t(A, B) \equiv Holds(TOP_{DL-RE}, d, T) \quad (A.2)$$

où $TOP_{DL-RE} \in \{S_1, \dots, S_{30}\}$, $d \in \{d_{ext+}, d_{ext-}, d_{ext=}, d_0, d_{int+}, d_{int-}, d_{int=}\}$.

Ces primitives de mouvements élémentaires sont classifiées en trois catégories selon les types d'intersection entre les disques de proximité des points de terminaison ou d'intersection avec une trajectoire.

- Intersection nulle : Approach, Leave, AroundOutside, MovetoInterior, MovetoBoundary, AroundInside;
- Une intersection ponctuelle de 0-dimension : Arrive, Depart, Exit, Enter, CrossIn, CrossOut, TouchOutside, and TouchInside;
- Une intersection linéaire de 1-dimension : Along, Arrive-Along, Exit-Along, Along-Depart, Along-Enter, Exit-Along-Depart, Arrive-Along-Enter, Arrive-Along-Depart, and Exit-Along-Enter.

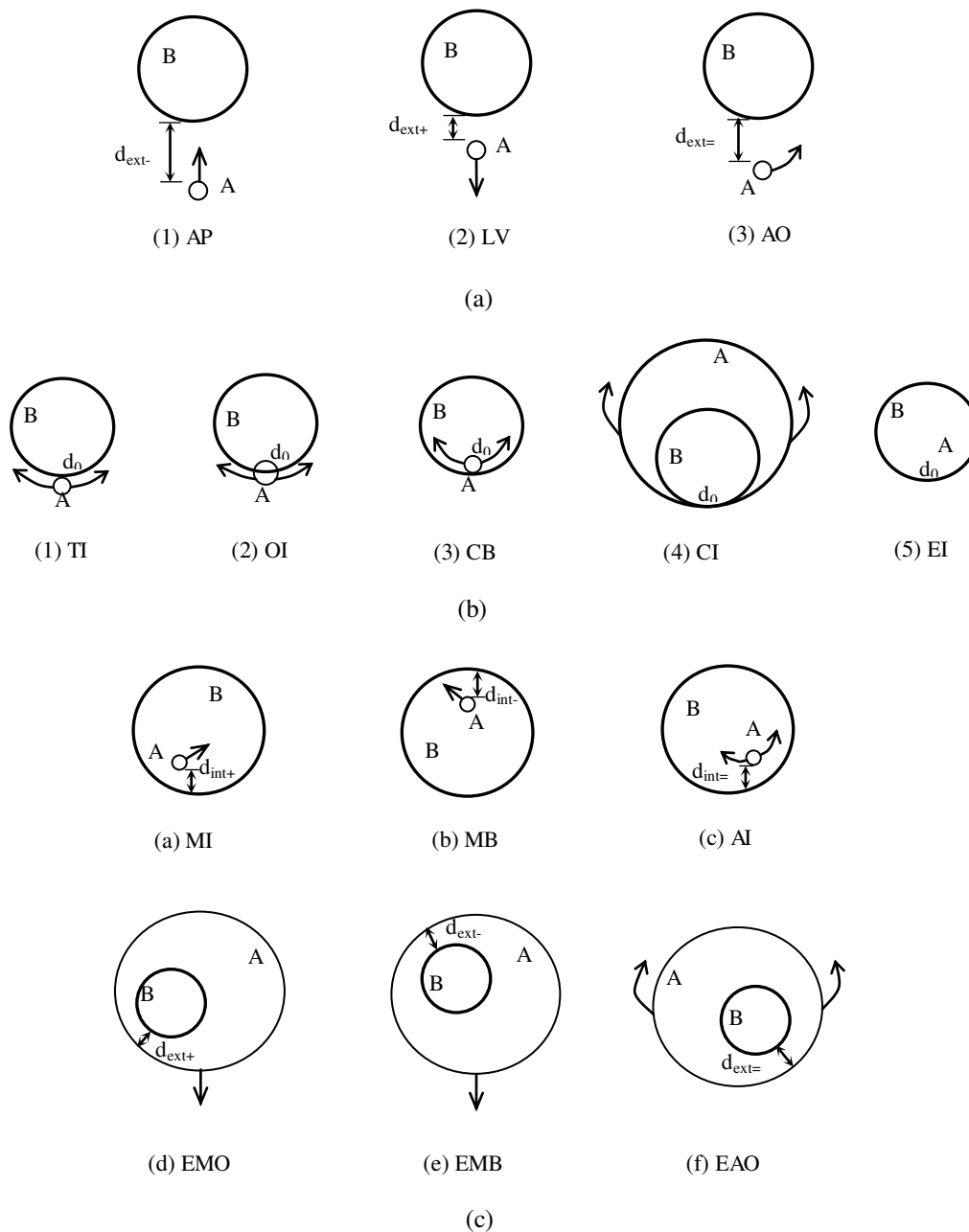

Figure A.3. Configurations de mouvement Région-Région: (a) extérieur d'une entité de référence; (b) frontière d'une entité de référence; (c) intérieur d'une entité de référence.

A.4 Raisonnement Qualitatif sur des Entités Mobiles

A partir des modèles de représentation développés nous proposons l'application de techniques usuellement appliquées pour la mise en œuvre de mécanismes de raisonnement qualitatif: (1) conceptual neighbors qui qualifient des changements graduels et continus, and (2) composition de relations qui permettent d'inférer une relation dérivée à partir de deux relations spatiales qui partagent une même entité spatiale.

4.1 Transitions Continues de Mouvements

Le mouvement d'une entité spatiale peut être qualitativement modélisé comme une séquence de configurations valides pour des intervalles temporels. La notion de Conceptual neighborhood diagram (CND) propose un concept de diagramme dont les relations identifiées sont connectées à partir d'une relation de proximité conceptuelle. Des diagrammes conceptuels (CND) pour des mouvements région-région et de trajectoire-région sont introduits et permettent en particulier de raisonner à partir de contextes d'informations incomplètes (Chapitre IV.2):

- **CND pour des mouvements de région-région:** deux mouvements de régions sont considérés comme conceptual neighbors s'ils sont chemin connectés dans le diagramme CND des mouvements possibles de région-région. Des déclinaisons de ce diagramme sont possible en prenant en compte différentes configurations de deux entités mobiles A and B, lorsque : (1) A est plus petit que B, (2) A est plus grand que B, and (3) A est égal à B. Une telle approche permet également de modéliser des similarités de mouvements de région-région à partir de distances de configuration de mouvement dans le diagramme CND. Ces notions de similarités permettent de développer des techniques de raisonnement à partir de la prise en compte de degrés de proximités dans le diagramme CND.
- **CND pour des mouvements de trajectoire-région:** nous introduisons un concept de conceptual transition qui permet de modéliser des mouvements possibles à partir de configurations de trajectoire incomplètes. C'est le cas d'une trajectoire dont le point de départ est connu mais pas le point d'arrivée et inversement. Une telle approche permet de dériver des trajectoires possibles en cas de connaissances incomplètes.

4.2 Tables de Composition

La composition de relations binaires est l'une des opérations les plus couramment utilisées en raisonnement qualitatif. La composition permet de générer de nouvelles relations quand deux relations partagent une même entité. Par la construction d'une table de composition $n \times n$, où les relations dérivées possibles sont représentées, des mécanismes d'inférence peuvent être calculés et permettre de raisonner sur des possibles mouvements spatio-temporels.

Afin de produire de nouvelles possibilités de raisonnement, nous identifions la table de composition des mouvements de région-région. Une telle table permet également de donner un support pratique à toute démarche d'implémentation. Les 14 mouvements de région-région identifiés génèrent une matrice de 196 entrées dans une table de composition. Pratiquement, cette table de composition identifie les possibles mouvements entre une entité spatiale A et une entité spatiale C, considérant les mouvements identifiés entre une entité spatiale A et une entité spatiale B, et une entité spatiale B et une entité spatiale C sur un intervalle de temps T.

Les applications potentielles de cette approche sont discutées (Chapitre IV.3). Les illustrations développées montrent les différentes possibilités d'inférences selon les domaines spatiaux des entités de référence considérées. La combinaison de ces tables avec d'autres catégories de relations spatiales comme les relations d'orientation permettent de contraindre les relations dérivées possibles.

A.5 Applications Expérimentales

Cette section résume les apports du chapitre présentant les applications expérimentales développées par notre recherche. Ces cas d'étude exploratoires illustrent et mettent en contexte le potentiel de représentation et de raisonnement de notre modèle.

5.1 Application au Transport Aérien

Considérons par exemple le contexte de trajectoires aériennes, un exemple représentatif du domaine du transport aérien, et où des milliers de trajectoires sont réalisées quotidiennement. Notre approche de modélisation est appliquée à l'analyse d'une série de trajectoires aériennes afin de dériver des patrons significatifs dans l'espace et dans le temps. Nous avons retenu l'exemple de l'analyse de patrons de trajectoires aériennes au niveau régional en considérant des pays de référence (Chapitre V.2). L'objectif consiste à

dériver les patrons de trajectoires dans le temps et dans l'espace pour un pays de référence considéré (Irlande et Islande dans notre cas d'étude). Ces trajectoires aériennes sont dérivées à partir du système de suivi de trajectoires Flightradar24.

Nous dérivons une série de mouvements élémentaires pour illustrer des patrons de trajectoires en Irlande, en qualifiant temporellement ces patrons (par intervalles temporels d'une ½ heure sur des journées de référence en semaine ou le week-end). Ces patrons sont ensuite analysés dans le cas de l'Irlande et comparés avec un autre pays de référence : l'Islande. L'approche montre que des patrons significatifs peuvent être dérivés (ex : trajectoires passant par l'Irlande, s'arrêtant ou quittant l'Irlande etc.), et également permettre de dériver des trajectoires aériennes possibles à partir du diagramme de conceptual neighbourhood dans des situations de données incomplètes et manquantes (ex : perte de signal).

5.2 Application au Transport Maritime

Le domaine maritime donne un contexte favorable à la manipulation de trajectoires. Un déplacement de navire est un exemple typique de trajectoire maritime. Mise en situation, une trajectoire maritime peut donner plusieurs cas pertinents d'analyse spatiale à un niveau local. En particulier, une trajectoire maritime peut être mise en relation avec des zones d'intérêt maritime ou des aires protégées. Le cas d'étude développé dans la thèse a pour objectif d'illustrer le potentiel de notre approche de modélisation dans un contexte relativement crédible du point de vue des situations possibles. Plusieurs trajectoires maritimes sont analysées à un niveau local et modélisées à partir des mouvements élémentaires identifiés par notre modèle. Des trajectoires possibles sont également explorées dans des situations d'informations incomplètes (Chapitre V.3).

Les données recueillies proviennent d'une base de données de trajectoires maritimes du nord-ouest de la France. Ces données sont stockées dans une base de données PostGIS et manipulées à partir d'interrogations spatiales qui permettent de filtrer quelques trajectoires maritimes à la demande. Le cas d'étude permet de montrer quelques configurations types et l'application des possibilités de raisonnement du diagramme CND pour des mouvements de trajectoire-région.

A.6 Conclusion

La recherche présentée dans cette thèse apporte plusieurs contributions au domaine de modélisation et de raisonnement spatial qualitatif appliqué à la représentation de mouvements dans un espace à deux dimensions. Les principaux apports de notre recherche sont les suivants :

- Les **patrons de mouvements** sont formellement décrits et dérivés à partir d'une étude systématique des relations qualifiant les mouvements de deux entités spatiales. Nous distinguons une entité de référence qui peut être une région ou une ligne. En conséquence, nous introduisons deux modèles formels qui respectivement (1) dérivent les patrons de mouvement basés sur les relations spatiales entre une entité observée et une entité de référence, et (2) distinguent les relations d'orientation entre la trajectoire d'une entité mobile et une entité de référence. Ces modèles formels sont dérivés à partir de relations topologiques et de distances qualitatives. Les mouvements élémentaires identifiés sont qualifiés par des expressions du langage naturel.
- L'approche de modélisation apporte plusieurs possibilités de **raisonnement et de manipulation** de patrons de mouvements. Les notions de diagramme de conceptual neighbourhood, conceptual transitions et de tables de composition sont introduits et permettent la dérivation des mouvements possibles dans des cas d'informations incomplètes.

La recherche développée est encore extensible dans plusieurs directions:

- **Extension du modèle** : Le modèle développé peut être enrichi par l'intégration de propriétés additionnelles comme les orientations relatives, vitesses et accélérations relatives, et ce, afin d'enrichir les sémantiques spatiales et temporelles associées aux mouvements élémentaires identifiés.
- **Intégration de la 3^{ème} dimension spatiale** : Par une extension des primitives identifiés par le modèle à la 3^{ème} dimension spatiale, de plus larges possibilités d'application et d'identification de patrons de mouvements pourraient être étudiées. Une telle approche offrirait de nouvelles perspectives applicatives.
- **Intégration de la dimension floue** : Afin de prendre en compte les notions d'incertitudes dans la définition des frontières des entités spatiales identifiées, le modèle pourrait être étendu à ce type de configuration et ainsi élargir le panel de mouvements élémentaires identifiés.

- **Raisonnement:** Nous envisageons d'étudier des techniques d'analyse et d'évaluation de similarités pour des mouvements de trajectoire-région à partir des diagrammes CND et de séquences de mouvements. Il est également possible d'appliquer des techniques dites de constraint satisfaction problem (CSP) qui permettent de prendre en compte des contraintes additionnelles définies par la sémantique d'une application.
- **Modélisation conceptuelle :** Les mouvements élémentaires identifiés par notre modèle fournissent des prédicats en langage naturel qui peuvent être intégrés en amont dans des démarches de conceptualisation et de représentation de la sémantique d'une application spatio-temporelle. Typiquement l'intégration de ces prédicats dans des outils de modélisation comme des outils CASE est une perspective offerte par notre modèle.
- **Evaluation cognitive des configurations de mouvement :** nous envisageons d'évaluer la valeur cognitive des différentes configurations des mouvements identifiés et qualifiés par des expressions du langage naturel à partir d'un panel d'utilisateurs.
- **Perspective d'implémentation:** les prédicats de mouvements identifiés peuvent être encapsulés au sein d'un langage d'interrogation de données spatio-temporelles, ou intégrés comme des algorithmes dédiés au sein d'un logiciel de SIG. Le développement d'interfaces spécialisées, orientées application ou génériques, sont d'autres voies à explorer pour la mise en œuvre de notre modèle au sein de prototypes applicatifs.
- **Validations applicatives :** Les cas d'étude présentés dans notre thèse et appliqués aux domaines maritimes et aériens étaient très exploratoires. Une telle démarche doit être poursuivie par des expérimentations à plus grande échelle voire étendue à d'autres domaines applicatifs comme par exemple celui de la biologie où de nombreuses applications manipulent et étudient des trajectoires d'animaux terrestres ou marins.

Le chemin est encore long pour aller vers un modèle opérationnel à court terme, mais une telle approche devrait, nous l'espérons, contribuer au développement d'approches formelles et intuitives qui permettent de progresser dans la manipulation de données spatio-temporelles.



List of Publications

Parts of this work presented in this thesis are based on papers published or accepted for publication in:

- [1] **Wu, J.**, Claramunt, C., Belouaer, L., and Deng, M. 2015. A Qualitative Modelling Approach for the Representation of Trajectories: Application to the Analysis of Flight Patterns. *Annals of GIS*, to be published.

CHAPTER III: SECTION 2, SECTION 3

CHAPTER IV: SECTION 2.1

CHAPTER V: SECTION 2

- [2] **Wu, J.**, Claramunt, C., and Deng, M. 2015. An Integrated Qualitative and Boundary-based Formal Model for a Semantic Representation of Trajectories. *The SIGSPATIAL Special*, 7(1): 35-42.

CHAPTER III: SECTION 4

- [3] **Wu, J.**, Claramunt, C., and Deng, M. 2014. Towards a Qualitative Representation of Movement. In: Indulska, M., Puro, S. (eds.) *Advances in Conceptual Modeling. Lecture Notes in Computer Science 8823*, 191-200. Springer-Verlag, Switzerland.

CHAPTER III: SECTION 2.2 , SECTION 3

CHAPTER IV: SECTION 2.1

- [4] **Wu, J.**, Claramunt, C. and Deng, M. 2014. Modelling Movement Patterns using Topological Relations between a Directed Line and a Region. In: Zhang, S., Basalamah, A. and Hendawi, A. (eds.), *Proceedings of the 5th ACM SIGSPATIAL International Workshop on GeoStreaming*, 43-52. Dallas, USA.

CHAPTER II: SECTION 2, SECTION 3

CHAPTER IV: SECTION 2.2

CHAPTER V: SECTION 3

- [5] **Wu, J.**, Deng, M., Liu, H. 2013. An Integrated Model to Represent Topological Relation and Directional Relation between Directed Line Objects. *Geomatics and Information Science of Wuhan University*, 38(11): 1358-1363. (In Chinese)

CHAPTER II: SECTION 4



Short Curriculum Vitae

Name: Jing WU

Place and Date of Birth: Fuzhou (China), 10/11/1982

Education:

- 1999-2003: **East China Institute of Technology, China**
B.S in Geographic Information System
- 2003-2006: **East China Institute of Technology, China**
M.S. in Cartography and Geographic Information Engineering
- 2011-2013: **Central South University, China**
Ph.D candidate in Geographic Information Science
- 2013-2015: **Naval Academy Research Institute, France**
Ph.D candidate in Geomatics

Appointments:

- 2006-2008: Teaching Assistant, **Shandong Jiaotong University, China**
- 2008- : Lecturer, **Shandong Jiaotong University, China**

Publications:

- Deng, M., Liu, Q., and **Wu, J.** 2015. Spatial Analysis. Surveying and Mapping Press, Beijing. (In Chinese)
- Deng, M., Li, Z., and **Wu, J.** 2013. Theories and Methods of Spatial Relations. Science Press, Beijing. (In Chinese)
- **Wu, J.**, He, B., and Li, H. 2011. ArcGIS 9 Desktop Geographic Information System Application Guide. Tsinghua University Press, Beijing. (In Chinese)
- **Wu, J.**, Claramunt, C., Belouaer, L., and Deng, M. 2015. A Qualitative Modelling Approach for the Representation of Trajectories: Application to the Analysis of Flight Patterns. *Annals of GIS*, to be published.
- **Wu, J.**, Claramunt, C., and Deng, M. 2015. An Integrated Qualitative and Boundary-based Formal Model for a Semantic Representation of Trajectories. *The SIGSPATIAL Special*, 7(1): 35-42.
- Ma, L., Deng, M., **Wu, J.**, and Liu Q. 2015. Modeling Spatio-Temporal Topological Relationships between Moving Object Trajectories along Road Networks based on Region Connection Calculus. *Cartography and Geographic Information Sciences*, to be published.
- **Wu, J.**, Claramunt, C., and Deng, M. 2014. Towards a Qualitative Representation of Movement. In: Indulska, M., Purao, S. (eds.) *Advances in Conceptual Modeling. Lecture Notes in Computer Science 8823*, 191-200. Springer-Verlag, Switzerland.
- **Wu, J.**, Claramunt, C. and Deng, M. 2014. Modelling Movement Patterns using Topological Relations between a Directed Line and a Region. In: Zhang, S., Basalamah, A. and Hendawi, A. (eds.), *Proceedings of the 5th ACM SIGSPATIAL International Workshop on GeoStreaming*, 43-52. Dallas, USA.
- **Wu, J.**, Deng, M., and Liu, H. 2013. An Integrated Model to Represent Topological Relation and Directional Relation between Directed Line Objects. *Geomatics and Information Science of Wuhan University*, 38(11): 1358-1363. (In Chinese)
- Huang, X., Deng, M., **Wu, J.**, and Ma, H. 2013. The Integrated Representation and Description of Natural-language Spatial Relations between a Line and an Area.

Geomatics and Information Science of Wuhan University, 38(2): 230-234. (In Chinese)

- **Wu, J.** and Yin, T. 2011. Research on Spatial Relation Similarity in Multi-Scale Maps. *Science of Surveying and Mapping*, 36(4): 69-71. (In Chinese)
- **Wu, J.**, Cheng, P., Chen, F., and Mao, J. 2006. Qualitative Reasoning for Direction Relation of Spatial Objects. *Acta Geodaetica et Cartographica Sinica*, 35(2): 160-165. (In Chinese)
- **Wu, J.**, Cheng, P., Mao, J., and Chen, F. 2006. The Maintenance of Spatial Relations in Map Generalization. *Science of Surveying and Mapping*, 31(1): 106-108. (In Chinese)
- **Wu, J.**, Cheng, P., and Mao, J. 2005. Description and Integrating Reasoning of Geographic Spatial Relations. *Geography and Geo-Information Science*, 21(5): 24-27. (In Chinese)

Research Grants:

- 2013: State Scholarship Fund (No. 201306370085), **China Scholarship Council**.
- 2012: Open Research Fund Program of Key Laboratory of Digital Mapping and Land Information Application Engineering (No. GCWD201206), **State Bureau of Surveying and Mapping**.
- 2012: Graduate Innovation and Creativity Funds (No. 2012zzts008), **Ministry of Education of the People's Republic of China**.

REFERENCES

- Allen, J. 1983. Maintaining knowledge about temporal intervals. *Communications of the ACM*, 26(11): 832-834.
- Allen, J. and Hayes, P. 1989. Moments and points in an interval-based temporal logic. *Computational Intelligence*, 5(3): 225-238.
- Alexandroff, P. 1961. *Elementary concepts of topology*. Dover, Mineola, NY.
- Álvarez-Bravo, J.V., Peris-Broch, J.C., Álvarez-Sánchez, J.J., and Escrig-Monferrer, M.T. 2006. A guide for blind people using a quantitative + qualitative spatial representation. In: *Proceedings of the first International Congress on Domotics, Robotics and Remote-Sistance for All*, 495-505. Madrid, Spain.
- Andrienko, N. and Andrienko, G. 2007. Designing visual analytics methods for massive collection of movement data. *Cartographica*, 42(2): 117-138.
- Asher, N. and Sablayrolles, P. 1995. A typology and discourse for motion verbs and spatial pps in French. *Journal of Semantics*, 12, 163-209.
- Balbiani, P., Condotta, J.F., and del Cerro, L.F. 1999. A new tractable subclass of the rectangle algebra. In: Dean, T. (ed.), *Proceedings of the 16th International Joint Conference on Artificial Intelligence*, 442-447.
- Bandini, S., Gorrini, A., and Vizzari, G. 2014. Towards an integrated approach to crowd analysis and crowd synthesis: A case study and first results. *Pattern Recognition Letters*, 44, 16-29.
- Beard, K., Deese, H., and Pettigrew, N.R. 2007. A framework for visualization and exploration of events. *Information Visualization*, 7, 133-151.
- Bedkowski, J. 2013. *Cognitive Supervision and Control of Robotic Inspection-Intervention System Using Qualitative Spatio-Temporal Representation and Reasoning*. In: Nguyen, N.T. (ed.), *Transactions on Computational Collective Intelligence IX*, LNCS 7770, 173-191. Springer-Verlag, Berlin.
- Benhamou, S. 2004. How to reliably estimate the tortuosity of an animal's path: straightness, sinuosity, or fractal dimension? *Journal of Theoretical Biology*, 229, 209-220.

- Bennett, B. 1994. Some observations and puzzles about composing spatial and temporal relations. In: Rodriguez, R. (ed.), Proceedings of the Eleventh European Conference on Artificial Intelligence, 65-72. Amsterdam, Netherlands.
- Bennett, B., Cohn, A.G., Torrini, P., and Hazarika, S.M. 2000. Describing rigid body motions in a qualitative theory of spatial region. In: Proceedings of the 17th National Conference on Artificial Intelligence, 503-509. AAAI Press.
- Bhatt, M. 2010. Reasoning about space, actions and change: A paradigm for applications of spatial reasoning. In: Qualitative Spatial Representation and Reasoning: Trends and Future Directions. IGI Global, USA.
- Bhatt, M. and Dylla, F. 2009. A qualitative model of dynamic scene analysis and interpretation in ambient intelligence systems. *International Journal of Robotics and Automation*, 24(3): 1-18.
- Bhatt, M., Guesgen, H., Woelfl, S., and Hazarika, S. 2011. Qualitative spatial and temporal reasoning: Emerging applications, trends and future directions. *Spatial Cognition and Computation*, 11(1): 1-14.
- Bhatt, M. and Wallgrün, J.O. 2014. Geospatial narratives and their spatio-temporal dynamics: Commonsense reasoning for high-level analyses in geographic information systems. *ISPRS International Journal of Geo-Information*, 3(1): 166-205.
- Bian, L. 2013. Spatial approaches to modeling dispersion of communicable diseases: A review. *Transactions in GIS*, 17, 1-17.
- Bogorny, V., Renso, C., de Aquino, A.R., de Lucca Siqueira, F., and Alvares, L.O. 2014. Constant: A conceptual data model for semantic trajectories of moving objects. *Transactions in GIS*, 18(1): 66-88.
- Carnap, R. 1958. Introduction to symbolic logic and its applications. New York: Dover Publications.
- Carnap, R. 1969. The logical structure of the world. Berkeley: University of California Press.
- Chen, J., Cohn, A.G., Liu, D., Wang, S., Ouyang, J., and Yu, Q. 2013. A survey of qualitative spatial representations. *The Knowledge Engineering Review*, 30, 106-136.
- Claramunt, C., Thériault, M. and Parent, C., 1997a. A qualitative representation of evolving spatial entities in two-dimensional spaces, In: Carver, S. (ed.), *Innovations in GIS V*, 119-129. Taylor & Francis.

-
- Claramunt, C., Parent, C. and Thériault, M., 1997b. Design patterns for spatio-temporal processes, In: Spaccapietra, S. and Maryanski, F. (eds.), *Searching for Semantics: Data Mining, Reverse Engineering*, 415-428. Chapman & Hall.
- Claramunt, C. and Jiang, B. 2001. An integrated representation of spatial and temporal relationships between evolving regions. *Geographical Systems*, 3(4): 411-428.
- Claramunt, C. and Stewart, K. 2015. Special Issue on spatio-temporal theories and models for environmental, urban and social sciences: where do we stand? *Spatial Computation and Cognition*, 15(2): 61-67.
- Clarke, B.L. 1981. A Calculus of Individuals Based of "Connection", *Notre Dame Journal of Formal Logic*, 22 (3): 204-218.
- Clarke, B.L., 1985. Individuals and points, *Notre Dame Journal of Formal Logic*, 236 (1): 61-75.
- Clementini, E., Di Felice, P., and Oosterom, Peter van, 1993. A Small Set for Formal Topological Relationships Suitable for End-user Interaction. In: David Abel, Beng Chin Ooi (eds.), *Advances in Spatial Databases*, 277-295. Springer-Verlag, New York.
- Clementini, E. and Di Felice, P. 1994. A comparison of methods for representing topological relationships. *Information Sciences*. 80, 1-34.
- Clementini, E., Di Felice, P., and Hernandez, D. 1997. Qualitative representation of positional information, *Artificial Intelligence*, 95 (2): 317-356.
- Clementini, E. and Di Felice, P. 1998. Topological invariants for lines. *IEEE Transactions on Knowledge and Data Engineering*, 10(1): 38-54.
- Cohn, A.G. 1996. Calculi for qualitative spatial reasoning, In: Calmet, J., Campbell, J.A. and Pfalzgraf, J. (eds.), *Proceedings of the 3rd International Conference on Artificial Intelligence and Symbolic Computation*, LNCS 1138, 124-143. Springer-Verlag.
- Cohn, A.G., Bennett, B., Gooday, J., and Gotts, N.M. 1997. Qualitative spatial representation and reasoning with the region connection calculus. *Geoinformatica*, 1, 275-316.
- Cohn, A.G. and Hazarika S.M. 2001. Qualitative spatial representation and reasoning: an overview. *Fundamenta Informaticae*, 43(1-2): 2-32.
- Cohn, A.G. and Renz, J. 2008. Qualitative Spatial Representation and Reasoning. In: Van Hermelen, F., Lifschitz, V., and Porter, B. (eds.), *Handbook of Knowledge Representation*, 551-596. Elsevier.

- Condotta, J.F., Ligozat, G., and Saade, M. 2006. A generic toolkit for n-ary qualitative temporal and spatial calculi. In: Proceedings of the 13th International Symposium on Temporal Representation and Reasoning, 78-86. Budapest, Hungary.
- Cui, Z., Cohn, A.G., and Randell, D.A. 1992. Qualitative simulation based on a logical formalism of space and time. In: Proceedings of the Tenth National Conference on Artificial Intelligence, 679-684. Menlo Park, California.
- Cui, Z., Cohn, A.G., and Randell, D.A. 1993. Qualitative and topological relationships in spatial databases, In: Abel, D. and Ooi, B.C. (eds.), *Advances in Spatial Databases*, LNCS 692, 293-315. Springer, Berlin.
- Davis, 1989. Order of magnitude reasoning in qualitative differential equations. In: de Kleer, J., and Weld, D. (eds.), *Readings in Qualitative Physical Reasoning*, 424-434. Morgan Kaufmann.
- Dee H.M. and Hogg D.C., Cohn A.G. 2009. Scene modeling and classification using learned spatial relations. In: Hornsby, K.S., Claramunt, C, Denis, M. and Ligozat, G. (eds.), *Proceedings of the 9th International Conference of Spatial Information Theory*, LNCS 5756, 295-311. Springer-Verlag, Berlin.
- Delafontaine, M., Bogaert, P., Cohn, A.G., Witlox, F., Maeyer, P.D., and Van de Weghe, N. 2011. Inferring additional knowledge from QTCN relations. *Information Sciences*, 181: 1573-1590.
- Delafontaine, M., Van de Weghe, N., Bogaert, P., and Maeyer, P.D. 2008. Qualitative relations between moving objects in a network changing its topological relations. *Information Sciences*, 178: 1997-2006.
- Del Mondo, G., Rodriguez, M.A., Claramunt, C., Bravo, L. and Thibaud, R. 2013. Modelling consistency of spatio-temporal Graphs, *Data and Knowledge Engineering*, 84(1): 59-80.
- Deng, M. 2008. A hierarchical representation of line-region topological relations. In: *Proceedings of the International Archives of the Photogrammetry, Remote Sensing and Spatial Information Sciences*, XXXVII, 25-30. Beijing, China.
- Deng, M., Cheng, T., Chen. X.Y. and Li, Z. L. 2007. Multi-level topological relations between spatial regions based upon topological invariants. *GeoInformatica*. 11, 239-267.
- Dodge, S., Laube, P., and Weibel, R. 2012. Movement similarity assessment using symbolic representation of trajectories. *International Journal of Geographical Information Science*, 26(9): 1563-1588.

- Dodge, S., Weibel, R., and Lautenschütz, A. 2008. Towards a taxonomy of movement patterns, *Information Visualization*, 7(3-4): 240-252.
- Düntsch, I., Wang, H, and McCloskey, S. 2001. A relation-algebraic approach to the region connection calculus. *Theoretical Computer Science*, 255(1-2): 63-83.
- Dylla, F. and Moratz, R. 2004. Empirical complexity issues of practical qualitative spatial reasoning about relative position. In: *Proceedings of Workshop on Spatial and Temporal Reasoning*, 1-10. Valencia, Spain.
- Dylla, F., Frommberger, L., Wallgrün, J.O., and Wolter, D. 2006. SparQ: A toolbox for qualitative spatial representation and reasoning. In: *Proceedings of the Workshop on Qualitative Constraint Calculi: Application and Integration*, 1-12. Bremen, Germany.
- Dylla, F., Frommberger, L., Wallgrün, J. O., Wolter, D., Nebel, B., & Wöfl, S. 2007. SailAway: Formalizing navigation rules. In: *Proceedings of the Artificial and Ambient Intelligence Symposium on Spatial Reasoning and Communication*, 470-474.
- Eddington, A. 1939. *The philosophy of physical science*. New York: University of Michigan Press.
- Eftimie, R., de Vries, G., Lewis, M.A. and Lutscher, F. 2007. Modeling group formation and activity patterns in self-organising collectives of individuals. *Bulletin of Mathematical Biology*, 69: 1537-1565.
- Egenhofer, M.J. 1994. Deriving the composition of binary topological relations. *Journal of Visual Languages and Computing*, 5(2): 133-149.
- Egenhofer, M. J. 1997. Query processing in spatial-query-by-sketch. *Journal of Visual Languages and Computing*, 8(4): 403-424.
- Egenhofer, M.J. 2010. The family of conceptual neighborhood graphs for region-region relations. In: Fabrikant, S.I., Reichenbacher, T., van Kreveld, M., and Schlieder, C. (eds.), *Proceedings of the 6th International Conference of Geographic Information Science*, LNCS 6292, 42-55. Springer-Verlag, Berlin.
- Egenhofer, M.J. and Al-Taha, K.K. 1992. Reasoning about gradual changes of topological relationships. In: Frank, A.U., Campari, I., and Formentini, U. (eds.), *Theories and Methods of Spatio-temporal Reasoning in Geographic Space*, LNCS 639, 196-219. Springer-Verlag, Berlin.
- Egenhofer, M.J. and Franzosa, R. 1991. Point-set topological spatial relationships. *International Journal of Geographical Information Systems*, 5(2): 161-174.
- Egenhofer, M.J. and Franzosa, R. 1995. On the equivalence of topological relations. *International Journal of Geographical Information Systems*, 9(2): 133-152.

- Egenhofer, M.J. and Herring, J. 1991. Categorizing binary topological relationships between regions, lines and points in geographic databases. Technical Report. National Center for Geographic Information and Analysis, Santa Barbara, CA, USA.
- Egenhofer, M.J. and Mark, D.M. 1995. Modelling conceptual neighbourhoods of topological line-region relations. *International Journal of Geographical Information Systems*, 9(5): 555-565.
- Egenhofer, M.J., Sharma, J., and Mark, D.M. 1993. A critical comparison of the 4-Intersection and the 9-Intersection models for spatial relations: Formal analysis, In: McMaster, R. and Armstrong, M. *Proceedings of Autocarta*, 1-11. Minneapolis, USA.
- Erwig, M. and Schneider, M. 2002. Spatio-temporal predicates. *IEEE Transactions on Knowledge and Data Engineering*, 14 (4): 881-901.
- Faltings, 1990. Qualitative kinematics in mechanisms. *Artificial Intelligence*, 44(1-2): 89-119.
- Forbus, K. 1982. Modelling motion with qualitative process theory. In: *Proceedings of the Second National Conference on Artificial Intelligence*, 205-208.
- Forbus, K. 1983. Qualitative reasoning about space and motion. In: Gentner, D. and Stevens, A. (eds.), *Mental Models*, 53-73. LEA Associates, New Jersey.
- Forbus, K., Nielsen, P., and Faltings, B. 1987. Qualitative kinematics: A framework. In: *Proceedings of International Joint Conference on Artificial Intelligence*, 430-435. Milan, Italy.
- Frank, A. 1991. Qualitative spatial reasoning with cardinal directions. In: Kaindl, H. (ed.), *Proceedings of 7th Österreichische Artificial Intelligence*, 162-178. Springer-Verlag.
- Frank, A.U. 1992. Qualitative spatial reasoning about distances and directions in geographic space, *Journal of Visual Languages and Computing*, 3, 343-371.
- Frank, A.U., 1996. Qualitative spatial reasoning: cardinal directions as an Example, *International Journal of Geographical Information Science*, 10 (3): 269-290.
- Freksa, C. 1991. Conceptual neighbourhood and its role in temporal and spatial reasoning. In : Singh, M. and Travé-Massuyès, L. (eds.), In: *Proceedings of the IMACS Workshop on Decision Support Systems and Qualitative Reasoning*, 181-187, North-Holland, Amsterdam.
- Freksa, C. 1992a. Temporal reasoning based on semi-intervals. *Artificial Intelligence*, 54, 199-227.

- Freksa, C. 1992b. Using orientation information for qualitative spatial reasoning. In: Frank, A.U., Campari, I., and Formentini, U. (eds.) *Theories and Methods of Spatio-Temporal Reasoning in Geographic Space*, LNCS, 639. Springer-Verlag, Berlin.
- Galton, A. 1995. Towards a qualitative theory of movement. In: Frank, A.U., Kuhn, W. (eds.) *Spatial Information Theory: A Theoretical Basis for GIS*. LNCS, 988, 377-396. Springer-Verlag, Berlin.
- Galton, A. 2000. *Qualitative spatial change*. Oxford University Press, Oxford.
- Galton, A. 2004. Fields and objects in space, time, and space-time. *Spatial Cognition and Computation*, 4(1): 39-68.
- Gantner, Z., Westphal, M., and Wöfl, S. 2008. GQR: A fast reasoner for binary qualitative constraint calculi. In: *Proceedings of the AAAI '08 Workshop on Spatial and Temporal Reasoning*, 24-29. Chicago, USA.
- Gao, S. 2015. Spatio-temporal analytics for exploring human mobility patterns and urban dynamics in the mobile age. *Spatial Computation and Cognition*, 15(2): 86-114.
- Getz, W.M. and Saltz, D. 2008. A framework for generating and analyzing movement paths on ecological landscapes. *Proceedings of the National Academy of Sciences of the United States of America*, 105 (49): 19066–19071.
- Glez-Cabrera, F.J., Álvarez-Bravo J.V., Díaz, F. 2013. QRPC: A new qualitative model for representing motion patterns. *Expert Systems with Applications*, 40(11): 4547-4561.
- González, M.C., Hidalgo, C.A., and Barabási, A. 2008. Understanding individual human mobility patterns. *Nature*, 453, 779-782.
- Goodchild, M.F. 2009. Geographic information systems and science: today and tomorrow. *Annals of GIS*, 15(1): 3-9.
- Goralwalla, I.A., Leontiev, Y., Ozsu, M.T., and Szafron, D. 1997. Modeling temporal primitives: Back to basics. In: *Proceedings of the Sixth International Conference on Information and Knowledge Management*, 24-31, Las Vegas, USA.
- Gottfried, B. 2004. Reasoning about intervals in two dimensions. In: *Proceedings of the IEEE International Conference on Systems, Man and Cybernetics*, 6, 5324-5332. The Hague, Netherlands.
- Gottfried, B. 2011. Interpreting motion events of pairs of moving objects. *GeoInformatica*, 15, 247-271.
- Gottfried, B. and Witte, J. 2007. Representing spatial activities by spatially contextualised motion patterns. In: Lakemeyer, G., Sklar, E., Sorrenti, D.G. and Takahashi, T. (eds.),

-
- RoboCup 2006: Robot soccer world cup X, LNCS 4434, 330-337. Springer-Verlag, Berlin.
- Gotts, N.M., Gooday, J., and Cohn, A.G. 1996. A connection based approach to common-sense topological description and reasoning, *The Monist*, 79 (1): 51-75.
- Goyal, R.K. 2000. Similarity assessment for cardinal directions between extended spatial objects. Ph.D. thesis, University of Maine, USA.
- Goyal, R.K. and Egenhofer, M.J. 2001. Similarity of cardinal directions. In: *Proceedings of the 7th International Symposium on Advances in Spatial and Temporal Databases*, 36-58, London, UK. Springer-Verlag.
- Grigni, M., Papadias, D., and Papadimitriou, C. 1995. Topological inference. In: *Proceedings of the 14th International Joint Conference on Artificial Intelligence*, 901-906, Montreal, Canada.
- Güting, R.F. and Schneider, M. 2005. *Moving Objects Databases*. Morgan Kaufmann, San Francisco.
- Hamblin, C.J. 1971. Instants and intervals, *Studium Generale*, 24, 127-134.
- Hanheide, M., Peters, A., and Bellotto, N. 2012. Analysis of human-robot spatial behaviour applying a qualitative trajectory calculus. In: *The 21st IEEE International Symposium on Robot and Human Interactive Communication*. 689-694. Paris, France.
- Harmelen, F., Lifschitz, V., and Porter, B. 2008. *Handbook of knowledge representation*. Elsevier, UK.
- Hawelka, B., Sitko, I., Beinat, E., Sobolevsky, S., Kazakopoulos, P., and Ratti, C. 2014. Geo-located twitter as proxy for global mobility patterns. *Cartography and Geographic Information Science*, 41(3): 260-271.
- Hayes, P.J. 1985. The second naive physics manifesto. In: Hubbs, J.R. and Moore, R.C. (eds.), *Formal Theories of the Commonsense World*, 71-89. Ablex Publishing Corporation, Norwood.
- Hazarika, S. *Qualitative Spatial Change: Space-time Histories and Continuity*. PhD thesis, The University of Leeds, 2005.
- Hernandez, D. 1994. *Qualitative Representation of Spatial Knowledge*. Lecture Notes in Artificial Intelligence, 804. Springer.
- Hernandez, D., Clementini, E., and Di Felice, P. 1995. Qualitative distances. *Lecture Notes in Computer Science*, 988: 45-58.
- Herskovits, A. 1986. *Language and spatial cognition : an interdisciplinary study of the prepositions in English*. Cambridge: New York.

- Hornsby K. 2001. Temporal zooming. *Transactions in GIS*, 5(3): 255-272.
- Hornsby, K. and Egenhofer, M.J. 1997. Qualitative representation of change. In: Frank, A.U. and Mark, D. (eds.), *Proceedings of the Conference on Spatial Information Theory*, LNCS 1329, 15-33. Springer-Verlag, Berlin.
- Hornsby, K. and Egenhofer, M.J. 2000. Identity-based change: a foundation for spatio-temporal knowledge representation. *International Journal of Geographical Information Science*, 14(3): 207-224.
- Hornsby, K. and Egenhofer, M.J. 2002. Modeling moving objects over multiple granularities. *Annals of Mathematics and Artificial Intelligence*, 36(1-2): 177-194.
- Hornsby, K., Egenhofer, M.J., and Hayes, P.J. 1999. Modeling cyclic change. In: Chen, P.P., Embley, D.W., Kouloumdjian, J., Liddle, S.W., and Roddick, J.F. (eds.), *Advances in Conceptual Modeling*, LNCS 1727, 98-109. Springer-Verlag, Berlin.
- Hornsby, K. and Li, N. 2009. Conceptual framework for modeling dynamic paths from natural language. *Transactions in GIS*, 13(s1): 27-45.
- Howarth, J.T. and Couclelis, H. 2005. A linguistics-based framework for modeling spatio-temporal occurrences and purposive change. In: Cohn, A.G. and Mark, D.M. (eds.), *Processings of the International Conference of Spatial Information Theory*, LNCS 3693, 316-329. Springer-Verlag, Berlin.
- Humberstone, I.L. 1979. Interval semantics for tense logic: some remarks. *Journal of Philosophical Logic*, 8, 171-196.
- Jeansoulin R. and Papini O. 2007. Under water archaeological knowledge analysis and representation in the VENUS project: a preliminary draft. In: Georgopoulos, A. (ed.), *Proceedings of the International Archives of Photogrammetry, Remote Sensing and Spatial Information Sciences*, XXXVI-5/C53, 394-399. Athens, Greece.
- Jensen, C.S. and Snodgrass, R.T. 2009. Time Instant. *Encyclopedia of Database Systems*, pp 3112. Springer, US.
- Kahn, K. M. and Gorry, A. G. 1977. Mechanizing temporal knowledge. *Artificial Intelligence*, 9(2): 87-108.
- Katsanevakis, S., Stelzenmüller V., South, A., Sørensen, T., et al. 2011. Ecosystem-based marine spatial management: Review of concepts, policies, tools, and critical issues. *Ocean and Coastal Management*, 54(11): 807-820.
- Klippel, A. 2011. Movement choremes: Bridging cognitive understanding and formal characterization of movement patterns. *Topics in Cognitive Science*. 3, 722-740.

- Kurata, Y. and Egenhofer, M. 2006. The head-body-tail intersection for spatial relation between directed line Segments. In: Raubal, M., Miller, H.J., Frank, A.U., and Goodchild, M.F. (eds.), Proceedings of the 4th International Conference of Geographic Information Science, LNCS, 4197, 269-286. Münster, Germany. Springer-Verlag, Berlin.
- Kurata, Y. and Egenhofer, M. 2007. The 9+-Intersection for topological relations between a directed line segment and a region. In: Gottfried, B. (ed.), 1st Workshop on Behavioral Monitoring and Interpretation, TZI-Bericht, 42, 62-76. Technologie-Zentrum Informatik, Universität Bremen, Germany.
- Lakoff, G. and Johnson, M. 1980. *Metaphors we live by*. Chicago: University of Chicago Press.
- Latecki, L.J. 1998. *Discrete representation of spatial objects in computer vision*. Kluwer Academic Publishers.
- Laube, P., Imfeld, S., and Weibel, R. 2005. Discovering relative motion patterns in groups of moving point objects. *International Journal of Geographical Information Science*, 19(6): 639-668.
- Laube, P., Dennis, T., Forer, P., and Walker, M. 2007. Movement beyond the snapshot: Dynamic analysis of geospatial lifelines. *Computers, Environment and Urban Systems*, 31(5): 481-501.
- Levinson, S.C. 1996. Frames of reference and Molyneux's question: Crosslinguistic evidence. In: Bloom, P., Peterson, M., Nadel, L., Garrett M. (eds.), *Language and Space*, 109–169. MIT Press.
- Li S. and Cohn A. G., 2012. Reasoning with topological and directional spatial information. *Computational Intelligence*, 28(4): 579-616.
- Li, S. and Ying, M. 2003. Region Connection Calculus: its models and composition table. *Artificial Intelligence*, 145(1-2): 121-146.
- Li, Z. and Deng, M. 2006. A hierarchical approach to the line-line topological relations. In: Riedl, A., Kainz, W., and Elmes, G. (eds.), *Progress in Spatial Data Handling*, 365-382. Springer-Verlag: Berlin.
- Ligozat, G. 1993. Qualitative triangulation for spatial reasoning. In: Frank, A.U. and Campari, I. (eds.): *Proceedings of International Conference on Spatial Information Theory*. LNCS, 716, 54-68. Springer-Verlag, Berlin.

- Ligozat, G. 2001. When tables tell it all: Qualitative spatial and temporal reasoning based on linear orderings. In: Montello, D.R. (ed.), *Spatial Information Theory: Foundations of Geographic Information Science*, LNCS 2205, 60-75.
- Ligozat, G. 2012. *Qualitative spatial and temporal reasoning*. ISTE Ltd, UK.
- Ligozat, G., Vetulani, Z., and Osiński, J. 2009. Spatio-temporal aspects of the monitoring of complex events. In: Guesgen, H.W., Bhatt, M. (eds.), *Proceedings of IJCAI-09 Workshop on Spatial and Temporal Reasoning*, 44-51, Pasadena, USA.
- Ligozat, G., Vetulani, Z., and Osiński, J. 2011. Spatiotemporal aspects of the monitoring of complex events for public security purposes. *Spatial Cognition and Computation: An Interdisciplinary Journal*, 11(1): 103-128.
- Liu, J. 1998. A method of spatial reasoning based on qualitative trigonometry. *Artificial Intelligence*, 98, 23-44.
- Liu, H. and Schneider, M. 2010. Detecting the topological development in a complex moving region. *Journal of Multimedia Processing and Technologies*, 1(3): 160-180.
- Lowe, J.C. and Moryadas, S. 1975. *The geography of movement*. Houghton Mifflin, Boston.
- Lücke, D., Mossakowski, T., and Moratz, R. 2011. Streets to the OPRA - finding your destination with imprecise knowledge. In: *Proceedings of the workshop on benchmarks and applications of spatial reasoning at IJCAI 2011*, 25-32.
- Mani, I. and Pustejovsky, J. 2012. *Interpreting motion: Grounded representations for spatial language*. Oxford University Press, Oxford.
- Mark, D.M. 1988. *Cognitive and linguistic aspects of geographic space: report of a workshop*. Santa Barbara, CA: National Center for Geographic Information and Analysis.
- Mark, D.M. and Frank, A.U. 1991. *Cognitive and linguistic aspects of geographic space*. Dordrecht: Boston.
- Mau, I., Hornsby K.S., and Bishop I.D. 2007. Modeling geospatial events and impacts through qualitative change. In: Barkowsky, T., Knauff, M., Ligozat, G., and Montello, D.R. (eds.), *Spatial Cognition V: Reasoning, Action, Interaction*, LNCS 4387, 156-174. Springer-Verlag, Berlin.
- McCarthy, J. and Hayes, P. 1969. Some philosophical problems from the standpoint of artificial intelligence. In: Meltzer, B., Michie, D. (eds.): *Machine Intelligence*, 4: 463-502. Edinburgh University Press, Edinburgh.

-
- Moratz, R., Renz, J., and Wolter, D. 2000. Qualitative spatial reasoning about line segments. In: Processings of ECAI 2000, 234-238.
- Moratz, R., Nebel, B. and Freksa, C. 2003. Qualitative spatial reasoning about relative position: The tradeoff between strong formal properties and successful reasoning about route graphs. In: Freksa, C., Brauer, W., Habel, C. and Wender, K.F. (eds.), *Spatial Cognition III*, 2685, 385-400. Springer.
- Moratz, R. 2006. Representing relative direction as a binary relation of oriented points. In: Brewka, G., Coradeschi, S., Perini, A., and Traverso, P. (eds.), *Proceedings of the European Conference on Artificial Intelligence*, 407-411. IOS Press.
- Moratz, R., Lücke, D., Mossakowski, T. 2011. A condensed semantics for qualitative spatial reasoning about oriented straight line segments. *Artificial Intelligence*, 175 (16-17): 2099-2127.
- Moratz, R. and Wallgrün, J.O. 2012. Spatial reasoning with augmented points: Extending cardinal directions with local distances. *Journal of Spatial Information Science*, 5, 1-30.
- Mortensen, M.E. 1997. *Geometric modeling*. John Wiley and Sons, New York, USA.
- Mountain, D. and Raper, J. 2001. Modelling human spatio-temporal behaviour: a challenge for location-based services. In: *Proceedings of the 6th International Conference on GeoComputation*, 24-26.
- Muller, P. 1998a. A qualitative theory of motion based on spatio-temporal primitives. In: Cohn, A.G., Schubert, L., Shapiro, S.C. (eds.): *Principles of Knowledge Representation and Reasoning*, 131-141. Morgan Kaufmann, San Francisco.
- Muller, P. 1998b. Space-time as a primitive for space and motion. In: Guarino, N. (ed.): *Formal ontology in Information Systems, Frontiers in Artificial Intelligence and Applications*, 46: 63-76. IOS Press.
- Muller, P. 2002. Topological spatio-temporal reasoning and representation. *Computational Intelligence*, 18(3): 420-450.
- Muñoz-Velasco, E., Burrieza, A., and Ojeda-Aciego, M. 2014. A logic framework for reasoning with movement based on fuzzy qualitative representation. *Fuzzy Sets and Systems*, 242(1): 114-131.
- Nathan, R., Getz, W.M., Revilla, E., Holyoak, M., Kadmon, R., Saltz, D., and Smouse, P.E. 2008. A movement ecology paradigm for unifying organismal movement research. *Proceedings of the National Academy of Sciences of the United States of America*, 105 (49): 19052-19059.

-
- Noyon, V., Claramunt, C., Devogele, D. 2007. A relative representation of trajectories in geographical spaces. *Geoinformatica*, 11, 479-496.
- Papadias, D. and Egenhofer, M.J. 1997. Algorithms for hierarchical spatial reasoning. *GeoInformatica*, 1(3): 251-273.
- Pacheco, J., Escrig, T., and Toledo, F. 2002. Qualitative spatial reasoning on three-dimensional orientation point objects. In: *Proceedings of the International Workshop on Qualitative Reasoning*, 1-12.
- Peuquet, D.J., 1994. It's about time: A conceptual framework for the representation of temporal dynamics in geographic information systems. *Annals of the Association of the American Geographers*, 84(3): 441-461.
- Peuquet, D.J. and Duan, N. 1995. An event-based spatio-temporal data model for Geographic Information Systems, *International Journal of Geographical Information Systems*, 9(1):7-24.
- Pindolia, D.K., Garcia, A.J., Huang, Z., Fik, T., Smith, D.L., and Tatem, A.J. 2014. Quantifying cross-border movements and migrations for guiding the strategic planning of malaria control and elimination. *Malaria Journal*, 13, 1-11.
- Praing, R. and Schneider, M. 2009. Topological feature vectors for exploring topological relationships. *International Journal of Geographical Information Science*, 23(3): 319-353.
- Pustejovsky, J. and Moszkowicz, J.L. 2011. The qualitative spatial dynamics of motion in language. *Spatial Cognition and Computation*, 11, 15-44.
- Quine, W.V.O. 1960. *Word and object*. MIT Press.
- Rajagopalan, R. 1994. A model for integrated qualitative spatial and dynamic reasoning about physical systems. In: *Proceedings of the 12th National Conference on Artificial Intelligence*, 1411-1417. Seattle, Washington.
- Randell, D. A., Cui, Z., Cohn, A. G. 1992. A spatial logic based on regions and connection. In: Nebel, B., Swartout, W., and Rich, C. (eds.), *Proceedings of the Third International Conference on Knowledge Representation and Reasoning*, 165-176. Morgan Kaufmann, San Mateo, USA.
- Ray, C., Grancher, A., Thibaud, R. and Etienne L. 2013. Spatio-Temporal rule-based analysis of maritime traffic. In: *Proceedings of the Conference on Ocean & Coastal Observation (OCOSS 2013)*, 171-178. Nice, France.

-
- Renz, J. 2001. A spatial odyssey of the interval algebra: 1. directed intervals. In: Nebel, B. (ed.), Proceedings of the 17th International Joint Conference on Artificial Intelligence, 51-56. Morgan Kaufmann.
- Renz, J. 2002. Qualitative spatial reasoning with topological information. Springer-Verlag, Berlin.
- Renz, J. and Ligozat, G. 2005. Weak composition for qualitative spatial and temporal reasoning. In: Proceedings of the Eleventh International Conference on Principles and Practice of Constraint Programming, 534-548. Sitges, Spain.
- Russell, B.A.W. 1914. Our knowledge of the external world. Routledge.
- Sablayrolles, P. 1995. The semantics of motion. In: Proceedings of the Seventh Conference of the European Chapter of the Association for Computational Linguistics, 281-283. Belfield, Ireland.
- Scivos, A. and Nebel, B. 2004. The finest of its class: The natural point-based ternary calculus for qualitative spatial reasoning. In: Freksa, C., Knauff, M., Krieg Brückner, B., Nebel, B. and Barkowski T. (eds.), Spatial Cognition, LNCS 3343, 283-303. Springer-Verlag, Berlin.
- Shi, H. and Kurata, Y. 2008. Modeling ontological concepts of motions with two projection-based spatial models. In: Processings of the second International Workshop on Behavioral Monitoring and Interpretation, 396, 42-56. Kaiserslautern, Germany.
- Schlieder, C. 1995. Reasoning about ordering. In: Frank, A. and Kuhn, W. (eds.), Spatial Information Theory: a theoretical basis for GIS, LNCS 988, 341-349. Springer-Verlag, Berlin.
- Schockaert, S., De Cock, M., Kerre, E.E. 2009. Spatial reasoning in a fuzzy region connection calculus. *Artificial Intelligence*, 173(2): 258-298.
- Schwartz, M.L. 2005. Encyclopedia of coastal science. Springer, Dordrecht, Netherlands.
- Schwering, A. 2007. Evaluation of a semantic similarity measure for natural language spatial relations. In: Winter, S., Duckham, M., Kulik, L., and Kuipers, B. (eds.), Proceedings of the Conference on Spatial Information Theory, LNCS 4736, 116-132. Springer-Verlag, Berlin.
- Song, C., Qu, Z., Blumm, N., and Barabasi, A.L. 2010. Limits of predictability in human mobility. *Science*, 327, 1018-1021.
- Song, Y. and Miller, H.J. 2014. Simulating visit probability distributions within planar space-time prisms. *International Journal of Geographical Information Science*, 28, 104-125.

-
- Stell, J.G., Del Mondo, G., Thibaud, R., and Claramunt, C. 2011. Spatio-temporal evolution as bigraph dynamics. In: Egenhofer, M.J., Giudice, N.A., Moratz, R., and Worboys, M.F. (eds.), Proceedings of 10th International Conference Conference on Spatial Information Theory, LNCS 6899, 148-167. Springer-Verlag: Berlin.
- Stewart Hornsby, K. and Li, N. 2009. Conceptual framework for modeling dynamic paths from natural language expressions. *Transactions in GIS*, 13(s1), 27-45.
- Talmy, L. 1983. How language structures space. In Pick, H., and Acredolo, L., eds., *Spatial Orientation: Theory, Research, and Application*. New York, NY: Plenum Press.
- Talmy, L. 1985. Lexicalization patterns: Semantic structure in lexical forms. In: Shopen, T. (ed.), *Language typology and semantic description volume 3: Grammatical categories and the lexicon*, 36-149. Cambridge: Cambridge University Press.
- Talmy, L. 2000. Force dynamics in language and cognition. *Toward a cognitive semantics. Volume I, Concept structuring systems*, 409-470. Cambridge, Mass: MIT Press.
- Tarski, A. 1941. On the calculus of relations. *The Journal of Symbolic Logic*, 6(3): 73-89.
- Tossebro, E. and Nygard, M. 2011. Representing topological relationships for spatio-temporal objects. *GeoInformatica*, 15(4): 633-661.
- Van de Weghe, N. 2004. Representing and reasoning about moving objects: A qualitative approach. Ph.D. thesis, Ghent University, Belgium.
- Van de Weghe, N., Cohn, A.G., Maeyer, P.D., and Witlox, F. 2005. Representing moving objects in computer-based expert systems: The overtake event example. *Expert Systems with Applications*, 29(4): 977-983.
- Van de Weghe, N., Cohn, A.G., De Tre, G., and Maeyer, P.D. 2006. A qualitative trajectory calculus as a basis for representing moving objects in geographical information systems. *Cybernetics and Control*, 35(1): 97-119.
- Vicsek, T. and Zafeiris, A. 2012. Collective motion. *Physics Reports*, 5(17): 71-140.
- Vieu, L. 1997. Spatial representation and reasoning in artificial intelligence. In: Stock, O. (ed.), *Spatial and Temporal Reasoning*, 5-41. Kluwer, Dordrecht, Netherlands.
- Vilain, M., Kautz, H., and van Beek, P. 1989. Constraint propagation algorithms for temporal reasoning: a revised report. In: Weld, D.S. and de Kleer J. (eds.), *Qualitative Reasoning about Physical Systems*, 373-381. Morgan Kaufmann, San Francisco.
- Wallgrün, J.O. 2010. Qualitative spatial reasoning for topological map learning. *Spatial Cognition and Computation*, 10(4): 207-246.

- Wang, X., Luo, Y. and Xu, Z. 2004. SOM: A novel model for defining topological line-region relations. In: Proceedings of the International Conference of Computational Science and Its Applications. LNCS 3045, 335-344. Assisi, Italy.
- Wittgenstein, L. 1953. Philosophical investigations. New York: Macmillan.
- Wood, Z. and Galton, A. 2008. Collectives and how they move: A tale of two classifications. In: Gottfried, B., Aghajan, H. (eds.), Proceedings of the 2nd workshop on behaviour monitoring and interpretation, 396, 57-71.
- Xu, J. 2007. Formalizing natural-language spatial relations between linear objects with topological and metric properties. International Journal of Geographical Information Science, 21(4): 377-395.
- Yuan, M. 2001. Representing complex geographic phenomena in GIS. Cartography and Geographic Information Science, 28, 83-96.
- Zimmermann, K. and Freksa, C. 1993. Enhancing spatial reasoning by the concept of motion. In: Sloman, A. (ed.), Prospects for Artificial Intelligence, IOS Press, 140-147.
- Zhou, Y., Fang Z., Thill, J.C. Li Q, and Li Y. 2015. Functionally critical locations in an urban transportation network: Identification and space-time analysis using taxi trajectories. Computers, Environment and Urban Systems, 52, 34-47.

A Qualitative Spatio-Temporal Modelling and Reasoning Approach for the Representation of Moving Entities

Abstract: The research developed in this thesis introduces a qualitative approach for representing and reasoning on moving entities in a two-dimensional geographical space. Movement patterns of moving entities are categorized based on a series of qualitative spatial models of topological relations between a directed line and a region, and orientation relations between two directed lines, respectively. Qualitative movements are derived from the spatio-temporal relations that characterize moving entities conceptualized as either points or regions in a two-dimensional space. Such a spatio-temporal framework supports the derivation of the basic movement configurations inferred from moving and static entities. The approach is complemented by a tentative qualification of the possible natural language expressions of the primitive movements identified. Complex movements can be represented by a composition of these primitive movements. The notion of conceptual transition that favors the exploration of possible trajectories in the case of incomplete knowledge configurations is introduced and explored. Composition tables are also studied and provide additional reasoning capabilities. The whole approach is applied to the analysis of flight patterns and maritime trajectories.

Keywords: Moving entities; trajectories; spatio-temporal representation; qualitative reasoning

Un Modèle Spatio-temporel de Raisonnement Qualitatif pour la Représentation d'Entités Dynamiques

Résumé : La recherche développée dans cette thèse introduit une approche qualitative pour représenter et raisonner à partir d'entités spatiales dans un espace géographique à deux dimensions. Les patrons de mouvements entre entités dynamiques sont catégorisés à partir d'un modèle qualitatif de relations topologiques entre une ligne orientée et une région, et de relations d'orientation entre deux lignes orientées, respectivement. Les mouvements qualitatifs sont dérivés à partir de relations spatio-temporelles qui caractérisent des entités dynamiques conceptualisées comme des points ou des régions dans un espace à deux dimensions. Cette architecture de raisonnement permet de dériver des configurations de mouvements basiques dérivées à partir d'entités statiques et dynamiques. L'approche est complétée par une qualification de ces configurations à partir d'expressions du langage naturel. Les compositions de mouvements sont étudiées tout comme les transitions possibles dans des cas de données incomplètes. Les tables de compositions sont également explorées et permettent d'étendre les possibilités de raisonnement. Le modèle est expérimenté dans le contexte de l'analyse de trajectoires aériennes et maritimes

Mots-clefs : Entités dynamiques; trajectoires; représentation spatio-temporelle, raisonnement qualitatif