



HAL
open science

Methods to enhance anaerobic digestion of food waste

Javkhlan Ariunbaatar

► **To cite this version:**

Javkhlan Ariunbaatar. Methods to enhance anaerobic digestion of food waste. Agricultural sciences. Université Paris-Est, 2014. English. NNT : 2014PEST1176 . tel-01206170

HAL Id: tel-01206170

<https://theses.hal.science/tel-01206170>

Submitted on 28 Sep 2015

HAL is a multi-disciplinary open access archive for the deposit and dissemination of scientific research documents, whether they are published or not. The documents may come from teaching and research institutions in France or abroad, or from public or private research centers.

L'archive ouverte pluridisciplinaire **HAL**, est destinée au dépôt et à la diffusion de documents scientifiques de niveau recherche, publiés ou non, émanant des établissements d'enseignement et de recherche français ou étrangers, des laboratoires publics ou privés.

Methods to Enhance Anaerobic Digestion of Food Waste



Javkhlan Ariunbaatar

Joint PhD degree in Environmental Technology

UNIVERSITÉ
— PARIS-EST

Docteur de l'Université Paris-Est
Spécialité : Science et Technique de l'Environnement



Dottore di Ricerca in Tecnologie Ambientali

UNESCO-IHE
Institute for Water Education



Degree of Doctor in Environmental Technology

Thèse – Tesi di Dottorato – PhD thesis

Javkhlan Ariunbaatar

Methods to enhance anaerobic digestion of food waste

To be defended December 17th, 2014

In front of the PhD committee

Prof. Vincenzo Belgiorno
Prof. Robin Gerlach
Prof. Giovanni Esposito
Prof. Dr. Ir. Piet N.L. Lens
Prof. Stéphanie Rossano
Prof. Francesco Pirozzi
Dr. Antonio Panico
Dr. Eric Van Hullebusch

Reviewer
Reviewer
Promoter
Co-promoter
Co-promoter
Co-supervisor
Co-supervisor
Examiner



Erasmus Joint doctorate programme in Environmental Technology for Contaminated Solids, Soils and Sediments (ETeCoS³)

Thesis committee

Thesis promoter

Dr. G. Esposito, PhD, MSc
Associate Professor of Sanitary and Environmental Engineering
University of Cassino and Southern Lazio
Cassino, Italy

Thesis co-promoters

Prof. dr. ir. P. N.L. Lens
Professor of Biotechnology
UNESCO-IHE Institute for Water Education,
Delft, The Netherlands

Prof. F. Pirozzi, PhD
Professor of Sanitary and Environmental Engineering
University of Naples Federico II,
Naples, Italy

Prof. D.H. Yeh, PhD
Associate Professor of Civil and Environmental Engineering
University of South Florida
Tampa, USA

Dr. A Panico, PhD
Researcher in Environmental Engineering,
Telematic University of PEGASO,
Naples, Italy

Other members

Prof. V. Belgiorno, PhD
Professor of Civil and Environmental Engineering
University of Salerno, Salerno, Italy

Dr. R. Gerlach, PhD
Associate Professor of Chemical and Biological Engineering
Montana State University, Bozeman, USA

Dr. E. Van Hullebusch, PhD
Associate Professor of Biogeochemistry
University of Paris-Est, Institut Francilien des Sciences Appliquées
Champs sur Marne, France

This research was conducted under the auspices of the Erasmus Mundus Joint Doctorate Environmental Technologies for Contaminated Solids, Soils and Sediments (ETECOS³).

ACKNOWLEDGEMENTS

First of all, I would like to thank the Erasmus Mundus Joint Doctoral Program ETeCOS³ (Environmental Technologies for Contaminated Solids, Soils and Sediments) under the EU grant agreement FPA n° 2010-0009 for giving me this unique opportunity to conduct my research in four different universities in three different countries. Embarking on this fantastic journey has broadened my horizons and deepened my knowledge.

I would like to express my deepest appreciation to my thesis promoter, Prof. Giovanni Esposito and co-promoter Prof. Piet N.L. Lens for being tremendous mentors. Their thoughtful attitude and substance of a genius have made me grow professionally as well as personally. Also I would like to thank my co-supervisors, Prof. Francesco Pirozzi, Dr. Daniel H. Yeh and Dr. Antonio Panico for their inestimable and motivating guidance throughout this research.

Furthermore, I would like to acknowledge with great appreciation the crucial roles of the lab technicians, colleagues and fellow PhD candidates, who helped me to accomplish my tasks. The interesting and inspiring discussions both in group meetings and social environments that I enjoyed with them made a great effect on me and my research.

Living abroad for a long time and acclimating at a new university and city every few months has been challenging. I would like to explicit my sincere gratitude to all my friends and the locals at each of my destination cities (Cassino and Naples in Italy, Delft in the Netherlands, Tampa in Florida, USA). Their warm welcome, kind support and understanding nature kept me motivated, focused and provided me the hospitable environment to complete this research.

Finally, I would like to thank my family and friends in Mongolia, who supported with guidance, encouraged with enthusiasm and made me who I am today. Nothing would have been possible without their care and love.



CONTENTS

1 INTRODUCTION	2
1.1 PROBLEM DESCRIPTION	2
1.2 RESEARCH OBJECTIVES AND STRUCTURE OF THESIS	3
1.3 REFERENCE.....	6
2 PRETREATMENT METHODS TO ENHANCE ANAEROBIC DIGESTION OF ORGANIC SOLID WASTE.....	8
2.1 INTRODUCTION	8
2.2 MECHANICAL PRETREATMENT.....	9
2.2.1 <i>Process description and mode of action</i>	9
2.2.2 <i>Mechanical pretreatment of OFMSW</i>	9
2.2.3 <i>Mechanical pretreatment of miscellaneous OSW</i>	10
2.3 THERMAL PRETREATMENT.....	12
2.3.1 <i>Process description and mode of action</i>	12
2.3.2 <i>Thermal pretreatment at lower temperatures (<110 °C)</i>	12
2.3.3 <i>Thermal pretreatment at higher temperature (>110 °C)</i>	13
2.4 CHEMICAL PRETREATMENT	13
2.4.1 <i>Process description and mode of action</i>	13
2.4.2 <i>Alkali pretreatment</i>	13
2.4.3 <i>Acid pretreatment</i>	14
2.4.4 <i>Effects of accompanying cations present in the acid/alkaline reagents</i>	14
2.4.5 <i>Ozonation</i>	14
2.4.6 <i>Chemical pretreatments of OSW</i>	15
2.5 BIOLOGICAL PRETREATMENT.....	15
2.5.1 <i>Conventional biological pretreatment</i>	15
2.5.2 <i>Two-stage AD</i>	16
2.5.3 <i>Temperature phased anaerobic digestion (TPAD)</i>	16
2.5.4 <i>Biohythane production</i>	17
2.6 COMBINATION OF VARIOUS PRETREATMENTS.....	17
2.6.1 <i>Thermo-chemical pretreatment</i>	17
2.6.2 <i>Thermo-mechanical pretreatment</i>	18
2.6.3 <i>Various pretreatments combined with a two-stage AD</i>	18
2.7 COMPARISON OF PRETREATMENT METHODS TO ENHANCE ANAEROBIC DIGESTION OF OFMSW	18
2.8 FEASIBILITY OF A FULL SCALE APPLICATION.....	24



2.9 ENERGY BALANCE	27
2.10 ECONOMIC FEASIBILITY	27
2.11 ENVIRONMENTAL ASPECTS AND SUSTAINABILITY OF PRETREATMENT METHODS	28
2.12 CONCLUSION	29
2.13 REFERENCE.....	29
3 ENHANCED ANAEROBIC DIGESTION OF FOOD WASTE BY THERMAL AND OZONATION PRETREATMENT METHODS.....	40
3.1 INTRODUCTION.....	40
3.2 MATERIALS AND METHODS.....	41
3.2.1 <i>Substrate and inoculum</i>	41
3.2.2 <i>Pretreatment of FW</i>	42
3.2.3 <i>Biomethane potential test</i>	42
3.2.4 <i>Analytical methods</i>	43
3.2.5 <i>Net energy production</i>	43
3.3 RESULTS.....	44
3.3.1 <i>Characteristics of substrate and inoculum</i>	44
3.3.2 <i>Cumulative biomethane production</i>	44
3.3.3 <i>Net energy production</i>	49
3.4 DISCUSSIONS	51
3.4.1 <i>Effects of pretreatment methods</i>	51
3.4.2 <i>Net energy production</i>	53
3.5 CONCLUSIONS	53
3.6 REFERENCE.....	53
4 EFFECTS OF THERMOPHILIC AND THERMAL PRETREATMENTS ON THE MESOPHILIC ANAEROBIC DIGESTION OF FOOD WASTE	57
4.1 INTRODUCTION.....	57
4.2 MATERIALS AND METHODS.....	58
4.2.1 <i>Batch experiment</i>	58
4.2.2 <i>Analytical methods</i>	59
4.2.3 <i>Energy balance</i>	59
4.3 RESULTS.....	59
4.3.1 <i>Characterization of substrate and inoculum</i>	59
4.3.2 <i>Effect of TPP on temperature and treatment time on Mes.AD</i>	60
4.3.3 <i>Comparison of the TPP and TP efficiencies</i>	62
4.4 DISCUSSIONS	66
4.4.1 <i>Effects of pretreatment methods</i>	66



4.4.2 <i>Energy efficiency</i>	66
4.5 CONCLUSIONS	67
4.6 REFERENCE.....	67
5 TRACE ELEMENT REQUIREMENTS FOR THE ANAEROBIC DIGESTION OF FOOD WASTE	71
5.1 INTRODUCTION	71
5.2 MATERIALS AND METHODS.....	72
5.2.1 <i>Substrate and inoculum</i>	72
5.2.2 <i>Biomethane potential test</i>	72
5.2.3 <i>Analytical Methods</i>	72
5.3 RESULTS	73
5.3.1 <i>Characterization of substrate and inoculum</i>	73
5.3.2 <i>Effect of TE concentration on AD of FW</i>	73
5.3.3 <i>Effect of Me (II) and Me (VI) on AD of FW</i>	74
5.3.4 <i>Hydrogen sulphide inhibition</i>	78
5.4 CONCLUSIONS	78
5.5 REFERENCE.....	79
6 BIOAUGMENTATION OF ANAEROBIC DIGESTION OF FOOD WASTE USING ZOO ANIMALS' DUNG	81
6.1 INTRODUCTION	81
6.2 MATERIALS AND METHODS	82
6.2.1 <i>Substrate and inoculum</i>	82
6.2.2 <i>Batch experiments on biomethane potential</i>	82
6.2.3 <i>Analytical Methods</i>	83
6.3 RESULTS AND DISCUSSIONS	84
6.3.1 <i>Characteristics of the inoculums and substrate</i>	84
6.3.2 <i>Biomethane potential test</i>	84
6.3.3 <i>Bioaugmentation mechanisms</i>	86
6.4 CONCLUSIONS	89
6.5 REFERENCE.....	89
7 EFFECT OF AMMONIACAL NITROGEN ON ONE-STAGE AND TWO-STAGE ANAEROBIC DIGESTION OF FOOD WASTE	91
7.1 INTRODUCTION	91
7.2 MATERIALS AND METHODS	92
7.2.1 <i>Substrate and inoculum</i>	92
7.2.2 <i>Batch experiments</i>	92



7.2.3	<i>Semi-continuous reactors</i>	93
7.2.4	<i>Analytical methods</i>	94
7.2.5	<i>Calculation</i>	94
7.3	RESULTS.....	95
7.3.1	<i>Substrate and inoculum characterization</i>	95
7.3.2	<i>Batch experiments on ammonium inhibition</i>	95
7.3.3	<i>Comparison of one-stage and two-stage reactors</i>	97
7.4	DISCUSSION.....	106
7.4.1	<i>Anaerobic digestion of food waste</i>	106
7.4.2	<i>Effect of TAN on buffer capacity in semi-continuous systems</i>	106
7.4.3	<i>Toxic effect of TAN on AD of FW</i>	106
7.5	CONCLUSION.....	108
7.6	REFERENCE.....	108
8	INFLUENCE OF HYDRAULIC RETENTION TIME AND ORGANIC LOADING RATE ON THE PERFORMANCE OF AnMBR TREATING FOOD WASTE..	112
8.1	INTRODUCTION.....	112
8.2	MATERIALS AND METHODS.....	113
8.2.1	<i>Seed sludge and influent</i>	113
8.2.2	<i>Analytical methods</i>	113
8.2.3	<i>Biomethane potential test</i>	113
8.2.4	<i>Design and operation of AnMBR</i>	114
8.3	RESULTS.....	115
8.3.1	<i>Seed sludge and FW characteristics</i>	115
8.3.2	<i>Performance of AnMBR</i>	115
8.3.3	<i>Biogas production</i>	121
8.3.4	<i>COD balance</i>	121
8.3.5	<i>Membrane performance</i>	122
8.4	CONCLUSION.....	123
8.5	REFERENCE.....	123
9	DISCUSSIONS AND FUTURE RESEARCH PERSPECTIVES.....	126
9.1	INTRODUCTION AND OBJECTIVES.....	126
9.2	MAJOR RESEARCH FINDINGS.....	127
9.2.1	<i>Batch experiments on the biomethane potential of food waste</i>	127
9.2.2	<i>Continuous experiments</i>	128
9.3	FUTURE RESEARCH PERSPECTIVES.....	130
9.4	REFERENCE.....	131

LIST OF TABLES

TABLE 1.1 ADVANTAGES OF AD	3
TABLE 1.2 DISADVANTAGES OF AD	3
TABLE 2.1 REVIEWS ON DIFFERENT PRETREATMENT METHODS TO ENHANCE AD OF VARIOUS SUBSTRATES	11
TABLE 2.2 COMPARISON OF PRETREATMENT METHODS TO ENHANCE AD OF OFMSW	20
TABLE 2.3 SUSTAINABILITY EVALUATION OF PRETREATMENT METHODS TO ENHANCE OFMSW	29
TABLE 3.1 COMPOSITION OF SYNTHETIC FW USED FOR THE EXPERIMENT	42
TABLE 3.2 CHARACTERIZATION OF FW AND INOCULUM USED IN THIS EXPERIMENT	44
TABLE 3.3 COST BENEFIT ANALYSIS OF OZONATION PRETREATMENT	50
TABLE 4.1 CHARACTERIZATION OF FW AND INOCULUM	60
TABLE 4.2 ENERGY REQUIREMENTS FOR THE PRETREATMENT METHODS	67
TABLE 5.1 CONCENTRATION OF TES IN THE FW AND INOCULUM	73
TABLE 5.2: ENHANCEMENT/INHIBITION OF SBP WITH RESPECT TO THE TES CONCENTRATIONS	74
TABLE 6.1: DIETS OF THE ZOO ANIMALS	82
TABLE 7.1: OPERATIONAL PARAMETERS OF R1 AND R2	93
TABLE 7.2: CHARACTERISTICS OF SUBSTRATE AND INOCULUM	95
TABLE 7.3: IC ₅₀ OF TAN AND FA	107
TABLE 8.1: BIOGAS PRODUCTION	121
TABLE 8.2: MEMBRANE PERFORMANCE	123
TABLE 9.1: THE HIGHEST ENHANCEMENT OF SBP ACHIEVED WITH DIFFERENT METHODS	127

LIST OF FIGURES

FIGURE 1.1: THESIS OUTLINE.....	5
FIGURE 2.1: MECHANICAL PRETREATMENT METHODS TO ENHANCE AD OF OFMSW: A) SCREW PRESS; B) DISC SCREEN; C) SHREDDER WITH MAGNET.....	24
FIGURE 2.2: SIMPLIFIED SCHEME OF CAMBI THP: A) CAMBI WHOLE PROCESS; B) DETAILED THP PROCESS.....	26
FIGURE 2.3: A SIMPLIFIED SCHEME OF TWO-STAGE AD.....	27
FIGURE 3.1: CBP CURVES OF FW PRETREATED AT VARIOUS TEMPERATURES FOR (A) 1 HOUR AND (B) 30 MIN.....	45
FIGURE 3.2: EFFECT OF THERMAL PRETREATMENT ON THE SPECIFIC BIOMETHANE PRODUCTION DURING THE INITIAL 20 DAYS OF THE BMP TEST.....	46
FIGURE 3.3: CBP CURVES OF FW PRETREATED AT (A) 70 °C AND (B) 80 °C FOR VARIOUS TREATMENT TIMES.....	47
FIGURE 3.4: EFFECT OF (A) 70 °C AND (B) 80 °C THERMAL TREATMENT TIME ON THE BIOMETHANE PRODUCTION DURING THE INITIAL 20 DAYS OF THE BMP TEST.....	48
FIGURE 3.5: EFFECT OF OZONE ON A) CBP CURVES; B) SBP OF FW DURING THE INITIAL 20 DAYS.....	49
FIGURE 3.6: EFFECT OF AMBIENT AIR TEMPERATURE ON THE NET ENERGY PRODUCTION FROM THERMAL PRETREATMENT AT 80 °C FOR 1.5 HOUR.....	50
FIGURE 4.1.: CUMULATIVE BIOMETHANE PRODUCTION CURVES OF FW PRETREATED WITH: A) TPP AT 50 °C; B) TPP AT 60 °C; C) TPP AT 70 °C.....	61
FIGURE 4.2: TEMPERATURE EFFECT OF TPP FOR 12 HOURS ON SBP AT DAY 20.....	62
FIGURE 4.3 CBP CURVES OF FW PRETREATED WITH TPP AND TP AT: A) 50 °C; B) 55 °C; 60 °C.....	63
FIGURE 4.4: EFFECT OF TP AND TPT ON CBP CURVES: A) 50 °C; B) 55 °; AND C) 60 °C.....	64
FIGURE 4.5: EFFECT OF TPP AND TP TEMPERATURE AND TREATMENT TIME EFFECT OF ON THE CODS CONCENTRATIONS: A) CODS AFTER PRETREATMENT; B) CODS AFTER BMP TESTS.....	65
FIGURE 5.1: EFFECT OF TE COCKTAIL CONCENTRATION ON THE SBP OF FW.....	73
FIGURE 5.2: EFFECT OF ME (II) ON THE SBP OF FW.....	75
FIGURE 5.3: EFFECT OF ME (II) ON THE SBP OF FW: A) CUMULATIVE METHANE CURVES; B) SBP.....	75
FIGURE 5.4: EFFECT OF ME (VI) ON THE SBP OF FW: A) CUMULATIVE METHANE CURVES; B) SBP.....	76
FIGURE 5.5: EFFECT OF SE (VI) AND FE (II) SUPPLEMENTATION ON THE VFA PRODUCTION: A) ACETIC ACID; B) PROPIONIC ACID; C) ISO-BUTYRIC ACID; D) BUTYRIC ACID.....	77
FIGURE 5.6: EFFECT SULPHIDE TOXICITY ON AD OF FW.....	78
FIGURE 6.1: LIQUID DISPLACEMENT METHOD.....	83
FIGURE 6.2: EFFECT OF DIFFERENT DUNG SOURCES ON THE NET SBP OF FW.....	84

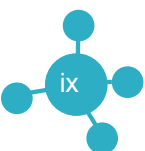

FIGURE 6.3: EFFECT OF DUNG MIXTURE PERCENTAGES ON THE NET SBP OF FW: A) GIRAFFE; B) SLOTH BEAR; C) KOALA.....	85
FIGURE 6.4: CUMULATIVE BIOMETHANE CURVES AND SBP OF SELECTED SAMPLES: A) GIRAFFE; B) SLOTH BEAR; C) KOALA.....	86
FIGURE 6.5: PROFILE OF CODs	87
FIGURE 6.6: PROFILE OF SOLUBLE CARBOHYDRATES.....	88
FIGURE 6.7: PROFILE OF SOLUBLE PROTEINS	88
FIGURE 7.1: EFFECT OF TAN ON PROCESS PARAMETERS OF THE BATCH ANAEROBIC DIGESTION OF FW: A) CUMULATIVE BIOMETHANE PRODUCTION OF FW; B) SBP AND INHIBITION PERCENTAGE; C) ACETIC ACID CONCENTRATION; AND D) PROPIONIC ACID CONCENTRATION;.....	96
FIGURE 7.2: RUN 1 – PERFORMANCE OF R1 AND R2 TREATING FW: A) VOA/PA RATIO; B) pH; C) TAN CONCENTRATION; AND D) DAILY BIOGAS PRODUCTION	98
FIGURE 7.3: RUN 2 – PERFORMANCE OF R1 AND R2 TREATING FW: A) VOA/PA RATIO; B) pH; C) TAN CONCENTRATION; AND D) DAILY BIOMETHANE PRODUCTION	100
FIGURE 7.4: VFA PRODUCTION DURING RUN 2: A) TOTAL VFA; B) ACETIC; C) PROPIONIC; AND D) BUTYRIC ACID.....	101
FIGURE 7.5: RUN 3 – PERFORMANCE OF R1 AND R2 TREATING FW: A) VOA/PA RATIO; B) TAN CONCENTRATION; B) SPECIFIC BIOMETHANE PRODUCTION; AND C) PERCENTAGE OF BIOMETHANE IN BIOGAS	103
FIGURE 7.6: VFA PRODUCTION DURING RUN 3: A) TOTAL VFA; B) ACETIC; C) PROPIONIC; AND D) BUTYRIC ACID.....	104
FIGURE 7.7: PERFORMANCE PARAMETERS OF THE FIRST STAGE OF R2: A) TOTAL VFA CONCENTRATION; B) GAS CONTENT; C) LACTIC ACID CONCENTRATION.....	105
FIGURE 8.1: SCHEMATIC DIAGRAM OF ANMBR.....	114
FIGURE 8.2: SOLIDS PROFILE: A) TS; B) VS; C) TSS; D) VSS.....	116
FIGURE 8.3: NUTRIENTS PROFILE: A) TAN; B) TN; C) TP.....	117
FIGURE 8.4: BIOREACTOR STABILITY PROFILE: A) pH; B) VOA/PA RATIO; C) VOA.....	118
FIGURE 8.5: COD PROFILE.....	119
FIGURE 8.6: OLR AND REMOVAL EFFICIENCY: A) COD _T AND COD _S ; B) TSS.....	120
FIGURE 8.7: COD BALANCE	122



ABSTRACT

Treatment of food waste (FW) by anaerobic digestion (AD) can lead to an energy production coupled to a reduction of the volume and greenhouse gas emissions from this waste type. Nevertheless, obtaining the highest possible methane recovery in a shorter time with a stable operation is challenging. To maximise the performance of AD treating FW several pretreatment methods, supplementation of trace elements, bioaugmentation using zoo animals' dung and comparison of reactor configurations, including one-stage and two-stage continuously stirred tank reactors (CSTR) as well as an anaerobic membrane bioreactor (AnMBR), were studied in the scope of this research.

Based on the results of the batch experiments, thermal pretreatment at 80 °C for 1.5 hours yielded 46 – 52% higher biomethane production, and it is more energy efficient than ozonation or thermophilic pretreatments.

Among the various trace elements tested Se (VI) was found to be the most important for the AD of FW at a concentration range of 25 – 50 µg/g resulting in 30 – 35% increase of biomethane production.

A better solubilization of proteins ($6.96 \pm 2.76\%$ higher) and recalcitrant carbohydrates (344.85 ± 54.31 mg/L as compared to zero) was obtained with bioaugmentation of giraffe dung (30% by volume), which yielded a $11.24 \pm 4.51\%$ higher biomethane production.

A two-stage CSTR with digestate re-circulation performed better than one-stage CSTR due to: (i) a better pH self-adjusting capacity; (ii) a higher resistance to organic loading shocks; (iii) almost 100% volatile solids (VS) was destroyed as compared to 71% in one-stage CSTR; (iv) 50-60% methane content in the biogas was obtained, while it was 40-50% in one-stage CSTR; (v) a small amount of hydrogen was also detected from the first stage of the two-stage reactor making it an attractive system for biohythane production. Nevertheless, the long hydraulic retention time (HRT) requirement, makes the conventional AD systems less attractive, hence an AnMBR equipped with a side-stream polyvinylidene fluoride membrane was proposed and a successful operation was achieved. Thanks to the membranes the HRT was reduced from 20 d to 1d, while maintaining an overall removal efficiency of >97% in terms of influent chemical oxygen demand and yielded a higher biogas production with 70% methane content.

SINTESI

La digestione anaerobica degli scarti alimentari rappresenta una tecnologia vantaggiosa per il trattamento di questo tipo di rifiuti che consente di garantire da un lato la produzione di energia e dall'altro il contenimento delle emissioni di gas serra. Tuttavia, la massimizzazione della produzione di energia e il mantenimento di condizioni stabili di funzionamento del processo sono obiettivi difficili da raggiungere. Per massimizzare le prestazioni di tale tecnologia, nel presente lavoro di tesi sono stati studiati i) diversi metodi di pre-trattamento, ii) l'aggiunta di elementi in traccia, iii) la bioaugmentazione con letame di diversi animali da zoo e iv) il confronto di varie configurazioni impiantistiche, tra cui reattori a completa miscelazione (CSTR) a uno e due stadi e reattori anaerobici a membrana (AnMBR).

Il pre-trattamento termico a 80 °C per 1.5 ore è risultato, sulla base degli esperimenti batch, più efficiente rispetto all'ozonizzazione e allo shock termofilo, con produzioni di biometano più elevate del 46 - 52% rispetto alla digestione anaerobica dello stesso substrato non pre-trattato.

Tra i vari elementi in traccia testati, Se (VI) è risultato essere il più importante la digestione anaerobica degli scarti alimentari in un intervallo di concentrazione di 25 –50 µg/g che hanno fornito incremento della produzione di biometano 30 – 35%.

Una migliore solubilizzazione delle proteine ($6.96 \pm 2.76\%$ in più) e dei carboidrati recalcitranti (344.85 ± 54.31 mg/L contro zero) è stata ottenuta attraverso la bioaugmentazione con letame di giraffa (30% in volume), con un incremento della produzione di biometano del $11.24 \pm 4.51\%$.

Gli esperimenti condotti con bioreattori in continuo hanno indicato maggiori efficienze del reattore CSTR a due stadi con ricircolo del digestato rispetto al reattore CSTR a uno stadio per i seguenti motivi: i) una migliore capacità di autoregolazione del pH, ii) una maggiore resistenza ai sovraccarichi organici, iii) quasi il 100% dei solidi volatili (VS) è stato degradato contro il 71% nel caso del reattore CSTR a uno stadio, iv) 50-60% di metano nel biogas contro il 40-50% ottenuto nel caso del reattore a uno stadio, v) la produzione di una piccola quantità di idrogeno è stata rilevata nel primo stadio del reattore a due stadi, indicando la possibilità di un interessante utilizzo per la produzione di biohythane. Tuttavia, l'uso di reattori convenzionali CSTR è limitato dalla necessità di elevati tempi di detenzione idraulica (HRT), per cui un reattore AnMBR è stato proposto come configurazione impiantistica alternativa. Con tale sistema è stato possibile ridurre l'HRT da 20 giorni a 1 giorno, mantenendo un'efficienza di rimozione del COD superiore al 97% e ottenendo una maggiore produzione di biogas con un contenuto di metano del 70%.

RÉSUMÉ

Le traitement des déchets alimentaires par digestion anaérobie peut conduire à une production d'énergie couplée à une réduction de volume et des émissions de gaz à effet de serre dues à ce type de déchets. Néanmoins, l'obtention la plus élevée possible du méthane dans un temps court avec un fonctionnement stable représente un défi. Pour optimiser la performance de la digestion anaérobie pour le traitement de déchets alimentaires plusieurs méthodes de pré-traitement, la supplémentation en oligo-éléments, la bioaugmentation en utilisant le fumier des animaux de zoo et la comparaison des configurations de réacteur (y compris des réacteurs agités en continu en une ou en deux étapes ainsi que un bioréacteur anaérobie de membrane), ont été étudiés dans le cadre de la présente recherche.

Basé sur les résultats des expériences de traitement par lots, le pré-traitement thermique à 80 ° C pendant 1,5 heures a donné une production de biométhane plus élevée (46 à 52%), et il est plus économe en énergie que l'ozonation ou les pré-traitements thermophiles.

Parmi les divers éléments traces testés Se (VI) se est avéré être le plus important pour l'AD de FW à une gamme de concentration de 25 à 50 pg / g résultant en 30 - augmentation de la production de biométhane de 35%.

Une meilleure solubilisation des protéines ($6,96 \pm 2,76\%$ de plus) et des glucides récalcitrants ($344,85 \pm 54,31$ mg / L par rapport à zéro) a été obtenue avec bioaugmentation de fumier de girafe (30% en volume), qui a donné une augmentation ($11,24 \pm 4,51\%$) de la production de biométhane.

Un réacteur agité en continu à deux étapes avec recirculation de digestat fait une meilleure performance que celui à une étape en raison de: (i) une meilleure capacité d'auto-ajustement du pH; (ii) une plus grande résistance aux chocs de charge organique; (iii) près de 100% de solides volatils (SV) ont été détruits par rapport à 71% dans le réacteur agité en continu à une étape; (iv) 50 à 60% de teneur en méthane dans le biogaz a été obtenu, alors qu'il était de 40 à 50% dans le réacteur agité en continu à une étape; (v) une petite quantité d'hydrogène a également été détectée à partir de la première étape dans le réacteur agité en continu à deux étapes, qui en fait un système attrayant pour la production de biohydrogène. Néanmoins, les longs temps de rétention hydraulique (TRH), font des systèmes classiques de digestion anaérobie moins attrayants, d'où un bioréacteur anaérobie de membrane équipée avec une membrane de fluorure de polyvinylidène avec courant latéral a été proposé et une opération réussie a été atteinte. Grâce aux membranes, le TRH a été réduit de 20 jours à 1 jour, tout en maintenant une efficacité d'élimination globale > 97% en termes de demande chimique en oxygène de l'influent et a également abouti à une production de biogaz supérieur à 70% de teneur en méthane.

SAMENVATTING

Behandeling van voedsel afval (VA) door anaërobe vergisting (Aerobic digestion, AD) kan leiden tot energie productie gekoppeld aan een reductie van het volume van dit afval en de uitstoot van broeikasgassen. Niettemin is het behalen van de hoogste mogelijke terugwinning van methaan in een zo kort mogelijke tijd onder stabiele omstandigheden erg uitdagend. Om de prestatie van de AD behandeling van VA te maximaliseren kunnen verschillende voorbehandelmethodes worden toegepast, zoals het toevoegen van sporenelementen, bioaugmentatie via het toevoegen van de mest van geschikte dieren uit een dierentuinen en het vergelijken van diverse reactor configuraties, inclusief één of twee fase continue gemengde tank reactoren (CSTR) of een anaërobe membraan bioreactor (AnMBR). Al deze strategieën zijn dit onderzoek bestudeerd.

Gebaseerd op de resultaten van batch experimenten leverde een voorbehandeling bij 80°C voor 1.5 uur een 46-52% hogere biomethaan productie. Ook is dit efficiënter dan ozonatie en thermofiele voorbehandeling.

Onder de verschillende geteste sporenelementen bleek Se(VI) in het concentratiebereik van 25 - 50 ug/g het belangrijkste element voor de AD van AV, resulterend in een 30 - 35% hogere biomethaan productie.

Een betere oplosbaarheid van proteïnen ($6.96 \pm 2.76\%$ hoger) en recalcitrante koolhydraten (344.85 ± 54.31 mg/L vergeleken met onoplosbaar) is gevonden bij bioaugmentatie van girafmest (30% in volume) aan het AD digestaat, wat een $11.24 \pm 4.51\%$ hogere biomethaan productie opleverde.

Een twee fase CSTR met digestaat recirculatie werkt beter dan een één fase CSTR dankzij: (i) een betere zelfaanpassingscapaciteit voor pH; (ii) een hogere weerstand tegen organische schokbelastingen; (iii) bijna 100% van de vluchtige vaste stoffen (VS) waren afgebroken in verlijking met slechts 71% in een één fase CSTR; (iv) een methaan gehalte van 50-60% in het biogas werd verkregen in vergelijking met 40-50% in de één fase CSTR; (v) een kleine hoeveelheid waterstof is ook gedetecteerd in het eerste stadium van de twee fase reactor, wat het een aantrekkelijk systeem maakt voor biomethaan productie uit VA.

Desalniettemin maken de lange hydraulische retentietijden conventionele AD systemen minder aantrekkelijk. Vandaar dat ook een AnMBR met een zijstroom polyvinylidene fluoride membraan werd bestudeerd. De succesvolle operationele condities werden vastgesteld. Dankzij de membranen kon de HRT gereduceerd worden van 20 d naar 1 d, terwijl de verwijderingsefficiëntie van de chemische zuurstofvraag hetzelfde ($> 97\%$) bleef, gekoppeld aan een hogere biogas productie met een methaan inhoud van 70%.

CHAPTER 1

INTRODUCTION

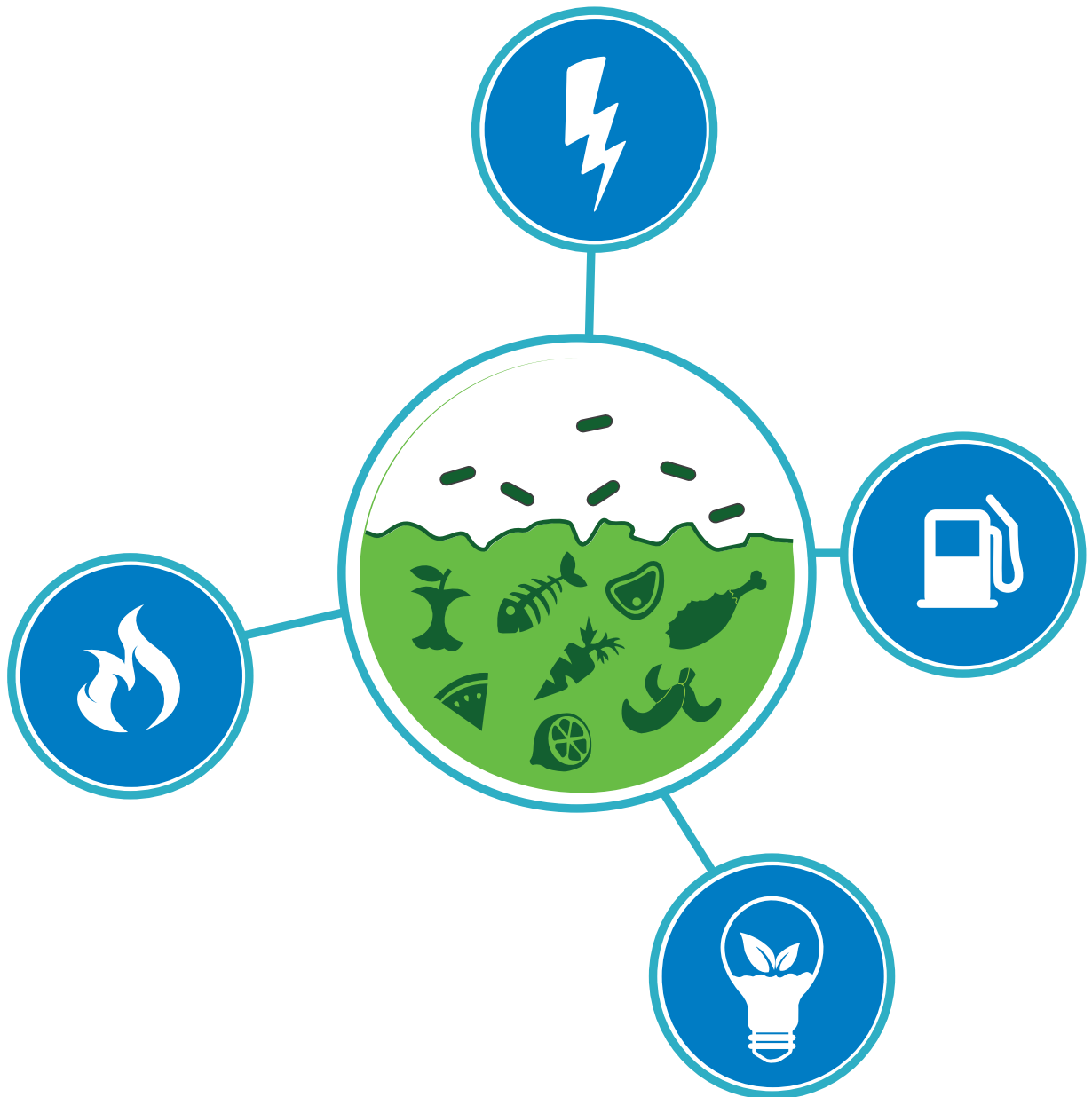

1 INTRODUCTION

The rapid population growth and increased consumption of natural resources have triggered environmental, economical, social and political issues all around the world. One of such crucial issues that both developed and developing countries are currently facing is the ever-increasing generation of organic solid waste (OSW). OSW is mostly composed of food waste (FW), which is a mixture of organic materials derived from the processing, sorting, preparation, cooking and handling of food as well as the leftover from post-consumers.

1.1 Problem description

The generation rate of FW depends on many factors such as region, season, culture, demographics, and economic income. In low-income countries, 40% of food is wasted during the production-to-processing stages, whereas in industrialized countries more than 40% of food loss occurs at retail and consumer stages [1]. FW generation rate in low to middle income countries is 0.35 kg/day.capita, whereas in high-income countries the rate is 0.6 kg/day.capita [2]. There are limited studies on the reasons of wasting food, however some studies suggest that in developed countries food is wasted mostly due to behaviors and simply the population can afford. For instance in UK 25% of purchased food is wasted [3], whereas in The Netherlands 8-11% of purchased food is wasted [4]. In USA also 25% of food (excluding food converted into composting, used to feed animals and discharged into sewage) is wasted at household level [4]. Another study in South Korea estimated that 26-27% household waste is composed of food [5].

In overall, FAO suggests that one-third of the food produced for human consumption is lost or wasted globally, which amounts to about 1.3 billion tons per year [1]. Besides the aesthetics issues associated with the FW, it is worth mentioning that 250 km³ of water and 28% of the world's agricultural area is used for the production of the FW generated [6]. Moreover, as a consequence of increased urbanization and income of the developing nations, FW generation rate is predicted to be increased by a 44% by year 2025 [4]. If current waste management is practiced global methane production from FW will increase from 3 to 48 Gkg by 2025 [7]. While it is important to reduce the FW generation rate, a sustainable treatment of unavoidable FW is crucial to reduce the environmental footprint from it.

At present the most common FW stabilization technology is still landfilling followed by conversion technologies. Landfills are strongly discouraged by legislations such as EU Directives on Landfill (1999/31/EC) and Waste Framework (2006/12/EC), as it contributes to further environmental impacts including soil and groundwater pollution, greenhouse gases emissions, utilization of huge land as well as being a reservoir of disease organisms and vectors. Furthermore, the outbreak of Bovine spongiform encephalopathy (BSE) or the mad cow disease and foot and mouth disease crisis led to the banning of animal feeding with FW, and necessities the treatment of FW [8].

Due to the high moisture content of FW a biological conversion is preferred over thermochemical or physicochemical conversion technologies. Anaerobic and aerobic biological treatment technologies are the cleanest alternatives for the treatment of FW [9]. Although aerobic treatment provides an alternative to landfill disposal, anaerobic digestion (AD) is more favourable than composting, due to its high-energy recovery and limited environmental impacts [9, 10]. The overall advantages of AD are depicted in Table 1.1.

Table 1.1 Advantages of AD

Aspects	Feature of benefits
Waste treatment benefits	A natural waste treatment process is performed Waste volume and weight are reduced Recycling is maximized
Energy benefits	A renewable fuel is generated Net energy is produced Reliance on energy imports is reduced
Environmental benefits	The natural carbon cycle is not altered GHG emissions are reduced Less land is required as compared to other OSW treatments More controlled air pollution (less production of malodorous gases) No landfill leachate is produced Dependence on inorganic fertilizers is minimized by recovering and reuse of nutrients present in waste Pathogens proliferation is prevented
Economic benefits	Produced biogas can be used as a source of electricity, heat, and transportation fuel Digestate can be used as fertilizer and soil conditioner

In detail, AD is a biological process that converts the complex organic matter into biogas (a mixture of methane (CH₄) and carbon dioxide (CO₂), and digestate by microbial action in absence of oxygen. AD consists of four different stages, which involves four types of microbial activities, namely: hydrolysis (hydrolytic bacteria); acidogenesis (acidogens); acetogenesis (acetogens); and methanogenesis (methanogens). AD of OSW has been studied well for the past decades, and matured in many technical aspects including process kinetics, modelling, digestion enhancement and etc. [11, 12]. However, AD still poses several limitations as shown in Table 1.2 [9-12].

Table 1.2 Disadvantages of AD

Aspects	Feature of limitations
Operational	Start-up times are long Capital costs are high Retention times could be long (depending on the characteristics of the substrate) Addition of alkalinity and/or specific additives could be required Adverse environmental changes could fail the process Heating to achieve adequate reaction rates is required Explosion risk is high
End products	Further treatments to meet discharge requirements could be required Odours and corrosive gases could be present

To reduce or prevent from these limitations, the AD process should be enhanced by reducing the retention time, while maintaining a stable process and recovering all the potential biomethane. This research is aimed at achieving the AD process enhancement of an abundant and a favourable substrate, FW.

1.2 Research objectives and structure of thesis

The main goal of this research was to enhance the AD of FW and obtain the highest possible biomethane production in the shortest possible time. Various methods were tested through

batch and continuous experiments at lab scale. The specific objectives and related sub-objectives of the research were as follows:

1. To study the effects of various pretreatment methods by (a) setting the optimum thermal pretreatment temperature and time; (b) determining the optimum ozone concentration range; (c) studying the effect of thermophilic shock pretreatment on mesophilic AD; (d) estimating the net energy balance of pretreatment methods.
2. To investigate the effects of supplements on the AD of FW by (a) examining the effect of trace elements addition; (b) determining the bioaugmenting effect of zoo animals' dung.
3. To compare reactor configurations through continuous experiments by (a) studying and comparing one-stage and two-stage CSTR performance; (b) investigating the potential of AnMBR for high-load AD process.

The research activities carried out to accomplish the objectives are explained below and illustrated in Figure 1.1.

Chapter 1 explains the general motivation of the research and problem description. It highlights the research objectives and activities carried out to achieve the aims.

Chapter 2 gives the comprehensive literature review on the pretreatment methods to enhance the anaerobic digestion of OSW. Among the publications reviewed for this chapter a considerable number of them were on FW.

Chapter 3 highlights the experimental results on thermal and ozonation pretreatment methods. Carrying out the research activities in this chapter the objectives 1a, 1b and 1d were accomplished.

Chapter 4 presents the effects of thermal pretreatment and thermophilic pretreatments for the enhancement of mesophilic AD of FW. With this chapter objectives 1c and 1d were achieved.

Chapter 5 activities were conducted to accomplish objective 2a. This chapter briefly explains the importance of trace elements on the AD of FW, and the possibility to enhance the process by supplementing various trace elements.

Chapter 6 elucidates the bioaugmentation effect of zoo animals' dung on the AD of FW. The research activities involved in this chapter achieved objective 2b.

Chapter 7 activities accomplished objective 3a. This chapter compares the performance of one-stage and two-stage CSTR for AD of FW. It also describes the buffering and/or inhibition effects of ammonium on the two different systems.

Chapter 8 explains the importance of AnMBR and its superior performance for the treatment of high-load AD of FW. With the activities involved in this chapter the final research objective 3b was accomplished.

Chapter 9 highlights the overall findings of the research and complete discussions are summarized. Future research perspectives and recommendations are also provided in this chapter.

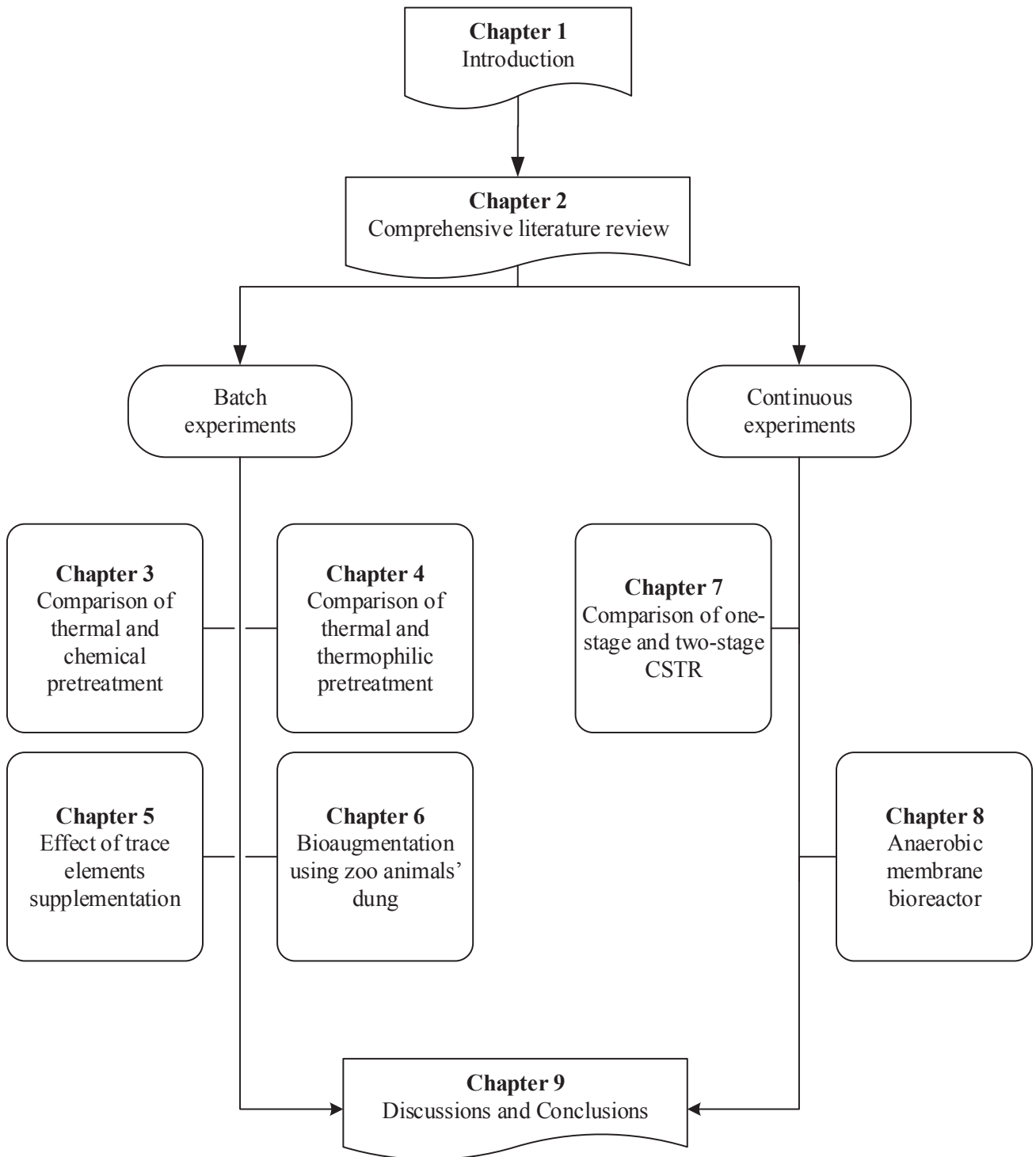

Figure 1.1: Thesis outline

1.3 Reference

1. FAO (2011) Swedish Institute for Food and Biotechnology, Global Food Losses and Food Waste – Study Conducted for the International Congress
2. ISWA (2013), Key Issue Paper: Food Waste As A Global Issue http://www.iswa.org/index.php?eID=tx_iswaknowledgebase_download&documentUId=3222.
3. WRAP (2009), Household food and drink waste in the UK, ISBN: 1-84405-430-6
4. Parfit J., Bartherl M., Macnaughton S. (2010) Food waste within food supply chains: quantification and potential for change to 2050, DOI: 10.1098/rstb.2010.0126
5. Kim S.W., Park J.Y., Kim J.K., Cho J.H., Chun Y.N., Lee I.H., Lee J.S., Park J.S., Park DH (2000), Development of a modified three-stage methane production process using food wastes, Applied Biochemistry and Biotechnology; 84-86: 731-741
6. FAO (2013), Food Waste Footprint: Impact On Natural Resources ISBN 978-92-5-107752-8
7. Adhikari BK., Barrington S. (2006), Predicted growth of world urban food waste and methane production, Waste Management and Research24: 421-33
8. Kirchmayr R., Scherzer R., Baggesen DL., Braun R., Wellinger A (2003), Animal by-products and anaerobic digestion, Requirements of the European Regulation (EC) No. 1774/2002., IEA Bioenergy Task 37, Energy from biomethane and landfill gas in cooperation with Bioexcell – Biomethane Center of Excellence
9. Kiran, E. U., Trzcinski, A. P., Ng, W. J., & Liu, Y. (2014). Bioconversion of food waste to energy: a review. Fuel, 134, 389-399.
10. Zhang R. El-Mashad H.M., Hartman K., Liu G., Choate C., Gamble P. (2007), Characterization of food waste as feedstock for anaerobic digestion, Bioresource Technology 98: 929-935
11. Ariunbaatar J., Panico A., Esposito G., Pirozzi F., Lens PNL. (2014), Pretreatment methods to enhance anaerobic digestion of organic solid waste, Applied Energy 15: 143-156
12. Mata-Alvarez J., Mace S., Llabres P. (2000), Anaerobic digestion of organic solid wastes. An overview of research achievements and perspectives, Bioresource Technology; 74: 3-16

CHAPTER 2

PRETREATMENT METHODS TO ENHANCE ANAEROBIC DIGESTION OF ORGANIC SOLID WASTE



This chapter has been published as:

Javkhlan Ariunbaatar, Antonio Panico, Giovanni Esposito, Piet NL Lens (2014), Francesco Pirozzi, Pretreatment methods to enhance anaerobic digestion of organic solid waste, Applied Energy 123:143-156

2 PRETREATMENT METHODS TO ENHANCE ANAEROBIC DIGESTION OF ORGANIC SOLID WASTE

This chapter reviews pretreatment techniques to enhance the anaerobic digestion of organic solid waste, including mechanical, thermal, chemical and biological methods. The effects of various pretreatment methods are discussed independently and in combination. Pretreatment methods are compared in terms of their efficiency, energy balance, environmental sustainability as well as capital, operational and maintenance costs. Based on the comparison, thermal pretreatment at low (<110 °C) temperatures and two-stage anaerobic digestion methods result in a more cost-effective process performance as compared to other pretreatment methods.

2.1 Introduction

Anaerobic digestion (AD) is one of the oldest and well-studied technologies for stabilizing organic wastes [1]. Among the treatment technologies available for treating organic solid wastes (OSW), AD is very suitable because of its limited environmental impacts [2, 3-5] and high potential for energy recovery [2-3, 6]. Such positive aspects coupled with the recent concerns on rapid population growth, increasing energy demand, and global warming have promoted further research on the AD process development and improvement in order to enhance biogas production, achieve faster degradation rates and reduce the amount of final residue to be disposed [3-4, 7].

AD is a biological process that converts complex substrates into biogas and digestate by microbial action in the absence of oxygen through four main steps, namely hydrolysis, acidogenesis, acetogenesis and methanogenesis. Most researchers report that the rate-limiting step for complex organic substrates is the hydrolysis step [8-26], due to the formation of toxic by-products (complex heterocyclic compounds) or non-desirable volatile fatty acids (VFA) formed during the hydrolysis step [27, 28]; whereas methanogenesis is the rate-limiting step for easily biodegradable substrates [24, 27, 29, 30]. Extensive research has been conducted on pretreatment methods to accelerate the hydrolysis step [31-32] and to obtain suitable by-products from this step [28], as well as to improve the quality of useful components like nitrogen and phosphorus to be recycled [33].

According to European Union Regulation EC1772/2002, substrates such as municipal solid waste (MSW), food waste (FW), and slaughterhouse wastes need to be pasteurized or sterilized before and/or after AD. Taking this regulation into account, pretreatment methods could be applied, thus obtaining a higher energy recovery and eliminating the extra cost for pasteurization and/or sterilization [34, 35]. Pretreatment methods could nevertheless be unsustainable in terms of environmental footprints, even if they enhance the AD process performance [36]. The effects of various pretreatment methods are highly different depending on the characteristics of the substrates and the pretreatment type. Hence, it is difficult to compare and systematically assess the applicability and sustainability of such methods at a full scale.

In the recent past a number of reviews have been published with a common aim to assess the pretreatment effects. Table 2.1 shows that most of the research on pretreatment methods has been conducted on wastewater treatment plant (WWTP) sludge and/or lignocellulosic substrates; whereas there is a limited number of reviews on the recently growing interest of pretreatment methods to enhance AD of OSW, specifically the organic fraction of municipal solid waste (OFMSW). Therefore, this paper aims to review the most recently studied pretreatment methods including mechanical, thermal, chemical and biological methods to

enhance AD of OSW, with an emphasis on OFMSW. The pretreatment methods will be compared in terms of efficiency, energy balance, cost and process sustainability.

2.2 Mechanical pretreatment

2.2.1 Process description and mode of action

Mechanical pretreatment disintegrates and/or grinds solid particles of the substrates, thus releasing cell compounds and increasing the specific surface area. An increased surface area provides better contact between substrate and anaerobic bacteria, thus enhancing the AD process [3, 24-25]. Esposito et al. (2011) suggested that a larger particle radius results in lower chemical oxygen demand (COD) degradation and a lower methane production rate [37]. Likewise, Kim et al. (2000) showed that particle size is inversely proportional to the maximum substrate utilization rate of the anaerobic microbes [38]. Therefore, mechanical pretreatments such as sonication, lysis-centrifuge, liquid shear, collision, high-pressure homogenizer, maceration, and liquefaction are conducted in order to reduce the substrate particle size.

In addition to size reduction, some methods result in other effects depending on the pretreatment. Hartmann et al. (2000) reported that the effect of maceration is more due to shearing than cutting of the fibers [39]. Sonication pretreatment generated by a vibrating probe mechanically disrupts the cell structure and floc matrix [40]. The main effect of ultrasonic pretreatment is particle size reduction at low frequency (20-40 kHz) sound waves [41]. High-frequency sound waves also cause the formation of radicals such as OH^* , HO_2^* , H^* , which results in oxidation of solid substances [42].

A high pressure homogenizer (HPH) increases the pressure up to several hundred bar, then homogenizes substrates under strong depressurization [43]. The formed cavitation induces internal energy, which disrupts the cell membranes [44]. These pretreatment methods are not common for OFMSW, but they are more popular with other substrates such as lignocellulosic materials, manure and WWTP sludge. Size reduction through beads mill, electroporation and liquefaction pretreatments of OFMSW has been studied at lab scale, whereas rotary drum, screw press, disc screen shredder, FW disposer and piston press treatment are successfully applied at full scale. Both electroporation and liquefaction pretreatments cause cellular structure damage, thus the effect on the AD process is similar to maceration [45, 46].

The advantages of mechanical pretreatment include no odour generation, an easy implementation, better dewaterability of the final anaerobic residue and a moderate energy consumption. Disadvantages include no significant effect on pathogen removal and the possibility of equipment clogging or scaling [47, 48].

2.2.2 Mechanical pretreatment of OFMSW

Mechanical pretreatments such as rotary drum were used as an effective technology for OFMSW separation and pretreatment prior to AD, which could enhance the biogas production by 18 – 36% [49, 50]. Davidson et al. (2007) found small variations in both methane yields per gVS (gram volatile solids) and content of methane in biogas while studying the biomethane potential of source-sorted OFMSW pretreated with different mechanical methods including screw press, disc screen shredder, FW disposer and piston press [51]. Similarly, Zhang and Banks (2013) found no significant enhancement with such pretreatment methods [52]. Hansen et al. (2007) studied the effects of the same pre-treatment technologies on the quantity and quality of source-sorted OFMSW. They found that screw press pretreatment

resulted in a smaller substrate particle size, while a shredder with magnetic separation yielded a higher (5.6 – 13.8% as compared to the other methods) methane production [53]. In contrast, Bernstad et al. (2013) reported that the screw press pretreatment method also result in a loss of biodegradable materials and nutrients, even though it enhances the biogas production in general [54].

Izumi et al. (2010) studied the effect of the particle size on FW biomethanation. Size reduction through a beads mill resulted in a 40% higher COD solubilization, which led to a 28% higher biogas production yield. However, excess size reduction to particles smaller than 0.7 mm caused an accumulation of VFA [8]. As the methanogens are sensitive to acidic intermediates [55], excessive size reduction may result in a decreased AD process performance. Few research on electroporation, liquefaction, and high frequency sonication pretreatment methods to enhance OFMSW has been conducted. Electroporation pretreatment of OFMSW resulted in 20-40% higher biogas production [46], and liquefaction resulted in 15-26% higher biogas production [3], whereas sonication resulted in 16% higher cumulative biogas production as compared to untreated substrates [56]. The higher biogas production was mostly due to the more extensive solubilization of the particulates.

2.2.3 Mechanical pretreatment of miscellaneous OSW

Maceration, sonication and HPH are the simplest mechanical pretreatments for OSW such as WWTP sludge and lignocellulosic substrates. Size reduction of lignocellulosic substrates results in a 5-25% increased hydrolysis yield, depending on the mechanical methods used [34], whereas for WWTP sludge and manure, the effects of pretreatments significantly differ. Generally, applying maceration pretreatment enhances biogas production by 10-60% [3]. For instance, maceration of fibers in manure up to 2 mm resulted in a 16% increase of the biogas production, while size reduction up to 0.35 mm resulted in a 20% increase, and no significant difference was observed with further size reduction [57].

Barjebruch and Kopplow (2003) treated surplus sludge with HPH at 600 bar, and showed that the filaments were completely disintegrated [44]. Engelhart et al. (2000) studied the effect of HPH on the AD of sewage sludge (SS), and achieved a 25% increased VS reduction. This improvement was induced by the increased soluble protein, lipid, and carbohydrate concentration [58]. The HPH of WWTP sludge has been applied at full scale, resulting in a 30% biogas enhancement, thus the working volume of digesters could be decreased by 23% [3].

Sonication prior to the AD process resulted in an enhancement of the biogas production of 24–140% in batch systems, and 10–45% in continuous or semi-continuous systems [3]. However, not all studies confirm the enhancement of VS destruction or higher biogas production. Sandino et al. (2005) studied sonication of waste activated sludge (WAS) and obtained only a negligible increase in both VS destruction and mesophilic methane production [59].

Table 2.1 Reviews on different pretreatment methods to enhance AD of various substrates

Substrate	Pretreatment methods	Important findings	Reference
OFMSW	All pretreatment methods	Physical pretreatments are widely applied for OFMSW, whereas other methods are not spread at industrial level. Further research on pretreatment should focus more on the modelling as well as mass and energy balance of the pretreatment effect and the whole AD process.	[61]
All organic substrates	All pretreatment methods	The most popular pretreatment methods are thermal and ultrasonic for WWTP sludge, chemical for lignocellulosic substrates, and mechanical for OFMSW. Systematic studies on energy balance and economic feasibility are necessary. Further development of descriptive and predictive variables is required.	[39]
Lignocellulosic substrates	Thermal, thermo-chemical, chemical	Pretreatments could improve the digestibility of lignocellulosic substrates Pretreatments could result in more efficient process as compared to the conventional process.	[73]
Lignocellulosic substrates	Thermal, thermo-chemical, and chemical	Thermal pretreatments as well as lime and ammonia based chemical methods are more effective in improving the digestibility of lignocellulosic substrates.	[34]
Pulp & paper sludge	Thermal, thermo-chemical, chemical	Pretreatments could result in reduced HRT, increased methane production, and reduced sludge size.	[40]
WWTP sludge	Ultrasound, chemical, thermal, and microwave	Pretreatments result in enhanced biogas production (30 – 50%). Comprehensive model for evaluating the economic feasibility was developed.	[22]
WWTP sludge	Thermal, thermo-chemical, and chemical	The effect of pretreatment methods depends on the characteristics of sludge and the intensity of the method. Pretreatments could yield a better digestate with high recoverable nutrients	[3]
WWTP sludge	Thermal and thermo-chemical	Thermal pretreatment at high temperature (>175 °C) as well as thermo-chemical methods are more effective in improving sludge dewaterability.	[60]

2.3 Thermal pretreatment

2.3.1 Process description and mode of action

Thermal treatment is one of the most studied pretreatment methods, and has been successfully applied at industrial scale [3, 31, 61]. Thermal pretreatment also leads to pathogen removal, improves dewatering performance and reduces viscosity of the digestate, with subsequent enhancement of digestate handling [2, 31, 32, 62]. Various temperatures (50 – 250 °C) to enhance the AD of different OSW (mainly WWTP sludge and lignocellulosic substrates) have been studied. However, to the best of our knowledge, no systematic research on various temperature and treatment times to enhance AD of OFMSW has been conducted.

The main effect of thermal pre-treatment is the disintegration of cell membranes, thus resulting in solubilization of organic compounds [17, 63-65]. COD solubilization and temperature have a direct correlation. Higher solubilization can also be achieved with lower temperatures, but longer treatment times. Mottet et al. (2009) compared different thermal pretreatment methods and found no significant difference between steam and electric heating, whereas microwave heating solubilized more biopolymers [66]. The higher rate of solubilization with microwave pretreatment can be caused by the polarization of macromolecules [47, 63]. Concerning the lignocellulosic substrates, temperatures exceeding 160 °C cause not only the solubilization of hemicellulose but also solubilization of lignin. The released compounds are mostly phenolic compounds that are usually inhibitory to anaerobic microbial populations [34].

Bougrier et al. (2006) suggested that thermal pretreatment at high temperatures (>170 °C) might lead to the creation of chemical bonds and result in the agglomeration of the particles [42]. One of the most known phenomena is the Mallaird reaction, which occurs between carbohydrates and amino acids, resulting in the formation of complex substrates that are difficult to be biodegraded. This reaction can occur at extreme thermal treatment at temperatures exceeding 150 °C, or longer treatment time at lower temperatures (<100 °C) [3, 25, 34, 67, 68].

In addition to these chemical reactions, thermal pretreatment can also result in loss of volatile organics and/or potential biomethane production from easily biodegradable substrates. Therefore, the effects of thermal pretreatment depend on the substrate type and temperature range.

2.3.2 Thermal pretreatment at lower temperatures (<110 °C)

Protot et al. (2011) suggested that thermal pretreatment at temperatures below 100 °C did not result in degradation of complex molecules, but it simply induces the deflocculation of macromolecules [64]. Barjenbruch and Kopplow (2003) obtained a similar conclusion with pretreatment at 90 °C. Their results showed that the filaments are not disintegrated, but they were only attacked with thermal pretreatment [44]. Neyens and Bayens (2003) reported that thermal pretreatment resulted in the solubilization of proteins and increased the removal of particulate carbohydrates [60].

Thermal pretreatment of sludge even at lower temperature (70 °C) has a decisive effect on pathogen removal [24]. Probably based on such results, the EU Regulation EC1772/2002 requires OSW to be pretreated at least an hour at 70 °C. In this regard, numerous studies on thermal pretreatment at 70 °C were conducted. For instance, pretreating household waste and algal biomass at 70 °C for 60 min and 8 hours, respectively, did not result in enhancement of

the biogas production [18, 69]. Appels et al. (2010) obtained a negligible increase of biogas production from sludge pretreated at 70 °C for 60 min, whereas the biogas production was improved 20 times when applying a 60 min pretreatment at 90 °C [19]. Rafique et al. (2010) achieved a maximal enhancement of 78% higher biogas production with a 60% methane content by pretreatment at 70 °C [10]. Ferrer et al. (2008) obtained a 30% higher biogas production with a 69% methane content [17], whereas Climent et al. (2007) obtained a 50% biogas volume increase with pretreatment at 70 °C [70] prior to thermophilic AD. Gavala et al. (2003) reported that pretreatment of primary and secondary WWTP sludge at 70 °C has a different effect on the thermophilic and mesophilic methane potential. Thermal pretreatment at 70 °C was shown to have a positive effect on mesophilic AD of primary sludge, but not on its thermophilic AD; whereas it enhanced both the thermophilic and mesophilic methane production of secondary sludge. This can be explained by the chemical composition of the OSW substrates: primary sludge contains higher amounts of carbohydrates, whereas secondary sludge contains higher amounts of proteins and lipids [26].

2.3.3 Thermal pretreatment at higher temperature (>110 °C)

Liu et al. (2012) studied the thermal pre-treatment of FW and fruit and vegetable waste at 175 °C; they obtained a 7.9% and 11.7% decrease of the biomethane production, respectively, due to the formation of melanoidins [62]. Ma et al. (2011) obtained a 24% increase of the biomethane production with FW pretreated at 120 °C [9]. Rafique et al. (2010) studied pretreatment of pig manure at temperatures higher than 110 °C. They observed hardening and darkening of manure, which resulted in a low biogas yield [10]. Hardening and the dark brownish color development of the substrate indicated the occurrence of Maillard reactions.

2.4 Chemical pretreatment

2.4.1 Process description and mode of action

Chemical pretreatment is used to achieve the destruction of the organic compounds by means of strong acids, alkalis or oxidants. AD generally requires an adjustment of the pH by increasing alkalinity, thus alkali pretreatment is the preferred chemical method [71]. Acidic pretreatments and oxidative methods such as ozonation are also used to enhance the biogas production and improve the hydrolysis rate. The effect of chemical pretreatment depends on the type of method applied and the characteristics of the substrates. Chemical pretreatment is not suitable for easily biodegradable substrates containing high amounts of carbohydrates, due to their accelerated degradation and subsequent accumulation of VFA, which leads to failure of the methanogenesis step [72]. In contrast, it can have a clear positive effect on substrates rich in lignin [13].

2.4.2 Alkali pretreatment

During alkali pretreatment, the first reactions that occur are solvation and saponification, which induce the swelling of solids [31]. As a result, the specific surface area is increased and the substrates are easily accessible to anaerobic microbes [34, 73, 74]. Then, COD solubilization is increased through various simultaneous reactions such as saponification of uronic acids and acetyl esters, as well as neutralization of various acids formed by the degradation of the particulates [75]. When substrates are pretreated with alkali methods, an important aspect is that the biomass itself consumes some of the alkali [34], thus higher alkali reagents might be required for obtaining the desired AD enhancement.

2.4.3 Acid pretreatment

Acid pretreatment is more desirable for lignocellulosic substrates, not only because it breaks down the lignin, but also because the hydrolytic microbes are capable of acclimating to acidic conditions [76]. The main reaction that occurs during acid pretreatment is the hydrolysis of hemicellulose into perspective monosaccharides, while the lignin condensates and precipitates [34, 77]. Strong acidic pretreatment may result in the production of inhibitory by-products, such as furfural and hydroxymethylfurfural (HMF) [73, 76]. Hence, strong acidic pretreatment is avoided and pretreatment with dilute acids is coupled with thermal methods (See also Section 2.5). Other disadvantages associated with the acid pretreatment include the loss of fermentable sugar due to the increased degradation of complex substrates, a high cost of acids and the additional cost for neutralizing the acidic conditions prior to the AD process [73, 78, 79].

2.4.4 Effects of accompanying cations present in the acid/alkaline reagents

In addition to the effects of the alkali and acid themselves, the AD might be affected by the accompanying cations present in these reagents including sodium, potassium, magnesium, calcium, since the chemicals are added mostly as salts or hydroxides of these cations. Therefore, the inhibitory concentrations of these cations should be considered [3, 80].

Kim et al. (2000) studied the inhibition of the sodium ion concentration on the thermophilic AD of FW, and reported that more than 5 g/L of sodium resulted in lower biogas production [38]. Sodium is more toxic to propionic acid utilizing bacteria as compared to other VFA degrading bacteria [81]. The inhibitory level of the potassium ion starts at 400 mg/L, though anaerobic microbes are able to tolerate up to 8 g/L potassium [82]. The potassium ion is more toxic to thermophilic anaerobes as compared to mesophilic or psychrophilic anaerobes [83].

The optimum concentrations of calcium and magnesium ions have been reported to be 200mg/L and 720mg/L, respectively [84, 85]. Excessive amounts of calcium ions can cause precipitation of carbonates and phosphates, which results in scaling of the reactors, pipes, and biomass; thus it reduces the specific methanogenic activity and results in a loss of buffer capacity [113]. Also high concentrations (>100 mM) of the magnesium ion can cause disaggregation of methanogens, thus the conversion of acetate is inhibited [85].

Furthermore, AD could also be enhanced indirectly due to the supplementation of trace metals such as cobalt (Co), molybdenum (Mo), selenium (Se), iron (Fe), tungsten (W), copper (Cu) and nickel (Ni), which play a role in many biochemical reactions of the anaerobic food web. For instance Zhang and Jahng (2012) used supplements of trace metals such as Fe, Co, Mo and Ni to stabilize a single-stage reactor treating FW, and concluded that Fe was the most effective metal for stabilization of the AD process [86]. Facchin et al. (2013) achieved a 45-65% higher methane production yield from FW with supplementation of a trace metals (Co, Mo, Ni, Se, and W) cocktail [87]. Nevertheless, supplementing trace metals to solid waste AD plants should not be considered as a pretreatment method, though it could be an effective method for achieving higher biogas production rates with a higher methane content.

2.4.5 Ozonation

Another chemical pretreatment method is ozonation [3], which does not cause an increase of the salt concentration and no chemical residues remain as compared to other chemical pretreatment methods. Moreover, it also disinfects the pathogens [88, 89]. Hence, ozonation has gained great interest for sludge pretreatment [3, 90], and to a lesser extend OFMSW. Ozone is a strong oxidant, which decomposes itself into radicals and reacts with organic

substrates [90] in two ways: directly and indirectly. The direct reaction depends on the structure of the reactant, whereas the indirect reaction is based on the hydroxyl radicals. As a result, the recalcitrant compounds become more biodegradable and accessible to the anaerobic bacteria [91].

2.4.6 Chemical pretreatments of OSW

Chemical pretreatments are widely applied on wastewater sludge and lignocellulosic substrates [3, 34, 73], while very limited research has been conducted on OFMSW. Ozonation pretreatment has only been conducted on wastewater or sludge from WWTP. In general, the optimal ozone dose for enhancing AD of WWTP sludge ranges between 0.05 to 0.5 g O₃/gTS [3, 91-93]. Cesaro and Belgiorno (2013) reported that the optimum ozone dose for source-sorted OFMSW is 0.16 gO₃/gTS, which resulted in a 37% higher cumulative methane production [56]. Lopez-Torres and Llorens (2008) obtained a 11.5% increased methane production with alkaline pretreatment of OFMSW [74]. Neves et al. (2006) achieved 100% of the potential production with alkaline (0.3 gNaOH/gTS) pretreated barley waste [28]. Patil et al. (2011) studied the effect of alkaline pretreatment of water hyacinth, which has a lower lignin content as compared to other plants. They found that the alkaline pretreatment had a smaller effect than mechanical pretreatments [94]. Therefore, acidic and alkaline pretreatment are not suitable for substrates with a low lignin content.

2.5 Biological pretreatment

Biological pretreatment includes both anaerobic and aerobic methods, as well as the addition of specific enzymes such as peptidase, carbohydrase and lipase to the AD system. Such conventional pretreatment methods are not very popular with OFMSW, but have been applied widely on other types of OSW such as WWTP sludge and pulp and paper industries.

The hydrolytic-acidogenic step (first step) of a two-phase AD process is considered as a biological pretreatment method by some researchers [3, 95 – 97], while others consider it as a process configuration of AD, but not a pretreatment method [31]. Physically separating the acidogens from the methanogens can result in a higher methane production and COD removal efficiency at a shorter hydraulic retention time (HRT) as to conventional single-stage digesters [98]. Parawira et al. (2005) reported that optimizing the first hydrolysis stage could stimulate the acidogenic microbes to produce more specific enzymes, thus resulting in more extended degradation of substrates [99]. Therefore, in this review paper the first step of the two-phase AD systems are considered as a pretreatment method.

2.5.1 Conventional biological pretreatment

Aerobic pretreatment such as composting or micro-aeration prior to AD can be an effective method to obtain a higher hydrolysis of complex substrates due to the higher production of hydrolytic enzymes, which is induced by the increased specific microbial growth [100]. Fdez-Guelfo et al. (2011) reported that pretreatment by composting resulted in a higher specific microbial growth rate (160 – 205% as compared to untreated OFMSW) than by thermochemical pretreatment [14]. Lim and Wang (2013) also affirmed that the aerobic pretreatment yielded a greater VFA formation due to the enhanced activities of the hydrolytic and acidogenic bacteria [100]. However, according to the results obtained by Brummeler and Koster (1990), a pre-composting treatment of OFMSW resulted in a 19.5% VS loss [101]. Mshandate et al. (2005) also observed a loss of potential methane production with a longer aerobic pretreatment of sisal pulp waste [102].

Miah et al. (2005) investigated the biogas production of SS pretreated with aerobic thermophilic bacteria closely related to *Geobacillus thermodenitrificans*. According to their results, the highest amount of biogas (70 ml/gVS) with a 80-90% methane content was achieved at 65 °C [15]. Melamane et al. (2007) studied the AD of wine distillery wastewater pretreated with the fungus *Trametes pubescens*. This fungal pretreatment obtained a 53.3% COD removal efficiency, which increased the total COD removal efficiency of the AD system up to 99.5% [103]. Muthangya et al. (2009) used pure cultures of the fungus *Trichoderma reesei* to aerobically pretreat sisal leaf decortication residues. Their results showed that aerobic incubation for 4 days resulted in a 30 – 40% cumulative biogas increase with a higher (50 – 66%) methane content [104]. Romano et al. (2009) studied two types of enzymes capable to hydrolyze plant cell walls to enhance the biomethanation of *Jose Tall* wheat grass [16]. They did not obtain a significant biogas enhancement or VS reduction, though the hydrolysis step was accelerated [15].

2.5.2 Two-stage AD

A two-stage AD system consists of a hydrolytic-acidogenic stage followed by the methanogenic stage. The advantages of such systems include: i) increased stability with better pH control; ii) higher loading rate; iii) increased specific activity of methanogens resulting in a higher methane yield; iv) increased VS reduction and v) high potential for removing pathogens [6, 105-109]. The disadvantages include: i) hydrogen built-up resulting in inhibition of acid-forming bacteria; ii) elimination of possible interdependent nutrient requirements for the methane forming bacteria; iii) technical complexity and iv) higher costs [110, 111].

Verrier et al. (1987) compared two-stage methanization of vegetable wastes with mesophilic and thermophilic single stage continuously stirred tank reactors (CSTR). They found that for easily biodegradable wastes, a two-stage reactor converted 90% of the wastes to biogas, which outperformed both the mesophilic and thermophilic single stage CSTR and could withstand higher organic loads [112]. Zhang et al. (2005) investigated the effect of pH on two-phase AD of FW, and suggested that adjusting the pH to 7 in the hydrolysis stage can improve both the total solids (TS) loading rate and biogas production yield [113].

2.5.3 Temperature phased anaerobic digestion (TPAD)

Recently more research is being conducted on temperature phased anaerobic digestion (TPAD). This method usually consists of a primary digester at thermophilic (or hyper-thermophilic) temperature followed by a mesophilic secondary digester. The advantages of TPAD include not only higher methane production yields, but also a pathogen free high nutrient digestate [114]. Riau et al. (2010) suggested that TPAD is preferred if the purpose is to achieve pathogen free digestate, which can be directly used as soil conditioner [115].

Schmit and Ellis (2001) reported that TPAD outperformed conventional AD processes including dry digestion of source separated OFMSW [116]. Lee et al. (2008) investigated TPAD of FW and excess sludge at 70 °C in the primary reactor, followed by a secondary reactor with temperatures of 35 °C, 55 °C and 65 °C. The best result was achieved at a solid retention time (SRT) of 4 days and 70 °C in the primary reactor, followed by a secondary reactor at 55 °C [117]. Wang et al. (2011) compared the conventional thermophilic digestion with TPAD (hyper-thermophilic (80 °C) and thermophilic (55 °C) primary reactor followed by a mesophilic reactor), treating FW with polylactide. They obtained a COD solubilization of 82%, 85.2%, 63.5% with TPAD with a hyper-thermophilic first stage, TPAD with a thermophilic first stage, and a conventional thermophilic digester, respectively. Moreover,

82.9%, 80.8%, 70.1% of the organics were converted into methane with TPAD with a hyperthermophilic first stage, TPAD with a thermophilic first stage and a conventional thermophilic digester, respectively [118]. Song et al. (2004) compared the biogas production and pathogen removal of WAS with TPAD compared to a single stage mesophilic and thermophilic digester. TPAD yielded a 12-15% higher VS reduction and it was as stable as the single stage mesophilic reactor, whereas pathogen removal was as high as in the single stage thermophilic reactor [119].

2.5.4 Biohydrogen production

Optimizing two-stage conditions may result in the production of bio-hydrogen from the primary reactor and biomethane from the second reactor, making it a very attractive biohydrogen producing system. Numerous studies have been conducted on the optimization of such systems with reactors both at mesophilic and/or thermophilic temperatures. Liu et al. (2006) obtained 43 mlH₂/gVS and 500 mlCH₄/gVS from household waste (HHW) [120], whereas Wang et al. (2009) obtained 65 mlH₂/gVS and 546 mlCH₄/gVS from FW [110]. Chu et al. (2008) reported that the optimum hydrogen production from FW is achieved at pH 5.5-6 in thermophilic AD. The bio-hydrogen content was 52% with no methane in the first stage, whereas the methane content was 70-80% in the secondary reactor. Based on a mass balance, 9.3% of the COD was converted to hydrogen and 76.5% converted to methane [121]. Escamilla-Alvarado et al. (2012) studied the optimization of two-stage AD of OFMSW, and obtained an overall biogas production of 661 ± 2.5 and 703 ± 2.9 ml/gVS for mesophilic and thermophilic operations, respectively. The biogas produced from the primary reactor contained 3-10% hydrogen, whereas the biogas from the secondary reactor contained 25-61% methane [122].

2.6 Combination of various pretreatments

2.6.1 Thermo-chemical pretreatment

Different pretreatment methods rely on various mechanisms to solubilize particulate organic matter [11, 27]. Hence pretreatment methods in combination have also been studied to obtain a further enhancement of biogas production and faster AD process kinetics.

Shahriari et al. (2012) investigated the AD of OFMSW pretreated with a combination of high temperature microwaves and hydrogen peroxide pretreatment. The combination of microwaves with chemical pretreatments as well as the microwave irradiation at temperatures higher than 145 °C resulted in a larger component of refractory material per gCOD, causing a decrease of the biogas production [123]. A similar trend was observed with pig manure pretreated with lime and heated at temperatures higher than 110 °C [10, 124]. This could be explained by the increased hydrolyses of proteins and carbohydrates due to the chemical pretreatment, and in the presence of heat the produced amino acids and sugars reacted together forming complex polymers such as melanoidins. However, alkaline pretreatment coupled with thermal methods at a lower temperature (70 °C) could result in a higher (78%) biogas production with a higher (60%) methane content as compared to the best results (28% increase of biogas production with 50% methane content) obtained by thermal pretreatment at higher temperatures (>100 °C) [10]. This enhancement of the AD process is due to the reduction of the hemicellulosic fraction [10, 124].

2.6.2 Thermo-mechanical pretreatment

Mechanical pretreatment combined with thermal treatment have also been studied to enhance the AD of OFMSW, though this combination is not popular for OFMSW. Zhang et al. (1999) obtained the highest enhancement of biogas production (17%) by grinding (up to 10 mm) rice straw and heating it to 110 °C [103]. Chiu et al. (1997) compared the hydrolysis yield of sludge pretreated with a combination of ultrasonic and alkaline pretreatment. Simultaneous ultrasonic and alkaline pretreatment of sludge resulted in the highest hydrolysis rate of 211 mg/l.min [25]. Wett et al. (2010) studied the disintegration of sludge pretreated at 19-21 bar pressure and 160-180 °C for 1 hour. The combined pretreatment resulted in a 75% increased biogas production at steady state, and the dewatering characteristics of the sludge were also improved, thus the disposal cost was reduced by 25%. However, the increased hydrolysis of protein caused a 64% increase of the ammonia concentration in the reactor [125], which may lead to process instability. Schieder et al. (2000) studied the temperature and pressure catalyzed (160-200 °C at 40 bar for 60 min) hydrolysis to improve the AD of SS, and achieved a 70% higher biogas recovery at 5 days shorter digestion as compared to AD of untreated SS [126].

2.6.3 Various pretreatments combined with a two-stage AD

Considering the first stage of two-stage AD as biological pretreatment, three-stage processes can be classified as a combined pretreatment system. Kim et al. (2000) studied semi-anaerobic CSTRs followed by two-stage upflow anaerobic sludge blanket (UASB) reactors treating FW, and obtained a 95% COD removal and a biogas production of 500 mg/gVS at HRT of 16 days [127]. The same research group also reported that the same amount of biogas with a higher methane content (67.4%) could be obtained at a lower HRT (10-12 days) by increasing the temperature of the acidogenic stage from mesophilic to thermophilic [128]. Kvesitadze et al. (2012) studied the two-stage thermophilic co-digestion of OFMSW and pretreated corn stalk by freeze explosion. The best results of 104 mlH₂/gVS and 520 mlCH₄/gVS were obtained with alkaline (pH=9) pre-hydrolysis, which could increase the heat and electricity production by 23% and 26%, respectively, as compared to the single stage process design [129]. Kim et al. (2012) investigated the hydrogen and methane production by a two-phase AD system fed with thermally pretreated FW; they found at least 3.4 days were necessary to produce hydrogen from FW [130]. Moreover, recycling the methanogenic effluent to the hydrogenesis step was applied to reduce water usage, which further increased the hydrogen production by 48% [130, 131].

2.7 Comparison of pretreatment methods to enhance anaerobic digestion of OFMSW

A systematic comparison of pretreatment methods in terms of their efficiencies, economic feasibility and environmental impacts are necessary for choosing the desired pretreatment method. To the best of our knowledge, no comparison of pretreatment efficiencies to enhance the AD of OFMSW has been conducted so far. The efficiency of the AD process can be evaluated through the methane yield per amount of removed or initial feed of TS, VS, and COD. The substrate solubilisation rate and anaerobic biodegradation is also used to evaluate the AD process performance. Table 2.2 compares the efficiency of pretreatment methods including mechanical, thermal, biological and a combination of them for enhancing the AD of OFMSW in terms of biogas production enhancement per amount of initial feed VS.

In general, OFMSW results in 280-557 ml/gVS biogas production, which is 70-95% of the organic matter in the feed. The pretreatment effects vary depending on the substrate characteristics and the type of AD system. The most commonly used mechanical pretreatment

methods are size reduction by beads mills, electroporation, pressurization, disc screen, screw press and shredder with magnetic separation. Mechanical pretreatments result in a 20-40% increased biogas yield as compared to the untreated substrates. Both chemical and thermochemical methods could yield up to 11.5-48% higher biogas yield depending on the pretreatment conditions and substrate characteristics.

In thermal pretreatment, temperature plays a major role in the enhancement of biogas production. Low temperature (70 °C) pretreatment can result in a 2.69% higher biogas production for FW, whereas it does not have any significant biogas production enhancement for HHW or commingled OFMSW. Pretreating FW at high temperature results in 24% and 11.7% increased biogas production at 120 °C and 150 °C, respectively. Higher temperatures (175 °C) result in a decreased biogas production, due to formation complex polymers such as melanoidins.

Conventional biological pretreatments are not very popular for OFMSW, whereas two-stage AD systems with hydrogen recovery have become an interesting research field among the scientific community. Pretreatments such as composting could result in higher microbial activities [14]; but also result in a loss of volatile organics, and thus a potential methane production [101]. Moreover, for easily biodegradable wastes such as FW, hydrolysis is not necessarily the rate-limiting step, thus the increased hydrolysis due to pretreatment may lead to VFA accumulation, which subsequently inhibits the methanogens. Therefore, a two-stage AD is preferred for easily biodegradable OFMSW, as compared to conventional single-stage digesters coupled with other pretreatment methods [132, 133].

Table 2.2 Comparison of pretreatment methods to enhance AD of OFMSW

Substrate	Pretreatment Condition	Type of AD system	Results	Reference
OFMSW (source-sorted)	Disc screen	Thermophilic batch	80.63% VS reduction with 338 ml CH ₄ /gVS	[51]
	Screw press		63.2% VS reduction with 354 ml CH ₄ /gVS	
	Shredder with magnetic separation		63% VS reduction with 289 ml CH ₄ /gVS	
OFMSW (source-sorted)	Screw press	Thermophilic batch	461 ml CH ₄ /gVS	[53]
	Disc Screen		428 ml CH ₄ /gVS	
	Shredder with magnetic separation		487 ml CH ₄ /gVS	
OFMSW	Rotary drum	Thermophilic batch	457 – 557 ml CH ₄ /gVS with 57.3 – 60.6% methane	[49]
OFMSW	Shear shredder, shredded and chopped, rotary drum, and wet macerator	Batch (wet and dry) Semi-continuous	Negligible effect on the enhancement of biogas production was achieved. However the kinetics of the process was faster at semi-continuous experiments	[52]
OFMSW (source-sorted)	Semi-composting with Rotary drum	Mesophilic batch	5 – 11.5% VS higher reduction, and 18 – 36% higher biogas production	[50]
OFMSW	Composting	Thermophilic dry batch	160 – 205% higher specific microbial growth rate	[14]
OFMSW	Composting	Mesophilic dry batch	19.5% VS loss, which is 40% loss of methane	[101]
Food waste	4 days microaeration with 37.5 mlO ₂ /Ld	Mesophilic wet batch	21% higher methane yield for inoculated substrate, and 10% higher methane yield for non-inoculated substrate	[100]
OFMSW (synthetic)	Thermophilic pre-hydrolysis	Thermophilic (continuous 2-stage)	81.5% COD removal with 95.7% VSS destruction and 2 times higher biogas production	[111]

OFMSW (synthetic)	Mesophilic and thermophilic pre-hydrolysis	Mesophilic and thermophilic (continuous two-stage)	Mesophilic pre-hydrolysis performed better in producing hydrogen, whereas thermophilic resulted in better solubilisation. The highest methane production from second stage was 341 mlCH ₄ /gVS.	[122]
OFMSW and corn stalk	Freeze explosion followed by thermophilic pre-hydrolysis	Thermophilic	104 mlH ₂ /gVS and 520 mlCH ₄ /gVS	[129]
OFMSW	Alkaline	NA*	11.5% higher COD solubilisation, methane yield of 0.15 m ³ CH ₄ /kgVS (172% higher than untreated)	[74]
OFMSW	Microwave pretreatment at 115-145 °C for 40 min	Mesophilic batch	4-7% higher biogas produced than untreated	[123]
OFMSW	Pre-hydrolysis at 55 °C (TPAD)	Mesophilic continuous	47.5 – 71.6% VS destruction and methane yield of 299-418 ml/g-VS	[85]
OFMSW	Sonication at 20kHz for 30-60min	Mesophilic batch	60% increased COD resulted in 24% higher methane yield	[56]
Household waste	70 °C for 60 min KOH until pH=10 at 70 °C, 60 min	Thermophilic batch	Methane yield of 500 mlCH ₄ /gVS, no enhancement due to pretreatment	[69]
Household waste	160-200 °C, 40 bar for 60min	Mesophilic continuous	55 – 70% COD solubilization, and 3% higher biogas production	[126]
Household waste	Mesophilic pre-hydrolysis (hydrogenogenic)	Mesophilic continuous	43 mlH ₂ /gVS from first stage, 500 mlCH ₄ /gVS from second stage which is 21% higher than single stage system	[120]
Food waste	Microwave with intensity of 7.8 °C/min	Mesophilic batch	24% higher COD solubilization and 6% higher biogas production	[63]
Food waste	Size reduction by beads mill	Mesophilic batch	40% higher COD solubilization and 28% higher biogas production.	8
Food waste	Addition of HCl until pH=2	Thermophilic batch	13 ± 7 % higher COD solubilization and 48% higher biogas production	9
	120° C, 1 bar for 30min		19 ± 3 % higher COD solubilization and 24% higher biogas production	

	HCl until pH=2 at 120° C		32 ± 8 % higher COD solubilization and 40% higher biogas production	[118]
	Pressurized until 10 bar and depressurized		12 ± 7 % higher COD solubilization and 48% higher biogas production	
	Frozen at -80° C for 6 hrs, and thawed for 30min		16 ± 4 % higher COD solubilization and 56% higher biogas production	
Food waste with polylactide	Hyper-thermophilic/thermophilic pre-hydrolysis	Thermophilic (TPAD)	15 – 18% higher methane conversion ratios than conventional thermophilic digester	[118]
Food waste	Semi-aerobic and anaerobic pre-hydrolysis	Mesophilic continuous	95% COD destruction which resulted in methane yield of 500 ml/gVS	[127]
Food waste	Thermophilic pre-hydrolysis	Thermophilic	HRT can be reduced to 10 days	[128]
Food waste	Thermophilic pre-hydrolysis	Mesophilic	61.3% VS destruction, methane yield of 280 ml/gVS	[150]
Food waste	Mesophilic pre-hydrolysis	Mesophilic continuous (2 stage system)	9% and 13% higher biogas production than mesophilic and thermophilic AD, respectively	[112]
Food waste	Mesophilic pre-hydrolysis	Mesophilic	Best results of 520 mlCH ₄ /gTS was achieved at pH=7	[113]
Food waste	Mesophilic pre-hydrolysis	Mesophilic continuous	65 mlH ₂ /gVS and 546 mlCH ₄ /gVS	[110]
Food waste	Thermophilic pre-hydrolysis	Mesophilic continuous	205 mlH ₂ /gVS and 464 mlCH ₄ /gVS	[121]
Food waste	400 pulses with electroporation	Mesophilic continuous	20 – 40% higher biogas production due to substrate cell breakage	[46]
Food waste	70 °C for 2 hours	Mesophilic continuous	2.69% higher methane production	21
	150 °C for 1 hour		11.9% higher methane production	
Food waste	Frozen/thawed and pre-hydrolysis for 7 days	Mesophilic continuous	10% higher COD solubilization, 23.7% higher biogas production	[151]
	Frozen/thawed and pre-hydrolysis for 12 days		4% higher COD solubilization, 8.5% higher biogas production	
Food waste	70 °C thermal and mesophilic pre-hydrolysis	Mesophilic continuous	91% of FW was converted to biohythane with 8% hydrogen and 83% methane	[127]

Food waste	175° C, 60min	Mesophilic batch	7. 9% decrease in biogas production	[62]
Fruits and vegetables waste			11.7% decrease in biogas production	

* NA – Not Available

2.8 Feasibility of a full scale application

This review showed pretreatment methods can enhance the AD performance. Nevertheless, the high capital cost, high consumption of energy, required chemicals and sophisticated operating conditions (maintenance, odor control etc.) are the major factor hindering their full-scale application [77, 124, 134-136]. There are only a few examples of the thermal hydrolysis process (THP) that have been applied at a full-scale such as the Cambi, Porteous, and Zimpro process, and thermochemical pretreatment methods such as Synox, Protox, and Krepro. It should be noted that these methods are all applied for WWTP sludge. Concerning OFMSW, only a few mechanical pretreatment methods (Figure 2.1), Cambi THP (Figure 2.2), and an AD with a pre-hydrolysis stage (two-stage AD, Figure 2.3) have been applied at a full scale.

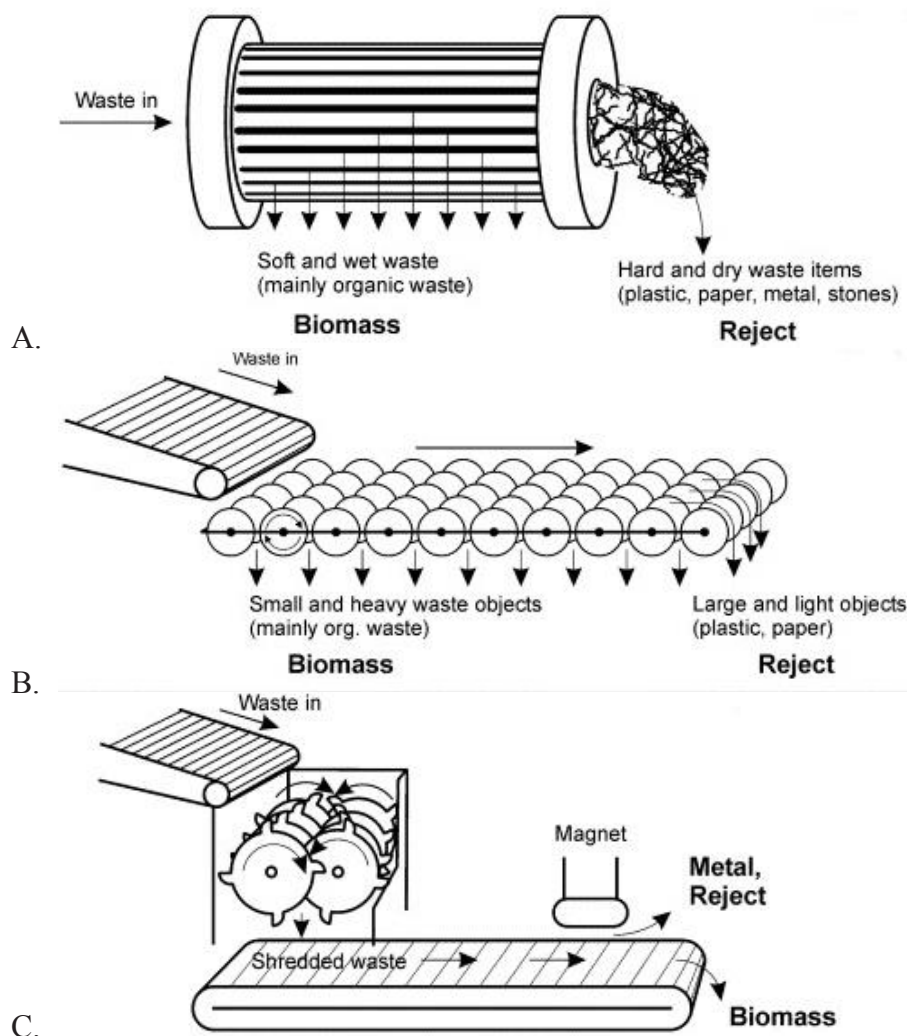
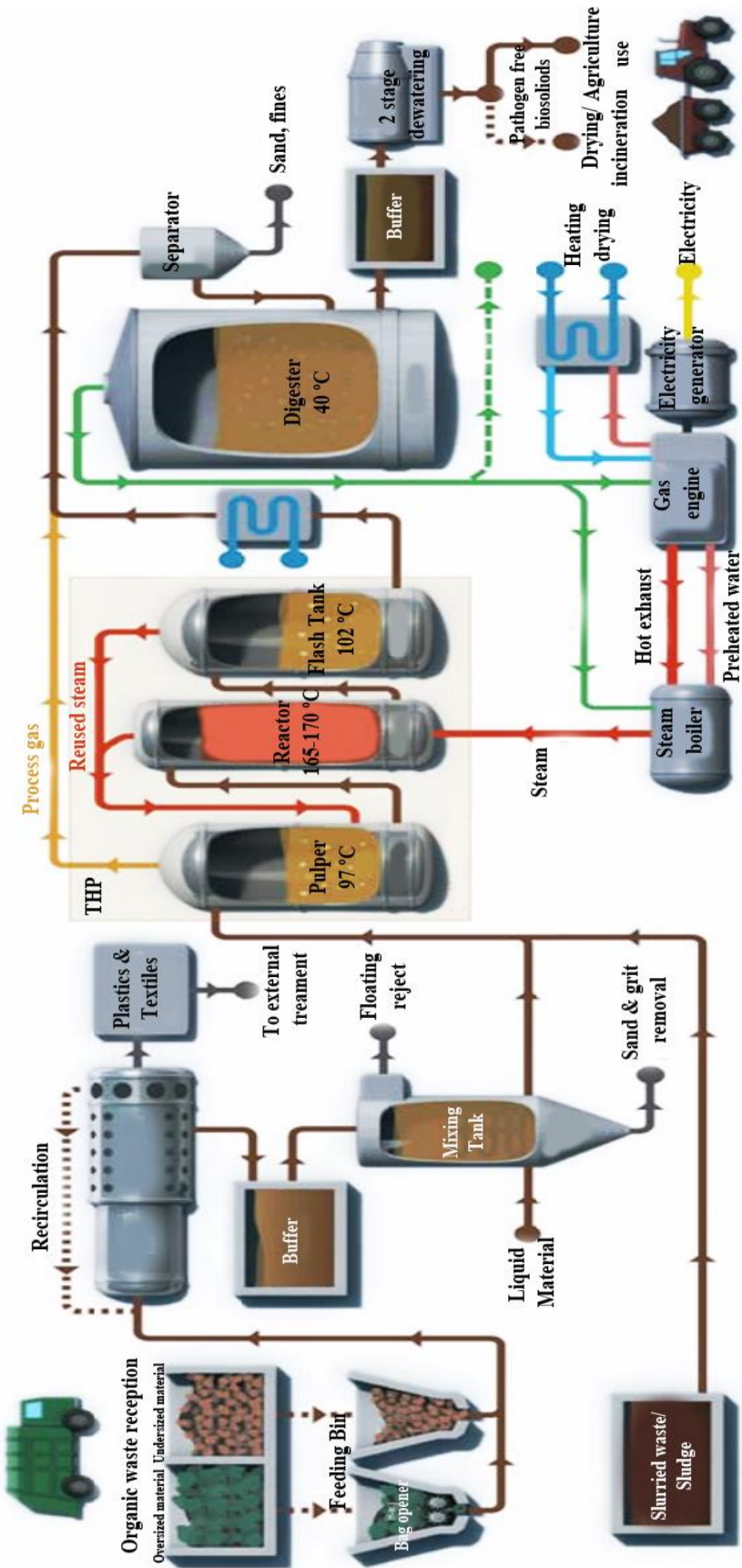

Figure 2.1: Mechanical pretreatment methods to enhance AD of OFMSW:

A) Screw press; B) Disc screen; C) Shredder with magnet

Source: Adapted from Hansen et al., (2007) [53]



A)

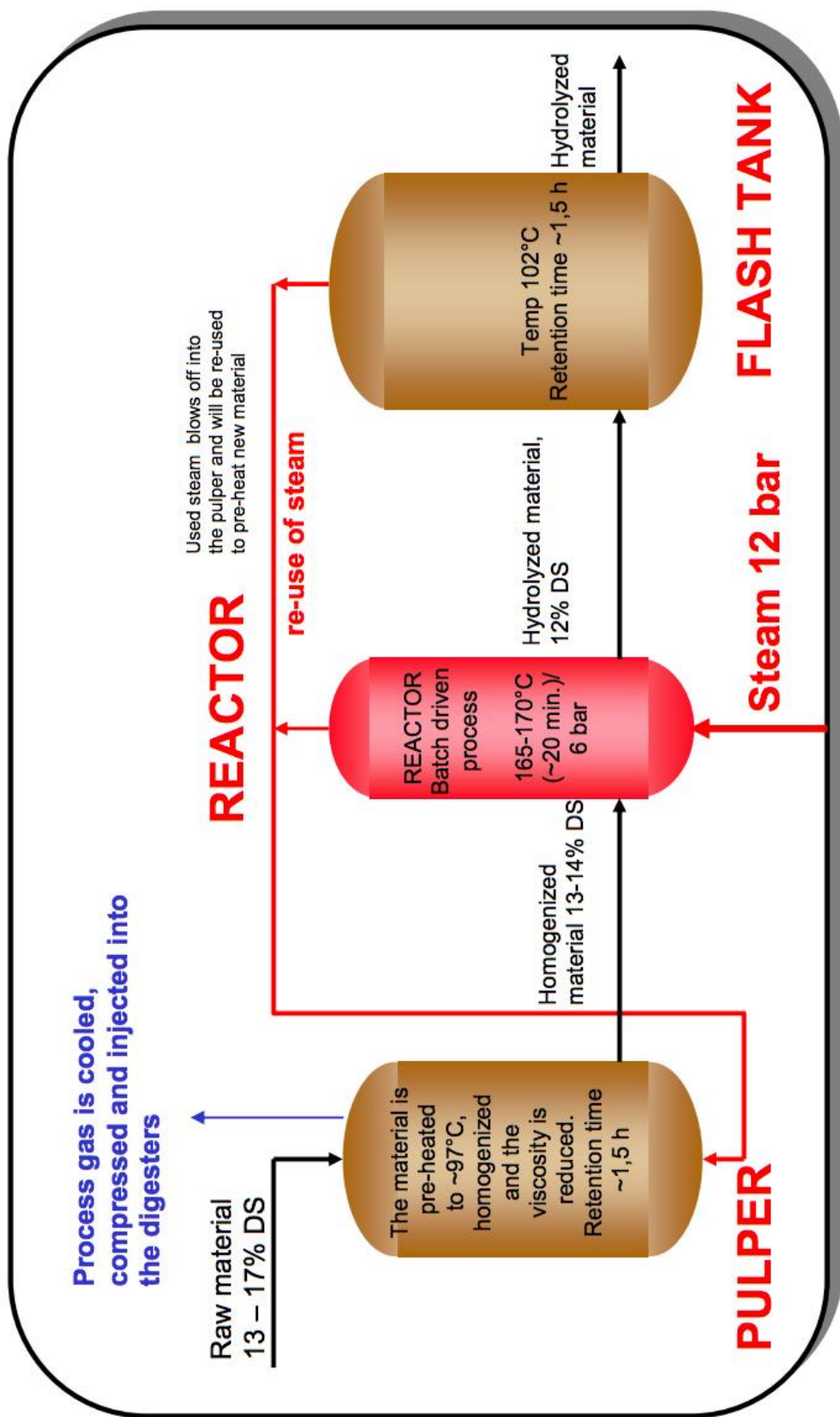

B)

Figure 2.2: Figure 2 A simplified scheme of Cambi THP; A) Cambi whole process; B) Detailed THP process

Source: Cambi official website <http://www.cambi.no>

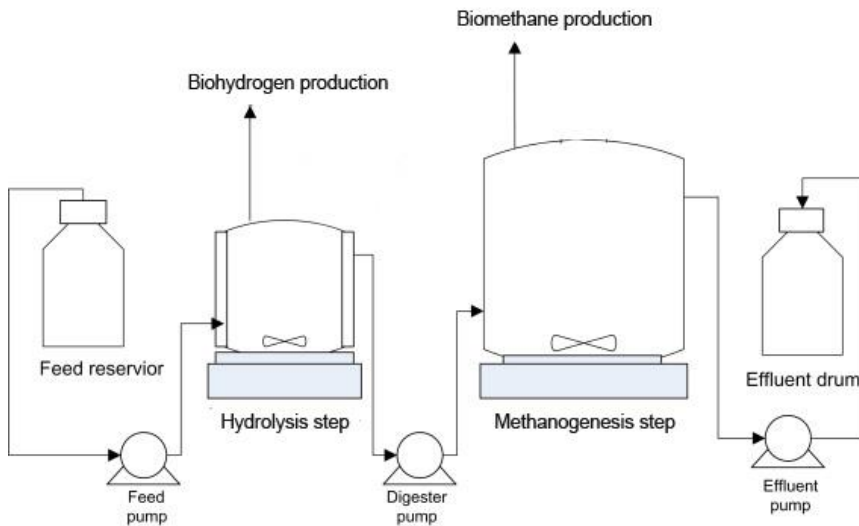

Figure 2.3: A simplified scheme of two-stage AD
 Source: Adapted from Ge et al. (2010) [95]

2.9 Energy balance

The required energy depends on the desired pretreatment temperature. If it is above 100 °C, most of the energy is utilized in water vaporization, thus making it less desirable [140]. Some researchers report that microwave heating has advantages over conventional heating due to the direct internal heating with no heat loss [22]. However, according to Mottet et al. (2010), neither microwave nor ultrasound was energy incentive for pretreating mixed sludge, as the enhanced methane yields were not enough to compensate the required energy [66]. Yang et al. (2010) reported that thermal pretreatment significantly improves the total amount of biogas produced, and the extra biogas produced can be utilized to reduce the costs through an efficient heat exchanger [137].

Escamilla-Alvarado et al. (2012) obtained a better energy balance with two-stage AD systems treating OFMSW. However, the higher gross energetic potential was due to the higher performance in the methanogenic reactor rather than the hydrogen production from the first stage [133]. Nasr et al. (2012) also estimated the energy balance of two-stage AD of thin stillage, and concluded that optimizing the two-stage AD process can increase the energy balance by 18.5% [138]. Lu et al. (2008) reported that a two-stage reactor showed a better energy balance with a surplus of 2.17 kJ/day, as compared to a single stage system for treating SS [27].

2.10 Economic feasibility

As the pretreatment of OFMSW is relatively new, its cost estimation is still based on lab-scale level data. For instance, Ma et al. (2011) estimated the net profit of various pretreatments to enhance the biogas production of FW, and obtained the best result (10-15 euro/ton FW) with less energy intensive methods (acid and freeze-thaw) [9]. However, they have not considered thermal pretreatment at lower temperatures, which could have been more economic.

The estimation of the economic feasibility of pretreatment methods based on a full-scale application has only been reported for WWTP sludge. Rittman et al. (2008) estimated the operational and maintenance (OM) cost of a full-scale AD (3300 m³) treating 380 m³ sludge

per day based on the application of focused-pulsed pretreatment technology, which could generate a benefit of 540,000 USD per year [139]. Muller (2001) reported that a rough cost estimate of pretreatment methods is between 70 and 150 US\$/tonTS for capital and OM cost [33]. Bordeleau and Droste (2011) estimated the cost of pretreatment methods to enhance the AD of sludge, based on the existing literature. They concluded that the microwave (0.0162 US\$/m³) and conventional thermal (0.0187 US\$/m³) pretreatments were cheaper than ultrasound (0.0264 US\$/m³) and chemical (0.0358 US\$/m³) methods [22]. However, the amount of sludge is an important factor to consider when estimating the pretreatment cost. Ultrasound pretreatment could be energetically feasible if a typical value of 6 kWh/m³ sludge for a full-scale application is considered [140]. If a higher energy is required, biological pretreatment such as adding hydrolytic bacteria could be a cheaper option [57, 141].

The cost estimation of conventional biological pretreatment has not been reported to date. The economical feasibility of a two-stage AD were estimated by Bolzonella et al. (2007), who reported that the pay back time for a full-scale two-stage AD system with hyper-thermophilic pre-stage followed by mesophilic reactor is 2-6 years depending on the method of sludge disposal [142].

In addition to the calculation of net benefits, local circumstances such as labor, treatment capacity, transport, collection cost, energy prices, tax, purchase tariffs, land price, market, price of digested material, disposal of residue, additional mixing and pumping should be considered as well [4, 5, 61, 132, 143-148].

2.11 Environmental aspects and sustainability of pretreatment methods

In addition to the energy balance and economic analysis, environmental consideration such as pathogen removal, use of chemicals, and the possibility for a sustainable use of the residues, impacts on human health and the environment should be considered as well when choosing a pretreatment method [4, 22, 134, 143-151]. Moreover, the anaerobic residues have the possibility to be used as soil fertilizers. Thus, the soil type as well as the potential gaseous emissions such as N₂O should be considered [149]. Carballa et al. (2012) evaluated the environmental aspects of different pretreatment methods including chemical (acidic and alkaline), pressurize-depressurize, ozonation and thermal treatment in terms of Abiotic Resources Depletion Potential, Eutrophication Potential, Global Warming Potential, Human and Terrestrial Toxicity Potential through a life cycle assessment. They concluded that the pressurize-depressurize and chemical pretreatment methods outperformed ozonation, freeze-thaw and thermal methods [36].

gives a simple sustainability assessment of pretreatment methods to enhance OFMSW was carried out based on existing literature. Pretreatment methods with higher efficiencies, and that are more economically as well as environmental friendly methods obtained more plus points. The pretreatment methods with the most number of plus points were evaluated as the most sustainable. Table 3 shows that the thermal pretreatment at low temperature and the two-stage AD system were assessed as the most sustainable methods to enhance the AD of OFMSW, followed by conventional biological methods and mechanical pretreatment. Chemical, thermochemical or thermal pretreatment methods at high temperatures could result in a higher enhancement of the AD process as compared to untreated substrates. However, the costs of the methods as well as the environmental considerations make it less desirable.

Table 2.3 Sustainability evaluation of pretreatment methods to enhance OFMSW

Pretreatment Method	Efficiency	Energy requirement and economic cost	Environmental impact
Mechanical	+++	++	+
Thermal at high temperatures (>110 °C)	+	+	+++
Thermal at low temperatures (<110 °C)	+++	+++	+++
Conventional biological methods (enzyme addition, composting etc.)	+	+++	+++
Two-stage AD (anaerobic pre-hydrolysis)	+++	+++	+++
Chemical	+++	+	+
Thermochemical	+++	+	+

2.12 Conclusion

The growing global concerns on the increasing amount of waste, energy demand, and global warming have stimulated research on the acceleration and enhancement of the AD process. Pretreatment methods can be categorized as mechanical, thermal, chemical, biological or a combination of them. Among the widely reported pretreatment methods tested at lab scale, only few mechanical, thermal and thermochemical methods were successfully applied at full scale. Based on a simple sustainability assessment, thermal pretreatment (at low temperatures) and two-stage AD systems offer more advantages as compared to the other pretreatment methods. These include: i) higher biogas yield; ii) decisive effect on pathogen removal; iii) reduction of digestate amount; iv) reduction of the retention time; v) better energy balance and vi) better economical feasibility.

2.13 Reference

1. Lier J.B., Tilche A., Ahring B.H., Macarie H., Moletta R., Dohanyos M., Hulshoff Pol L.W., Lens P., Verstraete W. (2001) New perspectives in anaerobic digestion., *Water Science and Technology*; 43: 1-18
2. Edelmann W., Baier U., Engeli H. (2005), Environmental aspects of the anaerobic digestion of the OFMSW and agricultural wastes., *Water Science and Technology*; 52: 553-559
3. Carrere H., Dumas C., Battimelli A., Batsone D.J., Delgenes J.P., Steyer J.P., Ferrer I. (2010), Pretreatment methods to improve sludge anaerobic degradability: A review, *Journal of Hazardous Materials*; 183:1-15
4. Sonesson U., Bjorklund A., Carlsson M., Dalemo M. (2000), Environmental and economic analysis of management systems for biodegradable waste, *Resources, Conservation and Recycling*; 28: 29-53
5. Esposito G., Frunzo L., Giardano A., Liotta F., Panico A., Pirozzi F. (2012), Anaerobic co-digestion of organic wastes, Review Paper, *Rev. Environ. Sci. Biotechnol*; 11: 235-341

6. Hartmann H., Moller H.B., Ahring B.K. (2004), Efficiency of the anaerobic treatment of the organic fraction of municipal solid waste: collection and pretreatment, *Waste Management Research*; 22: 35-41
7. Nielsen H JB., Seadi T. Al. (2009), Oleskowitz-Popiel P. The future of anaerobic digestion and biogas utilization, *Bioresource Technology*; 100: 5478-5484
8. Izumi K., Okishio YK., Niwa C., Yamamoto S., Toda T. (2010), Effects of particle size on anaerobic digestion of food waste, *International Bio-deterioration & Biodegradation*; 64: 601-608
9. Ma J., Duong T.H., Smits M., Vestraete W., Carballa M. (2011), Enhanced biomethanation of kitchen waste by different pretreatments, *Bioresource Technology*; 102: 592-599
10. Rafique R., Poulse T.G., Nizami A-S., Asam Z.Z., Murphy J.D., Kiely G. (2010), Effect of thermal, chemical and thermo-chemical pretreatments to enhance methane production, *Energy*; 35: 4556-4561
11. Valo A., Carrere H., Delgenes J.P. (2004) Thermal, chemical, and thermo-chemical pretreatment of waste activated sludge for anaerobic digestion, *Journal of Chemical Technology and Biotechnology*; 79:1197-1203
12. Heo N.H., Park S.C., Lee J.S., and Kang H. (2003) Solubilization of waste activated sludge by alkaline pretreatment and biochemical methane (BMP) tests for anaerobic co-digestion of municipal organic waste, *Water Science Technology*; 48:211-219
13. Fernandes T.V., Klaasse Bos G.J., Zeeman G., Sander J.P.M., Lier J.B. (2009) Effects of thermo-chemical pretreatment on anaerobic biodegradability and hydrolysis of lignocellulosic biomass, *Bioresource Technology*; 100: 2575-2579
14. Fdez-Guelfo L.A., Alvarez-Gallego C., Sales Marquez D., Romero Garcia L.I. (2011), The effect of different pretreatments on biomethanation kinetics of industrial organic fraction of municipal solid wastes (OFMSW), *Chemical Engineering Journal* 171: 411-417
15. Miah M.S, Tada C., Yang Y (2005), Aerobic thermophilic bacteria enhance biogas production, *Journal of Mater Cycles Waste Management*; 7: 48-54
16. Romano R.T., Zhang R., Teter S., McGarvey J.A. (2009), The effect of enzyme addition on anaerobic digestion of Jose Tall Wheat Grass, *Bioresource Technology*; 100: 4564-4571
17. Ferrer I., Ponsa S., Vasquez F., Font X (2008), Increasing biogas production by thermal (70°C) sludge pretreatment prior to thermophilic anaerobic digestion, *Biochemical Engineering Journal*; 42: 186-192
18. Gonzalez-Fernandez C., Sialve B., Bernet N., Steyer J.P. (2012), Thermal pretreatment to improve methane production of *Scenedesmus* biomass, *Biomass and Bioenergy*; 40: 105-111
19. Appels L., Degreve J., Bruggen B.V., Impe JV., Dewil R., (2010), Influence of low temperature thermal pre-treatment on sludge solubilization, heavy metal release and anaerobic digestion, *Bioresource Technology*; 101: 5743-5748
20. Vavilin V.A., Fernandez B., Palatsi J., Flotats X. (2008), Hydrolysis kinetics in anaerobic degradation of particulate organic materials: An overview, *Waste Management* 28: 939-951
21. Wang JY., Liu XY., Kao JCM., Stabnikova O. (2006), Digestion of pre-treated food waste in a hybrid anaerobic solid-liquid (HASL) system, *Journal of Chemical Technology and Biotechnology*; 81: 345-351
22. Bordeleau, É. L.; Droste, R. L. (2011), Comprehensive review and compilation of pretreatments for mesophilic and thermophilic anaerobic digestion, *Water Science and Technology*; 63: 291-296

23. Khalid A., Arshad M., Anjum M., Mahmood T., Dawson L (2011) The anaerobic digestion of solid waste: A Review, *Waste Management*; 31: 1737-1744
24. Skiadas I.V., Gavala H.N., Lu J., Ahring B.K. (2005), Thermal pre-treatment of primary and secondary sludge at 70° C prior to anaerobic digestion, *Water Science and Technology*; 52: 161-166
25. Elliot A. and Mahmood T. (2012), Comparison of mechanical pretreatment methods for the enhancement of anaerobic digestion of pulp and paper waste, *Water Science and Technology*; 84: 497-505
26. Raposo F., Rubia M.A.D., Fernandez-Cegri V., Borja R (2011), Anaerobic digestion of solid organic substrates in batch mode: An overview relating to methane yields and experimental procedures, *Renewable and Sustainable energy Reviews*; 16: 861-877
27. Lu J., Gavala H.N., Skiadas I.V., Mladenovska Z., Ahrin B.K. (2008), Improving anaerobic sewage sludge digestion by implementation of a hyper-thermophilic pre-hydrolysis step, *Journal of Environmental Management*; 88: 881-889
28. Neves L., Ribeiro R., Oliveira R., ALves M.M. (2006), Enhancement of methane production from barley waste, *Biomass and Bioenergy*; 30: 599-603
29. Gavala H.N., Yenal U., Skiadas I.V., Westermann P., Ahring B.K. (2003), Mesophilic and thermophilic anaerobic digestion of primary and secondary sludge. Effect of pre-treatment at elevated temperature, *Waster Research*; 37: 4561-4572
30. Rozzi A., Remigi E. (2004), Methods of assessing microbial activity and inhibition under anaerobic conditions: a literature review, *Reviews in Environmental Science and Biotechnology*; 3: 93-115,
31. Carlsson M., Lagerkvist A., Morgan-Sagastume F. (2012), The effects of substrate pretreatment on anaerobic digestion: A review, *Waste Management*; 32:1634-1650
32. Val del Rio A., Morales N., Isanta E., Mosquera-Corral A., Campos J.L., Steyer J.P., Carrere H. (2011), Thermal pretreatment of aerobic granular sludge: Impact on anaerobic biodegradability, *Water Research*; 45: 6011-6020
33. Muller J.A. (2001), Prospects and problems of sludge pre-treatment processes, *Water Science and Technology*; 44: 121-128
34. Hendriks A.T.W.M. and Zeeman G. (2009), Pretreatments to enhance the digestibility of lignocellulosic biomass: A Review, *Bioresource Technology*; 100: 10-18
35. Eggeman T., Elanderb RT., Process and economic analysis of pretreatment technologies, *Bioresource Technology*; 96: 2019–2025
36. Carballa M., Duran C., Hospido A. (2011), Should we pretreat solid waste prior to anaerobic digestion? An assessment of its environmental cost, *Environmental Science and Technology*; 45: 10306-10314
37. Esposito G., Frunzo L., Panico A., Pirozzi F. (2011), Modelling the effect of the OLR and OFMSW particle size on the performances of an anaerobic co-digestion reactor, *Process Biochemistry*; 46: 557-565
38. Kim IS., Kim DH, Hyun SH (2000), Effect of particle size and sodium ion concentration on anaerobic thermophilic food waste digestion, *Water Science Technology*; 41: 67-73
39. Hartmann H., Angelidaki I., Ahring B.K. (2000), Increase of anaerobic degradation of particulate organic matter in full-scale biogas plants by mechanical maceration, *Water Science and Technology*; 41: 145–153
40. Elliott A. and Mahmood T. (2007) Pretreatment technologies for advancing anaerobic digestion of pulp and paper biotreatment residues, *Water Research*; 41: 4273-4286
41. C.P Chua, Lee D.J., Chang B., You C.S., Tay J.H. (2002), Weak ultrasonic pre-treatment on anaerobic digestion of flocculated activated biosolids, *Water Research*; 36: 2681-2688

42. Bougrier C., Albasi C., Delgenes J.P., Carrere H. (2006), Effect of ultrasonic, thermal and ozone pretreatments on waste activated sludge solubilization and anaerobic biodegradability, *Chemical Engineering and Processing*; 45: 711-718
43. Mata-Alvarez J., Mace S., Llabres P. (2000), Anaerobic digestion of organic solid wastes. An overview of research achievements and perspectives, *Bioresource Technology*; 74: 3-16
44. Barjenbruch M., Kopplow O. (2003), Enzymatic, mechanical and thermal pretreatment of surplus sludge, *Advances in Environmental Research*; 7: 715-720
45. Shepherd T.A (2006), Pre-treatment technologies for increasing biogas potential of agricultural wastes <http://home.eng.iastate.edu/~tge/ce421-521/tshep.pdf>
46. Carlsson M., Anox Kaldnes AD. (2008), Electroporation for enhanced methane yield from municipal solid waste, ORBIT 2008 – 13-15th Oct. 2008, Wageningen, The Netherlands
47. Toreci I., Kennedy K.J., Droste R.L. (2009), Evaluation of continuous mesophilic anaerobic sludge digestion after high temperature microwave pretreatment, *Water Research*; 43: 1273-1284
48. Perez-Elvira S.I,m Nieto Diez P., Fdz-Polanco F. (2006), Sludge minimization technologies, *Reviews in Environmental Science and Bio/Technology*; 5: 375–398
49. Zhu B., Gikas P., Zhang R., Lord J., Jenkins B., Li X. (2009), Characteristics and biogas production potential of municipal solid wastes pretreated with rotary drum reactor, *Bioresource Technology*; 100: 1122-1129
50. Subramani T. and Ponkumar S. (2012), Anaerobic digestion of aerobic pretreated organic waste, *International Journal of Modern Engineering Research*; 2: 607-611
51. Davidson A. Gruvberger C., Christensen T.H., Hansen T.L., Jansen J.C. (2007), Methane yield in source-sorted organic fraction of municipal solid waste, *Waste Management*; 27: 406-414
52. Zhang Y, Banks CJ. (2013), Impact of different particle size distributions on anaerobic digestion of the organic fraction of municipal solid waste, *Waste Management* 33:297-307
53. Hansen T.L., Jansen J.C., Davidsson A., Christensen T.H. (2007), Effects of pretreatment technologies on quantity and quality of source-sorted municipal organic waste for biogas recovery, *Waste Management*; 27: 389-405
54. Bernstad A., Malmquist L., Truedsson C., Jansen J.C. (2013) Need for improvements in physical pretreatment of source-separated household food waste, *Waste Management* 33: 746-754
55. Li Y., Park S.Y., Zhu J. (2011), Solid-state anaerobic digestion for methane production from organic waste, *Renewable and Sustainable Energy Reviews* 15:821-826
56. Cesaro A., and Belgiorno V. (2013), Sonolysis and ozonation as pretreatment for anaerobic digestion of solid organic waste 20: 931-936
57. Angelidaki I., Ahring B.K. (2000), Methods for increasing the biogas potential from the recalcitrant organic matter contained in manure, *Water Science and Technology*; 41: 189–194
58. Engelhart M., Kruger M., Kopp J., Dichtl N. (2000), Effects of disintegration on anaerobic degradation of sewage excess sludge in down-flow stationary fixed film digesters, *Water Science and Technology*; 41: 171–179
59. Sandino J., Santha H., Rogowski S., Anderson W., Sung S., Isik F., (2005), Applicability of ultrasound pre-conditioning of WAS to reduce foaming potential in mesophilic digesters, *Residuals and Biosolids Management*; 17: 819-835

60. Neyens E., Baeyens J. (2003), A review of thermal sludge pre-treatment processes to improve dewaterability, *Hazardous Materials*; 98: 51-67
61. Cesaro A., and Belgiorno V. (2014), Pretreatment methods to improve anaerobic biodegradability of organic municipal solid waste fractions, *Chemical Engineering Journal* 240: 24-37
62. Liu X., Wang W., Gao X., Zhou Y., Shen R. (2012) Effect of thermal pretreatment on the physical and chemical properties of municipal biomass waste, *Waste Management*; 32: 249-255
63. Marin J., Kennedy K.J., Eskicioglu C. (2010), Effect of microwave irradiation on anaerobic degradability of model kitchen waste, *Waste Management*; 30: 1772-1779
64. Protot A., Julien L., Christophe D., Partick L. (2011), Sludge disintegration during heat treatment at low temperature: A better understanding of involved mechanisms with a multi-parametric approach, *Biochemical Engineering Journal*; 54: 178-184
65. Bien J.B, Malina G, Bien J.D, Wolny L (2004), Enhancing anaerobic fermentation of sewage sludge for increasing biogas generation, *Journal of Environmental Science and Health*; 39: 939-949
66. Mottet, J.P. Steyera, S. Délériss, F. Vedrenneb, J. Chauzyc, H. Carrère. (2009), Kinetics of thermophilic batch anaerobic digestion of thermal hydrolysed waste activated sludge, *Biochemical Engineering Journal*; 46: 169-175
67. Penaud V., Delgenes J.P., Moletta R. (1999), Thermo-chemical pretreatment of a microbial biomass: influence of sodium hydroxide addition on solubilization and anaerobic biodegradability, *Enzyme and Microbial Technology*; 25: 258-263
68. Pinnekamp J. (1989), Effects of thermal pretreatment of sewage sludge on anaerobic digestion, *Water Science and Technology*; 21: 97-108
69. Chamchoi N., Garcia H., Angelidaki I. (2011), Methane potential of household waste; batch assays determination, *Journal of Environmental Resources*; 33: 13-26
70. Climent M., Ferrer I., Baeza MM., Artola A., Vazquez F., Font X. (2007), Effect of thermal, mechanical pretreatments of secondary sludge on biogas production under thermophilic conditions, *Chemical Engineering Journal*; 133: 335-342
71. Li H., Li Chenchen, Liu W., Zou S. (2012), Optimized alkaline pretreatment of sludge before anaerobic digestion, *Bioresource Technology* 123: 189-194
72. Wang L., Mattsson M., Rundstedt J., Karlsson N. (2011), Different pretreatments to enhance biogas production, Master of Science Thesis, Halmstad University
73. Modenbach A.A and Nokes S.E (2012) The use of high-solids loading in biomass pretreatment – A Review, *Biotechnology and Bioengineering*; 109: 1430-1442
74. M.Lopez Torres, Ma. del Espinosa Llorens, (2008), Effect of alkaline pretreatment on anaerobic digestion of solid wastes, *Waste Management*; 28: 2229-2234
75. Kim J., Park C., Kim T., Lee M., Kim S., Kim S., and Lee J. (2003), Effects of various pretreatment for enhanced anaerobic digestion with waste activated sludge, *Journal of Bioscience and Bioengineering*; 95: 271-275
76. Mussoline W., Esposito G., Giordano A., Lens P. (2012), Anaerobic digestion of rice straw: A review, *Critical Reviews in Environmental Science and Technology*, DOI:10.1080/10643389.2011.627018
77. Mata-Alvarez J., (ed, 2003), *Biomethanation of the organic fraction of municipal solid wastes*, ISBN: 1 900222 14 0
78. Taherzadeh M.J, Karimi K (2008), Pretreatment of lignocellulosic wastes to improve ethanol and biogas production: A review, *International Journal of Molecular Science*; 9: 1621-1651

79. Kumar D., Murthy G.S. (2011), Impact of pretreatment and downstream processing technologies on economics and energy in cellulosic ethanol production, *Biotechnology for Biofuels* 4:27
80. Appels L., Baeyens J., Degreve J., Dewil R. (2008), Principles and potential of the anaerobic digestion of waste-activated sludge, *Progress in Energy and Combustion Science* 34: 755-781
81. Soto M, Mendez R, Kema J.M., (1993) Sodium inhibition and sulphate reduction in the anaerobic treatment of mussel processing wastewaters, *Journal of Chemical Technology and Biotechnology*; 58: 1-7
82. Basharat H. Bashir, and Asif Matin, Combined effect of calcium and sodium on potassium toxicity in anaerobic treatment processes <http://www.aseanenvironment.info/Abstract/41015401.pdf>
83. Chen Y, Chen J.J., Creamer K.S (2008), Inhibition of anaerobic digestion process: A review, *Bioresource Technology*; 99: 4044-4064
84. Kugelman I.J., McCarty P.L. (1965), Cation Toxicity and Stimulation in Anaerobic Waste Treatment, *Journal of Water Pollution Control Federation*; 37: 97-116
85. Schmidt J.E. and Ahring B.K. (1993), Effects of magnesium on thermophilic acetate degrading granules in upflow anaerobic sludge blanket (UASB) reactors, *Enzyme and Microbial Technology*; 15: 304–310
86. Zhang L. and Jahng D. (2012), Long term anaerobic digestion of food waste stabilized by trace elements, *Waste Management* 32: 1509-1515
87. Facchin V., Cavinato C., Fatone F., Pavan P., Cecchi F., Bolzonella D. (2013), Effect of trace element supplementation on the mesophilic anaerobic digestion of food waste in batch trials: The influence of inoculum origin, *Biochemical Engineering Journal* 70: 71-77
88. Weemaes M, Grootaerd H., Simens F., Verstaete W., (2000), Anaerobic digestion of ozonized biosolids, *Water Research*; 34: 2330-2336
89. Kianmehr P., Parker W., Seto P. (2010), An evaluation of protocols for characterization of ozone impacts on WAS properties and digestibility, *Bioresource Technology*; 101: 8565-8572
90. Sri Bala Kameswari K., Kalyanaraman C., Thanasekaran K. (2011), Effect of ozonation and ultrasonication pretreatment processes on co-digestion of tannery solid wastes, *Clean Technology Environmental Policy*; 13: 517-525
91. Carballa M., Manterola G., Larrea L., Ternes T., Omil F., Lema J. M., (2007) Influence of ozone pre-treatment on sludge anaerobic digestion: Removal of pharmaceutical and personal care products, *Chemosphere*; 67: 1444-1452
92. Goel R. Tokutomi T., Yasui H., Noike T. (2003), Optimal process configuration for anaerobic digestion with ozonation, *Water Science and Technology*; 8: 85-96
93. Yoem I., Lee K.R., Ahn K.H., Lee S.H (2002), Effects of ozone treatment on the biodegradability of sludge from municipal wastewater treatment plants, *Water Science and Technology*; 46: 421-5
94. Patil J.H, AntonyRaj M, Gavimath C.C. (2011), Study on effect of pretreatment methods on biomethanation of water hyacinth, *International Journal of Advanced Biotechnology and Research*; 2: 143-47
95. Ge H., Jensen PD., Batsone DJ. (2010), Pretreatment mechanisms during thermophilic-mesophilic temperature phased anaerobic digestion of primary sludge, *Water Research*; 44: 123-30
96. Ge H., Jensen PD., Batsone DJ. (2011), Increased temperature in thermophilic stage in temperature phased anaerobic digestion (TPAD) improves degradability of waste activated sludge, *Hazardous Material*; 187: 355-61

97. Ge H., Jensen PD., Batsone DJ. (2011), Temperature phased anaerobic digestion increases apparent hydrolysis rate for waste activated sludge, *Water Research*; 45: 1597-1606
98. Hartmann H. and Ahring BK. (2006), Strategies for the anaerobic digestion of the organic fraction of municipal solid waste: an overview, *Water Science and Technology* 53:7-22
99. Parawira W., Murto M., Read J.S., Mattiasson B. (2005), Profile of hydrolases and biogas production during two-stage mesophilic anaerobic digestion of solid potato waste, *Process Biochemistry*; 40: 2945-2952
100. Lim J.W. and Wang J-Y. (2013), Enhanced hydrolysis and methane yield by applying microaeration pretreatment to the anaerobic co-digestion of brown water and food waste, *Waste Management* 33: 813-819
101. Brummeler E.ten, Koster I.W (1990), Enhancement of dry anaerobic batch digestion of the organic fraction of municipal solid waste by anaerobic pretreatment step, *Biological Wastes*; 31: 199-210
102. Mshandete A. Bjornsson L., Kivaisi A.K., Rubindamayugi S.T., Mattiasson B. (2005), Enhancement of anaerobic batch digestion of sisal pulp waste by mesophilic aerobic pretreatment, *Water Research*; 39: 1569-1575
103. Melamane X., Tandlich R., Burgess J. (2007), Anaerobic digestion of fungally pre-treated wine distillery wastewater, *African Journal of Biotechnology*; 6 : 1990-1993
104. Muthangya M., Mshandete A.M., Kivaisi A.K (2009), Enhancement of anaerobic digestion of sisal leaf decortication residues by biological pre-treatment, *ARPN Journal of Agricultural and Biological Science*; 4: 66-73
105. Bouallagui H., Touhami Y., Cheikh R.B., Hamdi M. (2005), Bioreactor performance in anaerobic digestion of fruit and vegetable wastes: A Review, *Process Biochemistry* 40: 989-995
106. EPA – United States Environmental Protection Agency (2006), Biosolids Technology Factsheets, Multistage Anaerobic Digestion (Ref.No.832F06031) <http://nepis.epa.gov/>
107. Bouallagui H., Touhami Y., Cheikh R. B., Hamdi M. (2005), Bioreactor performance in anaerobic digestion of fruit and vegetable wastes, *Process Biochemistry*; 40 : 989-995
108. Blonskaja V., Menert A., Vilu R. (2003), Use of two-stage anaerobic treatment for distillery waste, *Advances in Environmental Research*; 7: 671-678
109. Riau V., De la Rubia M.A., Perez M. (2011), Assessment of solid retention time of a temperature phased anaerobic digestion system on performance and final sludge characteristics, *Journal of Chemical Technology and Biotechnology* 87:1074-1082
110. Wang X., Zhao Y. (2009), A bench scale study of fermentative hydrogen and methane production from food waste in integrated two-stage process, *International Journal of Hydrogen Energy*; 34: 245-254
111. Ueno Y., Tataru M., Fukui H., Makiuchi T., Goto M., Sode K. (2007), Production of hydrogen and methane from organic solid wastes by phase-separation of anaerobic process, *Bioresource Technology* 98:1861-1865
112. Verrier D., Roy F., Albagnac G. (1987), Two-phase methanization of solid vegetable wastes, *Biological Wastes*; 22: 163-177
113. Zhang B, Zhang SC, Shi HZ, Cai WM (2005), The influence of pH on hydrolysis and acidogenesis of kitchen wastes in two-phase anaerobic digestion, *Environmental Technology*; 26: 329-39

114. Sung S., Harikashan S. (2001), Performance of temperature-phased anaerobic digestion (TPAD) system treating dairy cattle wastes, *Tamkang Journal of Science and Engineering*; 4: 301-310
115. Riau V, Rubia M. A., Perez M. (2010), Temperature-phased anaerobic digestion (TPAD) to obtain Class A biosolids. A discontinuous study, *Bioresource Technology*; 101: 65–70
116. Schmit K.H and Ellis T.G. (2001), Comparison of temperature phased and other stage of the art process for anaerobic digestion of municipal solid waste, *Water Environment Research*; 73: 314-321
117. Lee M., Hidaka T., Hagiwara W., Tsuno H. (2009), Comparative performance and microbial diversity of hyper-thermophilic and thermophilic co-digestion of kitchen garbage and excess sludge, *Bioresource Technology*; 100: 578-585
118. Wang F., Hidaka T., Tsuno H., Tsubota J. (2011), Co-digestion of polylactide and kitchen garbage in hyper-thermophilic and thermophilic continuous anaerobic process, *Bioresource Technology*; 112: 67-74
119. Song YC., Kwon SJ., Woo JH., (2004), Mesophilic and thermophilic temperature co-phase anaerobic digestion compared with single-phase mesophilic and thermophilic digestion of sewage sludge, *Water Research*; 38: 1653-1662
120. Liu D., Liu D., Zheng R.J., Angelidaki I. (2006), Hydrogen and methane production from household solid waste in the two-stage fermentation process, *Water Research*; 40: 2230-2236
121. Chu C-F., Li Y-Y., Xu K-Q., Ebie Y., Inamori Y. (2008), A pH and temperature phased two-stage process for hydrogen and methane production from food waste., *International Journal of Hydrogen Energy*; 33: 4739-4746
122. Escamilla-Alvarado C., Rios-Leal E., Ponce-Noyola M.T., Poggi-Varaldo H.M. (2012), Gas biofuels from solid substrate hydrogenogenic-methanogenic fermentation of the organic fraction of municipal solid waste, *Process Biochemistry* 47:1572-1587
123. Shahriari H., Warith M., Hamoda M., Kennedy K.J. (2012), Anaerobic digestion of organic fraction of municipal solid waste combining two pretreatment modalities, high temperature microwave and hydrogen peroxide, *Waste Management*; 32: 41-52
124. Carrere H., Sialve B., Bernet N. (2009), Improving pig manure conversion into biogas by thermal and thermo-chemical pretreatments, *Bioresource Technology*; 100: 3690-3694
125. Wett B., Phothilangka P., Eladawy A (2010), Systematic comparison of mechanical and thermal sludge disintegration technologies, *Waste Management*; 30: 1057-1062
126. Schieder D., Schneider R and Bischof F. (2000), Thermal hydrolysis (TDH) as a pretreatment method for the digestion of organic waste, *Water Science and Technology*; 41: 181-187
127. Kim S.W., Park J.Y., Kim J.K., Cho J.H., Chun Y.N., Lee I.H., Lee J.S., Park J.S., Park DH (2000), Development of a modified three-stage methane production process using food wastes, *Applied Biochemistry and Biotechnology*; 84-86: 731-741
128. Kim JK., Oh RB., Chun YN., Kim SW. (2006), Effects of temperature and hydraulic retention time on anaerobic digestion of food waste, *Bioscience and Bioengineering*; 102: 328-332
129. Kvesitadze G., Sadunishvili T., Dudaury T., Zakariashvili N., Partshaladze G., Ugrekhelidze V., Tsiklauri G., Metreveli B., Jobava M. (2012), Two-stage anaerobic process for bio-hydrogen and bio-methane combines production from biodegradable solid waste, *Energy*; 37: 94-102

130. Kim S., Cheon H-C., Lee C-Y (2012), Enhancement of hydrogen production by recycling of methanogenic effluent in two-phase fermentation of food waste, *International Journal of Hydrogen Energy*; 37: 13777-13782
131. Chinellato G., Cavinato C., Bolzonella D., Heaven S., Banks C.J. (2013), Biohydrogen production from food waste in batch and semi-continuous conditions: Evaluation of a two-phase approach with digestate recirculation for pH control, *International Journal of Hydrogen Energy* 38 4351-4360
132. Tembhurkar A.R., Mhaisalkar V.A. (2007), Studies on Hydrolysis and Acidogenesis of kitchen waste in two phase anaerobic digestion, *Journal of the IPHE, India* 2
133. Escamilla-Alvarado C., Rios-Leal E., Ponce-Noyola M.T., Poggi-Varaldo H.M. (2012), Gas biofuels from solid substrate hydrogenogenic-methanogenic fermentation of the organic fraction of municipal solid waste, *Process Biochemistry* 47:1572-1587
134. Yadvika, Santosh, Sreekrishnan T.R., Kohli S., Rana V. (2004), Enhancement of biogas production from solid substrates using different techniques – A review, *Bioresource Technology*; 95: 1-10
135. Yadvika, Santosh, Sreekrishnan T.R., Kohli S., Rana V. (2004), Enhancement of biogas production from solid substrates using different techniques – A review, *Bioresource Technology*; 95: 1-10
136. Weiland P. (2010), Biogas production: current state and perspectives, *Applied Microbiology and Biotechnology*; 85: 849-860
137. Yang X., Wang X., Wang L. (2010), Transferring of components and energy output in industrial sewage sludge disposal by thermal pretreatment and two-phase anaerobic process, *Bioresource Technology* 101: 2580-2584
138. Nasr N., Elbeshbishy E., Hafez H., Nakhla G., Hesham El Naggar M. (2012), Comparative assessment of single-stage and two-stage anaerobic digestion for the treatment of thin stillage, *Bioresource Technology*; 111: 122-126
139. Rittmann B.E., Lee H-S., Zhang H., Alder J., Banaszak J.E., Lopez R (2008), Full-scale application of focused-pulsed pre-treatment for improving biosolids digestion and conversion on methane, *Water Science and Technology*; 58: 1895-1901
140. Perez-Elvira S., Fdz-Polanco, Plaza F.I., Garralon G., Fdz-Polanco (2009), Ultrasound pretreatment for anaerobic digestion improvement, *Water Science Technology*; 60: 1525-1532
141. Park C., Lee C., Kim S., Chen Y., Chase H.A. (2005), Upgrading anaerobic digestion by incorporating two different hydrolysis processes, *Bioscience and Bioengineering*; 100: 164-167
142. Bolzonella D., Pavan P., Zanette M., Cecchi F (2007), Two-phase anaerobic digestion of waste activated sludge: effect of an extreme thermophilic prefermentation, *Industrial Engineering and Chemistry Resources*; 46: 6650-6655
143. Salsabil M.R., Laurent J., Casellas M., Dagot C. (2010), Techno-economic evaluation of thermal treatment, ozonation and sonication for the reduction of wastewater biomass volume before aerobic or anaerobic digestion, *Journal of Hazardous Materials*; 174: 323-333
144. Barr K.G., Solley D.O., Starrenburg D.J., Lewis R.G. (2008), Evaluation, selection and initial performance of a large scale centralized biosolids facility at Oxley Creek Water Reclamation Plant Brisbane, 1579-1586
145. Müller JA, Winter A, Strükmann G. (2004), Investigation and assessment of sludge pre-treatment processes, *Water Science and Technology*; 49: 97-104
146. Fruergaard T., Astrup T. (2011), Optimal utilization of waste-to-energy in an LCA perspective, *Waste Management*; 31: 572-582

147. Berglund M., Borjesson P. (2006), Assessment of energy performance in the life-cycle of biogas production, *Biomass and Bioenergy*; 30: 254-266
148. Bolzonella D., Pavan P., Mace S., Cecchi F (2006) Dry anaerobic digestion of differently sorted organic municipal solid waste: a full scale experience. *Water Science and Technology*; 53: 23-32
149. Thorin E., Lindmark J., Nordlander E., Odlare M., Dahlquist E., Kastensson J., Leksell N., Pettersson CM. (2012), Performance optimization of the Vaxtkraft biogas production plant, *Applied Energy* 97: 503-508
150. Kim H.W., Han SK., Shin HS. (2004), Anaerobic co-digestion of sewage sludge and food waste using temperature-phased anaerobic digestion process, *Water Science Technology*; 50: 107-14
151. Stabnikova O., Liu X.Y., Wang J.Y (2008), Digestion of frozen/thawed food waste in the hybrid anaerobic solid-liquid system, *Waste Management*; 28: 1654-1659

CHAPTER 3

ENHANCED ANAEROBIC DIGESTION OF FOOD WASTE BY THERMAL AND OZONATION PRETREATMENT METHODS

This chapter has been published as:

Javkhlan Ariunbaatar, Antonio Panico, Luigi Frunzo, Giovanni Esposito, Piet NL Lens, Francesco Pirozzi (2014), Enhanced anaerobic digestion of food waste by thermal and ozonation pretreatment methods, *Journal of Environmental Management* 146:142-149



3 ENHANCED ANAEROBIC DIGESTION OF FOOD WASTE BY THERMAL AND OZONATION PRETREATMENT METHODS

Treatment of food waste by anaerobic digestion can lead to an energy production coupled to a reduction of the volume and greenhouse gas emissions from this waste type. According to EU Regulation EC1774/2002, food waste should be pasteurized/sterilized before or after anaerobic digestion. With respect to this regulation and also considering the slow kinetics of the anaerobic digestion process, thermal and chemical pretreatments of food waste prior to mesophilic anaerobic digestion were studied. A series of batch experiments to determine the biomethane potential of untreated as well as pretreated food waste was carried out. All tested conditions of both thermal and ozonation pretreatments resulted in an enhanced biomethane production. The kinetics of the anaerobic digestion process were, however, accelerated by thermal pretreatment at lower temperatures (<120 °C) only. The best result of 647.5 ± 10.6 mlCH₄/gVS, which is approximately 52% higher as compared to the specific biomethane production of untreated food waste, was obtained with thermal pretreatment at 80°C for 1.5 hours. On the basis of net energy calculations, the enhanced biomethane production could cover the energy requirement of the thermal pretreatment. In contrast the enhanced biomethane production with ozonation pretreatment is insufficient to supply the required energy for the ozonator.

3.1 Introduction

Food waste (FW) is the largest fraction of municipal solid waste (MSW). A study by the Food and Agricultural Organization (FAO, 2011) suggests that one-third of the food produced for human consumption is lost or wasted globally, which amounts to about 1.3 billion tons per year [1]. The generation of MSW and FW are predicted to increase with 51 and 44%, respectively, by 2025; and if the current integrated solid waste management is practiced, the global methane production from landfilled FW will increase from 3 to 48 Gkg by 2025, contributing to global warming [2]. While it is important to reduce the amount of FW generated, it is also necessary to develop sustainable treatment and management schemes [3, 4]. Hence, these have become an interesting research field in the scientific community.

As FW has a high moisture content and is readily biodegradable, it serves as a perfect substrate for anaerobic digestion (AD) [5, 6]. The AD process is characterized by a series of biochemical transformations brought about by microbial consortia, which convert complex macromolecules into low molecular weight compounds such as biomethane, carbon dioxide, water and ammonia [7]. Treating FW with AD produces renewable energy and yields a reduction of the amount of waste and greenhouse gas (GHG) emissions. Curry and Pillay (2009) estimated the potential energy recovery from FW based on the FAO studies, and suggested that 1.3 billion ton of waste can produce 894 TWh/year, which is approximately 5% of the total global electrical energy utilization. Nevertheless, the long retention time of the AD process is a major concern. Therefore, to accelerate the process and to enhance the biomethane production, methods for pretreating FW prior to the AD process have been developed [3, 9-12]. Various mechanical, biological, chemical, thermal pretreatment methods or a combination of them can be applied for FW. The effects of various pretreatment methods are highly different depending on the characteristics of the substrates and the pretreatment type [13]. Although according to EU regulation EC1774/2002, FW is categorized as a catering waste, and it should be pasteurized or sterilized prior to or after AD [5]. Taking this regulation into account, a thermal or a chemical pretreatment of FW could be more effective. These pretreatments could cause the degradation of complex molecules as well as the solubilization of recalcitrant particles, making the substrate more available for the anaerobes.

Thermal pretreatment is one of the easiest and most studied pretreatment methods and has already been applied at a full-scale [3, 12]. Among various chemical methods, ozonation is an attractive method, as it does not increase the salt concentration in the reactor and does not have oxidant residues in the organic waste [12]. However, previous research on thermal and ozonation pretreatment methods have been conducted mostly on wastewater sludge, and only a few studies were conducted on the organic fraction of municipal solid waste (OFMSW) such as FW. Ma et al. (2011) obtained a 24% increase of biomethane production from FW with a thermal pretreatment at 120 °C [15], whereas Liu et al. (2012) obtained a 7.9% decrease of the biomethane production from FW with thermal pretreatment at 170 °C [16]. Cesaro and Belgiorno (2013) obtained a negligible increase with ozonation pretreatment of source-separated OFMSW [17].

To the best of our knowledge, no study has been conducted on the comparison of thermal and ozonation pretreatment to enhance the AD of FW. Therefore, this research aims at investigating the effects of thermal and ozonation pretreatments. A series of batch biomethane potential (BMP) tests were conducted to investigate the effect of temperature and treatment time of thermal and ozonation pretreatments. Moreover, the net energy production from applying these pretreatment methods, which could be used for a generation of electricity and heat, was estimated.

3.2 Materials and methods

3.2.1 Substrate and inoculum

MSW is the most complex solid waste stream, as opposed to more homogenous waste streams resulting from industrial or agricultural activities [17]. The generation rate and composition of FW depends on many factors such as the region, season, culture, economic income and demographics. To reduce experimental bias due to the different compositions of collected FW, the substrate used for this research was synthetically generated based on an average compositional analysis of FW in some European countries, including UK, Finland, Portugal and Italy (Table 3.1) [18].

Table 3.1 shows the fractions of synthetic FW used in this experiment as well as the results from the study on mixed FW composition in selected European countries [18]. In order to make the substrate preparation simpler, an assumption was made to eliminate the mixed meals, drinks and snacks fraction. The calculation was made assuming that the miscellaneous fraction of FW (25.8%) contains the same 58.4% fruits/vegetables, 3.6% pasta/rice, 4.7% bread/bakery, 6.1% meat/fish, 1.4% dairy products ratio, thus resulting in the additional distribution of the miscellaneous fraction over these known fractions. Based on the final concentration of the FW composition shown in Table 1, different types of uncooked food were mixed and blended in order to obtain a homogenized synthetic FW that represents the typical FW of the above-mentioned EU countries.

Table 3.1 Composition of synthetic FW used for the experiment

% Wet weight fraction	Average from literature review (%) ^a	Distribution of miscellaneous fraction over the known ^a fraction (%)	Final concentration applied in the BMP test (%)
Fruits and vegetables	58.4	20.2	78.6 ~ 79.0
Pasta/rice/flour/cereals	3.6	1.3	4.9 ~ 5.0
Bread and bakery	4.7	1.7	6.4 ~ 6.0
Meat and fish	6.1	2.1	8.2 ~ 8.0
Dairy products	1.4	0.5	1.9 ~ 2.0
Miscellaneous	25.8	-	0
Total	100	25.8	100

^a MTT Agrifood Research Finland (2010)

3.2.2 Pretreatment of FW

EU Regulation EC1774/2002 dictates that catering waste should be pasteurized at >70 °C for at least an hour, or at >133 °C for 20 – 30 min. With respect to this regulation, pretreatment at 70 – 140°C for an hour and at 140 – 150 °C for 30 min was conducted to investigate their potential to enhance the AD of FW. Moreover, a set of experiments was subsequently conducted if a longer pretreatment time could result in a further enhancement of the biomethane production. Pretreatment times of 1.5, 4 and 8 hours were investigated at the selected temperature.

A simple oven (WTC Binder) was used for the thermal pretreatment. The FW was directly put in a 1L glass bottle GL 45 (Schott Duran), and then placed inside the oven. After the pretreatment, the bottle was cooled until room temperature and it was directly used for the BMP tests.

There are no regulations for ozonation pretreatment of FW prior to AD. An UV generator (model-Fischer) using air from a compressor was used for the ozonation pretreatment. It produces 0.6 mmol O₃ with a flow rate of 35 L/hour. The FW was placed in a vessel with inlet and outlet tubes. The ozone was introduced from the bottom for 10 – 60 min, and forced to flow out from the top, which generated 0.168 – 1.008 gO₃. Four concentrations (0.034 gO₃/gTS, 0.068 gO₃/gTS, 0.101 gO₃/gTS, 0.202 gO₃/gTS) of ozone doses were applied at room temperature prior to the BMP test. To reduce the potential ozone inhibition that can have an immediate killing effect on anaerobic microbes, the vessel was flushed with nitrogen gas after ozonation.

3.2.3 Biomethane potential test

As there is no standard protocol for BMP tests [19, 20], the most common reported method was applied [19-23]. BMP tests were conducted in a 1L glass bottle at mesophilic (32 – 34 °C) conditions. All the bottles were in duplicates and were placed on a magnetic stirrer (model-VELP) to provide continuous mixing. The substrate to inoculum (S/I) ratio was 0.5 gVS/gVS. The inoculum used for the BMP tests was from a full-scale AD plant located in Capaccio-Salerno (Italy). The plant treats the buffalo dung together with the milk whey and sewage sludge generated from the mozzarella producing industry. The expected microbial consortia responsible for the AD process would be the typical methanogens most commonly found in rumen, i.e. *Methanobrevibacter*, *Methanomicrobium*, *Methanobacterium*, and *Methanosarcina* [24].

Biomethane was measured once a day by a volumetric method as described by Esposito et al. (2012c) [23]. Each BMP test bottle was connected to an inverted 1L glass bottle containing an alkaline solution (120 gNaOH/L) to absorb the carbon dioxide. The cumulative biomethane production (CBP) was normalized to standard temperature and pressure (STP).

3.2.4 Analytical methods

Total Solids (TS), Volatile Solids (VS) and Total Kjeldahl Nitrogen (TKN) of both the synthetic FW and the inoculum were analysed according to the APHA standard methods [25]. Total proteins were calculated based on TKN, using a correction coefficient of 6.25 [26]. Total carbohydrates were determined with the phenol-sulphuric method and measured spectrophotometrically (TUV SR03210002) using glucose as standard solution [27]. Total lipids were extracted with a mixture of chloroform and methanol (1:2 by v/v), dried and weighted [28].

3.2.5 Net energy production

The net energy production was calculated based on the extra energy produced ($E_{Produced}$) and the required energy for operating the pretreatments. The extra energy from the enhanced biomethane production can be calculated as follows [13]:

$$E_{Produced} = E_{Biomethane} * V_{Biomethane} * \eta \quad (1)$$

where:

$E_{Biomethane}$ = energy content of biomethane (6.5 kWh/m³);

$V_{Biomethane}$ = extra biomethane produced due to pretreatment (m³);

η = conversion factor (0.85 for thermal energy);

The total required energy for the thermal pretreatment is the sum of the required energy ($E_{Thermal}$) to obtain the desired pretreatment temperature and the energy of the pretreatment chamber ($E_{Chamber}$) to maintain the heat [13]:

$$E_{Thermal} = C_{FW} * M_{FW} * \Delta T + C_{Water} * M_{Water} * \Delta T \quad (2)$$

where:

C_{FW} = heat capacity of dry food waste (1.92 kJ kg⁻¹ °C⁻¹);

M_{FW} = dry mass of food waste and/or TS (kg/ton FW);

C_{Water} = heat capacity of water (4.18 kJ kg⁻¹ °C⁻¹);

M_{Water} = mass of water in FW (kg/ton FW);

ΔT = temperature increase from room temperature to desired temperature (°C)

$$E_{Chamber} = \Delta T * A * (k / s) * t \quad (3)$$

where:

A = total surface area of the pretreatment chamber (m²);

s = thickness of the pretreatment chamber wall (m);

k = heat conductivity of material used of pretreatment chamber (W/m, °C);

t = pretreatment time (hours).

The density of FW ranges between 0.3 – 1 ton/m³ depending on its characteristics and compaction [27]. For simplicity, 1 ton/m³ was considered for this research. Hence, a small pretreatment chamber with 1.1 m-height and 0.55 m-radius width, made of polyurethane ($k = 0.022 \text{ W/m, } ^\circ\text{C}$) was considered for the thermal pretreatment of 1 ton FW. Since E Chamber depends on the outdoor temperature, various scenarios of ambient air temperature (-10 to 20 °C) were considered.

The total energy required for ozonation depends on the ozonation method and the characteristics of the ozonator. Ozone generation from air with the lowest energy efficiency of 2 – 3% requires 40 kWh/kgO₃ energy, whereas a high-energy efficiency of 30% requires 2.5 kWh/kgO₃ energy [28]. The average (21.3 kWh/kgO₃) of reported values was used to estimate the required energy for ozonation pretreatment. The calculation of the net energy production could not be compared with any other research, as so far no literature was found specifically referring to FW.

3.3 Results

3.3.1 Characteristics of substrate and inoculum

The results of the chemical and physical characterization of both the synthetic FW and the inoculum are shown in Table 3.2. The synthetic FW contains a high percentage ($76.5 \pm 0.7 \%$ VS) of carbohydrates, making it a suitable substrate for the AD process [30]. Values shown in Table 3.2 are the averages of the three sets of experiments and standard deviations are calculated based on the values of triplicate experiments of each set. The inoculum contains a higher amount of protein and lipids than carbohydrates. This suggests that the TS are mainly contained in the microbial biomass and very little FW substrate is available in the inoculum.

Table 3.2 Characterization of FW and inoculum used in this experiment

	FW	Inoculum
TS, %	22.2 ± 0.2	2.7 ± 0.2
VS, %	21.1 ± 0.2	1.5 ± 0.1
VS/TS, %	89.9 ± 1.9	57.0 ± 1.8
Protein, %VS	14.3 ± 1.8	59.3 ± 5.2
Lipid, %VS	9.2 ± 1.1	38.7 ± 5.3
Carbohydrate, %VS	76.5 ± 0.7	2.1 ± 0.1
TKN	$4.7 \pm 0.6 \text{ g/kg}$	$0.8 \pm 0.1 \text{ g/L}$

3.3.2 Cumulative biomethane production

3.3.2.1 Thermal pretreatment: effect of pretreatment temperature

The first set of experiments was conducted to investigate the effect of temperature (70 – 140 °C) to pretreat FW for an hour. Biomethane production of FW reached its maximum amount after 154 days, though the experiment was kept running for another 2 months to make sure the maximum was attained. The CBP curves are shown in Figure 3.1.

FW pretreated with the thermal method produced more biomethane than the untreated FW (Figure 3.1A). The CBP of pretreated FW was enhanced by 22.2 ± 1.3 , 18.9 ± 4.1 , 9.9 ± 0.6 , 7.5 ± 0.9 , $3.8 \pm 1.2 \%$ at pretreatment temperatures of 80, 100, 70, 120 and 140 °C, respectively.

The next set of BMP tests was carried out with FW pretreated at 140 – 150 °C for 30 min (Figure 3.1B). FW pretreated at higher temperatures produced less methane than the untreated FW during the initial 16 – 18 days. At the end of the experiment, the CBP of pretreated substrates were nevertheless increased by 6.9 ± 0.3 and $4.5 \pm 0.8\%$ at 140 and 150 °C, respectively. After the thermal pretreatment at 120, 140 and 150 °C for both 1 hour and for 30 min at 140 and 150 °C, the substrate turned brown.

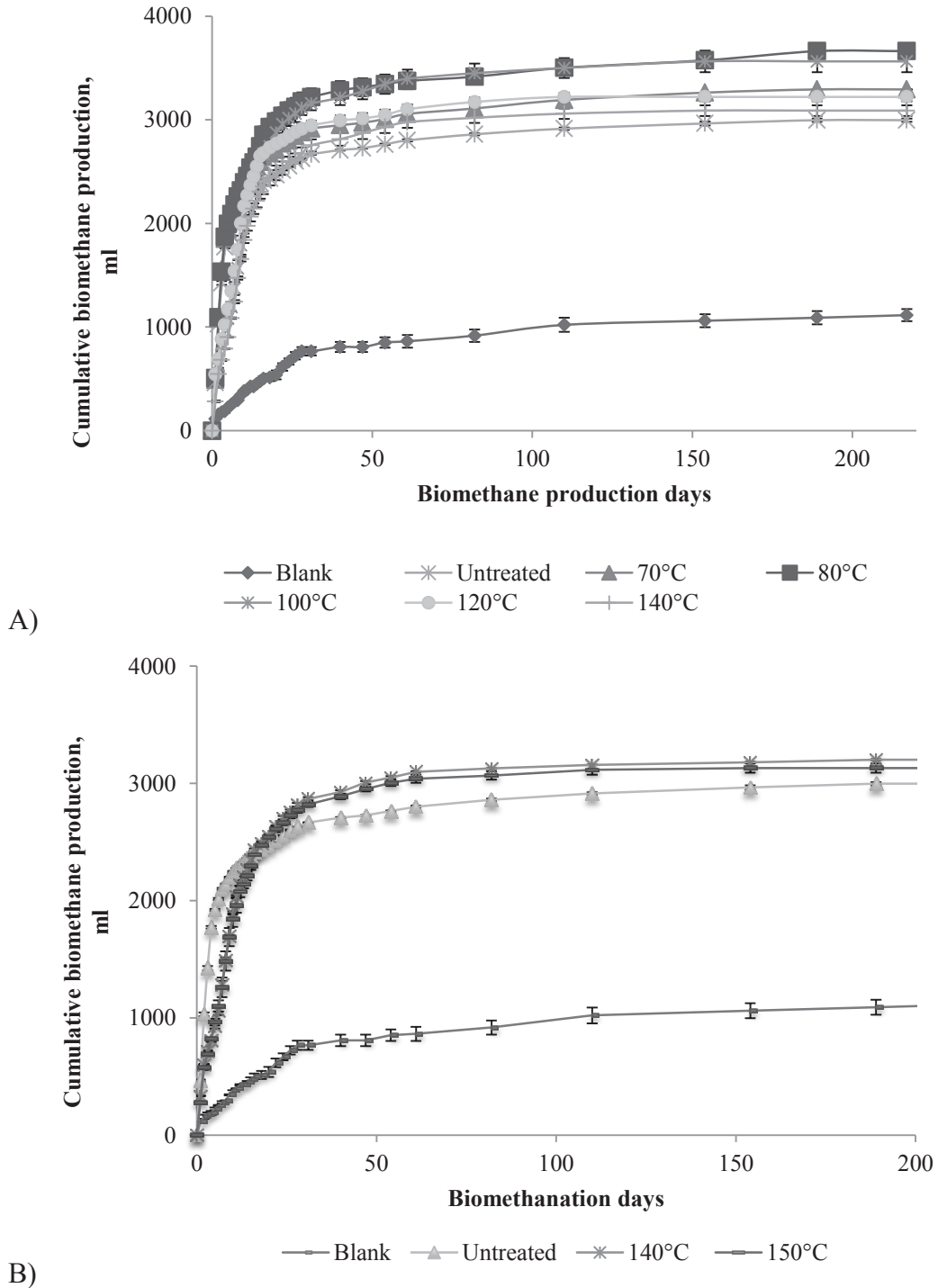

Figure 3.1: CBP curves of FW pretreated at various temperatures for (A) 1 hour and (B) 30 min

The effect of the thermal pretreatment on the AD process is particularly clear when comparing the SBP of the initial 20 days of biomethanation (Figure 3.2). Most of the organic matter (80-85%) is converted into biomethane in the initial 20 days. Figure 3.2 shows that all the thermally pretreated FW substrates have a higher SBP than the untreated FW (426.0 ± 8.5 mlCH₄/gVS). The highest SBP of 539.8 ± 8.7 mlCH₄/gVS was achieved with a pretreatment at 80 °C, followed by 516.1 ± 7.1 at 100 °C, 492.1 ± 16.3 at 120 °C and 479.3 ± 7.9 at 70 °C. The energy requirement for a thermal pretreatment higher than 100 °C is mostly utilized for evaporating the water, thus high temperatures (>100 °C) were not suitable for the pretreatment of FW due to a higher energy requirement and lower enhancement of the SBP. The BMP tests on the effect of treatment time were carried out with temperatures at 70 °C and 80 °C. Although for comparison reason, the net energy production was estimated for 120 °C.

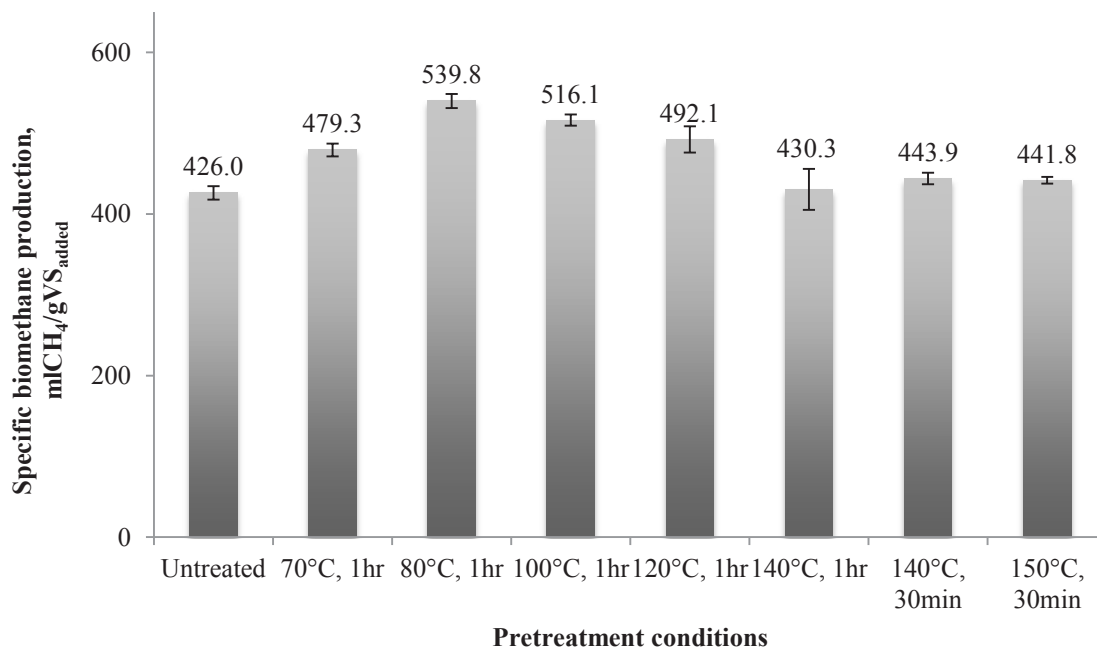

Figure 3.2: Effect of thermal pretreatment on the specific biomethane production during the initial 20 days of the BMP test

3.3.2.2 Thermal pretreatment: effect of pretreatment time

Figure 3.3 show that all pretreatment conditions applied resulted in a higher CBP when compared to the production of untreated FW. As shown in Figure 3.4 the highest SBP achieved was with 1.5 hours of pretreatment and amounted to 647.5 ± 10.6 and 510.6 ± 11.9 mlCH₄/gVS at 80 and 70 °C, respectively. It is interesting to note that after 14 days of biomethanation, the substrate treated at 80 °C for 1.5 hours showed a sudden increase in biomethane production, making up an additional increase to the CBP curve. Longer pretreatment times of 4 and 8 hours resulted in a higher SBP as compared to the untreated FW, though the accumulated increase is less when compared to the SBP of 1 hour pretreated FW at the same temperature. It is worthwhile to note that the FW pretreated at 70 °C and 80 °C for 4 and 8 hours turned light brownish.

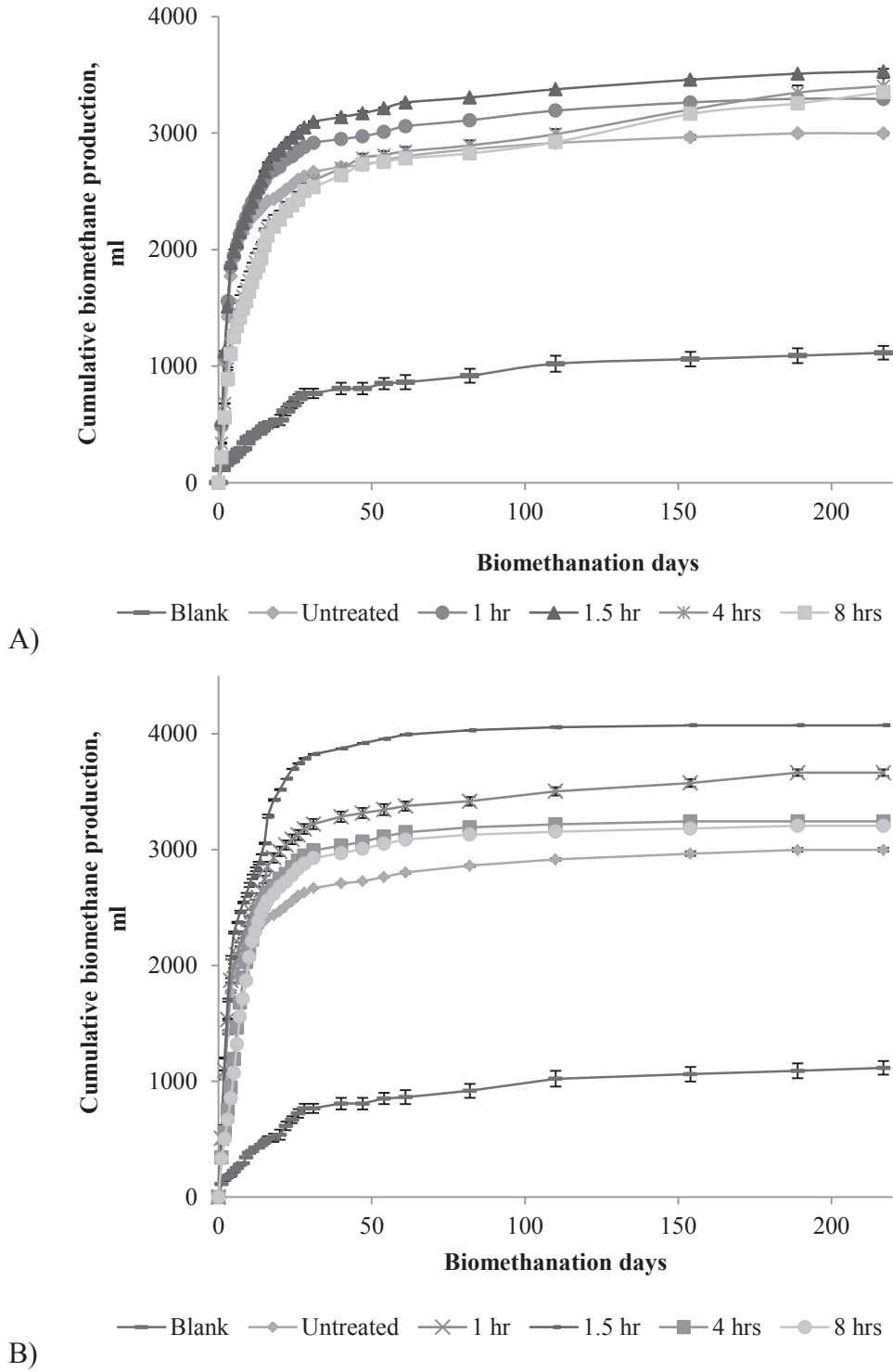

Figure 3.3: Figure 3 CBP curves of FW pretreated at (A) 70 °C and (B) 80 °C for various treatment times

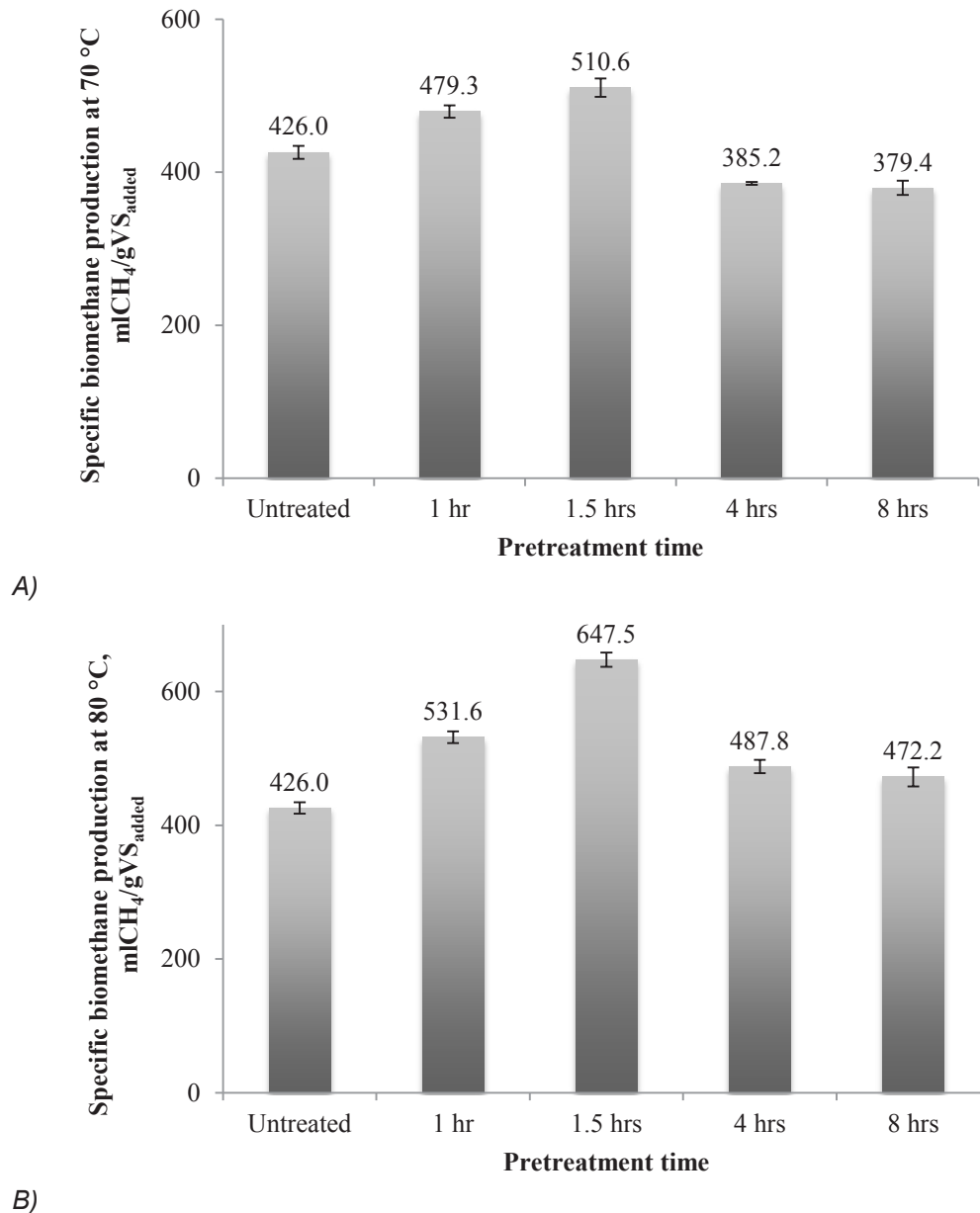

Figure 3.4: Effect of (A) 70 °C and (B) 80 °C thermal treatment time on the biomethane production during the initial 20 days of the BMP test

3.3.2.3 Ozonation pretreatment

CMP curves of the untreated and ozonated FW are shown in Figure 5. The net methane yield of untreated FW was 440.3 ± 2.6 mlCH₄/gVS, which is consistent with the first set of experiments and comparable with previous research. The BMP tests were kept on running for almost 220 days until the biomethanation was ceased. All ozonated FW produced less biomethane as compared to the untreated substrate during the initial 15 days. However, thereafter all the ozonated FW started producing higher amounts of biomethane than the untreated FW. At the end of the experiment, ozonation pretreatment resulted in 35.2 ± 1.5 , 46.4 ± 2.8 , 32.9 ± 1.8 , $22.2 \pm 1.3\%$ higher CMP at ozone doses of 0.034 gO₃/gTS, 0.068 gO₃/gTS, 0.101 gO₃/gTS, 0.202 gO₃/gTS, respectively. Similar to the thermal pretreatment at 80 °C for 1.5 hours, the ozonation pretreatment also caused an additional increase in the CBP curves (Figure 3.5) after 18 and 36 days of biomethanation.

The SBP of the 20 days biomethanation (Figure 3.5) shows that the net SBP of the untreated substrate was 420.9 ± 9.5 mlCH₄/gVS, which is consistent with the results from the first set (Figure 2). The highest SBP of $9.2 \pm 0.7\%$ was achieved with an ozone dose of 0.068 gO₃/gTS, followed by an increase of $7.8 \pm 0.1\%$ with 0.034 gO₃/gTS. Therefore, the required energy estimation was carried out for these conditions.

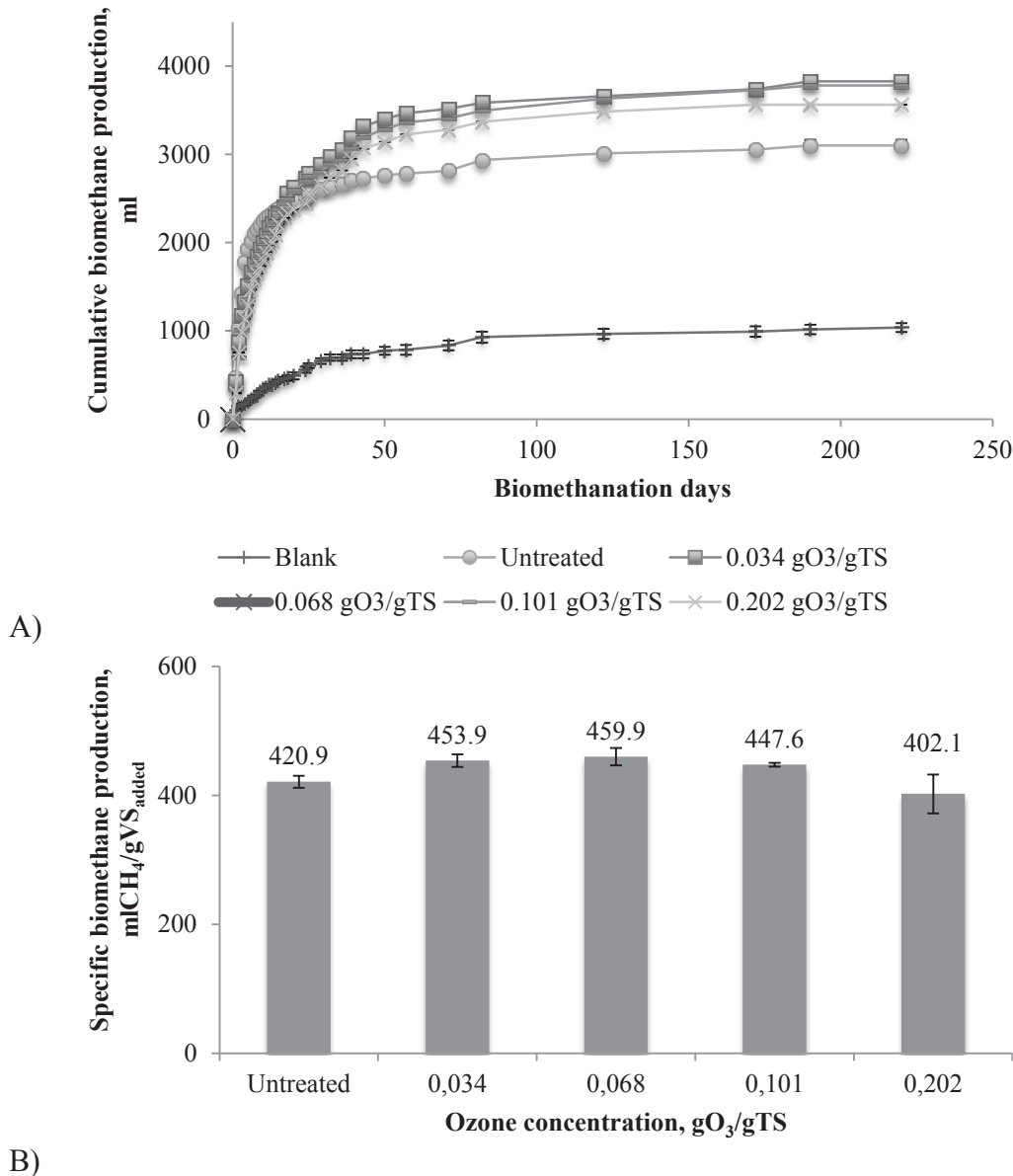

Figure 3.5: Effect of ozone on A) CBP curves; B) SBP of FW during the initial 20 days

3.3.3 Net energy production

On the basis of the BMP experimental results, thermal pretreatment at 80 °C for 1.5 hours, gave the highest enhancement of SBP. Its net energy production was calculated for different scenarios (Figure 3.6). Each scenario resulted in positive net energy production (Figure 3.6); thus the extra biomethane produced due to pretreatment is sufficient to generate the energy to apply the pretreatment. In contrast, the pretreatment at 120 °C resulted in a negative net energy production (Figure 6), suggesting the higher temperatures are not suitable for pretreating FW. Table 3 shows the calculation of the net energy production for ozonation pretreatment. Each condition resulted in a negative energy balance, which means the required

energy for ozonation pretreatment exceeds the energy that can be generated from the extra biomethane produced.

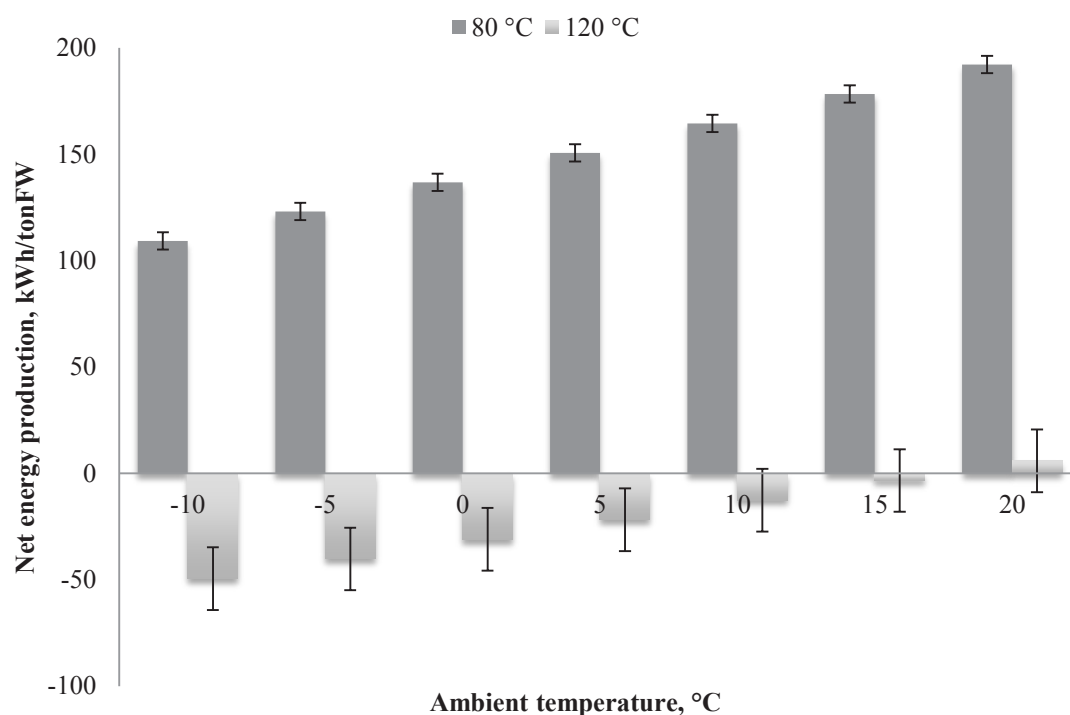

Figure 3.6: Effect of ambient air temperature on the net energy production from thermal pretreatment at 80 °C for 1.5 hour

Table 3.3 Cost benefit analysis of ozonation pretreatment

	0.034 gO ₃ /gTS	0.068 gO ₃ /gTS
Extra biomethane (V, m ³ /tonFW)	7.4 ± 0.1	8.7 ± 0.9
Extra energy (kWh/tonFW)	40.8 ± 0.5	48.2 ± 4.8
Required ozone (kgO ₃ /tonFW)	7.55	15.10
Required extra energy (kWh/tonFW)	160.77	321.54
Net energy production (kWh/tonFW)	-120.0 ± 0.5	-273.4 ± 4.5

3.4 Discussion

3.4.1 Effects of pretreatment methods

The CBP curves (Figure 3.1, Figure 3.5) of the untreated FW suggest a typical AD of a substrate rich in carbohydrates [30, 31], which agrees with the chemical analyses of the FW (Table 3.2). AD of lipids and proteins are relatively slow as compared to carbohydrates [32], and Breure et al. (1986) suggested that a complete degradation of proteins cannot be achieved in the presence of high carbohydrate concentrations [33]. Hence, the entire potential biomethane source cannot be recovered from a normal unstimulated biomethanation of complex substrates (such as FW), which contains both easily biodegradable (carbohydrates) and recalcitrant organic matter (lipids and proteins). This study, however, showed that pretreatment of FW with thermal and ozonation methods prior to AD can enhance the CBP (Figure 3.1, Figure 3.5). The results suggest that the recalcitrant organic matter was degraded to less complex substrates that are easily available for the anaerobic microbes. In this regard, focusing only on favourable C/N ratio, which is reported to be in the range of 14.7 – 36.4 [6, 9,] for the AD of FW is not suitable, as FW contains considerable amount of recalcitrant complex substances. Moreover, thermal and ozonation pretreatments disinfect the substrates, which contribute to a hospitable environment for the methanogenic consortia in the anaerobic digesters. Consequently, the more specialised microbial community could convert more organic matter to biomethane. Nevertheless, the effects of pretreatment methods were different depending on the conditions applied.

3.4.1.1 Effect of thermal pretreatment

Thermal pretreatment at all the tested conditions resulted in an enhanced CBP (Figure 3.2, Figure 3.3, Figure 3.5), which agrees with the previous research [11, 13, 30, 34]. These results indicate that the thermal pretreatment caused a deflocculation of macromolecules [34, 35], which increases the surface area of the substrates as proposed by previous research. Esposito et al. (2011b) confirmed that the increased surface area results in a better contact between the substrate and the microbial population, thus more organic matter is converted into biomethane [10].

In addition to the well-known enhancement of the CBP, this study showed the various effects of pretreatment temperature and time that was not very well explained specifically for FW by previous research. The effects of temperature and treatment time on the CBP and SBP were not linear, but parabolic (Figure 3.2, Figure 3.4). It suggests that the thermal pretreatment also caused the degradation of complex substances and/or increased the soluble organic matter, resulting the Maillard reaction, i.e. a reaction between amino acids and sugars. The product from the Maillard reaction, melanoidins, is difficult to degrade anaerobically [12, 32]. Depending on the type of carbohydrates and proteins in the substrates, the temperature range to cause Maillard reactions differ, though the colour development is an important confirmation of the reaction [14, 31]. The FW pretreated at higher (>120 °C) temperatures indeed turned brownish. Liu et al. (2012) obtained a similar conclusion with a study on the thermal pre-treatment of FW and fruit and vegetable waste at 175 °C, which resulted in a 7.9% and 11.7% decrease of the CBP, respectively, due to the formation of melanoidins [15]. Moreover, the FW pretreated at lower (70 and 80 °C) temperatures for longer times (4 and 8 hours) turned light brownish, suggesting an incomplete or mild Maillard reaction had occurred. Bougrier et al. (2006) proposed that the thermal pretreatment could also cause a reaction between the soluble carbohydrates and soluble proteins, forming amadori like

compounds [35]. These amadori compounds are the by-products of melanoidins [31, 32, 33, 34, 35]; and the formation of such compounds might have also yielded a lower enhancement of the SBP at these pretreatment conditions.

Further to the Maillard reaction, which is a confirmation of increased degradation of proteins and carbohydrates, degradation of lipid compounds was also induced by the thermal pretreatment. As suggested by Cirne et al. (2007), the major obstacle of biomethane production from lipid compounds are the long chain fatty acids (LCFA), which yields a long (6 – 10 days) lag phase [38]. However, this inhibition due to LCFA is not permanent and it takes time for the LCFA consuming anaerobic microbes to grow. Therefore, when organic substrates contain lipid compounds, the CBP curves usually illustrate a sudden increase. Figure 3.1, Figure 3.3, Figure 3.6 exhibited such a sudden increase in the CBP curves after approximately 2 weeks.

Besides the melanoidins and the LCFA inhibition due to increased degradation of the organic matter, the lower biomethane production of the thermally pretreated FW during the initial days (Figure 3.1, Figure 3.3) can be explained by volatilization of short chain organics, which are a potential biomethane source [34]. Since FW contains also the easily biodegradable, highly volatile carbohydrates, higher pretreatment temperatures ($>140\text{ }^{\circ}\text{C}$) and longer treatment times (>4 hours) can result in a loss of these fermentable sugars. Therefore, to obtain the highest amount of potential biomethane production from FW and to prevent a possible inhibition as well as a loss of potential biomethane, it is important to have a balance between the degradation of carbohydrate, lipid and protein substrates [32, 33].

3.4.1.2 Effect of ozonation pretreatment

Ozonation pretreatment yielded 22-46% enhancement of CBP (Figure 3.5), which is comparable with the previous results by Cesaro and Belgiorno (2013), who reported a 37% increase of CMP from ozonated source-separated OFMSW [13]. Even though the CBP enhancement is comparable, the ozone dose for such enhancement is much lower ($0.068\text{ gO}_3/\text{gTS}$ as compared to $0.16\text{ gO}_3/\text{gTS}$) in this research, and the CBP curves illustrate different trends. Figure 6 shows that all the ozonated FW produced less biomethane as compared to untreated FW during the initial 18 days.

Ozone is a strong oxidant, which decomposes itself into radicals that react with organic substrates in two ways: directly and indirectly [39]. The direct reaction based on the radicals of ozone can destroy the easily fermentable sugar, thus resulting in a loss of biomethane production. This effect is comparable with the more extreme thermal pretreatment conditions, e.g. higher temperatures and longer treatment times (3.4.1.1). The indirect reaction of ozone, which depends on the hydroxyl ion, causes the degradation of complex organic compounds such as lipids and proteins in FW, thus yielding a sudden increase in the biomethane production (Figure 3.4). However, a previous study on the AD of ozonated SS-OFMSW produced a higher biomethane yield from the beginning of the AD process [16], probably the SS-OFMSW used for their experiment contained a higher level of lipids and proteins. Unfortunately, the authors did not analyse the chemical content of the substrate. Based on the results obtained in this study (Table 3.3), ozonation found to be an inefficient method to enhance the AD of FW. Even though ozonation resulted in a higher CBP at all concentrations, considering the initial 20 days of AD process a high ozone dose of $0.202\text{ gO}_3/\text{gTS}$ found to be an inhibitory condition. It can be explained by a higher loss of fermentable sugar at a higher concentration of ozone, as FW contains a mostly carbohydrates (Table 3.2). Ozonation could be an attractive method for a substrate with high content of more complex and recalcitrant organics.

3.4.2 Net energy production

On the basis of the net energy estimation, the enhanced biomethane production could cover the required energy for the thermal pretreatment at 80 °C for 1.5 hours, regardless of the ambient air temperature; whereas the pretreatment at 120 °C gave a negative net energy production (Figure 3.6). Due to lack of existing literature on the subject, no comparison on the net energy production by other substrates or systems could be carried out. In order to compare with previous results, which reported a profit of 8.5 – 9.1 €/tonFW at 120 °C [13], the net energy production was converted to a net profit when considering a thermal energy cost of 0.07 €/kWh [13]. The net energy produced after thermal pretreatment could yield a profit of 7.65 – 13.45 €/tonFW at 80 °C for 1.5 hours, depending on the ambient air temperature of the plant location; whereas a pretreatment at 120 °C could have a profit of 0.41 €/tonFW only if the ambient temperature is 20 °C or higher. However, this research considered not only the required energy to reach the desired temperature, but also the energy to maintain the heat, with respect to the ambient air temperature, resulting in a lower profit as compared to other research.

3.5 Conclusions

This research investigated the thermal and ozonation pretreatment methods to enhance the biomethanation of a synthetic FW, which was prepared mimicking a typical FW in selected European countries. Based on a series of batch experiments, a thermal pretreatment at 80 °C for 1.5 hours yielded the highest enhancement (52%), amounting to 647.5 ± 10.6 mlCH₄/gVS. The enhanced biomethane production was enough to supply the required energy for the thermal pretreatment. Thermal pretreatment at a higher temperatures (>120 °C) and a longer time (> 4 hours) caused the formation of more complex substrates, melanoidins, which are difficult for anaerobes to digest. Pretreatment with a high dose of ozone (0.034 – 0.202 gO₃/gTS) resulted in a loss of fermentable sugars. Therefore, such aggressive pretreatment methods found out to be ineffective for the enhancement of AD treating FW.

3.6 Reference

1. FAO (2011) Swedish Institute for Food and Biotechnology, Global Food Losses and Food Waste – Study Conducted for the International Congress
2. Adhikari BK., Barrington S. (2006), Predicted growth of world urban food waste and methane production, *Waste Management and Research*24: 421-33
3. Carlsson M, Lagerkvist A., Morgan-Sagastume F. (2012), The effects of substrate pretreatment on anaerobic digestion: A review, *Waste Management* 32:1634-1650
4. Zaman, AU. (2013) Identification of waste management development drivers and potential emerging waste treatment technologies, *International Journal of Environmental Science and Technology*, 10 (3): 455-464
5. Kirchmayr R., Scherzer R., Baggesen DL., Braun R., Wellinger A (2003), Animal by-products and anaerobic digestion, Requirements of the European Regulation (EC) No. 1774/2002., IEA Bioenergy Task 37, Energy from biomethane and landfill gas in cooperation with Bioexcell – Biomethane Center of Excellence
6. Zhang R. El-Mashad H.M., Hartman K., Liu G., Choate C., Gamble P. (2007), Characterization of food waste as feedstock for anaerobic digestion, *Bioresource Technology* 98: 929-935
7. Mudhoo A., Kumar S. (2013), Effect of heavy metals as stress factors on anaerobic digestion processes and biogas production from biomass, *International Journal of Environmental Science and Technology* 10 (6), pp. 1383-1398

8. Curry N. and Pillay P. (2012), Biomethane prediction and design of a food waste to energy system for the urban environment, *Renewable Energy* 41: 200-209
9. Esposito G., Frunzo L., Panico A., Pirozzi F. (2011a), Model calibration and validation for OFMSW and sewage sludge co-digestion reactors, *Waste Management* 31: 2527-2535
10. Esposito G., Frunzo L., Panico A., Pirozzi F. (2011b). Modelling the effect of the OLR and OFMSW particle size on the performances of an anaerobic co-digestion reactor, *Process Biochemistry* 46: 557-565
11. Mata-Alvarez J., Mace S., Llabres P. (2000), Anaerobic digestion of organic solid wastes. An overview of research achievements and perspectives, *Bioresource Technology* 74: 3-16
12. Carrere H., Dumas C., Battimeli A., Batstone DJ., Delgenes JP., Steyer JP., Ferrer I. (2010), Pretreatment methods to improve sludge anaerobic degradability: A review, *Hazardous Material* 183:1-15
13. Ariunbaatar J., Panico A., Esposito G., Pirozzi F., Lens PNL. (2014), Pretreatment methods to enhance anaerobic digestion of organic solid waste, *Applied Energy* 15: 143-156
14. Ma J., Duong TH., Smits M., Vestraete W., Carballa M. (2011), Enhanced biomethanation of kitchen waste by different pretreatments, *Bioresource Technology* 102: 592-599
15. Liu X., Wang W., Gao X., Zhou Y., Shen R. (2012), Effect of thermal pretreatment on the physical and chemical properties of municipal biomass waste, *Waste Management* 32: 249-255
16. Cesaro A. and Belgiorno V. (2013), Sonolysis and ozonation as pretreatment for anaerobic digestion of solid organic waste, *Ultrasonics Sonochemistry* 20: 931 - 936
17. Sim EYS., Wu TY. (2010), The potential reuse of biodegradable municipal solid waste (MSW) as feedstocks in vermicomposting, *Journal of the Science and Food and Agriculture*, 90 (13), pp. 2153-2162
18. MTT Agrifood Research Finland (2010) Valorisation of food waste to biomethane, Deliverable report to 7th Framework Programme., Theme Energy.
19. Raposo F., De la Rubia MA., Fernandez-Cegri V., Borja R. (2011), Anaerobic digestion of solid organic substrates in batch mode: An overview relating to methane yields and experimental procedures, *Renewable and Sustainable Energy Review* 16: 861-877
20. Esposito G., Frunzo L., Panico A., Pirozzi F. (2012a). Enhanced bio-methane production by co-digestion of different organic wastes, *Environmental technology* 33: 2733-2740
21. Esposito G., Frunzo L., Giordano A., Liotta F., Pirozzi F. (2012b), Anaerobic co-digestion of organic wastes, *Reviews in Environmental Science and Biotechnology*, DOI: 10.1007/s11157-012-9277-8
22. Esposito G., Frunzo L., Liotta F., Panico A. Pirozzi F. (2012c), Bio-methane potential tests to measure the biomethane production from the digestion and co-digestion of complex organic substrates, *The Open Environmental Engineering Journal* 5: 1-8
23. Browne JD. and Murphy JD. (2013), Assessment of the resource associated with biomethane from food waste, *Applied Energy* 104: 170-177
24. Daquiado AR., Cho KM., Kim TY., Kim SC., Chang HH., Lee YB. (2014), Methanogenic archaea diversity in Hanwoo (*Bos Taurus coreanae*) rumen fluid, rectal dung, and barn floor manure using a culture-independent method based on *mcrA* gene sequences, *Anaerobe* 27: 77-81

25. APHA, Standard Methods for the examination of water and wastewater 21st edition ISBN: 0875530478
26. Codex Guidelines on Nutrition Labelling CAC/GL 2-1985 (Rev.1 – 1993)
27. Phillips KM., Tarragó-Trani MT., Grove TM., Grün I., Lugogo R., Harris RF., Stewart KK. (1997), Simplified Gravimetric Determination of Total Fat in Food Composites After Chloroform–Methanol Extraction, *Journal of American Oil Chemistry* 74 (2): 137-142
28. Tchobanoglous G., Theisen H., Vigil SA. (1993), *Integrated Solid Waste Management*, ISBN 0071128654, 9780071128650
29. Fridman A. (2008), *Plasma Chemistry*, Cambridge University Press, 978-0-521-84735-3 - Frontmatter
30. Neves L., Goncalo E., Oliveira R., Alves MM. (2008), Influence of composition on the biomethanation potential of restaurant waste at mesophilic temperatures, *Waste Management* 28: 965-972
31. Appels L., Degreve J., Van der Bruggen B., Van Impe J., Dewil R. (2010), Influence of low temperature thermal pre-treatment on sludge solubilization, heavy metal release and anaerobic digestion, *Bioreource Technology* 101: 5743-5748
32. Vavillin VA. Fernandez B., Palatsi J., Flotats X. (2008), Hydrolysis kinetics in anaerobic degradation of particulate organic material: An overview, *Waste management* 28: 939-951
33. Breure AM., Mooijman KA., van Andel JG. (1986), Protein degradation in anaerobic digestion: influence of volatile fatty acids and carbohydrates on hydrolysis and acidogenic fermentation of gelatin, *Applied Microbiology and Biotechnology* 24: 426-431
34. Eskicioglu C., Kennedy K.J., Droste RL. (2006), Characterization of soluble organic matter of waste activated sludge before and after thermal pretreatment, *Water Research* 40: 3725-36
35. Protot A., Julien L., Christophe D., Partick L. (2011), Sludge disintegration during heat treatment at low temperature: A better understanding of involved mechanisms with a multi-parametric approach, *Biochemical Engineering Journal*; 54: 178-184
36. Bougrier C., Delgenes JP., Carrere H. (2008), Effects of thermal treatments on five different waste activated sludge samples solubilisation, physical properties and anaerobic digestion, *Chemical Engineering Journal* 139: 236-244
37. Valo A., Carrere H., Delgene JP. (2004), Thermal, chemical and thermo-chemical pre-treatment of waste activated sludge for anaerobic digestion, *Chem Technol Biotechnol* 79:1197–1203, DOI: 10.1002/jctb.1106
38. Cirne DG., Paloumet X., Bjornsson L., Alves MM., Mattiasson B. (2007), Anaerobic digestion of lipid-rich waste – Effects of lipid concentration, *Renewable Energy* 32: 965-975
39. Carballa M., Manterola G., Larrea L., Ternes T., Omil F., Lema J.M. (2007), Influence of ozone pretreatment on sludge anaerobic digestion: Removal of pharmaceutical and personal care products, *Chemosphere* 67: 1444-1452

CHAPTER 4

EFFECTS OF THERMOPHILIC AND THERMAL PRETREATMENTS ON MESOPHILIC ANAEROBIC DIGESTION OF FOOD WASTE

This chapter has been submitted to Waste Management as:

Ariunbaatar J., Panico A., Lens P.N.L., Yeh D.H., Pirozzi F., Esposito G., Effects of thermophilic and thermal pretreatments on mesophilic anaerobic digestion of food waste



4 EFFECTS OF THERMOPHILIC AND THERMAL PRETREATMENTS ON THE MESOPHILIC ANAEROBIC DIGESTION OF FOOD WASTE

Food waste (FW) represents a source of high potential renewable energy if properly treated with anaerobic digestion (AD). Pretreating the substrates could yield a higher biomethane production in a shorter time. In this study, the effects of thermal (heating the FW in a separate chamber) and thermophilic (heating the reactor containing both FW and inoculum) pretreatments at 50, 60, 70 and 80 °C prior to mesophilic AD were studied through a series of batch experiments. Thermophilic pretreatments at higher temperatures (>55°C) and longer operating times (>12 h) yielded a higher soluble chemical oxygen demand (CODs) but had also a negative effect on the methanogenic activity. The thermal pretreatments at the same conditions resulted in a lower solubilization of COD. However, pretreatments at a lower temperature (50 °C) and a shorter time (<12 h) had a positive effect on the AD process. The highest enhancement of the biomethane production with an increase by 44 – 46% was achieved with a thermophilic pretreatment at 50 °C for 6-12 hours coupled to a thermal pretreatment at 80 °C for 1.5 hours. Based on the net energy calculations, the enhanced biomethane production is sufficient to heat up the FW for the thermal but not for the thermophilic pretreatment.

4.1 Introduction

Food waste (FW) is a mixture of organic materials derived from the processing, sorting, preparation, cooking and handling of food. On a global scale, the most common FW stabilization technology at present is still landfilling followed by biological, thermal and thermochemical conversation technologies. Landfills are strongly discouraged by legislations such as the EU Directive on Landfill (1999/31/EC) and the Waste Framework Directive (2008/98/EC), as it contributes to further environmental impacts including soil and groundwater pollution, greenhouse gas (GHG) emissions and utilization of huge land areas [1, 2]. Due to the high moisture content and easily biodegradable characteristics of FW, biological treatments (anaerobic or aerobic) are preferred over thermal or thermochemical conversation technologies. Although aerobic treatment like composting provides a promising alternative to landfill disposal, anaerobic digestion (AD) is more favourable due to the following advantages: i) production of renewable energy; ii) less land and space required; iii) more controlled emissions of GHG and toxic gases such as ketones and aldehydes; iv) digestate can be used as soil conditioner or fertilizer; and v) pathogen proliferation is prevented [3, 4, 5, 6, 7].

The AD process is mainly operated at mesophilic (30 – 40 °C) or thermophilic (45 – 60 °C) conditions. Theoretically, thermophilic AD (TherAD) is preferred over mesophilic AD (MesAD), as recent studies have shown that: i) TherAD is kinetically favoured over MesAD, thus resulting in a shorter retention time and poses a higher possibility to increase the organic loading rate [8, 9, 10], ii) TherAD has a higher rate of organic matter degradation with a higher biomethane production [11 – 13], iii) TherAD holds a better potential to inactivate pathogens, thus complying with the EU policy for elimination of pathogens as well as obtaining Class A biosolids according to the USEPA guidelines [12 – 15].

Despite the mentioned advantages, TherAD also poses the operational disadvantages such as: (i) a relatively higher operating cost; (ii) more sophisticated structural facilities; (iii) a lower process stability; and (iv) a higher susceptibility to inhibition due to sudden environmental changes [13, 16, 17]. Such disadvantages are mostly due to the acceleration of the biochemical reaction rates of the hydrolysis and acidogenesis steps producing higher amounts

of ammonia, propionate and long chain fatty acids (LCFA) that are known to cause inhibition of methanogenic activity [4, 13, 18]. Thus, in practice MesAD is preferred over TherAD for prolonged operations of AD of FW.

Coupling the advantages of TherAD with those of MesAD in the same digester could result in an enhanced process; although there has been limited study on this matter. Therefore, this research aims at investigating the effect of applying thermophilic/hyperthermophilic digestion for a shorter time to accelerate the AD process, and it was referred as thermophilic pretreatment (TPP) in this research. The results from TPP (a combination of biological and thermal pretreatment) were compared with conventional thermal pretreatment (TP), which heats the FW separately prior to MesAD.

A series of batch experiments on biomethane potential (BMP) were conducted using a synthetic FW as substrate. As both the improved hydrolysis and the pathogen inactivation are temperature and treatment time dependent [19], a first set of batch tests was carried out to identify the most favourable temperature range and treatment time of the TPP. The second series of BMP tests was conducted with the aim to compare the effects of TPP and TP when the operating condition (temperature and time) was set at the same range. Furthermore, Ariunbaatar et al. (2014a) reported that TP of FW at 80 °C for 1.5 hours resulted in a 52% higher biomethane production [3]. This scenario was also tested and compared with the results from the second set of experiments. Based on these lab-scale experimental data, the energy requirement estimate for the scenarios with the highest biomethane production enhancement by TPP and TP was done to suggest the most preferable pretreatment method to produce biomethane from FW.

4.2 Materials and Methods

4.2.1 Batch experiment

BMP tests were conducted in 1L glass bottles at mesophilic (35 ± 2 °C) conditions with a substrate to inoculum (S/I) ratio of 0.5 gVS/gVS, following the BMP protocol described by Esposito et al. (2012) [20]. Synthetic FW mimicking a typical European FW was prepared as described by Ariunbaatar et al. (2014a) and used as the substrate [3]. Various foods (fruits, vegetables, meat, rice, paste, and dairy products) were bought from the local supermarkets and blended together for homogenization. The synthetic FW slurry was prepared fresh for each set of experiments. Digestate from a full-scale anaerobic digester in Capaccio-Salerno (Italy) treating buffalo manure and dairy waste at mesophilic conditions was used as inoculum.

To perform the TPP, FW and inoculum were mixed in the BMP bottles, and then incubated at 50, 60, 70 and 80 °C for 12, 24, 36 and 48 hours. After each TPP, the temperature of the incubator was reduced to mesophilic (35 ± 2 °C) conditions. As for the TP, only FW was put inside the BMP bottles and directly placed in the oven at the selected temperatures for the desired time, which was identified during the first set of experiments. The inoculum was added in the bottles after the TP and incubated at the mesophilic condition. Each test was carried out in duplicate and prior to incubation the BMP bottles were flushed with nitrogen to provide anaerobic conditions. The daily biomethane production was measured with the liquid displacement method using a sodium hydroxide (120 gNaOH/L) to capture carbon dioxide [20]. Cumulative biomethane production (CBP) was normalized to standard temperature and pressure.

4.2.2 Analytical methods

Soluble chemical oxygen demand (CODs) was analyzed with HACH test kits following the manufacturer's instructions (HACH, Loveland, Colorado, USA). Total lipids were extracted with a mixture of chloroform and methanol (50% v/v). The extracted solution was put in aluminum caps and dried at room temperature in the laminar flow hood until constant weight. The leftover weight was used to calculate the lipids content [21]. Total carbohydrates were determined with the phenol-sulfuric method and measured with a spectrophotometer (TUV SR03210002) using glucose as standard solution [22]. Total solids (TS), volatile solids (VS) and total Kjeldahl nitrogen (TKN) were analyzed according to standard methods [23]. Total protein content was calculated based on TKN using a correction coefficient of 6.25, as suggested by CODEX Guidelines 2003 [22].

4.2.3 Energy balance

The energy balance was calculated only for the pretreatment application. The energy considerations related to the MesAD operation and the capital cost for the pretreatments were neglected in this study, because the main purpose of the study is to compare the efficiency of the pretreatment methods in terms of enhancing the biomethane production from FW. The energy balance was estimated based on the differences of the total energy requirements for the pretreatment of 1 ton FW, and the extra energy produced (E_{EXTRA}) due to the enhanced biomethane production. E_{EXTRA} and the energy requirement for thermal pretreatment (E_{TP}) were calculated as described in details by Ariunbaatar et al. (2014a) [3]. The implicit ambient temperature and the initial temperature of the FW were considered as 10 °C. The insulation material for both the digester and the pretreatment chamber for TP were assumed as polyurethane, as the thermal conductivity of it is less (0.022 W/m-K). The energy requirement for TPP (E_{TPP}) was estimated for the whole digester. Considering the substrate to inoculum ratio of 0.5gVS/gVS the digester volume was calculated as 31 m³, which contains 1 ton of FW. Since TPP is conducted in the same digester, the initial temperature was assumed to be equal to the digester operating temperature (35 ± 2 °C).

4.3 Results

4.3.1 Characterization of substrate and inoculum

The physical and chemical properties of both the synthetic FW and the inoculum are shown in Table 4.1. Synthetic FW contains mostly carbohydrates (71.5 ± 0.5 % VS) and a considerable amount of lipids (10.6 ± 0.3 % VS) and proteins (17.2 ± 0.8 % VS), whereas the inoculum contains a higher amount of proteins (56.5 ± 2.5 % VS) and lipids (40.7 ± 3.7 % VS) than carbohydrates (3.1 ± 0.5 % VS). These characterization results suggest that the FW is a suitable substrate for AD [4, 9] and the VS in the inoculum mainly contained microbial biomass [3].

Table 4.1 Characterization of FW and inoculum

	FW	Inoculum
TS, %	23.7 ± 0.8	2.24 ± 0.1
VS, %	21.6 ± 0.3	1.43 ± 0.3
Proteins, %VS	17.2 ± 0.8	56.5 ± 2.5
Lipids, %VS	10.6 ± 0.3	40.7 ± 3.7
Carbohydrates, %VS	71.5 ± 0.5	3.1 ± 0.5
TKN	4.0 ± 0.1 g/kg	1.3 ± 0.1 g/L

4.3.2 Effect of TPP on temperature and treatment time on Mes.AD

The CBP curve plateau was obtained after 20 – 25 days of incubation, although the methanogenic activity was completely ceased reaching zero production after 134 days (Figure 4.1). TPP at 50 °C resulted in the highest biomethane production during both the TPP and mesophilic biomethanation stage, yielding 44.6 (± 0.6), 36.1 (± 4.5), 31.1 (± 0.8), 15.7 (± 0.8)% higher CBP than the control (i.e. MesAD of untreated FW) with 12, 24, 36, and 48 hours pretreatment time, respectively (Figure 4.1A). FW pretreated at 60 °C produced a higher amount of biomethane as compared to the control during the TPP, but the biomethane production decreased instantly as soon as the temperature was changed to mesophilic conditions (Figure 4.1B). At the end of the BMP test, the CBP of FW pretreated at 60 °C for 12, 24, 36 hours was higher by 28.0 ± 1.6, 16.2 ± 0.9, 1.9 ± 0.6% respectively, while pretreatment for 48 hours resulted in 16.9 ± 2.8% lower CBP as compared to the control. Pretreatment at 70 °C yielded a lower biomethane production than the control for any length of the pretreatment time investigated (Figure 4.1C), while 80 °C pretreatment resulted in no biomethane production at all.

The highest biomethane production rates of the FW pretreated with TPP were achieved with 12 hours pretreatment at all temperatures tested. Figure 4.1 also shows that most of the organics (85 – 95%) are converted into biomethane during the initial 20 days of biomethanation, which is also considered as the typical hydraulic retention time (HRT) for AD [3]. Hence, the net specific biomethane productions (SBP) of the control and all 12 hours TPP scenarios were calculated using the data obtained during the initial 20 days (Figure 4.2).

A)

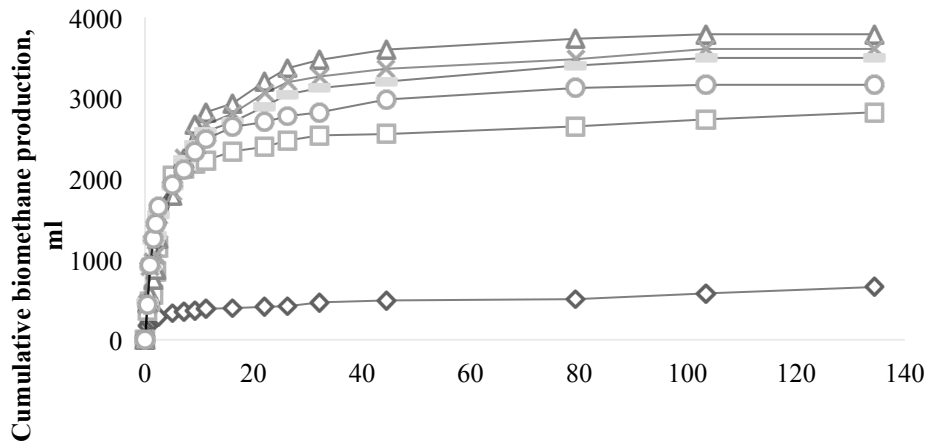

B)

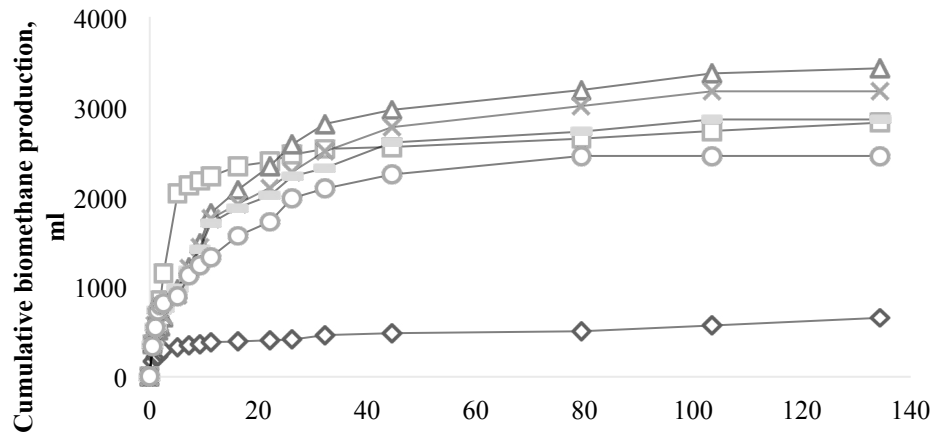

C)

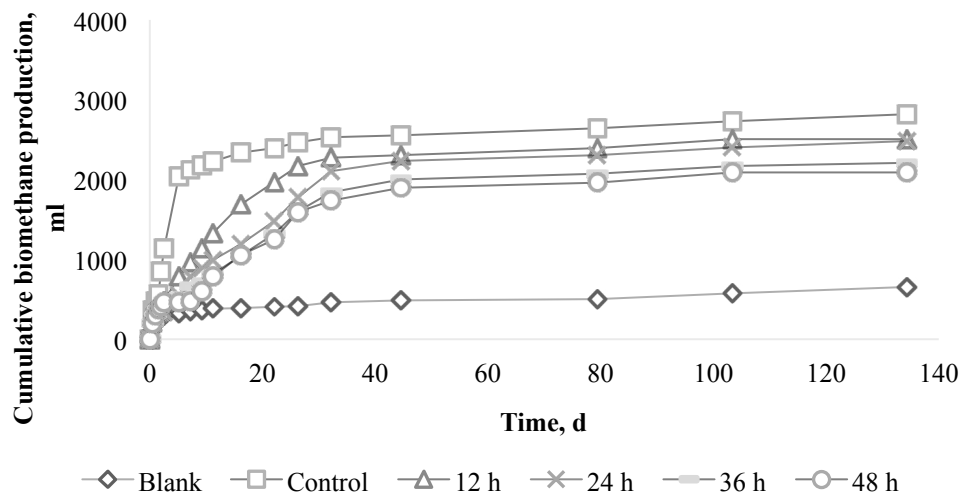

Figure 4.1.: Cumulative biomethane production curves of FW pretreated with: A) TPP at 50 °C; B) TPP at 60 °C; C) TPP at 70 °C

The SBP of the control was $407.4 (\pm 7.8)$ mlCH₄/gVS_{added}, and was enhanced by 41.1 (± 4.7)% with a TPP at 50 °C, while a TPP at higher temperatures (60 and 70 °C) resulted in a decrease of SBP (Fig. 2). As the decrease of SBP at 60 °C pretreatment is negligible (2%), the preferable experimental condition for TPP was chosen as 50 – 60 °C for 12 hours. Since the main purpose of TPP is not only to enhance the hydrolysis through enzymatic and thermal processes [24], but also to eliminate the pathogens, a minimum of 12 hours of TPP was desirable. A TPP time lower than 12 hours could inactivate the pathogens initially but may not permanently eliminate them [25, 26]. However, the possibility to enhance MesAD while saving energy by reducing the pretreatment time until 6 hours at the preferred temperature range was also investigated during the second series of experiments.

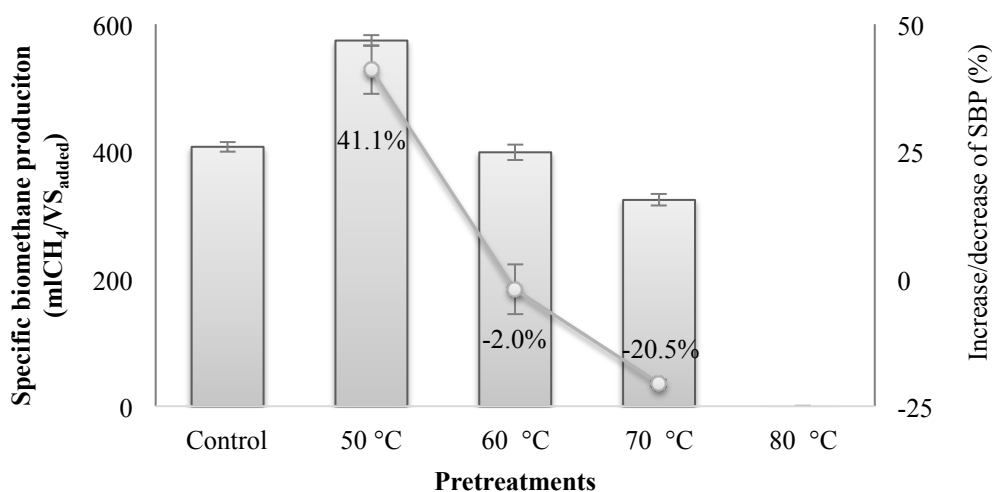

Figure 4.2: Temperature effect of TPP for 12 hours on SBP at day 20

4.3.3 Comparison of the TPP and TP efficiencies

Figure 4.3 shows the CBP curves from AD of FW pretreated with TPP and TP at 50, 55, and 60 °C for 6 and 12 hours. All the tested scenarios except for TPP at 60 °C resulted in a higher biomethane production than the control. Similar to the first set of experiments, after 20 – 25 days of biomethanation the CBP curves obtained a plateau. Hence, the experiments were stopped and the SBP was calculated for the initial 20 days as well (Figure 4.4). The SBP of the control was 413.90 ± 4.87 mlCH₄/gVS_{added}, which is consistent with the previous set of experiments.

The highest enhancement ($46.39 \pm 8.70\%$) of the SBP was obtained with a TP at 80 °C for 1.5 hours. It agrees with the results obtained by Ariunbaatar et al. (2014a) [3]. Figure 4.4 also illustrates that the highest SBP enhancement of 44 – 46% was obtained with a TPP at 50 °C for 6 and 12 hours; but the same condition with TP resulted in a lower (12 – 39%) enhancement of the SBP. Both TPP and TP at 55 °C yielded a higher SBP than the control, but lower than those conducted at 50 °C. When the effects of pretreatment times are compared, a negligible difference can be seen between 6 and 12 hours. It can also be observed that the enhancement of SBP with TPP is higher than those with TP at both 50 and 55 °C, which suggests that TPP performs better than TP. However, at a temperature higher than 60 °C the pretreated FW with TP had a higher SBP than the control, while TPP had a negative effect on the biomethane production.

A)

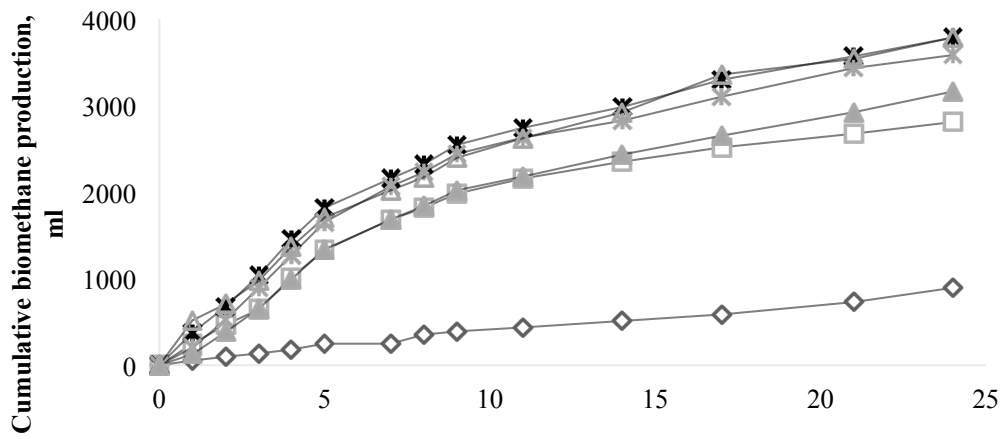

B)

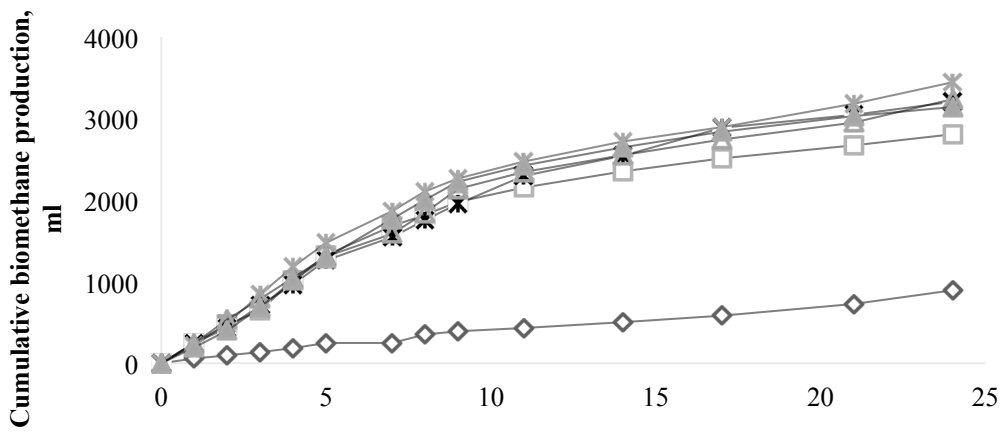

C)

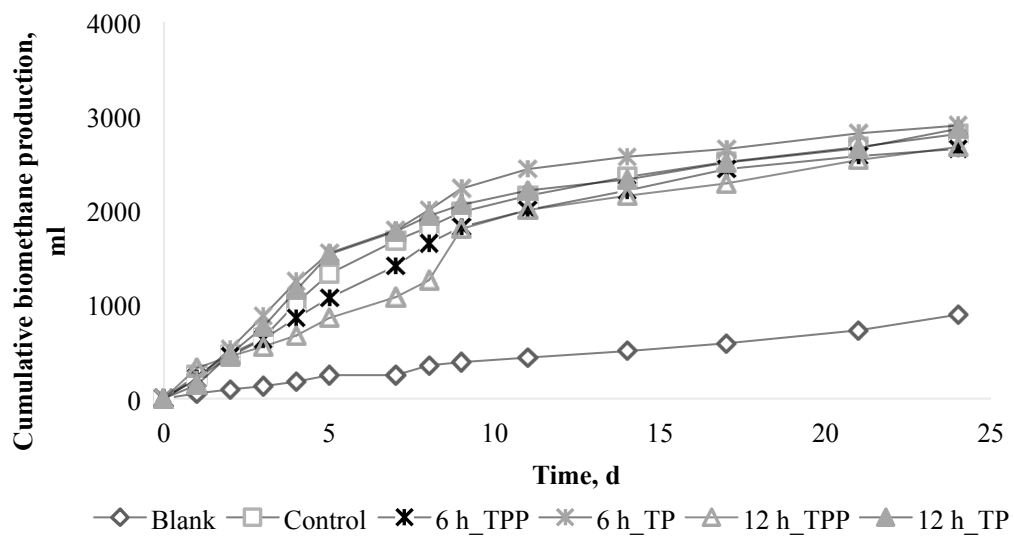

Figure 4.3 CBP curves of FW pretreated with TPP and TP at: A) 50 °C; B) 55 °C; 60 °C

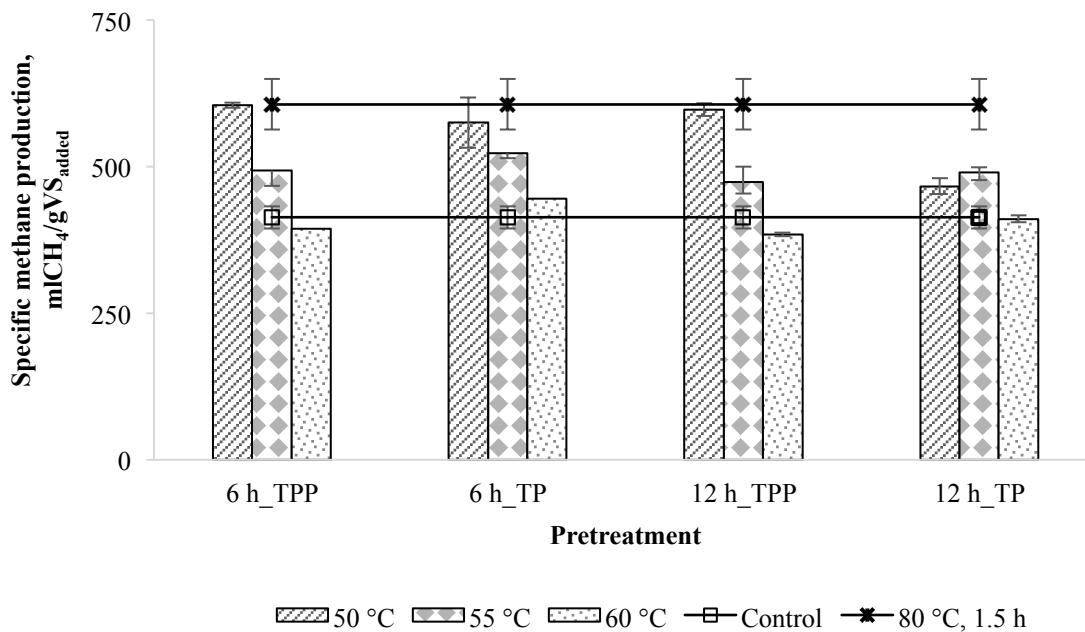

Figure 4.4: Effect of TP and TPT on CBP curves: A) 50 °C; B) 55 °; and C) 60 °C

To investigate the effects of TPP and TP on organic material removal by AD the CODs of each bottle was analysed after the pretreatment methods and BMP tests. Figure 4.5A shows that TPP temperature and digestion time has a direct correlation with COD solubilisation, whereas such intensive TP resulted in a reduction of CODs. Figure 4.5B shows that most of the digestates had a similar concentration of CODs as the blank (1934 ± 34 mg/L) and the control (2284 ± 4 mg/L) after the BMP tests.

In detail, both TPP and TP at 50 and 55 °C resulted in a 20 – 59% higher COD solubilisation than the control, and after 25 days of digestion all digestates except for the one produced by TPP at 55 °C for 12 hours showed a similar level of CODs concentration. Even though higher temperatures (55 and 60 °C) and a longer treatment times (>12 hours) of TPP caused a higher COD solubilization as shown in Figure 4.5A, the methanogenic activity was inhibited, and thus the CODs concentration at the end of the BMP test was 16 – 60% higher than the control. On the contrary, the TP at 60 °C resulted in a loss of organics yielding a 1 – 9 % lower CODs. It is also interesting to note that TP at 80 °C for 1.5 hours yielded the highest COD solubilization that at the end of the BMP test was almost completely consumed, as the final CODs concentration was only 144 (± 72) mg/L higher than the control.

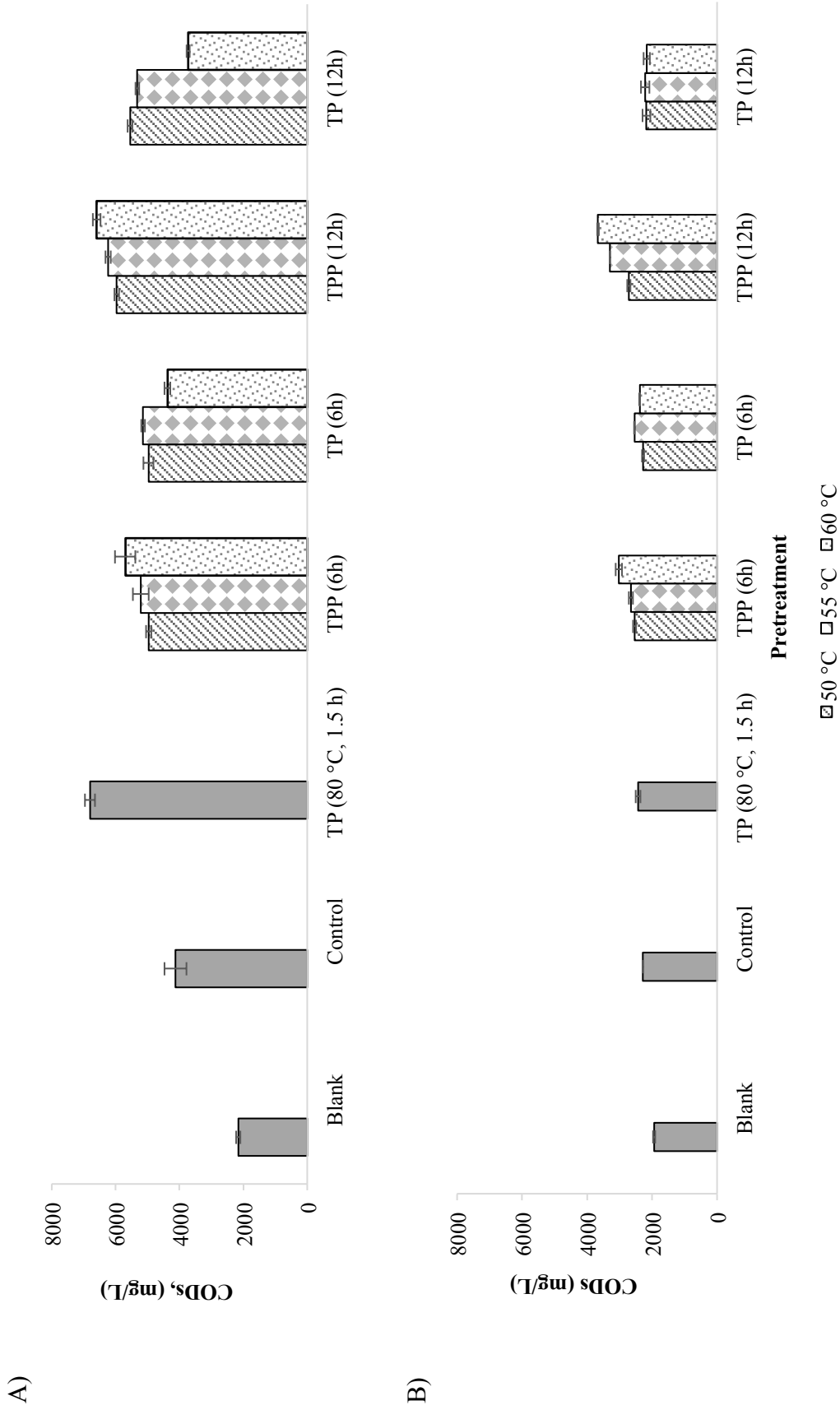

Figure 4.5: Effect of TPP and TP temperature and treatment time effect of on the CODs concentrations: A) CODs after pretreatment; B) CODs after BMP tests

4.4 Discussions

4.4.1 Effects of pretreatment methods

This study showed that the advantages of a faster hydrolysis of TherAD and a stable operation of MesAD can be achieved in the same digester (Figure 4.2, Figure 4.4). Compared to the sophisticated two-stage AD system, the temperature-phased anaerobic digestion (TPAD), TPP followed by MesAD prevents the possible reduction of the symbiotic activities between anaerobic microbes (hydrolytic/acidogenic and methanogenic) and thus this system preferred over TPAD [27, 28, 29].

The temperature and treatment time of TPP play an important role for the enhancement/inhibition of MesAD. It had a positive effect on the MesAD (Figure 4.1A, Figure 4.3A and Figure 4.3B) both during the pretreatment and the MesAD stage only at 50 – 55 °C. This can be attributed to the increased solubilisation of organic solids as compared to the control test (Figure 4.5A), making the substrates more available for the anaerobes.

TPP could have caused a shock in the system, which enhanced the activities and the survival skills of the microbial community. The heating of the reactor could also result in a deactivation of possible competitors to the specific anaerobes for the digestion of FW. Therefore, the enhancement of MesAD process could be due to the improved stronger microbial community. Such improved microbial community was also obtained with a focused pulse shock pretreatment by Zhang et al. (2009) [7], and with a repeated pulse feeding at mesophilic conditions by Vrieze et al. (2013) [30].

Chen et al. (1983) suggested that 9% of the microbial population in a mesophilic inoculum consists of facultative thermophiles. Hence the increased solubilization of COD (Figure 4.5) could also be due to their activation [31]. During TPP at 60 °C the methanogenic activities were higher than the control, but reduced as soon as the temperature was decreased, which agrees with the results obtained by Chachkhiani et al. (2004) [32], who showed that thermophiles adapt to MesAD more hardly than mesophiles to TherAD.

At an 80 °C, the anaerobic microbial activity was completely ceased (Figure 4.2), suggesting that no indigenous obligate thermophilic methanogens were present in the inoculum [11]. Also the high concentration of CODs in the digestate at the end of BMP tests (Figure 4.5A) suggests that the decreased methanogenic activity was probably due to the imbalance between the acidogens and methanogens [17, 24, 33].

When a conventional TP was applied at the same conditions as the TPP, all scenarios but at 50 °C yielded a lower SBP as compared to the TPP (Figure 4.4). As suggested by Ariunbaatar et al. (2014a), intensive TP with longer pretreatment time at higher temperatures resulted in a loss of easily fermentable sugars (Figure 4.5A) [3]. However, at lower temperatures (50 and 55 °C), the CODs concentration was similar to the TPP (Figure 4.5A), whereas SBP was higher than the control but lower than the TPP (Figure 4.4). This result can be attributed to the increased microbial activity after the TPP.

4.4.2 Energy efficiency

Table 4.2 shows that the extra energy produced by applying the pretreatment methods ranges between 219 – 229 kWh/tonFW. The energy requirement for TPP (ETPP) is much higher than TP (ETP), and thus a TP is more favourable than a TPP in terms of energy efficiency.

ETPP was calculated for the whole digester (31 m³) containing 1 ton of FW, whereas ETP was estimated for a separate pretreatment chamber containing 1 ton of FW. Also the high-energy requirement for TPP is due to the high water content in the digester. The main energy requirement (> 98%) for TPP was the energy to heat up the digester, and a very low amount of heat is lost. Hence, if such a TPP is applied for a MesAD with higher solids content, the extra energy produced could be enough to make the process self-sufficient, assuming the enhancement of the biomethanation process would be high as well. As there is limited research on the TPP of FW, the total energy requirement was calculated per ton of wet biowaste. The total energy requirement was 20.4 – 20.6 kWh, which is less than the results (29 – 31 kWh/wet ton of sewage sludge) of Ziemba and Paccia (2011) [15]. The relatively lower energy requirement could be due to the different experimental conditions of the pretreatment.

Table 4.2 Energy requirements for the pretreatment methods

	Unit	TTP 50 °C 6 h	TTP 50 °C 12 h	TP 80 °C 1.5 h
Extra biomethane	m ³ /tonFW	41.3 ± 0.9	39.7 ± 0.9	41.5 ± 5.8
Extra energy produced	kWh/tonFW	227.9 ± 5.1	219.1 ± 5.1	229.4 ± 32.3
Total energy requirement	kWh/tonFW	633.1	639.5	71
Net energy	kWh/tonFW	- 405.1 ± 5.1	- 420.4 ± 5.1	158.4 ± 32.3

4.5 Conclusions

The net specific biomethane production of synthetic food waste (FW) was 413.90 (± 4.87) mlCH₄/gVS_{added}, which represents a high potential of renewable energy from this type of waste. The possibility to enhance the AD of FW at mesophilic conditions by applying a thermophilic or thermal pretreatment was studied through a series of batch experiments. The highest enhancement of the biomethane production (higher than 40%) was obtained with a thermophilic pretreatment at 50 °C for 6 – 12 h or thermal pretreatment at 80 °C for 1.5 h. The main effect of these pretreatments was a higher solubilisation of COD. Although thermophilic pretreatment could improve the microbial community, the extra energy produced by the enhanced process is insufficient to heat up the reactor to the desired temperature. Despite the capital cost of the separate chamber, the thermal pretreatment heating up only the FW is more energy efficiency than heating up the complete digester

4.6 Reference

1. Holm-Nielsen J.B., Al Seadi T., Oleskowicz-Popiel P. (2009) The future of anaerobic digestion and biogas utilization. *Bioresource Technology* 100(22), 5478 – 5484
2. Grosso M., Motta A., Rigamonti L. (2010) Efficiency of energy recovery from waste incineration, in the light of the new Waste Framework Directive. *Waste Management*, 30(7), 1238 – 1243

3. Ariunbaatar J., Panico A., Frunzo L., Esposito G., Lens P.N.L., Pirozzi F. (2014a) Enhanced anaerobic digestion of food waste by thermal and ozonation pretreatment methods. *Journal of Environmental Management*, 146, 142-149
4. Kastner V, Somitsch W., Schnitzhoger W. (2012) The anaerobic fermentation of food waste: a comparison of two bioreactor systems. *Journal of Cleaner Production*, 34, 82-90
5. Guo X., Wang C., Sun F., Zhu W., Wu W. (2014) A comparison of microbial characteristics between the thermophilic and mesophilic anaerobic digesters exposed to elevated food waste loadings. *Bioresource Technology*, 152, 420-428
6. Mata-Alvarez J., Macé S., Llabrés P. (2000) Anaerobic digestion of organic solid wastes. An overview of research achievements and perspectives. *Bioresource Technology*, 74(1), 3 – 16
7. Zhang H., Banaszak J.E., Prathap P., Alder J., Krajmalnik-Brown, R., Rittman B.E. (2009) Focused-pulsed sludge pretreatment increases the bacterial diversity and relative abundance of acetoclastic methanogens in a full-scale anaerobic digester. *Water Research*, 43, 4517-4526
8. El Mashad H.M, Zeeman G., van Loon W.K.P., Bot G.P.A., Lettinga G. (1994) Effect of temperature and temperature fluctuation on thermophilic anaerobic digestion of cattle manure. *Bioresource Technology*, 95, 191-201
9. Angelidaki I, Chen X., Cui J., Kaparaju J., Ellegaard L. (2006) Thermophilic anaerobic digestion of source sorted organic fraction of household municipal solid waste: Start-up procedure for continuously stirred tank reactor. *Water Research*, 40, 2621-2628
10. Esposito G., Frunzo L., Panico A., Pirozzi F. (2011) Model calibration and validation for OFMSW and sewage sludge co-digestion reactors. *Waste Management*, 31, 2527-2535
11. Gavala, H. N., Yenal, U., Skiadas, I. V., Westermann, P., & Ahring, B. K. (2003). "Mesophilic and thermophilic anaerobic digestion of primary and secondary sludge. Effect of pre-treatment at elevated temperature." *Water Research* 37.19 (2003): 4561-4572.
12. Suhartinin S., Heaven S., Banks C.J. (2014) Comparison of mesophilic and thermophilic anaerobic digestion of sugar beet pulp: Performance, dewaterability and foam control. *Bioresource Technology*, 152, 202-211
13. Labatut R.A., Angenent L.T., Scott N.R. (2014) Conventional mesophilic vs. thermophilic anaerobic digestion: A trade-off between performance and stability? *Water Research*, 53, 249-258
14. Wagner A.O., Gstraunthaler G., Illmer P. (2008) Survival of bacterial pathogens during the thermophilic anaerobic digestion of biowaste: Laboratory experiments and in situ validation. *Anaerobe*, 14, 181-183
15. Ziembra C. and Peccia J. (2011) Net energy production associated with pathogen inactivation during mesophilic and thermophilic anaerobic digestion of sewage sludge. *Water Research*, 45, 4758-4768
16. De la Rubia, M. A., Perez, M., Romero, L. I., & Sales, D. (2002). Anaerobic mesophilic and thermophilic municipal sludge digestion. *Chemical and biochemical engineering quarterly*, 16(3), 119-124.
17. Kim M., Ahn Y., Speece A.E. (2002) Comparative process stability and efficiency of anaerobic digestion; mesophilic VS. thermophilic. *Water Research*, 36, 4369-4385

18. Scaglia B., D'Imporzano G., Garuti G., Negri M., Adani F. (2014) Sanitation ability of anaerobic digestion performed at different temperature on sewage sludge, *Science of the Total Environment*, 466-467, 888-897
19. Boušková A., Dohányos M., Schmidt J.E., Angelidaki I. (2005), Strategies for changing temperature for mesophilic to thermophilic conditions in anaerobic CSTR reactors treating sewage sludge. *Water Research*, 39, 1481-1488
20. Esposito G., Frunzo L., Panico A., Pirozzi F. (2012) Enhanced bio-methane production by co-digestion of different organic wastes. *Environmental Technology*, 33, 2733-2740
21. Phillips K.M., Tarrago-Trani M.T., Grove T.M., Grun I., Lugogo R., Harris R.F., Stewart K.K. (1997) Simplified gravimetric determination of total fat in food composites after chloroform-methanol extraction, *Journal of American Oil Chemists' Society*, 74(2), 137-142
22. Codex Guidelines on Nutrition Labelling CAC/GL 2-1985 (Rev.1 – 1993)
23. APHA, Standard Methods for the examination of water and wastewater 21st edition ISBN: 0875530478
24. Ferrer I., Ponsá S., Vázquez F., Font X. (2008) Increasing biogas production by thermal (70 °C) sludge pretreatment prior to thermophilic anaerobic digestion. *Biochemical Engineering Journal*, 42(2), 186 – 192
25. Lund, B., Jensen, V. F., Have, P., & Ahring, B. (1996). Inactivation of virus during anaerobic digestion of manure in laboratory scale biogas reactors. *Antonie van Leeuwenhoek*, 69(1), 25-31.
26. Popat, S. C., Yates, M. V., & Deshusses, M. A. (2010). Kinetics of inactivation of indicator pathogens during thermophilic anaerobic digestion. *water research*, 44(20), 5965-5972.
27. Ariunbaatar J., Panico A., Esposito G., Pirozzi F., Lens P.N.L. (2014b) Pretreatment methods to enhance anaerobic digestion of organic solid waste. *Applied Energy*, 15, 143-156
28. Bolzonela D., Cavinato C., Fatone F., Pavan P., Cecchi F. (2012) High rate mesophilic, thermophilic, and temperature phased anaerobic digestion of waste activated sludge: A pilot scale study. *Waste Management*, 32(2), 1196 - 1201
29. Carrère H., Dumas C., Battimelli A., Batstone D.J., Delgenès J.P., Steyer J.P., Ferre I. (2010) Pretreatment methods to improve sludge anaerobic biodegradability: A review. *Journal of Hazardous Materials*, 183(1-3), 1 – 15
30. Vrieze J.D., Verstaete W., Boon N. (2013) Repeated pulse feeding induces functional stability in anaerobic digestion, *Microbial biotechnology*, 6(4), 414-424
31. Chen M. (1983) Adaptation of mesophilic anaerobic sewage fermenter population to thermophilic temperatures. *Applied Environmental Microbiology*, 45(4), 1271 - 1276
32. Chachkiani M., Dabert P., Abzianidze T., Partskhaladze G., Tsiklauri L., Dudaauri T., Godon J.J. (1993) 16SrDNA characterization of bacterial and archaeal communities during start-up of anaerobic thermophilic digestion of cattle manure. *Bioresource Technology*, 93 (3), 227 – 232

TRACE ELEMENT REQUIREMENTS FOR THE ANAEROBIC DIGESTION OF FOOD WASTE



5 TRACE ELEMENT REQUIREMENTS FOR THE ANAEROBIC DIGESTION OF FOOD WASTE

This chapter discusses the possibility to enhance the anaerobic digestion (AD) of food waste (FW) by supplementing trace elements (Fe, Co, Ni, Zn, Mn, Cu, Se, and Mo) individually as well as in cocktails. A series of simultaneous batch experiments on biomethane potential of synthetic FW were conducted in Europe and USA, using the same inoculum. Regardless of the FW source, Se (VI) resulted in the highest (30 – 35%) increase of biomethane production at a concentration range of 25-50 µg/L. Moreover, supplementing Fe (II) enhanced the biomethane production of European FW by 39%, but it had no effect on the FW in USA.

5.1 Introduction

Anaerobic digestion (AD) of organic solid waste has become one of the most important research fields, as it couples the waste stabilization and energy production [1, 2]. Food waste (FW) contains easily biodegradable volatile solids (VS) and a high content of water, thus it serves as a perfect substrate for AD. Nevertheless, previous studies have shown that regardless of the FW and inoculum origins, a prolonged operation of AD, even at a low organic loading rate, could suffer from instability due to the increased inhibition of ammonia, sulphide, and/or volatile fatty acids [3, 4, 5]. Such instability is often linked with the lack of micronutrients or the trace elements (TEs), [3, 4, 5, 6]. Hence, the effects of TEs have been studied extensively to recover from a digester failure [5]. Supplementing TEs does not only prevent and/or recover from an inhibition; it could also enhance the AD process and yield a higher production of biomethane.

To understand the roles of TEs in the biochemical reaction of the anaerobic food web has always been the core of the research on TEs. It is well known that in anaerobic processes TEs generally act as: 1) micronutrients for various enzymatic reactions as the co-factors; 2) biomass stimulant beyond the enzymatic requirements e.g. acetoclastic activities of methanogens, 3) agents binding nutrients such as phosphates and carriers; 4) inhibitors to sulphide toxicity through metal precipitation and/or agglomeration; 5) toxicants to the microbial biomass at higher concentrations [7, 8]. These various effects of the TEs depend on the environmental conditions, the background concentrations, bioavailability and the microbial uptake of them. Bioavailability of elements is often correlated with the speciation of the TEs, which is the distribution of an element amongst the defined chemical species in a system.

Therefore, various concentrations of different TEs were studied for the AD of FW. For instance, Zhang and Jahng (2012) used supplements of trace metals (Fe, Co, Mo and Ni) to stabilize a single-stage reactor treating FW, and concluded that Fe was the most effective metal for a stable AD of FW [1]. Similarly, de Vrieze et al. (2013) obtained a higher methane production from co-digestion of FW with an iron-rich activated sludge [7]. Banks et al. (2011) found out that adding Se and Co could recover a FW digester suffering from a propionic acid accumulation due to elevated ammonium concentration [3]. Facchin et al. (2013) achieved a 45-65% higher methane production yield from FW with supplementation of TEs (Co, Mo, Ni, Se, and W) cocktail, and stressed the importance of Se and Mo [6]. Nevertheless, none of the studies carried out a systematic experiment on the trace element benchmark concentrations for an enhancement or an inhibition.

This research aims at investigating the concentration range of the TEs for an inhibition or enhancement. A series of batch experiments on the biomethane potential of a synthetic FW adding various concentrations of TEs was conducted. The next set of experiment was carried

out to determine the effects of the TEs individually as well as in a group. Moreover, it is well known and accepted that sulphide inhibition mostly acts in three ways: 1) enzyme formation; 2) inactive protein formation; and 3) forming a metal complexation leading to metal deficiency in the system [9, 10]. Hence, to understand the role of TE in anaerobic systems, an experiment on hydrogen sulphide inhibition experiment was also conducted.

5.2 Materials and methods

5.2.1 Substrate and inoculum

A simultaneous research were conducted in EU and USA, thus to reduce experimental bias due to the different compositions of collected FW, the substrate used for this research was synthetically generated according to Ariunbaatar et al. (2014), [11, 12]. The food was bought from a local supermarket Albert Heijn in EU, and Walmart in USA.

A digestate from a full-scale AD plant located in Capaccio-Salerno (Italy) was used as inoculum. The plant treats the buffalo dung together with the milk whey and sewage sludge generated from the mozzarella producing industry.

5.2.2 Biomethane potential test

Biomethane potential test of FW was conducted in serum bottles as described by Ariunbaatar et al. (2014) [11]. The substrate to inoculum ratio was 0.5gVS/gVS. Prior to incubation, all bottles were flushed with nitrogen (or helium) gas to ensure anaerobic environment. To maintain the initial total alkalinity (4 gCaCO₃/L) of the inoculum sodium bicarbonate (NaHCO₃) was added. The daily biomethane production was measured with liquid displacement method using sodium hydroxide. The first set of experiments was carried out to identify the concentration ranges for inhibition and/or enhancement of the AD process by adding a cocktail solution of TEs, whereas the second set focused on the effects of the individual and different groups of TEs in the enhancing concentration range.

A stock solution of each TEs (NiCl₂·6H₂O, CuCl₂·2H₂O, MnCl₂·2H₂O, MnCl₂·2H₂O, FeCl₂·4H₂O, CoCl₂·6H₂O, ZnCl₂, Na₂SeO₄, Na₂MoO₄) was prepared. Eight different concentrations (5, 10, 50, 100, 500 µg/L, and 1, 3, 10 mg/L) of TE cocktail solution were added for the first set of batch experiment.

Different concentrations of sodium sulphide (Na₂S) was added to perform the batch experiment on the hydrogen sulphide inhibition (H₂S) of BMP of FW. The concentrations of (H₂S) corresponded to 50, 75, 150, 250 and 500 mg/L.

5.2.3 Analytical Methods

Total solids (TS) and volatile solids (VS) were conducted according to the standard methods [13], and the ashes were preserved with 1% nitric acid. The TE speciation test was not able to be conducted during this research, thus the total concentrations of the TEs were analyzed in the preserved ash samples with ICP-MS. The minimum detection limit for the method was 2 µg/L, and the final values were converted to µg/gTS for comparison with literature. The volatile fatty acids (VFA) samples were analysed with gas chromatography (GC) equipped with Nukol Supelco FID column, using helium as a carrier gas.

5.3 Results

5.3.1 Characterization of substrate and inoculum

FW and inoculum has TS of 241.0 ± 4.4 and 24.6 ± 0.5 g/L, and VS of 219.5 ± 0.10 and 15.0 ± 0.4 g/L, respectively. Table 5.1 shows the concentrations of the TEs in the inoculum and the FW. It is interesting to note that the FW in US had a much higher concentration of all TEs, except for manganese (Mn). Selenium (Se) was not detected, and tungsten (W) was not analyzed in the European FW.

Table 5.1 Concentration of TEs in the FW and inoculum

	Buffalo manure ($\mu\text{g/gTS}$)	FW in EU ($\mu\text{g/gTS}$)	FW in US ($\mu\text{g/gTS}$)
Fe	682.72 ± 28.78	213.91 ± 24.50	510.93 ± 7.34
Ni	4.93 ± 0.05	3.97 ± 1.32	11.25 ± 0.95
Mn	107.78 ± 26.88	52.12 ± 5.10	20.33 ± 5.86
Co	1.35 ± 0.45	0.73 ± 0.07	2.73 ± 0.08
Cu	28.72 ± 22.07	3.97 ± 0.66	22.27 ± 4.65
Zn	214.42 ± 137.72	239.07 ± 33.77	361.34 ± 4.27
Se	4.81 ± 0.06	0.00	13.39 ± 4.51
Mo	7.32 ± 2.41	1.99 ± 0.66	10.67 ± 5.70
W	<0.03	N/A	0.43 ± 0.02

* N/A – not available

5.3.2 Effect of TE concentration on AD of FW

Figure 5.1 illustrates net SBP after 20 days of biomethanation test. The control had 421.19 ± 14.58 mlCH₄/gVS_{added}, which is a good agreement with the literature [3, 6, 11, 12]. Adding TE cocktail solution of 5 – 500 $\mu\text{g/L}$ to the BMP bottles yielded an enhancement of the AD process, while higher concentration resulted in an inhibition of the process.

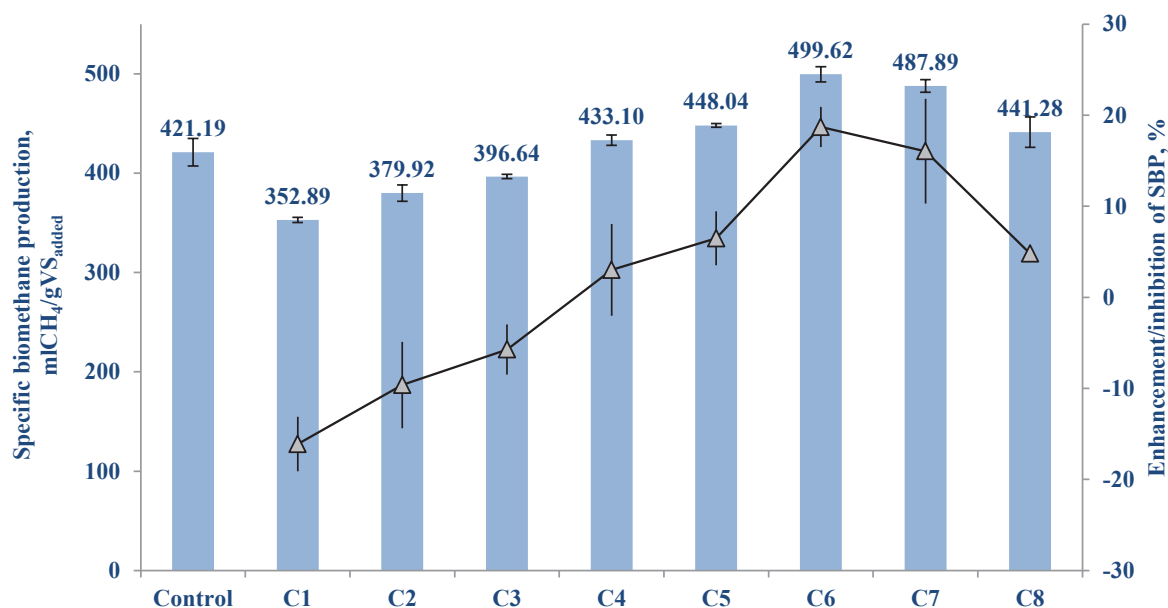

Figure 5.1: Effect of TE cocktail concentration on the SBP of FW

Table 5.2 shows the overall enhancement/inhibition on the net specific biomethane production (SBP) of European FW, with respect to the concentrations of the TE cocktail solution. The best SBP results of 499.62 ± 8 mlCH₄/gVS_{added} and 489.89 ± 7.29 mlCH₄/gVS_{added}, which are $18.70 \pm 2.21\%$ and $16.04 \pm 5.75\%$ higher than the control were achieved with a supplementation of 50 and 10 µg/L of TE cocktails, respectively. Hence, the optimum TE supplementation concentration range is 10 - 50 µg/L for this particular type of inoculum and FW.

Table 5.2: Enhancement/inhibition of SBP with respect to the TEs concentrations

	Concentration added	Inhibition/Enhancement of SBP, %
C1	10 mg/L	-16.11 ± 2.99
C2	3 mg/L	-9.63 ± 4.73
C3	1 mg/L	-5.73 ± 2.76
C4	500 µg/L	3.00 ± 5.04
C5	100 µg/L	6.48 ± 2.97
C6	50 µg/L	18.70 ± 2.21
C7	10 µg/L	16.04 ± 5.75
C8	5 µg/L	4.80 ± 0.88

5.3.3 Effect of Me (II) and Me (VI) on AD of FW

The effects of TEs in groups were studied in the selected concentration range. Figure 5.2 shows the effect of the four different group of Me (II): 1) Cobalt and nickel (Co, Ni); 2) Cobalt, nickel and iron (Co, Ni, Fe); 3) Cobalt, nickel, iron and zinc (Co, Ni, Fe, Zn); and 4) Cobalt, nickel, iron, zinc, manganese and copper (Co, Ni, Fe, Zn, Mn, Cu). Total concentration of TE cocktail solution added to the different groups were 50 µg/L, as it resulted in the highest enhancement during the first set of experiment. The cocktail with Co, Ni and Fe resulted in the highest SBP of 481.31 ± 10.13 mlCH₄/gVS_{added}, followed by Co, Ni, Fe, and Zn cocktail (472.37 ± 8 mlCH₄/gVS_{added}). The increase of SBP by Co, Ni cocktail and all Me (II) cocktail were almost similar with negligible difference (459.95 ± 8.85 and 462.78 ± 12.41 mlCH₄/gVS_{added}). From this result, it can be seen that Co, Ni, Fe, and Zn had more positive effect than Mn and Cu, thus the individual effects of these four TE were tested.

Figure 5.3A shows the cumulative biomethane production curves of the bottles with Fe, Zn, Ni, and Co addition of 50 µg/L, where all of them yielded higher biomethane than the control. Figure 5.3B shows the remarkable increase of SBP by $39.22 \pm 0.55\%$ was achieved with iron addition, making it the most important Me (II) in AD of FW. This is a good agreement with de Vrieze et al. (2013) and Zhang and Jahng (2012) [1, 7]. Also it is worth mentioning that almost same trend and SBP was obtained with Co and Ni addition. This implies the effect of both Ni and Co on the methanogens are the same, and their roles in AD food web could be attributed to the cofactor Methyl-CoM-reductase, as suggested by previous research [7, 8, 9, 14, 15].

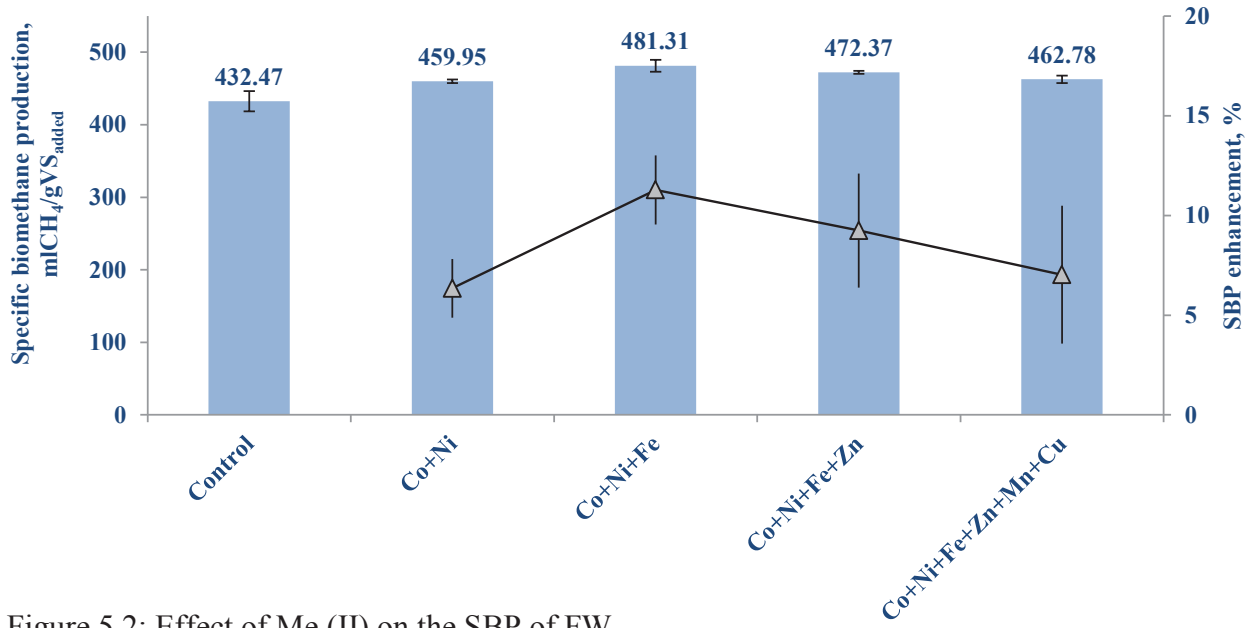

Figure 5.2: Effect of Me (II) on the SBP of FW

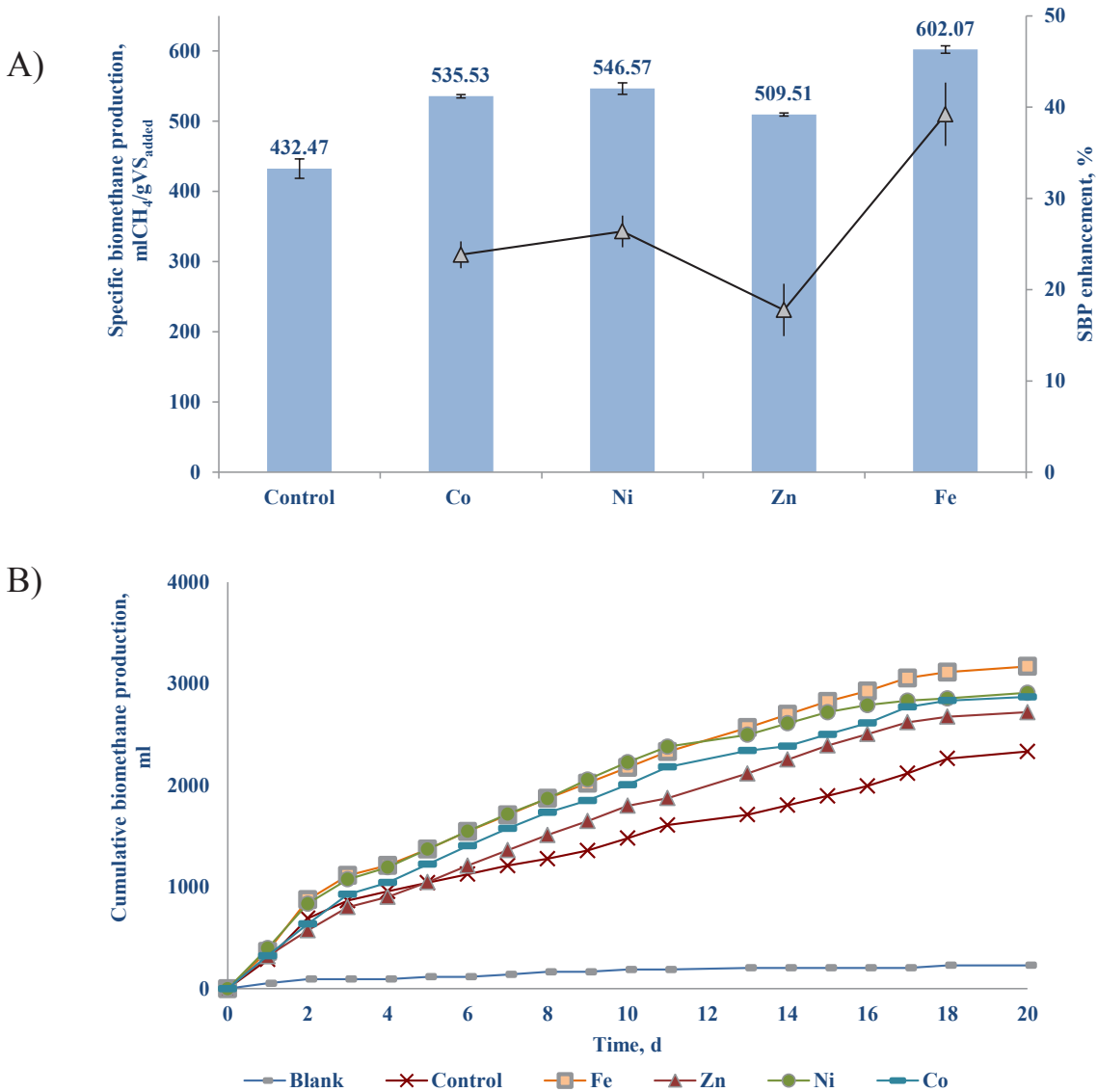

Figure 5.3: Effect of Me (II) on the SBP of FW: A) Cumulative methane curves; B) SBP

Another set of experiment on Me (VI) was carried out with Se and Mo cocktail and individual Se (Figure 5.4). Adding only Se to the bottles yielded $34.10 \pm 5.62\%$ higher SBP (Figure 5.4B), which is even higher than the enhancement by Co and Ni. This result agrees with Banks et al. (2011) and Facchin et al. (2013) [6]. However, the Se and Mo cocktail had a very little effect on the AD of FW, the enhancement of $9.50 \pm 1.28\%$ is mostly due to the Se, and hence Mo was neglected. The results with Mo are on the contrast with Facchin et al. (2013) [6], though it could be justified by the background concentration of the FW and inoculums used.

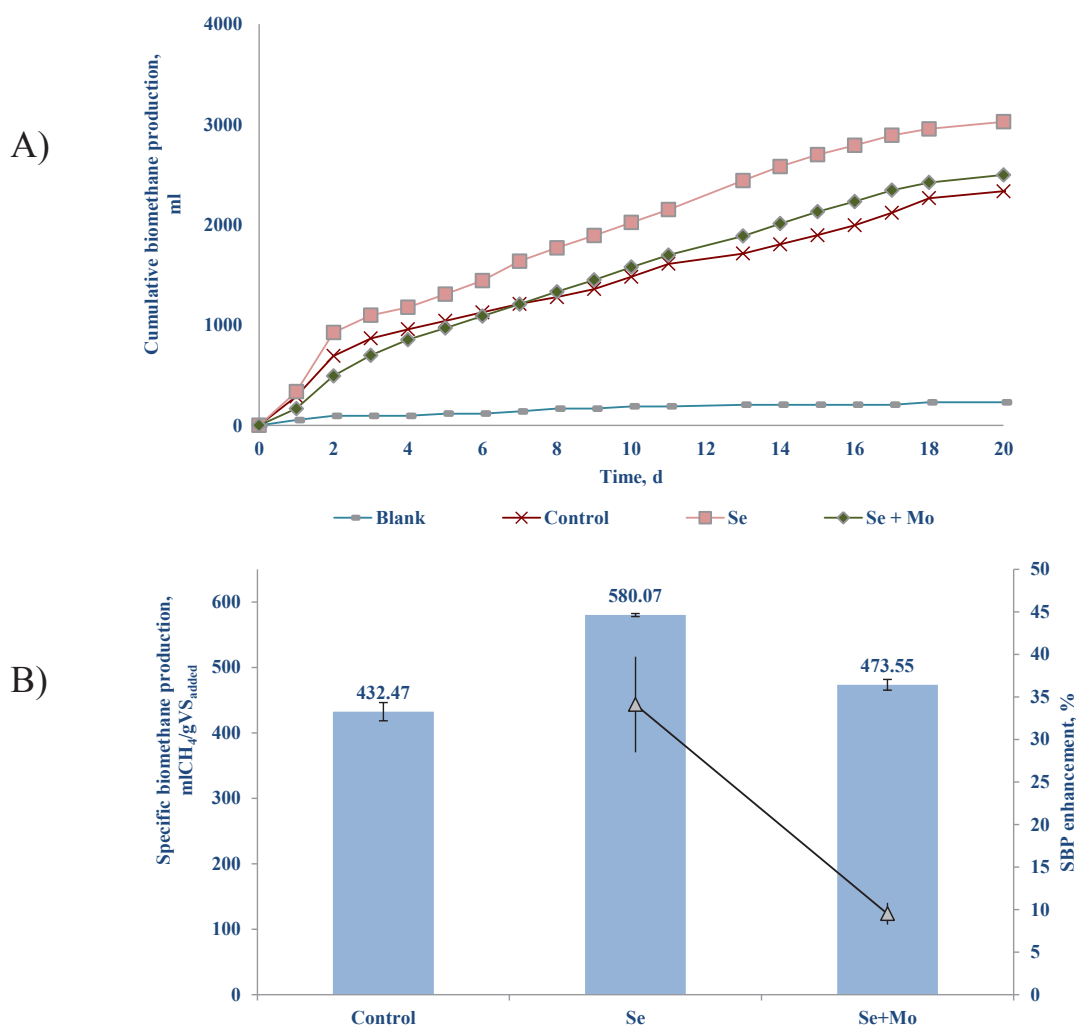
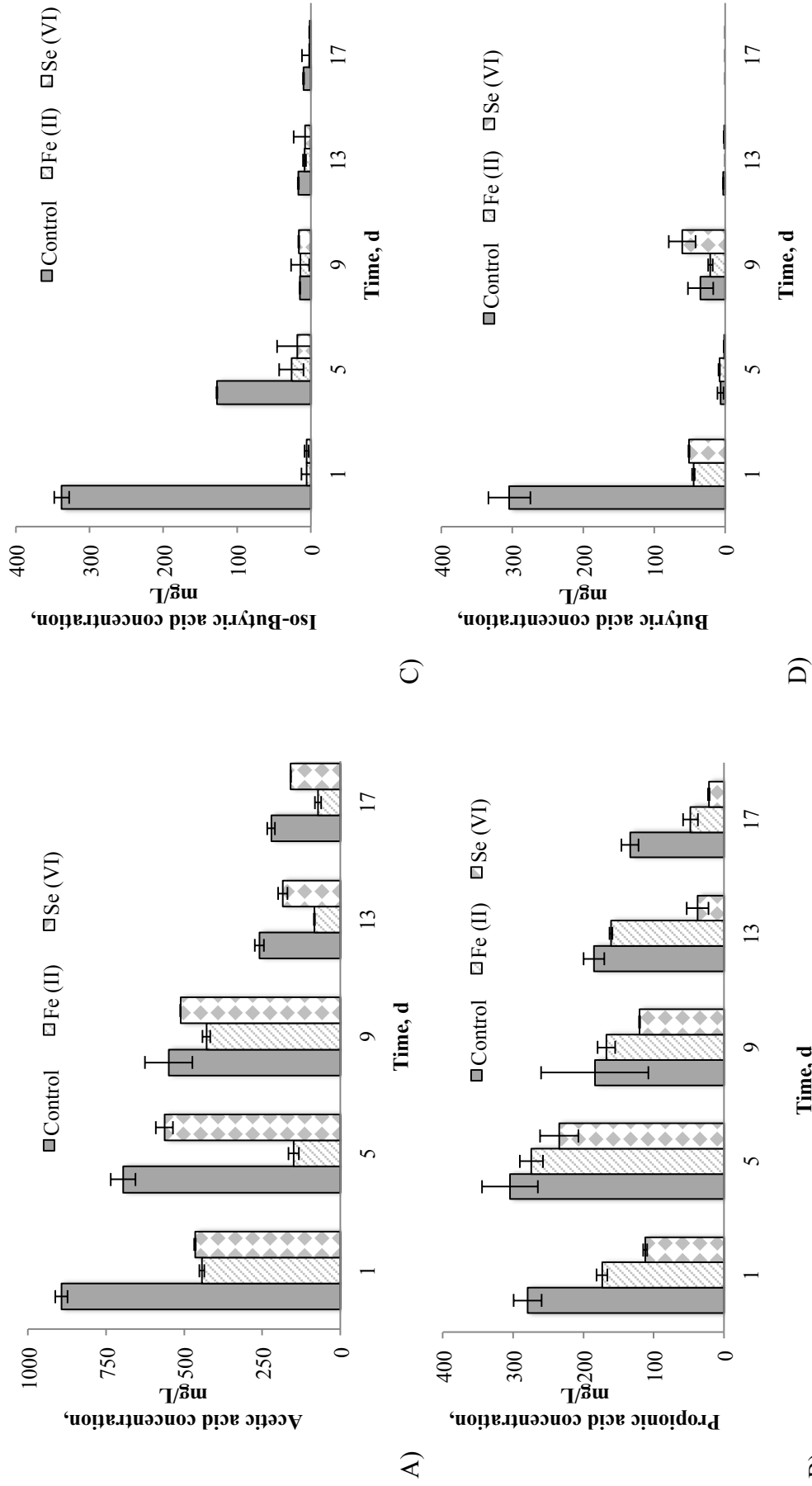

Figure 5.4: Effect of Me (VI) on the SBP of FW: A) Cumulative methane curves; B) SBP

The same experiments were conducted with the FW in USA. The net SBP of the FW was 412.48 ± 12.02 mlCH₄/gVS_{added}, which is in line with the experiments in EU as well as the published research. However, supplementation of TEs did not result in any enhancement of the biomethane production. Only the case of Se (VI) addition of 10 – 20 µg/L (making the total Se concentration in the solution 25 – 50 µg/L) yielded $30.06 \pm 2.38\%$ increase of biomethane methane. This result was attributed to the background concentration of the TEs in the FW in USA, which were much higher than the concentrations of European FW (Table 5.1).

Se (VI) and Fe (II) supplementation resulted in the highest enhancement of the biomethane production (Figure 5.3 and 5.4). The VFA concentrations of these samples were analysed. Figure 5.5 shows that the samples with the TE supplementation had much lower acetic, propionic, iso-butyric and valeric acids concentrations. It suggests that the supplementation of TEs enhanced the activities of the methanogens, thus resulted in a higher biomethane production, which agrees with the previous results [7].



B) Figure 5.5: Effect of Se (VI) and Fe (II) supplementation on the VFA production: A) Acetic acid; B) Propionic acid; C) Iso-butyric acid; D) Butyric acid

5.3.4 Hydrogen sulphide inhibition

It can be seen from Fig.5.5 that sulphide inhibition on the AD of FW starts around 50 mg/L, resulting in 5.13 ± 2.76 % SBP. Based on the SBP results with respect to the hydrogen sulphide concentrations, the IC_{50} was calculated as 215mg/L, which is in the range of reported values of 125 – 250 mg/L [16, 17]. Although the hydrogen sulphide concentration in all the tested scenarios with TE as well as the control had less than 15 mg/L in the system throughout the experiment, which implies that there was no hydrogen sulphide inhibition in AD of FW.

Hence, the enhancement of SBP by addition of TE must be only related to the enzymatic, biomass stimulating effect or nutrient binding levels. Further experiments on the intermediate products such as volatile organic acids should be analysed to get the full picture of the effect of TEs on the biochemical reaction of the AD food web.

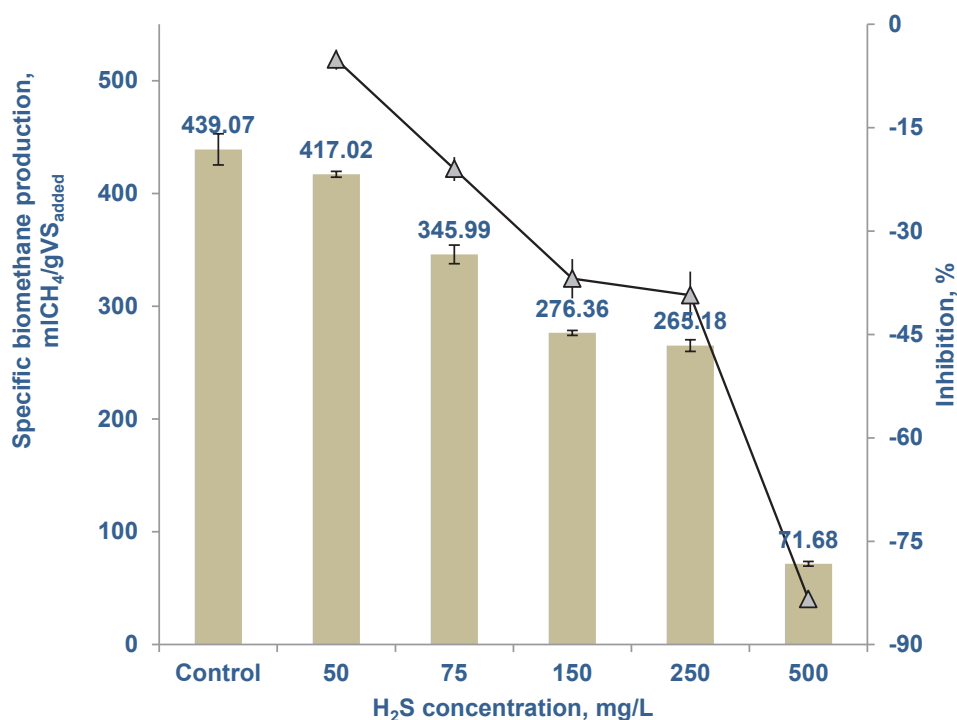

Figure 5.6: Effect sulphide toxicity on AD of FW

5.4 Conclusions

The supplementation of trace elements increased the biomethane potential of FW. The most effective elements were Fe with an increase of 39.22 ± 0.55 % of biomethane production, followed by Se (34.10 ± 5.62 %), Ni (26.38 ± 0.24 %) and Co (23.83 ± 0.24 %) for the anaerobic digestion of FW in Europe. The same experiments did not result in an increased biomethane production of FW in US, as the background concentrations of the trace elements in the FW were much higher. Although for both EU and US FW supplementing 25 – 50 μ g/L Se (VI) resulted in 30 – 35% increase of biomethane production. Sulphide inhibition was not observed, and hence the enhancing effect of trace elements should be at the enzymatic or biomass stimulating level. A further study on the TEs speciation, bioavailability and the exact biochemical pathways are highly encouraged.

5.5 Reference

1. Zhang, L., Lee, Y. W., & Jahng, D. (2011). Anaerobic co-digestion of food waste and piggery wastewater: focusing on the role of trace elements. *Bioresource technology*, *102*(8), 5048-5059
2. Ariunbaatar, J., Panico, A., Esposito, G., Pirozzi, F., & Lens, P. N. (2014). Pretreatment methods to enhance anaerobic digestion of organic solid waste. *Applied Energy*, *123*, 143-156.
3. Banks, C. J., Zhang, Y., Jiang, Y., & Heaven, S. (2012). Trace element requirements for stable food waste digestion at elevated ammonia concentrations. *Bioresource technology*, *104*, 127-135.
4. Demirel, B., & Scherer, P. (2011). Trace element requirements of agricultural biogas digesters during biological conversion of renewable biomass to methane. *Biomass and Bioenergy*, *35*(3), 992-998.
5. Zhang, W., Wu, S., Guo, J., Zhou, J., & Dong, R. (2015). Performance and kinetic evaluation of semi-continuously fed anaerobic digesters treating food waste: Role of trace elements. *Bioresource technology*, *178*, 297-305.
6. Facchin, V., Cavinato, C., Fatone, F., Pavan, P., Cecchi, F., & Bolzonella, D. (2013). Effect of trace element supplementation on the mesophilic anaerobic digestion of foodwaste in batch trials: the influence of inoculum origin. *Biochemical Engineering Journal*, *70*, 71-77.
7. De Vrieze, J., De Lathouwer, L., Verstraete, W., & Boon, N. (2013). High-rate iron-rich activated sludge as stabilizing agent for the anaerobic digestion of kitchen waste. *Water research*, *47*(11), 3732-3741.
8. Oleszkiewicz, J. A., & Sharma, V. K. (1990). Stimulation and inhibition of anaerobic processes by heavy metals—a review. *Biological Wastes*, *31*(1), 45-67.
9. Zandvoort, M. H., van Hullebusch, E. D., Gieteling, J., & Lens, P. N. (2006). Granular sludge in full-scale anaerobic bioreactors: trace element content and deficiencies. *Enzyme and microbial technology*, *39*(2), 337-346
10. Karhadkar, P. P., Audic, J. M., Faup, G. M., & Khanna, P. (1987). Sulfide and sulfate inhibition of methanogenesis. *Water Research*, *21*(9), 1061-1066.
11. Ariunbaatar, J., Panico, A., Frunzo, L., Esposito, G., Lens, P. N., & Pirozzi, F. (2014). Enhanced anaerobic digestion of food waste by thermal and ozonation pretreatment methods. *Journal of environmental management*, *146*, 142-149.
12. Ariunbaatar, J., Scotto Di Perta, E., Panico, A., Frunzo, L., Esposito, G., Lens, P. N., & Pirozzi, F. (2015). Effect of ammoniacal nitrogen on one-stage and two-stage anaerobic digestion of food waste. *Waste Management*.
13. APHA, Standard Methods for the examination of water and wastewater 21st edition ISBN: 0875530478
14. Pobeheim, H., Munk, B., Lindorfer, H., & Guebitz, G. M. (2011). Impact of nickel and cobalt on biogas production and process stability during semi-continuous anaerobic fermentation of a model substrate for maize silage. *Water research*, *45*(2), 781-787
15. Glass, J. B., & Orphan, V. J. (2012). Trace metal requirements for microbial enzymes involved in the production and consumption of methane and nitrous oxide. *Frontiers in microbiology*, *3*.
16. Koster, I. W., Rinzema, A., De Vegt, A. L., & Lettinga, G. (1986). Sulfide inhibition of the methanogenic activity of granular sludge at various pH-levels. *Water Research*, *20*(12), 1561-1567.
17. Oleszkiewicz, J. A., Marsteller, T., & McCartney, D. M. (1989). Effects of pH on sulfide toxicity to anaerobic processes. *Environmental Technology*, *10*(9), 815-822.

BIOAUGMENTATION OF ANAEROBIC DIGESTION OF FOOD WASTE USING ZOO ANIMALS' DUNG

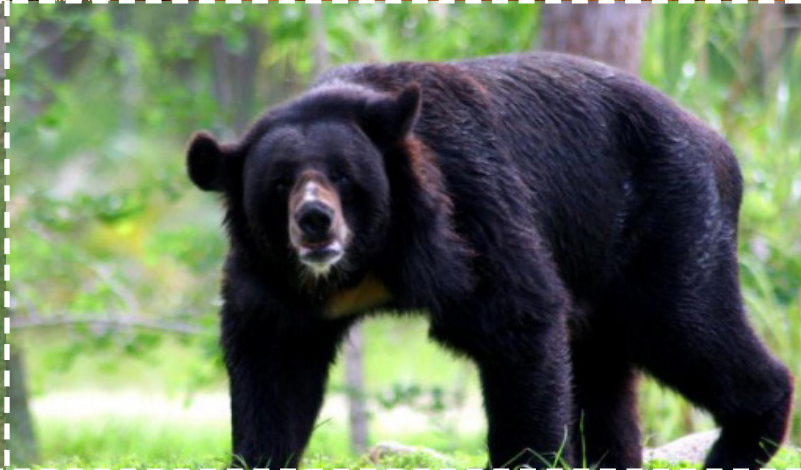

6 BIOAUGMENTATION OF ANAEROBIC DIGESTION OF FOOD WASTE USING ZOO ANIMALS' DUNG

This chapter discusses the bioaugmentation effect of zoo animals' dung on the anaerobic digestion of food waste. An anaerobic sludge (AS) from wastewater treatment plant was used as the main methanogenic inoculum. The effects of giraffe, llama, koala, sloth bear and tiger dungs were investigated in different ratios. Based on the results of all the tested scenarios 70% AS and 30% giraffe dung yielded the highest biomethane production with an increase of $11.24 \pm 4.51\%$ than the control (e.g. AS), due to a higher solubilisation of proteins ($6.96 \pm 2.76\%$) and recalcitrant carbohydrates (344.85 ± 54.31 mg/L as compared to zero).

6.1 Introduction

Food waste (FW) disposal has become one of the major societal problems as a larger volume of it is being produced by increasingly affluent societies. FW generation rate in low to middle income countries is 0.35 kg/day.capita, whereas in high-income countries the rate is 0.6 kg/day.capita [1]. There are increasing efforts across the U.S. and Europe to treat FW through anaerobic digestion (AD), as it offers energy and nutrients recovery with limited environmental impacts [2, 3].

AD is a microbial process that converts complex substrates into biogas and digestate through four main steps, namely hydrolysis, acidogenesis, acetogenesis and methanogenesis. It is well documented that for a complex substrates, the rate-limiting step is the hydrolysis step, whereas methanogenesis is the rate-limiting step for easily biodegradable substrates [4,5]. FW contains both easily fermentable and refractory complex organics. Hence, a successful operation of AD of FW is often challenging especially for a high-rate treatment. To accelerate the solubilisation step, research mainly focused on pretreatment methods of both inoculum and substrate and bioreactor configurations. However, intensive pretreatments result in a loss of easily fermentable sugars, which might lead to a lower biomethane production [4, 5].

Another approach that is yet to be explored is the bioaugmentation, the process of adding selected strains/mixed cultures to reactors to improve the catabolism of specific compounds, e.g. refractory organics, or overall chemical oxygen demand (COD) [6, 7]. It is believed that various animals should contain the specific microbes to breakdown the complex organics based on the diets of the animals. Carnivores have more microbes that degrades proteins and lipids, while herbivores should have more microbes that will breakdown recalcitrant carbohydrates. Based on such hypotheses Fangkum and Reungsang (2011) used elephant dung as inoculum to produce biohydrogen from sugarcane bagasse [8], whereas Fan et al. (2008) used panda manure to treat corn stalk [9].

Bioaugmentation of AD by adding different animal dung should improve the solubilisation of the complex organic substrates, without the loss of the easily fermentable sugar. To the best of our knowledge, using zoo animals' dung to enhance the AD of FW has not been studied. Therefore, this study investigated the effects of various animals' dung on the AD of FW. Different zoo animals including carnivores (tiger), herbivores (giraffe, llama and koala) and omnivores (sloth bear) were selected. Batch experiments on the biomethane potential of FW were conducted using the dungs of the selected animals as inoculums, and compared it with the commonly used cow dung. Based on the results of the first batch experiments, three of the dungs with the highest potential were chosen for the bioaugmentation of anaerobic sludge (AS).

6.2 Materials and Methods

6.2.1 Substrate and inoculum

A synthetic FW was used as substrate. The FW was prepared according to Ariunbaatar et al. (2014) [5, 10]. The substrates used for the FW were bought from a local store in Tampa.

AS from the Howard F. Curren Wastewater Treatment Plant in Tampa, Florida, USA was used as the main methanogenic inoculum (e.g. the control). Six different dungs were used as inoculums for the bioaugmentation experiments. Koala, sloth bear, giraffe, tiger, and llama dung were collected from the Lowry Park Zoo in Tampa, whereas cow dung was collected from a local farm also in Tampa, Florida. Table 6.1 shows the diets of the zoo animals. The unwanted matters (e.g. undigested food, grass and additional dirt) were removed mechanically and blended with additional water for homogenization. The anaerobic sludge as well the dung were all sieved through mesh no.20 to remove any unwanted debris or particles.

Table 6.1: Diets of the zoo animals

Animals	Diets per day
Koala	5 bundles of eucalyptus
Giraffe	14 commercial pellets and 3 bundles of romaine
Llama	1 commercial pellet and free choice of hay
Sloth bear	7.5 cups of ground leafeather in cod liver oil and 2 bananas (209g), 2 apple (250g) and 2 orange (370g)
Tiger	5 box of commercial beef for 5 days and 2 days of fasting

6.2.2 Batch experiments on biomethane potential

Batch experiments on biomethane potential (BMP) were conducted in serum bottles at mesophilic (35 ± 2 °C) condition with no mixing according to Anglelidaki (2009) [11]. Each batch experiment was conducted in duplicates, and all the bottles were placed in Fisher ISOTEMP incubator 200 series model 230D. The substrate to inoculum ratio was 0.5gVS/gVS. Prior to incubation, all bottles were flushed with helium gas to ensure anaerobic environment. Sodium bicarbonate was added to provide sufficient alkalinity throughout the experiment. The amount of NaHCO_3 (3.6 – 7.6 g NaHCO_3 /L) depended on the initial alkalinity of the dungs, as all the BMP bottles were subjected to the same alkalinity levels. Biomethane was measured every day by a liquid displacement method (Figure 6.1) using sodium hydroxide (120 g/L) as liquid to capture carbon dioxide.

The first set of experiment was conducted on the BMP of FW using six different dungs (cow, tiger, llama, giraffe, koala, sloth bear). Next set of batch experiments was carried out to investigate the bioaugmentation effect of the selected dungs on the anaerobic sludge. Different ratios were tested and compared with the control (e.g. anaerobic sludge) and the 100% dung.

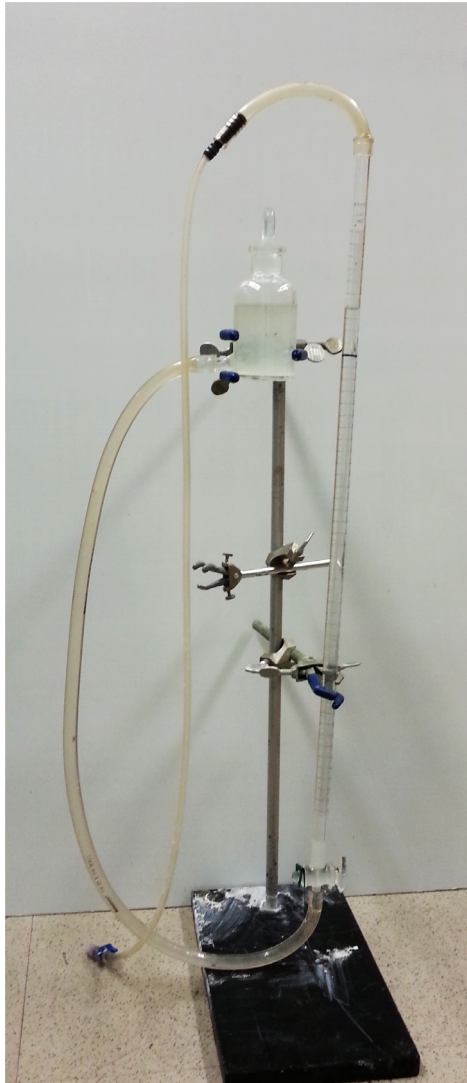

Figure 6.1: Effect of different dung sources on the net SBP of FW

6.2.3 Analytical Methods

Total solids (TS), volatile solids (VS), total alkalinity analyses were conducted according to the standard methods [12]. The soluble chemical oxygen demand (CODs) was measured with Hach test kits following the manufacturer's guidelines (HACH, Loveland, Colorado, USA). The soluble carbohydrates were measured with phenol-sulphuric method, using glucose as standard solution [13], and soluble proteins was measured by modified Lowry method using bovine serum albumin (BSA) as standard solution [14].

6.3 Results and Discussions

6.3.1 Characteristics of the inoculums and substrate

The pH, total alkalinity, TS and VS of the control AS were 7.5 ± 0.2 , 4389.7 ± 10.7 mgCaCO₃/L, 18.7 ± 2.4 , 13.1 ± 0.1 g/L. All the dungs were diluted with tap water to have the same VS content. The pHs of the dungs were in a neutral range of 6.5 – 7.8, except for the sloth bear (5.6 ± 0.4). The tiger dung had the highest alkalinity of 3100 ± 15.1 mgCaCO₃/L followed by the giraffe dung (1985.6 ± 15.4 mgCaCO₃/L), llama (963.6 ± 12.8 mgCaCO₃/L), cow (694.4 ± 12.8 mgCaCO₃/L) and sloth bear (603 ± 47.8 mgCaCO₃/L). TS of the synthetic FW was in the range of 238.6 – 266.6 mg/kg, and >95% were volatile solids

6.3.2 Biomethane potential test

BMP tests lasted for approximately 12 days. Figure 6.2 shows the net specific biomethane production (SBP) of FW using the six different dungs. The highest biomethane production of 156.05 ± 11.25 mlCH₄/gVS_{added} was achieved with giraffe dung, followed by sloth bear dung (128.25 ± 22.50 mlCH₄/gVS_{added}) and koala dung (121.74 ± 0.24 mlCH₄/gVS_{added}). The tiger dung initially expected to have higher recovery of biomethane from FW, however it resulted in relatively lower result of 89.20 ± 2.73 mlCH₄/gVS_{added}. The lower biomethane production of tiger dung was attributed to total ammoniacal nitrogen (TAN) toxicity of the slow growing methanogens, which was approximately 300 – 350 mg/L higher than the control.

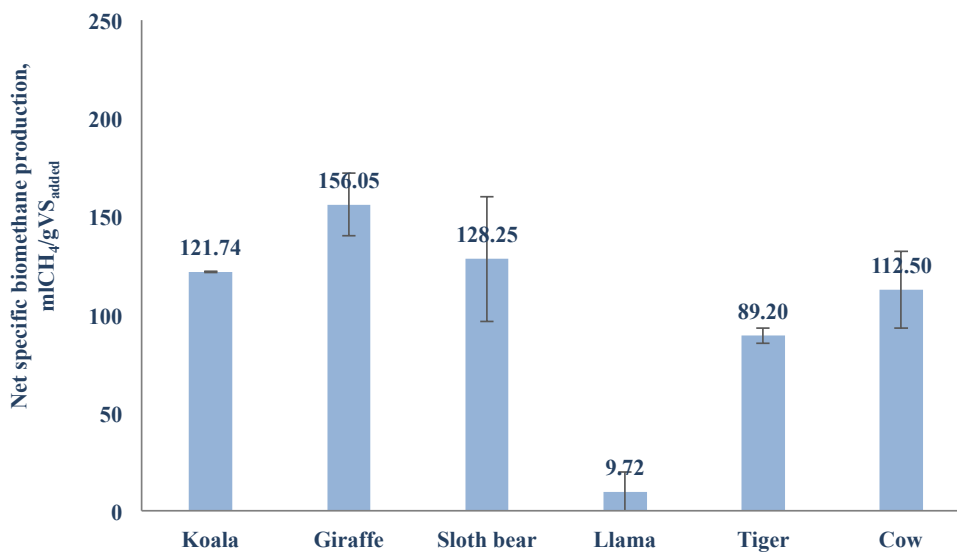

Figure 6.2: Effect of different dung sources on the net SBP of FW

Based on the first set of experiment, giraffe, koala and sloth bear dungs were selected. As it can be seen from Figure 6.2 that the SBP of FW is much lower than reported values [2, 7, 11]. This is probably due to the slow growing methanogens. Hence, the selected dungs were incubated for 2 weeks prior to the next set of experiment. The control sludge was mixed with the pre-digested dungs in ratio of 9:1, 7:3 and 5:5 respectively.

Figure 6.3 shows the net SBP of the control (e.g. FW with anaerobic sludge) was 507.34 ± 24.36 mlCH₄/gVS_{added}. Pre-digested giraffe dung addition of 10, 30 and 50% resulted in 5.25 ± 4.45 , 11.31 ± 6.11 and 4.88 ± 1.08 % higher biomethane production. Using 100% giraffe dung also performed 7.81 ± 2.94 % higher than the control. Mixture of Sloth bear dung by 30% resulted in 10.18 ± 3.23 % higher SBP, while all the other mixes including the pure sloth bear dung yielded much lower SBP than the control. Although adding koala dung did not result in increase of BMP, the highest enhancement of 1.37 ± 0.56 % higher SBP was with 30% addition.

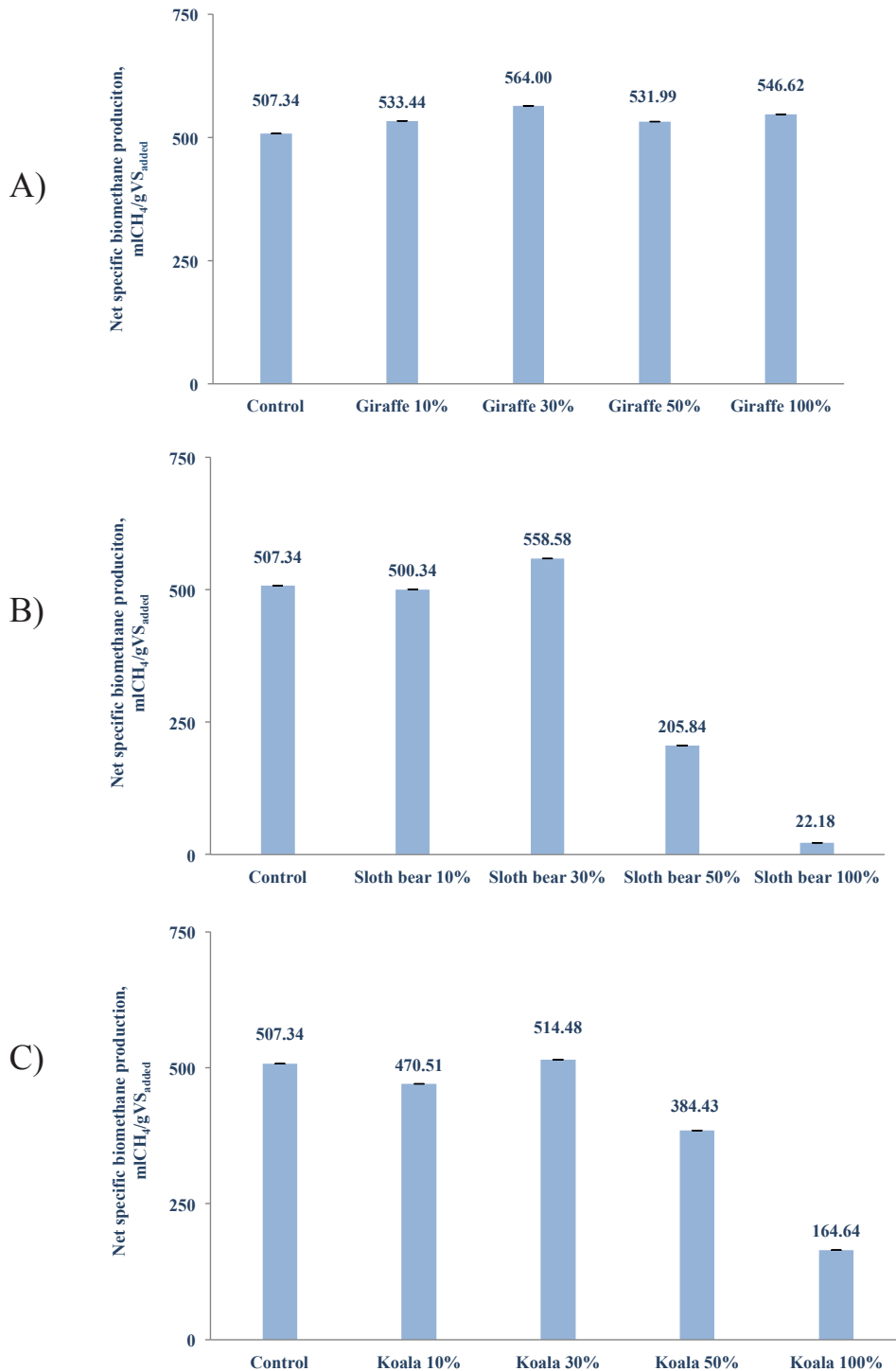

Figure 6.3: Effect of dung mixture percentages on the net SBP of FW: A) Giraffe; B) Sloth bear; C) Koala

6.3.3 Bioaugmentation mechanisms

Figure 6.4 shows the cumulative biomethane curves of the selected samples, which all lasted for 25 days of incubation. Most of the biomethanation profiles have similar trends as the control sludge, which exhibits a typical biomethanation curve of a substrate rich in easily fermentable carbohydrates [5]. However, 100% giraffe 30% giraffe curves have a sudden increase on day 15 (Figure 6.4A). Figure 6.4B and Figure 6.4C shows 30% sloth bear as well as 30% koala produced less biomethane than the control during the initial 12 and 17 days, respectively, but eventually started producing more than control afterwards.

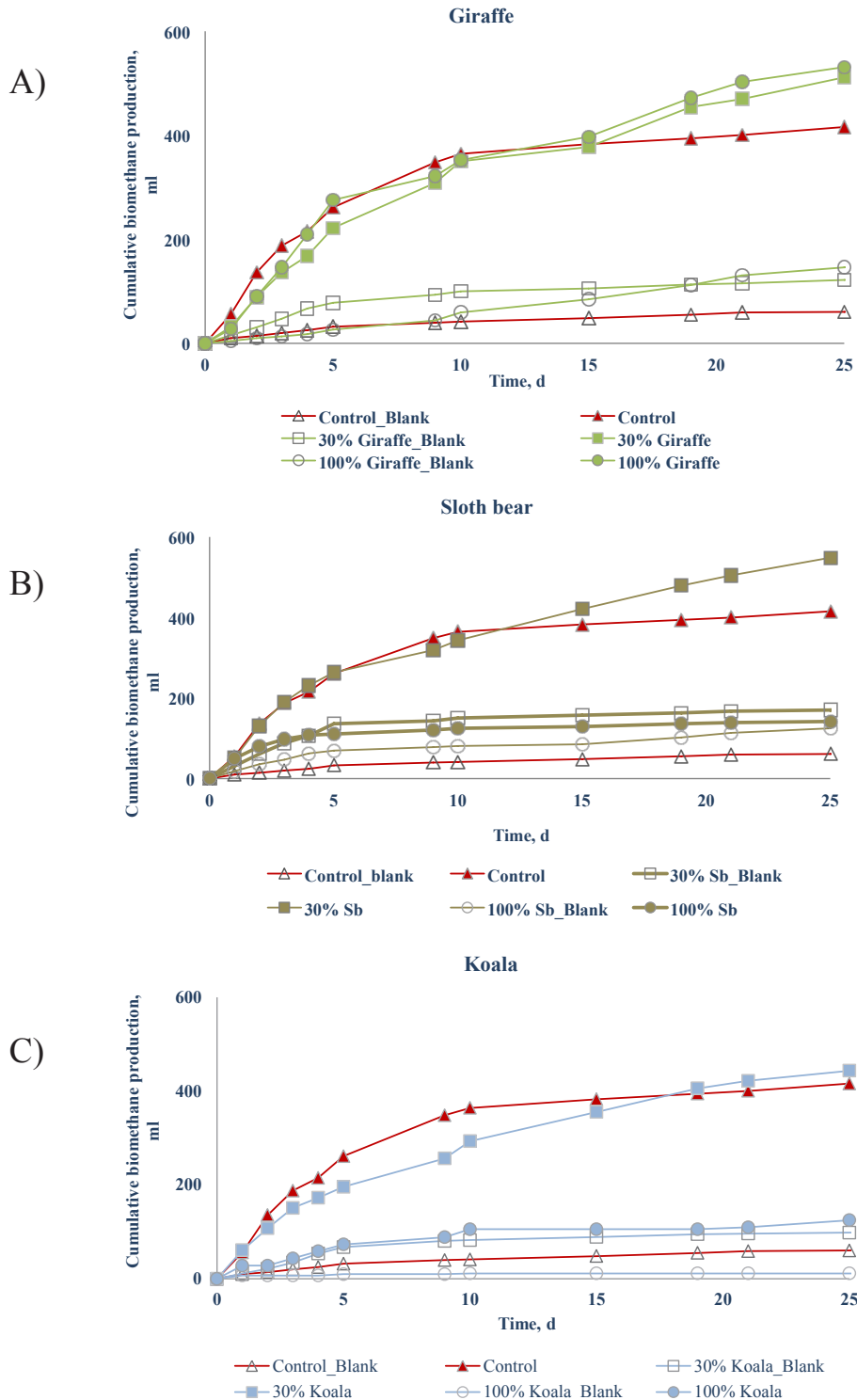

Figure 6.4: Cumulative biomethane curves and SBP of selected samples: A) Giraffe; B) Sloth bear; C) Koala

Another unusual curve are the 100% sloth bear and 100% koala, which produced significantly lower biomethane as compared to the other dung mixtures and the control (Figure 6.3B and Figure 6.3C). This data also matches the CODs profile where the 100% sloth bear and koala had an increasing concentration of CODs, and it was not utilized during the biomethanation like the other assays shown in Figure 6.5. It indicates lack of methanogens and/or imbalance of microbial community in the anaerobic systems.

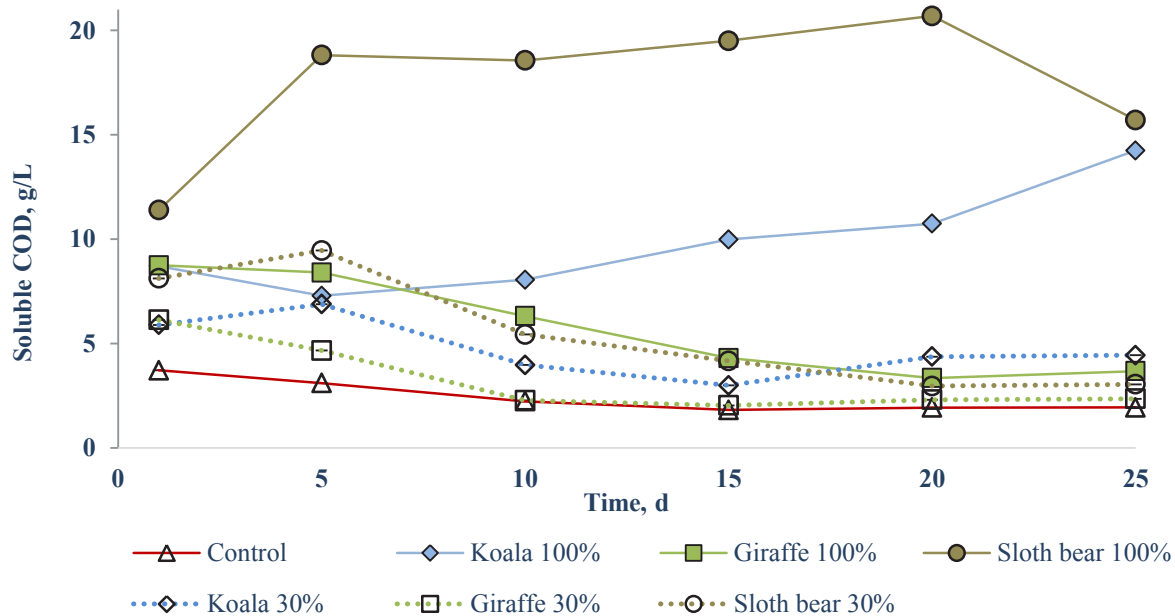

Figure 6.5: Profile of CODs

Figure 6.6 illustrates the soluble carbohydrate profiles of the chosen samples. It is interesting to note that the control as well as the 30% koala had the lowest (173.71 ± 91.91 mg/L and 36.87 ± 2.98 mg/L, respectively) on day 10 and soluble carbohydrates were not detected after that, whereas the other samples had generally decreasing trend until the day 10. This explains the exponential growth phase, and after the readily available carbohydrates were all consumed the anaerobic microbes hunt for other substrates. On day 15 several samples including 30% giraffe, 100% giraffe, 100% koala and 30% sloth bear had an extreme increase (3-10 folds) in the soluble carbohydrates concentration (Figure 6.6), indicating a degradation of a complex carbohydrates into simple sugars. All the readily available sugars were consumed, and when recalcitrant carbohydrates were released as fermentable the sudden increase in the biomethane production on day 15 with assay with 100% and 30% giraffe were observed. At the end of the experiment (day 25) soluble carbohydrates were detected only in the samples of the 100% koala, sloth bear and giraffe.

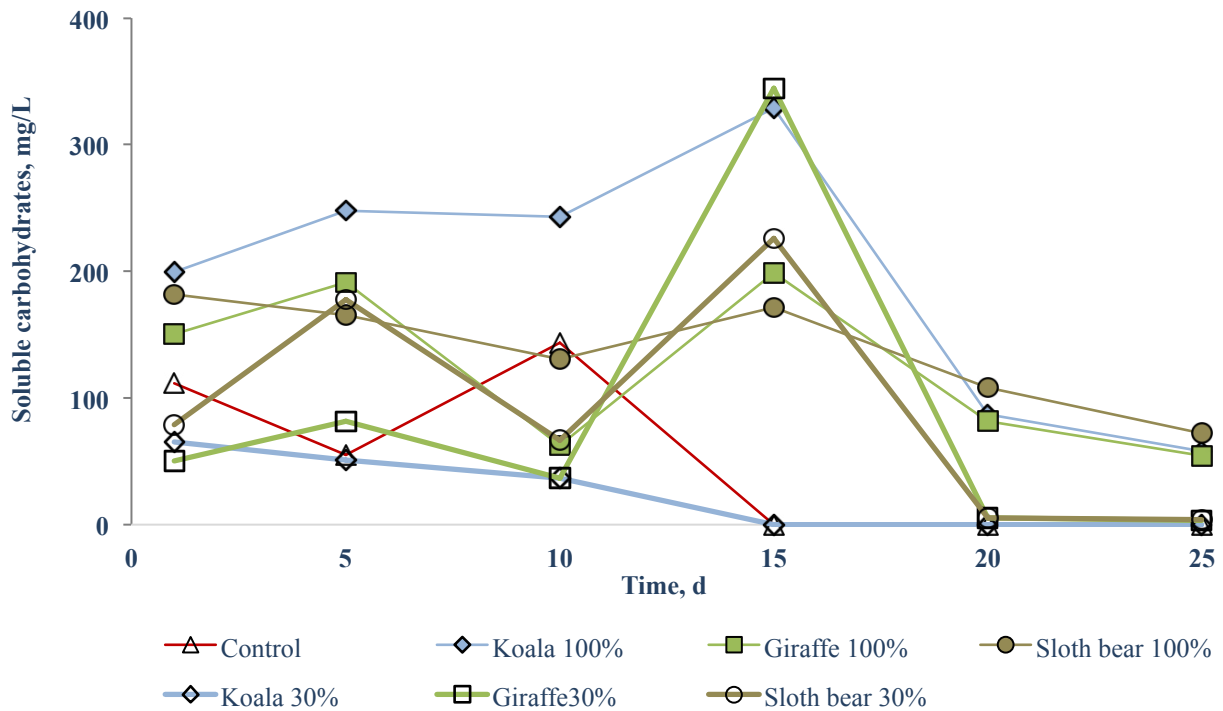

Figure 6.6: Profile of soluble carbohydrates

The control and the samples with 30% dungs had a very similar trend of protein profile throughout the experiment. The soluble protein concentrations did not change much for these samples and stayed below 600 mgBSA/L (Figure 6.7). However, the 100% dungs exhibit a different profile, but similar with each other. The soluble protein concentration of 100% sloth bear was in the range of 1273 – 1631 mgBSA/L until the day 20, but in the end of the experiment (day 25) the concentration dropped to 506.85 ± 105.06 mgBSA/L (Fig.6.6), which also explains the decrease of the CODs of the same sample (Figure 6.6). The soluble protein and carbohydrate concentration of 100% sloth bear and koala were all high, though very low biomethane was recovered with these inoculums (Figure 6.4B and Figure 6.4C). On the contrary giraffe dung had higher recovery of biomethane from FW, probably due to its potential to degrade more carbohydrates (Figure 6.6) as well as proteins (Figure 6.7). Moreover, giraffes are ruminants and thus its dung provides a better hospitable environment for the methanogens.

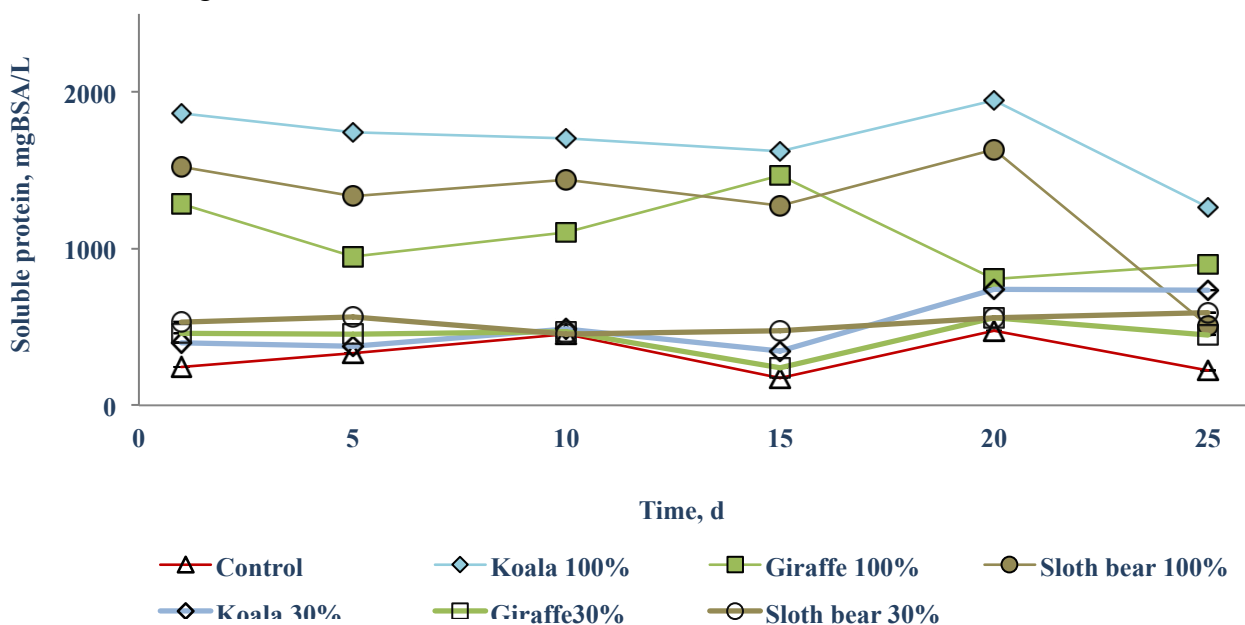

Figure 6.7: Profile of soluble proteins

6.4 Conclusions

The results from this experiment show that zoo animal dung has potential in bioaugmentation of AD of FW. Mixing giraffe dung with anaerobic sludge with 30% to 70% by volume ratio had the highest enhancement with $11.24 \pm 4.51\%$ increase of biomethane production. The bioaugmentation effect of giraffe dung was mainly due to a higher solubilisation of proteins ($6.96 \pm 2.76\%$) and release of carbohydrates (344.85 ± 54.31 mg/L as compared to zero) as compared to control (e.g. 100% anaerobic sludge).

6.5 Reference

1. ISWA (2013), Key Issue Paper: Food Waste As A Global Issue http://www.iswa.org/index.php?eID=tx_iswaknowledgebase_download&documentUID=3222.
2. Kim, J. K., Oh, B. R., Chun, Y. N., & Kim, S. W. (2006). Effects of temperature and hydraulic retention time on anaerobic digestion of food waste. *Journal of Bioscience and Bioengineering*, 102(4), 328-332.
3. Graunke, R. E., & Wilkie, A. C. (2014). Examining the mechanisms of short-term solubilization of ground food waste for high-rate anaerobic digestion. *International Biodeterioration & Biodegradation*, 86, 327-333.
4. Ariunbaatar, J., Panico, A., Esposito, G., Pirozzi, F., & Lens, P. N. (2014). Pretreatment methods to enhance anaerobic digestion of organic solid waste. *Applied energy*, 123, 143-156.
5. Ariunbaatar, J., Panico, A., Frunzo, L., Esposito, G., Lens, P. N., & Pirozzi, F. (2014). Enhanced anaerobic digestion of food waste by thermal and ozonation pretreatment methods. *Journal of environmental management*, 146, 142-149.
6. Herrero, M., & Stuckey, D. C. (2014). Bioaugmentation and its application in wastewater treatment: A review. *Chemosphere*
7. Schauer-Gimenez, A. E., Zitomer, D. H., Maki, J. S., & Struble, C. A. (2010). Bioaugmentation for improved recovery of anaerobic digesters after toxicant exposure. *Water research*, 44(12), 3555-3564.
8. Fangkum, A., & Reungsang, A. (2011). Biohydrogen production from sugarcane bagasse hydrolysate by elephant dung: effects of initial pH and substrate concentration. *International Journal of Hydrogen Energy*, 36(14), 8687-8696.
9. Fan, Y. T., Xing, Y., Ma, H. C., Pan, C. M., & Hou, H. W. (2008). Enhanced cellulose-hydrogen production from corn stalk by lesser panda manure. *International Journal of Hydrogen Energy*, 33(21), 6058-6065.
10. Ariunbaatar, J., Di Perta, E. S., Panico, A., Frunzo, L., Esposito, G., Lens, P. N., & Pirozzi, F. (2015). Effect of ammoniacal nitrogen on one-stage and two-stage anaerobic digestion of food waste. *Waste Management*.
11. Angelidaki, I., Alves, M. M., Bolzonella, D., Borzacconi, L., Campos, J. L., Guwy, A. J., ... & Van Lier, J. B. (2009). Defining the biomethane potential (BMP) of solid organic wastes and energy crops: a proposed protocol for batch assays.
12. APHA, Standard Methods for the examination of water and wastewater 21st edition ISBN: 0875530478
13. Masuko, T., Minami, A., Iwasaki, N., Majima, T., Nishimura, S. I., & Lee, Y. C. (2005). Carbohydrate analysis by a phenol-sulfuric acid method in microplate format. *Analytical biochemistry*, 339(1), 69-72.
14. John M. Walker (2002). The protein protocols handbook, ISBN: 978-0-89603-940-7 (Print) 978-1-59259-169-5 (Online)

CHAPTER 7

EFFECT OF AMMONIACAL NITROGEN ON ONE-STAGE AND TWO-STAGE ANAEROBIC DIGESTION OF FOOD WASTE

This chapter has been published in Waste Management as:

Javkhlan Ariunbaatar, Ester Scotto Di Pert, Antonio Panico, Luigi Frunzo, Giovanni Esposito, Piet NL Lens, Francesco Pirozzi, Effect of ammoniacal nitrogen on one-stage and two-stage anaerobic digestion of food waste, Waste Management (2015) <http://dx.doi.org/10.1016/j.wasman.2014.12.001>

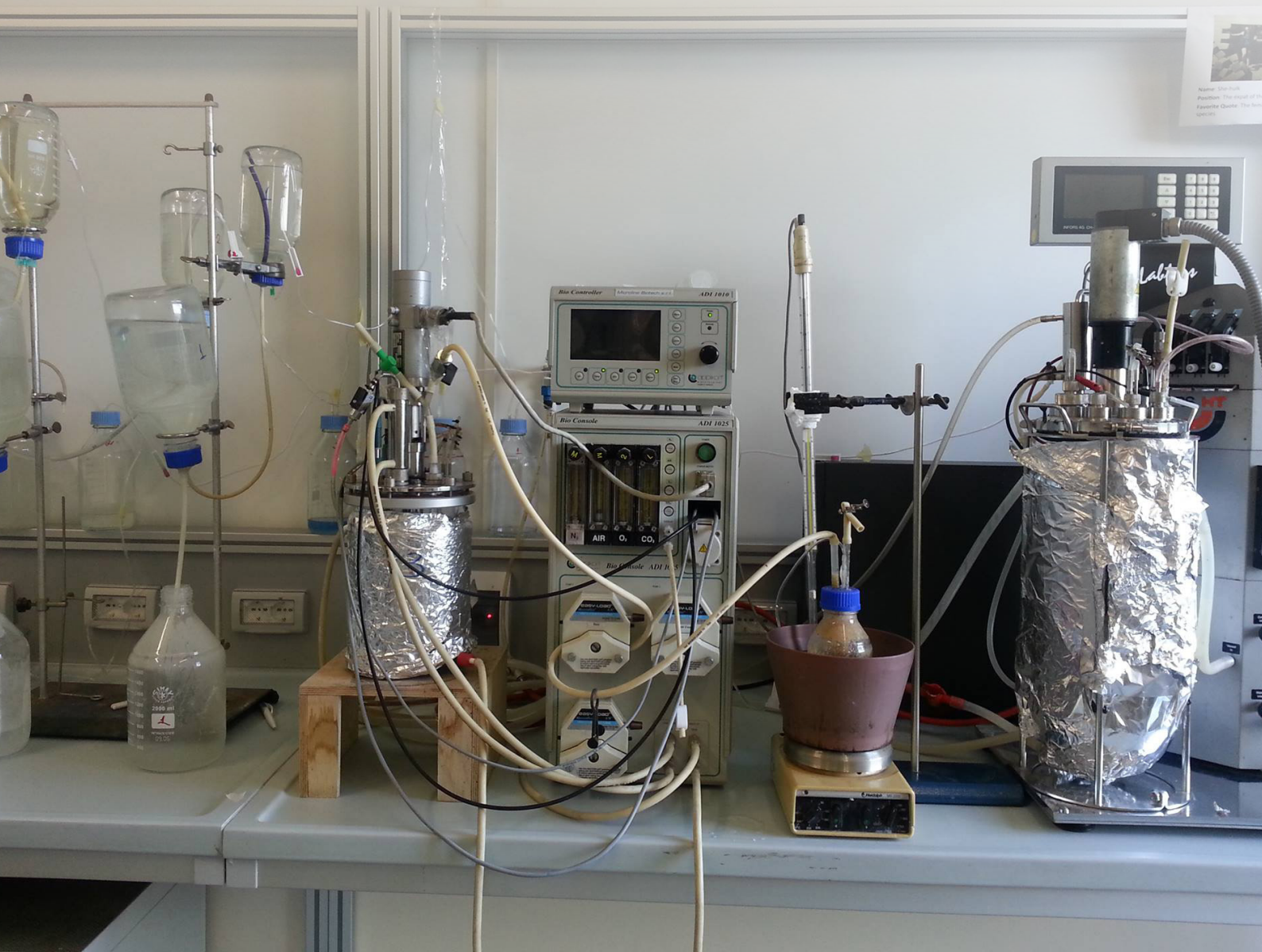

7 EFFECT OF AMMONIACAL NITROGEN ON ONE-STAGE AND TWO-STAGE ANAEROBIC DIGESTION OF FOOD WASTE

This chapter discusses the operation of one-stage and two-stage anaerobic continuously stirred tank reactor (CSTR) systems fed semi-continuously with food waste. The main purpose was to investigate the effects of ammoniacal nitrogen on the anaerobic digestion process. The two-stage system gave more reliable operation compared to one-stage thanks to: (i) a better pH self-adjusting capacity; (ii) a higher resistance to organic loading shocks; (iii) a higher conversion rate of organic substrate to biomethane. Also a small amount of hydrogen was detected from the first stage of the two-stage reactor making this system attractive for biohythane production. Re-circulation of digestate supernatant provided the necessary alkalinity since it contains ammoniacal nitrogen, thus preventing an eventual failure by volatile fatty acids (VFA) accumulation. However, re-circulation also resulted in ammonium accumulation, yielding a lower biomethane production. The 50% inhibitory concentration of ammonium was 3.8 g/L, corresponding to 146 mg/L free ammonia for the inoculum used for this research. The ammonium inhibition on methanogens is stronger in the two-stage system than in the one-stage system, as it requires less alkalinity and the physically separated methanogens are more sensitive to inhibitory factors, such as ammonium and propionic acid.

7.1 Introduction

The introduction of separated collection of different fractions of municipal solid waste (MSW) and subsidies for renewable energy production have been the main drivers for the development of the anaerobic digestion (AD) as a system to treat the organic fraction of municipal solid waste (OFMSW). Food waste (FW), the single largest fraction of MSW, has a high biomethane production potential ($200\text{-}670 \text{ mlCH}_4/\text{gVS}_{\text{added}}$) [1-5]. Thus, treating FW through AD has become an exciting research field. Designing and optimizing the AD process using FW is nevertheless challenging [2].

The performance of continuous anaerobic reactors fed with FW is initially good with increasing build-up of the acetic acid concentration, which reaches a peak after a few months [6]. During a long-term operation, the acetic acid concentration declines and the propionic acid concentration builds up. Eventually the volatile fatty acids (VFA) accumulation can overcome the digester buffer capacity, leading to acidification and failure of the system. The alkalinity already present in the FW stream feeding the reactors as well as that produced from the biological process contributes to provide the anaerobic system with the buffer capacity and therefore, it is an essential parameter for a successful operation as compared to the direct measurement of pH [7]. During the hydrolysis and fermentation stages of AD there is a consumption of alkalinity, while alkalinity is produced and acidification is compensated during the methanogenic stage. A higher buffer capacity allows AD to operate at higher organic loading rates (OLRs), thus resulting in a higher biomethane production without experiencing a pH drop and acidification.

The total ammoniacal nitrogen (TAN) concentration in anaerobic reactors plays a significant role for maintaining the required alkalinity. In anaerobic aqueous solution, the ammonium ions (NH_4^+) and free unionized ammonia (NH_3) ions are in a chemical equilibrium forming the TAN. The equilibrium between ammonium and free ammonia (FA) depends on the temperature and pH of the system. The bioreactors perform best at TAN concentrations of 600 – 800 mg/L (at pH = 7.2 – 7.5 and mesophilic condition), and a higher TAN concentration can lead to an inhibition of the methanogens and an eventual failure of the reactor [8, 9, 10].

It was proposed by several researchers that higher ammonium ($\text{NH}_4^+\text{-N}$) concentrations reduce the activities of the propionic acid utilizing anaerobes, thus propionic acid starts to build up [5, 6, 11]. Propionic acid accumulation further inhibits the methanogens, and consequently all VFA concentrations increase causing an imbalance of the reactors [6, 10, 11]. On the other hand, Nakakubo et al. (2008) and Prochazka et al. (2012) suggested that higher ammonium concentrations directly inhibit the enzymatic activity of the methanogens causing a lower biomethane production [8, 12]. A high concentration of FA is also extremely inhibitory to methanogens [12, 13] as it can diffuse passively into the bacterial cells. FA inside the cells cause an imbalance of the intercellular pH while it equilibrates with the ammonium ion, which further inhibits some enzymatic activities of the methanogens [9, 13].

It is widely recognised that the physiology of the anaerobic microbes, origin of inoculum, substrate characteristics and operational conditions affect the inhibitory level of both ionized and unionized forms of ammonia [15]. Hence, a wide range (1.7 – 14 gTAN/L) of inhibitory concentrations have been reported in the literature [12]. In general, earlier research reported that a TAN concentration of 1700 – 2000 mgTAN/L is toxic to unacclimated microbes [16, 17], whereas the 50% inhibition for acclimated methanogens could reach up to 12,000 – 14,000 mgTAN/L [12, 17].

To the best of our knowledge, the buffering and inhibitory effects of TAN on the AD of FW have not yet been studied in detail, whereas it has been widely studied for AD of swine manure [10, 13, 15] and waste activated sludge (WAS) [16, 17, 18]. Therefore, this research aims at investigating the effect of TAN on the AD of synthetic FW through batch and semi-continuous reactors. The buffering as well as inhibitory effects of ammonium were investigated in batch experiments as well as in one-stage (R1) and two-stage (R2) continuously stirred tank reactors (CSTR) treating synthetic FW at mesophilic conditions.

7.2 Materials and methods

7.2.1 Substrate and inoculum

As the FW composition can change depending on the season, region and the ways it is collected it might have a varying impact on the performance of the AD process. Hence, a synthetic FW was used for both batch and semi-continuous experiments in this study. The synthetic FW was prepared weekly following Ariunbaatar et al. (2014) [19], and it was stored in the fridge (4 °C) when not in use. The FW was added directly to the bottles for batch experiments, whereas it was mixed with water prior to feeding to the semi-continuous reactors. The inoculum used for the experiments was from a full-scale AD plant (treating buffalo manure and cheese whey) located in Capaccio-Salerno (Italy).

7.2.2 Batch experiments

The inhibitory effect of TAN on the AD of FW was studied through batch experiments to determine the biomethane potential (BMP) by adding a gradient series (0.5, 0.8, 1.67, 1.67, 1.67, 0.8, 0.8, 1.67, 1.67 g/L) of ammonium chloride (NH_4Cl) to the BMP bottles (marked as N series) and compared with the control (BMP bottle with no addition of NH_4Cl). The substrate to inoculum (S/I) ratio was 0.5 gVS/gVS. BMP tests were conducted in a 1L glass bottle, sealed with silicone filled stopper. The bottles were placed on a shaker to provide continuous mixing, and all tests were conducted in duplicate at mesophilic conditions (30 – 34 °C) as described by Esposito et al. (2011) [20]. The biomethane production was measured

with the liquid displacement method using a sodium hydroxide (120 gNaOH/L) solution to trap the carbon dioxide (CO₂) [20].

7.2.3 Semi-continuous reactors

The effect of TAN on the buffer capacity was studied through a semi-continuous one-stage (R1) and two-stage (R2) CSTR at a mesophilic (32-37 °C) condition. R2 consisted of two separate CSTRs connected with a tube, and the working volumes were 220 ml and 1980 ml for the first and second stage, respectively, making the total working volume (2.2 L) the same as R1. The stirring speed of all the CSTRs was 150 rpm.

Three independent runs of the reactors were carried out. The detailed operational parameters of each run are shown in Table 7.1. To investigate the effect of TAN on the buffering capacity as well as the robustness of the reactors, Run 1 was performed for 60 days by applying an organic loading shock with no additional buffer addition or re-circulating the liquid fraction of the digestate (LFD). During Run 1, the hydraulic retention time (HRT = V/Q) and the organic loading rate (OLR = C/HRT) were 20 d and 1.2 gVS/L.d, respectively. The main purpose of Run 2 was to study the effect of the LFD re-circulation on the buffer capacity and/or toxicity of TAN (in both R1 and R2); although to secure a prolonged stable operation, the HRT was increased to 40 d and the OLR was also reduced to 0.3 gVS/L.d by reducing the VS concentration in the feed (Table 7.1). The digestate was centrifuged at 3000 rpm for 5 minutes to separate the liquid and solid fractions. The LFD was used to prepare the feed for the reactors, thus the re-circulation was performed manually. However, the volume of the LFD was only sufficient for 75 – 80% of the feed volume, hence tap water was added. Run 2 lasted for 59 days and due to operational hitches, the reactors were stopped for a few weeks. Both reactors were re-started in Run 3 with the same operational conditions using the inoculum from Run 2 and lasted for 60 days. Starting day 61, the OLR was increased gradually up to 0.9 gVS/L.d by increasing the FW concentration in the feed.

Table 7.1: Operational parameters of R1 and R2

Parameters	One-stage CSTR (R1)	Two-stage CSTR (R2)	
		First stage	Second stage
<i>Run 1</i>			
pH	6.6–7.2	3.2–5.5	6.7–7.2
OLR (gVS/L.d)	1.2	1.2	1.2
HRT (d)	20	2	18
<i>Run 2</i>			
pH	7.2–7.4	5.2–6.1	7.2–7.6
OLR (gVS/L.d)	0.3	0.3	0.3
HRT (d)	40	4	36
<i>Run 3</i>			
pH	7.2–7.4	4.0–5.1	7.4–7.6
OLR (gVS/L.d)	0.4–0.9	0.4–0.9	0.4–0.9
HRT (d)	40	4	36

7.2.4 Analytical methods

TS, VS, Total Kjeldahl Nitrogen (TKN) and TAN were analysed according to the APHA standard methods. Total proteins were calculated based on TKN, using a correction coefficient of 6.25 [21]. Total carbohydrates were determined with the phenol-sulphuric method and measured spectrophotometrically (TUV SR03210002) using glucose as the standard solution [21]. Total lipids were extracted with a mixture of chloroform and methanol (1:2 by v/v), dried and weighted [22].

The biomethane production from both batch and semi-continuous experiments was measured continuously by the liquid displacement method as described by Esposito et al. (2011) [20]. The biomethane production was normalized to standard temperature and pressure (STP). Total alkalinity (TA) and partial alkalinity (PA) was calculated based on the volume of the consumed sulfuric acid (0.05 M) by titrating with it until pH 5.4 and 4.4, respectively. Based on the TA and PA values the volatile organic acid (VOA) alkalinity and VOA/PA ratio was calculated.

For the volatile fatty acids (VFA) analysis, 1.5 ml sample was collected and prepared by solid-phase micro-extraction as described by Abalos et al. (2000) [23]. The extracted VFA samples were analysed with gas chromatography (GC) equipped with Nukol Supelco FID column, using helium as a carrier gas. The gas samples were collected directly from the headspace for the analysis of the biomethane (CH₄) and biohydrogen (H₂) content. The gas content was analysed with a GC equipped with Restek Shin-Carbon column, using argon as the carrier gas.

7.2.5 Calculation

The inhibitory concentration (IC) of TAN on the Methanogenesis was calculated using the extended Boltzman equation [24]:

$$Y = b + ((a - b)/(1 + \exp(X - X_0/dX)))$$

$$IC_i = X_0 + dx * \ln((a - b)/(100 - i) - b - 1)$$

where,

a = initial value (lower horizontal asymptote)

b = final value (upper horizontal asymptote)

X₀ = point of inflection

IC_i = the concentration of i% inhibition of methanogenic activity

Once the IC₅₀ was estimated, the concentration of free ammonia (FA) was calculated according to Kayhanian (1999) [14]:

$$NH_3-N = (TAN \times (K_a / 10^{-pH})) / ((K_a / 10^{-pH}) + 1)$$

where,

TAN = total ammoniacal nitrogen concentration, mg/L

K_a = temperature dependent disassociation constant (K_a = 1.097 x 10⁻⁹ at 35 °C)

7.3 Results

7.3.1 Substrate and inoculum characterization

Table 7.2 shows the physical and chemical characteristics of the synthetic FW and inoculum. The synthetic FW contains mostly carbohydrates (67.75 ± 3.82 %VS), a balanced concentration of proteins (16.45 ± 0.19 %VS) and lipids (16.36 ± 0.82 %VS) making it a suitable substrate for anaerobic microbes. The inoculum contains mostly proteins (50.57 ± 1.29 %VS), lipids (33.15 ± 0.36 %VS) and a small amount of carbohydrates (16.28 ± 1.62 %VS), suggesting that the VS in the inoculum consist mainly of microbial biomass.

Table 7.2: Characteristics of substrate and inoculum

Parameter	Food waste	Inoculum
TS (%)	23.50 ± 0.60	2.23 ± 0.26
VS (%)	22.06 ± 0.16	1.13 ± 0.19
Proteins (%VS)	16.45 ± 0.19	50.57 ± 1.29
Lipids (%VS)	16.36 ± 0.82	33.15 ± 0.36
Carbohydrates (%VS)	67.75 ± 3.82	16.28 ± 1.62
TKN (g/L)	5.82 ± 0.07	1.07 ± 0.02
TAN (mg/L)	-	310.01 ± 19.95

7.3.2 Batch experiments on ammonium inhibition

Figure 7.1A shows that the BMP tests took 20 days to reach the maximum production and a plateau was achieved after 25 days. The specific biomethane production (SBP) amounted to 468.5 ± 6.8 mlCH₄/gVS_{added}. The inhibitory concentration (IC₅₀), which limits the methanogenic activity by 50% was calculated as 3.8 gTAN/L (146 mgFA/L). Figure 7.1B illustrates the sigmoid correlation between the TAN concentration and the SBP as well as the inhibition percentage.

The VFA concentration of each BMP bottle was analysed every 4 – 5 days during the BMP tests (Figure 7.1C and Figure 7.1D). The main VFA produced were acetic and propionic acid, negligible amounts of butyric and valeric acid were also detected. Figure 7.1C and Figure 7.1D show that higher the TAN concentration, the more acetic and propionic acids were accumulated at the end of the experiment.

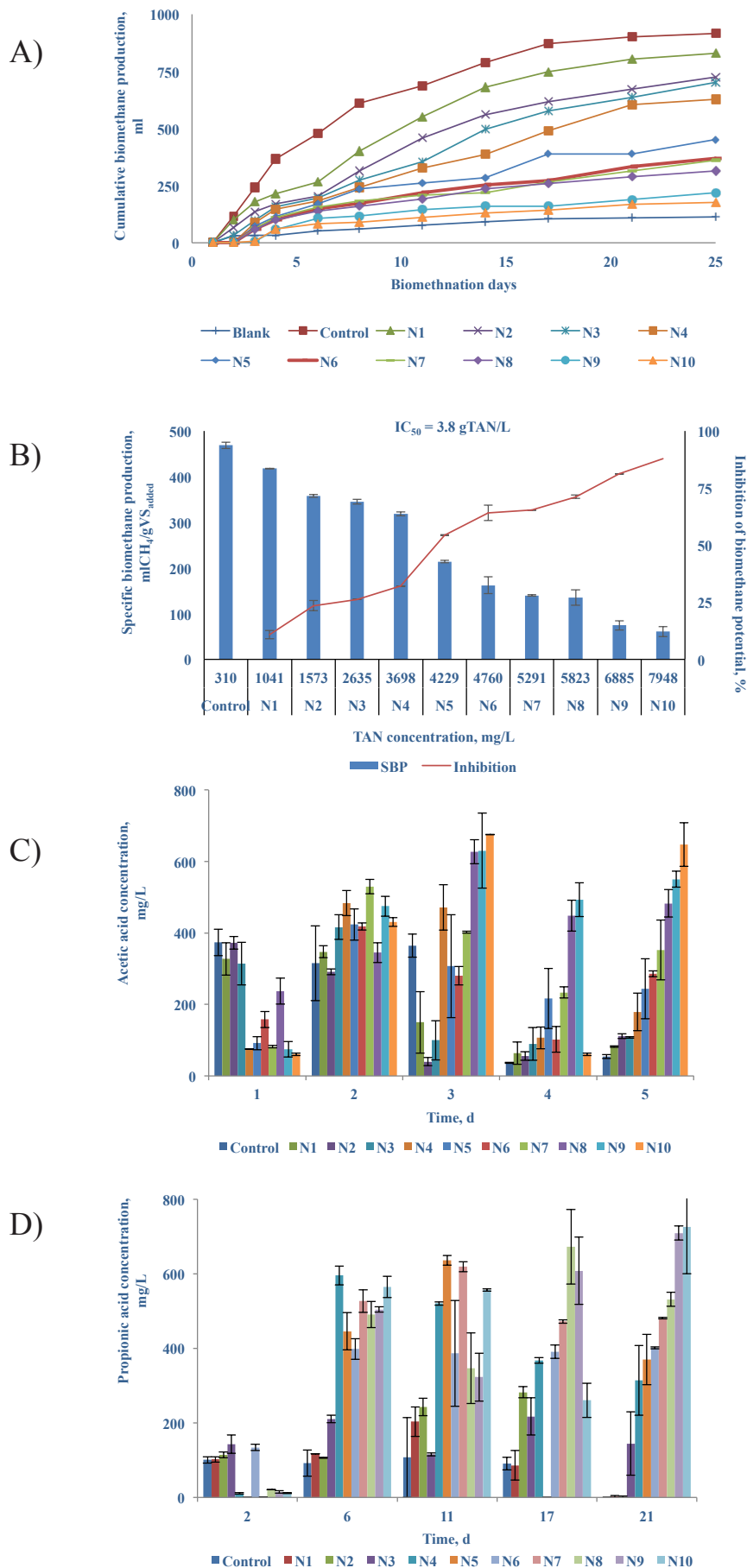

Figure 7.1: Effect of TAN on process parameters of the batch anaerobic digestion of FW: A) Cumulative biomethane production of FW; B) SBP and inhibition percentage; C) Acetic acid concentration; and D) Propionic acid concentration;

7.3.3 Comparison of one-stage and two-stage reactors

7.3.3.1 Run 1: Effect of organic loading shocks without leachate re-circulation

The reactor stability parameters, VOA/PA ratio and pH, as well as the daily biomethane production are shown in Figure 7.2. A steady state of the reactors was achieved when a constant or a steady value of these stability parameters was obtained. Once the steady state was achieved, no feed was supplied on days 7 and 15 to give shocks in the organic loading. These shocks caused a slight imbalance in the VOA/PA ratio (Figure 7.2A) and a decrease of the pH in the reactors (Figure 7.2B); although the reactors were able to recover themselves within a few days, when a stable feeding was supplied. On day 24, feed was not supplied again for 4 days, which explains the low biomethane production (Figure 7.2D). On day 28, the reactors were fed again, causing a sudden shock of the loading. Interestingly, R1 failed within 2 days (day 30) due to acidification, while R2 was relatively stable (Figure 7.2). Therefore, the feeding of R1 was stopped to see if it could recover by itself, while R2 kept on running with no change in operational conditions. On day 49, R2 also failed due to acidification, and the TA was 3660 mg/L (R1) and 3690 mg/L (R2).

The initial TA concentration during the start-up was in the range of 5500 – 6000 mg/L. Both R1 and R2 were not able to regain the alkalinity; hence, to increase the TA, sodium bicarbonate (NaHCO_3) was supplied to obtain a TA of 5700 – 5800 mg/L on day 52. On days 53 to 55, the pH was recovered (Figure 7.2B), and the biomethane production was similar to the steady state (Figure 7.2D). Nonetheless, both R1 and R2 failed again on day 56 due to the loss of alkalinity (Figure 7.2A and Figure 7.2B), and the reactors could not be recovered anymore.

The TAN concentration of R1 and R2 were 561 mg/L and 571 mg/L, respectively, during steady state operation (days 1 to 35). The TAN concentration slowly decreased to 400 mg/L (Figure 7.2C) as R1 and R2 lost alkalinity. When additional buffer was supplied, the TAN concentration also increased up to 500 mg/L (Figure 7.2C), but decreased immediately after R1 and R2 experienced acidification again (Figure 7.2A and Figure 7.2B).

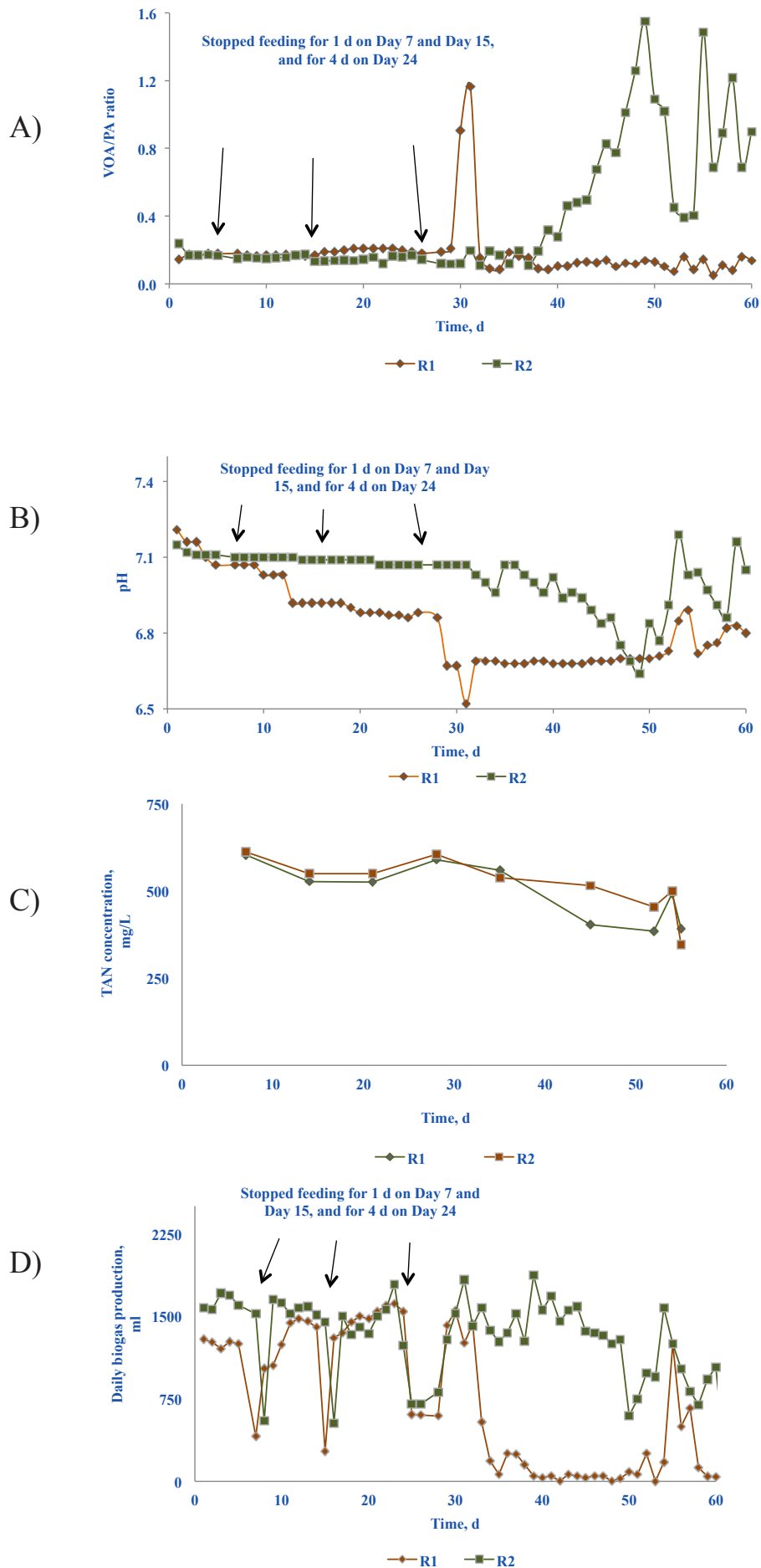

Figure 7.2: Run 1 – Performance of R1 and R2 treating FW: A) VOA/PA ratio; B) pH; C) TAN concentration; and D) Daily biogas production

7.3.3.2 Run 2: Effect of leachate re-circulation at constant OLR

The reactors were re-started with fresh inoculum, a higher HRT and a lower OLR to secure a longer steady state operation (Table 7.1). The reactor stability parameters, VOA/PA ratio and pH, are shown in Figure 7.3A and Figure 7.3B, respectively. The steady states of the reactors were obtained also within a week of operation (same as Run 1) with an average VOA/PA ratio of 0.21-0.22, thanks to the active and stable inoculum. After 18 days of operation, the VOA/PA ratio decreased and the pH increased from 7.3 to 7.8, and a slight instability was observed until day 33 (Figure 7.3A and Figure 7.3B). However, the reactors experienced a new steady state from day 34 onwards with an average VOA/PA ratio of 0.15 and the pH was in the range of 7.2 – 7.4 for both R1 and R2.

The daily biomethane production of the reactors (Figure 7.3D) was constant during the first steady state (day 1-19), with an average SBP between 567.6 mlCH₄/gVS_{added} and 758.9 mlCH₄/gVS_{added} for R1 and R2, respectively. During the operation days 20 to 34, the biomethane production rate was not stable and less biomethane production was observed. After 2 weeks of instability, the biomethane production of the reactors became constant again during days 34 to 59. However, the biomethane production was 468.1 mlCH₄/gVS_{added} and 518.2 mlCH₄/gVS_{added} for R1 and R2, respectively, which are 17.5% and 31.7% lower as compared to the first steady state.

The TAN concentration of the reactors was also analysed periodically (Figure 7.3C). During the first steady state, the average TAN concentrations of R1 and R2 were 513 mg/L and 536 mg/L, respectively. As a result of the LFD re-circulation, TAN was accumulated in both reactors and reached up to 1026 mg/L, which led to an instable operation (days 18 to 34). Although after 2 weeks of operation, the TAN concentration slowly reduced to 648 mg/L (R1) and 628 mg/L (R2).

VFA were not detected during the initial days of operation, but were present after the reactor reached steady state. The average VFA concentration in R1 and R2 were 44 mg/L and 80 mg/L, respectively. Similar to the batch experiments, the main VFA produced were acetic, propionic and butyric acids, and negligible amounts of valeric and caproic acid were detected (Figure 7.4).

During Run 2 the pH of the first stage of R2 reduced from 7.6 to 5.2 within 10 days. No biohydrogen was detected and a small amount of biomethane was produced. The effluent from the first stage of R2 contained an average of 2267 mg/L acetic acid, 752 mg/L butyric acid, 433 mg/L propionic acid, 292 mg/L caproic acid, 166 mg/L isobutyric acid, 126 mg/L valeric acid, and negligible amounts of medium or long chain fatty acids, which means the second stage of R2 was fed with a pre-hydrolysed substrate.

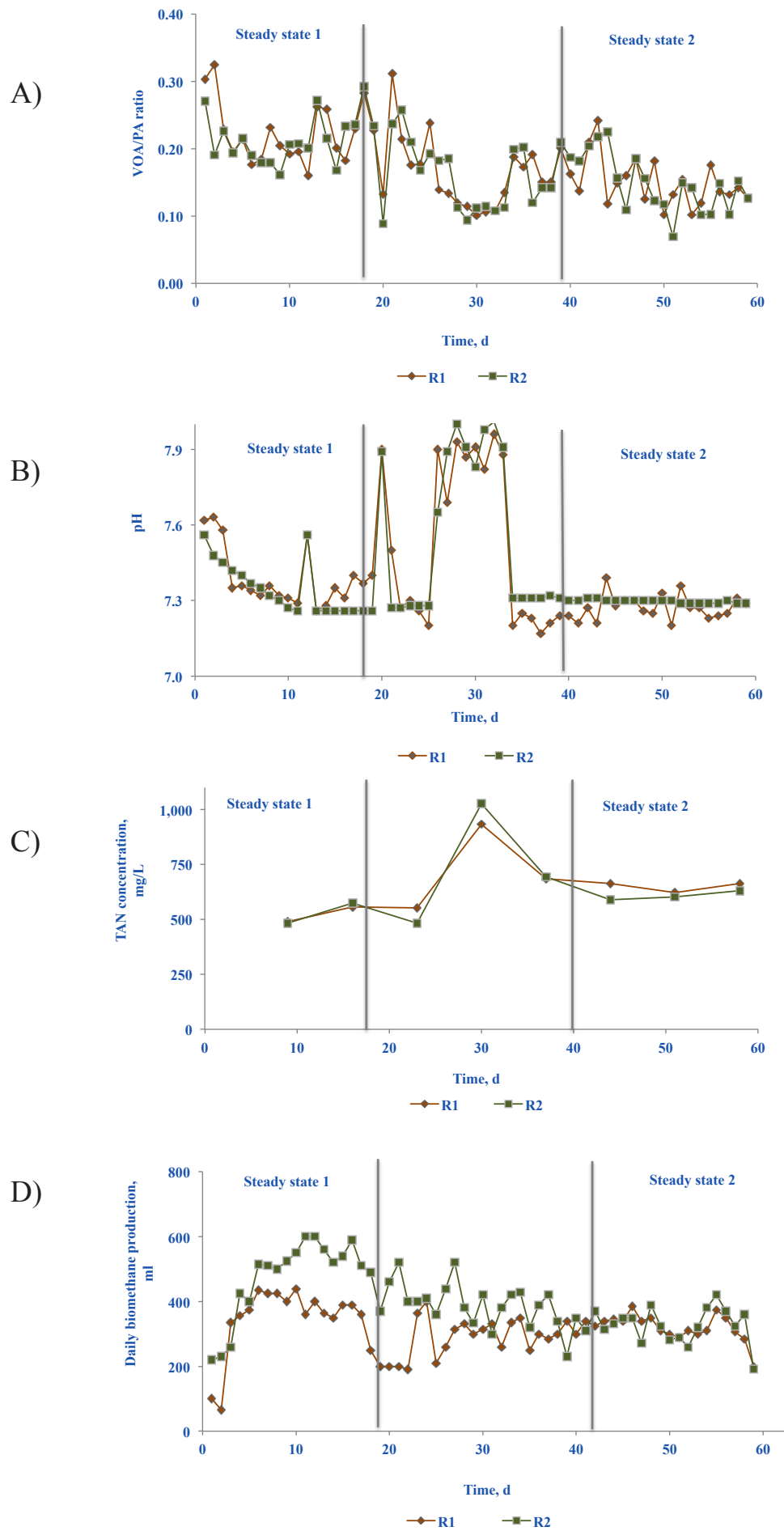

Figure 7.3: Run 2 – Performance of R1 and R2 treating FW: A) VOA/PA ratio; B) pH; C) TAN concentration; and D) Daily biomethane production

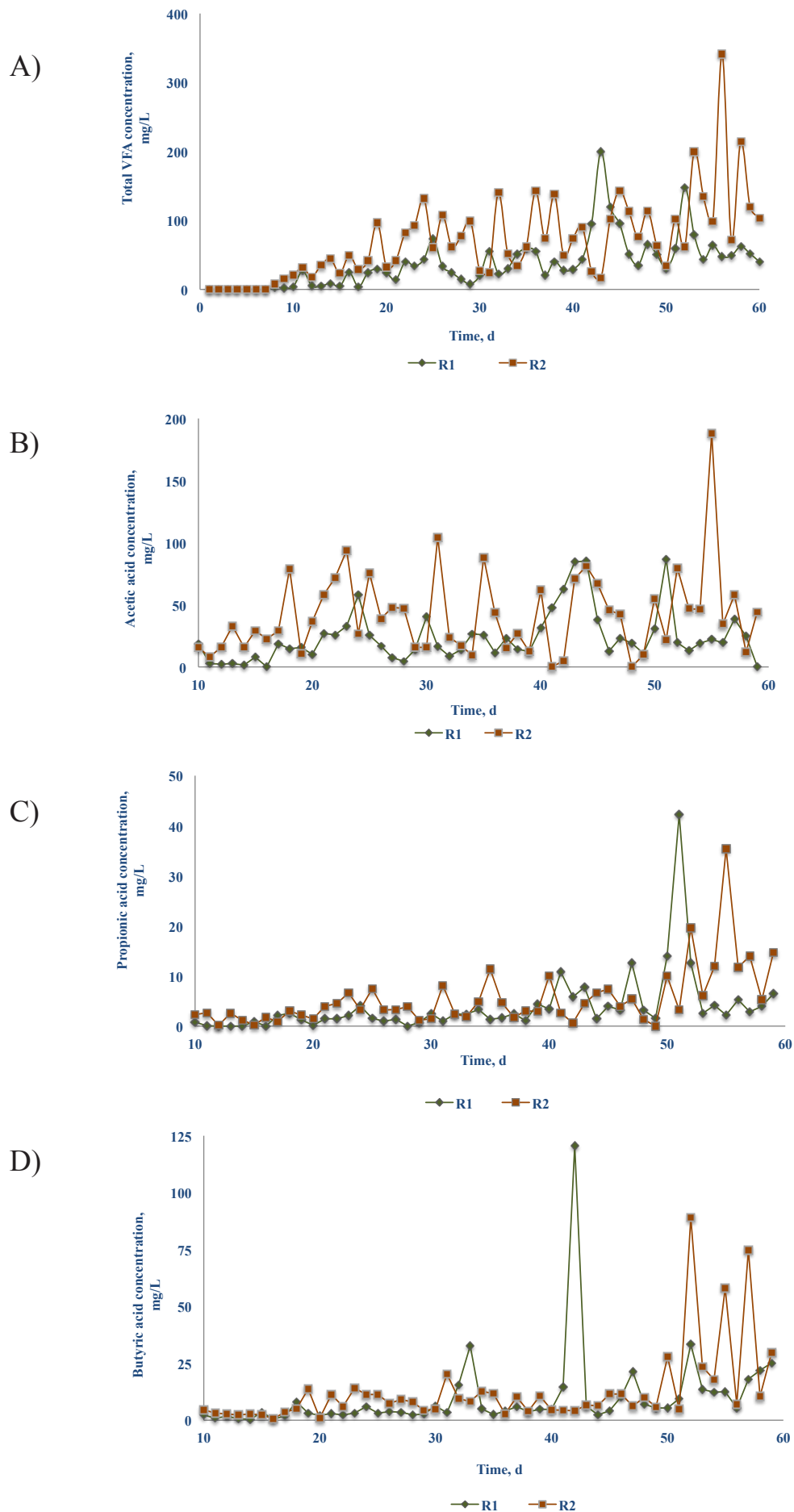

Figure 7.4: VFA production during Run 2: A) Total VFA; B) Acetic; C) Propionic; and D) Butyric acid

7.3.3.3 Run 3: Effect of OLR increase

When the reactors were re-started for Run 3 with the same inoculum as Run 2, the steady state was achieved within a week with a stable VOA/PA ratio (0.09 – 0.11). At an OLR of 0.3 gVS/L.d, the SBP of R2 was higher than R1, which accounted for 523.6 ml/gVS_{added} and 457.8 ml/gVS_{added}, respectively. The OLR of the reactors were gradually increased (from 0.3 – 0.9 gVS/L.d) keeping a constant VOA/PA ratio (Figure 7.5A). As the OLR increases, a higher TAN concentration was observed (Figure 7.5B), which led to a slight decrease of SBP (Figure 7.5C). Even though the performance of the reactors was slightly reduced at an OLR of 0.4 – 0.6 gVS/L.d, the average TAN concentration (less than 800 mgTAN/L) and the SBP were in a similar range for both R1 and R2 (430.8 – 466.6 mlCH₄/gVS_{added} and 428.6 – 459.4 mlCH₄/gVS_{added} for R1 and R2, respectively). There was no change in biomethane composition in both reactors (Figure 7.5D). However, the poor performance became evident at an OLR of 0.9 gVS/L.d after day 120. The TAN concentration reached average values of 815.8 mg/L and 959.7 mg/L in R1 and R2, which caused a SBP of 382.1 mlCH₄/gVS_{added} and 337.9 mlCH₄/gVS_{added}, respectively (Figure 7.5C). The increased TAN did not only affect the SBP, but also the methane content in the biogas reduced from 47% to 45% in R1 and from 55% to 49% in R2 (Figure 7.5D). In terms of VFA, the same amounts of acetic, propionic and butyric acids were detected, although the total VFA concentration in the reactors were higher than Run 2, which amounted to 148.7 mg/L and 95.84 mg/L in R1 and R2, respectively (Figure 7.6).

During Run 3, the pH of the first stage of R2 was 5.1, and the performance was very similar to Run 2 until operation day 80 (OLR = 0.5 gVS/L.d). It produced a small amount of biogas with 33% biomethane and negligible amounts of biohydrogen. The average VFA concentration in the first stage of R2 was 3450 mg/L (Figure 7.7A). However, as the OLR was increased the pH dropped to 4.3 and the biomethane content was reduced from 33% to 7.9% (Figure 7.7B). It is interesting to note that from day 89 onwards, lactic acid was produced (an average of 3723 mg/L), which was accompanied by a small amount (less than 2%) of biohydrogen production (Figure 7.7C).

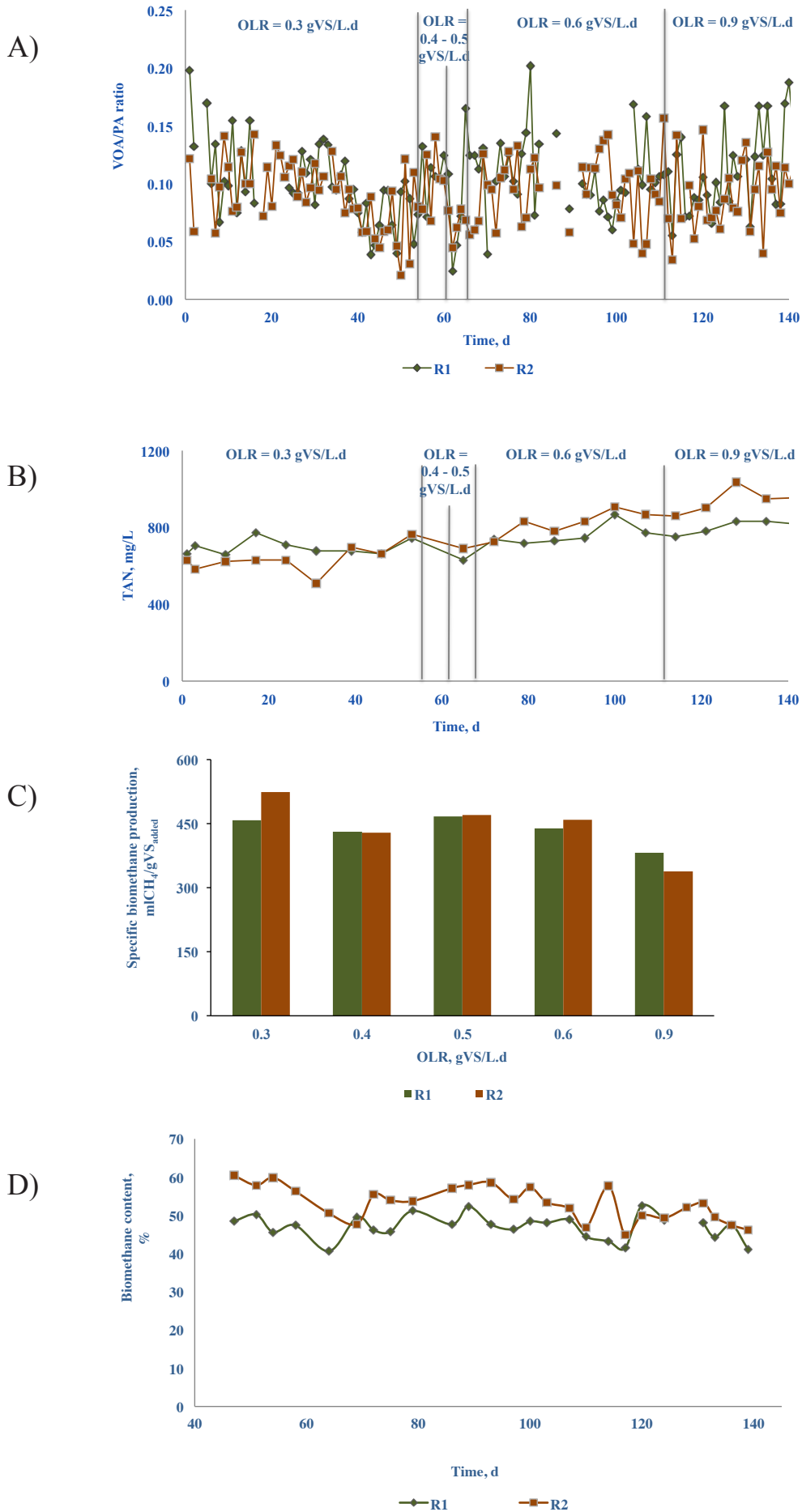

Figure 7.5: Run 3 – Performance of R1 and R2 treating FW: A) VOA/PA ratio; B) TAN concentration; B) Specific biomethane production; and C) Percentage of biomethane in biogas

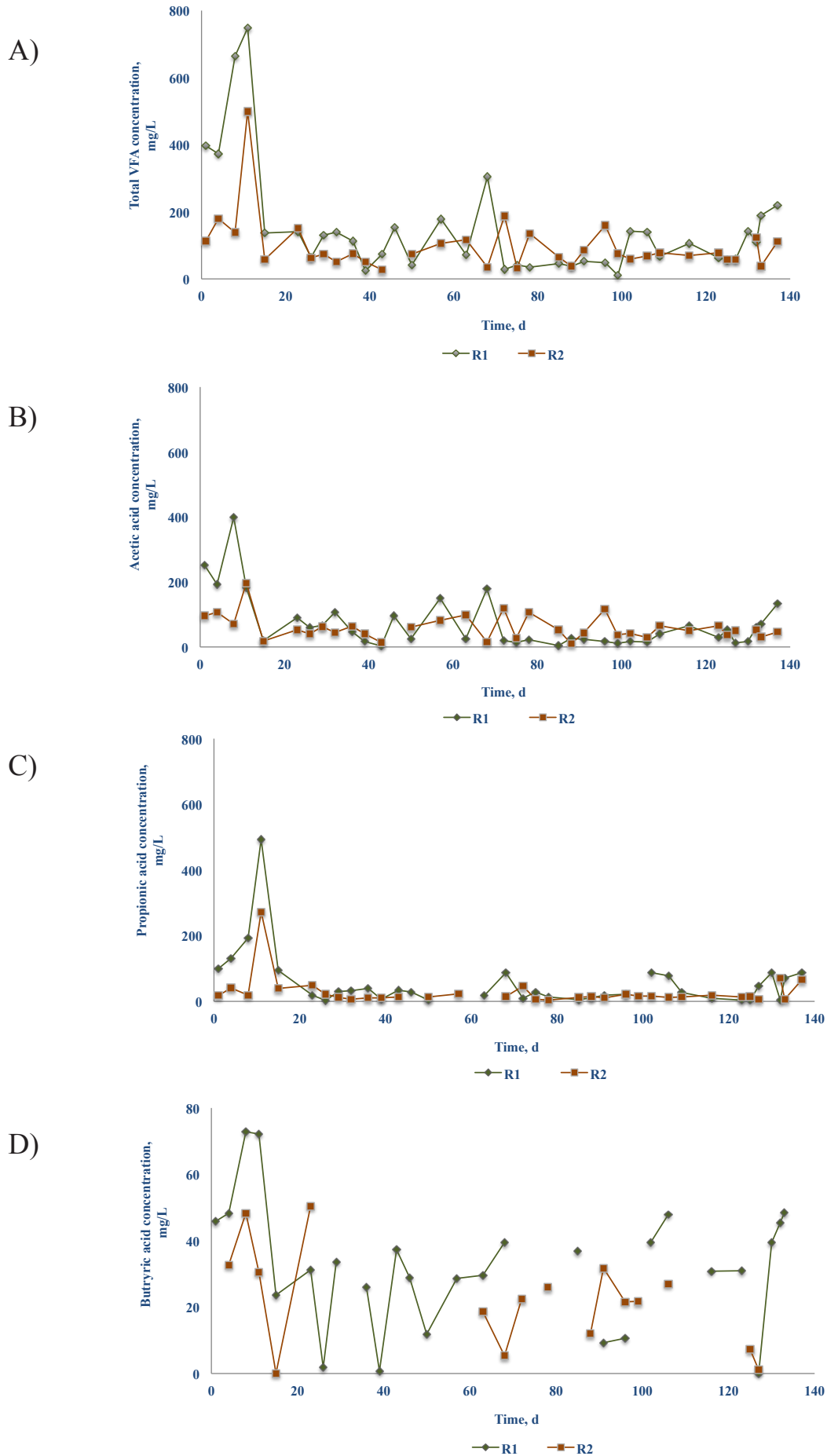

Figure 7.6: VFA production during Run 3: A) Total VFA; B) Acetic; C) Propionic; and D) Butyric acid

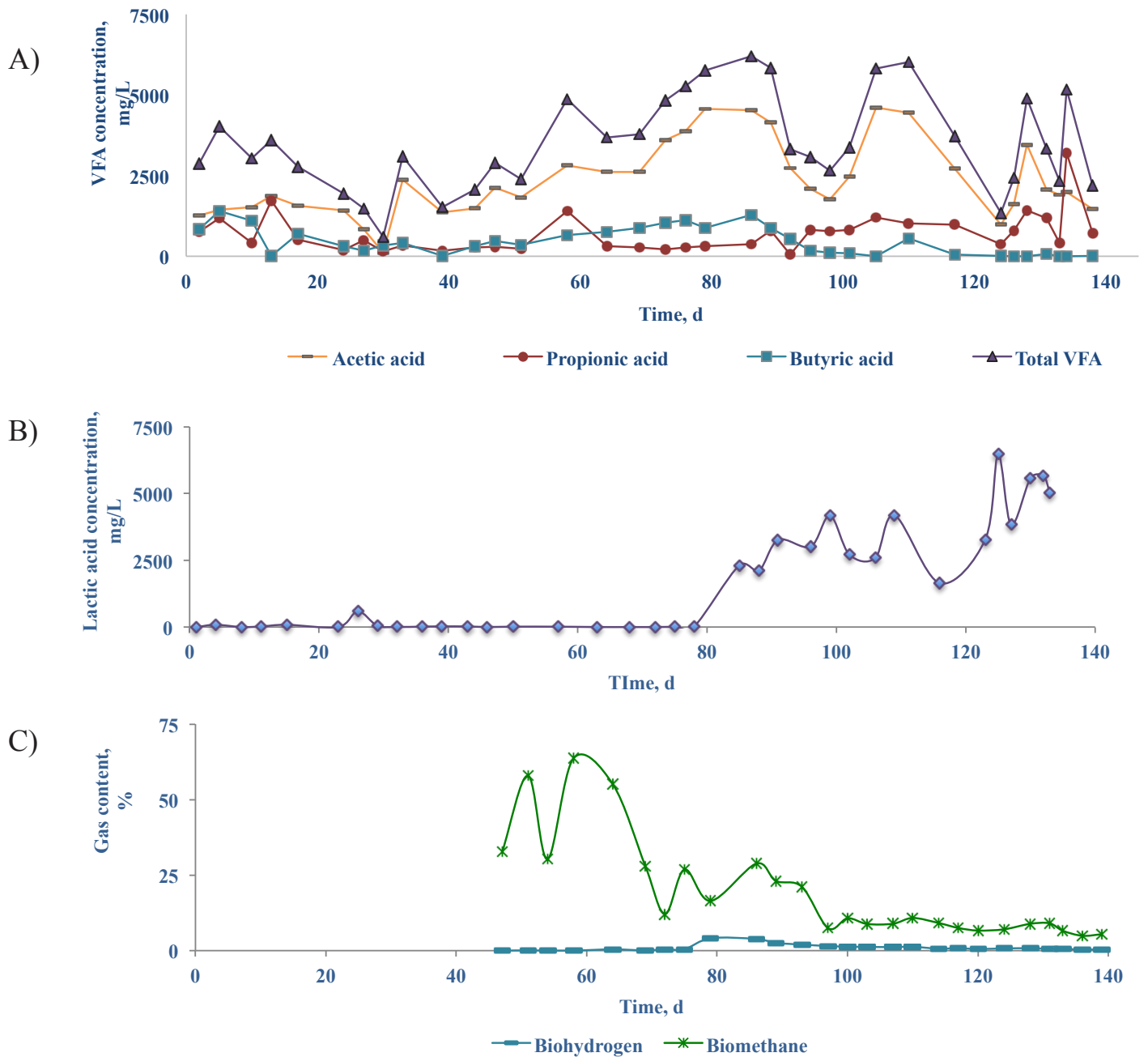

Figure 7.7: Performance parameters of the first stage of R2: A) Total VFA concentration; B) Gas content; C) Lactic acid concentration

7.4 Discussion

7.4.1 Anaerobic digestion of food waste

This study showed that FW has a high potential in biomethane production. The biomethane potential of $468.5 \pm 6.8 \text{ mlCH}_4/\text{gVS}_{\text{added}}$ was achieved with batch experiments, which is in the range of reported values for other types of FW [2, 3, 4, 5, 25]. Successful operation of the two-stage CSTR could achieve almost 100% of the biomethane potential of FW, whereas the one-stage CSTR converted only 71% of VS added into biomethane. Moreover, it was clear that R2 is more robust than R1, as it is more resistant to organic loading shocks (Figure 7.2). This result is in agreement with the literature suggesting that two-stage systems could have an increased stability with better pH control, a higher loading rate, and an increased specific activity of methanogens resulting in a higher methane yield [1, 26, 27, 28]. The advantage of R2 was not only the increased biomethane production and a better stability of the process, but also the possibility to produce biohydrogen from the first stage (Figure 7.7C). However, the biohydrogen production in this study was relatively small (less than 2%) as compared to other studies ($> 8.5\%$), even though the pH (4 – 5.5) was favourable for the main biohydrogen forming bacteria such as *Clostridium sp* [28, 29, 30]. As suggested by Kapdan and Kargi (2006), the low biohydrogen production could be due to the relatively slow biochemical pathways to produce biohydrogen from lactic and butyric acids [25].

7.4.2 Effect of TAN on buffer capacity in semi-continuous systems

R2 was more resistant to organic loading shocks than R1, however it also failed eventually due to acidification. OLR overloads and shocks lead to bacterial washout and/or low buffer capacity, which all result in VFA accumulation [32]. Once the alkalinity or the buffer capacity is consumed, it was very difficult to recover both the one-stage and two-stage CSTR system failures due to acidification (Figure 7.2). Only adding external buffer (NaHCO_3) could recover the system for a few days (Figure 7.2), but was not sufficient to support the recovery of the continuous operation.

Figure 7.2A shows that the main reason for the process failure was the low buffer capacity, and when the buffer capacity became low, the TAN concentration also decreased (Figure 7.2C). Therefore, the TAN concentration plays an important role in the buffering capacity of the reactors. Moreover, Takashi and Speece (1989) suggested that an adequate amount of TAN does not only provide the necessary buffer capacity, but it is also an essential nitrogen source for acetate utilizing methanogens [33]. Hence, in order to maintain a successful operation of acid digesters of FW, an adequate amount ($>500 \text{ mg/L}$) of TAN is necessary [8].

7.4.3 Toxic effect of TAN on AD of FW

Even though TAN inhibition has been widely studied, only limited research reported the IC_{50} of TAN and FA on the methanogenesis (Table 7.3). The calculated IC_{50} based on the batch experimental results (Figure 7.1) is in a good agreement with previous research. The exceptionally high IC_{50} (11,000 mgTAN/L) obtained by Nakakubo et al. (2008) was probably due to the source of inoculum, which was already acclimated to a high (5.7 gTAN/L) concentrations of TAN [13].

Table 7.3: IC₅₀ of TAN and FA

IC ₅₀ (TAN) mg/L	IC ₅₀ (NH ₃ -N) mg/L	Reference
11000	1450	13
3000	220 – 280	35
-	80 – 100	36
2900	92	37
3800	146	Present study

As a result of the re-circulation of LFD, the TAN concentration increased by almost 50%, reaching 933 mg/L in R1 and 1026 mg/L in R2 (Figure 7.3C) during days 20 to 34 of Run 2, and caused a lower biomethane production in this research (Figure 7.2D). Also an increased OLR yielded a higher TAN accumulation in both R1 and R2 (Figure 7.3D). Physically separating the hydrolytic and acidogenic microbes from the methanogens provided a better surviving environment for the relatively slow growing and sensitive methanogens [4, 27], thus R2 required less alkalinity than R1 (Figure 7.3C and Figure 7.5B). Consequently, a higher TAN concentration was accumulated in R2 than R1.

A different level of TAN inhibition on methanogenesis was observed in R1 and R2 (Figure 7.3D, Figure 7.5C and Figure 7.5D). The inhibition of TAN for R1 was 10% caused by 933 mg/L TAN (Fig 5D), which is in line with the batch experimental results (Figure 7.1). Hartman and Ahring (2005) also obtained a similar result by re-circulating the supernatant of cow manure and the organic fraction of MSW digestate, but they did not observe an inhibition even when the TAN concentration increased by 40% reaching 1000 mg/L [34]. This could be explained by the fact that they used a thermophilic inoculum: mesophilic inocula are more sensitive to TAN inhibition than thermophilic inocula [35]. A TAN concentration higher than 700 mg/L reduces the activities of mesophilic methanogenes [9, 14, 32, 36].

In R2, the TAN concentration higher than 850 mg/L resulted in a 31 – 35% inhibitory effect on the biomethane production (Figure 7.3C and Figure 7.5A). This could be due to the higher inhibitory effect of TAN on the sensitive methanogens. Also, according to Gallert and Winter (2008), propionate utilizers are the most critical members of the AD food chain [37]. Banks et al. (2012) suggested that a high concentration of TAN directly affects the propionate-utilizing bacteria, thus the propionic acid concentration in the systems increase [6]. When the propionate concentration increases, it has a direct inhibitory effect on the methanogens [6]. Figure 7.4C and Figure 7.6C show that a slightly higher (5 – 7%) propionic acid concentration was detected in R2 than R1. The batch experiments on TAN inhibition showed that the high TAN concentration resulted in a higher level of propionic acid build-up, which caused the accumulation of other VFA (Figure 7.4). Therefore, a high concentration of both TAN (1026 mg/L) and propionic acid (432 mg/L) entering the second stage of R2 could have caused the much lower biomethane production.

Nevertheless, after the TAN inhibition occurred during operation days 18 to 33 of Run 2 the TAN concentration fell back to the average value of 648 mg/L and 628 mg/L in R1 and R2, respectively (Figure 7.3C). This suggests that the methanogens could have acclimated to the

new environmental condition, although the biomethane production was still lower as compared to the first steady state of the reactors (Figure 7.3D). As suggested by Banks et al. (2012) the main biochemical pathway of FW digestion might have been changed due to the TAN accumulation [6], and the acclimated methanogens could be producing less biomethane than the initial methanogenic population. Further detailed studies on the characterization of the methanogenic population using molecular microbiology tools as well as the effect of environmental conditions should be carried out for a better understanding of the TAN inhibitory mechanisms on the metabolic pathways.

7.5 Conclusion

This study demonstrated that ammoniacal nitrogen plays a significant role in the AD of FW. An adequate amount of TAN is required for providing buffer capacity and meeting nutritional requirements for the methanogens. However, an excessive TAN concentration inhibits the biomethane production. The IC_{50} of TAN for unacclimated inoculum used for FW digestion amounted to 3.8 g/L, which corresponds to 146 mg/L free ammonia. Based on the comparison of one-stage and two-stage AD systems, the two-stage system is an attractive method for recovering biomethane and biohydrogen from FW. It is more robust than the one-stage system, as it resisted better to organic loading shocks thanks to its higher buffer capacity. However, since it requires less alkalinity than the one-stage system, TAN can accumulate more easily and yield a higher toxicity.

7.6 Reference

1. Ariunbaatar J., Panico A., Esposito G., Pirozzi F., Lens PNL. Pretreatment methods to enhance anaerobic digestion of organic solid waste, *Applied Energy* 2014; 123: 143-156
2. Kastner V., Somitsch W., Schnitzhofer W. The anaerobic fermentation of food waste: a comparison of two bioreactor systems, *Journal of Cleaner Production* 2012; 34: 82-90
3. Khalid A., Arshad M., Anjum M., Mahmood T., Dawson L. The anaerobic digestion of solid organic waste, *Waste Management* 2011; 31: 1737-1744
4. Xu SY., Lam H.P., Karthikeyan P., Wong JWC. Optimization of food waste hydrolysis in leach bed coupled with methanogenic reactor: Effect of pH and bulking agent, *Bioresource Technology* 2011; 102: 3702-3708
5. Zhang C., Xiao G., Peng L., Su H., Tan T. The anaerobic co-digestion of food waste and cattle manure, *Bioresource Technology* 2013; 129: 170-176
6. Banks C.J., Zhang Y., Jiang Y., Heaven S. Trace element requirements for stable food waste digestion at elevated ammonia concentrations, *Bioresource Technology* 2012; 104: 127-135
7. Ward A.J., Hobbs P.J., Holliman P.J., Jones D.L. Optimization of anaerobic digestion of agricultural resources, *Bioresource Technology* 2008; 99(17): 7928-7940
8. Prochazka J., Dolejs P., Maca J., Dohanyos M. Stability and inhibition of anaerobic processes caused by insufficiency or excess of ammonia nitrogen, *Applied Microbiology and Biotechnology* 2012; 93: 439-447
9. Yenigun O. and Demirel B. Ammonia inhibition in anaerobic digestion: A review, *Process Biochemistry* 2013; 48: 901-911
10. Kayhanian M. Ammonia inhibition in high-solids biogasification: An overview and practical solutions, *Environmental Technology* 1999; 20(4): 355-365

11. Angelidaki I., and Ahring B.K. Thermophilic anaerobic digestion of livestock waste: the effect of ammonia, *Applied Microbiology and Biotechnology* 1993; 38: 560-564
12. Chen Y., Cheng J.J., Creamer K.S. Inhibition of anaerobic digestion process: A review, *Bioresource Technology* 2008; 99(10): 4044-4064
13. Nakakubo R., Møller H.B., Nielsen A.M., Matsuda J. Ammonia Inhibition of Methanogenesis and Identification of Process Indicators during Anaerobic Digestion, *Environmental Engineering Science* 2008; 25(10): 1487-1496
14. Rajagopal R., Masse D.I., Singh G. A critical review on inhibition of anaerobic digestion process by excess ammonia, *Bioresource Technology* 2013; 143: 632-641
15. Braun R., Huber P., Meyrath J. Ammonia toxicity in liquid piggery manure digestion, *Biotechnology letters* 1981; 3(4): 159-164
16. Van Velsen AFM. Adaptation of methanogenic sludge to high ammonia-nitrogen concentrations, *Water Research* 1979; 13(10): 995-999
17. Koster IW. and Lettinga G. The influence of ammonia-nitrogen on the specific activity of pelletized methanogenic sludge, *Agricultural Wastes* 1984; 9: 205-216
18. Koster IW. and Lettinga G. Anaerobic digestion at extreme ammonia concentrations, *Biological wastes* 1988; 25: 51-59
19. Ariunbaatar J., Panico A., Frunzo L., Esposito G., Lens P.N.L., Pirozzi F. Enhanced anaerobic digestion of food waste by thermal and ozonation pretreatment methods, *Journal of Environmental Management* 2014; 146: 142 – 149
20. Esposito G., Frunzo L., Panico A. Pirozzi F. Model calibration and validation for OFMSW and sewage sludge co-digestion reactors, *Waste Management* 2011; 31: 2527-2535
21. Codex Guidelines on Nutrition Labelling CAC/GL 2-1985 (Rev.1 – 1993)
22. Phillips K.M., Tarragó-Trani M.T., Grove T.M., Grün I., Lugogo R., Harris R.F., Stewart K.K. Simplified Gravimetric Determination of Total Fat in Food Composites After Chloroform–Methanol Extraction, *Journal of American Oil Chemistry* 1997; 74 (2): 137-142
23. Abalos M., Bayona J.M., Pawliszyn J. Development of a headspace solid-phase microextraction procedure for the determination of free volatile fatty acids in wastewaters, *Journal of Chromatography A* 2000; 873(1):107-115
24. Niu Q., Hojo T., Qiao W., Qiang H., Li Y-Y., Characterization of Methanogenesis, acidogenesis and hydrolysis in the thermophilic methane fermentation of chicken manure, *Chemical Engineering Journal* 2014:587 – 596
25. Kapdan I.K. and Kargi F. Bio-hydrogen production from waste materials, *Enzyme and Microbial Technology* 2006; 38 (5): 569-582
26. Bouallagui H., Touhami Y., Cheikh R.B., Hamdi M. Bioreactor performance in anaerobic digestion of fruit and vegetable wastes, *Process Biochemistry* 2005; 40: 989–995
27. Wang X., Zhao Y. A bench scale study of fermentative hydrogen and methane production from food waste in integrated two-stage process, *International Journal of Hydrogen Energy* 2009; 34:245–254
28. Nathao C., Sirisukpoka U., Pisutpaisal N. Production of hydrogen and methane by one and two stage fermentation of food waste, *International Journal of Hydrogen Energy* 2013; 38 (35): 15764-15769
29. Kim DH., Kim SH., Jung KW., Kim MS., Shin HS. Effect of initial pH independent of operational pH on hydrogen fermentation of food waste, *Bioresource Technology* 2011; 102: 8646-8652
30. Han SK. And Shin HS. Biohydrogen production by anaerobic fermentation of food waste, *International Journal of Hydrogen Energy* 2004; 29: 569-577

31. Chu C.F., Ebie Y., Xu K.Q., Li Y.Y., Inamori Y. Characterization of microbial community in the two-stage process for hydrogen and methane production from food waste, *International Journal of Hydrogen Energy* 2010; 35(15): 8253-8261
32. Alvarez R. and Liden G. Semi-continuous co-digestion of solid slaughterhouse waster, manure, and fruit and vegetable, *Renewable energy* 2008; 33(4): 726-734
33. Takashi M. and Speece R.E. Mineral nutrient requirements for high-rate methane fermentation of acetate at low SRT, *Research Journal of the Water Pollution Control Federation* 1989; 61: 1645-1650
34. Hartman H. and Ahring BK. Anaerobic digestion of the organic fraction of municipal solid waste: Influence of co-digestion with manure, *Water Research* 2005; 39(8): 1543-1552
35. Gallert C. and Winter J. Mesophilic and thermophilic anaerobic digestion of source-sorted organic wastes: effect of ammonia on glucose degradation and methane production, *Applied Microbiology and Biotechnology* 1997; 48: 405-410
36. Nielsen H.B. and Angelidaki I. Strategies for optimizing recovery of the biogas process following ammonia inhibition, *Bioresource Technology* 1999; 99(17): 7995-8001
- Gallert C. and Winter J. Propionic acid accumulation and degradation during re-start of a full-scale anaerobic biowaste digester, *Bioresource Technology* 2008; 99(1): 170-178

INFLUENCE OF HYDRAULIC RETENTION TIME AND ORGANIC LOADING RATE ON THE PERFORMANCE OF AnMBR TREATING FOOD WASTE



8 INFLUENCE OF HYDRAULIC RETENTION TIME AND ORGANIC LOADING RATE ON THE PERFORMANCE OF ANMBR TREATING FOOD WASTE

This chapter presents a study on the effect of hydraulic retention time (HRT) and organic loading rate (OLR) on the stability and performance of an AnMBR, equipped with side-stream polyvinylidene fluoride (PVDF) membranes. The reactor was fed with a fixed influent concentration of 8.24 ± 0.12 gCOD/L, made with synthetic FW. The OLR was increased by reducing the HRT from 20 d to 1 d. The system obtained an overall removal efficiency of >97% and >98% of the influent chemical oxygen demand (COD) and total suspended solids (TSS), respectively. The biological process was able to convert 76% of the influent COD into biogas with 70% methane content, and the additional COD rejection was performed by the membrane filtration process.

8.1 Introduction

Anaerobic digestion (AD) is one of the most important and sustainable processes used for the treatment of organic solid waste (OSW). It combines pollution reduction, energy production and nutrients recovery from OSW with limited environmental impacts [1]. Among various substrates used for AD, there is a growing interest of treating food waste (FW) due to its high generation rate and easily biodegradable characteristics [2]. There is a strong policy to develop the AD of FW as the governments in Europe have set significant targets to reduce the amount of biodegradable waste to be landfilled and to increase the recycling rate as well as energy recovery [3].

AD is a biological process that converts complex substrates into biogas and digestate by microbial action in the absence of oxygen through four main steps, namely hydrolysis, acidogenesis, acetogenesis and methanogenesis. Anaerobic microbes grow very slowly and biomass retention is one of the most important aspects of AD [4]. It is well known that the AD of FW is more prone to failure at high organic loading rates (OLRs), as the slow growing methanogens could be washed out resulting in an acidification of the reactor [11]. Hence, a bigger volume of the reactor or a longer HRT is required. Considering the high amount of waste to be treated as well as the engineering and economical aspects an efficient reactor design is required to retain the microbial biomass in the system while maintaining a stable operation at a short hydraulic retention time (HRT). This has led to the growing popularity for the development of anaerobic membrane bioreactors (AnMBR), which separates the HRT from the solids retention time (SRT) [5, 6].

AnMBR offers several advantages over conventional AD processes: i) an ability to deal with higher organic loads even at unfavourable conditions; ii) increased production of biogas with a higher methane content; iii) less production of sludge; iv) better quality effluent with no pathogen and solids; and v) reduced footprints of the AD system. In fact, the AnMBR has been highlighted as a sustainable tool for capturing the resources (energy and nutrients) [3,5]. Although the performance of an AnMBR has been studied thoroughly for the treatment of various wastewater [8], there has been a limited research on the application of AnMBR for FW. With an appropriate pretreatment of the FW AnMBR holds a great potential for a high-rate treatment. Despite the mentioned advantages, AnMBR is an energy intensive technology and the biggest downfall of it is the fouling of membranes. To achieve a sustainable operation of the AnMBR measures to prevent from the limitations are required [7, 8, 9, 10].

The main focus of the research was to study the effects of increasing OLR and reducing the HRT on the performance of AnMBR, treating macerated FW. A fully automated lab-scale

AnMBR system was operated for a total of 100 days. Biological and filtration processes were observed and the effects on the membrane performance were also studied.

8.2 Materials and Methods

8.2.1 Seed sludge and influent

The influent was prepared with a synthetic FW mixed with tap water. The influent was blended and sieved through mesh no.20. Sodium bicarbonate (NaHCO_3) was added to provide necessary (>1500 mg/L and $\text{pH} > 7.2$) alkalinity.

The synthetic FW was prepared mimicking a typical post-consumer FW according to Ariunbaatar et al. (2014). Ingredients included meat (chicken, beef, pork and fish), cheese, bread, rice, pasta, oranges, tomatoes, potatoes, apples, eggplant, spring mix salad, and bananas. All of the ingredients were blended together to a homogenous pulp, and stored at 4°C not more than 2 weeks.

Anaerobic digester sludge from Howard F. Current Advanced Wastewater Treatment Plant (Tampa, Florida, USA) was used for both batch and AnMBR experiments. To remove any unwanted particles that could clog the membrane pores or block reactor tubing, the sludge was sieved through a no.20 mesh.

8.2.2 Analytical methods

Total solids, total suspended solids (TSS) and volatile solids (VS) were determined following the standard methods [12]. Total and soluble chemical oxygen demand (COD_t , COD_s), TN, TP, TAN were analysed with HACH test kits following the manufacturer's instructions (HACH, Loveland, Colorado, USA). Total alkalinity (TA) and partial alkalinity (PA) was calculated based on the volume of the consumed hydrochloric acid (0.1N) by titrating with it until pH 5.5 and 4.5, respectively. Based on the TA and PA values the volatile organic acid (VOA) alkalinity and VOA/PA ratio was calculated. Continuous biogas production from AnMBR was measured by a wet-tip meter, and methane content was analysed with a gas chromatography (GC) Agilent Technologies equipped with flame ionization detector (FID) column 30 m x 0.25 mm, 0.25 μm film (Supelco Nukol).

8.2.3 Biomethane potential test

Biomethane potential (BMP) test of FW was carried out in serum bottles (total volume of 120 mL) in duplicates without mixing according to Angelidaki et al. (2009) [13]. The food to inoculum ratio was 0.5 gVS/gVS, and sodium bicarbonate (NaHCO_3) was added to provide alkalinity. Prior to incubation at mesophilic ($35 \pm 2^\circ\text{C}$) all of the serum bottles were flushed with helium gas to provide anaerobic condition. The BMP test was continued until the cumulative biomethane production reached a plateau (approx. 20-25 days of incubation) and daily biogas production was measured by volumetric liquid displacement method using sodium hydroxide (120 gNaOH/L) as liquid to capture carbon dioxide.

8.2.4 Design and operation of AnMBR

A laboratory scale upflow anaerobic bioreactor column coupled with two side stream ultrafiltration membrane modules were used for this study (Figure 8.1). The total working volume was 10 L with a 3 L headspace. The temperature was kept at mesophilic ($35 \pm 2^\circ\text{C}$)

condition by recirculating warm water coils wrapped around the column. Each of the membrane module was a 0.88 m x 8 mm ID polyvinylidene fluoride (PVDF) tubular membrane (Norit X-Flow, F5385) with a mean pore size of 0.03 μm and overall active filtration area of 0.066 m^2 . Membrane feed was delivered by a peristaltic pump with a cross flow velocity (CFV) of 0.1 m/s. Filtration process was monitored following Prieto et al. (2013), using the same onsite data logger (HOBO online sensors, ONSET Computer Corporation, MA). Transmembrane pressure (TMP) was also calculated following Prieto et al. (2013) [14]. The membrane permeate flux was measured by Arduino board connected to the data logger [14]. Based on the flux and the TMP the filtration process was performed. Since the permeate flux equals to the influent flow rate, the filtration process controls the influent feeding automatically.

AnMBR system started with a HRT of 20 d (OLR of 0.3 gVS/L.d), and when a stable operation with a constant VOA/PA ratio, a high COD removal, and a stable methane production is achieved, the HRT was reduced to 10, 7, 5, 3 and 1 d corresponding to OLR of 0.6, 0.86, 1.2, 2, and 6 gVS/L.d, respectively. The HRT and OLR was calculated based on the produced permeate volume.

To keep the HRT values constant the filtration process run in 4 intervals per day during all phases except for HRT 1d where the intervals were increased to 8 per day. The filtration intervals were controlled by a timer connected to the permeate pump. Starting from HRT=5 d backwashing was performed after each filtration process stops, to reduce the membrane fouling. The strength of the backwash was 10 times higher than the filtration and it was also controlled by a timer.

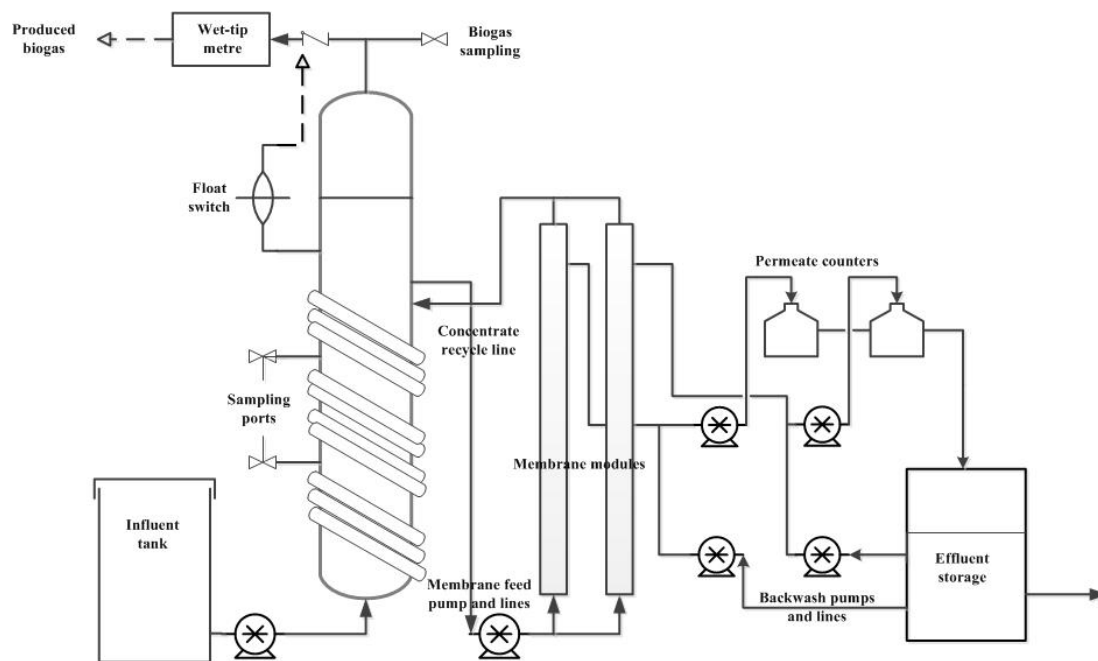

Figure 8.1: Schematic diagram of AnMBR

8.3 Results

8.3.1 Seed sludge and FW characteristics

The pH, TS, VS, total and partial (carbonate) alkalinity, total ammoniacal nitrogen (TAN), total nitrogen (TN), total phosphorus (TP) of the seed sludge were 7.7 ± 0.1 , 18.7 ± 2.4 , 13.1 ± 0.1 , 4389.7 ± 10.7 , 3886.0 ± 11.6 , 396.7 ± 2.4 , 405.0 ± 18.7 and 103.8 ± 7.0 mg/L, respectively. TS of the synthetic FW was always in the range of 238.6 – 266.6 mg/kg, and >95% were volatile solids.

Figure 8.2 shows the VS in the bioreactor and influent were 14.53 ± 0.43 and 6.09 ± 1.44 gVS/L, respectively. However, after 7 days of operation, the reactor VS was reduced to 9.08 ± 0.43 gVS/L. To keep the food to inoculum ratio of 0.5 gVS/gVS the influent VS was also reduced accordingly. After day 7 the VS in the influent was kept in the range of 3 – 4.7 mg/L, making a reduction of the OLR as compared to the original plan described in Section 8.2.4. The influent TS, VS, VSS were 6.68 ± 0.28 , 3.66 ± 0.29 , 2.05 ± 0.36 g/L, respectively (Figure 8.2). The soluble concentrations of TAN, TN and TP in the influent were 23.42 ± 0.48 , 15.69 ± 0.7 and 110.28 ± 2.46 mg/L (Figure 8.3).

8.3.2 Performance of AnMBR

8.3.2.1 Stability of AnMBR

Figure 8.4A shows the pH of the bioreactor, which is slightly lower than the effluent (e.g. permeates). The solids content in the bioreactor could be interfering with the pH measurement; hence the pH of the soluble fraction of the bioreactor was measured. There was no difference in the pH values between the centrifuged and uncentrifuged samples. Another explanation for the difference of pH values between the bioreactor and the effluent (e.g. permeate) could be the difference of carbon dioxide (CO₂) partial pressure in the headspace, and the effluent contains less CO₂ concentration yielding a higher pH value. This explanation is supported by the lower VOA concentration in the effluent (Figure 8.4C).

VOA/PA ratio of the reactor as well as the effluent was stabilized after 14-17 days at values of 0.86 and 0.49, respectively. Each time the OLR is increased (including the unintentional OLR shock due to over-feeding events on day 58, 60, 76 and 95) the ratio was increased immediately but after a while it stabilizes again (Figure 8.4B). Similar trend can be observed with VOA (Figure 8.4C). This indicates the AnMBR system could handle the OLR shocks and recover itself quickly thanks to the membranes. After each over-feeding event, the influent pump was stopped until the system recovers, which explains the rapid decrease of VOA on day 59, 62, and 77.

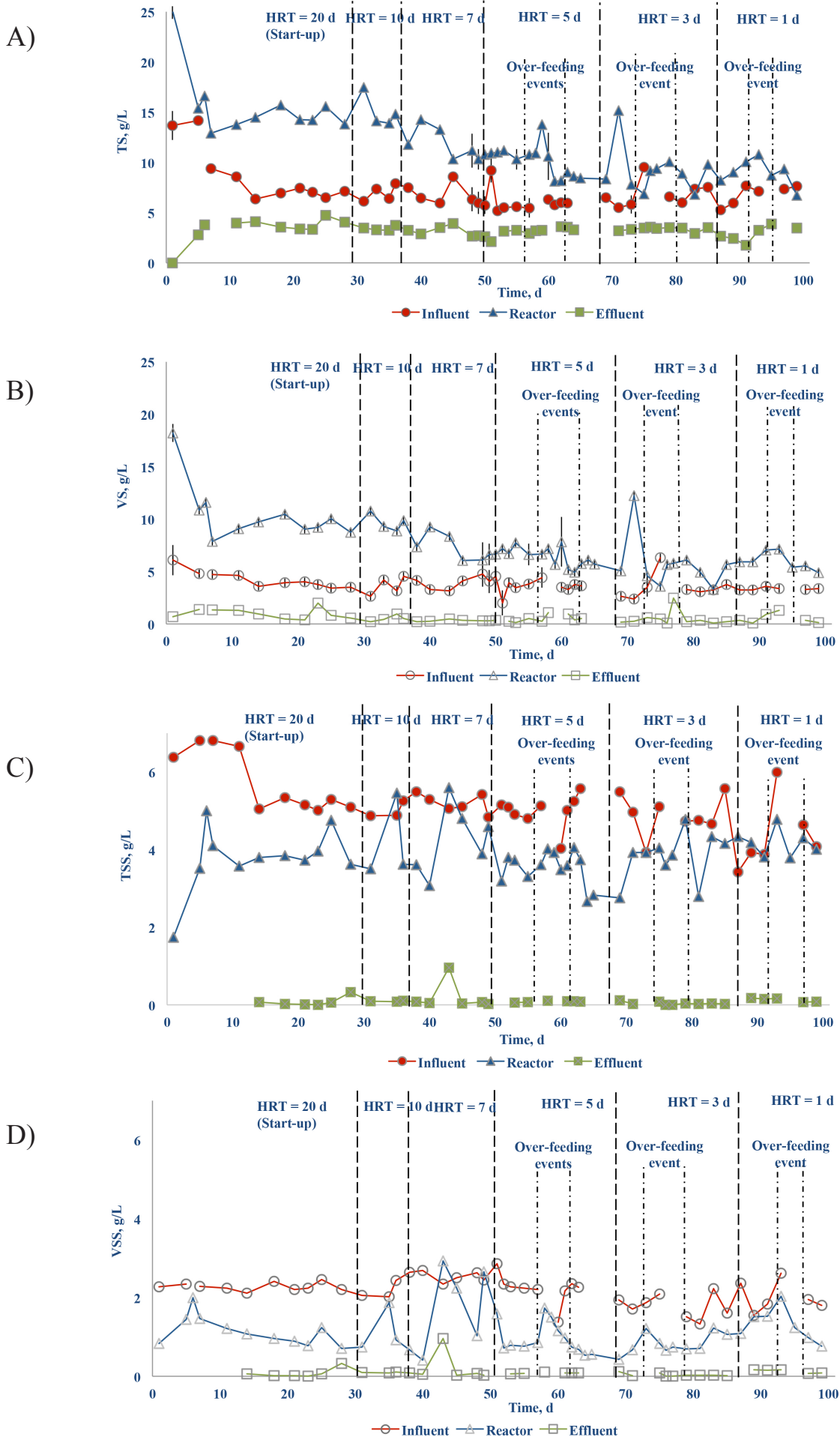

Figure 8.2: Solids profile: A) TS; B) VS; C) TSS; D) VSS

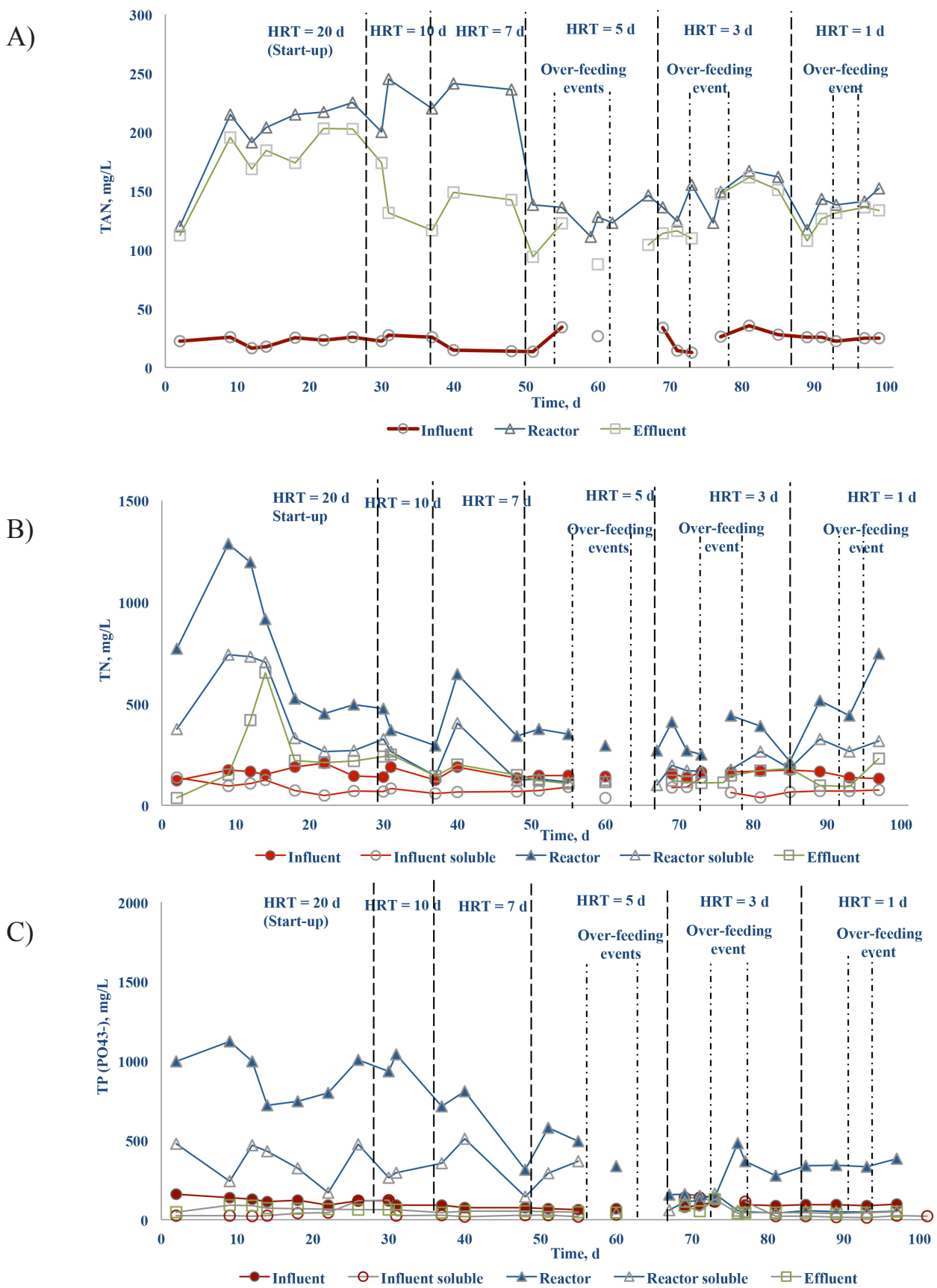

Figure 8.3: Nutrients profile: A) TAN; B) TN; C) TP

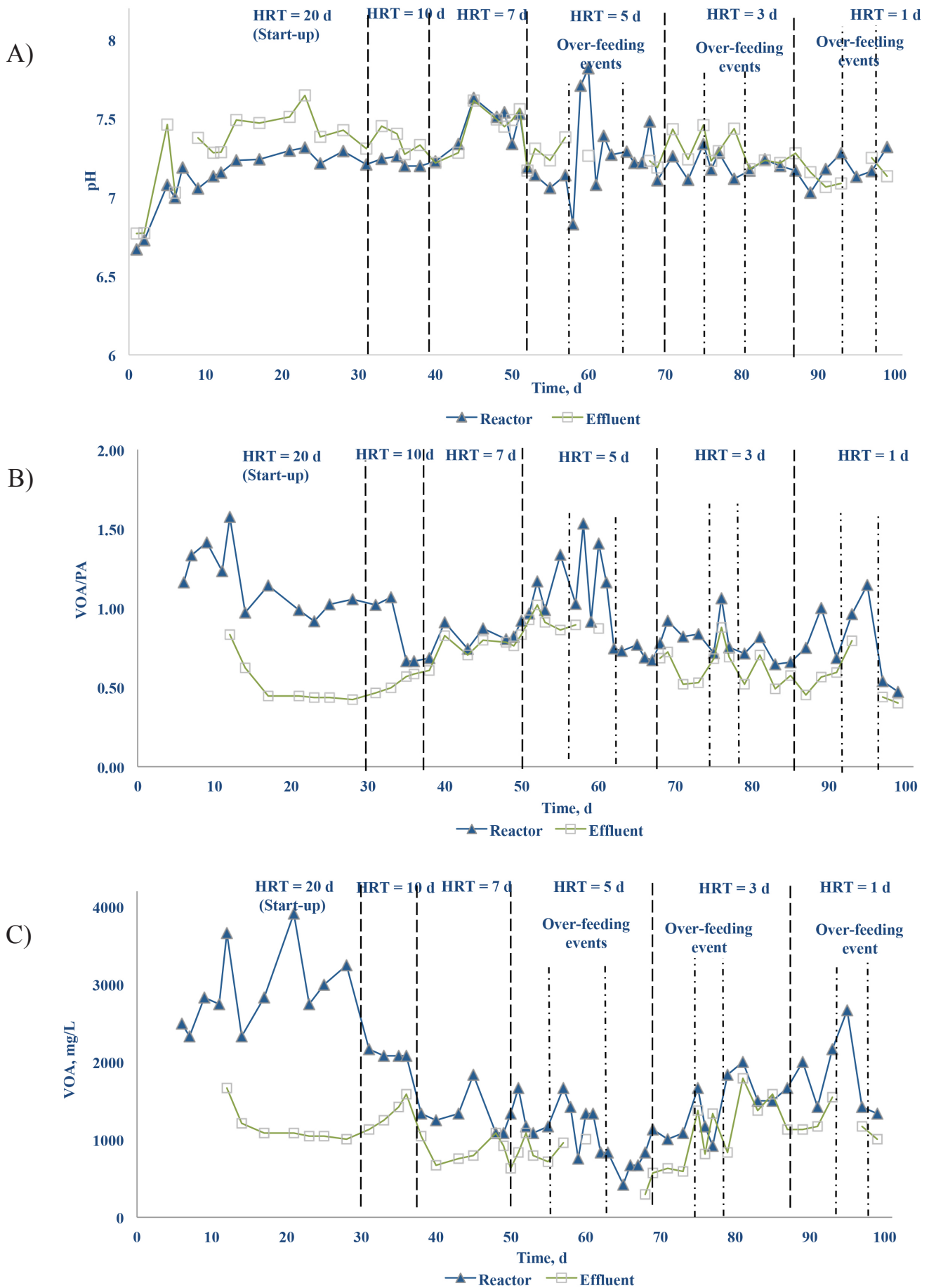

Figure 8.4: Bioreactor stability profile: A) pH; B) VOA/PA ratio; C) VOA

8.3.2.2 COD and solids removal

The influent COD_t and COD_s concentration were 8.24 ± 0.12 and 3.31 ± 0.05 g/L, while the COD concentration in the reactor varied depending on the OLR (Figure 8.5). Every time the OLR was increased (excluding the over-feeding events) the CODs in the reactor increased yielding a higher COD in the effluent ($0.35 - 0.77$ gCOD/L) (Figure 8.5). However, the reactor CODs was reduced immediately after 2 days as a result of the methanogenic activity resulting in an effluent COD of $0.03 - 0.15$ g/L. The highest CODs of 3.45 ± 0.13 gCOD/L in the reactor was observed on day 61 after the loss of biomass (approximately 3L) and over-feeding event. Nevertheless, thanks to the membranes the AnMBR was able to retain the remaining biomass in the system and was recovered remarkably within a week. After the first two over-feeding events the AnMBR responded to OLR shocks well and faster. Even during the unintentional over-feeding events on day 76 and 93 the AnMBR could recover in less than 2 days.

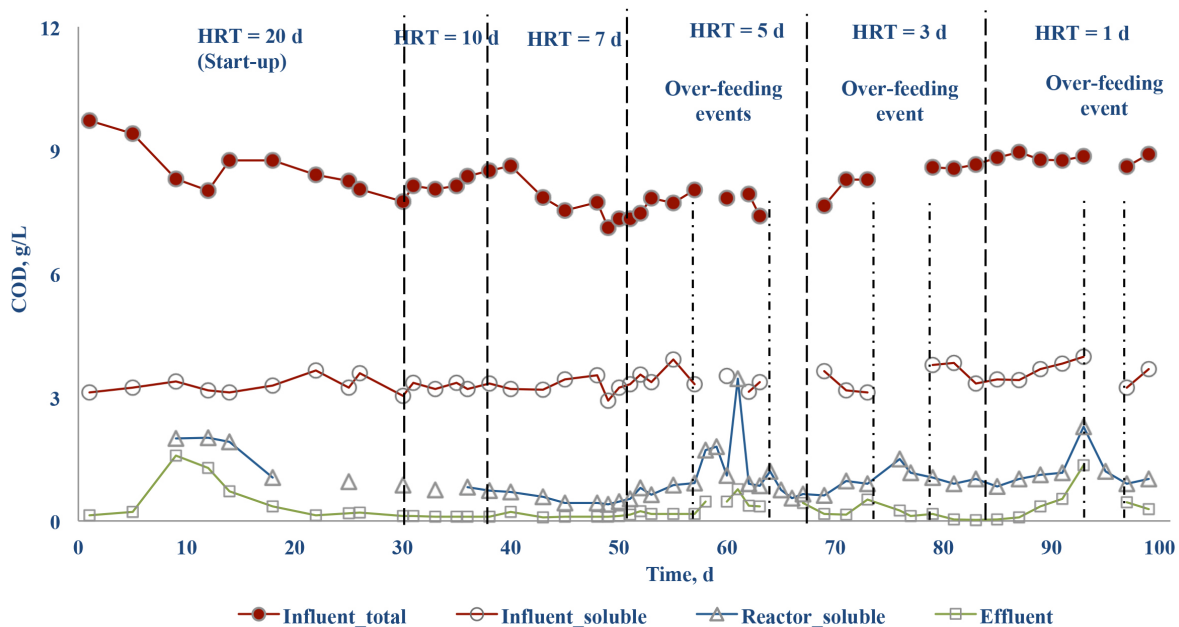

Figure 8.5: COD profile

Figure 8.2 shows the profile of the solids concentration of influent, bioreactor and the effluent. Throughout the experiment, the solids concentrations in the influent and the effluent were relatively constant. The effluent TS, VS, TSS were 3.31 ± 0.61 , 0.55 ± 0.53 , 0.08 ± 0.01 g/L, and VSS was not detected. However, on day 43 the solids content in the effluent were increased by 3 folds. This can be explained by the degradation of organic matter in the sludge. Concomitantly, TS and VS in the bioreactor were 14.29 ± 0.01 and 9.20 ± 0.03 g/L during the operation days 7-43, and it reduced to 11.01 ± 0.27 and 6.75 ± 0.18 g/L during day 45-60 (Figure 8.2A and Figure 8.2B). The TSS and VSS content in bioreactor were reasonably constant at values of 3.86 ± 0.62 and 1.08 ± 0.55 g/L. Moreover, the decrease of TSS and VSS on day 60 and 76 were caused by a loss of biomass due to malfunctioning of the peristaltic pumps and float switch, whereas the decrease on day 64 and 81 were due to no feeding as a result of over-feeding events.

The COD removal efficiency was calculated based on the influent and effluent concentrations; hence it combines the biological COD removal and the rejected COD by the membranes

(Figure 8.6A). After the over-feeding events, the feed pump was turned off, hence the removal efficiency was not calculated during operational days of 57-60, 63-69, 76-79. When the removal efficiency was calculated based on the influent, the COD_t and COD_s were >97 and >95%, respectively. Every time the HRT is reduced the COD removal efficiency dropped by 3 – 5% for 2–3 days, and recovered again. Similar trend was observed with TSS removal (Figure 8.6B), and during stable operation >98% of TSS removal was achieved.

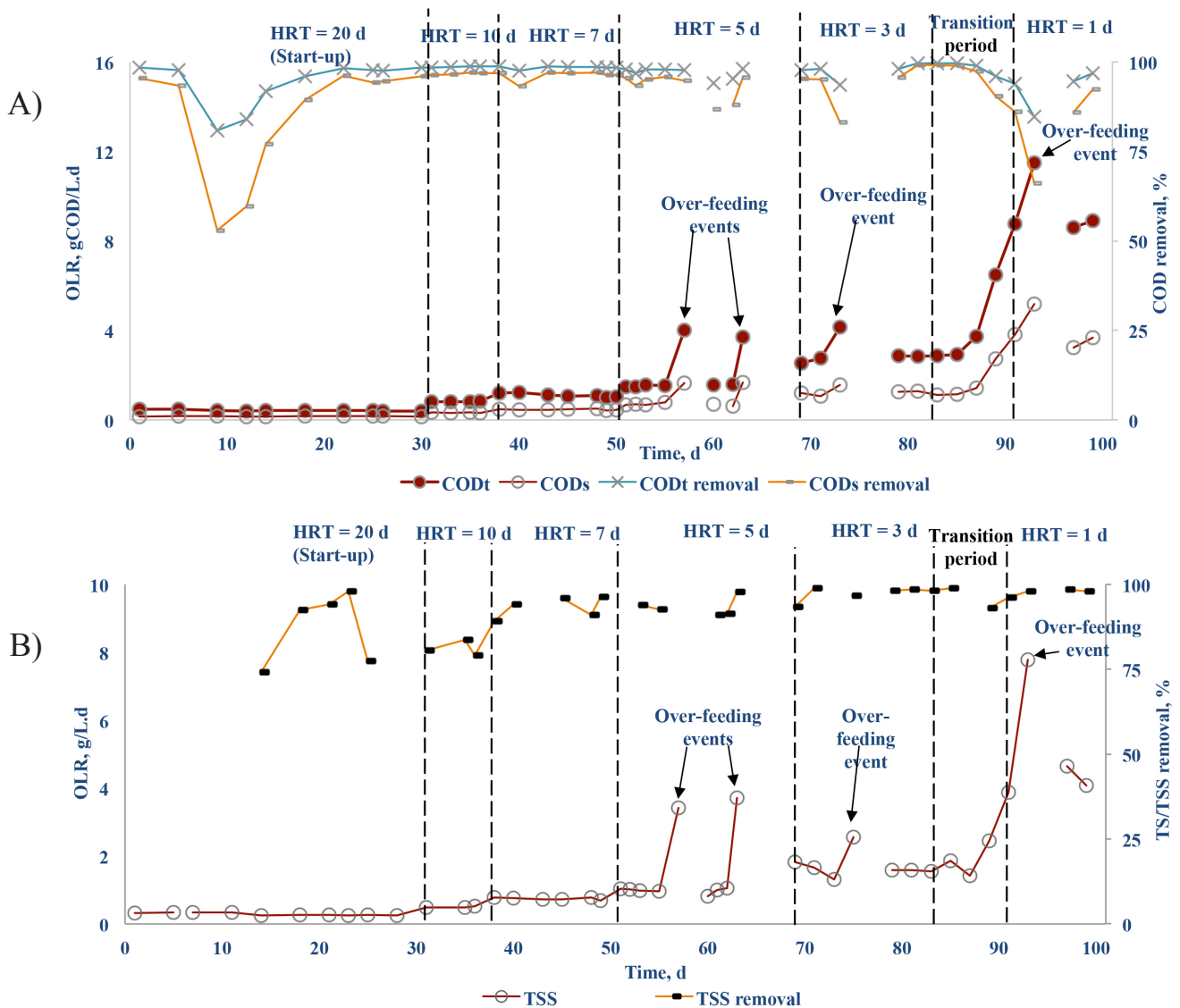

Figure 8.6: OLR and removal efficiency: A) COD_t and COD_s; B) TSS

8.3.2.3 Nutrients (TAN, TN, TP)

Figure 8.3 shows the nutrients profile of the AnMBR process. The TAN concentration in the bioreactor and the effluent were 210.75 ± 0.08 and 162.63 ± 1.04 mg/L, respectively during day 1-50, however starting day 51 until the end of the experiment it reduced to 138.28 ± 0.72 and 122.80 ± 1.93 mg/L (Figure 8.3A). The higher TAN level explains the slightly higher pH during the period of day 1-50 (Figure 8.2A).

The concentrations were higher during the first 2 weeks of the experiment, and slightly decreased and stabilized from day 15, which can be explained by the release of the artefact interstitial nitrogen and phosphorus from the sludge. After the stabilization the soluble TN concentration in the bioreactor and the effluent were 231.03 ± 8.45 and 80.91 ± 1.3 mg/L, respectively (Figure 8.3B). The soluble concentrations of TP in the bioreactor and effluent were 122.38 ± 2.28 and 60.36 ± 0.19 mg/L, respectively (Figure 8.3C).

Generally, the background nutrient concentrations stabilized after approximately 15 – 20 d. However, the nutrients are accumulated in the bioreactor as soluble forms, and were released with the effluent. This explains the 6 – 7 times lower concentration of nutrients in the influent than in the bioreactor and the effluent (Figure 8.3).

8.3.3 Biogas production

The BMP test of FW lasted for 25 days, and reached the maximum amount of 472.15 ± 1.75 mL/gVS_{added} (or 418.50 ± 1.55 mLCH₄/gVS_{added} at STP). This value was used to calculate the biogas production from the AnMBR, as due to several over-flowing and also leaking of headspace events the data from the wet-tip metre was unreliable. Table 8.1 shows the average biogas production calculated based on the VS loading. The biomethane production was then converted to COD using the theoretical conversion of 0.395 L/gCOD (0.35L/gCOD at STP). Due to the leaking of headspace the methane content in the biogas produced was not measured during the initial operation days. Methane content in biogas produced increased with increasing OLR and decreasing HRT. The max methane content detected was $70.5 \pm 3.5\%$. Zhang et al. (2007) also obtained a high methane content of 73% with an almost complete degradation of FW.

Table 8.1: Biogas production

HRT	VS _{added} (g/d)	Biomethane L/d	% Methane in biogas
20	1.97 ± 0.02	0.93	-
10	3.63 ± 0.05	1.71	-
7	5.72 ± 0.25	2.70	-
5	11.25 ± 0.69	5.31	49.6
3	13.07 ± 0.31	6.17	67.6
1	30.02 ± 0.05	14.17	70.5

8.3.4 COD balance

Figure 8.7 illustrates the COD balance, which calculated based on the influent COD, biomethane production, COD in effluent. The highest COD to methane conversion (76.71%) was obtained with OLR 1.84 gCOD/L.d. After this period the methane conversion rate reduced to 52.05% and 45.81% at OLR of 3 and 8.65 gCOD/L.d, respectively. A similar trend of biological activity reduction was observed with Wijekoon et al. (2011), who reported the

maximum COD removal efficiency by the biological activity at 8 ± 0.3 gCOD/L.d, while increasing OLR of a thermophilic AnMBR from 5 to 12 gCOD/L.d [15]. Nagao et al. (2012) also reported that the cell density of the active biomass increased with OLR up to 7.4 gVS/L.d, but further OLR increase resulted in a reduction of cell density, and hence an overall biological activity was reduced [16]. However, their reactor was not equipped with a membrane, but the solid fraction was re-circulated after a solid-liquid separator. A lower biological COD removal efficiency in this research can be explained by the loss of biomass (approximately 2-3L) due to malfunctioning of the pumps. Even though the biomethane conversion rate was reduced the effluent COD remained low (>280 mg/L) as a result of the membrane filtration.

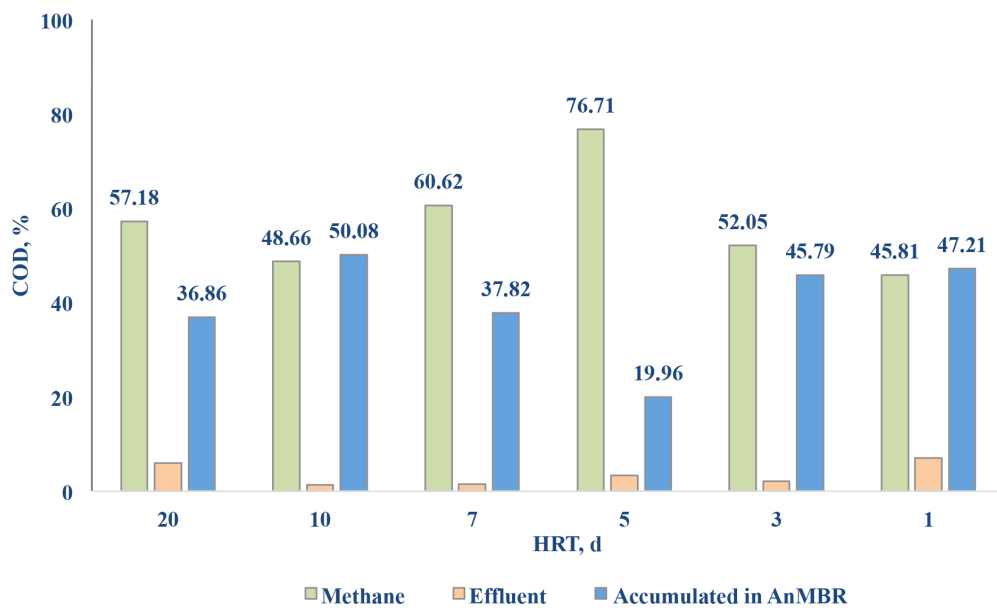

Figure 8.7: COD balance

8.3.5 Membrane performance

The experiment started with a high HRT (20d), which requires a very low (0.5L) permeate production. Based on the obtained flux the experimental flow rate (Q^*) and the experimental HRT (HRT^*) were calculated and compared with the original plan (Table 8.2). During the start-up period the average flux and TMP of the two membranes were stabilized at 7.18 LMH and 0.28 bar, respectively, which makes the HRT^* 18.5 d (Table 8.2). When the HRT was reduced by 1 step (from 20 to 10d), the TMP decreased, and flux increased. This is probably due to the adaptation period of the system, and hence a better performance was obtained. However another step of HRT reduction (from 10 to 7d) resulted in an increase of TMP and reduction of flux, suggesting a possible fouling on the membrane. Therefore, the next step of HRT decrease (from 7 to 5d) was coupled with a backwash cycles. Immediately after the backwash cycles started the TMP reduced significantly (from 0.24 to 0.18 bar), and flux was stabilized at 12.26 LMH. Both the flux (13.66 LMH) and TMP (0.20 bar) were relatively constant throughout the next step (from 5 to 3 d) as well. When the HRT was decreased from 3 to 1d the planned flux and TMP were not achieved as the membrane performance was not stable. The average flux and TMP during this period was 9.53 LMH and 0.32 bar, resulted in HRT^* of 2.41 d instead of the planned 1 d. This unplanned transition period lasted for 8 days, causing a lower performance of the whole system (Figure 8.6). The transition period probably caused by the intensive increase of OLR, which made the membrane stressed. Nevertheless,

the system was able to overcome the hurdle and a stable operation with HRT* of 0.88d was obtained.

Table 8.2: Membrane performance

HRT	Q (L/d)	Flux (LMH)	TMP (bar)	Q* (L/d)	HRT*(d)
20	0.50	7.18	0.28	0.54	18.50
10	1.00	8.26	0.20	1.21	8.29
7	1.43	7.71	0.24	1.66	6.04
5	2.00	12.26	0.18	1.93	5.18
3	3.33	13.66	0.20	3.48	2.88
-	10.00	9.53	0.32	7.27	2.41
1	10.00	14.21	0.28	11.40	0.88

8.4 Conclusion

The results of this study prove that the AnMBR is a very resilient system for the treatment of high rate AD of FW. Despite the few experimental hickups a typical HRT of 20 d was reduced to 1 d successfully in only 100d. The biological part of the system was fully stabilized after more than 2 weeks, and it was able to convert 50-76% of the influent COD into biogas with up to 70% methane content. Additional COD rejection was performed by the membrane filtration process, making the COD removal efficiency of the whole system > 97%. Moreover, >98% of the influent total suspended solids (TSS) was removed.

8.5 Reference

1. Khalid, A., Arshad, M., Anjum, M., Mahmood, T., & Dawson, L. (2011). The anaerobic digestion of solid organic waste. *Waste Management*, 31(8), 1737-1744.
2. Ariunbaatar, J., Panico, A., Esposito, G., Pirozzi, F., & Lens, P. N. (2014). Pretreatment methods to enhance anaerobic digestion of organic solid waste. *Applied Energy*, 123, 143-156.
3. Browne, J. D., & Murphy, J. D. (2013). Assessment of the resource associated with biomethane from food waste. *Applied Energy*, 104, 170-177.
4. Fuchs W., Binder H., Mavrias G., Barun R., 2003, Anaerobic treatment of wastewater with high organic content using a stirred tank reactor coupled with a membrane filtration unit, *Water Research* 37: 902-908
5. Stuckey, D. C. (2012). Recent developments in anaerobic membrane reactors. *Bioresource technology*, 122, 137-148.
6. Smith A.L., Stadler L.B., Love N.G., Skerlos S.J., Raskin L., 2012. Perspectives on anaerobic membrane bioreactor treatment of domestic wastewater: A critical review, *Bioresource Technology* 122: 149-159
7. Dereli R.K., Ersahin M.E., Ozgun H., Ozturk I., Jeison D., van der Zee F., van Lier J.B., 2012. Potentials of anaerobic membrane bioreactors to overcome treatment limitations induced by industrial wastewaters, *Bioresource Technology* 122: 160-170
8. Skouteris G., Hermosilla D., Lopez P., Negro C.m, Blanco A., 2012. Anaerobic membrane bioreactors for wastewater treatment: A review, *Chemical Engineering Journal* 198-199: 138-148

9. Lin, H., Gao, W., Meng, F., Liao, B. Q., Leung, K. T., Zhao, L., Hong, H. (2012). Membrane bioreactors for industrial wastewater treatment: a critical review. *Critical Reviews in Environmental Science and Technology*, 42(7), 677-740.
10. Lin H., Peng W., Zhang M., Chen J., Hong H., Zhang Ye., 2013. A review on anaerobic membrane bioreactors: Applications, membrane fouling and future perspectives, *Desalination* 314: 169-188
11. Guo, X., Wang, C., Sun, F., Zhu, W., & Wu, W. (2014). A comparison of microbial characteristics between the thermophilic and mesophilic anaerobic digesters exposed to elevated food waste loadings. *Bioresource technology*, 152, 420-428.
12. APHA, Standard Methods for the examination of water and wastewater 21st edition ISBN: 0875530478
13. Angelidaki, I., Alves, M. M., Bolzonella, D., Borzacconi, L., Campos, J. L., Guwy, A. J., Van Lier, J. B. (2009). Defining the biomethane potential (BMP) of solid organic wastes and energy crops: a proposed protocol for batch assays.
14. Prieto, A. L., Futselaar, H., Lens, P. N., Bair, R., & Yeh, D. H. (2013). Development and start up of a gas-lift anaerobic membrane bioreactor (Gl-AnMBR) for conversion of sewage to energy, water and nutrients. *Journal of Membrane Science*, 441, 158-167.
15. Wijekoon K.C., Visvanathan C., Abeynayaka A. (2011) Effect of organic loading rate on VFA production, organic matter removal and microbial activity of a two-stage thermophilic anaerobic membrane bioreactor, *Bioresource Technology* 102:5353-5360
16. Nagao N., Tajima N., Kawai M., Niwa C., Kurosawa N., Matsuyama T., Yusoff F.Md., Toda T. (2012) Maximum organic lading rate for the single-stage wet anaerobic digestion of food waste, *Bioresource technology* 118: 210-218

CHAPTER 9

DISCUSSIONS AND FUTURE RESEARCH PERSPECTIVES



9 DISCUSSIONS AND FUTURE RESEARCH PERSPECTIVES

9.1 Introduction and objectives

Food waste (FW) has become one of the major global concerns, as increasing affluent societies are producing more amount of it. The overall pollution prevention targets at national and international level, the objectives of Kyoto protocol, the conservation of natural resources as well as other crucial issues related to human and animal health have highlighted the need for a sustainable FW management [1, 2, 3, 4].

Anaerobic digestion (AD) is considered as the most important and sustainable processes used for the treatment of organic fraction of municipal solid waste (OFMSW) such as FW simply due to its: 1) waste reduction and stabilization; 2) pollution reduction; 3) energy production, which leads to reducing the fossil fuel consumption; 4) reducing greenhouse gases emissions and releasing carbon-neutral carbon dioxide back to the atmosphere; 5) nutrient recovery via utilization of the digestate or the effluent for agricultural purposes [3, 5, 6]. FW serves as a perfect substrate for AD and has a high potential of biomethane production ($200\text{-}670\text{ mlCH}_4/\text{gVS}_{\text{added}}$) [7, 8, 9]. In this regard, AD of FW has become one of the crucial topics in the field of research with a growing global attention.

AD is a complex microbial process characterized by a series of biochemical transformations in four main stages: hydrolysis, acidogenesis, acetogenesis and methanogenesis. Most researchers report that the rate-limiting step for complex organic substrates is the hydrolysis, whereas methanogenesis is the rate-limiting step for easily biodegradable substrates [Ariunbaatar et al. 2014a]. Although FW is considered as a readily biodegradable substrate with easily fermentable sugars, it also contains refractory carbohydrates, lipids and proteins. AD of lipids and proteins are relatively slow as compared to carbohydrates [10, 11]. It was also documented that a complete degradation of proteins cannot be achieved in the presence of high carbohydrate concentrations [12]. Hence, it is difficult to recover the entire potential biomethane from a normal unstimulated AD of complex organic substrates like FW, and research have been conducted to enhance the process.

Among the widely reported literatures, only few mechanical, thermal and thermochemical methods were successfully applied at full scale. Based on a simple sustainability assessment, thermal pretreatment (at temperatures $>100\text{ }^\circ\text{C}$) and two-stage AD systems offer more advantages as compared to other pretreatment methods. These include: i) higher biogas yield; ii) decisive effect on pathogen removal; iii) reduction of digestate amount; iv) reduction of the retention time; v) better energy balance and vi) better economic feasibility [Ariunbaatar et al. 2014a]. It is also well documented that the performance of a continuous anaerobic reactor fed with FW is initially good; however, during a long-term operation, the volatile fatty acids (VFA) accumulation can overcome the digester buffering capacity, leading the system to acidification and consequently a failure [13]. Various inhibitory by-products such as ammonia, hydrogen sulphide, lack of macro and micronutrients, or combination of them usually causes VFA accumulation. Therefore, understanding the exact causes of failure and the effects of trace elements (TE) and microbes or enzymes supplementation could reverse the inhibition and lead to an enhanced performance of anaerobic systems [13, 14, 15]. In addition, anaerobic microbes grow very slowly and anaerobic microbial washout is a critical aspect, thus membrane technologies have been used to retain the biomass inside the system [16, 17].

Based on the comprehensive literature review, this research focused on all the above-mentioned crucial aspects of AD. The primary goal of this research was to study the possibility to enhance the AD process treating FW through thermal, chemical (ozonation) and

thermophilic pretreatments, supplementing additives (trace elements and bioaugmenting inoculum), and using multi-stage CSTR as well as a novel AnMBR technology.

9.2 Major research findings

9.2.1 Batch experiments on the biomethane potential of food waste

In chapter 3, 4, 5 and 6 different methods to enhance the biomethane potential (BMP) of the synthetic FW were discussed. The plateau of the cumulative biomethane production curves were obtained after 20 – 25 days. For each batch experiment, the net specific biomethane production (SBP) of FW was calculated based on the results obtained during the initial 20 days, which amounted to values ranging between 420 and 465 mlCH₄/gVS_{added}. This range is in a good agreement with other published research [18, 19, 20, 21].

The carbohydrates, proteins and lipids concentration of the synthetic FW used in this experiment was 71 – 76, 14 – 17 and 9 – 10%VS, respectively. The relatively higher concentration of proteins and lipids indicates that with a suitable enhancing method more biomethane can be recovered from FW. Various methods to enhance the AD of FW affect the process in different ways, resulting in a wide range of SBP increase. Table 9.1 shows the highest biomethane production enhancements achieved with each method.

Table 9.1: The highest enhancement of SBP achieved with different methods

Method	Enhancement, %	Reference
Thermal pretreatment (> 80°C for 1.5 h)	47 – 52	Figure 3.4B, Table 4.2
Thermophilic pretreatment (< 50 °C for 6-12 h)	40 – 44	Figure 4.5
Supplementation of Se (VI)	30 – 35	Figure 5.3
Bioaugmentation with giraffe dung	10 – 11	Figure 6.3
Ozonation pretreatment (0.068 gO ₃ /gTS _{added})	9 – 10	Figure 3.5

The highest enhancement of SBP was achieved with thermal pretreatment (47-52%), followed by thermophilic shock (40-44%), trace elements supplementation (35-39%), bioaugmentation (10-11%) and ozonation pretreatment (9-10%). The main effects of pretreatment methods (thermal, thermophilic and ozonation) were as follow:

1. Deflocculation of macromolecules [22, 23], which increases the surface area of the substrates. Esposito et al. (2011b) confirmed that increasing the surface area results in a better contact between the substrate and the microbial population, thus more organic matter is converted into biomethane [24].
2. Increase of macromolecular degradation and higher solubilization of substrate due to thermal hydrolysis or radicals from ozonation. Consequently, the organic matter became more available for the anaerobic microbes, enhancing the biomethane production. Neyens and Bayens (2003) also reported that thermal pretreatment resulted in the solubilisation of proteins and increased the removal of particulate carbohydrates [25].
3. Disinfection contributes to a more hospitable environment to the methanogenic consortia in the anaerobic digesters. Consequently, the more specialised microbial community could convert more organic matter to biomethane. The heating of the reactor (thermophilic pretreatment) could have caused a shock in the system, which enhanced the activities and the survival skills of the microbial community. Zhang et al. (2009) also obtained an improved microbial community with a focused pulse shock

pretreatment [26], whereas Vrieze and Boon (2013) obtained with a repeated pulse feeding [27].

The lower enhancement of ozonation pretreatment can be explained by a higher loss of fermentable sugar, as FW contains a high amount of simple carbohydrates and ozone is a strong oxidant. Similar trend was observed with thermal pretreatment at higher temperatures ($>100\text{ }^{\circ}\text{C}$) and longer treatment time ($>4\text{ h}$) [9]. Moreover, another aspect that should be considered for intensive thermal pretreatment is the Maillard reaction i.e. a reaction between amino acids and sugars. The reaction is induced by intensive thermal conditions. One of the products from the Maillard reaction, melanoidins, is difficult to be anaerobically degraded [11, 28]. Therefore, such intensive thermal pretreatment and ozonation could be an attractive method for a substrate with a high content of proteins, lipids or more recalcitrant carbohydrates such as lignocellulosic materials, but not for FW.

The enhancing effect of bioaugmentation resulted in the higher solubilisation of proteins and carbohydrates as suspected. The microorganisms in the giraffe stomach were more effective in solubilizing proteins and carbohydrates than the ones in the sludge. Likewise, a high biohydrogen yield from sugarcane bagasse, corn stalk was obtained when elephant dung and panda dung were used, respectively [29, 30]. Although the enhancement was not remarkably high, it shows potential in recovering higher amount of biomethane, especially for a site-specific AD plant (e.g. treating FW at the amusement park or at the zoo).

Similarly, the supplementation of TE is also site-specific and/or substrate specific. Even though the importance of TE has been studied extensively, the effect and the concentration range for FW is still to be optimized. The results from Chapter 5 showed the importance of Fe (II), Se (VI), Ni (II) and Co (II) for the anaerobic digestion of FW in Europe. The same experiments did not result in an increased biomethane production of FW in US, as the background concentrations of the trace elements in the FW were much higher. Although for both EU and US FW supplementing 25 – 50 $\mu\text{g/L}$ Se (VI) resulted in 30 – 35% increase of biomethane production. The results from the sulphide tests helped to exclude the inhibitory effects of the TE on the hydrogen sulphide toxicity [31]. Therefore, the effects of TE were solely on the food web of the AD. The exact biochemical role of them were not identified in this research, but highly encouraged for further research.

Both the bioaugmentation and TE supplementation do not have any effect on the pathogen removal, and hence a post-treatment is required if the digestate is to be used for agricultural purposes. Based on the results obtained with batch experiments, pretreatment methods particularly thermal pretreatment is recommended for further research and/or scale-up implementation.

9.2.2 Continuous experiments

A continuous operation one-stage continuously stirred tank reactor (CSTR), two-stage CSTR and an anaerobic membrane reactor (AnMBR) were discussed in Chapter 7 and 8. The start-up time for all the reactors were less than two weeks. Successful operation of the two-stage CSTR and AnMBR could achieve almost 100% of the biomethane potential (based on VS_{added}) of FW, whereas the one-stage CSTR converted only 71% of VS_{added} into biomethane. Moreover, two-stage CSTR and AnMBR were more robust than one-stage CSTR, as they were more resistant to organic loading shocks. Physically separating the methanogens from the hydrolytic bacteria in two-stage systems resulted in an increased stability with better pH control, a higher organic loading rate, and an increased specific activity of methanogens resulting in a higher methane yield [5, 32, 33, 34]. After each organic

loading increase as well as shock operation, the AnMBR suffered from lower stability, and COD in the effluent (e.g. permeate) was 3-5% higher. Although this instable period lasted for only 1-2 days and the system could recover itself immediately. The superior stability of the AnMBR was due to the membranes, which helped to retain the methanogens in the system and have a greater performance.

The long retention time remains the main drawback of the conventional CSTRs. Both the CSTR systems started with a hydraulic retention time (HRT) of 20 d, but the CSTR system could not cope with the load, and hence the HRT had to be increased to 40 d. Rincon et al. (2008) also had a similar problem and recommended a HRT longer than 17 d for CSTR systems [35]. AnMBR, on the other hand, was more than capable to treat FW with a HRT of 20d, so it was successfully reduced to 1 d only within an operation of 100 days. Moreover, with the decrease of HRT the organic loading rate (OLR) was increased from 0.19 to 3.37 gVS/L.d, which amounts to 0.43 and 8.85 gCOD/L.d respectively. To prevent from bacterial washout the HRT of the CSTR systems were not reduced, though the OLR were increased from 0.3 to 0.9 gVS/L.d.

During the CSTR operations the digestate was re-circulated back to the system to provide alkalinity. However, it resulted in a 50% higher total ammoniacal nitrogen (TAN) concentration, reaching 933 mg/L in one-stage and 1026 mg/L in two-stage CSTR. Physically separating the hydrolytic and acidogenic microbes from the methanogens provided a better surviving environment for the relatively slow growing and sensitive methanogens, thus two-stage CSTR required less alkalinity than one-stage CSTR. Consequently, a higher TAN concentration was accumulated and a different level of TAN inhibition on the biomethane production was observed. After 2-3 weeks operation, the TAN concentration dropped to the average value of 648 mg/L and 628 mg/L in one-stage and two-stage systems respectively, although the biomethane production stayed low. As Banks et al. (2012) suggested the biochemical pathway might have been changed, and the new acclimated methanogens could have been producing less biomethane than the earlier methanogenic population [13]. To prevent from such inhibition the effluent (e.g. permeate) was not re-circulated back to system, but a buffer was added to provide alkalinity in the AnMBR influent, making the source of alkalinity different as compared to the CSTR operations [36].

The biogas composition in the one-stage and two-stage CSTR were 40-50% and 50-60%, respectively. As the OLR was increased, a reduction of methane concentration in the biogas was observed in both CSTR systems, which could be also due to the accumulated TAN concentration. However, the methane content in the biogas produced from the AnMBR was in the range of 49-55% initially, and it increased up to 70% as prolonged operation was kept. This is another proof that the AnMBR was able to retain the methanogens in the system, yielding a higher performance.

As compared to one-stage CSTR systems, an advantage of two-stage is the possibility to produce hydrogen from the first stage, making it an attractive biohydrogen producing system [37, 38, 39]. However, the hydrogen production in this study was relatively small as compared to other studies, even though the pH (4 – 5.5) was favourable for the main hydrogen forming bacteria such as *Clostridium sp* [40, 41, 42]. As suggested by Kapdan and Kargi (2006), the low hydrogen production could be a consequence of the relatively slow biochemical pathway, in which the microbes utilize lactic and butyric acids to produce hydrogen [43].

Anaerobic digestates contain bacteria such as *Salmonella*, *Listeria*, *Esterichia coli*, *Campylobacter*, *Mycobacteria*, *Clostridia* and *Yersinia*, which may be harmful to both humans and animals. *Salmonella*, *Listeria monocytogenes*, *Verotoxin producing E. coli o 157* are food-borne pathogens and *Campylobacter* is one of the major gastro-enteritis in people,

often associated with eating chicken. Spore forming bacteria such as *Clostridium spp.*, which are found common in dairy products are difficult to be eliminated. Temporary deactivation or die-off of pathogens differs in AD plants. Pathogen survival in AD plants range from min of 24 h up to several days. Hence a separate stage for permanent elimination of pathogens is required [44]. It validates the importance of pretreatment methods or an effective reactor design for the permanent destruction of the pathogens.

Despite no pathogenic study were studied within the scope of this research, two-stage and the AnMBR systems are often reported to have higher pathogen elimination. In two-stage systems, the pathogens are mainly deactivated or destroyed depending on the operational conditions and the type of waste [45, 46, 47, 48, 49]. In AnMBR systems the pathogens are rejected by the membranes, hence the effluent can be directly used for agricultural purposes such as fertigation [16, 17, 50].

In overall, the two-stage and AnMBR systems have superior performance over a conventional one-stage CSTR. Nonetheless, the operation of both of them are more sophisticated, the capital cost is higher, and for AnMBR systems the influent needs to be extensively pretreated to prevent from a possible clogging and fouling of the membrane lumens.

9.3 Future research perspectives

The batch experimental results showed that the biomethane potential can be enhanced through various methods. To scale-up operation for a batch system the operation is less complicated as compared to continuously operating reactors. Hence, the process needs to be optimized for a continuous operation, and the engineering challenges are encouraged to be studied further for a full-scale application. There are only a few examples of the thermal hydrolysis (e.g. thermal pretreatment) that have been applied at a full-scale such as the Cambi, Porteous, and Zimpro process. It should be noted that these methods are all applied for WWTP sludge, and concerning organic solid waste such as FW only the Cambi and a few two-stage AD systems are also applied at full-scale. In general, the high water and energy consumption is still the main downfall of AD.

To reduce water consumption and provide better alkalinity the digestate re-circulation is a good option. However, a high TAN is accumulated when digestate is re-circulated, causing an inhibition on the acetotrophic methanogens [51]. Numerous studies have been conducted on the removal and recovery of TAN. The most recent successful integration of such technology for FW digester is the side-stream stripping with the produced biogas and trapping of ammonia gas while recovering value-added high nitrogen digestate [52]. Although such technologies deal with the final products, it does not solve the source of the problem. It is well documented that possible inhibitors including TAN, sulphide, long-chain fatty acids and cations result in a higher propionic acid concentration in the digesters [53, 54]. Propionic acid accumulation further inhibits the methanogens, and consequently all VFA concentrations increase causing an imbalance of the reactors. The propionic acid utilizers are the most delicate microbial community in the AD food web [54, 55]. Therefore, understanding the physiology of propionic acid utilizers and reversing the inhibition on them could solve not only solve TAN but other inhibitions as well. Supplementation of the particular trace elements in the optimal concentration should balance the requirements and could recover a not fully operating digester [56, 57].

The requirement of iron, nickel, cobalt, molybdenum, selenium and tungsten from various methanogens including *Methanosarcina barkeri*; *Methanospirillum hungatii*, *Methanocorpusculum parvum*, *Methanobacterium thermoautotrophicum*, and

Methanobacterium wolfei and *Methanococcoides methylutens* have been well documented for AD of various substrates. Nevertheless, the concentration of trace elements requirement for the AD of organic solid waste (OSW) still needs to be optimized, and its effects on the biochemical pathways are to be identified. In general the most important TE for OSW, especially for FW are Se, W, Co and Fe. [13, 15, 59]. Glass and Orphan (2012) reported an extensive review summarizing the anaerobic pathways and the microbial population associated with the trace elements including Fe, Ni, Co, Zn, Mo and W, and highlighted the importance of Fe as it is contained in all the pathways, although their review excluded Se [60]. The importance of both Se and Fe in FW digestion was documented with this research (Chapter 5) and it is in line of previous studies [13, 14, 36, 59].

Understanding the involvement of microbial population would be useful to control the performance of AD reactors [35, 61]. Particularly, the identification of the specific activity and the behaviours of acetotrophic and hydrogenotrophic methanogens need to be studied. Microbial population selection according to the type of the substrate to be anaerobically digested and manipulating them to obtain the desired products should result in a stable and efficient reactor performance [62]. Manipulating the microbial community in the reactor brings back the importance of the trace elements. Hence, further studies are needed to be addressed to the gaps in microbial physiology and the bioavailability of TE.

Stage separation is important for reactor stabilization, and more works need to be done on the process modelling as well as control. There are few sensors that are sufficiently robust to monitor online the process performance, but the use of electrochemical probes and spectroscopic scanning has proven successful, although hydrogen sulphides inhibit them, and hence their application should be further studied and optimized.

Although AnMBRs perform superior in lab and pilot scale, the advantages still need to be proven at full-scale. Future researches on membrane reactors should focus on the reduction of energy demand, water recycling, membrane fouling and its cleaning strategies [63, 64, 65]. A special attention should be given to membrane fouling and the following questions need to be answered: i) the differences between aerobic and anaerobic membrane fouling; ii) how reactor operations can affect the fouling; and 3) how different additives influence fouling [16].

Furthermore, considering the superior performance of two-stage and AnMBR systems, a novel technology can be developed by integrating them. A few research have been conducted to treat OSW using this approach, and showed high potential for improved reactor efficiency [66, 67, 68, 69], although the process still needs to be optimized further to achieve a higher removal efficiency and a better control of membrane fouling.

9.4 Reference

1. Allesch and Brunner 2014, Assessment methods for solid waste management: A literature review, *Waste Management and Research* 32: 461-473
2. Browne, J. D., & Murphy, J. D. (2013). Assessment of the resource associated with biomethane from food waste. *Applied Energy*, 104, 170-177.
3. Khalid, A., Arshad, M., Anjum, M., Mahmood, T., & Dawson, L. (2011). The anaerobic digestion of solid organic waste. *Waste Management*, 31(8), 1737-1744.
4. Holm-Nielsen J.B., Al Seadi T., Oleskowicz-Popiel P. (2009), The future of anaerobic digestion and biogas utilization, *Bioresource Technology* 100: 5478-5484
5. Ariunbaatar J., Panico A., Esposito G., Pirozzi F., Lens PNL. (2014a), Pretreatment methods to enhance anaerobic digestion of organic solid waste, *Applied Energy* 15: 143-156

6. Ward AJ., Hobbs PJ., Holliman PJ., Jones DL. Optimization of anaerobic digestion of agricultural resources, *Bioresource Technology* 2008; 99(17): 7928-7940
7. Guo, X., Wang, C., Sun, F., Zhu, W., & Wu, W. (2014). A comparison of microbial characteristics between the thermophilic and mesophilic anaerobic digesters exposed to elevated food waste loadings. *Bioresource technology*, 152, 420-428.
8. Zhang, R., El-Mashad, H. M., Hartman, K., Wang, F., Liu, G., Choate, C., & Gamble, P. (2007). Characterization of food waste as feedstock for anaerobic digestion. *Bioresource technology*, 98(4), 929-935.
9. Ariunbaatar J., Panico A., Frunzo L., Esposito G., Lens P.N.L., Pirozzi F. (2014b), Enhanced anaerobic digestion of food waste by thermal and ozonation pretreatment methods. *Journal of Environmental Management* 146:142-149
10. Graunke, R. E., & Wilkie, A. C. (2014). Examining the mechanisms of short-term solubilization of ground food waste for high-rate anaerobic digestion. *International Biodeterioration & Biodegradation*, 86, 327-333.
11. Vavillin VA. Fernandez B., Palatsi J., Flotats X. (2008), Hydrolysis kinetics in anaerobic degradation of particulate organic material: An overview, *Waste management* 28: 939-951
12. Breure AM., Mooijman KA., van Andel JG. (1986), Protein degradation in anaerobic digestion: influence of volatile fatty acids and carbohydrates on hydrolysis and acidogenic fermentation of gelatin, *Applied Microbiology and Biotechnology* 24: 426-431
13. Banks, C. J., Zhang, Y., Jiang, Y., & Heaven, S. (2012). Trace element requirements for stable food waste digestion at elevated ammonia concentrations. *Bioresource technology*, 104, 127-135.
14. Zhang, L., Lee, Y. W., & Jahng, D. (2011). Anaerobic co-digestion of food waste and piggery wastewater: focusing on the role of trace elements. *Bioresource technology*, 102(8), 5048-5059
15. Demirel, B., & Scherer, P. (2011). Trace element requirements of agricultural biogas digesters during biological conversion of renewable biomass to methane. *Biomass and Bioenergy*, 35(3), 992-998
16. Stuckey D.C. (2012), Recent developments in anaerobic membrane reactors, *Bioresource Technology* 122: 137-148
17. Fuchs W., Binder H., Mavrias G., Barun R., 2003, Anaerobic treatment of wastewater with high organic content using a stirred tank reactor coupled with a membrane filtration unit, *Water Research* 37: 902-908
18. Kastner V., Somitsch W., Schnitzhofer W. The anaerobic fermentation of food waste: a comparison of two bioreactor systems, *Journal of Cleaner Production* 2012; 34: 82-90
19. Kapdan I.K. and Kargi F. Bio-hydrogen production from waste materials, *Enzyme and Microbial Technology* 2006; 38 (5): 569-582
20. Xu SY., Lam H.P, Karthikeyan P., Wong JWC. Optimization of food waste hydrolysis in leach bed coupled with methanogenic reactor: Effect of pH and bulking agent, *Bioresource Technology* 2011; 102: 3702-3708
21. Zhang C., Xiao G., Peng L., Su H., Tan T. The anaerobic co-digestion of food waste and cattle manure, *Bioresource Technology* 2013; 129: 170-176
22. Hendriks A.T.W.M. and Zeeman G. (2009), Pretreatments to enhance the digestibility of lignocellulosic biomass: A Review, *Bioresource Technology*; 100: 10-18
23. Eggeman T., Elanderb RT., Process and economic analysis of pretreatment technologies, *Bioresource Technology*; 96: 2019–2025

24. Esposito G., Frunzo L., Panico A., Pirozzi F. (2011), Modelling the effect of the OLR and OFMSW particle size on the performances of an anaerobic co-digestion reactor, *Process Biochemistry*; 46: 557-565
25. Neyens E., Baeyens J. (2003), A review of thermal sludge pre-treatment processes to improve dewaterability, *Hazardous Materials*; 98: 51-67
26. Zhang H., Banaszak J.E., Prathap P., Alder J., Krajmalnik-Brown, R., Rittman B.E., Focused-pulsed sludge pretreatment increases the bacterial diversity and relative abundance of acetoclastic methanogens in a full-scale anaerobic digester, *Water Research* 2009; 43: 4517-4526
27. Vrieze J.D., Verstaete W., Boon N., Repeated pulse feeding induces functional stability in anaerobic digestion, *Microbial biotechnology* 2013; 6(4): 414-424
28. Carrere H., Dumas C., Battimeli A., Batstone DJ., Delgenes JP., Steyer JP., Ferrer I. (2010), Pretreatment methods to improve sludge anaerobic degradability: A review, *Hazardous Material* 183:1-15
29. Fangkum, A., & Reungsang, A. (2011). Biohydrogen production from sugarcane bagasse hydrolysate by elephant dung: effects of initial pH and substrate concentration. *International Journal of Hydrogen Energy*, 36(14), 8687-8696.
30. Fan, Y. T., Xing, Y., Ma, H. C., Pan, C. M., & Hou, H. W. (2008). Enhanced cellulose-hydrogen production from corn stalk by lesser panda manure. *International Journal of Hydrogen Energy*, 33(21), 6058-6065.
31. Karhadkar, P. P., Audic, J. M., Faup, G. M., & Khanna, P. (1987). Sulfide and sulfate inhibition of methanogenesis. *Water Research*, 21(9), 1061-1066.
32. Bouallagui H., Touhami Y., Cheikh R.B., Hamdi M. Bioreactor performance in anaerobic digestion of fruit and vegetable wastes, *Process Biochemistry* 2005; 40: 989–995
33. Wang X., Zhao Y. A bench scale study of fermentative hydrogen and methane production from food waste in integrated two-stage process, *International Journal of Hydrogen Energy* 2009; 34:245–254
34. Nathao C., Sirisukpoka U., Pisutpaisal N. Production of hydrogen and methane by one and two stage fermentation of food waste, *International Journal of Hydrogen Energy* 2013; 38 (35): 15764-15769
35. Rincon B., Borja R., Gonzalez J.M., Portillo M.C., Saiz-Jimenez C. (2008), Influence of organic loading rate and hydraulic retention time on the performance, stability and microbial communities of one-stage anaerobic digestion of two-phase olive mill solid residue, *Biochemical Engineering Journal* 40: 253-261
36. Banks CJ., Chesshire M., Heaven S., Arnold R. Anaerobic digestion of source-segregated domestic food waste: Performance assessment by mass and energy balance, *Bioresource Technology* 2011; 102(2): 612-620
37. Wang X., Zhao Y. (2009), A bench scale study of fermentative hydrogen and methane production from food waste in integrated two-stage process, *International Journal of Hydrogen Energy*; 34: 245-254
38. Liu D., Liu D., Zheng R.J., Angelidaki I. (2006), Hydrogen and methane production from household solid waste in the two-stage fermentation process, *Water Research*; 40: 2230-2236
39. Escamilla-Alvarado C., Rios-Leal E., Ponce-Noyola M.T., Poggi-Varaldo H.M. (2012), Gas biofuels from solid substrate hydrogenogenic-methanogenic fermentation of the organic fraction of municipal solid waste, *Process Biochemistry* 47:1572-1587
40. Kim DH., Kim SH., Jung KW., Kim MS., Shin HS. Effect of initial pH independent of operational pH on hydrogen fermentation of food waste, *Bioresource Technology* 2011; 102: 8646-8652

41. Han SK. And Shin HS. Biohydrogen production by anaerobic fermentation of food waste, *International Journal of Hydrogen Energy* 2004; 29: 569-577
42. Chu C.F., Ebie Y., Xu K.Q., Li Y.Y., Inamori Y. Characterization of microbial community in the two-stage process for hydrogen and methane production from food waste, *International Journal of Hydrogen Energy* 2010; 35(15): 8253-8261
43. Kapdan I.K. and Kargi F. Bio-hydrogen production from waste materials, *Enzyme and Microbial Technology* 2006; 38 (5): 569-582
44. Sahlstrom L. (2003), A review of survival of pathogenic bacteria in organic waste used in biogas plants, *Bioresource Technology* 87:161-166
45. Demirel B. and Yenigun O. (2002), Two-phase anaerobic digestion processes: A Review, *Journal of Chemical Technology and Biotechnology* 77: 743-755
46. Bouallagui H., Touhami Y., Cheikh R.B., Hamdi M. (2005), Bioreactor performance in anaerobic digestion of fruit and vegetable wastes: A Review, *Process Biochemistry* 40: 989-995
47. Bouallagui H., Touhami Y., Cheikh R. B., Hamdi M. (2005), Bioreactor performance in anaerobic digestion of fruit and vegetable wastes, *Process Biochemistry*; 40 : 989-995
48. Blonskaja V., Menert A., Vilu R. (2003), Use of two-stage anaerobic treatment for distillery waste, *Advances in Environmental Research*; 7: 671-678
49. Riau V., De la Rubia M.A., Perez M. (2011), Assessment of solid retention time of a temperature phased anaerobic digestion system on performance and final sludge characteristics, *Journal of Chemical Technology and Biotechnology* 87:1074-1082
50. Prieto, A. L., Futselaar, H., Lens, P. N., Bair, R., & Yeh, D. H. (2013). Development and start up of a gas-lift anaerobic membrane bioreactor (GI-AnMBR) for conversion of sewage to energy, water and nutrients. *Journal of Membrane Science*, 441, 158-167
51. Fotidis I.A., Karakashev D., Angelidaki I. (2013), Bioaugmentation with an acetate-oxidising consortium as a tool to tackle ammonia inhibition of anaerobic digestion, *Bioresource Technology* 146:57-62
52. Serna-Maza A., Heaven S., Banks C.J. (2014), Ammonia removal in food waste anaerobic digestion using a side-stream stripping process 152: 307-315
53. Angelidaki I., and Ahring B.K. Thermophilic anaerobic digestion of livestock waste: the effect of ammonia, *Applied Microbiology and Biotechnology* 1993; 38: 560-564
54. Chen Y., Cheng J.J., Creamer K.S. Inhibition of anaerobic digestion process: A review, *Bioresource Technology* 2008; 99(10): 4044-4064
55. Pullammanappallil P.C., Chynoweth D.P., Lyberatos G., Svoronos S.A. (2001), Stable performance of anaerobic digestion in the presence of a high concentration of propionic acid, *Bioresource Technology* 78: 165-169
56. Raposo F., Rubia M.A.D., Fernandez-Cegri V., Borja R (2011), Anaerobic digestion of solid organic substrates in batch mode: An overview relating to methane yields and experimental procedures, *Renewable and Sustainable energy Reviews*; 16: 861-877
57. Zhang Y., Zhang Z., Suzuki K., Maekawa T. (2003), Update and mass balance of trace metals for methane producing bacteria, *Biomass and Bioenergy* 25: 427-433
58. Demirel, B., & Scherer, P. (2011). Trace element requirements of agricultural biogas digesters during biological conversion of renewable biomass to methane. *Biomass and Bioenergy*, 35(3), 992-998
59. Facchin V., Cavinato C., Fatone F., Pavan P., Cecchi F., Bolzonella D. (2013), Effect of trace element supplementation on the mesophilic anaerobic digestion of food waste in batch trials: The influence of inoculum origin, *Biochemical Engineering Journal* 70: 71-77

60. Glass J.B. and Orphan V.J. (2012), Trace metal requirements for microbial enzymes involved in the production and consumption of methane and nitrous oxide, *Frontiers in Microbiology* 3(61):1-20
61. Niu Q., Qiao W., Qiang H. and Li Yu-You (2013), Microbial community shifts and biogas conversion computation during steady, inhibited and recovered stage of thermophilic methane fermentation on chicken manure with a wide variation of ammonia, *Bioresource Technology* 146: 223-233
62. Demirel B and Schrer P. (2008), The roles of acetotrophic and hydrogenotrophic methanogens during anaerobic conversion of biomass to methane: A Review, *Rev. Environ. Sci. Biotechnol* 7: 173-190
63. Judd S. (2008), The status of membrane bioreactor technology, doi:10.1016/j.tibtech.2007.11.005
64. Drexler I. and Yeh D.H. (2014), Membrane applications for microalgae cultivation and harvesting: A Review, *Rev. Environ. Sci. Biotechnol* doi:10.1007/s11157-014-9350-6
65. Rajagopal R., Cata Saady N.M., Torrijos M., Thanikal J.V., Hung Y-T. (2013), Sustainable agro-food industrial wastewater treatment using high-rate anaerobic process, *Water* 5: 292-311,
66. Jeong E., Kim H-W., Nam J-Y., Shin H-S. (2010) Enhancement of bioenergy production and effluent quality by integrating optimized acidification with submerged anaerobic membrane bioreactor, *Bioresouce Technology* 101:S7-S12
67. Tzcinski A.P. and Stuckey D.C. (2009a), Anaerobic digestion of the organic fraction of municipal solid waste in a two-stage membrane process, *Water Science and Technology* 60.8, doi:10.2166/wst.2009.498
68. Tzcinski A.P. and Stuckey D.C. (2009b), Continuous treatment of the organic fraction of municipal solid waste in a two-stage membrane process with liquid recycle, *Water Research* 43: 2449-2462
69. Tzcinski A.P. and Stuckey D.C. (2010), Performance of a three-stage membrane bioprocess treating organic fraction of municipal solid waste and evolution of its archael and bacterial ecology, *Bioresource Technology* 101: 1652-1661