



**HAL**  
open science

# Assessment of the environmental benefits provided by closed-loop strategies for industrial products

Jorge Luis Amaya Rivas

► **To cite this version:**

Jorge Luis Amaya Rivas. Assessment of the environmental benefits provided by closed-loop strategies for industrial products. Other. Université de Grenoble, 2012. English. NNT : 2012GRENI074 . tel-01207291

**HAL Id: tel-01207291**

**<https://theses.hal.science/tel-01207291>**

Submitted on 30 Sep 2015

**HAL** is a multi-disciplinary open access archive for the deposit and dissemination of scientific research documents, whether they are published or not. The documents may come from teaching and research institutions in France or abroad, or from public or private research centers.

L'archive ouverte pluridisciplinaire **HAL**, est destinée au dépôt et à la diffusion de documents scientifiques de niveau recherche, publiés ou non, émanant des établissements d'enseignement et de recherche français ou étrangers, des laboratoires publics ou privés.

## THÈSE

Pour obtenir le grade de

## DOCTEUR DE L'UNIVERSITÉ DE GRENOBLE

Spécialité : **GENIE INDUSTRIEL – CONCEPTION ET PRODUCTION**

Arrêté ministériel : 7 août 2006

Présentée par

**Jorge Luis AMAYA RIVAS**

Thèse dirigée par **Peggy ZWOLINSKI**

préparée au sein du **Laboratoire G-SCOP**  
dans l'**École Doctorale IMEP-2**

# **Assessment of the environmental benefits provided by closed-loop strategies for industrial products**

Thèse soutenue publiquement le **08 Octobre 2012**,  
devant le jury composé de :

**Monsieur, Emmanuel, CAILLAUD**

Professeur à l'Université de Strasbourg – UNISTRA (Président)

**Monsieur, Dominique, MILLET**

Professeur à SUPMECA TOULON (Rapporteur)

**Monsieur, Bernard, YANNOU**

Professeur à l'Ecole Centrale Paris (ECP) (Rapporteur)

**Monsieur, Erik, SUNDIN**

Associate Professor Linköping University (Membre)

**Madame, Peggy, ZWOLINSKI**

Professeur à Grenoble-INP (Directrice de thèse)

**Monsieur, Eric, FREYBURGER**

Représentant Industriel Société Renault Trucks (Membre)

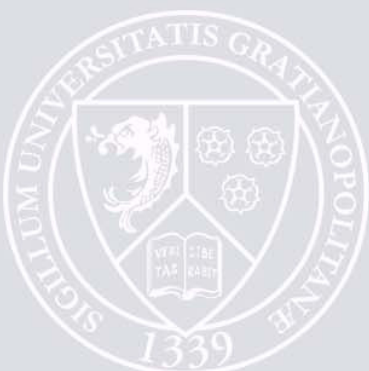



## THÈSE

Pour obtenir le grade de

## DOCTEUR DE L'UNIVERSITÉ DE GRENOBLE

Spécialité : **GENIE INDUSTRIEL – CONCEPTION ET PRODUCTION**

Arrêté ministériel : 7 août 2006

Présentée par

**Jorge Luis AMAYA RIVAS**

Thèse dirigée par **Peggy ZWOLINSKI**

préparée au sein du **Laboratoire G-SCOP**  
dans l'**École Doctorale IMEP-2**

# Evaluation des bénéfices environnementaux liés à des cycles de vie de produits en flux bouclés

Thèse soutenue publiquement le **08 Octobre 2012**,  
devant le jury composé de :

**Monsieur, Emmanuel, CAILLAUD**

Professeur à l'Université de Strasbourg – UNISTRA (Président)

**Monsieur, Dominique, MILLET**

Professeur à SUPMECA TOULON (Rapporteur)

**Monsieur, Bernard, YANNOU**

Professeur à l'Ecole Centrale Paris (ECP) (Rapporteur)

**Monsieur, Erik, SUNDIN**

Associate Professor Linköping University (Membre)

**Madame, Peggy, ZWOLINSKI**

Professeur à Grenoble-INP (Directrice de thèse)

**Monsieur, Eric, FREYBURGER**

Représentant Industriel Société Renault Trucks (Membre)





## RÉSUMÉ

Les produits avec des phases d'usage multiples sont de plus en plus pris en considération du fait des pressions économiques et environnementales. Ces produits aux cycles de vie complexes, utilisent des process tels que le remanufacturing. Ces process doivent être modélisés et évalués par des équipes de conception. Cette thèse montre comment représenter, modéliser et évaluer des produits en cycle de vie à boucle fermée. L'étude montre comment établir des évaluations environnementales pour ces produits et les comparer aux évaluations environnementales de cycles de vie classiques.

Les modèles ont été développés sur des travaux antérieurs, tels que la méthodologie de Gehin et al. basée sur le concept de brique du cycle de vie produit. La première approche proposée sert pour évaluer les bénéfices environnementaux des opérations et des activités autour du cycle de vie de produit en boucle fermée (remanufacturing scénario de fin de vie et systèmes de produit-service comme stratégie de vente des services).

L'introduction de systèmes produit-service vise à réduire les impacts environnementaux de produits par l'intensification de l'utilisation. Ainsi, la thèse propose un modèle pour évaluer les éléments de systèmes produits-service et leur cycle de vie du point de vue environnemental. La thèse se concentre sur l'élaboration d'un modèle qui intègre le cycle de vie d'un produit-service système et ses paramètres, en tenant en compte des éléments physiques, ainsi que l'infrastructure, la conception des unités de services, les acteurs dans la logistique et leurs interactions.

Les modèles permettent d'identifier et de distinguer les différentes phases du cycle de vie du produit et de réajuster la décision des concepteurs dans le processus de conception du produit. De plus, le modèle cherche l'intégration des paramètres du process de remanufacturing et des systèmes produit-service dans l'ensemble du cycle de vie du produit. Les modèles visent à aider la conception de produits et de processus, ainsi que les acteurs de la chaîne d'approvisionnement et les personnes chargées de la prise de décision sur la conception du produit et des changements dans le système.

Les résultats peuvent être utilisés, afin d'évaluer la performance environnementale des différents scénarios de fin de vie des produits, fournissant un outil pour les concepteurs qui permet de quantifier les avantages environnementaux liés à l'utilisation des produits en cycle de vie en boucle fermée.



## **ABSTRACT**

Products with multiple use phases have to be considered regarding new economic and environmental pressures. Therefore, the related complex life cycles of (re)manufactured products have to be modelled and assessed by design teams for a better understanding of their performance. This thesis presents methodologies to represent, model and assess closed-loop product lifecycle (focused on remanufacturing strategies). The study shows how to establish environmental assessments for remanufactured products life cycles and how to compare them to environmental assessments for classical life cycles.

The present study shows how to establish the models and how to compare the environmental assessments of remanufactured products life cycles vs. classical life cycle scenarios. The objective is to provide easy to use methods and tools for designers to allow them quantifying the environmental benefits related to the use of a closed loop strategy. In this project, a life cycle assessment, life cycle bricks, and a parametric model of the products are used to evaluate and compare the environmental benefits provided by the remanufacturing. The methodologies and models have been developed based on previous works, such as the the life cycle bricks concept developed by Gehin et al. [2007].

On the other hand, the thesis proposes a model to assess the product-service systems elements and their respective life cycle from an environmental point of view. Here, the thesis focuses on the development of a model which integrates the product lifecycle within those parameters by a product-service system strategy, taking into account physical elements, as well as the infrastructures network, unit services design, supply chain actors and their interactions.

Finally, a model has been developed to assess from an environmental point of view the data of the operations and activities around product life cycle of the products with final non classic disposition scenarios (remanufacturing as end-of-life scenario and multiple uses by the disposition of the service offers system as a business strategy). The methodologies and models proposed allow identifying and distinguishing impacts between the different product life cycle stages and readjust the designers' decision at the product design stage. The results can be further used in simulation, to evaluate the environmental performance of different product life cycle end-of-life scenarios.





## **ACKNOWLEDGEMENTS**

I would like to acknowledge the guidance of my supervisor, Prof. Peggy Zwolinski. First and foremost, I am grateful to Peggy for the intellectual discussions, for her clear mind and logic, for helping with big and small tasks, for mathematical formulas and language lessons, for long journeys of discussions and for quick idea swaps. I learned a lot from her and hope that I will continue learning. I would also like to thank certain member of my research's team (Alan Lelah and Prof. Daniel Brissaud) for getting involved in the middle of my research and honourably following it up to the end. I am grateful for their insightful guidance, constructive suggestions, encouragement and promotion. Special thanks also to my office colleague Hayder Alhomsy for his inspiration and useful comments at the beginning of thesis research and his continuous encouragement and care.

I am very grateful for the financial assistance and support of the Cluster Gospi and G-SCOP Laboratory. Furthermore, I would like to thank the collaboration of Renault Trucks Reman for the support of the consequent study and to specifically express my gratitude to Mr. Eric Freyburger from the Renault Trucks Xchange for disseminating the data for the results of the research, for stimulating discussions and fruitful collaboration. It was both intellectually stimulating and a real pleasure to work together.

I also wish to express my appreciation of the working group on remanufacturing at the Supmecca Toulon: Prof. Dominique Millet, Nicolas, Olivier and Akram; thanks for the discussions and exchange of ideas at seminars and conferences with critical comments, useful suggestions and encouragement during the project.

I am also very grateful to my colleagues with whom I discussed my work at different stages of the research, especially Jeremy Bonvoisin and Cong Chen. Other colleagues have also contributed with useful information and suggestions and by reading and providing feedback on the articles that contributed to this dissertation. I would like to especially mention Fabrice Mathieu and Lucie Domingo. I also had the pleasure of supervising and working with several masters' students who stimulated and supported this research at different stages. Thanks to the masters: Alejandro, Ana, Daniel, Mattieux, Moreno, Renalie, Rubén, Samuel, and Sergio.

My colleagues were simply the best! They created a wonderful atmosphere. I am grateful for the collaboration and support of Guillaume, Frederic, Guy, François, Bao, Chloe, and of course, Onur.

Without the administrative staff at the G-SCOP taking care of all the practicalities, I would not have been able to cope. Thank you very much Amandine, Jonathan, Sebastien, Souad, Kheira, Claudia, Roxane, Christine, Olivia, Fadila and Chantal.

Finally, but the most important, I would like to thank my family, especially to my mother, for making it possible for me to concentrate on writing the dissertation. I am grateful to my brothers and sisters, to my nephews for the support and care from the distance. I would like to thank all my friends from Ecuador, from France, from all around the world I met in this time for always being there for me!!!

I devote this work to my old sister Mayra. Wish you were here ...

Jorge Luis AMAYA RIVAS

Grenoble, October 2012





# **CONTENTS**

**Résumé**

**Abstract**

**Acknowledgments**

**Contents**

**List of Figures**

**List of Tables**

**Introduction**

<b>1. Industrial concerns of environmental issues</b>	<b>9</b>
1.1. End-of-life scenarios: environmental impacts	9
1.2. Design for environment constraints	10
1.3. Closed-loop product life cycle environmental assessment	11
<b>2. Remanufacturing model - environmental assessment</b>	<b>12</b>
<b>3. PSS model - environmental assessment</b>	<b>13</b>
<b>4. Organization of the thesis</b>	<b>14</b>

**Chapter 1**

**Environmental considerations on industrial product design**

<b>1. Environment and industry</b>	<b>19</b>
1.1. Sustainable development	19
1.2. Industrial interests and conflicts on the environment	20
1.3. Environmental constraints in the design process	20
1.4. Product life cycle strategies	21
1.5. Remanufacturing as a closed-loop end-of-life strategy	23
1.5.1. Remanufacturing benefits	24

1.5.2. Remanufacturing problems	25
1.6. Alternative closed-loop strategies	25
<b>2. Environmental methodologies to assess product lifecycle</b>	<b>27</b>
2.1. Life cycle assessment	27
2.2. Life cycle assessment phases	27
2.3. Life cycle assessment pertinence	29
2.4. Life cycle assessment limitations	30
<b>3. Problematic of the thesis</b>	<b>32</b>
3.1. Summary of chapter 1	32
3.2. Problematic	34

## Chapter 2

### Closed loop strategies for industrial products: Focus on the remanufacturing

<b>1. Introduction</b>	<b>41</b>
<b>2. Closed Loop End-of-Life strategies</b>	<b>42</b>
2.1. End-of-Life scenarios – Valorization Strategies	43
2.1.1. Reuse	44
2.1.2. Remanufacturing	45
2.1.3. Recycling	45
2.2. Life Cycle Assessment on the Closed Loop Life Cycle products	46
<b>3. Energy assessment on the Closed Loop Product Lifecycle</b>	<b>51</b>
3.1. Energy Assessment on the Closed Loop Product Lifecycle: the case of the remanufacturing process	51
3.2. Energy Performance on the Closed Loop Product Lifecycle: comparison between manufacturing and remanufacturing	52
3.3. Closed Loop Product Lifecycle energy assessment model of remanufacturing process	53
<b>4. Reusability and Modularity on the Closed Loop Product Lifecycle</b>	<b>55</b>
4.1. Reusability as scenario to assure Closed Loop Product Lifecycle	55
4.2. Modularity for Life Cycle Design	56
4.3. Performance Assessment on the Closed Loop Product Lifecycle	57
4.4. Life cycle scenarios design for End-of-Life strategy	57
<b>5. Product-Services Systems Strategy</b>	<b>59</b>
5.1. Product-Services Systems	59
5.2. Product-Services Systems benefits on the Closed Loop Product Lifecycle	60
5.3. Life Cycle simulation for analyzing Product-Service Systems	61
<b>6. Problematic for the Life Cycle Assessment of products with Closed Loop Lifecycles</b>	<b>63</b>
6.1. Life Cycle Assessment on Remanufacturing process to generate Closed Loop Lifecycle products	63

## Chapter 3

### Life Cycle Model Approach for Remanufactured Industrial Products

<b>1. Remanufactured products characterization to assess environmental impacts</b>	<b>71</b>
1.1. Parameters to consider on the remanufacturing products business model	71
1.2. Remanufactured product – life cycle	72
1.3. Product stock – inventory	73
1.4. Product performance and use	73
<b>2. Remanufacturing product life cycle</b>	<b>74</b>
2.1. Remanufacturing problematic context for the assessment of closed loop lifecycle products	74
2.2. Parameterization of closed loop products: remanufacturing process	75
2.2.1. Parameters quantity	76
2.2.2. Parameters type	77
2.3. Parameterization of closed loop life cycle products	77
<b>3. Closed Loop Product Life Cycle Assessment: Impacts for Remanufacturing Model</b>	<b>81</b>
3.1. Life cycle description	81
3.2. LCA integration on the closed loop end-of-life strategies products	82
3.3. General parameterisation on the closed loop end-of-life strategies products	83
3.4. Environmental impact equations	84
<b>4. Gearbox truck case study</b>	<b>86</b>
4.1. The analysis study case	86
4.2. The life cycle assessment tool for remanufactured products	87
4.2.1. Raw material parameters in the tool	87
4.2.2. Components manufacturing parameters in the tool	87
4.2.3. Components distribution parameters in the tool	88
4.2.4. Products distribution parameters in the tool	90
4.2.5. Products end-of-life parameters in the tool	90
4.3. Results	92
4.4. Assessment tool for remanufactured products	93
<b>5. Sensitivity Analysis of the Remanufacturing Model</b>	<b>95</b>
5.1. Initial Scenario (Scenario 0)	95
5.2. Sensitivity Analysis	97
5.2.1. Material parameters in the tool	97
5.2.2. Number of use cycles "n <sub>t</sub> " parameter	99
5.2.3. Performance at the remanufacturing process	100
5.2.4. Transport parameters	101
5.3. Parameters MIX Sensitivity Analysis	102
<b>6. Conclusion of Chapter 3</b>	<b>105</b>



## Chapter 4

### Life Cycle Model Approach on Multiple Usage Products – PSS Considerations

<b>1. Introduction</b>	<b>111</b>
<b>2. Characterization of pss from an engineering point of view</b>	<b>112</b>
2.1. PSS product requirements	112
2.2. PSS service requirements	113
2.3. Global PSS requirements	114
<b>3. An environmental impacts model for products in a PSS model</b>	<b>116</b>
3.1. Life cycle functional unit definition	116
3.2. The life cycle description	117
3.3. PSS design considerations	119
3.4. Environmental impact calculations	120
<b>4. System Definition in PSS design</b>	<b>123</b>
4.1. Elements of the PSS	123
4.2. Links between PSS elements and design parameters	124
<b>5. Velo’V case study</b>	<b>127</b>
5.1. A life cycle assessment tool for PSS business models	127
5.2. The life cycle assessment tool for PSS	128
5.3. Scenarios for the different PSS elements	129
5.3.1. Design parameters and environmental impacts	131
<b>6. Conclusion of Chapter 4</b>	<b>133</b>

## Chapter 5

### Environmental Assessment Model Approach on Closed Loop Life Cycle Products

<b>1. Introduction</b>	<b>139</b>
<b>2. Remanufacturing products compatibility with PSS model</b>	<b>140</b>
2.1. The role of remanufacturing and PSS organization	140
2.2. Product lifecycle requirements of remanufacturing – PSS	141
2.3. Logistics and reverse logistics considerations	142
2.4. Problems on remanufacturing – PSS	142
<b>3. Environmental assessment for closed-loop products lifecycle</b>	<b>144</b>
3.1. Integration of the remanufacturing approach in PSS	144
3.1.1. Model approach for remanufacturing – PSS	146
3.1.2. Environmental impact calculations for a remanufacturing – PSS strategy	149
3.2. Life cycle assessment of a catalytic converter	149

3.2.1. Goal definition _____	150
3.2.2. Product definition and functional unit _____	150
3.2.3. Life cycle description and inventory _____	151
3.2.4. Assumptions _____	152
3.2.5. Results for classic model: catalytic converter _____	152
<b>4. Environmental assessment simulation for closed-loop products lifecycle_____</b>	<b>155</b>
4.1. Case study _____	155
4.2. Influence of the end-of-life on the product life cycle _____	156
4.2.1. Closed – loop product life cycle by remanufacturing_____	156
4.3. Closed-loop life cycle simulation: remanufacturing – PSS_____	158
4.4. Catalytic converter: remanufacturing and PSS closed-loop life cycle results _____	162
<b>5. Conclusion of Chapter 5 _____</b>	<b>164</b>
<b>Conclusions and Perspectives _____</b>	<b>168</b>

## References



## **FIGURES**

Figure 1 - 1: Classic product life cycle _____	22
Figure 1 - 2: Closed loop end-of-life product life cycle _____	23
Figure 1 - 3: Five stages of the remanufacturing process _____	24
Figure 1 - 4: Four main phases of the LCA illustration _____	28
Figure 1 - 5: Injector diesel detailed product lifecycle _____	33
Figure 1 - 6: Flow diagram example for an industrial remanufacturing process _____	34
Figure 2 - 1: Product Life Cycle _____	42
Figure 2 - 2: Product – multiple use cycle phases approach _____	44
Figure 2 - 3: Product – multiple use cycle phases approach _____	47
Figure 2 - 4: Comparison of energy estimated for manufacturing and remanufacturing ____	52
Figure 2 - 5: Embodied energy of various engine components _____	53
Figure 2 - 6: Flow of components over multiple use cycles _____	53
Figure 2 - 7: Phats of components reuse _____	56
Figure 2 - 8: Representation of PSS and their relations _____	61
Figure 3 - 1: Remanufactured Product Life Cycle Period _____	72
Figure 3 - 2: Remanufacturing parameterization on the reconditioning Industrial Process ____	76
Figure 3 - 3: Consideting Remanufacturing Parameterization of the Product Life Cycle ____	78
Figure 3 - 4: Closed Loop Product Life Cycle and Parameterization _____	81
Figure 3 - 5: Gearbox ZF used by Renault Trucks and reconditioned by Renault Trucks Reman Parts _____	86
Figure 3 - 6: Type and Quantity Parameters for the Life Cycle Assessment – Raw Material	87
Figure 3 - 7: Type and Quantity Parameters for the Life Cycle Assessment – Manufacturing	88
Figure 3 - 8: Type Parameters for the Life Cycle Assessment – by each single component _	89

Figure 3 - 9: Type and Quantity Parameters for the Life Cycle Assessment – Components Distribution	89
Figure 3 - 10: Type and Quantity Parameters for the Life Cycle Assessment – Product Distribution	90
Figure 3 - 11: Type and Quantity Parameters for the Life Cycle Assessment – Product End-of-Life	91
Figure 3 - 12: Comparison: Gearbox ZF and gearbox reconditioned by Renault Trucks Reman Parts	93
Figure 3 - 13: Comparison: Gearbox ZF and gearbox reconditioned by Renault Trucks Reman Parts	93
Figure 3 - 14: Environmental Impacts on the Gearbox Life Cycle – Mass Reduction	98
Figure 3 - 15: Environmental Impacts on the Gearbox Life Cycle – Variation of type of material	99
Figure 3 - 16: Environmental Impacts on the Gearbox Life Cycle – Variation of the use cycles number	100
Figure 3 - 17: Environmental Impacts on the Gearbox Life Cycle – Variation of PMR	100
Figure 3 - 18: Environmental Impacts on the Gearbox Life Cycle – Variation of $\eta$	101
Figure 3 - 19: Environmental Impacts on the Gearbox Life Cycle – Variation of the distance for product distribution	102
Figure 3 - 20: Environmental Impacts on the Gearbox Life Cycle – Variation of the type of transport distribution	102
Figure 3 - 21: Environmental Impacts on the Gearbox Life Cycle – Scenarios Compariason	104
Figure 4 - 1: Product Life Cycle for the PSS	117
Figure 4 - 2: Technical life time ( $t_{tl}$ ) versus service provision time ( $t_{sp}$ ) products scenarios	118
Figure 4 - 3: Services in the product use phase of the PSS	121
Figure 4 - 4: Examples of PSS elements in Bicycle Sharing	124
Figure 4 - 5: Use states in the case of bicycle sharing	126
Figure 4 - 6: Environmental Impact for the Velo’V PSS Life Cycle	129
Figure 5 - 1: Classic Product Life Cycle modeling	144

Figure 5 - 2: Remanufacturing – Closed Loop Product Lifecycle modeling _____	145
Figure 5 - 3: Remanufacturing – Closed Loop Product Lifecycle modeling _____	146
Figure 5 - 4: Remanufacturing Parameterisation on the Reconditioning Industrial Process _____	148
Figure 5 - 5: Catalytic Converter life cycle environmental impacts – End of Life: Recycling (EcoPoints) _____	153
Figure 5 - 6: Remanufacturing Parameters: Product Definition Level and Logistics – Network _____	157
Figure 5 - 7: Catalytic converter life cycle environmental impacts – End of Life: Remanufacturing (EcoPoints) _____	158
Figure 5 - 8: PSS - Remanufacturing Parameters: Services and Use affectation of the catalytic converter _____	160
Figure 5 - 9: PSS - Remanufacturing Parameters: Services and Use affectation of the catalytic converter _____	161
Figure 5 - 10: PSS and remanufacturing environmental impacts – values in EcoPoints _____	161
Figure 5 - 11: PSS and remanufacturing analytical results – values in EcoPoints _____	162
Figure 5 - 12: PSS and remanufacturing analytical comparison results – values in EcoPoints _____	163



## **TABLES**

Table 2 - 1: Parameters to consider in the Product Lifecycle Assessment [Gehin and al. 09]	48
Table 2 - 2: Environmental Impacts calculation by Product Lifecycle Phase[Gehin and al. 09]	49
Table 2 - 3: Criterias to consider in design of reuse products [Umeda Y. and al. 06]	56
Table 3 - 1: Factors that affect the remanufactured product life cycle and its business model	71
Table 3 - 2: Chosen parameters to model remanufacturing strategies alternatives	83
Table 3 - 3: Factors used on the remanufactured product life cycle approach for the calculation of EIs	85
Table 3 - 4: Parameters simulation by components alternatives – Gearbox example	92
Table 3 - 5: Parameters values to the initial scenario – Gearbox example	96
Table 3 - 6: Comparasion of the mass reduction scenario – Gearbox example	97
Table 3 - 7: Parameters Scenario IMPROVEMENT	103
Table 4 - 1: PSS products requirements	113
Table 4 - 2: PSS services requirements	114
Table 4 - 3: PSS global requirements	114
Table 4 - 4: Effects of strategy requirements on the PSS parameters	125
Table 4 - 5: Parameters for the Velo’v Scenario	125
Table 4 - 6: Design parameters of the Velo’V Scenario and other scenarios	128
Table 4 - 7: Environmental Impact of the PSS	132
Table 5 - 1: Components of the catalytic converter	151
Table 5 - 2: Detail of the ceramics and precious metals contained in the catalytic converter	151
Table 5 - 3: Parameters for the catalytic converter PSS	159





# Introduction

<b>1. Industrial concerns of environmental issues</b>	<b>9</b>
1.1. Product life cycle and sustainability	9
1.2. Disposal end-of-life scenarios for sustainable development	10
1.3. Environmental assessment of products lifecycle	11
<b>2. Remanufacturing modeling - environmental assessment</b>	<b>12</b>
<b>3. PSS modeling - environmental assessment</b>	<b>13</b>
<b>4. Organization of the Thesis</b>	<b>14</b>

## **1. INDUSTRIAL CONCERNS OF ENVIRONMENTAL ISSUES**

Environmental impacts, by definition are deterioration of the environment through the depletion of natural resources such as air, water and soil, the destruction of ecosystems and the extinction of wildlife. Even when environmental impacts could be caused by natural phenomena, human activities have the most significant effects on the environment. For this reason, the introduction of the environmental dimension into the current industrial context becomes a necessity within the appearing of different environmental regulations. So, industrialists are now persuaded to reconsider the way they consume resources and produce goods for a sustainable development. They base their analysis on three pillars: environmental protection, economic growth and social equity [McAloon 03].

### **1.1. PRODUCT LIFE CYCLE AND SUSTAINABILITY**

In general, industrial's activities have a noticeable detrimental impact on the environment. Their potential harmfulness consequences are produced by the diversity of the processes and operations among the life cycle of the products they produce [Sutherland and al. 08]. Furthermore, the manufacturing of products has been considered as one of the activities within the highest environmental impact for a long time. However, considering the concept of product life cycle, the environmental impacts must be observed on each stage of the product life cycle with their correspondent operations. The evaluation of the activities on the product life cycle will determine whether the impacts are allocated within specified boundaries.

Actually, there exists an enormous interest to define new strategies for sustainable development, whether it involves precious material for recycling or the reuse of components with high added-value. But a large number of the components in products could be reused in a manufacturing process for new products. In that case, strategies as remanufacturing could help those new approaches. Actually, the remanufacturing strategies have demonstrated their economical interests but they have now to demonstrate their environmental interest. The remanufacturing process aims at extending the life of products by diverting products to a new second life instead of being buried. The economic interest comes from the fact that the added value due to the initial production of the product is preserved fully or partly. The environmental interest comes from the lower energy and raw material consumptions compared to the manufacturing of a second new product. Therefore by keeping the components, material extraction and energy consumption can be reduced but, it is necessary

to assess the whole life cycle to verify that environmental impacts do not increase by the use of remanufacturing processes or by transportation.

So, environmental impacts need to be assessed to determine their relevance, and compartment according to the implementation of strategies like remanufacturing and/or the selling of service offer instead a physical product. Environmental impacts assessment requires a listing of operations on the system, then measure or estimation of emissions, waste and pollution produced by them. The complexity and issues of the environmental impacts assessment process have tried to be minimized by the implementation of management systems and directives. However, the environmental management systems are limited to the creation of organization environmental programs in a comprehensive, systematic, planned and documented manner that support the reduction of environmental impacts generated by the industrial activities.

This study shows how to establish the models and how to compare the environmental assessments of remanufactured products life cycles vs. classical life cycle scenarios. The final objective is to provide easy to use methods and tools for designers to allow them quantifying the environmental benefits related to the use of a closed loop strategy. In this project, a Life Cycle Assessment, life cycle bricks, and a parametric model of the products are used to evaluate and compare the environmental benefits provided by the remanufacturing. The method can support the decision to change the business model and to reorient the activity from cradle-to-grave to cradle-to-cradle while testing different final disposal scenarios.

## **1.2. DISPOSAL END-OF-LIFE SCENARIOS FOR SUSTAINABLE DEVELOPMENT**

Considering the product life cycle and specifically the end-of-life of products, the first idea is the possibility for material recovery by a recycling process. At the beginning, manufacturers started to study how to use adequate products recycling processes. Of course the first approach was to rely on existing technologies. Since then, the recycling process has been improved according to the new developed materials and existing technologies. However, recycling in itself is inefficient to recover added value during the manufacturing operations of the product that is necessary for sustainable development. This means, most of the added value of a product is lost with the recycling process. Moreover, there are some constraints with the recycling material like the difficulty of the recovered material to have a good quality and go to find a future use.

Another interesting strategy at the products' end-of-life is the reuse. Product or component reuse consists in using an item again after its first use. The reuse is the end-of-life strategy with less material transformation. However, in most of the cases, it is complicated to obtain the same functions of the products starting a new life cycle.

So, when a product becomes worn out or damaged to perform properly functions, industrialists have introduced an industrial process to recover the products almost at their totality. The remanufacturing, as a more complex process, has for principal goal to prolong the life cycle of the products. Here, the idea is to preserve the added-value from the design and the manufacturing process. Thus, the remanufacturing strategy will keep the shape of the products and their added-value, while decreasing the extraction of the raw materials.

All the reflections and previous works on the characterization of the remanufacturing process and remanufactured products have proposals about modifications on the structure of the product or the design of the product. However, these studies are limited by the specific sector or type of profile, depending on the product that will be designed. Some analyses have considered remanufacturing products from an environmental impact assessment point of view. But they stay clearly at the product level and not at the system level.

Due to the growth potential of the development of those final disposition scenarios (remanufacturing and reuse), it is important to find a method that would make product end-of-life more efficient. The purpose of this thesis is to characterize remanufacturable products and their product life cycle as a central objective of the analysis.

### **1.3. ENVIRONMENTAL ASSESSMENT OF PRODUCTS LIFECYCLE**

Life cycle assessment can be used as a designer tool support evaluating the products environmental impacts. Using this tool, it is possible to determine the environmental contribution positive or negative of the products designed. However, most life cycle assessment tools determine the environmental impacts of a product by asking designers specific information about the product and the inputs linked to the environmental impacts. Then, it is necessary to select appropriate indicators to explain the severity of the impact associated with the resources and inputs used in the product.

A life cycle assessment tool is capable to perform a quantitative analysis of environmental impacts for a specific product, with limitations like the complexity of the data and the time invested to model each component. Complex scenarios are still difficult to assess. For closed-loop products life cycle products, there are important differences from the classical

products. In general, every component of the product can be designed to be destined to a specific end-of-life scenario.

Consequently, the present work has developed a model to assess from an environmental point of view the data of the operations and activities around product life cycle of the products with final non classic disposition scenarios (remanufacturing as end-of-life scenario and multiple uses by the disposition of the service offers system as a business strategy). The method is based on the life cycle bricks concept developed by Gehin et al. [2007]. The method allows identifying and distinguishing impacts between the different product life cycle stages and readjusts the designers' decision at the product design stage. The results can be further used in simulation, to evaluate the environmental performance of different product life cycle end-of-life scenarios.

## **2. REMANUFACTURING MODELING - ENVIRONMENTAL ASSESSMENT**

A theoretical precedent in the present work aims to give the foundation of the analytical framework, which consists of the theories on Remanufacturing, and will introduce these in the mentioned order. First the life cycle and nature of the remanufactured products will be explained followed by a more detailed description of its characteristics. The parameters related to remanufacturing and products in closed-loop product life cycles will then be introduced.

The life cycle analysis provides a comprehensive view of the problem for evaluating the environmental impacts for classic products. However, remanufacturing products life cycle is sensitive to diverse parameters (% of non recovered products, distance for transportation, material, etc.). So, the thesis tries to clarify such a model, integrating into the whole product lifecycle those remanufacturing process parameters. The model aims to support the product and process design, as well as the supply chain actors and people responsible of the business model to take decision about product design and recovery system changes. The model will be assessed using data from the heavy vehicles industry. Several components of this sector are assessed, and then compared with possible new end-of-life scenarios.

The data collection done in the heavy vehicle sector helps to represent an appropriate business model, taking into account the requirements to accomplish the remanufacturing of a specific used/broken product. Thanks to this representation, parameters interactions with all the other elements of the product life cycle are identified. Then those parameters are

extrapolated through product lifecycle model, where others treatment waste (end-of-life scenarios) are used in parallel.

The results obtained from different case studies show that the positioning of the industry for remanufacturing strategies at the product end-of-life influences the prior design of the product. Thus, the thesis proposed simple indicators to evaluate the remanufacturing strategy effects depending on a large vision than those considering the remanufacturing process alone. In accordance, a study regarding the remanufacturing strategy for several products/components is performed at Renault Trucks – Volvo Parts Reman Limoges, FRANCE.

### **3. PSS MODELING - ENVIRONMENTAL ASSESSMENT**

Conventional products sales make users to finance their purchase, then learn how to use it, arrange maintenance for it, insure it if needed, buy any consumables and auxiliary materials the product needs to be operational, discard it after its useful life time, and above all, apply the product for a useful purpose. This means, it is left to the user to transform the purchase of a product into something that fulfils effectively a final user need. In this context, product-service system would offer the value of use instead of the product itself. Making the value of use the centre of business could decrease its environmental load. Companies offering services have to make product-service system efficient.

So, product-service system is considered as a potential strategy to control and mitigate certain environmental impacts attributed to the product usage. Consequently, this thesis aims to evaluate the activities and processes involved in the product-services systems, then it proposes an approach to model the environmental impacts associated to this strategy. So, an identification of the parameters associated to the lifecycle of a product-service system is done (one or several use cycles, users, stand-by cycle, maintenances cycle, etc.), then, they are integrated in the product lifecycle product-service system strategy.



#### 4. ORGANIZATION OF THE THESIS

This dissertation is organized into seven parts:

- **“Introduction”** introduces the background, objectives, and methodologies of the present study;
- **“Chapter 1 - Environmental considerations of industrial products design”** gives a review of the environmental situation from an industrial point of view. The constraints to consider during the product design, how industry strategies have to evolve to new end-of-life scenarios, for a better environmental performance at the same time than important economical benefits;
- **“Chapter 2 - Closed loop strategies for industrial products: Focus on the remanufacturing”** gives a review of previous studies related to the methodologies proposed to assess process like the remanufacturing. Problems that need to be addressed in these research domains are discussed during the literature review. The problem statement is finally proposed;
- **“Chapter 3 - Life Cycle Model Approach for Remanufactured Industrial Products”** introduces a model with simple indicators that allow evaluating the remanufacturing products approach as well as making comparison of other end-of-life scenarios from an environmental point of view. The model is evaluated using the gearbox case study.
- **“Chapter 4 - Life Cycle Model Approach for Multiple Usage Products – PSS Considerations”** introduces a model with simple indicators for the analysis of product-service systems based on the characteristics of PSS that affect directly the product life cycle;
- **“Chapter 5 - Environmental Assessment Model Approach on Closed Loop Life Cycle Products”** introduces a global model for life cycle assessment of products regarded as a product-service system strategy that combine multiple choices for the end-of-life scenarios. The model is evaluated using a catalytic converter.
- **“Conclusions and perspectives”** summarizes the results obtained in this thesis and proposes future perspectives for this work.





## Chapter 1

# Environmental considerations on industrial products design

<b>1. Environment and industry</b>	<b>19</b>
1.1. Sustainable development	19
1.2. Industrial interests and conflicts on the environment	20
1.3. Environmental constraints in the design process	20
1.4. Product life cycle strategies	21
1.5. Remanufacturing as a closed-loop end-of-life strategy	23
1.5.1. Remanufacturing benefits	24
1.5.2. Remanufacturing problems	25
1.6. Alternative closed-loop strategies	25
<b>2. Environmental methodologies to assess product lifecycle</b>	<b>27</b>
2.1. Life cycle assessment	27
2.2. Life cycle assessment phases	27
2.3. Life cycle assessment pertinence	29
2.4. Life cycle assessment limitations	30
<b>3. Problematic of the thesis</b>	<b>32</b>
3.1. Summary of Chapter 1	32
3.2. Problematic	34

Figure 1 - 1: Classic product life cycle _____	22
Figure 1 - 2: Closed loop end-of-life product life cycle _____	23
Figure 1 - 3: Five stages of the remanufacturing process _____	24
Figure 1 - 4: Four main phases of the LCA illustration _____	28
Figure 1 - 5: Injector diesel detailed product lifecycle _____	33
Figure 1 - 6: Flow diagram example for an industrial remanufacturing process _____	34

## **1. ENVIRONMENT AND INDUSTRY**

In the last decades, researchers have noticed an increase of products' consumption in every business sector. This situation forces companies to diversify their products and to implement mass production system. This products' consumption tendency has caused over production systems for several industrial sectors within important environmental impacts. They appear during and after the lifecycle of products, especially at the end of use (most of the products were disposed to landfill process).

Regarding the current level of products' consumption, it is possible to consider industry and customers as the larger consumers of raw materials, water and energy. Those resources must be limited to a minimum to assure a reduction of the environmental impacts. However, in an increasingly industrial context, managers and designers sacrifice the immediate profitability only when the limit of the environmental regulation makes them improve, and be transparent on the process of production. That is a first step toward sustainable development that is defined in the next section.

### **1.1. SUSTAINABLE DEVELOPMENT**

A systematic review and analysis of manager responses to a survey defines business models as the design of organizational structures to enact a commercial opportunity [George G. and al. 11]. In general terms, a business model describes the rationale of how an organization creates, delivers, and captures value.

Society and environment are currently affected by the evolution of the actual business approach. It becomes important to integrate sustainable development to a model limited by the cost of production, quality of products and leadtimes in delivery. Sustainable development describes the necessity for the society to take into account the people, the planet and the economy, to create common benefits, and to obtain the equilibrium between the economy and the ecology [McAloone 03].

European Commission considers the objective of the sustainable development: "creation of a policy and strategy for continued economic and social development without detriment to the environment at the natural resources essential for human activity" [Directive 2179/98/EC

98]. To achieve this objective successfully, manufacturers must restructure their activities according to a sustainable society [Péro 03].

## **1.2. INDUSTRIAL INTERESTS AND CONFLICTS ON THE ENVIRONMENT**

Industrial activities play an important role in ensuring Europe's economy. However, those activities generate several negative environmental impacts, accounting for considerable total emissions of atmospheric pollutants and contributing to the production of waste and excessive use of energy. Actually, a significant number of companies has concerns and developed various types of frameworks to integrate the sustainable development in their business model. As an example, in the vehicle sector, gasoline and diesel engines are optimized to satisfy the current CO<sub>x</sub> emissions standards.

Sustainable development considerations from the beginning of the design process, permits to implement less complex solutions and redesign of the final product. The profits obtained can be reinvested in the equipments for the improvement of the products or processes, for the benefit of the consumers [R&D 02]. As an example of these investments, the vehicle sector in France has the objective to valorize 95% of the vehicle out of use. To reach this objective, manufacturers with other working sector collaborate to set up system of products' valorisation at its end of use (example: recycling), with the main condition that the use of these process must be technically and economically viable. To integrate sustainable development in the companies, designers must take into account the environmental impacts of the products they design [Millet and al. 02]. Then, it is necessary to seek new alternatives, materials and technologies to create new applications and new products.

## **1.3. ENVIRONMENTAL CONSTRAINTS IN THE DESIGN PROCESS**

Environmental impacts concern consumers, manufacturers, politicians, etc. Even today, the integration of the environment in the industrial sector is done under the pressure of national and international reglementations. After almost fifty years of critical analysis about the environmental problems finally designers are seriously taking into account those aspects in the definition of the product. There exists a list of environmental regulations applicable to products. Two types of regulations [Janin 00] are highlithed: the normatives, which give recommendations and actions to be followed by designers, and lists, which are used to evaluate a product and which can be also used to guide a team, to improve the design of a product from an environmental point of view. Reviewing the example of the vehicle sector, the law was mainly pointing at the reduction on the levels of authorized pollutants, the



obligation of processing liquid waste of the manufacturing processes, the treatment of the organic components, etc. [Jacqueson 02].

To satisfy the needs related to sustainable development, into the consumption of green products and legislation, designers must integrate environmental considerations in the product design process. It is necessary for designers to prevent high environmental impacts instead of having to create correction actions to minimize the environmental impacts on the products. The principal approaches are in particular methodologies and tools supporting the environmental integration of the constraints in the life cycle of the product. Here, the term product lifecycle refers to the process of managing the entire lifecycle of a product from its conception, through design and manufacture, to service and disposal. Product lifecycle integrates people, data, processes and business systems and provides a product information backbone for companies and their extended enterprise. Next section aims to regard briefly the concept of product lifecycle and the different strategies at the product end of use that could permit to improve the environmental impacts allocated to the products from the design process.

#### **1.4. PRODUCT LIFE CYCLE STRATEGIES**

Product lifecycle describes the engineering aspect of a product, from managing descriptions and properties of a product through its development and useful life. A formal representation of the classic product life cycle (Figure 1-1) considers the flows from the raw material extraction; then to the product assembly, the product distribution, the product use and finally the product arrives at its end-of-life. For each stage, one or more actors are implied, for example, at the raw materials' extraction several suppliers are generally used in the primary operations. A private small or more specialized company can also supply raw material like spare parts. Figure 1-1 represents the product lifecycle and it shows the material flows. The classic product life cycle as it was drawn previously takes as end-of-life scenarios: the landfill, the incineration or the recycling (strategy preferable to recover the raw material for some type of products).

The raw material extraction is a limited resource. Considering at the end-of-life other strategies which gives more importance to the valorization of the product at its end of use rather than its elimination, will contribute to limit the extraction of material resources. The limitation on the consumption of primary materials and energy bring us to consider the concept of closed-loop lifecycle.

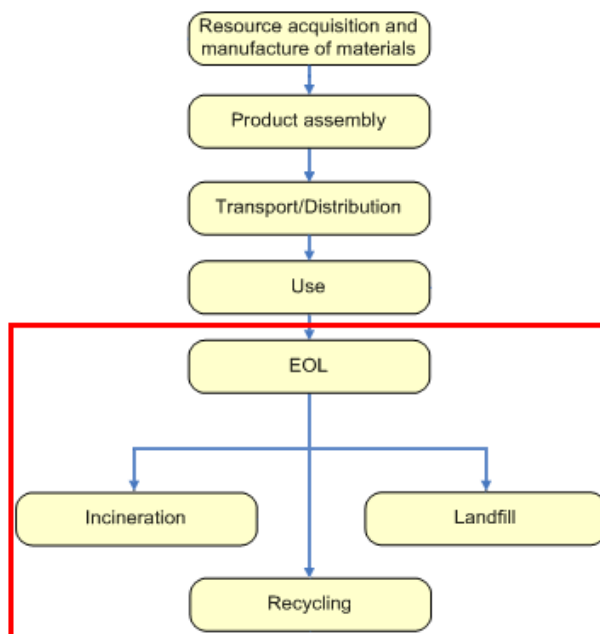

Figure 1 - 1: Classic product life cycle

Closed-loop lifecycle is considered as a natural extension of the classic product lifecycle. To obtain this extension of the lifecycle, closed-loop strategies require the creation of recollection networks that will respond to the necessity of grouping non-functional products, and the modification of the manufacturing and logistics process. Indeed, the central element of the industrial closed-loop lifecycle is the product. Therefore, it is all over the product that the supply chain has to be re-scheduled: new processes and actors have to be coordinated in order to give a new lifecycle to the product and to improve its end-of-life. Figure 1-2 shows the life cycle of a product that will be revalorized by reuse, remanufacturing or recycling (process ables to recover the main physical characteristics and energy of the raw material for a precise application).

The complexity of such a model starts at the combination of all the possible end-of-life strategies. It is hard to simulate the complexity of a production line considering new available products thanks to a reuse or remanufacturing strategy. And there exists an uncertainty related to the supply of remanufactured or reused components [Östlin 05]. This obstacle is often regarded as a priority in the companies. However this is also considered as a justification for the interest created for the companies in the development of a constant reuse/remanufacturing products chain.

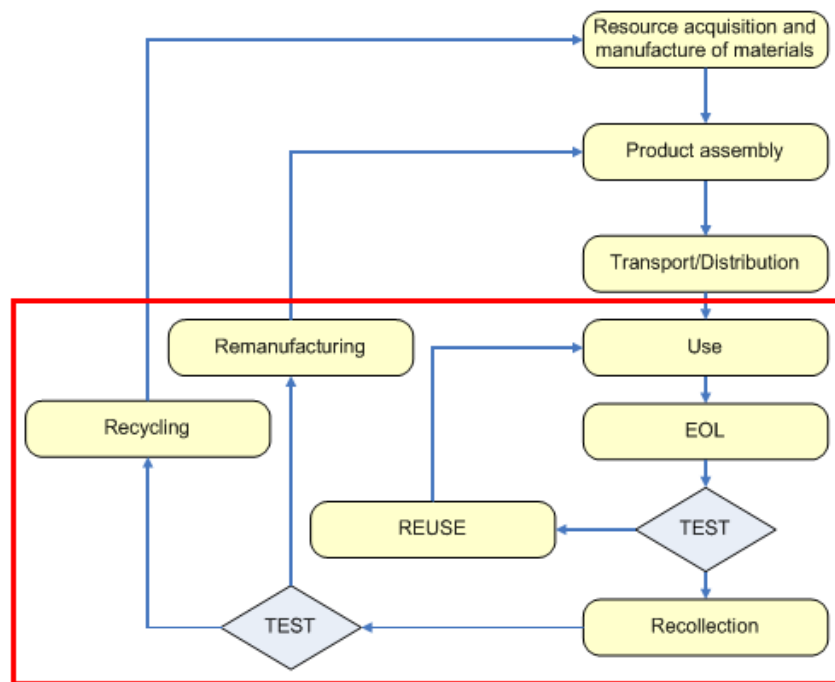

Figure 1 - 2: Closed loop end-of-life product life cycle

### 1.5. REMANUFACTURING AS A CLOSED-LOOP END-OF-LIFE STRATEGY

A better option, at the product end-of-life from an environmental point of view consists in reusing the components. When the product lifecycle does not accept a direct reuse of the product, then the remanufacturing becomes the second more desirable strategy. The remanufacturing strategy has, as principal goal, to prolong the life cycle of products. Using this strategy as product end-of-life, the value added during the product design and the product manufacturing [Williams and Shu 01] is a mean to keep the shape and the characteristics of the parts/components. This approach also makes possible to reduce the utilisation of raw materials [Ferrer 01].

The remanufacturing process comprises the following stages: product's reassembly, product's disassembly, partial tests, component's reconditioning, component's cleaning, inspection, and replacement of components [Watson 08] [Mabee et al. 99]. During each stage and especially at the component's reconditioning and product's reassembly, there are necessary controls to guaranty the quality of the product (Figure 1-3).

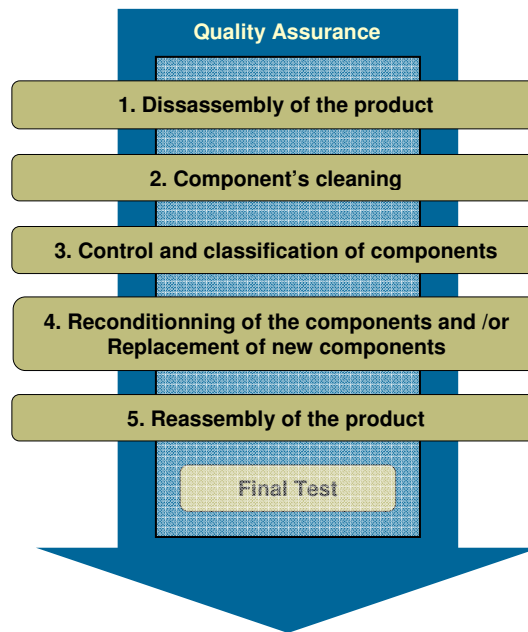

Figure 1 - 3: Five stages of the remanufacturing process

Other definition of the remanufacturing process says that: “the remanufacturing is a process in which a reasonably number of similar products are taken along to a central inspection service then disassembled. Product’s components are not necessary kept inside the same product. Specific parts of the product are collected by type, cleaned and examined for their reconditioning and reuse” [Sherwood and Shu 00] [Sundin and al. 00]. Considering this definition it is possible to extract:

- The remanufacturing process aims the restoration of a product through the reconditioning of its components as new.
- In the remanufacturing process, the aspects of each component add a considerable complexity to the approach.

### 1.5.1. REMANUFACTURING BENEFITS

From a financial point of view; the remanufacturing is two times more profitable than the production [Charter and al. 08]. The generation of profits is the basic objective of any business model, and it is the same for the remanufacturing.

From an environmental point of view; it is possible to affirm that remanufacturing brings the following benefits:

- The remanufacturing reduces the materials waste or the over production of waste.
- The remanufacturing process saves energy.

- The remanufacturing process saves consumable resources used during the product manufacturing.
- The reuses of existing components reduce in a company the acquisition costs of the new components. Companies can use remanufacturing to gather valuable for product improvements in design and functions.

### **1.5.2. REMANUFACTURING PROBLEMS**

The principal problems to avoid during the product design process are the characteristics that limit the used products to be restored to their original functionalities [Bromhead 10]. To accomplish that, it is necessary to avoid [Mok and al. 06]:

- Not robust and non durable materials which could break at the time of the remanufacturing.
- Assembly technologies which make not possible the future separation of the components or which could damage the components during their separation.
- Characteristics that do not favor the continuous improvement of the product or which require the use of chemicals or prohibited manufacturing methods.
- Characteristics which make expensive the reconditioning of the used products: time consumption, disassembly costs, etc.

### **1.6. ALTERNATIVE CLOSED-LOOP STRATEGIES**

The remanufacturing process has been defined as a process that allows used products to be reconditioned at its end-of-life and reused just with a performance equal than a new product. Another definition proposed that the remanufacturing is a series of manufacturing steps acting on an end-of-life part or product in order to return it to like-new or better performance conditions, with warranty to match. [Watson 08]

If a product transits this process, it can be considered as a remanufactured product. However, there exist other strategies at the product end-of-life that can be confused with the remanufacturing:

#### **Product recycling**

Remanufacturing is different from recycling because, as with all products reuse options, it involves preserving the whole form of things. In contrast, recycling activities require the destruction of the product to its component materials, so they can be melted, smelted or

reprocessed into new forms. Material can be recycled into the same products (called closed loop recycling) or into new ones (open loop recycling).

Certain industrialists utilise the term “recycling” to describe their products as being remanufactured products. Used products are recollected in a very good state and then products are introduced into a reconditioning process of very low performance level. In this process, it does not exist an accurate checking of all the technical specifications of the product. This reconditioning of the product is limited to the surface (cleaning) of the product, to packaging and to selling. In that case, a lower performance of the product is accepted.

### **Reuse**

Reuse encompasses a range of activities where whole products (or whole parts of products) are used again in one piece. This includes: straight reuse, possibly in a different way, refurbishment – cleaning, lubricating or other improvement, repairing a default and redeployment and cannibalisation using working parts elsewhere.

## **2. ENVIRONMENTAL METHODOLOGIES TO ASSESS PRODUCT LIFECYCLE**

### **2.1. LIFE CYCLE ASSESSMENT**

In order to be rigorous, from an environmental point of view in the decisions done during the product design process it is necessary to realise an evaluation of the impacts and consequences which follow in the product design process and decision making. Therefore, this section aims to present the definition of the Life Cycle Assessment (LCA) and the different stages used in the environmental impact assessment of a system (products or services).

The LCA is one of the most developed methodologies, making possible to carry out quantitative tasks. The ISO 14040 defines the Life Cycle Assessment as a compilation and evaluation of energy consumption, use of primary materials, discharge into the environment, and evaluation of the potential impact on the environment associated with the product or process or service for the entire lifecycle. This means, the LCA is a methodology to evaluate the environmental impacts in all the lifecycle phases of the product [Westkaemper and al. 00]. It considers the raw material extraction, manufacturing, distribution, use and finally, the re-use, recycling, landfill, etc [Borland and al. 98]. So, LCA is used to determine the most influential stages in the product lifecycle. When designers have to develop a "green product", it is necessary to reduce environmental impacts. The validity and relevance of the results obtained by an assessment methodology must be discussed, as well as the utility in their exploitation to support product design. Then, it is also necessary to make a zoom on the designer's needs and the facilities with the results obtained.

### **2.2. LIFE CYCLE ASSESSMENT PHASES**

The objective of LCA is to quantify the full range of the environmental impacts assignable to life cycle of products and services, in order to improve processes, and provide solid basis to change the original product design. The procedures of the LCA methodology are part of the ISO 14000 environmental management standards. The LCA have to follow an iterative process, and furthermore, it is necessary to determine an acceptable level of precision in the inventory data allocations. The LCA is carried out in four distinct phases: the definition of the goals and scope on the field of application, the inventory analysis, the environmental impacts

assessment and the search for improvements or interpretation [AFNOR 97a] [AFNOR 97b]. Figure 1-2 represents the stages of the LCA as recommended the ISO standards.

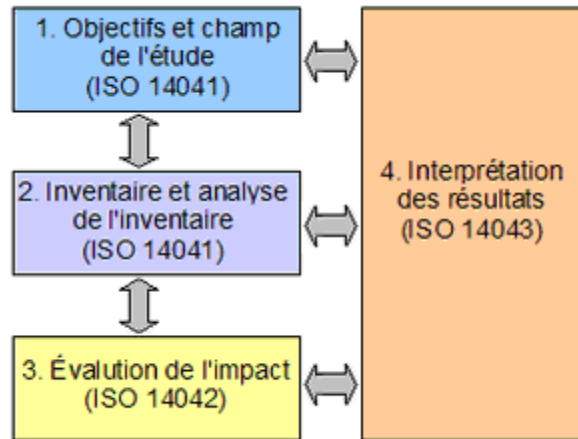

Figure 1 - 4: Four main phases of the LCA illustration

### Definitions of the goal and scope (functional unit)

In this phase, it is necessary to fix the limits of the study; and to define the data quality necessary and the exploitation of potential results. The objectives of the study must be defined in a clear and precise way to well interpretate the questions to clarify. The field of application of the study is arbitrary. The limits have to be defined by the choice of elementary flows (inputs and outputs). In general, the system consists of necessary operations to provide the main condition of the functional unit selected.

The functional unit is the minimal characteristic that could define the product, process or service. The functional unit defines precisely the functionality that is being studied and quantifies the functions delivered by the product, process or service providing a reference to which the inputs and outputs can be related.

### Inventory analysis

The inventory is the quantitative assessment of the inputs and outputs flows of the system delimited by its borders. In this phase, the flow's system is listed according to five factors: raw material consumption, energy consumption, emissions to air, quality of water, and solids waste. The input and output data needed for the construction of the model are collected for all activities within the system boundary, including from the supply chain. The data must be related to the functional unit defined in the goal and scope definition. The inventory must provide information about all inputs and outputs in the form of elementary flow to and from the environment for all the unit processes involved in the study.



## **Impacts assessment**

Inventory analysis is followed by impact assessment. This phase evaluate the preponderancy of each environmental impact; using the results of the inventory analysis. Here, the flows are classified by environmental criteria; then characterized, standardized and evaluated by indicators associated with the flows [Kljajin 00]. Classical life cycle impact assessment (LCIA) consists of the following mandatory elements:

- selection of impact categories, category indicators, and characterization models;
- classification stage, where the inventory parameters are sorted and assigned to specific impact categories; and
- impact measurement, where the categorized flows are characterized, using one of many possible assessment methodologies, into common equivalence units that are then summed to provide a total impact.

## **Interpretation**

The last phase intend to find a coherence in the results obtained, regarding the goal and objectives defined at the beginning of the study. And then identifying options whichs provide reduction of the environmental impacts. The results from the inventory analysis and impact assessment are summarized during the interpretation phase. Then, those results must be expressed in a way of conclusions and recommendations to designers. The interpretation should include:

- identification of significant issues based on the inventory analysis and impact assessment;
- conclusions, limitations and recommendations.

## **2.3. LIFE CYCLE ASSESSMENT PERTINENCE**

LCA starts to become appreciated when studies about material comparisons take a more significant role from an environmental point of view. Then, some studies also were conducted using the LCA methodology whithin the objective to measure the impact of the energy consumption in production and distribution of the industrial products during hard times of oil crisis. Later on, differents materials used in the packaging process of products have been regarded as impulsive factors for the use of the LCA methodology.

To carry out the LCA as it was defined in section 2.2., it is necessary to know perfectly the production and processes systems, to have all the essential resources for the inventory and

the impact's calculation. LCA is an iterative process. The precision of the results will depend on the time invested on its development. Thus, the paradox of the LCA in design is announced as follows: "Even with the most relevant database during the phase of the product design; results of the LCA cannot be obtained because information on the product does not exist yet or is under construction. When the LCA method can be carried out in a rigorous way, the product has been already fixed and changes on the design are almost not possible" [Lagerstedt 03].

So, it is possible to affirm that applying LCA during the product design process brings incomplete results, not solid enough to obtain reliable conclusions. In the same way, LCA after the product industrialization could only confirm or cancel design choices. This option could provide useful ideas for the design of future product's generations. Consequently, the utility of the LCA as a tool to support the phases before product design is limited.

## **2.4. LIFE CYCLE ASSESSMENT LIMITATIONS**

LCA methodology counts with several limitations. Those limitations depend in on the available databases (inventory analysis).

- Precision on LCA methodology is justified. In each phase, decisions and hypothesis are made by experts who will generate uncertainty (as example: definition of the functional unit, definition of the borders of the system, collects of information and choice of relevant data), and it is recommendable to have a rigorous documentation to verify the hypothesis and estimations.
- LCA users: during the product design, it is not possible to develop specific environmental databases. Designers must use the most relevant database according to the type of analysis. Therefore, the uncertainty on the environmental data becomes important when designers have to make choices of one material or process among a large group of equivalent materials or processes. The consequences are difficult to measure, unless the designers spend time to explore the recordings of the database.
- The databases are established by experts who defined a certain number of complex characteristics in order to evaluate inputs and outputs of the systems. When more than one expert analyze the same process, most of the time they have not defined the same inputs outputs, and frequently different results are obtained.
- When calculation methodologies are regarded, each user has his own understanding of the evaluation impact methodology and of the main consequences on the environment.

There exist different points of view to the environmental problems, consequences, methods of environmental impact calculation, etc.

- It happens that for the same modeling, different results using two different methods are obtained. It is the same with data from two different databases. These results make LCA not easily exploitable.

### **3. PROBLEMATIC OF THE THESIS**

#### **3.1. SUMMARY OF CHAPTER 1**

Section 1 of the present chapter presents the interest in the design of clean products and systems, creating affordable and respectful products for the environment. In the literature; the different methodologies and tools developed to assist designer looking upon the environmental issues are used with several benefits and difficulties:

- Methodologies like LCA, enable the redesign of products by the analysis and readjustment of the environmental insufficiencies pointed by the assessment methodology used,
- On the other hand, those analyses need high specialists' competence in the calculation and evaluation of the environmental impacts. The indicators and environmental impacts results are based on a large data resulting of the characterisation of the lifecycle product,
- The used methodologies to assess the environmental performance of products do not take into account, or in a superficial way, the end-of-life strategies of the products. This aspect takes an undeniable environmental value. Regarding this inconvenient; it is possible to find in the literature models (chapter 2: section 2) to support the environmental evaluation of closed-loop product lifecycle.

Here, the model must be evaluated in an industrial example. Then it will be possible to find the differences with conventional life cycle analysis used in traditional products with a single life cycle. In the case of closed-loop product lifecycle, the difficulty consists in: identifying the processes concerned in the lifecycle, defining the borders of the study and flows of resources (input outputs).

So, in addition to the model described in section 1.4., it is necessary to set up a model able to be used to represent a multiple option of scenarios. Considering that a product is an assembly of different components, each component could have a different life cycle scenario. The traditional product lifecycle should be considered as an option; as well as more complex lifecycles options (reuse, remanufacturing or recycling of certain components). So, the model must represent and design simultaneously the product and its life cycle. As an example of the level of detail of the model, the tree of processes for the lifecycle of injectors is presented

on figure 1-5. Here, each process has to be carefully observed in order to generate the correct diagrams and flows for each activity. Those injectors are used in the injection system of diesel engines for trucks. The lifecycle scenario for some components is the remanufacturing and the rest of components are destined to the recycling.

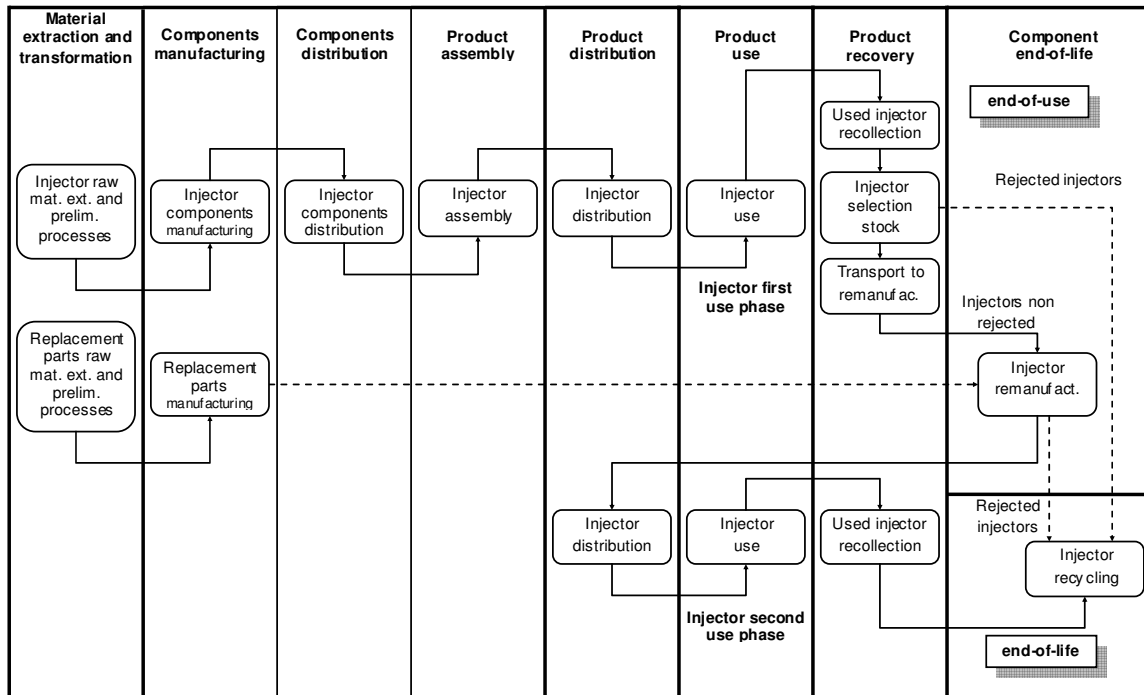

Figure 1 - 5: Injector diesel detailed product lifecycle

8 generic phases were employed to construct this model: 1) raw material extraction and transformation, 2) manufacture and assembly of components, 3) distribution of components, 4) assembly of the product, 5) distribution of the product, 6) use of the product, 7) reverse logistic 8) end-of-life of the components.

The goal of this model is to be able to have a certain flexibility in handling data, and to generate results for each component of the product combined with all the possible scenarios. An example of representation of the flows information data necessary in the activity of the remanufacturing is presented in figure 1-6.

After the evaluation of each component of the product, it is necessary to define the lifecycle scenarios to evaluate. Those scenarios must be compared with the traditional lifecycle scenarios (single use) and recycling at the end-of-life.

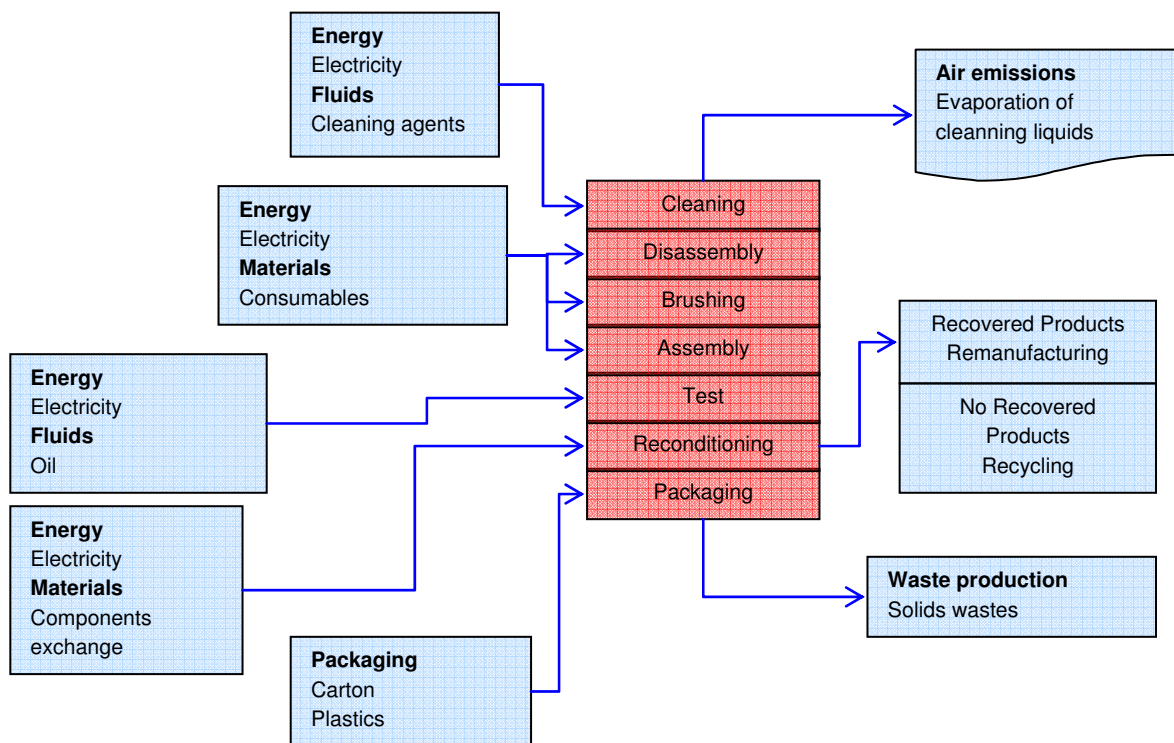

Figure 1 - 6: Flow diagram example for an industrial remanufacturing process

### 3.2. PROBLEMATIC

Actually, there are several tools available to support all the levels of decision making and which are supposed to consider predetermined criterias, often heterogeneous and sometimes contradictories. Even if product design process has to be regarded under those criterias of decision making, the main objective of the present research thesis is to contribute on those decision making tools from an environmental point of view. This means, to provide designers with tools adaptable to the disponible data. Designers or design team create little by little the data necessary to assess the environmental performance of the product. However, those data are hardly exploited during the design phase, and on another hand, current environmental approaches and tools do not integrate enough design choices.

This means, even if there exist a methodology like the LCA, used to measure the environmental impacts of product and to improve the design of products for one generation through the next one, it is necessary to provide designer or decision making responsible with an understandable model that will support the representation of the product. At the same time using the lifecycle there, that will permit to generate environmental calculations with clearer results.

So, the problematic of the thesis begin with an interest in the assessment of green products, designed to be respectful for the environment. The methods and tools that have to be developed should assist design and decision making considering:

- an assessment methodology that integrates the environmental issues with the life cycle of the product from the beginning of the design of the product. In this thesis, we will focus on closed loop strategies: the selling of remanufactured components and the selling of product-service systems (PSS). So we will have to consider: classical lifecycle analysis (with a single usage phase for the product), a lifecycle with remanufacturing (with many usage phases for the product) and lifecycle for product-service systems (with many usage phases for a product included in the PSS)
- the relevant indicators that will support designer and any responsible non specialist on the environmental topics.

So, consideration of the environmental concerns results today in building relevant indicators for the measurement of the products environmental performance. These indicators can then be used as guide for the ecodesign of future products or as selling arguments.

- the disposal scenario at the end-of-use of the products, and in particular the closed-loop product lifecycle which seems the strategy with the environmental profits.

So, many researches try to identify how to influence the products definition to limit their environmental impacts. But, the environmental impacts of a product are also related to the way it is used all along its lifecycle. For example, several closed loop strategies (remanufacturing, service selling...) can generate non negligible environmental losses if they are implemented in a bad way and could also generate lots of environmental benefits when implemented properly. So, indicators must be established and dedicated to assess the product lifecycle environmental performance to help manufacturers to make decisions.







## Chapter 2

Closed loop strategies for industrial products:  
Focus on the remanufacturing

<b>1. Introduction</b>	<b>41</b>
<b>2. Cosed-loop end-of-life strategies</b>	<b>42</b>
2.1. End-of-life scenarios – valorization strategies	43
2.1.1. Reuse	44
2.1.2. Remanufacturing	45
2.1.3. Recycling	45
2.2. Life cycle assessment of closed-loop product lifecycle	46
<b>3. Energy assessment of closed-loop product lifecycle</b>	<b>51</b>
3.1. Energy assessment of closed-loop product lifecycle: remanufacturing process	51
3.2. Energy performance of closed loop product lifecycle: comparison between manufacturing and remanufacturing	52
3.3. Closed-loop product lifecycle energy assessment model of remanufacturing process	53
<b>4. Reusability and modularity of closed loop product lifecycle</b>	<b>55</b>
4.1. Reusability as a scenario to assure closed-loop product lifecycle	55
4.2. Modularity for life cycle design	56
4.3. Performance assessment of closed-loop product lifecycle	57
4.4. Life cycle scenarios design of end-of-life strategy	57
<b>5. Product-services systems strategy</b>	<b>59</b>
5.1. Product-services systems	59
5.2. Product-services systems benefits of closed-loop product lifecycle	60
5.3. Life cycle simulation analyzing of product-service systems	61
<b>6. Problematic for the Life Cycle Assessment of products with closed-loop lifecycles</b>	<b>63</b>
6.1. Life cycle assessment of closed-loop product lifecycle: remanufacturing process	63
6.2. Life cycle assessment of closed-loop product lifecycle: pss strategy	64

Figure 2 - 1: Product Life Cycle _____	42
Figure 2 - 2: Product – multiple use cycle phases approach _____	44
Figure 2 - 3: Product – multiple use cycle phases approach _____	47
Figure 2 - 4: Comparison of energy estimated for manufacturing and remanufacturing _____	52
Figure 2 - 5: Embodied energy of various engine components _____	53
Figure 2 - 6: Flow of components over multiple use cycles _____	53
Figure 2 - 7: Phats of components reuse _____	56
Figure 2 - 8: Representation of PSS and their relations _____	61

Table 2 - 1: Parameters to consider in the Product Lifecycle Assessment [Gehin and al. 09] _____	48
Table 2 - 2: Environmental Impacts calculation by Product Lifecycle Phase[Gehin and al. 09] _____	49
Table 2 - 3: Criterias to consider in design of reuse of products [Umeda Y. and al. 06] _____	56

## 1. INTRODUCTION

For many years; influential businesses and governments have been against the idea that their activities and the consumer human behavior affect in a drastically way the different ecosystems all around the globe. Many of those activities have poured a lot of resources into discrediting what has generally been accepted for a long time as real.

Lately, scientists have been mainly concerned about environmental issues. Flexible mechanisms were defined in the Kyoto Protocol as different ways to achieve emissions reduction as part of the effort to address changes. Mechanisms that take a path on cleaner production technologies and sustainable development were introduced in the current business strategies.

The objective of this chapter is not to summarize a total framework of the current environmental situation which would conclude in a controversy not closed discussion. The main objective of this chapter is to make a detailed review of the common available strategies used to introduce on the market friendly environmental products. We will focus on strategies that need specific processes to increase the environmental performance through the product life cycle. Indeed, some companies try to preserve the added value obtained during the first product life cycle stages while extending the product life with different use cycles instead of assign the product toward more “conventional” end-of-life processes. In this chapter, those strategies to maintain the value added and to extend the product lifecycle are presented; as well as the different methodologies used by designers to improve the environmental performance during the design and the implementation of those strategies.

## 2. CLOSED LOOP END-OF-LIFE STRATEGIES

The perception of environmentally sustainable products has changed the focus from cradle-to-grave to cradle-to-cradle concept, as described by Gehin [Gehin and al. 08]. A better option at the product end-of-life, from the reduction of the environmental impacts point of view, consists in the component reuse or, for the case it is not possible, in the component remanufacturing. Strategies like reuse and remanufacturing have indeed as principal goal: to prolong the products life cycle. Using those strategies for the product end-of-life, is a mean to preserve the value added during the product design and the product manufacturing [Williams and Shu 01] keeping the shape, characteristics and functionality of used parts/components. The implementation of those strategies also makes possible the reduction of raw materials extraction [Ferrer 01].

According to [Gehin and al. 09], there are three possible “Product End-of-Life” scenarios that are capable to close the product lifecycle: reuse, remanufacturing and recycling. Those End-of-Life scenarios also relate the products with the concept of multiple use phases. In this section is presented the following procedure: the industrial product arrives to end-of-life, and then it is recollected by reverse logistic processes to be disposed following one scenario that close the product lifecycle (Figure 2-1).

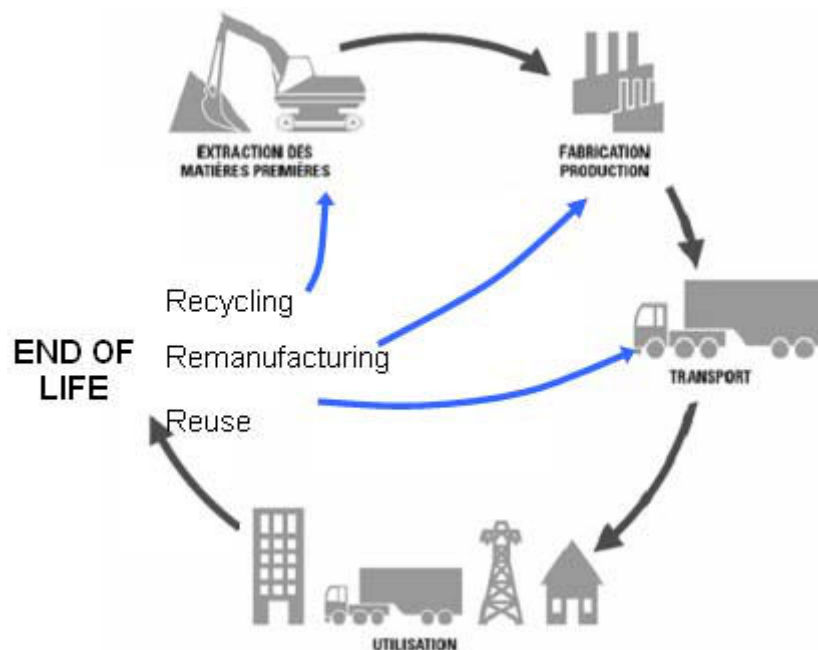

Figure 2 - 1: Product Life Cycle [Gehin and al. 08]

The design process of a product is described as a transition of a set of functional requirements into a complete product concept [Dominick and al. 01]. The concept of designing a product to reduce the environmental impact during its lifecycle is known as eco-design and its integration into the design process has become an important focal point for future product developments. However; since this concept is not incorporated from the early design phase, but rather considered as an afterthought, the initial value added through raw material extraction and manufacturing is decreased [Zwolinski and al. 05].

## **2.1. END-OF-LIFE SCENARIOS – VALORIZATION STRATEGIES**

Product's valorization influences all the phase of the product life cycle. One of the objectives of such a strategy is to preserve the material as well as the energy resources invested in the manufacturing of the product. At the moment it is possible to recollect broken products, to reuse and then recover them with an industrial strategy to make a competitive advantage to the industry. The simple craft industry goes directly through an increase of the scale of the number of recovered products.

The model presented in Figure 2-2; inspired from Gehin [Gehin and al. 09], can be used to represent all the possible scenarios in a closed loop product lifecycle. The closed loop product lifecycle is obtained from the classical product lifecycle and a very complex combination scenarios; using a mix between reuse, remanufacturing and/or recycling. In addition to the conventional product end-of-life scenarios that permit the recovery of energy while generating non recoverable wastes, we considered in the present work three strategies to valorize products at its end-of-use (reuse, remanufacturing and recycling) [Amaya and al. 10 a].

To consider end-of-life scenarios at the beginning of the design process is more efficient to solve environmental problems than if you consider them later. This means that the application of those strategies brings better results for the future than the corrective measures you have to deploy once environmental problems takes place. In addition, industrials need to find the right collaborators in order to ensure the coordination for the products at the end-of-life. It must appear new responsible actors now before to incinerate products.



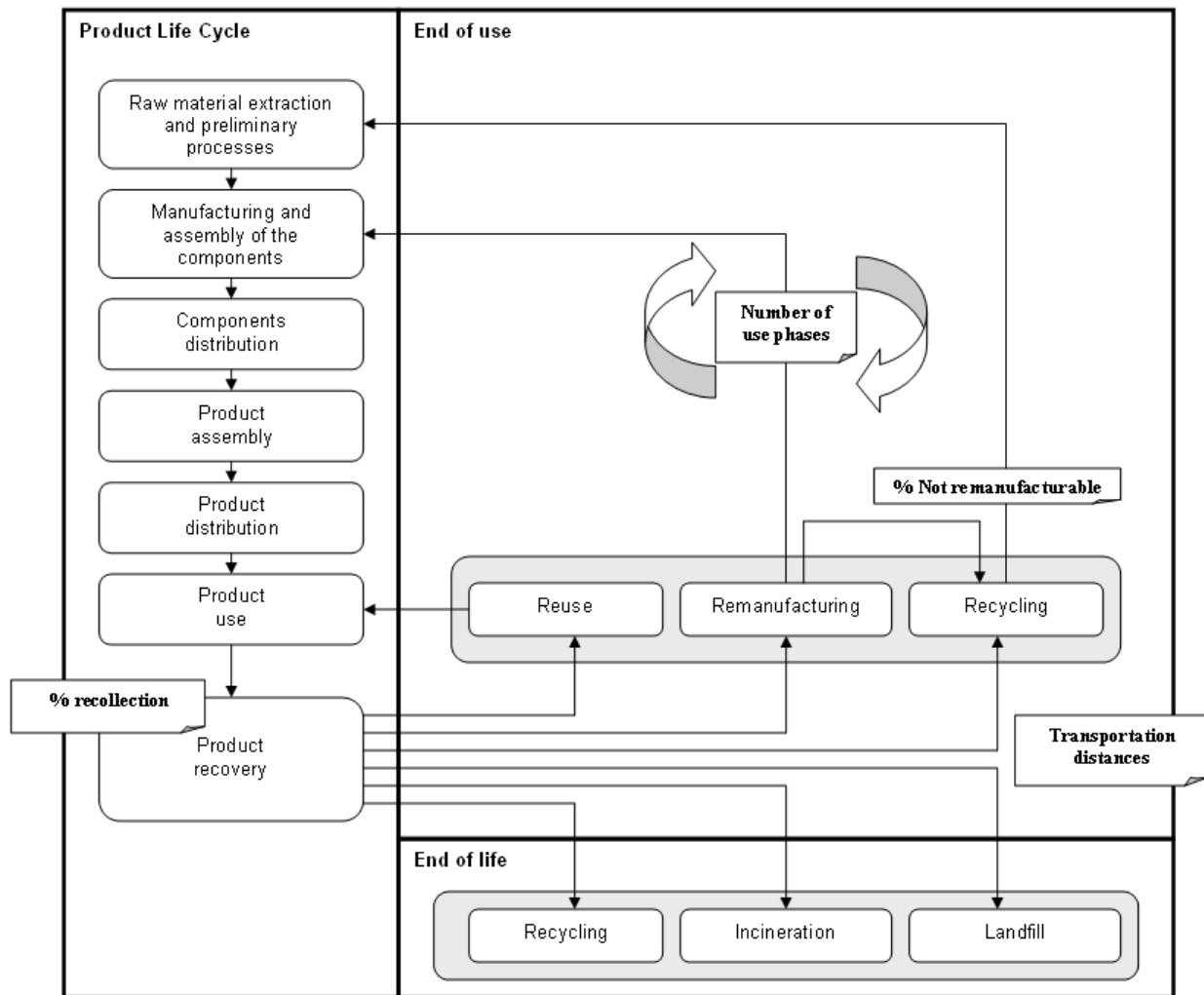

Figure 2 - 2: Product – multiple use cycle phases approach

### 2.1.1. REUSE

Component's reuse is the strategy with less material transformation and also the cleanest one from a manufacturing point of view. However, in most of the cases, it is just not possible to improve the component to reuse. This means it is necessary to consider the fact that reuse could become more significant to the environment in the use phase compared to a new product adopting less impacting technologies.

Once products are recollected and disassembled partly or completely, a percentage of the components have not finished their life at the end of the first use phase. So, it is possible to apply a reuse strategy for those components/products which only need an esthetic handling. Those components can be employed like spare parts or be integrated in remanufactured or new products.

### **2.1.2. REMANUFACTURING**

The remanufacturing is a more complex strategy. In the last years, a lot of authors established their own definitions; most of them were quite close but with some remarkable differences. Jacobsson defines remanufacturing as the “restoration of a used product at the state of new, (...) to assure the characteristics of performance and durability of the product at least as the same level that a new product” [Jacobsson 00]. Lopez also insists on the “industrial operations on the disassembly and the reconditioning operation to guaranty the performance level of the components of the product” and on “how to introduce those remanufactured components on a process of assembly with new parts.” [Lopez 04].

Remanufacturing process is also defined as a strategy that aims to recover a used broken product that will guaranty a performance level at least as high as the manufacturer specifications from the prospect of the consumer. This process allows the company to give a similar warranty to the remanufactured product and to new products. [Sundin 06] [Östlin and al. 09]

Definitions permit to discard a certain number of scenarios that could be distinguished sometimes unnecessarily. In other words, the definition highlights an essential dimension of the remanufacturing: the performance level and the warranty of the product functions. A well remanufactured component can be integrated in a new product without the risk to reduce the quality of the product. This distinction makes possible to consider the integration of remanufactured components on the assembly line of new products (Figure 2–2); those parts could be sold with a strategy of after-sales service.

To introduce remanufactured products (components) in the same product level of new components on the market generate several questions about the reorganization of the company, and even more on the restructuring of the supply chain.

### **2.1.3. RECYCLING**

The recycling term will be employed only to describe the recovering of materials in terms of the value added during the processing of the special high technology materials. The added value on the manufacturing process is lost.

Ideally, a recycling process should consider a whole product like an elementary component composed of a single material. But products complexity goes further than the use of a single material. For this reason recycling does not resolve completely the environmental

problematic for raw materials and sometimes this scenario could be regarded as more environmentally impacting in comparison to other valorization scenarios. With or without disassembly; recycled products and components lost their value added during the manufacturing and recovery processes. The recovered materials can be used in similar products or for the manufacturing of other components.

The reason recycling could be more impacting is due to the fact that recycled components will have to pass through an industrial process in order to recover their value and that processes used in recycling are generally more impacting than those used for the remanufacturing or the reuse. Nevertheless, recycling is systematically considered as a better strategy from the environmental point of view than landfill or incineration [Morris 05], even if its success is often conditioned by the reverse logistic [Choi and al. 06].

## **2.2. LIFE CYCLE ASSESSMENT OF CLOSED LOOP PRODUCT LIFECYCLE**

Life Cycle Assessment (LCA) tools have been developed to aid designers in evaluating the environmental impacts of their products. These tools determine the eco-efficiency of the designs of products which is defined as the product value per unit of environmental impact [Fleischer and Schmidt 97]. Most LCA tools determine the environmental impacts of a product by asking designers to fill in information about the product and these inputs are linked to impact types. Then, weighting indicators are used depending on the severity of the impact associated with the input [Bovea and Gallardo 04]. In general, LCA tools require detailed information about a product and produce either a single environmental impact indicator or a number of indicators separated into different environmental impact categories. A single quantitative environmental impact indicator is necessary to ensure that a comparison can be made between different design concepts for a product during the design process [Sun and al. 03].

It is important to note that LCA tools are only an approximation of the environmental impacts of a product design; however, these tools still produce accurate approximations of the real life impacts of the products. To enable the LCA tools to produce an indicator for material groups in the characterization phase, a common measurement unit must be used to compare the environmental impacts of each material group [Kobayashi and al. 05].

The majority of LCA tools requires detailed database about the product design; sometimes only available at the detailed design of the product and the process. This means, there is a large amount of inputs required for an environmental impact assessment, making the tools complex to use and to interpret [Sun and al. 03].

Most of LCA tools are capable of performing a quantitative analysis of products with the limitations before mentioned like the complexity of the data and time invested to model each component, but complex scenarios are still difficult to modelise and compare. That's the case for closed loop life cycle products which differ from classical products because of the number of usage phases they can realize. To establish comparative LCA for remanufactured products and classical products, Gehin proposed a specific life cycle model based on the concept of life cycle bricks, to structure product and life cycle data [Gehin and al. 09].

Each brick is defined by pieces of different input data: the components name, the lifecycle phase, product and component data related to lifecycle, product and component processes related to lifecycle. When any of these input data change a new brick is created. An example of a life cycle brick is shown in Figure 2-3.

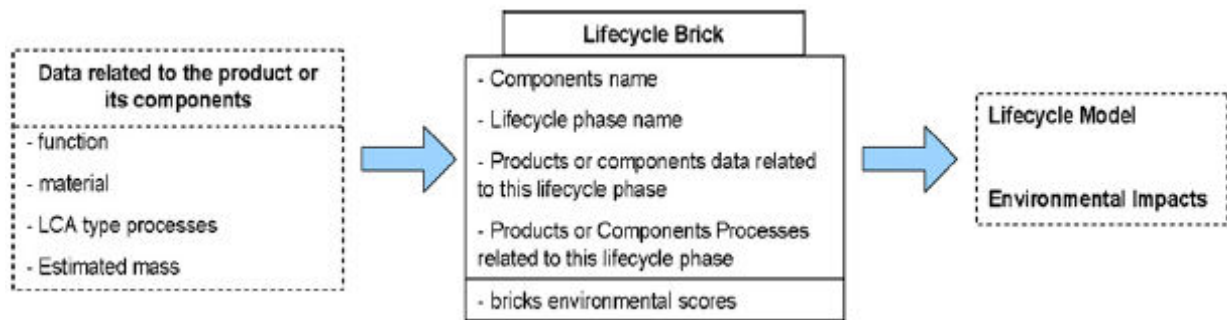

Figure 2 - 3: Description of a life cycle brick

Closed Loop Environmental Evaluations is an eco-design approach that incorporates life cycle brick methodology with the objective to analyze products with multiple use cycles. The input of environmental impact indicators from LCA results are extended to a more complex assessment; an environmental assessment of the multiple use cycles. This assessment requires the input of environmental impact indicators for each component raw material extraction, manufacturing, assembly, distribution, use, take-back and final disposition (end-of-life scenarios) options to assess the impact over the entire life cycle. Once bricks are defined, there exist also some rules to build lifecycles of closed-loop systems:

- A lifecycle is created as soon as the first component is created. The four product-level bricks are built as well as the four component-level bricks. The environmental impact of the product is the sum of the impacts of the bricks (only for weighted impacts or normalized impacts for certain methods).
- Each time the designer creates a new component, four new bricks of the component level are created and new impacts are added to the former ones for each lifecycle phase and for the whole product.

- The designers have to evaluate the number of usage cycles that the component can support at its maximum for the following closed-loop strategies (reuse, remanufacturing, recycling) and the component end-of-pipe strategy that will be adopted at the end. Because the strategy cannot certainly be 100% efficient due to the recovering process capability (quality of take-back parts, percentage of products recovered, efficiency of the remanufacturing process,...), end-of-pipe scenarios have to be determined as well as the estimation of the percentage of components that will be effectively reused/remanufactured.
- Once the model is ready for calculation, the environmental impacts are determined. Then, the impacts are brought back to one single usage cycle so that the designers can compare the different lifecycles alternatives they have envisioned.

The variables developed in order to build the lifecycle model of closed-loop systems are described in table 2-1; as follows:

$i$	component (1 to n components).
$u_i$	number of usage cycles (loops) that the components $i$ can support.
$X_i$	percentage of components that can be effectively reused, remanufactured, or recycled in the loop, at the end of the usage phase. In a first approach, it is assumed to be the same at every loop (same end-of-life option and same percentage).
$B_{i,j}$	environmental impact of the component $i$ for the lifecycle phase $j$ (environmental impact of the brick $(i,j)$ ).
$EoU_i$	end-of-usage option for the component $i$ (reused, remanufactured, recycled).
$EoL_i$	end-of-life option for the component $i$ (recycled, incinerated, landfilled) and for the percentage of components that cannot be reused at the end of the usage cycle.
$IEmat_i, IEman_i, IEdis_i, IEEoL_i,$	values of a component environmental impact, per unit of usage (the corresponding impacts of each loop are added and the result is then divided by the number of loops).
$IEmat, IEman, IEdis, IEEoL,$	environmental impact of the product for each lifecycle phase, per unit of usage.

Table 2 - 1: Parameters to consider in the Product Lifecycle Assessment [Gehin and al. 09]

Here are the rules to be considered:

1. If the component is recycled in a closed-loop system (it is assumed that the recycled material is used to manufacture the same type of components) or remanufactured, or reused, then for each usage cycle between 2 and  $u_i$  and for the percentage of recovered product, the material stage impact is set to zero.
2. If the component is remanufactured, or reused, then for each usage cycle between 2 and  $u_i$  and for the percentage of recovered product, the manufacturing impact is set to zero.

3. In a first approach, it is assumed that the distribution impact is the same whatever the chosen strategy for the component, but this can be further developed.
4. If the component  $i$  is remanufactured, or reused, the environmental cost of those processes are included in the end-of-life environmental impact.
5. The environmental value of a component per unit of usage is calculated by summing up the environmental impact of each brick of a component.
6. The environmental value of a lifecycle phase per unit of usage for the product is calculated by summing up the environmental impact of each brick for the corresponding lifecycle phase.

To summarize Gehin approach equations; the global amount of cores that are assigned to the remanufacturing chain ( $X_i$ ) is taken into account in table 2-2; the difference goes to the recycling process.

		<b>EI</b>		
Raw material		$B_{i,1} \times \frac{1 + (u_i - 1)(1 - X_i)}{u_i}$		
Manufacturing		$B_{i,2} \times \frac{1 + (u_i - 1)(1 - X_i)}{u_i}$		
	If recycling	$B_{i,2}$		
Distribution		$B_{i,3}$		
Use		$B_{i,5}$		
Reverse logistics		$B_{i,3}$		
End-of-Use End-of-Life		$\frac{\text{Remanufacturing}}{(u_i - 1) \times X_i \times (B_{i,4})_{EoU_i}}$	+	$\frac{\text{Recycling}}{[1 + (u_i - 1) \times (1 - X_i)] \times (B_{i,4})_{EoL_i}}$
		$u_i$		$u_i$

Table 2 - 2: Environmental Impacts calculation by Product Lifecycle Phase [Gehin and al. 09]

The model proposed by Gehin [Gehin and al. 08] showed the need to consider products as an ordered assembly of components, which become the central entities in the construction of the model for the impact assessment. Indeed, the life cycle brick are objects that can be manipulated by designers; those objects make possible to analyse in detail the data generated during the design process; finally those data will permit designers to make calculations of the environmental impacts and readjust with them, to accomplish the redesign of the products.

So, at the moment, to promote the valorization strategies and the duty to assess the impacts generated by those particular scenarios of end-of-life, the life cycle bricks could be used to model the life cycle of products in closed loop life cycles. It makes possible to observe the environmental performance of products in the long term.

### **3. ENERGY ASSESSMENT OF CLOSED LOOP PRODUCT LIFECYCLE**

Some bibliographical references present previous models developed to assess the energies intensities and consumption [Sutherland and al. 08] as well as a cost model for determining optimal size in remanufacturing facility [Sutherland and al. 10]. Hence, this section aims to make a short description of the value findings by those references.

The growing concern over consumption of resources has addressed current environmental challenges created by the consumption of industrial products [Jiang and al. 11]. The sustainability concept needs the development of closed loop products and systems in which used broken products are no more considered as waste, those products are recovered at the end-of-life [Heese and al. 05].

#### **3.1. ENERGY ASSESSMENT OF CLOSED LOOP PRODUCT LIFECYCLE: REMANUFACTURING PROCESS**

It could seem evident that environmental impacts due to the industrial uses are significant. However, the attribution of all the energy consumption to the manufacturing phase in the product life cycle is not a simple task; hence the environmental impacts related to energy across the lifecycle stages are not evident.

To reduce environmental issues due to the energy consumption, it should be noted that impacts emissions are proportional to energy consumption. Studies in the vehicle sector show how primary metals processing is significant in the manufacturing product life cycle stage, and accounts for nearly 10% of overall manufacturing energy consumption [Sutherland and al. 08]. Vehicle and heavy equipment manufacturers create products from primary metals (e.g., steel and aluminum) and reinforced polymers (e.g., carbon fiber) in larger quantities. Thus, they are responsible for the impacts related to the energy generation from the extraction to the operation's plants (a mix of electricity and fossil-fuel use) through the materials delivering.

Taking back used products is one of the possible choices to preserve some of the energy expended in converting extracted materials into a new product. In the management of used products, recycling is better than landfilling in that it recovers some material value and energy that has been invested via materials processing. However, both of these options are



less desirable than the introduction of the product in a closed loop lifecycle, using reuse or remanufacturing.

Remanufacturing reconditions degraded components and put the product back into service, thus retaining the whole value of the extracted and refined material, as well as a fraction of the original manufactured value [Kumar and al. 07].

Monetary benefits of remanufacturing have been documented [Amezquita and al. 95] [Lund and al. 03]. It has also been reported that automotive remanufacturing alone could save an annual energy equivalent of five nuclear power plants [Steinhilper 98]. Remanufacturing energy savings, or the difference between original and remanufacturing energy consumption, have been reported to be approximately 85% [Bollinger and al. 81]. Potential energy savings and pollution prevention benefits achieved through remanufacturing are quantified using LCA in products like engines, gearboxes, etc. The most significant energy savings were seen in the material and parts production stage. In those stages, there were 69% to 92% savings as a result of fewer new parts being required for the remanufactured engine, making it less material and energy intensive [Smith V. and Keolejian G. 08].

### 3.2. ENERGY PERFORMANCE OF CLOSED LOOP PRODUCT LIFECYCLE: COMPARISON BETWEEN MANUFACTURING AND REMANUFACTURING

Manufacturing contributes heavily to such environmental lifecycle measures as energy, materials use, and water consumption. Sutherland [Sutherland and al. 08] quantifies the environmental performance of remanufacturing. He obtains values for remanufacturing energy from measurements taken in the engine remanufacturing processes. These measurements were the production flow rate and workstation energy consumption.

Also in its findings, it is presented that diesel engine components are primarily composed of strong, durable materials such as cast iron and steel. Figure 2 – 4 shows a comparison of the energy consumption of a variety of products made using these materials [Boustead and al. 79]. The results of this work encompass the energy requirements of generic manufactured products.

Material	Extraction/refining (MJ/kg)	Casting/manufacturing (MJ/kg)	Remanufacturing (MJ/kg)
Aluminum	240	16	0.32–4.0
Cast iron	22	28	0.56–7.0
Steel	24	17	0.34–4.3

Figure 2 - 4: Comparison of energy estimated for manufacturing and remanufacturing [Boustead and al. 79]

The original manufacturing of the same components was characterized in a similar way. This characterization permits to calculate the ratio of remanufacturing energy to original manufacturing energy. Those ratios were ranged between 2% and 25%. Recovered components subject to harsh conditions, have a higher probability of large wear levels and/or structural failure, and therefore have higher relative remanufacturing energy requirements than those subjected to less severe conditions (Figure 2-5).

Component	Casting/manufacturing (MJ)	Remanufacturing (MJ)
Engine block (cast iron)	9970	600
Cylinder head (cast iron)	4445	1110
Crankshaft (steel)	2800	110
6 connecting rods (steel)	330	10
6 pistons (steel)	555	20
Total energy required	18100	1850
Avoided energy with remanufacture		16250

Figure 2 - 5: Embodied energy of various engine components [Sutherland and al. 08]

### 3.3. CLOSED LOOP PRODUCT LIFECYCLE ENERGY ASSESSMENT MODEL OF REMANUFACTURING PROCESS

The observed core remanufacturability efficiency ranged depends on the component. This is the efficiency with which a manufactured core actually is remanufactured. Sutherland considers losses of cores by three main reasons: cores non salvageable (heavily damaged components), inadequate remanufacturing procedures and systemic losses of cores.

The relative benefits of the alternatives were quantified to support decisions making about product design and recovery system changes to be implemented. To quantify the benefits of product and recovery system, it was proposed a method to analyze energy consumption. The model can be used to evaluate different energy assumptions and as part of an overall lifecycle energy analysis. Figure 2-6 shows the flow of new and recovered cores for manufacturing (M) and several uses (U), collection (C), remanufacturing (R), and assembly (A) cycles.

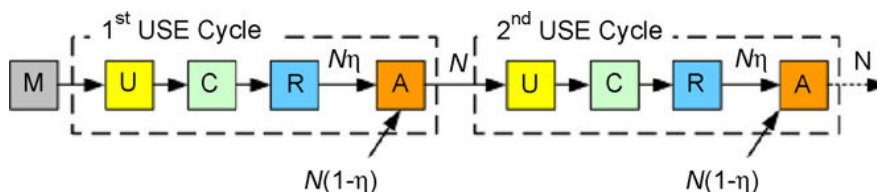

Figure 2 - 6: Flow of components over multiple use cycles [Sutherland and al. 08]

This method considers original manufacturing energy (EM), remanufacturing energy (ER), and the core remanufacturability efficiency ( $\eta$ ). With a total number of cores within a system is N. Following each remanufacturing step, core losses are made up with  $N \cdot (1 - \eta)$  virgin cores. Energy requirements are calculated assuming that manufacturing and remanufacturing energies remain constant, and that the system core remanufacturability efficiency also stays the same. The cumulative energy is calculated as a function of the number of use cycles.

#### **4. REUSABILITY AND MODULARITY OF CLOSED LOOP PRODUCT LIFECYCLE**

Reuse is a practice considered as a hopeful lifecycle option with higher environmental efficiency; expecting lower environmental loads, higher resale value, and potential cost reduction for procurement and reverse processes. There exist multiples critical factors besides the reuse rate and the design for reusability that affect a reuse strategy at the end-of-life phase of the product lifecycle.

This section presents the bibliography that aims at clarifying and formalizing critical factors for reusability. The balance between supply and demand of reusable components is indispensable for successful reuse to design lifecycles appropriately, in addition to designing products reusable.

On the other hand, considering the product life cycle of industrial product components, there is not always a way to reuse them immediately. So, used products must be grouped into modules for improving, e.g., disassemblability, maintainability, upgradability, reusability, and recyclability [Umeda Y. and al. 08]. This means design methods must consider successive generations of products, based on product functionality, commonality and life cycle similarity [Kimura F. and al. 01].

Modular design is an effective design strategy that relates product lifecycle to its design. Modular design can increase various performances of various lifecycle stages, such as disassemblability, maintainability, upgradability, reusability, and recyclability. Modular design could also be useful for enabling all lifecycle options (such as recycling, maintenance, reuse, and upgrading) [Fukushige S. and al. 12]. Therefore, we should evaluate lifecycle of modularized products by considering that modular design is a critical driver to implement planned lifecycle options of a product, also lifecycle options may not be realized in the real product lifecycle.

##### **4.1. REUSABILITY AS A SCENARIO TO ASSURE CLOSED LOOP PRODUCT LIFECYCLE**

Umeda classified the component reuse into three types depending of the site the components are used: extracts components reuse on the product installation; spare parts from maintenance and components reuse after reparation (figure 2-7) [Umeda Y. and al. 06]. Product installation reuse extracts components from disposed products and reused

components for manufacturing similar products. Spare parts reuse utilizes old components as spare parts for maintenance tasks. After cleaning and repairing, the component is reused again as a spare part for another task.

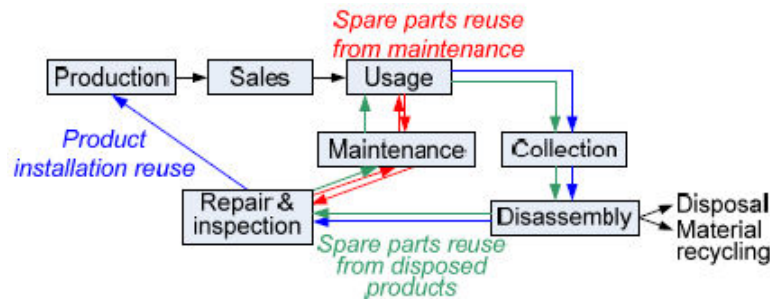

Figure 2 - 7: Phases of components reuse [Umeda Y. and al. 06]

Reuse should satisfy several conditions to guaranty a proper functionality of the used products. Umeda propose four principal conditions to fulfill at product reuse design. Those conditions are presented in table 2-3.

Component/Product Lifetime	Remaining lifetime of a component to be reused should be long enough comparing to lifetime of a destination product in which the component will be installed.
Costs	Costs for reusing components should be affordable comparing to the costs for manufacturing new components.
Value and quality	Remaining value and quality of the reusable component should satisfy those required by the destination product.
Balance between supply and demand of reusable	A component can be reused only if the manufacturer manufactures the destination product in the product installation reuse or if the destination product exists in the market in the spare parts reuse.

Table 2 - 3: Criteria to consider in design of reuse of products [Umeda Y. and al. 06]

## 4.2. MODULARITY FOR LIFE CYCLE DESIGN

A methodology to support designers indicates that it is necessary to represent a product life cycle as a life cycle scenario [Suesada R. and al. 07], then determines the life cycle strategy by appropriately assigning life cycle end-of-life scenarios (e.g.: recycling, maintenance, reuse, and upgrading) of each component. Then, the designer should design the product to realize the life cycle strategy.

In this design process, modular design can increase performance in every life cycle process. In this sense, modular design must have an idea of the appropriately assigning end-of-life cycle scenarios of the components. End-of-life cycle scenarios of the components are attributes to derive optimal modular structure. For example, for increasing recyclability, components of which materials can be recycled without any separation should be grouped

into the same module. For increasing maintainability, components with similar lifetime should be grouped into the same module. The modular structure must be evaluated from environmental loads and costs throughout a whole life cycle of each components point of views. This evaluation includes geometric information, connectivity of components and attributes of components. At the end the results of this evaluation give designers information on how to group component modules on the products, modules than later will be destined to the end-of-life scenario chosen during the product design.

### **4.3. PERFORMANCE ASSESSMENT OF CLOSED LOOP PRODUCT LIFECYCLE**

Modularization unifies related components that go through the same path in the lifecycle flow (figure 2-7). To represent or to estimate the environmental performance of modularization, resource efficiency for product modularity has been employed [Huppel and Ishikawa 07]. The evaluation method proposed by Umeda assesses the effects of the application of end-of-life scenarios, since this is the main advantage of the modularization [Umeda Y. and al. 09]. In evaluating modular structure, it is necessary to take into account the applicability of the lifecycle end-of-life scenario of the derived modules. In this way, plausible modular structure implementing executable lifecycle scenario exists in some equilibrium between process costs and reduction effects of environment.

### **4.4. LIFE CYCLE SCENARIOS DESIGN OF END-OF-LIFE STRATEGY**

As outlined above, environmentally conscious product design should be executed after an appropriate lifecycle end-of-life scenario has been planned and described. In determining a lifecycle strategy, designers should consider the business plan, environmental targets to be met, and the product concept to provide value to customers.

A lifecycle scenario represents all the scenes of a product lifecycle in terms of 5W1H expression (who, where, what, why, when and how). Lifecycle scenario definition is based on the following five elements:

1. *Lifecycle objective*: The objective is represented by a target parameter value. An example would be the objective statement: "To keep the manufacturer in profit and to halve CO2 emissions"...
2. *Lifecycle concept*: The construction of a scenario (such as extending product life or increasing the efficiency of recycling) as a bridge between the objective and the selection of lifecycle processes.

3. *Lifecycle options*: The lifecycle options of a product and its components determine the basic structure of scenarios. In order to manage combinations of lifecycle scenarios on product and components.
4. *Lifecycle flow*: This is the central model of the lifecycle scenario, and represents the flow of products, components, materials, information and money in the form of a lifecycle network. Each lifecycle process of the flow model has the inputs and outputs of the process (such as the income and expenditure of the process stakeholder) to allow lifecycle evaluation from environmental and economical viewpoints.

## **5. PRODUCT-SERVICES SYSTEMS STRATEGY**

Several authors have proposed the concept of product–services systems (PSS). A change or at least a translation towards a higher degree of integrated product/service offerings instead of just physical products can potentially be achieved with environmental benefits [Sundin 09]. Because of this, many manufacturing companies are changing their production strategy from a traditional life-cycle centered on the manufacturing of the physical product towards the life-cycle of the function of the products. As a result, more emphasis is now put on the use and end-of-life product lifecycle scenarios, including maintenance and remanufacturing. The aim of this section is to elucidate how manufacturers assess from an environmental point of view the product/service-systems with life-cycle perspectives.

### **5.1. PRODUCT-SERVICES SYSTEMS**

PSS's was defined by Mont as “a marketable set of products and services capable of jointly fulfilling a user's need [Mont 02]. This concept incorporates services into the design space, a space which has been traditionally dominated by physical products in manufacturing industries. In PSS, a strong focus is placed on how to fulfill customer needs and creates customer value [Lindahl M. and al. 01]. How to fulfill the function that customer buys by the leasing (renting) of the function of physical products. This means, products are not sold. Instead contracts are written between user and provider [Sundin 09].

The concept of sustainable product systems must cross company boundaries and includes all stakeholders in the life cycle of the product [Jansen L. and al. 97]. This means, strategic design points the design of the processes on an integration of products, services and communications [Manzini 96].

The aforementioned efforts obviously provide only parts of the solution. Each of these approaches is a separate element of a PSS, with its own strong and weak sides and limitations and possibilities to minimize environmental impact. However, when one is to integrate them into a system, sub-optimization might occur and overall environmental impact might not necessarily be reduced. Therefore, there is a need for a PSS, where the main focus on system solution is important. Thus, a PSS should be defined as a system of products, services, supporting networks and infrastructure that is designed to be:



competitive, satisfying customer needs and having a lower environmental impact than traditional business models.

A paramount goal of product–service systems should be to minimize the environmental impact of consumption by: closing material cycles, reducing consumption through alternative scenarios of product use, increasing overall resource productivity and dematerialization of PSSs, providing system solutions seeking the perfection in integrating system elements along with improving resource and functional efficiency of each element.

## **5.2. PRODUCT-SERVICES SYSTEMS BENEFITS OF CLOSED LOOP PRODUCT LIFECYCLE**

A PSS has the potential to decrease the total amount of products by introducing alternative scenarios of product use [Mont 02]. With the utilization of PSS offers strategy; producers become interested in having a control over the product life cycle and the product (during and after usage). Afterwards, products are taken-back, upgraded and reconditioned, if it is required to assure a proper performance of the service. Then another use by a new or the same customer will take place. To resume, producers become responsible for the product–services offer if the product lifecycle is closed. In this way, it is possible to obtain less incinerated or landfilled wastes.

However, product-services offers are not necessarily less impacting for the environment than conventional manufacturing products offers. So, it is necessary to evaluate the different offers proposed to justify opportunities that transforms environmental degradation into environmental potential improvement [Mont and al. 06]. On the other hand, PSS tries to control and optimize the use phase of the product life cycle: affecting the burdens of consumption in this phase. However, there is a need to consider carefully the impact of other phases such as manufacturing, distribution and the end-of-life scenarios chosen by the designers.

The design of PSSs can provide an incentive to manufacturers to design products that are more efficient in their use phase when there exist an interest of the preservation of the function quality through the next user. For instance, it may encourage the producers' interest in the reuse rate of products. The services could include new, used and refurbished products. Ideally, this could lead to completely closed product cycles under the responsibility of the manufacturers.

Saving of energy [Sutherland and al. 08] and substitution (reuse) of materials [Umeda Y. and al. 06] with efficient services may influence maintenance operations and process. Maintenance increases the product use phase. Products shared or used jointly may could decrease the total amount of products for a constant number of customers. The capacity for use can be fully realized resulting in greater resource efficiency and less impacts on the environment [Mont and al. 06].

### 5.3. LIFE CYCLE SIMULATION ANALYZING OF PRODUCT-SERVICE SYSTEMS

A life cycle simulator is able to virtually simulate stochastic behaviors of component lifetime distribution as well as dynamically changing behaviors of users and other stakeholders [Komoto H. and al. 05]. The simulator calculates economic and environmental performances. Simulations with different design parameters compare relative advantages of alternative scenarios in the product life cycle.

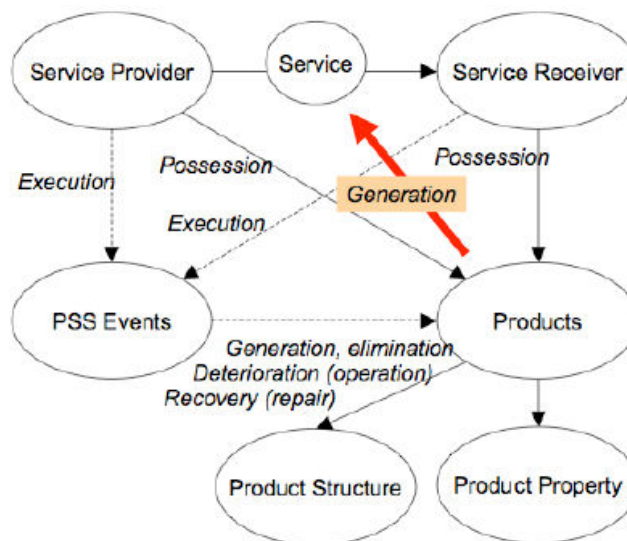

Figure 2 - 8: Representation of PSS and their relations [Komoto H. and al. 05]

To realize this, a set of objects are defined in the PSSs: the Service (customer and providers), the PSS-events and the products (structure and properties). Here, service is the main object of the PSS. A service receiver and a service provider can be literally interpreted. They possess PSS-events and products. PSS-events comprise: the generation and elimination of products, the deterioration of products (due to operations of products and generation of service) and the recovery of the state of products through maintenance service.

Figure 2-8 shows relation between these objects. From this figure it is possible to highlight the fact that providers and customers share PSS-events (e.g. maintenance).

## **6. PROBLEMATIC FOR THE LIFE CYCLE ASSESSMENT OF PRODUCTS WITH CLOSED LOOP LIFECYCLES**

Product design (material, weight, manufacturing process, etc.) plays a significant role in the environmental impacts generated. However, the whole activities that exist all along the product life cycle influence in a significant manner the environmental assessment. The different approaches regarded in the bibliography of the present chapter aim to support the evaluation of those activities, most of them already selected during the product design. However, designers need to make decision for the product during the design process as well as for its life cycle.

To establish the common ground for the integration of all the life cycle actors and the activities in the life cycle assessment of closed loop products lifecycle, it is necessary to define adequate parameters inside a product life cycle model. Those parameters are established by the team and their values would depend on the designers' choices. So, a common definition of those parameters during the design process will permit designers to avoid time consuming in the product optimisation during the detailed design.

Closed-loop life cycles products seem appropriate lifecycles strategies that generate proper products, environmentally friendly to the planet. However, there are few methods available to verify the environmental pertinence of the choices selected in the product lifecycle. As a response to such problem, life cycle assessment is a robust tool that supports expert in the environmental assessment task of the product lifecycle. But the bibliography does not identify a model that support and characterize the closed-loop product lifecycle including all the necessary paramaters for an environmental assessment.

So, this chapter identifies the need for a closed-loop life cycle assessment model where all the data used to characterize the products will be shared by all the design team.

### **6.1. LIFE CYCLE ASSESSMENT OF CLOSED-LOOP PRODUCT LIFECYCLE: REMANUFACTURING PROCESS**

Life cycle bricks methodology can be used to make decision concerning the disposition scenario at the end-of-life of components. At the same time; the brick methodology provides a solution for the assessment of the environmental impacts of product designs with multiple life cycles. The main objective is to make designers conscious about environmental impact

when selecting solutions. They are immediately aware of the environmental contribution of the lifecycle of the component they are describing, then, they are assisted in controlling their impact.

Benefits of strategies at the end-of-life of products like remanufacturing for heavy vehicles components production have been examined. The sensitivity of manufacturing energy to changes in design and remanufacturability efficiency has been evaluated. Model results showed that increases in core remanufacturability efficiency could significantly reduce energy consumption per part over multiple use cycles.

However, for products with complex architecture and multiple end-of-life strategies (recycling, remanufacturing, etc.) of their components, it becomes very difficult to manually calculate the final impact in a limited time, which could limit the number of lifecycle alternatives tested by designers. However, several parameters have to be added into the remanufacturing model; in addition to those regarded by the before proposed lifecycle brick methodology to better match the real life cycle scenario.

## **6.2. LIFE CYCLE ASSESSMENT OF CLOSED-LOOP PRODUCT LIFECYCLE: PSS STRATEGY**

There are many examples that illustrate parts of the solutions (eco-design, optimisation of distribution, product customisation, added services, take-back systems, remanufacturing, and recycling), but there are few examples of complete closed-loop solutions (Remanufacturing-PSSs) being globally assessed from an environmental point of view.

The essential implications on the use phase are therefore dictated by products with a single use phase. However, environmental concerns seek to readapt and reduce the effect of industrial activities by the intensification of the existent products. For this reason, offers of products with multiple-usage strategies, like PSS, have been proposed. The literature presents an initial state of the art about the environmental benefits or the sustainable potential of the implementation of a PSS approach; often taking for granted advantages such as the extension of the product life cycle through better maintenance.

So, the problematic in this section aims to clarify PSS strategies of multi-usage products in closed loop or prolonged lifecycles. PSS parameters related to the environmental performance of the strategies are identified. Products with PSS strategies of multi-usage products in closed loop or prolonged lifecycles many are also hard to evaluate the

environmental impact in a limited, and, at the moment, even harder at the moment to include many end-of-life strategies.

In the next sections (chapters 3 and 4); there will be the identification of those parameters to construct the LCA models for closed-loop strategie assessment.



## Chapter 3

# Life Cycle Model Approach for Remanufactured Industrial Products



<b>1. Remanufactured products characterization to assess environmental impacts</b>	<b>71</b>
1.1. Parameters to consider on the remanufactured products business model	71
1.2. Remanufactured product – life cycle	72
1.3. Product stock – inventory	73
1.4. Product performance and use	73
<b>2. Remanufacturing product life cycle</b>	<b>74</b>
2.1. Remanufacturing problematic context for the assessment of closed loop lifecycle products	74
2.2. Parametrization of closed-loop products: remanufacturing process	75
2.2.1. Quantity parameters	76
2.2.2. Parameters type	77
2.3. Parametrization of closed-loop life cycle products	77
<b>3. Closed-loop product life cycle assessment: impacts for remanufacturing model</b>	<b>81</b>
3.1. Life cycle description	81
3.2. LCA integration on the closed-loop end-of-life strategies products	82
3.3. General parameterisation of closed-loop end-of-life strategies products	83
3.4. Environmental impact equations	84
<b>4. Gearbox truck case study</b>	<b>86</b>
4.1. The case study	86
4.2. The life cycle assessment tool for remanufactured products	87
4.2.1. Components raw material parameters in the tool	87
4.2.2. Manufacturing parameters in the tool	87
4.2.3. Components distribution parameters in the tool	88
4.2.4. Products distribution parameters in the tool	90
4.2.5. Components/product end-of-life parameters in the tool	90
4.3. Results	92
4.4. Assessment tool for remanufactured products	93
<b>5. Sensitivity analysis of the remanufacturing model</b>	<b>95</b>
5.1. Initial scenario (scenario 0)	95
5.2. Sensitivity analysis	97
5.2.1. Material parameters in the tool	97
5.2.2. Number of use cycles “ $n_i$ ” parameter	99
5.2.3. Performance for remanufacturing process	100
5.2.4. Transport parameters	101
5.3. Parameters mix sensitivity analysis	102
<b>6. Conclusion of Chapter 3</b>	<b>105</b>

Figure 3 - 1: Remanufactured Product Life Cycle Period _____	72
Figure 3 - 2: Remanufacturing parameterization on the reconditioning Industrial Process _____	76
Figure 3 - 3: Consideting Remanufacturing Parameterization of the Product Life Cycle _____	78
Figure 3 - 4: Closed Loop Product Life Cycle and Parameterization _____	81
Figure 3 - 5: Gearbox ZF used by Renault Trucks and reconditioned by Renault Trucks Reman Parts	86
Figure 3 - 6: Type and Quantity Parameters for the Life Cycle Assessment – Raw Material _____	87
Figure 3 - 7: Type and Quantity Parameters for the Life Cycle Assessment – Manufacturing _____	88
Figure 3 - 8: Type Parameters for the Life Cycle Assessment – by each single component _____	89
Figure 3 - 9: Type and Quantity Parameters for the Life Cycle Assessment – Components Distribution _____	89
Figure 3 - 10: Type and Quantity Parameters for the Life Cycle Assessment – Product Distribution _____	90
Figure 3 - 11: Type and Quantity Parameters for the Life Cycle Assessment – Product End-of-Life _____	91
Figure 3 - 12: Comparison: Gearbox ZF and gearbox reconditioned by Renault Trucks Reman Parts	93
Figure 3 - 13: Comparison: Gearbox ZF and gearbox reconditioned by Renault Trucks Reman Parts	93
Figure 3 - 14: Environmental Impacts on the Gearbox Life Cycle – Mass Reduction _____	98
Figure 3 - 15: Environmental Impacts on the Gearbox Life Cycle – Variation of type of material ____	99
Figure 3 - 16: Environmental Impacts on the Gearbox Life Cycle – Variation of the use cycles number _____	100
Figure 3 - 17: Environmental Impacts on the Gearbox Life Cycle – Variation of PMR _____	100
Figure 3 - 18: Environmental Impacts on the Gearbox Life Cycle – Variation of $\eta$ _____	101
Figure 3 - 19: Environmental Impacts on the Gearbox Life Cycle – Variation of the distance for product distribution _____	102
Figure 3 - 20: Environmental Impacts on the Gearbox Life Cycle – Variation of the type of transport distribution _____	102
Figure 3 - 21: Environmental Impacts on the Gearbox Life Cycle – Scenarios Compariason _____	104

Table 3 - 1: Factors that affect the remanufactured product life cycle and its business model _____	71
Table 3 - 2: Chosen parameters to model remanufacturing strategies alternatives _____	83
Table 3 - 3: Factors used on the remanufactured product life cycle approach for the calculation of EIs _____	85
Table 3 - 4: Parameters simulation by components alternatives – Gearbox example _____	92
Table 3 - 5: Parameters values for the initial scenario – Gearbox example _____	96
Table 3 - 6: Comparasion of the mass reduction scenario – Gearbox example _____	97
Table 3 - 7: Parameters for IMPROVEMENT Scenario. _____	103

## 1. REMANUFACTURED PRODUCTS CHARACTERIZATION TO ASSESS ENVIRONMENTAL IMPACTS

The life cycle analysis provides a comprehensive view of the problem for evaluating the environmental impacts (EI) for remanufactured products. However, because EI of the remanufacturing life cycle are sensitive to numerous parameters (% of non recovered products, distance for transportation, material, etc.) it is necessary to develop a life cycle model integrating those parameters. This model will help the product, process and supply chain engineers and people in charge of the business model to make decision about product design and recovery system changes.

### 1.1. PARAMETERS TO CONSIDER ON THE REMANUFACTURED PRODUCTS BUSINESS MODEL

In a remanufacturing strategy; the sum of the added-values of the recovered components must justify the investments on the remanufacturing industrial operations (disassembly, assembly, reconditioning operations, etc.) [Ferrer 01]. For example, in the industry of the photocopier, the components which are recovered are the electrical motors which have great added-values. In computers, it is the recovery and the resale of the printed circuits which plays a big role at the time of the remanufacturing. Another example relates to the engines of remanufactured car which allow 33% of economy in labor and 50% of economy on the costs of energy [Hormozi 99]. However, many criterias come into play to establish the economic viability of a remanufactured product. From our literature review, four categories of criteria are constituted: those related to the product life cycle, the logistics and stocks, the remanufacturing process and the various types of incomes (Table 3-1).

CATEGORIES	FACTORS
PRODUCT LIFE CYCLE	Time to introduce remanufacturing on the market
	Time to become obsolete
STOCKS INVENTORY	Manufacturing average inventory
	Remanufacturing average inventory
PRODUCT PERFORMANCE	Performance before recovery
	Variation of performance rate
	Variation of warranty
PRODUCT USE	Mean use between failures
	Mean use before remanufacturing

Table 3 - 1: Factors that affect the remanufactured product life cycle and its business model

Those categories will be explained in the next sections.

## 1.2. REMANUFACTURED PRODUCT – LIFE CYCLE

The analysis of the product life cycle period (Figure 3-1) enables to identify various contexts of the remanufacturing product business model. In order to obtain an economical profitability; it is necessary to make an analytical analysis when the product is introduced into the market. First, we have to consider the period of time that will be necessary in order to recover the first cores to start with the remanufacturing strategy as a business. There exist a “time to introduce the remanufacturing on the market” – the time it takes from a product being designed until it is available to be recovered and remanufactured. Depending on the products characteristics (resistance, durability, etc.) cores will be more or less attractive to be integrated in a remanufacturing process, even if products have been designed with remanufacturing considerations.

Other characteristic in the lifecycle design of the product is the obsolescence [Millet and El korchi 10]. Products become obsolete frequently because a replacement on the main technology has become available. The technology is superior in one or more aspects to the precedent available product. The relation between the time to introduce remanufacturing on the market and the time a product becomes obsolete is essential to know to identify the economical performance of the system. When the remanufacturing business is introduced to the public market, it is not convenient if a drastic change of technology turns obsolete the products from the remanufacturing system.

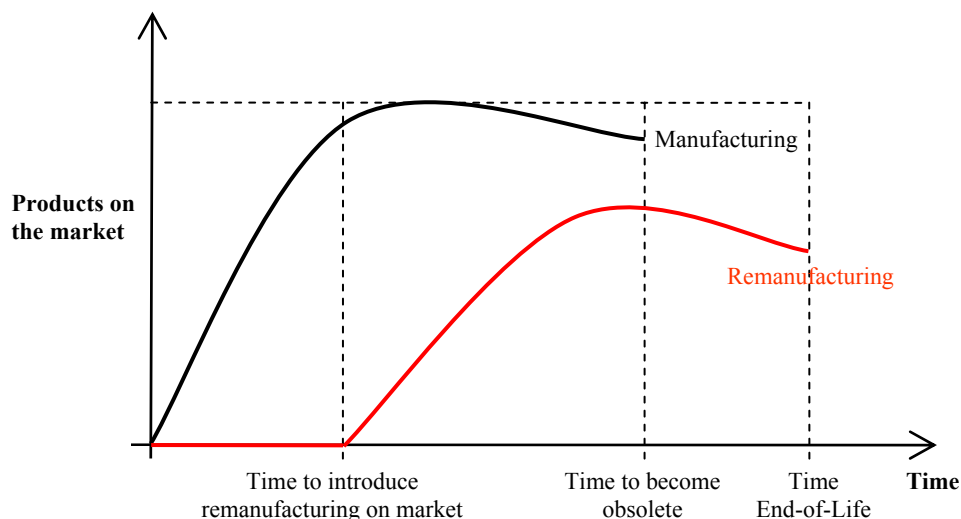

Figure 3 - 1: Remanufactured Product Life Cycle Period

Then, to finish with the characteristics of the product life cycle, the end-of-life has also to be considered in the remanufacturing business model. The end-of-life is a parameter that affects

remanufacturing products and not remanufactured products at the same scale. Indeed, it is possible to consider the remanufacturing as a theory to prolong or delay the end-of-life of a specific technology.

### **1.3. PRODUCT STOCK – INVENTORY**

It is necessary to characterize the economic aspects of the remanufacturing products before to arrive to the end-of-life, the process start from the cost of the activity of the purchasing of the core, having placed it on warehouse as stock (inventory), before to initiate the remanufacturing business. The cost of the reverse logistics of the cores must be relatively low compared to the price of the remanufactured product [El Korchi and al. 10].

Criteria like the ratio of products returned to the remanufacturers could be used as an indicator of the market demand. This difference can be translated near the manufacturers and the logistics as a necessity to plan a “manufacturing average inventory” of products for the manufacturing business and in parallel a “remanufacturing average inventory” of the cores that permits remanufacturing to enter the market.

In order to obtain an economical profitability, it is necessary to make an analytical analysis on the stock necessary before introducing remanufacturing on the market. If clients ask for remanufactured products before the remanufacturing chain starts, the supply of these orders with new products will incurs higher production costs.

### **1.4. PRODUCT PERFORMANCE AND USE**

Depending on products characteristics (value, price, etc.) cores will be more attractive to be integrated in a remanufacturing process. The cost of the reconditioning process is directly related to the condition of the product at the moment of the recollection and to the profile of the remanufactured product [Steinhilper 98]. That is the reason why it is necessary to note the “performance before recovering” of the products.

Also, in the analysis of the performance and use, it is necessary to concentrate on the “variation of the warranty” of the product. This variation on the warranty could also be used to assess the remanufacturing process.

## **2. REMANUFACTURING PRODUCT LIFE CYCLE**

### **2.1. REMANUFACTURING PROBLEMATIC CONTEXT FOR THE ASSESSMENT OF CLOSED LOOP LIFECYCLE PRODUCTS**

The studies on the characterization of the remanufactured products and remanufacturing processes developed until our days conduct us to the fact that remanufacturing of existing products and the main processes of recovering, reconditioning and remanufacturing must be adapted to the specific products' model [Amezquita and al. 95]. This brings us to make the analysis not only of the product, from now, but also within the remanufacturing process. It is necessary to include the external actors out of the process of some activities. Several characteristics of remanufactured products keep on technical criteria to assess the product [Rose 00]. All those observations and previous works on the characterization of the remanufactured products have, as principal results, proposals about modifications on the structure of the product. Some other authors proposed modifications on the design of the product [Williams and Shu 01].

Some other studies realized a characterization of the remanufacturing products with the objective to create remanufacturing profile group's and relate a product and its remanufacturing process to one of these profiles [Lopez 04]. The creation of these profiles tries to support designers to establish the requirement's list according to the product and product's profiles. However, these studies are limited by the specific sector or type of profile; depending on the product that will be designed.

Some analysis have been done considering remanufacturing products from an environmental impact assessment point of view [Sutherland and al. 08] [Umeda Y. and al. 08] [Sun and al. 03] and closed loop end-of-life strategies/scenarios [Gehin 08]. But they stay clearly at the product level and not at the system level.

In our context, in order to establish a set of parameters that will characterize a remanufacturable product and its whole product life cycle as a central object of the analysis, a detailed description of the remanufacturing products has been proposed with a vision based on the internal criteria (related to the context of the remanufacturing product life cycle) and external criteria (related to the choice on the design and the processes included in the whole system).

For our description, the heavy vehicles industry has been assessed. The step of data recollection and business model representation has the interest of examining the requirement in terms of internal – external actors needed to accomplish the remanufacturing of a specific used/broken product rather than in terms of solutions. The remanufacturing as a scenario of products' end-of-life forces interactions with all the other elements of the product life cycle.

## **2.2. PARAMETRIZATION OF CLOSED LOOP PRODUCTS: REMANUFACTURING PROCESS**

A quantitative method such as the “Life Cycle Assessment Bricks” [Gehin 2007] helps to define parameters related to closed loop product life cycles. This methodology needs to identify the inputs and outputs of each brick on the product life cycle. Here it is important for the designers to be involved in such tasks from the beginning of the design process. So, each brick is represented and analyzed to obtain the most pertinent information across the remanufacturing process.

Methodologies like conventional Life Cycle Assessment are recommended to give a first orientation on the project design of product lifecycle with single use. However, this current approach does not really support the assessment of products with closed loop life cycles. During the initial steps of the product process design, the representations and data of the product are considered as rough and far from the final products. However, the support bring to designers should be iterative all over the product definition and product life cycle formalization.

This section focuses on the remanufacturing process and the parameters identified to characterize the environmental impact of the global remanufacturing activity. The remanufacturing process starts after the take-of-back stage (recollection of the broken products) at the product life cycle. This means that a number of the original manufactured cores will be transported, and then inspected through a reconditioning process. Remanufacturing is generally composed of several stages: inspection, cleaning, disassembly, remanufacturing (repair, reconditioning, recovering, component's exchange, etc), controlling, assembling, monitoring and packaging.



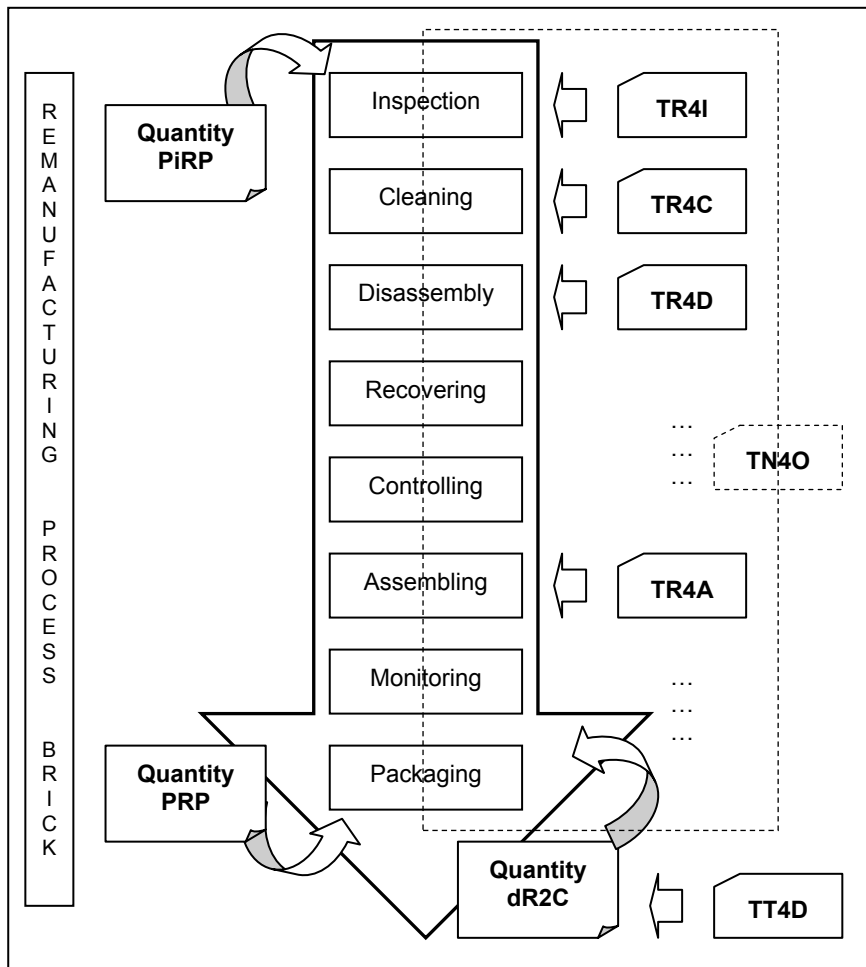

Figure 3 - 2: Remanufacturing parameterization on the reconditioning Industrial Process

According to the remanufacturing brick represented on the figure 3-2; it is possible to observe different parameters affecting the economical, technical and environmental performance of the life cycle model.

### 2.2.1. QUANTITY PARAMETERS

Quantity parameters affect the environmental impact of the brick in a logical linear relation. The more resources are used to be introduced in the remanufacturing of products, the more efficient becomes the process from the environmental point of view. For the remanufacturing process, the quantity parameters that will be used with the brick to influence the calculations are listed in the next lines:

- **Percentage of the product inside the remanufacturing process (PiRP).** This parameter is to evaluate the state of the product that gets into the process. Reverse logistic should be able to recover complete modules for a core. Even if the product is incomplete. Some modules of the product could be intended directly to the

remanufacturing process and other modules could have different recovering processes or waste treatment.

- **Performance of the remanufacturing process (PRP).** This parameter assesses the proportion of the broken products that are well recovered.
- **Distance from the remanufacturing site to the final client (dR2C).** A mean distance with the historical sales data or sales prevision could be provided.

### 2.2.2. PARAMETERS TYPE

Parameters that will be used to assess the end-of-life (end-of-use) brick:

- **Type of resources for inspection (TR4I).** Include all the inputs used for the inspection of the carcasses.
- **Type of resources for cleaning (TR4C).** Include all the inputs used for the cleaning of the cores (washing agents, anti-oxidants fluids, etc...).
- **Type of resources for disassembly (TR4D).** Include all the inputs used for the disassembly of the cores.
- **Type of resources for remanufacturing (TR4Rem).** Include all the inputs used for the reconditioning of the cores (tooling machines, standard components exchanges, etc...).
- **Type of resources for assembling (TR4A).** Include all the inputs used for the assembling of the cores.
- **Type of energy used on the operations (TE4O).** Include all the different sources of energy inputs used for each operation in the remanufacturing process.
- **Type of transport for distribution after remanufacturing (TT4D).** Include all the different type of transports for the distribution.

### 2.3. PARAMETRIZATION OF CLOSED LOOP LIFE CYCLE PRODUCTS

The Figure 3 - 3 represents the remanufacturing process algorithm, where several units of the same core are recovered by an industrial process. This model can be used to represent as many scenarios as possible. The classical lifecycle algorithm can be obtained as a complex mix of scenarios (reuse, remanufacturing and recycling).

To maintain the same research drivers than those proposed by Gehin 08, eight generic phases have been used to model the product lifecycle: 1) Material Extraction, 2) Component

Manufacturing, 3) Component Distribution, 4) Product Assembly, 5) Product Distribution, 6) Product Use, 7) Product Take- back and 8) Component end-of-life with 5 options (reuse, remanufacturing, recycle, incineration, landfill). To establish the common ground for the integration of all the actors, it is also necessary to define adequate parameters inside this model. Those parameters are established by the team and their values would depend on the designers' choices. The common definition of those parameters during the design process is necessary to avoid time consuming in the product redesign during the detailed design phase.

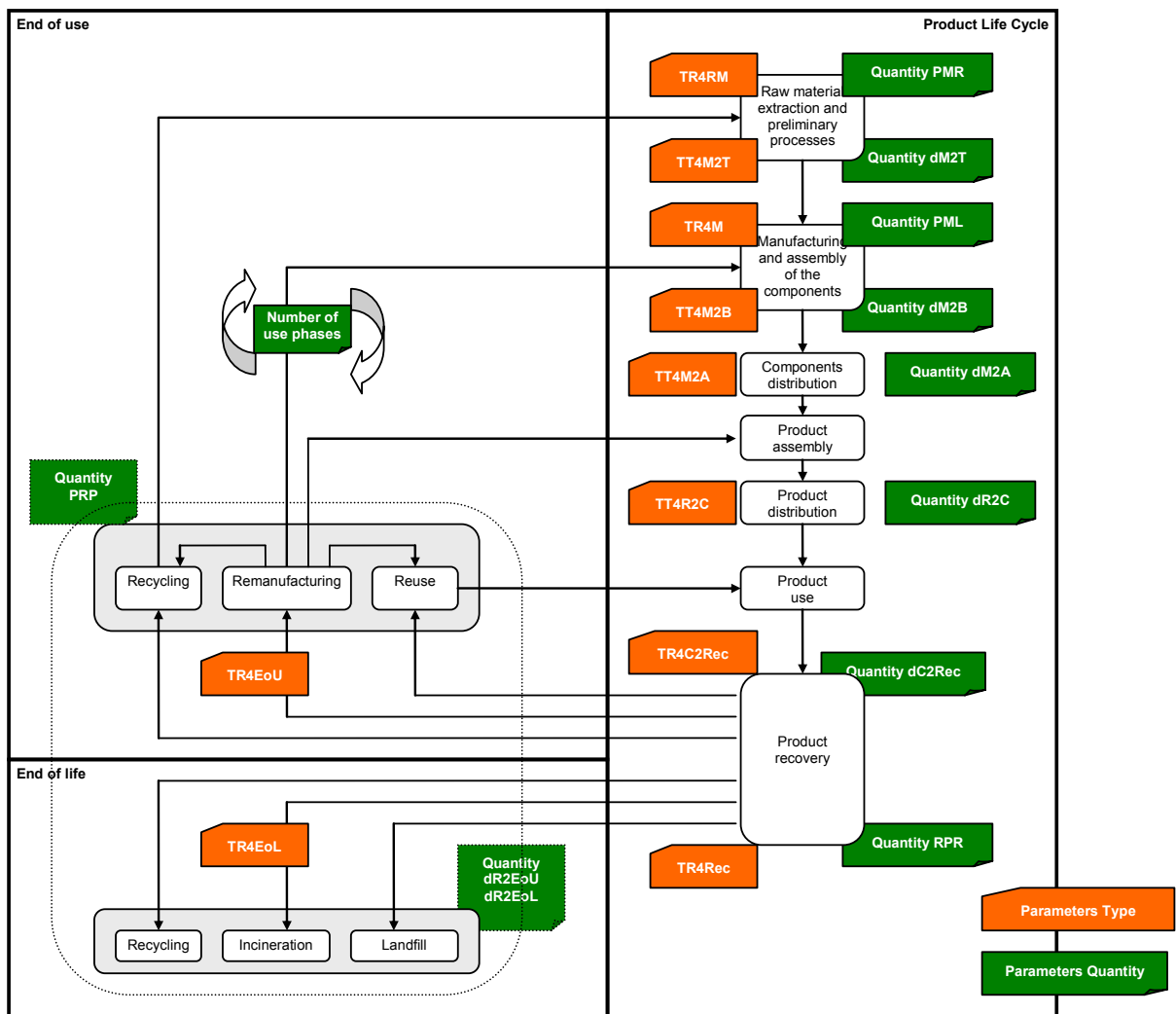

Figure 3 - 3: Considering Remanufacturing Parameterization of the Product Life Cycle

### Raw material extraction

The remanufacturing process needs to replace components or partial components that are not able to be recovered. This replacement must be done with new raw material that in a different ratio impacts the environment. In hence, parameters quantity and type must

considerer the material used for a first use phase and the material replacement to obtain other use cycles.

- Percentage of material replaced during the remanufacturing process (PMR); new raw material is added in the product to replace the non recovered components. This parameter considers the real material recovered by the remanufacturing process.
- Distance from the quarry to the material transformation (dM2T).
- Type of resources for the raw material extraction (TR4RM).
- Type of transport used from the mine to the transformation (TT4M2T)

#### **Component's manufacturing**

These parameters consider the products manufacturing on the first use, and the components that will be replaced in other uses cycles.

- Percentage of material removed on the machining tool (PML).
- Distance from the material transformation to the manufacturing site (dM2B).
- Type of resources used on the component's manufacturing (TR4M).
- Type of transport used from the material transformation to the manufacturing site (TT4M2B).

#### **Component's distribution**

Not all the components are manufactured in the same place for economic business strategies. Components are manufactured in different emplacements; for the assembly of a new product, those components are going to be transported to a common facility.

- Distance from the component's manufacturing to the assembly site (dM2A).
- Type of transport used from the manufacturing to the assembly site (TT4M2A).

#### **Product's assembly**

The product assembly here is supposed to have no significant impact on the product lifecycle.

#### **Product's distribution**

The product distribution considers that manufacturer and the remanufacturer are in different places.

- Distance from the manufacturing site to the final customers or concessionaires (dR2C).

- Type of transport used from the manufacturing site to customers or concessionaires (TT4R2C).

#### **Product's use**

The product use is supposed to have no variable impact on the product lifecycle.

#### **Product's take-back**

The product take-back considers the recollection of the cores; for the recovering of several components and waste treatment or final disposition for the non recovered components.

- Proportion of products that are recovered by the reverse logistic (RPR).
- Distance from concessionaires to warehousing/remanufacturing site (dC2Rec).
- Type of resources used on the recollection of the cores (TR4Rec).
- Type of transport used from concessionaires to warehousing/remanufacturing site (TT4C2Rec).

#### **Component's end-of-use**

The component's end-of-use / component's end-of-life stage will include the parameters for the others possible scenarios (technical strategies).

- Distance from remanufacturing (recollection) to the product end-of-use site (recycling and reuse) or end-of-life site (landfill and incineration) (dR2EoU/dR2EoL).
- Type of resources used at the product end-of-use or end-of-life strategy (TR4EoU/TR4EoL).

### 3. CLOSED LOOP PRODUCT LIFE CYCLE ASSESSMENT: IMPACTS FOR REMANUFACTURING MODEL

#### 3.1. LIFE CYCLE DESCRIPTION

The proposed life cycle model (Figure 3-4) shows the flow of remanufactured products. The different flows between the life cycle phases are represented by arrows. The possible ways or strategies are not exclusive and have to be precisely defined for each component. Eight phases of the product lifecycle have been used to model the remanufacturing process; at the end-of-life only two options are considered: remanufacturing and recycling.

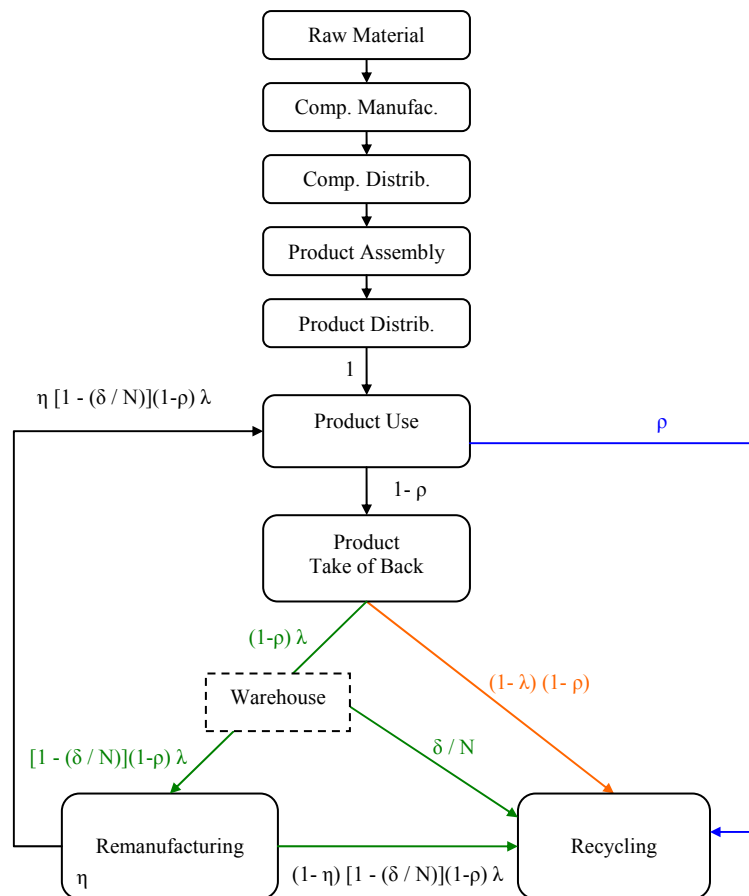

Figure 3 - 4: Closed Loop Product Life Cycle and Parameterization

To assess a product with multiple life cycle phases it is necessary to consider the number of use cycle phases. The “number of use phases” of the product is a parameters that affect the all product life cycle. This parameter impacts several processes (i.e. reverse logistic,

production). So it should be optimized while considering the whole life cycle. The other variables developed in order to build the lifecycle model of closed-loop systems are described as follow:

**N – Total number of product that are in use**

This parameter depends on the sales previsions of the product and the capacity of the production planning.

**$\varepsilon$  – Ratio of new products considered as remanufactured**

To maintain the fidelity of the customers; when orders of remanufactured products arrive before to introduce remanufacturing on the market, the orders are accepted; even if new products are sold instead and considered as remanufactured.

**$\rho$  – Number of products considered as none recollected (directly to recycling)**

To define this parameter, it is necessary to take into account market aspects to estimate a number of customers that do not get interested in the reconditioning service.

**$\lambda$  – Performance of the reverse logistic**

Cores recollected by the reverse logistics system.

**$\eta$  – Performance of the remanufacturing process**

Proportion of cores reconditioned on the remanufacturing process. Components not on a good condition will be replaced.

**$\delta$  – Ratio of cores considered as non remanufacturable**

Proportions of the cores directly send towards the recycling process; cores are in unreconditioned conditions or there exists an overstock of the specific core.

### **3.2. LCA INTEGRATION ON THE CLOSED LOOP END-OF-LIFE STRATEGIES PRODUCTS**

The proposed model is to be used by remanufacturers to make decision on product and life cycle properties. The objective is to provide them useful parameters, easy to identify and to fill in an assessment tool. The retained parameters are showed in table 3-2. They have been chosen because of their ability to be mobilized by all the actors that could be involved in the remanufacturing strategy assessment.

- The processes are the necessary actions to transform materials (first material processes, manufacturing processes, remanufacturing processes, recycling processes).

Once the type of the process is defined as well as the quantity of material to process, it is easy to calculate the environmental impact while multiplying the quantity (Q) by the equivalence factor ( $F_{\text{process}}$ ) indicated in LCA databases [Wenzel H. and al. 97].

- Material can be found in the bill of materials defined by designers and correspond also to packaging that could be used for transportation or consumables used during transformation process or use phase. Once you chose your materials and the mass, the same calculation can be done to obtain the environmental impact.
- Energy is present in the use phase and also already taken into account in the processes environmental impact.
- Transport has to be considered, either if it is sometimes neglected in some studies [Adler and al. 07]. Transport is present in each phase of the product life cycle and has to be optimized [Clarke A. et al. 08]. The corresponding environmental impact is function of the equivalence factor  $F_{\text{transport}}$  and the mass\*distance.

PARAMETERS	Environmental Impact CALCULATION
Process (type and quantity)	$Q * F_{\text{process}}$
Material (type and quantity)	$Q * F_{\text{material}}$
Energy (type and quantity)	$Q * F_{\text{energy}}$
Transport (type and quantity)	$Q * D * F_{\text{transport}}$

Table 3 - 2: Chosen parameters to model remanufacturing strategies alternatives

### 3.3. GENERAL PARAMETERISATION OF CLOSED LOOP END-OF-LIFE STRATEGIES PRODUCTS

The main objective in this section is to define the way environmental assessment has to be done to provide designers enough information to take actions on component end-of-life strategies. Lifecycle bricks are used to build lifecycles of the remanufacturing closed-loop systems:

- A lifecycle is created as soon as the first component is created. Product-level bricks are built as well as the component-level bricks. The environmental impacts of the product are the sum of the impacts in each brick.
- For closed-loop strategies; designers need to assess a “ $n_t$ ” parameter: “the number of usage cycles” that the component can cross through the reconditioning system. Once the model is ready for calculation, the environmental impacts are determined. Then, the impacts are brought back to one single usage cycle so that the designers can compare the different lifecycles alternatives they have envisioned.



- Component end-of-pipe strategy take place at the end of the product life (here in the model considering remanufacturing and recycling). Because the strategy cannot certainly be 100% efficient due to the recovering process capability (quality of take-back parts, percentage of products recovered, efficiency of the remanufacturing process, etc.), end of-pipe scenarios have to be determined as well as the estimation of the percentage of components that will be effectively reused/remanufactured.

### 3.4. ENVIRONMENTAL IMPACT EQUATIONS

General assumptions are realized to be able to conduct the life cycle assessment equations:

- In accordance with Sutherland and Amaya let assume that the total number of products “N” in the remanufacturing closed loop is constant. This means that for each N recycled product, core losses are made up with  $\partial / N$  and for each N remanufacturing, core losses are made up with  $1 - (\partial / N)(1 - \rho)\lambda$ . They have to be replaced by virgin cores at each remanufacturing step. For the development of the equations; the losses destined for recycling is considered as  $\Delta = \partial / N$ .
- Recycled material benefits were not integrated in the remanufacturing closed loop [Koltun P. and al. 05].
- The environmental impact in the use phase is the same for manufactured or remanufactured products.
- The number of reused cores will be directly proportional to the performance or percentage of recollected cores by the reverse logistic and the number of technical product reuses. In some cases, customers ask the reconditioning of it own products. The remanufacturing process aims reconditioning a broken down products. If technically it is not possible to reconditioning the ancient core, it has to be replaced by other core from the inventory.
- The environmental impacts for the processes which go directly to the recycling process will be expressed by the expressions used by the classical product life cycle  $EI_{raw\_material} + EI_{manufacturing} + EI_{distribution} + EI_{use} + EI_{take-of-back} + EI_{recycling}$ .

The environmental impacts of each stage of the remanufacturing product life cycle for one usage phase approach are expressed on table 3 - 3.

<b>EI FACTORS</b>	
Raw material	$EI_{raw\_material} \times \frac{1 + (n_t - 1)\{\rho + \Delta + (1 - \lambda)(1 - \rho) + (1 - \eta)[\lambda(1 - \rho)(1 - \Delta)]\}}{n_t}$
Manufacturing	$EI_{manufacturing} \times \frac{1 + (n_t - 1)\{\rho + \Delta + (1 - \lambda)(1 - \rho) + (1 - \eta)[\lambda(1 - \rho)(1 - \Delta)]\}}{n_t}$
Distribution	$EI_{distribution}$
Use	$EI_{use}$
Reverse logistics	$EI_{take-of-back}$
End-of-Use End-of-Life	Remanufacturing $EI_{remanufacturing} \times \frac{1 + (n_t - 1)[\lambda(1 - \rho)(1 - \Delta)]}{n_t}$
	Recycling $EI_{recycling} \times \frac{1 + (n_t - 1)\{\rho + \Delta + (1 - \lambda)(1 - \rho) + (1 - \eta)[\lambda(1 - \rho)(1 - \Delta)]\}}{n_t}$

Table 3 - 3: Factors used on the remanufactured product life cycle approach for the calculation of EIs

We will use the life cycle modeling and the different equations in the following case study.

## 4. GEARBOX TRUCK CASE STUDY

### 4.1. THE CASE STUDY

The model has been used to evaluate the remanufacturing strategy of gearboxes used in the heavy trucks industry (Figure 3-5). Because of its short lifetime compared to the trucks and of the economical interest of the remanufacturing strategy, the gearboxes are often remanufactured. But no information exists on the environmental profits that this strategy is able to generate and the system is not optimized from this view point. So, an analysis of this product lifecycle has been realized with the members of the remanufacturing site and of the reverse logistic site. Several interviews, surveys and visits have been carried out to define the values for the current parameters and to make some hypothesis on the possible evolutions. Here, the support and the experience of designers and of people involved in each phases of the life cycle are essentials in order to realize the assessment. In some cases, an analysis of the sensitivity of the model was used to discard irrelevant data. For this study, a representative gearbox has been chosen and the product data have been established for the current situation. The “type” parameters were filled in the excel sheets containing the EI databases. Each time the user modifies a “type” parameter for material, transportation or resources, he has to check if the related data are available in the database and to select it. If not, he has to ask an environmental expert to add a new brick calculation but all of the data corresponding to material, transportation and resources usually used by the firm are in the database. For the “quantity” parameters they are grouped in a single table and their modification does not involve any other operation.

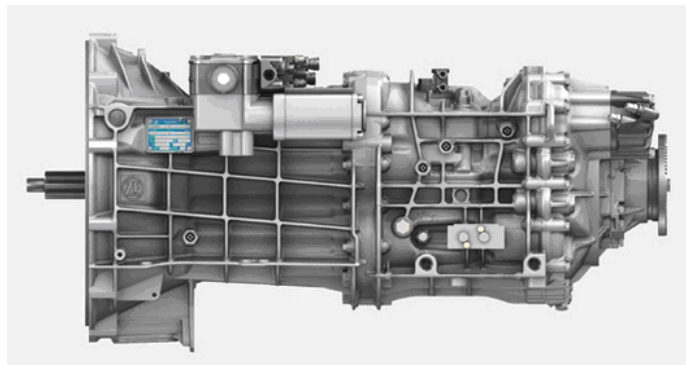

Figure 3 - 5: Gearbox ZF used by Renault Trucks and reconditioned by Renault Trucks Reman Parts

## 4.2. THE LIFE CYCLE ASSESSMENT TOOL FOR REMANUFACTURED PRODUCTS

### 4.2.1. COMPONENTS RAW MATERIAL PARAMETERS IN THE TOOL

Figure 3-6 presents all the material gains and losses that have to be considered by the parameterization. Also, the distances are defined for the transportation from the mine to the manufacturing site; with the correspondent type of transport used (truck, semi truck, etc.).

#### VARIABLES TYPE

Name / Module	Material TYPE	Resources TYPE	Transport TYPE
Comp. 01 Transmission case	Aluminium, production mix, cast alloy, at plant		Transport, lorry 16-32t, EURO3/RER S
Comp. 02 Input shaft	Aluminium, production mix, cast alloy, at plant		Transport, lorry 16-32t, EURO3/RER S
Comp. 03 Jack shaft	Aluminium, prod. mix, wrought alloy, at plant		Transport, lorry >32t, EURO3/RER S
Comp. 04 Tachometer take-off point	Aluminium, primary, at plant		Train (diesel & electric) B250
Comp. 05 Countershaft + Reverse	Aluminium, production mix, at plant		Train electric B250
Comp. 06 Connecting strip, brackets	Steel 25CrMo4 I		Transport, freight, rail/CH S
Comp. 07 Shift mechanism	Steel 30CrNiMo8 I		Transport, freight, rail/RER S
Comp. 08 Cross shaft case	Steel 35NiCr18 I		Transport, aircraft, freight, Europe/RER S
Comp. 09 Left shaft relay	Steel 36NiCr6 I		Transport, aircraft, freight/RER S
Comp. 10 Countershaft relay	Aluminium, production mix, cast alloy, at plant		Transport, lorry 16-32t, EURO3/RER S
Comp. 11 Mechanical control relay	Steel 25CrMo4 I		Transport, lorry 16-32t, EURO3/RER S
Comp. 12 Lubrication	GS-X40CrNiSi 25 12 I		Transport, lorry 16-32t, EURO3/RER S

#### VARIABLES LINEAR

Name / Module	Material QUANTITY (Kg)	Resources QUANTITY	Transport QUANTITY	
			dM2T(Km)	% PMR
Comp. 01 Transmission case	100,00		1500	36%
Comp. 02 Input shaft	19,50		1700	36%
Comp. 03 Jack shaft	26,00		1800	36%
Comp. 04 Tachometer take-off point	6,50		700	36%
Comp. 05 Countershaft + Reverse	26,00		800	36%
Comp. 06 Connecting strip, brackets	6,50		750	36%
Comp. 07 Shift mechanism	6,50		150	36%
Comp. 08 Cross shaft case	50,00		300	36%
Comp. 09 Left shaft relay	26,00		1250	36%
Comp. 10 Countershaft relay	19,50		1550	36%
Comp. 11 Mechanical control relay	6,50		1800	36%
Comp. 12 Lubrication	6,50		200	36%

Figure 3 - 6: Type and Quantity Parameters for the Life Cycle Assessment – Raw Material

### 4.2.2. MANUFACTURING PARAMETERS IN THE TOOL

In here, there is considered the resources (inputs) used to transform the virgin raw material into the different components for the final product. All the common resources for the manufacturing of the products are considered (figure 3-7) and assigned with a correspondent impact related to the mass proportion of the product component.

The parameters types consider the resources for the manufacturing process, as well as the type of transport used to replace the raw material.

VARIABLES TYPE

Name / Module	Material TYPE	Resources TYPE	Transport TYPE
Comp. 01 Transmission case	Aluminium, production mix, cast alloy, at plant		Transport, lorry 16-32t, EURO3/RER S
Comp. 02 Input shaft	Steel 25CrMo4 I		Transport, lorry 16-32t, EURO3/RER S
Comp. 03 Jack shaft	Steel 25CrMo4 I		Transport, lorry 16-32t, EURO3/RER S
Comp. 04 Tachometer take-off point	Steel 25CrMo4 I		Transport, lorry 16-32t, EURO3/RER S
Comp. 05 Countershaft + Reverse	Steel 25CrMo4 I		Transport, lorry >32t, EURO3/RER S
Comp. 06 Connecting strip, brackets	Steel 25CrMo4 I		Train (diesel & electric) B250
Comp. 07 Shift mechanism	Steel 25CrMo4 I		Train electric B250
Comp. 08 Cross shaft case	Aluminium, production mix, cast alloy, at plant		Transport, freight, rail/CH S
Comp. 09 Left shaft relay	Steel 25CrMo4 I		Transport, freight, rail/RER S
Comp. 10 Countershaft relay	Steel 25CrMo4 I		Transport, aircraft, freight, Europe/RER S
Comp. 11 Mechanical control relay	GS-X40CrNiSi 25 12 I		Transport, aircraft, freight/RER S
Comp. 12 Lubrication	GS-X40CrNiSi 25 12 I		Transport, lorry 16-32t, EURO3/RER S

Common Resources TYPE

RESOURCESS Materials

EUR-flat pallet/RER S (UNIT)
EUR-flat pallet/RER S (UNIT)
CC packaging production L (Kg.)
CC packaging production S (Kg.)
Production cardboard box I (Kg.)
Production cardboard box II (Kg.)
Folding boxboard, FB6, at plant (Kg.)
Production of carton board boxes, gravure printing, at plant (Kg.)
Production of carton board boxes, offset printing, at plant (Kg.)

Resources TYPE

Comp. 01 Transmission case	Quantity of material removed (Kg.)		
Cold impact extrusion, aluminium, 3 strokes	13,6	0,077634698	1,05683189
Drilling, CNC, aluminium	1,4	0,65594315	0,89208268
Drilling, CNC, aluminium	0,1	0,65922957	0,08965522
Drilling, CNC, cast iron	0,0	0	0,00000000
Drilling, conventional, aluminium	0,0	0	0,00000000
Drilling, CNC, chromium steel/RER S	0,0	0	0,00000000
Milling, aluminium, average	0,0	0	0,00000000
Milling, cast iron, average			2,03756960
Milling, steel, average			
Milling, chromium steel, large parts			

Figure 3 - 7: Type and Quantity Parameters for the Life Cycle Assessment – Manufacturing

The material losses on the manufacturing of the components have a direct relation with the performance of the machining tools defined at the design process. Just to illustrate an example, the gearbox manufacturing model considers 23 % of material loss, material that is considered as a solid waste and is treated by a recycling process. Figure 3-8 shows the machines used in the components manufacturing.

#### 4.2.3. COMPONENTS DISTRIBUTION PARAMETERS IN THE TOOL

At this stage, it is also important to take into account that not all the components are manufactured on the same site; there are products/components for which all the parts are manufactured on the same site (example: diesel injector study case for Renault Trucks in 2009) and in other cases, one component, a module or a group of components can be manufactured in different locations depending in most of the cases on manufacturing costs and technical warranties. Figure 3-9 shows the parameters types and quantity on the components distribution as well as the common resources used in the packaging operations.

### Chapter 3: Life Cycle Model Approach on Remanufacturing Industrial Products

Resources_TYPE	Quantity of material removed (Kg.)		
<b>Comp. 01 Transmission case</b>			
Cold impact extrusion, aluminium, 3 strokes	46,2	0,0776347	3,58982844
Turning, chromium steel, CNC, average/RER S	4,6	0,65594315	3,03308113
Casting, bronze/CH S	0,5	0,65922957	0,30482775
Heat treatment, hot impact extrusion, steel	0,0	0	0,00000000
Cold impact extrusion, aluminium, 1 stroke	0,0	0	0,00000000
Cold impact extrusion, aluminium, 2 strokes	0,0	0	0,00000000
Cold impact extrusion, aluminium, 3 strokes	0,0	0	0,00000000
Hot impact extrusion, steel, 1 stroke/RER S			6,92773731
Surface treatment, cold impact extrusion, aluminium/RER S			
<b>Comp. 02 Input shaft</b>			
Turning, cast iron, CNC, average	9,0	0,23536897	2,11267187
Milling, chromium steel, large parts	0,9	1,2431579	1,11585853
Heat treatment, hot impact extrusion, steel	0,1	0,00108219	0,00009714
	0,0	0	0,00000000
	0,0	0	0,00000000
	0,0	0	0,00000000
			3,22862754
<b>Comp. 03 Jack shaft</b>			
Turning, cast iron, CNC, average	12,0	0,23536897	2,81689583
Milling, chromium steel, large parts	1,2	1,2431579	1,48781137
Milling, chromium steel, dressing/RER S	0,1	1,5243571	0,18243506
Heat treatment, hot impact extrusion, steel	0,0	0,00108219	0,00001295
	0,0	0	0,00000000
	0,0	0	0,00000000
			4,48715522
<b>Comp. 04 Tachometer take-off point</b>			
Turning, chromium steel, CNC, average/RER S	3,0	1,2986868	3,88567091
Drilling, CNC, chromium steel/RER S	0,3	1,2544074	0,37531869
Milling, chromium steel, large parts	0,0	1,2431579	0,03719528
Heat treatment, hot impact extrusion, steel	0,0	0,00108219	0,00000324
	0,0	0	0,00000000
	0,0	0	0,00000000
			4,29818812
<b>Comp. 05 Countershaft + Reverse</b>			
Turning, chromium steel, CNC, average/RER S	12,0	1,2986868	15,54268362

Figure 3 - 8: Type Parameters for the Life Cycle Assessment – by each single component

VARIABLES TYPE			
Name / Module	Material TYPE	External Manufacturer	Transport TYPE
Comp. 01 Transmission case	Aluminium, production mix, cast alloy, at plant	NO	
Comp. 02 Input shaft	Steel 25CrMo4I	NO	
Comp. 03 Jack shaft	Steel 25CrMo4I	NO	
Comp. 04 Tachometer take-off point	Steel 25CrMo4I	YES	Transport, lorry 16-32t, EURO3/RER S
Comp. 05 Countershaft + Reverse	Steel 25CrMo4I	NO	
Comp. 06 Connecting strip, brackets	Steel 25CrMo4I	YES	Transport, lorry 16-32t, EURO3/RER S
Comp. 07 Shift mechanism	Steel 25CrMo4I	YES	Transport, lorry 16-32t, EURO3/RER S
Comp. 08 Cross shaft case	Aluminium, production mix, cast alloy, at plant	NO	
Comp. 09 Left shaft relay	Steel 25CrMo4I	YES	Transport, lorry 16-32t, EURO3/RER S
Comp. 10 Countershaft relay	Steel 25CrMo4I	YES	Transport, lorry 16-32t, EURO3/RER S
Comp. 11 Mechanical control relay	GS-X40CrIISI 25 12 I	YES	Transport, lorry 16-32t, EURO3/RER S
Comp. 12 Lubrication	GS-X40CrIISI 25 12 I	YES	Transport, lorry 16-32t, EURO3/RER S

Common Resources_TYPE	
Materials	
EUR-flat pallet/RER S (UNIT)	
Packaging film, LDPE, at plant/RER S (Kg.)	
Production cardboard box I (Kg.)	

	PML (%)	dM2A (Km)
Comp. 01 Transmission case	10%	1500
Comp. 02 Input shaft	10%	1500
Comp. 03 Jack shaft	10%	1500
Comp. 04 Tachometer take-off point	10%	1500
Comp. 05 Countershaft + Reverse	10%	1500
Comp. 06 Connecting strip, brackets	10%	1500
Comp. 07 Shift mechanism	10%	1500
Comp. 08 Cross shaft case	10%	1500
Comp. 09 Left shaft relay	10%	1500
Comp. 10 Countershaft relay	10%	1500
Comp. 11 Mechanical control relay	10%	1500
Comp. 12 Lubrication	10%	1500

Figure 3 - 9: Type and Quantity Parameters for the Life Cycle Assessment – Components Distribution

#### 4.2.4. PRODUCTS DISTRIBUTION PARAMETERS IN THE TOOL

Regarding the component distribution stage, it is possible to note that the present stage is defined by the transportation of the product to the final clients.

Figure 3-10 shows the parameters types and quantity for the product distribution as well as the common resources used in the operation of packaging. Also the figure 3-10 is used to show how the environmental impact caused by the transports and caused by the resources consumption are treated differently; then it is possible to make a weighting and to add both with the objective to make a global result.

Common Resources_TYPE		Resources_QUANTITY	
Materials			
EUR-flat pallet/RER S (UNIT)	1		1,11790950
Packaging film, LDPE, at plant/RER S (Kg.)	1		0,28868061
Production cardboard box I (Kg.)	1		0,01212992
	0		0,00000000
	0		0,00000000
			1,41872003

Name / Module	Resources_IMPACT	TOTAL
Comp. 01 Transmission case	0,47511924	0,47511924
Comp. 02 Input shaft	0,09222903	0,09222903
Comp. 03 Jack shaft	0,12297204	0,12297204
Comp. 04 Tachometer take-off point	0,03074301	0,03074301
Comp. 05 Countershaft + Reverse	0,12297204	0,12297204
Comp. 06 Connecting strip, brackets	0,03074301	0,03074301
Comp. 07 Shift mechanism	0,03074301	0,03074301
Comp. 08 Cross shaft case	0,23651156	0,23651156
Comp. 09 Left shaft relay	0,12297204	0,12297204
Comp. 10 Countershaft relay	0,09222903	0,09222903
Comp. 11 Mechanical control relay	0,03074301	0,03074301
Comp. 12 Lubrication	0,03074301	0,03074301
	1,41872003	1,41872003

GLOBAL IMPACTS			
Name / Module	Transport_IMPACT	Resources_IMPACT	TOTAL
Comp. 01 Transmission case	7,77082588	1,42535773	9,19618361
Comp. 02 Input shaft	1,50845444	0,27668709	1,78514152
Comp. 03 Jack shaft	2,01127258	0,36891612	2,38018870
Comp. 04 Tachometer take-off point	0,50281815	0,09222903	0,59504717
Comp. 05 Countershaft + Reverse	2,01127258	0,36891612	2,38018870
Comp. 06 Connecting strip, brackets	0,50281815	0,09222903	0,59504717
Comp. 07 Shift mechanism	0,50281815	0,09222903	0,59504717
Comp. 08 Cross shaft case	3,86827141	0,70953469	4,57780610
Comp. 09 Left shaft relay	2,01127258	0,36891612	2,38018870
Comp. 10 Countershaft relay	1,50845444	0,27668709	1,78514152
Comp. 11 Mechanical control relay	0,50281815	0,09222903	0,59504717
Comp. 12 Lubrication	0,50281815	0,09222903	0,59504717
	23,20391463	4,25616009	27,46007472

Figure 3 - 10: Type and Quantity Parameters for the Life Cycle Assessment – Product Distribution

#### 4.2.5. COMPONENTS/PRODUCT END-OF-LIFE PARAMETERS IN THE TOOL

This process is more complex because of the number of sub-operations in the remanufacturing line. To make a short review of the “Remanufacturing Processes”, the carcasses once recollected are disposed for cleaning (internal/external) depending of the condition the carcasses arrive on the remanufactured site. After the cleaning, the carcasses

must cross the disassembled line, and the components are situated into a special container well labeled for the future assembly. Some components are taken for a third cleaning, depending on the prior conditions. Once the whole carcass is dismantled, it is possible to classify the components that need to be adjusted (brushing ...), the components that need more complicated operations for the recovering and the components that will be disposed for a recycled system and replaced by new components. Critical components have to be inspected by ultrasound tests. Then, all the components are well organized into the containers and go to the assembly line. After the assembly, final test of performance are done to assure good conditions before the expedition, then the painting process and packaging are realised (Figure 3-11).

**VARIABLES TYPE**

Name / Module	Material TYPE		
Comp. 01 Transmission case	Aluminium, production mix, cast alloy, at plant		Recycling
Comp. 02 Input shaft	Steel 25CrMo4 I		Incineration
Comp. 03 Jack shaft	Steel 25CrMo4 I		Landfill
Comp. 04 Tachometer take-off point	Steel 25CrMo4 I		Recycling
Comp. 05 Countershaft + Reverse	Steel 25CrMo4 I		Remanufacturing
Comp. 06 Connecting strip, brackets	Steel 25CrMo4 I		Reuse
Comp. 07 Shift mechanism	Steel 25CrMo4 I		Recycling
Comp. 08 Cross shaft case	Aluminium, production mix, cast alloy, at plant		Recycling
Comp. 09 Left shaft relay	Steel 25CrMo4 I		Recycling
Comp. 10 Countershaft relay	Steel 25CrMo4 I		Recycling
Comp. 11 Mechanical control relay	GS-X40CrNiSi 25 12 I		Recycling
Comp. 12 Lubrication	GS-X40CrNiSi 25 12 I		Recycling

**Common Resources\_TYPE**

LANDFILL		INCINERATION		RECYCLING	
Transport, lorry 16-32t, EURO3/RER S		Transport, lorry 16-32t, EURO3/RER S		Transport, lorry 16-32t, EURO3/RER S	
				Transport, lorry 16-32t, EURO3/RER S	
				Transport, lorry >32t, EURO3/RER S	
				Train (diesel & electric) B250	
				Train electric B250	
				Transport, freight, rail/CH S	
				Transport, freight, rail/RER S	
				Transport, aircraft, freight, Europe/RER S	
				Transport, aircraft, freight/RER S	
<b>REMANUFACTURING</b>					
<b>Initial Inspection</b>	No data				Chromium steel 18/8, at plant/RER S
<b>Internal Cleaning</b>	Monoethanolamine, at plant/RER S			<b>Assembly</b>	
<b>External Cleaning (or Second Cleaning)</b>	Monoethanolamine, at plant/RER S			<b>Final Test</b>	Lubricating oil, at plant/RER S
<b>Disassembly</b>	Chromium steel 18/8, at plant/RER S			<b>Painting</b>	Alkyd paint, white, 60% in solvent, at plant/RER S
	Chromium steel 18/8, at plant/RER S			<b>Packaging</b>	EUR-flat pallet/RER S (UNIT)
	Cast iron, at plant/RER S				Production of carton board boxes, of plant/RER S
<b>Messure controls</b>	Chromium steel 18/8, at plant/RER S			<b>Various</b>	Brass, at plant/CH S
<b>Remanufacturing / Recondition</b>	DATA A FILL BY COMPONENT				

**Resources TYPE**

	Comp. 01 Transmission case	Quantity of material removed (Kg.)	ENVIRONMENTAL IMPACT (Pts)
Remanuf. / Recond. First OP	Drilling, CNC, cast iron	1,1	0,23199562
Remanuf. / Recond. Second OP	Drilling, CNC, cast iron	1,1	0,72258697
Remanuf. / Recond. Third OP	Drilling, conventional, aluminium	1,1	0,72620729
Remanuf. / Recond. Fourth OP	Drilling, CNC, chromium steel/RER S	1,1	0,23157458
Remanuf. / Recond. Fifth OP	Milling, aluminium, average	1,1	0,41573376
	Milling, cast iron, average	1,1	0,00000000
	Milling, steel, average	1,1	2,32809823
	Milling, chromium steel, large parts	1,1	
	Milling, chromium steel, dressing/RER S		

Figure 3 - 11: Type and Quantity Parameters for the Life Cycle Assessment – Product End-of-Life



Figure 3-11 shows the parameters types and quantity for the selection of the end-of-life scenario (incineration, landfill, recycling, remanufacturing and reuse). Also the resources used in each operation are considered as parameter type and selected to each component.

### 4.3. RESULTS

Graphical results are presented on figure 3-12. It is possible to situate the most important environmental impact into the life cycle of the gearbox. The objective of this kind of representation is to make multiples iteration with each of the components and with different parameters values for each component (Table 3 -4).

N	50000,00	Δ	5%
δ	2500,00		

	n <sub>t</sub>	01 C. RAW MAT. EXT.		02 C. MANUFACTURING.		03 C. DISTRIB.	04 P. DISTRIB.
		PMR (%)	dM2T (Km)	PML (%)	dM2B (Km)	dM2A (Km)	dR2C (Km)
Transmission case	3	20%	1500	23%	1350	1500	2000
Input shaft	3	10%	1500	23%	1350	1500	2000
Jack shaft	3	10%	1500	23%	1350	1500	2000
Tachometer take-off point	3	15%	1500	23%	1350	1500	2000
Countershaft + Reverse	3	5%	1500	23%	1350	1500	2000
Connecting strip, brackets	3	15%	1500	23%	1350	1500	2000
Shift mechanism	3	20%	1500	23%	1350	1500	2000
Cross shaft case	3	25%	1500	23%	1350	1500	2000
Left shaft relay	3	25%	1500	23%	1350	1500	2000
Countershaft relay	3	25%	1500	23%	1350	1500	2000
Mechanical control relay	3	25%	1500	23%	1350	1500	2000
Lubrication	3	10%	1500	23%	1350	1500	2000

	04 P. DISTRIB.	05 P. USE	06 P. TAKE/BACK		07 P. END/USE	
	dR2C (Km)	ρ	Λ	dC2REM (Km)	η	dR2EoL (Km)
Transmission case	2000	10%	75%	440	80%	400
Input shaft	2000	10%	75%	440	80%	400
Jack shaft	2000	10%	75%	440	80%	400
Tachometer take-off point	2000	10%	75%	440	80%	400
Countershaft + Reverse	2000	10%	75%	440	80%	400
Connecting strip, brackets	2000	10%	75%	440	80%	400
Shift mechanism	2000	10%	75%	440	80%	400
Cross shaft case	2000	10%	75%	440	80%	400
Left shaft relay	2000	10%	75%	440	80%	400
Countershaft relay	2000	10%	75%	440	80%	400
Mechanical control relay	2000	10%	75%	440	80%	400
Lubrication	2000	10%	75%	440	80%	400

Table 3 - 4: Parameters simulation by components alternatives – Gearbox example

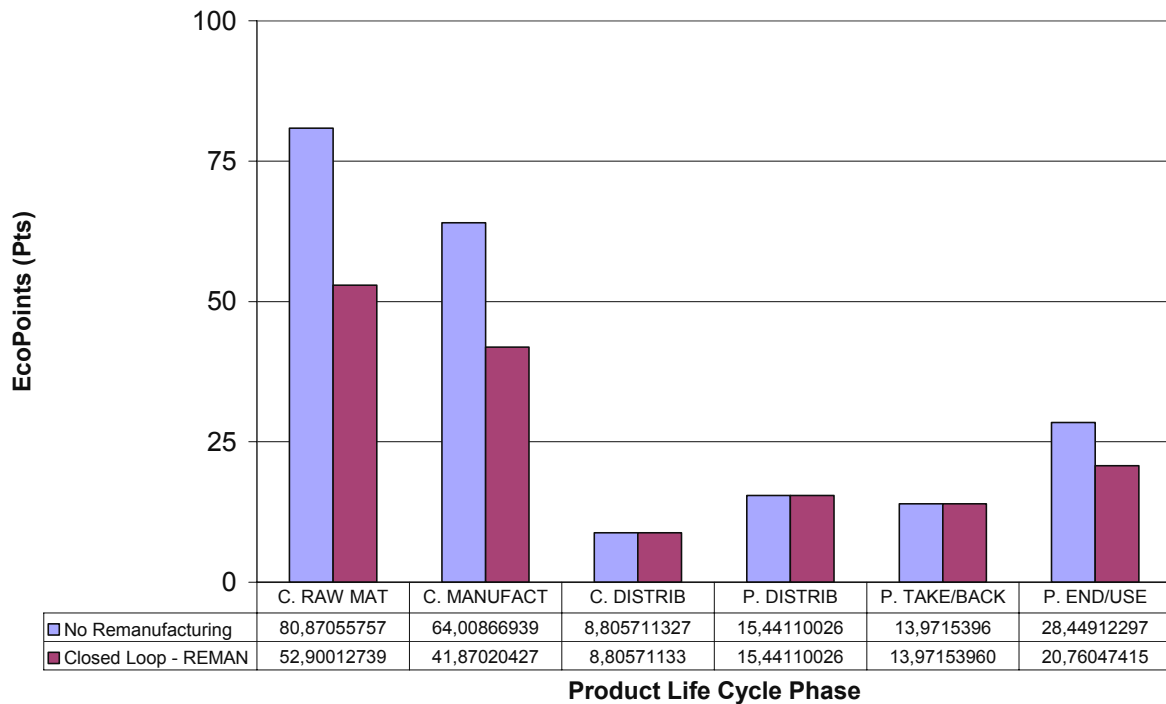

Figure 3 - 12: Comparison: Gearbox ZF and gearbox reconditioned by Renault Trucks Reman Parts

#### 4.4. ASSESSMENT TOOL FOR REMANUFACTURED PRODUCTS

Remanufacturing is a promising strategy; therefore, there is necessary methods and tools for those strategies to be considered during the product or life cycle design process. Figure 3-13 shows the methodology path elements of the modeling necessary to implement this approach in an industrial context using a design phase.

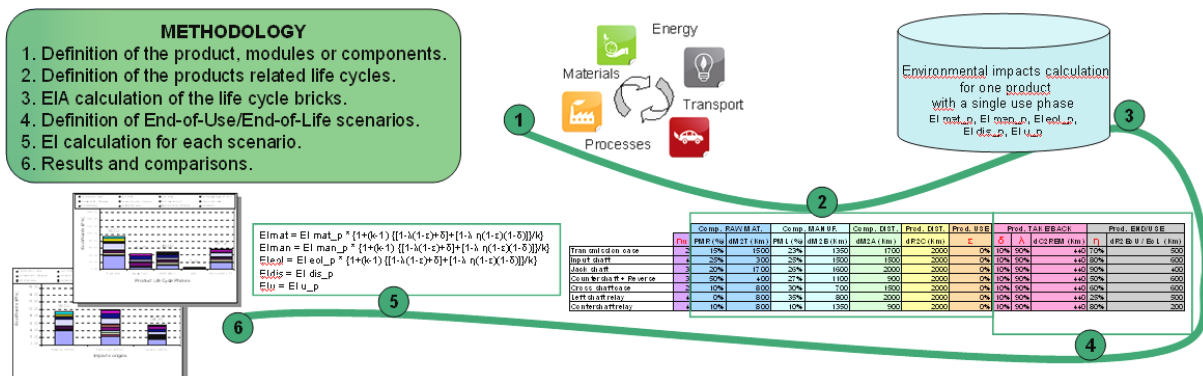

Figure 3 - 13: Comparison: Gearbox ZF and gearbox reconditioned by Renault Trucks Reman Parts

With the approach developed, product life cycle implications for remanufacturing are considered. The advantage of such a model is that it conducts to an integrated discussion during the assessment process of the remanufacturing strategy. Here, while assessing the closed loop strategy, one can see that parameters are not limited to the bill of materials. The processes that are used all along the life cycle, for each component are considered in relation with product design strategies because they influence a lot the environmental assessment.

## **5. SENSITIVITY ANALYSIS OF THE REMANUFACTURING MODEL**

The proposed model requires a sensitivity analysis with the objective to characterize the influence of the most relevant parameters. There exist a significant number of parameters influencing the environmental performance of the closed loop products life cycle. To mention some examples, the number of cycle uses of the product, the ratio of new products introduced into the market and considered like remanufactured, the ratio of products not recollected, the ratio of cores selected to remanufacturing by the reverse logistics and the performance of the remanufacturing model are parameters that will modify the performance of the total product lifecycle from an environmental point of view. However; thanks to the characterization of the remanufacturing business model (chapter 2); it was possible to establish the variables needed to recreate each of the product life cycle phases in the remanufacturing business model. Variables like the type of material and the mass are determined in section 2 and affect the raw material extraction of the product as well as the manufacturing product phase. The material extraction necessary to manufacture a component (product) depends of the materials losses through the manufacturing process. Those parameters are presented in the table 3-5. It is possible to highlight the influence of the logistics parametrisation, depending on the proximity site from the execution of one product life cycle phase and the next one. The numbers of kilometers as well as the type of transport are parameters fixed depending on the logistics facilities, economics benefits and now with the implementation of the methodology the environmental performance of the proposed model should be a design criteria.

### **5.1. INITIAL SCENARIO (SCENARIO 0)**

To clarify the environmental impacts on the product life cycle of remanufactured products, there is necessary to realize a comparative assessment. This analysis compares an initial scenario (scenario 0) issued from a realistic business model data, to other scenarios.

The products considered are the “gearboxes”. The number of times that their components can cross through the reconditioning system is  $n_t=2$ . This means the gearboxes are able to be reconditioned one time for scenario 0 (Table 3-5). Parameters like the number of products considered as non collectable ( $\rho=40\%$ ) are a real data from the remanufacturing sector, where not more than the 60% of the gearboxes is recovered. The product recollected by the reverse logistic could be qualified as good ( $\lambda=60\%$ ). The percentage of cores destined to

recycling after warehousing inspection is low ( $\Delta=10\%$ ). Finally, to define the whole parameters of the remanufacturing model, the performance of the product reconditioning is good ( $\eta=60\%$ ).

	1. Transmission Case	2. Input Shaft	3. Jack Shaft	4. Tachometer Take-Off Point	5. Countershaft + Reverse	6. Connecting Strip, Brackets
nt	2	2	2	2	2	2
$\rho$	40%	40%	40%	40%	40%	40%
$\lambda$	60%	60%	60%	60%	60%	60%
$\Delta$	10%	10%	10%	10%	10%	10%
$\eta$	60%	60%	60%	60%	60%	60%
<b>Transp_Type</b>	Transport, 16-32t	Transport, 16-32t	Transport, 16-32t	Transport, 16-32t	Transport, 16-32t	Transport, 16-32t
<b>Mat_TYP</b>	Aluminium, produc	Steel 25CrMo4 I	Steel 25CrMo4 I	Steel 25CrMo4 I	Steel 25CrMo4 I	Steel 25CrMo4 I
<b>Mat_QUANT</b>	100,00	19,50	26,00	6,50	26,00	6,50
<b>PMR (%)</b>	10%	10%	10%	10%	10%	10%
<b>PML (%)</b>	23%	23%	23%	23%	23%	23%
<b>PiRP(%)</b>	100%	100%	100%	100%	100%	100%
<b>Recur_TYPE</b>	LC Phase	LC Phase	LC Phase	LC Phase	LC Phase	LC Phase
<b>Recur_QUANT</b>	LC Phase	LC Phase	LC Phase	LC Phase	LC Phase	LC Phase
<b>dM2T (Km)</b>	1500	1500	1500	1500	1500	1500
<b>dM2B (Km)</b>	1350	1350	1350	1350	1350	1350
<b>dM2A (Km)</b>	1500	1500	1500	1500	1500	1500
<b>dR2C (Km)</b>	2000	2000	2000	2000	2000	2000
<b>dC2REM (Km)</b>	440	440	440	440	440	440
<b>dR2EoL (Km)</b>	400	400	400	400	400	400
<b>Env. Impact</b>	55,87018063	9,40907690	11,97240132	5,34263519	18,01528006	4,79837551

	7. Shift Mechanism	8. Cross Shaft Case	9. Left Shaft Relay	10. Contershaft Relay	11. Mechanical Control Relay	12. Lubrication
nt	2	2	2	2	2	2
$\rho$	40%	40%	40%	40%	40%	40%
$\lambda$	60%	60%	60%	60%	60%	60%
$\Delta$	10%	10%	10%	10%	10%	10%
$\eta$	60%	60%	60%	60%	60%	60%
<b>Transp_Type</b>	Transport, 16-32t	Transport, 16-32t	Transport, 16-32t	Transport, 16-32t	Transport, 16-32t	Transport, 16-32t
<b>Mat_TYP</b>	Steel 25CrMo4 I	Aluminium, produ	Steel 25CrMo4 I	Steel 25CrMo4 I	GS-X40CrNiSi 25	GS-X40CrNiSi 25
<b>Mat_QUANT</b>	6,50	50,00	26,00	19,50	6,50	6,50
<b>PMR (%)</b>	10%	10%	10%	10%	10%	10%
<b>PML (%)</b>	23%	23%	23%	23%	23%	23%
<b>PiRP(%)</b>	100%	100%	100%	100%	100%	100%
<b>Recur_TYPE</b>	LC Phase	LC Phase	LC Phase	LC Phase	LC Phase	LC Phase
<b>Recur_QUANT</b>	LC Phase	LC Phase	LC Phase	LC Phase	LC Phase	LC Phase
<b>dM2T (Km)</b>	1500	1500	1500	1500	1500	1500
<b>dM2B (Km)</b>	1350	1350	1350	1350	1350	1350
<b>dM2A (Km)</b>	1500	1500	1500	1500	1500	1500
<b>dR2C (Km)</b>	2000	2000	2000	2000	2000	2000
<b>dC2REM (Km)</b>	440	440	440	440	440	440
<b>dR2EoL (Km)</b>	400	400	400	400	400	400
<b>Env. Impact</b>	4,798375513	33,05660762	21,37054077	16,02790558	7,948045463	7,957573454

**TOTAL 196,566998**

Table 3 - 5: Parameters values for the initial scenario – Gearbox example

Table 3-5 also presents the quantity mass of materials and type of materials used to the manufacturing of each component; as well as each parameter that represent a variation on the material mass, and the variation of distance from one site to another one. In other side; parameters like the resources used in each life cycle of the gearbox are variables depending of the processes used in the correspondent phase.

## 5.2. SENSITIVITY ANALYSIS

### 5.2.1. MATERIAL PARAMETERS IN THE TOOL

Once the scenario 0 data fixed; the sensitivity analysis starts. The values for the parameters have been changed one by one. This brings an estimation of how parameters influence the final results of the methodology evaluation from an environmental point of view. To propose a realistic scenario, the main characteristic of the components have been considered in detail; the reason is that the gearbox is composed by a diversity of components with a diversity of characteristics from the design process. As example; when designers remake the selection of material or regard the calculation of the material mass for each component, the new data from those calculations are assessed by the model.

	Scenario 0 No Mat Reduc	Scenario Mass Reduc 10%	Scenario Mass Reduc 20%	Scenario Mass Reduc 30%
1. Transmission Case	55,87018063	50,92432566	45,9784707	41,03261573
2. Input Shaft	9,40907690	8,59319602	7,77731513	6,961434243
3. Jack Shaft	11,97240132	10,94186359	9,911325867	8,88078814
4. Tachometer Take-Off Point	5,34263519	4,89032662	4,438018045	3,985709471
5. Countershaft + Reverse	18,01528006	16,38045446	14,74562886	13,11080326
6. Connecting Strip, Brackets	4,79837551	4,40049291	4,002610301	3,604727695
7. Shift Mechanism	4,79837551	4,40049291	4,002610301	3,604727695
8. Cross Shaft Case	33,05660762	30,07152840	27,08644919	24,10136998
9. Left Shaft Relay	21,37054077	19,56130647	17,75207218	15,94283788
10. Countershaft Relay	16,02790558	14,67097986	13,31405413	11,95712841
11. Mechanical Control Relay	7,94804546	7,23519586	6,522346261	5,809496661
12. Lubrication	7,95757345	7,24377105	6,529968654	5,816166255
<b>TOTAL</b>	<b>196,56699800</b>	<b>179,31393381</b>	<b>162,06086961</b>	<b>144,80780542</b>

Table 3 - 6: Comparison of the mass reduction scenario – Gearbox example

Table 3-6 shows the environmental impact calculation of the gearbox product life cycle considering a reduction of material. In order to set the data of the scenarios of Table 3-6, scenario 0 have been taken as a main referencial scenario; this means that the unique parameters that have been varied is the mass; from a reduction of 10 % through a reduction of 30% considering the total mass of each component. Figure 3-14 presents the results of the comparison of those scenarios in a graphical way. It is possible to highlight that a reduction of 30% of the total mass of the gearbox implies a reduction of 52 ecopoints in the total environmental impact (a reduction of the 36% of the environmental impacts).

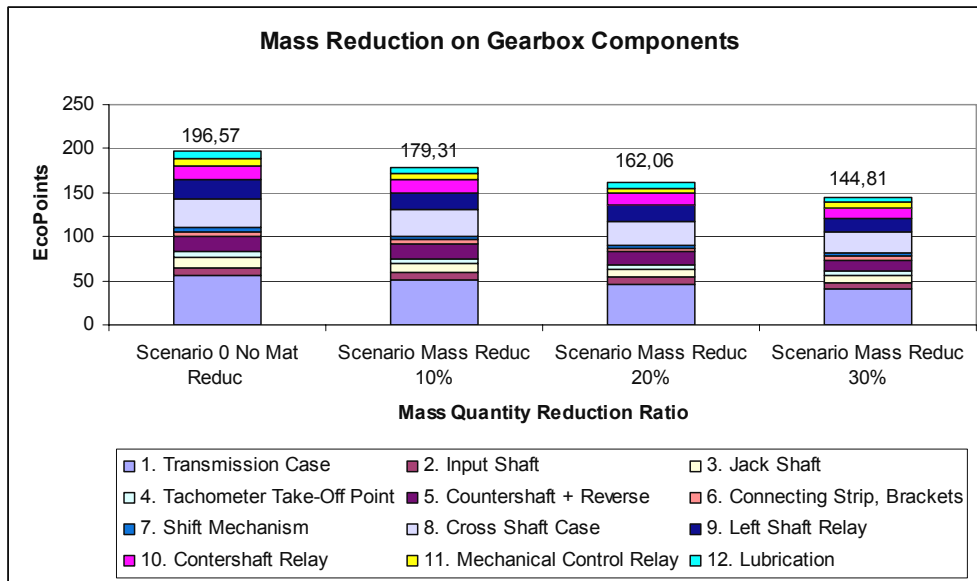

Figure 3 - 14: Environmental Impacts on the Gearbox Life Cycle – Mass Reduction

The type of material can also be an important axe in order to improve the performance of the gearbox. Figure 3-15 shows the environmental impact calculation of the gearbox product life cycle considering aluminium cast alloy and steel chromium-mollidenum alloy in the scenario 0 which considers a mix of both materials. The results of the comparison of those scenarios shows that using all the components on steel chromium-mollidenum alloy reduces in almost 40 ecopoints (a reduction of the 22% of the environmental impacts). However, this selection must be validating in the impact assessment of a more complex product like the truck. Changes of material on the gearbox could imply on a transfer of the environmental impact to other product lifecycle phase. Furthermore, to realize this evaluation, it is necessary to have a reliable data of the environmental impacts of the materials options for the components.

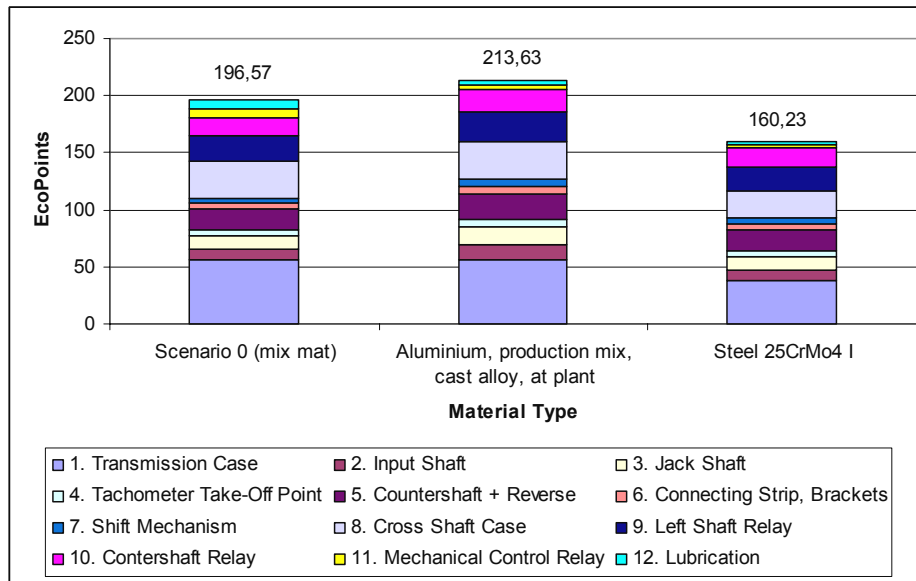

Figure 3 - 15: Environmental Impacts on the Gearbox Life Cycle – Variation of type of material

### 5.2.2. NUMBER OF USE CYCLES “ $n_t$ ” PARAMETER

The initial scenario (scenario 0) is limited to appreciate the environmental gain; due to a quite low performance of the reverse logistic and remanufacturing. For this reason; other scenario has been defined. The number of times that their components can cross through the reconditioning system starts at  $n_t=2$ . The number of products considered as non collectable ( $\rho=0\%$ ). The gearboxes are recovered at 95%. The product recollected by the reverse logistic could be qualified as good ( $\lambda=90\%$ ). The percentage of cores destined to recycling after warehousing inspection is low ( $\Delta=10\%$ ). Finally, to define the whole parameters of the remanufacturing model, the performance of the product reconditioning is good ( $\eta=95\%$ ).

This scenario tries to extend the product life cycle of the components in the gearbox. Here it is important to highlight that a component that goes through the remanufacturing process needs additional material and other supplies in the process. Closed loop life cycle assessment considers this dynamic in adding the environmental impacts of additional material and resources for the components with additional life cycles. Figure 3-16 shows the decrease of the environmental impacts on each component when the parameter  $n_t$  is modify. This relation is interesting because it is possible to appreciate there exist no linear decrease of the environmental impacts and the  $n_t$  values. Furthermore, this model can be used to find the limit of  $n_t$ ; from which, it is possible to obtain another use cycle; does not means there is a gain from the environmental point of view.



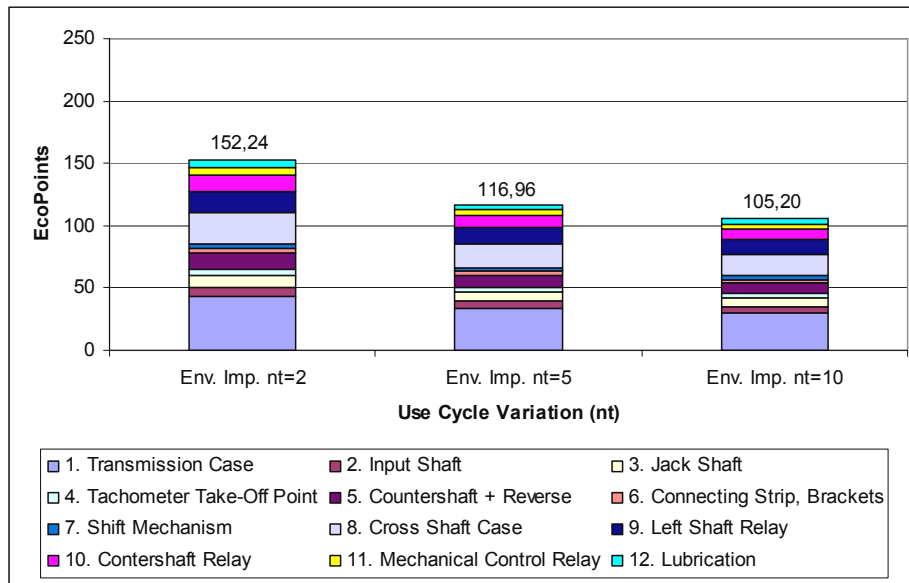

Figure 3 - 16: Environmental Impacts on the Gearbox Life Cycle – Variation of the use cycles number

### 5.2.3. PERFORMANCE FOR REMANUFACTURING PROCESS

The remanufacturing process is part of the possible scenarios at the product end of life. This specific phase integrates parameters that affect the process and parameters that affect the remanufacturing product model. To a better understanding an example is presented: the material not in good technical conditions at the end-of-use is replaced by new material, the ratio of the new material related to the total material of the product disturbs the end-of-life product phase as well as the raw material extraction phase.

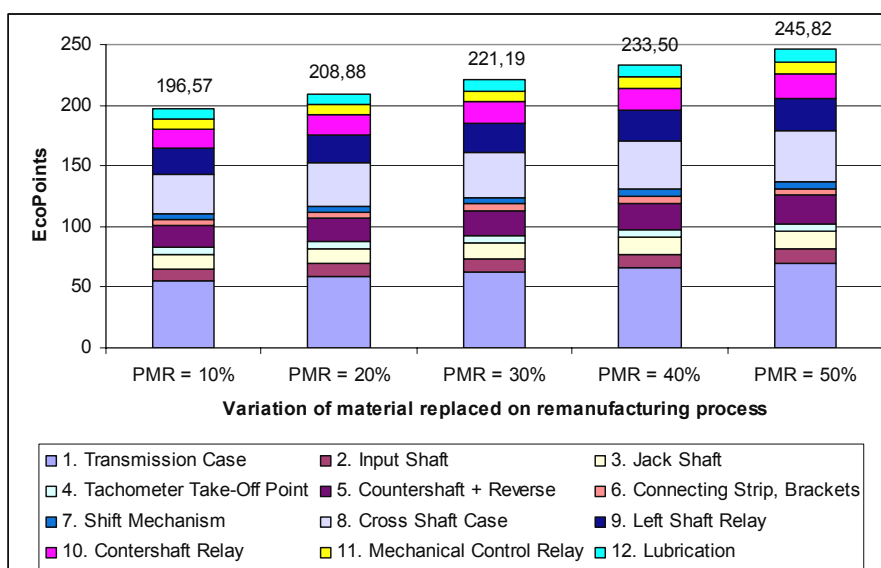

Figure 3 - 17: Environmental Impacts on the Gearbox Life Cycle – Variation of PMR

Figure 3-17 shows the environmental impact calculation of the gearbox product life cycle considering a variation on the ratio of the material replaced at the remanufacturing process. More material is replaced in this process; the products have not been designed for this process which corresponds to an increase on the total environmental impact of the gearbox.

To make the difference with the performance of the remanufacturing process, which is a parameter of the product model, a better performance of this parameter, the model gain in fewer cores that go through the remanufacturing process and fail at their reconditioning. Figure 3-18 shows the environmental impact calculation of the gearbox product life cycle considering a variation on the performance of the remanufacturing process.

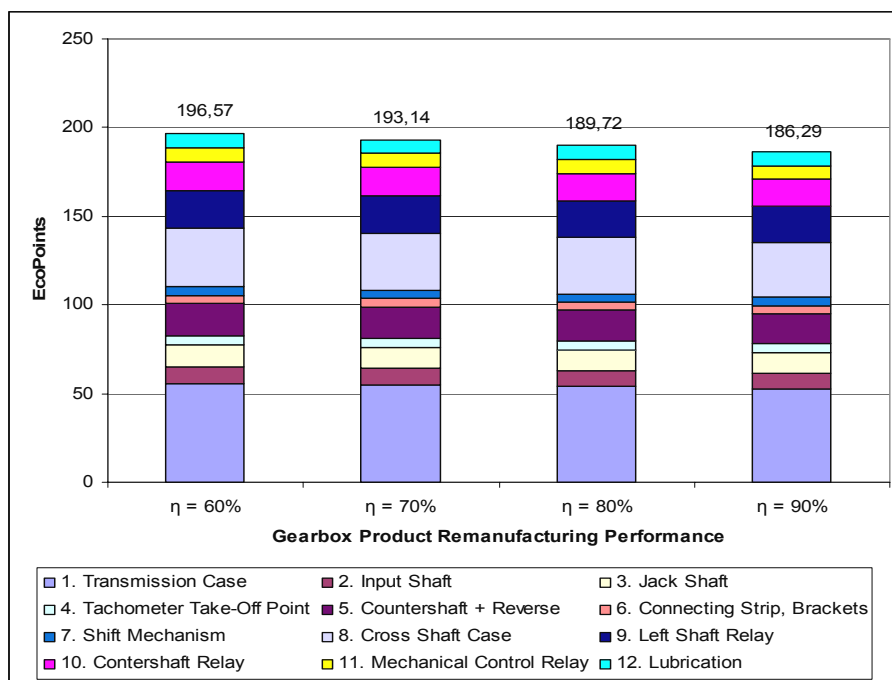

Figure 3 - 18: Environmental Impacts on the Gearbox Life Cycle – Variation of  $\eta$

## 5.2.4. TRANSPORT PARAMETERS

Table 3-6 shows the environmental impact calculation of the gearbox product life cycle considering the variation of the distance at the distribution of the gearbox. Figure 3-19 presents the results of the comparison of those scenarios in a graphical way; in here it is possible to highlight that a reduction of the distance for the distribution of the gearbox implies reduction of the global environmental impacts.

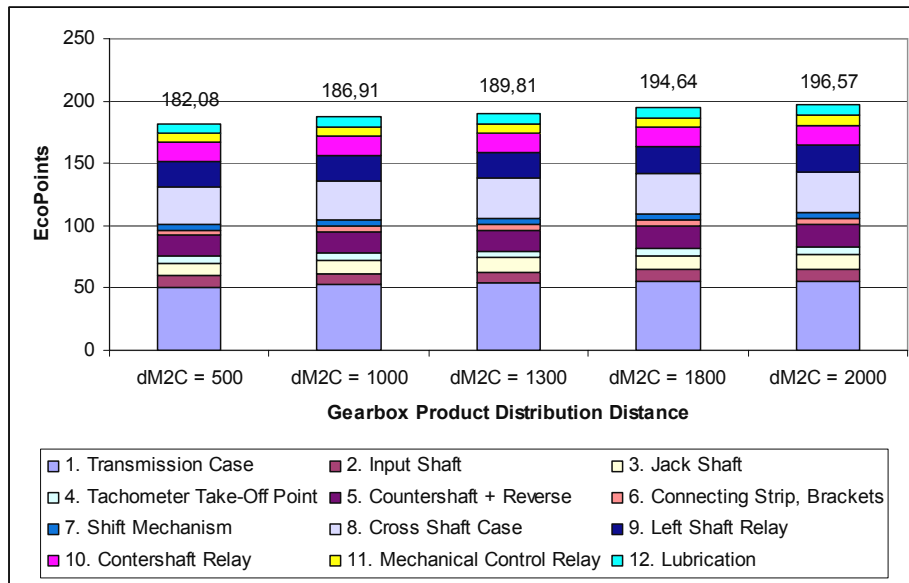

Figure 3 - 19: Environmental Impacts on the Gearbox Life Cycle – Variation of the distance for product distribution

Figure 3-20 shows the environmental impact calculation of the gearbox product life cycle considering other type of transports.

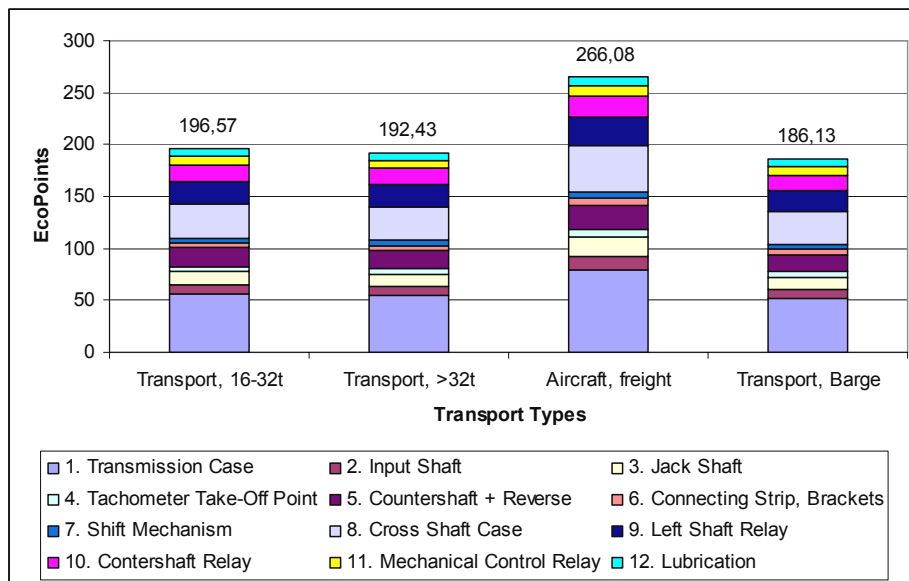

Figure 3 - 20: Environmental Impacts on the Gearbox Life Cycle – Variation of the type of transport distribution

### 5.3. PARAMETERS MIX SENSITIVITY ANALYSIS

To clarify the environmental impacts, it is also necessary to assess the dependence of the parameters in the model. This analysis should compare the scenario 0 with another scenario where several parameters change according to coherent hypothesis.

This scenario is known as “IMPROVEMENT scenario”. The products in here are designed for several times of reconditioning, this means a higher number of use cycles ( $n_t=4$ ); the gearboxes are able to be reconditioned three times. A better system of reverse logistic is offered ( $\lambda=70\%$ ). This aspect motivates customers to contact the remanufacturers instead of dispose the products at the end-of-use by themselves ( $\rho=10\%$ ). The percentage of cores destined to recycling after warehousing inspection is the same than the scenario 0 ( $\Delta=10\%$ ). Finally, to define the whole parameters of the remanufacturing model; the performance of the product reconditioning is good ( $\eta=80\%$ ). All the data of the IMPROVED scenario is detailed on table 3-7.

The comparison of those scenarios is to try to extend the product life cycle of the components in the gearbox. Figure 3-21 shows a gain of almost 40 ecopoints (a reduction of 22% of the environmental impacts). This comparison also highlights the environmental gain obtained by incrementing the number of uses for the product.

**Scenario IMPROVEMENT**

	1. Transmission Case	2. Input Shaft	3. Jack Shaft	4. Tachometer Take-Off Point	5. Countershaft + Reverse	6. Connecting Strip, Brackets
<b>nt</b>	4	4	4	4	4	4
<b><math>\rho</math></b>	10%	10%	10%	10%	10%	10%
<b><math>\lambda</math></b>	70%	70%	70%	70%	70%	70%
<b><math>\Delta</math></b>	10%	10%	10%	10%	10%	10%
<b><math>\eta</math></b>	80%	80%	80%	80%	80%	80%

	7. Shift Mechanism	8. Cross Shaft Case	9. Left Shaft Relay	10. Contershaft Relay	11. Mechanical Control Relay	12. Lubrication
<b>nt</b>	4	4	4	4	4	4
<b><math>\rho</math></b>	10%	10%	10%	10%	10%	10%
<b><math>\lambda</math></b>	70%	70%	70%	70%	70%	70%
<b><math>\Delta</math></b>	10%	10%	10%	10%	10%	10%
<b><math>\eta</math></b>	80%	80%	80%	80%	80%	80%

Table 3 - 7: Parameters for IMPROVEMENT Scenario.

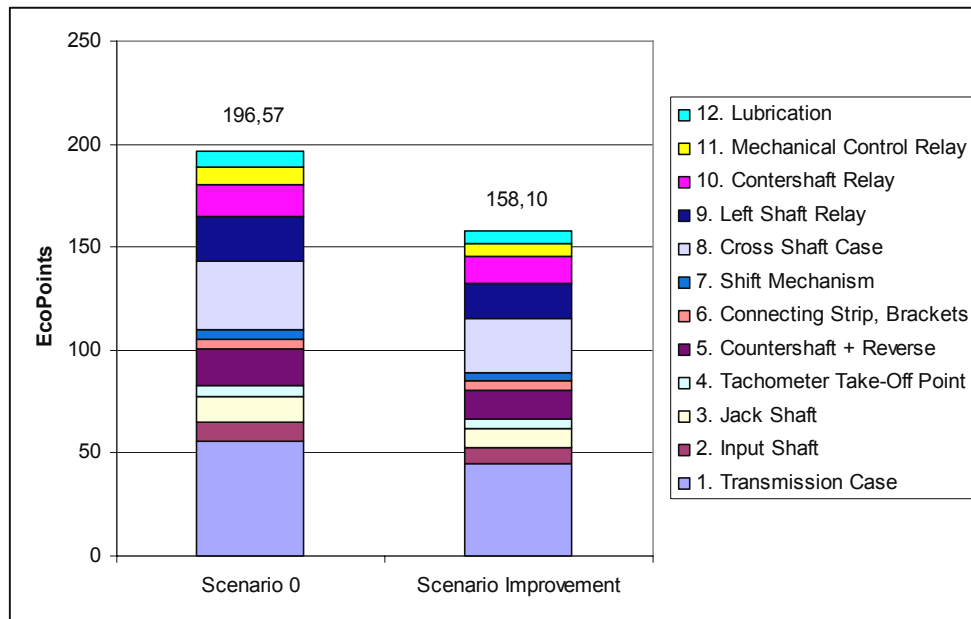

Figure 3 - 21: Environmental Impacts on the Gearbox Life Cycle – Scenarios Comparison

## **6. CONCLUSION OF CHAPTER 3**

In this chapter, it has been identified parameters to characterize remanufacturing product lifecycle. Then, it was defined a model that ables to support data for LCA using the concept of LCA bricks.

It was showed that the model is affected by many parameters variation and that it could provide good indicators to designers during the whole desing process.

So, this approach should help designers to make decision for the product design but also for its life cycle design. This approach can be used now to make decision concerning the remanufacturing of components.



## Chapter 4

# Life Cycle Model Approach for Multiple Usage Products – PSS Considerations



<b>1. Introduction</b>	<b>111</b>
<b>2. Characterization of pss from an engineering point of view</b>	<b>112</b>
2.1. PSS product requirements	112
2.2. PSS service requirements	113
2.3. Global PSS requirements	114
<b>3. An environmental impact model for pss</b>	<b>116</b>
3.1. Life cycle functional unit definition	116
3.2. The life cycle description	117
3.3. PSS design considerations	119
3.4. Environmental impact calculations	120
<b>4. System definition in pss design</b>	<b>123</b>
4.1. Elements of the PSS	123
4.2. Links between PSS elements and design parameters	124
<b>5. Velo’v Case Study</b>	<b>127</b>
5.1. A life cycle assessment tool for PSS business models	127
5.2. The life cycle assessment tool for PSS	128
5.3. Scenarios for the different PSS elements	129
5.3.1. Design parameters and environmental impacts	131
<b>6. Conclusion of Chapter 4</b>	<b>133</b>

Figure 4 - 1: Product Life Cycle for the PSS_____	117
Figure 4 - 2: Technical life time ( $t_{tl}$ ) versus service provision time ( $t_{sp}$ ) products scenarios_____	118
Figure 4 - 3: Services in the product use phase of the PSS _____	121
Figure 4 - 4: Examples of PSS elements in Bicycle Sharing_____	124
Figure 4 - 5: Use states in the case of bicycle sharing_____	126
Figure 4 - 6: Environmental Impacts for the Velo’V PSS Life Cycle_____	129

Table 4 - 1: PSS products requirements _____	113
Table 4 - 2: PSS services requirements _____	114
Table 4 - 3: PSS global requirements _____	114
Table 4 - 4: Effects of strategy requirements on the PSS parameters _____	125
Table 4 - 5: Parameters for the Velo'V Scenario _____	128
Table 4 - 6: Parameters of the Velo'V Scenario _____	131
Table 4 - 7: Environmental Impact of the PSS _____	132

## 1. INTRODUCTION

“Sustainability” has been defined as: “the ability of current generations to meet their needs without compromising the ability of future generations to meet their own needs” [Directive 2002/96/EC 03]. The concept is based on three pillars: environmental protection, economic growth and social equity.

Currently, there exists an enormous interest to define new strategies for sustainable development, especially when it involves the reuse of components with high added-value. Industrials, confronted to the market pressure, with customers who always want better technologies, generate more and more products with accelerated obsolescence. However, many components and products could be reused several times by different users when the relevant issue is to accomplish a predetermined service. In that case, strategies as PSS could help with new approaches. Today, such PSS strategies have to demonstrate their economical interests but they also have to demonstrate their environmental interest.

One of the aims of PSS strategy is the intensification of the product use with better availability of the product or with several users instead of only one user at a particular moment. The economic interest comes from the fact that the services provided by the products included in the PSS generate more economical gains. It should be the same for the environmental interest but, it is necessary to assess the whole life cycle to verify that environmental impacts don't increase by the use of maintenance processes or by inappropriate use by certain customers. Indeed, the environmental impacts of products are not only related to the material consumption in the manufacturing phase, or to the manufacturing process itself. Environmental impacts are also strongly related to the way they are used all along their lifecycle. However, those strategies could generate non negligible environmental impacts if they are wrongly implemented or generate appreciable environmental benefits when properly implemented. So, PSS strategies have to be precisely described and specific models have to be developed for their environmental assessment.

## **2. CHARACTERIZATION OF PSS FROM AN ENGINEERING POINT OF VIEW**

A PSS can be seen as a marketable set of products and services capable of jointly fulfilling user's needs [Tukker A. and al. 06]. This definition confers the character of a business model concept to PSS, in which companies replace selling of a product by functionality in the form of a service. In this strategy, the manufacturing companies would retain the ownership of their products and 'trade' the functionality to customers, for example on a relative 'per unit basis'. For the characterization of a PSS offer, we have adopted different requirements developed by authors. Those requirements will be grouped according to the products included in the PSS, to the Services provided and to the global PSS offer.

### **2.1. PSS PRODUCT REQUIREMENTS**

PSS seeks to improve the use phase through different services such as intensified use, improved maintenance, etc. Multiple uses imply that new requirements have to be checked. Indeed, a product introduced in the market in a PSS offer is not designed with the same requirement list as products introduced with a classic business model [Maussang N. and al. 09]. Lifecycle extended products highlight the aspect of sustainability [Meier H. and al. 10] by preserving the usability (product's main function) of the PSS offers, which can be achieved by a higher level of accompanying services.

Moving deeper into the PSS offer, it is possible to highlight the necessity to verify process capability in the model. This capability affects all the product life cycle actors (innovation, logistics, resources, firm performance...) [Yang C. and al. 09]. Inside this capability process definition we can relate the capacity planning [Georgiadis P. and al. 10] of the business model. The importance of all the aspects of capacity planning in product recovering networks is not only associated to the end-of-life of the products. In the PSS offers, product with multi-users should integrate a robust system of recovery. Capacity planning represents also an interest for planners. PSS aims to replace the satisfaction offered by a product and by a service; therefore it is important to undertake capacity planning of such services.

Robust Product Life Cycle Management has to be developed to consider process and business systems with the objective to structure solid product information that extend the period of the product lifecycle. Several approaches have been proposed for this [Kiritsis D. and al. 03]. Indeed, products at their end-of-use that are to be reused an unknown number of

times must be robust enough to go across the recovering process and enter other use phases. Operating stability and robustness cause direct impacts on the quality of the product or system output [Geng X. and al. 11] [Di Mascio R. 03]. Considering life cycle issues, modular design [Yu S. and al. 11] is also helpful for improving whole life cycle performances.

To conclude, other characteristics and requirements for products in PSS offers have been described in literature, like simplicity in the design, upgradability, etc. The most important ones are listed in the table 1.

<b>PSS Services Requirements</b>	Prolonged product lifecycle
	Disassembly planning
	Process capability
	Capacity planning
	Robustness
	Time of the process
	Modular structure
	Design simplicity
	Technical specifications –Tolerances
	Testing required
	Design for disposal
	Technical obsolescence
	Upgradable
	Suppliers/parts
	Reliability

Table 4 - 1: PSS products requirements

## 2.2. PSS SERVICE REQUIREMENTS

PSS strategy aims to decrease the necessary efforts to make the product function while increasing the number of possible use phases. When this is properly implemented, the results would be perceived by drastically reducing the overall impacts on the environment for each use.

So, PSS models have to consider two main aspects: the function of the product, with the idea of satisfying the customer with the provision of the required service and the related technical services to satisfy each customer’s requirements. Classical product sale models confer property to the customer so that the planning program and the necessity for maintenance to optimize the product lifecycle are taken in-charge by the customers. Nowadays, customer requirements are more related to reliable preventive maintenance and technical support [Di Mascio R. 03]. Product oriented services and preventive maintenance are seen as strong contributors for PSS [Aurich J. C. and al. 06] [Takata S. and al. 04].

Another requirement directly connected to preventive maintenance is the contract facilities between the supplier and the customer [Richter A. and al. 10]. Advising and consultancy are

required in PSS strategy to provide advice on the product service system. Consulting could be done for environmental, management or maintenance concerns. Consultancy strengthens close relations between producers and customers. For instance, the PSS offer will require advice or consulting in order to favour correct use [Williams A. 07]. The advice and consultancy provider gives recommendations to focus on more efficient use of the product, provision of system consumables, etc.

Some PSS offers are designed for specific customer necessities. The customization of the services involves the use of technology to accommodate the differences between the offers. There must be a description carried out individually for each customized PSS [Schweitzer E. and al. 10].

Customers' needs have to be translated into expectations. These expectations must be met by the delivery of functional results. Basic results concerning the main function of the components, modules or products have to be defined and improved at the use phase to justify the use of a PSS [Maxwell D. and al. 06]. Finally, the requirements for services in a PSS offer are listed in the table 2.

<b>PSS Services Requirements</b>	Preventive maintenance
	Customized service
	Advising / consultancy
	Outsourcing
	Controllable
	Delivering functional result

Table 4 - 2: PSS services requirements

### 2.3. GLOBAL PSS REQUIREMENTS

The complementarities of products or service sale approaches suggest that the adoption of product plus service system offerings could significantly gain from the introduction of products robust enough to be able to provide their functional result with different customers or user activities (customer behaviour). Whatever the product-service systems are, each one presents specific characteristics that must be considered in order to fully support meaningful delivery. The sharing concept intensifies the use of the products and hence efficient use [Tukker A. and al. 06]. Table 3 lists the requirements that PSS offers should perform in order to agree with multi-user expectations and service designer needs.

<b>PSS General Requirements</b>	Planning in the supply
	Efficiency improvements
	User behaviour

Table 4 - 3: PSS global requirements

New requirements related to PSS have been identified from an engineering point of view. These requirements are necessary to establish the products or services to be developed in the PSS offer to satisfy customer needs. The interest, from the environmental point of view, is that PSS involve the intensification of the use of the product: with the usage of the same product by several users (sharing); with the improvement of the availability ratio of the product, or by the both [Maxwell D. and al. 06]. This means that if the PSS provides the same service as classical product-maintenance with an equivalent consumption of resources, the PSS will have lower global environmental impacts compared to the traditional sale. If it is not the case, it becomes necessary to pay attention to the benefits obtained by the intensification of use. They would not be absorbed by the environmental over-costs related to the installation of the new solutions (services and products).

The next section presents a model for environmental assessment of a PSS. The parameters used in the model will be described. The parameters will simplify the environmental evaluation task.



### 3. AN ENVIRONMENTAL IMPACT MODEL FOR PSS

PSS have to be modelled and assessed from the environmental point of view by design teams to gain better understanding of their overall performance. Environmental Impact assessment should be done in accordance with the Life Cycle Assessment (LCA) methodology normalized in ISO 14040. However, ISO guidelines do not provide specific recommendations on how to proceed with the calculation of environmental impacts for “non classical” life cycle strategies [Adler and al. 07] and little or no research effort has focused on the life cycle assessment of PSS strategies. In this paragraph an approach is proposed to establish a clear environmental assessment of PSS. The aim of the assessment is to be able to compare PSS approaches during their design process and also to compare them to “classical” offers of the sale of a product. The starting point to establish comparison is related to the definition of the functional unit. Then, the life cycle model will be described and used to support calculation of environmental impacts presented in the last part of this section. In what follows, the “product” will denote the principal part of the PSS that replaces the “product for sale” (as opposed to infrastructure and support equipment for example).

#### 3.1. LIFE CYCLE FUNCTIONAL UNIT DEFINITION

To perform LCA for a PSS and to be able to compare it with others alternatives, it is necessary to define the functional unit (FU). The FU is the core of the life cycle assessment. It provides the reference in terms of elements to evaluate and identifies the frontier of the study. The FU should be, as far as possible, related to the *functions* of the product, service or PSS, rather than to the physical product. In order to assess or compare a PSS offer with the classical sale of a product it is strongly recommended to define equivalent FU. With this in mind, the proposition is to characterize the FU by the following elements of the PSS:

- Description of the quality of the service provided by the PSS; in terms of availability of the service. (see section 3.3)
- Time for each use ( $t_u$ ). Use can be characterized by a time or a quantity of use (distances, number of turns...), but here it is converted into time.
- Service provision time ( $t_{sp}$ ). It represents how long the PSS offer is available on the market (obsolescence of the service). The service provision can be characterized by a time or a quantity of use (distance, number of turns...), but here it is converted into time.

- Number of times the PSS is used ( $n_{u,i}$ ) by each individual user.
- Total number of different users ( $U$ ) of the PSS.

### 3.2. THE LIFE CYCLE DESCRIPTION

A life cycle model for the PSS is presented in figure 4-1. As for remanufacturing (section 2) the different flows between the life cycle phases are represented by arrows and each life cycle phase is represented by a rectangle with its name inside. Five generic phases have been used to model the lifecycle: Raw material extraction, Product manufacturing, Product distribution, Use phase and End-of-life. The raw material extraction phase includes the EI for the material extraction and the transport for initial material processing as well as the EI for the preliminary material process and the transport to the components manufacturing plant ( $EI_{\text{raw\_material}}$ ). The product manufacturing phase includes the EI for the manufacturing processes and transport to the product assembly plant ( $EI_{\text{manufacturing}}$ ). The product distribution includes EI for the transport to the customer/user ( $EI_{\text{distribution}}$ ). The use phase includes EI for resource consumption during use ( $EI_{\text{use}}$ ) and the End-of-life phase includes the EI for all recycling processes and the necessary transport ( $EI_{\text{end-of-life/use}}$ ).

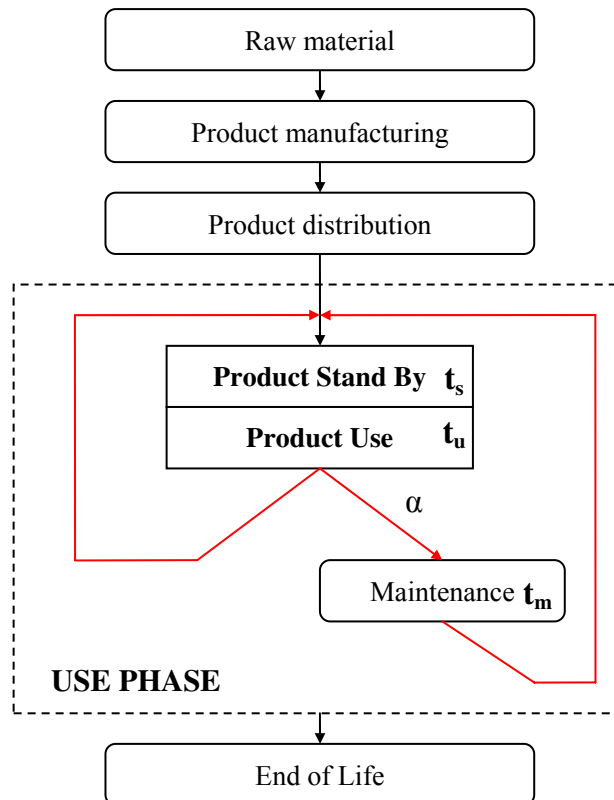

Figure 4 - 1: Product Life Cycle for the PSS

The use phase covers three stages:

- a stage of use, where a number of uses of each product ( $n_u$ ) during the life time of the product is considered, each usage being characterized by a time ( $t_u$ )
- a stage of maintenance, where the mean time for preventive maintenance ( $t_m$ ) is considered along with the expected ratio of products ( $\alpha$ ) that characterize the need for maintenance due to broken parts or degradations or for providing better services.
- a stage of stand-by where the available service is unused. Some products must be on stock in order to provide a minimal level of service for all the users (stock balance), the time the products will be on stock is  $t_s$ . This stage will be used to characterize the availability of service in Section 3.3.

Intensification of use occurs when, everything else being stable in the system, the total number of times that the PSS is used ( $U_T$ ) increases or if  $t_s$ ,  $t_m$  and  $\alpha$  decrease while maintaining the same quality of service.

The intensification of use is also influenced by the technical life time ( $t_{lt}$ ) of the products necessary to run the PSS. If the technical life time ( $t_{lt}$ ) is longer than the time for service provision ( $t_{sp}$ ) the products are capable of guaranteeing the PSS offer on the market during the expected  $t_{sp}$ . If the time of the service provision ( $t_{sp}$ ) is longer than the technical life time ( $t_{lt}$ ) then the products used in the PSS are not capable (robust enough) to support the offer during the time that the PSS is on the market. In order to maintain the same quality of service, new products able to satisfy exigencies have to replace worn out products, as long as  $t_{sp}$  is not fully covered.

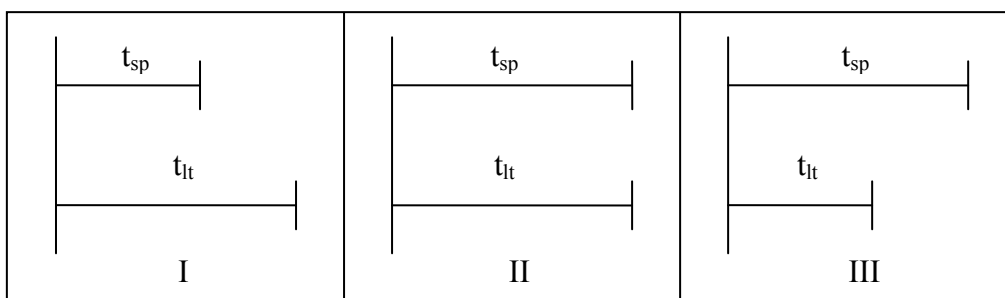

Figure 4 - 2: Technical life time ( $t_{lt}$ ) versus service provision time ( $t_{sp}$ ) products scenarios

Figure 4-2 represents technical life time scenarios. In the first two cases; the technical life times of the products are able to support the demands during service provision. In the third case the technical life time of the products requires more products with the same characteristics to fulfil service provision. To obtain the total number of products that are

necessary in the PSS; the number of products will be adjusted by the ratio  $\tau = \frac{t_{sp}}{\min(t_{sp}, t_{lt})}$ ;

that takes into account the wearing effect of time for all the possible scenarios.

### 3.3. PSS DESIGN CONSIDERATIONS

The equations defined in this section will assist designers in defining PSS strategies and controlling the life cycle properties. During the design process many lifecycle options are developed and it is necessary to determine the best ones, or at least avoid the worst cases, for the environment.

To be able to compare a PSS strategy to other strategies such as the sale of a product, the calculations are established for each usage. General assumptions are made to be able to calculate the environmental impacts.

The total number of products “N” is a value to be determined during the design process of the PSS. This means that N will be determined as a function of the number of times the PSS is used by user ( $n_u$ ) for a time  $t_u$ , and the time each product will be on stock ( $t_s$ ). The number of products in maintenance will be a function of the robustness of the product, and its optimization should be regarded as a maintenance management problem. Once the total number of products in the PSS is validated by the service provision conditions, the number of products can be expressed by a function of the products in use, in maintenance and on stand-by at one time, as follows:

$$N = (N_u + N_m + N_s) \times \tau$$

where  $N_u$  represents the products in use in the PSS and is calculated from the equation

$$N_u = \frac{n_u \cdot t_u}{n_u \cdot t_u + \alpha \times n_u \cdot t_m + t_s} \times N$$

$N_m$  represents the products on maintenance in the PSS and is calculated from the equation

$$N_m = \frac{\alpha \times n_u \cdot t_m}{n_u \cdot t_u + \alpha \times n_u \cdot t_m + t_s} \times N$$

$N_s$  represents the products on stand-by in the PSS and is calculated from the equation

$$N_s = \frac{t_s}{n_u \cdot t_u + \alpha \times n_u \cdot t_m + t_s} \times N$$

In addition, in the mathematical model, the number of times each customer uses the PSS ( $n_u$ ) will be given by the ratio of the total number of times the PSS is used ( $U_T$ ) by the number of different users ( $U$ ), according to the expression

$$U_T = n_u \times U$$

To precisely define the PSS model and to support designers, the number of times each product is used ( $n_u'$ ) throughout the service provision time is calculated as a function of the number of times each customer uses the PSS ( $n_u$ ). Considering the total number of users as a relation between the number of uses of the product and the number of products in the PSS offer, the number of uses of the products becomes a function of the variables mentioned above including the number of usages by each customer.

$$n_u' = \frac{U \times n_u}{N}$$

### 3.4. ENVIRONMENTAL IMPACT CALCULATIONS

The model proposed can now be used as a framework for EI evaluation in PSS offers. The equations defined in this section will assist designers in defining the impacts of the life cycle phases from an environmental point of view. They can then design to reduce, control and monitor the most impacting phases and the related processes. During the design process, many lifecycle options are developed and it is necessary to determine the best one, or at least avoid the worst ones for the environment.

Regarding the bibliographical research in section 5, chapter 2; the major studies on environmental assessment of PSS strategies list the potential advantages [Mont 02] obtained from the evolution from classical product sale to a product with added services. Other studies more recently simulate the different components of the PSS strategy [Komoto H. and al. 05]. Here, the idea is to define parameters to compare relative advantages of alternative scenarios in the product life cycle.

The present work aims to assess the potential advantages of the PSS offers considering the different elements of the system, stakeholders, etc. The environmental impacts will be evaluated using life cycle assessment methods, this means using the life cycle brick theory [Gehin. and al. 07] recommended for detailed evaluation of each lifecycle phase. The environmental impact assessment will consider that a proportion of the environmental impacts correspond to the activities and processes related to the product and that the rest is

a consequence of the services added during the use phase. Figure 4-3 shows some possible services during the use phase.

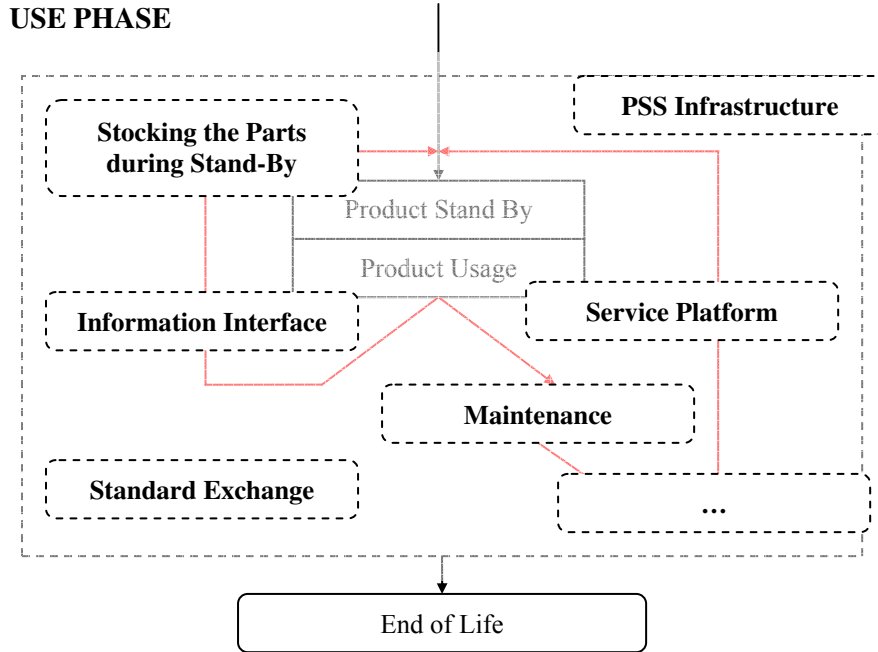

Figure 4 - 3: Services in the product use phase of the PSS

Therefore, if  $EI_{mat\_p}$  is the environmental impact necessary to extract material for one product involved in the PSS and  $EI_{mat\_s}$  is the Environmental impact for all the necessary material to provide the services; then  $EI_{mat}$  for one use of the PSS is:

$$EI_{mat}(luse) = \frac{(N_u + N_m + N_s) \times \tau}{U_T} EI_{mat\_p} + \frac{N_u \times \tau}{U_T} EI_{mat\_s}$$

If  $EI_{man\_p}$  is the environmental impact necessary to manufacture one product involved in the PSS and  $EI_{man\_s}$  is the Environmental impact necessary for all material manufacturing for the services then  $EI_{man}$  for one use of the PSS is:

$$EI_{man}(luse) = \frac{(N_u + N_m + N_s) \times \tau}{U_T} EI_{man\_p} + \frac{N_u \times \tau}{U_T} EI_{man\_s}$$

If  $EI_{eol\_p}$  is the environmental impact necessary for the End-of-Life of one product involved in the PSS and  $EI_{eol\_s}$  is the Environmental impact of the end of life of the services then  $EI_{eol}$  for one use of the PSS is:

$$EI_{eol}(luse) = \frac{(N_u + N_m + N_s) \times \tau}{U_T} EI_{eol\_p} + \frac{N_u \times \tau}{U_T} EI_{eol\_s}$$

If  $EI_{u\_p}$  is the environmental impact necessary for the use of one product involved in the PSS and  $EI_{use\_s}$  is the Environmental impact of the services then  $EI_u$  for one use of the PSS is:

$$EI_u(1use) = EI_{u\_p} + \frac{N_u \times \tau}{U_T} EI_{u\_s}$$

Depending on the results, designers will have to choose the correct strategies regarding the different parameters. They will also have to control the variations due to the calculation of the environmental impact for the products and services inside the PSS, but, the PSS parameters linked to the global organization of the PSS have also to be carefully considered.

## **4. SYSTEM DEFINITION IN PSS DESIGN**

### **4.1. ELEMENTS OF THE PSS**

PSS is often described as a system which includes physical objects and service units. These elements are structured with some kind of links that organize the system correctly. This organization assumes that the PSS is no longer limited to a physical product, but to functions, usage and results obtained from the implementation of a broader system, comprising service units, physical products, as well as the organizational links between them.

The main elements present in the PSS are: physical objects; service units (elements of the system); and the links used to correctly coordinate the offer (organization of the system).

#### **Physical objects**

The physical objects implied in the system are tangible entities which provide different technical functions. Generally, when referring to a product alone, the sale of the physical product takes place and the customer then satisfies his needs through ownership and total control of the use of the product.

A physical product, as an element in the PSS offer, contributes to the accomplishment of a functionality that participates in a larger system providing a service to the customer.

#### **Service units**

The service units are entities developed by designers and introduced in the PSS to facilitate the co-production, with the customers, of the value-in-use of the physical objects. The service units can also provide additional support functions to the customers or to the organization of the system. The service unit functions can be technical, for example repairing a physical object in the system, but can also provide other services like assistance to the customers, as for example, training for better use of the system.

The purpose of this unit is to provide the customer with the physical object necessary to fulfil his needs, as soon as he is ready to make use of it.

Service units can also include physical objects. For example, a mobile maintenance unit that moves to repair a physical object will require a vehicle, tools, etc. Such physical objects will appear during the detailed analysis of the service unit and its practical implementations.



### Organization of the system

To ensure the correct overall operation of the system, it is necessary to clarify the limits of the relations and the frontiers existing between the PSS's elements. Moreover, the activities carried out in the system are executed by the physical objects, the service units, and sometimes a combination of both. The concept of organization should be viewed as the set of relations that exist between the various elements of the system (physical objects or service units). This concept also joins the necessity to identify the main actors and partners implied in the PSS. Indeed, to integrate all the partners within the system and hence ensure correct progression of the service, it is necessary to detail the roles of each actor. This means that in order to precisely define the installation of the organization, whether to detail the bounds between the various elements and their operation within the system, or to define the role of the various partners, choices must be made during design of the global system. Figure 4-4 illustrates the different elements forming the system.

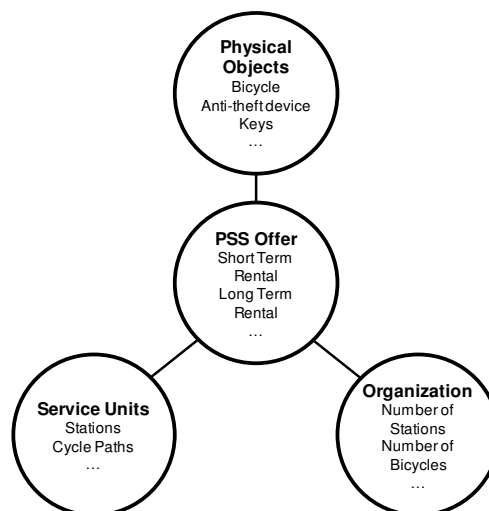

Figure 4 - 4: Examples of PSS elements in Bicycle Sharing

## 4.2. LINKS BETWEEN PSS ELEMENTS AND DESIGN PARAMETERS

The life cycle parametric model proposed in section 3.2 uses parameters that PSS designers can control and modify to assist decision making. An example of the links between the elements and the design parameter requirements for a PSS are listed in this section (table 4-4). For example, the number of times the PSS is used by each different user ( $n_u$ ) is influenced by the “prolonged product lifecycle”, as well as the quality of “technical specifications”, “technical obsolescence” and the fact that the product/service is “upgradable”, “reliable” and “customizable”, etc. These characteristics must be considered during the design of the products or the service units. Also, the expected ratio of products ( $\alpha$ )

that characterize the need for maintenance due to broken parts or degradations after each use is influenced by robustness, modularity, reliability, user behaviour, etc. When the design team needs to improve the value of  $\alpha$ , these different ways to improve the product exist.

	$n_u$	$t_u$	$t_m$	$t_s$	$t_t$	$t_{sp}$	$\alpha$
Prolonged product lifecycle	+	+				+	
Robustness					+		+
Modular structure			+				+
Technical specifications	+	+	+		+		
Technical obsolescence	+				+	+	
Upgradable	+		+		+	+	
Reliability	+	+	+	+			+
Preventive maintenance			+			+	+
Customized service	+	+	+	+			
Outsourcing			+				+
Delivering functional result	+	+					
User behaviour	+	+	+	+		+	+
High speed innovation	+					+	

Table 4 - 4: Effects of strategy requirements on the PSS parameters

By this way, designers will be able to select the right strategy to adopt for improving environmental benefits during the design process of the products. Considering the elements identified during the design of the PSS offer and the use phase states of the product life cycle, it is possible to construct different scenarios, depending on the relations existing between the PSS elements and the links between them. To show how complicated is to model a PSS offer from the user's point of view; Figure 4-5 shows the three main states of use of the product (use; maintenance and waiting) and the interactions with other elements of the PSS in the bicycle sharing example that will be introduced and evaluated in the next section. The model considers certain elements directly concerned with the use phase (number of bicycles in the system, number of bicycle stations, number of maintenance points, etc) and others that indirectly affect the use phase, the organization of the system (logistic strategy, total number of users in the market, service quality, etc.). The interactions and flows are not single way and their directions can reverse when the limits of the organization, service units or physical products are attained.

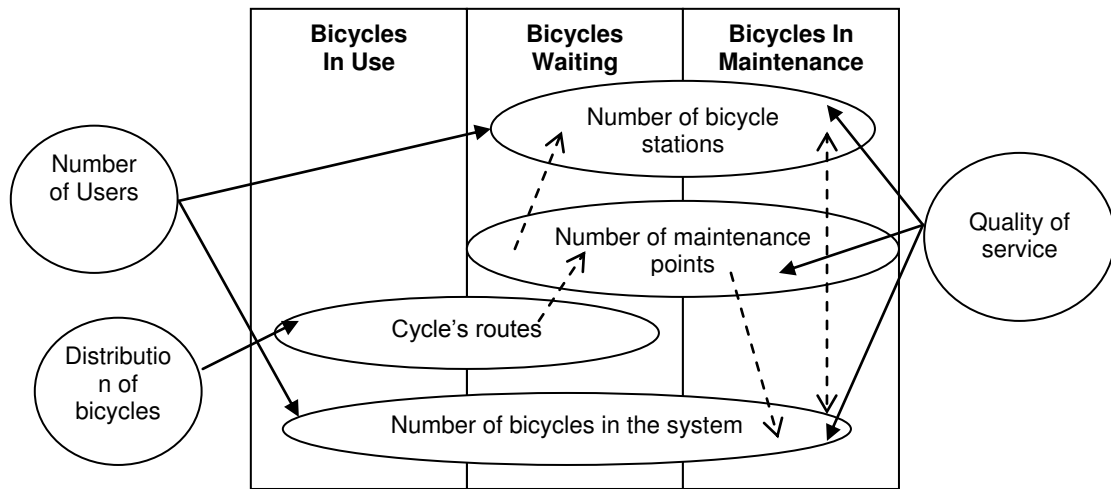

Figure 4 - 5: Use states in the case of bicycle sharing

## **5. VELO'V CASE STUDY**

The model has been used to evaluate the PSS strategy of the Velo'V offer in the city of Lyon. The PSS Velo'V offer was set up in May 2005. It is a system to rent bicycles to people travelling in the central area of Lyon. Using the bicycles requires a season ticket (1 year to 1 day) at a very low cost. Today, around 4000 bicycles can be taken out from the many stations in the city. A GPS system and pick-up trucks make sure that each bicycle station always has a sufficient number of bicycles available. A big advantage of this system is traceability and the data available from the stations provides information on all the trips. Records provide details of the location and times of trips, as well as exact trip distances measured by a counter on the bicycle. The average trip distance was, in 2007, 2.49 km and the average trip time, 14.7 min.

Due to the difference in lifetime compared to conventional bicycles (used even in classical renting systems), the products show an economical interest in the PSS strategy. However, no information exists on the environmental profits that this strategy is able to generate although the system should be optimised from this point of view. The main objective of this study is to compare the environmental assessment of different design alternatives and to use the results during the design process. The method can support changes in the business model or product requirements and open new perspectives for designers.

### **5.1. A LIFE CYCLE ASSESSMENT TOOL FOR PSS BUSINESS MODELS**

In order to describe the interactions existing between the customer and the system, it is necessary to employ use scenarios. These scenarios allow designers to describe all the activities undertaken by customers using the PSS.

The objective of the scenarios is to depict interactions between the customer and the system as well as within the system. Moreover, each activity has its own requirements. For example, the customer will not accept to wait more than 10 minutes to get a bicycle from any station in the system. The requirements can therefore be considered as constraints related to the activity.

Within the development framework of the PSS, there is a link between the lifecycle phases of the system and the customer activities. The customer will interact with the system mainly during the use phase. It is during this phase that it is possible to try to understand the

relations between customer activities and the elements of the PSS. For each customer activity, the designer will describe sub-activities, for example taking a bicycle out of the system or returning the bicycle back to the system. Considering the Velo'V system, the activities carried out during this phase are: borrowing a bicycle; transiting from one point of the town to another with the bicycle; returning the bicycle to a hiring station.

Using the data mentioned in the description of the Velo'v system, a FU can be defined by: 20000 users in the city of Lyon France; each user, on the average, requires a bicycle twice a day for 15 minutes each time; and the service must be available on the market for 3 years. With this definition it is possible to compare the environmental impacts of different scenarios. The parameters that define the Velo'v scenario are summarized in table 4-5.

Parameters	Units	Velo'V
Average number of times the PSS is used by each customer during the PSS provision time		1460
Average Time for each use	minutes	15
Average maintenance time for the bicycle	minutes	30
Average time bicycles are unused per year	weeks	7
Technical lifetime of the bicycle	years	1
Service provision time on the market	years	2
Total number of users		20000
Percentage of bicycles blocked in maintenance at any one time	%	30

Table 4 - 5: Parameters for the Velo'v Scenario

## 5.2. THE LIFE CYCLE ASSESSMENT TOOL FOR PSS

The PSS strategy process, just like the remanufacturing model presented in chapter 3, will model each system component or module in order to simplify the model and save time. Each component and model will consider its full product life cycle (from the raw material extraction to the end of life; figure 4-6); and each component will be represented in a database for each product life cycle phase, similar to the database used in the remanufacturing model (data of raw material, manufacturing processes, etc. This database contains all the necessary information to calculate the specific or global environmental impact of the product.

The environmental impacts represented in Figure 4-6 also consider components designed to support the service offers. These components must be considered while modelling the PSS strategy. All the material gains and losses have to be considered for parameterization together with other relevant parameters such as the distance from the different material and spare parts suppliers to the assembly plant or the type of transportation used, etc.

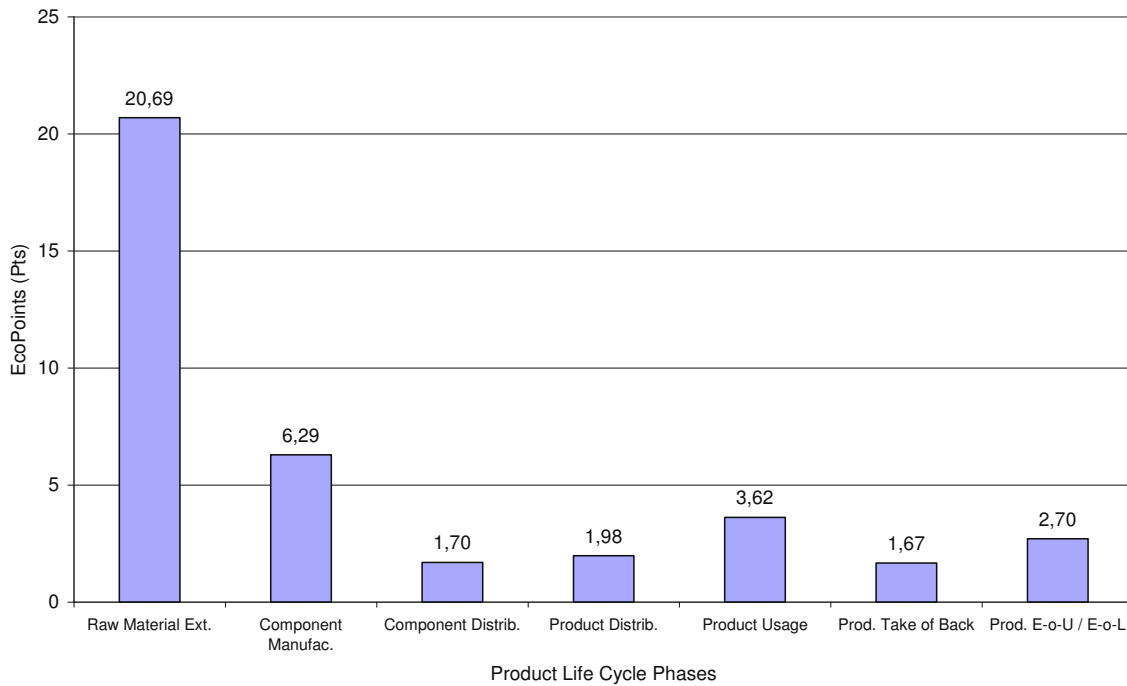

Figure 4 - 6: Environmental Impacts for the Velo'v PSS Life Cycle

The initial model must provide a first estimation of the global environmental impact of the whole PSS structure as well as the impact associated to each of the products. At the same time, this calculation will determine the environmental impact of the most significant product life cycle phases. Then, the objective is to minimize the most important environmental impact by the optimization of the use of the product by the PSS strategy.

### 5.3. SCENARIOS FOR THE DIFFERENT PSS ELEMENTS

Different scenarios can be imagined for the system. To compare their EI, it is necessary to assess the relative differences between the EI of the products and the services. To understand the influence of the different parameters, their variations are tested in the following scenarios:

- **Bicycle robustness:** Considering the evolution of the Velo'v study case from the beginning of the introduction of the service offer in the market in 2007, normal bicycles were initially used to fulfil the customers' needs. Approximately one year later; most of the bicycles in the system had to be replaced by new products. This showed that the products were not technically robust enough and that their technical lifetime was greatly reduced due to the extreme usage constraints that the PSS offer implied. In the beginning, PSS requirements did not consider users with random use behaviour. The

results indicated that the PSS significantly affected the product's technical lifetime and redesign of the product was necessary for reuse. Today, the PSS is provided with bicycles with a higher technical lifetime (3 years). This was obtained by modifying some of the components (mass, quantity and type of material). The differences between the use of normal bicycles and the redesigned bicycles (Velo'v) are presented in section 5.

- **Bicycle redistribution (Quality of the service):** The quality of service can be assimilated to the number of products available in each station. This means that a certain number of bicycles must be available to satisfy the potential customers. This condition can be met by the introduction of service units that support the redistribution of the bicycles to critical stations on certain hours. This means that the system needs specific units to relocate the bicycles from the stations with a high number of bicycles to the stations with a low number of bicycles.

On the other side, changing the number of service units that redistribute the bicycles also allows the optimization of the number of bicycles in the system. The variation could be significant if the distribution of the products in the PSS is good.

Another parameter that affects the quality of service (distribution of bicycles) is the time taken during the maintenance process. Due to different factors, like random use behaviour or vandalism, the number of bicycles in maintenance could be a high proportion of the total products in the system. By concentrating efforts on the number of maintenance stations and teams of preventive maintenance, this maintenance-time ratio could be reduced. Of course a large centralized maintenance station may be changed into two or more small stations in an optimal situation.

- **Availability of the bicycles (Quality of service):** This scenario shows how the quality of service significantly influences the environmental performance of the PSS. Indeed, “intensification within product lifecycles is considered crucial for dematerialisation, in particular, to design optimal product-service systems from the viewpoint of environmentally conscious design and manufacturing in advanced post industrial societies”.

This scenario tests the concept of the intensification of the use as a way to improve the EI of the PSS. In the case study it is possible to intensify the use of the bicycles by reducing the time they are unused. This means that organization is optimized to minimize the number of products in the system, and particularly in each station, according to historical system requirements.

The average unused time for the bicycles is reduced, because of more reliable products and better global use of the system.

### 5.3.1. DESIGN PARAMETERS AND ENVIRONMENTAL IMPACTS

As mentioned in the previous section; the main objective of this model is to establish the relation between the generation of environmental impacts and the relocation of these impacts using a PSS business strategy. This means that we want to determine the environmental impact relative to one use; for a projected number of users; with a basic infrastructure that guarantees an certain quality of service; with the necessary network of integrated services (maintenance, guarantee exchange, etc.); with a predefined number of products; with different characteristics of the products that limit the performance of the integrated service offer; and using the corresponding period of time for each scenario. Table 4-6 shows the design parameters in the use scenarios described in section 4.2 compared to the basic Velo'V (2005).

		Velo'V (2005)	Bicycle robustness	Redistrib. Bicycles city	Availability bicycles
Time for each use	minutes	15	15	15	15
Time of service provision	years	3	3	3	3
Times a bicycle is used by each different user	number of times	1460	2190	2920	4380
Number of differents users		20000	20000	20000	20000
Time preventive maintenance per usage	minutes per use	30	30	15	30
Ratio of bicycles need classical maintenance	percentage	5%	5%	5%	8%
Time of bicycle on stock	weeks	6	6	6	3
Technical life time	years	1	3	1	1
Number of bicycles available in the system		2697	2697	2574	2555
Total number of bicycles in the system		8091	2697	7722	7665

Table 4 - 6: Design parameters of the Velo'v and other scenarios

The first alternative scenario, "bicycle robustness", results in a reduction of the total number of bicycles in the system (from 8091 to 2697). However, increasing the mass could also affect maintenance operations, but this was not taken into account in the study.

The next scenario, "bicycle redistribution" readjusts the time for preventive maintenance (the global operation).

To simplify this scenario, the service units supporting the redistribution of the bicycles in the city were kept constant. Here again the total number of bicycles necessary in the system is reduced (from 8091 to 7722).

The third alternative scenario optimizes organization. By increasing the percentage of bicycles in maintenance at one time (from 5% to 8%), it is possible to reduce the time



products are on stock, or unused (from 6 to 3 weeks). Once again, the total number of bicycles necessary in the system is reduced (from 8091 to 7665).

Once the design parameters defined, the EI can be calculated for the products and other resources used in the PSS offer. A simplified assessment was done using the LCA software, SimaPro, and the results expressed in Ecopoints according to the Eco-indicator 99 method. The results are presented in Table 4-7.

Table 4-7 first presents the environmental impact of a “conventional use” (product sale) scenario; an initial scenario with one bicycle for each user (2000 users) and the elements of the service per bicycle used for the infrastructure (38,6 EcoPoints). Next, the introduction of the PSS offer (Velo’V 2005) produces a very significant reduction of the EI. This means that the introduction of intensive usage in the PSS largely compensates the impacts of the infrastructure elements to support the service (6,3 EcoPoints), a reduction of 84% of the environmental impacts approximately.

Reduction of EI depends on the scenario chosen. However, Table 4 shows that the benefits obtained by redistributing the bicycles in the city are equivalent to those from redesigning the bicycles. This result is obtained by a redefinition of the maintenance process reducing the mean time of the operations. Concentrating on the availability of the bicycles could result in a reduction of almost 50% (from 6,3 to 3,4 EcoPoints) of the EI compared to the original Velo’V 2005 system.

<b>Conventional Use</b>	<b>Raw Material Ext.</b>	<b>Component Manufac.</b>	<b>Component Distrib.</b>	<b>Product Distrib.</b>	<b>Product Usage</b>	<b>Prod. Take of Back</b>	<b>Prod. E-o-U / E-o-L</b>	<b>TOTAL</b>
<b>PRODUCT SALE</b>	20,69010226	6,29339553	1,69554135	1,97813157	3,62056300	1,66542916	2,70370973	<b>38,64687260</b>

<b>Velo’V (2005)</b>	<b>Raw Material Ext.</b>	<b>Component Manufac.</b>	<b>Component Distrib.</b>	<b>Product Distrib.</b>	<b>Product Usage</b>	<b>Prod. Take of Back</b>	<b>Prod. E-o-U / E-o-L</b>	<b>TOTAL</b>
<b>Velo’V Produit</b>	0,001010184	0,000310616	0,44814450	0,52283525	0,95694240	0,52283525	0,000132007	<b>2,45221021</b>
<b>Velo’V Service</b>	0,002085497	0,000641258	1,24739684	1,45529632	0,000364941	1,14259391	0,000272525	<b>3,84865129</b>
<b>Velo’V*</b>	0,00309568	0,00095187	1,69554135	1,97813157	0,95730734	1,66542916	0,00040453	<b>6,30086150</b>

Bicycle robustness	<b>Raw Material Ext.</b>	<b>Component Manufac.</b>	<b>Component Distrib.</b>	<b>Product Distrib.</b>	<b>Product Usage</b>	<b>Prod. Take of Back</b>	<b>Prod. E-o-U / E-o-L</b>	<b>TOTAL</b>
<b>Produit</b>	0,000336728	0,000103539	<b>2,75947E-05</b>	0,52283525	0,95694240	0,52283525	4,40024E-05	<b>2,00312476</b>
<b>Service</b>	0,000695166	0,000213753	<b>5,69684E-05</b>	1,45529632	0,000121647	1,14259391	9,08418E-05	<b>2,59906860</b>
<b>Velo’V*</b>	0,00103189	0,00031729	0,00008456	1,97813157	0,95706405	1,66542916	0,00013484	<b>4,60219337</b>

Redistrib. Bicycles city	<b>Raw Material Ext.</b>	<b>Component Manufac.</b>	<b>Component Distrib.</b>	<b>Product Distrib.</b>	<b>Product Usage</b>	<b>Prod. Take of Back</b>	<b>Prod. E-o-U / E-o-L</b>	<b>TOTAL</b>
<b>Produit</b>	0,000964113	0,00029645	<b>0,00007901</b>	0,52283525	0,95694240	0,52283525	9,78958E-05	<b>2,00405037</b>
<b>Service</b>	0,002085226	0,000641175	1,24739684	<b>0,000199364</b>	0,000364894	1,14259391	0,00027249	<b>2,39355390</b>
<b>Velo’V*</b>	0,00304934	0,00093763	1,24747585	0,52303461	0,95730729	1,66542916	0,00037039	<b>4,39760427</b>

Availability bicycles	<b>Raw Material Ext.</b>	<b>Component Manufac.</b>	<b>Component Distrib.</b>	<b>Product Distrib.</b>	<b>Product Usage</b>	<b>Prod. Take of Back</b>	<b>Prod. E-o-U / E-o-L</b>	<b>TOTAL</b>
<b>Produit</b>	0,000956997	0,000294262	0,44814450	0,52283525	1,17558860	<b>0,00009150</b>	9,78843E-05	<b>2,14800899</b>
<b>Service</b>	0,002084981	0,0006411	1,24739684	0,00019934	0,000364851	<b>0,00015651</b>	0,000272458	<b>1,25111608</b>
<b>Velo’V*</b>	0,00304198	0,00093536	1,69554135	0,52303459	1,17595345	0,00024800	0,00037034	<b>3,39912507</b>

Table 4 - 7: Environmental Impact of the PSS

## 6. CONCLUSION OF CHAPTER 4

A PSS strategy represents an excellent opportunity to improve sustainability. However, it requires careful consideration of all the design parameters in the system. Having this in mind, a model was developed that considers the importance of the use phase in the PSS lifecycle. From the work described herein, the following conclusions may be drawn:

1. A list of requirements for a PSS has been defined and is flexible enough to help designers create new scenarios of use according to the gains obtained from the environmental point of view.
2. The environmental impacts for the whole system depends on the products (technical lifetime, reliability, etc.), the services (preventive maintenance, stand-by time, etc.), but also on the global organisation of the PSS (number of users, number of uses, etc.). A model that can be used to simulate alternatives has been proposed.
3. The intensification of use is a major means for the improvement of environmental impacts in PSS. A comparison with classical sales is possible.

The results of this work suggest that care is needed during the PSS design process at the usage stage. Special attention must be given to design parameters such as  $(n_u, t_u, t_m, \alpha)$  as well as calculation of classical EI to select an appropriate number of products in the PSS from an environmental point of view.

This approach should now be formalized with software to be used in an industrial context for the design of a PSS offers. Indeed, PSS is a promising strategy and we need methods and tools for those strategies to be considered during the product, process or lifecycle design.

It is now possible to apply this approach to other products with closed loop strategies to help designers making decisions during the design process while taking into account environmental concerns.



## Chapter 5

# Environmental Assessment Model Approach on Closed Loop Life Cycle Products

<b>1. Introduction</b>	<b>139</b>
<b>2. Remanufacturing products compatibility with PSS model</b>	<b>140</b>
2.1. The role of remanufacturing and PSS organization	140
2.2. Product lifecycle requirements of remanufacturing – PSS	141
2.3. Logistics and reverse logistics considerations	142
2.4. Problems on remanufacturing – PSS	142
<b>3. Environmental assessment for closed-loop products lifecycle</b>	<b>144</b>
3.1. Integration of the remanufacturing approach in PSS	144
3.1.1. Model approach for remanufacturing – PSS	146
3.1.2. Environmental impact calculations for a remanufacturing – PSS strategy	149
3.2. Life cycle assessment of a catalytic converter	149
3.2.1. Goal definition	150
3.2.2. Product definition and functional unit	150
3.2.3. Life cycle description and inventory	151
3.2.4. Assumptions	152
3.2.5. Results for classic model: catalytic converter	152
<b>4. Environmental assessment simulation for closed-loop products lifecycle</b>	<b>155</b>
4.1. Case study	155
4.2. Influence of the end-of-life on the product life cycle	156
4.2.1. Closed – loop product life cycle by remanufacturing	156
4.3. Closed-loop life cycle simulation: remanufacturing – PSS	158
4.4. Catalytic converter: remanufacturing and PSS closed-loop life cycle results	162
<b>5. Conclusion of Chapter 5</b>	<b>164</b>

Figure 5 - 1: Classic Product Life Cycle modeling _____	144
Figure 5 - 2: Remanufacturing – Closed Loop Product Lifecycle modeling _____	145
Figure 5 - 3: Remanufacturing – Closed Loop Product Lifecycle modeling _____	146
Figure 5 - 4: Remanufacturing Parameterisation on the Reconditioning Industrial Process _____	148
Figure 5 - 5: Catalytic Converter life cycle environmental impacts – End of Life: Recycling (EcoPoints) _____	153
Figure 5 - 6: Remanufacturing Parameters: Product Definition Level and Logistics – Network ____	157
Figure 5 - 7: Catalytic converter life cycle environmental impacts – End of Life: Remanufacturing (EcoPoints) _____	158
Figure 5 - 8: PSS - Remanufacturing Parameters: Services and Use affectation of the catalytic converter _____	160
Figure 5 - 9: PSS - Remanufacturing Parameters: Services and Use affectation of the catalytic converter _____	161
Figure 5 - 10: PSS and remanufacturing environmental impacts – values in EcoPoints _____	161
Figure 5 - 11: PSS and remanufacturing analytical results – values in EcoPoints _____	162
Figure 5 - 12: PSS and remanufacturing analytical comparison results – values in EcoPoints ____	163

Table 5 - 1: Components of the catalytic converter _____	151
Table 5 - 2: Detail of the ceramics and precious metals contained in the catalytic converter _____	151
Table 5 - 3: Parameters for the catalytic converter PSS _____	159

## 1. INTRODUCTION

Actually, the present economical and technical strategies implemented by industry require an evolution on the description of products and the definition of the service offers. In some cases, an evolution on the service offers leads designers to consider a change in the perception of the invested material in the products' manufacturing phase. A coherent relation between products and services has to be created, with the objective to assure a fonctionnal harmony that integrates all the possible services in a single package. Traditional manufactured product processes focus on providing physical objects to final customers. However, service offers should provide to the industry the extension of its original business market: delivering one or several objects plus non tangible products in term of "services". So, there exists a constant practice in the industrial strategy which aims to obtain a better participation of the market. Those actions will provide results as the fact that industry no more distinguishes manufacturing of products and design of service offers. Instead, industrial designers should provide customers with a combinaison of high customized solutions to fulfil specific needs.

This means, services are to be preferred over products as a mean to perceive value creation. The combination of products and services can exceed the traditional functionality of products, in terms of quality, environmental costs and performance.

The traditional approach to environmental life cycle assessment has evolved from the pollution control, the end-of-pipe approach, to preventive or cleaner production approaches taking the initiative to develop tools to support the design process in a business model level. The latter is defined as the continous redesign of industrial process and products to prevent pollution, waste generation at their source and to minimize risks to humans and environment while optimizing resources. This approach was applied initially to industrial processes (cleaner technologies) and then, to be more inclusive, to the industrial products themselves (cleaner products). Nevertheless, cleaner production strategies must not be over at this point; it has become clear that such strategies have to go deeper than just the redesigning of existing products in order to obtain better benefits from a sustainable point of view. The present chapter aims to explain a methodology to assess those strategies.



## **2. REMANUFACTURING PRODUCTS COMPATIBILITY WITH PSS MODEL**

Remanufacturing as it was presented in chapter 2 and chapter 3 is a well established process which has been adopted within many manufacturing sectors. In addition, PSS also represents a growing area which attributes towards sustainable manufacturing, the uptake of which has also been significantly impacted due to the general lack of suitable supporting methodologies and tools. When considering the requirements of these two sets of strategies, several similarities have been identified for tools and methodologies that could potentially support these activities. This section presents the existent limitations in both strategies, analysing the opportunity of a tool combining the methodologies presented in chapter 3 and 4 and capable to support the remanufacturing activity using a service provision model. Logistics (and reverse logistics), remanufacturing process information and knowledge about the flows of materials must be identified and investigated to support the applications of remanufacturing and product service system.

### **2.1. THE ROLE OF REMANUFACTURING AND PSS ORGANIZATION**

In 2006, Tucker [Tucker and al. 06] related the PSS products to their sustainable impact. The theoretical studies realize that the systems developed to obtain benefits according to sustainability, regards the details of the different phases of the product lifecycle, searching for: the optimisation of energy consumption, the effective recycling of product parts; the material recovery feasible, etc. To obtain these benefits is not only dependent on the product design itself, the services around could provide those additional benefits. Those services can be technical, for example the maintenance of the system; but also an aspect of assistance, for example: customer training.

In order to assure the optimal strategy between remanufacturing and PSS, there exists a relation of different actors (organizations) between the various elements of the system (products or services). The concept of organization joins the need for identifying partners to be implied in the PSS. Indeed, to integrate those partners within the system, completes and assures the well functioning of the service. Therefore, the description of the boulder's limits of each partner must be detailed, as well as their operation in the system. In the conventional development of physical products, most of the organisational aspects are taken into account just after the product's development (design of the supply chain and logistics). However, PSS business strategy demands the identification and the design of the supply chain and logistics

as well as information on the different actors to integrate in the product lifecycle. The aim is to control the economic relevance of the system and the environmental costs as soon as a partner is integrated in the organization. Indeed, it is necessary for designers to assess at the same time the products and the services concerned in the systems and the general organization of the system.

## **2.2. PRODUCT LIFECYCLE REQUIREMENTS OF REMANUFACTURING – PSS**

In chapter 4 of the present work; it was presented that to increase intensive use or longevity for products utilised during service provision (e.g. product renting or sharing) can also significantly impact the sustainability of the system. However, the intensive use of products can stimulate their fast replacement. So, a more efficient model to assess the intensive use within a service provision model of the replaced products or components is needed.

Product manufacturers consider that the product life cycle starts with the decisions that are taken during the initial product design phase (material selections, manufacturing processes, etc.); then products are available to fulfil services. Activities such as the remanufacturing will strongly support the extended life of products, and will keep the value by the service provision business for a PSS model.

Remanufacturing and PSS require a specific set of tools and methodologies in order to fully support the delivery of the activity. When considering the requirements of those two sets of tools simultaneously, the data required to effectively implement one strategy would inherently support the other. A PSS model and a remanufacturing strategy aim products get a certain number of usages, within a minimum of performance to satisfy customers. For example, within the framework of a PSS defined for products transportation, trucks or spare parts will be the physical products of the system and customers will require a defined number of usage cycles with a minimum technical lifetime. So, in order to describe a global model, it is necessary to have in mind that single products could be part of a remanufacturing system that will guarantee those usage cycles and the expected performance.

So, the optimization of the products in a PSS business model must be done considering their whole lifecycle: raw material (material selection), manufacturing (selection of processes), distribution, use (services, energy), reverse logistics and final disposal (remanufacturing, recycling, disassembly, components exchange, cost time, recycling, etc.). Services, on the other hand, must provide customers an added value from the lifecycle point of view. As an example, support at purchasing (sales counselling and counselling of remanufacturing products), product usage (maintenance, spare parts stocks, remanufacturing components

conditions, functional warranty, etc.) and product disposal (take back, product conditions for remanufacturing and final disposition). Demands concerning the availability of the products functionality within the remanufacturing process behind are highly specific due to the multiple usages that a product could have depending on the number of users, product limitations and performance during utilisation.

### **2.3. LOGISTICS AND REVERSE LOGISTICS CONSIDERATIONS**

The logistics considerations are crucial for the development of a successful PSS strategy, and those requirements become more important to consider remanufacturing option. Customer and concessionary locations, frequency of product return and maintenance service plans are in the middle of a large range of logistical issues which must be taken into account in order to support the delivery of a PSS. When considering remanufacturing, a set of further external requirements are also included (the network between supplier and customer), as well as the addition of the internal process requirements once the core has been returned to the manufacturer.

Without remanufacturing, considering only a standard production process with standard disposal, a manufacturing company needs only to consider the flow of product. Once, remanufacturing is incorporated; the supply chain must also consider the return and reprocessing of the core. As it was presented in chapter 3, reverse logistics for remanufacturing influence the performance of the activities, so reverse logistics should be considered like a process, including transportation.

Therefore, any logistic support system developed for remanufacturing could in essence also support the implementation of a PSS strategy. Such support systems must consider the manufacturing and remanufacturing process requirements, and also understand the relationship between product and service (the needs of the customer and how the remanufacturing line can ensure that such requirements are met). The reverse logistics must be performing enough to take products of the market, as soon as they match with the remanufacturing process.

### **2.4. PROBLEMS ON REMANUFACTURING – PSS**

Some difficulties exist on the remanufacturing process that could increase when this strategy is combined to a PSS. Important problems in the PSS remanufacturing are: different recovering time and quantity as well as quality of product, and difficulty in the control of materials, components, and parts.

Remanufacturing includes the recovering, detection, disassembly and cleaning of products. Therefore, the product design must promote the introduction of the product into a remanufacturing process, taking into account that PSS design specifications could complicate the task. However, the PSS system could be seen as a supporting tool that will help to optimize the data of the product ensuring the possibility of remanufacturing.

The inventory (stock of cores and spare parts) in remanufacturing is complicated. Thus, the push-type inventory is one of the most used in industry for increasing the recovered products, and it is an optimal process for recovered products. So it is necessary to evaluate the model for the inventory, the remanufacturing environment, specifically for evaluating product lifecycle, equipment capacity, and operation for remanufacturing.

### 3. ENVIRONMENTAL ASSESSMENT FOR CLOSED-LOOP PRODUCTS LIFECYCLE

#### 3.1. INTEGRATION OF THE REMANUFACTURING APPROACH IN PSS

As it was described in chapter 3 and chapter 4, the modeling of products with several use cycles is a complex activity. Once the problem has been reduced to its simplest form, a more complicated approach model can take place. This means, to model products in a closed-loop lifecycle, the first model to understand is the classical product lifecycle.

The classical product lifecycle considers the products and its manufacturing process. In this case, the model should take into account the highest number of processes: the extraction of the raw material, the manufacturing process, the distribution of the components, the product assembly, the product distribution, the product use, the product take back and the end-of-life of the product. Those processes are represented in figure 5-1.

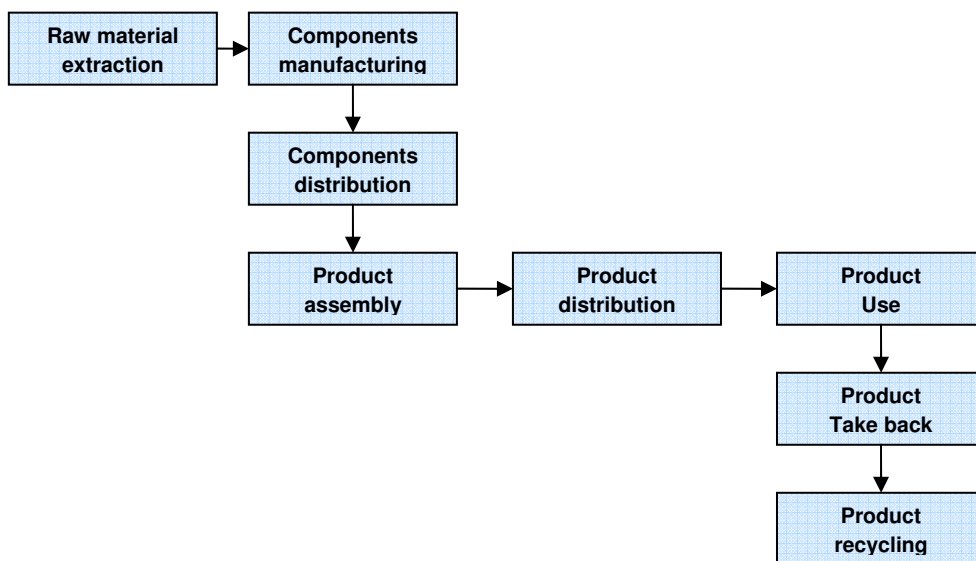

Figure 5 - 1: Classic Product Life Cycle modeling

To introduce remanufacturing in the model, the processes used to construct the different end-of-use/end-of-life scenarios are added to the previous model. All the processes listed in figure 5-2 are parts of the study. The figure represents the existing relations between new products which arrive to a final disposition scenario. Then, their product lifecycle is modified to add a process of remanufacturing (the parts/components of the products will be provided with a new use period).

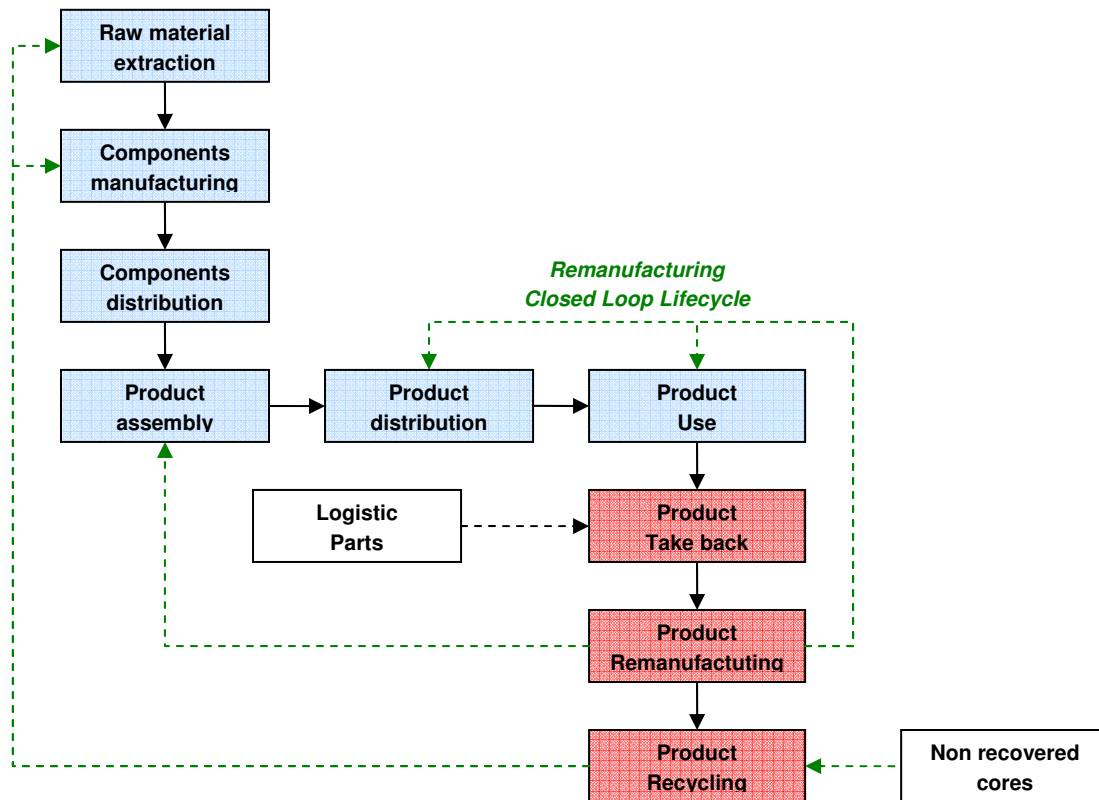

Figure 5 - 2: Remanufacturing – Closed Loop Product Lifecycle modeling

Looking at figure 5-2, one of the best possible scenarios could obtain a new use cycle for all the products recollected by the reverse logistics process. However, as presented in chapter 3, this will depend on the conditions of the recollected cores and the performance of the remanufacturing process. So, it is necessary to consider that there are a percentage of cores or components disposed to a recycling process.

How designers should consider the actions that will make possible a transition from a remanufacturing model or from a PSS model through a combination of them? How classic product life cycle should be redefined in order to integrate the remanufacturing and the PSS limitations and restrictions? Regarding the environmental concerns, the main objective of this kind of approach is to establish a reliable comparison between the classic product life cycle, the remanufacturing, and a combination of remanufacturing and PSS model. To develop an approach able to include remanufacturing (and other options for product end-of-life: reuse, recycling, etc.) and PSS, it is necessary to consider the processes among the product end-of-life as well as all the activities and process among the product use. This means, obtain a product able to cross the remanufacturing process. The PSS activities during the use (maintenance service, platform service, etc.) will assist and simplify later processes, introduced for the remanufacturing system (product inspection, component exchange, etc.).

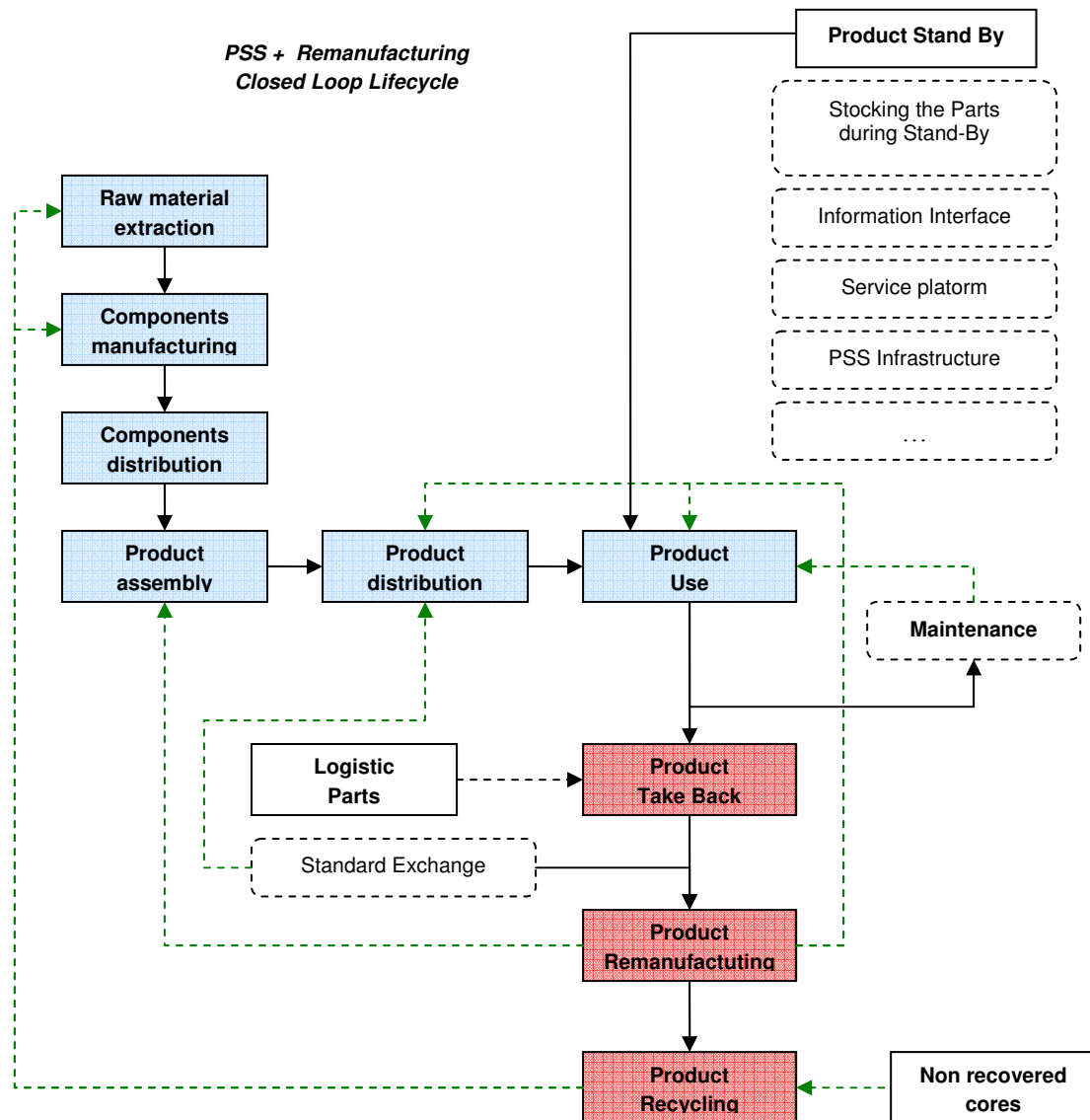

Figure 5 - 3: Remanufacturing – Closed Loop Product Lifecycle modeling

Figure 5-3 represents the approach used to assess the environmental performance of the combined model. There is an intensification of the product use related to activities designed on the PSS offer. At the same time, those activities support the take back and the remanufacturing of the products.

### 3.1.1. MODEL APPROACH FOR REMANUFACTURING – PSS

The precedent section makes a short revision on the product lifecycle of products, when the objective of the present chapter is to regard the necessary conditions and environmental consideration, related to the introduction of products in a remanufacturing PSS model. So, the present section describes how to model those strategies as closed-loop product life cycles.

The product life cycle of closed-loop models contains a large network of process to support and guarantee the performance of the product-service offer. This means, it is necessary to take into account and integrate new assumption to the remanufacturing and PSS strategies.

- It is assumed that product design process considers the aspect of modularity for remanufacturing and recycling. By this way the processes used to disassemble takes less time. Even other aspects like the maintenance get a better performance when modularity is considered.
- Environmental assessment and strategies comparison require the definition of the functional unit, when more than one strategy is used to fulfill customers' service. Functional units must be coherent and equivalent.

So, all the statements and assumptions take us to develop a model for the closed-loop product life cycles (considering remanufacturing and PSS). This model is composed by main processes, also regarded by Gehin [Gehin and al. 07]. Then complementary processes (e.g. usage, stand-by, maintenance) have been integrated to a better understanding of the influence of the PSS in a remanufacturing model. This model is presented in figure 5-4. Each phase is compared in terms of different levels. The first one is the product level: here the parameters used quantified material input and losses amount of waste and energy consumption in the product life cycle. The second level corresponds to the logistic network parameters: this means the influence of the allocation of each participant that executes an activity during the life cycle of the product. The third and last level: parameters are used to evaluate the performance of the services around the products, the assessment of this level define how the service benefits the products in terms of a more responsible use, an optimization of the reconditioning system then an extension of the product lifecycle, etc.

The model presented in figure 5-4 is a quite simple version but useful for the discussion of essential advantages and drawbacks of recycling, remanufacturing, reuse, and maintenance options. The different flows between the life cycle phases are represented by arrows and each life cycle phase is represented by a rectangle with its name inside. The possible paths or strategies in the figure are not exclusive and have to be precisely defined.

All the variables and parameters presented in figure 5-4 have been defined before, in chapter 3, for the parameters of the products and networks logistics, and in chapter 4, for the parameters of the service and use of the product.



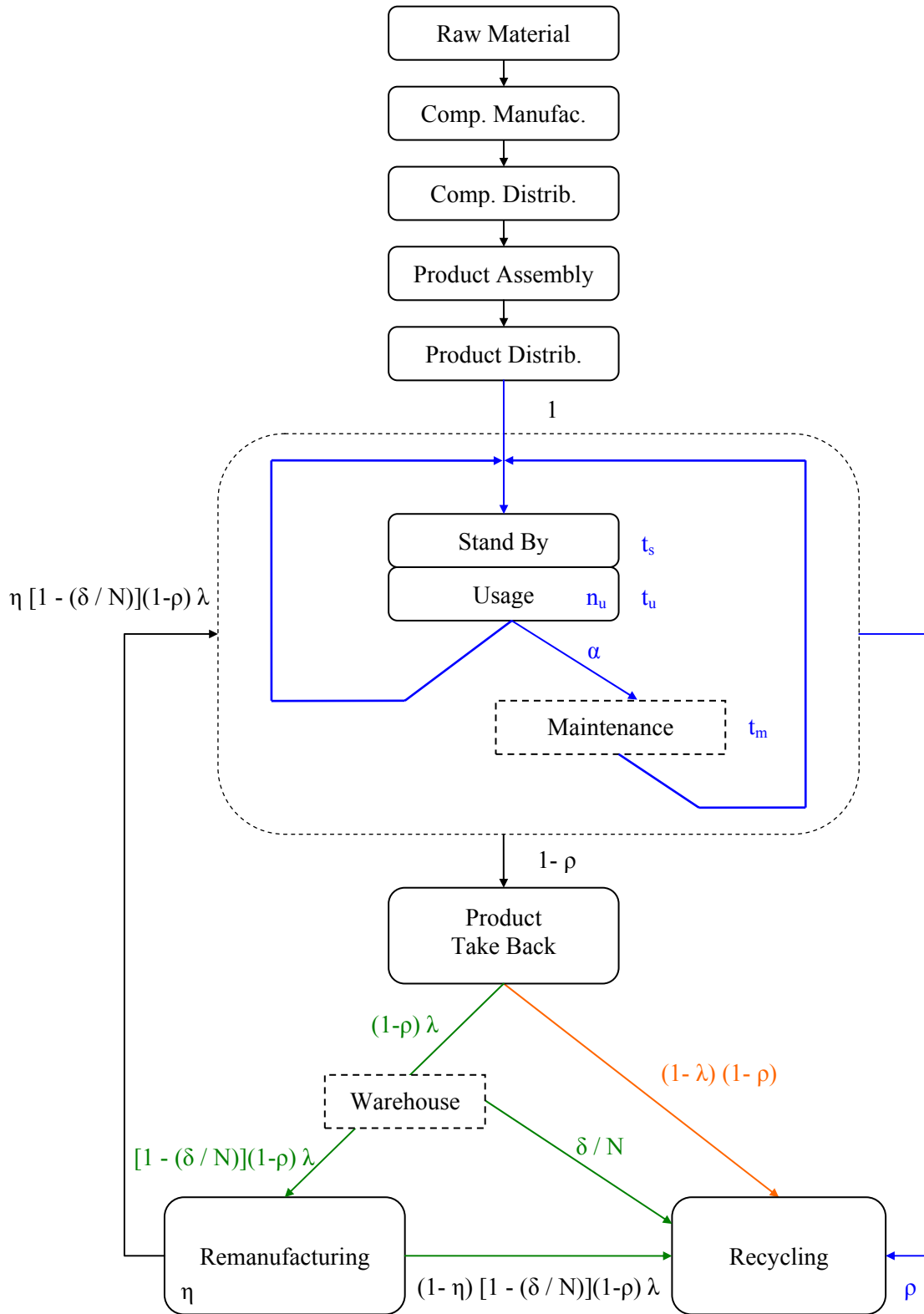

Figure 5 - 4: Integrated model – Remanufacturing Parameterisation on the Reconditioning Industrial Process

### 3.1.2. ENVIRONMENTAL IMPACT CALCULATIONS FOR A REMANUFACTURING – PSS STRATEGY

The proposed model is to be used as a framework for environmental impacts on Remanufacturing-PSS offers. The equations defined in this section will assist designers in taking action on PSS strategies and life cycle properties. Indeed, this would certainly make them consider all lifecycle phases. During the design process many lifecycle options are developed and it is necessary to determine the best one, or at least to avoid the worst one, for the environment. The present model assumes remanufacturable products and PSS strategies and fullfills the hypothesis described above:

- Products with connectivity of components and the components of a module are regrouped by fonctions types. The fonctions can be emphasized on a PSS strategy.
- A component is modeled as a set of attributes, such as possibility of recycling, reuse, remanufacturing, manufacturing energy, lifetime, weight, and material.
- A component can be disassembled or can use a chain of remanufacturing for the reconditioning (catalytic converter study case).
- A module can be repaired by replacing broken components with working ones.
- The size of the market for the service of remanufacturing products is growing, and when new products are sold as remanufactured, a better option from the financial point of view is to sell a leasing contract of a remanufactured product.

Because of all the assumptions mentioned, the assessment calculation must be done using the parameters defined in section 3.1.1. The environmental impacts on a remanufacturing modeling will be a function of the parameters selected for the definition of the product life cycle and logistics  $EI_{Re\,manufacturing} = f(EI_{product})$ ; therefore the environmental impacts on PSS-Remanufacturing approach will be a function of how the service influences the remanufacturing product by itself  $EI_{PSS\_Model} = f(EI_{Re\,manufacturing})$ .

### 3.2. LIFE CYCLE ASSESSMENT OF A CATALYTIC CONVERTER

Transport emissions are one of the most important contributors to air pollution problems. The emissions pollute the air and it contributes to global warming by transmitting greenhouse gases. To reduce those atmospheric emissions in transportation, practices like the integration of catalytic converters at the exhaust system of vehicles have been adopted. This

solution has become one of the most common and chosen because of its technologies feasibility. Since the introduction of converters, important emissions of hydrocarbons, carbon monoxide, nitrogen oxides and other atmospheric pollutants have been reduced substantially. Nevertheless, it is essential not only to consider the clear benefits of a catalytic converter only at the exhaust system, but also to take into account the environmental impact originated by the extraction of raw materials and manufacturing processes employed in the production of a catalytic converter. So, the life cycle assessment approach has been chosen as an environmental methodology to investigate the environmental performance of a catalytic converter inside a classic, a remanufacturing, and a remanufacturing-PSS model.

### **3.2.1. GOAL DEFINITION**

A catalytic converter is an exhaust emission control device. The main function is to convert toxic chemicals in the exhaust of an internal combustion engine into less toxic substances by the way of catalysed chemical reactions. The specific reactions vary with the type of catalyst installed.

The goal of the present study case is to assess the environmental impacts occurring during the life cycle of a catalytic converter designed for the exhaust system of trucks. In section 3.3., the possibility to integrate this product into a remanufacturing process will be regarded (extention of the product lifecycle) as well as the environmental benefits created by a PSS offers that complement the remanufacturing model.

### **3.2.2. PRODUCT DEFINITION AND FUNCTIONAL UNIT**

In the case of catalytic converters, the functional unit will be defined in terms of service distance for the vehicle (160000 kilometers per year of use). This functional unit is supported by the guaranteed service lifetime of catalytic converters from most of the manufacturers in their bussines. Over this service lifetime, it is assumed that the catalytic converter is not broken or malfunctions because of damage to the catalyst through accidental impacts or engine misfires.

During a vehicle driving, the catalytic converter service functions, it fills up of soot, creating an increase of the pressure in the exhaust line. When the pressure reaches a certain limit, a regeneration of the catalytic material must be done to warranty the ratio of incombustible elements in the catalytic reaction. This regeneration has to be done after 160000 kms.

### 3.2.3. LIFE CYCLE DESCRIPTION AND INVENTORY

In general, a catalytic converter is composed of 4 main components: a converter housing, a catalyst support, the mat washcoats and a lambda probe. The weights of each component are listed in table 5-1. In our study case, it is considered a catalytic converter with a high technology, manufactured in Nordic countries like Sweden. Its manufacturing requires really special material like: platinum, palladium and rhodium. The extraction of those hazardous materials is done in African countries. Other raw materials such as monolith ceramics and wire mesh can be produced in Europe (Germany). Finally, the steel needed for the housing chamber of the catalytic converter is also produced in Germany. The catalytic converter is installed, then there is an assembly on trucks and they are used in France.

	<b>Mass Component [Kg]</b>
Converter housing	4,99
Catalyst support	1,40
Mat washcoats	2,67
Lambda probe	0,43
Total Weight	9,50

Table 5 - 1: Components of the catalytic converter

The ceramic monolith and ceramic wire mesh components require also a combination of special materials. The composition and weight of those materials are presented in table 5-2.

In order to be able to effectively reduce exhaust emissions, an oxygen sensor (lambda probe) and electronic fuel management system are required to monitor the composition of the exhaust gas and to control the air fuel ratio. However, the environmental impacts occurring in the life cycle of the lambda probe on this study does not count with all the necessary data to realise a detailed inventory lifecycle.

	<b>Element</b>	<b>Mass Component [Kg]</b>
<b>Catalyst support</b>	MgO	0,14
	Al <sub>2</sub> O <sub>3</sub>	0,36
	SiO <sub>2</sub>	0,5
<b>Mat washcoats</b>	<b>Ceramic wire mesh</b>	<b>(2x0,25Kg)</b>
	<b>Metal oxides slurry</b>	
	Al <sub>2</sub> O <sub>3</sub>	0,1
	CeO <sub>2</sub>	0,2
	ZrO <sub>2</sub>	0,7
	<b>Precious metals</b>	
	Pt	0,0625
	Pd	0,875
Rh	0,0625	

Table 5 - 2: Detail of the ceramics and precious metals contained in the catalytic converter

### **3.2.4. ASSUMPTIONS**

To model the product lifecycle of the catalytic converter as a system, it is necessary to precise some points and clarify the product lifecycle of an existant product in an existant system. General assumptions are realized to be able to conduct the life cycle assessment, those assumption are:

- The energy used in the mining and production processes of the special metals (ceramic wire mesh) is basically obtained upon coal-fired power stations. LCA database takes this information into account during the lifecycle inventory.
- The amount of fuel consumption and emissions released during the transportation of raw materials from manufacturing site and the environmental impacts associated with its operations are also part of the LCA databases.
- The steel scraps in the manufacturing process are recycled for secondary steel production, so like that it is possible to reduce the material losses in the production system.
- The market where the product is used must be isolated. The catalytic converters are assembled in trucks destined to the french market. Therefore the recollection system and the remanufacturing process take also place in France.
- Exhaust flows through the catalytic converter cause an amount of pressure, resulting in an increase of the fuel consumption. This is therefore considered as a loss of energy considered later for the product use phase, as environmental impacts associated to the use of the catalytic converter.
- The mining and primary production of precious metals (wire mesh) is a significant contributor to environmental impacts occurring in the life cycle of a catalytic converter. Their processes are complex and require substantial amounts of energy and material resources and consequentially generate a large amount of solid wastes. The recycling and reuse rates of precious metals are therefore significant factors in reducing environmental impacts.

### **3.2.5. RESULTS FOR CLASSIC MODEL: CATALITYC CONVERTER**

In this section, the Life Cycle Assessment is presented for the whole life cycle of the catalityc converter described in section 3.2.3. The results for the classic catalytic converter model are formulated in order to be compared later on with other strategies that will improve the classic

life cycle model. Since the primary product is the same, the bill of materials, manufacturing processes, and a lot of processes and operations in most of the life cycle phases like the usage, are very similar. The limitations and assumptions used in this study are judged to not impact the results and conclusions in a significant degree. These qualitative statements are based on experiences from conducting LCAs of catalytic converters for passengers' cars instead of heavy vehicles - trucks. Figure 5-5 presents the results of the environmental impact assessment developed using the software SimaPro, methodology Eco-indicator 99 (H) V2.06 / Europe EI 99 H/H.

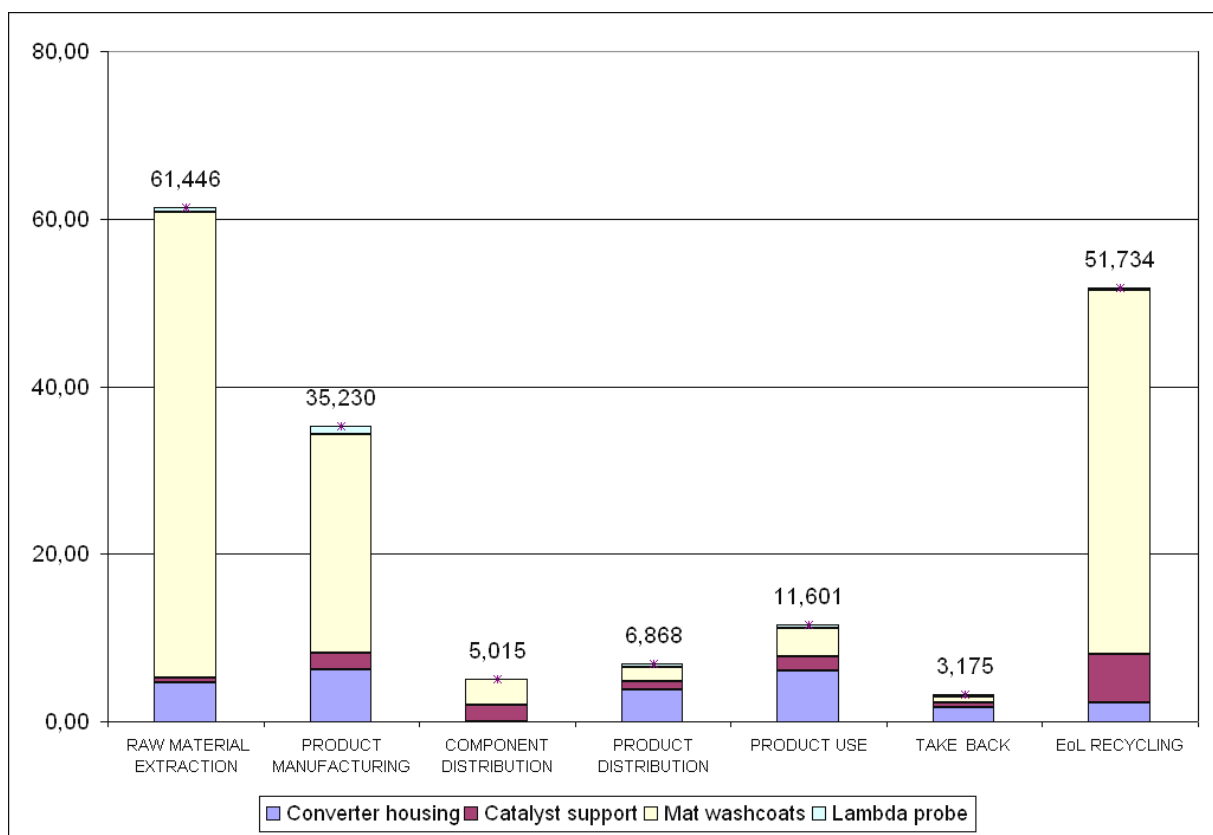

Figure 5 - 5: Catalytic Converter life cycle environmental impacts – End of Life: Recycling (EcoPoints)

In the present study comes out the following key results:

- The lambda probe in general has the lowest emissions with low ranking in all measured categories. However, there exist differences in the quality of the data: as it was mentioned in section 3.2.3 the lambda probe does not count within all the necessary data to support this result. So, there is in second place the catalyst support as the lowest emissions component.
- The precious materials used in the washcoats manufacturing are the elements that increase significantly product lifecycles like raw material extraction and manufacturing.

However, it is possible to highlight the important impact during the use phase of the catalytic converter. This product impact is due to the variation of the performance of the catalytic reaction. So, there exists direct realisation between the materials selection and how the performance of the product decreases with its use; this aspect complicates the reduction of the environmental impacts for the raw material extraction and manufacturing, because of the risk to transfer those impacts to the usage phase.

- The positive aspects associated with the use of recovering precious materials in the catalytic converter end-of-life (recycling) are also evaluated. Even, if the products are considered for recycling, and the whole product life cycle is optimized according to the recycling operations needs, the process must be considered as producing an important environmental impact. (Figure 5-5)

## **4. ENVIRONMENTAL ASSESSMENT SIMULATION FOR CLOSED-LOOP PRODUCTS LIFECYCLE**

The environmental impacts during the life cycle of catalytic converter were presented in the precedent section. Distribution and logistic could be considered as minors. This effect is mainly related to the importance and high impact of few grams of precious materials in the composition of the washcoat, and the handling of those materials.

In this section, the LCA of the remanufacturing and the remanufacturing-PSS model will be simulated, then, the results of those models will be compared to the classic product life cycle. All the processes that make possible the inventory analysis of the remanufacturing activities and the PSS support have been taken from SimaPro software. The results of the environmental impact assessment have been developed using the methodology Eco-indicator 99 (H) V2.06 / Europe EI 99 H/H.

### **4.1. CASE STUDY**

The product under consideration is a part of the large range of components for trucks medium sized, which need core competencies in the development and manufacturing with special hazard materials. It relies on a service network comprising branch site to realize the maintenance and standard product exchange of the catalytic converters, as well as independent partners. Thereby, the main tasks to be centrally performed, refers to product and service planning and design as well as product manufacturing. The service and distribution activities on the other hand are responsible for the direct customer contact. This refers to support the customers during product purchasing (e.g. counseling and product selection), product usage (e.g. maintenance) as well as product end-of-life (e.g. take back and disposal).

So, the case study analyzes the business model, which provides the environmental assessment function of closed-loop product lifecycle. Two alternative of business models are employed to compare performance from environmental perspective:

- In the remanufacturing model, catalytic converters use a reverse logistic network for the recollection of the broken products. Then, manufacturers provide the recollection of ancien products and reconditioning by remanufacturing process. Finally manufacturers guarantee performances of a precise range of converter with good performances.



Products and their life cycles in these two models are identical. However, difference arises in the logistic flow.

- Products designed under remanufacturing criterias are sold out under PSS offers. This means, manufacturers possess the catalytic converter by contract keeping the facilities of product state control. Then services packages go further than a simple maintenance service. Here, all the activities associated with product life cycles, such as maintenance, upgrade, and recycling/remanufacturing services are part of the service package.

## **4.2. INFLUENCE OF THE END-OF-LIFE ON THE PRODUCT LIFE CYCLE**

As it has been mentioned during the chapter 3 and 4, the end-of-use/end-of-life stage has a significant influence on the global environmental impacts generated by the product and the business strategy among itself. So, different end-of-life scenarios have to be simulated to show the influence on the overall performance. As it was presented in section 3.3., the LCA of the classic catalytic converter lifecycle serves as initial data to introduce in the new model. Then, it is necessary to observe how the remanufacturing-PSS model influences the environmental impacts.

### **4.2.1. CLOSED – LOOP PRODUCT LIFE CYCLE BY REMANUFACTURING**

The assessment of the total environmental benefits and impacts in closed-loop product life cycle depends on several factors such as the amount of precious materials used in a catalytic converter, the countries precious materials production, allocation procedure, emissions factors of the engine, service lifetime of a catalytic converter, fuel consumption due to the use of a catalytic converter, data quality, the recycling process and rates, remanufacturing performance process, etc. Those parameters of the remanufacturing and PSS will redefine the design process of the product as well as their environmental impacts. All those parameters are presented in figure 5-6. Just to illustrate, the catalytic converter model considers a 5% of material loss, material that is considered as a solid waste, treated by a recycling process.

Figure 5-6 presents the parameters of logistics (distribution) and reverse logistic performance (networks for the recollection of used products). All the locations where defined following the catalytic converter classic product life cycle: the distance defined for the transportation from the mine to the manufacturing site, with the correspondent type of transport used that depends on the type of vehicle (truck, semi truck, etc.). It is important to remark that those parameters are quantitative. However, the environmental impacts depend also on the quality

of the materials, resources, energy and transports. The selection of those parameters is exactly the same than illustrated in chapter 3.

**Remanufacturing Model Parameters**

CATALYTIC CONVERTER

	nt	01 C. RAW MAT. EXT.	02 C. MANUFACTURING		05 P. USE		06 P. TAKE/BACK	07 P. END/USE	
		PMR (%)	PML (%)	ρ	Δ	λ	η	PiRP (%)	
1 Converter Housing	2	10%	5%	30%	10%	60%	75%	100%	
2 Cordierite	2	10%	5%	30%	10%	60%	75%	100%	
3 Washcoat	2	10%	5%	30%	10%	60%	75%	100%	
4 Ceramic Substrate	2	10%	5%	30%	10%	60%	75%	100%	

	01 C. RAW MAT. EXT.	02 C. MANUFACTURING		03 C. DISTRIB.	04 P. DISTRIB.	06 P. TAKE/BACK	07 P. END/USE
	dM2T (Km)	dM2B (Km)	dM2A (Km)	d2C/dR2C (Km)	dC2REM (Km)	dR2EoL (Km)	
1 Converter Housing	1500	1350	1500	2000	440	400	
2 Cordierite	1500	1350	1500	2000	440	400	
3 Washcoat	1500	1350	1500	2000	440	400	
4 Ceramic Substrate	1500	1350	1500	2000	440	400	

Figure 5 - 6: Remanufacturing Parameters: Product Definition Level and Logistics – Network

At the beginning of the study of the classic catalytic converter life cycle, it was presented due to the insufficient natural occurrence of precious metal, that several significant environmental impacts occur during the mining and production of the precious metals used as catalytic elements. The results show that the environmental impact occurring during the extraction of raw materials and production, in one place, are significant, but it also exists significant environmental impacts in other places. The assessment of the classic product life cycle indicates that the environmental impacts of recycling are not less important than the environmental impacts of manufacturing phase processes.

So, for the material and resources that should be considered in the raw material extraction, manufacturing and end-of-life; the parameters will be equivalent to those described in the remanufacturing approach in chapter 4. Here there will be some material recovering and reprocessing; the use of new components at the manufacturing phases is avoided thanks to the remanufacturing of ancient components, etc. In fact, from a global and life cycle perspective, the environmental impacts may outweigh the environmental benefits because a small additional use of the precious materials may generate more environmental impacts than the further reduced emissions.

The results of the simulation for a remanufacturing approach are presented in figure 5-7, the global environmental impact of each phase of the catalytic converter life cycle. The remanufacturing process is compared to the global impact of the classic product life cycle with recycling at the end-of-life (figure 5-5). Here, it is possible to highlight that the implementation of a remanufacturing process implies a reduction of almost 10 EcoPoints at the

end-of-life phase environmental impact (a reduction of the 21% of the environmental impacts). However, the environmental gains at the raw material extraction and the component manufacturing phases (7 ecopoints and 4 ecopoints respectively) are not such significant as the remanufacturing. A reduction of the 11% of the environmental impacts in the raw material extraction and the manufacturing are obtained.

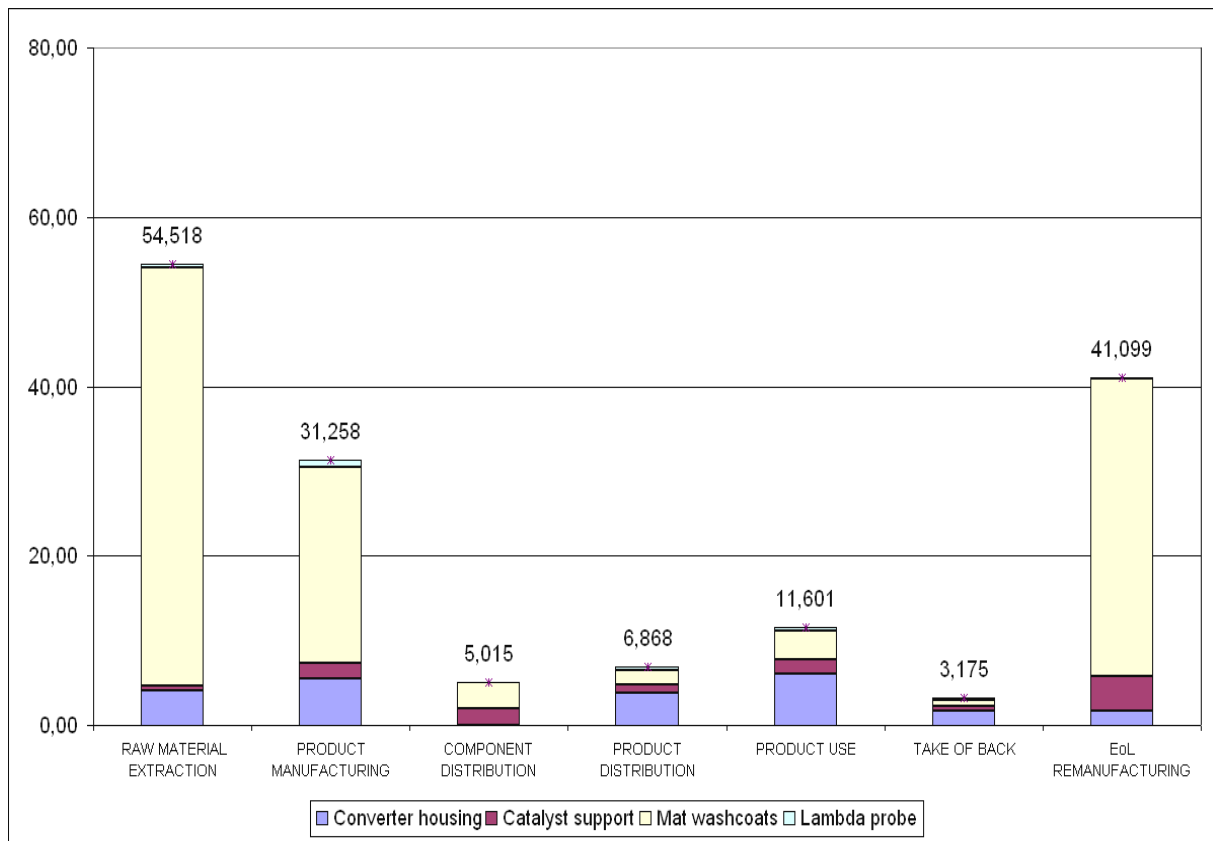

Figure 5 - 7: Catalytic converter life cycle environmental impacts – End of Life: Remanufacturing (EcoPoints)

So, substantially environmental impacts occurring during the raw material extraction and manufacturing with precious materials may reduce their exhaust emissions. As a strategy to recover the added value in those phases of the product life cycle and stop new emissions by the manufacturing of new products, the remanufacturing-PSS appears as an opportunity of improvement for the actual scenario.

### 4.3. CLOSED-LOOP LIFE CYCLE SIMULATION: REMANUFACTURING – PSS

As it was mentioned in the precedent chapter; three levels of parameters (physical objects, service units and organization on the system) must be used in order to illustrate the PSS strategy. However those parameters must be coherent within the remanufacturing strategy if the objective is to employ the PSS to support a remanufacturing for the product end-of-life.

Service units and organization on the system level

As it was mentioned, the closed-loop life cycle approach which considers PSS and remanufacturing includes product remanufacturing specifications, but also a broader characteristics parameters system, comprising service units and organization parameters to manage the system.

The PSS model introduces other aspect to manufacturers. This time, they possess the catalytic converter by contract. This gives manufacturers facilities in the control of the product state. Then they will be in charge of providing maintenance services to customers.

Using the data mentioned in the description of the catalytic converter, a FU can be defined for the remanufacturing-PSS by: 100 trucks possess the catalytic converter by a renting contract. Each catalytic converter, on the average, requires regeneration by remanufacturing every 1600000 Km., this means one in a year. Once the catalytic converter matches remanufacturing conditions, it is replaced by a remanufactured one. Considering if the remanufacturing stock is not able to fulfil demand, the catalytic converter will be replaced with a new unit. Necessary catalytic converter stock and the service must be available on the market for the trucks during 10 years. With this definition it is possible to compare the environmental impacts. The parameters that define the catalytic converter in PSS are summarized in table 5-3.

<b>Parameters</b>	<b>Units</b>	<b>Catalytic Converter</b>
Average Time for each use	minutes	960
Average maintenance time for the converter	minutes	30
Technical lifetime of the catalytic converter	years (Km.)	1 (160000Km)
Service provision time on the market	years	10
Total number of users		100
Percentage of catalytic converter blocked in maintenance at any time	%	20

Table 5 - 3: Parameters for the catalytic converter PSS

Figure 5-8 presents the parameters of the services and organization system, all those parameters were previously defined in chapter 4. Here, it is important to mention the parameters related to services on products and those parameters related to service structures and platform that support the performance of the service could be different. For a better understanding of those parameters, it is possible to make the link of the parameters with the quality of service. This concept of the quality of the service will be influenced by different parameters like the number of products available on the system, the technical life of

the products, etc. This means, even if the parameters are well different according to the level of the activities, all of them are useful at the moment to satisfy the customers needs.

			Catalytic Converter
$t_u$	Time for each use	minutes	960
$t_{sp}$	Time of service provision	years	10
$n_u$	Times a converter is used by each different user	number of times	3650
$U$	Number of trucks		100
$t_m$	Time preventive maintenance	minutes per use	30
$\alpha$	Ratio of converter need classical maintenance	percentage	20%
$t_s$	Time of converters on stock	weeks	6
$t_l$	Technical life time	years	1
$N$	Number of converters available in the system		102

Figure 5 - 8: PSS - Remanufacturing Parameters: Services and Use affectation of the catalytic converter

All the decisions taken to define the service among the product life cycle have to be translated into measures. With these parametrisation of the services, the environmental impacts of the services are evaluated at the same time that those impacts related to the the physical objects: product redesign (permit to support intensive of use), end-of-use/life disposition (remanufacturing process).

#### Physical objects level

The closed-loop product life cycle approach seeks to assess the environmental impacts of the product, the main parameters that describe the PSS remanufacturing model and those parameters in their different levels should be considered to generate detailed results. For example, to assess the impacts related to material resources and generation of solid waste, it is necessary to take into account that products introduced in a PSS system must be redesigned to fulfil with the technical specification. At the same time, considerations of the material resources performance will integrate the manufacturing and remanufacturing processes (estimation of the ratio of the product material loss, material saved by the performance of the remanufacturing process, etc.). This means, that those parameters of the remanufacturing and PSS will redefine the design process of the product as well as their environmental impacts. Considering the necessity to respond to remanufacturing process requirements and intensification of use, the catalytic converter has to be technically robust enough. So, the PSS will be considered providing with more robust catalytic converter with a similar performance of the ancient version (requires regeneration by remanufacturing every 1600000 Km) but a higher technical lifetime (5 years). This is obtained by modifying some of the components (mass and type of material). The differences between the use of classic catalytic converters and the redesigned catalytic converters are presented in figure 5-9.

			Catalytic Converter	Catalytic Converter Robustness
$t_u$	Time for each use	minutes	960	960
$t_{sp}$	Time of service provision	years	10	10
$n_u$	Times a converter is used by each different user	number of times	3650	3650
$U$	Number of trucks		100	100
$t_m$	Time preventive maintenance	minutes per use	30	30
$\alpha$	Ratio of converter need classical maintenance	percentage	20%	20%
$t_s$	Time of converters on stock	weeks	6	6
$t_{tl}$	Technical life time	years	1	5
$N$	Number of converters available in the system		102	102
$NT$	Total number of converters in the system		1020	204

Figure 5 - 9: PSS - Remanufacturing Parameters: Services and Use affectation of the catalytic converter

So, the redefinition of the parameters presented in figure 5-9 will have an incidence in the environmental assessment of the product life cycle. Figure 5-10 presents the environmental impacts assessment of the catalytic converter (increasing the mass) and the proportional impacts of the units of services. The product parameters, logistics (distribution) and reverse logistic performance (networks for the recollection of used products) were defined following the catalytic converter remanufactured in section 4.2.1.

PRODUCT	Raw Material Ext.	Component Manufac.	Component Distrib.	Product Distrib.	Product Usage	Prod. Take of Back	Prod. E-o-U / E-o-L	TOTAL
Converter Housing	7,646	10,153	0,000	0,000	7,572	12,212	3,500	41,084
Cordierite	0,930	3,340	3,934	0,000	2,120	3,420	0,980	14,723
Washcoat	91,152	42,791	6,097	0,000	3,286	6,520	1,519	151,366
Ceramic Substrate	0,993	1,464	0,000	0,000	0,757	1,051	0,350	4,816
<b>TOTAL (EcoPoints)</b>	<b>100,722</b>	<b>57,749</b>	<b>10,031</b>	<b>0,000</b>	<b>13,736</b>	<b>23,203</b>	<b>6,349</b>	<b>211,789</b>

SERVICE	Raw Material Ext.	Component Manufac.	Component Distrib.	Product Distrib.	Product Usage	Prod. Take of Back	Prod. E-o-U / E-o-L	TOTAL
Terminal Base	0,410	0,035	0,001	0,000	0,072	0,000	0,054	0,572
Terminal Locker	6,836	0,583	0,014	0,004	1,196	0,000	0,893	9,526
Electronic Network	0,656	0,056	0,001	0,000	0,115	0,000	0,086	0,915
Cycles Routes	1,230	0,105	0,002	0,001	0,215	0,008	0,161	1,722
Maintenance platform	0,041	0,003	0,000	0,000	0,007	0,000	0,005	0,057
<b>TOTAL (EcoPoints)</b>	<b>9,173</b>	<b>0,782</b>	<b>0,019</b>	<b>0,006</b>	<b>1,605</b>	<b>0,008</b>	<b>1,199</b>	<b>12,792</b>

Figure 5 - 10: PSS and remanufacturing environmental impacts – values in EcoPoints

Here, it is important to mention the parameters are related to services on products (standard exchange of products by remanufacturing process, technical warranty of products in the PSS, etc.) and those parameters related to service structures and platform (recollection system for maintenance, reverse logistics for remanufacturing, etc.) that support the performance of the service could be different. However, in order to realize a fair comparison, the environmental impacts of the remanufacturing PSS model have to be done for a single product use. Next section will present those results.

#### 4.4. CATALYTIC CONVERTER: REMANUFACTURING AND PSS CLOSED-LOOP LIFE CYCLE RESULTS

Here, is presented the environmental impacts benefits occurring in the life cycle of the catalytic converter when there is a model change: From the classic sales to the remanufacturing-PSS. The results take into account an increase of material consumption at the product initial life cycle, performance of the reverse logistic, performance of the remanufacturing process, distance to the factory site, assembly site, etc.

Figure 5-11 presents the environmental impact of the remanufacturing-PSS, this means the closed-loop life cycle approach considers PSS and remanufacturing and it includes product remanufacturing specifications. The use of a catalytic converter in a remanufacturing-PSS model represents approximately 62 EcoPoints. Then, the control of a remanufacturing process by a PSS strategy makes possible a significant reduction of the environmental impacts.

<b>Catalytic Converter (with robustness)</b>	<b>Raw Material Ext.</b>	<b>Component Manufac.</b>	<b>Component Distrib.</b>	<b>Product Distrib.</b>	<b>Product Usage</b>	<b>Prod. Take Back</b>	<b>Prod. E-o-U / E-o-L</b>	<b>TOTAL</b>
<b>Produit</b>	20,547	11,781	2,046	2,802	4,733	1,295	14,165	<b>57,370</b>
<b>Service</b>	1,828	0,156	0,004	0,001	0,320	2,813	0,239	<b>5,360</b>
<b>TOTAL</b>	<b>22,375</b>	<b>11,937</b>	<b>2,050</b>	<b>2,803</b>	<b>5,053</b>	<b>4,108</b>	<b>14,404</b>	<b>62,730</b>

Figure 5 - 11: PSS and remanufacturing analytical results – values in EcoPoints

Regarding those results, it is important to highlight how the impacts of the raw material extraction, the manufacturing, and the end-of-life are reduced thanks to the implementation of the PSS process. Since different environmental loads cannot directly be compared in terms of amounts, comparisons are carried out by environmental single score (ecopoints). The relative potential contributions of each input and output assigned to each life cycle phase of the catalytic converter.

On the other hand, the introduction of a PSS strategy results in a reduction of environmental impacts of the product life cycle. Figure 5-12 shows a comparison of the product life cycle in single manufacturing, in a remanufacturing model and in a remanufacturing-PSS model. The benefits obtained by the product intensification of use and robustness of the product, are not transposed to other life cycle phases like the raw material and manufacturing. However, activities like the reverse logistic could be affected in a contraproductent way. Finally, the introduction of a PSS remanufacturing strategy at the product end-of-life produces a very significant reduction of the environmental impacts. This means that the introduction of a well done remanufacturing process in the PSS largely compensates the impacts of the redesign of the products.

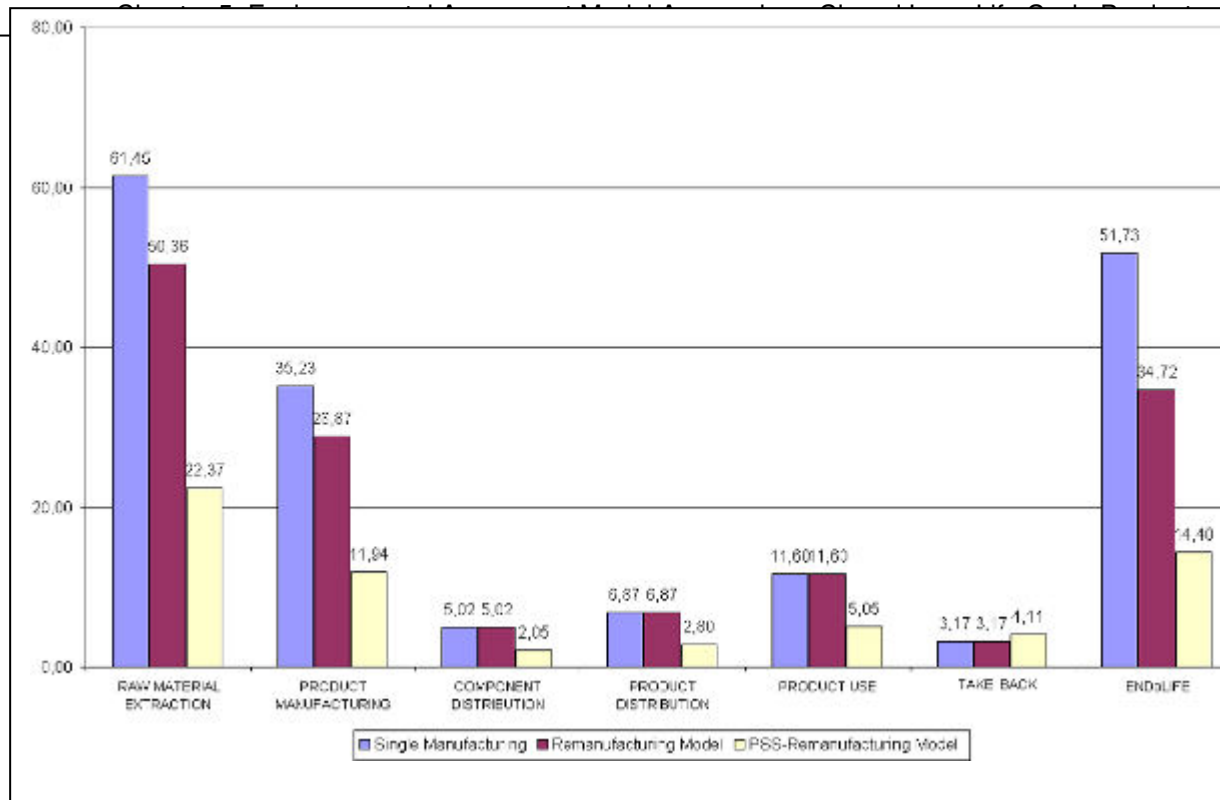

Figure 5 - 12: PSS and remanufacturing analytical comparison results – values in EcoPoints



## **5. CONCLUSION OF CHAPTER 5**

In this chapter, it was defined a model that is able to support data for LCA using the remanufacturing and the PSS strategies combined. Then, it has been implemented for a potential product that could be developed with this strategy in the future.

The result showed that the PSS strategy and the remanufacturing process significantly affect the product's technical lifetime and redesign of the product was necessary for its reuse.

The model is affected by many parameters variation. However, it could provide good indicators to designers during the whole design process. It is now possible to apply this approach to other products with closed loop strategies in other sectors than the heavy vehicles.

Decisions, like the introduction of service units supports for the control of the state of the catalytic converter, or the introduction of training support to users, can have significant results on the recollection and reconditioning by remanufacturing of the most dangerous elements (precious materials).





## Conclusions and Perspectives

## CONCLUSION

This work contributes to the integration of the environmental criterias in the product design within emphasis on modelling product closed-loop life cycles and multiple usage/user strategies. A literature review about the different methodologies and tools developed to assist designer looking upon the environmental issues is presented. This analysis put in evidence the different benefits and difficulties of the actual product life cycle assessment tools. So, this research analyzes the position of the industry facing the environmental issues and the justification of new end-of-life scenarios creation, as a response to the ecological problem. Later on, the discussion takes us to observe the characteristics of the implementation of these strategies. Those characteristics are related to environmental performance indicators to be considered early in the product design process.

So, from the lifecycle brick rules proposed by Gehin, a new model with new rules has been set up to represent multiple scenarios option. The traditional product lifecycle is considered as an option, as well as like cycles with more lifecycles end-of-life scenario (reuse, remanufacturing or recycling for certain components). Here, each process on the regarded lifecycle scenario has been carefully observed in order to generate the correct diagrams and flows for each activity. Designers are not expert on environmental issues, but the method allows them to respond to their constraints putting in balance the environmental assessment with more traditional constraints (cost, quality and time). Regarding the work developed, we underline that:

- The concept of product life cycle must be regarded from the early product design stages. The environmental impacts are observed on each stages of the product life cycle with their correspondent operations. The evaluation of the activities on the product life cycle determines the environmental impacts and their allocations within specified boundaries.
- New strategies for sustainable development involve the reuse of components with high added-value. Some analyses have considered remanufacturing products from an environmental impact assessment point of view, but they stay clearly at the product level and not at the system level. The remanufacturing strategies as well as the product-service systems offers have demonstrated their economical interest. Now a demonstration of their environmental interest is possible to accomplish including the process and the activities of the whole life cycle.

- Environmental impacts could be increased by the use of remanufacturing industrial processes, by transportation, etc. The environmental impacts have been assessed following a specific life cycle modelling to determine their relevance according to the implementation at the remanufacturing strategy.
- All the reflections and previous works on the characterization of the remanufacturing process, remanufactured products, and product-service systems offers have proposals about modifications on the structure of the product or the design of the product. However, these studies are limited by the specific sector or type of profile, depending on the product that will be designed. The present study generalized remanufacturable products and its product life cycle, their needs and requirements have been characterized by a general model that could be used to evaluate any remanufactured product.

## **LIFE CYCLE ASSESSMENT OF REMANUFACTURING TO SUPPORT CLOSED-LOOP PRODUCTS END-OF-LIFE**

In the present study, there is a model to assess the environmental impacts from those strategies that give products new use cycles. One of the most significant scenarios considered in this thesis is the remanufacturing strategy which recovers products totally or partially in an industrial process. The thesis work considers attentively the remanufacturing definition. However, the environmental gains for this process and from other scenarios are not obvious. Since, the main processes used at the products' end-of-use try to reduce the environmental impacts from the raw material extraction (material consumption), although those gains can be lost because third environmental impacts are generated by the activities to support product reconditioning, or transportation.

This research presents a characterization of the remanufacturing, having in mind, the characteristics needed that will be considered later for conducting the environmental evaluation. So, the present work highlights how remanufacturing and those activities in among the remanufacturing process affect the environmental performance of the model. Then, thanks to this characterisation, a parametrical model of the remanufacturing life cycle is proposed considering a set of parameters related with the product life cycle, supply chain (stocks–inventories), product performance and product use. The first conclusion is that

manufacturing, supply chain and economical aspects take an important role during the design of green products.

Later on, a methodology for assessing environmental impacts of remanufacturable products has been developed. The model approach addressed to the product design and designers clarified the environmental benefits of remanufacturing. The model approach also contributes to promote the environmental benefits from the remanufacturing process for products of the heavy vehicle sector. The design of the components (material, weight, etc.) plays a significant role in the product analysis. Anyway, the processes used all along the life cycle influence the environmental assessment. So, as a conclusion for this part of the work:

- This study shows how to establish a model and how to compare the environmental assessments of remanufactured products life cycles vs. classical life cycle scenarios. The life cycle assessment, the life cycle bricks, and a parametric model of the products are used to evaluate and compare the environmental benefits provided by the remanufacturing. An easy to use tool that allows quantify the environmental benefits related to the use of remanufacturing has been proposed. The method can support the decision to reorient the activity while testing different final disposal scenarios.
- The disposal scenarios at the product end-of-use, and in particular those inducing closed-loop product lifecycle are usually strategies with environmental profits. Even, when the environmental impacts of a product are related to the different processes and activities among the product life cycle, well implemented closed-loop strategies can generate significant environmental gains.
- The identification of relevant indicators supports designers and any responsible non specialist on the environmental topics. Those indicators can then be used as guide for the ecodesign of future products or as selling arguments. In this thesis, we focus on what exists to support the decision on the products development with closed-loop end-of-life strategies: the selling of remanufactured components. The parameters and indicators identified help us to propose a readjustment of the environmental insufficiencies pointed by the assessment methodology used (i.e. conventional life cycle assessment).
- Consequently, the present work has also developed an approach model to assess the data of the operations and activities around product life cycle and its final disposition scenarios (remanufacturing as end-of-life scenario and multiple uses by the disposition of the service offers system as a business strategy) from an environmental point of view. The method allows identifying and distinguishing between the different product life cycle

stages and readjust the designers' decision at the product design process. The results can be further used in simulation, to evaluate the environmental performance of different product life cycle end-of-life scenarios.

So, with this approach, product life cycle implications for remanufacturing are considered. The advantage of such a model is that it conducts to an integrated discussion during the assessment process of the remanufacturing strategy. Here, while assessing the closed-loop strategy, one can see that parameters are not limited to the bill of materials. The processes that are used all along the life cycle, for each component, are considered in relation with product design strategies because they influence a lot the environmental assessment.

This approach also brings help to designers in the hard task of decision making for the product design but also for life cycle design. Thus, the remanufacturers can use the parameters (materials, energy, processes, transport and number of product uses, performance of the remanufacturing and recover process) as potentiometers to try to obtain an acceptable environmental impact and to make decisions for future actions. They can easily test the sensitivity of the global environmental impact while varying parameters values. If the environmental impact is responsive to one or several parameters, a detailed "design for" approach can start. For example:

- If the environmental impacts respond to the number of product use, this implies a new design for the product with component materials modification to increase lifetime. Then, design for remanufacturing guidelines can be applied with a real motivation.
- If the environmental impact is high for processes, an optimization of the processes impact can be realized. Remanufacturers can also work on the product modularity or improve disassembly operations depending on the most affected parameter.
- If the environmental impact is low because of the parameter "performance of the recovery process", it is possible with a different marketing strategy or with a product system service approach to increase the rate of recovered products.

## **LIFE CYCLE ASSESSMENT OF PRODUCT-SERVICE SYSTEMS STRATEGIES**

Existing environmental assessment methodologies are limited at the moment to consider the development of a product-service systems business strategy. Product oriented methodologies are too focused on the product to take into account all the participants



involved in the realization of the system. Service methodologies are mainly based on the representation of the organization and do not consider the service delivering activities. So, the second part of this research work presents a characterization of the properties of the product-service system strategy and their products, having in mind that the main objective of this characterization is to be considered earlier into an environmental evaluation. This part of the work has helped to define how product-service systems strategy and the activities among their elements are related to the environmental issues. So, the product-service system strategy is characterized by a set of parameters related with the product requirements, service requirements and global requirements.

Later on in this research, the set of parameters are introduced into the system definition of the product-service system. This means, the main elements present in the product-service system (physical objects, service units, and the organization of the system) are associated with first set of parameters that designers can control and modify.

These results must be considered during the products or the service units design. However, it requires careful consideration of all the design parameters in the system. The model considers the importance of the use phase in the product-service systems lifecycle. From the work described in the present thesis, the following conclusions may be drawn:

- A list of requirements for product-service systems has been defined and is flexible enough to help designers create new scenarios of use according to the gains obtained from the environmental point of view.
- The representation of the system has to be done in a comprehensive way, it is necessary not to focus only on physical objects involved in these systems. Therefore, the environmental assessment problem is focused on physical products, service units and the organization. To represent these systems, we model the flows and the interactors of the different elements of the system. The contribution in these representations is the modelling and parametrisation of the physical objects, service units and organization.
- The environmental impacts for the whole system depends on the products (technical lifetime, reliability, etc.), the services (preventive maintenance, stand-by time, etc.), but also on the global organisation of the product-service systems (number of users, number of uses, etc.). A tool that can be used to simulate alternatives has been proposed.
- The intensification of use is a major means for the improvement of environmental impacts in product-service systems. A comparison with classical sales is possible. The

environmental assessment methodology contributes to the structuring of an approach between the system analysis within their provided functions in a real period of use time and the conventional product design that is also involved in these systems.

- The thesis evaluates the activities and processes involved in the product-services systems, then it proposes an approach to model the environmental impacts associated to this strategy. So, an identification of the parameters associated to the lifecycle of a product-service system is done (one or several use cycles, users, stand-by cycle, maintenances cycle, etc.), then, they are integrated in the product-service system lifecycle strategy.

The results of this work suggest that care is needed during the product-service systems design process during the usage stage. Special attention must be given to design parameters as well as calculation of classical environmental impacts to select an appropriate number of products in the product-service systems.

So, the present work contributes to the development of tools for the environmental assessment of complex and combined strategies (closed-loop product life cycles), once products arrive to end-of-use with no operational conditions. Those complex strategies bring the products' end-of-use to become a stage where several scenarios are possible, depending on the designer choices during the products design. On the other hand, the necessity to develop green products that fulfill the concept of sustainable development in an industrial problem, requires tools to support designers to act from the design process (proactive approach) and not only after products manufacturing (corrective approach).

The models and the proposed tools to realise the environmental assessment will contribute to make designers aware of the global situation during the design process.

## **PERSPECTIVES**

One of the most ambitious perspectives would be the use of this model and tool to establish an “ecolabel” on remanufactured products or on PSS. The model, in that case, would be the framework of the ecolabel.

A more classical perspective would be the validation of the proposed methodology while using it during company product design. The methodology has been developed using theoretical research applied to existent products, products that there are not always designed to be remanufactured or to be integrated in a product-service system. So, this work can be taken as a support to encourage industrial partners on the construction of tools based on the LCA of closed-loop product life cycle model. Indeed, remanufacturing strategies are promising strategies and methods and tools are needed for those strategies to be considered during the product or life cycle design process.

The first model developed is based on the characterization of a product from the remanufacturing point of view. It allows setting the different needs that the product and the design process must meet. So, it is possible to consider this approach and to apply it to other end-of-life strategies, considering that each strategy will present new parameters that will have an influence on the strategy. This means, the same approaches should be developed for recycling, reuse, or for mixed approaches to really encourage companies in those new ways for product manufacturing. The development of an associated cost model should also be encouraged to reinforce the positive image of the closed-loop product life cycle strategy by companies.

In addition, product-service system is becoming one of the most topics studied in research design. The implementation of product-service systems must achieve satisfaction of customers and environmental impacts benefits. So, the economic aspects of product-service systems must be taken into account in the assessment. The acceptance of the client to turn to these new modes of consumption has to be studied.

The social dimension of sustainable development has been largely overlooked by designers that are not experts. Nevertheless, the evaluation of the product-service system from the point of view of sustainable development cannot be achieved without taking into account this aspect that should be studied and integrated the earlier during the design process.





## References

- [Adler and al. 07] Adler D. P., Kumar V., Ludewig P. A., Sutherland J. W., 2007, Comparing Energy and Other Measures of Environmental Performance in the Original Manufacturing and Remanufacturing of Engine Components, Proceedings of ASME International Manufacturing Science and Engineering Conference, Atlanta, USA.
- [AFNOR 97a] AFNOR ISO guide/CEI 64, Guide pour l'introduction des aspects environnementaux dans les normes de produit, 1997.
- [AFNOR 97b] AFNOR NF ISO 14040, Management environnemental – Analyse du cycle de vie, 1997.
- [Alting, L. and al. 93] Alting, L., Jorgensen, J., 1993, The life cycle concept as a basis for sustainable industrial production, Annals of the CIRP, Volume 42, Issue 1, pp. 163-166.
- [Amaya and al. 10 a] Amaya J., Zwolinski P., Brissaud D., Environmental benefits of remanufacturing: the case study of truck injector, Proceedings of the First Summer School Sustainable Manufacturing 2010, Zurich SWITZERLAND, June 2010.
- [Amaya and al. 10 b] Amaya J., Zwolinski P., Brissaud D., Environmental benefits of parts remanufacturing: the truck injector case, Proceedings of the 17th CIRP International Conference on Life Cycle Engineering, China, May 2010.
- [Amezquita and al. 95] Amezquita T, Hammond R, Bras B, 1995, Characterizing the Remanufacturability of Engineering Systems, Proceedings of ASME Advance in Design and Automation Conference, Boston, MA, pp. 271-278.
- [Aurich J. C. and al. 06] Aurich J. C., Fuchs C., Wagenknecht C., 2006, Life cycle oriented design of technical Product-Service Systems, Journal of Cleaner Production, Volume 14, Issue 1, pp. 1480-1494.
- [Bollinger and al. 81] Bollinger L., Frenkel R., Grand R., Kutta R., Lund R., Stanovsky C., 1981, Remanufacturing Survey Findings, Center for Policy Alternatives, MIT, Cambridge, MA, USA.
- [Borland and al. 98] Borland N., Wallance D., Kaufmann H. P., 1998, Integrating Environmental Impact Assessment into Product Design, Proceedings of ASME Design Engineering Technical Conference, September 13-16, 1998, Atlanta, GA, USA, pp. 1-9.

- [Boustead and al. 79] Boustead I, Hancock G., 1979, Handbook of Industrial Energy Analysis. Halsted Press, NY.
- [Bovea and Gallardo 04] Bovea, M. D; Gallardo, A; 2004, The Influence of Impact Assessment Methods on Materials Selection for Eco-Design, *Materials and Design*, Volume 27, Issue 3, pp. 209-215.
- [Bromhead 10] Bromhead A., 2010, Designing office furniture to aid remanufacture, Center for Remanufacturing & Reuse, Sheffield (UK).
- [Charter and al. 08] Charter M., Gray C., 2008, Remanufacturing and product design, *International Journal of Products Development*, Volume 6, Issue 3-4, pp. 375-392.
- [Choi and al. 06] Choi B-C., Shin H-S., Lee S-Y., Hur T., 2006, Life Cycle Assessment of a Personal Computer and its Effective Recycling Rate, *Journal of Life Cycle Assessment*, Volume 11, pp 122-128.
- [Clarke A. and al. 08] Clarke A., Zhang Q., Gershenson J., Sutherland J., 2008, Selection of Remanufacturing Facility Locations to Minimize Cost and Environmental Impact, Proceedings of 15th CIRP International Conference on Life Cycle Engineering, Sydney, Australia, March 2008.
- [Di Mascio R. 03] Di Mascio R., 2003, Service process control: a method to compare dynamic robustness of alternative service processes, *Journal of Process Control*, Volume 13, Issue 7, October 2003, pp. 645-653.
- [Directive 2179/98/EC 98] The European Parliament and of the Council of the European Union, 1998, Directive 2179/98/EC of the European Parliament and of the Council on the review of the European Community Program of policy and actions in relation to the environmental and sustainable development 'Towards sustainability', Brussels, 1998.
- [Directive 2002/96/EC 03] The European Parliament and of the Council of the European Union, 2003, Directive 2002/96/EC of the European Parliament and of the Council on Waste Electrical and Electronic Equipment (WEEE), Brussels, 2003.
- [Dominick and al. 01] Dominick P. G., Demel J. T., Lawbaugh W. M., Freuler R. J., Kizel G. L., Fromme E., 2001, Tools and Tactics of Design; John Wiley & Sons, Inc; USA.
- [Ferrer 01] Ferrer G., 2001, *On the Widget Remanufacturing Operation*, *European Journal of Operational Research*, Volume 135, Issue 2, pp. 373-393.



- [Fleischer and Schmidt 97] Fleischer G., Schmidt W. P.. 1997, Iterative Screening LCA in an Eco-Design Tool; *International Journal of Life Cycle Assessment*, Volume 2, Issue 1, pp. 20-24.
- [Fukushige S. and al. 12] Fukushige S., Yamamoto K., Umeda Y., 2012 Lifecycle scenario design for product end-of-life strategy, *Journal of Remanufacturing*, published on 17 January 2012.
- [Gehin and al. 07] Gehin A., Zwolinski P., Brissaud D., 2007, Towards the Use of LCA During the Early Design Phase to Define EoL Scenarios, *Advances in Life Cycle Engineering for Sustainable Manufacturing Businesses*, Proceedings of the 14th CIRP Conference on Life Cycle Engineering, Tokyo, Japan, June 2007.
- [Gehin and al. 08] Gehin A., Zwolinski P., Brissaud D.; 2008, A Tool to Implement Sustainable End-of-Life Strategies in the Product Development Phase, *Journal of Cleaner Production*, Volume 16, Issue 5, pp. 566-576.
- [Gehin and al. 09] Gehin A., Zwolinski P., Brissaud D., 2009, Integrated Design of Product Lifecycles – The Fridge Case Study, *CIRP Journal of Manufacturing Science and Technology*, Volume 1, pp. 214-220.
- [Geng X. and al. 11] Geng X., Chu X., Xue D., Zhang Z., 2011, A systematic decision-making approach for the optimal product-service system planning, *Expert Systems with Applications*, Volume 38, Issue 9, September 2011, pp. 11849-11858.
- [George G. and al. 11] George G., Bock A. J., 2011, The Business model in practice and its implications for entrepreneurship research, *Entrepreneurship Theory and Practice*, Volume 35, Issue 1, pp. 83-111.
- [Georgiadis P. and al. 10] Georgiadis P. and Athanasiou E., 2010, The impact of two-product joint lifecycles on capacity planning of remanufacturing networks, *European Journal of Operational Research*, Volume 202, Issue 2, pp. 420-433.
- [Hauschild M. Z. and al. 99] Hauschild M. Z., Wenzel H., Alting L., 1999, Life cycle design – a route to the sustainable industrial culture?, *Annals of the CIRP*, Volume 48, Issue 1, pp. 93-96.
- [Hauschild, M.Z. and al. 04] Hauschild M. Z., Jeswiet J., Alting L., 2004, Design for Environment? Do We Get the Focus Right?, *Annals of the CIRP*, Volume 53, Issue 1, pp. 1-4.

- [Heese and al. 05] Heese H. S., Cattani K., Ferrer G., Gilland W., Roth A. V., 2005, Competitive advantage through take-back of used products, *European Journal of Operational Research*, Volume 164, Issue 1, pp. 143–157.
- [Hormozi 99] Hormozi A. M., 1999, Make it again, *Journal IIE Solutions*, Volume 31, Issue 4, pp. 39-44.
- [Huppes and Ishikawa 07] Huppes G., Ishikawa M., 2007, *Quantified Eco-efficiency in Industry and Science*, Volume 2, Springer Edition Book.
- [Ijomah W. L. 05] Ijomah, W. L., 2005, Remanufacturing: A route to rejuvenating European manufacturing, BEAMA Centenary conference, October 2005, Warwickshire, UK
- [Ijomah W. L. and al. 04] Ijomah, W. L., Childe S., McMahon C., 2004, Remanufacturing – a key strategy for sustainable development, *Proceedings of the third international conference on design and manufacture for sustainable development*, Loughborough, UK
- [Ijomah W. L. and al. 07] Ijomah, W. L., McMahon CA., Hammond GP., Newman ST., 2007, Development of design for remanufacturing guidelines to support sustainable manufacturing. *Robotics and Computer-Integrated Manufacturing*, Volume 23, pp. 712-719.
- [Jacobsson 00] Jacobsson N., 2000, *Emerging Product Strategies, Selling Services of remanufactured product*, Licenciate Dissertation, Lund University.
- [Jacqueson 02] Jacqueson L., 2002, *Intégration de l'environnement en entreprise: Proposition d'un outil de pilotage du processus de création de connaissances environnementales*, PhD thesis Ecole Nationale Supérieure d'Arts et Métiers, Paris (France).
- [Janin 00] Janin M., 2000, *Démarche d'éco-conception en entreprise un enjeu: construire la cohérence entre outils et processus*, PhD thesis Ecole National Supérieure d'Arts et Métiers, Chambéry (France).
- [Jansen L. and al. 97] Jansen L, Vergragt P., 1997, *Sustainable technology development vision (Key to sustainable prosperity)*. The Hague, Netherlands.
- [Jiang and al. 11] Jiang Z.G., Zhang H., Yan W., Zhao G., Wang Y.H., 2011, A correlation model of material resources and environmental impacts for iron and steel green manufacturing system, *Journal of Wuhan University of Science and Technology*, Volume 34, Issue 3, pp. 173–177

- [Kara and al. 07] Kara S.; Manmek H., Kaebernick H., 2007, An Integrated Methodology to Estimate the External Environmental Costs of Products, *Annals of the CIRP*, Volume 56, Issue 1, pp. 9-12.
- [Kimura F. and al. 01] Kimura F., Kato S., Hata T., Masuda T., 2001, Product Modularization for Parts Reuse in Inverse Manufacturing, *Annals of the CIRP*, Volume 50, Issue 1, pp. 89–92.
- [Kiritsis D. and al. 03] Kiritsis D., Bufardi A., Xirouchakis P., 2003, Research issues on product lifecycle management and information tracking using smart embedded systems, *Advanced Engineering Informatics.*, Volume 17, Issues 3-4, pp. 189-202.
- [Kljajin 00] Kljajin M., 2000, Design for Environment using Life Cycle Assessment, *Proceedings of the 6th International Design Conference - Design 2000*, Ed. Dorian Marjanović, pp. 175-180.
- [Kohonen T. 97] Kohonen T., 1997, *Self-organizing Maps*, Information Sciences, Springer-Verlag.
- [Kobayashi and al. 05] Kobayashi Y., Kobayashi H., Hongu A., Sanehira K., 2005, A Practical Method for Quantifying Eco-Efficiency Using Eco-Design Support Tools, *Journal of Industrial Ecology - MIT and Yale University*, Volume 9, Issue 4, pp. 131-144.
- [Koltun P. and al. 05] Koltun P., Tharumarajah A., Ramakrishnan S., 2005, An approach to treatment of recycling LCA study, 4th Australian LCA Conference, Sydney.
- [Komoto H. and al. 05] Komoto H., Tomiyama T., Nagel M., Silvester S., Brezet H., 2005, Life Cycle Simulation for Analyzing Product Service Systems, *Fourth International Symposium on Environmentally Conscious Design and Inverse Manufacturing*, IEEE Eco Design, pp. 386-393.
- [Kumar and al. 07] Kumar V, Shirodkar P. S., Camelio J. A., Sutherland J. W., 2007, Characterizing Value Flow during the Product Life Cycle Including the Effects of Reuse, Remanufacturing, and Recycling, *International Journal of Production Research*, Volume 45, Issues 18-19, pp. 4555–4572
- [Lagerstedt 03] Lagerstedt J., 2003, *Functional and Environmental Factors in Early Phases of Product Development – Eco-functional Matrix*, PhD Thesis, University of Stockholm KTH, Stockholm.

- [Lindahl M. and al. 01] Lindahl M., Ölundh G., 2001, The Meaning of Functional Sales, Proceedings of Life-cycle Engineering: Challenges and Opportunities, 8th International Seminar on Life-cycle Engineering, Varna, Bulgaria.
- [Lopez 04] Lopez M., 2004, Intégration des contraintes des remanufacturabilité en conception de produits, PhD thesis, INPG Grenoble, France.
- [Lund and al. 03] Lund R. T., Hauser W., 2003, The Remanufacturing Industry: Anatomy of a Giant, Department of Manufacturing Engineering, Boston University, Boston, MA, USA.
- [Mabee and al. 99] Mabee D. G., Bommer M., Keat W. D., 1999, Design charts for remanufacturing assessment, Journal of Manufacturing Systems, Volume 18, Issue 5, pp. 358-366.
- [Manzini 96] Manzini E., 1996, Different scenarios of products and services combinations, Conference: Challenges of Sustainable Development, International Network of Engineers and Scientists (INES), Workshop 'Industry and Sustainability: Pioneer Industries on Sustainable Services', Amsterdam, Netherlands.
- [Maussang N. and al. 09] Maussang N., Zwolinski P., Brissaud D., 2009, Product-service system design methodology: from the PSS - architecture design to the products specifications, Journal of Engineering Design, Volume 20, Issue 4, pp. 349-366.
- [Maxwell D. and al. 06] Maxwell D., Sheate W., Van der Vorst R., 2006, Functional and systems aspects of the sustainable product and service development approach for industry, Journal of Cleaner Production, Volume 14, Issue 17, pp. 1466-1479.
- [McAloone 03] McAloone T., 2003, Demands for Sustainable Development, Proceedings of International Conference on Engineering Design (ICED 03), Stockholm (Sweden), pp. 19-21, August 2003.
- [Meier H. and al. 10] Meier H., Roy R., Seliger G., 2010, Industrial Product-Service Systems-IPS2, CIRP Annals – Manufacturing Technology, Volume 59, Issue 2, pp. 607–627.
- [Millet and al. 02] Millet D., Jacqueson L., Minel S., Aoussat A., 2002, Environmental Knowledge Creation and Management Process: Formalisation, Diffusion and Valorisation Model, International Journal of Environmental Technology and Management, Volume 2, Issue 4, pp. 315-328.

- [Millet and al. 07] Millet D., Bistagnino L., Lanzavecchia C., Camous R., 2007, Does the potential of the use of LCA match the design team needs? Suitability of LCA for product design, *Journal of Cleaner Production*, Volume 15, Issue 4, pp. 335-346.
- [Millet and al. 08] Millet D., Ling H., Tcherchian N., El korchi A., 2008, A remanufacturing method for Eco-innovative products and supply chains, *Proceedings of IDMME – Virtual Concept*, Beijing, China, October 8-10 2008.
- [Millet and El korchi 10] Millet D., El korchi A., 2010, Designing a sustainable reverse logistics channel: the 18 generic structures framework, *Journal of Cleaner Production*, Volume 19, Issue 6-7, pp. 588-597.
- [Mok and al. 06] Mok H-S., Cho J-R., and Moon K-S., 2006, Design for Environment-Friendly Product, *Computational Science and its Applications*, Volume 3982, pp. 994-1003.
- [Mont 02] Mont O. K., 2002, Clarifying the concept of product–service system, *Journal of Cleaner Production*, Volume 10, Issue 3, pp. 237-245.
- [Mont and al. 06] Mont O. K., Tukker A., 2006, Product-Service Systems: reviewing achievements and refining the research agenda, *Journal of Cleaner Production*, Volume 14, Issue 17, pp. 1451-1454, March 2006.
- [Morris 05] Morris J., 2005, Comparative LCAs for Curbside Recycling versus either Landfilling or Incineration with Energy Recovery, *The International Journal of Life Cycle Assessment*, Volume 10, Issue 4, pp. 273-284.
- [Östlin 05] Östlin J., Svensson R., 2005, Material handling in the remanufacturing industry: a case study of a diesel engine remanufacturing process, *Proceedings of the CIRP Life Cycle Engineering Conference*, Grenoble, France.
- [Östlin and al. 09] Östlin J., Sundin E., Björkman M., 2009, Product life-cycle implications for remanufacturing strategies, *Journal of Cleaner Production*, Volume 17, Issue 1, pp. 999-1009.
- [Péro 03] Péro H., 2003, From Design to Life-Cycle Approaches: The EU Perspectives, *Proceeding of the International CIRP Design Seminar*, May 2003, Grenoble, France.
- [R&D 02] Développement durable, 2002, R&D le magazine de la recherche et du développement, Renault, No 26, pp. 22-36, Octobre 2002.

- [Richter A. and al. 10] Richter A., Sadek T., Steven M., 2010, Flexibility in industrial product-service systems and use-oriented business models, CIRP Journal of Manufacturing Science and Technology, Volume 3, Issue 2, pp. 128-134.
- [Rose 00] Rose C., 2000, Design for Environment: a method for formulating product end-of-life strategies, PhD thesis, University of Stanford.
- [Seliger G and al. 04] Seliger G., Franke C., Ciupek M., Basdere B., 2004, Process and Facility Planning for Mobile Phone Remanufacturing. CIRP Annals, Volume 53, Issue 1, pp. 9-12.
- [Seliger G and Zettl M. 04] Seliger G., Zettl M., 2008, Modularization as an enabler for cycle economy, Annals of CIRP, Manufacturing Technology, Volume 57, Issue 1, pp.133- 136.
- [Sherwood and Shu 00] Sherwood M., Shu L., 2000, Supporting Design for Remanufacture through Waste-Stream Analysis of Automotive Remanufacturers, CIRP Annals, Volume 49, Issue 1, pp. 87-90.
- [Smith V. and Keoleian G. 08] Smith V. M., Keoleian G. A., 2008, Life-Cycle Environmental and Economic Perspectives, Journal of Industrial Ecology, Volume 8, Issues 1-2, pp. 193-221.
- [Steinhilper 98] Steinhilper R., 1998, Remanufacturing: The Ultimate Form of Recycling, Fraunhofer IRB Verlag, Stuttgart.
- [Sroufe and al. 00] Sroufe R., Curkovic S., Montabon F., Melnyk S. A., 2000, The new product design process and design for environment "crossing the chasm"; International Journal Operation Production Management, Volume 20, Issue 2, pp. 267-291.
- [Subramoniama and al. 09] Subramoniama R., Huisingh D., Chinnamc R. B., 2009, Remanufacturing for the automotive aftermarket-strategic factors: literature review and future research needs, Journal of Cleaner Production, Volume 17, Issue 13, pp 999-1009.
- [Suesada R. and al. 07] Suesada R., Itamochi Y., Kondoh S., Fukushige S., Umeda Y., 2007, Development of Description Support System for Life Cycle Scenario, Advances in Life Cycle Engineering for Sustainable Manufacturing Businesses, Springer, pp. 29-34.

- [Sullivan J and al. 98] Sullivan J., Williams R., Yester S., Cobas-Flores E., Chubbs S., Hentges S., Pomper S., 1998, Life Cycle Inventory of a Generic US Family Sedan, SAE Paper No. 98216.
- [Sun and al. 03] Sun M., Rydh C. J., Kaebernick H., 2003, Material Grouping for Simplified Product Life Cycle Assessment, The Journal of Sustainable Product Design, Volume 3, Issues 1-2, pp. 45-58.
- [Sundin 05] Sundin E., The Swedish remanufacturing industry. An overview of present status and future potential, Proceedings of the CIRP Life Cycle Engineering Conference, CIRP LCE 2005, Grenoble, 2005.
- [Sundin 06] Sundin E., 2006, How can Remanufacturing Processes become Leaner?, Proceedings of the CIRP Life Cycle Engineering Conference, CIRP LCE 2006, Leuven.
- [Sundin 09] Sundin E., 2009, Life-Cycle Perspectives of Product/Service-Systems: In Design Theory, Introduction to Product/Service-System Design, Chapter 2, Springer, pp. 31-49.
- [Sundin and al. 00] Sundin E., Jacobsson N. and Biorkman M., 2000, Analysis of Service Selling and Design for Remanufacturing, Proceedings of the IEEE International Symposium on Electronics and the Environment, San Francisco, CA (USA), pp. 272-277.
- [Sundin and Bras 04] Sundin E., Bras B., 2004, Making functional sales environmentally and economically beneficial through product remanufacturing, Journal of Cleaner Production, Volume 13, Issue 9, pp. 913-925.
- [Sutherland and al. 08] Sutherland J. W., Adler D. P., Haapala K. R., Kumar V., 2008, A Comparison of Manufacturing and Remanufacturing Energy Intensities with Application to Diesel Engine Production, CIRP Annals, Volume 57, Issue 1, pp. 5-8.
- [Sutherland and al. 10] Sutherland J. W., Jenkins T. L., Haapala K. R., 2010, Development of a cost model and its application in determining optimal size of a diesel engine remanufacturing facility, CIRP Annals – Manufacturing Technology, Volume 59, Issue 1, pp. 49–52.
- [Schweitzer E. and al. 10] Schweitzer E., Aurich J. C., 2010, Continuous improvement of industrial product-service systems, Industrial Product-Service Systems - IPS2, CIRP Journal of Manufacturing Science and Technology, Volume 3, Issue 2, pp. 158-164.

- [Takata S. and al. 04] Takata S., Kimura F., Van Houten FJAM, Westkämper E., Shpitalni M., Ceglarek D., Lee J., 2004, Changing Role of Maintenance in Life Cycle Management, Annals of the CIRP, Volume 53, Issue 2, pp. 1-13.
- [Tukker A. and al. 06] Tukker A., Tischner U., 2006, Product-services as a research field: past, present and future. Reflections from a decade of research, Journal of Cleaner Production, Volume 14, Issue 17, pp. 1552–1556.
- [Umeda Y. and al. 06] Umeda Y., Kondoh S., Sugino T., 2006, Analysis of reusability using “Marginal Reuse Rate”, CIRP Annals – Manufacturing Technology, Volume 55, Issue 1, pp. 41-44.
- [Umeda Y. and al. 08] Umeda Y., Fukushige S., Tonoike K., Kondoh S., 2008, Product modularity for life cycle design, CIRP Annals – Manufacturing Technology, Volume 57, Issue 1, pp. 13-16.
- [Umeda Y. and al. 09] Umeda Y., Fukushige S., Tonoike K., 2009, Evaluation of scenarios-based modularization for lifecycle design, CIRP Annals-Manufacturing Technology, Volume 58, Issue 1, pp. 1-4.
- [Yang C. and al. 09] Yang C., Marlow P. B., Lu C., 2009, Assessing resources, logistics service capabilities, innovation capabilities and the performance of container shipping services in Taiwan, International Journal of Production Economics, Volume 122, Issue 1, pp. 4-20.
- [Yu S. and al. 11] Yu S., Yang Q., Tao J., Tian X., Yin F., 2011, Product modular design incorporating life cycle issues - Group Genetic Algorithm (GGA) based method, Journal of Cleaner Production, Volume 19, Issues 9-10, pp. 1016-1032.
- [Watson 08] Watson M., 2008, A review of literature and research on public attitudes, perceptions and behaviour relating to remanufactured, repair and reuse products, Center for Remanufacturing & Reuse, Sheffield (UK).
- [Wenzel H. and al. 97] Wenzel H., Hauschild M., Alting L., 1997, Environmental Assessment of Products, Volume 1, Kluwer Academic Publisher.
- [Westkaemper and al. 00] Westkaemper E., Alting L., Arndt G., Life Cycle, 2000, Management and Assessment: Approaches and Vision Towards Sustainable Manufacturing, Annals of CIRP, Volume 49, Issue 2, pp. 501-522.



- [Williams A. 07] Williams A., 2007, Product service systems in the automobile industry: contribution to system innovation?, *The Automobile Industry & Sustainability, Journal of Cleaner Production*, Volume 15, Issues 11-12, pp. 1093-1103.
- [Williams and Shu 01] Williams J, Shu L. H., 2001, Analysis of Remanufacturer Waste Streams Across Product Sectors, *CIRP Annals*, Volume 50, Issue 1, pp. 101–104.
- [Zwolinski and al. 05] Zwolinski P., Lopez-Ontiveros M. A., Brissaud D., 2005, Integrated Design of Remanufacturable Products Based on Product Profiles, *Journal of Cleaner Production*, Volume 14, Issues 15-16, pp. 1333-1345.





## **Résumé :**

Les produits avec des phases d'usage multiple sont de plus en plus pris en considération à du fait des pressions économiques et environnementales. Ces produits aux cycles de vie complexes, utilisent des process tels que le remanufacturing. Ces process doivent être modélisés et évalués par des équipes de conception. Cette thèse montre comment représenter, modéliser et évaluer des produits en cycle de vie à boucle fermées. L'étude montre comment établir des évaluations environnementales pour ces produits et les comparer aux évaluations environnementales de cycles de vie classiques.

Les modèles ont été développés sur des travaux antérieurs, tels que la méthodologie de Gehin et al. basée sur le concept du briques du cycle de vie produit. La première approche proposée sert pour évaluer les bénéfices environnementaux des opérations et des activités autour du cycle de vie de produit en boucle fermée (remanufacturing scénario de fin de vie et systèmes de produit-service comme stratégie de vente des services).

L'introduction de systèmes produit-service vise à réduire les impacts environnementaux de produits par l'intensification de l'utilisation. Ainsi, la thèse propose un modèle pour évaluer les éléments de systèmes produits-service et leur cycle de vie du point de vue environnemental. La thèse se concentre sur l'élaboration d'un modèle qui intègre le cycle de vie d'un produit-service système et ses paramètres, en tenant en compte des éléments physiques, ainsi que de l'infrastructures, la conception des unités de services, les acteurs dans la logistique et leurs interactions.

Les modèles permettent d'identifier et de distinguer les différentes phases du cycle de vie du produit et de réajuster la décision des concepteurs dans le processus de conception du produit. De plus, le modèle cherche l'intégration des paramètres du process de remanufacturing et des systèmes produit-service dans l'ensemble du cycle de vie du produit. Les modèles visent à aider la conception de produits et de processus, ainsi que les acteurs de la chaîne approvisionnement et les personnes chargées de la prise de décision sur la conception du produit et des changements dans le système.

Les résultats peuvent être utilisés, afin d'évaluer la performance environnementale des différents scénarios de fin de vie des produits, fournissant un outil pour les concepteurs qui permet de quantifier les avantages environnementaux liés à l'utilisation des produits en cycle de vie en boucle fermée.

## **Mots-clés :**

Paramètres pour l'Analyse du Cycle de Vie, Produits Cycle de Vie Boucle Fermée, Remanufacturing, Systèmes Produit Service.

## **Abstract:**

Products with multiple use phases have to be considered regarding new economic and environmental pressures. Therefore, the related complex life cycles of (re)manufactured products have to be modeled and assessed by design teams for a better understanding of their performance. This thesis presents methodologies to represent, model and assess closed-loop product lifecycle (focused on remanufacturing strategies). The study shows how to establish environmental assessments for remanufactured products life cycles and how to compare them to environmental assessments for classical life cycles.

The present study shows how to establish the models and how to compare the environmental assessments of remanufactured products life cycles vs. classical life cycle scenarios. The objective is to provide easy to use methods and tools for designers to allow them quantifying the environmental benefits related to the use of a closed loop strategy. In this project, a life cycle assessment, life cycle bricks, and a parametric model of the products are used to evaluate and compare the environmental benefits provided by the remanufacturing. The methodologies and models have been developed based on previous works, such as the the life cycle bricks concept developed by Gehin et al. [2007].

On the other hand, the thesis proposes a model to assess the product-service systems elements and their respective life cycle from an environmental point of view. Here, the thesis focuses on the development of a model which integrates the product lifecycle within those parameters by a product-service system strategy, taking into account physical elements, as well as the infrastructures network, unit services design, supply chain actors and their interactions.

Finally, a model has been developed to assess from an environmental point of view the data of the operations and activities around product life cycle of the products with final non classic disposition scenarios (remanufacturing as end-of-life scenario and multiple uses by the disposition of the service offers system as a business strategy). The methodologies and models proposed allow identifying and distinguishing impacts between the different product life cycle stages and readjust the designers' decision at the product design stage. The results can be further used in simulation, to evaluate the environmental performance of different product life cycle end-of-life scenarios.

## **Key words:**

Life Cycle Assessment Parameters, Closed-Loop Product Life Cycle, Remanufacturing, Product Service System.



# **EVALUATION DES BENEFICES ENVIRONNEMENTAUX LIES A DES CYCLES DE VIE DE PRODUITS EN FLUX BOUCLES**

L'analyse du cycle de vie (ACV) peut être utilisée comme un outil par les concepteurs, pour supporter l'évaluation des impacts environnementaux pendant la conception. Par l'utilisation de cet outil, il est possible de déterminer les contributions positives et négatives du produit à chaque étape de son cycle de vie. Mais si l'analyse du cycle de vie permet une analyse claire pour l'évaluation d'un produit classique, ce n'est pas le cas pour un produit à cycle de vie bouclé. Dans cette thèse, nous nous intéressons en particulier au cas des produits remanufacturés et des produits inclus dans des offres de type « systèmes produits-services ».

Dans le cas d'un produit remanufacturé, les impacts environnementaux sont sensibles à de nombreux paramètres (% de produit non récupérés, distance de transport, matériaux remplacés, ...). Ainsi, cette thèse va permettre de clarifier le concept de remanufacturing et de considérer tout au long du cycle de vie les paramètres des différents process impliqués qu'il s'agira d'inclure dans une étude d'ACV. Le modèle de cycle de vie proposé a pour objectif d'aider les concepteurs du produit et des process associés ainsi que les acteurs de la chaîne de valeur et les personnes en charge du business model, à prendre des décisions à propos du produit et des systèmes de récupération des produits en fin d'usage.

Dans le cas d'une vente de produit classique, les utilisateurs font l'acquisition du produit puis l'utilisent, réalisent la maintenance et l'entretien, assurent l'achat des consommables et des matériaux auxiliaires du produit pour qu'il reste opérationnel,

puis ils s'en débarrassent en fin d'usage. Ainsi, c'est l'utilisateur qui transforme l'achat d'un produit en une situation qui permet de satisfaire efficacement ses besoins. Un système produit-service va permettre à l'utilisateur de satisfaire ses besoins en l'affranchissant de toutes ces étapes. En effet, l'utilisateur va acquérir l'usage du produit (sa fonctionnalité) en se libérant des actions annexes à mener (maintenance, approvisionnement, ...). De plus en plus d'entreprises offrent de réaliser ces services annexes et concentrent leur business auprès du client sur la valeur d'usage. Au-delà des bénéfices économiques, ces nouvelles stratégies de vente peuvent contribuer à diminuer les impacts environnementaux, mais ils restent à estimer. Comme pour le remanufacturing, le modèle proposé dans cette thèse pour réaliser l'ACV d'un PSS doit permettre d'aider les concepteurs à la prise de décision concernant le dimensionnement d'une telle stratégie de vente, en intégrant le point de vue de l'environnement.

Ainsi, nous proposons dans cette thèse de développer des modèles, outils et indicateurs pour aider la prise de décision en conception, en considérant:

- Une méthodologie d'évaluation qui intègre les enjeux environnementaux sur le cycle de vie du produit depuis le début de la conception du produit. Dans cette thèse, nous allons nous concentrer sur les stratégies en boucle fermée: la vente des produits/composants remanufacturés et la vente des systèmes produit-services (SPS). Nous aurons donc à considérer: l'analyse du cycle de vie classique (avec une phase d'usage unique pour le produit), un cycle de vie remanufacturé – remis à neuf (avec plusieurs phases d'utilisation pour le produit) et un cycle de vie avec une phase d'usage partagée du produit (cas de certains systèmes produits-services)
- les indicateurs pertinents pour aider le concepteur et les membres autour de l'équipe de conception qui ne sont pas spécialistes sur les sujets environnementaux. Ainsi, des préoccupations environnementales doivent se traduire en indicateurs pertinents pour l'évaluation de la performance environnementale des produits. Ces indicateurs peuvent alors être utilisés comme guide pour l'éco-conception des futurs produits ou comme des arguments des ventes.

- les scénarios de traitement en fin d'usage des produits, et en particulier les scénarios avec cycle de vie des produits en boucle fermée qui semblent prometteurs du point de vue de l'environnement.

La méthode proposée est basée sur le concept de brique de cycle de vie, développées par Gehin (Gehin et al.,2007), qui permet de mieux identifier la provenance des impacts du produit/service étudié au cours des différentes phases du cycle de vie.



## **1. L'ACV POUR EVALUER L'IMPACT D'UN PRODUIT TOUT AU LONG DU CYCLE DE VIE DU PRODUIT**

Dans cette section, nous présentons une stratégie d'évaluation des impacts environnementaux, la méthodologie de l'analyse du cycle de vie (ACV), et ses différentes étapes utilisées pour l'évaluation d'un système (produits ou services).

L'analyse du cycle de vie est une méthodologie mondialement reconnue et utilisée. Cette méthodologie permet d'effectuer les calculs d'impacts environnementaux de façon quantitative. La série de la norme ISO 14040 fournit une documentation claire pour chaque étape de l'analyse du cycle de vie. En parallèle, il est possible d'avoir des lignes directrices pour mener certaines activités, comme par exemple : une compilation de la consommation d'énergie, l'utilisation des matières premières, la détermination des émissions et rejets vers l'environnement, et l'évaluation de l'impact potentiel associé au produit, process ou service (tout au long de leur cycle de vie). L'ACV est donc une méthode qui permet d'évaluer les impacts sur l'environnement à chacune des phases du cycle de vie du produit [Westkaemper et al. 00]. La méthodologie considère tout au début l'extraction des matières premières, la fabrication, la distribution, l'utilisation et enfin, la réutilisation, le recyclage, la mise en décharge, etc. [Borland et al. 98]. L'ACV est utilisé pour déterminer les étapes et process les plus influents, selon les impacts environnementaux, dans le cycle de vie du produit.

Les difficultés liées à l'obtention des données nécessaires pour réaliser l'ACV ainsi que les hypothèses formulées, amènent souvent à questionner la validité et la pertinence des résultats de l'ACV. En conception, ces analyses permettent néanmoins de comparer les solutions et d'identifier les voies d'amélioration.

## **1.1. Analyse du cycle de vie - méthodologie**

L'objectif de l'ACV est de quantifier l'ensemble des impacts environnementaux attribuables au cycle de vie des produits et des services, afin d'améliorer les processus et de fournir une base solide pour modifier la conception originale du produit. L'ACV est réalisée en quatre phases bien distinctes: la définition des objectifs et champ d'application, l'analyse de l'inventaire, l'évaluation des impacts environnementaux et l'interprétation ou recherche des améliorations des process dans le système [AFNOR 97a] [AFNOR 97b].

### Définitions des objectifs (unité fonctionnelle)

Dans cette phase, il est nécessaire de fixer les limites de l'étude et de définir la qualité des données nécessaires en relation avec l'exploitation des résultats potentiels. Les objectifs de l'étude doivent être définis de manière claire et précise. Le champ d'application de l'étude est arbitraire. Ses limites doivent être définies par le choix des flux élémentaires (entrées et sorties du système étudié). L'unité fonctionnelle est la mesure permettant de définir la fonction rendue par le produit, procédé ou service, en cours d'évaluation. Cette unité fonctionnelle doit être soigneusement choisie, car elle est déterminante dans les phases d'analyse.

### Analyse d'inventaire

L'inventaire est la liste de données : entrées et sorties du système délimitée par les frontières de l'étude. Dans cette étape de l'ACV, le système est répertorié en fonction de cinq facteurs: la consommation de matières premières, la consommation d'énergie, les émissions vers l'air, vers l'eau et les déchets solides. Les données d'entrée et de sortie nécessaires pour la construction du modèle sont recueillies pour toutes les activités à l'intérieur des frontières du système. Les données doivent être reliées à l'unité fonctionnelle définie dans la phase précédente de définition des objectifs. L'inventaire doit fournir des informations sur toutes les entrées et sorties sous la forme de flux élémentaires pour tous les process impliqués dans l'étude.

## Évaluation des impacts

L'analyse de l'inventaire est suivie d'une évaluation des impacts environnementaux. Dans cette phase de l'ACV, on sélectionne une méthode de calcul, puis on calcule chaque impact environnemental de la méthode en utilisant la liste des données créée dans la phase précédente d'analyse d'inventaire. Ici, les flux sont classés selon des critères environnementaux, puis caractérisés, normalisés et évalués par des indicateurs liés aux critères les plus significatifs [Kljajin 00].

## Interprétation

Dans cette dernière étape de l'analyse du cycle de vie, on vient vérifier la cohérence des résultats obtenus en lien avec les objectifs définis au début de l'étude. Ensuite, on identifie les options qui vont permettre une réduction des impacts environnementaux. Les résultats de l'analyse de l'inventaire et de l'évaluation des impacts sont résumés dans cette phase d'interprétation. Ensuite, les résultats sont exprimés sous forme de recommandations pour les concepteurs.

### **1.2. Limitations de l'analyse du cycle de vie**

La méthodologie de l'ACV compte plusieurs limitations. Ces limites dépendent principalement des bases de données disponibles au niveau de l'analyse de l'inventaire, mais d'autres limitations existent :

- *La précision dans la méthodologie de l'ACV.* Dans chaque étape de la méthodologie, les décisions et les hypothèses sont faites par des experts, ces hypothèses sont une source d'incertitudes (par exemple: la définition de l'unité fonctionnelle, définition des frontières du système, recueil de l'information et choix des données pertinentes). Il est recommandé d'avoir une documentation rigoureuse pour vérifier toutes les hypothèses et les estimations.
- *Les utilisateurs de l'ACV.* Au cours de la conception du produit, il n'est pas possible de développer des bases de données spécifiques sur l'environnement.

Les concepteurs doivent utiliser les bases de données les plus pertinentes en fonction du type d'analyse. Par conséquent, l'incertitude sur les données de l'environnement devient importante, c'est-à-dire que les concepteurs doivent faire des choix d'une matière ou d'un process parmi un grand groupe de matériaux ou process équivalents. Alors, les conséquences du choix d'une matière par rapport à une autre deviennent difficiles à mesurer, sauf si les concepteurs passent du temps à explorer la liste des bases de données de façon exhaustive.

- Les bases de données sont établis par des experts qui ont défini un certain nombre de caractéristiques complexes afin d'évaluer les entrées et les sorties des systèmes. Au moment d'utiliser la méthodologie ACV, plus d'un expert intervient dans l'analyse du système. La plupart du temps, ils n'ont pas défini les mêmes entrées et sorties alors les résultats sont fréquemment différents. Lorsque les méthodes de calcul sont considérées, chaque utilisateur possède sa propre compréhension de la méthodologie de l'évaluation d'impact et des principales conséquences sur l'environnement. Il existe donc différents points de vue dans les problèmes environnementaux, les méthodes de calcul de l'impact environnemental, etc.
- Pour une même modélisation, des résultats différents sont obtenus en utilisant deux méthodes différentes ou des bases de données différentes ou des localisations géographiques différentes. Les résultats de la méthodologie ACV restent donc difficilement exploitables par des non experts.

C'est principalement les écarts liés à la modélisation du produit ou du système étudié qui retiendront notre attention dans cette thèse. En effet, dans le cas des produits à cycle de vie bouclés ou à usages multiples, de nombreuses approximations peuvent être réalisées, conduisant à des résultats approximatifs voire erronés.

### **1.3. Adaptation de l'ACV pour la modélisation de cycles de vie en boucle fermée**

La plupart des outils d'ACV sont capables d'effectuer une analyse quantitative des impacts environnementaux d'un produit avec les limitations dont nous avons parlé précédemment (complexité des données, temps investis pour modéliser chaque composant, ...). Mais les scénarios de fin de vie complexes restent difficiles à modéliser et à comparer à des scénarios « classiques ». C'est le cas des produits avec un cycle de vie en boucle fermée qui se différencient des produits classiques en raison du nombre de phases d'utilisation qu'ils peuvent traverser. Pour établir une ACV comparative pour les produits remanufacturés et les produits classiques, Gehin a proposé un modèle de cycle de vie spécifique basée sur la notion de briques de cycle de vie [Gehin et al. 09]. Une brique donne un impact environnemental pour chaque composant à chaque étape de son cycle de vie. Une fois que les briques sont définies, il existe des règles pour construire des cycles de vie des systèmes en boucle fermée. Chaque brique est définie par plusieurs données: le nom de la brique, la phase du cycle de vie concernée (extraction des matières premières, fabrication, distribution composants, assemblage, distribution produit, utilisation, collecte et fin de vie), les produits ou les composants, les données liées aux processus rencontrés par le produit ou le composant dans cette étape du cycle de vie. Lorsqu'une de ces données d'entrée change une nouvelle brique est créée.

- Un cycle de vie apparaît quand le premier composant est créé. Des briques sont construites par rapport au produit (phases d'assemblage, de distribution du produit, d'usage et de collecte en fin de vie) et d'autres par rapport aux composants (phases d'extraction de la matière, fabrication des composants, distribution de composants, fin de vie). Dans le cas d'impacts pondérés ou normalisés disponibles avec certaines méthodes de calcul d'impact, les impacts environnementaux du produit sont la somme des impacts des briques.
- Chaque fois que le concepteur crée un nouveau composant, de nouvelles briques composants apparaissent et les impacts des nouvelles briques sont ajoutés aux impacts des briques précédentes pour chaque phase du cycle de vie et pour l'ensemble du produit.

- Le concepteur doit évaluer le nombre de cycles d'utilisation de chaque composant de façon individuel ainsi que la stratégie qui sera adoptée en fin de vie du produit (réutilisation, remanufacturing, recyclage).

Une fois que le modèle est prêt pour effectuer les calculs environnementaux, les impacts sont déterminés. Ensuite, les impacts environnementaux sont ramenés à un cycle d'utilisation unique, de sorte que les concepteurs puissent comparer ce scénario à un scénario « classique » à phase d'usage unique.

## 2. EVALUATION ENVIRONNEMENTALE DE PRODUITS REMANUFACTURÉS

### Modèle de cycle de vie

Le modèle de cycle de vie proposé (Figure 1) illustre le flux de produits remanufacturés traversant les différentes étapes de leur cycle de vie. Les flux de produits entre les phases du cycle de vie sont représentés par des flèches. Les cheminements possibles ne sont pas exclusifs et doivent être définis si besoin pour chaque composant du produit. Huit étapes de cycle de vie ont été utilisées. Pour la fin de vie, seules deux options sont considérées: le remanufacturing et le recyclage.

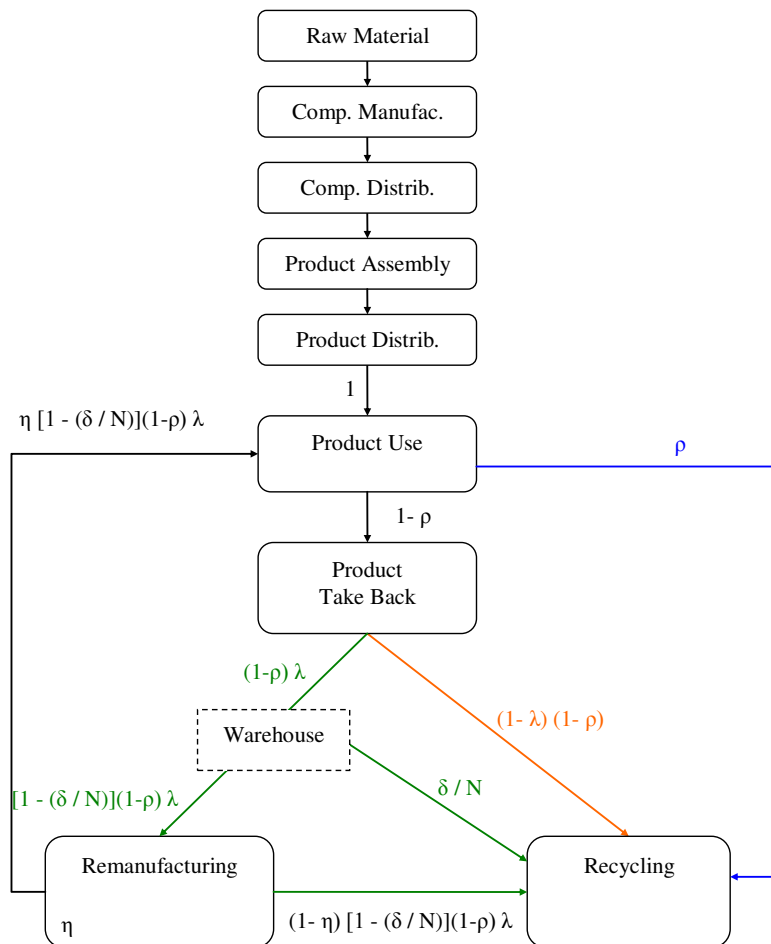

Figure 1 : Cycle de vie d'un produit remanufacturé et paramètres significatifs influençant les impacts environnementaux

Pour évaluer les impacts environnementaux d'un produit remanufacturé, il est nécessaire de prendre en compte le nombre de phases d'utilisation successives qui pourront être supportée par le produit. Le « nombre de phases d'utilisation » est le paramètre qui va influencer toute l'analyse du cycle de vie du produit. Les autres paramètres qui entrent dans le modèle sont :

### **N – nombre de produits en cours d'utilisation**

Ce paramètre dépend des ventes (ou prévisions des ventes) du produit et de la capacité de planification de la production.

### **$\rho$ – Taux de produits non collectés (mis directement au recyclage)**

Pour définir ce paramètre, il est nécessaire de prendre en considération les aspects du marché : estimer un nombre de clients qui ne sera pas intéressé par le remanufacturing.

### **$\lambda$ – performance de la logistique inverse**

Taux de carcasses collectées par le système de logistique inverse.

### **$\eta$ – rendement du processus de remanufacturing**

Proportion de carcasses reconditionnées par le process de remanufacturing. Des composants qui ne sont pas en bon état peuvent être remplacés.

### **$\Delta = \delta / N$ – proportion de carcasses considérées comme non remanufacturables**

Proportions des carcasses dont les conditions ne sont pas acceptables pour être remanufacturées ou excèdent dans le stock de carcasses.



Le modèle proposé doit être utilisé par les concepteurs pour les aider dans leurs décisions. D'autres paramètres ont ainsi été choisis du fait de leur capacité à être mobilisés dans les projets de conception (tableau 1) :

- Les process sont les actions nécessaires pour transformer les matériaux (transformation de la matière première, process de fabrication, process de remanufacturing, process de recyclage,...). Une fois le type de process défini, ainsi que la quantité de matériau à traiter par le process, il est facile de calculer l'impact environnemental en multipliant la quantité de matière (Q) par le facteur d'équivalence ( $F_{process}$ ) indiqué dans les bases de données ACV.
- Les matériaux peuvent être identifiés dans la nomenclature définie par les concepteurs. Ils correspondent aussi aux éléments d'emballage du produit qui sont utilisés dans les phases de transport ou les consommables utilisés en phase d'usage ou de transformation. Une fois le matériau choisi et sa masse définie, le calcul de l'impact peut être réalisé avec le facteur d'équivalence correspondant.
- L'énergie est présente en phase d'usage mais aussi prise en compte dans les process.
- Le transport est considéré à chaque phase du cycle de vie avec son facteur d'équivalence  $F_{transport}$  qu'il s'agit de multiplier avec la masse du composant et la distance parcourue.

<b>PARAMETRES</b>	<b>Calcul de l'impact Environmental</b>
Process (type and quantité)	$Q * F_{process}$
Materiau (type and quantité)	$Q * F_{material}$
Energie (type and quantité)	$Q * F_{energy}$
Transport (type and quantité)	$Q * D * F_{transport}$

Tableau 1-Paramètres choisis pour modéliser le cycle de vie de produits remanufacturés

## Calcul des impacts environnementaux

Les briques de cycle de vie sont utilisées pour construire le cycle de vie du produit remanufacturé :

- Un cycle de vie est créé dès qu'un composant existe. Les briques composants et les briques produit sont créées pour chaque phase du cycle de vie. Les impacts environnementaux du produit sont calculés en sommant les impacts environnementaux de toutes les briques.
- Le concepteur doit fixer le paramètre "nt": "le nombre de phases d'usage" qu'un composant peut assurer suite aux reconditionnements successifs. Une fois le modèle prêt pour le calcul, les impacts sont déterminés et ramenés aux impacts d'une phase d'usage, afin de pouvoir être comparés à d'autres alternatives de fin d'usage.

Plusieurs hypothèses ont été formulées :

- En accord avec Sutherland et Amaya [ ], on considère que le nombre total de produits "N" dans la boucle de remanufacturing est constante. Cela signifie que pour l'ensemble N de produits dans la boucle, si la perte de carcasse est  $1 - (\partial / N)(1 - \rho)\lambda$ , celles-ci sont remplacées par des produits neufs à chaque étape du remanufacturing.
- Les bénéfices liés à la récupération de la matière recyclée ne sont pas considérés au niveau de la boucle de remanufacturing elle-même [Koltun P. and al. 05].
- Les impacts environnementaux de la phase d'usage sont les mêmes pour les produits neufs ou remanufacturés.

Ainsi, les impacts environnementaux à chaque étape du cycle de vie d'un produit remanufacturé, ramenés à 1 phase d'usage, sont présentés dans le tableau 2.

	<b>EI FACTORS</b>
Raw material	$EI_{\text{raw\_material}} \times \frac{1 + (n_t - 1)\{\rho + \Delta + (1 - \lambda)(1 - \rho) + (1 - \eta)[\lambda(1 - \rho)(1 - \Delta)]\}}{n_t}$
Manufacturing	$EI_{\text{manufacturing}} \times \frac{1 + (n_t - 1)\{\rho + \Delta + (1 - \lambda)(1 - \rho) + (1 - \eta)[\lambda(1 - \rho)(1 - \Delta)]\}}{n_t}$
Distribution	$EI_{\text{distribution}}$
Use	$EI_{\text{use}}$
Reverse logistics	$EI_{\text{take-of-back}}$
End-of-Use End-of-Life	<b>Remanufacturing</b> $EI_{\text{remanufacturing}} \times \frac{1 + (n_t - 1)[\lambda(1 - \rho)(1 - \Delta)]}{n_t}$
	<b>Recycling</b> $EI_{\text{recycling}} \times \frac{1 + (n_t - 1)\{\rho + \Delta + (1 - \lambda)(1 - \rho) + (1 - \eta)[\lambda(1 - \rho)(1 - \Delta)]\}}{n_t}$

Table 2: Facteurs utilisés pour le calcul des impacts environnementaux des produits remanufacturés

Un outil a été développé sur excel, afin de faciliter les différents calculs et une étude de cas a été menée sur l'exemple d'une boîte de vitesse, ce qui a permis de vérifier la sensibilité du modèle et de valider ainsi les variables retenues.

## **EVALUATION ENVIRONNEMENTALE DES SPS**

Une approche pour établir une évaluation environnementale claire des stratégies SPS est proposée dans cette partie. L'objectif est de pouvoir évaluer les approches type SPS lors de leur conception ainsi que de faire des comparaisons avec des offres « classiques » de vente d'un produit. Le point de départ pour établir cette comparaison est la définition de l'unité fonctionnelle. Ensuite, un modèle de cycle de vie est décrit et utilisé pour pouvoir mener le calcul des impacts environnementaux.

### **Unité fonctionnelle**

Pour effectuer l'ACV d'une offre SPS et pour pouvoir faire des comparaisons avec d'autres alternatives, il est nécessaire de définir l'unité fonctionnelle (UF), qui est à la base de l'analyse du cycle de vie. L'UF fournit la référence en ce qui concerne les éléments à évaluer et la frontière de l'étude. L'UF devrait être, autant que possible, liée aux fonctions principales du produit, service ou offre SPS, plutôt qu'au produit physique. Pour faire de comparaisons d'offres SPS et de vente classique d'un produit, il est fortement recommandé de définir une UF équivalente. Ceci nous a amené à caractériser l'UF selon les éléments suivants:

- Qualité du service de l'offre SPS, en termes de disponibilité du service.
- Temps pour chaque utilisation ( $t_u$ ). L'usage doit être caractérisé par une quantité d'utilisation ou une période d'utilisation (distance, fréquence, etc.). Pour notre étude, on utilisera une unité de temps.
- Temps de prestation du service ( $t_{sp}$ ). Ce paramètre représente le temps durant lequel l'offre SPS sera disponible sur le marché (obsolescence du service). La prestation du service peut être caractérisée par la quantité d'utilisation ou par une période (distance, fréquence, etc.). Pour notre étude on utilisera une unité de temps.
- Nombre de fois ou l'offre SPS est utilisé ( $n_u$ ) par chaque utilisateur de façon individuel.
- Nombre total d'utilisateurs (U) qui vont se servir de l'offre SPS.

## **Description du cycle de vie d'une offre SPS**

Un modèle de cycle de vie pour les offres SPS est présenté figure 2. Pour garder la même structure que lors de notre étude sur la stratégie de remanufacturing (section 2), les interactions entre les différentes phases du cycle de vie sont également représentées par des flèches et chaque phase du cycle de vie est représentée par un rectangle avec son nom à l'intérieur. Cinq étapes génériques ont été utilisées pour modéliser le cycle de vie : extraction des matières premières, fabrication de produits, distribution des produits, phase d'utilisation et fin de vie. La phase d'extraction de matières premières comprend l'obtention des matières brutes, les process associés et les transports pour le traitement initial des matériaux ainsi que les process préliminaires de transformation de la matière et le transport des différents produits consommables vers les usines ( $EI_{\text{raw\_material}}$ ). La phase de fabrication du produit comprend les process de fabrication des composants et les transports vers l'usine d'assemblage de produit ( $EI_{\text{manufacturing}}$ ). La distribution des produits inclut les différents moyens de transport vers le client/utilisateur ( $EI_{\text{distribution}}$ ). La phase d'utilisation comprend la consommation de ressources pendant l'utilisation ( $EI_{\text{use}}$ ) et la phase de fin de vie inclut les process de recyclage et les moyens de transport nécessaires ( $EI_{\text{end-of-life/use}}$ ).

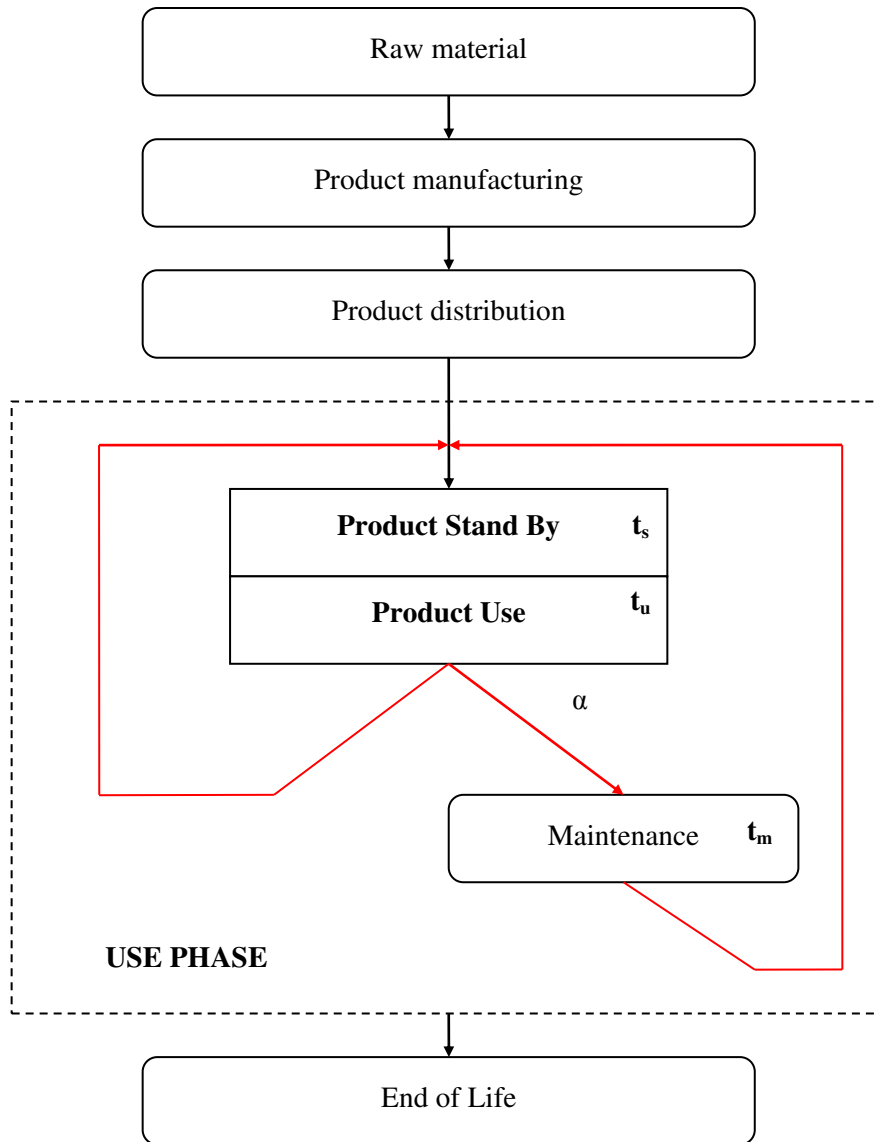

Figure 2: Cycle de vie du produit pour les SPS

La phase d'utilisation comprend trois sous phases :

- la phase d'utilisation, où le nombre d'utilisations de chaque produit ( $n_u$ ) pendant la durée de vie du produit est considéré, chaque utilisation étant caractérisée par un temps ( $t_u$ )
- une phase de maintenance, où le temps moyen pour effectuer la maintenance préventive ( $t_m$ ) est considéré, ainsi que la proportion espérée des produits ( $\alpha$ ) qui sont en maintenance (en raison de pièces cassées ou des dégradations) ou pour la prestation d'un meilleur service.

- une phase de stand-by où le service disponible n'est pas utilisé. Certains produits doivent être en stock afin de fournir un niveau minimal de service pour tous les utilisateurs (inventaire en stock),  $t_s$  est un paramètre qui caractérise le temps pendant lequel les produits seront en stock. Cette étape va permettre de caractériser la disponibilité du service.

L'intensification de l'utilisation d'un produit arrive quand le nombre d'usages augmente ou quand d'autres paramètres comme  $t_s$ ,  $t_m$  et  $\alpha$  diminuent, tout en conservant la même qualité de service.

L'intensification de l'utilisation est également influencée par la durée de vie technique ( $t_{tl}$ ) des produits, dure de vie qu'il est nécessaire de maîtriser pour concevoir une offre SPS. Dans le cas où la durée de vie technique ( $t_{tl}$ ) est plus longue que le temps de prestation du service ( $t_{sp}$ ) les produits sont capables de garantir le service proposé à travers l'offre PSS pendant la période  $t_{sp}$  attendu. Si le temps de prestation du service est plus long que la durée de vie technique ( $t_{tl}$ ) les produits utilisés dans l'offre SPS ne sont pas capables (car pas assez robuste) d'assurer l'offre pendant toute la période où le SPS sera sur le marché. Afin de maintenir la même qualité de service et d'être capables de satisfaire les exigences des clients, de nouveaux produits doivent remplacer des produits non fonctionnels pour couvrir le temps  $t_{sp}$ .

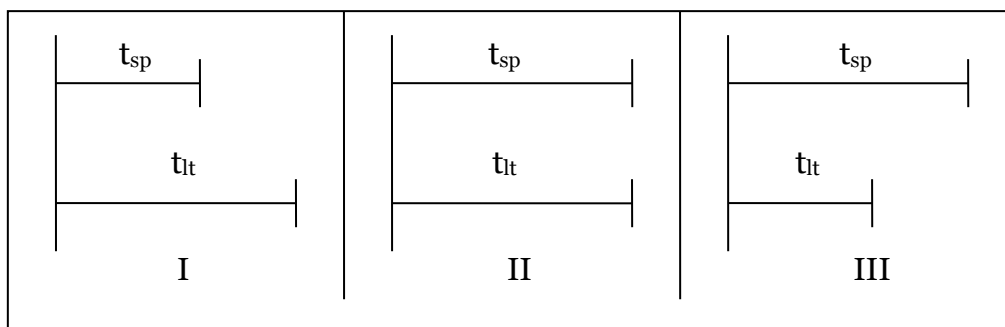

Figure 3: Durée de vie technique d'un produit ( $t_{tl}$ ) versus temps de mise à disposition du SPS ( $t_{sp}$ ) : 3 scenarios

La figure 3 représente les scénarios de temps de vie technique. Dans les deux premiers cas ; les temps de vie techniques des produits sont en mesure de satisfaire les demandes au cours de la période de prestation de services. Dans le troisième cas, la durée de vie technique des produits exige plus de produits. Pour obtenir le nombre total de produits qui sont nécessaires dans l'offre SPS, le nombre de produits sera ajusté par le rapport :

$$\tau = \frac{t_{sp}}{\min(t_{sp}, t_{lt})}.$$

### Calcul des impacts

Les équations définies dans cette section ont comme objectif d'aider les concepteurs dans la tâche de définition des offres SPS, pour contrôler les propriétés du cycle de vie. Pour pouvoir faire des comparaisons entre une stratégie SPS et d'autres stratégies telles que la vente classique d'un produit, les calculs d'impacts sont ramenés à une période d'utilisation. Des hypothèses générales sont faites pour être en mesure de calculer les impacts environnementaux.

Le nombre total de produits dans le système « N » est une valeur à déterminer lors de la conception de l'offre SPS. Cela signifie que N sera une valeur à déterminer en fonction du nombre de fois que l'offre SPS sera utilisée par des utilisateurs multiples ( $n_u$ '), pour une période de temps déterminée  $t_u$ . Pour assurer la qualité du service il y a un nombre de produits en stand-by pendant un période de temps  $t_s$ . Le nombre des produits en maintenance sera fonction de la robustesse du produit et son optimisation doit être considérée comme un problème de gestion de maintenance. Une fois que le nombre total de produits dans l'offre SPS est validé par les conditions de service, le nombre de produits peut être exprimé en fonction des produits en cours d'utilisation, en entretien et en stand-by à un moment donné :

$$N = (N_u + N_m + N_s) \times \tau$$

où  $N_u$  représente le nombre des produits en cours d'utilisation dans le SPS. Sa valeur est calculée à partir de l'équation :



$$N_u = \frac{n_u 't_u}{n_u 't_u + \alpha \times n_u 't_m + t_s} \times N$$

$N_m$  représente le nombre des produits en cours de maintenance. Sa valeur est calculée à partir de l'équation :

$$N_m = \frac{\alpha \times n_u 't_m}{n_u 't_u + \alpha \times n_u 't_m + t_s} \times N$$

$N_s$  représente le nombre des produits en cours stand-by (attente d'utilisation) pour assurer la qualité du service. Sa valeur est calculée à partir de l'équation :

$$N_s = \frac{t_s}{n_u 't_u + \alpha \times n_u 't_m + t_s} \times N$$

D'un autre côté, dans le modèle mathématique, le nombre d'utilisations pour chaque client ( $n_u$ ) est un rapport entre le nombre total d'utilisations des produits de l'offre SPS ( $U_T$ ) et le nombre d'utilisateurs différents ( $U$ ). Sa valeur est calculée à partir de l'expression :

$$U_T = n_u \times U$$

Pour définir avec précision le modèle de l'offre SPS et donner un outil support aux concepteurs, le nombre d'utilisations de chaque produit ( $n_u'$ ) tout au long de la période de prestation du service doit être calculé en fonction du nombre d'utilisations de chaque client ( $n_u$ ). Si l'on considère le nombre total d'utilisateurs comme une relation entre le nombre d'utilisations du produit et le nombre de produits dans l'offre SPS, alors, le nombre d'utilisations des produits devient une fonction des variables mentionnées ci-dessus y compris le nombre d'utilisations de chaque client.

$$n_u ' = \frac{U \times n_u}{N}$$

## Impacts environnementaux des offres SPS

Le modèle proposé dans la section précédent sert maintenant comme guide pour l'évaluation des impacts environnementaux d'une stratégie SPS. La présente section indique les équations nécessaires pour aider les concepteurs dans la tâche d'évaluation des impacts environnementaux. Au cours de la conception des produits, de nombreuses options de fin de vie sont proposées et il s'agit de déterminer la meilleure.

On considère  $EI_{mat\_p}$  comme l'impact sur l'environnement pour l'extraction de la matière d'un produit dans l'offre SPS et  $EI_{mat\_s}$  comme l'impact sur l'environnement pour l'extraction de matière nécessaire pour fournir un ou des services. Alors  $EI_{mat}$  pour une utilisation de l'offre SPS sera :

$$EI_{mat}(luse) = \frac{(N_u + N_m + N_s) \times \tau}{U_T} EI_{mat\_p} + \frac{N_u \times \tau}{U_T} EI_{mat\_s}$$

Si on considère  $EI_{man\_p}$  comme l'impact sur l'environnement nécessaire pour fabriquer un produit dans l'offre SPS et  $EI_{man\_s}$  comme l'impact sur l'environnement nécessaire pour fabrication des services associés à l'offre SPS, alors  $EI_{man}$  pour une utilisation de l'offre SPS sera :

$$EI_{man}(luse) = \frac{(N_u + N_m + N_s) \times \tau}{U_T} EI_{man\_p} + \frac{N_u \times \tau}{U_T} EI_{man\_s}$$

Si on considère  $EI_{eol\_p}$  comme l'impact sur l'environnement nécessaire à la fin de vie d'un produit dans l'offre SPS et  $EI_{eol\_s}$  comme l'impact sur l'environnement des services associés à la fin de vie des à l'offre SPS, alors,  $EI_{eol}$  pour une utilisation de l'offre SPS sera :

$$EI_{eol}(luse) = \frac{(N_u + N_m + N_s) \times \tau}{U_T} EI_{eol\_p} + \frac{N_u \times \tau}{U_T} EI_{eol\_s}$$

Si on considère  $EI_{u\_p}$  comme l'impact sur l'environnement nécessaire à l'utilisation d'un produit dans l'offre SPS et  $EI_{use\_s}$  comme l'impact sur l'environnement des services associé à l'utilisation de l'offre SPS ; alors  $EI_u$  pour une utilisation de l'offre SPS sera :

$$EI_u (luse) = EI_{u\_p} + \frac{N_u \times \tau}{U_T} EI_{u\_s}$$

Selon les résultats obtenus avec les équations proposées, les concepteurs peuvent choisir les stratégies correctes selon les différents paramètres et ainsi contrôler les variations des impacts environnementaux des produits.

Un outil a été développé sur excel, afin de faciliter les différents calculs et une étude de cas a été menée sur l'exemple des vélos à usages partagés, ce qui a permis de vérifier la sensibilité du modèle et de valider ainsi les variables retenues.

### **3. CONCLUSIONS ET PERSPECTIVES**

Ce travail de thèse contribue à l'intégration des critères environnementaux dans la conception d'un produit, mais en intégrant de manière détaillée les spécificités liées à son cycle de vie en boucle fermée ou à ses usages partagés. La revue de la littérature sur les différentes méthodologies et sur les outils élaborés pour aider les concepteurs lors des évaluations environnementales a permis de mettre en évidence les différents avantages et les difficultés actuelles. Nous avons ainsi pu mettre en évidence des critères qui vont permettre aux industriels de prendre des décisions vis-à-vis de la problématique environnementale et de la mise en place de nouveaux scénarios de fin de vie. Les analyses menées nous ont amenés à observer les caractéristiques influençant les performances environnementales de mise en œuvre de ces nouvelles stratégies bouclées, caractéristiques qu'il s'agit de considérer très tôt dans le processus de conception du produit.

En utilisant le concept de briques de cycle de vies proposé par Gehin, de nouveaux modèles ont été créés pour représenter de nouveaux scénarios de vie des produits (réutilisation, reconditionnement ou de recyclage de certains composants). Chaque processus, pour chaque scénario considéré, a été soigneusement observé afin de générer des modèles de cycle de vie fidèles avec des schémas corrects de flux pour chaque activité. Les concepteurs ne sont pas experts sur les questions environnementales, mais les méthodes finalement proposées leur permettent de répondre à leurs contraintes en mettant en balance l'évaluation environnementale avec des contraintes plus traditionnelles (coût, qualité et temps). Concernant le travail mis au point, nous soulignons que :

- Le concept de cycle de vie doit être considéré dès les premières étapes de conception du produit. Les impacts environnementaux sont observés à chaque étape du cycle de vie en considérant les process correspondants. L'évaluation des activités sur le cycle de vie permet de déterminer les impacts environnementaux et leur répartition dans la limite des frontières de l'étude.

- Les nouvelles stratégies pour le développement durable impliquent la réutilisation des composants à haute valeur ajoutée. Certaines analyses ont considéré les produits remanufacturés d'un point de vue de l'impact environnemental, mais ces analyses restent clairement au niveau du produit et non au niveau du système global du remanufacturing. Les stratégies de remanufacturing tout comme les offres produit-service ont démontré leur intérêt économique. Une démonstration de leur intérêt environnemental est maintenant possible, incluant le process et les activités du cycle de vie complet.
- Toutes les réflexions et les travaux antérieurs sur la caractérisation des processus de remise à neuf, produits remanufacturés et systèmes de service produit proposent au final des modifications sur la structure du produit ou sur sa conception. Cette étude permet de généraliser la représentation du cycle de vie d'un produit remanufacturé et ceci pour différents secteurs. Des modifications pourront également être apportées à ce cycle de vie dans le but de diminuer les impacts environnementaux.

## **PERSPECTIVES**

Une des perspectives la plus ambitieuse est l'utilisation de ces modèles et outils pour établir un « écolabel » sur les produits remanufacturés ou sur les SPS. Le modèle, dans ce cas, serait le cadre de l'Eco-label.

Une perspective plus classique est la validation de la méthodologie proposée pendant la conception de produits d'une entreprise. La méthodologie a été développée à l'aide d'une recherche théorique appliquée à des produits existants, produits qui ne sont pas toujours conçus pour être remis à neuf ou pour s'intégrer dans un système de produit-service. Ainsi, ce travail peut être considéré comme un soutien pour encourager les partenaires industriels à la construction d'outils basés sur l'ACV de produits en boucles fermées. En effet, les stratégies de remise à neuf sont prometteuses et des méthodes et outils sont nécessaires pour considérer ces stratégies au cours du processus de conception de produit ou de son cycle de vie.

Le premier modèle développé est basé sur la caractérisation d'un produit remanufacturé. Il permet de définir les différents besoins que le produit et le processus de conception doivent respecter. Ainsi, il est possible d'envisager d'appliquer cette approche à d'autres stratégies de fin de vie, étant donné que chaque stratégie présentera de nouveaux paramètres qui auront une influence sur la stratégie. Cela signifie que les mêmes approches doivent être développées pour la réutilisation, le recyclage ou les approches mixtes pour vraiment encourager les entreprises à ces nouvelles stratégies. L'élaboration d'un modèle de coûts associés devrait également être encouragée pour renforcer l'image positive de la stratégie de cycle de vie du produit en boucle fermée auprès des entreprises.

Les systèmes produit-service deviennent des sujets de plus en plus étudiés dans la recherche en conception. La mise en œuvre de ces systèmes produit service doit permettre de satisfaire les clients et de diminuer les coûts et les impacts sur l'environnement. L'acceptation du client à se tourner vers ces nouveaux modes de

consommation doit aussi être étudiée, afin de ne pas aller à l'encontre de prévisions et donc des bénéfices environnementaux attendus.