



HAL
open science

Etude de nouveaux facteurs moléculaires régulant la migration de neurones à GnRH, leur ciblage axonales et leur neurosécrétion : aperçues dans l'acquisition de la compétence reproductive

Irène Cimino

► **To cite this version:**

Irène Cimino. Etude de nouveaux facteurs moléculaires régulant la migration de neurones à GnRH, leur ciblage axonales et leur neurosécrétion : aperçues dans l'acquisition de la compétence reproductive. Médecine humaine et pathologie. Université du Droit et de la Santé - Lille II, 2014. Français. NNT : 2014LIL2S044 . tel-01208148

HAL Id: tel-01208148

<https://theses.hal.science/tel-01208148>

Submitted on 2 Oct 2015

HAL is a multi-disciplinary open access archive for the deposit and dissemination of scientific research documents, whether they are published or not. The documents may come from teaching and research institutions in France or abroad, or from public or private research centers.

L'archive ouverte pluridisciplinaire **HAL**, est destinée au dépôt et à la diffusion de documents scientifiques de niveau recherche, publiés ou non, émanant des établissements d'enseignement et de recherche français ou étrangers, des laboratoires publics ou privés.

UNIVERSITE DROIT ET SANTE DE LILLE II

Ecole Doctoral Biologie-Santé

These

Pour L'obtention du grade de

DOCTEUR DE L'UNIVERSITE DE LILLE II

Spécialité: Neurosciences

Study of new molecular factors regulating GnRH migration, axonal targeting and neurosecretion: insights into the acquisition of reproductive competence

Présentée par

Irene Cimino

Soutenue 24 Septembre 2014 devant le Jury composé de :

Rapporteurs :

Dr Philippe Ciofi Charge de Recherche, INSERM U862, Bordeaux
Dr Valérie Simonneaux Directeur de Recherche, CNRS UPR-3212 Strasbourg

Examineurs :

Pr Pascal Pigny Professeur des Universités et Praticien Hospitalier, CHRU Lille
Pr Nelly Pitteloud Chef de service Endocrinologie, diabétologie, et métabolisme, CHUV, Lausanne
Dr Vincent Prevot Directeur de Recherche INSERM U837, Lille

Directeur de These :

Paolo Giacobini Charge de Recherche, INSERM U837, Lille

Index.....	I
List of Abbreviations.....	VI
Resume.....	.X
Abstract.....	XIII

Introduction

Chapter I: The GnRH Neuronal Network and Fertility.....	1
1. Reproduction and Hypothalamic-Pituitary-Gonadal axis (HPG).....	2
1.1 The History of GnRH	4
1.2 The GnRH family of peptides.....	4
1.3 The ontogenesis of GnRH system.....	5
1.4 The GnRH migratory pathway.....	6
1.5 Molecular mechanisms of GnRH migration.....	8
1.6 GnRH physiology.....	13
1.6.1 Role of GnRH at puberty.....	13
1.6.2 Role of GnRH at Adulthood.....	16
1.7 GnRH from gene to peptide.....	18
1.7.2 GnRH transduction pathway.....	19
1.8 GnRH neuromodulators: neural inputs to GnRH neurons.....	21
1.8.1 Estrogens.....	.21
1.8.2 Estrogen Negative and Positive Feedbacks Controlling GnRH.....	22
1.8.3 Progesterone feedback.....	23
1.8.4 The Role of Kisspeptin.....	23
1.9 Neurotransmitters in the regulation of GnRH neuronal activity.....	25
1.9.1 Involvement of Glutamate in the regulation of reproduction.....	25
1.9.2 GABA Action.....	.26
1.9.3 Nitrogen Monoxide.....	28

Chapter II: Reproductive Syndromes..... 31

2.1 Hypogonadotropic Hypogonadism..... 32

 2.1.1 Kallmann Syndrome (KS)..... 32

 2.1.2 Normosmic IHH (nIHH)..... .36

2.2 Pathophysiology of PCOS..... 37

 2.2.1 Definition of Polycystic ovary syndrome (PCOS)..... .37

 2.2.2 Polycystic ovaries..... 38

 2.2.3 Hyperandrogenism..... .38

 2.2.4 Anovulation..... .38

 2.2.5 Altered hormonal profiles..... 39

 2.2.6 PCOS treatment..... 39

 2.2.7 Etiology..... 40

 2.2.7.1 Genetic basis of PCOS..... 40

 2.2.7.2 Developmental origin of PCOS: in uterus hyperandrogenism..... .41

 2.2.7.3 Neurodevelopmental origin of PCOS: new emerging hypotheses..... 42

Chapter III Anti Müllerian Hormone..... 44

3.1 Mammalian Sexual Differentiation..... 45

3.2 History and Discovery of AMH..... 46

3.3 AMH in Sexual Dimorphism..... 47

3.4 AMH in Male Physiology..... 48

 3.4.1 Paracrine regulation..... .49

 3.4.2 Endocrine regulation..... 50

3.5 AMH in Female Physiology..... 50

 3.5.1 Paracrine regulation..... .52

3.5.2 Curiosity.....	53
3.6 Background: molecular profile.....	54
3.6.1 TGF β superfamily.....	54
3.6.2 TGFs receptors.....	55
3.6.3 SMAD proteins.....	55
3.6.4 The non-canonical pathways.....	56
3.7 AMH: from gene to protein.....	57
3.7.1 AMH Gene.....	57
3.7.2 Gene regulation.....	58
3.7.3 Protein Activation.....	58
3.7.4 SMAD proteins.....	59
3.8 AMH receptors.....	60
3.8.1 AMHR2.....	61
3.8.1.1 Alternative splicing of <i>AMHR2</i>	61
3.8.1.2 AMH Expression Profile.....	62
3.8.2 AMH type 1 Receptor.....	63
3.8.2.1 ALK6.....	63
3.8.2.2 ALK2.....	63
3.8.2.3 ALK3.....	64
3.9 AMH in the Central Nervous System.....	65
3.9.1 AMH and AMHR2 expression in neurons.....	65
3.9.2 AMH and AMHR2 role in the brain.....	65
 Chapter IV Integrin.....	 66
4.1 Integrin Structure.....	67
4.2 Activation of Integrin pathway.....	67

4.3 Integrins' ligands.....	68
4.4 Signaling pathway.....	69
4.5 Integrins' roles.....	70
4.6 The integrin adhesome.....	70
4.7 Integrins' role in cell migration.....	71
4.8 Integrins' role in axonal/neurite elongation.....	72

Aim of the Study..... 73

Results..... 75

Article 1.....	76
----------------	----

“Suppression of β 1-Integrin in Gonadotropin-Releasing Hormone (GnRH) Cells Disrupts Migration and Axonal Extension Resulting in Severe Reproductive Alterations”

Article 2.....	116
----------------	-----

“Novel Role for Anti-Müllerian Hormone in the Regulation of GnRH Neuron Excitability and Hormone Secretion”

Discussion & perspectives..... 146

1 AMH, GnRH and PCOS.....	148
2 Modulation of AMH actions by sex steroids.....	150
3 Role of AMH in the GnRH physiology.....	150
4 Investigation of autocrine/paracrine mechanisms of action of AMH.....	153
5 AMH ^{fl/fl} mice and future perspectives.....	154
6 Generation of AMHR2 ^{fl/fl} mice: Short Mission in Germany.....	156

Conclusion.....	160
Bibliography.....	162
Acknowledgments.....	188

List of Abbreviations

List of Abbreviations**ALK: Activin like Kinase****AMH: Anti Müllerian Hormone****AMHR2: Anti Müllerian Hormone type 2 Receptor****AMPA R: α -Amino-3-hydroxy-5-Methyl-4-isoxazolePropionic Acid Receptor****ARC: Arcuate nucleus****ASRM: American Society for Reproductive Medicine****AVPV: AnteroVentral PeriVentricular nucleus****BMP R: BMP Receptor****BMP: Bone Morphogenetic Protein****CCK R: Cholecystokinin Receptor****CCK: Cholecystokinin****cGnRH: chicken GnRH****CHD7: Chromodomain helicase-DNA binding protein 7****CHH: Congenital hypogonadotropic hypogonadism****CNS: Central Nervous System****Co-Smad: Co-mediator Smad****CXCR4: Chemokine (C-X-C motif) Receptor 4****DAG: Diacylglycerol****DRG: Dorsal Root Ganglia****DYN: Dynorphin****E: Embryonic day****E₂: 17 β -Estradiol****Ebf: Early B-Cell Factor****ECM: Extracellular Matrix****EGF: Epidermal Growth Factor****EMX1: Empty Spiracles Homeobox 1****Enos: endothelial NOS (NOS-III)****Eph: Ephrin****ERE: Estrogen Response Element****ERK: Extracellular signal Regulated Kinase****ER α : Estrogen Receptor α** **ER β : Estrogen Receptor β** **ESHRE: Human Reproduction and Embryology****FAK: Focal Adhesion Kinase****FSH: Follicle Stimulating Hormone****GABA: γ -AminoButyric Acid****GAD67 (glutamic acid decarboxylase 67****GAP: GnRH Associated Protein****GFP: Green Fluorescent Protein****GnRH: Gonadotropin-Releasing Hormone**

GPCR: G Protein Coupled Receptor
GPR54: G Protein Coupled Receptor 54
hAMH: human AMH
HGF: Hepatocytes Growth Factor
HH: Hypogonadotropic Hypogonadism
HPG: Hypothalamic-Pituitary-Gonadal axis
HS6ST1: heparan sulfate 6-O-sulfotransferase 1
ICV: Intra-Cerebro-Ventricular
IHH: idiopathic HH
iNOS: inducible NOS (NOS-II)
IP3: 1,4,5-trisphosphate
I-Smad: Inhibitory Smad
Itg: Integrin
JNK: Jun N-terminal kinase
Kal1: Kallmann Syndrome 1
KCC2: Potassium Chloride cotransporter 2
KO: knock Out
KS: Kallmann Syndrome
LH: Luteinizing Hormone
LHRH: Luteinizing Hormone Releasing Hormone
L-NAME: NG-nitro-L-arginine methyl ester
MAPK: Mitogen-Activated Protein Kinases
ME: Median Eminence
mGnRH: mammalian GnRH
MH1/2: Mad Homology
MIS: Müllerian Inhibiting Substance
MT: metallothionein
NCAM: Neural Cell Adhesion Molecule
NELF: Nasal embryonic LHRH factor
nHH: normosmic HH
Nhlh2: nescient helix loop helix 2
NKB: Neurokinin B
NKCC1: Sodium Potassium Chloride cotransporter
NMDA R: N-Methyl-D-Aspartate Receptor
nNOS: neuronal NOS (NOS-I)
NO: Nitric Oxide
NOS: Nitric Oxide Synthase
Npl: Neuropilin
OEG: olfactory ensheathing glia
OP: Olfactory Placode
OVLT: Organum Vasculosum of the Lamina Terminalis
P: Postnatal day
PCOS: Polycystic Ovary Syndrome
PI3K: Phosphoinositide 3 Kinase

PKC: Protein Kinase C

Plex: Plexin

PMDS: Persistent Müllerian Duct Syndrome

PSI: Plexin-Semaphorin-Integrin

RGD: Arg-Gly-Asp

RMS: Rostral Migratory Stream

R-Smad: Regulated Smad

SDF1: Stroma Derived Factor 1

SF1: Steroidogenic Factor 1

sGnRH: salmon GnRH

SOX: SRY-related HMG-box

SRY: Sex-determining Region on chromosome Y

SVZ: Sub Ventricular Zone

TGF: Transforming Growth Factor

TYRO3: Tyrosine-Protein Kinase

UTR: UnTranslated Region

VNN: Vomero Nasal Nerves

WDR11: WD Repeat Domain 11

WT: Wild Type

WT1: Wilms Tumor 1

Résumé

Etude de nouveaux facteurs moléculaires régulant la migration de neurones à GnRH, leur ciblage axonales et leur neurosécrétion: aperçus dans l'acquisition de la compétence reproductive.

Chez les mammifères, la reproduction est régulée par des neurones spécifiques qui sécrètent le neuropeptide GnRH (Gonadotropin Releasing Hormone). Ces cellules naissent au stade prénatal dans la placode nasale et migrent dans l'hypothalamus, le long des nerfs olfactifs voméro-nasaux, pour devenir des membres à part entière de l'axe hypothalamo-hypophysogonadique. Un certain nombre de pathologies de la reproduction humaine sont associées à la perturbation soit de la migration neuronale des cellules à GnRH ou soit de la sécrétion de la GnRH.

L'objectif général de ma thèse était d'identifier de nouveaux facteurs moléculaires régulant la migration des cellules à GnRH, leur ciblage axonale à l'éminence médiane, mais aussi leur neurosécrétion au cours de la vie reproductive.

Les événements complexes du développement correcte du système à GnRH sont strictement régulés par l'expression spatio-temporelles des molécules de guidage et des molécules de la matrice extracellulaire, dont les fonctions, sont en partie médiées par leur liaison avec la β 1-intégrine (Itgb1). La première partie de mon travail a été d'étudier le rôle biologique de ces protéines de surface dans la reproduction. La technologie Cre/loxP a été utilisée pour générer des souris conditionnelles GnRH spécifiques KO pour la β 1-intégrine (GnRH-Itgb1^{-/-}). La perte d'activité de la β 1-intégrine altère la migration des neurones à GnRH, leur extension axonale à l'éminence médiane et la fertilité de ces souris. Ces résultats mettent en évidence que la β 1-intégrine joue un rôle important dans le développement normal du système GnRH et dans l'acquisition de compétences reproductives normales chez les rongeurs.

Dans la deuxième partie de ma thèse de doctorat, j'ai identifié de nouveaux facteurs moléculaires qui pourraient être responsables de l'apparition du syndrome des ovaires polykystiques (SOPK). Cette maladie est présente chez près de 10 % des femmes. Il s'agit d'une hyperandrogénie associée à une oligo-anovulation chronique, une morphologie ovarienne polykystique et d'autres situations cliniques de transition d'un état endocrinien à

un autre. Chez les patientes atteintes du SOPK, le niveau d'hormone antimüllérienne (AMH) est élevé et indique clairement que l'AMH pourrait être un marqueur possible dans le diagnostic et le traitement du SOPK. Une autre manifestation du syndrome est une élévation des sécrétions du GnRH provoquant une augmentation des taux de LH et un rapport LH/FSH élevés, qui stimulent la production d'androgènes ovariens. Toutefois, jusqu'à présent cette maladie a été considérée principalement comme une pathologie gonadique et des régulations possibles plus élevées au niveau du système nerveux central ou des interactions avec ce dernier n'ont pas été étudiées. En particulier, des informations concernant les effets extra-ovariens possibles de l'AMH sur l'axe hypothalamo-hypophyso-gonadique manquent actuellement.

Mon projet de recherche a été d'étudier le rôle encore méconnu de l'AMH dans la régulation de la physiologie du système à GnRH. Mes études ont permis d'identifier un nouveau rôle extra-ovarien pour l'AMH, et notamment comme un puissant activateur de la neurosécrétion de la GnRH.

Abstract

Study of new molecular factors regulating GnRH migration, axonal targeting and neurosecretion: insights into the acquisition of reproductive competence.

Reproduction in mammals is dependent on specific neurons secreting the neuropeptide Gonadotropin-Releasing Hormone (GnRH). These cells originate prenatally in the nasal placode and migrate into the hypothalamus apposed to the olfactory-vomeronasal nerves to become integral members of the hypothalamic-pituitary-gonadal axis. A number of reproductive disorders in humans are associated with the disruption of either the GnRH neuronal migration occurring during embryonic development or of GnRH secretion.

The overall purpose of my PhD was to identify new molecular factors regulating GnRH migration, axonal targeting to the median eminence, but also neurosecretion during the reproductive life.

The complex developmental events leading to the correct establishment of the GnRH system are tightly regulated by the specific spatiotemporal expression patterns of guidance cues and extracellular matrix molecules, the functions of which, in part, are mediated by their binding to β 1-subunit-containing integrins. In the first study, I have investigated the biological role of these cell-surface proteins in reproduction. Cre/LoxP technology was used to generate GnRH neuron-specific β 1-integrin conditional KO (GnRH-Itgb1^{-/-}) mice. Loss of β 1-integrin signalling impaired migration of GnRH neurons, their axonal extension to the ME, timing of pubertal onset, and fertility in these mice. These results identify β 1-integrin as a gene involved in normal development of the GnRH system and demonstrate a fundamental role for this protein in acquisition of normal reproductive competence in female mice.

In the second study presented in my PhD thesis, I have identified new molecular determinants that might be responsible for the onset of Polycystic Ovary Syndrome (PCOS), the most common female reproductive disorder affecting up to 10% of all women in reproductive age. It is a hyperandrogenic disorder associated with chronic oligo-anovulation, polycystic ovarian morphology and other clinical situations of transition from one endocrine status to another. In patients with PCOS, Anti-Müllerian Hormone (AMH) levels are elevated

and this clearly indicates that AMH could have a potential relevance in PCOS diagnosis and management. Another hallmark of the syndrome is a high GnRH pulse frequency resulting in elevated LH levels and LH/FSH ratio, stimulating ovarian androgen production. However, so far this disease has been considered mainly as a gonadal pathology and possible higher regulations from the central nervous system or interactions with it have not been investigated. In particular, information regarding the possible extra-ovarian effects of AMH on the hypothalamic-pituitary-gonadal axis is currently lacking.

My research project was to investigate the as-yet unexplored role of AMH in the regulation of GnRH system physiology and led to the identification of a novel function for AMH as a potent activator of the GnRH neurosecretion.

Chapter I: The GnRH Neuron Network and Fertility

1. Reproduction and Hypothalamic-Pituitary-Gonadal axis (HPG)

To understand reproductive function and all associated abnormal phenotypes it is necessary to have clear in mind the apparently simple organization of the hypothalamic pituitary gonadal axis (HPG), the connection between the central nervous system and the periphery. In mammals the HPG consists of three main components: 1) the hypothalamus, 2) the pituitary and 3) the gonads. In a very simplistic vision, the function of the HPG axis is the production of hormones required for sexual development and fertility, but of course is also implicated in many connected behaviors.

The hypothalamus is the main integrating center of reproduction, here is produced the decapeptide Gonadotropin Releasing Hormone (GnRH), from the neurons that take its name. GnRH neurons receive inputs from other parts of the brain and their release is seasonal, circadian and pulsatile depending on the species (Gore, 2002). GnRH neuropeptide is transported, by the portal venous system, to the pituitary gland, where it regulates synthesis and secretion of Luteinizing Hormone (LH) and Follicle-Stimulating Hormone (FSH). LH and FSH are two glycopeptides that are produced in both sexes and act mainly at the level of the gonads, where they control steroidogenesis, sex hormone release and maturation of the gonads. This axis is strictly regulated by negative and positive feedback loops from the gonads that sense the hormones concentration in the bloodstream and act back on the pituitary and hypothalamus to maintain a physiological balance (**Figure 1**).

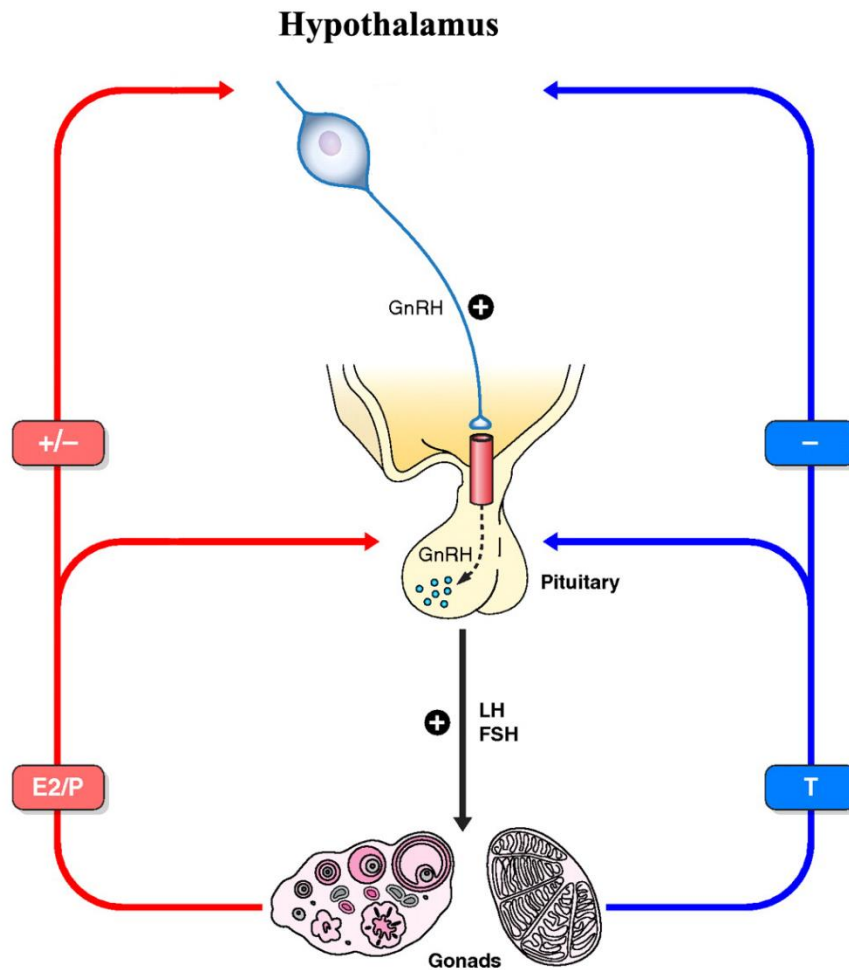

Figure 1: Neurobiology of the hypothalamic-pituitary-gonadal (HPG) axis. Schematic presentation of the neuroendocrine axis controlling reproduction. Hypothalamic GnRH neurons release GnRH to the portal blood system reaching the pituitary gland, where they regulate the pulsatile secretion of gonadotropins LH and FSH. At turn, LH and FSH regulate the maturation and functions of the gonads, ovaries and testis. From the gonads we observe a positive and negative feedback loops to the pituitary and hypothalamus. Abbreviations: (T) Testosterone, (E2) estradiol, (P) progesterone (Modified from (Pinilla et al., 2012)).

1.1 The History of GnRH

GnRH was discovered in the early 70s when two groups, Dr Schally's and Dr Guillemin's, respectively, published the primary structure of a decapeptide, named Luteinizing Hormone Releasing Hormone (LHRH) and capable to release LH. This discovery was rewarded with the Nobel Prize few years later (1977). As this molecule was able also to induce Follicle-Stimulating Hormone (FSH) release, it was called GnRH for gonadotropin-releasing hormone and mGnRH specifically in the case of the mammalian peptide. Pioneer experiments had already started to put in evidence the importance of the GnRH system in the control of reproduction, even before its discovery by Schally and Guillemin. In fact, in 1950s, Donovan and Harris demonstrated that cutting the pituitary stalk in female ferret caused the loss of cyclicity, and regeneration of the connections of the portal vessels between median eminence and pituitary reversed this condition (DONOVAN and HARRIS, 1954). The expression pattern of GnRH peptide was evidenced by the production of the first GnRH antibody that permitted the presence of GnRH fibers at the level of median eminence (Dubois and Barry, 1974).

The most interesting observations were delivered by Knobil's group that described the cyclic oscillations of circulating LH and correlated it with GnRH stimulation of the pituitary. These results highlighted the existence of a GnRH pulse generator (Dierschke et al., 1970; Belchetz et al., 1978; Wildt et al., 1981) (reviewed by (Christian and Moenter, 2010)).

1.2 The GnRH family of peptides

The GnRH variants are 24 known forms; at the beginning the peptides were called after the species of the discovery, for example the chicken was the cGnRH (King and Millar, 1982; Miyamoto et al., 1984), or the salmon sGnRH (Sherwood et al., 1983). Right now, 14 variants have been found in vertebrates, nine in tunicates and one in Octopus (reviewed by (Kah et al., 2007)).

The cloning of GnRH has permitted to regroup phylogenetically the peptide in three branches: type 1/2/3. Type 1 GnRH system, typically hypothalamic, is species-specific and variable, but it has been found in mammals, birds, amphibians and fish, and it is implicated in reproductive functions. GnRH-1 neurons originate in the nasal placode during embryonic development and they migrate into the presumptive hypothalamic areas along olfactory and vomeronasal axons (Schwanzel-Fukuda et al., 1989; Wray et al., 1989a). Disruption of GnRH neurons migration or GnRH secretion results in absent or reduced fertility (Hardelin et al., 2000). GnRH system 2 is represented mainly by the chicken II GnRH form, an ancient form of GnRH. It is localized in the tegmentum of the midbrain and its function is still not clear. In the teleosts it is present a third system that originates differently and resides in the telencephalon and in the terminal nerve (Whitlock et al., 2003) . Type 3 GnRH system includes sea bream GnRH, similar to the mammals GnRH structure except for a serine in position 8. The presence of more GnRH forms suggests gene changing during evolution. GnRH genes probably acquired structural diversity and were initially specified for different functions, giving rise to ontogenetically and functionally divergent GnRH system.

1.3 The ontogenesis of GnRH neurons

GnRH neurons originate during development from the olfactory placode (OP), in the nasal compartment, and only in a second moment migrate to reach the hypothalamus (Schwanzel-Fukuda et al., 1989; Wray et al., 1989a, 1989b). GnRH neurons' birth occurs during embryogenesis, in mice around E11.5 (Wray et al., 1989b), while in humans around 42 days of gestation (Kim et al., 1999; Schwanzel-Fukuda et al., 1989). As soon as GnRH neurons can be visualized, either by immunocytochemistry or in situ hybridization, are already post-mitotic; it has been shown in proliferation studies that GnRH fate specification happens before the beginning of migration, in mouse around E9.5/E10.5 in the medial ventral OP (Wray et al., 1989b). Indications of GnRH brain-ectopic origins are supported also by clinical observations from persons affected by a genetic reproductive disorder named Kallmann's syndrome (KS), KS individuals are not only lacking GnRH neurons within the brain but also the

ability of smell, functions that derives from the OP (Cariboni and Maggi, 2006; Wray, 2010). Moreover, if OP is ablated in mice and chicken there are less GnRH cells (Daikoku and Koide, 1998; Daikoku-Ishido et al., 1990). Another interesting hypothesis is an alternative GnRH progenitors' origin, that would support the ontogenesis of a subpopulation of GnRH neurons within the neural crest (el Amraoui and Dubois, 1993; Forni and Wray, 2012; Forni et al., 2011). Indeed, recent works have shown that about 30% of GnRH neurons migrating in the nasal region during early embryonic development have a common genetic lineage with cells arisen in the neural crest, whilst the other 70% seem to be generated from canonical OP progenitors, yet to be identified. This is coherent with a great number of genetic mouse mutations which affect consistently 30% of the GnRH population. Another proof supporting the neural crest origin of GnRH neurons derives from previous observations demonstrating that GnRH neurons do not express common olfactory markers, while they are positive for nestin, a marker of CNS system and neural crest progenitor cells (Kramer and Wray, 2000). More in-depth lineage tracing studies are required to fully identify the GnRH progenitors but these studies are complicated at the moment due to the lack of specific cell precursor's markers.

1.4 The GnRH migratory pathway

In mammals, GnRH neurons are distributed in a continuum from the olfactory bulbs to the hypothalamus but, as mentioned above, they are generated in extra-encephalic areas and more precisely in the developing vomeronasal organ. From this region, GnRH neurons undertake an axophilic migration, which occurs along olfactory and vomeronasal axon, and they eventually reach their final hypothalamic areas before birth (Wray, 2010) (**Figure 2**). GnRH migration has been reported in different species, and failure of this process during development is associated with different reproductive syndromes, such as hypogonadotropic hypogonadism (HH) (Iovane et al., 2004; Schwanzel-Fukuda et al., 1989).

GnRH neuronal migration occurs early during development. Four specific stages characterize the whole migratory process (Tobet and Schwarting, 2006; Tobet et al., 2001): 1) GnRH

neurons emerge from the presumptive vomeronasal organ (in the mouse at E11.5), attached to the vomeronasal fibers and start their migration across the nasal mesenchyme, 2) at the level of the cribriform plate, the vomeronasal nerve splits in two branches and GnRH neurons momentarily cluster at this region at E14.5; 3) GnRH neurons attach to the caudal branch of the vomeronasal nerve and migrate ventrally to reach the ventral forebrain; 4) GnRH neurons detach from their axonal guides, stop migrating and extend axons to contact the median eminence. Usually migration is complete before birth in all vertebrates but the system remains quiescent until puberty onset.

GnRH migration is axophilic in nature, in fact GnRH cell bodies use vomeronasal and olfactory fibers as scaffold to migrate (Marín and Rubenstein, 2003; Wray, 2001). The vomeronasal axons express different molecules important to mediate this axophilic migration, such as PSA-NCAM, laminin, DCC and TAG1, an axonal surface glycoprotein (Fueshko and Wray, 1994; Murakami et al., 2000; Tobet et al., 1993). This close relationship is necessary to the correct migration, in fact if the olfactory fibers do not reach the final destination, GnRH neurons display an aberrant migration and are found in ectopic position (MacColl et al., 2002). Moreover, GnRH migration is also assisted by the olfactory ensheathing glia cells (OEG), that create a permissive environment from the nasal compartment to the entry in the adult mammalian brain (Cummings and Brunjes, 1995; Franceschini et al., 2010).

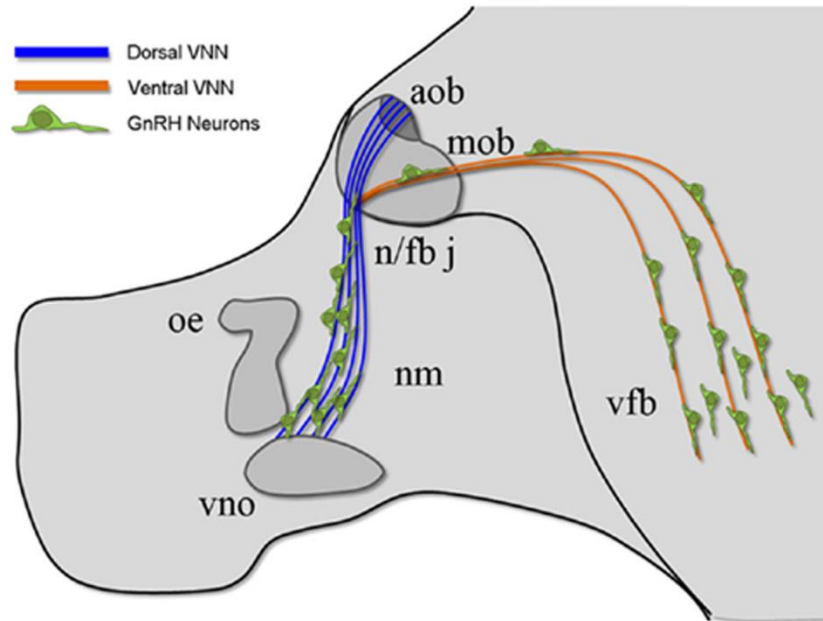

Figure 2: The GnRH neuronal migratory route. Schematic representation of the head of a mouse embryo at E14.5, GnRH neurons migrate from the vomeronasal organ (vno) across the nasal/forebrain junction (n/fb j) into the forebrain using the scaffold of vomeronasal/terminal nerve fibers. Abbreviations: VNN, vomeronasal nerve; nm, nasal mesenchyme; oe, olfactory epithelium; vno, vomeronasal organ; n/fb j, nasal/forebrain junction; aob, accessory olfactory bulb; mob, main olfactory bulb; vfb, ventral forebrain, (from (Messina and Giacobini, 2013)).

1.5 Molecular mechanisms regulating GnRH migration

There are lots of molecules that influence GnRH migration. In order to simplify their description/role, I will analyze some of the most relevant molecules, classified on the basis of their nature or role in specific time/locations of the migratory route.

During the first important step of migration, GnRH neurons have to attach to the olfactory/vomeronasal fibers, event that is mediated by **adhesion molecules**. These include proteins and glycoproteins expressed by the olfactory/vomeronasal axons as well as by GnRH migratory neurons. **PSA-NCAM** (polysialic acid form of neural cell adhesion molecule) is an homophilic binding glycoprotein expressed on the surface of neurons; in this context, removal of PSA by enzymatic digestion blocks GnRH migration in vitro. However, PSA-NCAM

deficient mice do not present any defects in GnRH neuronal development suggesting the existence of compensatory mechanisms (Yoshida et al., 1999). **Anosmin**, the product of the *Kal1* gene, is an extracellular matrix glycoprotein important for adhesion and expressed by the olfactory nerves. It was the first protein identified in X-linked KS-affected individuals and in neuronal migration (Legouis et al., 1991), indicating an indirect role on GnRH and migration (Cariboni et al., 2004). In the second class there are different **guidance molecules** that can act as attractant or repellent cues, influencing GnRH neurons in both direct and indirect manners. **Ephrins**, cell surface molecules which action is mediated by tyrosine kinase receptors (EphA and EphB), are mainly involved in axon guidance during brain development (Gamble et al., 2005). The analysis of mice overexpressing EphA receptor showed a damaged migration with disordered clumps of GnRH cells along the olfactory neurons, in this case only 10% of GnRH neurons reached the brain causing the impaired females sexual maturation and abnormal LH level (Herbison et al., 2008). **NELF** (Nasal embryonic LHRH factor) discovered by Kramer and Wray (Kramer and Wray, 2000) is expressed by migrating GnRH cells specifically in the nasal region and not in the forebrain, plus by the olfactory neurons. It has been shown that silencing of NELF can cause a decrease of GnRH neurons *in vitro*. In this class there are also neurotransmitters, represented basically by two important molecules, γ -Aminobutyric acid (GABA) and Cholecystinin (CCK). **GABA** is an excitatory/inhibitory neurotransmitter, widely expressed in the brain and produced by GAD67 (glutamic acid decarboxylase 67) enzyme. GnRH neurons express GABA_Areceptor (Fueshko et al., 1998a), and female mice overexpressing GAD67 in GnRH neurons exhibit altered estrus cycle and pregnancy rates (Heger et al., 2003). Moreover, GAD67 KO have an increased number of GnRH neurons at E14.5 and E17.5 out from the nasal placode, suggesting GABA inhibitory role on migration (Lee et al., 2008). **CCK** is a peptide hormone, implicated in different roles, among these, females' sexual behaviors. It transmits its action by a G-protein coupled receptor (CCK1R and CCK2R), whereof only the type 1 is expressed by GnRH neurons and modulate its migration. Mice CCK1R KO showed an increase number of GnRH neurons at E14.5 in the brain, proposing a role as inhibitory modulator of migration (Giacobini et al., 2004), however in adult KO mice the number and distribution of GnRH neurons were normal. Additionally, the

same group showed that CKK and its receptors are present in olfactory/vomeronasal neurons during development, inhibiting olfactory axons outgrowth, and, GnRH neurons that selectively express CKKR1 migrate along the CKK positive axons. Moreover, class 2 contains also growth, transcription factors and G protein receptor. Among growth factor, **FGF8** and its receptor FGFR1 are fundamental for neuron development and functionality, indeed FGF KO mice is lethal (Kim et al., 2008). FGF8 has a role in olfactory system development and its mutations are associated with Kallmann syndrome, in addition FGFR1 overexpressing or dominant negative mice conditionally in GnRH neurons have a decreased number of GnRH cells and abnormal projections to median eminence (Gill and Tsai, 2006; Tsai et al., 2005). The **G-protein receptor**, Prokineticin 2 receptor (PROKR2), and its ligand PROK2 have been shown to regulate GnRH migration and consequently reproductive functions (Matsumoto et al., 2006). Indeed, PROKR2-KO mice display less GnRH neurons in the hypothalamus and during development at E13.5, this is due to the fact that the lack of PROKR2 caused an alteration of the olfactory fibers on which GnRH neurons migrate. This indirect effect on GnRH neurons was confirmed also by mutations of these proteins connected with Kallmann syndrome (Dodé et al., 2006). **Ebf2** belongs to the **transcription factor** group. It is implicated in neural development and expressed by migrating GnRH neurons (Corradi et al., 2003). Ebf2 KO mice retained GnRH cells in the nasal mesenchyme in cluster, the effect is direct on GnRH neurons, because the olfactory system is not affected.

Class 3 includes the **guidance molecules** that guide the vomeronasal nerves (VNNs) and GnRH neurons **toward the forebrain**. **Netrin1/DCC** (Deleted in Colon Cancer) is a chemoattractant molecule that regulates vomeronasal nerves to turn caudally in the forebrain, for this indirect effect, GnRH neurons in DCC KO mice fail to turn ventrally in the brain, and deviate to reach the cerebral cortex (Schwartz et al., 2001). **Semaphorin/Plexin** is another fundamental protein family for GnRH migratory pathway. Semaphorins are secreted and membrane-bound proteins that act as axonal growth cone guidance molecules. Semaphorins have been widely studied in recent years in the development of the GnRH/olfactory system. These studies have been fully reviewed by Messina and Giacobini (Messina and Giacobini, 2013) and here I will briefly mention few works.

Sema 4D is a membrane-bound semaphorin proteolytically cleaved that binds to the PlexinB1 receptor expressed at the level of the olfactory placode and along the migratory route (Giacobini et al., 2008). In the same work, the authors demonstrated that PlexinB1 KO mice have a defective GnRH migration, with an accumulation of neurons in the nasal regions, while in adults the innervations of median eminence was decreased compared to wild type littermates. *In vitro* experiments conveyed that GnRH neurons migration is modulated by a crosstalk between different complex of ligand/receptor, like HGF/Met (described after) or Sema4D/PlexB1 (Giacobini et al., 2008). The other important type of complex formed by **Semaphorin** is represented by the one with **Neuropilin**. Among them, **Sema 3A** has been of particular interest, it mediates its action by Npn2 and observation of Npn2 KO mice has elucidated its role. In fact, mice lacking Npn2 display less GnRH neurons in adulthood due to defasciculation problems that affect vomeronasal axons (Cariboni et al., 2007). Recently, it has been shown that mice lacking a functional semaphorin-binding domain in neuropilin-1, an obligatory coreceptor of semaphorin-3A, have a Kallmann phenotype, with abnormal development of the peripheral olfactory system and defective embryonic migration of GnRH cells (Hanchate et al., 2012a) For reviewed (Giacobini and Prevot, 2013; Messina and Giacobini, 2013). **Reelin** family is also implicated in GnRH migration, in fact despite the fact that only a small percentage of GnRH neurons express Reelin receptor, this loss causes a decreased of GnRH neurons in the forebrain and impaired fertility (Cariboni et al., 2005). Last class, the molecules implicated in helping GnRH to cross the cribriform plate, mainly growth and transcription factors. Hepatocyte growth factor, **HGF** is a heterodimeric glycoprotein which action is mediated by **Met**, a tyrosine kinase receptor. Among its numerous roles as mitogenic, migratory and chemoattractant factor, HGF has been demonstrated to act in GnRH migration *in vitro* and *in vivo* (Giacobini et al., 2002, 2007). In fact, HGF not only increases the distance of cell migration in mouse nasal explants, but its inhibition causes a reduce GnRH and olfactory axons outgrowth, being involved in direct and indirect roles. **AXL** and **TYRO3** belong to the family of tyrosine kinase receptors, and as before, are implicated in crossing the cribriform plate and entrance in the brain. Consequently, KO mice display decreased number of GnRH cells at the level of the OVLT, despite unvaried number in the

nose (Pierce et al., 2008), this comports females mice estrus cycle abnormalities. **SDF1**, stroma derived factor 1, via its G protein receptor **CXCR4**, is a small cytokine that accelerate GnRH migration. CXCR4 KO mice have a severely impaired GnRH migration, at E12 almost all the cells are still in the nose, and none reach the hypothalamus (Schwartz et al., 2006). Recently, it has been demonstrated that SDF1 acts synergically with GABA to promote a linear rather than random movement of GnRH cells (Casoni et al., 2012). Last, **Nhlh2**, a transcription factor with a helix loop helix structure that achieves similar role. Mice Nhlh2 KO have a loss of GnRH cells in adulthood, and delayed first estrus (Cogliati et al., 2007). For review (Messina and Giacobini, 2013; Wierman et al., 2011).

The migration process has been studied with a great variety of techniques *in vivo* and *in vitro*, for examples immunohistochemistry at different stages of development, DiIO labeling, olfactory ablation (reviewed by (Tobet and Schwartz, 2006) , immortalized cell line, mouse nasal explants, slice cultured method and transgenic GnRH-GFP animals. All these methods have allowed to improve our knowledge of this pathway, but the main problem is that GnRH neurons cross very different anatomical region with their own molecular environment, suggesting different regulation by transcription and guidance factors, acting directly or indirectly on GnRH. Additionally, we have also to consider that all these different regions are crossed by GnRH in a very precise temporal window, suggesting that many factors could also be spatiotemporal regulated. The migration mechanism, as I explained before, is influenced by a great variety of molecules, and even the loss of a small percentage of GnRH neurons is often associated with defective phenotype, as it has been observed by the big variety of KO and conditional KO that affects GnRH migration or physiology (Messina and Giacobini, 2013).

1.6 GnRH physiology

1.6.1 Role of GnRH at puberty

Puberty is the process triggered by the activation of the hypothalamic-pituitary-gonadal axis, in which the body matures and begins to be capable of sexual reproduction. It is initiated by the hormonal signals in the central nervous system that led the maturation of the gonads and culminates with the production of gametes (Ojeda et al., 2006). It is a very dynamic event, in which different components work together to create a permissive timing, that is not just dependent on chronological age, but on a great variety of factors. First of all, the body, in any species, undergoes to rapid changes in size, shape, and composition, all of which are sexually dimorphic. This **growth** is determined by genetic, environmental factors and nutrition. In fact the **energy balance** and metabolic state are fundamental in the control of puberty, and, the initiation of sexual development and the maintenance of reproductive functions required a minimum energy store. If the equilibrium between energy intake and energy expenditure is disrupted, conditions like obesity or undernutrition are observed, where time of puberty is delayed or accelerated respectively, and fertility is impaired. The energy balance and body maturation are in association with hormonal changes, which occurs at a central and peripheral level all over the body, sending to GnRH neurons information about energy balance, development, season and social environment. There are many hormones involved in puberty onset, but only few have been demonstrated to be fundamental. At a peripheral level, besides sex steroids, two hormones have been shown to be essential: leptin and ghrelin. These hormones are secreted by the adipose tissue and stomach respectively, serve to signal to the brain the body's energy stores; acting as antagonists they maintain a balance to regulate food intake. Leptin increases energy expenditure and mutation of this hormone or its receptor cause altered pubertal development and infertility (review by (Elias and Purohit, 2013)). Ghrelin controls growth hormone secretion and food intake, reduces GnRH secretion in the pre-pubertal period (Lebrethon et al., 2007), moreover, it has been shown that chronic ghrelin administration partially prevented puberty onset in male. Similarly, different **central** neuropeptides are fundamental to modulate this process. Kisspeptin seems to be crucial for the onset of

puberty, switching on GnRH secretion at the right time. Human and mice with mutation for kiss or its receptor display hypogonadotropic hypogonadism (Roux et al., 2003; Seminara et al., 2003), while chronic central administration of Kisspeptin advances puberty in immature females (Navarro et al., 2004a).

GnRH neurons play a central role for puberty initiation because the increase in pulsatile release of GnRH from the hypothalamus is indispensable for this event to occur (Ojeda et al., 2006). Before puberty, GnRH neurons are maintained under inhibitory inputs to release minimum amount of GnRH peptide in the portal pituitary system until “the perfect timing comes” (Terasawa and Fernandez, 2001). In rodents, GnRH neurons have to mature to acquire the reproductive phenotype that reach the apices with the first ovulation (Knobil and Neill; Ojeda et al., 2006; Terasawa and Fernandez, 2001).

In these species, puberty can be simplified in 4 stages: in females, the first is the neonatal period, immediately after birth, until P7, when the gonads are still primitive and do not require GnRH or LH/FSH to develop. Immediately after, for the first 2/3 weeks of life, starts the infantile period, here the ovarian follicles begin to be responsive to FSH. The FSH increases over LH reaching a peak at P12, and after it declines. This is also called minipuberty and it is the first activation of the GnRH system, required for preantral follicles development. Also the LH secretion increases, but it remains less compared to FSH, because GnRH has not yet a high frequency capable to sustain high LH level. The third is the juvenile period, FSH level decreases and LH remains low, but GnRH pulse frequency begins increasing. In this period the sensitivity to the positive estradiol increases reaching a peak at P30. This stimulatory effect of estradiol on LH release involves GnRH activation. This is also the period in which the hypothalamic pituitary axis becomes sensible to low estradiol level produced from the gonads. Last phase is the peripubertal stage, whose transition is regulated by morning –afternoon serum LH concentration. LH levels and its amplitude increase from basal level, but not its frequency. This period is still not driven by the gonads, but it is a centrally driven gonad independent action. At puberty, the ovary acquires the ability to secrete high level of estrogens for at least 24h, triggering the first GnRH/LH surge. This elevated level of estrogens permits the GnRH release that causes the proestrus LH surge. Progesterone also

increases on the day of proestrus facilitating the stimulatory effect of estrogens on GnRH release. This occurs at around 1 month of life, in rodents, and is announced by the vaginal opening, and climax with the first ovulation. In contrast to infantile/juvenile and peripubertal period where the GnRH change are gonad independent, the onset of the preovulatory surge of gonadotropins is centrally driven (GnRH) gonad-dependent (estrogens) (**Figure 3**).

In males, in the neonatal period the gonads develop independently from the HP axis. This is controlled by testosterone produced by fetal Leydig cells, which, in contrast to the Leydig cells that develop postnatally, do not require LH for their proliferation or differentiation. At P5, FSH level increases while LH remains constant. Infantile/juvenile and peripubertal period start at 2 weeks of life, FSH level begin to elevate and reach a maximum around P30/40 GnRH pulse frequency gradually increases until puberty. Male puberty is characterized by presence of motile sperm and capacity of sexual reproduction.

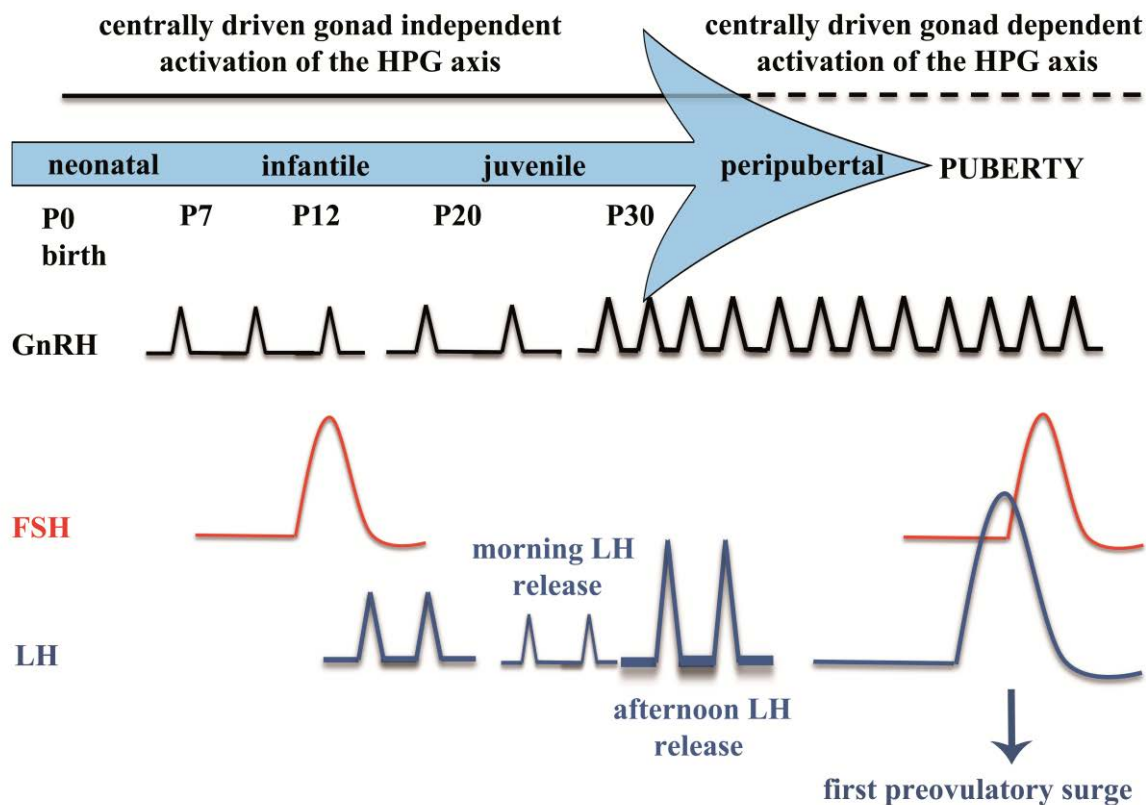

Figure 3: The phases of pubertal activation of the HPG axis in female mouse. Schematic diagrams illustrating the centrally-driven gonad-independent and gonad-dependent changes in hormonal profiles during female postnatal development: 1) in neonatal/infantile stage GnRH and LH are low, but FSH shows a peak at P12, 2) juvenile stage LH release is higher in the afternoon compare to the morning, 3) peripubertal stage ends with the first ovulation.

1.6.2 Role of GnRH at adulthood

GnRH neurons are a relative small population of neurons (800-1000 in the mouse), scattered from the olfactory bulb to the rostral pre-optic area until the caudal hypothalamus (Wray and Hoffman, 1986). Most of the GnRH soma are located at the level of the medial septum and the organum vasculosum of the lamina terminalis (OVLT), a circumventricular organ (**Figure 4**). However, few cells are also located in the olfactory bulb or in the median eminence. Independently of their location, the majority of GnRH cells send their axons to the median eminence, where the terminals release GnRH peptide close to the fenestrated capillary bed

of the hypophyseal portal blood, allowing GnRH to be transported to the pituitary gland. GnRH binds to its receptor GnRHR at the level of the adenohypophysis and stimulates the transcription and secretion of luteinizing hormone (LH) and follicles stimulating hormone (FSH) (Dalkin et al., 1989). Gonadotropins act at the level of the gonads, to permit maturation, steroidogenesis and sex hormone secretion. Interestingly, the release of LH and FSH is driven by two different secretory modes, tonic and phasic. Indeed it has been postulated that with higher GnRH pulse frequencies, LH secretion increases more than FSH, whereas at low pulse frequency is the FSH that is favored (reviewed by Constantin, 2011). This underlines a very particular GnRH pulsatile pattern, fundamental for the correct release of the gonadotropins and the correct operating of the ovary. It is well established that the lack of a pulsatile pattern of GnRH release and constant stimulation by GnRH suppress LH secretion. The balance between the secretory frequencies depends on hormonal feedback from gonads.

Another important factor that changes during life is the morphology of GnRH neurons. GnRH neurons morphology has a bipolar shape, with long extended axons that have to reach the median eminence for distance over 1000 μm . Their axons projections have a very particular intermediate phenotype, because they possess spines like dendrites for all the surface, but actively conduct action potentials to targets, for that reason some groups have called them "dendron" (Herde et al., 2013). The number of spines increases at puberty (Campbell et al., 2005; Wray and Hoffman, 1986) indicating plasticity to maintain the raise of synaptic inputs that accompany maturity and synchronization of secretion (Herde et al., 2013).

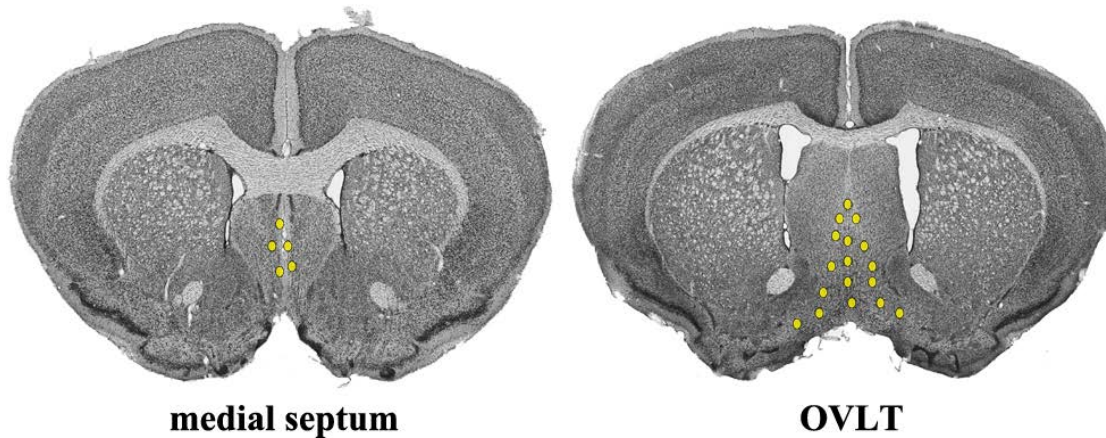

Figure 4: GnRH neurons distribution. Atlas sections defining the anatomical regions—medial septum OVLT in which are located the majority of GnRH neurons.

1.7 GnRH from gene to peptide

GnRH is a 10 aa peptide produced in specialized neurons of the hypothalamus, containing 4 short exons separated by 3 large introns. Exon 1 specifically is responsible for 5' UTR region, while exon 2 for the signal peptide, GnRH decapeptide and the first aa of the GnRH-associated peptide (GAP). Finally, exons 3 and 4 finish to codify GAP peptide plus the 3' UTR (reviewed by (Clarke and Pompolo, 2005) and from (Knobil and Neill).

The GnRH transcript is processed by post translational modification from a large precursor polypeptide, pre-pro GnRH consisting of 92 aa, it undergoes to different proteolytic steps. The first is the creation of a pro-hormone, constituted by GnRH and GAP that is sequent separated by an endopeptidase on a cleavage-site, creating an intermediate GnRH and mature GAP. GnRH intermediate is processed afterwards on its C terminal basic residues by a carboxypeptidase. The final step to create a biologically active decapeptide required the conversion of a N terminal glutamine in pyroglutamate. Some studies say that this last processing occurs in vesicles during its transport down to the axon and in the nerve terminals (Knobil and Neill).

The cleavage products, GnRH and its associated peptide called GAP, are transported down to the axons and secreted in the portal circulation. A physiologic role for GAP has not been established so far. Interestingly, GnRH peptide is packaged and stored in granules by the Golgi apparatus, where the final cleavage is thought to happen (reviewed by (Millar, 2005)). The vesicles can be of two types, dense core with a diameter of 100 nm and clear vesicles with a diameter smaller of 30-40 nm. The hormone is released in a synchronized manner, with frequency that varies along the ovarian cycle, for example is highest at the ovulatory LH surge and lowest during the luteal phase of the ovarian cycle, and LH and FSH release result from these changes. The degradation of this hormone, like its processing, is triggered by different enzymes, the most implicated are the zinc metalloendopeptidase and propyl endopeptidase (Knobil and Neill).

1.4.2 GnRH transduction pathway

Once reached the pituitary, GnRH binds its specific receptor GnRH R to initiate the downstream pathway (Naor, 1990). GnRH R, first cloned from the mouse pituitary gonadotrophs cell line (Tsutsumi et al., 1992), belongs to a G-protein coupled receptors (GPCRs). Like most of this family, it uses its extracellular domain to bind the peptide hormone and the intracellular to transduce the signal by interacting with G-proteins (reviewed by (Millar, 2005)). The GnRH R is coupled to Gq/11 protein to activate phospholipase C which transmits its signal to diacylglycerol (DAG) and inositol 1,4,5-trisphosphate (IP3). DAG activates the intracellular protein kinase C (PKC) pathway and IP3 induces a rise in intracellular calcium concentration (Naor, 2009), which, for this reason, can be used as marker for GnRH neurons activation. In addition to the classical Gq/11, Gs coupling is occasionally observed in a cell-specific manner. Signalling downstream of protein kinase C (PKC) leads to activation of mitogen-activated protein kinases (MAPKs), including extracellular-signal-regulated kinase (ERK), Jun N-terminal kinase (JNK) and p38 MAPK. Active MAPKs translocate to the nucleus, resulting in activation of transcription factors and rapid induction of early genes. (reviewed by (Anderson, 1996)).

Surprisingly, functional GnRHR has been found also in several brain regions, even though its role has never been studied (Wen et al., 2011) (Figure 5).

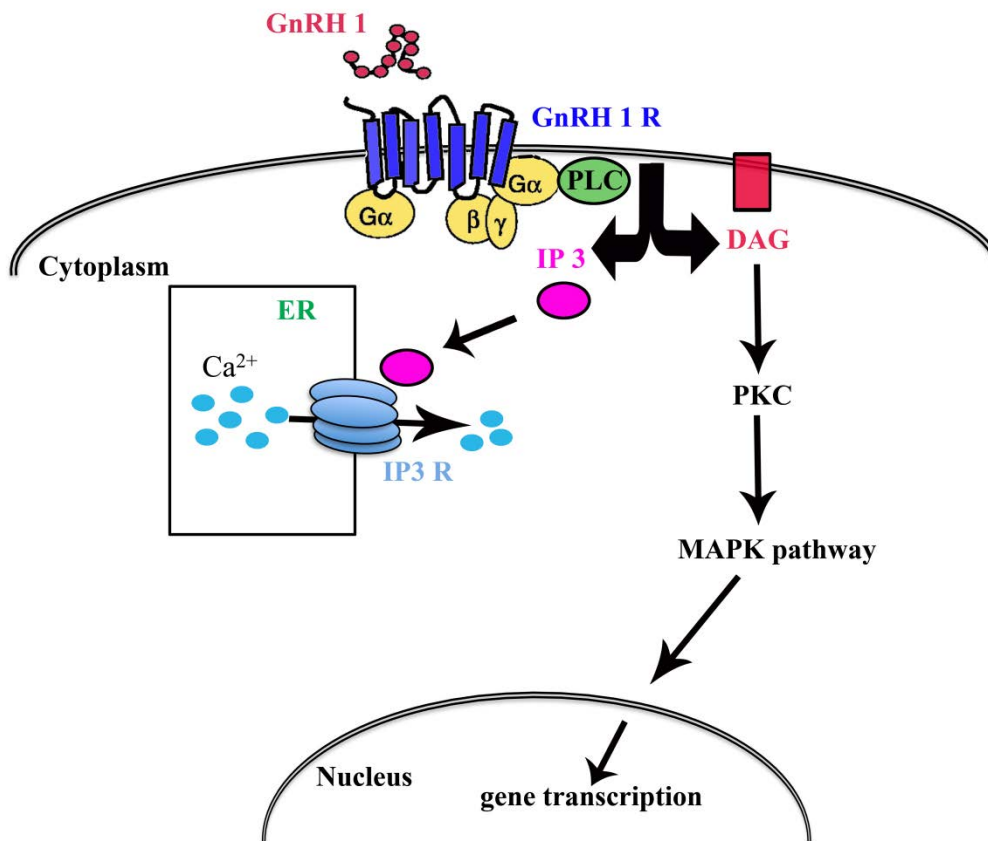

Figure 5: GnRH transduction pathway. GnRH peptide binds to its protein G coupled receptor (GnRH R) and induces the activation of different intracellular signal transduction cascades. Activation of the receptor stimulates phospholipase C (PLC) activity to generate inositol triphosphate (IP3) and diacylglycerol (DAG). Increases of these signal messengers lead to the activation of protein kinase C (PKC) and an increase in intracellular Ca²⁺ concentration from the endoplasmic reticulum (ER). PKC pathway activates the MAPK family that regulates the transcription of genes of interest.

1.8 GnRH Neuromodulators: neural inputs to GnRH neurons

Reproduction in mammals is a process requiring a lot of physiological cost, direct, like energy expenditure and nutrients demand, and indirect, like all the other physiological events that the animals choose to shut off to attend reproduction (Speakman, 2008). Moreover, at the time of reproduction and after, many physiological changes and reorganizations happen in the body, suffice to think to pregnancy or lactation. GnRH is only the first step of this huge process that takes place to grant species survival, but despite this, it is strictly and highly regulated to permit right timing and best conditions.

There is a large number of different neurotransmitters, direct and indirect, involved in modulating the behavior of the GnRH neurons (Todman et al., 2005) and their physiology through life. In the following chapters I am going to describe the most relevant ones and those which have obtained a general consensus on their mode of action (**Figure 6**).

1.8.1 Estrogens

Estrogens are fundamental dowels in the intricate mechanism that controls reproduction and preparation of the reproductive function. They are released from the gonads of both sexes. In females, the primary sources of estrogens are theca and granulosa cells of the ovary, even if the “two cell” theory of estrogen synthesis states that androgens are secreted by theca cells and after in granulosa cells are aromatized in estrogens, there are now clues of synthesis in both the cell types. In females, they promote the maturation of secondary sexual characteristic and the regulation of the estrous cycle, in males they are important for the maturation of the sperm cells (Hess, 2003). In male mice, testosterone, the main androgen, produced by testis, is responsible not only for sexual development, but also for the masculinization of the brain when it is converted in estradiol by the enzyme aromatase (McCARTHY, 2008). Moreover, estrogens also act specifically at the level of pituitary and hypothalamus to modulate GnRH activity. Since estrogens are steroidal hormone, they can passively pass through the phospholipid membranes of cell, their action is mediated by

different receptors, the most known are nuclear estrogen receptor alpha (ER α) and beta (ER β), that after complexing with estrogen, transduce the signal by binding to a specific estrogen response elements (EREs) that regulates transcription (McDevitt et al., 2008). ER knock-out mice have provided invaluable evidence for the biological functions of ER α and ER β (Krege et al., 1998; Lubahn et al., 1993). Despite the number of receptors, ER α is the one most studied in the reproductive axis because KO mice show aberrant phenotype compared to ER β , which lack any reproductive phenotype (Couse and Korach, 1999). In fact females ER α KO are infertile displaying hypoplastic uteri, no corpora lutea in ovaries, and altered hormone levels, like high level of testosterone (Couse and Korach, 1999; Lubahn et al., 1993).

1.8.2 Estrogen Negative and Positive Feedbacks Controlling GnRH

Estrogen has a bimodal effect on the hypothalamus with both an inhibitory and stimulatory influence on GnRH secretion (Radovick, 2012). GnRH neurons are regulated by estrogens by an indirectly way, by kisspeptin neurons, because they possess only ER β and no ER α (Radovick, 2012), that is the receptor responsible for positive/negative feedback (Tassigny and Colledge, 2010). During the estrous cycle the plasma level of estrogen, exactly 17 β -estradiol, are low, inhibiting GnRH secretion and maintaining low its pulse frequency (Herbison, 1998; Levine, 1997). However during the pre-ovulatory period estradiol secretion, from the preovulatory follicles, increases reaching a peak responsible for GnRH neurons stimulation (Christian and Moenter, 2010). This is the positive feedback, that happens in the late follicular phase in humans and in the afternoon of proestrus in rodents (Herbison, 1998; Levine, 1997; Simerly, 2002). Estrogens arrive at the level of the hypothalamus where they activate GnRH neurons to secrete GnRH peptide, it starts at this point a chain reaction through the LH surge that triggers ovulation (Clarke et al., 1987; Moenter et al., 1991; Pau et al., 1993). This estrogen feedback is involved in different anatomical regions in the

hypothalamus, mainly where Kisspeptin neurons are located: the negative feedback takes place in the Arcuate nucleus and median eminence, while the positive feedback occurs in the preoptic area, exactly in the AVPV and suprachiasmatic nucleus (reviewed by (Radovick, 2012)). The main transducer is Kisspeptin that regulates GnRH neurons via activation of ER α .

1.8.3 Progesterone feedback

Progesterone is another important ovarian steroid present in the circulation during all the estrous cycle. Its action on GnRH neurons is both inhibitory and facilitatory (reviewed by Levine, 2001), depending on the stage of the cycle. During the luteal phase it inhibits the GnRH and LH secretion, decreasing GnRH pulse frequency, but when it is administered in concomitance of estrogens it has a positive effects on GnRH amplifying and advancing the surge (reviewed by (Levine et al., 2001). Moreover, it has been shown that in rodents it acts to facilitate females sexual behaviour, including lordosis, when administered with estrogen (reviewed by (Levine et al., 2001).

1.8.4 The Role of Kisspeptin

Kisspeptin's significant role in reproduction was discovered by two independent groups in 2003, when it was put in evidence its importance in GnRH regulation (Roux et al., 2003; Seminara et al., 2003), and the deleterious consequences of its mutations, in humans and mice. In fact, they found deletions/mutations of Kisspeptin or Kiss receptor in patients with idiopathic hypogonadotropic hypogonadism (IHH) (Funes et al., 2003; Seminara et al., 2003), and mice KO for Gpr54/Kiss1r or Kiss1 do not undergo pubertal development, and both sexes are infertile. Kisspeptin signals through its receptor GPR54, a G protein coupled receptor, that has been shown to be present in most of GnRH neurons (Han et al., 2005), once bounded it activates a transduction pathways that culminates with the depolarization of GnRH neurons and GnRH peptide secretion (reviewed by (Tassigny and Colledge, 2010). Indeed, central or peripheral injection of kisspeptin stimulates gonadotropin secretion in

most species, including rodents (Gottsch et al., 2004; Navarro et al., 2005). GnRH responsiveness to kisspeptin is regulated during development; in fact the number of GnRH, that actually responds to kiss, increases in adult age compared to prior stages. This is also accompanied by an increase of hypothalamic Kiss mRNA in rodents at the time of sexual maturation (Clarkson and Herbison, 2006; Han et al., 2005; Navarro et al., 2004b). In contrast with the current prevailing view of Kisspeptin's essential role in regulating puberty, a very provocative recent study demonstrated that female mice, with specifically targeted ablation of Kisspeptin or GPR54 cells by diphtheria toxin A (DTA), can initiate and complete reproductive maturation suggesting that the essential effects of this hormone can be compensated for early in development (Mayer and Boehm, 2011).

Two populations of Kisspeptin neurons have been identified in different hypothalamic nuclei using *in situ* hybridization and immunohistochemistry, one located in the Arcuate nucleus and the other in the anteroventral periventricular nucleus (AVPV), both in proximity of sex steroids feedback (Clarkson and Herbison, 2006; Clarkson et al., 2009). Estrogens modulated Kisspeptin activity in a negative and positive manner depending on the hypothalamic area, it has been suggested that kiss populations in the arcuate nucleus mediate negative feedback, while kiss in the AVPV convey the positive one (Smith et al., 2005, 2006; Wintermantel et al., 2006), by the presence of ER α (and some ER β). This estrogenic effect on Kisspeptin is confirmed by the fact that in gonadectomized animals Kiss1 mRNA increases in the Arcuate conversely to kiss in the AVPV, and sex steroids replacement restores the normal levels (Smith et al., 2005, 2006). Kisspeptin soma located in the AVPV send their axons to the medial preoptic area in close apposition with GnRH perikarya to regulate the GnRH surge in rodents (Gu and Simerly, 1997), while the one in the arcuate nucleus has been proposed to contact GnRH axons at the level of the median eminence to modulate GnRH pulsatility. These are fundamental for controlling GnRH neurons, and the time specificity of the ovulation (Popolow et al., 1981). Kisspeptin neurons are sexually dimorphic for what concern cell number and transcriptional activity, with a greater number of kisspeptin neurons in females compared with males in AVPV (Clarkson and Herbison, 2006), but not in the Arcuate, where the number and density of neurons are the same between sex, at least in rodents. Recently,

Kisspeptin neurons in the Arcuate have been found to colocalize with other two neuropeptides that play central roles in reproduction, namely Dynorphin (DYN) and Neurokinin B (NKB). These neurons, now called KNDy (Kisspeptin, Dynorphin and Neurokinin B) neurons, are the major targets for steroid hormones and have direct projections to GnRH cell bodies and terminals (reviewed (Lehman et al., 2010)).

1.9 Neurotransmitters in the regulation of GnRH neuronal activity

1.9.1 Involvement of Glutamate in the regulation of reproduction

Glutamate is established as the principal and more abundant excitatory neurotransmitter used by neurons in the central nervous system, which action is transmitted by different types of receptors: ionotropic and metabotropic receptors. Ionotropic receptors are ionic channels that act by modulating cations passage. They are present at the postsynaptic density and usually transmit a fast response (Kew and Kemp, 2005). Metabotropic receptors act by a G-protein-stimulated release of intracellular Ca^{2+} or modulation of adenylate cyclase activity and mediate slower modulation (Kew and Kemp, 2005).

GnRH neurons are receptive to glutamate, indeed they express both ionotropic and metabotropic glutamate receptors. Between ionotropic receptors GnRH express 3 types: AMPA, NMDA, Kainate type receptors, concentrated at the postsynaptic terminals (for review (Maffucci and Gore, 2009). The site of action for NMDA receptor seems to be the preoptic area where GnRH cell bodies reside, while AMPA and kainate appear to act primarily at the level of arcuate nucleus/median eminence, the site of GnRH axons (Wintermantel et al., 2006)(Maffucci and Gore, 2009). For what concerns the expression of metabotropic receptor, it remains unclear if mGlu are present or not on GnRH neurons, through the controversial studies with agonist, in which mGluR binding seems to excite GnRH neurons (Dumalska et al., 2008) or have not effects (Chu and Moenter, 2005). Glutamate seems to exert its function on GnRH through NMDA, that it is one of the more expressed, around 50% of adult GnRH neurons express it in rodents (Gore et al., 2002; Jennes et al., 2002; Ottem et al., 2002). Glutamate receptors expression change during lifespan in GnRH neurons, in fact in

early development NMDAR is not expressed by GnRH neurons, and the ability of Glut to affect GnRH system is probably due to an indirect action from other NMDAR expressing cells, moreover expression of GlutR increase during puberty (Gore et al., 1996). Later during postnatal development, the number of NMDA receptors increases creating a permissive time for puberty (Herbison et al., 2001). At that time, it is clear that glutamate play a role in the maturation of HPG axis, in fact infusion of NMDA antagonist can delay puberty onset (MacDonald and Wilkinson, 1990; Urbansky and Ojeda, 1990) or LH secretion (Brann and Mahesh, 1991), while NMDAR agonist cause advancement in the timing of pubertal hallmarks (Urbanski and Ojeda, 1987) (review by (Maffucci and Gore, 2009) and induction of precocious puberty (Macdonald and Wilkinson, 1992; Smyth and Wilkinson, 1994). Moreover, increase of synthesis of glutamate happens in concomitance with increase of GnRH pulsatile release (Bourguignon et al., 1995), and, in adulthood NMDA agonist administration can cause LH increase (Carbone et al., 1992). Furthermore, these receptors are present not only on GnRH soma, but also in a number of hypothalamic nuclei implicated in GnRH secretary control, like the anteroventral periventricular nucleus (AVPV), arcuate nucleus (ARC), and median eminence (ME)(Gu et al., 1999; Mahesh and Brann, 2005), indicating that the glutamate affects GnRH in a direct but also indirect mechanism.

1.9.2 GABA Action

GABA is the dominant inhibitory amino acid neurotransmitter in the brain, including the hypothalamus, (Decavel and Van den Pol, 1990), like Glutamate, its action is transmitted by two types of receptors, inotropic GABA A (Farrant and Kaila, 2007) and C, and metabotropic, GABA B (Kerr and Ong, 1995). During development GABA exerts an excitatory activity, until it switches in the first to second postnatal weeks preferring an inhibitory role (Cellot and Cherubini, 2013).

This shift is due to reversed chloride gradient mediated by two types of cation chloride cotransporters, differently expressed from development to adulthood. In adult cells, KCC2 is the cotransporters more expressed, mediating mainly Cl^{-1} extrusion and maintaining a low

intracellular Cl^- concentration. The binding of GABA to GABA_A R causes a Cl^- entrance that hyperpolarizes the membrane, inhibiting action potential. In immature cells, the situation is reversed, with high Cl^- intracellular concentration thanks to NKCC1 cotransporter which mediates mainly Cl^- uptake, so the GABA binding provokes a net efflux of Cl^- , depolarizing the cells. With development the quantity of NKCC1 decrease and KCC2 increase reversing the effect (Reviewed by (Stein and Nicoll, 2003)). GABA levels, GABA_A receptors, receptor subunits and synapses experienced fundamental changes during hypothalamic development, it is known that GABA profile undergoes a developmental switch from excitatory to inhibitory (Ben-Ari, 2002). GnRH neurons express GABA_A receptor subunits (DeFazio et al., 2002) from early embryonic development through to adulthood, like it has been shown by expression profile studies that have indicated GABA_A in embryonic, prepubertal and adult rodents (Pape et al., 2001; Sim et al., 2000; Temple and Wray, 2005). GABA participates in different step of GnRH physiology, during embryogenesis it has a depolarizing role on GnRH (Kusano et al., 1995) that already express GABA_A receptor, and is necessary for correct migration (Fueshko et al., 1998b; Wray, 2001). At puberty, around P20/P30, it has been proposed a shift of the GABA activity from excitatory to inhibitory phenotype on the HPG axis (Brann et al., 1992; Moguilevsky et al., 1991; Szwarcfarb et al., 1994), hypothesis confirmed by the observation that a fall in GABA release is implicated in the generation of the preovulatory GnRH/LH surge in the female (Herbison and Dyer, 1991). Moreover, other studies have shown that the activation of GABA system was connected with an inhibition of GnRH release in vitro, LH release in vivo and the onset of puberty (Feleder et al., 1999). This inhibitory role in reproductive physiology has been changed in the last years because many groups have shown a persistent excitatory role of GABA also during adulthood. In the work of De Fazio et al. (DeFazio et al., 2002) activation of GABA_A receptor on GnRH neurons showed an excitatory response regardless of sex, time of day or age both on cell and perforated patch recordings. This was confirmed by second studies in which GABA_A R activation was exciting GnRH neurons cultured from rat GnRH-eGFP model, exerting a dose-dependent depolarizing action (Yin et al., 2008). Moreover, a recent work demonstrated stimulatory effect of GABA_A receptor activation on intracellular Ca^{2+} level in 70% adult GnRH neurons (Constantin et al.,

2010). Additionally, mRNA and protein of NKCC1 have been found in murine GnRH neurons, indicating that these neurons actively accumulate chloride, necessary condition for depolarizing/excitatory response to GABA. Considering GABA just inhibitory or excitatory is a simplification of a more complex response in this system, where other neurotransmitters in the vicinity play a role, for example Glutamate. It is also possible that GABA action on its receptor had different effects depending on the location on GnRH neurons, soma versus dendrites, and, some hypotheses have been raised regarding a possible synchronizing role in GnRH neurons (reviewed by (Herbison and Moenter, 2011).

1.9.3 Nitrogen Monoxide

Another important molecule that is implicated in the control of reproduction is the nitrogen monoxide (NO), which is a gaseous molecule generated by the conversion of *L*-arginine to *L*-citrulline. The production of NO is catalyzed by nitric oxide synthase (NOS) enzyme, of which are known three isoforms: two constitutives: neural-type NOS (nNOS) and endothelial-type (eNOS), and one inducible NOS II (iNOS) isoform (Förstermann et al., 1994). nNOS are expressed in the preoptic area (Dawson et al., 1991; Yamada et al., 1996) in close proximity with GnRH perikarya (Clasadonte et al., 2008; Herbison et al., 1996), while at the level of the median eminence nNOS immunoreactivity is distant from GnRH fibers indicating an indirect modulation (Herbison et al., 1996) (reviewed by (Prevot et al., 2000). These different anatomical organizations reflect a dual role on GnRH neurons, direct and indirect. In fact, NO synthesis and secretion are necessary for basal secretion of GnRH/LH from GnRH terminals (Knauf et al., 2001; Kohsaka et al., 1999; Moretto et al., 1993; Rettori et al., 1993) and i.c.v. administration of NO precursors stimulated LH secretion (Bonavera et al., 1993, 1994, 1996) while injections of NOS antisense nucleotide suppress the surge (Aguan et al., 1996). This indicates an indirect action of NO on GnRH terminals (Herbison et al., 1996). Controversy, NO acts directly at the level of soma to inhibit GnRH neuronal activity (Clasadonte et al., 2008; Sortino et al., 1994), how it has been demonstrated by injections of L-NAME i.p., a NOS inhibitor, that resulted in an increase of LH comparable to proestrus level (Hanchate et al.,

2012b). During diestrus the role of NO is to maintain a tonic inhibition of GnRH neurons, keeping LH level low. There is also to consider that nNOS neurons, at the level of the OVLT, are directly regulated by different hormones, like Kisspeptin, which after binding to GPR54 increase the phosphorylation/activation of nNOS (Hanchate et al., 2012b), or, leptin, which activates nNOS neurons increasing circulating LH levels (Bellefontaine et al., 2014). The hypothesis proposed is that nNOS neurons are able to sense signals required for reproductive axis, and, NO inhibitory action is needed to synchronize GnRH release from all GnRH nerve terminals (Clasadonte et al., 2008; López et al., 1997), hypothesis corroborated by the fact that NO production in the preoptic region varies during the estrous cycle. Moreover, the amplitude of NO effluxes is elevated in proestrous, when plasma estrogen are highest, and it stimulates endothelial NO release at ME facilitating a rapid and synchronized GnRH secretion and leading to the preovulatory GnRH/LH surge (reviewed by (Bellefontaine et al., 2011; Prevot et al., 2000). Further proof of NO implication in reproductive function is given by nNOS KO mice, that show hypogonadic phenotype, confirming the fundamental role of this enzyme in fertility (Gyurko et al., 2002).

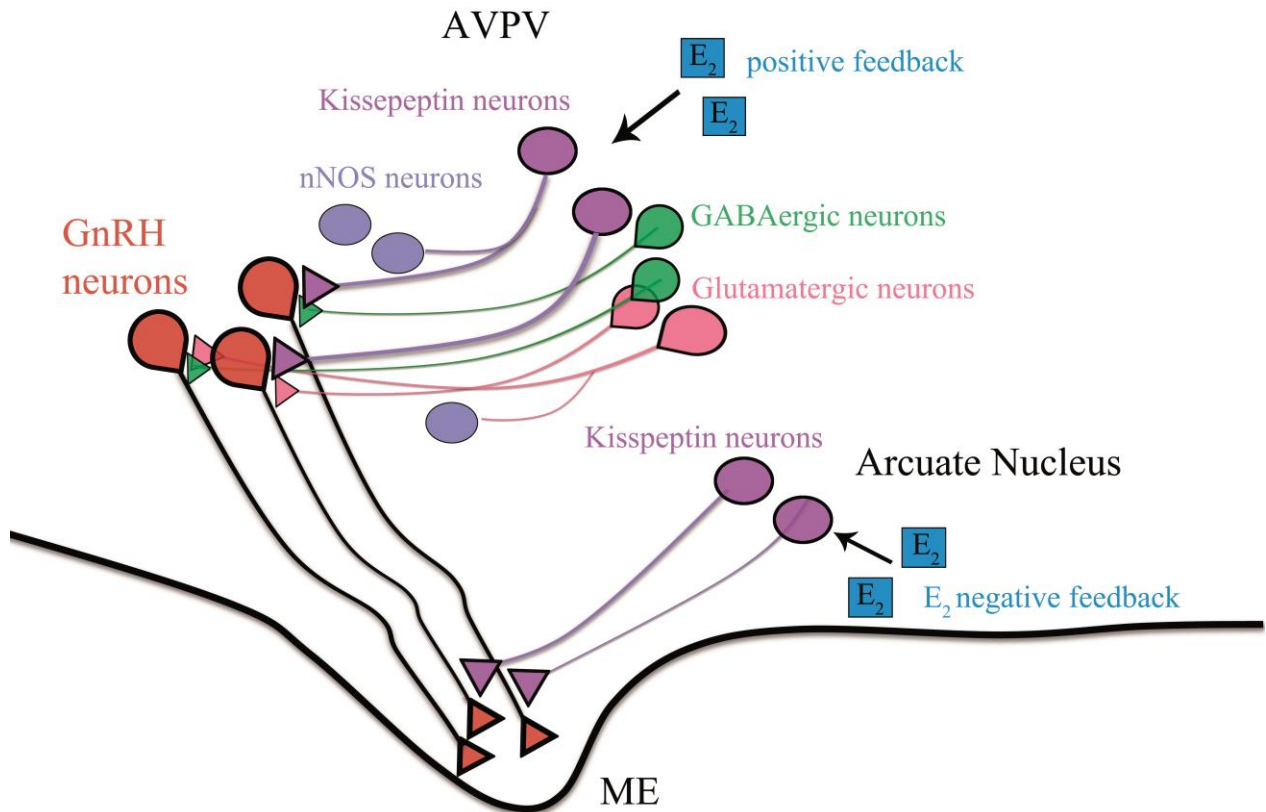

Figure 6: Regulators of GnRH neuron activity. Schematic drawing illustrating the synaptic mechanisms that modulate GnRH neurons. Kisspeptin neurons mediate estradiol positive and negative feedbacks respectively from AVPV and Arcuate Nucleus transmitting the information to GnRH neurons. In addition, there are excitatory, glutamatergic and GABAergic neurons, which contact GnRH neurons, modulating their frequency. nNOS neurons surround GnRH perikarya and they are apposed to Kisspeptin fibers, being another key components of this intricate net of inputs.

Chapter II: Reproductive Syndromes

GnRH aberrant migration or secretion is often associated with reproductive syndromes. Below I will describe two human reproductive disorders deriving respectively from a defective migration of GnRH neurons and from alterations in GnRH pulsatility and secretion at adult stage, respectively.

2.1 Hypogonadotropic Hypogonadism

Congenital hypogonadotropic hypogonadism (CHH) is a rare disorder defined by complete or partial failure of pubertal development due to an impaired secretion of gonadotropins and consequently low sex steroid levels, (Seminara et al., 1998). The prevalence of people affected by this disease is not well known, due to the great heterogeneity of this disease: Its phenotype varies with age of appearance (congenital vs. acquired) and with severity (complete vs. partial). Usually, in male the diagnosis is easier for the presence of micropenis at birth or for the lack of puberty during adolescence. Diagnosis is normally performed using the Tunner scale for adolescence patients and measures of plasma GnRH/LH, and the treatment, in most cases, consists in hormone therapy replacement, estrogen and testosterone, for females and males respectively. Usually, we can refer to isolated CHH when the deficiency involves the gonadal axis and or the hypothalamus or pituitary. Idiopathic hypogonadotropic hypogonadism (IHH) can be associated with the absent or reduced sense of smell, which defines the condition known as Kallmann syndrome. If HH individuals do not present perturbations of the olfactory system, they are referred to as normosmic IHH (nIHH) (Seminara et al., 1998).

2.1.1 Kallmann Syndrome (KS)

Kallmann syndrome is a type of CHH associated with anosmia, the lack of olfactory function, due to abnormal migration of embryonic GnRH neurons (Seminara et al., 1998). This syndrome was described for the first time in 1856 by Dr Maestre de San Juan, that observed by an autopsy, the absence of olfactory nerves in an hypogonadic individual (Maestre, 1856).

Later in 1944, Franz Kallmann asserted the presence of an hereditary hypogonadic syndrome associated with anosmia (Kallmann et al., 1944), while De Morsier added neuropathological details. Only more than 30 years later, with the discovery of GnRH, Kallmann syndrome was actually associated to a hypothalamic-gonadal syndrome. It is a very complex disorder because there is an abnormal olfactory system development and a lack of gonadotropins. In mammals, the olfactory system originates during embryonic development when olfactory and vomeronasal neuroepithelia arise from the olfactory placode (reviewed by (Cariboni and Maggi, 2006), the neurons project their axons to the main and accessory olfactory bulb where they form connections creating a very complex organization that permits to codify the external stimuli and transduce the signals to a central level (Mori et al., 1999). As I mentioned before also GnRH neurons arise from the same area and after they migrate to acquire adult phenotype, so it appears obvious that a failure of development of the olfactory/vomeronasal nerves cause a fail of migration of these neurons (reviewed by (Cariboni and Maggi, 2006). Kallmann syndrome has a prevalence of around 1 in 8,000 in male and 1/40,000 females, even if probably is underestimated; the mode of inheritance can be X-linked, for example *Kal1* located on X chromosome, autosomal dominant and recessive (Bose and Sarma, 1975), even if some case remain sporadic (Dodé and Hardelin, 2009). The most studied genetic mutations responsible for Kallmann syndrome are monogenic, but recently, it has been shown that this syndrome can be caused also by oligogenetic mutations, in which the phenotype is created by two or more mutated genes (Sykiotis et al., 2010). Below I have listed the KS causal genes identified so far.

Kal 1 gene encodes a 680-amino acid secreted extracellular-matrix glycoprotein called anosmin-1, this is a secreted multi-domain protein important for the formation of the olfactory guidance platform for GnRH neuronal migration. Human KS fetuses lacking this protein have an arrest of GnRH neuronal migration at the cribriform plate, indicating that in absence of anosmin-1 GnRH lost their trajectory to the hypothalamus (Franco et al., 1991; Legouis et al., 1991). **FGF8** and its receptor (**FGFR1**) are involved in Kallmann syndrome. Mutations of tyrosine kinase receptor FGFR1 during development disrupt formation of olfactory neurons, similar phenotype is triggered by its ligand FGF8, found in the olfactory

placode (Falardeau et al., 2008; Trarbach et al., 2010). Prokineticin 2 **PROK2**, and its receptor **PROKR2** encode respectively for a secreted bioactive protein and its G protein coupled receptor. They have been shown to play a role in the normal development of the olfactory bulb, indicating an indirect effect on GnRH migration process (Dodé et al., 2006). **WDR11** gene encodes a member of the WD repeat protein family, in Kallmann syndrome patients missense mutations have been found (Kim et al., 2010). **HS6ST1** protein encoded by this gene is a member of the heparan sulfate biosynthetic enzyme family and mutations in HS6ST1 contribute to Kallmann syndrome presumably through synergistic effects with mutant alleles of other disease-associated genes (Tornberg et al., 2011). **CHD7** gene encodes for the chromodomain helicase DNA binding protein 7 expressed in the olfactory epithelium, hypothalamus and pituitary; originally mutations of this protein were identified in CHARGE syndrome patients, a severe form of KS, but recently it has been shown an association also with Kallmann syndrome (Kim et al., 2008). **NELF**, the nasal embryonic LHRH factor, was found mutated by screening of Kallmann patients demonstrating an impaired functionality (Xu et al., 2011). Loss of function mutation in **Sema 3A** locus has been found also implicated in Kallmann syndrome, confirming its role in the development of the olfactory system and in controlling puberty (Hanchate et al., 2012a; Young et al., 2012). In the last years, two others genes have been identified by Sanger sequencing, **SOX 10** and **Sema 7A**; SOX 10 plays important roles, among them in particular, differentiation and development of neural crest, and loss of function mutations are present in 1/3 of Kallmann individuals with deafness (Pingault et al., 2013). Sema 7A, is also involved in this clinical condition, even if it is not sufficient alone, but in concomitance with others genes can modify the phenotype (Känsäkoski et al., 2014). Reviewed by (Buck et al., 1993).

Gene	Gene Product	Function	Clinical phenotype	Reference
KAL1	Anosmin 1	Cell Adhesion	KS	(Franco et al., 1991; Legouis et al., 1991)
FGF8	Fibroblast growth factor 8	Ligand of FGFR1	KS	(Falardeau et al., 2008)
FGFR1	Fibroblast growth factor receptor 1	Tirosine Kinase receptor	KS	(Dodé et al., 2003)
PROK2	Prokineticin 2	Ligand of PROK2	KS	(Dodé et al., 2006)
PROKR2	Prokineticin receptor 2	GPCR	KS	(Dodé et al., 2006)
WDR11	WD protein	Interaction with EMX1	KS	(Kim et al., 2010)
HS6ST1	heparan sulfate 6-O-sulfotransferase 1	biosynthetic enzyme	KS	(Tornberg et al., 2011)
CHD7	Chromodomain helicase-DNA binding protein 7	DNA binding protein, neural crest development	KS	(Kim et al., 2008)
NELF	Nasal Embryonic LHRH Factor	Neuronal Migration	KS	(Xu et al., 2011)
SEMA3A	Semaphorin 3A	Neuronal Migration	KS	(Hanchate et al., 2012a; Käsäkoski et al., 2014; Young et al., 2012)
SOX10	SRY-Related HMG-Box Gene 10	Transcription Factor	KS	(Pingault et al., 2013)
SEMA7A	Semaphorin 7A	Neuronal Migration	KS	(Käsäkoski et al., 2014)

Table: KS genes. List of Kallmann genes selected from literature. Abbreviations: KS Kallmann Syndrome.

2.1.2 Normosmic IHH (nIHH)

Normosmic IHH (nIHH), is a similar but etiologically different syndrome to KS, in fact it is associated with anomalies of the activation or/and secretion of the GnRH system, but the olfactory structure remains untouched. Patients with nIHH display absent puberty due to the impaired GnRH secretion or activation or insensitivity to GnRH. Often, this condition is associated with genetic mutations that involve GnRH or linked genes. The first mutations that were described in 1977 concerned the GnRH receptor gene, GnRH-R was mutated in its extracellular loop, decreasing the binding of GnRH peptide, or in an intracellular loop diminishing the activation of the downstream pathway (de Roux et al., 1997). Moreover, other relevant mutations linked to nIHH are GnRH frameshift mutations that result in an aberrant truncated peptide (Bouligand et al., 2009) and Kisspeptin/GPR54 mutations, that demonstrate how dysregulation of GnRH release regulators can result in severe phenotype (Seminara et al., 2003; Topaloglu et al., 2012). Notable, the same group also showed that mutations in the TAC3 and TACR3 gene, coding for Neurokinin B and its receptor, were associated with severe congenital gonadotropin deficiency and pubertal failure (Topaloglu et al., 2009).

2.2 Pathophysiology of PCOS

I have described above iHH as an example of a reproductive disorder caused by GnRH deficiency. However, other reproductive syndromes can also occur when the GnRH neurons are perfectly in place but their pulsatility is altered finally affecting normal functioning of the gonads.

Among them, Polycystic Ovary syndrome (PCOS) displays altered gonadotropin levels in 2/3 of its patients, elevated LH pulse amplitude and frequency and decreased FSH levels (Dumesic et al., 2007). The prevalence of the plasmatic LH increase has been reported in 30-80% of PCOS patients, taking into account the fact that LH synthesis and secretion are dependent on the pattern of GnRH pulse stimulation. The critical question that arises is whatever the rapid GnRH pulse frequency represents a primary hypothalamic defect or if it is rather secondary to other causes; in the following chapter I will try to expose this complex syndrome, evaluating the different hypothesis about its etiology. Reviewed by (Marshall and Eagleson, 1999).

2.2.1 Definition of Polycystic ovary syndrome (PCOS)

Polycystic ovary syndrome (PCOS) is the most common female reproductive disease, affecting up to 10% of all women of reproductive age. The initial descriptions of Stein and Leventhal accurately ascertained the complexity of this syndrome that includes women with a variegate phenotype: amenorrhea, obesity and polycystic appearance ovaries (IF Stein and Leventhal, 1935). Clinical diagnoses of PCOS have historically been hindered by the degree of the complexity and heterogeneity of the syndrome and so in an effort to better delineate its clinical symptoms, the 2003 Rotterdam congress, in which both the society of Human Reproduction and Embryology (ESHRE) and the American Society for reproductive Medicine (ASRM) were in attendance, PCOS was newly defined as the presence of two of these three hallmarks: hyperandrogenism, polycystic appearing ovaries and ovulatory dysfunction (Merino et al., 2011). In 2009,

the definition was further simplified to: 1. Hyperandrogenism, 2. Ovarian dysfunction (oligo-anovulation and/or polycystic ovaries), and 3. Exclusion of related disorders. Unfortunately, this simplified criteria fails to account for the myriad of related symptoms; PCOS remains an intricate disorder associated with altered hormone levels, including elevated levels of LH and Anti-Müllerian Hormone (AMH), and metabolic syndromes such as obesity, acne, hirsutism and hyperinsulinemia – which are not sufficiently accounted for by the current diagnostic criteria.

2.2.2 Polycystic ovaries

The polycystic appearing ovaries are an important criteria in PCOS diagnosis; in fact, the disruption to follicular development and the increased recruitment of the growing follicles from the primordial pool (due to altered gonadotropin balance) make the follicles degenerate and fill with fluid, a condition represented by the cyst. Using ultrasound, the presence of numerous small follicles (up to 20 for ovary) and the increase of the ovarian volume, can be used to diagnose the syndrome (Dewailly et al., 2011).

2.2.3 Hyperandrogenism

Most PCOS women display excessive androgen secretion, including elevated levels of testosterone or other cholesterol derivates; this results in the inability to release the egg from the ovulatory follicles that therefore remain in the ovary and degenerate, developing the cystic phenotype. The secondary effects of these elevated levels result in a masculinized phenotype, including hirsutism, acne and alopecia.

2.2.4 Anovulation

Abnormal menstrual cyclicity is common in PCOS patients, with 10% of PCOS women suffering from amenorrhea (also called primary amenorrhea – the total lack of vaginal bleeding) and up to 75% of oligomenorrhea or secondary amenorrhea that results in sporadic cycles. These irregular cycles are also interspersed with successful ovulations, making the syndrome complex.

2.2.5 Altered hormonal profiles

Along with altered androgen levels, PCOS is also associated with additional hormonal imbalances. The gonadotropin (LH/FSH) ratio is altered, with increased levels of **LH** compared to **FSH**. Serum LH is elevated in 40/60% of PCOS women (Balen et al., 1995). This is linked with the absence of menstrual cycles and infertility but also to the high level of testosterone produced by the theca cells in response to LH. Moreover, LH secretion also creates a diminished sensitivity to progesterone negative feedback (Marshall and Eagleson, 1999). The low level of FSH, on the other hand, does not permit follicular development and deregulates the conversion of androgen to estrogens by aromatase. Another hormone which has become a prognostic marker for the syndrome is **Anti-Müllerian Hormone (AMH)**, whose serum levels are elevated 2/3 times compared to healthy control (>5 ng/ml) (Dewailly et al., 2011). Moreover, AMH acts to control follicular development, blocking the follicles' maturation and assisting in the selection of a "dominant follicle" (Jonard and Dewailly, 2004), therefore high AMH levels can completely arrest follicular development. **Inhibin B**, an ovarian hormone, is also increased compounding the situation, stimulating androgen production which results in increased inhibin B levels mediated through a positive feedback loop. This can be explained in part by the low levels of FSH (Anderson et al., 1998). **Progesterone** levels in PCOS are low, because ovulation does not occur, so it is not produced, it is thought that this is also responsible for the lack of negative feedback on the hypothalamus. **Insulin** is also known to play a central role in the pathogenesis of PCOS; in fact 50/70% of women are insulin resistance and hyperinsulinemic. It acts synergistically with LH, increasing androgen levels and subsequent anovulation. It inhibits the serum sex hormone binding globulin (SHBG), which usually binds with great affinity to testosterone facilitate its transport in the blood stream. Lack of available SHBG increases the concentration of free testosterone (reviewed by (Ehrmann, 2005)).

2.2.6 PCOS treatment

There are different types of treatment depending on the severity of the disease and the symptom they cure, and 4 categories of PCOS drugs can be employed. The first is

represented by the **contraceptive pill**, which helps to regulate menstrual cycle and lower androgen level, reducing androgen secondary effect, like hair and acne. The second are the **insulin-sensitizing medicaments**, usually used to treat type 2 diabetes, have also an important role in PCOS because they normalize menstrual cycle by lowering insulin, and coordinate weight loss in women with insulin resistance. The most common used drug of this group is Metformin. The third group is described by the **ovulation-induction** medicaments, used in women that want to get pregnant, these drugs allow the release of egg, and there are several different options in this case depending on the grade of PCOS: clomiphene citrate, gonadotropins, Metformin, weight loss and in vitro fertilization. Finally, the **androgen-blockers** are also used to treat the unwanted secondary symptoms, like excess hair growth and acne.

2.2.7 Etiology

2.2.7.1 Genetic basis of PCOS

Different studies have shown that PCOS is hereditary (Azziz and Kashar-Miller, 2000; Ehrmann et al., 1995), underlining different targeted genes. These genes have been divided into three main categories: the gene codifying androgen production and metabolism, the ones responsible for the secretion and action of insulin, and the one related to folliculogenesis. In the first group, the more representative are the genes linked to androgen secretion, like LH and its receptor, and the ones connected to androgen production, like CYP19, encoding for P450 aromatase. In the second group, there are genes related with insulin gene and its receptor, while in the third, genes connected with ovaries (for reviewed look (Franks et al., 2001). Notably, it has been shown the presence of polymorphism in follistatin genic locus that could result in a PCOS phenotype, like reduced FSH level, impaired follicles development and increased of androgen (Jones et al., 2007). Others polymorphisms have been found also in the anti Müllerian hormone and its receptor, Amh type 2, connected with follicles development (Georgopoulos et al., 2013; Kevenaar et al., 2008). Moreover, a recent study has also found correlation between vitamin D receptor (VDR) polymorphism and increased risk of PCOS (El-Shal et al., 2013), even if another work showed the existence

of correlation between genetic variants of VDR and PCOS severity, rather than disease risk (Zadeh-Vakili et al., 2013). This genetic phenotype has been reported so far only in very small isolated cohort.

2.2.7.2 Developmental origin of PCOS: in uterus hyperandrogenism

Another etiological hypothesis of PCOS indicates as predisposing factor the androgen excess during embryonic life or later at birth. This in uterus hyperandrogenism can have different origins like placental aromatase deficiency or elevated free level of testosterone. It has been shown that women with PCOS have elevated androgen level during pregnancy, with high placental level of enzyme catalyzing androgen production and low level of P450 aromatase activity (Maliqueo et al., 2013). The effects of prenatal androgenization (PNA) have been well studied in monkey, sheep and rodents, because they mimic PCOS phenotype, but among these it is better to refer to androgenized model only in the case of perinatal exposure to dihydrotestosterone (DHT), a non-aromatizable androgen, not testosterone (T), since it has the ability to be aromatized to estrogen and exert its effects via estrogenic programming. Monkey and sheep are the most used animals model for studying PCOS, because they complete their ovarian differentiation in uterus, similar to human, and unlike rodents, they are not polyovular and show polycystic ovaries. In monkey the exposition to testosterone propionate during early gestation caused anovulation, hyperandrogenism, polycystic ovaries and LH increase. Moreover, these PNA animals have not only the main symptoms of PCOS, but also many metabolic syndromes that are associated, like insulin resistance, hyperlipidemia, glucose intolerance, and increased risk of type 2 diabetes. Similar phenotype is shown by sheep exposed to testosterone propionate during gestation, with the surplus of increases LH pulse frequency. In PNA mice, generated by DHT administration late in gestation, it is possible to observe a PCOS phenotype, female mice have irregular estrus cycles, with sporadic proestrus stage (Moore et al., 2013; Roland and Moenter, 2011). Anovulation is associated with altered ovarian morphology and low number of corpora lutea (Moore et al., 2013), the level of LH are elevated and in some mice also testosterone is increased (Sullivan and Moenter, 2003) (reviewed by (Goodarzi et al., 2011; Roland and Moenter, 2014).

2.2.7.3 Neurodevelopmental origin of PCOS: new emerging hypotheses

While PCOS etiology has traditionally been considered only at the gonadal level. The failure of intense combined efforts to identify such a causal factor have led to recent hypotheses postulating a neurodevelopmental origin of this syndrome. In PCOS patients, there is a 3 fold increase in the circulating plasmatic LH, while FSH is low; this condition is thought to be responsible for the ovarian problems associated with this syndrome such as amenorrhea and cysts. In addition, PCOS women also have an increased LH pulse frequency that is likely linked to a hyper acceleration of GnRH pulsatility (**Figure 8**).

The secretion and transcription of gonadotropins is under the control of GnRH pulse generator in the hypothalamus that differentially controls the secretion of LH and FSH depending on its amplitude and frequency. Being the transcription of the LH β -subunit controlled by high GnRH pulse frequency whiles the transcription of FSH by low, it has been speculated an altered GnRH pulsatility at the basis of these PCOS modified hormones levels. It is still not know the cause of this irregularity, if it is due to GnRH themselves or by the lack of progesterone negative feedback (reviewed by (Ehrmann, 2005). Recently, it has been proved in PNA mice that the abnormal prenatal androgen exposure caused also consequence at central level, by increasing GABAergic neurotransmission to GnRH neurons and so their activation (Sullivan and Moenter, 2003). This is evidence about a possible central deregulation of GnRH system, in which an abnormal central reprogramming could actually alter ovarian development. Other experiments are required to better clarify the origin syndrome (ovarian or central), but this is certainly complicated by the great heterogeneity of metabolic conditions that characterize this syndrome.

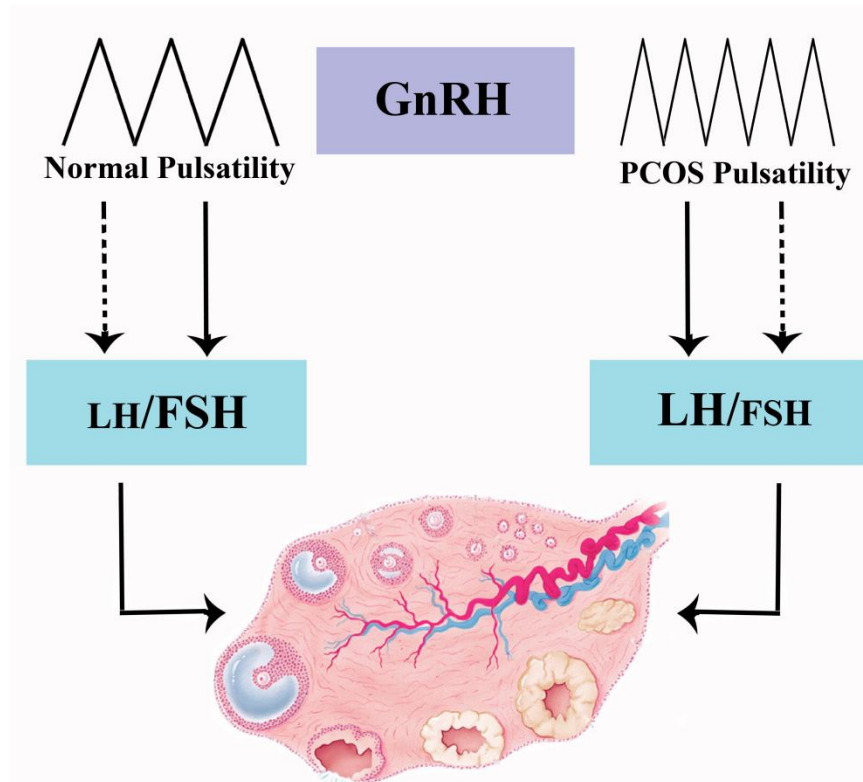

Figure 8: The hypothalamic-pituitary-gonadal axis in PCOS. PCOS shows abnormalities in the HPG axis: an increased frequency of luteinizing hormone (LH) pulse appears to result from an increased frequency of hypothalamic gonadotropin-releasing hormone (GnRH) pulses. This can result from an intrinsic abnormality in the hypothalamic GnRH pulse generator, favouring the production of luteinizing hormone over follicle-stimulating hormone (FSH) in patients with the polycystic ovary syndrome.

As previously described (in paragraph 2.2), the increase in the number of growing follicles in PCOS is primarily reflected by a two or three fold increase in blood Anti Müllerian Hormone (AMH) levels. Clinically, AMH can be used in the diagnosis of PCOS and as a marker of patient response to treatment. The next chapter will focus on defining its well-studied roles in the gonads and its new identified action in the nervous system.

Chapter III: Anti Müllerian Hormone

3.1 Mammalian Sexual Differentiation

Sex differentiation in mammals is governed by genetic and hormonal factors; the sexual fate is cast at fertilization, but revealed only later during fetal development, in fact gonadal differentiation and acquisition of endocrine functions are the necessary conditions for the dimorphic phenotypic characteristic of the reproductive system. These processes are not essential for the survival of a single individual but rather for the survival of the entire species.

During development the early mammalian embryo is in a sexually undifferentiated state, in which it has the potential to develop either male or female structures. Undifferentiated genital system is made by bipotential gonads with undifferentiated ducts and urogenital sinus (Wilhelm et al., 2007). The primitive ducts adjacent to each developing gonad can originate either male or female reproductive tracts. The one responsible for male reproductive tract are called Wolffian ducts and will give rise to seminal vesicles, epididymis, vas deferens and ejaculatory ducts. In females, Müllerian ducts, are the ones answerable to create the uterus, upper part of vagina and oviducts (Kobayashi and Behringer, 2003a). The dimorphic sex determination is started firstly, in human at 7 weeks after conception, by the Y chromosome that contains the SRY gene (Sex-determining Region), this gene initiates the correct biochemistry inside the testes to produce specific hormones that permit sexual differentiation (Page et al., 1987; Skaletsky et al., 2003). The second important part is triggered by sex hormones that are involved in sex differentiation: Anti Müllerian Hormone, which induces regression of the Müllerian duct and testosterone that induces the Wolffian ducts to differentiate into seminal vesicles, epididymis, vas deferens and ejaculatory ducts in male (Tsuji et al., 1992) (**Figure 9**). In female, the lack of Y chromosome and AMH expression makes the Wolffian duct regressing passively (Nef and Parada, 2000). This happens around the 8/9 weeks of gestational age in human and E13/14 in mice (Dyche, 1979).

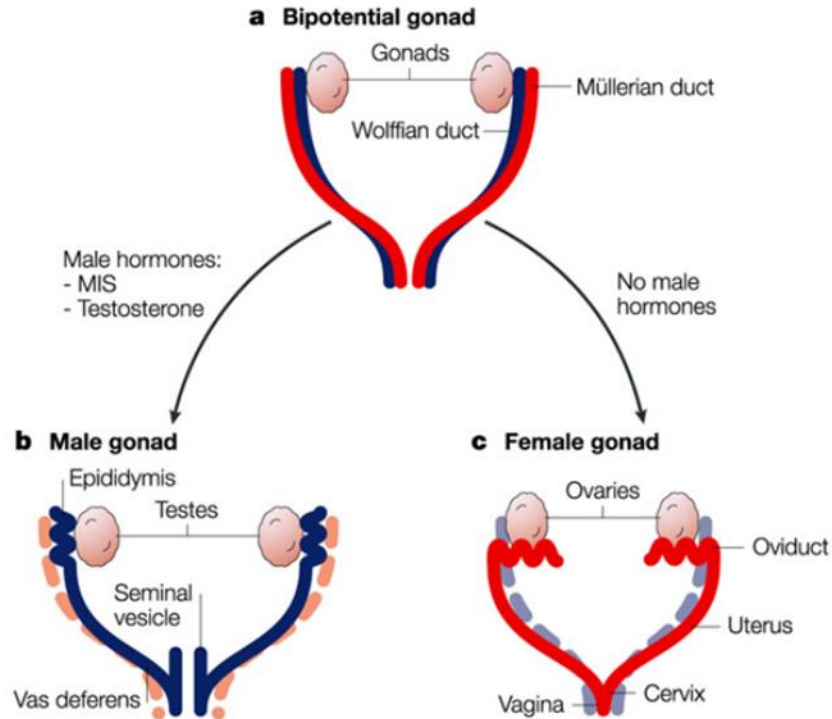

Figure 9: (a) Undifferentiated gonadal system: male and female embryos have bipotential gonads, possessing both Müllerian and Wolffian ducts. **(b) Male gonad:** Apart the expression on the Y chromosome Sry, the bipotential gonads will be transformed in testis, which will secrete different hormones like testosterone and Anti Müllerian Hormone. The first will promote Wolffian duct differentiation in epididymis, Vas Deferentia and seminal vesicles, while AMH will regress Müllerian ducts. **(c) Female gonads:** In absence of male hormones the bipotential gonads will develop in oviduct, uterus, cervix and upper part of vagina (Modified From (Kobayashi and Behringer, 2003b)).

3.2 History and Discovery of AMH

The discovery of Anti Müllerian hormone also known as Müllerian Inhibiting substance (MIS) was initiated by Professor Alfred Jost, which in 1947, set the idea of a testicular factor responsible for Müllerian duct regression.

In its famous experiments Jost noticed that rabbit embryonic Müllerian duct could independently develop in uterus, fallopian tubes and vagina *in vivo*, when a mysteriously substance from testis was absent (Jost, 1947). Jost gonadectomized during sexually undifferentiated stage rabbit embryos and provided different hormonal replacement by implanting either ovarian or testicular tissue or testosterone alone. The replacement with ovaries or with no gonads led to differentiation in female reproductive tract, while the

replacement with testis conducted in the opposite phenotype with differentiation of the Wolffian duct and regression of Müllerian duct. The key results arrived when he used testosterone and noticed that the Wolffian duct was stimulated to differentiate but there was not regression of the Müllerian duct, thus suggesting existence of a testicular hormone responsible for Müllerian duct regression. Jost not only revolutionized the current idea, at that time, that testosterone was the only responsible for male sexual differentiation but also provided a partial explanation for the clinical state of testicular feminization, the Freemartin syndrome. The freemartin syndrome is a frequent form of intersexuality found in cattle and other species that originates when vascular connections, between the placentae of developing **heterosexuality** twin foeti, permit the exchange of substances; the result is masculinization of the female reproductive tract (Padula, 2005).

In subsequent experiments, the activity of this mysterious substance was tested by co culturing rat Müllerian ducts, dissected at E14, with rat fetal testes. Also in this case this inhibiting molecule did its job regressing Müllerian ducts (Picon, 1969). Another disciple of Jost, Nathalie Josso showed that it was produced from human and bovine Sertoli cells of testis and that was the same active macromolecule capable of regress the rat Müllerian ducts if posted in co culture (Josso, 1972). After almost 3 decades, in 1978 several investigators identified AMH as a 140KDa glycoprotein homodimer (Picard et al., 1978), it was localized in male embryonic, neonatal and postnatal testis (Donahoe et al., 1977), but also in granulosa cells of female ovaries (Vigier et al., 1984). Finally in 1986, the human and bovine genes for AMH were isolated and sequenced (Cate et al., 1986), while the bovine cDNA was cloned (Picard et al., 1986). This was the beginning of new investigations aimed at identifying the mechanisms of action of AMH during embryogenesis and in postnatal gonads.

3.3 AMH in sexual dimorphism

AMH is essential for normal sexual differentiation as its absence results in a severe phenotype in both humans and animals. It can be considered as a dimorphic hormone, indeed its levels, are divergent in values if we compare men versus women and are also not matching in time. In male it rises rapidly during the first year of life and is highest during late infancy, then gradually declines until puberty, while in female AMH is lowest at birth and exhibits an

increase throughout the prepubertal years (Lee et al., 1996).

3.4 AMH in Male Physiology

The initial identification of AMH in males triggered the era of its endocrine relevance in sexual differentiation.

In human testes AMH is secreted during gestational age (8 weeks post amenorrhea) by the Sertoli cells of testis, and initiates Müllerian duct regression (Behringer et al., 1994; Mishina et al., 1996), which is completed by week 9 (Taguchi et al., 1984). In rodents, AMH mRNA is detected in mouse testis at E 11.5 and in rats at E13 (Tsuji et al., 1992).

The action of AMH on the Müllerian duct is irreversible, in fact when involution of the future female ducts begins, it continues even without AMH, showing permanent effects (Taguchi et al., 1984). In addition, it is a time specific event, in fact the duct sensitivity to AMH lasts for a precise time windows, called critical period (around E13/14 in mouse): before or after this period, regression of the Müllerian duct is not anymore hormone dependent (Taguchi et al., 1984; Tsuji et al., 1992). The critical period derives on the expression pattern of AMH specific receptor, AMHR2 (Josso et al., 2001), which expression is low when Müllerian ducts are no longer sensitive to AMH.

The Müllerian duct regression is a programmed cell death process (apoptosis) which is mediated by AMH via a paracrine mechanism, since the mesenchymal cells surrounding the Müllerian ducts express AMHR2 (Baarends et al., 1994; di Clemente et al., 1994; Teixeira et al., 1996). Some groups proposed that this regression takes place at multiple stages. In the first moments, coelomic epithelial cells expressing both AMHR2 and the type I receptor Alk2 undergo morphological transformation and are induced by AMH to migrate and to surround the Müllerian ducts (Zhan et al., 2006). This event does not happen in females, since AMH is not expressed in gonads during embryonic life. During the second stage, these newly differentiated mesenchymal cells switch their expression of AMH type 1 receptor, Alk2 to Alk3 (Bmpr1a), and the apoptosis begins (Roberts et al., 1999; Zhan et al., 2006). In male AMH is expressed also postnatally, even if its level declines progressively with the increase in testosterone and concomitant initiation of spermatogenesis (Rey, 2005). Androgens are in fact potent inhibitors of AMH expression, but this inhibitory action is exerted only at puberty (Rey et al., 1993). Indeed, during embryonic development and early

postnatal life, we can observe permissive coexistence of high level of AMH and androgens due to the lack of androgen receptor expression in Sertoli cells (Al-Attar et al., 1997; Boukari et al., 2009; Chemes et al., 2008). AMH plays also a role in postnatal male physiology (Matuszczak et al., 2013). Indeed, it has been shown that AMH acts as negative regulator of Leydig cells development (Racine et al., 1998). In postnatal testes, Leydig cells differentiate, but remain quiescent until puberty, when they start to produce testosterone (Griffin et al., 2010). This was also confirmed in AMH-KO mice whose testes display Leydig cells hyperplasia and absence of postnatally differentiated Leydig cells (Racine et al., 1998). Moreover, the analysis of transgenic mice that chronically overexpress human AMH (hAMH), under the control of the mouse metallothionein-1 promoter (MT-hAMH mice), showed that AMH blocks the differentiation of Leydig cell precursor in the postnatal testis (Racine et al., 1998). Additionally AMH is a distinctive marker of immature Sertoli cells and of action on the prepubertal testis, in fact low AMH serum correlates with small testis (Lukas-Croisier et al., 2003).

There is an associated disease with AMH or AMH receptors mutation (Behringer et al., 1994; Jamin et al., 2002; Mishina et al., 1996), a rare form of internal pseudohermaphroditism called Persistent Müllerian Duct syndrome (PMDS). In this syndrome men have male reproductive organs as well as uterus, upper part of vagina and fallopian tubes. Approximately 45% of cases of persistent Müllerian duct syndromes are caused by mutations in the AMH gene and are called persistent Müllerian duct syndrome type 1 ((OMIM): 600957).

Another 40% of cases are caused by mutations in the AMHR2 gene and are called persistent Müllerian duct syndrome type 2((OMIM): 600956). The mutant mice for AMH and AMHR2 present the same developmental defects observed in PMDS syndrome (Behringer et al., 1994; Mishina et al., 1996).

3.4.1 Paracrine regulation

It is well established that AMH is regulated by testosterone. Data from clinical studies and rodent models proposed the hypothesis that androgens are negative regulators of post-natal testicular AMH secretion (Rey, 1998). This is supported by the fact that patients with defective androgen production or androgen insensitivity syndrome (AIS: mutation of androgen receptor) show abnormally elevated serum levels of AMH (Rey et al., 1994),

while MT-hAMH mice, besides being incompletely masculinized, have low level of circulating testosterone (Behringer et al., 1990). Moreover, adult rats treated with AMH diminished the level of serum testosterone (Sriraman et al., 2001).

3.4.2 Endocrine regulation

Another important control of AMH during postnatal life is achieved by FSH. FSH is a positive regulator of postnatal AMH secretion in Sertoli cells, it stimulates AMH production, indeed mice lacking prepubertal FSH have low level of AMH, but they can recover after FSH treatment (Lukas-Croisier et al., 2003). FSH can also activate AMH transcription (Lukas-Croisier et al., 2003) via adenylate cyclase, cAMP, and protein kinase A but involving a non classical cAMP-response pathway. When the negative effect of androgens is absent AMH output can be stimulated by FSH (Al Attar et al., 1997). The cellular and molecular mechanisms underlying FSH stimulation of AMH production are not known.

3.5 AMH in Female Physiology

In 1984, Vigier and colleagues showed for the first time that AMH was produced postnatally in the ovaries and it was detectable in the follicular fluid of granulosa cells (Vigier et al., 1984). This ovarian AMH had the same structure/sequence of male AMH and could also induce regression of the Müllerian ducts (Vigier et al., 1984). In females, AMH starts to be expressed post-natally.

The isolation of cDNA and genomic clone of mouse AMH clarified the exact timing and localization of AMH in female (Hirobe et al., 1992; Munsterberg and Lovell-Badge, 1991; Taketo et al., 1993): it was absent in embryonic stage, and it firstly appeared at day 6 after birth, in granulosa mouse cells. The expression profile was confirmed by analysis of female serum from infancy to adulthood (Lee et al., 1996; Rajpert-De Meyts et al., 1999), in female AMH level was lowest at birth and exhibited a minimal increase throughout the prepubertal years (Hudson et al., 1990). Lack of expression in early stages guaranteed a normal differentiation of the female internal reproductive tract structures, as it is shown by female transgenic mice over expressing AMH (Behringer et al., 1990), that are infertile, with blind vagina due to the lack of a uterus and oviducts.

Further analysis of AMH protein expression at different stages of the estrous cycle (Ueno et

al., 1989) started to elucidate its role in rodent ovaries, AMH was found in preantral and antral follicles in all stages of cycle, with a more intense staining during proestrous in granulosa cells located near to the oocytes of preovulatory large antral follicles.

AMH has a role in folliculogenesis, in fact among different factors that work in a positive and negative way, it displays an inhibitory effects, acting in autocrine/paracrine manner. It inhibits the initial follicle recruitment, delaying the primordial follicle to initiate to growth (**Figure 10**) (Broekmans et al., 2008; Durlinger et al., 2002), so it reflects the size of the primordial follicle pool in mice. Consequently, AMH-KO mice show an early depletion of the primordial follicles pool, and enter in menopause earlier compare to WT mice (Behringer et al., 1994; Durlinger et al., 2002).

Moreover, it inhibits the cyclic follicles recruitment, reducing the sensitivity to FSH that permits the maturation of the growing follicles and the entrance in the preovulatory stage (Broekmans et al., 2008; Durlinger et al., 2002; Visser et al., 2006) (**Figure 10**). These AMH actions are observed also in humans, where it is expressed in the growing maturing follicles to allow them to reach the size (diameter bigger than 8mm) and the right differentiation state at which they are selected for dominance (Weenen et al., 2004). Despite we could expect that its level is modulated during the menstrual cycle, because its action is controlled by gonadotropin, AMH fluctuation are still debated. Some group showed that AMH level does not significantly change during menstrual cycle (La Marca et al., 2006), while others, registered significant cyclical fluctuation in AMH level that were lower during early luteal phase (Streuli et al., 2009; Wunder et al., 2008) and higher at ovulation (Cook et al., 2000).

In women, AMH plasma level is proportional to the number of developing follicles in the ovaries (La Marca and Volpe, 2006), decreasing at menopause, with the end of fertility (de Vet et al., 2002). For this reason AMH is used as marker for ovarian reserve and with low levels symptomatic of follicular reserve exhaustion (Kevenaar et al., 2006). In contrast, clinically elevated levels due to an excess of antral follicles are utilized as a marker for the ovarian pathophysiology Polycystic Ovary Syndrome (PCOS) (Cook et al., 2002; Pigny et al., 2003).

PCOS is a very common endocrine disorder in women and although it affects up to 10% of female population, its diagnosis can be difficult since it is normally associated with other metabolic disturbances such as obesity, diabetes, cardiovascular disease and insulin

resistance. For this reason the Rotterdam consensus stated the presence of two of the following three criteria to define PCOS: PCO morphology; clinical or biochemical hyperandrogenism and sporadic ovulation (reviewed by Ehrmann, 2005). Even if AMH level is not included so far in PCOS diagnostic criteria, in the great majority of cases, AMH is 2- to 3-fold higher compared with normal ovaries (Laven et al., 2004; Mulders et al., 2004; Piltonen et al., 2005).

Surprisingly, in women AMH does not seem to be fundamental for reproduction since analysis of AMH deficient female mice did not report any defects in fertility, besides early menopause (Behringer et al., 1994; Durlinger et al., 2002).

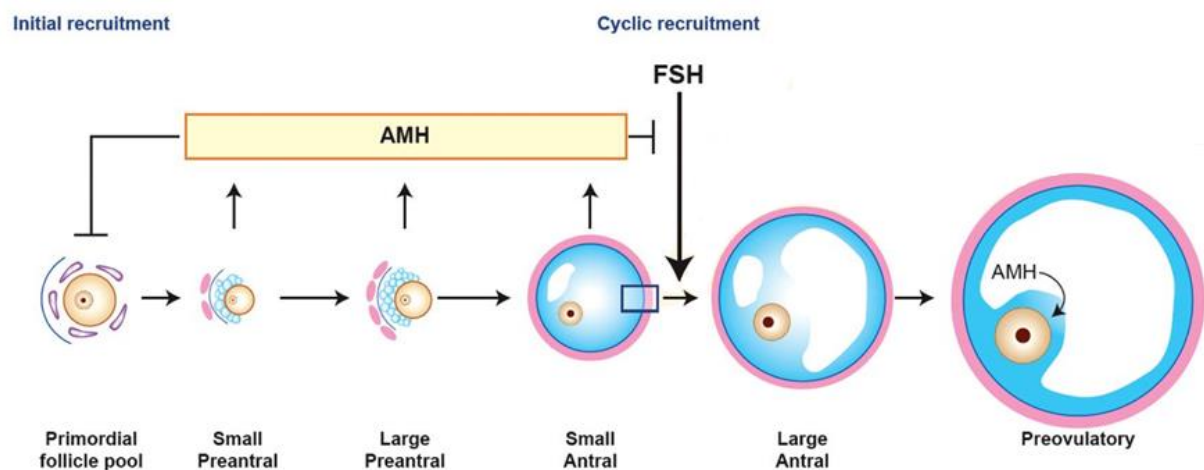

Figure 10: Schematic model of AMH actions in the ovary. During folliculogenesis, two regulatory selection processes happen, the initial follicles recruitment, a first selection where the follicles are recruited from dormant primordial pool and cyclic follicles recruitment, where follicles are selected to growth under FSH action. AMH, produced by granulosa cells of growing follicles, inhibits both these processes, exerting negative regulation also on FSH. modified from (modified from Dewailly et al., 2014).

3.5.1 Paracrine regulation

FSH exerts an inhibitory effect on AMH. It has previously been shown that FSH treatment in prepubertal rats causes downregulation of *Amh* and *Amhr2* mRNA expression in follicles

(Baarends et al., 1995). This is also supported by clinical evidence showing that FSH treatment of PCOS women prior to *in vitro* fertilization procedures induces a decrease in AMH plasma concentration (Baarends et al., 1995). Conversely, it has been demonstrated, by *in vivo* and *in vitro* experiments, that AMH reduces follicle's sensitivity to FSH and their consequent growth (Durlinger et al., 2002). Additionally, it blocks aromatase activity and decreased AMH levels are correlated with increased estrogen levels (Grynberg et al., 2012).

Further, it negatively controls LH receptor synthesis in granulosa cells (di Clemente 1994) and it downregulates the progesterone synthesis of cultured human granulosa/luteal cells (Kim et al., 1992; Seifer et al., 2002).

3.5.2 Curiosity

In literature there are not cases of women with mutation of AMH or AMHR2 gene and strong/visible phenotype compared to men. But in AMH overexpressing transgenic female mice the phenotype looks like in Freemartin syndrome, with masculinized ovaries and seminiferous tubules (Behringer et al., 1990).

3.6 Background: molecular profile

3.6.1 TGF β superfamily

AMH belongs to the huge family of Transforming Growth Factor proteins (TGFs), consequently it shares homology but also differences with them. TGFs name comes after their ability to confer to untransformed fibroblasts functional properties associated with neoplastic transformation (de Larco and Todaro, 1978). This family of molecules is implicated in different and huge spectrum processes like development, proliferation or cellular differentiation (Watabe and Miyazono, 2009). Their functions are often indispensable and very heterogeneous during development since in several mutant mice lacking different TGF family members (i.e.: TGF β 1 KO) die in uterus or show abnormal phenotype (TGF β 2/3 KO) (Dickson et al., 1995; Kaartinen et al., 1995; Sanford et al., 1997). These examples indicate the relevance of this family but also the difficulty of the analysis of this class of molecules. Moreover, deregulated expression of or response to TGF β has been implicated in a wide variety of clinical disorders including bone and vascular diseases, neurodegenerative disease, and carcinogenesis (reviewed by Itoh et al., 2000a). TGFs are involved in paracrine signaling and can be found in many different tissue types. In human, more than 33 proteins including TGF β , the bone morphogenetic proteins (BMPs), activin/inhibin and AMH, have been identified so far, defined by sequence similarity and specificity of activated signaling pathway (Massagué, 1998; Massagué and Wotton, 2000). The superfamily of ligands can be phylogenetically divided into two main groups: the TGF- β /Activin and BMP/growth and differentiation factor (GDF) branches (de Caestecker, 2004).

The TGF- β members are synthesized as a dimeric complex containing a preproprotein comprising a N-terminal signal peptide, a large proregion, and a smaller biologically active mature region, the C-terminal (Massagué, 1990). After dimerization this complex is directed by the signal peptide in the RE/Golgi where the pro-region undergo posttranslational processing for activation (Massagué, 1998; Kingsley, 1994), exactly is cleaved by furin-like endoproteinase, but remains attached by non-covalent bounds (Hyytiäinen et al., 2008).

3.6.2 TGFs receptors

TGFs receptor are single pass serine threonine kinase receptors, they exist in different isoforms that can be homo- or –heterodimeric (Doré et al., 1998). TGF receptors comprise two groups, the type I and the type II serine/threonine kinases. Usually, for the signal transmission it is necessary the interaction of two type I and two type II receptors, that results in the receptor complex formation. Type I receptors are indicated as the Activin-like Kinases (ALKs), while the type II receptors are named after the ligands they bind. ALKs type I receptors are from 1 through 7. The type II receptors include activin type II and type IIB receptors (ActR-II and ActR-IIB), TGF β type II receptor (TGF β R-II), BMP type II receptor (BMPR-II), and AMH type II receptor (AMHR2). It is theoretically possible that more than 30 different combinations of type II and type I receptors could occur (Shi and Massagué, 2003). However, certain type II receptors tend to interact with specific type I receptors, thus, the combinations of type II and type I receptors appear to be limited under physiological conditions. The numbers of characterized ligands in the TGF β superfamily is greater than the number of identified receptors, suggesting that many receptors are common and implicated in different signaling pathways. The type 2 receptor kinases are constitutively active/phosphorylated and ligands binding do not seem to affect this status (Luo and Lodish, 1997). After ligand binding, the tetrameric complex is established and type 2 receptor transphosphorylate a glycine-serine-rich domain of the type I, so the signal is propagated downstream, by the Smad proteins. These are usually attached to type 1 receptor, which phosphorylates them, allowing the detachment and their nuclear translocation where they control transcription.

3.6.3 SMAD proteins

There are 8 distinct Smad proteins, constituting 3 functional classes: the receptor regulated Smad (R-Smad), the co-mediator Smad (Co-Smad) and the inhibitory Smad (I-Smad) (Heldin et al., 1997). R-Smads (1, 2, 3, 5, and 8) are directly phosphorylated and once activated by the type I receptor kinases activity form a complex with Co-Smads (Smad 4). This complex translocates into the nucleus and regulates transcription of target genes by binding to DNA in a direct or indirect manner. The I-Smads (6, 7) negatively regulate TGF β signaling and by competing with R-Smad for the binding to Co-Smad degrade the receptors; they actually act as antagonists of TGF β /BMP signaling inside the cells (Hayashi et al., 1997). The

SMAD proteins are constituted by two specific domains: one N-terminal domain called Mad homology domain MH1 and a C-terminal domain called MH2, separated by a linker region, a proline rich sequence (Shi and Massagué, 2003). The MH1 domain is the responsible for DNA binding, while MH2 is important for protein interaction. MH2 is fundamental for homomeric and heteromeric complex formation (Itoh et al., 2000b).

Smad proteins undergo a constant process of nucleocytoplasmic shuttling: from cytoplasm to nucleus and the other way around. In the absence of phosphorylation/activation, R/Co Smad complex resides in the cytoplasm, where they undergo phosphorylation which decreases their affinity for cytoplasmic anchors and increases their affinity for nuclear factors (Shi and Massagué, 2003; Xu and Massagué, 2004). Dephosphorylation of Smads causes their return to the cytoplasm for another round of receptor-mediated phosphorylation and nuclear translocation (Inman and Hill, 2002). This mechanism allows a constant sensing of the receptor activation state by the Smad pathway.

TGF β s and activins signal their transcription responses through Smad2 and Smad3 (Macías-Silva et al., 1996), whereas bone morphogenetic proteins (BMPs) signal through Smad1, Smad5 and Smad8 (Kretschmar et al., 1997). Selective recruitment of Smad proteins is associated also to specific receptor implying the existence of two major signaling pathways: 1) Smad2 or Smad3 are recruited by type I receptors, ALK5 (T β RI) and ALK4, and 2) Smad1, Smad5, or Smad8 are recruited by ALK2, ALK3, and ALK6 or so-called BMP type I receptors. However, recently has become apparent that TGF β can activate also Smad canonical proteins associated to others members indicating a big versatility of Smad proteins in signaling mechanism.

3.6.4 The non-canonical pathways

There are now proofs of the existence of non-Smad signaling mechanism. These involve the MAP kinase signaling (Erk, p38 and JNK MAP kinases) (Zhang, 2009). TGF β has been shown to induce ERK activation and tyrosine phosphorylation (Mulder and Morris, 1992). GTP loading of Ras after TGF β causes recruitment of RAF, a MAP3K to the plasma membrane and leads to activation of ERK through MEK1. Activation of ERK after TGF β was observed in epithelial cells and several other cell types (Hartsough et al., 1996). The kinetic of ERK phosphorylation can vary in response to TGF β , with a kinetics of P-ERK ranging from minutes to hours after ligand (Olsson et al., 2001). ERK activation by TGF β is important for epithelial to mesenchymal

transition (EMT), when the cells lose epithelial characteristic and acquire the properties of mesenchyme, including downregulation of adherens junctions and proteins such as E cadherin, induction of actin stress fibers, and acquisition of motile and invasive properties. TGF β induced JNK/p38 activation. Rho like GTPase in TGF β mediated EMT: TGF β can activate RhoA dependent pathway to induce stress fibers formation and mesenchymal characteristics in epithelial cells (Bhowmick et al., 2001). PI3K/Akt pathway in TGF β /Smad mediated response: TGF β can activate PI3K, as indicated by the phosphorylation of Akt (Bakin et al., 2000).

3.7 AMH: from gene to protein

3.7.1 AMH Gene

AMH gene, cloned first in mouse in 1991 (Munsterberg and Lovell-Badge, 1991), is located on chromosome 10 in mouse and on chromosome 19 in human (Cohen-Haguenaer et al., 1987; King et al., 1991), is 4 Kb long and characterized by a high GC content. It is constituted by 5 exons relatively close to each other (Cate et al., 1986), where the first four encode for the N-terminal domains of the protein, that is important for enhancing the activity of the C-terminal domain (Wilson et al., 1993) (**Figure 11**). Exon 5 encodes for the C-terminal domain, which shares homology with TGF β family, and which is responsible for the bioactivity after photolytic cleavage (Pepinsky et al., 1988). No alternative splicing isoform have been so far identified (Ensemble, genome).

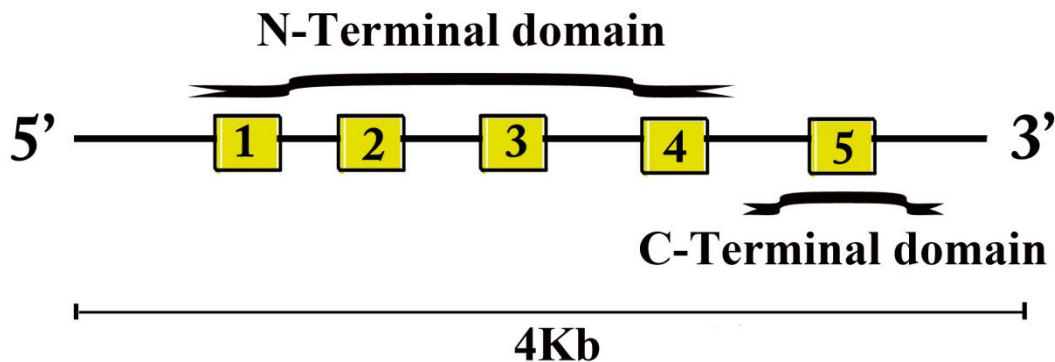

Figure 11: AMH gene. Schematic representation of AMH gene; AMH is constituted by 5 exons, for a total distance of 4Kb, exons 1-4 are responsible for the N terminal domain, while exon 5 for the C terminal domain.

3.7.2 Gene regulation

It was thought that AMH expression was directly regulated by SRY (Sex determining Region Y), to increase AMH promoter activity (Haqq et al., 1994), but subsequent experiments rejected the hypothesis of a direct action of SRY on AMH and showed that a combined action of multiple transcription factors was required to activate and maintain AMH expression.

AMH expression in early fetal life is triggered by SOX9 gene, and enhanced by SF1 and WT1, independently of gonadotropin control (Lasala et al., 2011; Lee and Donahoe, 1993). In fact SOX 9 binds to a specific response element that is essential for the initiation of AMH expression in early fetal development (Arango et al., 1999; Morais da Silva et al., 1996). SF1 is also involved, and binding to AMH seems to be crucial for AMH promoter activity (Giulli et al., 1997; Nachtigal et al., 1998), even if it plays its role in cooperation with others transcription factors. It was suggested that WT1 association with SF1 results in a synergetic activation to enhance AMH promoter (Pelletier et al., 1991) and its transcriptional activity. Two GATA sites are also relevant because they can enhance AMH promoter activity by two different mechanisms: by directly binding to DNA (Viger et al., 1998) and by cooperatively interacting with SF1 (Tremblay and Viger, 1999).

3.7.3 Protein Activation

AMH is a 140 KDa dimeric glycoprotein (Budzik et al., 1980; Picard et al., 1978), and, as the other TGF β family members, it needs post translational proteolytic processing to generate the bioactive C-terminal domain (Pepinsky et al., 1988). In fact, it is translated as dimeric precursor protein containing a large N-terminal pro-region and a much smaller C-terminal mature domain, which must undergo cleavage to generate the bioactive protein. AMH precursor after cleavage generates a 110 KDa N-terminal and 25 KDa C-terminal homodimers, which remain associated in a noncovalent complex (Pepinsky et al., 1988). This complex, differently from TGF β or BMP, is biologically active (Wilson et al., 1993). The C-terminal domain is responsible for the main function of AMH, but its action is drastically enhanced by the N-terminal domain (Wilson et al., 1993). The cleavage is made up by a kex2/substilis-in-like member of the prohormone convertase family of proteases (Pepinsky et al., 1988; Wilson et al., 1993). The uncleaved form seems to be completely

inactive. It is still not clear if AMH is cleaved *in loco* or at the target site; further investigations on enzymes activity are required.

3.7.4 SMAD proteins

AMH transduces its signal through a heterodimeric receptor complex formed by the interaction of AMHR2 and AMH type 1 (next chapter). Once type 1 is activated, it interacts transiently with specific receptor-regulated SMAD (R SMAD) and phosphorylates these proteins on two serine residues at the C-terminal (Kretzschmar et al., 1997). The phosphorylated SMADs translocate into the nucleus complexed with the common SMAD4 (Co-SMAD) and regulate the transcription of specific sets of targeted genes (**Figure 12**) (for reviews, see (Attisano and Wrana, 2002; Massagué, 2000; Massagué et al., 2000). There are indications that support that AMH activated 3 different R-SMADs: 1, 5 and 8 (Kobayashi and Behringer, 2003a; Zhan et al., 2006)in concomitance with Co-Smad4 (Visser, 2003). AMH induces the specific phosphorylation of SMAD1 and promotes SMAD1/SMAD4 interaction and SMAD1 nuclear accumulation (Clarke et al., 2001a; Gouédard et al., 2000). Moreover, also SMAD5 is implicated in AMH signaling because mutant SMAD5 attenuates AMH induced activation in vitro (Visser et al., 2001) and it is expressed in the mesenchymal cell surrounding the Müllerian duct. Like others, SMAD8 is prominent expressed in the mesenchyme surrounding the male Müllerian duct(Clarke et al., 2001a).

AMH intracellular transduction pathway

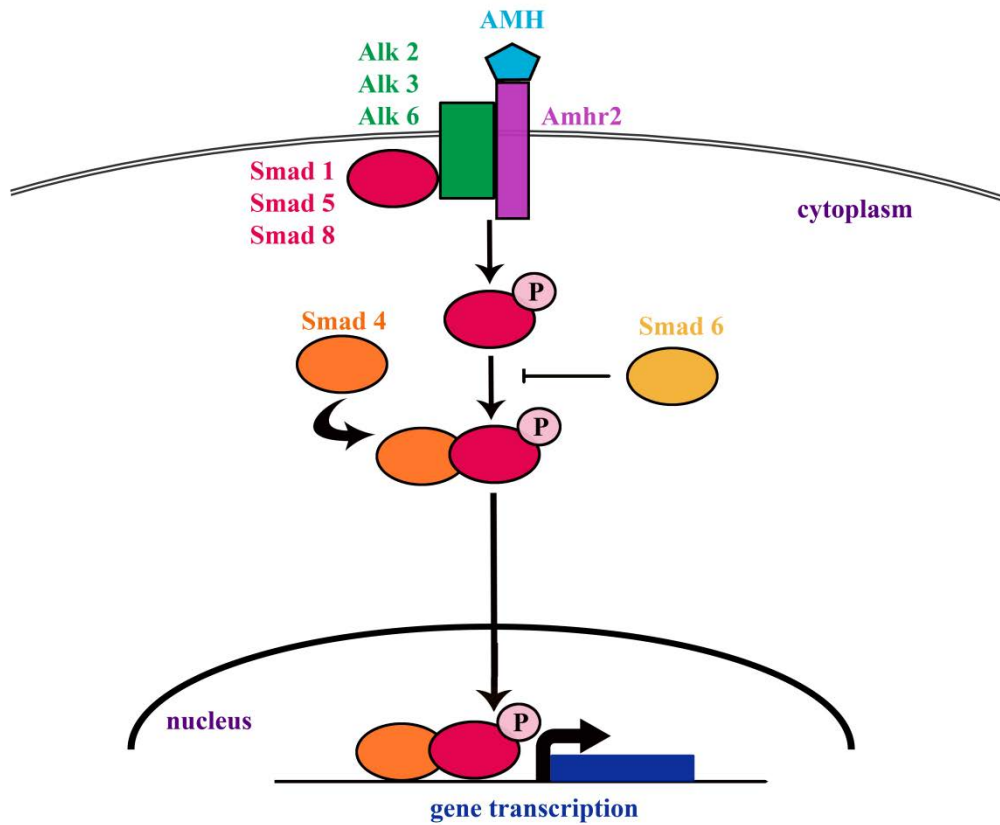

Figure 12: AMH transduction intracellular pathway. AMH binds to its receptor Amhr2 and phosphorylates AMH type 1, Alk 2/3/6. The activated type 1 receptor phosphorylates R-Smads (Smad1, Smad5, or Smad8), which form a heteromeric complex with Co-Smad (Smad4). The heteromeric Smad complexes translocate into the nucleus, where they can bind directly or through transcriptional partners to specific target genes and regulate their transcription.

3.8 AMH receptors

AMH action is mediated by a heterodimeric receptor formed by AMH type 2 receptor (AMHR2) and AMH type 1 (Jamin et al., 2003). AMH binds to AMHR2, which recruits AMH type 1 to form the receptor complex and phosphorylates its serine threonine kinase domain. Once activated AMH type 1 receptor phosphorylates a receptor-regulated SMAD (R-Smad), allowing these proteins to associate with Smad4 and move into the nucleus where they control transcription (Massagué, 1998).

3.8.1 AMHR2

AMHR2 is the main and exclusive receptor for AMH binding (Baarends et al., 1994; Visser, 2003) and signal transmission (Mishina et al., 1999). It is a threonine serine kinase receptor constitutively active (Wrana et al., 1992), that has been cloned in 1994 by two independent groups (Baarends et al., 1994; di Clemente et al., 1994) from a rabbit ovary library and a rat testis library respectively. The human gene was isolated shortly after (Imbeaud et al., 1995) and it is located on chromosome 12 in human, and 15 in mouse; it is constituted by 11 exons divided by a big intron of more than 7Kb. The three first exons encode for the extracellular domain, the fourth one for the transmembrane domain, and the last seven exons for the intracellular kinase domain. The relevance of this receptor for AMH biological actions was proven by the detection of mutations in patients affected by the Persistent Müllerian Duct Syndrome (PMDS) (Belville et al., 1999; Imbeaud et al., 1995), and also by the AMHR2-KO mice that are hermaphrodite (Mishina et al., 1999) and phenocopy the AMH-deficient mice (Mishina et al., 1996).

3.8.1.1 Alternative splicing of AMHR2

AMHR2 gene undergoes alternative splicing. This was suggested in rabbit (di Clemente et al., 1994) and in human (Imbeaud et al., 1995) and in both species it has been identified an isoform that lacked exon 2, which is necessary for the binding. *Amhr2Δ2* isoform is non functional, as we can observe in PMDS mutation (di Clemente et al., 1994; Imbeaud et al., 1995).

Recently, it has been showed in rodents the presence of dominant negative alternative splicing variants, which could inhibit AMH signaling (Imhoff et al., 2013), these two isoforms lack or exon 2 (*Amhr2Δ2*) or exon 8/9 (*Amhr2Δ8/9*), which encode respectively for

AMH binding domain and kinase domain (Imhoff et al., 2013) (**Figure 13**). The level of Amhr2 Δ 8/9 mRNA in testis and brain is 5% compared to canonical spliced AMHR2, while Amhr2 Δ 2 is even lower. The role of these isoforms is not yet elucidated, but they could actually act as transporter for AMH from gonads to the brain. While the Amhr2 Δ 2 could have a role in a ligand-independent signaling (Imhoff et al., 2013). Unfortunately the current lack of proof for these additional activities renders them speculations until such functional experiments are conducted.

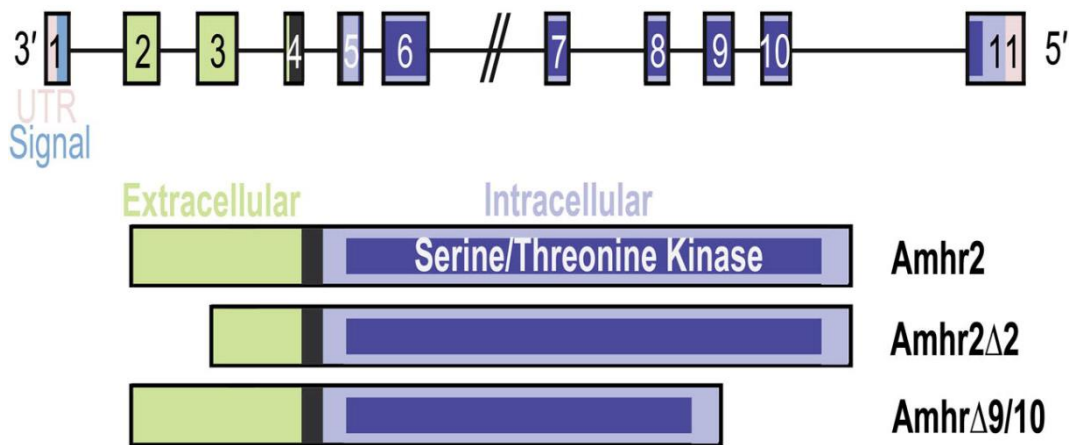

Figure 13: Amhr2 Alternative splicing. Amhr2 map showing the 11 exons codifying for the extracellular (green) and intracellular serine/threonine kinase (blue) domain. Schematic illustration of Amhr2 proteins: wild type and 2 isoforms lacking exon 2 or exons 9/10. (from Imhoff et al., 2013).

3.8.1.2 AMH Expression Profile

AMHR2 expression pattern reflects AMH profile, it is expressed in the Müllerian duct during embryonic development (E14 in mice), exactly by the mesenchymal cells surrounding the Müllerian duct (Baarends et al., 1994; di Clemente et al., 1994; Teixeira et al., 1996). Moreover, AMHR2 has been found also in the fetal and adult gonads of both the sexes (Durlinger et al., 2002; Teixeira et al., 2001). In male, AMHR2 is expressed in the testes from fetal life to puberty, while in female postnatally in granulosa cells of preantral and antral follicles (Baarends et al., 1994). The role of this receptor is to mediate the action of AMH, during development it plays a crucial role in the regression of

the Müllerian duct, because only *Amhr2* positive cells migrate and change their phenotype in response of AMH signal (Zhan et al., 2006). In the ovary, AMHR2 signals the paracrine action of AMH to regulate follicular development and maturation.

3.8.2 AMH type 1 Receptor

AMH type 1 receptors belong to the ALKs family and are not specific for AMH but they are shared by different ligands. Since the efforts to clone a specific AMH type 1 receptor have been fruitless, it has been tested the capacity of AMHR2 to interact with type 1 receptors and its coexpression in AMH target tissues (di Clemente and Belville, 2006). Moreover, it has been generated a dominant negative version of these receptors as well as total knock-out mice to check their effects *in vivo*. There are different candidate for AMHR2, namely *Alk2/3/6*, that seem to interact with AMHR2 in a time specific manner, at least in the urogenital ridge (Zhan et al., 2006).

3.8.2.1 ALK6

ALK6 was the first AMH type 1 receptor to be discovered (Gouédard et al., 2000), thanks to its ability to interact with AMHR2 (Imbeaud et al., 1995) in an AMH dependent manner. Succeeding experiments of co-immunoprecipitation confirmed and highlighted *Alk6* (Gouédard et al., 2000) as another possible candidate (Gouédard et al., 2000). *Alk6* mRNA was found at low level in urogenital ridges of both sexes, in the epithelial cells layer of the Müllerian duct and in adult gonads (Visser et al., 2001), where it was expressed in oocytes of small antral follicles and granulosa cells of large antral follicles (Yi et al., 2001). On the other side, *Alk6* was neither detected in fetal gonads (Visser et al., 2001) and surrounding mesenchymal layer (Clarke et al., 2001a; Dewulf et al., 1995) and, *Alk6* mutant mice did not show PMDS (Clarke et al., 2001a), but only abnormal seminal vesicles and female infertility (Yi et al., 2000). Hence, *Alk6* is important for AMH action in the ovary but not required for Müllerian duct regression during male sexual differentiation.

3.8.2.2 ALK2

Despite *Alk2* was not detected by co immunoprecipitation in CHO-3W cells (Gouédard et al., 2000), its expression was more stringent than *Alk6* because it overlaps with AMHR2 perfectly. In fact, while *Alk6* is expressed only at the level of the epithelium of

the Müllerian duct, Alk2 is expressed in all AMH target tissues early in development (Zhan et al., 2006), like the urogenital (Wang et al., 2005) ridge, gonads at different embryonic stages (Visser et al., 2001) and mesenchymal cells adjacent to the Müllerian duct. Moreover, the blockage of Alk2 by antisense or siRNA can partially or fully stop AMH induced Müllerian duct regression, but also the transition of AMHR2 expression from the coelomic epithelium to the mesenchyme, while ALK6 do not (Visser et al., 2006; Zhan et al., 2006). Alk2 KO is lethal and die early during development (Gu et al., 1999; Mishina et al., 1999), making difficult to speculate possible role in Müllerian duct regression.

3.8.2.3 ALK3

Although it interacts weakly with AMHR2 (Clarke et al., 2001b), it has been shown that lack of expression of Alk3 in the developing gonads leads to persistent Müllerian duct syndrome in mice (Jamin et al., 2002). This was determined using a conditional mutant mouse line which lacks Alk3 expression in AMHR2-expressing cells, (Alk3LOXP:AMHR2 CRE). Moreover, Alk3 seems to be regulated spatiotemporally by AMH, because its expression appears later when Alk2 decreases and it is restricted to the mesenchyme, suggesting sequential role in Müllerian duct regression (Zhan et al., 2006).

3.9 AMH in the Central Nervous System

Until now, AMH has been studied mainly at the level of the gonads, but recently it has been found also in different tissues, such as in the endometrium, breast, prostate, cervix in humans and fetal lungs of mice. Given the broad expression of AMHR2 in several peripheral organs as well as in the postnatal brain, future years will be surely characterized by intense new studies focused on AMH role in extra-gonadal tissues.

3.9.1 AMH and AMHR2 expression in neurons

AMH mRNA and proteins are expressed at low levels in the embryonic/developing brain, but they increase in rodent's postnatal brain, where they are broadly expressed by distinct neuronal populations in several areas (Wang et al., 2005). This expression pattern overlaps in part with that of AMHR2 whose expression in the brain is instead elevated both in embryos and postnatal animals. A LacZ reporter mouse driven by AMHR2 promoter showed an almost ubiquitous pattern of expression (Wang et al., 2009) in different and heterogeneous populations of neurons and some glial cells. In the mouse embryos (E16) AMHR2 immunoreactivity was detected in the telencephalic wall and in the developing ventricles, especially the ventricular cell layer and the surrounding subventricular zone. Later in adulthood, cortex, hippocampus, corpus callosum, cerebellum and brain capillaries are immunoreactive for AMHR2, suggesting a fundamental role in the brain. AMHR2 has been found also at the level of the pituitary, in gonadotrope cells (Bedecarrats et al., 2003).

3.9.2 AMH and AMHR2 role in the brain

It has been suggested that AMH acts through an autocrine mechanism on motoneurons, increasing their survival rate and their neurite branching. Its lack causes a feminization of the number of motoneurons, with male AMH KO resembling female WT mice (Wang et al., 2005). AMH and AMHR2 expression and functions have been shown also at the level of the pituitary (Bedecarrats et al., 2003). Indeed, it has been shown that AMH increases FSH β transcription, and long AMH treatment enhances the basal LH β promoter activity. Interesting it seems to work synergistically with GnRH agonist increasing LH promoter activity. These data open new perspectives in AMH regulation also at the central level.

Chapter IV: Integrin

Integrins are heterodimeric cell adhesion receptors which mediate attachment of cell to the extracellular matrix and cell-cell interactions. Their name comes after their relevant roles in maintaining the integrity of the membrane (Hynes, 2004; Tamkun et al., 1986).

4.1 Integrin Structure

Integrins are constituted by two non covalently associated subunits, α and β , each containing a large extracellular domain, a single transmembrane domain and an intracellular tail (Hynes, 2004), connected by flexible linkers between them. The α subunit contains a seven-bladed β propeller domain followed by a THIGH, CALF1, CALF2 domains. The β propeller domain binds Ca^{2+} , that influences the ligand binding. Some, but not all the α subunit possesses also an additional domain called α I. The β subunit, is not less complicated, because it also contains different ectodomains: a β I inserted in a Hybrid domain, which is included in a Plexin-Semaphorin-Integrin (PSI) domain, 4 cysteine rich epidermal factor (EGF) modules and last a β tail domain (Lee et al., 1995). The ligand is recognized in a specific region between the β propeller in α subunit and the β 1 domain, where the α subunit is responsible for the specificity of the binding. These domains contain also binding site for cations like Ca^{2+} , Mg^{+2} and Mn^{+2} that are responsible for coordinating the conformational change that precedes the receptor activation (Humphries et al., 2003).

4.2 Activation of Integrin pathway

Each integrin recognizes one specific ligand or different types, allowing a great diversity of biological responses. On the other side the ligands can bind one single receptor or multiple ones, activating different intracellular pathways. In vertebrates, 18 α subunits and 18 β subunits can combine forming up to 24 different combinations (Takada et al., 2007). They can be classified depending on the ligand binding or on the subunits compositions. (for review look (Barczyk et al., 2010; Campbell and Humphries, 2011; Kim et al., 2011) **(Figure 14)**). In the brain, the β 1 and α_v classes are the most expressed by neurons, glial and

endothelial cells, while $\beta 2$ is more predominantly expressed by microglia (reviewed by (Milner and Campbell, 2002)).

Integrins can transmit signals bidirectionally, from outside of the cell to the cytoplasm, but also vice versa. The inside-out signal usually constitutes an activation of the receptor, which acquires its activated state, while the outside-in pathway happens when, after ligand binding, integrins change conformations. Compared to other kind of receptors, they do not possess enzymatic activity. Indeed the information is transduced by the formation of a complex with other proteins, i.e., scaffolds or/and adaptors that link integrins to kinase or Src.

4.3 Integrins' ligands

The ligands recognized by integrins can be generally divided in two classes belonging to extracellular matrix molecules, like laminin or fibronectin, and, cell receptors of the immunoglobulin family, such as I CAM1. Depending on the basis of the molecular interaction the ligands can be subdivided into 4 categories. The first class of integrins recognizes ligands containing an Arg-Gly-Asp (RGD) active site and the second an acidic motif called LDV, functionally related to RGD. Further groups contain integrins in which the α and β domain combine and form a laminin/collagen-binding subfamily and those that are highly selective laminin receptors.

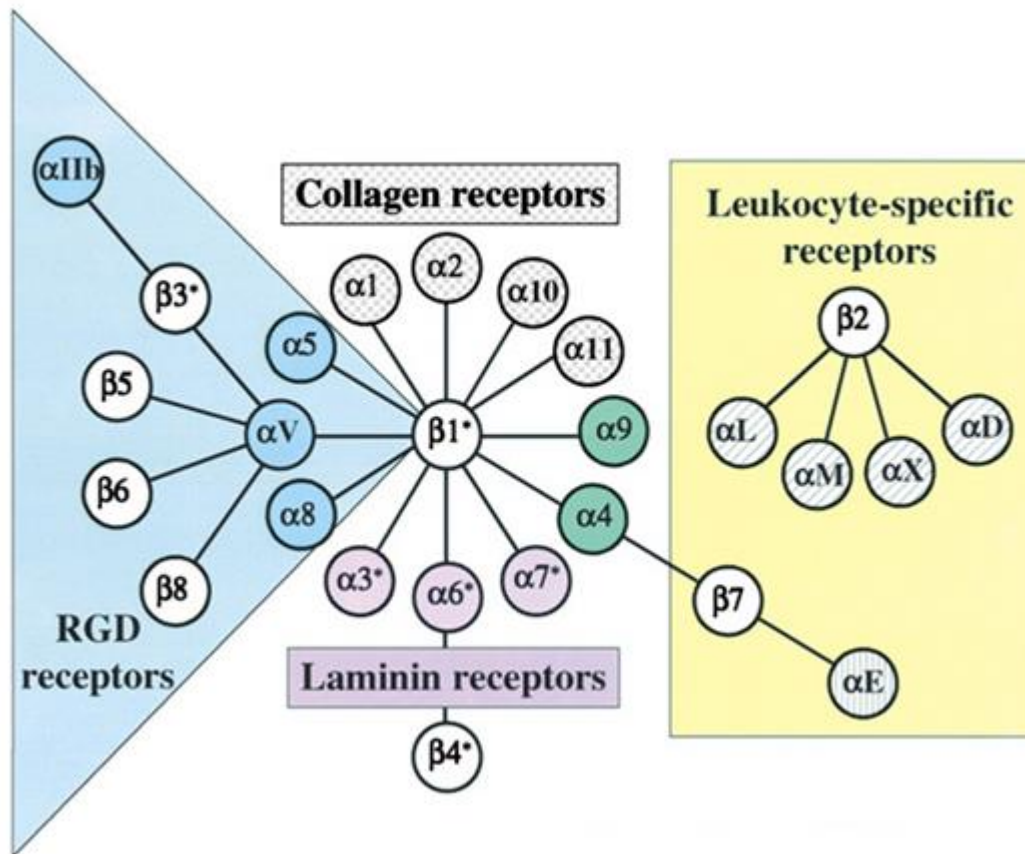

Figure 14: the Integrin receptor family. Integrins are $\alpha\beta$ heterodimers; the schema shows the mammalian subunits and their associations. 8 β subunits can combine with 18 α subunits to form 24 distinct integrins, creating several subfamilies based on evolutionary relationships or ligand specificity, for example β 2 and β 7 integrins restricted expression on white blood cells. α subunits with gray color have inserted I domains. Such α subunits are restricted to chordates, as are α 4 and α 9 (green) and subunits β 2- β 8. In contrast, α subunits with specificity for laminins (purple) or RGD (blue) are found throughout the metazoa. Asterisks denote alternatively spliced cytoplasmic domains. From (Hynes, 2004).

4.4 Signalling pathway

One important signalling pathway of integrin depends on a tyrosine kinase protein named focal adhesion kinase (FAK), present in the cytoplasm. When integrins interact with the cell matrix, FAK is attached to the complex by anchor proteins, which connect also integrins. FAK proteins phosphorylate other kinases, such as Src, that also cross-phosphorylate FAK,

creating new binding sites for others ligands. Sometimes, conventional signalling receptors can activate integrin pathway to enhance the intracellular response. One example is the cooperation between integrin and classic receptors to activate the Ras/MAP kinase pathway.

4.5 Integrins' Roles

Integrins are "mechanosensory" receptors that operate in a context-dependent manner; they have heterogeneous roles from development to adulthood. In the brain, they play multiple roles during brain development, proliferation, migration, axonal guidance, synaptogenesis, gene expression (reviewed by (Milner and Campbell, 2002)). In neurons, integrins roles have been shown in many areas, where these receptors are spatially and temporally regulated and cell-type specific (Schmid and Anton, 2003). They are highly implicated in pathophysiological conditions such as in cancer cell biology. In tumor metastasis, integrins mediate the invasion and extravasation of cancer cells into a new tissues (Hood and Cheresch, 2002).

4.6 The integrin adhesome

Integrins mediated cell adhesion to the extracellular matrix (ECM) forming this "adhesome", a complex of molecules connected among them. The molecules involved can be of two types: the scaffolds molecules and the signalling/regulatory molecules, or both. Usually, the binding of integrin to the extracellular ligands starts the assembly of this complex, the conformation of integrin change exposing the intracellular binding sites to cytoplasmic proteins. There is no direct link between integrin and actin, but usually is adapted by specific proteins that reinforce the adhesion. This phenomenon has been divided into different steps; the first is the creation of the **nascent adhesion**, small structure under the lamellopodium. When the lamellopodium contacts the matrix, the integrins are activated and cluster to generate the initial complex. This nascent adhesion takes place very rapidly and involves only few integrins and induces actin polymerization. The next step involves the pull of myosin on this complex, which reinforces the adhesion strength, thus creating the **focal complex**. If it grows becoming larger, it evolves in **focal adhesion** or disassemble. Focal adhesion can become more elongated and involve integrin mediated contact with fibronectin fibrils, called the **fibrillar**

adhesion. The interesting characteristic of these complexes of integrin and other molecules is the great dynamic and balance between complexing and disassembling (Reviewed by (Wolfenson et al., 2013)).

4.7 Integrins' role in cell migration

Migration is physically mediated by the alteration of the cytoskeleton, which uses adhesion molecules attached to a substrate to pull the cell and move. Integrins play double roles, creating contacts between the extracellular matrix and the cellular membrane, necessary to tract the cell forward and by organizing the signaling network downstream. There are many examples of integrin functions in neural development. During corticogenesis, neurons, born in the ventricular zone migrate along the radial glia to reach the cortex and establish the different layers (Marín and Rubenstein, 2003). Many publications have demonstrated the fundamental involvement of integrin receptors in regulating correct migration. Indeed virus injections of antisense mRNA of $\beta 1$ and $\alpha 6$ integrin reduce cellular migration (Galileo et al., 1992; Zhang and Galileo, 1998), the inhibition of $\alpha 3 \beta 1$ (Anton et al., 1999) or the absence of integrin is responsible for an aberrant phenotype, including the $\alpha 6$ integrin KO mice that displays an overmigration in ectopic regions (Georges-Labouesse et al., 1998). Also removal of integrin $\beta 1$ from neurons and glia results in perturbed development of the cerebral cortex and the organizations of its layers (Graus-Porta et al., 2001)(for review see (Milner and Campbell, 2002)).

Other important populations of neurons with migratory phenotypes include neuroblasts that migrate in chains from the subventricular zone (SVZ) to the olfactory bulb in along a specific anatomic route, the rostral migratory stream (RMS). This migration unlike that seen in the cortex, is a tangential form of migration, where integrins are involved. For example, integrin $\alpha 6 \beta 1$ is responsible to maintain the direction of neuroblasts and their cohesiveness in chains (Emsley and Hagg, 2003), while α_v subunit also plays a role in chain migration (Murase and Horwitz, 2002). Furthermore, integrin $\beta 8$ is highly expressed by neuroblasts and genetic ablations result in impaired directional migration through the RMS (Mobley and McCarty,

2011). Taken together these results emphasize the critical role integrin signaling plays in regulating migratory processes.

GnRH neurons are another example of migratory population of neurons that migrate from the nose to inside the brain. These neurons express the integrin family of receptors and conditional ablation of $\beta 1$ integrin in GnRH neurons affects the migratory route during development (Parkash et al., 2012). In addition, integrin ligands are also involved in this process, among them semaphorin 7A (a ligand of integrin $\beta 1$) which regulates the directional migration of GnRH neurons during early embryogenesis (Messina et al., 2011).

4.8 Integrins' role in axonal/neurite elongation

Neurite growth is a widely regulated mechanism, occurring mainly during development to create functional connections between different regions. This process is guided by rearrangement of microtubule and actin cytoskeleton at the level of the growth cone in response to chemotropic factors in the extracellular microenvironment. Integrins transduce the signalling pathway of these molecules to promote neurite growth and guidance, in many cell types, and lack of integrin expression/functions has been associated with defective axon elongation. There are different papers that highlighted the important role of integrin in axon growth and their potential roles in axonal regeneration after trauma. In GnRH neurons lack of $\beta 1$ -integrin results into a decrease of the axonal projections at the level of the median eminence (Parkash et al., 2012). I will widely discuss this study in the first chapter of my results section. Other examples of the involvement of integrins in the axonal and/or neurite extension concern the developing retinal ganglion cells, in which inhibition of $\beta 1$ -integrin signalling blocks dendritic growth (Lilienbaum et al., 1995), and cortical neurons in which integrins promotes dendritic branching and extension (Moresco et al., 2005). Similar effects have been reported in a variety of cell types, such as astrocytes (Tomaselli et al., 1988), and dorsal root ganglia (DRG)(Andrews et al., 2009)

Aim of the Study

The mammalian reproductive axis is under the control of a specific neuronal population, named Gonadotropin Releasing Hormone (GnRH) neurons. These cells originate prenatally in the nasal placode and migrate along olfactory/vomer nasal nerves to the ventral forebrain to reach their final hypothalamic destination. At the end of their migratory process, GnRH neurons extend their axons to the median eminence; however the system remains quiescent until the GnRH surge occurs at puberty onset. At puberty, GnRH neurons start releasing the GnRH decapeptide into the portal-pituitary circulation. The GnRH neuropeptide then reaches the anterior pituitary and acts on GnRH-R expressing cells regulating Luteinizing Hormone (LH) and Follicle Stimulating Hormone (FSH) secretion. The complex developmental events leading to the correct establishment of the GnRH system are tightly regulated by the specific spatiotemporal expression patterns of guidance cues and extracellular matrix molecules, the functions of which, in part, are mediated by their binding to β 1-subunit-containing integrins. The **first aim** of my study was to characterize the action of integrin β 1 in GnRH migration and axonal targeting. Combining *in vitro* manipulations with mouse genetics (conditional GnRH neuron-specific β 1-integrin conditional KO (GnRH::Cre;Integrin- β 1^{LoxP/LoxP}) mice. We determined how the lack of this receptor impacts severely the reproductive function.

Among reproductive syndromes, Polycystic Ovary Syndrome (PCOS) is certainly the most common disorder affecting 10% of women worldwide. The main hallmarks of this common disease are high androgen levels, chronic oligo anovulation and polycystic appearing ovaries. PCOS endocrine phenotype is characterized by elevated GnRH pulse frequency, which results in high LH/FSH ratio. Another hallmark of PCOS is elevated levels of plasmatic Anti Müllerian Hormone (AMH), an ovarian hormone produced by granulosa cells which regulates folliculogenesis. During the last few years, AMH receptors have been identified also in the central nervous system, suggesting that AMH could potentially act at this level. The **second aim** of my study was to verify this hypothesis, investigating in particular a potential role of AMH on the regulation of GnRH neuronal activity and secretion and to identify a possible link with PCOS onset.

Results

FULL TITLE

Suppression of β 1-Integrin in Gonadotropin-Releasing Hormone (GnRH) Cells Disrupts Migration and Axonal Extension Resulting in Severe Reproductive Alterations

ABBREVIATED TITLE

Itgb1 regulates GnRH development

AUTHOR NAMES

Jyoti Parkash 1,2§, Irene Cimino 1,2§, Nicoletta Ferraris 3, Filippo Casoni 1,2, Susan Wray 4, Hélène Cappy 1,2, Vincent Prevot 1,2, Paolo Giacobini 1,2,3 *

1 Inserm, Jean-Pierre Aubert Research Center, Development and Plasticity of the Postnatal Brain, Unité 837; 2 UDSL, School of Medicine, Place de Verdun, 59045, Lille Cedex, France; 3 Dept. Human and Animal Biology, University of Turin, Turin, 10123 Italy; 4 Cellular and Developmental Neurobiology Section, NINDS, NIH, Bethesda, Maryland 20892, USA

* To whom correspondence should be addressed

Address: Inserm, Jean-Pierre Aubert Research Center, Unit 837, Development and Plasticity of the Postnatal Brain, Place de Verdun, 59045, Lille Cedex, France

Tel: +33-320622060

Fax: +33-320538562

Email: paolo.giacobini@inserm.fr

[J Neurosci](#). 2012 Nov 21;32(47):16992-7002. doi: 10.1523/JNEUROSCI.3057-12.2012.

§ These authors equally contributed to this work

Number of pages: 32

Number of figures: 8

Number of words for Abstract: 178

Number of words for Introduction: 442

Number of words for Discussion: 1239

Acknowledgements: This work was supported by: Compagnia di San Paolo [grant number: 2008.1224 to P.G.], Turin, Italy; the Institut National de la Santé et de la Recherche Médicale, Inserm, France, [grant number: U837]; Agence Nationale de la Recherche, ANR, France, [grant number: ANR-2010-JCJC-1404-01 to P.G.; ANR-09-BLAN-0267 to V.P.]; the University of Lille 2, Lille, France (grant: Appel à Projets du Conseil Scientifique de l'Université Lille 2 to P.G.) and the Intramural Research Program of the National Institute of Neurological Disorders and Stroke, National Institutes of Health. We thank Meryem Tardivel of the Imaging Core Facility of IFR114 of the University of Lille 2 for technical assistance, Julien Devassine and Delphine Cappe (Animal facility-IFR114) for the maintenance of transgenic mouse lines, and the histology facility, University of Lille 2, Prof. Défossez and Prof. Claude-Alain Maurage for the histological analyses of specimens and Nathalie Jouy from the cytometry core facilities (BioImaging Center Lille Nord de France - IFR114).

Conflict of Interest: the authors declare no competing financial interests

ABSTRACT

Reproduction in mammals is dependent on the function of hypothalamic neurons whose axons project to the hypothalamic median eminence (ME) where they release gonadotropin-releasing hormone (GnRH) into a specialized capillary network for delivery to the anterior pituitary. These neurons originate prenatally in the nasal placode and migrate into the forebrain along the olfactory-vomeronasal nerves. The complex developmental events leading to the correct establishment of the GnRH system are tightly regulated by the specific spatiotemporal expression patterns of guidance cues and extracellular matrix molecules, the functions of which, in part, are mediated by their binding to β 1-subunit-containing integrins. To determine the biological role of these cell-surface proteins in reproduction, Cre/LoxP technology was used to generate GnRH neuron-specific β 1-integrin conditional knockout (GnRH-Itgb1^{-/-}) mice. Loss of β 1-integrin signaling impaired migration of GnRH neurons, their axonal extension to the median eminence, timing of pubertal onset and fertility in these mice. These results identify β 1-integrin as a gene involved in normal development of the GnRH system and demonstrate a fundamental role for this protein in acquisition of normal reproductive competence in female mice.

INTRODUCTION

Reproductive competence in mammals is centrally regulated through the hypothalamic-pituitary-gonadal axis and depends on GnRH secretion (Wray, 2010). These neurons project to the median eminence of the hypothalamus where GnRH is released into the pituitary portal blood for delivery to the anterior pituitary, eliciting the secretion of luteinizing hormone (LH) and follicle-stimulating hormone (FSH) (Wray, 2010). GnRH-secreting neurons originate in the nasal placode during embryonic development and migrate to the hypothalamus apposed to olfactory-vomer nasal nerves (Schwanzel-Fukuda and Pfaff, 1989; Wray et al., 1989).

During the last 20 years, many molecular pathways that guide GnRH migration have been identified. However, only a few factors, including fibroblast growth factor-2 (Gibson et al., 2000; Tsai et al., 2005; Gill and Tsai, 2006), brain-derived neurotrophic factor (BDNF) (Cronin et al., 2004), and kisspeptin (Fiorini and Jasoni, 2010), are known to affect GnRH axon or neurite growth in vitro and/or in vivo. Secreted signaling molecules as well as extra-cellular matrix proteins control the activity of cell surface receptors that regulate the interactions of GnRH cells with each other, with the olfactory axonal scaffold and with environmental cues (Wray, 2010). The integrins are a family of heterodimeric transmembrane receptors consisting of an α and β subunit, which mediate interactions between cells as well as between cells and the extracellular matrix (Reichardt and Tomaselli, 1991; Hynes, 2002). During brain development, integrins are involved in migration, axonal guidance, synaptogenesis and peripheral nerve regeneration (Pasterkamp et al., 2003; Brakebusch and Fassler, 2005; Gardiner et al., 2005; Gardiner et al., 2007; Cingolani and Goda, 2008; Plantman et al., 2008; Moser et al., 2009).

The $\beta 1$ subunit-containing integrins ($\beta 1$ -integrin) represent the largest subgroup of integrins (Brakebusch and Fassler, 2005). GnRH neurons express $\beta 1$ -integrin throughout their development and Semaphorin 7A signals through this cell surface protein to regulate GnRH cell migration (Messina et al., 2011). Null mutation of the $\beta 1$ -integrin gene in vivo has been achieved in mice and results in embryonic lethality (Fassler and Meyer, 1995; Stephens et al.,

1995). The experiments in this paper study the effect of β 1-integrin on development of the GnRH system and reproduction by generating mice lacking this gene in GnRH neurons using the Cre/LoxP binary recombination system (Hamilton and Abremski, 1984; Singh et al., 2009). The absence of β 1-integrin altered migration of GnRH neurons and targeting of their axons to the median eminence, resulting in suboptimal maturation of the GnRH system in the adult brain. Examination of fertility revealed that lack of β 1-integrin in GnRH neurons caused delayed pubertal onset and disruption of estrous cyclicity in female GnRH-Itgb1^{-/-} mice, greatly impairing reproduction. These results demonstrate a critical role for β 1-integrin in GnRH neuronal function and mammalian reproduction.

MATERIALS AND METHODS

Generation of GnRH neuron-specific β 1-integrin (Itgb1) conditional KO mice.

GnRH::Cre mice (Yoon et al., 2005) were kindly provided by Dr. Catherine Dulac (Howard Hughes Medical Institute, Cambridge MA). Itgb1loxP/loxP mice, in which exon 3 of β 1-integrin is flanked by loxP sites, were purchased from Jackson laboratory (Maine, USA), maintained on a controlled 12h : 12h light cycle, provided with food and water ad libitum, and genotyped as described earlier (Stephens et al., 1995). The GnRH::Cre; Itgb1loxP/loxP mice, designated as GnRH-Itgb1^{-/-} mice, were generated by first mating female GnRH::Cre with male Itgb1loxP/loxP mice and then crossing a heterozygous (GnRH::Cre; Itgb1loxP/+) female with a heterozygous male to generate six genotype combinations. GnRH::Cre; Itgb1loxP/loxP mice represent the homozygous conditional knock-out mice. GnRH::Cre; Itgb1^{+/+} (GnRH-Itgb1^{+/+}) littermates were used as controls for all studies. All the transgenic lines were bred in our laboratory on a C57BL/6J;129sv background.

Generation of GnRH::Cre;Itgb1loxP/loxP; GnRH::GFP triple transgenic mice

GnRH::GFP mice (Spergel et al., 1999) were kindly provided by Dr. Daniel J. Spergel (Section of Endocrinology, Department of Medicine, University of Chicago, Chicago, Ill., USA). GnRH-Itgb1^{-/-} mice were first crossed with GnRH::GFP animals to obtain triple heterozygous transgenic mice. Then a heterozygous (GnRH::Cre;Itgb1loxP/+; GnRH::GFP) female was crossed with a heterozygous male to generate all genotype combinations.

Genotyping and DNA extraction

For genotyping, three pairs of primers were used: GnRH-Cre-specific primers, sense 5'-CTGGTG TAGCTGATGATCCG -3' and antisense 5'-ATG GCT AAT CGC CAT CTT CC-3'; and Itgb1loxP/loxP primers, sense 5'-CGGCTCAAAGCAGAGTGTCAGTC-3' and antisense 5'-CCACAACCTTTCCAG TTA GCT CTC-3'. GnRH-GFP mice were selected by PCR analysis of mouse

tail DNA with primer GnRH 51 5'-GAAGTACTCAACCTACCAACGGAAG-3' and antisense primer hGFP1 5'-GCCATCCAGTTCCACGAGAATTGG-3', which amplified a 278 bp DNA fragment in mice transgenic for the GnRH-GFP minigene.

To obtain the genomic DNA of pups, a clipping from the ear or tail was collected and placed in 10% Chelex-100 resin (Bio-Rad) with 0.1% Tween-20 and 0.15 mg/ml proteinase K. Samples were incubated at 50°C for 90 min, proteinase K was inactivated at 95°C for 20 min, and the solution was cooled to 10°C. PCR reactions were carried out using 7 µl of DNA.

PCR was performed using a thermocycler (35 cycles: 30 s denaturation at 94°C, 1 min annealing at 58–65°C, and 2 min elongation at 72°C).

Animals

Mice were housed in a room with controlled photoperiod (12 h of light and 12 h of darkness) and temperature (21–23°C) with food and water ad libitum, in the animal facility of the Jean-Pierre Aubert Research Center (JPARC) at the Lille 2 University School of Medicine, France. All experiments were performed in accordance with the guidelines for animal use specified by the European Communities Council Directive of November 24th, 1986 (86/609/EEC) regarding mammalian research and in accordance with National Institutes of Health (NIH)/National Institute of Neurological Disorders and Stroke guidelines, and Institutional Animal Care and Use Committee approval.

For immunohistochemical analysis, embryos were obtained from timed-pregnant control or conditional $\alpha 1$ -integrin KO mice and anaesthetized with an intraperitoneal (i.p) injection of chloral hydrate (8%; 350 mg/kg). Heads from the embryos were washed thoroughly in cold 0.1M PBS, fixed in fixative solution (4% paraformaldehyde, 0.2% picric acid in 0.1M PBS; pH 7.4) for 6 to 8 hours at 4°C and cryoprotected in 20% sucrose overnight at 4°C. The following day, heads were embedded in OCT embedding medium (Tissue-Tek®, Sakura, Villeneuve d'Ascq, France), frozen on dry ice and stored at -80°C until sectioning. Postnatal day 7 pups and adult mice (3-5 months old) were anesthetized with chloral hydrate (400 mg/kg, i.p.) and

perfused transcardially with 10 ml of saline, followed by 100 ml of 4% paraformaldehyde (PFA), pH7.4. Brains were removed and immersed in the same fixative for 2 h at 4°C and stored in 0.1M PBS until slicing. Free-floating coronal sections (35 µm-thick) were cut on a vibratome (VT1000S; Leica, Wetzlar, Germany) and processed for immunohistochemistry.

Fluorescence-activated cell sorter analysis

Heterozygous GnRH::Cre;Itgb1loxP/+; GnRH::GFP mutants were crossed to obtain in the same litter GnRH::Cre; Itgb1+/+; GnRH::GFP, GnRH::Cre; Itgb1loxP/+; GnRH::GFP and GnRH::Cre; Itgb1loxP/loxP; GnRH::GFP. Embryos were harvested at E12.5 from timed-pregnant GnRH::Cre;Itgb1loxP/+; GnRH::GFP mice, previously anaesthetized with an intraperitoneal (i.p) injection of chloral hydrate (8%; 350 mg/kg) and sacrificed by cervical dislocation. Nasal regions were dissected from each embryo and dissociated using a papain-based dissociation protocol previously described (Maric et al., 2003). After dissociation, the cells were physically purified using an EPICS ALTRA flow cytometer (Beckman Coulter). Sorted GFP-positive cells (yield: 600-800 cells obtained from each E12.5 embryo of the litter) were collected into a tube containing 500 µl of sterile Hanks' Balanced Salt Solution (HBSS, Invitrogen) and subsequently centrifuged for 1 min at 7500 g (maximum) to relocate material to the bottom of the tube. HBSS was then aspirated and 8 µl of a solution containing 1 µl of 0.1% Triton X-100 and 7 µl of Prime RNase inhibitor (diluted 1:100 in DEPC-treated water; Invitrogen) was added. Captured cells were used to synthesize first-strand cDNA using the SuperScript III First-Strand Synthesis System for RT-PCR (Invitrogen) following the manufacturer's instructions. Controls without reverse transcriptase were performed to demonstrate the absence of contaminating genomic DNA. RNAs isolated from heads of E12.5 embryos and GT1-7 cells were also reverse transcribed and used as positive controls. Total RNA from GT1-7 cells and E12.5 heads was isolated by extraction with TRIzol (Invitrogen).

The genotype of embryos was verified after FACS isolation and cDNAs of GnRH-GFP neurons isolated either from GnRH::Cre;Itgb1+/+;GnRH::GFP or GnRH::Cre;Itgb1loxP/loxP; GnRH::GFP embryos (n = 5 for each genotype) were used for the PCR analysis. PCR was performed for

GnRH and Itgb1 at 35 cycles on a thermocycler (30 s denaturation at 94°C, 30 s annealing at 55–65°C, and 2 min elongation at 72°C). PCR primer pairs were as follows: GnRH forward primer, 5'-GCTAGGCAGACAGAACTTGC-3'; GnRH reverse primer, 5'-GCATCTACATCTTCTTCTGCC-3'; L19 (ribosomal housekeeping gene) forward primer, 5'-CCTGAAGGTCAAAGGGAATGTGTTC-3' and reverse primer, 5'-GGACAGAGTCTTGATGATCTCCTCC-3'; Itgb3 forward primer, 5'-AGGCTTGTGGTGCTTGGGCG-3'; Itgb3 reverse primer, 5'-GGAGGTGGGAGGGTGTTCAGG-3'. Itgb1 primers were designed in exon 3 of β 1-integrin gene, which is floxed in conditional mutant mice when Cre recombination takes place. PCR primer pairs were as follows: Itgb1 forward primer, 5'-GCAGGGCCAAATTGTGGGTGGT-3'; Itgb1 reverse primer, 5'-GGCCGGAGCTTCTCTGCCAT-3'.

Ovarian histology and quantitative analysis

Ovaries were collected from 3-month-old control and conditional KO mice, fixed in 4% PFA solution and stored at 4°C. Paraffin-embedded ovaries were sectioned at a thickness of 5 μ m (histology facility, University of Lille 2, France) and stained using hematoxylin-eosin protocol. The number of corpora lutea, Graafian follicles and atretic follicles were counted on photomicrographs from every 10th section throughout the ovary and statistical analysis was performed as described below.

Estrous cyclicity

To examine the possible effects of mutations on estrous cyclicity, vaginal lavage of female GnRH::Cre; Itgb1loxP/loxP mice and their control littermates (GnRH::Cre; Itgb1+/+) was performed every day (10 a.m. to 1 p.m.) using 0.9 % saline. Smears were observed under the microscope and the phase identified as diestrus (M/D) if they predominantly contained leukocytes, as proestrus (P) if they predominantly contained basal and cornified nucleated cells and as estrous (E) if they predominantly contained cornified epithelial cells. An estrous

cycle was considered normal when the vaginal lavage had leukocytes for 2 d followed by 1 d of nucleated and 1-2 d of cornified cells.

Gonadal steroid-induced LH surge protocol in ovariectomized animals

Mice were bilaterally ovariectomized (OVX) and implanted subcutaneously with Silastic capsules containing 17β -estradiol (E2; 1 $\mu\text{g}/20$ g body weight). Silastic capsules were prepared as follows: crystalline E2 was dissolved in absolute ethanol, mixed with Silastic medical adhesive (Type A) (Dow Corning) at a concentration of 0.1 mg/ml adhesive and injected into Silastic tubing (Dow Corning; internal diameter, 1mm; external diameter, 2.125 mm) (Bronson, 1981; Clarkson et al., 2008). Six days after OVX, mice received a single injection (s.c.) of 17β -estradiol 3-benzoate (1 $\mu\text{g}/20$ g of body weight in sesame oil) at 9 a.m. On the following day, animals received another injection (s.c.) of progesterone (500 $\mu\text{g}/20$ g body weight in sesame oil) at 9 a.m. Between 7:30 - 8:30 p.m (lights off at 8 p.m.) on the same day, mice were anesthetized with an overdose of chloral hydrate (400 mg/kg; i.p.) and trunk blood was collected for LH assay. Trunk blood was collected in tubes containing EDTA (0.2 M), centrifuged at 6500 rpm for 15 min at 4°C and the supernatant obtained (plasma) was stored at -80°C until ELISA for LH.

Luteinizing hormone assay

Plasma LH was measured using Rodent LH ELISA kit (ERKR7010-A; Endocrine Technologies, Newark, CA) with a sensitivity of 0.3 ng/ml and 7% intra-assay and 10% inter-assay coefficients of variation.

Immunohistochemistry

Tissues were cryo-sectioned (Leica cryostat) at 16 μm for embryos, and at 35 μm for free-floating sections for adult brains. Immunohistochemistry was performed as previously reported (Giacobini et al., 2008), using Alexa-Fluor 488- (1:400) and Cy3- (1:800) conjugated secondary antibodies (Invitrogen, Molecular Probes). Fluorescent specimens were mounted using 1,4-diazabicyclo[2.2.2]octane (DABCO; Sigma-Aldrich). The primary antisera used were as follows: rabbit anti-GnRH (1:3000), a generous gift from Prof. G. Tramu (Centre Nationale de la Recherche Scientifique, URA 339, Université Bordeaux I, Talence, France) (Beauvillain and Tramu, 1980) ; rat anti- β 1-integrin (1: 500; BD 558741).

Image analysis

Images were captured using a Nikon microscope (Eclipse 80i) and 2x/0.06 NA, 10x/0.30 NA, and 20x/0.50 NA objectives (Nikon) equipped with a digital camera (CX 9000; MBF Bioscience). For observation coupled with confocal analysis, a laser-scanning Fluoview confocal system (IX70; Olympus) and 10x/0.30 NA, 20x/0.70 NA, and 60x/1.25 NA objectives (Olympus) were used. Subsequent analysis of digitized images was performed with ImageJ (U. S. National Institutes of Health, Bethesda, Maryland, USA, <http://imagej.nih.gov/ij/>, 1997-2011) and Photoshop (Adobe) software to process, adjust and merge the photomontages.

Analysis of GnRH neurons in transgenic mice

Serial sagittal sections (16 μm) from E14.5 GnRH-Itgb1^{+/+} (n = 4) and GnRH-Itgb1^{-/-} (n = 7) mice were cut and immunolabeled for GnRH throughout the head. Quantitative analysis of GnRH neuronal number, as a function of location, was performed over three regions (the nasal compartment, the nasal/forebrain junction and ventral forebrain). Serial coronal sections (35 μm) through the OVLT and median eminence of adult GnRH-Itgb1^{+/+} (females, n = 5; males, n = 3) and GnRH-Itgb1^{-/-} (females, n = 5; males, n = 4) mouse brains were

labeled for GnRH. Total number of GnRH cells was calculated for each brain (throughout the entire brain) and combined to give group means \pm SEM. No ectopic localization of GnRH neurons was detected in the brains of mutant mice, both during embryonic development as well as at the adult stage, as compared with control animals, suggesting that the GnRH neurons were not misrouted.

The density of GnRH-immunoreactive terminals in the median eminence of control and GnRH-Itgb1^{-/-} mice was also evaluated. 2 medial sections per animal (n = 3 each genotype) were chosen. Fiber intensity was evaluated with a confocal microscopy, Zeiss LSM 710 (Carl Zeiss, Oberkochen, Germany). 24-bit images were collected with set parameters at 1.5 μ m intervals through a 35 μ m section using a 10x objective. Maximum intensity projections were calculated with ZEN 2009 (Carl Zeiss) algorithms for each series of confocal images that were binarized with imageJ software (U. S. National Institutes of Health, Bethesda, Maryland, USA, <http://imagej.nih.gov/ij/>, 1997-2011). A user-defined threshold parameter was employed and applied to each section to optimize detection of labeled fibers. The same threshold values were applied to all images to avoid subjective evaluation. The density values of labeled fibers were calculated based on the number of total pixels in each binarized image per area and combined to give group means \pm SEM.

Nasal explants

Embryos were obtained from timed-pregnant animals. Nasal pits of E11.5 NIH Swiss mice were isolated under aseptic conditions in Gey's Balanced Salt Solution (Invitrogen) enriched with glucose (Sigma-Aldrich) and maintained at 4°C until plating. Explants were placed onto glass coverslips coated with 10 μ l of chicken plasma (Cocalico Biologicals, Inc.). Thrombin (10 μ l; Sigma-Aldrich) was then added to adhere (thrombin/plasma clot) the explant to the coverslip. Explants were maintained in defined serum-free medium (SFM) (Fueshko and Wray, 1994) containing 2.5 mg/ml Fungizone (Sigma-Aldrich) at 37°C with 5% CO₂ for up to 30 days in vitro (div). From culture day 3 to 6, fresh medium containing fluorodeoxyuridine (8 x 10⁻⁵ M; Sigma-Aldrich) was provided to inhibit the proliferation of dividing olfactory

neurons and non-neuronal explant tissue. The medium was replaced with fresh SFM twice a week.

Functional assays in nasal explants

To determine the function of β -integrin on GnRH cell migration and axon outgrowth, pharmacological perturbation was carried out on explants using Echistatin. Echistatin is a 49-aminoacid protein with an Arg-Lys-Asp (RGD) sequence that is a member of the disintegrin family that occurs in the venom of *Echis carinatus*. It specifically inhibits β 1- and β 3-integrins (Pfaff et al., 1994). Explants in experimental groups were maintained in SFM or SFM plus Echistatin (0.1 μ M) at 3 div for 72 hours. Drug concentrations were based on data from previous studies (Pasterkamp et al., 2003). Control explant medium was changed, as in the treatment group, at 3 and 6 div. At 7 div, explants were processed for immunocytochemistry for GnRH and density of the fibers in the periphery of the explants quantified. The main tissue mass contained the nasal pit/olfactory epithelial region, surrounding mesenchyme, and nasal midline cartilage. The periphery refers to the area surrounding the main tissue mass into which cells had spread and/or migrated.

Quantification of GnRH fiber density was performed on digitized photomicrographs (using a 20x UPlanFI Phase objective; Olympus I X 50 inverted microscope, Hamburg, Germany, equipped with a CCD CoolSNAP-Pro camera, Media Cybernetics, Silver Spring). First, a threshold was manually set to specifically demonstrate the network structures in the image. The quality and resolution of the images allowed reliable and exclusive threshold of the networks without the need of image filtering. Images were then placed in bins and subjected to the "Skeletonize" function of ImageJ software, which excluded the GnRH cell somas from the analysis (see Fig. 4d, f). The corresponding density was measured by dividing the mean pixel area of GnRH fibers for the total area occupied by the fiber network. This quantitative method was chosen because the complex nature of the fiber network prevented the quantification of individual fiber length and branching. Three pictures were taken for each explant and average density was calculated for each sample to homogenize internal

variability. Finally, mean density among treatment groups was calculated. Twelve animals were used for the control group (n = 12) and 7 for the treatment group (Echistatin; n = 7).

The data are presented as means \pm SEM. All experiments utilized explants generated from different individuals on multiple culture dates.

Statistical analysis

For comparison of multiple groups, statistical significance was determined using a one-way analysis of variance (ANOVA; for Gaussian distributed data) followed by Fisher 's least significant difference post-hoc analysis test. For comparison between two groups, a 2-tailed unpaired Student's t test was used. The significance level was set at $P < 0.05$. Data groups are indicated as mean \pm SEM.

RESULTS

Generation of conditional KO mice lacking β 1-integrin in GnRH neurons

Recently it was shown that GnRH neurons begin expressing β 1-integrin at early stages of embryonic development and that Semaphorin 7A regulates the migration of immortalized GnRH cells through β 1-integrin activation (Messina et al., 2011). Interestingly, in the same work it has been shown that GnRH neurons expressed β 1-integrin at comparable levels in the migratory and post-migratory stages, supporting the notion that this molecule might regulate several biological processes throughout development.

In the present work, the gene encoding the β 1-integrin subunit was inactivated in GnRH neurons by crossing floxed β 1-integrin (Itgb1) mice with LoxP sites flanking exon 3 (Jax mice; Fig. 1a) with GnRH::Cre mice (Yoon et al., 2005), which express the Cre recombinase gene in GnRH neurons, to obtain GnRH::Cre; Itgb1^{+/+} (GnRH-Itgb1^{+/+}) and GnRH::Cre; Itgb1^{loxP/loxP} (GnRH-Itgb1^{-/-}) mice. Crosses typically displayed Mendelian segregation of the three embryonic genotypes: GnRH::Cre; Itgb1^{loxP/loxP} animals, which were homozygous null for the Itgb1 gene in GnRH cells and wild-type for this gene in other cell types, GnRH::Cre; Itgb1^{loxP/+} animals which were heterozygous for the Itgb1 gene in GnRH cells, and GnRH::Cre; Itgb1^{+/+} which were wild-type for Itgb1 in all cells, including GnRH cells. To confirm cell-specific deletion of Itgb1 in GnRH cells, GnRH::Cre; Itgb1^{loxP/loxP} were crossed with GnRH::GFP animals, which express the green fluorescent protein (GFP) under the control of the GnRH promoter (Spergel et al., 1999) so that RT-PCR analysis could be performed on embryonic GnRH-GFP cells isolated through Fluorescent Activated Cell Sorting (FACS). E12.5 embryos were harvested from pregnant triple-mutant mice. At this stage, the majority of the GnRH population is located within the nasal region (Fig. 1b, green dots) (Schwanzel-Fukuda and Pfaff, 1989; Wray et al., 1989). Therefore, noses were dissected from mutant GnRH::Cre; Itgb1^{loxP/loxP}; GnRH::GFP (GnRH-Itgb1^{-/-};GnRH-GFP) and control GnRH::Cre; Itgb1^{+/+};GnRH::GFP E12.5 embryos (GnRH-Itgb1^{+/+}; GnRH-GFP) and purified GnRH-GFP-positive neurons were isolated by FACS (Fig. 1b). RT-PCR experiments were performed on cDNAs of primary GnRH-GFP neurons, positive controls (GT1-7 cells and E11.5 heads) and negative control cDNAs

(water and –RT). Transcripts of the expected molecular size for mouse GnRH and the housekeeping gene L19 were found in all samples but negative control (Fig. 1c). Primers within the third exon of the *Itgb1* gene, which is floxed upon Cre recombination were used. RT-PCR analysis revealed expression of *Itgb1* in the positive samples and in the GnRH-*Itgb1*^{+/+}; GnRH-GFP cells, whereas *Itgb1* was lacking in GnRH-*Itgb1*^{-/-}; GnRH-GFP neurons (Fig. 1c), confirming cell-specific deletion of *Itgb1* in GnRH neurons in conditional-KO mice.

Lack of β 1-integrin expression in GnRH neurons leads to defects in their migratory process and their axonal targeting to the target tissues

To investigate whether the absence of β 1-integrin signaling in GnRH neurons affects their development and migration, the number and distribution of GnRH neurons was examined at E14.5 in control (GnRH-*Itgb1*^{+/+}) and GnRH-*Itgb1*^{-/-} mice (Fig. 2a-d). The number of GnRH cells in the nasal compartment (cells located in the olfactory/vomer nasal epithelia and across the nasal mesenchyme), olfactory bulb (ob) and ventral forebrain (vfb) areas of embryos was determined (Fig. 2e, upper panel, red boxes). GnRH-*Itgb1*^{-/-} animals showed a significant accumulation of GnRH cells in the nasal compartment as compared with control littermates (Fig. 2e, lower panel). Concomitantly, in mutant mice fewer GnRH neurons were located in the final brain target area (vfb; Fig. 2c-e), consistent with a migratory defect (one-way ANOVA, $F(7, 43) = 44.3$, $p < 0.0001$). In order to assess whether this defect was compensated after birth, the number and distribution of GnRH neurons was analyzed in brains of postnatal day 7 mice. Indeed, the total number of these neuroendocrine cells as well as their localization within the brain was unchanged between GnRH-*Itgb1*^{-/-} and control infantile animals (GnRH-*Itgb1*^{+/+} mice, $n = 6$, mean GnRH cell number = 873 ± 31 ; GnRH-*Itgb1*^{-/-} mice, $n = 4$, mean GnRH cell number = 829 ± 52 ; unpaired Student's t-test, $t(8) = -0.768$, $p = 0.46$).

However, in adult animals, a significant 30% reduction was found in the number of GnRH cell bodies (Fig. 3a, b) of GnRH-*Itgb1*^{-/-} mice as compared to control littermates, regardless of the sex (GnRH-*Itgb1*^{+/+}, $n = 8$, mean GnRH cell number = 712 ± 33 ; GnRH-*Itgb1*^{-/-}, $n = 9$, mean GnRH cell number = 436 ± 14 . n , number of mice; unpaired Student's t-test, $t(15) = 7.98$, $p <$

0.0001). No differences in the number and bilateral distribution of GnRH neurons was observed between males and females brains of the same genotype (GnRH-Itgb^{+/+} females, n = 5, mean GnRH cell number = 672 ± 44; GnRH-Itgb^{+/+} males, n = 3, mean GnRH cell number = 780 ± 15; unpaired Student's t-test, t(6) = -1.81, p = 0.12. GnRH-Itgb^{-/-} females, n = 5, mean GnRH cell number = 443 ± 26; GnRH-Itgb^{-/-} males, n = 4, mean GnRH cell number = 427 ± 5; unpaired Student's t-test, t(7) = 0.52, p = 0.62).

Notably, the GnRH neurons of GnRH-Itgb1^{-/-} animals displayed shorter neurites than those of GnRH-Itgb^{+/+} mice (see insets in Fig. 3a and b). Consistent with this observation, densitometric analysis of immunostaining of the median eminence, the terminal field of GnRH neuroendocrine neurons, revealed a marked loss of GnRH fibers in homozygous mice when compared with control mice (Fig. 3c, d). The innervation of the median eminence of female GnRH-Itgb1^{-/-} mice was reduced by more than 70% when compared with control mice (GnRH-Itgb^{+/+}, n = 3, mean density of fibers = 409.8 ± 97; GnRH-Itgb^{-/-}, n = 3, mean density of fibers = 80.6 ± 25; unpaired Student's t-test, t(15) = 3.12, p < 0.005). Quantitative analysis revealed a 33% reduction in the innervation of the median eminence in males (GnRH-Itgb^{+/+}, n = 3, mean density of fibers = 410 ± 20; GnRH-Itgb^{-/-}, n = 4, mean density of fibers = 271.3 ± 12; unpaired Student's t-test, t(5) = 6.43, p < 0.005), thus evidencing a marked sex difference (% reduction of fiber density in males vs. females, p < 0.05).

Inhibition of β 1-integrin in vitro disrupts GnRH fibers' network

To determine the role of Itgb1 in regulation of GnRH fibers elongation, a nasal explant model was used (Fig. 4a). Explants were treated with Echistatin (0.1 μ M), a selective inhibitor of β 1- and β 3-integrins (Pfaff et al., 1994). RT-PCR experiments for β 3-integrin (Itgb3) were performed on cDNAs of primary E12.5 GnRH-GFP sorted neurons, GT1-7 cells, which display features of mature post-migratory GnRH neurons, and water (Fig. 4b). A transcript of the expected molecular size for the mouse Itgb3 was found in GT1-7 cells but not in primary migratory GnRH cells and in the negative control (Fig. 4b), indicating that Echistatin could only act via Itgb1 signaling in GnRH cells in explants.

The application of Echistatin severely restricted the GnRH fiber network in the periphery of the explant (Fig. 4c-f). Quantitative analysis revealed a significant reduction in the density of the GnRH-immunoreactive fiber network following β 1-integrin blockage (controls, $n = 12$, mean density of fibers = 0.057 ± 0.005 ; Echistatin-treated, $n = 7$, mean density of fibers = 0.042 ± 0.002). Data are combined values from three independent experiments. n , number of explants; unpaired Student's t-test, $t(17) = 3.06$, $p < 0.05$). The absence of a change in GnRH cell number after Echistatin treatment (control: 197 ± 24 , $n = 12$; Echistatin: 220 ± 29 , $n = 7$; unpaired Student's t-test, $t(17) = -0.72$, $p = 0.48$) indicates that this drug does not exert mitogenic or survival effects on GnRH neurons in vitro and is consistent with the hypothesis that β 1-integrin regulates neurite sprouting of primary GnRH neurons.

GnRH::Cre;Itgb1^{loxP/loxP} female mice exhibit impaired fertility

The observation that GnRH-Itgb1^{-/-} mice had a dramatic loss of GnRH innervation in the median eminence suggested that fertility could be disrupted. Since alterations in neuroendocrine activity are expected to result in impaired reproductive capacity, fertility was examined in control and conditional Itgb1 knock-out mice using a continuous mating protocol for 90 days. Male reproductive capacity was assessed by breeding young adult (P90) GnRH-Itgb1^{-/-} males with confirmed control dams (GnRH-Itgb1^{+/+}) and monitoring the occurrence of litters over 3 months. In adult males, all fertility parameters examined: 1) number of days required to produce one litter (unpaired Student's t-test, $t(7) = 0.4$, $p = 0.7$), 2) fertility index (number of litters/month) (unpaired Student's t-test, $t(13) = 0.26$, $p = 0.79$) and 3) number of pups/litter, did not differ between control and GnRH-Itgb1^{-/-} mice (Fig. 5a-c, unpaired Student's t-test, $t(56) = 0.63$, $p = 0.53$). In contrast, female GnRH-Itgb1^{-/-} mice showed significant alterations of the reproductive axis. Both the fertility index (one-way ANOVA, $F(2, 18) = 4.09$, $p = 0.04$) and the number of pups/litter (one-way ANOVA, $F(2, 66) = 5.94$, $p = 0.004$), were significantly reduced in the GnRH-Itgb1^{-/-} females (Fig. 5a-c). Whereas, the latency to first pregnancy was not affected in any group analyzed (one-way ANOVA, $F(2, 16) = 0.12$, $p = 0.9$).

To determine whether the observed defects were associated with an ovulation deficiency, ovarian morphology in 3-5 month-old control and GnRH-Itgb1^{-/-} female mice was evaluated. In contrast to control mouse ovaries, which contained large Graafian follicles and several corpora lutea, histological inspection of adult conditional null mouse ovaries revealed a significant reduction in the number of corpora lutea (unpaired Student's t-test, $t(8) = 3.1$, $p = 0.01$), which serves as a confirmation that there are reduced numbers of ovulations (Fig. 5d, e).

GnRH::Cre;Itgb^{loxP/loxP} female mice exhibit delayed puberty and abnormal estrous cycles

Since the lack of $\beta 1$ -integrin in GnRH neurons impacted only the reproductive axis in females and not in males, female mice were further characterized. Vaginal opening and first estrus have been shown to be estrogen-dependent processes, which correlate with the onset of puberty in rodents (Ojeda and Skinner, 2006). Thus, weaned GnRH-Itgb1^{+/+} ($n = 12$) and GnRH-Itgb1^{-/-} ($n = 12$) female littermates were examined for vaginal opening and first estrus. Vaginal opening was significantly delayed by approximately 6 days in GnRH-Itgb1^{-/-} female mice as compared to control females (Fig. 6a; GnRH-Itgb1^{+/+}: 29.1 days \pm 0.23, GnRH-Itgb1^{-/-}: 35.4 days \pm 0.57; unpaired Student's t-test, $t(22) = -10.3$, $p < 0.0001$). Analysis of cumulative percentage of vaginal opening within the two groups revealed that whereas, in control females, 100% of the mice had vaginal opening by the 28th day of postnatal life, the entire population of GnRH-Itgb1^{-/-} displayed vaginal opening at the 37th postnatal day (Fig. 6b). Similarly, the first estrus was significantly delayed by approximately 10 days in GnRH-Itgb1^{-/-} versus GnRH-Itgb1^{+/+} mice (Fig. 6a, c; GnRH-Itgb1^{+/+}: 32.5 days \pm 0.23, GnRH-Itgb1^{-/-}: 41.9 days \pm 0.58; unpaired Student's t-test, $t(22) = -15$, $p < 0.0001$). Daily inspection of vaginal cytology in GnRH-Itgb1^{-/-} mice revealed absence of normal estrous cyclicity (Fig. 7a). GnRH-Itgb1^{-/-} mice exhibited a persistent diestrus state (GnRH-Itgb1^{+/+} mean percentage time in proestrus: 14 \pm 2, GnRH-Itgb1^{-/-} mean percentage time in proestrus: 1 \pm 0.7, unpaired Student's t-test, $t(22) = 7$, $p < 0.0001$; GnRH-Itgb1^{+/+} mean percentage time in estrus: 26.5 \pm 2, GnRH-Itgb1^{-/-} mean percentage time in diestrus: 10.5 \pm 1, unpaired Student's t-test, $t(22) =$

7, $p < 0.0001$; GnRH-Itgb1^{+/+} mean percentage time in diestrus: $5^9 \pm 1$; GnRH-Itgb1^{-/-} mean percentage time in diestrus: 88 ± 1 ; unpaired Student's t-test, $t(22) = -15$, $p < 0.0001$) with the sporadic occurrence of complete 4-5-d ovarian cycles (Fig. 7c), whereas control littermates showed regular estrous cyclicity (Fig. 7a, b). These findings show that GnRH-Itgb1^{-/-} mice display ovarian cyclicity deficits.

GnRH::Cre;Itgb1^{loxP/loxP} mice do not elevate LH under gonadal steroid positive feedback condition

In female mice, GnRH-induced LH surge stimulates ovulation, which is an essential process in fertility and is induced by positive feedback of gonadal steroids on the hypothalamic-pituitary axis. To examine the GnRH/LH surge, an OVX-E-P replacement model was used as previously described (Hanchate et al., 2012). While OVX GnRH-Itgb1^{+/+} mice exhibited a LH surge in response to gonadal steroid treatment (Fig. 8; unpaired Student's t-test, $t(6) = -198$, $p < 0.0001$), OVX GnRH-Itgb1^{-/-} littermates did not exhibit an LH surge, displaying levels of LH that were near the limit of detection (Fig. 8; unpaired Student's t-test, $t(8) = 0.67$, $p = 0.52$).

DISCUSSION

Integrins are heterodimeric ($\alpha\beta$) extracellular matrix (ECM) receptors that are widely expressed throughout the mammalian nervous system (Pinkstaff et al., 1999), where they regulate development and function of neurons (Anton et al., 1999; Benson et al., 2000; Chavis and Westbrook, 2001; Graus-Porta et al., 2001; Huang et al., 2006; Belvindrah et al., 2007; Webb et al., 2007). Using a novel mouse model of β 1-integrin ablation in GnRH neurons we uncovered a fundamental role of integrins in the development of the GnRH system, establishment of the hypothalamic-pituitary-gonadal axis and involvement of β 1-integrin signaling in the initiation of puberty and regulation of the preovulatory gonadotropin surge.

RT-PCR analysis on GnRH-sorted cells deriving from triple-mutant embryos (GnRH::Cre;Itgb1^{loxP/loxP}; GnRH::GFP) revealed that recombination has already occurred at E12.5, when the majority of this population is migrating across the nasal mesenchyme. Analysis of conditional mutant embryos at E14.5 shows deficits consistent with the reduced migration of GnRH neurons. However, this delay appears to be compensated during later developmental stages with the number and distribution of GnRH neurons being unaffected in the brain of P7 mutants as compared with control mice. Indeed, many factors controlling the precise journey of these neuroendocrine cells from nose to brain have been elucidated (Wierman et al., 2011), which could be responsible for such compensatory mechanism.

Interestingly, the number of GnRH cells is significantly reduced by approximately a third in the brains of adult GnRH-Itgb1^{-/-} mice, implying that cell death might occur within this cell population between the infantile and the adult stage. Indeed, it is very well established that integrin-mediated signals are necessary in normal cells to control cell survival and apoptosis (via PI3-kinase and Akt; Hynes, 2002). However, due to the small size of the GnRH neuronal population and the limited temporal window during which apoptosis takes place, it is not possible to determine whether this is the case. The loss of GnRH immunoreactive neurons has also been reported in other mutant mice, such as neuropilin 2^{-/-}, netrin 1^{-/-} and ephrin 3-

5^{-/-} mice, but its cause remains undetermined (Schwartz et al., 2004; Gamble et al., 2005; Cariboni et al., 2007).

At the end of the migratory process, GnRH neurons undergo striking structural plasticity, and elongate their axons to contact the median eminence. Previous studies have shown that many neurons use members of the integrin family of cell surface receptors to respond to factors that promote neurite growth and axonal elongation to their final target areas (Hynes, 2002). Consistently, ablation of *Itgb1* gene in GnRH neurons leads to defects in neuritogenesis. In fact, GnRH-*Itgb1*^{-/-} animals display shorter neurites than those of GnRH-*Itgb*^{+/+} mice. In order to verify that such defects were caused by the removal of β 1-integrin, perturbation of primary GnRH cells was performed in nasal explants. Indeed, inhibition of β 1-integrin significantly disrupted the GnRH fibers network in vitro, further substantiating the notion that integrins are required for the proper neurite outgrowth of these neuroendocrine cells.

The selective deletion of *Itgb1* in GnRH neurons is also responsible of striking reproductive defects in female mice, as evidenced by the delay in the onset of puberty, alterations in ovarian morphology and the reduced number and size of litters. GnRH-*Itgb1*^{+/-} female mice did not show any reproductive abnormalities (data not shown) indicating that one *Itgb1* allele is sufficient to grant normal development of the GnRH axis.

A very interesting aspect of the present study is the finding that male reproductive function was not affected by the disruption of β 1-integrin signaling in GnRH neurons, as shown by the continuous mating experiments. Notably, both male and female GnRH-*Itgb1*^{-/-} mice have a comparable decrease in the size of the GnRH neuronal population within the brain when compared to control mice (30% reduction). However, the extent of reduction in GnRH neuronal projections was sexually dimorphic, being milder in male than in female GnRH-*Itgb1*^{-/-} mice (33 % reduction in male versus 70 % reduction in female mutant mice). Hormonal factors, such as sex steroids including estrogens and testosterone, direct formation of sexually dimorphic circuits by influencing axonal guidance and synaptogenesis, neurogenesis, cell migration, cell differentiation and cell death, (Simerly, 2002; Tobet et al.,

2009). Several reports indicate that gonadal steroids are capable of modulating the expression of different classes of guidance molecules, which are known to bind β 1-integrin to activate their intracellular signaling pathway, in physiological as well as in pathological conditions (Cullinan-Bove and Koos, 1993; Liu et al., 1994; Nikolova et al., 1998; Pavelock et al., 2001; Khan et al., 2005; Nguyen et al., 2011; Richeri et al., 2011). Thus, it is possible that gonadal steroids-dependent mechanisms could be responsible of the sex difference observed in the GnRH neuronal projections to the median eminence in GnRH-Itgb1^{-/-} mice.

A strong precedent for this notable sex difference does exist since several gene mutations including cyclooxygenase (Lim et al., 1997), progesterone receptor (Lydon et al., 1996), ErbBs (Prevot et al., 2005) and FSH (Kumar et al., 1997), cause female infertility but have no effect on male reproductive capacity.

The phasic secretion of LH from the pituitary gland is perhaps the most significant sex difference in endocrine physiology (Simerly, 1998). In female rats, plasma levels of estradiol increase during the estrous cycle and lead to a massive surge in LH secretion on the afternoon of proestrus (Simerly, 1998). Treatment of ovariectomized adult female rats with exogenous estradiol causes afternoon surges in LH release, yet treatment of gonadectomized male rats fails to cause a similar response due to organizational effect of androgens around the time of birth (Jarzab and Dohler, 1984).

Gonadal steroids via positive feedback to the hypothalamic-pituitary gonadotropic axis, control the onset of the LH surge and thus ovulation. After exogenous administration of estradiol benzoate and progesterone to ovariectomized GnRH-Itgb1^{-/-} females, GnRH neurons failed to induce an LH surge, suggesting that the reproductive dysfunction of these animals is due to an attenuated GnRH-system function. We cannot exclude that additional defects affecting the development and function of synapses on GnRH dendrites could occur in the absence of β 1-integrin. Recent studies have demonstrated that the dendritic tree of GnRH neurons is subject to marked remodeling during postnatal development (Cottrell et al., 2006) and that the density of spines along GnRH dendrites increases not only during sexual maturation (Cottrell et al., 2006), but also at the onset of the GnRH/LH surge induced by

gonadal steroids in ovariectomized adult mice (Chan et al., 2011). Notably, previous works have demonstrated the essential role of integrins in synapse maturation and plasticity (Benson et al., 2000; Chavis and Westbrook, 2001; Huang et al., 2006; Webb et al., 2007; Warren et al., 2012). In addition to these functions, β 1-containing integrins have been also shown to influence circuit function by controlling dendritic arbor formation and/or stability. For instance, inhibiting β 1-integrin signaling in developing retinal ganglion cells block dendritic growth (Lilienbaum et al., 1995), and plating cortical neurons on integrin substrates such as laminin promotes dendritic branching and extension (Moresco et al., 2005).

Thus, the dysfunction of the GnRH system in β 1-integrin mutants likely derive from a combination of multiple developmental defects ultimately affecting neuronal activity and secretion of GnRH neurons.

This work demonstrates the critical role of GnRH Itgb1 in the complex developmental signaling pathways that control mammalian reproduction.

Future studies should determine which ligands activating β 1-integrin signaling cascade could be modulated by sexual hormones within the central nervous system and what effect they have on neuronal connectivity and function during critical period of the GnRH network activation.

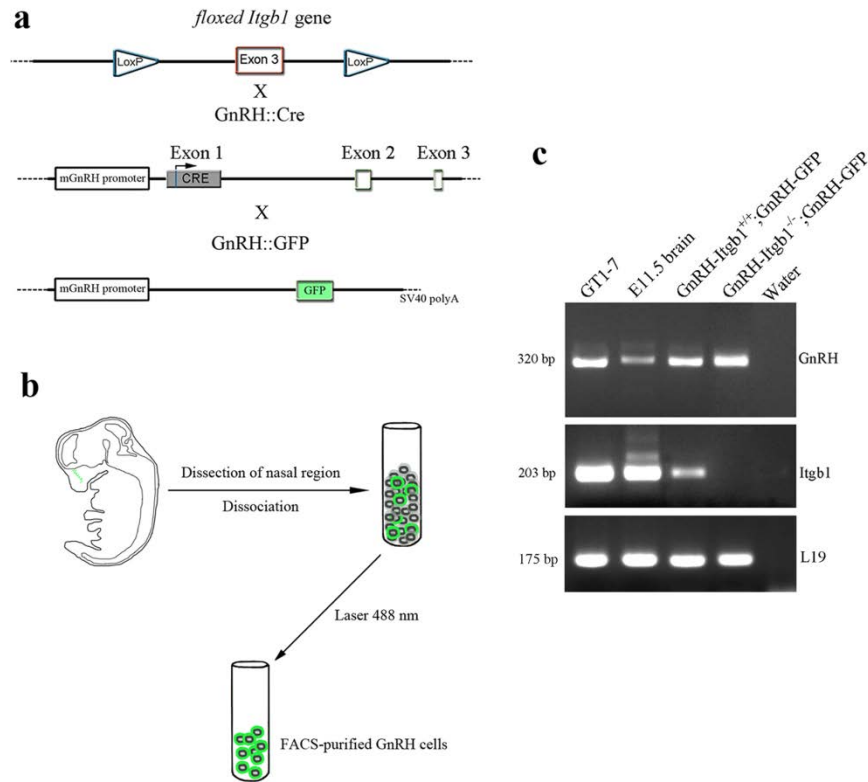

Figure 1. Generation of GnRH neuron-specific *Itgb1* KO mouse. (a) Exon 3 of the $\beta 1$ -integrin gene (*Itgb1*) is flanked by two *LoxP* sites; Cre recombinase expression is regulated by the mouse GnRH promoter. *GnRH::Cre*; *Itgb1*^{loxP/loxP} mice were crossed with *GnRH::GFP* animals, which express the green fluorescent protein (GFP) under the control of the GnRH promoter, to generate triple-transgenic mice. (b) Schematic summarizing the steps of GnRH-GFP cells' isolation. E12.5 embryos were harvested from *GnRH::Cre*; *Itgb1*^{loxP/+}; *GnRH::GFP* pregnant mice; the nasal regions were dissected and GnRH-GFP cells were purified by FACS. (c) RT-PCR for GnRH and *Itgb1* was performed on total RNA isolated from the indicated samples. Positive (GT1-7 cells; E11.5 whole heads) and negative controls (water; W) were included in the reaction mix.

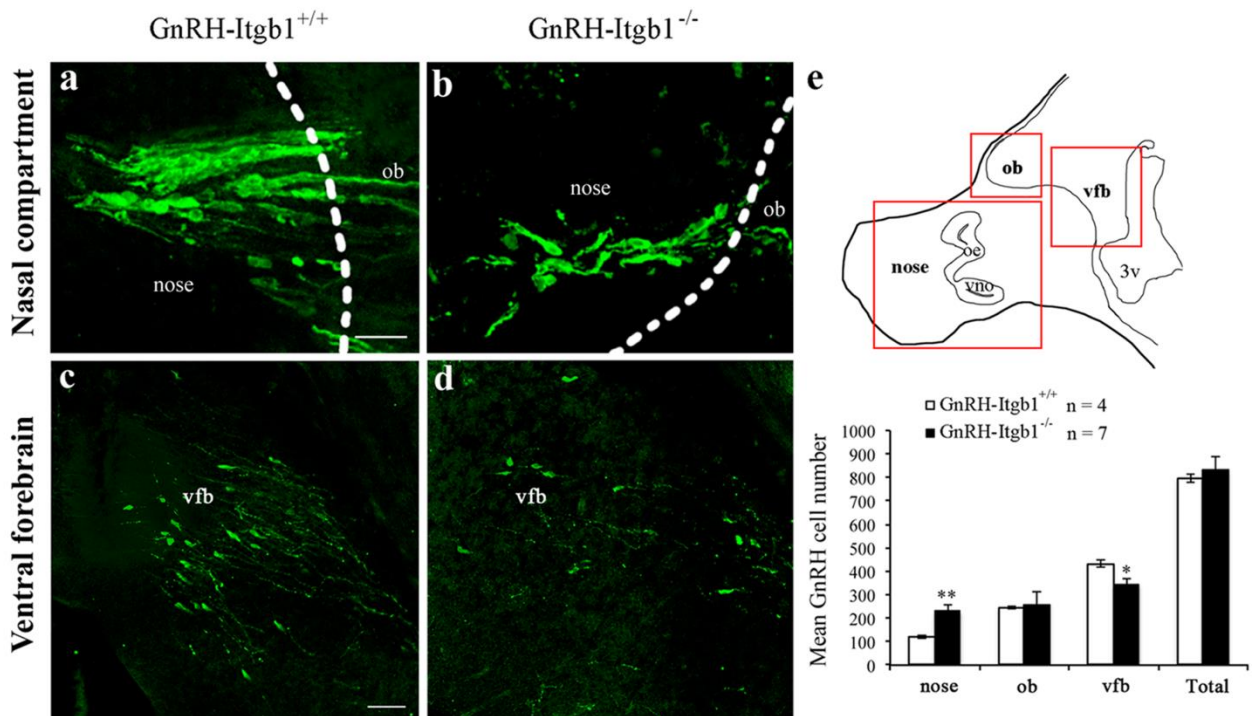

Figure 2. GnRH-Itgb1^{-/-} mice show defective GnRH migration during embryonic development (a-d) Confocal photomicrographs showing GnRH immunoreactivity in sagittal sections of E14.5 control (a, c) and GnRH-Itgb1^{-/-} (b, d) embryo heads. Dashed lines indicate the boundary between the nose and the forebrain (fb). Analysis of the location of GnRH neurons in three regions along the migratory pathway, nasal compartment (nose), olfactory bulb (ob) and ventral forebrain (vfb), reveals a significant accumulation of cells in the nasal region of GnRH-Itgb1^{-/-} mice when compared with control mice (a, b). Consistently, fewer GnRH neurons are located in the vfb of GnRH-Itgb1^{-/-} than of GnRH-Itgb1^{+/+} embryos (c versus d). (e, upper panel) Schematic of a sagittal section of an E14.5 embryo. Red boxes indicate the areas of the analysis of GnRH cell distribution. (e, lower panel) Quantitative analysis revealed a migratory defect of GnRH neurons at this developmental stage. Data are represented as means \pm SEM (n, number of embryos; **p < 0.005, *p < 0.05, Fisher's least significant difference post-hoc analysis). Scale bars: (a, b) 20 μ m, (c, d) 40 μ m.

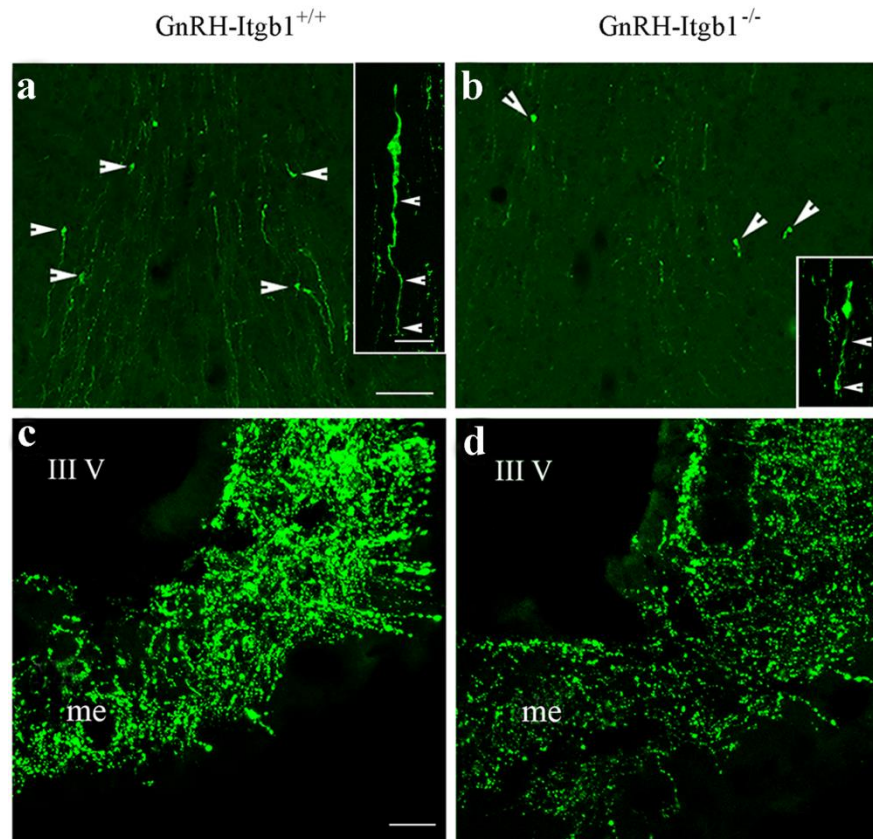

Figure 3. The lack of $\beta 1$ -integrin in GnRH cells leads to a suboptimal number of GnRH neurons and reduced innervation of the median eminence in adulthood. (a-d) Confocal photomicrographs showing GnRH-immunoreactivity in coronal sections of adult control (a, c) and conditional mutant (b, d) brains. Images show a significant reduction in the number of GnRH neurons at the level of the organum vasculosum of the lamina terminalis (OVLT, arrowheads). In addition, $\beta 1$ -integrin-KO GnRH neurons also display shorter neurites than control cells (insets in a and b, arrowheads). (c, d) The median eminence (me) shows a dramatic loss of GnRH-immunoreactive terminals in GnRH-Itgb1^{-/-} mice (d) when compared with control littermates (c). III V, third ventricle; me, median eminence. Scale bars: (a, b and insets) 40 μ m and 20 μ m, respectively, (c, d) 200 μ m.

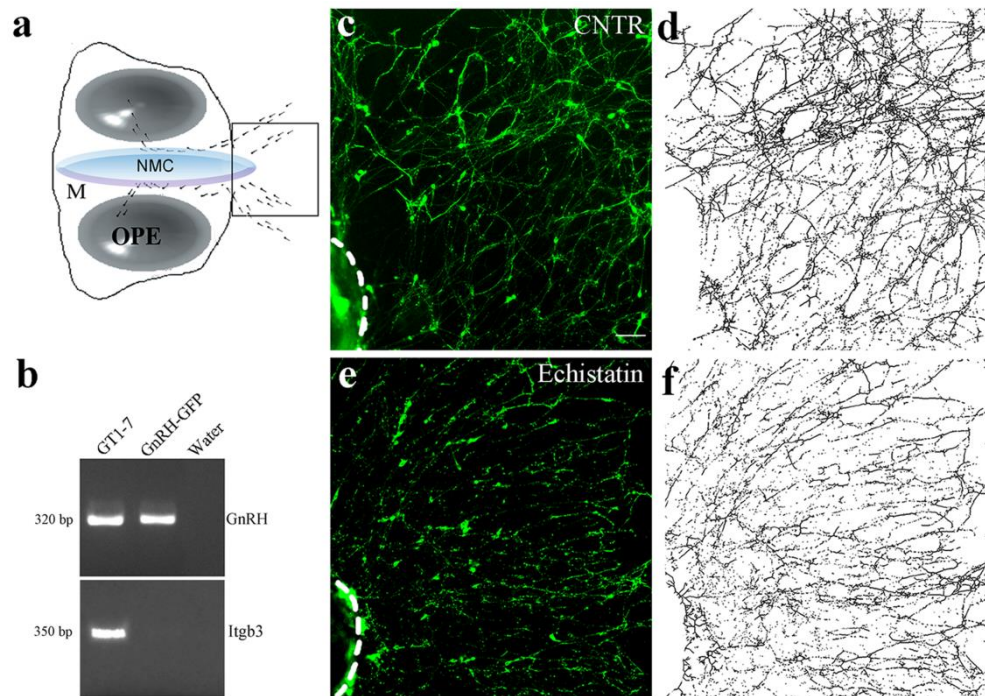

Figure 4. β 1-integrin inhibition disrupts GnRH fibers network in vitro. (a) Schematic of a nasal explant removed from an E11.5 mouse and maintained in serum-free media for 7 div. Ovals represent olfactory pit epithelium (OPE); in center is nasal midline cartilage (NMC) and surrounding mesenchyme (M). GnRH neurons (dots) migrate from OPE and follow olfactory axons to the midline and off the explant into the periphery. Boxed region within schematic is area shown in c–f. (b) Representative gel of PCR products for GnRH and β 3-integrin (Itgb3) from GnRH neurons isolated from GnRH::GFP E12.5 nasal regions through Fluorescent Activated Cell Sorter (FACS). Positive (GT1-7 cells) and negative controls (water; W) were included in the reaction mix. (c, e) Explants in experimental groups were maintained in serum-free medium (CNTR) with or without Echistatin (0.1 mM) at 3 div for 72 hours and fixed at 7 div for immunocytochemical processing (GnRH, green). (d, f) Representative images binarized and subjected to the “Skeletonize” function of ImageJ software. Scale bars: (c-f) 40 mm.

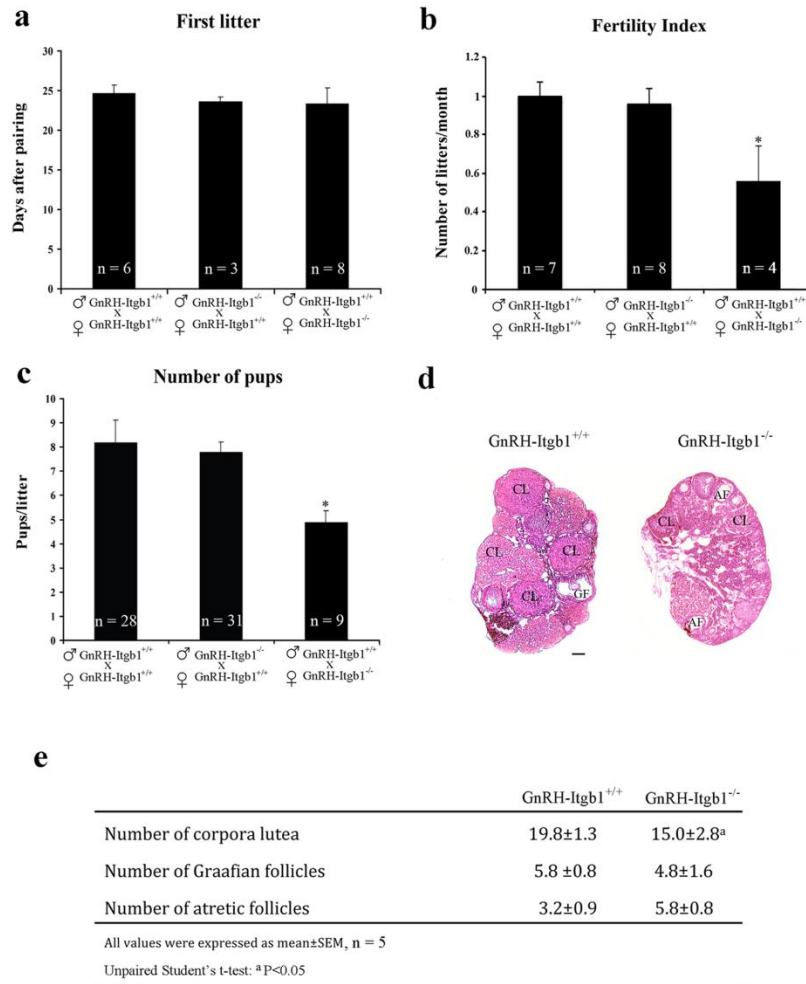

Figure 5. Female GnRH-Itgb1^{-/-} mice exhibit impaired fertility. Fertility in GnRH-Itgb1^{+/+} and GnRH-Itgb1^{-/-} female mice. Matings were carried out for 90 d. (a) The latency to first pregnancy was not affected in any group analyzed. (b) The total number of litters per female was significantly reduced in conditional mutant female mice as compared to control females mated with either GnRH-Itgb1^{-/-} or GnRH-Itgb1^{+/+} males. (c) Conditional mutant female mice gave birth to a reduced number of pups per litter as compared to control females. Data are represented as means ± SEM (n, number of animals; *p < 0.01, Fisher's least significant difference post-hoc analysis). (d) Morphological analysis of ovaries from 3-5 month-old control (GnRH-Itgb1^{+/+}; n = 5) and mutant mice (GnRH-Itgb1^{-/-}; n = 5). Ovary sections (5 μm-thick) were stained with hematoxylin-eosin. In GnRH-Itgb1^{-/-} females, the ovaries displayed a greater number of atretic follicles and a relative paucity of corpora lutea (CL), when compared with the ovaries of control littermates in which follicular development was normal.

(e) The numbers of corpora lutea, Graafian follicles and atretic follicles were quantified in the ovaries of CNTR and KO mice. Data are represented as means \pm SEM. $p < 0.05$, unpaired Student's t-test. Scale bar: 100 μ m.

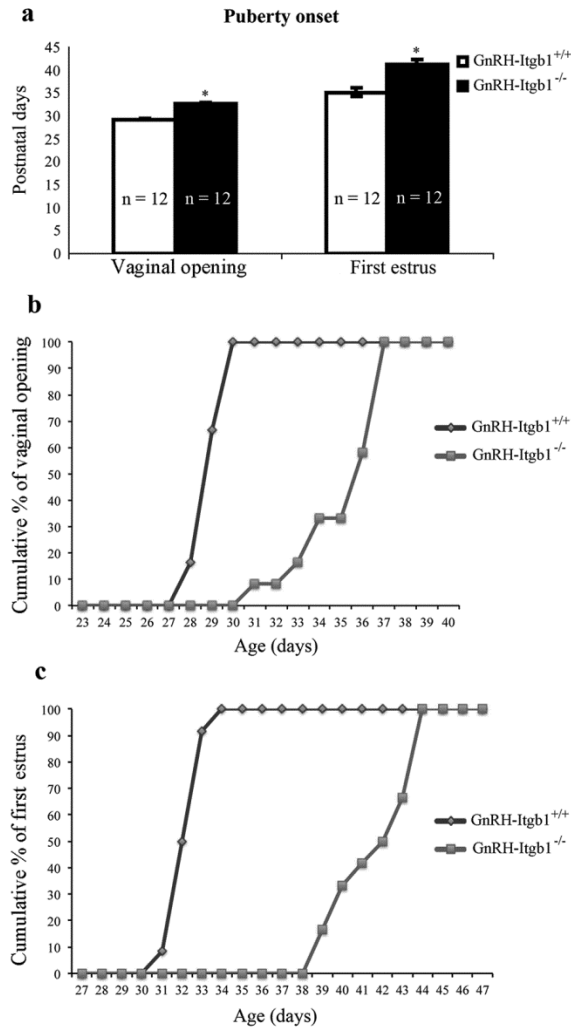

Figure 6. Female GnRH-Itgb1^{-/-} mice exhibit delayed puberty and abnormal estrous cyclicity. (a) Vaginal opening and time of the first estrus were examined daily from postnatal day 21 as good indicators of puberty onset in rodents. Vaginal opening in GnRH-Itgb1^{-/-} females was delayed by approximately 6 days when compared with control females. Vaginal smears were prepared daily following vaginal opening, and the age at first estrus (defined by the presence of a majority of cornified epithelial cells) was recorded (n = 12 each group). First estrus was delayed by approximately 10 days in GnRH-Itgb1^{-/-} females. Data are represented as means ± SEM. n, number of animals; *p < 0.0001, unpaired Student's t-test. (b) Analysis of cumulative percentage of vaginal opening within the two groups. In control females, 100% of the mice displayed vaginal opening by the 28th day of postnatal life, whereas the entire population of GnRH-Itgb1^{-/-} mice had vaginal opening by the 37th postnatal day. (c) Analysis of cumulative

percentage of the first estrus within the two groups. In control females, 100% of the mice had the first estrus by the 34th day of postnatal life, whereas the entire population of GnRH-Itgb1^{-/-} mice entered puberty at the 44th postnatal day.

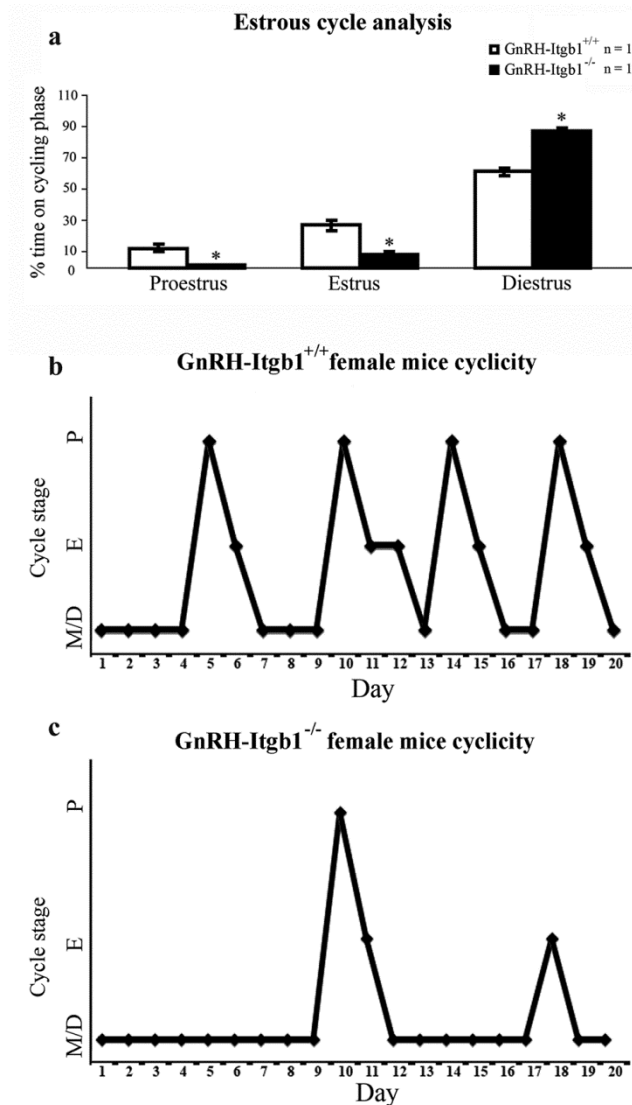

Figure 7. Female GnRH-Itgb1^{-/-} mice show abnormal estrous cyclicality. Vaginal cytology was assessed for 20 d in GnRH-Itgb1^{+/+} (n = 12) and GnRH-Itgb1^{-/-} mice (n = 12). (a) Time in each estrous cycle phase as a percentage of the cycle. GnRH-Itgb1^{-/-} females remained in a predominantly diestrus state with the sporadic occurrence of complete ovarian cycles, whereas control littermates showed a regular estrous cyclicality. Data are represented as means \pm SEM. n, number of animals; *p < 0.0001, unpaired Student's t-test. M/D: metestrus/diestrus; E: estrus; P: proestrus. (b, c), Representative estrous cyclicality of control (b) and GnRH-Itgb1^{-/-} mice (c). Control females typically show a regular 4-d ovarian cycles (b), whereas GnRH-Itgb1^{-/-} mice are characterized by with highly irregular cycles (c).

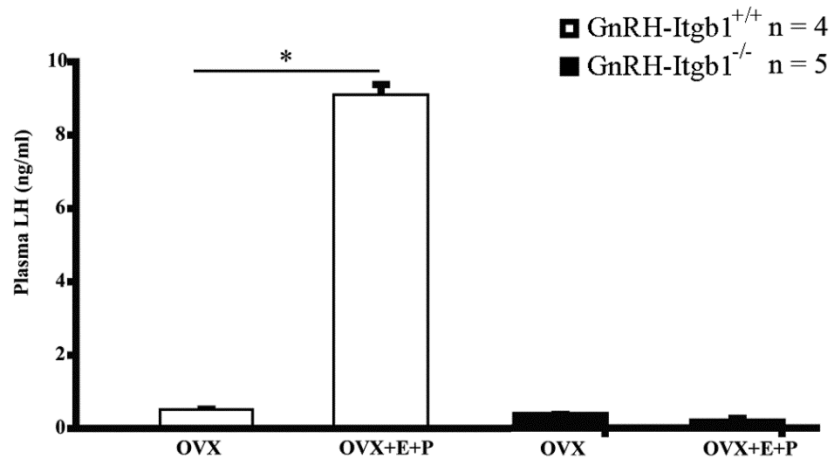

Figure 8. LH surge in GnRH-Itgb1^{-/-}. Profile of LH surge in ovariectomized mice of the two genotypes treated with estrogen and progesterone. Note that while control OVX mice (n = 4) exhibited an LH surge in response to gonadal steroid treatment, GnRH-Itgb1^{-/-} littermates (n = 5) did not, confirming that estrogen-based positive feedback is disrupted. Data are represented as means \pm SEM. n, number of animals; *p < 0.0001, unpaired Student's t-test.

REFERENCES

- Anton ES, Kreidberg JA, Rakic P (1999) Distinct functions of alpha3 and alpha(v) integrin receptors in neuronal migration and laminar organization of the cerebral cortex. *Neuron* 22:277-289.
- Beauvillain JC, Tramu G (1980) Immunocytochemical demonstration of LH-RH, somatostatin, and ACTH-like peptide in osmium-postfixed, resin-embedded median eminence. *J Histochem Cytochem* 28:1014-1017.
- Belvindrah R, Hankel S, Walker J, Patton BL, Muller U (2007) Beta1 integrins control the formation of cell chains in the adult rostral migratory stream. *J Neurosci* 27:2704-2717.
- Benson DL, Schnapp LM, Shapiro L, Huntley GW (2000) Making memories stick: cell-adhesion molecules in synaptic plasticity. *Trends Cell Biol* 10:473-482.
- Brakebusch C, Fassler R (2005) beta 1 integrin function in vivo: adhesion, migration and more. *Cancer Metastasis Rev* 24:403-411.
- Bronson FH (1981) The regulation of luteinizing hormone secretion by estrogen: relationships among negative feedback, surge potential, and male stimulation in juvenile, peripubertal, and adult female mice. *Endocrinology* 108:506-516.
- Cariboni A, Hickok J, Rakic S, Andrews W, Maggi R, Tischkau S, Parnavelas JG (2007) Neuropilins and their ligands are important in the migration of gonadotropin-releasing hormone neurons. *J Neurosci* 27:2387-2395.
- Chan H, Prescott M, Ong Z, Herde MK, Herbison AE, Campbell RE (2011) Dendritic spine plasticity in gonadotropin-releasing hormone (GnRH) neurons activated at the time of the preovulatory surge. *Endocrinology* 152:4906-4914.
- Chavis P, Westbrook G (2001) Integrins mediate functional pre- and postsynaptic maturation at a hippocampal synapse. *Nature* 411:317-321.
- Cingolani LA, Goda Y (2008) Differential involvement of beta3 integrin in pre- and postsynaptic forms of adaptation to chronic activity deprivation. *Neuron Glia Biol* 4:179-187.
- Clarkson J, d'Anglemont de Tassigny X, Moreno AS, Colledge WH, Herbison AE (2008) Kisspeptin-GPR54 signaling is essential for preovulatory gonadotropin-releasing hormone neuron activation and the luteinizing hormone surge. *J Neurosci* 28:8691-8697.

Cottrell EC, Campbell RE, Han SK, Herbison AE (2006) Postnatal remodeling of dendritic structure and spine density in gonadotropin-releasing hormone neurons. *Endocrinology* 147:3652-3661.

Cronin AS, Horan TL, Spergel DJ, Brooks AN, Hastings MH, Ebling FJ (2004) Neurotrophic effects of BDNF on embryonic gonadotropin-releasing hormone (GnRH) neurons. *Eur J Neurosci* 20:338-344.

Cullinan-Bove K, Koos RD (1993) Vascular endothelial growth factor/vascular permeability factor expression in the rat uterus: rapid stimulation by estrogen correlates with estrogen-induced increases in uterine capillary permeability and growth. *Endocrinology* 133:829-837.

Fassler R, Meyer M (1995) Consequences of lack of beta 1 integrin gene expression in mice. *Genes Dev* 9:1896-1908.

Fiorini Z, Jasoni CL (2010) A novel developmental role for kisspeptin in the growth of gonadotrophin-releasing hormone neurites to the median eminence in the mouse. *J Neuroendocrinol* 22:1113-1125.

Fueshko S, Wray S (1994) LHRH cells migrate on peripherin fibers in embryonic olfactory explant cultures: an in vitro model for neurophilic neuronal migration. *Dev Biol* 166:331-348.

Gamble JA, Karunadasa DK, Pape JR, Skynner MJ, Todman MG, Bicknell RJ, Allen JP, Herbison AE (2005) Disruption of ephrin signaling associates with disordered axophilic migration of the gonadotropin-releasing hormone neurons. *J Neurosci* 25:3142-3150.

Gardiner NJ, Fernyhough P, Tomlinson DR, Mayer U, von der Mark H, Streuli CH (2005) Alpha7 integrin mediates neurite outgrowth of distinct populations of adult sensory neurons. *Mol Cell Neurosci* 28:229-240.

Gardiner NJ, Moffatt S, Fernyhough P, Humphries MJ, Streuli CH, Tomlinson DR (2007) Preconditioning injury-induced neurite outgrowth of adult rat sensory neurons on fibronectin is mediated by mobilisation of axonal alpha5 integrin. *Mol Cell Neurosci* 35:249-260.

Giacobini P, Messina A, Morello F, Ferraris N, Corso S, Penachioni J, Giordano S, Tamagnone L, Fasolo A (2008) Semaphorin 4D regulates gonadotropin hormone-releasing hormone-1 neuronal migration through PlexinB1-Met complex. *J Cell Biol* 183:555-566.

Gibson MJ, Ingraham L, Dobrjansky A (2000) Soluble factors guide gonadotropin-releasing hormone axonal targeting to the median eminence. *Endocrinology* 141:3065-3071.

- Gill JC, Tsai PS (2006) Expression of a dominant negative FGF receptor in developing GNRH1 neurons disrupts axon outgrowth and targeting to the median eminence. *Biol Reprod* 74:463-472.
- Graus-Porta D, Blaess S, Senften M, Littlewood-Evans A, Damsky C, Huang Z, Orban P, Klein R, Schittny JC, Muller U (2001) Beta1-class integrins regulate the development of laminae and folia in the cerebral and cerebellar cortex. *Neuron* 31:367-379.
- Hamilton DL, Abremski K (1984) Site-specific recombination by the bacteriophage P1 lox-Cre system. Cre-mediated synapsis of two lox sites. *J Mol Biol* 178:481-486.
- Hanchate NK, Parkash J, Bellefontaine N, Mazur D, Colledge WH, d'Anglemont de Tassigny X, Prevot V (2012) Kisspeptin-GPR54 signaling in mouse NO-synthesizing neurons participates in the hypothalamic control of ovulation. *J Neurosci* 32:932-945.
- Huang Z, Shimazu K, Woo NH, Zang K, Muller U, Lu B, Reichardt LF (2006) Distinct roles of the beta 1-class integrins at the developing and the mature hippocampal excitatory synapse. *J Neurosci* 26:11208-11219.
- Hynes RO (2002) Integrins: bidirectional, allosteric signaling machines. *Cell* 110:673-687.
- Jarzab B, Dohler KD (1984) Serotonergic influences on sexual differentiation of the rat brain. *Prog Brain Res* 61:119-126.
- Khan KN, Masuzaki H, Fujishita A, Kitajima M, Sekine I, Matsuyama T, Ishimaru T (2005) Estrogen and progesterone receptor expression in macrophages and regulation of hepatocyte growth factor by ovarian steroids in women with endometriosis. *Hum Reprod* 20:2004-2013.
- Kumar TR, Wang Y, Lu N, Matzuk MM (1997) Follicle stimulating hormone is required for ovarian follicle maturation but not male fertility. *Nat Genet* 15:201-204.
- Lilienbaum A, Reszka AA, Horwitz AF, Holt CE (1995) Chimeric integrins expressed in retinal ganglion cells impair process outgrowth in vivo. *Mol Cell Neurosci* 6:139-152.
- Lim H, Paria BC, Das SK, Dinchuk JE, Langenbach R, Trzaskos JM, Dey SK (1997) Multiple female reproductive failures in cyclooxygenase 2-deficient mice. *Cell* 91:197-208.
- Liu Y, Lin L, Zarnegar R (1994) Modulation of hepatocyte growth factor gene expression by estrogen in mouse ovary. *Mol Cell Endocrinol* 104:173-181.
- Lydon JP, DeMayo FJ, Conneely OM, O'Malley BW (1996) Reproductive phenotypes of the progesterone receptor null mutant mouse. *J Steroid Biochem Mol Biol* 56:67-77.

Maric D, Maric I, Chang YH, Barker JL (2003) Prospective cell sorting of embryonic rat neural stem cells and neuronal and glial progenitors reveals selective effects of basic fibroblast growth factor and epidermal growth factor on self-renewal and differentiation. *J Neurosci* 23:240-251.

Messina A, Ferraris N, Wray S, Cagnoni G, Donohue DE, Casoni F, Kramer PR, Derijck AA, Adolfs Y, Fasolo A, Pasterkamp RJ, Giacobini P (2011) Dysregulation of Semaphorin7A/beta1-integrin signaling leads to defective GnRH-1 cell migration, abnormal gonadal development and altered fertility. *Hum Mol Genet* 20:4759-4774.

Moresco EM, Donaldson S, Williamson A, Koleske AJ (2005) Integrin-mediated dendrite branch maintenance requires Abelson (Abl) family kinases. *J Neurosci* 25:6105-6118.

Moser M, Legate KR, Zent R, Fassler R (2009) The tail of integrins, talin, and kindlins. *Science* 324:895-899.

Nguyen H, Ivanova VS, Kavandi L, Rodriguez GC, Maxwell GL, Syed V (2011) Progesterone and 1,25-dihydroxyvitamin D(3) inhibit endometrial cancer cell growth by upregulating semaphorin 3B and semaphorin 3F. *Mol Cancer Res* 9:1479-1492.

Nikolova Z, Djonov V, Zuercher G, Andres AC, Ziemiecki A (1998) Cell-type specific and estrogen dependent expression of the receptor tyrosine kinase EphB4 and its ligand ephrin-B2 during mammary gland morphogenesis. *J Cell Sci* 111 (Pt 18):2741-2751.

Ojeda SR, Skinner MK (2006) Physiology of the gonadotropin-releasing hormone neuronal network. In: Knobil and Neill's Physiology of Reproduction, pp. 2061-2126. New York: Elsevier, 3rd Ed.

Pasterkamp RJ, Peschon JJ, Spriggs MK, Kolodkin AL (2003) Semaphorin 7A promotes axon outgrowth through integrins and MAPKs. *Nature* 424:398-405.

Pavelock K, Braas K, Ouafik L, Osol G, May V (2001) Differential expression and regulation of the vascular endothelial growth factor receptors neuropilin-1 and neuropilin-2 in rat uterus. *Endocrinology* 142:613-622.

Pfaff M, McLane MA, Beviglia L, Niewiarowski S, Timpl R (1994) Comparison of disintegrins with limited variation in the RGD loop in their binding to purified integrins alpha IIb beta 3, alpha V beta 3 and alpha 5 beta 1 and in cell adhesion inhibition. *Cell Adhes Commun* 2:491-501.

Pinkstaff JK, Detterich J, Lynch G, Gall C (1999) Integrin subunit gene expression is regionally differentiated in adult brain. *J Neurosci* 19:1541-1556.

Plantman S, Patarroyo M, Fried K, Domogatskaya A, Tryggvason K, Hammarberg H, Cullheim S (2008) Integrin-laminin interactions controlling neurite outgrowth from adult DRG neurons in vitro. *Mol Cell Neurosci* 39:50-62.

Prevot V, Lomniczi A, Corfas G, Ojeda SR (2005) erbB-1 and erbB-4 receptors act in concert to facilitate female sexual development and mature reproductive function. *Endocrinology* 146:1465-1472.

Reichardt LF, Tomaselli KJ (1991) Extracellular matrix molecules and their receptors: functions in neural development. *Annu Rev Neurosci* 14:531-570.

Richeri A, Chalar C, Martinez G, Greif G, Bianchimano P, Brauer MM (2011) Estrogen up-regulation of semaphorin 3F correlates with sympathetic denervation of the rat uterus. *Auton Neurosci* 164:43-50.

Schwanzel-Fukuda M, Pfaff DW (1989) Origin of luteinizing hormone-releasing hormone neurons. *Nature* 338:161-164.

Schwarting GA, Raitcheva D, Bless EP, Ackerman SL, Tobet S (2004) Netrin 1-mediated chemoattraction regulates the migratory pathway of LHRH neurons. *Eur J Neurosci* 19:11-20.

Simerly RB (1998) Organization and regulation of sexually dimorphic neuroendocrine pathways. *Behav Brain Res* 92:195-203.

Simerly RB (2002) Wired for reproduction: organization and development of sexually dimorphic circuits in the mammalian forebrain. *Annu Rev Neurosci* 25:507-536.

Singh P, Chen C, Pal-Ghosh S, Stepp MA, Sheppard D, Van De Water L (2009) Loss of integrin alpha9beta1 results in defects in proliferation, causing poor re-epithelialization during cutaneous wound healing. *J Invest Dermatol* 129:217-228.

Spergel DJ, Kruth U, Hanley DF, Sprengel R, Seeburg PH (1999) GABA- and glutamate-activated channels in green fluorescent protein-tagged gonadotropin-releasing hormone neurons in transgenic mice. *J Neurosci* 19:2037-2050.

Stephens LE, Sutherland AE, Klimanskaya IV, Andrieux A, Meneses J, Pedersen RA, Damsky CH (1995) Deletion of beta 1 integrins in mice results in inner cell mass failure and peri-implantation lethality. *Genes Dev* 9:1883-1895.

Tobet S, Knoll JG, Hartshorn C, Aurand E, Stratton M, Kumar P, Searcy B, McClellan K (2009) Brain sex differences and hormone influences: a moving experience? *J Neuroendocrinol* 21:387-392.

Tsai PS, Moenter SM, Postigo HR, El Majdoubi M, Pak TR, Gill JC, Paruthiyil S, Werner S, Weiner RI (2005) Targeted expression of a dominant-negative fibroblast growth factor (FGF) receptor in gonadotropin-releasing hormone (GnRH) neurons reduces FGF responsiveness and the size of GnRH neuronal population. *Mol Endocrinol* 19:225-236.

Warren MS, Bradley WD, Gourley SL, Lin YC, Simpson MA, Reichardt LF, Greer CA, Taylor JR, Koleske AJ (2012) Integrin beta1 Signals through Arg to Regulate Postnatal Dendritic Arborization, Synapse Density, and Behavior. *J Neurosci* 32:2824-2834.

Webb DJ, Zhang H, Majumdar D, Horwitz AF (2007) alpha5 integrin signaling regulates the formation of spines and synapses in hippocampal neurons. *J Biol Chem* 282:6929-6935.

Wierman ME, Kiseljak-Vassiliades K, Tobet S (2011) Gonadotropin-releasing hormone (GnRH) neuron migration: initiation, maintenance and cessation as critical steps to ensure normal reproductive function. *Front Neuroendocrinol* 32:43-52.

Wray S (2010) From nose to brain: development of gonadotrophin-releasing hormone-1 neurones. *J Neuroendocrinol* 22:743-753.

Wray S, Grant P, Gainer H (1989) Evidence that cells expressing luteinizing hormone-releasing hormone mRNA in the mouse are derived from progenitor cells in the olfactory placode. *Proc Natl Acad Sci U S A* 86:8132-8136.

Yoon H, Enquist LW, Dulac C (2005) Olfactory inputs to hypothalamic neurons controlling reproduction and fertility. *Cell* 123:669-682.

Novel Role for Anti-Müllerian Hormone in the Regulation of GnRH

Neuron Excitability and Hormone Secretion

Irene Cimino ^{1,2}, Filippo Casoni ^{1,2}, Xinhuai Liu ³, Andrea Messina ^{1,2}, Jyoti Parkash ^{1,2}, Soazik P Jamin ⁴,
Sophie Catteau-Jonard ^{1,2,5}, Francis Collier ^{2,5}, Marc Baroncini ^{1,2}, Didier Dewailly ^{1,2,5}, Allan E Herbison ³,
Vincent Prevot ^{1,2}, Paolo Giacobini ^{1,2*}

1 Inserm, Jean-Pierre Aubert Research Center, U837, Development and Plasticity of the Postnatal Brain, Lille, France

2 Université Lille Nord de France, Institut de Médecine Predictive et de Recherche Thérapeutique (IMPRT-IFR114), Lille, France

3 Centre for Neuroendocrinology and Department of Physiology, University of Otago School of Medical Sciences, Dunedin 9054, New Zealand

4 Inserm U1085-IRSET, Université de Rennes 1, Rennes, France

5 Service de Gynécologie Endocrinienne et Médecine de la Reproduction, Hôpital Jeanne de Flandre, CHU de Lille, Lille, France

* To whom correspondence should be addressed

Address: Inserm, Jean-Pierre Aubert Research Center, Unité 837, Development and Plasticity of the Postnatal Brain, Place de Verdun, 59045, Lille Cedex, France

Tel: +33-320622060

Fax: +33-320538562

Email: paolo.giacobini@inserm.fr

Submitted to "LETTERS TO NATURE MEDICINE"

Polycystic ovary syndrome (PCOS) is the most common cause of female infertility, affecting up to 10% of all women worldwide ^{1,2}. It is a clinically heterogeneous reproductive disorder associated with both genetic and environmental factors ³. The reproductive dysfunction involves persistently rapid gonadotropin-releasing hormone (GnRH) pulsatility, which favors the pituitary synthesis of luteinizing hormone (LH) over follicle-stimulating hormone (FSH) ⁴. These observations indicate that elevated GnRH release is an important pathophysiological feature in many cases of PCOS, although the origin of this dysregulation remains unknown.

Another hallmark of PCOS is elevated levels of circulating anti-Müllerian hormone (AMH) ^{5,6}. In addition to the ovaries, AMH and its receptors are expressed in multiple areas of the murine central nervous system, indicating that the brain represents another region of AMH signaling ⁷⁻¹¹. However, the possible extra-ovarian effects of AMH on the hypothalamic-pituitary-gonadal axis have never been investigated.

Here, we show that AMH is an important regulator of GnRH neuronal function and significantly stimulates the firing activity of GnRH neurons as well as the secretion of GnRH and LH, highlighting how aberrant AMH signaling in GnRH neurons might culminate in PCOS.

AMH, also known as Müllerian-inhibiting substance (MIS), is a member of the transforming growth factor- β (TGF- β) superfamily. It is a homodimeric glycoprotein with a molecular weight of 140 kDa, in which the two monomers are linked by disulfide bonds¹². AMH is produced by the fetal testis playing an important role during sexual differentiation of the male genital tract where it inhibits Müllerian duct development into the female reproductive tract. In the absence of AMH or in cases of AMH receptor insensitivity, the Müllerian ducts generate fallopian tubes, a uterus and the upper vagina in both sexes¹³. In females, AMH is secreted by the granulosa cells of ovarian follicles¹⁴ and appears to regulate early follicular development, controlling the transition from resting primordial follicles to growing follicles¹⁵. In addition, in PCOS women, AMH is suspected to play a significant role in causing anovulation due to its inhibitory influence on FSH that normally promotes follicular development from the small antral stage to ovulation stage¹⁶.

AMH binds to a specific type II receptor (AMHR2)^{17,18} that heterodimerizes with one of a variety of type I receptors (ALK2, ALK3 and ALK6) to transduce its signal¹⁹. The type II receptor contains an intracellular kinase domain that phosphorylates serine and threonine residues located near the transmembrane region of the type I receptor, in the glycine/serine rich (GS) domain, and recruits Smad proteins that are translocated to the nucleus to regulate the expression of their target genes²⁰.

AMH is the only known ligand of AMHR2, suggesting that tissues that express this receptor are likely to be targets of AMH. In females, the distribution and function of AMHR2 have not been extensively studied beyond its role in the ovaries, even though it is expressed in extragonadal tissues including the developing brain^{7,8}. In a preliminary analysis, we thus examined the expression pattern of AMHR2 protein in the adult (postnatal day P90) female mouse brain by labeling sections with a purified polyclonal antiserum to AMHR2 (**Supplementary Fig. 1a, b**). AMHR2-immunoreactive cells were widely distributed in several brain regions including the cortex (**Supplementary Fig. 1a**), hypothalamus (**Fig. 1e**), hippocampus and cerebellum (data not shown). Pre-incubation of the antiserum with its specific immunogen resulted in an absence of immunoreactivity, indicating its specificity to AMHR2 (**Supplementary Fig. 1b**). This was also confirmed by western blot analysis on protein

extracts of ovaries harvested from *Amhr2* wild-type and knock-out mice (**Supplementary Fig. 1c**).

In order to determine whether GnRH neurons express AMHR2 during their development and maturation, double-immunofluorescence experiments were performed on sections of mouse (**Fig. 1a-c**) and human fetuses (**Fig. 1j-m**) as well as on sections of the hypothalamus of adult female mice (**Fig. 1d-i**) and humans (**Fig. 1n-p**). We found that in both mice and humans, AMHR2 was expressed in GnRH neurons from early embryonic development, coincident with the beginning of the migratory process^{21,22}, up to adulthood. In adult mice, immunolabeling of sections containing the rostral preoptic area, including the organum vasculosum of the lamina terminalis (OVL; n = 5; **Fig. 2d-i**), revealed that GnRH neurons located in this region express AMHR2.

In order to further study the expression of AMHR2 in these regions, we took advantage of a transgenic mouse line (*AMHR2::Cre*) that expresses the Cre recombinase under the control of the AMHR2 promoter²³ and crossed it with a tdTomato reporter line (*tdTomato^{loxP/STOP}*) to generate fluorescent AMHR2-expressing cells in double-transgenic offspring (*AMHR2::Cre; tdTomato^{loxP/STOP}*) (**Supplementary Fig. 2**). Consistent with our immunohistochemical data, within the hypothalamus, we observed tdTomato expression cells in GnRH cell bodies (**Supplementary Fig. 2a-e**), as well as in endothelial and ependymal cells of the median eminence (ME) (**Supplementary Fig. 2f-h**), which are known to interact closely with GnRH terminals in the ME^{24,25}. The co-expression of vimentin by many cells in the ependymal layer indicated that they are tanycytes, specialized glial cells of the hypothalamus that play essential roles in regulating neurohormone secretion by GnRH neurons²⁶.

We next took advantage of *GnRH::GFP*²⁷ mice to isolate GFP-positive GnRH neurons by FACS (Fluorescence-Activated Cell Sorting)²⁸ and we analyzed by qRT-PCR the expression of genes of interest in these neurons isolated at different developmental stages. GnRH neurons were harvested respectively from the noses of embryonic day 12.5 (E12.5) embryos, in which the majority of the GnRH population is still located in the nasal region (**Fig. 2a**)^{21,22}, and from the hypothalamic/preoptic area of juvenile (postnatal day 12; P12) and adult female mice, in which GnRH neurons have finished their migration into the brain (**Fig. 2a**). The expression of the *AMHR2* transcript in GnRH neurons was low during embryonic development but

significantly increased in juvenile and adult mice (**Fig. 2b**). In addition to *AMHR2*, mature GnRH neurons expressed the three ALK receptors (**Fig. 2c**).

We next performed electrophysiological recordings of GnRH neurons in acute brain-slice preparations from the rostral preoptic area of *GnRH::GFP* mice. AMH at 1, 10 and 100 ng/ml concentrations was tested on GnRH-GFP neurons located in the rostral preoptic area by bath application. This concentration range is physiological; indeed serum AMH levels in adult mice (4-8 months old) have been reported to be about 30 ng/ml²⁹.

AMH at 1 ng/ml was applied to 20 GnRH neurons, of which 8 exhibited a mean increase in firing rate from $0.82 \pm 0.36\text{Hz}$ to $1.76 \pm 0.38\text{Hz}$ ($p = 0.0142$; Wilcoxon Signed Ranks Test for paired samples) that lasted 6.12 ± 1.67 min (**Fig. 3a, b**). The 8 responding cells were then tested with 10 ng/ml AMH, which was found to induce a more marked increase in neuronal activity (firing rate: $1.25 \pm 0.43\text{Hz}$ to $2.75 \pm 0.37\text{Hz}$, $p = 0.0142$; paired sample Wilcoxon Signed Ranks Test for paired samples) with a mean duration of 12.7 ± 1.4 min (**Fig. 3a, b**). Another group of GnRH neurons was tested with 100 ng/ml of bath applied AMH, and 4 out of the 10 displayed an increase in excitation ranging from 0.93 ± 0.55 Hz to 2.47 ± 0.24 Hz ($p < 0.05$, paired sample Wilcoxon Signed Ranks Test for paired samples), with the duration of enhanced activity lasting 13.2 ± 1.2 min. To determine whether the effects of AMH on GnRH neurons involve ionotropic amino acid transmission, an amino acid receptor blocker (AAB) cocktail consisting of the AMPA/kainate antagonist CNQX, the NMDA receptor antagonist kynurenic acid and the GABAA receptor antagonist GABAazine was applied to the bath before AMH application. AMH (10 ng/ml) continued to increase GnRH neuronal activation in the presence of the AAB cocktail ($n = 3$, **Fig. 3c, d**), indicating that the actions of AMH on GnRH neurons are independent of ionotropic receptor-mediated presynaptic inputs. We then tested GnRH neurons from male ($n = 9$ cells), diestrous female ($n = 11$ cells) and proestrous female ($n = 24$ cells) mice with the sub-maximal concentration of AMH (10 ng/ml) to determine whether the response of GnRH neurons to AMH differed according to sex or estrous cycle phase. In all groups, approximately 50% of GnRH neurons responded to AMH (56% in males, 64% in diestrous and 49% in proestrous females) with a 70-80% increase in activity that lasted for 10-17 min (**Fig. 3e**). The percentage of cells responding and the magnitude of the increase in firing were not different between the three groups (Chi Squared test and ANOVA). However,

the duration of the response was significantly reduced in GnRH neurons from proestrous mice compared with diestrous animals ($p < 0.01$; Fisher's Least Significant Difference, LSD, **Fig. 3e**). These electrophysiological investigations show that AMH is a potent activator of nearly 50% of GnRH neurons, independent of sex. Notably, only 50–70% of all GnRH neurons are thought to be involved in controlling pituitary gonadotropin secretion^{30,31}, indicating that the AMH-induced increase in the pulsatile secretion of GnRH might indeed be relevant to the regulation of LH secretion under physiological and pathological conditions. Remarkably, our results also indicate that AMH at subnanomolar concentrations (from 0.01 to 1 nM) can exert potent stimulatory effects on GnRH neurons, a property rarely displayed by peptides with respect to these neurons, with the exception of kisspeptin^{32,33}.

In order to test whether the activatory effect of AMH on GnRH neurons was of functional importance, we studied whether AMH could enhance GnRH secretion from nerve terminals in rat ME explants (**Fig. 3f-h**). The ME is one of eight circumventricular organs – regions surrounding the cerebral ventricles – in the central nervous system, in which the blood-brain barrier is modified by the fenestration of endothelial cells to allow the release of neurohormones by neuroendocrine cell terminals into pituitary portal blood vessels for delivery to the anterior pituitary^{34,35}. Plasma AMH could thus access this region through fenestrated capillaries and act on GnRH terminals directly to trigger the rapid secretion of the neurohormone and/or indirectly via tanycytes or vascular endothelial cells, which also express AMHR2 (**Supplementary Fig. 2g, h**).

ME explants, which only contain GnRH axon terminals but not cell bodies, were generated as previously described³⁶⁻³⁸ from adult female rats during diestrus, when GnRH secretion is low, and challenged with AMH (3 $\mu\text{g/ml}$) for 4 hours before using ELISA to measure the amount of GnRH secreted into the medium (**Fig. 3g**). In explants from diestrous rats, treatment with AMH resulted in a 4-fold increase in GnRH release when compared to vehicle-treated explants (**Fig. 3g**), although further investigations are necessary to determine which cell type or types are involved in this increased release. These results were confirmed by repeating the same experiments in adult female rats four weeks after they were ovariectomized (OVX), to remove the effects of the endogenous gonadal hormones on the explant preparations (**Fig. 3h**).

Since AMH is a member of the TGF- β superfamily, we then tested whether TGF- β 1 similarly elicited GnRH secretion from the ME of OVX rats (**Fig. 3h**). In agreement with earlier studies³⁸, we found that TGF- β 1 treatment was not able to alter GnRH release (**Fig. 3h**), confirming the specificity of the AMH signaling pathway in the increase in GnRH neuronal activity and hormone secretion.

To examine the effects of AMH on gonadotropin secretion *in vivo*, we next administered AMH directly into the lateral ventricle of diestrous female mice, and measured LH secretion, an index of GnRH release and function (**Fig. 4a**). We first analyzed plasma LH concentrations 15 minutes after administering increasing doses of AMH (**Fig. 4b**), and found that 3 μ g/ml of AMH injected intracerebroventricularly (i.c.v.) induced the strongest increase in LH release. We thus used this concentration in subsequent experiments, and analyzed LH levels 15 and 30 min after the injection. AMH administration induced a rapid increase in LH secretion 15 min after treatment (**Fig. 4c**), but returned to baseline by 30 minutes, strongly suggesting that this action of AMH is not mediated by the canonical Smad proteins, whose activation normally requires a few hours, but rather through a fast and non-genomic pathway. Interestingly, the effects of AMH treatment on LH secretion were significantly attenuated by the intravenous delivery of an ALK 2/3/6 inhibitor (100 μ M), suggesting that the AMH-induced rise in LH is nevertheless dependent on AMH receptor signaling (**Fig. 4c**).

In order to determine whether the actions of AMH administered i.c.v. on GnRH/LH secretion were indeed mediated by GnRH neuronal activity and not by a direct effect on the pituitary, we administered a GnRH antagonist (cetorelix acetate; 0.5 mg/Kg), intraperitoneally (i.p.) 30 min prior to AMH i.c.v. administration (3 μ g/1 μ l per mouse). Cetorelix acetate is known to specifically saturate GnRH receptors at the level of the anterior pituitary^{39,40}, thus preventing LH secretion. The effects of AMH on LH secretion were totally blocked by cetorelix treatment, excluding a direct effect of AMH at the level of the pituitary, where both the ligand and its receptor are expressed and active in gonadotropin transcription⁴¹. This provides further support for the central action of AMH on GnRH neurons (**Fig. 4c**).

This work shows for the first time that AMH acts on the central nervous system and in particular at the hypothalamic level increasing GnRH neuronal activation and secretion. This is

particular relevant since it points to AMH not only as a diagnostic marker of PCOS but also as a potential target for PCOS treatment.

Indeed, we can speculate that elevated AMH levels detected in PCOS women could contribute to the dysregulation of the GnRH and LH pulsatility that characterize the syndrome (**Supplementary fig. 3**). In fact, elevated immunoreactive and bioactive LH levels have been detected in the serum of about 70% of women with PCOS, and the elevation of LH pulse amplitude and frequency induces a two-to-threefold elevation in circulating LH levels when compared to FSH⁴².

The intriguing concept that AMH may act as a trigger for GnRH release via AMHR2 at the hypothalamic level by targeting GnRH neurons not only in rodents but also in humans (**Fig. 2j-p**) raises the thought-provoking idea that certain types of PCOS could primarily be due to a hypothalamic dysfunction.

Interestingly, in a recent study, a role for the AMHR2-482 A>G gene polymorphism in the pathogenesis of PCOS has been suggested⁴⁴. Notably, Rigon and co-authors⁴⁵ have also shown that genetic variants of the AMHR2 gene are associated with idiopathic, non-PCOS-related, female infertility, further supporting the relevance of AMH signaling in the hypothalamic-pituitary-gonadal axis in physiological and pathological conditions.

ACKNOWLEDGMENTS

This work was supported by the Institut National de la Sante et de la Recherche Medicale, Inserm, France (grant number U837), Agence Nationale de la Recherche, ANR, France (grant numbers ANR-2010-JCJC-1404 – 01 to P.G. and ANR-09-BLAN-0267 to V.P.), the Fondation pour la Recherche Medicale (Equipe FRM 2005 & DEQ20130326524, France to V.P), the Institut de Médecine Prédictive et de Recherche Thérapeutique (IMPRT-IFR114, France; electron microscopy core facility), the University of Lille 2, Lille, France (Appel à Projets du Conseil Scientifique de l'Universite Lille 2 to P.G.), the New Zealand Health Research Council (A.H and X.L.). We thank Meryem Tardivel (imaging core facility, IMPRT-IFR114), Nathalie Jouy (cell sorting core facility, IMPRT-IFR114), Delphine Taillieu and Julien Devassine (animal core facility, IMPRT-IFR114) for their expert technical assistance and Dr. S. Rasika for the editing of our manuscript.

AUTHOR CONTRIBUTIONS

I.C. prepared the original draft of the manuscript and was involved in all aspects of the experimental design and research, including execution of rodent surgeries (i.c.v injections), dissections, ELISA and immunohistochemical experiments in rodents and part of the transcripts' analyses. F.C. performed immunohistochemistry on human tissues and participated in some experimental designs. X.L. performed all electrophysiological recordings. A.M. performed FACS sorting and quantitative PCR execution. J.P. performed explant cultures. S.P.J. provided the AMHR2::Cre mice. S.J. and D.D. were involved in the interpretation of results and preparation of the manuscript. F.C. was responsible for human tissue generation and preparation of relevant human subjects' information. M.B. collected the hypothalamus from adult post-mortem brains. A.E.H. was involved in the analysis and interpretation of the electrophysiological experiments. V.P. was involved in all aspects of study design and interpretation of results. P.G. was involved in all aspects of study design, data analysis, interpretation of results, preparation of the manuscript and figures and funded the project. All authors discussed the results presented in the manuscript.

COMPETING FINANCIAL INTERESTS

The authors declare no competing financial

REFERENCES

1. Broekmans, F.J. & Fauser, B.C. Diagnostic criteria for polycystic ovarian syndrome. *Endocrine* **30**, 3-11 (2006).
2. Ehrmann, D.A. Polycystic ovary syndrome. *The New England journal of medicine* **352**, 1223-1236 (2005).
3. Roland, A.V. & Moenter, S.M. Reproductive neuroendocrine dysfunction in polycystic ovary syndrome: Insight from animal models. *Frontiers in neuroendocrinology* (2014).
4. Taylor, A.E., *et al.* Determinants of abnormal gonadotropin secretion in clinically defined women with polycystic ovary syndrome. *The Journal of clinical endocrinology and metabolism* **82**, 2248-2256 (1997).
5. Piouka, A., *et al.* Anti-Mullerian hormone levels reflect severity of PCOS but are negatively influenced by obesity: relationship with increased luteinizing hormone levels. *American journal of physiology. Endocrinology and metabolism* **296**, E238-243 (2009).
6. Cook, C.L., Siow, Y., Brenner, A.G. & Fallat, M.E. Relationship between serum mullerian-inhibiting substance and other reproductive hormones in untreated women with polycystic ovary syndrome and normal women. *Fertility and sterility* **77**, 141-146 (2002).
7. Lebeurrier, N., *et al.* Anti-Mullerian-hormone-dependent regulation of the brain serine-protease inhibitor neuroserpin. *J Cell Sci* **121**, 3357-3365 (2008).
8. Wang, P.Y., *et al.* Mullerian inhibiting substance contributes to sex-linked biases in the brain and behavior. *Proceedings of the National Academy of Sciences of the United States of America* **106**, 7203-7208 (2009).
9. Wittmann, W. & McLennan, I.S. Anti-Mullerian hormone may regulate the number of calbindin-positive neurons in the sexually dimorphic nucleus of the preoptic area of male mice. *Biology of sex differences* **4**, 18 (2013).
10. Wittmann, W. & McLennan, I.S. The bed nucleus of the stria terminalis has developmental and adult forms in mice, with the male bias in the developmental form being dependent on testicular AMH. *Hormones and behavior* **64**, 605-610 (2013).
11. Kow, L.M., *et al.* Development of a sexually differentiated behavior and its underlying CNS arousal functions. *Current topics in developmental biology* **79**, 37-59 (2007).
12. Cate, R.L., *et al.* Isolation of the bovine and human genes for Mullerian inhibiting substance and expression of the human gene in animal cells. *Cell* **45**, 685-698 (1986).
13. Behringer, R.R., Finegold, M.J. & Cate, R.L. Mullerian-inhibiting substance function during mammalian sexual development. *Cell* **79**, 415-425 (1994).

14. Vigier, B., Picard, J.Y., Tran, D., Legeai, L. & Josso, N. Production of anti-Mullerian hormone: another homology between Sertoli and granulosa cells. *Endocrinology* **114**, 1315-1320 (1984).
15. Durlinger, A.L., *et al.* Control of primordial follicle recruitment by anti-Mullerian hormone in the mouse ovary. *Endocrinology* **140**, 5789-5796 (1999).
16. Homburg, R. & Crawford, G. The role of AMH in anovulation associated with PCOS: a hypothesis. *Human reproduction* **29**, 1117-1121 (2014).
17. di Clemente, N., *et al.* Cloning, expression, and alternative splicing of the receptor for anti-Mullerian hormone. *Molecular endocrinology* **8**, 1006-1020 (1994).
18. Baarends, W.M., *et al.* A novel member of the transmembrane serine/threonine kinase receptor family is specifically expressed in the gonads and in mesenchymal cells adjacent to the mullerian duct. *Development* **120**, 189-197 (1994).
19. Josso, N. & Clemente, N. Transduction pathway of anti-Mullerian hormone, a sex-specific member of the TGF-beta family. *Trends in endocrinology and metabolism: TEM* **14**, 91-97 (2003).
20. Visser, J.A. & Themmen, A.P. Anti-Mullerian hormone and folliculogenesis. *Molecular and cellular endocrinology* **234**, 81-86 (2005).
21. Wray, S., Grant, P. & Gainer, H. Evidence that cells expressing luteinizing hormone-releasing hormone mRNA in the mouse are derived from progenitor cells in the olfactory placode. *Proceedings of the National Academy of Sciences of the United States of America* **86**, 8132-8136 (1989).
22. Schwanzel-Fukuda, M. & Pfaff, D.W. Origin of luteinizing hormone-releasing hormone neurons. *Nature* **338**, 161-164 (1989).
23. Jamin, S.P., Arango, N.A., Mishina, Y., Hanks, M.C. & Behringer, R.R. Requirement of *Bmpr1a* for Mullerian duct regression during male sexual development. *Nature genetics* **32**, 408-410 (2002).
24. Prevot, V., *et al.* Neuronal-glial-endothelial interactions and cell plasticity in the postnatal hypothalamus: implications for the neuroendocrine control of reproduction. *Psychoneuroendocrinology* **32 Suppl 1**, S46-51 (2007).
25. Giacobini, P., *et al.* Brain Endothelial Cells Control Fertility through Ovarian-Steroid-Dependent Release of Semaphorin 3A. *PLoS Biol* **12**, e1001808 (2014).
26. Mullier, A., Bouret, S.G., Prevot, V. & Dehouck, B. Differential distribution of tight junction proteins suggests a role for tanycytes in blood-hypothalamus barrier regulation in the adult mouse brain. *The Journal of comparative neurology* **518**, 943-962 (2010).

27. Spergel, D.J., Kruth, U., Hanley, D.F., Sprengel, R. & Seeburg, P.H. GABA- and glutamate-activated channels in green fluorescent protein-tagged gonadotropin-releasing hormone neurons in transgenic mice. *J Neurosci* **19**, 2037-2050 (1999).
28. Parkash, J., *et al.* Suppression of beta1-Integrin in Gonadotropin-Releasing Hormone Cells Disrupts Migration and Axonal Extension Resulting in Severe Reproductive Alterations. *J Neurosci* **32**, 16992-17002 (2012).
29. Kevenaar, M.E., *et al.* Serum anti-mullerian hormone levels reflect the size of the primordial follicle pool in mice. *Endocrinology* **147**, 3228-3234 (2006).
30. Silverman, A.J., Jhamandas, J. & Renaud, L.P. Localization of luteinizing hormone-releasing hormone (LHRH) neurons that project to the median eminence. *J Neurosci* **7**, 2312-2319 (1987).
31. Merchenthaler, I., Setalo, G., Petrusz, P., Negro-Vilar, A. & Flerko, B. Identification of hypophysiotropic luteinizing hormone-releasing hormone (LHRH) neurons by combined retrograde labeling and immunocytochemistry. *Experimental and clinical endocrinology* **94**, 133-140 (1989).
32. Pielecka-Fortuna, J., Chu, Z. & Moenter, S.M. Kisspeptin acts directly and indirectly to increase gonadotropin-releasing hormone neuron activity and its effects are modulated by estradiol. *Endocrinology* **149**, 1979-1986 (2008).
33. Han, S.K., *et al.* Activation of gonadotropin-releasing hormone neurons by kisspeptin as a neuroendocrine switch for the onset of puberty. *J Neurosci* **25**, 11349-11356 (2005).
34. Page, R. *The anatomy of the hypothalamo-hypophysial complex.* In: Knobil E. and Neill J.D., editors. *Physiology of Reproduction*, (New York, Raven Press, 1994).
35. Langlet, F., *et al.* Tanycytic VEGF-A boosts blood-hypothalamus barrier plasticity and access of metabolic signals to the arcuate nucleus in response to fasting. *Cell metabolism* **17**, 607-617 (2013).
36. Prevot, V., *et al.* Estradiol coupling to endothelial nitric oxide stimulates gonadotropin-releasing hormone release from rat median eminence via a membrane receptor. *Endocrinology* **140**, 652-659 (1999).
37. Prevot, V., Cornea, A., Mungenast, A., Smiley, G. & Ojeda, S.R. Activation of erbB-1 signaling in tanycytes of the median eminence stimulates transforming growth factor beta1 release via prostaglandin E2 production and induces cell plasticity. *J Neurosci* **23**, 10622-10632 (2003).
38. Ojeda, S.R., Urbanski, H.F., Costa, M.E., Hill, D.F. & Moholt-Siebert, M. Involvement of transforming growth factor alpha in the release of luteinizing hormone-releasing hormone from the developing female hypothalamus. *Proceedings of the National Academy of Sciences of the United States of America* **87**, 9698-9702 (1990).

39. Halmos, G., Schally, A.V., Pinski, J., Vadillo-Buenfil, M. & Groot, K. Down-regulation of pituitary receptors for luteinizing hormone-releasing hormone (LH-RH) in rats by LH-RH antagonist Cetrorelix. *Proceedings of the National Academy of Sciences of the United States of America* **93**, 2398-2402 (1996).
40. Pinski, J., *et al.* Chronic administration of the luteinizing hormone-releasing hormone (LHRH) antagonist cetrorelix decreases gonadotrope responsiveness and pituitary LHRH receptor messenger ribonucleic acid levels in rats. *Endocrinology* **137**, 3430-3436 (1996).
41. Bedecarrats, G.Y., O'Neill, F.H., Norwitz, E.R., Kaiser, U.B. & Teixeira, J. Regulation of gonadotropin gene expression by Mullerian inhibiting substance. *Proceedings of the National Academy of Sciences of the United States of America* **100**, 9348-9353 (2003).
42. Goodarzi, M.O., Dumesic, D.A., Chazenbalk, G. & Azziz, R. Polycystic ovary syndrome: etiology, pathogenesis and diagnosis. *Nat Rev Endocrinol* **7**, 219-231 (2011).
43. Eagleson, C.A., *et al.* Polycystic ovarian syndrome: evidence that flutamide restores sensitivity of the gonadotropin-releasing hormone pulse generator to inhibition by estradiol and progesterone. *The Journal of clinical endocrinology and metabolism* **85**, 4047-4052 (2000).
44. Georgopoulos, N.A., *et al.* Increased frequency of the anti-mullerian-inhibiting hormone receptor 2 (AMHR2) 482 A>G polymorphism in women with polycystic ovary syndrome: relationship to luteinizing hormone levels. *The Journal of clinical endocrinology and metabolism* **98**, E1866-1870 (2013).
45. Rigon, C., *et al.* Association study of AMH and AMHR2 polymorphisms with unexplained infertility. *Fertility and sterility* **94**, 1244-1248 (2010).

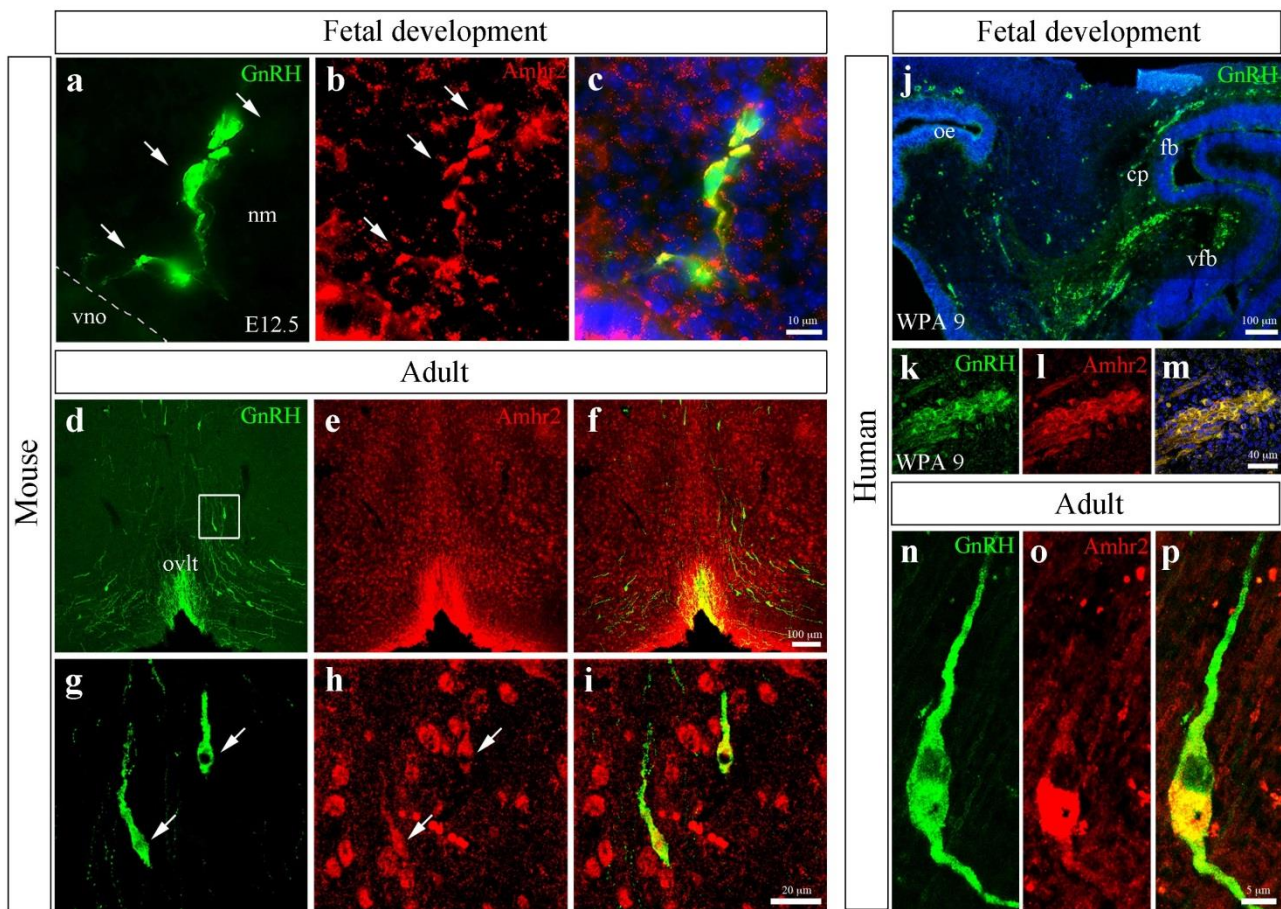

Figure 1 *AMHR2* is expressed in mouse and human GnRH neurons. (a-c) Confocal photomicrographs showing GnRH and AMHR2 immunoreactivity in sagittal sections of E12.5 embryo nasal compartment (E12.5, n = 5). Dashed lines indicate the boundary between the vomeronasal organ (vno) and the nasal mesenchyme (nm). GnRH neurons migrating out of the vno express AMHR2. (d-i) Confocal photomicrographs showing GnRH (d, g) and AMHR2 (e, h) immunoreactivity in coronal sections of adult female hypothalami (P90-120, n = 5). Images show a wide expression of AMHR2 at the level of the organum vasculosum of the lamina terminalis (OVLT). (g-i) High magnification images of boxed area in d. Arrows point to GnRH neurons expressing AMHR2. (j-m) Representative sagittal section of a 9 weeks post-amenorrhea (WPA) human fetus immunolabeled for GnRH (n = 3). At this developmental stage, the majority of GnRH neurons are still located in the nasal region, at the beginning of their migratory process. Double-immunofluorescence shows co-expression of these antigens in the same migratory neurons. (n-p) Representative coronal section of an adult hypothalamus double-stained for GnRH and AMHR2. Human hypothalami were obtained

between 24 and 36 hours postmortem from two autopsied individuals: a 20-year-old female and 72 years old male subjects. In both cases, GnRH neurons were found immunopositives for AMHR2. Oe: olfactory epithelium; cp: cribriform plate; fb: forebrain; vfb: ventral forebrain.

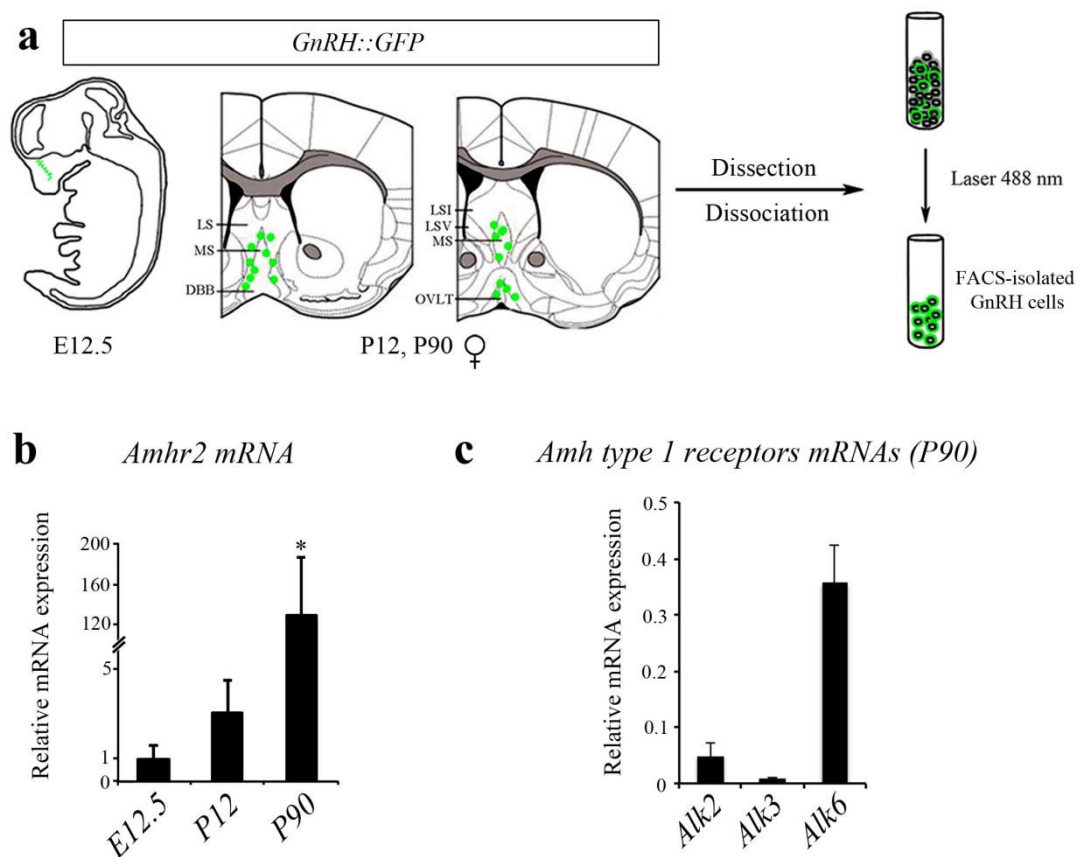

Figure 2 *AMH* receptors' transcript expression in *GnRH* neurons. **(a)** Schematic summarizing the steps of *GnRH-GFP* cells' isolation. *GnRH-GFP* positive cells were isolated by fluorescent activated cell sorting from the nasal regions of E12.5 embryos ($n = 3$) and from the hypothalamic preoptic areas of postnatal (P12, $n = 3$) and adult (P90, $n = 3$) female mice. **(b)** Real-time PCR analysis of expression levels of *Amhr2* mRNAs in *GnRH* cells sorted at E12.5, P12 and P90. *Amhr2* transcript expression was detectable in *GnRH* neurons at all stages, although it reached the highest expression at P90 as compared to E12.5 and P12. Values are expressed relative to E12.5, set at 1, and shown as means \pm SEM. One-way ANOVA, $F_{(2,8)} = 7.6$, $p = 0.02$. * $p < 0.05$, Fischer's least significant difference post hoc test, between P90 and E12.5 mice and P90 versus P12. **(c)** Relative mRNA expression of *AMH* type-I receptors (*Alk2*, *Alk3* and *Alk6*) in *GnRH* neurons isolated from the preoptic regions of adult female mice (P90, $n = 3$). All receptors' transcripts were detectable in adult *GnRH* neurons.

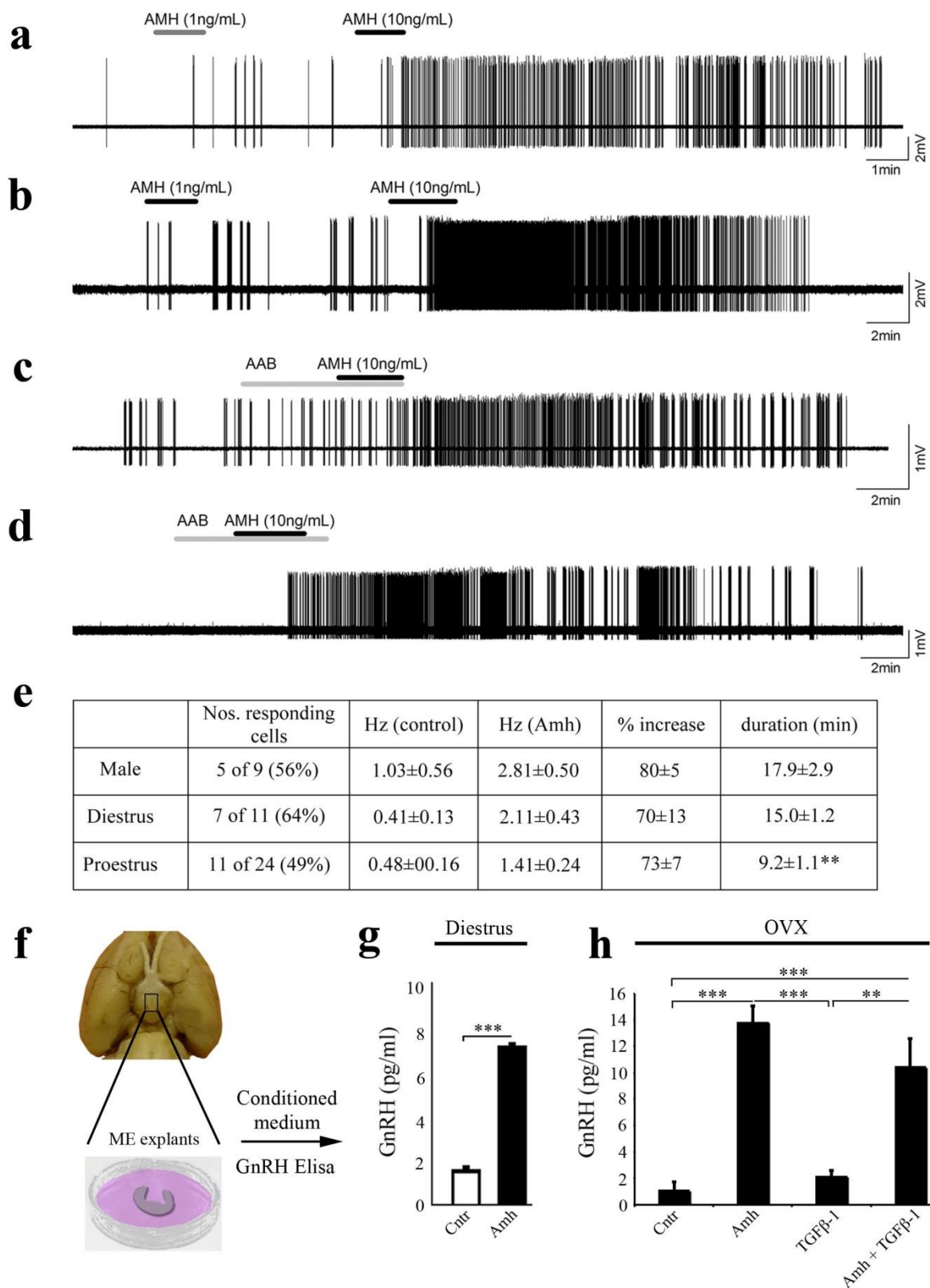

Figure 3 AMH activates GnRH neuron firing. (**a**, **b**) Cell-attached current recordings of two GnRH neurons from two GnRH-GFP male mice showing a dose-dependent activation by 1 and

10 ng/ml AMH. **(c, d)** Cell-attached current recordings of two GnRH neurons from two GnRH-GFP female mice showing that AMH excitation of GnRH neurons is not dependent upon amino acid transmission. AAB, amino acid blocker cocktail. **(e)** Table showing the numbers of cells activated by AMH with % in brackets; the mean \pm SEM firing frequency before and in response to AMH exposure; the percentage increase in firing rate, and duration of increased firing. ****P** < 0.005 Fisher LSD test, compared to diestrus.

AMH increases GnRH secretion from median eminence explants. **(f)** Schematic diagram illustrating the ME dissection and ME explant preparation. Hypothalamic MEs were microdissected from adult diestrus or ovariectomized (OVX) female rats and incubated at 37°C for 4 hours at 300 rpm until medium collection. **(g)** Quantification of GnRH secretion from ME explants of diestrus rats stimulated or not for 4 hours with AMH (Die, n = 4 ; Die + AMH, n = 4, AMH = 3 μ g/ml). Conditioned medium was collected for each culture condition and processed by GnRH Elisa. Explants from the diestrus phase treated with AMH show significantly increased GnRH secretion as compared to control cultures (Die). GnRH concentrations are represented as means \pm SEM. Unpaired Student's t test, $t_{(6)} = -6.01$, *******: p < 0.001. **(h)** MEs were dissected from OVX rats one month after the surgery and cultured as described above with the indicated treatments (Cntr, n = 4; AMH, n = 4; TGF β -1, n = 4; TGF β -1 + AMH, n = 4). AMH but not TGF β -1 induced a strong GnRH release from the hypothalamic ME. GnRH concentrations are represented as means \pm SEM. One-way ANOVA, $F_{(3,15)} = 30.9$, p < 0.0001. ******* p: < 0.0001, ****** p: < 0.001 Fischer's least significant difference post hoc test.

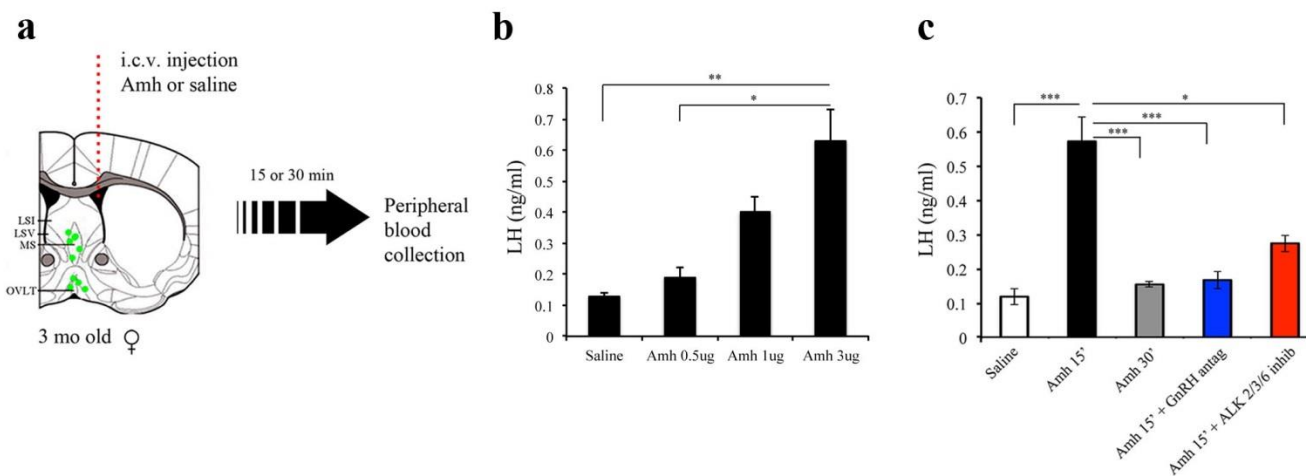

Figure 4 Intracerebroventricular (*i.c.v.*) administration of AMH *in vivo* induces increase in plasma LH levels. **(a)** Schematic representation of AMH injection into the lateral cerebral ventricle of diestrous female mice. Animals were sacrificed 15 or 30 minutes after the surgical procedure and trunk blood was collected. **(b)** Following AMH administration (AMH 0.5 $\mu\text{g}/\text{ml}$, $n = 3$; AMH 1 $\mu\text{g}/\text{ml}$, $n = 4$; AMH 3 $\mu\text{g}/\text{ml}$, $n = 6$) plasma LH levels significantly increased in a dose-dependent manner as compared to the control group (saline-treated, $n = 5$). Values are expressed as means \pm SEM. One-way ANOVA, $F_{(3,19)} = 6.6$, $p = 0.004$. * $p < 0.01$, ** $p < 0.001$, Fischer's least significant difference post hoc test. **(c)** Adult female mice in diestrus were injected into the lateral ventricle (ICV) with 3 $\mu\text{g}/\text{ml}$ of AMH ($n = 20$), or sterile saline ($n = 7$). Plasma circulating LH levels were measured following the indicated treatments. LH secretion peaked at 15 minutes after AMH injection ($n = 20$) as compared to control group (saline, $n = 7$) but returned to basal levels 30 minutes after AMH administration ($n = 7$). To exclude a possible role of AMH at the pituitary level, we injected AMH *i.c.v.* in concomitance with intraperitoneal administration of the GnRH antagonist and sacrificed the mice 15 minutes later ($n = 7$). GnRH antagonist blunted the AMH-induced LH rise. Also the ALK receptors inhibitor (ALK 2/3/6 inhib) treatment prevented the AMH-dependent increase in LH secretion ($n = 6$). One-way ANOVA, $F_{(4,47)} = 11.1$, $p < 0.0001$. * $p < 0.01$, *** $p < 0.0001$, Fischer's least significant difference post hoc test.

METHODS

Animals

Sprague Dawley female rats and C57BL/6J mice (Charles River, USA) were housed under specific pathogen-free conditions in a temperature-controlled room (21-22°C) with a 12h light/dark cycle and ad libitum access to food and water. *tdTomato*^{loxP/STOP} mice were purchased from the Jackson Laboratories (Bar Harbor, ME). *Amhr2-cre* knock-in mice have been previously characterized ¹. Digenic *Amhr2-cre*^{+/-}; *tdTomato*^{loxP/STOP} mice were generated in our laboratory. *GnRH-GFP* ² were a generous gift of Dr. Daniel J. Spergel (Section of Endocrinology, Department of Medicine, University of Chicago, IL). Animal studies were approved by the Institutional Ethics Committees of Care and Use of Experimental Animals of the Universities of Lille 2 (France) and the University of Otago School of Medical Sciences, Dunedin (New Zealand). All experiments were performed in accordance with the guidelines for animal use specified by the European Union Council Directive of September 22, 2010 (2010/63/EU).

Human tissues

Human fetuses (9 weeks post-amenorrhea; n = 3): have been obtained from voluntarily terminated pregnancies, with the parent's written informed consent. Tissues were made available in accordance with the French bylaw (Good practice concerning the conservation, transformation and transportation of human tissue to be used therapeutically, published on December 29, 1998). Permission to utilize human brain tissues was obtained from the French agency on biomedical research (Agence de le Biomédecine, Saint-Denis la Plaine, France). The fetuses were immersion-fixed in 4% paraformaldehyde in 0.1 M PB (pH 7.4) for 3 weeks, cryoprotected in 30% sucrose in PBS for 48 hours, embedded in Tissue Tek (Miles, Elkhart, IN), and frozen in liquid nitrogen. Human hypothalami were obtained between 24 and 36 hours postmortem from two autopsied individuals: a 20-year-old female subject and a 72 years old male subjects, who had donated their body to science in accordance with the French bioethics laws. A review of their medical records indicated that they had no known neurological or

neuroendocrinological disorders, and the cause of their death was cardiac and respiratory failures. The hypothalamus was isolated and immersion-fixed in 4% paraformaldehyde in 0.1 M PB (pH 7.4) for 1 week, cryoprotected in 20% sucrose in PBS for 48 hours, embedded in Tissue Tek (Miles, Elkhart, IN), and frozen in liquid nitrogen.

Tissue preparation

For immunohistochemical analysis, embryos (embryonic day 12.5) were obtained after cervical dislocation from timed-pregnant C57BL/6J mice. Embryos were washed thoroughly in cold 0.1 m PBS, fixed in fixative solution [4% paraformaldehyde (PFA), 0.2% picric acid in 0.1 m PBS, pH 7.4] for 4 h at 4°C and cryoprotected in 30% sucrose overnight at 4°C. The following day, embryos were embedded in OCT embedding medium (Tissue-Tek), frozen on dry ice, and stored at -80°C until sectioning. Adult female mice and rats (3–4 months old) were anesthetized with 100 mg/kg of Ketamine-HCl and 10mg/kg Xylazine-HCl and perfused transcardially with 20 ml of saline, followed by 100 ml of 4% PFA, pH7.4. Brains were collected, postfixed in the same fixative for 2 h at 4°C, embedded in OCT embedding medium (Tissue-Tek), frozen on dry ice, and stored at -80°C until cryosectioning.

Immunohistochemistry

Tissues were cryosectioned (Leica cryostat) at 16 µm for embryos and at 35µm for free-floating sections for adult brains. Immunohistochemistry was performed as previously reported ³, using Alexa-Fluor 488-conjugated (1:400) and Cy3-conjugated (1:800) secondary antibodies (Invitrogen). The primary antisera used were as follows: rabbit anti-GnRH (1:3000), a generous gift from Prof. G. Tramu (Centre Nationale de la Recherche Scientifique, URA 339, Université Bordeaux I, Talence, France) ⁴, guinea-pig anti-GnRH (1:10000), a generous gift from Dr. Erik Hrabovszky (Laboratory of Endocrine Neurobiology, Institute of Experimental Medicine of the Hungarian Academy of Sciences, Budapest, Hungary), chicken anti-vimentin (1:2000, AB5733, Millipore), polyclonal rabbit anti-AMHR2 (1:2000, immunogen peptide: CELWALAVEERKRPNIPS-NH2, CASLO, Denmark).

Immunoblotting

Protein extracts of each sample were prepared in 100 μ l lysis buffer (pH 7.4, 25 mM Tris, 50 mM β -glycerophosphate, 1.5mM EGTA, 0.5mM EDTA, 1 mM sodium pyrophosphate, 1mM sodium orthovanadate, 10 μ g/ml leupeptin and pepstatin, 10 μ g/ml aprotinin, 100 μ g/ml PMSF, and 1% Triton X-100) by trituration of the fragments through 22 and 26G needles in succession. The tissue lysates were cleared by centrifugation at 12,000xg for 15 min and protein content was determined using the Bradford method (BioRad, Hercules, CA). We added 4x sample buffer (Invitrogen) and 10X reducing agent (Invitrogen) to the samples and boiled for 5 min before electrophoresis at 150 V for 75 min in precast 3–8% SDS-polyacrylamide Tris-acetate gels according to the protocol supplied with the NuPAGE system (Invitrogen). When necessary, the samples were stored at –80°C until use.

Samples were boiled for 5 min after thawing and electrophoresed for 75 min at 150 V for 75 min in precast 3–8% SDS-polyacrylamide Tris-acetate gels according to the protocol supplied with the NuPAGE system (Invitrogen, Carlsbad, CA). After size-fractionation, the proteins were transferred onto Nitrocellulose membranes (0.2 μ m pore-size membranes; LC2002; Invitrogen) in the blot module of the NuPAGE system (Invitrogen) for 75 min at room temperature. Blots were blocked for 1 h in TBS with 0.05% Tween 20 (TBST) and 5% non-fat milk at room temperature, incubated overnight at 4°C with their respective primary antibodies (polyclonal rabbit anti-AMHR2; 1:1000, CASLO, Denmark; goat polyclonal anti-actin, sc-1616; 1:1000, Santa Cruz) washed four times with TBST before being exposed to horseradish peroxidase-conjugated secondary antibodies [anti-rabbit (1:10000); anti-goat/sheep (1:10000) Sigma] diluted in 5% non-fat milk-TBST for 1 h at room temperature. The immunoreactions were detected with enhanced chemiluminescence (NEL101, PerkinElmer, Boston, MA).

GnRH secretion determination

ME explants were dissected and processed as previously described⁵. Briefly, ME explants were incubated in artificial cerebrospinal fluid (aCSF) with the following composition (in mM): NaCl, 117; KCl, 4.7; NaH₂PO₄, 1.2; NaHCO₃, 25; CaCl₂, 2.5; MgCl₂, 1.2; glucose, 10, bubbled with 95% O₂-5% CO₂. (pH: 7.4, osmolarity: 304 mOsm). Explants were treated with

recombinant human Anti Müllerian Hormone (R&D System, 3ug/ml), recombinant human TGF β -1 (Millipore, 100 ng/ml) or both, and incubated at 37°C for 4 hours at 300 rpm until medium collection. The same concentration of TGF β -1 was previously used to evaluate GnRH secretion from median eminence explants ⁶. KCl 0.05 M treatment, performed at the end of the incubation time, was applied to confirm viability of the explants. Collected media were analyzed for GnRH secretion, before and after the treatments, following a GnRH Elisa protocol (Phoenix Pharmaceuticals, Inc California, Catalog no. # FEK-040-02).

Intracerebroventricular (ICV) Injections

The mice were placed in a stereotactic frame (Kopf® Instruments, California) under anesthesia (isoflurane), and a burr hole was drilled 1.7 mm posterior to the Bregma, according to a mouse brain atlas. A 10 μ l Hamilton syringe was slowly inserted into the lateral ventricle (5.6 mm deep relative to the dura), and 1.5 μ l of saline or human recombinant AMH (R&D System, 0,5 ug/mouse, 1 ug/mouse and 3 ug/mouse) was injected using an infusion pump over 5 min.

LH assay

Following AMH i.c.v injection, animals were sacrificed by cervical dislocation 15 and 30 min after they woke up. Trunk blood was collected in sterile eppendorf and left in ice until centrifugation, plasma was frozen and stored at -80°C, until use. Plasma LH was measured using a sensitive sandwich ELISA recently described ⁷ with a theoretical detection range of whole blood mLH (in a 1:30 dilution) of 0.117 to 30 ng/ml. The intra- and interassay coefficients of variation were 6.05% and 4.29%, respectively. GnRH antagonist (Cetrorelix Acetate, SIGMA, 0.5mg/Kg) was injected i.p. one hour before i.c.v. injection, while Alk inhibitor (Dorsomorphin dihydrochloride TOCRIS, 100 μ M) was injected i.c.v. 2 h before.

Fluorescence-activated cell-sorter analysis

Embryos were harvested at E12.5 from timed-pregnant *GnRH-GFP* mice, previously anesthetized with an intraperitoneal injection of 100 mg/kg of Ketamine-HCl and sacrificed by cervical dislocation. Juvenile (P12) and adult female mice (3 months old) were anesthetized with 50-100 mg/kg of Ketamine-HCl and 5-10mg/kg Xylazine-HCl before being sacrificed by cervical dislocation. Microdissections from embryonic nasal region and post-natal/adult

hypothalamic preoptic region were enzymatically dissociated using Papain Dissociation System (Worthington, Lakewood, NJ) to obtain single-cell suspensions as previously described⁸. After dissociation, the cells were physically purified using a FACSAria III (Beckman Coulter) flow cytometer equipped with FACSDiva software (BD Biosciences). The sort decision was based on measurements of GFP fluorescence (excitation: 488nm, 50 mW; detection: GFP bandpass 530/30 nm, autofluorescence bandpass 695/40nm) by comparing cell suspensions from *Gnrh-GFP* and wild-type animals. For each animal, 500 GFP-positive cells were sorted directly into 8µl extraction buffer: 0.1% Triton® X-100 (Sigma-Aldrich) and 0.4 U/µl RNaseOUT™ (Life Technologies). Captured cells were used to synthesize first-strand cDNA using the SuperScript III First-Strand Synthesis System for reverse transcription (RT)-PCR (Invitrogen) following the manufacturer's instructions. Controls without reverse transcriptase were performed to demonstrate the absence of contaminating genomic DNA.

Quantitative RT-PCR analyses

For gene expression analyses, mRNAs obtained from FACS-sorted GnRH neurons were reverse transcribed using SuperScript® III Reverse Transcriptase (Life Technologies) and a linear preamplification step was performed using the TaqMan® PreAmp Master Mix Kit protocol (Applied Biosystems). Real-time PCR was carried out on Applied Biosystems 7900HT Fast Real-Time PCR System using exon-boundary-specific TaqMan® Gene Expression Assays (Applied Biosystems): *Gnrh1* (Gnrh1-Mm01315605_m1), *Amhr2* (AMH2r-Mm00513847_m1), *Alk2* (Acvr1-Mm01331069_m1), *Alk3* (Bmpr1a-Mm00477650_m1), *Alk6* (Bmpr1b-Mm03023971_m1), *Smad 1* (Smad1-Mm00484723_m1), *Smad 4* (Smad4-Mm03023996_m1), *Smad 5* (Smad5- Mm03024001_g1) and *Smad 8* (Smad8/9-Mm00649885_m1). Control housekeeping genes: *r18S* (18S-Hs99999901_s1); *Actb* (Actb-Mm00607939_s1). Quantitative real-time PCR were performed using TaqMan Low-Density Arrays (Applied BioSystems) on Applied BioSystems 7900HT thermocycler using the manufacturer's recommended cycling conditions. Gene expression data were analyzed using SDS 2.4.1 and Data Assist 3.0.1 software (Applied BioSystems).

Electrophysiology

Adult male and female C57BL/6J homozygous *GnRH-GFP* mice were housed under 12 h light/dark cycles (lights on at 7:00 A.M.) with ad libitum access to food and water. All experimentation was approved by the University of Otago Animal Welfare and Ethics Committee. The estrous cycle stage of female mice was determined by daily vaginal smear, with all male, diestrous and proestrous mice killed for experiments between 10 and 11am. Cell-attached electrophysiology was undertaken on 250 μm -thick coronal brain slices obtained from *GnRH-GFP* mice as reported previously⁹. AMH (1-100 ng/mL) was added to the perfusing (2-3 ml/min; 32 ± 1 C) artificial cerebrospinal fluid (95%O₂, 5%CO₂; (in mM) 118 NaCl, 3 KCl, 2.5 CaCl₂, 1.2 MgCl₂, 11 D-glucose, 10 HEPES, 25 NaHCO₃,) for 1-3 min. In some experiments the AAB cocktail (kynurenic acid 2 mM, CNQX 20 μM and GABA_A 5 μM) was included in the perfusion medium before adding AMH. Action currents were analyzed by determining the number of events per 1s bin across the time of the recording. A cell was considered to have changed its firing rate if the mean firing frequency in response to AMH (over 2 min) was significantly different to its firing rate in the 2 min control period immediately prior to testing with AMH ($p < 0.05$, paired sample Wilcoxon Signed Ranks Test). Differences between groups were assessed using the Mann-Whitney test.

Statistics

All analyses were performed using Prism 5 (GraphPad Software) and assessed for normality (Shapiro-Wilk test) and variance, when appropriate. Sample sizes were chosen according to the standard practice in the field. Data were compared by a two-tailed unpaired Student's *t* test, one-way ANOVA for multiple comparisons followed by Fischer's least significant difference *post hoc* test. The significance level was set at $p < 0.05$. Data groups are indicated as mean \pm SEM. For comparison between two groups not having a normal distribution, the non-parametric tests Wilcoxon Signed Ranks Test was used. A *p*-value < 0.05 was considered to indicate a significant difference. Data groups are indicated as mean \pm SEM. The number of biologically independent experiments, *P* values and degrees of freedom are indicated in the figure legends.

SUPPLEMENTARY FIGURES

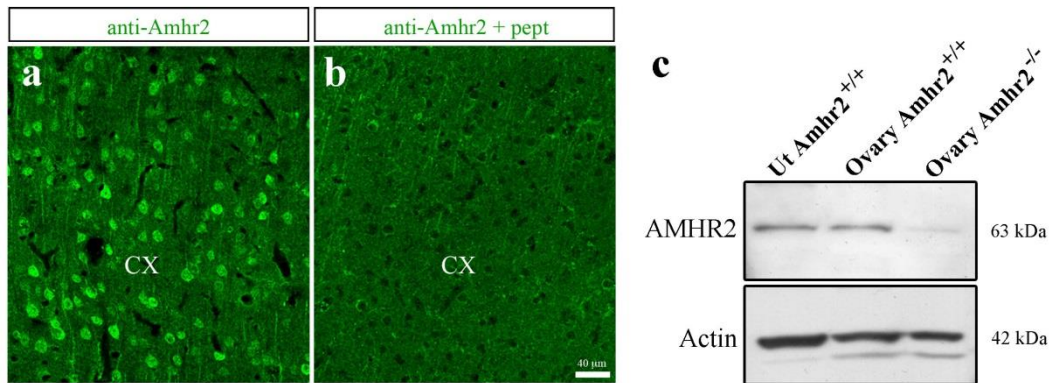
**Supplementary fig.1** *Specificity tests of anti-AMHR2 antibody*

(a, b) Specificity control of the immunohistochemistry shows lack of AMHR2-immunoreactivity when sections were incubated with anti-AMHR2 antibody together with its specific immunogen peptide. (c) Representative western blot experiment for AMHR2 (upper panel) and actin (lower panel) in the uterus (Ut) and ovary of *Amhr2* wild-type mice and in the ovary of *Amhr2* null mice (*Amhr2-cre*).

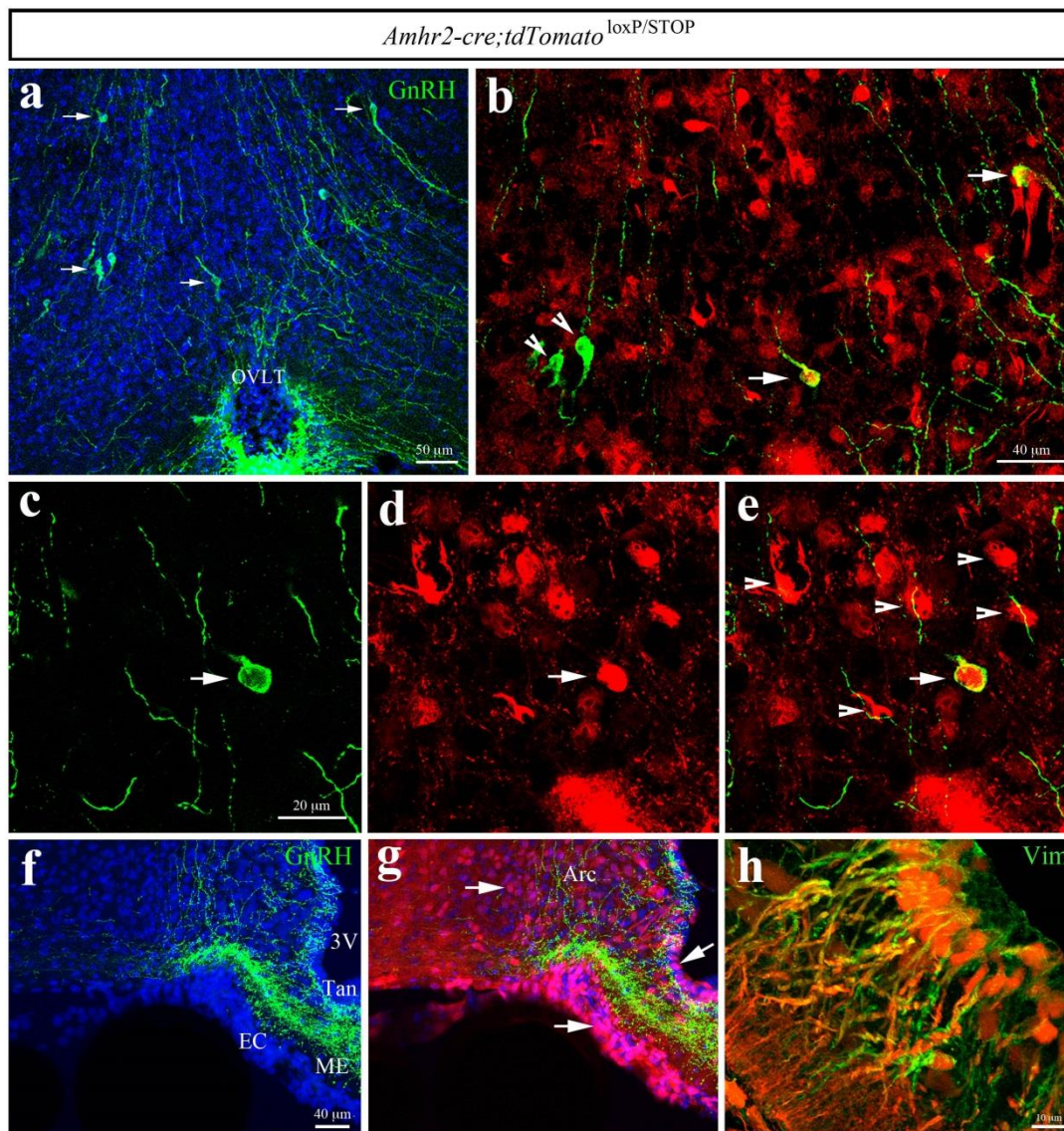

Supplementary fig.2 Lineage tracing of AMHR2 expression in the adult mouse hypothalamus. (a-h) Coronal sections represented, from adult $AMHR2::Cre^{+/-};tdTomato^{loxP/STOP}$ brains (n = 5 females, P120), are hypothalamus (organum vasculosum of the lamina terminalis, OVLT, a-e) and hypothalamic median eminence (ME)/arcuate nucleus (Arc, f-h). Lineage tracing shows AMHR2-expressing cells ($AMHR2::Cre^{+/-};tdTomato^{loxP/STOP}$) in the GnRH neuronal (a-e), Arcuate, ependymal cells and endothelial (EC) cell lineages (arrows in g). (h) Representative fluorescent labeling image showing the co-expression of AMHR2/Tomato-positive cells lining the third ventricle (3V) with the tancytic cell marker vimentin (green).

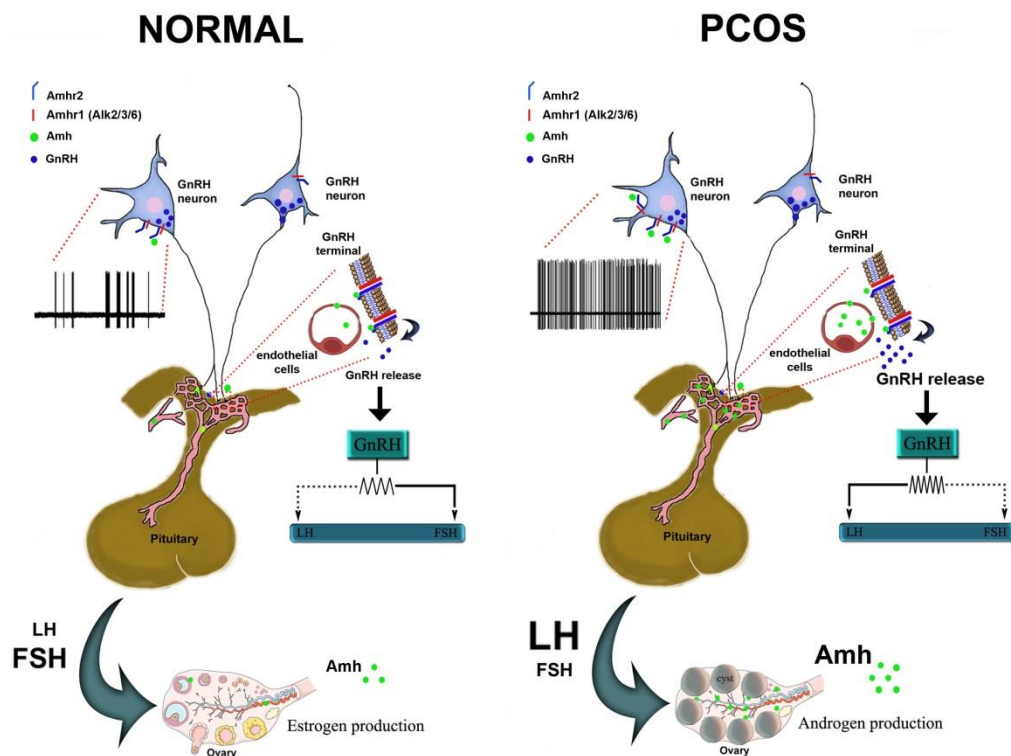

Supplementary fig.3 Schematic representation of the proposed mechanism of action of AMH on the GnRH neurons in normal and PCOS women. In normal women in reproductive age the levels of circulating AMH are low and do not significantly fluctuate over the menstrual cycle. GnRH neurons express AMHR2 as well as AMH Type-I receptors. Plasmatic AMH could pass through the blood-brain barrier through the fenestrated capillaries at the level of the median eminence and act on GnRH terminals allowing a rapid secretion of the hormone and/or via the intermediacy of tanycytes and vascular endothelial cells, which also express AMHR2. The central diagnostic features of PCOS are hyperandrogenemia, hyperandrogenism (hirsutism), oligoanovulation and polycystic ovaries. Moreover, in PCOS, AMH levels are 2-3 times higher than in normal women and this could lead to a hyperactivation of the GnRH neurons and subsequently to an increase in GnRH secretion and pulse frequency, which results in elevated LH levels. The altered ratio of LH to FSH is known to be responsible for the ovarian androgen production.

In PCOS, ovarian hyperandrogenism, hyperinsulinemia from insulin resistance and altered intraovarian paracrine signaling can disrupt follicle growth. The consequent follicular arrest in PCOS is accompanied by menstrual irregularity, anovulatory subfertility and the accumulation

of small antral follicles within the periphery of the ovary, giving it a polycystic morphology ¹⁰.

FSH: follicle stimulating hormone; LH: lutenizing hormone.

1. Jamin, S.P., Arango, N.A., Mishina, Y., Hanks, M.C. & Behringer, R.R. Requirement of *Bmpr1a* for Mullerian duct regression during male sexual development. *Nature genetics* **32**, 408-410 (2002).
2. Spergel, D.J., Kruth, U., Hanley, D.F., Sprengel, R. & Seeburg, P.H. GABA- and glutamate-activated channels in green fluorescent protein-tagged gonadotropin-releasing hormone neurons in transgenic mice. *J Neurosci* **19**, 2037-2050 (1999).
3. Hanchate, N.K., *et al.* SEMA3A, a Gene Involved in Axonal Pathfinding, Is Mutated in Patients with Kallmann Syndrome. *PLoS genetics* **8**, e1002896 (2012).
4. Beauvillain, J.C. & Tramu, G. Immunocytochemical demonstration of LH-RH, somatostatin, and ACTH-like peptide in osmium-postfixed, resin-embedded median eminence. *J Histochem Cytochem* **28**, 1014-1017 (1980).
5. Prevot, V., *et al.* Estradiol coupling to endothelial nitric oxide stimulates gonadotropin-releasing hormone release from rat median eminence via a membrane receptor. *Endocrinology* **140**, 652-659 (1999).
6. Ojeda, S.R., Urbanski, H.F., Costa, M.E., Hill, D.F. & Moholt-Siebert, M. Involvement of transforming growth factor alpha in the release of luteinizing hormone-releasing hormone from the developing female hypothalamus. *Proceedings of the National Academy of Sciences of the United States of America* **87**, 9698-9702 (1990).
7. Steyn, F.J., *et al.* Development of a methodology for and assessment of pulsatile luteinizing hormone secretion in juvenile and adult male mice. *Endocrinology* **154**, 4939-4945 (2013).
8. Parkash, J., *et al.* Suppression of beta1-Integrin in Gonadotropin-Releasing Hormone Cells Disrupts Migration and Axonal Extension Resulting in Severe Reproductive Alterations. *J Neurosci* **32**, 16992-17002 (2012).
9. Liu, X., *et al.* Frequency-dependent recruitment of fast amino acid and slow neuropeptide neurotransmitter release controls gonadotropin-releasing hormone neuron excitability. *J Neurosci* **31**, 2421-2430 (2011).
10. Goodarzi, M.O., Dumesic, D.A., Chazenbalk, G. & Azziz, R. Polycystic ovary syndrome: etiology, pathogenesis and diagnosis. *Nat Rev Endocrinol* **7**, 219-231 (2011).

Discussion

During the last three years I have focused my attention on different signalling molecules regulating GnRH system development and function. In the first study I have provided novel evidences showing that β 1-integrin regulates the migratory process of GnRH neurons during early embryonic development. Defective β 1-integrin signalling in GnRH neurons delays their migration, a defect eventually compensated at later post-natal stages. The strongest phenotype observed in the GnRH::Cre;Itgb1^{LoxP/LoxP} conditional knock-out mice was an impairment in GnRH axonal innervation of the median eminence which resulted in striking reproductive defects in female mice, as evidenced by the delay in the onset of puberty, alterations in ovarian morphology, and the reduced number and size of litters. Indeed, inhibition of β 1-integrin significantly disrupted the GnRH fibers network *in vitro*, further substantiating the notion that integrins are required for the proper neurite outgrowth of these neuroendocrine cells. Finally, using a novel mouse model of β 1-integrin ablation in GnRH neurons we uncovered a fundamental role of integrins in the development of the GnRH system, establishment of the hypothalamic–pituitary–gonadal axis and involvement of β 1-integrin signaling in the initiation of puberty and regulation of the pre-ovulatory gonadotropin surge.

In the second study, currently submitted to *Nature Medicine*, I have challenged the hypothesis that AMH could act not only at the level of the ovaries, regulating ovarian physiology (see introduction) but also in the central nervous system regulating the neuronal activity/secretion of GnRH neurons. Up to now, a direct correlation between AMH and GnRH neuronal activity has never been investigated. We confirmed that *Amhr2* transcripts are widely expressed in several brain regions, including hypothalamus and GnRH neurons. We demonstrated that AMH is a potent activator of nearly 50% of GnRH neurons, independently of the sex. The second striking observation emerging from this study is that GnRH neurons display potent responses to low nanomolar concentrations of AMH. To our knowledge, so far only Kisspeptin has been shown to induce such a strong response in GnRH neurons at these concentration ranges.

In summary, our data suggest that AMH can activate GnRH neurons directly. Future studies will identify the transynaptic mechanisms through which AMH acts on GnRH neurons as well as the source (autocrine/paracrine versus the circulating AMH) of such stimulus.

In the discussion below I will provide complementary information, that for space limitations were not included in the submitted manuscript. Moreover, I will present some mouse-genetic work that I have been performing during my PhD with the final goal of generating new conditional knock out models to fully address the role of AMH on GnRH-pituitary-gonadal axis in physiological and pathological conditions.

1 AMH, GnRH and PCOS

It is known that dysregulation of the GnRH secretion is associated with various human fertility disorders, among which the common reproductive disease PCOS. In PCOS, in fact, GnRH pulse frequency remains high, favoring LH synthesis and secretion over FSH. Variations in GnRH pulse frequency during the cycle are indeed critical for the differential synthesis and release of LH and FSH; low frequency pulses favor FSH, and high frequencies favor LH (Marshall and Griffin, 1993; Wildt et al., 1981). Our work shed light on AMH signaling as a relevant component in the regulation of GnRH/LH secretion.

In PCOS women, the elevated concentrations of circulating AMH (Kissell et al., 2014) could be thus responsible for the deregulated GnRH secretion which characterize these women and lead to increased LH secretion and ovarian androgen production.

The intriguing concept that ovarian AMH may act as a trigger for GnRH release at the hypothalamic level by directly targeting GnRH neurons not only in rodents but also in humans (**see results**) raises the thought-provoking idea that certain types of PCOS could primarily be due to a hypothalamic dysfunction. This new insight may substantially improve our understanding of PCOS and our ability to develop specific diagnostic and therapeutic tools.

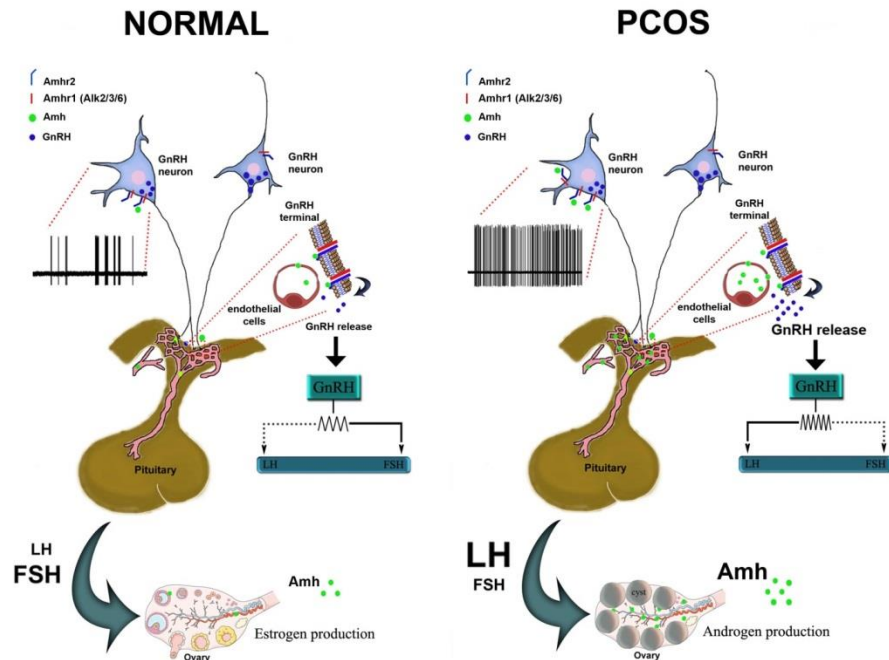

Figure 15: Schematic representation of the proposed mechanism of action of AMH on the GnRH neurons in normal and PCOS women. In normal women in reproductive age the levels of circulating AMH are low and do not significantly fluctuate over the menstrual cycle. GnRH neurons express AMHR2 as well as AMH Type-I receptors. Plasmatic AMH could pass through the blood-brain barrier through the fenestrated capillaries at the level of the median eminence and act on GnRH terminals allowing a rapid secretion of the hormone and/or via the intermediacy of tanycytes and vascular endothelial cells, which also express AMHR2. The central diagnostic features of PCOS are hyperandrogenemia, hyperandrogenism (hirsutism), oligoanovulation and polycystic ovaries. Moreover, in PCOS, AMH levels are 2-3 times higher than in normal women and this could lead to a hyperactivation of the GnRH neurons and subsequently to an increase in GnRH secretion and pulse frequency, which results in elevated LH levels. The altered ratio of LH to FSH is known to be responsible for the ovarian androgen production. In PCOS, ovarian hyperandrogenism, hyperinsulinemia from insulin resistance and altered intraovarian paracrine signaling can disrupt follicle growth. The consequent follicular arrest in PCOS is accompanied by menstrual irregularity, anovulatory subfertility and the accumulation of small antral follicles within the periphery of the ovary, giving it a polycystic morphology 36. FSH: follicle stimulating hormone; LH: lutenizing hormone.

2 Modulation of AMH actions by sex steroids

AMH and AMHR2 expression levels are sexually dimorphic in the gonads, being elevated during embryonic life in males while undetectable in females. During adult life, the opposite situation holds true with AMH being higher in the ovaries of women in reproductive age. In adult women, the fluctuation of AMH serum levels during the estrous cycle is still debated (Cook et al., 2000; Kissell et al., 2014; La Marca et al., 2006; Streuli et al., 2009; Wunder et al., 2008)

At present we do not know whether AMH and AMHR2 expressions in GnRH neurons change as a function of gonadal status. Future experiments would be required to analyse transcripts' changes in GnRH neurons isolated through FACS-sorting at diestrus, proestrus and estrus. Interestingly, the electrophysiology data indicated that the GnRH cells were activated by AMH both in proestrus and diestrus, however the duration of the response was significantly reduced in GnRH neurons recorded from proestrous mice compared with diestrous animals. This suggests a potential difference in the GnRH response to AMH stimulation during the estrous cycle, which deserves further investigation.

3 Role of AMH in the GnRH physiology

Glutamate and GABA are regulators of GnRH physiology, both during development and adulthood, indeed these two excitatory neurotransmitters are known to modulate the GnRH behavioral responses from puberty onset onward (Maffucci and Gore, 2009). Our electrophysiological recordings revealed that the aminoacid blocker AAB did not prevent GnRH neuronal activation, implying that AMH effect was not mediated by neurotransmitters but it rather acts directly on GnRH neurons inducing secretion. In order to dissect the mechanism of action of AMH in modulating such response, we performed Ca^{2+} imaging experiments on immortalized GnRH cells, namely the GT1-7 cells, in collaboration with the laboratory of Physiology of the University of Turin, Italy. Increase in Ca^{2+} influx is normally associated with elevated neuronal activity and it has been previously used to monitor GnRH secretion *in vitro* (Moore et al., 2002).

These experiments clearly showed that AMH (100 ng/ml) significantly increased both the number of peaks/cell as well as the peak amplitude of Ca^{2+} signals in immortalized GnRH cells via a fast non-genomic action (without activation of the SMADs signalling).

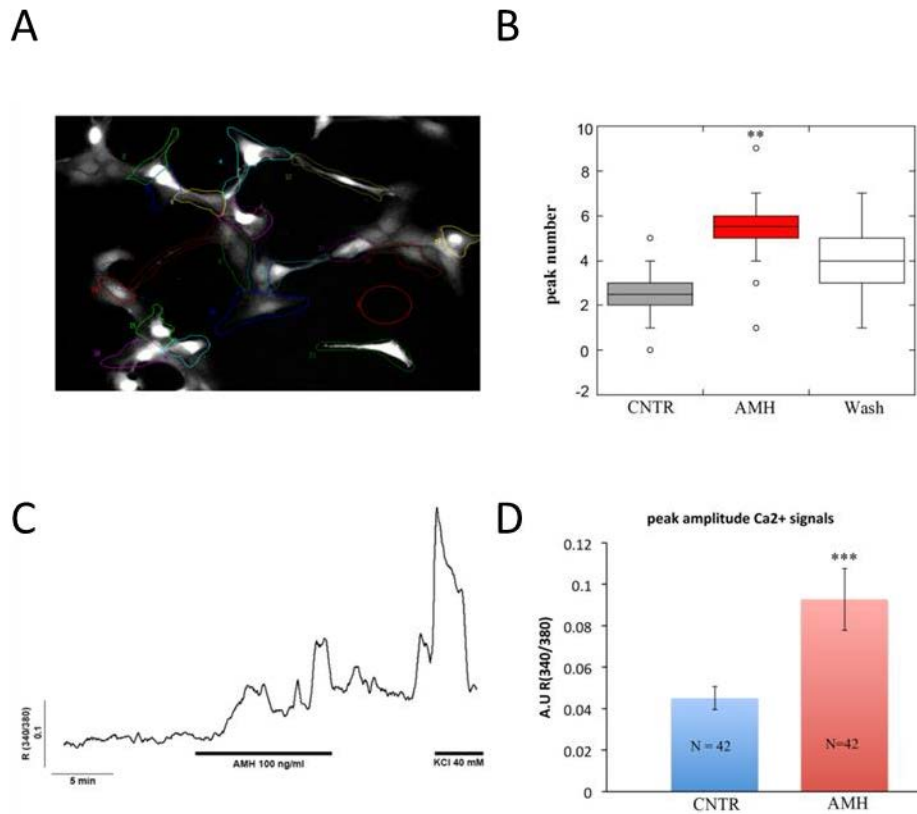

Fig 16: **AMH activates GT1-7.** (A) Calcium imaging on GT1-7 cells. (B-D) AMH (100ng/ml) applied to GT1-7 causes an increase of the peak number and their amplitude compare to the control.

In order to dissect the intracellular signalling pathway activated by AMH stimulation, we performed some biochemical studies on GT1-7 cells. Since activation of the ERK pathway is known to elicit GnRH release (Perrett and McArdle, 2013), we focused on the phosphorylation of these proteins, ERK1/2, upon AMH stimulation. Western-blot analyses revealed a significant increase in the ERKs phosphorylation with a peak detectable already at 10 min after AMH stimulation. This is consistent with our *in vivo* data showing that i.c.v. AMH administration induces potent LH secretion at 15 min. Interestingly, we also collected preliminary results showing that AMH rapidly induces GnRH secretion from ME organotypic

cultures in a MAPK-dependent manner. Indeed, co-treatment with AMH and the ERKs inhibitor (U0126) prevents AMH-mediated GnRH release.

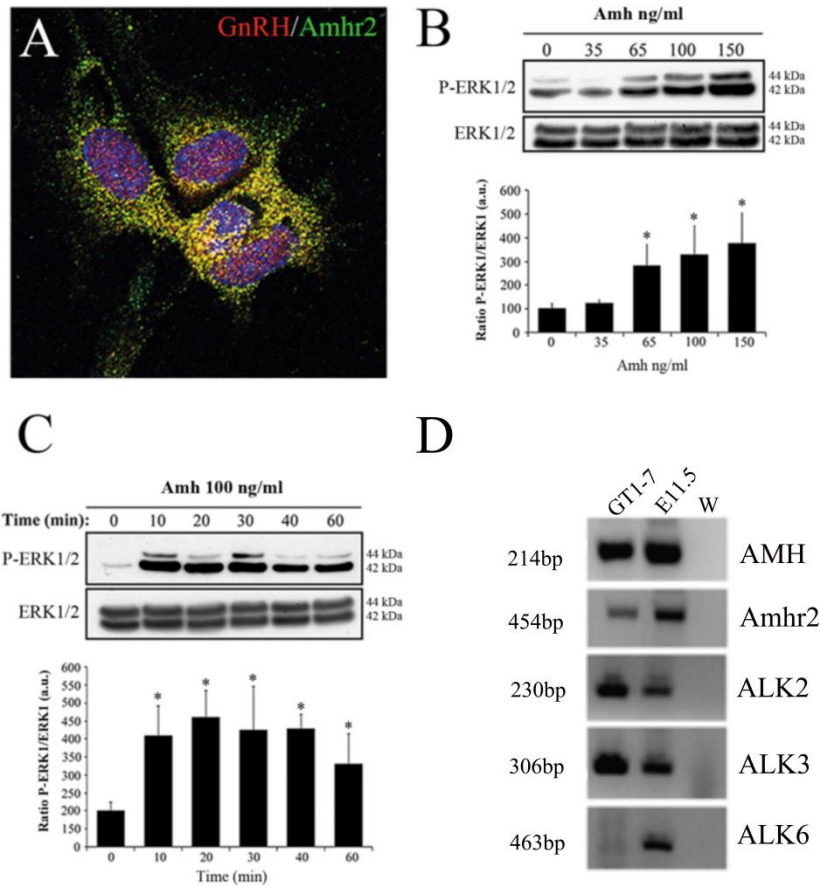

Figure 17 AMH stimulates GnRH secretion through a fast non-genomic action involving activation of the MAPK pathway. (A) GT1-7 express AMHR2 protein (green). (B) Western blot quantification showing that when GT1-7 are treated with AMH we observe the activation of the MAPK pathway (ERK1/2), inducing phosphorylation of ERK1/2 in a dose-dependent manner (with plateau activation at 65 ng/ml), 10 min after the treatment and sustained for one hour. (C) Western blot quantification showing the phosphorylation of ERK depending on the time. (D) RT-PCR analyses showing the expression of AMH, AMH-type I (ALK 2, 3 and 6) and -type II receptors (Amhr2) in GT1-7. All these genes except for ALK6 were detected in GT1-7 cells, confirming the pertinence of this model.

4 Investigation of autocrine/paracrine mechanisms of action of AMH

The ME is one of eight circumventricular organs – regions surrounding the cerebral ventricles – in the central nervous system, in which the blood-brain barrier is modified to allow the release of neurohormones by neuroendocrine cell terminals into the pituitary portal blood vessels for delivery to the anterior pituitary. Plasma AMH could thus access this region through fenestrated capillaries and act on GnRH terminals directly to trigger the rapid secretion of the neurohormone and/or indirectly via tanycytes, which also express AMHR2 and which, moreover, are known to interact closely with GnRH terminals in the ME.

However, we cannot rule out the possibility that AMH could act in an autocrine/paracrine manner on GnRH neurons. Indeed, our q-PCR experiments performed on FACS-sorted GnRH neurons revealed that these cells express both ligand and receptor from early embryonic development to adulthood (**Figure 18**). These findings were confirmed also at a protein level by immunocytochemistry performed on primary GnRH neuronal cultures (nasal explants) (**Figure 18**).

The existing *Amh* and *Amhr2* null mouse models (Vigier et al., 1984; Visser and Themmen, 2005), where all cells lack *Amh* or its receptor, do not allow discriminating between *Amh* signalling in/by the ovaries and that in GnRH neurons. In order to address this important issue, mouse lines harboring a conditional *Amh*^{fl/fl} allele will be needed in the future in order to be crossed with specific mouse lines expressing Cre recombinase under the control of GnRH or ovarian promoters.

Finally, at present, we do not know whether AMH acts directly on GnRH neurons or indirectly via tanycytes. In order to address this question, *Amhr2*^{fl/fl} mice would be needed to specifically silence AMHR2 in GnRH cells (by generating conditional GnRH::Cre; *Amhr2*^{fl/fl} mutant mice) or in tanycytes (by injecting the recombinant Tat-Cre protein in the third ventricle of *Amhr2*^{fl/fl} animals; a model previously validated in our laboratory (Langlet et al., 2013). In the following two chapters I will briefly describe the work that I have performed in order to generate these two novel mouse strains.

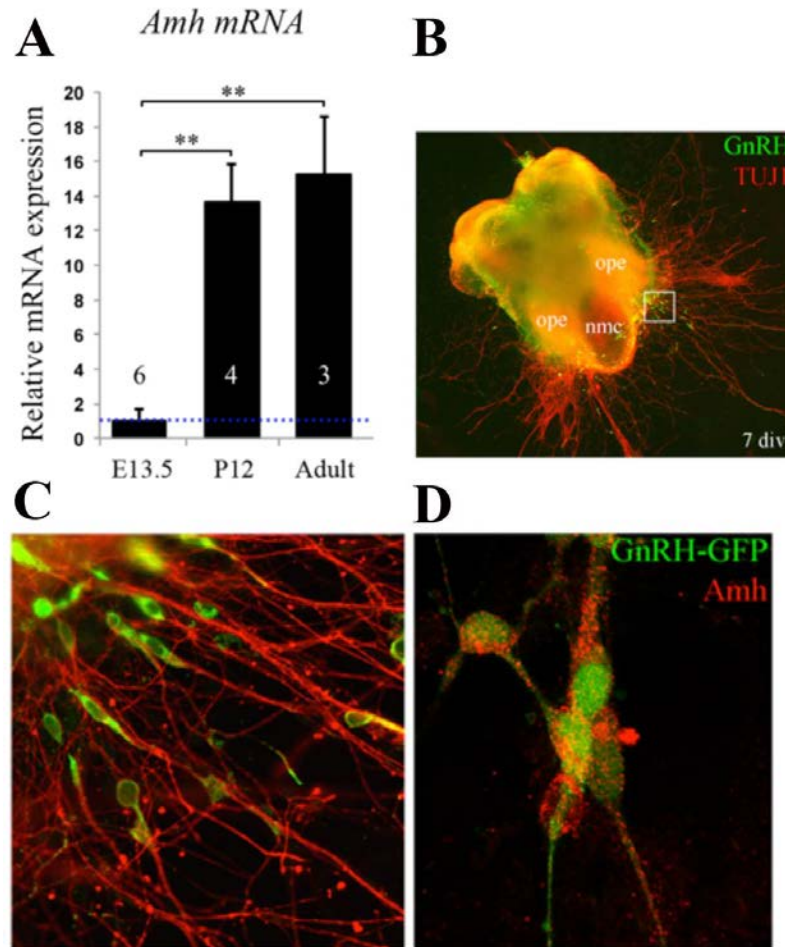

Figure 18: AMH transcript and protein expression in GnRH neurons. (A) Real-time PCR analysis of expression levels of *AMH* mRNAs in GnRH cells sorted at E13.5, P12 and adult (P90). *AMH* transcript expression was detectable in GnRH neurons at all stages, although it shows the highest expression in postnatal/adult life compare to embryonic stage. (B) Mouse nasal explant (E11.5) after 7div, showing the migration of GnRH-GFP neurons (green). (C) GnRH-GFP neurons migrate apposed to the olfactory fibers (red), labeled with TUJ1, a marker for the cytoskeleton. (D) Immunocytochemistry showing that AMH (red) is expressed from GnRH-GFP (green) primary cells. Abbreviations: ope olfactory pit epithelium, nmc nasal midline cartilage.

5 *Amh*^{fl/fl} mice

Amh^{fl/fl} animals were not readily available. We thus ordered the mutant embryonic stem (ES) cell clones for *Amh*^{fl/fl} from *Eucomm* (The European Conditional Mouse Mutagenesis Program), which provides vectors, mutant ES cells and mutant mice.

We have ordered an embryonic stem cell clone recombined with conditional AMH KO targeting vector, to split the possible action in two. This targeting vector can be used to specifically delete AMH in GnRH neurons or in the ovary, by crossing it with GnRH-Cre or with an ovarian-promoter-dependent-Cre. Moreover, this mouse can be used also as reporter, because it contains the *LacZ* gene, which encodes the bacterial enzyme, β -galactosidase, which by an enzymatic reaction produces an insoluble blue dye.

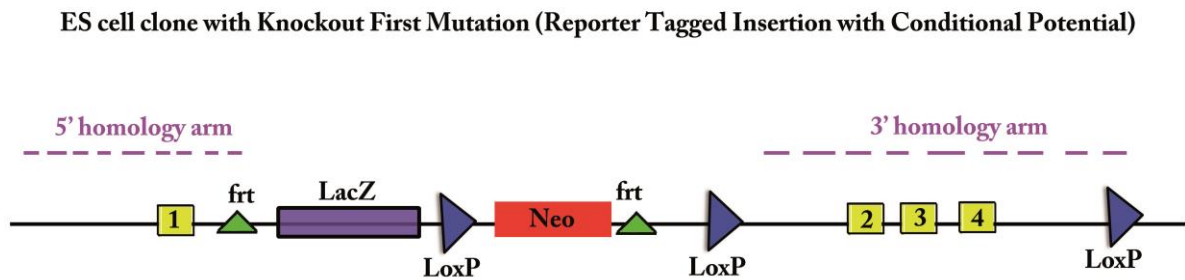

Fig 19: AMH^{fl/fl} ES cell clone with conditional mutation. ES cell clones containing the targeted AMH^{fl/fl}-Neo allele. The floxed exons are 2-4, coding the C and N terminal domains.

We have already generated the first chimeras of this transgenic mouse (figure 20); these will be bred with wild type mice to get the heterozygous animals, which will inter-breed to generate the homozygous AMH^{fl/fl} mice. We plan to cross the AMH^{fl/fl} with GnRH-CRE animals to obtain specific AMH conditional KO in GnRH neurons. This mouse will be used to investigate the autocrine/paracrine action of AMH in GnRH neurons and how its lack impacts the reproductive system. We will count the number of GnRH neurons to see if the lack of central AMH (GnRH-Amh^{-/-}) causes defects in the GnRH development: migration or survival. Moreover, we will characterize the reproductive phenotype by measuring the hormonal levels and by performing continuous mating protocol experiments. In order to check whatever the lack of AMH impacts puberty we will also check the first estrus and the vaginal opening by analysing daily the vaginal smears.



Figure 20: AMH^{fl/fl} chimera. A chimeric mouse in which the albino and brown skin are derived from either the host and targeted embryonic stem cells.

6 AMHR2 Conditional KO mice: Short mission in Germany

To better elucidate the role of AMHR2 signalling on the GnRH system and in fertility, we will employ another transgenic strategy. The animal model that we will analyze is an *Amhr2* conditional KO that I started to generate last year in Germany in the lab of Prof. Dr. Ulrich Boehm, in the University of Saarland; this short term mission was sponsored by the COST action of GnRH deficiency (www.gnrhnetwork.eu/). In the following paragraph I will explain my strategy to flox *AMHR2* gene. By crossing these mice with GnRH-CRE, we will have AMHR2 lacking only in GnRH neurons.

The gene encoding *Amhr2* is located on chromosome 15 in the mouse, its coding region consists of 11 exons that are distributed to form two exon clusters over 9Kb, which are divided by a large intron of over 4Kb. Exons 1 to 3 code for signal sequence and extracellular domain, exon 4 corresponds to the transmembrane domain and exons 5 to 11 code for the intracellular serine/threonine kinase domains (**Figure 21**).

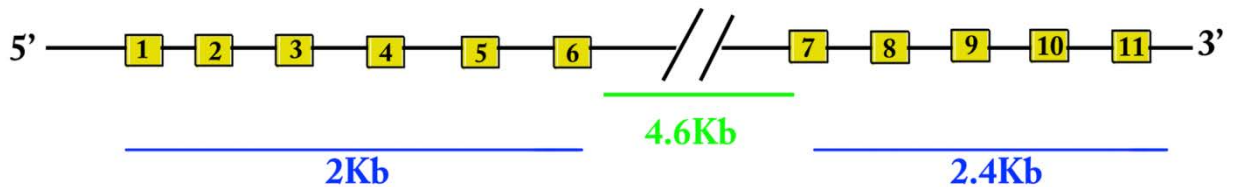

Figure 21: Amhr2 wild type locus. Schematic map of the wild type Amhr2 locus showing the 11 exons distributed in two clusters divided by a big intron of more than 4Kb.

We have decided to concentrate our analysis on the first cluster of exons, 1-6, and to insert the LoxP site in this region; to be sure to disrupt completely the AMH transduction pathway after CRE mediated recombination. By screening the DNA sequence, we have noticed a huge amount of repetitive sequence flanking the coding region; these make the recombination, southern blot probe creation and PCR very problematic. To resolve this problem we have planned a very specific strategy. The targeting vector is in total 3Kb, and includes the two arms at 5' and 3' end homologous to the locus of interest, the two LoxP sites flanking the exon of interest (in our case exon 4 and 5) and the FRT sites flanking the neomycin cassette. The homology arms are very short; the one at the 5' end is 1Kb, while the other at the 3' is less than 1Kb. The homology arm at the 5' end includes the coding region from exons 1 to 3 and the homology arm at the 3' end includes exon 6 and part of intron 6-7. The LoxP sites flanking exon 4 and 5 correspond to the transmembrane domain and to part of the serine/threonine kinase domains (**Figure 22**). The specific deletion of exon 5 could comport a frameshift of the open reading frame and insert a premature stop codon in exon 6, disrupting the normal transduction of the protein. As a positive selection marker we used the neomycin resistance cassette, flanked by the Flp recombinase recognition (FRT) sites under the *phosphoglycerate kinase* (*pgk*) promoter. We chose to insert the neomycin cassette inside the intron 4-5 with the intent to remove completely the FRT site via CRE mediated recombination and also because PGK is a strong promoter and its presence could result in the overexpression of genes downstream of the integrated construct.

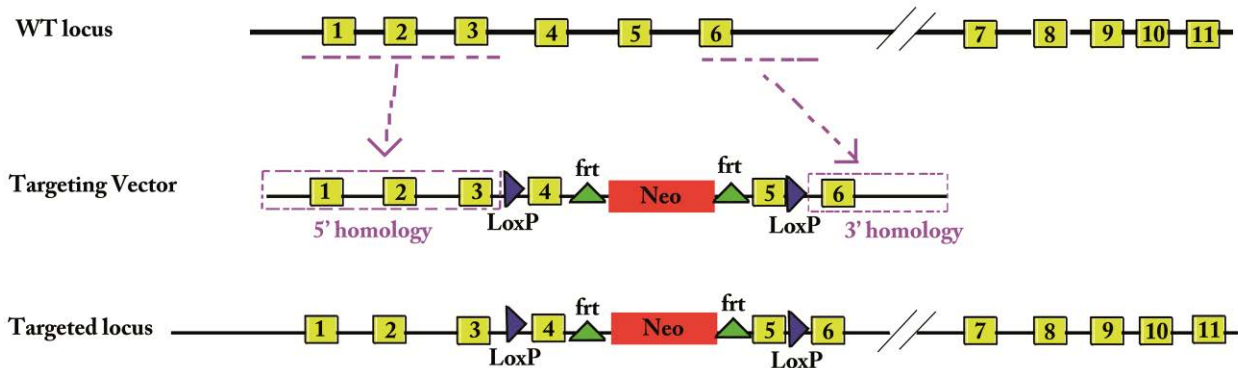

Figure 22: Generation of *Amhr2*-conditional alleles. Schematic diagram of the *Amhr2* wild-type allele, *Amhr2*-conditional targeting vector, and *Amhr2* targeted locus.

First of all, we will check the GnRH cell number, by counting GnRH in adulthood. We will also evaluate the consequences of this lack on puberty onset, by checking vaginal opening and first estrus, and reproductive phenotype by daily vaginal smear checking and mating experiments. Finally, we will also characterize the hormonal profile, LH/FSH and testosterone plasmatic concentrations by Elisa assay.

Given the broad distribution of AMHR2 in the brain, this mouse model will be particularly useful to address the role of AMH in different brain areas during development or at post-natal stages.

Conclusions

Polycystic ovary syndrome (PCOS) is one of the most important social syndromes of our age, affecting up to 10% of women of reproductive age and despite efforts to define this syndrome, we still remain far from understanding its complex etiology. PCOS is a syndrome characterized by altered hormonal profiles, including Luteinizing hormone, levels of which are directly determined by GnRH secretion. It is unclear, however, whether the accelerated GnRH pulsatility is caused by an intrinsic abnormality in the GnRH pulse generator or by the relatively low levels of progesterone resulting from infrequent ovulatory events. Moreover, the serum levels of Anti Müllerian Hormone (AMH) are elevated 2/3 times in PCOS patients compared to healthy women. We therefore aimed to assess the possible extra-ovarian effects of AMH on the hypothalamic system and more specifically, on the regulation of gonadotropin release.

This thesis presents novel data on the central role of AMH in controlling GnRH physiology. We have shown for the first time that GnRH neurons express AMH and its specific receptor AMHR2. Moreover, we provide evidence demonstrating that AMH regulates GnRH neuronal activity and secretion (even at low concentrations) and GnRH/LH secretion, in vitro and in vivo. To our knowledge this work provides the first evidence of a central action of AMH, specifically in the hypothalamus. These results thereby open new avenues in the study of AMH in the regulation of the GnRH system biology in physiological and pathological conditions (Figure 15).

Bibliography

- Aguan, K., Mahesh, V.B., Ping, L., Bhat, G., and Brann, D.W. (1996). Evidence for a physiological role for nitric oxide in the regulation of the LH surge: effect of central administration of antisense oligonucleotides to nitric oxide synthase. *Neuroendocrinology* *64*, 449–455.
- El Amraoui, A., and Dubois, P.M. (1993). Experimental evidence for an early commitment of gonadotropin-releasing hormone neurons, with special regard to their origin from the ectoderm of nasal cavity presumptive territory. *Neuroendocrinology* *57*, 991–1002.
- Anderson, L. (1996). Intracellular mechanisms triggering gonadotrophin secretion. *Rev. Reprod.* *1*, 193–202.
- Anderson, R.A., Groome, N.P., and Baird, D.T. (1998). Inhibin A and inhibin B in women with polycystic ovarian syndrome during treatment with FSH to induce mono-ovulation. *Clin. Endocrinol. (Oxf.)* *48*, 577–584.
- Andrews, M.R., Czvitkovich, S., Dassie, E., Vogelaar, C.F., Faissner, A., Blits, B., Gage, F.H., French-Constant, C., and Fawcett, J.W. (2009). Alpha9 integrin promotes neurite outgrowth on tenascin-C and enhances sensory axon regeneration. *J. Neurosci. Off. J. Soc. Neurosci.* *29*, 5546–5557.
- Anton, E.S., Kreidberg, J.A., and Rakic, P. (1999). Distinct functions of alpha3 and alpha(v) integrin receptors in neuronal migration and laminar organization of the cerebral cortex. *Neuron* *22*, 277–289.
- Arango, N.A., Lovell-Badge, R., and Behringer, R.R. (1999). Targeted mutagenesis of the endogenous mouse *Mis* gene promoter: in vivo definition of genetic pathways of vertebrate sexual development. *Cell* *99*, 409–419.
- Ben-Ari, Y. (2002). Excitatory actions of gaba during development: the nature of the nurture. *Nat. Rev. Neurosci.* *3*, 728–739.
- Al-Attar, L., Noël, K., Dutertre, M., Belville, C., Forest, M.G., Burgoyne, P.S., Josso, N., and Rey, R. (1997). Hormonal and cellular regulation of Sertoli cell anti-Müllerian hormone production in the postnatal mouse. *J. Clin. Invest.* *100*, 1335–1343.
- Attisano, L., and Wrana, J.L. (2002). Signal transduction by the TGF-beta superfamily. *Science* *296*, 1646–1647.
- Azziz, R., and Kashar-Miller, M.D. (2000). Family history as a risk factor for the polycystic ovary syndrome. *J. Pediatr. Endocrinol. Metab. JPEM* *13 Suppl 5*, 1303–1306.
- Baarends, W.M., Helmond, M.J. van, Post, M., Schoot, P.J. van der, Hoogerbrugge, J.W., Winter, J.P. de, Uilenbroek, J.T., Karels, B., Wilming, L.G., and Meijers, J.H. (1994). A novel member of the transmembrane serine/threonine kinase receptor family is specifically expressed in the gonads and in mesenchymal cells adjacent to the mullerian duct. *Development* *120*, 189–197.
- Baarends, W.M., Uilenbroek, J.T., Kramer, P., Hoogerbrugge, J.W., van Leeuwen, E.C., Themmen, A.P., and Grootegoed, J.A. (1995). Anti-müllerian hormone and anti-müllerian hormone type II receptor messenger ribonucleic acid expression in rat ovaries during postnatal development, the estrous cycle, and gonadotropin-induced follicle growth. *Endocrinology* *136*, 4951–4962.
- Bakin, A.V., Tomlinson, A.K., Bhowmick, N.A., Moses, H.L., and Arteaga, C.L. (2000). Phosphatidylinositol 3-kinase function is required for transforming growth factor beta-mediated epithelial to mesenchymal transition and cell migration. *J. Biol. Chem.* *275*, 36803–36810.

- Balen, A.H., Conway, G.S., Kaltsas, G., Techatrasak, K., Manning, P.J., West, C., and Jacobs, H.S. (1995). Polycystic ovary syndrome: the spectrum of the disorder in 1741 patients. *Hum. Reprod. Oxf. Engl.* *10*, 2107–2111.
- Barczyk, M., Carracedo, S., and Gullberg, D. (2010). Integrins. *Cell Tissue Res.* *339*, 269–280.
- Bedecarrats, G.Y., O’Neill, F.H., Norwitz, E.R., Kaiser, U.B., and Teixeira, J. (2003). Regulation of gonadotropin gene expression by Mullerian inhibiting substance. *Proc. Natl. Acad. Sci.* *100*, 9348–9353.
- Behringer, R.R., Cate, R.L., Froelick, G.J., Palmiter, R.D., and Brinster, R.L. (1990). Abnormal sexual development in transgenic mice chronically expressing müllerian inhibiting substance. *Nature* *345*, 167–170.
- Behringer, R.R., Finegold, M.J., and Cate, R.L. (1994). Müllerian-inhibiting substance function during mammalian sexual development. *Cell* *79*, 415–425.
- Belchetz, P.E., Plant, T.M., Nakai, Y., Keogh, E.J., and Knobil, E. (1978). Hypophysial responses to continuous and intermittent delivery of hypophthalamic gonadotropin-releasing hormone. *Science* *202*, 631–633.
- Bellefontaine, N., Hanchate, N.K., Parkash, J., Campagne, C., de Seranno, S., Clasadonte, J., d’ Anglemont de Tassigny, X., and Prevot, V. (2011). Nitric oxide as key mediator of neuron-to-neuron and endothelia-to-glia communication involved in the neuroendocrine control of reproduction. *Neuroendocrinology* *93*, 74–89.
- Bellefontaine, N., Chachlaki, K., Parkash, J., Vanacker, C., Colledge, W., d’ Anglemont de Tassigny, X., Garthwaite, J., Bouret, S.G., and Prevot, V. (2014). Leptin-dependent neuronal NO signaling in the preoptic hypothalamus facilitates reproduction. *J. Clin. Invest.* *124*, 2550–2559.
- Belville, C., Josso, N., and Picard, J.-Y. (1999). Persistence of müllerian derivatives in males. *Am. J. Med. Genet.* *89*, 218–223.
- Bhowmick, N.A., Zent, R., Ghiassi, M., McDonnell, M., and Moses, H.L. (2001). Integrin beta 1 signaling is necessary for transforming growth factor-beta activation of p38MAPK and epithelial plasticity. *J. Biol. Chem.* *276*, 46707–46713.
- Bonavera, J.J., Sahu, A., Kalra, P.S., and Kalra, S.P. (1993). Evidence that nitric oxide may mediate the ovarian steroid-induced luteinizing hormone surge: involvement of excitatory amino acids. *Endocrinology* *133*, 2481–2487.
- Bonavera, J.J., Sahu, A., Kalra, P.S., and Kalra, S.P. (1994). Evidence in support of nitric oxide (NO) involvement in the cyclic release of prolactin and LH surges. *Brain Res.* *660*, 175–179.
- Bonavera, J.J., Kalra, P.S., and Kalra, S.P. (1996). L-arginine/nitric oxide amplifies the magnitude and duration of the luteinizing hormone surge induced by estrogen: involvement of neuropeptide Y. *Endocrinology* *137*, 1956–1962.
- Bose, K.S., and Sarma, R.H. (1975). Delineation of the intimate details of the backbone conformation of pyridine nucleotide coenzymes in aqueous solution. *Biochem. Biophys. Res. Commun.* *66*, 1173–1179.
- Boukari, K., Meduri, G., Brailly-Tabard, S., Guibourdenche, J., Ciampi, M.L., Massin, N., Martinerie, L., Picard, J.-Y., Rey, R., Lombès, M., et al. (2009). Lack of androgen receptor expression in Sertoli cells accounts for the absence of anti-Müllerian hormone repression during early human testis development. *J. Clin. Endocrinol. Metab.* *94*, 1818–1825.

- Bouligand, J., Ghervan, C., Tello, J.A., Brailly-Tabard, S., Salenave, S., Chanson, P., Lombès, M., Millar, R.P., Guiochon-Mantel, A., and Young, J. (2009). Isolated familial hypogonadotropic hypogonadism and a GNRH1 mutation. *N. Engl. J. Med.* *360*, 2742–2748.
- Bourguignon, J.P., Gerard, A., Alvarez Gonzalez, M.L., Purnelle, G., and Franchimont, P. (1995). Endogenous glutamate involvement in pulsatile secretion of gonadotropin-releasing hormone: evidence from effect of glutamine and developmental changes. *Endocrinology* *136*, 911–916.
- Brann, D.W., and Mahesh, V.B. (1991). Endogenous excitatory amino acid involvement in the preovulatory and steroid-induced surge of gonadotropins in the female rat. *Endocrinology* *128*, 1541–1547.
- Brann, D.W., Zamorano, P.L., Putnam-Roberts, C.D., and Mahesh, V.B. (1992). gamma-Aminobutyric acid-opioid interactions in the regulation of gonadotropin secretion in the immature female rat. *Neuroendocrinology* *56*, 445–452.
- Broekmans, F.J., Visser, J.A., Laven, J.S.E., Broer, S.L., Themmen, A.P.N., and Fauser, B.C. (2008). Anti-Müllerian hormone and ovarian dysfunction. *Trends Endocrinol. Metab.* *TEM* *19*, 340–347.
- Buck, C., Balasubramanian, R., and Crowley, W.F. (1993). Isolated Gonadotropin-Releasing Hormone (GnRH) Deficiency. In *GeneReviews*(®), R.A. Pagon, M.P. Adam, H.H. Ardinger, T.D. Bird, C.R. Dolan, C.-T. Fong, R.J. Smith, and K. Stephens, eds. (Seattle (WA): University of Washington, Seattle),.
- Budzik, G.P., Swann, D.A., Hayashi, A., and Donahoe, P.K. (1980). Enhanced purification of Mullerian inhibiting substance by lectin affinity chromatography. *Cell* *21*, 909–915.
- De Caestecker, M. (2004). The transforming growth factor-beta superfamily of receptors. *Cytokine Growth Factor Rev.* *15*, 1–11.
- Campbell, I.D., and Humphries, M.J. (2011). Integrin Structure, Activation, and Interactions. *Cold Spring Harb. Perspect. Biol.* *3*, a004994.
- Campbell, R.E., Han, S.-K., and Herbison, A.E. (2005). Biocytin filling of adult gonadotropin-releasing hormone neurons in situ reveals extensive, spiny, dendritic processes. *Endocrinology* *146*, 1163–1169.
- Carbone, S., Szwarcfarb, B., Otero Losada, M.E., and Moguilevsky, J.A. (1992). Effects of ovarian steroids on the gonadotropin response to N-methyl-D-aspartate and on hypothalamic excitatory amino acid levels during sexual maturation in female rats. *Endocrinology* *130*, 1365–1370.
- Cariboni, A., and Maggi, R. (2006). Kallmann’s syndrome, a neuronal migration defect. *Cell. Mol. Life Sci.* *CMLS* *63*, 2512–2526.
- Cariboni, A., Pimpinelli, F., Colamarino, S., Zaninetti, R., Piccolella, M., Rumio, C., Piva, F., Rugarli, E.I., and Maggi, R. (2004). The product of X-linked Kallmann’s syndrome gene (KAL1) affects the migratory activity of gonadotropin-releasing hormone (GnRH)-producing neurons. *Hum. Mol. Genet.* *13*, 2781–2791.
- Cariboni, A., Rakic, S., Liapi, A., Maggi, R., Goffinet, A., and Parnavelas, J.G. (2005). Reelin provides an inhibitory signal in the migration of gonadotropin-releasing hormone neurons. *Dev. Camb. Engl.* *132*, 4709–4718.
- Cariboni, A., Hickok, J., Rakic, S., Andrews, W., Maggi, R., Tischkau, S., and Parnavelas, J.G. (2007). Neuropilins and their ligands are important in the migration of gonadotropin-releasing hormone neurons. *J. Neurosci. Off. J. Soc. Neurosci.* *27*, 2387–2395.

- Casoni, F., Hutchins, B.I., Donohue, D., Fornaro, M., Condie, B.G., and Wray, S. (2012). SDF and GABA interact to regulate axophilic migration of GnRH neurons. *J. Cell Sci.* *125*, 5015–5025.
- Cate, R.L., Mattaliano, R.J., Hession, C., Tizard, R., Farber, N.M., Cheung, A., Ninfa, E.G., Frey, A.Z., Gash, D.J., Chow, E.P., et al. (1986). Isolation of the bovine and human genes for müllerian inhibiting substance and expression of the human gene in animal cells. *Cell* *45*, 685–698.
- Cellot, G., and Cherubini, E. (2013). Functional role of ambient GABA in refining neuronal circuits early in postnatal development. *Front. Neural Circuits* *7*, 136.
- Chemes, H.E., Rey, R.A., Nistal, M., Regadera, J., Musse, M., González-Peramato, P., and Serrano, A. (2008). Physiological androgen insensitivity of the fetal, neonatal, and early infantile testis is explained by the ontogeny of the androgen receptor expression in Sertoli cells. *J. Clin. Endocrinol. Metab.* *93*, 4408–4412.
- Christian, C.A., and Moenter, S.M. (2010). The neurobiology of preovulatory and estradiol-induced gonadotropin-releasing hormone surges. *Endocr. Rev.* *31*, 544–577.
- Chu, Z., and Moenter, S.M. (2005). Endogenous Activation of Metabotropic Glutamate Receptors Modulates GABAergic Transmission to Gonadotropin-Releasing Hormone Neurons and Alters Their Firing Rate: A Possible Local Feedback Circuit. *J. Neurosci.* *25*, 5740–5749.
- Clarke, I.J., and Pompolo, S. (2005). Synthesis and secretion of GnRH. *Anim. Reprod. Sci.* *88*, 29–55.
- Clarke, I.J., Thomas, G.B., Yao, B., and Cummins, J.T. (1987). GnRH secretion throughout the ovine estrous cycle. *Neuroendocrinology* *46*, 82–88.
- Clarke, T.R., Hoshiya, Y., Yi, S.E., Liu, X., Lyons, K.M., and Donahoe, P.K. (2001a). Müllerian Inhibiting Substance Signaling Uses a Bone Morphogenetic Protein (BMP)-Like Pathway Mediated by ALK2 and Induces Smad6 Expression. *Mol. Endocrinol.* *15*, 946–959.
- Clarke, T.R., Hoshiya, Y., Yi, S.E., Liu, X., Lyons, K.M., and Donahoe, P.K. (2001b). Müllerian inhibiting substance signaling uses a bone morphogenetic protein (BMP)-like pathway mediated by ALK2 and induces SMAD6 expression. *Mol. Endocrinol. Baltim. Md* *15*, 946–959.
- Clarkson, J., and Herbison, A.E. (2006). Postnatal development of kisspeptin neurons in mouse hypothalamus; sexual dimorphism and projections to gonadotropin-releasing hormone neurons. *Endocrinology* *147*, 5817–5825.
- Clarkson, J., Boon, W.C., Simpson, E.R., and Herbison, A.E. (2009). Postnatal development of an estradiol-kisspeptin positive feedback mechanism implicated in puberty onset. *Endocrinology* *150*, 3214–3220.
- Clasadonte, J., Poulain, P., Beauvillain, J.-C., and Prevot, V. (2008). Activation of neuronal nitric oxide release inhibits spontaneous firing in adult gonadotropin-releasing hormone neurons: a possible local synchronizing signal. *Endocrinology* *149*, 587–596.
- Di Clemente, N., Wilson, C., Faure, E., Boussin, L., Carmillo, P., Tizard, R., Picard, J.Y., Vigier, B., Josso, N., and Cate, R. (1994). Cloning, expression, and alternative splicing of the receptor for anti-Müllerian hormone. *Mol. Endocrinol.* *8*, 1006–1020.
- Cogliati, T., Delgado-Romero, P., Norwitz, E.R., Guduric-Fuchs, J., Kaiser, U.B., Wray, S., and Kirsch, I.R. (2007). Pubertal impairment in Nhlh2 null mice is associated with hypothalamic and pituitary deficiencies. *Mol. Endocrinol. Baltim. Md* *21*, 3013–3027.

- Cohen-Haguenaer, O., Picard, J.Y., Mattéi, M.G., Serero, S., Nguyen, V.C., de Tand, M.F., Guerrier, D., Hors-Cayla, M.C., Josso, N., and Frézal, J. (1987). Mapping of the gene for anti-müllerian hormone to the short arm of human chromosome 19. *Cytogenet. Cell Genet.* *44*, 2–6.
- Constantin, S. (2011). Physiology of the Gonadotrophin-Releasing Hormone (GnRH) Neurone: Studies from Embryonic GnRH Neurones. *J. Neuroendocrinol.* *23*, 542–553.
- Constantin, S., Jasoni, C.L., Wadas, B., and Herbison, A.E. (2010). Gamma-aminobutyric acid and glutamate differentially regulate intracellular calcium concentrations in mouse gonadotropin-releasing hormone neurons. *Endocrinology* *151*, 262–270.
- Cook, C.L., Siow, Y., Taylor, S., and Fallat, M.E. (2000). Serum müllerian-inhibiting substance levels during normal menstrual cycles. *Fertil. Steril.* *73*, 859–861.
- Cook, C.L., Siow, Y., Brenner, A.G., and Fallat, M.E. (2002). Relationship between serum müllerian-inhibiting substance and other reproductive hormones in untreated women with polycystic ovary syndrome and normal women. *Fertil. Steril.* *77*, 141–146.
- Couse, J.F., and Korach, K.S. (1999). Estrogen receptor null mice: what have we learned and where will they lead us? *Endocr. Rev.* *20*, 358–417.
- Cummings, D.M., and Brunjes, P.C. (1995). Migrating luteinizing hormone-releasing hormone (LHRH) neurons and processes are associated with a substrate that expresses S100. *Brain Res. Dev. Brain Res.* *88*, 148–157.
- Daikoku, S., and Koide, I. (1998). Spatiotemporal appearance of developing LHRH neurons in the rat brain. *J. Comp. Neurol.* *393*, 34–47.
- Daikoku-Ishido, H., Okamura, Y., Yanaihara, N., and Daikoku, S. (1990). Development of the hypothalamic luteinizing hormone-releasing hormone-containing neuron system in the rat: In vivo and in transplantation studies. *Dev. Biol.* *140*, 374–387.
- Dalkin, A.C., Haisenleder, D.J., Ortolano, G.A., Ellis, T.R., and Marshall, J.C. (1989). The frequency of gonadotropin-releasing-hormone stimulation differentially regulates gonadotropin subunit messenger ribonucleic acid expression. *Endocrinology* *125*, 917–924.
- Dawson, T.M., Bredt, D.S., Fotuhi, M., Hwang, P.M., and Snyder, S.H. (1991). Nitric oxide synthase and neuronal NADPH diaphorase are identical in brain and peripheral tissues. *Proc. Natl. Acad. Sci. U. S. A.* *88*, 7797–7801.
- Decavel, C., and Van den Pol, A.N. (1990). GABA: a dominant neurotransmitter in the hypothalamus. *J. Comp. Neurol.* *302*, 1019–1037.
- DeFazio, R.A., Heger, S., Ojeda, S.R., and Moenter, S.M. (2002). Activation of A-type gamma-aminobutyric acid receptors excites gonadotropin-releasing hormone neurons. *Mol. Endocrinol. Baltim. Md* *16*, 2872–2891.
- Dewailly, D., Gronier, H., Poncelet, E., Robin, G., Leroy, M., Pigny, P., Duhamel, A., and Catteau-Jonard, S. (2011). Diagnosis of polycystic ovary syndrome (PCOS): revisiting the threshold values of follicle count on ultrasound and of the serum AMH level for the definition of polycystic ovaries. *Hum. Reprod. Oxf. Engl.* *26*, 3123–3129.

- Dewailly, D., Andersen, C.Y., Balen, A., Broekmans, F., Dilaver, N., Fanchin, R., Griesinger, G., Kelsey, T.W., Marca, A.L., Lambalk, C., et al. (2014). The physiology and clinical utility of anti-Müllerian hormone in women. *Hum. Reprod. Update* dmt062.
- Dewulf, N., Verschueren, K., Lonnoy, O., Morén, A., Grimsby, S., Vande Spiegle, K., Miyazono, K., Huylebroeck, D., and Ten Dijke, P. (1995). Distinct spatial and temporal expression patterns of two type I receptors for bone morphogenetic proteins during mouse embryogenesis. *Endocrinology* 136, 2652–2663.
- Dickson, M.C., Martin, J.S., Cousins, F.M., Kulkarni, A.B., Karlsson, S., and Akhurst, R.J. (1995). Defective haematopoiesis and vasculogenesis in transforming growth factor-beta 1 knock out mice. *Dev. Camb. Engl.* 121, 1845–1854.
- Dierschke, D.J., Bhattacharya, A.N., Atkinson, L.E., and Knobil, E. (1970). Circhoral oscillations of plasma LH levels in the ovariectomized rhesus monkey. *Endocrinology* 87, 850–853.
- Dodé, C., and Hardelin, J.-P. (2009). Kallmann syndrome. *Eur. J. Hum. Genet. EJHG* 17, 139–146.
- Dodé, C., Levilliers, J., Dupont, J.-M., De Paepe, A., Le Dû, N., Soussi-Yanicostas, N., Coimbra, R.S., Delmaghani, S., Compain-Nouaille, S., Baverel, F., et al. (2003). Loss-of-function mutations in FGFR1 cause autosomal dominant Kallmann syndrome. *Nat. Genet.* 33, 463–465.
- Dodé, C., Teixeira, L., Levilliers, J., Fouveaut, C., Bouchard, P., Kottler, M.-L., Lespinasse, J., Lienhardt-Roussie, A., Mathieu, M., Moerman, A., et al. (2006). Kallmann syndrome: mutations in the genes encoding prokineticin-2 and prokineticin receptor-2. *PLoS Genet.* 2, e175.
- Donahoe, P.K., Ito, Y., Morikawa, Y., and Hendren, W.H. (1977). Mullerian Inhibiting Substance in human testes after birth. *J. Pediatr. Surg.* 12, 323–330.
- DONOVAN, B.T., and HARRIS, G.W. (1954). Effect of pituitary stalk section light-induced oestrus in the ferret. *Nature* 174, 503–504.
- Doré, J.J., Jr, Edens, M., Garamszegi, N., and Leof, E.B. (1998). Heteromeric and homomeric transforming growth factor-beta receptors show distinct signaling and endocytic responses in epithelial cells. *J. Biol. Chem.* 273, 31770–31777.
- Dubois, M.P., and Barry, J. (1974). [Proceedings: Localization of three hypothalamic neurofactors LH-RH, SRIH and neurophysin in the hypothalamus and the median eminence: immunofluorescent study]. *Ann. Endocrinol.* 35, 663–664.
- Dumalska, I., Wu, M., Morozova, E., Liu, R., van den Pol, A., and Alreja, M. (2008). Excitatory effects of the puberty-initiating peptide kisspeptin and group I metabotropic glutamate receptor agonists differentiate two distinct subpopulations of gonadotropin-releasing hormone neurons. *J. Neurosci. Off. J. Soc. Neurosci.* 28, 8003–8013.
- Dumesic, D.A., Abbott, D.H., and Padmanabhan, V. (2007). Polycystic ovary syndrome and its developmental origins. *Rev. Endocr. Metab. Disord.* 8, 127–141.
- Durlinger, A.L.L., Gruijters, M.J.G., Kramer, P., Karels, B., Ingraham, H.A., Nachtigal, M.W., Uilenbroek, J.T.J., Grootegoed, J.A., and Themmen, A.P.N. (2002). Anti-Müllerian Hormone Inhibits Initiation of Primordial Follicle Growth in the Mouse Ovary. *Endocrinology* 143, 1076–1084.
- Dyche, W.J. (1979). A comparative study of the differentiation and involution of the Mullerian duct and Wolffian duct in the male and female fetal mouse. *J. Morphol.* 162, 175–209.

- Ehrmann, D.A. (2005). Polycystic ovary syndrome. *N. Engl. J. Med.* *352*, 1223–1236.
- Ehrmann, D.A., Sturis, J., Byrne, M.M., Karrison, T., Rosenfield, R.L., and Polonsky, K.S. (1995). Insulin secretory defects in polycystic ovary syndrome. Relationship to insulin sensitivity and family history of non-insulin-dependent diabetes mellitus. *J. Clin. Invest.* *96*, 520–527.
- Elias, C.F., and Purohit, D. (2013). Leptin signaling and circuits in puberty and fertility. *Cell. Mol. Life Sci. CMLS* *70*, 841–862.
- El-Shal, A.S., Shalaby, S.M., Aly, N.M., Rashad, N.M., and Abdelaziz, A.M. (2013). Genetic variation in the vitamin D receptor gene and vitamin D serum levels in Egyptian women with polycystic ovary syndrome. *Mol. Biol. Rep.* *40*, 6063–6073.
- Emsley, J.G., and Hagg, T. (2003). $\alpha 6\beta 1$ integrin directs migration of neuronal precursors in adult mouse forebrain. *Exp. Neurol.* *183*, 273–285.
- Falardeau, J., Chung, W.C.J., Beenken, A., Raivio, T., Plummer, L., Sidis, Y., Jacobson-Dickman, E.E., Eliseenkova, A.V., Ma, J., Dwyer, A., et al. (2008). Decreased FGF8 signaling causes deficiency of gonadotropin-releasing hormone in humans and mice. *J. Clin. Invest.* *118*, 2822–2831.
- Farrant, M., and Kaila, K. (2007). The cellular, molecular and ionic basis of GABA(A) receptor signalling. *Prog. Brain Res.* *160*, 59–87.
- Feleder, C., Ginzburg, M., Wuttke, W., Moguilevsky, J.A., and Arias, P. (1999). GABAergic activation inhibits the hypothalamic-pituitary-ovarian axis and sexual development in the immature female rat. Associated changes in hypothalamic glutamatergic and taurinergergic systems. *Brain Res. Dev. Brain Res.* *116*, 151–157.
- Forni, P.E., and Wray, S. (2012). Neural Crest and Olfactory System: New Prospective. *Mol. Neurobiol.* *46*, 349–360.
- Forni, P.E., Taylor-Burds, C., Melvin, V.S., Williams, T., and Wray, S. (2011). Neural Crest and Ectodermal Cells Intermix in the Nasal Placode to Give Rise to GnRH-1 Neurons, Sensory Neurons, and Olfactory Ensheathing Cells. *J. Neurosci.* *31*, 6915–6927.
- Förstermann, U., Closs, E.I., Pollock, J.S., Nakane, M., Schwarz, P., Gath, I., and Kleinert, H. (1994). Nitric oxide synthase isozymes. Characterization, purification, molecular cloning, and functions. *Hypertension* *23*, 1121–1131.
- Franceschini, I., Desroziers, E., Caraty, A., and Duittoz, A. (2010). The intimate relationship of gonadotropin-releasing hormone neurons with the polysialylated neural cell adhesion molecule revisited across development and adult plasticity. *Eur. J. Neurosci.* *32*, 2031–2041.
- Franco, B., Guioli, S., Pragliola, A., Incerti, B., Bardoni, B., Tonlorenzi, R., Carozzo, R., Maestrini, E., Pieretti, M., Taillon-Miller, P., et al. (1991). A gene deleted in Kallmann's syndrome shares homology with neural cell adhesion and axonal path-finding molecules. *Nature* *353*, 529–536.
- Franks, S., Gharani, N., and McCarthy, M. (2001). Candidate genes in polycystic ovary syndrome. *Hum. Reprod. Update* *7*, 405–410.
- Fueshko, S., and Wray, S. (1994). LHRH cells migrate on peripherin fibers in embryonic olfactory explant cultures: an in vitro model for neurophilic neuronal migration. *Dev. Biol.* *166*, 331–348.
- Fueshko, S.M., Key, S., and Wray, S. (1998a). GABA inhibits migration of luteinizing hormone-releasing hormone neurons in embryonic olfactory explants. *J. Neurosci. Off. J. Soc. Neurosci.* *18*, 2560–2569.

- Fueshko, S.M., Key, S., and Wray, S. (1998b). GABA inhibits migration of luteinizing hormone-releasing hormone neurons in embryonic olfactory explants. *J. Neurosci. Off. J. Soc. Neurosci.* *18*, 2560–2569.
- Funes, S., Hedrick, J.A., Vassileva, G., Markowitz, L., Abbondanzo, S., Golovko, A., Yang, S., Monsma, F.J., and Gustafson, E.L. (2003). The KiSS-1 receptor GPR54 is essential for the development of the murine reproductive system. *Biochem. Biophys. Res. Commun.* *312*, 1357–1363.
- Galileo, D.S., Majors, J., Horwitz, A.F., and Sanes, J.R. (1992). Retrovirally introduced antisense integrin RNA inhibits neuroblast migration in vivo. *Neuron* *9*, 1117–1131.
- Gamble, J.A., Karunadasa, D.K., Pape, J.-R., Skynner, M.J., Todman, M.G., Bicknell, R.J., Allen, J.P., and Herbison, A.E. (2005). Disruption of ephrin signaling associates with disordered axophilic migration of the gonadotropin-releasing hormone neurons. *J. Neurosci. Off. J. Soc. Neurosci.* *25*, 3142–3150.
- Georges-Labouesse, E., Mark, M., Messaddeq, N., and Gansmüller, A. (1998). Essential role of alpha 6 integrins in cortical and retinal lamination. *Curr. Biol. CB* *8*, 983–986.
- Georgopoulos, N.A., Karagiannidou, E., Koika, V., Roupas, N.D., Armeni, A., Marioli, D., Papadakis, E., Welt, C.K., and Panidis, D. (2013). Increased frequency of the anti-mullerian-inhibiting hormone receptor 2 (AMHR2) 482 A>G polymorphism in women with polycystic ovary syndrome: relationship to luteinizing hormone levels. *J. Clin. Endocrinol. Metab.* *98*, E1866–1870.
- Giacobini, P., and Prevot, V. (2013). Semaphorins in the development, homeostasis and disease of hormone systems. *Semin. Cell Dev. Biol.* *24*, 190–198.
- Giacobini, P., Giampietro, C., Fioretto, M., Maggi, R., Cariboni, A., Perroteau, I., and Fasolo, A. (2002). Hepatocyte growth factor/scatter factor facilitates migration of GN-11 immortalized LHRH neurons. *Endocrinology* *143*, 3306–3315.
- Giacobini, P., Kopin, A.S., Beart, P.M., Mercer, L.D., Fasolo, A., and Wray, S. (2004). Cholecystokinin Modulates Migration of Gonadotropin-Releasing Hormone-1 Neurons. *J. Neurosci.* *24*, 4737–4748.
- Giacobini, P., Messina, A., Wray, S., Giampietro, C., Crepaldi, T., Carmeliet, P., and Fasolo, A. (2007). Hepatocyte Growth Factor Acts as a Motogen and Guidance Signal for Gonadotropin Hormone-Releasing Hormone-1 Neuronal Migration. *J. Neurosci.* *27*, 431–445.
- Giacobini, P., Messina, A., Morello, F., Ferraris, N., Corso, S., Penachioni, J., Giordano, S., Tamagnone, L., and Fasolo, A. (2008). Semaphorin 4D regulates gonadotropin hormone-releasing hormone-1 neuronal migration through PlexinB1–Met complex. *J. Cell Biol.* *183*, 555–566.
- Gill, J.C., and Tsai, P.-S. (2006). Expression of a dominant negative FGF receptor in developing GNRH1 neurons disrupts axon outgrowth and targeting to the median eminence. *Biol. Reprod.* *74*, 463–472.
- Giulii, G., Shen, W.H., and Ingraham, H.A. (1997). The nuclear receptor SF-1 mediates sexually dimorphic expression of Mullerian Inhibiting Substance, in vivo. *Dev. Camb. Engl.* *124*, 1799–1807.
- Goodarzi, M.O., Dumesic, D.A., Chazenbalk, G., and Azziz, R. (2011). Polycystic ovary syndrome: etiology, pathogenesis and diagnosis. *Nat. Rev. Endocrinol.* *7*, 219–231.
- Gore, A.C. (2002). GnRH: The Master Molecule of Reproduction (Springer Science & Business Media).
- Gore, A.C., Wu, T.J., Rosenberg, J.J., and Roberts, J.L. (1996). Gonadotropin-Releasing Hormone and NMDA Receptor Gene Expression and Colocalization Change during Puberty in Female Rats. *J. Neurosci.* *16*, 5281–5289.

- Gore, A.C., Oung, T., and Woller, M.J. (2002). Age-related changes in hypothalamic gonadotropin-releasing hormone and N-methyl-D-aspartate receptor gene expression, and their regulation by oestrogen, in the female rat. *J. Neuroendocrinol.* *14*, 300–309.
- Gottsch, M.L., Cunningham, M.J., Smith, J.T., Popa, S.M., Acohido, B.V., Crowley, W.F., Seminara, S., Clifton, D.K., and Steiner, R.A. (2004). A role for kisspeptins in the regulation of gonadotropin secretion in the mouse. *Endocrinology* *145*, 4073–4077.
- Gouédard, L., Chen, Y.G., Thevenet, L., Racine, C., Borie, S., Lamarre, I., Josso, N., Massague, J., and di Clemente, N. (2000). Engagement of bone morphogenetic protein type IB receptor and Smad1 signaling by anti-Müllerian hormone and its type II receptor. *J. Biol. Chem.* *275*, 27973–27978.
- Graus-Porta, D., Blaess, S., Senften, M., Littlewood-Evans, A., Damsky, C., Huang, Z., Orban, P., Klein, R., Schittny, J.C., and Müller, U. (2001). Beta1-class integrins regulate the development of laminae and folia in the cerebral and cerebellar cortex. *Neuron* *31*, 367–379.
- Griffin, D.K., Ellis, P.J., Dunmore, B., Bauer, J., Abel, M.H., and Affara, N.A. (2010). Transcriptional profiling of luteinizing hormone receptor-deficient mice before and after testosterone treatment provides insight into the hormonal control of postnatal testicular development and Leydig cell differentiation. *Biol. Reprod.* *82*, 1139–1150.
- Grynberg, M., Pierre, A., Rey, R., Leclerc, A., Arouche, N., Hesters, L., Catteau-Jonard, S., Frydman, R., Picard, J.-Y., Fanchin, R., et al. (2012). Differential regulation of ovarian anti-müllerian hormone (AMH) by estradiol through α - and β -estrogen receptors. *J. Clin. Endocrinol. Metab.* *97*, E1649–1657.
- Gu, G.B., and Simerly, R.B. (1997). Projections of the sexually dimorphic anteroventral periventricular nucleus in the female rat. *J. Comp. Neurol.* *384*, 142–164.
- Gu, G., Varoqueaux, F., and Simerly, R.B. (1999). Hormonal regulation of glutamate receptor gene expression in the anteroventral periventricular nucleus of the hypothalamus. *J. Neurosci. Off. J. Soc. Neurosci.* *19*, 3213–3222.
- Gyurko, R., Leupen, S., and Huang, P.L. (2002). Deletion of exon 6 of the neuronal nitric oxide synthase gene in mice results in hypogonadism and infertility. *Endocrinology* *143*, 2767–2774.
- Han, S.-K., Gottsch, M.L., Lee, K.J., Popa, S.M., Smith, J.T., Jakawich, S.K., Clifton, D.K., Steiner, R.A., and Herbison, A.E. (2005). Activation of gonadotropin-releasing hormone neurons by kisspeptin as a neuroendocrine switch for the onset of puberty. *J. Neurosci. Off. J. Soc. Neurosci.* *25*, 11349–11356.
- Hanchate, N.K., Giacobini, P., Lhuillier, P., Parkash, J., Espy, C., Fouveaut, C., Leroy, C., Baron, S., Campagne, C., Vanacker, C., et al. (2012a). SEMA3A, a Gene Involved in Axonal Pathfinding, Is Mutated in Patients with Kallmann Syndrome. *PLoS Genet* *8*, e1002896.
- Hanchate, N.K., Parkash, J., Bellefontaine, N., Mazur, D., Colledge, W.H., d' Anglemont de Tassigny, X., and Prevot, V. (2012b). Kisspeptin-GPR54 signaling in mouse NO-synthesizing neurons participates in the hypothalamic control of ovulation. *J. Neurosci. Off. J. Soc. Neurosci.* *32*, 932–945.
- Haqq, C.M., King, C.Y., Ukiyama, E., Falsafi, S., Haqq, T.N., Donahoe, P.K., and Weiss, M.A. (1994). Molecular basis of mammalian sexual determination: activation of Müllerian inhibiting substance gene expression by SRY. *Science* *266*, 1494–1500.
- Hardelin, J.P., Soussi-Yanicostas, N., Ardouin, O., Levilliers, J., and Petit, C. (2000). Kallmann syndrome. *Adv. Otorhinolaryngol.* *56*, 268–274.

- Hartsough, M.T., Frey, R.S., Zipfel, P.A., Buard, A., Cook, S.J., McCormick, F., and Mulder, K.M. (1996). Altered transforming growth factor signaling in epithelial cells when ras activation is blocked. *J. Biol. Chem.* *271*, 22368–22375.
- Hayashi, H., Abdollah, S., Qiu, Y., Cai, J., Xu, Y.Y., Grinnell, B.W., Richardson, M.A., Topper, J.N., Gimbrone, M.A., Jr, Wrana, J.L., et al. (1997). The MAD-related protein Smad7 associates with the TGFbeta receptor and functions as an antagonist of TGFbeta signaling. *Cell* *89*, 1165–1173.
- Heger, S., Seney, M., Bless, E., Schwarting, G.A., Bilger, M., Mungenast, A., Ojeda, S.R., and Tobet, S.A. (2003). Overexpression of glutamic acid decarboxylase-67 (GAD-67) in gonadotropin-releasing hormone neurons disrupts migratory fate and female reproductive function in mice. *Endocrinology* *144*, 2566–2579.
- Heldin, C.H., Miyazono, K., and ten Dijke, P. (1997). TGF-beta signalling from cell membrane to nucleus through SMAD proteins. *Nature* *390*, 465–471.
- Herbison, A.E. (1998). Multimodal influence of estrogen upon gonadotropin-releasing hormone neurons. *Endocr. Rev.* *19*, 302–330.
- Herbison, A.E., and Dyer, R.G. (1991). Effect on luteinizing hormone secretion of GABA receptor modulation in the medial preoptic area at the time of proestrous luteinizing hormone surge. *Neuroendocrinology* *53*, 317–320.
- Herbison, A.E., and Moenter, S.M. (2011). Depolarising and hyperpolarising actions of GABA(A) receptor activation on gonadotrophin-releasing hormone neurones: towards an emerging consensus. *J. Neuroendocrinol.* *23*, 557–569.
- Herbison, A.E., Simonian, S.X., Norris, P.J., and Emson, P.C. (1996). Relationship of neuronal nitric oxide synthase immunoreactivity to GnRH neurons in the ovariectomized and intact female rat. *J. Neuroendocrinol.* *8*, 73–82.
- Herbison, A.E., Pape, J.R., Simonian, S.X., Skynner, M.J., and Sim, J.A. (2001). Molecular and cellular properties of GnRH neurons revealed through transgenics in the mouse. *Mol. Cell. Endocrinol.* *185*, 185–194.
- Herbison, A.E., Porteous, R., Pape, J.-R., Mora, J.M., and Hurst, P.R. (2008). Gonadotropin-releasing hormone neuron requirements for puberty, ovulation, and fertility. *Endocrinology* *149*, 597–604.
- Herde, M.K., Iremonger, K.J., Constantin, S., and Herbison, A.E. (2013). GnRH neurons elaborate a long-range projection with shared axonal and dendritic functions. *J. Neurosci. Off. J. Soc. Neurosci.* *33*, 12689–12697.
- Hess, R.A. (2003). Estrogen in the adult male reproductive tract: A review. *Reprod. Biol. Endocrinol.* *1*, 52.
- Hirobe, S., He, W.W., Lee, M.M., and Donahoe, P.K. (1992). Mullerian inhibiting substance messenger ribonucleic acid expression in granulosa and Sertoli cells coincides with their mitotic activity. *Endocrinology* *131*, 854–862.
- Hood, J.D., and Cheresch, D.A. (2002). Role of integrins in cell invasion and migration. *Nat. Rev. Cancer* *2*, 91–100.
- Hudson, P.L., Douglas, I., Donahoe, P.K., Cate, R.L., Epstein, J., Pepinsky, R.B., and MacLaughlin, D.T. (1990). An immunoassay to detect human müllerian inhibiting substance in males and females during normal development. *J. Clin. Endocrinol. Metab.* *70*, 16–22.

- Humphries, M.J., McEwan, P.A., Barton, S.J., Buckley, P.A., Bella, J., and Mould, A.P. (2003). Integrin structure: heady advances in ligand binding, but activation still makes the knees wobble. *Trends Biochem. Sci.* *28*, 313–320.
- Hynes, R.O. (2004). The emergence of integrins: a personal and historical perspective. *Matrix Biol. J. Int. Soc. Matrix Biol.* *23*, 333–340.
- Hyytiäinen, M., Penttinen, C., and Keski-Oja, J. (2008). Latent TGF- β Binding Proteins: Extracellular Matrix Association and Roles in TGF- β Activation.
- IF Stein, and Leventhal, M. (1935). Amenorrhea associated with bilateral polycystic ovaries.
- Imbeaud, S., Faure, E., Lamarre, I., Mattéi, M.-G., di Clemente, N., Tizard, R., Carré-Eusèbe, D., Belville, C., Tragethon, L., Tonkin, C., et al. (1995). Insensitivity to anti-Müllerian hormone due to a mutation in the human anti-Müllerian hormone receptor. *Nat. Genet.* *11*, 382–388.
- Imhoff, F.M., Yang, D., Mathew, S.F., Clarkson, A.N., Kawagishi, Y., Tate, W.P., Koishi, K., and McLennan, I.S. (2013). The type 2 anti-Müllerian hormone receptor has splice variants that are dominant-negative inhibitors. *FEBS Lett.* *587*, 1749–1753.
- Inman, G.J., and Hill, C.S. (2002). Stoichiometry of active smad-transcription factor complexes on DNA. *J. Biol. Chem.* *277*, 51008–51016.
- Iovane, A., Aumas, C., and Roux, N. de (2004). New insights in the genetics of isolated hypogonadotropic hypogonadism. *Eur. J. Endocrinol.* *151*, U83–U88.
- Itoh, S., Itoh, F., Goumans, M.-J., and ten Dijke, P. (2000a). Signaling of transforming growth factor- β family members through Smad proteins. *Eur. J. Biochem.* *267*, 6954–6967.
- Itoh, S., Ericsson, J., Nishikawa, J., Heldin, C.H., and ten Dijke, P. (2000b). The transcriptional co-activator P/CAF potentiates TGF-beta/Smad signaling. *Nucleic Acids Res.* *28*, 4291–4298.
- Jamin, S.P., Arango, N.A., Mishina, Y., Hanks, M.C., and Behringer, R.R. (2002). Requirement of *Bmpr1a* for Müllerian duct regression during male sexual development. *Nat. Genet.* *32*, 408–410.
- Jamin, S.P., Arango, N.A., Mishina, Y., Hanks, M.C., and Behringer, R.R. (2003). Genetic studies of the AMH/MIS signaling pathway for Müllerian duct regression. *Mol. Cell. Endocrinol.* *211*, 15–19.
- Jennes, L., Lin, W., and Lakhani, S. (2002). Glutamatergic regulation of gonadotropin-releasing hormone neurons. *Prog. Brain Res.* *141*, 183–192.
- Jonard, S., and Dewailly, D. (2004). The follicular excess in polycystic ovaries, due to intra-ovarian hyperandrogenism, may be the main culprit for the follicular arrest. *Hum. Reprod. Update* *10*, 107–117.
- Jones, M.R., Wilson, S.G., Mullin, B.H., Mead, R., Watts, G.F., and Stuckey, B.G.A. (2007). Polymorphism of the follistatin gene in polycystic ovary syndrome. *Mol. Hum. Reprod.* *13*, 237–241.
- Josso, N. (1972). [Inhibitory action of calf fetus testis on rat fetus Müllerian ducts in organotypic culture: role of seminiferous tubes]. *Comptes Rendus Hebd. Séances Académie Sci. Sér. Sci. Nat.* *274*, 3573–3576.
- Josso, N., di Clemente, N., and Gouédard, L. (2001). Anti-Müllerian hormone and its receptors. *Mol. Cell. Endocrinol.* *179*, 25–32.
- Jost, A. (1947). Recherches sur la différenciation de l'embryon de lapin III.

- Kaartinen, V., Voncken, J.W., Shuler, C., Warburton, D., Bu, D., Heisterkamp, N., and Groffen, J. (1995). Abnormal lung development and cleft palate in mice lacking TGF-beta 3 indicates defects of epithelial-mesenchymal interaction. *Nat. Genet.* *11*, 415–421.
- Kah, O., Lethimonier, C., Somoza, G., Guilgur, L.G., Vaillant, C., and Lareyre, J.J. (2007). GnRH and GnRH receptors in metazoa: a historical, comparative, and evolutive perspective. *Gen. Comp. Endocrinol.* *153*, 346–364.
- Kallmann, F., Schoenfeld, W., and Barrera, S. (1944). The genetic aspects of primary eunuchoidism. *Am J Mental Deficiency.*
- Känsäkoski, J., Fagerholm, R., Laitinen, E.-M., Vaaralahti, K., Hackman, P., Pitteloud, N., Raivio, T., and Tommiska, J. (2014). Mutation screening of SEMA3A and SEMA7A in patients with congenital hypogonadotropic hypogonadism. *Pediatr. Res.* *75*, 641–644.
- Kerr, D.I., and Ong, J. (1995). GABAB receptors. *Pharmacol. Ther.* *67*, 187–246.
- Kevenaar, M.E., Meerasahib, M.F., Kramer, P., van de Lang-Born, B.M.N., de Jong, F.H., Groome, N.P., Themmen, A.P.N., and Visser, J.A. (2006). Serum anti-mullerian hormone levels reflect the size of the primordial follicle pool in mice. *Endocrinology* *147*, 3228–3234.
- Kevenaar, M.E., Laven, J.S.E., Fong, S.L., Uitterlinden, A.G., de Jong, F.H., Themmen, A.P.N., and Visser, J.A. (2008). A functional anti-mullerian hormone gene polymorphism is associated with follicle number and androgen levels in polycystic ovary syndrome patients. *J. Clin. Endocrinol. Metab.* *93*, 1310–1316.
- Kew, J.N.C., and Kemp, J.A. (2005). Ionotropic and metabotropic glutamate receptor structure and pharmacology. *Psychopharmacology (Berl.)* *179*, 4–29.
- Kim, C., Ye, F., and Ginsberg, M.H. (2011). Regulation of integrin activation. *Annu. Rev. Cell Dev. Biol.* *27*, 321–345.
- Kim, H.-G., Kurth, I., Lan, F., Meliciani, I., Wenzel, W., Eom, S.H., Kang, G.B., Rosenberger, G., Tekin, M., Ozata, M., et al. (2008). Mutations in CHD7, encoding a chromatin-remodeling protein, cause idiopathic hypogonadotropic hypogonadism and Kallmann syndrome. *Am. J. Hum. Genet.* *83*, 511–519.
- Kim, H.-G., Ahn, J.-W., Kurth, I., Ullmann, R., Kim, H.-T., Kulharya, A., Ha, K.-S., Itokawa, Y., Meliciani, I., Wenzel, W., et al. (2010). WDR11, a WD protein that interacts with transcription factor EMX1, is mutated in idiopathic hypogonadotropic hypogonadism and Kallmann syndrome. *Am. J. Hum. Genet.* *87*, 465–479.
- Kim, J.H., Seibel, M.M., MacLaughlin, D.T., Donahoe, P.K., Ransil, B.J., Hametz, P.A., and Richards, C.J. (1992). The inhibitory effects of müllerian-inhibiting substance on epidermal growth factor induced proliferation and progesterone production of human granulosa-luteal cells. *J. Clin. Endocrinol. Metab.* *75*, 911–917.
- Kim, K.H., Patel, L., Tobet, S.A., King, J.C., Rubin, B.S., and Stopa, E.G. (1999). Gonadotropin-releasing hormone immunoreactivity in the adult and fetal human olfactory system. *Brain Res.* *826*, 220–229.
- King, J.A., and Millar, R.P. (1982). Structure of chicken hypothalamic luteinizing hormone-releasing hormone. II. Isolation and characterization. *J. Biol. Chem.* *257*, 10729–10732.
- King, T.R., Lee, B.K., Behringer, R.R., and Eicher, E.M. (1991). Mapping anti-müllerian hormone (amh) and related sequences in the mouse: Identification of a new region of homology between MMU10 and HSA19p. *Genomics* *11*, 273–283.

- Kingsley, D.M. (1994). The TGF-beta superfamily: new members, new receptors, and new genetic tests of function in different organisms. *Genes Dev.* *8*, 133–146.
- Kissell, K.A., Danaher, M.R., Schisterman, E.F., Wactawski-Wende, J., Ahrens, K.A., Schliep, K., Perkins, N.J., Sjaarda, L., Weck, J., and Mumford, S.L. (2014). Biological variability in serum anti-Müllerian hormone throughout the menstrual cycle in ovulatory and sporadic anovulatory cycles in eumenorrheic women. *Hum. Reprod. Oxf. Engl.*
- Knauf, C., Ferreira, S., Hamdane, M., Mailliot, C., Prevot, V., Beauvillain, J.C., and Croix, D. (2001). Variation of endothelial nitric oxide synthase synthesis in the median eminence during the rat estrous cycle: an additional argument for the implication of vascular blood vessel in the control of GnRH release. *Endocrinology* *142*, 4288–4294.
- Knobil, E., and Neill, E. (1980). *Knobil and Neill's physiology of Reproduction*.
- Kobayashi, A., and Behringer, R.R. (2003a). Developmental genetics of the female reproductive tract in mammals. *Nat. Rev. Genet.* *4*, 969–980.
- Kobayashi, A., and Behringer, R.R. (2003b). Developmental genetics of the female reproductive tract in mammals. *Nat. Rev. Genet.* *4*, 969–980.
- Kohsaka, A., Watanobe, H., Kakizaki, Y., and Suda, T. (1999). A comparative study of the effects of nitric oxide and carbon monoxide on the in vivo release of gonadotropin-releasing hormone and neuropeptide Y from rat hypothalamus during the estradiol-induced luteinizing hormone surge: estimation by push-pull perfusion. *Neuroendocrinology* *69*, 245–253.
- Kramer, P.R., and Wray, S. (2000). Midline Nasal Tissue Influences Nestin Expression in Nasal-Placode-Derived Luteinizing Hormone-Releasing Hormone Neurons during Development. *Dev. Biol.* *227*, 343–357.
- Krege, J.H., Hodgin, J.B., Couse, J.F., Enmark, E., Warner, M., Mahler, J.F., Sar, M., Korach, K.S., Gustafsson, J.-Å., and Smithies, O. (1998). Generation and reproductive phenotypes of mice lacking estrogen receptor β . *Proc. Natl. Acad. Sci.* *95*, 15677–15682.
- Kretschmar, M., Liu, F., Hata, A., Doody, J., and Massagué, J. (1997). The TGF-beta family mediator Smad1 is phosphorylated directly and activated functionally by the BMP receptor kinase. *Genes Dev.* *11*, 984–995.
- Kusano, K., Fueshko, S., Gainer, H., and Wray, S. (1995). Electrical and synaptic properties of embryonic luteinizing hormone-releasing hormone neurons in explant cultures. *Proc. Natl. Acad. Sci.* *92*, 3918–3922.
- Langlet, F., Levin, B.E., Luquet, S., Mazzone, M., Messina, A., Dunn-Meynell, A.A., Balland, E., Lacombe, A., Mazur, D., Carmeliet, P., et al. (2013). Tanycytic VEGF-A boosts blood-hypothalamus barrier plasticity and access of metabolic signals to the arcuate nucleus in response to fasting. *Cell Metab.* *17*, 607–617.
- De Larco, J.E., and Todaro, G.J. (1978). Growth factors from murine sarcoma virus-transformed cells. *Proc. Natl. Acad. Sci. U. S. A.* *75*, 4001–4005.
- Lasala, C., Schteingart, H.F., Arouche, N., Bedecarrás, P., Grinspon, R.P., Picard, J.-Y., Josso, N., di Clemente, N., and Rey, R.A. (2011). SOX9 and SF1 are involved in cyclic AMP-mediated upregulation of anti-Müllerian gene expression in the testicular prepubertal Sertoli cell line SMAT1. *Am. J. Physiol. Endocrinol. Metab.* *301*, E539–547.
- Laven, J.S.E., Mulders, A.G.M.G.J., Visser, J.A., Themmen, A.P., De Jong, F.H., and Fauser, B.C.J.M. (2004). Anti-Müllerian hormone serum concentrations in normoovulatory and anovulatory women of reproductive age. *J. Clin. Endocrinol. Metab.* *89*, 318–323.

- Lebrethon, M.C., Aganina, A., Fournier, M., Gérard, A., Parent, A.S., and Bourguignon, J.P. (2007). Effects of in vivo and in vitro administration of ghrelin, leptin and neuropeptide mediators on pulsatile gonadotrophin-releasing hormone secretion from male rat hypothalamus before and after puberty. *J. Neuroendocrinol.* *19*, 181–188.
- Lee, M.M., and Donahoe, P.K. (1993). Mullerian inhibiting substance: a gonadal hormone with multiple functions. *Endocr. Rev.* *14*, 152–164.
- Lee, J.M., Tiong, J., Maddox, D.M., Condie, B.G., and Wray, S. (2008). Temporal migration of gonadotrophin-releasing hormone-1 neurones is modified in GAD67 knockout mice. *J. Neuroendocrinol.* *20*, 93–103.
- Lee, J.O., Bankston, L.A., Arnaout, M.A., and Liddington, R.C. (1995). Two conformations of the integrin A-domain (I-domain): a pathway for activation? *Struct. Lond. Engl.* *1993* *3*, 1333–1340.
- Lee, M.M., Donahoe, P.K., Hasegawa, T., Silverman, B., Crist, G.B., Best, S., Hasegawa, Y., Noto, R.A., Schoenfeld, D., and MacLaughlin, D.T. (1996). Mullerian inhibiting substance in humans: normal levels from infancy to adulthood. *J. Clin. Endocrinol. Metab.* *81*, 571–576.
- Legouis, R., Hardelin, J.P., Leveilliers, J., Claverie, J.M., Compain, S., Wunderle, V., Millasseau, P., Le Paslier, D., Cohen, D., and Caterina, D. (1991). The candidate gene for the X-linked Kallmann syndrome encodes a protein related to adhesion molecules. *Cell* *67*, 423–435.
- Lehman, M.N., Coolen, L.M., and Goodman, R.L. (2010). Minireview: kisspeptin/neurokinin B/dynorphin (KNDy) cells of the arcuate nucleus: a central node in the control of gonadotropin-releasing hormone secretion. *Endocrinology* *151*, 3479–3489.
- Levine, J.E. (1997). New concepts of the neuroendocrine regulation of gonadotropin surges in rats. *Biol. Reprod.* *56*, 293–302.
- Levine, J.E., Chappell, P.E., Schneider, J.S., Sleiter, N.C., and Szabo, M. (2001). Progesterone receptors as neuroendocrine integrators. *Front. Neuroendocrinol.* *22*, 69–106.
- Lilienbaum, A., Reszka, A.A., Horwitz, A.F., and Holt, C.E. (1995). Chimeric integrins expressed in retinal ganglion cells impair process outgrowth in vivo. *Mol. Cell. Neurosci.* *6*, 139–152.
- López, F.J., Moretto, M., Merchenthaler, I., and Negro-Vilar, A. (1997). Nitric oxide is involved in the genesis of pulsatile LHRH secretion from immortalized LHRH neurons. *J. Neuroendocrinol.* *9*, 647–654.
- Lubahn, D.B., Moyer, J.S., Golding, T.S., Couse, J.F., Korach, K.S., and Smithies, O. (1993). Alteration of reproductive function but not prenatal sexual development after insertional disruption of the mouse estrogen receptor gene. *Proc. Natl. Acad. Sci.* *90*, 11162–11166.
- Lukas-Croisier, C., Lasala, C., Nicaud, J., Bedecarrás, P., Kumar, T.R., Dutertre, M., Matzuk, M.M., Picard, J.-Y., Josso, N., and Rey, R. (2003). Follicle-stimulating hormone increases testicular Anti-Mullerian hormone (AMH) production through sertoli cell proliferation and a nonclassical cyclic adenosine 5'-monophosphate-mediated activation of the AMH Gene. *Mol. Endocrinol. Baltim. Md* *17*, 550–561.
- Luo, K., and Lodish, H.F. (1997). Positive and negative regulation of type II TGF-beta receptor signal transduction by autophosphorylation on multiple serine residues. *EMBO J.* *16*, 1970–1981.
- MacColl, G., Quinton, R., and Bouloux, P.M.G. (2002). GnRH neuronal development: insights into hypogonadotrophic hypogonadism. *Trends Endocrinol. Metab. TEM* *13*, 112–118.

- Macdonald, M.C., and Wilkinson, M. (1992). Characterization and ontogenesis of N-methyl-D-aspartate-evoked luteinizing hormone secretion in immature female rats. *J. Neuroendocrinol.* *4*, 223–229.
- MacDonald, M.C., and Wilkinson, M. (1990). Peripubertal treatment with N-methyl-D-aspartic acid or neonatally with monosodium glutamate accelerates sexual maturation in female rats, an effect reversed by MK-801. *Neuroendocrinology* *52*, 143–149.
- Macías-Silva, M., Abdollah, S., Hoodless, P.A., Pirone, R., Attisano, L., and Wrana, J.L. (1996). MADR2 is a substrate of the TGFbeta receptor and its phosphorylation is required for nuclear accumulation and signaling. *Cell* *87*, 1215–1224.
- Maestre, de S.J.A. (1856). . Falta total de nervios olfatorios con anosmia en un individuo en quien existía una atrofia congénita de los testículos y miembro viril.
- Maffucci, J.A., and Gore, A.C. (2009). Chapter 2 Hypothalamic Neural Systems Controlling the Female Reproductive Life Cycle. In *International Review of Cell and Molecular Biology*, (Elsevier), pp. 69–127.
- Mahesh, V.B., and Brann, D.W. (2005). Regulatory role of excitatory amino acids in reproduction. *Endocrine* *28*, 271–280.
- Maliqueo, M., Lara, H.E., Sánchez, F., Echiburú, B., Crisosto, N., and Sir-Petermann, T. (2013). Placental steroidogenesis in pregnant women with polycystic ovary syndrome. *Eur. J. Obstet. Gynecol. Reprod. Biol.* *166*, 151–155.
- La Marca, A., and Volpe, A. (2006). Anti-Müllerian hormone (AMH) in female reproduction: is measurement of circulating AMH a useful tool? *Clin. Endocrinol. (Oxf.)* *64*, 603–610.
- La Marca, A., Stabile, G., Arsenio, A.C., and Volpe, A. (2006). Serum anti-Mullerian hormone throughout the human menstrual cycle. *Hum. Reprod. Oxf. Engl.* *21*, 3103–3107.
- Marín, O., and Rubenstein, J.L.R. (2003). Cell migration in the forebrain. *Annu. Rev. Neurosci.* *26*, 441–483.
- Marshall, J.C., and Eagleson, C.A. (1999). NEUROENDOCRINE ASPECTS OF POLYCYSTIC OVARY SYNDROME. *Endocrinol. Metab. Clin. North Am.* *28*, 295–324.
- Massagué, J. (1990). Transforming growth factor-alpha. A model for membrane-anchored growth factors. *J. Biol. Chem.* *265*, 21393–21396.
- Massagué, J. (1998). TGF-beta signal transduction. *Annu. Rev. Biochem.* *67*, 753–791.
- Massagué, J. (2000). How cells read TGF-beta signals. *Nat. Rev. Mol. Cell Biol.* *1*, 169–178.
- Massagué, J., and Wotton, D. (2000). Transcriptional control by the TGF-beta/Smad signaling system. *EMBO J.* *19*, 1745–1754.
- Massagué, J., Blain, S.W., and Lo, R.S. (2000). TGFbeta signaling in growth control, cancer, and heritable disorders. *Cell* *103*, 295–309.
- Matsumoto, S.-I., Yamazaki, C., Masumoto, K.-H., Nagano, M., Naito, M., Soga, T., Hiyama, H., Matsumoto, M., Takasaki, J., Kamohara, M., et al. (2006). Abnormal development of the olfactory bulb and reproductive system in mice lacking prokineticin receptor PKR2. *Proc. Natl. Acad. Sci. U. S. A.* *103*, 4140–4145.
- Matuszczak, E., Hermanowicz, A., Komarowska, M., and Debek, W. (2013). Serum AMH in Physiology and Pathology of Male Gonads. *Int. J. Endocrinol.* *2013*, 128907.

- Mayer, C., and Boehm, U. (2011). Female reproductive maturation in the absence of kisspeptin/GPR54 signaling. *Nat. Neurosci.* *14*, 704–710.
- McCARTHY, M.M. (2008). Estradiol and the Developing Brain. *Physiol. Rev.* *88*, 91–134.
- McDevitt, M.A., Glidewell-Kenney, C., Jimenez, M.A., Ahearn, P.C., Weiss, J., Jameson, J.L., and Levine, J.E. (2008). New insights into the classical and non-classical actions of estrogen: evidence from estrogen receptor knock-out and knock-in mice. *Mol. Cell. Endocrinol.* *290*, 24–30.
- Merino, P.M., Codner, E., and Cassorla, F. (2011). A rational approach to the diagnosis of polycystic ovarian syndrome during adolescence. *Arq. Bras. Endocrinol. Metabol.* *55*, 590–598.
- Messina, A., and Giacobini, P. (2013). Semaphorin Signaling in the Development and Function of the Gonadotropin Hormone-Releasing Hormone System. *Front. Endocrinol.* *4*, 133.
- Messina, A., Ferraris, N., Wray, S., Cagnoni, G., Donohue, D.E., Casoni, F., Kramer, P.R., Derijck, A.A., Adolfs, Y., Fasolo, A., et al. (2011). Dysregulation of Semaphorin7A/ β 1-integrin signaling leads to defective GnRH-1 cell migration, abnormal gonadal development and altered fertility. *Hum. Mol. Genet.* *20*, 4759–4774.
- Millar, R.P. (2005). GnRHs and GnRH receptors. *Anim. Reprod. Sci.* *88*, 5–28.
- Milner, R., and Campbell, I.L. (2002). The integrin family of cell adhesion molecules has multiple functions within the CNS. *J. Neurosci. Res.* *69*, 286–291.
- Mishina, Y., Rey, R., Finegold, M.J., Matzuk, M.M., Josso, N., Cate, R.L., and Behringer, R.R. (1996). Genetic analysis of the Müllerian-inhibiting substance signal transduction pathway in mammalian sexual differentiation. *Genes Dev.* *10*, 2577–2587.
- Mishina, Y., Whitworth, D.J., Racine, C., and Behringer, R.R. (1999). High specificity of Müllerian-inhibiting substance signaling in vivo. *Endocrinology* *140*, 2084–2088.
- Miyamoto, K., Hasegawa, Y., Nomura, M., Igarashi, M., Kangawa, K., and Matsuo, H. (1984). Identification of the second gonadotropin-releasing hormone in chicken hypothalamus: evidence that gonadotropin secretion is probably controlled by two distinct gonadotropin-releasing hormones in avian species. *Proc. Natl. Acad. Sci. U. S. A.* *81*, 3874–3878.
- Mobley, A.K., and McCarty, J.H. (2011). β 8 integrin is essential for neuroblast migration in the rostral migratory stream. *Glia* *59*, 1579–1587.
- Moenter, S.M., Caraty, A., Locatelli, A., and Karsch, F.J. (1991). Pattern of gonadotropin-releasing hormone (GnRH) secretion leading up to ovulation in the ewe: existence of a preovulatory GnRH surge. *Endocrinology* *129*, 1175–1182.
- Moguilevsky, J.A., Carbone, S., Szwarcfarb, B., and Rondina, D. (1991). Sexual maturation modifies the GABAergic control of gonadotrophin secretion in female rats. *Brain Res.* *563*, 12–16.
- Moore, A.M., Prescott, M., and Campbell, R.E. (2013). Estradiol negative and positive feedback in a prenatal androgen-induced mouse model of polycystic ovarian syndrome. *Endocrinology* *154*, 796–806.
- Moore, J.P., Shang, E., and Wray, S. (2002). In situ GABAergic modulation of synchronous gonadotropin releasing hormone-1 neuronal activity. *J. Neurosci. Off. J. Soc. Neurosci.* *22*, 8932–8941.

- Morais da Silva, S., Hacker, A., Harley, V., Goodfellow, P., Swain, A., and Lovell-Badge, R. (1996). Sox9 expression during gonadal development implies a conserved role for the gene in testis differentiation in mammals and birds. *Nat. Genet.* *14*, 62–68.
- Moresco, E.M.Y., Donaldson, S., Williamson, A., and Koleske, A.J. (2005). Integrin-mediated dendrite branch maintenance requires Abelson (Abl) family kinases. *J. Neurosci. Off. J. Soc. Neurosci.* *25*, 6105–6118.
- Moretto, M., López, F.J., and Negro-Vilar, A. (1993). Nitric oxide regulates luteinizing hormone-releasing hormone secretion. *Endocrinology* *133*, 2399–2402.
- Mori, K., Nagao, H., and Yoshihara, Y. (1999). The olfactory bulb: coding and processing of odor molecule information. *Science* *286*, 711–715.
- Mulders, A.G.M.G.J., Laven, J.S.E., Eijkemans, M.J.C., de Jong, F.H., Themmen, A.P.N., and Fauser, B.C.J.M. (2004). Changes in anti-Müllerian hormone serum concentrations over time suggest delayed ovarian ageing in normogonadotrophic anovulatory infertility. *Hum. Reprod. Oxf. Engl.* *19*, 2036–2042.
- Munsterberg, A., and Lovell-Badge, R. (1991). Expression of the mouse anti-mullerian hormone gene suggests a role in both male and female sexual differentiation. *Development* *113*, 613–624.
- Murakami, S., Seki, T., Rutishauser, U., and Arai, Y. (2000). Enzymatic removal of polysialic acid from neural cell adhesion molecule perturbs the migration route of luteinizing hormone-releasing hormone neurons in the developing chick forebrain. *J. Comp. Neurol.* *420*, 171–181.
- Murase, S., and Horwitz, A.F. (2002). Deleted in colorectal carcinoma and differentially expressed integrins mediate the directional migration of neural precursors in the rostral migratory stream. *J. Neurosci. Off. J. Soc. Neurosci.* *22*, 3568–3579.
- Nachtigal, M.W., Hirokawa, Y., Enyeart-VanHouten, D.L., Flanagan, J.N., Hammer, G.D., and Ingraham, H.A. (1998). Wilms' tumor 1 and Dax-1 modulate the orphan nuclear receptor SF-1 in sex-specific gene expression. *Cell* *93*, 445–454.
- Naor, Z. (1990). Signal transduction mechanisms of Ca²⁺ mobilizing hormones: the case of gonadotropin-releasing hormone. *Endocr. Rev.* *11*, 326–353.
- Naor, Z. (2009). Signaling by G-protein-coupled receptor (GPCR): studies on the GnRH receptor. *Front. Neuroendocrinol.* *30*, 10–29.
- Navarro, V.M., Fernández-Fernández, R., Castellano, J.M., Roa, J., Mayen, A., Barreiro, M.L., Gaytan, F., Aguilar, E., Pinilla, L., Dieguez, C., et al. (2004a). Advanced vaginal opening and precocious activation of the reproductive axis by KiSS-1 peptide, the endogenous ligand of GPR54. *J. Physiol.* *561*, 379–386.
- Navarro, V.M., Castellano, J.M., Fernández-Fernández, R., Barreiro, M.L., Roa, J., Sanchez-Criado, J.E., Aguilar, E., Dieguez, C., Pinilla, L., and Tena-Sempere, M. (2004b). Developmental and hormonally regulated messenger ribonucleic acid expression of KiSS-1 and its putative receptor, GPR54, in rat hypothalamus and potent luteinizing hormone-releasing activity of KiSS-1 peptide. *Endocrinology* *145*, 4565–4574.
- Navarro, V.M., Castellano, J.M., Fernández-Fernández, R., Tovar, S., Roa, J., Mayen, A., Nogueiras, R., Vazquez, M.J., Barreiro, M.L., Magni, P., et al. (2005). Characterization of the potent luteinizing hormone-releasing activity of KiSS-1 peptide, the natural ligand of GPR54. *Endocrinology* *146*, 156–163.
- Nef, S., and Parada, L.F. (2000). Hormones in male sexual development. *Genes Dev.* *14*, 3075–3086.

- Ojeda, S.R., Lomniczi, A., Mastronardi, C., Heger, S., Roth, C., Parent, A.-S., Matagne, V., and Mungenast, A.E. (2006). Minireview: the neuroendocrine regulation of puberty: is the time ripe for a systems biology approach? *Endocrinology* 147, 1166–1174.
- Olsson, N., Piek, E., Sundström, M., ten Dijke, P., and Nilsson, G. (2001). Transforming growth factor-beta-mediated mast cell migration depends on mitogen-activated protein kinase activity. *Cell. Signal.* 13, 483–490.
- Ottem, E.N., Godwin, J.G., and Petersen, S.L. (2002). Glutamatergic signaling through the N-methyl-D-aspartate receptor directly activates medial subpopulations of luteinizing hormone-releasing hormone (LHRH) neurons, but does not appear to mediate the effects of estradiol on LHRH gene expression. *Endocrinology* 143, 4837–4845.
- Padula, A.M. (2005). The freemartin syndrome: an update. *Anim. Reprod. Sci.* 87, 93–109.
- Page, D.C., Mosher, R., Simpson, E.M., Fisher, E.M., Mardon, G., Pollack, J., McGillivray, B., de la Chapelle, A., and Brown, L.G. (1987). The sex-determining region of the human Y chromosome encodes a finger protein. *Cell* 51, 1091–1104.
- Pape, J.R., Skynner, M.J., Sim, J.A., and Herbison, A.E. (2001). Profiling gamma-aminobutyric acid (GABA(A)) receptor subunit mRNA expression in postnatal gonadotropin-releasing hormone (GnRH) neurons of the male mouse with single cell RT-PCR. *Neuroendocrinology* 74, 300–308.
- Parkash, J., Cimino, I., Ferraris, N., Casoni, F., Wray, S., Cappy, H., Prevot, V., and Giacobini, P. (2012). Suppression of β 1-Integrin in Gonadotropin-Releasing Hormone Cells Disrupts Migration and Axonal Extension Resulting in Severe Reproductive Alterations. *J. Neurosci.* 32, 16992–17002.
- Pau, K.Y., Berria, M., Hess, D.L., and Spies, H.G. (1993). Preovulatory gonadotropin-releasing hormone surge in ovarian-intact rhesus macaques. *Endocrinology* 133, 1650–1656.
- Pelletier, J., Bruening, W., Kashtan, C.E., Mauer, S.M., Manivel, J.C., Striegel, J.E., Houghton, D.C., Junien, C., Habib, R., and Fouser, L. (1991). Germline mutations in the Wilms' tumor suppressor gene are associated with abnormal urogenital development in Denys-Drash syndrome. *Cell* 67, 437–447.
- Pepinsky, R.B., Sinclair, L.K., Chow, E.P., Mattaliano, R.J., Manganaro, T.F., Donahoe, P.K., and Cate, R.L. (1988). Proteolytic processing of müllerian inhibiting substance produces a transforming growth factor-beta-like fragment. *J. Biol. Chem.* 263, 18961–18964.
- Perrett, R.M., and McArdle, C.A. (2013). Molecular mechanisms of gonadotropin-releasing hormone signaling: integrating cyclic nucleotides into the network. *Front. Endocrinol.* 4, 180.
- Picard, J.Y., Tran, D., and Josso, N. (1978). Biosynthesis of labelled anti-müllerian hormone by fetal testes: evidence for the glycoprotein nature of the hormone and for its disulfide-bonded structure. *Mol. Cell. Endocrinol.* 12, 17–30.
- Picard, J.Y., Benarous, R., Guerrier, D., Josso, N., and Kahn, A. (1986). Cloning and expression of cDNA for anti-müllerian hormone. *Proc. Natl. Acad. Sci. U. S. A.* 83, 5464–5468.
- Picon, R. (1969). [Action of the fetal testis on the development in vitro of the Müllerian ducts in the rat]. *Arch. Anat. Microsc. Morphol. Expérimentale* 58, 1–19.
- Pierce, A., Bliesner, B., Xu, M., Nielsen-Preiss, S., Lemke, G., Tobet, S., and Wierman, M.E. (2008). Axl and Tyro3 modulate female reproduction by influencing gonadotropin-releasing hormone neuron survival and migration. *Mol. Endocrinol. Baltim. Md* 22, 2481–2495.

- Pigny, P., Merlen, E., Robert, Y., Cortet-Rudelli, C., Decanter, C., Jonard, S., and Dewailly, D. (2003). Elevated Serum Level of Anti-Müllerian Hormone in Patients with Polycystic Ovary Syndrome: Relationship to the Ovarian Follicle Excess and to the Follicular Arrest. *J. Clin. Endocrinol. Metab.* *88*, 5957–5962.
- Piltonen, T., Morin-Papunen, L., Koivunen, R., Perheentupa, A., Ruukonen, A., and Tapanainen, J.S. (2005). Serum anti-Müllerian hormone levels remain high until late reproductive age and decrease during metformin therapy in women with polycystic ovary syndrome. *Hum. Reprod. Oxf. Engl.* *20*, 1820–1826.
- Pingault, V., Bodereau, V., Baral, V., Marcos, S., Watanabe, Y., Chaoui, A., Fouveaut, C., Leroy, C., Vérier-Mine, O., Francannet, C., et al. (2013). Loss-of-function mutations in SOX10 cause Kallmann syndrome with deafness. *Am. J. Hum. Genet.* *92*, 707–724.
- Pinilla, L., Aguilar, E., Dieguez, C., Millar, R.P., and Tena-Sempere, M. (2012). Kisspeptins and reproduction: physiological roles and regulatory mechanisms. *Physiol. Rev.* *92*, 1235–1316.
- Popolow, H.B., King, J.C., and Gerall, A.A. (1981). Rostral medial preoptic area lesions' influence on female estrous processes and LHRH distribution. *Physiol. Behav.* *27*, 855–861.
- Prevot, V., Bouret, S., Stefano, G.B., and Beauvillain, J.-C. (2000). Median eminence nitric oxide signaling. *Brain Res. Rev.* *34*, 27–41.
- Racine, C., Rey, R., Forest, M.G., Louis, F., Ferré, A., Huhtaniemi, I., Jossen, N., and Clemente, N. di (1998). Receptors for anti-Müllerian hormone on Leydig cells are responsible for its effects on steroidogenesis and cell differentiation. *Proc. Natl. Acad. Sci.* *95*, 594–599.
- Radovick, S. (2012). Estrogenic regulation of the GnRH neuron. *Genomic Endocrinol.* *3*, 52.
- Rajpert-De Meyts, E., Jørgensen, N., Graem, N., Müller, J., Cate, R.L., and Skakkebaek, N.E. (1999). Expression of anti-Müllerian hormone during normal and pathological gonadal development: association with differentiation of Sertoli and granulosa cells. *J. Clin. Endocrinol. Metab.* *84*, 3836–3844.
- Rettori, V., Belova, N., Dees, W.L., Nyberg, C.L., Gimeno, M., and McCann, S.M. (1993). Role of nitric oxide in the control of luteinizing hormone-releasing hormone release in vivo and in vitro. *Proc. Natl. Acad. Sci. U. S. A.* *90*, 10130–10134.
- Rey, R. (1998). Endocrine, paracrine and cellular regulation of postnatal anti-müllerian hormone secretion by sertoli cells. *Trends Endocrinol. Metab. TEM* *9*, 271–276.
- Rey, R. (2005). Anti-Müllerian hormone in disorders of sex determination and differentiation. *Arq. Bras. Endocrinol. Metabol.* *49*, 26–36.
- Rey, R., Lordereau-Richard, I., Carel, J.C., Barbet, P., Cate, R.L., Roger, M., Chaussain, J.L., and Jossen, N. (1993). Anti-müllerian hormone and testosterone serum levels are inversely during normal and precocious pubertal development. *J. Clin. Endocrinol. Metab.* *77*, 1220–1226.
- Rey, R., Mebarki, F., Forest, M.G., Mowszowicz, I., Cate, R.L., Morel, Y., Chaussain, J.L., and Jossen, N. (1994). Anti-müllerian hormone in children with androgen insensitivity. *J. Clin. Endocrinol. Metab.* *79*, 960–964.
- Roberts, L.M., Hirokawa, Y., Nachtigal, M.W., and Ingraham, H.A. (1999). Paracrine-mediated apoptosis in reproductive tract development. *Dev. Biol.* *208*, 110–122.
- Roland, A.V., and Moenter, S.M. (2011). Prenatal androgenization of female mice programs an increase in firing activity of gonadotropin-releasing hormone (GnRH) neurons that is reversed by metformin treatment in adulthood. *Endocrinology* *152*, 618–628.

- Roland, A.V., and Moenter, S.M. (2014). Reproductive neuroendocrine dysfunction in polycystic ovary syndrome: Insight from animal models. *Front. Neuroendocrinol.*
- Roux, N. de, Genin, E., Carel, J.-C., Matsuda, F., Chaussain, J.-L., and Milgrom, E. (2003). Hypogonadotropic hypogonadism due to loss of function of the KiSS1-derived peptide receptor GPR54. *Proc. Natl. Acad. Sci.* *100*, 10972–10976.
- De Roux, N., Young, J., Misrahi, M., Genet, R., Chanson, P., Schaison, G., and Milgrom, E. (1997). A family with hypogonadotropic hypogonadism and mutations in the gonadotropin-releasing hormone receptor. *N. Engl. J. Med.* *337*, 1597–1602.
- Sanford, L.P., Ormsby, I., Gittenberger-de Groot, A.C., Sariola, H., Friedman, R., Boivin, G.P., Cardell, E.L., and Doetschman, T. (1997). TGFbeta2 knockout mice have multiple developmental defects that are non-overlapping with other TGFbeta knockout phenotypes. *Dev. Camb. Engl.* *124*, 2659–2670.
- Schmid, R.S., and Anton, E.S. (2003). Role of Integrins in the Development of the. *Cereb. Cortex* *13*, 219–224.
- Schwanzel-Fukuda, M., Bick, D., and Pfaff, D.W. (1989). Luteinizing hormone-releasing hormone (LHRH)-expressing cells do not migrate normally in an inherited hypogonadal (Kallmann) syndrome. *Mol. Brain Res.* *6*, 311–326.
- Schwarting, G.A., Kostek, C., Bless, E.P., Ahmad, N., and Tobet, S.A. (2001). Deleted in colorectal cancer (DCC) regulates the migration of luteinizing hormone-releasing hormone neurons to the basal forebrain. *J. Neurosci. Off. J. Soc. Neurosci.* *21*, 911–919.
- Schwarting, G.A., Henion, T.R., Nugent, J.D., Caplan, B., and Tobet, S. (2006). Stromal cell-derived factor-1 (chemokine C-X-C motif ligand 12) and chemokine C-X-C motif receptor 4 are required for migration of gonadotropin-releasing hormone neurons to the forebrain. *J. Neurosci. Off. J. Soc. Neurosci.* *26*, 6834–6840.
- Seifer, D.B., MacLaughlin, D.T., Christian, B.P., Feng, B., and Sheldon, R.M. (2002). Early follicular serum müllerian-inhibiting substance levels are associated with ovarian response during assisted reproductive technology cycles. *Fertil. Steril.* *77*, 468–471.
- Seminara, S., Hayes, F.J., and Crowley, Jr., W.F. (1998). Gonadotropin-Releasing Hormone Deficiency in the Human (Idiopathic Hypogonadotropic Hypogonadism and Kallmann's Syndrome): Pathophysiological and Genetic Considerations. *Endocr. Rev.* *19*, 521–539.
- Seminara, S.B., Messager, S., Chatzidaki, E.E., Thresher, R.R., Acierno, J.S., Jr, Shagoury, J.K., Bo-Abbas, Y., Kuohung, W., Schwinof, K.M., Hendrick, A.G., et al. (2003). The GPR54 gene as a regulator of puberty. *N. Engl. J. Med.* *349*, 1614–1627.
- Sherwood, N., Eiden, L., Brownstein, M., Spiess, J., Rivier, J., and Vale, W. (1983). Characterization of a teleost gonadotropin-releasing hormone. *Proc. Natl. Acad. Sci. U. S. A.* *80*, 2794–2798.
- Shi, Y., and Massagué, J. (2003). Mechanisms of TGF-beta signaling from cell membrane to the nucleus. *Cell* *113*, 685–700.
- Sim, J.A., Skynner, M.J., Pape, J.-R., and Herbison, A.E. (2000). Late postnatal reorganization of GABAA receptor signalling in native GnRH neurons. *Eur. J. Neurosci.* *12*, 3497–3504.
- Simerly, R.B. (2002). WIRED FOR REPRODUCTION: Organization and Development of Sexually Dimorphic Circuits in the Mammalian Forebrain. *Annu. Rev. Neurosci.* *25*, 507–536.

- Skaletsky, H., Kuroda-Kawaguchi, T., Minx, P.J., Cordum, H.S., Hillier, L., Brown, L.G., Repping, S., Pyntikova, T., Ali, J., Bieri, T., et al. (2003). The male-specific region of the human Y chromosome is a mosaic of discrete sequence classes. *Nature* *423*, 825–837.
- Smith, J.T., Cunningham, M.J., Rissman, E.F., Clifton, D.K., and Steiner, R.A. (2005). Regulation of Kiss1 gene expression in the brain of the female mouse. *Endocrinology* *146*, 3686–3692.
- Smith, J.T., Popa, S.M., Clifton, D.K., Hoffman, G.E., and Steiner, R.A. (2006). Kiss1 neurons in the forebrain as central processors for generating the preovulatory luteinizing hormone surge. *J. Neurosci. Off. J. Soc. Neurosci.* *26*, 6687–6694.
- Smyth, C., and Wilkinson, M. (1994). A critical period for glutamate receptor-mediated induction of precocious puberty in female rats. *J. Neuroendocrinol.* *6*, 275–284.
- Sortino, M.A., Aleppo, G., Scapagnini, U., and Canonico, P.L. (1994). Involvement of nitric oxide in the regulation of gonadotropin-releasing hormone release from the GT1-1 neuronal cell line. *Endocrinology* *134*, 1782–1787.
- Speakman, J.R. (2008). The physiological costs of reproduction in small mammals. *Philos. Trans. R. Soc. B Biol. Sci.* *363*, 375–398.
- Sriraman, V., Niu, E., Matias, J.R., Donahoe, P.K., MacLaughlin, D.T., Hardy, M.P., and Lee, M.M. (2001). Müllerian inhibiting substance inhibits testosterone synthesis in adult rats. *J. Androl.* *22*, 750–758.
- Stein, V., and Nicoll, R.A. (2003). GABA generates excitement. *Neuron* *37*, 375–378.
- Streuli, I., Fraisse, T., Chapron, C., Bijaoui, G., Bischof, P., and de Ziegler, D. (2009). Clinical uses of anti-Müllerian hormone assays: pitfalls and promises. *Fertil. Steril.* *91*, 226–230.
- Sullivan, S.D., and Moenter, S.M. (2003). Neurosteroids alter gamma-aminobutyric acid postsynaptic currents in gonadotropin-releasing hormone neurons: a possible mechanism for direct steroidal control. *Endocrinology* *144*, 4366–4375.
- Sykiotis, G.P., Plummer, L., Hughes, V.A., Au, M., Durrani, S., Nayak-Young, S., Dwyer, A.A., Quinton, R., Hall, J.E., Gusella, J.F., et al. (2010). Oligogenic basis of isolated gonadotropin-releasing hormone deficiency. *Proc. Natl. Acad. Sci. U. S. A.* *107*, 15140–15144.
- Szwarcfarb, B., Carbone, S., Stein, M.L., Medina, J., and Moguilevsky, J.A. (1994). Sexual differences in the effect of the GABAergic system on LH secretion and in the hypothalamic ontogenesis of GABAA receptors in prepubertal rats. *Brain Res.* *646*, 351–355.
- Taguchi, O., Cunha, G.R., Lawrence, W.D., and Robboy, S.J. (1984). Timing and irreversibility of Müllerian duct inhibition in the embryonic reproductive tract of the human male. *Dev. Biol.* *106*, 394–398.
- Takada, Y., Ye, X., and Simon, S. (2007). The integrins. *Genome Biol.* *8*, 215.
- Taketo, T., Saeed, J., Manganaro, T., Takahashi, M., and Donahoe, P.K. (1993). Müllerian inhibiting substance production associated with loss of oocytes and testicular differentiation in the transplanted mouse XX gonadal primordium. *Biol. Reprod.* *49*, 13–23.
- Tamkun, J.W., DeSimone, D.W., Fonda, D., Patel, R.S., Buck, C., Horwitz, A.F., and Hynes, R.O. (1986). Structure of integrin, a glycoprotein involved in the transmembrane linkage between fibronectin and actin. *Cell* *46*, 271–282.

- Tassigny, X. d'Anglemon de, and Colledge, W.H. (2010). The Role of Kisspeptin Signaling in Reproduction. *Physiology* 25, 207–217.
- Teixeira, J., He, W.W., Shah, P.C., Morikawa, N., Lee, M.M., Catlin, E.A., Hudson, P.L., Wing, J., Maclaughlin, D.T., and Donahoe, P.K. (1996). Developmental expression of a candidate müllerian inhibiting substance type II receptor. *Endocrinology* 137, 160–165.
- Teixeira, J., Maheswaran, S., and Donahoe, P.K. (2001). Müllerian inhibiting substance: an instructive developmental hormone with diagnostic and possible therapeutic applications. *Endocr. Rev.* 22, 657–674.
- Temple, J.L., and Wray, S. (2005). Developmental Changes in GABAA Receptor Subunit Composition Within the Gonadotrophin-Releasing Hormone-1 Neuronal System. *J. Neuroendocrinol.* 17, 591–599.
- Terasawa, E., and Fernandez, D.L. (2001). Neurobiological mechanisms of the onset of puberty in primates. *Endocr. Rev.* 22, 111–151.
- Tobet, S.A., and Schwarting, G.A. (2006). Minireview: recent progress in gonadotropin-releasing hormone neuronal migration. *Endocrinology* 147, 1159–1165.
- Tobet, S.A., Crandall, J.E., and Schwarting, G.A. (1993). Relationship of migrating luteinizing hormone-releasing hormone neurons to unique olfactory system glycoconjugates in embryonic rats. *Dev. Biol.* 155, 471–482.
- Tobet, S.A., Bless, E.P., and Schwarting, G.A. (2001). Developmental aspect of the gonadotropin-releasing hormone system. *Mol. Cell. Endocrinol.* 185, 173–184.
- Todman, M.G., Han, S.-K., and Herbison, A.E. (2005). Profiling neurotransmitter receptor expression in mouse gonadotropin-releasing hormone neurons using green fluorescent protein-promoter transgenics and microarrays. *Neuroscience* 132, 703–712.
- Tomaselli, K.J., Neugebauer, K.M., Bixby, J.L., Lilien, J., and Reichard, L.F. (1988). N-cadherin and integrins: Two receptor systems that mediate neuronal process outgrowth on astrocyte surfaces. *Neuron* 1, 33–43.
- Topaloglu, A.K., Reimann, F., Guclu, M., Yalin, A.S., Kotan, L.D., Porter, K.M., Serin, A., Mungan, N.O., Cook, J.R., Ozbek, M.N., et al. (2009). TAC3 and TACR3 mutations in familial hypogonadotropic hypogonadism reveal a key role for Neurokinin B in the central control of reproduction. *Nat. Genet.* 41, 354–358.
- Topaloglu, A.K., Tello, J.A., Kotan, L.D., Ozbek, M.N., Yilmaz, M.B., Erdogan, S., Gurbuz, F., Temiz, F., Millar, R.P., and Yuksel, B. (2012). Inactivating KISS1 mutation and hypogonadotropic hypogonadism. *N. Engl. J. Med.* 366, 629–635.
- Tornberg, J., Sykiotis, G.P., Keefe, K., Plummer, L., Hoang, X., Hall, J.E., Quinton, R., Seminara, S.B., Hughes, V., Van Vliet, G., et al. (2011). Heparan sulfate 6-O-sulfotransferase 1, a gene involved in extracellular sugar modifications, is mutated in patients with idiopathic hypogonadotropic hypogonadism. *Proc. Natl. Acad. Sci. U. S. A.* 108, 11524–11529.
- Trarbach, E.B., Abreu, A.P., Silveira, L.F.G., Garmes, H.M., Baptista, M.T.M., Teles, M.G., Costa, E.M.F., Mohammadi, M., Pitteloud, N., Mendonca, B.B., et al. (2010). Nonsense mutations in FGF8 gene causing different degrees of human gonadotropin-releasing deficiency. *J. Clin. Endocrinol. Metab.* 95, 3491–3496.
- Tremblay, J.J., and Viger, R.S. (1999). Transcription factor GATA-4 enhances Müllerian inhibiting substance gene transcription through a direct interaction with the nuclear receptor SF-1. *Mol. Endocrinol. Baltim. Md* 13, 1388–1401.

- Tsai, P.-S., Moenter, S.M., Postigo, H.R., El Majdoubi, M., Pak, T.R., Gill, J.C., Paruthiyil, S., Werner, S., and Weiner, R.I. (2005). Targeted expression of a dominant-negative fibroblast growth factor (FGF) receptor in gonadotropin-releasing hormone (GnRH) neurons reduces FGF responsiveness and the size of GnRH neuronal population. *Mol. Endocrinol. Baltim. Md* *19*, 225–236.
- Tsuji, M., Shima, H., Yonemura, C.Y., Brody, J., Donahoe, P.K., and Cunha, G.R. (1992). Effect of human recombinant mullerian inhibiting substance on isolated epithelial and mesenchymal cells during mullerian duct regression in the rat. *Endocrinology* *131*, 1481–1488.
- Tsutsumi, M., Zhou, W., Millar, R.P., Mellon, P.L., Roberts, J.L., Flanagan, C.A., Dong, K., Gillo, B., and Sealton, S.C. (1992). Cloning and functional expression of a mouse gonadotropin-releasing hormone receptor. *Mol. Endocrinol. Baltim. Md* *6*, 1163–1169.
- Ueno, S., Kuroda, T., Maclaughlin, D.T., Ragin, R.C., Manganaro, T.F., and Donahoe, P.K. (1989). Mullerian Inhibiting Substance in the Adult Rat Ovary During Various Stages of the Estrous Cycle*. *Endocrinology* *125*, 1060–1066.
- Urbanski, H.F., and Ojeda, S.R. (1987). Activation of luteinizing hormone-releasing hormone release advances the onset of female puberty. *Neuroendocrinology* *46*, 273–276.
- Urbansky, H.F., and Ojeda, S.R. (1990). A ROLE FOR N-METHYL-D-ASPARTATE (NMDA) RECEPTORS IN THE CONTROL OF LH SECRETION AND INITIATION OF FEMALE PUBERTY. *Endocrinology* *126*, 1774–1776.
- Vachon, P.H. (2011). Integrin Signaling, Cell Survival, and Anoikis: Distinctions, Differences, and Differentiation. *J. Signal Transduct.* *2011*, e738137.
- De Vet, A., Laven, J.S.E., de Jong, F.H., Themmen, A.P.N., and Fauser, B.C.J.M. (2002). Antimüllerian hormone serum levels: a putative marker for ovarian aging. *Fertil. Steril.* *77*, 357–362.
- Viger, R.S., Mertineit, C., Trasler, J.M., and Nemer, M. (1998). Transcription factor GATA-4 is expressed in a sexually dimorphic pattern during mouse gonadal development and is a potent activator of the Müllerian inhibiting substance promoter. *Dev. Camb. Engl.* *125*, 2665–2675.
- Vigier, B., Picard, J.Y., Tran, D., Legeai, L., and Josso, N. (1984). Production of anti-Müllerian hormone: another homology between Sertoli and granulosa cells. *Endocrinology* *114*, 1315–1320.
- Visser, J.A. (2003). AMH signaling: from receptor to target gene. *Mol. Cell. Endocrinol.* *211*, 65–73.
- Visser, J.A., Olaso, R., Verhoef-Post, M., Kramer, P., Themmen, A.P.N., and Ingraham, H.A. (2001). The Serine/Threonine Transmembrane Receptor ALK2 Mediates Müllerian Inhibiting Substance Signaling. *Mol. Endocrinol.* *15*, 936–945.
- Visser, J.A., de Jong, F.H., Laven, J.S.E., and Themmen, A.P.N. (2006). Anti-Müllerian hormone: a new marker for ovarian function. *Reprod. Camb. Engl.* *131*, 1–9.
- Wang, P.-Y., Koishi, K., McGeachie, A.B., Kimber, M., MacLaughlin, D.T., Donahoe, P.K., and McLennan, I.S. (2005). Mullerian Inhibiting Substance acts as a motor neuron survival factor in vitro. *Proc. Natl. Acad. Sci. U. S. A.* *102*, 16421–16425.
- Wang, P.-Y., Protheroe, A., Clarkson, A.N., Imhoff, F., Koishi, K., and McLennan, I.S. (2009). Müllerian inhibiting substance contributes to sex-linked biases in the brain and behavior. *Proc. Natl. Acad. Sci. U. S. A.* *106*, 7203–7208.

- Watabe, T., and Miyazono, K. (2009). Roles of TGF-beta family signaling in stem cell renewal and differentiation. *Cell Res.* *19*, 103–115.
- Weenen, C., Laven, J.S.E., Von Bergh, A.R.M., Cranfield, M., Groome, N.P., Visser, J.A., Kramer, P., Fauser, B.C.J.M., and Themmen, A.P.N. (2004). Anti-Müllerian hormone expression pattern in the human ovary: potential implications for initial and cyclic follicle recruitment. *Mol. Hum. Reprod.* *10*, 77–83.
- Wen, S., Götze, I.N., Mai, O., Schauer, C., Leinders-Zufall, T., and Boehm, U. (2011). Genetic identification of GnRH receptor neurons: a new model for studying neural circuits underlying reproductive physiology in the mouse brain. *Endocrinology* *152*, 1515–1526.
- Whitlock, K.E., Wolf, C.D., and Boyce, M.L. (2003). Gonadotropin-releasing hormone (GnRH) cells arise from cranial neural crest and adenohypophyseal regions of the neural plate in the zebrafish, *Danio rerio*. *Dev. Biol.* *257*, 140–152.
- Wierman, M.E., Kiseljak-Vassiliades, K., and Tobet, S. (2011). Gonadotropin-releasing hormone (GnRH) neuron migration: initiation, maintenance and cessation as critical steps to ensure normal reproductive function. *Front. Neuroendocrinol.* *32*, 43–52.
- Wildt, L., Häusler, A., Marshall, G., Hutchison, J.S., Plant, T.M., Belchetz, P.E., and Knobil, E. (1981). Frequency and amplitude of gonadotropin-releasing hormone stimulation and gonadotropin secretion in the rhesus monkey. *Endocrinology* *109*, 376–385.
- Wilhelm, D., Palmer, S., and Koopman, P. (2007). Sex Determination and Gonadal Development in Mammals. *Physiol. Rev.* *87*, 1–28.
- Wilson, C.A., di Clemente, N., Ehrenfels, C., Pepinsky, R.B., Josso, N., Vigier, B., and Cate, R.L. (1993). Mullerian inhibiting substance requires its N-terminal domain for maintenance of biological activity, a novel finding within the transforming growth factor-beta superfamily. *Mol. Endocrinol. Baltim. Md* *7*, 247–257.
- Wintermantel, T.M., Campbell, R.E., Porteous, R., Bock, D., Gröne, H.-J., Todman, M.G., Korach, K.S., Greiner, E., Pérez, C.A., Schütz, G., et al. (2006). Definition of estrogen receptor pathway critical for estrogen positive feedback to gonadotropin-releasing hormone neurons and fertility. *Neuron* *52*, 271–280.
- Wolfenson, H., Lavelin, I., and Geiger, B. (2013). Dynamic regulation of the structure and functions of integrin adhesions. *Dev. Cell* *24*, 447–458.
- Wrana, J.L., Attisano, L., Cárcamo, J., Zentella, A., Doody, J., Laiho, M., Wang, X.F., and Massagué, J. (1992). TGF beta signals through a heteromeric protein kinase receptor complex. *Cell* *71*, 1003–1014.
- Wray, S. (2001). Development of Luteinizing Hormone Releasing Hormone Neurons. *J. Neuroendocrinol.* *13*, 3–11.
- Wray, S. (2010). From Nose to Brain: Development of Gonadotrophin-Releasing Hormone -1 Neurons. *J. Neuroendocrinol.* *22*, 743–753.
- Wray, S., and Hoffman, G. (1986). A developmental study of the quantitative distribution of LHRH neurons within the central nervous system of postnatal male and female rats. *J. Comp. Neurol.* *252*, 522–531.
- Wray, S., Nieburgs, A., and Elkabes, S. (1989a). Spatiotemporal cell expression of luteinizing hormone-releasing hormone in the prenatal mouse: evidence for an embryonic origin in the olfactory placode. *Brain Res. Dev. Brain Res.* *46*, 309–318.

- Wray, S., Grant, P., and Gainer, H. (1989b). Evidence that cells expressing luteinizing hormone-releasing hormone mRNA in the mouse are derived from progenitor cells in the olfactory placode. *Proc. Natl. Acad. Sci. U. S. A.* *86*, 8132–8136.
- Wunder, D.M., Bersinger, N.A., Yared, M., Kretschmer, R., and Birkhäuser, M.H. (2008). Statistically significant changes of antimüllerian hormone and inhibin levels during the physiologic menstrual cycle in reproductive age women. *Fertil. Steril.* *89*, 927–933.
- Xu, L., and Massagué, J. (2004). Nucleocytoplasmic shuttling of signal transducers. *Nat. Rev. Mol. Cell Biol.* *5*, 209–219.
- Xu, N., Kim, H.-G., Bhagavath, B., Cho, S.-G., Lee, J.H., Ha, K., Meliciani, I., Wenzel, W., Podolsky, R.H., Chorich, L.P., et al. (2011). Nasal embryonic LHRH factor (NELF) mutations in patients with normosmic hypogonadotropic hypogonadism and Kallmann syndrome. *Fertil. Steril.* *95*, 1613–1620.e1–7.
- Yamada, K., Emson, P., and Hökfelt, T. (1996). Immunohistochemical mapping of nitric oxide synthase in the rat hypothalamus and colocalization with neuropeptides. *J. Chem. Neuroanat.* *10*, 295–316.
- Yi, S.E., Daluiski, A., Pederson, R., Rosen, V., and Lyons, K.M. (2000). The type I BMP receptor BMPRI_B is required for chondrogenesis in the mouse limb. *Dev. Camb. Engl.* *127*, 621–630.
- Yi, S.E., LaPolt, P.S., Yoon, B.S., Chen, J.Y., Lu, J.K., and Lyons, K.M. (2001). The type I BMP receptor BmprI_B is essential for female reproductive function. *Proc. Natl. Acad. Sci. U. S. A.* *98*, 7994–7999.
- Yin, C., Ishii, H., Tanaka, N., Sakuma, Y., and Kato, M. (2008). Activation of A-Type γ -Amino Butyric Acid Receptors Excites Gonadotrophin-Releasing Hormone Neurones Isolated from Adult Rats. *J. Neuroendocrinol.* *20*, 566–575.
- Yoshida, K., Rutishauser, U., Crandall, J.E., and Schwarting, G.A. (1999). Polysialic acid facilitates migration of luteinizing hormone-releasing hormone neurons on vomeronasal axons. *J. Neurosci. Off. J. Soc. Neurosci.* *19*, 794–801.
- Young, J., Metay, C., Bouligand, J., Tou, B., Francou, B., Maione, L., Tosca, L., Sarfati, J., Brioude, F., Esteva, B., et al. (2012). SEMA3A deletion in a family with Kallmann syndrome validates the role of semaphorin 3A in human puberty and olfactory system development. *Hum. Reprod. Oxf. Engl.* *27*, 1460–1465.
- Zadeh-Vakili, A., Ramezani Tehrani, F., Daneshpour, M.S., Zarkesh, M., Saadat, N., and Azizi, F. (2013). Genetic polymorphism of vitamin D receptor gene affects the phenotype of PCOS. *Gene* *515*, 193–196.
- Zhan, Y., Fujino, A., MacLaughlin, D.T., Manganaro, T.F., Szotek, P.P., Arango, N.A., Teixeira, J., and Donahoe, P.K. (2006). Müllerian inhibiting substance regulates its receptor/SMAD signaling and causes mesenchymal transition of the coelomic epithelial cells early in Müllerian duct regression. *Development* *133*, 2359–2369.
- Zhang, Y.E. (2009). Non-Smad pathways in TGF-beta signaling. *Cell Res.* *19*, 128–139.
- Zhang, Z., and Galileo, D.S. (1998). Retroviral transfer of antisense integrin α 6 or α 8 sequences results in laminar redistribution or clonal cell death in developing brain. *J. Neurosci. Off. J. Soc. Neurosci.* *18*, 6928–6938.