



HAL
open science

The vehicle as a source and consumer of information : collection, dissemination and data processing for sustainable mobility

Sara Mehar

► To cite this version:

Sara Mehar. The vehicle as a source and consumer of information : collection, dissemination and data processing for sustainable mobility. Networking and Internet Architecture [cs.NI]. Université de Bourgogne, 2014. English. NNT : 2014DIJOS069 . tel-01233783

HAL Id: tel-01233783

<https://theses.hal.science/tel-01233783>

Submitted on 25 Nov 2015

HAL is a multi-disciplinary open access archive for the deposit and dissemination of scientific research documents, whether they are published or not. The documents may come from teaching and research institutions in France or abroad, or from public or private research centers.

L'archive ouverte pluridisciplinaire **HAL**, est destinée au dépôt et à la diffusion de documents scientifiques de niveau recherche, publiés ou non, émanant des établissements d'enseignement et de recherche français ou étrangers, des laboratoires publics ou privés.



SPIM

Thèse de Doctorat



école doctorale **sciences pour l'ingénieur et microtechniques**

U N I V E R S I T É D E B O U R G O G N E

The vehicle as a source and consumer of information:

Collection, dissemination and data processing for sustainable mobility

■ SARA MEHAR

SPIM

Thèse de Doctorat



école doctorale sciences pour l'ingénieur et microtechniques

U N I V E R S I T É D E B O U R G O G N E

N° | . | . | . |

THÈSE présentée par

SARA MEHAR

pour obtenir le

Grade de Docteur de
l'Université de Bourgogne

Spécialité : **Informatique**

The vehicle as a source and consumer of information:

Collection, dissemination and data processing for sustainable mobility

Soutenue publiquement le 05 décembre 2014 devant le Jury composé de :

HOUDA LABIOD	Rapporteur	Maitre de Conférences (HDR), Télécom ParisTech, France Commentaire secondaire
STEVEN MARTIN	Rapporteur	Professeur des universités, Université Paris-Sud, France
SHERALI ZEADALLY	Examineur	Associate Professor, University of Kentucky, U.S.A.
PAUL MÜHLETHALER	Examineur	Directeur de Recherche, INRIA, France
PHILIPPE BRUNET	Examineur	Maitre de Conférences, Université de Bourgogne, France
DOMINIQUE GRUYER	Examineur	Directeur de Recherche, IFSTTAR, FRANCE
SIDI-MOHAMMED SENOUCI	Directeur de thèse	Professeur des universités, Université de Bourgogne, France

ACKNOWLEDGMENT

This thesis is the result of three years of work whereby I have been accompanied and supported by many people. I have now the opportunity to express my gratitude for all of them.

The first person I would like to thank is my supervisor who has supported me throughout my thesis with his patience, knowledge, enthusiasm, sympathy and who was more than generous with his expertise and precious time.

Besides my supervisor, I would like to express my gratitude to every kind person who contributes directly or indirectly in this work or who helped me to develop my research skills.

My sincere thanks also goes to all DRIVE Laboratory team and all ISAT employees who greeted me with empathy during the last three years, and also to CRB (Conseil Regional de Bourgogne), in Burgundy, France that provided me a grant to support my researches.

And I don't forget to deeply thank the members of the reading committee for their precious time.

Last, but definitely not least, my family and all my friends for supporting me all the time.

CONTENTS

1	Introduction	1
1.1	Context and motivation	1
1.2	Methodology and contributions	2
1.3	Organization of the thesis	3
I	Connected mobility	5
2	Background and Related Work	7
2.1	Introduction	7
2.2	Connected vehicle: an overview	8
2.2.1	Connected vehicle: embedded system	9
2.2.2	Connected vehicle: communication technologies and modes	9
2.3	Connected vehicle: applications	12
2.3.1	Safety and emergency applications	12
2.3.2	Traffic related applications	13
2.3.3	Comfort applications	14
2.4	Connected vehicle: characteristics and requirements	14
2.4.1	Characteristics of a connected vehicle	15
2.4.2	Requirements of a connected vehicle	16
2.5	Connected vehicle: projects and standardizations efforts	16
2.5.1	On going projects	17
2.5.2	Standardization efforts	19
2.6	Connected vehicle: Technical challenges - Focus on data dissemination and routing	22
2.7	Conclusion	24
3	Efficient data dissemination strategy for vehicular networks considering vehicles heterogeneity and road topology	25
3.1	Introduction and problem statement	25

3.2	Dissemination protocol for Heterogeneous cooperative Vehicular Networks (DHVN)	28
3.2.1	DHVN assumptions	28
3.2.2	DHVN description	29
3.3	Performance evaluation	35
3.3.1	Simulation environment and parameters	35
3.3.2	Simulation results and analysis	36
3.4	Conclusion	39
4	Delay-Sensitive Routing Based on Optimized RSU-Deployment	41
4.1	Introduction and problem statement	41
4.1.1	Background and related work on RSUs deployment	42
4.1.2	Background and related work on delay-sensitive routing	44
4.2	ODEL and RDEL descriptions	48
4.2.1	Optimized RSUs placement for delay-sensitive applications (ODEL)	48
4.2.2	Routing for delay-sensitive applications (RDEL)	58
4.3	Conclusion	63
II	Sustainable mobility	65
5	Background and related work	67
5.1	Introduction and problem statement	67
5.2	Sustainable mobility: an overview	68
5.2.1	Sustainable mobility: definition and role	68
5.2.2	Sustainable mobility: background on transportation technologies	69
5.3	Sustainable mobility: basic components	70
5.3.1	Infrastructure and basic required facilities	72
5.3.2	Communication technologies	73
5.3.3	Facilities value chain (business model of electric vehicles and supplies market)	74
5.4	Sustainable mobility: management architectures and on going projects	75
5.4.1	Fleet management system	75
5.4.2	Fleet model for charging regulation and scheduling	76
5.4.3	Green itinerary planning	77
5.4.4	Ongoing projects on electric transportation	78
5.5	Sustainable mobility: standardization efforts	79

5.5.1	Standardization requirements	79
5.5.2	Standards	80
5.6	Sustainable mobility: challenges and issues	80
5.6.1	The cost	80
5.6.2	Standards	81
5.6.3	Power generation and Smart Grid	82
5.6.4	Incentive efforts	83
5.6.5	Communication security	83
5.6.6	Discussion	83
5.7	Conclusion	85
6	Itinerary planning for electric vehicles in Smart Cities	87
6.1	Introduction and problem statement	87
6.2	Electric vehicle fleet management architecture (Ev-Drive)	88
6.2.1	Ev-Drive architecture description	89
6.2.2	Energy consumption process	93
6.3	Proof of concept	95
6.4	Conclusion	96
7	Optimized deployment of electric vehicles' charging stations	99
7.1	Introduction and problem statement	99
7.2	An optimization location scheme for electric charging stations (OLoCs) . . .	100
7.2.1	Optimization problem modeling	101
7.2.2	OLoCs resolution	102
7.3	Performance evaluation	105
7.3.1	Case-study: Tapas Cologne	105
7.3.2	Results	106
7.4	Conclusion	109
III	Conclusion and perspectives	111
8	Conclusion and perspectives	113
8.1	Conclusion	113
8.2	Perspectives	114
9	Publications	117

Acronyms and glossary	137
IV Appendix	143
A HINTS: A Novel Approach for Realistic Simulations of Vehicular Communications	145
A.1 introduction and problem statement	145
A.2 background and related work on network simulators	146
A.3 HINTS description	147
A.3.1 Integration platform	147
A.3.2 The general hybrid platform architecture	148
A.3.3 Simulation flow overview	149
A.3.4 SUMO and NS-3 implementation details	150
A.4 Performance evaluation of HINTS	151
A.4.1 Application's operating mode	152
A.4.2 Results	152
A.5 Conclusion	153

INTRODUCTION

1.1/ CONTEXT AND MOTIVATION

Nowadays, the recent development of tablets, smartphones and other connected devices make the use of wireless networks more and more common and increasingly demanding for various purposes and in several contexts. In particular, in transportation sector, new communication interfaces and technologies (e.g., WiFi, Bluetooth 802.11p/G5, 3G, 4G/*Long Term Evolution* (LTE)) allow the apparition of the "connected car" concept with intra- and inter-vehicle communications capabilities. This new concept stimulates also the emergence of a large amount of new applications and services that aim to bring efficient traffic management, road safety and infotainment. Over the last few years, it has garnered a significant attention of industry, government authorities, automotive and communication standardization organizations. Their main objective is to contribute to the transformation of the automotive industry to achieve low cost and safe transportation. By the year 2025, connected vehicles will integrate the first 5G network, which uses a meshed network topology to provide low latency, high throughput and a better routing delivery [193]. Furthermore, over a twenty to thirty-year horizon, we expect that connected vehicles will be able to drive autonomously on roads without human intervention. In addition, for many years, the international community has been committed to reduce or at least contain anthropogenic environmental pollution. In this field, an other objective that triggered numerous worldwide initiatives, is to reduce greenhouse gas emissions. These new initiatives open up the door to new research areas in transportation that consider the environment, the energy and the use of information exchange to ensure safe, comfortable and sustainable mobility.

These promising technologies and directives aim to have efficient and sustainable transportation systems with Connected and Energy efficient cars. Therefore, this thesis focuses on one hand on communication and data collection and exchange in vehicular context and on the other hand, on processing the collected data in order to provide innovative services for a green transportation system. The first part of this manuscript focuses on enhancing vehicular communication at the network layer under different realistic scenarios, considering both *Vehicle-to-Vehicle* (V2V) and *Vehicle-to-Infrastructure* (V2I) communications. Existing solutions as well as some of the most critical issues in the field of vehicular communication along with new research directions to optimize broadcasting, routing and data collection are presented and analyzed. The second part of this manuscript discusses new ecological transportation systems. First, an overview of current projects and challenges in this field are exposed with a focus on electric vehicles

(*Electric Vehicles* (EVs)) as they are expected to replace conventional gasoline and diesel vehicles. Clean energy electric vehicles are technologically feasible, economically viable and will be the next paradigm shift toward green transportation. Then, new solutions and services for electric vehicles are proposed. The next section introduces our contributions.

1.2/ METHODOLOGY AND CONTRIBUTIONS

We proposed in this thesis to take advantages of interoperability and interchangeability between communication and transportation technologies to design new protocols, new architectures and new deployment strategies to make transportation more intelligent, more efficient and more sustainable. Each contribution in this thesis focuses on a particular research field and aims to address the relevant defiance of nowadays transportation technologies. All proposed solutions are extremely beneficial to many emerging challenges in transportation, energetic and ecologic contexts.

In this thesis, we took a closer look to communication technologies in transportation systems and especially vehicular networks. In fact, vehicles can communicate directly among vehicles (i.e. vehicle-to-vehicle) or between each vehicle and the infrastructure (i.e. vehicle-to-infrastructure). However, both paradigms, V2V and V2I, exhibit connectivity problems due to special characteristics of vehicular scenario such as quick topology network changes, random vehicle speed, and traffic density (i.e. sparse, dense, or totally disconnected nodes). Many efforts have been made to cope with these particular limitations. Nevertheless, current contributions still require further investigations. Thus, in the first part of this thesis, we focused on connected mobility with the aim to enhancing vehicular communications under various realistic scenarios. We explored both vehicle to vehicle communication and vehicle to infrastructure communication. We studied the possibility of data disseminating in a vehicular network without the use of any additional infrastructure, and the possibility of data routing while taking into account several constraints such as delay for time-sensitive applications. In our first contribution regarding data dissemination, we implemented a new dissemination protocol called *Dissemination protocol for Heterogeneous Cooperative Vehicular Networks* (DHVN). DHVN aims to increase the delivery ratio of broadcasted data when confronted within different scenarios. To that end, DHVN considers the non-homogeneous topology and connectivity characterizing urban vehicular environment. It also takes into consideration the non-homogeneity of the vehicles in terms of communication capabilities. The discussion of the obtained results in DHVN has allowed us to identify the undesired impact of network fragmentation on communication delays. This, helped us to define new strategies to route data using *Road-Side Units* (RSUs). Thus, in our second contribution, we proposed two complementary solutions: *an Optimized Road-Side Units (RSUs) placement for DELay aware applications* (ODEL) and a new *Routing protocol for DELay aware applications* (RDEL). ODEL is a two-steps solution that optimizes RSUs deployment for vehicular networks applications with high delay sensitive constraints. In the first step, we developed a strategy to find the most relevant RSUs candidate locations based on network connectivity and hence avoiding the useless positions with high density where vehicles can communicate with each other's without using any additional infrastructure. In the second step we mathematically modeled the RSUs placement problem and we included application delay requirement. Then, we solved it using heuristic and short path algorithms. RDEL uses the optimally deployed RSUs using ODEL to optimally deliver information to the fi-

nal destination. To find the best paths to send data, RDEL incorporates density, location and lower layer information while making the routing decision. While we were working on connected mobility, we observed that the new innovative trends in transportation field require to meet the needs of society to move freely, efficiently, more sustainably and without sacrificing other essential human and ecological requirements. In fact, sustainable mobility is one big part of the smart city objectives. In addition, since the ongoing investigations in this area are still at an early stage, we dedicated the second part of this thesis to tackle sustainable mobility. We extended our study to consider new constraints related to environment and energy efficiency and we focus our interest on EVs. Indeed, electric vehicles are new transportation alternatives toward green and less-polluting mobility. However, they still require further investigations due to short autonomy limitations. Thus, we proposed new solutions and services to cope with these limitations. In our third contribution, we proposed an advanced electric vehicles' fleet management architecture called Ev-Drive. This architecture considers the most important factors that can affect the traveling mode of electric vehicles, in order to offer different services to fleet management companies for an efficient monitoring and management of their fleets. One of the most important services, considered in this contribution, consists on providing economic itineraries planning for electric vehicles. In Ev-Drive, we collect using our protocol RDEL information about road topology, weather conditions, vehicle characteristics, driver profile, traffic conditions and electric charging stations positions. Then, we processed these collected information in order to compute and provide the best routes, in terms of electric power consumption. In case of battery drop, new routes passing through the nearest available charging stations are recalculated and provided again to the driver. During Ev-Drive development, we noticed another important sustainable challenge related to energy balance. Consequently, we studied drivers' energy demand and considered electric supplies' maximum capacity and we proposed as final contribution an *Optimized Location Scheme for electric charging stations* (OLOCs). OLOCs is a heuristic solution; in which we adapted a genetic algorithm to solve the charging stations location problem to find the best positions to place the charging stations while taking into account energy balance. In the next section, we describe the structure of our thesis report.

1.3/ ORGANIZATION OF THE THESIS

This manuscript includes two main parts. The first one aims to enhance communication in connected vehicles context and the second one deals with sustainable mobility and green transportation.

In the first part, we gave in chapter 2 an overview of connected vehicles, we detailed their major characteristics and challenges and we provide an in-depth description of the standardization effort and projects dedicated to promote connected vehicles. In chapter 3, we presented the design of our Dissemination protocol for Heterogeneous cooperative Vehicular Networks (DHVN). DHVN is a dissemination protocol that avoids bandwidth waste by considering the best relay to broadcast information. In this chapter we provide the simulation results to evaluate the DHVN performance. In chapter 4, we proposed two complementary contributions, in the first one, we presented an Optimized RSUs placement for Delay-sensitive applications (ODEL) that optimally deploys RSUs to improve connectivity and reduce delays. In the second contribution, we described a new routing protocol called routing for Delay-sensitive applications (RDEL) that routes information us-

ing the optimally deployed RSUs. We included in this chapter a performance evaluation for both contributions.

For the second part, in chapter 5 we gave an overview of sustainable mobility. We surveyed basic transportation technologies and components, studied current contributions and projects in the field of green transportation, defined the main challenges and open research area that still need a further investigations and finally we presented an integrated architecture for sustainable transportation management systems.

In chapter 6, we described a new architecture for electric vehicles' fleet management called Ev-Drive. EV-Drive collects, explores and processes traffic information in order to provide new services for electric vehicles such as fleet management and itinerary planning. In chapter 7, we presented OLoCs that optimally deploys charging stations in order to satisfy the electric vehicles' drivers demand and maintain a balance between the demand and the available energy. We provided in this chapter the performance evaluation of OLoCs.

Finally, in chapter 8, we concluded the thesis with a discussion of open issues and future work concerning connected and sustainable mobility applications. This is followed by a list of our publications, acronyms and the bibliography.



CONNECTED MOBILITY

BACKGROUND AND RELATED WORK

2.1/ INTRODUCTION

Transport market has known a tremendous development in recent decades; the transportation means grew by more than thousand times after the World War [57] [58]. This development has made life easier for peoples and accelerated economic growth around the world. However, this transport revolution involved many disadvantages such as congestion and jams that impact the drivers behavior and traffic efficiency. In addition, high velocity and weather conditions led sometimes to dramatic events, fatal accidents and heavy economics loss. In 2010, the road crash caused the death of 1.24 million people and around 50 million sustain non-fatal injuries on the world's roads [69]. Moreover, the means of transportation entailed dangerous environmental degradation due to the use of non-renewable fossil fuels. In order to fit with these problems, governments, researchers and standardization organizations initiate urgent programs and projects with the main objectives safety of drivers, measurement and alleviation of traffic congestion and reduction of greenhouse gas emission. These objectives require an exchange of a huge amount of traffic information collected from vehicles and their environment such as average speed of vehicles, velocity limits, events warning, parking availability, etc. Thanks to transport and communication innovations that led to introduce the smart and connected vehicles by adding communication capabilities, smart processors and controllers. This development is also known as connected mobility where connected vehicles assist drivers and offers them more comfort and safety.

Connected and assisted navigation, for fleet management, was the first application that implements connectivity. Subsequently, many other applications have emerged as the emergency call (e-Call), the breakdown call (B-Call) in case of failure), tracking stolen vehicles, community applications such as "COYOTE" for info traffic, etc. Furthermore and responding to the rapid emergence of in-vehicle technologies and taking advantage of the rise of smartphones, many companies launch different innovative projects [42] [45] [139] [127] to monitor, self-monitor and interact remotely with the car at any distance, like: *Open Automotive Alliance* (OAA) [38] by Google on 2014 where they integrate a new android platform inside vehicles with the collaboration of automakers (Jeep, Audi, Ford, Fiat, Honda, Nissan, Hyundai and Nvidia...). Apple introduces a new system called "Carplay" [2] to connect iPhone iOS7 operating system to the dashboard of the cars using Lightning connectors. The system allows eyes-free and hands-free operation mode, satellite navigation, telephony instruction and control, music control, etc. We believe that the development of cooperative vehicular networks will be a catalyst for the development

of new applications like safety applications, autonomous vehicle, real-time info traffic, etc. Nevertheless, connected vehicles are still in the initial phase and they would require extensive new standardizations, tests and procedures for qualifying and approving applications and devices and ensuring their interoperability. To that end, researchers must explore the area where technology and regulatory policy meet and develop strategies for testing and certifying connected vehicle technology.

In this chapter, we aim to present current communication technologies, protocols, projects, issues and challenges in transportation communication field in order to propose novel solutions. To that end, we first introduce the connected vehicle concept, the different communication technologies and modes to exchange information between connected car and its surrounding environment. Then, we classify the mainstream and trending applications of connected vehicles. After that, we cite the major characteristics, challenges and requirements, and we present an overview of major standardizations efforts along with recent projects in the field of emerging connected vehicles. Finally, we outline a short survey on data dissemination and routing protocols since we are dealing with these challenges in this thesis.

2.2/ CONNECTED VEHICLE: AN OVERVIEW

Earlier vehicle drivers had to manually control the majority of the car components to be able to drive safely. In fact, microprocessors have been introduced inside the cars since the 1960s to improve the stability of the car, control it and bring new features such as: port injection system, electronic spark ignition, cruise control, navigation using Global Positioning System (GPS) [196], etc. Modern port fuel injection system [25] sends fuel directly to the individual cylinders and uses sensors to detect airflow, vacuum, temperature and exhaust. *Electronic Spark Timing* (EST) [14] replaces the mechanical contact breaker in older cars to optimize spark timing for better control of exhaust emissions and for fuel economy improvements. *Global Positioning System* (GPS) was first introduced in military vehicles prior to its use with a less precise version in private and companies cars in the 1990s. During the last decade, other electronic components have been integrated to vehicles forming a whole embedded system on board [186] [95] to make cars more intelligent. Today, many common tasks have been automated; for example, cars may be equipped with assisted steering equipment and gearbox, automatic and remote opening and closing car's doors, etc. The concept and operating philosophy of connected vehicle is founded on two main parts: first, on the embedded system inside the vehicle itself, and secondly on telecommunication technologies and infrastructures. The interoperability between these two parts constitute an *Intelligent Transportation System* (ITS) and allows several features like data collection and routing, data processing and decision making. Indeed, connected vehicle explores different kind of data such as: traffic information, weather conditions, road state, emergency warning and several infotainment data. We detail the embedded system and communication technologies in the following subsections.

2.2.1/ CONNECTED VEHICLE: EMBEDDED SYSTEM

An embedded system is an autonomous electronic system designed for a specific task, often with real-time constraints. An embedded system in a connected vehicle includes various software and hardware like sensors, control units, human machine interface, etc [95]. Sensors measure and collect information about vehicles' state and its surrounding environment. We can find different sensors within a modern car such as speed sensor for automatic door locking when the vehicle moves, battery sensor to measure the state of charge, rain sensor for automatic switch of wipers, humidity sensors and thermostats in the engine to avoid that temperature and humidity affects the engine performance [166]. Control units whether recover and process locally collected information or send it to a remote server according to type of data and the environment affected by these data. Some information is stored if necessary in the vehicles' memory. For example, the car collect the driving information during different trips and send those information to a remote server to study and optimize the driver's behavior in the future travels. Embedded system contains several control units [78] like *Body Control Module* (BCU) that controls door and windows locks, *Brake Control Module* (BCM) that allows to maintain tractive contact with the road surface according to driver inputs while braking, *Engine Control Unit* (ECU) and *Transmission Control Unit* (TCU) that optimizes the use of internal combustion engine to ensure the best performance and save fuel, etc.

Vehicle's embedded system becomes more advanced. It requires to manage some important information by using *Human Machine Interface* (HMI) [197] that allows drivers to interact with their vehicles and to view the performance and condition of the vehicle. As indicated before, a hole operating system has been integrated to the car by Google. Google's driverless (OAA) [38] car is a very prominent innovation in automated transportation. The system facilitates *machine-to-machine* (M2M) communication, data process and manages efficiently events inside and outside the car to prevent crashes, improve traffic flow, and share information.

In addition, sometimes connected vehicles must react in real time to exchange delay sensitive information i.e. each reported event must be processed in a very short time. An additional delay can involve dangerous incidents. Let's take the example of the detection of a pedestrian crossing the road via an embedded camera; the reaction time must be short to avoid a dramatic accident. The hardware components of the embedded system are connected by an on-board network, which is mostly wired and sometimes wireless. Connected vehicles communicate to each other directly or through an additional infrastructures. We provide below more details of vehicles communication technologies and communication modes in vehicular network.

2.2.2/ CONNECTED VEHICLE: COMMUNICATION TECHNOLOGIES AND MODES

Connected vehicle aims to provide continuous connectivity for drivers and passengers while they travel. Thus, it employs heterogeneous communication technologies: embedded in the vehicle to communicate among components (micro-controllers, sensors and devices) or outside the car to communicate with the infrastructure or with other vehicles. Inside the car, wired and wireless communication are used. Common examples of embedded communications technologies are summarized in table 2.1. Wired medium includes *Local Interconnect Network* (LIN) [31], Ethernet [103], FlexRay [186], *Controller*

Area Network (CAN) [216], Media Oriented Systems Transport (MOST) [33], Domestic Digital data Bus (D2B) [3], etc. Vehicles also use wireless medium inside the car, such as Bluetooth [167], Zigbee (802.15.4) [104], Radio-Frequency Identification (RFID) [76], etc.

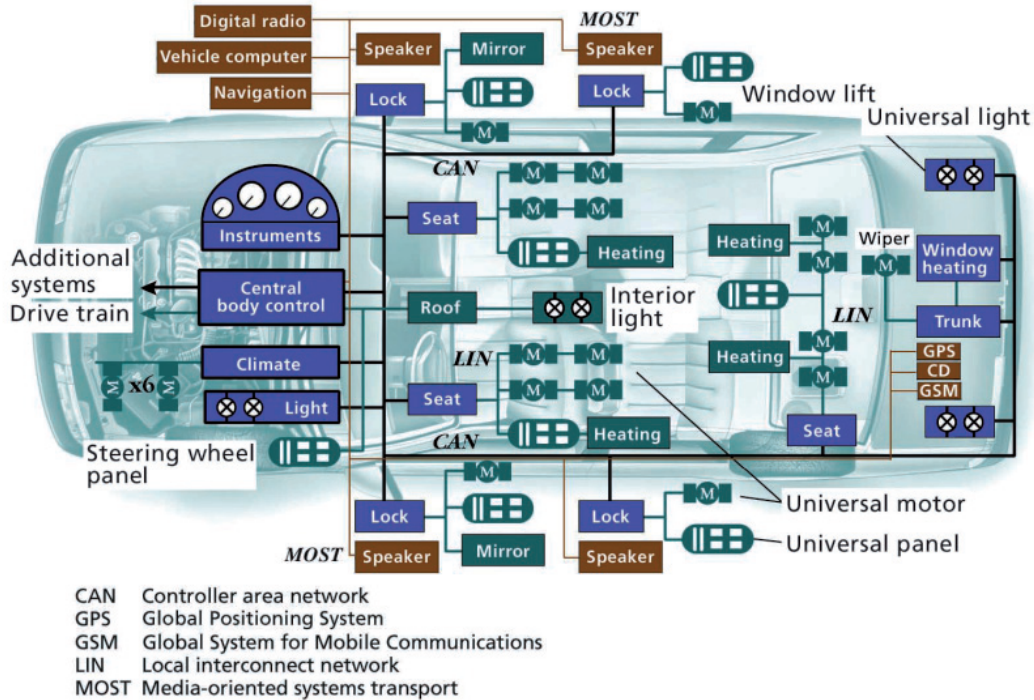

Figure 2.1: Embedded vehicle networks

Table 2.1: Comparison between different embedded communication technologies

Embedded network	Medium	Speed	Usage
Domestic Digital Bus (D2B) [101]	Optical fiber	12 Mbit/s	Digital audio transmission
Media Oriented Systems Transport (MOST) [162]	Optical fiber	24,8 Mbit/s	Multimedia: audio, video, control
FlexRay [162]	Bus	10 Mbit/s	Enable applications with high data rates and time constraint, enable fast adaptive damping system, x-by-wire applications
Byteflight [186]	BUS	10 Mbit/s	Preallocate slots for critical messages
Time-Triggered Architecture (TTA), TTA-Bus [186]	Bus	20-1000 Kbit/s	Safety-critical applications
Bluetooth [167]	Radio waves	1.5 Mbit/s	Multimedia and short range services

Continued on next page

Table 2.1 – continued from previous page

Embedded network	Medium	Speed	Usage
CAN [216]	Bus	1 Mbit/s	Accommodate vehicle control signals and communicate between different subsystem inside the car.
LIN [31]	Bus	20 kbit/s	Enable low-cost, single-wire network for data transfer
Ethernet [103]	Connecteur RJ45	10 Mbit/s à 10 Gbit/s	Enable communication to camera and transmit multimedia data

For wide coverage, the connected vehicle utilizes WiFi (802.11.a, b,n) [24], WAVE (802.11p) [60], and WiMAX (802.16) [64] technologies to communicate with other cars or to transmit the collected data like road traffic conditions to remote servers. In addition, 3G [1] and 4G/LTE [85] technologies are used for high performance, to ensure rapid communication in case of low network density, or to deliver a highest Quality of Service (QoS). In the recent years, mobile communication allows to combine cellular and vehicular communication technologies and use each one to the best of its ability. Table 2.2 shows the relative positioning of leading candidates technologies based on macroscopic criteria.

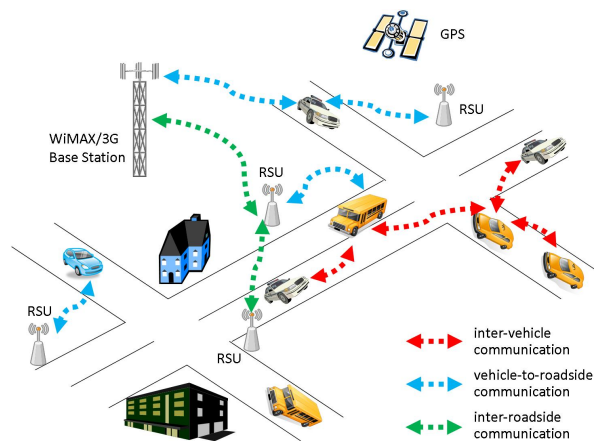

Figure 2.2: Communication modes

Vehicles communicate using three communication modes as depicted in figure 2.2: (i) Vehicle to Vehicle communication (V2V) or Inter-Vehicle communication (IVC) where the network is self-organized as an ad hoc network and vehicles communicate with each other without any access to a fixed infrastructure, (ii) Vehicle to infrastructure (V2I), it may use Road-Side Units (RSUs) or a mobile telecommunication network infrastructure. In this mode, vehicles communicate only through the infrastructure that allows to route information to the final destination, and (iii) Hybrid communication (*Vehicle-to-X* (V2X)) where vehicles may communicate with both other vehicles in the same coverage or with a fixed infrastructure.

Wireless characteristics	Technology			
	802.11p WAVE	WiFi	Cellular	Infrared
Bit rate	3–27 Mb/s	6–54 Mb/s	<2 Mb/s	<1 Mb/s, <2 Mb/s
Communication range	<1000 m	<100 m	<15 km	<100 m (CALM IR)
Transmission power for mobile maximum)	760 mW (US), 2 W EIRP (EU)	100 mW	2000 mW (GSM), 380 mW (<i>Universal Mobile Telecommunications System</i> (UMTS))	12800 W/Sr pulse peak
Channel bandwidth	10 MHz 20 MHz	1–40 MHz	25 MHz (GSM), 60 MHz (UMTS)	NA (optical carrier)
Allocated spectrum	75 MHz (US), 30 MHz (EU)	50 MHz @ 2.5 GHz, 300 MHz @ 5 GHz	(Operator-dependent)	N/A (optical carrier)
Suitability for mobility	High	Low	High	Medium
Frequency band(s)	5.86–5.92 GHz	2.4 GHz, 5.2 GHz	800 MHz, 900 MHz, 1800 MHz, 1900 MHz	835–1035 nm
Standards	IEEE, ISO, ETSI	IEEE	ETSI, 3GPP	ISO

Table 2.2: Comparison between different leading candidates technologies

2.3/ CONNECTED VEHICLE: APPLICATIONS

Connected vehicles bring new promising and growing business area. They garner a huge attention for the services that can be offered to the drivers. Connected vehicles' applications have different purposes and some common requirements. Vehicular applications can be classified into three categories [162]: safety, traffic efficiency and infotainment or comfort applications. Herein, we detail these three applications classes and give some use cases:

2.3.1/ SAFETY AND EMERGENCY APPLICATIONS

The first class, i.e. the safety applications, plays a key role in drivers protection. It is primarily developed to avoid collision and accidents and keep driver and passengers safe during their trips by providing information about vehicle state, roads and weather, etc. We give below some use-cases:

- *Intersection and lane change assistance:* In roads with many lanes or in intersections, drivers move from lane to lane or from road to road which increase the risk of accidents. Intersection and lane change assistance services help to avoid crash by informing drivers if adjacent lane is clear or not.

- *Collision risk warning:* When a car exceeds the speed allowed on the road or ignores a traffic signal, surrounding vehicles or roadside units will send a warning message to prevent the car driver in order to avoid the collision.

- *Road's events warning:* When cameras, radars or an effective visual route monitoring system detect obstacles on road, it is important to warn drivers to avert a crash or inform the following cars that a collision has already happen on this road. This will significantly reduce the accidents mortality rate and economic damages.

- *Weather event warning:* A vehicle informs the following and the upcoming cars that there is visibility problem due to fog or any other driving problems caused by the presence of ice in order to reduce their velocity and to be prudent.

- *Rescue warning:* When an emergency car (e.g. police car, ambulance,...etc.) is approaching toward other vehicles, it sends a warning message to ask the driving vehicles to move across lanes to yield the way and let it pass.

2.3.2/ TRAFFIC RELATED APPLICATIONS

This second class of applications aims to inform drivers about traffic flow to efficiently manage the traffic and avoid congestion. As use-cases, we can mention:

- *Congestion management services:* Vehicles and monitoring infrastructure collect traffic information, predict congestion and optimize the traffic light signals to manage the traffic flow. Traveling vehicles could choose best routes and avoid highly congested ones.

- *Autonomous navigation:*

Vehicle platooning is one of the innovations solutions in the automotive industry that enables vehicles to travel together closely yet safely. In fact, platooning aims to reduce the amount of space used by vehicles. Thus, more cars can share the roads without traffic congestion. Moreover, new advance embedded platforms such as Google OAA enable

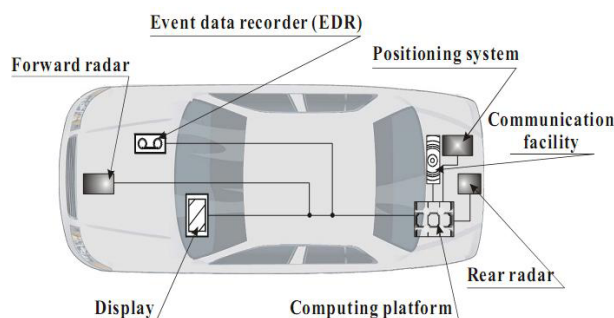

Figure 2.3: Autonomous vehicle

self-driving without human support. As depicted in figure 2.3, an autonomous car is able to sense its environment using radars, cameras and navigation information. It is able to detect obstacles and avoid them or reduce its velocity depending on traffic signals.

- *Parking managements*: In this use-case, the aim is to efficiently use parking resources and get pricing and availability information of the parking slots. In addition, a lot of modern vehicles are able to assist drivers when they park.

- *Green itinerary planning services*: Itinerary planning services provide recommended itinerary to the drivers in order to reduce the traveling time by avoiding congested routes. In addition, new itinerary applications deal with pollution and power consumption. They allow more sustainable mobility by computing the most economic itinerary as our solution Ev-Drive proposed in chapter 6.

2.3.3/ COMFORT APPLICATIONS

Finally, this third class of application aims to bring comfort to drivers and passengers during their trip. Comfort applications represent the future convergence of computers and Smartphone applications. They provide travelers with needed information support and entertainment to make the journey more pleasant. Through inter-vehicle communications, passengers could download road map, share music, photos or enjoy shared gaming. They also give the possibility to control automatically the air conditioning and windows depending on the sensed temperature and collected information about pollution. Comfort applications do not require a hard delay criterion as safety applications. However, they may need large bandwidth resources depending on the amount of exchanged information. Many relevant applications are proposed in this field including:

- *Infotainment and advertisement applications*: Vehicles or roadside infrastructure broadcast announcement about shows, parties and spectacles and disseminate commercial advertisements around outlets and stores [144].

- *Internet access and services*: These services aim to connect to remote web pages, download files and video gaming, and to use social networks,...etc. At present, passengers uses internet through cellular communication (3G, 4G, etc). However, a full ability to access web on vehicles in motion is still under development to adopt the characteristics of vehicular context (see section 2.4).

2.4/ CONNECTED VEHICLE: CHARACTERISTICS AND REQUIREMENTS

A set of connected vehicles forms a *Vehicular Ad-hoc Network* (VANET). Indeed, VANET network is a particular case of ad hoc networks in which the connected nodes are highly mobile. These nodes may use infrastructures in addition of the mobile nodes to increase connectivity in wide area. In VANET, the traffic density is either very dense or sparse. In case of sparse network, no direct end-to-end path between communicating entities exists. In case of high dense network, a direct end-to-end path requires to send frequent update messages due to highly dynamic topology.

This section describes first the different characteristics of vehicular networks and then, the main requirements that this network must satisfy.

2.4.1/ CHARACTERISTICS OF A CONNECTED VEHICLE

Herein, we explain in details some unique characteristics of vehicular networks [195]:

- *Highly dynamic topology and frequently disconnected network:* Vehicular nodes move so fast building a high dynamic network. Thus, the network topology changes frequently causing links break between nodes. Continual disconnection implies data losses and additional computations and delay to retransmit data,

- *Large scale:* The size of vehicular networks is very important and researchers need to consider a large scale network in the design and the development phases. In fact, the number of connected vehicles is increasing over time especially in large cities. The exchange of a high amount of data between entities could create a bottleneck/collision and therefore the network may go down,

- *Energy and processing capacities:* Unlike traditional wireless networks where the energy constraint represents an important limiting factor, vehicular networks' nodes have large energy capacities since they have the ability to use vehicle's energy supply. Even if the engine stops and turns off the supply system, it is always possible for a board to use the vehicle's batteries. So, the vehicle's embedded system can be fully fed and the different required processing can be done,

- *Mobility modeling and prediction:* Vehicles move on predefined trajectory on highways, roads, and streets; therefore, it is possible to predict the future position of the moving vehicle based on the velocity, the density on the traffic, and the road map. Positions prediction helps to design more efficient protocols and deduce the connectivity between nodes,

- *Intermittent connection:* A vehicular network is a *Delay-Tolerant Network* (DTN) ; which means lack of continuous connectivity and frequently disconnected network especially in low-density scenarios due to the high mobility of vehicles and frequent topology changes,

- *Hard delay constraints:* Through buffering and *Store and Forward* (SNF), the message can eventually be delivered to the destination even if a path does not immediately exists between source and destination. However, the SNF introduces a long delay. Thus, the delay does not meet applications latency requirements. For example, in an highway scenario, when a car crashes, a warning message must be transmitted to the surrounding vehicles to avoid collision. In this case, the maximum delay is more vital and extremely short,

- *Interaction with various communication environments:* In the vehicular network, vehicular nodes communicate with each other in different environment scenarios to collect, route and disseminate information. In urban scenarios, buildings, bridges, tunnels represent barriers and obstacles that decrease the connectivity of mobile nodes,

- *Interaction with infrastructures and with on-board sensors:* Vehicular nodes communicate with internal on-board sensors using wired or wireless communication technologies to collect information about location, battery state of charge, etc. Also, each vehicle communicates to other vehicles or road side units (RSUs) using wireless links to exchange data,

- *Communication based on geographic location:* In VANET, most of existing protocols send data to the destination using geographic routing and broadcasting instead of using only destination address to fit with the high mobility of vehicular nodes and the network

disconnection. Therefore, it requires location services to establish path toward the destination,

- *Security*: VANET transmits information via radio communication. Consequently, an attacker could eavesdrop, misbehave, change and drop messages or introduce a wrong routing information. Thus, the network is vulnerable and requires additional mechanisms to ensure the security and privacy in each node during data exchange.

2.4.2/ REQUIREMENTS OF A CONNECTED VEHICLE

Applications for connected vehicle are subject to technical and scientific requirements. These requirements are difficult to meet in an environment where the radio link is not always reliable, and the high mobility of vehicles affects the Quality of Services (QoS). These requirements include:

- *Economical requirements*: To achieve a required level of connectivity for connected vehicles, we need to deploy a required communication infrastructures and outfit vehicles with sophisticated embedded system. This will introduce heavy costs. Thus, we need also a good business plan to ensure the balance between the investment cost and customers billing,

- *Organizational requirements*: A plethora of applications, communication technologies and different architectures and standardization are proposed for vehicular networks. However, many solutions are incompatible with common vehicle market. Thus, standardization organizations along with research institutions around the world need to deal with such conflicts such as: unifying IPv6 or IPv4 address allocation schemes, manage the interoperability between different communication technologies, etc. [139],

- *Latency-related requirements*: In case of sparse network, no direct end-to-end paths between communicating entities exists. Thus, communication in this context falls into the category of Vehicular Delay Tolerant Network (VDTN). In figure 2.4 , we summarize the time and distance requirements based on the application's category. For example, safety applications have higher priority and lower latency requirements than infotainment or advertisement applications,

- *System performance requirements*: In order to use some applications, some system performance and resources availability are required such as sufficient bandwidth, reliable radio channel, accurate navigation system, etc. In addition, applications design claims considerable attention to support the size of the network as the number of nodes may increase in case of traffic jam which exhausts the network resources.

2.5/ CONNECTED VEHICLE: PROJECTS AND STANDARDIZATIONS EFFORTS

Many research programs and industrial projects focus their efforts on connected mobility and its applications. In addition, standardization organizations works on new emerging communication technologies in vehicular networks. We give a further details of those projects and standardizations efforts bellow.

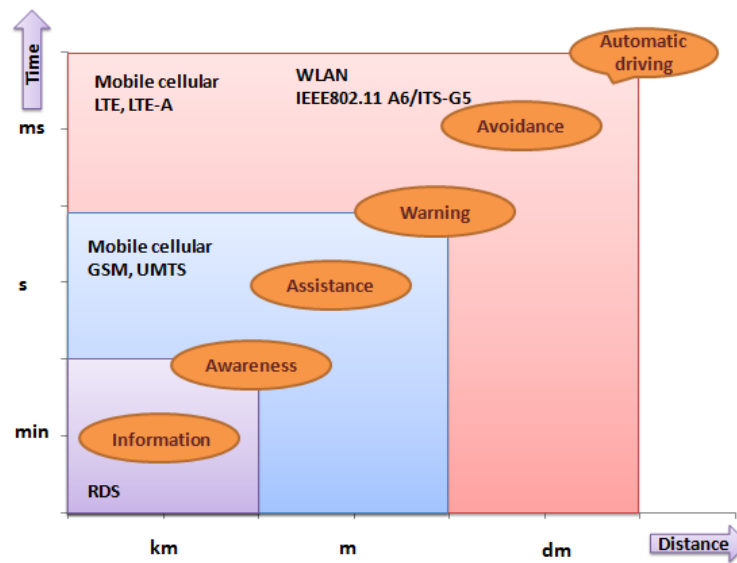

Figure 2.4: Latency-related requirements

2.5.1/ ON GOING PROJECTS

Vehicular networking has great potential to enable diverse applications. Different countries and international organizations initiate a lot of programs and launched many projects concerning traffic safety, traffic efficiency and infotainment such as: CAMP/VSC-21, California PATH, IntelliDrive, PLATA-PROTON, Co-Drive, DRIVE C2X, etc. In table 2.3, we summarize some of recent initiatives to build a robust intelligent transportation system with connected vehicles as central component.

Table 2.3: VANET projects

Project	Year	Objectives
IntelliDrive (USA) [26]	2004-2011	To develop an architecture and standards to provide an open platform for wireless communications between vehicles and roadside infrastructure, To establish test beds to support operational tests and demonstrations for public and private sector use, Study liability and privacy issues.
SKY (JAPAN) [50] [175]	2004 -XXXX	To reduce traffic accidents, shorten travel times, and increase fuel savings by using in-vehicle technology.
Intelligent access program (IAP) (AUSTRALIA) [23]	2006-XXXX	To improve access to the Australian road network and remotely monitor heavy vehicles.

Continued on next page

Table 2.3 – continued from previous page

Project	Year	Objectives
Secure Vehicular Communication (SeVeCom) (EUROPE) [182] [48]	2006-2008	To improve road safety and optimize road traffic, To identify and investigate IPv6 security issues, To specify an architecture and security mechanisms to provide the right level of protection.
CARWINGS (JAPAN) [7]	2008-2011	To develop an on-board computer navigation system to make car navigation systems more convenient by connecting them to mobile phones, To provide a range of services to support eco-driving and ease congestion.
Intelligent Speed Adaptation Trial (ISA) (AUSTRALIA) [27]	2009-XXXX	To provide an advanced systems that assist drivers to improve road safety, To inform drivers about changes of speed zones in order to decrease the proportion of time drivers spent traveling over the speed limit.
GeoNet - INRIA (FRANCE) [20]	2009-2010	To specify the architecture to combine C2C-CC's geographic routing with ISO's CALM (see section standardization 2.5.2) IPv6 features.
hline Cooperative Vehicle-Infrastructure Systems (CVIS) (EUROPE) [9]	2010-XXXX	To improve the road traffic by using V2I communication, To define and validate an open-architecture and system concept for a number of cooperative system applications (real-time exchange of traffic information, road safety, security and privacy), To develop and test the technologies for V2V and V2I communication.
European Field Operational Test on Safe, Intelligent and Sustainable Road Operation (FOTsis) [42] (EUROPE)	2010-2014	To provide a large scale field testing of the road infrastructure management systems, To secure a proper connectivity from the traffic control centers, To contribute to the safety, mobility and sustainability challenges that face transport systems.
Platform télématique multistandard pour l'automobile (PLATA) [41] (EUROPE)	2010-2013	To propose a multistandard telematic platform to improve road information system, To provide navigation systems that receive the navigation maps along with traffic information via the TMC (Traffic Message Channel).

Continued on next page

Table 2.3 – continued from previous page

Project	Year	Objectives
DRIVE C2X - Accelerate cooperative mobility [10] [47] (EUROPE)	2010-2014	To improve road safety using V2V, V2I and I2V communications, To test the design of cooperative driving and other proposed applications, To deploy the required communications infrastructures, To contribute to the standardization process ongoing at ETSI TC ITS, To exchange important information that enhance safety and enable sustainable mobility.
New Traffic Information System Model Project [35] (CHINA)	2012-XXXX	Alleviate traffic congestion and reduce fuel consumption using recorded driving data.
Platform for Smart Car to Car Content Delivery (CARCODE) [5] (EUROPE)	2012-2015	To design and implement a open platform to explore the Information and communications technology (ICT) of modern vehicles. This platform autonomously collect and exchange information to provide safety, comfort and environment-friendly applications. To propose different services such as fleet management, itinerary planning...etc, To enhance the security and detect threats while exchanging information.
California Partners for Advanced Transportation Technology (PATH) [40] (USA)	Over 25 years	To provide a vehicle automation solution to reach to a fully automated system and get autonomous driving, To create an advanced traffic signal controls using connected vehicle data, To provide several services like truck platooning, congestion management, etc, To propose sustainable transportation solutions.
Open Automotive Alliance (OAA) (GOOGLE) (USA) [38]	2014	To propose an android platform for vehicle self-driving.

2.5.2/ STANDARDIZATION EFFORTS

Major standardization organizations, companies and research laboratories in different countries make a great efforts by launching projects and proposing new standardization architectures that meet the special characteristics of *Vehicular Ad-hoc Networks* (VANETs). In fact, the high mobility of the nodes break the wireless link in short time. Thus, robust wireless protocols and architectures that ensure reliable communication across the vehicles are being proposed by standardization organizations.

In the united state, a collaboration between government transportation agencies, private businesses, and academia has developed in 1992 Intelligent Vehicle Highway Systems

(IVHS) program to alleviate many transportation problems [206]. In the field of communication technologies, the program proposed to utilize 902–928 Mhz frequency for ITS services such as automatic tolling. However, this frequency band is insufficient and inadequate for the needs of major ITS services. Thus, in 1999 FCC (Federal Communications Commission) [19] has allocated the 75 MHz frequency of 5.9 GHz band called DSRC in USA to vehicular communication. The European Telecommunications Standards Institute (ETSI) [18] has allocated 30 MHz of spectrum in the 5.9 GHz band for ITS communications in 2008. The DSRC radio technology is essentially IEEE 802.11a adjusted for low overhead operations in the DSRC spectrum, and it is being standardized as IEEE 802.11p [99]. U.S. Department of Transportation (USDOT) proposed a set of standards and specifications for the protocol stack WAVE depicted in figure 2.5. The WAVE architecture gathered IEEE802.11p and IEEE1609 standards.

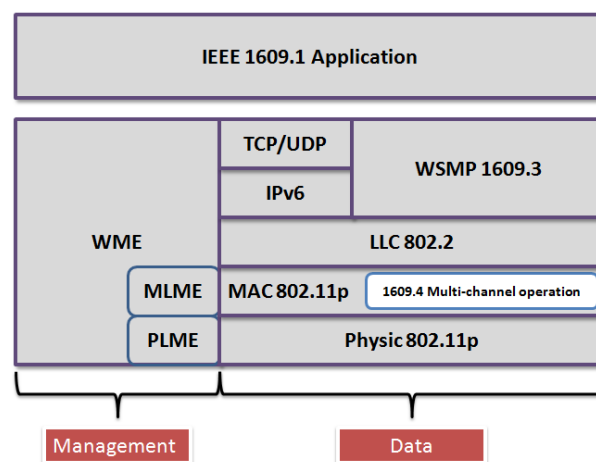

Figure 2.5: WAVE architecture

IEEE802.11p is the lower layer standard that uses OFDM (Orthogonal Frequency Division Multiplex) technique. OFDM uses multiple carrier signals at different frequencies to send out data. In general, 802.11p explores the spectrum of 5.8GHz, 5.9GHz, 700MHz and 900MHz is used depending on the geographic location. IEEE 1609 is the higher layer standard that defines V2V and V2I communication architecture and a complementary set of applications and interfaces. It aims to provide safety services, enhanced navigation, traffic management and many other services dedicated to transportation environment.

In Europe, European Telecommunications Standards Institute (ETSI) [18] [114] group for Intelligent Transport Systems proposed ETSI-ITS architecture standard depicted in figure 2.6. This framework is composed of four horizontal protocol layers (application, facilities, networking and transportation, access to medium) with two vertical protocol entities: management and safety plans. ETSI introduced ITS-G5 technology based on 802.11p to consider geographic protocols for V2V and V2I communication. In ETSI- ITS, the access medium layer covers various communication media and related protocols for the physical and data link layers. The network and transport layer comprises both network protocols stack and transport protocols stack. The network stack includes data routing from source to destination through intermediate nodes and the efficient dissemination of data in geographical areas. Transport stack is adapted to the high dynamic vehicular network. It provides the end-to-end delivery of data and, depending on requirements of ITS facilities and applications, additional services, such as reliable data transfer, flow

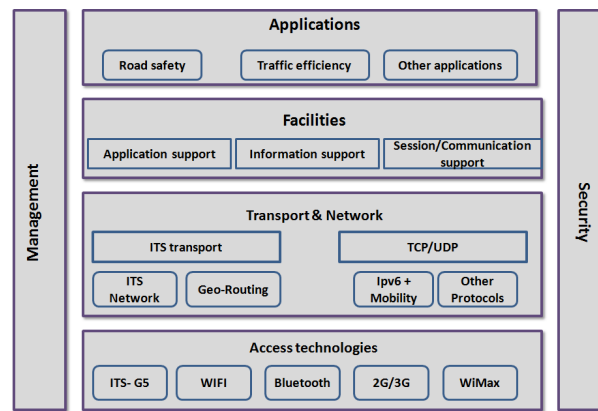

Figure 2.6: ETSI-ITS architecture

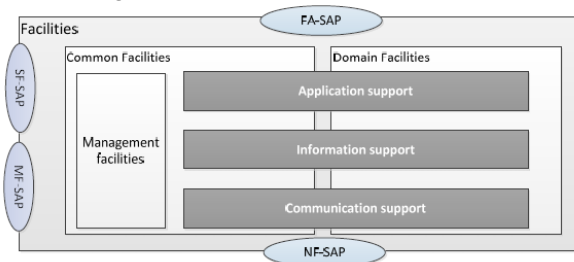

Figure 2.7: Facilities layer

control and congestion avoidance.

Facilities layer is a new layer introduced by ETSI (see figure 2.7). It exchanges data with lower layers and with management and security entities of the ITS architecture. It is considered as a middleware that provides multiple functionalities and services such as updating the geographic dynamic map (LDM) to be used by upper application layer. The LDM reflects the dynamic events occurring on the road. Facilities (services and functionalities) provided by facility layer can be classified into two categories: (i) Common facilities: basic services to support the reliable operation such as time service, positioning service...etc. (ii) Domain facilities: provide services and functions for one or several specific applications such as cooperative road hazard warning applications,...etc. The applications layer refers to ITS applications and use cases for road safety, traffic efficiency, infotainment and business. Management entity is responsible for configuration of an ITS station, cross-layer information exchange among the different layers and others tasks. Security entity provides security and privacy services, including secure messages at different layers of the communication stack, identities management and security credentials, and aspects for secure platforms (firewalls, security gateway, tamper-proof hardware).

At world level, International Organization for Standardization (ISO) established in 1993 ISO/TC204 standard covering activities on ITS, excluding information and control in the transport vehicle system covered by ISO/TC22 standard. ISO/TC204 proposed the general communication system including all types of ITS communications ITS and a normalized related protocols called CALM (Continuous Air-interface Long and Medium Range) as depicted in figure 2.8. The aim of CALM is to develop an embedded software platform that incorporates multiple communication mediums 2G, 3G, UMTS, 5GHz DSRC, MWB (802.16e, 802.20 and HC-SDMA) and manages the handover between these technolo-

gies to allow continuous connectivity. In addition, CALM allows to use always the most appropriate available physical access medium.

ISO/TC204 is working closely with ETSI. Moreover, a task force between the united states, Europe and Asia is working to ensure harmonization between standards, identify areas which are not yet covered and report experimentation results of the different standards organization.

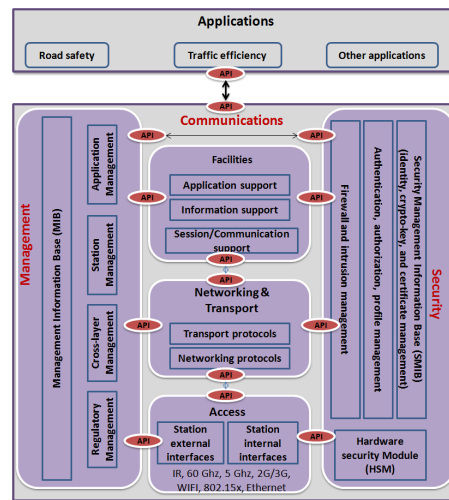

Figure 2.8: CALM architecture

2.6/ CONNECTED VEHICLE: TECHNICAL CHALLENGES - FOCUS ON DATA DISSEMINATION AND ROUTING

Transportation modernization promises to bring enormous numbers of applications and services to automotive industry customers. Those applications requires to exchange increasing amount of data using routing protocols. In addition, vehicular networks emerge as a mobile adhoc network with specific requirements and characteristics as we already explain in section 2.4. Those characteristics deeply impact the information communication. Thus, we focus in this subsection on network layer by giving an overview of the different routing protocols classes. This helps us to design a novel routing protocol that fits with the vehicular network requirements. Several surveys describe many vehicular routing protocols [195] [194] [88] [156] [87] [77] [139]. We briefly survey below the main strategies proposed in the literature and include further details in the next two chapters 3 4.

As shown in figure 2.9, we can classify vehicular routing protocols into different categories based on various criteria: (i) Destination: we can classify them also into three types: dissemination (broadcasting), multicast and unicast routing protocols, (ii) Forwarding strategies: we can classify them into topology-based routing, geo-routing and density-aware protocols, (iii) Requirements and kind of the provided services: we can classify them into vehicle-to-vehicle-based (V2V) routing protocols, vehicle-to-infrastructure-based (V2I) routing protocols, and vehicle-to-x (V2X) protocols, (iv) Network organization: we can classify them into hierarchical and non-hierarchical protocols.

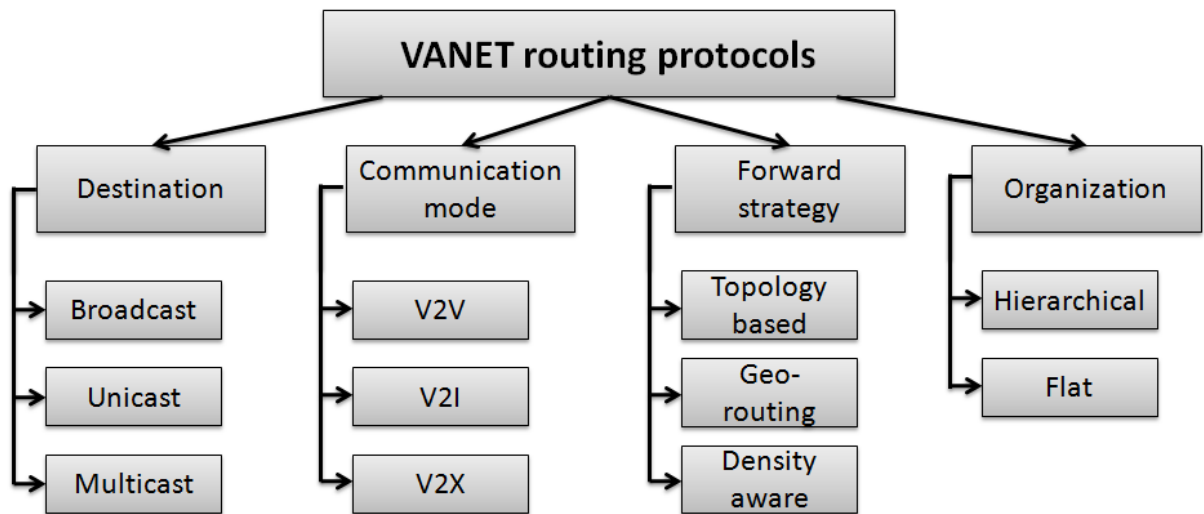

Figure 2.9: Connected vehicle: routing protocols classification

Broadcast protocols are used by source vehicle to send messages to a set of close vehicles or to all other vehicles in the network. This category of protocols are usually used to send infotainment messages or to disseminate warning messages in limited area. However, since too many vehicles can simultaneously send messages in the same time using the same wireless link, packets will be lost and this will eventually cause the whole network to melt down and lead to the failure of network communication. This phenomenon is called broadcast storm problem. To avoid this problem, many works proposed to alleviate the number of vehicles that retransmit the packets by using a set of selected relays.

Unicast (resp. multicast) routing protocols communicate data from a single source to a single destination (resp. multiple destinations) via wireless multi-hop forwarding mechanism using intermediate vehicles. Intermediate vehicles act as data relays between the source and the destination (resp. destinations). To build the routes, different approaches are proposed. The earlier routing schemes use topology-based routing protocols from MANETs networks and build a route to destinations. However, this kind of protocols are no longer efficient in high dynamic topologies due to frequent link breaks and the high generated overhead to maintain and update routing tables. A better approach called georouting or position-based routing is more appropriate for vehicular environment. It performs data routing by using an extra knowledge of physical position that allows to perform data routing. It uses geographic position information instead of using network address only to overcome the limitation of the dynamic destination. A more efficient approach establishes a routing path from source to destination by choosing intermediate nodes in junctions with high connectivity to reduce the impacts of link breaks and sparse network. Further detailed section about broadcast and unicast routing protocols is given in chapter 3 and chapter 4.

Strong constraints of VANET imply the need of the organization of the connected nodes to provide advanced services to the drivers and constitute a virtual backbone. Indeed, the organization in small groups of vehicles (clusters) facilitate data exchange for the applications. Each cluster has a cluster head (CH), and potentially one or more cluster members. In general, cluster members have common characteristics such as speed,

coordinates and/or similar directions. These clusters are dynamic due to high changing topology and need a frequent update. This hierarchical organization can be decentralized (self-organization), in which vehicles cooperate together to decide the cluster topology or centralized, in which an external entity (e.g., a remote server) organizes the clusters and updates the network topology. This organization may help to enhance reliability but it does not meet all VANET's requirements. In fact, VANET suffers from network partitioning because of high mobility. More sophisticated service as Internet access require a higher rate, a longer distance and continuous connectivity. Thus, current research tends to combine between pure V2V communication and infrastructures to enable a higher performance and reduce the end-to-end delays. One approach is to deploy the roadside units along the road to enhance the reliability [195]. Another solution, is to use the cellular network. The incorporation of new cellular technologies (3G, 4G/LTE, etc) grants a better coverage especially in sparse regions. Nevertheless, the deployment of cellular and roadside infrastructure incurs high costs and requires an extensive study to find the best deployment positions. This problem is well detailed in 4.

To summarize this section, we notice that a wide range of routing protocols for VANETs are proposed in literature. Each protocol is designed to support one or various architectures, applications and requirements and usually aims to maximize throughput while reducing packet losses and controlling bandwidth utilization. As mentioned in section 2.4, the major technological challenges faced by VANET are to conceive efficient communication protocols that stand the highly changeable topology. Thus, we focus in chapter 3 on challenges related to dissemination process in vehicular networks and we introduce our proposed protocol that aims to optimize the information dissemination in both high and sparse network scenario. Then, in chapter 4, we deal with delay-sensitive requirements and present two approaches: the first one aims to optimally deploy roadside units and the second approach addresses the routing using these optimally deployed roadside units to route data.

2.7/ CONCLUSION

The main goal of this chapter is to give an overview of connected vehicles that differ considerably from ordinary vehicles by incorporating communication and intelligence capabilities. Connected vehicles bring a plethora of new services to an enormous number of customers including drivers, passengers, governments, companies, etc. These services include warning dissemination, congestion avoidance, fleet management, file sharing, etc. However, providing those services in vehicular network is not an easy task due to different technical, socio-economic constraints. In this chapter, an investigation about the different applications and services as well as innovative projects carried out to fit with those constraints is presented. In addition, a short survey about vehicular routing protocols is provided in order to cover the main research directions in the field of vehicular communication. Indeed, till today the vehicular network is undergoing experimentation and development and still need further investigations and this is the purposes of the next two chapters.

EFFICIENT DATA DISSEMINATION STRATEGY FOR VEHICULAR NETWORKS CONSIDERING VEHICLES HETEROGENEITY AND ROAD TOPOLOGY

3.1/ INTRODUCTION AND PROBLEM STATEMENT

Connected vehicles play a key role in information dissemination on roads; they propagate data in limited to a wide geographic area and allow to distribute these data to one or several destinations without direct feedback or acknowledgment in order to decrease the bandwidth utilization. These data include driving-assistance data, emergency and safety warning and commercial advertisement, etc. However, dissemination engenders two main problems: on one hand, it is difficult to ensure messages delivery due to frequent disconnection in vehicular networks. On the other hand, collisions' probability grows significantly as the number of nodes sending messages increases (e.g. collision warnings). To meet these problems, we dedicate this chapter to study new dissemination strategies that allow to alleviate these problems. Hence, we first present an overview of the main existing work on information dissemination. Then, we present our new protocol called Dissemination protocol for Heterogeneous Cooperative Vehicular Networks (DHVN) that aims to improve data dissemination in vehicular networks.

There exists a plethora of proposed broadcasting protocols for vehicular ad hoc networks. Several surveys describe many of them [137] [224] [195]. In [137], the authors classify the broadcast mechanisms into two categories: (i) flooding protocols and (ii) single relay protocols.

In flooding protocols [141], each node receiving a packet retransmits it at most once; if the message is already received, it will be ignored. Flooding method engenders an enormous number of redundant packets, increases the risk of collisions and entails data losses. Thus, flooding can not be applied on vehicular network. To reduce message collisions, different broadcasting schemes that use single relay were proposed in literature. In this category of broadcasting protocols only one selected node takes over the rebroadcast. The relay node can be chosen randomly, based on its location (Position-based), ac-

ording to a given probability (probability-based), depending on density (density-based), hierarchically (cluster-based) or using a hybrid selection mechanism that combines the different mechanism cited above. Herein we give some examples of single relay broadcasting protocols:

Authors in [125] [126] eliminated the redundant messages forwarding using probabilistic broadcasting. This means that when a message is received the first time, not all receivers rebroadcast it, but it is only disseminated with probability P , otherwise it is dropped. The probability can be random [125], depends on neighbors counts [126] [172], or depends on the number of received copy of the broadcasted message [86].

Later works proposed a more intelligent position-based strategies in which one relay is selected to rebroadcast based on the location of the sender and the receiver. In [204], the authors proposed Distance Defer Transfer (DDT) protocol that uses only the farthest receiver to rebroadcast the message. When a node receives a packet the first time, it initializes a backoff timer that is inversely proportional to the physical distance. Farther is the node, shorter is the backoff timer. The receiver checks first the validity of time-to-live of the message and resends it in his coverage if the previous sender does not already cover almost the same area. Therefore, the message is rebroadcasted by the best relay. This method ensures better coverage with minimum transmissions, which permits to save the bandwidth resource. In [116], the authors proposed Contention Based Forward (CBF), in this protocol a timer is also triggered before rebroadcasting the message. This timer is calculated using two methods: (i) Distance-based where the timer is inversely proportional to the distance between transmitter and receiver. With this method, the selected relay node is the farthest one, and (ii) Random-based where a random node is selected as relay. In UMB [148], the authors aimed to use efficiently the channel and solve the problem of hidden terminal. They introduce new request and reply messages exchange (RTB/CTB: Ready to Broadcast/ Clear to Broadcast) between the sender and the farthest node. This mechanism is similar to RTS/CTS and it concerns the sender and the farthest chosen node for rebroadcasting only. In addition, in each intersection they use repeaters to rebroadcast the disseminated message in order to reach all the directions. In [108], the authors proposed BROADCASTCOMM to improve the broadcast in flooding protocol by using hierarchical relay selection. In BROADCASTCOMM, the road is divided into virtual mobile cells and the nodes are organized in a hierarchical way. The first level includes all nodes in a cell, and the second level represents vehicles in the center of the cell that handles emergency messages sent by the members of the same cell or by a nearby neighbors.

Since vehicular networks are also highly partitioned networks, continuous connectivity may not be assumed in a protocol design. Thus, all the methods described above suffer from message losses when no relay is available. To bypasses this problem and allow long-range information dissemination beyond the extension of a single network partition, concepts from delay-tolerant networking can be applied. This concept allows to retransmit messages periodically in constant or irregular interval. In particular, when no relay node is available, it uses store-and-forward (SNF) approaches. In a SNF approach, nodes do not immediately forward messages, but carry the information as they move from a road to another. When opportunities arise, e.g., by meeting other vehicles, the information is transmitted to forward it further. The SNF depends on applications requirements.

In [164], the authors proposed enhanced Multi-Hop Vehicular Broadcast (MHVB) by retransmitting the packet periodically until the node leaves the dissemination area. Retransmission period is modulated by some parameters (e.g. traffic density). In MHVB the

node stores the information and calculates the waiting time before retransmission based on the distance from the source of the received packet, and by counting the number of neighbor vehicles. If congestion is detected, MHVB changes the retransmitting period to a new value that is inversely proportional to the number of vehicles around the receiver. In [164], the authors proposed some MHVB improvements that use an angle to focus the rebroadcast in the forwarding direction and dynamically schedule the backoff timer. In [145] also, the receiver node decides to rebroadcast the message or not depending on the coverage threshold and angle between the sender and receiver. In [98], the authors proposed a directional and distance-based protocol called Road Oriented Dissemination (ROD). ROD takes into account roads' directions and intersections and uses SNF mechanism. It assumes that each car is equipped with a positioning system (e.g. GPS) and the dissemination origin is a fixed bridge on Road-Side Unit (*Road-Side Unit* (RSU)). Messages are propagated in one direction of the road. Only nodes with the same road and direction can rebroadcast the received messages. When a sender reaches an intersection, it broadcasts the messages in all directions. Consequently, the cars on other roads receives and retransmit data in new directions. When no relay is available, packets are stored and forwarded periodically to avoid packet losses in case of a partitioned network. Our protocol is based on some of the concepts defined in ROD. However, the relay selection and rebroadcast conditions are different. We give further details of our protocol DHVN in the next section. In [158], the authors designed Direction Propagation Protocol DPP where vehicles are organized in clusters to propagate messages. It uses the SNF mechanism to solve disconnection issues due to network partition. In [210], authors developed Distributed Vehicular Broadcast (DV-CAST) with the main goal to solve the broadcast storm in VANET broadcast techniques. DV-CAST is a broadcast mechanism in which each node periodically sends out beacon messages (Hello messages) to continuously collect its local vicinity state. The broadcast decision varies based on the connectivity state. In case of dense network, a node that receives a broadcast message retransmits it according to probability P . In normal traffic conditions, vehicles can instantly retransmit the broadcasted message within vehicles moving in the same and opposite directions. In a sparse density scenario, nodes use SNF mechanism until another vehicle enters the transmission range. Otherwise, the packet is discarded when the time-to-live expires.

Nowadays, emerging trend to improve data broadcast are driven by the use of new cellular networks. Authors in [123], developed LTE4V2X, a novel framework for a centralized vehicular network organization based on LTE technology. LTE4V2X uses a centralized clustering mechanism where the eNodeB is responsible for organizing the distributed vehicular network into clusters and maintaining this structure. When no LTE coverage is available for example in tunnels, a multi-hop extension is proposed. This latter is based on Clustered Gathering Protocol (CGP) [188] where the road is divided into fixed short length segments and each segment corresponds to a cluster in order to ensure reachability of an adjacent cluster using a single-hop communication.

We noticed that the majority of existing dissemination protocols fail to reach good delivery ratios in case of low-density network or within an urban environment. In fact, using the farthest vehicle as a relay in an intersection leads to a retransmission of the message but not in all the directions. In addition, random-based technique has a drawback as the selected relay is not necessarily the best relay for the dissemination. However, it does not need information about the network topology or the geographical position. Moreover, some of these approaches require the knowledge of local network topology to organize

the network into clusters. However, building and maintaining such structure needs frequent update messages exchanges and consumes a big part of bandwidth resources especially in high dynamic networks. Furthermore, these approaches are adapted only in some particular situations. Indeed, they have been developed for an environment fulfilling the following three conditions: (i) homogeneous topology where all vehicles are uniformly distributed in space, (ii) homogeneous connectivity where the information reception probability is equal in space, and (iii) homogeneous communication capabilities where all vehicles have equal transmission capabilities. Unfortunately, the vehicular environment does not fulfill any of them. Hence, in this chapter we present a new efficient approach for data dissemination called Dissemination protocol for Heterogeneous Cooperative Vehicular Networks (DHVN). We focus on information dissemination for infotainment applications. DHVN permits to: (i) avoid the waste of bandwidth by optimizing the number of vehicles that have to rebroadcast the packets, taking into account roads architecture as well as network density, (ii) use a store and forward module to limit disconnection effects in a partitioned network, and (iii) deliver the information as promptly as possible with a high delivery ratio.

3.2/ DISSEMINATION PROTOCOL FOR HETEROGENEOUS COOPERATIVE VEHICULAR NETWORKS (DHVN)

Broadcasting protocols deliver information to a set of nodes in a given geographic area. They propagate data through multi-hop relaying. In contrast to routing techniques, they do not use a unicast path to a destination. Thus, there is no need to routing table and topology update. Nevertheless, to ensure a high efficiency of data dissemination in vehicular networks, a broadcasting protocol must guarantee the adaptability to different vehicular scenarios. Regardless whether the network is highly crowded (e.g. urban area at rush hours) or extremely sparse (e.g. small rural area at night), the protocol should ensure high network coverage and perform better in terms of data delivery and average delay at the expense of the least possible transmissions. As aforementioned in the previous section, different approaches to disseminate information have been proposed for VANETS with good characteristics and acceptable performance. Nevertheless, those approaches can be improved by considering other characteristics of vehicular networks. In this section we introduce our dissemination protocol called DHVN that aims to support an effective and optimized way to propagate infotainment information in both highway and urban environments. To that end, we first present the assumptions that we consider in the implementation of DHVN and then we detail the three main modules of DHVN: (i) relay selection, (ii) topology-aware broadcast (iii) Store and Forward period (SNF) computation.

3.2.1/ DHVN ASSUMPTIONS

In our work, we consider that each vehicle is equipped with a positioning system such as GPS device that enables positioning and time synchronization. In addition, each vehicle can identify the intersections on the road through preloaded digital map. We consider both urban and highway environments. So, velocity ranges from 30 km/h to 110 km/h. Moreover, in our DHVN protocol, we do not use infrastructure to disseminate the messages, we only use V2V communication to exchange and broadcast information in a given area.

Furthermore, vehicles communicate using IEEE 802.11p as wireless technology. Finally, we assume that the vehicle amplifies the signal before rebroadcasting the message, so only coherent messages are sent.

3.2.2/ DHVN DESCRIPTION

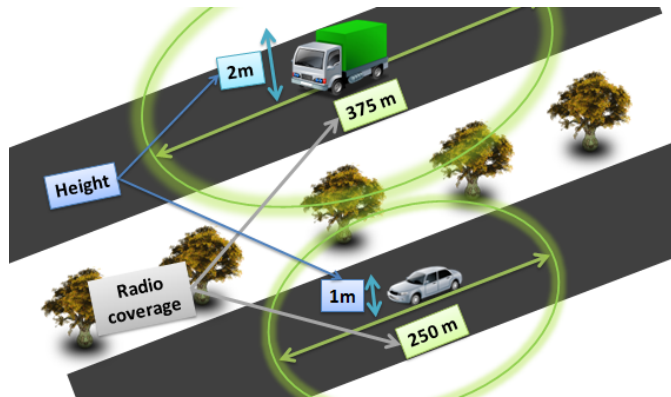

Figure 3.1: Radio coverage vs. vehicle's height

DHVN is a distance-based protocol; instead of flooding the network, we choose a relay based on distance and vehicles' height. Indeed, the vehicles on roads are heterogeneous, 20% of them are at least one meter higher than regular vehicles such as buses and trucks, etc. As shown in figure 3.1, a higher vehicle covers a large area and therefore improves the communication range compared to a regular vehicle.

When the vehicle disseminates a packet, it includes in the packet different information as shown in figure 3.2 e.g., *Sender-location* field is used to trigger the timer and disseminate the data, *Origin-location* field helps to prevent dissemination outside the area of interest, *Outgoing-Zone* field contains the intersection identifier, it helps to calculate the driving direction of the sender, the *time-to-live* (TTL) field represents the lifetime of data message. Vehicles stop rebroadcasting once the TTL expires.

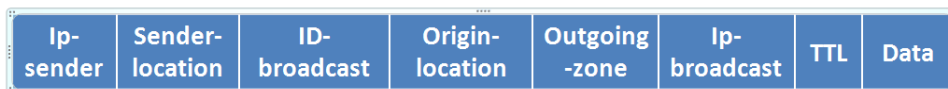

Figure 3.2: DHVN header

Each receiving vehicle on the same road triggers a timer based on the distance from the sender and its height. It retrieves the sender position information from the packet header and calculates the backoff timer using equation (3.1).

$$TimerT = 1/(distance + Car_height * (MD)) \quad (3.1)$$

where distance is the distance between the sender and the receiver, Car_height is the receiver vehicle's height, MD is the maximum additional distance when the node is one meter higher (in our case, we find MD equal to 125m after simulation). An illustration is given in figures 3.3(a) and 3.3(b) to explain how to choose the best relay. In this

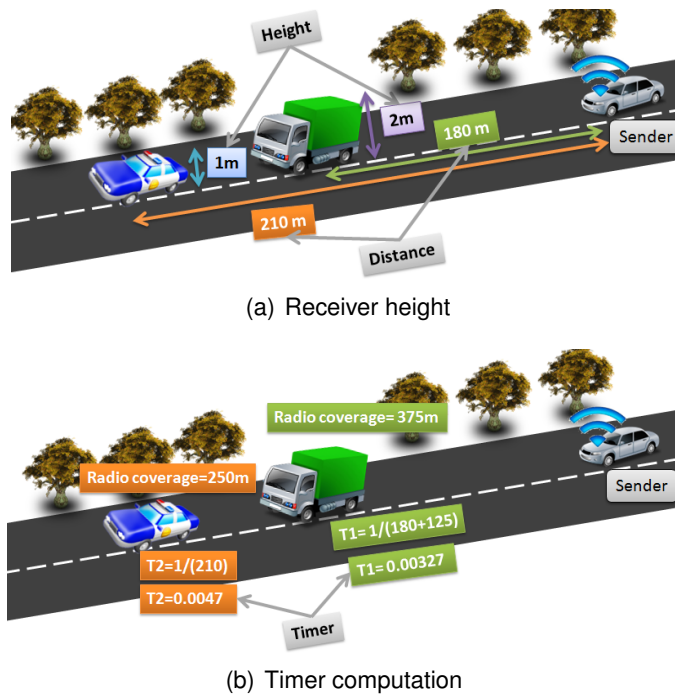

Figure 3.3: Illustrative example of relay selection in DHVN using vehicles with heterogeneous communication capabilities

example the truck is higher than the vehicle, they have radio range equal to 375m and 250m respectively; we compute the backoff timer and we find that the truck backoff timer is shorter than the vehicle one even if it is not the farthest, so the truck retransmits the message, and the vehicle cancels transmission. Based on relay selection process, DHVN provides a higher chance for vehicles with good dissemination properties to broadcast the packets to a larger area.

DHVN is a topology-based protocol; it considers roads' topology to avoid message losses especially for low-density networks. In DHVN, we specify two methods to broadcast packets based on the position of the sender as in ROD protocol [98] i.e. broadcast inside or outside the "Outgoing-Zone" as follows:

- Dissemination inside the Outgoing-Zone

An Outgoing-zone is near the intersection as shown in figure 3.4. The Outgoing-Zone depends on the road section length 'l', the velocity 'v', the maximum allowed velocity on the road 'vmax' and the mean wireless coverage range 'r' as expressed in equation (3.2)

$$Outgoing - Zone(l, v, r) = Min[0.15 * l * (1 + v/v_{max}), 0.9 * r] \quad (3.2)$$

Once the relay node arrives to the Outgoing-Zone and broadcasts the message, all vehicles receiving the message take it into account. One relay is elected for each road and each direction to propagate the message. This should enhance the delivery ratio and latency and avoid packet losses if obstacles are around roads. Figure 3.5 illustrates this concept, where vehicle 1 broadcasts a message. Vehicles 2 and 3 receive it. Vehicle 2 retransmits the packet as it is the farthest vehicle from vehicle 1. Vehicle 3 receives a second copy from vehicle 2 of the packet but it does not cancel the transmission as they

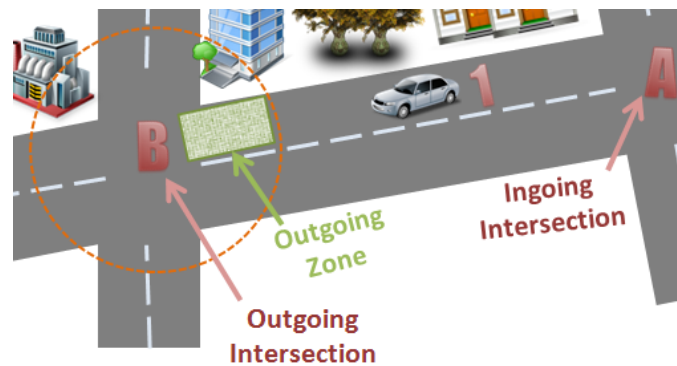

Figure 3.4: Vehicle 1 moves from Ingoing intersection (A) to the Outgoing intersection (B)



Figure 3.5: Illustrative example of broadcast in Outgoing-Zone

are not on the same road. Then, vehicle 3 rebroadcasts the packet and vehicle 4 receives it.

- Dissemination outside the Outgoing-ZONE

In this case, when a vehicle receives a packet, it checks if the sender is on the same road using Sender-location and Outgoing-Zone fields and verifies that it receives the message for the first time and then it triggers a timer as explained in equation (3.1). Otherwise, the received message is considered as a duplicated copy and the receiver cancels retransmission. An example of this scenario is given in figure 3.6 where vehicle 1 broadcasts a message. Both vehicles 2 and 3 receive the message, vehicle 3 rebroadcasts it and vehicle 2 cancels retransmission as it receives a second copy of the same message.

- *Store and Forward (SNF) Mechanism* Since vehicular networks are also highly partitioned networks, continuous connectivity is not guaranteed. To allow long-range information dissemination beyond the extension of a single network partition, we used the store-and-forward SNF approach. In our SNF approach, nodes carry the information along with their movement and transmit it periodically. In DHVN, the choice of the SNF period is crucial. Indeed, a small period causes a bandwidth waste and a high period implies a high delay. Therefore, to choose our SNF dissemination period, we use an analytical model described in [99]. This mathematical model represents the probability of connection between two vehicles. Then, based on this model, we determined the most appropriate value for the SNF retransmission period. According to many works [105] [219], the inter-vehicle distance in vehicular networks can be modeled mathematically with an exponential distribution. Thus, in [105], the authors define the probability to have a multi-hop

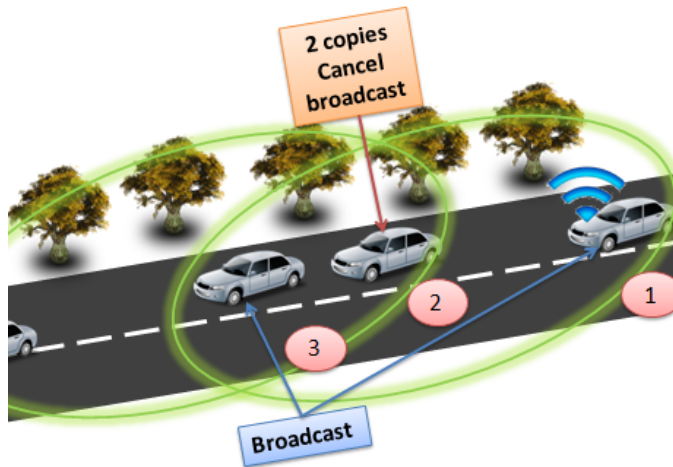

Figure 3.6: Illustrative example of broadcast outside the Outgoing-Zone

connection between two x -distant vehicles, $P_c(x)$, given by equation (3.3):

$$P_c(x) = \begin{cases} 1 & \text{if } 0 \leq x \leq R \\ \left(\sum_{i=0}^{\lfloor x/R \rfloor} \frac{(-\alpha e^{-\alpha R(x-iR)})^i}{i!} \right) - \left(e^{-\alpha R} \sum_{i=0}^{\lfloor x/R \rfloor} \frac{(-\alpha e^{-\alpha R(x-(i+1)R)})^i}{i!} \right) & \text{if } x > R \end{cases} \quad (3.3)$$

where r , α , x denote respectively the radio range, traffic density, and inter distance between vehicles, $\lfloor x/R \rfloor$ is the largest integer smaller than or equal to x/R . In [99], the probability of connection of two disconnected vehicles is given by equation (3.4):

$$P(x) = (1 - P_c(x)) * P_c(x - (SNF * \Delta V)) \quad (3.4)$$

equation (3.4) permits to calculate a minimal necessary SNF period to have an acceptable probability of connection between two disconnected vehicles. This probability depends on the network density, the radio coverage, and the average standard deviation of velocity. Using Scilab software [46], we plot $P(x)$, the variation of the probability of connection of two disconnected vehicles as a function of SNF period in figure 3.7.

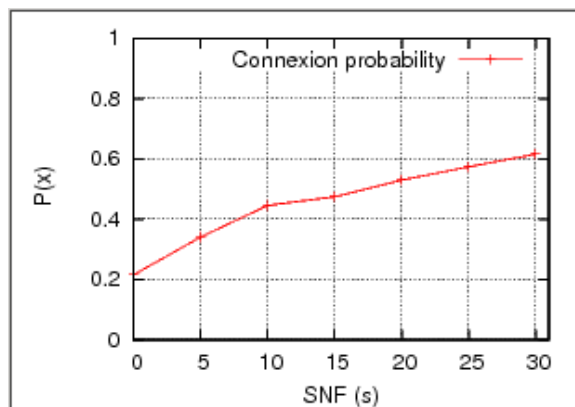

Figure 3.7: Connectivity vs. SNF period

We can notice that the probability to meet a new vehicle increases as function of SNF; for example, when SNF equals to 0 seconds, the probability of multi-hop connection is 0.2

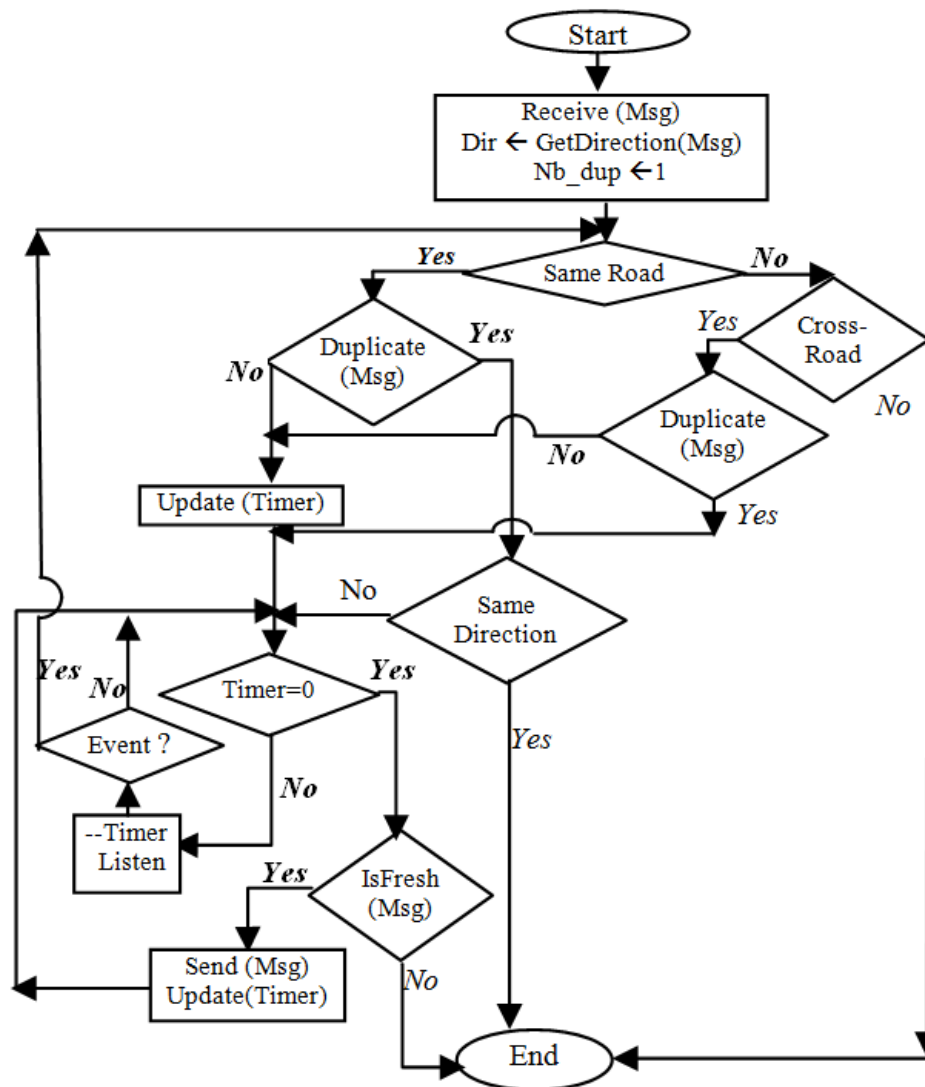

Figure 3.8: DHVN diagram

and it reaches more than 0.5 when SNF is about 20 seconds. - *Summary* In figure 3.8 and algorithm 3.1, we summarize the DHVN protocol with its three main modules: relay selection, topology-aware broadcast, SNF period computation.

Algorithm 3.1 DHVN Pseudo-code

```

while (Position is in the dissemination area and new msg) do
  FunctionReceive(msg)
end while

FunctionReceive(msg)
if Same road then
  if First reception then
    Trigger timer
  else
    if (duplicated reception and sender is before receiver) then
      Cancel timer
    end if
  end if
end if
if position in Outgoing Zone then
  if First reception then
    Trigger timer
  else
    if (duplicated reception and sender is not in the same road) then
      Ignore the reception and continue to disseminate
    end if
  end if
end if
EndFunction {End function receive}
Function TimerFired()
  Trigger timer with SNF period
EndFunction

```

3.3/ PERFORMANCE EVALUATION

In this section, we present the performances study conducted on DHVN. In the first subsection, we introduce the programming environment and the different metrics used in simulation. After that we present and analyze the simulation results.

3.3.1/ SIMULATION ENVIRONMENT AND PARAMETERS

We evaluate the performances of our protocol using NS-3 simulator [36]. We conducted simulations in $3000 \times 3000 m^2$ Manhattan grid map, with 36 intersections. In our simulations, we vary the velocity from 30kms/h to 120kms/h (urban area) and the number of vehicles varies from 50 to 650. We use the two-ray ground propagation model; this model considers both the direct path and a ground reflection path and takes into account the node's height. We notice that higher is the node or the antenna, larger is the radio coverage. We repeat simulation with at least ten separate mobility patterns to reach a 95% confidence interval. We summarize the simulation parameters in table 3.1

Parameter	Value
Simulation area	$3000 * 3000 m^2$
Simulation time	350 s
Road length	500 m (2 lanes)
Number of nodes	50-550
Initial position	Random
Vehicle speed	30-50 km/s
Propagation model	Two ray ground
Car height	1 m (regular vehicle) - 2m (truck)
Rate of vehicles with highest height	20%
Regular vehicle rate	80%
Radio range	250m (regular vehicle) -375 m (truck)

Table 3.1: Simulation parameters

To evaluate the performances of our protocol, we focus on three performance metrics: (i) Packet Delivery Ratio (PDR), representing the average number of packets successfully received divided by the total number of sent packets, (ii) Transmission duplication defined as the average number of transmissions of each unique message for each sender, and (iii) Reception duplication which is the average number of receptions of each unique message for each receiver. We evaluate each metric as function of density and velocity. We also compare DHVN performances to those of different protocols: a simple distance-based protocol that uses the farthest receiver as a relay (Farthest.Relay), *Distance Defer Transfer* (DDT) (see section 3.1), DDT with a store and forward mechanism that we call DDTSNF, and an enhancement of this later that takes into account the ability to choose relays based on their height and relaying capabilities that we call EDDTSNF.

3.3.2/ SIMULATION RESULTS AND ANALYSIS

In this section, we present simulation results and analyze them in order to show the performance of our DHVN protocol. Figure 3.9 shows the PDR when varying the number

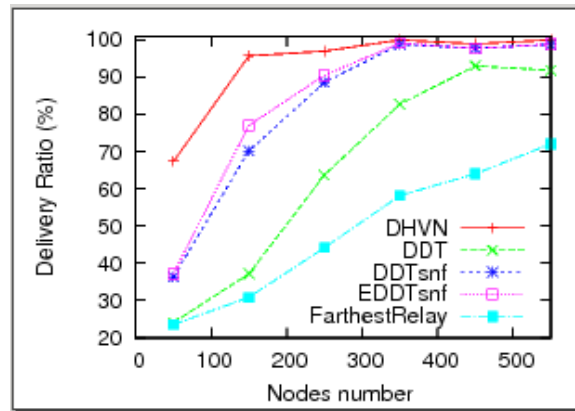
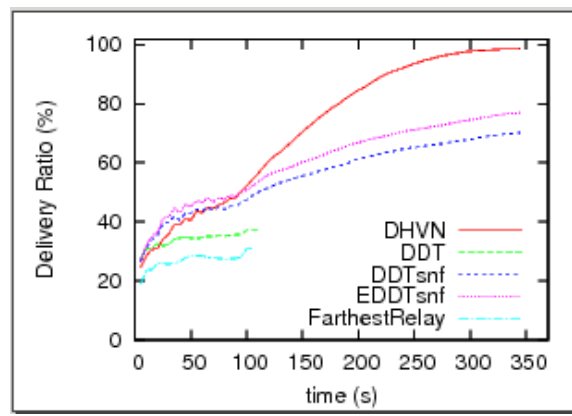

Figure 3.9: PDR vs. Number of nodes

of nodes from 50 to 550 (low to high density). As expected, the delivery ratio in DHVN, DDTSNF and EDDTSNF is higher than DDT or Farthest_Relay. Indeed, in both DDT and Farthest_Relay the dissemination stops at the first connectivity break, i.e. when no relay is available. Protocols that use SNF continue rebroadcasting till they reach the border of the dissemination area. In low density (50 nodes), DHVN gives more than 60% of delivery ratio. This shows that DHVN is more efficient because it takes into account roads' topology and the message could be sent in all directions within an intersection. With SNF technique, DDTSNF and EDDTSNF give less than 40% of delivery ratio. This is due to message losses especially in intersection zones where the message is often propagated in some directions only. To see that, we depict in figures 3.10(a)3.10(b) the PDR evolution versus time for 150 and 550 nodes. In both figures DDT and Farthest_Relay stop sending message after 100 seconds because each message is sent only once and it could be lost when node is alone or all of its neighbors have already received a message as previously explained. We note also that DHVN is faster than the other protocols and it can reach a higher delivery ratio very quickly. In fact, the choice of the highest relay reduces the necessary time to achieve farthest nodes in the broadcasting area. This metric is evaluated instead of the end-to-end delay because this delay is not bounded in the Vehicular Delay Tolerant Networks and especially in case of broadcast protocols where the number of destination vehicles is unknown [189].

Figure 3.11 shows the transmission duplication. Both DDT and Farthest_Relay transmit the packet exactly once since they do not have the SNF module. We notice that the average transmission in DHVN is higher. In fact, in a low-density network each vehicle sends the packet more frequently until it finds another relay. The transmission decreases when the network is dense because farthest neighbors cancel the transmission and take over the message forward. This result shows a tradeoff between high packet delivery ratio and transmission overhead.

We can see in figure 3.12 representing the reception duplication that the number of useless receptions increases when the network is dense. In DHVN, vehicles receive more messages since they are transmitted in all directions at intersections.



(a) 150 nodes

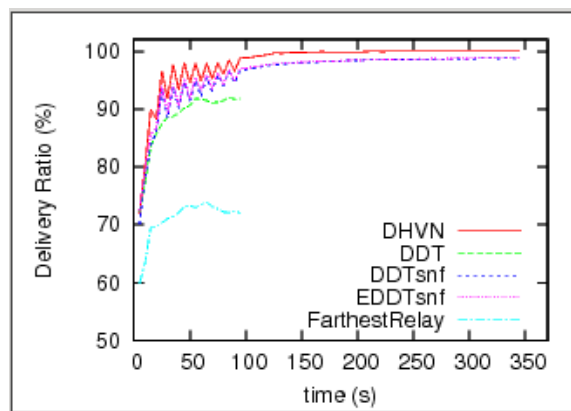

(b) 550 nodes

Figure 3.10: PDR vs. Time

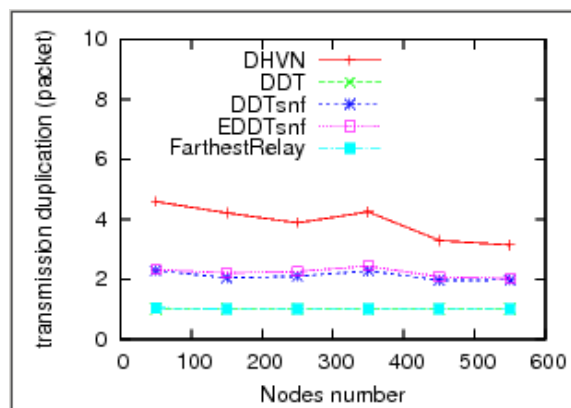

Figure 3.11: Transmission duplication vs. Number of nodes

In figure 3.13, we show the delivery ratios of the five protocols as a function of velocity. We vary the speed of 300 vehicles between 30 and 130 kms/h. DHVN gives the best results whatever the speed. This is very encouraging, since we can state that DHVN can be used not only in urban environment but also on highways. Figure 3.14 shows the PDR when varying the ratio of higher nodes between 10% and 40% using 300 vehicles. The PDR increases when the ratio of higher nodes increases. We can observe that with 40%

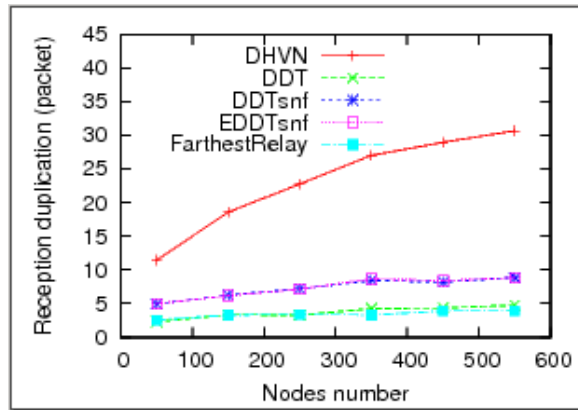

Figure 3.12: Reception duplication vs. Number of nodes

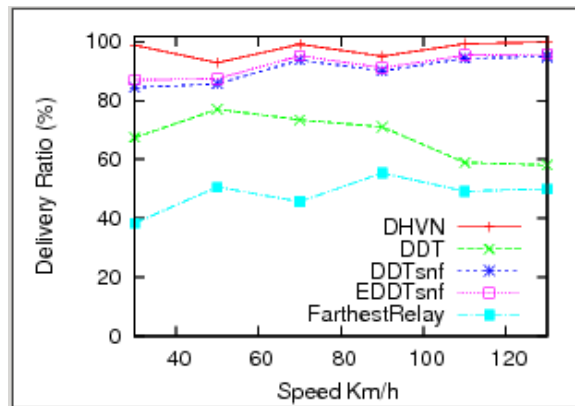

Figure 3.13: PDR vs. Vehicles' speed (300 vehicles)

(respectively 20%) of higher vehicles (bus, truck, etc.) to improve the delivery ratio of DHVN that can reach 99% (respectively 90%). A scenario with 20% of higher vehicles reflects a real life urban scenario.

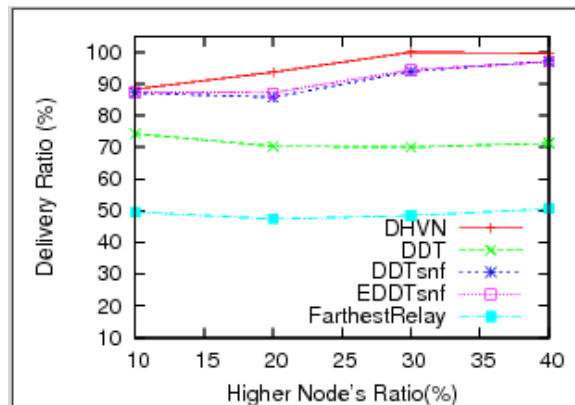

Figure 3.14: PDR vs. Higher nodes ratio (300 nodes)

3.4/ CONCLUSION

To achieve high reliability and delivery ratio when broadcasting data, we developed a dissemination protocol called Dissemination protocol for Heterogeneous Cooperative Vehicular Networks (DHVN). DHVN optimizes the bandwidth usage by using the same principle as distance-based protocols where the farthest node is selected as relay to propagate data. However, DHVN selects one vehicle for each direction in order to accelerate the propagation. It also accommodates with the vehicular environment and roads architecture: DHVN uses a specific algorithm to optimize the packets retransmission within intersections that makes it suitable especially for urban environment. To fulfill the second requirement, DHVN adds a store and forward mechanism used when no vehicle is able to further disseminate the packets. An important characteristic of DHVN is its ability to select relays based on their relaying capabilities. Indeed, it is more appropriate to use taller vehicles with higher antenna than regular vehicles since their radio range are larger. The proposed algorithm, DHVN, requires neither prior neighbor's information nor any road-side units and it is robust in a city and a highway for any node density. Even though it is not the best one for the overhead; it solves the message losses problem and enhances the delivery ratio. Moreover, it takes into account the heterogeneity of vehicles that helps to have a best coverage. DHVN improves the delivery delay and make the data delivery faster than other protocols. However, when no relay is available after SNF period. The delivery delay increases which make DHVN not adequate for delay-sensitive applications. Thus, in the next chapter, we propose to optimally place Road-Side Units (RSUs) in order to route data for such applications that have delay constraints.

DELAY-SENSITIVE ROUTING BASED ON OPTIMIZED RSU-DEPLOYMENT

4.1/ INTRODUCTION AND PROBLEM STATEMENT

Over the last few years, a lot of applications have been developed for VANETs to exchange information between vehicles. Many of them require to respect some constraints such as maximum end-to-end delay (E2E). However, VANET is basically a Delay Tolerant Network (DTN) [192] or opportunistic network characterized by periods of connectivity interspersed with periods where nodes are largely disconnected (see subsection 2.4.1). VANET requires the use of an infrastructure such as Roadside Units (RSUs) that permits to enhance the network connectivity. Nevertheless, due to their deployment cost, RSUs need to be optimally deployed. Many works are proposed in the literature that focus on RSUs placement and routing through RSUs. The main purpose of this deployment is to communicate information to a large number of vehicles. In these work, the authors either consider intersections as potential positions to place RSUs or simply distribute RSUs randomly or uniformly within the roads. Nonetheless, they do not cope with the intermittent property of vehicular networks and they may place RSUs in useless locations. Thus, many roads with low density are not covered which makes the routing inefficient, especially for delay-sensitive applications. As indicated before, it is important that only necessary RSUs need to be placed. Hence, the main objective of this chapter is to improve the end-to-end delay when routing data. Thus, we propose two novel and complementary contributions: (i) an Optimized RSUs placement for Delay-sensitive applications (ODEL) that optimally places RSUs in order to improve the network connectivity, and (ii) Routing with delay-sensitive constraints (RDEL) that optimally routes information to final destination through the most reliable paths.

ODEL is a two-steps technique that places RSUs only in useful locations and it allows both vehicle-to-vehicle and vehicle-to-infrastructure communication: (i) the first step is comprehensive study that looks for the RSUs candidates locations based on connectivity information, and (ii) the second step uses genetic algorithm [163] and Dijkstra algorithm [102] to reduce the number of RSUs based on the deliverance time requirement and the deployment cost.

RDEL is a new routing protocol designed to improve information routing through both vehicles and infrastructure. In fact, RDEL considers V2X communication on an area where RSUs are optimally deployed to cover all low-density road segments. RDEL incorporates density information, position and lower layer information to make the best routing

decision.

In this chapter, we cover and survey major work on RSUs deployment and routing with delay-sensitive constraints. Then, we present our two contributions ODEL and RDEL. We expose after that the results of the optimized deployment of RSUs using ODEL, followed by the simulation performance results of the routing protocol RDEL.

4.1.1/ BACKGROUND AND RELATED WORK ON RSUS DEPLOYMENT

Road-side units positioning is a covering location optimization problem. In covering location problems, the goal is to find the optimal positions to cover all the clients (vehicles), while taking several constraints into account such as deployment cost and applications Quality of Services (QoS) requirements. A plethora of work is done to cover the field of RSUs optimized siting. In [94], [84], [205], [159], [100], the authors aimed to place RSUs optimally in order to enhance connectivity. They consider intersections as best locations in urban scenarios since the density in intersections is usually higher and information can propagate in all directions.

In [94], the authors aimed to improve data dissemination in an urban area. They modeled the location problem as a Maximum coverage with Time Threshold Problem (MCTTP [211]). To optimally deploy RSUs to cover the maximum vehicles in the road, they used a genetic heuristic to solve the MCTTP and get the best RSUs' placement. In [83], the goal was to find the optimal positions to cover the vehicles in urban roads and reduce the delay of safety messages propagation. The authors considered intersection positions as potential locations to deploy RSUs. They mathematically modeled the problem and use two methods to resolve it: (i) analytical Binary Integer Programming (BIP) [80] to find best time to broadcast in the whole area, and (ii) Balloon Expansion Heuristic (BEH) method to find best time over each route. In [205], the authors proposed a cost-efficient RSUs deployment scheme. They aimed to update security certificates in urban area within short delay using the deployed RSUs. In this scheme, they supposed that each vehicle can communicate with RSUs in bounded driving time whatever its actual position, and the extra overhead time used for adjusting routes to update certificates. They modeled the problem as a set-covering problem and use the polynomial-time approximation algorithm called "Greed Set Cover" [79] to solve it. In [159], the authors propose an RSUs siting strategy for file downloading in the case of urban scenario. The main goal is to guarantee file downloading success ratio and delay requirement with the lowest deployment cost. They also use intersections as RSUs initial placement and consider only V2I communications. To improve file downloading success ratio, they first model the intermeeting time between vehicles and RSUs as a time continuous homogeneous Markov chain with two states (disconnected and connected to RSU). Then, they deduce the objective function that relates RSUs deployment and file download ratio success and delay. After that, they model the road network as a weighted undirected graph where each edge represents the average passing time on the corresponding road. Finally, they use the depth-first traversal algorithm to get optimal placement to deploy RSUs. However, the authors in [84, 94, 159, 205] consider only V2I communications, which introduce a large delay when no car is available to drive toward the RSUs.

In [223], the authors studied the problem of deploying gateways to provide the required coverage while minimizing the deployment cost in urban area. They formulate the problem as a Maximum Coverage Problem (MCP) [81]. They extracted and analyzed traffic

data over several hours in a given area. They divided the studied area in uniform zones and count the number of vehicles entering and leaving each zone for each time unit to obtain the distribution of transition probability between two zones. The later is used to find the candidate zones to deploy gateways. Finally, they developed their own heuristic algorithm called “MobGDeploy” to find the optimal gateways locations. However, the authors tried to cover the maximum clients by choosing to put gateways in the zones with high density; so the solution does not take into account the delay requirement especially in low-density cases. Such a solution is also not efficient to transmit safety messages for example. In [161], the authors aimed to optimize the travel time between neighbors landmarks. They tried to optimally find the best RSUs positions in urban area in order to efficiently aggregate traffic information on the road and use it to improve route planning. They used genetic algorithm to find best positions. For each iteration of the genetic algorithm, they use NS2 [56] simulator to evaluate the current solutions and to estimate the required travel time by simulation. However, they choose a random candidates deployment positions, which increases the solution complexity and does not take into account density information.

In [181], the authors’ goal is to study the size of the gaps between RSUs to improve data collection and delivery ratio in highway scenario. They initially distributed RSUs along the road equidistantly and formulated the distance upper bound between RSUs. Then, they used Omnet++ simulator [37] to evaluate the considered system under realistic settings to find the best gap between every two successive RSUs. In [84], the authors’ goal was to minimize the average reporting time of information to a given RSU. To effectively collect data in highway scenario, they proposed to use a uniform initial RSUs distribution (each twice radio range distance). To reduce the deployment cost and get the best RSUs placement, they developed a heuristic based on balloon expansion method. However, the authors in [181] and [84] proposed their solution only for a single road. In addition, the uniform distribution is not the best initial distribution, as it does not take into account the density of the cars in the road and increase the delivery delay of information.

In [130], the authors modeled the network connectivity using a composite of fluid model and stochastic model. They proposed RSUs assignment as an application of their model. The fluid model is used to compute the network density. The stochastic model takes into account the vehicles’ random behavior. This model is different than the Poisson-arrival-location model (PALM) described in [165]. In fact, this model is designed for urban scenarios; it takes into account traffic-light and interactions between vehicles. It allows determining the connectivity degree in a given road. Then, the connectivity degree helps to assign the RSU where the number of connected nodes is lower than a threshold in order to enhance the connectivity. However, the authors found the best positions to place RSUs although they did not optimize the number of RSUs. In [138], the authors studied the connectivity in VANETs based on results of percolation theory [214]. They considered cars density, the rate of equipped vehicles, and communication coverage to study the distribution of isolated nodes and the impact of putting the RSU in intersections. The authors showed that RSUs placement in crossroads does not impact significantly the proportion of isolated cars.

In Table 4.1, we summarize and compare existing work based on: Applications type (safety, security, multimedia, etc.), Initial candidate location (intersection, uniform, random, etc.), Connected (RSUs connected or not) Communication mode (V2I or V2X), Scenarios (Urban, Highway).

Work	Scenario	Communication mode	Connected	Initial location	Application
[94]	Urban	V2X	Yes	Intersection	Broadcast
[83]	Urban	V2I	Yes	Intersection	Broadcast
[205]	Urban	V2I	Yes	Intersection	Security certificate
[159]	Urban	V2I	Yes	Intersection	File download
[223]	Urban	V2I	Yes	High density zone	NA (Coverage)
[161]	Urban	V2X	Yes	Random	Traffic information collection
[181]	Highway	V2I	Yes	Equidistantly	Floating car data collection
[84]	Highway	V2X	No	Uniform	Data collection
[130]	Urban	V2X	Yes	connectivity	NA (Coverage)
[138]	Urban	V2X	Yes	Intersection	NA

Table 4.1: Comparison between RSUs deployment existing contributions

From the related work and the comparison in the table above, we can observe that the problem of RSUs deployment depends on the application. Many works considered only V2I communication i.e. the vehicle must be in the RSUs' radio range to communicate. In addition, the authors usually chose to use intersections in the case of urban scenario and uniform distribution in the case of highway scenario, which are not the best RSUs positions. In fact, these solutions did not cope with the intermittent property of vehicular networks since random and intersection-based deployment do not cover low density roads and uniform distribution may place RSUs in useless locations and increase the deployment cost. In subsection 4.2.1, we detail our proposed solution for RSUs deployment.

4.1.2/ BACKGROUND AND RELATED WORK ON DELAY-SENSITIVE ROUTING

The characteristics of vehicular network make data-exchange more challenging and more complex. Many works have been done in literature in the field of data routing by adopting different approaches based on forwarding strategies, network organization, communication mode, etc. (see section 2.2.2). Several studies worth to be mentioned as background for routing in vehicular network. Herein, we present them based on communication mode: (i) V2V routing protocols, (ii) V2I and V2X routing protocols and we discuss the major challenges in protocol design for vehicular networks.

V2V routing protocols perform vehicle-to-vehicle communication that depends mainly on the forwarding strategies between vehicles (e.g., topology-based, geo-routing and density-aware see section 2.6). Topology based routing protocols also called table-driven routing protocols are derived from conventional ad hoc routing protocols. In this approach, each node establishes the path toward the destination using proactive or reactive approaches. Proactive routing protocols (link state routing) require a knowledge about the whole network. They build all possible paths toward destination nodes by broadcasting link state messages (e.g., DSDV, OLSR, GSRP, etc.) [195]. Reactive routing protocols (on-demand routing) broadcast a route discovery request in the network to find the destination. Then, the destination chooses the shortest path toward the source node and replies back to the request (e.g., AODV, DSR, TORA, etc.) [195]. However, due to the high mobility, established paths require frequent updates. Thus, a topology-based strategy is

not efficient and consumes a large amount of the available bandwidth by exchanging control messages (route request and route reply, etc.).

Unlike topology-based routing protocols that establish routes based on hop count metric, the position-based or geo-routing protocols utilize distance metric. They use global position systems to get location and distance information in order to make the routing decision. Position-based protocols do not require to create and maintain a global route from the source node to the destination node. They use instead a greedy routing approach where each node sends packets to its closest neighbor to the destination [140] [171] [160] [191]. Thus, they are more efficient than topology-based protocols especially in large scale networks. However, the forwarding strategy might be unsuccessful if the neighbors are not nearer to the destination than the sender; this case is also called local maximum. In [140], the authors proposed Greedy Perimeter Stateless Routing (GPSR). In GPSR, each node forwards a packet to a direct neighbor that is closest to the destination by using information about the position of immediate neighbors. When, the node reaches a local maximum, it uses perimeter forwarding as a recovery mode by routing around the perimeter of the local maximum region and forwards a packet to a node that is further from the destination but may have a path to the destination. In [171], the authors proposed Advanced Greedy Forwarding (AGF) to improve GPSR protocol. In AGF, the source and destination nodes exchange information about their moving directions and speeds inside the beacon packets. Every node forwarding a data packet adds its own processing time into the packet header to calculate travel time. With travel time, each forwarding node can better compute the divergence of the destination's original position and approximate its current location. Location, velocity and travel time information are stored in the neighbors table. These information help to select and forward the packet to the next neighbor and FILTER the out-of-dated neighbors. In [143], the authors proposed a Cross-Layer Optimized Position Based Routing Protocol for VANETs (CLWPR). CLWPR uses the lower layer information in weighted function to optimize the routing decision. It uses PHY and *Medium Access Control* (MAC) layer (Signal to Interference plus Noise Ratio (SINR) and bit rate error (BER)) to estimate the link quality. It uses queuing information to get a traffic balancing and also E-map loaded in each node and speed information to predict the neighbors positions. In case of local maximum, it uses the store and forward (SNF) mechanism. In [160], the authors proposed Geographic Source Routing (GSR). GSR combines geographical information and urban topology (street awareness). In GSR, the sender calculates the shortest path to the destination using Dijkstra algorithm and the street map. GSR selects a sequence of intersections (anchors) by which the data packet has to travel by using reactive location service (RLS) [142]. RLS is a position discovery mechanism, like the route discovery procedure used in reactive ad hoc routing protocols, in which the querying node floods the network with a position request for some specific node identifier. When the node that corresponds to the requested identifier receives the position request, it sends a position reply back to the querying node. To send messages from one intersection to another, GSR uses the greedy forwarding approach. A greedy approach is a scalable solution. However, it is not efficient when the chosen relay to transmit the packet is the closer node to the destination and there is no route to reach the destination as the density information is not considered. Thus, new density-aware protocols have been presented to efficiently route information to the destination. Like GSR, the authors in [191] proposed Anchor-based Street and Traffic Aware Routing (A-STAR). A-STAR uses anchor through which data packets need to be transmitted. However, it uses connectivity rate in addition of traditional metrics (distance, number of hops, latency) when making routing decisions. Connectivity rate is assigned to the roads

depending on the capacity and the number of bus crossing them. In [135], the authors improved Greedy Traffic Aware Routing protocol (GyTAR) in the same way of A-STAR. GyTAR calculates traffic information for each segments using Infrastructure-Free Traffic Information System mechanism (IFTIS) [134]. IFTIS is a decentralized approach that exchanges traffic information between vehicles in the roads in order to estimate road traffic density information. GyTAR takes a routing decision based on traffic information provided by IFTIS and distance toward the destination. When no route is available, it uses the store and forward mechanism. In [221], the authors proposed a map-based stateless VANET routing (GeoSvr). GeoSvr is a routing protocol that uses a greedy forwarding strategy. GeoSvr restricts the maximum signal strength when choosing the farthest relay in order to avoid the packets loss and enhance reliability. It considers the vehicle density on every road in order to avoid sparse paths and optimally route messages to the destination. However, it calculates the density based on the road width, which does not reflect a real scenario as it is possible that no vehicle passes through some roads whatever their width. In [170], the authors proposed Connectivity-Aware Routing (CAR). CAR protocol combines between topology routing, geo-routing and density-aware routing. In fact, it uses path discovery request and reply to get path from the source to the destination; it uses greedy forwarding to transmit packets and it selects best path based on density information. CAR broadcasts continuously a Hello messages to get information about direct neighbors. The beaconing messages include information about moving directions and speeds of the nodes. The hello interval changes according to the number of the registered nearby neighbors to reduce the overhead. CAR protocol disables MAC address filtering to implicitly collect information about neighbors and reduce the number of Hello messages. In addition, it uses a new type of multi-hop information called "Guard" as new field in the Hello message or in the data packet headers. It contains an identifier, a time-to-live (TTL) counter, a guarded position and radius, and some other information to track the position of destinations. To estimate the connectivity on a routing path, each forwarder node updates hops count, average neighbors number and minimum neighbors number fields.

From previous work, it is clear that position-based along with density-aware routing protocols as opposed to topology-based routing protocols are more suitable for VANETs. They improve packets delivery, reduce significantly data losses and circumvent several problems in vehicular context. However, many of them do not consider the required delay to collect traffic information and still have a serious matter with data delivery delay. In fact, in case where source node and destination node are separated by a large gap, the only way to deliver packets is to meet the destination or a relay that can handle the packets; this could come after a long store and forward period. Thus, V2X communication can be more promising and the most adequate for all possible scenarios. In fact, the infrastructure provides more reliability and flexibility. In [177], the authors presented Roadside-Aided Routing protocol (RAR). RAR uses the RSUs for advertisement purpose. It routes data in a single hop of RSUs and no multi-hop is allowed. In fact, vehicles are affiliated to an area bounded by RSUs. This protocol ameliorates data delivery. However, it is expensive to deploy as each area must have a full coverage and direct communication to RSUs. In [152], the authors proposed a Static-Node Assisted Adaptive Routing Protocol in Vehicular Networks (SADV). SADV uses a static node at intersections to improve connectivity. It uses several management strategies to schedule messages such as First In First Out (FIFO), First In Last Out (FILO), etc. In intersections, it routes messages through the best multi-path (two best paths) to load balance the traffic and improve data delivery. In case of sparse network, messages are stored in the static node. In [91], the

authors proposed Infrastructure-assisted Geo-routing for cooperative vehicular networks. This solution uses V2X communication. It routes messages through the closest RSUs to the source (resp, destination) using greedy algorithm. SADV and Infrastructure-assisted Geo-routing improve data delivery ratio. Nevertheless, they do not reduce the delivery delay, as they keep packets stored in the RSUs until a new mobile node passes through its radio range. In addition, they consider that the RSUs are in the intersections and they do not consider the traffic density information out of intersections. So, routing takes larger delays to reach RSUs in the intersection when no relay is available.

Other studies proposed to use cellular infrastructures such as 3G and LTE [122] [123] [184] [131] [176]. These solutions achieve a better performance comparing to the decentralized solution. Nevertheless, cellular communication technologies have a high cost as they generally require a direct communication and full coverage to optimize the delay delivery. In [133], the authors proposed a cross-layer position-based communication protocol for delay-aware vehicular access networks (PROMPT). PROMPT is designed to allow V2X communications. It uses base stations installed at fixed locations along the road. Vehicle can communicate to each other's and with the base stations through multi-hop communication. PROMPT uses beaconing to collect statistic information to build paths and applies G/G/1 to estimate the end-to-end delay (E2E) for each path. It uses lower layer information to reduce the impact of high mobility. It uses a position-based MAC function to search the next relay. To further reduce the average delay, relay nodes try to bundle different packets with the same path and send them in a single batch. The authors claimed that PROMPT outperforms many other vehicular routing protocols in term of the end-to-end delay. However, no details about the location and the distribution of base stations and vehicular nodes are given. In fact, it is obvious that a full coverage of the studied area by base stations and uniform distribution of vehicular nodes improve the delays results; moreover, the distribution of the base stations has a huge impact on network connectivity; using simple deployment assumptions they do not reflect real scenario.

Some other studies utilize mobile infrastructures with cellular infrastructures. Mobile infrastructures exploit the concept of mobile gateways where RSUs are replaced with mobile vehicles that function as mobile gateways. In [176], the authors presented Mobile-Gateway Routing for Vehicular Networks (MGRP). MGRP combines V2V and V2I communications, and utilizes certain vehicles as mobile gateways. Each mobile gateway connects with a base station through a 3G interface and communicates with other vehicles through an IEEE 802.11 interface. Mobile gateway is a good alternative but these gateways have a limited capacity comparing to RSUs and they are not efficient in extra traffic jam as they move very slowly and thus cover a very small zone. In [154], the authors presented Intelligent Adjustment Forwarding (IAF) as a compromise between end-to-end and hop-by-hop transmissions in VANET environments. IAF is an application layer forwarding that uses segment to segment transmission to enhance data delivery. It explores both mobile Intermittently Connected Points (ICP) and static points (non-cellular) within intersection as relay. The ICP node ensures the store function in sparse network. IAF establishes partial of full path toward the destination. Then, it chooses the ICP based on downstream links. IAF shows that there is a trade-o between delivery delay and delivery ratio.

From the related work we conclude that previous routing protocols can improve data delivery and end-to-end delays for some scenarios but not all real-life scenarios. Most of them use greedy forwarding optimized with density information to find best paths. These approaches work perfectly in dense scenario or for non delay-sensitive applications. In

case of sparse network, store and forward mechanism increases the delays. Even for solutions that use RSUs to enhance reliability the delays can be very high when RSUs are deployed only in the intersections and no connectivity is available within the rest of the roads (outside the intersections). Thus, we propose in subsection 4.2.2 our protocol RDEL that aims to improve data delivery, enhance reliability, reduce routing delays by using our first contribution ODEL that optimizes deployment of RSUs for delay-sensitive applications.

4.2/ ODEL AND RDEL DESCRIPTIONS

In this section, we propose two novel solutions ODEL and RDEL. In the first one, we deal with RSUs deployment in both urban and highway scenarios for delay-sensitive applications. We use V2X communications to enhance the network connectivity and reduce unnecessary infrastructures. Our solution ODEL provides the best positions to deploy RSUs based on the road connectivity while taking into account applications delay requirements and deployment cost constraint. In the second contribution RDEL, we propose a new routing protocol that optimally routes data and reduces the delivery delays through vehicles and RSUs especially deployed to improve delay delivery using our ODEL solution. RDEL takes full advantage of RSUs connectivity, position information, density information and other lower layer information to find best relays to reach the final destination as short as possible delay.

For the two solutions, we suppose a decentralized communication architecture as depicted in figure 4.1. This architecture allows us to delimit the general context and the applications of our contributions. Among these applications, we focus on data collection and information routing from vehicles to remote infrastructure such as fire station, police station fleet management systems, electric charging stations, etc. We explore both V2V and V2I communication modes in order to ensure short delays and consider real-time applications.

In our two contributions, we take into account the following assumptions: we consider V2X communications i.e. messages are transmitted through both vehicles and RSUs; we assume that all RSUs are connected to each other through wired links. Therefore, we considered only the message delivery delay to the closest RSU. The delay from this RSU to the final destination – a server within the cloud – is supposed fixed.

4.2.1/ OPTIMIZED RSUS PLACEMENT FOR DELAY-SENSITIVE APPLICATIONS (ODEL)

For our RSUs siting problem, we aim to find the best RSUs locations in urban or highway scenarios. The challenges consist on ensuring the application delay constraint and reducing the deployment cost. In fact, our objective is to find the best RSUs placement and respect the delay required to transmit a message while minimizing the number of RSUs.

For initial distribution positions, we consider roads with low connectivity as best RSUs location candidates, so our solution could be applied to both urban and highway scenarios; then, for final placement, we reduce the delay constraint and deployment cost by modeling the location problem and solving it. Herein we give our mathematical modeling of

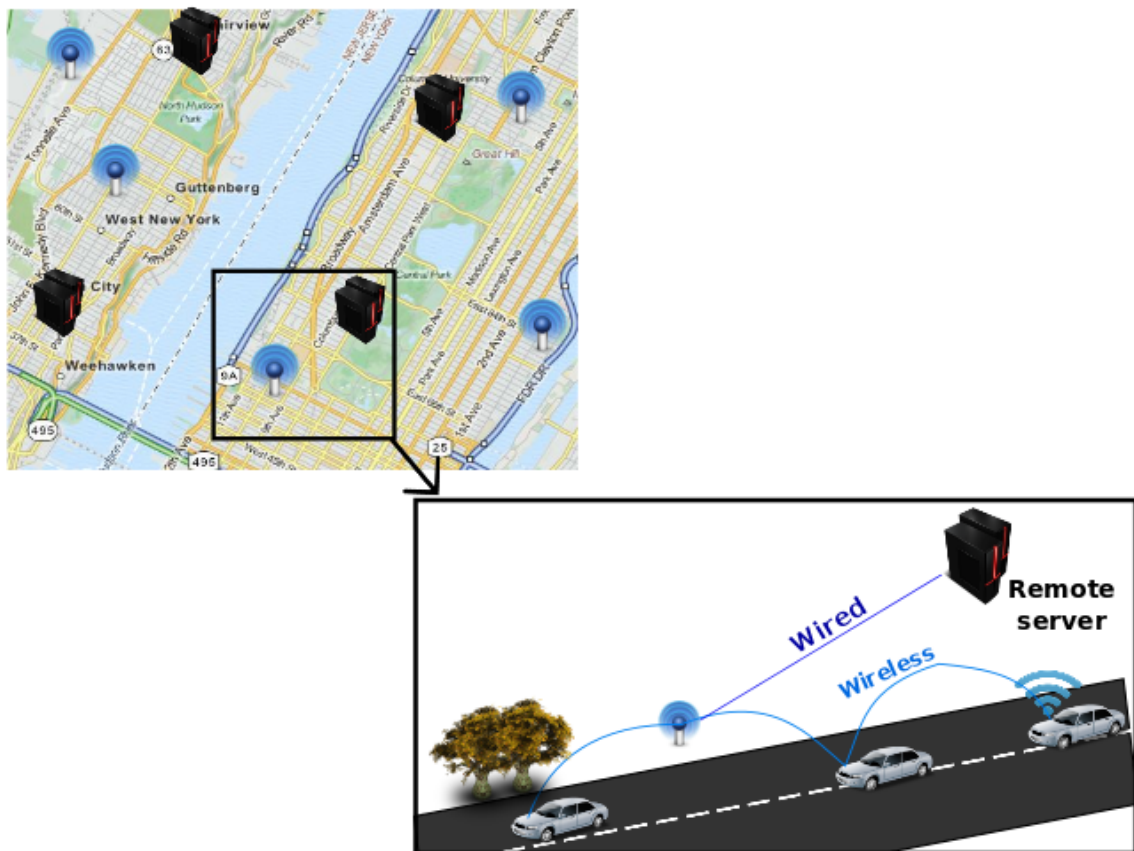

Figure 4.1: V2X communication architecture

RSUs siting problem followed by the complexity details of the exact solution.

4.2.1.1/ RSUs DEPLOYMENT: PROBLEM MODELING

Let $I = \{1, \dots, m\}$ be the set of candidate positions to install the RSUs, a_i be the RSU_i deployment cost, $J = \{1, \dots, n\}$ be the set of all road segments in the studied area and t_j be the required delay to route the message from road segment j to the closest RSU. Let also y_i be the variable that indicates if the RSU_i is open or not. All variables used in the problem modeling are summarized in Table 4.2.

To solve the RSU placement problem, we model it using equations ^(4.1) to ^(4.6).

equation ^(4.1) represents the objective function to minimize. It is a weighted function composed of two sub-functions: (i) $F1$ ^(4.2) representing the RSUs installation cost and (ii) $F2$ ^(4.3) representing the delay to reach the closest RSU.

$$F = \alpha F1 + \beta F2 \quad (4.1)$$

Where α and β represent the weight of each sub-function. We choose $\alpha=1/3$, $\beta=2/3$ as

Variable	Notation
Deployment cost to build RSU_i	a_i
Decision variable to open or not the RSU_i	y_i
Minimum delay to transmit a message from a vehicle in road segment j to the closest RSU	t_j
The number of RSU candidates	m
The number of road segments	n
Vehicles' radio range	r
Application delay threshold	$T_{threshold}$

Table 4.2: Notation

the delay constraint is the most important.

$$F1 = \min \sum_{i=1}^m a_i \cdot y_i \quad (4.2)$$

$$F2 = \min \sum_{j=1}^n t_j \quad (4.3)$$

$$t_j = \min_{1 < s < m} t_{js} \quad (4.4)$$

Equation (4.4) indicates the shortest delay t_j to send messages from road segment j to any RSU and t_{js} is the required delay to send a message from segment j to the RSU number s . The solution feasibility must respect the constraints given by equations: (4.5) to ensure that delay t_j to transmit message from road segment j is lower than a given application threshold $T_{threshold}$; (4.6) and (4.7) represent the integrity constraints.

$$t_j < T_{threshold} \forall j \in \{1, \dots, n\} \quad (4.5)$$

$$\sum_{i=1}^m y_i \leq m \quad (4.6)$$

$$y_i \in \{0, 1\} \quad (4.7)$$

Exhaustive solution complexity

RSUs placement is a NP-hard problem [82] and it requires huge computation capacities to find the best solution. We give in equation (4.8) the complexity of exhaustive solution to show the number of possible combinations to solve it. In fact, in this problem, we need to find the optimal number of RSUs to be deployed and their optimal positions. Therefore, we need to find the optimal number of k RSUs from m possible initial positions (see table 4.2) ($k \leq m$). We can write it as a mathematic combination $\binom{m}{k}$. However, k is unknown and it is in the interval $\{1..m\}$. Consequently, the problem complexity becomes $\sum_{k=1}^m \binom{m}{k}$.

In addition, to calculate the time to the closest RSU, we need to apply a short path algorithm to evaluate the delay to send messages to nearest RSUs for each solution combination. Therefore, for each possible solution, we add the complexity of the short path algorithm that is given by $o(n^2)$, where n is the number of total segments on the studied area (see table 4.2). We get finally equation (4.8).

$$\sum_{k=1}^m \binom{m}{k} * o(n^2) \quad (4.8)$$

Equation (4.8) is equivalent to 2^m by using the generalized hypergeometric function [109].

Due to the problem complexity and the heavy computation required by the exhaustive method, we propose to use a heuristic to solve it in order to reduce the resolution computation time and get the best solution. In the next subsection, we explain in details our proposed solution ODEL and the several adaptations introduced to the genetic heuristic to solve the delay-sensitive RSUs placement problem.

4.2.1.2/ RSUS DEPLOYMENT: 2-STEPS SOLUTION

In our work, the objective is to find the optimal number of RSUs to be deployed and their optimal positions while respecting the application delay requirements and the deployment cost constraint. To do that, we propose two processing steps as depicted in 4.2.

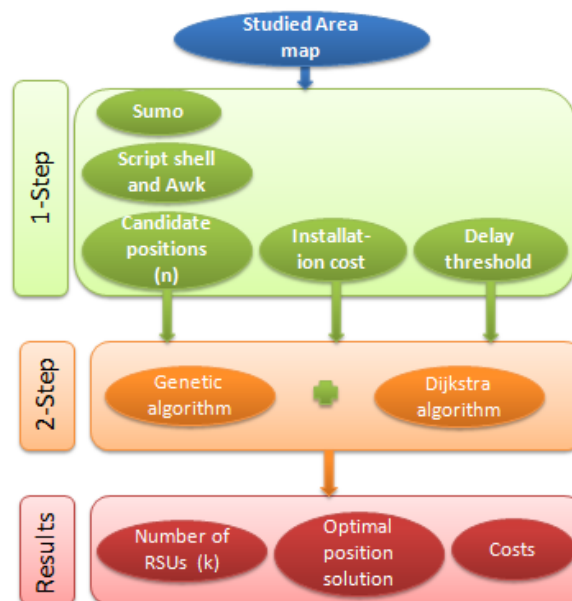

Figure 4.2: ODEL 2-steps solution

To apply ODEL, we need to introduce several parameters such as: the map of the studied area, the traffic information, the application delay constraints and deployment cost information. Then, we apply the two steps solution 4.2.1.3 4.2.1.4 as follows: (i) we propose a first processing in order to choose the best candidate positions based on the road connectivity. We select as candidate road segments with lower connectivity. In roads with higher connectivity we use V2V communication capability instead of installing RSUs, (ii) we propose the second processing in order to optimize RSUs siting taking into account the delay requirements of the application and the deployment cost constraint.

4.2.1.3/ FIRST-STEP RESOLUTION: INITIAL SELECTION OF RSUs' CANDIDATE POSITIONS

In this phase, we calculate RSUs initial positions. In contrast to related work that choose initial positions randomly, uniformly or in intersections, we study the area and find the strategic positions based on the probability of connectivity. In fact, several works use the connectivity to optimize the information collection and dissemination between vehicles or mobile nodes [107] [153] [73] [158] [75]. Though, the connectivity information is not used to determine best RSU positions except in [130]. However, the authors did not optimize the number of RSUs candidates. Herein we explain how to get the initial candidates' positions. For a given area, we extract information about density and speed in each segment of length $2*r$ meters using SUMO (Simulation of Urban Mobility) [150] [53]. Then, we use some scripts that we developed to calculate the connectivity probability. For urban scenario we use formula of connectivity probability in equation (4.9) and (4.10) proposed in [138]. Due to lack of space, the formula for a highway scenario is not described in this manuscript; but readers can refer to [138] for more details.

$$p_u = \begin{cases} 1 & \text{if } 0 \leq L \leq R \\ \left(\sum_{i=0}^{\lfloor L/R \rfloor} \frac{(-\lambda e^{-\lambda R}(L-iR))^i}{i!} \right) - \left(e^{-\lambda R} \sum_{i=0}^{\lfloor L/R \rfloor - 1} \frac{(-\lambda e^{-\lambda R}(L-(i+1)R))^i}{i!} \right) & \text{if } L > R \end{cases} \quad (4.9)$$

$$p_l = \begin{cases} 1 & \text{if } 0 \leq L \leq R \\ \left(\sum_{i=0}^{\lfloor L/R \rfloor + 1} \frac{(-\lambda e^{-\lambda R}(L-(i-1)R))^i}{i!} \right) - \left(e^{-\lambda R} \sum_{i=0}^{\lfloor L/R \rfloor} \frac{(-\lambda e^{-\lambda R}(L-iR))^i}{i!} \right) & \text{if } L > R \end{cases} \quad (4.10)$$

Where p_u is the probability that there is a sequence of connected nodes in the road segment, p_l is the sufficient condition to have a distance between two consecutive vehicles at most equal to the radio range r . λ is the vehicle arrival rate and L is the road segment length. After that, we choose the segment with lower connectivity probability as best candidate locations as depicted in 4.3.

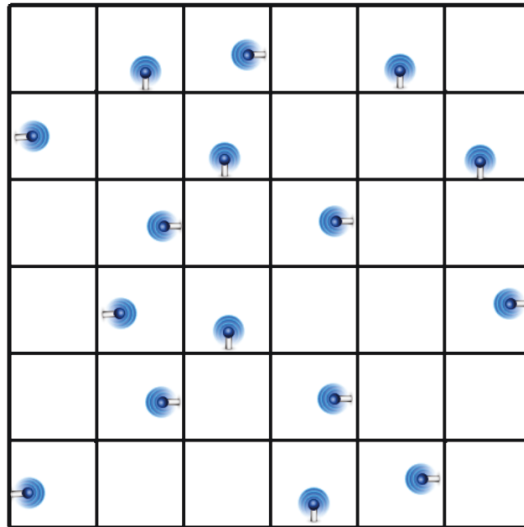

Figure 4.3: Example of RSUs candidate locations

Also, based on the traffic information and road topology, we deduce the adjacency matrix. This matrix contains the neighborhoods of all road segments and the propagation delay in each road segment.

4.2.1.4/ SECOND-STEP RESOLUTION: OPTIMAL PLACEMENT

As mentioned above, our solution takes into consideration both the application delay requirement and the deployment cost related to RSU deployment. To ensure that, we implement two optimization algorithms: (i) Dijkstra to find best routing time from any segment on the road to the closest RSU, and (ii) Genetic algorithm to find the best deployment positions for RSUs that satisfies the application time constraints and takes into account the deployment cost. This cost includes RSUs and network installation costs. The main entries of the second-step are: the adjacency matrix, the RSUs candidates table and related deployment cost. We explain here our optimization algorithm with the different adaptations introduced to resolve RSUs locations problem.

Genetic algorithm

We apply the Genetic algorithm illustrated in Algorithm 4.1. We run this algorithm many times. Each iteration consists of natural operations: selection, crossover, mutation and recombination [163]. In order to enhance the efficiency of the genetic algorithm, we use the Gaussian mutation [209] to create a new chromosome by modifying one or more genes value and Roulette-wheel selection [157] to stochastically choose new offspring chromosomes from the pool for the new generation. Where P_c is the crossover probability

Algorithm 4.1 Genetic algorithm

```

Genetic algorithm (Adjacency matrix Madj, RSU Candidate Tcand, deployment cost)
Pop.Create (random, initial population)
Pop.CalculateFitness();
while (!MaxIterations) do
  Offspring = Select (Roulette-wheel, Pop, Nb-chromosoms)
  Offspring.Crossover(uniform,  $P_c$ );
  Offspring.Mutation(Gaussian,  $P_m$ );
  Offspring.Permut();
  Recombination(Keep-Best, Offspring, Pop)
end while
Pop.BestSolution(Nb CS, position CS)

```

and P_m is the mutation probability. The genetic algorithm generates and evaluates many solution combinations coded as a genetic chromosome or code and look for the best one as final results.

Genetic code

We code each solution combination using a suitable binary code as depicted in figure 4.4. The binary code is composed of m bits; each bit is equal to one if the RSU is "ON" (deployed), else it takes the value 0. We evaluate the chromosome using the objective function detailed below.

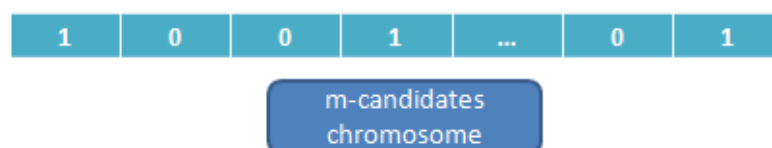

Figure 4.4: Binary-chromosome

Objective function

Equation (4.1) is equivalent to equation (4.11). This formula is used in the genetic algorithm to evaluate each chromosome. In this equation, we calculate the deployment cost and the delay required to transmit messages to the closest RSU using our adapted Dijkstra algorithm as further explained below.

$$F = \min \left(\sum_{j=1}^n \alpha \sum_{i=1}^m a_i + \beta \min_{i=1, \dots, m} (\text{Dijkstra}(j, i)) \right) \quad (4.11)$$

Dijkstra algorithm adaptation

We adapt the Dijkstra algorithm to our problem to reduce its complexity from $o(n^2)$ to $o(Nb * n)$. In fact, each vertex has at most Nb neighbors as shown in figure 4.3. Given the adjacency matrix Mad_j got from the first-step of the solution, we construct a graph G to apply Dijkstra algorithm, each edges E in the graph G is the distance in term of delay from road segment v_1 to its neighbor v_2 . Dijkstra calculates the delay from a given source vertex to all other vertices in the graph G . Only the shortest path toward the RSUs candidates is used to evaluate the solution. The Dijkstra adaptation is mainly done in line 9 of algorithm 4.2.

Algorithm 4.2 Dijkstra algorithm

```

Dijkstra algorithm(Adjacency matrix  $Mad_j$ , RSU Candidate  $Tcand$ , Source vertex  $s$ )
for  $i = 0$  to  $V - 1$  do
     $Tdistance[i] = INFINITY$ 
     $Previous[i] = NULL$ 
end for
 $dist[s] = 0;$ 
while ( $List.size() \neq Nbvertex$ ) do
    pick vertex  $v1$  with shortest path to  $s$  from  $Unvisited$  and add it to  $List$ 
    for each edge of  $v1$ , ( $v1$  to neighbor  $v2$ ) do
        if ( $Tdistance[v1] + length(v1, v2) < Tdistance[v2]$ ) then
             $Tdistance[v2] = Tdistance[v1] + length(v1, v2)$ 
             $Previous[v2] = v1$ 
        end if
    end for
end while

```

Where $Tdistance$ is an array of distances from the source s to each vertex in V , $Previous$ is an array of vertices' predecessors, $List$ is the list of visited vertices and $Unvisited$ is a set of remaining vertices.

We present and analyze bellow the different ODEL's results.

4.2.1.5/ ODEL PERFORMANCES EVALUATION

In order to evaluate our optimized solution ODEL, we develop automatic scripts in order to generate different maps, traffic scenarios and to extract density and speed information in each road segments using Sumo traffic simulator [53], awk, shell and xml. The density changes over the time and from one road segment to another. Then, we implement

Dijkstra, Genetic algorithms and the different adaptations inside evolutionary framework proposed in [174] using C++. We run several tests with different scenarios for both low and high density. We carry out all the performance tests on virtual machine with Intel i5 64Bits processor and 3 Gb of memory.

In Table 4.3 we present the parameters used in our tests and we summarize the optimization results in Table 4.4.

Parameter	Value
Radio range r	250
Number of total road segments	60-500
Number of RSU candidates	25-150
Road density (vehicle/km)	1-30
Vehicles average speed (km/s)	15-50
Road segment length (m)	500
$T_{threshold}$ (s)	0.1-10
Crossover probability P_c	0.3-0.5
Permutation probability P_m	0.8
Population size	50

Table 4.3: ODEL parameters Table

To evaluate our solution performances, we choose three criteria: (i) the delivery delay required to send messages from any road segment toward the nearest RSUs, (ii) the number of necessary RSUs to guarantee applications delay requirements and (iii) the computation performance in term of number of iterations to find best solutions.

In RSUs siting problem, we want to activate only some RSUs candidates. In fact, we do not need to cover the whole area. Table 4.4 illustrates 9 different examples; for each example we give the total number of segments, the number of possible candidate's positions found in step 1, and the number of RSUs found as best solution in step 2. The cost efficiency is obtained by dividing the number of RSUs "off" (non-deployed) resulting from step 2 by the number of RSUs candidates resulting from step 1. These results show that our solution could meet the requirement of the application without siting unnecessary RSUs. We note that the optimization results depend on the delay constraint $T_{threshold}$ of the application given in the third column of table 4.4 (e.g. in example 1, the total number of segments in the studied area is 60, it requires 15 RSUs candidates by applying step 1 and 11 RSUs "On" (deployed) by applying step 2 to ensure that the application threshold of 3 seconds is satisfied. In example 2 (respectively 3), the number of RSUs "On" (deployed) after the step 2 is 26 (respectively 7) to have a delay lower than the $T_{threshold}$ of 1 second (respectively 5 seconds.)). The cost efficiency results show that our solution reduces at least 23% of the deployment cost comparing to the deployment cost without the optimization of step 2. And it could reach 79% of efficiency if the delay constraint are larger (see example 3).

Example	Total number of segments	Application delay $T_{threshold}$	Number of candidates	Number of final positions (found in step1)	Number of final positions (found in step2)	Cost Efficiency	Number of exhaustive iteration	Number of genetic iteration	Genetic Computation time	Delay when no RSU is deployed	Delay with optimal RSU number	Average Delay	Delay Efficiency
1.	60	3	15	11	11	26.66 %	32768	1000	31	340.4	18.76	0.31	94.5%
2.	60	1	34	26	26	23.52 %	1717×10^7	1000	30.39	423.74	11.73	0.19	97.2%
3.	60	5	34	7	7	79.41%	1717×10^7	1000	19.6	340.4	53.23	0.88	84.36%
4.	144	5	25	19	19	24%	33×10^6	1000	141	1279.22	388.93	2.7	69.66%
5.	144	5	64	42	42	34%	18×10^{18}	1000	105	1762.4	105	0.72	94.04%
6.	144	7	64	33	33	48%	18×10^{18}	1000	120	1762.4	157.74	1.09	89.5%
7.	220	5	60	40	40	33.33%	1.15×10^{18}	1000	1100	1359.06	99.36	0.45	92.68%
8.	220	6.5	88	37	37	57.95%	3.09×10^{26}	1000	1500	1436.83	99.36	0.45	93.08%
9.	220	7	74	26	26	64.86%	1.8×10^{22}	1000	532.31	1019.26	156.65	0.71	84.63%

Table 4.4: Performance results for RSUs placement in term of delay, computation time and cost using ODEL

For the same examples, we compare between the number of iterations (complexity) of our Genetic algorithm and those required by the exhaustive solution explained further above in equation ^(4.8). The number of iterations depends on the number of total road segments and the number of candidate positions. We can see in table 4.4 that the number of iterations in our solution is significantly lower. We note that the number of iterations increases at expense of the total number of segments in the studied examples as the delay is measured in each road segment and not only in candidate ones. However, it is always lower than the number of iterations of the exhaustive resolution method (e.g. In the example 1, the genetic solution requires 31 time units and 1000 iterations while the exhaustive solution for the same scenario requires 32768 iterations, which corresponds to 2^{15} combinations in exact solution). We calculate then the delay efficiency of our solution; we compare the minimum delay to deliver messages from all road segments to the destination with and without using RSUs. These results show that our solution is a much more effective (e.g. for example 1, the average delay required to transmit data to the destination is 0.31 second which is lower than 340 seconds when no RSU is used and only V2V communication is employed to forward messages). Finally, simulation results show that our solution ODEL achieves desirable efficiency in term of delay requirement, while preserving necessary coverage in the whole area using both V2I and V2V communication capabilities. In addition, our solution is designed to support large scale scenarios and reduce significantly the computation operation.

We note that ODEL aims to improve the delay by deploying RSUs in road with low density unlike the related works that improve connectivity only in the intersections. However, when the density is lower than the density considered in our study, neither our solution, nor the related work contributions achieve a low delay. In fact, our solution optimizes the number of deployed RSUs to ensure a full covered area over V2X communication. Moreover, when density is very low, it is more interesting to use 3G or LTE solutions as the number of messages is very low and does not consume huge cellular network resources.

4.2.2/ ROUTING FOR DELAY-SENSITIVE APPLICATIONS (RDEL)

We present in this subsection our new routing protocol called routing for delay-sensitive applications (RDEL). Unlike the related work that do not consider roads with large disconnection or use store and forward mechanism that increases the routing end-to-end delays, RDEL routes information through RSUs optimally placed based on our first contribution ODEL. In RDEL, vehicles communicate between each other's via multi-hop retransmission or directly with the RSUs that are in the same radio range. To further improve delay delivery we utilize RSUs that are connected via wired link. Thus, when information is sent from source, RDEL retransmits it through best relays until it reaches the final destinations. In addition, RDEL fits with special characteristic of vehicular network. In fact, to choose the best relay, RDEL incorporates traffic information, position information and other lower layer metric (MAC information). Herein we describe in details our routing protocol.

4.2.2.1/ RDEL ROUTING ALGORITHM

In RDEL, we virtually divide the studied area to uniform segments as described in the first step of ODEL. The segment's length is twice the radio range of vehicles. To implement the optimal information exchange and the best forwarding strategy, we route information through both vehicles (V2V) and infrastructure (V2I). We choose the best relay based on information collected from beacons messages. In fact, each node sends periodically (*HelloMsg*) beacons to inform its direct neighbors (1-hop neighbors) about its position, velocity and direction information and one node is selected periodically within the center of road segment or beside an intersection to broadcast local density information (*DensityMsg*). For each reception of *HelloMsg* or *DensityMsg* packets, we update the routing table. The routing table contains the following information fields (*DestAddress*, *Nexthop*, *Weight*). The *DestAddress* field is the IP address of the destination node, *Nexthop* field indicates which neighbor relay to use to reach the destination and finally, weight field that is calculated using weighted function based on: (i) the distance that separates the relay node and the destination node (Euclidean distance), (ii) the connectivity information from *DensityMsg* and (iii) MAC information from *MacInfo* field in *HelloMsg*. The weighted function is given by equation ^(4.12)

$$Weight = \alpha * Distance + \beta * Density + \gamma * MacInfo \quad (4.12)$$

with α, β, γ are the weighting factors according to the importance of each metric (density information, MAC information and distance toward the destination). In RDEL, we add a routing entry for each neighbor toward the destination. In fact, it is possible that one of the neighbors has an optimal route toward the destination in term of weight. When node sends data message, it checks the routing table to find a relay to the destination with lowest weight field. Then it sends the message to the chosen relay. This relay repeats the same process until a message reach a RSU that routes the packet directly to the destination through wired link in a shorter time than a whole multi-hop wireless communication.

An example of this mechanism is depicted in figure 4.5. Figures 4.5(a)4.5(b) show one scenario where the information is routed through a RSU instead of multi-hop path. Using orange arrows, we show the route that greedy routing protocols use to route the warning message. The blue arrows represent the route that RDEL uses to route the warning packet to the police station. Using RDEL (blue path), the warning message reaches the

destination in shorter time and a lower hop counts. The source node has the RSU and the node number 1 as a neighbors. The weight field for the entry corresponding to the RSU is lower than the weight field of node 1 as the RSU is more reliable than node 1. Thus, node one chooses the RSU as a relay, uses the RSU as a gateway and routes data to the final destination (police station) via wired link.

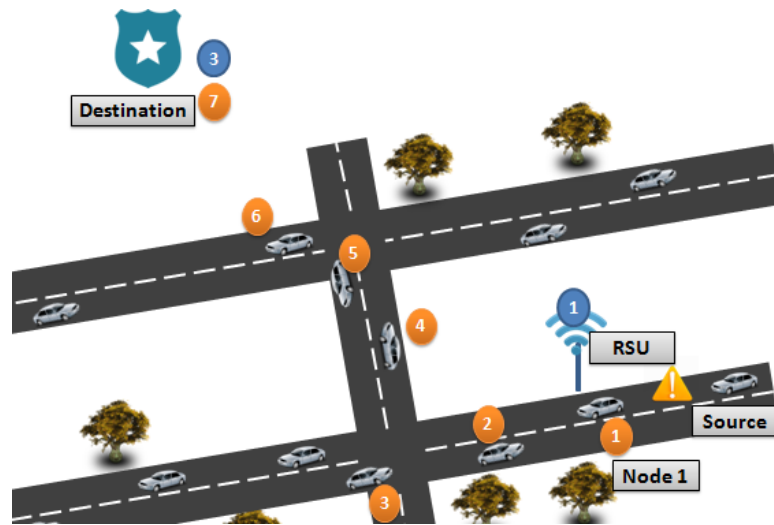

(a) Routing scenario

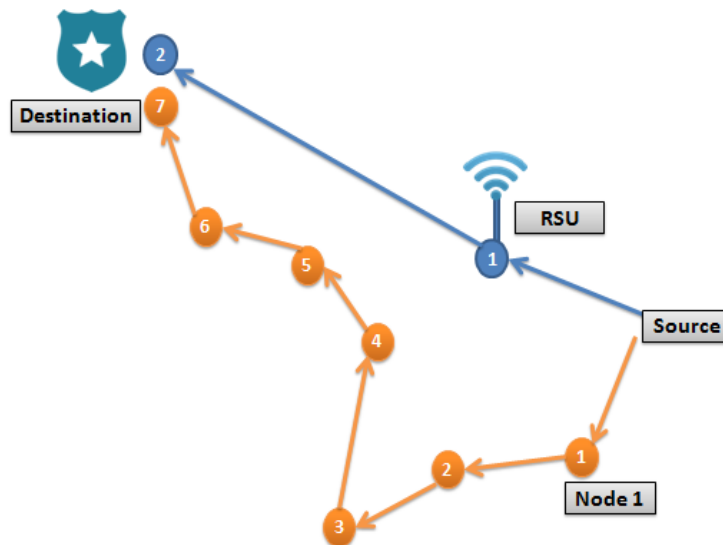

(b) Multi-hop communication VS V2X communication using RDEL

Figure 4.5: An example to illustrate the V2X communication

In diagram 4.6 we summarize RDEL routing protocol.

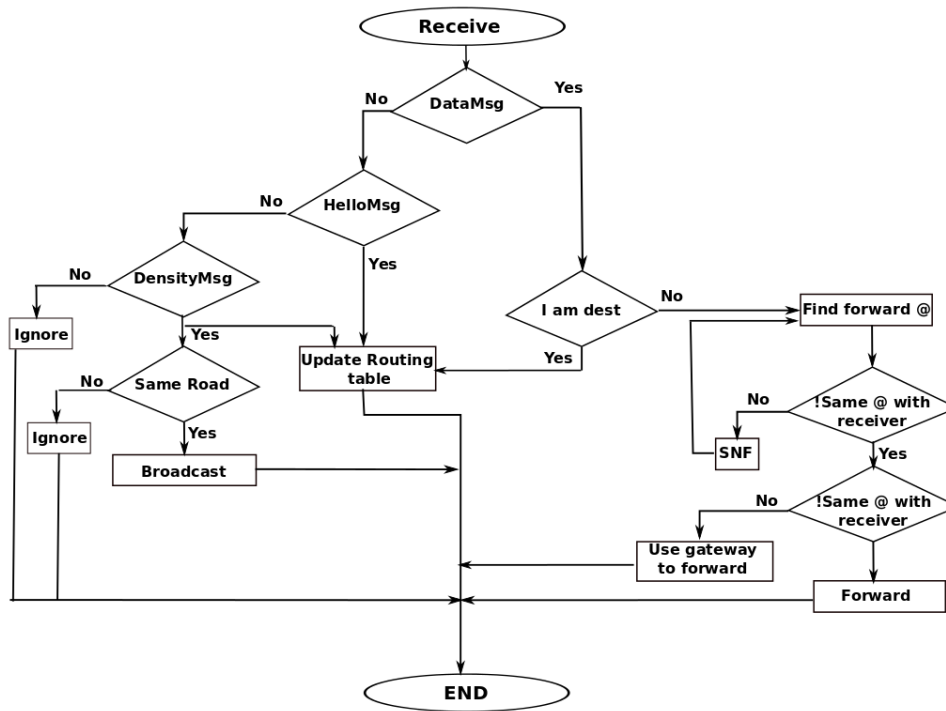

Figure 4.6: RDEL diagram

Herein we describe each routing control messages.

4.2.2.2/ RDEL MESSAGE TYPES

As above mentioned, in the RDEL protocol, each node periodically sends two types of beacon messages *HelloMsg* packet and *DensityMsg* packet. The first one holds information about position and velocity in order to maintain the neighbors table and the second one is used to exchange density information of each road in a distributive way. The *Hel-*

Originator Address	Sequence Number (seq)	TimeToLive (ttl)	Vector Position	Heading	Velocity	MacInfo
--------------------	-----------------------	------------------	-----------------	---------	----------	---------

Figure 4.7: Hello message (*HelloMsg*)

loMsg packet format is depicted in figure 4.7. The *Originator Address* represents the IP address of the sender. *Timetolive(ttl)* and the *SequenceNumber(seq)* indicate whether the message is fresh or not. The position vector field defines the current position of the sender. This information is used to calculate distance between neighbors and also to compute the distance to a distant nodes. Velocity and heading fields indicate the velocity and direction of the node; these information help to predict its position over time. *Mac-Info* field gives the MAC frame bit error rate, which is used also in the routing process to find the most robust path and avoid routes with high interferences. When a neighbor node receives a *HellowMsg*, it processes the message, retrieves relevant information and check whether an entry in the routing table for the sender exists to update it. Otherwise, it

creates a new entry, computes a distance to reach the message's sender and inserts the new entry in the routing table. *HelloMsg* packets are sent to 1-hop neighbors and they are utilized to compute the local density (i.e. the number of neighbors). The *DensityMsg*

Originator Address	Sequence Number (seq)	TimeToLive (ttl)	Seg ID	Road ID	Density information
--------------------	-----------------------	------------------	--------	---------	---------------------

Figure 4.8: Density message (DensityMsg)

packet format is depicted in figure 4.8. This message type is inspired from IFTIS [134] mechanism in GYTAR [135] protocol. To get density information, we divide each road into a set of segments; the size of each segment is equal to twice the radio range of a vehicular node. Then, in each segment we select a node to inform the other vehicles about the local density using *DensityMsg*. The local density is calculated using the number of neighbors. When the road segment contains a RSU, the local density is equal to the maximum number of nodes that can drive on this segment e.g. if the length is equal to 500m and safety distance between vehicles is 5m, then, the density is equal to 500 divided by 5m which gives 100 vehicles. The density message contains beside density information field, the originator address, the corresponding segment identifier (Seg ID), road identifier (Road ID), a sequence number *SequenceNumber (seq)* and *TimeToLive (ttl)* to get the freshness of the information. *DensityMsg* is not broadcasted to only direct neighborhood (1-hop neighbors) but it is rebroadcasted along a road where the sender's segment belong. These information are used to update the routing table with exact density information. When a RSU covers a segment, it makes the segment the best candidate to transmit data packet. In fact the RSUs are connected to each other by wired link, which helps them to transmit information to further node in very short delays. The density computation in RDEL is inspired from IFTIS mechanism [135]. However, in RDEL density messages are sent in the two directions and not only toward one junction of the road as in IFTIS. RDEL also considers the connectivity of RSUs. When a segment contains a RSU, the density of this segment is higher than segments without RSU where data is simply routed in V2V to the destination.

In the next subsection we give the performance results of our protocol RDEL.

4.2.2.3/ PERFORMANCE EVALUATION

In this section, we evaluate the performance of our proposed routing protocol ODEL. We chose two widely spread simulator to simulate our protocol: SUMO [53] that provides real-traffic scenarios and NS3 network simulator [36]. The mobility traces provided by SUMO are injected into NS3 simulator to evaluate real vehicular mobility. In the following, we focus on the impact of our routing technique on delays. Findings corroborate the efficiency of our proposal compared to a simple routing without using additional infrastructure.

To simulate our proposed routing protocol, we consider that all nodes have the same transmission/receiving range, which is denoted by r and equal to 250 m. For the road topology, we have different scenarios and we varied the area size from 12 segments to 120 segments. The number of vehicles varies from 300 to 1500. The number of RSUs varies from 3 to 30. The application delay threshold varies from 0.5 to 1 sec.

All details of the simulation setup parameters are listed in table 4.5

Parameter	Value
Radio range r	250
Number of segments in the area	12-120
Number of nodes	300-1200
Application delay threshold	0.5-5 sec
Simulation duration	50-100

Table 4.5: Simulation parameters of RDEL routing protocol

As depicted in figure 4.9, we plot the end-to-end delay results for the same scenario using RSUs and without using RSUs. We plot three scenarios: road with 12 segments, 24 seg-

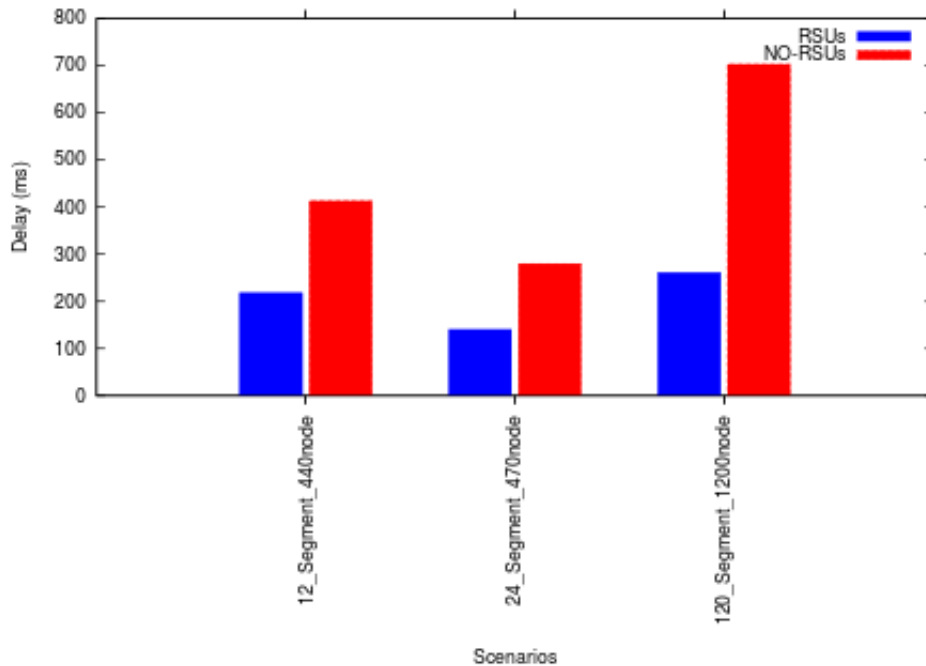

Figure 4.9: End-to-End delay results for RDEL with and without RSUs

ments, and 120 segments. We apply ODEL on each scenario, which gives the following results: the first scenario requires only 3 RSUs, the second scenario requires 10 RSUs and the last scenario requires 30 RSUs. The histogram shows that our protocol RDEL (+ODEL) improves the end-to-end delay when it uses the optimized deployed RSUs. This also due to the fact RDEL uses adequate metrics to choose the next relay candidate like the geographic position, density and lower layer information.

Finally, we remind that these work is still under development to provide further results such as overhead and delivery ratio. We also intend to compare it with existing solutions especially those using random-based or intersection-based RSUs placement.

4.3/ CONCLUSION

In this chapter, the purpose of our study is to deal with delay requirements for delay-sensitive vehicular networks applications. We outlined the major challenges for network-layer protocols in vehicular networks and discuss the different research contributions and strategies corresponding to these challenges. Then, we gave the weaknesses of these existing solutions. To fit with these weaknesses, we proposed two novel contributions that aim to reduce the message communication delay and cope with intermittent connectivity in vehicular context. The first solution ODEL optimizes the infrastructure (roadside units) deployment and the second one is a new routing protocol called RDEL. RDEL aims to optimally route data and allows to further test the applicability and the efficiency of the first contribution. In order to optimize RSUs location, we mathematically model the problem as an optimization problem. Then, we propose to solve it using ODEL solution. ODEL first finds strategic locations candidates based on a study of traffic information in the studied area. Then, it optimizes the number of final RSUs locations using two optimization algorithms Genetic and Dijkstra algorithms. We proposed after that RDEL. This routing protocol routes information through both vehicles and infrastructures. It integrates density, distance and lower layer information to make a routing decision. Comparing to existing work that are designed without considering application delay constraints and usually place RSUs randomly, uniformly or in intersections, ODEL and RDEL provide very interesting delay boundaries and could be applied in different scenarios. From these results, we conclude that in the design of vehicular routing protocols, it is extremely important to pay attention to the position of the infrastructure in order to ensure reliability over the network, guarantee high delivery ratio and respect delay constraints.

Finally, to conclude the first part of this thesis, we remind that connected vehicles are the key of future transportation systems as they can provide a large amount of new applications and services that aim to bring efficient traffic management, road safety and infotainment. In the next part of this thesis, we show how to use connected vehicles to provide new services for sustainable transportation system.



SUSTAINABLE MOBILITY

BACKGROUND AND RELATED WORK

5.1/ INTRODUCTION AND PROBLEM STATEMENT

Recently, several efforts have been focusing on leveraging Internet and communication technologies to access sensitive and important information that helps to manage transportation systems and power consumption efficiently. For example, real time traffic information can reduce power consumption and greenhouse gaz emission while renewable energy can help us to achieve energy independence and a green transportation system. In fact, the widespread ownership of vehicles causes unwanted effects on flora and fauna due to increased fuel consumption and greenhouse gas emissions. The US Department Of Transportation (US DOT) [57] and the European Commissioner for Climate Action [44] reported that the average fleet emission is 158.7 g/km, and the US Environmental Protection Agency (EPA) reported that the annual greenhouse gas emissions per passenger vehicle is 4.8 tons of CO₂ per vehicle per year (based on average daily mileage in the US) [63]. Fuel consumption increases the rate of hydrocarbons, carbon dioxide and nitrogen oxides in the atmosphere and introduces toxic particles that make fresh air poisonous. Consequently, pollution of the atmosphere by greenhouse gas emissions [169] has generated significant environmental degradation and respiratory diseases.

In addition, the petrol production rate has reached a critical threshold, and it is expected to decrease over time as the world's crude oil dwindles [121]. In a few decades, we will very likely face serious shortages of almost all petrol and gas sources [121] [225] [151] [74]. The lack of energy is a serious problem for transportation systems because it could freeze mobility in large urban areas and affect the economy and industrial activities of the world. For these reasons, sustainable mobility is now a real requirement rather than an option. Researchers have dedicated increasing attention to sustainable transportation [93] in an effort to improve long-term mobility by monitoring vehicle emissions, reducing gas consumption and introducing new alternative energy resources. The US Electric Power Research Institute (EPRI), the Natural Resources Defense Council (NRDC), the Electrochemical Energy Laboratory (EEL) and the European Commissioner for Climate Action studied the environmental impact of the manufacturing and deployment of large fleets of Plug-in Hybrid Electric Vehicles (PHEVs) and found that they emit less greenhouse gas by using cleaner energy sources to produce energy and replacing pollutant and expensive raw materials during the cars' fabrication processes [213] [44]. Thus, in this part of this thesis, we tackle sustainable mobility paradigm; in particular, electric vehicles with the main goal to make a better use of energy based on data collection and processing.

The rest of the chapter is organized as follows. In Section 5.2, we define sustainable

mobility and we present the background of alternative transportation. Then, in section 5.3, we describe the basic components of a smart transportation management system by focusing on the required infrastructures, communication technologies and value chain of electric vehicle integration into the Smart Grid. In section 5.4, we analyze various transportation management systems to classify them into three main categories: (i) fleet management system that optimally schedules the fleet to optimize the energy consumption, (ii) itinerary planning that chooses the most economic route in terms of energy, and (iii) Grid to Vehicle (G2V) and Vehicle to Grid (V2G) regulation solution that aims to balance the power utilization load. After that, in sections 5.5 and 5.6, we present some standardization efforts and challenges in the area of green transportation systems that still need to be addressed in the future. We also propose our complete STMS integration framework. The latter considers all the factors that impact power consumption, the Smart Grid load management and electric vehicles fleet management. Finally, we offer some concluding discussion and remarks.

5.2/ SUSTAINABLE MOBILITY: AN OVERVIEW

Promoting mobility is an integral part of our profession and business. However, this goal requires to meet the overall demand for transportation in terms of safety and cost, while reducing their side effects on the environment and using the most advanced technologies. Over the past few years, major international automotive and energy companies, have reflected together about the possible evolution strategies to improve the sustainability in transportation. To understand the concept of sustainable mobility, we give a brief definition and we present its main roles and goals. Then, we present current transportation technologies and we compare between them.

5.2.1/ SUSTAINABLE MOBILITY: DEFINITION AND ROLE

There is a tendency to frame definitions of sustainable mobility. In fact, the concept of transport sustainability is related to ecologic, socio-economic and political contexts: it depends on power resources types, gas emission rate, energy costs, people habits and needs and equity within and between the present and future generations. Thus, it is difficult to give a universal definition of sustainable mobility as sustainability targets level can vary depending on context and over time. We choose a basic definition of World Business Council for sustainable development as part of Mobility Project 2030 [119] [218] which defines sustainable mobility as: "mobility that meets the needs of society to move freely, gain access, communicate, trade and establish relationships without sacrificing other essential human or ecological requirements today or in the future".

The key roles of sustainable mobility that can be drawn from the definition above include that the environment should not be degraded by transport-related activity, and should maintain human health and safety by reducing direct and indirect impact of transport systems. Moreover, sustainable mobility should meet the travel needs of the population as reliability and comfort and ensure the carriage of goods between different locations. Furthermore, to achieve sustainability and independence from fossil fuels; it is important to guarantee fair prices of sustainable means of transportation and renewable energy in order to prompt the usage of those less-polluted transportation means. Finally, to ensure

long-term viability of sustainable transport system; transport infrastructure and services need to be continuously maintained; and as an integrated system, all components must work together for optimum effectiveness.

5.2.2/ SUSTAINABLE MOBILITY: BACKGROUND ON TRANSPORTATION TECHNOLOGIES

Many solutions have been proposed to reduce transportation pollution (carplatooning, carsharing, carpooling, electric rail transportation, etc.). Car platooning is a solution that involves a group of vehicles that follow a lead driver along the trip unless the platoon is dissolved. It aims to increase road capacity and reduce traffic congestion and pollution [13]. Carsharing and carpooling systems [14] are car rental models in which many clients share a car. These systems are used today in many countries such as: France (AutoLib carsharing), the USA (City Carshare), the UK (City Car Club), etc. Optimizing the cars' allocation reduces congestion and air pollution. alternative means of transportation are attractive solutions that can decrease the level of harmful gas emissions. Nowadays, there are several types of vehicles (fuel-based, electric and hybrid vehicles). Herein, we review the main characteristics (such as operating mode, power consumption, etc.) of fuel-based, electric, and hybrid cars.

5.2.2.1/ FUEL-BASED CARS

Fuel-based cars use an internal combustion engine to produce power. In a combustion chamber, air and fuel are mixed, compressed and burned to produce forces that transform chemical energy into useful mechanical energy. This process suffers from high energy losses because only between 15 % to 40 % of the fuel power is transformed; more than 60 % of the energy is lost [124]. The more efficient the engine, however, the more effectively it produces mechanical power and reduces CO₂ emission and fuel consumption. CO₂ emission depends on the quantity of energy that is used to produce the required roll forces, the type of fuel and the driving cycle mode [124]. Electric and hybrid cars are more energy efficient than fuel-based cars. We note that hydrogen cars produce energy either by burning hydrogen in an internal combustion engine, or by reacting hydrogen with oxygen in a fuel cell to run electric motors [200] [117]. However, it does not produce CO₂. In this subsection, we refer to fuel-based vehicles that does not use hydrogen.

5.2.2.2/ ELECTRIC VEHICLES

Electric cars have a small electric motor rather than a combustion engine. Electric cars can reach an energy efficiency around 90% [110] [132] and have many benefits for both the economy and the environment. They enable energy independence by using locally generated electricity rather than relying on imported fossil resources. In addition, electricity is cheaper than fuel and can be generated using various natural and renewable resources. Multiple studies have shown that renewable energy has the potential to meet the vast majority of our energy needs and to minimize air pollution. The first electric car called "La Jamais Contente (The Never Satisfied)" was invented in 1899 [96]. It was able to achieve a speed of about 100 km/h. However, due to some batteries' limitations and low fuel costs, electric motors were used only in rail transportation and small bicycles.

In fact, batteries have limited the progress of electric vehicles. The distance that electric cars can cover is limited; electric vehicles (e.g., Tesla electric cars) can travel at most 450 kilometers with a fully charged battery [55]. Moreover, the electric battery needs a long time to charge depending on the charging type. There are three types of charging for Electric Vehicles (EVs) [61] [113]: (i) Slow charge requires between four and eight hours, (ii) Normal charge requires around two to four hours, and (iii) Fast charge requires at least thirty minutes.

5.2.2.3/ HYBRID VEHICLES

Hybrid vehicles are a compromise between gasoline and electric vehicles. Baker and Woods introduced hybrid vehicles in 1916 in the United States [117]. Since the creation of the first commercial gasoline-electric engine, several hybrid models, from small cars to Sport Utility Vehicle (SUVs) have been made. A hybrid car combines an internal combustion engine with an electric battery. The vehicle starts working on battery power, and it switches the power source to the internal combustion engine as the speed of the car increases. The electric battery is also used when the car needs more power to climb a hill or to move at a higher speed. The advantage of hybrid cars is the fact that they have two power sources, which means they can use the appropriate power source when needed. Additionally, hybrid cars have very low emissions and high fuel efficiency. However, some of the disadvantages of hybrid vehicles include their price, the environmental hazards associated with recycling their batteries and CO₂ emission. There are many different types of hybrid vehicles detailed in [61] [113] [117], but only the gasoline-electric hybrid is currently commercially available.

5.2.2.4/ COMPARISON OF FUEL, ELECTRIC, HYBRID CARS

In Table 5.1¹, we summarize the features of the three types of cars [11] [124]. As we can see from the table, there is a compromise between using cheap fuel cars and expensive clean electric and hybrid vehicles. As electric vehicles are still in the development phase, we can assume that the prices are likely to fall in future years.

5.3/ SUSTAINABLE MOBILITY: BASIC COMPONENTS

Today, new communication technologies, high speed information access and large storage capacities all enable the design of new and complex systems such as: smart buildings, smart cities, smart grids, smart transportation systems, smart clients, and many others. To enable long-term smart, safe, and sustainable mobility, it is important to guarantee a balance between energy, environment and transportation, which leads to a smart Sustainable Transportation Management System (STMS). A STMS is a combination of several smart entities such as smart vehicles, sensors, Road Side Units (RSUs), charging stations, and traffic lights, all of which are usually connected via a communication network to each other and to centralized or distributed control centers. The term "smart" here is used because the devices are managed in order to collect, analyze and process

¹Miles per gallon gasoline equivalent (MPGe) in Table 5.1 is used to measure the distance traveled per unit of energy consumed for fuel and electric vehicles. Here, each gallon is equivalent to 33.7 kW.

Table 5.1: Fuel cars vs electric cars vs hybrid cars

	Fuel cars	Electric cars	Hybrid cars
Gas Emission	25 kg/100km	0 kg/100km	12-21 kg/100km
Power consumption	<40 MPGe = 7.1 L/100km	<50 MPGe = 5.6 L/100km	47-76 MPGe = 3.7-6L/100km
Maximum distance	>320km	Between 160-480km	Between 320-800 km
Charge duration	Fuel: <5 min	Electricity: 30 min to 8 hours	NA
Energy price	5-6.25 \$/100km	0.62-1.25 \$/100km	NA
Car price	>9.500\$	>\$35.000\$	>25.000\$

information to provide various transportation services such as traffic light management, fleet management and others. The term "sustainable" is related to the use of renewable sources of energy to make transportation green and cleaner.

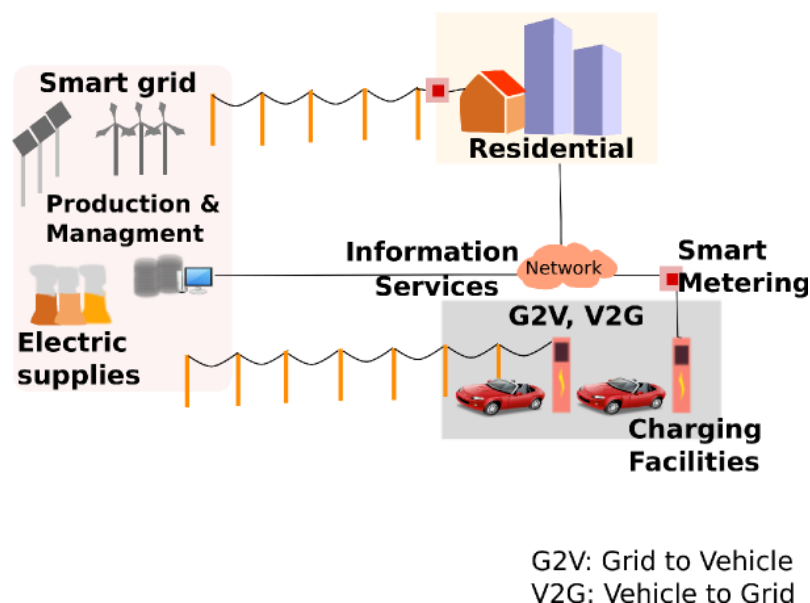

Figure 5.1: Basic Components of a Smart Sustainable Transportation Management System

Figure 5.1 depicts the main system entities of STMSs (such as customers, Smart Grid, facilities, decision-making system, data, and network) and the relationship between them. The Smart Grid acts as the power provider and power manager. The customers (vehicles) and facilities (charging stations and RSUs) collect information (energy load and road traffic). The network is the backbone of the system and ensures communication and interoperability among all STMS' entities. Operation centers analyze and process information and make decisions based on various factors and criteria (e.g., energy cost and greenhouse gas emission). Thus, the role of a STMS is to provide a required set of flexible components to collect information, communicate requests, organize resources and integrate services effectively. However, until today traffic information is not fully consid-

ered by existing transportation management systems. Additionally, existing solutions and projects view the Smart Grid and transportation management system as two independent systems.

In this section, we introduce the basic required infrastructures (power generation facilities, electric vehicles supplies, Smart meters, etc.). The wired and wireless communication technologies of connected vehicles is already discussed in sub-section 2.2.2; we briefly to introduce communication technologies used between vehicles and electric supplies. Then, we explain the value chain of electric vehicles and supplies markets. In fact, an early phase in any management system is to take into account the financial considerations.

5.3.1/ INFRASTRUCTURE AND BASIC REQUIRED FACILITIES

In this part of work, we focus on electrical vehicles. Fuel-based vehicles are not considered in this work because our goal is to promote alternative and clean transportation. Electric motors consume a large amount of electrical energy and require mainly basic resources and hardware such as electricity factories and utility, charging stations, sensors, metering devices, etc. Electricity generation and supplies together with energy management utilities constitute the Smart Grid, which uses communication technologies to collect and analyze the state of electric grids in order to monitor the production and the consumption of electricity. It defines how energy is transmitted, distributed, and measured efficiently. In addition, Smart Grid technologies aim to keep grid load balanced and promote the utilization of renewable grid resources. The Smart Grid produces energy from several resources (wind, solar, water, nuclear, bio-energy, coal, fuel, etc.), carries electricity and delivers it to consumers by using transmission and distribution units. When consumption is lower than production, the additional energy is stored in storage units. The Smart Grid uses metering units (also known as Smart Meters) to record electricity consumption and evaluate the usage of electric energy. Communication units integrated into the Smart Grid facilitate remote control by communicating information to all other units. Finally, the Smart Grid uses security units to prevent and control damage.

Electric cars come with a new type of charging station or *Electric Vehicle Supply Equipment* (EVSE) to charge the cars' batteries. Indeed, an important element of charging stations is the chargers' efficiency. Electric vehicles can be recharged from a domestic wall socket or external charging station. Other solutions, such as mobile charging stations and battery replacement stations, have been introduced recently to the charging market. IEC 61851 [61] is the international standard of the electric vehicle charging system. This standard describes all circuit and protective device requirements. As mentioned previously, there are three types of recharging, which are summarized in table 5.2.

We note that the charging voltage and current for an electric vehicle depend on the design and setting of the on-board charger of the electric vehicle manufacturer, which may cause the charging time to vary [61]. A higher charging current shortens the charging time. Shneider electric provides a full list of commercial charging station facilities designed for north American commercial and residential end-users [49].

Many research programs and industrial projects focus their efforts on optimally deploying electric utilities, especially charging stations, to balance the load of the Smart Grid so that electric vehicles do not overload the electric grid. The first deployment solution for charging stations used fuel charging stations at specific parking locations. Next, people

Table 5.2: Recharging Types

	Charging Voltage and Current	Charging Power	Charging Time Required
Slow charge	220V, 13A*	2.9 kW	6-7 hours
Normal charge	220V, 16A*	3.5 kW	4-5 hours
	220V, 32A*	7.0 kW	2-3 hours
Fast charge	DC Quick Charging 400 A	50 kW	≈ 30 min

began installing charging stations in their homes. These home charging stations can potentially cause instability in the electric grid. To optimize the deployment of charging stations and balance the energy consumption and production loads, many studies were proposed. They take into account the energy load in the roads and financial cost of building electric utilities and charging stations [207] [220]. In addition, the Electrical and Mechanical Services Department has specified and revised technical regulations in order to satisfy the requirements needed to deploy electric charging facilities [61]. Charging infrastructures can be categorized as follows:

- Public charging station (e.g., in public parking, outlet and commercial area).
- Private charging station (e.g., home, company's parking, etc.).
- Private-shared charging station (e.g., shared electric taxi).

Smart Grid infrastructures and facilities are summarized in [147] [89].

5.3.2/ COMMUNICATION TECHNOLOGIES

Smart networks open up many possibilities to make an electric power transmission system smart. Many technologies cooperate to ensure real-time communication to transmit crucial data (demand load, road traffic information, client location, and charging duration information) and to provide various transport applications and services (charging station reservation request and reply, safety control information, battery state, path planning, and authentication).

As shown in figure 5.2, several wired and wireless communication technologies could be used. We focus in this subsection on communication technologies between vehicle and electric supplies as we already introduce all communication technologies used by the connected cars in Section 2.2.2:

Communication is possible over power lines, telephone lines, coaxial cables, and unshielded twisted pair or optic fibers. These technologies are used to communicate between fixed facilities, and they offer reliable data transmission to the energy management system. Wired networks are also used to communicate among components (micro-controllers, sensors and devices) inside the vehicle (see 2.2.2). Wired installation is expensive and does not support mobile communication between vehicles and infrastructures; wireless technologies, in contrast, are more flexible and cheaper to use. The smart transport management systems also use many wireless technologies depending on the

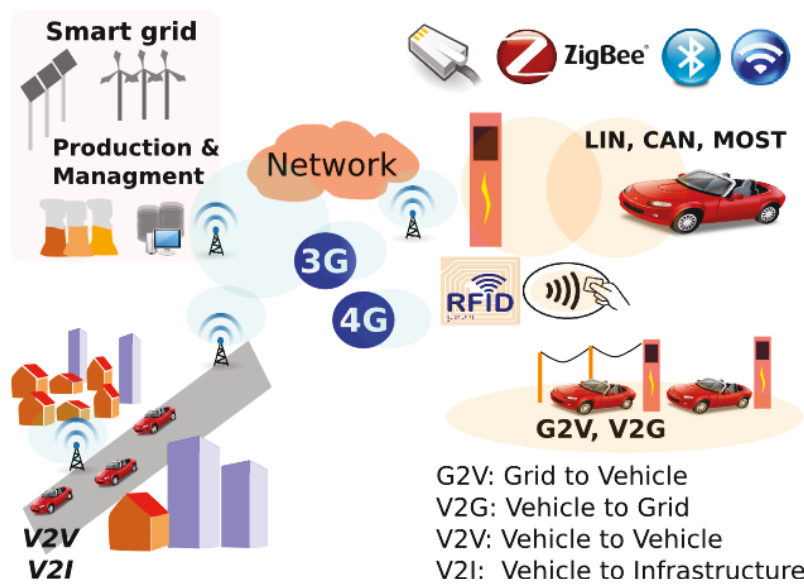

Figure 5.2: Communication Technologies

services being supported. For example, to achieve low power monitoring, they utilize Radio-Frequency Identification (RFID) to authenticate the car for parking or charging. Bluetooth is used to monitor charging remotely, and Zigbee (802.15.4) is used to send information about the battery state to the charging station. For long range communication and highest QOS, it uses WiFi, WAVE, wimax, 3G, 4G/LTE (see sec:concomtech). These technologies plays key role and facilitate communication between mobile vehicles and energy management systems and facilities.

5.3.3/ FACILITIES VALUE CHAIN (BUSINESS MODEL OF ELECTRIC VEHICLES AND SUPPLIES MARKET)



Figure 5.3: Simplified value chain of electric vehicles and supplies market

Depending on the infrastructure deployment model and the provided services, the total cost of deployment includes one or all of the investments and service costs shown in figure 5.3. The total cost covers: (i) the deployment of infrastructure, which includes electric

5.4. SUSTAINABLE MOBILITY: MANAGEMENT ARCHITECTURES AND ON GOING PROJECTS 75

utility deployment and generation as well as the cost of metering devices which enable power management, (ii) the fee for the charging process and the fee for renting the battery. Given that the battery is more expensive than a car today, car vendors rent a battery, and clients pay a monthly bill, (iii) the network infrastructure and maintenance costs, and (iv) Management services costs which include power grid management, charging operation management, etc. These fees depend on government policies in place during the construction of the charging infrastructure. The government could finance the projects, or funding could be sought from private companies.

Europe has created a high-speed electric rail network that joins almost all of its countries together. Other electric vehicle projects are currently under progress. EURELECTRIC [17] is the European electricity industry association that has 32 European countries as members. Its mission is to cover issues affecting the electricity industry, energy policy, renewable power and the environment. [66] presents two models to deploy charging infrastructures to be used for electric vehicles and to organize the Electric Market (E-Market). Two possible charging station models have been proposed: (i) in *the independent e-mobility market model*, the infrastructure investment is recovered only by the electric-mobility (e-mobility) customers. This model is currently being implemented in Germany, France, Spain and Denmark. When customers want to use a charging station operated by a different e-Mobility service provider, access can be granted via a roaming agreement. In (ii) *the integrated infrastructure market model*, the infrastructure investment is included in the grid fees. Thus, all grid clients pay for the construction of the charging stations and a multi-vendor platform with competitive offers among e-Mobility service providers and continue to have access to the public charging infrastructures. This market model is already being implemented in Italy, Ireland and Luxembourg.

5.4/ SUSTAINABLE MOBILITY: MANAGEMENT ARCHITECTURES AND ON GOING PROJECTS

Through connected vehicles; collecting and processing information that affects energy consumption is now possible. These information help manufacturers and drivers to cope with some of the electric vehicles' limitations (such as short battery autonomy). By using such information, we can achieve, for example, most efficient itineraries. In this section, we first review some recent research efforts and projects on transportation management systems, focusing on data acquisition and processing. Then, we describe three types of applications: (i) fleet management systems, (ii) G2V and V2G management systems and charging stations' reservation solutions, and (iii) itinerary planning applications.

5.4.1/ FLEET MANAGEMENT SYSTEM

Fleet management systems and architectures are designed mainly to collect useful information and to support several services. Those systems aim to improve driving efficiency, perform smart resource allocations, reduce traffic jams, etc. The provided services decrease pollution and the amount of consumed energy. Several research efforts cover the fleet management system [208] [120] [201] [203].

The authors in [208] implemented a fleet management system that collects data such as mileage, fuel consumption, and driving speed via General Packet Radio Service (GPRS)

and Short Message Service (SMS). The information collected is used to obtain more accurate location information while tracking the fleet. The tracking system receives real-time vehicle positions by combining two technologies such as a Global Positioning System (GPS) and Global System for Mobile Communications (GSM) and by using a Kalman filter to improve the location accuracy. To be able to perform autonomous decisions (e.g., avoid congested roads and decelerate if an obstacle blocks the road), cars are equipped with front-end intelligent technology, which makes them less dependent on remote backend servers that are usually used to calculate the cars' positions and send them back to the cars' GPS (e.g., a Tomtom GPS device receives positioning information from a remote server). In addition to vehicle tracking, this solution provides other features such as driver assignment, maintenance alert, etc. In [120], the authors developed a health management system for military vehicles. To verify a vehicle's state, the architecture collects data using the engine's internal sensor and axle measurements and sends them via Zigbee to a central computer. The latter uses a fuzzy model developed on expert knowledge and a linear damage model in order to obtain accurate vehicle diagnostic information and to locate axle fatigue damage. In [201], the authors designed a multi-agent traffic management system. Each agent in this system collects real-time traffic information and sends it to a centralized controller. The centralized controller retrieves optimum green light duration information in order to reduce traffic jams by using the traffic information and a genetic optimization algorithm. In [203] and [202], the authors proposed a web information system for fleet management and transport telematics. The architecture collects information using GPRS, Wireless Application Protocol (WAP), and SMS. This information is used to provide several services in addition to vehicle tracking, fleet management, itinerary generation, and vehicle rerouting.

5.4.2/ FLEET MODEL FOR CHARGING REGULATION AND SCHEDULING

The regulation service monitors electricity consumption in order to ensure the Smart Grid's stability even during peak hours. For example, by reducing the power price at night, customers are encouraged to modify their charging habits and pushes them to choose the off-peak periods for charging. Vehicle to Grid (V2G) is a regulation solution that encourages individuals to sell electricity stored in the vehicle to the Smart Grid rather than buying from it. This solution helps to support the Smart Grid in peak load hours. It requires to recover a large quantity of energy from many charged cars that are parked for a long time. However, the disadvantage of frequent charging and discharging is to damage the battery and reduce its lifetime. In [129], the authors studied the financial impact of battery degradation. To avoid the case in which the V2G gain is lower than the investment cost, the fleet company forecasts the V2G revenue and studies the impact of parameters such as battery cycle life and regulation requests (request to generate more or less power). In addition, the authors considered a fleet of trucks instead of private cars because the fleet company can manage the truck fleet efficiently and pay for the battery recycling costs. The results show that the battery life duration is one of the critical parameters in the V2G financial model; therefore, to make such a model profitable, it needs to be supported with higher energy rates (higher renewable energy penetration). In [198], the authors proposed a multi-charging station. A multi-charging station is a set of charging stations that are connected to the same electric distribution node in residential, office and commercial areas. The idea is to monitor a large fleet of electric vehicles using a Fuzzy logic model in order to balance the electric charging load and to keep the Smart

Grid stable. Thus, it manages electric vehicle charge/discharge decisions depending on time, the client's charge/discharge preferences, and the studied area type (residential, market, and office). Simulation results show that this model is easy to implement and that it can give the available power in the charging stations, the charging demands, and the total unused energy in cars in each area. The unused energy could be used to supply the Smart Grid and balance the load in the charging points.

Recent efforts described in [92] [222] [185] [180] [228] [212] aim to reduce energy cost and usage and to increase the stability of the local power system by managing the charging and discharging operations of electric vehicles. In [92], the authors implemented a hardware-based, three-layered architecture for a Battery Management System (BMS). The BMS estimates the battery charging status and helps to extend battery life by including a fully integrated active charge equalizer. The charge equalizer balances the voltage between the battery cells during the charge/discharge periods and ensures the full charge of all cells while charging and the full discharge of all cells while discharging. In [222], the authors studied the characteristics of charging station loads. To forecast daily electric vehicles' charging load, they proposed three models: the back-propagation neural network model, radial basis function neural network model, and grey model. In [185], the authors proposed the Reliable Broadcast for Electric vehicle Charging Assignment (REBECA). REBECA aims to determine the number of electric vehicles that can be served efficiently using queuing theory (M/M/1) and statistical analysis to keep the latency and the probability of EVSE overloads as low as possible. In [180], the authors analytically modeled the waiting time in charging station queues. They proposed a distributed solution to charging station scheduling in order to minimize the waiting time in the charging queue and to balance the power utilization among several stations. To do so, each electric vehicle sends a reservation request to the nearest charging stations. The charging stations exchange reservation information via the internet and 3G. This information helps to estimate the current waiting time at each charging station. The results of this estimation are sent to the clients who later choose the best station for the next charging process to reduce the waiting time and minimizing air pollution at the same time. Below, we cite examples of ongoing projects regarding electric transportation.

5.4.3/ GREEN ITINERARY PLANNING

Green itinerary planning is a type of route planning based on energy consumption. Unfortunately, green itinerary planning is an underexplored area of research. In [183] the authors described a green fleet management architecture called EcoDrive. EcoDrive provides a route planning service and supplies a wide range of real-time services based on the information collected from the road traffic and high precision fuel consumption. As depicted in figure 5.4.3, Ecodrives consists of a global server (a server from the company Orange in this work), the company's server, and a vehicular network. The client books a car on a company server that sends the request to the global server. This server then computes the best itinerary using: (i) road cartography information based on information such as elevation and speed limits, (ii) the vehicle's feature, including its weight and engine efficiency; and (iii) weather conditions, including wind speed, temperature, etc. During the trip, the *Floating Car Data* (FCD) and "special vehicle" notifications are sent and stored on the global server database for further use. At the end of the process, the economic itineraries are sent to the company fleet, and the best one is uploaded into the GPS device or into the smart phone of the driver. However, this solution considers fuel

vehicles only.

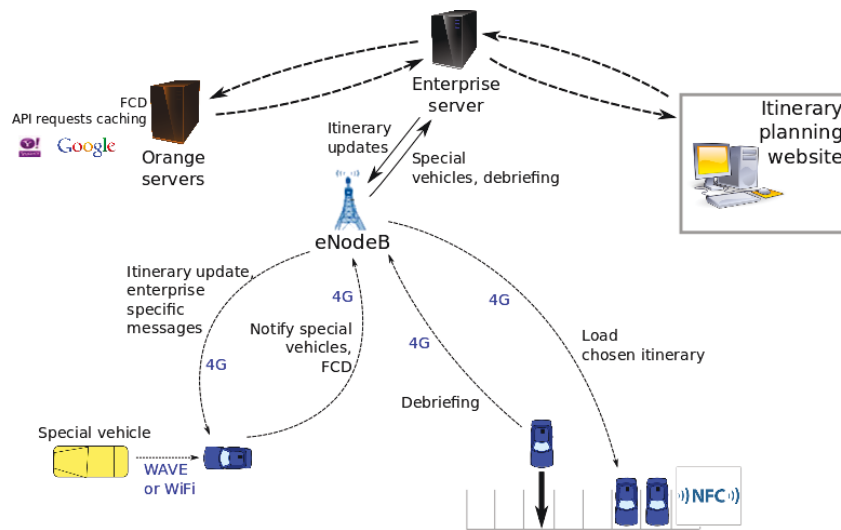

Figure 5.4: EcoDrive green fleet management system [183]

In the next chapter 6, we details electric vehicle itinerary planning solutions and we present our novel solution that optimizes the energy utilization and consider the battery short autonomy.

5.4.4/ ONGOING PROJECTS ON ELECTRIC TRANSPORTATION

ECOtality, a leader in clean electric transportation technologies, has deployed chargers in major cities across the United States as a part of its electric vehicle project [67] [21]. ECOtality has three charging station solutions: (i) Blink for consumers and businesses, (ii) Minit Charger for industrial applications, and (iii) ETEC LABS for research testing to improve battery technology and the use of electric vehicles. Through the Blink membership program and free charge rewards, the ECOtality EV project obtains information from electric vehicle drivers and charging stations about the consumption patterns of electric vehicles in any weather condition. This collected information is analyzed in order to evaluate the effectiveness of charging facilities, the evolution of the green transportation system, and the commercialization of electric vehicles. The Electric Drive Transportation Association (EDTA) is a US industry association working on hybrid and electric vehicles and transportation technologies. The EDTA works with policymakers to promote electric drive transportation [12]. The Edison Electric Institute (EEI) (a member of EDTA) focuses on increasing the awareness, acceptance, and adoption of electric transportation by enhancing the management of the power grid, promoting electric power generation, and providing strategic business information. To optimize the energy use, the company Southern California Edison [52] provides useful guidelines for safe and reliable electric vehicle charging installations. The company proposes equipment upgrades to achieve energy savings in current facilities, and it organizes workshops and classes to teach how to manage the power usage.

European countries, such as Spain, Ireland, France, and Italy, have also started to use renewable energy through many projects. For example, the ENDESA company started the SmartCity project in Malaga, Spain. This project is the largest eco-efficient city ini-

tiative in Europe. It relies on a renewable energy generation and management system, a charging infrastructure, smart meters, and advanced communication to optimize the energy distribution for the charging of electric vehicles. The project also allows clients to monitor their energy consumption habits online [51]. In the city of Saitama, Japan, Honda launched the Smart home system in collaboration with other companies. As an efficient home energy management system, the Smart home system manages the urban use of electric vehicles. The project manages the urban use of electric vehicles. It aims to reduce CO₂ emissions and to optimize the generation and consumption of power through electric car sharing, commercial use of electric cars, strategic implementation of electric supplies in Saitama, and infrastructure and car maintenance to ensure compatibility and long life-cycles [30].

5.5/ SUSTAINABLE MOBILITY: STANDARDIZATION EFFORTS

STMS is a green intelligent transportation system that aims to address economic and ecological issues. However, STMS is composed of many complex sub-systems (Smart Grid for power generation, distribution and metering, fleet management systems, communication network) and is the result of the integration of efforts from many different countries, companies and research institutes (see sub-section 5.4.4). Thus, it is important that we get a set of standards to follow in the next decades to ensure interoperability and growth.

5.5.1/ STANDARDIZATION REQUIREMENTS

A successful STMS design and deployment needs to satisfy the following requirements:

- Guarantee the interoperability and integration between heterogeneous sub-systems (Smart Grid, fleet management system, charging reservation, authentication and payment systems),
- Unify the framework and schemes to fabricate compatible universal devices (cars, batteries, charging stations),
- Define guidelines to develop the required electric and network equipments (inlet, connector, plug and socket-outlets, wired or wireless devices to connect the cars to the charging stations, etc.),
- Design user-friendly interfaces to simplify the utilization of new equipment and technologies related to green transportation,
- Ensure safety of all electric installations (define the maximum current and voltage to use in domestic or commercial charging stations),
- Introduce a set of rules and best practices for many situations and conditions (e.g., advice for electric battery maintenance, safety caution after a collision when driving an electric vehicle, etc.),
- Define economic models for the electric-transportation market in which standard organizations define how to deploy publicly accessible charging infrastructures, organize electric cars and electric charging stations investment in order to ensure balance between reducing costs and getting a profitable gain,

- Define priority actions to ensure the long-term system utilization and upgrade (for example recycling the battery instead of throwing it away).

5.5.2/ STANDARDS

Automotive and power generation companies proposed a wide variety of products and solutions to meet the highly diverse needs of green transportation trends. The standardization of those solutions presents a growing need in the transportation sector. International standard organizations such as SAE, ISO/IEC, IEEE, have started to create a set of standards for electric and hybrid vehicles and charging utilities to avoid incompatibility among products, to simplify the production of various components, and to ensure safety as high voltage is used in ESVE to feed electric and hybrid vehicles [59] [62] [70] [22] [28] [71]. As shown in Table 5.2, we can classify these standards into three categories: (i) Electric component connectors, inlet standards and EVSE standards, which specify connectors (inlet, connectors, plug and socket-outlets, etc.) and the different charging modes and describe general design requirements for electric and hybrid vehicles, (ii) Communication standards, which describe the communication between vehicles' internal components (CAN bus, sensors, etc.), communication between electric vehicles and the EVSE, network and application protocol requirements for V2G communication interface, physical and data-link layers requirements for V2G communication interface, etc.; and (iii) Safety standards, which specify safety features to cover all life-cycle phases (design requirements, test units, recycling programs, etc.). These features help to prevent hardware and software failures in the automotive system, estimate potential system hazards, and specify installation protection for electric telecommunication facilities for electric supply locations.

In addition to electric and hybrid standards, there is another standard for renewable energy called the Renewable Portfolio Standard (RPS) which specifies the required rules to increase renewable energy production by power companies [65].

5.6/ SUSTAINABLE MOBILITY: CHALLENGES AND ISSUES

The increasing shortage of fuel expected in the future is motivating researchers, designers, car manufacturers, and transportation agencies to seek alternative sources of power, such as electric power, for vehicles. In table 5.4, we present some of the benefits of green transportation and the main drawbacks that can delay a large-scale deployment of this kind of transportation. Then, we discuss some of the issues and challenges associated with the deployment and management of electric vehicles:

5.6.1/ THE COST

The raw materials needed to manufacture electric batteries are scarce and costly. In addition, the battery state degrades quickly with poor or inconsistent charging habits or in case of frequent fast charging. Thus, many additional maintenance fees are needed to keep electric vehicles operational. Moreover, new innovative engineering solutions are needed to improve the efficiency of electric vehicles, to increase the amount of battery

Table 5.3: SAE, ISO/IEC Standards

Type	SAE Standard	ISO/IEC Standard
Connector, inlet & EVSE	J1772TM: PEV conductive charge coupler, J2954: PEV wireless charge, J2894: Power quality requirements for plug-in electric vehicle chargers, J2894: 1) Requirements, 2) Test methods, J2990: Design preferences identification, systems and components descriptions, testing procedures definition.	IEC62196: 1) Industrial plugs and socket-outlets, 2) Plug types, 3) DC fast charging (draft standards), IEC61980-1: Inductive charging safety coupler supply equipment.
Communication	J2836TM: General information (use cases), J2836/1TM: 1) Utility programs, 2) Off-board charger communications, 3) Reverse energy flow, 4) Diagnostics, 5) Customer and Home Area Network (HAN), 6) Wireless charging, discharging, J1939 Vehicle's internal communication components.	ISO, IEC15118: 1) Vehicle to grid communication interface, general information and use-case definition, 2) Network and application protocols requirements for V2G communication interface, 3) Physical and data-link layers requirements for V2G communication interface.
Safety	J2344: Electric, HEV and Plug-in, Vehicle Safety, J1766: Crash integrity testing.	ISO6469: EV safety. IEC61851: Operating conditions and safety requirements.

charge, and to reduce the charging duration to increase maximum driving distances. Furthermore, the Smart Grid and fleet management systems require more funds to maintain and manage the currently deployed infrastructures for electric vehicles.

5.6.2/ STANDARDS

Another challenge is the lack of universal standards and regulations for electric facilities and electric vehicle markets. Indeed, many vehicle manufacturers, renewable power producers, researchers, and governments simultaneously started many initiatives and projects to improve the electric cars' efficiency and to deploy them to ensure cleaner transportation. This led to the development of many different types of electric motors, charging stations, electric plugs, communication technologies, and pricing models. Thus,

Table 5.4: Benefits and Drawbacks of Green Transportation

Advantages	Drawbacks
<ul style="list-style-type: none"> - Highly efficient vehicles that reduce the power consumption, - Clean vehicles with low CO₂ emission, - Uses renewable energy sources such as solar, water, wind, etc, - Allow sustainable mobility. 	<ul style="list-style-type: none"> - Electric and hybrid cars are still expensive, - Electric vehicles are not useful for long trips and limited to daily driving profile, - Battery charging takes a long time, - Initial deployment is still expensive and needs a deep financial study to organize it.

the electric car has many charging modes (see Table 5.2) and, most of the time, an electric car bought from one manufacturer cannot be charged automatically in any charging station except the one designed for its model (Section 5.5.2) [128]. In addition, most of the solutions presented in earlier sections assume that electric vehicles and charging stations share the same characteristics (same plug type, charging mode, capacities, etc.). As a result, a common standard must be specified to support a variety of devices as well as battery types (Lead-acid, Nickel metal hydride, and Zebra Lithium ion), chargers (fast, slow, and normal), traction motors (induction motor, interior permanent magnet synchronous motor, and spoke-type interior permanent magnet synchronous motor), power converters, and vehicle types (small car, truck, or bicycle), each of which has its own constraints and charging preferences. Moreover, standardization will play a paramount role in the future of electric vehicles. It motivates manufacturers to produce electric vehicles and encourage drivers to buy them. In fact, standards help to open up competition and reduce the manufacturing and deployment costs. Additional work is still needed in the standardization area to address the following emerging issues: updating the current standards to include the electric distribution network of electric cars, developing energy efficiency measurement capabilities for on-board chargers, standardizing voltage levels in all types of electric vehicles in addition to the standardization established for industrial vehicles (personnel and burden carriers, scrubbers and sweepers, etc.). The development of a future standard will require closer collaboration between the standardization organizations (SAE, IEC, and ECE), researchers, and manufacturers.

5.6.3/ POWER GENERATION AND SMART GRID

Given that electric vehicles consume a large amount of electric energy, the Smart Grid faces a considerable challenge in that it must ensure the generation and management of the required energy. Currently, we face two issues: limited power production if we use only renewable resources (such as wind, solar, etc.) and environment pollution if fuel is transformed to produce electricity. In addition, power transmission is limited to the capacity of the distribution grid (transmission lines). Consequently, it is difficult to build a distribution grid to address the need of charging on a large scale due to substantial costs and high load safety considerations [227]. Unlike fuel-based cars, electric cars are mainly designed to drive over short distances. To get the required charge for daily driving profiles, they could use only the home plug to charge. However, home charging capacities are limited to one or two cars at most, which can become an issue for customers and for the Smart Grid if many cars need to be charged simultaneously every day.

Additionally, although electric vehicles owners are able to sell back the power stored in the electric battery, as we pointed out earlier (Subsection 5.4.2), the battery has a low quantity of power, and we need many cars to feed and support the Smart Grid during peak usage periods. Furthermore, retrieving the power stored in the battery may harm the battery and reduce its life cycle. However, the power recovery depends on the preferences of the car's owner and requires metering and discharging terminals which heavily increase the investment costs. Thus, no guarantee is provided to obtain the required energy from cars, and we risk exceeding the power lines' capacities if the power retrieval pulls from too many cars in a limited area [227].

5.6.4/ INCENTIVE EFFORTS

The high costs of electric vehicles, charging stations and the associated infrastructure remain a challenge because the market penetration of electric cars is still not very high. To fund future transportation projects, cooperation is needed between the electric car industry, electricity companies, and the government. Several previously proposed initiatives have attempted to promote the manufacturing, marketing, and sale of electric vehicles. Many governments have proposed customer incentives to increase electric vehicle sales. These governments reimburse a part of the electric vehicle's purchase price. Electric vehicle manufacturers rent electric batteries to costumers rather than including the battery cost in the final price of the car, thereby decreasing the cost of electric cars. Finally, electric companies propose lower electricity prices in off-peak times to encourage clients not to charge their electric vehicles during peak periods in order to ensure the stability of the Smart Grid and to minimize the charging cost of cars.

5.6.5/ COMMUNICATION SECURITY

The Smart Grid and fleet management systems exchange a large quantity of information, such as charging station load, electric vehicle battery states, traffic information, and unexpected events and accidents in the Smart Grid, in real-time. Most of the available solutions neglect the security of data transmission when communicating information to and from the Smart Grid, electric cars, and charging stations. Any security attack may affect the operation of the Smart Grid, the charging stations, and electric cars. For example, falsification and alteration of voltage or current level information may burn the electronic components in both electric vehicles and charging stations. Likewise, the transmission of unencrypted information about customers' personal and location information threatens the customers' privacy [226], and middle man attacks can change information in order to control billing information. More effort is required to ensure secure, reliable data transmissions among the various entities of the management system.

5.6.6/ DISCUSSION

As shown in previous sections, the major barriers for electric vehicle consumers include both the high prices of the vehicles and the lack of infrastructure to support them. For green transportation to become reality, we cannot focus on one specific aspect of transportation and ignore other factors that can affect energy management. A fully integrated

framework where all entities are energy-aware is required to enable sustainable transportation. A complete smart transportation management system is illustrated in figure 5.5. The STMS integration is not possible without the cooperation and collaboration of car manufacturers, scientists, electricity companies, governments, and standardization organizations.

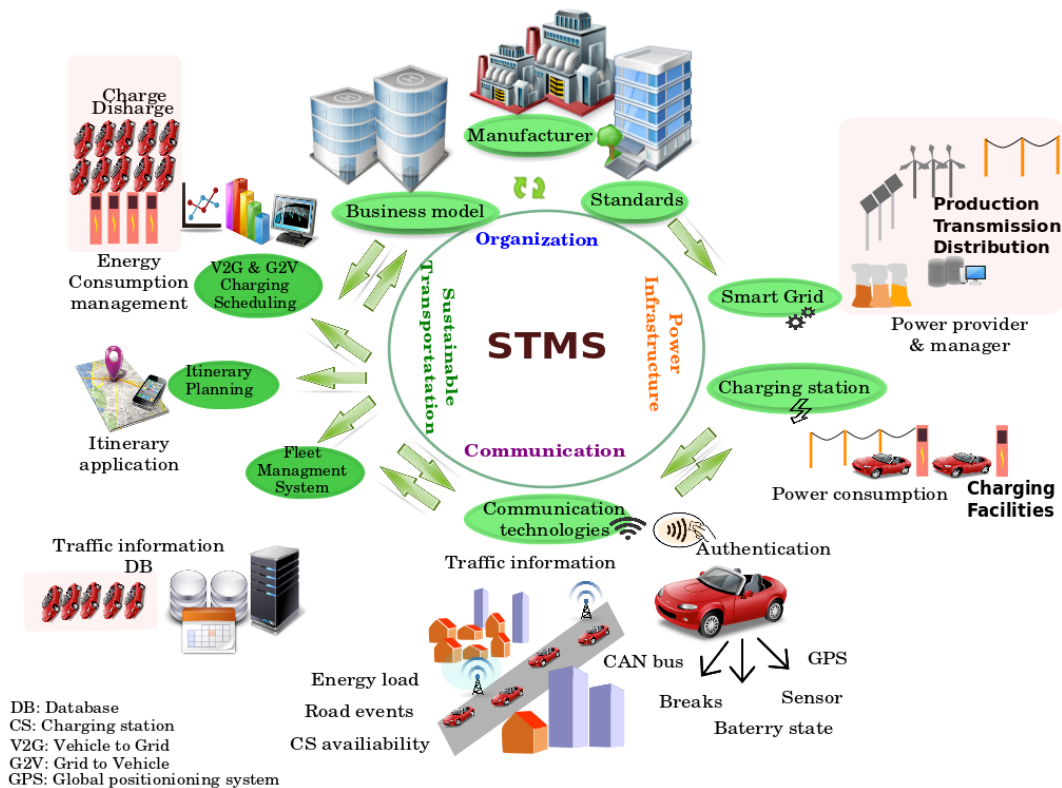

Figure 5.5: Toward a Smart Sustainable Transportation Management System (STMS)

We depict the STMS integration in layers in figure 5.6. We summarize the interaction between the different layers as follows: first, collaborative organizers studied the actual deployment state of electric vehicles and supplies, considered all previous experiments and leakages, and then suggested universal standards and policies. After that, the manufacturers should produce the required components, such as electric batteries, charging stations, plugs, etc., by following the organizers' specifications. At the same time, the electric power industry should build the required power infrastructure to support the electric vehicles' charging load. The next step is the most important. The cycle of power production and consumption should ensure: (i) real-time communication that has a crucial role in delivering and exchanging sensitive information (such as energy load from Advanced Metering Interfaces (AMI), the vehicle's battery state, charging requests and replies, etc.) between electric utility companies and customers, (ii) load balancing and optimized energy management (production, distribution, and consumption) that scale with the new transportation market's energy demands, (iii) efficient fleet management (fleet assignment, itinerary planning, etc.), and (iv) charging station management that schedules electric vehicles' reservations and charging. Finally, each layer sends feedback regarding its functionality (for example: charging stations efficiency, energy production and consumption information, etc.) to the upper layers to improve the STMS.

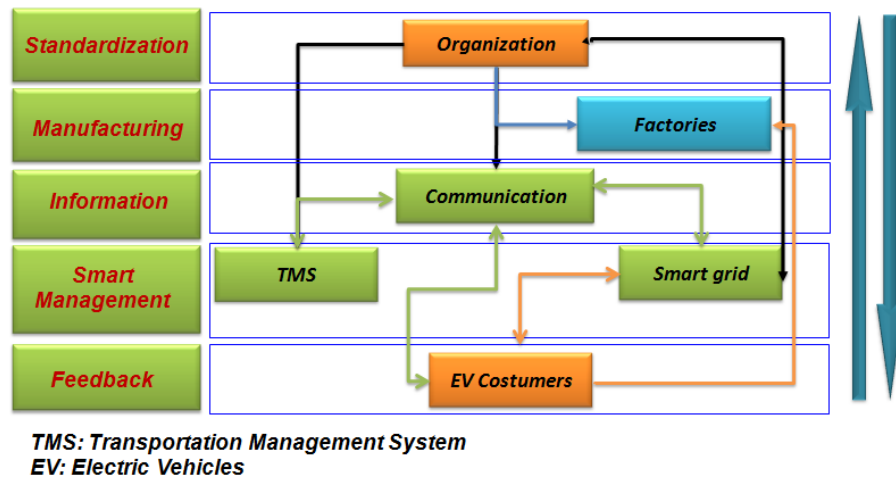

Figure 5.6: STMS: Layers' interaction

5.7/ CONCLUSION

The main goal behind this chapter is to present sustainable mobility concept as a new paradigm in the research fields. The chapter gives an overview of sustainable mobility and future transportation systems that aims to reduce pollution by using new communication technologies to manage energy consumption. Indeed, transport and mobility constitute one of our main priorities. Many countries are seeking to solve sustainability equation to increase mobility while reducing the side effects of transport on our quality of life. To achieve these two objectives an intensive investigation about different possible solutions decisions and choices need to be done. Therefore, in this chapter, different transportation technologies, communication technologies that form sustainable mobility are introduced. In addition, several transportation architectures and systems as well as innovative projects carried out to fit with energy consumption constraints and pollution problems are presented. Moreover, recent standardization efforts in regard to various issues related to electric transportation are reviewed. Furthermore, challenges and issues that still need be addressed in the future to have a fully functional and cost-effective green transportation system are discussed. Finally, this chapter aims to introduce the next two chapters, where we address two problems related to sustainable mobility. In chapter 6, we present our first solution for electric vehicle itinerary planning and in chapter 7, we present another solution that optimally deploys electric charging stations.

ITINERARY PLANNING FOR ELECTRIC VEHICLES IN SMART CITIES

6.1/ INTRODUCTION AND PROBLEM STATEMENT

As shown in chapter 5, great efforts are invested in reducing emissions of greenhouse gas at a world scale. The use of electric vehicles (EVs) is considered as one of the best green transportation alternative. In fact, the utilization of electric vehicles is impacting both economy and ecology; they allow achieving energy independence by using domestically-generated electricity rather than relying on foreign oil. In addition, electricity is cheaper than fuel, and can be generated using natural renewable resources, such as solar or wind power, and hence helps to limit pollution [15]. Furthermore, electric vehicles are more efficient and consume less energy than fuel vehicles, even for the same weight. We should therefore elaborate new global solutions in which fleets of electric vehicles are heavily contributing.

Today, electric vehicles face the same battle that any new technology must overcome: hype and skepticism. According to the EDTA, there are nearly 90,000 EVs on the road in the United States [72], with each auto maker introducing their own electric vehicle model to the marketplace. From the vision of future smart transportation, electric vehicles are expected to gradually replace gasoline-powered vehicles. In fact, electric vehicle sales grew about 10 times from 2011 to 2013, and they represent 0.3% of total vehicle sales in the United States [72]. In Europe, diesel and gasoline cars account for 97% of all new car registrations. Electrics and natural gas and ethanol-fueled vehicles combine to make up the remaining 3%. Electric vehicles make up about 0.2% of vehicle registrations, with the Netherlands being the front-runner at about 0.8% of vehicle registrations in 2012 [68]. However, electric batteries limitations have contributed to hindering their progress. In fact, the autonomy is at most close to 400 kms for a full charged battery (see table 5.1). In addition, the electric battery needs long charging duration that depends on the charging type ¹ as shown in table 5.2. These limitations lead us to think about more practical way to drive electric vehicles, for example by choosing the most economic itinerary in term of power consumption and considering the battery drop. As already described in section 5.4, few works have addressed the economic itinerary for fuel vehicles. For electric vehicle itinerary planning, one solution is to use the Dijkstra algorithm. It uses a weighted directed graph to determine the shortest path between the source and the destination node [115]. However, the Dijkstra algorithm does not solve a graph with negative edges;

¹An alternative solution is to replace the battery instead of charging it for long duration [97]

for electric vehicles, some path costs are negative because electric vehicles regenerate the energy when they decelerate (e.g., along the way down). To address the issue of negative path cost, the authors in [136] calculated the shortest path by using the Johnson algorithm or an adaptation of the Bellman Ford algorithm [168]. In addition, the vehicle's weight, air friction, and road elevation are considered while computing the most efficient path. The green navigation solution [187] [111] extended the shortest path algorithm as follows: (i) energy-consumption and recharge are formalized as a particular case of the constrained shortest path problem, (ii) an adaptation of the four shortest path algorithms (i.e., Dijkstra, First in First Out (FIFO), expand, and expand-distance) is proposed to evaluate the negative path cost in the case of charging or regeneration of the power, and (iii) a prototype software system for energy efficient routing is implemented based on open source libraries, including OpenStreetMap (OSM) [39] and NASA Shuttle Radar Topographic Mission (SRTM). Other solutions are proposed to provide the positions of charging stations. For example, CarStations [6] is a web application that shows the positions of the charging stations on a map. This application does not provide itinerary or power consumption computation. The electric vehicle charging station location application [13] displays the shortest itinerary based on distance and the number of charging stations on the road, but it provides no alternative route if the shortest path does not have any close charging station. Almost all previous studies calculate the most economic itinerary. However, they neglect to consider that drivers may not follow the planned route to find a charging station when the battery power level drops. In [106], the authors designed a framework that collects data (position, speed, state of charge, weather, etc.), transmits them via GPRS to a central server, and performs the following analyses on electric fleet vehicles: (i) road utilization statistics to calculate road usage in order to locate charging points optimally, (ii) trip statistics to report information about battery State-Of-Charge (SOC) and the trip duration, (iii) determination of charging intervals in order to define charging intervals and durations.

All previous solutions may help to find best itinerary in term of distance or consumption. However, in case of battery drop, the driver has to leave the already planned route to find an electric charging station.

Accordingly, we propose an extension of green fleet management architecture for fuel cars (EcoDrive) [183] described in section 5.4. The new extension: Electric vehicle fleet management architecture (Ev-Drive) aims to cope with the limitations of existing solutions. The most important challenge in case of electric vehicles itinerary planning is the consideration of battery limitations and hence the obligation to include battery charging in the trip calculation.

This chapter includes three sections. Section 6.2 describes Ev-Drive architecture and details the process of itinerary planning. Section 6.2.2 explains the power consumption procedure for electric vehicles. Section 6.3 introduces a proof of concept through a description of the performed implementation. Finally, 6.4 concludes this chapter.

6.2/ ELECTRIC VEHICLE FLEET MANAGEMENT ARCHITECTURE (EV-DRIVE)

We propose in this section our advanced fleet management architecture for electric vehicles. This architecture considers the most important factors that can affect the traveling

mode of electric vehicles, in order to offer different services to fleet management companies for an efficient monitoring and management of their fleets. In addition, one of the most important service of our architecture, consists on providing economic itineraries planning for electric vehicles. Best routes, in term of electric power consumption, are computed based on the collected information about road topology, weather conditions, vehicle characteristics, driver profile, traffic conditions and electric charging stations positions. In case of battery drop, new routes passing through the nearest available charging stations are calculated and provided to the driver.

Herein, we present the architecture of the solution, primary entities, communication technologies and necessary steps to compute the best economic itinerary for electric vehicles.

6.2.1/ EV-DRIVE ARCHITECTURE DESCRIPTION

As shown in figure 6.1(a), the architecture is mainly composed of: (i) one global server, (ii) several companies' fleet servers, and (iii) electric charging stations. The main server collects data about roads events and charging stations availabilities, processes them and stores them in three databases. The first database contains technical characteristics for both fuel and electric vehicles, the second database contains electric charging stations information (address, capacity, efficiency, prices, availability, etc.), and the third database contains other information about road state (road works, race or any show days dates, etc.). The main role of the global server is the computation of best itinerary using all available data.

The company's fleet server provides web interface to its clients, to book a vehicle and enter the trip information (source, destination, chosen vehicle). After that, the fleet server requests the global server to compute the best route. It also sends the collected traffic information and anonymous information about driver behavior to improve the accuracy of the results. Vehicular communications (V2V and V2I) are used to transmit data (e.g. itinerary update) from the fleet server to the vehicles, and to transmit information messages from the vehicles to the fleet server. The messages can contain information about accidents or road works notifications.

In our work, we suppose that charging stations are connected to Internet through a wired or wireless connection and can send their real time availability information to the global server.

Thereby, to plan a trip, a client books a vehicle from the available fleets of the company using the web application as shown in figure 6.2. The fleet server sends the request to the global server. Then, the global server uses Google Maps API and Yahoo Weather API to get the possible routes from the source to the destination, the road elevation and road speed limits, the vehicle's characteristics and all the weather conditions that can impact the computation. It uses the replies and all cached data to compute the electric power consumption using a process detailed in the next section. We have two cases: (i) Non-drained battery: the battery charge is insufficient to complete the whole trip and there is no need to recharge, and (ii) Drained battery: the battery power is lower than a certain threshold (we choose third of full capacity) and the global server has to provide a route that includes an electric charging station; the charging station should be close to the drop position. Figure 6.1(b) summarizes the communication steps between the different system components. Figure 6.3 represents the energy computation algorithm used by the global server. In the case of non-drained battery, the main server calculates the needed

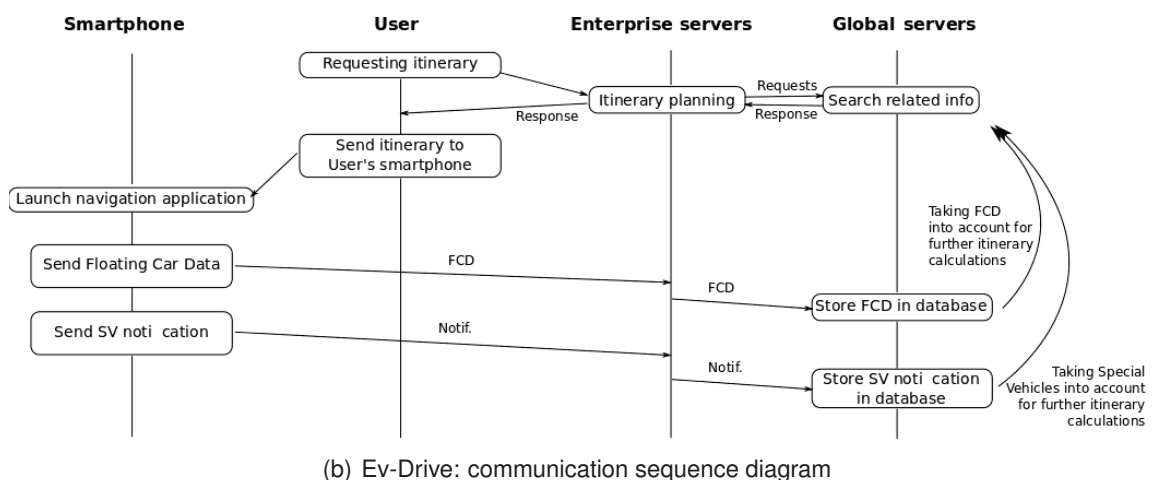
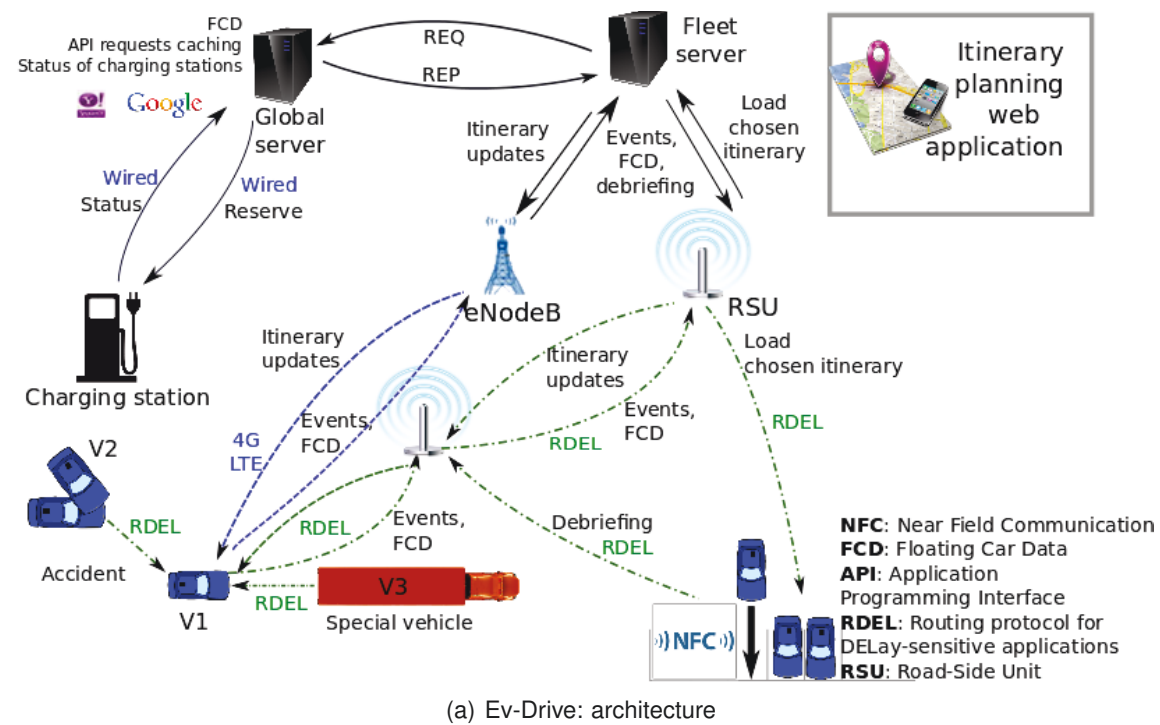

Figure 6.1: Electric vehicle fleet management architecture Ev-Drive

power for each route segment. In the case of drained battery, the global server requests the nearest charging stations from its local database and recalculates the routes from the draining point to the final destination. At the end, sub-routes' consumption are added to the main routes and the results are sent back to the fleet server. This later displays the different possible itineraries in a map with different details of consumption, and suggests the most economic one to the driver. Upon the validation of one of the itineraries by the driver, the planned trip is sent on the GPS of the chosen vehicle, or on the driver's Smartphone.

During the trip, the vehicle collects information about the route and sends periodic feedback messages (Floating Car Data, FCD) and event-triggered messages (special vehicle, road works, accident, etc.) using RDEL protocol (see section 4.2.2) to the fleet server.

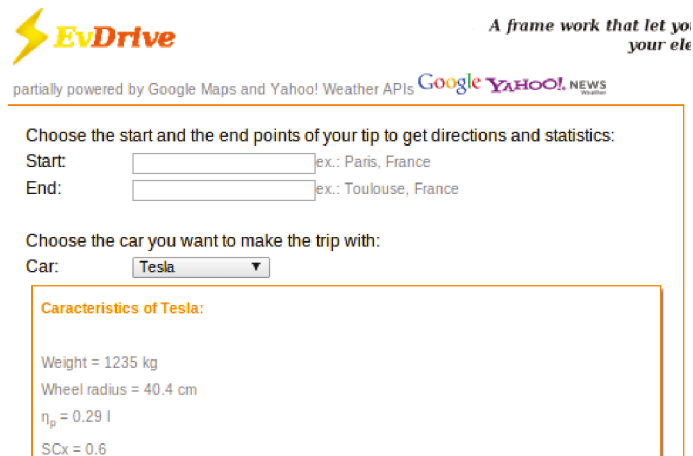

Figure 6.2: Web interface to book electric vehicle

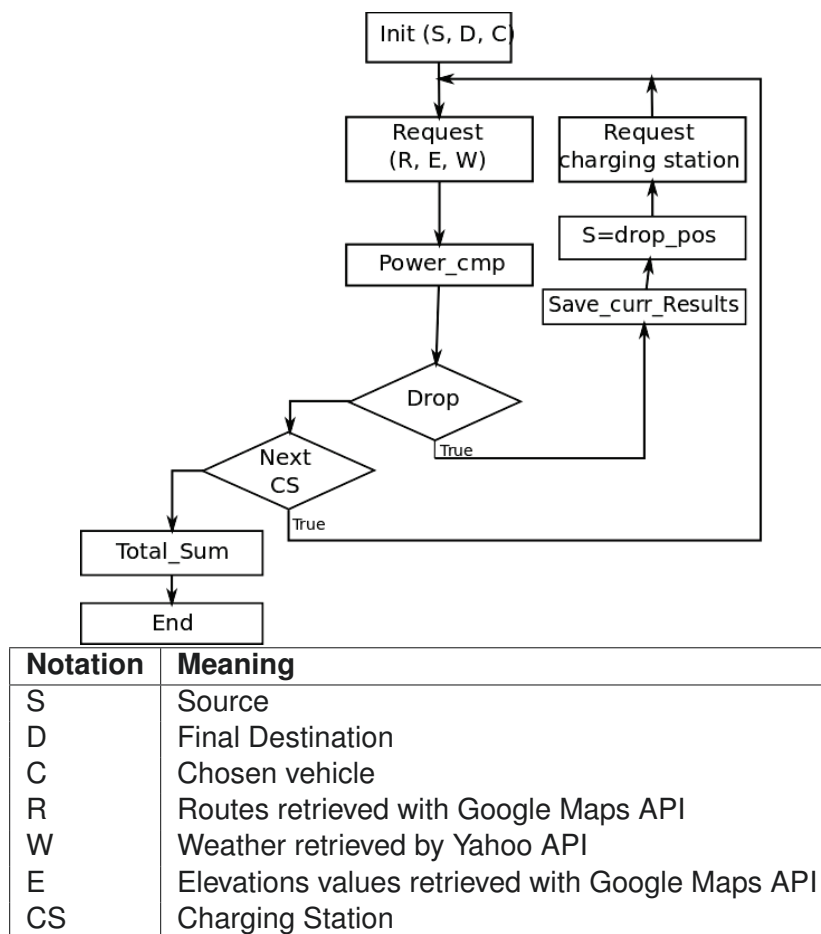

Figure 6.3: Electric power computation diagram

For example, in figure 6.1 when vehicle V1 receives accident notification from vehicle V2 via V2X communication using RDEL, it sends an event to the fleet server. The fleet server retransmits the information to the global server, which calculates itinerary updates. Then, the fleet server transmits the received itinerary updates from the global server to the affected vehicles via LTE or using RDEL depending on current density of the road.

Later, the vehicle stores an aggregated trip information and driver behavior in a black box and sends it to its fleet server using RDEL when they get back to the company. This information helps to enhance fleet management and monitoring.

In the next subsection, we explain the electric power consumption calculation and clarify how weather condition and road topology impact electric consumption.

6.2.2/ ENERGY CONSUMPTION PROCESS

To reduce power consumption, it is important to understand all the factors that can affect the vehicle's driving performance and energy utilization. As with an internal combustion engine (ICE) vehicle, drive range for an electric vehicle is affected by elevation, temperature, speed, use of climate control, and so on. As shown in figure 6.4, many forces act upon the vehicle when it moves at any given speed: F_d , F_r and F_p are the aerodynamic force, the rolling force and the force due to the gravity, respectively.

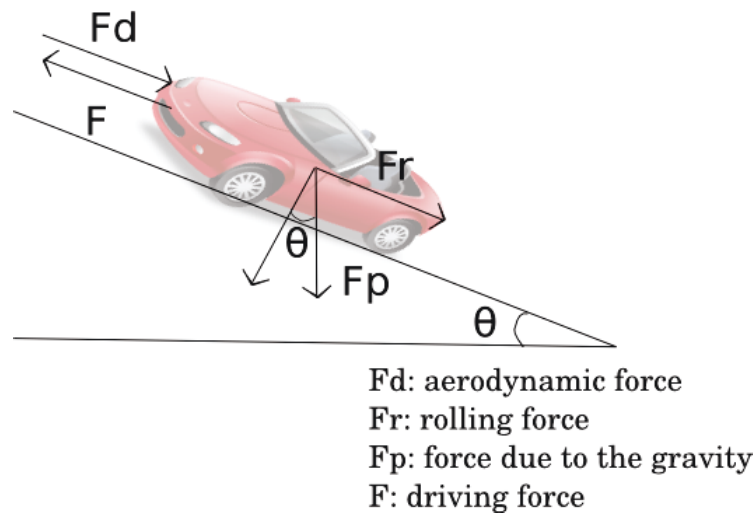

Figure 6.4: Power Consumption

To compute the electric power consumption, we perform the following steps:

First of all, we calculate the force F to drive a car as shown in equation 6.1. The definitions of the variables are given in Table 6.1.

$$\begin{aligned}
 F &= F_d + F_p + F_r \\
 F_d &= \frac{1}{2} \cdot \rho_{air} \cdot S_{C_x} \cdot v_{relative}^2 \\
 F_p &= m \cdot g \cdot \sin(\theta) \\
 F_r &= C_r \cdot m \cdot g \cdot \cos(\theta)
 \end{aligned} \tag{6.1}$$

The second step consists in computing the needed power P that overcomes the force resistance. P is given by equation 6.2.

$$P = F \cdot v, \text{ where } v \text{ is the speed} \tag{6.2}$$

After that, we need to calculate the effective power P_e . Indeed, the real power consumption or the effective power P_e depends on the efficiency of the engine i.e. the useful engine power that the driver has. Compared to fuel cars, electric propulsion systems are characterized by the presence of an electrochemical or electrostatic energy storage system, and the electric motor is totally responsible of the vehicle's propulsion. There are two cases

Table 6.1: Variables' Definition

Variable	Definition
m	mass (KG)
g	gravity value
θ	inclination of the road
v	velocity of the vehicle (m/s)
$v_{relative}$	(m/s) relative velocity (difference between vehicle's and wind speeds)
S	vehicle's frontal surface
air	air friction
Cx	aerodynamic coefficient
Cr	rolling coefficient
W_{EM}	electric motor angular speed
T_{EM}	electric motor torque
ρ	engine's global efficiency
P	power provided by the engine
P_e	effective power provided by the engine

for the effective power computation of electric vehicles, depending on torque and angular speed values (see equation 6.3 if the torque value is positive and 6.4 otherwise).

$$P_e = \frac{P}{\eta} \quad \text{if } (\omega_{EM} > 0 \text{ and } T_{EM} > 0) \quad (6.3)$$

$$P_e = P \cdot \eta \quad \text{if } (\omega_{EM} > 0 \text{ and } T_{EM} < 0) \quad (6.4)$$

where Tork $T = \omega \cdot I$

(where ω is the angular speed

and Inertia $I = \frac{m}{r^2}$

where r is the wheel radius)

The overall efficiency η indicates the percentage of the input power used from that is actually available as propulsion power, taking all losses into consideration. It is a limiting factor on the performance, a higher overall efficiency means that the battery capacity is used more effectively. η could be retrieved directly from the efficiency map and in this case (see equation 6.5, where equations 6.3 and 6.4 are combined in one level curve map [124]). Further details on power consumption are given in [117].

$$P_e = P \cdot \eta \quad (6.5)$$

At the end, the power consumption is divided by $36 \cdot 10^5$ to get the consumption in kW.

Finally, we can sum all the total power consumption of each route i , $P_e(i, j, k)$ being P_e for the k sub-segment of the segment j of the route i (see equation 6.6), then we can deduce

what is the most economic route and provide the results to the driver.

$$\sum_{j=0}^{nSeg} \sum_{k=0}^{nSubSeg} P_e(i, j, k) \quad (6.6)$$

6.3/ PROOF OF CONCEPT

This section describes how we implemented a part of the previously presented architecture. This implementation consists of the most important and complex entities of the system: the global and company's fleet server.

On the global server's side, all databases are created, the first one is filled in with vehicles' characteristics (name, weight, S, Cx, battery capacity, battery type, etc), in second one we add all information about charging stations (address, recharge type, prices, etc.), and we are currently collecting information about roads and drivers profiles for the third database (work in progress within the European CarCoDe project).

All API requests required to calculate the power consumption are implemented, and the primary server is able to keep the cached results for later reuse. Our solution uses three main types of API requests: in the first one, we obtain using Google map API all possible path between any source and a destination. Indeed, Google map API already offers a free route computation service, and it would have been pointless and unnecessary for us to do our own route computation algorithm in this context. In the second request and using the same API, we get more details about each segment of the road such as speed limits, road elevation, etc. In the last API request, we obtain using Yahoo API weather conditions such as temperature, wind speed, etc.

After obtaining all information using API requests and local databases (vehicle characteristics), we calculate in the global server the power consumption for each possible route in order to know which is the most economic. The consumption computation process presented in Section 6.2.2 is also fully programmed on the global server. In the company's fleet server we developed the web application using PHP and JavaScript to efficiently book electric vehicles and display the routes' computations results received from the global server. To illustrate the results, we give an example of the economic itinerary calculation in both non-drained battery and drained battery cases. In both cases, the possible routes are displayed on a map and all consumption, duration and distance details are given in the right side as shown in 6.3.

In case of critical battery state, the Ev-planning application generates alternative routes that include the nearest charging station, as depicted in 6.3, where the green circle marker is the drop position, the pink and the green pins markers are nearest charging stations; with pink color to indicate that the charging station is chosen in one of alternative path. From the position where the battery drops, we see that three routes are provided to charge the battery and reach the final destination. The final power consumption is the sum of the consumption from the source to the drop position and from the drop position to the final destination, passing through the charging station.

The majority of the previously architecture blocks are implemented, and we are working on additional services, such as Smartphone notification and charging station reservation. A real fleet of vehicles is not yet tested, but the architecture is functional and can be soon fully deployed.

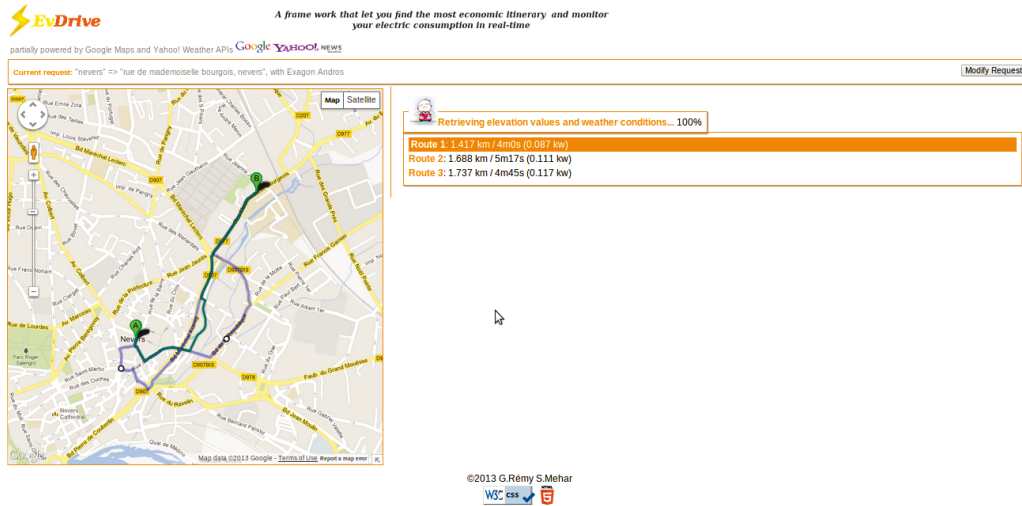

Figure 6.5: Result in case of non-drained battery

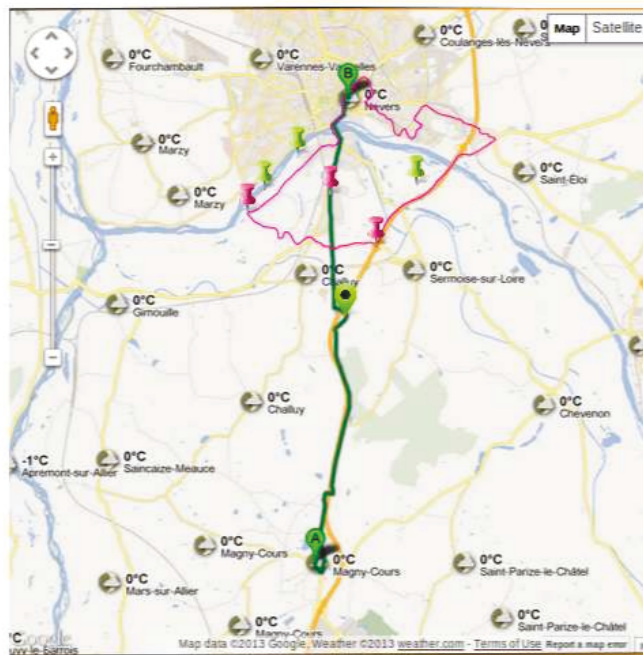

Figure 6.6: Result in case of drained battery

6.4/ CONCLUSION

In this chapter we proposed an advanced fleet management architecture for electric vehicles. This architecture offers several real time services to the fleet management companies in order to enhance the fleet monitoring. It collects data from fleet vehicles to provide the best economic itinerary. The electric power consumption is computed based on the moving force of vehicles and the effective power needed to overcome the force

resistance. In case of battery drop, it generates routes passing through nearest available charging stations. This architecture is the first solution that considers both electric vehicle short autonomy and all factors that can impact the power consumption. Also, the collected information helps to locate unexpected events and improve accuracy of the planned itinerary. This architecture fit with an important sustainable mobility challenges related to energy efficiency. However, we noticed that the random distribution of charging stations may lead to energy imbalance, especially when energy demand exceeds electric supplies' capacity. Thereby, we propose in the next chapter a new Optimized Location Scheme for electric charging stations (OLOCs) that aims to grantee equilibrium of energy distribution based on drivers demands.

OPTIMIZED DEPLOYMENT OF ELECTRIC VEHICLES' CHARGING STATIONS

7.1/ INTRODUCTION AND PROBLEM STATEMENT

As mentioned in previous chapters 5 and 6, the introduction of alternative vehicle technologies such as electrical vehicles aims to achieve a sustainable mobility. However, it brings new challenges such as a balance between vehicle recharging and available energy. Indeed, charging infrastructures are paramount for the imminent organization of large-scale electric vehicles systems, and they need be in place prior to the introduction of a electric vehicles. To that end, a lot of efforts are done to install the necessary infrastructure and facilities such as charging station, electricity factory and solar panel, etc. In this chapter we focus on electric vehicles' charging stations deployment. We first present existing solutions and then, we propose our new deployment solution.

Charging stations placement is a location optimization problem. In this field, many works are proposed and the most known are facilities location and covering location. In facilities location problem, each facility [112] [163] has to be placed optimally in order to distribute goods to the clients with a minimum cost. The considered criteria are relative to the client position and investment cost. In covering location problem, the goal is to find the optimal positions to cover the clients demand (e.g. RSUs location as seen in chapter 4).

For the charging stations placement problem, the goal is to satisfy the clients' energy demands while taking into account the capacity of energy resources. Many works are done to optimally place the charging stations. In [118] the authors proposed a method of locating and sizing charging stations for electric vehicles. The idea is to divide a Manhattan area into a small identical grid. In each grid, they calculated the traffic sum of all intersection, and then deduced the cost of the transportation power consumed toward the charging station. They estimated the number of initial partitions based on the charging demand of the electric vehicles in the planning area and the maximum and minimum capacity of a charging station. They supposed the cost of power loss equal to the sum of weighted distance from the charging station to the demand nodes in the service area. A *Genetic algorithm* (GA) is used to get the best solution to minimize the loss. In each step of GA, they adjusted the partition depending on demand. At the last iteration, the GA gives the final number of charging stations with the best distribution. However, this solution does not take into account the investment constraint. Also, the traffic density of the

road is not considered in the formation of the initial partition. This implies that the solution is not global and depends on the chosen scenario. In [155], the authors' goal is to find the optimum placement of portable charging stations to serve electric vehicles in case of peak hours and overload demand or outage. The architecture of the solution is composed of portable energy storage stations and the operation center to manage the distribution of these stations. Each electric vehicle sends the battery's state to the operation center periodically or in demand. Based on the collected information, the operation center calculates the optimum point for deploying a single portable charging station that has the maximum total reward (successful travel). The portable charging stations are equipped with sensors to measure their remaining energy level to be replaced when they are out of energy. The exchanged messages between operator center and electric vehicle are transmitted with optional communication protocols, using a peer-to-peer or centralized approach. This method allows EVs to a better load balancing of the power. However, this solution is not well detailed; it suggests using sufficient number of mobile charging stations and then calculates the rate of electric vehicles' travel without draining. It supposes that the best position to place charging stations is the points that maximize the rate of successful travel. However, no method is proposed to get these optimal points. In [207], the authors proposed an optimization model of charging station planning for electric vehicles. This solution combines the global searching ability of the particle Swarm Optimization and weighted Voronoi diagram. The area is partitioned with Voronoi diagram and then the Swarm Optimization is applied to get the best distribution of charging stations.

We notice that most of these works focus on some parameters and ignore others. Usually only the distance between clients and the charging station parameter is considered. In addition, the details of the solutions are not sufficient and no performance evaluations are given. In next subsection 7.2, we describe how we solve charging stations location problem using our optimization location scheme for electric charging stations (OLOCs) that takes into account energy demand and energy availability for a given area.

7.2/ AN OPTIMIZATION LOCATION SCHEME FOR ELECTRIC CHARGING STATIONS (OLOCs)

Our aim is to minimize the deployment costs of new charging stations in order to satisfy the customer demands. We take into account many factors and constraints to have a real model that can be used in any area or topology. In our work, we consider the following parameters:

- Area traffic density (helps to deduce the energy demand),
- Land cost, infrastructure cost, investment cost,
- Transportation cost toward the charging station,
- Charging station's capacity (Capacity),
- Electric grid capability (Total Capacity).

7.2.1/ OPTIMIZATION PROBLEM MODELING

In our work, we need to answer these questions: how many charging stations are needed in a given area? Where can we deploy them? How to assign clients to the charging stations and respect constraints? So, we propose to model this problem as follows:

Let $I = \{1, \dots, m\}$ be the set of possible locations to establish a charging station, $J = \{1, \dots, n\}$ be the set of customers, C_{ij} denoting the amount of transportation from charging station i to customer j , d_j be the demand of customer j and a_i be the opening cost of charging station i . Let y_i be a decision variable that is not null if the charging station i is opened and X_{ij} a binary variable not null if the client j is assigned to charging station i , and W_i is the i^{th} charging station capacity. These variables are summarized in the table 7.1.

Variable	Notation
Investment cost to build charging station i	a_i
Capacity of the charging station i	W_i
Binary decision variable of affecting client j to charging station i	X_{ij}
Decision variable to open or not charging station i	y_i
Transportation cost of client j toward charging station i	C_{ij}
Client j demand	d_j
Max charging station	m
Client number (Demand cluster number in our case)	n

Table 7.1: OLoCs mathematic notation

In order to optimize the placement of charging stations, we must minimize two objectives functions: F_1 minimizes the investment cost equation ^(7.2) and F_2 minimizes the transportation cost ^(7.3). We combine the two functions into a single objective function F ^(7.1):

$$F = \alpha F_1 + \beta F_2 \quad (7.1)$$

$$F_1 = \min \sum_{i=1}^m a_i \cdot y_i \quad (7.2)$$

$$F_2 = \min \sum_{i=1}^m \sum_{j=1}^n C_{ij} \cdot x_{ij} \quad (7.3)$$

Where α and β represent the weight of each function. We choose $\alpha=\beta = 1$ to give equitable importance to the investment and transportation costs.

The solution feasibility depends on different constraints represented by the following equations: ^(7.4) ensures that client j is affected only to one charging station; ^(7.5) guarantees that the sum of energy demand d_j is smaller than the charging station capacity; finally, ^(7.6) and ^(7.7) are the integrity constraints.

$$\sum_{j=1}^m x_{ij} = 1 \quad (7.4)$$

$$\sum_{j=1}^n d_j \cdot x_{ij} < W_i \quad (7.5)$$

$$x_{ij} \in \{0 - 1\} \quad (7.6)$$

$$y_i \in \{0, 1, 2, \dots, n\} \quad (7.7)$$

In the next sub-section, we explain how to apply our solution to solve the charging station location problem.

7.2.2/ OLoCs RESOLUTION

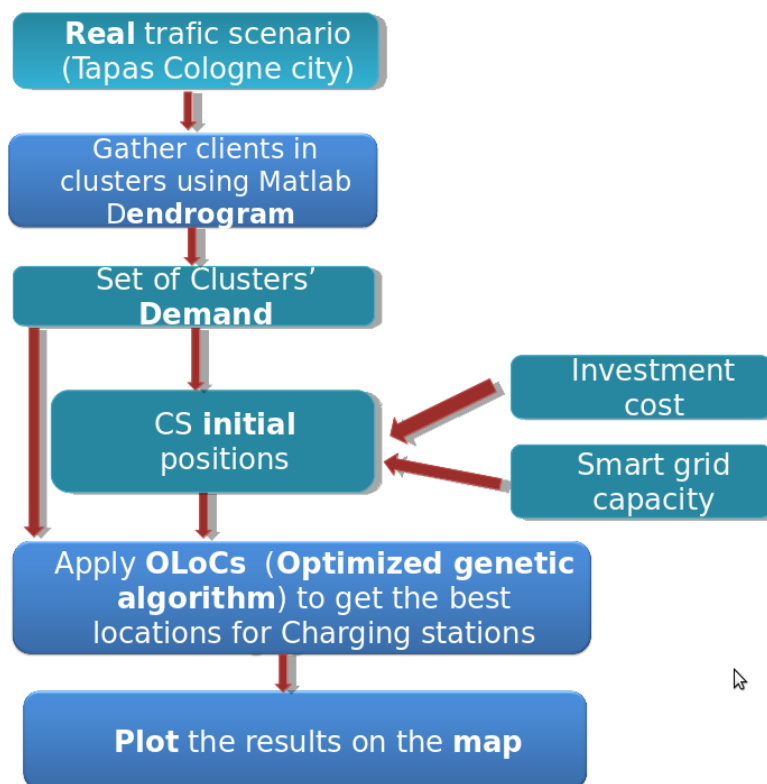

Figure 7.1: OLoCs steps

Our objective is to find the necessary number of charging stations and the best positions to locate them in order to satisfy the clients demand. Thus, we resolve the mathematical model defined in 7.2.1 in two steps as shown in figure 7.1. The first step preprocesses the input data (traffic scenario and the map of studied area). Indeed, instead of using a big number of clients (thousands of vehicles), we gather them into groups using a hierarchical clustering algorithm. Then, we calculate the energy demand for each cluster to use it as an input of the second step. The second step, solves the location problem using our optimized genetic algorithm called OLoCs. In fact, the location problem is Np-hard problem; thus, we use heuristic solution instead of an exact solution, which is

not adequate for a big number of variables and constraints. In the genetic algorithm, we introduce a new operator "permute" that helps to find the optimal solution and avoid premature convergence, using some intelligent permutation. Hence, the preprocessing step and the optimized genetic algorithm reduce the execution time and get the optimal solution rapidly. Herein we give more details about the two resolution steps.

7.2.2.1/ FIRST-STEP: PREPROCESSING

In this step, we get real time traffic in a peak hour; we subdivide the studied area into n square (e.g. $1km^2$); we use Matlab [32] Dendrogram to split data and form n hierarchical clusters; after that we calculate the one hour demands for each cluster using equation (7.8) and table 7.2. This demand depends on the rate of electric vehicles, traffic, charging station capacity and daily driving trip [149] [118].

$$d_k = \sum_{k=1}^{nb} T_k \cdot E_r \cdot CsCapacity \cdot dur \cdot D_r \quad (7.8)$$

Parameter	Value
Electric vehicles rate (E_r)	6%
Charging demand rate (D_r)	3%
Charging station capacity (CsCapacity)	22Kva
Daily driving	30km
Sufficient charging duration (dur) for daily driving	1/4 hours
One hour traffic in sub zone k	T_k

Table 7.2: Charging demand parameters

Where d_k is the demand in cluster k , and nb is the number of clusters. We summarize the area partitioning and energy demand calculation in algorithm 7.1.

Algorithm 7.1 pseudo-code of OLOCs preprocessing

Input (traffic trace, Area map)

Subdivide the area in a small sub-grid;

Merge the sub-grid into hierarchical clusters using Dendrogram;

Calculate the Energy demand in each Demand cluster using (7.8);

Output: (Area partitioning, Charging demand)

7.2.2.2/ SECOND-STEP: GENETIC ALGORITHM

To understand this step, we first define a classical genetic algorithm. Then, we give below the suitable genetic code for our problem and explain the different adaptation introduced to resolve charging stations location problem.

- **Genetic algorithm definition**

A genetic algorithm is one of the evolutionary algorithms developed to resolve optimization complex problems. It encodes a specific problem on a simple chromosome structure, applies to the population genetic operators (crossover, mutation, recombination) to generate new offspring individuals, and using a fitness function it preserves the best individuals. At the end, it gives the best solution to the problem. In fact, we use a genetic algorithm instead of an exact solution as the location problem is Np-hard problem and the exhaustive resolution is inefficient and requires a lot of memory resources for a big number of variables. A heuristic algorithm such as genetic algorithm reminds the better than exhaustive way to consider time and resource constraints simultaneously.

- **Genetic code**

An important step in genetic algorithms is the individual code (chromosome). As depicted in figure 7.2, the chromosome is divided into two parts of information, the first part is the Charging Station (CS) state and the second part is the Clients' iDentifier (CD).

CS1	CS2	CS3	CS4	CD1	CD2	CD3	CD4	CD5	CD6
3	1	0	5	2	3	5	1	6	4

Stations

Clients

Figure 7.2: OLoCs chromosome (genetic code)

When the state of CS_i is null, this means that the CS is closed. Otherwise, CS_i gives the index of the first assigned client to the CSi. Each CS_i has many clients; the number of clients is deduced when we subtract the current index value from the smallest index bigger than the current one. For example in figure 7.2, $CS_1=3$, so the first client is in CD_3 , the next smallest index bigger than the current is $CS_4=5$. Hence, clients CD_3 and CD_4 are assigned to CS_1 . In the same way, $CD_2=1$ and the next smallest index bigger than the current is $CS_1=3$. Hence, CD_1 and CD_2 are assigned to CS_2 . $CS_4=5$ and the next smallest index bigger than the current is the maximum number of client 5 so, CD_5 is assigned to CS_4 . $CS_3=0$ which means that this charging station is closed.

- **Crossover**

The cross over is done on a selected part of population. We use the roulette wheel [157] selection method to stochastically select from one generation to create the basis of the next generation. We chose to use the two-point crossover [173].

- **Mutation**

This operation is a random change in the population. In our solution, we use a Gaussian mutation [209] that modifies one or more gene values in a chromosome to have a new chromosome value in the pool.

- **Permute**

As we use two-point crossover on non-ordered chromosomes, the offspring chromosomes may contain some individual with repeated affectations. We add this step to delete the repeated affectations and ensure that each client is affected at most

one time to any charging station. This operator also corrects the non-feasible solutions, when the capacity constraints are not respected or when some clients are not affected at all. To do this, we use permutation and change the clients' assignments to ensure that the charging station's capacity is not violated and that the clients are affected to the nearest charging station.

- **Recombination**

Recombination combines the chromosomes from the initial population and the new offspring chromosomes.

- **Objective function**

In order to calculate the cost of each chromosome configuration, we use equation (7.1), which is equal to (7.9) by replacing F_1 and F_2 by equations (7.2) and (7.3) respectively. The objective function helps to find the chromosomes with the best fitness value (i.e. the best solution).

$$F = \min \left(\sum_{i=1}^m a_i \cdot y_i + \sum_{i=1}^m \sum_{j=1}^n C_{ij} \cdot x_{ij} \right) \quad (7.9)$$

- **OLoCs algorithm**

After the definition of all operations, we apply the OLoCs genetic algorithm 7.2. With

Algorithm 7.2 pseudo-code of OLoCs genetic algorithm

Input: (Clusters of demand, Area coordinates, initial position)

Population.*Create*("random", initial population)

Population.*CalculateFitness*()

while (!stop condition) **do**

 Offspring = *Select*("Roulette- wheel", Population, Nb-chromosomes)

 Offspring.*Crossover*("2-point", Pc) ;

 Offspring.*Mutation*("Gaussian", Pm) ;

 Offspring.*Permut*() ;

Recombination("Keep-Best", Offspring, Population);

end while

Population.*BestSolution*()

Output: (Nb CS, position CS)

Pc (resp. Pm) is the crossover probability (resp. mutation probability).

7.3/ PERFORMANCE EVALUATION

In this section, we study "Tapas Cologne" town scenario and we present the results of charging station deployment after applying our solution.

7.3.1/ CASE-STUDY: TAPAS COLOGNE

The "TAPAS Cologne" simulation scenario describes the traffic within the city of Cologne (Germany) from 6:00 to 8:00 am, which is considered as peak hour. This scenario is generated based on information about traveling habits in this city [54] (see figure 7.3).



Figure 7.3: Tapas Cologne city's map

As described in the first step 7.2, we subdivide the studied area (64Km^2) using algorithm 7.1 in order to reduce the number of variables. Instead of 26 000 clients, we use 30 clusters (the number of clusters is variable and depends on the maximum allowed capacity by a cluster). To calculate the number of charging stations, we divide the total charging demand by the minimum charging stations capacity. In the second step, we use our OLoCs algorithm 7.2 to get the best location. As shown in figure 7.4, we can see that 11 stations out of 16 were chosen. Figure 7.5 shows the final partition where we mark out the clusters assigned to the solution charging station.

7.3.2/ RESULTS

All the tests were carried out on Intel i5 64Bits with 4 Go of memory. We summarized in table 7.3 the results of 100 simulations for each scenario. Each scenario is represented by 3 rows: Best solution, Average solution and Worst solution. For example, Best solution in scenario1 (16:30) is the best solution to plan 16 charging stations for 30 demand clusters. Column Fitness represents the final cost of the solution; Time column is the execution time, Nb_{Iter} column is the number of necessary iteration and $NBC_{S_{Final}}$ is the number of charging station to deploy. As no benchmark scenarios are available in the Internet for charging station deployment, we generate different scenarios, where we vary the chromosomes size, the cost constraints' value and charging capacity. We repeated the tests 100 times and in each test we run the algorithm for 4000 to 9000 iterations or less if we get the same fitness after 400 iterations. The size of initial population is 100 chromosomes.

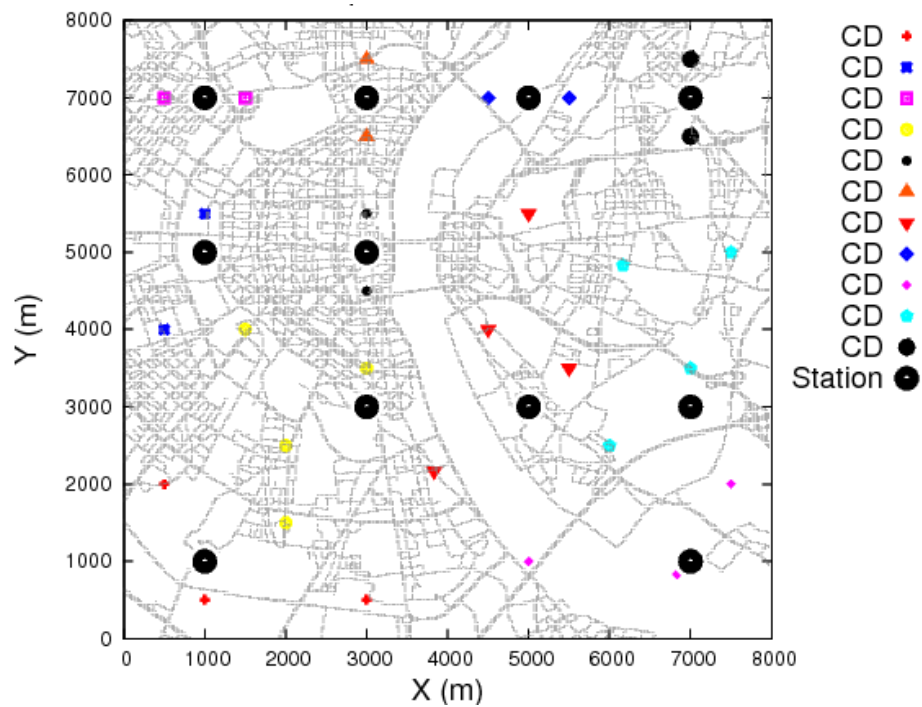

Figure 7.4: The CS optimized location with aggregated clients (clusters)

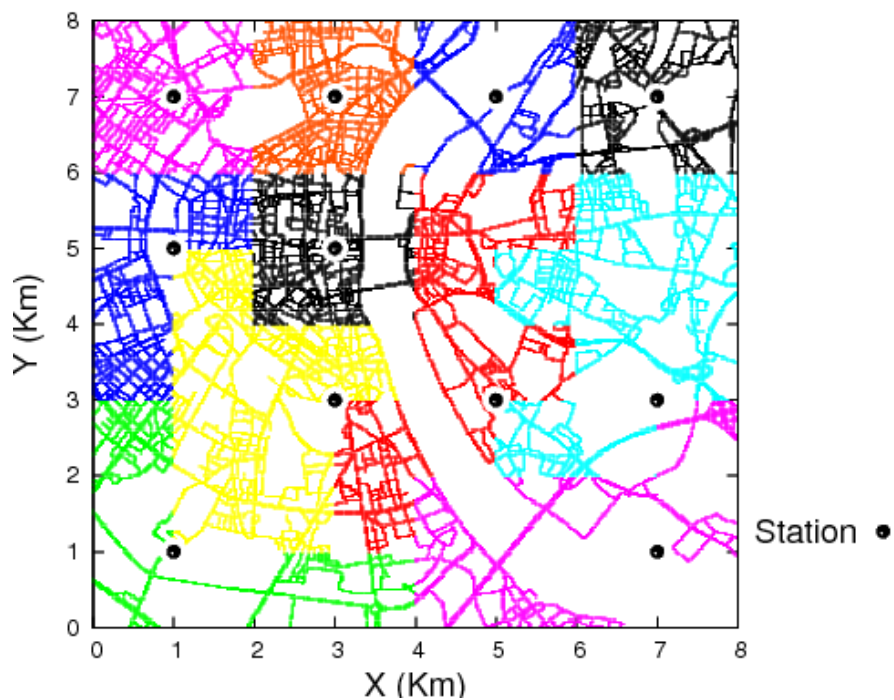

Figure 7.5: The CS optimized location with real clients (clusters zoom)

Even if the initial population is completely random, the results show that OLoCs algorithm is able to find the optimal solution after a short time. The variation in the results is due to the fact that in our scenario the demand clusters have no equitable load, which results to more computation. To validate our approach, we compare our approach to an exact so-

Sol	NbCs_{Init}	Nb clients' clusters	NbCs_{Final}	Nb_{Iteration}	Fitness	Time
Best solution in scenario1 (16:30)	16	30	12	183	4620	0.06
Average solution in scenarion1 (16:30)	16	30	12	682	5354	0.25
Worst solution in scenario1 (16:30)	16	30	13	3850	5909	1.27
Best solution in scenario2 (25:64)	25	64	16	350	9858	0.24
Average solution in scenarion2 (25:64)	25	64	16	4240	11720	2.3
Worst solution in scenario2 (25:64)	25	64	17	8055	13325	4.46

Table 7.3: OLoCs performance results

lution generated by Cplex [8]. The results, represented in table 7.4, correspond to a new scenario with 9 charging stations for 15 demand clusters. For this simple scenario, we

Approach	NbCs_{Final}	Fitness	Type	Time
OLoCs	7	2732	Optimal	0.01
CPLEX: MIP	7	2732	Optimal	0.03

Table 7.4: Comparison between OLoCs and exhausted solution

can notice that the exact solution is slowest and we can clearly state that it is expected to worsen with more complex scenarios. We remind that it is possible to use only exhausted solution to solve the location problem. However, exhausted solution is limited in term of scalability and requires a huge amount of memory and processing resources. The performance results confirm that OLoCs finds the optimal fitness more rapidly than the exact solution, which evaluates all possible solutions and hence, our solution allows us to deploy a mobile charging stations or a battery replacing stations in real-time to support the already deployed one when the demand outstrips the available energy.

7.4/ CONCLUSION

In this chapter, we propose an optimized deployment scheme to optimally place the electric vehicles' charging stations based on traffic data processing. We first mathematically model the problem. Then, we applied a pre-process phase to reduce the complexity of the problem by creating clusters of energy demand from traffic data. After that, we solve the location problem using an optimized genetic algorithm. In this algorithm, we introduced a "Permutation operator" that helps to respect the problem's constraints and to converge to the optimal solution. The results show OLoCs' efficiency in terms of time and optimality. The optimized placement of electric vehicle charging station is very important for new generation of electric cars to ensure a balance between energy demand and energy available capacity. In addition, OLoCs allows to deploy a new charging station or to distribute a portable charging station in case of overload of the existing deployed charging station. Finally, to conclude this second and last part of this thesis, we underline the fact that the emergence of technologies such as the Smart Grid and electric vehicles promise to pave the way toward green transportation management systems. As we shown in these three chapter many projects and standardization efforts are done in regard to various issues related to electric transportation. We presented two of contributions to tackle some inherent challenging problems related energy efficiency and balance. However, as shown in challenges subsection 5.6, various architectural components still need to be designed, implemented, or deployed to make a green transportation system a reality.

In the next chapter we conclude this thesis and we present out future work.



CONCLUSION AND PERSPECTIVES

CONCLUSION AND PERSPECTIVES

8.1/ CONCLUSION

Transportation has greatly evolved through time to make our travel faster, safer and more comfortable. Today, it embeds several electronic entities and integrates different communication interfaces inside vehicles to make them smart and connected. In addition, new vehicles may include electric motors that provide a clean and safe alternative to the internal combustion engine. These innovative technologies make transportation more and more sophisticated. However, they still require to be efficiently incorporated together in order to draw the maximum benefits in the future. Thus, we focused our attention in this thesis on how to overcome new transportation challenges to meet the ever-increasing levels of complexity and efficiency of this domain. Hence, we dealt on two main aspects: connected mobility and sustainable mobility. For the first aspect, we proposed new information dissemination and routing strategies that fit perfectly with the special characteristics of vehicular context. Then, for the second aspect, we proposed new architecture and applications that mainly provide energy efficiency and balance for sustainable means of transportation by processing relevant information collected using our routing protocol. Below we conclude our contributions for both connected and sustainable mobility.

We dedicated the first part of our thesis to cover different ways to exchange information in the context of connected mobility. We first presented new communication technologies, standardization efforts and the challenges that face information dissemination and routing in this context. Then, we analyzed the major dissemination contributions and we proposed a new dissemination protocol (DHVN). DHVN's performance results confirm that choosing a relay based on his height, his positions and related traffic density improves significantly data delivery and reduce the required time to spread information in the whole area of broadcast.

After that, we studied the existing routing protocols which focused mainly on increasing data delivery ratio while they missed to consider intermittent connectivity in a vehicular environment, which impacts considerably the end-to-end delay. Thus, we proposed two complementary contributions to improve data routing based on infrastructure. In the first contribution, we proposed a new strategy to deploy roadside units (RSUs) for delay-sensitive applications based on traffic information. In the second contribution we implemented a new routing protocol that uses both vehicle to vehicle and vehicle to infrastructure communication to route information toward destinations. The results of these two contributions show that routing information through the optimally deployed RSUs and using extra traffic information enhance reliability and reduce significantly the delay. Hence,

our solutions are more adequate to delay-sensitive applications.

As we mentioned above, in the second part of this thesis, we addressed sustainable mobility, we described the architectural components of a future sustainable means of transportation, and we reviewed current solutions, projects and standardization efforts related to green transportation with particular focus on electric vehicles. We also highlighted the main issues that face the deployment of electric vehicles such as short autonomy, lack of necessary charging infrastructures, energy unbalance, etc. Thus, we proposed new solutions and services to cope with these limits. As first solution, we proposed fleet management architecture for electric vehicles (Ev-Drive). Ev-Drive considers vehicles as source of traffic information and as a consumer of services. Ev-Drive offers several real-time services to fleet management companies based on data collection, exchange and processing. It mainly provides the best itinerary planning in term of energy consumption for electric vehicles. Ev-Drive allows electric vehicle to travel long-distances and to charge its battery when needed and it adjusts the planned itinerary in real time when an event is registered during the trip. From this work, we noticed that the electric battery can impact the electric grid when charging demands increase in high density areas. Therefore, to further ensure an energy balance, we proposed in the second solution OLoCs to optimally deploy electric vehicle charging stations based on traffic density processing, related charging demands and available energy resources in the studied area. This solution helps to share efficiently the energy and avoid the charging concentration on single charging station.

To conclude these two parts, the key issue of this intensive work is to use efficiently communication technologies to meet new transportation systems requirements such as delay constraints and energy efficiency. We believe that we achieve our goal in one hand by implementing robust dissemination and routing protocols that consider the special characteristics of vehicular context, and in the other hand by proposing new application and services for sustainable transportation based on data exchange and processing. Our work can be extended to address new related challenges and issues in the future to have a fully functional and cost-effective transportation system. We tackle these points in our future work described in the next section.

8.2/ PERSPECTIVES

In pursuit of our thesis projects, this chapter provides our perspectives for research or direct applications of our contributions in this thesis. First of all, as a direct application of our work, we start to work on a CarCoDe project's platform to implement our routing protocols and test our Ev-Drive architecture. In addition, we envision to continue research on our previous contributions to enhance both connected mobility and sustainable mobility.

In connected mobility, we aim to improve the DHVN protocol by adjusting transmission frequency and using RSUs when no relays are available. Moreover, we plan to go further in the delay analysis started in chapter 4 and to analytically study the impact of high data traffic on ODEL and DHVN routing solutions to see how can we extend them to support new real-time applications such as: file download, video transmission, etc. Furthermore, in our thesis we focused on communication without taking into account security problems. Thus, we plan to include a security layer to protect data exchange from intruders (DoS, selfish, etc.). Furthermore, we intend to evaluate our protocols using our simulation

framework detailed in appendix A for applications that require an interaction between the traffic generator and the network simulator such as an emergency warning dissemination, where vehicles should change their itinerary to avoid a danger.

For sustainable mobility part, we aim to undertake more original investigations to better integrate the different sustainable transportation entities to gather. As we above mentioned, the sustainable mobility sector is still in earlier stages, it brings many new challenges which drive us to follow these challenges and seek to improve current advancement state by proposing new management solutions and identifying measurements and best conditions to deploy and use efficiently energy infrastructures and sustainable means of transportations. We plan also to make intensive simulation and tests to validate our work and consider new parameters such as drivers behavior, energy dissipation and battery life-cycle.

Journals**-2014**

- S. Mehar, Z. Sheraly, S. M. Senouci, and G. Remy, "Sustainable Transportation Management System for a Fleet of Electric Vehicles (STMS)," Accepted in IEEE Transactions on Intelligent Transportation Systems.

- S.-M. Senouci, H. Sedjelmaci, S. Mehar, B. Villeforceix, P. Martinolli, and F. Benbadis, "Véhicule connecté : Architectures, Normes, Défis et Solutions," Revue de l'Electricité et de l'Electronique (REE N4), A paraitre en Novembre 2014.

International conferences and workshops**-2014**

- S. Mehar, S. mohammed Senouci, A. kies "An Optimized Roadside Units (RSU) Placement for Delay-Sensitive Applications in Vehicular Networks", IEEE CCNC'2015, Las vegas, US, 9-12 January, 2015.

-2013

- S. Mehar, G. Rémy, SM. Senouci, "EV-Planning: Electric Vehicle Itinerary Planning", IEEE SaCoNet'2013, Paris, France, 17-19 June, 2013.

- S. Mehar, G. Rémy, SM. Senouci, "An Optimization Location Scheme for Electric Charging Stations", IEEE SaCoNet'2013, Paris, France, 17-19 June, 2013.

-2012

- A. Kies, S. Mehar, B. Rodwane, Z. Mekkakia Maaza, SM. Senouci, "Self-organization Framework for Mobile Ad Hoc Networks", IEEE IWCMC'2012, Cyprus, 27-31 August 2012.

- S. Mehar, G. Rémy, SM. Senouci, "Dissemination Protocol for Heterogeneous Cooperative Vehicular Networks", IEEE Wireless Days 2012, Dublin, Ireland, 21-23 November 2012.

- S. Zemouri, S. Mehar, SM. Senouci, "HINTS: A Novel Approach for Realistic Simulations of Vehicular Communications", IEEE GIIS 2012, Choroní, Venezuela, 17-19 December 2012.

- G. Rémy, S. Mehar, T. Sophy, SM. Senouci, F. Jan, Y. Gourhant, "Green Fleet Management Architecture: Application to Economic Itinerary Planning", IEEE Globecom'12 Workshop: Green Internet of Things, Anaheim, CA, USA, December 7th 2012.

- Talks

- S. Mehar, G. Rémy, SM. Senouci, "EV-Planning: Electric Vehicle Itinerary Planning", REVE2014, PARIS, France, 06 JUNE 2014.
- S. Mehar, G. Rémy, SM. Senouci, "EV-Planning: Electric Vehicle Itinerary Planning", JNCT2013, NEVERS, France, 29-30 MAI 2013.
- S. Zemouri, S. Mehar, SM. Senouci, "HINTS : HYBRID Integration between network and traffic simulators ", JNCT2013, NEVERS, France, 29-30 MAI 2013.
- S. Mehar, SM. Senouci, "An optimization Location Scheme for Electric Vehicle Charging Stations", JNCT2013, NEVERS, France, 29-30 MAI 2013.
- S. Mehar, SM. Senouci, "Heterogeneous and Road-Oriented Dissemination Protocol for Cooperative Vehicular Networks", JNCT2012, Clermont-Ferrand, France, 30 Aout 2012.

BIBLIOGRAPHY

- [1] 3rd Generation Partnership Project (3GPP). <http://www.3gpp.org/>.
- [2] Appel CarPlay. <https://www.apple.com/ios/carplay/>.
- [3] Automotive Buses. http://www.interfacebus.com/Design_Connector_Automotive.html.
- [4] CAR 2 CAR Communication Consortium. <https://www.car-2-car.org/index.php?id=5>.
- [5] CarCode. <https://itea3.org/project/carcode.html>.
- [6] CarStations. <http://www.carstations.com>.
- [7] CARWINGS-Japan. <http://www.nissan-global.com/EN/ENVIRONMENT/SOCIAL/CARWINGS/>.
- [8] Cplex. <http://www-01.ibm.com/software/integration/optimization/cplex-optimizer/>.
- [9] CVIS. <http://www.cvisproject.org/>.
- [10] DRIVE-C2X. <http://www.drive-c2x.eu/project>.
- [11] Electric Car Costs vs Gasoline Cars vs Hybrids. <http://www.carsdirect.com/car-pricing/new-electric-car-costs-vs-standard-gasoline-vehicles>.
- [12] Electric Drive Transportation Association, EDTA. <http://www.electricdrive.org/#sthash.RWpWUMMG.dpuf>.
- [13] Electric Vehicle Charging Station Locations. http://www.afdc.energy.gov/fuels/electricity_locations.html.
- [14] Electronic spark timing.
- [15] Energy consumption, CO2 emissions and other considerations related to Battery Electric Vehicles. <http://www.going-electric.org/>.
- [16] ETSI TS 102637-2 Intelligent Transport Systems (ITS); Vehicular Communications; Basic Set of Applications; Part 2: Specification of Cooperative Awareness Basic Service. Technical report.
- [17] EuroElectric. <http://www.eurelectric.org/>.
- [18] European Telecommunications Standards Institute. www.etsi.org.
- [19] Federal Communications Commission Fcc. <http://www.fcc.gov/>.
- [20] GeoNet - INRIA. <http://raweb.inria.fr/rapportsactivite/RA2008/imara/uid89.html>.
- [21] Go electric. <http://www.goelectricdrive.com>.

- [22] Hybrid and EV First and Second Responder Recommended Practice, J2990-201211. Technical report.
- [23] IAP-Australia. <http://www.tca.gov.au/certified-services/iap>.
- [24] IEEE Standard for Information technology–Telecommunications and information exchange between systems Local and metropolitan area networks–Specific requirements Part 11: Wireless LAN Medium Access Control (MAC) and Physical Layer (PHY) Specifications Ame. *IEEE Stand. Inf. Technol. Inf. Exch. between Syst. Local Metrop. area networks–Specific Requir. Part 11 Wirel. LAN Mediu. Access Control Phys. Layer Specif. Ame*, pages –.
- [25] injection system. <http://www.gerrysap.com/efi.html>.
- [26] intellidrive-program. <http://deviceguru.com/us-dot-ditches-intellidrive-program-name/>.
- [27] ISA australia. <http://roadsafety.transport.nsw.gov.au/aboutthecentre/research/roadsafetytechnology/isa/index.html>.
- [28] ISO 26262 Software Compliance: Achieving Functional Safety in the Automotive Industry.
- [29] ITETRIS simulator. <http://www.ict-itetris.eu>.
- [30] Japan Honda project. <http://world.honda.com/news/2011/c110523E-KIZUNA-Project/>.
- [31] LIN bus. http://www.specifications.nl/lin/lin_UK.php?requestedpage=1.
- [32] Matlab. www.mathworks.com.
- [33] MOST. <http://www.mostcooperation.com/home/index.html>.
- [34] MOVE simulator. http://lens.csie.ncku.edu.tw/Jo%5Bonline%5D,omla_-version/%0Aindex.php/research-%20projects/past/18-rapid-vanet.
- [35] New traffic information system model project. http://www.nissan-global.com/EN/NEWS/2013/_STORY/130913-03-e.html?rss.
- [36] ns3. <http://www.nsnam.org>.
- [37] Omnet++. <http://www.omnetpp.org/>.
- [38] Open Automotive Alliance (OAA). <http://www.openautoalliance.net/#about>.
- [39] Open street map. <http://www.openstreetmap.org>.
- [40] PATH California. <http://www.path.berkeley.edu/>.
- [41] PLATA. <http://www.inrets.fr/linstitut/unites-de-recherche-unites-de-service/leost/projets/projets-termines/plata.html>.
- [42] Project FOTSIS. <http://www.fotsis.com/index.php/about-fotsis/european-context>.
- [43] QualNet simulator. <http://web.scalable-networks.com/content/qualnet>.

- [44] Reducing CO2 emissions from passenger cars, European commission, climate action. http://ec.europa.eu/clima/policies/transport/vehicles/cars/index_en.htm.
- [45] RITA. <http://www.standards.its.dot.gov/Factsheets/Factsheet/80>.
- [46] SCILAB. <http://www.scilab.org/>.
- [47] SCOREF. <https://project.inria.fr/scoref/en/>.
- [48] SeVeCom. <http://www.sevecom.org>.
- [49] Shneider electric. <http://www.pluginamerica.org/accessories?page=2>.
- [50] SKY-Japan. <http://www.nissan-global.com/EN/ENVIRONMENT/SOCIAL/ITS/>.
- [51] Smartcity project ENDESA.
- [52] Southern California Edison. <https://www.sce.com>.
- [53] Sumo: Simulation of Urban MObility. <http://sumo-sim.org/>.
- [54] Sumo tapas Cologne scenario. <http://sumo-sim.org/doc/current/docs/userdoc/Data/Scenarios/TAPASCologne.html>.
- [55] Tesla motors. <http://www.teslamotors.com/goelectric>.
- [56] The Network Simulator - ns-2. <http://www.isi.edu/nsnam/ns/>.
- [57] US Department Of Transport (DOT), Table 3-16: Personal Consumption Expenditures on Transportation by Subcategory. http://www.rita.dot.gov/bts/sites/rita.dot.gov.bts/files/publications/national_transportation_statistics/html/table_04_13.html.
- [58] US Department Of Transport (DOT), Table 4-9: Motor Vehicle Fuel Consumption and Travel. http://www.rita.dot.gov/bts/sites/rita.dot.gov.bts/files/publications/national_transportation_statistics/html/table_04_09.html.
- [59] International standard IEC 62196-1- ed1. <http://webstore.iec.ch/>, 2003.
- [60] IEEE Standard for Wireless Access in Vehicular Environments (WAVE) - Networking Services - Redline. *IEEE Std 1609.3-2010 (Revision IEEE Std 1609.3-2007) - Redline*, pages 1–212, December 2010.
- [61] Vehicle conductive charging system IEC 61851-1, 2010.
- [62] EC 62196-2 ed1.0, 2011.
- [63] Calculations and References, Environment protection agency (EPA), 2012.
- [64] IEEE Standard for WirelessMAN-Advanced Air Interface for Broadband Wireless Access Systems. *IEEE Std 802.16.1-2012*, pages 1–1090, September 2012.
- [65] Renewables Portfolio Standard (RPS). http://www.cpuc.ca.gov/NR/ronlyres/3AB3B7C0-DBA1-426C-AA26-88EF69470DC9/0/CPUC01367802v1RPS_Rpt_to_Legislature_-_Q1_2009.pdf, 2012.

- [66] Deploying publicly accessible charging infrastructure for electric vehicles : how to organise the market ? Technical Report July, 2013.
- [67] ECOtality's Blink Network Integrates with Cisco's Home Energy Management Solution, 2013.
- [68] European Vehicle Market Statistics Pocketbook 2013. 2013.
- [69] Global status report onroad safety 2013. Technical report, 2013.
- [70] IEC 62196-3 Ed. 1.0. Technical report, 2013.
- [71] IEEE Draft Standard for the Electrical Protection of Communication Facilities Serving Electric Supply Locations Through the Use of Optical Fiber Systems. *IEEE P487.2/D4, May 2013*, pages 1–31, 2013.
- [72] EV sales' statistic, 2014.
- [73] Khadige Abboud and Weihua Zhuang. Modeling and Analysis for Emergency Messaging Delay in Vehicular Ad Hoc Networks. *GLOBECOM 2009 - 2009 IEEE Glob. Telecommun. Conf.*, pages 1–6, November 2009.
- [74] M. A. Adelman. The Real Oil Problem, 2004.
- [75] Ashish Agarwal, David Starobinski, and Thomas D. C. Little. Analytical Model for Message Propagation in Delay Tolerant Vehicular Ad Hoc Networks. In *VTC Spring 2008 - IEEE Veh. Technol. Conf.*, number May, pages 3067–3071. IEEE, May 2008.
- [76] A Al Masud, M N I Mondal, and K M Ahmed. Vehicular communication system for vehicle safety using RFID. In *Commun. (MICC), 2009 IEEE 9th Malaysia Int. Conf.*, pages 697–702, December 2009.
- [77] Salim Allal and Saadi Boudjit. Geocast Routing Protocols for VANETs : Survey and Geometry-Driven Scheme Proposal Routing protocols in VANETs. pages 20–36.
- [78] Miguel Almeida. *ADVANCES IN VEHICULAR NETWORKING*.
- [79] A Aloisio, V Izzo, and S Rampone. FPGA implementation of a greedy algorithm for set covering. In *14th IEEE-NPSS Real Time Conf. 2005.*, page 5 pp. IEEE, 2005.
- [80] İ Kuban Altınel, Necati Aras, Evren Güney, and Cem Ersoy. Binary integer programming formulation and heuristics for differentiated coverage in heterogeneous sensor networks. *Comput. Networks*, 52(12):2419–2431, 2008.
- [81] Nicola Apollonio and Bruno Simeone. The maximum vertex coverage problem on bipartite graphs. *Discret. Appl. Math.*, 165(0):37–48, 2014.
- [82] Sanjeev Arora, David Karger, and Marek Karpinski. Polynomial time approximation schemes for dense instances of NP -hard problems. In *Proc. twenty-seventh Annu. ACM Symp. Theory Comput. - STOC 95, STOC '95*, pages 284–293, New York, New York, USA, 1995. ACM Press.
- [83] Baber Aslam, Faisal Amjad, and Cliff C Zou. Optimal roadside units placement in urban areas for vehicular networks. In *2012 IEEE Symp. Comput. Commun.*, pages 000423–000429. IEEE, July 2012.

- [84] Baber Aslam and Cliff C Zou. Optimal roadside units placement along highways. In *2011 IEEE Consum. Commun. Netw. Conf.*, pages 814–815. IEEE, January 2011.
- [85] Rainer Bachl, Peter Gunreben, Suman Das, and Said Tatesh. The long term evolution towards a new 3GPP air interface standard. *Bell Labs Tech. J.*, 11(4):25–51, 2007.
- [86] B Bako, F Kargl, E Schoch, and M Weber. Advanced Adaptive Gossiping Using 2-Hop Neighborhood Information. In *Glob. Telecommun. Conf. 2008. IEEE*, pages 1–6, November 2008.
- [87] Nabil Benamar, Kamal D. Singh, Maria Benamar, Driss El Ouadghiri, and Jean-Marie Bonnin. Routing protocols in Vehicular Delay Tolerant Networks: A comprehensive survey. *Comput. Commun.*, i, April 2014.
- [88] Sardar Muhammad Bilal, Carlos Jesus Bernardos, and Carmen Guerrero. Position-based routing in vehicular networks: A survey. *J. Netw. Comput. Appl.*, 36(2):685–697, March 2013.
- [89] Seth Blumsack and Alisha Fernandez. Ready or not, here comes the smart grid! *Energy J.*, 37(1):61–68, January 2012.
- [90] Luciano Bononi, Marco Di Felice, Gabriele D’Angelo, Michele Bracuto, and Lorenzo Donatiello. MoVES: A framework for parallel and distributed simulation of wireless vehicular ad hoc networks. *Comput. Networks*, 52(1):155–179, 2008.
- [91] D. Borsetti and J. Gozalvez. Infrastructure-assisted geo-routing for cooperative vehicular networks. *2010 IEEE Veh. Netw. Conf.*, pages 255–262, December 2010.
- [92] M. Brandl, H. Gall, M. Wenger, V. Lorentz, M. Giegerich, F. Baronti, G. Fantechi, L. Fanucci, R. Roncella, R. Saletti, S. Saponara, A. Thaler, M. Cifrain, and W. Prochazka. Batteries and battery management systems for electric vehicles. In *Proc. Des. Autom. Test Eur. Conf. Exhib.*, pages 971–976, March 2012.
- [93] M Brenna, M.C. Falvo, F Foiadelli, L Martirano, and D Poli. Sustainable Energy Microsystem (SEM): preliminary energy analysis. In *Proc. IEEE PES Innov. Smart Grid Technol.*, pages 1–6. IEEE, January 2012.
- [94] Evellyn S Cavalcante, André L.L. Aquino, Gisele L Pappa, and Antonio A.F. Loureiro. Roadside unit deployment for information dissemination in a VANET. In *Proc. fourteenth Int. Conf. Genet. Evol. Comput. Conf. companion - GECCO Companion ’12*, page 27, New York, New York, USA, 2012. ACM Press.
- [95] S. Chakraborty, M. Lukasiewicz, C. Buckl, S. Fahmy, P. Leteinturier, and H. Adlkofer. Embedded systems and software challenges in electric vehicles. *2012 Des. Autom. Test Eur. Conf. Exhib.*, pages 424–429, March 2012.
- [96] K T Chau and Y S Wong. Overview of power management in hybrid electric vehicles. *Energy Convers. Manag.*, 43(15):1953–1968, 2002.
- [97] Changxian Cheng and Jianhua Yan. Research on Energy Supply Modes of Electric Vehicle. In David Jin and Sally Lin, editors, *Adv. Electron. Eng. Commun. Manag. Vol.2*, volume 140 of *Lecture Notes in Electrical Engineering*, pages 291–296. Springer Berlin Heidelberg, 2012.

- [98] M O Cherif, S.-M. Secouci, and B Ducourthial. How to disseminate vehicular data efficiently in both highway and urban environments? In *Wirel. Mob. Comput. Netw. Commun. (WiMob), 2010 IEEE 6th Int. Conf.*, pages 165–171, October 2010.
- [99] Mohamed Oussama CHERIF. *Title : Optimization of V2V and V2I communications in an operated vehicular network*. PhD thesis, 2010.
- [100] Jeonghee Chi, Yeongwon Jo, and H Park. An Effective RSU Allocation Strategy for Maximizing Vehicular Network Connectivity. *Int. J. . . .*, 6(4):259–270, 2013.
- [101] C Ciocan. The Domestic Digital Bus system (D2B)-a maximum of control convenience in audio video. *Consum. Electron. IEEE Trans.*, 36(3):619–622, August 1990.
- [102] Thomas H Cormen, Clifford Stein, Ronald L Rivest, and Charles E Leiserson. *Introduction to Algorithms*. McGraw-Hill Higher Education, 2nd edition, 2001.
- [103] R.M. Daoud, H.H. Amer, H.M. Elsayed, and Y Sallez. Ethernet-Based Car Control Network. In *Proc. Can. Conf. Electr. Comput. Eng.*, pages 1031–1034. IEEE, 2006.
- [104] S D Dissanayake, P P C R Karunasekara, D D Lakmanarachchi, A J D Rathnayaka, and A T L K Samarasinghe. Zigbee Wireless Vehicular Identification and Authentication System. In *Inf. Autom. Sustain. 2008. ICIAFS 2008. 4th Int. Conf.*, pages 257–260, December 2008.
- [105] O. Dousse, P. Thiran, and M. Hasler. Connectivity in ad-hoc and hybrid networks. In *Proceedings. Twenty-First Annu. Jt. Conf. IEEE Comput. Commun. Soc.*, volume 2, pages 1079–1088. IEEE.
- [106] Timo Duchrow, Martin Schroer, Britta Griesbach, Sebastian Kasperski, Fabian Maas Genannt Bempohl, Stefan Kramer, and Frank Kirchner. Towards electric mobility data mining. In *Proc. IEEE Int. Electr. Veh. Conf.*, pages 1–6. IEEE, March 2012.
- [107] Le The Dung and Beongku An. A modeling framework for supporting and evaluating performance of multi-hop paths in mobile ad-hoc wireless networks. *Comput. Math. with Appl.*, 64(5):1197–1205, September 2012.
- [108] M Durresi, A Durresi, and L Barolli. Emergency Broadcast Protocol for Inter-Vehicle Communications. In *Parallel Distrib. Syst. 2005. Proceedings. 11th Int. Conf.*, volume 2, pages 402–406, July 2005.
- [109] J Dziok and H M Srivastava. Classes of analytic functions associated with the generalized hypergeometric function. *Appl. Math. Comput.*, 103(1):1–13, 1999.
- [110] By Martin Eberhard, Marc Tarpenning, and Donald Sadoway. The 21 st Century Electric Car. Technical report, 2006.
- [111] Jochen Eisner, Stefan Funke, and Sabine Storandt. Optimal Route Planning for Electric Vehicles in Large Networks. In *Proc. 25 Int. Conf. Artif. Intell.*, pages 1108–1113, 2011.
- [112] M Adel El-Baz. A genetic algorithm for facility layout problems of different manufacturing environments. *Comput. Ind. Eng.*, 47(2–3):233–246, 2004.

- [113] Mehdi Etezadi-Amoli, Kent Choma, and Jason Stefani. Rapid-Charge Electric-Vehicle Stations. *IEEE Trans. Power Deliv.*, 25(3):1883–1887, July 2010.
- [114] ETSI. Vehicular Communications ; Part 3 : Network architecture. Technical report, 2010.
- [115] J Fakcharoenphol and S Rao. Planar graphs, negative weight edges, shortest paths, and near linear time. In *Proc. IEEE Int. Conf. Clust. Comput.*, pages 232–241, 2001.
- [116] Holger Fubler, Hannes Hartenstein, Jörg Widmer, Martin Mauve, and Wolfgang Effelsberg. Contention-Based Forwarding for Street Scenarios, 2004.
- [117] Allen Fuhs. *Hybrid Vehicles*. CRC Press, September 2008.
- [118] Shaoyun Ge, Liang Feng, and Hong Liu. The planning of electric vehicle charging station based on Grid partition method. In *Electr. Control Eng. (ICECE), 2011 Int. Conf.*, pages 2726–2730, 2011.
- [119] A. Gottschalk and Shoichiro Toyoda. Mobility 2030. Technical report, 2004.
- [120] Janos Grantner, Bradley Bazuin, Jumana Al-shawawreh, Matthew P. Castanier, and Shabbir Hussain. Condition Based Maintenance for light trucks. In *Proc. IEEE Int. Conf. Syst. Man Cybern.*, pages 336–342. Ieee, October 2010.
- [121] David L. Greene, Janet L. Hopson, and Jia Li. Have we run out of oil yet? Oil peaking analysis from an optimist’s perspective. *Energy Policy J.*, 34(5):515–531, March 2006.
- [122] R Guillaume and Yvon Gourhant. LTE4V2X - Impact of High Mobility in Highway Scenarios. 2011.
- [123] R Guillaume, Sidi-mohammed Senouci, and Yvon Gourhant. LTE4V2X - Collection , dissemination and multi-hop forwarding.
- [124] Lino Guzzella and Antonio Sciarretta. *Vehicle Propulsion Systems*. Springer Berlin Heidelberg, 2013.
- [125] Zygmunt J Haas, Joseph Y Halpern, and Li Li. Gossip-based Ad Hoc Routing. *IEEE/ACM Trans. Netw.*, 14(3):479–491, June 2006.
- [126] Abdalla M Hanashi, Aamir Siddique, Irfan Awan, and Mike Woodward. Performance evaluation of dynamic probabilistic broadcasting for flooding in mobile ad hoc networks. *Simul. Model. Pract. Theory*, 17(2):364–375, 2009.
- [127] Hannes Hartenstein, Laberteaux, and Kenneth P. *VANET*. John Wiley & Sons, Ltd, Chichester, UK, January 2010.
- [128] J E Hernandez, F Kreikebaum, and D Divan. Flexible electric vehicle (EV) charging to meet renewable portfolio standard (RPS) mandates and minimize green house Gas emissions. In *Proc. IEEE Energy Convers. Congr. Expo.*, pages 4270–4277, 2010.
- [129] Davion M. Hill, Arun S. Agarwal, and Francois Ayello. Fleet operator risks for using fleets for V2G regulation. *Energy Policy J.*, 41:221–231, February 2012.

- [130] Ivan Wang-Hei Ho, Kin K. Leung, and John W. Polak. Stochastic Model and Connectivity Dynamics for VANETs in Signalized Road Systems. *IEEE/ACM Trans. Netw.*, 19(1):195–208, February 2011.
- [131] Ekram Hossain, Garland Chow, Victor C.M. Leung, Robert D. McLeod, Jelena Mišić, Vincent W.S. Wong, and Oliver Yang. Vehicular telematics over heterogeneous wireless networks: A survey. *Comput. Commun.*, 33(7):775–793, May 2010.
- [132] Xiaosong Hu, Nikolce Murgovski, Lars Johannesson, and Bo Egardt. Energy efficiency analysis of a series plug-in hybrid electric bus with different energy management strategies and battery sizes. *Appl. Energy J.*, 111:1001–1009, November 2013.
- [133] Boangoat Jarupan and Eylem Ekici. PROMPT: A cross-layer position-based communication protocol for delay-aware vehicular access networks. *Ad Hoc Networks*, 8(5):489–505, July 2010.
- [134] M Jerbi, S M Senouci, T Rasheed, and Y Ghamri-Doudane. An Infrastructure-Free Traffic Information System for Vehicular Networks. In *Veh. Technol. Conf. 2007. VTC-2007 Fall. 2007 IEEE 66th*, pages 2086–2090, September 2007.
- [135] Moez Jerbi, S.-M. Senouci, T. Rasheed, and Y. Ghamri-Doudane. Towards Efficient Geographic Routing in Urban Vehicular Networks. *IEEE Trans. Veh. Technol.*, 58(9):5048–5059, November 2009.
- [136] Donald B Johnson. Efficient Algorithms for Shortest Paths in Sparse Networks. *ACM J.*, 24(1):1–13, January 1977.
- [137] K R Jothi and Ebenezer Jeyakumar A. A Survey on Broadcasting Protocols in VANETs. (6):100–103, 2013.
- [138] Mohamed Kafsi, Panos Papadimitratos, Olivier Dousse, Tansu Alpcan, and Jean-pierre Hubaux. VANET Connectivity Analysis. *IEEE AutoNet, New Orleans, LA, USA, December 2008*, 2008.
- [139] Georgios Karagiannis, Onur Altintas, Eylem Ekici, Geert Heijenk, Boangoat Jarupan, Kenneth Lin, and Timothy Weil. Vehicular Networking : A Survey and Tutorial on Requirements ,. pages 1–33, 2011.
- [140] Brad Karp and H T Kung. GPSR : Greedy Perimeter Stateless Routing for Wireless Networks. 2000.
- [141] N Karthikeyan, V Palanisamy, and K Duraiswamy. Performance Comparison of Broadcasting methods in Mobile Ad Hoc Network. 2(2):47–58, 2009.
- [142] M. Kasemann, H. Fubler, H. Hartenstein, and M. Mauve. A Reactive Location Service for Mobile Ad Hoc Networks. Technical report, Department of Computer Science, University of Mannheim, 2002.
- [143] Konstantinos Katsaros, Mehrdad Dianati, Rahim Tafazolli, and Ralf Kernchen. CLWPR — A novel cross-layer optimized position based routing protocol for VANETs. In *2011 IEEE Veh. Netw. Conf.*, pages 139–146. IEEE, November 2011.

- [144] S. Khalfallah, M. Cherif M. Jerbi, SM. Senouci, and B. Ducourthial. Expérimentations des communications inter-véhicules: Implémentation d'un service de diffusion d'annonces publicitaire autour d'un magasin Orange utilisant les communications I2V et V2V. Technical report, CFIP, Les Arcs, France, 2008.
- [145] Maria Kihl, Mihail L Sichițiu, and Harshvardhan P Joshi. Design and Evaluation of two Geocast protocols for Vehicular Ad-hoc Networks. *J. Internet Eng.*, 2(1), 2008.
- [146] Moritz Killat, Felix Schmidt-Eisenlohr, Hannes Hartenstein, Christian Rössel, Peter Vortisch, Silja Assenmacher, and Fritz Busch. Enabling Efficient and Accurate Large-scale Simulations of VANETs for Vehicular Traffic Management. In *Proc. Fourth ACM Int. Work. Veh. Ad Hoc Networks, VANET '07*, pages 29–38, New York, NY, USA, 2007. ACM.
- [147] Eric D Knapp and Raj Samani. Chapter 1 - What is the Smart Grid? In *Appl. Cyber Secur. Smart Grid*, pages 1–15. Syngress, Boston, 2013.
- [148] Gökhan Korkmaz, Eylem Ekici, Füsün Özgüner, and Ümit Özgüner. Urban multi-hop broadcast protocol for inter-vehicle communication systems. *Proc. first ACM Work. Veh. ad hoc networks - VANET '04*, page 76, 2004.
- [149] F Koyanagi, T Inuzuka, Y Uriu, and R Yokoyama. Monte Carlo simulation on the demand impact by quick chargers for electric vehicles. In *Power Eng. Soc. Summer Meet. 1999. IEEE*, volume 2, pages 1031–1036 vol.2, 1999.
- [150] Daniel Krajzewicz, Jakob Erdmann, Michael Behrisch, and Laura Bieker. Recent Development and Applications of {SUMO - Simulation of Urban MObility}. *Int. J. Adv. Syst. Meas.*, 5(3&4):128–138, December 2012.
- [151] California L. F. Ivanhoe, Novum Corp., Ojai. FUTURE WORLD OIL SUPPLIES: THERE IS A FINITE LIMIT, 1995.
- [152] East Lansing. A Static-Node Assisted Adaptive Routing Protocol in Vehicular Networks.
- [153] Uichin Lee, Biao Zhou, Mario Gerla, Eugenio Magistretti, Paolo Bellavista, and Antonio Corradi. Mobeyes: smart mobs for urban monitoring with a vehicular sensor network. In *IEEE Wirel. Commun.*, volume 13, pages 52–57, October 2006.
- [154] Jung-Shian Li, I-Hsien Liu, Chuan-Kai Kao, and Chao-Ming Tseng. Intelligent Adjustment Forwarding: A compromise between end-to-end and hop-by-hop transmissions in VANET environments. *J. Syst. Archit.*, 59(10):1319–1333, November 2013.
- [155] Zheng Li, Z Sahinoglu, Zhifeng Tao, and Koon Hoo Teo. Electric Vehicles Network with Nomadic Portable Charging Stations. In *Veh. Technol. Conf. Fall (VTC 2010-Fall), 2010 IEEE 72nd*, pages 1–5, 2010.
- [156] YW Lin, YS Chen, and SL Lee. Routing Protocols in Vehicular Ad Hoc Networks A Survey and Future Perspectives. *J. Inf. Sci. . . .*, 1(c), 2010.
- [157] Adam Lipowski and Dorota Lipowska. Roulette-wheel selection via stochastic acceptance. *Phys. A Stat. Mech. its Appl.*, 391(6):2193–2196, 2012.

- [158] T D C Little and A Agarwal. An information propagation scheme for VANETs. In *Intell. Transp. Syst. 2005. Proceedings. 2005 IEEE*, pages 155–160, September 2005.
- [159] Yazhi Liu, Jianwei Niu, Jian Ma, and Wendong Wang. File downloading oriented Roadside Units deployment for vehicular networks. *J. Syst. Archit.*, 59(10):938–946, November 2013.
- [160] C Lochert, H Hartenstein, J Tian, H Fussler, D Hermann, and M Mauve. A routing strategy for vehicular ad hoc networks in city environments. In *IEEE IV2003 Intell. Veh. Symp. Proc. (Cat. No.03TH8683)*, pages 156–161. IEEE, June 2003.
- [161] Christian Lochert, Björn Scheuermann, Christian Wewetzer, Andreas Luebke, and Martin Mauve. Data aggregation and roadside unit placement for a vanet traffic information system. In *Proc. fifth ACM Int. Work. Veh. Inter-NETworking, VANET '08*, pages 58–65, New York, NY, USA, 2008. ACM.
- [162] lorenzo galati Giordano and Luca Reggiani. *Vehicular Technologies - Deployment and Applications*. InTech, February 2013.
- [163] M Maric. An Efficient Genetic Algorithm for Solving the Multi-Level Uncapacitated Facility Location Problem. *Comput. Informatics*, 29(2):183–201, 2010.
- [164] M N Mariyasagayam, T Osafune, and M Lenardi. Enhanced Multi-Hop Vehicular Broadcast (MHVB) for Active Safety Applications. In *Telecommun. 2007. ITST '07. 7th Int. Conf. ITS*, pages 1–6, June 2007.
- [165] William a. Massey and Ward Whitt. Networks of infinite-server queues with nonstationary Poisson input. *Queueing Syst.*, 13(1-3):183–250, March 1993.
- [166] Felix Jesus Villanueva Molina. *Ambient Intelligence*. 2010.
- [167] P Murphy, E Welsh, and J P Frantz. Using Bluetooth for short-term ad hoc connections between moving vehicles: a feasibility study. In *Veh. Technol. Conf. 2002. VTC Spring 2002. IEEE 55th*, volume 1, pages 414–418 vol.1, 2002.
- [168] K Nahrstedt. On finding multi-constrained paths. In *Proc. IEEE Int. Conf. Commun. Conf.*, volume 2, pages 874–879. IEEE, 1998.
- [169] Jaya Sudha Natarajan and Lakshmi Sevukamoorthy. Auto-clever fuzzy (ACF) based intelligent system for monitoring and controlling the hydrocarbons -air toxics emitted by the vehicle motors. *Proc. Int. Conf. Adv. Comput. Commun. Informatics*, pages 1187–1192, 2012.
- [170] V. Naumov and T. R. Gross. Connectivity-Aware Routing (CAR) in Vehicular Ad-hoc Networks. *IEEE INFOCOM 2007 - 26th IEEE Int. Conf. Comput. Commun.*, pages 1919–1927, 2007.
- [171] Valery Naumov, Rainer Baumann, and Thomas Gross. An Evaluation of Inter-vehicle Ad Hoc Networks Based on Realistic Vehicular Traces. In *Proc. 7th ACM Int. Symp. Mob. Ad Hoc Netw. Comput.*, MobiHoc '06, pages 108–119, New York, NY, USA, 2006. ACM.
- [172] M Nekovee. Epidemic algorithms for reliable and efficient information dissemination in vehicular. *Intell. Transp. Syst. IET*, 3(2):104–110, June 2009.

- [173] Andre Neubauer. The circular schema theorem for genetic algorithms and two-point crossover. In *Genet. Algorithms Eng. Syst. Innov. Appl. 1997. GALEZIA 97. Second Int. Conf. (Conf. Publ. No. 446)*, pages 209–214, 1997.
- [174] Quang Huy Nguyen, Yew-Soon Ong, and Meng-Hiot Lim. A Probabilistic Memetic Framework. *Evol. Comput. IEEE Trans.*, 13(3):604–623, June 2009.
- [175] NISSAN. SKY project. Technical report, 2003.
- [176] Hsin-ya Pan, Rong-hong Jan, Andy An-kai Jeng, and Chien Chen. Mobile-Gateway Routing for Vehicular Networks. 2011.
- [177] Yanlin Peng, Zakhia Abichar, and J Morris Chang. Roadside-Aided Routing (RAR) in Vehicular Networks. 00(c):3602–3607, 2006.
- [178] Y Pigne, G Danoy, and P Bouvry. A platform for realistic online vehicular network management. In *GLOBECOM Work. (GC Wkshps), 2010 IEEE*, pages 595–599, December 2010.
- [179] M Piórkowski, M Raya, A Lezama Lugo, P Papadimitratos, M Grossglauser, and J.-P. Hubaux. TraNS: Realistic Joint Traffic and Network Simulator for VANETs. *SIGMOBILE Mob. Comput. Commun. Rev.*, 12(1):31–33, January 2008.
- [180] Hua Qin and Wensheng Zhang. Charging scheduling with minimal waiting in a network of electric vehicles and charging stations. In *Proc. 8th ACM Int. Work. Veh. inter-networking - VANET '11*, page 51, New York, New York, USA, 2011.
- [181] Maryam Rashidi, Iulian Batros, Tatiana K Madsen, Muhammad T Riaz, and Thomas Paulin. Placement of Road Side Units for floating car data collection in highway scenario. In *2012 IV Int. Congr. Ultra Mod. Telecommun. Control Syst.*, pages 114–118. IEEE, October 2012.
- [182] Sabih Rehman, M Arif Khan, Tanveer A Zia, and Lihong Zheng. Vehicular Ad-Hoc Networks (VANETs) - An Overview and Challenges. 3(3):29–38, 2013.
- [183] Guillaume Remy, Sara Mehar, Tonino Sophy, Sidi-Mohammed Senouci, Francois Jan, and Yvon Gourhant. Green fleet management architecture: Application to economic itinerary planning. In *Proc. IEEE Globecom Work.*, pages 369–373. IEEE, December 2012.
- [184] Guillaume Remy, Sidi-mohammed Senouci, François Jan, and Yvon Gourhant. LTE4V2X : LTE for a Centralized VANET Organization. pages 61–66, 2011.
- [185] Jihene Rezgui, Soumaya Cherkaoui, and Dhaou Said. A two-way communication scheme for vehicles charging control in the smart grid. *Proc. 8th Int. Wirel. Commun. Mob. Comput. Conf.*, pages 883–888, August 2012.
- [186] John Rushby, S R I International, and Menlo Park. *A Comparison of Bus Architectures for Safety-Critical Embedded Systems*, volume 2211 of *Lecture Notes in Computer Science*. Springer Berlin Heidelberg, 2001.
- [187] Martin Sachenbacher, Martin Leucker, and Andreas Artmeier. Efficient Energy-Optimal Routing for Electric Vehicles. In *Proc. 25th Int. Conf. Artif. Intell.*, pages 1402–1407, San Francisco, California, USA, 2011.

- [188] I Salhi, M O Cherif, and S M Senouci. A New Architecture for Data Collection in Vehicular Networks. In *Commun. 2009. ICC '09. IEEE Int. Conf.*, pages 1–6, June 2009.
- [189] Hugo Cruz Sanchez, Franck Laurent, and Andre-Luc Beylot. Routing metrics in Delay Tolerant Networks. Technical report, National Polytechnic Institute of Toulouse, Toulouse, 2007.
- [190] Christoph Schroth, Florian Dötzer, Timo Kosch, Benedikt Ostermaier, and Markus Strassberger. Simulating the traffic effects of vehicle-to-vehicle messaging systems, 2005.
- [191] Boon-chong Seet, Genping Liul, Bu-sung Leel, Chuan-heng Fohl, Kai-juan Wong, and Keok-kee Lee. A-STAR : A Mobile Ad Hoc Routing Strategy for Metropolis Vehicular Communications. *Lect. Notes Comput. Sci.*, 3042:989–999, 2004.
- [192] Matthew Seligman, Kevin Fall, and Padma Mundur. Storage routing for DTN congestion control. *Wirel. Commun. Mob. Comput.*, 7(10):1183–1196, December 2007.
- [193] Sidi-Mohammed Senouci, H Sedjelmaci, Sara Mehar, Bernadette Villeforceix, Patrick Martinolli, and F Benbadis. le véhicule connecté. *Rev. l'Electricité l'Electronique (REE N4)*, 2014.
- [194] Baraa T. Sharef, Raed a. Alsaqour, and Mahamod Ismail. Comparative Study of Variant Position-based VANET Routing Protocols. *Procedia Technol.*, 11:532–539, 2013.
- [195] Baraa T. Sharef, Raed a. Alsaqour, and Mahamod Ismail. Vehicular communication ad hoc routing protocols: A survey. *J. Netw. Comput. Appl.*, October 2013.
- [196] Shuanggen Jin. *GLOBAL NAVIGATION SATELLITE SYSTEMS – SIGNAL , THEORY AND APPLICATIONS*. InTech, 2012.
- [197] Javier Silvestre-Blanes. *Factory Automation*. 2010.
- [198] Mukesh Singh, Praveen Kumar, and Indrani Kar. Coordination of multi charging station for Electric Vehicles and its utilization for vehicle to Grid scenario. *Proc. IEEE Transp. Electrifi. Conf. Expo*, pages 1–7, June 2012.
- [199] C Sommer, R German, and F Dressler. Bidirectionally Coupled Network and Road Traffic Simulation for Improved IVC Analysis. *Mob. Comput. IEEE Trans.*, 10(1):3–15, January 2011.
- [200] BK Sovacool and MA Brown. Energy and American society-thirteen myths. 2007.
- [201] D Srinivasan. Multi-agent System based Urban Traffic Management. In *Proc. Congr. Evol. Comput.*, volume 117576, pages 1740–1747. IEEE, September 2007.
- [202] D. Stojanovic, B Predic, and D Djordjevic-Kajan. A Service Platform for Context-Aware Mobile Transport-Related Information Services. In *Proc. Int. Conf. Environ. Sci. Technol.*, volume 1, pages 301–304, Veliko Tarnovo, Bulgaria, 2009.
- [203] Dragan Stojanovic, Bratislav Predic, Igor Antolovic, and Slobodanka Dordevic-Kajan. Web information system for transport telematics and fleet management. In *Proc. 9th Int. Conf. Telecommun. Mod. Satell. Cable, Broadcast. Serv.*, pages 314–317, October 2009.

- [204] Min-Te Sun, Wu-chi Feng, Ten-Hwang Lai, K Yamada, H Okada, and K Fujimura. GPS-based message broadcast for adaptive inter-vehicle communications. In *Veh. Technol. Conf. 2000. IEEE-VTS Fall VTC 2000. 52nd*, volume 6, pages 2685–2692 vol.6, 2000.
- [205] Yipin Sun, Xiaodong Lin, Rongxing Lu, X. Shen, and Jinshu Su. Roadside Units Deployment for Efficient Short-Time Certificate Updating in VANETs. In *Commun. (ICC), 2010 IEEE Int. Conf.*, number January 2014, pages 1–5. IEEE, May 2010.
- [206] L.E. Sweeney. An overview of intelligent vehicle highway systems (IVHS). In *Proc. WESCON '93*, pages 258–262. IEEE.
- [207] Xiangang Tang, Junyong Liu, Xiaoyin Wang, and Jie Xiong. Electric vehicle charging station planning based on weighted Voronoi diagram. In *Int. Conf. Transp. Mech. Electr. Eng. (TMEE)*,, pages 1297–1300, 2011.
- [208] Stephen Teang Soo Thong, Chua Tien Han, and Tharek Abdul Rahman. Intelligent Fleet Management System with Concurrent GPS & GSM Real-Time Positioning Technology. In *Proc. 7th Int. Conf. ITS Telecommun.*, pages 1–6. IEEE, June 2007.
- [209] R Tinos and Shengxiang Yang. Evolution Strategies with q-Gaussian Mutation for Dynamic Optimization Problems. In *Neural Networks (SBRN), 2010 Elev. Brazilian Symp.*, pages 223–228, 2010.
- [210] Ozan Tonguz*, Nawapom Wisitpongphan*, Fan Bait, Priyantha Mudaliget, and Varsha Sadekart. Broadcasting in VANET. In *2007 Mob. Netw. Veh. Environ.*, pages 7–12. IEEE, 2007.
- [211] O. Trullols, J. M. Barcelo-Ordinas, M. Fiore, C. Casetti, and C.-F. Chiasserini. A Max Coverage Formulation for Information Dissemination in Vehicular Networks. In *2009 IEEE Int. Conf. Wirel. Mob. Comput. Netw. Commun.*, pages 154–160. IEEE, October 2009.
- [212] Ovidiu Vermesan, Lars-Cyril Blystad, Reiner John, Peter Hank, Roy Bahr, and Alessandro Moscatelli. Smart, Connected and Mobile: Architecting Future Electric Mobility Ecosystems. In *Proc. Des. Autom. Test Eur. Conf. Exhib.*, pages 1740–1744, New Jersey, 2013. IEEE Conference Publications.
- [213] John Voelker. IEEE Spectrum.
- [214] Pu Wang, Ian F. Akyildiz, and Abdullah M. Al-Dhelaan. Percolation theory based connectivity and latency analysis of cognitive radio ad hoc networks. *Wirel. Networks*, 17(3):659–669, December 2010.
- [215] Shie-Yuan Wang and Chih-Che Lin. NCTUns 5.0: A Network Simulator for IEEE 802.11(p) and 1609 Wireless Vehicular Network Researches. In *Veh. Technol. Conf. 2008. VTC 2008-Fall. IEEE 68th*, pages 1–2, September 2008.
- [216] Conal Watterson. Controller Area Network (CAN) Implementation Guide. Technical report, 2012.
- [217] Axel Wegener, Michał Piórkowski, Maxim Raya, Horst Hellbrück, Stefan Fischer, and Jean-Pierre Hubaux. TraCI: An Interface for Coupling Road Traffic and Network Simulators. In *Proc. 11th Commun. Netw. Simul. Symp., CNS '08*, pages 155–163, New York, NY, USA, 2008. ACM.

- [218] Rory Williams. A Definition of Sustainable Mobility. Technical Report March, 2007.
- [219] N Wisitpongphan, Fan Bai, P Mudalige, V Sadekar, and O Tonguz. Routing in Sparse Vehicular Ad Hoc Wireless Networks. *Sel. Areas Commun. IEEE J.*, 25(8):1538–1556, October 2007.
- [220] Ling-Yun Wu, Xiang-Sun Zhang, and Ju-Liang Zhang. Capacitated facility location problem with general setup cost. *Comput. Oper. Res.*, 33(5):1226–1241, 2006.
- [221] Yong Xiang, Zheng Liu, Ruilin Liu, Weizhen Sun, and Wei Wang. GeoSVR: A map-based stateless VANET routing. *Ad Hoc Networks*, 11(7):2125–2135, September 2013.
- [222] Feixiang Xie, Mei Huang, WeiGe Zhang, and Juan Li. Research on electric vehicle charging station load forecasting. *Proc. Int. Conf. Adv. Power Syst. Autom. Prot.*, pages 2055–2060, October 2011.
- [223] Y Xiong, J Ma, W Wang, and J Niu. Optimal Roadside Gateway Deployment for VANETs. *Prz. ELEKTROTECHNICZNY*, (7):273–276, 2012.
- [224] Sherali Zeadally, Ray Hunt, Yuh-Shyan Chen, Angela Irwin, and Aamir Hassan. Vehicular ad hoc networks (VANETS): status, results, and challenges. *Telecommun. Syst.*, 50(4):217–241, December 2010.
- [225] Sherali Zeadally, Samee Ullah Khan, and Naveen Chilamkurti. Energy-efficient networking: past, present, and future. *J. Supercomput.*, 62(3):1093–1118, May 2011.
- [226] Sherali Zeadally, Al-Sakib Khan Pathan, Cristina Alcaraz, and Mohamad Badra. Towards Privacy Protection in Smart Grid. *Wirel. Pers. Commun. J.*, 73(1):23–50, December 2012.
- [227] Changhua Zhang, Qi Huang, Jiashen Tian, Lei Chen, Yongxing Cao, and Ran Zhang. Smart Grid Facing the New Challenge: The Management of Electric Vehicle Charging Loads. *Proc. Int. Conf. Smart Grid Clean Energy Technol.*, 12:98–103, January 2011.
- [228] Xiaoxing Zhu, Houtao Chen, Wulin Liu, and Jie Luo. Design and exploitation of supervisory control system for commercial electric vehicle charging station based on virtual DPU technology. *Proc. Int. Conf. Power Syst. Technol.*, pages 1–5, October 2010.

LIST OF FIGURES

2.1	Embedded vehicle networks	10
2.2	Communication modes	11
2.3	Autonomous vehicle	13
2.4	Latency-related requirements	17
2.5	WAVE architecture	20
2.6	ETSI-ITS architecture	21
2.7	Facilities layer	21
2.8	CALM architecture	22
2.9	Connected vehicle: routing protocols classification	23
3.1	Radio coverage vs. vehicle's height	29
3.2	DHVN header	29
3.3	Illustrative example of relay selection in DHVN using vehicles with heterogeneous communication capabilities	30
3.4	Vehicle 1 moves from Ingoing intersection (A) to the Outgoing intersection (B)	31
3.5	Illustrative example of broadcast in Outgoing-Zone	31
3.6	Illustrative example of broadcast outside the Outgoing-Zone	32
3.7	Connectivity vs. SNF period	32
3.8	DHVN diagram	33
3.9	PDR vs. Number of nodes	36
3.10	PDR vs. Time	37
3.11	Transmission duplication vs. Number of nodes	37
3.12	Reception duplication vs. Number of nodes	38
3.13	PDR vs. Vehicles' speed (300 vehicles)	38
3.14	PDR vs. Higher nodes ratio (300 nodes)	38
4.1	V2X communication architecture	49
4.2	ODEL 2-steps solution	51
4.3	Example of RSUs candidate locations	52

4.4	Binary-chromosome	53
4.5	An example to illustrate the V2X communication	59
4.6	RDEL diagram	60
4.7	Hello message (<i>HelloMsg</i>)	60
4.8	Density message (<i>DensityMsg</i>)	61
4.9	End-to-End delay results for RDEI with and without RSUs	62
5.1	Basic Components of a Smart Sustainable Transportation Management System	71
5.2	Communication Technologies	74
5.3	Simplified value chain of electric vehicles and supplies market	74
5.4	EcoDrive green fleet management system [183]	78
5.5	Toward a Smart Sustainable Transportation Management System (STMS)	84
5.6	STMS: Layers' interaction	85
6.1	Electric vehicle fleet management architecture Ev-Drive	90
6.2	Web interface to book electric vehicle	91
6.3	Electric power computation diagram	91
6.4	Power Consumption	93
6.5	Result in case of non-drained battery	96
6.6	Result in case of drained battery	96
7.1	OLoCs steps	102
7.2	OLoCs chromosome (genetic code)	104
7.3	Tapas Cologne city's map	106
7.4	The CS optimized location with aggregated clients (clusters)	107
7.5	The CS optimized location with real clients (clusters zoom)	107
A.1	HINTS general integration platform	148
A.2	HINTS general integration platform	149
A.3	An illustration of topology used to evaluate HINTS	151
A.4	Percentage of the subscribed vehicles	152
A.5	Mean travel time results	153

LIST OF TABLES

2.1	Comparison between different embedded communication technologies . . .	10
2.2	Comparison between different leading candidates technologies	12
2.3	VANET projects	17
3.1	Simulation parameters	35
4.1	Comparison between RSUs deployment existing contributions	44
4.2	Notation	50
4.3	ODEL parameters Table	55
4.4	Performance results for RSUs placement in term of delay, computation time and cost using ODEL	56
4.5	Simulation parameters of RDEL routing protocol	62
5.1	Fuel cars vs electric cars vs hybrid cars	71
5.2	Recharging Types	73
5.3	SAE, ISO/IEC Standards	81
5.4	Benefits and Drawbacks of Green Transportation	82
6.1	Variables' Definition	94
7.1	OLoCs mathematic notation	101
7.2	Charging demand parameters	103
7.3	OLoCs performance results	108
7.4	Comparison between OLoCs and exhausted solution	108

LIST OF ALGORITHMS

3.1	DHVN Pseudo-code	34
4.1	Genetic algorithm	53
4.2	Dijkstra algorithm	54
7.1	pseudo-code of OLOCs preprocessing	103
7.2	pseudo-code of OLoCs genetic algorithm	105
A.1	Iterative behavior of the application embedded on vehicles	152

ACRONYMS AND GLOSSARY

- **2G:** is the second generation of mobile telecommunications technology. 21, 141
- **3G:** is the third generation of mobile telecommunications technology. 1, 11, 14, 21, 24, 47, 57, 74, 77, 139, 141
- **4G:** is the fourth generation of mobile telecommunications technology, also called LTE.. 1, 11, 14, 24, 74, 139, 141
- **5G:** is the fifth generation of mobile telecommunications, the next major phase of mobile telecommunications standards beyond the current 4G-Advanced standards.. 1, 141
- **BCM:** *Brake Control Module.* 9, 141
- **BCU:** *Body Control Module.* 9, 141
- **CAN:** *Controller Area Network.* 9, 11, 141
- **D2B:** *Domestic Digital data Bus.* 10, 141
- **DDT:** *Distance Defer Transfer.* 35, 36, 141
- **DHVN:** *Dissemination protocol for Heterogeneous Cooperative Vehicular Networks.* 2, 3, 27, 28, 30, 31, 33, 35–39, 114, 141
- **DTN:** *Delay-Tolerant Network.* 15, 41, 141
- **ECU:** *Engine Control Unit.* 9, 141
- **eNodeB:** evolved Node B is a base station of 3G network. It provides a cellular network with a radius up to several kilometers in interurban areas. 27, 141
- **EST:** *Electronic Spark Timing.* 8, 141
- **EV:** *Electric Vehicle.* 141
- **EVs:** *Electric Vehicles.* 2, 3, 70, 87, 141
- **EVSE:** *Electric Vehicle Supply Equipment.* 72, 77, 80, 81, 141
- **FCD:** *Floating Car Data.* 77, 90, 141
- **G5:** a spectrum allocated in Europe for road safety and traffic efficiency application.. 1, 20, 141
- **GA:** *Genetic algorithm.* 99, 141

- **GPS:** *Global Positioning System.* 8, 28, 76, 77, 90, 141, 152, 156
- **HMI:** *Human Machine Interface.* 9, 141
- **IEEE:** *Institute of Electrical and Electronics Engineers.* 141
- **ITS:** *Intelligent Transportation System.* 8, 19–21, 141, 145, 147, 148, 150, 151
- **LIN:** *Local Interconnect Network.* 9, 11, 141
- **LTE:** *Long Term Evolution.* 1, 11, 24, 27, 45, 47, 57, 74, 76, 91, 139, 141
- **M2M:** *machine-to-machine.* 9, 141
- **MAC:** *Medium Access Control.* 45–47, 58, 60, 141
- **MHVB:** *Multi-Hop Vehicular Broadcast.* 141
- **MOST:** *Media Oriented Systems Transport.* 10, 141
- **NFC:** *Near Field Communication.* 141
- **OAA:** *Open Automotive Alliance.* 7, 9, 13, 19, 141
- **ODEL:** *an Optimized Road-Side Units (RSUs) placement for DELay aware applications.* 2, 3, 41, 42, 48, 51, 54, 57, 58, 61–63, 114, 141
- **OLoCs:** *an Optimized Location Scheme for electric charging stations.* 3, 4, 97, 100, 102, 105–109, 114, 141
- **RAR:** *Roadside-Aided Routing protocol.* 141
- **RDEL:** *Routing protocol for DELay aware applications .* 2, 3, 41, 42, 48, 58, 60–63, 90–92, 141
- **RFID:** *Radio-Frequency Identification.* 10, 141
- **RSU:** *Road-Side Unit.* 27, 42, 43, 48–50, 52–59, 61, 141
- **RSUs:** *Road-Side Units.* 2–4, 11, 15, 39, 41–44, 46–55, 57, 58, 61–63, 99, 113, 114, 141, 156
- **SEFC:** *Specific Equivalent Fuel Consumption.* 141
- **SNF:** *Store aNd Forward.* 15, 26–28, 31–34, 36, 39, 141
- **TCU:** *Transmission Control Unit.* 9, 141
- **UMTS:** *Universal Mobile Telecommunications System.* 12, 21, 141
- **V2I:** *Vehicle-to-Infrastructure.* 1, 2, 11, 18–20, 22, 42–44, 47, 48, 57, 58, 89, 141
- **V2V:** *Vehicle-to-Vehicle.* 1, 2, 11, 18–20, 22, 24, 28, 44, 47, 48, 51, 57, 58, 61, 89, 141

- **V2X:** *Vehicle-to-X*. 11, 22, 41, 43, 44, 46–48, 57, 91, 141
- **VANET:** *Vehicular Ad-hoc Network*. 14–16, 23, 24, 27, 41, 46, 47, 141, 145–148, 150, 153
- **VANETs:** *Vehicular Ad-hoc Networks*. 19, 24, 41, 43, 45, 46, 141, 145, 153

IV

APPENDIX

HINTS: A NOVEL APPROACH FOR REALISTIC SIMULATIONS OF VEHICULAR COMMUNICATIONS

A.1/ INTRODUCTION AND PROBLEM STATEMENT

One of the main challenges in the Vehicular Ad-Hoc Networks (VANETs) research domain is the simulation of vehicular communications using realistic mobility models.

One simple way of evaluating protocols and applications in VANET is by using communication network simulators. However, this solution appears to be inadequate since existing mobility models, implemented in network simulators, are not realistic. To solve this problem, an approach called offline simulation was introduced; it consists of integrating realistic mobility traces into a network simulator. These traces are extracted from movements of real vehicles that were collected by multiple monitoring systems like induction loops and video surveillance cameras installed in real roads. Another way of extracting these traces is by using a traffic simulator with realistic mobility patterns. The traffic simulator generates the realistic mobility traces prior to the network simulator execution. This approach allows the nodes in the network simulator, to move according to a realistic mobility model that reflects the reality. However, this approach only solves the VANET applications evaluation problem partially. In fact, it is suitable for large scenarios without any unexpected events occurring during simulation time, as it allows the communication between the simulators in one way but not in the opposite way. For example, in a traffic efficiency application which informs the vehicles about the state of the road, a vehicle can decide to change its route to avoid the traffic jam; hence, the need for a bidirectional communication. We can think of a solution where mobility traces are generated after the occurrence of each event, but this will require an enormous amount of time, as the generation of the mobility traces is very slow. The other major advance in this domain is the online simulation approach. In this case, no static mobility traces are generated by the traffic simulator, but instead, the latter is launched simultaneously with the network simulator. Thus, all the alterations caused by the network simulation can be taken into account in real time. This was made possible with the insertion of an efficient feedback loop which consists in sending the required information (position, speed. . .) to the network simulator on each simulation step. In the following, we refer to the information sent for each vehicle as a subscription for this vehicle. Although this approach seems to be a good alternative to evaluate and validate Intelligent Transportation Systems (ITS) applications,

it shows some major drawbacks. In fact, it is more suitable for small scenarios on account of the large number of messages exchanged between the simulators on each time step and their important lengths; not to mention the high computational cost and the consequent long simulation times. As emphasized earlier in this section, the offline simulation approach is suitable for large scenarios without any unexpected events occurring during runtime; where the online simulation is more appropriate for smaller scenarios with a large number of events. In this work, we advocate a novel simulation approach and develop a corresponding optimized platform for realistic simulations of vehicular communications. Our hybrid approach has the advantage of using both offline and online simulations so it overcomes the limitations of one using the other and vice versa. The remainder of this appendix is organized as follows: The next section is a quick review of the most popular related works in the literature. We describe our approach and its architecture in sections A.3 ; evidence of its performance is given in section A.4. Finally, section A.5 presents our conclusion and future perspectives.

A.2/ BACKGROUND AND RELATED WORK ON NETWORK SIMULATORS

The most common classification for the different integration approaches, briefly addressed in the previous section and referred to in [127] for coupling network and traffic simulators, sort the literature solutions into three distinct categories: (i) isolated or offline simulators, (ii) embedded simulators, and (iii) federated or online simulators. In the first category, the interaction between the network and the traffic simulators is petty or non-existent as the mobility model is bounded to a static mobility trace. MOVE (MObility model generator for VEhicular networks) [34], is a dedicated open source tool that generates mobility traces readable in network simulators like NS2 [56] and QualNet [43]. SUMO Player and Trace Exporter [53] are also tools designed to convert netstate dump files (XML files containing all the simulation's details) generated from traffic microsimulators like SUMO (Simulation of Urban MObility), into mobility traces interpretable by network simulators like NS2 and VISSIM [190]. In the embedded approach, the traffic and the network simulators are natively coupled as they are incorporated to form a unique entity. MoVES [90], NCTUns [215] and VCOM [146] the embedded module in VISSIM fall into this category. However, the major limitation of these platforms is the simplified network or traffic capabilities. In fact, most of these platforms were initially meant either for traffic or network simulations but not both; and were provided by additional modules to support VANET simulations. To overcome this limitation, the third category was introduced. In this case, a bidirectional communication is established between the simulators. The network simulator takes control of the traffic simulator by sending commands to change the nodes behavior. The latter responds to the former by reporting the positions of the loaded nodes. In the following, this two-ways interaction will be referred to as feedback loop. This approach is considered so far as the most suitable solution in the literature for vehicular communications simulations offering an acceptable level of realism. TraNS [179], an open-source simulation environment, was the first implementing a federated approach; as it links the traffic simulator SUMO [150] and the network simulator NS2 using a specific interface called TraCI [217], which we will evoke further in Section 3. iTERIS [29] project, also an online approach implementation, aims at providing a framework to combine traffic mobility and network simulations for large scale testing of traffic management

solutions. This framework uses SUMO as a traffic simulator and NS-3 [36] as a network simulator. Although it was a promising project, iTERIS has not been updated in its official website since 2010. Ovnis [178] and Veins [199] are the latest attempts to implement an online simulation platform as it couples SUMO with NS-3, and SUMO with OMNeT++ [37] respectively. The reason behind the miscarriage of the latest category, even though it presents the most realistic results one can get from the literature tools, is the long simulation times and the high computational cost. In fact, this constraint narrows the scope of the correspondent platforms to small scenarios, unless a supercomputer is used to perform the simulation. This will continue to restrain the progress of the ITS field as long as VANET simulations are not trivialized enough. Our approach, named HINTS, advances all state-of-the-art solutions in terms of performance as it uses resources more efficiently and considerably reduces the computational cost and the simulation time. The combination of the online and the offline approaches brought forth a new approach that uses one full mobility trace and a feedback loop, for an active exchange and a real time interaction between the network and the traffic simulators.

A.3/ HINTS DESCRIPTION

HINTS stands for Hybrid Integration of Network and Traffic Simulators. Our approach combines all the benefits from state of the art solutions. We propose an approach that is as flexible as the online approach, but with less computational cost and shorter simulations times by taking advantage of the offline simulation approach benefits also. As a result, our hybrid approach will be suitable for large scenarios simulations and will adapt with the number of events to offer better simulation times and less computational cost. This approach is inspired from the hierarchical approach for image and video compression, where a first image is stored entirely as a background and the next images are obtained from storing the parts of the image that differ from the original one. We noticed many similarities between our problem and the image/video compression problem as both aim for reducing the computational cost and the size of data transferred in each time step, and reducing the size of data stored respectively. We noticed also that if an event occurs, this will be likely to alter the state of only a few nodes in the network while the bigger percentage of nodes will not be affected by this event. This led us to come up with a novel approach in this domain: the hybrid approach for realistic simulations of vehicular communications. In brief, we use a mobility trace as a background image of the network state, generated beforehand by the traffic simulator; and since the alteration in our case comes from the network simulator, we can determine exactly the nodes for which the behavior has changed. In this case, only the positions of the nodes concerned by an event are sent to the network simulator, and these new values will come to overload the values extracted from the original mobility trace.

A.3.1/ INTEGRATION PLATFORM

As pointed out above, the analysis of protocols and applications in VANET require a real time bidirectional interaction between a network and a traffic simulator. HINTS consists of three essential blocks which are the traffic simulator, the network simulator and the ITS application. These three blocks interact with each other in real time via some dedicated communication interfaces. To benefit from the best tools in the literature, we chose the

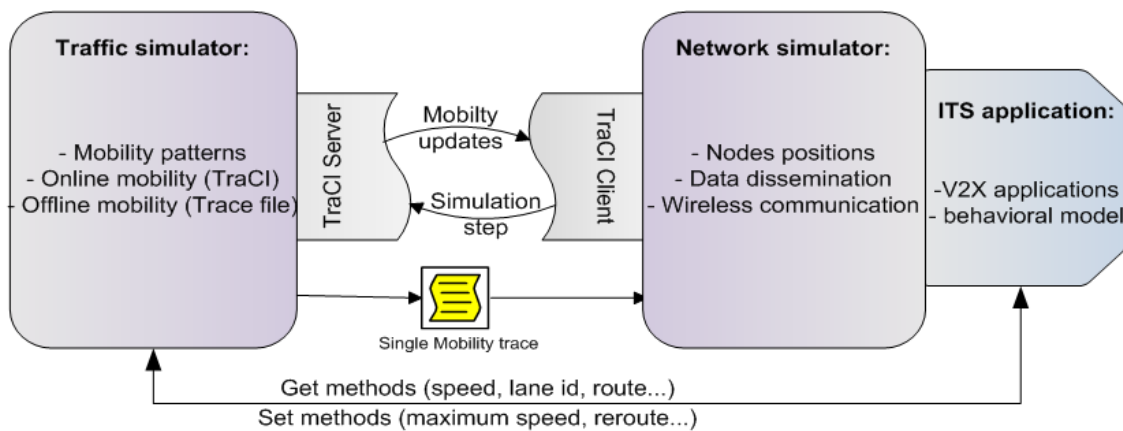

Figure A.1: HINTS general integration platform

widely spread traffic simulator SUMO that has proved its reliability and performance within the Intelligent Transportation Systems community; and the successor of the most used network simulator: NS-3 also validated in the academia. The TraCI API accessible in SUMO has confirmed our selection for the traffic simulator as it allows running SUMO as a server and controlling it by any third-party application using a TCP socket connection. NS-3 was chosen due to its accurate implementation of physical layers and communications standards, its improved scalability (including parallelization capabilities) and its active development community. The accessibility of both simulators' source code in C++ is a further reason that reinforced our choice for these two simulators.

A.3.2/ THE GENERAL HYBRID PLATFORM ARCHITECTURE

Our coupled platform uses SUMO in one hand to provide the required information about the state of the network (position, speed, lanes. . .) and supply the network simulator with the necessary feedback. In the other hand, NS-3 is used to perform data dissemination in order to inform the ITS applications embedded on each node about the surrounding environment and the state of the network. It is now up to the ITS applications that takes the role of the behavioral model to decide whether a node should change its behavior or not. This efficient feedback loop is extended with the insertion of a mobility trace that includes the movements of all nodes from the entire simulation duration, and which represents a background image of the network; and thereby, considerably reduces the amount of data transferred between the traffic simulator and the network simulator in each time step since only the positions of nodes concerned by a certain event are sent. Figure A.1 shows the general overview of the architecture. In this figure, the traffic simulator in the leftmost box manages the nodes' mobility and generates both static traces and dynamic micro-traces. The middle box represents the network simulator whose role is handling the data dissemination via wireless communications, in addition to translating received data about the nodes movements; and that, in order to implement its own realistic mobility model based on the decisions taken by the rightmost box, which represents the user level model. This latter block represents the communication protocol or user VANET application to be analyzed. The communication between these three blocks is provided by the TraCI client/server interface, which allows real time, bidirectional communication between

the network and the traffic simulators.

A.3.3/ SIMULATION FLOW OVERVIEW

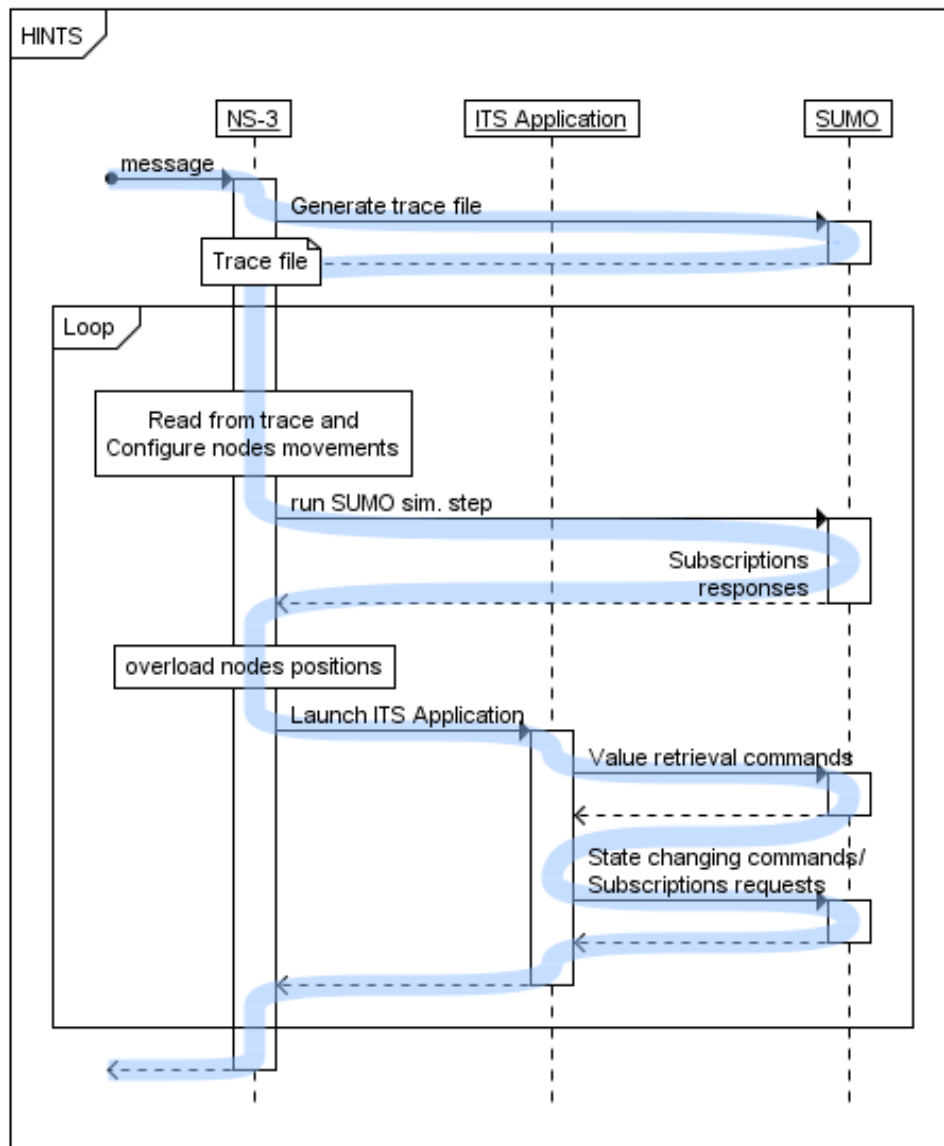

Figure A.2: HINTS general integration platform

As the simulation starts, SUMO generates one complete mobility trace to constitute the base structure of the mobility model. This mobility trace is injected into the network simulator and the two simulators are launched simultaneously with NS-3 as the client application and SUMO as the server application. NS-3 reads from the previously generated mobility trace and sends commands to SUMO via TraCI to execute simulation steps in order to stay synchronized in time. Information about the surrounding environment of a node (speed, route, destination, etc.) is provided by SUMO while the cooperative awareness messages (CAM) [16] exchanged between these nodes (safety messages, traffic state messages...) are provided by NS-3. All these information are operated in the

ITS application in order to decide whether a node should change its behavior (speed, trajectory, route or destination). Once the decision is taken for a node to change its trajectory, the corresponding information will be retrieved on each time step and until the node reaches its destination, and overload the values given by the static mobility trace. Figure A.2 shows the flow of events in HINTS.

A.3.4/ SUMO AND NS-3 IMPLEMENTATION DETAILS

A.3.4.1/ MODIFICATIONS AND ADDITIONAL MODULES

Note that the nodes in direct interaction with the nodes affected by a certain event are likely to change their trajectory too and the corresponding positions need, therefore, to be reported as well. To select these nodes, we used a simple technique that consists of marking each node interacting directly with an altered behavior node. In other words, all nodes in the same lane close enough from a marked node, and all nodes that want to change lane but are blocked by a marked node, are themselves marked. At the end of each time step, the positions of all marked nodes are reported to the network simulator. One inconvenient of the offline approach is the time taken to parse the generated mobility trace and convert it to a format understandable by the network simulator. For example, in the case of one simple intersection simulation, the generation of the raw output produced by SUMO for 1h30 scenario with 3400 nodes takes 10 seconds; while the conversion of this raw trace to a tcl format with two of the most efficient tools for this purpose, SUMO Player and Trace Exporter, takes 15 and 18 minutes respectively. To tackle this shortcoming, we modified SUMO so it produces an optimized generic format of mobility traces (tcl format) directly usable in NS-3. This way, the mobility trace generation is shortened to the traffic microsimulation time, which is relatively short. In addition to that, we have optimized NS-3 so it reads through the produced mobility trace more efficiently by preventing it from parsing the file multiple times, and reading only the desired portions of the trace instead, at each time step, allowing gaining considerable time. To furnish our platform with an efficient feedback loop (figure A.1), we have provided NS-3 with a TraCI client that takes control of the SUMO simulation via the TraCI server, and therefore, supplies NS-3 and the ITS application with the needed data about the network and the nodes mobility; with the help of value retrieval methods, state changing methods and control-related methods. The latter category performs SUMO simulation steps, and subscriptions for the concerned nodes (speed and value retrieval on each time step).

A.3.4.2/ SPECIFICATIONS ABOUT HINTS

We have classified the events that are susceptible to alter the behavior of a node into two essential classes: primary events and secondary events. The first class touches the infrastructure and affects the mobility of nodes in a major way, while the second class only concerns a group of vehicles, and affects the traffic in a more microscopic manner. The reason behind this appellation is due to the nature of the events. In other words, the occurrence of a primary event will lead to the occurrence of multiple secondary events. As an example for a primary event, we can cite a blocked road. This event will most probably lead to traffic congestion and a number of vehicles changing their routes, which in this case, are considered as secondary events. Based on this classification and the VANET

application taxonomy proposed by the C2C-CC [4], we decided to provide the TraCI client with five vehicle state changing mobility primitives: Stop, Change speed, Change lane, Change route and Change target. These five primitives are sufficient to handle mobility alteration in a microscopic level from any scenario, and thereby, increase the efficiency of our feedback loop. HINTS was designed to reduce the simulation complexity procedure from a developer point of view. Apart from the XML files needed to generate the mobility trace in SUMO, and the ITS application written in C++ and executed in NS-3; no additional files will be required for the simulation execution.

Also, most of this simulation process will be automated. From NS-3 side, a simple call for the method “Install ()” which configures the positions of nodes, will trigger the synchronized execution of SUMO time steps. In addition to that, subscription messages are sent to SUMO automatically with each call for a state changing method of the corresponding node. The novelty for the developer is the use of the methods provided by our platform to supply the ITS application with the required data (get speed, get lane, get route, etc.) and influence the mobility model (stop node, set speed, reroute, etc.) as wished.

A.4/ PERFORMANCE EVALUATION OF HINTS

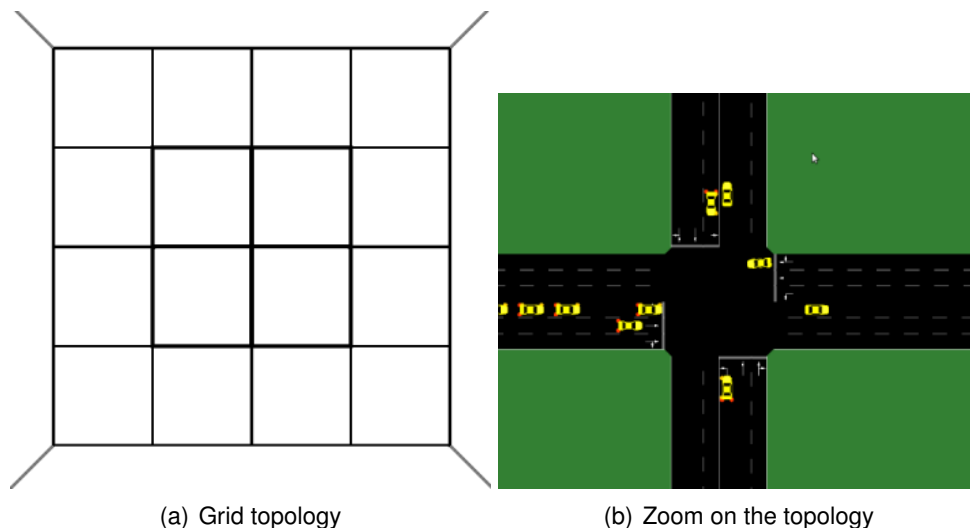

Figure A.3: An illustration of topology used to evaluate HINTS

In order to prove the efficiency and the performance of the developed platform, we considered testing it on a modified Manhattan grid scenario depicted in Fig. 3 and representing a city of 20000 inhabitants. We used a 2 km^2 network with 3 types of roads (1 lane, 2 lanes and 3 lanes) to show the importance of each road. The represented city has 4 main entrances. In the following, we will briefly introduce the operating mode of the tested ITS application. The performance of HINTS is justified using the percentage of subscriptions metric while the efficiency is substantiated using a metric called Mean Sojourn Time or the Mean Travel Time metric in our case: the average time vehicles spend on the road before reaching their destinations, calculated for the arrived vehicles at the end of each simulation step.

A.4.1/ APPLICATION'S OPERATING MODE

In the following, we assume that vehicles are equipped with interfaces for wireless communications, and also with an onboard GPS that keeps track of the current road id. Each vehicle follows its planned route; if any unexpected event occurs (accident, blocked road), the vehicle in front will emit warning messages within a range of 250 meters. This warning message is composed of the current road id and time. Vehicles that receive the warning message can then check if this road is part of the initially planned route with the help of the onboard GPS, and can then change their route if possible. Algorithm A.1 shows the iterative behavior of the application embedded on vehicles.

Algorithm A.1 Iterative behavior of the application embedded on vehicles

```

if stop_condition then
    StopApplication();
end if
current_road GetRoadId();
if (road_is_blocked) then
    BroadcastPacket(time , current_road);
end if
if receivePacket(time, roadId) then
    if (current_road = roadId) then
        ChangeRoute();
    end if
end if

```

A.4.2/ RESULTS

The simulated scenario counts an overall of 7730 vehicles running for 5400 seconds. The simulation starts at time 25000, which corresponds to the morning rush hour (around 7:00 AM). At time 26000 seconds, we block one of the main roads of the city. The road remains blocked for 2000 seconds then it is opened again. In figure A.4, we show the performance of our platform by illustrating the decreased number of subscribed vehicles (vehicles for whom the speed and positions are retrieved from SUMO on each time step).

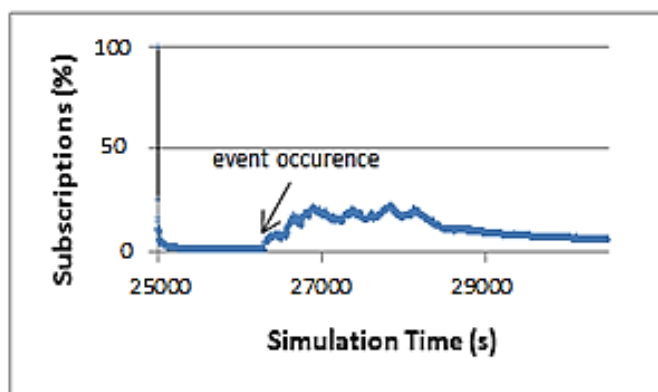

Figure A.4: Percentage of the subscribed vehicles

We can notice that the number of subscriptions doesn't exceed 25% of the loaded vehicles over the event occurrence period; while an online implementation requires the subscriptions of 100% of the loaded vehicles. This allows decreasing the simulations' computational cost letting the simulation run faster.

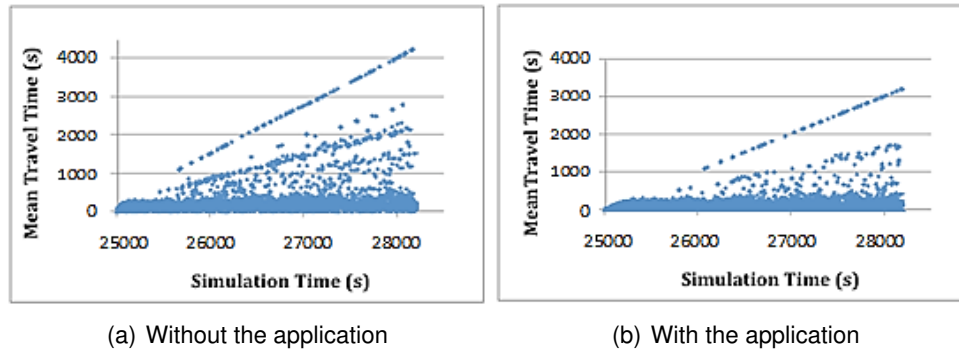

Figure A.5: Mean travel time results

The efficiency of our platform is shown using the Mean Travel Time metric. The results reflecting the fluidity of road traffic obtained after launching the tested application are illustrated in figure A.4. The minimum interval between two packets sent by a vehicle was set to 5 seconds and the time to live for a packet is 1 second. In the observed period, the number of vehicles and the mean travel times increases starting from around 25600 seconds. Figure A.5(a) shows the mean travel time of vehicles without the application reaching higher than 4000s in some cases. The enhancement can be observed in figure A.5(b), showing the mean travel times with the application launched, as the maximum travel time is slightly higher than 3000s. In other terms, vehicles spend less time on the road and reach their destinations faster compared with the scenario wanting the application.

A.5/ CONCLUSION

In this appendix, we introduced a novel approach for realistic simulations of vehicular communications, and the design of the platform HINTS, the corresponding implementation. It reposes on SUMO for the realistic mobility of nodes, and on NS-3 for the wireless communications. The goal of this new approach is to decrease the simulations' times and their computational costs in order to trivialize VANET application simulations. Future works will focus on improving the open source platform HINTS, and using it for its main purpose, that is, to evaluate VANETs protocols and applications especially those proposed in this thesis.

Abstract:

Today, vehicles have become more sophisticated, intelligent and connected. Indeed, they are equipped with sensors, radars, GPS, communication interfaces and high processing and storage capacities. They can collect, process and communicate information related to their working conditions and their environment forming a vehicular network. The incorporation of communication technologies on vehicles garnered a huge attention of industry, government authorities and standardizations organizations and opened the way for innovative applications that revolutionized the automotive market with the main goals to ensure safety on roads, increase transport efficiency and provide comfort to drivers and passengers. In addition, transportation is still an actively evolving sector. More sustainable means of transportation such as electric vehicles are introduced progressively to the automotive market with new challenges related to energy consumption and environment preservation that remain to be solved. Many research investigations and industrial projects are done to exploit the advantages of information and communication technologies (ICT) to fit with transportation challenges. However, having connected and cooperative vehicles creates a highly dynamic network characterized by frequent link breaks and message losses. To cope with these communication limitations, this thesis focuses on two major axis: (i) connected vehicle or connected mobility and (ii) sustainable mobility. In the first part of this thesis, data dissemination, collection and routing in vehicular networks are addressed. Thus, a new dissemination protocol is proposed to deal with frequent network fragmentation and intermittent connectivity in these networks. Then, a new deployment strategy of new communication infrastructure is developed in order to increase network connectivity and enhance the utilization of the network resources. Finally, a new routing protocol, for delay-sensitive applications, that uses the optimized infrastructure deployment is proposed. The second part focuses on sustainable mobility with a focus on electric vehicles and with the main objective is to reduce pollution issues and make better use of energy. A new architecture for electric vehicles fleet management is proposed. This latter uses the implemented protocols of the first part of this thesis in order to collect, process and disseminate data. It helps to overcome the limitations related to short autonomy of electric vehicles. Then, to meet energy balance challenges, a new deployment scheme for electric vehicles charging stations is developed. This solution helps to satisfy drivers' demands in term of energy while taking into account available resources.

Keywords: Connected mobility, infrastructure deployment, routing and dissemination, sustainable mobility, electric vehicle, energy consumption

Résumé :

Aujourd'hui, les véhicules sont devenus de plus en plus sophistiqués, intelligents et connectés. En effet, ils sont équipés de capteurs, radars, GPS, interfaces de communication et capacités de traitement et de stockage élevés. Ils peuvent collecter, traiter et communiquer les informations relatives à leurs conditions de travail et leur environnement formant un réseau véhiculaire. L'intégration des technologies de communication sur les véhicules fait l'objet d'une immense attention de l'industrie, des autorités gouvernementales et des organisations de standardisations; elle a ouvert la voie à des applications innovantes qui vont révolutionner le marché de l'automobile avec les principaux objectifs d'assurer la sécurité sur les routes, augmenter l'efficacité des transports et offrir un confort aux conducteurs et passagers. En outre, le transport est un secteur en évolution active. Des moyens de transport plus durables comme les véhicules électriques s'introduisent progressivement sur le marché de l'automobile tout en créant de nouveaux défis liés à la contrainte énergétique et la protection de l'environnement qui restent à résoudre. De nombreux projets et études ont été initiés exploitant les avantages des technologies de l'information et de communication (TIC) afin de répondre aux différents défis des systèmes de transport. Cependant, avoir des véhicules connectés et coopératifs crée un réseau hautement dynamique caractérisé par des ruptures de lien et de pertes de messages très fréquentes. Pour résoudre ces problèmes de communication, cette thèse se concentre sur deux axes majeurs: (i) le véhicule connecté (ou mobilité connectée) et (ii) la mobilité durable. Dans la première partie de cette thèse, la diffusion, la collecte et l'acheminement de données dans un réseau de véhicule sont adressés. Ainsi, un nouveau protocole de diffusion est proposé afin de faire face à la fragmentation et la connectivité intermittente dans ces réseaux. Ensuite, une nouvelle stratégie de déploiement d'infrastructure de communication est conçue afin d'améliorer la connectivité réseau et l'utilisation des ressources. Enfin, un nouveau protocole de routage, pour applications sensibles au délai, utilisant cette nouvelle infrastructure de communication est proposé. La deuxième partie se concentre sur la mobilité durable avec un focus sur les véhicules électriques et avec un objectif de réduire les problèmes de pollution et d'utiliser efficacement l'énergie. Une nouvelle architecture de gestion de flottes de véhicules électriques est proposée. Cette dernière utilise les protocoles implémentés dans la première partie de cette thèse afin de collecter, traiter et diffuser les données. Elle permet de surmonter les limitations liées à la courte autonomie des batteries des véhicules électriques. Ensuite, pour répondre aux besoins et défis d'équilibre énergétique, un nouveau schéma de déploiement des stations de recharge pour véhicules électriques est proposé. Cette solution permet de satisfaire les demandes des conducteurs en terme d'énergie, tout en tenant compte les capacités énergétiques disponibles.

Mots-clés : mobilité connecté, déploiement d'infrastructures, dissémination et routage dans les réseaux de véhicules, mobilité durable, véhicule électriques, consommation d'énergie

SPIM