



**HAL**  
open science

# The proposition of structured models and process for development of synchronous collaborative environments : application for design review meeting

Samira Sadeghi

► **To cite this version:**

Samira Sadeghi. The proposition of structured models and process for development of synchronous collaborative environments : application for design review meeting. Other. Université Grenoble Alpes, 2015. English. NNT : 2015GREAI053 . tel-01238781

**HAL Id: tel-01238781**

**<https://theses.hal.science/tel-01238781>**

Submitted on 7 Dec 2015

**HAL** is a multi-disciplinary open access archive for the deposit and dissemination of scientific research documents, whether they are published or not. The documents may come from teaching and research institutions in France or abroad, or from public or private research centers.

L'archive ouverte pluridisciplinaire **HAL**, est destinée au dépôt et à la diffusion de documents scientifiques de niveau recherche, publiés ou non, émanant des établissements d'enseignement et de recherche français ou étrangers, des laboratoires publics ou privés.

# UNIVERSITÉ GRENOBLE ALPES

## THÈSE

Pour obtenir le grade de

### DOCTEUR DE L'UNIVERSITÉ GRENOBLE ALPES

Spécialité : **Génie Industriel : Conception et Production**

Arrêté ministériel : 7 août 2006

Présentée par

« **Samira SADEGHI** »

Thèse dirigée par « **Frédéric NOEL** » et

Co-encadrée par « **Cédric MASCLET** »

préparée au sein du **Laboratoire G-SCOP**

dans l'**École Doctorale IMEP2 - Ingénierie - Matériaux, Mécanique, Environnement, Energétique, Procédés, Production**

## **Proposition des modèles et de processus structurés pour le développement d'environnements collaboratifs synchrones: *application aux réunions de revue de conception***

Thèse soutenue publiquement le « **19 Novembre 2015** »,

devant le jury composé de :

**M, Vincent CHEUTET**

Professor, INSA Lyon, FR (Rapporteur)

**M, Jérôme PAILHES**

Maitre de conférences, Arts et Métiers Paris Tech, Bordeaux, FR (Rapporteur)

**Mme, Caroline HAYES**

Professor, Iowa State University, IA, USA (Examineur)

**M, Lionel ROUCOULES**

Professor, Arts et Métiers Paris Tech, LSIS, FR (Examineur)

**M, Frédéric NOEL**

Professor, Université de Grenoble, G-SCOP, FR (Directeur)

**M, Cédric MASCLET**

Maitre de conférences, Université de Grenoble, FR (Co-encadrant)



**The proposition of structured models and process  
for development of synchronous collaborative  
environments:**  
*Application for design review meeting*

**Résumé:**

Le développement d'un environnement collaboratif est un processus complexe. La complexité réside dans le fait que ce développement implique beaucoup de prise de décisions. De multiples compromis doivent être faits pour répondre aux exigences actuelles et futures d'utilisateurs aux profils variés. La prise en compte de cette complexité pose des problèmes aux chercheurs, développeurs et les entreprises. Les informations et données requises pour prendre des décisions adéquates de conception et évaluer rigoureusement ces décisions sont nombreuses, parfois indéterminées et en constante évolution. Dans la partie-I de cette thèse, nous formulons les informations et les connaissances générales sur le travail collaboratif synchrone qui constituent l'état de l'art du domaine du problème. Nous pratiquons de même pour les environnements collaboratifs synchrones (domaine de la solution technique) et cette formulation s'appuie sur une étude de la littérature et conduit à la proposition de Schéma Conceptuel (Concept Maps). Nous en déduisons trois modèles: SyCoW (travail collaboratif synchrone), SyCoE (environnement collaboratif synchrone) et SyCoEE (évaluation environnement collaboratif synchrone). Dans la partie II de cette thèse, nous proposons un processus pour la sélection / développement d'un environnement collaboratif, où nous démontrons comment les modèles SyCoW, SyCoE et SyCoEE structurent ce processus. Grâce à la mise en œuvre de la démarche proposée, nous présentons le développement d'un nouvel environnement collaboratif synchrone pour une réunion de revue de conception nommé MT-DT. MT-DT a été conçu, développé et évalué par l'auteur dans sa thèse de doctorat. MT-DT est une application logicielle 3D spécifique à une table multi-touche qui assiste les activités de revue de conception collaborative. Les résultats de l'évaluation ont confirmé la convivialité de MT-DT et fournissent des éléments de validation des choix que nous avons faits au cours du développement de MT-DT.

**Abstract:**

Development of collaborative environment is a complex process. The complexity lies in the fact that collaborative environment development involves a lot of decision-making. Several tradeoffs need to be made to satisfy current and future requirements from a potentially various set of user profiles. The handling of these complexities poses challenges to researchers, developers, and companies. The knowledge required to make suitable design decisions and to rigorously evaluate those design decisions is usually broad, complex, and evolving. In Part-I of this thesis, we investigate to formulate the general knowledge and information about: synchronous collaborative work which conceptualize the problem domain, synchronous collaborative environment which conceptualize the solution domain and, synchronous collaborative environment evaluation which conceptualize the evaluation of whole or part of the proposed solution for the specified problem. This formulation has been done through literature study and led to the Concept Maps. The results generate three models: SyCoW (synchronous collaborative work), SyCoE (synchronous collaborative environment) and SyCoEE (synchronous collaborative environment evaluation). In Part-II of this thesis, we proposed a structured process for selection/development of collaborative environment, where we demonstrate how SyCoW, SyCoE, and SyCoEE support this process in different ways. Through the proposed process we present the development of a new synchronous collaborative environment for design review meeting, named, MT-DT. MT-DT has been designed, developed and evaluated by the author during her PhD. MT-DT consists of a multi-touch table with specific 3D software application which support collaborative design review activities. The results of evaluation confirmed the usability of MT-DT and provide arguments about our choices which we made during the development of MT-DT.



# Preface and acknowledgments

This thesis is defined in the frame of VISIONAIR (Vision Advanced Infrastructure for Research). VISIONAIR is international research infrastructure, financed by the European Union, with the aim of providing for a wide range of European researchers by means of high-level visualization and interaction facilities for scientific data visualization and interaction.

**Story:** I started my PhD in October 2010 under the supervision of Pr. Frederic Noel and Dr. Cedric Masclet at Grenoble INP. The research work has been finished at the end of September 2013. I gave the first draft of my report to my advisors and I left France to the USA for a visiting researcher/ post-doc position at Iowa State University (ISU). I had planned to have my defense within some months. However, after I went to the USA, I got some personal issues which I decided to postpone my defense. At ISU, I had the opportunity to work with Pr. Caroline Hayes. We started to build her collaborative tool laboratory. We have setup two collaborative environments for distributed collaboration. For one setup, we used zSpace devices which support 3D visualization and interaction. For the second setup, we used 3 multi-touch tables (Perspective Pixel Microsoft). For each multi- touch table we attached a perpendicular display to support the collaborators visualization. During my stay in USA, I worked on a project with Rockwell Collins Company on ‘Collaborative Product Review Using 3D Computer Interface Devices’. The long-term goal of this work was to provide the understanding necessary to: Help organizations make informed decisions about investments in technological systems for virtual collaboration, and also help developers of virtual collaboration systems to make informed decisions about what features are appropriate to include in new tools, and for particular tasks. In September 2014, I came back to France and I started lecturer-researcher position at Arts et Metier Paris Tech. Hence, during this year, beside teaching and research, I have completed my PhD report. I also worked on my PhD perspective where I implemented a knowledge-based tool for management and reuse of synchronous collaborative environment knowledge. The case based reasoning and semi-structured knowledge repository has been used to make the knowledge available for usage during the different phase of a synchronous collaborative environment development process. The prototype has been implemented under TEEEXMA®. TEEEXMA® is a technical knowledge management platform. It provides a collaborative flexible interface for capitalizing the data, information and knowledge in the form of objects, the relation between objects and instances.

**Acknowledgments:** I wish to express my gratitude to my supervisor Pr. Frederic Noel, and my co-supervisor Dr. Cedric Masclet. They have taught me what it means to be a researcher. They have also encouraged me to strive for excellence while remaining modest. More importantly, they gave me the freedom to explore many research directions. I would like to thank Pr. Joshua Summers, talking with him about my research motivated me to move forward. I would like to thank Pr. Caroline Hayes. Working with her was wonderful and gave me the opportunity to use the knowledge that I obtained in three years of My PhD work. I would like to thank Pr. Lionel Roucoules for helping me to focus and keep motivated to finalize my report and to work on my PhD perspective. I would like to express my gratitude to my parents, who have always supported me through out each and every step of the way. I thank them for their unconditional love and their trust. I would like to thank my loving sisters Leyla and Rezvan and my brothers Mohsen, Hossein and Behnam for their love, support and encouragement. Last but not least, I would like to thank all the students who participated in the experiments in this thesis. Also many thanks to other colleagues at G-SCOP, Iowa State University and Arts et Metier Paris Tech for being supportive.

# Table of content

<b>Preface and acknowledgments .....</b>	<b>IV</b>
<b>Glossary .....</b>	<b>1</b>
<b>List of Figures .....</b>	<b>2</b>
<b>List of Tables .....</b>	<b>4</b>
<b>Introduction.....</b>	<b>5</b>
Research Motivation.....	5
Research Questions .....	7
Research Audience .....	7
Thesis Organization.....	7
<b>Part-I: Capturing and Modeling the Synchronous Collaboration Domain Concepts .....</b>	<b>9</b>
<b>Part-I: Introduction.....</b>	<b>10</b>
<b>Part-I: Chapter 1 .....</b>	<b>11</b>
<b>Abstract.....</b>	<b>11</b>
<b>1. SyCoW Concept Map: A General Model of Synchronous Collaborative Work .....</b>	<b>12</b>
1.1 Introduction.....	12
1.2 Related work .....	12
1.3 Motivation for Developing SyCoW Concept Map .....	13
1.4 Methodology .....	13
1.5 SyCoW (Synchronous Collaborative Work) Concept Map .....	14
1.6 SyCoW Extension for Product Design and Development Domain .....	17
1.7 SyCoW Usage .....	28
1.8 Conclusion and Discussion .....	29
<b>Part-I: Chapter 2 .....</b>	<b>30</b>
<b>Abstract.....</b>	<b>30</b>
<b>2. SyCoE Concept Map: A General Model of Synchronous Collaborative Environment.....</b>	<b>31</b>
2.1 Introduction.....	31
2.2 Related work .....	31
2.3 Motivation for Developing SyCoE Descriptive Model.....	33
2.4 Methodology .....	33
2.5 SyCoE (Synchronous Collaborative Environment) Concept Maps /General view .....	34
2.6 SyCoE Concept Maps /Detail view .....	34
2.7 SyCoE Usage .....	49
2.8 Conclusion and Discussion .....	49
<b>Part-I: Chapter 3 .....</b>	<b>50</b>
<b>Abstract.....</b>	<b>50</b>
<b>3. SyCoEE Concept Map: A General Model of Synchronous Collaborative Environment Evaluation .....</b>	<b>51</b>
3.1 Introduction.....	51
3.2 Related work .....	52
3.3 Motivation for Developing SyCoEE Descriptive Model .....	53
3.4 Methodology .....	54
3.5 SyCoEE (Synchronous Collaborative Environment Evaluation) Concept Maps .....	54
3.6 SyCoEE Usage .....	60
3.7 Conclusion and Discussion .....	60
<b>Part-I: Conclusion .....</b>	<b>62</b>

<b>Part-II: A Process for Development/Selection of Synchronous Collaborative Environment .....</b>	<b>63</b>
<b>Part-II: Introduction .....</b>	<b>64</b>
<b>Part-II: Chapter 4.....</b>	<b>66</b>
<b>Abstract.....</b>	<b>66</b>
<b>4. Exploring the Problem and Possible Solutions .....</b>	<b>68</b>
4.1 [Step S]: Starting with the objective identification .....	68
4.2 [Step 1-1]: Analyzing the collaborative situation and determining the collaboration As-It-Is and the corresponding specifications...	69
4.3 [Step 1-2]: Finding the most adapted solutions among existing cases .....	75
4.4 Conclusion and Discussion .....	79
<b>Part-II: Chapter 5.....</b>	<b>80</b>
<b>Abstract.....</b>	<b>80</b>
<b>5. Development of a new Synchronous Collaborative Environment.....</b>	<b>82</b>
5.1 [Step2]: Development of a new Synchronous Collaborative Environment.....	82
5.2 [Step 2-1]: Design a new Synchronous Collaborative Environment.....	82
5.2.1 Facilities Selection: .....	83
5.2.2 Software Design .....	85
5.2.3 Software Architecture Design: .....	88
5.2.4 SyCoE Configuration .....	93
5.3 [Step 2-2]: Implementation of the proposed Synchronous Collaborative Environment.....	93
5.4 Conclusion and Discussion .....	94
<b>Part-II: Chapter 6.....</b>	<b>95</b>
<b>6. Evaluation of Synchronous Collaborative Environment .....</b>	<b>97</b>
6.1 [Step 3]: Evaluation of Synchronous Collaborative Environment .....	97
6.2 [Step 3-1]: Evaluation Specification.....	97
6.3 [Step 3-2]: Conducting the Evaluation .....	107
6.4 [Step 3-3]: Analyzing the data and identifying the results of evaluation .....	109
6.5 [Step E]: Adding the new case to the case base.....	121
6.6 Conclusion and Discussion .....	121
<b>Part-II: Conclusion.....</b>	<b>123</b>
<b>Discussion, Conclusion, Future Work and Perspectives .....</b>	<b>124</b>
<b>Résumé en Français.....</b>	<b>130</b>
<b>Reference .....</b>	<b>151</b>
<b>Appendix.....</b>	<b>165</b>
7.1 Documents for Evaluating MT-DT .....	166
7.1.1 Information Letter for Participant.....	166
7.1.2 Advertising to attract people for participation and giving a general view about the experiment and how it looks like.....	167
7.1.1 Pre-Questionnaire.....	168
7.1.2 Post-Questionnaire (Just after Experiment) .....	169
7.1.3 Post-Questionnaire (by Delay after Experiment).....	171
7.1.4 Post-Questionnaire after the second experiment (paper V.S. digital).....	174
7.1.5 Marketing Role and Task .....	177
7.1.6 Design Role and Task.....	179
7.1.7 Manufacturing Role and Task .....	183
7.1.8 Environmental Role and Task .....	187
7.2 Documents for Analyzing Collaboration As-Is .....	191
7.2.1 Marketing Role.....	191
7.2.2 Marketing Task .....	195
7.2.3 Design Role (Frame Design).....	196
7.2.4 Design Task (Frame Design).....	204
7.2.5 Design Role (Design Accessory).....	205
7.2.6 Design Task (Design Accessory).....	211
7.2.7 Environmental Role.....	212
7.2.8 Environmental Task .....	219

# Glossary

<b>SyCoW</b>	Synchronous Collaborative Work
<b>SyCoE</b>	Synchronous Collaborative Environment
<b>SyCoEE</b>	Synchronous Collaborative Environment Evaluation
<b>MT-DT</b>	Multi-Touch for Design Team, a software application developed by author through her PhD to support design review meeting
<b>CSCW</b>	Computer Supported Cooperative Work
<b>CVE</b>	Collaborative Virtual Environment
<b>HCI</b>	Human Computer Interaction

*The general aim of this thesis is to demonstrate that the formulation and capitalizing each piece of data, information, knowledge and experience will facilitate the work of researcher and developers in this domain. No matter what you name it (data, information, knowledge or experience), capitalizing and making them easily available is the key to reduce the complexity of development or selection of an appropriate collaborative environment for specific collaborative situation.*

# List of Figures

Figure 1-1: High level view on model of Synchronous Collaborative Work (SyCoW) with main element and main relations	16
Figure 1-2: Product development process	19
Figure 1-3: SyCoW Objective Model	20
Figure 1-4: Participant model	22
Figure 1-5: Task category based on social point of view adapted from [Mandviwalla & Olfman 1994]	24
Figure 1-6: SyCoW Task Model	24
Figure 1-7: Participant activity model	25
Figure 1-8: Meeting input descriptive model	26
Figure 1-9: Visual design representation	27
Figure 1-10: Product category based on its size and user position relative to the product (cubes define the product size)	28
Figure 2-1: Time-Space Matrix [Johansen 1988]	32
Figure 2-2: MPG place in Time-Space Matrix [Tang et al. 2004]	32
Figure 2-3: Synchronous Collaborative Environment Model	34
Figure 2-4: Facilities general model	35
Figure 2-5: Input Device Description	36
Figure 2-6: Output device	38
Figure 2-7: Visual Display Device	39
Figure 2-8: The six-channel CAVE system, the 10' x 10' environment features wireless tracking and communication devices and a three-dimensional audio system, IOWA State University [IOWA 2013]	40
Figure 2-9: Stereoscopic 3D display types: (a) anaglyph [Brain 2003], (b) LC shutter [Nolde 2011], and (c) polarized 3D system [Brain 2003]	41
Figure 2-10: Left: [Grossman et al. 2004] Right: [Lantz 2007]	42
Figure 2-11: (a) Five screen pCube showing a 3D model of the globe (b) direct selection of a object with a 3D pointer; (c) Rotation of pCube to see the 3D object from different point of view; (d) dynamic cow models react to display motion; (f) 3D navigation through the virtual landscape; [Stavness et al. 2010]	42
Figure 2-12: Synchronous Collaborative software tool	47
Figure 3-1: Synchronous Collaborative Environment Evaluation (SyCoEE)	56
Figure 3-2: Evaluation Methods part of SyCoEE model	58
Figure 4-1: Face to face collaborative design review among a customer (marketing member from the company X), two designers with different design specialty and one manufacturing member from the company Y.	70
Figure 4-2: A part of participant's conversation during the meeting and analyzing their action	71
Figure 4-3: A part of participant's conversation during the meeting and analyzing their action	71
Figure 5-1: Relation between multi-touch table properties and application requirement specifications	84
Figure 5-2: Diamond Touch Table record in data base of existing displays	84
Figure 5-3: Some possible options for designing workspace	86
Figure 5-4: The first prototype of MT-DT interface	87
Figure 5-5: MT-DT architecture specifications	89
Figure 5-6: MT-DT documentation Meta-model	91
Figure 5-7: Hyper link time line: a proposed way for visualizing the result of data gathered from meeting by MT-DT	92
Figure 5-8: Zoom able timeline: a proposed way for visualizing the result of data gathered from meeting by MT-DT	92
Figure 5-9: The first prototype of MT-DT testing rotation, translation and link creation function	93
Figure 5-10: Some functionalities of MT-DT	94
Figure 6-1: The time line of conducting the comparative experiments	105
Figure 6-2: The configuration of the camera relative to the users and other facilities positions. Left: experimental study in paper based version. Right: Experimental study on MT-DT	107
Figure 6-3: The graphical representation of users' interaction on MT-DT for simultaneous setup (User 1: Design/ User 2: Environmental expert /User 3: Manufacturing/ User 4: Marketing)	111
Figure 6-4: The graphical representation of users' interaction on MT-DT for sequential setup (User 1: Design/ User 2: Marketing /User 3: Environmental expert / User 4: Manufacturing)	111
Figure 6-5: Time line of users' interaction for simultaneous setup	112
Figure 6-6: Time line of users' interaction for sequential setup	112
Figure 6-7: Users interactions with MT-DT over the time in simultaneous setup	112
Figure 6-8: Left: time percentage of users' interaction for simultaneous setup, Right: time percentage of users' interaction for sequential setup	113
Figure 6-9: Left: Without individual space, Right: With individual space	115
Figure 6-10: The characteristics of different user interface configuration feature for multi-touch table	115

Figure 6-11: Participant personality dimensions-----	116
Figure 6-12: Left: The Max, Min and average of personality dimensions for all participants, Right: The average of personality dimensions for each group of participants-----	116
Figure 6-13: The result of note taking by different participants in one of our experiments -----	117
Figure 6-14: Suitability rate for the size of shared space-----	118
Figure 6-15: Suitability rate for the size of individual space-----	118
Figure 6-16: Usefulness rate for scaling functionality -----	119
Figure 6-17: A case has been built by three components of problem, solution and solution evaluation and outcomes -----	127
Figure 6-18: The architecture of KBT_SyCoE (Knowledge-based Tool for Management and Reuse of (Synchronous Collaborative Environment Knowledge) -----	128
Figure 6-19: Modèle conceptuel du Travail Collaboratif Synchronique (SyCoW)-----	135
Figure 6-20: Modèle Général de l'Environnement Collaboratif Synchronique (SyCoE)-----	137
Figure 6-21: l'outil logiciel -----	138
Figure 6-22: Modèle Général de l'Evaluation de l'Environnement Collaboratif Synchronique (SyCoEE)-----	141
Figure 6-23: le processus de développement ou de sélection d'un environnement collaboratif synchronique -----	143
Figure 6-24: L'architecture de MT-DT -----	148
Figure 6-25: Certaines fonctionnalités de MT-DT -----	149

# List of Tables

Table 2-1: Some possible configuration of collaborative environment -----44

Table 2-2: The variables require to be considered in designing the configuration of place i-----45

Table 3-1: Taxonomy of data collection methods [Andriessen 1996]-----57

Table 3-2: Characterization of Evaluation Methods [Antunes et al. 2012] -----59

Table 3-3: From each cluster one or a few examples are given. Between brackets the total number of tools per cluster [Andriessen et al. 1998].--59

Table 4-1: A part of participant’s conversation during the meeting and analyzing their action -----71

Table 4-2: List of requirements for collocated design review among small group -----75

Table 4-3: Some existing cases on collaborative environment -----78

Table 6-1: Identification of the objectives of evaluation and the reason of defining those objectives-----99

Table 6-2: Different Experimental Styles in Family of experiments ----- 100

Table 6-3: Element was checked to select two similar products ----- 101

Table 6-4: Design options for coffee makers----- 102

Table 6-5: Information distribution among different documents dedicated for each role and comparison between there design options ----- 102

Table 6-6: Two categories of documents prepared for each role for design review of Coffee makers ----- 103

Table 6-7: Role difference analysis ----- 104

Table 6-8: The conducted experiments and their characteristics ----- 108

Table 6-9: MT-DT usability analysis based on T-CUA framework [Pinelle & Gutwin 2008]----- 110

Table 6-10: Participants’ answers about the interest of having individual space ----- 114

Table 6-11: The result of analyzing the impact of the size of the shared space on collaboration and working condition ----- 118

Table 6-12: The result of analyzing the impact of the size of the individual space on collaboration and working condition ----- 119

Table 6-13: The result of analyzing the impact of scaling functionality on collaboration and working condition----- 120

Table 6-14: Comparison between MT-DT and paper based design review meeting ----- 120

# Introduction

The product market of collaboration technologies and environments is growing fast. Some of these solutions are designed for special purpose and some are designed for specific application domain. Hence selection among potential solution is not an easy process. On the other hand, development of collaborative environment is complex process. During the collaborative environment development process (including: design, implementation and evaluation), a lot of information and knowledge is being used and produced. The information and experienced knowledge produced and consumed during this process is broad, complex and multi-disciplinary. This information and knowledge includes the collaborative working domain (Collaborative design, Collaborative product development, collaborative Learning, etc.), software engineering (HCI, Multi-user interface, software implementation, software evaluation, etc.), the nature of collaborative work, knowledge coming from anthropology, philosophy, sociology, ethnography or psychology. Hence development of collaborative environment requires knowledge and information in many specific domains. The knowledge and information which comes from experience and practice is important during development process. This knowledge and information needs to be captured, shared and reused across different life-cycle phases.

We find various form of data, information and knowledge created and used during collaborative environment life cycle development which can be reused easily if we make it available in more a formalized way. However, there has been little effort spent on providing appropriate guidance and/or effective infrastructure for capturing and managing the different type of data and knowledge required or produced during collaborative environment development process. Huge numbers of articles can be found in collaboration, collaborative tool and environment and evaluation of collaborative environment literature, which represent the main knowledge elements in this domain. Most specifically the knowledge created in CSCW (Computer Supported Cooperative Work) research community which seeks to understand how people and organizations interact with one another and to integrate this understanding with the development of computer based tools to support real world settings. However, we still have the lack of a big picture about the data, information and knowledge and the lack of suitable way to access them. Mostly they are embedded in articles in text format, which is not structured and consequently is not easily accessible. Hence it is necessary to provide more formalized way of representing the data, information and knowledge to make it easily available and accessible for later on usage.

The collaborative environments that we focus in this thesis are synchronous collaborative environment. Synchronous collaborative environment is a type of collaborative environment that supports synchronous collaborative working session where communication and collaboration happen in real-time. However, the proposed approach in this thesis is generic and can be extended to other type of collaborative environments. Also the approach and proposed methods could be applied to other domains which have similar problems.

## Research Motivation

In general, the difficulty and complexity of collaborative environment selection/development motivates the work conducted in this thesis.



The collaborative environment development process consists of a macro level process and several micro level processes which consist of lot of activities, tasks and decision making for design, implementation and evaluation. If we capitalize the experience created during this process, in an appropriate way, it can be helpful for researcher and developer during the future development of new collaborative environment. In other words, formalization of collaborative environment data and knowledge should improve the complex process of development of collaborative environments.

Hence, the overall objective of this thesis is to improve the process of selection/ development of collaborative environment, towards providing appropriate supporting tool. In order to improve this process it's required to have knowledge based process where developers will be able to discover the potential solutions and to make decision about alternative solutions based on formalized and available knowledge. In other words, improve the process by making the reusable knowledge, solutions and data easily available. To achieve this objective, it is important to not only capture and share the general knowledge in domain, but also document the experienced knowledge which includes: collaborative environment solution, the specification of target collaborative situation, the decisions which led to those solutions, its rationale, etc.

We can found various types of data, information and knowledge in this domain. An important part of this data concerns the specification of the problem domain and the solution chosen, in terms of components of collaborative environment and software solution used in this environment. It is clear that the decisions, which lead to a specific solution, are important ingredients of development process knowledge. Also, an important knowledge requires and produced in this process is about how specific solution may impact on collaboration, people performance and collaborative environment success.

We firstly identified the type of data and knowledge that we wanted to formalize for further usage. Some knowledge is application-generic knowledge and some knowledge is application specific. Application-generic knowledge can be applied in several applications independently to the specific collaborative situation characteristics. Application-specific knowledge is related to particular collaborative situation. For this type of knowledge, it is necessary to provide the entire information component of collaborative situation in order to be able to reuse it in similar applications with certain level of accuracy. Synchronous collaboration knowledge is related to various topics. Hence, we defined five main views on synchronous collaboration knowledge:

- 1) Synchronous collaborative work nature, requirements, concepts and the relation between concepts;
- 2) Synchronous collaborative environment nature, specification, functionalities, concepts and the relation between concepts;
- 3) Synchronous collaborative environment evaluation nature, specification, concepts and the relation between concepts;
- 4) The lesson learned from experience and existing cases;
- 5) The rules defined between the concepts cross these three main domains.

In Part-1 of this thesis we investigated in formulating the first, second and third type of knowledge in the form of concept maps. Investigation in the fourth and fifth type of knowledge has been defined as future perspective of this thesis.

## **Research Questions**

This thesis addresses the following question: How may be formalized a reusable knowledge to select or develop a collaborative environment which fits a target collaborative situation?

This question spans issues about: understanding collaborative situations and specifying its elements, analyzing the existing collaborative solutions and their potential in providing new solutions to the target collaborative situation, selecting the best fitted potential technology based on requirements, designing appropriate software for selected hardware, implementing prototypes, and evaluating the impact of these prototypes on that collaborative work. Hence, several sub-questions are raised within the context of this research.

1- How we can provide more formalized way about the knowledge required and produced during collaborative environment development?

1.1- How can we provide a formal and structure representation of collaborative work context and concepts usable by researchers and software engineers for analyzing the specification of a target collaborative work?

1.2- How can we provide a formal and structure representation of collaborative environment context, concepts and specifications usable by researchers and software engineers to analyze the specification of the existing collaborative environment or solution components of a collaborative environment?

1.3- How can we provide a formal and structure representation of collaborative environment evaluation context and concepts, usable by researchers and software engineers for designing and conducting their evaluations?

1.4- How can we formalize the general and specific knowledge obtained in this domain?

1.5- How can we capitalize the knowledge and experience about an existing collaborative environment to make its knowledge more reusable?

2- How can we support the development process through the formalized knowledge?

## **Research Audience**

The thesis by giving a broad understanding of the data and knowledge elements produced or required during development of collaborative environment is intended to be relevant to three major audiences. However it's not just limited to these groups:

- First group of audience are researcher who has research interest in designing supporting tool for synchronous collaborative work or has interest in synchronous collaboration.
- Second group of audience are software developer and engineer who are involved in design and development of supporting tool for synchronous collaborative work.
- Third group are organizations and companies with the need to develop or select appropriate supporting tool and environment for their synchronous collaborative works and activities.

## **Thesis Organization**

This document consists of two main parts. Each part starts with general introduction to the part and finish by conclusion for the part. General conclusion draws the conclusion and presents the potential

future work and perspectives based on the results obtained during this PhD. At the end we are presenting the summary of this thesis in French and finally, the appendix which consists of all the material prepared for the experiments.

- **Part-I: Capture and Modeling the Synchronous Collaboration Domain Concepts**

In Part-I we investigate on formulating the concepts in problem domain, solution domain and solution evaluation domain in the form of concept maps. This part is split in three chapters: chapter1, chapter2, chapter3:

- **Chapter 1\_ *SyCoW Concept Map\_A General Model of Synchronous Collaborative Work***: In this chapter we present the SyCoW (Synchronous Collaborative Work) Concept Map. The proposed model conceptualizes the synchronous collaborative work specifications and characteristics.
- **Chapter 2\_ *SyCoE Concept Map\_A General Model of Synchronous Collaborative Environment***: In this chapter we present the SyCoE (Synchronous Collaborative Environment) Concept Map. The proposed model conceptualizes the synchronous collaborative environment specifications and characteristics.
- **Chapter 3\_ *SyCoEE Concept Map\_A General Model of Synchronous Collaborative Environment Evaluation***: In this chapter we present the SyCoEE (Synchronous Collaborative Environment Evaluation) Concept Map. The proposed model conceptualizes the synchronous collaborative environment evaluation specifications and characteristics.

- **Part-II: A Process for Development/Selection of Synchronous Collaborative Environment**

In Part-II we formalize the collaborative environment development process and how this process can be supported with existing knowledge. The usage of the proposed models in Part-I, is demonstrated through the proposed process in Part-II. Through this process we present the development of a new synchronous collaborative environment dedicated to design review meeting, named, MT-DT. MT-DT has been designed, developed and evaluated during the PhD. Part-II is split also in three chapters: chapter 4, chapter 5 and chapter 6.

- **Chapter 4\_ *Exploring the Problem and Possible Solutions***: In this chapter we present the first step of the proposed process. In step 1-1 based on SyCoW and SyCoE Concept Maps we analyzed the collaboration As-It-Is and identified the requirements. In step 1-2 by the help of SyCoW and SyCoE Concept Maps we analyzed the experienced cases in order to explore the possible collaborative solutions for our target collaborative environment.
- **Chapter 5\_ *Development of a New Synchronous Collaborative Environment***: In this chapter we present the second step of the proposed process which focuses on the design and development of new collaborative environment.
- **Chapter 6\_ *Evaluation of Synchronous Collaborative Environment***: In this chapter we present the third step of the proposed process which focuses on the evaluation of collaborative environment.

# **Part-I: Capturing and Modeling the Synchronous Collaboration Domain Concepts**

## **Part-I: Introduction**

The data and experience obtained and used during collaborative environment development process is usually documented in research articles. As far as we know, there is no framework or approach to capitalize this data and experience in a formal way to make access to this information easy. Synchronous collaboration domain general knowledge in the form of concepts consists of the concepts of three main sub-domains: synchronous collaborative work which specifies the problem domain, synchronous collaborative environment which specifies the solution domain and synchronous collaborative environment evaluation which specify the evaluation of the whole or the part of the proposed solution for the specified problem. Capitalizing the general and specific knowledge about problem domain, solution domain and evaluation of solution domain is necessary to support the process of development/selection of synchronous collaborative environment. Also the information gained from previous experiences is a potential source of knowledge to support this process. In Part-I of this thesis we investigate to conceptualize the identified domains. The Chapter 1 presents the Synchronous Collaborative Work (SyCoW) Concept Map. The Chapter 2 presents the Synchronous Collaborative Environment (SyCoE) Concept Map. The Chapter 3 presents Synchronous Collaborative Environment Evaluation (SyCoEE) Concept Map. In Part-II, we will show the usages of the proposed models during the process of selection/ development of synchronous collaborative environment.

# Part-I: Chapter 1

## SyCoW Concept Map: A General Model of Synchronous Collaborative Work

### Abstract

A better understanding of collaborative situations can lead to a better selection of a collaborative environment. This chapter is formulating the general concepts of synchronous collaborative work through the Concept Map express by UML class diagram. The proposed model, named SyCoW, provides a structured view of synchronous collaborative work. It structures and reports the concepts found in literature review on multiple domains. This model can be used in different way during the design and development of collaborative environment. An extension of SyCoW is proposed for product design and development domain which demonstrated extensibility of this model.

### Table of Content

1.1	Introduction .....	12
1.2	Related work.....	12
1.3	Motivation for Developing SyCoW Concept Map.....	13
1.4	Methodology .....	13
1.5	SyCoW (Synchronous Collaborative Work) Concept Map.....	14
1.6	SyCoW Extension for Product Design and Development Domain .....	17
1.7	SyCoW Usage.....	28
1.8	Conclusion and Discussion .....	29

# 1. SyCoW Concept Map: A General Model of Synchronous Collaborative Work

## 1.1 Introduction

Synchronous collaborative works in real world have a number of characteristics that must be taken into account when designing successful supporting tools. Several factors may impact on the usability, utility, and acceptance of the collaborative environments. Hence the consideration about collaboration characteristics is essential for success of collaborative tools. Here the questions are: What makes a collaborative situation different from others? Why one collaborative environment is successful in some situations but unsuitable or rejected within other situations?

Much research effort in the Computer Supported Collaborative Work (CSCW) field emphasize on understanding the nature of cooperative work in order to better support people in their cooperative efforts. Understanding the nature and requirements of collaborative situations will lead to a better specification of computer-based technology to support collaboration. On the other hand, establishing the requirements for a computer-supported collaborative environment is complex. However, many synchronous collaborative situations have similar characteristics and consequently similar requirements respect to collaborative environment. Hence, better recognition of similarities and differences between different collaborative situations should lead to better use the previous work and somehow the knowledge obtained from these works. It is expected to recognize the different concepts of synchronous collaborative situations and provide a more structured view on the concepts and their relations. Specifications of relations between concepts simplify the understanding of a new situation or context and thus support the design of an appropriate collaborative environment. Oliveira et al. [Oliveira et al. 2007] emphasized on the importance of the topic, and the necessity to conceptualize and formalize a common vocabulary to represent collaboration.

In section 1.2, related work, we are going to represent the existing ontology, classification and categories of collaboration and collaborative work. Then in section 1.3, we will present our motivation for developing a new concept model for synchronous collaborative work. In section 1.4 we will present our methodology for developing the concept map. Section 1.5 is presenting the SyCoW (Synchronous Collaborative Work) Concept Map. In section 1.6 we are presenting an extension of SyCoW model for product design and development domain. Section 1.7 identifies the different usage for SyCoW. Section 1.8 presents the conclusion of this chapter.

## 1.2 Related work

Oliveira et al. [Oliveira et al. 2007] proposed collaboration ontology based on the structure defined by the 3C Model and shows how it can be used to promote integration among collaborative software tools. They divided the Collaboration Ontology in three sub-ontologies: Cooperation, Communication and Coordination Ontology. Their proposed ontology is in the context of collaborative web browsing. Pattberg and Fluegge [Pattberg & Fluegge 2007] proposed a layered ontology of collaboration patterns. Their proposed ontology provides different levels of abstraction. Knoll et al. [Knoll et al. 2010], [Knoll et al. 2012] proposed a collaboration ontology that builds a common vocabulary for the key concepts of

collaboration and the relations and dependencies between them. Their proposed ontology is divided into two ontologies: One named collaboration ontology (co) that describes the external point of view on collaboration of a client, and another one named collaboration process ontology (cpo) that contains the concepts belonging to the internal description of collaboration processes.

In the context of design and product development, several researches provide classifications and taxonomies of factors influencing collaboration. Ostergaard et al. [Ostergaard et al. 2009] proposed taxonomy for the classification of collaborative design situations. Team composition, communication, distribution, design approach, information, and nature of the problem were introduced in their taxonomy as main factors that have influence on collaboration. Gierhardt et al. [Gierhardt et al. 1999] developed the taxonomy System named “Distributed Product Design and Development” as a tool and method for distributed product design and development process optimization. Grieb et al. [Grieb et al. 2005] proposed an abstract classification of situations and communication media in distributed design. Their intention about representing this kind of structured representation of media, situations and their interrelations was to gain a deeper understanding of communication media in distributed development processes. Eckert et al. [Eckert et al. 2001] explore the variety of interaction in design by developing a set of dimensions for classifying design scenarios.

### **1.3 Motivation for Developing SyCoW Concept Map**

Literature review demonstrates, most of the given collaboration ontologies and classifications represent a special domain of collaboration. They are too abstract to be operational for designing software support systems for specific instances of synchronous collaboration. The ontology models represent the concepts and the relation between the concepts. In most existing taxonomies, the relation between the concepts is not clear. None of the previous work had the sole focus on synchronous collaborative work and none of them had the objective of modeling the overall domain. All these motivated us to model the knowledge of synchronous collaborative work by explicitly conceptualizing this domain.

### **1.4 Methodology**

A variety of graphical representation schemes, typically involving nodes and links, have been created to facilitate the externalization of knowledge [Coffey et al. 2006]. Coffey et al. [Coffey et al. 2006] argued that concept maps are the most general and inclusive of knowledge representations. Hence, we used concept maps to provide a model which conceptualizes the characteristics and specification of synchronous collaborative work. Concept maps are an effective way to visually represent domain knowledge [Coffey et al. 2002], [Cañas et al. 2005], [Coffey et al. 2006], [Leake & Valerio 2006]. It provides a graphical tool that enables anybody to express their knowledge in a form that is easily understood by others [Cañas et al. 2005]. Concept Maps origin comes from research on human learning and knowledge construction [Novak & Gowin 1984]. It has proven a useful approach for constructing and sharing knowledge [Leake et al. 2014].

A concept map is a type of the diagram that shows knowledge objects as nodes and the relationships between them as links. Concepts are the things that constitute a domain (e.g., physical objects, ideas, people, and organizations). Each concept is described by its relationships to other concepts in the domain and by its attributes and values. Relationships represent the way knowledge objects are related to one



another. Words on the line specify the relationship between the two concepts [Coffey et al. 2002], [Cañas et al. 2005], [Cañas & Novak 2009]. Each pair of concepts, together with their joining linking phrase, can be read as an individual statement or proposition that makes sense [Cañas et al. 2005].

As proposed by [Rhem 2005] for modeling the concept map with UML class diagram, we decided to use UML for our modeling. UML is a standard and it is widely diffused and has wide acceptance in both academic and non-academic settings.

As proposed by Novak & Cañas [Novak & Cañas 2006] the starting point for constructing a concept map can consist of only the focus question. Hence we defined the focus question: ‘What are the characteristics of a synchronous collaborative work that may impact on collaboration itself or may impact on the requirements of appropriate collaborative environment to support collaboration? Which concepts help to describe synchronous collaborative work?’

The experienced and knowledge have been collected from the literature in diverse domain and then we conceptualized them in a formal way so that it is easy to reuse. In order to develop SyCoW, we have synthesized the existing classification, and categories of collaboration and collaborative work. During the development of SyCoW one objective was to ensure that identified concepts are sufficiently complete, correct, clear, and brief that could lead to define and specify the characteristic of a synchronous collaboration situation. We used ontology like approach to conceptualize this domain. The reason for using ontologies like approach was to have a flexible model, possibility of modifications and extensions of the data structures. This characteristic is a requirement for modeling the collaborative domain elements because of the complexity of the domain.

## **1.5 SyCoW (Synchronous Collaborative Work) Concept Map**

Synchronous Collaborative Work (SyCoW) concept map (Figure 1-1) demonstrates the element of a synchronous collaborative work. In the proposed model we captured the concepts which specify the characteristics of synchronous collaborative situations.

To fit collaboration, a SyCoW instance is the aggregation of participants. In other words in SyCoW more than two participants collaborate. A set of participant can create a group, a group is a collection of more than two participants who work together to achieve a common set of goals. So a SyCoW instance must have almost one group which itself can be the aggregation of several groups. A group has size; the size of group will be specified by the number of participants that are in the same group. History of group members is an element which affects collaboration.

Participant has location and a participant can be present in only one physical location. Participants can be located at different geographical location [Maier et al. 2005]. Hence group has one or several locations. If all members of group (participant in same group) are at the same location, group has one location. In the case where group members are distributed, the group will have several locations. Location of group and participant define the type of collaborative situation. If all participants are in the same location, the type of collaboration is named “co-located collaboration”. If each participant location is different from others the type of collaboration is distributed and the conditions with both co-located and distributed participants are named mixed collaboration.

Group and participant may have one or several roles during a meeting. The role in a meeting impacts on the action of group and participants.

A collaborative use-case, represented by SyCoW instance, has almost one objective. Each objective is the aggregation of different sub-objectives. Group and participants also have one or several objectives. Their objective can be the same as the collaborative work objective but it may be different. Group and participants may also have different (and in some situations conflicting) objectives.

Objectives are achieved through and participants' tasks and activities. The participants' activity is part of the task. In other words, "activities represent the basic communication interaction unit, which in combination will accomplish a task" [Salvador et al. 1996]. Camolesi & Martins [Camosesi & Martins 2006] defined activity as an element of execution that can be performed by a single actor or by a group of actors. The activity is a measurable amount of work performed to convert inputs into outputs. Previous research emphasized on the need to understand the activity that occurs in workspaces in order to inform the design, development, and introduction of these new technologies intended to support it. A better understanding of workspace activity could also lead to insights into improving the design of supporting tools. Participant activity is conducted through the series of actions in relation to the goal or object of activity. Operation contributes to the realization of actions [Bodker 1990]. Actions describe the means of producing the activity [Tang & Leifer 1988]. Participants perform a series of actions which usually aimed at reaching a common goal [Pallotta et al. 2007].

Based on Camolesi & Martins [Camosesi & Martins 2006] definition, interactions are dynamic relationships that occur among actors (human or non-human) and objects in collaborative environments. In a SyCoW model we focused on interaction as kind of action that occurs between human and human or between human and artifacts. Human interaction with computer is a type of human interaction with artifacts. Human to human interaction can be the aggregation of spoken, written, gesture interaction and communication and human interaction with artifact (human communication via artifact: a participant can use his gesture while talking to communicate and interact with other members of the group.

The collaborative working session input aggregates several inputs. Inputs are entered at any time during the collaborative work. Inputs are identified before the collaborative session or on the fly. Participant use inputs to realize their activities and to create the outputs of the collaborative work. The output also aggregates several outputs. Outputs are predictable or non-predictable depending on the type of activity occurring during the collaborative session. The documentation of collaborative session is also a meeting output. The output is what is delivered after the collaborative session. The outcome is what the project gains from the outputs. In product design domain, a particular objective might be coordination; the output contains modified design artifacts and list of decisions, while the outcome is the project progress. Agreements on future action items, assigned tasks, solved conflicts, etc. [Pallotta et al. 2007] are some examples of outcomes in the product design context.

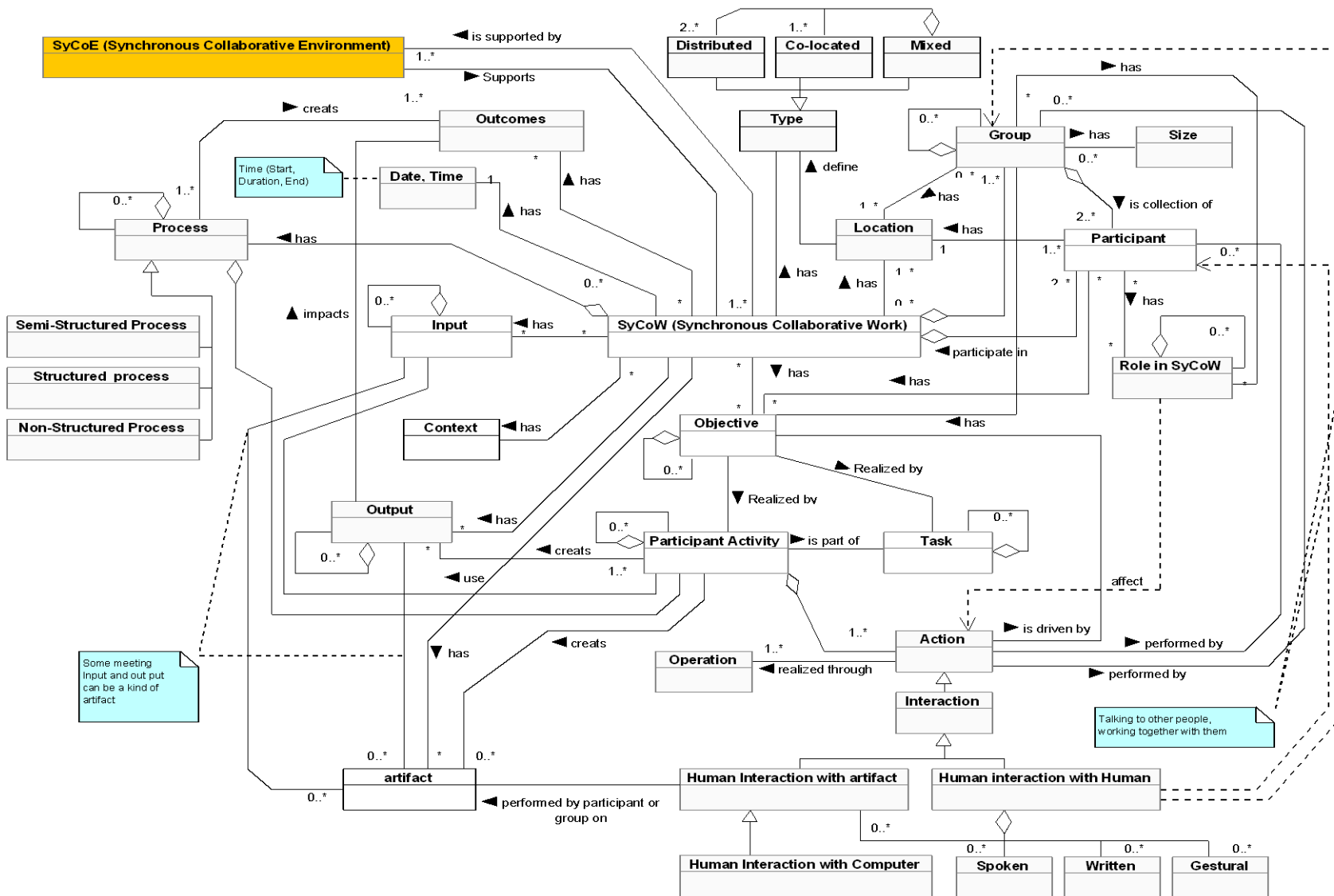

Figure 1-1: High level view on model of Synchronous Collaborative Work (SyCoW) with main element and main relations

A SyCoW instance models a specific collaborative working session. It is then stamped by a time and date. Participants who are distributed in different location around the world may have different time zones.

Time and date may impact on required facility and specification of support for a long duration collaborative working session, because of the ergonomic aspect of collaborative environment. The positions that participant must hold for long periods of time, can restrict blood flow and damage muscles [OSHA 2000]. Using the low quality furniture for long time create fatigue and decrease the participant's performance so comfortable furniture could be expected. People may have different performance, during the different time of the day [Hines 2004], [Wieth & Zacks 2011] or they may have different performance over days of the week [Bryson & Forth 2007]. These elements impact on the collaboration and participant performance and it's important to provide the tools and environment that reduce such effect on collaboration. Also such variable is important to be considered in conducting experimental studies for evaluation of collaborative environment, specifically for comparative study.

SyCoW models a situation which requires an appropriate collaborative environment in order to produce successful results and outcomes and thus to achieve the objectives. A collaborative environment must support a SyCoW instance in different ways from different aspects (see the next chapter). Anson and Bostrom [Anson & Bostrom 1995] demonstrate the effect of supporting tool and environment on meeting outcomes. All the characteristics and specification related to SyCoW that we are presenting in this chapter have impacts on the specification and requirement of collaborative environment and thus on collaboration itself.

A SyCoW process is the set of activities that participants must execute in order to accomplish the meeting objectives [Antunes and Carrio 2003]. The process used in a collaborative session depends on the objectives and goals of the collaboration. In other words a process is an activity, or a sequence of activities, that convert an input, into an output. Processes only exist to add value, and achieve outcomes. It is the aggregation of several sub process which depends on collaboration domain and context. For example in the product development context a process could be the aggregation of: opening the meeting, closing the meeting, problem solving or idea generation session, etc. This process is either a structured process or a non-structured process or a semi-structured process. Structured process is used to improve collaboration efficiency and group performance.

When modeling a synchronous collaborative work as SyCoW instance, some elements from the reference model don't need so much analysis to specify their value: number of participant, distribution of participant, etc. But some of them like: task, activity, action, process require more effort to analyses them. Task, activities and actions analysis can use various exploration methods like interviews and observations, walk through/talk through analysis, questionnaire [Hackos & Redish 1998], [Kirwan & Ainsworth 2004], [Van Der Veer et al. 1996] to identify their value and specifications.

## **1.6 SyCoW Extension for Product Design and Development Domain**

Working at collaborative design group in G-SCOP Lab motivates us to specifically focus on product design and development domain as context of the collaboration. Hence we decided to extend the SyCoW for this specific domain. This extension also confirmed the capability of extending this model in future. During product design and development process, through synchronous collaborative work, people

virtually or physically meet together to achieve an objective related to design project. There is a growing need to understand the factors that influence team performance in collaborative product design and engineering contexts and to build better technological tools to support it [Milne 2005]. Most design and engineering tools (CAD/CAM/PLM/PDM) focused highly on specialized and formal approaches to support asynchronous collaboration among members of a design and engineering teams. However, these tools neglect an important part of product development activities that occur during the synchronous mode through formal or informal, planned or unplanned, regular or irregular manner, between diverse members of product design and development projects. Coordination and collaboration that happens in synchronous collaborative mode are playing an important role for product development project success.

Different types of synchronous collaborative work and meeting occur during product development process. The synchronous collaborative work and meetings are joined by different stakeholders; collaboration between designers, collaboration between engineers, collaboration between designers and customers, collaboration between managers and customers, and others. The variety of synchronous collaborative work and meeting in each phase of product development process with different objectives and specifications is great. Considering this wide variety, we cannot find a unique and obvious collaborative environment for all synchronous collaborative situations. Even if a collaborative environment in collaboration between designers in a company seems successful, it is not necessarily suitable for collaboration between designers and other stakeholders in the same company or, it is not necessarily suitable for collaboration between designers of this company and another one. Collaborative tool developed for the conceptual design phase to support idea generation activities, will usually not be suitable for design reviews that contain completely different evaluation, comparison, and analysis activities.

### **Product Design and Development Project:**

Project characteristics impact the requirements and specifications of tool for synchronous collaboration during product design and development process. Figure 1-2 demonstrates the product design and development project model.

Novelty is a project characteristic that impacts on the specification of collaborative meeting. Novelty of a project measures how much stakeholders and experts know about the final product when they start the design project. Project novelty will be high, if the product is completely new and the project involved radically different product or production technologies and may help to address new and unfamiliar markets [Ulrich & Eppinger 1995]. Project novelty will be low, if the design project is related to extend an existing product. For example for platform to address familiar markets with one or more new products, adding or modifying some features of existing product to keep the product line competitive [Ulrich & Eppinger 1995]. The level of novelty of a project impacts activities of the product development process. During a conceptual design phase of a completely new project in synchronous collaborative session, idea generation stands for a major step; decision making is then usually complex and uncertainty is high: to decrease such complexity by simplifying collaborative tools is a good trend. The tool could focus on the collaborative decision making, voting and collaborative idea generation management and similar functionality. While for project with lower novelty, the required functionality of tool could focus on a better accessibility to the data and information related to existing products and previous projects. Complex PDM system with change management processes are a usual practice.

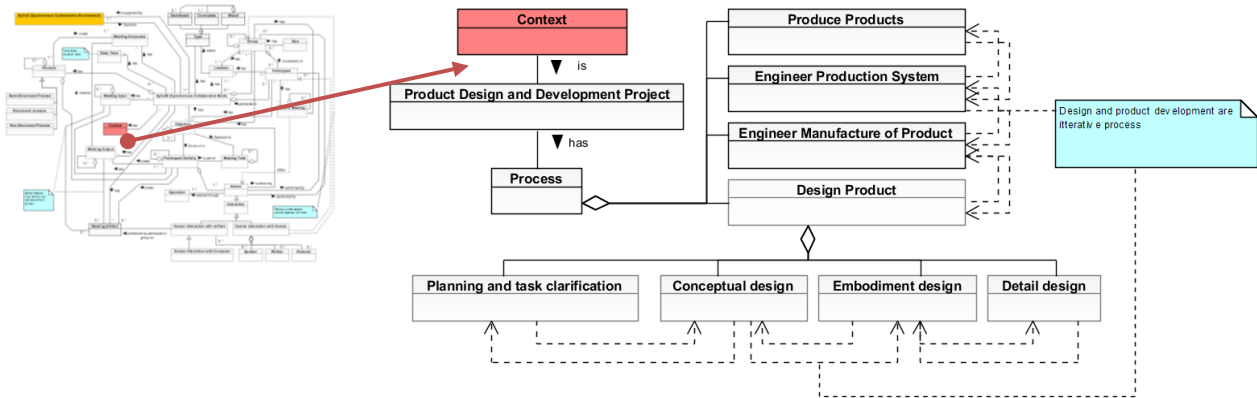

Figure 1-2: Product development process

[Tatikonda & Rosenthal 2000] defined three project complexity characteristics: the degree of interdependence between and among the product and process technologies to be developed; the Novelty of the project's objectives for the development organization; and the difficulty of the project objectives. Griffin [Griffin 1997] uses the terms “product complexity” and “project complexity” interchangeably but based on our definition we distinguish them. Activities in highly complex projects will be more complex and will require more support [Giles 1997], [Ahn & Crawford 1994].

Product design and development project have a process. This process is the aggregation of design, manufacturing study, industrialization, and production [Barkmeyer et al. 1996]. Product development process and product design are iterative processes. Iteration is usually due to unexpected failure of the design to meet an existing specification [Smith & Eppinger 1993].

Because of the importance of product design, we specifically focus on this phase and we entered in more detail about this phase. Design product consists of: Planning and task clarification (Specifications of information), Conceptual Design (specification of principle solution (concept)), Embodiment Design (specification of layout (construction)), Detail Design (specification of production) [Pahl et al. 2007].

The type of activities and nature of the Synchronous Collaborative Work in each phase of product development phase could be different depending on the nature of the project.

### SyCoW Objectives:

Meeting goal and objective specify why the groups of users are interacting in virtual or physical environment. It refers to expected goals of groups and individuals during the meeting? Drucker defined two main reasons for meeting [Drucker 2006]: 1) People holding different jobs have to cooperate to get a specific task done; 2) The knowledge and experience needed in a specific situation are not available in one head, but have to be pieced together out of the knowledge and experience of several people.

Literature shows that groups meet for different purposes: Make Decisions, Socialize, Review, Synergy, Solve Problems, Share work, Avoid Decisions, Build Trust, Share Visions, Build Consensus, Surface Perspectives, Build Teams, Long Range Planning, Handling Emergencies, Education, Training Information Exchange, Sales, Reorganization, Reconcile conflict, Reach a group judgment or decision, Solve a problem, Ensure that everyone understands, Facilitate staff communication, Gain support for a program, Explore new ideas and concepts, Accept reports, Demonstrate a project or system, etc. [Mosvick

et al. 1987][Nunamaker et al. 1991][Monge et al. 1989]. Marin et al. [Marin et al. 2006] has mentioned some goals of design meeting: “Project review, validation and presentation/demonstration “for planned meeting and “Work within a corporate body, technical work interdisciplinary and Specific problem solving” for impromptu meeting.

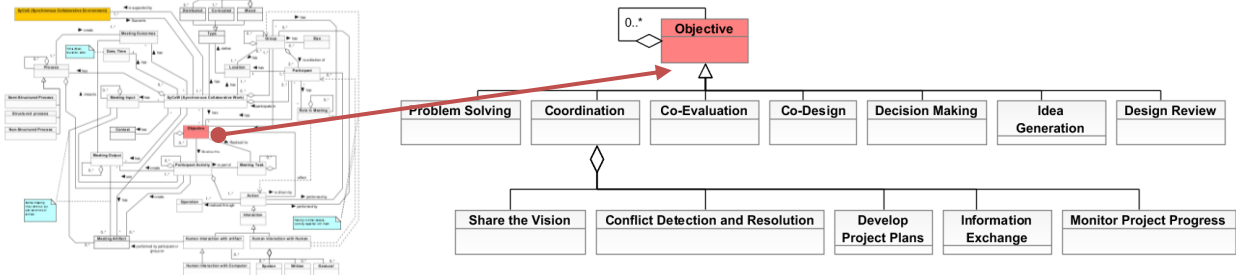

Figure 1-3: SyCoW Objective Model

Figure 1-3 demonstrate some possible objective of meeting during product development process. In product development a specific meeting could aggregate these objectives. For example in a design review meeting, the objective could be the co-evaluation of design options and finally to make the decision and to select the final option. The literature is wide in this domain, the ‘SyCoW Objectives’ model is not exhaustive and it just demonstrates some more common objectives:

*Co-evaluation:* is the evaluation of design artifact or design idea or solution in collaborative way. The evaluation is the analysis of completed or ongoing design activities. Co-evaluation helps to view the solution from different points of view of the same domain expertise or interdisciplinary domain expertise.

*Co-Design or Co-creation:* Creation of design artifact in collaborative way, like using sketching in primary phase of product development or collaborative creating the interior design of an apartment [Ulrich et al. 2011]. The actors of Co-creation or Co-design can be from same or different discipline. For an example co-creation can be done by customers or designers. This encourages a more active involvement from the customer to create a value in design.

*Decision Making:* The thought process of selecting a logical choice from the available options. Decision making is the activities that happen in different phase of the product development [Hiltz et al. 1986], [Rehman and Yan 2007]. Based on the nature of the problem and existing alternative, different methodology and process are applied for decision making.

*Problem Solving:* [Thomke and Fujimoto 2000] describes product development project as a bundle of interdependent problem solving cycles. Problem solving is the process of working through a problem to reach a solution. Creative problem-solving meetings are held to assist design groups in exploring the solution space and ensuring an overview of potential design directions [Van der Lugt 2000].

*Idea Generation:* One other objective of meeting can be idea generation for design problem [Perttula & Sipilä 2007], [McLeod & Lobel 1992], [Van der Lugt 2002]. Idea generation have specific attention in conceptual design phase of product development. Idea generation is the process of creating, developing, and communicating ideas which are abstract, concrete, or visual. A wide range of formal methods have been proposed and used for idea generation in conceptual design phase of product development process [Shah et al. 2000], [Shah et al. 2001], [De Bono 2010]. Idea generation can be a sub objective of problem solving.

*Coordination:* Coordination objective can be the aggregation of several sub objectives like: share the vision, conflict detection and resolution, monitor project progress, develop project plans and information exchange.

*Conflict detection and resolution:* Conflicts detection and resolution can be considered as part of coordination in order to converge to a new common view of the project. During project review experts must identify potential conflicts issued from asynchronous activities, and then they must try to solve them by finding the best compromise between different objectives related to different domains [Sadeghi et al. 2012].

*Share the vision:* Share the vision or converging to a new common view of the project is required for coordination and avoiding conflicts among different member of the project.

*Monitor project progress:* monitoring the amount of progress and advancement or move toward the completion of tasks assigned to the group or members or project activities toward refinement of project planning.

*Develop project plans:* project plans specify systematic sequence and schedule of the tasks and activities required to be done in the project over the time to achieve project objectives and goals.

### **Participant Model:**

Participant Model represents characteristics of participant that helps for the further analysis of the requirements related to participant. This model provides the characteristics and specification of participant that explicitly and implicitly has been identified. The model assumes that the users of the same class are treated at the same way. [Bullen and Bennett 1990] suggested that organizations should consider the perspectives of people at all levels when introducing technology. As mentioned by [Grudin 1994] Groupware must be “group friendly” and for minimizing the distribution, it requires interface adapted to user’s backgrounds, roles and preference.[Eckert et al. 2001] defined several dimensions for participants in communication situations. They emphasize that these dimension influence on how participants behave and what they need in the way of computer support for their collaborative activities.

Figure 1-4 represents the participant description model. Participant in SyCoW are people involved in the product development project. Product design projects typically involve the participation of various groups of experts, managers and stakeholders. A participant may have different role in the project. He may have the role of stakeholders (Customer, End user, and Supplier) or manager (Project manager, sells manager, project manager) or he can be a technical expert (Designer, manufacturing expert, Product engineer, Environmental expert or marketing expert). Each role in the project has its own objective and requirements and it impacts on the specification of environment for synchronous collaboration. By modeling this classification we assume the support may be adapted for each class of participant. Participant from the same class can be treated in the same way from different perspectives. For example a customer may have no experience of 3D CAD software, while designers can easily and quite intuitively use such tools. So CAD software can be used for co-creation of 3D model of product in meeting between designers while for meetings involving designer and customers the practice of CAD software must be adapted. The participant role impacts on specification of the access right or customized representation to the documentation of the information from the meeting.



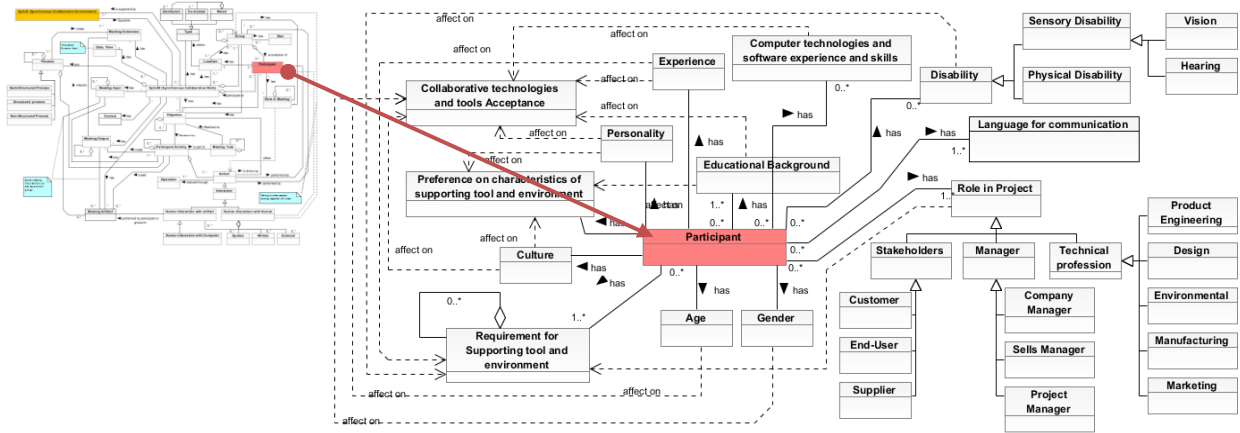

Figure 1-4: Participant model

Background, personality, experience and culture are the element that impacts on participant preference about supporting tool and environment characteristics. Preferences are the things that participant like more than another thing and he will choose if he can. Preferences aren't exclusive, whereas requirements are. However preference also is the element that can lead in design or selection appropriate supporting tool and environment for collaboration.

Among the previous characteristics participant personality must be undertaken deeper. Several researches have analyzed the effect of personality on group and collaboration [George 1990], [George et al.1993], [Barry et al. 1997], [Hoffman et al. 1959], [Walle et al. 2009], [Sfetsos et al. 2009], [Hons 2008]. Each participant has a personality type. Different theories and models have been developed to determine the types of personality of individuals; however the most successful and widely accepted model of personality is the “big five personality model” (Openness to Experience, Conscientiousness, Extraversion, Agreeableness, Neuroticism [Barrick and Mount 1991], [Gosling et al. 2003] (See Part-II chapter 6 for more explanation about different type of personality). The “big five personality model” is used to determine the personality profiles of end users of collaboration technology. In general the user’s personality profile is obtained using questionnaires, which and person must answer as truthfully as possible [Hons 2008]. Personality is a variable that impacts on the preference of the user about characteristics of supporting tool and environment and the acceptance of new tool. [Devaraj et al. 2008] found that the “big five personality” dimensions are related to key dimensions of technology acceptance.

The factors contributing to the acceptance of CSCW vary with the technology, target users, and context [Vandenbosch & Ginzberg 1996]. Collaborative technology acceptance is important for success of a collaborative tool. The new technologies offer potential to substantially improve the performance; however users’ unwillingness to accept and use the system is a barrier to achieve this improvement. In a collaborative work if some users don’t accept to use the new collaborative tools and environments, it will impact the whole group work and performance. Several theoretical models were proposed to provide an understanding about the factors that impact acceptance and the use of information technology and user behavior [Davis 1989], [Venkatesh et al. 2003]. On the basis of an extensive literature review about user acceptance [Venkatesh et al. 2003] proposed the Unified theory of Acceptance and Use of Technology (UTAUT).In their proposed model, gender, age, experience are the characteristics of the user that will impact on technology acceptance. [Vandenbosch & Ginzberg 1996] emphasized on four essential prerequisites for the implementation, acceptance and use of groupware by end-users: 1) the need to

collaborate, 2) an individual's knowledge of the software, 3) management support, and 4) organizational culture. The first two prerequisites can be viewed as individual needs, while the latter two are more organizational in nature. [Reyna 2005] explored the first two prerequisites 1) an individual's need to collaborate and 2) an individual's knowledge of groupware software as it relates to CSCW technology. To have successful collaborative work, collaboration technology required to fit with the organization [Vandenbosch & Ginzberg 1996]. Analyzing the factors related to the technology acceptance is important for the success when introducing a new technology for specific collaborative situation.

[Chen & Lou 2000] investigates in understanding the behavioral intention in using groupware system. The result of their study demonstrates that the overall attractiveness of a groupware application to the user is comprised of four potential outcomes: 1) enhancing communications among co-workers; 2) increasing the ability to coordinate activities; 3) facilitating collaboration among co-workers; and 4) improving competence in performing a job. They also examined the extent that the difficulty of using a groupware application will impact user's motivation to utilize the system.

Another characteristic of participants is their cultural similarity and difference. Hofstede defined culture as "the collective programming of the mind which distinguishes the members of one group or category of people from another" [Hofstede 1997]. The cultural difference may be the result of various conditions including: location, gender, history, nationality, language, sexuality, religious beliefs, ethnicity, aesthetics and enterprise work style [Barzilai 2003]. Research has shown that culture impacts on computer supported cooperative work [Borchers 2003], [Kayen et al. 2006], [Olson et al. 2003], [Setlock et al. 2004], [Setlock et al. 2007] and culture variable required to be considered in design and implementation of group support system [Watson et al. 1994/A]. The result of the research conducted by [Orlikowski 1992] emphasizes on the cultural aspect of work practice that must be taken into consideration to ensure a successful adoption of collaborative tool.

Participants also may have a physical disability or a sensory disability [wiki\_ Disability 2013]. Participant disability puts constraint when selecting a collaborative environment or when designing a tool. Such disable people need special kinds of user interfaces or special kinds of visualization and interaction designs [Andreas et al. 2007]. Obviously a person who has disabled hands will not collaborate around a multi-touch table, or he will need another way of interaction to collaborate with others. In the case of sensory disability like vision or hearing disability, here again the perception of models may be altered: a one-eyed person will not be able to see 3D stereoscopic models. A deaf man cannot use verbal communication: they will expect other communication channels to collaborate with others.

Participant description leads collaborative environment developers to analyze the requirements of the specific situation from the participant perspective. The elements presented in this model, highlight the investigation when considering and analyzing these elements in more detail. For example diversity in culture of participant highlights why the tool or environment characteristics should be defined based on the culture preferences to satisfy the participant from different culture. Supporting environment must not disturb the work of participants. When setting up collaborative environments, we must be aware that the social aspects are at least as important as the technical aspects. Indeed, it is clear that the technical solutions have a significant impact on the social dimension of the cooperative environment [Heerwagen et al. 2004].

The participant profiles impacts on the required time for learning technology. Are people from different profile able to easily use the tool and collaborate with each other in an efficient way? Does the

tool hinder the collaboration because the participants don't have so much experience and it creates usage difficulty? Is there any effect from these elements on acceptance of the new tool? Several similar questions are tightly related to the elements that have been proposed in the participant model and are important for the success of the collaborative environment. These analyses are specifically important in human computer interaction design. Investigation about the personal profile are helpful to considerate these factors and to provide the collaborative environment. User profile information in the company can help to decide about collaborative environment that will support the work of the users in group.

**Task Description:**

Task is defined by [Vicente 1999] as actions that can or should be performed by a participant or group of participants to achieve a particular goal. In general task can be defined as “The smallest identifiable and essential piece of a job that serves as a unit of work, and as a means of differentiating between the various components of a project” [B.Dic. 2014].The goal of task analysis is to discover necessary and sufficient features to be delivered in the specified tool [Andreaset al. 2007]. Different classification schemes distinguish tasks in various ways. In our proposed model we chose two types of classifications helpful to analyze the tasks. Task types make differences in collaboration. A Synchronous Collaborative Work is the transition between different tasks from a social point of view. Based on the context of collaborative work, some situations require considering both individual and collective behavior of the group situation [Milne 2005]. [Gutwin et al. 2002], [Grudin 1994] emphasized on the importance of supporting both users’ individual task—task work—and the group’s cooperative tasks—teamwork by groupware systems. Researches show that members of a group often shift back and forth between individual tasks and cooperative tasks [Dourish et al. 1992], [Tang 1991].The cooperative tasks is among group task, within group task or group task (See Figure 1-5 and Figure 1-6).

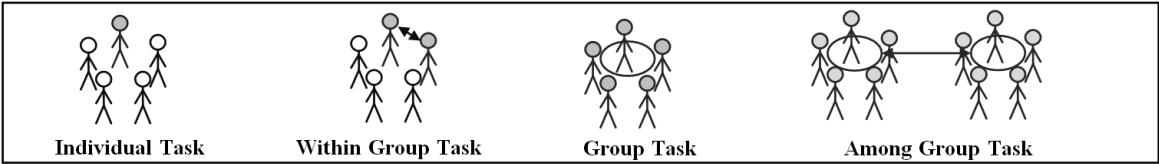

Figure 1-5: Task category based on social point of view adapted from [Mandviwalla & Olfman 1994]

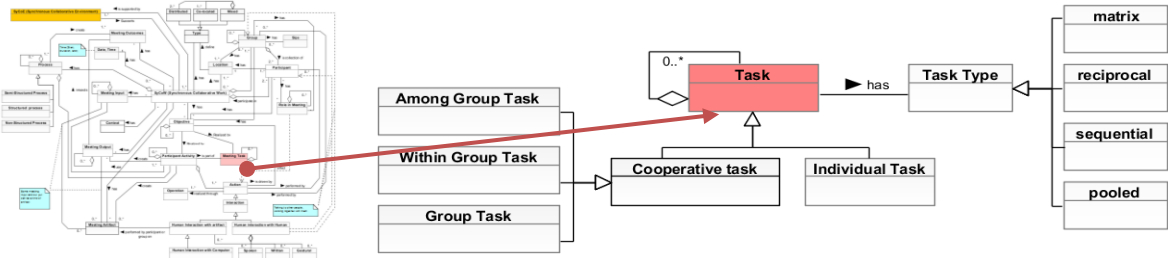

Figure 1-6: SyCoW Task Model

If the meeting task is the aggregation of individual task and group task, each individual works on his task and then needs to switch to group task for coordination of individual results. In literature, mixed-focus collaboration is used to describe this type of meeting task and collaboration. Mixed-focus

collaboration happens during synchronous work; both the individual tasks and the shared activity are required to requirements identification and designers switch between independent and shared activity [Gutwin & Greenberg 1998]. [Watson et al. 1994/B] described four types of group tasks: 1) pooled: sub-tasks are independent and are performed in parallel, 2) sequential: the output of one sub-task is the input of the next task, 3) reciprocal: the output of a participant is input of the other participants (for example, someone's voiced opinion in a group meeting) 4) matrix: a hybrid of pooled and sequential.

**Activity Description:**

Figure 1-7 is representing the Activity description model which has been developed based on what we found in literature.

Olson et al. [Olson et al. 1992] categorized meeting activities into the following four categories:

- 1) Coordination activities are verbal actions to manage the meeting or the project.
- 2) Design-focused activities: verbal or non-verbal interactions focusing on identification and resolution of project issues, clarifying the issue or a characteristic of the object artifact, communicating the rationale of the current object artifact, or creating new alternative designs of the object artifact.
- 3) Taking stock activities: verbal or non-verbal interactions summarizing project issues or walking through the current state of the object artifact as a user, i.e., contractor, client, etc.
- 4) Digression or other activities: verbal and non-verbal interactions unrelated to the project or project issues, e.g., sidebar conversations, parallel conversation, meeting breaks, or off-topic conversation.

Although Olson et al. work context was related to software design but the same type of activity is observed in product development and design meeting and we apply the same category of activities to product design context.

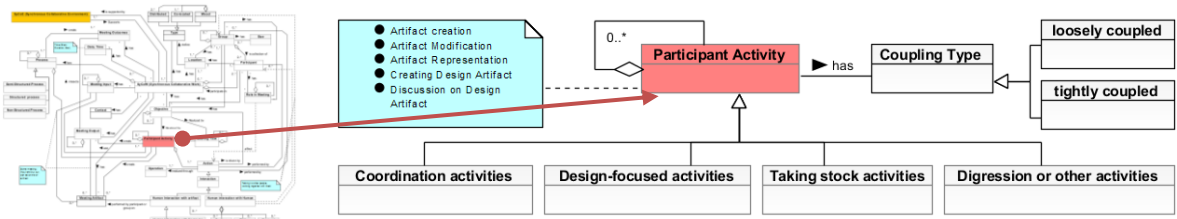

Figure 1-7: Participant activity model

For [Malone & 1994], coordination is the process to manage dependencies among activities. Here the list of activities that we are representing has been identified from literature review from both software and product design meeting domain. These activities were mentioned more or less explicitly as collaboration activities occurring during design meetings. There may exist some overlapping or hierarchy between the activities that we are presenting here and some activities could be the aggregation of others. There isn't a unique classification for activities and our objective was not to provide that but to fix what type of support each activity requires? Are there any other elements in relation with activity which impacts the

specification of Collaborative tool? As an example if a situation requires an activity to exchange information, what need to be considered for detail analysis of the requirements? Here is the list of some activities has been proposed by [D’Astous et al. 2004] and [Pallotta et al. 2007]: Exchange information, Negotiate alternatives, Make decisions, Make suggestions, Provide arguments (pro or con), Express opinions, Raise issues, Clarification which concerned the activities with the construction of a shared representation of the current state of the solution, Evaluation activities which concerned with the evaluation of solutions or alternative solutions, on the basis of criteria , Design activities which concerned with the elaboration of solutions and of alternative solutions.

Collaborative coupling is a way of describing group activity [Tang et al. 2006/B]. Coupling refers to dependencies between two things. “Participants is loosely coupled, where relatively few interactions are required to make relatively significant progress, or tightly coupled, where participants need to interact frequently relative to the amount of work that needs to get done” [Salvador et al. 1996].

**Input Description:**

Inputs consist of market need, product need, visual design representation, design brief, etc. Input types are physical or digital and have two formats of 2D and 3D. It can have one or several owners (Figure 1-8). Theses input come from Outputs of previous activities in asynchronous mode and Outputs of previous Synchronous meeting.

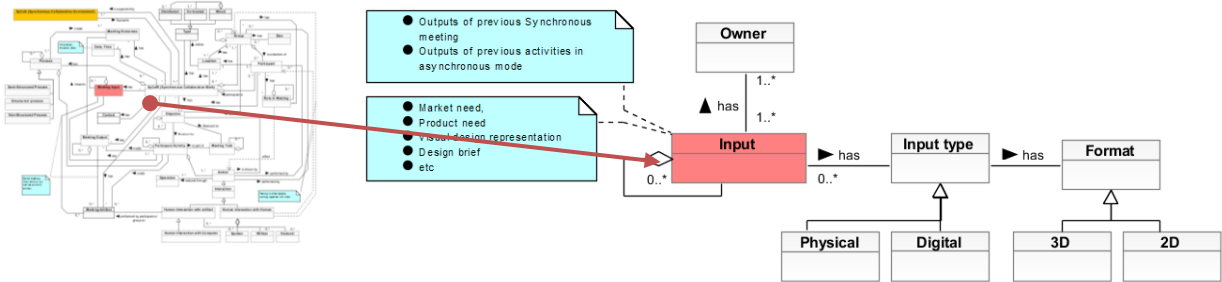

Figure 1-8: Meeting input descriptive model

**Design artifacts:**

Design artifacts consist of digital documents as well as paper and other tangible artifacts [Perry & Sanderson 1998], [Schmidt & Wagner 2004], [Tory et al. 2008]. Meeting artifacts consist of design artifacts or representational artifacts which directly represent the design information, and are therefore critical to design coordination [Tory et al. 2008]. Some meeting input and output are a type of meeting artifact. Participant activity creates meeting artifacts, like drawing during meeting. A designer communicates a design idea by pointing to design artifacts.

Design artifact has visual design representation which presents properties of a product in a physical or digital format [Johnson1998]. Visual design representation requires to be visualized and has representation type and representation format. The visual representation of design is created or modified or just projected from a pre-existing model during the synchronous collaboration in individual or collaborative way. One visual representation can be just presented during the meeting and some information like note and annotation can be added as new design information. Based on the type and format of representation, and the activity and action related to it, the requirement for supporting tool i.e. required functionalities,

visualization and interaction methodologies could be different. [Saddler 2001] defined design representations as “perceptible expression of a design idea, proposal or fact”.

Obviously, visual design representation requires a visualization media. Visualization media can be digital or physical depending on the representation type and format. Representation is either 2D or 3D. Sketch, drawing, models and prototypes are different types of representation. Models and prototype have 3D representation and Sketch and drawing have 2D representation (Figure 1-9). Visual design representation and the activities related to them will impact on the selection of visualization and interaction component and methods expected within the collaborative tool [Pei 2009].

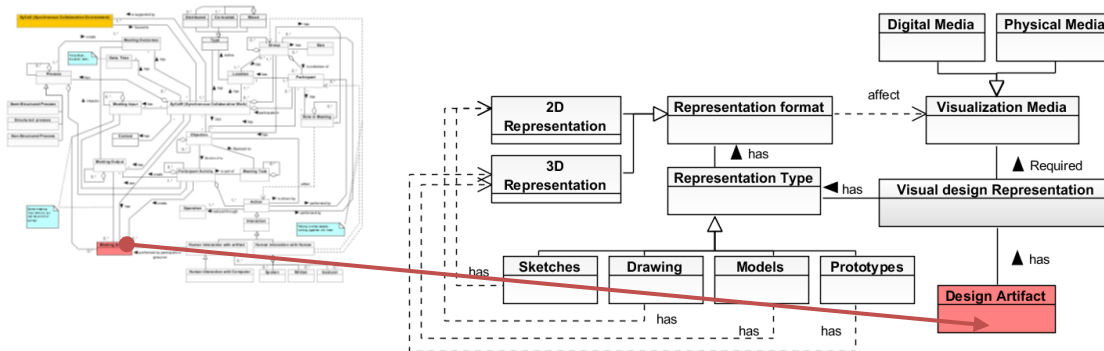

Figure 1-9: Visual design representation

If the visual design representation is the product model in 3D format, the level of complexity of product model will be important in selecting the visualization media.

Hobday [Hobday 1998] listed many of the critical factors which define the character of a product and its 'complexity'. Critical dimensions suggest the difficulties of the coordination task”. Based on [Hobday 1998] definition, important indicators of product complexity include the quantity of tailored components and sub-systems, the hierarchical manner in which they are integrated together and the degree of technological novelty. We define the level of complexity (1: Very Simple, 2: Simple, 4: Complex, 5: Very Complex) of product based on the number of subsystems and components of the product, degree of technological novelty and variety of distinct knowledge and skill bases which need to be integrated into the final product and amount of information that will be created in each phase of product development process [Hobday 1998].

Product complexity may impact on: the memory expected to display the product 3D model; the amount of information that have to be accessible during the meeting; the number of experts and stakeholders involved on the project; the complexity of activity and task of individual and group; the difficulty of decision making, problem solving, coordination and etc.

Another characteristic of product that makes one product different from others is the size of the product. It impacts the requirement about supporting tool for Synchronous Collaborative Work. To distinguish product about its size a comparison to human size is a good criterion since it refers to the designer’s perception of the product.

Then five type of product exist: Extra Large Product, Big size product, Medium size product and Small size product and Micro/ Nano size Products (Figure 1-10):

- 1) Extra size product is out of user point of view (railway, urban design, etc.).

- 2) Big size products, in most case user can walk through the product or the size is like the products that human can walk through (Building, aircraft, Dam, Urban planning, factory design, Ship, Train, bus, etc.) and in usage phase of the product, user is inside the product or around the product.
- 3) Medium size product, user can see the detail of product if the product just turned, they are bigger than half of human body size but not so much big (car, desk, refrigerator, kayak, chair, etc.).
- 4) Small size product, are the products that user can hold it by his hand and is smaller than the half of human body size (Mobile phone, laptop, mouse, boiler, coffeemaker, toaster, Headset, etc.).
- 5) Micro/ Nano product are at scale where usual vision does not perceive them anymore. These product characteristics are important for visualization and interaction considerations.

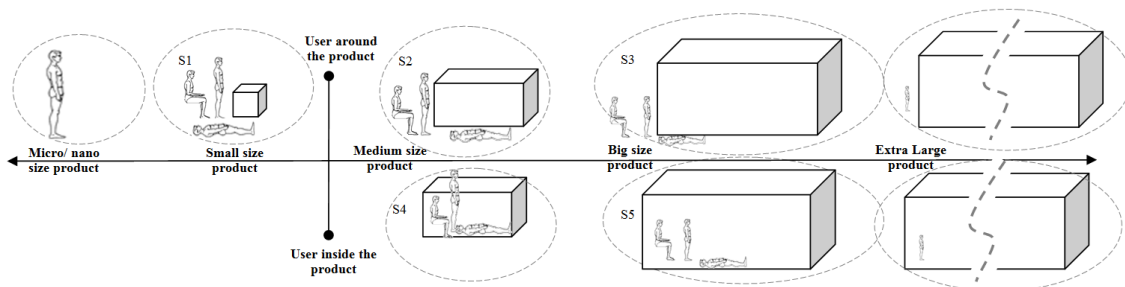

Figure 1-10: Product category based on its size and user position relative to the product (cubes define the product size)

## 1.7 SyCoW Usage

SyCoW is dedicated to researchers and developers of collaborative technologies and companies. Part II shows the usage of SyCoW through the design or selection process of a synchronous collaborative environment.

1. SyCoW Usage for analyzing the collaboration As-It-Is and requirement specification: Requirement specification is carried out at the early stage of the development of a collaborative tool. It is often difficult to define the limits of the domain. Because of the lack of structure representation of the domain there is a considerable degree of uncertainty about the nature and possible solutions. The SyCoW model decreases such difficulties by providing more structured view about synchronous collaborative work. It helps in a better understanding of the collaborative situation and consequently in the tool specification. In other words, we use SyCoW model to clarify the current specifications of the target collaborative situation ('Collaboration as it is') and requirements of desired collaborative environment to support that situation.
2. SyCoW usage for selection or adaptation of existing solution (similar solutions for similar problem): SyCoW conceptualize the characteristics and specifications of synchronous collaborative work, thus it will be helpful to reuse the knowledge obtained from already existing collaborative tools. It will help to find similar collaborative situations and then by analyzing the compatibility of their corresponding collaborative tools for the new situation.



3. SyCoW usage for Collaborative Environment Evaluation: SyCoW also provides guidance for researchers about what they need to consider for evaluating synchronous collaborative environment. If the number of participant for the target collaborative situation is varying, it requires checking the effect of number of participants in collaborative environment effectiveness and success. Or if the number of groups and distribution of groups are varying in target collaborative situation; it requires designing a comparative study about the effect of distribution of participants in different groups. Also in a scenario based evaluation it will help in defining the scenario and designing the experiments.

## **1.8 Conclusion and Discussion**

In this chapter we proposed a Concept Map named SyCoW (Synchronous Collaborative Work) which conceptualize the specification and characteristics of collaborative situations in synchronous mode. In other words, SyCoW model the problem domain. The proposed model is derived from literature in different domains. Through diverse reference, we identified factors, and relationships between factors that have impact on specifications and requirements of collaborative environment or on collaboration itself. In our proposed model we used the definition which matches with definitions from different research communities. We also extend the primary model for product design and development context. This extension confirmed the extensibility of the proposed model.

The proposed model helps in finding existing solutions for similar problem, providing guidance in requirement specifications for selecting or developing appropriate collaborative environment and also providing guidance for appropriate evaluation. In Part-II of this thesis we will demonstrate the usages of SyCoW during development of a new synchronous collaborative environment for design review meeting.



# Part-I: Chapter 2

## SyCoE Concept Map: A General Model of Synchronous Collaborative Environment

### Abstract

The aim of this chapter is to identify and to model the components of a collaborative environment. Hence we proposed a concept model named SyCoE (Synchronous Collaborative Environment) presented through UML (Unified Modeling Language) structuring information from literature review. SyCoE describes potential synchronous collaborative environments and helps a better analysis and characterization of existing collaborative environments. Also, it can be considered as a model to guide designers and developers when building new supporting tool and environment for synchronous collaborative situation. It will facilitate finding the justifications of collaborative environments and to reuse the existing environment when designing a new for a specific target situation. By characterizing a collaborative situation with SyCoW and characterizing a collaborative environment which is efficient for that collaborative situation by using SyCoE, we are characterizing the problem and solution domain which helps to use similar solution for similar type of problem. Here, we focus on synchronous collaboration environment which support synchronous collaborative work but it could be adapted to a wider domain and context.

### Table of Content

2.1	Introduction .....	31
2.2	Related work.....	31
2.3	Motivation for Developing SyCoE Descriptive Model.....	33
2.4	Methodology .....	33
2.5	SyCoE (Synchronous Collaborative Environment) Concept Maps /General view .....	34
2.6	SyCoE Concept Maps /Detail view .....	34
2.7	SyCoE Usage.....	49
2.8	Conclusion and Discussion.....	49

## **2. SyCoE Concept Map: A General Model of Synchronous Collaborative Environment**

### **2.1 Introduction**

Various collaborative environments and prototypes have been developed by researchers and companies. However it's not clear which type of collaborative environment is suitable for which type of synchronous collaborative work. On the other hand, design and development of collaborative environment is difficult due to the multidisciplinary knowledge required for that and the complexity of the problem domain. SyCoW in Chapter 1 helps to better understand the type of synchronous collaborative situation and its characteristics; in this chapter we are going to specify the type and characteristics of a collaborative environment. This understanding can help in design, development and selection of appropriate collaborative environment for a specific type of collaborative situation. One way of understanding is through classification. We are going to represent the existing classifications for collaborative environment and their advantages and disadvantages. The rest of the chapter presents a Concept Maps which conceptualize the characteristics and features of synchronous collaborative environment.

In section 2.2, related work, we are going to represent the existing ontology, classification and categories of collaborative tools and environments. Then in section 2.3, we will present our motivation for developing a new concept model for synchronous collaborative environment. In section 2.4 we will present our methodology for developing the concept map. Section 2.5 is presenting the general view of SyCoE (Synchronous Collaborative environment) Concept Map. In section 2.6 we are presenting the detail view on SyCoE. Section 2.7 identifies the different usage for SyCoE. Section 1.8 provides conclusion to this chapter.

### **2.2 Related work**

Classification and categorization are the basic cognitive process in which ideas and objects are recognized, differentiated, and understood [Cohen, H. & Lefebvre 2005]. It helps to recognize the complexity of scientific topics and to analyze their various aspects [Vickery 1958]. Variety of classification and categories with different intention has been proposed in the context of collaboration tools and technologies specifically in literature related to Computer Supported Collaborative Work (CSCW), Group Support System (GSS), Group Decision Support System (GDSS) and Computer-Mediated communication (CMC). The most popular classification is time-space taxonomy proposed by [Johansen 1988]. It takes into account the physical location of the users and when they participate in the collaborative work. Four categories can be distinguished according to whether the actors' work takes place in the same space or in different spaces at the same time (synchronous) or delayed (asynchronous). Some tools have been positioned in this matrix (Figure 2-1) that specifies the condition to use such tool. [Tang et al. 2004] emphasized that in practice, people's collaborative practices cross these boundaries. They placed mixed presence groupware (MPG) in this matrix. Mixed presence groupware supports both co-located and distributed participants working over a shared visual workspace in real time (Figure 2-2).

[DeSanctis & Gallupe 1987] proposed a multi-dimensional taxonomy of systems as an organizing framework for research in the group decision support systems. Three environmental contingencies have

been identified as critical to Group Decision Support Systems (GDSS) design: the size of the group {Small, Large}; the member proximity {Dispersed, face-to-face}, and the task type {Planning, Creativity, Intellective, Performance, Cognitive conflict, Mixed Motive}. Even if this classification has been proposed for GDSS, the factors of size of group, member proximity and task type are factors that impact collaborative environment specifications in other context and domain as well. Still in the same article DeSanctis and Gallupe proposed three levels to support the group. Level1 provides technical features to remove common communication barriers; this level improves the decision process by facilitating information exchanged among members, such as large screens for instantaneous display of idea. Level2 system provides decision modeling and group decision technique to reduce the uncertainty and “noise” that occurs in group decision process. This level provides automated planning tools or support for group member to work on and view simultaneously or using large screen. Level 3 systems are high-level and described by machine-induced group communication pattern. It can include expert tools in selection and arrangement of rules to be applied during a meeting.

		Time	
		Same time (synchronous)	Delayed different time (asynchronous)
Space	Same workspace (co-located)	<ul style="list-style-type: none"> <li>- Meeting room equipped with a computer for each member of the group with one common user interface or with a single computer and a projector</li> <li>- Working through a table</li> <li>- software that allow electronic voting (for decisions)</li> <li>- etc.</li> </ul>	<ul style="list-style-type: none"> <li>- electronic diaries in order to set a date</li> <li>- The electronic newsgroups or forums discussing</li> <li>- Resource center shared the same space on the local network.</li> <li>- Management project tracking</li> <li>- Planning tools</li> </ul>
	Different workspaces (distributed)	<ul style="list-style-type: none"> <li>- Videoconference</li> <li>- Chat</li> <li>- Application sharing</li> <li>- File transfer</li> <li>- Publishers multi-user</li> <li>- Systems whiteboards</li> <li>- Etc.</li> </ul>	<ul style="list-style-type: none"> <li>- E-mail</li> <li>- Calendar sharing</li> <li>- common database</li> <li>- System data management techniques</li> <li>- Systems workflow</li> </ul>

Figure 2-1: Time-Space Matrix [Johansen 1988]

		Time	
		Same time (synchronous)	Delayed different time (asynchronous)
Space	Same workspace (co-located)	<div style="border: 1px solid black; padding: 5px; display: inline-block;">Mixed presence groupware</div>	
	Different workspaces (distributed)		

Figure 2-2: MPG place in Time-Space Matrix [Tang et al. 2004]

[Rana et al. 1997] proposed to analyze each Group Support Systems (GSS) in term of its component parts on the basis of the presence and absence of generic support features. Their proposition based on refinement of DeSanctis and Gallupe Levels 1, 2, 3, consists of four general class of support: a) individual

support; b) Group Process support; c) Meta process support; d) Group model support. [Pinsonneault & Kraemer 1989] proposed classification based on the type of aid provided by system. They differentiate two broad technological support systems for group processes: Group Decision Support Systems (GDSS), and Group Communication Support Systems (GCSS). [Ellis et al. 1991] proposed a taxonomy based on application-level functionality. [McGrath and Hollingshead 1994] proposed a classification based on primary function of the system consisting of: group internal communication support system, group information support system, group external communication support system, group performance support system. [Weiseth et al. 2006] proposed a framework based on a set of key concepts, including collaborative environment, collaboration process and collaboration support. [Zigurs & Buckland 1998] point out regardless of the hardware or physical configuration of a system, support for communication, process structuring, and information processing are the distinguishing characteristics of GSS that are used the most often in the classifications.

### **2.3 Motivation for Developing SyCoE Descriptive Model**

Literature review demonstrates that collaborative tools and technologies have been characterized from many different perspectives. Taxonomies provide a way to classify different groupware tools. Even if existing classification methods gives better insight on collaboration environment, they are not sufficient to understand the different aspects of collaboration environment and their relationship. In other words they are suitable when the focus is on specific aspects of the collaborative environment. In addition, the usability of these classifications is challenged by the increasing integration of functionality in collaboration tools and environments. Some systems are so complicated that they need a new different method to classify them [Weiseth et al. 2006], [Penichet et al. 2007]. The existing classification focus was on the representation of limited characteristics or functionality of collaborative environment, which hinders to see the relations of them with other characteristics and functionalities. Even there are different theories and frameworks that provide an important basis for our understanding of the characteristics of collaboration tasks, processes and technology; however they are not able to provide practical guidance for designer and developer or customer in selection or design of appropriate collaborative environment [Weiseth et al. 2006]. The work of [Weiseth et al. 2006] was an investigation to deal with this challenge and shortcomings; however their framework remains at abstract level and suffers from being usable in design and evaluation of collaborative environment. There is not so much study about how existing classification could be used to design, select or evaluate collaborative environments. In other words, the proposed frameworks remain too general; they do not provide enough detailed representation of collaborative environment knowledge, characteristics and capabilities: they are not usable for detailed analysis and evaluation of alternative solution for a specific context. As far as we know, no structured model supports the selection/development process of synchronous collaborative environment.

### **2.4 Methodology**

The same methodology which explained in chapter 1, in methodology section, has been used for developing SyCoE. Hence, in order to develop SyCoE, we formulated the focus questions: What are the specifications and characteristics of a synchronous collaborative environment? Which concepts help to describe a synchronous collaborative environment and its solution components? We have synthesized the

existing classification, and categories of collaborative environment and underlying technologies. During the development of SyCoE one objective was to ensure that their characterizations are sufficiently complete, correct, clear, and brief that could lead to define and specify the characteristic of a synchronous collaborative environment.

## 2.5 SyCoE (Synchronous Collaborative Environment) Concept Maps /General view

In this section we are presenting the SyCoE Concept Map which models the concepts and knowledge elements of synchronous collaborative environment. We make distinction between collaborative environments based on three main aspects: the types of collaborative situation it can support, the types of facilities which is used and the way how these facilities were configured. The proposed model includes concepts for describing different aspects required for the description and construction of a synchronous collaborative environment.

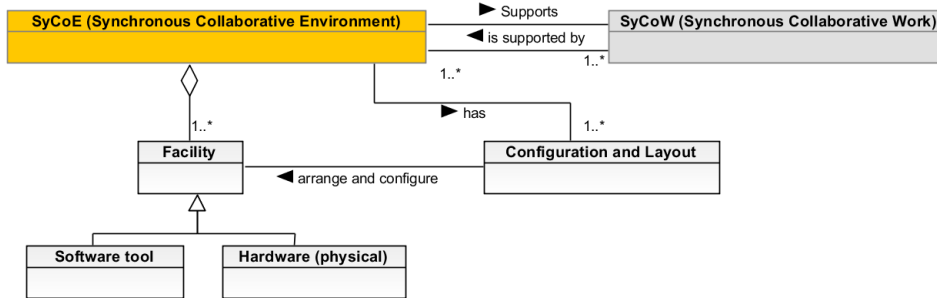

Figure 2-3: Synchronous Collaborative Environment Model

Figure 2-3 represents the high level view of Synchronous Collaborative Environment (SyCoE) Model. A SyCoE is dedicated to support SyCoW and its components from different perspectives. Depending on the type of SyCoW which is defined based on locations of participants and group(s) (i.e. distributed, co-located and mixed), SyCoE will be distributed, collocated or mixed. SyCoE is the aggregation of several facilities. A SyCoE may have one or several configurations. The configuration is fixed or flexible. Placing and positioning group(s), participants and facilities defines configuration and layout of a SyCoE. The next section details this model.

## 2.6 SyCoE Concept Maps /Detail view

### Facility:

Figure 2-4 proposes a general model for facilities. Facilities are software tool and hardware (physical) elements that support synchronous collaborative work from different perspectives. Hence facilities mainly provide the following functionalities:

- A. Ergonomic aspects support through appropriate physical environment for participant and supporting user comfort.
- B. Recording and capturing the collaborative work (documentation and information capture).

C. Task support by enabling activities and actions of participant: to support communication, coordination, cooperation, data sharing and information exchange, etc.

Chair, Table, Light, Heating, Ventilation and Air-Conditioning (HVAC) Systems, food and beverages are type of physical facilities. They support the participants from comfort and ergonomic aspect as their main functionality.

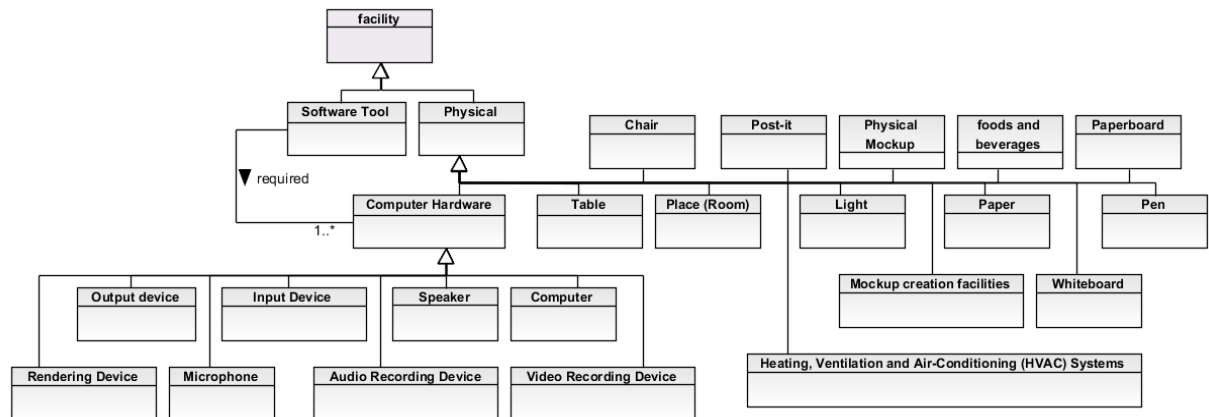

Figure 2-4: Facilities general model

**Light:**

There should be appropriate lighting, conforming to the task’s needs and the lighting should be uniform over the working person’s visual field [Margaritis & Marmaras 2007]. Using specific visualization technology may put the constraint in the light adjustment of the room or the direction of the light in relation to the direction of some display devices.

**Ventilation and Air-Conditioning (HVAC) Systems:**

There should be no annoying hot or cold in the workplace [Margaritis & Marmaras 2007] so appropriate Heating, Ventilation and Air-Conditioning (HVAC) Systems is required. In the selection of such systems, the size of room, facilities that produce heat (computer, light, etc.), number of maximum people who can be in the room for collaboration, room isolation, window, etc., must be considered in order to make an appropriate choice.

**Place (Room):**

Physical space for collaboration, other facilities and participants will be embedded in rooms. The room size must be appropriate for the number of participants, type and number of facilities, and their required configuration. Hence the facility type and numbers, numbers of participant and the configuration of collaborative environment put constraint on the room selection or vice versa. Today by advancing the technology, participant place becomes more mobile. Participants to synchronous collaborative work will be out-door by using mobile devices.

**Input Device:**

Input devices allow user to communicate with computer. They are the physical tools that are used to implement various interaction techniques [Foley & Wallace 1974]. Choosing appropriate input devices and interaction techniques are an important part of collaborative tool. There are various types of input device and interaction techniques to select when developing a collaborative environment. For any given input devices, several interaction techniques can be adapted. In general, many different interaction techniques can be mapped onto any given input device. It is important to find the device and interaction technique adapted to the application. The question is how natural, efficient, and appropriate the mapping between a given input device and a given technique will be. This choice depends on different aspects. For example, in [Basdogan et al. 2000] authors analyzed the gender, personality, or emotional experiences of users impact on haptic communication, using haptic device, in shared virtual environment.

Input devices with underlying software support different functions in a collaborative environment. Some examples of the common functions include: context related function, model modification, selection, drawing, annotation, text entry, object manipulations, transformation, rotation, zoom in/out, walk through 3D world, flying in 3D world, 3D scene manipulation (Figure 2-5).

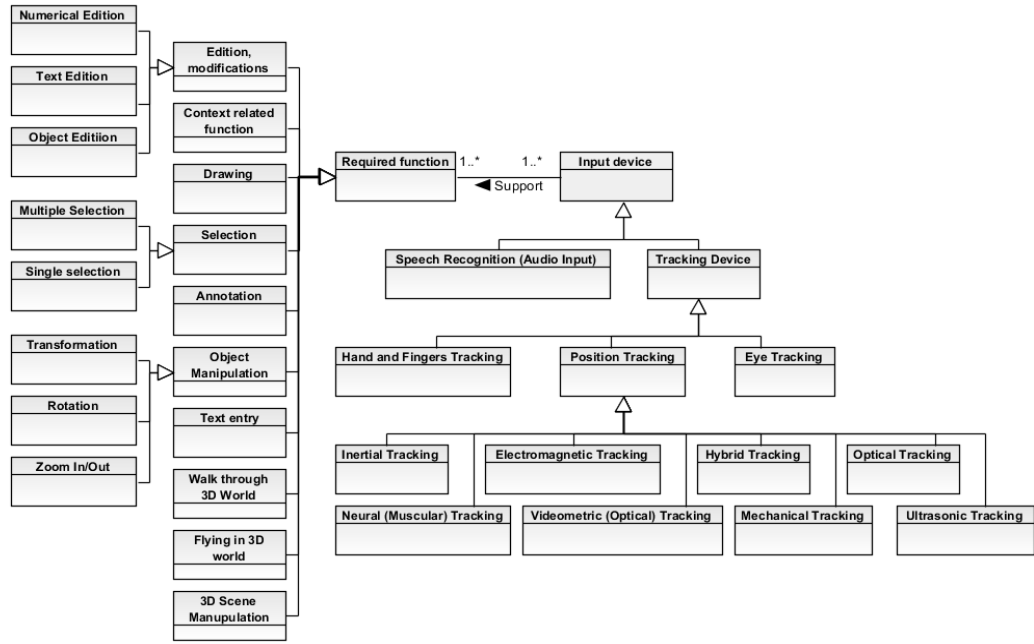

Figure 2-5: Input Device Description

**Tracking Device:**

Tracking devices are input devices. They include position tracking, eye tracking, and hand and fingers tracking.

**Position Tracking:**

A position sensor is a device that reports its location and/or orientation to the computer. Motion tracking is performed using a variety of techniques, including electromagnetic tracking, mechanical tracking, optical tracking, videometric (optical) tracking, ultrasonic tracking, inertia tracking, neural (muscular) tracking and hybrid tracking [Sherman & Craig 2002], [Bowman et al. 2004]:

1. **Electromagnetic Tracking:** These systems localize small electromagnetic field sensors in an electromagnetic field of known geometry. The signal in the receiver is measured to determine its relative position respect to the transmitter. The transmitter unit is fixed at a known location and orientation so that the absolute position of the receiving unit can be calculated. A small sensor, the receiver, determines its position and orientation relative to this magnetic source.
2. **Mechanical Tracking:** Mechanical trackers have a number of interconnected mechanical connections combined with electromechanical transducers. One end is fixed in place, while the other is attached to the object to be tracked. As the tracked object moves, the connections move as well, and measurements are taken from the transducers to obtain position and orientation information.
3. **Optical Tracking:** Optical tracking systems use visual information to track the user. There are a number of techniques for that. The most common is to use a video camera that acts as an electronic eye to "watch" the tracked object or person. The video camera is normally in a fixed location. Computer vision techniques determine the object's position based on the camera viewing.
4. **Videometric (Optical) Tracking:** Videometric tracking is an alternate method of optical tracking. In this method the camera is attached to the object being tracked and watches the surroundings, rather than being mounted in a fixed location watching the tracked object.
5. **Ultrasonic Tracking:** Ultrasonic tracking uses high-pitch sounds emitted at timed intervals to determine the distance between the transmitter (a speaker) and the receiver (a microphone). As with optical tracking, three transmitters combined with three receivers provide enough data for the system to triangulate the full 6-DOF position of an object.
6. **Inertial Tracking:** Inertial tracking uses electromechanical instruments to detect the relative motion of sensors by measuring change in gyroscopic forces, acceleration, and inclination.
7. **Neural (Muscular) Tracking:** Neural or muscular tracking is a method of sensing individual body-part movement, relative to some other part of the body. Small sensors are attached to the fingers or limbs, with something like a Veicro© strap or some type of adhesive to hold the sensor in place. The sensor measures nerve signal changes or muscle contractions and reports the posture of the tracked limb or finger.
8. **Hybrid Tracking:** Hybrid trackers are the combination of several tracking technology which help to increase accuracy and reduce latency.

#### *Eye Tracking:*

Eye trackers are technologies for tracking the user's eyes movement. There are two types of eye movement monitoring techniques: those measuring the position of the eye relative to the head, and those measuring the orientation of the eye in space, or the "point of regard" [Young & Sheena 1975]. There are four broad categories of eye movement measurement methodologies involving the use or measurement of: Electro-OculoGraphy (EOG), scleral contact lens/search coil, Photo-OculoGraphy (POG) or Video-OculoGraphy (VOG), and video-based combined pupil and corneal reflection. [Duchowski 2007], [Sherman & Craig 2002], [Bowman et al. 2004].



### *Hand and Fingers Tracking:*

Hand and Fingers Tracking provide information about the user's hands, how the fingers are bending or if two fingers have made contact with each other. Data gloves are input devices that provide this information. Data gloves come in two basic varieties: bend-sensing gloves and pinch gloves." [Bowman et al. 2004]. New tools like Leapmotion© use gesture recognition.

### *Speech Recognition (Audio Input):*

As speech recognition systems become increasingly practical, they provide an excellent opportunity for natural communication with computer systems.

### **Output device:**

Three type of output device has been identified by [Sherman & Craig 2002], [Bowman et al. 2004]: auditory display device, haptic display device and visual display device (Figure 2-6). They used the term display broadly to mean a method of presenting information to any of the senses. Following we are representing more detail about each type. There are three basic arrangements for all sensory displays [Sherman & Craig 2002]: stationary, head-based, and hand-based. Stationary displays are fixed in place. Head-based displays (HBDs) are worn on or in some way attached to the user's head and move in conjunction with the head. Hand-based displays move in conjunction with the user's hand.

Each feasible combination of display and input devices can provide a system with specific properties that enable new possibilities for interaction and may require developing new interface and application software to support expected combinations of functions.

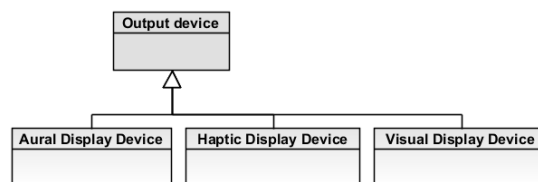

**Figure 2-6: Output device**

### *Aural Display Device:*

Auditory displays use sound to communicate information from a computer to the user. Aural display systems typically fall into one of the two general display categories we've been discussing: stationary displays and head-based displays. Headphones are analogous to head-mounted visual displays. Headphones may be constructed to isolate the participant from sounds in the natural world or to allow real-world sounds to overlap with virtual sounds. Speakers allow multiple participants to hear the sounds [Sherman & Craig 2002].

### *Haptic Display Device:*

The words haptic and haptics are used to refer to all touch and touch-related capabilities. Haptic devices provide physical contact between the computer and the user. They take advantage of the sense of

touch by applying forces, vibrations, or motions to the user. In general, tactile sensations include pressure, texture, puncture, thermal properties, softness, wetness, and friction-induced phenomena such as slip, adhesion, and micro failures, as well as local features of objects such as shape, edges, embossings and recessed features. In addition, vibrotactile sensations refer to the perception of oscillating objects in contact with the skin [Hayward et al. 2004].

The nature of the haptic interface dictates that it is a form of both input and output: as output it is physical stimuli displayed by the computer, and because of its physical connection to the participant, it is also an input device to the computer. However, we should note that there are cases where it is used strictly as input or output [Sherman & Craig 2002].

**Visual Display Device:**

Visual displays present information to users, through their visual channel, in a collaborative environment. Today we find numerous visual displays with various types and characteristics and more or less adapted to application domains. Some of them have been widely used in different applications. But till now only some became commercialized and only few became ubiquitous. The main reasons are a) technology maturity. Some technologies are not sufficiently mature to be commercialized; b) current technology limitations. Some display technologies have some limitation in term of resolution and size that make them not-suitable for real case applications; c) the usage of the display technology has been shown in some limited applications that do not make it feasible for further investigation, or there isn't sufficient potential applications for the technology or the value of investigation and potential application domain is not sufficient). d) difficulty in the development of new software application. It lacks appropriate toolkit to support software development; c) technology cost (the value that people may gain is much less than the cost for investment and maintenance).

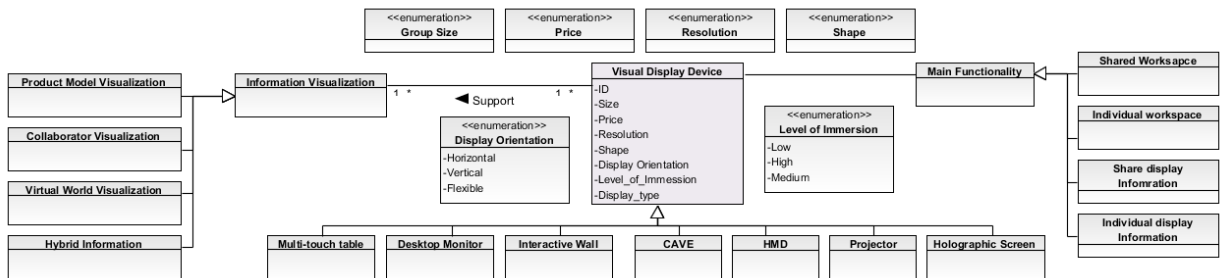

Figure 2-7: Visual Display Device

Deciding which display technology is appropriate for a collaborative situation is not easy. Besides analyzing the requirements of collaborative situation it is necessary to understand the characteristic of visual displays and the impact of those characteristics on collaborative work (communication, collaboration, accomplishing the task, individual, group, ergonomic aspects, etc.).

Visual displays main functionalities include: shared workspace, individual workspace, shared display and individual display. Visual displays support information visualization. A visual display is used for visualizing the collaborator/s which are located in different place or visualizing information or visualizing a virtual world but it is also used to visualize the combination of this information in a hybrid mode. Using

several displays enable people to take advantage of the different characteristic of different display categories [Rashid et al. 2012].

Different categories are found in the literature to describe visual displays. Lantz [Lantz 2007] classified immersive displays based on their size and number of users into three categories: small-scale, single-user displays (head-mounted displays and desktop stereoscopic displays); medium-scale displays designed for small numbers of collaborative users (CAVEs, reality centers and power walls); and large-scale displays designed for group immersion experiences (IMAX, simulator rides, domes).

Here, we identified the characteristic of a visual display that could be important to consider within collaborative environment based on specification and requirements of collaborative situation: size, price, resolution, shape, display type, orientation (horizontal, vertical, flexible), level of immersion (low, medium, high), field of view (Figure 2-7).

Many different types of display device used in 3D user interface include: monitors, surround-screen displays, workbenches, hemispherical displays, head mounted displays, arm-mounted displays, virtual retinal displays, and auto stereoscopic displays [Bowman et al. 2004]. Bowman et al. through some examples identified the advantages and disadvantages of each visual display type with respect to 3D interaction. Here some examples of displays are presented even if this list is not exhaustive:

CAVE (CAVE Automatic Virtual Environment): The CAVE (Figure 2-8) provides immersive virtual reality environment where projectors are directed to three, four, five or six walls of a room-sized cube. It has been developed as a “Virtual Reality Theater” with scientific content and projection [Cruz-Neira et al. 1993].



Figure 2-8: The six-channel CAVE system, the 10' x 10' environment features wireless tracking and communication devices and a three-dimensional audio system, IOWA State University [IOWA 2013]

In polarized head-mounted projection displays, the polarization states of the light are deliberately manipulated to maximize the luminous transfer efficiency [Zhang & Hua 2008].

See-through head mounted display allows user to see computer-generated objects superimposed on the real-world view. This see-through capability is accomplished using either an optical see-through HMD [Ellis & Bucher 1994] or a video see-through HMD [Edwards et al. 1993]. Using mirrors to superimpose computer generated graphics optically onto directly viewed real-world scenes is the most common methodology used for optical see-through HMDs. In other words, this technology optically combines the real- and virtual-world views. In video see-through HMD, the real-world view and the computer-generated images are electronically combined with the video representation of the real world that is captured with video cameras mounted on the head gear [Rolland & Fuchs 2000]. The advantage of using this technology in collaborative work is that it should not affect natural communication and interaction, making

collaboration very effective. “Users see the same spatially aligned model, but can independently control their viewpoint and different layers of the data to be displayed” [Szalavári et al. 1998].

Computer Monitor displays output from a computer. The display device in modern monitors is typically a thin film transistor liquid crystal display (TFT-LCD) thin panel, while older monitors use a cathode ray tube (CRT) as deep as the screen size. The most important parameters to select monitors are the size, resolution and cost. Other parameters like power consumption, contrast ratio, refresh rate, response time, luminance, aspect ratio, dot pitch; may be considered as decision parameters [Ikegulu 1998]. Newer monitors are able to provide 3D viewing (i.e. giving the perception of depth) by displaying a different image for each eye, often with the help of special glasses. This type of display was based on stereopsis, where an observer’s left and right eyes receive different perspectives separated by stereoscopic glasses [Kim et al. 2013]. Anaglyph stereoscopic systems use two color-filtered images and glasses that usually utilize typically red and cyan [Zone 2014]. The LC shutter system, also known as an active-shutter system, sends the left image to the left eye while the right eye’s view is blocked by the display device and user glasses, then presents the right image to the right eye while the left eye’s view is blocked [Kawagoe 2010], [Kim et al. 2013]. A polarized 3D system, which sends polarized images to the corresponding eyes through polarization glasses create the illusion of three-dimensional images [Kwon et al. 2010] (Figure 2-9).

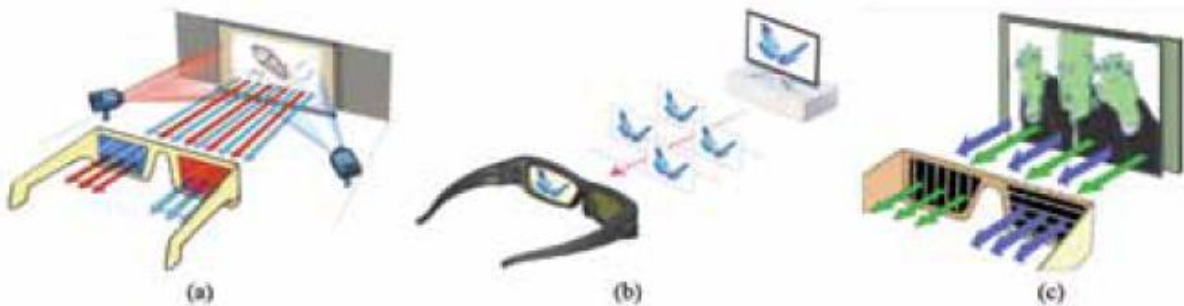

**Figure 2-9: Stereoscopic 3D display types: (a) anaglyph [Brain 2003], (b) LC shutter [Nolde 2011], and (c) polarized 3D system[Brain 2003]**

Holographic Screen seems to be a step further more natural. User can turn around a 3D object without glasses. The 3D shape is perceived in front of the screen. “Three-dimensional (3D) holographic display is a true 3D display technology because it provides all the depth cues required by human visual system and eliminates visual discomfort caused by stereoscopic displays” [Xu et al. 2013]. Various holographic display systems have been proposed and investigated by different research groups around the world like: [St-Hilaire et al. 1990], [Maeno et al. 1996], [Stanley et al. 2004], [Yamaguchi 2011], [Xu et al. 2013]. Resolution, size, price, orientation, field of view and provided 3D depth are the most important criteria for decision.

Cylindrical displays are panoramic projections on cylindrical or spherical curved surface. The field of view can be up to 360°. “Front projection curved screen displays deliver excellent image quality over a continuous field of view and are suitable for larger audiences. They show acceptable, homogeneous geometric distortion for untracked viewers” [Simon and Gobel 2002].

Multi touch table (table-top) technology provides concurrent, multi-user interactions around a shared display. Tabletops are natural interaction substrates for people to meet around and collaborate on.

Currently, several type of multi-touch table has been developed with different underlying technologies and some of them became commercialized like the Diamond touch table from MERL and Microsoft tabletop from Microsoft. Such table-top is either single or multi-user.

With sphere shape displays the user is located inside the sphere or outside the sphere. THEATER 360, a 12.8m, 360° spherical display (Figure 2-10-Right) at National Museum of Nature and Science, Japan (Courtesy GOTO, Inc.) [Lantz 2007]. (Figure 2-10-Left) is working with a volumetric display; with finger input tracked using a camera-based motion tracking system [Grossman et al. 2004]. pCubee (Figure 2-11) is a personal cubic display that offers interaction techniques for static and dynamic 3D content.

A collaborative environment may contain multiple displays. Terrenghi et al. proposed the criteria for the design of multi-person-display ecosystems, in which multiple displays are coupled. They considered physical constraints, human focus of attention, social context and type of body movement/ interaction [Terrenghi et al. 2009].

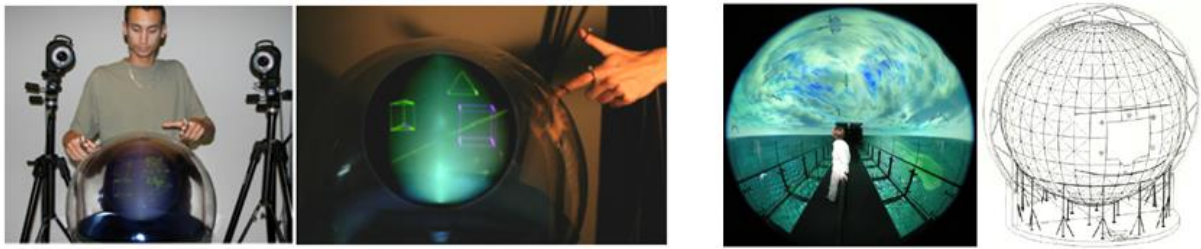

Figure 2-10: Left: [Grossman et al. 2004] Right: [Lantz 2007]

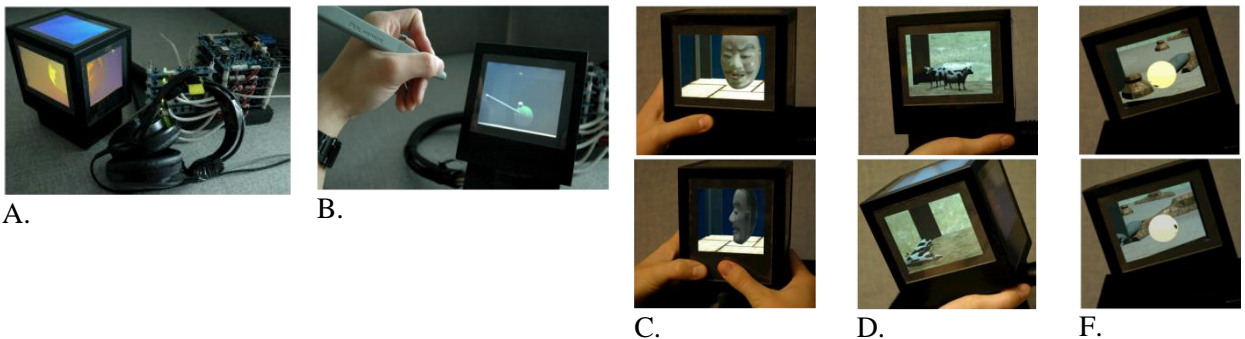

Figure 2-11: (a) Five screen pCubee showing a 3D model of the globe (b) direct selection of a object with a 3D pointer; (c) Rotation of pCubee to see the 3D object from different point of view; (d) dynamic cow models react to display motion; (f) 3D navigation through the virtual landscape; [Stavness et al. 2010]







Other types of facilities include: computer hardware, post-it, paper, pen, whiteboard, paperboard, physical mockup, mockup creation facilities.

### Configuration and Layout in Co-located and Distributed Collaboration:

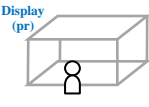
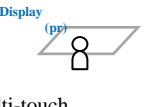
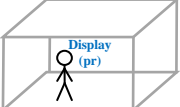
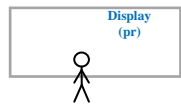
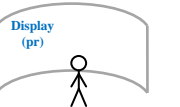
Table 2-1 demonstrates some possible configuration of collaborative environment by considering the participant and facility (display devices, tables and chairs (*chair is not visible in the shape but the state where participant is sitting*  $\Delta$  specify seating on the chair)).

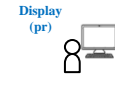
This table does not seek to give an exhaustive representation of possible configuration for display devices and participants. However, the table presents the most commonly used types of device and

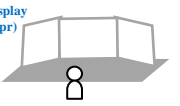
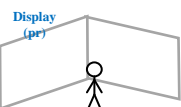
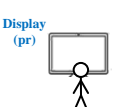
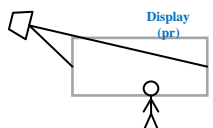
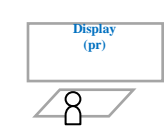
possible layout of participant. The combination of different cells of this table in the same place or distributed place can also define a new configuration for collaborative environment.

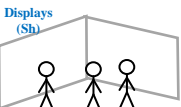
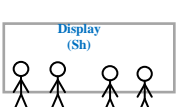
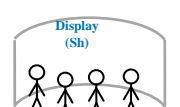
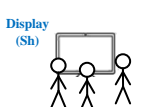
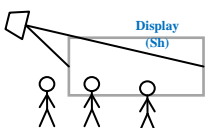
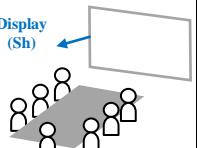
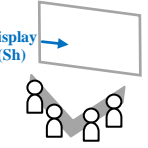
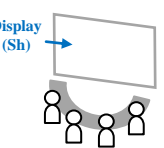
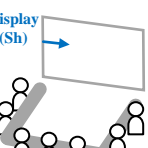
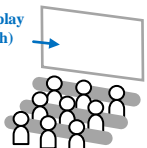
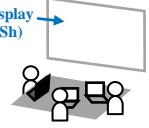
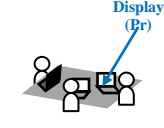
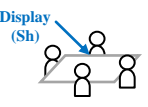
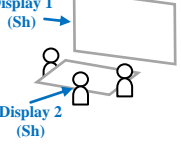
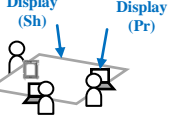
Symbols definition	SU(SD)	Single User use Single Display device		
	SU(MD)	Single User use Multiple Display device		
	G(SD) @ SP	Group use Single display device at the Same Space		
SU(SD)	SU(SD)	SU(SD)	SU(SD)	SU(SD)
				
Mini CAVE # N 1.1	Multi-touch # N 1.2	CAVE # N 1.3	Interactive Wall # N 1.4	Interactive Wall # N 1.5
SU(SD)	SU(SD)	SU(SD)	SU(SD)	SU(SD)
				
HMD # N 2.1	Laptop # N 2.2	Desktop Monitor # N 2.3	Tablet # N 2.4	Tablet # N 2.5
SU(MD)	SU(SD)	SU(SD)	SU(SD)	SU(MD)
				
# N 3.1	# N 3.2	# N 3.3	# N 3.4	# N 3.5
G(MD) @ SP	G(SD) @ SP	G(SD) @ SP	G(SD) @ SP	G(SD) @ SP
				
# N 4.1	# N 4.2	# N 4.3	# N 4.4	# N 4.5
G(SD) @ SP	G(SD) @ SP	G(SD) @ SP	G(SD) @ SP	G(SD) @ SP
				
# N 5.1	# N 5.2	# N 5.3	# N 5.4	# N 5.5
G(MD) @ SP	G(MD) @ SP	G(SD) @ SP	G(MD) @ SP	G(MD) @ SP
				



# N 6.1 G(MD) @ SP 	# N 6.2 G(MD) @ SP 	# N 6.3 G(MD) @ SP 	# N 6.4 G(MD) @ SP 	# N 6.5 G(SD) @ SP 
# N 7.1 G(MD) @ SP 	# N 7.2 G(MD) @ SP 	# N 7.3 G(MD) @ SP 	# N 7.4 G(MD) @ SP 	# N 7.5 G(MD) @ SP 
# N 7.1 G(MD) @ SP 	# N 7.2 G(MD) @ SP 	# N 7.4 G(MD) @ SP 		
# N 8.1 G(SD) @ SP 	# N 8.2 G(MD) @ SP 	# N 8.3 G(MD) @ SP 		
# N 9.1 G(MD) @ SP 	# N 9.2 G(MD) @ SP 	# N 9.3 G(MD) @ SP 		

Table 2-1: Some possible configuration of collaborative environment

The configuration visualized in each cell of the table is related to:

- the number of participant in the specific place
- position and orientation of participant respect to other participants,
- position and orientation of display device respect to other displays
- position and orientation of display device respect to participant
- position and orientation of table respect to display device, participant and other tables
- position and orientation of chairs respect to tables, to display devices and to other chairs.

Different variables are important when defining the layout and configuration of a collaborative environment. The table 2-2 identifies the variables that lead the decisions to configure collaborative environment in specific place. The variable with the sign “{Decision}” are the variable must be specified

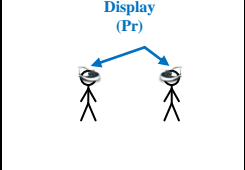
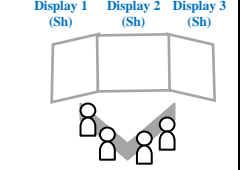
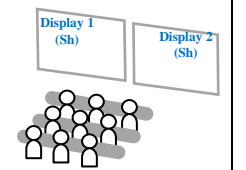
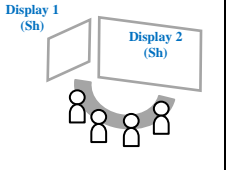
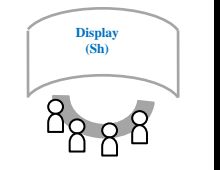
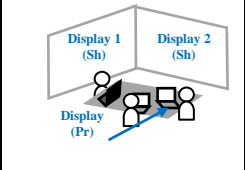
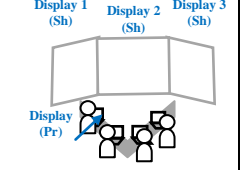
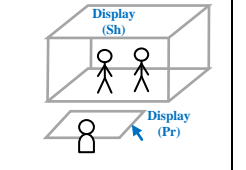
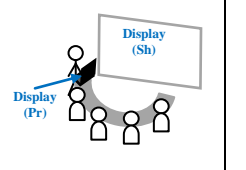
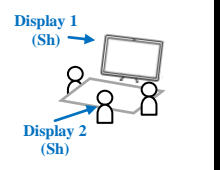
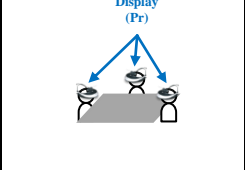
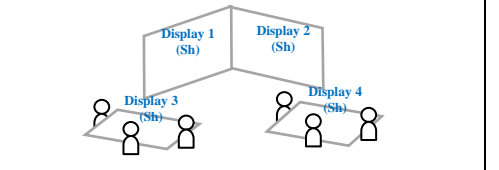
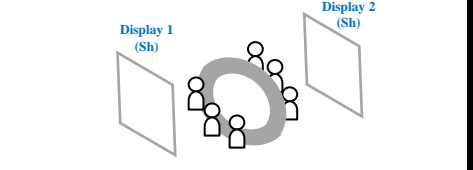
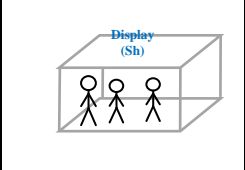
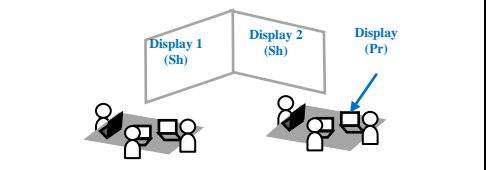
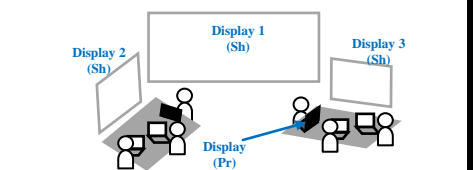
based on the characteristics and requirements of collaborative situation. Determining these variables define the collaborative environment layout and configuration. The variables with no sign are the variable that have been specified based on collaborative situation characteristics and the information that are already available.

Level ( I ) Variables and concepts	Level ( II ) Variables	Comment and explanation
{ <i>Decision &amp; Design</i> } Configuration of place i (Pi)	The Participants in place i	The participant profile characteristics and roles, in project and meeting
	Number of Participant in place i	Number of participants can play a critical rule in configuration of collaborative environment
	{ <i>Decision</i> }The Set of Facilities in place i	Based on the requirements the set of facilities have to be specified the types, numbers and characteristics of facilities will affect in our decision about configuration and layout of collaborative environment
	{ <i>Decision</i> } The Set of Displays in place i	Same explanation as previous
	Number of Groups in place i	Number of groups in the same place depending on their task and activities during collaboration speciation can impact on configuration
	Set of Groups in place i	The participant that is in the same group, based on the characteristics of participant can impact on configuration.
	Set of Groups distributed between place i and other places	If there are some people in the same place but some of them are part of the groups that other members of groups are in the different place
	{ <i>Decision</i> } Relative Position and Orientation of each Participant to each Displays in the Place i	Depending on the functionality of Display device (shared display, individual display, shared with some participant not whole the participant, etc.), work context and requirements and ergonomic aspect, participant characteristic; relative position and orientation of each participant to each display can be different.
	{ <i>Decision</i> } Relative Position and Orientation of a Display to other Displays in the Place i	Depending on the functionality of Display device and its contextual relation to other display devices, the relative position and orientation of a display to other display can be different.
	{ <i>Decision</i> } Relative Position and Orientation of a Participant to other Participants in the Place i	If participant are in the same group, or the activities of group are loosely coupled
	{ <i>Decision</i> }Relative Position and Orientation of a Facility to other Facilities in the Place i	Depending on the facilities and their functionalities and characteristics and collaborative environment requirement it can be different
	{ <i>Decision</i> } Relative Position and Orientation of each Facility to each Displays in the Place i	depending on functionalities and characteristics of facility and the number of its users, its position and orientation could be changed
	{ <i>Decision</i> } Relative Position and Orientation of each Participant to each Facilities in the Place i	Depending on the facilities functionalities and characteristics the position and orientation of the user can be changed. It could be mobile as well. i.e. seating on the chair when he's working on his personal computer and stand when want to share the result on the large share display and use gesture for explaining the results
	{ <i>Decision</i> } Relative Position and Orientation of each Participant to each Displays in the Place i	Depending on the display functionalities and characteristics the position and orientation of the user can be change
	{ <i>Decision &amp; Design</i> } Configuration of other places	In distributed collaborative situation the configurations of other places may impact on the configuration of place i
Physical Distribution of participants	Participants may locate in different place, each place will require its own configuration which has to be	

**Table 2-2: The variables require to be considered in designing the configuration of place i**

Flexibility requirement could be achieved through the reconfiguration of collaborative environment. The main reasons for configuration flexibility are: the room could be used for different collaborative situations with different characteristics (different number of participants, different objectives, different tasks, activities and actions, etc.). Meeting tasks consist of individual tasks, group tasks, between group tasks and among group tasks. For example in a specific collaborative design work people may need to work in small group then to switch to collaboration on presentation mode.

Interaction type and device also put constraint on the participant position and orientation respect to the display device. An interactive wall requires the user to change his position around the display device to be



able to interact with information that is embedded in display device. While, if user use the mouse to interact with display device and information, user can just seat on the chair without any movement. The question will be: which one is the best fitting to the requirement of the collaborative situation?

The type of display device based on its field of view, size, type, orientation and resolution may constrain the appropriate distance and orientation of participant respect to display device in order to properly see the visualized content. For example, the holovizio 128 WLD (Holographica ©) has 45° of field of view. Windows in the room add a constraint on the place of the display devices or it requires specific window curtain to protect unwanted light that can impact on visualization.

### **Software Tool:**

A software tool is a piece of software, or a hardware-software combination, used during the collaborative work to accomplish its corresponding activities and tasks. Three types of software can be used to support these activities and tasks during collaborative session: single user software and multi-user software and software which support both single user and multi-user activities.

Here we analyze the software specification to support synchronous collaboration. We named this type of software synchronous collaborative software and for the hardware-software combination, we named synchronous collaborative software tool. To describe synchronous collaborative software, the following model contains the features and specifications of collaborative software (Figure 2-12).

Synchronous collaborative software is task dependent or task independent. Task dependent means the main functionality of the software supports the specific task in an application context while task independent software supports collaboration independent to the application context and task. Skype © and similar software are task independent. They provide a generic communication function.

Collaborative software has a focus area: It is user centered when collaborative tasks focus on the user (Collaborative software which creates a communication channel between collaborators: it does not depend what the users do with the channel). It is artifact centered when collaborative software provides methods to collaborate on a specific artifact. It is workspace centered when collaborative software provides a workspace which stores the state and in this way allows asynchronous user centered collaboration. Then collaborative users share the same workspace [Rama & Bishop 2006].

Based on Rama and Bishop [Rama & Bishop 2006], the main functionality of collaborative software consist of: document management systems, document collaboration systems (include document management functionalities and extend them by providing history, versioning and change management), messaging systems, conferencing and electronic meeting systems, group decision support systems and compound document management systems which allow users to view the single merged or compound version of the documents.

The platform is another feature of collaborative software [Rama & Bishop 2006]. It defines the execution criteria which include: mobile platforms, operating system-based platform, browser based platforms and platform independent.

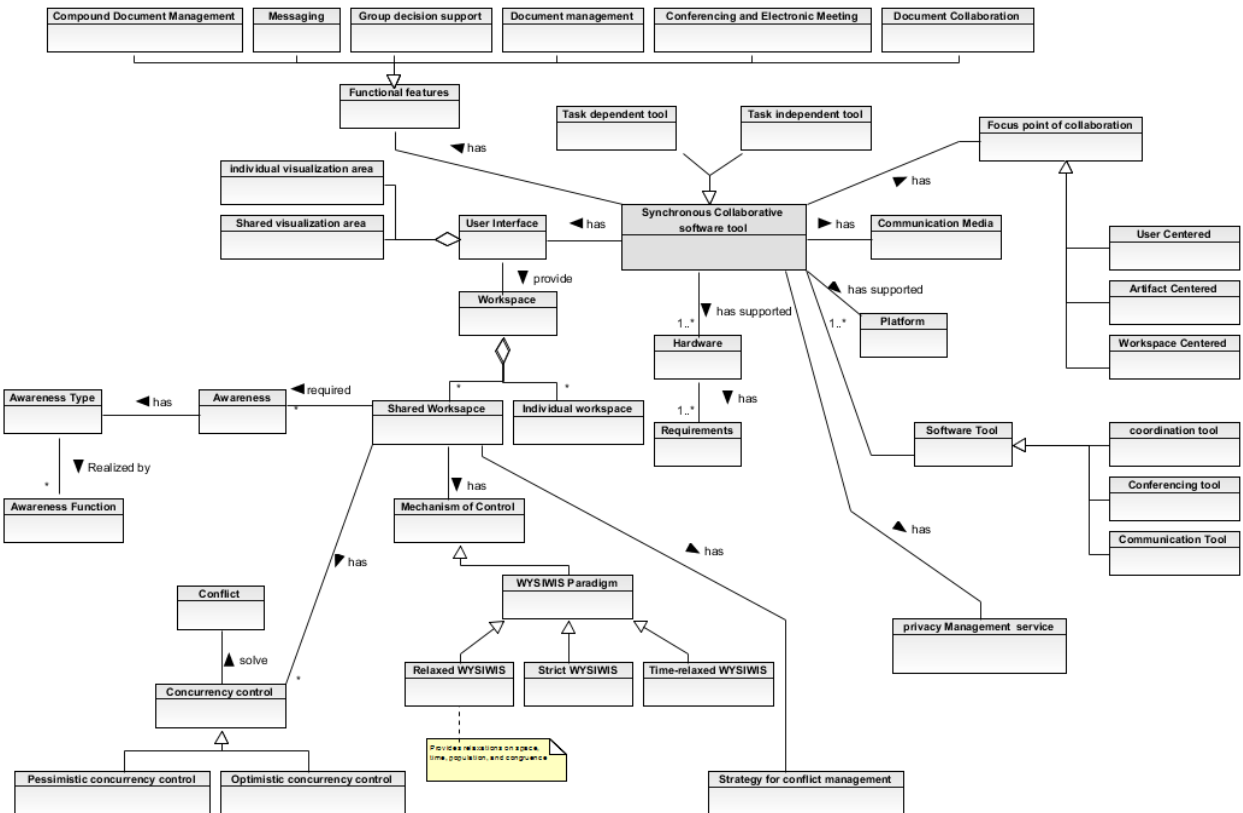

Figure 2-12: Synchronous Collaborative software tool

**Awareness Type:**

In a face-to-face collaborative situation people are able to maintain their awareness about other member’s actions and activities naturally by using their visual and verbal channels. But in virtual and distributed collaborative condition, most of the time, we are losing these rich communication channels and natural group awareness. Literature demonstrates that supporting group awareness helps to enhance group collaboration facilitating communication and coordination [Gutwin et al. 2004], [Gross & Prinz 2003], [Schmidt 2002].

Although there are clear benefits to increase awareness of activities of others, there are costs in terms of individual privacy and perceived loss of freedom [Xiao et al. 2003]. There is always a tradeoff between privacy and awareness, and between awareness and disturbance [Hudson & Smith 1996]. Godefroid et al. [Godefroid et al. 2000] proposed a framework to ensure that presence awareness systems compatible with complex policies about data access. Different collaborative tools may have different levels to support awareness.

Kraut et al. [Kraut et al. 2002] argued that shared visual space is essential for complex collaborative visual problem solving because it facilitates the ability of the pairs to maintain awareness of the task state.

**Privacy Management Service:**

Privacy is an important human right to be considered in a collaborative environment. Individuals and groups have a fundamental right to privacy and control over information from themselves in a collaborative environment [Clement 1993]. Depending on the context of work and on the specification of collaboration situation, the expected support to privacy is different. According to literature we have different type of privacy: privacy of a person, privacy of personal behavior, privacy of personal communications, and privacy of personal data [García-Barrios 2009]. Usually, most security and privacy studies concerns data access [Bourimi et al. 2011]. Some privacy control mechanisms include: default privacy which provides the users with the pre-configured privacy settings [Kaur 2011]; customizable privacy which allows users to set or configure their privacy setting based on their requirements [Kaur 2011]; informational self-determination is right of individuals (and groups) to decide when and under what circumstances their personal information may be processed; bounding personal or group space defines intermediate privacy zone between the personally private and the public space; Equality/Reciprocity enable What You May See Of Me Is What I May See Of You "WYMSOMIWIMSOY?". Personal/group "ownership" of resources or information does not need to be regarded as owned exclusively by the employer [Clement 1993].

#### ***Access Control:***

In general, the goal of an access control system is to prevent people, or computers, from performing unwanted actions [Lampson 2004]. Access control is an indispensable part of a collaborative environment. For an effective collaboration, participants must be able to share specific data and functionality with the collaborative partners, while ensuring their resources are safe from inappropriate access. Hence a collaborative environment requires access control models, policies, and enforcement mechanisms [Zhou 2008].

Shen & Dewan [Shen & Dewan 1992] identified several requirements that a generic access control model for collaborative environments should support: multiple and dynamic user roles, collaboration rights, flexibility, easy specification, efficient storage and evaluation, automation.

Several access control model were proposed by different researcher: Shen & Dewan [Shen & Dewan 1992] proposed an access control model based on a generalized editing model of collaboration, which assumes that users interact with a collaborative application by concurrently editing its data structures. [Martin 2009] proposed a generalized context-based access control model for making access control decisions completely based on context information.

There is a trade-offs between information access and preservation of privacy. Information access control is frequently framed under the consideration of privacy [Xiao et al. 2003].

#### ***Concurrency Control and Conflict Management:***

Concurrency control is the coordination of interfering actions operates in parallel [Greenberg & Marwood 1994]. Ellis & Gibbs [Ellis & Gibbs 1989] emphasized on the need for concurrency control within groupware systems to solve conflicts between participants and to allow them to perform tightly coupled group activities. "Concurrency control is a well-known problem in design and implementation of multi-user system" [Yang & Kaiser 1998]. Several methods have been proposed for concurrency control. Different methods of concurrency control and conflict management have different impacts on the interface

and how operations are displayed and perceived by group members [Greenberg & Marwood 1994]. Both human and technical aspects have to be considered in choosing a particular concurrency control method [Greenberg & Marwood 1994].

Lee et al. [Lee et al. 2012] proposed hybrid concurrency control mechanism method for networked virtual environment which consists of two concurrency control approaches: task-based concurrency control and personal workspaces. In the task-based concurrency control approach, non-owners do some tasks if they do not conflict with the tasks of the shared object owner. In the personal workspaces approach, a user can manipulate copies of the shared objects in an independent workspace [Lee et al. 2012].

## **2.7 SyCoE Usage**

SyCoE can be used in different way by researcher and developers of collaborative technologies and companies:

- 1) As a guide line and frame work can be used during development of collaborative environment
- 2) For selection or adaptation of existing solution
- 3) To capture and capitalize collaboration knowledge

Part-II will show the usage of SyCoE through the process of selection/development of a specific synchronous collaborative environment.

## **2.8 Conclusion and Discussion**

In chapter1 of Part-I we proposed the SyCoW Concept Maps which facilitates the understanding of collaborative situation and its characteristics and consequently its requirements. In this chapter we proposed SyCoE Concept Maps which conceptualize the synchronous collaborative environment specification and characteristics. In other words SyCoE models the solution domain for an appropriate collaborative environment to fit the collaborative situation. SyCoE is the integration of the concepts currently found in the literature and thus should fit the expectations of numerous use cases. Hence both developers and researchers find useful information about the specification and solution components of synchronous collaborative environment.

The proposed model can be used in different way during the design and development of collaborative environment. In Part-II of this thesis we will demonstrate the usages of SyCoE during development of a new synchronous collaborative environment for design review meeting.

# Part-I: Chapter 3

## SyCoEE Concept Map: A General Model of Synchronous Collaborative Environment Evaluation

### Abstract

This chapter highlights the challenges in the evaluation of collaborative environment. This chapter identifies and models the concepts of a collaborative environment evaluation. A new concept model, named SyCoEE (Synchronous Collaborative Environment Evaluation) is presented through UML (Unified Modeling Language) structuring knowledge extracted from literature review. We tried to model the knowledge of collaborative environment evaluation domain by explicitly conceptualizing this domain. In other words we organized the concepts of collaborative environment evaluation into a meaningful taxonomy including the types of relations by which concepts are tied together. It can be considered as a model to guide designers and developers during the evaluation process. It must facilitate the justification of collaborative environments and the reuse of existing knowledge when designing a new environment for a specific target situation.

### Table of Content

3.1	Introduction .....	51
3.2	Related work.....	52
3.3	Motivation for Developing SyCoEE Descriptive Model .....	53
3.4	Methodology .....	54
3.5	SyCoEE (Synchronous Collaborative Environment Evaluation) Concept Maps.....	54
3.6	SyCoEE Usage.....	60
3.7	Conclusion and Discussion .....	60

### **3. SyCoEE Concept Map: A General Model of Synchronous Collaborative Environment Evaluation**

#### **3.1 Introduction**

The objective of collaborative environment is to support the group toward successful collaborative work and to maximize their performance and satisfaction. Hence, in general, the main objective of evaluation is to know how the system as a whole or its specific features and functions help to achieve this objective. Antunes et al. [Antunes et al. 2012] points out the importance of appropriate evaluation for investment justification, to satisfy the stakeholders, or to redirect systems development to successful requirements matching.

Different research demonstrated that several aspects impact on the success of the collaborative tool [Pinelle & Gutwin 2000], [de Araujo et al. 2004], Hamadache & Lancieri 2009], [Antunes et al. 2012]. Ross et al. highlighted the difficulty of CSCW evaluation because of the range of different perspectives that need to be considered: usability, individual psychology, group dynamics, efficiency of communications, effects of and on organizational structures and cultures, and so on [Ross et al. 1995]. Ramage also emphasized the difficulty and complexity of evaluation from methodological, practical, psychological and political points of view [Ramage 1997]. Neale et al. [Neale et al. 2004] stated that evaluation in CSCW often has been vaguely defined, hard to implement and time consuming. New strategies are expected to find out what is central in groupware success and failure.

Using new technological component as part of collaborative environment makes evaluation even more complex. The user interface design problem for new technologies (new display and interaction devices or the combination of several technologies) is more complex than traditional desktop interface design. Some technologies are relatively new; thus, the user-interfaces still lack of sufficient studies to establish comprehensive design guidelines and standards. Hence, designers may rely on their intuition rather than methodic approaches based on formal and proven specifications. So, most of the time, the decision that designers are making must be evaluated to be sure about the quality and success of their decision and to expect further capitalization on the design process.

The evaluation of collaborative environments and their components is important in the sense that they create the new knowledge to be used in future developments as guidelines for designers. For instance [Cornelius et al. 2013] conducted an experimental study to compare the cognitive effort required when using sketched surrogate gestures versus natural gestures in a virtual mechanical design tasks. Their larger goal was informing the design of future virtual collaboration tools by specifying the benefits of natural gestures in such collaborative situation. However, again, we emphasized the lack of formalization of knowledge which has been obtained from evaluation of different collaborative environment. This knowledge is not easily accessible and is mostly capitalized in article without specific formal structure.

Several researchers tried to evaluate specific hypothesis related to collaborative tool to provide guidance for future developments; however, most of the time it is difficult to generalize the results which were obtained in such evaluation [Grudin 1988], [Baker et al. 2001], [Steves & Scholtz 2005]. Depending

on the type of task, participants' roles and background, number of people, etc. the result could change. The number of participant involved in collaborative situation is varying; it thus requires to check the effect of the number of participants in collaborative environment effectiveness. If the number of groups and distribution of groups are varying; the effect of distribution and assignment of participant in groups on the success of collaborative tool must be checked. However the evaluation of these variables may be ignored for evaluation of the collaborative environment by simulating the maximum number of participants involved in the target collaborative situation, increasing the number of participant always will enhance the complexity of collaboration; if the tool is successful for ten people it should be successful for five people as well.

Despite various researches has been done about evaluation of collaborative environment and several methodologies developed for evaluation [Damianos et al. 1999], [de Araujo et al. 2002], [Huang 2005], [Steves & Scholtz 2005], [Antunes et al. 2012], it's still difficult and a challenging issue for developer to decide what they need to evaluate. Because of the complex nature of collaborative tool and environment and the various numbers of elements that impact on its results, it's often difficult to determine the scope of evaluation. Which hypothesis is required to be evaluated? How to conduct successful evaluation method? Hence the evaluation of collaborative system is a critical part of the research in this domain.

In section 3.2, related work, we are going to represent the existing investigation on methodologies, classification of evaluation methods to support the evaluation process. Then in section 3.3, we will present our motivation for developing a new concept model for synchronous collaborative environment evaluation. In section 3.4 we will present our methodology for developing the concept map. Section 3.5 is presenting the SyCoEE (Synchronous Collaborative Environment Evaluation) Concept Map. Section 3.6 identifies the different usage for SyCoEE. Section 3.7 provides conclusion to this chapter.

## **3.2 Related work**

Several researches investigate evaluation of collaborative environment frameworks. They proposed methodologies, classification of evaluation methods to support the evaluation process. Here we are presenting the researches which somehow helped to better understand collaborative environment evaluation. The Evaluation Working Group (EWG) in the Defense Advanced Research Projects Agency (DARPA) Intelligent Collaboration and Visualization (IC&V) program has developed a methodology to evaluate collaborative systems [Cugini et al. 1997], [Damianos et al. 1999]. This methodology consists of a classification framework of CSCW, the metrics and evaluation methodology for achieving effective and economical evaluation of the collaborative technologies. Scenario based evaluation as a particular approach for evaluation has been proposed in this framework. Andriessen [Andriessen 1999] proposed 'Nested Effects Testing-approach' which is based on a combination of various theoretical approaches, stemming from four research traditions: human-computer interaction, communication theory, group dynamics, and organizational effectiveness. This approach investigates on the techniques that focus on the user-centered aspects of evaluation, including interface usability, human communicative behaviour, collaborative work, and teamwork within the social context. Pinelle & Gutwin [Pinelle & Gutwin 2000] have reviewed 45 papers from the ACM/CSCW conference 1990 – 1998 which discussed groupware systems and evaluations of groupware. They used set of categories and criteria for analyzing the papers.

Their objective was to see how different evaluation techniques have been used in the past, the strengths and weaknesses of the different methods. Later [Wainer & Barsottini 2007] have reviewed 169 full papers from the ACM/CSCW conference from 1998 to 2004, by using the same categories and criteria proposed by Pinelle & Gutwin. de Araujo et al. [de Araujo et al. 2002] proposed a conceptual framework (CSCW Lab) which defines a method for groupware evaluation based on the dimensions for evaluation and the steps to investigate each dimension. They identified four dimensions for groupware evaluation: group context, usability, collaboration and cultural impact. Later in [de Araujo et al. 2004] authors defined ontology of groupware evaluations within the Lab based on CSCW Lab conceptual framework. Neale et al. [Neale et al. 2004] proposed a multifaceted evaluation framework which focuses on the work coupling, awareness and processes of group work, namely communication, collaboration, and coordination. Huang proposed a conceptual framework for the understanding of collaborative systems evaluation using the lifecycle based approach. The proposed framework is formed within five domains: Content, Context, Process, Stakeholders and Success factors [Huang 2005]. Steves & Scholtz proposed an evaluation method which uses a framework to structure evaluations by mapping system goals to evaluation objectives, metrics, and measures [Steves & Scholtz 2005]. Terken & Sturm proposed a framework and specifies procedures for evaluation of services supporting human-human communication and collaboration. The framework outlines areas that are relevant to the evaluation of Computers in the Human Interaction Loop type services, and maps the areas onto metrics and measures [Terken & Sturm 2005]. Herskovic et al. proposed three classifications of groupware evaluation methods. 1- Classification based on stakeholders and product state, 2- Classification based on type, scope and duration (people's participation, time of application, evaluation type, place, time span and goal) 3-, classification based on the evaluation cost [Herskovic et al. 2007]. Hamadache & Lancieri [Hamadache & Lancieri 2009] proposed taxonomy to provide a base to represent CSCW systems evaluation context. POPA [POPA 2010] summarized the process of collaborative systems assessment through its characteristics, types of measurement scales, requirements that must be met, template for defining and documenting measures. He also presented the way in which an assessment system based on metrics must be implemented. Antunes et al. proposed a framework to evaluate collaborative systems according to given variables and performance levels. A collection of guidelines have been proposed to evaluate collaborative systems according to product development status [Antunes et al. 2012].

### **3.3 Motivation for Developing SyCoEE Descriptive Model**

As sited in related works, several researches proposed collaborative environment evaluation frameworks, methodologies or classifying the existing evaluation methods. Our motivation was to explicitly conceptualize collaborative environment evaluation. In other words we organized the concepts of collaborative environment evaluation into a meaningful taxonomy including the types of relations by which elements are tied together. We came up with similar objective as de Araujo et al. [de Araujo et al. 2002], i.e. organizing, storing and retrieving evaluation information which helps R&D teams in designing new evaluation experiments.

We propose the Synchronous Collaborative Environment Evaluation (SyCoEE) model with two main objectives: to represent a formal and structural representation of collaborative environment evaluation context and concepts to be used by researchers and software engineers for designing and conducting their



evaluations. The second objective is to provide a repository of collaborative environment evaluation knowledge. Knowing how evaluation has been done in experienced cases will help to know in which extend the obtained knowledge from evaluation is reliable.

### **3.4 Methodology**

The same methodology which explained in chapter 1 in methodology section has been used for developing SyCoEE. Hence, in order to develop SyCoEE, we formulated the focus question: What are the characteristics and specification of the evaluation of synchronous collaborative environment? Which concepts help to describe synchronous collaborative environment evaluation? We have synthesized the existing classification, and categories of collaborative environment evaluation and underlying technologies. During the development of SyCoEE one objective was to get sufficiently complete, correct, clear, and brief characterizations that could lead to define and specify the characteristic of a synchronous collaborative environment evaluation.

### **3.5 SyCoEE (Synchronous Collaborative Environment Evaluation) Concept Maps**

Figure 3-1 represents SyCoEE (synchronous collaborative environment evaluation) model in the concept map form. The proposed model includes concepts to describe different aspects which are required for the description and construction of a synchronous collaborative environment evaluation. The main concepts of this model are: Evaluation Objective, Impacts of Collaborative Tool, and Time to Conduct an Evaluation, Data Collection Technique, Evaluation Data, and Methodology for data analysis, Evaluation Results, Evaluation Location, Evaluation Cost, Evaluator's Type, Evaluation Methodologies Type model and Conclusions Drawn from the evaluation. Following we explain these concepts and their relation in more detail.

#### **Evaluation Objective:**

The evaluation of synchronous collaborative environment has one or several objectives. The types of objectives are:

- *Hypothesis validation:* hypothesis validation tried to validate the hypothesis. Hypothesis formulated during development process and comprises issues.
- *Requirement Validation:* evaluation of the whole or part of collaborative environment respect to the requirements of collaborative environment.
- *Answer to specific question:* Researcher may come up with specific questions during the development process. Evaluation objective could answer these questions.
- *Validation the design option or specific solution:* evaluation may validate a specific solution selected during the development process.
- *Validation the quality of technical solution:* evaluation may validate the quality of a specific technical solution.

Collaborative tools are often multi-objective. In many situations the purpose of the collaborative tool is not clearly identified and it makes it difficult to determine the evaluation objectives [Ross et al. 1995].

### **The Impacts of Collaborative Tool:**

Evaluation determines the impact of collaborative tool on person, group or organization [de Araujo et al. 2002], [Neale et al. 2004], [Terken & Sturm 2005], [Antunes et al. 2012]. About impact on person, the focus of evaluation is mostly at cognitive level and social performance. The events and time frame is in minutes or seconds. About impact on group, the focus of evaluation is mostly on activities, in interaction and communication level and time frames are in minutes or hours. About impact on organization, the focus of evaluation is mostly on organizational concerns, tool acceptance and usage and time frame is in days, months or years [Antunes et al. 2012], [Terken & Sturm 2005].

### **Time to Conduct an Evaluation:**

Evaluation is conducted during the development or usage of collaborative environment. [Pinelle & Gutwin 2000] considered six potential evaluation placements: 1) Periodic evaluations throughout development process, 2) Continuous evaluation throughout development, 3) Evaluation of a prototype, 4) Evaluation of a finished piece of software, 5) Periodic evaluations after software implementation, 6) Continuous evaluation after software implementation. There is a difference between the preliminary and the final development stages in term of the type of evaluation [Zaychik et al. 2000], [Antunes et al. 2012]. Formative [Scriven 1967] evaluation is conducted during the preliminary stages and summative [Scriven 1967] after the final development. Formative evaluation is an assessment of the state of development [Antunes et al. 2012]. Formative provides information about the viability of design ideas, usability problems, and perceived satisfaction with the technology, possible focal points for innovation, and alternative solutions, and also feedback about the development process itself. Summative evaluation provides complete and definitive information about the developed product and its impact on the users, the group, and the organization [Zaychik et al. 2000], [Antunes et al. 2012].

### **Data Collection Technique:**

Collaborative environment evaluation requires data collection techniques and methodologies to analyze data. Data collection techniques are direct or indirect.

The direct techniques consists of video/audio records, observation, automatic recording with IT devices. A type of automatic data collection is recording user interaction via computer which named data logging. [Helms et al. 2000] argue that using data logging with other sources provide comprehensive strategy for evaluating groupware. They describe how events passed between collaborating users in multi-user applications served as a rich source of log data.

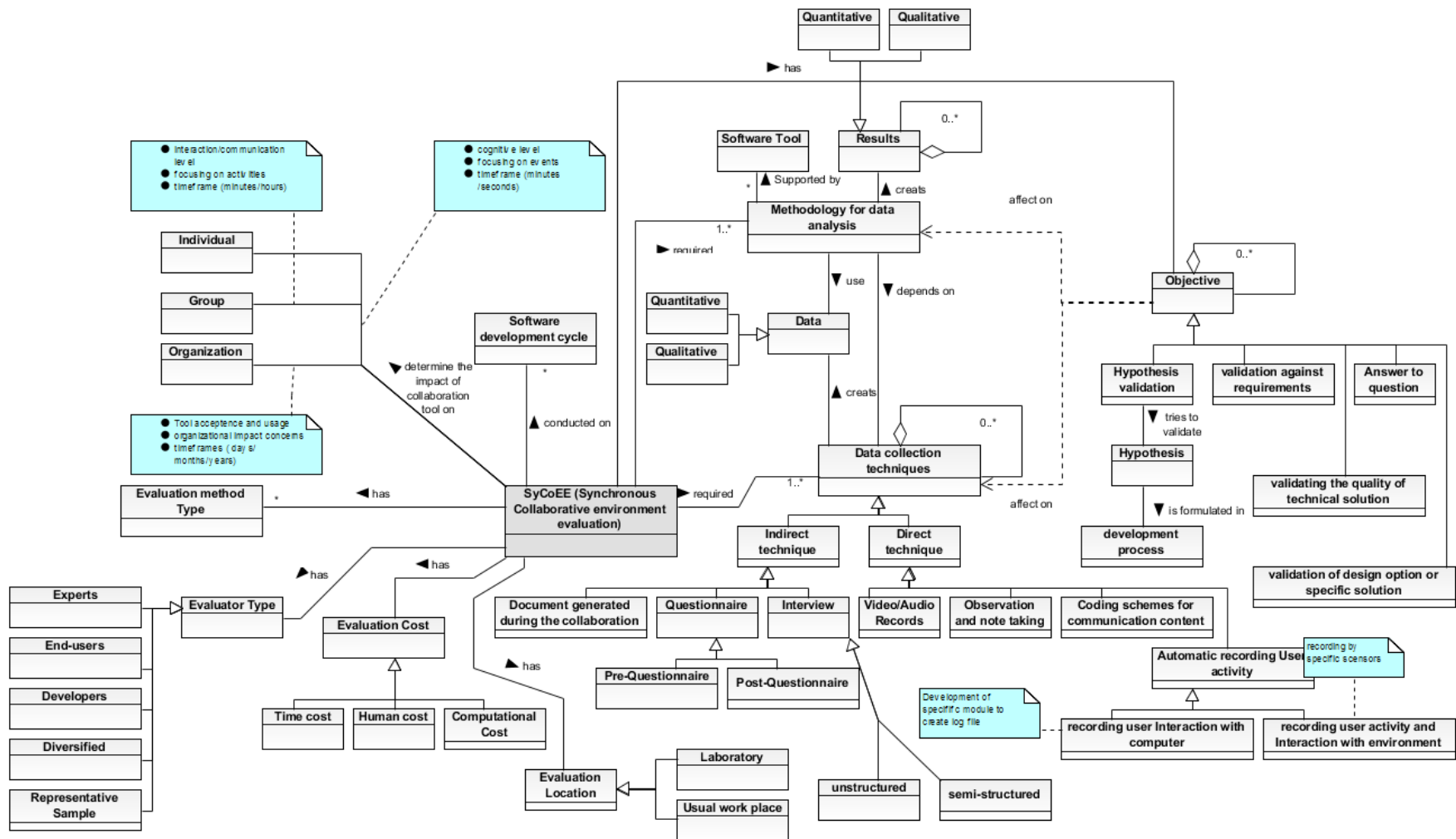

Figure 3-1: Synchronous Collaborative Environment Evaluation (SyCoEE)

The raw data and event collected through log file require several types of filter and analysis to produce meaningful data which define the type of user actions. Merging these data with other sources provides comprehensive description of collaborative situation. Another type of automatic data collection records user activity and interaction with environment via different trackers or sensors or using computer vision technologies.

Indirect techniques consist of interviews, document generated during the collaborative sessions and questionnaires. Questionnaires also are used before experimental evaluation (Pre-questionnaire) or after (Post-questionnaire). Table 3-1 represents a taxonomy of data collection method which has been proposed by Andriessen [Andriessen 1996].

Data source	Structured	Unstructured
Users	<ul style="list-style-type: none"> <li>• Questionnaires/rating scales on attitudes, satisfaction and stress</li> <li>• Structured interviews</li> <li>• Systematic contact data-logs, e.g. communication matrix</li> </ul>	<ul style="list-style-type: none"> <li>• Open interviews (individual or group interviews)</li> <li>• Critical incident technique</li> <li>• Talk aloud protocols (during interaction)</li> <li>• Post hoc comments (after interaction)</li> <li>• Diaries</li> </ul>
Researcher observing	<ul style="list-style-type: none"> <li>• Systematic observation and coding of user interaction</li> </ul>	<ul style="list-style-type: none"> <li>• Impressions</li> <li>• Participative observation</li> </ul>
Recording equipment	<ul style="list-style-type: none"> <li>• Data from experimental equipment, e.g. speech-frequency analyzer</li> <li>• Physiological registration, e.g. heart-rate variability</li> </ul>	<ul style="list-style-type: none"> <li>• General video recording</li> <li>• General computer logs files</li> </ul>
Expert judgment	<ul style="list-style-type: none"> <li>• Formal, theory-based analysis of software, e.g. to predict performance time</li> <li>• Delphi</li> <li>• Rating against checklists</li> </ul>	<ul style="list-style-type: none"> <li>• Brainstorming</li> </ul>
Archives	<ul style="list-style-type: none"> <li>• Recorded data (e.g. number of messages)</li> </ul>	<ul style="list-style-type: none"> <li>• Personal documents, e.g. email messages</li> </ul>

**Table 3-1: Taxonomy of data collection methods [Andriessen 1996]**

### **Evaluation Data:**

The evaluation techniques create new data; the types of data have different formats which depend on the evaluation technique. The created data will be used by methodologies for data analysis in order to create the evaluation result. There are two general types of data: Quantitative data and Qualitative data. Qualitative data approximates or characterizes but does not measure the attributes, characteristics, properties, etc., of a phenomenon [B.Dic. 2014]. Quantitative data provides information about quantities; they can be verified, and is usable for statistical manipulation [B.Dic. 2014]. For example Interview data are qualitative data. But time to accomplish the task is quantitative. Questionnaire data are qualitative and quantitative (Likert-type questionnaires create the quantitative data) [Terken & Sturm 2005].

### **Methodology for data analysis:**

Selecting the appropriate methodology for data analysis highly depends on the data collection techniques and the type of data generated by them. Methodology for data analysis which most of the time uses appropriate data analysis software can create both qualitative and quantitative results.

### **Evaluation Cost:**

Each evaluation generally have three types of costs: time cost, human cost and computational cost. Time cost merges the time for designing the evaluation experiment or method, the time for conducting evaluation and time for analyzing the evaluation data. Human costs consist of the involvement of people

who are conducting the evaluation and people who participate in evaluation [Hamadache & Lancieri 2009].

**Evaluation Location:**

Evaluation are processed in vitro (in a laboratory) or in a usual workspace [Herskovic et al. 2007], [Hamadache & Lancieri 2009]. Laboratory observation and experiments takes place in the artificial environment of the laboratory. Workspace observation refers to the observation of behaviors in the natural environment. The laboratory is an unnatural environment and there is the concerns about whether the behaviors we observe there are as we would see in the real world. However, the laboratory is a highly controlled environment we can adjust it to our comfort. The control in usual workspace observation is more difficult and it is costly for the observer.

**Evaluator’s Type:**

Evaluators of a collaborative system can be experts, end-users, developers, representative sample and diversified (any combination of them) [Herskovic et al. 2007], [Hamadache & Lancieri 2009]. Evaluators of a collaborative system are identified based on evaluation objective and evaluation methodology.

**Evaluation Methodologies Type model:**

Several types of evaluation methods exist in literature and each of them has its own advantages and disadvantages. Figure 3-2 represents the extension of SyCoEE model for Evaluation Methods. The evaluation method types presented in this model is not exhaustive; however other evaluation methods could be easily added to this model.

Antunes et al. [Antunes et al. 2012] in table 3-2 summarized characterization of the some evaluation methods, describing the purpose of the evaluation (why), the evaluation tools being used in each method (how), the outcomes of the evaluation (what), and the moment in which evaluation is conducted (when).

Antunes et al. used the characterization of the objective of an evaluation, proposed by McGrath [McGrath 1984]. Based on their proposition, the objective of an evaluation addresses three main goals: precision, generalizability, and realism.

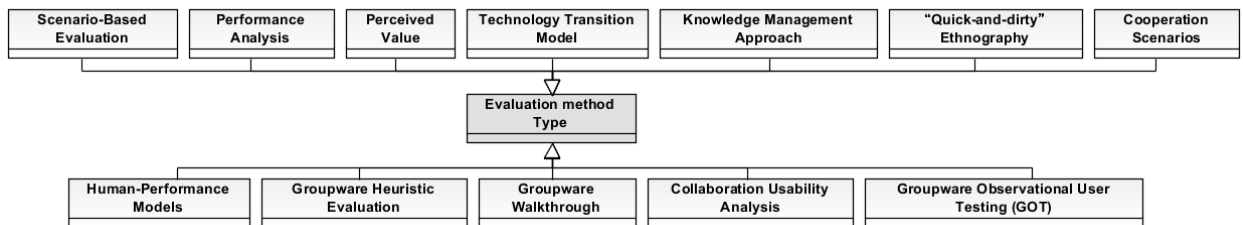

Figure 3-2: Evaluation Methods part of SyCoEE model

The first goal concerns the precision of the data obtained by the instrument being used. Generalizability identifies how the obtained results may be applied to a population. Realism addresses

how closely the obtained results represent real-world conditions by considering the work setting, the population of users, and the tasks, stimulus, time stress, and absence of observers, etc.

Method	Why	How	What	When
<i>Groupware Heuristic Evaluation</i> (GHE) [Baker et al. 2002]	Precision	Software checklist	Analysis, Effectiveness, efficiency, satisfaction	Summative
<i>Groupware Walkthrough</i> (GWA) [Pinelle and Gutwin 2002]	Precision	Software Analysis	Effectiveness, efficiency, satisfaction	Formative
<i>Collaboration Usability Analysis</i> (CUA) [Pinelle et al. 2003]	Precision	Software Analysis	Effectiveness, efficiency, satisfaction	Formative
<i>Groupware Observational User Testing</i> (GOT) [Gutwin and Greenberg 2000]	Realism	Observation, checklist	Effectiveness, efficiency, satisfaction	Summative
<i>Human-Performance Models</i> (HPM) [Antunes et al. 2006]	Precision	Interaction Analysis	Group performance	Formative
<i>“Quick-and-dirty” Ethnography</i> (QDE) [Hughes et al. 1994]	Realism	Observation	Redesign	Summative
<i>Performance Analysis</i> (PAN) [Baeza-Yates and Pino 2006]	Generalizability	Formal analysis	Efficiency	Formative
<i>Perceived Value</i> (PVA) [Antunes and Costa 2003]	Realism	Questionnaire, checklist	Organizational Impact	Formative
<i>Scenario-Based Evaluation</i> (SBE) [Haynes et al. 2004]	Realism	Interviews	Organizational Contributions	Formative
<i>Cooperation Scenarios</i> (COS) [Stiemerling and Cremers 1998]	Realism/Generalizability	Interviews, observation	Redesign	Formative
<i>Technology Transition Model</i> (TTM) [Briggs et al. 1998]	Generalizability	Interviews, observation	Predicted actual use	Formative
<i>Knowledge Management Approach</i> (KMA) [Vizcaíno et al. 2005]	Generalizability	Software checklist	analysis, Knowledge circulation	Formative

**Table 3-2: Characterization of Evaluation Methods [Antunes et al. 2012]**

1. Inspection methods (8) • Heuristic Evaluation	Heuristic evaluation incorporates usability expert studies to identify any potential weaknesses in the design of an interface.
2. Performance analysis(2) • Human Reliability Analysis	HRA is used to measure the reliability of the interaction between man and machines by analyzing errors.
3. Behaviour analysis (3) • Diagnostic Recorder for Usability Measurement (DRUM)	DRUM is a software tool that provides assistance throughout the process of usability evaluation, by recording various aspects of user performance, such as the duration of task activities and the occurrence of errors.
4. Effort and satisfaction (6) • NASA-Task Load Index (NASA-TLX) • Measuring the Usability of Multi-Media Systems (MUMMS) • MultiMedia Communication Questionnaire (MMCQ)	The TLX provides an indication of cognitive workload, based on a weighted average of ratings on six subscales. The MUMMS is a questionnaire, concerned with the users' perception of and satisfaction with six usability-aspects of Multi-Media applications: helpfulness, learnability, efficiency, control, affect and excitement. The MMCQ is a questionnaire for assessing the quality of on-line communication such as videoconferencing.
5. Task aspects and relations(2 ) • Extended Delft Measurement Kit	The EDMK or Quality of Working Life Questionnaire contains a set of well-tested questionnaire modules used to measure aspects of work and organization such as task characteristics, relationships, conditions and terms of employment, characteristics of work behaviour and expenditure of effort.
6. Network performance ( 11) • NetPerf	NetPerf is a software tool that can measure aspects of tele-communication network performance, such as speed of transmission and CPU time.
7. System usage and interaction registration (5) • Computer logging • Coding schemes for communication content	Automatic registration of the use of the system and of separate functionalities. Analytical schemes for coding the type of words or expressions in computer mediated communication.

**Table 3-3: From each cluster one or a few examples are given. Between brackets the total number of tools per cluster [Andriessen et al. 1998].**

In the MEGATAQ project founded by the European commission [Andriessen et al. 1998], many methods and tools for the assessment of the quality of ICT applications and ICT supported cooperation were collected. The methods and tools are clustered in seven groups: Inspection methods, Performance analysis, Behaviour analysis, Effort and satisfaction, Task aspects and relations, Network performance, System usage and interaction registration. From each cluster one or a few examples are given. Between

brackets the total number of tools per cluster. Table 3-3 contains some examples of evaluation methods collected in the framework of the MEGATAQ research project.

### **Evaluation Results:**

The results answer to the evaluation objectives. The result of evaluation depends on methodology for data analysis and data collection and is qualitative or quantitative. Qualitative results deals with description and quantitative results with numbers. The results drawn from evaluation create knowledge in the domain.

The conclusion and results drawn from evaluation creates new information about the domain: indeed quite a new knowledge. Depending on the collaborative situation, the type of collaborative environment and evaluation process, the conclusion is generic. However, most of the time, because of the complexity of the domain and different elements which are involved in evaluation process and impact on it, is not easy to generalize the knowledge obtained from evaluation process. For the knowledge which is not generic, the evaluation conditions must be recorded. Then this knowledge will be usable to evaluate similar collaborative environment or applicable for similar collaborative situation. The knowledge obtained from evaluation required to accompany with SyCoW and SyCoE and SyCoEE instances for the target situation. During the development process it is necessary to document the element of these three models. Knowing in which condition an evaluation has been done is an important knowledge gained from experiments. It will help people to use the result of evaluations in appropriate way.

### **3.6 SyCoEE Usage**

SyCoEE can be used in different way by researcher and developers of collaborative technologies and companies:

- 1) SyCoEE can be used as a framework during evaluation phase. SyCoEE provides a holistic point of view which specifies which elements required to be considered during the evaluation process.
- 2) SyCoEE can be used to record evaluation aspects. By using SyCoEE evaluator describes evaluation situation and its characteristics.

### **3.7 Conclusion and Discussion**

In this chapter we proposed the third model SyCoEE which conceptualize the synchronous collaborative environment evaluation aspects. SyCoEE model the solution evaluation domain. It is the integration of the concepts currently found in the literature. Concepts and their relation provide the conceptual picture about the elements of this domain. SyCoEE helps developer and designer during the evaluation process and also it supports capitalization of the knowledge obtained during evaluation process of specific collaborative environment. By using SyCoEE evaluator can describe evaluation situation and its characteristics. Knowing in which condition an evolution has been done is an important knowledge element of evaluation gained from experiments. This will help people to use the result of the evaluations in an appropriate and informed way.

SyCoEE and its relations with SyCoW and SyCoE which are presented in chapter 1 and 2 provide guidance for researcher about what they need to consider when designing and conducting appropriate evaluation.



# **Part-I: Conclusion**

In chapters 1, 2, and 3, we proposed three concept models SyCoW and SyCoE and SyCoEE which modeled the concepts and the relations between the concepts of synchronous collaborative work, synchronous collaborative environment and synchronous collaborative environment evaluation. The conceptual model for organizing collaborative environment knowledge can help the developers to define and obtain data on various aspects of the collaborative situation and collaborative environment. The usage of the different models identified in the Part-I are presented during the process for development of synchronous collaborative environment in Part-II.

## **Part-II: A Process for Development/Selection of Synchronous Collaborative Environment**

## Part-II: Introduction

As already argued, the complexity of selection or development of collaborative environment remains a challenging issue. Different collaboration technologies are available but it is challenging to select the right tool from a number of technologies. Despite the multiplicity of existing collaborative environments, their development still remains complex and unsystematic. Technological solutions are advancing every day. On the other hand, collaborative environment development process required not only to address technical issues related to software development but also to consider the human aspects and social group processes that should be supported with the collaborative environment.

There is a lack of a practical, holistic framework or process that may guide organizations in their efforts to specify, evaluate and acquire collaborative environment that support their collaborative work and activities. The existing frameworks, categories and model are either too general and not offer sufficient information for a detailed requirements analysis nor access to alternative solutions.

On the other hand, the development of collaborative environment aims to solve a mix of ill- and well-defined problems, which involve processing a significant amount of knowledge from different domains.

In Part-II we are proposing design or selection process of synchronous collaborative environment. This process has been established based on the models which have been identified in Part-I. The figure in the next page shows the steps of the knowledge-based process. The process consists of three main steps. We present it in three chapters 4, 5 and 6. The usage of the proposed models in Part-I, is demonstrated through the proposed process in Part-II. Through this process we present the development of a new synchronous collaborative environment dedicated to design review meeting, named, MT-DT. MT-DT has been designed, developed and evaluated during the PhD. MT-DT environment consists of a multi-touch table with specific 3D software application which supports collaborative design review activities. It demonstrates how the process should be instantiated.

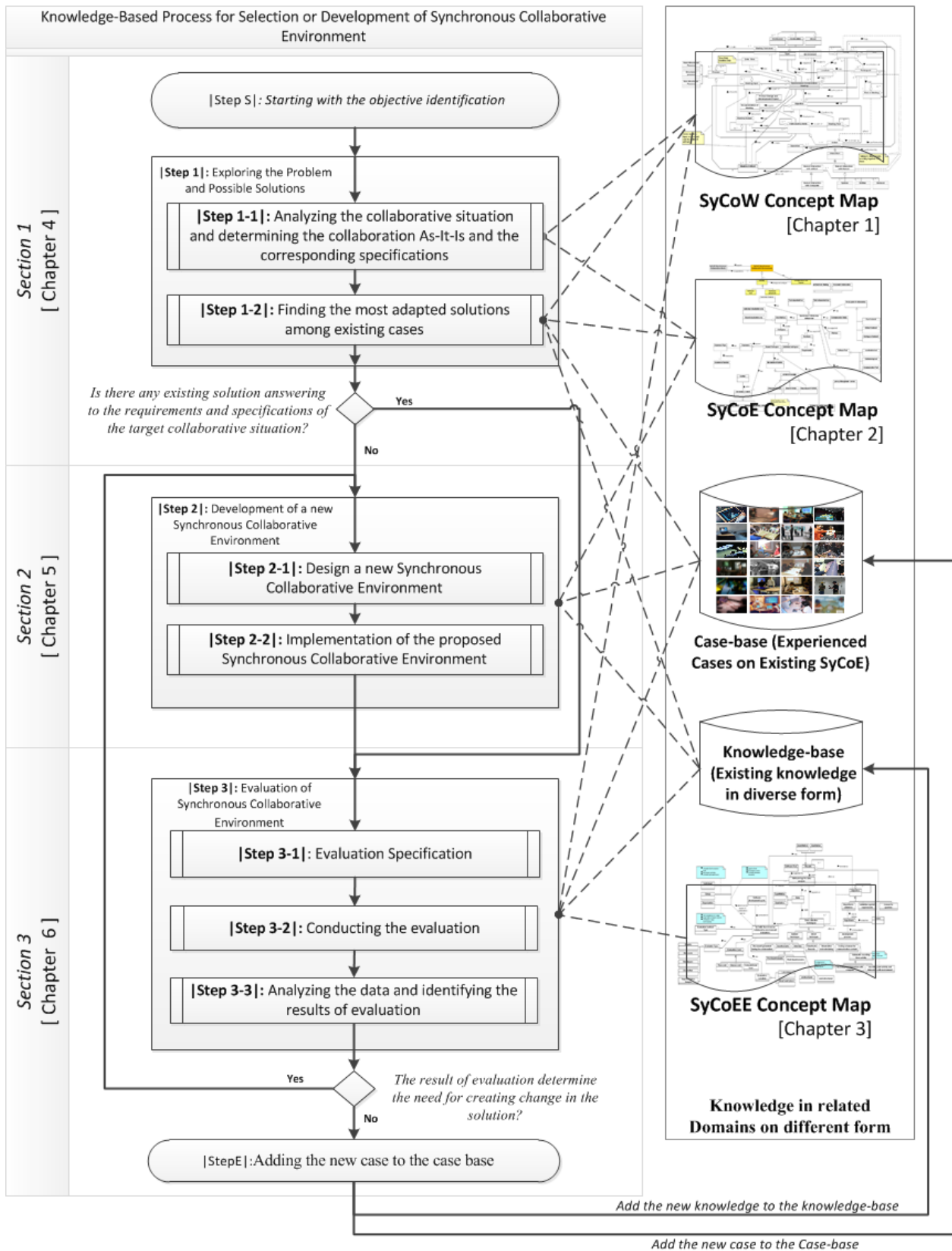

**Knowledge-Based Process for Selection or Development of SyCoE**

# Part-II: Chapter 4

## Exploring the Problem and Possible Solutions

### Abstract

This chapter represents the first step of the process for the selection/ development of synchronous collaborative environment. The first step is consisting of two main sub-steps which explore the problem and possible solutions. Before starting with the first step we identify the target collaborative situation for which we are expecting a collaborative environment. Then in the step 1-1 we analyze the current collaborative situation As-It-Is in order to better understand it. For this analysis we will use SyCoW and SyCoE concept models. Through different methodologies we identify the elements of these two models, which help us to specify the collaboration As-It-Is. At the end of this step, through the analysis of the shortcomings and potential improvements of the current solution, we will identify the general requirements for SyCoE. In the step1-2, we retrieve the most adapted solution among existing collaborative environments. Then decide if we want to use an existing collaborative environment or if we want to design a new environment. If we decide to use an existing collaborative environment then we need to evaluate it and continue with step 3 presented in chapter 6 and if we decide to design a collaborative environment we should continue with step2 presented in chapter 5.

### Table of Content

4.1	[Step S]: Starting with the objective identification .....	68
4.2	[Step 1-1]: Analyzing the collaborative situation and determining the collaboration As-It-Is and the corresponding specifications .....	69
4.3	[Step 1-2]: Finding the most adapted solutions among existing cases .....	75
4.4	Conclusion and Discussion .....	79

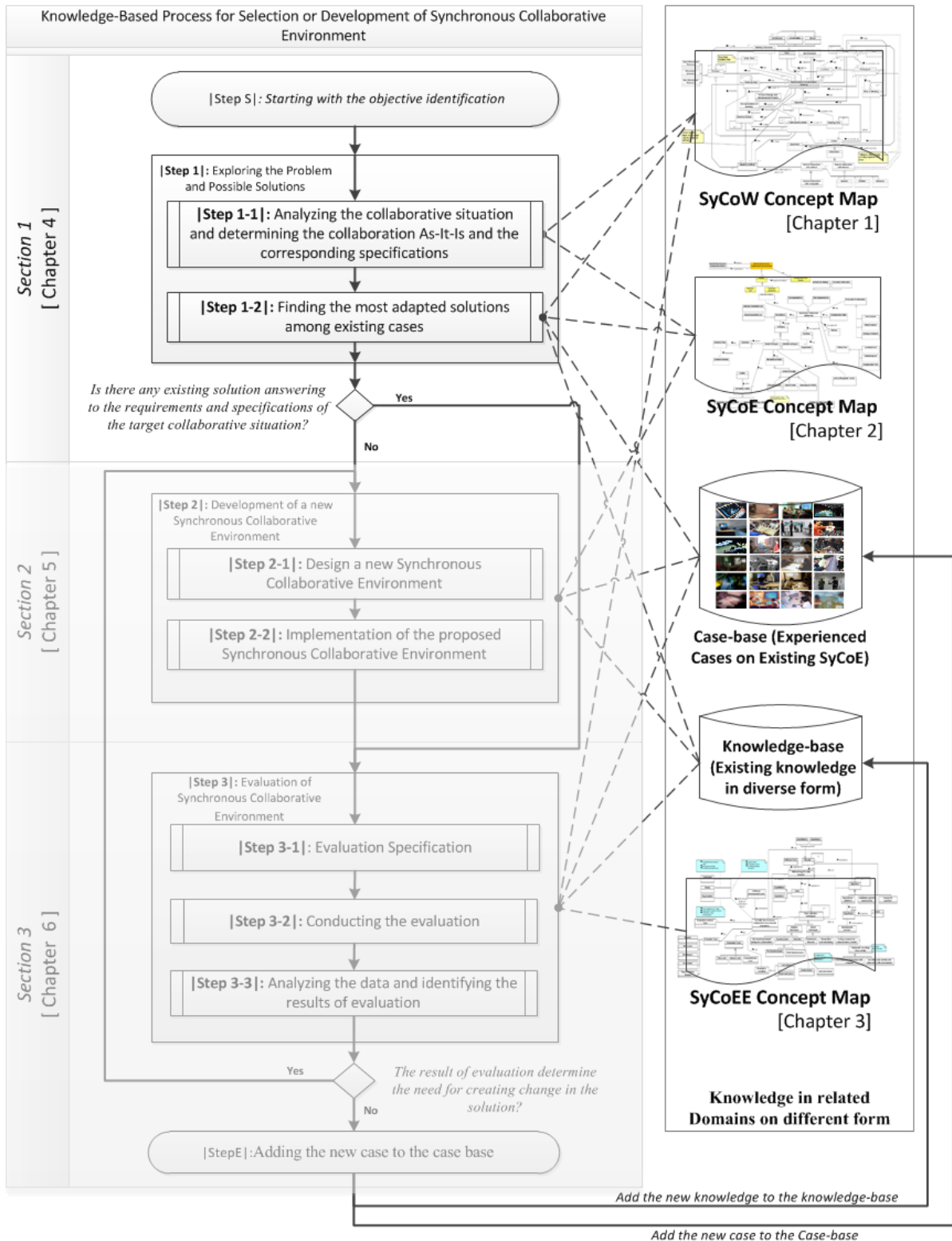

**Knowledge-Based Process for Selection or Development of SyCoE**

## 4. Exploring the Problem and Possible Solutions

### 4.1 [Step S]: Starting with the objective identification

User starts with the objective to improve his collaborative situation. The term “user” used to explain the process as a person who is involved in the selection or development of synchronous collaborative environment.

There are two categories of people interested to improve a specific collaborative situation: people from companies and researchers. A company may see the importance of specific collaborative situation and expect to improve this situation by providing appropriate collaborative environment. Making the change in some elements of the collaborative work create the need to support it with a new collaborative environment. Various triggers initiate such a process. For example: frequently occurring collaborative situation whose improvement will save time and money for the company or observing the need for improvement in specific aspects of collaborative situation.

The previous defined standpoints are based on the phenomena of techno pull, when people are looking for the most appropriate collaborative environment which provides improvement in collaborative situation. However there are also some researchers that see the benefits of using a specific technology in collaborative environment. Such technologies have potential to make improvement in collaborative situation. Researcher may look for finding appropriate collaborative activities to demonstrate the technology performance and usability. This proposed process is dealing with the first standpoints type.

When the main expected improvement is identified, it's necessary to systematically analyze the different improvement aspects which can lead him to find a solution that cover all the aspects. Hence user may create fundamental change or may decide to change step by step over the time. This choice will affect the behavior of the end-users and their acceptance of the environment.

#### **Case-Study:**

We expect to provide an appropriate collaborative environment for multidisciplinary design review among small group of participants in collocated situation. Our motivation for investigating in this type of meeting came from the limited offer of collaborative environment adapted to design review. Our target collaborative situation is a co-located collaborative design review meeting among small group of people.

The ISO 9000 definition implies that “a design review is an activity undertaken to determine the suitability, adequacy and effectiveness of a design to meet the design requirements. Suitability means ‘An appropriate design solution is developed’. Adequacy means ‘The design solution meets all the design requirements’ and effectiveness means ‘The right design objective is reached’ ” [Hoyle 2009]. Design review happen frequently during product development process to evaluate the design in terms of costs, quality and delivery, to ensure that the most suitable knowledge and technology are incorporated into the design, and to solve possible problems instead of passing them downstream [Huang et al. 2004]. It consists of structural review, ergonomic review aspect, review from aesthetic aspect, and review functionalities of product. The design review involving different experts and stakeholders is widely recognized as a fundamental activity for the project success [Caruso & Re 2010], [Huang et al. 2004], [Knöpfle & Voß 2000], [Ichida & Voigt 1996]. The key design decisions, design experiences, and

associated rationale are frequently made explicit during design review [Huet et al. 2007]. It involves conflict resolution and helps to negotiate about the required change and decision making. Involving customers and end users can also enable to check their requirements and satisfaction before the final product delivery. Design review between designers in charge of designing specific part in a concurrent and collaborative way ensures the consistency between different parts of the product.

Hence we can have diverse type of design review meeting which may impose different type of requirements and constraints for the collaborative environment. Review from aesthetic aspect may require an immersive environment to visualize the product. Ergonomic review may require specific environment supported by force or tactile feedbacks. In setp1 we explain more about the specification of the type of design review we are considering here.

## **4.2 |Step 1-1|: Analyzing the collaborative situation and determining the collaboration As-It-Is and the corresponding specifications**

In this step user analyzes his target collaborative situation and identifies the collaboration As-It-Is. Attempt to improve a collaborative situation, begins with understanding how it works currently. Modeling the current situation is the basis to identify shortcomings and potential improvements. Highlighting and explaining existing shortcomings provide the justification for the need of adapted\_collaborative environment and convince people to investigate and to accept a new environment. In other words, sufficient understanding of the current situation is a prerequisite to select or develop a new collaborative environment. In chapter 1 we emphasized on understanding the nature of cooperative work in order to better support people in their cooperative efforts.

The primary goal of As-It-Is modeling is to present the problem domain and the current environment. The main goal of the As-It-Is analysis is to create a complete list of weakness and potential improvements based on the identified elements of current collaborative situation. It helps to clarify exactly what are the specifications of the collaborative work and how it is done today. Both SyCoW and SyCoE help us in order to specify the current state of collaboration. SyCoW is presenting more the aspects related the nature of the collaborative work and SyCoE how currently collaborative work has been supported. For identifying collaboration As-It-Is, user needs to walk through SyCoW and SyCoE models and create instances of these models for his specific collaborative situation. To do so, user need to collect data to analyze the As-It-Is situation through different means: information repositories in organization, observational study, interview with people already involved in As-It-Is collaborative situation, etc.

Hence, at this step by looking at the elements of SyCoW and SyCoE, user needs to define the potential added value he proposed to each element. So it is important to see which elements are worth to keep As-It-Is and which elements require evolutions and improvements. The observation and the capitalized experience in the field help in this identification. For example, it has been proven that people use their gesture for communication [Tory et al. 2008]. So for tasks where gestures play an important role to convey information, it is necessary to keep it or if it's not possible, it is necessary to provide a gesture representative element.

Deciding to change an element of SyCoW<sub>i</sub> (SyCoW instance) could change the other elements of the SyCoW<sub>i</sub> and may require changing the elements of SyCoE<sub>i</sub> (SyCoE instance) to support this modification. For example, using the digital document instead of using the printed version required



modification on SyCoE<sub>i</sub>. It changes the interaction with artifact and consequently the SyCoW<sub>i</sub>. A new technology with new functionalities which were not available in paper based version of documents (changes other elements of SyCoE<sub>i</sub>). Sometimes the SyCoE<sub>i</sub> designed to answer specific requirement may create some constraint which change the other elements of SyCoW<sub>i</sub>.

The outcome of the As-It-Is analysis is a clear view of a collaborative situation its specifications and the corresponding requirements for new synchronous collaborative environment.

### Case-Study:

In this part we will show the |Step1| through our case study. In order to identify the collaboration As-It-Is for our target design review meeting we used observational study and literature review, both SyCoW and SyCoE. Observational study is a methodology used by different researcher to analyze the collaborative situation [Tang 1991], [Brereton & McGarry 2000].

We conducted an observational study in the lab by designing a simplified collaborative situation similar to the potential real collaborative situation we are targeting. We chose an observational study in laboratory conditions in order to simplify the situation studied to better understand our current target collaborative situation As-It-Is.



Figure 4-1: Face to face collaborative design review among a customer (marketing member from the company X), two designers with different design specialty and one manufacturing member from the company Y.

The scenario was built for a group of four participants around a table manipulating paper documents. The meeting was video recorded. Meeting gathered a customer (marketing member from the company X), two designers with different design specialty and one manufacturing member from the company Y (See Appendix 7.2 for more detail about the observational study and underlying scenario). The observation was video recorded by four cameras which captured the meeting from four different directions: two cameras for capturing the workspace from top and side and two cameras for capturing the participants' faces. Figure 4-1 demonstrates a snapshot of the video during the observational study.

Through our observational analysis we investigate to analyze the collaborative situation As-It-Is by identifying the elements of SyCoW and SyCoE. We wrote down the elements of the SyCoW and SyCoE as a list and then we filled out it by making an instant of the SyCoW model and SyCoE model for our target collaborative situation based on our observation.

In order to identify 'SyCoW:: Activity', 'SyCoW:: Interaction', 'SyCoW:: Human Interaction with Artifact', 'SyCoW::Human Interaction with Human' and 'SyCoW:: Action', we analyzed participant's interaction, communication and actions: how they used the different communication channels through

direct and indirect interactions to accomplish the required task how they share their knowledge and information to make decisions.

[01:08] Designer of bicycle frame: "... I can start presenting some models that I have for the bicycle that you might be interested [*putting the paper containing the model in the center of the table the direction toward the customer*] this is bicycle two wheels, this is another model that I have [*putting it in the center side by side by first model*] besides that I have Tri-cycle, I have Quadra-cycle as well with different accessories. [*Putting another Tri-cycle on the center of the table*] with different accessories, would you explain that what you exactly looking for ...” (figure 4-2)

[09:22] Designer of bicycle frame: "... So, can I have modification on these tricycles? [First showing the first tricycles model and then the second one at the same time looking at manufacturer to express that he asking the question from him and talking to him # attract attention of manufacturer and direct his attention #] I think I can add, for example I have one seat here [Pointing to the model and demonstrating the seating part in the tricycle #Describe #], Can I add another seat here [showing a part of the model that the new seat can be add to it #Describe #]?”



**Figure 4-2: A part of participant’s conversation during the meeting and analyzing their action**

[09:38] Manufacturer: “I can add but the frame has to changed also”

[09:42] Designer of bicycle frame: “OK”

[09:44] Manufacturer: “But here [*Pointing to the model #Describe#*] I have to remove this container [*Pointing to container part #Describe #*]”

[09:46] Designer of bicycle frame: “OK”

[09:48] Manufacturer: “and then I can add one more seat” [*Pointing to the model #Describe #*]

[09:52] Designer of bicycle frame: “OK, which means one more seat can be added here [*Pointing to the model #Describe #*]”

[09:55] Manufacturer: “But the storage will be taking out from this” [*Pointing to the model #Describe #*]

[09:59] Designer of bicycle frame: “can I add this [*Pointing to the model #Describe #*] as well, for example I can add two seats here [*Pointing to the model #Describe #*] another seat along this carriage? [*Pointing to container part #Describe #*]”

[10:05] Manufacturer: “I can add [*Pointing to the model #Describe #*], but frame needs TO- BE change”

[10:08] Designer of bicycle frame: “so it could be changed” “Do I have some container that I can add to the bicycle”

[10:16] Manufacturer: “No, I don’t have that so I need to...” [*point to the designer of accessory # direct the attention to demonstrate that she may have the answer #*]

[10:21] Designer of bicycle frame: “Do I have in accessories, some kind of containers?” [*Looking at designer of accessory and pointing to her documents and asking*]

[*She looking for requested information on her documents and diffuse the documents in front of herself to find the requested information #lookup #*]” [*At the same time other participants looking at her documents*] (figure 4-3)

[10:29] designer of accessory: “No in accessories I have mirrors, I have the handles and I have the pedals and Pedal body cover grip”.

[10:37] Designer of bicycle frame: “ok”

[10:41] manufacturer: “So then it’s better to, you select a particular model [*pointing to the center of the table and all models, covering #direct attention#*] then I can discuss how I can change based on your requirements [*“looking at customer” # attract attention#*]

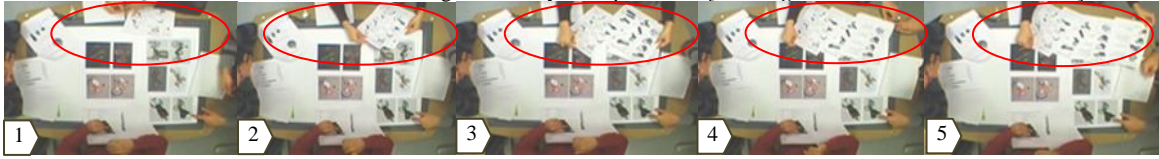

**Figure 4-3: A part of participant’s conversation during the meeting and analyzing their action**

**Table 4-1: A part of participant’s conversation during the meeting and analyzing their action**

Table 4-1 as example demonstrates the part of participant’s conversation during the design review meeting and how they use different gestures for communication.

Based on observations and literature review we came up with the following specification for SyCoW, As-It-Is:

- **SyCoW::Meeting Objectives:** Design review (Co-evaluation, Coordination, and Decision making are sub objectives of a design review meeting).
- **SyCoW::Participant:** Participants with various backgrounds, personality, culture, age, gender, rule in project and rule in meeting and various levels of computer skills with no specific disability. Based on the participant sub model, which has been defined in SyCoW

model, we are going to clarify the specification of participants during design review. The design review meeting happens between the people that are involved in the project. Design review activities involve interdisciplinary members within and outside the enterprise, either geographically collocated or dispersed. Design includes not only the designers but those sponsoring the design such as the customers, marketing staff or upper management, those that will be responsible for transforming the design into a product or service, those responsible for maintaining the product, using the product or disposing of the product indeed any party that has an interest in the quality of the design solution [Hoyle 2009]. Hence meeting could be from same discipline or from different disciplines, could be from same company or from different company. Consequently the role of participant in the meeting could be variable. Participant can be from one of these set of category: technical profession {{product engineer} {designer}, {Marketing}, {Environment}, and {Manufacturing}} stakeholder {{Customer}, {End-user}, and {Supplier}} and Manager. Obviously Participants can have different personality. Their experience and educational background also vary. They could have different cultures. We assume that no participant has disability. They may have different gender and age. So the supporting tools have to consider the participants with different and various profile. Because of this possible diversity of final users of the collaborative environment, it is necessary to consider the ease of use and intuitiveness aspect when designing interface. Also the acceptability of the tool has to be evaluated among the users with divers' profile.

- **SyCoW::Number of Participants:** Our target collaborative situation is collaboration between small groups of people, 2-4 participants
- **SyCoW::Link (Participant\_ Location):** Our assumption is that the company wants to provide appropriate supporting tool for the type of meeting held in the company and all participant to the meeting are in the same location.
- **SyCoW::Number of Groups:** There is just one group in the meeting.
- **SyCoW::Group Size:** The size of group (in our case is equal to the numbers of participants) is varying between 2 and 4. We decided to focus on providing collaborative environment for small group of participants
- **SyCoW::Link (Group\_ Location):** All participants are at the same location so the group is co-located.
- **SyCoW::Link (Group\_ Participant):** all participants are in the same group
- **SyCoW::Location:** SyCoW just have one location, it can be the design office or meeting room
- **SyCoW::Link (Type\_ Location):** Based on the location of group and participants, the type of collaborative situation is co-located collaboration.
- **SyCoW::The Role of Participant:** Participants may have different roles in the meeting. As mentioned based on the difference in the role of the participant in the project, they may have different role in the meeting as well. Participants to the meeting could have equal decision power or one person may lead the meeting, in some cases manager or end-user or customer may have more decision power. Someone may have the responsibility of the meeting management. Someone may have the responsibility of writing meeting minute.

- **SyCoW::Meeting Input:** Meeting inputs are the result of design activities. “The results of the design may be concepts, models, calculations, drawings, specifications or any output which describes the maturity of the design at a particular stage” [Hoyle 2009]. Information artifact varies but consists of analysis results, visual design presentations, product specifications, and market needs and product options. Each participant comes to the meeting with his documents.
- **SyCoW::Meeting Artifact:** Meeting artifacts include the information about the product which is in digital or physical form. In the collaborative situation we analyzed, the digital 2D and 3D documents were printed and used in paper based format during the meeting
- **SyCoW::Meeting Outcomes:** Meeting outcomes are the decision and planned tasks for participants, to solve conflicting points.
- **SyCoW::Meeting Outputs:** Annotated documents, and notes from the meeting.
- **SyCoW::Phase of Product Development:** Design reviews occur at the end of a design activities.
- **SyCoW::Product:** Products of the company are more in the category of the small size product Level of complexity varying.
- **SyCoW::Meeting Documentation:** The most common way of documentation of design review meeting is note taking and archiving the documents with annotation. There is an evident need for indexing, retrieving and accessing meeting and related documents for diverse organizational purposes [Sabol et al. 2007]. So Documentation of meeting is an important aspect that must be considered during development of an appropriate tool.
- **SyCoW:: Meeting Process:** The meeting process is unstructured because of the nature of the work. However people agree at any time about a sequence of activities.
- **SyCoW::Meeting Task:** Meeting task are individual and group tasks. Individual task is when user takes the note for himself. The group task is when the group communicates to achieve the meeting objectives.
- **SyCoW::Participant Activities:** The activities of participant are the aggregation of the artifact representation, verbal conversation (negotiation, information and knowledge representation, discussion) and note taking and documentation of the meeting. Independent to the type of design review, design review in general consists of these activities [Ichida & Voigt 1996]: collecting and compiling information, defining quality targets, evaluating product and process designs and supporting operations, proposing improvements, defining subsequent action, confirming readiness for the next step.
- **SyCoW::Interaction:** The meeting was consisting of human interaction with human and human interaction with artifacts.
- **SyCoW::Human Interaction with Artifact:** gesturing, navigation, annotation, and viewing were the four primary interactions meeting participants have with design artifacts [Tory et al. 2008]. It is not just the design artifacts themselves that are important for collaboration, but also the mechanics of interaction with the artifacts play an important role [Tang & Leifer 1988], [Tang 1991]. Based on our observation we got the similar results.

- **SyCoW::Human Interaction with Human:** People are face to face and it make easy to communicate by using their facial expression, hand and body gestures, by voice and via artifacts and any combinations of these. Also people naturally used different communication channels to identify the group member who is the receiver of their communicated information.

Based on observations we came up with the following specification for SyCoE, As-It-Is:

- **SyCoE::Facilities:** Physical resource are including table and chairs
- **SyCoE::Shared Space:** The center of the table used as shared space for sharing documents
- **SyCoE::Private Space:** Laptop, tablet, note book used as private space
- **SyCoE::Individual Space:** Users naturally used the area in front of them as individual space for putting their individual documents.
- **SyCoE::Accessibility to Shared Space and Shared Documents:** Accessible for all experts
- **SyCoE::Awareness:** Because of the configuration, users have awareness about other group members' activities and actions. However for some of these actions or activities users may not have full awareness. For example, members are aware about the action (note taking) but not necessary about the exact result of this action which is the content of the note.
- **SyCoE::Privacy:** User don't have so much control on his individual documents which he puts in front of him and other group members take his document without his explicit permission.
- **SyCoE::Documentation of Discussion:** The documentation of the meeting has been created by participants via note taking and annotation.
- **SyCoE::Documentation of Discussion::Annotation:** each person annotates the documents; user should place the document in a position to be able to write the annotation, it is hard for two persons to put annotation on document at the same time. All annotations on shared artifacts are public.
- **SyCoE::Configuration and Layout:** participants seat around the table and are face to face.

Walking through the As-It-Is model allow, for each element of this model, to specify what should be improved.

Identifying the specifications of the proposed tool has been leaded by getting a tool as intuitive as possible for most users. It is thus based on an interaction metaphor which is really close to the usual meeting experience. Through the analysis's based on SyCoW model and supported with the observational studies and literature review on previous work we identified the list of requirement that collaborative environment should provide to support design review and we specified the SyCoW component which derived each requirement (Table 4-2).

R.N.	Requirement	SyCoW component which derived the requirement
R1	Collaboration environment have to support 2-4 users	SyCoW::Size of Group
R2	Collaboration environment have to support co-located collaboration	SyCoW::Participants, SyCoW::Group, SyCoW::Location
R3	Collaboration tool have to be easy to use in order to participants accept using the tool	SyCoW:: Participant
R4	Collaboration tool have to be intuitive in order to participant easily accept the new tool with less effort in term of changing their habits of work (Just changing the aspect that will bring the added value without changing the other aspects)	SyCoW:: Participant

R5	Collaborative environment must facilitate the information sharing with group	SyCoW::Activity
R6	Collaborative tool have to support 2D and 3D design representation with appropriate media	SyCoW::Artifacts
R7	Share more than one document at the same time have to be possible in collaborative environment	SyCoW::Process, SyCoW::Activity, SyCoW::Task , SyCoW::Objective
R8	Simultaneous interaction with artifacts have to be supported	SyCoW::Activity, SyCoW::Action
R9	Parallel visualization of different meeting artifacts	SyCoW::Objective, SyCoW::Activity
R10	For each participant document transformation from his private space to shared space and vice versa have to be possible	SyCoW::Activity
R11	Visualization media have to support small size product with different level of complexity	SyCoW::Input type
R12	Documentation of meeting have to be improved	SyCoW::Documentation
R13	Annotation on artifacts have to be possible by each user	SyCoW::Activity, SyCoW::Action, SyCoW::Documentation
R14	Note taking from collaborative session have to be facilitate by collaborative environment	SyCoW::Activity, SyCoW::Documentation
R15	Editing the design artifact (this can be helpful in the case that participants can rapidly checking their decision to have the feedback)	SyCoW::Activity, SyCoW::Action
R16	The process is unstructured, and sequence of participants activities is varied so it's important to facilitate the switching between the activities	SyCoW::Process, SyCoW::Participants SyCoW::Activities
R17	Individual space, shared space and private space is required	SyCoW::Activity, SyCoW::Action, SyCoW::Process
R18	Collaborative environment has to be face to face	SyCoW::Human to Human Interaction
R19	Keeping the natural way of interaction with artifact. In As-It-Is participants are able to easily manipulate artifacts and use their gesture to communicate the knowledge and information with other members. We want to keep this specification of the situation	SyCoW::Interaction with Artifact

**Table 4-2: List of requirements for collocated design review among small group**

### 4.3 |Step 1-2|: Finding the most adapted solutions among existing cases

At this step user finds the most adapted solution among existing collaborative environment. The existing solutions for synchronous collaborative environment are used as inspiration for selection/ re-design within a new collaborative environment. The information gained from previous experiences (cases or instances) is an important source of knowledge. This specific knowledge provides more easily usable advice than general and abstract knowledge.









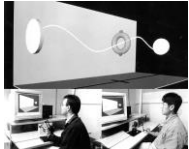

Solutions to support collaborative work is a wicked problem hence, the answers are never true or false but are qualitatively judged as better or worse. A ‘satisfying’ or ‘good enough’ solution is the realistic goal [Fitzpatrick 1998]. Hence it is important to use the capitalized experiences. The idea is that it is possible to find a similar past case and reuse the whole or part of solution component for the target collaborative situation. For each previously experienced case, user may start to analyze the similarity and difference between the SyCoW parts of the case with the new SyCoW. Then user needs to analyze the SyCoE part of the case to see in which extend this solution is answering to the requirements specified in the previous step. The results and specification of the SyCoEE part of the case give an idea of the reliability level of the solution. After analyzing the three elements of the existing cases, user need to determine if there is an existing collaborative environment which answers the specification and requirements of his target collaborative situation. He may directly apply an existing solution to his situation or he may need to do minor modifications in existing solution in order to adapt it to the target collaborative situation, or he needs to design a new collaborative environment. The decision is taken by user (expert) based on his experience.

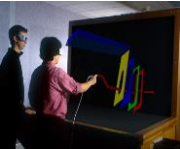
Following the user's answer to the question: 'Is there any existing solution answering to the requirements and specifications of the target collaborative situation?' the next step will be [Step 2] or [Step 3]. If user is able to find an existing solution which answers to the requirement of his target collaborative situation, then it is necessary to evaluate the selected solution. Hence, by answering 'Yes' to the question, the following step will be [Step 3] i.e. 'Evaluation of collaborative environment for the target situation'. Evaluation helps to judge the impact of changing component on the collaboration through the new solution. If none of existing environment is able to answer the requirement of target collaboration situation, then it's required to design a new collaborative environment and to implement it. Hence, by answering 'No' to this question, the following step will be [Step 2] i.e. 'design a new synchronous collaborative environment'.

### Case-Study:

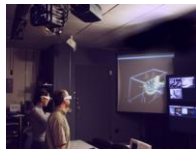
In previous step we analyzed collaborative design review meeting As-It-Is. In this step we try to find existing experienced cases which have similar SyCoW\_i to our SyCoW\_i. Table 4-3 presents the list of 75 cases found in current literature. The first specification of collaborative work that we need to look at is its type (SyCoW::Type). The cases numbers 1 to 50 are the co-located collaborative type while the cases 51 to 75 are distributed or mixed presence collaboration. The type of our target collaborative situation was co-located collaboration; hence we are going to focus on the cases 1 to 50. The domain context (SyCoW::Domain context) of these cases are diverse: design review [Regenbrecht et al. 2002], [Dunston et al. 2011], [Granum et al. 2003], [ImmersaDesk2 2010], [Krüger et al. 1995], [Cruz-Neira et al. 1992], [Wang & Dunston 2008], [Rauterberg et al. 1997], [Krüger et al. 1995], preliminary design [Jones et al. 2011], game [Sandor et al. 2002], [Tse et al. 2007], learning [Szalavári et al. 1998], [Dünser et al. 2006], therapy [Apted et al. 2005], etc. The number of participants they can support also is quite diverse (SyCoW::Number of participants) case 35 supports two users on a single computer by using two mouse input. Cases 3, 4, 9, 10, 11, 12, 13, 14, 15, 18, 19, 20, 24, 25, 26, 32, 33, 34, 39, 40, 41, 42, 43, 44, 46, 47 and 49 providing similar setup, i.e. around the table. Different technology has been used in different cases. Some environment support simultaneous multi-user interactions and the level of immersion depend on the environment and underlying technology.

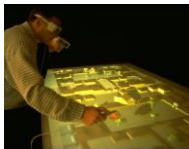
By analyzing the existing cases based on SyCoW, SyCoE and SyCoEE, they were not directly applicable for our situation and it was necessary to design a new synchronous collaborative environment. Hence we continued with [Step 2].

<p><b>Case 1</b></p>  <p>[Basdogan et al. 2000]</p>	<p><b>Case 2</b></p>  <p>[Wong and Chee 2003]</p>	<p><b>Case 3</b></p>  <p>[Tan © Holobench 2010]</p>	<p><b>Case 4</b></p>  <p>[Arthur et al. 1998]</p>	<p><b>Case 5</b></p>  <p>[SGI © RealityCenter 2010]</p>	<p><b>Case 6</b></p>  <p>[Fakespace ImmersaDesk 2010]</p>
<p><b>Case 7</b></p>  <p>[Cruz-Neira et al. 1992]</p>	<p><b>Case 8</b></p>  <p>[Leigh et al. 2002]</p>	<p><b>Case 9</b></p>  <p>[Adcock et al. 2004]</p>	<p><b>Case 10</b></p>  <p>[Krüger et al. 1995]</p>	<p><b>Case 11</b></p>  <p>[Billinghurst et al. 2001]</p>	<p><b>Case 12</b></p>  <p>[Sandor et al. 2002]</p>
<b>Case 13</b>	<b>Case 14</b>	<b>Case 15</b>	<b>Case 16</b>	<b>Case 17</b>	<b>Case 18</b>



 [Regenbrecht et al. 2002]	 [Poupyrev et al. 2002]	 [Butz et al. 1999]	 [Billinghurst et al. 1998]	 [Schmalstieg et al. 1996]	 [Kiyokawa et al. 1999]
<b>Case 19</b>  [Hua et al. 2004]	<b>Case 20</b>  [Ong and Shen 2009]	<b>Case 21</b>  [Schmalstieg et al. 2000]	<b>Case 22</b>  [Szalavári et al. 1998]	<b>Case 23</b>  [Dünser et al. 2006]	<b>Case 24</b>  [Grasset and Gascuel 2002]
<b>Case 25</b>  [Granum et al. 2003]	<b>Case 26</b>  [Rekimoto 2002]	<b>Case 27</b>  [Fakespace ImmersaDesk 2010]	<b>Case 28</b>  [Stefik et al. 1987]	<b>Case 29</b>  [Leigh et al. 2002]	<b>Case 30</b>  [Barco CadWall 2010]
<b>Case 31</b>  [Goebbels et al. 2003]	<b>Case 32</b>  [Rauterberg et al. 1997]	<b>Case 33</b>  [Rekimoto et al. 1999]	<b>Case 34</b>  [Dietz & Leigh 2001]	<b>Case 35</b>  [Stewart et al. 1999]	<b>Case 36</b>  [Grønbaek et al. 2001]
<b>Case 37</b>  [Johanson et al. 2002]	<b>Case 38</b>  [Streitz et al. 2002]	<b>Case 39</b>  [Tse et al. 2007]	<b>Case 40</b>  [Smith & Graham 2010]	<b>Case 41</b>  [Haller et al. 2006]	<b>Case 42</b>  [Wang & Dunston 2008]
<b>Case 43</b>  [Shen et al. 2003]	<b>Case 44</b>  [Apted et al. 2005]	<b>Case 45</b>  [Dunston et al. 2011]	<b>Case 46</b>  [Hunter et al. 2011]	<b>Case 47</b>  [Jones et al. 2011]	<b>Case 48</b>  [Rekimoto 1996]
<b>Case 49</b>  [Kitamura et al. 2001]	<b>Case 50</b>  [Jota et al. 2010]	<b>Case 51</b>  [Barakonyi et al. 2004]	<b>Case 52</b>  [Ahlers et al. 1995]	<b>Case 53</b>  [Gunn et al. 2003]	
<b>Case 54</b>  [Schremmer and Müller-Tomfelde 2008]	<b>Case 55</b>  [Microsoft 2012]	<b>Case 56</b>  [Pauchet et al. 2007]	<b>Case 57</b>  [McNelley 2005]		
<b>Case 58</b>		<b>Case 59</b>	<b>Case 60</b>		













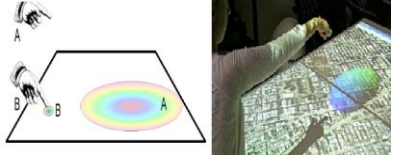
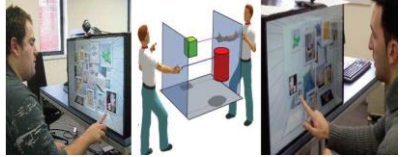

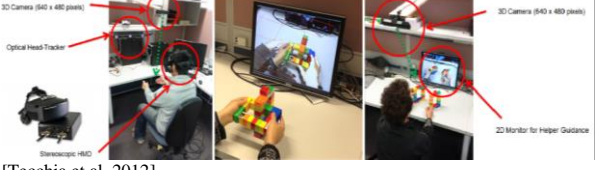
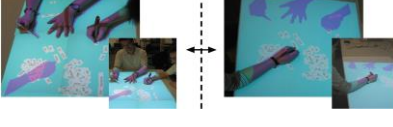

 <p>[Genest and Gutwin 2012]</p>	 <p>[Ardaiz et al. 2010]</p>	 <p>[Petit et al. 2010]</p>	
<p><b>Case 61</b></p>  <p>[Kuechler &amp; Kunz 2010]</p>	<p><b>Case 62</b></p>  <p>[Tang et al. 2004]</p>	<p><b>Case 63</b></p>  <p>[Nam and Sakong 2009]</p>	
<p><b>Case 64</b></p>  <p>[Tang and Greenberg 2005]</p>	<p><b>Case 65</b></p>  <p>3D Camera (540 x 480 pixels) Optical Head Tracker StereoScope HMD 3D Camera (540 x 480 pixels) 2D Monitor for Helper Guidance</p> <p>[Tecchia et al. 2012]</p>		
<p><b>Case 66</b></p>  <p>[Tuddenham and Robinson 2007]</p>	<p><b>Case 67</b></p>  <p>"Spatial-Local" Videoconferencing "2D" Videoconferencing "Spatial-Remote" Videoconferencing</p> <p>[Hauber et al. 2006]</p>	<p><b>Case 68</b></p>  <p>Destination setup Projection avatar Panoramic camera Sphere avatar Depth IR sensor Speakers &amp; microphone</p> <p>[Oyekoya et al. 2012]</p>	
<p><b>Case 69</b></p>  <p>[Uva et al. 2010]</p>	<p><b>Case 70</b></p>  <p>[Kato et al. 1999]</p>	<p><b>Case 71</b></p>  <p>[Sidharta et al. 2006]</p>	<p><b>Case 72</b></p>  <p>[Lee and Takayama 2011]</p>
<p><b>Case 73</b></p>  <p>[Sirkin and Ju 2012]</p>	<p><b>Case 74</b></p>  <p>[Kuzuoka et al. 2004]</p>	<p><b>Case 75</b></p>  <p>[Ishii et al. 1993]</p>	

Table 4-3: Some existing cases on collaborative environment

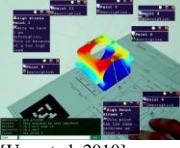
We didn't select an existing solution, and then we decided to use a multi-touch table as shared display which keep the face to face configuration and provide the natural and intuitive way of the interaction with design artifact. Hence by selecting multi-touch table we were able to keep the advantages of the collaborative session As-It-Is and to answer to the specified requirements. However none of the existing software application we found in the experienced cases which used multi-touch table answers our requirements. Hence, we designed and implemented a specific software application for multi-touch table which supports our target design review meeting.

#### **4.4 Conclusion and Discussion**

In this chapter we present the first section of the process for development/selection of synchronous collaborative environment. The models which have been used in the step 1 of this process are the SyCoW and SyCoE concept map, which helped us to analyze the collaboration As-It-Is and to identify the requirements for a new environment. In the step 2 of this process we used SyCoW, SyCoE and SyCoEE to analyze the existing experienced cases in order identify 'is any existing solution answering to the requirements and specifications of the target collaborative situation?'. None of the existing solution was able to fully answer to our requirements and situation specifications. Hence we decided to develop our own collaborative environment for design review. However the existing cases lead us to select a multi-touch table as shared display and we decided to develop our own application for multi-touch table. In the chapter 5 we design and develop the software application for multi-touch table which will support our design review meeting among small group of participants.

# Part-II: Chapter 5

## Development of a new Synchronous Collaborative Environment

### Abstract

This chapter presents the second step of the process to select/ develop a synchronous collaborative environment. The objective of this step is to develop a new collaborative environment. This step is including two sub steps: design a new synchronous collaborative environment and implementation of the proposed environment. Different types of knowledge help user during development and implementation process. In previous chapter in Step 1-1, we analyzed the collaboration As-It-Is and we identified the requirements for design review meeting among small group of participants. In Step 1-2, we explored the existing solutions and solution components by analyzing the experienced cases based on SyCoW and SyCoE model. In this chapter, based on the result obtained from previous chapter, we will present the design and implementation of appropriate collaborative environment for our target collaborative situation. We will demonstrate how existing knowledge led us in our decisions during this step. SyCoW and SyCoE supported us during the creation of MT-DT software for multi-touch table to support design review meetings.

### Table of Content

5.1	Step2 : Development of a new Synchronous Collaborative Environment .....	82
5.2	Step 2-1 : Design a new Synchronous Collaborative Environment .....	82
5.2.1	Facilities Selection: .....	83
5.2.2	Software Design .....	85
5.2.3	Software Architecture Design: .....	88
5.2.4	SyCoE Configuration.....	93
5.3	Step 2-2 : Implementation of the proposed Synchronous Collaborative Environment .....	93
5.4	Conclusion and Discussion.....	94

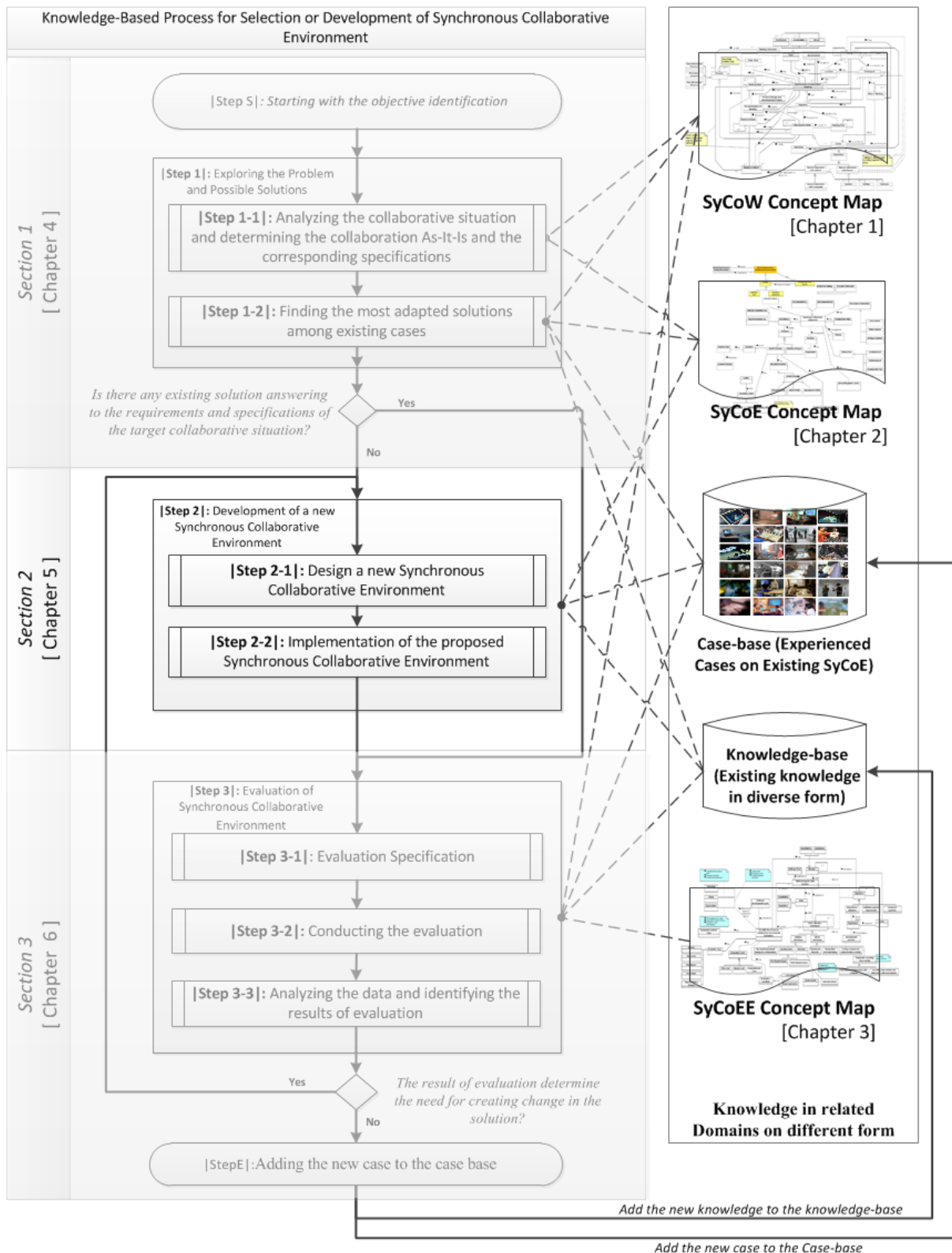

**Knowledge-Based Process for Selection or Development of SyCoE**

## **5. Development of a new Synchronous Collaborative Environment**

### **5.1 |Step2|: Development of a new Synchronous Collaborative Environment**

In |Step 1-1| user determines the specification of the target collaborative work and he identifies the general list of requirements for synchronous collaborative environment. In |Step 1-2|, the objective is to find the existing cases which match with the specifications of the target collaborative work and requirements. If user made decision to develop a new collaborative environment, he should now continue with this step. Development of new synchronous collaborative environment consists of two main sub-steps: |Step 2-1|: design a new synchronous collaborative environment and |Step 2-2|: Implementation of the proposed synchronous collaborative environment. Following each sub-step is explained and explored through the development of a new collaborative environment for design review meeting.

### **5.2 |Step 2-1|: Design a new Synchronous Collaborative Environment**

In this step user designs a new synchronous collaborative environment. He starts with the most fitted existing solutions and then makes appropriate modifications in order to come up with a new solution which answers to the specifications and requirements of his target situation.

The SyCoE concept map helps user to know what aspects he should consider during design or re-design of his new synchronous collaborative environment. The new synchronous collaborative environment should support the target synchronous collaborative working session. As has been defined in SyCoE concept map, depending on the type of SyCoW which is defined based on locations of participants and group(s) (i.e. distributed, co-located and mixed), SyCoE will be distributed, collocated or mixed (SyCoE::Type). SyCoE is the aggregation of several facilities configurations (SyCoE::Facilities). Placing and positioning group(s), participants and facilities defines configuration and layout of a SyCoE. A SyCoE may have one or several configurations (SyCoE::Configuration). The configuration is fixed or flexible. Hence the first decisions that user need to make is the selection of facilities and designing appropriate configuration. This decision is bi-directional. Some requirements of the SyCoW may fix the configuration first, and then user needs to choose appropriate facilities which fit to the configuration and answer to the requirements. For example, the face to face communication and collaboration, force the specific configuration. Then user needs to select the technologies and design a configuration to create the face to face property for configuration of SyCoE. Another example, the need for 3D visualization limits the user's choices for the type of visual display devices. If user based on other requirements select the CAVE. Then the characteristic of this facility force the specific type of configuration.

#### **Case-Study:**

In this part we are going to represent our design elements for synchronous collaborative environment which support our target design review meeting.

### 5.2.1 Facilities Selection:

Based on the existing cases which were similar to our case and analyzing them based on SyCoE model, we decided to use multi-touch table to share display.

Multi-touch table supports multi-user interaction and natural way of interaction with digital content. It provides face to face configuration around the table (keeping the traditional and most common way of collaboration). Other selected facilities are 4 chairs for users in order to seat them around the table. Also, for some configurations, tablet or computer could be used as private space during design review meeting.

In order to select the appropriate multi-touch table, the relation between multi-touch properties and the application requirements is necessary. Figure 5-1 demonstrates capitalized knowledge about this relation. Multi-touch table properties include: cost/price, size, shape, resolution, touch precision, user identity detection, ergonomic aspect, hand-detection, finger-detection, underlying technology, multi-user interaction support and supporting physical input detection. Application requirements are including: required touch precision, required resolution, cost, number of users, activity duration, customized user interface, tracing user action on the table, application context and nature, required workspace for visualization, user interaction with digital content, user states in doing the activity around the table. The table of figure 5-1 provides the information at an abstract level. It helps us to know what we need to consider when selecting appropriate multi-touch table based on our requirements.

For our application at this step we were not sure about the expected resolution and tactile precision. Ideally we expected a technology with high visual resolution and tactile precision for the visual representation of the artifacts in different form with different information during design review. Tactile precision is required for more natural hand writing on the table for annotating artifacts or for drawing to communicate the concepts during design review. However we do not know how resolution and precision will impact on the users' work, performance and acceptance of the tool. We had the same concern about the required workspace for visualization. The new collaborative environment should supports between 2 and 4 users. Hence the size of the table must fit this number of users. Ideally we expected a table with sufficient workspace but the right size for our application and how this size impacts on the success of the tool is unknown. Indeed, these issues are part of usual context of tool innovation and they usually lead to many re-design loops.

The collaborative environment must support design review among potentially diverse combination of stakeholders, then the user interface should be independent of the final users. However another objective could be to develop a specific application for design review among customer, designer and manufacturer, where visualized artifacts are different and adapted to the actor point of view. In such a case user interface should be customized.

Based on requirement R12 (Table 4-2) the design review must be enhanced in term of documentation of the collaborative work. It became natural to build an application tracing users' actions on the table enabling to report collaborations.

		Application Requirements										
		Required Touch Precision	Required Resolution	Cost	Number of users	Activity duration	Customized user interface	Training users actions on the table	Application context and nature	Training users actions on the table	Required workspace for visualization	User Interaction with Digital content
Multi-touch Table Properties	Cost /Price											
	Size											
	Shape											
	Resolution											
	Touch Precision											
	User Identity detection											
	Ergonomic Aspect											
	Hand-Detection											
	Finger-Detection											
	Underlying technology											
	Multi-User Interaction Support											
	Supporting physical input detection											

Figure 5-1: Relation between multi-touch table properties and application requirement specifications

Name : DiamondTouch

Model : DT107

User Identity detection : ✓

Hand Detection : ✗

Finger Detection : ✗

Multi-user Interaction Support : ✓

Supporting physical Input Detection : ✗

Number of simultaneous users : 4

Active display area(cm) : 86 x 65

Device dimensions(cm) : 99 x 77 x 6

Touch resolution (precision) : 2752 x 2064

SDK language support : C, C++, Java, ActiveX (For C#, DHTML, VB.NET), Adobe Flash

Resolution : depends on projector

Device weight(kg) : 13

Operating system : Windows (Win7, Vista, XP), Linux driver available on request

Computer hardware : Requires USB; no special RAM / processor requirements

Developer Name : Circle Twelve Inc

Stylus support : ✗

Number of Stylus support : 0

Frame Rate (Hz) : 30

Description :  
 - Ability to distinguish who is who  
 - Control of any Windows® software using multi-touch mouse emulator  
 - required 4 receiver pads with 10-foot RCA cable  
 - need 16-foot USB cable

Image : 

Figure 5-2: Diamond Touch Table record in data base of existing displays

The decisions about the selection of the multi-touch table were also directed by the existence of a specific multi-touch table in the G-SCOP laboratory and the constraint to avoid a new investment. Hence we developed our application on a Diamond-touch table which was available at the lab. Obviously newer technology with bigger size, with higher level of resolution and precision would be more appropriate later. DiamondTouch is a multi-touch input technology that supports multiple, simultaneous users [Dietz & Leigh 2001]; it had the unique specificity when we started our development in 2011, to distinguish who is touching the table and where. This performance is particularly important for an intuitive trace of

collaboration activities. Every action on the table can be recorded and automatically associated with its author.

The used version of DiamondTouch has a rectangular shape with the active display area of X=65 cm by Y=86 cm. The sensors which detect the users are embedded on the seating pads. Users are able to interact with the table when they have contact with these pads. We were able to detect and trace each user through his identification. As already mentioned it is then possible to capitalize the users' actions. The finger detection is not possible with this technology and we were able only to have access to the number of fingers and a set of x and y locations of interaction. Hence the touch information for each user was limited to the touch region defined by the bounding box and the number of touching fingers. Detecting the hands (right hand with left hand) and detecting which finger belongs to which hand was not possible with this table. The visualization aspect of the table was supported with projector embedded on the top of the table hence the visualization resolution and brightness depends on the projector used while the tactile resolution (precision) is fixed 2752\*2064, associated with the DiamondTouch tactile panel. DiamondTouch supports multi-touch, multi-user interaction. However, it has limitation on the number of users. With the version we used, up to four people were able to interact with the table. DiamondTouch didn't support other physical input detection than human fingers and we were not able to interact with tagged objects (figure 5-2 details the features of this device)

### 5.2.2 Software Design

Now we need to enter in deeper details about the multi-touch table application to answer all the requirements. Software design integrates the software architecture and graphical user interface (GUI) plus the Human Computer interaction (HCI). Here we present the final design and some justification of our choices made based on general and specific knowledge. Several type of knowledge helped us during design process:

- The existing application for multi-touch table for similar or different application domain. [Jones et al. 2011], [Haller et al. 2006], [Apted et al. 2005], [Smith & Graham 2010], [Shen et al. 2003], [Tse et al. 2007].
- The guidelines [Scott et al. 2003].
- Existing Multi-touch frameworks and their architecture, scopes and features [Kammer et al. 2010].
- Knowledge about different aspects required to be consider in designing the interface:
  - . The effects of group size and table size on interactions with tabletop shared-display groupware [Ryall et al. 2004].
  - . Division of the table to the participants' territoriality [Scott et al. 2004].
  - . Artifact orientation on table and its effect on comprehension, coordination and communication [Kruger et al. 2003].
  - . Interaction techniques for Multi-user interaction on Multi-touch table [Wu & Balakrishnan 2003], [Wu et al. 2006], [Hinrichs & Carpendale 2011].



- User gestures for manipulating 3D objects [Cohé & Hachet 2012], [Steinicke et al. 2012], [Bollensdorff et al. 2012].

### 5.2.2.1 User Interface Design:

In order to design the user interface several aspects were considered [Scott et al. 2004]. Possible options are defined based on dividing the interface to private, individual and shared spaces. Figure 5-3 demonstrated the possible configuration for 2, 3 and 4 users based on the interface options. Among these possible solutions we selected the S4.1 which contain the shared space at the center of the table and fix individual spaces around the table for each user and private space which can be a mobile phone or tablet or a laptop which satisfy the requirement R17.

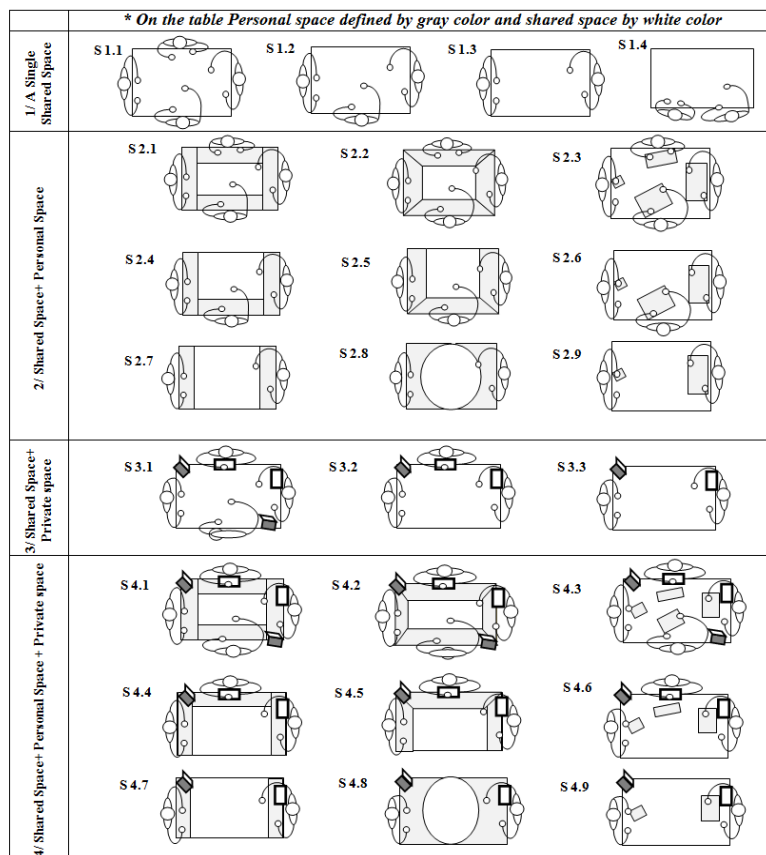

Figure 5-3: Some possible options for designing workspace

Hence the table surface was divided into the shared space and individual spaces. Figure 5-4 schematically demonstrates our primary design for the interface of the application. Shared space, the center of the multi-touch table is accessible for all experts to present and share any document, putting the annotation for common decision or remark or reminder, etc. Individual space support individual activities without interfering with group activities. These activities consist: manipulating, viewing in detail and having closer look at a document, putting annotation on the document without distracting the rest of the group from their discussion. Individual space is the part of the multi touch that is accessible just for one

end-user to manipulate, to add documents related to his/her works. The individual space is not masked to collaborators who can see it but cannot manipulate it. It is thus a semi private space, here named individual space, because non associated people can see what user is doing but don't have access to the artifacts in this space. It's an advantage in term of awareness. This interface concept enforces that an artifact in the individual space of a participant cannot simply be taken, without explicit permission. Here, this permission is given by the participant moving an artifact currently contained in his individual space to the shared space. Based on the effective number of meeting participant (requirement specify 2 to 4 participants, software must adapt itself to the context) the individual space will be defined on the table (the table that we are using lets up to four users to interact with it).

Greenberg et al. [Greenberg et al. 1999] analyzed how people move from individual to group work through the use of both personal digital assistants (PDAs) and a shared public display. Using another device as private space like, tablet, laptop computer could interrupt the people during the meeting. But by providing this semi- private space in tabletop, it's possible to decrease the number of times that user needs to come back to his/her individual device to share the document with others. These options were not implemented but could lead to new developments to check the best options.

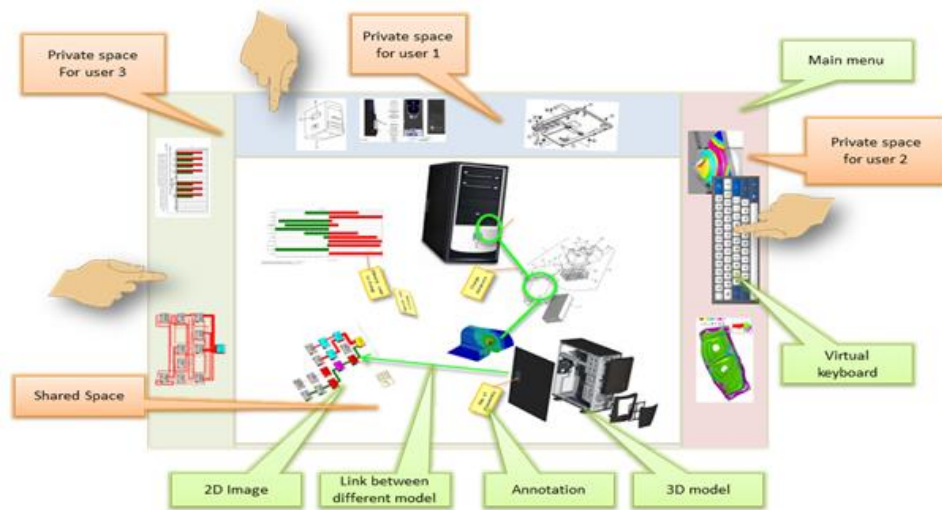

Figure 5-4: The first prototype of MT-DT interface

### 5.2.2.2 Interaction Design:

Multi touch table provides a natural way of interaction with displayed objects. Based on existing gestural interaction on multi-touch devices applications, we made following design decisions:

- **Gestural interaction:** to use gestural interaction to select, to rotate, to translate and to change the scale of documents both for 2D and 3D artifacts. An Artifact is selected when user physically touches it. When 2D artifact is selected, it will be shown in front of other artifacts. Then user can start to relocate the selected artifact to rotate it or to change its scale. When multiple users are interacting and selecting, conflict occur. In order to avoid such conflicts, a user cannot select an artifact if another user is already touching it. To relocate an artifact, a user must first select it. As user moves his finger on the display, the artifact will be moved with the same displacement

keeping its current size and orientation. To rotate the artifact we used three finger interactions. When user start to move his three fingers, the object will be rotated around its center and in the same direction as the three fingers displacement. In order to resize the artifact we used two finger interactions, the distances between user's fingers (same hand or different hands) changes the scale within the same ratio.

- **Interaction by menu:** to use popup menu for every artifact to do additional actions on them. When user executes a finger tap on the document in his individual space, the menus of the document appear. User accesses to three menus: to put annotation to the document with virtual keyboard, to delete it and to create a copy of the document (In some scenarios it can be helpful to retain a copy of documents. It provides simultaneous access to personal copies of the same information and users annotate their personal copy during discussion.) User has four seconds to select the sub menus after this time the menus disappear. After finger tap and before this time if user starts to do another action instead of selecting one of the menus, the menus disappear also. When user produces a finger tap on the document placed in the shared space, in addition to the three sub menus a link menu also appeared in shared space enabling to connect documents together. This function is important here since it is an added value of a digital table. We could imagine during a usual meeting people putting paper documents on the desktop, and drawing links with pencils. But a soon as the papers will be moved this links will be broken. In a virtual space these links can be maintained and redrawn whatever is the position of documents on the spaces.

Figure 5-10 demonstrates the interactions which have been implemented.

### 5.2.3 Software Architecture Design:

The architecture of the system is decomposed into a set of modules. Figure 5-5 the left side represents the architecture of MT-DT. It consists of four layers: "Input hardware Layer", "Input Processing Layer" and "Presentation Layer" and "MT-DT Server".

- **Input Hardware Layer:**

The Diamond-touch table API provides at any time the interaction bounding box for every user id, with a three state value (Touch Up, Touch Down and Touch During), and the number of active fingers. A java SDK library is used and connected to our python development through the Jpype module. JPype allows python programs to get a full access to java class libraries. This is achieved not through re-implementing Python, as Jython/JPython has done, but rather through interfacing at the native level in both Virtual Machines [JPype 2013].

- **Input Processing Layer:**

The received inputs are processed to recognize end-user gesture on the table. This layer is the responsible of analyzing the raw data coming from the input hardware layer in order to recognize the type of end-users' gestures. Three categories of gestures have been defined: One finger (the single tap and movement), two fingers (zoom in- zoom out), and three fingers (Rotation).

- **Presentation Layer:**

Presentation layer consists of the user interface manager and documentation manager.

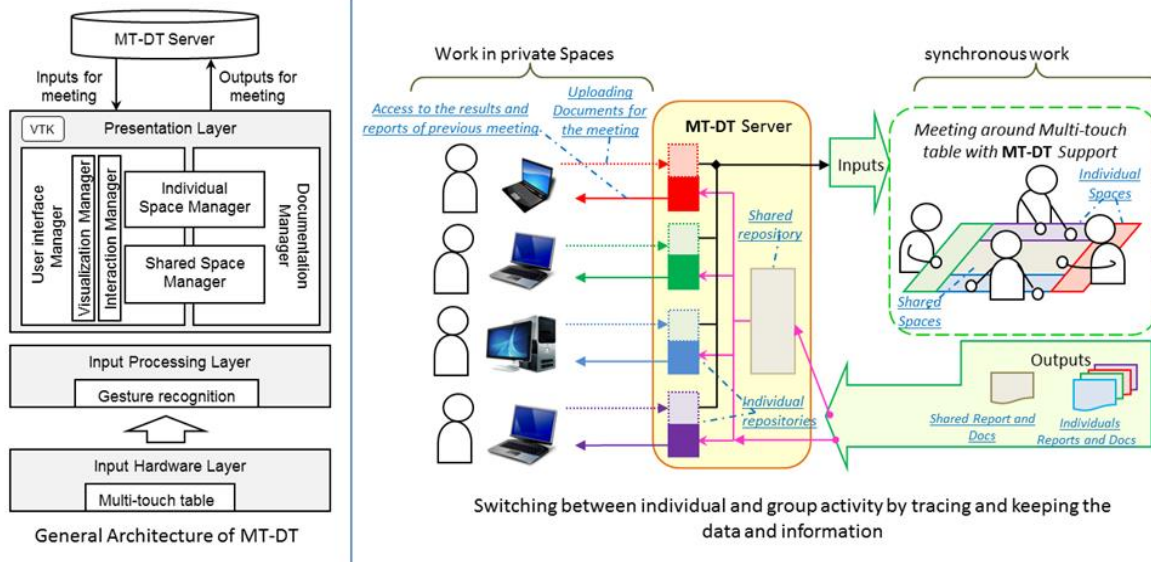

Figure 5-5: MT-DT architecture specifications

- **User Interface Manager:**

User interface manager is responsible for managing visualization and interaction of users in individual spaces and shared space.

The main object types defined in our software application include: 3D artifact, 2D artifact, the pup-up menu on artifacts in shared space and individual spaces, virtual keyboard, the created link between two artifacts, the annotation created on the artifacts or links, and control menus for individual spaces. The UI manager manages the visualization and interaction with these objects. This management has to be done in different aspects.

The UI manager manages the multi-user interaction on the shared space. Working in parallel can be an advantage, but it could also be a disadvantage if each user has conflicting actions. When a user has a specific interaction with an artifact (The finger is touching the artifact) the other users cannot interact with that artifact until it is released. This strategy manages the conflicts due to simultaneous user interaction in shared space. However several users can simultaneously annotate an artifact.

The UI manager manages the document transformation from individual space to shared space and vice versa. It removes the artifact from a space and adds it to another space and keeps the trace of these events for documentation purpose. Also if user wants to transfer a shared document which has been attached to another document through a link, it automatically creates a copy of that document. Hence user can transfer the copy of the document to his individual space.

The management of the interaction in individual spaces is different from shared space. Some user's interactions in individual spaces create different results than user interaction in shared space. For example, when user taps on a specific artifact in shared space, in the pup-up menu there will be link creation sub menu which has not been included in artifact pup-up menu in individual space.

The UI manager manages the user access to each space. Each user interacts just with his individual space and the shared space.

The UI manager traces the user annotations and notes in both spaces. The notes and annotations in individual space are considered as individual documentation while the annotations and notes in shared space consider as shared documentation.

The UI manager manages the creation of the new individual spaces. Because of the small size of the individual space we also added specific menus for creating new individual space which provides an unlimited individual space and user can easily navigate between created spaces.

- **Documentation Manager:**

The Documentation manager is responsible for managing documentation aspect of the events and the information in both shared and individual spaces. Report generator generates individual and shared reports. Hand writing meeting minutes is not able to truly and precisely cover the important elements of such type of meeting. DiamondTouch table distinguishes who is touching where. By using DiamondTouch table as hardware and MT-DT as underlying software, we can capture automatically user action on the table to know: who puts the annotation on which document, which was the owner of the document and shared it with others, who create a copy of document for himself, who was the creator of links between documents. Also defining shared and individual spaces and tracing user action in each space. All this information is expected to automate individual and shared reports based on user's interaction. This provides a partial documentation of the meeting to complete the meeting report. The verbal conversations should be integrated in this document after the meeting. The meeting report is a folder of documents presented in the shared space during the meeting and all information created along the meeting: list of annotations, list of linked objects, etc. The report also integrates meeting minutes with a time sorted list of all annotations and notes typed during the meeting. With hyper link document capacity, the minute steps are linked to the corresponding documents. Someone who reads the document follows and accesses all relevant information and documents.

The report may be generated at any time. The specific hardware capability allows associating the author identity (name, picture, function, expertise, or personal id) to the items along the meeting timeline. This function provides a way to automatically report the content of a cooperation meeting. We designed three possible solutions for documenting the generated report by MT-DT:

- 1- Static document without visualization elements (Basic structuring report through the file)(pdf or word file)
- 2- Visualization through static time line with (hyper link to access to the detail Information) (navigation on the information through the hyper link) (Pdf or word file) Figure 5-7.
- 3- Visualization through a zoom able time line (Zooming to access to the detail, Information embedded in different level Based on their importance, easily access to the more frequent requested information) (Navigation on the information through zooming, zoom out) (Specific visualization environment) Figure 5-8.

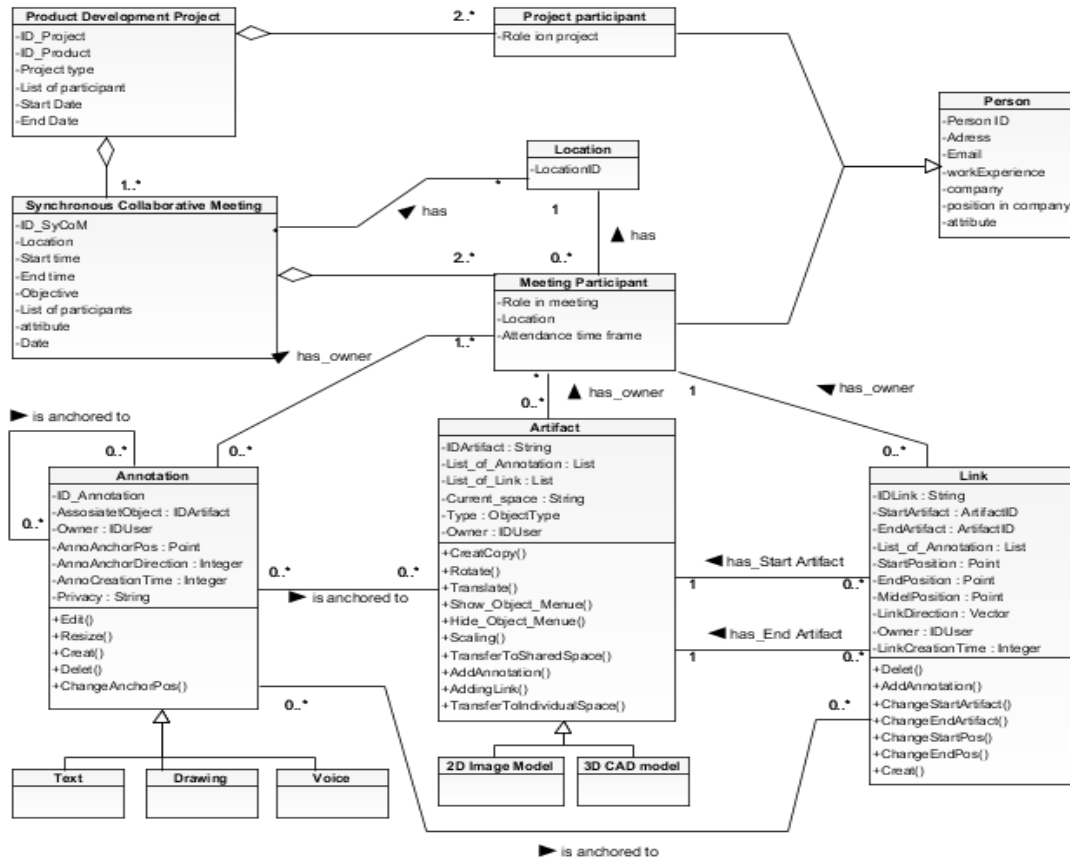

Figure 5-6: MT-DT documentation Meta-model

- **MT-DT Server layer:**

A participant connects himself through the network to the MT-DT Server (see Figure 5-5 the right side) to upload the corresponding document for the meeting. Their documents will be saved in their individual repository for specific meeting and no one have access to their repository. Also they can review the overall reports and results of previous meetings. They also access individual reports generated for the user based on what he/she did during the previous meeting in individual space. MT-DT Server saves all the results and schedule of meetings through the entire life of the project. The meeting manger has the access to the overall and detailed documentation of project review meetings. It is helpful to trace the meetings results to analyze and discover the project issues. The entire documents that are added to individual repository in MT-DT Server by the user are displayed in user's individual space. When user is sitting down around the table, he needs to enter his user and password on the table, in this way the related documents to the person will be displayed in his/her individual space in front of him/her. Individual space support individual activities without interfering with group activity, it allows participants to access information at any time from their private space.

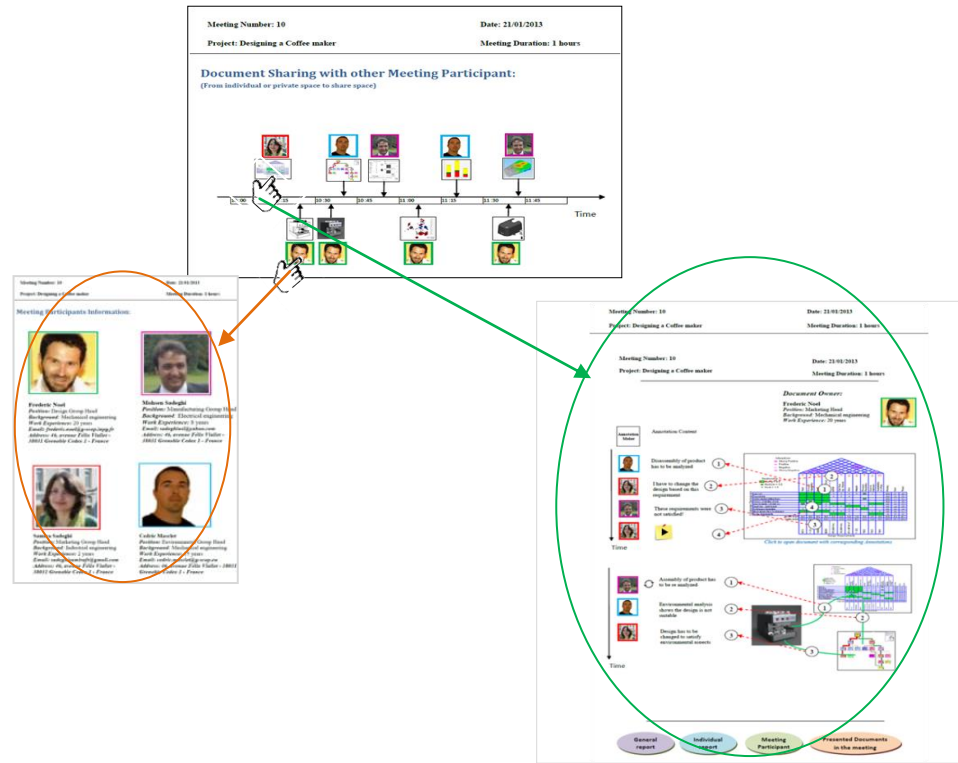

Figure 5-7: Hyper link time line: a proposed way for visualizing the result of data gathered from meeting by MT-DT

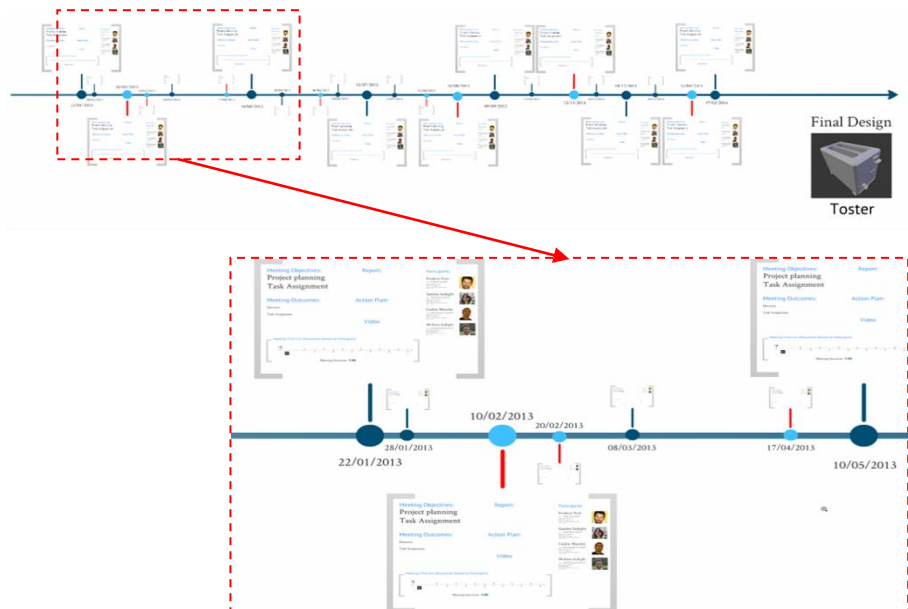

Figure 5-8: Zoom able timeline: a proposed way for visualizing the result of data gathered from meeting by MT-DT

#### 5.2.4 SyCoE Configuration

We kept the same configuration as traditional meetings because of advantages for small group of people. Thus users will seat around the multi-touch table. They may have their own display device as well.

### 5.3 |Step 2-2|: Implementation of the proposed Synchronous Collaborative Environment

In this step user implements the SyCoE which he designed at previous step. He may have different options for the implementation. Different factors impact on his choices for implementing solutions (time, cost, and availability of resources).

#### Case-Study:

Based on the comparison provided by Kammer et al. [Kammer et al. 2010] about existing framework we selected MT4j and PyMT as options for our development, but after the difficulty that we encountered in integrating the input data from Diamond-Touch table and implementing the specific functionality of our software application we decided to use another solution. The requirement for 3D and 2D visualization for our software led us to select a library for 3D visualization and image processing. We selected the Visualization Toolkit (VTK) for implementing MT-DT application. VTK is an open-source, portable (WinTel/Unix), object-oriented software system for 3D computer graphics, visualization, and image processing. VTK provides a variety of data representations including unorganized point sets, polygonal data, images, volumes, etc. VTK comes with readers/importers and writers/ exporters to exchange data with other applications with the support of parallel processing. VTK's rendering model supports 2D, polygonal, volumetric, and texture-based approaches that can be used in any combination [VTK 2013], [Schroeder et al. 2000]. Hence VTK was able to answer our requirements for implementing MT-DT specifically easing the integration of a wide set of document types.

We had several prototypes during implementation; figure 5-9 demonstrate the first prototype of the MT-DT. Some functionalities of the final prototype have been demonstrated in figure 5-10.



Figure 5-9: The first prototype of MT-DT testing rotation, translation and link creation function



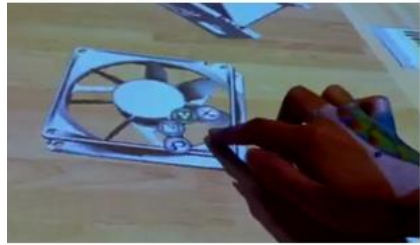

**A.** Finger-tap on the object in shared space and access to the menu for duplication, delete and annotation and Link creation



**D.** Virtual keyboard for typing annotation



**F.** Scaling object with two finger interaction

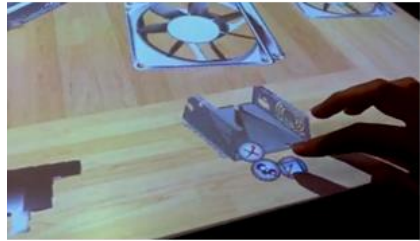

**B.** Finger-tap on the object in individual space and access to the menu for duplication, delete and annotation

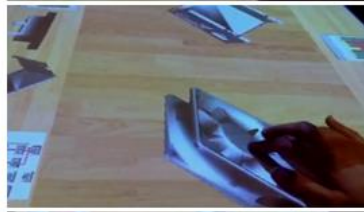

**E.** Rotation of 3D document: rotation is down based on more than 2 finger interaction and around the center of object with user hand replacement direction

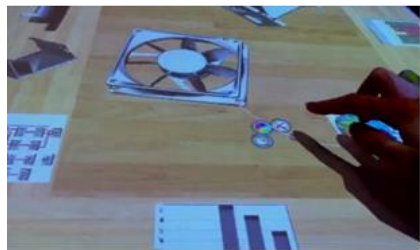

**C.** Finger-tap on the middle point of the link and access to the menu for delete, annotation and changing the link's color



**G.** Creating new space for individual space by keeping the previous one this provides endless space for making digital notes and categorizing documents

**Figure 5-10: Some functionalities of MT-DT**

## 5.4 Conclusion and Discussion

In this chapter we presented the second step of the knowledge based process for development/selection of synchronous collaborative environment. This step is including two sub steps: Re-design or design a new synchronous collaborative environment and implementation of the proposed environment. Based on the specification and requirements which has been identified in step 1 we designed MT-DT environment for design review meeting. MT-DT environment consist of a multi-touch table with specific 3D software application which support collaborative design review activities. Different types of knowledge supported us in design and implementation of software application for multi-touch table: The experienced knowledge in this domain, i.e. existing application for multi-touch table for similar or different application domain, Knowledge in the form of guidelines, Knowledge about Multi-touch frameworks and their architecture, scopes and features, Knowledge about different aspects required to be consider in designing the interface. SyCoW and SyCoE also helped us in analyzing the existing cases and consequently in our decisions during this step.

# Part-II: Chapter 6

## Evaluation of Synchronous Collaborative Environment

### Abstract

This chapter presents the final step of the proposed process where we evaluate a given synchronous collaborative environment. Different types of knowledge helped user for making decisions in this step: The general knowledge about synchronous collaborative environment evaluation, the experienced knowledge about evaluation of existing solutions and other form of knowledge in this domain. The SyCoEE model as a framework helps in designing and conducting the evaluation. SyCoW and SyCoE help in designing the scenario and conducting experiments. At the end, the knowledge which has been created in this step will be added to the knowledge body of collaboration domain. In this chapter through the proposed evaluation process, we will evaluate the MT-DT which has been designed and developed for design review meeting. For evaluation purpose we formed certain questions and hypothesis. The objectives of our evaluation study are to provide answers to the questions and to validate the identified hypothesis. We will demonstrate how different forms of knowledge helped us during the evaluation process of MT-DT. The results obtained from evaluation provide the arguments about the validity of our hypothesis and answer the identified questions.

### Table of Content

6.1	[Step 3]: Evaluation of Synchronous Collaborative Environment .....	97
6.2	[Step 3-1]: Evaluation Specification .....	97
6.3	[Step 3-2]: Conducting the Evaluation.....	107
6.4	[Step 3-3]: Analyzing the data and identifying the results of evaluation .....	109
6.5	[Step E]: Adding the new case to the case base .....	121
6.6	Conclusion and Discussion.....	121

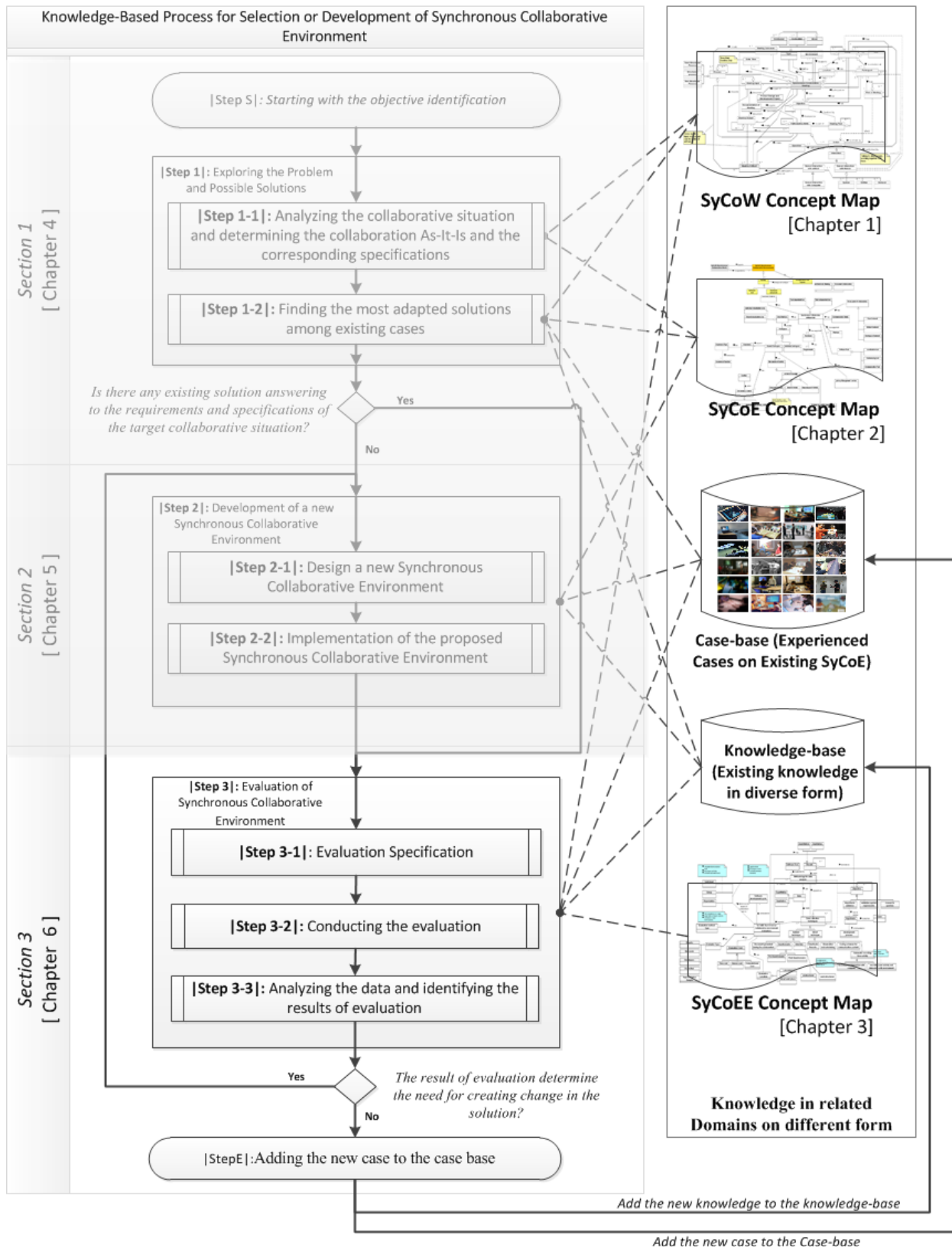

**Knowledge-Based Process for Selection or Development of SyCoE**

## 6. Evaluation of Synchronous Collaborative Environment

### 6.1 |Step 3|: Evaluation of Synchronous Collaborative Environment

The last step of the process is the evaluation of a given synchronous collaborative environment. As highlighted in chapter 3, evaluating collaborative environment is difficult and complex, because of the range of different perspectives that need to be considered. Hence several knowledge sources are required to facilitate this task. The source of knowledge and information that we proposed to use in evaluation process are:

- The general understanding about synchronous collaborative environment evaluation which has been formulated in SyCoEE Concept Maps. This will guide the user during evaluation process.
- The experienced knowledge about evaluation of existing solutions. User by searching in previous experienced cases with the help of SyCoW Concept Maps and SyCoE Concept Maps will find similar collaborative work and environment. Then he has access to the evaluation of the experienced cases which helps in different ways. Knowing that previously specific aspect of synchronous collaborative environment has been evaluated in similar synchronous collaborative situation helps user to evaluate the same aspect or not. If not, then user investigates the aspects of collaborative environment which have not been evaluated previously. If yes, user investigates aspects for which no sufficient evidence was set in previous evaluations, thus providing complementary knowledge.
- Additional knowledge under multiple forms: rules and semi structured knowledge which makes the frameworks and guidelines for evaluation of specific technologies.

The step 3 consists of three sub steps: |Step 3-1|: Evaluation Specification, |Step 3-2|: Conducting the evaluation and |Step 3-3|: Results Analysis. Every following sub-step is explained and explored through the evaluation of MT-DT.

### 6.2 |Step 3-1|: Evaluation Specification

The first sub-step identifies ‘what aspect requires evaluation’: in other words ‘what are the objectives of evaluation?’, ‘Why are we interested on these objectives ’, and then ‘how can we achieve these objectives’. Hence user should start by answering to ‘what’ and ‘why’. Based on the SyCoEE concept map, user analyzes the impact of the collaborative environment specification on person, group or organization or a combination of them. The evaluation objective (SyCoEE::Objective) validate that a SyCoEE matches the initial SyCoW requirement. An objective is formulated in the form of question or hypothesis. When ‘why’ and ‘what’ are identified, the appropriate evaluation methodologies should be selected (SyCoEE::evaluation methodologies). Then user needs to identify the type of the data (SyCoEE::Data) he must collect during the evaluation. He also needs to select the methodologies for data collection (SyCoEE:: Data collection techniques). He should then analyze the data based on appropriate methods and tools (SyCoEE::Methodology for data analysis). SyCoEE helps user in this process by providing the overall evaluation scheme.

## Case-Study:

Here we are thus specifying ‘what to’, ‘why’ and ‘how’ evaluate the MT-DT environment. SyCoEE and some specific domain knowledge justify the evaluation process and our decisions.

- **SyCoEE::Objective**

Our objective for MT-DT evaluation (SyCoEE::Objective) is to check what makes multi-touch table an appropriate technology for design review among small group of people and if MT-DT provides appropriate functionalities and features to support design review activities. The first thing to be evaluated is MD-DT usability [Pinelle & Gutwin 2008]. We also evaluate how different features of the multi-touch table and the underlying software application impacts on the individual and groups work during collaborative design review meeting. Thus, we come up with some questions and hypothesis (SyCoEE::Objective::Answer to question, SyCoEE::Objective:: Hypothesis validation). The following table instantiates the objectives and corresponding interests:

SyCoEE::Objective	
Objective	Objective interest
<b>H1:</b> Simultaneous users’ interaction with artifacts in the shared space during design review meeting can enhance the individual and group work and consequently the collaboration.	Simultaneous users interaction is one of the unique properties of the multi-touch table, verification of this feature on design review justify the one of the advantages of this technology for design review.
<b>H2:</b> Defining the explicit individual space on the user interface of software application has several interests: 1) to give this possibility to the users to manage their documents. 2) Individual report for each participant based on capturing the notes which user puts in the individual space and annotation he puts on the artifacts located in individual space. 3) To provide awareness about the documents of each individual to the other member of the group. 4) To facilitate the document transformation to the shared space for sharing purpose.	In paper-based design review meeting people put their documents in front of them, so the individual space has been defined implicitly on the table. Hence, in designing the user interface we divided the table surface to the shared space and individual spaces. Our hypothesis was that explicit individual spaces have several advantages.
<b>H3:</b> The tool is intuitive enough to be accepted by users with different profile	It was important for us to evaluate the acceptance of the tool by users with different profiles (gender, age, culture, personality, experience, educational background, etc.). Because the targeted final users for MT-DT will have different profiles and we used relatively new technology for our SyCoE. Hence we were not sure if users with different profiles would accept the tool and if it’s providing an intuitive environment.
<b>H4:</b> the documentation provided by MT-DT can enhance the meeting documentation.	Because of the nature of synchronous collaboration in product development context, it contains direct and indirect communication among participants. Hence synchronous collaborative work is a rich source of tacit and explicit knowledge that are exchanged between the project members. It could consist of large amount of product development information from previous work that comes together from different sources. It is also a source of new information: modifying existing artifact, creating new artifact or new idea, decision, action item for future, etc. Capitalizing this information and making it available for further access by different interested stakeholders, in most of the case is expected. Hence we were interest to analyze the improvement that we need to make in documentation aspect and how MT-DT can help in this improvement.
<b>Q1:</b> Is MT-DT providing the appropriate size for individual and shared space?	Size is constrained by the available technology. We were interested in analyzing if the size of the interaction surface is suitable to the individual and group activities.
<b>Q2:</b> What is the impact of the scaling functionality in individual and group activity and consequently on collaboration?	The scaling functionality for artifacts can be provided in a digital environment. In paper based activities, users don’t have access to such functionality. We were interest to analyze the impact of this functionality on group and individual activities and behaviors.
<b>Q3:</b> What are the similarity and difference between paper-based	We decided to make improvement in paper-based design review; hence

design review meeting and MT-DT design review meeting?	it's necessary to verify what improvement has been realized.
<b>Q4:</b> What are the improvement recommendations in design or development of MT-DT?	We were interested to identify the required future improvements on the implemented prototype. In order to commercialize the software prototype it's important to identify the improvement aspects for the ideal software application.

**Table 6-1: Identification of the objectives of evaluation and the reason of defining those objectives**

The experienced knowledge about evaluation of existing solution led us in defining our hypothesis and questions. Following, we justify how the knowledge led us to decide to investigate or not such specific aspect:

- No investigation of the added value of the tactile aspect of multi-touch table: It has been already widely evaluated by different researchers. For instance, Forlines et al. [Forlines et al. 2007] compared the direct-touch and mouse input for tabletop displays and Hansen & Hourcade [Hansen & Hourcade 2010] compared multi-touch tabletops and multi-mouse single-display groupware setups. Our assumption was that this aspect is related to HCI and is not so much application dependent; hence we decided to avoid analyzing this aspect for our collaborative environment.
- Analyzing the impact of table division into individual and shared spaces (validating the hypothesis H2): even though researchers already investigated the division of the table into the participants territoriality [Scott et al. 2004], we consider this parameter application's dependent. Hence we decide to analyze its impact on groups and individuals in a design review meeting context.
- Analysing the adequateness of shared and individual spaces (Answering to Question Q1): Ryall et al. [Ryall et al. 2004] analysed the effects of group size and table size on interactions with tabletop. However the collaborative work they choose for this comparison was based on the game "Magnetic Poetry" where groups searched for words on the table with the goal of reproducing a target poem. Based on SyCoW concept map their collaborative work specifications are quite different from design review meeting specifications. Also based on SyCoE concept map the specifications of their software are also different form MT-DT. For example in their software they had just a share space without any individual spaces which may impact on the evaluation of the size of the table. Hence we decided to analyze the compatibility of the size of the shared and individual spaces respect to our target collaborative work (design review meeting) by fixing the size of the group (four members which is the max number of participants for our target collaborative situation).

▪ **SyCoEE::Evaluation Method Type**

To provide a first quick and effective feedback about MT-DT and to be able to answer identified questions and to validate identified hypothesis, we decided to conduct a series of experiments. We identified four styles of experiments in this series of experiments which is presented in Table 6-2.

Ex.S.N.2 (Experiment Style Number 2) comparison with Ex.S.N.3 helps to validate the H2. The comparison between Ex.S.N.2 and Ex.S.N.4 helps to validate the H1. Experiment Style 2, 3 and 4 helps to validate the H3. Ex.S.N.2 and Ex.S.N. 4 helps to answer to Q1. The Ex.S.N.1 comparison with Ex.S.N.2 helps to answer the Q3 in Table 6-1. Results obtained from all experiments will lead to answer the questions Q4 and H4. *(In Table 6-2 : # Hypothesis/Questions Number , identify the list of hypothesis or questions which each series of experiments help to validate or answer to them)*

Experiment Style N.	Experiment style specifications	Hypothesis/Questions Number
Ex.S.N.1	Paper based design review meeting	Q3, Q4, H4
Ex.S.N.2	MT- with Individual space , MT- simultaneous users' interaction, Without 3D, Note in paper	H1, H3, Q1, Q4, H4
Ex.S.N.3	MT- without Individual space, MT- simultaneous users' interaction, Without 3D, Note in paper	H2, H3, Q4, H4
Ex.S.N.4	MT- with Individual space, MT- sequential users' interaction, Without 3D, Note in paper	H1, H3, Q1, Q4, H4

**Table 6-2: Different Experimental Styles in Family of experiments**

- **Designing the scenario:**

To design the scenario for experiments we consider the specified elements of our target collaborative situation. Those elements have been specified based on the SyCoW in the first step of the proposed process. In addition, we consider the following constraints as well: 1-The meeting objective and the role of each participant must be sufficiently attractive for the participant (Since they voluntarily accepted to participate to the experiments, we had to provide a maximum enjoyment and comfort for them without hindering our goals and objectives), 2- Avoid the need for strong disciplinary background. Task should be based on general engineering skills that won't require specific knowledge (The available participant in experiments are PhD and Master student in G-SCOP Lab, with different educational background), 3-Not too complicated problem (because of participants different educational background, the problem must be understandable for them), 4- Minimum effort for learning the roles and playing the roles in order to avoid discouragement and minimize the time investment of the participants 5. Time constraint for experiment duration (people availability and time of analysis).

In designing the experiment scenario we considered the specification of the SyCoW model. We maintain a realistic scenario for participants in the design review meeting. As mentioned in previous chapter the target users of our collaborative tool are experts within product design and development activities about medium size products.

A design review (SyCoW::Meeting objectives) focuses on decision making and option selection. It gathers four participants (SyCoW::Participant) with the following roles in the company (SyCoW::Roles): Head of marketing group, Head of design group, Head of manufacturing group and Head of Environmental group. The participants in the experiments are representative participants. We enrolled students engineering PhD and master levels with different educational background and different cultures, genders, computer skills and personalities which provide diverse participants profiles for our experiments. All experiments were conducted in MEXICO room (a room for experimental study equipped with required material for video and audio capture and for direct observation) at G-SCOP Lab (SyCoW::Location). All participants are in the same location and the SyCoW type is Co-located collaboration. All participants are in the same group (SyCoW::Group). No specific process is imposed to participants (SyCoW::Process). Participants are invited to present the results of the work of their group during the meeting. All participants are expected to document as if they would need to report the meeting result to their group, the reason for changes in product should be documented as well to be sent to the other member involved in this project (SyCoW:: Task). Each participant receives documents related to his role that he introduces during the meeting (SyCoW:: Input). The possible meeting outcomes (SyCoW:: outcomes) are the decision made about the best option and the assignment of the future tasks. The outputs of the meeting (SyCoW:: output) are: annotated documents, note of each participant consisting of the decision, a future task assignment. Meeting documentation (SyCoW::Meeting documentation) is done by each participant by taking the note on the paper. Two products (SyCoW::Product) a coffeemaker and a

toaster were prepared to play the design review scenario. Participant’s roles in the meeting (SyCoW::The role of participant in meeting) depends on their role in the company and the person from marketing is responsible for meeting organization, keeping the time, and meeting management. The general scenario is defined in a story format:

*“Marketing group of ElecDev brand analyzed the market for new products for kitchen (coffee maker and Toaster) the target groups are the small French family that want to buy these products. Four groups are involved in this project: Marketing group, design group, manufacturing group and environmental analysis group. Marketing department asked the design group to design these products. Design group designed the product with 3 options, and they have sent them to the environmental analysis group and manufacturing group. In manufacturing group they determined the manufacturing process and the required time and cost for producing each product. In environmental analysis group they analyzed the environmental effects of each product options. Now, the head of each group have to participate in meeting to represent the result of their analysis to the other member of the project, to negotiate and make a choice between 3 options that is more adapted based on different requirements. If they aren’t agreeing with the presented product, they have the select one that is more compatible with requirements and determined the required change that have to be done to respond the violated requirements. The person from marketing is the meeting responsible for keeping the time, and meeting organization and management. All participants in meeting have to take note about the result of meeting and what happens in meeting to transfer to their group, the reason for selection or change has to be documented as well to send to the other member involved in this project.”*

This version is adapted in the appropriate format to explain the task and meeting condition for participants and give them the general context. It creates a common ground about the objective of the meeting they will participate to. For each participant the required information related to his role was build and added to the documents dedicated to his role. (See the role of each participant in appendix 1.7, 1.8, 1.9 and 1.10).

We design two equivalent scenarios for comparative studies to validate hypothesis. To avoid learning effect we used two equivalent (same complexity) products the toaster and the coffee maker. The whole characteristics of the products are due to the same skills and, as an assumption, should generate the same type of activities. Table 6-3 demonstrates the criteria that we checked in selecting two products. Finally we concentrated on small kitchen electrical appliances. We selected toasters and coffeemakers for our study which have equivalent value for every criterion. For each product we prepared information related to each option (see appendix: Documents for evaluating MT-DT).

<b>Analyzing selected products from different points of view</b>	
<b>General characteristics</b>	Household goods, kitchen equipment, Well known products, everyday use products
<b>Manufacturing point of view</b>	Composite of different Material, Required assembly process, Have electrical component, Required different manufacturing process
<b>Design point of view</b>	Required Aesthetics design, Material and Color is important , User perception is important, Dimension
<b>Environmental point of view</b>	Energy consumption, Recycling / End of life strategy, Product life
<b>Marketing point of view</b>	Price target, Expected volume, Target group for product, Delivery time, Aesthetics aspect of product, Eco-friendly, Quality importance, Variety in color, Appropriate size, Guarantee

**Table 6-3: Element was checked to select two similar products**

A list of requirements was created to be undertaken by the marketing role. Information required checking the satisfaction of the requirements was distributed in different documents dedicated to the different roles. The documents dedicated to the manufacturing role provide manufacturing costs and quality control information for each product option while documents for the environmental role specified the eco-friendly aspect of each option.



Values dedicated to different variable for each option intentionally create antagonism between participants. Conflicting requirements frequently happens in real world situation [Lam & Chin 2005] and this condition hinders the decision process. Participant needs to negotiate and make compromise to select the best option or determine the required design changes to make it acceptable from different point of views. Three product options have been designed by design group (Table 6-4). Table 6-5 demonstrates the comparison between the options for specific requirements. Option1 is considered better for aesthetic aspect and guarantee size requirement. It has the expected variety of colors and it is appropriate for the size of the targeted group, but it is worst on environmental aspects. The price of this option is higher than other options and its usage is difficult in comparison to the option 3.

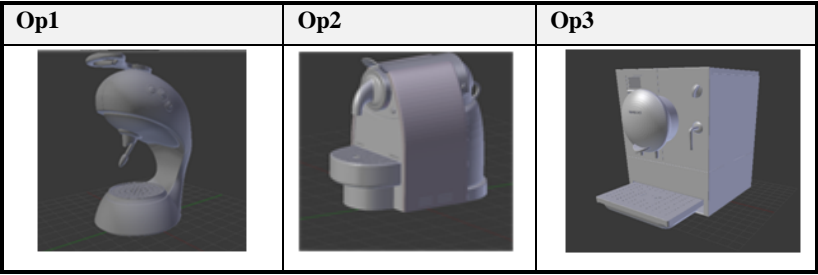

Table 6-4: Design options for coffee makers

		Design	Manufacturing	Environmental
Marketing point of view	Price target (cost comparison)		Op1>Op2>Op3	
	Expected volume		Op1=Op2=Op3	
	Target group for product	Op1=Op2>Op3		
	Delivery time		Op1=Op2=Op3	
	Aesthetics aspect of product	Op1>Op2>Op3		
	Eco-friendly			Op1<Op2<Op3
	Quality importance		Op1=Op2=Op3	
	Variety in color	Op1=Op2>Op3		
	Appropriate size	Op1>Op2>Op3		
	Guarantee			Op1>Op2>Op3
Ease of Use	Op1=Op2<Op3			

Table 6-5: Information distribution among different documents dedicated for each role and comparison between there design options

Two categories of document have been prepared for each role (SyCoW::Participants Roles): the first category of documents explained the conditions and the role in the meeting to prepare participants to play their role. It constitutes the initial information that each participant should have about the context and a few directions to play his role. The second category contains the information related to design specification and result analysis for each role. Two days before the experiment, we sent these documents to the participants. We explained them that during the meeting they will just have access to the second category of documents. Hence they must carefully read the information which has been explained in the first category in order to remember the required information during the meeting. Table 6-6 demonstrates the snapshots of documents dedicated to each role in each category for coffee maker scenario. The original documents are available in appendix ‘Documents for evaluating MT-DT’.

Role	Documents for each role reading before experiment (Not accessible during experiments)	Documents for each role reading before experiment (accessible during experiments)
------	---	---

Design	<p>Participation in a collaborative meeting about a product option choice</p> <p>Information provided</p> <p>Information provided</p>	<p>Easy to use design</p> <ul style="list-style-type: none"> <li>Model 444</li> <li>Model 555</li> <li>Model 333</li> </ul> <p>Easy to use (breakdown)</p> <ul style="list-style-type: none"> <li>Model 444</li> <li>Model 555</li> <li>Model 333</li> </ul> <p>Easy to use (breakdown)</p> <ul style="list-style-type: none"> <li>Model 444</li> <li>Model 555</li> <li>Model 333</li> </ul> 
Environmental	<p>Participation in a collaborative meeting about a product option choice</p> <p>Information provided</p> <p>Information provided</p>	<p>3 options for design of coffee maker</p>  <p>End of use strategy for comparing 3 design options</p>  <p>Energy consumptions</p>  <p>Product life</p>  <p>Disassembly difficulty</p> 
Marketing	<p>Participation in a collaborative meeting about a product option choice</p> <p>Information provided</p> <p>Information provided</p>	<p>User Requirements based on Marketing Analysis</p> <ul style="list-style-type: none"> <li>Having appropriate size for small kitchen</li> <li>Price is estimated between 40-100 €</li> <li>Aesthetic design</li> <li>Variety in color</li> <li>Eco-friendly (having the eco-friendly label on the product)</li> <li>The target group: small family with in France</li> <li>Easy to use</li> <li>Product volume estimated 1000 per month to cover Carrefour stores in France</li> <li>To enter the product at the beginning of April 2013 to the market</li> <li>Quality of the product</li> <li>With guarantee of minimum 3 years</li> </ul>
Manufacturing	<p>Participation in a collaborative meeting about a product option choice</p> <p>Information provided</p> <p>Information provided</p>	<p>3 options for design of coffee maker</p>  <p>Assembly difficulty</p>  <p>Product volume per month during the year</p>  <p>Estimated production time per product</p>  <p>Estimated cost per product</p> 

Table 6-6: Two categories of documents prepared for each role for design review of Coffee makers

▪ **Role Assignment:**

Participant's role assignment can be applied randomly or according to user's profile. As discussed in chapter 1, participant has different profile (gender, age, culture, personality, experience, educational background, etc.). The participant profile impacts on the collaboration or on the acceptance of collaborative tool. Hence, it is important to consider these elements in our experiments. Because of the comparative nature of some of our experiments and because of the limited number of potential population to participate to our experiments, it was difficult to find sufficient persons with the required profile. People may have quite the same background but not the same level of experience, or capability. So we decided to assign randomly the roles. However we captured user profiles to consider them in our analysis.

When we had the same participants for series of experiments, we changed the role of participant to avoid learning effect of the roles. At the same time to compare user behavior changes between two

situations, role with same level of difficulty and same level of information were assigned to the same person.

In the first experiment the task assignment was randomly assigned but in the second experiment we assigned the roles by considering the participant role in the first experiment. We analyzed the difference between the roles based on the number of document and the type of task dedicated to each role. The results are presented in the Table 6-7. Based on this analysis, manufacturing and environment, in one hand, have similar level of difficulty of task and, on the other hand, design and marketing have also similar level of difficulty. Thus we assign manufacturing role for someone who had environmental role in first experiment and the design role is assigned to someone who had marketing role in the first experiment and vice versa for others.

	Number of Documents	Type of task	Notes
Design	3	Representation of 3 options	To understand the result of manufacturing and environment analysis and to be sure about marketing satisfaction
Manufacturing	5	Representing the result of analyzing each options	Representing the result of analyzing each options and try to keep the option that is more appropriate in term of manufacturing time and cost
Environment	5	Representing the result of analyzing each options	Representing the result of analyzing each options and try to keep the option that is more environmental friendly
Marketing	1	Requirement representation and asking about result and meeting management	To ask about the result, by collaborating with group member to select the option that is more compatible with the requirements

**Table 6-7: Role difference analysis**

- **Facilities:**

Facilities used in experiments include four chairs with a table, pen for each user to be able to write notes and to annotate documents (available for paper based experiment), and notebooks for each user for taking notes during the meeting.

- **Experiment Timeline:**

We involved the same group in two experimental styles. On the other hand we wanted to give enough time to the participants to forget what happened in their previous experiment to avoid possible learning effect. Hence we put about two month delay between the first and the second experiments. The Figure 6-1 schematically represents the planning for conducting the comparative experiments. We sent by email, the D1 documents (the documents for first experiment) with Pre-questionnaire to participants two days before conducting the first experiment. The duration of the first experiment was 30-50 minutes (we tell participants that they have 30 minutes to finish their task. however, we let them continue until 50 minutes, if they have not finished their task.). At the end of the experimental session we gathered the annotated documents and participants' notes. We planned the second experiment two month after the first experiment. Two days before the second experiment, we sent by email, the D2 documents (the documents for second experiment). The duration of the second experiments was also 30-50 minutes. After the second experiment also, we gathered the annotated documents and participants notes. We asked participants to fill the first post-questionnaire just after the second experiment. Two month after the second experiment we sent the second post-questionnaire to the participants with the scan of their notes and we asked them to fill the questionnaire based on what they remembered from the experiment and their notes.

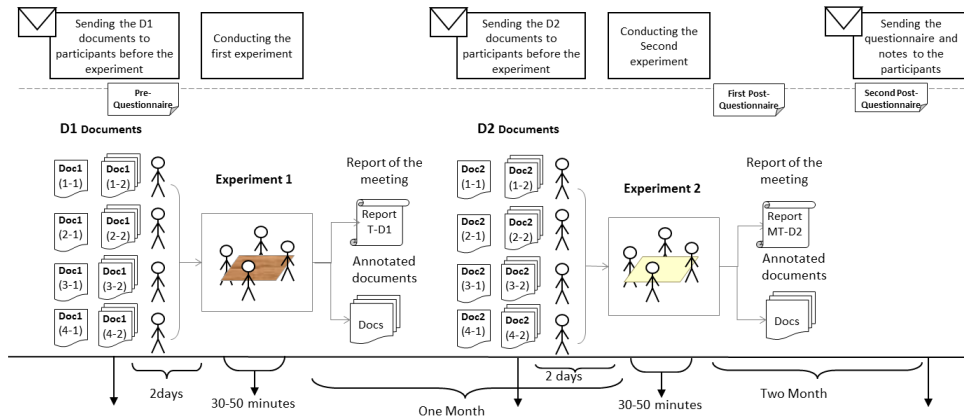

Figure 6-1: The time line of conducting the comparative experiments

▪ **Population for Experiments:**

Population available for our experiment was PhD, Master Students and faculty members from the lab. They are anyhow from different research teams with multidisciplinary research interests and different educational background and nationality. As we mentioned previously the target group of our collaborative tool are people with various profiles. Hence they were appropriate representative end-users for our collaborative environment. Hence our multi-disciplinary laboratory helped us to select the representative users of our target group of users (MT-DT should be usable for people with diverse profile).

▪ **SyCoEE::Data Collection Techniques**

We used different techniques to collect the data: video of collaborative meeting which provide the data and information in two streams of videos and audios. The log file developed as a module in MT-DT software, pre and post-questionnaires, annotated documents and participants' notes.

▪ **SyCoEE::Data Collection Techniques::Pre-Questionnaires**

A pre-questionnaire was designed for diagnostic purposes. We analyze the participants' profile. Capturing participants' profile specifically was required in validating the hypothesis H3 (Table 6-1). The elements mentioned in participant's model in chapter 1 have been considered as a reference model for designing the questionnaire. Pre-questionnaire is reported in Appendix 7.1.3: it captures each elements of user profile by considering the specification of our case for further analysis. For example, we ask the questions about user experience working with multi-touch device, and typing with virtual keyboard to know the user experience about similar technology and software functionality. We also asked questions about the participant skills in note-taking. We want to be sure that when someone does not take note during the meeting it is related to his skills in note-taking or not. We also ask questions about user educational background and user experience in design and collaborative work. Other questions related to participant profile (age, gender, cultural difference) are also included in the pre-questionnaire. The personality of participants is evaluated with the Bigfive personality test. This test measures what many

psychologists consider to be the five fundamental dimensions of personality<sup>1</sup>. We used the online version of this test [BigFive2013]. All personal information is confidential and is processed in an anonymous way.

- **SyCoEE::Data Collection Techniques::Post-Questionnaire**

We designed two post-questionnaires with two different objectives. The objective of the first one was to capture the result of user experience when using the MD-DT tool. The questions capture quantitative and qualitative feelings from user experience about different functionality and features of the software and its effect on collaboration and group efficiency. Questions about: Individual space, scaling function, creating new individual space, the size of individual and shared space, difficulty of readability of documents. The first post-questionnaire was made to validate the hypothesis H2 and H3 and answer to questions Q1 and Q2 (Table 6-1). The post- questionnaires are filled by the participants just after experiments or at the latest the same day to be sure they will not forget the experience with the software.

The second post-questionnaire is designed with the objective of validating the hypothesis H4 about the need for improvement of meeting documentation. We send the questionnaire to the participants with 2 month delay after the experiments. We assume they forgot the meeting details in the meantime. So the most important resource for the access to the information and events about meeting will be their notes and documents. The participants are informed about this task at the beginning of experimental studies. We provide participant's scan of his notes and the documents related to his role to the questionnaires. Hence we asked them to answer to the questions according to their notes and the documents that were related to their role.

- **SyCoEE::Data Collection Techniques::Event Log**

We also developed a module to record the low level user interaction events with multi-touch table. These logs are saved in a specific format for further analysis. Helms et al. [Helms et al. 2000] argue logs with other sources provide comprehensive strategy to evaluate groupware. They describe which events happened between participants in multi-user. Event logs are specifically required to validate the hypothesis H1 and H2. H1 and H2 are directly related to user interaction with table surface and event logs capture the user interaction with interface in micro level.

The raw data and event collected through logs files require several types of filter and analysis to produce meaningful data which define the type of user actions. Merging these data with other sources provide comprehensive description of collaborative situation.

A basic element in the log file consists of : Time, User ID, Bonding box of touching space, Number of fingers touching the surface, State of user (Touch Down, Touch During, Touch Up), Space user Touching (Individual Space, Shared Space), Selected Artifact for manipulation, Action on the selected Artifact). In step 3-3, Result Analysis, we explain how this very low level raw data becomes meaningful and helps validating hypothesis.

---

1 - Openness to Experience/Intellect, Conscientiousness, Extraversion, Agreeableness, Neuroticism

- **SyCoEE::Data Collection Techniques::Audio and Video Recording**

The installation of cameras and configuration of the collaborative environment is described in Figure 6-2 (left side for the paper based experiment and right side for experiment around the multi-touch table by MT-DT software application and digital artifacts).

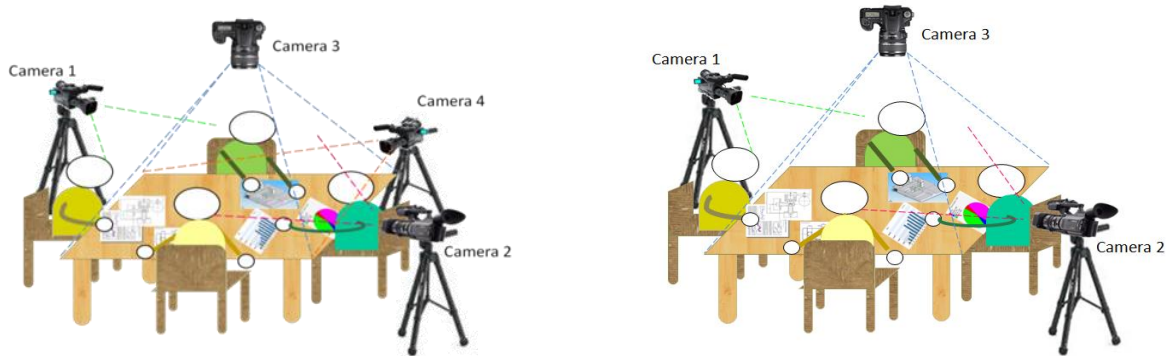

**Figure 6-2: The configuration of the camera relative to the users and other facilities positions. Left: experimental study in paper based version. Right: Experimental study on MT-DT**

Camera 1 captures the faces of users 1 and 2 in order to analyze the communication via facial gestures. Camera 2 captures the faces of users 3 and 4 for the same reason. Camera 3 captures the entire table in order to analyze user interaction with design artifacts (position of camera will be vertical to provide top point of view on the table). A fourth camera (only used in paper based experiment, Ex.S.N.1, Table 6-2) captures the entire table from another point of view in order to analyze user interaction with design artifacts (position of camera provides diagonal point of view on the table). In experiments on MT-DT, instead of the camera 4, we capture the direct output of the table surface with specific software. The video and audio captured with cameras are automatically assembled in a unique video stream (4 views) with a video manager system (quad view) installed in the Mexico's observation room.

- **SyCoEE::Data Collection Techniques::The artifact created or modified in meeting**

Annotated documents (in the paper based experiment) and the notes taken by participant are scanned for further usage and analysis. This data was specifically important to validate the hypothesis H4 (Table 6-1).

### **6.3 |Step 3-2|: Conducting the Evaluation**

After designing the evaluation, user must conduct the evaluation. For example for experimental study that require representative user, the evaluator should start to gather the participants which are qualified as representative users. He needs then to schedule the experiments based on the availability of participants and the planning designed for comparative experiments. Then he should conducts the experiment and gather the data.

## Case-Study:

We conducted a series of experimental studies by participants with diverse profiles.

### ▪ Conducting the experimental studies

By sending email and advertising we started to gather volunteers to participate to our experiments. Based on availability of the people, we selected volunteers and formed group of four people. We randomly assigned the task and we sent the pre-questionnaire and documents related to context explanation and participant role before the experiments. We asked them not to talk with any one about the experiment and their role before the end of the year when we will have done all the experiment sessions. In this way we expected that participant knowledge will not be affected by other participants.

Before the experiments we checked they have read the documents and that they are ready to play their role during the experiment. If they are not we postponed the experiment. After conducting the experiments we asked participants to fill out the post-questionnaires.

Table 6-8 summarizes the experiments and their characteristics which were successfully conducted during this PhD thesis. Each column has been colored based on the similarity of the elements. Nine experiments have been processed with groups of four participants. The language of the documents is English, because all participants were able to read English. The language of verbal conversation in each experimental session was the native or fluent language of the participants to enable easy communication. Hence, the experiments have been done in three languages. The comparative studies have been processed by the same groups in order to keep similar conditions. This helps to focus on the purpose of the comparison.

Exp.N.	Experiment	Language	Experiment style (Ref. Table 6-2)	H/Q. N. (Ref. Table 6-1)	G.N.
1	Design Review (Product: Coffee Maker)	French	Ex.S.N.3: MT-without Individual space, MT- simultaneous users' interaction, Without 3D, Note in paper	H2, H3, Q4, H4	1
2	Design Review (Product: Coffee Maker)	Persian	Ex.S.N.2: MT-with Individual space , MT-simultaneous users' interaction, Without 3D, Note in paper	H2, H1, H3, Q3, Q4, H4	2
3	Design Review (Product: Toaster)	Persian	Ex.S.N.1: Paper based	Q3, Q4, H4	2
4	Design Review (Product: Coffee Maker)	French	Ex.S.N.2: MT-with Individual space, MT- simultaneous users' interaction, Without 3D, Note in paper	H3, Q1, Q4, H4	3
5	Design Review (Product: Coffee Maker)	French	Ex.S.N.2: MT-with Individual space, MT- simultaneous users' interaction, Without 3D, Note in paper	H1, H3, Q1, Q4, H4	4
6	Design Review (Product: Toaster)	French	Ex.S.N.4: MT-with Individual space, MT- sequential users' interaction, Without 3D, Note in paper	H1, H3, Q1, Q4, H4	4
7	Design Review (Product: Toaster)	English	Ex.S.N.2: MT-with Individual space, MT- simultaneous users' interaction, Without 3D, Note in paper	H1, H3, Q1, Q4, H4	5
8	Design Review (Product: Coffee Maker)	English	Ex.S.N.4: MT-with Individual space, MT- sequential users' interaction, Without 3D, Note in paper	H1, H3, Q1, Q4, H4	5
9	Design Review (Product: Toaster)	French	Ex.S.N.2: MT-with Individual space, MT- simultaneous users' interaction, Without 3D, Note in paper	H3, Q1, Q4, H4	6

**Table 6-8: The conducted experiments and their characteristics**

One comparative study has been done between paper based design review and design review with MT-DT (Exp.N. 1&2). Two comparative studies have been done between MT-DT with simultaneous users' interaction and MT-DT with sequential users' interactions. Exp.N. 5&6 and 7&8). Seven experiments were processed on MT-DT with individual space and one was processed on MT-DT without individual

space. (In Table 6-8 : #Exp.N. Experiment Number; # G.N. Group Number; #H/Q. N. identify the list of hypothesis or questions number that each experiment helps to validate; # in each column, the colors indicate that the cells with the same colors have the same values).

#### **6.4 |Step 3-3|: Analyzing the data and identifying the results of evaluation**

Here the user should identify how this data can become meaningful to respond to the questions or validate the hypothesis. Depending on the data type the methodology for data analysis will be different.

##### **Case-Study:**

- **MD - DT is usable: result of usability analysis based on T-CUA**

Gutwin & Greenberg [Gutwin & Greenberg 2000] emphasized that some usability problems in collaborative systems are the result of poor support for the basic activities of collaborative work in shared spaces and that they are not inherently tied to the social context in which the system is used.

They proposed a conceptual framework based on support for the “mechanics of collaboration”: the low level actions and interactions that must be carried out to complete a task in a shared manner. For evaluating table-top collaborative application usability, based on the idea of Gutwin & Greenberg, Pinelle and Gutwin [Pinelle & Gutwin 2008] developed a usability evaluation technique, T-CUA, which focuses attention on teamwork issues and helps to determine whether prototypes provide adequate support for the basic actions and interactions that team members must perform in order to work collaboratively. These mechanics consist of communication and coordination of related actions and interactions essential to teamwork, such as explicit communication (spoken, written, gestural), basic awareness, consequential communication, feed through, and coordination actions in terms of the group's overall ability to work together.

The proposed actions related to each mechanism, on tabletop were easily observable. The communication mechanisms are less directly observable and required more analysis. Based on our observations from the experimental study among 8 groups of participants we analyzed their interaction with MT-DT. All explicit communication was observable during MT-DT usage.

The last column of the Table 6-9 identifies the capability of MT-DT in answering the usability requirements identified in each aspect. Our observation from experimental study helped us to verify each usability requirement. ‘Yes’ indicate that we were able to explicitly observe that type of action on tabletops by participants during our experimental studies. ‘NO’ indicate that that type of action of tabletops was not possible. We did not put any sign on documents to specify its owner. Users were seating along the meeting and changing the position was not allowed due to the presence of sensors embedded in the chairs that were used for users’ events identification. For action ‘Take object(s) from another’s personal space’, MT-DT protects the user individual space. i.e. each user is able to just interact with his individual space and shared space. Hence user was not able to take object(s) from another’s personal space. However they were able to point to specific object(s) in another’s personal space and ask that user to transfer that object to themselves, by transferring that object to the shared space. Because of this feature of MT-DT, the action ‘Move object(s) into another person’s workspace’ was not explicitly possible,



however users were able to by moving object towards another person’s workspace, ask that user to transfer the object to his workspace.

Category Communication	Mechanic	Typical actions on tablespots	MT-DT	
Explicit communication	Spoken messages	Discussions about artifacts	Yes	
		Discussions to coordinate activities	Yes	
		Social conversations	Yes	
	Written messages	Annotate shared objects	Yes	
		Share documents, e.g., minutes, agendas, ideas, etc.	Yes	
	Gestural messages	Orient object toward others to assist with comprehension or to indicate interest	Yes	
		Point to workspace or object to signal intent	Yes	
		Gesture toward object to ask another to pass it	Yes	
	Combinations of verbal and gestural messages	Point to object during conversation to discuss content	Yes	
		Point and ask another person to pass an object	Yes	
Information gathering	Basic awareness	Who owns tools and artifacts?	NO	
		Where are people positioned at the table?	Yes	
		Where are people working on the table surface?	Yes	
		What objects are they using?	Yes	
		What activities are they carrying out?	Yes	
	Activity information from objects	An object’s appearance has changed	Yes	
		The orientation of an object has changed	Yes	
		An object’s proximity to group members has changed	Yes	
	Activity information from people’s bodies	People are interacting with objects	Yes	
		People are changing position at the table	NO	
		People are interacting with others	Yes	
<b>Coordination</b>				
Shared access (to tools, objects, space)	Obtain resource (Take an object or tool)	Reach for distant object(s)	Yes	
		Ask another person for object(s)	Yes	
		Take object(s) from group workspace	Yes	
		Take object(s) from another’s personal space	-	
	Reserve resource (Reserve objects and spaces for future use)	Move object(s) into personal space	Yes	
		Rotate object(s) to face working position	Yes	
		Put hand/arm on object(s)	Yes	
		Hold object(s)	Yes	
		Move next to an area to show intent to use space	Yes	
	Protect work (Keep others from interfering with or destroying work)	Keep object(s) in personal space	Yes	
		Put hand/arm on object(s)	Yes	
		Work with object(s)	Yes	
		Mark the objects to indicate ownership	NO	
		Move next to area	Yes	
Transfer Handoff	Handoff (Synchronous transfer of an object to another person)	Put object(s) in another person’s hand	Yes	
		Put object(s) in front of another person	Yes	
		Rotate and move object(s) to another person	Yes	
	Deposit (Asynchronous transfer where an object is left for a specific person or for anyone in the group)	Move object(s) into shared space	Yes	
		Move object(s) into another person’s workspace	-	
		Rotate object(s) so that it faces another person	Yes	
		Rotate object(s) so that it has ambiguous orientation	Yes	
		Move away from protected area	Yes	

Table 6-9: MT-DT usability analysis based on T-CUA framework [Pinelle & Gutwin 2008]

The results of usability analysis demonstrate that MT-DT answers to the usability requirements. Also, all participants were able to easily learn and use the MT-DT to accomplish their tasks.

▪ **Result: Simultaneous users' interaction impact on collaboration**

This result has been derived from validating the hypothesis H1. In order to analyze the importance of simultaneous users' interaction capability of MT-DT during design review we conducted a comparative study. One setup was the MT-DT with sequential users' interaction and the other setup was MT-DT with simultaneous users' interaction (Ex.S.N.3 and Ex.S.N.4, Table 6-2 ). Two groups of participants have been involved in two setups. We kept the same people in order to better analyze the effect of this feature by trying to preserve the other parameters same in the two setups.

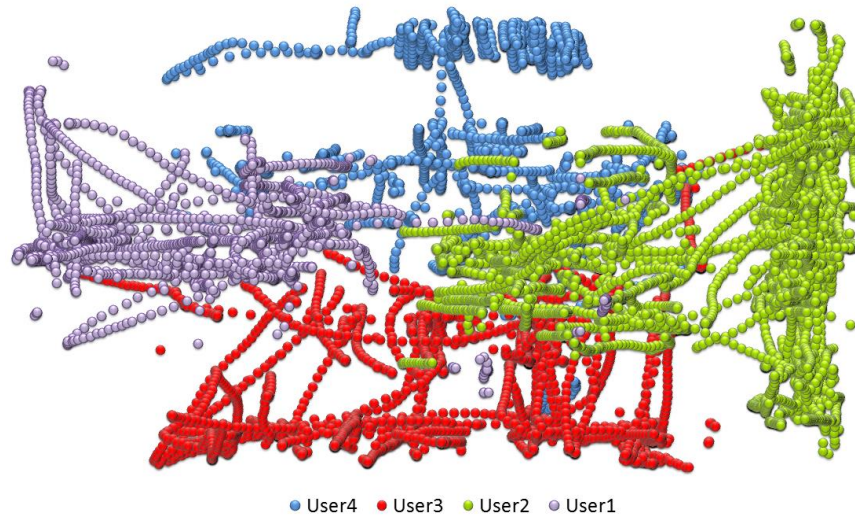

Figure 6-3: The graphical representation of users' interaction on MT-DT for simultaneous setup (User 1: Design/ User 2: Environmental expert /User 3: Manufacturing/ User 4: Marketing)

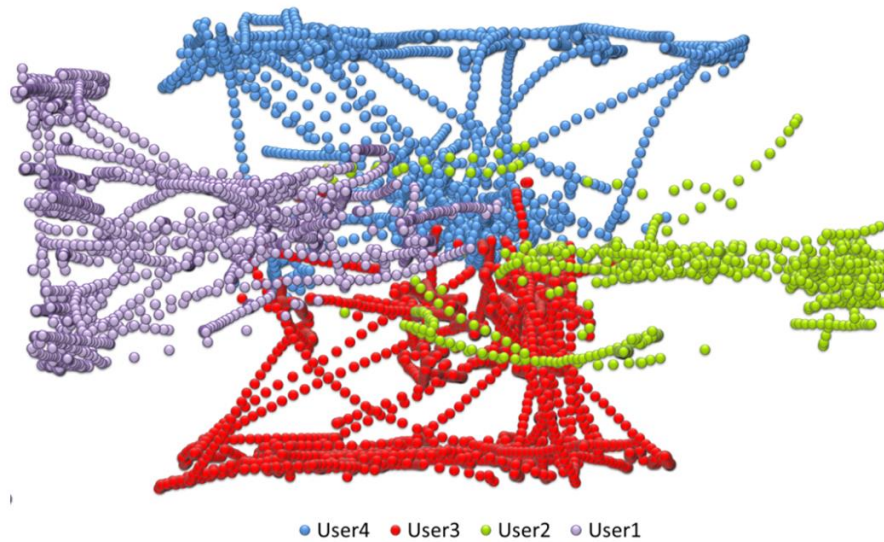

Figure 6-4: The graphical representation of users' interaction on MT-DT for sequential setup (User 1: Design/ User 2: Marketing /User 3: Environmental expert / User 4: Manufacturing)

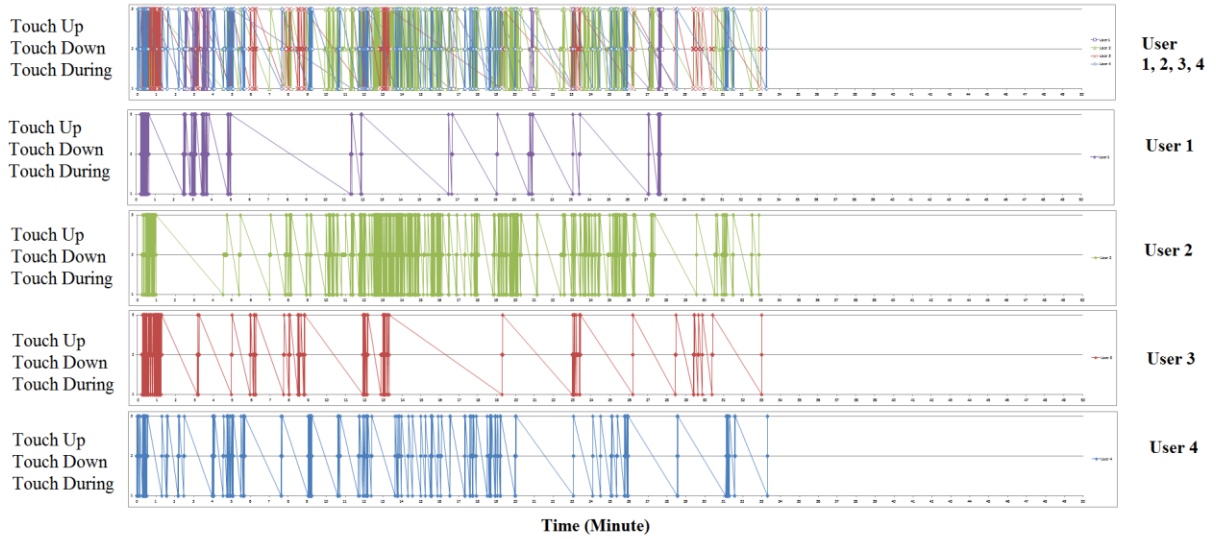

Figure 6-5: Time line of users' interaction for simultaneous setup

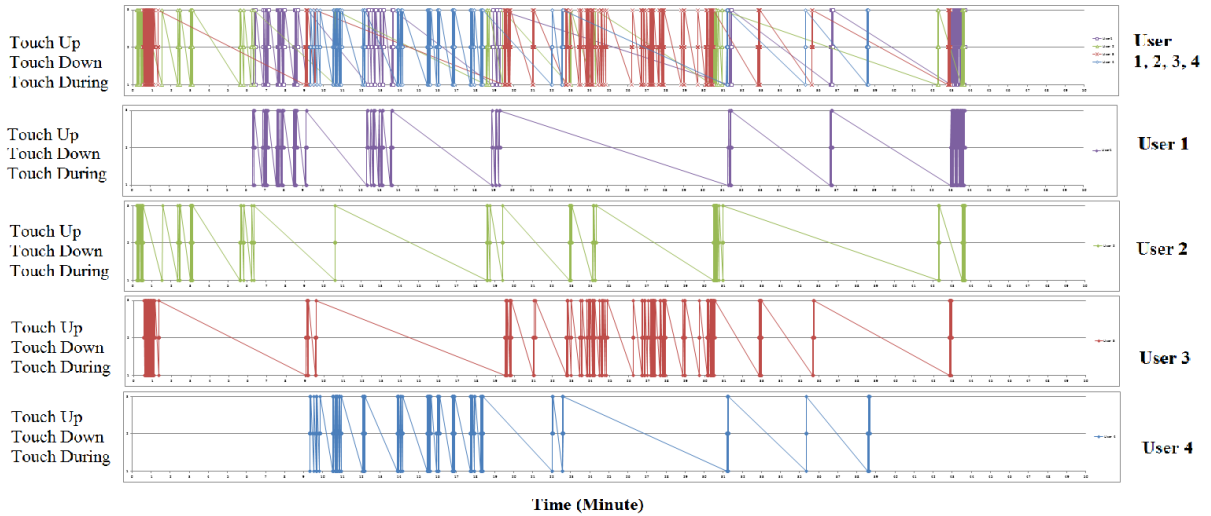

Figure 6-6: Time line of users' interaction for sequential setup

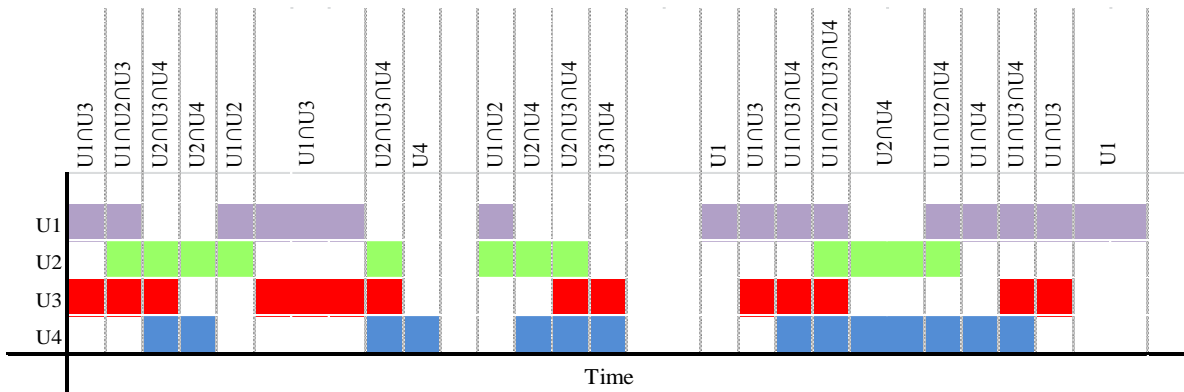

Figure 6-7: Users interactions with MT-DT over the time in simultaneous setup

All groups in the two setups are able to successfully accomplish their task. The quality of the result of accomplishing the task was satisfactory. They were able to select the best option and identify the required changes on the design. However the time they spent to accomplish their task is different. Figure 6-3 and Figure 6-4 graphically represent the users' interaction on MT-DT for the two setups. In the sequential user interaction setup, participant needs to take the 'Hand' to interact within the shared space. Hence it limits their interaction with the shared space to the time that he has the 'Hand'. The difference is observable in the pattern presented in Figure 6-3 and Figure 6-4. The points on the figure trace the user interaction with table surface. However because of the lack of time in this figure we are not able to see the sequence of the touch over the time. To see the interaction coupled by time we proposed the Figure 6-5 and Figure 6-6 which visualize the three states (Touch Down, Touch During and Touch Up) of user interaction on the table over the time. Comparison between two setups demonstrate that in simultaneous setup user interaction are more dense and compact and they spent less time to achieve the meeting objective (decision making about design options).

In simultaneous setup, at the same time several users can interact on the table User interaction over the time in simultaneous setup has been demonstrated schematically in Figure 6-7. Hence we have different times depending on the number of persons acting simultaneously on the table: 0, 1, 2, 3 or 4.

We analyze the percentage of users' interaction in two setups. Figure 6-8 is representing the result of this analysis. The comparison demonstrates that in the simultaneous setup 60, 42% of the meeting time there is no one interacting with the table while in sequential setup this time is the 85, 95% of meeting time. The time when just one user is interacting with the table for simultaneous setup is 33, 96 % while in sequential setup this time is 14, 05% of the meeting time. This shows that the sequential setup make it difficult for user to have access to the share space whenever he wants hence decrease the time of user interaction. Indeed user needs to wait for someone which has the control to finish his task to get his turn.

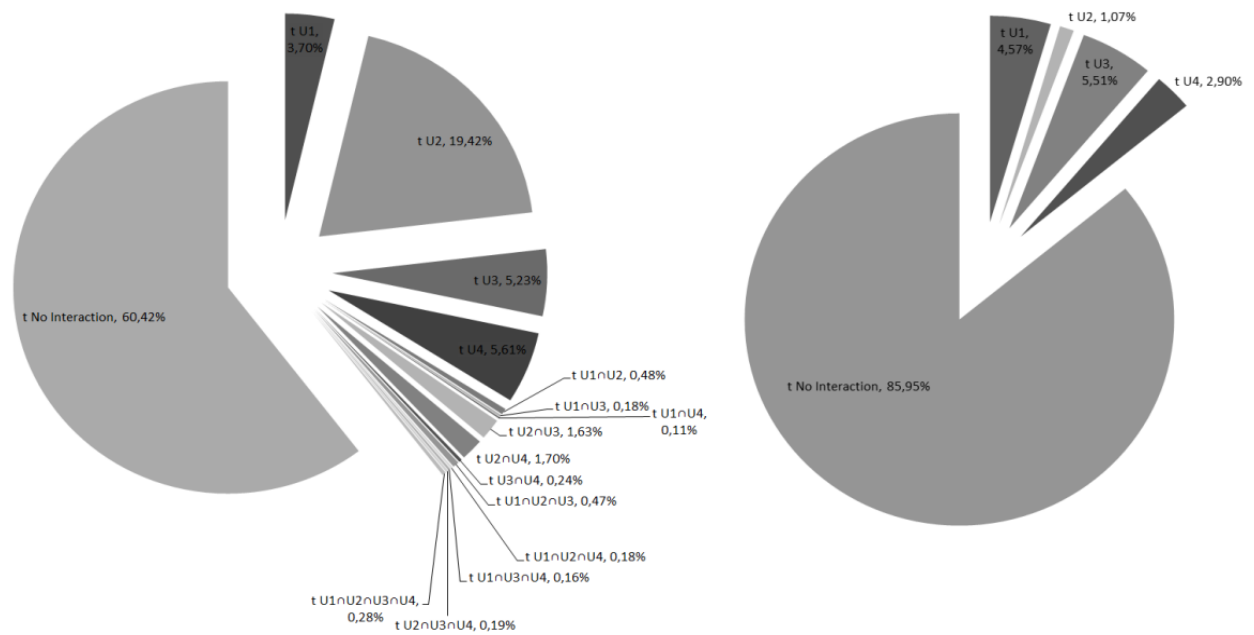

Figure 6-8: Left: time percentage of users' interaction for simultaneous setup, Right: time percentage of users' interaction for sequential setup

In the simultaneous setup, 0.28 % of the meeting time four users were interacting with table simultaneously. 1% of the meeting time three users were interacting with table simultaneously. 4, 34 % of the meeting time two users were interacting with table simultaneously. Hence in total 5, 62% of the meeting time we had simultaneous user's interaction on the table. However the fact that this simultaneous user's interaction facilitates the communication via artifact helped users to achieve the meeting faster in comparison within the sequential setup.

- **Result: Explicit individual space on the user interface of software application has several interests (Managing personal documents, To keep privacy and ownership, Prepare documents before sharing with other member of group, Awareness about the documents of other participants)**

This result has been derived from validating the hypothesis H2. The result of post-questionnaires demonstrates that 73% of participants found existence of individual space is helpful and 27% agreed that it can be helpful. The result validated our hypothesis about the interest of having individual space. Based on observation and user feedbacks, we categorized the reasons which make the existence of individual space useful. The summary of the results has been presented in Table 6-10. The comparison between the experimental setup with individual space and without individual space, also confirmed the hypothesis (Ex.S.N.2 and Ex.S.N.2, Table 6-8). Also the result of comparison demonstrated that even in setup without individual space, user naturally act the area in front of them as their individual area for keeping and managing their individual documents and they used the center area of the table as the shared space (Figure 6-9). In MT-DT without individual space we observed some problems and users difficulties which hindered the collaboration and working conditions. When user wanted to enlarge an individual document for his own benefit without the intention of sharing it with others, his document was covering the documents located in the shared space and this caused group interruption and created delay in group activities. The registration of the user actions on the log file and observation also confirmed that user just used the center of the table as the shared space as demonstrated by the graphical representation of users' interaction on MT-DT with individual space for one of our experiments based on information gathered through log-file. (See Figure 6-3 and Figure 6-4)

The reasons user found the existence of individual space useful	Some points from users comments
Managing personal documents	Separating the individual space and shared space make it easy for users to manage the personal documents.
To keep privacy and ownership	It's helpful in the sense if user wanted to hide information and present it later, others were obliged to respect this coz they didn't have accesses to his space.
Prepare documents before sharing with other member of group	Individual space is helpful as users can arrange their documents that they have to talk about later in the meeting. Users can also arrange them in the particular order they are going to use them. It works like the presentation slides they are used to off and so make them feel comfortable while presenting their stuff to the other participants.
Awareness about the documents of other participants	It was helpful to see what type of documents other members have. So, if users need specific information that they knew someone had in his documents in his individual space, even they didn't have the direct access to his individual space; they were able to ask him to share that document with group.

**Table 6-10: Participants' answers about the interest of having individual space**



Figure 6-9: Left: Without individual space, Right: With individual space

The summary of the feedbacks obtained from experiment has been presented in Figure 6-10. This table compares the 4 options for user interface configuration options and the criteria which are important in selection of the options. Individual space in both form of fix and dynamic provide awareness about users activities and visibility of individual documents when user intend to share them with other members. Individual documents of a user could be accessible for participants or not. It will depend on the design of the application. We designed the MT-DT in a way which makes it inaccessible for other members. In term of flexibility for using the space, dynamic individual space will provide flexibility in using the space of the table surface.

		Criteria			
		Visibility of individual documents when user intend to share them with other members	Accessibility of other members to individual documents	Flexibility in using the spcae	Awareness about users activities
User interface configuration options	<b>Fix individual space</b>	Yes	Yes / No	No	Yes
	<b>Dynamic individual space</b> (reduce or disappear the individual space)	Yes	Yes / No	Yes	Yes
	<b>Private space</b> (tablet or laptop as private space)	No	No	-	No
	<b>Without individual or private space</b>	No	Yes	-	Yes

Figure 6-10: The characteristics of different user interface configuration feature for multi-touch table

▪ **Result: The tool is intuitive enough to be accepted by users with different profiles**

This result has been derived from validating the hypothesis H3. As explained in chapter 1 personalities of participant is a factor which impacts on the collaboration, communication and acceptance of the new tool or technology. We analyzed the participants profile based on the Bigfive personality test (five major dimensions of human personality) and the results of the pre-questionnaire.

Participants have quiet diverse personalities. As presented in Figure 6-11 and Figure 6-12 (Figure 6-11 demonstrates the five dimensions of the personality for all participants. Figure 6-12 left side shows the Max, Min and average dimensions for all participants, and the right side shows the average values for each group of participants). All participants were able to easily learn how to use MT-DT and to accomplish their tasks and all groups were able to accomplish the meeting objectives. They were able to collaborate and communicate naturally around the multi-touch table. Hence our conclusion is that people with diverse personality profiles will not have specific problem to accept MT-DT.



**Openness to Experience/Intellect:** High scorers tend to be original, creative, curious, and complex and open to new experiences; Low scorers tend to be conventional, down to earth, narrow interests, uncreative and closed-minded.

**Conscientiousness:** High scorers tend to be reliable, well-organized, self-disciplined, careful and conscientious; Low scorers tend to be disorganized, undependable, and negligent.

**Extraversion:** High scorers tend to be extraverted, sociable, friendly, fun loving, talkative; Low scorers tend to be introverted, reserved, inhibited, and quiet.

**Agreeableness:** High scorers tend to be agreeable, good natured, sympathetic, forgiving, courteous; Low scorers tend to be disagreeable, critical, rude, harsh, and callous.

**Neuroticism:** High scorers tend to be nervous, high-strung, insecure, worrying; Low scorers tend to be calm, relaxed, secure, and hardy

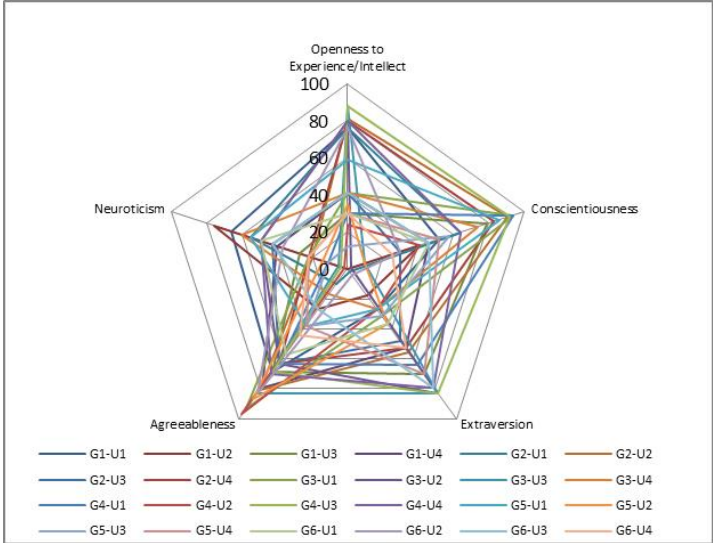

Figure 6-11: Participant personality dimensions

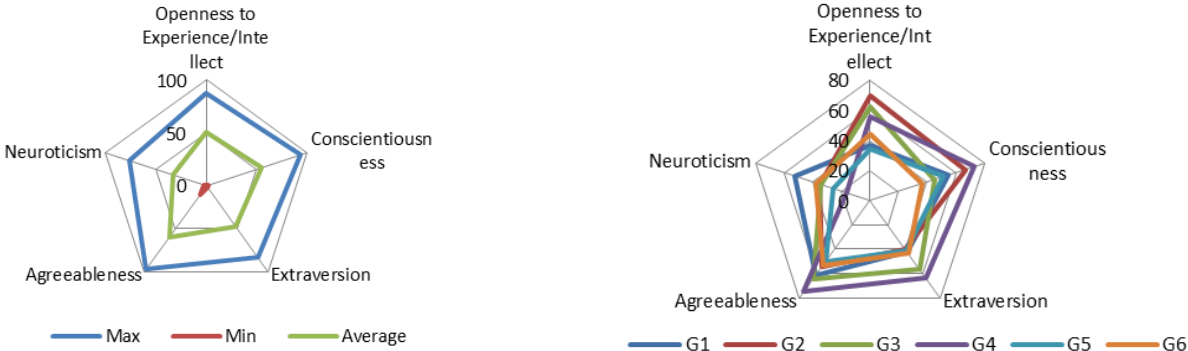

Figure 6-12: Left: The Max, Min and average of personality dimensions for all participants, Right: The average of personality dimensions for each group of participants

- **Result: Usual meeting documentation requires improvement and the documentation provided by MT-DT enhances the meeting documentation.**

This result has been derived from validating the hypothesis H4. In this section we present the results of the experiments about documentation aspects. One of our objectives in these series of experiments is to evaluate our hypothesis related to documentation (H4, Table 6-1). We asked participants to take notes on whatever happens in the meeting in all series of experiments. Instructions are to imagine they need to transfer the meeting results to their group and they could re-use this information in future meeting.

Three sources of information are used to evaluate our hypothesis. The video raw corpus where four simultaneous views of experiments were recorded helps us to analyze participant behavior during note-taking activity. Notes of participants are the second source of information. The third one is the post-questionnaire which is sent to the participants 2 months after the meeting. If participant was a good note taker and wrote the important things in such a way that after 2 months he is able to read his note, he should be able to answer to these questions. The questionnaire was consisting of several questions about

the information that was shared between each participant during the meeting and information about the result of meeting, like: the final choice, future task of each participant, etc. For each role we had a specific post-questionnaire. Some questions were answerable based on participant document and role and some of them were based on the important things that happened during the meeting. If participant was a good note taker, he wrote the important things and he wrote in a manner that after this delay he is able to read his note and he is able to answer the questions.

By analyzing the note taking process via the three sources of data, we found out that most of the notes were not understandable by other people and after two months delay the author himself has some difficulty to understand his own notes and to remember what happened during the meeting. Figure 6-13 shows some result notes from different participants. We observe that some information is repeated in all the notes of the group members. Users try to write the code (each product has a unique code in documents prepared for experiments) of the product to track relations between notes and documents. However they have difficulties to keep relations between notes and specific part of the product. Some part of the notes is related to the information that other members exchanged with the group through their documents. Even participants who mentioned they are good note taker were not able to answer all the questions after the two months delay.

MT-DT documentation module provides a solution which answers the problem we mentioned above. MT-DT has potential to facilitate the annotation action on documents in comparison with paper based version. In MT-DT, each person can put annotation on documents, user do not need to take the document to put in a position to be able to write the note. Hence several users can simultaneously annotate on the same artifact. All the notes and annotations users put in shared space are public and note and annotation they write in their individual space is personal which manage the personal and shared documentation of the meeting.

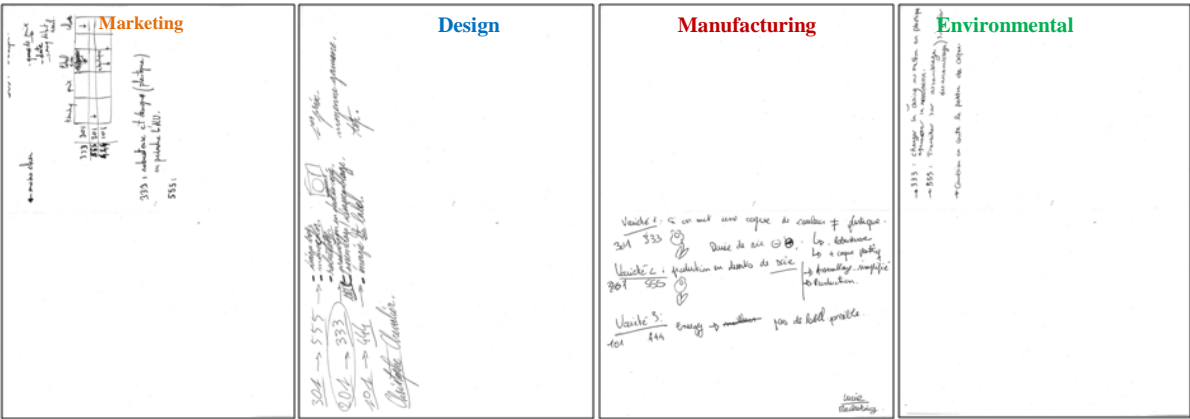

Figure 6-13: The result of note taking by different participants in one of our experiments

- **Result: Appropriateness of individual and shared space dimension is not confirmed by all users**

This result has been derived from answering the question Q1. 55% of participants found that the shared space has the right size and 28% believed that it's smaller than the appropriate size and 17 % believed that it is bigger than appropriate size (Figure 6-14)



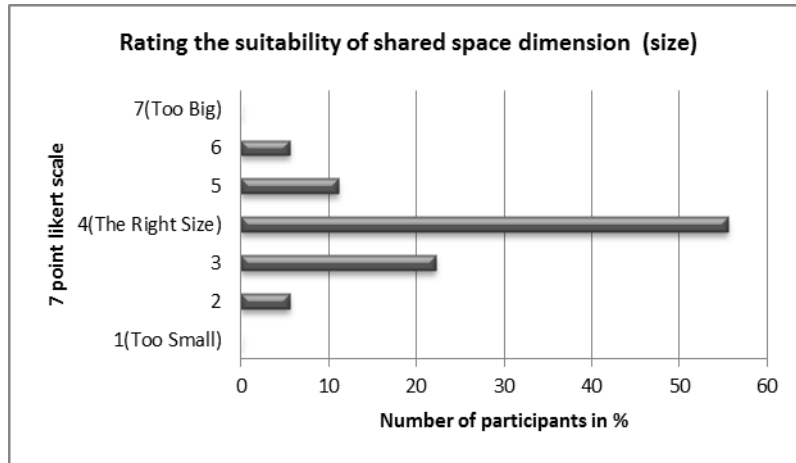

Figure 6-14: Suitability rate for the size of shared space

Participants brought some reasons why the shared individual space can create problem. For each reason we mentioned some points from observation and user’s answers and we indicated how each aspect impact on working condition and collaboration. The result has been summarized in Table 6-11.

The reasons for the need of bigger shared space	Some points from users comments	Impact on Collaboration or working condition
Resolution problem and need for enlarging the documents	The problem of resolution which come back to the projector resolution and image document resolution force the users to enlarge the documents to be able to read. Hence actual size wasn’t appropriate. With a better resolution the actual size could be fine.	The problem hinder the working condition, also will cause problem for communication via artifact.
Need for representing several documents with big size at the same time in shared space	Usually users wanted to have at least 3 documents on the table in the same time and the size of the shared space was not appropriate when documents were large.	The problem hinders the working condition. Also will cause problem for communication via artifact.

Table 6-11: The result of analyzing the impact of the size of the shared space on collaboration and working condition

16% of participant found that the individual space has the right size and 74% believed that it’s smaller than the appropriate size and 10 % believed that it is bigger than appropriate size (Figure 6-15).

Participants brought some reasons why the small individual space can create problem. For each reason we mentioned some points from observation and user’s answers and we indicated how each aspect impact on working condition and collaboration. The result has been summarized in Table 6-12.

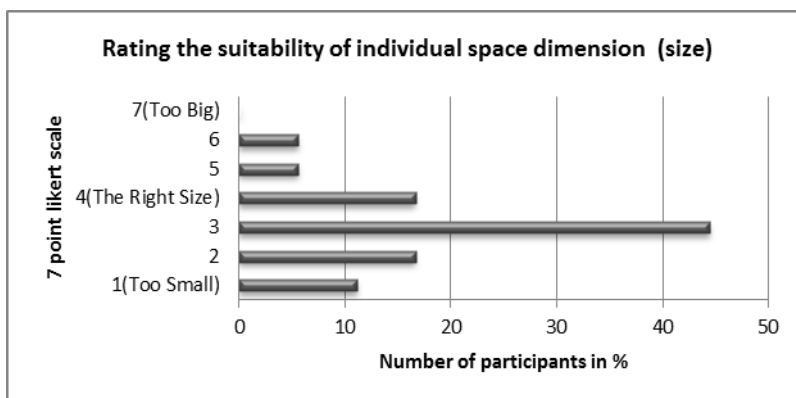

Figure 6-15: Suitability rate for the size of individual space

The reasons for the need of bigger individual space	Some points from users comments	Impact on Collaboration or working condition
Resolution problem and need for enlarging the documents	Same as shared space resolution was the problem for readability of the documents.	The problem hinders the working condition.
Difficulty of manipulation of the files	The size was small to be able to easily manipulate the documents in order to organize and see correctly the content.	The problem hinders the working condition.

**Table 6-12: The result of analyzing the impact of the size of the individual space on collaboration and working condition**

- **Result: The scaling functionality improve the individual and group activity and consequently on collaboration by making it possible to : display main document under discussion on big size and keep the focus attention of the group on one document, help for organization of documents, better seeing the detail of documents and managing to display several documents at the same time in shared space**

This result has been derived from answering the question Q2. All participants found the scaling functionality useful or highly useful (100%) and most of the participants agreed that this functionality is extremely useful (61%) (See Figure 6-16). They found this function useful generally for four main reasons.

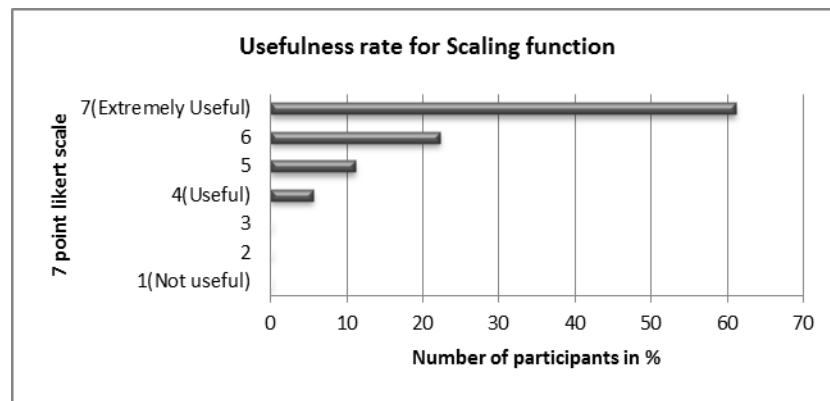

**Figure 6-16: Usefulness rate for scaling functionality**

For each reason we mentioned some points from observation and user’s answers and we indicated for each aspect how this functionality helps to improve collaboration or working condition. The result is summarized in Table 6-13.

What makes scaling function useful	Some points from users comments	How it helps to improve Collaboration or working condition
Display main document under discussion on big size and keep the focus attention of the group on one document	Enlarging the document under discussion help for focus attention of the group on one document hence they can focus easier on the current document, hide other documents, permit to diminish and tidy the remaining or already used document.	Enhancing the focus attention of the group improve the collaboration
Organization of documents	It helps for organizing the documents; this is really helpful when there are lots of documents on the workspace.	Organization of documents helps to find the required information faster. Hence avoid time lost for finding the required information. Consequently by decreasing the time of certain activities and actions. It improves the performance and working condition.
Better seeing the detail of documents	Zooming is very helpful when pictures are small originally. Going through the details of the document is easy with scaling. Given the	Better seeing the detail, better transformation of the information and data which cannot be

	resolution of the projection, the scaling feature is a necessity for actually reading the documents. Plus, even in normal cases with proper projection resolution it is highly useful for making the best of the available workspace (since each document can be reduced to its required thumbnail size at that particular point of the meeting).	seen without zooming. It improves the working condition for individuals and group.
Managing to display several documents at the same time in shared space	It's useful when it is required to visualize several documents at the same time for the purpose of the comparison. Hence by scaling documents user can manage the appropriate visualization of several documents	This will facilitate exchanging data and information which can be found in different documents and better management of discussion which need several documents. Hence it improves working condition for individuals and group.

**Table 6-13: The result of analyzing the impact of scaling functionality on collaboration and working condition**

▪ **Result: The similarity and difference between paper-based design review meeting and MT-DT design review meeting**

This result has been derived from answering the question Q3. Based on direct observation of experiments and analyzing the raw corpus streaming video files, we compared the paper based design review meeting with MT-DT usage in design review meeting. We specified similarities and differences of the two collaborative environments respect to participants and group behaviors (Table 6-14).

Specifications	Project review around the table with physical material (printed documents)	Design review by MT-DT
Physical resource in room	Table and chairs	Multi-touch table and chairs
Artifacts	Printed documents(2D) and physical mockups	Digital documents and digital mockups (2D and 3D)
Documentation of discussion	each expert can have his/her own notebook for documenting discussion	Documentation can be down with software (MT-PR) and each experts
Shared space	The center of the table used as shared space for sharing documents	The center of multi-touch table used as shared space for sharing documents
Individual space	Users naturally used the area in front of them as individual space	The individual space has been defined in front of the each user
Private Space	Laptop, tablet, note book used as private space	Laptop, tablet, note book used as private space
Users accessibility to shared space and shared documents	Accessible for all experts	Accessible for all experts
Manipulating documents / level of manipulation	User have tangible interaction with artifacts	Comparing to other technologies multi-touch device provide more natural interaction with digital content
Ability to create link between artifacts	Hardly (staples, paper clips...)	Possible to create link between digital documents (2D and 3D) by each expert
Configuration	Face to face , around the table	Face to face, around the table
Communication	All combination of the communication is possible in this setup , user easily can communicate via the facial expression, hand and body gestures, by voice and via artifacts and any combinations of these	All combination of the communication is possible in this setup , user easily can communicate via the facial expression, hand and body gestures, by voice and via artifacts and any combinations of these
Annotation on documents	Each person can put annotation to the documents, user should take the document to put in a position to be able to write the note, its hard that two person put the annotation on document at the same time. All annotations on shared artifacts are public	Each person can put annotation to the documents, user doesn't need to take the document to put in a position to be able to write the note and several users simultaneously can put annotation on the same artifact. All the notes and annotations users put in shared space are public and note and annotation they write in their individual space is personal.
Creating the copy of shared documents	Creating copy of documents require printer, scanner or simply users can take the picture with their smartphone	Users can easily create a copy of document and put it in their individual space, then the document will be available in his repository via MT-DT server
Discussion on several documents at the same time	User put the several documents side by side to do comparison or to associate the information	User put the several documents side by side to do comparison or to associate the information

**Table 6-14: Comparison between MT-DT and paper based design review meeting**

- **Result: MT-DT requires improvement in Multi-touch table characteristics and specifications**

This result has been derived from answering the question Q4. Based on the results obtained from hypothesis validation and answering to previous questions, we found out that the major difficulty that we had with this collaborative environment was the technology limitation:

- The next generation of the MT-DT should use multi-touch table with high visual resolution and high touch precision.
- Using a multi-touch table with the capability of 3D visualization will enhance the intuitiveness of the 3D model visualization.
- Using another touch technology may require create changes in the way users interact with the MT-DT.
- To provide the flexible management of the workspace, our suggestion is to have dynamic individual space, where users will be able to change the size of their individual space.
- Multi-modal user interaction as an interaction solution could be considered in the next generations

## **6.5 |Step E|: Adding the new case to the case base**

When the results of evaluation justify the proposed solution, we can finish the process of development. The experienced case can be added to the case base as a new case and the knowledge obtained from this process can be added to the knowledge base.

Depending on the collaborative situation, the type of collaborative environment and evaluation process, the conclusion may be generalizable. However, most of the time, because of the complexity of the domain and different elements which are involved in evaluation process and impact on it, is not easy to generalize the experience obtained from evaluation process. For the type of which is not generic recording the evaluation condition is necessary. This data will be usable in evaluating similar collaborative environment or applicable for similar collaborative situation. The obtained from evaluation required to accompany with SyCoW and SyCoE and SyCoEE instances for the target situation. During development process it is necessary to document the element of these three models for target situation. Knowing in which condition an evolution has been done is an important data of evaluation gained from experiments. This will help people to use the result of the evaluations in appropriate way.

## **6.6 Conclusion and Discussion**

In this chapter we followed the process for evaluation of collaborative environment. During this process we used different sources of knowledge in order to make decision on each step. We used SyCoEE Concept Maps as general framework during the evaluation process. Based on the proposed process, we evaluated the MT-DT solution. We identified a list of hypothesis and questions as evaluation objectives and we brought our reasons for each objective. This list has been identified based on the existing scientific knowledge and practices about evaluation and the experienced knowledge from evaluation aspect of similar cases. Through a series of experiments, we answered identified questions and we checked the validity of our hypothesis. SyCoEE Concept Maps was used to justify the experiments and SyCoW

Concept Maps for the justification of the scenario. The SyCoW, SyCoE and SyCoEE Concept Maps are used as a general framework to analyze the existing cases in order to decide which-existing case can be reused for a new context.

## Part-II: Conclusion

In Part-II of this thesis, we proposed a process for selection/ development of synchronous collaborative environments. Through this process we demonstrated how models of Part-I helped us through this process.

Our target collaborative situation was the design review meeting among small group of people. Our objective was to select/develop an appropriate collaborative environment to support our target situation. For this purpose, we followed the proposed process. Through this process, we designed, developed and evaluated a new SyCoE for design review meeting, named MT-DT. We used Multi-touch table as shared display in this SyCoE and we developed a software application for multi-touch table to support the design review activities.

MT-DT mimics the traditional, collaborative environment specifications around the table. Hence it keeps the main advantages of this traditional collaborative environment and provides additional advantages which include:

- Simultaneous 2D and 3D digital artifact visualization and tangible way of interaction with these artifacts,
- Capability to make rapid copy of the presented artifacts,
- Better organization of the documents and changing the size of the artifacts,
- Explicit individual and shared space definition,
- Capability of creating link between artifacts,
- Capability of simultaneous annotation making on the artifacts and enhancing the awareness about this action,
- Capability of putting individual or shared annotation on the artifact
- Semi-automatic documentation of design review meeting for individual users and for group.

The result of evaluation confirmed the usability and the added value of the MT-DT software.

# Discussion, Conclusion, Future Work and Perspectives

Various collaborative environments and prototypes have been developed by researchers and companies to support specific collaborative situation. However it's not clear which type of collaborative environment is suitable for which type of synchronous collaborative work. The design and development of collaborative environment is difficult due to the multidisciplinary knowledge required for that and the complexity of the problem domain.

The collaborative development process consist several activities such as collaborative situation analysis, requirement specifications of collaborative environment, design of collaborative environment, evaluating collaborative environment, implementing collaborative environment. All of these activities require and generate technical as well as contextual knowledge for development of collaborative environment. On the other hand, technology is evolving and brings the potential improvements and changes on the way people work.

The outcome of research is new knowledge [Khosrojerdi et al. 2014]. Every year researchers create new knowledge about collaboration, by studying and analyzing how people work together in specific collaborative situation, by introducing new collaborative environment, by using an existing collaborative environment in new situation and context, by making improvement in existing solutions or by evaluating the solution from specific perspective. However, we still have the lack of the big picture about this knowledge and the lack of suitable way to access to this knowledge. Mostly this knowledge is embedded in articles in text format, which is not presented in formal way and consequently is not easily accessible. Despite the relatively huge amount of research in collaborative tools and environments and their related issues, there is no established approach, methodology or framework that help to structure and reuse of experience created in this domain by different researchers, developers and users of such tools.

Synchronous collaborative situation experience is issued from main sub-domains: synchronous collaborative work which specifies the problem domain, synchronous collaborative environment which represents the solution domain and synchronous collaborative environment evaluation which specify the evaluation of whole or part of the proposed solution for the specified problem. Hence capitalizing the general and specific information and experience about problem domain, solution domain and evaluation of solution domain is necessary to support the process of development/selection of synchronous collaborative environment. Also the information gained from previous experiences is a potential source to support this process. Some experience obtained and used during this process is application-generic and can be applied in several applications independently of specific collaborative situation characteristics. But some experience is application-specific and is related to particular collaborative situation. Hence for this type of experience it is necessary to capitalize it jointly with the characteristic of corresponding collaborative situation.

This thesis was an effort to deal with the challenges mentioned above. In order to facilitate the development or selection of appropriate supporting tool and environment for synchronous collaborative work and developing a successful collaborative environment, In part-I of this thesis, we investigate on providing more structured view on 3 main aspects of collaboration:

1) Understanding and knowledge of collaborative work context (in chapter 1 we developed SyCoW Concept Maps) SyCoW covers the factors and relationships between the factors that have influence on specifications and requirements of collaborative environment or on collaboration itself.

2) Understanding and knowledge of potential option and solution for collaborative tools and environment and their components (in chapter 2 we developed SyCoE Concept Maps),

3) Understanding and knowledge about different aspects that required to be considered in evaluation of collaborative environment (in chapter 3 we developed SyCoEE Concept Maps).

SyCoW, SyCoE and SyCoEE structure and reports the existing experience found in literature review on multiple domains.

In Part-II of this thesis, we investigate to formulate the collaborative environment development process, and how this process can be supported with the models proposed in Part-I.

We used SyCoW in different ways during this process. At the first step of the process, we use SyCoW model to clarify the current specifications of the target collaborative situation ('Collaboration as it is') and requirements of desired collaborative environment to support that situation. It helps in a better understanding of the collaborative situation and consequently in the tool specification. We also used SyCoW in order to analyses the experienced cases. SyCoW conceptualize the characteristics and specifications of synchronous collaborative work. By finding the cases which have similar SyCoW we may be able to use or adapt their solution for our situation. Thus it helps to reuse the knowledge obtained from already existing collaborative tools. Also, during Evaluation process, we used SyCoW to make decision about the evaluation aspect. Besides, SyCoW helped us in designing the experiments.

SyCoE facilitate finding the justifications for collaborative environments and to reuse the existing knowledge when designing a new environment for a new situation. During the process, we used SyCoEE in order to analyses the existing solution. SyCoE also helped us during design and development of collaborative environment as a guide line for designing the solution.

SyCoEE helps evaluator to evaluate how well a given collaborative environment supports their collaborative situation. Also SyCoEE helps in analyzing the solution evaluation part of the experienced cases.

The validity of the proposed process and usability of the proposed models has been demonstrated through the development of a new environment for design review meeting among small group of participants. Based on the proposed process we developed a new environment for design review meeting which named MT-DT. Along this process the proposed models and different knowledge in the domain helped us in our decisions. MT-DT consists of a multi-touch table with specific 3D software application which supports collaborative design review activities. The evaluation of MT-DT confirmed its usability and provided the arguments for the decision which we made during design and development process.

The SyCoW, SyCoE and SyCoEE models are issued from a literature review which is highly interdisciplinary and from personal experience. The models by themselves are not perfect and would need to be refined and checked on many use cases and by a really collective process.

Anyhow they are expected to support the overall process and provide a first formalism to initiate the research. It is also our conviction that these models could be used for a real knowledge management system. We already started to work in this direction and highlight this as a perspective in the next section.



## Future Work and Perspectives

The several research perspectives have been identified for this research. As a summary they consist of:

- Retrieving the information about existing collaborative environment based on SyCoE and SyCoW models.
- Formalizing the knowledge has been obtained from evaluation of specific aspect of specific collaborative environment in specific situation, based on SyCoW, SyCoE and SyCoEE models.
- Implementing the knowledge-based tool for management and reuse of synchronous collaborative environment knowledge.

For future work we proposed an approach based on Case-Based Reasoning (CBR) in order to capture and reuse the specific knowledge of previously experienced, concrete problem situations. The design of collaborative environment and finding collaborative environment for specific collaborative work is type of ill-defined problem. Cases are useful in interpreting the ill-defined problems [Kolodner 2014]. The information gained from previous experiences (cases or instances) can be an important source of knowledge to support collaborative environment selection/development process. Reference to previous similar situations is often necessary to deal with the complexities of novel situations [Kolodner 2014]. The idea is that it is possible to find a similar past case and reuse the whole or part of solution component in our target collaborative situation. This provides the ability to match new problems to “cases” from a historical database and then adapting successful solutions component from the past to target collaborative situation.

CBR solves a new problem by referring to a previous similar situation and reusing information and knowledge of that situation [Rhem 2005], [Aamodt & Plaza 1994]. Case-based reasoning is known solution for knowledge capture and reuse in software engineering domain [Althoff & Wilke 1997], [Smyth et al. 2001], [Shepperd 2003]. The concept of case based reasoning is founded on the idea of using explicit, documented experiences to solve new problems [Mansar et al. 2003]. Reasoning by reusing past cases is a powerful and frequently applied way to solve problems for humans. CBR also handles failed cases [Shepperd 2003], [Richter & Weber 2013], which enables to identify solutions that have the potential to be failed and help to avoid the mistakes.

The advantage of the cases is that they chunk together knowledge that belong together [Kolodner 2014]. In addition, they capture knowledge that might be too hard to capture in the form of general knowledge. Cases can represent the type of knowledge which makes sense in the context and is not generalizable. It is usually easier to learn by retaining a concrete collaborative situation experience than to generalize from it.

In our approach, a case represents specific knowledge tied to specific collaborative situation. This knowledge at an operational level, make explicit: what was the specification of collaborative work? What type of collaborative environment has been used to support the collaboration? What were the functionalities and characteristics of that collaborative environment? How successful was the collaborative environment for that situation? How the collaborative environment evaluation has been done? What results have been obtained from the evaluation? How specific solution component has been applied in specific collaborative environment and what were the problem domain specifications?

In order to interpret the existing cases appropriately, it is necessary to provide a structure representation of its specifications. We used the three models, SyCoW, SyCoE and SyCoEE, in order to code the cases in a meaningful way.

The way that we are representing the cases make it possible to have easy access to different parts of the cases. The proposed structures of the data make it possible to accessing parts of cases independently of the whole case. Also the potential solution component can be added to data based even we may not have any cases in case based which used that solution component. We can consider pieces of a case as cases themselves. For example the software tool in collaborative environment is a case itself. Links between components of the model preserve the structure of the reasoning.

We define the cases for our application as the aggregation of three parts (Figure 6-17):

- **Problem/situation description:** the state of the world at the time the case was happening; i.e. synchronous collaborative work which has been characterized through SyCoW.
- **Solutions:** the stated or derived solution to the problem specified in the problem description; i.e. synchronous collaborative environment which has been characterized through SyCoE.
- **Solution Evaluation:** the result of evaluation of solutions and the way evaluation has been carried out and the resulting state of the world when the solution was applied to the situation; i.e. synchronous collaborative environment evaluation which has been characterized through SyCoEE.

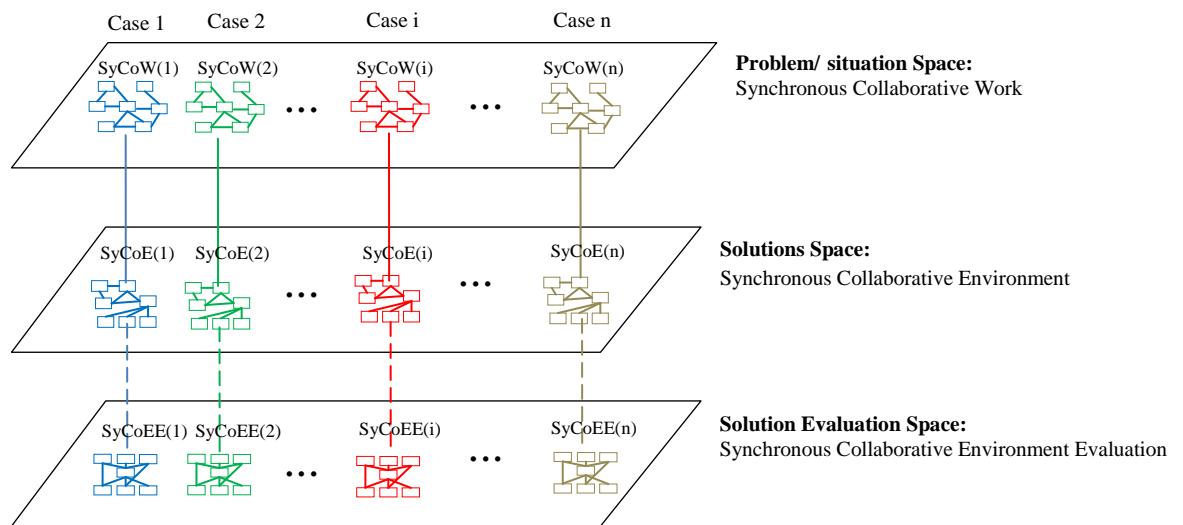

Figure 6-17: A case has been built by three components of problem, solution and solution evaluation and outcomes

In proposed approach, existing solutions for synchronous collaborative environment are used as inspiration for selection/ re-design of them for new collaborative working situation. This specific knowledge provides more easily usable advice than general and abstract knowledge.

At the end, we are proposing KBT-SyCoE, a software tool for management and reuse of synchronous collaborative environment knowledge. These tools have several modules which provide the flexible repository of knowledge. The proposed tool will manage both general and specific knowledge in the form

of concept map, case based reasoning, data base, rule based and relational tables. Figure 6-18 demonstrate the architecture of the proposed tool.

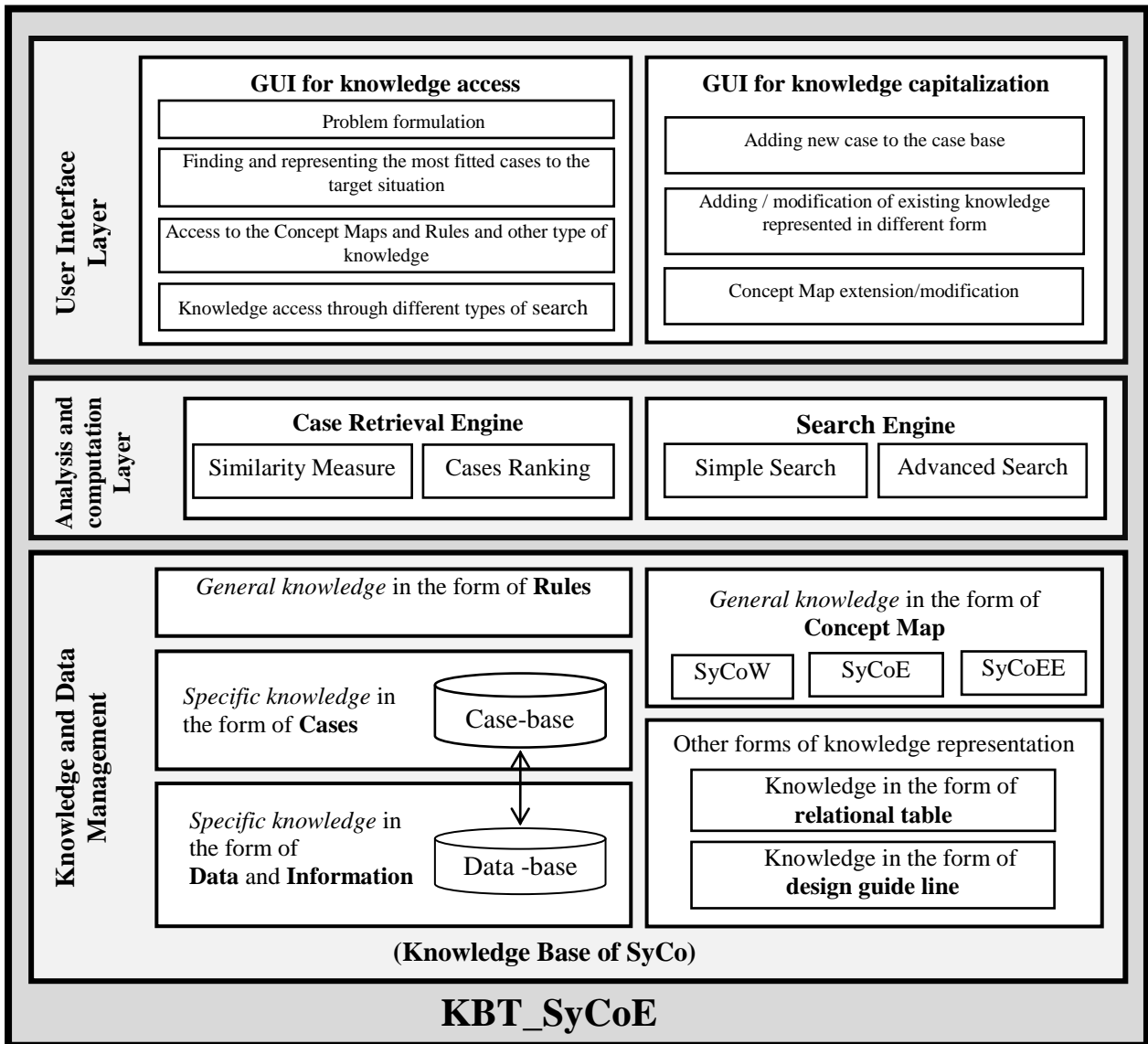

Figure 6-18: The architecture of KBT\_SyCoE (Knowledge-based Tool for Management and Reuse of (Synchronous Collaborative Environment Knowledge))

The first prototype of this tool has been implemented under TEEXMA® [Bassetti © 2015] a technical knowledge management platform. TEEXMA® provides a collaborative flexible interface for capitalizing the data, information and knowledge in the form of objects, the relation between objects and instances [Rachedi et al. 2010]. Changing or extension of the knowledge and data structure includes adding deleting, relocating or modifying objects and their characteristics are relatively easy in TEEXMA®.

TEEXMA® provides a search engine and comparisons criteria by capability of adding the weight to the criteria. Also we have the capacity of using the web services outside TEEXMA. Hence it was an appropriate and simple option for implementing the KBT-SyCoE prototype.

In administrative mode of TEEXMA® we create the data, information and cases structure based on the SyCoW, SyCoE and SyCoEE models.

Cases can come from several different sources: textbooks, articles, human experts, working environments and companies, etc. The case base evolves over time. We will be able to capitalize the learning from new experiences and add these cases to the knowledge base.

# Résumé en Français

## Introduction

La complexité de développement d'environnement collaboratif pour la conception collaborative de produits manufacturés motive le travail effectué dans cette thèse.

Le processus de développement d'un environnement de collaboration consiste en un procédé de niveau macro et plusieurs processus au niveau micro qui se composent de beaucoup d'activités, tâches et de prise de décision pour sa conception, sa mise en œuvre et son évaluation.

Par conséquent, l'objectif général de cette thèse est d'améliorer le processus de développement de l'environnement de collaboration, en fournissant une méthode structurée et un outil support à cette méthode. La méthode proposée nécessite un processus de structuration des informations et de réutilisation d'expériences existantes par les développeurs pour élaborer les solutions potentielles et sélectionner une solution guidés par les informations et expériences existantes. L'amélioration du processus est obtenue en rendant les expériences et les solutions réutilisables facilement disponibles. Pour atteindre cet objectif, il est important non seulement de capturer et de partager des éléments d'expériences et les informations générales au domaine, mais aussi des éléments d'expérience qui comprend: des solutions d'environnements de collaboration déjà développées, la spécification de la situation de collaboration cible, les justifications qui ont conduit à ces solutions, leurs raisons d'être, etc.

Une partie importante de ces informations concernent la spécification du problème et de la solution choisie, en termes de composants de l'environnement collaboratif et de solution logicielle utilisée pour cet environnement. Il est clair que les décisions qui conduisent à une solution spécifique, sont des ingrédients importants des processus de développement. En outre, une information importante requise et produite dans ce processus mesure l'impact d'une solution sur la collaboration, la performance des personnes et la réussite de l'environnement collaboratif.

Nous avons tout d'abord identifié les types d'informations que nous voulions formaliser pour un usage ultérieur. Nous différencions les applications génériques, qui s'appliquent à plusieurs contextes d'usage indépendamment des caractéristiques spécifiques de la situation de collaboration, et les applications spécifiques dédiées à une activité de collaboration particulière dédié à un contexte très local. Il est nécessaire de modéliser les situations de collaboration afin d'être en mesure de réutiliser les solutions apportées dans des applications similaires dépendant d'un certain niveau de précision. Nous avons identifiés cinq sous domaines d'expertise autour de la collaboration synchrone:

1) la nature du travail collaboratif synchrone, des exigences, des concepts et de la relation entre ces concepts;

2) les outils, aussi appelés environnement. Collaboratif synchrone, leurs spécifications, leurs fonctionnalités, leurs concepts et les relations entre ces concepts;

3) les modes d'évaluation des environnements collaboratifs, de la spécification aux résultats de l'évaluation;

4) les règles définies entre les concepts traversent ces trois domaines principaux.

5) la modélisation de l'expérience acquise via des cas d'études existants;

Dans un premier temps, partie 1 de cette thèse, nous étudions la formulation du premier, deuxième et troisième domaine sous la forme de Schémas Conceptuels. Investigation dans les quatrième et cinquième types de connaissances a été définie comme perspective d'avenir de cette thèse.

Cette thèse aborde la question suivante: comment formaliser une connaissance réutilisable pour sélectionner ou de développer un environnement de collaboratif qui correspond à une situation de collaboration cible? Cette question impose:

- la compréhension des situations de collaboration et de préciser ses éléments,
- l'analyse des solutions de collaboration existants et leur potentiel à fournir de nouvelles solutions pour la situation de collaboration ciblent,
- la sélection de la meilleure technologie en fonction des besoins,
- la conception de logiciel approprié pour le matériel choisi,
- la mise en œuvre de prototypes.
- et finalement, l'évaluation de l'impact de ces prototypes sur le travail collaboratif.

Plusieurs sous-questions sont soulevées dans le cadre de cette recherche:

1- Comment formaliser l'information requise et produite au cours du développement de l'environnement de collaboration?

1.1- Quelles représentation formelle et structure du contexte et des concepts de travail collaboratif utilisable par les chercheurs et les développeurs logiciels pour analyser la spécification d'un travail collaboratif cible?

1.2- Quelles représentation formelle et structure d'un environnement collaboratif, les concepts et les spécifications utilisables par les chercheurs et développeurs logiciels pour analyser la spécification de l'environnement ou les composants d'une solution de collaboration existante d'un environnement collaboratif?

1.3- Comment formaliser l'évaluation de l'environnement et des concepts, formalisation utilisable par les chercheurs et développeurs logiciels pour les concevoir et les mener?

1.4- Comment capitaliser les résultats de chaque étude pour tirer profit des expériences acquises et les réutiliser ?

2- Comment organiser la réutilisation de l'information formalisée?

## **Partie-I: Modèles support au développement d'environnement de conception collaborative**

Les informations acquises et utilisées lors de processus de développement d'un environnement collaboratif sont en partie documentées dans des articles de recherche qui ont tenté d'offrir des réponses à ce processus de conception. A notre connaissance, il n'y a pas de cadre ou d'approche de capitalisation

formelle de ces informations. Dès lors, l'accès à ces informations n'est pas facile. Le domaine de la collaboration Synchronique consiste en de trois principaux sous-domaines: 1) 'le travail collaboratif synchronique' qui spécifie le domaine de problème, 2) 'l'environnement collaboratif synchronique' qui présente le domaine de la solution et 3) 'l'évaluation de l'environnement collaboratif synchronique' qui évalue tout ou une partie de la solution proposée pour le problème spécifique.

Ainsi la formalisation des spécifications, de l'environnement solution et du processus d'évaluation de la solution sont nécessaires pour soutenir le processus de développement / sélection des environnements collaboratif synchronique. Aussi les informations obtenues à partir des expériences précédentes est un soutien potentielle à ce processus.

Dans cette première partie, nous investiguons la modélisation des trois domaines identifiés. Le Chapitre 1 présente un schéma conceptuel des spécifications du travail collaboratif synchronique (SyCoW). Le Chapitre 2 présente un schéma conceptuel du domaine de la solution, l'environnement collaboratif synchronique(SyCoE). Le Chapitre 3 représente un schéma conceptuel du domaine de l'évaluation de la solution, évaluation de l'environnement collaboratif synchronique (SyCoEE).

## **Méthodologie pour développement de SyCoW, SyCoE et SyCoEE**

Une variété de systèmes de représentation graphique, impliquant généralement des noeuds et des liens, ont été créés pour faciliter le partage de modèles formalisés [Coffey et al. De 2006]. Coffey et al. [Coffey et al. De 2006] affirment que le Schéma Conceptuel est la représentation la plus générale et globale pour la représentation des connaissances. Par conséquent, nous avons utilisé le Schéma Conceptuel pour fournir un modèle qui conceptualise les caractéristiques et les spécifications du domaine des spécifications, de la solution et l'évaluation de la solution. Les Schéma Conceptuels sont un moyen efficace pour représenter visuellement des concepts manipulés dans un domaine [Coffey et al. 2,002], [Cañas et al. 2005], [Coffey et al. 2006], [Leake & Valerio 2006]. Il fournit un outil graphique qui permet à toute personne d'exprimer leur concept sous une forme qui est facilement comprise par les autres [Cañas et al. 2005].

Une Schéma Conceptuel est un type de diagramme qui visualise des concepts comme des nœuds et les relations entre eux via des liens. Les concepts sont les éléments qui caractérisent un domaine (par exemple, des objets physiques, des idées, des personnes et organisations). Chaque concept est décrit par ses relations avec d'autres concepts dans le domaine et par ses attributs et les valeurs. Les relations représentent la manière dont les objets sont liés les uns aux autres. Chaque relation peut être associée à une sémantique au travers d'un ou plusieurs mots [Coffey et al. 2,002], [Cañas et al. 2005], [Cañas & Novak 2009]. Chaque paire de concepts, ainsi que leur liaison, peut être lue comme une déclaration individuelle ou une proposition qui a du sens [Cañas et al. 2005]. Comme proposé par [Rhem 2005] nous avons décidé d'utiliser UML pour notre modélisation. UML est un standard, est largement diffusé et a une large acceptation dans les milieux universitaires et non universitaires. Dans notre approche, nous avons décidé de commencer à capturer les concepts et les relations existantes dans le domaine cible, les diagrammes de classes UML était donc une option appropriée à cet effet. Comme proposé par Novak et Cañas [Novak et Cañas 2006], le point de départ pour la construction d'un Schéma Conceptuel est la question centrale. Pour chaque modèle que nous avons développé dans cette thèse, nous avons défini les questions centrales:

- **SyCoW:** Quelles sont les caractéristiques d'un travail collaboratif synchrone qui ont un impact sur la collaboration sur les exigences de l'environnement de collaboration appropriée pour soutenir la collaboration? Quels sont les concepts décrivant une situation de travail collaboratif synchrone?
- **SyCoE:** Quelles sont les spécifications et les caractéristiques d'un environnement collaboratif synchrone? Quels sont les concepts décrivant un environnement collaboratif synchrone et les composants de la solution?
- **SyCoEE:** Quelles sont les caractéristiques et les spécifications de l'évaluation de l'environnement collaboratif synchrone? Quels sont les concepts décrivant l'évaluation de l'environnement collaboratif synchrone?

L'expérience et les connaissances ont été collectées à partir de la littérature dans des domaines divers et puis nous les avons formalisés pour les rendre utilisables. Afin de développer SyCoW, SyCoE et SyCoEE nous avons synthétisé des classifications existantes et exprimées dans diverses publications. Pendant le développement de SyCoW, SyCoE et SyCoEE, un objectif est d'assurer que les concepts identifiés sont suffisamment complets, corrects, clairs, et brefs pour les rendre utiles et autant que faire se peut univoque.

## **Chapitre 1 : SyCoW : un Modèle conceptuel du Travail**

### **Collaboratif Synchrone**

Les situations de travail collaboratif synchrones ont un certain nombre de caractéristiques qui doivent être prises en compte lors de la conception d'un outil support. Plusieurs facteurs peuvent influencer sur la facilité d'utilisation, l'utilité et l'acceptation des environnements collaboratifs. Ainsi l'examen des caractéristiques de la collaboration est essentiel pour le succès de l'outil de collaboration. Ici, les questions sont: Ce qui rend une situation de collaboration différente des autres? Pourquoi un environnement de collaboration est une réussite pour certaines situations mais impropre ou rejetée dans les autres situations? Une meilleure compréhension des situations de collaboration peut conduire à une meilleure sélection d'un environnement collaboratif.

Une revue de la littérature permet d'identifier les classifications de collaboration. Les classifications sont souvent trop abstraites pour être opérationnelle pour la conception de systèmes de soutien de logiciels pour des cas spécifiques de collaboration synchrone. Les modèles conceptuels entités/rerelations existants sont plus des taxonomies où les relations entre concepts sont faibles ont exprimées. A notre connaissance, aucun des travaux antérieurs ne m'a mis l'accent sur le travail collaboratif synchrone. Ceci nous motive pour modéliser les situations de travail collaboratif synchrone en conceptualisant explicitement ce domaine. En d'autres termes pour organiser les concepts et leurs relations pour aller en delà des traditionnelles taxonomies.

Ce chapitre est la formulation des concepts généraux caractérisant le travail collaboratif synchrone à travers un Schéma Conceptuel développé par un diagramme de classes UML. Le modèle proposé, nommé SyCoW, fournit une vue structurée du travail collaboratif synchrone. Il structure les concepts existants trouvé dans revue de littérature sur plusieurs domaines. Une spécialisation de SyCoW est proposée pour le domaine de la conception et le développement de produits qui a démontré l'extensibilité de ce modèle.



## **Le modèle général de SyCoW :**

Le schéma conceptuel (Figure 6-19) présente les éléments caractéristiques d'un travail collaboratif synchrone.

Une situation de collaboration est l'agrégation de participants. En d'autres mots dans SyCoW agrège, au moins deux participants qui collaborent. Un ensemble de participants peut créer un groupe, un groupe est une collection de plus de deux participants qui travaillent ensemble pour atteindre un ensemble d'objectifs communs. Donc une instance SyCoW doit avoir près d'un groupe qui lui-même peut être l'agrégation de plusieurs groupes. Un groupe a une taille; la taille du groupe est le nombre de participants qui sont dans le même groupe. L'histoire des membres du groupe est un élément qui affecte la collaboration.

Un participant est cotisé en un lieu et un participant peut être présent dans un seul lieu physique. Les participants peuvent être situés en différents lieux géographiques [Maier et al. 2005]. Ainsi le groupe est associée plusieurs lieux. Si tous les membres du groupe (participants au même groupe) sont au même endroit, le groupe a un seul lieu. Si tous les participants sont dans le même lieu, le type de collaboration est «co-localisée». Si le lieu de chaque participant est différent la collaboration est distribuée. Les conditions où deux participants sont co-localisés et d'autres sont distribués sont nommées collaborations mixtes.

Groupe et participant peut avoir un ou plusieurs rôles au cours d'une réunion. Les rôles impactent l'action du groupe et des participants.

Une collaboration a un objectif. Chaque objectif est l'agrégation des sous-objectifs différents. Les groupes et les participants ont également un ou plusieurs objectifs. Leur objectif peut être le même que l'objectif commun, mais il peut aussi être différent. Groupe et participants ont parfois des objectifs contradictoires.

Les objectifs sont atteints via les tâches et activités des participants. L'activité des participants fait partie de la tâche. En d'autres termes, "les activités représentent l'unité d'interaction et de communication de base, qui, par combinaison permettra d'accomplir une tâche" [Salvador et al. 1,996]. Camolesi & Martins [Camolesi & Martins 2006] définissent l'activité comme un élément d'exécution qui peut être effectuée par un seul acteur ou par un groupe d'acteurs. L'activité est une quantité mesurable de travail effectuée pour convertir les données entrantes en données sortantes. Une meilleure compréhension de l'activité de l'espace de travail pourrait également conduire à des idées sur l'amélioration de la conception de l'outil de support. L'activité est conduite à travers des séries d'actions par rapport à l'objectif ou de l'objet de l'activité [BØDKER 1990]. Les actions sont les moyens de production de l'activité [Tang & Leifer 1,988]. Les participants effectuent une série d'actions qui, généralement, vise à atteindre un objectif commun [Pallotta et al. 2007].

Les interactions sont des relations dynamiques qui se produisent entre les acteurs (-humains non humain ou) et des objets dans les environnements collaboratifs [Camolesi & Martins de 2006]. Dans un modèle SyCoW nous nous sommes concentrés sur l'interaction comme une sorte d'action qui se produit entre l'homme et l'homme ou entre humains et artefacts. L'interaction humaine avec l'ordinateur est un type d'interaction humaine avec l'artefact. Les interactions humaines utilisent la parole, l'écriture, les gestes, etc. La communication et l'interaction humaine/artefact peut être simultanée aux interactions humaines.

Une session collaborative agrège des données d'entrée. Les entrées interviennent à tout moment pendant le travail collaboratif. Les entrées sont identifiées avant la session de collaboration ou à la volée. Les participants utilisent ces données pour réaliser leurs activités et créer les données de sorties du travail collaboratif.

Les données de sorties sont prévisibles ou non prévisibles en fonction du type d'activité survenant au cours de la session de collaboration. La documentation (compte rendu) de la session de collaboration est aussi une donnée de sortie de la réunion. La sortie est ce qui est livré après la session de collaboration. Le résultat est ce que le projet gagne des sorties. Dans le domaine de la conception des produits, un objectif particulier pourrait être la coordination; la sortie contient des artefacts de conception modifiés des listes de décisions, tout autre résultat dans l'avancement du projet: accords sur les futures actions, tâches assignées, conflits résolus, [Pallotta et al. 2007] sont d'autres résultats obtenus lors d'activité de collaboration.

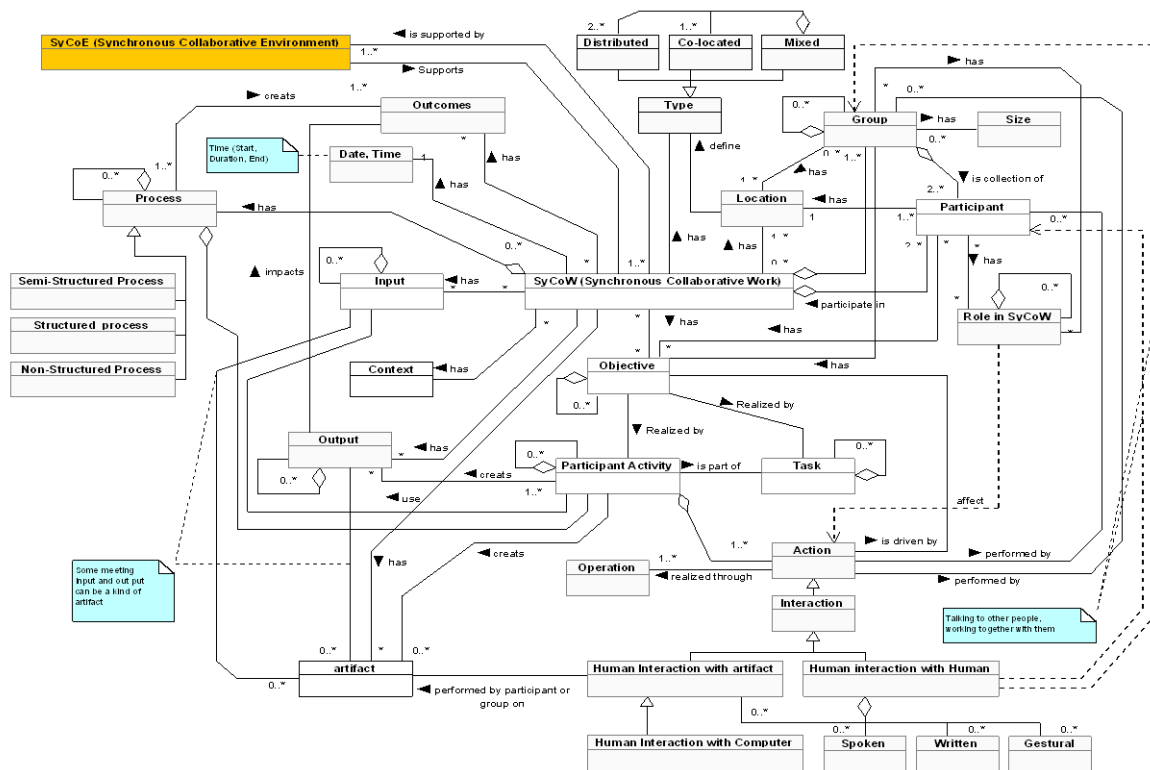

Figure 6-19: Modèle conceptuel du Travail Collaboratif Synchronique (SyCoW)

### Usage de SyCoW :

Ce modèle peut être utilisé de manière différente au cours de la conception et le développement de l'environnement collaboratif :

1. l'analyse de la collaboration ' telle qu'elle est' et la spécification des exigences: le cahier des charges est construit à un stade précoce de l'élaboration d'un outil collaboratif. Il est souvent difficile de définir les limites de l'usage. En raison de l'absence de représentation de la structure du domaine il y a un degré considérable d'incertitude sur la nature et les solutions possibles. Le modèle SyCoW diminue ces difficultés en fournissant une vision plus structurée sur le travail collaboratif synchronique. Il contribue à une

meilleure compréhension de la situation de collaboration et par conséquent dans la spécification de l'outil. En d'autres termes, nous utilisons le modèle SyCoW pour clarifier les spécifications actuelles de la situation collaborative cible («Collaboration comme il est») et les exigences de l'environnement de collaboration souhaitée pour soutenir cette situation.

2. la sélection ou l'adaptation de la solution existante (solutions similaires pour le même problème): SyCoW conceptualise les caractéristiques et les spécifications de travail collaboratif synchrone, donc il sera utile de réutiliser l'expérience acquise à partir des outils de collaboration déjà existants. Il aidera à trouver des situations similaires de collaboration.

3. l'évaluation de l'environnement collaboratif: SyCoW fournit également les fonctions et usages attendus pour les environnements conseils conçus. Ce sont ces fonctions et usages qui doivent être évalués. Si le nombre de participants pour la situation de collaboration cible varie, il faut vérifier l'effet du nombre de participants sur l'efficacité de l'environnement de collaboration. Si le nombre de groupes et leurs distributions sont variables dans la situation cible, une étude comparative de l'effet de répartition des participants dans les différents groupes sera bienvenue. Aussi SyCoW aidera à définir le scénario de conception pour une étude comparative expérimentale.

## **Chapitre 2 : SyCoE Schéma Conceptuel: un Modèle Général de l'Environnement Collaboratif Synchrone**

Différents environnements collaboratifs sont développés par des chercheurs ou des entreprises. Cependant on ne sait pas aisément quel type d'environnement collaboratif est le plus approprié pour un type de travail collaboratif synchrone. D'autre part, la conception et le développement de l'environnement de collaboration est difficile en raison de la connaissance pluridisciplinaire nécessaire pour cela et la complexité des spécifications. SyCoW permet de mieux comprendre le type de situation de collaboration synchrone et ses caractéristiques; dans ce chapitre, nous précisons le type et les caractéristiques d'un environnement collaboratif. Cette compréhension supporte la conception, le développement et la sélection de l'environnement de collaboration appropriée pour un type spécifique de la situation de collaboration. Une revue de la littérature a permis d'identifier que les outils collaboratifs et les technologies ont été caractérisées à partir de nombreux points de vue différents. Des taxonomies offrent un moyen de classer les différents outils de groupware. Même si les méthodes de classification existantes donnent un meilleur aperçu sur l'environnement de collaboration, ils ne sont pas suffisants pour comprendre les différents aspects de l'environnement de collaboration et leurs relations. En d'autres termes, ils sont adaptés lorsque l'accent est mis sur des aspects spécifiques de l'environnement collaboratif. En outre, la facilité d'utilisation de ces classifications est contestée par l'intégration croissante de fonctionnalités dans les outils et environnements de collaboration. Certains systèmes sont tellement compliqués qu'ils ont besoin d'une méthode spécifique pour eux [Weiseth et al classer. 2006], [Penichet et al. 2007]. Les classifications existantes focalisent sur la représentation des caractéristiques ou fonctionnalités d'environnement de collaboration, ce qui empêche de voir les relations entre eux avec d'autres caractéristiques et fonctionnalités limitées.

Différentes théories (cf. chapitre 2, version anglaise) fournissent une base importante pour notre compréhension des caractéristiques des tâches et des environnements collaboratifs. Cependant ces théories

ne fournissent pas des conseils pratiques aux concepteurs, développeurs ou clients lors la sélection ou de la conception d'un environnement de collaboration approprié [Weiseth et al. De 2006]. [Weiseth et al. De 2006] propose une enquête pour faire face à ce défi et ces lacunes; Cependant leur cadre reste abstrait et n'est pas directement utilisable dans la conception et l'évaluation de l'environnement collaboratif. Peu d'études explicitent la façon dont une classification existante peut être utilisée pour concevoir, sélectionner ou évaluer des environnements collaboratifs. En d'autres termes, les cadres ne fournissent pas assez de représentation détaillée des environnements collaboratifs, de leurs caractéristiques et de leurs capacités: ils ne permettent pas une analyse détaillée et l'évaluation de solutions alternatives dans un contexte spécifique. Pour autant aucun modèle structuré soutient le processus de sélection / développement de l'environnement de collaboration synchrone.

Ce chapitre identifie et modélise les composants d'un environnement collaboratif. Ainsi, nous avons proposé un modèle conceptuel nommé SyCoE présenté sous le format UML pour structurer l'information issue de notre revue de la littérature. SyCoE décrit les environnements collaboratifs synchrones potentiels et contribue à une meilleure analyse et à la caractérisation des environnements collaboratifs existants. En outre, il peut être considéré comme un modèle pour guider les concepteurs et les développeurs lors de la construction de nouvel outil support à une situation de collaboration synchrone. Il facilitera la justification des environnements collaboratifs et leur réutilisation lors de la conception d'un nouvel environnement pour une nouvelle situation de collaboration cible. En caractérisant une situation de collaboration avec SyCoW et en caractérisant un environnement de collaboration dédié à cette situation de collaboration en utilisant SyCoE, nous caractérisons le domaine du problème/spécifications et nous le lions à la solution. Ceci permet la réutilisation de solutions similaires quand des spécifications apparaissent elles-mêmes similaires. Ici, nous nous concentrons sur l'environnement de collaboration qui soutient le travail collaboratif synchrone, mais SyCoE pourrait être adapté à un domaine plus large.

### Le modèle général de SyCoE :

Dans cette section, nous présentons le model SyCoE qui modélise les concepts et les éléments de l'environnement Collaboratif synchrone. Nous faisons la distinction entre les environnements collaboratifs basés sur trois aspects principaux: 1) les types de situation de collaboration qui il peut soutenir, 2) les facilités qui sont utilisées et 3) la manière dont ces facilités ont été configurées. Le modèle proposé comprend des concepts pour décrire différents aspects nécessaires à la description et de la construction d'un environnement collaboratif synchrone.

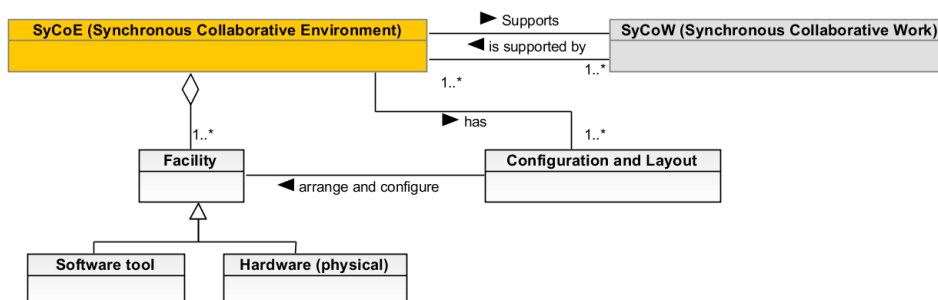

Figure 6-20: Modèle Général de l'Environnement Collaboratif Synchrone (SyCoE)

La Figure 6-20 présente la vue de haut niveau de SyCoE. Un SyCoE est dédiée à répondre à une situation de conception identifiées via un modèle SyCoW à partir de différentes perspectives. SyCoE est

l'agrégation de plusieurs facilités. Un SyCoE peut avoir une ou plusieurs configurations. La configuration est fixe ou flexible. Placement et positionnement groupe (s), les participants et les facilités définissent la configuration et la disposition d'un SyCoE. En outre ces environnements sont aujourd'hui systématiquement soutenus par un **Outil logiciel**: Un outil logiciel (Figure 6-21) est utilisé pendant le travail de collaboratif pour accomplir les activités et tâches correspondantes. Trois types de logiciels peuvent être utilisés pour soutenir ces activités et les tâches lors de la session de collaboration: des logiciels utilisateur unique, des logiciels multi-utilisateur et des logiciels qui supportent à la fois les activités de l'utilisateur unique et multi-utilisateurs.

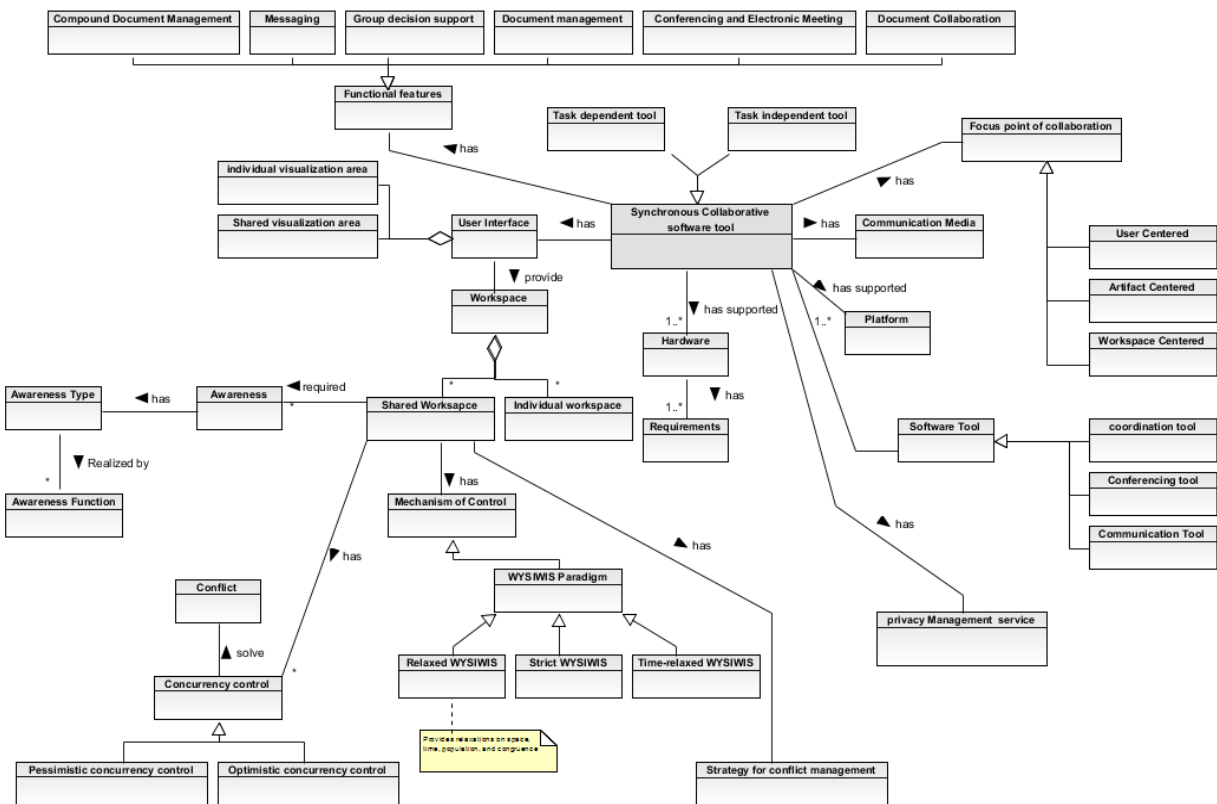

Figure 6-21: l'outil logiciel

Ici, nous analysons la spécification de logiciels pour appuyer la collaboration synchrone. Nous avons appelé ce type de logiciel, logiciel collaboratif synchrone et nous nommons un ensemble connecté 1 hardware-logiciel, outil logiciel collaboratif synchrone. Pour décrire le logiciel collaboratif synchrone, le modèle suivant contient les caractéristiques et les spécifications des logiciels de collaboration.

Un logiciel collaboratif synchrone est dépendant ou indépendant du type de tâche réalisée. Skype © et les logiciels de visio conférence similaires sont indépendants de la tâche. Des tableaux blancs supportant un travail techniques sont fortement associés aux types d'objets que l'on peut partager.

Un logiciel de collaboration a donc un domaine d'application: Il est centré utilisateur lorsque les tâches de collaboration sont axées sur le rôle des utilisateurs, sur la communication mais pas nécessairement sur les données manipulées. Il est centré artefact lorsque le logiciel de collaboration fournit des méthodes pour collaborer sur un artefact spécifique. Il peut être organisé autour d'un espace de travail commun ou d'espaces individuels dédiés aux tâches asynchrones [Rama & Bishop, 2006].

Les fonctions principales d'un logiciel collaboratif sont: son système de gestion de documents, son système de collaboration documentaire (incluant des fonctionnalités de gestion de documents, historique, versionnement, et processus de modification), un système de messagerie, un système de communication (de conférence) et systèmes de prise de décision en groupe.

La plate-forme technologique est une autre caractéristique du logiciel collaboratif. Il définit les critères d'exécution qui comprennent: les plates-formes mobiles, plate-forme du système d'exploitation, plates-formes à base de navigateur voir dans certains cas des solutions dites indépendante des plateformes.

#### **Usage de SyCoE :**

SyCoE peut être utilisé par les chercheurs et les développeurs de technologies de collaboration:

1. pour formaliser la description d'environnements existants, permettant ainsi la capitalisation de l'expérience.
2. comme support à la sélection ou l'adaptation de la solution existante
3. comme une guide et cadre de travail pour le développement de l'environnement collaboratif

## **Chapitre 3 : SyCoEE Schéma Conceptuel: un Modèle Général de l'Évaluation de l'Environnement Collaboratif Synchron**

L'objectif de l'environnement collaboratif est de soutenir le groupe dans son travail collaboratif et de maximiser sa performance et sa satisfaction. Par conséquent, l'objectif principal de l'évaluation est de vérifier comment le système dans son ensemble ou ses caractéristiques et ses fonctions spécifiques contribuent à atteindre cet objectif. Antunes et al. [Antunes et al. 2012] souligne l'importance d'une évaluation appropriée de la justification de l'investissement, pour satisfaire les parties prenantes, ou réorienter le développement des systèmes en fonction des exigences.

Différentes recherches ont démontré que plusieurs aspects impactent le succès d'un outil collaboratif [Pinelle & Gutwin 2000], [de Araujo et al. 2004], [Hamadache & Lancieri 2009], [Antunes et al. 2012]. Ross et al. mis en évidence la difficulté de l'évaluation TCAO en raison de la gamme de points de vue différents qui doivent être pris en considération: la convivialité, la psychologie individuelle, la dynamique de groupe, l'efficacité des communications, les effets de et sur les structures et les cultures organisationnelles, etc [Ross et al. 1995]. Ramage a également souligné la difficulté et la complexité de l'évaluation des points méthodologiques, pratiques, psychologiques et politiques de vue [Ramage 1997]. Neale et al. [Neale et al. 2004] a déclaré que l'évaluation dans le TCAO a souvent été vaguement définie, difficile à mettre en œuvre notamment pour des raisons de temps. De nouvelles stratégies sont attendues pour découvrir ce qui est central dans la réussite et l'échec d'un environnement collaboratif.

L'utilisation de nouvelles composantes technologiques rend l'évaluation d'un environnement collaboratif encore plus complexe. Le problème de conception d'interface utilisateur pour les nouvelles technologies (nouveaux dispositifs d'affichage et d'interaction ou la combinaison de plusieurs technologies) est plus complexe que la conception de l'interface traditionnelle. Certaines technologies sont relativement nouvelles; Ainsi, les interfaces utilisateur manquent encore d'études suffisantes pour établir des lignes directrices et des normes de conception complètes. Par conséquent, les concepteurs doivent

compter sur leur intuition plutôt que des approches méthodiques sur la base de spécifications formelles et éprouvées. Donc, la plupart du temps, la décision que les concepteurs font doit être évaluée pour assurer la qualité et le succès de leur décision et éventuellement une capitalisation efficace de cette expérience de conception.

L'évaluation d'environnements collaboratifs et de leurs composants est importante dans le sens où ils créent les nouvelles connaissances pour être utilisés dans les développements futurs que les lignes directrices pour les concepteurs.[Cornelius et al. 2013] ont mené une étude expérimentale pour comparer l'effort cognitif requis lors de l'utilisation des gestes de substitution par rapport aux gestes esquissés naturellement dans une des tâches mécaniques virtuelles de conception. Leur objectif plus large informait la conception des futurs outils de collaboration virtuelle en précisant les avantages des gestes naturels dans une telle situation de collaboration. Cependant, encore une fois, nous insistons sur le manque de formalisation de ces expériences obtenues à partir de l'évaluation d'environnements de collaboration différents. Cette expérience n'est plus facilement accessible hormis la rédaction d'un article sans structure formelle spécifique.

Plusieurs chercheurs ont tenté d'évaluer des hypothèses spécifiques liées à un outil collaboratif et de fournir des orientations pour de futurs développements; Cependant, la plupart du temps, il est difficile de généraliser les résultats qui ont été obtenus dans cette évaluation [Grudin 1,988], [Baker et al. 2001], [Steves et Scholtz 2005]. Selon le type de tâche, les rôles des participants et le nombre de personnes, etc. le résultat pourrait changer. Le nombre de participants impliqués dans la situation de collaboration est variable; il faut donc vérifier l'effet du nombre de participants à l'efficacité de l'environnement collaboratif. Si le nombre de groupes et la répartition des groupes sont variables; l'effet de la répartition et l'affectation des participants en groupes sur le succès de l'outil collaboratif doit être vérifiée. Cependant souvent, l'évaluation de ces variables peut être ignorée pour l'évaluation de l'environnement collaboratif en simulant le nombre maximum de participants impliqués dans la situation de collaboration cible : augmenter le nombre de participants augmente la complexité de la collaboration; si l'outil est efficace pour dix personnes, il devrait être couronné de succès pour cinq personnes ainsi mais cela n'est pas une règle générale.

Malgré des recherches sur l'évaluation des environnements de collaboration et plusieurs méthodologies développées pour l'évaluation [Damianos et al. 1,999], [de Araujo et al. 2,002], [Huang 2,005], [Steves et Scholtz 2,005], [Antunes et al. 2012], il demeure difficile pour les développeurs de décider ce qu'ils doivent évaluer. En raison de la nature complexe de l'outil collaboratif, de l'environnement et des différents éléments qui impactent ses résultats, il est souvent difficile de déterminer la portée de l'évaluation. Quelle est l'hypothèse qui doit être évaluée ? Comment mener l'évaluation avec succès? Ainsi l'évaluation des systèmes de collaboration demeure un défi de recherche.

Ce chapitre identifie les modèles et les concepts d'une évaluation de l'environnement collaboratif. Un nouveau modèle conceptuel, nommé SyCoEE (Synchronous collaboration évaluation Environnement) est présenté à travers UML (Unified Modeling Language) pour la structuration des expériences extraites de notre revue de la littérature. En d'autres termes, nous avons organisé les concepts de l'évaluation de l'environnement de collaboration dans une taxonomie significative, ainsi que les relations par lesquels ces concepts sont reliés. SyCoEE peut être considéré comme un guide pour les concepteurs et les développeurs au cours du processus d'évaluation. Il doit faciliter la justification d'environnements collaboratifs et la réutilisation des expériences passées lors de la conception d'un nouvel environnement pour une situation de cible spécifique.

Des travaux connexes ont proposés des cadres méthodologiques et la classification des méthodes d'évaluation existantes. Notre motivation est de structurer l'évaluation de l'environnement collaboratif. Nous avons un objectif similaire à celui de Araujo et al. [de Araujo et al. 2002] pour organiser, stocker et récupérer des informations d'évaluation qui aident les équipes de R & D dans la conception de nouvelles expériences d'évaluation.

### Le modèle général de SyCoEE:

Nous proposons le modèle d'évaluation de l'environnement collaboratif synchrone (SyCoEE). La Figure 6-22 représente SyCoEE. Le modèle proposé comprend des concepts pour décrire les différents aspects qui sont nécessaires pour la description et la construction d'une évaluation de l'environnement collaboratif synchrone.

Les principaux concepts de ce modèle sont les suivants: Objectif de l'évaluation, les impacts de l'outil de collaboration, le temps de mener une évaluation, de collecte de données Technique, données d'évaluation, la méthodologie d'analyse des données, Résultats de l'évaluation, Lieu de l'évaluation, La coûts de évaluation, les type de évaluateurs, méthodes d'évaluation, les conclusions tirées de l'évaluation.

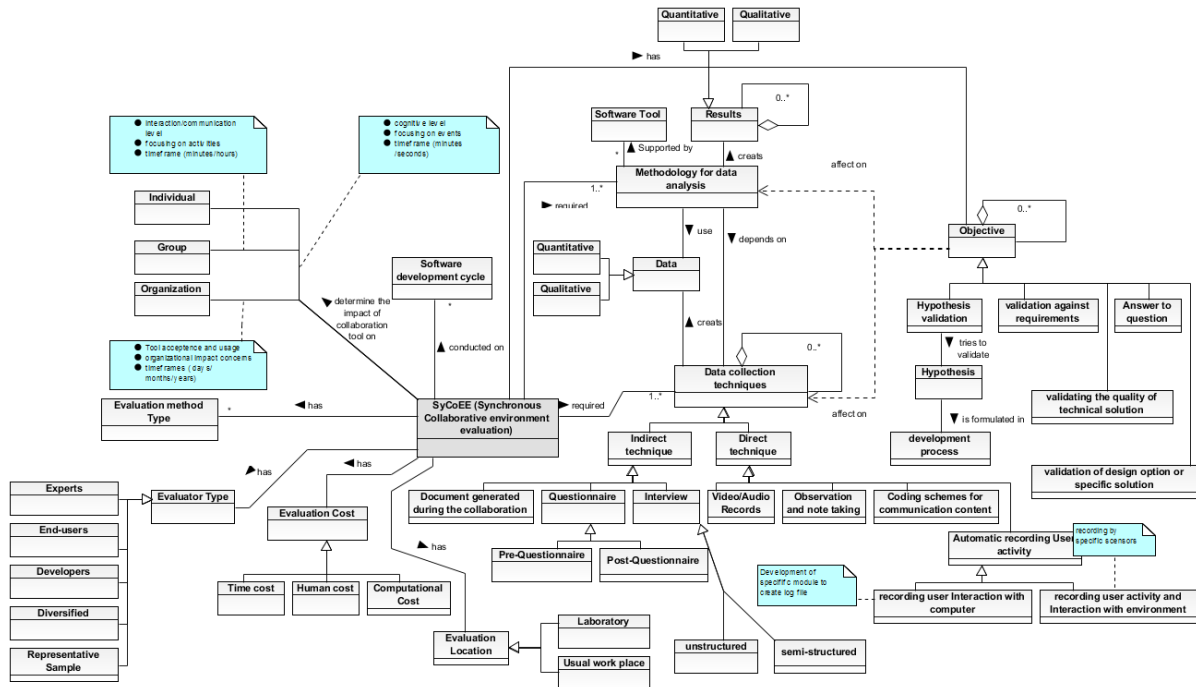

Figure 6-22: Modèle Général de l'Évaluation de l'Environnement Collaboratif Synchrone (SyCoEE)

### Usage de SyCoEE :

SyCoEE peut être utilisé de manière différente par le chercheur et les développeurs de technologies de collaboration:

- 1) SyCoEE peut être utilisé comme un cadre pendant la phase d'évaluation. SyCoEE fournit un point de vue qui précise quels sont les éléments qui doivent être pris en compte lors du processus d'évaluation.
- 2) SyCoEE peut être utilisé pour enregistrer un résultat d'évaluation et ainsi capitaliser une expérience. En utilisant SyCoEE l'évaluateur décrit dans un formalisme réutilisable, la situation d'évaluation et ses caractéristiques.



## **Partie-I: conclusion**

Dans les chapitres 1, 2 et 3 ; nous avons proposé trois modèles conceptuels SyCoW et SyCoE et SyCoEE qui couvrent l'ensemble des tâches de développement d'un outil support au travail de collaboration synchrone.

Les modèles proposés sont déduits de la littérature dans différents domaines. Grâce à des références diversifiées, nous avons identifié des concepts, et les relations entre les concepts qui ont un impact sur les spécifications et les exigences d'outil collaboratif ou sur la collaboration lui-même. Dans notre modèle, nous avons fusionné les définitions qui correspondent à différentes communautés de recherche pour converger sur un modèle unique.

L'utilisation des différents modèles identifiés dans la Partie-I sont mis en œuvre pour le développement d'un outil support à la collaboration en systématisant un processus de développement des environnements de collaboration synchrone: cela fait l'objet de la Partie II de cette thèse.

## **Partie II: Introduction**

La complexité de la sélection ou du développement d'environnements de collaboration est importante. Différentes solutions technologiques pour la collaboration sont disponibles, mais il est difficile de choisir le bon outil parmi ces technologies. Malgré la multiplicité des environnements collaboratifs existants, leur développement reste encore complexe et non systématique. Les solutions technologiques deviennent elles-mêmes rapidement obsolètes. D'autre part, le processus de développement de l'environnement collaboratif nécessite non seulement de résoudre les problèmes techniques liés au développement de logiciels, mais aussi de tenir compte des aspects humains et facteurs liés au fonctionnement de groupe qui doivent être pris en charge par l'environnement collaboratif.

Il manque un processus cadré ou une approche pouvant guider les organisations dans leurs efforts pour définir, évaluer ou acquérir un environnement collaboratif qui soutienne leur activités en contexte collaboratif. Les approches et processus existants sont soit trop général et n'offrent pas suffisamment d'informations pour une analyse détaillée des besoins, soit insatisfaisants à fournir des solutions alternatives.

Dans la partie II, nous proposons un processus de développement (cf. Figure 6-23) ou de sélection d'un environnement collaboratif. Ce processus a été établi sur la base des modèles qui ont été identifiés dans la Partie-I. Le processus consiste en trois étapes principales que nous présentons dans les chapitres 4, 5 et 6. L'utilisation des modèles proposés dans la Partie I, est organisée selon le processus proposé. Nous présentons la mise en œuvre de ce processus dans le cas du développement d'un nouvel environnement de collaboration synchrone dédiée à la réunion de revue de conception, nommé, MT-DT. MT-DT est une solution collaborative développée et évaluée au cours de la thèse composant d'une table multi-touch associée à une application logicielle 3D spécifique dédiée aux activités collaboratives de revue de conception. Nous illustrons ainsi comment le processus peut être instancié.

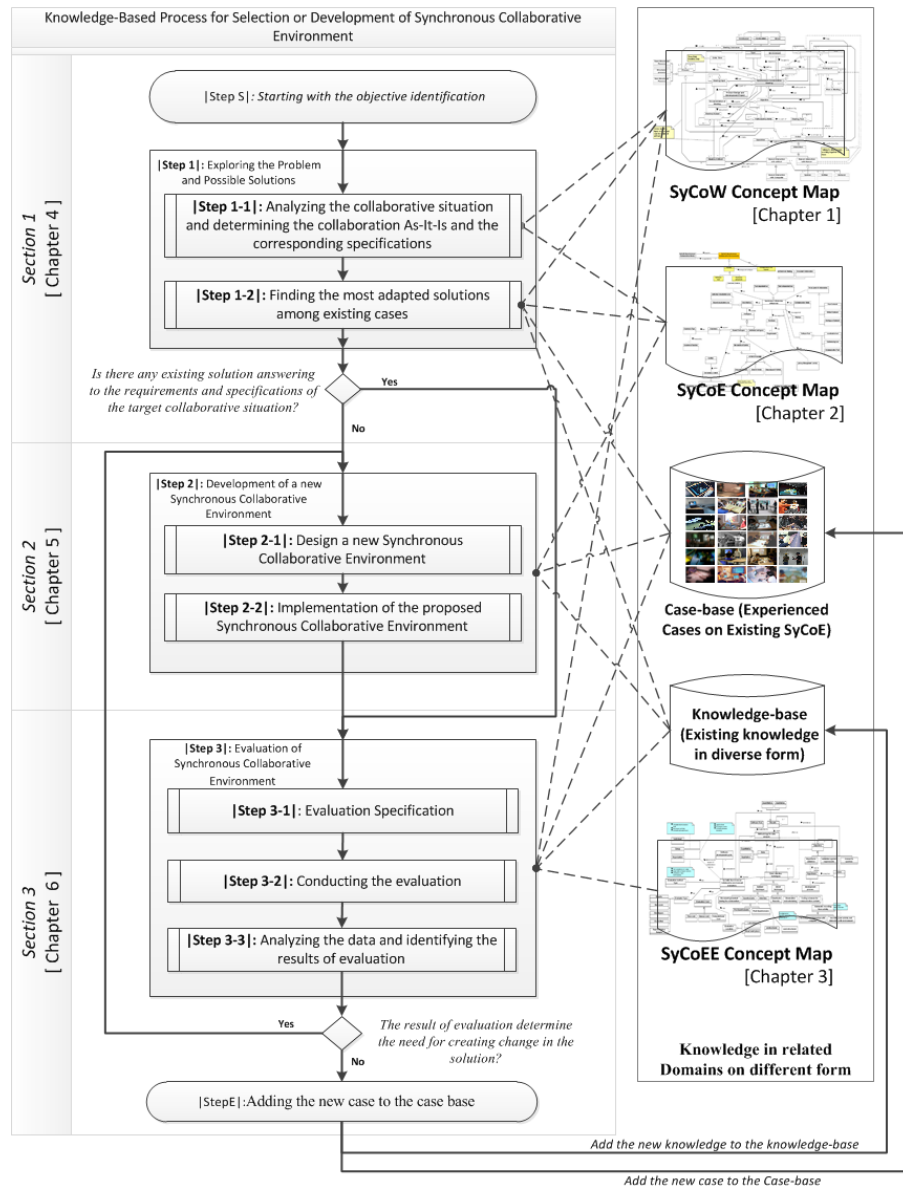

Figure 6-23: le processus de développement ou de sélection d'un environnement collaboratif synchrone

## Chapitre 4 : Explorer le problème et les solutions possibles

Les différentes étapes du processus séquentiel sont expliquées dans l'ordre chronologique.

### | Étape S |: l'identification d'objectif

L'utilisateur commence avec l'objectif d'améliorer sa situation de collaboration. Le terme «utilisateur» est utilisé pour désigner la personne impliquée dans le choix ou le développement de l'environnement de collaboration synchrone.

### | Étape 1 |: Explorer le problème et les solutions possibles

Cette étape se décompose de la façon suivante :

### **| Étape 1-1 |: Analyse de la situation de collaboration et détermination de la collaboration existante et les spécifications correspondantes**

Dans cette étape, *l'utilisateur* analyse la situation collaborative existante et identifie la collaboration telle qu'elle se pratique à l'instant de l'étude. La modélisation de la situation actuelle est la base pour identifier les points faibles, justifiant la nécessité d'un nouvel environnement collaboratif adapté, et les améliorations possibles. . En d'autres termes, une compréhension suffisante de la situation actuelle est une condition préalable pour sélectionner ou développer un nouvel environnement collaboratif en respectant les modes de collaboration des acteurs (cf. chapitre 1).

Les deux modèles SyCoW et SyCoE nous aident à formaliser l'état actuel de la collaboration. Pour identifier la collaboration existante, *l'utilisateur* doit parcourir les modèles SyCoW et SyCoE et créer des instances de ces modèles à partir de la situation de collaboration étudiée. Pour ce faire, *l'utilisateur* a recueilli des données de la situation par des moyens et sources différents: référentiels d'information de l'organisation, étude d'observation, entrevue avec les personnes déjà impliquées dans la situation de collaboration, etc.

Par conséquent, à cette étape en examinant les éléments de SyCoW et SyCoE, *l'utilisateur* doit définir la valeur ajoutée potentielle pour chaque élément. Il est donc important de voir quels éléments doivent être conservés et ceux qui nécessitent des évolutions ou améliorations. L'observation et l'expérience existante va guider cette identification. Le résultat de l'analyse est une vision claire et objective d'une situation de collaboration, de ses spécificités et des exigences correspondantes pour la mise en place d'un nouvel environnement collaboratif synchrone.

### **| Étape 1-2 |: Trouver les solutions les plus adaptées parmi les cas existantes:**

Dans cette étape, *l'utilisateur* trouve la solution la plus adaptée parmi les environnements collaboratifs existants. Ces solutions existantes peuvent être également utilisées comme source d'inspiration pour le développement d'un nouvel environnement collaboratif. L'information acquise par les expériences précédentes est une source importante d'information. Cette information spécifique fournit des conseils plus facilement opérables par *l'utilisateur* que des informations générales et abstraites.

La recherche de solutions pour soutenir le travail collaboratif s'appuie sur des problèmes mal définis et, par conséquent, les réponses ne sont jamais vraies ou fausses, mais elles sont jugées qualitativement meilleures ou pires. Les solutions satisfaisantes ou assez bonne sont un objectif réaliste [Fitzpatrick, 1998]. Par conséquent, il est important d'utiliser les expériences capitalisées. L'idée est qu'il est possible de trouver un cas similaire passé et de réutiliser tout ou partie des composants de la solution pour une nouvelle situation collaborative. Pour chaque cas déjà connu, *l'utilisateur* peut commencer à analyser la similarité et la différence entre les modèles SyCoW. Ensuite, *l'utilisateur* a besoin pour analyser la partie SyCoE de cas d'expérience pour voir quelles parties de cette solution répondent aux exigences spécifiées dans l'étape précédente. Les résultats et les spécifications de l'exploitation de SyCoEE donnent une idée du niveau de validité de la solution. Après avoir analysé les trois aspects (problème, solution et évaluation de solution) des cas existants avec les trois modèles, *l'utilisateur* a besoin de déterminer si il y a un environnement de collaboration existant qui répond aux spécifications et exigences de la situation collaborative cible. Il peut appliquer directement une solution existante à la situation où il peut avoir besoin de faire des modifications mineures à la solution existante afin de l'adapter à la situation de collaboration cible, ou il a besoin concevoir un nouvel environnement collaboratif. La décision est prise par *l'utilisateur*.

Suite à la réponse de *l'utilisateur* à la question: «Existe-t-il une solution répondant aux exigences et aux spécifications de la situation collaborative cible? » le processus s'oriente vers l'Étape 2 | ou l'Étape 3 |. Si *l'utilisateur* est en mesure de trouver une solution existante qui répond à l'exigence de sa situation collaborative cible, alors il est nécessaire d'évaluer la solution choisie. Ainsi, en répondant «Oui» à la question, l'étape suivante sera | Étape 3 | «l'évaluation de l'environnement collaboratif pour la situation cible ». L'évaluation permet de juger de l'impact de composante sur la collaboration grâce à la nouvelle solution. Si aucun environnement existant recensé dans la base n'est en mesure de répondre à l'exigence de la situation de la collaboration cible, alors il est nécessaire de concevoir ou adapter un nouvel environnement collaboratif. Ainsi, en répondant «non» à cette question, l'étape suivante sera | Étape 2 | «Développement d'un nouvel environnement de collaboration synchrone.

## **Chapitre 5: Développement d'un nouvel environnement de collaboration synchrone**

| Étape 2 |: le développement d'un nouvel environnement de collaboration synchrone

*L'utilisateur* a pris la décision de développer un nouvel environnement de collaboration, il doit maintenant suivre deux sous-étapes principales: | Étape 2-1 |: concevoir un nouvel environnement de collaboration synchrone et | Étape 2-2 |: Implémentation l'environnement collaboratif synchrone proposé.

**| Étape 2-1 |: concevoir une nouvelle Environnement collaboratif synchrone**

*L'utilisateur* doit sélectionner une solution existante appropriée et ensuite fait les modifications appropriées dans le but de trouver une nouvelle solution qui réponde aux spécifications et exigences de sa situation cible.

**| Étape 2-2 |: implémentation de la proposition de l'environnement collaboratif Synchrone**

Dans cette étape *l'utilisateur* met en œuvre le SyCoE qu'il a conçu à l'étape précédente. Il peut avoir différentes options pour implémentation. Différents facteurs comme le temps, le coût, la disponibilité des ressources affectent ses choix pour implémentation des solutions.

## **Chapitre 6: Évaluation de l'Environnement collaboratif synchrone**

**| Étape 3 |: Évaluation de l'environnement collaboratif Synchrone**

La dernière étape du processus est l'évaluation d'un environnement collaboratif synchrone choisie ou élaboré. Comme souligné dans le chapitre 3, l'évaluation d'un environnement collaboratif est difficile et complexe. Ainsi plusieurs sources de l'information et connaissances sont nécessaires pour faciliter cette tâche. Ses ressources que nous avons proposé d'utiliser dans le processus d'évaluation sont:

- La compréhension générale de l'évaluation de l'environnement collaboratif synchrone qui a été formulée dans SyCoEE Schéma Conceptuel. Ceci guide l'utilisateur dans le processus d'évaluation.

- L'expérience sur l'évaluation des solutions existantes. *L'utilisateur* en recherchant dans les cas précédents expérimentés avec l'aide de SyCoW et SyCoE vas trouver des cas similaire. Ensuite, il a accès à l'historique des évaluations déjà réalisées. Sachant que précédemment un aspect spécifique de

l'environnement collaboratif synchrone a été évalué dans une situation semblable de collaboration synchrone, ceci aide l'utilisateur à décider pour évaluer le même aspect ou non. Si non, alors l'utilisateur étudie les aspects de l'environnement de collaboration qui n'ont pas été évalués précédemment. Si oui, l'utilisateur étudie les aspects pour lesquels aucune preuve suffisante n'a été consignée dans les évaluations précédentes, fournissant ainsi des informations complémentaires.

- Des informations supplémentaires sous de multiples formes: les règles et les connaissances semi-structurées.

L'étape 3 se compose de trois sous-étapes:

### **| Étape 3-1 |: évaluation de Spécification**

La première sous-étape identifie « Quels sont les objectifs de l'évaluation? », « Pourquoi sommes-nous intéressés sur ces objectifs ? », et ensuite « comment pouvons-nous atteindre ces objectifs ? ». Basé sur le modèle de SyCoEE, *l'utilisateur* analyse l'impact de la spécification de collaboration de l'environnement sur la personne, un groupe ou une organisation ou une combinaison d'entre eux. L'objectif de l'évaluation (SyCoEE :: Objectif) est de valider qu'une SyCoE correspond à l'exigence de SyCoW initiale. Un objectif est formulé sous forme de question ou d'hypothèse. Lorsque «pourquoi» et le «quoi» sont identifiés, les méthodologies d'évaluation appropriées sont sélectionnées (méthodologies SyCoEE :: évaluation). Ensuite, l'utilisateur doit identifier le type de données (SyCoEE :: données) qu'il doit recueillir au cours de l'évaluation. Il a également besoin de sélectionner les méthodes de collecte de données (techniques de collecte SyCoEE :: données). Il devrait ensuite analyser les données basées sur les méthodes et outils (SyCoEE :: Méthodologie d'analyse des données appropriées). Le SyCoEE en fournissant les concepts de l'évaluation aide à l'utilisateur dans ce processus.

### **| Étape 3-2 |: Conduite de l'évaluation**

L'étape suivante concerne l'évaluation elle-même. Après la conception de l'évaluation qui a été faite à l'étape précédente, *l'utilisateur* doit réaliser l'évaluation dans cette étape. Par exemple pour l'étude expérimentale, l'évaluateur devrait commencer à rassembler les participants. Il doit ensuite planifier les expériences basées sur la disponibilité des participants et de la planification conçu pour des expériences comparatives. Puis il doit réaliser l'expérience et recueillir les données.

### **| Étape 3-3|: Analyse des résultats**

Ici, l'utilisateur doit déterminer comment ces données peuvent devenir significatives pour répondre aux questions ou valider l'hypothèse. Selon le type de données la méthodologie d'analyse des données sera différente.

### **| Étape E |: Ajout le nouveau cas à la base de cas**

Lorsque les résultats de l'évaluation justifient la pertinence de la solution proposée nous pouvons terminer le processus de développement. Le résultat de l'expérimentation peut être ajouté à la base de cas comme un nouveau cas. Ensuite, cette connaissance sera utilisable dans l'évaluation d'environnements collaboratifs similaires. Les connaissances acquises à partir de l'évaluation sont accompagné avec les instances de SyCoW, SyCoE et SyCoEE de la situation cible. Pendant le processus de développement, il est nécessaire de documenter ces trois modèles pour la situation cible. Savoir comment une évolution a été faite est un élément important de l'évaluation des résultats acquises à partir d'expériences. Cela aidera les gens à utiliser le résultat des évaluations de manière appropriée.

## Étude de cas

Dans l'Étape S |, nous nous attendons à fournir un environnement collaboratif approprié pour une revue de conception multidisciplinaire entre petit groupe de participants en situation co-localisée. Dans l'Étape 1 |, afin de qualifier la collaboration existante pour notre situation collaborative cible, nous avons utilisé étude observationnelle et revue de la littérature. Nous avons listé les éléments des SyCoW et SyCoE et ensuite nous avons rempli cette list en faisant une instance de ces modèles pour notre situation de collaboration cible sur la base de notre observation (cf. chapitre 4, *la version anglaise*). En analysant les éléments Syców et SyCoE pour notre stitatuin, nous avons défini la liste des exigences pour le nouveau environnement collaboratif ('Table 4-2: List of requirements for collocated design review among small group', *la version anglaise*).

Nous nous sommes positionnés dans le cas où les modèles SyCoW, SyCoE et SyCoEE recensés dans la base n'étaient pas directement applicables à notre situation et il a été nécessaire de concevoir un nouvel environnement de collaboration synchrone. Par conséquent, nous avons continué avec l'Étape 2 |.

Dans l'Étape 2, nous avons conçu l'environnement MT-DT pour le cas de la revue de la conception de produit. MT-DT se compose d'une table multi-touch avec application logicielle 3D spécifiques qui soutient les activités pendant revue de la conception de produit. Différentes expertises ont été nécessaires pour concevoir et mettre en œuvre le logiciel d'application pour la table multi-touch:

- L'application existante pour la table multi-touch pour les domaines d'application similaire ou différente. [Jones et al. 2011], [Haller et al. De 2006], [Apted et al. 2005], [Smith & Graham 2010], [Shen et al. 2003] [Tse et al. 2007].

- Les guidelines [Scott et al. 2003].

- Les frameworks existants pour la conception de l'interface et l'architecture de les applications multi-touch [Kammer et al. 2010].

- La connaissance sur des différents aspects nécessaires à prendre en compte dans la conception de l'interface:

- . Les effets de la taille du groupe et la taille de la table sur les interactions [Ryall et al. 2004].
- . Devision de la table à la territorialité participants [Scott et al. 2004].
- . Orientation des artefacts sur la table et son effet sur la compréhension, la coordination et la communication [Kruger et al. 2003].
- . Techniques d'interaction multi-utilisateurs sur la table multi-touch [Wu et Balakrishnan 2003], [Wu et al. De 2006], [Hinrichs & Carpendale 2011].
- . Gestes de l'utilisateur pour manipulation des objets 3D [COHE & HACHET 2012], [Steinicke et al. 2012], [Bollensdorff et al. 2012].

L'architecture du système est décomposé en un ensemble de modules. Figure 6-24 le côté gauche représente l'architecture de la MT-DT. Il se compose de quatre couches: "couche matérielle d'entrée", "couche de traitement d'entrée» et «couche de présentation» et «couche de serveur MT-DT".

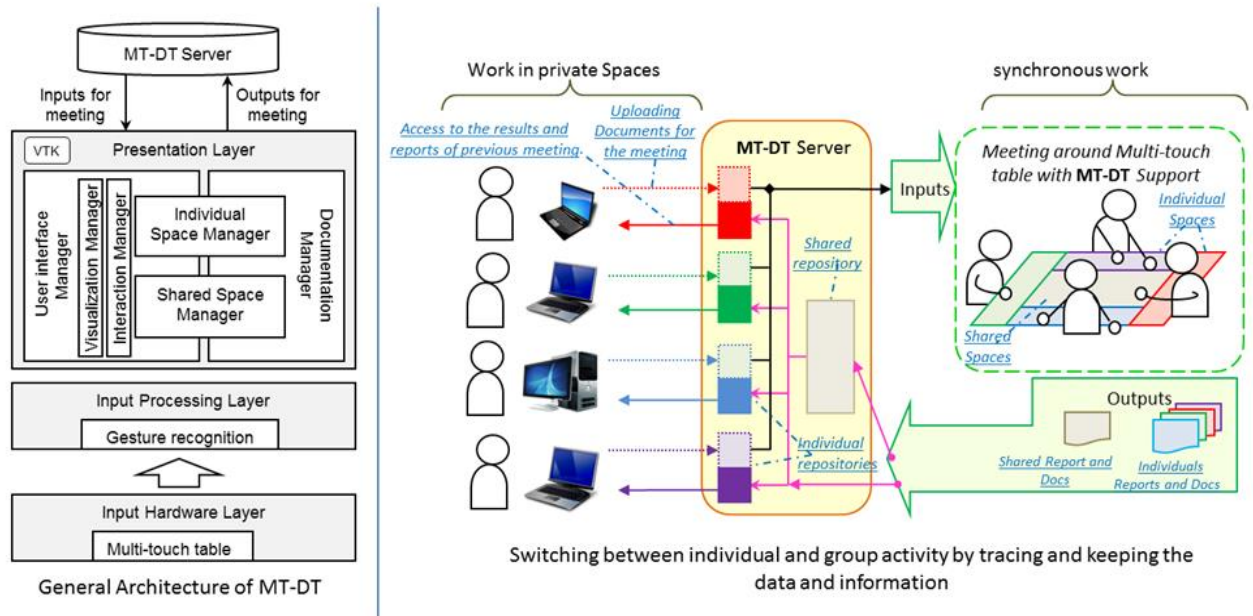

Figure 6-24: L'architecture de MT-DT

MT-DT imite les environnements collaboratifs traditionnels, c'est-à-dire les gens sont face à face autour de la table. Par conséquent, il conserve les principaux avantages de cet environnement collaboratif traditionnel et offre des qui comprennent:

- visualisation simultanée 2D et 3D d'artefact numérique et de l'interaction avec ces objets dans manière tangible
- Capacité à faire une copie rapide des artefacts présentés,
- Une meilleure organisation des documents et un changement de taille des objets,
- Définition explicite de l'espace partagé et de l'espace individuel,
- Possibilité de créer des liens entre les artefacts,
- Capacité d'annotation simultanée sur les artefacts et l'amélioration de la prise de conscience à propos de cette action,
- Possibilité de mettre des annotations partagée ou individuelles sur l'artefact
- La documentation semi-automatique de réunion de revue de conception pour les utilisateurs individuels et pour le groupe.

Certaines fonctionnalités du prototype final sont illustrées dans la figure 6-25.

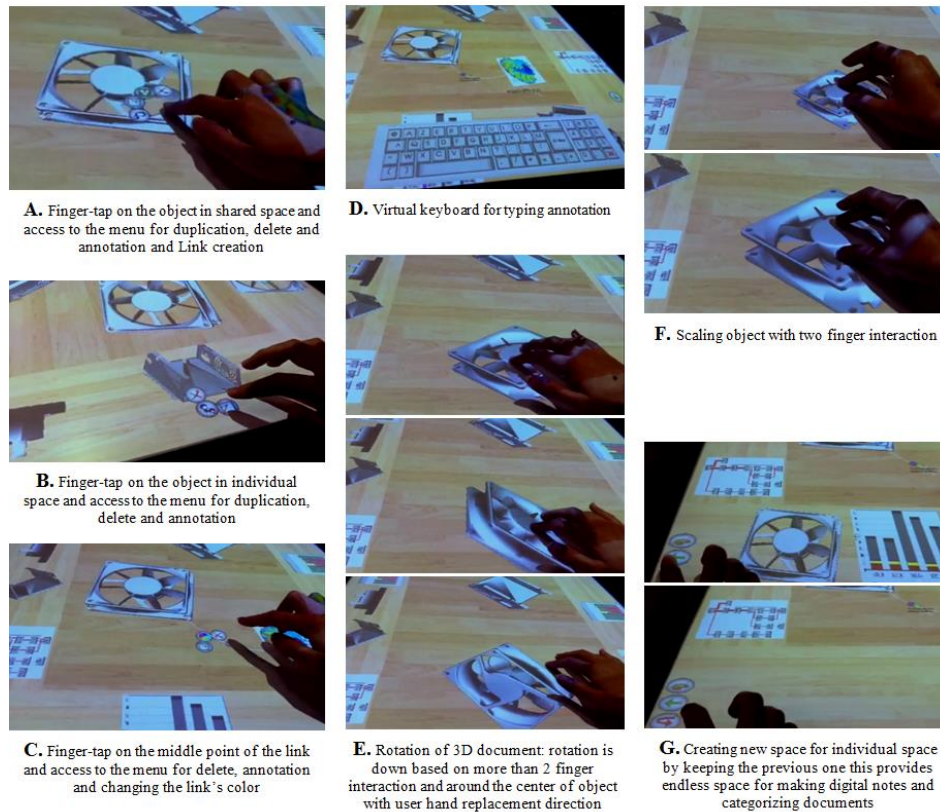

Figure 6-25: Certaines fonctionnalités de MT-DT

Dans l'Étape 3, nous avons identifié une liste d'hypothèses et de questions comme objectif d'évaluation et nous avons apporté nos raisons pour chaque objectif ('Table 6-1: Identification of the objectives of evaluation and the reason of defining those objectives', *la version anglaise*). Une série d'études expérimentales ont été menées pour répondre aux questions et pour valider nos hypothèses. Tableau 6-8 (Table 6-8: The conducted experiments and their characteristics, *la version anglaise*) résume les expériences et leurs caractéristiques qui ont été menées avec succès au cours de cette thèse. Chaque colonne a été colorée sur la base de la similitude entre les éléments. Neuf expériences ont été traitées avec des groupes de quatre participants. La langue des documents est l'anglais, parce que tous les participants ont été en mesure de lire l'anglais. La langue de la conversation verbale dans chaque session expérimentale était la langue maternelle ou couramment des participants pour permettre une communication fluide. Ainsi, les expériences ont été faites dans trois langues. Les études comparatives ont été traitées par les mêmes groupes afin de maintenir des conditions similaires. Cela permet de se concentrer sur l'objectif de la comparaison.

Grâce à une série d'expériences, nous avons répondu à des questions identifiées et nous avons vérifié la validité de notre hypothèse. (cf. chapitre 6, *la version anglaise*)



## Partie II: Conclusion

Dans la partie II de cette thèse, nous nous intéressons à formuler le processus de développement de l'environnement de collaboration, et comment ce processus peut être pris en charge avec les modèles proposés dans la Partie-I.

Nous avons utilisé SyCoW de différentes façons au cours de ce processus. Lors de la première étape du processus, nous utilisons le modèle SyCoW pour clarifier les spécifications actuelles de la situation collaborative cible et les exigences de l'environnement de collaboration souhaitée pour soutenir cette situation. Il contribue à une meilleure compréhension de la situation de collaboration et par conséquent dans la spécification de l'outil. Nous avons également utilisé SyCoW afin d'analyser les cas issus de l'expérience. En trouvant les cas qui ont un SyCoW similaire, nous sommes en mesure d'utiliser ou adapter leur solution pour notre situation. Ainsi, il contribue à réutiliser l'expérience acquise à partir des outils de collaboration déjà existants.

SyCoE facilite la recherche des justifications pour les environnements collaboratifs et la réutilisation des expériences précédentes lors de la conception d'un nouvel environnement pour une nouvelle situation. Pendant le processus, nous avons utilisé SyCoEE afin d'analyser la solution souhaitée. SyCoE nous a également aidés lors de la définition et du développement de l'environnement collaboratif pour la conception de la solution.

SyCoEE aide évaluateur d'évaluer dans quelle mesure un environnement collaboratif donnée supporte la situation collaborative souhaitée. Aussi SyCoEE aide à analyser la partie de l'évaluation de la solution des cas d'expérience.

Basé sur le processus proposé nous avons développé un nouvel environnement pour la réunion de revue de conception nommé MT-DT. Au long de ce processus, les modèles proposés et les ressources mobilisées dans les différents domaines nous ont aidé dans nos décisions. L'évaluation de la MT-DT a confirmé sa facilité d'utilisation.

Nous sommes convaincus que ces modèles pourraient être utilisés pour un système de capitalisation de la connaissance réelle. Nous avons déjà commencé à travailler dans ce sens et évoquons cela comme une perspective.

# Reference

## A

- [Adcock et al. 2004] Adcock, M., Hutchins, M., & Gunn, C. (2004, August). Haptic collaboration with augmented reality. In ACM SIGGRAPH 2004 Posters (p. 41). ACM. Chapter 4
- [Ahlers et al. 1995] Ahlers, K. H., Kramer, A., Breen, D. E., Chevalier, P. Y., Crampton, C., Rose, E., ... & Greer, D. (1995, August). Distributed augmented reality for collaborative design applications. In Computer Graphics Forum (Vol. 14, No. 3, pp. 3-14). Blackwell Science Ltd. Chapter 4
- [Ahn & Crawford 1994] Ahn, J. S., & Crawford, R. H. (1994). Complexity analysis of computational engineering design processes. In The 1994 ASME Design Technical Conferences (pp. 205-220). Chapter 1
- [Andreas et al. 2007] Andreas. Kerren, Ebert, A., & Meyer, J. (2007). Human-centered visualization environments. Springer-Verlag. Chapter 1
- [Andriessen 1996] Andriessen, J. E. (1996). The why, how and what to evaluate of interaction technology: a review and proposed integration. In CSCW requirements and evaluation (pp. 107-124). Springer London. Chapter 3
- [Andriessen 1999] Andriessen, J. H. (1999). Nested effects testing: a multidimensional approach for evaluating CSCW systems. ACM SIGGROUP Bulletin, 20(2), 52-54. Chapter 3
- [Andriessen et al. 1998] Andriessen, J. H. E., Koorn, R., & Arnold, B. G. (1998). Multidimensional evaluation of generic aspects of telematics applications quality: The MEGATAQ model. In IFIP world computer congress (pp. 272-283). Chapter 3
- [Anson & Bostrom 1995] Anson, R., Bostrom, R., & Wynne, B. (1995). An experiment assessing group support system and facilitator effects on meeting outcomes. Management Science, 41(2), 189-208. Chapter 1
- [Antunes & Carrio 2003] Antunes, P., & Carrio, L. (2003, October). Modeling the information structures of meetingware. In Proc. of Workshop de Sistemas de InformaoMultimidia Cooperativos (COOP-MEDIA'03). Chapter 1
- [Antunes et al. 2012] Antunes, P., Herskovic, V., Ochoa, S. F., & Pino, J. A. (2012). Structuring dimensions for collaborative systems evaluation. ACM Computing Surveys (CSUR), 44(2), 8. Chapter 3
- [Apted et al. 2005] Apted, T., Kay, J., & Quigley, A. (2005). A study of elder users in a face-to-face collaborative multi-touch digital photograph sharing scenario. School of Information Technologies, University of Sydney. Chapter 4, 5
- [Ardaiz et al. 2010] Ardaiz, O., Arroyo, E., Righi, V., Galimany, O., & Blat, J. (2010, June). Virtual collaborative environments with distributed multitouch support. In Proceedings of the 2nd ACM SIGCHI symposium on Engineering interactive computing systems (pp. 235-240). ACM. Chapter 4
- [Arthur et al. 1998] Arthur, K., Preston, T., Taylor, R., Brooks, F., Whitton, M., & Wright, W. (1998, May). Designing and building the pit: a head-tracked stereo workspace for two users. In 2nd International Immersive Projection Technology Workshop (pp. 11-12). Chapter 4
- [Aamodt & Plaza 1994] Aamodt, A., & Plaza, E. (1994). Case-based reasoning: Foundational issues, methodological variations, and system approaches. AI communications, 7(1), 39-59.
- [Althoff & Wilke 1997] Althoff, K. D., & Wilke, W. (1997). Potential uses of case-based reasoning in experience based construction of software systems and business process support. In Proc. of the 5th German Workshop on Case-Based Reasoning, LSA-97-01E, Centre for Learning Systems and Applications, University of Kaiserslautern (pp. 31-38).

## B

- [B.Dic. 2014] <http://www.businessdictionary.com/>, (2014) Chapter 3
- [Baker et al. 2001] Baker, K., Greenberg, S., & Gutwin, C. (2001). Heuristic evaluation of groupware based on the mechanics of collaboration. In Engineering for human-computer interaction (pp. 123-139). Springer Berlin Heidelberg. Chapter 3
- [Barakonyi et al. 2004] Barakonyi, I., Fahmy, T., & Schmalstieg, D. (2004, May). Remote collaboration using augmented reality videoconferencing. In Proceedings of Graphics interface 2004 (pp. 89-96). Canadian Human-Computer Communications Society. Chapter 4
- [Barco CadWall 2010] Barco CadWall. <http://www.barco.com/virtualreality/>. (2010) Chapter 4
- [Barkmeyer et al. 1996] Barkmeyer, E. J., Christopher, N., Feng, S., Fowler, J. E., Frechette, S., Jones, A., ... & Wallace, E. (1996). SIMA reference architecture part 1: activity models. NIST Technical Report (in publication). Chapter 1
- [Barrick & Mount 1991] Barrick, M. R., & Mount, M. K. (1991). The big five personality dimensions and job performance: a meta-analysis. Personnel psychology, 44(1), 1-26. Chapter 1
- [Barry et al. 1997] Barry, Bruce, and Greg L. Stewart. "Composition, process, and performance in self-managed groups: the role of personality." Journal of Applied Psychology 82, no. 1 (1997): 62. Chapter 1

[Barzilai 2003]	Barzilai, G. (2003). <i>Communities and law: Politics and cultures of legal identities</i> . University of Michigan Press.	Chapter 1
[Basdogan et al. 2000]	Basdogan, C., Ho, C. H., Srinivasan, M. A., & Slater, M. (2000). An experimental study on the role of touch in shared virtual environments. <i>ACM Transactions on Computer-Human Interaction (TOCHI)</i> , 7(4), 443-460.	Chapter 4, 2
[Basili et al. 1999]	Basili, V. R., Shull, F., & Lanubile, F. (1999). Building knowledge through families of experiments. <i>Software Engineering, IEEE Transactions on</i> , 25(4), 456-473.	Chapter 6
[Biffl et al. 2006]	Biffl, S., Grünbacher, P., & Halling, M. (2006). A family of experiments to investigate the effects of groupware for software inspection. <i>Automated Software Engineering</i> , 13(3), 373-394.	Chapter 6
[BigFive2013]	<a href="http://www.outofservice.com/bigfive/">http://www.outofservice.com/bigfive/</a> , (2013)	Chapter 6
[Billinghurst et al. 1998]	Billinghurst, M., Weghorst, S., & Furness III, T. (1998). Shared space: An augmented reality approach for computer supported collaborative work. <i>Virtual Reality</i> , 3(1), 25-36.	Chapter 4
[Billinghurst et al. 2001]	Billinghurst, M., Kato, H., & Poupirev, I. (2001). The MagicBook: a transitional AR interface. <i>Computers &amp; Graphics</i> , 25(5), 745-753.	Chapter 4
[Bodker 1990]	Bodker, S. (1990). <i>Through the interface: A human activity approach to user interface design</i> .	Chapter 1
[Bollensdorff et al. 2012]	Bollensdorff, B., Hahne, U., & Alexa, M. (2012, May). The effect of perspective projection in multi-touch 3D interaction. In <i>Proceedings of Graphics Interface 2012</i> (pp. 165-172). Canadian Information Processing Society.	Chapter 5
[Borchers 2003]	Borchers, G. (2003). Experience reports: process and tools: The software engineering impacts of cultural factors on multi-cultural software development teams. <i>Proceedings of the 25th international conference on Software engineering</i> , 540 - 545.	Chapter 1
[Bourimi et al. 2011]	Bourimi, M., Tesoriero, R., Villanueva, P. G., Karatas, F., & Schwarte, P. (2011, October). Privacy and security in multi-modal user interface modeling for social media. In <i>Privacy, security, risk and trust (passat), 2011 IEEE third international conference on and 2011 IEEE third international conference on social computing (socialcom)</i> (pp. 1364-1371). IEEE.	Chapter 2
[Bowman et al. 2004]	Bowman, D. A., Kruijff, E., LaViola Jr, J. J., & Poupirev, I. (2004). <i>3D user interfaces: theory and practice</i> . Addison-Wesley.	Chapter 2
[Brereton & McGarry 2000]	Brereton, M., & McGarry, B. (2000, April). An observational study of how objects support engineering design thinking and communication: implications for the design of tangible media. In <i>Proceedings of the SIGCHI conference on Human Factors in Computing Systems</i> (pp. 217-224). ACM.	Chapter 4
[Bryson & Forth 2007]	Bryson, A., & Forth, J. (2007). Are there day of the week productivity effects? Centre for Economic Performance, Manpower Human Resources Lab: Document number MHRLdp004, London School of Economics.	Chapter 1
[Bullen & Bennett 1990]	Bullen, C. V., & Bennett, J. L. (1990, September). Learning from user experience with groupware. In <i>Proceedings of the 1990 ACM conference on Computer-supported cooperative work</i> (pp. 291-302). ACM.	Chapter 1
[Butz et al. 1999]	Butz, A., Hollerer, T., Feiner, S., MacIntyre, B., & Beshers, C. (1999). Enveloping users and computers in a collaborative 3D augmented reality. In <i>Augmented Reality, 1999.(IWAR'99) Proceedings. 2nd IEEE and ACM International Workshop on</i> (pp. 35-44). IEEE.	Chapter 4
[Bassetti © 2015]	<a href="http://bassetti.fr/">http://bassetti.fr/</a> (2015)	

## C

[Camolesi & Martins 2006]	Camolesi Jr, L., & Martins, L. E. G. (2006). A model for interaction rules to define governance policies in collaborative environments. In <i>Computer Supported Cooperative Work in Design II</i> (pp. 11-20). Springer Berlin Heidelberg.	Chapter 1
[Cañas & Novak 2009]	Cañas, A. J., & Novak, J. D. (2009). <i>What is a concept map</i> . Institute for Human and Machine Cognition.	Chapter 1
[Cañas et al. 2005]	Cañas, A. J., Carff, R., Hill, G., Carvalho, M., Arguedas, M., Eskridge, T. C., ... & Carvajal, R. (2005). Concept maps: Integrating knowledge and information visualization. In <i>Knowledge and information visualization</i> (pp. 205-219). Springer Berlin Heidelberg.	Chapter 1
[Caruso & Re 2010]	Caruso, G., & Re, G. M. (2010, February). Interactive augmented reality system for product design review. In <i>IS&amp;T/SPIE Electronic Imaging</i> (pp. 75250H-75250H). International Society for Optics and Photonics.	Chapter 4
[Chen & Lou 2000]	Chen, Y., & Lou, H. (2000, May). Toward an understanding of the behavioral intention to use a groupware application. In <i>IRMA Conference</i> (pp. 419-422).	Chapter 1
[Clement 1993]	Clement, A. (1993). Privacy considerations in CSCW: report on the CSCW'92 workshop. <i>ACM SIGCHI Bulletin</i> , 25(4), 34-39.	Chapter 2
[Coffey et al. 2002]	Coffey, J. W., Hoffman, R. R., Cañas, A. J., & Ford, K. M. (2002). A concept map-based knowledge modeling approach to expert knowledge sharing. <i>Proceedings of IKS</i> , 212-217.	Chapter 1

[Coffey et al. 2006]	Coffey, J. W., Hoffman, R., & Cañas, A. (2006). Concept map-based knowledge modeling: perspectives from information and knowledge visualization. <i>Information Visualization</i> , 5(3), 192-201.	Chapter 1
[Cohé & Hachet 2012]	Cohé, A., & Hachet, M. (2012, May). Understanding user gestures for manipulating 3D objects from touchscreen inputs. In <i>Proceedings of Graphics Interface 2012</i> (pp. 157-164). Canadian Information Processing Society.	Chapter 5
[Cohen, H. & Lefebvre 2005]	Cohen, H., & Lefebvre, C. (Eds.). (2005). <i>Handbook of categorization in cognitive science</i> (Vol. 4, No. 9.1). Amsterdam:: Elsevier.	Chapter 2
[Cornelius et al. 2013]	Cornelius, C. J., Nguyen, M. A., Hayes, C. C., & Makena, R. (2013). Supporting virtual collaboration in spatial design tasks: Are surrogate or natural gestures more effective?. <i>Human-Machine Systems</i> , IEEE Transactions on, 43(1), 92-101.	Chapter 3
[Cruz-Neira et al. 1992]	Cruz-Neira, C., Sandin, D. J., DeFanti, T. A., Kenyon, R. V., & Hart, J. C. (1992). The CAVE: audio visual experience automatic virtual environment. <i>Communications of the ACM</i> , 35(6), 64-72.	Chapter 4
[Cruz-Neira et al. 1993]	Cruz-Neira, C., Sandin, D. J., & DeFanti, T. A. (1993, September). Surround-screen projection-based virtual reality: the design and implementation of the CAVE. In <i>Proceedings of the 20th annual conference on Computer graphics and interactive techniques</i> (pp. 123-142). ACM.	Chapter 2
[Cugini et al. 1997]	Cugini, J., Damianos, L., Hirschman, L., Kozierok, R., Kurtz, J., Laskowski, S., & Scholtz, J. (1997). Methodology for evaluation of collaboration systems. The evaluation working group of the DARPA intelligent collaboration and visualization program, Rev, 3.	Chapter 3
<b>D</b>		
[D'Astous et al. 2004]	D'Astous, P., Détienné, F., Visser, W., & Robillard, P. N. (2004). Changing our view on design evaluation meetings methodology: a study of software technical review meetings. <i>Design studies</i> , 25(6), 625-655.	Chapter 1
[Damianos et al. 1999]	Damianos, L., Hirschman, L., Kozierok, R., Kurtz, J., Greenberg, A., Walls, K., & Scholtz, J. (1999). Evaluation for collaborative systems. <i>ACM Computing Surveys (CSUR)</i> , 31(2es), 15.	Chapter 3
[Davis 1989]	Davis, F. D. (1989). Perceived usefulness, perceived ease of use, and user acceptance of information technology. <i>MIS quarterly</i> , 319-340.	Chapter 1
[de Araujo et al. 2002]	de Araujo, R. M., Santoro, F. M., & Borges, M. R. (2002). The CSCW lab for groupware evaluation. In <i>Groupware: Design, Implementation, and Use</i> (pp. 222-231). Springer Berlin Heidelberg.	Chapter 3
[de Araujo et al. 2004]	de Araujo, R. M., Santoro, F. M., & Borges, M. (2004, May). The CSCW Lab ontology for groupware evaluation. In <i>Computer Supported Cooperative Work in Design, 2004. Proceedings. The 8th International Conference on</i> (Vol. 2, pp. 148-153). IEEE.	Chapter 3
[De Bono 2010]	De Bono, E. (2010). <i>Lateral thinking: Creativity step by step</i> . HarperCollins.	Chapter 1
[DeSanctis & Gallupe 1987]	Desanctis, G., & Gallupe, R. B. (1987). A foundation for the study of group decision support systems. <i>Management science</i> , 33(5), 589-609.	Chapter 2
[Devaraj et al. 2008]	Devaraj, S., Easley, R. F., & Crant, J. M. (2008). Research note—how does personality matter? Relating the five-factor model to technology acceptance and use. <i>Information Systems Research</i> , 19(1), 93-105.	Chapter 1
[Dietz & Leigh 2001]	Dietz, P., & Leigh, D. (2001, November). DiamondTouch: a multi-user touch technology. In <i>Proceedings of the 14th annual ACM symposium on User interface software and technology</i> (pp. 219-226). ACM.	Chapter 4, 5
[Dourish et al. 1992]	Dourish, P., & Bellotti, V. (1992, December). Awareness and coordination in shared workspaces. In <i>Proceedings of the 1992 ACM conference on Computer-supported cooperative work</i> (pp. 107-114). ACM.	Chapter 1
[Drucker 2006]	Drucker, P. F. (2006). <i>The Effective Executive: The Definitive Guide to Getting the Right Things Done</i> (Harperbusiness Essentials). New York: Collins.	Chapter 1
[Duchowski 2007]	Duchowski, A. (2007). <i>Eye tracking methodology: Theory and practice</i> (Vol. 373). Springer Science & Business Media.	Chapter 2
[Dünser et al. 2006]	Dünser, A., Steinbügl, K., Kaufmann, H., & Glück, J. (2006, July). Virtual and augmented reality as spatial ability training tools. In <i>Proceedings of the 7th ACM SIGCHI New Zealand chapter's international conference on Computer-human interaction: design centered HCI</i> (pp. 125-132). ACM.	Chapter 4
[Dunston et al. 2011]	Dunston, P. S., Arns, L. L., Mcglothlin, J. D., Lasker, G. C., & Kushner, A. G. (2011). An immersive virtual reality mock-up for design review of hospital patient rooms. In <i>Collaborative design in virtual environments</i> (pp. 167-176). Springer Netherlands.	Chapter 4

## E

[Eckert et al. 2001]	Eckert, C., & Stacey, M. (2001, August). Dimensions of communication in design. In 13th	Chapter 1
----------------------	---	-----------

International Conference on Engineering Design (ICED 01) (pp. 473-480).

- [Edwards et al. 1993] Edwards, E. K., Rolland, J. P., & Keller, K. P. (1993, September). Video see-through design for merging of real and virtual environments. In *Virtual Reality Annual International Symposium, 1993.*, 1993 IEEE (pp. 223-233). IEEE. Chapter 2
- [Ellis & Bucher 1994] Ellis, S. R., & Bucher, U. J. (1994, October). Distance perception of stereoscopically presented virtual objects optically superimposed on physical objects by a head-mounted see-through display. In *Proceedings of the Human Factors and Ergonomics Society Annual Meeting (Vol. 38, No. 19, pp. 1300-1304)*. SAGE Publications. Chapter 2
- [Ellis & Gibbs 1989] Ellis, C. A., & Gibbs, S. J. (1989, June). Concurrency control in groupware systems. In *AcM Sigmod Record (Vol. 18, No. 2, pp. 399-407)*. ACM. Chapter 2
- [Ellis et al. 1991] Ellis, C. A., Gibbs, S. J., & Rein, G. (1991). Groupware: some issues and experiences. *Communications of the ACM*, 34(1), 39-58. Chapter 2

## F

- [Fakespace ImmersaDesk 2010] Fakespace ImmersaDesk. <http://www.fakespace.com/>, (2010) Chapter 4
- [Fitzpatrick 1998] Fitzpatrick, G. A. (1998). *The locales framework: Understanding and designing for cooperative work* (Doctoral dissertation, University of Queensland). Chapter 4
- [Foley & Wallace 1974] Foley, J. D., & Wallace, V. L. (1974). The art of natural graphic man—Machine conversation. *Proceedings of the IEEE*, 62(4), 462-471. Chapter 2
- [Forlines et al. 2007] Forlines, C., Wigdor, D., Shen, C., & Balakrishnan, R. (2007, April). Direct-touch vs. mouse input for tabletop displays. In *Proceedings of the SIGCHI conference on Human factors in computing systems* (pp. 647-656). ACM. Chapter 6

## G

- [García-Barrios 2009] García-Barrios, V. M. (2009, August). User-centric Privacy Framework: Integrating Legal, Technological and Human Aspects into User-Adapting Systems. In *Computational Science and Engineering, 2009. CSE'09. International Conference on (Vol. 3, pp. 176-181)*. IEEE. Chapter 2
- [Genest & Gutwin 2012] Genest, A., & Gutwin, C. (2012, February). Evaluating the effectiveness of height visualizations for improving gestural communication at distributed tabletops. In *Proceedings of the ACM 2012 conference on Computer Supported Cooperative Work* (pp. 519-528). ACM. Chapter 4
- [George 1990] George, J. M. (1990). Personality, affect, and behavior in groups. *Journal of applied psychology*, 75(2), 107. Chapter 1
- [George et al. 1993] George, J. M., & James, L. R. (1993). Personality, affect, and behavior in groups revisited: Comment on aggregation, levels of analysis, and a recent application of within and between analysis. Chapter 1
- [Gierhardt et al. 1999] Gierhardt, H., Gaul, H. D., & Ott, T. (1999). Distribution in product design and development processes. In *Proceedings of the 1999 ASME Design Engineering Technical Conferences and Computers in Engineering Conference*. Chapter 1
- [Giles 1997] Giles, M. B. (1997). *Aerospace design: a complex task*. Chapter 1
- [Godefroid et al. 2000] Godefroid, P., Herbsleb, J. D., Jagadeesany, L. J., & Li, D. (2000, December). Ensuring privacy in presence awareness: an automated verification approach. In *Proceedings of the 2000 ACM conference on Computer supported cooperative work* (pp. 59-68). ACM. Chapter 2
- [Goebbels et al. 2003] Goebbels, G., Kruijff, E., Galunic, G., Orthey, T., Ivanovic, A., & Sanfilippo, L. (2003). Ofuturo-a mixed reality desk environment for supporting creativity methods. In *Symposium on Virtual Reality (SVR) (Vol. 3, No. 2.3, p. 3)*. Chapter 4
- [Gosling et al. 2003] Gosling, S. D., Rentfrow, P. J., & Swann Jr, W. B. (2003). A very brief measure of the Big-Five personality domains. *Journal of Research in personality*, 37(6), 504-528. Chapter 1
- [Granum et al. 2003] Granum, E., Moeslund, T. B., Stoerring, M., Broll, W., & Wittkaemper, M. (2003). Facilitating the presence of users and 3D models by the augmented round table. In *PRESENCE Conference, Aalborg, Denmark, October 2003*. Chapter 4
- [Grasset & Gascuel 2002] Grasset, R., & Gascuel, J. D. (2002, July). Mare: Multiuser augmented reality environment on table setup. In *ACM SIGGRAPH 2002 conference abstracts and applications* (pp. 213-213). ACM. Chapter 4
- [Greenberg & Marwood 1994] Greenberg, S., & Marwood, D. (1994, October). Real time groupware as a distributed system: concurrency control and its effect on the interface. In *Proceedings of the 1994 ACM conference on Computer supported cooperative work* (pp. 207-217). ACM. Chapter 2
- [Greenberg et al. 1999] Greenberg, S., Boyle, M., & LaBerge, J. (1999). PDAs and shared public displays: Making personal information public, and public information personal. *Personal Technologies*, 3(1-2), 54-64. Chapter 5
- [Grieb et al. 2005] Grieb, J., & Lindemann, U. (2005). Providing Communication Media for Distributed Design. In *DS 35: Proceedings ICED 05, the 15th International Conference on Engineering Design*, Chapter 1

Melbourne, Australia, 15.-18.08. 2005.

- [Griffin 1997] Griffin, A. (1997). The effect of project and process characteristics on product development cycle time. *Journal of Marketing Research*, 24-35. Chapter 1
- [Grønbaek et al. 2001] Grønbaek, K., Gundersen, K., Mogensen, P., & Ørbæk, P. (2001, July). Interactive room support for complex and distributed design projects. In *Proceedings of the Interact (Vol. 1, pp. 407-414)*. Chapter 4
- [Gross & Prinz 2003] Gross, T., & Prinz, W. (2003, September). Awareness in context: a light-weight approach. In *Proceedings of the eighth conference on European Conference on Computer Supported Cooperative Work (pp. 295-314)*. Kluwer Academic Publishers. Chapter 2
- [Grossman et al. 2004] Grossman, T., Wigdor, D., & Balakrishnan, R. (2004, October). Multi-finger gestural interaction with 3d volumetric displays. In *Proceedings of the 17th annual ACM symposium on User interface software and technology (pp. 61-70)*. ACM. Chapter 2
- [Grudin 1988] Grudin, J. (1988, January). Why CSCW applications fail: problems in the design and evaluation of organizational interfaces. In *Proceedings of the 1988 ACM conference on Computer-supported cooperative work (pp. 85-93)*. ACM. Chapter 3
- [Grudin 1994] Grudin, J. (1994). Groupware and social dynamics: Eight challenges for developers. *Communications of the ACM*, 37(1), 92-105. Chapter 1
- [Gunn et al. 2003] Gunn, C., Hutchins, M., Adcock, M., & Hawkins, R. (2003, July). Trans-world haptic collaboration. In *ACM SIGGRAPH 2003 Sketches & Applications (pp. 1-1)*. ACM. Chapter 4
- [Gutwin & Greenberg 1998] Gutwin, C., & Greenberg, S. (1998, November). Design for individuals, design for groups: tradeoffs between power and workspace awareness. In *Proceedings of the 1998 ACM conference on Computer supported cooperative work (pp. 207-216)*. ACM. Chapter 1
- [Gutwin & Greenberg 2000] Gutwin, C., & Greenberg, S. (2000). The mechanics of collaboration: Developing low cost usability evaluation methods for shared workspaces. In *Enabling Technologies: Infrastructure for Collaborative Enterprises, 2000.(WET ICE 2000)*. Proceedings. IEEE 9th International Workshops on (pp. 98-103). IEEE. Chapter 6
- [Gutwin et al. 2002] Gutwin, C., & Greenberg, S. (2002). A descriptive framework of workspace awareness for real-time groupware. *Computer Supported Cooperative Work (CSCW)*, 11(3-4), 411-446. Chapter 1
- [Gutwin et al. 2004] Gutwin, C., Penner, R., & Schneider, K. (2004, November). Group awareness in distributed software development. In *Proceedings of the 2004 ACM conference on Computer supported cooperative work (pp. 72-81)*. ACM. Chapter 2
- H**
- [Hackos & Redish 1998] Hackos, J. T., & Redish, J. (1998). User and task analysis for interface design. Chapter 1
- [Haller et al. 2006] Haller, M., Brandl, P., Leithinger, D., Leitner, J., Seifried, T., & Billingham, M. (2006). Shared design space: Sketching ideas using digital pens and a large augmented tabletop setup. In *Advances in artificial reality and tele-existence (pp. 185-196)*. Springer Berlin Heidelberg. Chapter 4,5
- [Hamadache & Lancieri 2009] Hamadache, K., & Lancieri, L. (2009). Strategies and taxonomy, tailoring your CSCW evaluation. In *Groupware: Design, Implementation, and Use (pp. 206-221)*. Springer Berlin Heidelberg. Chapter 3
- [Hansen & Hourcade 2010] Hansen, T. E., & Hourcade, J. P. (2010, November). Comparing multi-touch tabletops and multi-mouse single-display groupware setups. In *Proceedings of the 3rd Mexican Workshop on Human Computer Interaction (pp. 36-43)*. Universidad Politécnica de San Luis Potosí. Chapter 6
- [Hauber et al. 2006] Hauber, J., Regenbrecht, H., Billingham, M., & Cockburn, A. (2006, November). Spatiality in videoconferencing: trade-offs between efficiency and social presence. In *Proceedings of the 2006 20th anniversary conference on Computer supported cooperative work (pp. 413-422)*. ACM. Chapter 4
- [Hayward et al. 2004] Hayward, V., Astley, O. R., Cruz-Hernandez, M., Grant, D., & Robles-De-La-Torre, G. (2004). Haptic interfaces and devices. *Sensor Review*, 24(1), 16-29. Chapter 2
- [Heerwagen et al. 2004] Heerwagen, J. H., Kampschroer, K., Powell, K. M., & Loftness, V. (2004). Collaborative knowledge work environments. *Building research & information*, 32(6), 510-528. Chapter 1
- [Helms et al. 2000] Helms, J., Neale, D. C., Isenhour, P. L., & Carroll, J. M. (2000, July). Data logging: Higher-level capturing and multi-level abstracting of user activities. In *Proceedings of the Human Factors and Ergonomics Society Annual Meeting (Vol. 44, No. 2, pp. 303-306)*. SAGE Publications. Chapter 3,6
- [Herskovic et al. 2007] Herskovic, V., Pino, J. A., Ochoa, S. F., & Antunes, P. (2007). Evaluation methods for groupware systems. In *Groupware: Design, Implementation, and Use (pp. 328-336)*. Springer Berlin Heidelberg. Chapter 3
- [Hiltz et al. 1986] [Hiltz, S. R., Johnson, K., & Turoff, M. (1986). Experiments in Group Decision Making Communication Process and Outcome in Face-to-Face Versus Computerized Conferences. *Human communication research*, 13(2), 225-252.] Chapter 1
- [Hines 2004] Hines, C. B. (2004). Time-of-day effects on human performance. *Catholic Education: A Journal of Inquiry and Practice*, 7(3). Chapter 1
- [Hinrichs & Carpendale 2011] Hinrichs, U., & Carpendale, S. (2011, May). Gestures in the wild: studying multi-touch gesture sequences on interactive tabletop exhibits. In *Proceedings of the SIGCHI Conference on Human* Chapter 5

Factors in Computing Systems (pp. 3023-3032). ACM.

[Hobday 1998]	Hobday, M. (1998). Product complexity, innovation and industrial organisation. <i>Research policy</i> , 26(6), 689-710.	Chapter 1
[Hoffman et al. 1959]	Hoffman, L. R. (1959). Homogeneity of member personality and its effect on group problem-solving. <i>The Journal of Abnormal and Social Psychology</i> , 58(1), 27.	Chapter 1
[Hofstede 1997]	Hofstede, G. (1997). <i>Cultures and Organizations: Software of the Mind, Intercultural Cooperation and its Importance for Survival</i> : McGraw-Hill.	Chapter 1
[Hons 2008]	Hons, S. M. G. B. (2008). Evaluation of the Influence of Personality Types on Performance of Shared Tasks in a Collaborative Environment (Doctoral dissertation, Dublin City University).	Chapter 1
[Hoyle 2009]	Hoyle, D. (2009). <i>ISO 9000 Quality Systems Handbook: Using the standards as a framework for business improvement</i> . Routledge.	Chapter 4
[Hua et al. 2004]	Hua, H., Brown, L. D., & Gao, C. (2004). SCAPE: supporting stereoscopic collaboration in augmented and projective environments. <i>Computer Graphics and Applications, IEEE</i> , 24(1), 66-75.	Chapter 4
[Huang 2005]	Huang, J. P. (2005, June). A conceptual framework for understanding collaborative systems evaluation. In <i>Enabling Technologies: Infrastructure for Collaborative Enterprise, 2005. 14th IEEE International Workshops on</i> (pp. 215-220). IEEE.	Chapter 3
[Huang et al. 2004]	Huang, G. Q., Bin Zhao, J., & Jiang, Z. (2004). Web-based design review portal with fuzzy set theoretic methods for fuel pump designs. <i>International Journal of Computer Integrated Manufacturing</i> , 17(3), 265-278.	Chapter 4
[Hudson & Smith 1996]	Hudson, S. E., & Smith, I. (1996, November). Techniques for addressing fundamental privacy and disruption tradeoffs in awareness support systems. In <i>Proceedings of the 1996 ACM conference on Computer supported cooperative work</i> (pp. 248-257). ACM.	Chapter 2
[Huet et al. 2007]	Huet, G., Culley, S. J., McMahon, C. A., & Fortin, C. (2007). Making sense of engineering design review activities. <i>AI EDAM: Artificial Intelligence for Engineering Design, Analysis, and Manufacturing</i> , 21(03), 243-266.	Chapter 4
[Hunter et al. 2011]	Hunter, S., Maes, P., Scott, S., & Kaufman, H. (2011, May). MemTable: an integrated system for capture and recall of shared histories in group workspaces. In <i>Proceedings of the SIGCHI Conference on Human Factors in Computing Systems</i> (pp. 3305-3314). ACM.	Chapter 4

## I

[Ichida & Voigt 1996]	Ichida, T., & Voigt, E. C. (1996). <i>Product design review: a methodology for error-free product development</i> . Productivity Press.	Chapter 4
[Ikegulu 1998]	Ikegulu, P. R. (1998). <i>Effects of Screen Designs in CBI Environments</i> .	Chapter 2
[Ishii et al. 1993]	Ishii, H., Kobayashi, M., & Grudin, J. (1993). Integration of interpersonal space and shared workspace: ClearBoard design and experiments. <i>ACM Transactions on Information Systems (TOIS)</i> , 11(4), 349-375.	Chapter 4

## J

[Johansen 1988].	Johansen, R. (1988). <i>Groupware: Computer support for business teams</i> . The Free Press.	Chapter 2
[Johanson et al. 2002]	Johanson, B., Fox, A., & Winograd, T. (2002). <i>The Interactive Workspaces Project: Experiences with Ubiquitous Computing Rooms [Version# 2, 4/11/02]</i> .	Chapter 4
[Johnson1998]	Johnson, S. (1998). What's in a representation, why do we care, and what does it mean? Examining evidence from psychology. <i>Automation in Construction</i> , 8(1), 15-24.	Chapter 1
[Jones et al. 2011]	Jones, A., Kendira, A., Lenne, D., Gidel, T., & Moulin, C. (2011, June). The TATIN-PIC project: A multi-modal collaborative work environment for preliminary design. In <i>Computer Supported Cooperative Work in Design (CSCWD), 2011 15th International Conference on</i> (pp. 154-161). IEEE.	Chapter 4,5
[Jota et al. 2010]	Jota, R., de Araújo, B. R., Bruno, L. C., Pereira, J. M., & Jorge, J. A. (2010). IMMIView: a multi-user solution for design review in real-time. <i>Journal of Real-Time Image Processing</i> , 5(2), 91-107.	Chapter 4
[JPype 2013]	<a href="http://jpype.readthedocs.org/en/latest/">http://jpype.readthedocs.org/en/latest/</a> . (2013)	Chapter 5

## K

[Kammer et al. 2010]	Kammer, D., Keck, M., Freitag, G., & Wacker, M. (2010, June). Taxonomy and overview of multi-touch frameworks: Architecture, scope and features. In <i>Workshop on Engineering Patterns for Multitouch Interfaces</i> .	Chapter 5
[Kato et al. 1999]	Kato, H., & Billinghurst, M. (1999). Marker tracking and hmd calibration for a video-based augmented reality conferencing system. In <i>Augmented Reality, 1999.(IWAR'99) Proceedings. 2nd</i>	Chapter 4

IEEE and ACM International Workshop on (pp. 85-94). IEEE.

- [Kaur 2011] Kaur, P. (2011). Designing User Centric Online Privacy. In Aalto University, Seminar on Network Security, Fall (Vol. 4, p. 83). Chapter 2
- [Kawagoe 2010] Kawagoe, K. (2010). U.S. Patent Application 13/201,060. Chapter 2
- [Kayan et al. 2006] Kayan, S., Fussell, S. R., & Setlock, L. D. (2006). Cultural differences in the use of instant messaging in Asia and North America. Paper presented at the Proceedings of the conference on Computer supported cooperative work. Chapter 1
- [Kim et al. 2013] Kim, N., Phan, A. H., Erdenebat, M. U., Alam, A. M., Kwon, K. C., Piao, M. L., & Lee, J. H. (2013). 3D display technology. *Disp. Imag. Technol*, 1, 73-95. Chapter 2
- [Kirwan & Ainsworth 2004] Kirwan, B., & Ainsworth, L. K. (Eds.). (2004). A guide to task analysis: the task analysis working group. CRC press. Chapter 1
- [Kitamura et al. 2001] Kitamura, Y., Konishi, T., Yamamoto, S., & Kishino, F. (2001, August). Interactive stereoscopic display for three or more users. In Proceedings of the 28th annual conference on Computer graphics and interactive techniques (pp. 231-240). ACM. Chapter 4
- [Kiyokawa et al. 1999] Kiyokawa, K., Takemura, H., & Yokoya, N. (1999, July). SeamlessDesign: A face-to-face collaborative virtual/augmented environment for rapid prototyping of geometrically constrained 3-d objects. In *Multimedia Computing and Systems, 1999. IEEE International Conference on* (Vol. 2, pp. 447-453). IEEE. Chapter 4
- [Khosrojerdi et al. 2014] Khosrojerdi, A., Rezapour, S., Allen, J. K., & Mistree, F. (2014, August). Five Steps for Crafting a Doctoral Research Proposal in Engineering Design. In *ASME 2014 International Design Engineering Technical Conferences and Computers and Information in Engineering Conference* (pp. V003T04A026-V003T04A026). American Society of Mechanical Engineers.
- [Knoll et al. 2010] Knoll, S. W., Plumbaum, T., Hoffmann, J. L., & De Luca, E. W. (2010). Collaboration ontology: Applying collaboration knowledge to a generic group support system. In *Group Decision and Negotiation Meeting (GDN) 2010* (pp. 12-26). Chapter 1
- [Knoll et al. 2012] Knoll, S. W., Plumbaum, T., De Luca, E. W., & Predoiu, L. (2012). Ontological Collaboration Engineering. *IGI Global, collaboration and the semantic web: social networks, knowledge networks and knowledge resources edition*, 219-245. Chapter 1
- [Knöpfle & Voß 2000] Knöpfle, C., & Voß, G. (2000, May). An intuitive VR user interface for design review. In *Proceedings of the working conference on Advanced visual interfaces* (pp. 98-101). ACM. Chapter 4
- [Kraut et al. 2002] Kraut, R. E., Gergle, D., & Fussell, S. R. (2002, November). The use of visual information in shared visual spaces: Informing the development of virtual co-presence. In *Proceedings of the 2002 ACM conference on Computer supported cooperative work* (pp. 31-40). ACM. Chapter 2
- [Krüger et al. 1995] Krüger, W., Bohn, C. A., Fröhlich, B., Schüth, H., Strauss, W., & Wesche, G. (1995). The responsive workbench: A virtual work environment. *Computer*, (7), 42-48. Chapter 4
- [Kruger et al. 2003] Kruger, R., Carpendale, S., Scott, S. D., & Greenberg, S. (2003, November). How people use orientation on tables: comprehension, coordination and communication. In *Proceedings of the 2003 international ACM SIGGROUP conference on Supporting group work* (pp. 369-378). ACM. Chapter 5
- [Kuechler & Kunz 2010] Kuechler, M., & Kunz, A. M. (2010, November). Collaboard: a remote collaboration groupware device featuring an embodiment-enriched shared workspace. In *Proceedings of the 16th ACM international conference on Supporting group work* (pp. 211-214). ACM. Chapter 4
- [Kuzuoka et al. 2004] Kuzuoka, H., Yamazaki, K., Yamazaki, A., Kosaka, J. I., Suga, Y., & Heath, C. (2004, April). Dual ecologies of robot as communication media: thoughts on coordinating orientations and projectability. In *Proceedings of the SIGCHI conference on Human factors in computing systems* (pp. 183-190). ACM. Chapter 4
- [Kwon et al. 2010] Kwon, K. C., Lim, Y. T., Kim, N., Yoo, K. H., Hong, J. M., & Park, G. C. (2010). High-definition 3D stereoscopic microscope display system for biomedical applications. *Journal on Image and Video Processing*, 2010, 2. Chapter 2
- [Kolodner 2014] Kolodner, J. (2014). Case-based reasoning. Morgan Kaufmann.
- L**
- [Lam & Chin 2005] Lam, P. K., & Chin, K. S. (2005). Identifying and prioritizing critical success factors for conflict management in collaborative new product development. *Industrial Marketing Management*, 34(8), 761-772. Chapter 6
- [Lampson 2004] Lampson, B. W. (2004). Computer security in the real world. *Computer*, 37(6), 37-46. Chapter 2
- [Lantz 2007] Lantz, E. (2007, August). A survey of large-scale immersive displays. In *Proceedings of the 2007 workshop on Emerging displays technologies: images and beyond: the future of displays and interacton* (p. 1). ACM. Chapter 2
- [Leake & Valerio 2006] Leake, D. Valerio, A. (2006). Jump-starting concept map construction with knowledge extracted from documents. In *Proceedings of the Second International Conference on Concept Mapping*



(CMC.

- [Leake et al. 2014] Leake, D., Maguitman, A., & Reichherzer, T. (2014). Experience-based support for human-centered knowledge modeling. *Knowledge-Based Systems*, 68, 77-87. Chapter 1
- [Lee & Takayama 2011] Lee, M. K., & Takayama, L. (2011, May). Now, I have a body: Uses and social norms for mobile remote presence in the workplace. In *Proceedings of the SIGCHI Conference on Human Factors in Computing Systems* (pp. 33-42). ACM. Chapter 4
- [Lee et al. 2012] Lee, J., Lim, M., Kim, H., & Kim, J. I. (2012). Supporting Fine-Grained Concurrent Tasks and Personal Workspaces for a Hybrid Concurrency Control Mechanism in a Networked Virtual Environment. *Presence: Teleoperators and Virtual Environments*, 21(4), 452-469. Chapter 2
- [Leigh et al. 2002] Leigh, J., Johnson, A., Park, K., Nayak, A., Singh, R., Chowdhry, V., & DeFanti, T. A. (2002, November). Amplified collaboration environments. In *VizGrid Symposium*, Tokyo. Chapter 4

## M

- [Maeno et al. 1996] Maeno, K., Fukaya, N., Nishikawa, O., Sato, K., & Honda, T. (1996, March). Electro-holographic display using 15mega pixels LCD. In *Electronic Imaging: Science & Technology* (pp. 15-23). International Society for Optics and Photonics. Chapter 2
- [Maier et al. 2005] Maier, A. M., Eckert, C. M., & Clarkson, P. J. (2005). A meta-model for communication in engineering design. *CoDesign*, 1(4), 243-254. Chapter 1
- [Malone & 1994] Malone, T. W., & Crowston, K. (1994). The interdisciplinary study of coordination. *ACM Computing Surveys (CSUR)*, 26(1), 87-119. Chapter 1
- [Margaritis & Marmaras 2007] Margaritis, S., & Marmaras, N. (2007). Supporting the design of office layout meeting ergonomics requirements. *Applied ergonomics*, 38(6), 781-790. Chapter 2
- [Martin 2009] Martin, H. (2009, November). A generalized context-based access control model for pervasive environments. In *Proceedings of the 2nd SIGSPATIAL ACM GIS 2009 International Workshop on Security and Privacy in GIS and LBS* (pp. 12-21). ACM. Chapter 2
- [McGrath & Hollingshead 1994] McGrath, J. E., & Hollingshead, A. B. (1994). *Groups interacting with technology: Ideas, evidence, issues, and an agenda*. Sage Publications, Inc. Chapter 2
- [McGrath 1984] McGrath, J. E. (1984). *Groups: Interaction and performance* (Vol. 14). Englewood Cliffs, NJ: Prentice-Hall. Chapter 3
- [McLeod & Lobel 1992] McLeod, P. L., & Lobel, S. A. (1992, August). The effects of ethnic diversity on idea generation in small groups. In *Academy of Management Proceedings* (Vol. 1992, No. 1, pp. 227-231). Academy of Management. Chapter 1
- [McNelly 2005] McNelly, S. (2005). Immersive Group Telepresence and the Perception of Eye Contact. Chapter 4
- [Microsoft 2012] <http://www.engadget.com/2012/05/12/microsoft-researchs-miragetable-brings-some-augmented-reality-t/> (2012) Chapter 4
- [Milne 2005] Milne, A. J. (2005). An information-theoretic approach to the study of ubiquitous computing workspaces supporting geographically distributed engineering design teams as group-users. Stanford University. Chapter 1
- [Monge et al. 1989] Monge, P. R., McSween, C., & Wyer, J. (1989). A profile of meetings in corporate America: Results of the 3M meeting effectiveness study. Annenberg School of Communications, University of Southern California. Chapter 1
- [Mosvick et al. 1987] Mosvick, R. K., & Nelson, R. B. (1987). *We've got to start meeting like this: a guide to successful business meeting management*. Scott Foresman Trade. Chapter 1
- [Mansar et al. 2003] Mansar, S. L., Marir, F., & Reijers, H. A. (2003). Case-based reasoning as a technique for knowledge management in business process redesign. *Electronic Journal on Knowledge Management*, 1(2), 113-124.

## N

- [Nam & Sakong 2009] Nam, T. J., & Sakong, K. (2009). Collaborative 3D workspace and interaction techniques for synchronous distributed product design reviews. *International Journal of Design*, 3(1), 43-55. Chapter 4
- [Neale et al. 2004] Neale, D. C., Carroll, J. M., & Rosson, M. B. (2004, November). Evaluating computer-supported cooperative work: models and frameworks. In *Proceedings of the 2004 ACM conference on Computer supported cooperative work* (pp. 112-121). ACM. Chapter 3
- [Novak & Cañas 2006] Novak, J. D., & Cañas, A. J. (2006). *The theory underlying concept maps and how to construct them*. Florida Institute for Human and Machine Cognition, 1. Chapter 1
- [Novak & Gowin 1984] Novak, J. D., & Gowin, D. B. (1984). *Learning how to learn*. Cambridge University Press. Chapter 1
- [Nunamaker et al. 1991] Nunamaker, J. F., Dennis, A. R., Valacich, J. S., Vogel, D., & George, J. F. (1991). Electronic meeting systems. *Communications of the ACM*, 34(7), 40-61. Chapter 1

## O

- [Oliveira et al. 2007] Oliveira, F. F., Antunes, J. C., & Guizzardi, R. S. (2007, October). Towards a collaboration ontology. In *Proc. of the Snd Brazilian Workshop on Ontologies and Metamodels for Software and Data Engineering*. Chapter 1
- [Olson et al. 1992] Olson, G. M., Olson, J. S., Carter, M. R., & Storosten, M. (1992). Small group design meetings: An analysis of collaboration. *Human-Computer Interaction*, 7(4), 347-374. Chapter 1
- [Olson et al. 2003] Olson, J., & Olson, G. (2003). Culture Surprises in Remote Software Development Teams. *Queue*, 1(9), 52 - 59. Chapter 1
- [Ong & Shen 2009] Ong, S. K., & Shen, Y. (2009). A mixed reality environment for collaborative product design and development. *CIRP Annals-Manufacturing Technology*, 58(1), 139-142. Chapter 4
- [Orlikowski 1992] Orlikowski, W. J. (1992, December). Learning from Notes: organizational issues in groupware implementation. In *Proceedings of the 1992 ACM conference on Computer-supported cooperative work* (pp. 362-369). ACM. Chapter 1
- [OSHA 2000] OSHA, (2000), *Ergonomics: The Study of Work*, U.S. Department of Labor, Occupational Safety and Health Administration, OSHA 3125 Chapter 1
- [Ostergaard et al. 2009] Ostergaard, K. J., & Summers, J. D. (2009). Development of a systematic classification and taxonomy of collaborative design activities. *Journal of Engineering Design*, 20(1), 57-81. Chapter 1
- [Oyekoya et al. 2012] Oyekoya, O., Steptoe, W., & Steed, A. (2012, May). SphereAvatar: a situated display to represent a remote collaborator. In *Proceedings of the 2012 ACM annual conference on Human Factors in Computing Systems* (pp. 2551-2560). ACM. Chapter 4

## P

- [Pahl et al. 2007] Pahl, G., Wallace, K., & Blessing, L. (2007). *Engineering design: a systematic approach* (Vol. 157). Springer-Verlag London Limited. Chapter 1
- [Pallotta et al. 2007] Pallotta, V., Seretan, V., & Ailomaa, M. (2007). User requirements analysis for meeting information retrieval based on query elicitation. In *ANNUAL MEETING-ASSOCIATION FOR COMPUTATIONAL LINGUISTICS* (Vol. 45, No. 1, p. 1008). Chapter 1
- [Pattberg & Fluegge 2007] Pattberg, J., & Fluegge, M. (2007, April). Towards an Ontology of Collaboration Patterns. In *CCE* (pp. 85-96). Chapter 1
- [Pei 2009] Pei, E. (2009). *Building a common language of design representations for industrial designers & engineering designers*, PhD thesis, Loughborough University. Chapter 1
- [Penichet et al. 2007] Penichet, V. M. R., Marin, I., Gallud, J. A., Lozano, M. D., & Tesoriero, R. (2007). A classification method for CSCW systems. *Electronic Notes in Theoretical Computer Science*, 168, 237-247. Chapter 2
- [Perry & Sanderson 1998] Perry, M., & Sanderson, D. (1998). Coordinating joint design work: the role of communication and artefacts. *Design studies*, 19(3), 273-288. Chapter 1
- [Perttula & Sipilä 2007] Perttula, M., & Sipilä, P. (2007). The idea exposure paradigm in design idea generation. *Journal of Engineering Design*, 18(1), 93-102. Chapter 1
- [Petit et al. 2010] Petit, B., Dupeux, T., Bossavit, B., Legaux, J., Raffin, B., Melin, E., ... & Boyer, E. (2010, October). A 3d data intensive tele-immersive grid. In *Proceedings of the international conference on Multimedia* (pp. 1315-1318). ACM. Chapter 4
- [Pinelle & Gutwin 2000] Pinelle, D., & Gutwin, C. (2000). A review of groupware evaluations. In *Enabling Technologies: Infrastructure for Collaborative Enterprises, 2000.(WET ICE 2000). Proceedings. IEEE 9th International Workshops on* (pp. 86-91). IEEE. Chapter 3
- [Pinelle & Gutwin 2008] Pinelle, D., & Gutwin, C. (2008). Evaluating teamwork support in tabletop groupware applications using collaboration usability analysis. *Personal and Ubiquitous Computing*, 12(3), 237-254. Chapter 6
- [Pinsonneault & Kraemer 1989] Pinsonneault, A., & Kraemer, K. L. (1989). The impact of technological support on groups: An assessment of the empirical research. *Decision Support Systems*, 5(2), 197-216. Chapter 2
- [POPA 2010] POPA, L. M. (2010). *Framework for Collaborative Systems Assessment Based on Metrics*. *Journal of Applied Collaborative Systems Vol*, 2(2). Chapter 3
- [Poupyrev et al. 2002] Poupyrev, I., Tan, D. S., Billinghurst, M., Kato, H., Regenbrecht, H., & Tetsutani, N. (2002). Developing a generic augmented-reality interface. *Computer*, 35(3), 44-50. Chapter 4

## R

- [Rama & Bishop 2006] Rama, J., & Bishop, J. (2006, October). A survey and comparison of CSCW groupware applications. In *Proceedings of the 2006 annual research conference of the South African institute of computer scientists and information technologists on IT research in developing countries* (pp. 198-205). South African Institute for Computer Scientists and Information Technologists. Chapter 2
- [Ramage 1997] Ramage, M. (1997, August). Developing a methodology for the evaluation of cooperative systems. In *Proceedings of IRIS* (Vol. 20, pp. 9-12). Chapter 3
- [Rana et al. 1997] Rana, A. R., Turoff, M., & Hiltz, S. R. (1997, January). Task and technology interaction (TTI): a Chapter 2

- theory of technological support for group tasks. In *System Sciences, 1997, Proceedings of the Thirtieth Hawaii International Conference on* (Vol. 2, pp. 66-75). IEEE.
- [Rashid et al. 2012] Rashid, U., Nacenta, M. A., & Quigley, A. (2012, June). Factors influencing visual attention switch in multi-display user interfaces: a survey. In *Proceedings of the 2012 International Symposium on Pervasive Displays* (p. 1). ACM. Chapter 2
- [Rauterberg et al. 1997] Rauterberg, M., Fjeld, M., Krueger, H., Bichsel, M., Leonhardt, U., & Meier, M. (1997). BUILD-IT: a computer vision-based interaction technique for a planning tool. In *People and Computers XII* (pp. 303-314). Springer London. Chapter 4
- [Regenbrecht et al. 2002] Regenbrecht, H. T., & Wagner, M. T. (2002, April). Interaction in a collaborative augmented reality environment. In *CHI'02 Extended Abstracts on Human Factors in Computing Systems* (pp. 504-505). ACM. Chapter 4
- [Rehman & Yan 2007] Rehman, F. U., & Yan, X. T. (2007). Supporting early design decision making using design context knowledge. *Journal of Design Research*, 6(1), 169-189. Chapter 1
- [Rekimoto 1996] Rekimoto, J. (1996, September). Transvision: A hand-held augmented reality system for collaborative design. In *Proc. Virtual Systems and Multimedia* (pp. 85-90). Chapter 4
- [Rekimoto 2002] Rekimoto, J. (2002, April). SmartSkin: an infrastructure for freehand manipulation on interactive surfaces. In *Proceedings of the SIGCHI conference on Human factors in computing systems* (pp. 113-120). ACM. Chapter 4
- [Rekimoto et al. 1999] Rekimoto, J., & Saitoh, M. (1999, May). Augmented surfaces: a spatially continuous work space for hybrid computing environments. In *Proceedings of the SIGCHI conference on Human Factors in Computing Systems* (pp. 378-385). ACM. Chapter 4
- [Reyna 2005] Reyna, J. (2005). *The Impact of Predisposition Towards Group Work on Intention to Use a CSCW System* (Doctoral dissertation, University of North Texas). Chapter 1
- [Rolland & Fuchs 2000] Rolland, J. P., & Fuchs, H. (2000). Optical versus video see-through head-mounted displays in medical visualization. *Presence: Teleoperators and Virtual Environments*, 9(3), 287-309. Chapter 2
- [Ross et al. 1995] Ross, S., Ramage, M., & Rogers, Y. (1995). PETRA: Participatory evaluation through redesign and analysis. *Interacting with Computers*, 7(4), 335-360. Chapter 3
- [Ryall et al. 2004] Ryall, K., Forlines, C., Shen, C., & Morris, M. R. (2004, November). Exploring the effects of group size and table size on interactions with tabletop shared-display groupware. In *Proceedings of the 2004 ACM conference on Computer supported cooperative work* (pp. 284-293). ACM. Chapter 5,6
- [Rachedi et al. 2010] Rachedi, S., Boujut, J. F., & Poussier, G. (2010, September). Etude de cas d'une offre industrielle de management des connaissances techniques. In *Actes du 3<sup>ème</sup> Colloque GeCSO Gestion des Connaissances, Université de Strasbourg*.
- [Rhem 2005] Rhem, A. J. (2005). *UML for developing knowledge management systems*. CRC Press.
- [Richter & Weber 2013] Richter, M. M., & Weber, R. (2013). *Case-Based Reasoning*. Springer, Heidelberg.
- ## S
- [Sabol et al. 2007] Sabol, V., Gütl, C., Neidhart, T., Juffinger, A., Klieber, W., & Granitzer, M. (2007). Visualization Metaphors for Multi-modal Meeting Data. In *BTW Workshops* (pp. 250-269). Chapter 4
- [Saddler 2001] Saddler, H. J. (2001). Understanding design representations. *INTERACTIONS-NEW YORK-*, 17-24. Chapter 1
- [Sadeghi et al. 2012] Sadeghi, S., Masolet, C., & Noël, F. (2012). Visual and Interactive Tool for Product Development Process Enhancement: Towards Intuitive Support of Co-located Project Review. In *Product Lifecycle Management. Towards Knowledge-Rich Enterprises* (pp. 213-225). Springer Berlin Heidelberg. Chapter 1
- [Salvador et al. 1996] Salvador, T., Scholtz, J., & Larson, J. (1996). The Denver model for groupware design. *ACM SIGCHI Bulletin*, 28(1), 52-58. Chapter 1
- [Sandor et al. 2002] Sandor, C., MacWilliams, A., Wagner, M., Bauer, M., & Klinker, G. (2002, September). Sheep: The shared environment entertainment pasture. In *IEEE and ACM International Symposium on Mixed and Augmented Reality ISMAR* (Vol. 2002, No. 1.3, pp. 1-5). Chapter 4
- [Schmalstieg et al. 2000] Schmalstieg, D., Fuhrmann, A., & Hesina, G. (2000). Bridging multiple user interface dimensions with augmented reality. In *Augmented Reality, 2000.(ISAR 2000). Proceedings. IEEE and ACM International Symposium on* (pp. 20-29). IEEE. Chapter 4
- [Schmalstieg et al. 1996] Schmalstieg, D., Fuhrmann, A., Hesina, G., Szalavári, Z., Encarnaçao, L. M., Gervautz, M., & Purgathofer, W. (2002). The studierstube augmented reality project. *Presence: Teleoperators and Virtual Environments*, 11(1), 33-54. Chapter 4
- [Schmidt & Wagner 2004] Schmidt, K., & Wagner, I. (2004). Ordering systems: Coordinative practices and artifacts in architectural design and planning. *Computer Supported Cooperative Work (CSCW)*, 13(5-6), 349-408. Chapter 1
- [Schmidt 2002] Schmidt, K. (2002). The problem with awareness': Introductory remarks on awareness in CSCW'. *Computer Supported Cooperative Work (CSCW)*, 11(3-4), 285-298. Chapter 2

[Schroeder et al. 2000]	Schroeder, W. J., Avila, L. S., & Hoffman, W. (2000). Visualizing with VTK: a tutorial. <i>Computer Graphics and Applications</i> , IEEE, 20(5), 20-27.	Chapter 5
[Scott et al. 2003]	Scott, S. D., Grant, K. D., & Mandryk, R. L. (2003, January). System guidelines for co-located, collaborative work on a tabletop display. In <i>ECSCW 2003</i> (pp. 159-178). Springer Netherlands.	Chapter 5
[Scott et al. 2004]	Scott, S. D., Carpendale, M. S. T., & Inkpen, K. M. (2004, November). Territoriality in collaborative tabletop workspaces. In <i>Proceedings of the 2004 ACM conference on Computer supported cooperative work</i> (pp. 294-303). ACM.	Chapter 6, 4
[Scriven 1967]	Scriven, M. S. (1967). <i>The methodology of evaluation</i> (Perspectives of Curriculum Evaluation, and AERA monograph Series on Curriculum Evaluation, No. 1). Chicago: Rand McNally.	Chapter 3
[Setlock et al. 2004]	Setlock, L. D., Fussell, S. R., & Neuwirth, C. (2004). Taking it out of context: collaborating within and across cultures in face-to-face settings and via instant messaging. <i>Proceedings of the 2004 ACM conference on Computer supported cooperative work</i> , 604-613.	Chapter 1
[Setlock et al. 2007]	Setlock, L. D., Quinones, P. A., & Fussell, S. R. (2007). Does culture interact with media richness? The effects of audio vs. video conferencing on Chinese and American dyads. Paper presented at the 40th Annual Hawaii International Conference on System Sciences (HICSS'07).	Chapter 1
[Sfetsos et al. 2009]	Sfetsos, P., Stamelos, I., Angelis, L., & Deligiannis, I. (2009). An experimental investigation of personality types impact on pair effectiveness in pair programming. <i>Empirical Software Engineering</i> , 14(2), 187-226.	Chapter 1
[SGI © RealityCenter 2010]	<a href="http://www.sgi.com/realitycenter/">http://www.sgi.com/realitycenter/</a> . (2010)	Chapter 4
[Shah et al. 2000]	Shah, J. J., Kulkarni, S. V., & Vargas-Hernandez, N. (2000). Evaluation of idea generation methods for conceptual design: effectiveness metrics and design of experiments. <i>Journal of Mechanical Design</i> , 122, 377.	Chapter 1
[Shah et al. 2001]	Shah, J. J., VARGAS-HERNANDEZ, N. O. E., Summers, J. D., & Kulkarni, S. (2001). Collaborative Sketching (C-Sketch)—An idea generation technique for engineering design. <i>The Journal of Creative Behavior</i> , 35(3), 168-198.	Chapter 1
[Shen & Dewan 1992]	Shen, H., & Dewan, P. (1992, December). Access control for collaborative environments. In <i>Proceedings of the 1992 ACM conference on Computer-supported cooperative work</i> (pp. 51-58). ACM.	Chapter 2
[Shen et al. 2003]	Shen, C., Everitt, K., & Ryll, K. (2003, January). UbiTable: Impromptu face-to-face collaboration on horizontal interactive surfaces. In <i>UbiComp 2003: Ubiquitous Computing</i> (pp. 281-288). Springer Berlin Heidelberg.	Chapter 4,5
[Sherman & Craig 2002]	Sherman, W. R., & Craig, A. B. (2002). <i>Understanding virtual reality: Interface, application, and design</i> . Elsevier.	Chapter 2
[Sidharta et al. 2006]	Sidharta, R., Oliver, J., & Sannier, A. (2006, July). Augmented reality tangible interface for distributed design review. In <i>Computer Graphics, Imaging and Visualisation, 2006 International Conference on</i> (pp. 464-470). IEEE.	Chapter 4
[Simon & Gobel 2002]	Simon, A., & Gobel, M. (2002). The i-Cone™-a panoramic display system for virtual environments. In <i>Computer Graphics and Applications, 2002. Proceedings. 10th Pacific Conference on</i> (pp. 3-7). IEEE.	Chapter 2
[Sirkin & Ju 2012]	Sirkin, D., & Ju, W. (2012, March). Consistency in physical and on-screen action improves perceptions of telepresence robots. In <i>Proceedings of the seventh annual ACM/IEEE international conference on Human-Robot Interaction</i> (pp. 57-64). ACM.	Chapter 4
[Smith & Graham 2010]	Smith, J. D., & Graham, T. C. (2010, May). Raptor: sketching games with a tabletop computer. In <i>Proceedings of the International Academic Conference on the Future of Game Design and Technology</i> (pp. 191-198). ACM.	Chapter 4, 5
[Smith & Eppinger 1993]	Smith, R. P., & Eppinger, S. P. (1993). Characteristics and models of iteration in engineering design (pp. 564-571). <i>International Motor Vehicle Program</i> , Massachusetts Institute of Technology.	Chapter 1
[Stanley et al. 2004]	Stanley, M., Smith, M. A., Smith, A. P., Watson, P. J., Coomber, S. D., Cameron, C. D., ... & Wood, A. (2004, February). 3D electronic holography display system using a 100-megapixel spatial light modulator. In <i>Optical Systems Design</i> (pp. 297-308). International Society for Optics and Photonics.	Chapter 2
[Stavness et al. 2010]	Stavness, I., Lam, B., & Fels, S. (2010, April). pCubee: a perspective-corrected handheld cubic display. In <i>Proceedings of the SIGCHI Conference on Human Factors in Computing Systems</i> (pp. 1381-1390). ACM.	Chapter 2
[Stefik et al. 1987]	Stefik, M., Bobrow, D. G., Foster, G., Lanning, S., & Tatar, D. (1987). WYSIWIS revised: early experiences with multiuser interfaces. <i>ACM Transactions on Information Systems (TOIS)</i> , 5(2), 147-167.	Chapter 4
[Steinicke et al. 2012]	Steinicke, F., Benko, H., Krüger, A., Keefe, D., de la Rivière, J. B., Anderson, K., ... & Pakanen, M. (2012, May). The 3rd dimension of CHI (3DCHI): touching and designing 3D user interfaces. In <i>CHI'12 Extended Abstracts on Human Factors in Computing Systems</i> (pp. 2695-2698). ACM.	Chapter 5
[Steves & Scholtz]	Steves, M. P., & Scholtz, J. (2005, January). A framework for evaluating collaborative systems in	Chapter 3

2005] the real world. In System Sciences, 2005. HICSS'05. Proceedings of the 38th Annual Hawaii International Conference on (pp. 29c-29c). IEEE.

[Stewart et al. 1999] Stewart, J., Bederson, B. B., & Druin, A. (1999, May). Single display groupware: a model for co-present collaboration. In Proceedings of the SIGCHI conference on Human Factors in Computing Systems (pp. 286-293). ACM.

[St-Hilaire et al. 1990] St-Hilaire, P., Benton, S. A., Lucente, M. E., Jepsen, M. L., Kollin, J., Yoshikawa, H., & Underkoffler, J. S. (1990, May). Electronic display system for computational holography. In OE/LASE'90, 14-19 Jan., Los Angeles, CA (pp. 174-182). International Society for Optics and Photonics.

[Streitz et al. 2002] Streitz, N., Prante, T., Müller-Tomfelde, C., Tandler, P., & Magerkurth, C. (2002, April). Roomware©: the second generation. In CHI'02 Extended Abstracts on Human Factors in Computing Systems (pp. 506-507). ACM.

[Szalavári et al. 1998] Szalavári, Zsolt, Dieter Schmalstieg, Anton Fuhrmann, and Michael Gervautz. "'Studierstube'": An environment for collaboration in augmented reality." *Virtual Reality* 3, no. 1 (1998): 37-48.

[Shepperd 2003] Shepperd, M. (2003). Case-based reasoning and software engineering. In *Managing Software Engineering Knowledge* (pp. 181-198). Springer Berlin Heidelberg.

[Smyth et al. 2001] Smyth, B., Keane, M. T., & Cunningham, P. (2001). Hierarchical case-based reasoning integrating case-based and decompositional problem-solving techniques for plant-control software design. *Knowledge and Data Engineering, IEEE Transactions on*, 13(5), 793-812.

## T

[Tan © Holobench 2010] TAN Holobench. [www.barco.com/virtualreality/](http://www.barco.com/virtualreality/) (2010) Chapter 4

[Tang & Greenberg 2005] Tang, A., & Greenberg, S. (2005). Supporting awareness in mixed presence groupware. In *From Awareness to HCI Education: The CHI2005 Workshop Papers Suite* (p. 10). Chapter 4

[Tang & Leifer 1988] Tang, J. C., & Leifer, L. J. (1988, January). A framework for understanding the workspace activity of design teams. In Proceedings of the 1988 ACM conference on Computer-supported cooperative work (pp. 244-249). ACM. Chapter 1, 4

[Tang 1991] Tang, J. C. (1991). Findings from observational studies of collaborative work. *International Journal of Man-machine studies*, 34(2), 143-160. Chapter 1, 4

[Tang et al. 2004] Tang, A., Boyle, M., & Greenberg, S. (2004, January). Display and presence disparity in Mixed Presence Groupware. In Proceedings of the fifth conference on Australasian user interface-Volume 28 (pp. 73-82). Australian Computer Society, Inc. Chapter 2, 4

[Tang et al. 2006/B] Tang, A., Tory, M., Po, B., Neumann, P., & Carpendale, S. (2006, April). Collaborative coupling over tabletop displays. In Proceedings of the SIGCHI conference on Human Factors in computing systems (pp. 1181-1190). ACM. Chapter 1

[Tatikonda & Rosenthal 2000] Tatikonda, M. V., & Rosenthal, S. R. (2000). Technology novelty, project complexity, and product development project execution success: a deeper look at task uncertainty in product innovation. *Engineering Management, IEEE Transactions on*, 47(1), 74-87. Chapter 1

[Tecchia et al. 2012] Tecchia, F., Alem, L., & Huang, W. (2012, December). 3D Helping Hands: a gesture based MR system for remote collaboration. In Proceedings of the 11th ACM SIGGRAPH International Conference on Virtual-Reality Continuum and its Applications in Industry (pp. 323-328). ACM. Chapter 4

[Terken & Sturm 2005] Terken, J.M.B. & Sturm, J.A. (2005). Recommendations and Best Practices for Evaluation of Ubiquitous Groupware Services. *ICMI 2005 Workshop on User-Centred Design and Evaluation of Service for Human-Human Communication and Collaboration*, Trento. Chapter 3

[Terrenghi et al. 2009] Terrenghi, L., Quigley, A., & Dix, A. (2009). A taxonomy for and analysis of multi-person-display ecosystems. *Personal and Ubiquitous Computing*, 13(8), 583-598. Chapter 2

[Thomke & Fujimoto 2000] Thomke, S., & Fujimoto, T. (2000). The Effect of "Front-Loading" Problem-Solving on Product Development Performance. *Journal of product innovation management*, 17(2), 128-142. Chapter 1

[Tory et al. 2008] Tory, M., Staub-French, S., Po, B. A., & Wu, F. (2008). Physical and digital artifact-mediated coordination in building design. *Computer Supported Cooperative Work (CSCW)*, 17(4), 311-351. Chapter 1, 4

[Tse et al. 2007] Tse, E., Greenberg, S., Shen, C., & Forlines, C. (2007). Multimodal multiplayer tabletop gaming. *Computers in Entertainment (CIE)*, 5(2), 12. Chapter 4, 5

[Tuddenham & Robinson 2007] Tuddenham, P., & Robinson, P. (2007, October). Distributed tabletops: Supporting remote and mixed-presence tabletop collaboration. In *Horizontal Interactive Human-Computer Systems, 2007. TABLETOP'07. Second Annual IEEE International Workshop on* (pp. 19-26). IEEE. Chapter 4

## U

[Ulrich & Eppinger 1995] Ulrich, K. T., & Eppinger, S. D. (1995). *Product design and development* (Vol. 384). New York: McGraw-Hill. Chapter 1

[Ulrich et al. 2011] Ulrich, K. T., Eppinger, S. D., & Goyal, A. (2011). *Product design and development* (Vol. 2). Chapter 1

McGraw-Hill.

[Uva et al. 2010] Uva, A. E., Cristiano, S., Fiorentino, M., & Monno, G. (2010). Distributed design review using tangible augmented technical drawings. *Computer-Aided Design*, 42(5), 364-372. Chapter 4

## V

[Van der Lugt 2002] Van der Lugt, R. (2002, October). Functions of sketching in design idea generation meetings. In *Proceedings of the 4th conference on Creativity & cognition* (pp. 72-79). ACM. Chapter 1

[Van Der Veer et al. 1996] Van Der Veer, G. C., Lenting, B. F., & Bergevoet, B. A. (1996). Gta: Groupware task analysis—modeling complexity. *Acta Psychologica*, 91(3), 297-322. Chapter 1

[Vandenbosch & Ginzberg 1996] Vandenbosch, B., & Ginzberg, M. J. (1996, January). Lotus Notes and collaboration: le plus c, a change. In *System Sciences, 1996., Proceedings of the Twenty-Ninth Hawaii International Conference on*, (Vol. 3, pp. 61-71). IEEE. Chapter 1

[Venkatesh et al. 2003] Venkatesh, V., Morris, M. G., Davis, G. B., & Davis, F. D. (2003). User acceptance of information technology: Toward a unified view. *MIS quarterly*, 425-478. Chapter 1

[Vicente 1999] Vicente, K. J. (1999). *Cognitive work analysis: Toward safe, productive, and healthy computer-based work*. CRC Press. Chapter 1

[Vickery 1958] Vickery, B. C. (1958). Classification and indexing in science. *Classification and indexing in science*. Chapter 2

[VTK 2013] <http://www.vtk.org/>, (2013) Chapter 5

## W

[Wainer & Barsottini 2007] Wainer, J., & Barsottini, C. (2007). Empirical research in CSCW—a review of the ACM/CSCW conferences from 1998 to 2004. *Journal of the Brazilian Computer Society*, 13(3), 27-35. Chapter 3

[Walle et al. 2009] Walle, T., & Hannay, J. E. (2009, October). Personality and the nature of collaboration in pair programming. In *Empirical Software Engineering and Measurement, 2009. ESEM 2009. 3rd International Symposium on* (pp. 203-213). IEEE. Chapter 1

[Wang & Dunston 2008] Wang, X., & Dunston, P. S. (2008). User perspectives on mixed reality tabletop visualization for face-to-face collaborative design review. *Automation in construction*, 17(4), 399-412. Chapter 4

[Watson et al. 1994/A] Watson, R. T., Ho, T. H., & Raman, K. S. (1994). Culture: A fourth dimension of group support systems. *Communications of the ACM*, 37(10), 44-55. Chapter 1

[Watson et al. 1994/B] Watson Richard T., Bostrom Robert P. and Dennis Alan R., (1994), *Fragmentation to Integration, in Groupware in the 21st Century: Computer Supported Co-operative Working Towards the Millennium*, Adamantine Press, London, England, 1994, pp29-39, Mentioned in Osguthorpe, G., Steele, B., & Houldcroft, A. (1996, June). A method for developing CSCW systems. In *Enabling Technologies: Infrastructure for Collaborative Enterprises, 1996. Proceedings of the 5th Workshop on* (pp. 214-219). IEEE. Chapter 1

[Weiseth et al. 2006] Weiseth, P. E., Munkvold, B. E., Tvedte, B., & Larsen, S. (2006, November). The wheel of collaboration tools: a typology for analysis within a holistic framework. In *Proceedings of the 2006 20th anniversary conference on Computer supported cooperative work* (pp. 239-248). ACM. Chapter 2

[Wieth & Zacks 2011] Wieth, M. B., & Zacks, R. T. (2011). Time of day effects on problem solving: When the non-optimal is optimal. *Thinking & Reasoning*, 17(4), 387-401. Chapter 1

[wiki\_ Disability 2013] [http://en.wikipedia.org/wiki/Disability#Physical\\_disability](http://en.wikipedia.org/wiki/Disability#Physical_disability) , (2013) Chapter 1

[Wong & Chee 2003] L. K. Wong and Y. S. Chee. *Constructivist physics learning in an immersive hot air balloon simulation program (ihabs)*. In SIGGRAPH. Educators Program, 2003. Chapter 4

[Wu & Balakrishnan 2003] Wu, M., & Balakrishnan, R. (2003, November). Multi-finger and whole hand gestural interaction techniques for multi-user tabletop displays. In *Proceedings of the 16th annual ACM symposium on User interface software and technology* (pp. 193-202). ACM. Chapter 5

[Wu et al. 2006] Wu, M., Shen, C., Ryall, K., Forlines, C., & Balakrishnan, R. (2006, January). Gesture registration, relaxation, and reuse for multi-point direct-touch surfaces. In *Horizontal Interactive Human-Computer Systems, 2006. TableTop 2006. First IEEE International Workshop on* (pp. 8-pp). IEEE. Chapter 5

## X

[Xiao et al. 2003] Xiao, Y., Hu, P., Seagull, F. J., Mackenzie, C. F., de Visser, J., & Wieringa, P. (2003, October). Distributed planning and monitoring in a dynamic environment: trade-offs of information access and privacy. In *Systems, Man and Cybernetics, 2003. IEEE International Conference on* (Vol. 5, pp. 4141-4146). IEEE. Chapter 2

[Xu et al. 2013] Xu, X., Liang, X., Pan, Y., Zheng, R., Lum, Z. A., Lwin, P. P. M. Y., & Solanki, S. (2013, March). Development of full-color full-parallax digital 3D holographic display system and its prospects. In *SPIE OPTO* (pp. 864409-864409). International Society for Optics and Photonics. Chapter 2

## Y

- [Yamaguchi 2011] Yamaguchi, M. (2011, May). Ray-based and wavefront-based holographic displays for high-density light-field reproduction. In *SPIE Defense, Security, and Sensing* (pp. 804306-804306). International Society for Optics and Photonics. Chapter 2
- [Yang & Kaiser 1998] Yang, J. J., & Kaiser, G. E. (1998, May). Jpernlite: An extensible transaction server for the world wide web. In *Proceedings of the ninth ACM conference on Hypertext and hypermedia: links, objects, time and space---structure in hypermedia systems: links, objects, time and space---structure in hypermedia systems* (pp. 256-266). ACM. Chapter 2
- [Young & Sheena 1975] Young, L. R., & Sheena, D. (1975). Survey of Eye Movement Recording Methods. *Behavior Research Methods & Instrumentation*, 7(5), 397-439. Chapter 2

## Z

- [Zaychik et al. 2000] Zaychik, V., Regli, W. C., & Hewett, T. T. (2000). Evaluation-Guided Research and Development for Collaborative Engineering Environments. Chapter 3
- [Zhang & Hua 2008] Zhang, R., & Hua, H. (2008). Design of a polarized head-mounted projection display using ferroelectric liquid-crystal-on-silicon microdisplays. *Applied optics*, 47(15), 2888-2896. Chapter 2
- [Zigurs & Buckland 1998] Zigurs, I., & Buckland, B. K. (1998). A theory of task/technology fit and group support systems effectiveness. *MIS quarterly*, 313-334. Chapter 2
- [Zone 2014] Zone, R. (2014). *Stereoscopic Cinema and the Origins of 3-D Film, 1838-1952*. University Press of Kentucky. Chapter 2

# Appendix

Appendix provides some supplementary material which has been developed and used during this PhD.

## Table of Content

- 7.1 Documents for Evaluating MT-DT .....166
  - 7.1.1 Information Letter for Participant.....166
  - 7.1.2 Advertising to attract people for participation and giving a general view about the experiment and how it looks like 167
    - 7.1.1 Pre-Questionnaire .....168
    - 7.1.2 Post-Questionnaire (Just after Experiment) .....169
    - 7.1.3 Post-Questionnaire (by Delay after Experiment) .....171
    - 7.1.4 Post-Questionnaire after the second experiment (paper V.S. digital) .....174
    - 7.1.5 Marketing Role and Task.....177
    - 7.1.6 Design Role and Task.....179
    - 7.1.7 Manufacturing Role and Task .....183
    - 7.1.8 Environmental Role and Task .....187
- 7.2 Documents for Analyzing Collaboration As-Is .....191
  - 7.2.1 Marketing Role .....191
  - 7.2.2 Marketing Task .....195
  - 7.2.3 Design Role (Frame Design) .....196
  - 7.2.4 Design Task (Frame Design).....204
  - 7.2.5 Design Role (Design Accessory) .....205
  - 7.2.6 Design Task (Design Accessory).....211
  - 7.2.7 Environmental Role .....212
  - 7.2.8 Environmental Task .....219



## 7.1 Documents for Evaluating MT-DT

### 7.1.1 Information Letter for Participant



Dear Participant,

Thank you for your participation in this study.

Your participation in these series of experiments implies that you voluntarily agree to be video recorded for use in a research project. The data collected during this study will contribute to evaluating a supporting tool for synchronous collaborative design meeting of team involved in product design and development. The video recording is from 3 cameras. Data and video recordings collected during this observation study will be retained for 2 years in a secure area in the G-SCOP Lab to which only authorized researchers involved with this study will have access. There are no known or anticipated risks associated with participation in this study.

The personal or identifying information was collected during your participation will be secure and will be used in general sense. Please remember that any data pertaining to you as an individual participant will be kept confidential. Once all the data, such as video recordings, are collected and analyzed for this project, we plan on sharing this information with the research community through my thesis.

If you are interested in receiving more information regarding the results of this study, or if you have any questions or concerns, please contact us at the email addresses listed at the bottom of the page. If you would like a summary of the results, please let us know by providing us with your email address. When the study is completed, we will send it to you. The study is expected to be completed by September 2013.

Thank you again,

Samira Sadeghi

PhD Student

G-SCOP Laboratory,  
Polytechnique de Grenoble

[Samira.sadeghi@g-scop.grenoble-inp.fr](mailto:Samira.sadeghi@g-scop.grenoble-inp.fr)  
[sadeghisamirafr@gmail.com](mailto:sadeghisamirafr@gmail.com)

Cedric Masclet

Associate-professor

UJF – IUFM,  
G-SCOP Laboratory

[cedric.mascllet@g-scop.inpg.fr](mailto:cedric.mascllet@g-scop.inpg.fr)

Frederic Noel

VISIONAIR Scientific coordinator

Professor, Institut Polytechnique de  
Grenoble

[frederic.noel@g-scop.inpg.fr](mailto:frederic.noel@g-scop.inpg.fr)

The current research work is made under the scope of the VISIONAIR project. VISIONAIR project creates a European Infrastructure for Visualization and Interaction Based Research. VISIONAIR, led by Grenoble INP, 46 avenue Felix Viallet, F-38 031 Grenoble cedex 1, FRANCE is a project funded by the European Commission under grant agreement 262044.

[www.infra-visionair.eu](http://www.infra-visionair.eu)



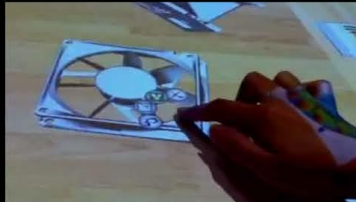

Finger tap on the object in shared space and access to the Menu for duplication, delete and annotation and Link creation



Rotation of 3D document: rotation is down based on more than 2 finger interaction and around the center of object with user hand replacement direction



Virtual keyboard for typing annotation

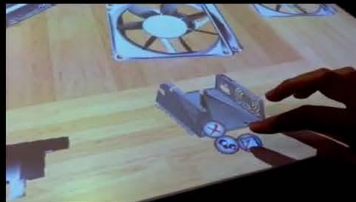

Finger tap on the object in individual space and access to the Menu for duplication, delete and annotation

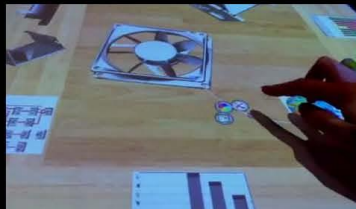

Finger tap on the middle point of the link and access to the Menu for delete, annotation and changing the link's color

## Design Review Meeting around Multi-touch Table



Creating new space for individual space by keeping the previous one / this provide endless space for making digital notes and categorizing documents



Duplication of artifacts to prevent conflicting issues (transferring artifact from shared space to individual space in the case that artifact has a link connected to it)



Scaling object with two finger interaction

Some functionalities of **MT-PR** (a Supporting Tool for Project Review Meeting around Multi-touch table)

Experimental Study on a Supporting Tool for Design Review Meeting

Contact : [sadeghisamiracs@gmail.com](mailto:sadeghisamiracs@gmail.com)



6 – Rate your ability in note-taking during a meeting (scale of 1-7)?

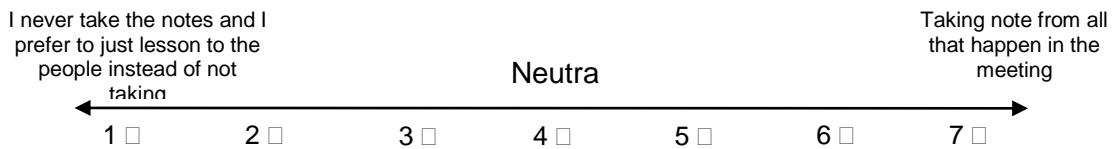

### 7.1.2 Post-Questionnaire (Just after Experiment)

Post-Questionnaire



Thank you so much for your participation.  
Please answer to the following questions:

Personal Details:

Name:

Please evaluate the usefulness of the following functions (Give the rat for your selection and explain why you find it useful or not useful)

1 - Scaling Function to increase or decrease the size of 2D documents or 3D models:



Please explain why:

2 - Creating New Individual Space Functionality to provide an unlimited individual space:

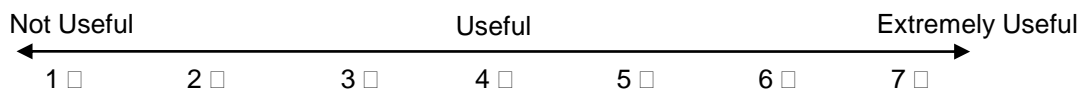

Please explain why:

3 – Was the size of Shared Space adequate, give a rate on a scale of 1-7?

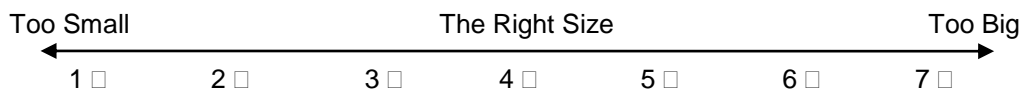

Please explain why do you prefer to have a bigger or smaller one?



### 7.1.3 Post-Questionnaire (by Delay after Experiment)

#### Post-Questionnaire



Thanks again for your participation.

Please **answer** to the following questions based on **your documents** and **your note** from the meeting, Please **If you don't remember**, just write **"Don't remember"** or **If you are not sure** about you answer, Please write in front of the question: **"Not sure"**

#### Personal Details:

Name: \_\_\_\_\_

1 – What were the objectives of your meeting?

2 – What was your responsibility during the meeting?

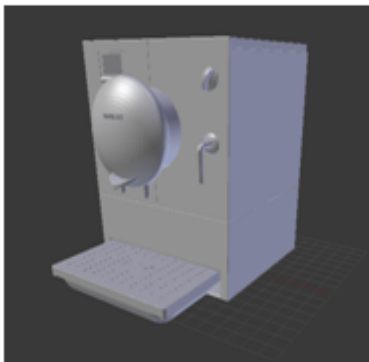

Option 1

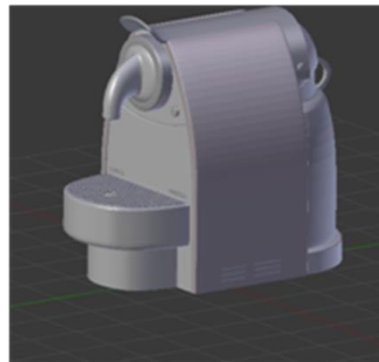

Option 2

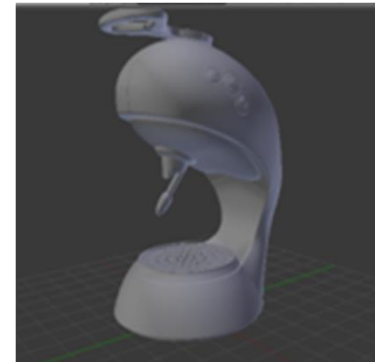

Option 3

Sort the options based on the following criteria (put each option in appropriate place)

3 – Energy consumption:

Low	Medium	High

4 – Manufacturing Cost

Low	Medium	High

5 – Assembly difficulty

Low	Medium	High

6 – Disassembly difficulty

Low	Medium	High

7 – Aesthetic aspect

Low	Medium	High

8 – Ease of Use

Low	Medium	High

9 – Appropriateness of the size of product

Low	Medium	High

10 – Attractiveness aspect

Low	Medium	High

11 – Production Time

Low	Medium	High

12 – Which options satisfy the required volume (1000 per month)?

13 – Who was the target group of product?

14 – Which options had the variety in color?

15 – For which option the environmental group was able to give an eco-friendly label without any change in existing design?

16 – Which type of changes in other options was necessary for having eco-friendly label?

17 – Finally which option did you selected with which condition for selection?

18 – Who made the decision for the final selection?

19 – Which option was the best in repair?

20 – Which option was the best in recycling?

21 – Which option was the best in remanufacturing?

22 – What was the task of manufacturing group for the next meeting?

23 – What was the task of environment group for the next meeting?

24 – What was the task of design group for the next meeting?

25 – What was the task of marketing group for the next meeting?

Thank you for your response



### 7.1.4 Post-Questionnaire after the second experiment (paper V.S. digital)



Post-Questionnaire

Thank you so much for your participation.  
Please answer to the following questions:

Personal Details:

Name: \_\_\_\_\_

General Feedback about the software:

– List the most positive aspect of the system:

– List the most negative aspect of the system:

– General comments:

Please evaluate the usefulness of the following functions (Give the rat for your selection and explain why you find it useful or not useful)

- Duplication Functionality for creating a copy of document:



*Please explain why:*

- Link Creation Functionality to create link between two documents:



*Please explain why:*

- Scaling Function to increase or decrease the size of 2D documents or 3D models:

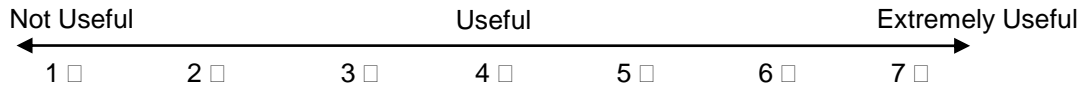

*Please explain why:*

- Creating New Individual Space Functionality to provide an unlimited individual space:



*Please explain why:*

- Was the size of Shared Space adequate, give a rate on a scale of 1-7?

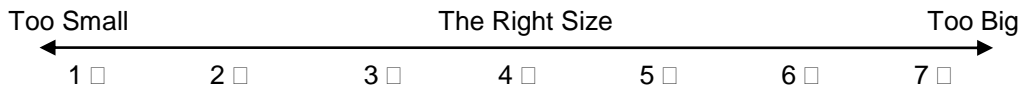

*Please explain why do you prefer to have a bigger or smaller one?*

- Was the size of Individual Space adequate, give a rate on a scale of 1-7?

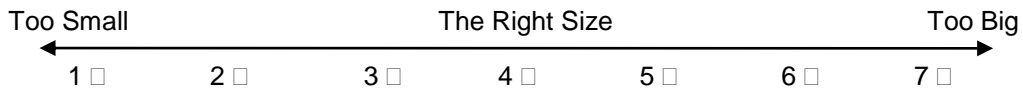

*Please explain why do you prefer to have a bigger or smaller one?*

- Rate the difficulty of typing with virtual keyboard on a scale of 1-7:

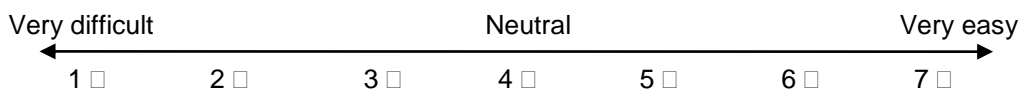

- Rate the difficulty of readability of Texts in the Documents on a scale of 1-7:

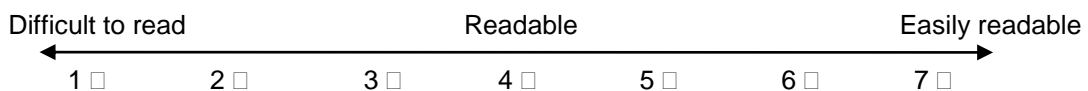

-What do you think about having Individual Space?  
It was helpful

It can be helpful  
It's not helpful  
I don't know!

*Please explain why:*

–What do you think about the difference between two situations that you had during these two experiments? Which one do you prefer? Please Explain why?

Thank you for your response

## 7.1.5 Marketing Role and Task

### Membre of Marketing Group



#### Participation to a collaborative meeting about a product option choice

What you are going to do:

Marketing group of Carrefour brand analyzed the market for new products for kitchen: a coffee maker with Carrefour brand. Four groups are involved in this project: Marketing group, design group, manufacturing group and environmental analysis group.

Marketing group asked the design group to design this product. Design group designed 3 options for coffee maker after they asked from manufacturing group to analysis the manufacturability of each option and they also asked from environmental analysis group to analysis the environmental effect of each option.

Now people from each group have to participate in the meeting to represent their results. Marketing group asked from you to participate in the meeting to represent their results in the meeting.

Marketing group asked from you to participate in the meeting to represent their results in the meeting.

The meeting:

You are participating in a collaborative design review meeting. This meeting has four participants: one person in charge of representing design results, one in charge of environmental analysis representation, one in charge of manufacturing analysis result representation, and one in charge of marketing aspect representation. The product is a coffee maker. Three options will be presented during the meeting by person that is in charge of the design task.

The objective of the meeting is to choose the most appropriate option based on requirements and results of manufacturing analysis and environmental analysis. If participant do not agree with the presented option, they will have to select the one they feel more compatible with the requirements and they will have to determine the required change that have to be done to respond to the violated requirements. The results of the meeting will be documented in order to be transferred to the main responsible of their part, the reason for selection or change has to be documented as well to send to the other member involved in this project.

You are in charge of marketing aspect and you have to participate in this meeting to represent the marketing aspect and to see the other aspects of product, to ensure satisfaction of marketing requirements.

You are the meeting responsible for the organization, keeping the time, and meeting management.

The Important points you are in charge during the meeting to fit marketing issues:

The target groups are the small family with in France that want to buy the coffee maker.

The acceptable price is estimated between 40 -100 €.

The Product volume to enter in the market is estimated 1000 per month to cover Carrefour stores in France.

The first volume of product has to be entered in the market at the beginning of April 2013.

For each decision that seems important to you, please put the annotation on the related documents. You have to transfer the result to Marketing group. This transferring has to be done through the annotations.

If you don't have the answer to the questions that people asked you during the meeting, you have to write the note or putting the annotation on the related document to transfer this question to Marketing group. (Don't bother yourself, if you don't have the answer, just say: "I have to transfer your question to Marketing group, they will send the answer to you")

You have to negotiate with other members of the project (environmental analysis, manufacturing and design) to make a common decision.

Satisfactions of marketing requirements that are important (here you can see the requirements and how you can be sure about their satisfactions):

Having appropriate size for small kitchen [asking the size of product from design responsible]

Price is estimated between 40 -100 € [asking from manufacturing responsible estimated cost for manufacturing]

Aesthetic design [your opinion + design responsible opinion]

Variety in color [asking from design responsible and manufacturing responsible]

Eco-friendly (having the eco-friendly label on the product) [asking from environmental responsible]

Time to market [asking from manufacturing responsible about manufacturing time]

Product volume [asking from manufacturing responsible]

Easy to use [asking from design responsible]

With guarantee of minimum 3 years [asking from environmental responsible for the life time analysis]

Quality aspect [asking from manufacturing responsible]

### 7.1.5.1 Marketing (Document 1/1 for Meeting)

Document 1 for Meeting



User Requirements based on Marketing Analysis	
	Having appropriate size for small kitchen
	Price is estimated between 40 -100 €
	Aesthetic design
	Variety in color
	Eco-friendly (having the eco-friendly label on the product)
	The target groups :small family with in France
	Easy to use
	Product volume estimated 1000 per month to cover Carrefour stores in France.
	To enter the product at the beginning of April 2013 to the market.
	Quality of the product
	With guarantee of minimum 3 years

## 7.1.6 Design Role and Task

Member of Design Group



Participation to a collaborative meeting about a product option choice

What you are going to do:

Marketing group of Carrefour brand analyzed the market for new products for kitchen: a coffee maker with Carrefour brand. Four groups are involved in this project: Marketing group, design group, manufacturing group and environmental analysis group.

Marketing group asked the design group to design this product. Design group designed 3 options for coffee maker after they asked from manufacturing group to analysis the manufacturability of each option and they also asked from environmental analysis group to analysis the environmental effect of each option.

Now people from each group have to participate in the meeting to represent their results.

Design group asked from you to participate in the meeting to represent their results in the meeting.

The meeting:

You are participating in a collaborative design review meeting. This meeting has four participants: one person in charge of representing design results, one in charge of environmental analysis representation, one in charge of manufacturing analysis result representation, and one in charge of marketing aspect representation. The product is a coffee maker. Three options will be presented during the meeting by person that is in charge of the design task.

The objective of the meeting is to choose the most appropriate option based on requirements and results of manufacturing analysis and environmental analysis. If participant do not agree with the presented option, they will have to select the one they feel more compatible with the requirements and they will have to determine the required change that have to be done to respond to the violated requirements. The results of the meeting will be documented in order to be transferred to the main responsible of their part, the reason for selection or change has to be documented as well to send to the other member involved in this project.

You are in charge of design aspect and you have to participate in this meeting to represent the design results and to see the other aspects of product, to ensure satisfaction of the product requirements and to transfer the results to the design group.

The person from marketing is the meeting responsible for the organization, keeping the time, and meeting management.

The Important points you are in charge during the meeting to fit Design issues:

You have to represent the design options in the meeting and make the discussion around them.

Any remark or decision, or required change on the design has to be documented by using the annotation on that design.

For each decision that seems important to you, please put the annotation on the related documents. You have to transfer the result to the design group. This transferring has to be done through the annotations.

If you don't have the answer to the questions that people asked you during the meeting, you have to write the note or putting the annotation on the related document to transfer this question to the design group. (Don't bother yourself, if you don't have the answer, just say: "I have to transfer your question to design group, they will send the answer to you")

You have to negotiate with other members of project (environmental analysis, manufacturing and marketing) to make a common decision.

### 7.1.6.1 Design (Document 1/3 for Meeting)

Document 1 for Meeting



- Easy to use (high)
- Attractive (Low)
- Size (length: 25, width: 25, height: 25) (in cm)
- Body Material (AL aluminum)
- Color: one color Aluminum color

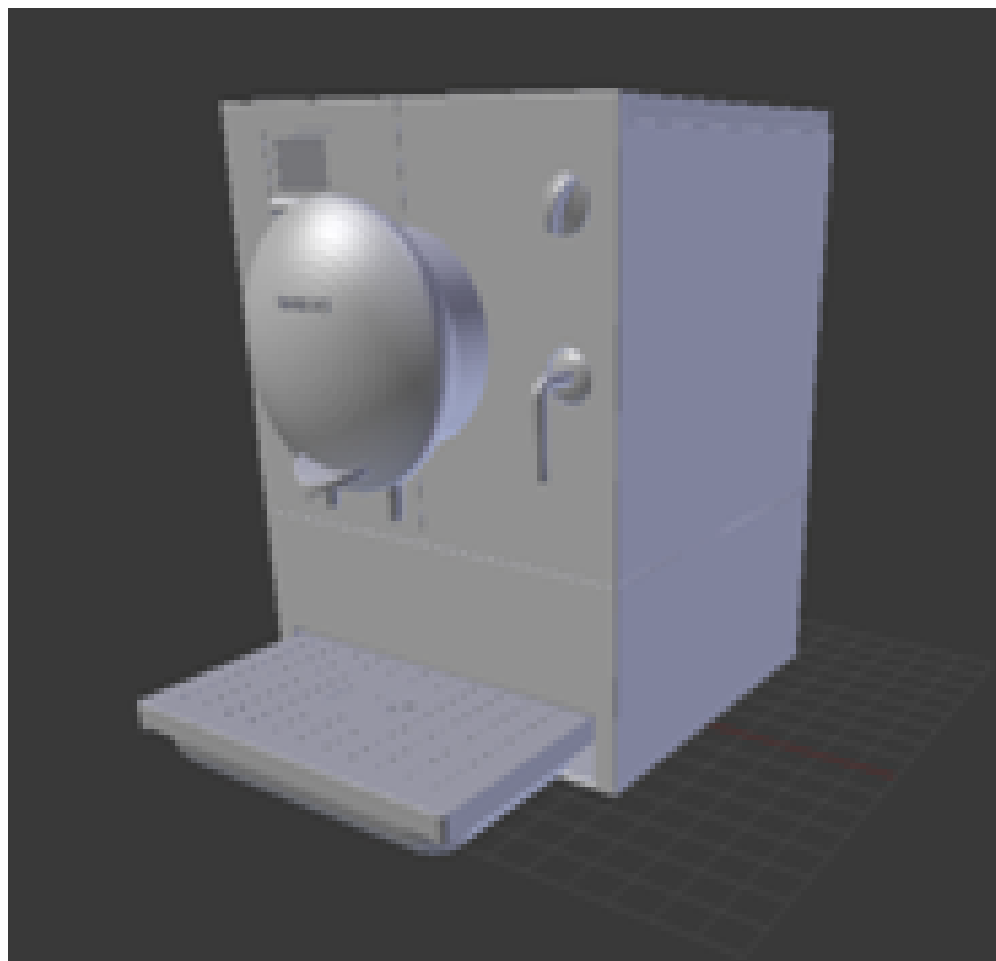

### 7.1.6.2 Design (Document 2/3 for Meeting)

Document 2 for Meeting



- Easy to use (medium)
- Attractive (medium)
- Size (length: 20, width: 15, height: 25) (in cm)
- Body Material (internal part: AL aluminum, external layer: plastic)
- Color: Variety in color can be possible in plastic parts

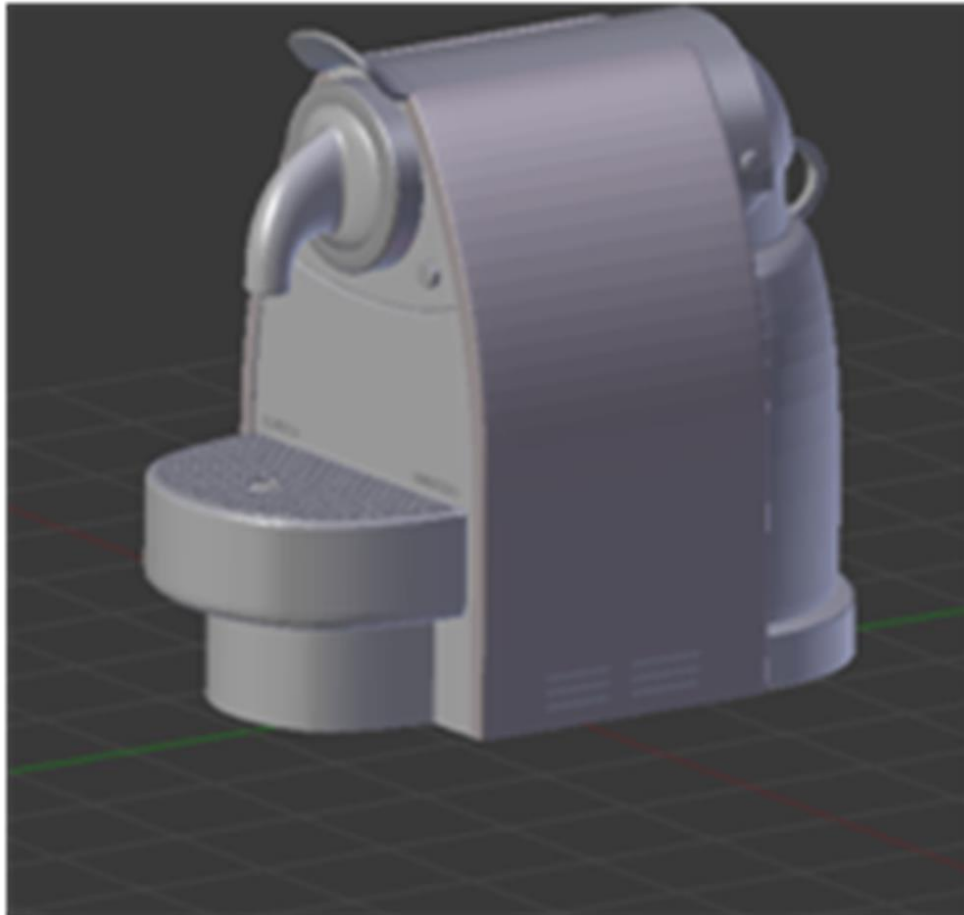



### 7.1.6.3 Design (Document 3/3 for Meeting)

Document 3 for Meeting



- Easy to use (medium)
- Attractive (high)
- Size (length: 15, width: 15, height: 25) (in cm)
- Body Material (internal part: AL aluminum, external layer: plastic)
- Color: Variety in color can be possible in plastic parts

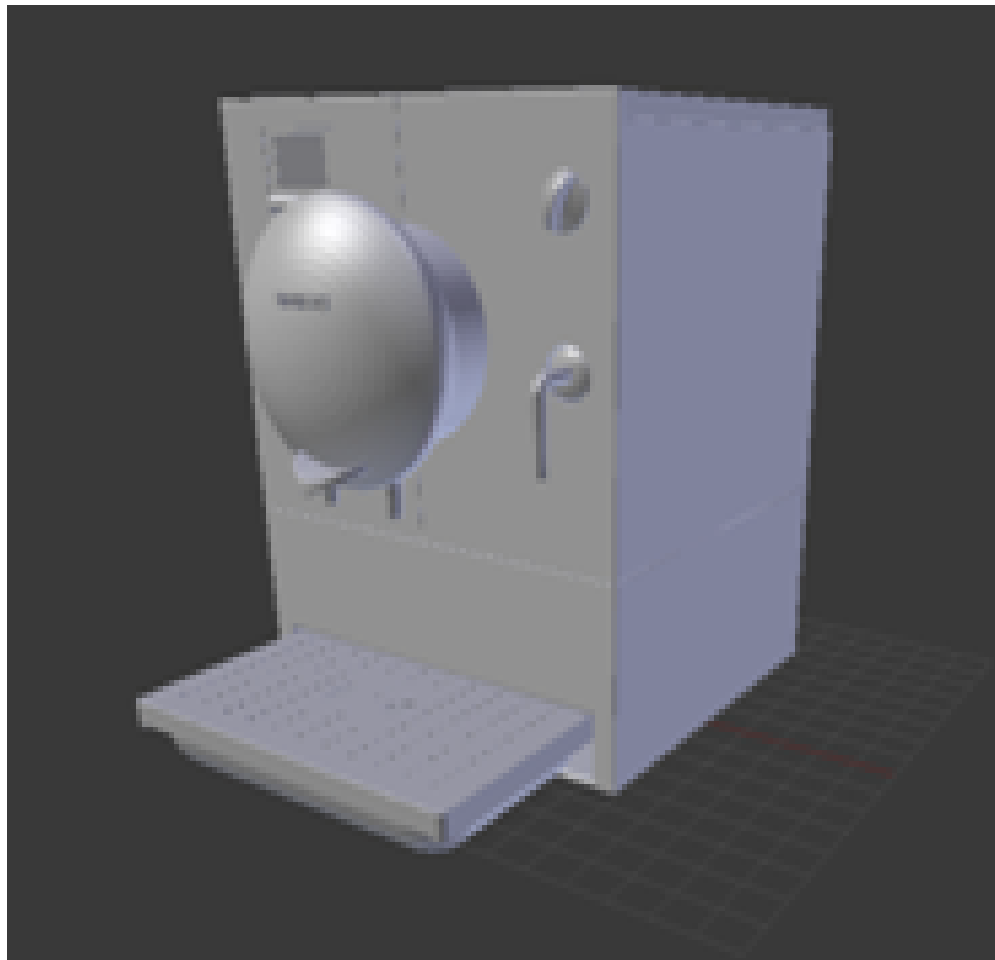

## 7.1.7 Manufacturing Role and Task

Member of Manufacturing Group



Participation to a collaborative meeting about a product option choice

What you are going to do:

Marketing group of Carrefour brand analyzed the market for new products for kitchen: a coffee maker with Carrefour brand. Four groups are involved in this project: Marketing group, design group, manufacturing group and environmental analysis group.

Marketing group asked the design group to design this product. Design group designed 3 options for coffee maker after they asked from manufacturing group to analysis the manufacturability of each option and they also asked from environmental analysis group to analysis the environmental effect of each option.

Now people from each group have to participate in the meeting to represent their results.

Manufacturing group asked from you to participate in the meeting to represent their results in the meeting.

The meeting:

You are participating in a collaborative design review meeting. This meeting has four participants: one person in charge of representing design results, one in charge of environmental analysis representation, one in charge of manufacturing analysis result representation, and one in charge of marketing aspect representation. The product is a coffee maker. Three options will be presented during the meeting by person that is in charge of the design task.

The objective of the meeting is to choose the most appropriate option based on requirements and results of manufacturing analysis and environmental analysis. If participant do not agree with the presented option, they will have to select the one they feel more compatible with the requirements and they will have to determine the required change that have to be done to respond to the violated requirements. The results of the meeting will be documented in order to be transferred to the main responsible of their part, the reason for selection or change has to be documented as well to send to the other member involved in this project.

You are in charge of manufacturing aspect and you have to participate in this meeting to represent the Manufacturing analysis results and to see the other aspects of product, to ensure satisfaction of the product requirements.

The person from marketing is the meeting responsible for the organization, keeping the time, and meeting management.

The Important points you are in charge during the meeting to fit Manufacturing issues:

For each decision that seems important to you, please put the annotation on the related documents. You have to transfer the result to your group. This transferring has to be done through the annotations.

If you don't have the answer to the questions that people asked you during the meeting, you have to write the note or putting the annotation on the related document to transfer this question to your group. (Don't bother yourself, if you don't have the answer, just say: "I have to transfer your question to my group, I will send the answer to you")

You have to negotiate with the other members of the project (environmental analysis, Marketing and design) to make a common decision.

The manufacturing group analyzed each option from different manufacturing aspects:

The cost of manufacturing each product

The time of manufacturing each product

Quality aspect for each option

Assembly difficulty level

product volume per month in one year

# The Options for design of coffee Maker



**Model 444**

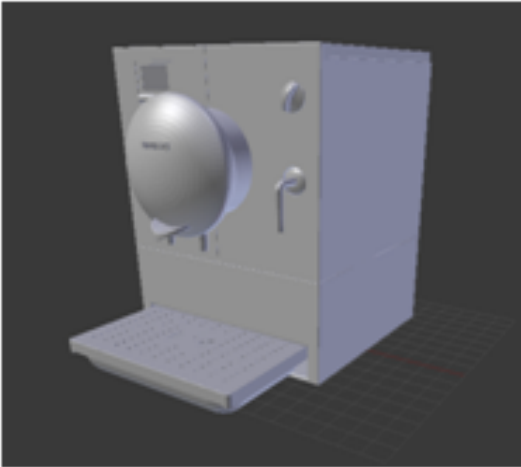

**Model 333**

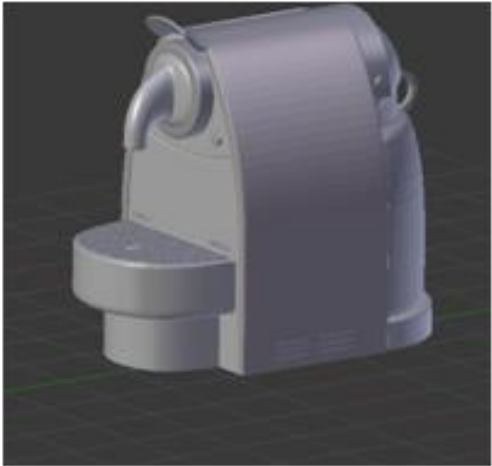

**Model 555**

### 7.1.7.2 Manufacturing (Document 2/5 for Meeting)

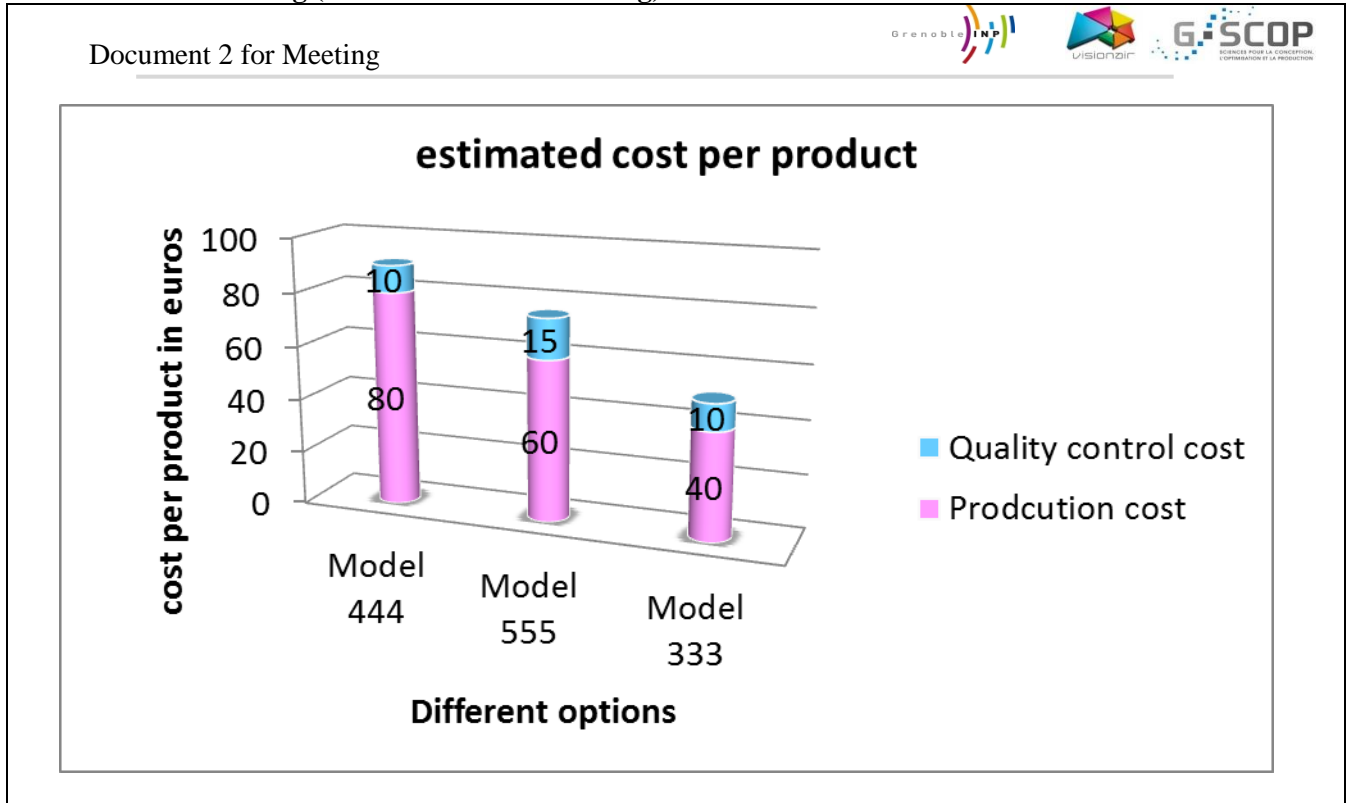

### 7.1.7.3 Manufacturing (Document 3/5 for Meeting)

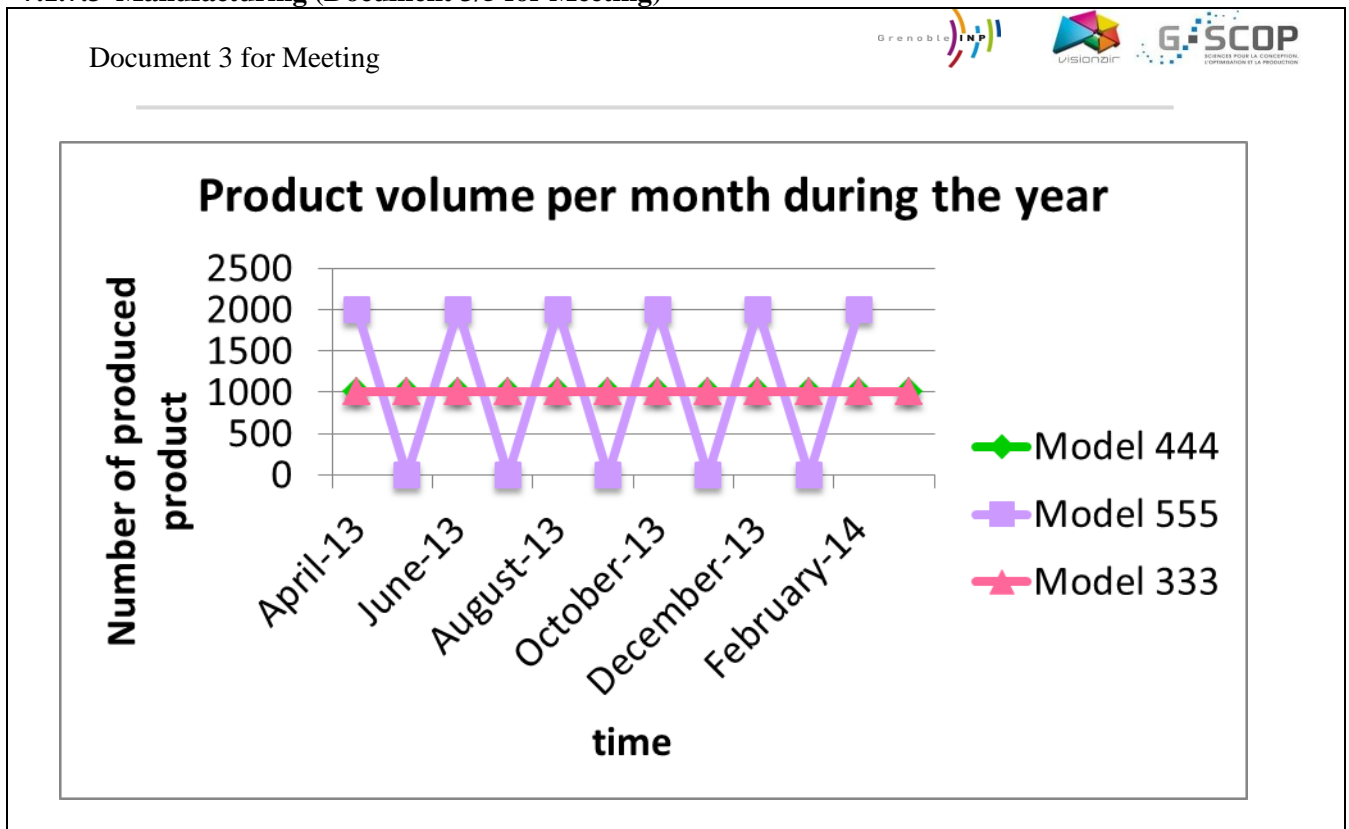

### 7.1.7.4 Manufacturing (Document 4/5 for Meeting)

Document 4 for Meeting

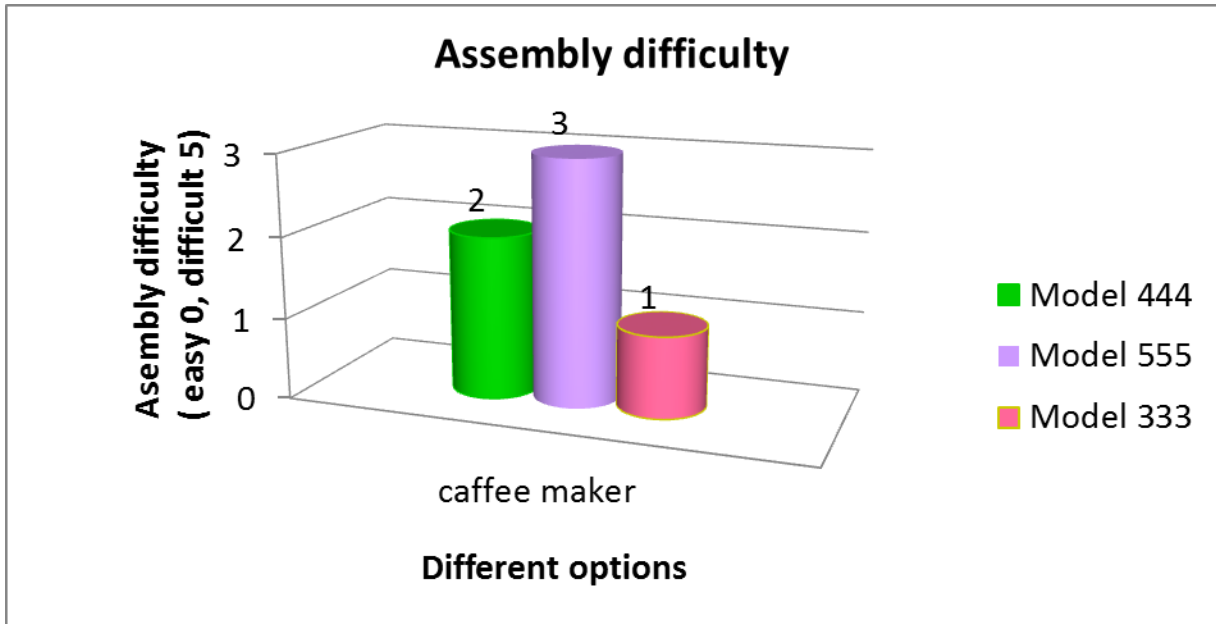

### 7.1.7.5 Manufacturing (Document 5/5 for Meeting)

Document 5 for Meeting

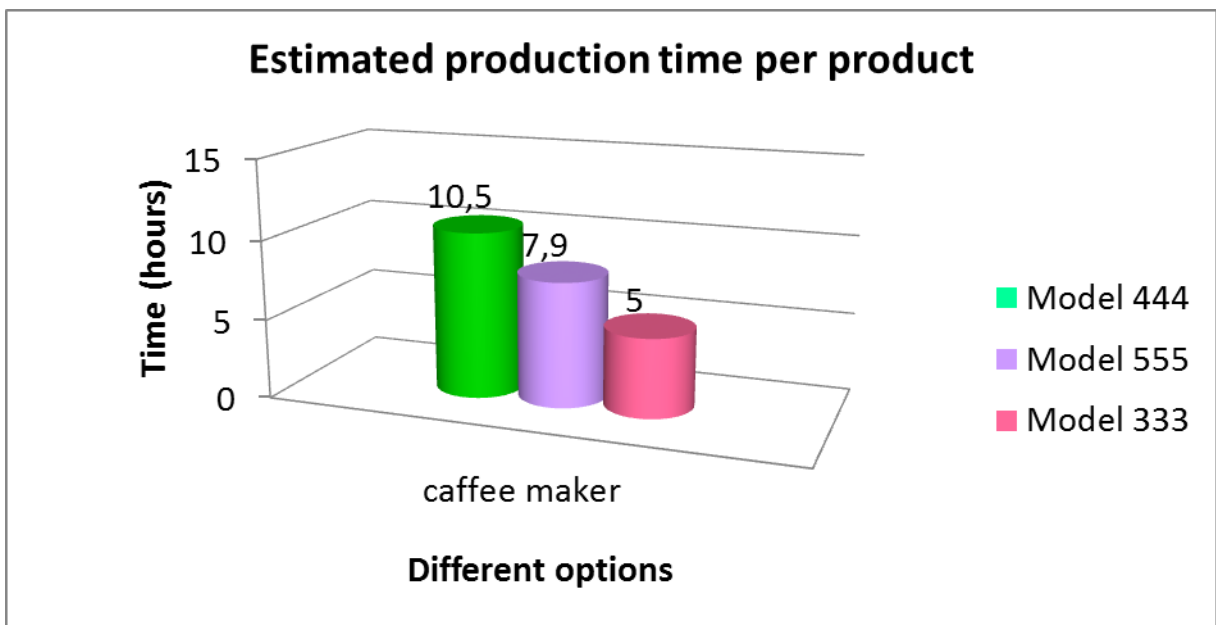

## 7.1.8 Environmental Role and Task

### Member of Environmental Group



#### Participation to a collaborative meeting about a product option choice

What you are going to do:

Marketing group of Carrefour brand analyzed the market for new products for kitchen: a coffee maker with Carrefour brand. Four groups are involved in this project: Marketing group, design group, manufacturing group and environmental analysis group.

Marketing group asked the design group to design this product. Design group designed 3 options for coffee maker after they asked from manufacturing group to analysis the manufacturability of each option and they also asked from environmental analysis group to analysis the environmental effect of each option.

Now people from each group have to participate in the meeting to represent their results. Environmental group asked from you to participate in the meeting to represent their results in the meeting.

The meeting:

You are participating in a collaborative design review meeting. This meeting has four participants: one person in charge of representing design results, one in charge of environmental analysis representation, one in charge of manufacturing analysis result representation, and one in charge of marketing aspect representation. The product is a coffee maker. Three options will be presented during the meeting by person that is in charge of the design task.

The objective of the meeting is to choose the most appropriate option based on requirements and results of manufacturing analysis and environmental analysis. If participant do not agree with the presented option, they will have to select the one they feel more compatible with the requirements and they will have to determine the required change that have to be done to respond to the violated requirements. The results of the meeting will be documented in order to be transferred to the main responsible of their part, the reason for selection or change has to be documented as well to send to the other member involved in this project.

You are in charge of Environmental aspect and you have to participate in this meeting to represent the Environmental analysis results and to see the other aspects of product, to ensure satisfaction of the product requirements.

The person from marketing is the meeting responsible for the organization, keeping the time, and meeting management.

The Important points you are in charge during the meeting to fit Environmental issues:

4 important aspects that were required to be analyzed in environmental aspect of product are: Product life, Energy consumptions, End of use strategy, Disassembly difficulty for recycling or remanufacturing

The environmental effect of product is important, Environmental analysis group will put the eco-friendly label on the product if it answers to the environmental requirements.

For you the best choice is the product that is more environmental friendly product.

For each decision that seems important to you, please put the annotation on the related documents. You have to transfer the result to the environmental group. This transferring has to be done through the annotations.

If you don't have the answer to the questions that people asked you during the meeting, you have to write the note or putting the annotation on the related document to transfer this question to environmental analysis department. (Don't bother yourself, if you don't have the answer, just say: "I have to transfer your question to environmental analysis group, they will send the answer to you")

You have to negotiate with other members of project (marketing, manufacturing and design) to make a common decision.

Here is the summery of the results (Please see the diagrams of comparison between three options):

The condition for accepting the Model 101 for putting eco-friendly label is to redesign the electrical part for energy consumption issue.

For Model 201 condition for accepting is to change the assembly process, it's difficult to disassembly.

However with current condition model 301 is acceptable for eco-friendly label

If they accept to change the Model 101 or model 102, environmental analysis group need to do analysis again to see which one is more eco-friendly product.

### 7.1.8.1 Environmental (Document 1/5 for Meeting)

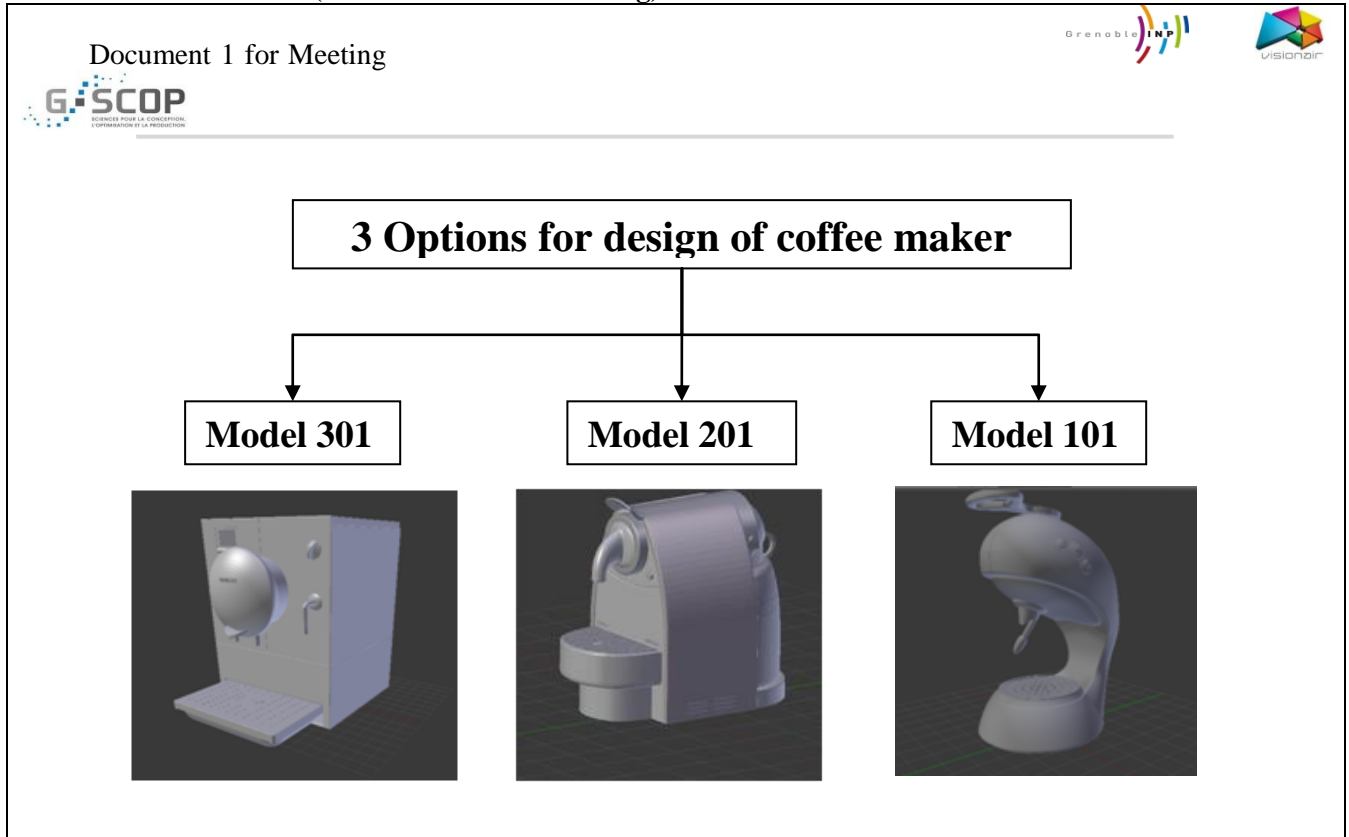

### 7.1.8.2 Environmental (Document 2/5 for Meeting)

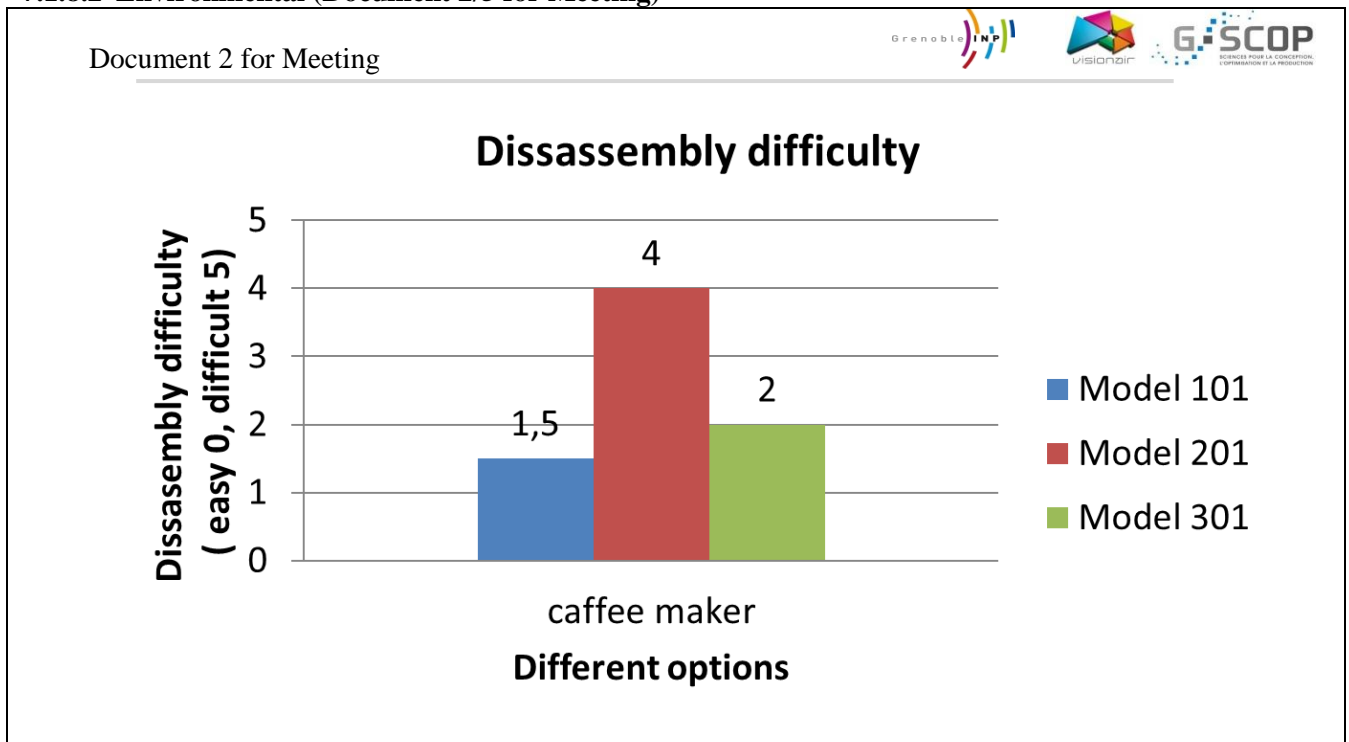

### 7.1.8.3 Environmental (Document 3/5 for Meeting)

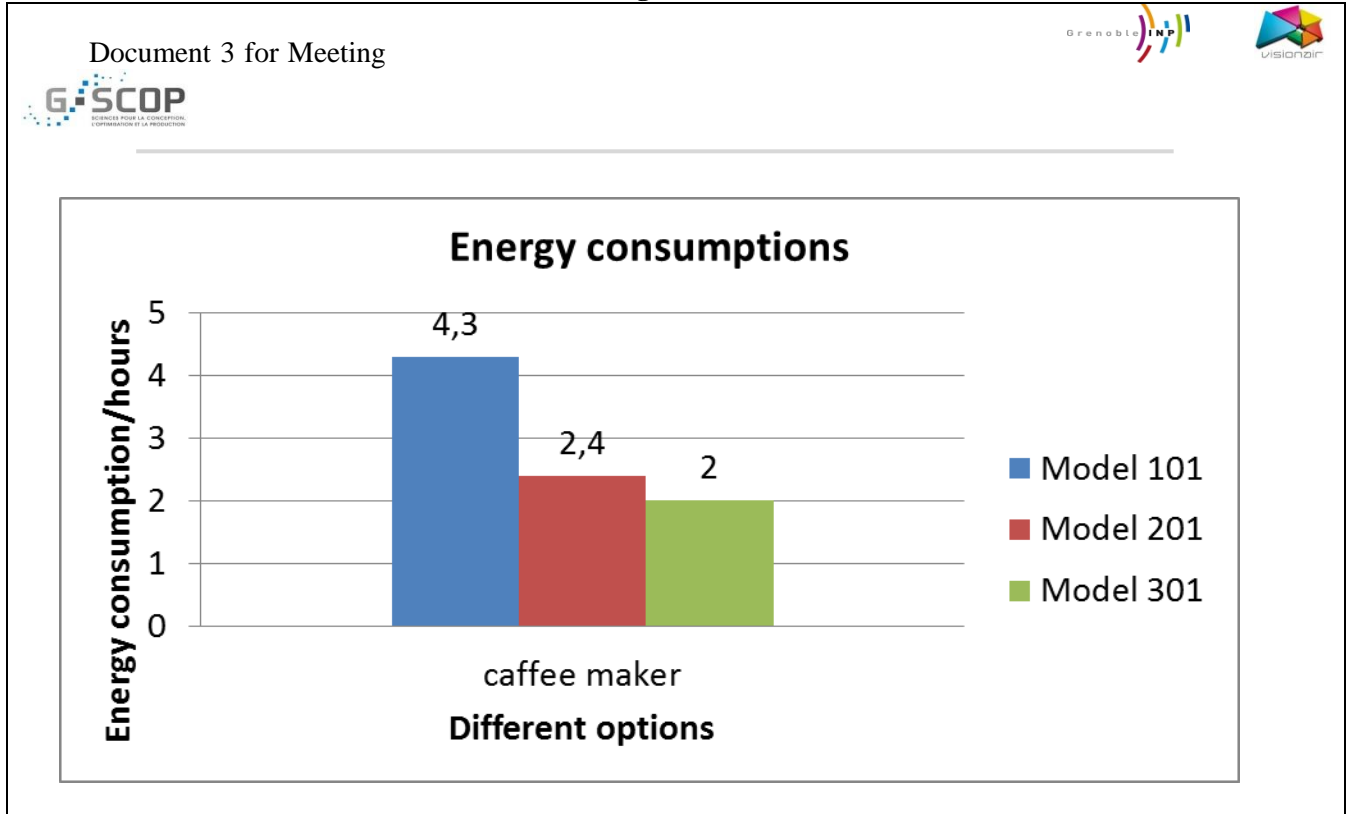

### 7.1.8.4 Environmental (Document 4/5 for Meeting)

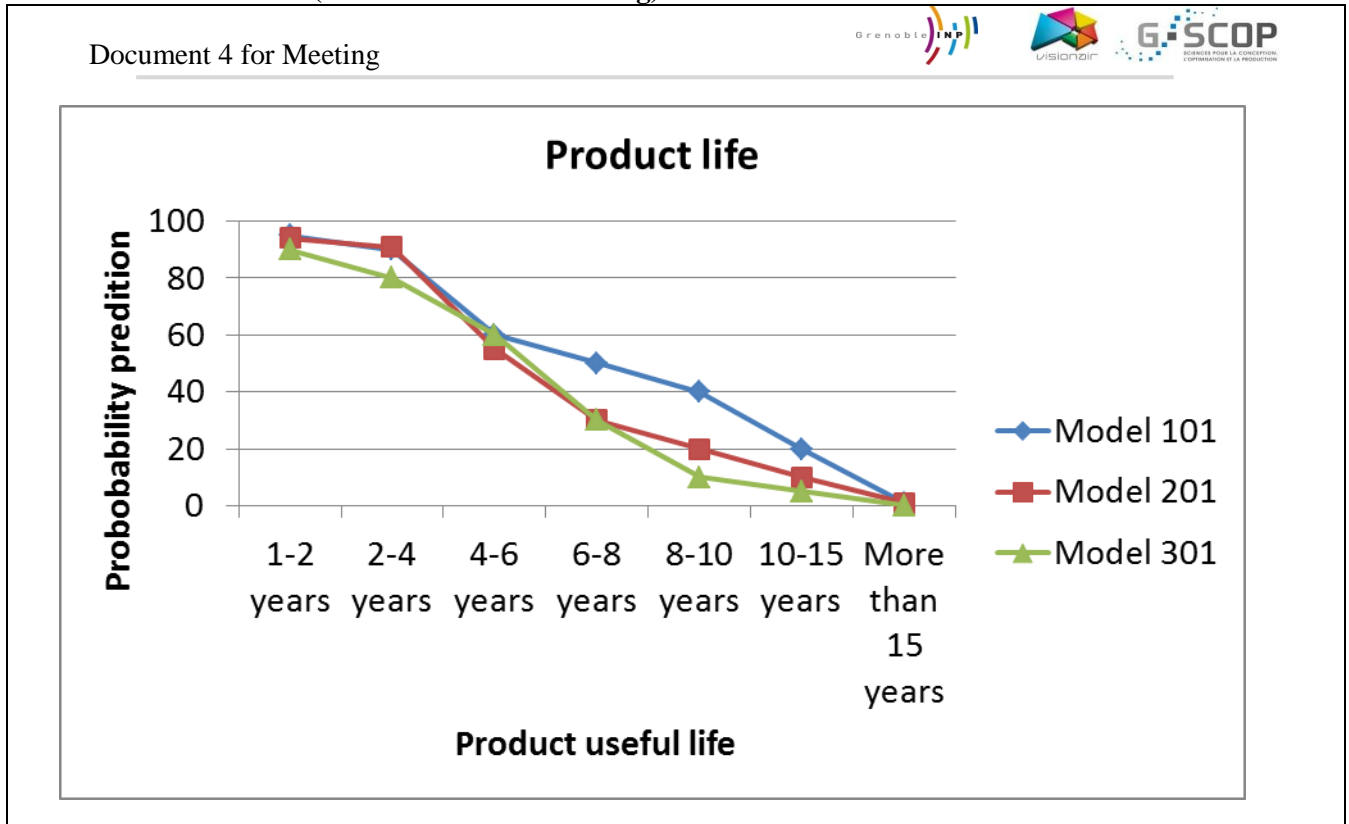



### 7.1.8.5 Environmental (Document 5/5 for Meeting)

Document 5 for Meeting



## End of use strategy for comparing 3 design options

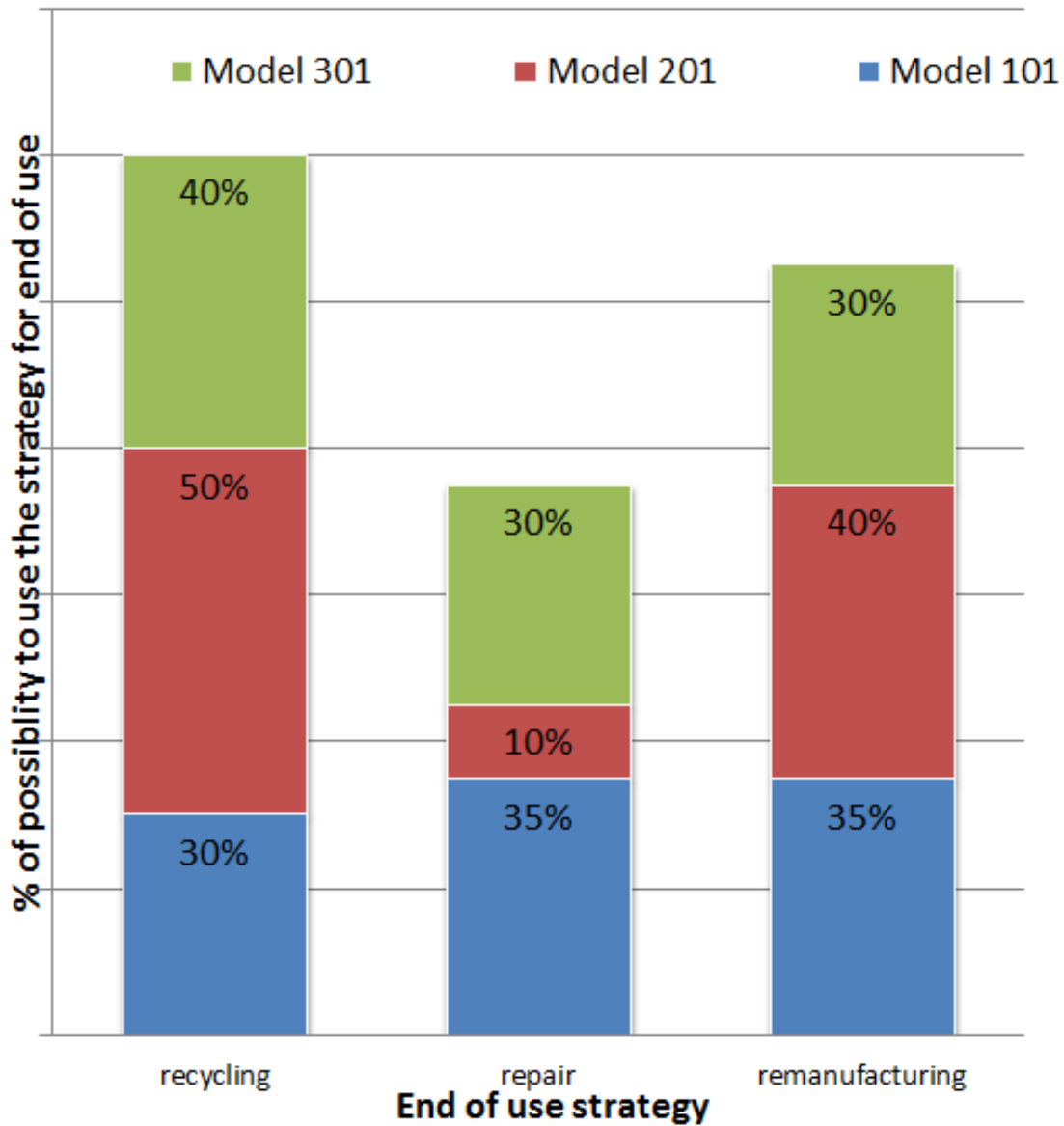

## 7.2 Documents for Analyzing Collaboration As-Is

### 7.2.1 Marketing Role

Member of Marketing Group



You are a member of **Marketing and R&D** department in **EnjoyYourHoliday**.

Company EnjoyYourHoliday is a big company that sales the equipments and accessories for picnic, camping and leisure.

You decided to bring the new product to your market. Based on your marketing analysis you found out that there is the big interest for couple to go to picnic during the weekend. You did interviews and questionnaires between big populations of couple. The results shows that most of them prefer to have a comfortable, sportive, eco-friendly vehicle for going on a picnic.

However there are some people that they select car instead of other vehicle or they prefer to do other staffs instead of going on a picnic, you found the following reasons:

- Some of them, they answered if they want to go on a picnic, they have to follow a big distance, and going by public transportation is not so funny because of picnic staffs and a big population in metro and bus during the weekend; so most of them select the car.
- Some people they prefer to have a fun and sport at the same time.
- Other groups of people, they are environmental friendly people and they prefer to use environmental friendly vehicle

The last two groups, they prefer to use bicycle. But they had some problem with the bicycles (here is some example of their problem):

I can ride the bicycle for longtime without the problem; so for me it's easy to go to picnic in the place that are far from our home, but for my wife is not the case. So we cancel to going to picnic with bicycle.

For me and my couple riding bicycle for longtime with having the picnic staffs in addition is tedious activity. We did it for several times after we stop that.

We're getting old, it's not so easy for me and my couple to use bicycle. The sitting of bicycle is not so comfortable and I have a little problem in my backbone.

And the answers with these contents.

These groups prefer to do another staffs instead of picnic just because they don't want to use car to going to the picnic and there is no suitable vehicle for them to using it instead of car.

Company Bi-Tri Cycle has a specialty in production and custom design of bicycle. They do custom design for their customers. So you select this company to design and produce your new product (comfortable, sportive, eco-friendly vehicle for couple to going on a picnic). You will have a meeting with their specialist to express your requirements and negotiate about the features of product and its cost and time. You will make decision with together.

The four attached documents are summery of your funding based on market and user analysis that is presented in the graphs and table. You will go to the meeting with these graphs and table :

### 7.2.1.1 Marketing (Document 1/4 for Meeting)

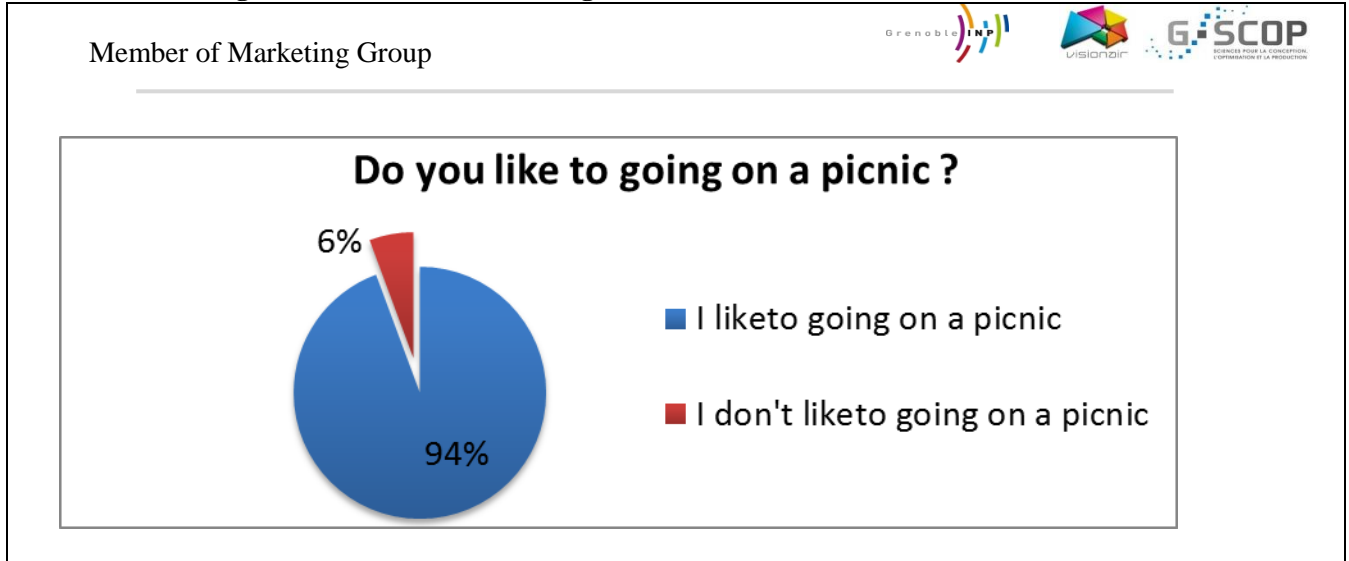

### 7.2.1.2 Marketing (Document 2/4 for Meeting)

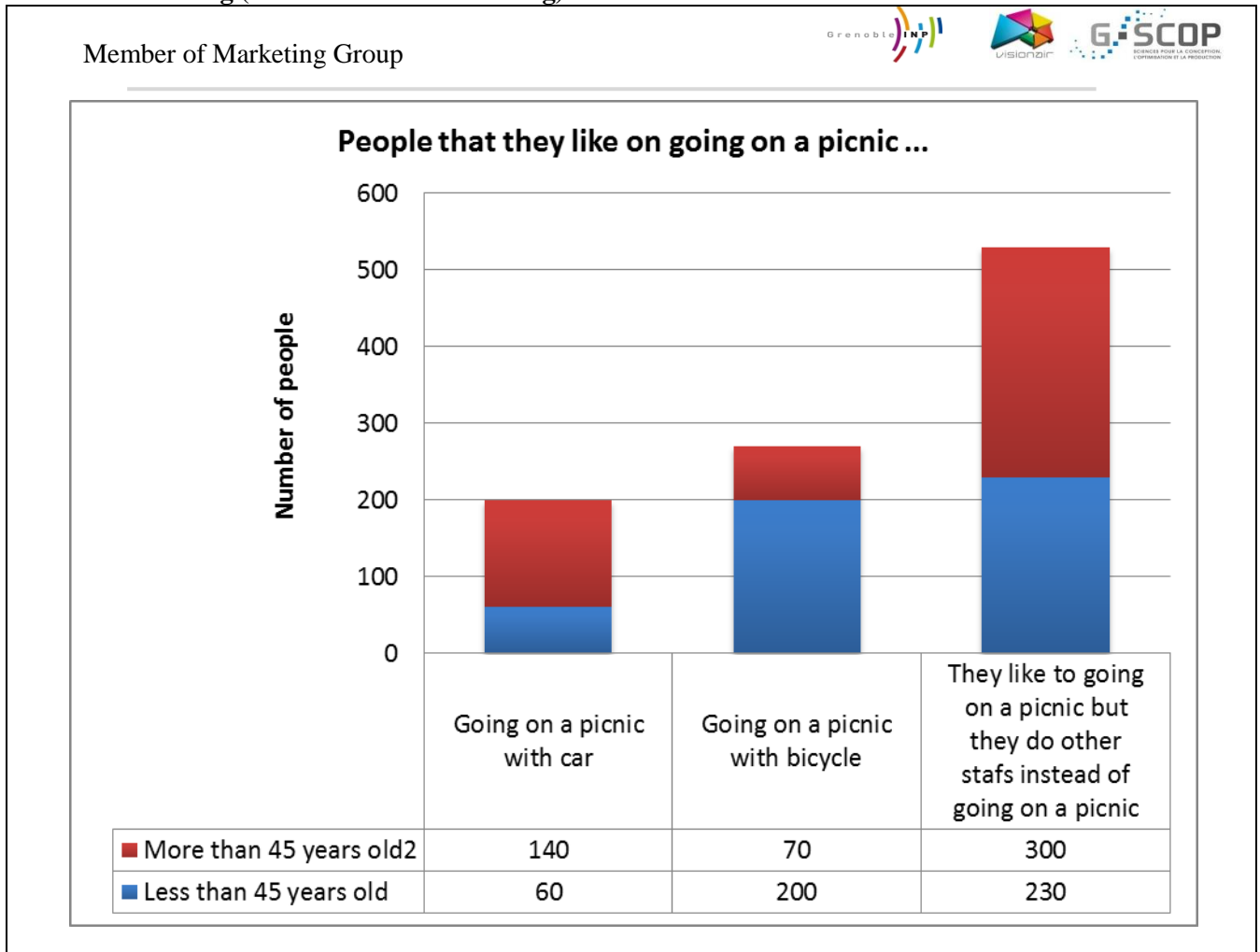

7.2.1.3 Marketing (Document 3/4 for Meeting)

Member of Marketing Group

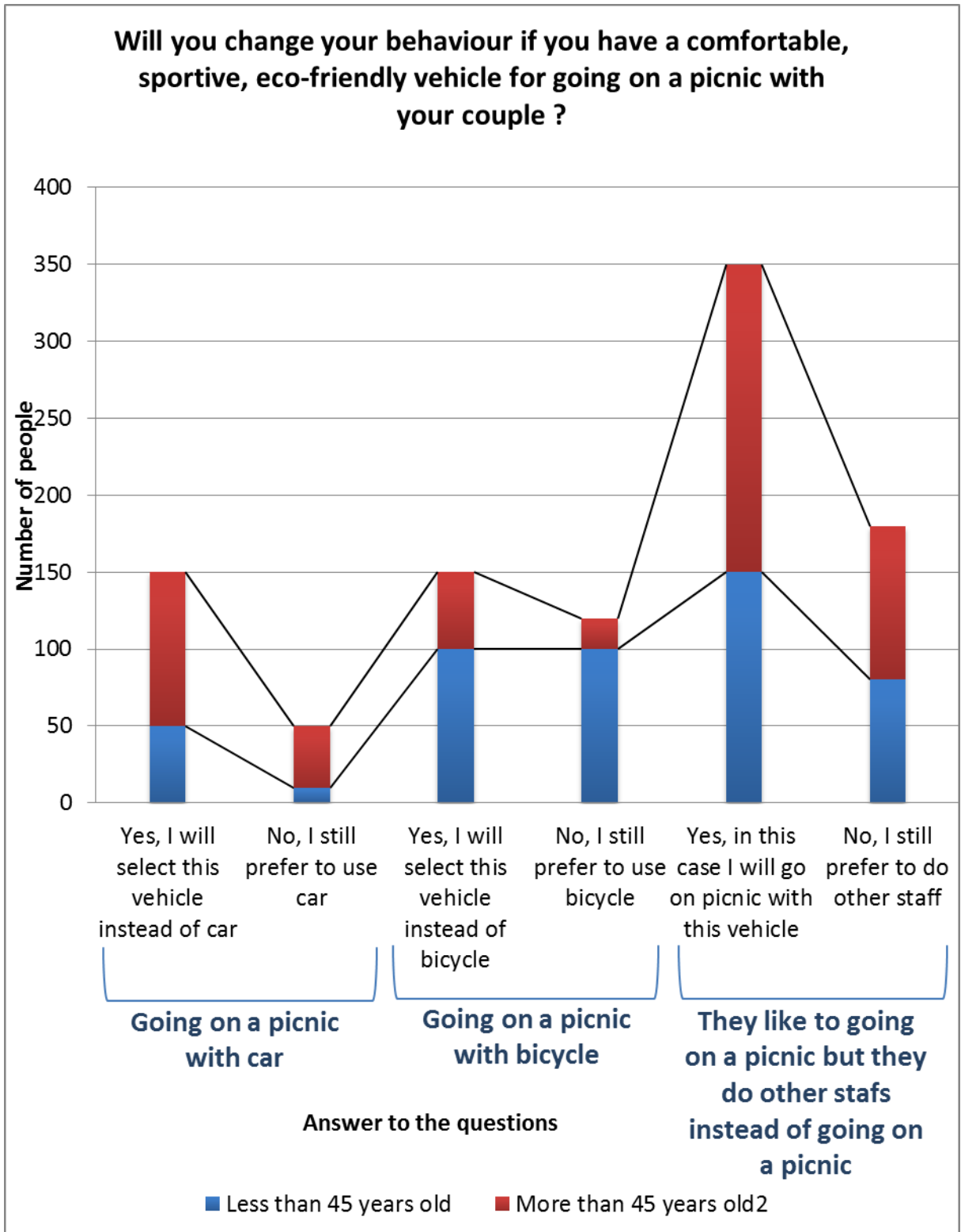

#### 7.2.1.4 Marketing (Document 4/4 for Meeting)

Member of Marketing Group





#### User Requirements based on Marketing Analysis

	A vehicle for couple to share the difficulty of the riding in a big distance between couples.
	Comfortable seat
	Having back rest
	Place for putting picnic staffs
	Place for Smartphone or GPS holder
	Variety in color
	Eco-friendly
	Having fun situation
	Share the love between couple

## 7.2.2 Marketing Task



Marketing Task

---

**Before Experiment**

Please carefully read the documents ( prepare yourself for experiment based on documents to be able to play your role)  
 Don't speak with no one about the experiment, what you will do!

---

**During Experiment**

You have to play your role during the experiment  
 You will have the documents that I already send to you on the table (all file in Doc for meeting folder)  
 The layout of design office will be similar to following image



You have to document all the results of the meeting, everyone have to write the interested point for him in his notebook. You can also put annotation on the document to record the results of the meeting. You have to prepare a report of what was happened during the meeting for your boss! You have 15 min after meeting to do that ( you can use the annotated documents and your notes for writing the report)

Here in the red part of the shape, the time line of the meeting and your task as a part of EnjoyYourHoliday company is determined.

<b>Experts of EnjoyYour Holiday</b>	Taking the note whenever that is required		
	Select the product that you preference and compatibility with your requirements	Discusses about your requirement and what you want to change in your selected model/ represent your documents if required for better explanation of what you want	15 min for Writing The
<b>Experts of Bi-Tri Cycle Company</b>	Taking the note whenever that is required		
	Present their existing product	- Discussion - Documentation of the results, important points, required changes Putting annotation on the parts that required to be	15min Writing The

0 min  
Start of meeting
30 min  
End of
45min

**Meeting Time-line /the tasks of each expertise and the sequence of doing the tasks**

---

**After Experiment**

Don't speak with no one about the experiment and what you did until the end of July!

### 7.2.3 Design Role (Frame Design)

Member of Design Group



## You are a member of Design Group in Bi-Tri Cycle.

You are a member of Company of Bi-Tri Cycle<sup>1</sup> that has a specialty in production and custom design of bikes.

Your company does custom design for the customers by minimizing the cost. So your strategy is to use existing elements of existing products, because in this way you will reduce the time and cost of designing new element.

Unicycles, tricycles and quadracycles are not strictly bicycles, as they have respectively one, three and four wheels, but are often referred to informally as "bikes".

A bicycle frame is the main component of a bicycle, on to which wheels and other components are fitted. You have specialty in designing the frame of Unicycles, bicycle, tricycles and quadracycles. It's a function of Shape (see Table 1), Number of user (see Table2) and Number of wheels (see Table3).

### Your New Customer

Company EnjoyYourHoliday is a big company that sales the equipments and accessories for picnic, camping and leisure. They decided to bring the new product to their market. A vehicle for couple for picnic proposes. They demand for design and manufacturing their new product. So now they are your customer.

You decided to have a meeting between 3 experts from your company (You as frame design expert, expert of manufacturing and expert of design accessory) and one expert from EnjoyYourHoliday members.

The objective of the meeting is to discover what kind of changes you have to make in existing design model to adapt it for EnjoyYourHoliday with specific requirements.

In this meeting you will present some of products that by changing the some element or adding another element you can adapt your design for new customer. After your presentation you have to ask from your customers to select the product that is more compatible based on their requirements. After, you have to determine the parts and aspects of product that have to be changed or new parts that have to be added in existing product to satisfy customers requirements. These determinations of modification will be based on asking user requirement, negotiation and your knowledge to finally making the decision.

During the meeting you have to present your design to the customer, and taking into account the need of customers and asking the manufacturer about the cost and time, if you use this model or if you change the model what will be the new cost.

Don't forget to write every aspect of the meeting that could be important for further steps related to design modification. (i.e. every change , modification in existing design, or adding new element to the existing design and etc).

Bi-TriCycle is not a real company

Many different frame types have been developed for the bicycle

Table 1

Frame design

Diamond



Step-through

This was to allow the rider to dismount while wearing a [skirt](#) or [dress](#). The design has since been used in utility bikes to facilitate easy mounting and dismounting for both genders



Cantilever

In a cantilever bicycle frame the seat stays continue past the seat post and curve downwards to meet with the down tube



Recumbent

A recumbent bicycle is a bicycle that places the rider in a laid-back reclining position. Most recumbent riders choose this type of design for ergonomic reasons; the rider's weight is distributed comfortably over a larger area, supported by back and buttocks.





Many different frame types have been developed for the bicycle

# Table 1

Most bicycles are designed for a single rider



Bikes with child seats or single-child trailers can carry an adult and a child



Bikes with double child trailers can carry an adult and two children



Bikes with double child trailers can carry an adult and two children



A Sociable has two riders side by side.



A tandem or twin has two or more riders behind each other.



In most of these types the riders ride one behind the other (referred to as tandem seating). Exceptions are "The Companion", or "Sociable," a side-by-side two-person bike



Many different frame types have been developed

# Table 3

Number of Wheels

Unicycles have only one wheel, and they use bicycle wheels, tires, cranks, and pedals



Bicycles have two wheels.



Tricycles have three wheels.



Quadracycles have four wheels.



7.2.3.1 Design (Document 1/6 for Meeting)

Document for Meeting

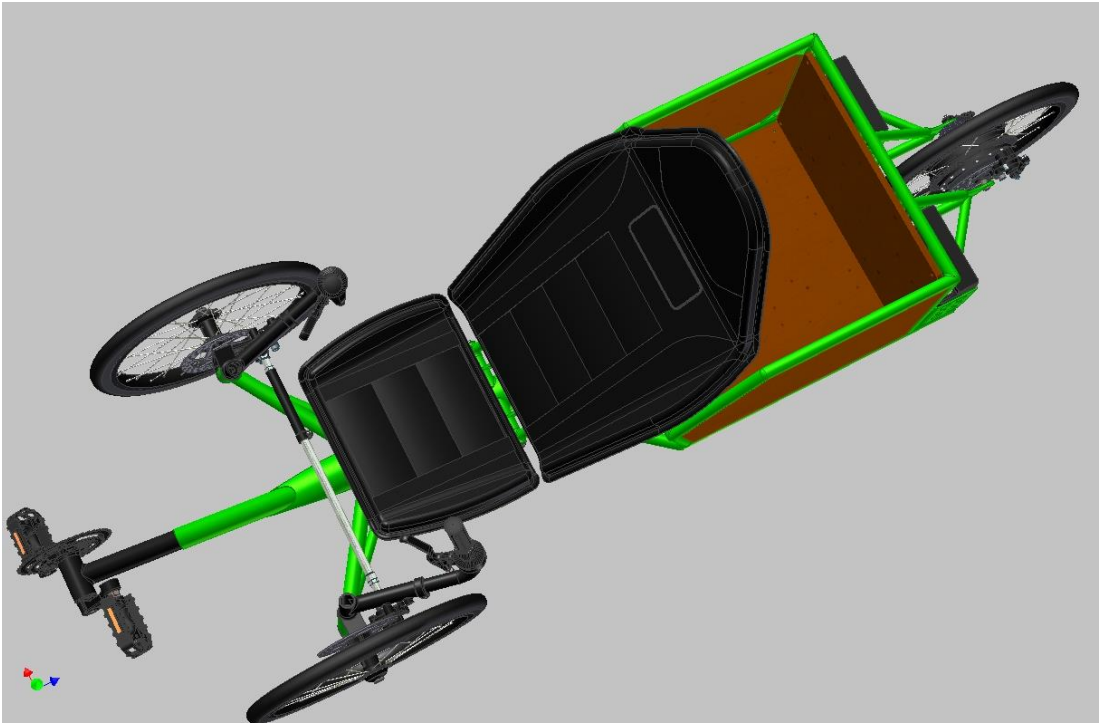
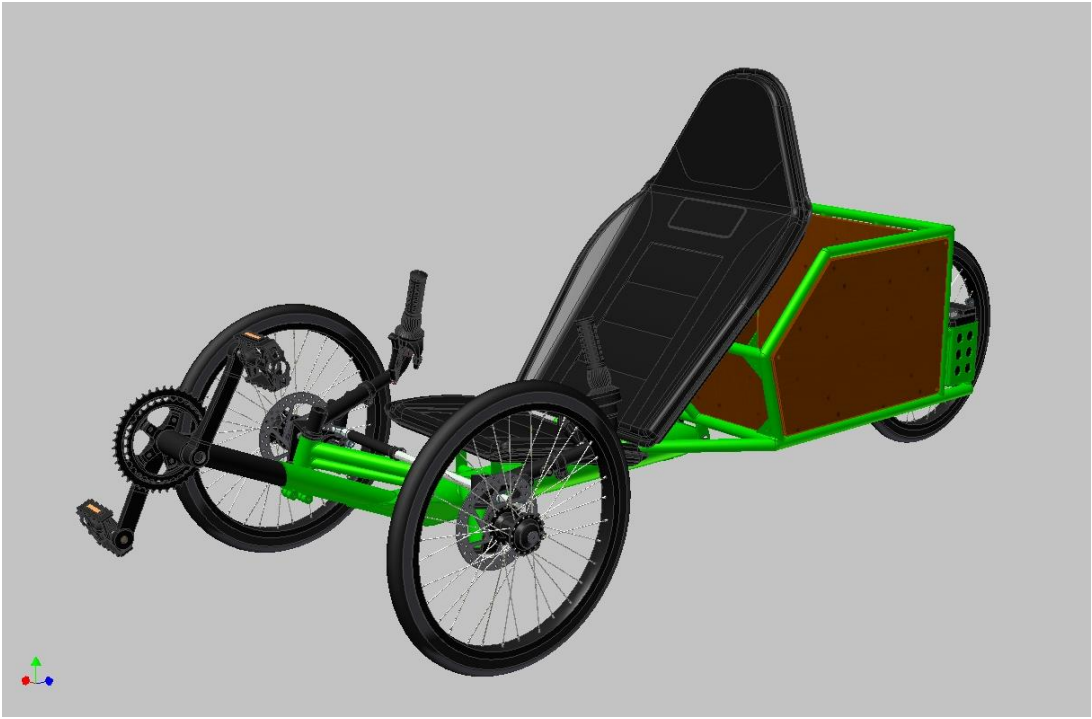

7.2.3.2 Design (Document 2/6 for Meeting)

Document for Meeting

Grenoble INP visionair G-SCOP



A 3D digital rendering of a red bicycle with a step-through frame, silver handlebars, and black tires. The bicycle is shown from a three-quarter front view against a dark grey background.

7.2.3.3 Design (Document 3/6 for Meeting)

Document for Meeting

Grenoble INP visionair G-SCOP



A 3D digital rendering of a yellow road bicycle with a drop handlebar, a brown saddle, and black tires. The bicycle is shown from a three-quarter front view against a dark grey background, with a shadow cast on the ground below.



7.2.3.4 Design (Document 4/6 for Meeting)

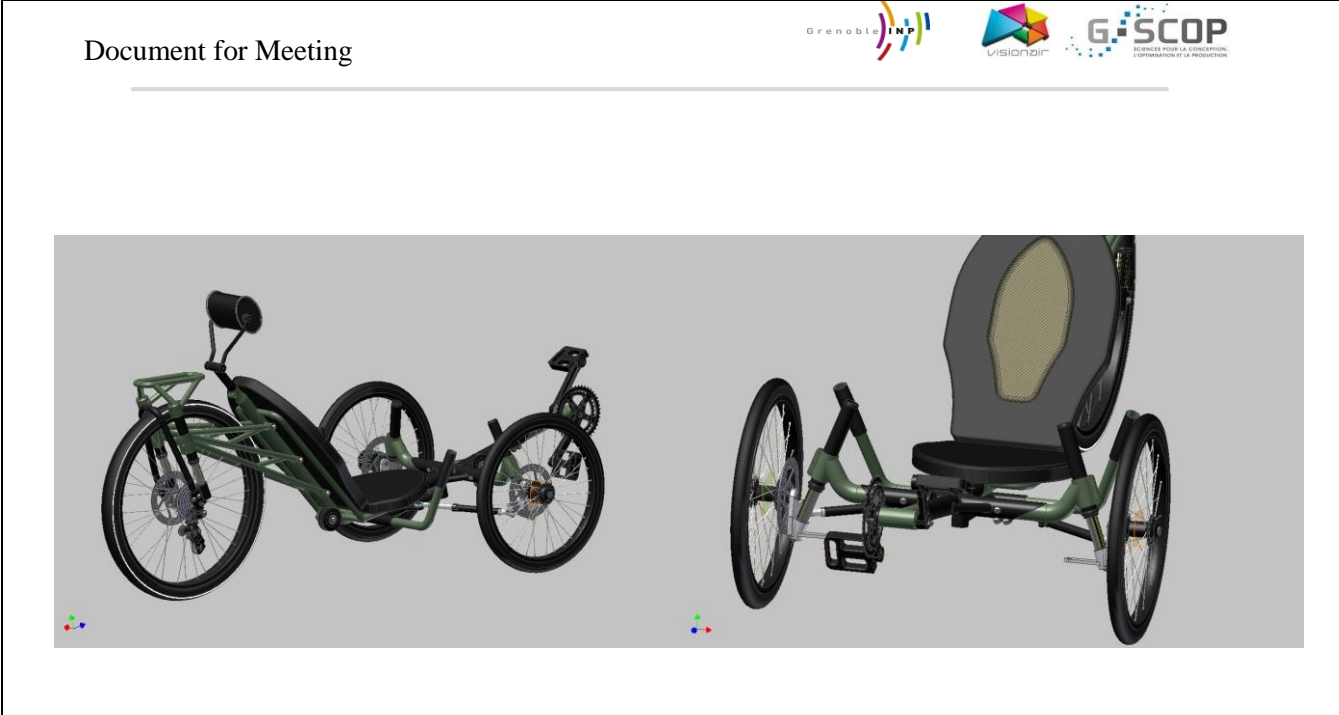

7.2.3.5 Design (Document 5/6 for Meeting)

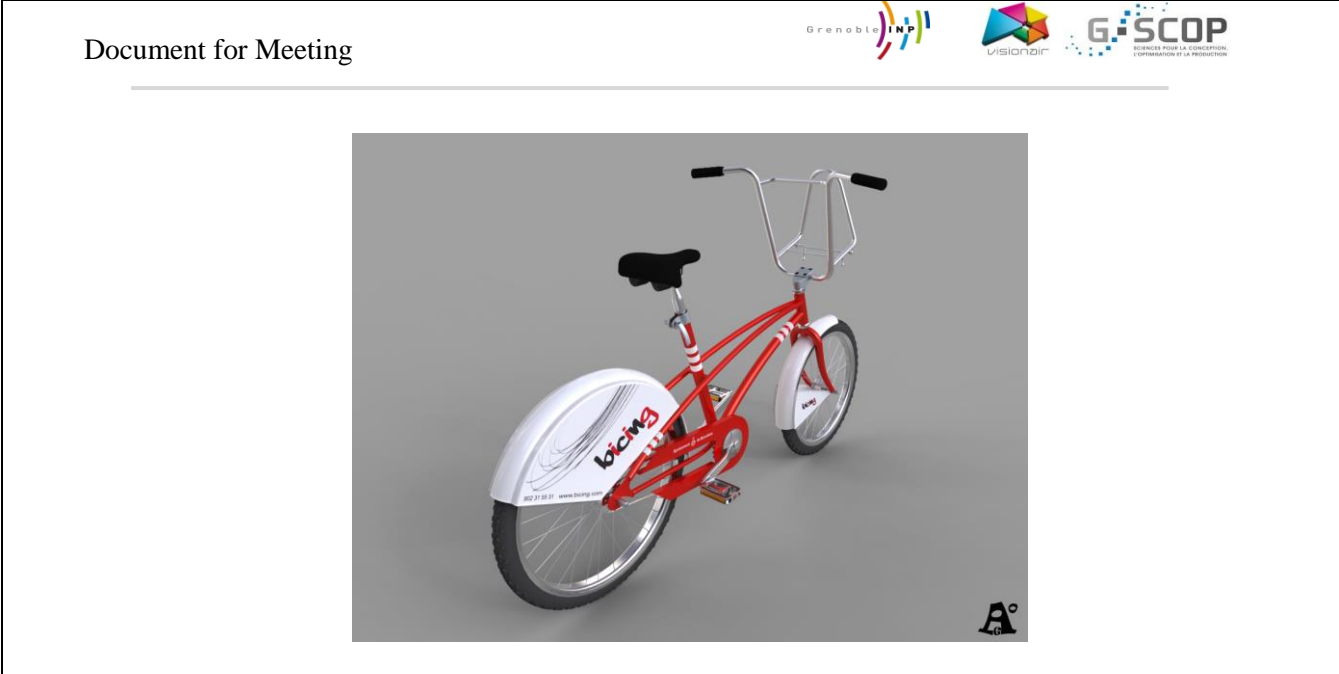

7.2.3.6 Design (Document 6/6 for Meeting)

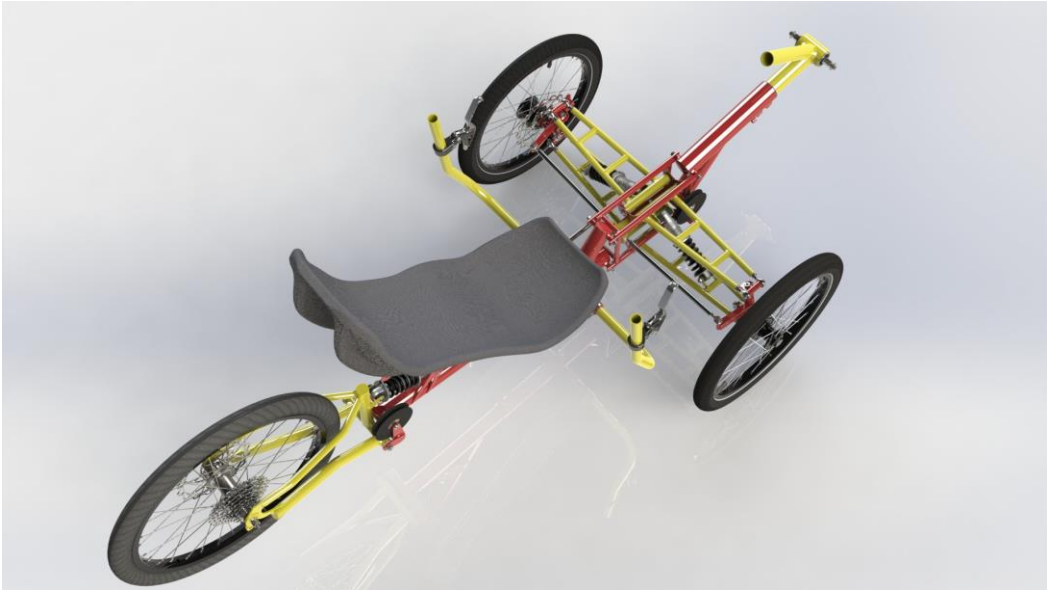

Document for Meeting



## 7.2.4 Design Task (Frame Design)



Design Task

---

**Before Experiment**

Please carefully read the documents ( prepare yourself for experiment based on documents to be able to play your role)

Don't speak with no one about the experiment, what you will do!

---

**During Experiment**

You have to play your role during the experiment

You will have the documents that I already send to you on the table (all file in Doc for meeting folder)

The layout of design office will be similar to following image



You You have to document all the results of the meeting, everyone have to write the interested point for him in his notebook. You can also put annotation on the document to record the results of the meeting. You have to prepare a report of what was happened during the meeting for your boss! This report has to be generated with your group (responsible of design accessory and responsible of Manufacturing). You have 15 min after meeting to do that ( you can use the annotated documents and your notes for writing the report)

Here in the red part of the shape, the time line of the meeting and your task as a part of Bi-Tri Cycle company is determined.

	Taking the note whenever that is required			
Experts of <b>EnjoyYo ur Holiday</b>	Select the product that you preference and compatibility with your requirements	→	Discusses about your requirement and what you want to change in your selected model/ represent your documents if required for better explanation of what you want	15 min for Writin g The
Experts of <b>Bi-Tri Cycle Company</b>	Present their existing product	→	- Discussion - Documentation of the results, important points, required changes - Putting annotation on the parts that required to be	15min Writin g
0 min Start of meeting				30 min End of
Time				

**Meeting Time-line /the tasks of each expertise and the sequence of doing the tasks**

---

**After Experiment**

Don't speak with no one about the experiment and what you did until the end of July!

## 7.2.5 Design Role (Design Accessory)

Member of Design Group



You are a member of **Design Accessory Group** in **Bi-Tri Cycle**.

You are a member of Company of Bi-Tri Cycle1 that has a specialty in production and custom design of bikes.

Your company does custom design for the customers by minimizing the cost. So your strategy is to use existing elements of existing products, because in this way you will reduce the time and cost of designing new element.

Unicycles, tricycles and quadracycles are not strictly bicycles, as they have respectively one, three and four wheels, but are often referred to informally as "bikes".

You have specialty in designing the different accessory for unicycles, bicycle, tricycles and quadracycles. See the next pages.

### Your New Customer

Company EnjoyYourHoliday is a big company that sales the equipments and accessories for picnic, camping and leisure. They decided to bring the new product to their market. A vehicle for couple for picnic proposes. They demand for design and manufacturing their new product. So now they are your customer. You decided to have a meeting between 3 experts from your company (You as frame design expert, expert of manufacturing and expert of design accessory) and one expert from EnjoyYourHoliday members. The objective of the meeting is to discover what kind of changes you have to make in existing design model to adapt it for EnjoyYourHoliday with specific requirements.

During the meeting you have to present your products (accessory that you already designed and manufactured). And based on customer requirements, they have to choose appropriate product between your proposed products. If there is not suitable product between existing products, you will make a decision to design and manufacture new product based on user requirement.

Don't forget to write every aspect of the meeting that could be important for further steps related to design modification and every type of decision that is related to your expertise. (i.e. selecting a accessory, every change, modification in existing design, or adding new element to the existing design and

Bi-TriCycle is not a real company



**Mirror:** Bicycle mirrors are useful for being aware of your surroundings. Those taxi drivers driving too close to your back wheel or a cyclist about to perform a dangerous overtaking manoeuvre are all easier to spot.

**Handel grip:** provides a comfortable rubberized grip for hand- and shoulder-mount rigs. The improved pattern of our style grip enhances overall comfort while reducing moisture build-up.

**Pedal:** A bicycle pedal is the part of a [bicycle](#) that the rider pushes with their foot to propel the bicycle.

Next pages are the Catalogs of your products that you already designed and produced them. You will go to the meeting with these Catalogs:

Mirror Catalogs



Mirror M101  
€ 6.60



Mirror M102  
€ 10.55



Mirror M103  
€ 11.15



Mirror M104  
€ 13.00



Mirror M105  
€ 9.10



Mirror M106  
€ 5.99



Mirror M107  
€ 12.22



Mirror M108  
€ 11.99

Handel grip Catalogs

**G101**  
**€ 11.61**



**G102**  
**€ 12.65**



**G103**  
**€ 5.15**



**G104**  
**€ 8.00**



**G105**  
**€ 7.17**



**G106**  
**€ 4.99**



**G107**  
**€ 5.62**



**G108**  
**€ 8.99**

Pedal Catalogs (1)



P101 € 14.10

- Lightweight Carbon composite pedal body.
- Extra-wide platform for efficient power transfer.
- Durable stainless steel body cover.



P102 € 11.35

- Extra-wide platform for a much more efficient transfer of power
- Durable stainless steel body



P103 € 9.90

- Wide pedal platform for foot-pedal stability.
- Color: Black and Silver



P104 € 8.18

- Pedal Body Material aluminum / painted Cage Material aluminum Reflector
- Average Weight 492g (pair)

Pedal body cover grip Catalogs (2)



P105 € 7.67

- Colors: Bone Grey, Code Red, Diamond Black, Silver, White
- Special magnesium alloy (Lighter than aluminum)
- Weight: 434g, 354g

P106 € 5.15



- Low cost performance
- Various translucent colors
- Weight – 360g



P107 € 9.89

Pedals with Toe Clips

- Toe clips offered significant advantages over platform pedals because they allow the cyclist to drive the pedal during the full rotation





P108 € 6.99

- Lightweight
- Adjustable
- Increases Pedaling Efficiency

## 7.2.6 Design Task (Design Accessory)



Design Task

---

**Before Experiment**

Please carefully read the documents ( prepare yourself for experiment based on documents to be able to play your role)

Don't speak with no one about the experiment, what you will do!

---

**During Experiment**

You have to play your role during the experiment

You will have the documents that I already send to you on the table (all file in Doc for meeting folder)

The layout of design office will be similar to following image



You You have to document all the results of the meeting, everyone have to write the interested point for him in his notebook. You can also put annotation on the document to record the results of the meeting. You have to prepare a report of what was happened during the meeting for your boss! This report has to be generated with your group (responsible of design accessory and responsible of Manufacturing). You have 15 min after meeting to do that ( you can use the annotated documents and your notes for writing the report)

Here in the red part of the shape, the time line of the meeting and your task as a part of Bi-Tri Cycle company is determined.

	Taking the note whenever that is required	
Experts of <b>EnjoyYo</b> ur <b>Holiday</b>	<div style="display: flex; justify-content: space-between;"> <div style="border: 1px solid black; padding: 5px; width: 45%;">                     Select the product that you preference and compatibility with your requirements                 </div> <div style="border: 1px solid black; padding: 5px; width: 45%;">                     Discusses about your requirement and what you want to change in your selected model/ represent your documents if required for better explanation of what you want                 </div> </div>	15 min for Writin g The
Experts of <b>Bi-Tri Cycle</b> Company	<div style="display: flex; justify-content: space-between;"> <div style="border: 1px solid black; padding: 5px; width: 30%;">                     Present their existing product                 </div> <div style="border: 1px solid black; padding: 5px; width: 50%;">                     - Discussion                      - Documentation of the results, important points, required changes                      - Putting annotation on the parts that required to be                 </div> </div>	15min Writin g
0 min Start of meeting	30 min End of	45min

**Meeting Time-line /the tasks of each expertise and the sequence of doing the tasks**

---

**After Experiment**

Don't speak with no one about the experiment and what you did until the end of July!

## 7.2.7 Environmental Role

Member of Design Group



# You are a member of **Design Accessory Group** in **Bi-Tri Cycle**.

You are a member of Company of Bi-Tri Cycle<sup>1</sup> that has a specialty in production and custom design of bikes.

Your company does custom design for the customers by minimizing the cost. So your strategy is to use existing elements of existing products, because in this way you will reduce the time and cost for manufacturing reconfiguration line, or changing manufacturing process or creating new production line.

Unicycles, tricycles and quadracycles are not strictly bicycles, as they have respectively one, three and four wheels, but are often referred to informally as "bikes".

For each new product, if the change in existing product is huge or the product completely changed, you have to do the analysis of manufacturability, but for the changes like change in dimension, or little change in the form, you know ~~it will be manufactured but~~ it will have additional cost for the product line configuration or changing the process.

Your New Customer

Company EnjoyYourHoliday is a big company that sales the equipments and accessories for picnic, camping and leisure. They decided to bring the new product to their market. A vehicle for couple for picnic proposes. They demand for design and manufacturing their new product. So now they are your customer. You decided to have a meeting between 3 experts from your company (You as frame design expert, expert of manufacturing and expert of design accessory) and one expert from EnjoyYourHoliday members. The objective of the meeting is to discover what kind of changes you have to make in existing design model to adapt it for EnjoyYourHoliday with specific requirements.

In this meeting your company will present some of products that by changing the some element or adding another element the company can adapt the design for new customer. After the presentation design expert will ask from your customers to select the product that is more compatible based on their requirements. After, they have to determine the parts and aspects of product that have to be changed or new parts that have to be added in existing product to satisfy customers requirements. These determinations of modification will be based on asking user requirement, negotiation and the knowledge of you and the designers to finally making the decision. Your rule as manufacturing expert is to determine the time and cost based on their decision.

During the meeting, Don't forget to write every aspect of the meeting that could be important for further steps related to the manufacturing. (i.e. every change, modification in existing design, or adding new element to the existing design that means modification in manufacturing and you need to do the manufacturing analysis and you have to transfer this kind of information to your group in the company). If you didn't have answer for the questions like: time and cost, or you didn't have sufficient data or knowledge or information to answer to the question. You have to taking note about the question for asking from your manufacturing group in company or having additional analysis to be able to answer to the questions.

Bi-TriCycle is not a real company

The cost and time of manufacturing different parts of model

You will go to the meeting with the following documents :

The Element	Time	Cost
P102	for producing one $\approx$ 3.5 h	35 €
P103	for producing one $\approx$ 4 h	15€
P104	for producing one $\approx$ 3 h	16 €
P106	for producing one $\approx$ 2 h	14€
P107	for producing one $\approx$ 5 h	30€

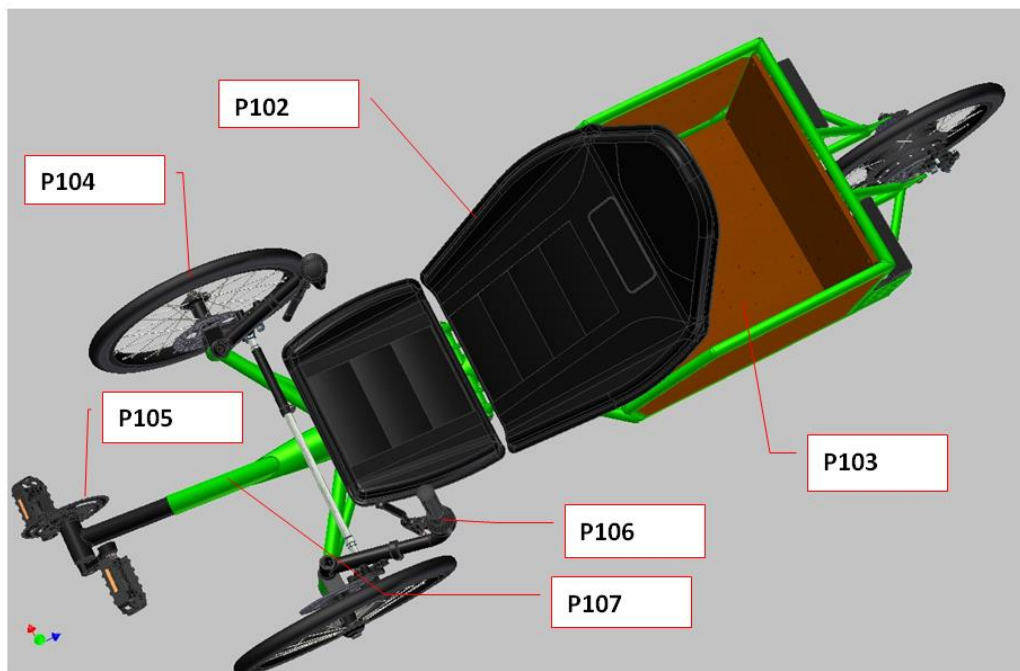

**Model 100**



The Element	Time	Cost
P202	for producing one ≈ 4h	25 €
P203	for producing one ≈ 2 h	11€
P204	for producing one ≈ 2.5 h	10€
P205	for producing one ≈ 1.5 h	10€
P206	for producing one ≈ 2 h	8€



Model 200

The Element	Time	Cost
P302	for producing one ≈ 4h	25 €
P303	for producing one ≈ 2 h	11€
P304	for producing one ≈ 2.5 h	10€
P305	for producing one ≈ 1.5 h	10€
P306	for producing one ≈ 2 h	8€
P307	for producing one ≈ 1.5 h	10€
P308	for producing one ≈ 2 h	8€

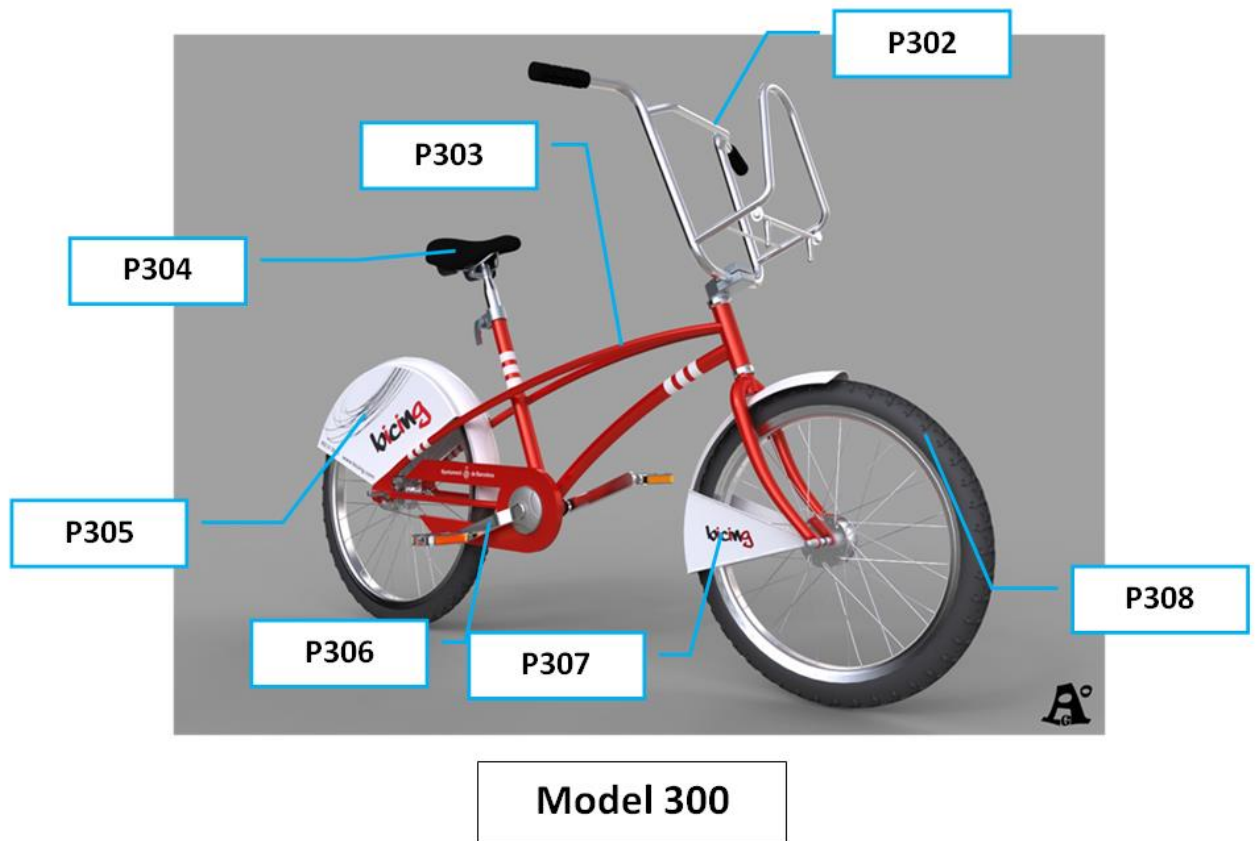

The Element	Time	Cost
P402	for producing one € 4h	25 €
P403	for producing one € 2 h	11€
P404	for producing one € 2.5 h	10€
P405	for producing one € 1.5 h	10€
P406	for producing one € 2 h	8€

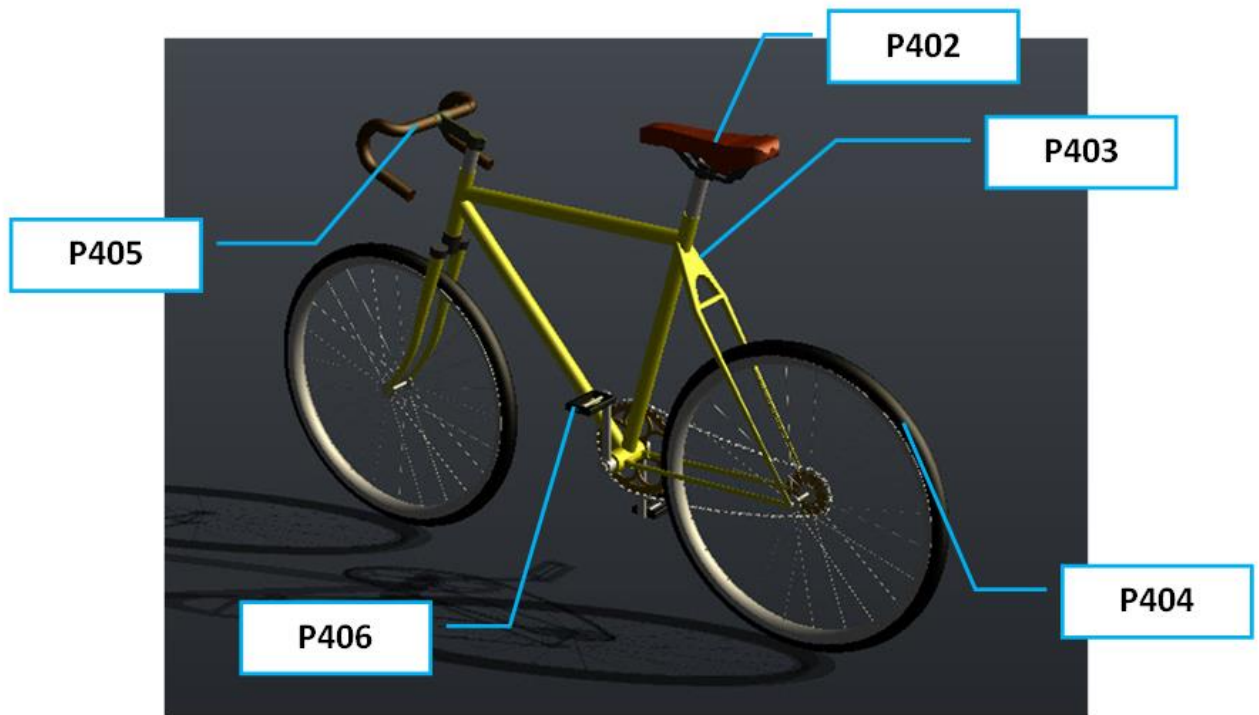

**Model 400**

The Element	Time	Cost
P502	for producing one ≈ 4h	25 €
P503	for producing one ≈ 2 h	11€
P504	for producing one ≈ 2.5 h	10€
P505	for producing one ≈ 1.5 h	10€
P506	for producing one ≈ 2 h	8€
P507	for producing one ≈ 1.5 h	10€
P508	for producing one ≈ 2 h	8€

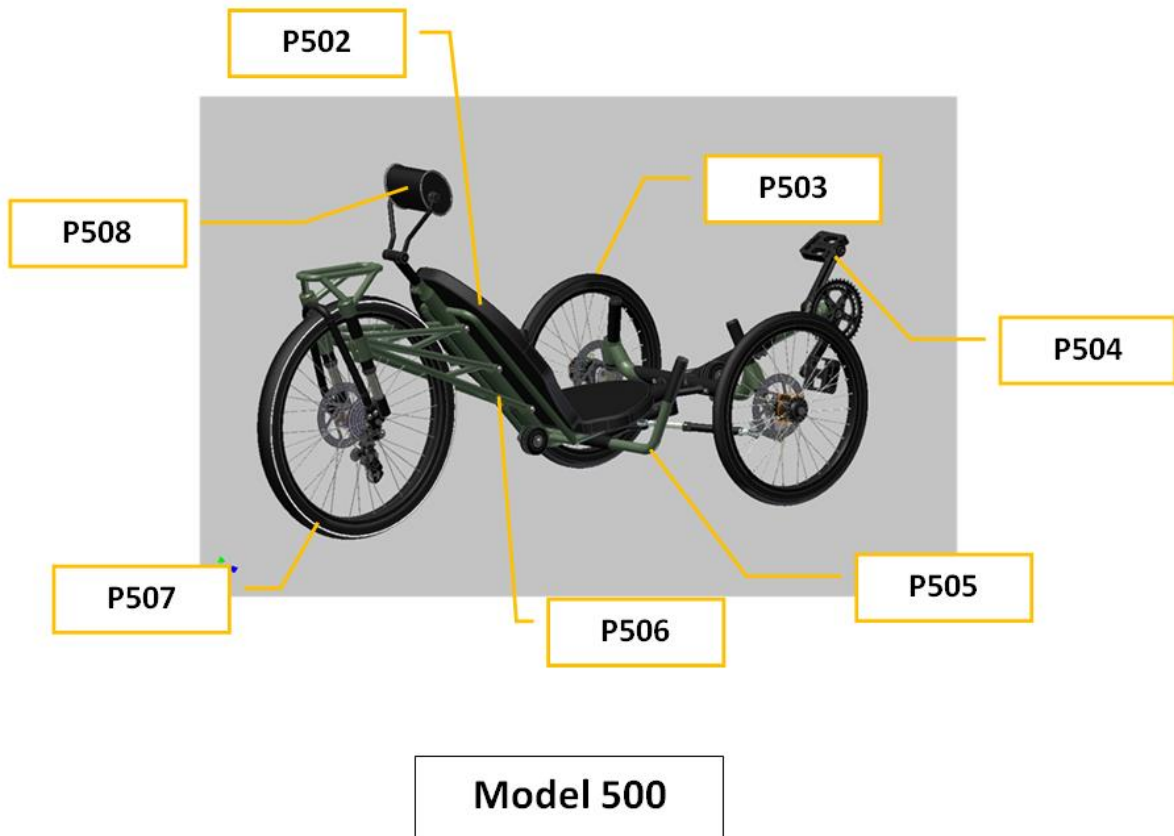

The Element	Time	Cost
P602	for producing one ≈ 4h	25 €
P603	for producing one ≈ 2 h	11€
P604	for producing one ≈ 2.5 h	10€
P605	for producing one ≈ 1.5 h	10€
P606	for producing one ≈ 2 h	8€
P607	for producing one ≈ 1.5 h	10€
P608	for producing one ≈ 2 h	8€

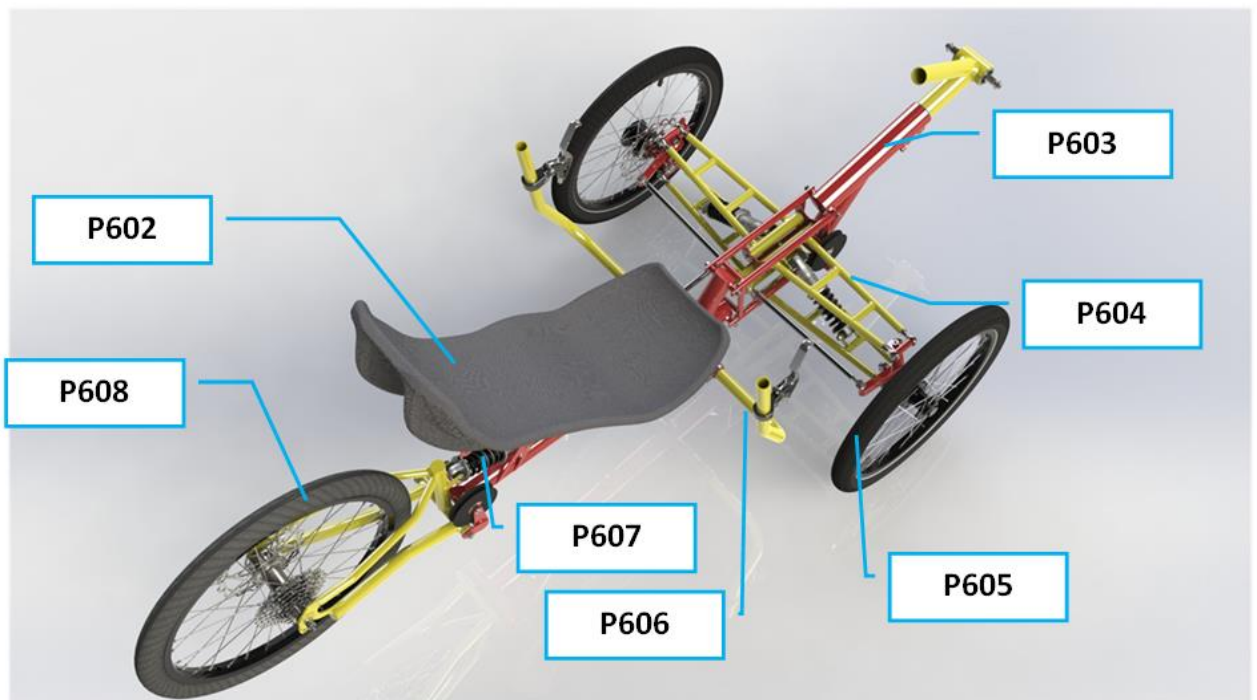



**Model 600**

## 7.2.8 Environmental Task



Design Task

---

**Before Experiment**

Please carefully read the documents ( prepare yourself for experiment based on documents to be able to play your role)  
 Don't speak with no one about the experiment, what you will do!

---

**During Experiment**

You have to play your role during the experiment  
 You will have the documents that I already send to you on the table (all file in Doc for meeting folder)  
 The layout of design office will be similar to following image

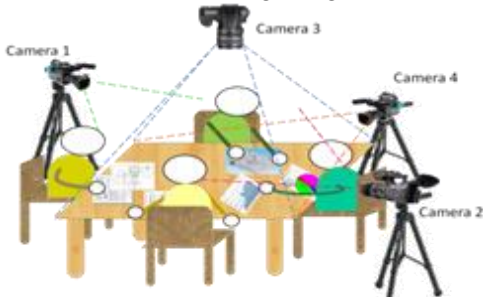

You You have to document all the results of the meeting, everyone have to write the interested point for him in his notebook. You can also put annotation on the document to record the results of the meeting. You have to prepare a report of what was happened during the meeting for your boss! This report has to be generated with your group (responsible of design accessory and responsible of design frame). You have 15 min after meeting to do that ( you can use the annotated documents and your notes for writing the report)

Here in the red part of the shape, the time line of the meeting and your task as a part of Bi-Tri Cycle company is determined.

Experts of EnjoyYour Holiday Company

Taking the note whenever that is required

Select the product that you preference and compatibility with your requirements

→

Discusses about your requirement and what you want to change in your selected model/ represent your documents if required for better explanation of what you want

15 min for Writing The Report

---

Experts of Bi-Tri Cycle Company

Taking the note whenever that is required

Present their existing product

- Discussion  
 - Documentation of the results, important points, required changes  
 - Putting annotation on the parts that required to be changed

15min Writing The Report

**Time**

**0 min**  
Start of meeting

**30 min**  
End of meeting

**45min**

Meeting Time-line /the tasks of each expertise and the sequence of doing the tasks

---

**After Experiment**

Don't speak with no one about the experiment and what you did until the end of July!

219