



HAL
open science

Analyse anatomo-fonctionnelle et moléculaire des conséquences anxiodépressives de la douleur neuropathique dans un modèle murin : importance du cortex cingulaire antérieur

Florent Barthas

► **To cite this version:**

Florent Barthas. Analyse anatomo-fonctionnelle et moléculaire des conséquences anxiodépressives de la douleur neuropathique dans un modèle murin : importance du cortex cingulaire antérieur. Neurosciences [q-bio.NC]. Université de Strasbourg, 2014. Français. NNT : 2014STRAJ029 . tel-01250329

HAL Id: tel-01250329

<https://theses.hal.science/tel-01250329>

Submitted on 4 Jan 2016

HAL is a multi-disciplinary open access archive for the deposit and dissemination of scientific research documents, whether they are published or not. The documents may come from teaching and research institutions in France or abroad, or from public or private research centers.

L'archive ouverte pluridisciplinaire **HAL**, est destinée au dépôt et à la diffusion de documents scientifiques de niveau recherche, publiés ou non, émanant des établissements d'enseignement et de recherche français ou étrangers, des laboratoires publics ou privés.



UNIVERSITÉ DE STRASBOURG



École Doctorale des Sciences
de la Vie et de la Santé

THÈSE présentée par :

Florent Barthas
Soutenue le 02 juillet 2014

Pour obtenir le grade de : **Docteur de l'Université de Strasbourg**
Spécialité : Neurosciences

**Analyse anatomo-fonctionnelle et moléculaire
des conséquences anxiodépressives de la
douleur neuropathique dans un modèle murin :
importance du cortex cingulaire antérieur**

THÈSE dirigée par :

M. Michel Barrot

Directeur de recherche, CNRS UPR 3212, Strasbourg

RAPPORTEURS :

Mme Catherine Belzung

Professeur à l'Université François Rabelais de Tours – Inserm U930

Mme Sophie Pezet

Maître de Conférences à l'ESPCI ParisTech – CNRS UMR 8249

EXAMINATEURS :

Mme Claire Gavériaux-Ruff

Professeur à l'Université de Strasbourg CNRS UMR 7104

M. Luis Garcia-Larrea

Directeur de recherche, Inserm U1028 – CNRS UMR 5292, Lyon

Remerciements

Je tiens à remercier Monsieur le Docteur Michel Barrot pour m'avoir accueilli dans son équipe. Il m'a permis de poursuivre une thèse en neurosciences fondamentales, ce qui a été mon souhait dès le début de mes études à la Faculté des Sciences Pharmaceutiques de Toulouse. Grâce à la confiance dont il a fait preuve en me recrutant et tout au long de cette thèse, j'ai pu pleinement m'épanouir sur le plan professionnel. Pour cela, je lui serai toujours reconnaissant.

Je voudrais témoigner de ma sincère gratitude à l'égard de Madame le Docteur Ipek Yalcin-Christmann. L'énoncé de ses très nombreuses qualités ne suffirait pas à témoigner du respect que je lui porte. J'ai trouvé chez Ipek un modèle de qualités humaines et scientifiques dont l'approche suffirait à me combler. Ipek fut là pour moi tout au long de cette thèse et son aide ses conseils me furent extrêmement précieux. Les étudiants qui auront, après moi, la chance de travailler auprès d'elle, vivront sans aucun doute une expérience aussi enrichissante que la mienne.

Je tiens à remercier Madame le Professeur Freund-Mercier pour les conseils et l'aide reçus au cours de cette thèse, que ce soit pour l'écriture ou pour l'enseignement ainsi que pour sa gentillesse au quotidien.

Je souhaite remercier Monsieur le Dr Pierre Veinante pour son expertise et les conseils dont il m'a fait profiter en neuroanatomie, et Monsieur le Docteur Luc-Henri Tessier pour son implication dans ma formation à la biologie moléculaire.

Je désire aussi faire part de ma gratitude à Monsieur le Professeur Rémy Schlichter et Monsieur le Docteur Sylvain Hugel pour les discussions scientifiques passionnantes et leur disponibilité constante.

Je souhaite faire part de ma gratitude à Madame le Professeur Catherine Belzung et à Madame le Docteur Sophie Pezet pour avoir accepté d'être rapporteurs de cette thèse malgré le travail que cela représente. Qu'elles trouvent ici le témoignage de ma reconnaissance.

Je voudrais également remercier très respectueusement Madame le Professeur Claire Gavériaux-Ruff et Monsieur le Docteur Luis Garcia-Larrea pour leur travail d'examineur. La présence de scientifiques d'aussi grande qualité dans mon jury de thèse est un honneur.

Je souhaite remercier toutes les personnes du laboratoire qui ont supporté ma patience bien connue.

Merci à Salim, mon meilleur public, pour sa bonne humeur et tous les moments partagés. Merci à Fred pour son humour, à Romain pour son amitié et à Jérôme pour son accueil chaleureux. Merci à María-Jose pour le partage du bureau et sa très grande gentillesse.

Merci à Betty pour ses précieux conseils et son aide dès mon arrivée dans le laboratoire.

Merci aux anciens, Yohann, Sophie, Hughes et Maya qui m'ont très gentiment et très rapidement intégré à l'équipe.

Merci aux jeunes et à ceux qui le sont moins, Dorothée, Mélanie, Clémentine, Alice, Éric, Taddy et Jim.

Je souhaite évidemment remercier ma famille pour son soutien moral et financier tout-au-long de mes longues études qui trouvent un point final aujourd'hui. À ma mère, à mon père, à ma sœur qui ont toujours été là, et pour qui ma reconnaissance et mon respect sont sans limite.

Un immense merci à Maud pour son soutien constant et sa capacité sans égal à me comprendre.

Publications et communications

Publications liées aux travaux de thèse :

The Sciatic Nerve Cuffing Model of Neuropathic Pain in Mice.

Ipek Yalcin, Salim Megat, **Florent Barthas**, Elisabeth Waltisperger, Mélanie Kremer, Eric Salvat, Michel Barrot

The Journal of Visualized Experiments (JoVE), sous presse.

The anterior cingulate cortex is a critical hub for pain-induced depression.

Florent Barthas, Jim Sellmeijer, Sylvain Hugel, Michel Barrot, Ipek Yalcin

En révision.

Emotional consequences of neuropathic pain: insight from preclinical studies. Revue.

Ipek Yalcin, **Florent Barthas**, Michel Barrot

Neuroscience and Biobehavioral Reviews, sous presse.

Involvement of MAPK Phosphatase 1 (MKP-1) in the emotional consequences of neuropathic pain.

Florent Barthas, Elisabeth Waltisperger, Ralf Gilsbach, Lutz Hein, Michel Barrot, Ipek Yalcin

En écriture.

The anterior cingulate cortex: neuroanatomy, roles in mood and pain. Revue.

Florent Barthas, Jim Sellmeijer, Clémentine Fillinger, Pierre Veinante, Michel Barrot, Ipek Yalcin

En écriture.

Publications issues de collaboration :

BDNF parabrachio-amygdaloid pathway in morphine-induced analgesia.

Maysa Sarhan, Sophie Anne Pawlowski, **Florent Barthas**, Ipek Yalcin, Jennifer Kauffling, Hugues Dardente, Venetia Zachariou, Ralph Joseph DiLeone, Michel Barrot et Pierre Veinante

International Journal of Neuropsychopharmacology (2013), 16, 1649–1660.

Activation of TRPV2-expressing primary afferents stimulates synaptic transmission in deep dorsal horn of the rat spinal cord and elicits mechanical hyperalgesia.

Hugues Petitjean, Sylvain Hugel, **Florent Barthas**, Johann Bohren, Michel Barrot, Ipek Yalcin et Rémy Schlichter

European Journal of Neuroscience, sous presse.

Publication issue du master :

Opposite control of body temperature by NPFF1 and NPFF2 receptors in mice.

Lionel Moulédous, **Florent Barthas**, Jean-Marie Zajac

Neuropeptides (2010), 44, 453–45.

Communications affichées :

Involvement of Anterior Cingulate Cortex in neuropathic pain induced-mood disorders

Florent Barthas, Elisabeth Waltisperger, Michel Barrot, Ipek Yalcin-Christmann

42^{ème} congrès de la Society for Neuroscience, Nouvelle-Orléans, USA, Octobre 2012

Involvement of different cortical regions in the somatosensory component and the affective consequences of neuropathic pain in mice.

Florent Barthas, Elisabeth Waltisperger, Michel Barrot, Ipek Yalcin-Christmann

4th International Congress on Neuropathic Pain, Toronto, Canada, Mai 2013

Involvement of different cortical regions in the sensory component and the affective consequences of neuropathic pain in mice.

Florent Barthas, Elisabeth Waltisperger, Michel Barrot, Ipek Yalcin-Christmann

Meeting annuel de Neurex, Basel, Suisse, Juin 2013

Cortical segregation of chronic pain components.

Florent Barthas, Michel Barrot, Ipek Yalcin-Christmann

Neural circuits underlying nociception and pain and their plasticity Congress, Heidelberg, Allemagne, Octobre 2013

Communication orale :

Ségrégation corticale des composantes sensorielle et émotionnelle et des conséquences anxio-dépressives de la douleur neuropathique.

Florent Barthas, Elisabeth Waltisperger, Michel Barrot, Ipek Yalcin-Christmann

9^{ème} Symposium Réseau Inserm de Recherche sur la Douleur, Bordeaux, Mars 2013

Financement de la thèse :

Mon contrat doctoral a été financé par une bourse fléchée de l'Université de Strasbourg du 01/10/2010 au 30/09/2013. J'ai été recruté pour un poste d'attaché temporaire d'enseignement et de recherche à mi-temps en physiologie animale à l'Université de Strasbourg du 01/10/2013 au 31/08/2014.

Bourse obtenue :

Obtention d'une bourse Aviesan – ITMO Neurosciences, Sciences Cognitives, Neurologie, Psychiatrie, couvrant les frais de déplacement pour la participation au 42^{ème} congrès de la Society for Neuroscience à la Nouvelle-Orléans (USA) en Octobre 2012.

Résumé



Analyse anatomo-fonctionnelle et moléculaire des conséquences anxiodépressives de la douleur neuropathique dans un modèle murin : importance du cortex cingulaire antérieur

Résumé

La douleur neuropathique est un syndrome secondaire à une maladie ou à une lésion affectant le système nerveux somatosensoriel. Environ 30% des patients souffrant de douleurs neuropathiques présentent des troubles de l'humeur. Les causes biologiques de ces comorbidités ne sont pas clairement établies. Grâce à l'utilisation d'un modèle murin de douleur neuropathique, nous avons cherché à comprendre l'apparition des conséquences émotionnelles de cette douleur. Pour cela, nous avons cherché à identifier des régions cérébrales impliquées dans les différentes composantes et conséquences de la douleur ainsi que les modifications moléculaires y prenant place. Nous avons mis en évidence une ségrégation corticale de la douleur avec l'intégration de la composante sensorielle par le cortex insulaire postérieur d'une part et l'intégration de la composante aversive et des conséquences émotionnelles par le cortex cingulaire antérieur d'autre part. Nous avons ensuite montré l'implication de la protéine MKP-1 dans l'expression des comportements de type anxiodépressif dans notre modèle.

Mots-clés : douleur neuropathique, dépression, anxiété, modèle animal, MKP-1.

Abstract

Neuropathic pain is defined as a pain caused by a lesion or disease of the somatosensory nervous system. Around 30% of neuropathic pain patients develop mood disorders. The biologic bases of these comorbidities are not clearly established. Using a murine model of neuropathic pain, we tried to understand the emotional consequences of neuropathic pain. Thus, we identified cerebral regions involved in the different components of pain and molecular modifications taking place in these regions. We showed a cortical separation of the pain experience with on one hand the integration of the sensory component of pain in the posterior insular cortex and on the other hand the integration of the aversive component and the emotional consequences of pain in the anterior cingulate cortex (ACC). Looking at the molecular modifications in the ACC, we showed that MKP-1, a protein able to dephosphorylate the MAPK, is involved in the development of pain-related mood disorders in our model of neuropathic pain.

Keys words : neuropathic pain, depression, anxiety, animal model, MKP-1.

Sommaire

Introduction.....	5
I. Avant-propos	6
II. Emotional consequences of neuropathic pain: insight from preclinical studies.	8
A. Introduction.....	8
B. Preclinical modelling of the anxiodepressive consequences of neuropathic pain.	9
C. Preclinical insights into the neurobiology of neuropathic pain consequences.....	13
1. Neuroanatomy and neuroplasticity of neuropathic pain consequences.....	13
a. The cortex.....	13
b. The hippocampus	16
c. The amygdala	17
d. The mesolimbic pathway.....	19
2. Neuroendocrine parameters.....	20
3. Neuroimmune response.....	21
4. Monoamine systems	22
5. Neurotrophic factors	23
D. Conclusion and perspectives	24
III. The anterior cingulate cortex: Role in mood disorders and in pain.....	25
A. Neuroanatomy of the ACC	25
1. The general organization of the cingulate cortex	25
2. The ACC connections: insights from rodents and primates studies.....	26
a. The ACC inputs	27
b. The ACC outputs	29
B. The role of the ACC in mood disorders	31
C. The role of the ACC in pain.....	35
1. Insights from clinical studies	35
a. The role of the ACC in physiological conditions	35
b. The role of the ACC in pathological pain conditions	36
c. The role of the ACC in the affective component of pain.....	37
d. The role of the ACC in the cognitive component of pain	37
2. Insights from preclinical studies.....	39
a. Insight from lesion studies	39
b. Insights from ex vivo electrophysiology	41
c. Insights from in vivo electrophysiology.....	41
d. Insights from imaging studies.....	41

e.	Insights from molecular studies	42
f.	Discrepancies between studies	43
IV.	Le cortex insulaire : rôle dans la douleur chez l'Homme et le rongeur.....	44
A.	Organisation générale du cortex insulaire	44
1.	Chez les singes et l'Homme	44
2.	Chez les rongeurs	44
B.	Connexions du cortex insulaire	45
1.	Connexions intrainsulaires	45
2.	Connexions extrainsulaires.....	45
a.	Cortex cérébral	45
b.	Structures limbiques.....	46
c.	Thalamus	46
C.	Fonctions du cortex insulaire	46
1.	Observation de quatre grands domaines fonctionnels.....	46
2.	Fonctions du cortex insulaire dans la somatosensation et la douleur chez l'Homme	47
3.	Fonction du cortex insulaire dans la somatosensation et la douleur chez le rongeur.....	48
	Objectifs de thèse	49
	Résultats	51
I.	The sciatic nerve cuffing model of neuropathic pain in mice	52
II.	The anterior cingulate cortex is a critical hub for pain-induced depression.....	66
III.	Rôle de la protéine MAPK Phosphatase 1 (MKP-1) dans les conséquences émotionnelles de la douleur neuropathique	94
A.	Introduction.....	94
B.	Matériel et méthode	97
C.	Résultats	101
1.	Analyse génomique	101
2.	Analyse du profil d'expression protéique	101
3.	Comportement des animaux KO MKP-1	102
D.	Discussion	103
	Discussion générale	106
I.	Pertinence du modèle utilisé dans l'étude de la douleur neuropathique	107
A.	L'étude de la douleur chez les rongeurs	107
B.	Discussion sur les termes hyperalgésie et allodynie	108
C.	La modélisation de la douleur neuropathique dans le modèle du cuff	109

D.	Discussion de la mesure de la douleur spontanée par CPP	110
II.	Pertinence du modèle utilisé pour l'étude des comportements anxiodépressifs	113
A.	Précautions et précisions sur les termes employés	113
B.	Modélisation des comportements de type anxiodépressif chez la souris	113
C.	Modélisation des comportements de type anxiodépressif dans le modèle du cuff.....	115
D.	Autres considérations méthodologiques	117
III.	Mécanismes responsables de l'apparition des troubles anxiodépressifs dans notre modèle de douleur neuropathique	120
IV.	Modifications moléculaires au sein de l'ACC	122
V.	Dissociation corticale : risques de simplification et de généralisation des résultats.....	125
	Perspectives.....	129
	Annexe.....	133
	Bibliographie	135

Introduction

I. Avant-propos

La douleur neuropathique est un syndrome secondaire à une maladie ou à une lésion affectant le système nerveux somatosensoriel (Jensen et al., 2011), d'étiologies diverses, se traduisant par de multiples signes cliniques. Tandis que la douleur chronique concerne environ 30 % de la population, les douleurs chroniques ayant des caractéristiques neuropathiques affectent environ 6,8 % de la population en France (Bouhassira et al., 2008). Les signes cliniques observés sont de plusieurs types (**Tableau 1**). Ils peuvent être dits « positifs », comme par exemple l'hyperalgésie, qui est une réponse douloureuse exagérée à un stimulus nociceptif, ou encore l'allodynie, qui est une réponse douloureuse à un stimulus normalement non nociceptif. D'autres signes sont dits « négatifs », tels que l'hypoesthésie, qui est une perte de la sensibilité générale, ou l'hypoalgésie, qui est une perte de la sensibilité à la douleur. Les douleurs neuropathiques sont chroniques et peuvent perturber de manière dramatique la vie des patients qui en souffrent (Attal et al., 2011). L'apparition de troubles de l'humeur tels que l'anxiété et la dépression chez environ 30 % des patients souffrant de douleurs neuropathiques (Radat et al., 2013) est une des raisons de cette altération de la qualité de vie. Les causes biologiques de ces comorbidités psychiatriques ne sont pas clairement établies. La connaissance de ces causes pourrait permettre une prise en charge plus globale de la douleur neuropathique et ainsi une amélioration de la santé des patients.

Les troubles psychiatriques développés dans le cadre de douleurs neuropathiques concernent principalement l'anxiété et la dépression. Le diagnostic des troubles anxieux généralisés est présenté dans le *Diagnostic and Statistical Manual of Mental Disorders IV (DSM-IV)*. Les patients doivent souffrir d'anxiété et d'inquiétude excessives à propos d'une variété d'évènements et de situations depuis au moins 6 mois et présenter au moins trois des signes suivants : une tension ou une agitation, de la fatigue, des problèmes de concentration, une irritabilité et une tension musculaire. La dépression majeure est le trouble dépressif le plus fréquent. Selon le *DSM-IV*, elle doit durer au moins deux semaines consécutives et présenter au moins cinq des symptômes résumés ci-après : une humeur dépressive, une perte d'intérêt ou de plaisir pour presque toutes les activités, une perte ou un gain de poids, des troubles du sommeil, une agitation ou un ralentissement moteur,

Tableau 1. Symptômes rencontrés dans la douleur neuropathique.
(IASP Taxonomy Task Force)

Signes	Définitions
Positifs	Allodynie : douleur due à un stimulus normalement non douloureux
	Hyperalgésie : douleur exagérée en réponse à un stimulus douloureux
	Hyperesthésie : sensibilité exagérée à une stimulation
	Hyperpathie : réaction retardée anormalement douloureuse et souvent explosive à un stimulus, le plus souvent répété
Sensations anormales	Dysesthésie : sensation anormale et déplaisante, spontanée ou provoquée
	Paresthésie : sensation anormale, spontanée ou provoquée
Négatifs	Hypoalgésie : douleur diminuée en réponse à un stimulus douloureux
	Hypoesthésie : sensation diminuée à une stimulation

de la fatigue, un sentiment de dévalorisation ou de culpabilité, des difficultés de concentration et enfin des pensées de mort et des idées suicidaires.

C'est dans ce contexte que s'inscrit mon travail de thèse. Grâce à l'utilisation d'un modèle murin de douleur neuropathique, nous avons cherché à comprendre l'apparition des conséquences anxiodépressives de cette douleur. Pour cela, nous avons étudié des régions cérébrales impliquées dans les aspects sensoriels et aversifs de la douleur, dans les troubles de l'humeur ainsi que les modifications moléculaires prenant place dans ces régions.

La première partie de l'introduction sera consacrée à un état des lieux des connaissances précliniques concernant la relation entre la douleur neuropathique et les troubles de l'humeur. La deuxième partie détaillera la neuroanatomie, les connexions et l'implication du cortex cingulaire antérieur dans les troubles de l'humeur et dans la douleur. Cette région est connue pour participer chez l'Homme (Rainville et al., 1997) et chez le rat (Johansen et al., 2001) à la composante affective de la douleur. Enfin, la troisième partie de l'introduction sera consacrée au cortex insulaire (IC), et en particulier à sa partie postérieure (pIC). Nous résumerons sa neuroanatomie et son rôle crucial dans la composante sensorielle de la douleur chez l'Homme (Peyron et al., 2000) et chez le rat (Benison et al., 2011). Ces deux structures corticales, l'ACC et le pIC, acteurs majeurs de l'expérience douloureuse, sont les cibles étudiées au cours de ces travaux de thèse.

II. Emotional consequences of neuropathic pain: insight from preclinical studies.

Cette première partie de l'introduction, écrite en langue anglaise, est une revue de la littérature devant donner lieu à publication. Elle a été coécrite avec mes encadrants, Ipek Yalcin et Michel Barrot.

A. Introduction

Pain is defined as an unpleasant sensory and emotional experience associated with actual or potential tissue damage, or described in terms of such damage (International Association for the Study of Pain). It is thus a multidimensional and subjective experience. While acute pain can be protective and adaptive (Morrison et al., 2013), chronic pain is often a debilitating disease, affecting 20 to 60% of the world population (Elliott et al., 1999; Breivik et al., 2006). Either of neuropathic or inflammatory origin, chronic pain remains difficult to treat and has major socio-economic impacts (Bouhassira and Attal, 2011). In this review, we focus on neuropathic pain which is defined as a pain arising as a consequence of a lesion or disease affecting the somatosensory system (Treede et al., 2008). For most patients, neuropathic pain has a peripheral origin, arising as a consequence of peripheral nerve injury or as a consequence of a metabolic disease such as diabetes. Nerve injuries and diabetic peripheral neuropathy account for almost two-thirds of the patients. However, neuropathic pain can also result from infectious diseases, as in post-herpetic neuralgia, from exposure to neurotoxic compounds, such as those used for cancer chemotherapy, or be of central origin, as observed after spinal cord injury or local post-stroke ischemia (Attal et al., 2008). Both physical examination and questionnaires such as the DN4 (Bouhassira et al., 2008; Attal et al., 2011) and the Neuropathic Pain Symptom Inventory (Freeman et al., 2014) are used to diagnose the neuropathic characteristic of pain and its different symptoms. These symptoms include spontaneous pain, evoked pain such as allodynia, hyperalgesia or hyperpathia, abnormal sensations such as paresthesia or dysaesthesia and sensitive deficits like hypoesthesia (Attal et al., 2008).

Neuropathic pain can affect multiple aspects of the patient's health and quality of life, including mood, sleep and cognitive processes (Attal et al., 2011; Haanpaa et al., 2011). Mood disorders such as depression and anxiety are frequently observed in patients suffering from chronic pain. Epidemiological studies report around 50% mean prevalence rate for major depressive disorder in patients with chronic pain (Bair et al., 2003; Maletic and Raison, 2009). This prevalence is around 30% for patients suffering from neuropathic pain (Gustorff et al., 2008; Radat et al., 2013), and it may even reach around 80% in fibromyalgia patients (Fietta and Manganelli, 2007). While this co-morbidity is clinically well established, the underlying mechanism(s) remained unclear. The recent development of animal models now allows us to address the consequences of neuropathic pain.

Here we report the evidences from anatomical, neuroimaging, behavioral, pharmacological and biochemical preclinical studies that address the affective consequences of neuropathic pain. We first review articles aimed at modeling the anxiodepressive consequences of neuropathic pain and we discuss the challenges and parameters to consider when generating animal models. We then discuss the possible mechanism(s) underlying these consequences, by describing morphological and functional changes associated with affective disorders in neuropathic animals.

B. Preclinical modelling of the anxiodepressive consequences of neuropathic pain.

Models of neuropathic pain in rodents can be based on peripheral nerve injuries, central injuries, trigeminal neuralgia, diabetic neuropathies, chemo-induced neuropathies, postherpetic neuralgia, and so forth (Sorkin and Yaksh, 2009; Colleoni and Sacerdote, 2010; Jaggi et al., 2011; Barrot, 2012). Almost all of the preclinical studies on the affective consequences of neuropathic pain were performed on models related to sciatic nerve manipulation, using either nerve compression or section. These models rely on three or four loose ligatures around the main branch of the sciatic nerve (chronic constriction injury, CCI) (Bennett and Xie, 1988), on the tight ligation of the sciatic nerve (partial sciatic nerve ligation, PSL) (Seltzer et al., 1990) or of the L5 and L6 spinal nerves (spinal nerve ligation, SNL) (Kim and Chung, 1992), on the ligation of the common peroneal nerve (Vadakkan et al., 2005), or on

Table 2. Summary of studies on the affective consequences of neuropathic pain.

Pain Model	Species	Test	Results	References
PSNL	Rat	BT	BB deficits	Andrews et al., 2012
	Mouse	OF, EPM, TST	No effect	Hasnie et al., 2007b
	Mouse	OF	No effect	Kodama et al., 2011
	Mouse	LD, EPM	ALB	Narita et al., 2006a,b
	Mouse	LD, EPM	ALB	Matsuzawa-Yanagida et al., 2008
SNL	Rat	OF, EPM, LD, FST	No effect	Kontinen et al., 1999
	Mouse	OF, EPM, LD, FST	ALB, DLB	Suzuki et al., 2007
CCI	Rat	FST, SP	No effect	Bravo et al., 2012
	Rat	FST, OF	DLB	Zeng et al., 2008
	Rat	EPM	ALB	Roeska et al., 2009
	Rat	FST	DLB	Fukuhara et al., 2012
	Mouse	EZM, FST, OF	no effect	Urban et al., 2011
SNI	Rat	OF, EPM, FST	no ALB, DLB	Gonçalves et al., 2008
	Rat	OF, EPM, FST	ALB, DLB	Leite-Almeida et al., 2009
	Rat	FST, SP	DLB	Wang et al., 2011
	Mouse	OF, FST	no ALB, DLB	Norman et al., 2010
	Mouse	EZM, FST, OF	no effect	Urban et al., 2011
	Mouse	DL, NSF	ALB	Mutso et al., 2012
Cuff	Mouse	EPM, MB, SI, TST	ALB	Benbouzid et al., 2008
	Mouse	LD, MB, NSF, Splash, FST	ALB, DLB	Yalcin et al., 2011
SNT	Rat	FST	DLB	Hu et al., 2010
	Rat	BT	BB deficits	Andrews et al., 2012
Antiretroviral	Rat	OF, BT	ALB, BB deficits	Huang et al., 2013

List of abbreviations: ALB, Anxiety-like behavior; BB, Burrowing behavior; BT, Burying test; CCI, Chronic construction injury; DLB, Depression-like behavior; EPM, Elevated-plus maze; EZM, Elevated zero maze; FST, Forced swimming test; LD, Light-dark test; MB, Marble burying; NSF, Novelty-suppressed feeding; OF, Open field; SI, Social interaction; SNI, Spared nerve injury; SNL, Spinal nerve ligation; SNT, Spinal nerve transection; SP, Sucrose preference; PSLN, Partial sciatic nerve ligation; TST, Tail suspension test.

the implantation of a polyethylene cuff around the main branch of the sciatic nerve (Mosconi and Kruger, 1996; Benbouzid et al., 2008b). The spared nerve injury (SNI) is another frequently used model, for which two of the three terminal branches of the sciatic nerve are tightly ligated before their distal axotomy (Decosterd and Woolf, 2000). A shared feature of these models is to induce mechanical allodynia, as well as changes in thermal sensitivity for most of them.

Since the late 90's, several research groups worked on modeling the affective consequences of neuropathic pain in animal. The first studies (Kontinen et al., 1999) and some recent ones (Hasnie et al., 2007a; Kodama et al., 2011; Urban et al., 2011; Bravo et al., 2012) failed to evidence any association between neuropathic pain and anxiety/depression related behaviors, while other studies reported anxiety and/or depression-related phenotypes in rodent models (see **Table 2**) (Suzuki et al., 2007; Benbouzid et al., 2008b; Goncalves et al., 2008; Zeng et al., 2008; Roeska et al., 2009; Hu et al., 2010; Yalcin et al., 2011; Alba-Delgado et al., 2013). The former studies were however performed during the first 3 weeks following pain induction, while the latter considered later time-points. This suggests that the time factor may be one of the critical points to model chronic pain-induced mental disorders, and that models providing a time-dependent evolution of the anxiety- or depression-related phenotypes are valuable to study the etiology and pathogenesis of mood disorders (Roeska et al., 2009; Yalcin et al., 2011). Besides the temporal parameter, species, strains of animals, neuropathic pain models and the time of the day-night cycle when the animals are tested may all influence the results. Additionally, it has recently been shown that the side of the nerve injury (left vs. right) may differently influence the affective and cognitive consequences of neuropathic pain (Leite-Almeida et al., 2012). Indeed, left-side and right-side nerve lesions in rats were proposed to preferentially alter emotional behavior and cognitive performances respectively.

Even though neuropathic pain may have different origins (see Introduction), animal studies are presently using traumatic models to study the affective consequences of neuropathic pain (see **Table 2**). As a consequence, the relation between diabetic peripheral neuropathic pain and depression/anxiety was not examined yet in rodent, despite the fact that a high rate of comorbidity has been reported in patients (Jain et al., 2011). Nevertheless, recent studies reported that the HIV as well as the antiretroviral therapy-induced peripheral neuropathy causes thigmotaxis and decreases burrowing behavior (indexes of anxiety-like behavior),

which can be attenuated by gabapentinoid treatment and benzodiazepine anxiolytic treatment (Wallace et al., 2007b; Wallace et al., 2007a; Wallace et al., 2008; Huang et al., 2013). Similarly, postherpetic neuralgia in a rat model of varicella zoster virus-associated neuropathic pain also induces anxiety-like behavior (Hasnie et al., 2007b).

The studies aiming at modeling the anxiodepressive consequences of neuropathic pain use well-known behavioral tests. The most frequently performed tests to evaluate the anxiety-related behavior are exploratory-based approach/avoidance conflict tests, such as the elevated plus maze, the open field or the dark-light exploration test (see **Table 2**). The novelty-suppressed feeding test, which is based on a conflict between the drive to eat and the fear of venturing into the centre of the testing open field, responds to chronic but not acute antidepressant drug treatments and is thus used to address the frequent intermixture of anxiety/depression symptoms (Nestler and Hyman, 2010). The most frequently used tests for assessing depression-related behaviors in rodents involve exposure to stressful situations and the measure the time spent in active versus passive stress coping, such as the forced swimming test or the tail suspension test (see **Table 2**). In addition to depressed mood, depression also includes homeostatic, neurovegetative (abnormalities in sleep, appetite, weight) or cognitive symptoms. Unfortunately, these symptoms are less often studied under a neuropathic pain paradigm. Another symptom, more frequently examined, is the animal's interest in pleasurable activities such as the preference for sucrose solution or engaging in social interactions. For instance, both sucrose consumption (Wang et al., 2011) and social interactions (Benbouzid et al., 2008b) decrease in neuropathic animals. A recent study, using fossorial and therefore naturally burrowing rats, showed that the burrowing behavior is reduced by peripheral nerve injury (Andrews et al., 2012). Burrowing is an evolutionarily conserved behavior and alterations of such activity likely reflect the effect of chronic pain on motivation and general well being. Insomnia or hypersomnia is another common problem associated with chronic pain (Palermo et al., 2011; Tang et al., 2012) and depression (Krystal, 2012) in patients. Accordingly, sleep alterations such as reduced sleep efficiency, increased number of arousals (Andersen and Tufik, 2003), increased wakefulness and decrease in non-rapid eye movement (NREM) sleep (Narita et al., 2011; Takemura et al., 2011) have been

observed under neuropathic pain state, using functional magnetic resonance imaging (fMRI) and brain wave analysis.

The diminished ability to think or concentrate, i.e. a cognitive symptom, is one of the symptoms of major depression according to Diagnostic and Statistical Manual of Mental Disorders (DSM) IV. Patients with neuropathic pain often complain about memory and attention deficits which may significantly decrease their intellectual ability (Dick and Rashiq, 2007; Legrain et al., 2009). A growing number of preclinical studies confirmed that neuropathic pain can induce cognitive impairments. Indeed, altered working memory (Ren et al., 2011; Cardoso-Cruz et al., 2013), short term memory (Ren et al., 2011) spatial memory (Leite-Almeida et al., 2012), impaired attention (Leite-Almeida et al., 2012) and impaired cognitive flexibility in middle aged animals (Leite-Almeida et al., 2009) have been reported in models of peripheral nerve injury.

As almost all the behavioral tests used to assess anxiety and depression related behavior in rodents depend on the motor activity of the animals, it is always critical to control the effects of the neuropathic pain model on locomotor activity before performing any of these tests. For instance, the general locomotor activity of the neuropathic animals remain unaffected in the spinal nerve ligation (Suzuki et al., 2007), spared nerve injury (Goncalves et al., 2008; Norman et al., 2010), partial sciatic nerve ligation (Narita et al., 2006a; Kodama et al., 2011) and cuff (Benbouzid et al., 2008b; Yalcin et al., 2011) models of neuropathic pain.

Besides the face validity, showing the capacity of the model to demonstrate the symptoms of the given pathology, few studies also explored the predictive validity of neuropathic pain models, i.e. their capacity to answer to clinically relevant treatments. Results of these studies showed that neuropathic pain-induced mood disorders are sensitive to treatments with anxiolytic such as etizolam (Narita et al., 2006a) or antidepressants such as the tricyclic antidepressant imipramine, the serotonin and noradrenaline selective reuptake inhibitor milnacipran, or the selective serotonin reuptake inhibitor paroxetine (Matsuzawa-Yanagida et al., 2008).

Altogether these studies illustrate that it is possible to reliably model the anxiodepressive phenotype in animals with neuropathic pain. This modeling is critical for understanding the molecular and neural mechanism leading to the anxiodepressive consequences of neuropathic pain.

C. Preclinical insights into the neurobiology of neuropathic pain consequences.

While this review focuses on preclinical research, which offers a unique opportunity to test cellular and molecular hypotheses, human clinical investigations provide critical neuroanatomical insights, particularly through functional imaging studies. Indeed, recent human studies in neuropathic pain patients point out morphological and functional changes as well as reorganization in brain structures associated with affective and cognitive disorders, such as the medial prefrontal cortex (mPFC) (Baliki et al., 2006; Baliki et al., 2008), the anterior cingulate cortex, an integrative part of the mPFC (Peyron et al., 2000; Obermann et al., 2013), the hippocampus (Zimmerman et al., 2009; Mutso et al., 2012), the amygdala (Liu et al., 2013) and the thalamus (Apkarian et al., 2004; Maarrawi et al., 2013). The animal models allow testing the factors of causal relationships and the hypotheses on the mechanism(s) underlying pain-induced mood disorders.

1. Neuroanatomy and neuroplasticity of neuropathic pain consequences

In the past two decades, several authors have considered the possibility that plasticity of brain structures and cellular remodeling are involved in the pathophysiology and the treatment of mood disorders (Pittenger and Duman, 2008; Ota and Duman, 2013). This hypothesis may also apply to pain-induced mood disorders since cortical and subcortical functional and structural neuroplastic alterations have been observed in chronic pain. However, while stress-induced changes in plasticity have been extensively studied in the depression field, the detailed mechanisms remain poorly understood in the context of neuropathic pain.

a. The cortex

Cortical areas such as the somatosensory I (SI) and II (SII), the anterior cingulate as well as the insular cortices are involved in mediating and modulating the pain experience (Garcia-Larrea and Peyron, 2013). Among these areas, the somatosensory cortices are primarily thought to play a role in discriminating the location and intensity of painful stimuli (Peyron et al., 2000), while other cortical areas including the cingulate cortex, the insula or the mPFC were proposed to support the

affective, motivational and cognitive aspects of pain. Although we will mostly present data on the possible role of the anterior cingulate and the insular cortices, it is important to note that the other cortical regions such as the somatosensory cortex may exert indirect influence. Indeed, peripheral nerve injury induces a rapid rewiring of SI (Kim and Nabekura, 2011). This synaptic remodeling, including an increased synaptogenesis and synapse elimination and an enhanced strength of persisting synapses, causes SI hyperexcitability in response to peripheral stimulation and might also affect the ACC or other pain-related cortical areas (Kim et al., 2012).

i. The anterior cingulate cortex

The anterior cingulate cortex (ACC) is an integration centre that interconnects neurons from the frontal cortex, the thalamus and the amygdala, processing cognitive, emotional and autonomic functions (Vogt, 2005; Shackman et al., 2011). Importantly, the ACC is strongly implicated in the pathophysiology of depression as well as in pain processing. Indeed, imaging studies showed hypermetabolism (Drevets, 2001) and reduced volume (Drevets et al., 1998) of the ACC in depressed patients. On the other hand, clinical (Vartiainen et al., 2009) and preclinical studies (Paulson et al., 2002; Li et al., 2010; Ning et al., 2013) in the neuropathic pain field revealed changes in the ACC, which also processes information related to the emotional component of the neuropathic pain experience. Indeed, the ACC neurons are strongly activated by painful experiences, and the lesional deletion of this cortical structure blocks the aversive component of neuropathic pain (Qu et al., 2011). Besides its implication in the pain-related unpleasantness, the ACC also contributes to the anticipation of pain (Porro et al., 2002) and to the avoidance learning observed as a secondary reaction to pain (LaGraize and Fuchs, 2007).

By using an MRI approach, the longitudinal cortical changes associated with pain-like and anxiety-like behaviors were determined in the rat spared nerve injury model of neuropathic pain (Seminowicz et al., 2009). The cortical volume of the ACC as well as of the retrosplenial, entorhinal and insular cortices bilaterally decreased in a time-dependent manner, and the changes in the prefrontal and retrosplenial cortices were correlated with anxiety-related behaviors. Preclinical studies on the mPFC, comprising the ACC, also evidenced significant morphological alterations with neuropathic pain. Thus, an increase in the number of arborisation and in the length of basal but not apical dendrites of pyramidal cells, together with increased spine density, was observed in the early phase after spinal nerve injury (Metz et al.,

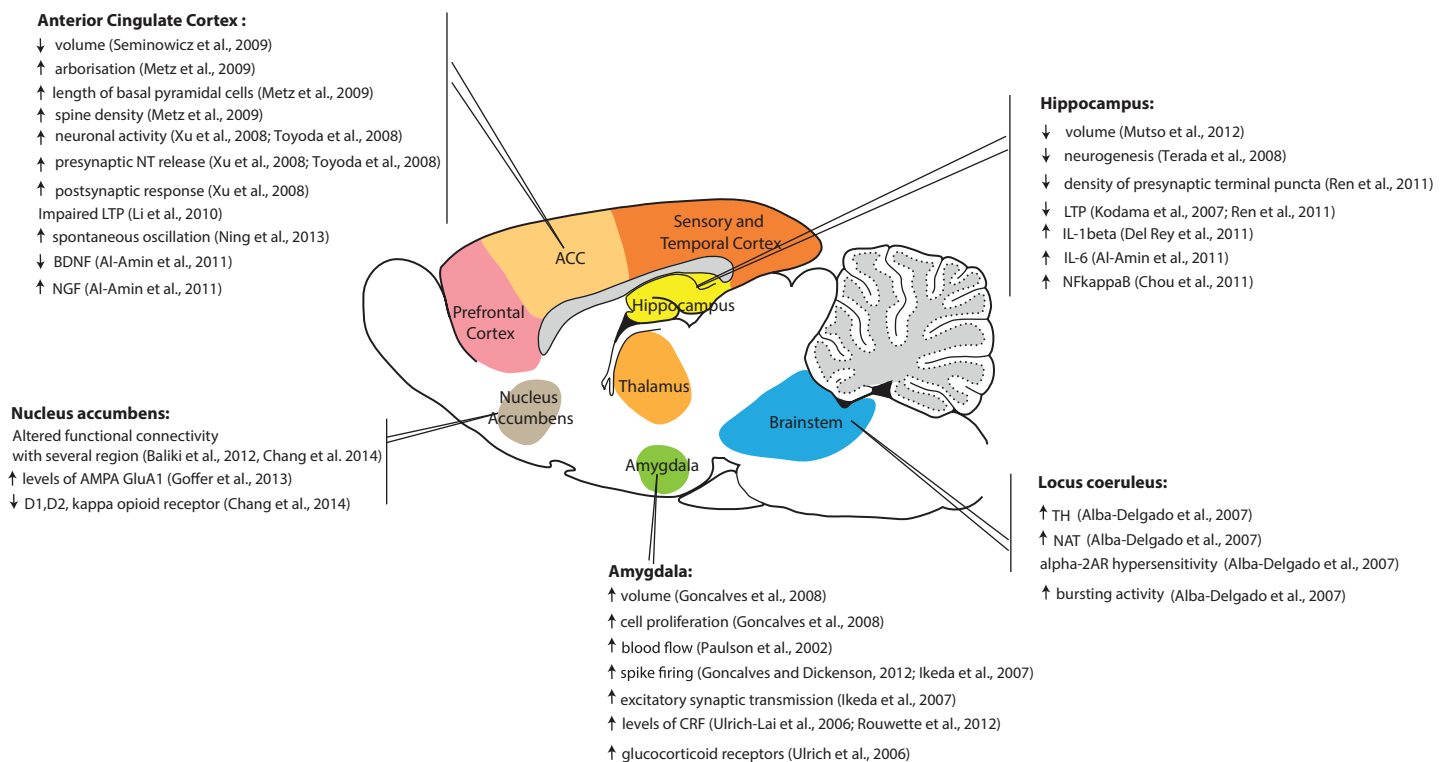

Figure 1. Summary of on functional and morphological alterations in animal with neuropathic pain. List of abbreviations: ACC, Anterior cingulate cortex; AR, Adrenoceptor; BDNF, Brain derived neurotrophic factor; CRF, Corticotropin releasing factor; D, Dopamine; IL, Interleukine; LTP, Long-term potentiation; NAT, Noradrenaline transporter; NGF, Nerve growth factor; NFkappaB, Nuclear factor kappa B; NT, Neurotransmitter; TH, Tyrosine hydroxylase.

2009). While these results may seem to differ from MRI data (Seminowicz et al., 2009) and from the report showing no changes in dendritic length of amygdala neurons in neuropathic animals (Goncalves et al., 2008), it is important to point out that the alterations are likely region- and time-dependent and may also depend on whether the neuropathy is accompanied with anxiodepressive behaviors or not.

Synaptic transmission and neuronal excitability are important factors of the functional plasticity which are modified in the ACC after neuropathic pain. For example, the common peroneal nerve ligation model of neuropathic pain increases both presynaptic neurotransmitter release (Xu et al., 2008; Toyoda et al., 2009) and postsynaptic responses (Xu et al., 2008). At microcircuitry level, a sciatic nerve injury results in structural modification in the layer V of the ACC (Blom et al., 2014). A loss of inhibitory synapses onto excitatory pyramidal neurons and a loss of the excitatory drive onto inhibitory fast-spiking interneurons lead to a local disinhibition of the cortical network (Blom et al., 2014). This loss of connectivity between excitatory and inhibitory neurons could have large effects on circuit behavior and might explain the increased activity observed in the ACC in patients with nerve injury (Hsieh et al., 1995). However, the capacity of expressing new plasticity within the ACC, such as the long-term potentiation (LTP) (Li et al., 2010) of synaptic connections is impaired in neuropathic pain condition (see **Figure 1**).

These *ex vivo* electrophysiological studies also raise the question of *in vivo* neuropathic pain-associated changes in neuronal ACC activity, particularly in spontaneous neuronal oscillations, a process believed to be fundamental for many forms of brain function and plasticity. A recent *in vivo* whole recording study demonstrated that neuropathic pain is accompanied by an increase in the rates of spontaneous oscillations of ACC neurons (Ning et al., 2013). However, whether these various neuroplastic alterations are a cause or a consequence of neuropathic pain-induced affective disorders remains to determine, for example through direct longitudinal correlative study (see **Table 3**).

ii. The insular cortex

The insular cortex (IC) is reciprocally connected with the PFC, the ACC, the SII as well as the amygdala; and it has been suggested to play an important role in pain processing, especially in pain intensity coding (Coghill et al., 1999). The complexity of IC connectivity and the variability of pain-related activity between different IC

Table 3. Involvement of neurobiological substrates of depression in neuropathic pain models.

Neurobiological basis of depression	Observations in neuropathic pain models	Signs present in pain-related mood disorders
Monoamine	increased LC bursting activity (Alba-Delgado et al., 2013) alpha-2 AR hypersensitivity (Alba-Delgado et al., 2013) increased TH expression (Alba-Delgado et al., 2013) increased NAT (Alba-Delgado et al., 2013)	yes
Neuroendocrine	no changes	n.a.
Neurogenic	decreased neurogenesis in HC (Mutso et al., 2012) increased cell proliferation in AMY (Goncalves et al., 2008)	yes
Neurotrophic	decreased BDNF (Al-Amin et al., 2011) increased NGF (Al-Amin et al., 2011)	not determined
Neuroanatomic	decreased volume of ACC, HC (Semiowicz et al., 2009; Mutso et al, 2012) increased volume of AMY (Goncalves et al., 2008)	yes
Neuroplastic	changes in excitability (Ikeda et al., 2007) changes in synaptic transmission (Ikeda et al., 2007; Goncalves and Dickenson, 2012) alterations in LTD or LTP (Kodama et al., 2007; Ren et al., 2011)	not determined
Neuroimmune	increased proinflammatory cytokines (Ren and Torres, 2009; Del Rey et al., 2011; Al-Amin et al., 2011) decreased antiinflammatory cytokines (Clarck et al., 2013)	not determined
Epigenetic	not determined	n.a.

List of abbreviations: ACC, Anterior cingulate cortex; AMY, Amygdala; AR, Adrenoceptor; BDNF, Brain derived neurotrophic factor; CRF, corticotropin releasing factor; HC, Hippocampus; IL, Interleukine; LC, Locus coeruleus; LTD, Long-term depression; LTP, Long-term potentiation; n.a., not applicable; NAT, noradrenaline transporter; NGF, Nerve growth factor; TH, Tyrosine hydroxylase.

subregions suggest that this cortical area may play a multifaceted role in pain. For example, some studies reported a preferential pain activation of the posterior IC (pIC) (Alkire et al., 2004), whereas others have also described it in the mid-insula (Treede et al., 2000) or in the operculoinsular area (Greenspan and Winfield, 1992; Mazzola et al., 2012b). While the activation of the IC has been implicated in both antinociceptive and pronociceptive processes (Treede et al., 2000), the role of the IC in the aversive component as well as the anxiodepressive consequences of chronic pain is still unclear. Nevertheless, it has been shown that the IC displays functional and morphological alterations in depressive states, including reduced volume (Cohen et al., 2013) and altered basal neuronal resting state activity in depressed patients (Sliz and Hayley, 2012).

b. The hippocampus

The hippocampus, one of the crucial brain regions involved in learning and memory processes (Colgin et al., 2008; Wicking et al., 2014) but also in anxiety and depression (Eisch and Petrik, 2012; Wingenfeld and Wolf, 2014), is an important candidate as substrate for the cognitive and affective consequences of neuropathic pain. Indeed, neuropathic animals exhibit deficits in working memory (Ren et al., 2011; Leite-Almeida et al., 2012), in short-term memory (Ren et al., 2011) as well as in recognition memory (Kodama et al., 2011), and some of these studies directly linked these deficits to hippocampal abnormalities (Kodama et al., 2011; Ren et al., 2011).

A recent translational study reported a decreased volume of the hippocampus in neuropathic pain patients (Mutso et al., 2012) and associated this morphological change in a rodent model of neuropathic pain to a decreased neurogenesis in the dentate gyrus (Mutso et al., 2012). These findings complete a previous report showing an impairment in the enriched environment induced neurogenesis in neuropathic animals (Terada et al., 2008). Moreover, a reduced density of presynaptic terminal puncta at CA3-CA1 synapses was also observed after peripheral nerve injury (Ren et al., 2011) (see **Figure 1**). In rodents, neuropathic pain-induced morphological changes in the hippocampus have thus been correlated with increased anxiety, impaired contextual fear extinction (Mutso et al., 2012) and memory deficits (Ren et al., 2011). This may be related to a decrease in the hippocampal volume reported in chronic pain patients.

The chronic pain-induced LTP and LTD plastic changes in the hippocampus depend on the type of pain, on the animal model and on the studied hippocampal synapses. Indeed, different from the inflammatory pain (Zhao et al., 2009), neuropathic pain reduces the induction of LTP without affecting LTD. This was observed at dentate gyrus, CA1 and/or CA3 synapses, after partial sciatic nerve ligation (Kodama et al., 2007) as well as after spared nerve injury (Ren et al., 2011). These studies brought major information, by analyzing plastic modifications at late time-points of the neuropathic pain when the affective and cognitive consequences are clearly observed and also by completing the electrophysiological approaches with behavioral analyses.

c. The amygdala

An increasing body of evidence from anatomical, neurochemical, electrophysiological and behavioral studies emphasizes the amygdala as an important player in the affective and cognitive dimensions of pain (Rouwette et al., 2012; Veinante et al., 2013; Carr and Zachariou, 2014). In particular, the central (CeA) and the basolateral (BLA) nuclei have been implicated in the affective components and consequences of neuropathic pain (LeDoux, 2000; Pare and Duvarci, 2012; Veinante et al., 2013). While the BLA is largely associated with the processing of mood disorders and fear (Boyle, 2013; Lalumiere, 2014), the field of pain research mostly focused on the CeA. Indeed, the CeA has been referred to as the “nociceptive amygdala” because of its high content in nociceptive neurons and the major inputs it receives from the parabrachial nucleus (PB), a direct relay from nociceptive information ascending from the spinal cord (Veinante et al., 2013).

In contrast to the hippocampus and to the ACC, morphological analyses showed an increased volume of the amygdala in animals with a spared nerve injury and displaying anxiodepressive behaviors. This alteration was associated with an increased cell proliferation in the CeA as well as in the BLA, while no alterations were found in the dendritic arborisations (Goncalves et al., 2008).

In neuropathic pain models, the PB-CeA synapses and the BLA-CeA synapses are potentiated and the excitability of the CeA neurons is increased (Ikeda et al., 2007). While the synaptic changes observed at the PB-CeA synapses appear to be NMDA-receptor independent (Ikeda et al., 2007), the intra-CeA administration of NMDA or group I mGluR antagonists reduces the pain-induced place avoidance

behavior (Ansah et al., 2010). It suggests that the amygdaloid NMDA receptors play a role in the maintenance of neuropathic pain by facilitating BLA inputs or by facilitating synaptic signaling between CeA interneurons rather than by facilitating ascending PB-CeA inputs (Ansah et al., 2010). In a model of neuropathic pain, changes in the activity of the CeA were shown to be asymmetrical and time-dependent. Indeed, the spontaneous and the stimulus-evoked neuronal activities are higher in the left CeA at 2 and 6 days after the induction of neuropathic pain, while the activity in the right CeA becomes more important at day 14 (Goncalves and Dickenson, 2012). The time-dependency of changes in the activity of the amygdala is further supported by the increased blood flow observed in the BLA at 8 or 12 weeks, but not at 2 weeks, after the induction of neuropathic pain in rats (Paulson et al., 2002) (see **Figure 1**).

Besides the glutamatergic system, the amygdala GABAergic (Pedersen et al., 2007) and opioidergic transmissions (Narita et al., 2006a) also play critical roles in a neuropathic context. Indeed, a pharmacological manipulation of GABA-A receptors in the CeA can modify the escape/avoidance behavior in neuropathic animals, suggesting that the CeA is implicated not only in sensory processing but also in the affective-motivational dimension of neuropathic pain (Pedersen et al., 2007). Some of the CeA neurons co-synthesize GABA with the corticotropin releasing factor (CRF) (Marchant et al., 2007), a neuropeptide which has a well established role in anxiety (Hauger et al., 2009; Homberg and Contet, 2009; Binder and Nemeroff, 2010). The CRF system of the extended amygdala, a continuum of basal forebrain structures stretching from the CeA caudally to the bed nucleus of the stria terminalis (BST) rostrally (Alheid et al., 1995; Cassell et al., 1999), is also altered in neuropathic pain, with increased levels of CRF (Ulrich-Lai et al., 2006; Rouwette et al., 2012) and glucocorticoid receptors (Ulrich-Lai et al., 2006) after peripheral nerve injury (see **Figure 1**).

The opioid system in the amygdala modulates the stress response and anxiety-like behaviors (Kastenberger et al., 2012; Poulin et al., 2013). In this context, a possible correlation was found between the activity of the amygdala opioid receptors and neuropathic pain-induced anxiety (Narita et al., 2006a). The effect of the mu-opioid receptor agonist DAMGO or the delta-opioid receptor agonist SNC80 (but not of the kappa-opioid receptor agonist ICI199,441) on [³⁵S]GTPγ binding to the amygdala membranes was significantly decreased 4 weeks after a sciatic nerve

ligation, when neuropathic pain-induced anxiogenic consequences can be observed.

d. The mesolimbic pathway

Growing evidence points out the role of the mesolimbic pathway from the ventral tegmental area (VTA) to the nucleus accumbens (NAc) in depression and its treatment (Nestler and Carlezon, 2006; Russo and Nestler, 2013). These regions participate to the “brain reward circuits”, but they also respond to aversive and nociceptive stimuli (Becerra et al., 2001). Surprisingly, few studies focused on the role of the NAc in neuropathic pain.

Human imaging data showed that chronic pain activates the NAc and changes its response to noxious stimuli (Baliki et al., 2010); and the increased functional connectivity between the NAc and the PFC is predictive of the transition from acute to chronic pain (Baliki et al., 2012). Preclinical imaging and molecular evidence are also supportive of a time-dependent and structure-dependent reorganization of the NAc core and shell with the transition to neuropathic pain (Chang et al., 2014). As shown by using fMRI, the functional connectivity of the NAc core to the caudate/putamen, the insula and the SI/SII cortices decreases at day 28 of SNI, as well as the NAc shell functional connectivity to the SI/SII cortices and to the insula. These changes are however not present at days 2 or 5 of SNI. The genomic analyses showed an increased gene expression of dopamine receptors at day 5, and a decreased expression of dopamine 1A receptor, dopamine 2 receptor and kappa-opioid receptor at day 28 of SNI, and correlated the NAc functional connectivity with dopamine receptor gene expression (Chang et al., 2014) (see **Figure 1**).

Neuropathic pain in rodents also increases the levels of the GluA1 subunit of the AMPA-type glutamate receptors at the NAc synapses (Goffer et al., 2013), which leads to the formation of calcium-permeable AMPA receptors (CPARs). These changes were related to the affective consequences of chronic pain, since the pharmacological blockade of the CPARs in the NAc increases neuropathic pain-induced depression-like behaviors, while an AMPA receptor potentiator decreases them (Goffer et al., 2013). These results are in accordance with studies done by research groups in the depression field, showing that mice that are susceptible to

depression present increased GluA1 levels in the NAc in the social defeat model (Vialou et al., 2010).

2. Neuroendocrine parameters

Although mood disorders have frequently been associated with alterations of the hypothalamo-pituitary-adrenal (HPA) axis (Krishnan and Nestler, 2010), published data do not support such alterations in the context of neuropathic pain. Indeed, three weeks after the induction of nerve constriction injury, there is no change in corticosterone and adrenocorticotrophic hormone levels in the rats when measures are done at rest or after a restraint stress (Bomholt et al., 2005; Ulrich-Lai et al., 2006). This lack of basal and stress-induced alterations is further supported by a study comparing corticosterone levels at 2, 4 and 8 weeks of peripheral nerve compression (Yalcin et al., 2011), also showing unaltered adrenal and pituitary weights and HPA feedback controls. These results emphasize that sustained neuropathic pain differs from a simple chronic stress, at least concerning the neuroendocrine response, even though it induces similar behavioral consequences (see **Table 3**).

While neuropathic pain was not preclinically associated with changes in HPA function (Bomholt et al., 2005; Ulrich-Lai et al., 2006; Kilburn-Watt et al., 2010; Yalcin et al., 2011), it should be acknowledged that fibromyalgia, which is another type of chronic pain with a high rate of concurrent mood disorders (Alciati et al., 2012) can be associated with decreased cortisol production and release (Heim et al., 2000; Raison and Miller, 2003), similar to posttraumatic stress disorders (Heim et al., 2000; Raison and Miller, 2003). Moreover, preclinical models of inflammatory pain such as injections of carrageenan or complete Freund's adjuvant increased corticosterone level in mice (Benedetti et al., 2012). These observations demonstrate that neuroendocrine alterations strongly depend on the conditions leading to chronic pain. This also suggests that the mechanism leading to mood disorders may differ, at least partly, according to the type of chronic pain.

Besides HPA axis alterations, neuroendocrine abnormalities in depression can also include changes in thyroid axis, in growth hormone and in prolactin secretion (Brown, 1989; Lang and Borgwardt, 2013). After ligation of the sciatic nerve, a decrease in the plasma levels of thyroxine (T4), free thyroxine (fT4) and triiodothyronine (T3), but not of free T3 and thyroid stimulating hormone (TSH), is

observed in the subpopulation of nerve-injured rats that displays a persistent decrease in social dominance behavior towards an intruder (Kilburn-Watt et al., 2010). However, the possible presence and significance of other neuroendocrine changes in the context of neuropathic pain remains largely unexplored.

3. Neuroimmune response

Neuroimmune alterations are increasingly recognized to play important roles in the pathophysiology of depression (Dantzer et al., 2008; Capuron and Miller, 2011) and of chronic pain (Miller et al., 2009; Clark et al., 2013). During the course of an immune challenge the release of pro-inflammatory cytokines is usually transient and highly regulated by anti-inflammatory mechanisms, but clinical (Backonja et al., 2008) and preclinical studies (Calvo et al., 2012; Clark et al., 2013) have presented evidence for a sustained imbalance between pro- and anti-inflammatory cytokines in neuropathic pain. While primarily studied with the peripheral nervous system and the spinal cord, the recruitment of neuroimmune mechanisms in neuropathic pain also affects the brain.

Cytokines are synthesized by a variety of immune cells such as neutrophils, macrophages or lymphocytes, but can also be produced by non immune cells like glial cells. At early phase of the neuropathic pain, an increase in microglial staining is observed in the periaqueductal grey and the hypothalamus (Takeda et al., 2009), and an astroglial activation in the periaqueductal grey (Mor et al., 2010); while at later phase, when an anxiety-like behavior is present, an astrogliosis is observed in the cingulate cortex (Narita et al., 2006b).

The upregulation of IL-1 β , a proinflammatory cytokine implicated in the induction and maintenance of neuropathic pain (Ren and Torres, 2009), has been reported in the brainstem and the prefrontal cortex during the early phase of a peripheral neuropathic pain (Apkarian et al., 2006). The expression of IL-1 β also increases in the hippocampus of rats with SNI or with CCI, both at early and later phase of the neuropathic pain (del Rey et al., 2011). In the hippocampus, rats with neuropathic pain also show a bilateral increase in IL-6 levels (Al-Amin et al., 2011) and in Nuclear Factor kappa B (NF- κ B) expression (Chou et al., 2011), an important transcription factor known to be implicated in immune responses (see **Figure 1**). These abnormal regulations of cytokine expression may participate to the

hippocampal reorganization, since the induction of LTP in the hippocampus can increase the expression of IL-1 β and IL-6 (Schneider et al., 1998; Balschun et al., 2004) while the blockade of IL-1 (Schneider et al., 1998) and IL-6 (Balschun et al., 2004) can impair or prolong the maintenance of LTP, respectively.

While neuroimmune mechanisms after nerve injury are well studied in the peripheral nervous system and in the spinal cord (Calvo et al., 2012; Clark et al., 2013), the studies on cytokine expression in specific brain areas are sparse in the context of neuropathic pain (Ignatowski et al., 1999; Covey et al., 2000; Covey et al., 2002; Apkarian et al., 2006; Uceyler et al., 2008). Moreover, these studies do not directly address the potential link between cytokines and the emotional consequences of neuropathic pain. Another important drawback is that most research focuses on early changes, from an hour to 7 days post nerve injury, rather than on long term changes, whereas emotional consequences of neuropathic pain develop over time.

4. Monoamine systems

The monoamine hypothesis, despite its limitations, still remains one of the most studied hypotheses of depression (Krishnan and Nestler, 2008; Goldberg et al., 2014). It proposes that depression results from decreased monoamine function in the brain since treatments such as antidepressant drugs increase monoamine transmission by inhibiting monoamine oxidase or by inhibiting the reuptake of serotonin and/or noradrenaline. This hypothesis is also supported by biochemical studies reporting alterations in the receptor density and the metabolites of noradrenaline and serotonin in cortical and limbic structures. Imaging studies show decreased dopamine receptor binding and genetic studies provide evidence for polymorphisms of the catechol-O-methyl-transferase (COMT) (Antypa et al., 2013) or the serotonin transporter (Kenna et al., 2012) in depressed patients.

The monoaminergic systems are implicated in pain control, as the serotonergic and the noradrenergic brainstem regions provide descending pain modulating pathways. Furthermore, antidepressants acting on noradrenergic uptake, but not on serotonergic uptake only, are a first-line treatment against neuropathic pain (Finnerup et al., 2010; Attal, 2013). Recent studies also evidenced that alterations in the monoaminergic systems might promote the depressive and anxiogenic

behaviors observed in chronic pain. Indeed, neuropathic pain-induced anxiodepressive behaviors coincided with marked modifications in noradrenergic locus coeruleus neurons, such as increased tyrosine hydroxylase and noradrenaline transporter expression, and α_2 -adrenoceptor hypersensitivity influencing locus coeruleus firing and noradrenaline release in the prefrontal cortex terminal areas (Alba-Delgado et al., 2013). Similar changes in tyrosine hydroxylase, noradrenaline transporter and α_2 -adrenoceptor levels in the locus coeruleus have also been described in animal models of depression and in the postmortem brain tissue of depressed individuals (Ordway et al., 1994a; Ordway et al., 1994b; Zhu et al., 1999). In addition, chronic pain can exacerbate chronic mild stress-induced increase in the number of tyrosine hydroxylase positive cells in the locus coeruleus (Bravo et al., 2014), further supporting a possible key role of the locus coeruleus in the interaction between chronic pain and depression (see **Figure 1, Table 3**).

5. Neurotrophic factors

Changes in neurotrophic factors, particularly BDNF (brain-derived neurotrophic factor), and subsequent alterations in synaptic plasticity and synapse dynamics can contribute to depression and antidepressants' effect (Autry and Monteggia, 2012). BDNF is the most widely expressed neurotrophin in the central nervous system where it regulates neuronal survival and differentiation and critically participates in activity-dependent synaptic plasticity mechanisms (McAllister et al., 1999; Poo, 2001).

The neurotrophic theory of depression stemmed from preclinical studies reporting that stress reduces BDNF-mediated signaling pathway in the hippocampus while chronic antidepressant treatment activates this pathway (Krishnan and Nestler, 2008, 2010). Post-mortem studies also showed decreased hippocampal BDNF levels in depressed patients (Karege et al., 2005). In the field of neuropathic pain, BDNF was particularly studied in the spinal cord, where it actively participates to the neuropathic pain pathogenesis. Indeed, the BDNF release from activated spinal microglial cells causes the disinhibition of pain-transmitting signals (Coull et al., 2005; Ferrini and De Koninck, 2013). Less information is available at supraspinal level. Two weeks after SNI or CCI, BDNF levels decrease in the cingulate cortex, the striatum and the hippocampus, while the levels of another neurotrophic factor, the nerve growth factor (NGF), increase in the same regions (Al-Amin et al., 2011) (see **Figure 1, Table 3**). Moreover, the subchronic administration of a potent stimulator of BDNF

synthesis, the 4-methylcatechol, suppresses neuropathic pain-induced depression (Fukuhara et al., 2012). It suggests that decreased BDNF levels may participate to neuropathic pain-induced depression. Further work is however needed to detail the possible relations between neuropathic pain-induced depression and brain BDNF signalling.

D. Conclusion and perspectives

In the past ten years, a growing number of studies have focused on the affective consequences of neuropathic pain, aiming at modeling them and at understanding the pathophysiology of neuropathic pain and mood disorder comorbidity. For this purpose, animal models seem necessary even though the development of convincing models for psychiatric disorders represents a major challenge. In this review, we have highlighted some of the difficulties in generating such models and pointed out critical parameters that should be considered such as the time factor, emphasizing the necessity for longitudinal studies.

While sustained neuropathic pain differs from a simple stress regarding neuroendocrine HPA alterations, there are some common features such as changes in monoaminergic system or neuroimmune responses. These observations may thus suggest that the elucidation of mechanisms underlying neuropathic pain-induced depression should be expanded by considering the molecular players already identified in the depression field such as transcription factors, circadian genes, epigenetic actors, mediators of energy homeostasis etc.

Recent studies show that most of the central nervous system pathologies are related to alterations in brain networks rather than to changes occurring in a single brain structure. While future investigations are still necessary to divulge the precise role of target brain structures, and to build causal link between the morphological and functional alterations and the neuropathic pain-induced mood disorders, analysis performed on the circuitry level is also necessary to unravel the circuit dysfunctions underlying this comorbidity.

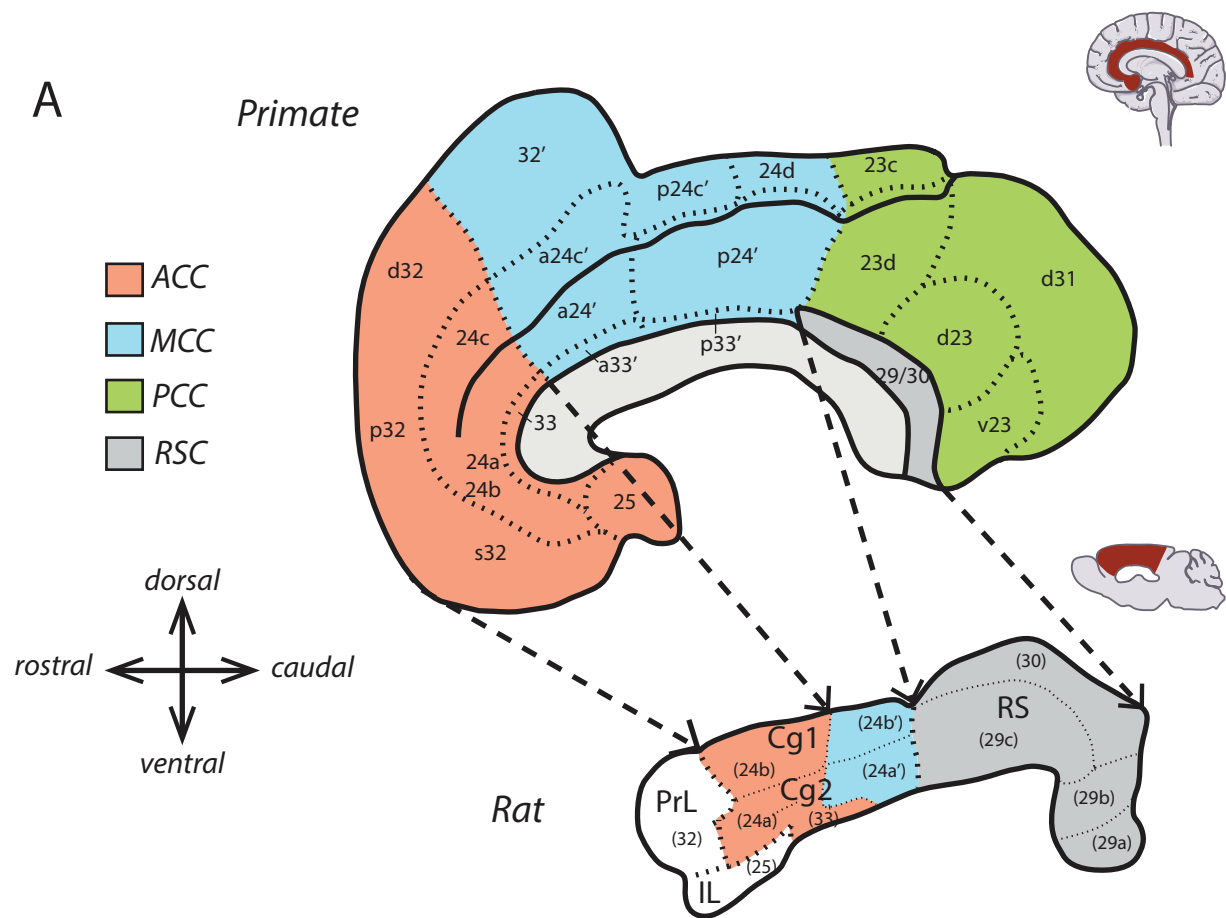

B

Primate	24a	24b	24c	33	25	(s,p)32	d32	(a,p)24a'	(a,p)24b'	(a,p)24c'	24d	(a,p)33'	32'	23,31	29,30
Rodent	Cg2	Cg1	~	Cg2	IL	PrL	~	Cg2	Cg1	~	~	Cg2	~	~	RS

Figure 2. Organization of the ACC in primates and rodents.

A. Schematic views of cingulate cortex subregions in primates and rodents.

In primates, the cingulate cortex arches around the dorsal aspect of the corpus callosum, in the medial part of the prefrontal cortex. It is composed by an anterior part in red (ACC, Brodmann's areas 24, 25, 32 and 33), a middle part in blue (MCC, Brodmann's areas 24', 32' and 33'), a posterior part in green (PCC, Brodmann's areas 23 and 31) and the retrosplenial cortex in grey (RS, Brodmann's areas 29 and 30). The ACC is divided into subgenual (areas 24, 25 and s32) and perigenual (areas p32 and d32) parts and the MCC into anterior (a) and posterior (p) parts. In rodents, the ACC region, homologous to primate's areas 24a, 24b, 25 and 32, is located anterior to the bregma. Caudally, the MCC is more undifferentiated and composed by region homologous to primate's areas 24a' and 24b'. The rodent RS correspond to a region homologous to primate's areas 29 and 30. However, primate's Brodmann areas 23c, 23d, d23, v23 and d31 constituting PCC, and sulcal areas 24c, d32, 24c', 24d and 32' don't have any counterpart in rodent.

B. Correspondence between cingulate cortex nomenclatures in primates and rodents.

The ACC, MCC, PCC and the RS are represented with the same colors than in A. The symbol '~' indicates areas with no counterpart in rat.

The nomenclature in rodents is the one used in the Franklin and Paxinos's stereotaxic atlas (2007). Prelimbic (PrL) and infralimbic (IL) cortices correspond to areas 32 and 25, respectively, but are not considered as a part of the ACC in rodents. Rostral regions of cingulate subdivisions Cg1 and Cg2 correspond to the ACC and caudal regions to the MCC.

III. The anterior cingulate cortex: Role in mood disorders and in pain

Cette revue de la littérature est le fruit d'une collaboration avec deux autres doctorants de l'équipe. Clémentine Fillingier a rédigé la section neuroanatomie et Jim Sellmeijer la partie concernant l'implication de l'ACC dans les troubles de l'humeur. J'ai quant à moi rédigé les parties concernant l'ACC dans la douleur clinique et préclinique. Ce travail, après finalisation sera publié dans une revue scientifique.

A. Neuroanatomy of the ACC

In 1878, Broca first described the cingulate cortex as a component of the great limbic lobe. Ever since, the knowledge of this structure has greatly evolved. Today, it is considered as a heterogeneous structure, composed of several subdivisions with different cytoarchitecture, connections and functions.

1. The general organization of the cingulate cortex

In primate, including human, the cingulate cortex is located in the medial wall of the cerebral cortex spanning from the supracallosal to the cingulate sulci. It is composed of four subregions: the anterior cingulate (ACC), the midcingulate (MCC) and the posterior (PCC) cingulate cortices and the retrosplenial (RS) cortex (Vogt et al., 2005). The ACC, often divided into perigenual and subgenual parts according to the anteroposterior axis, covers Brodmann' areas 24, 25, 32 and 33. While the MCC covers areas 24', 32' and 33', the PCC includes areas 23 and 31, and the RS areas 29 and 30. Each area contains additional subdivisions (**Figure 2A**). For example, the area 24 contains the 24a, the 24b and the 24c parts; likewise, the area 32 is divided into a subgenual (s32), a perigenual (p32) and a dorsal (d32) part (Vogt et al., 2005).

Comparing the cingulate cortex of primates and rodents is challenging due to the absence of the supracallosal and the cingulate sulci in lissencephalic mammals. The organization of cingulate regions in rodents has recently been reviewed (Vogt and Paxinos, 2014). The anterior, middle and retrosplenial regions were identified on the basis of their cytoarchitecture by homology with the primate cingulate cortex.

The rodent's ACC appears to be composed of regions homologous to Brodmann' areas 24a, 24b, 25 and 32, with a residual area 33 observed in rats but not in mice. The MCC is composed of regions homologous to areas 24a' and 24b', the PCC is absent in rodents, and the RS is composed of regions homologous to areas 29 and 30 as in primates. The limit between the ACC and the MCC in rodents is located approximately at the level of the bregma (Vogt et al., 2005; Vogt and Paxinos, 2014). While this description offers a direct comparison with the primate cingulate cortex, it doesn't completely overlap with the nomenclature often used in rodents. Thus, in the classic stereotaxic atlases of the rat brain and of the mouse brain (Franklin and Paxinos, 2007; Paxinos and Watson, 2007), the areas 24a/24a' and 24b/24b' are respectively labeled cingulate cortex Cg2 (ventral) and Cg1 (dorsal), according to the nomenclature of (Zilles and Wree, 1995). However, the difference between the areas 24a/24b and 24a'/24b', i.e. between the ACC *per se* and the MCC, is not labeled. The rodent's infralimbic cortex (IL) corresponds to the area 25 and the prelimbic cortex (PrL) to the area 32 (**Figure 2B**). Thus, the classical nomenclature used in rodents restricts the ACC to Cg1 and Cg2 regions, which, along with the IL, the PrL and the secondary motor cortex, constitutes the medial prefrontal cortex (Van Eden and Uylings, 1985; Heidbreder and Groenewegen, 2003).

In rodents, the ACC (i.e; Cg1 and Cg2) is an agranular cortex lacking a true layer IV. The molecular layer I is relatively large compared to more lateral cortices. The layers II/III are thinner than the layers V/VI, divided into two parts, Va/VIa and Vb/VIb, based on their neuronal density. Layers II to VI mainly contain pyramidal cells, and these neurons are globally smaller in all layers of the area 24 compared to the area 24', but their density is higher in area 24, especially in the layers V/VI. On the caudal borders of the ACC, the limit between the area 24' and the RS is characterized by an accumulation of small and densely packed neurons in the layers II/III. The area 33 in the rat, wedged between the areas 24a/24a' and the indisium griseum, remain poorly differentiated (Farber et al., 2004; Vogt and Paxinos, 2014).

2. The ACC connections: insights from rodents and primates studies

The connections of the ACC have been largely studied in the rat, mostly as a part of the medial prefrontal cortex (Heidbreder and Groenewegen, 2003; Gabbott et al., 2005; Hoover and Vertes, 2007; Euston et al., 2012; Bissonette et al., 2013;

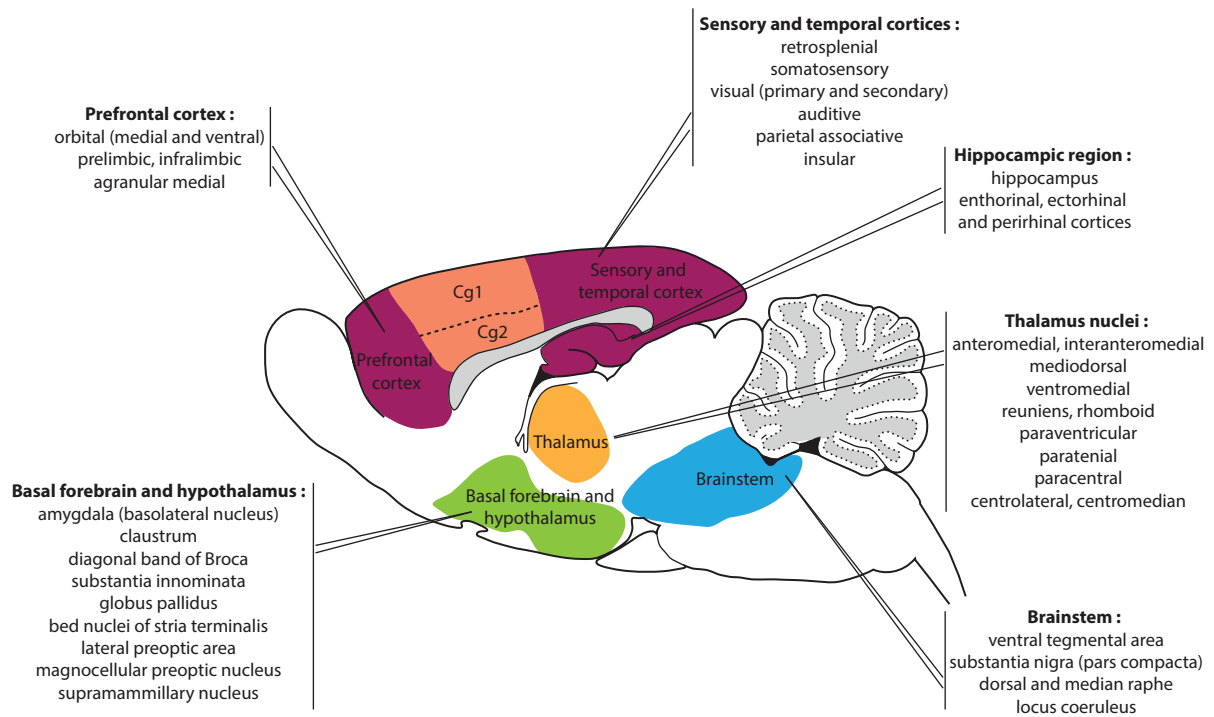

Figure 3. Main inputs to the anterior cingulate cortex in the rat. In addition to strong intra-cingulates connections, the other principal regions sending projections to the ACC are the cerebral cortex in purple, the basal forebrain and the hypothalamus in green, the thalamus in orange and the brainstem in blue. For each region, the main structures projecting to the ACC are detailed.

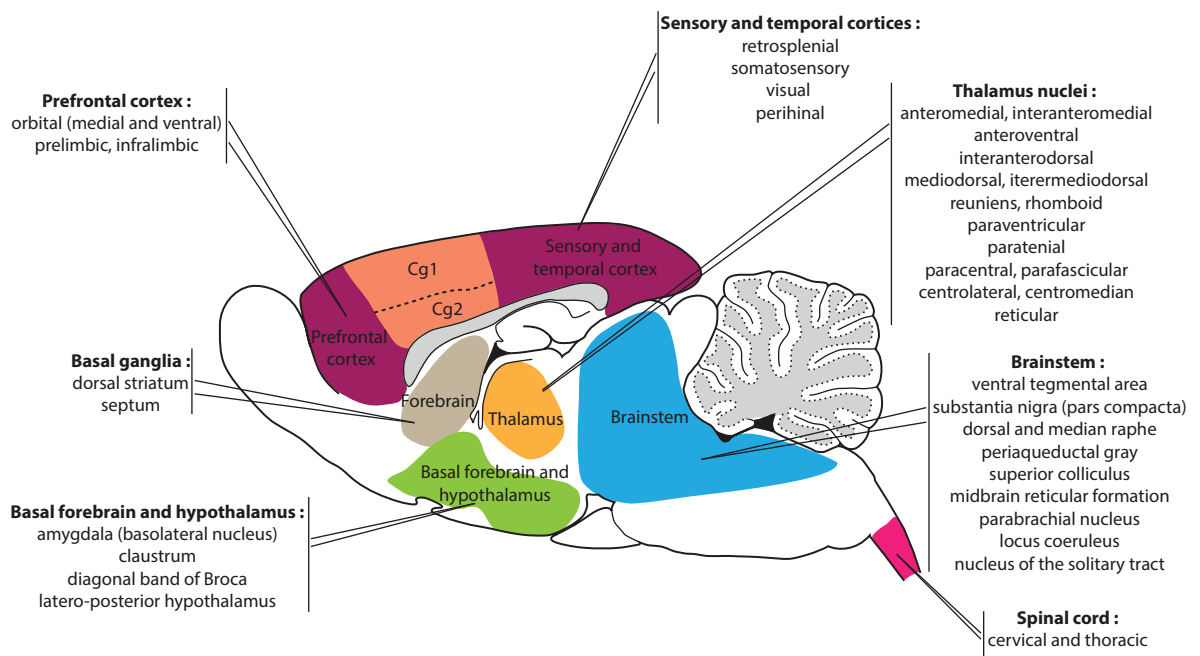

Figure 4. Main outputs from the anterior cingulate cortex in the rat. In addition to strong intra-cingulates connections, the other principal regions receiving projections from the ACC are the cerebral cortex in purple, the basal ganglia in brown, the basal forebrain and the hypothalamus in green, the thalamus in orange, the brainstem in blue and the spinal cord in pink. For each region, the main structures receiving projections from the ACC are detailed.

Courtin et al., 2013; Dilgen et al., 2013). For this reason, we will use the classical Cg1/Cg2 nomenclature in the following descriptions. The connectivity will be presented with respect to rats' studies since, according to our knowledge, a systematic exploration of the mouse ACC connectome is not yet available. Additional information concerning the primate's ACC will also be given for comparison.

The different subregions of the rat ACC are strongly interconnected. The caudal part of the Cg1 projects to the caudal part of the Cg2, and the entirety of the Cg2 projects to the middle part of the Cg1 (Jones et al., 2005).

a. The ACC inputs

Concerning afferents (**Figure 3**), the ACC receives strong inputs from cortical, thalamic regions, as well as from a few other forebrain structures and from a limited number of brainstem centers. At cortical level, the ACC receives moderate to strong inputs from frontal regions, especially from the medial prefrontal cortex and the orbital cortex. The PrL sends the strongest projection to the the rostral ACC (Jones et al., 2005). Inputs from the IL, the medial and ventral orbital cortex and the agranular medial cortex are moderate and a light projection also arises from the posterior agranular insular cortex (Conde et al., 1995; Heidbreder and Groenewegen, 2003; Jones et al., 2005; Hoover and Vertes, 2007). The ACC also receives a prominent projection from the RS, with a topographical organization of connections between the RS and the ACC subdivisions (Heidbreder and Groenewegen, 2003; Jones et al., 2005; Hoover and Vertes, 2007; Vogt and Paxinos, 2014). Caudally, the associative somatosensory, visual and auditive areas send moderate to strong inputs to the ACC. These afferents originate mainly in the parietal associative, the secondary visual and the temporal auditory cortices (Vogt and Miller, 1983; Miller and Vogt, 1984; Conde et al., 1995; Heidbreder and Groenewegen, 2003; Jones et al., 2005; Hoover and Vertes, 2007). Globally, these cortical afferents to the ACC in the rat are similar to those described for homologous areas in the primate brain (Pandya and Kuypers, 1969; Jurgens, 1983; Barbas and Pandya, 1989; Van Hoesen et al., 1993; Carmichael and Price, 1995; Ongur and Price, 2000; Morecraft et al., 2012).

The hippocampal region also projects to the ACC in the rat. The entorhinal and the perirhinal cortices send a moderate projection to the ACC (Heidbreder and Groenewegen, 2003; Hoover and Vertes, 2007). The hippocampus *per se* strongly projects to the IL and the PrL (Conde et al., 1995; Heidbreder and Groenewegen,

2003; Hoover and Vertes, 2007), but recently Hoover and Vertes (2007) showed an input from the ventral CA1 and the subiculum to the ACC. A similar organization has been described in primates where inputs from the hippocampus target the rostral part of the cingulate gyrus, especially the areas 25 and 32, but weakly innervate the area 24, with no projection to the area 24' (Vogt and Pandya, 1987; Van Hoesen et al., 1993; Carmichael and Price, 1995; Bachevalier et al., 1997; Morecraft et al., 2012) **(Figure 3)**.

The second major input to the ACC originates in the thalamus, mainly from the anterior, the midline and the intralaminar nuclei (Horikawa et al., 1988; Conde et al., 1990; Shibata, 1993; Van der Werf et al., 2002; Heidbreder and Groenewegen, 2003; Hoover and Vertes, 2007). In the anterior group, strong inputs to the ACC arise from the anteromedial and the interanteromedial nuclei, while the anterodorsal nucleus projects predominantly to the MCC (Horikawa et al., 1988; Shibata, 1993; Hoover and Vertes, 2007; Vogt and Paxinos, 2014). An additional strong projection originates in the lateral mediodorsal and the ventromedial nuclei (Conde et al., 1990; Heidbreder and Groenewegen, 2003; Hoover and Vertes, 2007). As for midline nuclei, the ventrally located reuniens and rhomboid nuclei were found to strongly project to the ACC, while the dorsal midline nuclei, the paraventricular and the paratenial nuclei, send a meager projection (Van der Werf et al., 2002; Vertes et al., 2006; Hoover and Vertes, 2007; Vertes and Hoover, 2008). Among the intralaminar group, the centrolateral, the centromedial, the paracentral and the parafascicular nuclei project with variable density to the ACC with a slight preference to Cg1 (Van der Werf et al., 2002; Hoover and Vertes, 2007). While most of the thalamic inputs to the ACC are comparable in rats and primates, the afferents from the anteromedial and the anterodorsal nuclei which are strong in rodents are almost absent in the primate ACC (Jurgens, 1983; Vogt and Pandya, 1987; Carmichael and Price, 1995; Bachevalier et al., 1997; Romanski et al., 1997) **(Figure 3)**.

A few additional forebrain regions contribute to the ACC afferents. The basolateral nucleus of the amygdala and the claustrum both project to the ACC (Heidbreder and Groenewegen, 2003; Hoover and Vertes, 2007). A distinctive projection arises from the diagonal band of Broca and from the basal nucleus complex. Additionally, ACC projecting neurons are found spread through the basal forebrain, in the substantia innominata, the globus pallidus and the bed nucleus of the stria terminalis (Heidbreder and Groenewegen, 2003; Hoover and Vertes, 2007;

Chandler et al., 2013). At least a part of these projections is cholinergic (Chandler et al., 2013). Finally, the hypothalamus appears to send a limited projection to the ACC, especially from the lateral hypothalamus and the supramammillary nucleus (Hoover and Vertes, 2007). The same projections have been described in primates (Pearson et al., 1982; Jurgens, 1983; Barbas and De Olmos, 1990; Carmichael and Price, 1995; Frankle et al., 2006) (**Figure 3**).

The brainstem afferents to the ACC are sparse and originate selectively in dopaminergic, serotonergic and noradrenergic centers (Heidbreder and Groenewegen, 2003; Hoover and Vertes, 2007; Chandler et al., 2013). As the rest of the medial prefrontal cortex, the ACC receives a sizeable projection from the ventral tegmental area (VTA) (Heidbreder and Groenewegen, 2003; Chandler et al., 2013), but a moderate projection also arises from the medial substantia nigra pars compacta (SNc) (Conde et al., 1995; Hoover and Vertes, 2007). Afferents from the raphe nuclei originate preferentially in the dorsal raphe and to a lesser extent in the median raphe (Hoover and Vertes, 2007). While at least a portion of the VTA/SNc and raphe afferents are dopaminergic and serotonergic, respectively, non monoaminergic projections from these centers to the ACC have been shown (Chandler et al., 2013). Noradrenergic afferents take their origin in the locus coeruleus (LC) (Hoover and Vertes, 2007; Chandler et al., 2013). In primates' ACC, the inputs from monoaminergic centers such as the VTA, the SNc and the LC, are completed by other brainstem inputs from the mesencephalopontine formation, the area prerulealis, the periaqueductal gray, the dorsal tegmental nucleus of Gudden and the superior vestibular nucleus (Jurgens, 1983; Berger et al., 1988; Lewis, 1992; Paus, 2001).

b. The ACC outputs

Regarding ACC outputs (**Figure 4**), most of the afferents reaching the ACC are reciprocated by an efferent projection, with only a few exceptions. Additionally, the ACC also sends axons to some structures which do not project cortically.

Substantial projections from the ACC to the orbital, the sensorimotor, the visual-related, the retrosplenial and the temporal areas, such as the perirhinal cortex, have been described (Vogt and Miller, 1983; Sesack et al., 1989; Arikuni et al., 1994; Heidbreder and Groenewegen, 2003; Jones et al., 2005). The hippocampus is a notable exception to the reciprocity of cortical connections as it doesn't appear to receive any input from the ACC (Sesack et al., 1989; Heidbreder and Groenewegen,

2003). In primates, projections from ACC to motor and premotor cortices have been described (Pandya et al., 1981; Van Hoesen et al., 1993; Arikuni et al., 1994), but the most interesting thing is that outputs to presubiculum and to CA1 have also been reported (Baleydier and Mauguiere, 1980; Arikuni et al., 1994). The thalamic nuclei receiving projections from the ACC are generally the same as the ones projecting to it (Vertes, 2002; Heidbreder and Groenewegen, 2003). The stronger outputs of the rat ACC are directed to the lateral part of the mediodorsal nucleus, and to the anteromedial, the interanteromedial, the paraventricular and the reuniens/rhomboid nuclei (Vertes, 2002; Gabbott et al., 2005). In primates, similar cortico-thalamic connections have been described, including a strong output to the mediodorsal nucleus, in addition to a moderate output to the pulvinar (Leichnetz and Astruc, 1976; Tanaka, 1976; Carmichael and Price, 1995; Romanski et al., 1997; Ongur and Price, 2000) (**Figure 4**).

In the basal forebrain, the efferents from the rat ACC target the basolateral amygdala and the claustrum in a reciprocal way (Cassell and Wright, 1986; Sesack et al., 1989; Heidbreder and Groenewegen, 2003; Gabbott et al., 2005). The cholinergic diagonal band of Broca is also reached by ACC axons, especially its horizontal limb (Sesack et al., 1989; Heidbreder and Groenewegen, 2003). A unidirectional cortico-striatal projection from the ACC concerns the dorsal striatum, mainly the medial and intermediate parts of the caudate putamen, and only marginally encroaches on the ventral striatum (Sesack et al., 1989; Heidbreder and Groenewegen, 2003; Gabbott et al., 2005). The ACC projections to the hypothalamus seem to be directed to the lateral and the posterior hypothalamus (Sesack et al., 1989; Heidbreder and Groenewegen, 2003; Gabbott et al., 2005). However in primates, the cingulo-striatal projection is directed only to the central, central, medial and lateral parts of the ventral striatum, whereas the dorsal striatum is connected mainly to the MCC (Pandya et al., 1973; Baleydier and Mauguiere, 1980; Van Hoesen et al., 1993; Kunishio and Haber, 1994; Carmichael and Price, 1995; Ongur et al., 1998) (**Figure 4**).

In the brainstem, the ACC axons terminate in monoaminergic centers such as the dorsal raphe, the VTA, the SNc and the LC, which contribute to ACC afferents (Sesack et al., 1989; Ongur and Price, 2000; Heidbreder and Groenewegen, 2003; Gabbott et al., 2005). It should be noted that the ACC projections to these regions are generally less dense than the ones from the PrL and the IL (Heidbreder and

Groenewegen, 2003; Gabbott et al., 2005). In addition, the ACC also projects to brainstem centers from which it doesn't receive any direct afferent. Thus, the periaqueductal gray matter is the recipient of an ACC projection mainly targeting its dorsolateral column (Sesack et al., 1989; Floyd et al., 2000; Ongur and Price, 2000; Heidbreder and Groenewegen, 2003; Gabbott et al., 2005). Other minor efferents of the ACC have been described to the superior colliculus, the midbrain reticular formation and the nucleus of the solitary tract. Finally, ACC neurons have been found to project to the cervical and the thoracic spinal cord (Miller, 1987; Gabbott et al., 2005).

In primates, the ACC efferents to the brainstem have also been identified. The abundant projections include the SNc, the VTA, the dorsolateral part of the periaqueductal gray matter, the midbrain reticular formation, the red nucleus, the dorsal raphe and the LC (Leichnetz and Astruc, 1976; Van Hoesen et al., 1993; An et al., 1998; Burman et al., 2000; Frankle et al., 2006). Regarding the spinal cord, the primate cingulospinal projection originates preferentially from the MCC while the main projection to the spinal cord comes from the ACC in rat (Luppino et al., 1994; Vogt and Paxinos, 2014).

B. The role of the ACC in mood disorders

Clinically, the structural analysis of the ACC revealed that a reduction of its volume is correlated with the number of depression episodes (Yucel et al., 2008), the correlation with an increased risk of major depression being more specifically related to less gray matter volume in the subgenual ACC (sACC) (Drevets et al., 1997; Botteron et al., 2002; Coryell et al., 2005) and in the vACC (Boes et al., 2008). However, such reduction of the ACC volume is also found in various other psychiatric disorders, including post-traumatic stress disorder (PTSD) (Rauch et al., 2003; Yamasue et al., 2003; Kitayama et al., 2006), borderline personality disorder (Whittle et al., 2009; Niedtfeld et al., 2013), schizophrenia (Byun et al., 2012; Sinka et al., 2012; Lee et al., 2013) and obsessive-compulsive disorder (OCD) (Kuhn et al., 2013). In both the PTSD (Yamasue et al., 2003) and the borderline personality disorder (Bouras et al., 2001; Whittle et al., 2009), the symptom severity was negatively correlated with the size of the ACC.

The anterior cingulotomy, a lesion of the cingulum bundles, can be clinically used as a last resort treatment for patients suffering from treatment resistant major depression. This type of ablative surgery leads to improvements in around 75% of the patients with intractable major depression (Shields et al., 2008). The anterior cingulotomy is most successful when the lesion is performed more anteriorly and interrupts the connectivity with the posterior part of the ACC (Steele et al., 2008). This “rostral extension” of the ablative procedure hints towards a participation of the vACC in major depression, which is in line with data showing an increased vACC activity in depressed patients during the processing of emotional stimuli (Yoshimura et al., 2010). Furthermore, it has been shown that antidepressant drugs such as the serotonin/noradrenaline reuptake inhibitor clomipramine decrease the activity of the ACC (de Almeida et al., 2010). Confirming the ACC as a target for invasive surgical procedures to treat depression, deep brain stimulation of the ACC has been shown to be effective in the treatment of depression symptoms (Lipsman et al., 2013).

These clinical results suggest that an increased ACC activity may underlie the depression phenotype. This notion is further supported by animal studies. For instance, in the social-defeat-paradigm, the presence of depression-like behavior is accompanied by an increased cingulate activity (Yu et al., 2011). Reciprocally, when the rat's infralimbic cortex is inactivated, which can be argued to be equivalent to the primate subgenual ACC, the depression-like phenotype decreases (Slattery et al., 2011). However, the detailed influence of cingulate sub-regions require further exploration, since lesions of the rostral ACC in the rat has been reported to have either no effect on the immobility in the forced swim test (Li et al., 2012), or to result in increased immobility (Bissiere et al., 2006).

Altered ACC activity has also been associated with another psychiatric condition, the PTSD. In an fMRI study, PTSD patients performed an emotional counting Stroop task (ecStroop) (Shin et al., 2001). During the ecStroop, participants count the words presented on a computer screen which have, depending on the condition, neutral, negative or combat related contents. The PTSD patients show a diminished rACC activity during the presentation of combat related words, in contrast to healthy subjects (Shin et al., 2001). The authors propose that the rostral/ventral ACC would have a regulating role, inhibiting the activity of the amygdala in response to fearful stimuli. In PTSD patients this inhibition, as reflected by

an ACC hypo-responsivity, is disrupted, which results in a hyper-responsive activation of the amygdala during the processing of fearful stimuli (Shin et al., 2005). A similar hypothesis has also been done for another psychiatric disorder, the general anxiety disorder (Greenberg et al., 2013). On the contrary, other studies reported an increased dACC activity in PTSD patients, which would therefore refute the above theory (Phan et al., 2006). However, as stated previously, the function of the dACC is thought to differ from the one of the vACC, suggesting different significance for altered activity observed in one or the other region.

A decreased activity of the dACC during the anticipation and the perception of non-emotional stimuli has been associated with borderline personality disorder (Gruber et al., 2004; Scherpiet et al., 2014). Moreover, an increased pregenual activity during the anticipation of negative stimuli (Scherpiet et al., 2014) together with an increased ventral activity during anger processing (Minzenberg et al., 2007) and an increased connectivity between the amygdala and the vACC (Cullen et al., 2011) suggest that borderline patients suffer from a disrupted interplay between cognitive and emotional processes. This is further reflected by the finding that error-related negativity amplitudes, a signal generated by the ACC after erroneous responses, were decreased in borderline disorder patients (de Bruijn et al., 2006). This reduced action monitoring might be the reason why borderline patients do not learn from their errors as well as healthy individuals.

In a number of studies, the obsessive compulsive disorder (OCD) has been associated with greater error-related processing. For instance, the severity of OCD symptoms has been correlated with an increased vACC error-related processing (Fitzgerald et al., 2005). It has moreover been shown that the vACC is more active in OCD patients during response competition tasks and that the dACC is deactivated during reinforced learning tasks (Cavanagh et al., 2010). The OCD patients were also shown to have increased ACC resting state activity (Hou et al., 2012; Cheng et al., 2013). Accordingly, a chronic anterior capsular electrostimulation decreased both the subgenual ACC activity and the OCD rating scores (Van Laere et al., 2006). Functional connectivity studies showed that connectivity between the ACC and the orbital frontal cortex (OFC) is decreased in OCD patients (Fontenelle et al., 2012; Cheng et al., 2013). As the OFC is implicated in choice evaluation, whereas the ACC neurons encode choice prediction, this might be part of the neuronal basis for the impaired error detection phenotype in OCD patients (Cheng et al., 2013).

Additionally, as the connectivity between these regions is reduced after sad mood induction, this might reflect why OCD patients experience an increased symptomatology during negative emotional states (Fontenelle et al., 2012). Diffusion-tensor imaging showed that the cingulum bundle (CB), which is the white matter bundle connecting the cingulate cortex with limbic regions, is also altered in OCD patients (Cannistraro et al., 2007).

Concerning the ACC activity in schizophrenia, both increased (Mendrek et al., 2005; White et al., 2011) and decreased activity (Kim et al., 2003; Boksman et al., 2005; Fu et al., 2005; Wagner et al., 2013) have been reported. Nevertheless, the predominant part of these studies reports a decreased activation during cognitive tasks (Adams and David, 2007). Such decreased activity correlated with task performance, providing a neuronal basis for the cognitive deficit in schizophrenia patients (Yan et al., 2012a). A disrupted functional connectivity between the ACC and the mediodorsal thalamus has also been reported (Wagner et al., 2013). In the same study a stronger connectivity is observed between the dorsolateral prefrontal cortex and the mediodorsal thalamus, which might function as a compensatory mechanism. This is hypothesized to result from disrupted white matter connectivity. Among other regions, a decreased positive connectivity with the bilateral putamen and an increased negative connectivity with the posterior cingulate cortex have also been reported, indicating hemispheric asymmetries in schizophrenia (Yan et al., 2012a). Molecular findings indicate that α -Amino-3-hydroxy-5-methyl-4-isoxazolepropionic acid (AMPA) and N-Methyl-D-aspartate (NMDA) signaling might be responsible for the disrupted ACC activity in schizophrenia. For instance, transmembrane ionotropic glutamate receptor regulatory protein (TARP) dysregulation is hypothesized to result in disrupted AMPA receptor activity (Drummond et al., 2013). Neurogranin, which is associated with NMDA receptor signaling (Ohi et al., 2012), and N-acetyl aspartate (NAA) concentration, whose release is increased due to NMDA receptor activation, are both reduced in schizophrenia patients (Premkumar et al., 2010). This disturbed glutamate signaling might be the cause for the decreased ACC activity observed in schizophrenia patients.

C. The role of the ACC in pain

Pain consists of at least two distinct dimensions, the sensory-discriminative component encompasses qualities such as the localization and intensity of pain while the affective-motivational component is characterized by the unpleasantness or negative affect of pain. A growing number of clinical and preclinical studies explored the critical role of the ACC in these components as well as in the cognitive and attention aspects of pain.

1. Insights from clinical studies

In the 60's, the cingulotomy, which refers to the ablation of a part of the ACC, was used in patients suffering from neuropsychiatric illness and intractable pain resistant to classical treatments (Ballantine et al., 1967). Those cingulotomies (Ballantine et al., 1967) resulted in a decrease in the perceived unpleasantness of pain without affecting the ability to discriminate the location, intensity and quality of the noxious stimulus, emphasizing that the ACC is essentially involved in the affective/motivational component of pain experience.

a. The role of the ACC in physiological conditions

Most of the clinical studies focusing on the implication of the ACC in mediating and modulating pain were performed in healthy volunteers. Imaging studies show that a thermal stimulus such as heat, laser and cold stimuli applied on skin increases the fMRI signal in the ACC. However, the localization and the lateralization of the activated area may differ between studies. Indeed, some report an activation of the contralateral ACC (Coghill et al., 1994), others of the midcingulate and of the perigenual part of the ACC (Vogt et al., 1996), of the bilateral ACC (Coghill et al., 2001) or of the anterior, ventral and posterior part of the ACC (Kwan et al., 2000). In fact, the subregional patterns of activation partly changes according to the type of stimulus. Indeed, the ventral pACC is abundantly activated following an electrical stimulus, while more dorsal part of the pACC is activated after a thermal stimulation. Besides skin stimulation, several studies have been performed with direct nerve (Davis et al., 1995) and gastrointestinal tract (Silverman et al., 1997) stimulation. Concerning nerve stimulation, only painful stimulation induces an activation in the ACC (Davis et al., 1995; Dowman et al., 2007). The activation of the trigeminal nerve after different

type of stimulus, chemical, electrical and mechanical, also confirm the previous studies showing an activation of the ACC in a similar way (Iannilli et al., 2008).

b. The role of the ACC in pathological pain conditions

The ACC is a structure that is, according to human studies, consistently activated during pain experience in healthy subjects. It is worthy to wonder if, according to these results, the ACC could be involved in the pathological chronic pain. We will discuss in the next part chronic pain conditions such as fibromyalgia and neuropathic pain.

i. Fibromyalgia

According to the American College of Rheumatology, fibromyalgia is characterized by widespread pain with sleep disturbance, fatigue and is frequently associated with psychological disorders. Compared to healthy control, patients suffering from fibromyalgia display a decrease in gray matter volume in several brain regions including the ACC. Even if the duration of pain did not correlate with the gray matter volume, brain structural changes seem to be involved in this pathology (Burgmer et al., 2009). Using fMRI in fibromyalgia patients, it was shown that the ACC is activated in response to a mechanical stimulus that would only recruit the somatosensory cortex in healthy subjects (Pujol et al., 2009).

ii. Neuropathic pain

Neuropathic pain is a pain caused by a lesion or disease of the somatosensory nervous system (Jensen et al., 2011). This general definition points to the large heterogeneity of the causes (traumatic, metabolic, infectious, etc) and the clinical signs (allodynia, hyperalgesia, hypoalgesia, analgesia, etc) of the neuropathic pain. Thus, it is tricky to make general conclusions about this heterogeneous condition since the changes observed within the ACC could differ according to the etiology.

Both morphological and functional alterations were reported in the ACC in neuropathic pain conditions. For example, a decrease in gray matter density in the ACC has been observed in patient suffering from neuropathic pain secondary to recurrent herpes simplex virus infections (Vartiainen et al., 2009).

In a fMRI study conducted on patients suffering from different nervous system lesions (spinal, brainstem, thalamic or cortical lesions), mechanical and cold allodynia recruited the mid-ACC (Peyron et al., 2004) and in diabetic neuropathy thermal hyperalgesia has been shown to activate the ACC (Tseng et al., 2013). While

the previous studies addressed the question of brain response to evoked pain, positron emission tomography showed an activation of the bilateral PCC as well as right ACC, regardless of the side of the neuropathy, during ongoing pain in patients suffering from mononeuropathy (Hsieh et al., 1995).

c. The role of the ACC in the affective component of pain

The pain is a multidimensional experience involving both somatosensory and emotional components. Being a part of the limbic system, the ACC has been associated with the affective/emotional component of pain. In the late 90's, a study, using hypnosis coupled to live imaging in humans confirmed this role of the ACC (Rainville et al., 1997). Without changing the perceived intensity (i.e. the somatosensory component) of a nociceptive stimulus, hypnotic suggestions to healthy subjects were made in order to vary the unpleasantness (i.e. the affective motivational component) of the stimulation. It appears that the variations of unpleasantness were correlated with the variation of regional cerebral blood flow (rCBF) in the ACC, but not in other structures (Rainville et al., 1997). Using a PET correlation analysis, another study confirmed the role of the pACC in the encoding of pain unpleasantness induced by a hot painful stimulus (Tolle et al., 1999). Interestingly, the pACC was the only region where the activation was correlated with an increase of the reported pain unpleasantness.

Pain relief can be considered as rewarding (Leknes et al., 2011), and another argument for the involvement of the ACC in the affective/motivational aspects of pain is the activation of the ACC both in human and in rats in response to the offset of an noxious heat stimulus (Becerra et al., 2013).

d. The role of the ACC in the cognitive component of pain

Another major component of the pain experience is the cognitive aspect. Indeed, pain involves different cognitive features as expectation, anticipation, attention, appraisal, empathy, learning and memory (Legrain et al., 2012) which are necessary for the defensive behavior produced in response to actual or potential pain (Eccleston and Crombez, 1999). A very intense pain recruits all the personal attention to the site of injury, and, as a consequence, diminishes the cognitive functions allowed treating other internal and external information. When pain becomes chronic, the focus on the pain becomes prominent (Eccleston et al., 1997) and can seriously impaired cognitive functions, having important consequences on the daily life, the work and the social interactions of chronic pain patients. The

involvement of the ACC in different cognitive parameters is detailed in the following sections.

i. Expectation – Anticipation of pain

The first question that comes to mind is whether it is possible to differentiate the pain expectation and pain anticipation. In theory, pain expectation is linked to an uncertain painful event whereas pain anticipation should be associated with a later, but certain painful event. In other words, does the brain react in the same way when the painful event is uncertain (expectation) or certain (anticipation) beforehand to the stimulus? Trying to anticipate an unpredictable and an unlearned pain stimulus has been shown to activate the right ACC while anticipating a learned painful stimulus decreased the activity in this same region (Hsieh et al., 1999), showing that expectation and anticipation does not necessarily recruit the same pathway. Then, do these cognitive processes modify brain activity related to painful stimuli? A study, in which groups of subjects were submitted to either a simple non painful stimulus or non painful stimulus alternated with painful stimulus reported that the activity of the ACC increased in the latter condition after the non painful stimulus (Sawamoto et al., 2000). Another interesting question is to know if the intensity of pain and the activation of pain-related regions can be influenced by the degree of expected pain. When expected pain is manipulated, expectations of decreased pain powerfully reduce both the subjective experience of pain and the activation of regions involved in pain processing such as the ACC and the insular cortex (Koyama et al., 2005).

ii. Attention – Distraction induced by a pain state

It has been stated that pain can modify our attention (Eccleston and Crombez, 1999). In the case of acute pain, this is a useful reaction in order to direct the attention to the source of pain, aiming at stopping or avoiding it. Chronic pain patients can develop hypervigilance towards pain (Tiemann et al., 2012), which may alter the interactions with relatives and the environment, the ability to work and the overall quality of life (Grisart and Plaghki, 1999). To evaluate the interaction between pain and attention, studies monitoring brain activity during attention demanding tasks and painful stimuli had been developed (Bantick et al., 2002). It has been shown that during high demanding attentional tasks, pain ratings following thermal noxious stimulus diminishes, which was correlated with an increase in the activity of the affective ACC (rostral) and a decrease in the activity of the cognitive ACC

(medial) (Bantick et al., 2002). The decrease in the ACC activity is confirmed in another study using CO₂ laser pulse as noxious stimulus and MEG as brain activity monitoring technique (Qiu et al., 2004).

iii. Empathy

Empathy is our ability to understand and share other person feelings. We can demonstrate empathy for other's pain, and the involvement of the ACC in this situation is already described. Indeed, the rostral ACC is activated in a person receiving a noxious stimulus, but also in a person witnessing it (Morrison et al., 2004). Such activation is observed in the anterior IC (aIC), but not in the SI/SII, the caudal ACC and the posterior IC, in which the activation was only present after an actual noxious stimulus. These results suggest that the empathy for pain could activate the cortical structures involved in the emotional but not the sensory component of pain (Singer et al., 2004). Persons with a congenital insensitivity to pain have normal mid-cingulate activity while witnessing other's pain. This suggests that the empathy mediated by this structure do not rely only on mirror matching, since these patients never felt pain (Danziger et al., 2009).

2. Insights from preclinical studies

In this section, we review preclinical studies and discuss them from macroscale (imaging and behavioral studies) to microscale level (electrophysiology and molecular studies).

a. Insight from lesion studies

i. The role of the ACC in the sensory component of pain

Although some studies showed that lesions of the ACC decreased the sensory component of thermal (Lee et al., 1999) or inflammatory pain (Donahue et al., 2001), others reported no effects of lesions on inflammatory response such as licking and biting of the inflamed paw (Johansen et al., 2001) and on mechanical allodynia (LaGraize et al., 2004). These discrepancies may be explained by the nature of the painful stimulus that was used (cold vs nerve injury), by the precise localisation (rostral vs medial, dorsal vs ventral) of the lesion or by the extent (unilateral, bilateral, rostro-caudal) of the lesion.

ii. The role of the ACC in the aversive-motivational component of pain

Pain is defined as an unpleasant experience with sensory and emotional dimensions. The latter has been for long not evaluated in animal research. This was due to the difficulties for the experimenters to assess and quantify the emotional state of animals. Since the 2000's, several paradigms have addressed this question.

Some articles reported a role for the ACC in the aversive aspects of evoked mechanical allodynia in neuropathic pain models by using the place escape/avoidance paradigm (LaGraize et al., 2004). This test measures the escape behavior of animals towards an evoked painful stimulus. Interestingly, this avoidance behavior was abolished after bilateral lesion of the ACC while the paw withdrawal response reflecting the mechanical sensitivity remained unchanged. Therefore, the ACC seems to mediate the aversive component of evoked pain without affecting its somatosensory aspect in a model of neuropathic pain.

A study published in 2001 associated the injection of formalin into the hind-paw, which induces an inflammatory pain, with a place-conditioning paradigm. In this test, the rats developed an aversion to the context paired with formalin. Interestingly, ACC lesions prior to this place-conditioning test prevented the avoidance for the formalin-paired compartment without having any effects on nociceptive behaviors such as paw lifting, licking and flinching (Johansen et al., 2001). These results suggest that the ACC mediates the aversive-motivational component but not the sensory component of inflammatory ongoing pain.

Conditioned place preference experiments have been developed recently to study the spontaneous pain in a rat model of neuropathic pain (King et al., 2009). The conditioning stimulus is the relieving effects of a non-rewarding analgesic drug such as clonidine. The animal shows a preference for the analgesic drug-paired context, in absence of any evoked painful stimuli, showing that the drug relieves the spontaneous pain state. The lesion of the ACC blocked this preference for the analgesic-paired compartment, indicating that the ACC is involved the aversive component of spontaneous pain (Qu et al., 2011). These results were generalized in other models of pain. Indeed, the ACC is also implicated in the affective component of visceral pain (Yan et al., 2012b) and of cephalic pain (De Felice et al., 2013).

b. Insights from ex vivo electrophysiology

In the context of a neuropathic pain model, it has been shown that the spontaneous membrane-potential oscillations and action potential firing of pyramidal neurons of the layers II/III of the ACC are higher in neuropathic rats (Ning et al., 2013). In another study, the nerve injury induced an enhancement of the probability of the presynaptic glutamate release and postsynaptic glutamate AMPA receptor-mediated responses (Xu et al., 2008). In chronic inflammatory pain, by using in vitro patch-clamp recordings, the group of Min Zhuo reported an enhancement in neurotransmitter release probability in the ACC synapses mediated, at least in part, by calmodulin-stimulated adenylyl cyclase AC1, AC8 (Zhao et al., 2006) and TNF- α (Jia et al., 2007). Using a bee venom persistent pain model, Gong et al. observed an increase in the frequency and the amplitude of spontaneous excitatory post-synaptic currents (sEPSCs) and a decrease in the spontaneous inhibitory post-synaptic currents (sIPSCs) in ACC slices compared to the controls (Gong et al., 2010).

c. Insights from in vivo electrophysiology

Several teams have highlighted an increase of the neuronal activity of the ACC neurons in a context of pain processing. Electrical stimulation of supraspinal pain centers such as the medial thalamus induces the activation of the ipsilateral cingulate cortex (Kung and Shyu, 2002) confirming the ACC as a target of the medial thalamic pain pathway. In anesthetized rats, spontaneous activities of the pyramidal neurons of layers II/III are characterized according to their firing pattern: regular spiking, intermediate and intrinsic bursting. Acute noxious but not non noxious mechanical stimulation of the hindpaw evoked spike responses in all three types of neurons (Koga et al., 2010). In freely moving rats, noxious laser stimulation to the hindpaw induced neuronal activation in the ACC (Zhang et al., 2011). Altogether, these studies show that the ACC neurons could be activated by different kinds of peripheral nociceptive stimuli (mechanical, thermal) in both anesthetized and freely moving animals.

d. Insights from imaging studies

Imaging studies in animals have shown an activation of the ACC during noxious stimulation in anesthetized (Tuor et al., 2002) or awake animals (Becerra et al., 2011), whereas innocuous stimulation failed to activate the ACC (Yang et al., 2011). For instance, the electrical or the chemical stimulation of the forepaw induced a bilateral activation of the ACC which was decreased by a pre-treatment with

morphine (Tuor et al., 2000). While most of the imaging studies have measured the activity of the ACC following peripheral stimulation in naïve animals (Tuor et al., 2002), there are some studies focusing on the chronic pain condition such as neuropathic pain. Using autoradiographic techniques to monitor changes in rCBF in a model of chronic constriction injury (Bennett and Xie, 1988), an activation of the ACC can be observed 10 days (Mao et al., 1993), 2 weeks (Paulson et al., 2000), 8 weeks or 12 weeks (Paulson et al., 2002) after the induction of the neuropathy. Structural MRI studies showed a decreased volume of the ACC (Seminowicz et al., 2009) in the spared nerve injury model (Decosterd and Woolf, 2000) and the functional MRI studies confirmed the activation of the ACC in this model, 3 weeks after the induction of the neuropathy (Thompson et al., 2014).

e. Insights from molecular studies

Molecular manipulations of the ACC modify the expression of several pain behaviors. For instance, inhibiting protein kinase M zeta (PKM ζ), an atypical isoform of protein kinase C thought to be involved in long term potentiation (LTP), resulted in a reduction of mechanical allodynia in neuropathic animals (Piombino et al., 2010). AC1 and AC8, two major adenylate cyclases in the brain which link NMDA receptor activation to the cAMP intracellular signaling pathway are overexpressed in the ACC (Wei et al., 2002). Furthermore, it has been shown in the same study that double AC1 and AC8 KO mice responses to acute noxious stimulation in the hot plate test, in the tail flick test and in the paw mechanical pressure test are similar to those observed in wild type mice. However, following paw injection of formalin, the nociceptive behavior (licking and biting the formalin injected paw), and the mechanical allodynia were reduced in double KO AC1/AC8 mice. Mechanical allodynia secondary to partial nerve ligation (a neuropathic pain model) was also reduced in the same animals (Wei et al., 2002). Moreover, overexpression of the NMDA receptor subunit NR2B in the ACC of mice induced an enhanced nociceptive behavioral response (licking and biting the formalin injected paw) and an enhanced mechanical allodynia to paw injection of formalin although response to acute nociceptive stimulation (hot plate and cold plate tests, tail flick test) was not altered (Wei et al., 2001). Moreover, local injection of NR2B antagonist within the ACC in the model of formalin-induced inflammation reduced nociceptive responses (licking and biting the formalin injected paw) (Quintero et al., 2011).

f. Discrepancies between studies

We already showed some discrepancies between the effects of ACC lesions on the response in inflammatory and neuropathic pain conditions, with most of studies showing no effects of the ACC lesions (Johansen et al., 2001; LaGraize et al., 2004; King et al., 2009) on the observed behaviors. However, the molecular studies show an involvement of the ACC in response to nociceptive stimuli in chronic inflammatory condition and neuropathic but not in response to acute nociceptive stimulation. The observed differential involvement of the ACC in pain responses depend probably on the type of pain model that is used (acute model of pain or tonic inflammatory model or chronic neuropathic model) and the precise localization of the manipulations in the ACC.

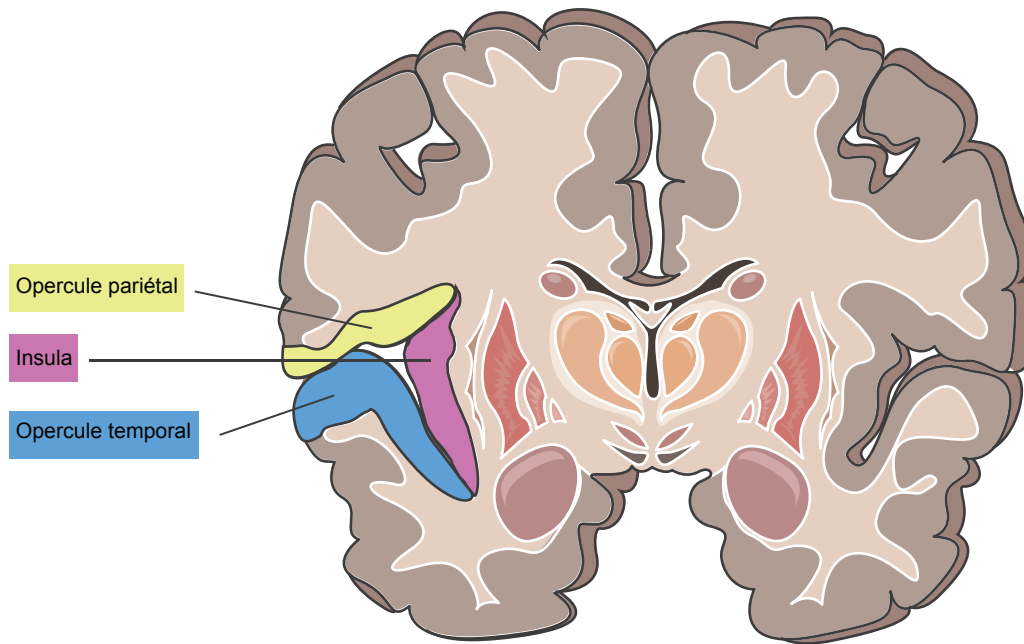

Figure 5. Représentation schématique d'un cerveau humain vu en coupe coronale. Sont représentés les opercules pariétal (fond jaune) et frontal (fond bleu) recouvrant l'insula (fond violet) située en profondeur du sillon latéral.

Coupe coronale provenant de la banque d'image Servier.

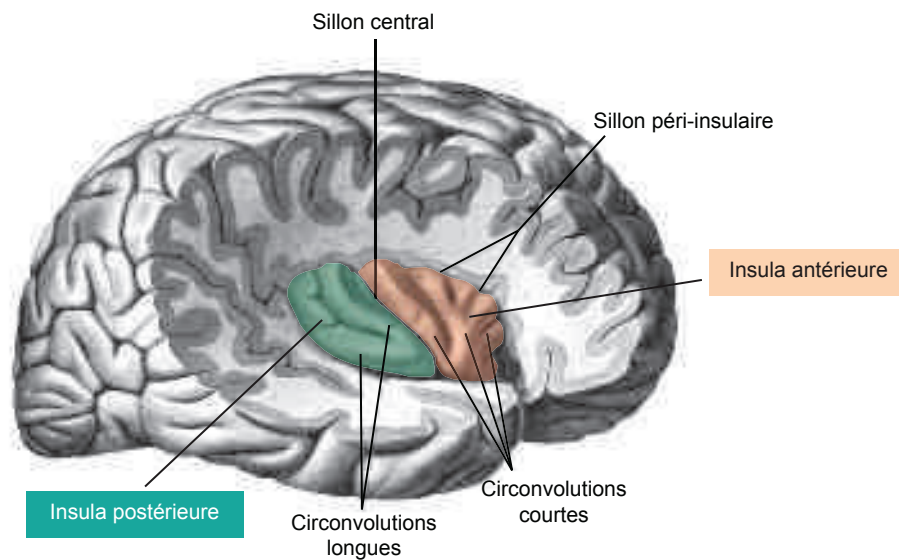

Figure 6. Représentation schématique d'un cerveau humain où l'on a supprimé une partie des lobes frontal, pariétal et temporal. La morphologie de l'insula est visible avec sa partie antérieure en orange et sa partie postérieure en vert.

Adapté de Sobotta J, Atlas of Human Anatomy, 1908.

IV. Le cortex insulaire : rôle dans la douleur chez l'Homme et le rongeur

A. Organisation générale du cortex insulaire

1. Chez les singes et l'Homme

Le cortex insulaire ou insula, du latin île, est une structure corticale décrite et nommée par le médecin allemand Johann Christian Reil en 1809 (Reil, 1809). Elle se situe en profondeur sous la scissure latérale, sous les opercules frontaux, pariétaux et temporaux qui la bordent et est séparée d'eux par les sillons péri-insulaires (**Figures 5 et 6**). L'insula est organisée en deux parties, la partie antérieure est séparée de la partie postérieure par le sillon central insulaire. La partie antérieure contient trois courtes circonvolutions, antérieure, moyenne et pré-centrale. La partie postérieure est composée de deux circonvolutions longues, post-centrale et postérieure (**Figure 6, adapté de (Sobotta, 1908)**). Elle est considérée comme le cinquième lobe du cerveau.

La cytoarchitecture de l'insula révèle une organisation concentrique avec une partie agranulaire (absence de couche IV) du côté antéroventral, entourée par une zone dysgranulaire (couche IV discontinue), elle-même circonscrite par une zone granulaire (couche IV bien définie) (**Figures 7 et 8**) (Mesulam and Mufson, 1985; Bonthuis et al., 2005; Kurth et al., 2010b). Notons que cette description est très sommaire et que jusqu'à 31 subdivisions ont pu être décrites.

2. Chez les rongeurs

Chez les espèces lissencéphales, l'insula est à la surface latérale du cerveau et se situe au niveau de la fissure rhinale. Elle s'étend le long de cette fissure, de la fin du cortex orbital dorsolatéral (DLO) jusqu'au début des aires corticales auditives et temporales d'association. Sa limite dorsale est constituée par les cortex somatosensoriels (SI et SII) et le cortex piriforme borde sa limite ventrale. Ses couches les plus profondes sont accolées à la capsule externe et au claustrum qui forment sa limite latérale interne (Aleksandrov and Fedorova, 2003). La cytoarchitecture de l'insula définit trois sous-structures, comparables à celles trouvées chez le primate : l'insula agranulaire sous-divisée en partie ventrale et dorsale, l'insula dysgranulaire et

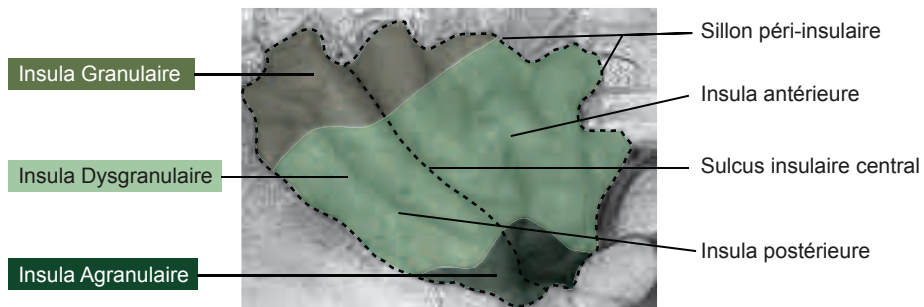

Figure 7. Vue latérale de l'insula avec le positionnement typique des sous-régions de l'insula selon leur cytoarchitecture.

Adapté de Bonthius DJ, J Neuropathol Exp Neurol, 2005.

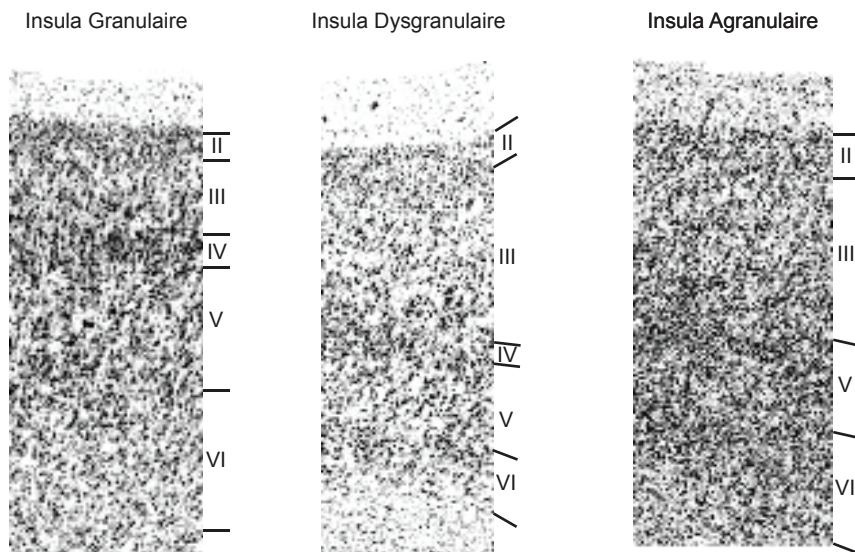

Figure 8. Photographies représentatives des différentes cytoarchitectures de l'insula. L'insula granulaire possède une couche IV bien définie et continue, dans l'insula dysgranulaire cette couche est discontinue et est absente de l'insula agranulaire.

D'après Kurth F, Cerebral Cortex, 2010

l'insula granulaire. Rostralement, c'est l'insula agranulaire qui apparaît en premier, suivi par l'insula granulaire qui s'y superpose dorsalement. Apparaît ensuite la partie dysgranulaire les séparant (**Figures 9 et 10**).

B. Connexions du cortex insulaire

Dans cette section sont présentées les connexions de l'insula avec les régions impliquées soit dans la douleur (ACC, thalamus), soit dans les émotions (cortex préfrontal, structures limbiques), et retrouvées à la fois chez les singes ou chez l'Homme, ainsi que chez le rongeur.

1. Connexions intrainsulaires

L'étude de ces connexions a été récemment menée chez l'Homme (Almashaikhi et al., 2013). Elle montre des connexions réciproques entre quasiment chaque zone de l'insula, s'opposant ainsi aux données chez le singe et chez le rat où les connexions suivent préférentiellement une direction postéro-antérieure (Mesulam and Mufson, 1982; Shi and Cassell, 1998). Notons aussi que l'article d'Almashaikhi et collaborateurs n'a pas réussi à montrer de communications entre les insula droite et gauche, probablement du fait du nombre trop faible d'expériences permettant de répondre à cette question.

2. Connexions extrainsulaires

a. Cortex cérébral

Des connexions réciproques sont retrouvées entre certaines régions du cortex cingulaire et l'insula (Vogt and Pandya, 1987; Allen et al., 1991; Jasmin et al., 2004). L'insula est aussi connectée réciproquement avec différentes zones du lobe frontal impliquées dans les émotions (cortex préfrontal et orbital) (Allen et al., 1991; Morecraft et al., 1992; Jasmin et al., 2004) et des zones du lobe pariétal (opercule pariétal, cortex somatosensoriels) impliquées dans la somatosensation (Augustine, 1985; Shi and Cassell, 1998).

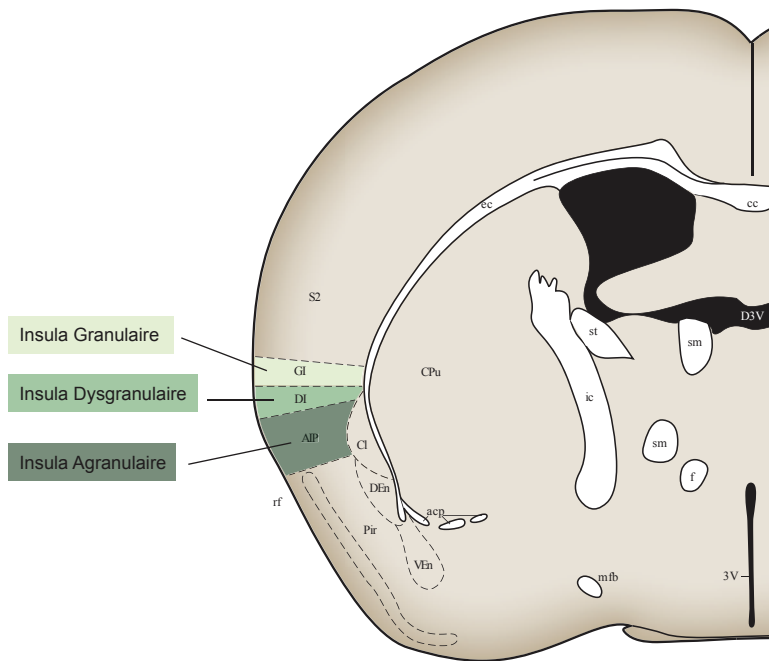

Figure 9. Représentation schématique d'un cerveau de souris vu en coupe coronale. Les différentes parties de l'insula sont représentées ainsi que les structures voisines. Liste d'abréviations : 3V, troisième ventricule; aap, partie antérieure de la commissure antérieure; AIP, cortex insulaire agranulaire postérieur; cc, corps calleux; Cl, claustrum; CPU, noyau caudé-putamen; D3V, troisième ventricule dorsal; DEn, noyau endopiriforme dorsal; DI, cortex insulaire dysgranulaire; ec, capsule externe; f, fornix; GI, cortex insulaire granulaire; ic, capsule interne; mfb, faisceau médian du télencéphale; Pir, cortex piriforme; rf, fissure rhinale; S2, cortex somatosensoriel secondaire; sm, strie médullaire; st, strie terminale; VEn, noyau endopiriforme ventral.

D'après The Mouse Brain in Stereotaxic coordinates, Franklin KBJ et Paxinos G, Troisième édition, 2008

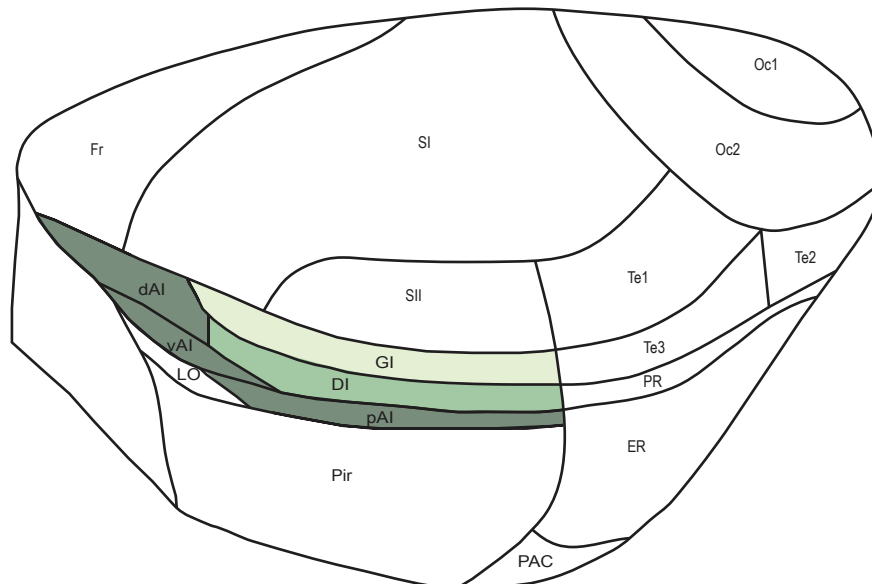

Figure 10. Représentation schématique de la surface latérale du cerveau de rat. Sont figurés en couleur les différentes sous-régions de l'insula. Liste d'abréviations : dAI, cortex insulaire agranulaire antérieur dorsal; DI, cortex insulaire dysgranulaire; ER, cortex entorhinal; Fr, cortex frontal; GI, cortex insulaire granulaire; LO, cortex latéral orbital; Oc1, aire corticale occipitale 1; Oc2, aire corticale occipitale 2; PAC, cortex périamygdaloïde; pAI, cortex insulaire agranulaire postérieur; Pir, cortex piriforme; PR, cortex périrhinal; SI, cortex somato-sensoriel primaire; SII, cortex somatosensoriel secondaire; Te1, aire corticale temporale 1; Te2, aire corticale temporale 2; Te3, aire corticale temporale 3; vAI, cortex insulaire agranulaire antérieur ventral.

D'après Shi CJ et Cassell MD, J Comp Neurol, 1998

b. Structures limbiques

Les structures limbiques, très impliquées dans les émotions et les pathologies associées sont interconnectées avec l'insula. Les relations entre l'insula et l'amygdale sont importantes, avec des projections préférentielles vers les parties basolatérale et cortico-médiane de l'amygdale (Augustine, 1985). Les parties médiane et antérieure de l'amygdale projettent en retour vers l'insula (Augustine, 1985). L'hippocampe, les cortex prorhinal, périrhinal, piriforme et entorhinal reçoivent également des afférences de l'insula tandis que le cortex péri-amygdaloïde, le tubercule olfactif et les bulbes olfactifs y envoient des projections (Augustine, 1985).

c. Thalamus

L'insula projette vers des noyaux thalamiques cruciaux pour le traitement de la douleur comme les noyaux du groupe ventral postérieur (latéral, VPL ; inférieur, VPI) et reçoit des fibres de nombreux noyaux dont le VPI, ainsi que de la partie parvocellulaire du noyau ventral postéromédian (VPMpc) (Augustine, 1985; Allen et al., 1991; Nakashima et al., 2000). Chez le primate, l'insula est une sortie privilégiée du système spinothalamique avec 40 % des projections pour l'insula postérieure, 30 % pour l'opercule pariétal voisin et 24 % pour le cortex cingulaire médian (Dum et al., 2009).

C. Fonctions du cortex insulaire

1. Observation de quatre grands domaines fonctionnels

Les fonctions liées à l'activité de l'insula sont très nombreuses. La revue de la littérature très complète de Nieuwenhuys (Nieuwenhuys, 2012) liste vingt fonctions impliquant cette structure chez l'Homme. Dans une méta-analyse de la littérature consacrée aux fonctions de l'insula, 4 domaines fonctionnels ont été mis en évidence, les domaines socio-émotionnel, olfacto-gustatif, cognitif et sensori-moteur (Kurth et al., 2010a). Concernant les fonctions qui nous intéressent, il apparaît que les tâches relevant du domaine sensori-moteur activent la partie médiane et postérieure de l'insula alors que les fonctions socio-émotionnelles sont attribuées à la partie antéro-ventrale.

L'insula chez le rongeur est elle aussi impliquée dans diverses fonctions. Par exemple, des neurones de l'insula postérieure répondent à des stimuli différents tels que le pincement de la queue, une stimulation des barorécepteurs et des chémorécepteurs artériels, ou encore une stimulation gustative (Hanamori et al., 1998).

2. Fonctions du cortex insulaire dans la somatosensation et la douleur chez l'Homme

L'insula postérieure et l'opercule pariétal adjacent sont les structures corticales qui sont les plus fréquemment activées dans les expériences d'imagerie cérébrale lors d'un stimulus douloureux (Peyron et al., 2000; Apkarian et al., 2005). De plus, l'insula paraît être la seule structure corticale dont la stimulation électrique est capable de déclencher une sensation de douleur (Mazzola et al., 2012a).

Nous savons que la douleur est une expérience multidimensionnelle et l'insula joue un rôle dans ses diverses composantes. Les lésions de l'insula postérieure peuvent être responsables de la perte de la sensibilité aux modalités thermiques (chaud ou froid) ou mécanique de la douleur (Greenspan et al., 1999; Veldhuijzen et al., 2010). Ceci suggère que cette région est impliquée dans la composante somatosensorielle de la douleur. Cependant, d'autres études démontrent également que l'insula intervient dans la composante émotionnelle de la douleur, que ce soit l'insula dorsale sans précision de la localisation antéropostérieure (Schreckenberger et al., 2005) ou l'insula postérieure (Kulkarni et al., 2005). Enfin, il paraît probable que, via la transmission de l'information nociceptive de l'insula postérieure vers l'insula antérieure, une intégration de la douleur d'un plus haut niveau de complexité, telle que la prise de conscience de l'expérience douloureuse, naisse dans l'insula antérieure, impliquant cette structure dans la composante cognitive de la douleur (Garcia-Larrea and Peyron, 2013).

L'expérience douloureuse peut être modifiée par notre contexte émotionnel. Ainsi, la présentation d'indices visuels dotés d'une valence émotionnelle négative va augmenter la perception de la douleur, ceci étant mis en relation avec une augmentation de l'activité de l'insula antérieure en imagerie par résonance magnétique (Ploner et al., 2011). Le rôle de l'insula dans les émotions et les troubles de l'humeur est détaillé dans une revue récente (Gasquoin, 2014). Des études d'imagerie cérébrale ont montré une augmentation de l'activité de l'insula chez des

patients atteints de dépression majeure (Drevets, 2000). Il apparaît donc pertinent de se demander, de la même manière que pour l'ACC, quelle peut être l'implication de l'insula dans les conséquences émotionnelles de la douleur chronique.

3. Fonction du cortex insulaire dans la somatosensation et la douleur chez le rongeur

Plusieurs approches ont permis de mettre en évidence le recrutement de l'insula dans la douleur chez le rongeur. Des études d'IRM fonctionnelle et de PET ont montré une activation du cortex insulaire suite à divers stimuli nociceptifs chez l'animal anesthésié (Tuor et al., 2002) et vigile (Becerra et al., 2011). La stimulation électrique des pattes entraîne une réponse de l'insula, mesurée par l'enregistrement de potentiels évoqués (Benison et al., 2011). Enfin, une augmentation de l'expression du marqueur d'activité neuronale précoce c-Fos dans l'insula a été observée suite à un stimulus nociceptif de la région colorectale (Traub et al., 1996).

Réciproquement, chez le rat, des expériences de lésions du cortex insulaire ont permis de mesurer son implication dans la réponse à un stimulus nociceptif. Ainsi, une lésion du cortex antérieur agranulaire diminue les comportements nocifensifs dans des modèles de douleur inflammatoire soutenue et neuropathique chronique, mais pas dans le cas d'une douleur aiguë. Cela est observé indépendamment du site de la lésion corticale, qu'elle soit ipsilatérale ou controlatérale au côté du stimulus nociceptif, ou encore bilatérale (Coffeen et al., 2011). La lésion du cortex insulaire postérieur granulaire n'empêche pas l'initiation de l'allodynie mécanique dans un modèle de douleur neuropathique mais prévient son maintien à long terme (Benison et al., 2011). Ces deux études, bien que lésant deux zones différentes (antérieur agranulaire vs postérieur granulaire), montrent toutes deux une implication de l'insula dans la composante somatosensorielle de la douleur.

La réexposition de rats à un compartiment préalablement associé à une douleur (injection de formaline dans la patte) augmente l'expression de c-Fos dans de nombreuses structures cérébrales, parmi lesquelles l'insula (Lei et al., 2004). Ce résultat reste néanmoins difficile à interpréter et il n'y a, à notre connaissance, pas de preuve plus directe de l'implication de l'insula dans la composante aversive-motivationnelle de la douleur chez le rongeur, de même que dans les conséquences émotionnelles de la douleur chronique.

Objectifs de thèse

Cette thèse a été consacrée à l'étude des conséquences émotionnelles de la douleur neuropathique chez la souris. Elle se situe dans la continuité d'un travail mené par le Dr. Ipek Yalcin et ayant donné lieu à une publication dans la revue *Biological Psychiatry* en 2011. Cette étude montrait le développement chez les souris neuropathiques de comportements de type anxieux puis dépressifs, à partir de 4 semaines après l'induction de la neuropathie. Nous avons alors cherché à comprendre les bases neurobiologiques sous-tendant cette apparition.

Ce travail a été organisé autour de trois objectifs :

- **Permettre la description précise du modèle de neuropathie utilisé et favoriser ainsi sa diffusion et son utilisation par d'autres équipes.**

Pour atteindre cet objectif un article a été consacré d'une part à la revue de la littérature utilisant ce modèle et d'autre part à une mise en vidéo de la procédure de chirurgie et du test nociceptif utilisés dans l'équipe.

- **Déterminer les rôles des cortex cingulaire antérieur et insulaire postérieur dans les composantes sensorielle et affective de la douleur, ainsi que dans ses conséquences émotionnelles.**

Pour cela nous avons utilisé une approche lésionnelle afin d'inactiver ces structures. L'utilisation de divers tests comportementaux nous ont permis d'évaluer la présence ou l'absence des différents aspects de la douleur. Ce travail a été complété par l'activation via une technique d'optogénétique d'une zone corticale impliquée dans les conséquences anxiodépressives de la douleur neuropathique.

- **Identifier les modifications moléculaires au sein de l'ACC chez les animaux développant des troubles anxiodépressifs consécutifs à la douleur neuropathique.**

Afin de réaliser cet objectif, nous avons procédé à une analyse génomique globale par microarray sur les ARN extraits à partir de dissection d'ACC. Pour certains gènes cibles mis en évidence, les résultats obtenus en génomique ont été complétés par des approches de quantification protéique (Western blot) dans cette même région. L'importance de l'un des gènes a ensuite été confirmée par l'utilisation de souris déficientes pour ce gène.

Les trois chapitres suivants détaillent les résultats obtenus pour chacun de ces trois objectifs.

Résultats

I. The sciatic nerve cuffing model of neuropathic pain in mice

Ipek Yalcin, Salim Megat, **Florent Barthas**, Elisabeth Waltisperger, Mélanie Kremer, Eric Salvat, Michel Barrot

Différents modèles animaux sont utilisés dans le domaine de la recherche préclinique consacrée à l'étude de la douleur neuropathique (Colleoni and Sacerdote, 2010; Jaggi et al., 2011; Barrot, 2012). Ils reposent essentiellement sur des lésions mécaniques du système nerveux périphérique. Le modèle du cuff, développé chez le rat (Mosconi and Kruger, 1996; Fisher et al., 1998), consiste en la pose d'un manchon (cuff en anglais) de polyéthylène de 2 mm de longueur, unilatéralement autour de la branche principale du nerf sciatique. Ce modèle de constriction chronique du nerf sciatique a l'avantage, selon nous, d'induire une pression calibrée sur le nerf et de réduire la variabilité inter-expériences et inter-équipes. Ce modèle a donc été adapté et caractérisé dans l'équipe, chez la souris (Benbouzid et al., 2008b).

La réalisation pratique de ce modèle présente des difficultés techniques. Par exemple, la localisation précise de l'incision ou le geste permettant la pose du cuff demandent de la précision. Une mise en vidéo du protocole présente un intérêt pour la standardisation du modèle et pour sa diffusion dans le champ de la recherche sur la douleur neuropathique.

L'équipe a produit récemment un protocole vidéo montrant de manière précise les différentes étapes de la chirurgie et le déroulement des tests sensoriels permettant de mettre en évidence le développement des comportements nocifensifs. Cette vidéo est accompagnée d'une revue de la littérature utilisant ce modèle de douleur neuropathique.

Mon rôle dans cet article a été d'effectuer une partie de la recherche bibliographique et de participer au tournage vidéo.

The Sciatic Nerve Cuffing Model of Neuropathic Pain in Mice

Authors:

Ipek Yalcin, Salim Megat, Florent Barthas, Elisabeth Waltisperger, Mélanie Kremer, Eric Salvat, Michel Barrot

Keywords: Neuroscience, Pain, Neuropathic pain, Allodynia, von Frey, Mouse, Model, Sciatic, Cuff

Short abstract:

Neuropathic pain is a consequence of a lesion or disease affecting the somatosensory system. The “cuff model” of neuropathic pain in mice consists in the implantation of a polyethylene cuff around the main branch of the sciatic nerve. Mechanical allodynia is tested using von Frey filaments.

Long abstract:

Neuropathic pain arises as a consequence of a lesion or a disease affecting the somatosensory system. This syndrome results from maladaptive changes in injured sensory neurons and along the entire nociceptive pathway within the central nervous system. It is usually chronic and challenging to treat. In order to study neuropathic pain and its treatments, different models have been developed in rodents. These models derive from known etiologies, thus reproducing peripheral nerve injuries, central injuries, and metabolic-, infectious- or chemotherapy-related neuropathies. Murine models of peripheral nerve injury often target the sciatic nerve which is easy to access and allows nociceptive tests on the hind paw. These models rely on a compression and/or a section. Here, we present the detailed surgery procedure for the “cuff model” of neuropathic pain in mice. In this model, a cuff of PE-20 polyethylene tubing of standardized length (2 mm) is unilaterally implanted around the main branch of the sciatic nerve. It induces a long-lasting mechanical allodynia, i.e. a nociceptive response to a normally non-nociceptive stimulus, that can be evaluated by using von Frey filaments. We present the detailed protocol for model and testing procedures, and discuss the interest of this model for the study of neuropathic pain mechanism, of neuropathic pain sensory and anxiodepressive aspects, and of neuropathic pain treatments.

Introduction:

Neuropathic pain is usually chronic and arises as a consequence of a lesion or a disease affecting the somatosensory system. Maladaptive changes in injured sensory neurons and along the entire nociceptive pathway within the central nervous system participate to this complex syndrome. To preclinically study neuropathic pain and its treatments, various models have been developed in rodents (reviewed in **1, 2, 3**).

Based on known etiologies, the models of neuropathic pain aim at reproducing peripheral nerve injuries, central injuries, trigeminal neuralgia, diabetic neuropathies, chemo-induced neuropathies, post-herpetic neuralgia, etc... Different murine models of peripheral nerve injury target the sciatic nerve and rely on a compression and/or a section. This nerve is indeed relatively easy to access, and nociceptive tests can be easily done based on hind paw withdrawal reflexes. The chronic constriction injury (CCI) (**4, 5**), the sciatic nerve cuffing (**6, 7, 8, 9**), the partial sciatic nerve ligation (PSL) (**10**), the spinal nerve ligation (SNL) (**11**), or the common peroneal nerve ligation (**12**) are examples of chronic nerve compression models. In the spared nerve injury (SNI) models, two of the three terminal branches of the sciatic nerve are tightly ligated followed by a distal axotomy, the third branch being left intact (**13, 14, 15**). The various models of neuropathic pain that target the sciatic nerve result in a chronic mechanical allodynia (a nociceptive response to a normally non-nociceptive stimulus) that concerns the injured hind paw.

Here, we present the detailed surgery procedure for the “cuff model” of neuropathic pain in mice that consists in the implantation of a polyethylene cuff around the main branch of the sciatic nerve (**6, 7, 8, 9**). We also detail the use of von Frey filaments to assess the mechanical allodynia which is a long lasting nociceptive symptom present in this model.

Protocol text:

Protocols have been approved by the “comité d'éthique en matière d'expérimentation animale de Strasbourg” (CREMEAS).

1. Baseline measurement prior to the surgery, using von Frey filaments

- 1.1 Let the mice habituate to the animal facilities for at least 10 days to 2 weeks before initiating the testing procedures.
- 1.2 Habituate the mice to the von Frey testing set-up and procedure that are described in detailed in section 4.
- 1.3 Before surgery, evaluate the mechanical thresholds with von Frey filaments on separate days until at least three stable consecutive values are obtained for paw withdrawal thresholds.
- 1.4 Assign the animals to the different experimental groups so that these groups do not initially differ for the mechanical nociceptive threshold.

2. Surgery procedures for cuff implantation

- 2.1 Mouse body weight should be over 20 g for the cuff insertion procedure described below.
- 2.2 Anesthetize the animal with an intraperitoneal injection of a mixture of ketamine (17 mg/mL) and xylazine (2.5 mg/mL) in 0.9% NaCl, 4 mL/kg.
- 2.3 Check the paw reflexes by pinching a hindpaw with tweezers and check the eye reflexes to make sure that animals are fully anesthetized.
- 2.4 Shave the right leg from the knee to the hip using an electrical shaver.
- 2.5 Apply protective eye liquid gel to the eyes with a cotton-tipped swab.
- 2.6 Place the animal on its left side and place the right hindlimb on a small pillow, maintain this limb to the pillow with adhesive tape.

- 2.7 Disinfect the surgery field with 70% ethanol using gauze pad or cotton-tipped swab.
- 2.8 Find the femur with your forefinger and make an approximately 0.5 cm incision parallel to the femur.
- 2.9 Separate the muscles close to the femur with two autoclaved sticks. Never cut the muscle. Normally, the muscle layers separate easily without any bleeding and the sciatic nerve appears. In case of bleeding, use sterile cotton-tipped swab to absorb the blood.
- 2.10 To expose the main branch of the sciatic nerve, insert two autoclaved sticks below the nerve and hydrate it with a physiological solution (0.9% NaCl).
- 2.11 Catch the pre-prepared sterile 2 mm section of split PE-20 polyethylene tubing (cuff), 0.38 mm ID / 1.09 mm OD, with the help of a pointed steel stick and a bulldog clamp. For this, insert the pointed steel stick into the cuff, which will slightly open it. Then insert the bulldog through the lateral opening of the cuff, rotate the bulldog (180°) so that it will hold the cuff by the opposite side to the lateral opening, close the bulldog and remove the pointed steel stick. The rotation is done to allow holding the cuff in an optimized position for the insertion, the bulldog clamp also help maintaining the cuff partly open. The model and size of the bulldog clamp is critical for this step of the procedure.
- 2.12 A second experimenter holds the two sticks under the nerve and gently separates them to facilitate the access to around 4 mm of the sciatic nerve. Then insert the 2 mm cuff around the main branch of the sciatic nerve, starting by inserting the part of the cuff that is distal to the bulldog around the part of the nerve that is proximal to the hip.
- 2.13 Once the cuff is in place, gently close it by exerting a pressure on its two distal sides with pliers, without squeezing or changing the form of the tube.
- 2.14 Suture the shaved skin layer with surgical knots.

2.15 Place the mouse on his left side in a clean homecage. Keep it under the heat lamp until it is awake.

2.16 Add extra water and place some chow directly in the homecage.

3. Surgery procedures for sham controls

3.1 From steps 2.1 to 2.9 and steps 2.14 to 2.16, the procedures are identical as the ones described above for cuff implantation. The steps 2.10 to 2.13 of the cuff insertion are omitted in the sham controls.

4. von Frey testing

4.1 Place the mice in clear individual Plexiglas® boxes (7cm x 9cm x 7cm) with holes, on an elevated perforated plate of smooth stainless steel (100 cm x 50 cm, 5-mm circle perforations with 2.5 mm in between perforation borders. Up to 12 mice can be concomitantly tested on this set-up.

4.2 Allow the animals to habituate for 15 minutes prior to testing.

4.3 Verify that the mice are calm and apply the von Frey filaments to the plantar surface of each hindpaw in a series of ascending forces. The von Frey filaments (or von Frey hairs) are calibrated plastic hairs, 5 cm long and of various diameters, fixed on applicators. Their end is not sharp but blunt. They are applied locally until they bend, at which point they exert a calibrated pressure. For the most common brand, the thinner filaments may go down to 0.008 g, and are far below detection threshold, whereas the larger ones can lead to a pressure up to 300 g. The speed of filament application, the degree of bending and the duration of the application are critical factors that influence the absolute values that are obtained with this test (**3**). With presently described procedures in mice (i.e. application of the filament until it just bends), the filaments that are normally used are the ones of 0.16, 0.4, 0.6, 1, 1.4, 2, 4, 6, 8, and 10 g. In C57BL/6J mice, the pre-surgery tests start with the 1.4 g filament as

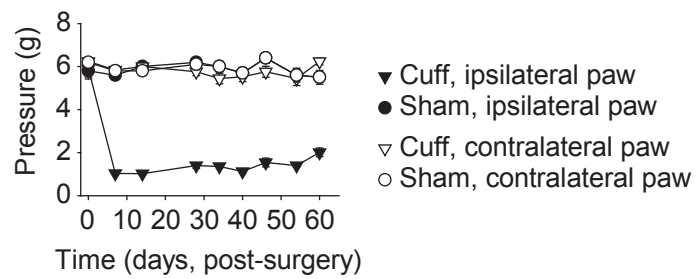

Figure 1. Mechanical paw withdrawal thresholds in the cuff model of neuropathic pain in mice. Adult male C57BL/6J mice were habituated to the von Frey procedure until a stable baseline was obtained (the baseline is represented at point 0 on the graph). Both paws were tested. The Cuff mice display ipsilateral mechanical allodynia as showed by the lowered paw withdrawal thresholds (n = 10 per group).

these mice do not respond to the ones exerting lower pressure. After surgery, the tests start with the 0.4 g filament. Normally, responses are not positive with these first tested filaments, but if it happens, then test a filament of lower force at step 4.5.

- 4.4 Apply the chosen filament, until it just bends, three to five consecutive times to the plantar surface of the left paw, and then do the same to the right paw. Avoid paw lateral borders that can be more sensitive. The expected response is a paw withdrawal, sudden flinching or paw licking. The response is considered as positive if at least three expected responses are observed out of five trials. A given paw is always tested three times, but the 4th and the 5th trials are done only if 1 or 2 response(s) was (were) observed during the first three tests. Once the filament was tested on both paws, test the next animal.
- 4.5 Apply the same filament to the next animals according to the 4.4 procedure. Once all animals are tested, start again on the first animal with the next filament of greater force, repeat the procedure...
- 4.6 Each animal is tested until at two consecutive filaments are giving a positive response. The gram value of the lower filament that gave a positive response is considered as the paw withdrawal threshold for this animal.

Representative results:

With the procedures that are described above, the cuff implantation results in an ipsilateral allodynia, as illustrated in **Figure 1**. Once the mouse is habituated to the testing procedure, the values for paw withdrawal thresholds in the von Frey test remain stable over time and are not affected by the surgical procedure *per se*, as illustrated in Sham animals. It should however be noted that a transitory post-surgical allodynia can usually be observed in Sham mice. When such allodynia is present, the paw withdrawal response returns to baseline after a few days post-surgery. In Cuff mice, the ipsilateral allodynia is already present on the first days post-surgery and is maintained for more than 2 months (see **9**, and **Figure 1**). The cuff-induced allodynia remains ipsilateral in C57BL/6J mice measured by the von Frey test as detailed above, but in other conditions a presence of allodynia on the contralateral paw can

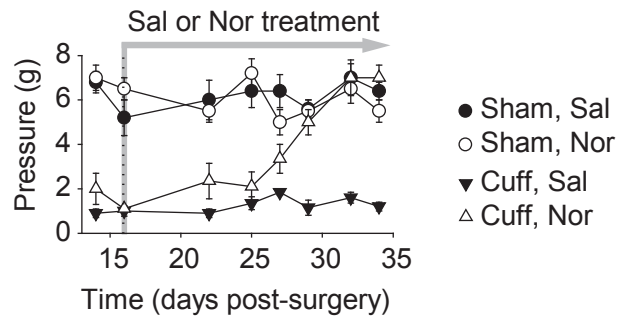

Figure 2. Delayed antiallodynic action of a tricyclic antidepressant. After two weeks post-surgery, mice received intraperitoneal treatment twice a day (morning and evening) with either 0.9% NaCl or 5 mg/kg nortriptyline hydrochloride (n = 5 or 6 per group). The von Frey test was done before the morning treatment. With this procedure, a delayed antiallodynic action of nortriptyline is observed, which requires around 12 days of treatment.

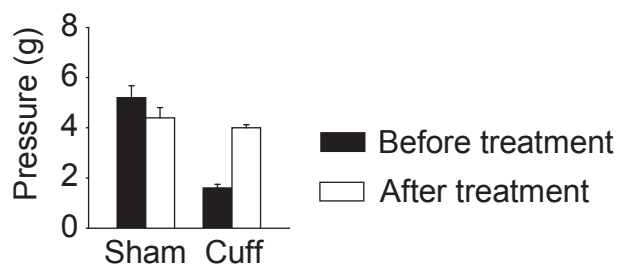

Figure 3. Antiallodynic action of a gabapentinoid. After three weeks post-surgery, mice received intraperitoneal treatment twice a day (morning and evening) with either 0.9% NaCl or 10 mg/kg gabapentin (n = 5 per group). The von Frey test was done before the morning treatment. With this procedure, a delayed and lasting antiallodynic action of gabapentin is observed. Data are presented before starting the treatments and at the 6th day of treatments.

also be observed (8). The absolute values for baseline are usually between 4 and 6 g in C57BL/6J mice, but the testing protocol may affect these values (3).

In this model, the tricyclic antidepressant drug nortriptyline (5 mg/kg, intraperitoneal, twice a day) relieves the neuropathic allodynia after around 2 weeks of treatment, as illustrated in **Figure 2**. At this dose, no acute analgesic action of the antidepressant is observed (16, 17). To mimic the lasting pain relief that is present in patients taking such drugs, the mice can be tested before the morning drug administration rather than after. Such procedure allows assessing a long-lasting effect primed by previous days of treatment. In this case, it requires 1-2 weeks of treatment to observe a lasting relief of the neuropathic allodynia. When the treatment is interrupted, a relapse is usually observed within 3-4 days (18). Beside some antidepressants, gabapentinoids are the other first-choice treatments for neuropathic pain. Gabapentin has an acute and transitory analgesic action in this model (16), but it also displays a delayed and long-lasting antiallodynic action when testing the animal each day before the drug administration, as illustrated in **Figure 3**. This action is faster than with antidepressant drugs.

Discussion:

The “cuff” model was initially developed in rats to obtain a standardized and reproducible chronic constriction injury with the implantation of multiple cuffs around the sciatic nerve (6). It was then modified to implant a single cuff (7, 8), even though some groups also use multiple cuff insertion (19, 20, 21, 22). It was also adapted to mice (9, 23), which opened the possibility to use transgenic animals. The cuff is usually 2-mm long, but other lengths have also been used in rats (22). The polyethylene tubing depends on the species: PE-20 in mice (9), and PE-60 (24, 25) or PE-90 (7, 8, 26, 27) in rats.

The mechanical allodynia is measured with von Frey hairs. In this test, the absolute values for paw withdrawal thresholds may depend upon the surface on which the animal stands (28) or upon the duration of filament bending (3), but these factors do not affect the detection of the neuropathic allodynia.

The “cuff” model is of interest for the study of neuropathic pain mechanisms. It was used to study morphological changes in myelinated and unmyelinated fibers (**6, 29**), and functional changes in sensory neurons, primary afferents and spinal neurons (**19, 21, 22, 30, 31, 32, 33, 34, 35**). It allowed demonstrating that glial activation and a central shift in neuronal anion gradient participate to changes in the activity and the responses of spinal nociceptive neurons and to neuropathic allodynia (**24, 36, 37, 38**). The influences of glutamate receptors (**7, 39, 40, 41**), of opioid receptors (**16, 42, 43, 44, 45**) and of nicotinic receptors (**46**) were also studied in this model.

Another interest of the model is its response to actual treatments of neuropathic pain, i.e. gabapentinoids and antidepressants. Similar to clinical observations: gabapentinoids display both an acute short-lasting analgesic action at high dose and a delayed sustained relieving action that appears after 2-4 days of treatment, tricyclic antidepressants and selective serotonin and noradrenaline reuptake inhibitors have no acute analgesic effect at relevant dose but display a delayed sustained relieving action that requires 1-2 weeks of treatment, and the selective serotonin reuptake inhibitor fluoxetine is ineffective (**16**). The model is thus appropriate to study the molecular mechanism underlying these treatments (**16, 17, 18, 44, 45, 47**), which may reveal new therapeutic targets to test in patients (**48, 49, 50, 51**).

Last, the model also allows studying the anxiodepressive consequences of neuropathic pain. Clinically, these consequences affect around a third of neuropathic pain patients but are preclinically less studied than the sensory aspects of pain. In this model, a time-dependent development of anxiety-like and depressive-like phenotypes is present (**52**) and the related mechanism can thus be addressed.

The standardized cuffs and procedures in this mouse model of neuropathic pain result in low interindividual variability for the mechanical allodynia. The possibility to use genetically modified animals (**17, 18, 44, 45, 46, 47, 52**), the long-lasting allodynia, the response to clinically used treatments and the time-dependent development of anxiodepressive symptoms make this model appropriate for the study of the various

aspects and consequences of neuropathic pain and its treatments, which already brought valuable information to this field of research.

Acknowledgements: This work was supported by the Centre National de la Recherche Scientifique (contract UPR3212), the University of Strasbourg and by a NARSAD Young Investigator Grant from the Brain & Behavior Research Foundation.

Disclosures: The authors declare that they have no competing financial interests.

References:

1. Colleoni, M. & Sacerdote, P. Murine models of human neuropathic pain. *Biochim. Biophys. Acta.* **1802**, 924-933 (2010).
2. Jaggi, A.S., Jain, V., & Singh, N. Animal models of neuropathic pain. *Fundam. Clin. Pharmacol.* **25**, 1-28 (2011).
3. Barrot, M. Tests and models of nociception and pain in rodents. *Neuroscience.* **211**, 39-50 (2012).
4. Bennett, G.J. & Xie, Y.K. A peripheral mononeuropathy in rat that produces disorders of pain sensation like those seen in man. *Pain.* **33**, 87-107 (1988).
5. Austin, P.J., Wu, A., & Moalem-Taylor, G. Chronic constriction of the sciatic nerve and pain hypersensitivity testing in rats. *J. Vis. Exp.* **13**, 61 (2012).
6. Mosconi, T. & Kruger, L. Fixed-diameter polyethylene cuffs applied to the rat sciatic nerve induce a painful neuropathy: ultrastructural morphometric analysis of axonal alterations. *Pain.* **64**, 37-57 (1996).
7. Fisher, K., Fundytus, M.E., Cahill, C.M., &Coderre, T.J. Intrathecal administration of the mGluR compound, (S)-4CPG, attenuates hyperalgesia and allodynia associated with sciatic nerve constriction injury in rats. *Pain.* **77**, 59-66 (1998).
8. Pitcher, G.M., Ritchie, J., & Henry, J.L. Nerve constriction in the rat: model of neuropathic, surgical and central pain. *Pain.* **83**, 37-46 (1999).
9. Benbouzid, M., et al. Sciatic nerve cuffing in mice: a model of sustained neuropathic pain. *Eur. J. Pain.* **12**, 591-599 (2008).
10. Seltzer, Z., Dubner, R., & Shir, Y. A novel behavioral model of neuropathic pain disorders produced in rats by partial sciatic nerve injury. *Pain.* **43**, 205-218 (1990).

11. Kim, S.H. & Chung, J.M. An experimental model for peripheral neuropathy produced by segmental spinal nerve ligation in the rat. *Pain*. **50**, 355-363 (1992).
12. Vadakkan, K.I., Jia, Y.H., & Zhuo, M. A behavioral model of neuropathic pain induced by ligation of the common peroneal nerve in mice. *J. Pain*. **6**, 747-756 (2005).
13. Decosterd, I. & Woolf, C.J. Spared nerve injury: an animal model of persistent peripheral neuropathic pain. *Pain*. **87**, 149-158 (2000).
14. Shields, S.D., Eckert, W.A., & Basbaum, A.I. Spared nerve injury model of neuropathic pain in the mouse: a behavioral and anatomic analysis. *J. Pain*. **4**, 465-470 (2003).
15. Richner, M., Bjerrum, O.J., Nykjaer, A., & Vaegter, C.B. The spared nerve injury (SNI) model of induced mechanical allodynia in mice. *J. Vis. Exp.* **18**, 54 (2011).
16. Benbouzid, M., *et al.* Chronic, but not acute, tricyclic antidepressant treatment alleviates neuropathic allodynia after sciatic nerve cuffing in mice. *Eur. J. Pain*. **12**, 1008-1017 (2008).
17. Yalcin, I., *et al.* β 2-adrenoceptors are essential for desipramine, venlafaxine or reboxetine action in neuropathic pain. *Neurobiol. Dis.* **33**, 386-394 (2009).
18. Yalcin, I., *et al.* β 2-adrenoceptors are critical for antidepressant treatment of neuropathic pain. *Ann. Neurol.* **65**, 218-225 (2009).
19. Balasubramanyan, S., Stenkowski, P.L., Stebbing, M.J., & Smith, P.A. Sciatic chronic constriction injury produces cell-type-specific changes in the electrophysiological properties of rat substantia gelatinosa neurons. *J. Neurophysiol.* **96**, 579-590 (2006).
20. Ikeda, T., *et al.* Effects of intrathecal administration of newer antidepressants on mechanical allodynia in rat models of neuropathic pain. *Neurosci. Res.* **63**, 42-46 (2009).
21. Thakor, D.K., *et al.* Increased peripheral nerve excitability and local NaV1.8 mRNA up-regulation in painful neuropathy. *Mol. Pain*. **5**, 14 (2009).
22. Zhu, Y.F., Wu, Q., & Henry, J.L. Changes in functional properties of A-type but not C-type sensory neurons in vivo in a rat model of peripheral neuropathy. *J. Pain Res.* **5**, 175-192 (2012).
23. Cheng, H.Y., *et al.* DREAM is a critical repressor for pain modulation. *Cell*. **108**, 31-43 (2002).

24. Zhang, J. & De Koninck, Y. Spatial and temporal relationship between monocyte chemoattractant protein-1 expression and spinal glial activation following peripheral nerve injury. *J. Neurochem.* **97**, 772-783 (2006).
25. Beggs, S., Liu, X.J., Kwan, C., & Salter, M.W. Peripheral nerve injury and TRPV1-expressing primary afferent C-fibers cause opening of the blood-brain barrier. *Mol. Pain.* **6**, 74 (2010).
26. Vachon, P., Massé, R., & Gibbs, B.F. Substance P and neurotensin are up-regulated in the lumbar spinal cord of animals with neuropathic pain. *Can. J. Vet. Res.* **69**, 86-92 (2004).
27. Aouad, M., Petit-Demoulière, N., Goumon, Y., & Poisbeau, P. Etifoxine stimulates allopregnanolone synthesis in the spinal cord to produce analgesia in experimental mononeuropathy. *Eur. J. Pain.* In Press, (2013).
28. Pitcher, G.M., Ritchie, J., & Henry, J.L. Paw withdrawal threshold in the von Frey hair test is influenced by the surface on which the rat stands. *J. Neurosci. Meth.* **87**, 185-193.
29. Beaudry, F., Girard, C., & Vachon, P. Early dexamethasone treatment after implantation of a sciatic-nerve cuff decreases the concentration of substance P in the lumbar spinal cord of rats with neuropathic pain. *Can. J. Vet. Res.* **71**, 90-97 (2007).
30. Pitcher, G.M. & Henry, J.L. Cellular mechanisms of hyperalgesia and spontaneous pain in a spinalized rat model of peripheral neuropathy: changes in myelinated afferent inputs implicated. *Eur. J. Neurosci.* **12**, 2006-2020 (2000).
31. Pitcher, G.M. & Henry, J.L. Nociceptive response to innocuous mechanical stimulation is mediated via myelinated afferents and NK-1 receptor activation in a rat model of neuropathic pain. *Exp. Neurol.* **186**, 173-197 (2004).
32. Pitcher, G.M. & Henry, J.L. Governing role of primary afferent drive in increased excitation of spinal nociceptive neurons in a model of sciatic neuropathy. *Exp. Neurol.* **214**, 219-228 (2008).
33. Lu, V.S., *et al.* Brain-derived neurotrophic factor drives the changes in excitatory synaptic transmission in the rat superficial dorsal horn that follow sciatic nerve injury. *J. Physiol.* **587**, 1013-1032 (2009).
34. Ruangsri, S., Lin, A., Mulpuri, Y., Lee, K., Spigelman, I., & Nishimura, I. Relationship of axonal voltage-gated sodium channel 1.8 (Nav1.8) mRNA accumulation to

- sciatic nerve injury-induced painful neuropathy in rats. *J. Biol. Chem.* **286**, 39836-39847 (2011).
35. Zhu, Y.F. & Henry, J.L. Excitability of A β sensory neurons is altered in an animal model of peripheral neuropathy. *BMC Neurosci.* **30**, 13:15 (2012).
 36. Coull, J.A., *et al.* Trans-synaptic shift in anion gradient in spinal lamina I neurons as a mechanism of neuropathic pain. *Nature.* **424**, 938-942 (2003).
 37. Coull, J.A., *et al.* BDNF from microglia causes the shift in neuronal anion gradient underlying neuropathic pain. *Nature.* **438**, 1017-1021 (2005).
 38. Keller, A.F., Beggs, S., Salter, M.W., & De Koninck, Y. Transformation of the output of spinal lamina I neurons after nerve injury and microglia stimulation underlying neuropathic pain. *Mol. Pain.* **3**, 27 (2007).
 39. Fundytus, M.E., Fisher, K., Dray, A., Henry, J.L., &Coderre, T.J. In vivo antinociceptive activity of anti-rat mGluR1 and mGluR5 antibodies in rats. *Neuroreport.* **9**, 731-735 (1998).
 40. Fundytus, M.E., *et al.* Knockdown of spinal metabotropic glutamate receptor 1 (mGluR(1)) alleviates pain and restores opioid efficacy after nerve injury in rats. *Br. J. Pharmacol.* **132**, 354-367 (2001).
 41. Coderre, T.J., Kumar, N., Lefebvre, C.D., & Yu, J.S. Evidence that gabapentin reduces neuropathic pain by inhibiting the spinal release of glutamate. *J. Neurochem.* **94**, 1131-1139 (2005).
 42. Kabli, N. & Cahill, C.M. Anti-allodynic effects of peripheral delta opioid receptors in neuropathic pain. *Pain.* **127**, 84-93 (2007).
 43. Holdridge, S.V. & Cahill, C.M. Spinal administration of a delta opioid receptor agonist attenuates hyperalgesia and allodynia in a rat model of neuropathic pain. *Eur. J. Pain.* **11**, 685-693 (2007).
 44. Benbouzid, M., *et al.* δ -opioid receptors are critical for tricyclic antidepressant treatment of neuropathic allodynia. *Biol. Psychiatry.* **63**, 633-636 (2008).
 45. Bohren, Y., *et al.* μ -opioid receptors are not necessary for nortriptyline treatment of neuropathic allodynia. *Eur. J. Pain.* **14**, 700-704 (2010).
 46. Yalcin, I., *et al.* Nociceptive thresholds are controlled through spinal β 2-subunit-containing nicotinic acetylcholine receptors. *Pain.* **152**, 2131-2137 (2011).
 47. Bohren, Y., *et al.* Antidepressants suppress neuropathic pain by a peripheral β 2-adrenoceptor mediated anti-TNF α mechanism. *Neurobiol. Dis.* In Press, (2013).

48. Choucair-Jaafar, N., Yalcin, I., Rodeau, J.L., Waltisperger, E., Freund-Mercier, M.J., & Barrot, M. β 2-adrenoceptor agonists alleviate neuropathic allodynia in mice after chronic treatment. *Br. J. Pharmacol.* **158**, 1683-1694 (2009).
49. Yalcin, I., *et al.* Chronic treatment with agonists of β 2-adrenergic receptors in neuropathic pain. *Exp. Neurol.* **221**, 115-121 (2010).
50. Cok, O.Y., Eker, H.E., Yalcin, I., Barrot, M., & Aribogan, A. Is there a place for β -mimetics in clinical management of neuropathic pain? Salbutamol therapy in six cases *Anesthesiology.* **112**, 1276-1279 (2010).
51. Choucair-Jaafar, N., *et al.* Cardiovascular effects of chronic treatment with a β 2-adrenoceptor agonist relieving neuropathic pain in mice. *Neuropharmacology.* **61**, 51-60 (2011).
52. Yalcin, I., *et al.* A time-dependent history of mood disorders in a murine model of neuropathic pain. *Biol. Psychiatry.* **70**, 946-953 (2011).

II. The anterior cingulate cortex is a critical hub for pain-induced depression.

Florent Barthas, Jim Sellmeijer, Sylvain Hugel, Michel Barrot, Ipek Yalcin

Nous avons décrit dans la section précédente le modèle de douleur neuropathique utilisé et les troubles sensoriels qui s'y développent. Une étude réalisée dans l'équipe a permis de caractériser l'apparition de comportements de type anxieux puis dépressifs à partir de quatre semaines après la chirurgie induisant la neuropathie (Yalcin et al., 2011). Ainsi, nous avons à notre disposition un modèle pertinent pour l'étude des conséquences anxiodépressives de la douleur neuropathique et pouvons désormais chercher à élucider les causes biologiques de ces comorbidités. Nous avons basé notre stratégie sur la recherche de structures cérébrales impliquées dans les voies de la douleur et dans les processus émotionnels. Les cibles sur lesquelles nous avons porté notre choix sont l'ACC et le pIC.

Pour contrôler le rôle de ces régions, nous avons procédé à leur lésions par injections localisées d'acide iboténique chez la souris. Cette toxine, du fait de ses propriétés excitotoxiques provoque une mort neuronale. Nous avons suivi dans un premier temps le développement de l'allodynie mécanique grâce au test des filaments de von Frey. Nous avons constaté que seule la lésion du pIC prévient le maintien de l'allodynie mécanique, impliquant cette structure dans la composante somatosensorielle de la douleur. Puis nous avons regardé l'effet des lésions corticales sur la composante aversive de la douleur par le test de préférence de place conditionnée. Dans cette expérience, seule la lésion de l'ACC inhibe cet aspect de la douleur. Enfin, nous avons étudié le développement de comportements anxiodépressifs grâce aux tests d'hyponéophagie, de toilettage provoqué et de nage forcée. La lésion de l'ACC mais pas du pIC prévient l'apparition ces comportements. Ces expériences de lésion ont mis en évidence le rôle du pIC dans la composante sensorielle de la douleur neuropathique, et celui de l'ACC dans la composante aversive et les conséquences anxiodépressives de cette douleur. Pour confirmer le rôle causal de l'ACC dans l'apparition des comportements anxiodépressifs, nous avons stimulé de manière répétée l'ACC de souris exprimant un canal cationique channelrhodopsine-2 activable par la lumière bleue par une

méthode d'optogénétique. Ces animaux ont développé des comportements anxiodépressifs confirmant le rôle important de l'ACC dans ces comportements.

Mon rôle dans ce travail a été de participer au choix des structures analysées, au design des expériences, de réaliser la chirurgie stéréotaxique induisant les lésions corticales, de participer à celle induisant la neuropathie, de tester et de suivre le développement des comportements douloureux et anxiodépressifs, de perfuser les animaux, d'effectuer le contrôle histologique des lésions (coupes des cerveaux, immunohistochimie, vérification de l'emplacement des lésions), de récolter et d'analyser les données, de réaliser les figures et de participer à l'écriture de l'article.

The Anterior Cingulate Cortex is a Critical Hub for Pain-Induced Depression

Florent Barthas, Jim Sellmeijer, Sylvain Hugel, Michel Barrot, and Ipek Yalcin

Key words: Anterior cingulate cortex, depression, anxiety, insular cortex, neuropathic pain, behavior, optogenetic

Abstract

Background: Besides chronic stress, chronic pain is among the prevalent determinant for depression. The alterations induced in specific brain regions by sustained pain may alter the processing of affective information, thus resulting in anxiodepressive disorders. Here, we compared the role of the anterior cingulate (ACC) and posterior insular (pIC) cortices in the anxiodepressive, sensory and affective aspects of chronic pain in mice.

Methods: Neuropathic pain was induced by inserting a cuff around the right common sciatic nerve. The lesion of the ACC and of the pIC were performed by local injection of ibotenic acid and the chronic activation of the ACC was performed by optogenetic stimulation. Anxiodepressive-related behaviors were evaluated by using novelty suppressed feeding, splash and forced swimming tests. The mechanical threshold was determined using von Frey filaments while the aversive component of spontaneous pain was evaluated by using place conditioning.

Results: The lesion of the ACC completely prevents the anxiodepressive consequences of chronic pain and the aversive aspect of spontaneous pain without affecting the sensory mechanical allodynia. Conversely, the aversive component and the anxiodepressive consequences of pain are still present after lesion of the pIC, even though the mechanical allodynia is suppressed. Furthermore, the optogenetic stimulation of the ACC is sufficient to provoke anxiety and depressive-like behavior in naïve animals.

Conclusions: Our results show that, at cortical level, the sensory component of chronic pain remains functionally segregated from its affective and anxiodepressive components. The ACC appears as a specific hub for the anxiodepressive consequences observed in chronic pain. The optogenetic study further supported the essential role of the ACC in mood disorders, thus constituting an important target for divulging the underlying mechanisms.

Introduction

Depression, the most common mental disorder, is a disabling and long-lasting medical condition, estimated to be the foremost contributor to the worldwide burden of disease by 2030 (WHO, 2008). Among several precipitating factors, chronic pain is a prevalent determinant for depression. Indeed, a mean prevalence rate of around 50% for major depressive disorder is reported in patients with chronic pain (Radat et al., 2013). The existence of pain-induced affective disorders is further supported by preclinical studies showing that chronic pain models can induce anxiety- and/or depression-like behaviors in animals in a time-dependent manner (Narita et al., 2006a; Yalcin et al., 2011; Alba-Delgado et al., 2013). While it could be suggested that chronic pain may be a chronic inescapable stress (Blackburn-Munro and Blackburn-Munro, 2001), preclinical and clinical studies have shown that sustained neuropathic pain strongly differs from a simple stress regarding neuroendocrine hypothalamo-pituitary-adrenal (HPA) alterations, even if it induces similar behavioral consequences. Indeed, neuropathic pain does not modify the basal or stress-induced levels of corticosterone or the HPA axis negative feed-back (Ulrich-Lai et al., 2006; Yalcin et al., 2011), while this is the case in the several models of stress induced-depression (Ibarguen-Vargas et al., 2008; McQuaid et al., 2013). Another hypothesis for pain-induced depression could be based on a shared neuroanatomical substrate, proposing that specific brain regions processing pain are also involved in mood-related processing, and that the alterations induced in these regions by long-term pain may alter the processing of affective information, thus resulting in mental disorders. Among the candidates, the anterior cingulate cortex (ACC) and the insular cortex (IC) appear to be critical in the networks involved in the building of both pain and mood (Vogt, 2005; Shackman et al., 2011; Bushnell et al., 2013).

The ACC is a relay that interconnects neurons from the frontal cortex, thalamus and amygdala, integrating cognitive, emotional and autonomic functions (Vogt, 2005; Shackman et al., 2011). Clinical imaging studies have shown the recruitment of the ACC in pain processing (Rainville et al., 1997), and preclinical studies have more precisely associated the activation of the ACC neurons with pain-like aversive behavior, while the inhibition of these neurons blocks such behavior (Johansen et al., 2001). The IC is another cortical area of interest since both human

and animal studies have shown its recruitment in acute and chronic pain (Greenspan and Winfield, 1992; Benison et al., 2011; Isnard et al., 2011). The complexity of IC connectivity and the variability of pain-related activity between different IC subregions suggest that this cortical area may play a multifaceted role in pain processing. For example, some studies have reported a preferential pain activation of the posterior IC (pIC) (Alkire et al., 2004), whereas others have also described it in the mid-insula (Treede et al., 2000) or in the operculoinsular area (Greenspan and Winfield, 1992; Mazzola et al., 2012b). The activation of the IC has been implicated in both antinociceptive and pronociceptive processes (Treede et al., 2000) while its role in the aversive component of pain is still unclear.

Despite the lack of direct evidence, the ACC and the IC could also play a role in the anxiodepressive consequences of chronic pain. Indeed, both cortices are known to display functional and morphological alterations in depressive states (Pizzagalli, 2011; Mutschler et al., 2012; Sliz and Hayley, 2012), such as the observation of decreased connectivity (Matthews et al., 2008), altered glucose metabolism (Drevets, 2001) and reduced volume (Drevets et al., 1998) in the ACC of depressed patients and also altered basal neuronal resting state activity in the IC (Sliz and Hayley, 2012). Studies showing the alleviation of depressive symptoms in treatment-resistant patients by ablative surgery (Shields et al., 2008) or deep brain stimulation (Lipsman et al., 2013) of the ACC further support the implication of this region in major depression. However, these data come from the psychiatric field and the involvement of these regions in the affective consequences of chronic pain has not yet been studied.

Although clinical and preclinical studies strongly suggest a role of the ACC and the IC in pain processing, respective functions of these cortical areas in the anxiodepressive consequences as well as in the sensory and affective components of chronic pain remain unknown. Using a lesional approach in a murine model of neuropathic pain, we demonstrate that the ACC is critical in both the anxiodepressive and aversive aspects of chronic pain, while conversely the pIC is only critical in mechanical allodynia. The optogenetic study showing that the sub-chronic stimulation of the ACC induces anxiodepressive behavior in naïve animals further reinforce the essential role of this region in mood disorders.

Methods and Materials

Animals

All the lesion experiments were conducted in male C57BL/6J mice (Charles River, L'Arbresle, France). Genetically modified mice expressing channelrhodopsin-2 and yellow fluorescent protein (Thy1-ChR2-YFP) in a subset of pyramidal neurons were used (Chaumont et al., 2013) for optogenetic studies. They were produced onsite from breeders provided by Jackson Laboratory. Experiments started with 8 to 12 week-old mice, group-housed five per cage and kept under a 12-hour light/dark cycle with food and water available ad libitum. For optogenetic studies only, mice were separated after the cannula implantation to avoid possible damage to the implant. Animal facilities are registered for animal experimentation (Agreement C67-482-1). The protocols were approved by the local ethical committee of the University of Strasbourg (CREMEAS, n°AL-04).

Excitotoxic Lesion

Animals were anesthetized with an intraperitoneal injection of sodium pentobarbital (63 mg/kg, 0.035 ml) and installed on a stereotaxic apparatus (Kopf). Either ibotenic acid (56.7 mM, Biotrend, Köln, Germany) or PBS (1X, Euromedex, Souffelweyersheim, France) was bilaterally injected to the ACC (0.3 μ l; anteroposterior: + 0.7 mm from bregma, lateral: \pm 0.3 mm, dorsoventral: -1.7 mm from the skull) or to the pIC (0.2 μ l; anteroposterior: + 0.2 mm, lateral: \pm 3.8 mm, dorsoventral: - 4 mm) using a 5 μ l Hamilton syringe (0.1 μ l/minute). The needle remained in place for a further 5 minutes before removal. Following surgery, animals were left undisturbed for one week before peripheral nerve injury.

Neuropathic Pain Model

Chronic neuropathic pain was induced by placing a cuff around the right common sciatic nerve (Yalcin et al., 2011). Before surgery, mice were assigned to experimental groups so that these groups did not initially differ for the mechanical nociceptive threshold or for body-weight. Surgery was performed under ketamine/xylazine anesthesia (ketamine 17 mg/ml, xylazine 2.5 mg/ml;

intraperitoneal i.p., 4 ml/kg) (Centravet, Taden, France). The common branch of the right sciatic nerve was exposed and a 2 mm section of split PE-20 polyethylene tubing (Harvard Apparatus, Les Ulis, France) was placed around it for the Cuff group. The Sham group underwent the same procedure without cuff implantation.

Nociceptive Tests

The mechanical threshold of hindpaw withdrawal was evaluated using von Frey hairs (Bioseb, Chaville, France) (Yalcin et al., 2011). Mice were placed in clear Plexiglas® boxes (7 x 9 x 7 cm) on an elevated mesh screen and allowed to habituate for 15 minutes before testing. Filaments were applied to the plantar surface of each hindpaw in a series of ascending forces (0.16 to 8 grams). Each filament was tested five times per paw, being applied until it just bent, and the threshold was defined as 3 or more withdrawals observed out of the 5 trials. All animals were tested before and after the lesion and every week after the neuropathic pain induction. The latency for hindpaw withdrawal in response to thermal stimulation was determined using the Hargreaves method (Hargreaves et al., 1988). Mice were placed in clear Plexiglas boxes (mice: 7 cm × 9 cm × 7 cm) on a glass surface, and were allowed to habituate for 15 minutes before testing. The infrared beam of the radiant heat source (7370 Plantar Test; Ugo Basile, Comerio, Italy) was applied to the plantar surface of each hind paw. The cutoff to prevent damage to the skin was set at 15 seconds. Paw withdrawal latency were measured twice for each hind paw. All animals were tested 12 days and 46 days after the neuropathic pain induction.

Place Conditioning

All experiments were conducted by using the single trial conditioned place preference (CPP) protocol as described previously for rats (King et al., 2009). The apparatus (Imetronic, Pessac, France) consists of 3 Plexiglas chambers separated by manually operated doors. Two chambers (size 15 cm x 24 cm x 33 cm) distinguished by the texture of the floor and by the wall patterns are connected by a central chamber (size 15 cm x 11 cm x 33 cm). Eight to ten weeks after the Cuff/Sham surgery, mice went through a 3-day pre-conditioning period with full access to all chambers for 30 minutes each day. Time spent in each chamber was analyzed to

Novelty suppressed feeding test

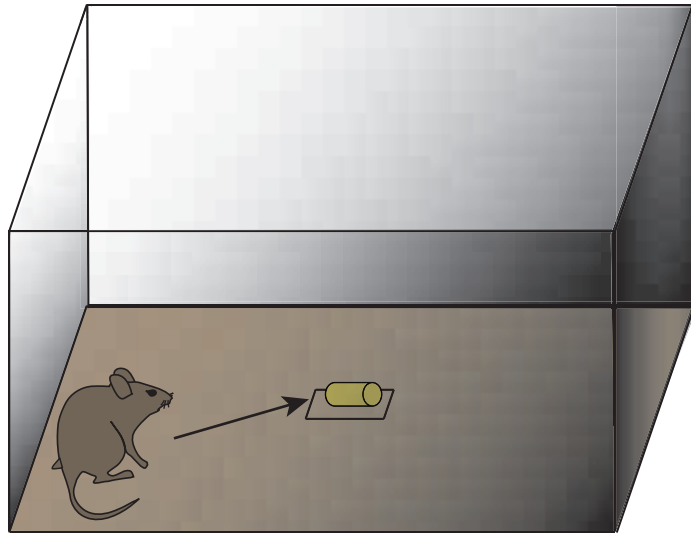

Figure 1. The testing apparatus consisted of a 40 x 40 x 30cm plastic box with the floor covered with 2 cm of sawdust. Twenty-four hours before the test, food was removed from the home cage. At the time of testing, a single pellet of food was placed on a paper in the center of the box. An animal was then placed in a corner of the box and latency to first contact or to eat the pellet were recorded within a 5-min period. This test induces a conflict between the drive to eat the pellet and the fear of venturing in the center of the box.

control for the lack of spontaneous preference for one of the compartments. Animals spending more than 75% or less than 25% of the total time in one of the lateral chambers were removed from the study. On the conditioning day (day 4), mice first received intrathecal saline (10 μ l) and were placed in a conditioning chamber. Four hours later, mice received intrathecal clonidine (10 μ g/ 10 μ l) and were placed in the opposite chamber. Clonidine, an α 2-adrenoceptor agonist, induces analgesia after intrathecal administration. Conditioning sessions lasted 15 minutes each, without access to the other chambers. On the test day (day 5, 20 hours after the last afternoon session), mice were placed in the center chamber with free access to all chambers and the time spent in each chamber was recorded for 30 minutes. CPP results from combined spontaneous pain-induced aversion to the unpaired side and spontaneous pain relief-induced reward in the clonidine paired side.

Locomotor Activity

Five to six weeks after induction of neuropathic pain, locomotor activity was monitored for both Sham and neuropathic mice. Mice were individually placed in activity cages (32 x 20 cm floor area, 15 cm high) with 7 photocell beams. The number of beam breaks was recorded over 4 hours.

Anxiodepressive-Related Behavior

Behavioral testing was performed during the dark phase, under red light. While each mouse went through different tests, these were conducted according to the following rules: 1) at least one week separated 2 tests done on the same animal; 2) no mouse went through the same test twice; 3) the forced swimming test was always considered as terminal (i.e. no other test was done on mice after they went through forced swimming). Body weights were measured weekly.

Novelty Suppressed Feeding (NSF) Test. The testing apparatus consisted of a 40 x 40 x 30 cm plastic box with the floor covered with 2 cm of sawdust (**Figure 1**). Twenty four hours prior to the test, food was removed from the home cage. At the time of testing, a single pellet of food was placed on a paper in the center of the

Splash test

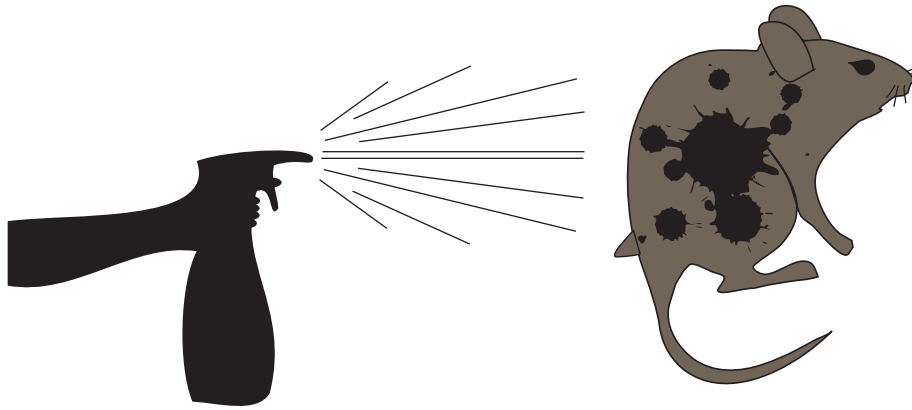

Figure 2. The frequency and latency of the grooming behavior were scored during 5 min after spraying a 10% sucrose solution on the dorsal coat of the mice.

box. An animal was then placed in a corner of the box and the latency to eat the pellet was recorded within a 5 minute period. This test induces a conflict between the drive to eat the pellet and the fear of venturing into the center of the box (Santarelli et al., 2003). The test was conducted 6 weeks after the peripheral nerve injury for the lesion study and one day after the last stimulation for the optogenetic study.

Splash Test. This test, based on grooming behavior, was performed as previously described (Santarelli et al., 2003; Yalcin et al., 2011) (**Figure 2**). The frequency and duration of grooming behavior were scored during 5 minutes after spraying a 10% sucrose solution on the dorsal coat of the mice. Grooming is an important aspect of rodent behavior and decreased grooming in this test may be related to the loss of interest in performing self-oriented minor tasks (Yalcin et al., 2008). The test was performed 7 weeks after the peripheral nerve injury for the lesion study and four days after the last stimulation for the optogenetic study.

Forced Swimming Test (FST). FST (Porsolt et al., 1977) was conducted by gently lowering the mouse into a glass cylinder (height 17.5 cm, diameter 12.5 cm) containing 11.5 cm of water (23-25°C) (**Figure 3**). Test duration was 6 minutes. The mouse was considered immobile when it floated in the water, in an upright position, and made only small movements to keep its head above water. Since little immobility was observed during the first 2 minutes, the duration of immobility was quantified over the last 4 minutes of the 6 minutes test. The test was done 8 weeks after the peripheral nerve injury.

Preparation of Acute Slices

9-12 weeks mice were killed by decapitation. The brain was removed and immediately immersed in cold (0–4 °C) sucrose-based artificial cerebrospinal fluid containing (in mM): 248 sucrose, 11 glucose, 26 NaHCO₃, 2 KCl, 1.25 KH₂PO₄, 2 CaCl₂ and 1.3 MgSO₄ (bubbled with 95% O₂ and 5% CO₂). Transverse slices (400 μm thick) were performed with a vibratome (VT1000S, Leica, Nussloch, Germany). Slices were stored at room temperature in a chamber filled with artificial cerebrospinal fluid

Forced swimming test

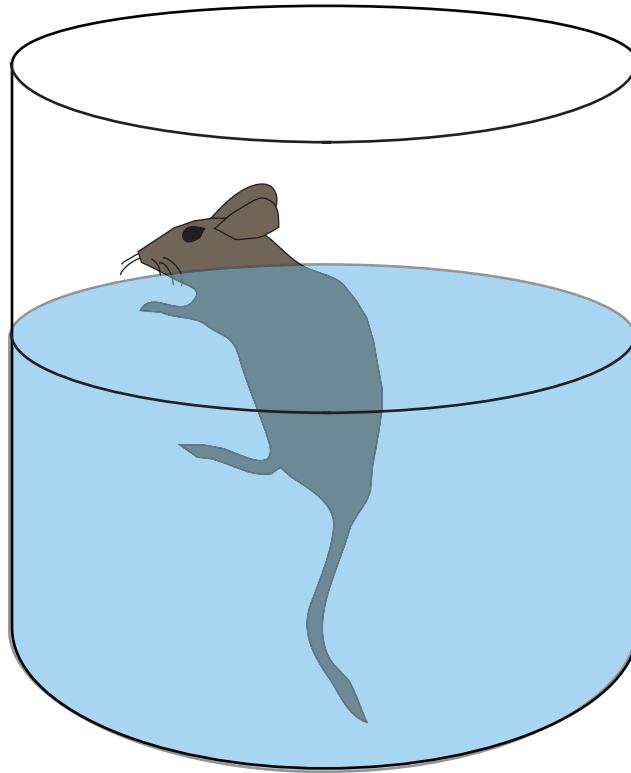

Figure 3. This test was done by gently lowering the mouse into a glass cylinder (height 17.5 cm, diameter 12.5 cm) containing 11.5 cm of water (23°–25°C). Test duration was 6 min. The mouse was considered immobile when it floated in an upright position and made only small movements to keep its head above water. Because little immobility was observed during the first 2 min, the duration of immobility was quantified over the last 4 min of the 6-min test.

containing (in mM): 126 NaCl, 26 NaHCO₃, 2.5 KCl, 1.25 NaH₂PO₄, 2 CaCl₂, 2 MgCl₂ and 10 glucose (bubbled with 95% O₂ and 5% CO₂; pH 7.3; 310 mOsm measured).

Electrophysiological Recordings

Slices were transferred to a recording chamber and continuously superfused with oxygenated artificial cerebrospinal fluid. Pyramidal ACC neurons were recorded in the whole-cell configuration. Patch pipettes were pulled from borosilicate glass capillaries (Harvard Apparatus, Edenbridge, UK) using a P-2000 puller (Sutter Instruments, Novato, CA, USA). They were filled with a solution containing the following (in mM): 145 KCl, 10 HEPES and 2 MgCl₂ (pH 7.3, adjusted with KOH; osmolarity 310 mOsm adjusted with sucrose) (3.5–4.5 MΩ). All recordings were performed in presence of CNQX (10 μM) and bicuculline (10 μM). Voltage-clamp and current-clamp recordings were performed with an Axopatch 200B amplifier (Molecular Devices, Union City, CA, USA) at a holding potential fixed at -60 mV or a holding current allowing maintaining the resting neuron around -60 mV. Recordings were acquired with WinWCP 4.3.5 (courtesy of Dr. J. Dempster, University of Strathclyde, Glasgow, United Kingdom). All recordings were performed at 34°C. The ACC was illuminated with the same system used for the in vivo experiments (see below) triggered with WinWCP 4.3.5, the optic fiber being localized in the recording chamber at 3 mm from the recorded neuron.

Optogenetic Cannula Implantation and light stimulation

Animals were anesthetized with a mixture of ketamine and xylazine (ketamine 17 mg/ml, xylazine 2.5 mg/ml, i.p. 4ml/kg) before being placed in a stereotaxic frame (Kopf). Single glass fiber canula's, 1.7 mm long with a diameter of 220 μm (MFC_220/250-0.66_1.7 mm_RM3_FLT, Doric lenses, Doric lenses) were implanted in the left ACC. Coordinates derived from Franklin and Paxinos (2008) were set to 0.7 mm anterior and 0.3 mm lateral (left side) from the Bregma. The fiber optic canula was lowered until 1.5 mm of fiber was inserted in the brain, covering the whole vertical span of the ACC. To fix the implant to the skull Paladur dental cement was used. After fixation with the cement, the skin flaps were sutured to cover the cement of the implant and provide additional support.

After a recovery period of 3-7 days the animals were stimulated with a blue light emitting diode (LED) with a peak wavelength of 463 nm (LEDFRJ-B_FC, Doric Lenses). From the LED, light traveled through the fiber optic patch cable (MFP_240/250/2000-0.63_0.75m_FC_CM3) to the implant canula. Light pulses were generated through an USB connected transistor-transistor logic pulse (TTL) generator (OPTG_4, Doric Lenses) connected to a LED driver (LEDRV_2CH v.2, Doric Lenses). TTLs were generated by open source software developed by Doric Lenses (USBTTL V1.9). Optical power was measured at the fiber tip using a photodetector (UNO, Gentec).

Optogenetic stimulation took place on 4 consecutive days for 30 minutes. Stimulated animals received repetitive stimulation sequences of 10 seconds consisting of: 8 seconds at 20 Hz with 40 msec pulses and 2 seconds without stimulation (Chaudhury et al., 2013). Light intensity was measured before implantation and was set between 4 and 5 mW. Control animals underwent the same implant procedures but instead the light was turned off during stimulation. Animals were tested on the novelty suppressed feeding test one day after the last stimulation day. Splash test was performed the fourth day after the final stimulation.

Immunohistochemistry

For the lesion study, after the behavioral testing, the animals were perfused under deep sodium pentobarbital anesthesia (273.5 mg/kg; 0.15 ml) with 10 ml phosphate buffer (PB, 0.1 M, pH 7.4) followed by 100 mL of a paraformaldehyde solution (4% in phosphate buffer). Brains were removed and post-fixed overnight in the same fixative. Frontal sectioning of the brain (40 μ m) was performed on a vibratome (Leica, Rueil-Malmaison, France). For NeuN immunostaining, sections were washed in PBS (3 x 10 minutes), incubated 15 minutes in a 1% H₂O₂ / 50% ethanol solution, washed in PBS (3 x 10 minutes) and pre-incubated in PBS containing Triton X-100 (0.3%) and 5% donkey serum for 45 minutes. Sections were then incubated overnight at room temperature in PBS containing Triton X-100 (0.3%), 1% donkey serum and a mouse anti-NeuN primary antibody (1:50000; Millipore, MAB377, Molsheim, France). Sections were then washed in PBS (3 x 10 minutes), incubated with a biotinylated horse anti-mouse secondary antibody (1:200 in PBS containing Triton X-100, 1% donkey serum) for 1h30, washed in PBS (3 x 10 minutes) and

incubated with PBS containing the avidin-biotin-peroxidase complex (ABC kit; 0.2% A and 0.2% B; Vector laboratories) for 1h30. After being washed in Tris-HCl buffer, sections were incubated in 3,3'diaminobenzidine tetrahydrochloride (DAB) and H₂O₂ in Tris-HCl for approximately 4 minutes and washed again. Sections were serially mounted on gelatine-coated slides, air dried, dehydrated in graded alcohols, cleared in Roti-Histol (Carl Roth, Karlsruhe, Germany) and coverslipped with Eukitt. Lesions were indicated by neuronal cell loss localized bilaterally and extended from 1.18 to 0.14 mm from the bregma for ACC lesion and from 0.38 to -1.22 mm from the bregma for pIC lesion.

Concerning the optogenetic study, after the completion of the behavioral tests the animals were stimulated once with the same procedure as described before. 90 minutes later the animals were perfused and c-Fos immunohistochemistry was performed. This was done to check the implant location and the presence of c-Fos, a biomarker for neuronal activity. For c-Fos immunostaining, the procedure used was the same as that described for NeuN immunostaining. The primary antibody was a rabbit anti-c-Fos (1:10000; Santa Cruz Biotechnology E1008) and a biotinylated donkey anti-rabbit secondary antibody (1:300 in PBS containing Triton X-100, 1% donkey serum). Animals having c-Fos staining outside of the ACC, for instance in the motor cortex, were excluded from analysis.

Analysis and Illustrations

Coded slides were used to analyze the extent of the lesions of the ACC and the pIC. Blind verification was done using a Nikon Eclipse 80i microscope with the Neurolucida® 8.0 software (MicrobrightField, Williston, VT, USA). 3D reconstructions of ACC and pIC lesions were done using Neurolucida® 8.0 software. Pictures were taken with a Nikon E80i microscope. Adobe Photoshop CS5 was used to adjust contrast, brightness and sharpness.

Statistical Analysis

Data are expressed as mean \pm SEM. Statistical analyses were performed using multi-factor analysis of variance (ANOVA) with independent or repeated measures. In case of significant effect following ANOVA, multiple group comparisons were

performed with Duncan post-hoc analysis. Significance level was set at $p < .05$. All the analysis was performed with STATISTICA 7.1 (Statsoft, Tulsa, OK, USA).

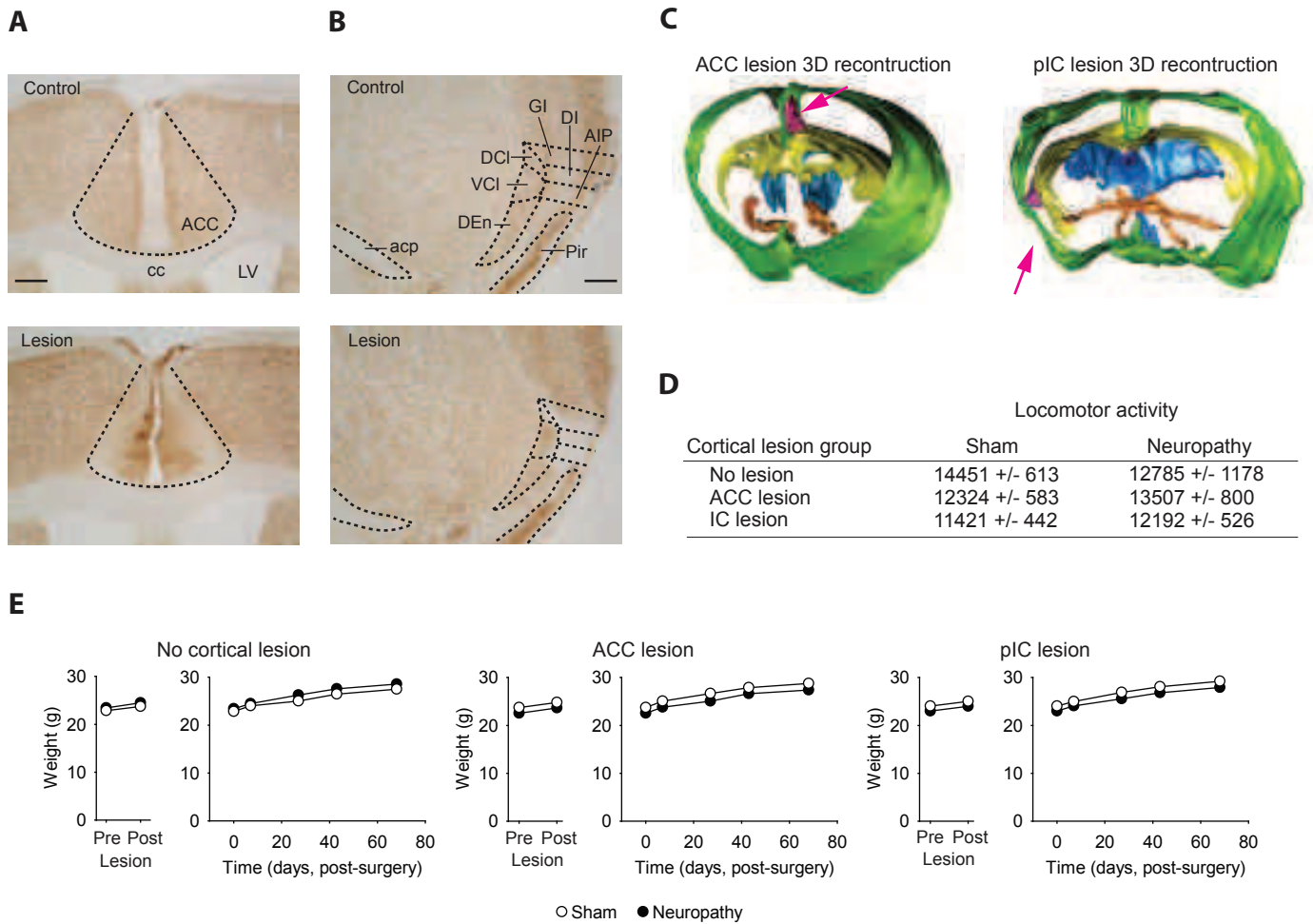

Figure 4. Illustrations of the anterior cingulate cortex (ACC) and the posterior insular cortex (pIC) lesions and their effects on locomotor activity and body weight. (A) Representative examples of NeuN immunohistochemistry of the ACC lesion or non-lesioned control section at the same level. (B) Representative examples of NeuN immunohistochemistry of the pIC lesion or non-lesioned control section at the same level; scale bar = 300 μ m. (C) 3D reconstructions of representative ACC and pIC lesions, borders of the brain are colored in green, corpus callosum and external capsule in yellow, anterior commissure and fornix in orange, lateral and third ventricles in blue and the lesions of the ACC and the pIC in magenta. (D) The lesion of the ACC and the pIC did not affect the general locomotor activity. (E) Neither the lesion of the ACC nor the pIC has an effect on the weight gain. Data are expressed as mean \pm SEM.

Results

Excitotoxic Lesions of the ACC or the pIC

To concurrently analyze the role of the ACC and the pIC in the consequences of chronic pain, we used a murine model of chronic neuropathic pain (Yalcin et al., 2011) and performed localized excitotoxic lesions of these cortices with ibotenic acid. NeuN immunostaining allowed visualization of the extent of the lesions at the end of the experiments (**Figure 4A-C**). To control whether the behavioral phenotypes were independent from possible activity deficits, the spontaneous locomotor activity was evaluated. We observed no difference between control and neuropathic animals and no influence of the lesion on spontaneous activity (**Figure 4D**) nor on body weight (**Figure 4E**).

The pIC but not the ACC is Necessary for the Somatosensory Component of Chronic Pain

In the neuropathic pain model, we observed decreased mechanical sensitivity thresholds, referred to as mechanical allodynia, by using von Frey filaments ($F_{14,434} = 7.41$, $p < .001$, **Figure 5A**). Current preclinical data suggest different influences of the ACC and the IC (Johansen et al., 2001; Benison et al., 2011) in neuropathic mechanical allodynia. In accordance with this prediction, we found that while the lesion of the ACC did not affect mechanical allodynia ($F_{8,160} = 4.79$, $p < .001$, **Figure 5B**), the lesion of the pIC completely suppressed its long-term development ($F_{14,420} = 9.25$, $p < .001$, **Figure 5C**). More precisely, the early postsurgical allodynia remained present in the pIC lesioned mice during the first two weeks after sciatic nerve surgery, whereas the long term allodynia reflecting the chronicity of this symptom was abolished. The pIC is thus a core substrate of long-term allodynia in chronic neuropathic pain. Human studies also support these results, showing that IC subdivisions are activated by mechanical allodynia in neuropathic pain (Peyron et al., 2013). Clinical studies showed that the IC lesion may modify nociceptive sensitivity in humans, but these studies remain difficult to interpret due to the interindividual variability in the extent of the lesion (Greenspan and Winfield, 1992; Starr et al., 2009). Interestingly, our results show that neither the lesion of the ACC nor the pIC altered the mechanical thresholds *per se* in control animals (**Figure 5B,C**). This

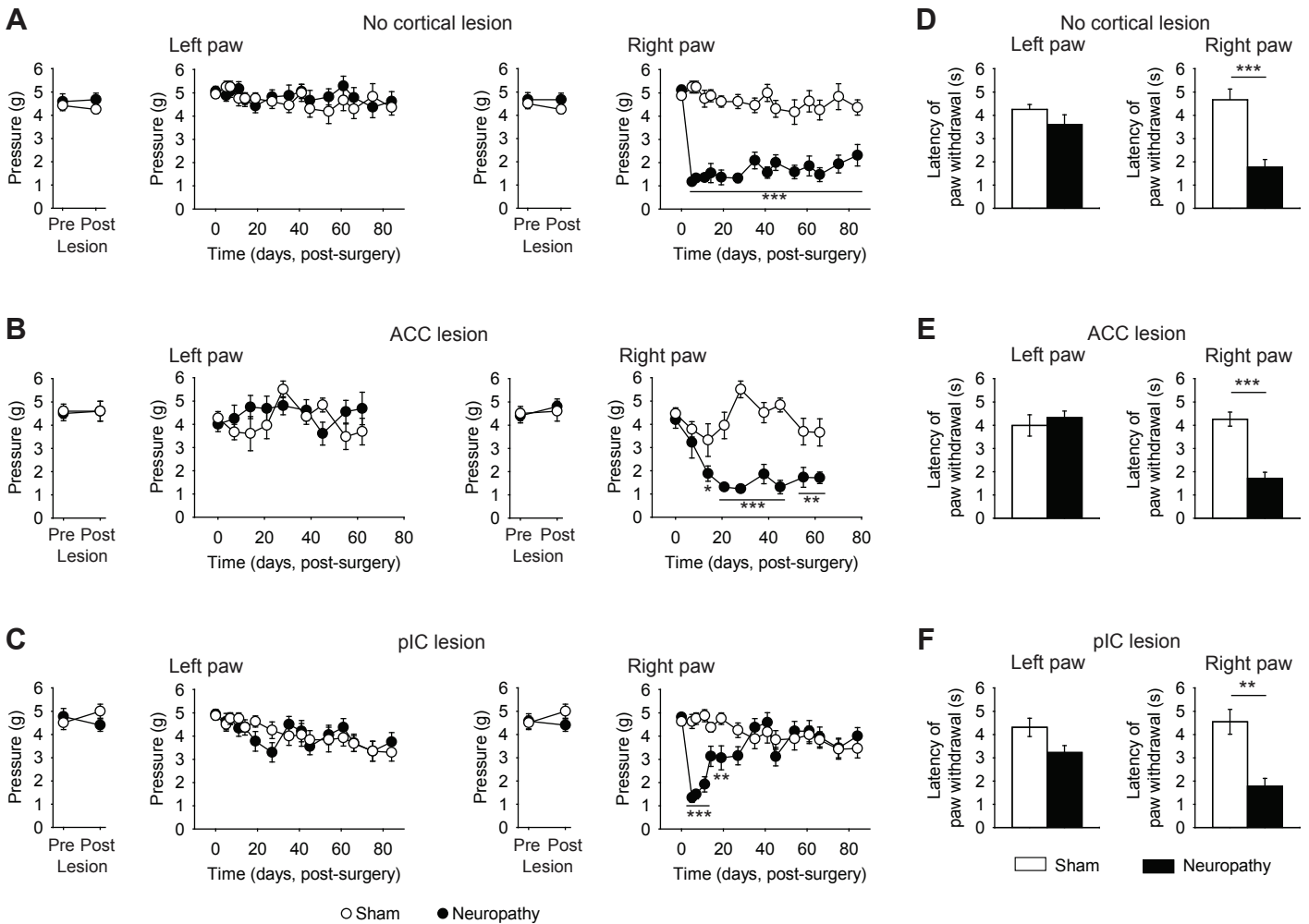

Figure 5. Influence of the anterior cingulate cortex (ACC) and the posterior insular cortex (pIC) on the somatosensory components of neuropathic pain. Neuropathic animals display a unilateral increase of mechanical (A) and thermal (D) sensitivity in the right hindpaw. The lesion of the ACC has no effect on these behaviors (B,E). The lesion of the pIC prevents the maintenance of the long term mechanical hypersensitivity (C) without affecting short term thermal sensitivity (F). Data are expressed as mean \pm SEM. * $p < .05$, ** $p < .01$, *** $p < .001$ Sham versus Neuropathy; $n = 10-17$ animals per group for von Frey test, $n = 5-6$ animals per group for radiant heat test.

suggests that neuropathic mechanical allodynia is integrated by the pIC, being selectively revealed under chronic pain conditions.

Thermal hyperalgesia is another sensory symptom that may be present in neuropathic pain patients. We evaluated the role of the ACC and the pIC by using the radiant heat paw-withdrawal test. Similar to mechanical allodynia, neither the ACC nor the pIC lesion modified the thermal sensitivity in control animals nor the hypersensitivity observed during the early phase of the neuropathy (12 days post-surgery) (**Figure 5D-F**, lesion x surgery $F_{(2,27)}=0.09$, $p=0.91$). In addition, the lesion of the targeted cortical areas had no effect on the thermal sensitivity in the later phase of the neuropathy (46 days post-surgery) when thermal hyperalgesia was no longer present in the neuropathic animals (data not shown).

The ACC but not the pIC is a Core for the Anxiodepressive Consequences of Chronic Pain

The above data revealed a distinct role of the ACC and the pIC in the sensory components of neuropathic pain. It was then of interest to determine the implication of these cortices in the anxiodepressive consequences of neuropathic pain. We observed the anxiodepressive-like behaviors accompanying chronic pain through the increased latency to first bite in the novelty suppressed feeding (NSF) test (Two-way ANOVA; lesion x surgery $F_{2,62}=5.70$, $p<0.01$, No lesion sham<cuff, $p<0.002$, **Figure 6A**), the decreased grooming duration in the splash test ($F_{2,81}=3.796$, $p<0.02$, No lesion sham<cuff, $p<0.001$, **Figure 6B**) and the prolonged immobility in the forced swimming test (FST) ($F_{2,78}=10.24$, $p<0.001$, No lesion sham<cuff, $p<0.001$, **Figure 6C**). In the NSF test, which relies on both anxiety and depression-like aspects, the lesion of the ACC ($p = .65$) but not the pIC ($p < .001$, **Figure 6A**) suppressed the chronic pain-induced delayed latency to feed. Similarly, depressive-like behaviors observed in neuropathic animals were prevented by the lesion of the ACC but not the pIC in the splash test (for ACC, $p = .55$; pIC $p < .01$ **Figure 6B**) and the FST (for ACC, $p = .22$; pIC $p < .001$, **Figure 6C**). The lesion of either the ACC or the pIC had no effect *per se* on the behavioral tests in control animals (For NSF, ACC $p=0.91$, pIC $p=0.71$, for splash test, ACC $p=0.16$, pIC $p=0.37$, for FST ACC $p=0.95$, pIC $p=0.72$, **Figures 6A-C**). The role of the ACC on anxiodepressive parameters is thus selective of the context (e.g. neuropathic pain). These data, to the best of our knowledge, are the first evidence

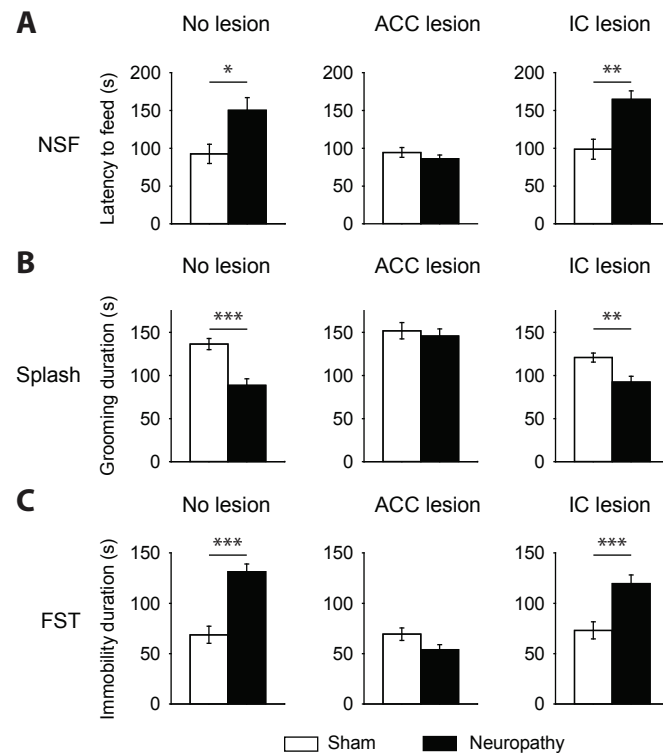

Figure 6. Influence of the anterior cingulate cortex (ACC) and the posterior insular cortex (pIC) on the anxiodepressive consequences of neuropathic pain. An increased latency to feed in the novelty suppressed feeding (NSF) test (A), a decrease in the grooming behavior in the splash test (B) and an increase in the immobility duration in the forced swimming test (FST) (C) is observed in neuropathic mice compared to controls. While these effects are prevented by the ACC lesion (A-C), the lesion of the pIC has no effect on the anxiodepressive behavior observed in neuropathic mice (A-C). Data are expressed as mean \pm SEM. * $p < .05$, ** $p < .01$, *** $p < .001$ Sham versus Neuropathy. For all experiments, $n = 9-17$ per group.

showing that the ACC is a hub for the anxiodepressive consequences observed in chronic pain.

The Optogenetic Stimulation of the ACC Induces Anxiodepressive-like Behavior

Since the deactivation of the ACC blocked the anxiodepressive-like behavior induced by chronic pain, we wonder whether the activation of this structure may induce depressive-like behavior. We thus performed chronic optogenetic stimulation of the pyramidal neurons of the ACC using naïve Thy1-ChR2-YFP mice (**Figure 7A**). The functional validation of ChR2-YFP expression using *in vitro* electrophysiological recordings confirmed that optogenetic stimulation enables to increase frequency and inward current in the ACC. Indeed, we first examined the effect of light pulses on ChR2-expressing pyramidal neurons recorded from the ACC acute slices. Light-gated membrane currents recorded in the voltage clamp mode depended on light dose. When illuminated at 450 nm with a 35 W/mm² intensity, the average peak inward current amplitude was of -309 ± 35 pA ($n = 3$). No current was induced when 650 nm light was used ($n=2$) (**Figure 7C-D**). We next examined whether ChR2 could reliably and repeatedly drive spiking of neurons held in current-clamp mode. We applied trains of 15 ms light flashes at various frequencies during 5 s, at 35 W/mm² intensity. The percentage of flashes triggering at least one action potential was of 100 ± 0 % at 5 Hz, 71 ± 7 % at 20 Hz, and 31 ± 8 % at 50 Hz when the whole 5-s train was considered ($n=3$) (**Figure 7E-F**). These data indicate the reliability and sustainability of ChR2-based photostimulation in acute slices. To validate further that optogenetic stimulation of the ACC successfully induce neuronal activity within this brain region, we assessed c-Fos expression. For this purpose, at the end of the behavioral tests, each animal was stimulated once again and perfused 90 minutes after. We found a robust and significant increase in the number of cells positive for c-Fos protein in stimulated animals compared to control (**Figure 7B**). In addition, we also observed c-Fos expression on the contralateral side of the fiber optic. Interestingly, we showed that chronic activation of the ACC induces anxiodepressive behavior in naïve animals. Indeed, the stimulated animals displayed significantly increased latency to first bite in the NSF test ($F_{1,16} = 28.88$, $p < .001$, **Figure 7G**) and a decrease in overall grooming time ($F_{1,15} = 13.01$, $p < .01$, **Figure 7G**) in comparison to controls. These data confirm the major role of the ACC in the mood disorders.

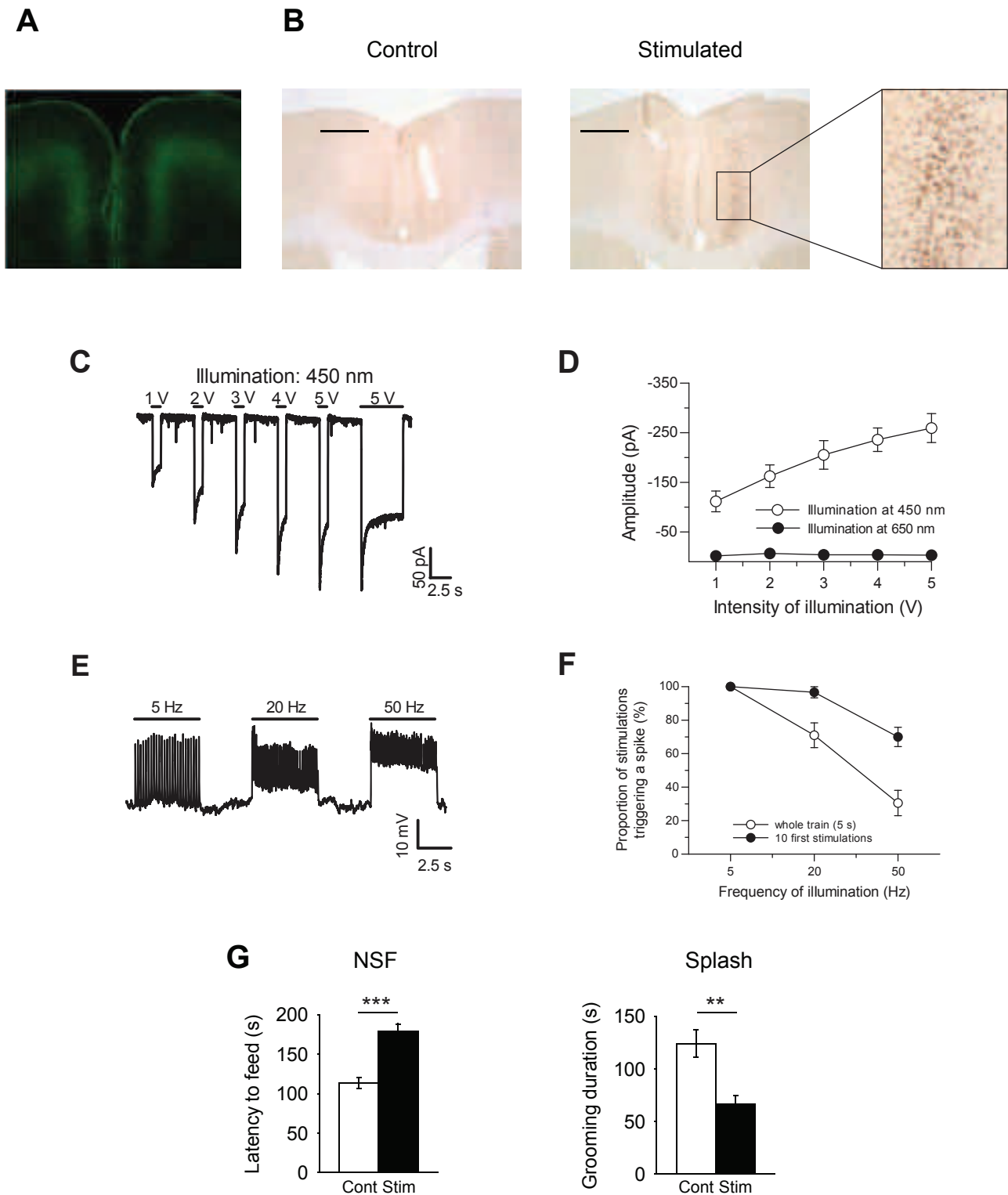

Figure 7. Influence of the optogenetic stimulation of the anterior cingulate cortex (ACC) on the anxiodepressive-like behavior. (A) Representative picture of the ACC in the Thy-1-ChR2-YFP mice. (B) Light-mediated stimulation of the ACC induces local c-Fos protein expression. Patch clamp recordings of light-evoked responses in the ACC pyramidal neurons expressing channelrhodopsin-2. Whole cell patch clamp recordings. (C) Light-gated currents induced by illumination at various light intensities and duration (1 s and 5 s) recorded in the ACC pyramidal neuron. Holding potential: -60 mV. (D) Stimulation-response relationship of the peak current induced by 1 s illumination at 450 nm and 650 nm. No current is induced at 650 nm. (E) Light-evoked action potentials evoked by 5 s-trains of illumination at 5 Hz, 20 Hz and 50 Hz. (F) Proportion of 15 ms stimulations triggering at least one action potential as a function of the stimulation frequency. Open circles: proportion of stimulations giving rise to at least one action potential during the whole 5-s train. Black circles: proportion of the 10 first stimulations triggering at least one action potential. (G) Chronic activation of the ACC induces increased latency to feed in the NSF test and decreased grooming time in splash test in comparison to controls. Data are expressed as mean \pm SEM. ** $p < .01$, *** $p < .001$ Control versus stimulated. Scale bars 400 μ m.

The ACC but not the pIC Mediates the Spontaneous Pain-Induced Aversive State

Clinically, the presence of spontaneous pain is often more debilitating than the alteration of evoked nociceptive response. For long, this parameter had remained elusive in animal research. Recently, it has been shown that such spontaneous pain can be unmasked in animal models of neuropathic pain (King et al., 2009) by relieving the tonic-aversive state in chronic pain thanks to non-rewarding analgesic drugs. The cerebral network mediating the aversive component of pain includes the ACC (Johansen et al., 2001; Qu et al., 2011), but its connections with somatosensory pain pathways are poorly described, while its relations with anxiodepressive behaviors remain unknown. We thus compared the role of the ACC and the pIC in the aversive component of neuropathic pain 10 weeks after the induction of peripheral nerve injury, using the conditional place preference (CPP) paradigm. Following spinal clonidine administration (10 μ g), we observed a CPP in neuropathic animals ($F_{1,18} = 12.07$, $p < .01$, **Figure 8A**), resulting from pain relief. This effect of clonidine was not present in control mice ($F_{1,16} = .39$, $p = .54$, **Figure 8A**), supporting the idea that this drug selectively unmasked the tonic-aversive state in chronic pain. The lesion of the ACC ($F_{1,18} = .83$, $p = .37$, **Figure 8B**), but not the pIC ($F_{1,16} = 14.51$, $p < .01$, **Figure 8C**), blocked the pain relief CPP, showing that spontaneous pain arising from injured nerve fibers produces an aversive state that is selectively mediated by the ACC.

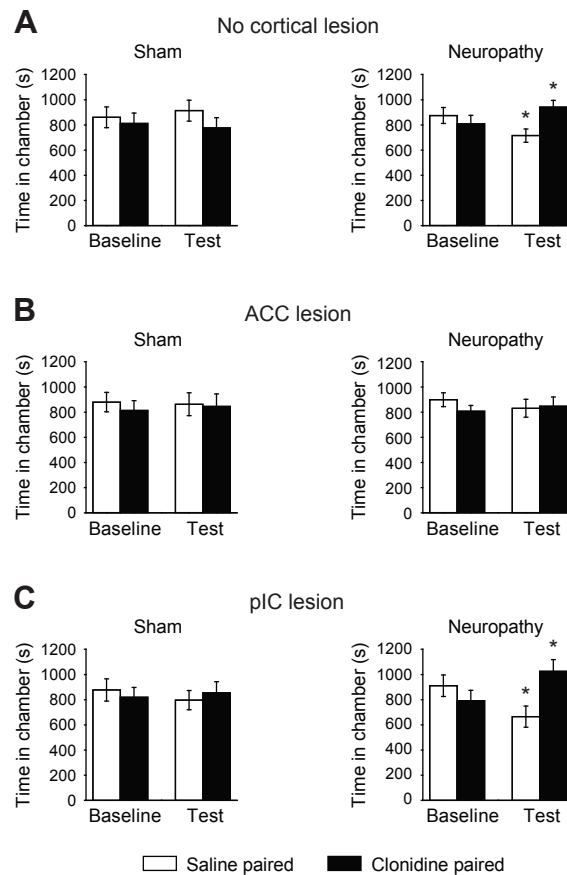

Figure 8. Influence of the anterior cingulate cortex (ACC) or the posterior insular cortex (pIC) on the aversive component of spontaneous pain. (A) Spinal clonidine (10 μ g) increased the time spent in the paired chamber, with a corresponding decrease in the saline-paired chamber, in neuropathic but not sham-operated mice. The lesion of the ACC (B) but not the pIC (C) blocked the clonidine-induced conditioned place preference in neuropathic animals. Data are expressed as mean \pm SEM. * $p < .05$ Test versus Baseline. For all experiments, $n = 7-10$ per group.

Discussion

Our findings show that the sensory component of chronic pain is functionally dissociated from its affective and anxiodepressive components and that the ACC is a critical brain region for the latter. Indeed, the presence of the ACC is necessary for the anxiodepressive consequences as well as the aversive component of chronic pain while the pIC is important only for the somatosensory component. Our optogenetic study further supports the role of the ACC in mood disorders by showing that a sustained stimulation of the ACC repeated over 4 days induces anxiodepressive behavior.

Besides chronic stress, chronic pain is another risk factor for depression. However, it differs from chronic stress, as neuropathic pain does not induce alterations of HPA axis (Ulrich-Lai et al., 2006; Yalcin et al., 2011). In present study, we showed that the ACC is a critical brain region for the neuropathic pain-induced depression. The ACC has been implicated in the pathophysiology of depression since imaging studies have shown hypoactivity in the dorsal portions of the ACC, hyperactivity in its ventral regions (Ebert and Ebmeier, 1996) and a reduced volume of the ACC (Drevets et al., 1998) in depressed patients. This notion is further supported by preclinical studies showing that the social-defeat-paradigm is accompanied with increased cingulate activity (Yu et al., 2011). By using optogenetic, we showed that direct stimulation of pyramidal neurons in the ACC provokes anxiodepressive-like behavior. In contrast, it has previously been reported that the optogenetic stimulation of the mPFC induced antidepressant-like effect (Covington et al., 2010). The difference between the localization of the implant and experimental design can explain the difference between two studies. Indeed, Covington et al (Covington et al., 2010) stimulated the anterior part of the mPFC covering both the pre and the infralimbic region and the behavioural experiments were performed during the optogenetic stimulation. However, in the present study, all the anxiodepressive tests performed after the completion of the stimulation. The persistent effect over several days suggests the implication of possible neuroplastic mechanism.

The lesion of either the ACC or the pIC had absolutely no effect per se in control animals. This confirms results showing a lack of effect of the ACC lesion on the

anxiodepressive-like behavior in naïve animals (Li et al., 2012). However, the paper from Bissiere et al, 2006 (Bissiere et al., 2006) reported that a lesion of the rostral cingulate cortex can diminish the immobility time in the FST. But these results are again different in terms of species used, the extent and the localization of the lesion.

Preclinical studies showed that the ACC is also affected by chronic pain. Indeed, chronic pain can induce functional alterations such as decreased long term depression (Li et al., 2010) or triggered synaptic potentiation implicating both presynaptic enhancement of glutamate release and postsynaptic potentiation of AMPA receptor-mediated responses in the ACC (Descalzi et al., 2009). However, the functional role of the ACC in the consequences of chronic pain remains still unexplored. In this context, our results provide a causal link between the ACC and the development of anxiodepressive symptoms following chronic pain. As the ACC is also the core of the aversive component of pain (Johansen et al., 2001; Qu et al., 2011) (present study), it is possible that the anxiodepressive behaviors observed in neuropathic animals are triggered by the affective component of pain rather than the somatosensory one. This hypothesis is supported by our results showing that the lesion of the ACC also blocked the spontaneous pain-induced aversion in neuropathic animals. In this study, the CPP paradigm is used to unmask the presence of an aversive state due to non evoked ongoing pain. In this regard, a non-rewarding pain alleviating drug (i.e. intrathecal clonidine) may induce a place preference when it suppresses the spontaneous pain in the paired compartment, thus revealing that the animal was in a spontaneous (unprovoked) pain state in the other compartment. This is thus the result of both a preference of the animal for the compartment where the pain is alleviated, together with an avoidance of the compartment where the spontaneous pain is still present (King et al., 2009). The lesion of the ACC prevents this preference for the intrathecal clonidine-paired side, which shows its involvement in the affective/motivational aspect of spontaneous pain. Interestingly, the lesion of pIC had no effects either on the anxiodepressive consequences or on the aversive component of neuropathic pain. However, a clinical study suggests a correlation between the activation of insula and the unpleasantness of tonic pain stimulus (Schreckenberger et al., 2005) and a recent preclinical study showed increased cerebral blood flow in the anterior part of insular cortex during anxiety-like behaviors (Pang et al., 2011). These observations differ in many variables from present work such as the type of stimulus (acute versus chronic),

the targeted insular cortex subregion (anterior versus posterior). Indeed, it has been suggested that the posterior division of the insula is involved in somatosensory processing while the anterior insula codes higher level cognition/emotion related sensory modalities (Wiech and Tracey, 2009; Simmons et al., 2013). Imaging (Peyron et al., 2004) and lesion (Benison et al., 2011) studies showed that besides the somatosensory cortex II, the insula - especially its posterior part - is one of the main brain region involved in the mechanical allodynia. In addition to the direct projection from the spinothalamic pathway, it also receives information from the somatosensory cortex and it projects to the striatal complex. Our results showing the total blocking of the long-term development of mechanical allodynia by the pIC lesion reinforce the essential role of the pIC in this sensory symptom.

The nociceptive information is transmitted to the brain by various parallel ascending pathways such as the spinopontine, the spinomesencephalic and the spinothalamic pathways (Lima, 2009). These pathways are not fully independent as they polysynaptically terminate in cortical regions that can be interconnected. They thus participate in higher integration of nociceptive inputs creating the complex sensory and emotional experience constituting pain. In such context of brain circuitry, however, our results support the idea that at cortical level, the sensory component of chronic pain remains functionally dissociated from its affective and anxiodepressive components. This functional segregation that is observed between the ACC and the pIC may rely on differences in respective connectomes. Indeed, even though the ACC and the IC share several common inputs and outputs, such as the paracentral, the intermediodorsal and the central lateral nuclei of the thalamus (Van der Werf et al., 2002), these cortical areas also have distinct afferents and efferents. For example, the central medial thalamus projects only to the ACC, but not to the IC, and the ACC sends projections to the basolateral but not to the central amygdala while the pIC preferentially innervates the central amygdala (Conde et al., 1995; Wright and Groenewegen, 1995; Shi and Cassell, 1998). A network level of analysis would thus be important to further understand this functional segregation.

In conclusion, this study supports the idea that the ACC and the pIC are integrally involved in pain processing, but our findings go beyond this general assertion by providing direct side by side evidence for the cortical dissociation between pain components. Importantly, it reveals the critical role of the ACC but not

the pIC in encoding anxiodepressive consequences of chronic pain. Our optogenetic study further reinforces the essential role of the ACC in mood disorders. The ACC may thus constitute a primary target for unveiling the precise cellular and molecular bases of the changes occurring in chronic pain-induced depression.

Acknowledgements

We thank Elisabeth Waltisperger, Yasmin Hohn for technical assistance and Dr Pierre Veinante for comments on the manuscript. This work was supported by the Centre National de la Recherche Scientifique (contract UPR3212), the University of Strasbourg and by a NARSAD Young Investigator Grant from the Brain & Behavior Research Foundation.

References

1. WHO, Update TGBOD (2008)): The Global Burden of Disease: 2004 Update.
2. Radat F, Margot-Duclot A, Attal N (2013): Psychiatric co-morbidities in patients with chronic peripheral neuropathic pain: A multicentre cohort study. *Eur J Pain*.
3. Narita M, Kaneko C, Miyoshi K, Nagumo Y, Kuzumaki N, Nakajima M, et al. (2006): Chronic pain induces anxiety with concomitant changes in opioidergic function in the amygdala. *Neuropsychopharmacology*. 31:739-750.
4. Yalcin I, Bohren Y, Waltisperger E, Sage-Ciocca D, Yin JC, Freund-Mercier MJ, et al. (2011): A time-dependent history of mood disorders in a murine model of neuropathic pain. *Biol Psychiatry*. 70:946-953.
5. Alba-Delgado C, Llorca-Torralla M, Horrillo I, Ortega JE, Mico JA, Sanchez-Blazquez P, et al. (2013): Chronic pain leads to concomitant noradrenergic impairment and mood disorders. *Biol Psychiatry*. 73:54-62.
6. Blackburn-Munro G, Blackburn-Munro RE (2001): Chronic pain, chronic stress and depression: coincidence or consequence? *J Neuroendocrinol*. 13:1009-1023.
7. Ulrich-Lai YM, Xie W, Meij JT, Dolgas CM, Yu L, Herman JP (2006): Limbic and HPA axis function in an animal model of chronic neuropathic pain. *Physiol Behav*. 88:67-76.
8. Ibarguen-Vargas Y, Surget A, Touma C, Palme R, Belzung C (2008): Multifaceted strain-specific effects in a mouse model of depression and of antidepressant reversal. *Psychoneuroendocrinology*. 33:1357-1368.
9. McQuaid RJ, Audet MC, Jacobson-Pick S, Anisman H (2013): The differential impact of social defeat on mice living in isolation or groups in an enriched environment: plasma corticosterone and monoamine variations. *Int J Neuropsychopharmacol*. 16:351-363.
10. Vogt BA (2005): Pain and emotion interactions in subregions of the cingulate gyrus. *Nat Rev Neurosci*. 6:533-544.
11. Shackman AJ, Salomons TV, Slagter HA, Fox AS, Winter JJ, Davidson RJ (2011): The integration of negative affect, pain and cognitive control in the cingulate cortex. *Nat Rev Neurosci*. 12:154-167.

12. Bushnell MC, Ceko M, Low LA (2013): Cognitive and emotional control of pain and its disruption in chronic pain. *Nat Rev Neurosci*. 14:502-511.
13. Rainville P, Duncan GH, Price DD, Carrier B, Bushnell MC (1997): Pain affect encoded in human anterior cingulate but not somatosensory cortex. *Science*. 277:968-971.
14. Johansen JP, Fields HL, Manning BH (2001): The affective component of pain in rodents: direct evidence for a contribution of the anterior cingulate cortex. *Proc Natl Acad Sci U S A*. 98:8077-8082.
15. Greenspan JD, Winfield JA (1992): Reversible pain and tactile deficits associated with a cerebral tumor compressing the posterior insula and parietal operculum. *Pain*. 50:29-39.
16. Benison AM, Chumachenko S, Harrison JA, Maier SF, Falci SP, Watkins LR, et al. (2011): Caudal granular insular cortex is sufficient and necessary for the long-term maintenance of allodynic behavior in the rat attributable to mononeuropathy. *J Neurosci*. 31:6317-6328.
17. Isnard J, Magnin M, Jung J, Mauguiere F, Garcia-Larrea L (2011): Does the insula tell our brain that we are in pain? *Pain*. 152:946-951.
18. Alkire MT, White NS, Hsieh R, Haier RJ (2004): Dissociable brain activation responses to 5-Hz electrical pain stimulation: a high-field functional magnetic resonance imaging study. *Anesthesiology*. 100:939-946.
19. Treede RD, Apkarian AV, Bromm B, Greenspan JD, Lenz FA (2000): Cortical representation of pain: functional characterization of nociceptive areas near the lateral sulcus. *Pain*. 87:113-119.
20. Mazzola L, Faillenot I, Barral FG, Mauguiere F, Peyron R (2012): Spatial segregation of somato-sensory and pain activations in the human operculo-insular cortex. *Neuroimage*. 60:409-418.
21. Pizzagalli DA (2011): Frontocingulate dysfunction in depression: toward biomarkers of treatment response. *Neuropsychopharmacology*. 36:183-206.
22. Sliz D, Hayley S (2012): Major depressive disorder and alterations in insular cortical activity: a review of current functional magnetic imaging research. *Front Hum Neurosci*. 6:323.

23. Mutschler I, Ball T, Wankerl J, Strigo IA (2012): Pain and emotion in the insular cortex: evidence for functional reorganization in major depression. *Neurosci Lett*. 520:204-209.
24. Matthews SC, Strigo IA, Simmons AN, Yang TT, Paulus MP (2008): Decreased functional coupling of the amygdala and supragenual cingulate is related to increased depression in unmedicated individuals with current major depressive disorder. *J Affect Disord*. 111:13-20.
25. Drevets WC (2001): Neuroimaging and neuropathological studies of depression: implications for the cognitive-emotional features of mood disorders. *Curr Opin Neurobiol*. 11:240-249.
26. Drevets WC, Ongur D, Price JL (1998): Neuroimaging abnormalities in the subgenual prefrontal cortex: implications for the pathophysiology of familial mood disorders. *Mol Psychiatry*. 3:220-226, 190-221.
27. Shields DC, Asaad W, Eskandar EN, Jain FA, Cosgrove GR, Flaherty AW, et al. (2008): Prospective assessment of stereotactic ablative surgery for intractable major depression. *Biol Psychiatry*. 64:449-454.
28. Lipsman N, Woodside DB, Giacobbe P, Hamani C, Carter JC, Norwood SJ, et al. (2013): Subcallosal cingulate deep brain stimulation for treatment-refractory anorexia nervosa: a phase 1 pilot trial. *Lancet*. 381:1361-1370.
29. Chaumont J, Guyon N, Valera AM, Dugue GP, Popa D, Marcaggi P, et al. (2013): Clusters of cerebellar Purkinje cells control their afferent climbing fiber discharge. *Proc Natl Acad Sci U S A*. 110:16223-16228.
30. Hargreaves K, Dubner R, Brown F, Flores C, Joris J (1988): A new and sensitive method for measuring thermal nociception in cutaneous hyperalgesia. *Pain*. 32:77-88.
31. King T, Vera-Portocarrero L, Gutierrez T, Vanderah TW, Dussor G, Lai J, et al. (2009): Unmasking the tonic-aversive state in neuropathic pain. *Nat Neurosci*. 12:1364-1366.
32. Santarelli L, Saxe M, Gross C, Surget A, Battaglia F, Dulawa S, et al. (2003): Requirement of hippocampal neurogenesis for the behavioral effects of antidepressants. *Science*. 301:805-809.

33. Yalcin I, Coubard S, Bodard S, Chalon S, Belzung C (2008): Effects of 5,7-dihydroxytryptamine lesion of the dorsal raphe nucleus on the antidepressant-like action of tramadol in the unpredictable chronic mild stress in mice. *Psychopharmacology (Berl)*. 200:497-507.
34. Porsolt RD, Le Pichon M, Jalfre M (1977): Depression: a new animal model sensitive to antidepressant treatments. *Nature*. 266:730-732.
35. Chaudhury D, Walsh JJ, Friedman AK, Juarez B, Ku SM, Koo JW, et al. (2013): Rapid regulation of depression-related behaviours by control of midbrain dopamine neurons. *Nature*. 493:532-536.
36. Peyron R, Faillenot I, Pomares FB, Le Bars D, Garcia-Larrea L, Laurent B (2013): Mechanical allodynia in neuropathic pain. Where are the brain representations located? A positron emission tomography (PET) study. *Eur J Pain*.
37. Starr CJ, Sawaki L, Wittenberg GF, Burdette JH, Oshiro Y, Quevedo AS, et al. (2009): Roles of the insular cortex in the modulation of pain: insights from brain lesions. *J Neurosci*. 29:2684-2694.
38. Qu C, King T, Okun A, Lai J, Fields HL, Porreca F (2011): Lesion of the rostral anterior cingulate cortex eliminates the aversiveness of spontaneous neuropathic pain following partial or complete axotomy. *Pain*. 152:1641-1648.
39. Ebert D, Ebmeier KP (1996): The role of the cingulate gyrus in depression: from functional anatomy to neurochemistry. *Biol Psychiatry*. 39:1044-1050.
40. Yu T, Guo M, Garza J, Rendon S, Sun XL, Zhang W, et al. (2011): Cognitive and neural correlates of depression-like behaviour in socially defeated mice: an animal model of depression with cognitive dysfunction. *Int J Neuropsychopharmacol*. 14:303-317.
41. Covington HE, 3rd, Lobo MK, Maze I, Vialou V, Hyman JM, Zaman S, et al. (2010): Antidepressant effect of optogenetic stimulation of the medial prefrontal cortex. *J Neurosci*. 30:16082-16090.
42. Li F, Li M, Cao W, Xu Y, Luo Y, Zhong X, et al. (2012): Anterior cingulate cortical lesion attenuates food foraging in rats. *Brain Res Bull*. 88:602-608.

43. Bissiere S, McAllister KH, Olpe HR, Cryan JF (2006): The rostral anterior cingulate cortex modulates depression but not anxiety-related behaviour in the rat. *Behav Brain Res.* 175:195-199.
44. Li XY, Ko HG, Chen T, Descalzi G, Koga K, Wang H, et al. (2010): Alleviating neuropathic pain hypersensitivity by inhibiting PKMzeta in the anterior cingulate cortex. *Science.* 330:1400-1404.
45. Descalzi G, Kim S, Zhuo M (2009): Presynaptic and postsynaptic cortical mechanisms of chronic pain. *Mol Neurobiol.* 40:253-259.
46. Schreckenberger M, Siessmeier T, Viertmann A, Landvogt C, Buchholz HG, Rolke R, et al. (2005): The unpleasantness of tonic pain is encoded by the insular cortex. *Neurology.* 64:1175-1183.
47. Pang RD, Wang Z, Klosinski LP, Guo Y, Herman DH, Celikel T, et al. (2011): Mapping functional brain activation using [14C]-iodoantipyrine in male serotonin transporter knockout mice. *PLoS One.* 6:e23869.
48. Wiech K, Tracey I (2009): The influence of negative emotions on pain: behavioral effects and neural mechanisms. *Neuroimage.* 47:987-994.
49. Simmons WK, Rapuano KM, Kallman SJ, Ingelholm JE, Miller B, Gotts SJ, et al. (2013): Category-specific integration of homeostatic signals in caudal but not rostral human insula. *Nat Neurosci.* 16:1551-1552.
50. Peyron R, Schneider F, Faillenot I, Convers P, Barral FG, Garcia-Larrea L, et al. (2004): An fMRI study of cortical representation of mechanical allodynia in patients with neuropathic pain. *Neurology.* 63:1838-1846.
51. Lima D (2009): Ascending Pathways: Anatomy and Physiology. In: Basbaum AI BC, editor. *Science of Pain.* San Diego: Elsevier, pp 477-527.
52. Van der Werf YD, Witter MP, Groenewegen HJ (2002): The intralaminar and midline nuclei of the thalamus. Anatomical and functional evidence for participation in processes of arousal and awareness. *Brain Res Brain Res Rev.* 39:107-140.
53. Conde F, Maire-Lepoivre E, Audinat E, Crepel F (1995): Afferent connections of the medial frontal cortex of the rat. II. Cortical and subcortical afferents. *J Comp Neurol.* 352:567-593.

54. Wright CI, Groenewegen HJ (1995): Patterns of convergence and segregation in the medial nucleus accumbens of the rat: relationships of prefrontal cortical, midline thalamic, and basal amygdaloid afferents. *J Comp Neurol.* 361:383-403.
55. Shi CJ, Cassell MD (1998): Cortical, thalamic, and amygdaloid connections of the anterior and posterior insular cortices. *J Comp Neurol.* 399:440-468.

III. Rôle de la protéine MAPK Phosphatase 1 (MKP-1) dans les conséquences émotionnelles de la douleur neuropathique

A. Introduction

Dans le modèle de douleur neuropathique utilisé au laboratoire ((Benbouzid et al., 2008b)et I. Partie résultats de cette thèse), les souris développent des troubles sensoriels, affectifs-motivationnels et anxiodépressifs ((Yalcin et al., 2011)et II. Partie résultats de cette thèse). Le cortex cingulaire antérieur (ACC) a été identifié comme étant nécessaire au développement des conséquences émotionnelles de la douleur neuropathique (II. Partie résultats de cette thèse). Cela sous-entend que des modifications ont lieu dans cette structure en condition neuropathique et qu'elles sont responsables, au moins en partie, de l'apparition des comportements anxiodépressifs observés. Ces changements peuvent être de plusieurs types, avec par exemple des variations dans la transcription de gènes ou dans l'expression de protéines, des changements d'activité neuronale ou morphologique, ou encore une réorganisation des circuits et de la communication entre les régions cérébrales.

- **Notre objectif pour cette étude est d'identifier d'éventuelles modifications moléculaires au sein de l'ACC.**

Pour cela, nous avons choisi de comparer l'expression d'ARN par une technique de puce à ADN, chez des animaux non neuropathiques (sham) et des animaux neuropathiques (cuff), à deux points temporels. En effet, deux semaines après l'induction de la neuropathie, les animaux montrent une allodynie mécanique, mais pas encore de troubles anxiodépressifs. Huit semaines après l'induction de la neuropathie, les animaux développent l'allodynie mécanique ainsi que des troubles anxiodépressifs.

Ce travail, réalisé grâce à une collaboration avec le Dr Ralf Gilsbach de l'Université de Fribourg-en-Brisgau (Allemagne), nous a permis d'identifier différentes cibles et nous avons choisi de nous focaliser particulièrement sur l'ARN correspondant à la protéine Mitogen-Activated Protein Kinase (MAPK) Phosphatase 1 (**MKP-1**), aussi appelée Dual-specificity Phosphatase 1 (**DUSP-1**), une protéine qui inactive les MAPK en les déphosphorylant.

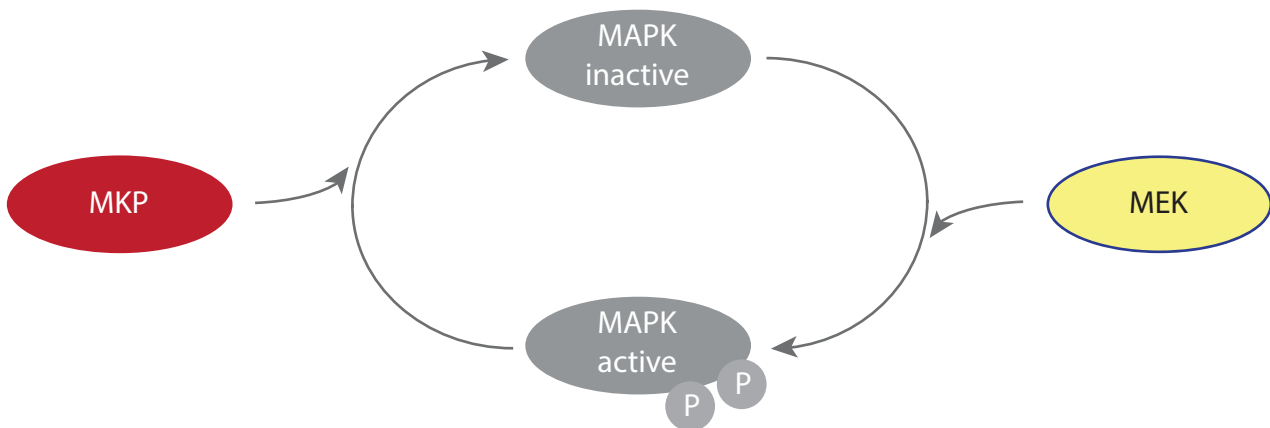

Figure 11. Représentation simplifiée des voies d'activation et d'inactivation des MAPK.

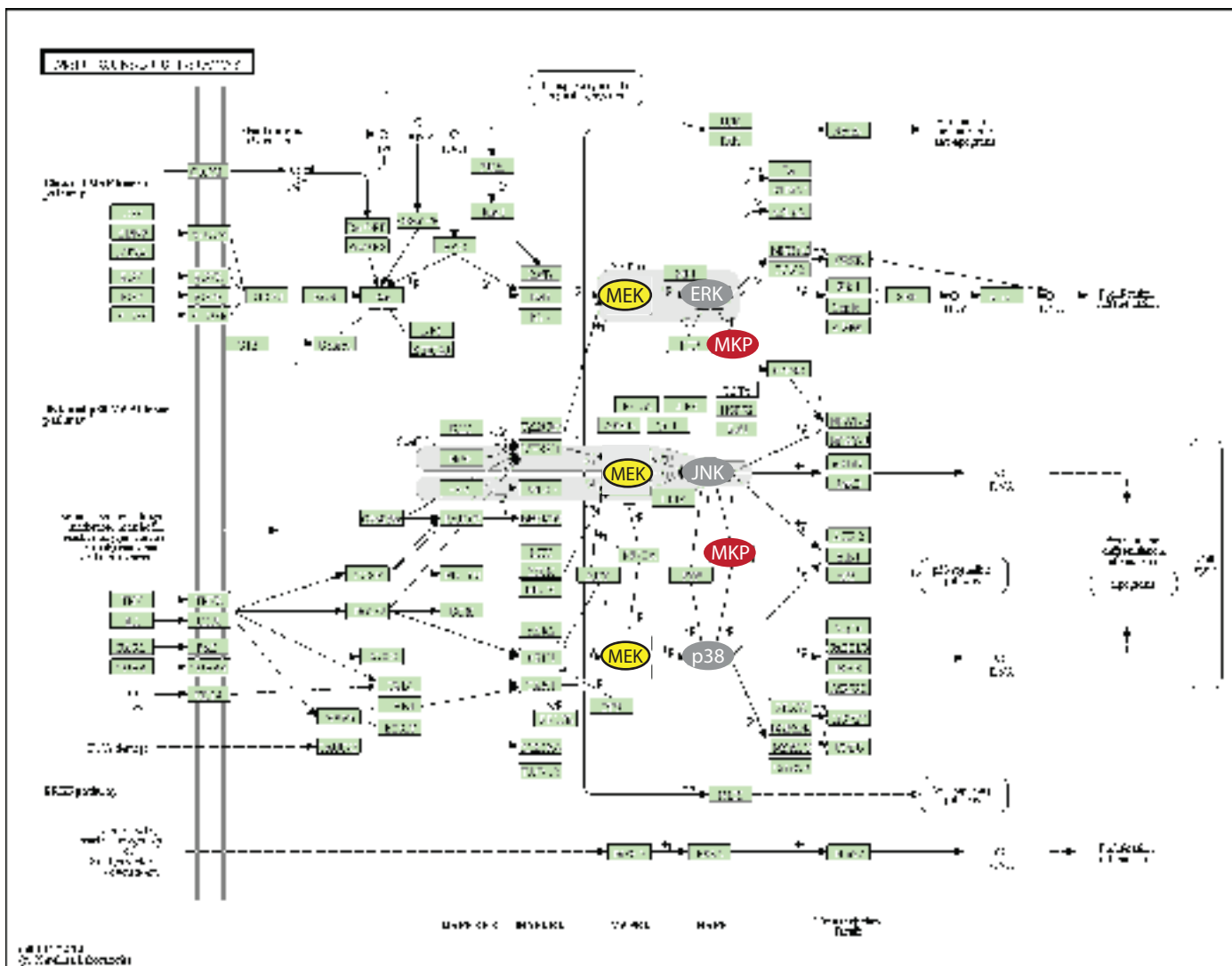

Figure 12. Représentation détaillée de la voie des MAPK. En gris apparaissent les MAPK, en jaune les MEK, en rouge les MKP.

D'après Kanehisa Laboratories.
http://www.genome.jp/kegg-bin/show_pathway?hsa04010

Les MAPK sont une famille de protéines hautement conservées au long de l'évolution. Elles jouent un rôle prédominant dans la régulation de l'activité des protéines en intervenant sur leur équilibre de phosphorylation et agissent de fait sur de nombreuses voies de signalisation et dans un très grand nombre de fonctions cellulaires (prolifération, différenciation, survie et mort cellulaire), de processus physiologiques (embryogénèse, immunité, homéostasie métabolique, fonction cardiaque et plasticité neuronale)(Jeffrey et al., 2007; Boutros et al., 2008). Elles sont associées à des pathologies telle que le diabète, l'arthrite rhumatoïde, les maladies neurodégénératives et le cancer (Dhillon et al., 2007; Lawrence et al., 2008). Du fait de leur homologie de séquence, des différences dans leurs mécanismes d'activation et de la spécificité de leurs substrats, les MAPK se classent en trois catégories majeures : les extracellular signal-regulated kinases 1 et 2 (ERK1/2), les c-Jun NH₂-terminal kinases 1, 2 et 3 (JNK 1/2/3) et les p38 α , β , δ et γ kinases (Cobb, 1999). La voie de signalisation des MAPK est très complexe, des processus variés interviennent dans leur activation et leur inactivation, et leurs protéines cibles sont nombreuses (**Figures 11 et 12**). Leur voie d'activation comprend les MAPK Kinases Kinases (MKKK ou MEKK) qui activent par phosphorylation les MAPK Kinases (MKK ou MEK) activant à leur tour les MAPK en phosphorylant deux résidus Thréonine et Tyrosine inclus dans un motif Thr – X – Tyr spécifique de cette famille. Les deux résidus de la boucle d'activation des MAPK doivent être phosphorylés pour une activité maximale. De très nombreuses phosphatases sont capables de désactiver les MAPK, que ce soit en déphosphorylant un seul, ou les deux sites Thr et Thy. Parmi ces différents enzymes se trouve la classe des MAPK Phosphatases (MKP), aussi nommées Dual-specificity Phosphatases (DUSP) du fait de leur capacité à déphosphoryler les deux résidus Thr et Tyr, dont notre candidat MKP-1 est le représentant archétypal (Lawan et al., 2013). Cette famille comprend 10 MKP chez les mammifères, qui ont en commun un domaine N-terminal non-catalytique et un domaine C-terminal catalytique. Les variations de séquence, de localisation cellulaire et de spécificité de substrat classent le MKP en trois sous-familles (**Figure 13** d'après (Caunt and Keyse, 2013)). MKP-1, à laquelle nous nous intéressons, fait partie de la sous-famille préférentiellement nucléaire. Elle est capable d'interagir avec les trois types de MAPK avec une préférence pour JNK et p38.

Les trois voies des MAPK sont impliquées dans le domaine de la douleur. La phosphorylation d'ERK dans la corne dorsale de la moelle épinière est provoquée

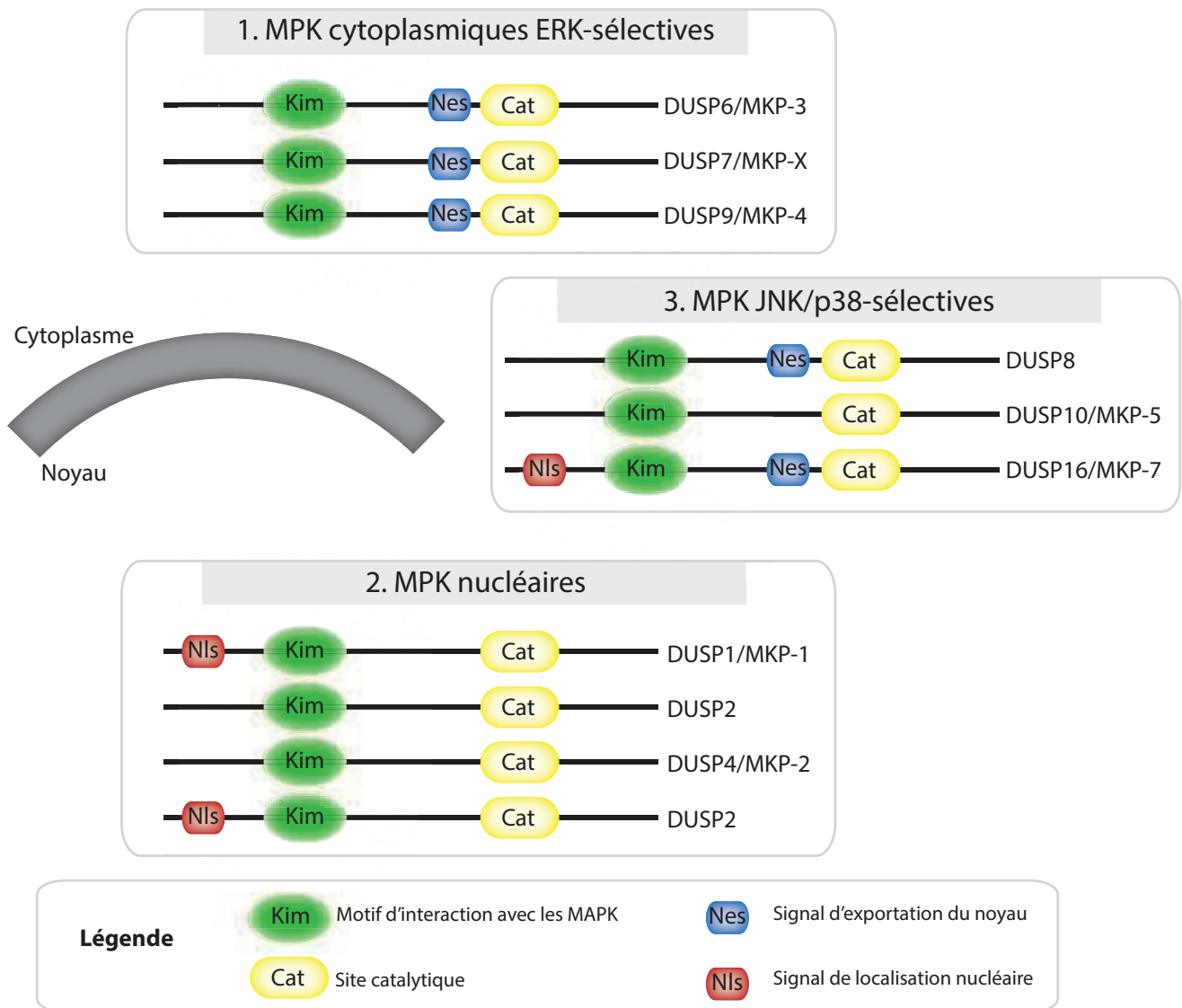

Figure 13. Famille des MKP. Les 10 MKP se répartissent en 3 sous-familles : 1. Cytoplasmiques et spécifiques d'ERK, 2. Nucléaires et 3. Cytoplasmiques et nucléaires et spécifiques de JNK/p38.

D'après Caunt CJ et Keyse SM, FEBS, 2013

par des stimuli nociceptifs thermique (chaud et froid) et mécanique. Cette activation est dépendante de l'intensité du stimulus nociceptif (Ji et al., 1999). Dans des modèles de douleur neuropathique, l'activation d'Erk a été démontrée dans la microglie de la corne dorsale de la moelle épinière (Ma and Quirion, 2002). Dans les mêmes cellules, la phosphorylation de p38 a été démontrée dans plusieurs modèles de douleur neuropathique (Jin et al., 2003; Wen et al., 2007). Le rôle de JNK dans la douleur est moins bien connu bien que plusieurs études confirment son implication. Une augmentation de l'expression d'une forme activée de JNK a été mise en évidence dans les astrocytes de la moelle épinière dans un modèle de douleur neuropathique (Zhuang et al., 2006). Compte tenu du rôle de MKP-1 dans la voie des MAPK et de l'implication de cette voie dans la douleur, quelques études se sont intéressées à l'implication de MKP-1 dans la douleur. Par exemple, des travaux ont montré qu'une surexpression de MKP-1 dans la moelle épinière prévient le développement d'une hypersensibilité mécanique dans un modèle de douleur neuropathique (Ndong et al., 2012).

L'implication de la voie des MAPK a aussi été mise en évidence dans les troubles de l'humeur. Par exemple, une diminution de p-ERK est observée dans l'hippocampe de souris dans un modèle de dépression (Gourley et al., 2008). Le niveau de p-ERK revient à la normale lorsque les animaux ayant un comportement de type dépressif sont traités par un antidépresseur tricyclique (Gourley et al., 2008). Dans une expérience de stress de défaite sociale induisant normalement un comportement d'isolement social et constituant un modèle de dépression, la délétion localisée de la protéine p38 dans les neurones sérotonergiques du noyau du raphé dorsal prévient l'apparition des comportements de type dépressif (Bruchas et al., 2011). Le test de nage forcée, largement utilisé pour l'évaluation de l'efficacité des antidépresseurs en phase préclinique, entraîne une activation de JNK dans l'hippocampe et le cortex préfrontal, deux régions cérébrales impliquées dans la dépression. De plus, l'administration intracérébroventriculaire d'un inhibiteur de JNK entraîne un effet de type antidépresseur dans ce même test (Galeotti and Ghelardini, 2012). Enfin, une étude menée en parallèle chez l'Homme et chez la souris a montré une surexpression de la protéine MKP-1 dans l'hippocampe de patients ayant souffert de dépression, de même que dans un modèle murin de dépression, le stress chronique imprédictible. Ce même stress chronique mené chez des souris KO pour cette protéine n'entraîne plus de comportement de type

Expérience	Statut génétique	Groupe chirurgie	Point temporel du prélèvement de l'ACC
① - Génomique	WT	Sham	2 semaines post-chirurgie
	WT	Cuff	2 semaines post-chirurgie
	WT	Sham	8 semaines post-chirurgie
	WT	Cuff	8 semaines post-chirurgie
② - Immunoblot	WT	Sham	8 semaines post-chirurgie
	WT	Cuff	8 semaines post-chirurgie
③ - KO MKP-1	WT	Sham	NA
	WT	Cuff	NA
	KO MKP-1	Sham	NA
	KO MKP-1	Cuff	NA

Tableau 4. Classification des groupes expérimentaux utilisés dans les 3 expériences menées. NA : non applicable

dépressif (Duric et al., 2010). Ces données confèrent à MKP-1 un rôle critique dans le développement de la dépression.

Compte tenu de l'implication des voies des MAPK et de MKP-1 en particulier dans la douleur et la dépression, ainsi que de l'augmentation de l'expression de l'ARN de MKP-1 dans notre modèle, nous avons voulu tester l'implication de cette protéine dans les conséquences émotionnelles de la douleur neuropathique. Notre objectif a été double :

- **Confirmer au niveau protéique la surexpression de MKP-1 chez les souris ayant des comportements anxiodépressifs.** Une approche par immunoblot a confirmé la surexpression de MKP-1 chez ces animaux.
- **Etudier le comportement de souris KO pour le gène MKP-1.** Nous nous sommes procurés ces souris (Dorfman et al., 1996), nous les avons exposées à notre modèle de douleur neuropathique et nous avons étudié le développement des comportements douloureux et anxiodépressifs. Ces animaux présentent l'allodynie mécanique attendue après la pose du cuff, mais par contre ne manifestent plus de comportement de type dépressif.

Ces données confirment le rôle majeur joué par la protéine MKP-1 dans l'apparition de comportements anxiodépressifs, avec un rôle probablement important de l'ACC dans ces troubles.

B. Matériel et méthode

Groupes expérimentaux

Trois ensembles d'expériences sont réalisées : une partie génomique, une partie expression protéique de MKP-1 et une partie comportements nociceptif et anxiodépressif des souris KO MKP-1. Les groupes expérimentaux utilisés sont classés dans le **tableau 4**.

Animaux

Les tests concernant les parties génomique et expression protéique sont conduits chez des souris C57BL/6J (Charles River, L'Arbresle, France). La chirurgie est

pratiquée sur des souris mâles âgées d'au moins 8 semaines, stabulées par groupe de cinq, sous un cycle de 12 heures de lumière suivies par 12 heures de nuit, avec nourriture et eau *ad libitum*. Les animaux KO MKP-1 (Dorfman et al., 1996) nécessaires à la reproduction pour la constitution de nos groupes expérimentaux nous ont été fournis gracieusement par le Dr. Andrew Cato de l'Institute of Toxicology and Genetics de Karlsruhe, après accord de la firme Bristol-Myers Squibb, créateurs originaux de ces souris transgéniques. Les animaux KO MKP-1 nécessaires aux expériences ont été élevés à partir de croisements entre les souris KO et des souris WT C57BL/6J. Les animaux hétérozygotes obtenus ont été croisés entre eux, les souris KO et WT ont été sélectionnées après génotypage pour la suite de l'étude et élevées dans notre animalerie dans les mêmes conditions et dans les mêmes salles que nos animaux non-transgéniques. L'animalerie est enregistrée et agréée pour l'expérimentation animale (agrément C67-482-1). Les protocoles sont validés par le comité d'éthique de l'Université de Strasbourg (CREMEAS, n°AL-04).

Modèle de douleur neuropathique

Le protocole chirurgical d'induction de la neuropathie est décrit dans l'article « The Sciatic Nerve Cuffing Model of Neuropathic Pain in Mice » en partie 1 de la section résultats.

Test sensoriel

Le test des filaments de von Frey, qui mesure ici la sensibilité mécanique des pattes postérieures des animaux, est décrit dans l'article « The Sciatic Nerve Cuffing Model of Neuropathic Pain in Mice » en partie 1 de la section résultats.

Tests mesurant les comportements de type anxiodépressif

Ces tests sont décrits dans la partie matériel et méthode de l'article « The anterior cingulate cortex is a critical hub for pain-induced depression », en partie 2 de la section résultats. Nous avons utilisé les tests d'hyponéophagie (NSF) et de toilettage provoqué (splash test).

Dissection des tissus

Les animaux sont euthanasiés par dislocation cervicale, le cerveau est immédiatement prélevé et mis dans une matrice pour réaliser des tranches frontales de 1 mm d'épaisseur. Toutes les opérations, à partir du prélèvement du cerveau, sont effectuées sur de la glace. Les tranches contenant la région d'intérêt (2 à 3 par animal) sont déposées dans du liquide céphalorachidien artificiel (Glucose 11,8 mM, NaHCO₃ 27,5 mM, NaCl 62,5 mM, KCl 1,2 mM, CaCl₂ 2H₂O 0,55 mM, MgCl₂ 0,4 mM, KH₂PO₄ 0,25 mM, Na₂SO₄ anhydre 0,25 mM) et disséquées manuellement sous une loupe binoculaire. Les parties d'ACC prélevées sont immédiatement déposées dans des tubes préalablement placés dans de la carboglace, puis sont conservés à -80°C jusqu'à l'extraction des ARN ou des protéines.

Extraction et dosage des ARN et des protéines

ARN - Les ARN totaux sont récupérés grâce au kit RNeasy (QIAGEN) et selon le protocole fourni dans le kit. Leur dosage est effectué grâce à un NanoDrop (Thermoscientific). Ils sont ensuite envoyés au laboratoire du Pr. Lutz Hein et du Dr. Ralf Gilsbach à Fribourg-en-Brigau pour l'étude génomique.

Protéines - Les tissus prélevés sont mis dans 150 µl d'une solution de lyse (20 mM de Tris pH 7,5 ; 150 mM de NaCl ; 10% de glycérol, 1% de NP40 ; cocktail d'inhibiteurs de protéases Roche). Les tissus sont homogénéisés manuellement et brièvement passés au sonicateur. Les tubes sont centrifugés 10 minutes à 11.500 rotations par minute. Le surnageant est récupéré puis dosé par le kit DC Protein Assay (Biorad). Après dosage, les échantillons sont conservés à -20°C.

Analyse de l'expression de l'ARN par les puces à ADN

Cinq cents ng d'ARN sont amplifiés et biotinylés en utilisant le kit Illumina® TotalPrep™ RNA Amplification Kit (Life). Les ARN obtenus sont ensuite hybridés à la puce à ADN MouseWG-6 v2.0 Expression BeadChips (Illumina), puis les puces sont traitées selon les instructions du fabricant. Les résultats sont analysés à l'aide du Gene expression analysis module du GenomeStudio V2010.3 (Illumina) après

normalisation par quantiles. Six extraits d'ARN provenant chacun d'un animal sont utilisés par condition, soit au total 24 extraits d'ARN.

Immunoblot

Les protéines sont chauffées à 90°C pendant 5 minutes. Trente µg de protéines sont déposés dans les puits d'un gel de polyacrylamide à 8% en présence de Sodium Dodécyl Sulfate (SDS). La migration est effectuée par électrophorèse dans un tampon de migration (TRIS base 25 mM ; Glycine 192 mM) avec 0,1% de SDS, à une tension constante de 100 V. Les protéines sont ensuite transférées sur une membrane de PVDF pendant 1 heure dans un tampon de transfert (TRIS base 25 mM ; Glycine 192 mM ; méthanol 20%) à une intensité constante de 0,03 A et à 4°C. Une saturation des sites aspécifiques est effectuée dans une solution d'albumine sérique bovine à 5% pendant 4 heures. Les membranes sont ensuite incubées pendant une nuit dans des solutions contenant les anticorps primaires dirigés contre la tubuline (1:10.000, Abcam, ab108342) et MKP-1 (1:200, Santa Cruz Biotechnology, V-15 sc-1199). Après rinçage, les membranes sont incubées dans des solutions d'anticorps secondaires couplé à la peroxydase de raifort (1:5.000, Millipore, AP307P) dirigés contre les anticorps anti-tubuline et anti-MKP-1 pendant une heure. Les bandes d'intérêt sont détectées par chimioluminescence après incubation dans une solution issue du kit ECL Prime Western Blotting Detection Reagent (Amersham Biosciences, GE Healthcare). Nous procédons à la quantification à l'aide du logiciel Adobe Photoshop CS6 après scan des films photographiques.

Statistiques

Les résultats sont exprimés en moyenne \pm l'erreur type de la moyenne. Pour les tests comportementaux et l'immunoblot, les analyses statistiques consistent en des analyses de variance (ANOVA) sur des mesures indépendantes ou répétées selon le design expérimental. Les résultats des puces à ADN sont comparés par un t-test. Une analyse post-hoc de Duncan pour comparaison intergroupes est réalisée en cas d'atteinte d'un niveau de significativité de $p < 0,05$. Le logiciel STATISTICA 10.0 (Statsoft, Tulsa, OK, USA) est utilisé pour toutes les analyses statistiques.

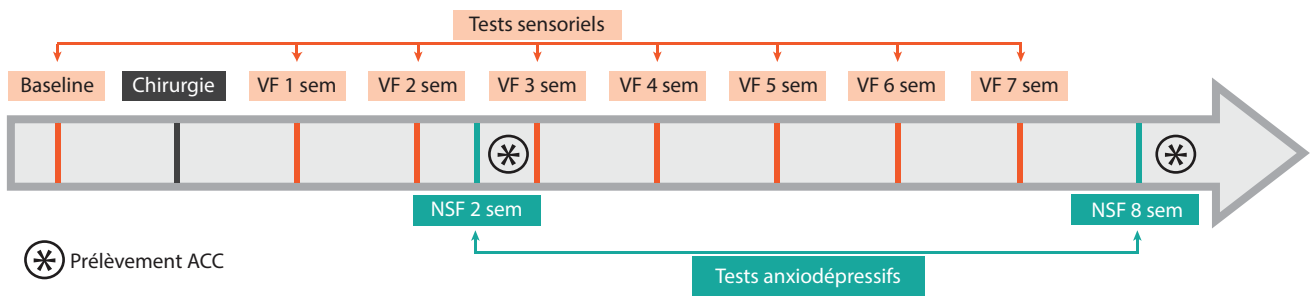

Figure 14. Schéma représentant le déroulement des expériences. Les tests évaluant la sensibilité mécanique (test des filaments de von Frey, VF) sont effectués avant la chirurgie (baseline) et chaque semaine après la chirurgie. Ils sont représentés sur fond orange. Les tests évaluant les comportements anxiodépressifs (NSF) sont effectués soit deux semaines, soit huit semaines après la chirurgie. Ils sont représentés sur fond vert. L'astérisque représente le point temporel auquel le prélèvement de l'ACC a été effectué.

C. Résultats

1. Analyse génomique

Le déroulement des expériences et la constitution des groupes expérimentaux sont exposés en **Figure 14**.

Nous avons constaté, chez les animaux cuff uniquement, le développement d'une allodynie mécanique ipsilatérale au côté de l'implantation du cuff (2 semaines : $F_{2,20}=20,65$, $p<0,001$; 8 semaines : $F_{7,70}=6,04$, $p<0,001$), qui a duré le temps précédant le prélèvement de l'ACC (2 ou 8 semaines selon le groupe) (**Figure 15A**).

Nous avons parallèlement aux études évaluant les changements de sensibilité, étudié le développement de comportements de type anxiodépressif par le test d'hyponéophagie. Nous n'avons pas observé de différence dans ce test entre les animaux sham et cuff 2 semaines après la chirurgie (**Figure 15B**) ($F_{1,10}=0,002$, $p=0,96$), ce qui est cohérent avec les résultats déjà obtenu dans l'équipe qui montrent que le développement de ce type de comportement n'est observable, avec ce test, qu'à partir de 5 semaines après l'induction de la neuropathie (Yalcin et al., 2011). Par contre, nous avons pu montrer des comportements anxiodépressifs chez les animaux cuff 8 semaines (**Figure 15B**) ($F_{1,10}=9,32$, $p<0,05$), ce qui confirme que notre modèle de douleur neuropathique induit des conséquences émotionnelles après un délai temporel.

Suite à l'extraction des ARN, l'utilisation de la technique de puces à ADN nous a permis de distinguer des variations d'expression de nombreux ARN entre les groupes sham et cuff à 2 et 8 semaines après l'induction de la neuropathie (**Figure 16**). Après avoir effectué des recherches bibliographiques sur les différents candidats, nous avons décidé de continuer notre travail en nous intéressant à MKP-1 dont l'ARN présente l'une des augmentations les plus importantes dans notre structure à la fois à 2 (ratio cuff/sham = 2,10, $p<0,05$) et 8 semaines post-chirurgie (ratio cuff/sham = 1,72, $p<0,05$) (**Figure 16**).

2. Analyse du profil d'expression protéique

Nous avons à nouveau constitué deux groupes d'animaux, un groupe sham et un groupe cuff que nous avons suivi pendant 8 semaines, avec mesure de la

A

von Frey hair test

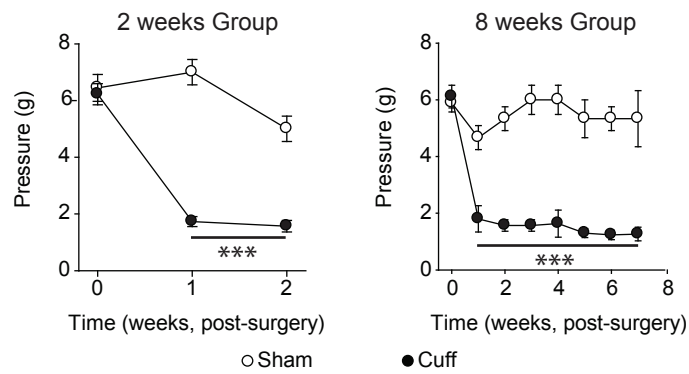

B

Novelty Suppressed Feeding test

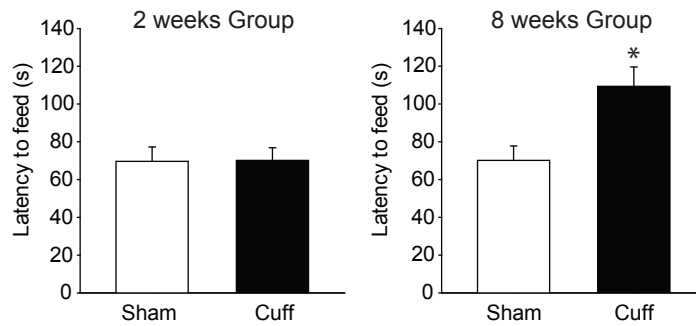

Figure 15. Résultats comportementaux des animaux dont les ARN ont été analysés par la technique de puce à ADN. (A) Une allodynie mécanique persistante est mise en évidence chez les animaux cuff. (B) Les comportements anxiodépressifs sont visibles chez les animaux cuff 8 semaines après la chirurgie, comme le montre l'augmentation du temps de latence avant la première prise de nourriture chez ces animaux. n = 6 animaux par condition. * p<0,05, *** p<0,001.

sensibilité mécanique via le test des filaments de von Frey et évaluation des troubles anxiodépressifs avec le test d'hyponéophagie (**Figure 17A**). Comme précédemment, les souris cuff ont montré une allodynie mécanique (**Figure 17B**) ($F_{7,70}=9,58$, $p<0,001$) et un comportement de type anxiodépressif (**Figure 17C**) ($F_{1,10}=13,10$, $p<0,01$). La dissection de l'ACC a cette fois été faite afin d'en isoler les protéines. Les immunoblots provenant de ces animaux ont montré, conformément aux résultats obtenus sur les ARN, une augmentation du niveau d'expression de la protéine MKP-1 chez les animaux cuff (**Figure 17D,E**) ($F_{1,10}=106,19$, $p<0,001$).

3. Comportement des animaux KO MKP-1

Deux groupes sont constitués en fonction de leur statut génétique, le groupe WT et le groupe KO MKP-1. Au sein de chaque groupe, nous repartissons les animaux en deux sous-groupes, sham et cuff. Nous avons donc à notre disposition 4 groupes que nous avons comparés : WT sham, WT cuff, KO sham, KO cuff. Nous avons suivi, pendant 8 semaines, la sensibilité mécanique et les troubles anxiodépressifs (**Figure 18A**).

Tout d'abord il est important de noter que les animaux KO n'ont pas de troubles de la sensibilité. Selon le test des filaments de von Frey, le seuil de sensibilité mécanique des animaux KO n'est pas différent de celui des animaux WT (**Figure 18B**) ($F_{1,43}=3,33$, $p=0,075$). Après la chirurgie induisant la neuropathie, les animaux cuff ont développé une allodynie mécanique ipsilatérale à l'implantation du cuff, indépendamment de leur statut génétique (**Figure 18C**) ($F_{3,123}=50,25$, $p<0,001$). La perte de l'expression de MKP-1 ne modifie pas ni la sensibilité mécanique, ni la capacité à montrer des troubles de type neuropathie au sein de notre modèle.

Les tests d'hyponéophagie et de toilettage provoqué précédemment décrits sont utilisés pour étudier le développement de troubles anxiodépressifs chez les animaux WT et KO. Les animaux WT cuff, comparés au WT sham montrent une augmentation du temps de latence avant la première prise de nourriture ($p<0,01$) dans le test d'hyponéophagie (**Figure 18D**) et une diminution du temps de toilettage ($p<0,001$) dans le test de toilettage provoqué (**Figure 18E**), confirmant ainsi la mise en place de comportements anxiodépressifs chez les animaux neuropathiques. Par contre, pour les souris KO cuff, il n'existe pas de différence comportementale par rapport aux KO sham dans aucun des deux tests (**Figure 18D,E**) (hyponéophagie :

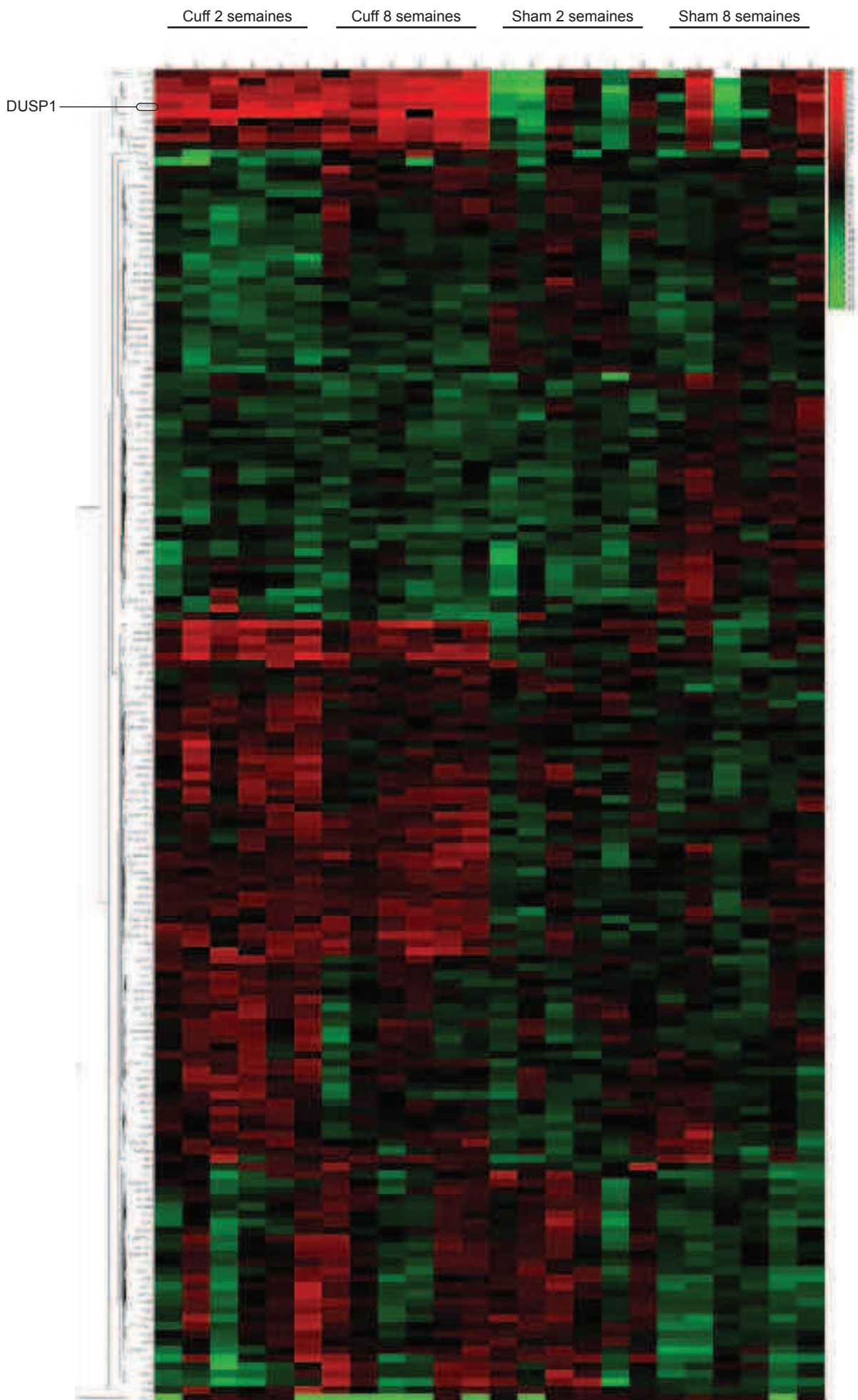

Figure 16. Variation d'expression des ARN extraits de l'ACC de souris sham et cuff. Sont représentés ici les 167 gènes modifiés soit 2 semaines soit 8 semaines après l'induction de la neuropathie. Les ARN surexprimés sont visualisés en rouge, les ARN sous-exprimés en vert, en noir les ARN ne variant pas.

$p=0,58$; toilette provoqué : $p=0,84$), montrant en cela une incapacité à développer des comportements anxiodépressifs chez les animaux déficients en MKP-1. Il est important de noter que les animaux WT sham et KO sham ont des réponses similaires dans les deux tests, le statut génétique n'ayant pas d'effet sur le comportement anxiodépressif basal des animaux (**Figure 18D,E**) (hyponéophagie : $p=0,86$; toilette provoqué : $p=0,44$). Nous pouvons donc conclure que la protéine MKP-1 est responsable, au moins en partie, des conséquences émotionnelles dans notre modèle murin de douleur neuropathique.

D. Discussion

Au sein de l'ACC, structure impliquée dans le développement des troubles anxiodépressifs liés à la douleur neuropathique, des modifications dans l'expression de certains ARN apparaissent dès deux semaines après l'induction de la neuropathie. Parmi les ARN modifiés, nous avons choisi de nous intéresser à celui codant la protéine MKP-1. L'augmentation de l'expression de l'ARN de MKP-1 a été confirmée par l'augmentation de l'expression de la protéine MKP-1 chez les animaux neuropathiques. Enfin, les animaux KO pour MKP-1 qui ont une sensibilité mécanique normale en condition basale ou en condition neuropathique ne montrent pas les comportements de type anxiodépressif en condition neuropathique. Ceci suggère que la perte de cette protéine inhibe l'apparition des conséquences émotionnelles de la douleur neuropathique, au sein de notre modèle. Malgré les apports, selon nous importants de ces résultats, des expériences complémentaires restent nécessaires pour une meilleure compréhension du rôle de MKP-1 dans les conséquences émotionnelles de la douleur neuropathique.

Premièrement, les causes induisant la surexpression de l'ARN codant MKP-1 dans l'ACC au sein de notre modèle ne sont pas connues. MKP-1 a été originellement identifié comme un gène de réponse précoce dont l'expression peut-être induite par des facteurs de croissance ou le stress (Sun et al., 1993). De plus, les MAPK elles-mêmes provoquent une augmentation de l'activité transcriptionnelle de MKP-1, constituant ainsi une boucle de rétrocontrôle cohérente (Brondello et al., 1997). La stabilité de son ARNm, qui peut être une autre cause de l'augmentation de son expression, est contrôlée par les protéines de liaison à l'ARN HuR et NF90

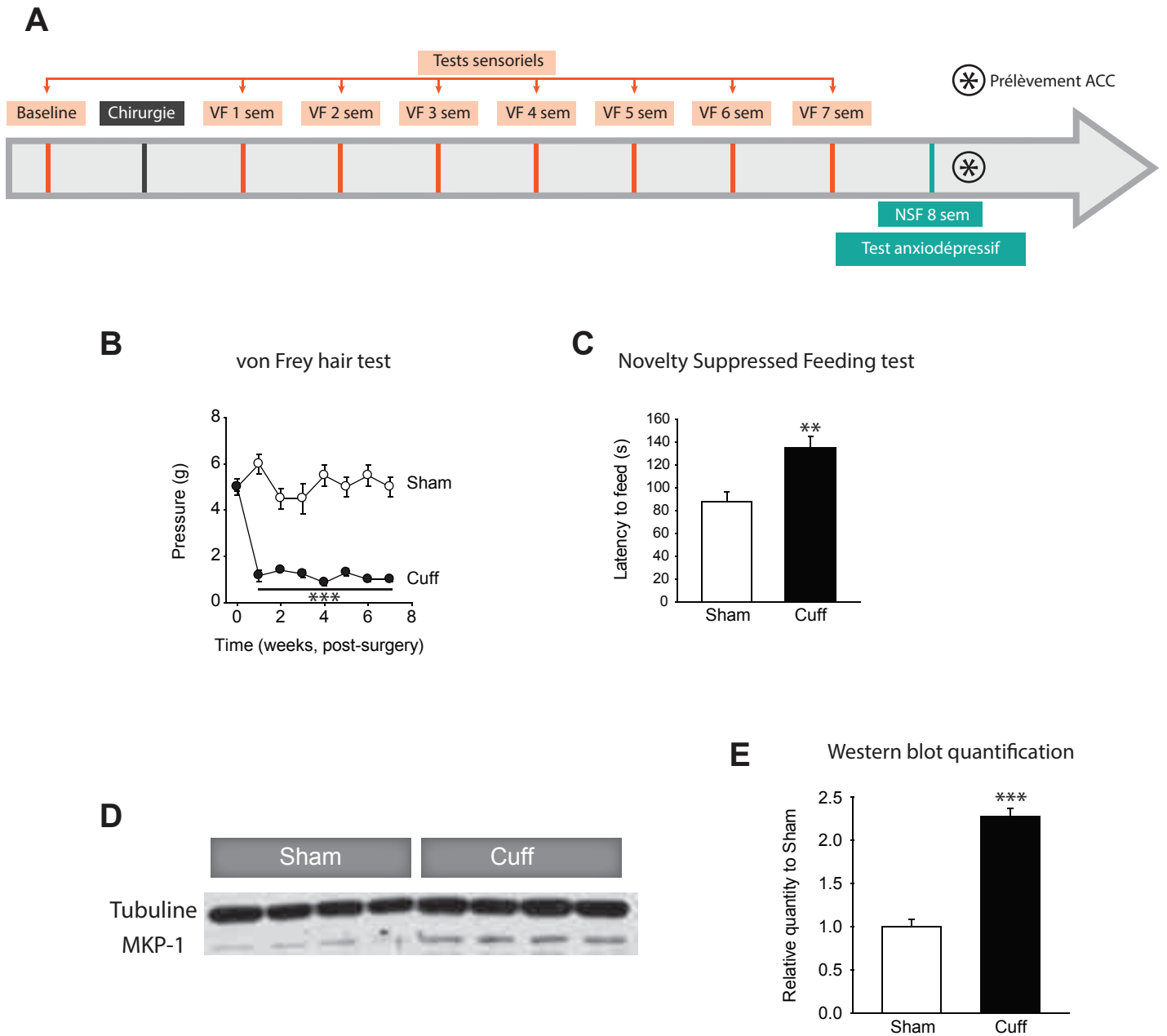

Figure 17. Expression de la protéine MKP-1 dans l'ACC en condition neuropathique. (A) Schéma représentant le déroulement des expériences. Les tests évaluant la sensibilité mécanique (test des filaments de von Frey) sont effectués avant la chirurgie (baseline) et chaque semaine après la chirurgie. Ils sont représentés sur fond orange. Le test évaluant les comportements anxiodépressifs (NSF) est effectué huit semaines après la chirurgie. Il est représenté sur fond vert. L'astérisque représente le point temporel auquel le prélèvement de l'ACC a été effectué. (B) Les animaux cuff développent une allodynie mécanique ipsilatérale au site de la lésion nerveuse. (C) Les animaux cuff ont un temps de latence avant la première prise de nourriture plus long, mettant en évidence un comportement anxiodépressif. (D) Exemple d'un immunoblot et (E) sa quantification. La protéine MKP-1 est surexprimée dans l'ACC des animaux cuff. $n = 6$ animaux par condition. ** $p < 0,01$, *** $p < 0,001$.

(Kuwano et al., 2008), l'activité de ces protéines devra donc être analysée dans notre modèle. La surexpression de l'ARNm codant MKP-1 est probablement une des raisons de la surexpression de la protéine MKP-1, mais ce n'est pas forcément la seule. Certaines études montrent que la stabilité de MKP-1 est augmentée lorsque cette protéine est phosphorylée par ERK1/2 (Brondello et al., 1999), alors que d'autres montrent que la phosphorylation de MKP-1 par ERK1/2 entraîne sa dégradation via un mécanisme impliquant le système ubiquitine/protéasome (Lin et al., 2003). Les mécanismes de régulation croisée entre les MAPK et MKP-1 sont très complexes et varient en fonction des conditions physiopathologiques et des tissus observés. Ces mécanismes devront être précisés dans notre modèle au sein de l'ACC.

Deuxièmement, l'effet de l'augmentation de MKP-1 sur ses cibles doit être mis en évidence. L'observation de l'état de phosphorylation des cibles directes de MKP-1 que sont JNK, p38 et ERK devra être faite, préférentiellement sur les protéines nucléaires du fait de la compartimentalisation de MKP-1. Après avoir déphosphorylé leurs cibles, les MKPs peuvent soit les libérer soit les séquestrer. L'état de phosphorylation de leurs cibles n'est donc pas le seul indice de leur activité, et des expériences de coimmunoprécipitations peuvent fournir des informations importantes sur l'implication de MKP-1 dans les voies de signalisation cellulaire.

Troisièmement nous avons utilisé des animaux transgéniques dont l'expression de MKP-1 est inhibée à travers tout l'organisme, et pas uniquement dans l'ACC. Or nous savons que la surexpression localisée de MKP-1 dans l'hippocampe de souris est capable d'induire des comportements anxiodépressifs (Duric et al., 2010). Bien que nous ayons observé une surexpression de l'ARN et de la protéine MKP-1 dans l'ACC, l'absence de ces comportements chez les animaux KO n'est pas forcément corrélée à la perte de l'expression de cette protéine dans l'ACC, mais peut-être à celle dans l'hippocampe ou dans une autre structure impliquée dans la dépression. Une solution pour confirmer l'implication spécifique de l'ACC serait d'induire des pertes d'expression de MKP-1 localisées dans l'ACC (par exemple par la technique Cre/LoxP ou l'injection locale de siRNA). Nous pourrions aussi entraîner une surexpression localisée de MKP-1 dans l'ACC par transgénèse virale. Ces deux approches complémentaires pourraient permettre de confirmer l'implication de MKP-1 dans l'ACC, dans les conséquences émotionnelles de la douleur neuropathique.

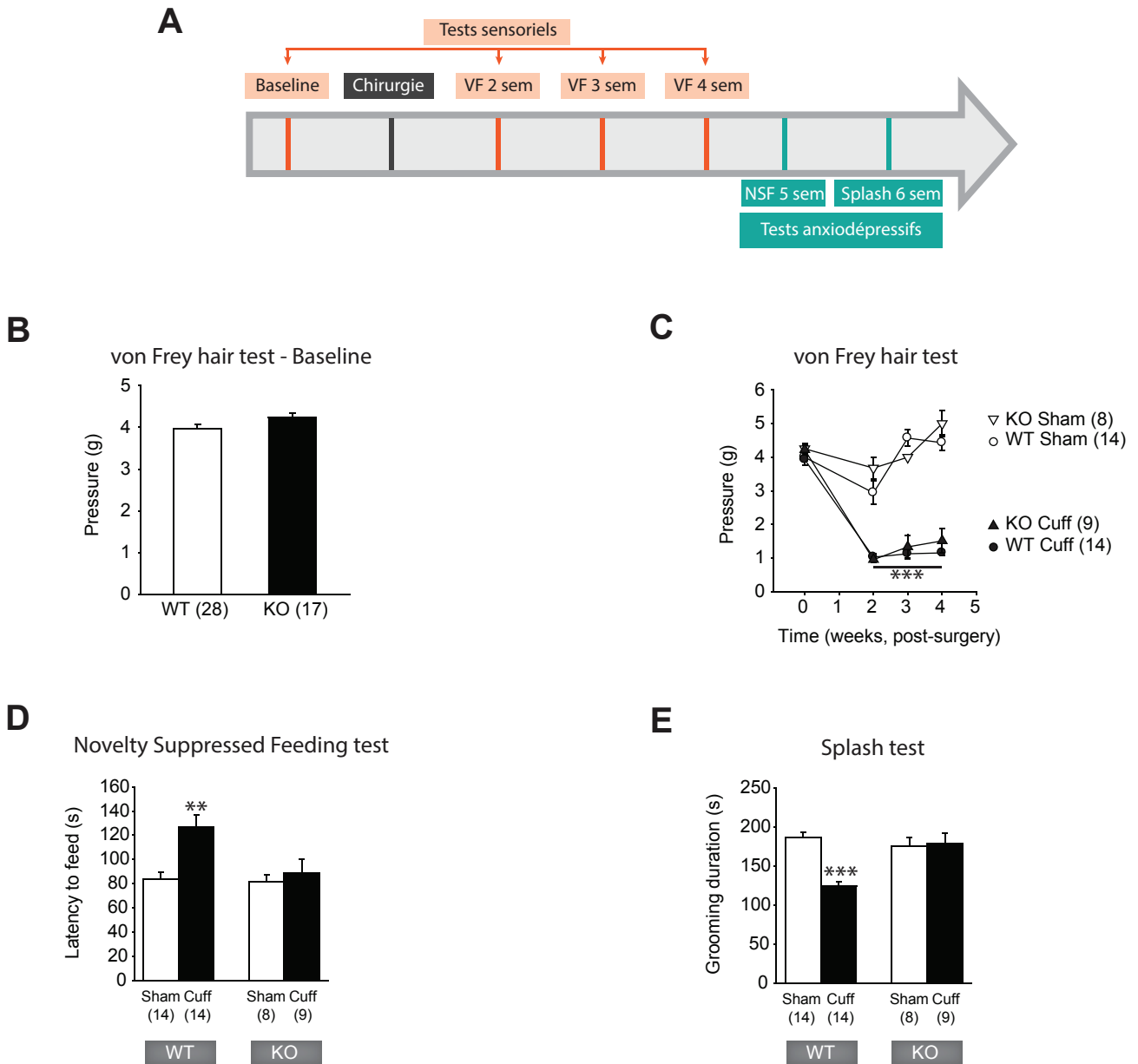

Figure 18. Comportements nociceptifs et anxiodépressifs des souris KO MKP-1. (A) Schéma représentant le déroulement des expériences. Les tests évaluant la sensibilité mécanique (test des filaments de von Frey) sont effectués avant la chirurgie (baseline) et chaque semaine après la chirurgie. Ils sont représentés sur fond orange. Le test évaluant les comportements anxiodépressifs (NSF) est effectué 5 semaines après la chirurgie. Il est représenté sur fond vert. (B) La sensibilité mécanique est identique chez les animaux WT et KO avant l'induction de la neuropathie. (C) Les animaux cuff développent une allodynie mécanique ipsilatérale indépendamment de leur statut génétique. (D) Les animaux cuff WT ont un temps de latence avant la première prise de nourriture plus long, mettant en évidence un comportement anxiodépressif. Ce n'est pas le cas pour les animaux KO cuff. (E) Les animaux cuff WT ont un temps de toilettage plus court, mettant en évidence un comportement anxiodépressif. Ce n'est pas le cas pour les animaux KO cuff. Les nombres entre parenthèses correspondent au nombre d'animaux par condition. ** $p < 0,01$, *** $p < 0,001$

Enfin, il nous semble important de noter que l'ARN codant MKP-1 n'est pas le seul membre de la famille de MKP à être surexprimé dans notre modèle. Les ARN codant MKP-3 et MKP-4, qui font partie des deux autres familles de MKP sont aussi surexprimés. L'effet de la surexpression de MKP-1 sur la voie des MAPK doit donc être pondéré par les modifications d'expression des autres acteurs de cette voie, en particulier des autres MKP dans notre modèle de douleur neuropathique.

La mise en évidence du rôle de MKP-1 dans le développement des comportements anxiodépressifs dans notre modèle, constitue une piste de recherche très intéressante pour une meilleure compréhension de ces troubles.

Discussion générale

I. Pertinence du modèle utilisé dans l'étude de la douleur neuropathique

A. L'étude de la douleur chez les rongeurs

Certains auteurs ont questionné le bien fondé de l'utilisation des rongeurs pour l'étude de la douleur dans un but translationnel (Langley et al., 2008; Craig, 2009). Cette interrogation est pertinente au vue de la difficulté à développer chez l'Homme de nouveaux traitements pharmacologiques sur la base de leur potentiel thérapeutique chez l'animal (Hill, 2000). Comme le dit A.D. Craig, un rat n'est pas un singe qui n'est pas un humain (Craig, 2009). Sa critique de l'utilisation des rongeurs repose sur le manque d'homologie des structures qui convoient et intègrent l'information nociceptive pour aboutir à l'expérience douloureuse. Nous avons discuté en partie de cette question dans l'introduction. En effet, toutes les structures des voies spino-thalamo-corticales ne sont pas identiques chez l'Homme ou les singes et chez les rongeurs. Un des exemples le plus frappant au niveau anatomique est l'individualisation de l'insula chez l'Homme, absente chez les rongeurs, espèces lissencéphales. Cependant, les voies de projections spinothalamiques existent chez le rat, et ces voies ont bien des terminaisons corticales dans le cortex cingulaire (Hoover and Vertes, 2007) et le cortex insulaire (Allen et al., 1991). Ainsi, dire que l'absence d'homologie stricte des structures et des circuits neuroanatomiques entre l'Homme et les rongeurs rend caduque l'étude des voies et des mécanismes de la douleur chez les rongeurs dans un but translationnel nous paraît excessif.

Au cours du temps, des tests mesurant, non plus uniquement des réponses réflexes, mais aussi des comportements motivés (Johansen et al., 2001; LaGraize et al., 2004) mettant en œuvre des processus corticaux plus complexes sont apparus. Ils ont permis la mise en évidence chez le rongeur de la composante aversive/motivationnelle de la douleur. Dans le cadre de la douleur neuropathique, la présence de douleurs spontanées est particulièrement handicapante pour les patients (Backonja and Stacey, 2004). L'étude de cette composante a longtemps été ignorée chez les rongeurs du fait d'obstacles expérimentaux. Le développement de nouveaux tests a montré que la douleur spontanée est mesurable indirectement avec des protocoles de préférence de place ((King et al., 2009), et partie II. de la section résultats). Ces tests sont relativement récents et leur portée translationnelle

ne peut être anticipée. Nous pensons toutefois que la diversification des tests utilisés et des comportements observés chez le rongeur est en faveur d'une meilleure compréhension des processus mis en jeu dans la douleur. Les difficultés rencontrées dans la mise en place de ces tests, leur reproductibilité et le nombre d'animaux nécessaires doivent toutefois être mis en perspective avec l'information recherchée.

B. Discussion sur les termes hyperalgésie et allodynie

Les signes modélisant la douleur chez l'animal sont majoritairement des réponses à des stimuli provoqués. Les termes hyperalgésie et allodynie sont largement utilisés dans la recherche préclinique et nous pensons nécessaire de préciser leur signification et leur pertinence dans notre modèle.

L'hyperalgésie se traduit par une réponse douloureuse exagérée à un stimulus qui induit normalement de la douleur. Selon les nouvelles recommandations de l'IASP, c'est désormais un terme générique pouvant inclure à la fois une diminution du seuil de sensibilité et une augmentation de la réponse lorsque le seuil est dépassé.

L'allodynie est une douleur en réponse à un stimulus normalement non nociceptif. Le groupe d'étude de l'IASP travaillant sur la taxonomie précise que le stimulus ne doit pas activer les nocicepteurs. L'allodynie se réfère alors majoritairement à l'activation des fibres A β et aux fibres A δ et C à bas seuil d'activation. Cette définition n'est pas en contradiction avec l'utilisation que nous en faisons, cependant, l'activation de ces fibres dans notre modèle n'est pas démontrée.

En l'absence d'études électrophysiologiques démontrant quels types de fibres sont recrutés dans les situations neuropathique et non neuropathique, les seules conclusions que nous pouvons tirer est que nous observons une diminution du seuil de sensibilité mécanique chez les animaux cuff.

C. La modélisation de la douleur neuropathique dans le modèle du cuff

Nous allons discuter dans notre modèle de douleur neuropathique, des signes observables et de ceux qui ne le sont pas, en comparaison aux signes décrits chez l'Homme.

Une diminution du seuil de sensibilité mécanique est mise en évidence dans notre modèle dès les premiers jours après la chirurgie et persiste pendant trois mois. Le stimulus consiste en l'application statique de filaments de von Frey sur le côté inférieur de la patte des animaux. Chez l'Homme, c'est la stimulation mécanique dynamique qui est principalement perçue comme douloureuse. La mesure de la sensibilité à un tel stimulus (Thibault et al., 2014), par effleurement de la face inférieure des pattes avec un pinceau est possible chez le rat mais difficile chez la souris du fait de la petite taille des pattes des animaux et de leurs mouvements fréquents dans les boîtes de test.

Une hyperalgésie à un stimulus thermique chaud est transitoirement observée pendant les quinze premiers jours suivant la chirurgie chez les souris cuff par le « radiant heat paw-withdrawal test » (Benbouzid et al., 2008b). Ce test a l'avantage de mesurer indépendamment les réponses des pattes gauche et droite (Cheppudira, 2006). L'hyperalgésie ne dure pas dans le temps, ce test n'est pas très utile pour nos travaux où nous étudions les conséquences à long terme de la douleur neuropathique. Le temps moyen avant le retrait de la patte pour nos animaux naïfs doit être au moins de 5 secondes si l'on veut pouvoir observer une diminution de ce temps chez nos animaux neuropathiques. Les souris C57BL/6J utilisées ne passent que très rarement plus de 3 secondes immobiles, même après un temps d'habituation. Il est donc compliqué d'obtenir des valeurs correctes pour un grand nombre d'animaux.

Les réponses à un stimulus thermique froid peuvent être mesurées par le test de la plaque froide, mais ce test ne permet pas la différenciation entre la patte gauche et la patte droite. Le test à l'acétone, où une goutte d'acétone est appliquée indépendamment sur la face inférieure de chaque patte des animaux permet de faire cette distinction. Cependant, l'utilisation de ce test dans notre modèle murin n'a pas été concluante malgré les différents essais faits par différents expérimentateurs de notre laboratoire.

Le « Place/Escape Avoidance Paradigm » (PEAP) permet de mettre en évidence la composante aversive de la douleur provoquée (LaGraize et al., 2004). Ce test n'a pas encore été effectué dans notre modèle mais pourrait compléter de manière pertinente les résultats déjà obtenus dans l'équipe.

Tous les tests mentionnés jusqu'ici mesurent la réponse des animaux à une douleur ou un stimulus provoqués par l'expérimentateur et mettent en évidence des signes positifs. Nous savons qu'en clinique, ces signes sont accompagnés de troubles de la sensibilité comme la dysesthésie et la paresthésie. Ces manifestations ne sont pas détectables dans les modèles animaux y compris le nôtre. Les signes négatifs d'hypoalgésie et d'hypoesthésie sont probablement observables par les tests classiques des filaments de von Frey, mais n'ont pas été détectés dans notre modèle.

Enfin, les tests permettant la mesure de la composante aversive de la douleur spontanée ont été menés avec succès dans notre modèle (II. section résultats). La pertinence et les difficultés rencontrées au cours de ces tests sont détaillées dans la partie suivante.

En résumé, notre modèle permet de mettre en évidence les signes positifs de diminution du seuil de sensibilité mécanique et d'hyperalgésie thermique et la composante aversive de la douleur spontanée mais pas, à notre connaissance, les troubles de la sensibilité, les signes déficitaires ou la composante aversive de la douleur provoquée. Si la multiplication des signes retrouvés à la fois chez l'Homme et chez l'animal augmente la qualité du modèle animal, il n'est pas pour autant nécessaire de les retrouver en totalité pour que le modèle utilisé soit pertinent. Ceci est particulièrement vrai pour les douleurs neuropathiques où les signes cliniques sont très variables en fonction de l'étiologie (Baron et al., 2010) et même entre des patients ayant des douleurs neuropathiques d'origines comparables (Defrin et al., 2001).

D. Discussion de la mesure de la douleur spontanée par CPP

La douleur spontanée est très invalidante en clinique mais n'est observée que depuis peu en recherche fondamentale. Comme nous l'avons vu dans la partie II. de la section résultats, c'est la préférence des animaux pour un compartiment

associé à un traitement analgésique parallèlement à une aversion pour le compartiment associé à la douleur qui met en évidence la composante aversive/motivationnelle de la douleur spontanée. Cette mise en évidence est donc indirecte car on ne mesure pas un niveau de douleur spontanée. Ce test, simple en théorie, est très compliqué à mettre en œuvre, en particulier chez la souris.

Dans ce test développé chez le rat (King et al., 2009), les animaux montrent une préférence pour le compartiment associé à l'analgésique après une seule injection intrathécale (i.t.) de clonidine, démontrant que le conditionnement est extrêmement efficace. En effet, la morphine, substance récompensante classiquement utilisée ne permet pas de conditionnement aussi rapide (Aguilar et al., 2009). Chez le rat, l'injection i.t. est réalisée via un cathéter installé à demeure. Cela permet une ou plusieurs injections successives chez l'animal vigile sans pratiquement de douleur. Chez la souris, l'espace intervertébral est moins favorable à la pose d'un cathéter, et l'injection i.t. doit se faire sous anesthésie gazeuse. Après le réveil qui survient dans les 30 secondes après l'injection, il est fort probable que les animaux ressentent la douleur due à l'injection. Cette douleur post-injection risque de s'ajouter à la douleur spontanée que nous souhaitons mesurer et de cacher ainsi l'effet analgésique de la clonidine sur la douleur spontanée. Ceci est en partie contrôlé par l'utilisation du groupe sham. En effet, si l'analgésie induite par la clonidine entraîne un soulagement de la douleur due aux injections i.t., alors le groupe sham présentera aussi une préférence pour le compartiment associé à la clonidine. Or, ce n'est pas le cas, ni dans notre modèle chez la souris, ni dans le modèle de « spinal nerve ligation » chez le rat (King et al., 2009).

Le fait que la pose d'un cathéter soit difficilement réalisable chez la souris entraîne un autre problème. Les injections i.t. sont traumatisantes et un tissu cicatriciel commence à se former après l'injection du matin augmentant le risque d'une injection inefficace l'après-midi. De plus, cela rend impossible les injections répétées sur plusieurs jours et donc nous ne pouvons pas augmenter les chances que les souris associent la drogue au contexte par des appariements successifs.

Afin de maximiser les chances d'apprentissage, nous avons choisi un protocole où les souris sont placées dans le compartiment immédiatement après l'injection i.t. pour une durée de 15 minutes, l'effet analgésique aigu de la clonidine diminuant au bout de 30 minutes. Après ce temps, les souris sont remises dans leurs cages. Pour que les animaux associent la clonidine à un soulagement, il faut que durant les 15

minutes où ils se trouvent dans le compartiment associé à la solution saline contrôle (i.e. le matin), les animaux aient un accès douloureux. Or, nous savons qu'en clinique, les patients souffrant de douleurs neuropathiques n'éprouvent pas de douleurs spontanées en continu mais qu'elles apparaissent de manière épisodique. La fréquence et la durée de ces épisodes ne sont pas connues dans notre modèle, et il est possible qu'ils ne surviennent chez les souris pas pendant la phase de conditionnement associé à la solution saline. Ainsi, lorsqu'elles seront placées dans le compartiment associé à la clonidine, même si elles ressentent un épisode de douleur spontanée et que l'injection de clonidine les soulage, elles ne pourront associer ce compartiment à un soulagement de la douleur, car elles n'auront pas ressenti de douleur dans l'autre compartiment.

Le choix de la clonidine se justifie par la nécessité d'avoir un analgésique d'action immédiate, sans propriété récompensante. L'injection i.t. est choisie pour éviter les effets cardiovasculaires de la clonidine administrée par voie générale. Cependant, ces effets ne sont pas totalement absents lors d'une administration i.t. car on peut observer une hypotension, une bradycardie et une sédation lors d'une administration i.t. de clonidine chez le rat (Kawamata et al., 2003).

Une alternative à l'injection i.t. de clonidine est l'injection de lidocaïne (un bloqueur des canaux sodium) dans le bulbe rostro-ventral (RVM). En effet, chez le rat, l'hypersensibilité consécutive à une lésion nerveuse dépend d'un contrôle descendant facilitant provenant de cette structure (Burgess et al., 2002). Une préférence de place pour le compartiment associé à une injection de lidocaïne dans le RVM a ainsi été mise en évidence chez le rat (King et al., 2009). Cette alternative n'a pas été essayée dans notre laboratoire.

L'utilisation de ce test de préférence de place nécessite également un point de discussion. La préférence pour le compartiment associé à la clonidine résulte selon nous, d'une part de l'effet récompensant du soulagement de la douleur spontanée ressentie dans le compartiment associé à l'analgésique et d'autre part de l'effet aversif de la douleur spontanée ressentie dans le compartiment associé à la solution saline. Il n'est donc pas possible de dissocier l'effet récompensant du soulagement de la douleur de l'effet aversif de la douleur.

Critère de validité	Sous-critère de validité	Similarité recherchée entre le modèle et la pathologie humaine	Application dans notre modèle
Homologie	Espèce	phylogénétique	Souris
	Souche		C57BL6/J, Thy1-ChR2-YFP
Pathogénie	Ontopathogénie	facteurs environnementaux produisant au cours du développement un organisme vulnérable	Inconnue
	Déclenchement	facteurs environnementaux produisant à l'âge adulte un organisme pathologique	Douleur neuropathique
Mécanistique		mécanismes produisant les symptômes, les biomarqueurs et mécanismes sensibles à l'action des agents thérapeutiques	Inconnue
Isomorphisme des symptômes	Ethologie	comportements observés	Perte d'intérêt pour des activités usuelles (toiletage provoqué), résignation (nage forcée)
	Biomarqueurs	marqueurs biologiques mesurés	Inconnue
Prédictivité	Induction	facteurs responsables des comportements ou des marqueurs biologiques	Inconnue
	Rémission	effets des traitements sur les comportements ou les marqueurs biologiques	Inconnue

Tableau 5. Résumé des validités selon C. Belzung et M. Lemoine (2011) et application à notre modèle pour l'anxiodépression.

II. Pertinence du modèle utilisé pour l'étude des comportements anxiodépressifs

A. Précautions et précisions sur les termes employés

Nous avons parlé tout au long de ce travail de comportements de type anxiodépressif. Ce terme est utilisé car la dépression est une maladie humaine et il serait donc abusif de parler de souris dépressives. Nous utilisons le terme anxiodépressif car il est difficile chez le rongeur, dans la plupart des tests comportementaux, de dissocier la composante anxieuse de la composante dépressive (Cryan and Holmes, 2005). Enfin, nous l'utilisons aussi car le test d'hyponéophagie dont nous nous servons, conçu initialement pour mesurer des comportements de type anxieux, mesure en réalité un comportement mixte anxiodépressif. La composante dépressive a été mise en évidence par l'efficacité dans ce test de traitements chroniques par des antidépresseurs (Santarelli et al., 2003).

B. Modélisation des comportements de type anxiodépressif chez la souris

La modélisation chez l'animal de comportements complexes comme les troubles anxieux et dépressifs est sujette à débat au sein de la communauté scientifique (Crabbe and Morris, 2004). On peut en effet se demander si des processus psychologiques et cognitifs comme le sentiment d'impuissance, la culpabilité, le sentiment d'inutilité, le découragement, les ruminations, communément retrouvés chez les patients dépressifs peuvent être modélisés chez les rongeurs. Toutefois, même si ces questions sont pertinentes, il convient de souligner que des informations apportées par les modèles animaux (Santarelli et al., 2003) ont été confirmées dans la recherche sur les troubles de l'humeur chez l'homme (Boldrini et al., 2009).

Comme les douleurs neuropathiques, les troubles de l'humeur regroupent une grande variété de causes et de manifestations cliniques tels que les troubles anxieux généralisés, le trouble de stress post-traumatique, le trouble obsessionnel compulsif,

la dépression majeure pour en citer quelques-uns. La nécessité de définir des critères de validité pour les modèles animaux utilisés est indiscutable. De nombreux travaux ont été consacrés à cette question (McKinney and Bunney, 1969; Willner, 1984; van der Staay et al., 2009) et les critères utilisés, du moins pour certains d'entre eux, varient entre les auteurs (Belzung and Lemoine, 2011).

La validité d'un modèle expérimental repose sur deux aspects : la validité interne et la validité externe (Belzung and Lemoine, 2011). La validité interne traite de la qualité intrinsèque du design expérimental. L'expérimentateur est-il informé des groupes expérimentaux (test en aveugle) ? L'attribution des animaux dans les différents groupes est-elle randomisée ? Est-ce que des groupes contrôles sont présents ? Est-ce que les résultats sont reproductibles par le même ou un autre expérimentateur ? De la réponse à ces questions vont dépendre la qualité et la validité interne de l'expérience.

La validité externe est une notion plus complexe et regroupe des critères variant selon les auteurs, mais qui dans le cas de la modélisation de la dépression sont basés très souvent sur ceux proposés par Paul Willner en 1984 (Willner, 1984) : l'isomorphisme des symptômes (face validity), la validité de prédiction (predictive validity) et la validité de construction (construct validity).

Depuis ce travail précurseur, différents auteurs ont retravaillé ces validités et nous allons décrire et résumer un ensemble de 5 critères définis en 2011 (Belzung and Lemoine, 2011), que l'on peut retrouver dans le **tableau 5** : la validité d'homologie (homology validity), la validité pathogénique (pathogenic validity), la validité mécanistique (mechanistic validity), l'isomorphisme des symptômes (face validity) et la validité de prédiction (predictive validity), les deux derniers critères étant formulés de manière identique aux deux critères de Willner avec cependant des différences dans leur signification.

La **validité d'homologie** s'intéresse au degré d'homologie entre l'espèce et la souche servant de modèle et l'Homme. Ainsi, la drosophile a une validité d'homologie moindre que la souris, qui elle-même a un degré d'homologie moins important qu'un singe. La **validité pathogénique** évalue la similarité entre les processus aboutissant à la maladie chez le modèle et chez l'Homme. Au sein de ce critère sont distingués la validité ontopathogénique, définissant la similarité des facteurs environnementaux responsables, au cours du développement, de la

vulnérabilisation de l'organisme et la validité de déclenchement, qui compare les facteurs capables de déclencher la transition entre un organisme vulnérabilisé et un organisme pathologique, à l'âge adulte. La **validité mécanistique** s'intéresse à la similarité des mécanismes produisant les symptômes (et les marqueurs biologiques), et à la similarité des mécanismes sensibles aux effets thérapeutiques. La « face validity » est historiquement traduite en **isomorphisme des symptômes** mais étant donné la réévaluation de ce critère faite dans ce travail, cette traduction peut ne plus correspondre. Nous utiliserons cependant le terme historique d'isomorphisme des symptômes dans un souci de cohérence lexicale. Ce critère se réfère à la similarité des comportements observés chez le modèle et chez l'Homme (validité éthologique), mais aussi à la similarité des biomarqueurs (validité des biomarqueurs). Enfin, la **validité de prédiction** peut être résumée par la ressemblance entre les effets des facteurs étiologiques (validité d'induction) et des traitements (validité de rémission) sur des comportements directement observables ou des marqueurs biologiques. Dans le paragraphe suivant, nous appliquerons ces critères à notre modèle du cuff dans l'étude des conséquences émotionnelles de la douleur.

C. Modélisation des comportements de type anxiodépressif dans le modèle du cuff

Nos expériences sont menées en aveugle. Toutefois, il faut prendre en compte le fait que les animaux cuff, lors des premiers jours suivant la chirurgie induisant la neuropathie, vont garder les doigts de la patte où l'on a posé le cuff partiellement fermés. Ce comportement disparaît peu à peu mais persiste lorsque les souris sont suspendues par la queue dans le vide. Ainsi, lorsqu'on les sort de leur cage pour les mettre dans un dispositif de test comportemental, il est possible que l'expérimentateur observe, même involontairement, une rétraction de la patte avec le cuff faussant ainsi le test en aveugle. L'attribution des souris en fonction des groupes est faite de manière randomisée, de sorte qu'ils sont homogènes avant le début des expériences. Initialement, les animaux des différents groupes expérimentaux étaient mélangés dans les mêmes cages, puis nous les avons groupés en fonction de leur condition. En effet, il a été montré que la cohabitation d'une souris non malade avec une souris malade entraîne chez la souris saine une modification de son comportement (Morgulis et al., 2004). Néanmoins, les animaux

d'une même expérience sont tous placés sur une même étagère à l'intérieur d'une même pièce. Dans la mesure du possible, un test comportemental est accompli sur une seule journée pour éviter un effet « jour ». Si le nombre d'animaux est trop important, leur passage dans un test comportemental est réparti sur deux jours pour éviter qu'il y ait une différence entre les comportements du matin et ceux de l'après-midi. Dans ce cas un nombre d'animaux équivalent de chaque groupe passe chaque jour. Les vagues expérimentales comprennent systématiquement les groupes contrôles que nous avons jugés adéquats et nécessaires. La disposition spatiale dans la pièce contenant les tests comportementaux est conservée au cours du temps et les paramètres de luminosité sont mesurés et reproduits afin de conserver les mêmes conditions expérimentales. Les animaux (hors animaux transgéniques) proviennent du même fournisseur (Charles River). L'âge des animaux est contrôlé pour être le même entre les groupes et entre les expériences successives. Les résultats ont été reproduits à plusieurs reprises par le même expérimentateur et par différents expérimentateurs. Toutes ces précautions valident selon nous la qualité du design expérimental.

Reprenons maintenant les critères de validité externe décrit dans la partie précédente et voyons lesquels s'appliquent à notre modèle (**Tableau 5**). Concernant la **validité d'homologie** nous travaillons sur l'espèce souris et la souche C57BL/6J. L'utilisation de la souche C57BL/6J est pertinente car sensible à des modèles de dépression et aux traitements antidépresseurs (Ibarguen-Vargas et al., 2008). La **validité pathogénique** nous paraît correcte au niveau de la validité de déclenchement car la lésion nerveuse chez nos souris peut induire, comme chez l'Homme des comportements de type anxiodépressif. Par contre la **validité mécanistique** nous semble difficile à établir du fait que les processus aboutissant aux symptômes dépressifs ne sont pas établis chez le patient souffrant de douleurs neuropathiques. La recherche de ces processus constitue d'ailleurs un des objectifs de ce travail de thèse. La **validité éthologique** présente un score assez important dans notre modèle. Par exemple la diminution du comportement de toilettage chez les souris peut être comparée à la perte d'intérêt pour les activités quotidiennes rencontrée chez les patients dépressifs. De même la résignation observée dans le test de nage forcée peut être assimilée à une forme d'impuissance et de résignation face à une situation adverse chez les patients dépressifs. Le risque dans la validité éthologique est néanmoins une surinterprétation anthropomorphique des

comportements animaux observés. La **validité des marqueurs biologiques** ne peut être analysée dans notre modèle étant donné qu'il n'existe pas à notre connaissance de biomarqueurs spécifiques et valides des conséquences émotionnelles de la douleur neuropathique. La **validité de prédiction** reste à évaluer. L'efficacité des traitements antidépresseurs seulement sur les comportements anxiodépresseurs est difficile à mettre en évidence dans notre modèle car certaines classes comme les inhibiteurs de la recapture de la noradrénaline et de la sérotonine (Yalcin et al., 2009), les inhibiteurs spécifiques de la recapture de la noradrénaline (Yalcin et al., 2009) ou les antidépresseurs tricycliques (Benbouzid et al., 2008a) sont également efficaces sur l'allodynie mécanique. La difficulté est donc d'utiliser des traitements antidépresseurs qui ne soulagent pas la douleur neuropathique. Par exemple, la fluoxétine, un antidépresseur de la classe des inhibiteurs sélectifs de la recapture de la sérotonine, n'a pas d'effet sur la sensibilité mécanique. Son effet sur les comportements anxiodépresseurs pourrait nous donner des informations concernant la validité de rémission dans notre modèle.

Les validités interne et externe remplissent suffisamment de critères selon nous et font du cuff un modèle tout-à-fait pertinent pour l'étude des conséquences émotionnelles de la douleur neuropathique.

D. Autres considérations méthodologiques

La difficulté d'obtenir des résultats régulièrement reproductibles lors d'études comportementales chez l'animal est bien connue de tous les expérimentateurs. De nombreux paramètres peuvent influencer le comportement des animaux, certains sont contrôlables, d'autres non. Par exemple, nous avons fait passer les souris dans les tests comportementaux pendant la phase nocturne, cette phase correspondant à la phase active des souris qui sont des animaux nocturnes. Ceci est important dans nos tests (NSF, splash, FST), car les souris ayant un comportement de type anxiodépresseur présentent une diminution de l'activité motrice dans l'exploration du champ ouvert (NSF), dans le toilettage (splash) ou dans la nage (FST). Ainsi, observer une diminution de cette activité peut être difficile pendant la phase inactive diurne, ceci prévenant l'observation de comportements anxiodépresseurs pourtant présents, mais non détectables à ce moment de la journée. Notons que l'activité locomotrice

des différents groupes est contrôlée de manière systématique dans une expérience indépendante afin de nous affranchir d'un possible effet sur la locomotion des chirurgies induisant la neuropathie ou les lésions corticales. Les tests présentés dans ces travaux sont ceux pour lesquels les résultats sont les plus reproductibles entre les différentes expériences et entre les différents expérimentateurs. D'autres tests, s'intéressant plutôt au comportement de type anxieux, sont moins reproductibles, comme le labyrinthe en croix surélevé, le test de clair/obscur ou encore le test d'enfouissement des billes. Nous n'avons pas de réponse concrète pour expliquer pourquoi certains tests sont plus reproductibles que d'autres dans notre modèle. Soit il peut y avoir un facteur intrinsèque à notre modèle le rendant moins sensible aux traits comportementaux modélisés par certains tests, soit nos animaux sont plus sensibles à des facteurs externes non contrôlés et non identifiés influençant leur réponse dans ces tests, les deux possibilités ne s'excluant pas.

Dans ces travaux de thèse, dans la partie II. de la section résultats, les comportements anxiodépressifs observés sont reproductibles dans trois tests différents. Ceci nous paraît un gage important de la qualité des résultats obtenus. Cependant, dans ces trois tests, on observe systématiquement une diminution d'un comportement chez les animaux neuropathiques : diminution de l'activité exploratoire dans l'hyponéophasie, diminution du comportement de toilettage dans le test de toilettage provoqué, diminution de la nage dans le test de nage forcée. L'utilisation de tests permettant la mise en évidence de l'augmentation ou de l'apparition d'un comportement pourrait être complémentaire et pertinente. Le test d'enfouissement des billes est en ce sens intéressant et a déjà été utilisé avec succès dans notre modèle, mais comme évoqué plus haut, la reproductibilité de ses résultats n'est pas systématique.

La plupart des tests utilisés pour mesurer des comportements de type anxieux ou dépressif ne peuvent pas être réutilisés sur les mêmes animaux car la réponse observée est en partie dépendante de l'exposition à un contexte inhabituel lors du premier test. La répétition du test ferait perdre cette composante « nouveauté ». Ainsi, si l'on veut comparer différentes conditions, par exemple le comportement anxiodépressif 2 et 8 semaines post-chirurgie, il est nécessaire de constituer deux groupes d'animaux. C'est la même chose si l'on veut étudier l'effet d'un traitement ou encore l'effet d'une stimulation en optogénétique. Un nombre d'animaux

important est donc nécessaire, allant à l'encontre de la règle éthique de la réduction de leur nombre.

III. Mécanismes responsables de l'apparition des troubles anxiodépressifs dans notre modèle de douleur neuropathique

Les travaux d'Ipek Yalcin, dont cette thèse est la continuité, ont mis en évidence que le modèle du cuff n'est pas un modèle de stress chronique. Dans les modèles de dépression induits par le stress chronique, l'axe corticotrope est hyperactivé en lien avec une déficience du rétrocontrôle négatif (Krishnan and Nestler, 2008). Dans notre modèle, il n'y a pas d'altération de l'axe corticotrope (Yalcin et al., 2011) montrant en cela que ce modèle de douleur ne peut être associé à un stress chronique, et qu'il permet ainsi une modélisation spécifique des troubles de l'humeur liés à la douleur chronique. Toutefois, ce travail a montré que notre modèle partage des traits communs à d'autres modèles de dépression. En effet, la voie de signalisation intracellulaire de la « cyclic adenosine monophosphate (cAMP) response element (CRE)-binding protein » (CREB) est connue pour être impliquée dans la réponse aux antidépresseurs au sein du système limbique (Chen et al., 2001) et le travail d'Ipek Yalcin a montré une modification de l'activité CRE dans le gyrus denté des animaux 8 semaines après la pose du cuff (Yalcin et al., 2011).

Les expériences de lésions du cortex ont montré que les animaux « neuropathiques » dont l'ACC est lésé ne sont pas capables de développer des comportements de type anxieux et dépressifs. Ceci montre de manière concluante l'implication de l'ACC dans les conséquences émotionnelles de la douleur neuropathique. Bien que la multiplication des tests (test d'hyponéophagie, de toilettage provoqué et de nage forcée) renforce le résultat, nous avons voulu savoir si, réciproquement, la stimulation de la structure serait capable de produire des comportements de type anxiodépressif. Nous avons stimulé de manière répétée l'ACC de souris Thy1-ChR2-YFP et montré que ces stimulations sont capables d'induire au bout de seulement 4 jours un comportement de type anxiodépressif mis en évidence par les tests d'hyponéophagie et de toilettage provoqué (II. section résultats). Ces résultats nous paraissent d'un grand intérêt et complémentaires des résultats obtenus par les expériences de lésions et confirment le rôle de l'ACC dans les comportements de type anxiodépressif.

Nous ne connaissons pas les mécanismes responsables de l'apparition des troubles de l'humeur dans notre modèle murin ainsi que chez les patients douloureux

chroniques. Néanmoins, nous suggérons que l'ACC, structure impliquée dans le traitement de la douleur, est activée de façon chronique lors des douleurs neuropathiques, que cette activation est responsable de phénomènes de plasticité moléculaire et cellulaire. Ces modifications entraînent à leur tour une réorganisation des circuits cérébraux et induisent ainsi des comportements de type anxiodépressif chez les animaux et des troubles de l'humeur en clinique humaine. Cependant tous les patients souffrant de douleur chronique ne développent pas de troubles de l'humeur associés. La douleur neuropathique serait donc le facteur déclenchant qui entraîne le passage d'un organisme vulnérabilisé mais non pathologique au regard des troubles de l'humeur à un organisme pathologique. C'est pour répondre à cette question que nous nous sommes intéressé aux modifications moléculaires prenant place au sein de l'ACC des souris développant des troubles de type anxiodépressif.

IV. Modifications moléculaires au sein de l'ACC

Nous avons mis en évidence la surexpression de l'ARN et de la protéine MKP-1 dans l'ACC des souris dans notre modèle de douleur neuropathique. Cette protéine est surexprimée dans l'hippocampe de patients ayant souffert de dépression et dans un modèle murin de dépression (Duric et al., 2010). De plus, les animaux KO MKP-1 ne sont pas capables de développer des comportements anxiodépressifs dans notre modèle de douleur neuropathique (partie III. section résultats). Nous pouvons donc conclure que MKP-1 est impliquée dans le développement des comportements de type anxiodépressif consécutifs à une lésion du nerf sciatique.

Nous avons déjà discuté de l'implication de MKP-1 dans ces troubles au cours de la discussion du paragraphe III. de la section résultats. Brièvement, nous devons nous demander :

- quels sont les facteurs responsables de l'augmentation de l'expression de l'ARN et de la protéine MKP-1,
- quel est l'effet de ces augmentations sur les cibles de MKP-1 (les MAPK), quel est le rôle de MKP-1 au niveau de l'ACC dans l'apparition des troubles
- quels sont les rôles des autres protéines de la famille des MKP dont l'expression varie également dans le développement des troubles de type anxiodépressif consécutifs à la douleur neuropathique ?

Au-delà de ces considérations sur MKP-1, des discussions plus générales sur les modifications moléculaires dans l'ACC dans le cadre des conséquences émotionnelles de la douleur sont nécessaires.

Pour observer ces modifications par la technique de puce à ADN, nous avons procédé à la dissection de l'ACC dans des tranches de cerveau frais. Cette technique a permis de prélever la partie antérieure du cortex cingulaire, mais pas de faire de distinction entre les parties droite et gauche car la quantité d'ARN extraite est insuffisante pour l'analyse génomique. Nous avons pourtant observé des variations d'expression des protéines ERK1/2 entre les côtés gauche et droit de l'ACC (résultats non présentés car inconsistants entre les méthodes utilisées, western blot et immunohistochimie). Nous n'avons pas distingué ni les régions Cg1 et Cg2 ni les couches corticales de l'ACC. Les modifications moléculaires observées doivent

donc être précisées dans leur localisation, en tenant compte du fait que plus la région analysée se réduit, plus la quantité d'ARN ou de protéines pouvant être extraite des tissus est réduite. L'analyse de l'expression d'ARN ou de protéines souris par souris telle que nous l'avons faite ne permettant pas d'atteindre la localisation anatomique souhaitée, nous pourrions grouper des zones comparables provenant de différents animaux. Ainsi les modifications moléculaires pourraient être comparées au niveau de régions neuroanatomiques plus précises. Une autre solution serait de mesurer par des techniques d'hybridation in situ l'expression localisée des ARN cibles sur des coupes de cerveaux. Pour mesurer les variations d'expression protéique, des techniques d'immunohistochimie pourraient donner le même type d'information sous réserve d'avoir des anticorps spécifiques et fonctionnels dans les conditions de l'immunohistochimie. Nous avons procédé à des expériences préliminaires d'immunohistochimie avec un anticorps dirigé contre MKP-1 mais les marquages obtenus ne sont pas convaincants.

Dans notre modèle, les signes traduisant une diminution de la sensibilité mécanique apparaissent dès la première semaine suivant la pose du manchon sur le nerf sciatique. Les comportements de type anxiodépressif sont observables à partir de la 4^{ème} semaine. Pour les expériences de génomique, la constitution de groupes expérimentaux dont l'ACC fut prélevé 2 et 8 semaines post-chirurgie nous a permis de distinguer les gènes dont l'expression varie dès le début de la neuropathie (groupe 2 semaines) de ceux dont l'expression varie plus tard (groupe 8 semaines). Notons qu'une troisième catégorie regroupe les gènes dont l'expression varie dès 2 semaines et se maintient au moins jusqu'à 8 semaines après la chirurgie.

La question est alors de savoir comment interpréter ces résultats dans le contexte de la douleur neuropathique d'une part et de ses conséquences émotionnelles d'autre part.

Nous avons vu par exemple que l'expression de l'ARN MKP-1 augmente dès la deuxième semaine post-chirurgie et nous savons aussi que MKP-1 est responsable des comportements de type anxiodépressif observés à partir de la 5^{ème} semaine. Des phénomènes de plasticités doivent donc être mis en place dès la 2^{ème} semaine mais ne donnant lieu à des comportements de type anxiodépressif que plus tard.

Pour connaître l'influence réelle des augmentations d'expression d'ARN sur les comportements mesurés, il faudrait être capable de les bloquer selon des schémas

temporels précis. Comparer l'effet du blocage chronique ou aigu d'un ARN pourrait nous permettre de connaître son rôle dans le développement (blocage chronique) ou l'expression (blocage aigu) des signes observés.

De plus, les cascades d'évènements intracellulaires sont complexes et des communications croisées existent entre différentes voies de signalisation cellulaire. Observer attentivement nos résultats et raisonner en termes de voies de signalisation et pas seulement au niveau d'un ou deux effecteurs est indispensable à une compréhension globale des processus impliqués.

V. Dissociation corticale : risques de simplification et de généralisation des résultats

Un des résultats principaux de ces travaux de thèse montre une dissociation corticale de l'expérience douloureuse avec d'une part la composante sensorielle allodynique traitée par l'insula postérieure et d'autre part la composante aversive et les conséquences émotionnelles traitées par le cortex cingulaire antérieur. Ce résultat semble solide car plusieurs fois répété mais nécessite toutefois quelques précautions dans son analyse.

La mise en relation d'une fonction avec une région précise du cerveau a été établie de manière déterminante par le neurologue Paul Broca au XIX^e siècle, qui établit que la perte de parole d'un de ses patients était liée à une lésion localisée du lobe frontal gauche. Dès lors, des recherches systématiques portant sur les fonctions des régions cérébrales furent menées. Les progrès scientifique et technique, depuis les lésions mécaniques jusqu'aux techniques d'imagerie cérébrale et d'électrophysiologie ont permis de confirmer et d'affiner le rôle des différentes zones du cerveau. Ces progrès nous ont aussi montrés qu'une structure cérébrale n'est pas homogène. Ces sous-régionalisations se traduisent par des différences dans la cytoarchitecture, dans la connectivité et bien sûr dans les fonctions assurées. En termes de cytoarchitecture, la différenciation en couches du cortex est un exemple de cette hétérogénéité (Kurth et al., 2010b). Une structure peut aussi être différenciée entre sa partie dorsale et ventrale, comme le montrent les régions Cg1 dorsale et Cg2 ventrale du cortex cingulaire, ou encore selon l'axe antéropostérieur.

Un des problèmes de la technique lésionnelle par excitotoxicité que nous avons utilisée est son manque relatif de précision sur la localisation des lésions induites. Celui-ci est dû en partie à notre démarche scientifique. Nous savons que l'ACC est impliqué dans la composante aversive de la douleur (Johansen et al., 2001), cependant son implication dans les conséquences émotionnelles de la douleur est inconnue. Pour l'insula, ses parties antérieure agranulaire (Coffeen et al., 2011) ou postérieure granulaire (Benison et al., 2011) sont impliquées dans la composante sensorielle de la douleur. Son implication dans la composante aversive et les conséquences émotionnelles de la douleur ne sont pas établies. Nous avons choisi de léser préférentiellement la partie postérieure, celle-ci étant selon la littérature

impliquée plus directement dans la composante sensorielle. Les comportements anxiodépressifs observés requièrent d'avoir des groupes d'animaux assez importants (au moins dix animaux par groupe). Les zones visées, ACC et pIC, sont petites chez la souris, et obtenir une dizaine d'animaux correctement lésé pour chaque condition (sham, cuff), et pour chaque zone du cortex exige d'avoir des cohortes d'animaux importantes. Rajouter des distinctions entre les régions ventrale/dorsale, antérieure/postérieure multiplie rapidement par deux, quatre, voire plus le nombre d'animaux nécessaires. Il nous a donc semblé préférable de commencer par des lésions plutôt étendues dans un premier temps et de voir si celles-ci avaient des conséquences comportementales, avant de nous focaliser, si nécessaire, sur des zones plus précises. A cela il faut rajouter les contraintes techniques. Les lésions par injection d'acide iboténique ne sont pas selon nous, du fait de la difficulté de contrôler l'étendue de la lésion induite, optimales pour différencier des sous-régions aussi proches que Cg1 et Cg2 par exemple.

L'attribution de fonctions à des régions discrètes du cerveau peut amener à une simplification trop importante de la fonction étudiée. La douleur, nous l'avons dit, est une expérience complexe ayant une composante sensorielle et une composante émotionnelle. Ces composantes paraissent pouvoir être séparées l'une de l'autre dans notre modèle. Cependant, nous savons aussi que l'ACC et le pIC communiquent entre eux directement et qu'ils sont connectés en partie aux mêmes régions. Il est donc très probable que la lésion de l'un agisse directement ou indirectement sur l'autre. Il faut aussi tenir compte de l'implication d'autres régions dans les fonctions étudiées. Nous avons conscience que la mise en évidence de l'implication d'une région cérébrale dans une fonction ne signifie pas que seule cette région est active dans cette fonction. Le rôle de l'insula antérieure, par exemple, pourra aussi être étudié dans les conséquences émotionnelles de la douleur neuropathique. Au-delà de la multiplicité des structures impliquées, nous devons également tenir compte de l'interaction entre ces différentes régions, c'est-à-dire qu'il faut aussi raisonner en terme de circuits.

De nouvelles méthodes d'analyse de l'activité spontanée des régions cérébrales en condition basale, c'est-à-dire en dehors de toute stimulation ou tâche à effectuer, sont développées en imagerie par résonance magnétique fonctionnelle (IRMf). Elles permettent de mettre en évidence des connexions entre des régions du cerveau dont les activités basales sont cohérentes entre elles (Fox and Raichle,

2007). Les variations de cette connectivité pourraient être responsables de la chronicisation de la douleur. En effet, la force de connectivité entre le cortex préfrontal médian et le noyau accumbens est corrélée au passage d'une pathologie subaiguë à une pathologie chronique de douleur lombaire (Apkarian AV et al., 2013). Chez des patients atteints de fibromyalgie, les niveaux de connectivités vont augmenter ou diminuer selon les régions des cortex insulaire et cingulaire auxquelles on s'intéresse (Ichesco et al., 2014). Ces résultats nous semblent d'un grand intérêt et sont à mettre en perspective avec la nécessité de raisonner non plus en termes de variation d'activité dans une structure isolée mais dans un réseau de structures interconnectées.

En induisant une lésion du système nerveux périphérique, nous travaillons dans un contexte de modélisation d'une maladie et nous avons montré que les régions étudiées subissent des modifications entraînant les changements de comportements observés. L'implication de l'ACC et du pIC dans les composantes de la douleur chronique n'est peut-être pas comparable à leur rôle dans la douleur aiguë, les circuits cérébraux pouvant être modifiés du fait de la maladie. Nous devons donc nous garder de conclure sur le rôle de l'ACC et du pIC dans la douleur en général.

Nous devons ainsi prendre garde à une trop grande généralisation des résultats obtenus. Nous observons chez nos animaux plusieurs réponses comportementales traduisant différentes composantes de la douleur.

Concernant la composante sensorielle de la douleur, nous mesurons essentiellement l'allodynie mécanique statique. Ainsi, il serait intéressant de connaître l'effet de la lésion du pIC ou de l'ACC sur l'allodynie mécanique dynamique, mais aussi dans la réponse à des stimuli thermiques chaud et froid.

Nous nous sommes aussi intéressés à la composante aversive de la douleur à l'aide du test de préférence de place. Ce test mesure l'effet de soulagement d'une drogue analgésique en l'absence de stimulus nociceptif induit par l'expérimentateur. Contrairement aux tests évoqués plus haut qui mesurent une réponse à une douleur provoquée, ce test mesure une réponse à une douleur spontanée (King et al., 2009). Ceci est très important car nous savons que les douleurs spontanées sont très invalidantes et très fréquentes chez les patients souffrant de douleur neuropathique (Backonja and Stacey, 2004). Toutefois, ce signe est difficile à mettre en évidence chez l'animal dont la plainte ne peut pas être

perçue de manière évidente par les expérimentateurs. Nous avons ainsi pu mettre en évidence l'implication de l'ACC mais pas du pIC dans la composante aversive de la douleur spontanée. Cependant, nous n'avons pas parlé de la composante aversive de la douleur provoquée, dans laquelle l'ACC paraît aussi être impliqué (LaGraize et al., 2004).

Enfin, l'ACC est au moins en partie responsable de l'apparition de troubles anxiodépressifs liés à une douleur chronique. Il paraît aussi nécessaire de se questionner sur son implication dans d'autres modèles de dépression et d'anxiété. La résultante anxiodépressive de l'activité de l'ACC n'est peut-être pas spécifique de la condition douloureuse chronique.

Perspectives

Nous avons produit au cours de ce travail de thèse un certain nombre d'informations importantes portant sur les conséquences émotionnelles de la douleur neuropathique :

- Le cortex insulaire postérieur, dans notre modèle murin de douleur neuropathique est impliqué dans la composante somatosensorielle d'un stimulus mécanique statique, mais pas dans la composante aversive de la douleur spontanée ni dans les conséquences émotionnelles de la douleur neuropathique.
- Le cortex cingulaire antérieur est impliqué dans la composante aversive de la douleur spontanée et dans les conséquences émotionnelles de la douleur neuropathique
- Ceci montre une ségrégation corticale, au sein de notre modèle, de la composante sensorielle d'une part et de la composante aversive et des conséquences émotionnelles de la douleur neuropathique d'autre part.
- Des modifications de l'expression d'un grand nombre d'ARN a lieu dans l'ACC des souris soumises au modèle du cuff. Parmi les différentes cibles, nous avons identifié la surexpression de MKP-1, confirmé sa surexpression au sein de l'ACC au niveau protéique, et mis en évidence que les souris KO MKP-1 ne sont pas capables de développer des comportements de type anxiodépressif suite à l'induction de la neuropathie.

Des expériences devront être menées et plusieurs pistes devront être suivies à court terme afin de compléter les expériences en cours.

Nous devons poursuivre les expériences sur les rôles de l'ACC et de l'IC dans l'expression de la douleur. Nous pourrions par exemple montrer leur rôle dans la composante aversive de la douleur provoquée par le « Place/Escape Avoidance Paradigm ». Nous pourrions aussi nous intéresser au rôle de l'insula antérieure qui n'a pas été étudié dans notre modèle, dans aucune composante de la douleur.

Nous devons aussi diversifier les tests comportementaux destinés à évaluer les comportements anxiodépressifs. Par exemple, nous avons discuté de la nécessité d'utiliser des tests pouvant être reproduits chez un même animal ou d'employer des tests mettant en évidence l'augmentation d'un comportement (type enfouissement des billes). Les changements neurovégétatifs concernant la perte d'appétit ou

l'alternance veille-sommeil, paramètres très importants en clinique humaine et modélisable chez la souris pourront aussi être étudiés dans notre modèle. Le rôle de l'ACC dans d'autre modèle de dépression serait aussi intéressant à analyser.

En ce qui concerne la partie moléculaire, il faudra poursuivre les résultats obtenus pour l'ARN et la protéine MKP-1 et chercher quelles sont les causes et les conséquences de la surexpression de MKP-1 sur les voies de signalisation intracellulaire et observer le rôle des autres protéines de la famille MKP dont l'expression varie également (MKP-3 et MKP-4) dans notre modèle. L'identification des sous-structures au sein de l'ACC (antérieur ou postérieur, Cg1 ou Cg2, couches du cortex) dans lesquelles ont lieu ces modifications devra aussi être faite. Un travail important devra aussi être mené pour identifier parmi les nombreux ARN dont l'expression varie dans nos conditions ceux ayant un rôle sur les conséquences émotionnelles de la douleur et faire le même travail que pour MKP-1. L'action de ces cibles sur l'induction ou l'expression des comportements devra aussi être mise en évidence.

La morphologie des neurones, leur arborisation dendritique en particulier, a un effet sur leur capacité de communication. Afin de voir si des modifications de ces paramètres sont présentes dans l'ACC, des techniques d'analyse morphologique de type coloration de golgi ont débuté (résultats non présentés) et seront poursuivies. Afin d'observer l'effet de la lésion nerveuse sur l'activité des neurones de l'ACC, l'activité électrique spontanée de ces neurones a commencé à être mesurée par des enregistrements électrophysiologiques in vivo et comparée entre les animaux sham et cuff (résultats non présentés). Compte tenu des connaissances et des techniques maîtrisées dans le laboratoire, ces expériences pourront être menées à court terme.

A moyen terme, il faudra se mettre à chercher non plus les modifications dans une structure spécifique mais raisonner en termes de réseaux. L'identification des différentes structures impliquées dans la douleur et l'émotion, l'étude de la communication entre ces structures sont des paramètres cruciaux à étudier si on cherche à mieux comprendre des comportements complexes comme la douleur et les troubles de l'humeur. L'activation et l'inactivation de structures par optogénétique et l'observation des conséquences sur l'activité du réseau sont aussi d'un grand intérêt et peuvent être réalisées à moyen terme dans l'équipe au vu des connaissances préliminaires et du matériel à notre disposition.

Des études des connexions inter-structures grâce à des techniques d'imagerie fonctionnelle en collaboration avec l'Université de Fribourg-en-Brigau doivent être développées. Elles permettront d'identifier les modifications d'activité liées à notre modèle et de mettre en évidence des changements dans les réseaux cérébraux afin de mieux comprendre les conséquences émotionnelles de la douleur neuropathique.

Annexes

BDNF parabrachio-amygdaloid pathway in morphine-induced analgesia.

Maysa Sarhan, Sophie Anne Pawlowski, **Florent Barthas**, Ipek Yalcin, Jennifer Kaufling, Hugues Dardente, Venetia Zachariou, Ralph Joseph DiLeone, Michel Barrot et Pierre Veinante

Parallèlement aux études menées sur mon sujet de thèse, j'ai eu l'opportunité de collaborer au sein de notre équipe à un projet traitant du rôle du facteur neurotrophique dérivé du cerveau (Brain Derived Neurotrophic Factor, BDNF) dans la voie parabrachio-amygdaloïde sur l'effet analgésique de la morphine. Ce travail a donné lieu à une publication dans la revue the International Journal of Neuropsychopharmacology.

La voie spino-parabrachio-amygdaloïde relie la moelle épinière au noyau parabrachial, qui projette à son tour vers le noyau central de l'amygdale (CeA). Les terminaisons de cette voie dans le CeA expriment fortement le BDNF. De plus, cette voie est connue pour convoier des informations nociceptives et des études montrent l'implication du CeA dans l'effet analgésique de la morphine. Au vu de ces résultats, nous avons fait l'hypothèse d'une implication du BDNF de la voie parabrachio-amygdaloïde dans l'effet analgésique de la morphine au niveau supraspinal.

Pour vérifier ces hypothèses, une délétion localisée de l'expression du BDNF dans le noyau parabrachial a été réalisée grâce à des souris floxées pour le gène codant le BDNF. Chez ces animaux la somatosensibilité n'est pas modifiée, par contre, l'effet analgésique de la morphine est réduit. Pour confirmer que l'origine de cette perte d'efficacité provenait bien d'une diminution des projections parabrachio-CeA-BDNFergiques, nous avons procédé à une inactivation de la signalisation du BDNF au sein de ce noyau. Nous avons injecté localement le TrkB-Fc, un fragment constant du récepteur du BDNF, capable de lier et de séquestrer le BDNF endogène, s'opposant ainsi à sa fixation sur son récepteur. Là encore, l'effet analgésique de la morphine chez les animaux ayant reçu localement le TrkB-Fc dans le CeA a été moindre, confirmant le rôle du BDNF de la voie parabrachio-amygdaloïde dans l'effet analgésique de la morphine.

Mon rôle dans cette étude a été de réaliser les expériences qui utilisent le TrkB-Fc (Figure 4 de l'article).

BDNF parabrachio-amygdaloid pathway in morphine-induced analgesia



Maysa Sarhan^{1*}, Sophie Anne Pawlowski^{1,2*}, Florent Barthas^{1,2}, Ipek Yalcin², Jennifer Kaufling^{1,2}, Hugues Dardente³, Venetia Zachariou⁴, Ralph Joseph DiLeone⁵, Michel Barrot^{2*} and Pierre Veinante^{1,2*}

¹ Université de Strasbourg, Strasbourg, France

² Institut des Neurosciences Cellulaires et Intégratives, Centre National de la Recherche Scientifique, Strasbourg, France

³ INRA UMR085, Nouzilly, France

⁴ Pharmacology and Systems Therapeutics, Mount Sinai School of Medicine, New York, USA

⁵ Department of Psychiatry, Yale University School of Medicine, New Haven, CT, USA

Abstract

In addition to its neurotrophic role, brain-derived neurotrophic factor (BDNF) is involved in a wide array of functions, including anxiety and pain. The central amygdaloid nucleus (CeA) contains a high concentration of BDNF in terminals, originating from the pontine parabrachial nucleus. Since the spino-parabrachio-amygdaloid neural pathway is known to convey nociceptive information, we hypothesized a possible involvement of BDNF in supraspinal pain-related processes. To test this hypothesis, we generated localized deletion of BDNF in the parabrachial nucleus using local bilateral injections of adeno-associated viruses in adult floxed-BDNF mice. Basal thresholds of thermal and mechanical nociceptive responses were not altered by BDNF loss and no behavioural deficit was noticed in anxiety and motor tests. However, BDNF-deleted animals displayed a major decrease in the analgesic effect of morphine. In addition, intra-CeA injections of the BDNF scavenger TrkB-Fc in control mice also decreased morphine-induced analgesia. Finally, the number of c-Fos immunoreactive nuclei after acute morphine injection was decreased by 45% in the extended amygdala of BDNF-deleted animals. The absence of BDNF in the parabrachial nucleus thus altered the parabrachio-amygdaloid pathway. Overall, our study provides evidence that BDNF produced in the parabrachial nucleus modulates the functions of the parabrachio-amygdaloid pathway in opiate analgesia.

Received 5 June 2012; Reviewed 23 August 2012; Revised 30 November 2012; Accepted 27 December 2012;

First published online 21 February 2013

Key words: Brain-derived neurotrophic factor, extended amygdala, morphine, pain, parabrachio-amygdaloid pathway.

Introduction

Many aspects of the emotional, endocrine and autonomic components of pain are mediated by the spino-parabrachio-amygdaloid pathway, which sends nociceptive information to the central extended amygdala (EAc) via the parabrachial nucleus (PB) (Bernard et al., 1996). The EAc is a continuum of basal forebrain structures, stretching from the central nucleus of the amygdala (CeA) caudally to the lateral bed nucleus of the stria terminalis (BSTL) rostrally (Alheid et al., 1995; Cassell et al., 1999). In the pain context, the EAc on the one hand elaborates the affective response to pain and on the other exacerbates, facilitates or inhibits reactivity to pain, by controlling affective states (Neugebauer et al.,

2009). As such, the EAc and the neural projection transferring nociceptive signals to its components play an important role in both endogenous and exogenous analgesia, among which opioid-related analgesia.

The CeA is necessary for the expression of the morphine analgesic properties as evidenced by lesion studies in rodents and primates (Manning and Mayer, 1995; Manning et al., 2001) and morphine suppresses electrophysiological responses to nociceptive stimulus in CeA-projecting PB neurons and in CeA neurons (Huang et al., 1993a, b). The EAc is enriched with a wide range of neuropeptides, most of which are released from terminals originating from the PB (Yamano et al., 1988). One of them, calcitonin gene-related peptide (CGRP), exerts naloxone-dependent analgesic properties when injected directly in the CeA (Xu et al., 2003). In our study, we are specifically interested in brain-derived neurotrophic factor (BDNF), a neuropeptide present in axonal terminals in the EAc originating from the PB (Conner et al., 1997). In the EAc, BDNF positive terminals form pericellular

Address for correspondence: Dr P. Veinante, Institut des Neurosciences Cellulaires et Intégratives, 21 rue Descartes, 67084 Strasbourg, France.

Tel.: +33(0) 368 851 471 Fax: +33(0) 388 613 347

Email: veinantep@inci-cnrs.unistra.fr

* These authors contributed equally to this work.

baskets, similar to those described for CGRP (Yamano et al., 1988; Conner et al., 1997; Agassandian et al., 2006), and co-localization of CGRP and BDNF in the same terminals within CeA has been described in rats and mice (Salio et al., 2007). The BDNF role in neural plasticity is clearly established in drug addiction (Graham et al., 2007; Ghitza et al., 2010) and nociception (Pezet et al., 2002; Merighi et al., 2008). A recent study demonstrated the role of mesolimbic BDNF in the rewarding properties of morphine (Koo et al., 2012). Regarding pain studies, while most of the literature on BDNF and pain focuses on the spinal cord, the supraspinal role of BDNF remains unclear (Merighi et al., 2008). Considering the well-described role of the parabrachio-amygdaloid pathway in nociception, we formulated the hypothesis that BDNF could modulate pain mechanisms in this pathway.

In this study, we investigated the role of PB BDNF in morphine-induced analgesia using viral-mediated gene deletion in floxed-BDNF mice (Adachi et al., 2008). We first defined the parabrachio-amygdaloid pathway in mice using a tract-tracing approach. Following anxiety and motor skills assessment, we studied baseline pain threshold and morphine-induced analgesia. Morphine-induced analgesia was also tested after CeA injection of the BDNF scavenger TrkB-Fc. We then examined the impact of PB BDNF deletion on morphine-induced c-Fos expression in the EAc and in the basolateral nucleus of the amygdala (BLA). Our results reveal a critical role of BDNF in the parabrachio-amygdaloid pathway in morphine-induced analgesia.

Method

Animals

Experiments were performed using male transgenic mice homozygous for a floxed allele (exon 5) encoding the BDNF gene, with a C57BL/6J background (Rios et al., 2001). Mice were housed four to five per cage in a colony maintained at a constant temperature (23 °C) with a 12 h light/dark cycle (lights on 07:00 hours) and *ad libitum* food and water. The facilities are legally registered for animal experimentation (Animal House Agreement B67-482-1/C67-482-1) and scientists in charge of the experiments possess the certificate authorizing experimentation on living animals, delivered by the governmental veterinary office.

Surgeries

Mice were anaesthetized using either a 2.5% Avertin solution or Ketamine–Xylazine (90–10 mg/kg respectively). Surgeries were done according to a standard protocol, using glass micropipettes for tracer injections (Sarhan et al., 2005) and Hamilton syringes for viral injections (Hommel et al., 2003). The following coordinates from Bregma were used for the PB to target the external lateral portion: 14° anteroposterior (AP) angle, –4.1 mm

AP, 1.4 mm mediolateral (ML), –4 mm dorsoventral (DV). CeA targeting was –1.4 mm AP, 2.9 mm ML and –3.9 to –4.1 mm DV from dura (Franklin and Paxinos, 2008). For intra-CeA injections of TrkB-Fc, stainless 26-gauge single guide cannulas were bilaterally implanted 500 µm above the CeA. They were affixed to the skull with dental cement. A 33-gauge dummy cannula was inserted in each guide to avoid clogging and mice were allowed to recover 7–8 d before testing.

Tract tracing

Tracers were iontophoretically injected. The anterograde tracer biotin dextran amine (BDA; MW 10 000; Molecular Probes, USA; 2% in K-acetate 0.5 M) was injected in the PB using a glass micropipette broken at 10 µm tip diameter with a Midgard constant current source (+1 µA, 7 s on/off, 15 min). The retrograde tracer hydroxystilbamidine methanesulfonate (Fluoro-Gold®, FG, Fluorochrome, USA; 2% in NaCl 0.5 M) was injected in the CeA with a glass micropipette broken at 50 µm tip diameter (+3 µA, 7 s on/off, 10 min). Six to eight days after injection, anaesthetized animals were fixed by paraformaldehyde perfusion, brains were removed, sectioned on a vibratome (Leica, Germany; 40 µm, frontal plane) and treated for BDA histochemical revelation (Sarhan et al., 2005) or analysed under the fluorescence microscope (FG injection).

Adeno-associated virus (AAV)-mediated deletion of BDNF

Local expression of either enhanced green fluorescent protein (eGFP) alone or eGFP fused to the Cre recombinase was achieved using viral-mediated gene delivery (Berton et al., 2006). The DNA constructs were cloned into an AAV-2 vector in which the genes of interest were under the control of the ubiquitous cytomegalovirus promoter. Viral production was accomplished using a triple-transfection, helper-free method and purified as described earlier (Hommel et al., 2003). A total of 0.5 µl was bilaterally injected into the PB over 5 min (0.05 µl/30 s) and the needle was removed after 10 min. The age of mice at the time of deletion ranged from 9 to 14 wk. Behavioural tests were conducted at least 3 wk (usually 4–5 wk) following AAV injections.

BDNF expression assessment

In situ hybridization was done using a 1085 bp probe based on the rat BDNF gene (accession number NM_012513). The probe was labelled with [³⁵S]UTP, purified and used at 350 pM. Cryostat (Microm, France) frontal sections (20 µm) were fixed, acetylated, dehydrated and de-fatted prior to hybridization with the probe in hybridization buffer at 54 °C overnight. Sections were then washed, fixed, treated with RNase and dehydrated, left to dry, then exposed to BioMax MR films for 6 d.

Behavioral scoring

Assessors were blind to group assignment. Anxiety levels were assessed with the dark–light, open-field and elevated plus-maze tests. Tests were performed during the light phase, under controlled light conditions (90 lux), videotaped and analysed using an automated video-tracking system (Ethovision, USA). These tests were conducted using the same animals with a 1 wk space between tests.

Dark–light

The dark–light test was performed in place-preference boxes (Med Associates, USA). One compartment was dark while the other larger one was lit. Animals were placed in the dark compartment for 2 min and the door between the two compartments was opened allowing the animal to freely move from one to the other for 10 min. Photoelectric beams at the door detected when the animal explored or entered the light compartment. Total time spent in lit compartment was measured.

Open-field

The open-field test was conducted over 10 min. Animals were placed in the centre of the apparatus (49 cm × 49 cm boxes). The average distance relative to the borders of the box and the total distance were measured.

Elevated plus-maze

Mice were placed in the centre of the maze, the head in the direction of a closed arm. Over a 5 min period, they were evaluated for the time spent in the open and closed arms (55 cm from the floor, 12 cm × 50 cm arms; Monteggia et al., 2007).

Rotarod

The rotarod test was performed to evaluate motor coordination. Animals were placed on immobile cylinders, which ramped up from 0 to 45 rotations/min (IITC, USA). The timer was stopped when the mouse fell off the cylinder or did a whole turn with it. This procedure was repeated three consecutive times.

Nociceptive tests

Mechanical noxious threshold was determined using the von Frey microfilaments (Bioseb, France) as described previously (Yalcin et al., 2011). Mice were placed in Plexiglas boxes (7 cm × 9 cm × 7 cm) on an elevated grid. Calibrated filaments were applied on the plantar surface of the hindpaw. The filaments were tested five times per paw in ascending forces until the paw withdrawal threshold was reached (Barrot, 2012). Noxious threshold was defined as the lower filament for which three or more withdrawals were observed. The cut-off was set at 15 g.

Thermal noxious response was determined using a hot plate (IITC). Mice were placed on a 52 °C plate, in a Plexiglas cylinder and latency to first paw licking was used to define noxious thermal threshold. The cut-off time was set at 50 s.

To evaluate opiate-induced analgesia, morphine (10 mg/kg) and saline were injected s.c. 30 min prior to testing. Mechanical and thermal responses were assessed in independent sets of mice.

Intra-CeA TrkB-Fc injection

Mice implanted with guide cannulas were tested for morphine-induced mechanical analgesia after CeA bilateral infusion of the BDNF scavenger TrkB-Fc. TrkB-Fc (0.5 µl per side; R&D Systems; 0.1 µg/µl in PBS) or PBS was delivered via a 33-gauge cannula that extended 500 µm below the end of the guide cannula. Injections were performed at a constant rate over 2.5 min (CMA 400 Syringe Pump). The cannula was left in place for 5 min before removing it. One hour later, mice received morphine (10 mg/kg s.c.). Mechanical noxious thresholds were determined 20 min before morphine injection (40 min after intra-CeA TrkB-Fc or PBS infusion) and 20 min after morphine injection (80 min after TrkB-Fc or PBS infusion).

Morphine-induced c-Fos response

Five wk following AAV injection in the PB, animals received a saline injection the day prior to the experiment for habituation to the procedure. The day of the experiment, 2 h after morphine (10 mg/kg s.c.) or saline injection, animals were anaesthetized and fixed using standard procedures (Sarhan et al., 2005). Brains were sectioned on a vibratome (40 µm frontal sections) and immunostained for c-Fos. Free-floating sections were washed in PBS and endogenous peroxidase activity was blocked (50% ethanol, 1% H₂O₂). After PBS washes, aspecific binding sites were saturated in 5% donkey serum in PBS 0.3% triton (PBS-t) and incubation in primary antibody (rabbit anti-c-Fos 1:2000, Santa Cruz Biotechnology, SC-52; 1% donkey serum; PBS-t 0.3%) was done overnight (Kaufling et al., 2009). Next, sections were washed, incubated with secondary biotinylated antibody (donkey anti-rabbit, 1:200, GE Healthcare, UK; 1% donkey serum), washed and incubated in ABC kit (1:500; ABC Elite, Vector Laboratories, USA). Diaminobenzidine revelation was performed (DAB 0.0125%, H₂O₂ 0.0009%) and after extensive washes, sections were mounted on gelatine-coated slides, air-dried and coverslipped with Eukitt (O. Kindler GmbH, Germany). c-Fos positive nuclei were counted in the BLA, the dorsal BSTL and the capsular (CeC), lateral (CeL) and medial (CeM) subdivisions of the CeA using a microscope attached to a camera Lucida. On average, four sections per animal were counted for the BSTL and 4–6 for the BLA and the CeA.

Histology

At the end of the behavioural experiments, anaesthetized animals were fixed and the brains were sectioned on a vibratome (40 μ m frontal sections). For BDNF PB deletion experiments, the PB was examined under fluorescence for eGFP expression. For intra-CeA TrkB-Fc experiments, the bilateral placement of cannulas was assessed on Cresyl Violet stained sections. Pictures were taken using an epifluorescence microscope (Leica) with a digital camera (Cool Snap, USA) or using a Nikon E80i microscope. Adobe Photoshop (Adobe, USA) was used to adjust contrast, brightness and sharpness.

Statistical analysis

Data are expressed as mean \pm S.E.M. and analyses were performed with STATISTICA 8 (Statsoft, USA). To assess effects on morphine-induced analgesia, multifactor analysis of variance was used. When appropriate, the Neuman–Keuls test was used for *post hoc* comparisons. For analysis of c-Fos induction, Student's *t* test was used for two groups' comparisons. The significance level was set at $p < 0.05$.

Results

Anatomical substrate for the parabrachial BDNF projection

Tract tracing

Anterograde tracer injections ($n=2$ for successful placement of injection site) targeting the PB (lateral PB, external part, PBel; Fig. 1i) led to terminal fibre labelling in the CeL, the CeC and the dorsal BSTL (Fig. 1ii,iii), with very few labelled regions outside of them. Moreover, retrograde tracing from the CeA ($n=2$ for successful placements) resulted in strong labelling of cell bodies concentrated into the PBel (Fig. 1iv,v). These results establish that our subsequent AAV injections targeted the PB-EAc pathway.

Local BDNF deletion

The placement and extent of the AAV injections were assessed by the presence of eGFP-positive neurons for both control (eGFP alone) and BDNF-deleted animals (eGFP-Cre fusion). eGFP labelling had to be present and concentrated in the lateral PB for the injection placement to be considered as valid, although it often also included labelling spreading into the median PB. The pontine PB was the main targeted area, but some injections displayed a larger rostro-caudal spread, thereby also including the mesencephalic PB (Fig. 2a,b,d). eGFP expressing neurons were often clustered in the external aspect of PB, namely, the external lateral, lateral crescent and external medial nuclei. Animals were included for

data analysis if the viral infection comprised the lateral PB, remained within the boundaries of the PB and was validated bilaterally.

Cellular aspects of the eGFP labelling differ whether or not it is fused to the Cre recombinase. eGFP alone, in control animals, is cytoplasmic and displays a labelling that fills the entire soma as well as its dendritic (Fig. 2c) and axonal processes. Terminal axonal labelling can be observed in brain regions receiving afferents from the injection site. Strong eGFP labelling was found in both the lateral part of the CeA (CeL and CeC) and the dorsal BSTL for all control animals (Fig. 2f–h). Moreover, the eGFP-positive terminals in these structures display the characteristic pericellular basket appearance (Fig. 2h) described for CGRP-containing terminals in the CeA and BSTL. When fused to the Cre recombinase, the eGFP labelling appears nuclear (Fig. 2e), while the number of infected cells per injection site was comparable in both control and deleted animals.

In agreement with previous reports (Berton et al., 2006; Monteggia et al., 2007; Adachi et al., 2008; Koo et al., 2012) in different brain regions, *in situ* hybridization reveals a decrease in BDNF mRNA levels in BDNF-deleted animals (Fig. 2i,j). In all animals, BDNF appears concentrated in few brain nuclei, but BDNF transcripts were highly expressed in the PBel in control animals, as opposed to AAV-eGFP-Cre injected animals.

Parabrachial BDNF mediates morphine-induced analgesia

General behavioural assessment

Following histological validation, 10 control and 10 BDNF-deleted animals were used for behavioural analyses. Prior to morphine-induced analgesia measurement, animals were assessed for their anxiety levels and motor skills. No differences were noted for anxiety levels as measured by the dark-light, elevated plus-maze and open-field tests (Fig. 3a–d). Similarly, motor coordination measured using the rotarod was not altered by BDNF deletion in the PB (Fig. 3g). Finally, no difference was observed for general locomotor activity in the open-field test (Fig. 3f).

Morphine-induced analgesia

In the hot-plate test, control and BDNF-deleted animals displayed similar responses following saline injections (Fig. 4a). Morphine-induced analgesia was present in both groups, but it dramatically decreased in PB BDNF-deleted animals (38% reduction, $p < 0.001$). Both controls and BDNF-deleted animals showed a tolerance to the analgesic properties of morphine (Fig. 4a), with the largest drop in efficacy noted for the second day of morphine injection. Following tolerance procedure, thermal nociceptive response was reassessed, with both groups

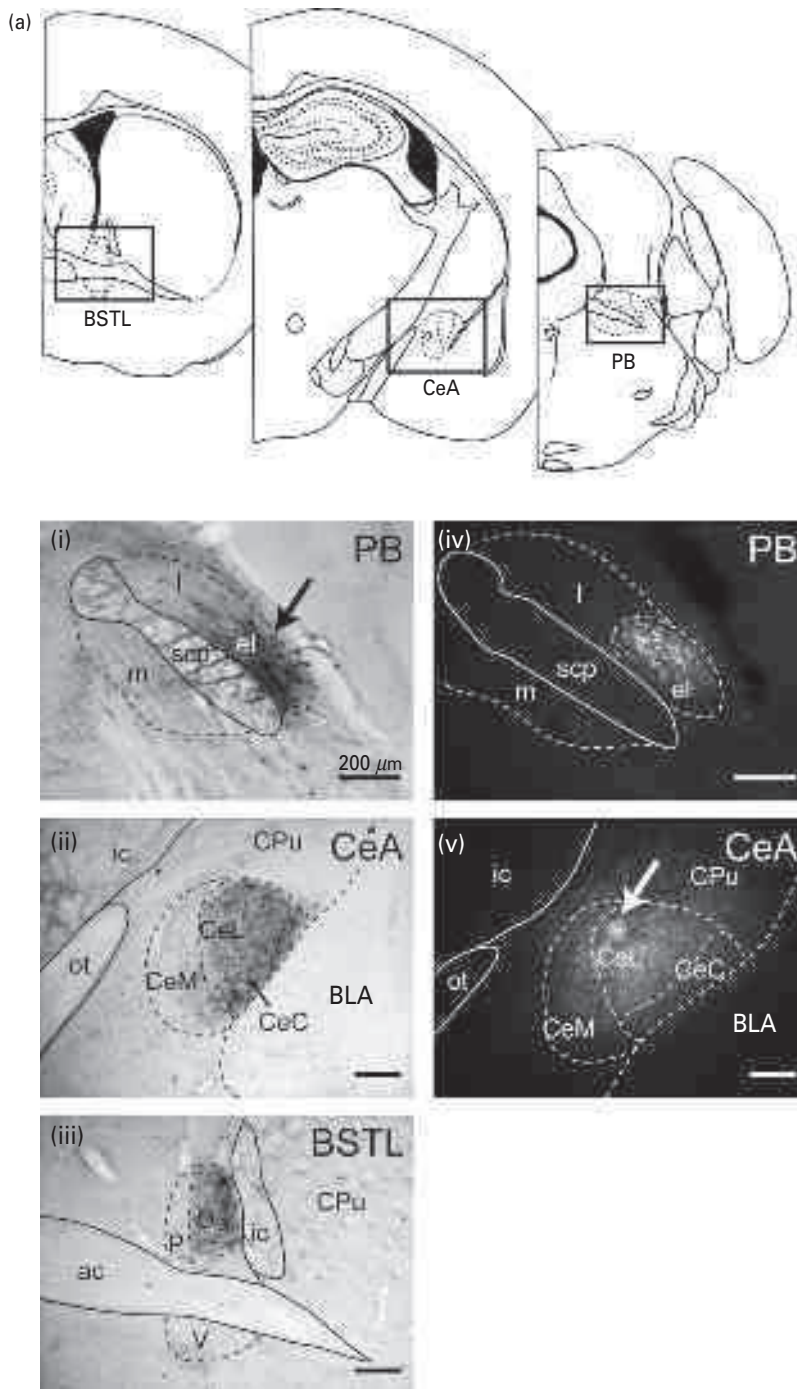

Fig. 1. Parabrachio-amygdaloid pathway in mouse. (a) Shows the structures of interest (boxed areas) on frontal brain sections drawings (adapted from Franklin and Paxinos, 2008). After deposit of biotin dextran amine in the parabrachial nucleus (PB; i, black arrow), anterogradely labelled axons are found in the lateral part of the central nucleus of the amygdala (CeA; ii) and in the dorsal part of the lateral bed nucleus of stria terminalis (BSTL; iii). Retrogradely labelled somas are found in the PB (iv) after Fluoro-gold[®] injection in the CeA (v, white arrow). Scale bars: 200 μ m. ac, anterior commissure; dorsal (D), ventral (V), posterior (P) parts; BLA, basolateral amygdala; lateral (CeL), capsular (CeC), medial (CeM) parts; CPu, caudate putamen; ic, internal capsule; ot, optical tract; lateral (l), lateral external (el), medial (m) parts; scp, superior cerebellar peduncle.

again showing similar values in response to saline injections (Fig. 4a).

Mechanical nociceptive response was evaluated in an independent experiment. Similar to thermal sensitivity,

no baseline difference was noted between control and BDNF-deleted animals (Fig. 4b), but morphine-induced analgesia was reduced in BDNF-deleted animals (58% reduction, $p < 0.001$; Fig. 4b).

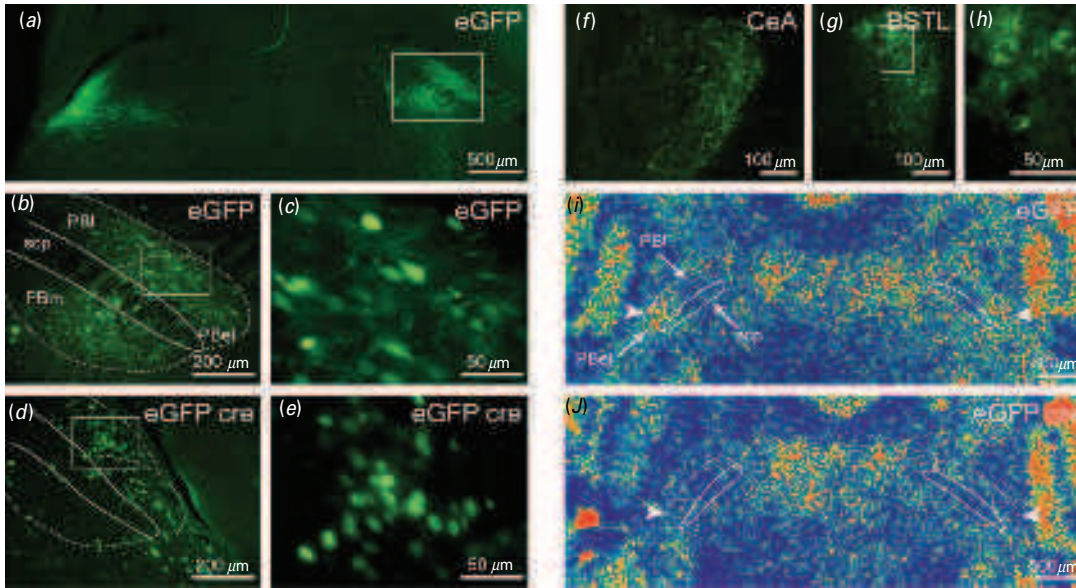

Fig. 2. Adeno-associated virus (AAV) injections. Enhanced green fluorescent protein (eGFP) expression in the parabrachial nucleus (PB) following AAV-eGFP (a–c) or AAV-eGFP-Cre (d, e) injections. Following AAV-eGFP injection in the external lateral PB (PBel), fluorescent terminals are observed in the central nucleus of the amygdala (CeA; f) and in the lateral bed nucleus of stria terminalis (BSTL; g, h) with typical perisomatic basket appearance. *In situ* hybridization, with optical density changes converted to a colour scale shows a decrease in brain-derived neurotrophic factor (BDNF) mRNA levels in the external lateral PB (white arrowheads) of AAV-eGFP-Cre injected mice (j) as compared to AAV-eGFP controls (i). Lateral (l), medial (m) parts; scp, superior cerebellar peduncle.

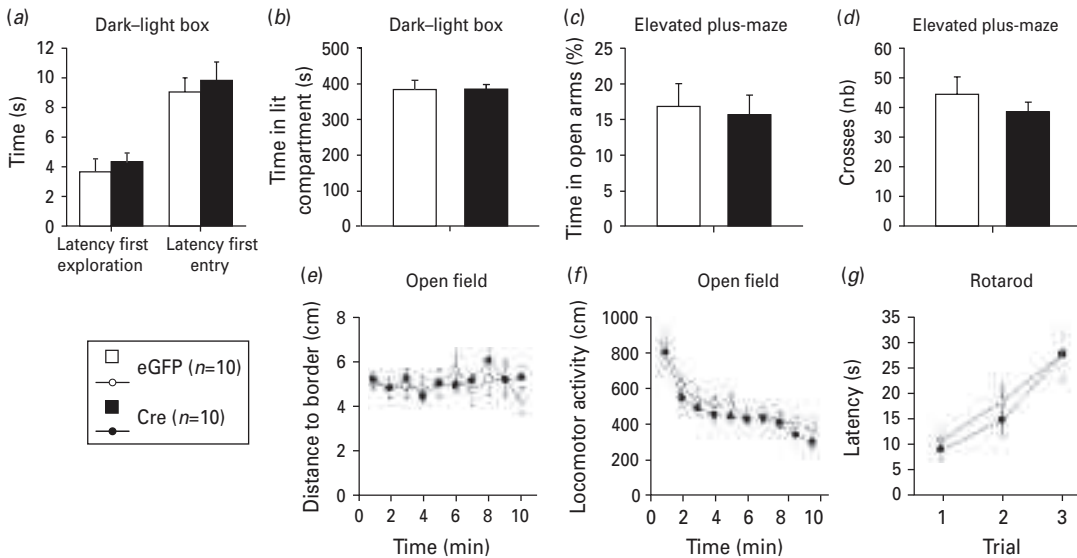

Fig. 3. Behavioural measure (\pm S.E.M) of anxiety using the dark-light (a, b), the elevated plus-maze (c, d) and the open-field (e, f) tests. Locomotor activity was assessed with the open-field (f) and motor coordination with the rotarod test (g). eGFP, enhanced green fluorescent protein.

BDNF into the CeA mediates morphine-induced analgesia

Following histological validation of cannula placement, morphine-induced mechanical analgesia was analysed on nine mice with intra-CeA PBS (control mice) and six mice with intra-CeA TrkB-Fc (TrkB-Fc mice). The nociceptive thresholds before morphine injection were similar between control and TrkB-Fc mice (Fig. 4c), but a

decrease in morphine-induced analgesia was observed in TrkB-Fc mice (49% reduction, $p < 0.001$; Fig. 4c).

Parabrachial BDNF mediates morphine-induced early cellular responses

In both control and BDNF-deleted animals, morphine injection increased the number of c-Fos positive nuclei in the dorsal BSTL, the BLA and the three subdivisions of

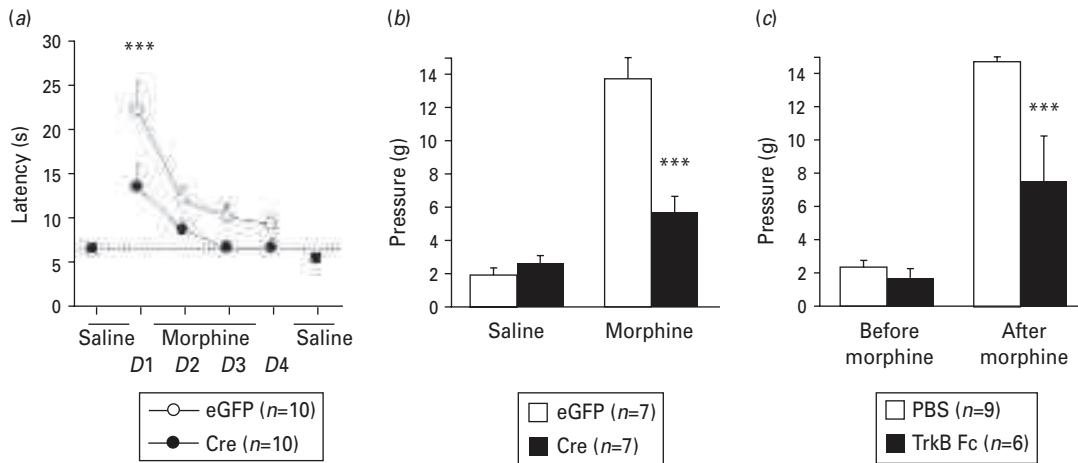

Fig. 4. Effect of brain-derived neurotrophic factor parabrachial nucleus deletion (a, b) and TrkB-Fc infusion into central nucleus of the amygdala (c) on thermal (a) and mechanical (b, c) nociceptive responses during morphine analgesia (mean \pm S.E.M.). *** $p < 0.001$. eGFP, Enhanced green fluorescent protein.

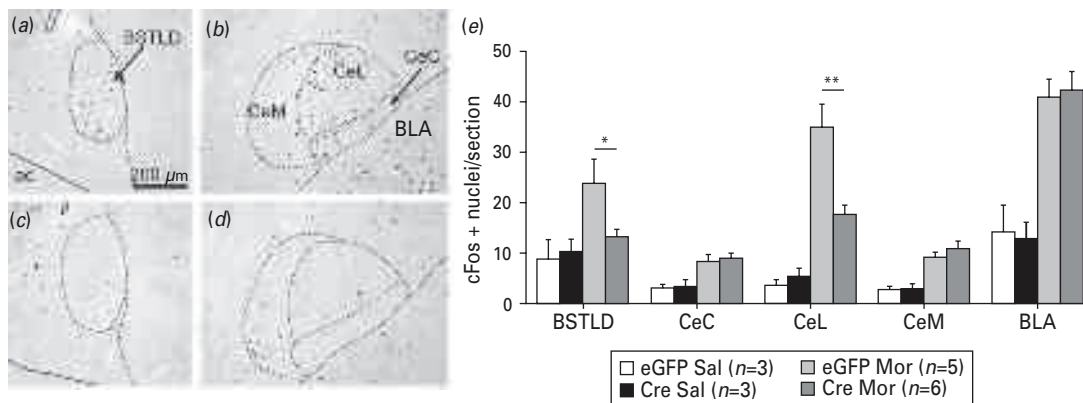

Fig. 5. Morphine-induced c-Fos in control (a, b) and brain-derived neurotrophic factor-deleted (c, d) animals in the lateral bed nucleus of stria terminalis dorsal part (BSTLD; a, c) and in the amygdala (b, d). Quantification (\pm S.E.M.) in the BSTLD, the central nucleus of the amygdala (CeA) subdivisions and the basolateral amygdala (BLA; e). * $p < 0.05$, ** $p < 0.03$. ac, Anterior commissure; lateral (CeL), capsular (CeC), medial (CeM) divisions; morphine (Mor); saline (Sal).

the CeA (Fig. 5e). In control animals, the number of c-Fos positive nuclei was at least doubled (BSTL 171%, CeC 176% and CeM 233% over saline), with the largest morphine-induced elevations being counted in the CeL (929%) and the BLA (187%; Fig. 5e). No difference between control and BDNF-deleted animals is noted for responses to saline, but these groups differ widely when comparing their response to morphine (Fig. 5a–d). More specifically, c-Fos positive nuclei were reduced by approximately 50% in both the dorsal BSTL (control *vs.* BDNF-deleted groups, $p < 0.05$) and the CeL ($p < 0.05$), while the CeC, CeM and BLA were equally responsive to morphine regardless of the PB deletion (Fig. 5e).

Discussion

We used tract-tracing techniques to visualize the mouse parabrachio-amygdaloid projection, a pharmacological

approach to block BDNF actions in the CeA and molecular tools to delete the BDNF gene in the PB. From a cellular perspective, this deletion led to a decrease in c-Fos induction in the CeL and BSTL following morphine administration. From a behavioural perspective, it resulted in decreased morphine-induced analgesia. This reveals an essential role for the BDNF parabrachio-amygdaloid pathway in opiate-induced analgesia.

Morphological and functional aspects of the spino-parabrachio-amygdaloid nociceptive pathway have been thoroughly described in rats (Bernard et al., 1996; Sarhan et al., 2005). While it is expected to be similar in mice, supporting evidence is only starting to emerge (Tokita et al., 2010). Here, both anterograde and retrograde tracing methods showed that neurons in PBel extensively project to the EAc in mice. In addition, the anterograde transport of eGFP expressed by AAV-infected neurons in the PBel led to terminal labelling in the EAc, thus

confirming the targeting of the PB-EAc pathway. It should also be noted that, in the rat, PB neurons projecting to the EAc, notably those in the PBel, do not innervate other structures except a light projection to the lateral hypothalamus and midbrain reticular formation (Sarhan et al., 2005).

BDNF immunoreactivity was described in the CeA and BSTL in rats and mice (Conner et al., 1997; Yan et al., 1997; Krause et al., 2008). In the PB, a BDNF immunoreactive plexus is described along with BDNF expressing neurons (Ceccatelli et al., 1991; Conner et al., 1997) and these neurons project to the ipsilateral EAc (Conner et al., 1997). Distinctive pericellular structures are described for the EAc BDNF terminal labelling, featuring a similar morphology to the axonal terminals originating from the PB-EAc projection (Conner et al., 1997; Sarhan et al., 2005; Agassandian et al., 2006). Locally, dense core vesicles were shown to contain simultaneously BDNF, substance P and CGRP (Salio et al., 2007). Furthermore, the BDNF receptor TrkB was post-synaptically described in the EAc (Yan et al., 1997; Agassandian et al., 2006). Behaviourally, both EAc (Davis et al., 2010) and BDNF (Rattiner et al., 2004; Monteggia et al., 2007) were implicated in anxiety-like behaviours. Indeed, BDNF global deletion leads to enhanced anxiety-related behaviour (Rios et al., 2001). However, our results suggest that the parabrachio-amygdaloid pathway may not be relevant in this context since local manipulation of BDNF in the PB is not accompanied by a change in anxiety.

The spino-parabrachio-amygdaloid pathway carries nociceptive information to the EAc, which then mediates sensorimotor, emotional and affective dimensions of pain (Neugebauer et al., 2009). This is achieved via connections with ascending and descending nociceptive systems (Oliveira and Prado, 2001; Neugebauer et al., 2009). Lesion studies demonstrated that the CeA is not critical for generating the physical response to acute pain, but it is involved in the expression of several forms of analgesia, such as conditioned- or stress-induced (Helmstetter, 1993; Helmstetter et al., 1993; Watkins et al., 1993; Manning and Mayer, 1995). The CeA inactivation or lesion also reduces morphine-induced analgesia (Manning and Mayer, 1995; Manning et al., 2001) and, while systemic morphine is expected to exert its properties on multiple relays along the pain matrix, this indicates that CeA is a required element of the anti-nociceptive circuit recruited by morphine. Moreover, morphine and β -endorphin injections into the amygdala were shown to induce analgesia through periaqueductal grey (PAG) connections (Helmstetter et al., 1993; Pavlovic and Bodnar, 1998), thus suggesting that morphine can directly act on CeA circuitry. The three opioid receptors subtypes are present in the EAc, both pre and post-synaptically (Zhu and Pan, 2005; Jaferi and Pickel, 2009; Poulin et al., 2009). In the three CeA subdivisions, neurons can be post-synaptically inhibited by μ -receptor agonists (Chieng et al., 2006), but presynaptic inhibition of glutamate or GABA release

has also been reported (Finnegan et al., 2005; Zhu and Pan, 2005). We found that acute morphine injection increased the number of neurons expressing c-Fos in the CeA, dorsal BSTL and BLA, which is consistent with previous reports (Hamlin et al., 2007). As almost all EAc neurons are GABAergic (Alheid et al., 1995; Cassell et al., 1999), and activation of μ -receptors usually results in an inhibitory outcome, the local effects of morphine would mainly be due to disinhibitory mechanisms. Thus, morphine would mimic the physiological activation of the opioid system in the CeA to promote anti-nociceptive processes normally activated during life-threatening situations. The cellular mechanisms underlying this activation are, however, poorly understood.

Part of the inhibitory circuit of the mice CeA has been recently disclosed in the context of fear conditioning (Ciocchi et al., 2010; Haubensak et al., 2010). It has been suggested that, in the CeL, GABA neurons (OFF cells) tonically inhibit CeM projection neurons responsible for fear-induced freezing. Another population of GABA CeL neurons (ON cells) can be excited by BLA and/or cortical afferents following presentation of a shock-paired tone. As a consequence, ON cells would inhibit OFF cells, thus disinhibiting CeM neurons and triggering the activation of defensive pathways in the brainstem. As hypoalgesia occurs during expression of conditioned fear, it could be suggested that a similar circuit in the CeA controls conditioned analgesia. However, while Finnegan et al. (2005) proposed that μ -receptor agonists trigger the disinhibition of CeM PAG-projecting neurons, Chieng and Christie (2009) suggest the contrary, i.e. inhibition of CeM projection neurons. Several neuropeptides such as oxytocin, neurotensin, corticotrophin-releasing factor and CGRP also induce opioid-dependent anti-nociception when injected into the CeA (Kalivas et al., 1982; Xu et al., 2003; Cui et al., 2004; Han and Yu, 2009). This would be achieved, at least for oxytocin, through the inhibition of CeM projection neurons since oxytocin activates ON cells in the lateral CeA and decreases freezing (Haubensak et al., 2010; Knobloch et al., 2012). Finally, in addition to its anti-nociceptive roles, the CeA is also involved in pro-nociceptive processes, especially during prolonged pain (Neugebauer et al., 2009). A bidirectional control of CeA output has thus to be achieved either through a single circuit with both anti- and pro-nociceptive potentialities or through the balance between two opposite circuits. Our results show that deleting BDNF from the PB-EAc pathway, or directly inhibiting BDNF actions in the CeA, reduces morphine-induced analgesia. It is thus possible that BDNF is involved in maintaining the balance in CeA circuits and in tuning the reactivity to emotionally relevant situations.

BDNF has been thoroughly studied in the context of pain modulation, but most studies focused on the spinal level (Pezet et al., 2002; Ren and Dubner, 2007; Merighi et al., 2008). BDNF involvement in supraspinal pain

mechanisms was explored in the PAG and its main downstream effector, the rostroventromedial medulla (RVM). Midbrain BDNF infusions (Guo et al., 2006) as well as intracerebroventricular administrations (Cirulli et al., 2000) appear anti-nociceptive without affecting basal nociceptive thresholds. In contrast, BDNF transmission within the RVM appears pro-nociceptive and facilitates hyperalgesia (Guo et al., 2006). Thus the BDNF pathways are part of descending pain control systems with both anti-nociceptive and pro-nociceptive roles. Interestingly, TrkB controls morphine-induced analgesia without affecting basal nociceptive responses (Lucas et al., 2003). Our results are consistent with these data, since suppressing BDNF in the PB-EAC projection results in unaltered basal pain responses, but decreases morphine-induced analgesia. From a cellular aspect, morphine increases c-Fos expression in all analysed EAC nuclei as well as in the BLA. In BDNF-deleted mice, this induction is reduced in the CeL and dorsal BSTL, but not in the BLA. Since the CeL and the dorsal BSTL are directly innervated by PB axons containing BDNF (Conner et al., 1997), it appears that cellular recruitment in the EAC in response to morphine is, at least partially, dependent on BDNF released by PB terminals.

Our results suggest that BDNF is necessary to obtain effective morphine-induced analgesia. Several mechanisms can be proposed. BDNF may act in the PB itself by modifying dendritic morphology (Horch, 2004) or by modulating the expression of neuropeptides such as CGRP in parabrachio-amygdaloid neurons. If BDNF regulates PB expression and/or release of CGRP, it would eventually impact its main anatomical target, the EAC. However, the role of CGRP in pain-related mechanisms in the CeA remains controversial, both pro-nociceptive (Han et al., 2010) and anti-nociceptive (Xu et al., 2003) actions being reported. While we cannot rule out a local action of BDNF in the PB, the behavioural effect of TrkB-Fc infusion in the CeA shows that BDNF can modulate morphine analgesia by an acute local effect in the CeA. BDNF-TrkB signalling is able to facilitate glutamatergic transmission (Guo et al., 2006; Ren and Dubner, 2007; Merighi et al., 2008) and also leads to the rapid internalization of GABA_A receptors in the amygdala, allowing for transient hyperexcitability (Mou et al., 2011). In the CeA, BDNF is present in pericellular pre-synaptic terminals containing glutamate (Agassandian et al., 2006; Delaney et al., 2007). Post-synaptically, both BDNF and TrkB immunoreactivities are detected on post-synaptic densities of asymmetric synapses facing BDNF-positive axons, presumably from PB origin, but also BDNF-negative axons from BLA or cortical origin (Agassandian et al., 2006). PB-derived BDNF in the CeA may thus modulate excitatory synapses. In a given physiological situation, this would allow selecting a specific circuit by targeted disinhibition via the opioid system and enhanced excitation via the BDNF system. During morphine analgesia, μ -receptors in the CeL could thus trigger the silencing of a GABA

population, thus disinhibiting a second population that could be activated by BDNF-potentiated excitatory afferents. The absence or blockade of BDNF in our experiments would reduce this excitation, as suggested by the decreased c-Fos recruitment in the CeL, and consequently reduce the positive influence of CeA on anti-nociceptive processes. Interestingly, the CeC has often been associated with pro-nociception while the CeL has been more associated with anti-nociception (Hamlin et al., 2007; Neugebauer et al., 2009). It is, however, too speculative to further develop a potential circuit for BDNF action in the CeA. First, we do not know if PB inputs preferentially target ON or OFF cells or another group. The PB in the rat indeed projects to CeL and CeC via different neuronal populations (Sarhan et al., 2005) and the distribution of ON and OFF cells in the CeA has not been described with enough precision to differentiate between CeL and CeC. Second, the correlation between the CeA distribution of μ -receptors and their cellular and behavioural effects is only partial and controversial. Third, whereas morphine can directly act on μ -receptors in the CeA, the overall changes in CeA activity, including those involving BDNF, can also be due to μ -receptors in CeA-projecting structures, such as the intercalated cell masses, which provide an inhibitory input to the CeA (Palomares-Castillo et al., 2012). Dissecting the mechanisms of BDNF action in the CeA will thus need additional anatomical and functional studies.

The potential role of BDNF in the BSTL remains elusive. We show that BDNF deletion in the PB-EAC pathway leads to decreased morphine-induced c-Fos activation in the dorsal BSTL, similar to what was observed in the CeL. The CeA and the BSTL share similar cytoarchitectural, neurochemical and hodological features and are strongly interconnected (Alheid et al., 1995; Cassell et al., 1999). BDNF innervation in the BSTL originates in the PB (Conner et al., 1997) and PB-BSTL axons arise as collaterals of PB neurons innervating the CeA (Sarhan et al., 2005). However, our TrkB-Fc experiment shows that blocking BDNF signalling in CeA is sufficient to decrease morphine-induced analgesia. Indeed, while the role of BSTL in pain is less studied than the CeA, it may be mainly related to affective and neuroendocrine dimensions (Deyama et al., 2007), with little or no evidence of an involvement in nociceptive sensitivity. Thus, BDNF in the BSTL may be involved in a circuit similar to the CeA, but with a preferential impact on the affective aspects of pain.

This study shows that BDNF produced in the PB-EAC pathway is important for morphine analgesia. BDNF deletion in PB neurons leads to a significant decrease in c-Fos response to morphine in the CeL and BSTL. This deletion does not alter baseline nociceptive responses, but affects the analgesic properties of morphine. While further research is necessary to address the implications of supraspinal BDNF in nociception processes, this study provides candidate anatomical and

molecular substrates that are likely involved in opiate analgesia.

Acknowledgements

This work was supported by Centre National de la Recherche Scientifique (UPR3212) and University of Strasbourg. We thank Dr Maribel Rios for access to loxP-BDNF mice and Dr Eric Nestler for hosting parts of the experiments.

Statement of Interest

Dr Barrot received lecture fees from Adir and Lilly France and contract from Missions-Cadres. Drs Barrot and Yalcin reported a CNRS-filed patent for pain treatments.

References

- Adachi M, Barrot M, Autry AE, Theobald D, Monteggia LM (2008) Selective loss of brain-derived neurotrophic factor in the dentate gyrus attenuates antidepressant efficacy. *Biol Psychiatry* 63:642–649.
- Agassandian K, Gedney M, Cassell MD (2006) Neurotrophic factors in the central nucleus of amygdala may be organized to provide substrates for associative learning. *Brain Res* 1076:78–86.
- Alheid GF, De Olmos JS, Beltramino CA (1995) Amygdala and extended amygdala. In: *The rat nervous system* (Paxinos G, ed), pp495–578. New York: Academic Press Inc.
- Barrot M (2012) Tests and models of nociception and pain in rodents. *Neuroscience* 211:39–50.
- Bernard JF, Bester H, Besson JM (1996) Involvement of the spino-parabrachio-amygdaloid and -hypothalamic pathways in the autonomic and affective emotional aspects of pain. *Prog Brain Res* 107:243–255.
- Berton O, McClung CA, Dileone RJ, Krishnan V, Renthal W, Russo SJ, Graham D, Tsankova NM, Bolanos CA, Rios M, Monteggia LM, Self DW, Nestler EJ (2006) Essential role of BDNF in the mesolimbic dopamine pathway in social defeat stress. *Science* 311:864–868.
- Cassell MD, Freedman LJ, Shi C (1999) The intrinsic organization of the central extended amygdala. *Ann NY Acad Sci* 877:217–241.
- Ceccatelli S, Ernfors P, Villar MJ, Persson H, Hokfelt T (1991) Expanded distribution of mRNA for nerve growth factor, brain-derived neurotrophic factor, and neurotrophin 3 in the rat brain after colchicine treatment. *Proc Natl Acad Sci USA* 88:10352–10356.
- Chiang B, Christie MJ (2009) Chronic morphine treatment induces functional delta-opioid receptors in amygdala neurons that project to periaqueductal grey. *Neuropharmacology* 57:430–437.
- Chiang BC, Christie MJ, Osborne PB (2006) Characterization of neurons in the rat central nucleus of the amygdala: cellular physiology, morphology, and opioid sensitivity. *J Comp Neurol* 497:910–927.
- Ciocchi S, Herry C, Grenier F, Wolff SB, Letzkus JJ, Vlachos I, Ehrlich I, Sprengel R, Deisseroth K, Stadler MB, Muller C, Luthi A (2010) Encoding of conditioned fear in central amygdala inhibitory circuits. *Nature* 468:277–282.
- Cirulli F, Berry A, Alleva E (2000) Intracerebroventricular administration of brain-derived neurotrophic factor in adult rats affects analgesia and spontaneous behaviour but not memory retention in a Morris Water Maze task. *Neurosci Lett* 287:207–210.
- Conner JM, Lauterborn JC, Yan Q, Gall CM, Varon S (1997) Distribution of brain-derived neurotrophic factor (BDNF) protein and mRNA in the normal adult rat CNS: evidence for anterograde axonal transport. *J Neurosci* 17:2295–2313.
- Cui XY, Lundberg T, Yu LC (2004) Role of corticotropin-releasing factor and its receptor in nociceptive modulation in the central nucleus of amygdala in rats. *Brain Res* 995:23–28.
- Davis M, Walker DL, Miles L, Grillon C (2010) Phasic vs sustained fear in rats and humans: role of the extended amygdala in fear vs anxiety. *Neuropsychopharmacology* 35:105–135.
- Delaney AJ, Crane JW, Sah P (2007) Noradrenaline modulates transmission at a central synapse by a presynaptic mechanism. *Neuron* 56:880–892.
- Deyama S, Nakagawa T, Kaneko S, Uehara T, Minami M (2007) Involvement of the bed nucleus of the stria terminalis in the negative affective component of visceral and somatic pain in rats. *Behav Brain Res* 176:367–371.
- Finnegan TF, Chen SR, Pan HL (2005) Effect of the μ opioid on excitatory and inhibitory synaptic inputs to periaqueductal gray-projecting neurons in the amygdala. *J Pharmacol Exp Ther* 312:441–448.
- Franklin KB, Paxinos G (2008) *The mouse brain in stereotaxic coordinates*, 3rd edn. New York: Academic Press.
- Ghitza UE, Zhai H, Wu P, Airavaara M, Shaham Y, Lu L (2010) Role of BDNF and GDNF in drug reward and relapse: a review. *Neurosci Biobehav Rev* 35:157–171.
- Graham DL, Edwards S, Bachtell RK, DiLeone RJ, Rios M, Self DW (2007) Dynamic BDNF activity in nucleus accumbens with cocaine use increases self-administration and relapse. *Nat Neurosci* 10:1029–1037.
- Guo W, Robbins MT, Wei F, Zou S, Dubner R, Ren K (2006) Spinal brain-derived neurotrophic factor signaling: a novel mechanism for descending pain facilitation. *J Neurosci* 26:126–137.
- Hamlin AS, McNally GP, Osborne PB (2007) Induction of c-Fos and zif268 in the nociceptive amygdala parallel abstinence hyperalgesia in rats briefly exposed to morphine. *Neuropharmacology* 53:330–343.
- Han JS, Adwanikar H, Li Z, Ji G, Neugebauer V (2010) Facilitation of synaptic transmission and pain responses by CGRP in the amygdala of normal rats. *Molecular Pain* 6:10.
- Han Y, Yu LC (2009) Involvement of oxytocin and its receptor in nociceptive modulation in the central nucleus of amygdala of rats. *Neurosci Lett* 454:101–104.
- Haubensak W, Kunwar PS, Cai H, Ciocchi S, Wall NR, Ponnusamy R, Biag J, Dong HW, Deisseroth K, Callaway EM, Fanselow MS, Luthi A, Anderson DJ (2010) Genetic dissection of an amygdala microcircuit that gates conditioned fear. *Nature* 468:270–276.
- Helmstetter FJ (1993) Stress-induced hypoalgesia and defensive freezing are attenuated by application of diazepam to the amygdala. *Pharmacol Biochem Behav* 44:433–438.
- Helmstetter FJ, Bellgowan PS, Tershner SA (1993) Inhibition of the tail flick reflex following microinjection of morphine into the amygdala. *Neuroreport* 4:471–474.

- Hommel JD, Sears RM, Georgescu D, Simmons DL, DiLeone RJ (2003) Local gene knockdown in the brain using viral-mediated RNA interference. *Nat Med* 9:1539–1544.
- Horch HW (2004) Local effects of BDNF on dendritic growth. *Rev Neurosci* 15:117–129.
- Huang GF, Besson JM, Bernard JF (1993a) Morphine depresses the transmission of noxious messages in the spino(trigemino)-ponto-amygdaloid pathway. *Eur J Pharmacol* 230:279–284.
- Huang GF, Besson JM, Bernard JF (1993b) Intravenous morphine depresses the transmission of noxious messages to the nucleus centralis of the amygdala. *Eur J Pharmacol* 236:449–456.
- Jaferi A, Pickel VM (2009) Mu-opioid and corticotropin-releasing-factor receptors show largely postsynaptic co-expression, and separate presynaptic distributions, in the mouse central amygdala and bed nucleus of the stria terminalis. *Neuroscience* 159:526–539.
- Kalivas PW, Gau BA, Nemeroff CB, Prange Jr. AJ (1982) Antinociception after microinjection of neurotensin into the central amygdaloid nucleus of the rat. *Brain Res* 243:279–286.
- Kaurling J, Veinante P, Pawlowski SA, Freund-Mercier MJ, Barrot M (2009) Afferents to the GABAergic tail of the ventral tegmental area in the rat. *J Comp Neurol* 513:597–621.
- Knobloch HS, Charlet A, Hoffmann LC, Eliava M, Khrulev S, Cetin AH, Osten P, Schwarz MK, Seeburg PH, Stoop R, Grinevich V (2012) Evoked axonal oxytocin release in the central amygdala attenuates fear response. *Neuron* 73:553–566.
- Koo JW, Mazei-Robison MS, Chaudhury D, Juarez B, LaPlant Q, Ferguson D, Feng J, Sun H, Scobie KN, Damez-Werno D, Crumiller M, Ohnishi YN, Ohnishi YH, Mouzon E, Dietz DM, Lobo MK, Neve RL, Russo SJ, Han MH, Nestler EJ (2012) BDNF is a negative modulator of morphine action. *Science* 338:124–128.
- Krause S, Schindowski K, Zechel S, von Bohlen und Halbach O (2008) Expression of trkB and trkC receptors and their ligands brain-derived neurotrophic factor and neurotrophin-3 in the murine amygdala. *J Neurosci Res* 86:411–421.
- Lucas G, Hendolin P, Harkany T, Agerman K, Paratcha G, Holmgren C, Zilberter Y, Sairanen M, Minichiello L, Castren E, Ernfors P (2003) Neurotrophin-4 mediated TrkB activation reinforces morphine-induced analgesia. *Nat Neurosci* 6:221–222.
- Manning BH, Mayer DJ (1995) The central nucleus of the amygdala contributes to the production of morphine antinociception in the rat tail-flick test. *J Neurosci* 15:8199–8213.
- Manning BH, Merin NM, Meng ID, Amaral DG (2001) Reduction in opioid- and cannabinoid-induced antinociception in rhesus monkeys after bilateral lesions of the amygdaloid complex. *J Neurosci* 21:8238–8246.
- Merighi A, Salio C, Ghirri A, Lossi L, Ferrini F, Betelli C, Bardoni R (2008) BDNF as a pain modulator. *Prog Neurobiol* 85:297–317.
- Monteggia LM, Luikart B, Barrot M, Theobald D, Malkovska I, Nef S, Parada LF, Nestler EJ (2007) Brain-derived neurotrophic factor conditional knockouts show gender differences in depression-related behaviors. *Biol Psychiatry* 61:187–197.
- Mou L, Heldt SA, Ressler KJ (2011) Rapid brain-derived neurotrophic factor-dependent sequestration of amygdala and hippocampal GABA(A) receptors via different tyrosine receptor kinase B-mediated phosphorylation pathways. *Neuroscience* 176:72–85.
- Neugebauer V, Galhardo V, Maione S, Mackey SC (2009) Forebrain pain mechanisms. *Brain Res Rev* 60:226–242.
- Oliveira MA, Prado WA (2001) Role of PAG in the antinociception evoked from the medial or central amygdala in rats. *Brain Res Bull* 54:55–63.
- Palomares-Castillo E, Hernandez-Perez OR, Perez-Carrera D, Crespo-Ramirez M, Fuxe K, Perez de la Mora M (2012) The intercalated paracapsular islands as a module for integration of signals regulating anxiety in the amygdala. *Brain Res* 1476:211–234.
- Pavlovic ZW, Bodnar RJ (1998) Opioid supraspinal analgesic synergy between the amygdala and periaqueductal gray in rats. *Brain Res* 779:158–169.
- Pezet S, Malcangio M, McMahon SB (2002) BDNF: a neuromodulator in nociceptive pathways? *Brain Res Rev* 40:240–249.
- Poulin JF, Arbour D, Laforest S, Drolet G (2009) Neuroanatomical characterization of endogenous opioids in the bed nucleus of the stria terminalis. *Prog Neuropsychopharmacol Biol Psychiatry* 33:1356–1365.
- Rattiner LM, Davis M, French CT, Ressler KJ (2004) Brain-derived neurotrophic factor and tyrosine kinase receptor B involvement in amygdala-dependent fear conditioning. *J Neurosci* 24:4796–4806.
- Ren K, Dubner R (2007) Pain facilitation and activity-dependent plasticity in pain modulatory circuitry: role of BDNF-TrkB signaling and NMDA receptors. *Mol Neurobiol* 35:224–235.
- Rios M, Fan G, Fekete C, Kelly J, Bates B, Kuehn R, Lechan RM, Jaenisch R (2001) Conditional deletion of brain-derived neurotrophic factor in the postnatal brain leads to obesity and hyperactivity. *Mol Endocrinol* 15:1748–1757.
- Salio C, Averill S, Priestley JV, Merighi A (2007) Costorage of BDNF and neuropeptides within individual dense-core vesicles in central and peripheral neurons. *Dev Neurobiol* 67:326–338.
- Sarhan M, Freund-Mercier MJ, Veinante P (2005) Branching patterns of parabrachial neurons projecting to the central extended amygdala: single axonal reconstructions. *J Comp Neurol* 491:418–442.
- Tokita K, Inoue T, Boughter Jr. JD (2010) Subnuclear organization of parabrachial efferents to the thalamus, amygdala and lateral hypothalamus in C57BL/6J mice: a quantitative retrograde double labeling study. *Neuroscience* 171:351–365.
- Watkins LR, Wiertelak EP, Maier SF (1993) The amygdala is necessary for the expression of conditioned but not unconditioned analgesia. *Behav Neurosci* 107:402–405.
- Xu W, Lundeberg T, Wang YT, Li Y, Yu LC (2003) Antinociceptive effect of calcitonin gene-related peptide in the central nucleus of amygdala: activating opioid receptors through amygdala-periaqueductal gray pathway. *Neuroscience* 118:1015–1022.
- Yalcin I, Charlet A, Cordero-Erausquin M, Tessier LH, Picciotto MR, Schlichter R, Poisbeau P, Freund-Mercier MJ, Barrot M (2011) Nociceptive thresholds are controlled through

spinal beta(2)-subunit-containing nicotinic acetylcholine receptors. *Pain* 152:2131–2137.

Yamano M, Hillyard CJ, Girgis S, Emson PC, MacIntyre I, Tohyama M (1988) Projection of neurotensin-like immunoreactive neurons from the lateral parabrachial area to the central amygdaloid nucleus of the rat with reference to the coexistence with calcitonin gene-related peptide. *Exp Brain Res* 71:603–610.

Yan Q, Rosenfeld RD, Matheson CR, Hawkins N, Lopez OT, Bennett L, Welcher AA (1997) Expression of brain-derived neurotrophic factor protein in the adult rat central nervous system. *Neuroscience* 78:431–448.

Zhu W, Pan ZZ (2005) Mu-opioid-mediated inhibition of glutamate synaptic transmission in rat central amygdala neurons. *Neuroscience* 133:97–103.

Bibliographie

- Adams R, David AS (2007) Patterns of anterior cingulate activation in schizophrenia: a selective review. *Neuropsychiatr Dis Treat* 3:87-101.
- Aguilar MA, Rodriguez-Arias M, Minarro J (2009) Neurobiological mechanisms of the reinstatement of drug-conditioned place preference. *Brain Res Rev* 59:253-277.
- Al-Amin H, Sarkis R, Atweh S, Jabbur S, Saade N (2011) Chronic dizocilpine or apomorphine and development of neuropathy in two animal models II: effects on brain cytokines and neurotrophins. *Exp Neurol* 228:30-40.
- Alba-Delgado C, Llorca-Torralba M, Horrillo I, Ortega JE, Mico JA, Sanchez-Blazquez P, Meana JJ, Berrocoso E (2013) Chronic pain leads to concomitant noradrenergic impairment and mood disorders. *Biol Psychiatry* 73:54-62.
- Alciati A, Sgiarovello P, Atzeni F, Sarzi-Puttini P (2012) Psychiatric problems in fibromyalgia: clinical and neurobiological links between mood disorders and fibromyalgia. *Reumatismo* 64:268-274.
- Aleksandrov VG, Fedorova KP (2003) Structure of the insular region of the rat neocortex. *Neurosci Behav Physiol* 33:199-202.
- Alheid GF, de Olmos JS, Betramino CA, eds (1995) *Amygdala and extended amygdala*, 2nd Edition. San Diego: CA: Academic.
- Alkire MT, White NS, Hsieh R, Haier RJ (2004) Dissociable brain activation responses to 5-Hz electrical pain stimulation: a high-field functional magnetic resonance imaging study. *Anesthesiology* 100:939-946.
- Allen GV, Saper CB, Hurley KM, Cechetto DF (1991) Organization of visceral and limbic connections in the insular cortex of the rat. *The Journal of comparative neurology* 311:1-16.
- Almashaikhi T, Rheims S, Ostrowsky-Coste K, Montavont A, Jung J, De Bellescize J, Arzimanoglou A, Keo Kosal P, Guenot M, Bertrand O, Ryvlin P (2013) Intra-insular functional connectivity in human. *Human brain mapping*.
- An X, Bandler R, Ongur D, Price JL (1998) Prefrontal cortical projections to longitudinal columns in the midbrain periaqueductal gray in macaque monkeys. *J Comp Neurol* 401:455-479.
- Andersen ML, Tufik S (2003) Sleep patterns over 21-day period in rats with chronic constriction of sciatic nerve. *Brain Res* 984:84-92.
- Andrews N, Legg E, Lisak D, Issop Y, Richardson D, Harper S, Pheby T, Huang W, Burgess G, Machin I, Rice AS (2012) Spontaneous burrowing behaviour in the rat is reduced by peripheral nerve injury or inflammation associated pain. *Eur J Pain* 16:485-495.
- Ansah OB, Bourbia N, Goncalves L, Almeida A, Pertovaara A (2010) Influence of amygdaloid glutamatergic receptors on sensory and emotional pain-related behavior in the neuropathic rat. *Behav Brain Res* 209:174-178.
- Antypa N, Drago A, Serretti A (2013) The role of COMT gene variants in depression: Bridging neuropsychological, behavioral and clinical phenotypes. *Neurosci Biobehav Rev* 37:1597-1610.
- Apkarian AV, Bushnell MC, Treede RD, Zubieta JK (2005) Human brain mechanisms of pain perception and regulation in health and disease. *European journal of pain* 9:463-484.
- Apkarian AV, Sosa Y, Sonty S, Levy RM, Harden RN, Parrish TB, Gitelman DR (2004) Chronic back pain is associated with decreased prefrontal and thalamic gray matter density. *J Neurosci* 24:10410-10415.
- Apkarian AV, Lavarello S, Randolph A, Berra HH, Chialvo DR, Besedovsky HO, del Rey A (2006) Expression of IL-1beta in supraspinal brain regions in rats with neuropathic pain. *Neurosci Lett* 407:176-181.
- Apkarian AV, Baliki MN, Farmer MA (2013) Predicting transition to chronic pain. *Curr Opin Neurol* 26:360-367.
- Arikuni T, Sako H, Murata A (1994) Ipsilateral connections of the anterior cingulate cortex with the frontal and medial temporal cortices in the macaque monkey. *Neurosci Res* 21:19-39.
- Attal N (2013) [Pharmacological treatment of neuropathic pain in primary care]. *Rev Prat* 63:795-802.
- Attal N, Lanteri-Minet M, Laurent B, Fermanian J, Bouhassira D (2011) The specific disease burden of neuropathic pain: results of a French nationwide survey. *Pain* 152:2836-2843.

- Attal N, Fermanian C, Fermanian J, Lanteri-Minet M, Alchaar H, Bouhassira D (2008) Neuropathic pain: are there distinct subtypes depending on the aetiology or anatomical lesion? *Pain* 138:343-353.
- Augustine JR (1985) The insular lobe in primates including humans. *Neurological research* 7:2-10.
- Autry AE, Monteggia LM (2012) Brain-derived neurotrophic factor and neuropsychiatric disorders. *Pharmacol Rev* 64:238-258.
- Bachevalier J, Meunier M, Lu MX, Ungerleider LG (1997) Thalamic and temporal cortex input to medial prefrontal cortex in rhesus monkeys. *Exp Brain Res* 115:430-444.
- Backonja MM, Stacey B (2004) Neuropathic pain symptoms relative to overall pain rating. *J Pain* 5:491-497.
- Backonja MM, Coe CL, Muller DA, Schell K (2008) Altered cytokine levels in the blood and cerebrospinal fluid of chronic pain patients. *J Neuroimmunol* 195:157-163.
- Bair MJ, Robinson RL, Katon W, Kroenke K (2003) Depression and pain comorbidity: a literature review. *Arch Intern Med* 163:2433-2445.
- Baleydier C, Mauguier F (1980) The duality of the cingulate gyrus in monkey. *Neuroanatomical study and functional hypothesis. Brain* 103:525-554.
- Baliki MN, Geha PY, Apkarian AV, Chialvo DR (2008) Beyond feeling: chronic pain hurts the brain, disrupting the default-mode network dynamics. *J Neurosci* 28:1398-1403.
- Baliki MN, Geha PY, Fields HL, Apkarian AV (2010) Predicting value of pain and analgesia: nucleus accumbens response to noxious stimuli changes in the presence of chronic pain. *Neuron* 66:149-160.
- Baliki MN, Chialvo DR, Geha PY, Levy RM, Harden RN, Parrish TB, Apkarian AV (2006) Chronic pain and the emotional brain: specific brain activity associated with spontaneous fluctuations of intensity of chronic back pain. *J Neurosci* 26:12165-12173.
- Baliki MN, Petre B, Torbey S, Herrmann KM, Huang L, Schnitzer TJ, Fields HL, Apkarian AV (2012) Corticostriatal functional connectivity predicts transition to chronic back pain. *Nat Neurosci* 15:1117-1119.
- Ballantine HT, Jr., Cassidy WL, Flanagan NB, Marino R, Jr. (1967) Stereotaxic anterior cingulotomy for neuropsychiatric illness and intractable pain. *Journal of neurosurgery* 26:488-495.
- Balschun D, Wetzel W, Del Rey A, Pitossi F, Schneider H, Zuschratter W, Besedovsky HO (2004) Interleukin-6: a cytokine to forget. *FASEB J* 18:1788-1790.
- Bantick SJ, Wise RG, Ploghaus A, Clare S, Smith SM, Tracey I (2002) Imaging how attention modulates pain in humans using functional MRI. *Brain* 125:310-319.
- Barbas H, Pandya DN (1989) Architecture and intrinsic connections of the prefrontal cortex in the rhesus monkey. *J Comp Neurol* 286:353-375.
- Barbas H, De Olmos J (1990) Projections from the amygdala to basoventral and mediodorsal prefrontal regions in the rhesus monkey. *J Comp Neurol* 300:549-571.
- Baron R, Binder A, Wasner G (2010) Neuropathic pain: diagnosis, pathophysiological mechanisms, and treatment. *Lancet Neurol* 9:807-819.
- Barrot M (2012) Tests and models of nociception and pain in rodents. *Neuroscience* 211:39-50.
- Becerra L, Chang PC, Bishop J, Borsook D (2011) CNS activation maps in awake rats exposed to thermal stimuli to the dorsum of the hindpaw. *Neuroimage* 54:1355-1366.
- Becerra L, Navratilova E, Porreca F, Borsook D (2013) Analogous responses in the nucleus accumbens and cingulate cortex to pain onset (aversion) and offset (relief) in rats and humans. *Journal of neurophysiology* 110:1221-1226.
- Becerra L, Breiter HC, Wise R, Gonzalez RG, Borsook D (2001) Reward circuitry activation by noxious thermal stimuli. *Neuron* 32:927-946.
- Belzung C, Lemoine M (2011) Criteria of validity for animal models of psychiatric disorders: focus on anxiety disorders and depression. *Biol Mood Anxiety Disord* 1:9.
- Benbouzid M, Choucair-Jaafar N, Yalcin I, Waltisperger E, Muller A, Freund-Mercier MJ, Barrot M (2008a) Chronic, but not acute, tricyclic antidepressant treatment alleviates neuropathic allodynia after sciatic nerve cuffing in mice. *Eur J Pain* 12:1008-1017.
- Benbouzid M, Pallage V, Rajalu M, Waltisperger E, Doridot S, Poisbeau P, Freund-Mercier MJ, Barrot M (2008b) Sciatic nerve cuffing in mice: a model of sustained neuropathic pain. *Eur J Pain* 12:591-599.

- Benedetti M, Merino R, Kusuda R, Ravanelli MI, Cadetti F, dos Santos P, Zanon S, Lucas G (2012) Plasma corticosterone levels in mouse models of pain. *Eur J Pain* 16:803-815.
- Benison AM, Chumachenko S, Harrison JA, Maier SF, Falci SP, Watkins LR, Barth DS (2011) Caudal granular insular cortex is sufficient and necessary for the long-term maintenance of allodynic behavior in the rat attributable to mononeuropathy. *J Neurosci* 31:6317-6328.
- Bennett GJ, Xie YK (1988) A peripheral mononeuropathy in rat that produces disorders of pain sensation like those seen in man. *Pain* 33:87-107.
- Berger B, Trottier S, Verney C, Gaspar P, Alvarez C (1988) Regional and laminar distribution of the dopamine and serotonin innervation in the macaque cerebral cortex: a radioautographic study. *J Comp Neurol* 273:99-119.
- Binder EB, Nemeroff CB (2010) The CRF system, stress, depression and anxiety-insights from human genetic studies. *Mol Psychiatry* 15:574-588.
- Bissiere S, McAllister KH, Olpe HR, Cryan JF (2006) The rostral anterior cingulate cortex modulates depression but not anxiety-related behaviour in the rat. *Behav Brain Res* 175:195-199.
- Bissonette GB, Powell EM, Roesch MR (2013) Neural structures underlying set-shifting: roles of medial prefrontal cortex and anterior cingulate cortex. *Behav Brain Res* 250:91-101.
- Blackburn-Munro G, Blackburn-Munro RE (2001) Chronic pain, chronic stress and depression: coincidence or consequence? *J Neuroendocrinol* 13:1009-1023.
- Blom SM, Pfister JP, Santello M, Senn W, Nevian T (2014) Nerve injury-induced neuropathic pain causes disinhibition of the anterior cingulate cortex. *J Neurosci* 34:5754-5764.
- Boes AD, McCormick LM, Coryell WH, Nopoulos P (2008) Rostral anterior cingulate cortex volume correlates with depressed mood in normal healthy children. *Biol Psychiatry* 63:391-397.
- Boksman K, Theberge J, Williamson P, Drost DJ, Malla A, Densmore M, Takhar J, Pavlosky W, Menon RS, Neufeld RW (2005) A 4.0-T fMRI study of brain connectivity during word fluency in first-episode schizophrenia. *Schizophr Res* 75:247-263.
- Boldrini M, Underwood MD, Hen R, Rosoklija GB, Dwork AJ, John Mann J, Arango V (2009) Antidepressants increase neural progenitor cells in the human hippocampus. *Neuropsychopharmacology* 34:2376-2389.
- Bomholt SF, Mikkelsen JD, Blackburn-Munro G (2005) Normal hypothalamo-pituitary-adrenal axis function in a rat model of peripheral neuropathic pain. *Brain Res* 1044:216-226.
- Bonthius DJ, Solodkin A, Van Hoesen GW (2005) Pathology of the insular cortex in Alzheimer disease depends on cortical architecture. *Journal of neuropathology and experimental neurology* 64:910-922.
- Botteron KN, Raichle ME, Drevets WC, Heath AC, Todd RD (2002) Volumetric reduction in left subgenual prefrontal cortex in early onset depression. *Biol Psychiatry* 51:342-344.
- Bouhassira D, Attal N (2011) Diagnosis and assessment of neuropathic pain: the saga of clinical tools. *Pain* 152:S74-83.
- Bouhassira D, Lanteri-Minet M, Attal N, Laurent B, Touboul C (2008) Prevalence of chronic pain with neuropathic characteristics in the general population. *Pain* 136:380-387.
- Bouras C, Kovari E, Hof PR, Riederer BM, Giannakopoulos P (2001) Anterior cingulate cortex pathology in schizophrenia and bipolar disorder. *Acta Neuropathol* 102:373-379.
- Boutros T, Chevet E, Metrakos P (2008) Mitogen-activated protein (MAP) kinase/MAP kinase phosphatase regulation: roles in cell growth, death, and cancer. *Pharmacol Rev* 60:261-310.
- Boyle LM (2013) A neuroplasticity hypothesis of chronic stress in the basolateral amygdala. *Yale J Biol Med* 86:117-125.
- Bravo L, Torres-Sanchez S, Alba-Delgado C, Mico JA, Berrocoso E (2014) Pain exacerbates chronic mild stress-induced changes in noradrenergic transmission in rats. *Eur Neuropsychopharmacol*.
- Bravo L, Mico JA, Rey-Brea R, Perez-Nievas B, Leza JC, Berrocoso E (2012) Depressive-like states heighten the aversion to painful stimuli in a rat model of comorbid chronic pain and depression. *Anesthesiology* 117:613-625.
- Breivik H, Collett B, Ventafridda V, Cohen R, Gallacher D (2006) Survey of chronic pain in Europe: prevalence, impact on daily life, and treatment. *Eur J Pain* 10:287-333.
- Brondello JM, Pouyssegur J, McKenzie FR (1999) Reduced MAP kinase phosphatase-1 degradation after p42/p44MAPK-dependent phosphorylation. *Science* 286:2514-2517.

- Brondello JM, Brunet A, Pouyssegur J, McKenzie FR (1997) The dual specificity mitogen-activated protein kinase phosphatase-1 and -2 are induced by the p42/p44MAPK cascade. *J Biol Chem* 272:1368-1376.
- Brown GM (1989) Neuroendocrine probes as biological markers of affective disorders: new directions. *Can J Psychiatry* 34:819-823.
- Bruchas MR, Schindler AG, Shankar H, Messinger DI, Miyatake M, Land BB, Lemos JC, Hagan CE, Neumaier JF, Quintana A, Palmiter RD, Chavkin C (2011) Selective p38alpha MAPK deletion in serotonergic neurons produces stress resilience in models of depression and addiction. *Neuron* 71:498-511.
- Burgess SE, Gardell LR, Ossipov MH, Malan TP, Jr., Vanderah TW, Lai J, Porreca F (2002) Time-dependent descending facilitation from the rostral ventromedial medulla maintains, but does not initiate, neuropathic pain. *J Neurosci* 22:5129-5136.
- Burgmer M, Gaubitz M, Konrad C, Wrenger M, Hilgart S, Heuft G, Pfliegerer B (2009) Decreased gray matter volumes in the cingulo-frontal cortex and the amygdala in patients with fibromyalgia. *Psychosomatic medicine* 71:566-573.
- Burman K, Darian-Smith C, Darian-Smith I (2000) Macaque red nucleus: origins of spinal and olivary projections and terminations of cortical inputs. *J Comp Neurol* 423:179-196.
- Bushnell MC, Ceko M, Low LA (2013) Cognitive and emotional control of pain and its disruption in chronic pain. *Nat Rev Neurosci* 14:502-511.
- Byun MS, Kim JS, Jung WH, Jang JH, Choi JS, Kim SN, Choi CH, Chung CK, An SK, Kwon JS (2012) Regional cortical thinning in subjects with high genetic loading for schizophrenia. *Schizophr Res* 141:197-203.
- Calvo M, Dawes JM, Bennett DL (2012) The role of the immune system in the generation of neuropathic pain. *Lancet Neurol* 11:629-642.
- Cannistraro PA, Makris N, Howard JD, Wedig MM, Hodge SM, Wilhelm S, Kennedy DN, Rauch SL (2007) A diffusion tensor imaging study of white matter in obsessive-compulsive disorder. *Depress Anxiety* 24:440-446.
- Capuron L, Miller AH (2011) Immune system to brain signaling: neuropsychopharmacological implications. *Pharmacol Ther* 130:226-238.
- Cardoso-Cruz H, Lima D, Galhardo V (2013) Impaired spatial memory performance in a rat model of neuropathic pain is associated with reduced hippocampus-prefrontal cortex connectivity. *J Neurosci* 33:2465-2480.
- Carmichael ST, Price JL (1995) Limbic connections of the orbital and medial prefrontal cortex in macaque monkeys. *J Comp Neurol* 363:615-641.
- Carr FB, Zachariou V (2014) Nociception and pain: lessons from optogenetics. *Front Behav Neurosci* 8:69.
- Cassell MD, Wright DJ (1986) Topography of projections from the medial prefrontal cortex to the amygdala in the rat. *Brain Res Bull* 17:321-333.
- Cassell MD, Freedman LJ, Shi C (1999) The intrinsic organization of the central extended amygdala. *Ann N Y Acad Sci* 877:217-241.
- Caunt CJ, Keyse SM (2013) Dual-specificity MAP kinase phosphatases (MKPs): shaping the outcome of MAP kinase signalling. *FEBS J* 280:489-504.
- Cavanagh JF, Grundler TO, Frank MJ, Allen JJ (2010) Altered cingulate sub-region activation accounts for task-related dissociation in ERN amplitude as a function of obsessive-compulsive symptoms. *Neuropsychologia* 48:2098-2109.
- Chandler DJ, Lamperski CS, Waterhouse BD (2013) Identification and distribution of projections from monoaminergic and cholinergic nuclei to functionally differentiated subregions of prefrontal cortex. *Brain Res* 1522:38-58.
- Chang PC, Pollema-Mays SL, Centeno MV, Procissi D, Contini M, Baria AT, Martina M, Apkarian AV (2014) Role of nucleus accumbens in neuropathic pain: Linked multi-scale evidence in the rat transitioning to neuropathic pain. *Pain*.
- Chaudhury D et al. (2013) Rapid regulation of depression-related behaviours by control of midbrain dopamine neurons. *Nature* 493:532-536.
- Chaumont J, Guyon N, Valera AM, Dugue GP, Popa D, Marcaggi P, Gautheron V, Reibel-Foisset S, Dieudonne S, Stephan A, Barrot M, Cassel JC, Dupont JL, Doussau F, Poulain B, Selimi F,

- Lena C, Isope P (2013) Clusters of cerebellar Purkinje cells control their afferent climbing fiber discharge. *Proc Natl Acad Sci U S A* 110:16223-16228.
- Chen AC, Shirayama Y, Shin KH, Neve RL, Duman RS (2001) Expression of the cAMP response element binding protein (CREB) in hippocampus produces an antidepressant effect. *Biol Psychiatry* 49:753-762.
- Cheng Y, Xu J, Nie B, Luo C, Yang T, Li H, Lu J, Xu L, Shan B, Xu X (2013) Abnormal resting-state activities and functional connectivities of the anterior and the posterior cortexes in medication-naive patients with obsessive-compulsive disorder. *PLoS One* 8:e67478.
- Cheppudira BP (2006) Characterization of hind paw licking and lifting to noxious radiant heat in the rat with and without chronic inflammation. *J Neurosci Methods* 155:122-125.
- Chou CW, Wong GT, Lim G, McCabe MF, Wang S, Irwin MG, Mao J (2011) Peripheral nerve injury alters the expression of NF-kappaB in the rat's hippocampus. *Brain Res* 1378:66-71.
- Clark AK, Old EA, Malcangio M (2013) Neuropathic pain and cytokines: current perspectives. *J Pain Res* 6:803-814.
- Cobb MH (1999) MAP kinase pathways. *Prog Biophys Mol Biol* 71:479-500.
- Coffeen U, Manuel Ortega-Legaspi J, Lopez-Munoz FJ, Simon-Arceo K, Jaimes O, Pellicer F (2011) Insular cortex lesion diminishes neuropathic and inflammatory pain-like behaviours. *Eur J Pain* 15:132-138.
- Coghill RC, Gilron I, Iadarola MJ (2001) Hemispheric lateralization of somatosensory processing. *Journal of neurophysiology* 85:2602-2612.
- Coghill RC, Sang CN, Maisog JM, Iadarola MJ (1999) Pain intensity processing within the human brain: a bilateral, distributed mechanism. *J Neurophysiol* 82:1934-1943.
- Coghill RC, Talbot JD, Evans AC, Meyer E, Gjedde A, Bushnell MC, Duncan GH (1994) Distributed processing of pain and vibration by the human brain. *The Journal of neuroscience : the official journal of the Society for Neuroscience* 14:4095-4108.
- Cohen JD, Nichols T, Keller J, Gomez RG, Schatzberg AF, Reiss AL (2013) Insular cortex abnormalities in psychotic major depression: relationship to gender and psychotic symptoms. *Neurosci Res* 75:331-339.
- Colgin LL, Moser EI, Moser MB (2008) Understanding memory through hippocampal remapping. *Trends Neurosci* 31:469-477.
- Colleoni M, Sacerdote P (2010) Murine models of human neuropathic pain. *Biochim Biophys Acta* 1802:924-933.
- Conde F, Audinat E, Maire-Lepoivre E, Crepel F (1990) Afferent connections of the medial frontal cortex of the rat. A study using retrograde transport of fluorescent dyes. I. Thalamic afferents. *Brain Res Bull* 24:341-354.
- Conde F, Maire-Lepoivre E, Audinat E, Crepel F (1995) Afferent connections of the medial frontal cortex of the rat. II. Cortical and subcortical afferents. *J Comp Neurol* 352:567-593.
- Coryell W, Nopoulos P, Drevets W, Wilson T, Andreasen NC (2005) Subgenual prefrontal cortex volumes in major depressive disorder and schizophrenia: diagnostic specificity and prognostic implications. *Am J Psychiatry* 162:1706-1712.
- Coull JA, Beggs S, Boudreau D, Boivin D, Tsuda M, Inoue K, Gravel C, Salter MW, De Koninck Y (2005) BDNF from microglia causes the shift in neuronal anion gradient underlying neuropathic pain. *Nature* 438:1017-1021.
- Courtin J, Bienvenu TC, Einarsson EO, Herry C (2013) Medial prefrontal cortex neuronal circuits in fear behavior. *Neuroscience* 240:219-242.
- Covey WC, Ignatowski TA, Knight PR, Spengler RN (2000) Brain-derived TNFalpha: involvement in neuroplastic changes implicated in the conscious perception of persistent pain. *Brain Res* 859:113-122.
- Covey WC, Ignatowski TA, Renauld AE, Knight PR, Nader ND, Spengler RN (2002) Expression of neuron-associated tumor necrosis factor alpha in the brain is increased during persistent pain. *Reg Anesth Pain Med* 27:357-366.
- Covington HE, 3rd, Lobo MK, Maze I, Vialou V, Hyman JM, Zaman S, LaPlant Q, Mouzon E, Ghose S, Tamminga CA, Neve RL, Deisseroth K, Nestler EJ (2010) Antidepressant effect of optogenetic stimulation of the medial prefrontal cortex. *J Neurosci* 30:16082-16090.

- Crabbe JC, Morris RG (2004) Festina lente: late-night thoughts on high-throughput screening of mouse behavior. *Nat Neurosci* 7:1175-1179.
- Craig AD (2009) A rat is not a monkey is not a human: comment on Mogil (*Nature Rev. Neurosci.* 10, 283-294 (2009)). *Nat Rev Neurosci* 10:466.
- Cryan JF, Holmes A (2005) The ascent of mouse: advances in modelling human depression and anxiety. *Nat Rev Drug Discov* 4:775-790.
- Cullen KR, Vizueta N, Thomas KM, Han GJ, Lim KO, Camchong J, Mueller BA, Bell CH, Heller MD, Schulz SC (2011) Amygdala functional connectivity in young women with borderline personality disorder. *Brain Connect* 1:61-71.
- Dantzer R, O'Connor JC, Freund GG, Johnson RW, Kelley KW (2008) From inflammation to sickness and depression: when the immune system subjugates the brain. *Nat Rev Neurosci* 9:46-56.
- Danziger N, Faillenot I, Peyron R (2009) Can we share a pain we never felt? Neural correlates of empathy in patients with congenital insensitivity to pain. *Neuron* 61:203-212.
- Davis KD, Wood ML, Crawley AP, Mikulis DJ (1995) fMRI of human somatosensory and cingulate cortex during painful electrical nerve stimulation. *Neuroreport* 7:321-325.
- de Almeida JR, Phillips ML, Cerqueira CT, Zilberman M, Lobo D, Henna E, Tavares H, Amaro E, Gorenstein C, Gentil V, Busatto GF (2010) Neural activity changes to emotional stimuli in healthy individuals under chronic use of clomipramine. *J Psychopharmacol* 24:1165-1174.
- de Bruijn ER, Grootens KP, Verkes RJ, Buchholz V, Hummelen JW, Hulstijn W (2006) Neural correlates of impulsive responding in borderline personality disorder: ERP evidence for reduced action monitoring. *J Psychiatr Res* 40:428-437.
- De Felice M, Eyde N, Dodick D, Dussor GO, Ossipov MH, Fields HL, Porreca F (2013) Capturing the aversive state of cephalic pain preclinically. *Ann Neurol*.
- Decosterd I, Woolf CJ (2000) Spared nerve injury: an animal model of persistent peripheral neuropathic pain. *Pain* 87:149-158.
- Defrin R, Ohry A, Blumen N, Urca G (2001) Characterization of chronic pain and somatosensory function in spinal cord injury subjects. *Pain* 89:253-263.
- del Rey A, Yau HJ, Randolph A, Centeno MV, Wildmann J, Martina M, Besedovsky HO, Apkarian AV (2011) Chronic neuropathic pain-like behavior correlates with IL-1beta expression and disrupts cytokine interactions in the hippocampus. *Pain* 152:2827-2835.
- Descalzi G, Kim S, Zhuo M (2009) Presynaptic and postsynaptic cortical mechanisms of chronic pain. *Mol Neurobiol* 40:253-259.
- Dhillon AS, Hagan S, Rath O, Kolch W (2007) MAP kinase signalling pathways in cancer. *Oncogene* 26:3279-3290.
- Dick BD, Rashedi S (2007) Disruption of attention and working memory traces in individuals with chronic pain. *Anesth Analg* 104:1223-1229, tables of contents.
- Dilgen J, Tejada HA, O'Donnell P (2013) Amygdala inputs drive feedforward inhibition in the medial prefrontal cortex. *J Neurophysiol* 110:221-229.
- Donahue RR, LaGraize SC, Fuchs PN (2001) Electrolytic lesion of the anterior cingulate cortex decreases inflammatory, but not neuropathic nociceptive behavior in rats. *Brain Res* 897:131-138.
- Dorfman K, Carrasco D, Gruda M, Ryan C, Lira SA, Bravo R (1996) Disruption of the *erp/mkp-1* gene does not affect mouse development: normal MAP kinase activity in ERP/MKP-1-deficient fibroblasts. *Oncogene* 13:925-931.
- Dowman R, Darcey T, Barkan H, Thadani V, Roberts D (2007) Human intracranially-recorded cortical responses evoked by painful electrical stimulation of the sural nerve. *NeuroImage* 34:743-763.
- Drevets WC (2000) Neuroimaging studies of mood disorders. *Biological psychiatry* 48:813-829.
- Drevets WC (2001) Neuroimaging and neuropathological studies of depression: implications for the cognitive-emotional features of mood disorders. *Curr Opin Neurobiol* 11:240-249.
- Drevets WC, Ongur D, Price JL (1998) Neuroimaging abnormalities in the subgenual prefrontal cortex: implications for the pathophysiology of familial mood disorders. *Mol Psychiatry* 3:220-226, 190-221.
- Drevets WC, Price JL, Simpson JR, Jr., Todd RD, Reich T, Vannier M, Raichle ME (1997) Subgenual prefrontal cortex abnormalities in mood disorders. *Nature* 386:824-827.

- Drummond JB, Tucholski J, Haroutunian V, Meador-Woodruff JH (2013) Transmembrane AMPA receptor regulatory protein (TARP) dysregulation in anterior cingulate cortex in schizophrenia. *Schizophr Res* 147:32-38.
- Dum RP, Levinthal DJ, Strick PL (2009) The spinothalamic system targets motor and sensory areas in the cerebral cortex of monkeys. *The Journal of neuroscience : the official journal of the Society for Neuroscience* 29:14223-14235.
- Duric V, Banasr M, Licznanski P, Schmidt HD, Stockmeier CA, Simen AA, Newton SS, Duman RS (2010) A negative regulator of MAP kinase causes depressive behavior. *Nat Med* 16:1328-1332.
- Ebert D, Ebmeier KP (1996) The role of the cingulate gyrus in depression: from functional anatomy to neurochemistry. *Biol Psychiatry* 39:1044-1050.
- Eccleston C, Crombez G (1999) Pain demands attention: a cognitive-affective model of the interruptive function of pain. *Psychological bulletin* 125:356-366.
- Eccleston C, Crombez G, Aldrich S, Stannard C (1997) Attention and somatic awareness in chronic pain. *Pain* 72:209-215.
- Eisch AJ, Petrik D (2012) Depression and hippocampal neurogenesis: a road to remission? *Science* 338:72-75.
- Elliott AM, Smith BH, Penny KI, Smith WC, Chambers WA (1999) The epidemiology of chronic pain in the community. *Lancet* 354:1248-1252.
- Euston DR, Gruber AJ, McNaughton BL (2012) The role of medial prefrontal cortex in memory and decision making. *Neuron* 76:1057-1070.
- Farber NB, Vogt BA, Vogt LJ (2004) Cingulate cortex and disease models. In: *The rat nervous system*, 3 Edition ((ed) PG, ed), pp 705-727.
- Ferrini F, De Koninck Y (2013) Microglia control neuronal network excitability via BDNF signalling. *Neural Plast* 2013:429815.
- Fietta P, Manganelli P (2007) Fibromyalgia and psychiatric disorders. *Acta Biomed* 78:88-95.
- Finnerup NB, Sindrup SH, Jensen TS (2010) Recent advances in pharmacological treatment of neuropathic pain. *F1000 Med Rep* 2:52.
- Fisher K, Fundytus ME, Cahill CM, Coderre TJ (1998) Intrathecal administration of the mGluR compound, (S)-4CPG, attenuates hyperalgesia and allodynia associated with sciatic nerve constriction injury in rats. *Pain* 77:59-66.
- Fitzgerald KD, Welsh RC, Gehring WJ, Abelson JL, Himle JA, Liberzon I, Taylor SF (2005) Error-related hyperactivity of the anterior cingulate cortex in obsessive-compulsive disorder. *Biol Psychiatry* 57:287-294.
- Floyd NS, Price JL, Ferry AT, Keay KA, Bandler R (2000) Orbitomedial prefrontal cortical projections to distinct longitudinal columns of the periaqueductal gray in the rat. *J Comp Neurol* 422:556-578.
- Fontenelle LF, Harrison BJ, Pujol J, Davey CG, Fornito A, Bora E, Pantelis C, Yucel M (2012) Brain functional connectivity during induced sadness in patients with obsessive-compulsive disorder. *J Psychiatry Neurosci* 37:231-240.
- Fox MD, Raichle ME (2007) Spontaneous fluctuations in brain activity observed with functional magnetic resonance imaging. *Nat Rev Neurosci* 8:700-710.
- Frankle WG, Laruelle M, Haber SN (2006) Prefrontal cortical projections to the midbrain in primates: evidence for a sparse connection. *Neuropsychopharmacology* 31:1627-1636.
- Franklin KBJ, Paxinos G (2007) *The mouse brain in stereotaxic coordinates*. San Diego: Academic Press 3th edition
- Freeman R, Baron R, Bouhassira D, Cabrera J, Emir B (2014) Sensory profiles of patients with neuropathic pain based on the neuropathic pain symptoms and signs. *Pain* 155:367-376.
- Fu CH, Suckling J, Williams SC, Andrew CM, Vythelingum GN, McGuire PK (2005) Effects of psychotic state and task demand on prefrontal function in schizophrenia: an fMRI study of overt verbal fluency. *Am J Psychiatry* 162:485-494.
- Fukuhara K, Ishikawa K, Yasuda S, Kishishita Y, Kim HK, Kakeda T, Yamamoto M, Norii T, Ishikawa T (2012) Intracerebroventricular 4-methylcatechol (4-MC) ameliorates chronic pain associated with depression-like behavior via induction of brain-derived neurotrophic factor (BDNF). *Cell Mol Neurobiol* 32:971-977.

- Gabbott PL, Warner TA, Jays PR, Salway P, Busby SJ (2005) Prefrontal cortex in the rat: projections to subcortical autonomic, motor, and limbic centers. *J Comp Neurol* 492:145-177.
- Galeotti N, Ghelardini C (2012) Regionally selective activation and differential regulation of ERK, JNK and p38 MAP kinase signalling pathway by protein kinase C in mood modulation. *Int J Neuropsychopharmacol* 15:781-793.
- Garcia-Larrea L, Peyron R (2013) Pain matrices and neuropathic pain matrices: a review. *Pain* 154 Suppl 1:S29-43.
- Gasquoine PG (2014) Contributions of the Insula to Cognition and Emotion. *Neuropsychology review*.
- Goffer Y, Xu D, Eberle SE, D'Amour J, Lee M, Tukey D, Froemke RC, Ziff EB, Wang J (2013) Calcium-permeable AMPA receptors in the nucleus accumbens regulate depression-like behaviors in the chronic neuropathic pain state. *J Neurosci* 33:19034-19044.
- Goldberg JS, Bell CE, Jr., Pollard DA (2014) Revisiting the monoamine hypothesis of depression: a new perspective. *Perspect Medicin Chem* 6:1-8.
- Goncalves L, Dickenson AH (2012) Asymmetric time-dependent activation of right central amygdala neurones in rats with peripheral neuropathy and pregabalin modulation. *Eur J Neurosci* 36:3204-3213.
- Goncalves L, Silva R, Pinto-Ribeiro F, Pego JM, Bessa JM, Pertovaara A, Sousa N, Almeida A (2008) Neuropathic pain is associated with depressive behaviour and induces neuroplasticity in the amygdala of the rat. *Exp Neurol* 213:48-56.
- Gong KR, Cao FL, He Y, Gao CY, Wang DD, Li H, Zhang FK, An YY, Lin Q, Chen J (2010) Enhanced excitatory and reduced inhibitory synaptic transmission contribute to persistent pain-induced neuronal hyper-responsiveness in anterior cingulate cortex. *Neuroscience* 171:1314-1325.
- Gourley SL, Wu FJ, Kiraly DD, Ploski JE, Kedves AT, Duman RS, Taylor JR (2008) Regionally specific regulation of ERK MAP kinase in a model of antidepressant-sensitive chronic depression. *Biol Psychiatry* 63:353-359.
- Greenberg T, Carlson JM, Cha J, Hajcak G, Mujica-Parodi LR (2013) Ventromedial prefrontal cortex reactivity is altered in generalized anxiety disorder during fear generalization. *Depress Anxiety* 30:242-250.
- Greenspan JD, Winfield JA (1992) Reversible pain and tactile deficits associated with a cerebral tumor compressing the posterior insula and parietal operculum. *Pain* 50:29-39.
- Greenspan JD, Lee RR, Lenz FA (1999) Pain sensitivity alterations as a function of lesion location in the parasyllvian cortex. *Pain* 81:273-282.
- Grisart JM, Plaghki LH (1999) Impaired selective attention in chronic pain patients. *European journal of pain* 3:325-333.
- Gruber SA, Rogowska J, Yurgelun-Todd DA (2004) Decreased activation of the anterior cingulate in bipolar patients: an fMRI study. *J Affect Disord* 82:191-201.
- Gustorff B, Dorner T, Likar R, Grisold W, Lawrence K, Schwarz F, Rieder A (2008) Prevalence of self-reported neuropathic pain and impact on quality of life: a prospective representative survey. *Acta Anaesthesiol Scand* 52:132-136.
- Haanpaa M, Attal N, Backonja M, Baron R, Bennett M, Bouhassira D, Cruccu G, Hansson P, Haythornthwaite JA, Iannetti GD, Jensen TS, Kauppila T, Nurmikko TJ, Rice AS, Rowbotham M, Serra J, Sommer C, Smith BH, Treede RD (2011) NeuPSIG guidelines on neuropathic pain assessment. *Pain* 152:14-27.
- Hanamori T, Kunitake T, Kato K, Kannan H (1998) Neurons in the posterior insular cortex are responsive to gustatory stimulation of the pharyngolarynx, baroreceptor and chemoreceptor stimulation, and tail pinch in rats. *Brain research* 785:97-106.
- Hargreaves K, Dubner R, Brown F, Flores C, Joris J (1988) A new and sensitive method for measuring thermal nociception in cutaneous hyperalgesia. *Pain* 32:77-88.
- Hasnie FS, Wallace VC, Hefner K, Holmes A, Rice AS (2007a) Mechanical and cold hypersensitivity in nerve-injured C57BL/6J mice is not associated with fear-avoidance- and depression-related behaviour. *Br J Anaesth* 98:816-822.
- Hasnie FS, Breuer J, Parker S, Wallace V, Blackbeard J, Lever I, Kinchington PR, Dickenson AH, Pheby T, Rice AS (2007b) Further characterization of a rat model of varicella zoster virus-

- associated pain: Relationship between mechanical hypersensitivity and anxiety-related behavior, and the influence of analgesic drugs. *Neuroscience* 144:1495-1508.
- Hauger RL, Risbrough V, Oakley RH, Olivares-Reyes JA, Dautzenberg FM (2009) Role of CRF receptor signaling in stress vulnerability, anxiety, and depression. *Ann N Y Acad Sci* 1179:120-143.
- Heidbreder CA, Groenewegen HJ (2003) The medial prefrontal cortex in the rat: evidence for a dorso-ventral distinction based upon functional and anatomical characteristics. *Neurosci Biobehav Rev* 27:555-579.
- Heim C, Ehlert U, Hellhammer DH (2000) The potential role of hypocortisolism in the pathophysiology of stress-related bodily disorders. *Psychoneuroendocrinology* 25:1-35.
- Hill R (2000) NK1 (substance P) receptor antagonists--why are they not analgesic in humans? *Trends Pharmacol Sci* 21:244-246.
- Homberg JR, Contet C (2009) Deciphering the interaction of the corticotropin-releasing factor and serotonin brain systems in anxiety-related disorders. *J Neurosci* 29:13743-13745.
- Hoover WB, Vertes RP (2007) Anatomical analysis of afferent projections to the medial prefrontal cortex in the rat. *Brain Struct Funct* 212:149-179.
- Horikawa K, Kinjo N, Stanley LC, Powell EW (1988) Topographic organization and collateralization of the projections of the anterior and laterodorsal thalamic nuclei to cingulate areas 24 and 29 in the rat. *Neurosci Res* 6:31-44.
- Hou J, Wu W, Lin Y, Wang J, Zhou D, Guo J, Gu S, He M, Ahmed S, Hu J, Qu W, Li H (2012) Localization of cerebral functional deficits in patients with obsessive-compulsive disorder: a resting-state fMRI study. *J Affect Disord* 138:313-321.
- Hsieh JC, Stone-Elander S, Ingvar M (1999) Anticipatory coping of pain expressed in the human anterior cingulate cortex: a positron emission tomography study. *Neuroscience letters* 262:61-64.
- Hsieh JC, Belfrage M, Stone-Elander S, Hansson P, Ingvar M (1995) Central representation of chronic ongoing neuropathic pain studied by positron emission tomography. *Pain* 63:225-236.
- Hu Y, Yang J, Wang Y, Li W (2010) Amitriptyline rather than lornoxicam ameliorates neuropathic pain-induced deficits in abilities of spatial learning and memory. *Eur J Anaesthesiol* 27:162-168.
- Huang W, Calvo M, Karu K, Olausen HR, Bathgate G, Okuse K, Bennett DL, Rice AS (2013) A clinically relevant rodent model of the HIV antiretroviral drug stavudine induced painful peripheral neuropathy. *Pain* 154:560-575.
- Iannilli E, Del Gratta C, Gerber JC, Romani GL, Hummel T (2008) Trigeminal activation using chemical, electrical, and mechanical stimuli. *Pain* 139:376-388.
- Ibarguen-Vargas Y, Surget A, Touma C, Palme R, Belzung C (2008) Multifaceted strain-specific effects in a mouse model of depression and of antidepressant reversal. *Psychoneuroendocrinology* 33:1357-1368.
- Ichesco E, Schmidt-Wilcke T, Bhavsar R, Clauw DJ, Peltier SJ, Kim J, Napadow V, Hampson JP, Kairys AE, Williams DA, Harris RE (2014) Altered resting state connectivity of the insular cortex in individuals with fibromyalgia. *J Pain* doi: 10.1016/j.jpain.2014.04.007
- Ignatowski TA, Covey WC, Knight PR, Severin CM, Nickola TJ, Spengler RN (1999) Brain-derived TNFalpha mediates neuropathic pain. *Brain Res* 841:70-77.
- Ikeda R, Takahashi Y, Inoue K, Kato F (2007) NMDA receptor-independent synaptic plasticity in the central amygdala in the rat model of neuropathic pain. *Pain* 127:161-172.
- Isnard J, Magnin M, Jung J, Mauguiere F, Garcia-Larrea L (2011) Does the insula tell our brain that we are in pain? *Pain* 152:946-951.
- Jaggi AS, Jain V, Singh N (2011) Animal models of neuropathic pain. *Fundam Clin Pharmacol* 25:1-28.
- Jain R, Jain S, Raison CL, Maletic V (2011) Painful diabetic neuropathy is more than pain alone: examining the role of anxiety and depression as mediators and complicators. *Curr Diab Rep* 11:275-284.
- Jasmin L, Burkey AR, Granato A, Ohara PT (2004) Rostral agranular insular cortex and pain areas of the central nervous system: a tract-tracing study in the rat. *The Journal of comparative neurology* 468:425-440.

- Jeffrey KL, Camps M, Rommel C, Mackay CR (2007) Targeting dual-specificity phosphatases: manipulating MAP kinase signalling and immune responses. *Nat Rev Drug Discov* 6:391-403.
- Jensen TS, Baron R, Haanpaa M, Kalso E, Loeser JD, Rice AS, Treede RD (2011) A new definition of neuropathic pain. *Pain* 152:2204-2205.
- Ji RR, Baba H, Brenner GJ, Woolf CJ (1999) Nociceptive-specific activation of ERK in spinal neurons contributes to pain hypersensitivity. *Nat Neurosci* 2:1114-1119.
- Jia D, Gao GD, Liu Y, He SM, Zhang XN, Zhang YF, Zhao MG (2007) TNF-alpha involves in altered prefrontal synaptic transmission in mice with persistent inflammatory pain. *Neurosci Lett* 415:1-5.
- Jin SX, Zhuang ZY, Woolf CJ, Ji RR (2003) p38 mitogen-activated protein kinase is activated after a spinal nerve ligation in spinal cord microglia and dorsal root ganglion neurons and contributes to the generation of neuropathic pain. *J Neurosci* 23:4017-4022.
- Johansen JP, Fields HL, Manning BH (2001) The affective component of pain in rodents: direct evidence for a contribution of the anterior cingulate cortex. *Proc Natl Acad Sci U S A* 98:8077-8082.
- Jones BF, Groenewegen HJ, Witter MP (2005) Intrinsic connections of the cingulate cortex in the rat suggest the existence of multiple functionally segregated networks. *Neuroscience* 133:193-207.
- Jurgens U (1983) Afferent fibers to the cingular vocalization region in the squirrel monkey. *Exp Neurol* 80:395-409.
- Karege F, Vaudan G, Schwald M, Perroud N, La Harpe R (2005) Neurotrophin levels in postmortem brains of suicide victims and the effects of antemortem diagnosis and psychotropic drugs. *Brain Res Mol Brain Res* 136:29-37.
- Kastenberger I, Lutsch C, Herzog H, Schwarzer C (2012) Influence of sex and genetic background on anxiety-related and stress-induced behaviour of prodynorphin-deficient mice. *PLoS One* 7:e34251.
- Kawamata T, Omote K, Yamamoto H, Toriyabe M, Wada K, Namiki A (2003) Antihyperalgesic and side effects of intrathecal clonidine and tizanidine in a rat model of neuropathic pain. *Anesthesiology* 98:1480-1483.
- Kenna GA, Roder-Hanna N, Leggio L, Zywiak WH, Clifford J, Edwards S, Kenna JA, Shoaff J, Swift RM (2012) Association of the 5-HTT gene-linked promoter region (5-HTTLPR) polymorphism with psychiatric disorders: review of psychopathology and pharmacotherapy. *Pharmacogenomics Pers Med* 5:19-35.
- Kilburn-Watt E, Banati RB, Keay KA (2010) Altered thyroid hormones and behavioural change in a sub-population of rats following chronic constriction injury. *J Neuroendocrinol* 22:960-970.
- Kim JJ, Kwon JS, Park HJ, Youn T, Kang DH, Kim MS, Lee DS, Lee MC (2003) Functional disconnection between the prefrontal and parietal cortices during working memory processing in schizophrenia: a [¹⁵O]H₂O PET study. *Am J Psychiatry* 160:919-923.
- Kim SH, Chung JM (1992) An experimental model for peripheral neuropathy produced by segmental spinal nerve ligation in the rat. *Pain* 50:355-363.
- Kim SK, Nabekura J (2011) Rapid synaptic remodeling in the adult somatosensory cortex following peripheral nerve injury and its association with neuropathic pain. *J Neurosci* 31:5477-5482.
- Kim SK, Eto K, Nabekura J (2012) Synaptic structure and function in the mouse somatosensory cortex during chronic pain: in vivo two-photon imaging. *Neural Plast* 2012:640259.
- King T, Vera-Portocarrero L, Gutierrez T, Vanderah TW, Dussor G, Lai J, Fields HL, Porreca F (2009) Unmasking the tonic-aversive state in neuropathic pain. *Nat Neurosci* 12:1364-1366.
- Kitayama N, Quinn S, Bremner JD (2006) Smaller volume of anterior cingulate cortex in abuse-related posttraumatic stress disorder. *J Affect Disord* 90:171-174.
- Kodama D, Ono H, Tanabe M (2007) Altered hippocampal long-term potentiation after peripheral nerve injury in mice. *Eur J Pharmacol* 574:127-132.
- Kodama D, Ono H, Tanabe M (2011) Increased hippocampal glycine uptake and cognitive dysfunction after peripheral nerve injury. *Pain* 152:809-817.
- Koga K, Li X, Chen T, Steenland HW, Descalzi G, Zhuo M (2010) In vivo whole-cell patch-clamp recording of sensory synaptic responses of cingulate pyramidal neurons to noxious mechanical stimuli in adult mice. *Mol Pain* 6:62.

- Kontinen VK, Kauppila T, Paananen S, Pertovaara A, Kalso E (1999) Behavioural measures of depression and anxiety in rats with spinal nerve ligation-induced neuropathy. *Pain* 80:341-346.
- Koyama T, McHaffie JG, Laurienti PJ, Coghill RC (2005) The subjective experience of pain: where expectations become reality. *Proceedings of the National Academy of Sciences of the United States of America* 102:12950-12955.
- Krishnan V, Nestler EJ (2008) The molecular neurobiology of depression. *Nature* 455:894-902.
- Krishnan V, Nestler EJ (2010) Linking molecules to mood: new insight into the biology of depression. *Am J Psychiatry* 167:1305-1320.
- Krystal AD (2012) Psychiatric disorders and sleep. *Neurol Clin* 30:1389-1413.
- Kuhn S, Kaufmann C, Simon D, Endrass T, Gallinat J, Kathmann N (2013) Reduced thickness of anterior cingulate cortex in obsessive-compulsive disorder. *Cortex* 49:2178-2185.
- Kulkarni B, Bentley DE, Elliott R, Youell P, Watson A, Derbyshire SW, Frackowiak RS, Friston KJ, Jones AK (2005) Attention to pain localization and unpleasantness discriminates the functions of the medial and lateral pain systems. *The European journal of neuroscience* 21:3133-3142.
- Kung JC, Shyu BC (2002) Potentiation of local field potentials in the anterior cingulate cortex evoked by the stimulation of the medial thalamic nuclei in rats. *Brain Res* 953:37-44.
- Kunishio K, Haber SN (1994) Primate cingulo-striatal projection: limbic striatal versus sensorimotor striatal input. *J Comp Neurol* 350:337-356.
- Kurth F, Zilles K, Fox PT, Laird AR, Eickhoff SB (2010a) A link between the systems: functional differentiation and integration within the human insula revealed by meta-analysis. *Brain structure & function* 214:519-534.
- Kurth F, Eickhoff SB, Schleicher A, Hoemke L, Zilles K, Amunts K (2010b) Cytoarchitecture and probabilistic maps of the human posterior insular cortex. *Cereb Cortex* 20:1448-1461.
- Kuwano Y, Kim HH, Abdelmohsen K, Pullmann R, Jr., Martindale JL, Yang X, Gorospe M (2008) MKP-1 mRNA stabilization and translational control by RNA-binding proteins HuR and NF90. *Mol Cell Biol* 28:4562-4575.
- Kwan CL, Crawley AP, Mikulis DJ, Davis KD (2000) An fMRI study of the anterior cingulate cortex and surrounding medial wall activations evoked by noxious cutaneous heat and cold stimuli. *Pain* 85:359-374.
- LaGraize SC, Fuchs PN (2007) GABAA but not GABAB receptors in the rostral anterior cingulate cortex selectively modulate pain-induced escape/avoidance behavior. *Exp Neurol* 204:182-194.
- LaGraize SC, Labuda CJ, Rutledge MA, Jackson RL, Fuchs PN (2004) Differential effect of anterior cingulate cortex lesion on mechanical hypersensitivity and escape/avoidance behavior in an animal model of neuropathic pain. *Exp Neurol* 188:139-148.
- Lalumiere RT (2014) Optogenetic dissection of amygdala functioning. *Front Behav Neurosci* 8:107.
- Lang UE, Borgwardt S (2013) Molecular mechanisms of depression: perspectives on new treatment strategies. *Cell Physiol Biochem* 31:761-777.
- Langley CK, Aziz Q, Bountra C, Gordon N, Hawkins P, Jones A, Langley G, Nurmikko T, Tracey I (2008) Volunteer studies in pain research--opportunities and challenges to replace animal experiments: the report and recommendations of a Focus on Alternatives workshop. *Neuroimage* 42:467-473.
- Lawan A, Shi H, Gatzke F, Bennett AM (2013) Diversity and specificity of the mitogen-activated protein kinase phosphatase-1 functions. *Cell Mol Life Sci* 70:223-237.
- Lawrence MC, Jivan A, Shao C, Duan L, Goad D, Zaganjor E, Osborne J, McGlynn K, Stippec S, Earnest S, Chen W, Cobb MH (2008) The roles of MAPKs in disease. *Cell Res* 18:436-442.
- LeDoux JE (2000) Emotion circuits in the brain. *Annu Rev Neurosci* 23:155-184.
- Lee DE, Kim SJ, Zhuo M (1999) Comparison of behavioral responses to noxious cold and heat in mice. *Brain Res* 845:117-121.
- Lee TY, Kim SN, Jang JH, Shim G, Jung WH, Shin NY, Kwon JS (2013) Neural correlate of impulsivity in subjects at ultra-high risk for psychosis. *Prog Neuropsychopharmacol Biol Psychiatry* 45:165-169.

- Legrain V, Damme SV, Eccleston C, Davis KD, Seminowicz DA, Crombez G (2009) A neurocognitive model of attention to pain: behavioral and neuroimaging evidence. *Pain* 144:230-232.
- Legrain V, Mancini F, Sambo CF, Torta DM, Ronga I, Valentini E (2012) Cognitive aspects of nociception and pain: bridging neurophysiology with cognitive psychology. *Neurophysiol Clin* 42:325-336.
- Lei LG, Zhang YQ, Zhao ZQ (2004) Pain-related aversion and Fos expression in the central nervous system in rats. *Neuroreport* 15:67-71.
- Leichnetz GR, Astruc J (1976) The efferent projections of the medial prefrontal cortex in the squirrel monkey (*Saimiri sciureus*). *Brain Res* 109:455-472.
- Leite-Almeida H, Almeida-Torres L, Mesquita AR, Pertovaara A, Sousa N, Cerqueira JJ, Almeida A (2009) The impact of age on emotional and cognitive behaviours triggered by experimental neuropathy in rats. *Pain* 144:57-65.
- Leite-Almeida H, Cerqueira JJ, Wei H, Ribeiro-Costa N, Anjos-Martins H, Sousa N, Pertovaara A, Almeida A (2012) Differential effects of left/right neuropathy on rats' anxiety and cognitive behavior. *Pain* 153:2218-2225.
- Leknes S, Lee M, Berna C, Andersson J, Tracey I (2011) Relief as a reward: hedonic and neural responses to safety from pain. *PloS one* 6:e17870.
- Lewis DA (1992) The catecholaminergic innervation of primate prefrontal cortex. *J Neural Transm Suppl* 36:179-200.
- Li F, Li M, Cao W, Xu Y, Luo Y, Zhong X, Zhang J, Dai R, Zhou XF, Li Z, Li C (2012) Anterior cingulate cortical lesion attenuates food foraging in rats. *Brain Res Bull* 88:602-608.
- Li XY, Ko HG, Chen T, Descalzi G, Koga K, Wang H, Kim SS, Shang Y, Kwak C, Park SW, Shim J, Lee K, Collingridge GL, Kaang BK, Zhuo M (2010) Alleviating neuropathic pain hypersensitivity by inhibiting PKMzeta in the anterior cingulate cortex. *Science* 330:1400-1404.
- Lima D (2009) Ascending Pathways: Anatomy and Physiology. In: *Science of Pain* (Basbaum AI BC, ed), pp 477-527. San Diego: Elsevier.
- Lin YW, Chuang SM, Yang JL (2003) ERK1/2 achieves sustained activation by stimulating MAPK phosphatase-1 degradation via the ubiquitin-proteasome pathway. *J Biol Chem* 278:21534-21541.
- Lipsman N, Woodside DB, Giacobbe P, Hamani C, Carter JC, Norwood SJ, Sutandar K, Staab R, Elias G, Lyman CH, Smith GS, Lozano AM (2013) Subcallosal cingulate deep brain stimulation for treatment-refractory anorexia nervosa: a phase 1 pilot trial. *Lancet* 381:1361-1370.
- Liu J, Hao Y, Du M, Wang X, Zhang J, Manor B, Jiang X, Fang W, Wang D (2013) Quantitative cerebral blood flow mapping and functional connectivity of postherpetic neuralgia pain: a perfusion fMRI study. *Pain* 154:110-118.
- Luppino G, Matelli M, Camarda R, Rizzolatti G (1994) Corticospinal projections from mesial frontal and cingulate areas in the monkey. *Neuroreport* 5:2545-2548.
- Ma W, Quirion R (2002) Partial sciatic nerve ligation induces increase in the phosphorylation of extracellular signal-regulated kinase (ERK) and c-Jun N-terminal kinase (JNK) in astrocytes in the lumbar spinal dorsal horn and the gracile nucleus. *Pain* 99:175-184.
- Maarrawi J, Peyron R, Mertens P, Costes N, Magnin M, Sindou M, Laurent B, Garcia-Larrea L (2013) Brain opioid receptor density predicts motor cortex stimulation efficacy for chronic pain. *Pain*.
- Maletic V, Raison CL (2009) Neurobiology of depression, fibromyalgia and neuropathic pain. *Front Biosci* 14:5291-5338.
- Mao J, Mayer DJ, Price DD (1993) Patterns of increased brain activity indicative of pain in a rat model of peripheral mononeuropathy. *J Neurosci* 13:2689-2702.
- Marchant NJ, Densmore VS, Osborne PB (2007) Coexpression of prodynorphin and corticotrophin-releasing hormone in the rat central amygdala: evidence of two distinct endogenous opioid systems in the lateral division. *J Comp Neurol* 504:702-715.
- Matsuzawa-Yanagida K, Narita M, Nakajima M, Kuzumaki N, Niikura K, Nozaki H, Takagi T, Tamai E, Hareyama N, Terada M, Yamazaki M, Suzuki T (2008) Usefulness of antidepressants for

- improving the neuropathic pain-like state and pain-induced anxiety through actions at different brain sites. *Neuropsychopharmacology* 33:1952-1965.
- Matthews SC, Strigo IA, Simmons AN, Yang TT, Paulus MP (2008) Decreased functional coupling of the amygdala and supragenual cingulate is related to increased depression in unmedicated individuals with current major depressive disorder. *J Affect Disord* 111:13-20.
- Mazzola L, Isnard J, Peyron R, Mauguiere F (2012a) Stimulation of the human cortex and the experience of pain: Wilder Penfield's observations revisited. *Brain* 135:631-640.
- Mazzola L, Faillenot I, Barral FG, Mauguiere F, Peyron R (2012b) Spatial segregation of somatosensory and pain activations in the human operculo-insular cortex. *Neuroimage* 60:409-418.
- McAllister AK, Katz LC, Lo DC (1999) Neurotrophins and synaptic plasticity. *Annu Rev Neurosci* 22:295-318.
- McKinney WT, Jr., Bunney WE, Jr. (1969) Animal model of depression. I. Review of evidence: implications for research. *Arch Gen Psychiatry* 21:240-248.
- McQuaid RJ, Audet MC, Jacobson-Pick S, Anisman H (2013) The differential impact of social defeat on mice living in isolation or groups in an enriched environment: plasma corticosterone and monoamine variations. *Int J Neuropsychopharmacol* 16:351-363.
- Mendrek A, Kiehl KA, Smith AM, Irwin D, Forster BB, Liddle PF (2005) Dysfunction of a distributed neural circuitry in schizophrenia patients during a working-memory performance. *Psychol Med* 35:187-196.
- Mesulam MM, Mufson EJ (1982) Insula of the old world monkey. III: Efferent cortical output and comments on function. *The Journal of comparative neurology* 212:38-52.
- Mesulam MM, Mufson EJ (1985) The insula of Reil in man and monkey. Association and auditory cortices:179-226.
- Metz AE, Yau HJ, Centeno MV, Apkarian AV, Martina M (2009) Morphological and functional reorganization of rat medial prefrontal cortex in neuropathic pain. *Proc Natl Acad Sci U S A* 106:2423-2428.
- Miller AH, Maletic V, Raison CL (2009) Inflammation and its discontents: the role of cytokines in the pathophysiology of major depression. *Biol Psychiatry* 65:732-741.
- Miller MW (1987) The origin of corticospinal projection neurons in rat. *Exp Brain Res* 67:339-351.
- Miller MW, Vogt BA (1984) Direct connections of rat visual cortex with sensory, motor, and association cortices. *J Comp Neurol* 226:184-202.
- Minzenberg MJ, Fan J, New AS, Tang CY, Siever LJ (2007) Fronto-limbic dysfunction in response to facial emotion in borderline personality disorder: an event-related fMRI study. *Psychiatry Res* 155:231-243.
- Mor D, Bembrick AL, Austin PJ, Wyllie PM, Creber NJ, Denyer GS, Keay KA (2010) Anatomically specific patterns of glial activation in the periaqueductal gray of the sub-population of rats showing pain and disability following chronic constriction injury of the sciatic nerve. *Neuroscience* 166:1167-1184.
- Morecraft RJ, Geula C, Mesulam MM (1992) Cytoarchitecture and neural afferents of orbitofrontal cortex in the brain of the monkey. *The Journal of comparative neurology* 323:341-358.
- Morecraft RJ, Stilwell-Morecraft KS, Cipolloni PB, Ge J, McNeal DW, Pandya DN (2012) Cytoarchitecture and cortical connections of the anterior cingulate and adjacent somatomotor fields in the rhesus monkey. *Brain Res Bull* 87:457-497.
- Morgulis MS, Stankevicius D, Sa-Rocha LC, Palermo-Neto J (2004) Cohabitation with a sick cage mate: consequences on behavior and on ehrlich tumor growth. *Neuroimmunomodulation* 11:49-57.
- Morrison I, Lloyd D, di Pellegrino G, Roberts N (2004) Vicarious responses to pain in anterior cingulate cortex: is empathy a multisensory issue? *Cogn Affect Behav Neurosci* 4:270-278.
- Morrison I, Perini I, Dunham J (2013) Facets and mechanisms of adaptive pain behavior: predictive regulation and action. *Front Hum Neurosci* 7:755.
- Mosconi T, Kruger L (1996) Fixed-diameter polyethylene cuffs applied to the rat sciatic nerve induce a painful neuropathy: ultrastructural morphometric analysis of axonal alterations. *Pain* 64:37-57.
- Mutschler I, Ball T, Wankerl J, Strigo IA (2012) Pain and emotion in the insular cortex: evidence for functional reorganization in major depression. *Neurosci Lett* 520:204-209.

- Mutso AA, Radzicki D, Baliki MN, Huang L, Banisadr G, Centeno MV, Radulovic J, Martina M, Miller RJ, Apkarian AV (2012) Abnormalities in hippocampal functioning with persistent pain. *J Neurosci* 32:5747-5756.
- Nakashima M, Uemura M, Yasui K, Ozaki HS, Tabata S, Taen A (2000) An anterograde and retrograde tract-tracing study on the projections from the thalamic gustatory area in the rat: distribution of neurons projecting to the insular cortex and amygdaloid complex. *Neuroscience research* 36:297-309.
- Narita M, Kaneko C, Miyoshi K, Nagumo Y, Kuzumaki N, Nakajima M, Nanjo K, Matsuzawa K, Yamazaki M, Suzuki T (2006a) Chronic pain induces anxiety with concomitant changes in opioidergic function in the amygdala. *Neuropsychopharmacology* 31:739-750.
- Narita M, Kuzumaki N, Kaneko C, Hareyama N, Miyatake M, Shindo K, Miyoshi K, Nakajima M, Nagumo Y, Sato F, Wachi H, Seyama Y, Suzuki T (2006b) Chronic pain-induced emotional dysfunction is associated with astrogliosis due to cortical delta-opioid receptor dysfunction. *J Neurochem* 97:1369-1378.
- Narita M, Niikura K, Nanjo-Niikura K, Furuya M, Yamashita A, Saeki M, Matsushima Y, Imai S, Shimizu T, Asato M, Kuzumaki N, Okutsu D, Miyoshi K, Suzuki M, Tsukiyama Y, Konno M, Yomiya K, Matoba M, Suzuki T (2011) Sleep disturbances in a neuropathic pain-like condition in the mouse are associated with altered GABAergic transmission in the cingulate cortex. *Pain* 152:1358-1372.
- Ndong C, Landry RP, DeLeo JA, Romero-Sandoval EA (2012) Mitogen activated protein kinase phosphatase-1 prevents the development of tactile sensitivity in a rodent model of neuropathic pain. *Mol Pain* 8:34.
- Nestler EJ, Carlezon WA, Jr. (2006) The mesolimbic dopamine reward circuit in depression. *Biol Psychiatry* 59:1151-1159.
- Nestler EJ, Hyman SE (2010) Animal models of neuropsychiatric disorders. *Nat Neurosci* 13:1161-1169.
- Niedtfeld I, Schulze L, Krause-Utz A, Demirakca T, Bohus M, Schmahl C (2013) Voxel-based morphometry in women with borderline personality disorder with and without comorbid posttraumatic stress disorder. *PLoS One* 8:e65824.
- Nieuwenhuys R (2012) The insular cortex: a review. *Progress in brain research* 195:123-163.
- Ning L, Ma LQ, Wang ZR, Wang YW (2013) Chronic constriction injury induced long-term changes in spontaneous membrane-potential oscillations in anterior cingulate cortical neurons in vivo. *Pain Physician* 16:E577-589.
- Norman GJ, Karelina K, Zhang N, Walton JC, Morris JS, Devries AC (2010) Stress and IL-1beta contribute to the development of depressive-like behavior following peripheral nerve injury. *Mol Psychiatry* 15:404-414.
- Obermann M, Rodriguez-Raecke R, Naegel S, Holle D, Mueller D, Yoon MS, Theysohn N, Blex S, Diener HC, Katsarava Z (2013) Gray matter volume reduction reflects chronic pain in trigeminal neuralgia. *Neuroimage* 74:352-358.
- Ohi K, Hashimoto R, Yasuda Y, Nemoto K, Ohnishi T, Fukumoto M, Yamamori H, Umeda-Yano S, Okada T, Iwase M, Kazui H, Takeda M (2012) Impact of the genome wide supported NRG1 gene on anterior cingulate morphology in schizophrenia. *PLoS One* 7:e29780.
- Ongur D, Price JL (2000) The organization of networks within the orbital and medial prefrontal cortex of rats, monkeys and humans. *Cereb Cortex* 10:206-219.
- Ongur D, An X, Price JL (1998) Prefrontal cortical projections to the hypothalamus in macaque monkeys. *J Comp Neurol* 401:480-505.
- Ordway GA, Smith KS, Haycock JW (1994a) Elevated tyrosine hydroxylase in the locus coeruleus of suicide victims. *J Neurochem* 62:680-685.
- Ordway GA, Widdowson PS, Smith KS, Halaris A (1994b) Agonist binding to alpha 2-adrenoceptors is elevated in the locus coeruleus from victims of suicide. *J Neurochem* 63:617-624.
- Ota KT, Duman RS (2013) Environmental and pharmacological modulations of cellular plasticity: role in the pathophysiology and treatment of depression. *Neurobiol Dis* 57:28-37.
- Palermo TM, Wilson AC, Lewandowski AS, Toliver-Sokol M, Murray CB (2011) Behavioral and psychosocial factors associated with insomnia in adolescents with chronic pain. *Pain* 152:89-94.

- Pandya DN, Kuypers HG (1969) Cortico-cortical connections in the rhesus monkey. *Brain Res* 13:13-36.
- Pandya DN, Van Hoesen GW, Domesick VB (1973) A cingulo-amygdaloid projection in the rhesus monkey. *Brain Res* 61:369-373.
- Pandya DN, Van Hoesen GW, Mesulam MM (1981) Efferent connections of the cingulate gyrus in the rhesus monkey. *Exp Brain Res* 42:319-330.
- Pang RD, Wang Z, Klosinski LP, Guo Y, Herman DH, Celikel T, Dong HW, Holschneider DP (2011) Mapping functional brain activation using [¹⁴C]-iodoantipyrine in male serotonin transporter knockout mice. *PLoS One* 6:e23869.
- Pare D, Duvarci S (2012) Amygdala microcircuits mediating fear expression and extinction. *Curr Opin Neurobiol* 22:717-723.
- Paulson PE, Morrow TJ, Casey KL (2000) Bilateral behavioral and regional cerebral blood flow changes during painful peripheral mononeuropathy in the rat. *Pain* 84:233-245.
- Paulson PE, Casey KL, Morrow TJ (2002) Long-term changes in behavior and regional cerebral blood flow associated with painful peripheral mononeuropathy in the rat. *Pain* 95:31-40.
- Paus T (2001) Primate anterior cingulate cortex: where motor control, drive and cognition interface. *Nat Rev Neurosci* 2:417-424.
- Paxinos G, Watson C (2007) *The rat brain in stereotaxis coordinates*. Elsevier 6th edition.
- Pearson RC, Brodal P, Gatter KC, Powell TP (1982) The organization of the connections between the cortex and the claustrum in the monkey. *Brain Res* 234:435-441.
- Pedersen LH, Scheel-Kruger J, Blackburn-Munro G (2007) Amygdala GABA-A receptor involvement in mediating sensory-discriminative and affective-motivational pain responses in a rat model of peripheral nerve injury. *Pain* 127:17-26.
- Peyron R, Laurent B, Garcia-Larrea L (2000) Functional imaging of brain responses to pain. A review and meta-analysis (2000). *Neurophysiol Clin* 30:263-288.
- Peyron R, Faillenot I, Pomares FB, Le Bars D, Garcia-Larrea L, Laurent B (2013) Mechanical allodynia in neuropathic pain. Where are the brain representations located? A positron emission tomography (PET) study. *Eur J Pain*.
- Peyron R, Schneider F, Faillenot I, Convers P, Barral FG, Garcia-Larrea L, Laurent B (2004) An fMRI study of cortical representation of mechanical allodynia in patients with neuropathic pain. *Neurology* 63:1838-1846.
- Phan KL, Britton JC, Taylor SF, Fig LM, Liberzon I (2006) Corticolimbic blood flow during nontraumatic emotional processing in posttraumatic stress disorder. *Arch Gen Psychiatry* 63:184-192.
- Piombino P, Iaconetta G, Ciccarelli R, Romeo A, Spinzia A, Califano L (2010) Repair of orbital floor fractures: our experience and new technical findings. *Craniofacial Trauma Reconstr* 3:217-222.
- Pittenger C, Duman RS (2008) Stress, depression, and neuroplasticity: a convergence of mechanisms. *Neuropsychopharmacology* 33:88-109.
- Pizzagalli DA (2011) Frontocingulate dysfunction in depression: toward biomarkers of treatment response. *Neuropsychopharmacology* 36:183-206.
- Ploner M, Lee MC, Wiech K, Bingel U, Tracey I (2011) Flexible cerebral connectivity patterns subserve contextual modulations of pain. *Cerebral cortex* 21:719-726.
- Poo MM (2001) Neurotrophins as synaptic modulators. *Nat Rev Neurosci* 2:24-32.
- Porro CA, Baraldi P, Pagnoni G, Serafini M, Facchin P, Maieron M, Nichelli P (2002) Does anticipation of pain affect cortical nociceptive systems? *J Neurosci* 22:3206-3214.
- Porsolt RD, Le Pichon M, Jalfre M (1977) Depression: a new animal model sensitive to antidepressant treatments. *Nature* 266:730-732.
- Poulin JF, Berube P, Laforest S, Drolet G (2013) Enkephalin knockdown in the central amygdala nucleus reduces unconditioned fear and anxiety. *Eur J Neurosci* 37:1357-1367.
- Premkumar P, Parbhakar VA, Fannon D, Lythgoe D, Williams SC, Kuipers E, Kumari V (2010) N-acetyl aspartate concentration in the anterior cingulate cortex in patients with schizophrenia: a study of clinical and neuropsychological correlates and preliminary exploration of cognitive behaviour therapy effects. *Psychiatry Res* 182:251-260.

- Pujol J, Lopez-Sola M, Ortiz H, Vilanova JC, Harrison BJ, Yucel M, Soriano-Mas C, Cardoner N, Deus J (2009) Mapping brain response to pain in fibromyalgia patients using temporal analysis of fMRI. *PloS one* 4:e5224.
- Qiu Y, Inui K, Wang X, Nguyen BT, Tran TD, Kakigi R (2004) Effects of distraction on magnetoencephalographic responses ascending through C-fibers in humans. *Clinical neurophysiology : official journal of the International Federation of Clinical Neurophysiology* 115:636-646.
- Qu C, King T, Okun A, Lai J, Fields HL, Porreca F (2011) Lesion of the rostral anterior cingulate cortex eliminates the aversiveness of spontaneous neuropathic pain following partial or complete axotomy. *Pain* 152:1641-1648.
- Quintero GC, Herrera J, Bethancourt J (2011) Cortical NR2B NMDA subunit antagonism reduces inflammatory pain in male and female rats. *J Pain Res* 4:301-308.
- Radat F, Margot-Duclot A, Attal N (2013) Psychiatric co-morbidities in patients with chronic peripheral neuropathic pain: a multicentre cohort study. *Eur J Pain* 17:1547-1557.
- Rainville P, Duncan GH, Price DD, Carrier B, Bushnell MC (1997) Pain affect encoded in human anterior cingulate but not somatosensory cortex. *Science* 277:968-971.
- Raison CL, Miller AH (2003) When not enough is too much: the role of insufficient glucocorticoid signaling in the pathophysiology of stress-related disorders. *Am J Psychiatry* 160:1554-1565.
- Rauch SL, Shin LM, Segal E, Pitman RK, Carson MA, McMullin K, Whalen PJ, Makris N (2003) Selectively reduced regional cortical volumes in post-traumatic stress disorder. *Neuroreport* 14:913-916.
- Reil J (1809) Untersuchungen über den Bau des großen Gehirns im Menschen: Vierte Fortsetzung VIII. *Arch Physiol Halle* 9:136-146.
- Ren K, Torres R (2009) Role of interleukin-1beta during pain and inflammation. *Brain Res Rev* 60:57-64.
- Ren WJ, Liu Y, Zhou LJ, Li W, Zhong Y, Pang RP, Xin WJ, Wei XH, Wang J, Zhu HQ, Wu CY, Qin ZH, Liu G, Liu XG (2011) Peripheral nerve injury leads to working memory deficits and dysfunction of the hippocampus by upregulation of TNF-alpha in rodents. *Neuropsychopharmacology* 36:979-992.
- Roeska K, Ceci A, Treede RD, Doods H (2009) Effect of high trait anxiety on mechanical hypersensitivity in male rats. *Neurosci Lett* 464:160-164.
- Romanski LM, Giguere M, Bates JF, Goldman-Rakic PS (1997) Topographic organization of medial pulvinar connections with the prefrontal cortex in the rhesus monkey. *J Comp Neurol* 379:313-332.
- Rouwette T, Vanelderden P, de Reus M, Loohuis NO, Giele J, van Egmond J, Scheenen W, Scheffer GJ, Roubos E, Vissers K, Kozicz T (2012) Experimental neuropathy increases limbic forebrain CRF. *Eur J Pain* 16:61-71.
- Russo SJ, Nestler EJ (2013) The brain reward circuitry in mood disorders. *Nat Rev Neurosci* 14:609-625.
- Santarelli L, Saxe M, Gross C, Surget A, Battaglia F, Dulawa S, Weisstaub N, Lee J, Duman R, Arancio O, Belzung C, Hen R (2003) Requirement of hippocampal neurogenesis for the behavioral effects of antidepressants. *Science* 301:805-809.
- Sawamoto N, Honda M, Okada T, Hanakawa T, Kanda M, Fukuyama H, Konishi J, Shibasaki H (2000) Expectation of pain enhances responses to nonpainful somatosensory stimulation in the anterior cingulate cortex and parietal operculum/posterior insula: an event-related functional magnetic resonance imaging study. *The Journal of neuroscience : the official journal of the Society for Neuroscience* 20:7438-7445.
- Scherpiet S, Bruhl AB, Opialla S, Roth L, Jancke L, Herwig U (2014) Altered emotion processing circuits during the anticipation of emotional stimuli in women with borderline personality disorder. *Eur Arch Psychiatry Clin Neurosci* 264:45-60.
- Schneider H, Pitossi F, Balschun D, Wagner A, del Rey A, Besedovsky HO (1998) A neuromodulatory role of interleukin-1beta in the hippocampus. *Proc Natl Acad Sci U S A* 95:7778-7783.

- Schreckenberger M, Siessmeier T, Viertmann A, Landvogt C, Buchholz HG, Rolke R, Treede RD, Bartenstein P, Birklein F (2005) The unpleasantness of tonic pain is encoded by the insular cortex. *Neurology* 64:1175-1183.
- Seltzer Z, Dubner R, Shir Y (1990) A novel behavioral model of neuropathic pain disorders produced in rats by partial sciatic nerve injury. *Pain* 43:205-218.
- Seminowicz DA, Laferriere AL, Millicamps M, Yu JS,Coderre TJ, Bushnell MC (2009) MRI structural brain changes associated with sensory and emotional function in a rat model of long-term neuropathic pain. *Neuroimage* 47:1007-1014.
- Sesack SR, Deutch AY, Roth RH, Bunney BS (1989) Topographical organization of the efferent projections of the medial prefrontal cortex in the rat: an anterograde tract-tracing study with Phaseolus vulgaris leucoagglutinin. *J Comp Neurol* 290:213-242.
- Shackman AJ, Salomons TV, Slagter HA, Fox AS, Winter JJ, Davidson RJ (2011) The integration of negative affect, pain and cognitive control in the cingulate cortex. *Nat Rev Neurosci* 12:154-167.
- Shi CJ, Cassell MD (1998) Cortical, thalamic, and amygdaloid connections of the anterior and posterior insular cortices. *The Journal of comparative neurology* 399:440-468.
- Shibata H (1993) Efferent projections from the anterior thalamic nuclei to the cingulate cortex in the rat. *J Comp Neurol* 330:533-542.
- Shields DC, Asaad W, Eskandar EN, Jain FA, Cosgrove GR, Flaherty AW, Cassem EH, Price BH, Rauch SL, Dougherty DD (2008) Prospective assessment of stereotactic ablative surgery for intractable major depression. *Biol Psychiatry* 64:449-454.
- Shin LM, Whalen PJ, Pitman RK, Bush G, Macklin ML, Lasko NB, Orr SP, McInerney SC, Rauch SL (2001) An fMRI study of anterior cingulate function in posttraumatic stress disorder. *Biol Psychiatry* 50:932-942.
- Shin LM, Wright CI, Cannistraro PA, Wedig MM, McMullin K, Martis B, Macklin ML, Lasko NB, Cavanagh SR, Krangel TS, Orr SP, Pitman RK, Whalen PJ, Rauch SL (2005) A functional magnetic resonance imaging study of amygdala and medial prefrontal cortex responses to overtly presented fearful faces in posttraumatic stress disorder. *Arch Gen Psychiatry* 62:273-281.
- Silverman DH, Munakata JA, Ennes H, Mandelkern MA, Hoh CK, Mayer EA (1997) Regional cerebral activity in normal and pathological perception of visceral pain. *Gastroenterology* 112:64-72.
- Simmons WK, Rapuano KM, Kallman SJ, Ingeholm JE, Miller B, Gotts SJ, Avery JA, Hall KD, Martin A (2013) Category-specific integration of homeostatic signals in caudal but not rostral human insula. *Nat Neurosci* 16:1551-1552.
- Singer T, Seymour B, O'Doherty J, Kaube H, Dolan RJ, Frith CD (2004) Empathy for pain involves the affective but not sensory components of pain. *Science* 303:1157-1162.
- Sinka L, Kovari E, Santos M, Herrmann FR, Gold G, Hof PR, Bouras C, Giannakopoulos P (2012) Microvascular changes in late-life schizophrenia and mood disorders: stereological assessment of capillary diameters in anterior cingulate cortex. *Neuropathol Appl Neurobiol* 38:696-709.
- Slattery DA, Neumann ID, Cryan JF (2011) Transient inactivation of the infralimbic cortex induces antidepressant-like effects in the rat. *J Psychopharmacol* 25:1295-1303.
- Sliz D, Hayley S (2012) Major depressive disorder and alterations in insular cortical activity: a review of current functional magnetic imaging research. *Front Hum Neurosci* 6:323.
- Sobotta J (1908) Atlas of human anatomy.
- Sorkin LS, Yaksh TL (2009) Behavioral models of pain states evoked by physical injury to the peripheral nerve. *Neurotherapeutics* 6:609-619.
- Starr CJ, Sawaki L, Wittenberg GF, Burdette JH, Oshiro Y, Quevedo AS, Coghill RC (2009) Roles of the insular cortex in the modulation of pain: insights from brain lesions. *J Neurosci* 29:2684-2694.
- Steele JD, Christmas D, Eljamel MS, Matthews K (2008) Anterior cingulotomy for major depression: clinical outcome and relationship to lesion characteristics. *Biol Psychiatry* 63:670-677.
- Sun H, Charles CH, Lau LF, Tonks NK (1993) MKP-1 (3CH134), an immediate early gene product, is a dual specificity phosphatase that dephosphorylates MAP kinase in vivo. *Cell* 75:487-493.

- Suzuki T, Amata M, Sakaue G, Nishimura S, Inoue T, Shibata M, Mashimo T (2007) Experimental neuropathy in mice is associated with delayed behavioral changes related to anxiety and depression. *Anesth Analg* 104:1570-1577, table of contents.
- Takeda K, Muramatsu M, Chikuma T, Kato T (2009) Effect of memantine on the levels of neuropeptides and microglial cells in the brain regions of rats with neuropathic pain. *J Mol Neurosci* 39:380-390.
- Takemura Y, Yamashita A, Horiuchi H, Furuya M, Yanase M, Niikura K, Imai S, Hatakeyama N, Kinoshita H, Tsukiyama Y, Senba E, Matoba M, Kuzumaki N, Yamazaki M, Suzuki T, Narita M (2011) Effects of gabapentin on brain hyperactivity related to pain and sleep disturbance under a neuropathic pain-like state using fMRI and brain wave analysis. *Synapse* 65:668-676.
- Tanaka D, Jr. (1976) Thalamic projections of the dorsomedial prefrontal cortex in the rhesus monkey (*Macaca mulatta*). *Brain Res* 110:21-38.
- Tang NK, Goodchild CE, Sanborn AN, Howard J, Salkovskis PM (2012) Deciphering the temporal link between pain and sleep in a heterogeneous chronic pain patient sample: a multilevel daily process study. *Sleep* 35:675-687A.
- Terada M, Kuzumaki N, Hareyama N, Imai S, Niikura K, Narita M, Yamazaki M, Suzuki T (2008) Suppression of enriched environment-induced neurogenesis in a rodent model of neuropathic pain. *Neurosci Lett* 440:314-318.
- Thibault K, Calvino B, Rivals I, Marchand F, Dubacq S, McMahon SB, Pezet S (2014) Molecular mechanisms underlying the enhanced analgesic effect of oxycodone compared to morphine in chemotherapy-induced neuropathic pain. *PLoS One* 9:e91297.
- Thompson SJ, Millecamps M, Aliaga A, Seminowicz DA, Low LA, Bedell BJ, Stone LS, Schweinhardt P, Bushnell MC (2014) Metabolic brain activity suggestive of persistent pain in a rat model of neuropathic pain. *Neuroimage* 91:344-352.
- Tiemann L, Schulz E, Winkelmann A, Ronel J, Henningsen P, Ploner M (2012) Behavioral and neuronal investigations of hypervigilance in patients with fibromyalgia syndrome. *PLoS One* 7:e35068.
- Tolle TR, Kaufmann T, Siessmeier T, Lautenbacher S, Berthele A, Munz F, Zieglgansberger W, Willoch F, Schwaiger M, Conrad B, Bartenstein P (1999) Region-specific encoding of sensory and affective components of pain in the human brain: a positron emission tomography correlation analysis. *Annals of neurology* 45:40-47.
- Toyoda H, Zhao MG, Zhuo M (2009) Enhanced quantal release of excitatory transmitter in anterior cingulate cortex of adult mice with chronic pain. *Mol Pain* 5:4.
- Traub RJ, Silva E, Gebhart GF, Solodkin A (1996) Noxious colorectal distention induced-c-Fos protein in limbic brain structures in the rat. *Neuroscience letters* 215:165-168.
- Treede RD, Apkarian AV, Bromm B, Greenspan JD, Lenz FA (2000) Cortical representation of pain: functional characterization of nociceptive areas near the lateral sulcus. *Pain* 87:113-119.
- Treede RD, Jensen TS, Campbell JN, Cruccu G, Dostrovsky JO, Griffin JW, Hansson P, Hughes R, Nurmikko T, Serra J (2008) Neuropathic pain: redefinition and a grading system for clinical and research purposes. *Neurology* 70:1630-1635.
- Tseng MT, Chiang MC, Chao CC, Tseng WY, Hsieh ST (2013) fMRI evidence of degeneration-induced neuropathic pain in diabetes: enhanced limbic and striatal activations. *Hum Brain Mapp* 34:2733-2746.
- Tuor UI, McKenzie E, Tomanek B (2002) Functional magnetic resonance imaging of tonic pain and vasopressor effects in rats. *Magnetic resonance imaging* 20:707-712.
- Tuor UI, Maliszka K, Foniok T, Papadimitropoulos R, Jarmasz M, Somorjai R, Kozlowski P (2000) Functional magnetic resonance imaging in rats subjected to intense electrical and noxious chemical stimulation of the forepaw. *Pain* 87:315-324.
- Uceyler N, Tschärke A, Sommer C (2008) Early cytokine gene expression in mouse CNS after peripheral nerve lesion. *Neurosci Lett* 436:259-264.
- Ulrich-Lai YM, Xie W, Meij JT, Dolgas CM, Yu L, Herman JP (2006) Limbic and HPA axis function in an animal model of chronic neuropathic pain. *Physiol Behav* 88:67-76.
- Urban R, Scherrer G, Goulding EH, Tecott LH, Basbaum AI (2011) Behavioral indices of ongoing pain are largely unchanged in male mice with tissue or nerve injury-induced mechanical hypersensitivity. *Pain* 152:990-1000.

- Vadakkan KI, Jia YH, Zhuo M (2005) A behavioral model of neuropathic pain induced by ligation of the common peroneal nerve in mice. *J Pain* 6:747-756.
- van der Staay FJ, Arndt SS, Nordquist RE (2009) Evaluation of animal models of neurobehavioral disorders. *Behav Brain Funct* 5:11.
- Van der Werf YD, Witter MP, Groenewegen HJ (2002) The intralaminar and midline nuclei of the thalamus. Anatomical and functional evidence for participation in processes of arousal and awareness. *Brain Res Brain Res Rev* 39:107-140.
- Van Eden CG, Uylings HB (1985) Cytoarchitectonic development of the prefrontal cortex in the rat. *J Comp Neurol* 241:253-267.
- Van Hoesen GW, Morecraft RJ, Vogt BA (1993) Connections of the monkey cingulate cortex. In: *Neurobiology of cingulate cortex and limbic thalamus* (Vogt BA, Gabriel M, eds), pp 249-283. Birkhäuser; Boston.
- Van Laere K, Nuttin B, Gabriels L, Dupont P, Rasmussen S, Greenberg BD, Cosyns P (2006) Metabolic imaging of anterior capsular stimulation in refractory obsessive-compulsive disorder: a key role for the subgenual anterior cingulate and ventral striatum. *J Nucl Med* 47:740-747.
- Vartiainen N, Kallio-Laine K, Hlushchuk Y, Kirveskari E, Seppanen M, Autti H, Jousmaki V, Forss N, Kalso E, Hari R (2009) Changes in brain function and morphology in patients with recurring herpes simplex virus infections and chronic pain. *Pain* 144:200-208.
- Veinante P, Yalcin I, Barrot M (2013) The amygdala between sensation and affect: a role in pain. *J Mol Psychiatry* 1:14.
- Veldhuijzen DS, Greenspan JD, Kim JH, Lenz FA (2010) Altered pain and thermal sensation in subjects with isolated parietal and insular cortical lesions. *European journal of pain* 14:535 e531-511.
- Vertes RP (2002) Analysis of projections from the medial prefrontal cortex to the thalamus in the rat, with emphasis on nucleus reuniens. *J Comp Neurol* 442:163-187.
- Vertes RP, Hoover WB (2008) Projections of the paraventricular and paratenial nuclei of the dorsal midline thalamus in the rat. *J Comp Neurol* 508:212-237.
- Vertes RP, Hoover WB, Do Valle AC, Sherman A, Rodriguez JJ (2006) Efferent projections of reuniens and rhomboid nuclei of the thalamus in the rat. *J Comp Neurol* 499:768-796.
- Vialou V et al. (2010) DeltaFosB in brain reward circuits mediates resilience to stress and antidepressant responses. *Nat Neurosci* 13:745-752.
- Vogt BA (2005) Pain and emotion interactions in subregions of the cingulate gyrus. *Nat Rev Neurosci* 6:533-544.
- Vogt BA, Miller MW (1983) Cortical connections between rat cingulate cortex and visual, motor, and postsubicular cortices. *J Comp Neurol* 216:192-210.
- Vogt BA, Pandya DN (1987) Cingulate cortex of the rhesus monkey: II. Cortical afferents. *J Comp Neurol* 262:271-289.
- Vogt BA, Paxinos G (2014) Cytoarchitecture of mouse and rat cingulate cortex with human homologies. *Brain Struct Funct* 219:185-192.
- Vogt BA, Derbyshire S, Jones AK (1996) Pain processing in four regions of human cingulate cortex localized with co-registered PET and MR imaging. *The European journal of neuroscience* 8:1461-1473.
- Vogt BA, Vogt L, Farber NB, Bush G (2005) Architecture and neurocytology of monkey cingulate gyrus. *J Comp Neurol* 485:218-239.
- Wagner G, Koch K, Schachtzabel C, Schultz CC, Gaser C, Reichenbach JR, Sauer H, Bar KJ, Schlosser RG (2013) Structural basis of the fronto-thalamic dysconnectivity in schizophrenia: A combined DCM-VBM study. *Neuroimage Clin* 3:95-105.
- Wallace VC, Segerdahl AR, Blackbeard J, Pheby T, Rice AS (2008) Anxiety-like behaviour is attenuated by gabapentin, morphine and diazepam in a rodent model of HIV anti-retroviral-associated neuropathic pain. *Neurosci Lett* 448:153-156.
- Wallace VC, Blackbeard J, Segerdahl AR, Hasnie F, Pheby T, McMahon SB, Rice AS (2007a) Characterization of rodent models of HIV-gp120 and anti-retroviral-associated neuropathic pain. *Brain* 130:2688-2702.

- Wallace VC, Blackbeard J, Pheby T, Segerdahl AR, Davies M, Hasnie F, Hall S, McMahon SB, Rice AS (2007b) Pharmacological, behavioural and mechanistic analysis of HIV-1 gp120 induced painful neuropathy. *Pain* 133:47-63.
- Wang J, Goffer Y, Xu D, Tukey DS, Shamir DB, Eberle SE, Zou AH, Blanck TJ, Ziff EB (2011) A single subanesthetic dose of ketamine relieves depression-like behaviors induced by neuropathic pain in rats. *Anesthesiology* 115:812-821.
- Wei F, Wang GD, Kerchner GA, Kim SJ, Xu HM, Chen ZF, Zhuo M (2001) Genetic enhancement of inflammatory pain by forebrain NR2B overexpression. *Nat Neurosci* 4:164-169.
- Wei F, Qiu CS, Kim SJ, Muglia L, Maas JW, Pineda VV, Xu HM, Chen ZF, Storm DR, Muglia LJ, Zhuo M (2002) Genetic elimination of behavioral sensitization in mice lacking calmodulin-stimulated adenylyl cyclases. *Neuron* 36:713-726.
- Wen YR, Suter MR, Kawasaki Y, Huang J, Pertin M, Kohno T, Berde CB, Decosterd I, Ji RR (2007) Nerve conduction blockade in the sciatic nerve prevents but does not reverse the activation of p38 mitogen-activated protein kinase in spinal microglia in the rat spared nerve injury model. *Anesthesiology* 107:312-321.
- White T, Hongwanishkul D, Schmidt M (2011) Increased anterior cingulate and temporal lobe activity during visuospatial working memory in children and adolescents with schizophrenia. *Schizophr Res* 125:118-128.
- Whittle S, Chanen AM, Fornito A, McGorry PD, Pantelis C, Yucel M (2009) Anterior cingulate volume in adolescents with first-presentation borderline personality disorder. *Psychiatry Res* 172:155-160.
- WHO (2008) The Global Burden of Disease: 2004 Update.
- Wicking M, Nees F, Steiger F (2014) Neuropsychological measures of hippocampal function. *Front Neurol Neurosci* 34:60-70.
- Wiech K, Tracey I (2009) The influence of negative emotions on pain: behavioral effects and neural mechanisms. *Neuroimage* 47:987-994.
- Willner P (1984) The validity of animal models of depression. *Psychopharmacology (Berl)* 83:1-16.
- Wingenfeld K, Wolf OT (2014) Stress, memory, and the hippocampus. *Front Neurol Neurosci* 34:109-120.
- Wright CI, Groenewegen HJ (1995) Patterns of convergence and segregation in the medial nucleus accumbens of the rat: relationships of prefrontal cortical, midline thalamic, and basal amygdaloid afferents. *J Comp Neurol* 361:383-403.
- Xu H, Wu LJ, Wang H, Zhang X, Vadakkan KI, Kim SS, Steenland HW, Zhuo M (2008) Presynaptic and postsynaptic amplifications of neuropathic pain in the anterior cingulate cortex. *J Neurosci* 28:7445-7453.
- Yalcin I, Coubar S, Bodard S, Chalon S, Belzung C (2008) Effects of 5,7-dihydroxytryptamine lesion of the dorsal raphe nucleus on the antidepressant-like action of tramadol in the unpredictable chronic mild stress in mice. *Psychopharmacology (Berl)* 200:497-507.
- Yalcin I, Tessier LH, Petit-Demouliere N, Doridot S, Hein L, Freund-Mercier MJ, Barrot M (2009) Beta2-adrenoceptors are essential for desipramine, venlafaxine or reboxetine action in neuropathic pain. *Neurobiol Dis* 33:386-394.
- Yalcin I, Bohren Y, Waltisperger E, Sage-Ciocca D, Yin JC, Freund-Mercier MJ, Barrot M (2011) A time-dependent history of mood disorders in a murine model of neuropathic pain. *Biol Psychiatry* 70:946-953.
- Yamasue H, Kasai K, Iwanami A, Ohtani T, Yamada H, Abe O, Kuroki N, Fukuda R, Tochigi M, Furukawa S, Sadamatsu M, Sasaki T, Aoki S, Ohtomo K, Asukai N, Kato N (2003) Voxel-based analysis of MRI reveals anterior cingulate gray-matter volume reduction in posttraumatic stress disorder due to terrorism. *Proc Natl Acad Sci U S A* 100:9039-9043.
- Yan H, Tian L, Yan J, Sun W, Liu Q, Zhang YB, Li XM, Zang YF, Zhang D (2012a) Functional and anatomical connectivity abnormalities in cognitive division of anterior cingulate cortex in schizophrenia. *PLoS One* 7:e45659.
- Yan N, Cao B, Xu J, Hao C, Zhang X, Li Y (2012b) Glutamatergic activation of anterior cingulate cortex mediates the affective component of visceral pain memory in rats. *Neurobiol Learn Mem* 97:156-164.

- Yang PF, Chen DY, Hu JW, Chen JH, Yen CT (2011) Functional tracing of medial nociceptive pathways using activity-dependent manganese-enhanced MRI. *Pain* 152:194-203.
- Yoshimura S, Okamoto Y, Onoda K, Matsunaga M, Ueda K, Suzuki S, Shigetoyamawaki (2010) Rostral anterior cingulate cortex activity mediates the relationship between the depressive symptoms and the medial prefrontal cortex activity. *J Affect Disord* 122:76-85.
- Yu T, Guo M, Garza J, Rendon S, Sun XL, Zhang W, Lu XY (2011) Cognitive and neural correlates of depression-like behaviour in socially defeated mice: an animal model of depression with cognitive dysfunction. *Int J Neuropsychopharmacol* 14:303-317.
- Yucel K, McKinnon MC, Chahal R, Taylor VH, Macdonald K, Joffe R, MacQueen GM (2008) Anterior cingulate volumes in never-treated patients with major depressive disorder. *Neuropsychopharmacology* 33:3157-3163.
- Zeng Q, Wang S, Lim G, Yang L, Mao J, Sung B, Chang Y, Lim JA, Guo G (2008) Exacerbated mechanical allodynia in rats with depression-like behavior. *Brain Res* 1200:27-38.
- Zhang Y, Wang N, Wang JY, Chang JY, Woodward DJ, Luo F (2011) Ensemble encoding of nociceptive stimulus intensity in the rat medial and lateral pain systems. *Mol Pain* 7:64.
- Zhao MG, Ko SW, Wu LJ, Toyoda H, Xu H, Quan J, Li J, Jia Y, Ren M, Xu ZC, Zhuo M (2006) Enhanced presynaptic neurotransmitter release in the anterior cingulate cortex of mice with chronic pain. *J Neurosci* 26:8923-8930.
- Zhao XY, Liu MG, Yuan DL, Wang Y, He Y, Wang DD, Chen XF, Zhang FK, Li H, He XS, Chen J (2009) Nociception-induced spatial and temporal plasticity of synaptic connection and function in the hippocampal formation of rats: a multi-electrode array recording. *Mol Pain* 5:55.
- Zhu MY, Klimek V, Dilley GE, Haycock JW, Stockmeier C, Overholser JC, Meltzer HY, Ordway GA (1999) Elevated levels of tyrosine hydroxylase in the locus coeruleus in major depression. *Biol Psychiatry* 46:1275-1286.
- Zhuang ZY, Wen YR, Zhang DR, Borsello T, Bonny C, Strichartz GR, Decosterd I, Ji RR (2006) A peptide c-Jun N-terminal kinase (JNK) inhibitor blocks mechanical allodynia after spinal nerve ligation: respective roles of JNK activation in primary sensory neurons and spinal astrocytes for neuropathic pain development and maintenance. *J Neurosci* 26:3551-3560.
- Zilles K, Wree A (1995) Cortex: areal and laminar structure. In: *The rat nervous system*, pp 649-685. San Diego: Academic.
- Zimmerman ME, Pan JW, Hetherington HP, Lipton ML, Baigi K, Lipton RB (2009) Hippocampal correlates of pain in healthy elderly adults: a pilot study. *Neurology* 73:1567-1570.



Analyse anatomo-fonctionnelle et moléculaire des conséquences anxiodépressives de la douleur neuropathique dans un modèle murin : importance du cortex cingulaire antérieur

Résumé

La douleur neuropathique est un syndrome secondaire à une maladie ou à une lésion affectant le système nerveux somatosensoriel. Environ 30 % des patients souffrant de douleurs neuropathiques présentent des troubles de l'humeur. Les causes biologiques de ces comorbidités ne sont pas clairement établies. Grâce à l'utilisation d'un modèle murin de douleur neuropathique, nous avons cherché à comprendre l'apparition des conséquences émotionnelles de cette douleur. Pour cela, nous avons cherché à identifier des régions cérébrales impliquées dans les différentes composantes et conséquences de la douleur ainsi que les modifications moléculaires y prenant place. Nous avons mis en évidence une ségrégation corticale de la douleur avec l'intégration de la composante sensorielle par le cortex insulaire postérieur d'une part et l'intégration de la composante aversive et des conséquences émotionnelles par le cortex cingulaire antérieur d'autre part. Nous avons ensuite montré l'implication de la protéine MKP-1 dans l'expression des comportements de type anxiodépressif dans notre modèle.

Mots-clés : douleur neuropathique, dépression, anxiété, modèle animal, MKP-1.

Abstract

Neuropathic pain is defined as a pain caused by a lesion or disease of the somatosensory nervous system. Around 30 % of neuropathic pain patients develop mood disorders. The biologic bases of these comorbidities are not clearly established. Using a murine model of neuropathic pain, we tried to understand the emotional consequences of neuropathic pain. Thus, we identified cerebral regions involved in the different components of pain and molecular modifications taking place in these regions. We showed a cortical separation of the pain experience with in one hand the integration of the sensory component of pain in the posterior insular cortex and in the other hand the integration of the aversive component and the emotional consequences of pain in the anterior cingulated cortex (ACC). Looking at the molecular modifications in the ACC, we showed that MKP-1, a protein able to dephosphorylate the MAPK, is involved in the development of pain-related mood disorders in our model of neuropathic pain.

Keys words : neuropathic pain, depression, anxiety, animal model, MKP-1.