



HAL
open science

A methodological framework to support integrated ecodesign for companies : requirements and conceptualization towards a software platform

Maud Dufrene

► **To cite this version:**

Maud Dufrene. A methodological framework to support integrated ecodesign for companies : requirements and conceptualization towards a software platform. Other. Université Grenoble Alpes, 2015. English. NNT : 2015GREAI083 . tel-01267717

HAL Id: tel-01267717

<https://theses.hal.science/tel-01267717>

Submitted on 4 Feb 2016

HAL is a multi-disciplinary open access archive for the deposit and dissemination of scientific research documents, whether they are published or not. The documents may come from teaching and research institutions in France or abroad, or from public or private research centers.

L'archive ouverte pluridisciplinaire **HAL**, est destinée au dépôt et à la diffusion de documents scientifiques de niveau recherche, publiés ou non, émanant des établissements d'enseignement et de recherche français ou étrangers, des laboratoires publics ou privés.

THÈSE

Pour obtenir le grade de

DOCTEUR DE L'UNIVERSITÉ GRENOBLE ALPES

Spécialité : **Génie Industriel**

Arrêté ministériel : 7 août 2006

Présentée par

Maud DUFRENE

Thèse dirigée par **Peggy ZWOLINSKI**

préparée au sein du **Laboratoire G-SCOP**
dans l'**École Doctorale I-MEP²**

Proposition d'un cadre méthodologique comme support aux approches d'écoconception en entreprise : Exigences et conceptualisation pour une plateforme logicielle

Thèse soutenue publiquement le **29 Avril 2015**
devant le jury composé de :

M. Dominique MILLET

Professeur, Université de Toulon, Rapporteur

M. Lionel ROUCOULES

Professeur, Arts et Métiers ParisTech, Rapporteur

M^{me} Nadège TROUSSIER

Professeur, Université de Technologie de Troyes, Présidente de jury

M. Michele GERMANI

Professeur, Università Politecnica delle Marche (It), Examineur

M^{me} Tracy BHAMRA

Professeur, Loughborough University (UK), Examineur

M^{me} Peggy ZWOLINSKI

Professeur, Université de Grenoble Alpes, Directrice de thèse



THÈSE

Pour obtenir le grade de

DOCTEUR DE L'UNIVERSITÉ GRENOBLE ALPES

Spécialité : **Génie Industriel**

Arrêté ministériel : 7 août 2006

Présentée par

Maud DUFRENE

Thèse dirigée par **Peggy ZWOLINSKI**

préparée au sein du **Laboratoire G-SCOP**
dans l'**École Doctorale I-MEP²**

A methodological framework to support integrated ecodesign for companies: Requirements and conceptualization towards a software platform

Thèse soutenue publiquement le **29 Avril 2015**
devant le jury composé de :

M. Dominique MILLET

Professeur, Université de Toulon, Rapporteur

M. Lionel ROUCOULES

Professeur, Arts et Métiers ParisTech, Rapporteur

M^{me} Nadège TROUSSIER

Professeur, Université de Technologie de Troyes, Présidente de jury

M. Michele GERMANI

Professeur, Università Politecnica delle Marche (It), Examineur

M^{me} Tracy BHAMRA

Professeur, Loughborough University (UK), Examineur

M^{me} Peggy ZWOLINSKI

Professeur, Université de Grenoble Alpes, Directrice de thèse



Remerciements

Je tiens à remercier Nadège Troussier d'avoir présidé le jury de ma soutenance de thèse. Je remercie Dominique Millet et Lionel Roucoules pour avoir accepté de rapporter mes travaux. Leurs contributions m'ont permis de clarifier et d'enrichir des points précis et ont ainsi levé de nouvelles perspectives. Je remercie également Tracy Bhamra, Michele Germani d'avoir participé à mon jury de thèse en tant qu'examineurs.

Je remercie ma directrice Peggy Zwolinski d'avoir dirigé ces travaux de recherche et de m'avoir accordé sa confiance dès le début de ma thèse. Je la remercie également pour la diversité des activités que j'ai pu réaliser pendant ces années, notamment grâce à ma participation au projet G.EN.ESI qui fut enrichissante (pour nous deux je pense) sur bien des aspects.

Je remercie tous les membres du Projet européen G.EN.ESI, Molly Buckingham, Elies Dekoninck, Mendy Mombeshora, Helen Cornwell, Michele Germani, Marco Marconi, Marco Mandolini, Marta Rossi, Ilaria Balloriani, Donna Dykeman, Manuelle Clavel, James Goddin, Sara Cortesi, Patrizia Buttol, Alessandra Zamagni, Marco Mengarelli, Mario Cipriani et Simone Biocco pour leur accueil au sein de l'entreprise Faber, Laurent Dupon et Denis Sanchez au sein de Sibuet.

Je remercie l'entreprise Aubrilam de m'avoir reçue et de m'avoir permis de suivre un projet de conception. Merci à Dominique Logerot, Sonia Duffaud et Florent Madjaris.

Je tiens à remercier tous les membres du laboratoire G-SCOP sans qui les conditions de travail ne seraient pas les mêmes, un grand merci notamment à Souad pour mes missions à l'étranger et Marie-Jo pour le support humain et technique qu'elle apporte aux doctorants tout au long de leur séjour à G-SCOP.

Merci aux éco-concepteurs : Guillaume, Maud, Lucie, Lucile, Manu, Yacine, Natalia, Feng, Mauricio, Tom, Camille et tous les autres.

Une pensée pour le bureau de l'A-DOC 2011/2012 avec Michaël et Anne-Laure. Je salue également la lignée de trésoriers ! Un grand merci à Anne-Laure avec qui j'ai partagé le bureau tout au long de ma thèse et dont je salue les diverses compétences qui m'ont maintes fois éclairée. Merci à Julien et Karim qui ont ensuite rejoint le bureau de l'avoir si parfaitement complété.

Je remercie les « anciens doctorants » pour leur accueil et leurs discussions autour de la recherche et autres sujets abracadabrantiques : Bertrand BL, Ariel, Bertrand H, Sam, Olivier, Guillux... Et mes contemporains et successeurs pour tous ces moments passés ensemble : Clément, Michaël, Yohann, Lucile, Julien V, Anne-Laure, Karim, Natalia, Yacine, Julien G, Audrey, Boris, Nico, Manu, Tom...

Un grand merci Karim pour ton soutien inestimable dans le bureau et l'amitié qui en a émergé l'est tout autant. Merci Boris de partager mon humour, on se comprend. Merci Nico.

Pour toutes nos discussions et pour tes retours successifs lors de la préparation de ma soutenance. Yacine, je ne t'oublie pas cette fois tu as ton mot personnalisé et tu le mérites. Merci pour ton soutien, bien que différent de tous les autres, entre tes blagues et autres taquineries tu sais trouver les mots. Merci de m'avoir accompagnée chez Abm et de m'avoir laissé ta chambre chez A et B.

Manu, par quoi commencer pour te remercier ? Je pense que tu l'as déjà compris mais tu as été d'une grande d'aide et ce dès le premier jour où tu es arrivée à G-SCOP. Finalement à force de nous l'entendre dire, tu es presque devenu ma sœur ! Merci pour ton soutien, tes conseils et tes retours. Les lieux invraisemblables dans lesquelles nous nous sommes retrouvées lors du projet G.EN.ESI resteront un souvenir gravé.

Merci Clément, tu as toujours été à l'écoute (de ma vie passionnante...), donné de bons conseils, et même en étant loin tu as su rester présent. C'est toujours un plaisir de partager des moments avec toi, bref tu l'as compris tu es un ami formidable.

Marine, Marine, Marine. Merci pour ton accueil si chaleureux. Nous n'avons nul besoin de nous parler pour nous comprendre. Ton foyer est devenu ma deuxième maison et tu fais partie de mon quotidien.

Maintenant bien sûr ma famille, qui bien que loin s'est manifestement inquiétée pour moi : mes parents mais aussi mes frères. J'ai été touchée de voir les présents à ma soutenance et de recevoir les messages d'encouragement des absents.

Enfin, merci Maxime. Tu m'as soutenu pendant cette aventure, dans les bons moments mais aussi dans les plus difficiles. Merci pour ta patience et le soin avec lequel tu t'occupes de moi. Que les aventures ensemble soient encore nombreuses !

Abstract

Today the consideration of environmental issues is essential in relation to companies' sustainability policy. The literature review reveals that ecodesign is not an easy viewpoint to integrate due to its specificities. Despite the great number of existing tools and methods, companies still encounter difficulties for implementing ecodesign in their design process.

This research work aims at providing a methodological framework: a combined solution including a methodology supported by a software platform. The methodology guides the design team through a series of steps to be realized in the design process. And, to manage ecodesign activities, we defined the structure of a software platform gathering the necessary tools for the design team: tools for the design of the product life cycle, an assessment tool for the cost and the environmental impacts, a guidance tool based on ecodesign rules and case studies, a monitoring tool for the project indicators, and databases in relation with the model of the product and its life cycle.

The results of two industrial experiments demonstrate the validity of our proposal. However, a limit of the platform has been identified during the second case study. A third experiment has therefore been realised during a workshop in an international conference to tackle this point.

Key words: Ecodesign methodology, Ecodesign platform, Integrated design, Product development, Household appliances, G.EN.ESI European project

La prise en compte des enjeux environnementaux est aujourd'hui un point essentiel dans la stratégie de développement durable des entreprises. La revue de la littérature montre que l'écoconception n'est pas simple à intégrer du fait de ses spécificités. Malgré le nombre important d'outils et de méthodes existantes, les entreprises rencontrent encore souvent des difficultés à intégrer l'écoconception dans leur processus de conception.

Ces recherches proposent donc un cadre méthodologique : une solution couplant une méthodologie et une plateforme logicielle. La méthodologie guide l'équipe de conception à travers une série d'étapes à réaliser dans le processus de conception. Et pour gérer les activités d'écoconception, nous avons défini la structure d'une plateforme logicielle rassemblant les outils nécessaires à l'équipe de conception : des outils pour la conception du cycle de vie du produit, un outil d'évaluation des impacts coût et environnement, un outil d'aide à base de règles de conception et d'études de cas, un outil de suivi des indicateurs projet et des bases de données en relation avec le modèle produit et son cycle de vie.

Les résultats de deux expérimentations industrielles démontrent la validité de notre proposition. Cependant, une limite de la plateforme a été identifiée lors du second cas d'étude. Une troisième expérimentation a donc été réalisée lors d'un atelier pendant une conférence internationale pour solutionner ce point.

Mots clés : Méthodologie d'éco-conception, Plate-forme d'éco-conception, Conception intégrée, Développement de produits, Appareils électroménagers, Projet européen G.EN.ESI

Contents

ABSTRACT	i
CONTENTS.....	iii
LIST OF TABLES.....	vii
LIST OF FIGURES	viii
ACRONYMS	x
CHAPTER 1 GENERAL INTRODUCTION.....	1
CHAPTER 2 CONTEXT	13
1 THE SPECIFICITIES OF ECODESIGN INTEGRATION.....	15
1.1 <i>Ecodesign definition</i>	15
1.2 <i>Ecodesign principles</i>	16
1.2.1 Early integration into the design process.....	16
1.2.2 The product life cycle and multicriteria approaches.....	17
1.2.3 Functionality.....	18
1.3 <i>Specificities of ecodesign integration at different levels of the company</i>	18
1.3.1 The green wall.....	18
1.3.2 Involvement of the company strategy.....	19
1.3.3 Identification and collection of environmental data.....	21
1.3.4 New knowledge and skills.....	21
1.3.5 A broader vision of the product.....	22
1.4 <i>Methods and tools</i>	23
1.4.1 Definition.....	23
1.4.2 Tools.....	23
1.4.3 Limits of the applications of those tools.....	26
2 SYNTHESIS OF THE CONTEXT, PROBLEMATIC AND BARRIERS.....	27
CHAPTER 3 STATE-OF-THE-ART	31
1 ORGANIZATIONAL BARRIER: ANALYSIS OF INTEGRATED DESIGN PROPERTIES.....	33
1.1 <i>Definition</i>	33
1.2 <i>Properties to set up an integrated design approach</i>	35
1.2.1 Consideration of viewpoints.....	36
1.2.2 Implementation of constraints into requirements.....	37
1.2.3 New organizations.....	37
1.2.4 Creation of a multidisciplinary design team.....	37
1.2.5 Project manager.....	38
1.3 <i>Integrated design for ecodesign: Benefits and Limits</i>	39
2 TECHNICAL BARRIER: REVIEW OF TOOLS, METHODS AND INTERCONNECTED SOLUTIONS.....	42
2.1 <i>Integrated design: tools and methods</i>	42
2.1.1 Product model and data management.....	42
2.1.2 Specific management tools.....	44
2.1.3 Limits of the tools.....	45
2.2 <i>Interconnected solutions for ecodesign</i>	46
2.2.1 Interconnecting tools and platforms for ecodesign.....	47

2.2.2	Collaborative platforms for environmental data sharing	52
2.2.3	Conclusions on interconnected tools and platforms	52
3	METHODOLOGICAL BARRIER: REVIEW OF EXISTING METHODOLOGIES	55
3.1	<i>Ecodesign methodologies</i>	55
3.1.1	Methodologies linking environmental management and design activities	56
3.1.2	Methodologies focused on the product development process	62
3.1.3	Methodologies focused on energy concerns	64
3.1.4	Conclusions on methodologies	65
4	CONCLUSIONS	66
CHAPTER 4 DETAILED PROBLEMATIC		67
1	DETAILED PROBLEMATIC	69
2	DESCRIPTION OF THE WORKING HYPOTHESIS.....	71
2.1	<i>N1) The role of stakeholders: Involvement of all actors of the product life cycle</i>	71
2.1.1	Need for an environmental design manager	71
2.1.2	Involvement of all company departments.....	72
2.1.3	Involvement of the management	73
2.1.4	Involvement of the supply chain.....	73
2.2	<i>N2) Tools for the design of products and its life cycle</i>	73
2.2.1	Need for specific life cycle tools	73
2.2.2	Communication between classic tools and specific tools	74
2.3	<i>N3) Indicators and guidance tool to manage environmental information</i>	74
2.3.1	A guidance tool	74
2.3.2	A way to assess the product on environmental and cost features	75
2.3.3	Link between the evaluation module and the guidance tool	75
2.3.4	A way to monitor environmental criteria	75
2.4	<i>N4) Data and information management</i>	76
2.4.1	A way to store new information and taken decisions.....	76
2.4.2	A link between the product and life cycle models with the evaluation module.....	76
2.4.3	Databases	76
2.4.4	A way for supplier to provide their information to the lead company	76
2.5	<i>N5) A procedure to be in line with the design process</i>	77
3	CONCLUSION	77
CHAPTER 5 A WHOLE SOLUTION: A METHODOLOGY SUPPORTED BY AN ENGINEERING PLATFORM.....		79
1	THE PROPOSED STRUCTURE FOR THE PLATFORM	81
1.1	<i>Involved stakeholders</i>	82
1.2	<i>Tools for project management support</i>	83
1.3	<i>Tools for operating design activities</i>	84
1.4	<i>Vehicles of the environmental information</i>	85
1.5	<i>Models</i>	85
1.6	<i>The proposed eco design methodology related to the platform</i>	90
2	ILLUSTRATION OF A SOFTWARE IMPLEMENTATION OF THE PLATFORM: THE G.EN.ESI PLATFORM	99
2.1	<i>Platform generalities</i>	99
2.2	<i>Detailed description of the tools</i>	101
2.2.1	Eco-Audit	101
2.2.2	DfEE	104
2.2.3	LeanDFD.....	104
2.2.4	CBR	104
2.2.5	eVerDEE	104
2.2.6	The Supplier Web portal	105
2.3	<i>G.EN.ESI Platform use</i>	105

2.4	<i>G.EN.ESI implementation</i>	107
2.5	<i>G.EN.ESI platform advantages</i>	108
2.6	<i>G.EN.ESI platform weaknesses</i>	108
3	CONCLUSION	109
CHAPTER 6 EXPERIMENTAL STUDIES		111
1.	HYPOTHESIS AND EXPERIMENTAL PROGRAM	113
1.1.	<i>Hypothesis</i>	113
1.2.	<i>Experimental program</i>	113
2.	EXPERIMENT N°1: ILLUSTRATION OF THE DEPLOYMENT OF THE SOLUTION THROUGH THE REDESIGN OF A COOKER HOOD	115
2.1.	<i>Objective of the experiment in Faber</i>	115
2.2.	<i>Faber</i>	115
2.3.	<i>A timeline to implement the methodology and the software platform into Faber product design process</i>	116
2.4.	<i>PHASE 1: The current Faber product design process</i>	118
2.5.	<i>PHASE 2: Illustration of the application of the methodology and the associated platform in Faber design process</i>	125
2.5.1.	Changes before the start of the new design project	125
2.5.2.	Changes in the design process through the application of the methodology	128
2.6.	<i>PHASE 3: Necessary steps for a full integration of the methodology and the platform in Faber design process</i>	140
2.6.1.	Training sessions	140
2.6.2.	Other training materials	140
2.6.3.	The redesign of the Stilux cooker hood by Faber	141
2.7.	<i>Conclusion and validation of assumption</i>	141
2.7.1.	Conclusion	141
2.7.2.	Validation of the assumption	141
3.	EXPERIMENT N°2: IMPLEMENTATION OF THE APPROACH IN THE DESIGN OF A NEW RANGE OF PUBLIC BENCHES	144
3.1.	<i>Objective of the experiment in Aubrilam</i>	144
3.2.	<i>Aubrilam</i>	144
3.3.	<i>Choice of the case study</i>	144
3.4.	<i>Implementation of the methodology in Aubrilam</i>	146
3.4.1.	PHASE 1: First contact with the company, setting up of the general objectives of the collaboration ...	148
3.4.2.	PHASE 2: Interviews with the different departments to establish the modelling of the design process	148
3.4.3.	PHASE 3A: Application of the methodology during the range design process	152
3.4.4.	PHASE 3B: Realization of the mapping between the different departments	159
3.4.5.	PHASE 4: Feedbacks and recommendations to improve ecodesign integration	163
3.5.	<i>Development of a demonstrator tool</i>	164
3.5.1.	General structure	164
3.5.2.	General use	165
3.6.	<i>Synthesis and perspective</i>	169
3.7.	<i>Conclusion and validation of the thesis hypothesis</i>	169
4.	EXPERIMENT N°3: A SERIOUS GAME FOR A WORKSHOP	172
4.1.	<i>Objective of the experiment during the workshop</i>	172
4.2.	<i>Context of the workshop</i>	172
4.3.	<i>Proceedings of the session</i>	173
4.4.	<i>Content of the serious game</i>	173
4.4.1.	Building design teams	174
4.4.2.	Materials	174
4.4.3.	Aim of the game	174
4.4.4.	How to play the game	175

4.5.	<i>Exploitation of the results</i>	177
4.6.	<i>Feedback of the participants</i>	178
4.7.	<i>Conclusion of this experiment</i>	181
5.	CONCLUSION OF THE THREE EXPERIMENTS	182
CHAPTER 7	CONCLUSIONS AND PERSPECTIVES	185
REFERENCES	195
RESUME EN FRANÇAIS	205
ANNEX	239

List of Tables

TABLE 1: SUMMARY OF SOFTWARE NEEDS FOR A COMPLETE INTEGRATION OF ECODESIGN IN THE DESIGN PROCESS..... 53

TABLE 2: THE ARPI FRAMEWORK (SIMON ET AL. 2000)..... 58

TABLE 3: SUMMARY OF METHODOLOGICAL NEEDS FOR A COMPLETE INTEGRATION OF ECODESIGN IN THE DESIGN PROCESS 65

TABLE 4: COMPOSITION OF THE OUTPUTS OF THE SPECIFIC TOOLS..... 86

TABLE 5: THE FIVE TOOLS AND THE SEVEN FUNCTIONALITIES PROVIDED BY THE G.EN.ESI PLATFORM..... 100

TABLE 6: OVERVIEW OF THE CURRENT ECODESIGN ASPECTS IN THE COMPANY 151

TABLE 7: ILLUSTRATION OF THE MAPPING REALIZED BETWEEN THE LIFE CYCLE PARAMETERS AND THE COMPANY DEPARTMENTS 160

TABLE 8: MAPPING BETWEEN LIFECYCLE PARAMETERS AND COMPANY DEPARTMENTS (PART 1)..... 161

TABLE 9: MAPPING BETWEEN LIFECYCLE PARAMETERS AND COMPANY DEPARTMENTS (PART 2)..... 162

TABLE 10: CONTENT OF THE DROP-DOWN MENUS..... 166

TABLE 11: RESULTS OF THE SIX TEAMS 178

List of Figures

FIGURE 1: OVERVIEW OF THE DESIGN RESEARCH METHODOLOGY (DRM) (BLESSING & CHAKRABARTI 2009)	7
FIGURE 2 TYPES OF DESIGN RESEARCH PROJECTS AND THEIR MAIN FOCUS (BLESSING & CHAKRABARTI 2009)	8
FIGURE 3: SYNOPTIC OF OUR RESEARCH APPROACH.....	11
FIGURE 4: LINGUISTIC MAP OF “ECODESIGN” (KARLSSON & LUTTROPP 2006)	16
FIGURE 5: POTENTIAL FOR ENVIRONMENTAL IMPROVEMENT (DOTTED CURVE) AND KNOWLEDGE ABOUT THE PRODUCT (FULL CURVE) DURING THE DIFFERENT PHASES OF THE DESIGN PROCESS (IN (HAUSCHILD ET AL. 2004) FROM (HAUSCHILD ET AL. 1999))... ..	17
FIGURE 6: PRODUCT LIFE CYCLE	17
FIGURE 7: PRODUCT DEVELOPMENT TEAM (WHITE ET AL. 2008).....	20
FIGURE 8: CONSIDERATIONS WITHIN THE DESIGN PROCESS (LUTTROPP & LAGERSTEDT 2006)	22
FIGURE 9: SCOPE OF APPLICATION OF THREE TYPES OF LIFE CYCLE COST (UNEP 2011)	26
FIGURE 10: CHALLENGES FOR A GOOD INTEGRATION OF ECODESIGN AND IDENTIFICATION OF BARRIERS.....	28
FIGURE 11: PRODUCT CENTERED ACTIVITY (ADAPTED FROM (POVEDA 2001)).....	34
FIGURE 12: DISCONNECTION BETWEEN THE DESIGN TEAM AND THE ENVIRONMENTAL ACTOR (LEFT) AND INTEGRATED ENVIRONMENTAL ACTOR (RIGHT) (MILLET ET AL. 2007)	40
FIGURE 11: SOLIDWORKS SUSTAINABILITY DASHBOARD (DASSAULT SYSTÈMES 2011)	48
FIGURE 14: ENOVIA ENVIRONMENTAL DATA WORKBENCH (EDW) ARCHITECTURE (THERET ET AL. 2011).....	49
FIGURE 15: EROD PLATFORM ARCHITECTURE (FAVI ET AL. 2012)	50
FIGURE 16: ILLUSTRATION OF THE FRAMEWORK OF AN ECODESIGN METHODOLOGY	55
FIGURE 17: ECODESIGN STRATEGY WHEEL LIFE CYCLE DESIGN STRATEGY WHEEL – LIDS WHEEL (BREZET ET AL. 1997)	57
FIGURE 18: IMPLEMENTATION OF THE EDIMS METHOD FOR AN ECODESIGN PROJECT WITH AN ADVISORY TECHNICAL CENTRE (LE POCHAT ET AL. 2007)	59
FIGURE 19: THE PRINCIPAL FRAMEWORK OF “CONVERGENCE” PROPOSALS (ZHANG ET AL. 2013).....	61
FIGURE 20: EXAMPLE OF A GENERIC MODEL OF INTEGRATING ENVIRONMENTAL ASPECTS INTO THE PRODUCT DESIGN AND DEVELOPMENT PROCESS (ISO 14062 2002).....	62
FIGURE 21: MODEL FOR SYSTEMATIC USE OF DIFFERENT TOOLS FOR THE ENVIRONMENTAL PRODUCT DEVELOPMENT (GURAUŠKIENE & VARŽINSKAS 2006)	63
FIGURE 22: SUMMARY OF THE RESEARCH APPROACH TO BUILD THE PROPOSAL.....	70
FIGURE 23: MISSIONS OF AN ENVIRONMENT ACTOR IN PRODUCT DEVELOPMENT (ZWOLINSKI ET AL. 2004)	72
FIGURE 24: LINKS BETWEEN THE ELEMENTS OF THE METHODOLOGY	82
FIGURE 25: REPRESENTATION OF THE DIFFERENT INPUTS AND OUTPUTS OF THE TOOLS	88
FIGURE 26: REPRESENTATION OF THE FEEDBACK LOOP TOWARDS DESIGNERS	89
FIGURE 27: THE PROPOSED METHODOLOGY	90
FIGURE 28: PRODUCT DESIGN PROCESS AND THE THREE MAIN PHASES OF THE METHODOLOGY	91
FIGURE 29: ADDING AN INDICATOR TO THE DASHBOARD.....	92
FIGURE 30: PROCESS OF FEEDBACK TO DESIGNERS FROM LCA RESULTS.....	97
FIGURE 31: G.EN.ESI PLATFORM ARCHITECTURE.....	100
FIGURE 32: INTEGRATION WITH CAD SYSTEMS “CREO”	101
FIGURE 33: INTEGRATION WITH PLM SYSTEM “TEAMCENTER”	102
FIGURE 34: CAD ENVIRONMENT WITH THE MI:MATERIALS GATEWAY PLUGIN, INCLUDING THE <i>EcoAudit</i> DASHBOARD.....	103
FIGURE 35: G.EN.ESI PLATFORM ENVIRONMENTS	106
FIGURE 36: ACTIVITIES REALIZED DURING THE G.EN.ESI PROJECT IN ORDER TO IMPLEMENT THE METHODOLOGY AND THE SOFTWARE PLATFORM IN FABER.....	117
FIGURE 37: ACTIVITY BOX AND INTERFACE ARROWS USED IN THE ANALYSIS.....	118

FIGURE 38: IDEFO "PARENTAL DIAGRAM" STRUCTURE.....	119
FIGURE 39: LEVEL BB _ PRODUCT DEVELOPMENT PROCESS GLOBAL ACTIVITY	120
FIGURE 40: LEVEL A.0 _ THE FOUR MAJOR PHASES OF THE PRODUCT DEVELOPMENT PROCESS.....	122
FIGURE 41: LEVEL A.1 _ FEASIBILITY PHASE	123
FIGURE 42: LEVEL A.2 _ DEVELOPMENT PHASE	124
FIGURE 43: FUNCTIONAL GROUPS AND STANDARD COMPONENTS FOR COOKER HOODS (LEFT) _ IMAGE OF THE STILUX COOKER HOOD (RIGHT)	125
FIGURE 44: LEVEL BB _ GENERAL PRODUCT DEVELOPMENT PROCESS WITH THE ELEMENTS OF THE METHODOLOGY	126
FIGURE 45: CO ₂ EMISSIONS OF THE COOKER HOOD FOR EACH LIFE CYCLE PHASE	130
FIGURE 46: ENERGY USES OF THE COOKER HOOD FOR EACH LIFE CYCLE PHASE.....	131
FIGURE 47: CAD MODEL OF THE COOKER HOOD	132
FIGURE 48: ENVIRONMENTAL KNOWLEDGE FEEDBACK LOOP.....	134
FIGURE 49: LEVEL A.0 _ PRODUCT DEVELOPMENT PROCESS WITH THE FOUR MAJOR PHASES AND WITH THE ELEMENTS OF THE METHODOLOGY	135
FIGURE 50: LEVEL A.1 _ FEASIBILITY PHASE WITH THE ELEMENTS OF THE METHODOLOGY	136
FIGURE 51: LEVEL A.1.3 _ PRELIMINARY DESIGN WITH THE ELEMENTS OF THE METHODOLOGY	137
FIGURE 52: LEVEL A.2 _ DEVELOPMENT PROCESS WITH THE ELEMENTS OF THE METHODOLOGY	138
FIGURE 53: LEVEL A.2.5 _ DETAILED ENVIRONMENTAL DEVELOPMENT	139
FIGURE 54: MEETINGS IN AUBRILAM AND MAIN ACTIONS REALIZED	147
FIGURE 55: MAIN STEPS OF THE AUBRILAM DESIGN PROCESS WITH THE MAIN OUTPUTS AFTER EACH STEP	148
FIGURE 56: CONTRIBUTION OF THE DIFFERENT COMPONENTS TO THE LCA OF THE MANUFACTURING PHASE	153
FIGURE 57: DETAILED CONTRIBUTION OF THE WOODEN SLATS TO THE LCA OF THE MANUFACTURING PHASE.....	154
FIGURE 58: DETAILED CONTRIBUTION OF THE STEEL STRUCTURE TO THE LCA OF THE MANUFACTURING PHASE	154
FIGURE 59: LCA OF THE FIRST DETAILED VERSION OF THE BENCH	156
FIGURE 60: LCA OF THE SECOND VERSION OF THE BENCH AFTER THE FIRST PROTOTYPE	157
FIGURE 61: COMPARISON OF THE TWO VERSIONS OF THE BENCH.....	157
FIGURE 62: AUBRILAM NEW RANGE CALLED "RENDEZ-VOUS".....	158
FIGURE 63: OPERATING MODE TO USE THE DEMONSTRATOR TOOL AS A USER	165
FIGURE 64: PART OF THE SHEET FOR THE MANUFACTURING PHASE INVENTORY.....	167
FIGURE 65: CONTENT OF THE 'RESULTS' SHEET.....	168
FIGURE 66: PROCESS OF FEEDBACK TO DESIGNERS FROM LCA RESULTS.....	170
FIGURE 64: BENCH TO REDESIGN	173
FIGURE 68: EXAMPLE OF TWO ACTIONS CARDS FOR THE PURCHASING MANAGER	176
FIGURE 69: ILLUSTRATION OF THE GAME PROCEEDINGS	177
FIGURE 70: ILLUSTRATION OF THE INTERRELATIONS BETWEEN THE COMPANY DEPARTMENTS SHOWED TO THE PARTICIPANTS	180
FIGURE 71: FRAMEWORK FOR A KNOWLEDGE-SHARING PLATFORM.....	191
FIGURE 72: PRODUCT LIFE CYCLE	210
FIGURE 73: LES ENJEUX DE L'INTEGRATION DE L'ECO-CONCEPTION.....	212
FIGURE 74: LES ENJEUX DE L'INTEGRATION DE L'ECO-CONCEPTION ET REPONSE DE LA CONCEPTION INTEGREE A CERTAINS DE CES ENJEUX (EN BLANC).....	215
FIGURE 75: STRUCTURE DE LA PLATEFORME PROPOSEE ET LIENS AVEC LES ACTEURS.....	221
FIGURE 76: LA METHODOLOGIE PROPOSEE.....	223
FIGURE 77: ACTIVITES REALISEES PENDANT LE PROJET G.EN.ESI POUR METTRE EN PLACE LA METHODOLOGIE ET LA PLATEFORME LOGICIELLE DANS L'ENTREPRISE FABER	228
FIGURE 78: CHRONOLOGIE DES ACTIONS ET DES REUNIONS REALISEES AVEC AUBRILAM	232
FIGURE 79: EXTRAIT DE LA CARTOGRAPHIE.....	233

Acronyms

BOM	Bill Of Materials
CAD	Computer Aided Design
CAPM	Computer-Aided Production Management systems
CBR	Case based reasoning
DfEE	Design for Energy Efficiency
EPD	Environmental Product Declaration
CSR	Corporate social responsibility
ERP	Enterprise Resource Planning
FEA	Finite Element Analysis
FMEA	Failure Mode and Effects Analysis
G.EN.ESI	Green ENgineering and dESIgn
LCA	Life Cycle Assessment
LCC	Life Cycle Costing
LeanDFD	Lean Design For Disassembly
PEP	Product Environmental Profile
PERT	The program (or project) evaluation and review technique
PLM	Product Lifecycle Management
S-LCA	Simplified Life Cycle Assessment
S-LCC	Simplified Life Cycle Cost
UML	Unified Modeling Language
XML	Extensible Markup Language

Chapter 1

General introduction

The environmental situation

Following the industrial revolution, 150 years of industrial evolution saw the development of a consumer society that has dramatically increased the demand for natural resources. The production and consumption model of this society is based on abundant natural resources and a linear approach: ‘Take, Make, Dispose’. Companies manufacture products from extracted materials, and sell them to consumers. The products are then discarded after use. According to a report of the Ellen MacArthur Foundation:

*“This is more true now than ever - in terms of volume, some 65 billion tonnes of raw materials entered the economic system in 2010, and this figure is expected to grow to about 82 billion tonnes in 2020.”*¹

According to different works from the United Nations Environment Programme (UNEP) and other organizations, the level of consumption of natural resources will be unacceptable before the middle of this century due to the global population growth, the consumption growth in developed countries and the aspiration of the inhabitants of developing countries to achieve lifestyles comparable to ours. The use of natural resources has already exceeded the Earth's biocapacity, its capacity to regenerate renewable resources, to provide nonrenewable resources and to absorb waste. Moreover, the scarcity of some minerals and metals such as cobalt, magnesium, rare earths, tungsten, etc., can create socio-political tensions and inequalities.

Furthermore, this resource depletion is not the whole story; climate change is the greatest environmental challenge situation. Indeed, the current warming of the Earth's climate system, called global warming, has disastrous effects: a rise in sea levels, glacier retreats, a change in the amount and pattern of precipitation, a probable expansion of subtropical deserts, etc. In its fourth assessment², the Intergovernmental Panel on Climate Change (IPCC) reported that scientists were more than 90% certain that most of global warming was being caused by increasing concentrations of greenhouse gases produced by human activities.

In December 2008, the European Parliament passed the "20-20-20" plan, which stipulated a 20% reduction in greenhouse gas emissions, a 20% improvement in energy efficiency and a 20% share for renewable energy in the fuel mix of European Union member countries by 2020. The industrial sector plays a fundamental role in this scheme since it is responsible for a consistent part of the emissions and of resources depletion.

Industries' responsibility

As part of the linear economy and the consumption society, manufacturers developed production strategies to reduce the products' lifespans and marketing strategies driving the

¹ “Towards the Circular Economy 1: Economic and Business Rationale for an Accelerated Transition” is a report commissioned by the Ellen MacArthur Foundation and developed by McKinsey & Company in 2012.

² IPCC. Fourth Assessment Report: Climate Change 2007 (AR4)

products obsolescence through fashion, advertisement and technic planned obsolescence. Planned obsolescence is the deliberate creating of products that will not last and cannot be repaired. Manufacturing industries therefore needs to put efforts into changing their habits. In 1984, Papanek already said that by putting products on the world market, companies, their network of suppliers and partners, have a huge responsibility and a key role in the paradigm shift (Papanek 1984).

Approaches known as “Design for the Environment” (DfE) or ecodesign, defined as the systematic integration of environmental considerations into product and process design, are proposed in the literature as possible solutions. Ecodesign aims at designing a product or a system considering its negative effects on the environment throughout its life cycle in order to reduce them without altering its quality or its performance. **Our research is positioned in the field of ecodesign of products and systems.**

Ecodesign in companies

Ecodesign is today an essential topic of sustainability policy in companies. Ecodesign has been developed since the first wave of sustainability during the 1960’s (Bhamra & Lofthouse 2007), when designers such as Victor Papanek began to link the environmental concerns of scientist with the art of production. In the last two decades, the interest for ecodesign became increasingly important in order to prevent further degradation of many environmental indicators (waste production, CO₂ emissions, resources depletion, biodiversity loss, etc.). Ecodesign is an approach leading to new technological solutions able to consume fewer natural resources; it also limits all the environmental impacts, while still producing economic wealth.

Ecodesign has a major role to play in the reduction of the environmental impacts of the products. Indeed, the design phase is an important phase of the product life because it determines the success or failure of the commercial offer and because decisions made during the design phase have a significant effect on the product environmental impacts. It is estimated that 80% of environmental impacts are pre-defined in the product design phase.

Since millions of products are sold every day, new means of actions are necessary to support companies, and especially designers, in the ecodesign approach.

A wealth of ecodesign tools have been developed to support designers during all stages of the product design process (Navarro et al. 2005). Three broad categories of methods and tools dedicated to environmental assessment were first developed to help ecodesign decision-making:

- Quantitative environmental assessments often used in detailed design phase or for a product redesign.
- Qualitative tools such as "guidelines" used at the conceptual design phase, even if they do not return quantitative indications to designers.
- Indicators (rate of recyclability, energy use, etc.) that are often developed in-house in order to provide a reference to ensure compliance with standards and guidelines.

Despite the great number of tools and methods, their use is still limited (Lindahl 2005). One reason for this low use is that tools and methods are dedicated to experts due to specific knowledge requirement (Le Pochat et al. 2007); another is that there is a lack of information about how to use them (Fargnoli & Kimura 2007). Furthermore, the compatibility between tools is not guaranteed (Le Pochat et al. 2007). Thus a methodology is needed to choose and use the existing tools. The ISO 14062 standard describes how to integrate environmental aspects into product development; Fargnoli and Kimura (Fargnoli & Kimura 2007) propose a new design process for the development of sustainable products, supported by a series of indications providing information on how to apply the most common ecodesign tools. However, despite this methodological development, literature around the topic still reveals a disappointing lack of successful and entrenched examples of ecodesign (Knight & Jenkins 2009). The reasons given for this discrepancy vary from a misalignment between the tools and the working practices of designers (Lofthouse 2006a), to a failure to support ecodesign from a wider business perspective (White et al. 2008). Moreover, these tools are usually stand-alone and not well integrated into traditional design tools. As a result, these tools only achieve very limited penetration to industry (Lofthouse 2006a).

It therefore appears that the challenge lies more in the integration of existing tools and in a real ecodesign implementation in design processes than in the development of new tools.

A transition towards a real integration in design processes

In order to propose a transition towards a real integration of ecodesign in design processes, we propose to consider the concurrent engineering field.

Concurrent engineering supports the different viewpoints to be taken into account to achieve the best trade-off in a product development process (Sohlenius 1992). A point of view is the vision and expertise of an expert involved in a design team (Brissaud & Tichkiewitch 2001). An expert can see the product under consideration in a particular phase of its life cycle from his own perspective and then he can describe the objectives and the constraints that the product will meet at a particular stage of its life cycle. This concept of perspective allows him to express the objectives related to the product. The different experts' viewpoints have then to be considered simultaneously to make the final solution emerge. The approach that supports this viewpoint integration is called **integrated design** (Tichkiewitch & Brissaud 2003). Thus, integrated design is a practice to integrate different values of the product life cycle in the early phases of the design process, values that include not only the primary functions of the product, but also aesthetics, manufacturability, assemblability, recyclability (Ishii 1993; Sakai & Takata 2012). The question is: How to support the integration of ecodesign activities in a design project team, knowing that numerous disciplines are addressed by the environmental concerns? Indeed, given the definition of integrated design, **ecodesign results in the introduction of an additional perspective in integrated design teams: the environmental point of view.**

Moreover, ecodesign projects are very various in nature (Hernandez Pardo et al. 2011). So, different approaches exist to integrate a new expertise in a team.

A first approach could be the integration of new experts into the design team. But design teams cannot continue to grow at the pace of the integration of every new expertise; as highlighted by Asquin et al. (Asquin et al. 2010), this form of organization may leave some employees distraught.

A second solution is to ask a team member to assume multiple roles by becoming multi-experts, following the example of quality engineers who are now Quality/Safety/Environment experts. The difficulty here lies in the fact that increasing the number of areas of expertise of the same person will inevitably reduce its general level of expertise.

A third option is to support the integration of the new expertise by tools and methods that make expert knowledge and skills available for the project. For environment-based knowledge, dedicated methods and tools have already been but did not achieve the expected performance because of their difficulty to be used consistently and complementary.

We highlight here difficulties to integrate a new perspective.

Research methodology developed for this work:

“The overall aim of design research: to make design more effective and efficient, in order to enable design practice to develop more successful products” (Blessing & Chakrabarti 2009). Regarding the industries’ responsibility to the current environmental situation, the objective of this research is thus to improve the consideration and the implementation of ecodesign in companies in order to develop eco-designed products.

This work was carried out following a Design Research Methodology (DRM) referring to Blessing and Chakrabarti framework (2009) which provides a flexible framework for design research in order to improve the chances of producing a successful product. DRM consists of four stages, depicted in Figure 1: Research Clarification, Descriptive Study I, Prescriptive Study and Descriptive Study II.

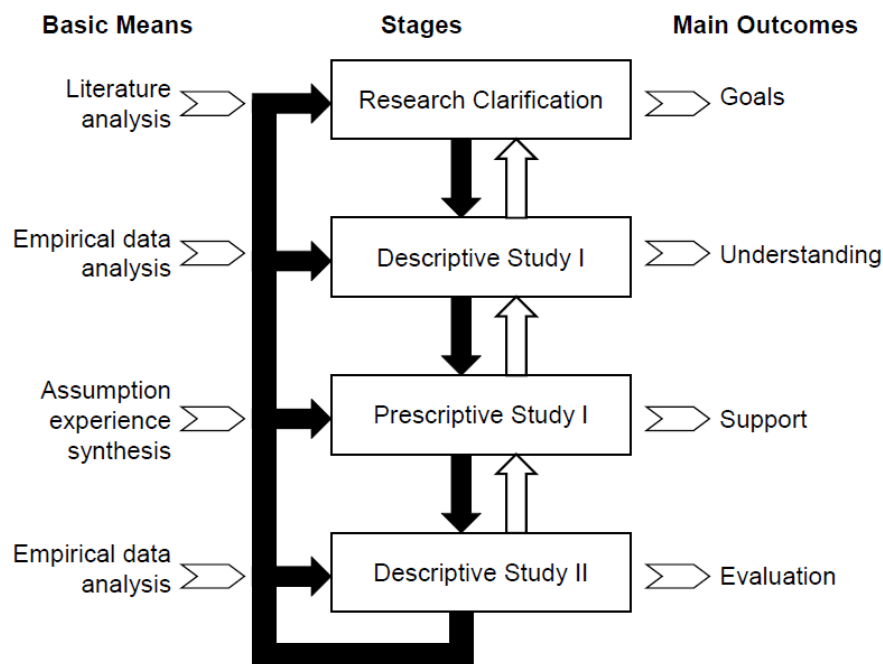

Figure 1: Overview of the Design Research Methodology (DRM) (Blessing & Chakrabarti 2009)

Blessing and Chakrabarti specify that “*DRM is not a set of stages and supporting methods to be executed rigidly and linearly*”; nevertheless the stages can be summarized as followed (Blessing & Chakrabarti 2009):

- The Research Clarification (RC) stage is essential to determine the aim, focus and scope of the research project.
- The Descriptive Study I (DS-I) stage aims at increasing the understanding of design, to elaborate the initial description of the existing situation and to inform the development of a support.
- The Prescriptive Study (PS) stage aims at developing a design support. This support can be a new method or tool that is expected to provide a practical benefit to the research objectives.
- The Descriptive Study II (DS-II) stage focuses on evaluating the usability and applicability of the support and its usefulness.

Blessing and Chakrabarti lists seven possible types of research depending on the research question and hypotheses, the available time and resources. It means that for a particular research project a comprehensive study could be required or a review-based study could be sufficient. A review-based study consists in a review of the literature while a comprehensive study involves a literature review and a study in which the results are produced by the researcher. An initial study ends a project and consists in the first few steps of a particular stage. Figure 2 illustrates the different types of research.

Research Clarification	Descriptive Study I	Prescriptive Study	Descriptive Study II
1. Review-based	→ Comprehensive		
2. Review-based	→ Comprehensive	→ Initial	
3. Review-based	→ Review-based	→ Comprehensive	→ Initial
4. Review-based	→ Review-based	→ Review-based Initial/ Comprehensive	→ Comprehensive
5. Review-based	→ Comprehensive	→ Comprehensive	→ Initial
6. Review-based	→ Review-based	→ Comprehensive	→ Comprehensive
7. Review-based	→ Comprehensive	→ Comprehensive	→ Comprehensive

Figure 2 Types of design research projects and their main focus (Blessing & Chakrabarti 2009)

PhD projects in 3 to 4 years in research design usually follow the first four types of research because of time and resources constraints (Blessing & Chakrabarti 2009). This work is a type of research 3. Each stage is described below, referring to Figure 3 summarizing the general research approach.

Research Clarification (RC)

The design process must now consider the entire life cycle of the product, from raw material to its end of life. In particular, design approaches have to consider environmental constraints early and throughout the whole design process. An analysis of the different specificities of ecodesign integration realized in chapter 2 reveals that the environmental aspect is not an easy viewpoint to integrate. We highlight thus the challenges of ecodesign integration and emphasize three barriers related to organizational, technical and methodological aspects. As these aspects have strong relationships between them, the objective of our research will be to simultaneously remove these barriers.

Descriptive Study I (DS-I)

Through a literature review, we highlight different concepts and elements, that we called “key elements”. They are required to remove each of the highlighted barriers acting against ecodesign integration. This work is presented in chapter 3.

The problematic resulting from the state-of-the-art analysis is thus:

How all these key elements can be considered during the design process in order to remove simultaneously the barriers of ecodesign integration?

According to the key elements identified in the literature review, we develop five working hypotheses representing the needs for an effective integration of ecodesign. Those needs are related to:

- The role of design stakeholders (N1),
- Tools for the design of products life cycles (N2),
- Indicators and guidance tool (N3),
- Data and knowledge management (N4),
- An ecodesign integration procedure (N5).

The problematic and the working hypotheses of our thesis are exposed in Chapter 4.

Prescriptive Study (PS)

Our proposal is built on these working hypotheses. Our goal is not to develop a new ecodesign tool but to propose a solution to improve ecodesign integration. We propose a methodological framework describing an ecodesign methodology and the concepts of a software platform. The combined solution would support design teams in ecological design choices, without losing sight of cost and typical practicalities of industry. The platform gathers the necessary tools to manage ecodesign activities. The proposal is presented in chapter 5.

In order to validate this proposal (i.e. verification of initial hypothesis), we carried out two experiments in different industrial contexts: the first one within the framework of the European project G.EN.ESI and the second within Aubrilam, a French SME.

The G.EN.ESI project

This doctoral work is in relation with a European project aiming at developing a methodology and the related software engineering platform to support the ecodesign of electro-mechanical products. The G.EN.ESI project was a 3-year project, co-financed by the European Commission and made possible within the VII Framework Program FP7. G.EN.ESI stands for Green ENgineering and dESIgn. The G.EN.ESI Consortium is a multidisciplinary team that combines industry and research:

- *Università Politecnica delle Marche, and its Department of Industrial Engineering and Mathematical Science (Italy);*
- *Granta Design, expert in materials information technology (UK);*
- *Bonfiglioli Vectron, specialized in the design and manufacture of electrical drive systems and electric motors (Germany);*
- *FABER Spa, specialized in the design and manufacture of cooker hoods (Italy);*
- *Sibuet Environnement, a waste processing company (France);*
- *University of Bath, and its Mechanical Engineering Department (UK);*
- *Grenoble Institute of Technology, and more particularly the G-SCOP lab, responsible for ecodesign aspects (France);*

- *ENEA, the Italian National Agency for New Technologies, Energy and Sustainable Economic Development (Italy).*

During the G.EN.ESI project, a software implementation of the proposed platform has been developed by Granta Design, ENEA and Università Politecnica delle Marche. The first experiment illustrates the deployment of our methodological framework with this platform through the redesign of a cooker hood. The experiment showed that the methodology associated to the software platform enabled to remove the barriers. Moreover, the solution has been implemented in the Faber Company via training sessions so that the design team could use the solution autonomously.

The second experiment takes place in the Aubrilam Company and shows the importance of the environmental design manager role. This role was performed by me but as I did not know the influence networks between the different departments, this could lead to an inefficient ecodesign process. Indeed, this knowledge is necessary to optimize the redesign process in bringing together the appropriate stakeholders to address each hotspot.

Descriptive Study II (DS-II)

A limit of the proposal has thus been identified during this experiment. A third experiment has therefore been realized at a workshop during an international conference to highlight this point.

These three experiments are presented in chapter 6. Considering the assumptions verifications during the experimentations, the conclusion is that ecodesign integration in industries is stimulated by three main axes: organizational, technical and methodological. The framework proposed in this work acts simultaneously on these three axes and thus facilitates ecodesign integration in companies.

We finally conclude the work conducted in this research thesis in chapter 7 with a summary of the contributions and a list of perspectives.

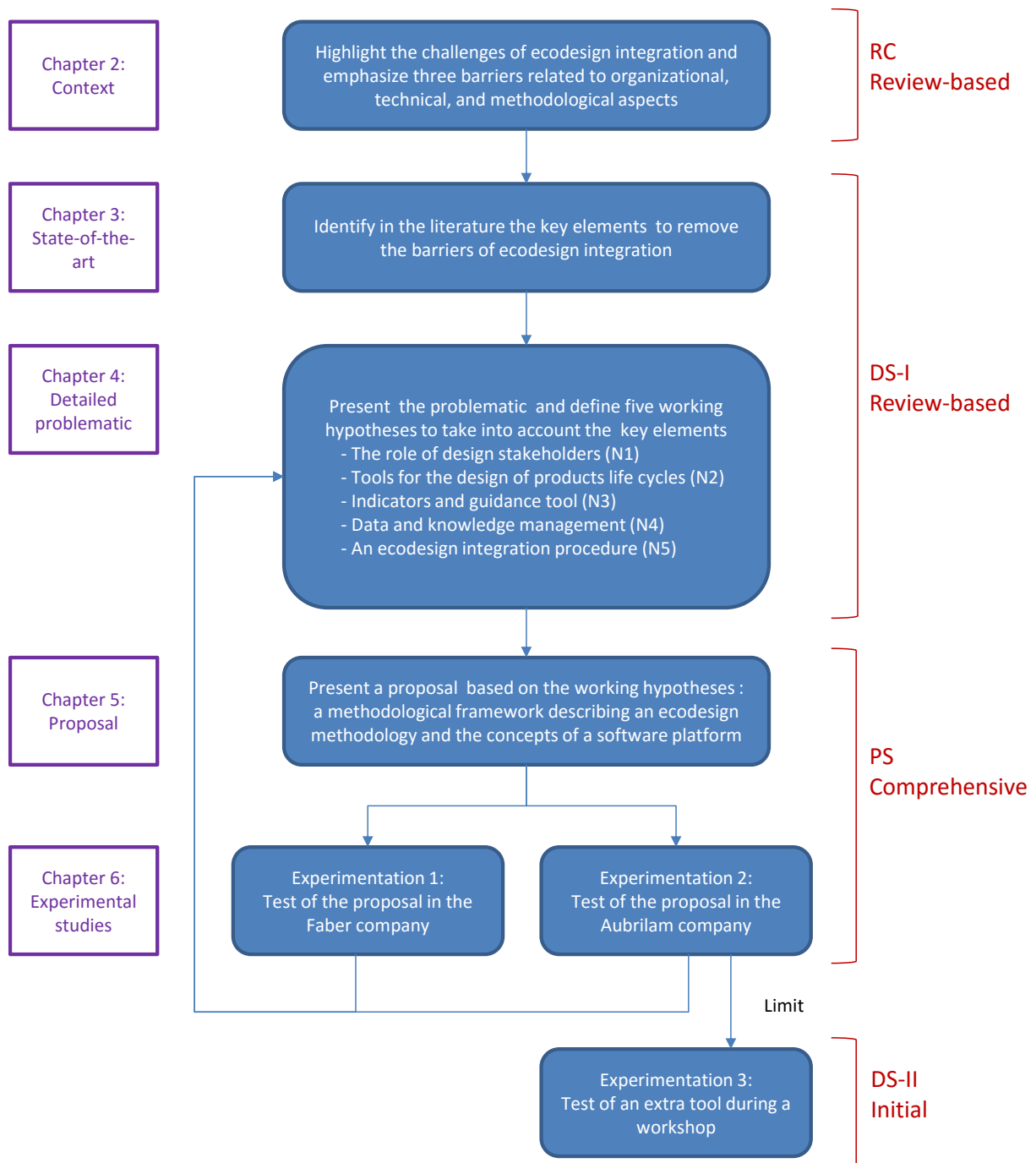

Figure 3: Synoptic of our research approach

Chapter 2

Context

- 1 THE SPECIFICITIES OF ECODESIGN INTEGRATION 15**
- 1.1 ECODESIGN DEFINITION 15
- 1.2 ECODESIGN PRINCIPLES 16
 - 1.2.1 *Early integration into the design process* 16
 - 1.2.2 *The product life cycle and multicriteria approaches* 17
 - 1.2.3 *Functionality*..... 18
- 1.3 SPECIFICITIES OF ECODESIGN INTEGRATION AT DIFFERENT LEVELS OF THE COMPANY 18
 - 1.3.1 *The green wall* 18
 - 1.3.2 *Involvement of the company strategy*..... 19
 - 1.3.3 *Identification and collection of environmental data* 21
 - 1.3.4 *New knowledge and skills* 21
 - 1.3.5 *A broader vision of the product*..... 22
- 1.4 METHODS AND TOOLS 23
 - 1.4.1 *Definition*..... 23
 - 1.4.2 *Tools* 23
 - 1.4.3 *Limits of the applications of those tools*..... 26
- 2 SYNTHESIS OF THE CONTEXT, PROBLEMATIC AND BARRIERS 27**

1 The specificities of ecodesign integration

Currently, mechanical designers provide technical solutions to meet companies' and customers' requirements such as the function to perform, the cost of the product, or its ability to be mass produced. However, increasing focus on the environmental issues leads to looking at new requirements and forces product designers to consider environmental criteria in the design process (Ilgin & Gupta 2010). Thus, ecodesign focuses on the integration of environmental considerations into product development (Karlsson & Luttrupp 2006). In the first section, different definitions are given in the first section and the specificities of ecodesign are explained in the second section.

1.1 Ecodesign definition

The standard ISO/TR 14062 (ISO 14062 2002), related to environmental management, defines ecodesign as the “integration of environmental aspects into product design and development”. In the literature surrounding this research area, there is a range of terms closely referring to this definition. These terms include among others: environmental product development (EPD) (Baumann et al. 2002), green design, ecodesign (van Hemel & Cramer 2002; Gottberg et al. 2006), environmental design, design for the environment (DfE) (Lenox et al. 1996), life cycle design (Vezzoli & Sciama 2006), and sustainable design (Ramani et al. 2010).

All definitions can be included in the general definition of the standard ISO/TR 14062 but some authors expand the idea by adding a characteristic or a specific viewpoint. Hauschild et al (Hauschild et al. 2004) add details such as improving the environmental performance of the product: *“Ecodesign or Design for Environment, DfE, covers any design activity which aims at improving the environmental performance of a product.”* Van Hemel and Cramer (van Hemel & Cramer 2002) express also this concept but introduce another idea which is the inclusion of life cycle thinking: *“By ‘ecodesign’ is meant the systematic and consistent strife for improving the environmental profile of product(s) in all stages of the product life cycle, including proper recycling and disposal.”* Life cycle thinking is inherent in the ecodesign field; that is why other authors highlight this important aspect like Johansson (Johansson 2002). He also refers to the inclusion of environmental considerations alongside traditional design issues, and the synergic nature with which this must be achieved: *“The term ecodesign refers to actions taken in product development aimed at minimising a product’s environmental impact during its whole life cycle, without compromising other essential product criteria such as performance and cost.”* Indeed as this is an engineering domain where companies are subject to competition, cost is always a major criterion. Moreover Karlsson and Luttrupp explains in Figure 4 the linguistic roots of the word EcoDesign and shows the similarity with economy and ecology (Karlsson & Luttrupp 2006).

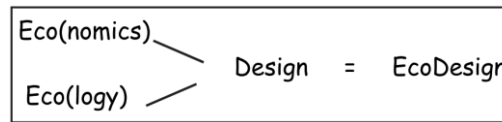

Figure 4: Linguistic map of “EcoDesign” (Karlsson & Luttropp 2006)

However ecodesign refers to a wider perspective than just design activities in a design office and some authors such as Pigosso and Sousa define ecodesign as a management activity: “*Ecodesign is a proactive management approach which directs product development towards environmental impacts reduction along its life cycle*” (Pigosso & Sousa 2011).

So many different definitions exist for ecodesign and it seems necessary to highlight its main principles, developed in the next section.

1.2 Ecodesign principles

According to Bovea and Pérez-Belis, three key factors are required to optimize the design process in term of environmental performance (Bovea & Pérez-Belis 2012):

- The early integration of environmental aspects into the product design and development process.
- The consideration of the entire product life cycle.
- The consideration of a multi-criteria approach.

The functionality of the product is also an important parameter to consider in ecodesign. These four factors are detailed in the following paragraphs.

1.2.1 Early integration into the design process

The integration of the environmental aspects in the early stages of the product design process is necessary to influence the design. Indeed, at the beginning, no decisions have been taken yet and designers have a large freedom on the products (Luttropp & Lagerstedt 2006). Knowledge about the product is weak but this offers the flexibility needed to be able to carry out changes and incorporate improvements into products (Bovea & Pérez-Belis 2012). On the contrary, the more the design process progresses, the more decisions are taken and the less there are possibilities to change the product design regarding environmental considerations. Luttropp and Lagerstedt discuss the dilemma where environmental solutions as well as cost allocations are primarily dependent upon decisions made in the early part of the design process (Luttropp & Lagerstedt 2006). Figure 5 illustrates this concept.

Thus, environmental aspects must be considered already at the moment of specifications. Bhamra et al. noted that “*if ecodesign is only used at the post-specification stage relatively minor environmental changes can be affected and organisation may have difficulty in implementing the principles fully*” (Bhamra et al. 1999). This can lead to “*a lack of enthusiasm for ecodesign once both managers and designers find it difficult to implement their eco-decisions*”. Luttropp and Lagerstedt go further and identify a lack of environmental consideration during the pre-specification stage as a reason for designers not attempting

ecodesign at all (Luttrupp & Lagerstedt 2006). This early inclusion again poses difficulties for those trying to understand how to support ecodesign, because, as Bhamra points out, “*unfortunately this pre-specification stage rarely involves designers.*”

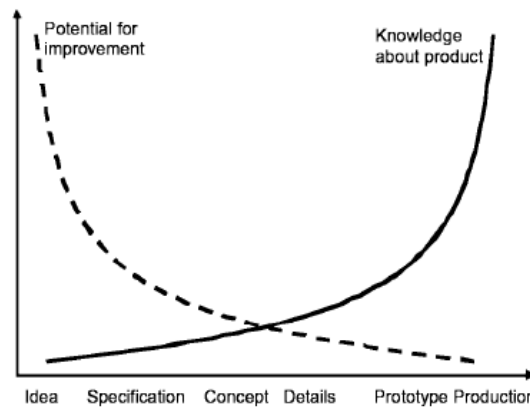

Figure 5: Potential for environmental improvement (dotted curve) and knowledge about the product (full curve) during the different phases of the design process (in (Hauschild et al. 2004) from (Hauschild et al. 1999)).

1.2.2 The product life cycle and multicriteria approaches

The concept of life cycle thinking is the most basic principle of ecodesign. According to ISO 14006, it means considering, during the design and development process, the significant environmental aspects throughout the product life cycle stages. It is important to consider the entire life cycle to have a holistic view of the environmental impacts of the product. Figure 6 represents the product life cycle of the product including raw materials extraction, design and production, packaging and distribution, use and maintenance and end-of-life. The different transport steps existing between the phases are also taken into consideration. The end-of-life phase includes different steps but also different kind of steps. They can be following, complementary, or distinct according to the cases. The end-of-life phase can include, as shown in Figure 6, reuse, materials or components recycling, recovery, incineration and disposal.

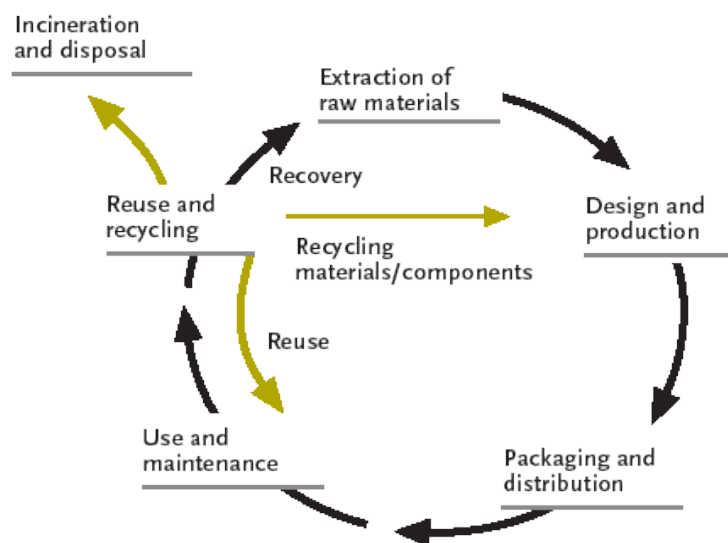

Figure 6: Product life cycle

This life cycle approach is applied to a product which is according to ISO 14040 “any goods or service”. The standard categorizes products under services, software, hardware and processed materials.

Unlike a local approach, the life cycle approach enables to avoid impact transfers between the phases of the life cycle (Millet et al. 2003). For example, improving the energy efficiency of a motor to reduce its energy consumption in use can lead to increasing impacts in another phase of the life cycle. Thus design activity has an influence on all phases of the life cycle; that is why it is important for designers to understand and take into account this notion.

At every stage of its life cycle, the product causes environmental impacts. There are a variety of impacts and they have a different spatial and temporal scale. Indeed, they have short to long term effects and local, regional, or global effects. Environmental impacts can be correlated but a multicriteria approach is required to avoid impacts transfers on the different scales.

In conclusion, these "life cycle" and "multi-criteria" approaches are the core pillars of any environmental assessment in order to prevent the transfer of environmental impacts when modifying product solutions during design.

1.2.3 Functionality

A product is never developed only to respect the environment therefore the first requirement is that the product fulfils its functionalities. Ecodesigning product is really connected to functionality because most research in the area focuses on how to reduce the environmental impact of products throughout their life-cycle by focusing on environmental aspects, while keeping the functionality of the product unchanged (Lagerstedt 2003). The most famous method to evaluate environmental impacts of a product, called Life Cycle Assessment (LCA) bases his evaluation on a functional unit. It is standardized in the ISO 14040 series. The definition given in the ISO 14040 for the functional unit is the “quantified performance of a product system for use as a reference unit”. The aim of ecodesign is then to reduce and optimize environmental impacts without reducing performance.

1.3 Specificities of ecodesign integration at different levels of the company

An analysis conducted by Le Pochat concerning the notion of integration concludes that integration is a change with an organizational objective to improve efficiency (Le Pochat 2005). But ecodesign, with its principles, induced several specificities regarding its integration. The following subsections present these specificities.

1.3.1 The green wall

The integration of ecodesign in companies seems to follow the same scheme than the field of expertise of environmental, health, and safety (EHS). In 1997, Shelton and Shopley said that almost all companies are not integrating EHS knowledge into their management decisions.

Moreover they added that EHS departments are traditionally the least integrated of all business functions and this phenomenon is called “the green wall” (Shelton & Shopley 1997). In other words, the green wall represents the separation of "environmental divisions" and conventional structures. Haveman and Dorfman published in 1999 an article entitled “Breaking Down the ‘Green Wall’: Early Efforts at Integrating Business and Environment at SC Johnson” where they discussed the business integration of EHS issues (Haveman & Dorfman 1999).

However concerning ecodesign activities, a double disconnection is observed: a separation of the environmental stakeholder or division with the rest of departments of the company (Le Pochat 2005) but also with the design team itself (Millet et al. 2003). In his thesis, Le Pochat highlighted that environmental issues must be structurally integrated to all company departments. He added that all the company's businesses - design office, R&D, methods, industrialization, marketing, purchasing department, logistics, etc. - must be involved in ecodesign projects but also suppliers, customers, and those who are involved in recycling networks. Millet noticed that the complexity of tools generates the disconnection between the environmental stakeholder and the design team. He described this disconnection as *temporal* because of the incompatibility between the huge quantity of data necessary for environmental evaluations and the design timeline and as *cognitive* because designers cannot interpret results of these evaluations.

So, two main challenges have been identified. First, we need to promote relational flows within and outside the company. The creation of a new network of internal and external actors and changes in the way the project teams functions are needed. Second, a way must be found to improve the relations between the environmental stakeholder and the design team.

1.3.2 Involvement of the company strategy

We already saw that all the company departments must be involved in an ecodesign project. Designers have a central importance in the ecodesign process but White et al. considered that the design process involves a variety of players, exemplified in Figure 7, who interact in a complex way (White et al. 2008).

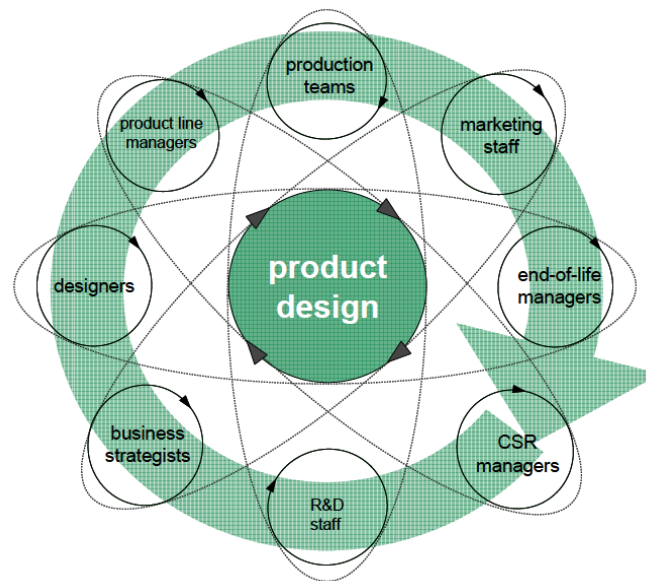

Figure 7: Product development team (White et al. 2008)

The multi-disciplinary nature of the product development process means that designers rarely have the sole responsibility of design decisions, and may not have the power to make decisions which support ecodesign; that is why the involvement of the entire company is necessary. This point of view is supported by Sherwin who points out that “*even in companies recognised for their best practice in eco-/sustainable design, it is no guarantee that it will be designers that are doing it*” (Sherwin 2004). Moreover, the involvement of the company strategy is particularly important to support initiatives and create a common thread. Indeed, integrating ecodesign involves changes within the corporate strategy at two levels (Sarkis 2003):

- At the level of its policy.
- At the level of the strategic approach of the product development, i.e. for the definition of the product specifications.

Policy: the environment as a value

The company has to define the environment as a value in order to explain its involvement among the workforce of the company. Thus, the integration of this environmental constraints change the hierarchy of usual values within the company (performance, quality, cost, etc.). This hierarchy has then to be redefined. Millet mentioned a paradigm shift in the business (Millet et al. 2003).

This change in the corporate strategy will contribute to the modification of the communication system of the company, both internally (information, involvement and motivation of staff) and externally (marketing, CSR, etc.).

Definition of the product specifications

Defining the product specifications is difficult in the evolving context of a company. The integration of ecodesign, by changing the influence of each constraint on each other, will

force the company to change its business strategy to enable the project team to prioritize constraints, and define product specifications.

1.3.3 Identification and collection of environmental data

Dewulf and Duflou claimed that what is difficult about ecodesign integration is the complexity and quantity of new information encapsulated within environmental aspects and their addition to an already information heavy process (Dewulf & Duflou 2004). Indeed, another feature of ecodesign implementation is that a huge variety of data is necessary for conducting environmental assessments and for advising product improvements. Those data will also come from inside and outside the boundaries of the company, from the raw material extraction phase to the end-of life phase. This inventory shows that beyond the classical design teams, ecodesign projects require the involvement of all the divisions of the company. Sarkis (Sarkis 2003) showed that when strategic decisions about environmental constraints have to be made at the strategic level, they have to modify their internal organization and the relations with the customers and the supply chain.

As mentioned by Gondran (Gondran 2001), environmental data is necessary to manage environmental impacts for a company and data flows are really important in order to integrate environmental aspects during the design process. The more a company builds relations with its partners, the better environmental aspects are integrated.

At this stage it is worth noting two potential problems:

- On one hand, the necessary environmental data are outside the boundaries of the company and are spread on numerous suppliers, subcontractors, customers, recyclers, etc.
- On the other hand, these data are not always directly available. In fact, the need for data may appear gradually while ecodesign emerges in companies. As data is not needed before, it is not collected.

This shows the necessity to create those environmental data flows to complete the existing ones. Many companies are now working on these questions. Nevertheless, this modification is not trivial for companies, because:

- The full data network does not exist. This leads companies to modify their habits and the relations with their partners;
- The data are rare and distributed, which generates difficulties in the collection process and induces time consuming processes and additional costs.

In conclusion, it implies new strategic decisions that affect the organization and relationships with customers and suppliers.

1.3.4 New knowledge and skills

Ecodesign integration, through the integration of new and complex constraints, will involve for the design stakeholders more and different knowledge. All the modifications presented in

this section require knowledge and skills which need to be built because they do not initially exist in the company. They will enable the different stakeholders of the company to:

- Define the strategy.
- Use the ecodesign tools.
- Manage the environmental data of the product.

Jacqueson (Jacqueson 2002) declares that these environmental knowledge and skills are the driver of the ecodesign integration.

1.3.5 A broader vision of the product

Ecodesign integration also changes the vision that designers have of their product because of the addition of the life cycle approach and the new environmental dimension. Each lifecycle phase of the product shows this product with characteristics different from those usually considered. The specification is not only expressed as functions that meet the performance requirements for the customer. *The product must also be considered in terms of "disutility" (Millet 1995), expressed as functions of environmental impacts.*

Ecodesign forces designers, and even the wider company, to adopt a different view on their product. They must not only consider the design and manufacturing phases of the product, but also the use and end-of-life phases as well as the raw materials extraction and production phases. Moreover, the design team has to consider, in addition to the usual technical criteria such as hardness, strength, weight, etc., the environmental technical criteria such as environmental toxicity, the embodied energy, the CO₂ emitted, the disassemblability, etc. Therefore, environment must be considered among all the other demands, tasks and issues, as shown in Figure 8. Moreover, the priorities vary according to company, projects and products. In conclusion, ecodesign requires adopting a broader vision of the product.

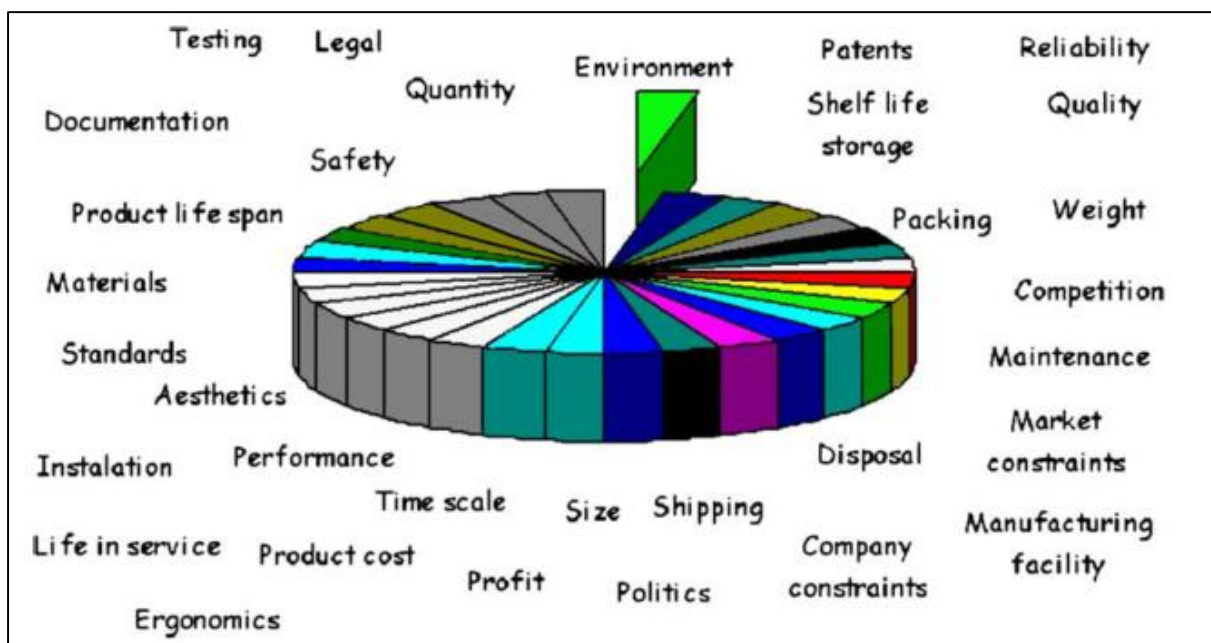

Figure 8: Considerations within the design process (Luttropp & Lagerstedt 2006)

1.4 Methods and tools

In order to help designers perform ecodesign integration, an ever growing number of tools have been developed, which can be used for a series of ecodesign problems, at varying stages in the design process (Navarro et al. 2005).

1.4.1 Definition

In the literature, ecodesign tool is the term mostly used but some authors use the term eco-tool. In its most generic sense, the term eco-tool refers to any tool a designer uses to complete the process of ecodesign. Definitions of this term are relatively rare within literature with authors focusing instead on the discussion of their application or classification. A definition is offered by Baumann et al. who described eco-tools as: *“Any systematic means for dealing with environmental issues during the product development process”* (Baumann et al. 2002).

It is common in literature to find the terms ecodesign methods and tools but most authors do not make a distinction between tools and methods. We could feel that tools are somehow physical, such as a matrix or spider-diagram, and methods refer to an approach. It was however felt that this terminology, when combined with the term methodology resulted in ambiguity. We have therefore chosen to call indifferently methods and tools to refer to those means by which we achieve inputs to the design process and to call methodology a more general approach.

1.4.2 Tools

During past years, many methods and tools for ecodesign were developed; Baumann et al. (2002) found in their literature review near 150 eco-tools. The aim of this section is not to draw up an exhaustive list of methods and tools but rather to present briefly the existing types of tools and to present their limits within design projects. Indeed, despite of this important quantity, the use of ecodesign methods and tools is still limited (Lindahl 2005).

Developing the idea of a tool as an input to the design process we can begin to analyse the different types of tools. These tools will only be useful if they are applied to the right problem and at the right time. This point is made by Navarro et al. who used a physical analogy, when he pointed out that *“a Torx screwdriver is not suitable for a slotted screw”* (Navarro et al. 2005). This analogy is useful as it not only highlights the need for selecting the right tool for the task, but also helps the reader to understand the inadequate results you are likely to achieve with the wrong tool. Navarro cements this point when he states that previous ecodesign projects may not have worked because, *“the applied ecodesign toolset may not be appropriate for that particular problem”*.

Three broad categories of methods and tools dedicated to environmental assessment to help ecodesign decision-making were first developed:

- Quantitative environmental assessments often used in detailed design phase or for a product redesign.

- Qualitative tools such as "guidelines" used at the conceptual design phase, even if they do not return quantitative indications to designers.
- Indicators (rate of recyclability, energy use, etc.) that are often indicators developed in-house in order to have a reference to ensure compliance with standards and guidelines.

The following paragraphs show the main classes of ecodesign tools. The types of tools presented below are limited to assessment and improvement tools, other types (eco-innovation, communication, etc.) are not listed here.

LCA, Simplified-LCA, Streamlined LCA

Life cycle assessment is a tool that was developed for the evaluation of environmental impacts of systems along their life. Ecodesigners use these as an evaluation tool of the current state of environmental pressure generated by their product design. Since performing a full LCA is time and resources consuming, industry and research have proposed various solutions to simplify it.

Simplified LCA aims at simplifying the assessment by reducing the number of data to process. Streamlined LCA decreases the number of indicators to manage. Finally, Matrix LCA proposes a semi-quantitative assessment that can be performed with little information on product shape and lifecycle.

LCA demands a huge quantity of data but according to Millet et al., this is an "indispensable tool to draw up a precise cartography of the environmental effects and impacts generated by a product" (Millet et al. 2007).

Matrix approaches

The matrix approaches represent a group of qualitative or semi-quantitative ecodesign tools in the form of table or matrix to be filled in by intended users. Most of those approaches derive from LCA and can be considered as somewhat simplified LCA. Due to its relative simplicity, they have potential to be accepted by enterprise, especially by small and medium ones.

Check-list

According to Janin (Janin 2000), checklists refer to a list of questions that can help to have a quick evaluation on the environmental profile of the product under design. The list has been established based on the experience and does not necessarily take into account the whole life cycle for the product.

Guideline, Spider diagram, Design for X guideline

Design for Environment (DfE) guidelines are widely used as a mean to adapt products to environmental demands, and the literature is full of various DfE rules. Those rules tend to focus on a specific issue, e.g. material reduction or on a specific phase of a product's life

cycle. They are generic for different companies but can also be very product-specific, and require different levels of knowledge and education.

Design for X tool

Design for “X” concept was proposed due to the ever increased pressure on the competitiveness of product. Products are required not only to meet the traditional requirements (e.g.. functionality) but also other aspects that may increase customer or stakeholder’s satisfaction, e.g. safety, reliability, serviceability, maintainability, recyclability, disassemblability, etc. So, tools called design for “X” paradigm, with each X representing a product property have been developed: Design for Environment (DfE), Design for Recycling (DfR), Design for Disassemblability (DfD), etc.

CAD integrated environmental feedback, Adapted design tools

Some Computer-aided design (CAD) tools provide an environmental module, but they are not widely used yet in companies. There are also others classical design tools which were adapted to environmental issues such as Quality functional deployment for environment (QFDE) (Masui et al. 2001; Zhang et al. 1999) or Environmental Failure Mode Effect Analysis (EFMEA) (Lindahl 1999).

Life Cycle Cost tool

As already shown, environmental requirements must coexist in harmony with other traditional requirements (Bovea & Wang 2007). In the industrial world, cost is one of the top priority requirements. Thus some tools were developed to perform economic analyses. Life cycle costing (LCC) tools were originally developed from a strict financial cost accounting perspective but now different types of LCC exist. In a report of the United Nations Environment Programme (UNEP 2011), three of them are represented in Figure 9:

- Conventional LCC, incorporating private costs and benefits.
- LCC, taking into account external relevant costs and benefits anticipated to be privatized.
- Societal LCC in which all private and external costs and benefits are considered.

First LCC were developed before LCA and this explains the differences between the different approaches. Swarr et al. (Swarr et al. 2011) underlined that integration of these methods - LCA and LCC - are limited although the value of LCC for sustainability has been recognized (Hunkeler & Rebitzer 2003; Kloepffer 2008). In 2011, Society of Environmental Toxicology and Chemistry (SETAC) has published a guidance for environmental LCC as a Code of Practice, where the methodology is based on the ISO 14040 standard to facilitate definition and application of consistent system boundaries for complementary LCC and LCA studies of a given product system (Swarr et al. 2011).

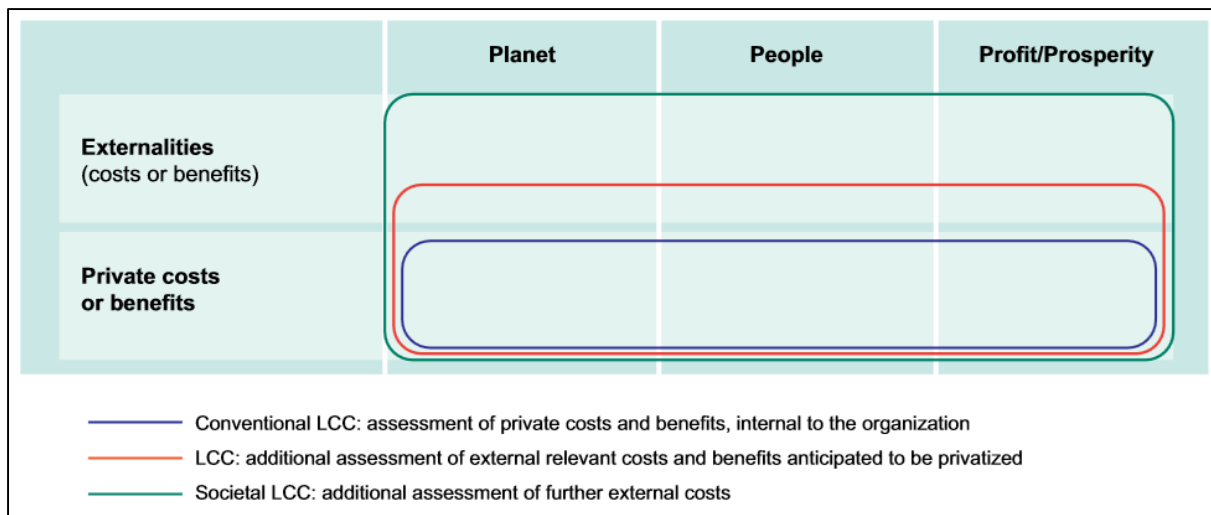

Figure 9: Scope of application of three types of life cycle cost (UNEP 2011)

Moreover, these assessments are going further since some authors talk about Life Cycle Sustainability Assessment (LCSA) where the third dimension of sustainability Social-LCA is taken into account. Klöpffer suggested combining the three techniques (Environmental-LCA, LCC, Social-LCA) and proposed a conceptual formula:

$$\text{LCSA} = (\text{environmental}) \text{LCA} + \text{LCC} + \text{Social-LCA} \quad (\text{Kloepffer 2008})$$

This formula will enable an integrated decision-making based on a life cycle perspective and the consideration of the three sustainability dimensions (UNEP 2011).

1.4.3 Limits of the applications of those tools

While ecodesign tools have been briefly presented in previous sub-sections, this section will move the focus on the issues surrounding their application, particularly on those issues needed to support ecodesign and encourage its successful commercial application.

Despite the great number of tools and methods, their use is still limited (Lindahl 2006). One reason for this low use is that tools and methods are for expert because they require specific knowledge (Le Pochat et al. 2007); another is that there is a lack of information about how to use them (Fagnoli & Kimura 2007). Lofthouse strongly criticized existing ecodesign tools for failing to “focus on design”, failing to “take into account the culture of Industrial Design”, and failing to “recognise that ecodesign is not a priority issue but is one of a number of things that designers have to contend with” (Lofthouse 2006a). This lack of user focus is documented by other authors with Lindahl noting that “there seems to be a gap between the developers and the presumptive users” of ecodesign tools (Lindahl 2006) and Poole et al. noting that from her research within commercial companies, “little evidence that many of the software DfE tools developed in research institutes are actually used” (Poole et al. 1999).

Tools and methods for environmental impact assessment of products are widely regarded as tools reserved for environmental experts due mainly to the complexity of environmental sciences on which those tools are based. Therefore, those tools are by nature not designers

friendly and also are not designed promptly for being used by SMEs or companies starting with ecodesign approaches.

For tools aiming to improve environmental performance of products, they are generally designed to be adapted to designers, which is not the case for environmental impact assessment tools. Thus, they are thought as less complicated to be employed by both large company and SMEs. However, the problem is that those tools cannot play alone because in that case, they do not address the main environmental issues for the product. Then, they generally fail to optimize the overall environmental performance (Hauschild et al. 2004).

Furthermore, as each ecodesign tool has a particular function and a specific use, several tools can be used to ecodesign a same product. However, the compatibility between tools is not guaranteed (Le Pochat et al. 2007) and there is a lack of information about how to use the tools (Fagnoli & Kimura 2007).

2 Synthesis of the context, problematic and barriers

Previous sections have revealed a complex and varied set of issues related to the inclusion of ecodesign within the design approach, collected in the Figure 10. This section aims at summarizing and discussing the different challenges observed for ecodesign consideration and integration in the company and in the product design process. We group these challenges into four categories: ecodesign principles, organizational issues, data and knowledge, and tools.

Ecodesign principles

Having identified the multi-disciplinary nature of ecodesign, and the importance of including it during the early stages of the design process, it becomes clear why so many authors are now widening the scope of their focus to look at the organizational structure supporting ecodesign (White et al. 2008; Johansson 2002). This topic is not novel to ecodesign, it has long been recognized within traditional design circles *“that success is also related to cross-functional teams, which communicate internally”* (Johansson 2002). Successful product development has long been associated with a cross-disciplinary approach, good communication across departments and knowledge management. What changes with the introduction of novel and complex issues, such as environmental considerations, is the importance of these features (White et al. 2008; Johansson 2002).

Organizational issues

Indeed, we saw the necessity to involve all the departments of the company and even, if possible, to have an enlarged vision of the company and to consider the extended company with a greater consideration of the supply chain. Involvement of the company strategy was highlighted to ensure a consistency within the company and to promote initiatives.

Data and knowledge, and tools

Methods and tools to conduct ecodesign were briefly reviewed and their limits were pointed out. In her study of the needs of the Industrial Design community, Lofthouse concludes that tools must support ecodesign by offering inspiration, information, education and guidance and that these tools must “*fit their way of working better, communicate in a language they understand, provide a resource of relevant , product specific ecodesign information and a starting point for ecodesign*” (Lofthouse 2006a). Dewulf and Duflou agree that information and education are important but also expands the issue to include knowledge management, and highlights the importance of easy access to these resources and organization wide inclusion (Dewulf & Duflou 2004).

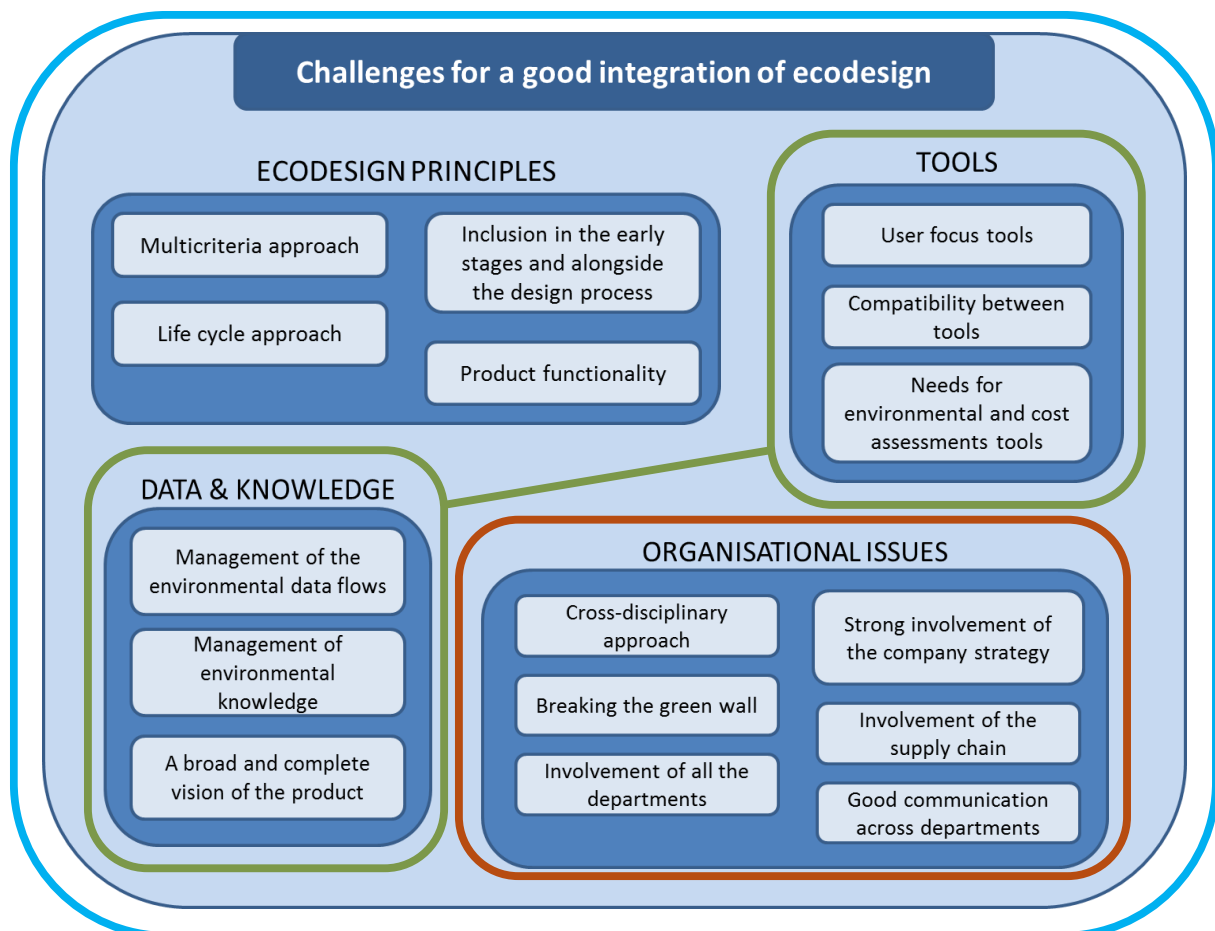

- 3 BARRIERS:**
- Organizational
 - Technical
 - Methodological

Figure 10: Challenges for a good integration of ecodesign and identification of barriers

This synthesis of the context leads us to shape our problematic.

Problematic

“How to manage all the challenges of ecodesign integration grouped into four categories: ecodesign principles, organizational issues, data and knowledge, and tools?”

Organizational, technical and methodological barriers

Three barriers of ecodesign integration could then be identified from the analysis of the context: an organizational barrier, a technical barrier and a methodological barrier.

The organizational barrier is linked to the involvement and the collaboration of all stakeholders who may be implicated in ecodesign activities.

The technical barrier is related to the limits of the applications of the ecodesign tools: it means the non-guarantee of the compatibility between tools, the lack of user focus, or still the fact that tools are dedicated to experts.

The methodological barrier is related to the lack of methodology able to link ecodesign activities, ecodesign tools and stakeholders involved in the design process.

A primordial aspect is the combination of these barriers. It means that to be effective these three barriers need to be simultaneously removed: this is the objective of our research. The next chapter will be dedicated to the state-of-the-art in order to highlight the key elements to remove the barriers of ecodesign integration and manage the associated challenges.

Chapter 3

State-of-the-art

1	Organizational barrier: analysis of integrated design properties	33
1.1	DEFINITION.....	33
1.2	PROPERTIES TO SET UP AN INTEGRATED DESIGN APPROACH	35
1.2.1	<i>Consideration of viewpoints</i>	36
1.2.2	<i>Implementation of constraints into requirements</i>	37
1.2.3	<i>New organizations.....</i>	37
1.2.4	<i>Creation of a multidisciplinary design team.....</i>	37
1.2.5	<i>Project manager</i>	38
1.3	INTEGRATED DESIGN FOR ECODESIGN: BENEFITS AND LIMITS	39
2	Technical barrier: review of tools, methods and interconnected solutions	42
2.1	INTEGRATED DESIGN: TOOLS AND METHODS	42
2.1.1	<i>Product model and data management</i>	42
2.1.2	<i>Specific management tools</i>	44
2.1.3	<i>Limits of the tools</i>	45
2.2	INTERCONNECTED SOLUTIONS FOR ECODESIGN.....	46
2.2.1	<i>Interconnecting tools and platforms for ecodesign.....</i>	47
2.2.2	<i>Collaborative platforms for environmental data sharing.....</i>	52
2.2.3	<i>Conclusions on interconnected tools and platforms.....</i>	52
3	Methodological barrier: review of existing methodologies	55
3.1	ECODESIGN METHODOLOGIES.....	55
3.1.1	<i>Methodologies linking environmental management and design activities.....</i>	56
3.1.2	<i>Methodologies focused on the product development process.....</i>	62
3.1.3	<i>Methodologies focused on energy concerns</i>	64
3.1.4	<i>Conclusions on methodologies</i>	65
4	Conclusions	66

The previous chapter identified three barriers which will guide our state-of-the-art in this chapter. Indeed, each section is dedicated to a barrier:

- Section 1 related to the organizational barrier: analysis of integrated design properties.
- Section 2 related to the technical barrier: review of tools, methods and interconnected solutions.
- Section 3 related to the methodological barrier: review of existing methodologies.

The objective is to extract from the analysis the key elements to remove the barriers.

1 Organizational barrier: analysis of integrated design properties

In order to develop a product, a team of designers looks for information to generate and assess solutions that satisfy both the requirements and the constraints (Janthong et al. 2010). The product design process consists of a set of actions realized by different actors. Each actor has his own jurisdiction but the design team work together. To facilitate well integrated design teams, companies are now developing more integrated processes. In the previous section, principles and specificities of ecodesign integration were described and discussed. The aim of this section is to determine how integrated design is able to absorb ecodesign specificities in order to remove the first barrier, the organizational barrier. The first part provides elements about concurrent engineering and explains the different types of concurrent engineering. The second part describes some properties to set up an integrated design approach. The third part is a discussion of how integrated design can answer the challenges of ecodesign integration.

1.1 Definition

According to Prudhomme, concurrent engineering is described as a design process where all product life cycle characteristics are considered simultaneously (Prudhomme 1999), where they were considered sequentially in the past. Thus, concurrent engineering is a practice to integrate different values of the product life cycle in the early phases of the design process; values that include not only the primary functions of the product, but also aesthetics, manufacturability, assemblability, recyclability (Ishii 1993), (Sakai & Takata 2012).

The objective is to create a product-oriented design: the product does not evolve through successive actions of designers, instead the product is central (Poveda 2001). Figure 11 illustrates this change. Tang et al. explained that the sequential design process was inefficient because it generated “*greater development time, greater cost, and lower overall design quality*” (Tang et al. 2000).

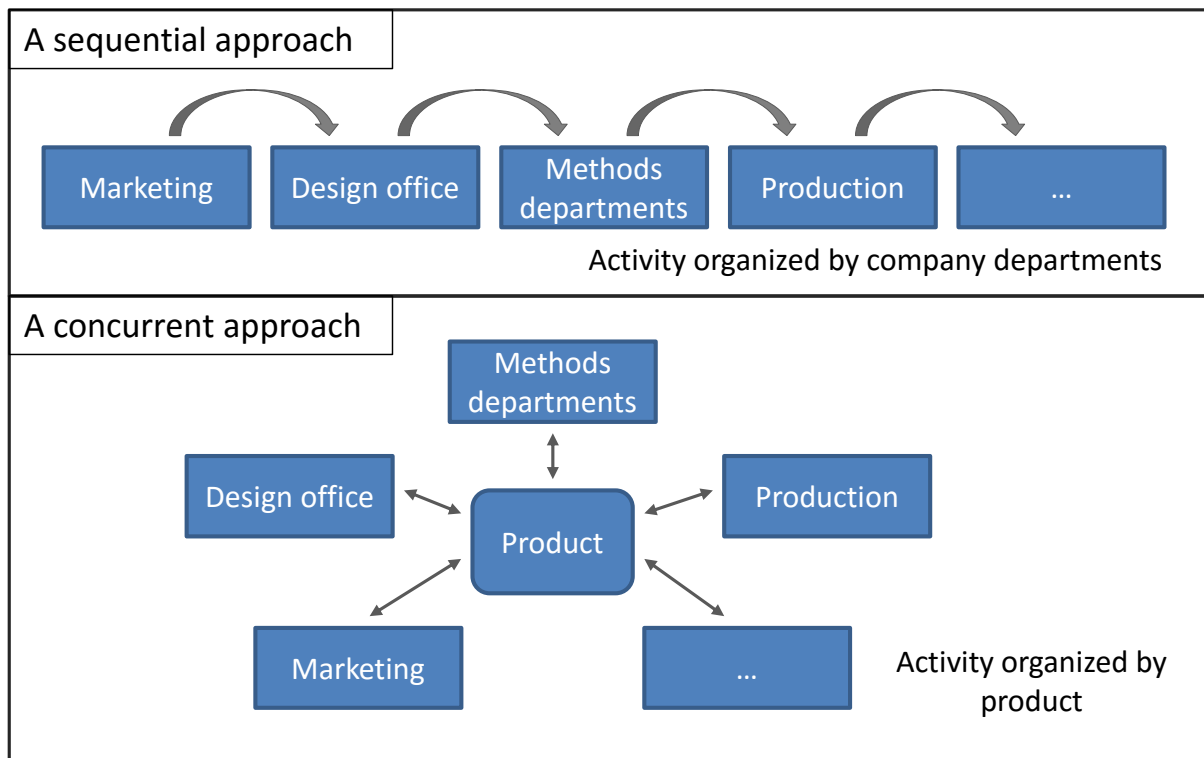

Figure 11: Product centered activity (adapted from (Poveda 2001))

Various structures were developed to model the design activity and to try to encourage this concurrent approach. Two main ways were developed (Prudhomme 1999):

- The first is by dividing up the design task amongst different groups who simultaneously work on different life cycle stages; each group is defined by its expertise. This is referred to as parallel design.
- The second is to develop a multidisciplinary group who consider the whole product life cycle together. This is called integrated design.

Having defined these two concurrent engineering approaches we will now discuss on each one in more details, based on Prudhomme PhD dissertation.

Parallel design

As described above, parallel design is when the tasks are shared among the design team and when those design tasks are realized in parallel with each other. This concept is a simultaneous design approach that is characterized by parallel design activities which often rely on a common database. This parallelism is necessary to decrease development time.

This can be induced by the fact that:

- The study is very large and has to be separated into different studies. This is typically the case of airplanes or cars. To encourage successful design integration, an interface has to be developed to achieve consistency between the different results.
- The project is subcontracted by a prime contractor.

- A task has been separated into sub tasks depending on the design team's knowledge and skills.

Integrated design

In an integrated design approach, a design team is created with the aim of integrating the constraints from different areas of expertise, early in the design process.

When the concept of integrated design was first formalized, the first step was to externalize³ expert tacit knowledge linked to the product life cycle (i.e. manufacturing) and make the explicit knowledge useful for designers through the creation of databases. Two major problems have been identified with this approach:

- The difficulty of externalizing the knowledge of the different experts.
- The fact that knowledge could be misunderstood or differently understood in the different contexts and by the different experts.

As integrated design evolved, a new approach was proposed. This second approach involves the integration of the experts themselves within the design team. The objective is to integrate all life cycle actors into the design process and to provide all of them with the necessary data to think about the solution and to allow them to act on the product definition. This does not only involve problems related to knowledge externalization, but also requires the creation of new tools that increase cooperation between the different actors, whilst addressing the different viewpoints they have on the product, during its definition.

Currently, two perspectives of this integration coexist. The first gives priority to the effective cooperation of the different life cycle actors, working on common objects created during the different interactions of the design team. The second is software tools oriented. In that case, the work of each actor of the life cycle is realized taking into account its own knowledge and skills. The representation of each expert viewpoint is stored in a common database.

1.2 Properties to set up an integrated design approach

This section presents some characteristics for the setting up of an integrated design approach in company.

³ We use here the definitions given by Nonaka et al. about explicit and tacit knowledge (Nonaka et al. 2000). To summarize, explicit knowledge can be expressed although tacit knowledge is personal and hard to formalize. The conversion process of articulating tacit knowledge into explicit knowledge, called externalization, enables to share this knowledge among people. This approach is a part of the SECI process defined by Nonaka et al which aims to create knowledge through conversion between tacit and explicit knowledge. In this document, we do not always precise to which types of knowledge we are referring to.

1.2.1 Consideration of viewpoints

To be able to consider all the product life cycle aspects the designer needs to understand the specific problems related to the product for each life cycle phase. Here, the design process has to consider the point of view of all life cycle actors. This highlights two notions that were not really considered in previous sequential design methodologies: the product life cycle and the life cycle actor's viewpoints.

Life cycle concept for design

The life cycle thinking force designers to consider all the changes related to the product. This means that the life cycle considers all the successive states a product encounters during its life: from its definition, to its manufacturing, assembly, distribution, usage and end-of-life. To take all those aspects into account during the design implies that designers have to consider the future, to imagine the product in the different life cycle phases, to define, during the design phase, solutions that will be able to solve specific questions encountered by the product.

Recycling for example will be optimized only if the product has been developed to be recycled. This is not easy, because designers have to plan what will happen in the future in order to identify the best recycling process. Taking the automotive industry as an example, designers have to consider what processes or technology may be in use in 15 years, in order to design a product that will be easily recycled.

To be able to consider all the life cycle aspects, viewpoints of the different life cycle actors must be integrated during the product design process.

Designers view points during the design process

A point of view is the vision and expertise of an expert involved in a design team (Brissaud & Tichkiewitch 2001). An expert can see the product under development in a particular phase of its life cycle from his own perspective. This personal view becomes a point of view only when it is finally formalized and shared during the design process. The viewpoint represents a potential solution, or concept, developed within the designer's field of expertise. This concept provides the basis for the expert to describe the constraints the product will encounter during each life cycle stage. Thus, a viewpoint is the expression by an expert of:

- Its knowledge.
- Constraints linked to its field of expertise.
- Specific objectives to optimize the product within the expert field.

The final design should represent a combination of the viewpoints of all the relevant life cycle actors. This global product perspective demands that all relevant actors within a company and its supply chain are able to express their viewpoint during the design development. Then, they need to be aware of the design process taking place and to be able to communicate their ideas

to the wider design team. Integrated design is therefore based on the viewpoints integration (Tichkiewitch & Brissaud 2003).

1.2.2 Implementation of constraints into requirements

Integrated design aims to allow all disciplines concerned by the product, to intervene in its design, by taking into account all the different expert viewpoints to simplify design decisions. However, even when the design objectives are clear, this it is not always easy to implement.

At the beginning, the recommendations and constraints from the different life cycle experts need to be captured. Then, they need to be translated from recommendations and constraints, into product requirements. In addition to this, there is the even more difficult question of how the different viewpoints coexist. There are often antagonisms (for example, manufacturing constraint vs aesthetics).

To help with this implementation, a company needs to determine general rules or guidelines that can be followed when translating differing viewpoints into product requirements. These rules must dictate which viewpoints they prioritize and define how to develop an optimized product solution that addresses all viewpoints. The way a company defines these parameters is not the jurisdiction of one actor but must instead be agreed by all actors in the design process. Achieving this may require new relationships to be established and new communication channels to be used.

1.2.3 New organizations

The success of an integrated design approach is based on its capacity to provide designers tools that support knowledge building in their field of practice, and to make this knowledge usable in other fields (Poveda 2001). Integrated design also needs a common environment of work for everyone within the design team to work cooperatively and to share knowledge. In this approach, questions concerning the organization of the activities, the management of competences and know-how, and the organization of cooperation must be considered. The answers depend on a lot of parameters, such as the product nature, the company, or the design context. No strict rules govern the implementation of integrated design; instead, they are often defined on a case by case basis, and differ from one project to another. Thus, the main changes for companies choosing to pursue an integrated design approach lie in their organizational process. The objective of these changes is to create a product-oriented design. This requires an adapted environment for exchange and communication, a product-oriented organization and specific tools to be able to communicate and manage the different competences.

1.2.4 Creation of a multidisciplinary design team

Within a product oriented process, a multidisciplinary group is created to enable different company departments and perspectives to be voiced during the design development. Through this process, compromises are reached to provide the balance between the desirable, technical and economical factions.

To reach an integrated approach for the designers and promote good coordination among the multidisciplinary team, it is essential to appoint a project manager. In this organization, a project manager is needed to maintain a global overview and resolve conflicts. He is the direct link between all the different areas of expertise. Within this multidisciplinary group, representatives from each area of expertise have the opportunity to assess the project from their viewpoint and communicate their perspective to the project manager and other experts.

1.2.5 Project manager

The design development towards integrated design involves changes in the process and requires an actor to carry out the management of the activities and the coordination of the design team: this person is the project manager. This section describes the role and the activities of the project manager.

The project manager makes sure that the rules and measures defined in the integrated design process are respected and applied. He or she is also responsible for internal organization and external representation. The project manager (or the team leading the project) represents the link between the project and its external environment. This actor is the project spokesperson in the company and the special correspondent with the company strategy. The project manager is then the main vector of the constraints imposed on the project by the external business environment.

The project manager leads all the operations necessary for the completion of a project. These can be divided into four areas that represent the framework of the project manager activity:

- Supporting the current state of the product and its evolutions.
- Integrating the different points of view.
- Organizing the cooperation.
- Taking decisions.

In a context of integrated design, the product is at the center of the activity and the process developed with each product evolves. It means there is no product checkpoint between each actor to confirm choices, decisions or constraints, as it is the case in a sequential process. The product, or rather its representations, are therefore not stable but are subject to change at all times, in all aspects. A representation is a way for a designer to present a potential solution; this representation is mostly a CAD model, such as a component, an assembly, or a sketch. These representations are important because they are used as common references for the actors and lead their actions in the design process. However if the current state of the product was the only guide of the design activity, the product would struggle to meet all the requirements and satisfy all the constraints of the different design actors. That is the reason why the project manager regulates the activity, according to the product evolution, in order to maintain a unity between the various product design viewpoints. The manager assumes the responsibility for leading the design process towards an optimum solution. To lead the design process, he must integrate the different points of view and establish cooperation within the project.

In addition to this the project manager must also encourage cooperation between the different actors. His role is not just to bring the various perspectives together, but also to direct the activity of each one and help bring the actors to common expectations.

The project manager does not determine all the measures taken within the project, but he guarantees that all the operations move in the same direction to meet the different constraints. This section has shown that the management activity is complex. Indeed, being a project manager is a multidisciplinary activity and the activity evolves over time, according to the process configuration. That is the reason why the current trend is to develop multidisciplinary teams to support the leading task.

1.3 Integrated design for ecodesign: Benefits and Limits

The aim of this section is to confront principles and properties of integrated design (described in this part) to the challenges tied to the ecodesign integration related to organizational aspects.

An integrated design approach recommends building a multidisciplinary team to consider simultaneously all life cycle characteristics. The different life cycle actors are therefore integrated into the design process. The objective is to integrate the constraints from the different areas of expertise early in the design process. Thus, it means that in this configuration, we can imagine that an environmental actor can be integrated to this design team. The green wall is avoided and the environmental actor has a place in the multidisciplinary team as shown in Figure 12. In addition, integrated design involves new means of communication that is essential for an ecodesign approach.

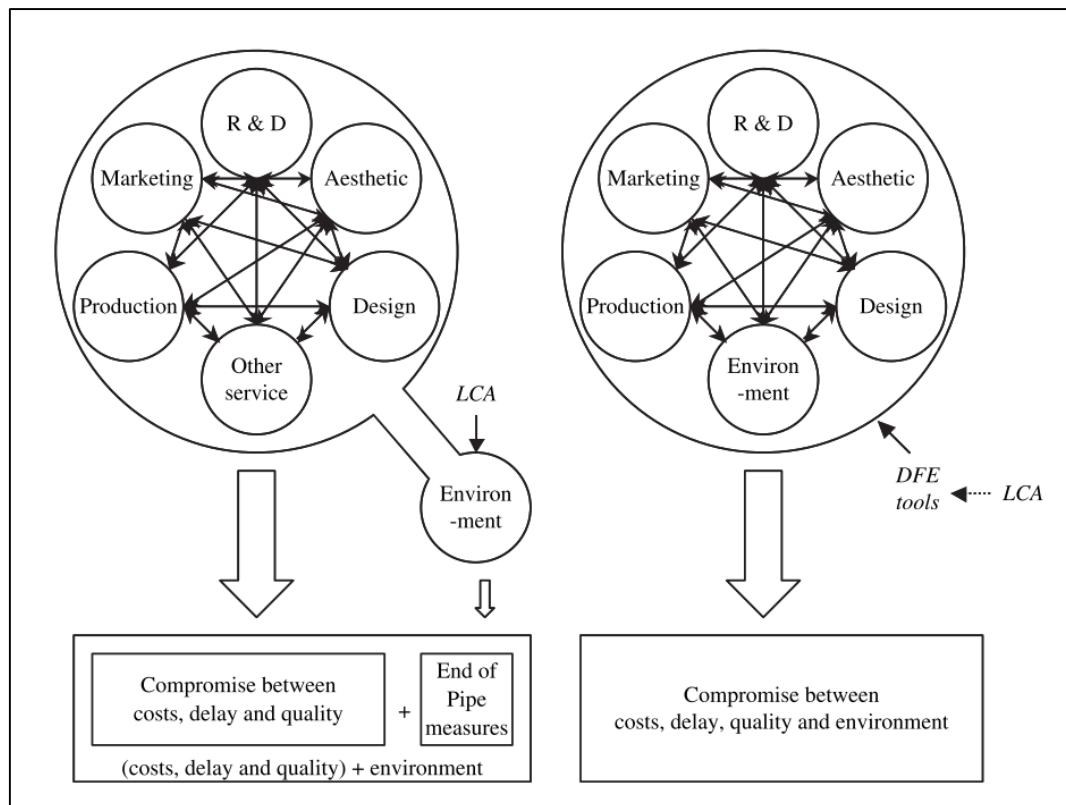

Figure 12: Disconnection between the design team and the environmental actor (left) and integrated environmental actor (right) (Millet et al. 2007)

According to the definition of integrated design, we could say that ecodesign results in the introduction of an additional perspective in the team: the environmental point of view. Environmental constraints would be then exposed to the team in order for them to be taken into account. However one particularity of the environmental viewpoint is that it has some consequences on all the areas of expertise. As well as quality, environment is a transverse discipline and this is not so easy to consider and implement.

Concurrent engineering is often presented as a balance between technical design constraints, the designers' goals and costs throughout the life cycle. With ecodesign, environmental concerns are added to this balance that shows the importance of the role of the project manager, to manage all the constraints, and of the involvement of the company strategy, to define a clear policy.

Thus, integrated design seems to be a necessary condition to ecodesign integration. Besides, Sherwin and Bhamra stated that ecodesign implies a concurrent engineering process (Sherwin & Bhamra 2001). But the integration of environmental aspects during the design process is also dependent upon the use of new tools, new design processes and new knowledge (Millet et al. 2003).

So, the new organization for ecodesign, based on integrated design, should consider the following transformations during the design process (Le Pochat et al. 2007):

- The use of new tools (ecodesign tools).

- The creation of new indicators to be able to assess the product under design from an environmental point of view.
- The use of new data.
- The implementation of new procedures to allow the inclusion, the definition and the validation of environmental constraints into the product requirements.

Indeed, the success of an integrated design approach is based on its capacity to provide designers tools supporting knowledge building in their field of practice, and to make this knowledge usable in other fields. This is a real challenge for ecodesign as this knowledge will strongly influence some designers' activities. They have to increase and build their environmental knowledge to be able to interpret and use environmental data.

To conclude, integrated design is seen as the best approach to reach our future environmental goals, absorb the specificities of environmental concerns integration and then remove the organizational barrier. In fact, the involvement and the collaboration of all stakeholders who may be implicated in ecodesign activities are guaranteed in an integrated working environment. However this approach is not enough and complementary aspects need to be considered, as mentioned in the list above. These aspects (tools, data, and procedure) will be reviewed in the two following sections.

2 Technical barrier: review of tools, methods and interconnected solutions

In this section we will review the different technical solutions which could be able to remove the technical barrier. We will show their limits and extract requirements for a suitable solution. As a reminder, the technical barrier is related to the limits of the applications of the ecodesign tools: it means the non-guarantee of the compatibility between tools, the lack of user focus, or still the fact that tools are dedicated to experts.

2.1 Integrated design: tools and methods

In the approach of integrated design, the tools supporting the design team's knowledge must evolve to enable the dissemination of this knowledge within the company. The need for mutual exchanges in the design process, results in the creation of new expert tools designed to enable an integrated approach. Thus, a new generation of tools is developed to allow easy reorganization and diffusion of information in order to quickly and efficiently integrate them into the product design process. Different fields were concerned with these changes, including assembly (Rejneri 2000), calculation (Fine et al. 2000), manufacturing (Brissaud 1992) (Blondaz 1999), or even ergonomics (Zwolinski 1999).

Moreover, a multitude of tools for project management were developed in order to facilitate the steering work. Some of them are commercially available and others have been developed internally by companies to manage the projects in a way specifically tailored to their products or their internal process. These tools cover almost all of the tasks that are required in a steering team. However a single tool cannot support all of these tasks. These tools are therefore built to meet specific features concerning the needs of the management activity.

The following sub-sections present some of these solutions.

2.1.1 Product model and data management

As we saw, integrated design is based on the viewpoints integration of the different stakeholders linked to the design process. To share information related to product life cycle, different authors work on the development of models. A model can be defined as a "projection of the real world" (Tichkiewitch et al. 2008) or a "description of a system written in a specific language" (adapted from (Favre et al. 2006)). In Model Driven Engineering (MDE) models can be used to "drive" engineering processes. The information system based on those models would allow some data exchanges between tools or automatic reasoning for instance. The first models used to aggregate product information were geometry CAD models. However first geometry models were not fully adapted to the collaboration needs of the design activities. That is why Noël and Roucoules showed that "an open framework is required to connect any of the tools whenever expected by the collaboration" (Noël &

Roucoules 2008). In a concurrent mode different frameworks were developed to provide assistance to collaboration. Some researches and approaches are developed below.

In their article entitled “Product models for life-cycle”, Brissaud and Tichkiewitch described a multi-view product model supporting integrated design (Brissaud & Tichkiewitch 2001). They explained that during the design process a team of designers creates many virtual models to characterize the product on different aspects such as its geometry, manufacturing and assembly processes, mechanical behavior, maintenance planning, or even performances. A multi-view and multi-user product model enables each design actor (defined as each person who needs to intervene during the design process) to structure the product in a convenient way for his design activity and the tool he uses. The product model could thus be:

- Multiview to represent the different views of the actors.
- Multirepresentation (2D, 3D, etc.).

Based on other preliminary works on the product model (Tichkiewitch 1996; Chapa 1997), Roucoules and Tichkiewitch propose a software solution to assist the integration and the co-operation of design stakeholders: the Co-operative Design Modeller or CoDeMo (Roucoules & Tichkiewitch 2000). It consists in graphic interfaces used to fill a shared database with actor’s own data and own constraints. The product is therefore progressively constrained by decomposing the Product Model as the association of a multi-views data model (components, links, and relations) and a knowledge model (features). The association of these two models contextualizes the features associated to a specific product decomposition. The multi-views decomposition was introduced by Chapa to gather every data that describe the product with a specific vision of it (Roucoules & Tichkiewitch 2000). There are mainly two kinds of views:

- The trade views which store the data that describe the product with a specific trade vision (technologist, tooling, stamping, structure analysis, etc.).
- The Ossature and Geometric views which describe respectively the nominal dimensions and the functional characteristics of every surfaces of the product.

CoDeMo can thus be considered as a Computer Aided Integrated Design; it takes place in the global design environment connected to specific applications based on specific design tasks (process planning, structure analysis).

Others solutions are realizing data and information sharing as Product Data Management (PDM) or Product Lifecycle Management (PLM). The PLM approach capitalizes all the data on an industrial product. The objective of the PLM system is to enable the different company departments to share their information on the different phases of the product lifecycle. Various PLM software systems have been developed to support this approach (e.g. Enovia©, PDM-Link©).

However different authors showed limits of PLM systems in collaborative design processes (Noël & Roucoules 2008; Etienne et al. 2011; Van Wijk 2011). From an operational perspective, Wijk noted a mismatch between PLM tools capacities and what design actors really do with them. Providing structures managing shared spaces or the right of access to

resources is not enough for a successful collaboration. Furthermore, Wijk showed that the interoperability issues are still little addressed by PLM platforms. Interoperability issues will be presented in the next section.

To preserve the overall coherence of the company information system, Noël and Roucoules focused on a Product-Process-Organization (PPO) Model that has been proposed to create a collaborative environment for new product design process (Noël & Roucoules 2008). The objective was to develop a sharing space to manage relations among existing models. The PPO model consists of product, process and organization models. Robin explained the three models as follows (Robin 2005). The product model enables the formalization of the technological knowledge of the product (function, structure, trades, etc.) and can be enriched by the design stakeholders. The transformation of this knowledge is represented using the process model which ensures the following up, the traceability and the capitalization of the design rationale for its reuse or its evolution. The modeling of driving decisions in an organizational model allows considering the organization and the coordination of all projects to meet the internal and external objectives of the company. The PPO Model UML diagram proposed in (Noël & Roucoules 2008) consists of four classes for the product definition (component, interface, function and behavior), five classes to schedule a project planning (project, human, hardware, software and information) and three classes for the company organization and capabilities (decision center, decision framework and design framework). Moreover the interest of this model is also to be extensible. Indeed, the set of attributes of each class can be completed for any expert target.

To conclude, in the light of information sharing issues, a product model or an extended version as in the PPO model would be necessary. Those models would require to be implemented with ecodesign issues. For example new models would take into considerations specific information that are necessary for the environmental analyses, managed by an environmental expert.

2.1.2 Specific management tools

Some tools have been developed specifically for the activity of steering a project. They are intended to enable steering actors to lead their activity regarding the constraints that the project must meet.

Planning and resource sharing

The project manager aims at promoting a concurrent engineering approach. To achieve that, he has several tools including for example PERT (program (or project) evaluation and review technique) and Gantt diagrams. PERT was developed to simplify the planning and scheduling of large and complex projects. The DePlan approach and associated software tool also proposes a way to plan, control, and schedule for integrated design management (Choo et al. 2004). Thus, these tools enable the steering team to plan, monitor and control the allocation and the execution of the project tasks.

Investment and cost tracking

Many financial tools, cost calculation or investment calculations are also available in order to determine the economic side of the project.

Other tools are also used to support project management. Some of them are not originally designed for that purpose but they can be useful because they represent tools with common formats, able to support the integration of different expertise.

Visualization tools

The CAD (Computer Aided Design) tools can be used as steering tools. They make it possible to quickly visualize the assembly of solutions and the steering team can thus detect technical, geometrical or functional design problems. Although they were not developed for this purpose, they represent a support that is now essential to manage integration.

Simulation

Simulation tools, like in the case of CAD tools, are not specifically dedicated to project management but their contribution is important. They encourage awareness among the management team about the performance of different components, and help them define the next tasks required to create a coherent solution.

There are also many other tools to address specific aspects such as control of risks, innovation management or marketing position. However, whatever the tools used in project management, they do not deal with all the complexities of management problems.

2.1.3 Limits of the tools

Providing effective management tools that meet the physical reality of the project is a challenge for tool development companies. This challenge has still not been entirely addressed. Currently tools only partially meet the specific needs of a project. Effective management tools are those that approach the steering activity through the characteristics shared by all projects, such as market, budgetary or time constraints.

Furthermore, it appears that taking into account the physical or technological characteristics of a product required to translate multiple viewpoints is not obvious. This integration is different according to the nature of the product being designed and the development process. Thus, having a global vision of the ongoing design project could be only possible if there is an information management system enabling to share and exchange information on the product and the project. It means that the interactions between the different tools used by the different design experts and between those tools and the management team tools needs to be improved. This is referred to as interoperability issue. We highlight this issue in the context of integrated

design but this is also particularly true with ecodesign tools. The next section will present the interoperability concept and some interconnected solutions for ecodesign.

2.2 Interconnected solutions for ecodesign

In the previous section, we presented some product models developed for information sharing required to improve interactions between design process tools. This point is linked to the capacity of tools to exchange and use exchanged information. This then introduces interoperable tools (Paviot 2010). Interoperable tools generating product life cycle's information are all the more important that life cycle assessment tools required a lot of data in various format. Interoperability between tools is here presented by referring to model driven engineering environment.

Models can be related to each other through three ways: integration, unification or federation (ISO 14258 1998). To be explained some definitions need to be given.

A model is a description of a system written in a well-defined language (Favre et al. 2006). A model has a syntax, it means a textual or graphic notation, and a semantic. The model enables software tools to do automatic reasoning and to share the data between tools.

A meta-model is the model of the model defining the structure and the language of the model.

Each one is explained below.

- Product models are integrated when they are merged in a same data model. A standard model form is used for all the constituent models. A change involves redefining the standard model form and then to modify all the models.
- Product models are unified when there exists a template which provides a common meta-level structure across constituent models, providing a means for establishing semantic equivalence.
- Product models are federated when specific mappings are used to link dynamically one or more source model(s) to one or more target model(s). There is no standard model form between all models; model federation is based on a dynamic adjustment. This solution offers more flexibility to integrate new tools based on different models (syntax, semantic, etc.).

These three approaches can be presented as complementary because they do not meet the same needs. Rio reviewed the use of these three types of interoperability in product engineering to analyze their assets or issues in a Design To Environment context (Rio 2012). Historically, integrated approaches were developed forty years ago based on a single CAD product model. Then they had to be adapted to the increased complexity of information system. Indeed, each new trade application generates a new trade model. As a consequence, standards developed semantically generic models that could be used between different trade

applications. New problems appear when information evolved faster than standardization. The complexity increase of products, trade applications, processes, exchange needs, etc. requires that software developers propose more and more complex systems.

Integration of ecodesign needs to adapt to the evolution of new tools and knowledge linked to environmental analysis, while keeping dynamic links between the tools. As a consequence, the integration approach is no more appropriate, in terms of flexibility and dynamism to consider environmental issues (Rio et al. 2013). In a context of Design To Environment Rio concludes that federation could enable more flexibility and adaptation of the information system, enabling to adjust continually and dynamically the information exchanges between two different tools.

To illustrate this point, we will then review some current software solutions to interconnect design and ecodesign tools. Different kinds of platform supporting ecodesign will be also reviewed. “Platform” is a concept not really defined in the literature. According to our review, ecodesign platform can refer to:

- A web interface gathering different software tools to carry out ecodesign activities.
- A set of design and ecodesign tools integrated in the same structure and able to communicate among themselves. As for the case of Computer-Aided Production Management systems (CAPM), different users can handle it and use the tools or the parts for which they are well-qualified.
- A website, often collaborative to collect, share and classify different types of environmental information.

The first subsection presents the platforms and solutions for interconnecting tools and the second one presents the collaborative platforms for data sharing.

2.2.1 Interconnecting tools and platforms for ecodesign

Environmental assessment tools such as LCA are said to present certain setbacks such as the time required to fill in their input data (Millet *et al.* 2007, Ramani *et al.* 2010, Reap *et al.* 2008). A promising approach is to interconnect environmental assessment tools with design tools used daily by designers, such as Computer Aided Design (CAD) and Product Lifecycle Management (PLM) tools, used for designing products based on “Life Cycle Thinking”.

The crux of this problem is more complicated than extracting the product digital structure from a CAD Tool, and then send them as inputs into environmental assessment tools. Indeed, efficient product stewardship requires that product and environmental information is shared among the design stakeholders and along the product design process. Several attempts have been carried out to couple Ecodesign and Design tools and particularly LCA tools and CAD tools.

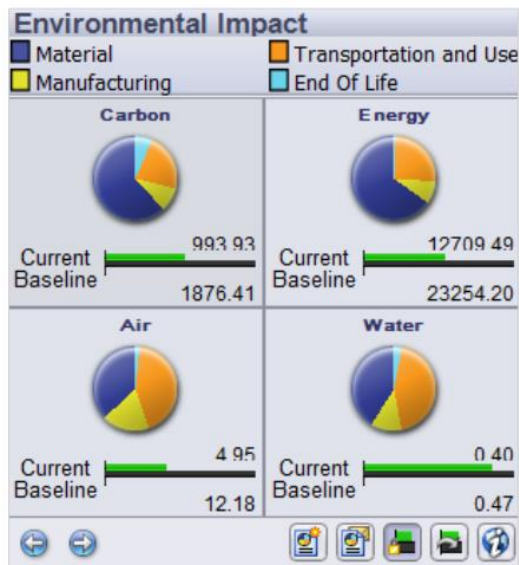

Figure 13: Solidworks sustainability dashboard (Dassault Systèmes 2011)

Solidworks is a well-known CAD software system and for a few years their developers include to the CAD environment a possibility to calculate environmental impact. Solidworks Sustainability enables to realize real-time environmental impact evaluation directly within the design window; the designer can thus visualize some environmental impacts values of his/her choices till features attribution (Dassault Systèmes 2011). SolidWorks Sustainability uses the GaBi LCA environmental impact database from PE International. The Sustainability interface is integrated and provides a dashboard of LCA information (see Figure 13). Four environmental indicators are measured over the life cycle of the product modeled: carbon footprint, total energy consumed, and air and water

impacts. Thus the available environmental indicators are very limited. This approach uses a CAD plug-in, therefore ecodesign is restricted to the product designer (in charge of CAD) and the multidisciplinary aspects of sustainability are not addressed. In particular social and economic aspects are not at all addressed in this “sustainability” module.

Cappelli et al. present a methodology to develop a new ecodesign tool, EcoDesign Helper (Cappelli et al. 2006). The main purpose is to create software application that, on one hand, allows the designer to assess the environmental implications of design choices based on the CAD structure, and, on the other hand, suggests to the user environmental advices through an ecodesign guidelines database.

Morbidoni et al. also describe an approach to support S-LCA during the early design phases (Morbidoni et al. 2012). The approach is based on data extraction from traditional design system databases (PLM, CAD data structure, ERP) to be used for environmental analysis. The authors focus on the importance of considering all the life cycle phases to get back data on these phases.

Gaha et al. (Gaha et al. 2014) expose a methodology to provide environmental evaluation based on feature technology and scenarios provided by:

- CAD & CAPP (Computer Aided Process Planning) integration.
- CAD and PLM (Product Life Management) integration.

Environmental impacts calculated with the CML method are shown to the designer as End-Point Indicators (Resources, Human Health, Eco-system damages). A new Ecodesign tool will be developed from this approach having the name of “Green-CAD”.

Mathieux et al. present the connection of the CAD tool, CATIAv5™, and the LCA tool, EIME™, via the PLM tools, ENOVIA Smarteam™ with Visual Basic™ Macros (Mathieux et al. 2007). Benefits had been identified: time savings, more data collected, data keyed-in only

once and for all. In this example, the limits were that all the environmental data required by the LCA tool could not be located in the CAD & PLM tools. Indeed, most of the data were related to the product structure (component tree, mass...), and others to the product and related processes in the other life cycle phases, hence the need for something more comprehensive containing all the necessary data.

We saw in the previous examples that a lot of authors concentrate their researches on the plug in, the connection or the federation of LCA tools with CAD tools. Sure these approaches are interesting and necessary but other authors are going further and develop more in-depth approaches, in the form of platform to provide the users a more complete environment of work. Some examples are presented in the following paragraphs.

In the GIPIE project, Theret et al. define principles of a software platform, the Environmental Data Workbench (EDW) platform, able to support environmental assessment tools (Life Cycle Assessment) or compliance tools (Theret et al. 2011). The objective is to collect from CAD and other PLM applications the environmental data, to validate them using an adapted workflow and to publish them to the environmental analyst applications: restricted substances compliance Check and LCA. The EDW architecture, illustrated in Figure 14 is based on a hub component interacting with all other applications: CAD and CAE, other PLM applications, materials or components databases and environment analysis applications.

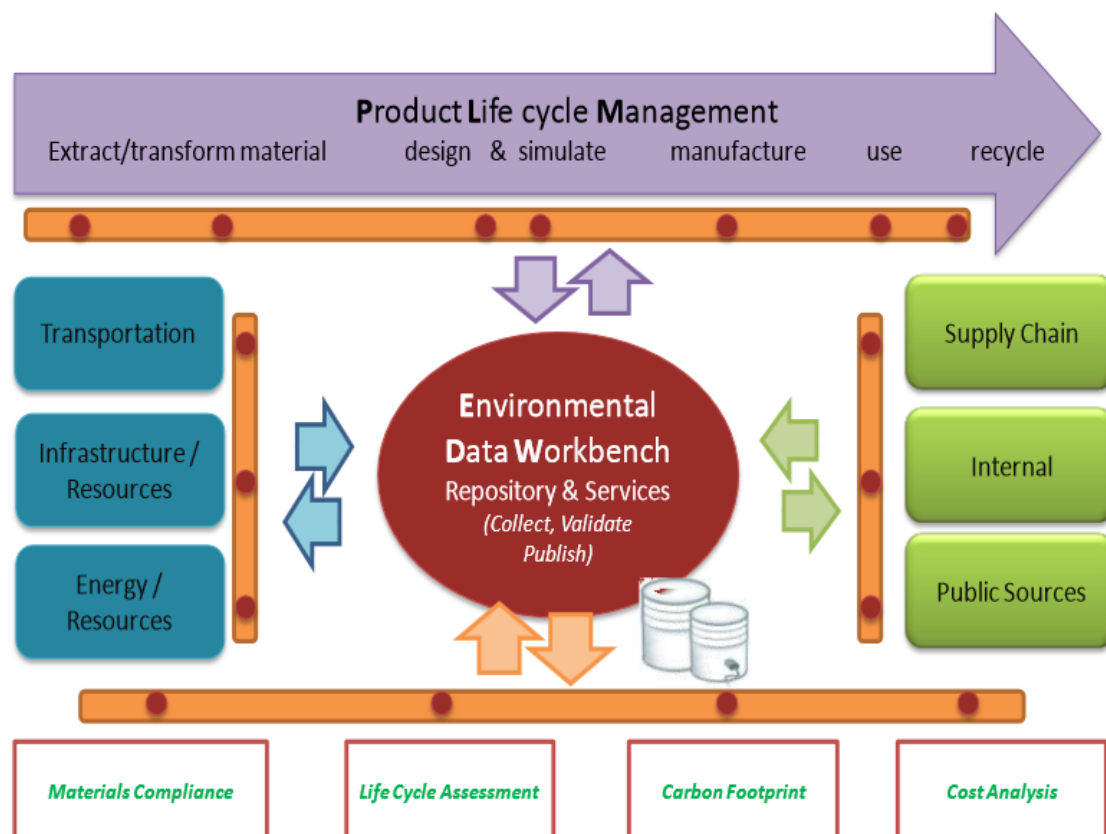

Figure 14: ENOVIA Environmental Data Workbench (EDW) architecture (Theret et al. 2011)

At this time, two demonstrators have been built to prove the benefits of this platform: one with CATIA/DELMIA v6 with customizations and an import function to collect all the

environmental data to build the Bill of Substances (BoS) and Bill of Processes (BoP); another one is integration between ENOVIA EDW & OpenLCA.

Favi et al. define a web-based software platform to design energy efficient electric motors (Favi et al. 2012). The platform, called the EROD (Energy Reduction Oriented Design) platform and illustrated in Figure 15 consists of a set of integrated software tools aiming to support electric motors designers during the whole design process. The different modules are:

- Knowledge-based system (KBS): it is a central tool linked to the other tools to manage and collect data. In particular, the tool is linked to a simulation tool to verify the electromechanical performance of the new motor.
- Design for Energy Efficiency (DfEE) module: it gives rules and guidelines for the best configuration of electric motors and is also linked to the simulation tool to assess the motor.
- LCA module: it aims at estimating environmental impacts specifically in manufacturing phase and use phase as these are the most critical phases for an electric motor. The tool is directly linked to the KBS and the DfEE.
- Cost Estimation module: it aims at evaluating and monitoring the manufacturing costs of electric motor components during the early design phases.
- Co-Design module: it is a collaborative area to improve the collaboration among users involved in the design process thanks to the sharing of design data and models.

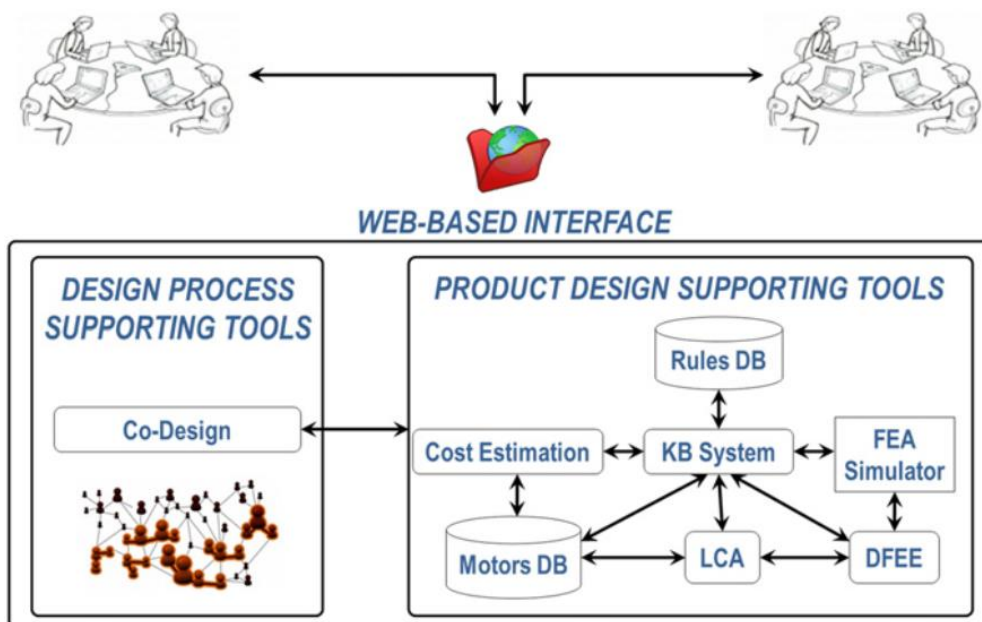

Figure 15: EROD platform architecture (Favi et al. 2012)

These platforms are very interesting on different aspects. For examples: firstly they provide the users a common environment or workbench, secondly they have a strong data management system, and thirdly they link environmental assessment tools to traditional designer tools as CAD tools or simulation tools. Finally these approaches highlight important features but are still too light in terms of ecodesign proposals.

Rio et al. present another approach. They show the lack of dynamism and flexibility of existing solutions supporting data exchange among software to codesign products (Rio et al. 2013). They propose a method to federate product designers and environmental engineers' activities during the design process. The three-step method aims to build dynamic information exchanges between designers and environmental engineers:

Step 1: Modelling the design process through for instance UML (Unified Modelling Language) activity diagrams of usual activities

Step 2: Modelling the data involved in activities through UML class diagrams

Step 3: Modelling the knowledge transformations needed to link the environmental engineer activity models and product designer activity models.

The IT developer establishes then supports for users using the knowledge transformations. In their case study Rio et al. illustrate the method by building knowledge transformations firstly to federate product designers' tools and LCA and secondly to translate environmental results to product designers. This approach has the advantage of being tailored to the company and enable a dynamic and bilateral exchange of information but thus needs time to be developed and the work has to be done for each company in which the approach is implemented.

Following examples show another type of proposals, strongly focused on codesign.

The Austrian ECODESIGN Information platform⁴ aims to collect all interesting information and links about codesign and make it accessible to a broad audience. This platform is available on a free access website and also includes different tools and notably ECODESIGN PILOT - Product Innovation Learning and Optimization Tool. The ECODESIGN PILOT is designed as a product improvement tool, that supports the decision making process to find appropriate codesign measures to improve products (Wimmer et al. 2002). The tool helps identifying the most impacting phases of a product life cycle through a design assessment procedure and finding practical measures to environmentally improve products. They also develop a methodological support to implement the approach with the design process.

Sustainable minds⁵ is a web platform aiming at estimating environmental impacts of a product, compare different design concepts and use design strategies to improve the environmental performance of a product. Sustainable Minds is composed of one web interface that import the bill of materials (BOM) of CAD software to realize the environmental assessment. A learning center is available to the user and gives how-to information on environmental performance strategy, design practices and LCA, in context.

EcoMundo gathered their expertise in codesign into one tool: the CORINE software. CORINE was developed during the French CORINE project⁶ which aims at developing an codesign approach within the supply chain of a complex product: a helicopter. CORINE is a

⁴ Ecodesign Information platform: <http://www.ecodesign.at/>, March 2015

⁵ Sustainable Minds: <http://www.sustainableminds.com/>, March 2015

⁶ The CORINE project: <http://www.corinecodesign.eu/en>, March 2015

web collaborative ecodesign tool shared between contractors and suppliers. The platform enables to realize a qualitative analysis for rapid assessment but also quantitative assessment based on LCA methodology. It provides also a REACH indicator to answer the REACH regulation on chemical substances. CORINE offers the possibility to have a global approach by building projects with the company partners. The software is based on a database specific to the aeronautics sector. From now, the software has been tested only on a few parts of a helicopter.

These web interfaces propose environmental evaluation and often recommendation to improve the product. They aim to be user-friendly and their web access provides them an accessibility advantage. However these approaches are less linked to the design tools and also to the design process. Moreover they seems to be used by a standalone person and do not promote collaborative activities.

2.2.2 Collaborative platforms for environmental data sharing

This subsection is thus dedicated to collaborative platforms for the sharing of environmental information. We already talked about the ECODESIGN Information platform gathering information and links on ecodesign but some platform are specialized in this type of delivering. Here are some examples.

Seeds4Green⁷ is a wiki platform that aims at gathering and sharing documents related to the environmental evaluation of products and services. The purpose of the platform is to collaboratively build knowledge on the environmental quality of goods and to diffuse the results of LCA studies (Teulon & Canaguier 2012).

A similar initiative is observed: the P2I⁸ (Intelligent Information Platform) is developed for the cluster CREER which stands for Cluster Research: Excellence in Ecodesign and Recycling. The P2I tool has to support the gathering, classification and sharing of technological and legal information on recycling and ecodesign.

Oree⁹ is also ecodesign platform to let the user discover what an ecodesign approach is. The platform is composed of three axes. The first one gathers thematic articles on environmental concepts or existing environmental methods and tools. The second one deals with the role of the various authorities within a company. The last one offers concrete experiences of ecodesign process implementation in France.

2.2.3 Conclusions on interconnected tools and platforms

Some important points and ideas have been highlighted with this review.

First of all, the connection between LCA and CAD (and/or PLM) tools seems to be necessary to get automatically data for the LCA and thus save time: “Integrating environmental

⁷ Seeds4Green: <http://seeds4green.net/>, March 2015

⁸ P2I: <http://www.clustercreer.com>, March 2015

⁹ <http://www.oree.org/en/eco-design-platform.html>, March 2015

concerns with CAD and PLM is of major importance to really be able to develop greener products and services” (Theret et al. 2011). This connection enables to get data most from the product structure and others from the product and the related processes and therefore data associated to the manufacturing phase. However for the LCA data from all the life cycle it is required a more comprehensive solution containing all the necessary data (Mathieux et al. 2007). For example, as they are looking at electric motors, Favi et al. develop a specific tool for the use phase called Design for Energy Efficiency to manage energy efficiency (Favi et al. 2012). This tool is directly connected to the LCA in order to fill in the use phase data. However we do not find a system covering all the life cycle phases.

Moreover approaches connecting CAD tools with LCA tools are restricted to the designer and if any to the environmental expert but it does not involve all the team and the multidisciplinary aspects are not addressed.

Others are going further and developed platforms gathering different kind of tools (data management system, environmental assessment tools linked to traditional designer tools as CAD tools or simulation tools, etc.) to provide users a common and more complete environment of work. It enables various users to interact through the platform. However we observe that some aspects of ecodesign are still not taken into account.

The web interfaces exposed in this review present more complete solutions to ecodesign: LCA, ecodesign guidelines, databases on existing cases, ecodesign learning center, cost estimation, etc. These web platforms highlight the need for guidance for designers in order to improve the product environmental performance once this performance has been assessed. The advantage of these approaches is the web access and their inconvenient is that they are not linked to others tools from the design process and the user has to enter manually all the data (or in some cases has the possibility to import the bill of materials).

Some authors (Favi et al. 2012; Gaha et al. 2014) pointed out the importance of translating environmental knowledge, mainly LCA results to designers. This aspect needs to be studied to improve the efficiency of the ecodesign process.

To conclude, software solutions reviewed enables to highlight some important needs for ecodesign integration, for example in the form of a software platform. They are summed up in the following table.

Table 1: Summary of software needs for a complete integration of ecodesign in the design process

Software needs for an ecodesign software platform
A common environment of work (e.g. in a the form of a platform)
A connection between traditional design tools, especially CAD tool, with LCA tool (via PLM or other data management system)
A flexible solutions for data exchange
A solution to get back data from the other phases of the life cycle

A guidance tool to help designer to improve the environmental performance of the product

A way to translate environmental knowledge to designers

3 Methodological barrier: review of existing methodologies

Ecodesign implies an integrated design approach but we showed that it is not sufficient to meet all the ecodesign needs. In particular, we saw that there is a need for a new organization involving transformations during the design process. This part aims at removing the third barrier, the methodological barrier, related to the lack of methodology able to link ecodesign activities, ecodesign tools and stakeholders involved in the design process. The first subsection reviews methodologies enabling to structure the necessary steps to realize an ecodesign approach. Subsection 2 presents some trials of connected tools and reviews different types of ecodesign platform. Then subsection 3 concludes the review.

The review presented here does not claim to be exhaustive, gathering all the methodologies but rather to show the different approaches and their characteristics. These approaches are illustrated by a number of examples.

3.1 Ecodesign methodologies

One solution to remedy the problem of environmental concerns integration within a company and specifically during the design process is the development of a methodology. But what is a methodology? According to Howell, the methodology is “*the general research strategy that outlines the way in which a research project is to be undertaken and, among other things, identifies the methods to be used in it*”. And the methods described in the methodology are defined as “*the means or modes of data collection or, sometimes, how a specific result is to be calculated*” (Howell 2014). Thus in our case, an ecodesign methodology is a term used to describe the different steps necessary for a good integration of environmental concerns in the design process. The methodology could also precise which design or ecodesign tools and methods should be used at each step to have an overall vision of what actions to do, when and how. Figure 16 illustrates this concept.

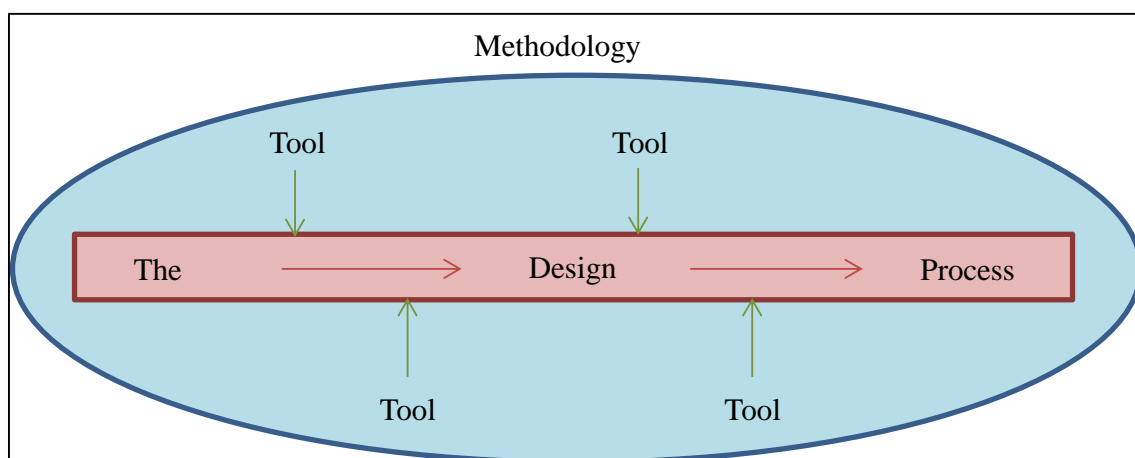

Figure 16: Illustration of the framework of an ecodesign methodology

Defining a methodology is really essential because each tool has a particular function and a specific use. This means that in an ecodesign approach several tools can be used to design a same product. But as the compatibility between tools is not guaranteed (Le Pochat et al. 2007) and as there is a lack of information about how to use the tools (Fargnoli & Kimura 2007), defining a methodology enables to apply the right tools at the right point in the design process.

Different authors proposed ecodesign methodologies to tackle raised problems and to systematize ecodesign activities. Some methodologies are more related to environmental management and design issues while others are focused more particularly on design issues. A focus on methodologies dedicated to energy concerns will also be presented.

3.1.1 Methodologies linking environmental management and design activities

In 1997, Brezet and van Hemel already highlighted the importance of developing a step by step methodology with the tools and guidelines necessary to help companies to implement ecodesign in their product development process (Brezet et al. 1997). Thus in their PROMISE-manual they described a methodology in seven steps:

Step 1: Organizing an ecodesign project

Step 2: Selecting a product

Step 3: Establishing an ecodesign strategy in 5 activities:

- Analyse the environmental product profile using tools as MET Matrix, EcoDesign Checklist, or LCA.
- Analyse internal and external ecodesign drivers
- Generate improvement options via the Ecodesign Strategy Wheel Life Cycle Design Strategy Wheel – LiDS wheel (classification of eight potential ecodesign strategies as shown in Figure 17)
- Study feasibility of the improvement options
- Define the ecodesign strategy

Step 4: Generating product ideas

Step 5: Detailing the concept

Step 6: Communicating the product

Step 7: Follow up activities

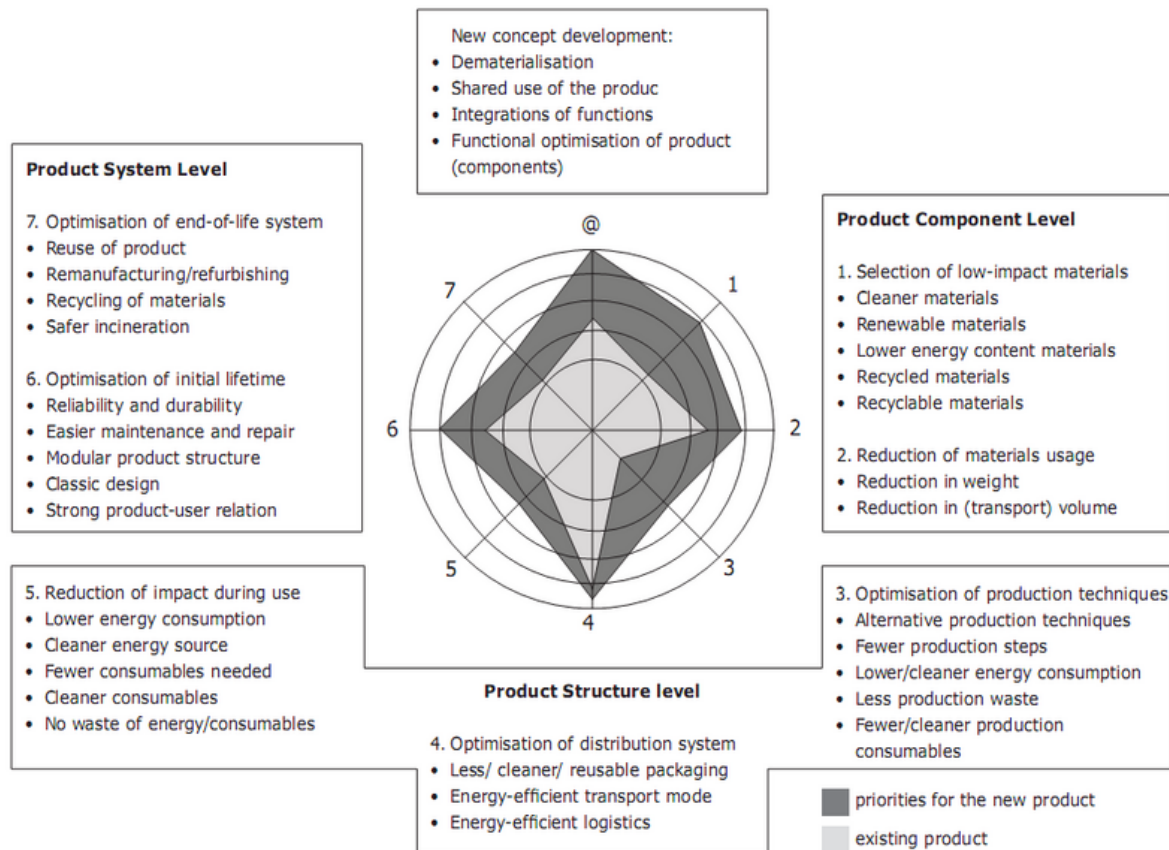

Figure 17: Ecodesign Strategy Wheel Life Cycle Design Strategy Wheel – LiDS wheel (Brezet et al. 1997)

The same year, Cramer and Stevels developed a methodology called Selection of sTRategic EnvironmenTal Challenges (STRETCH) and tested it at Philips Sound & Vision (Cramer & Stevels 1997). Five steps are managed with the aim to incorporate environmental considerations into the business strategy and to select strategic environmental challenges in an early phase of the business development.

In 2001, Stevels completed the approach to embed ecodesign into the business (Stevels 2001). The processes were divided in three levels. The main stream level consists of green idea generation, product creation and green communication/sales. The level above is the strategy level and the level below is the level of supporting tools. This approach is interesting because different methodologies are used inside this methodology: a generic environmental benchmark method (Jansen & Stevels 1998) and the STRETCH methodology (Cramer & Stevels 1997).

Another methodology offered by Navarro et al, describes a series of activities that make up the ecodesign process (Navarro et al. 2005). This methodology includes activities that cross the boundaries between traditional design and wider management issues:

Step 1: Preparing the Project. Identification of objectives which are consistent with the company's policy. Project Team. Planning. Preliminary selection of Ecodesign tools. Search for internal and external support. Analysis of success factors, both internal and external.

Step 2: Identifying Environmental and Social Impacts. Indicators and Assessment. Environmental Accounting. Definition of goals and environmental specification.

Step 3: Improvement Ideas. Proposal of ideas which can resolve the problem. Evaluation and selection of the most feasible ideas, economically, technically and environmentally.

Step 4: Conceptual Design. Development of the most feasible ideas into concepts (or embodiment designs). Analysis of Feasibility and selection of solution(s).

Step 5: Detail Design. Final design. Production Project. Documentation. Production Support.

Step 6: Action Plan. Support in the product's launch. Support in communication activities. Promotion and Sales. Environmental Reports.

Step 7: Evaluation of the Process. Proposals for the improvement of the functions and the systems which have taken part. Preparing the next Ecodesign project.

This methodology is inspired by the PROMISE-manual developed by Brezet and van Hemel. The methodology built by Navarro et al. is useful for numerous reasons. Firstly it takes traditional design activities and adds environmental considerations, helping to envision the ecodesign as an integral part of a standard design process. Secondly it addresses management related issues and transforms them into defined activities. Then it helps understand how organizational support can be offered. Finally it introduces ecodesign planning activities in the early design stages and evaluation activities during the later design stages which are important for successful implementation.

Another approach linking environmental management and design activities exists in the "ARPI framework" (Simon et al. 2000) where a parallel methodology is applied between the strategic level and the operational level. The methodology consists in four phases: Analyze, Report, Prioritize and Improve (see Table 2 below).

Table 2: THE ARPI framework (Simon et al. 2000)

Step	Strategic level	Operational level
Analyse	Assess the external and internal drivers for ecodesign and benchmark the organization	Assess the product in the light of specific drivers (e.g. legislation), using LCA or similar tools
Report	Communicate the corporate environmental status and policy to improve environmental culture	Communicate the results to the design team and obtain feedback
Prioritize	Develop an ecodesign strategy (within corporate product development strategy) and set overall ecodesign objectives	Set targets for the product for inclusion in the specification; targets may be chosen levels for company metrics
Improve	Plan action such as pilot projects and training; develop or customize metrics, tools and methods	Carry out normal product design incorporating appropriate tools used by trained and aware designers

The separation of the strategic level from the operational level is interesting because each department is aware of its tasks and the activities can be realized at the same time. However due to the nature and the structure of small and medium sized enterprises (SMEs) this approach may not be relevant for this kind of company (Simon et al. 2000). Ecodesign could indeed be a problem for SMEs because the ecodesign tools are not created for an easy integration into this type of business.

Due to the need for integration Le Pochat et al. are putting forward a user guide for technical centers for assisting a company with an ecodesign pilot project (Le Pochat et al. 2007). This methodology called the EcoDesign Integration Method for SMEs (EDIMS) aims at integrating ecodesign in SMEs and to make the new ecodesign practices durable. Two aspects are developed in EDIMS: first an environmental analysis of the product using the specific tool Typological Environmental Analysis TEA and then assistance for conducting changes in the business. Figure 18 shows the different steps to follow the EDIMS methodology.

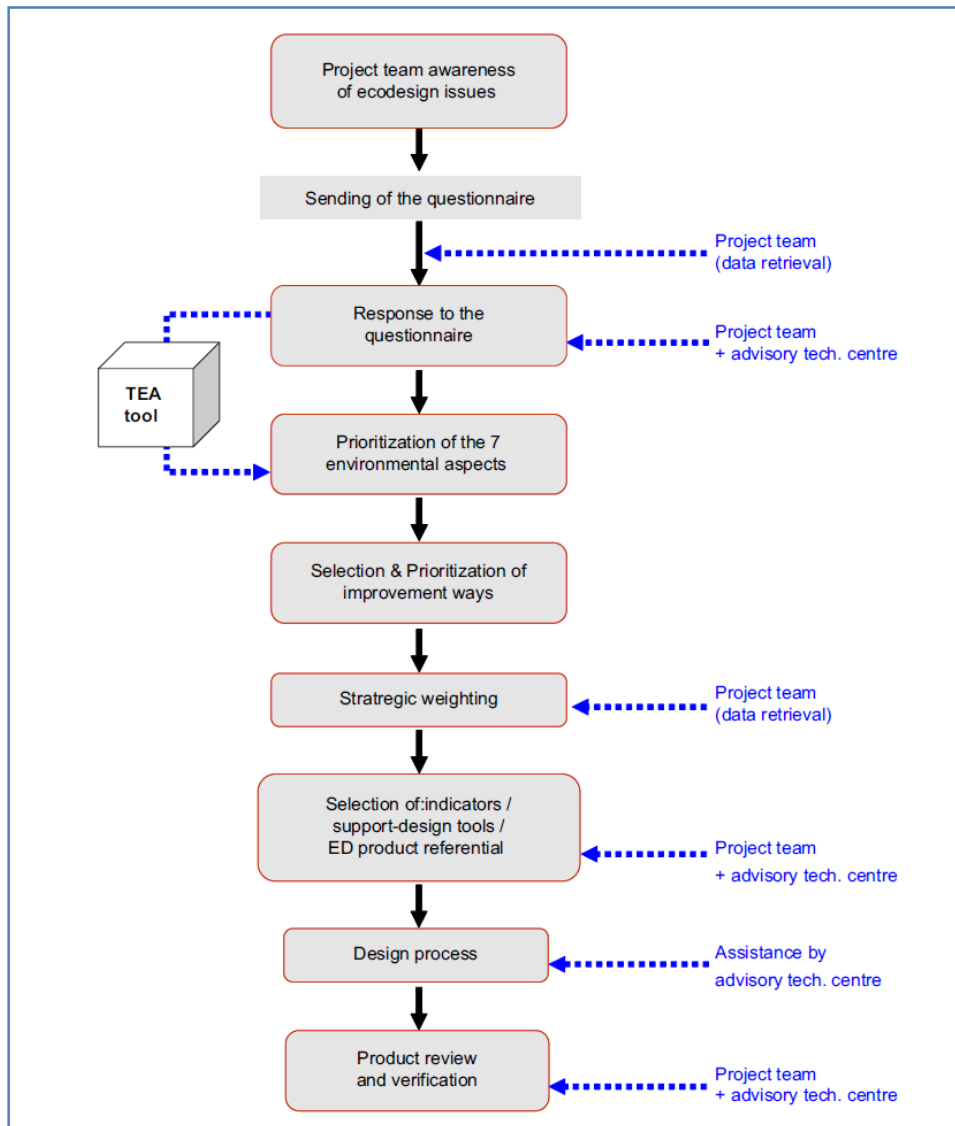

Figure 18: Implementation of the EDIMS method for an ecodesign project with an advisory technical centre (Le Pochat et al. 2007)

The methodology they propose is addressed not to the enterprise itself but to the external organizations that provide assistance during an ecodesign pilot project. However nothing ensures the success of the integration. Indeed, the time required to establish an ecodesign approach is much longer than the time during which the advisory technical center steps in (Le Pochat et al. 2007).

In another kind of methodology, Pigozzo et al propose a management framework with a step-by-step approach that they call ecodesign maturity model (Pigozzo et al. 2013). The ecodesign maturity model aims to support companies in carrying out ecodesign implementation through a process improvement from a managerial perspective rather than a product improvement from a technical perspective. The model consists of three main elements: Ecodesign practices, Ecodesign maturity levels and an application method.

Ecodesign practices include a collection of ecodesign management practices and ecodesign operational practices. Ecodesign techniques and tools supporting the application of both kinds of practices has been listed and classified.

Ecodesign maturity levels are composed by a set of successive stages for the incorporation of environmental issues into the product development and related processes. Two axes define the maturity levels: evolution level in ecodesign (describing a recommendation of the stages to be followed for ecodesign implementation) and capability level (qualitatively measuring how well a company applies an ecodesign management practice).

An application method has been developed to support companies with ecodesign implementation and management. The method aims at guiding ecodesign management by the application of the model and to establish a framework for continuous improvement via the incorporation of ecodesign practices into the product design process:

Step 1: Diagnosis of the current maturity profile in ecodesign

Step 2: Proposal of ecodesign management practices and improvement project

Step 3: Portfolio management of improvement projects for ecodesign implementation

Step 4: Planning of the improvement projects for ecodesign implementation

Step 5: Implementation of the improvement projects

Step 6: Assessment of the results

The French National Research Agency founded a national research project called “Convergence”. The objective of this project is “*to determine whether sustainable integration could be improved by better cooperative circulation between the different company levels (strategic, tactical and operational), and to propose a navigation-based approach to support this improvement*” (Zhang et al. 2013). The convergence proposal is focused on environmental aspects of sustainability and consists in a navigation system which provides support to companies willing to integrate environmental concerns in their processes. The

navigation system consists of three complementary modules presented in Figure 19. Each module is dedicated to different and complementary stakeholders in the company, in line with their own activity and expertise.

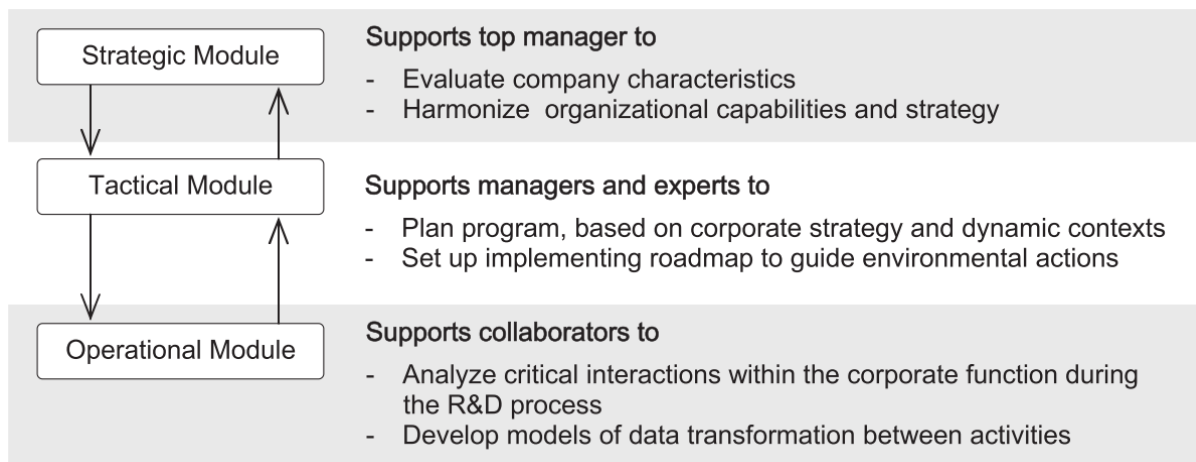

Figure 19: The principal framework of “convergence” proposals (Zhang et al. 2013)

The ISO/TR 14062 standard

Another important approach to consider is the one given in the ISO/TR 14062 (2002) standard which looks at the issue of environmental aspects integration into design from an environmental management perspective. This standard offers a broad methodology that covers topics of business structure, management and specific design activities. The methodology is wide reaching, generic and offers useful advice relating to the processes related to environmental management and design. Figure 20 shows possible actions to lead in order to integrate environmental aspects during the design process. The standard lists tools or kind of tools that could be used at the main steps of the product design process.

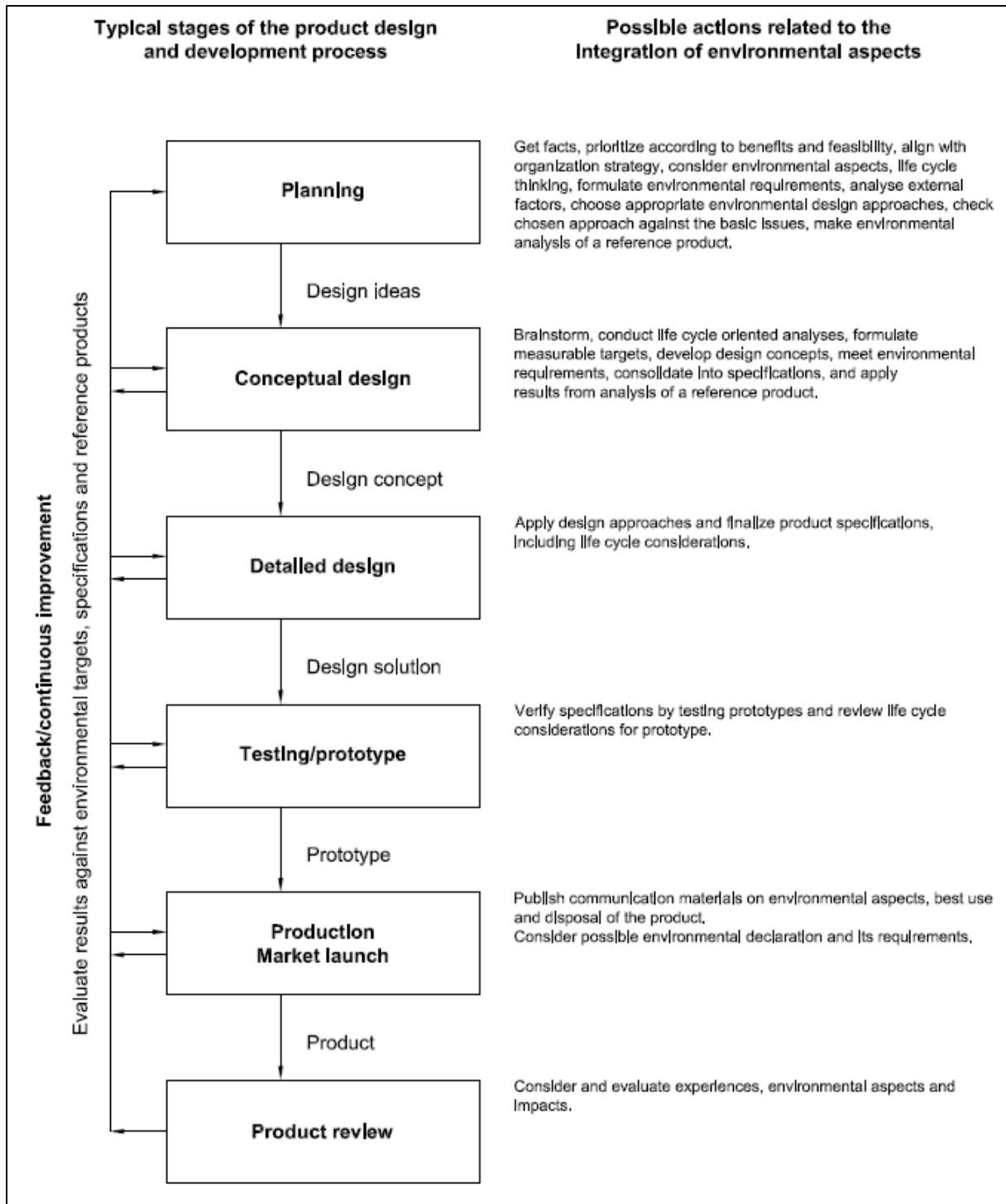

Figure 20: Example of a generic model of integrating environmental aspects into the product design and development process (ISO 14062 2002)

3.1.2 Methodologies focused on the product development process

Some authors chose to focus their efforts more particularly in terms of ecodesign on the product development process. Typically, Gorauskiene and Varzinskas offer for each product development phase a set of specific corresponding tools (Figure 21) in order to maximize the environmental performance of the product (Gorauskiene & Varžinskas 2006). They specify

that the whole product system must be considered, i.e. the product, the auxiliary products, the consumables, etc. to ensure coherence in the ecodesign approach.

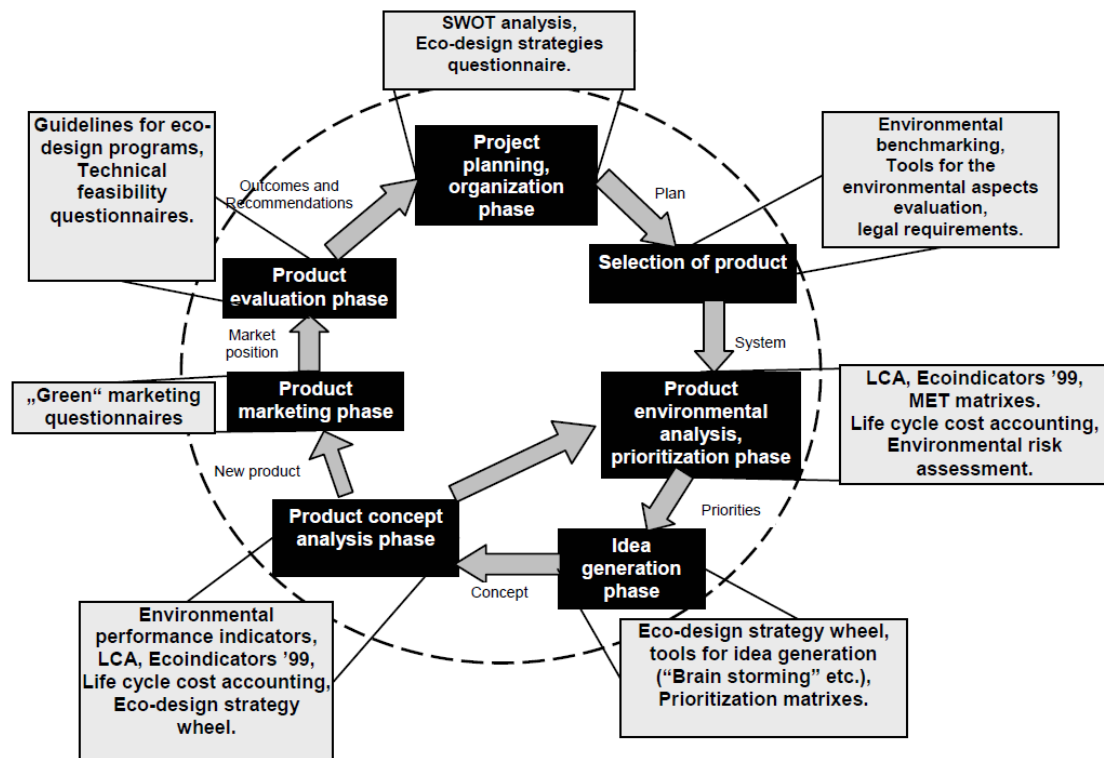

Figure 21: Model for systematic use of different tools for the environmental product development (Gurauskiene & Varžinskas 2006)

Fargnoli and Kimura consider also the use of the most common ecodesign tools inside the design process, as well as the integration with recent environmental regulations (Fargnoli & Kimura 2007). Indeed, they define an easy-to-use design process' scheme made up of a series of activities, which supply explanations on the use of some ecodesign tools and on the application of the regulations.

Platcheck et al. propose a methodology of ecodesign for the development of sustainable electric/electronic equipments (Platcheck et al. 2008). The difference with the authors mentioned above lies in the considered design stages. Here, the design process and then methodology is divided into four phases: briefing phase, development phase, projection phase and communication phase. The briefing phase places the project in its context and defines a framework. The development phase draws up an analysis of the situation in seven stages. During the projection phase alternatives and technical draws of the final solution are created. The last phase refers to the communication part.

Gurauskiene and Varzinskas (2006), Fargnoli and Kimura (2007), and Platcheck et al. (2008) offered methodologies encompassing the whole product design process. Other methodologies focusing on one aspect were developed, for instance, the Life Cycle Planning - LCP – methodology (Kobayashi 2006).

The early design phase of the product development process is very important concerning the environmental issue because significant environmental decisions are taken in the pre-specification phase of design (Bhamra et al. 1999). Kobayashi has developed a product life cycle planning (LCP) methodology in order to integrate quality, cost, and environmental aspects simultaneously in the early design phase (Kobayashi 2006). The author adds to this methodology a systematic approach to eco-innovative product design consisting of idea generation using TRIZ, design uncertainty evaluation and an eco-efficiency indicator.

All those different methodologies highlight important ecodesign activities but they do not provide specific tools to support the design process. Moreover the role of the different actors and the links between them are not highlighted.

3.1.3 Methodologies focused on energy concerns

Here are presented two methodologies which are dedicated to the energy issue: the Synergico methodology (Domingo, Evrard, et al. 2011) and the Methodology for the Ecodesign of Energy-related Products - MEERP - (<http://www.meerp.eu/>).

Synergico is a methodology which aims to help designers to better consider the energy consumption of electrical and electronic equipment during its design and to facilitate the integration of this criterion as any other design criteria (Domingo, Evrard, et al. 2011). The methodology is based on three tools, namely the in-use energy consumption tool (IUE), the guidelines, and the lifecycle check tool. Design data are used to calculate an In-Use Energy consumption indicator for several use scenarios and to monitor the compliance with the objectives defined earlier. Guidelines can then be used to obtain a list of strategies in order to converge towards an objective. Eight criteria help the designers to select the guidelines according to their needs. Finally, Synergico includes a simplified lifecycle check tool to compare the environmental impacts of the product along its lifecycle with a reference product to verify that a solution improving energy efficiency in use does not entail impacts in the other phases. This tool performs a very simplified LCA aimed at helping designers to take the best decision but it cannot replace a full LCA according to the ISO 14040 standard.

Another methodology related to the energy issue is the Methodology for Ecodesign of Energy-related Products - MEERP - (<http://www.meerp.eu/>). This methodology is an extension and an updated version of the Methodology for the Ecodesign of Energy-using Products (MEEuP). The MEEuP allowed evaluating whether and to which extent various energy-using products fulfil certain criteria that make them eligible for implementing measures under the original Ecodesign Directive 2005/32/EC. The MEEuP was developed in 2005 in the framework of the Directive 2005/32/EC on Ecodesign of Energy-using Products and thus the MEERP is a response to the new directive 2009/125/EC which repealed the former directive.

3.1.4 Conclusions on methodologies

Different types of methodologies have been reviewed, those combining environmental management and design activities, those focusing on design activities and specific ones focused on energy concerns. Separation between the two first groups is not so obvious, because some of the methodologies focused on design activities include also some tasks related to the management. An important point highlighted in this review is that ecodesign aspects really need to be integrated into the design process. For the sake of completeness, an ecodesign methodology should include the following information to help at best and precisely companies and their design teams:

- Considering management perspectives.
- The different steps to realize for a good implementation of ecodesign.
- When to realize the actions into the traditional design process.
- The corresponding tools to be used to carry out the actions.

Only few methodologies contains all the characteristics (ISO 14062 2002; Brezet et al. 1997; Pigosso et al. 2013). However, although they consider these aspects, there are still some imprecise and blurred territories. Indeed, there is little or no indications on the persons supposed to use the tools and more broadly on who is supposed to do what and when in the design team during the process. Moreover, some methodologies recommend specific types of tools or even proposed their own tools but none of them (to our knowledge) bring a solution to support and facilitate the collection and the management of environmental data and information at every step of the methodology and the connection with traditional design tools.

To conclude, methodologies reviewed enables to highlight some important needs for ecodesign integration summed up in the following table.

Table 3: Summary of methodological needs for a complete integration of ecodesign in the design process

Methodological needs
Including management perspectives
The different steps to realize for a good implementation of ecodesign
The moment to realize the actions into the traditional design process
The corresponding tools to use to carry out the actions
The person in the design team in charge of each activity

4 Conclusions

In this chapter, we reviewed the different solutions found in the literature to remove each of the identified barriers. Integrated design is seen as the best approach to reach the future environmental goals, absorb the specificities of environmental concerns integration and then remove the organizational barrier. Looking at the technical barriers, authors developed software solutions to interconnect tools (design tools among themselves or with ecodesign tools). The review enabled us to point the software needs required for a software platform for ecodesign. Regarding the methodological barrier, we reviewed the existing methodologies and extracted the methodological needs required for the elaboration of a complete methodology. We thus defined the key elements to remove the barriers. Furthermore, we showed in the last chapter that a crucial point of our analysis lies in the simultaneous removing of three barriers. The following chapter will then expose the problematic and define our working hypothesis to build our proposal.

Chapter 4

Detailed problematic

- 1 DETAILED PROBLEMATIC..... 69**
- 2 DESCRIPTION OF THE WORKING HYPOTHESIS 71**
 - 2.1 N1) THE ROLE OF STAKEHOLDERS: INVOLVEMENT OF ALL ACTORS OF THE PRODUCT LIFE CYCLE..... 71
 - 2.1.1 *Need for an environmental design manager..... 71*
 - 2.1.2 *Involvement of all company departments..... 72*
 - 2.1.3 *Involvement of the management 73*
 - 2.1.4 *Involvement of the supply chain..... 73*
 - 2.2 N2) TOOLS FOR THE DESIGN OF PRODUCTS AND ITS LIFE CYCLE..... 73
 - 2.2.1 *Need for specific life cycle tools..... 73*
 - 2.2.2 *Communication between classic tools and specific tools..... 74*
 - 2.3 N3) INDICATORS AND GUIDANCE TOOL TO MANAGE ENVIRONMENTAL INFORMATION..... 74
 - 2.3.1 *A guidance tool..... 74*
 - 2.3.2 *A way to assess the product on environmental and cost features 75*
 - 2.3.3 *Link between the evaluation module and the guidance tool 75*
 - 2.3.4 *A way to monitor environmental criteria 75*
 - 2.4 N4) DATA AND INFORMATION MANAGEMENT 76
 - 2.4.1 *A way to store new information and taken decisions 76*
 - 2.4.2 *A link between the product and life cycle models with the evaluation module 76*
 - 2.4.3 *Databases..... 76*
 - 2.4.4 *A way for supplier to provide their information to the lead company 76*
 - 2.5 N5) A PROCEDURE TO BE IN LINE WITH THE DEISGN PROCESS..... 77
- 3 CONCLUSION..... 77**

1 Detailed problematic

This section aims to formulate the problematic from the different observations we made about ecodesign and its integration in the design process. The state-of-the-art realized in the previous chapter enables to raise some issues and lacks.

We showed that integrated design by its definition and its principles met some of the challenges. Indeed, the simultaneous consideration of all design constraints, the organization change and the creation of multidisciplinary teams are among the factors to facilitate ecodesign integration. However we saw that some of the challenges are still unsolved by integrated design and there is a need for something else.

Authors develop methodologies and software solutions to try to improve respectively the integration in the design process and the compatibility between the tools. The review of these approaches showed that none of the authors defines a complete solution but allowed us to list the necessary features, methodological as well as software application, to build a global solution.

This is how we identified from the literature review the key elements for ecodesign integration in the design process. Then, our general research question is:

How all these key elements can be considered during the design process in order to remove simultaneously the barriers of ecodesign integration?

Section 2 summarizes the needs to be taken into consideration for a good introduction of ecodesign in the design team and the design process, according to the key elements outcome from the state-of-the-art analysis. Figure 22 synthetizes the research approach to build our proposal (presented in chapter 5).

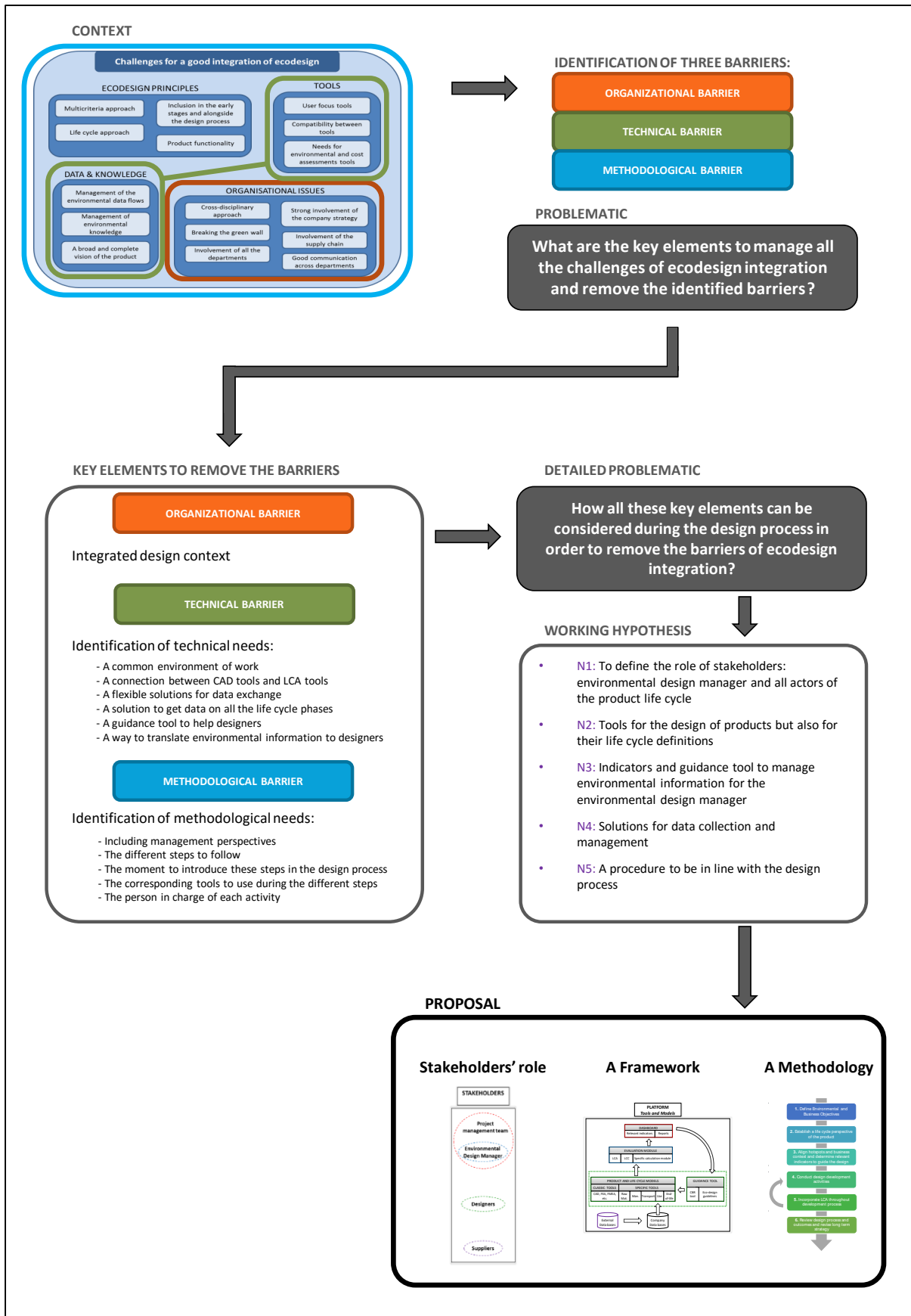

Figure 22: Summary of the research approach to build the proposal

2 Description of the working hypothesis

Through the state-of-the-art, we highlight different concepts and elements that are required for a good integration of ecodesign in the design process. According to our analysis of the literature, we develop five working hypothesis represented the needs for a better integration of ecodesign. It means that we assume that if these needs are met, the barriers will be removed and ecodesign integration will be a success. Those needs are related to:

ORGANIZATIONAL BARRIER

N1) The role of stakeholders: Involvement of an environmental design manager and of all actors of the product life cycle

TECHNICAL BARRIER

N2) Tools for the design of products and their life cycles

N3) Indicators and guidance tool to manage environmental information

N4) Data and information management

METHODOLOGICAL BARRIER

N5) A procedure taking into account the methodological needs to be in line with the design process

N1 is related to the organizational barrier. N2, N3 and N4 are related to the technical barrier. N5 is related to the methodological barrier.

The needs are developed and explained in the following subsections.

2.1 N1) The role of stakeholders: Involvement of all actors of the product life cycle

One major principle of ecodesign is the consideration of the product life cycle. Consequently each actor of the product life cycle has a role in the environmental profile of the product and can contribute within his context and at its scale to improve the environmental performance of the product. A focus is made on the need for an environmental design manager.

2.1.1 Need for an environmental design manager

Ecodesigning product involves a lot of environmental knowledge and according to the current level of training of designers and managers we think that it is necessary to have someone leading environmental issues in the company. Moreover, all the company departments are concerned by ecodesign. To have someone dedicated to this task enables a permanent and available resource able to work with each department in order to train them and to help them in their choices at least at the beginning of the implementation of ecodesign. Zwolinski et al.

show how it is important to integrate environmental specialists, environmental actors, in projects teams (Zwolinski et al. 2004). They detailed the roles of the environmental actor illustrated in Figure 23. According to them, he has first to participate to the product design in making its constraints integrated by the others actors of the projects team and secondly and principally has a role of watching for legislative, technological and economic aspects linked to the environment. They propose that, for the case of SMEs, this environmental actor become common to several firms. As its major activity will be the watching, then, for each firm, he could specify evolutions on tools, methods, manufacturing processes, dismantling processes, taking into account watching results and anticipated resulting recommendations.



Figure 23: Missions of an environment actor in product development (Zwolinski et al. 2004)

We have now a more complete vision of the role of the environmental actor. According to us, its role in the design process is more important; that is why we call this environmental actor an “environmental design manager”. The environmental design manager must be involved in the strategy of the company to take part of the decisions concerning the environmental policy of the company. He has a great role in each design project in defining the environmental requirements and targets. These objectives are decided together with the project management team, in accordance with the other product specifications. He has then to choose driver indicators for the product design and follow them alongside the project. He realizes the product environmental assessment and guide designers in the redesign and in the improvement of the product environmental performance. These different activities are supported by tools in order to help him in the implementation of ecodesign. He has the role of watching and also of training for people in the company. We agree that after some pilot projects and more ambitious projects, his role will be less in the organization and coordination of ecodesign activities because each department will be aware of its role and its contribution in the ecodesign process. However he always has a great contribution in the choice of design trade-offs to meet the project objectives as environmental indicators definitions stay its specialty. According to Brissaud and Zwolinski, “Engineering design is a negotiation process among the numerous members involved within the design team throughout the design process” (Brissaud & Zwolinski 2004); ecodesign adds then a dimension to this negotiation that is why we talk about design trade-offs.

2.1.2 Involvement of all company departments

Environmental issues concerns all company departments because each company activity (or at least most of them) has an impact on choices made for the product and for the life cycle of the product. For example, the purchasing department has an influence on the type of materials or components chosen, their suppliers and so their origins which affects the environmental

balance. Indeed, for example the composition of the material, its extraction mean, the modes of transport and travelled distances are parameters of the environmental assessment. Thus, each department can introduce in its activity an environmental point of view and then participate to the implementation of ecodesign in the design process and in the company.

2.1.3 Involvement of the management

We talk about the necessary involvement of all company departments but we would like to insist on the importance of the involvement of the company management in the ecodesign process (Johansson 2002; Boks 2006). Indeed, ecodesign must be a common approach for all people in the company but if the management and particularly the top management of the company are not engaged in the process, it can hardly work in the other levels of the company. Thus having a top management engaged is a driver for the other departments.

Moreover, this allows including in the specifications of the product some requirements concerning environmental features. Discussion about environmental issues at the specification stage is really necessary; this shows the commitment of the company in the ecodesign approach.

2.1.4 Involvement of the supply chain

Data collection is a real problem for the realization of LCA. Involving the supply chain in the ecodesign approach can bring real benefits (Johansson 2002). If there is a good relationship between the suppliers and the lead company and if they understand and are happy with the ecodesign approach, suppliers will be more likely to provide data and to make environmental efforts for the lead company. The company can then give feedbacks to their suppliers in providing them an LCA of their production (material, component, etc.) or to show them the contribution of their part to the global LCA of the product. It can make them aware of the environmental performance of their own product and convince them to think about benefits of environmental considerations.

2.2 N2) Tools for the design of products and its life cycle

2.2.1 Need for specific life cycle tools

We can define the term tool as any structured activity which aids a designer in the completion of a design process step. These can be seen as inputs to the design process that provide information, guidance or definition to the project and help achieve outputs. In the literature review we highlight the needs for specific life cycle tools. At least, one tool should exist for each life cycle phase: Raw material extraction, manufacturing, distribution, use, and end-of-life. Inputs for these tools are data on the product specific for each life cycle phase. The objective is at least to collect data for the life cycle assessment and therefore to realize easier and faster the LCA.

2.2.2 Communication between classic tools and specific tools

Classic tools and specific life cycle tools need to be connected to avoid entering data which already exist. For example, the majority of data concerning the materials are already present in the CAD tool. Indeed, the bill of material is the base for the modeling of the manufacturing phase. Linking specific life cycle tools and classic tools enable to build a product model but also a life cycle model to store all the data about the product.

2.3 N3) Indicators and guidance tool to manage environmental information

2.3.1 A guidance tool

Currently, designers are still insufficiently trained to ecodesign. According to different authors, however, it is necessary to incorporate into engineering curriculums at universities high-quality ecodesign courses (Ilgin & Gupta 2010; Vallet 2012). Moreover Ilgin and Gupta add that “With stricter environmental regulations and increased environmental awareness in society, firms must educate their employees in environmental aspects of manufacturing to increase their competitive edge”. Thus some training sessions can be organized by the environmental design manager to bring basic ecodesign knowledge and practices to employees. Moreover there is a need for a guidance tool to manage environmental knowledge and support designers during the design process. Ecodesign rules and guidelines need to be recorded and stored in a tool to be available at any time for designers.

Furthermore, knowledge acquired by designers throughout the projects must be capitalized to help realizing the new projects. Using efficiently designers’ previous experience to make new designs is the role of the method known as Case-Based Reasoning (CBR) (Yang & Chen 2011). First, the creation of CBR has been described by Schank and Abelson in 1977 (Schank & Abelson 1977) and has then been developed over the past decades for different fields, e.g. artificial intelligence, architectural design, and product design. According to Kolodner, “*Case-based reasoning can mean adapting old solutions to meet new demands, using old cases to explain new situations, using old cases to critique new solutions, or reasoning from precedents to interpret a new situation (...) or create an equitable solution to a new problem (...)*” (Kolodner 1993). The CBR method has resulted in the deployment of a number of successful systems based on a database used to store previous cases in order to help users to solve problems. In ecodesign, we can note the work of Yang and Chen (Yang & Chen 2011) and the work of Germani et al. (Germani, Mandolini, et al. 2013). Yang and Chen linked the CBR method with the TRIZ method¹⁰ in order to accelerate the preliminary eco-innovation product design. Germani et al. developed an approach based on CBR method to support the consideration of environmental aspects in the product design process. This approach has been implemented in a CBR tool containing ecodesign guidelines integrated with the designers’

¹⁰ TRIZ is a Russian acronym which means “Theory of Inventive Problem Solving” and is a tool helping designers to more easily solve inventive problems (Altshuller 1996)

past experiences. This last approach is suitable with our requirements; that is why we promote the need for a guidance tool containing at the same time ecodesign rules and guidelines and the knowledge about past design choices.

2.3.2 A way to assess the product on environmental and cost features

A tool to assess the environmental performance of the product is needed. As seen in the part of the literature review about interoperability approaches, most of authors chose to include a LCA tool in ecodesign approaches. It enables to provide environmental indicators. Environmental evaluation through LCA is useful to detect critical points (material, components, phases, etc.). Indeed, Hauschild et al. tackled the issue of getting the right focus, i.e. addressing the most important environmental impact, in introducing a hierarchy of focusing (Hauschild et al. 2004). It allows then to identify the potential improvements in order to optimize the product environmental performance.

Another evaluation tool is also necessary, a cost evaluation tool, to be consistent with the reality of the industrial world. Cost is always a driver for company that is why project teams needs to monitor it to be sure to respect the requirements of the management. Life cycle cost (LCC) tool can be used to have an overview of the cost of the product on its life cycle.

These tools, LCA and LCC, both provide indicators and can be gathered in an evaluation module. This module could also include other sub-module to calculate some particular indicators which seem essential for the design project (i.e. recyclability rate).

2.3.3 Link between the evaluation module and the guidance tool

The product is assessed with different types of indicators and notably with environmental indicators in the LCA of the evaluation module. Critical points of the product on the environment are deduced from the evaluation and if necessary designers have then to improve the environmental performance of the product. We showed in a previous paragraph that a guidance tool needs to be developed to guide designers in the improvement work. However this aspect is quite difficult for designers as they do not have experiences and a strong training in ecodesign; that is why we think that it should exist a link between the evaluation module and the guidance tool to propose guidelines and ecodesign strategies according to the evaluation results.

2.3.4 A way to monitor environmental criteria

Ecodesign does not have to be an absolute priority but rather must be considered as an additional viewpoint to take into account in the design process. To make design trade-offs and meet the specifications it is important to consider environmental criteria at the same time than traditional design criteria. Thus, a way to monitor environmental criteria could thus be developed in order to inform the project management team as the design project progresses. The design team has therefore a better vision of the product and can establish priorities.

2.4 N4) Data and information management

2.4.1 A way to store new information and taken decisions

Designers will increase their ecodesign knowledge of their own activity during each design project. For example, they will see, on one hand, the impact of their first choices on the environmental assessment and on the other hand, the impact of their potential improvements on the following environmental assessment. They gain experience and are more and more comfortable with ecodesign topics. Thus it seems to be useful to store this new knowledge; it means taken decisions for each project with the results of the corresponding LCA. Designers could then consult these data in future projects where they find similarities with previous projects. It can also be used for new designers in order to show them what kind of changes has been done on the project according to the type of environmental objective and identified problems. Therefore there is a need to find a way to store knowledge in order to capitalize and to make it available in future projects.

2.4.2 A link between the product and life cycle models with the evaluation module

Realizing an LCA is therefore recommended to focus on the critical points of the product. In order to make the life cycle inventory of the product, a lot of data are needed. We anticipate this need in recommending the creation of specific life cycle tools and the sending of all data in the product and life cycle models (also provisioned by usual design tools as CAD tool). The evaluation module should be directly linked to the product and life cycle models to collect necessary data and to directly fill in some categories in the LCA. It enables to save effort and time for designers and environmental design manager. The connection exists both ways. It means that if some extra data are filled in during the LCA about the product or its life cycle, this data can be sent and stored in the product and life cycle models. Moreover sub-modules of the evaluation module can also need data from models in this case data are also collected. These data connections between the software tools enable a better integration and enable to decrease the time of data entering as time is precious in the design process.

2.4.3 Databases

Databases are already an important matter in company. Creation of systems as PLM or ERP shows the importance to have a good and easy way for data management. This issue is even more real when introducing ecodesign. Indeed, as we saw, we need database to store the product and lifecycle models, ecodesign rules and guidelines, product evaluations, taken decisions during design projects and their influence on the evaluations. These databases needs to be carefully connected to the good tools to be sure minimizing time of data collection and to make easier the work with the different tools for designers.

2.4.4 A way for supplier to provide their information to the lead company

In order to have an entire vision of the product and its different features, it is important to involve suppliers in the ecodesign approach. Thus, they can provide information to the lead

company for example for the environmental assessment. From the perspective of building a platform to support ecodesign activities, it seems necessary to give suppliers a way to directly communicate on their product. They have then the possibility to enter data on their material or component useful for the product evaluation and could have some feedbacks from the lead company on their product, for example the contribution of their part on the LCA or on the LCC. It means that a real partnership is created between the company and their supplier and this partnership involves the creation of a support tool to enable the data exchange between the lead company and suppliers.

2.5 N5) A procedure to be in line with the design process

The last need is related to the methodological aspect. Indeed, we assume that a procedure or methodology must be developed in order to remove the methodological barrier. This methodology will have to include the key elements identified in the state-of-the-art and reminded below:

- Including management perspectives,
- Including management perspectives,
- The different steps to realize for a good implementation of ecodesign,
- The moment to realize the actions into the traditional design process,
- The corresponding tools to use to carry out the actions,
- The person in the design team in charge of each activity.

3 Conclusion

We identified in the previous section the different needs for a good integration of ecodesign concerning the people to involve and the tools to provide to the design team. We focused on the need for an environmental design manager for the first implementation of ecodesign in the design process. We highlighted the needs for specific life cycle tools and their communication with classic design tools, and then we showed the importance for an evaluation module and for a guidance tool but also the data management as a key element of ecodesign activity.

We describe in the following chapter the specifications related to an engineering software platform which gather all the requirements highlighted in this section. Moreover we associate to this platform an ecodesign methodology describing the different steps necessary for a good integration of environmental concerns in the design process. The methodology also specifies at each step which ecodesign tools of the software platform should be used and by which stakeholder to have an overall vision of the activities.

Chapter 5

A whole solution: a methodology supported by an engineering platform

- 1 THE PROPOSED STRUCTURE FOR THE PLATFORM 81**
 - 1.1 INVOLVED STAKEHOLDERS..... 82
 - 1.2 TOOLS FOR PROJECT MANAGEMENT SUPPORT 83
 - 1.3 TOOLS FOR OPERATING DESIGN ACTIVITIES 84
 - 1.4 VEHICLES OF THE ENVIRONMENTAL INFORMATION..... 85
 - 1.5 MODELS 85
 - 1.6 THE PROPOSED ECODSIGN METHODOLOGY RELATED TO THE PLATFORM..... 90

- 2 ILLUSTRATION OF A SOFTWARE IMPLEMENTATION OF THE PLATFORM: THE G.EN.ESI PLATFORM 99**
 - 2.1 PLATFORM GENERALITIES 99
 - 2.2 DETAILED DESCRIPTION OF THE TOOLS..... 101
 - 2.2.1 *Eco-Audit* 101
 - 2.2.2 *DfEE* 104
 - 2.2.3 *LeanDFD* 104
 - 2.2.4 *CBR* 104
 - 2.2.5 *eVerdEE* 104
 - 2.2.6 *The Supplier Web portal*..... 105
 - 2.3 G.EN.ESI PLATFORM USE 105
 - 2.4 G.EN.ESI IMPLEMENTATION 107
 - 2.5 G.EN.ESI PLATFORM ADVANTAGES..... 108
 - 2.6 G.EN.ESI PLATFORM WEAKNESSES 108

- 3 CONCLUSION..... 109**

According to the needs to integrate ecodesign activities in the design process presented in the problematic, we propose a methodological framework where we associate a methodology to an engineering platform. As already observed in the state-of-the-art, the term “platform” is not a generic term with a universal definition but rather refers to different types of concepts. In our case the proposed and described platform is a set of tools, integrated in the same structure, and able to communicate among themselves. As for the case of Computer-Aided Production Management systems (CAPM), different users can handle it and use the tools for which they are well-qualified.

This research was conducted within the framework of the European Project G.EN.ESI. We contributed to this project through the development of a methodology and the specifications of a platform to integrate environmental considerations in the design process. A software implementation of this platform was proposed in this project and developed by a software editor involved in the consortium.

Section 1 presents the methodological framework; it means first the requirements and the conceptualization of the platform gathering solutions for the needs described in the problematic, and then the methodology related to the platform. Section 2 illustrates a software implementation of the platform developed within the G.EN.ESI project.

1 The proposed structure for the platform

The elements chosen to support the methodology and the platform are first presented: the involved stakeholders, the tools for project management support, the tools for operating design activities and the vehicles of the environmental information. The interactions between the different tools and the stakeholders will then be described in section 2 through the description of the methodology.

Figure 24 represents the main tools of the platform and the links between them and with the stakeholders:

- The red color is dedicated to elements related to the Project Management Team.
- The blue color is dedicated to elements related to the Environmental Design Manager.
- The green color is dedicated to elements related to the Designers.
- The purple color is dedicated to elements related to the Suppliers.

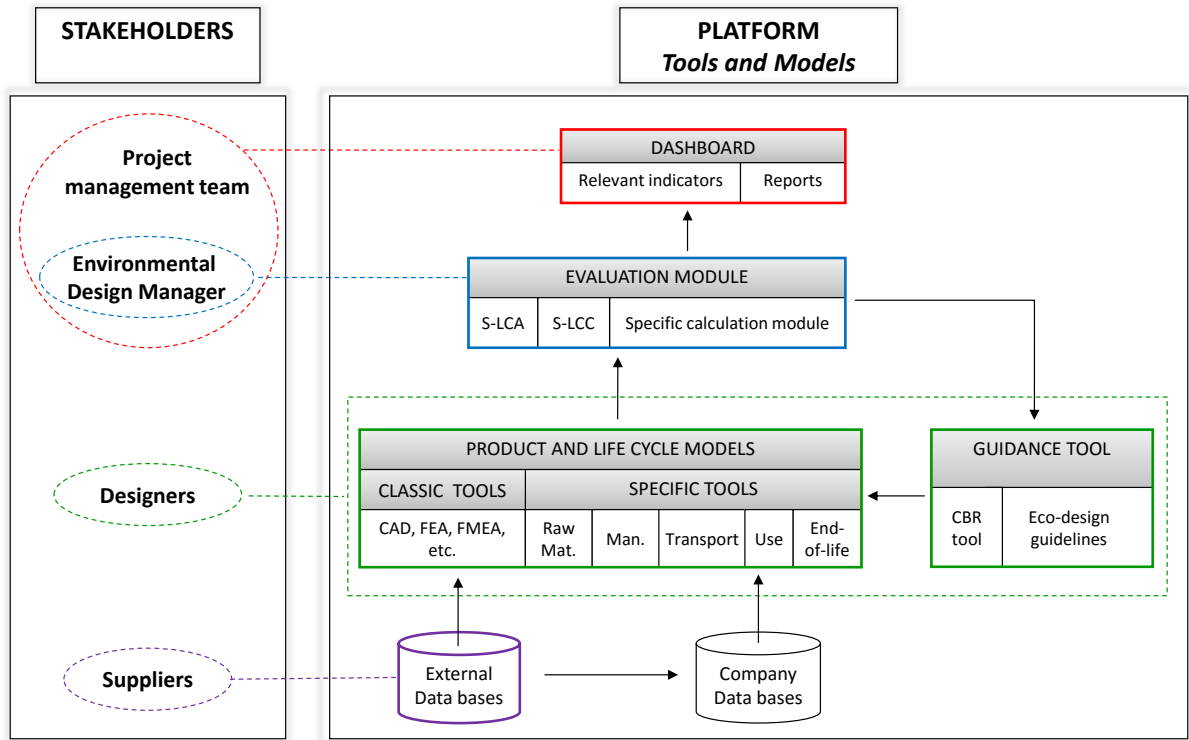
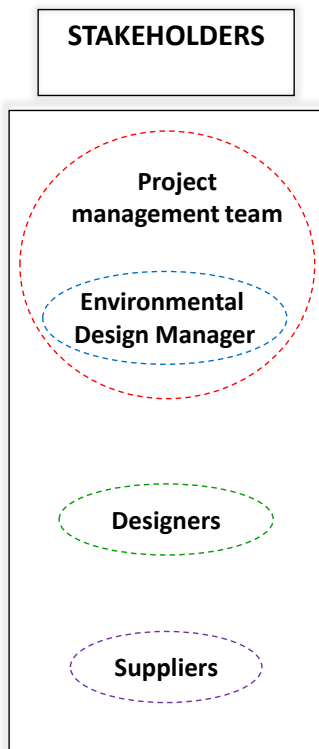

Figure 24: Links between the elements of the methodology

1.1 Involved stakeholders



The design project team consists of *Designers* from the design office but also stakeholders from every department relevant for the project, mainly R&D, production, purchasing department, quality, etc. Designer is used as the universal term to refer to every stakeholder of the design team, regardless of the department they come from.

The design project is managed by a steering team, so-called the *Project Management team*. It can be usually reduced to one person known as *the Project Manager*. The project manager has a multidisciplinary role. He ensures the coordination between the different stakeholders and the integration of their points of view in order to meet all the constraints related to the design project.

For ecodesign purpose, we strongly recommend an environment expert, called *the Environmental Design Manager*, to manage environmental issues in the product development process. Indeed, the project manager needs to be assisted by the

environmental design manager because he usually does not have the skills to understand the environmental data and thus cannot make informed decisions. The environmental design manager should thus be a member of the steering team.

Large environmental data is needed to assess environmental issues, including data related to suppliers business. *Suppliers* can be therefore requested to share information about their products, components, materials, factories or other. This close relationship and data exchange between suppliers and the design team are quite new and require careful and rigorous management.

1.2 Tools for project management support

The product and life cycle models are the core elements of the product development process. They include both the whole information about the product in its life cycle (Umeda et al. 2012) and the current then final product definition. They are composed of heterogeneous models to support functions, life cycle phases and CAD information and are mainly supported by PLM software but also by company ERP. These models are not always formalized but are essential for environmental aspects integration. For example, the function model supports the definition of the product functional unit required for LCA techniques. The product and life cycle models are created as and when the tools users fill in information about the product. The LCA tool, for example, can then retrieve data automatically from the product and life cycle models, which facilitate the work of data entering.

EVALUATION MODULE		
S-LCA	S-LCC	Specific calculation module

The evaluation module consists at least of three modules: a simplified life cycle assessment module (S-LCA), a simplified life cycle cost module (S-LCC) and specific

calculation modules for ad-hoc indicators. LCA and LCC are now standards and well known. Simplified LCA and LCC are suggested because they allow focusing on the most critical aspects to check while complete LCA and LCC demand too much data and time. Ad-hoc indicators are very relevant for ecodesign; they allow to highlight specific points of the project (energy efficiency for example (Domingo, Mathieux, et al. 2011)) not well covered by LCA and LCC techniques (for example end-of-life indicators are quite poor) and are often much efficient because of their easiness of interpretation. Even if they are not standardized and sometimes specifically built for the project, their efficiency makes them very used. This module is managed by the environmental design manager because it needs specific expertise in both data collection and results interpretation.

DASHBOARD	
Relevant indicators	Reports

To address the problem of visualization and prioritization between the design and ecodesign criteria, we propose a dashboard. On one hand, the dashboard consists of a panel of suitable environmental indicators and of a panel

with classic design indicators, both chosen by the project management team. The project manager decides then which stakeholders are allowed to access the dashboard. The dashboard

helps conducting the product development. It is composed of indicators relevant to the project under consideration; that means that the dashboard is configurable. Its configuration results from expert decision made at the initialization of the project. The current values of the indicators are continuously calculated throughout the design process.

1.3 Tools for operating design activities

PRODUCT AND LIFE CYCLE MODELS					
CLASSIC TOOLS	SPECIFIC TOOLS				
CAD, FEA, FMEA, etc.	Raw Mat.	Man.	Transport	Use	End-of-life

Ecodesign is mainly a design process based on the use of traditional design tools. It consists in improving data available from these tools to help understand and solve

environmental issues. Therefore the engineering platform is composed of Computer Aided Design (CAD) software, Finite Element Analysis (FEA), Failure Modes and Effects Analysis (FMEA), etc. None of these tools integrate direct environmental concerns even though the decisions made when using these tools impact the environment. Ecodesign consists in including every phase of the life cycle of the product during the design. We promote in this work to create specific tools related to each life cycle phase: Raw material extraction, Manufacturing, Transportation, Use, and End-of-life. Output data from these tools will be the core elements for the environmental analysis. The tools will give accurate and specialized information for analysis but could be also very useful to optimize the product on a particular life cycle phase according to the redesign objectives. Output data from classic tools and specific tools enable to build and update the product and life cycle models. Moreover classic tools and specific tools communicate together to exchange data. For example, the manufacturing tool can retrieve data from the CAD tool.

GUIDANCE TOOL	
CBR tool	Eco-design guidelines

The guidance tool assists designers in improving the environmental performance of the product through the use of two resources: relevant ecodesign guidelines based on both general principles and product-oriented advices, and a case-based reasoning (CBR) tool based on existing information reuse.

The concept of this tool is based on the adaptation of previous solutions to solve the current problems (Janthong et al. 2010). It is an activity based on a lot of knowledge and skills, supported by large databases and controlled by environmental feedbacks from the evaluation module. As seen in the previous chapter, the work proposed by Germani et al. is a suitable base for the guidance tool; they developed an approach implemented in a CBR tool containing a repository of ecodesign guidelines and knowledge relative to the past designers experience (Germani, Mandolini, et al. 2013).

1.4 Vehicles of the environmental information

Environmental assessment is mainly based on indicators. Different types of indicators are used in the methodology to assess the product; environmental indicators, coming from the S-LCA, cost indicator coming from the S-LCC (Sutherland et al. 2010), indicators typically used by designers, such as energy efficiency of electrical motors, and other ad hoc indicators such as the recyclability rate or the disassembly rate. This set of indicators aims to monitor the main environmental hot spots of the products to conduct their reduction process but also to have a multicriteria vision of the product necessary to prevent environmental impacts transfer. The environmental design manager reports the results of the evaluation module.

Two kinds of reports are generated from the platform. The first report is dedicated to the project management team and consists of environmental and cost reports. These reports, associated with the dashboard, aim at having a comprehensive vision of the product under development and highlighting areas of weaknesses. The second report is dedicated to designers. According to the results described in the report, it focuses on levers to improve the current design in any life cycle phase (Gehin et al. 2009) and specific rules and guidelines are suggested to reduce the critical points of the product design.

1.5 Models

We will now look at the models of the platform structure. It means that we will examine the inputs and outputs of the different tools and the way data are exchanged between them.

Figure 25 illustrates the inputs and outputs of the different tools proposed on the platform. The following descriptions will be based on this figure. As the platform structure previously described, three levels compose the platform. The first one contains the specific tools dedicated to each life cycle phase. Each specific tool (i.e. related model) will be filled in by the person in charge. The second one presents the three evaluation modules and the last one supports the dashboard. In parallel to these three levels, there is the guidance tool which is transversal.

In order to allow those tools to exchange information (represented between the doubles lines on the figure), some dynamic and flexible exchange models would be required. What IT solutions enable to do that? It would be interesting to explore possibilities offered by model federation, as suggested by Rio (Rio 2012).

During the design process, the future product is progressively defined by the sum of Bill of Material (BoM), which would emerge from the multiple designers activities involved along the design process. Regarding interoperability issues, this framework using model federation would allow collecting and exchanging models that would keep the semantic associated to each of their data (as illustrated by the method proposed by (Rio et al. 2013)). For example, if we look in details at the tool for the use phase, we have in input the BoM. These are the information coming from the CAD with the structure of the product including at least the

components and types of material. We have in output of the use phase tool this BoM enriched with the data of the use phase represented with the letter U: BoM_U. These data include consumables, electricity quantity, electricity mix and use costs. So the tool enables to collect these data and associate the expertise of the choice to the BoM.

This approach is the same with the other specific tools. Table 4 summarizes the composition of the different BoM. The data corresponding to each life cycle phase are here the minimum data required to realize a life cycle inventory (first stage of LCA method). These lists could be extended for detailed and fine analysis.

Table 4: Composition of the outputs of the specific tools

BoM _{RM}	BoM + raw material data <ul style="list-style-type: none"> • raw or recycled • material costs
BoM _M	BoM + manufacturing data <ul style="list-style-type: none"> • processes • manufacturing costs
BoM _T	BoM + transport data <ul style="list-style-type: none"> • Means of transport • Geographical position of suppliers and end-users • Transports costs
BoM _U	BoM + use data <ul style="list-style-type: none"> • Consumables • Electricity quantity • Electricity mix • Use costs
BoM _{EoL}	BoM + end-of-life data <ul style="list-style-type: none"> • Components EoL treatments • EoL costs

Now if we look at the LCA module, we have in input the BoM enriched with all the data of the life cycle: BoM_{RM-M-T-U-EoL}. The inputs are thus a combination of these data. In output, the tool provides environmental indicators which are function of the data of the BoM which keeps the knowledge of the experts concerned with choosing this data. This representation enables to show that we really would like to keep knowledge associated to the reason why the data has been chosen, “a kind of data traceability”, in order to be able to analyze the results.

The dashboard has in input the different indicators of the evaluation module; it could be environmental indicators, cost indicators, or specific indicators as recyclability rate. The project management team chooses among these indicators a few ones according to the projects objectives. Reports are also generated in order to identify the critical elements.

These reports will be analyzed by the environmental design manager so that he can give feedbacks to designers (Figure 26). These advices could be materialized via the guidance tool in filtering ecodesign guidelines and past design choices in order to support the designers.

Here again, some transformations of models would be required to federate different models from different software together that have different semantics and languages and which are used by different experts. That would particularly help routine design processes.

Regarding the types of models, Product-Process-Organization model could be used here, enriched with some classes enabling to contain the information required for ecodesign.

This ends the description of the minimum configuration of the platform, providing guidance to support the information exchanges between tools (and their users).

An upgradeable platform

Indeed, this configuration should be flexible and upgradeable. We illustrate this notion with an example.

We consider that a basic recyclability rate calculation should be included in the specific calculation module. This rate will be the recyclable fraction of the equipment. Required data for the calculation will come from the raw material tool.

However, if the recyclability rate is considered as the sum of the fractions of equipment potentially reused and recycled. Required data for the calculation will come from the raw material tool and the end-of-life tool. The platform structure should be able to support evolutions. Moreover if the company has a tool dedicated to the study of the energy consumption of motors, this extra tool should be plugged in or connected with the use tool.

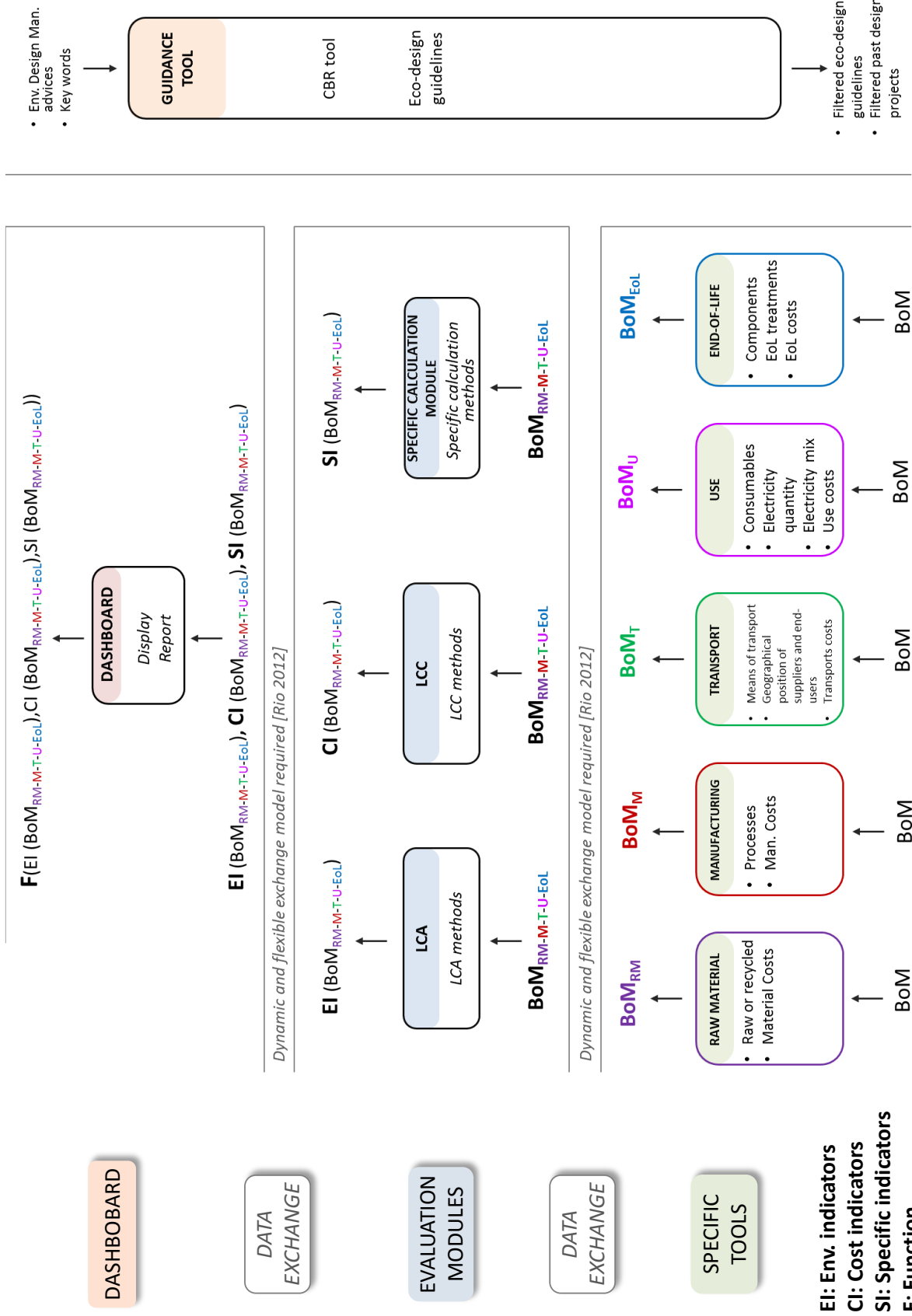

Figure 25: Representation of the different inputs and outputs of the tools

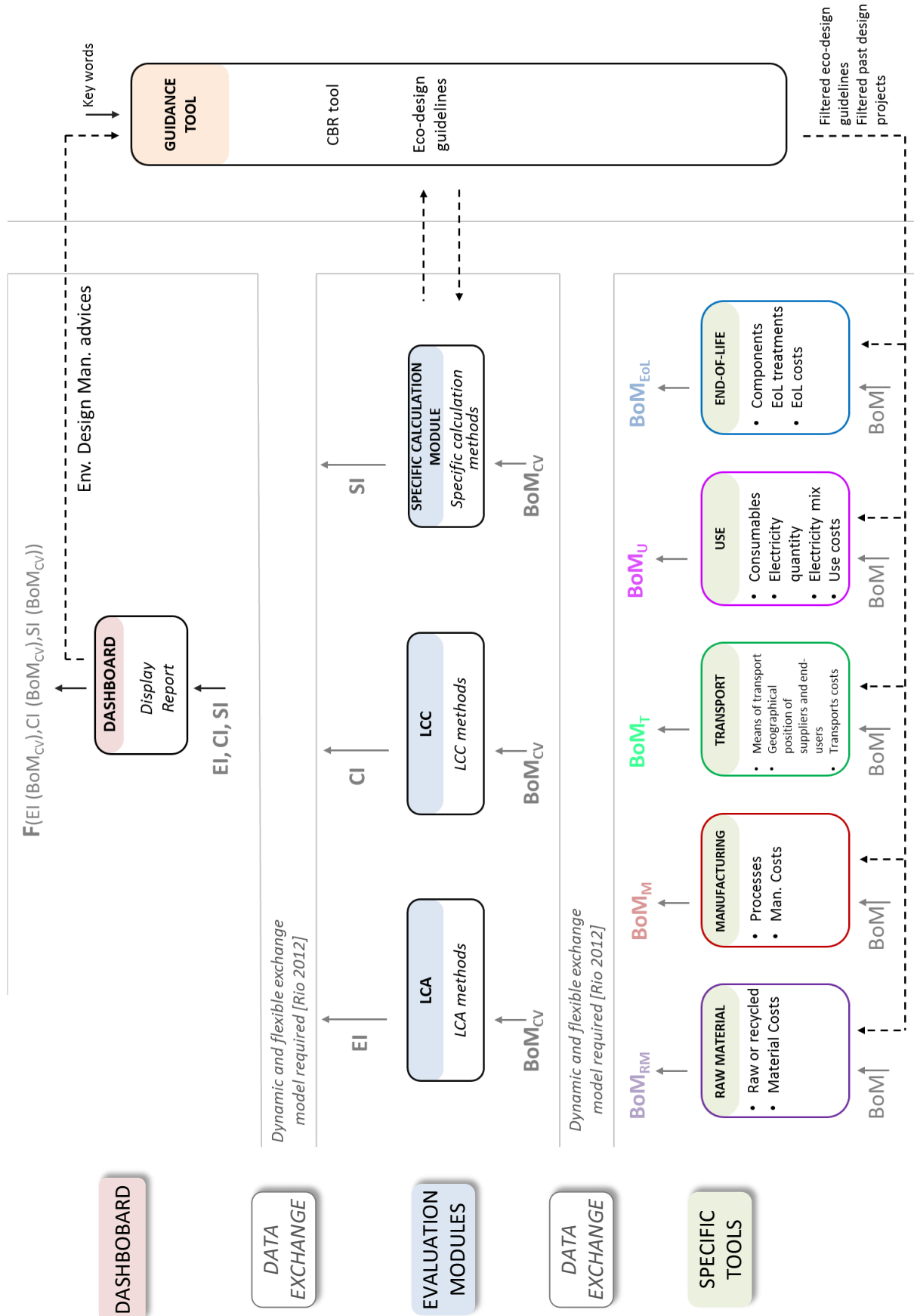

Figure 26: Representation of the feedback loop towards designers

1.6 The proposed ecodesign methodology related to the platform

Our methodology takes over the necessary steps to integrate ecodesign in the product development process. For that reason, the methodology presents some similar aspects with other methodologies already developed as described in the state-of-the-art (ISO 14062, NF X30-264, etc.). The novelty in this approach is the association of the methodological steps with the integrated tools of the platform and their users. The proposed methodology is developed in three main phases: initialization, main core design phase and capitalization. These three phases include six steps as described in Figure 27.

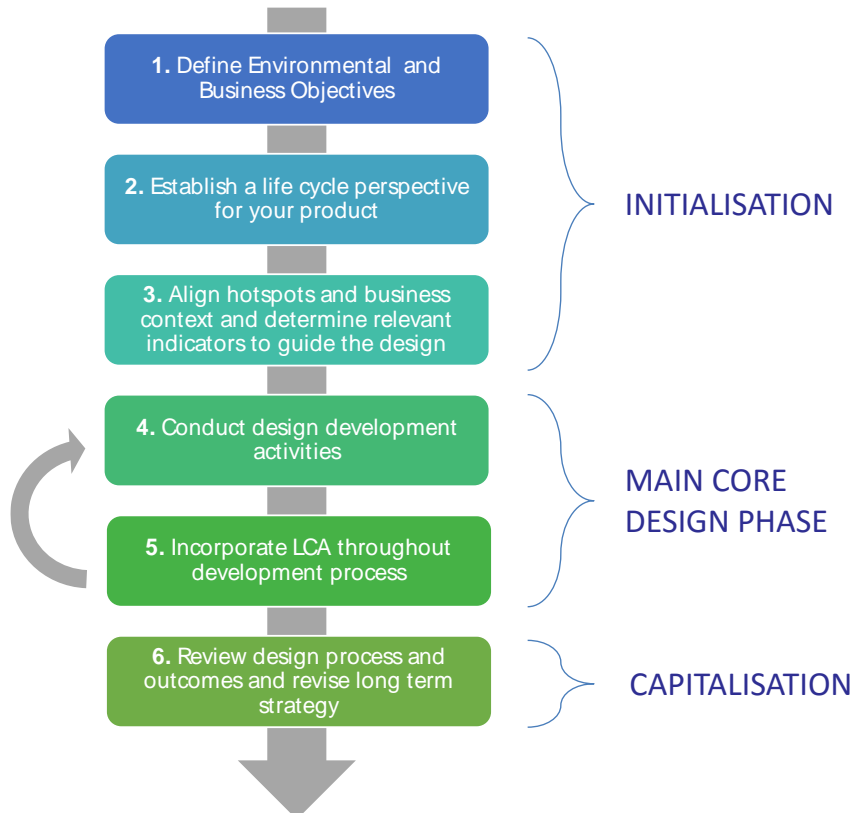

Figure 27: The proposed Methodology

The methodology can be used for different types of ecodesign levels: environmental assessment, redesign, ecodesign of products, etc.

As the methodology is dedicated to be integrated into the design process, we will include in the description the main steps of a product development process. Every company has its own design process and even inside the same company the process can change to a product from another. Figure 28 shows basic steps that we will use to explain the methodology into a classic design process context.

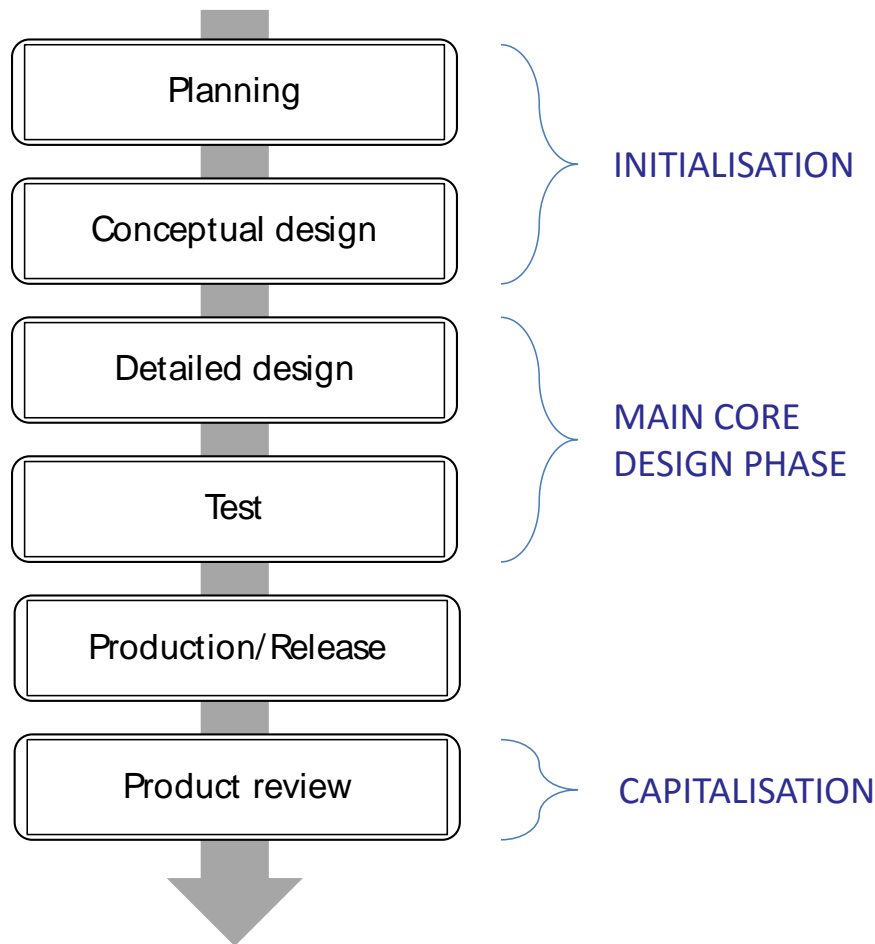

Figure 28: Product design process and the three main phases of the methodology

An engineering design process can commonly be described with the following steps: planning and problem definition, generation of concepts, detailed design, test and prototyping, production and market launch and finally a product review.

INITIALISATION

After the setting up of the design team, the project begins with a ‘design brief’ outlining the tasks at hand (Deutz et al. 2013). Indeed, the project management team determines the objectives of the project while considering constraints, deadlines, resources and budget available. At this stage, it is important for the management team to define the environmental objectives for the project in accordance with the company strategy. Environmentally improved products are only feasible if they make good business sense.

1. Define Environmental and Business Objectives

The establishment of these objectives enables to integrate the environmental aspects in the very early product development process. The objectives can be translated into specific indicators to monitor the redesign project. These indicators will be then included in the dashboard thus the management team could follow these indicators throughout the project.

How to add an indicator to the dashboard? Illustration with the disassembly cost

For example, if one project objective is the improvement of the end-of-life performance of the product, the disassembly cost can be chosen to represent one aspect of the end-of-life. Two configurations are then possible for adding this indicator in the dashboard.

In the first one, this indicator is already calculated by one of the platform tool, for example in the specific tool dedicated to end-of-life optimization. The environmental design manager can add this indicator to the dashboard. Obviously as this is still the preliminary stage of the design process, no data is already entered about the new product in the platform. It just means that the environmental design manager chooses to return and display in the dashboard information already computed in the software platform.

In the second configuration, this indicator is not calculated by one of the platform tool. The environmental design manager needs therefore to develop a sub-module in the specific calculation module to calculate the disassembly cost of the product. Data required to establish this rate could come from the product and life cycle models. If they are not yet available at this design stage, new specific collection of data can be implemented in a specific tool. When the indicator is created, this indicator can be added to the dashboard as in the first configuration.

Figure 29 illustrates these two configurations.

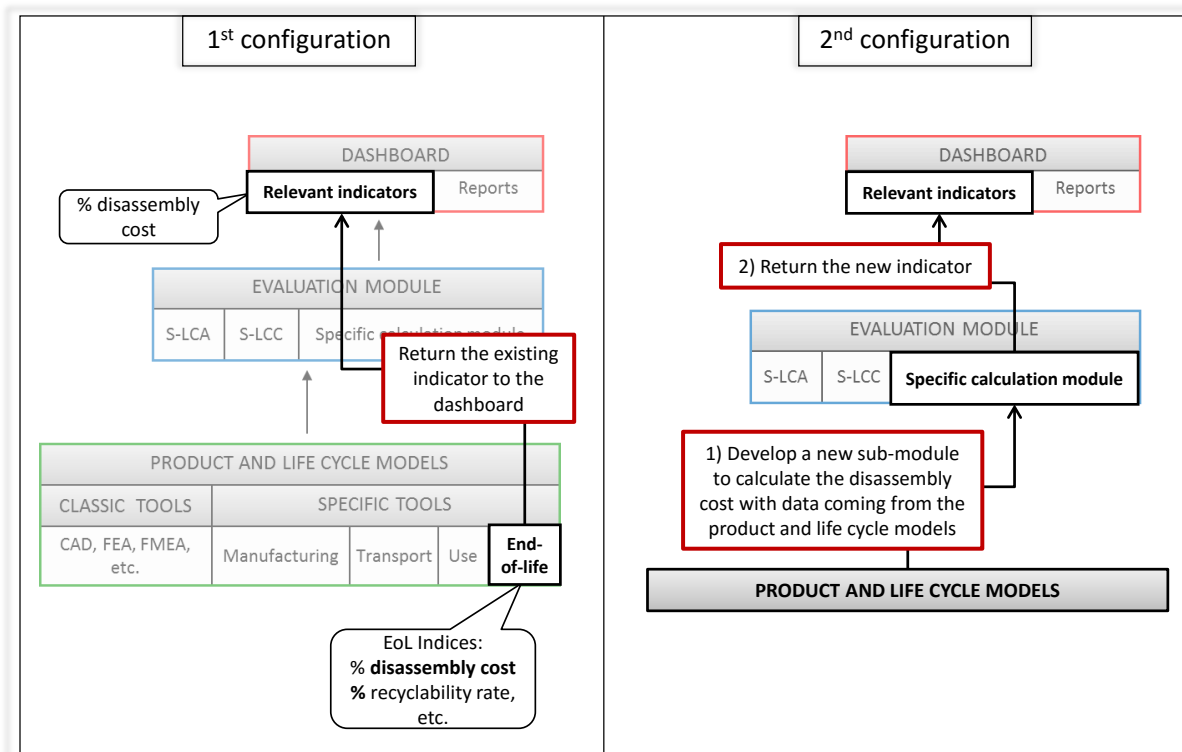

Figure 29: Adding an indicator to the dashboard

In addition, the product stewardship manager or the environmental manager ensures that the environmental objectives are in accordance with the legislation and regulation.

From all the objectives, the team defines the project planning and the product requirements and, in particular, designers deduce functional requirements (Deutz et al. 2013). This is a necessary step because, with ecodesign, the goal is to maintain needed functionality whilst minimizing environmental impacts and use of resources. Moreover, it will be useful for the next stages when the environmental manager will set the functional unit for performing the simplified life cycle assessment.

In the next phase of the design process, -the conceptual design phase-, ideas or concepts are developed in light of the functional requirements. Various potential solutions are generated: this is a divergent phase, as explained in the literature review. Creativity techniques and innovation methods, among other ways, can be used to support this activity. As we consider ecodesign as a functional requirement, it is important to take into account its integration and to support designers in their work.

[Sustainability needs to be recognised as a functional requirement before concept generation otherwise there is the danger of its being merely a design criterion (a consideration in selecting the preferred solution) rather than a fundamental proposal inherent in the generation of potential design solutions (Deutz et al. 2013).]

The platform contains for that purpose the guidance tool including checklists and guidelines for ecodesign. Then the design concepts are assessed against each other in order to select one or more possible concepts that best meet all requirements: this is a divergent phase.

2. Establish a life cycle perspective of the product

The second step of the methodology is to realize an initial product environmental assessment and cost analysis of the different concepts or of the chosen concept defined in step 1. The environmental design manager uses S-LCA and S-LCC which are connected to the product and life cycle models to facilitate the data collection. He determines the functional unit of the product and collects data from the different databases of the company; indeed it can be necessary to extract new information from classic design and specific tools and to update information from suppliers and purchasers. Moreover, he has to calculate the initial value of the new project dedicated indicators related to the project objectives.

3. Align hotspots and business context and determine relevant indicators to guide the design

From the results of the initial analysis, the third step carried out by the environmental design manager consists in identifying the most environmental critical points, called “environmental hot spots” (Hauschild et al. 2004) during the life cycle of the product. The environmental hot spots represent the worst environmental impacts in the product life cycle, for example energy depletion or waste production during a specific life cycle stage. The environmental design manager realizes sensitivity analyses to determine design parameters that the most influence

LCA results. The most significant environmental impacts that the products generate may come from unexpected places. Adopting a life cycle perspective and mapping the environmental impacts related to each lifecycle phase will help identifying unexpected impacts.

Previous experience can be very useful to support this phase. This internal knowledge could be completed by external knowledge, literature, regulatory watch, etc. For example, literature is useful to find similar case studies already analyzed and regulation can help determine priorities and relevance to improve the environmental performance of the product.

These hotspots must then be aligned with the wider business context to further prioritize efforts and ensure that the design focus makes good business sense. Indeed, the hotspots can be translated into design criteria and targets that will drive environmentally improved product development. The targets are defined according to environmental hot spots, company objectives, product market, and legislation or could be specialized to the place where the product will be used or the type of end-users. The targets illustrate the points where the environmental performance of the product has to be mainly improved. The set of corresponding indicators are displayed on the dashboard to every member of the management team.

This step is documented in a report by the ecodesign manager in explaining the results of the initial assessment, characterizing hot spots as well as targets and thus explaining the directions the designers should take to improve the product performance. This report is stored in the database of the CBR tool in order to be available for the future projects. It closes the initialization phase; requirements and objectives are now ready for the core part of product development.

MAIN CORE DESIGN PHASE

4. Conduct design development activities

The next step in the design process is the detailed design phase. The concepts are developed further to meet the specifications. Materials, processes and other characteristics of the product are determined by taking into account all the constraints. This is an iterative process where the different departments involved in the design process must work in close cooperation. This is the classic approach for a conventional design process and we propose now some changes to integrate environmental issues at this crucial step.

5. Incorporate LCA throughout development process

The product is further designed and optimized in every facet and phase according to the priorities and targets established by the management team in the previous steps (Hauschild et al. 2004). Designers follow instructions given by the environmental design manager in the reports and they can use the guidance tool to find how to act on the current design based on

previous solutions and optimizations, and guidelines. *More information about instructions to designers is given in the following paragraph.* During this stage new environmental information is integrated within design decision making. It doesn't matter if achievements are very limited at first, what is important is that the project team carefully manage and communicate knowledge development, allowing them to build their understanding over time. Developing and sharing tailored environmental guidelines can be very useful during these stage efforts.

Design efforts must be checked throughout the process to ensure environmental improvements are being made. These checks will require a lifecycle focus to ensure that impact reductions in one lifecycle phase do not generate disproportionate increases elsewhere. To ensure that these checks do not disrupt design efforts, it is important that the lifecycle assessment methodology is easy to understand and conducted quickly and efficiently. The results of these lifecycle checks may also require designers to conduct further research and development activities. It is a continuous and iterative phase of assessment, advice and action. At the same time, the environmental design manager controls all indicators on the dashboard and sends an alert if there are unacceptable impacts transfers.

Instructions to designers

A great problem with life cycle assessment results is the interpretation phase. Indeed, for non-LCA experts, it is quite difficult to realize a correct interpretation of the results in order to find the causes of the different LCA outcomes. This is one of the reasons why it is difficult to perform LCA during the design phase, in addition with the problem of data and time. We recommend therefore having someone, the environmental design manager, to conduct this activity.

An important task is to identify the best way to communicate with designers and define which information to give to them in order to design/redesign/improve the components and products. One issue is that designers do not have the knowledge to understand the specific environmental terminology. By environmental terminology, we mean the vocabulary linked to environment and its meaning, this can be environmental impacts (eutrophication, acidification, etc.), some of the ecodesign guidelines, or any terms or concept related to the environment. For example in a project where the objective is to decrease the global warming potential indicator, this indicator could have poor meaning for a designer. Another example is that if you provide some ecodesign guidelines to a designer to redesign a product, how can we be sure that he really understands the guideline? Is that the right way to involve the designer is the ecodesign process? That is why we need to find a way to link design parameters and life cycle assessment results.

Linking environmental indicators with design parameters

Linking environmental indicators with design parameters will enable to provide feedbacks for designers to allow them making environmentally informed design choices. We remind here that the term “designers” is used as the universal term to refer to every stakeholder of the design team, regardless of the department they come from.

In the project, the environmental design manager first uses the platform to retrieve data from life cycle models, and then he realizes and analyzes the S-LCA of the studied product. He determines, with sensitivity analyses, which elements of the life cycle models have the greatest influence on the environmental impacts.

To facilitate the interpretation and the means of action for the redesign, it would be useful to link these elements with design parameters. In some cases, it will be direct in the sense where the hotspot is already a design parameter. In other cases, the environmental design manager and the designers have to find how the critical elements are linked to design parameters. *For example if the hotspots come from the transport by plane of a specific material, the solution to reduce this impact is not always trivial. Indeed, the solutions could be to change the material, to change the supplier or to change the means of transportation.* In both cases the platform will support them in the activity. For each data they could know from which tool the data has been entered, before going in the life cycle model, and also which stakeholder or which department entered this data. In every case, if the environmental design manager is not sure he can meet the concerned service and discuss about the data. Information is then given to designers to enable them redesign the product. Designers will improve the environmental

performance of the product in improving these parameters. Suitable guidelines from the guidance tool can be used to help them at this stage.

The approach summarized in Figure 30 enables designers to have feedback coming from S-LCA but already translated into design parameters. It means that they use their usual tool to ecodesign the product.

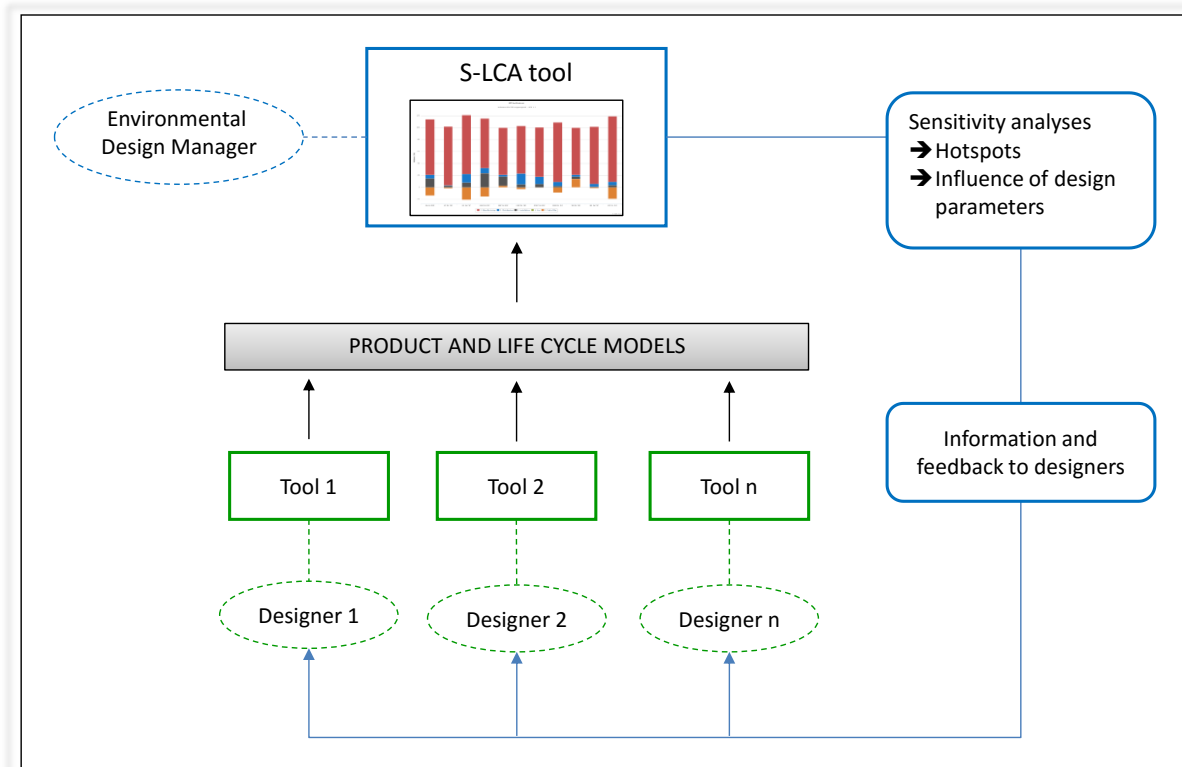

Figure 30: Process of feedback to designers from LCA results

Prioritization

Emerging issues coming from the link of environmental indicators with design parameters are a possible occurrence of contradictions. In fact, some parameters can be in contradiction. These contradictions can appear to a designer in two main cases:

- If a designer has to change more than one parameter and if these parameters influence environmental impacts in opposite way.
- If two designers have to change parameters which have an opposite influence on environmental impacts.

In these cases, a prioritization between the parameters must be considered. This is why we have to consider an integrated design approach to be sure that all parameters are intelligible and negotiable between experts.

When the design is finished and optimized, the project management team carries out the final sustainability check. The evaluation phase is based on a collection of data from experts and contributes to the establishment of the different reports. The project manager and the environmental design manager check that the design reaches all the targets and that no impact transfers were generated. As the detailed design step is an iterative step with a continuous evaluation, targets should be always reached at the end of the design. However if this is not the case, the management team can investigate the causes and write a report on why it has not been carried through. This experience and this report will be useful to improve the choices for next projects. The project stewardship manager or the environmental design manager also checks the compliance of the product with the legislation.

Finally reports are generated to collect the different changes operated during the redesign of the product. Results of the last assessment are also included in reports that are finally stored in the CBR.

CAPITALISATION

6. Review design process and outcomes and revise long term strategy

The final stage in the methodology is designed to capitalize on the learning and experience. This is achieved by assessing the project and using this to systematize the consideration of environmental aspects in product design. The project management team assesses the impacts of the previous decisions. To do that they need to review the development process to understand the environmental achievement that occurred and the outcomes they produced. The review can then be used to identify the company's current environmental position and to adjust the long term strategic goals accordingly. A final report can be created with observations, assessments and recommendations, useful for future projects. This report is then stored in the CBR database and accessible anytime by the design team.

2 Illustration of a software implementation of the platform: the G.EN.ESI platform

The previous sections explained our proposal: the different elements of a platform and their interactions within a methodology. This section will now present one software implementation of the platform: the G.EN.ESI platform. The G.EN.ESI project was co-financed by the European Commission and was made possible within the VII Framework Programme. The objective of the project was to develop a methodology and the related software engineering platform that supports the ecodesign of electro-mechanical products. In the framework of the G.EN.ESI European project, one implementation of the platform described in the proposal has been developed through the collaborative work of all partners and more specifically: Granta Design (UK), Universita Politecnica delle Marche (Italy), and ENEA (Italy) – the Italian National Agency for New Technologies, Energy and Sustainable Economic Development. The general platform is firstly described and then details for each box are explained. The work presented in this section is also partially presented in the following articles:

- Germani, M., Dufrene, M., Mandolini, M., Marconi, M., Zwolinski, P., 2013. “Integrated Software Platform for Green Engineering Design and Product Sustainability”, Proceedings of the 20th CIRP International Conference on Life Cycle Engineering, Singapore 17-19 April, 2013, pp. 87–92.
- Germani, M., Mandolini, M., Marconi, M., Dufrene, M., Zwolinski, P., 2013. “A Methodology and a Software Platform to Implement an Ecodesign Strategy in a Manufacturing Company”. Proceedings of ASME 2013 International Design Engineering Technical Conferences & Computers and Information in Engineering Conference IDETC/CIE 2013 (Vol. 4). Portland, Oregon, USA.

2.1 Platform generalities

As recommended to facilitate data exchange and to avoid wasting time, the G.EN.ESI platform consists of a set of software tools integrated in the same platform. The tools are supposed to be synergistic and able to communicate to each other to support the whole product design process. Figure 31 represents the platform architecture for the G.EN.ESI project. The platform is interfaced with CAD software and a PLM system, in order to retrieve the information required by each single tool.

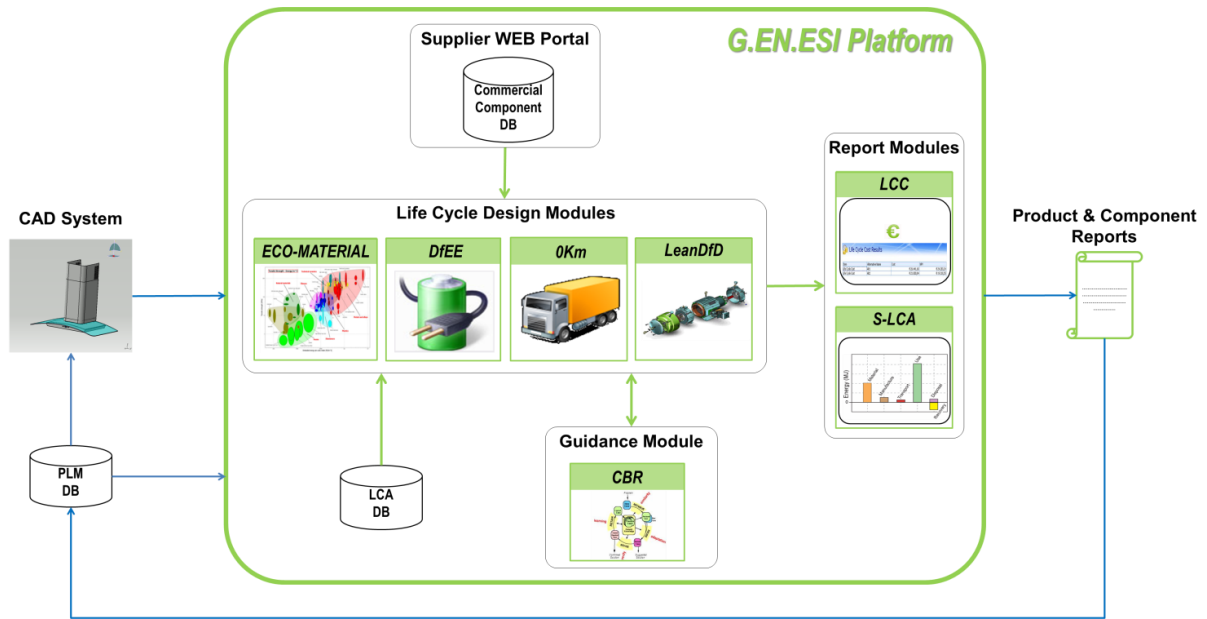

Figure 31: G.EN.ESI platform architecture

Table 5 shows the seven functionalities supporting the implementation of the G.EN.ESI platform and the five software tools providing these functionalities.

Table 5: The five tools and the seven functionalities provided by the G.EN.ESI platform

Software tools	Functionalities
<i>Eco-Audit</i>	Streamlined life cycle assessment (<i>S-LCA</i>)
	Streamlined life cycle costing (<i>S-LCC</i>)
	Materials and processes selection (<i>Eco-Material</i>)
	Transportation impacts (<i>Okm</i>)
<i>eVerdEE</i>	Streamlined LCA
<i>DfEE</i>	Design for Energy Efficiency
<i>LeanDFD</i>	Design for disassembly
<i>CBR</i>	Case Based Reasoning

Eco-Material for the manufacturing phase, *Okm* for the transport phase, *DfEE* for the use phase and *LeanDFD* for the end-of-life phase are the four functionalities representing the specific life cycle tools of our model. *Eco-Audit* includes specific life cycle tools like *Eco-Material* and *Okm* but also evaluation tools with a streamlined LCA and LCC. The integration of the different tools enables quick and automatic or at least facilitated information transfer between the tools. *EVerdEE* is also a streamlined LCA tool; the differences with *Eco-Audit* will be explained in the following section. A *CBR* tool supports designers in providing ecodesign guidelines.

Having in mind the Extended Enterprise concept, an additional web-based tool, the *Supplier Web Portal*, has been designed to allow suppliers of the lead company to give data on their products.

2.2 Detailed description of the tools

The previous section introduced briefly the different tools of the platform; we will now describe further in detail the different tools and their functionalities.

2.2.1 Eco-Audit

Eco-Audit is a tool developed by Granta Design. The tool is directly plugged in to the CAD software through the MI:Materials Gateway. The GRANTA MI:Materials Gateway™ is a solution providing easy and quick access to materials data within CAD, CAE (Computer-aided engineering) and PLM software. Then from the MI:Materials Gateway, you can open *Eco-Audit*. Figure 32 shows the integration of the plugin MI:Materials Gateway in the CAD software “Creo” and Figure 33 shows the integration with the PLM software solution “Teamcenter”.

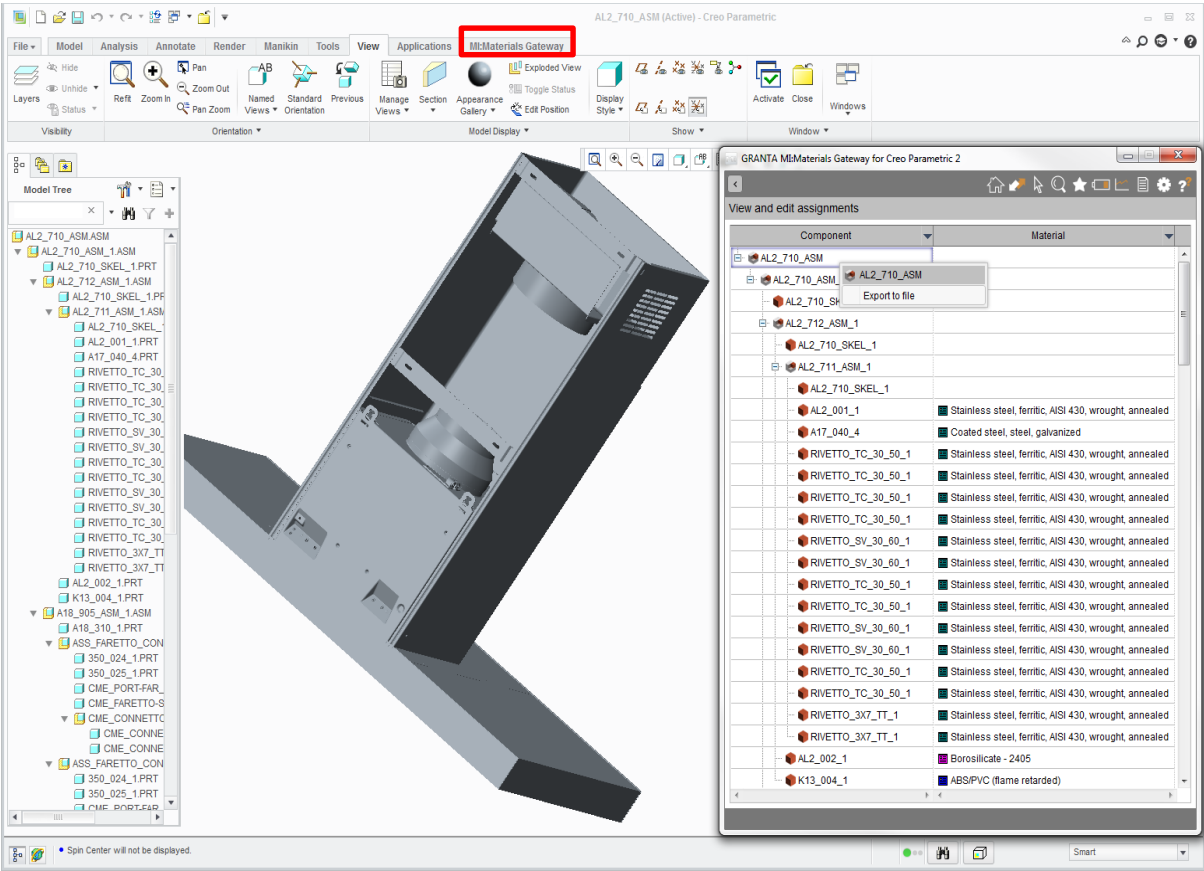

Figure 32: Integration with CAD systems “Creo”

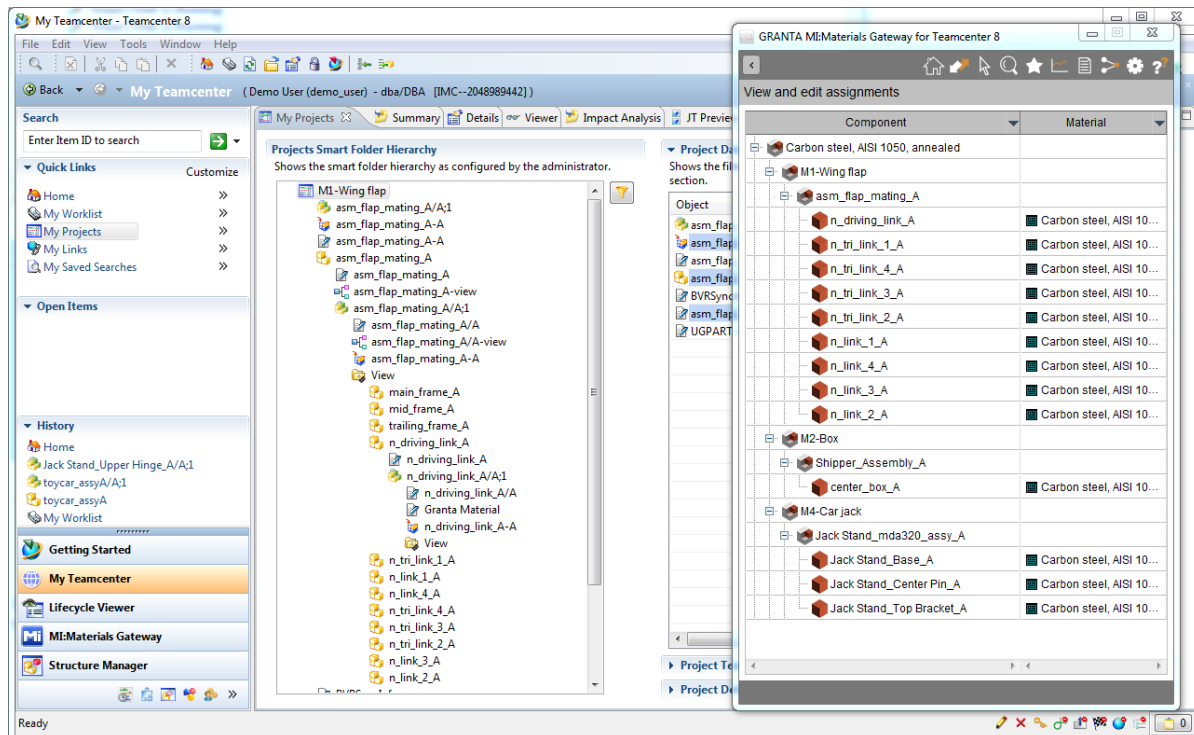

Figure 33: Integration with PLM system “Teamcenter”

Eco-Audit is mainly based on the Granta Material Database specific database containing about 4000 engineering materials with the corresponding manufacturing processes. Each material is characterized by multiple environmental indicators (energy consumption, CO₂ emission and water consumption) and by its unitary cost (Germani, Dufrene, et al. 2013). *Eco-Audit* contains four functionalities; each of them is presented here:

Eco-Material is a tool of the G.EN.ESI Platform dedicated to the management of the material selection and manufacturing phase, supporting the designer in the choice of the most sustainable material. The tool evaluates the most sustainable materials on the basis of different indicators embodiment energy needed for primary extraction and production, the exploitation of resources and minerals, the quantity of greenhouse gases emitted and the possibility of recycling. According to the selected material, the tool allows the selection of the manufacturing processes to finish a component model.

Okm is a tool dedicated to the management of the transportation phases along the product life cycle, from component supplying to dismantling. Considering the geographic positions of the suppliers, producers and dismantlers, the tool is able to provide the transport links necessary to move a component during its lifecycle, with corresponding environmental and economic impacts.

S-LCA and *S-LCC* are reporting tools which use the information filled in the other functionalities and provide a framework to enter simplified data on the use phase and on the end-of-life phase. *S-LCA* and *S-LCC* are integrated tools and they generate a common report containing the environmental and economic data referred to a single product component and to a single life cycle phase. In addition, also the overall evaluation for the entire product in all the life cycle phases is provided.

Thus, *Eco-Audit* is an integrated tool enabling to model the different phases of the life cycle with a particular attention to the material selection because of the great material database available. The tool provides a simplified environmental evaluation on the three indicators previously given: energy consumption, CO₂ emission and water consumption and a simplified cost evaluation of raw materials. This tool is very useful for the early design phases because of its connection with the CAD software and of its ease of use. Moreover, the designer has therefore a dashboard with the four mentioned indicators. It enables for example the designer to explore alternatives in setting a reference and then look at the impact of changes in the material choices via the interactive dashboard. Figure 34 shows the CAD environment with the window of the plugin. In this window, we can see the *Eco-Audit* dashboard. *Eco-Audit* provides a report with the environmental and economic evaluations.

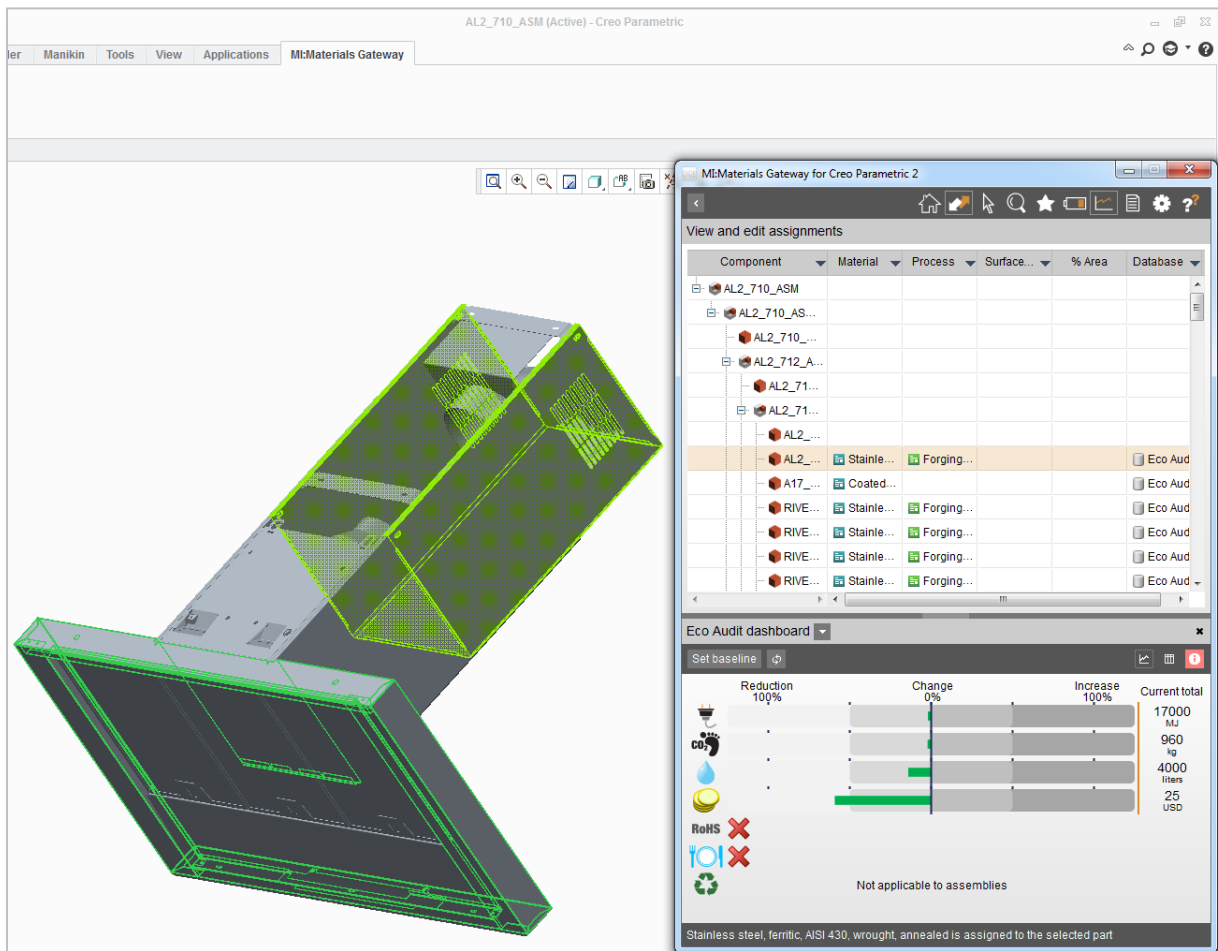

Figure 34: CAD environment with the MI:Materials Gateway plugin, including the *EcoAudit* dashboard.

A Web interface called the Web-BOM analyser tool enables to access the bill of materials (BOM), assigned materials and processes and other data without CAD software. The data are uploaded from XML file that can be generated by the CAD software. The advantage is that the project manager can perform himself the environmental assessment like in the CAD gateway. He has also the possibility to explore alternatives and to assign new parts to the BOM.

2.2.2 DfEE

DfEE is a tool developed by Università Politecnica delle Marche (Italy) to realize a detailed analysis of the use phase of energy consuming components. It provides a support to carry out the calculation of the energy consumption along the whole lifetime on the basis of the component performances and of the use profile. The tool also provides two other indicators: CO₂ footprint and costs related to the use phase. The CO₂ footprint and the costs during the use phase are respectively calculated on the basis of the total energy consumption and of the unitary environmental impact of the chosen country, and on the basis of the total energy consumption and of the unitary energy cost of the chosen country.

DfEE aims at understanding the energy consumption during the use phase in evaluating the contribution of the different energy using components and then identifying the major contributor. It offers the possibility to compare different alternative components (available in the database) and also to compare different use scenarios.

2.2.3 LeanDfD

LeanDfD is a tool developed by Università Politecnica delle Marche (Italy) dedicated to the product Disassembly and End-of-Life (EoL) management. The tool permits to evaluate manual disassembly times and relative costs of the entire product or of a specific component (or subassembly). *LeanDfD* is also able to calculate a degree of recyclability for the whole product and for single components. *LeanDfD* recovers the product data through the import of the XML file generated by *Eco-Audit* or its web interface. The user can then define the disassembly model in defining level and link between the components.

Thus the tool enables the user to understand the product and components criticalities regarding the disassembly time and cost (according to feasible disassembly sequences) and regarding the recyclability.

2.2.4 CBR

CBR is a tool developed by Università Politecnica delle Marche (Italy) which collects the explicit knowledge and the “best practices” for the ecodesign of mechatronic products. It helps the designer in the design process through the acquired company knowledge on these products and the well-established ecodesign guidelines. The knowledge is represented by all the choices made from the designer during the development of other similar products. Using this knowledge, the designer can be assisted and guided during the design/redesign process of environmental product in the selection of the best material, geometry, commercial components and so on. The database includes for example ecodesign guidelines that suggest strategies for the improvement of the product environmental performance. The database can be completed with solutions applied in the previous projects for similar products.

2.2.5 eVerDEE

eVerDEE is a tool developed by ENEA to realize a life cycle assessment of the product. The tool contains ten impact categories and enables an easy comparison of two product options.

The tool is able to import an extended BOM containing the details of components, materials, manufacturing processes, transport. It is also able to import the detailed energy use profile from *DfEE* tool. The user, mainly the environmental manager, complete then the data to realize the LCA. However you can also carry out a product LCA without a CAD model. This LCA, as it demands more data, is rather realized at the end of the design process in order to get the environmental profile of the product.

2.2.6 The Supplier Web portal

The *SWP (Supplier Web Portal)* allows suppliers to upload products, components, processes and logistics data within a specific database. Thanks to this information, the designers can choose a particular component that will be used by the platform in the product life cycle analysis. Therefore, this module is used at first by suppliers, that input data related to components they sell, and then by designers to choose those components from a list of different options. The *Supplier Web Portal* database is supervised by the company where the G.EN.ESI platform is deployed. Only suppliers which receive authorization from the lead company can upload the data related to their products into the Supplier Web Portal. It is the company that certifies its suppliers. The SWP provides to each analysis tool some necessary information related to commercial components. For example, in case of electric motors, such information is:

- Energy consumption used by *DfEE*.
- Production site of the supplier used by *Okm* in *Eco-Audit* to calculate the necessary transportation links.
- Cost used by *LCC* during the report generation and by *LeanDfD* for the calculation of some End-of-life indices.

At this stage of development in January 2015, the supplier web portal is a form that the lead company sends to the supplier for completion with the required information.

2.3 G.EN.ESI Platform use

The G.EN.ESI platform gathers the different tools presented in the previous sections. Some of the tools are integrated and some of them use information from other tools via an XML file. Designers, the environmental manager and the project manager are the main users of the platform. In the case the supplier web portal is fully developed, suppliers will become platform users to provide essential information about their commercial components. All this information is stored in the component database and can be used by designers to perform analyses. Therefore, suppliers are “providers” of data necessary to designers to assess the environmental and cost impacts of their products, and permits to consider components that the company does not manufacture internally.

Designers can use the G.EN.ESI platform to quickly estimate the impacts of products, during the product development process, when the available information about the life cycle and the time are limited. Thanks to the link with the company CAD system and with the PLM

database, the platform is able to retrieve the necessary data to start an analysis. Using the platform tools, designers are able to build a model of the whole product life cycle performing the following actions:

- Selection of materials and processes for each component which is manufactured internally by the company (Eco-Material tool).
- Selection of the necessary commercial components (from Supplier Web Portal or the current spreadsheet).
- Modeling and evaluation of the use phase of energy using components (DfEE tool).
- Modeling and evaluation of the transport phases required in the entire product life cycle (Okm tool in Eco-Audit).
- Evaluation of the disassembly and EoL phases (LeanDfD tool).

The product model definition is guided by the CBR tool which is able to suggest to the designer the most convenient choice from an economical and environmental point of view, using at the same time the ecodesign guidelines and the company knowledge about past design choices done in similar products. The platform is able to update the product and component reports via the XML file in order to provide to the user an estimation of his choices. When the designer reaches the pre-established objectives the reports can be saved in the PLM database as an attribute of components or products.

For more information about the platform use during the design process please refer to section *1.6 The proposed ecodesign methodology related to the platform* of this chapter.

Figure 35 sums up the G.EN.ESI platform environments.

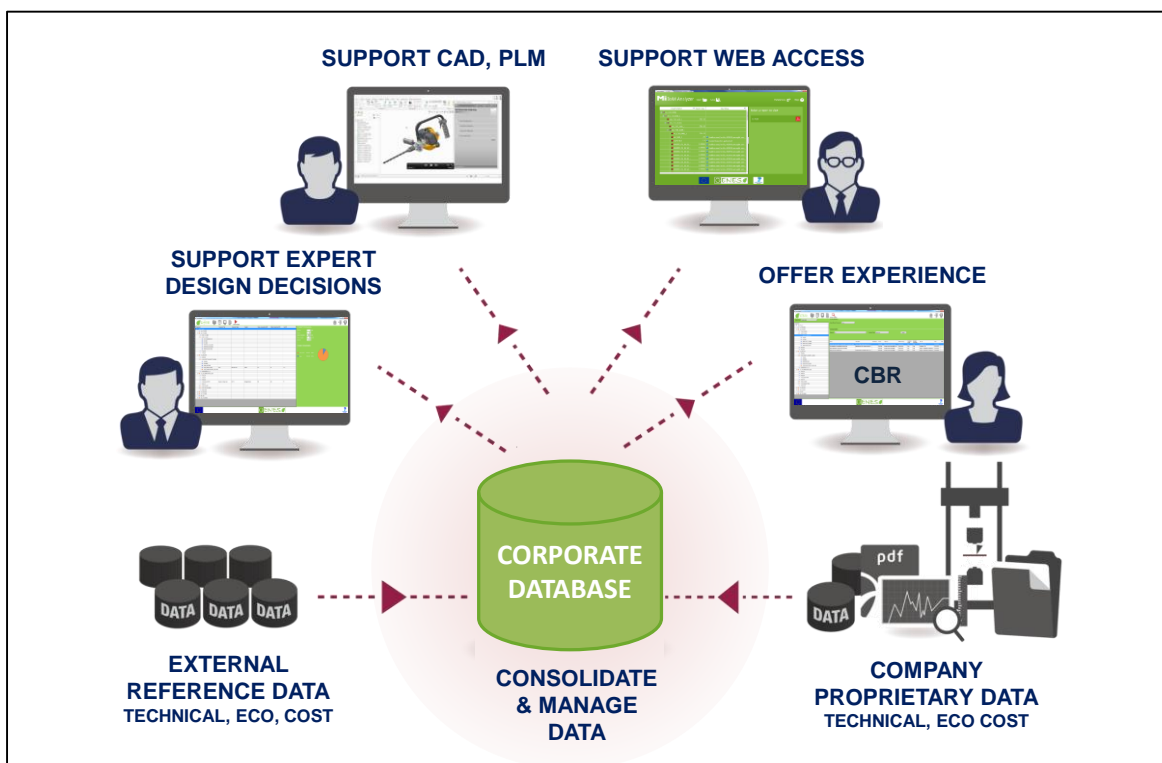

Figure 35: G.EN.ESI platform environments

2.4 G.EN.ESI implementation

As explained before, the G.EN.ESI platform is one implementation of our proposal but presents some differences with it because of technological choices, existing solutions or resources problems. Regarding the elements of the methodological framework reminded in the following figure, some main differences can be noticed:

- Some of the tools has been integrated within the same tool, thus Eco-Audit gathers the functionalities of Raw Material tool, Manufacturing tool, Transport tool, S-LCA and S-LCC.
- A dashboard that could be parametrized and tailored according to each project requirements were not developed.
- Data exchanges between the tools are possible but they are not so dynamic and flexible than expected (e.g. model unification and model federation are not used at this point of achievement).

Specific explanations about the Granta tool:

The Granta MI: Materials Gateway can be used directly by several CAD systems (Catia, ProeE, Creo, Inventor, Nx) and PDM systems (Windchill, Teamcenter). The Granta solution is used as plug-in of these CAD systems.

Internal and external developments to Granta have been realized for the projects:

- Internal: e.g. the Web-BOM analyzer.
- External: development of the XML exchange format to enable the other tools (it means those which are not developed by Granta) to get data in Granta software tools and to use them.

Internal Granta tools can be used for other applications than for household appliances. Tools can be tailored to the users. Nonetheless, they are commercial off-the-shelf software¹¹ systems and the computer code can only be modified by Granta.

External tools, as the content of the XML file, are open and can be modified. Then the applications using the file should be adapted to consider the modifications.

Specific explanations about the Universita Politecnica delle Marche (UNIVPM) tools:

The UNIVPM tools (LeanDFD, CBR and DfEE) are not internally integrated with the CAD systems. They are stand-alone software tools. However, LeanDFD has a functionality to import 3D product models in two ways. The first one consists in importing .step file (neutral

¹¹ "Short for commercial off-the-shelf, an adjective that describes software or hardware products that are ready-made and available for sale to the general public. For example, Microsoft Office is a COTS product that is a packaged software solution for businesses. COTS products are designed to be implemented easily into existing systems without the need for customization" definition from www.webopedia.com/TERM/C/COTS.html /October 2015

interchange file), the second one, in connecting directly with the specific CAD system, avoiding to pass through an interchange file. Using this approach, it is possible to retrieve from the CAD system as much information as possible. The UNIVPM tools are characterized by an open access database that can be easily customized, just having Microsoft Access.

2.5 G.EN.ESI platform advantages

The platform was used in the partner company of the G.EN.ESI project (in Faber: the cooker hood manufacturer) to test its applicability. More information about this experiment is available in the following chapter. Several meaningful advantages are reached thanks to the use of the G.EN.ESI platform:

- Designers are able to compare different design solutions, considering environmental and economic aspects through the Eco-Audit tool. The S-LCA is a simplified assessment tool which does not require detailed information. The designer could choose the best design solution, even if the tool does not allow a full assessment. The S-LCA analysis is done quickly without harness the design process. Same considerations can be outlined for the S-LCC tool (which calculates raw material costs);
- The life cycle tools enable to collect data for each life cycle phase of the product;
- The proposed platform includes a specific web portal where suppliers can specify LCA and LCC data related to their own products. This information is used by each platform tool, providing to designers a quite accurate assessment, without asking them to input this information;
- The platform is integrated with the CAD system in order to create a single workbench where are performed environmental and economic analyses. Also the integration with the PLM system is proposed, in order to retrieve information required during the analysis. This solution avoids data duplication.

2.6 G.EN.ESI platform weaknesses

The G.EN.ESI platform is able to meet most of the requirements we described in the proposal but we identified some weaknesses that we explained in this paragraph.

First of all, the supplier web portal is currently only a form that the supplier fills in and sends back to the lead company. There is no real interaction between the supplier and the company. For example we can imagine a web portal where the information entered by the supplier are directly included in the database to be exploited by the different tools. Moreover, once the S-LCA of the product has been realized, the designer or the environmental manager (or directly the platform in an automatic way) could return some feedbacks to the supplier, for example in the form of an environmental analysis with the components contribution analysis in order to sensitize the supplier on their product/components/material impacts. In this way, the supplier increases his environmental awareness and then can be integrated deeper in the ecodesign approach.

Then the S-LCC module included into the Eco-Audit tool takes into account only raw materials costs. The tool could be improved to take into account the whole-life cost including for example planning, design, manufacturing, transportation, use (operations, maintenance), end-of-life. Moreover if the tool is modular, it means able to take into account only the steps the project manager decides to include, it will be then possible for the project manager to choose a “cost” indicator convenient for the project or for the company.

Another point concerns the current dashboard of the Eco-Audit tool. The dashboard consists of four indicators (energy consumption, CO2 emissions, water consumption and raw materials costs) thus the user do not have the choice in the indicators. However, in the methodology, we specify that we would like to give the possibility to the design team to choose a set of indicators relevant for the current product or project according to the environmental strategy of the company.

Finally another weakness of the G.EN.ESI platform is about the notion of integration. The current development enables to use the bill of materials of the products in the different tools however the user has to import an XML file in the specific tools to get the data and he has then to export (when possible according to the tools) an XML file to update the data in the Web interface. This system of XML file involves an important number of handlings for the user that does not facilitate the platform use and that increase the use time which is quite precious during the design process. There is therefore no automatic update of the product life cycle model; it means that there is no real “live” estimation of the product analyses.

3 Conclusion

This chapter summarizes the key concepts we identified to implement an ecodesign approach in the design process. Then we exposed an ecodesign methodology supported by a software platform to meet the different key concepts and reach an easy integration within the product development process. The platform is designed to consist in a set of integrated tools. Some tools are dedicated to a specific life cycle phase and their integration allows controlling the environmental and economic aspects along the entire product lifecycle. The designers are consequently always conscious of their choices and the consequences on the product. To finish, we presented an example of a software development of the platform described in the proposal via the G.EN.ESI project. Different stakeholders took part into this development. We then analyzed the platform regarding the key concepts identified in order to show advantages and weaknesses.

Chapter 6

Experimental studies

- 1. HYPOTHESIS AND EXPERIMENTAL PROGRAM 113**
 - 1.1. HYPOTHESIS 113
 - 1.2. EXPERIMENTAL PROGRAM..... 113

- 2. EXPERIMENT N°1: ILLUSTRATION OF THE DEPLOYMENT OF THE SOLUTION THROUGH THE REDESIGN OF A COOKER HOOD..... 115**
 - 2.1. OBJECTIVE OF THE EXPERIMENT IN FABER..... 115
 - 2.2. FABER..... 115
 - 2.3. A TIMELINE TO IMPLEMENT THE METHODOLOGY AND THE SOFTWARE PLATFORM INTO FABER PRODUCT DESIGN PROCESS116
 - 2.4. PHASE 1: THE CURRENT FABER PRODUCT DESIGN PROCESS 118
 - 2.5. PHASE 2: ILLUSTRATION OF THE APPLICATION OF THE METHODOLOGY AND THE ASSOCIATED PLATFORM IN FABER DESIGN PROCESS..... 125
 - 2.6. PHASE 3: NECESSARY STEPS FOR A FULL INTEGRATION OF THE METHODOLOGY AND THE PLATFORM IN FABER DESIGN PROCESS140
 - 2.7. CONCLUSION AND VALIDATION OF ASSUMPTION..... 141

- 3. EXPERIMENT N°2: IMPLEMENTATION OF THE APPROACH IN THE DESIGN OF A NEW RANGE OF PUBLIC BENCHES 144**
 - 3.1. OBJECTIVE OF THE EXPERIMENT IN AUBRILAM..... 144
 - 3.2. AUBRILAM 144
 - 3.3. CHOICE OF THE CASE STUDY..... 144
 - 3.4. IMPLEMENTATION OF THE METHODOLOGY IN AUBRILAM 146
 - 3.5. DEVELOPMENT OF A DEMONSTRATOR TOOL 164
 - 3.6. SYNTHESIS AND PERSPECTIVE 169
 - 3.7. CONCLUSION AND VALIDATION OF THE THESIS HYPOTHESIS 169

- 4. EXPERIMENT N°3: A SERIOUS GAME FOR A WORKSHOP 172**
 - 4.1. OBJECTIVE OF THE EXPERIMENT DURING THE WORKSHOP 172
 - 4.2. CONTEXT OF THE WORKSHOP..... 172
 - 4.3. PROCEEDINGS OF THE SESSION 173
 - 4.4. CONTENT OF THE SERIOUS GAME..... 173
 - 4.5. EXPLOITATION OF THE RESULTS 177
 - 4.6. FEEDBACK OF THE PARTICIPANTS 178
 - 4.7. CONCLUSION OF THIS EXPERIMENT 181

- 5. CONCLUSION OF THE THREE EXPERIMENTS 182**

In the previous chapter, we described the proposed solution associating an ecodesign methodology with an engineering platform for ecodesign to meet the issues head-on in the problematic. This chapter presents the case studies realized in order to test and validate the proposal.

The first section reminds the hypothesis made to show that the methodology and the platform facilitate the consideration of environmental issues in the design process and it also presents the three experiments we conducted to test the assumption.

The first experiment described in section 2 aims at testing the application of the methodology with some of the tools in Faber design process, an Italian cooker hoods manufacturing company. The second experiment was conducted in an industrial sector in a French medium company. The approach and the results of these experiments are presented in section 3. A third experiment, developed in section 4, was conducted during an international conference workshop with industrials and academics.

1. Hypothesis and experimental program

This section is dedicated to the reminder of the hypothesis related to this thesis and to the explanation of the experimental program established to test the hypothesis.

1.1. Hypothesis

To validate our solution, we need to verify the five assumptions:

The methodological framework makes easier the identification of critical environmental elements or “hot spots” and the development of ecodesigned products by promoting:

- The connections between the stakeholders of the design process (N1).
- The use of classic tools and life cycle parameters (N2).
- The use of environmental indicators (N3).
- The creation of new data and new knowledge and elements for their management (N4).
- A procedure taking into account the methodological needs to be in line with the design process (N5).

1.2. Experimental program

The aim of the experimental program established for this work is to define a set of experiments enabling to get the best validation of our proposal. This program was implemented to test the different assumptions.

Experiment N°1: Industrial case study in the Faber Italian company. The experiment N°1 objective is to validate the five assumptions in Faber, which designs and manufactures cooker hoods. We tested the methodology and some of the platform tools on the redesign of a cooker hood in order to illustrate the different steps of the methodology and to identify possible problems and weaknesses in our approach. We also analyzed the redesign process managed by the company itself after being trained by the G.EN.ESI project team.

Experiment N°2: Industrial case study in the French SME Aubrilam. The experiment N°2 aims also at validating the five assumptions in a different context. The company designs and manufactures urban furniture and lighting columns for public and private sectors. The methodology was implemented in the design process during a new design project for public benches. As the platform was still not developed when the experiment was conducted, we played ourselves the role of the software platform in order to link necessary data and to establish the life cycle assessment of the on-going product.

Experiment N°3: Organization and realization of a workshop during the Conference DESIGN 2014, Croatia. The purpose of the experiment N°3 is to show that knowing the interrelations between the different departments of a company enables to give more efficient instructions for the design process, which is an observation coming from the analyze of the two first case studies. The workshop was co-organized with two members of the University of Bath. The aim was to let the audience of the workshop work on two parts, the usefulness of the connections between the different company departments, life cycle parameters and environmental indicators, and the importance of the links with the supply chain.

Experiments and results are described in the followings sections.

2. Experiment N°1: Illustration of the deployment of the solution through the redesign of a cooker hood

The methodology described in the previous part shows the steps needed to be realized by the different stakeholders during the design process to take into consideration environmental criteria. This part illustrates now the introduction of the solution in a company and more particularly in the design process of the company. We base our explanations on data coming from the Italian company Faber S.p.A., a company which designs and manufactures domestic cooker hoods. Faber is a partner of the G.EN.ESI. project and this is in this framework that we work with them. We therefore had access to data from their products, their organization and their design process.

As a first step, we remind the objective of the experiment and secondly, we detail the different steps which are necessary to a full integration of the methodology and the G.EN.ESI platform in Faber. To do that, the current product design process of Faber was modelled. Then we present a first study where the methodology is applied to redesign a cooker hood, after which we propose some changes in their design process. Next we present the necessary steps for a full integration of the platform. Finally we conclude on key success factors for the integration of the solution.

2.1. Objective of the experiment in Faber

The experiment aims to validate that the methodology supported by the software platform facilitates the identification of environmental hot spots and the development of ecodesigned products through the connection between the stakeholders (N1), the use of classic tools and life cycle parameters (N2), the use of environmental indicators (N3), the creation of new data and new knowledge and their management (N4), the procedure to consider the whole (N5).

The objective of this experiment is also to illustrate the different steps of the methodology through the example of the redesign of a cooker hood and to show the changes in the design process involved by the implementation of the methodology.

2.2. Faber

Faber SpA is an Italian company that designs, produces and sells cooker hoods for domestic use. It is based in Fabriano and was founded in 1955. Faber grows from a local business to a European and global enterprise and has now manufacturing sites in different countries and notably in Spain, France, Sweden, Argentina, Turkey, and India. The group is the first in its sector in Italy, where half of the sold cooker hoods is a Faber product, and is present globally with its own brand and leading local brands such as Roblin in France, Mepamsa in Spain and Spar in Argentina. Faber was acquired in 2005 by the Franke Group, a major Swiss multinational leader in Kitchen Systems. Working with Faber on environmental impacts is

therefore interesting because it belongs to a large business group that sells millions of products a year and because the company is confronted to a changing environmental regulation context.

2.3. A timeline to implement the methodology and the software platform into Faber product design process

Implementing a new procedure in a company is often a long and difficult process and integrating environmental considerations in the design process is part of this. We present the three main phases which were necessary for the deployment of the methodology and the software platform into the Faber product design process.

PHASE 1: The current Faber product design process

The first phase aims to understand how the design teams are working in Faber. We reviewed the design process modelled by our project partners. We interviewed in particular the manager for innovation projects and the head of Strategic R&D & Innovation for the Faber Group. Thus, it helped us to determine the best way to introduce ecodesign in their design process, presented in the Phase 2.

PHASE 2: Illustration of the application of the methodology and the associated platform in Faber design process

The second phase shows from our understanding of Faber design process how ecodesign can be implemented through the example of a typical Faber cooker hood. We showed how the methodology steps can be linked with the design process steps. We illustrated thus the redesign of a cooker hood using the methodology and the Eco Audit tool from GRANTA Design. Eco Audit was used to realize the simplified life cycle assessment of the existing product.

PHASE 3: Necessary steps for a full integration of the methodology and the platform in Faber

The third phase shows the different training sessions which were necessary to teach the ecodesign basics and train the Faber design team (mostly designers and the manager for innovation projects) to the G.EN.ESI software tools and platform. We took part in some training sessions and in the elaboration of different materials realized by the dissemination team of the G.EN.ESI project.

Figure 36 summarizes the main activities realized through a timeline. The activities have been divided into three categories: those we managed, those to which we contributed and those realized by the G.EN.ESI partners for the implementation of the combined solution (methodology and software platform). The three phases are described in detail in the following sections.

ACTIVITIES REALIZED DURING THE G.EN.ESI PROJECT IN ORDER TO IMPLEMENT THE METHODOLOGY AND THE SOFTWARE PLATFORM IN FABER

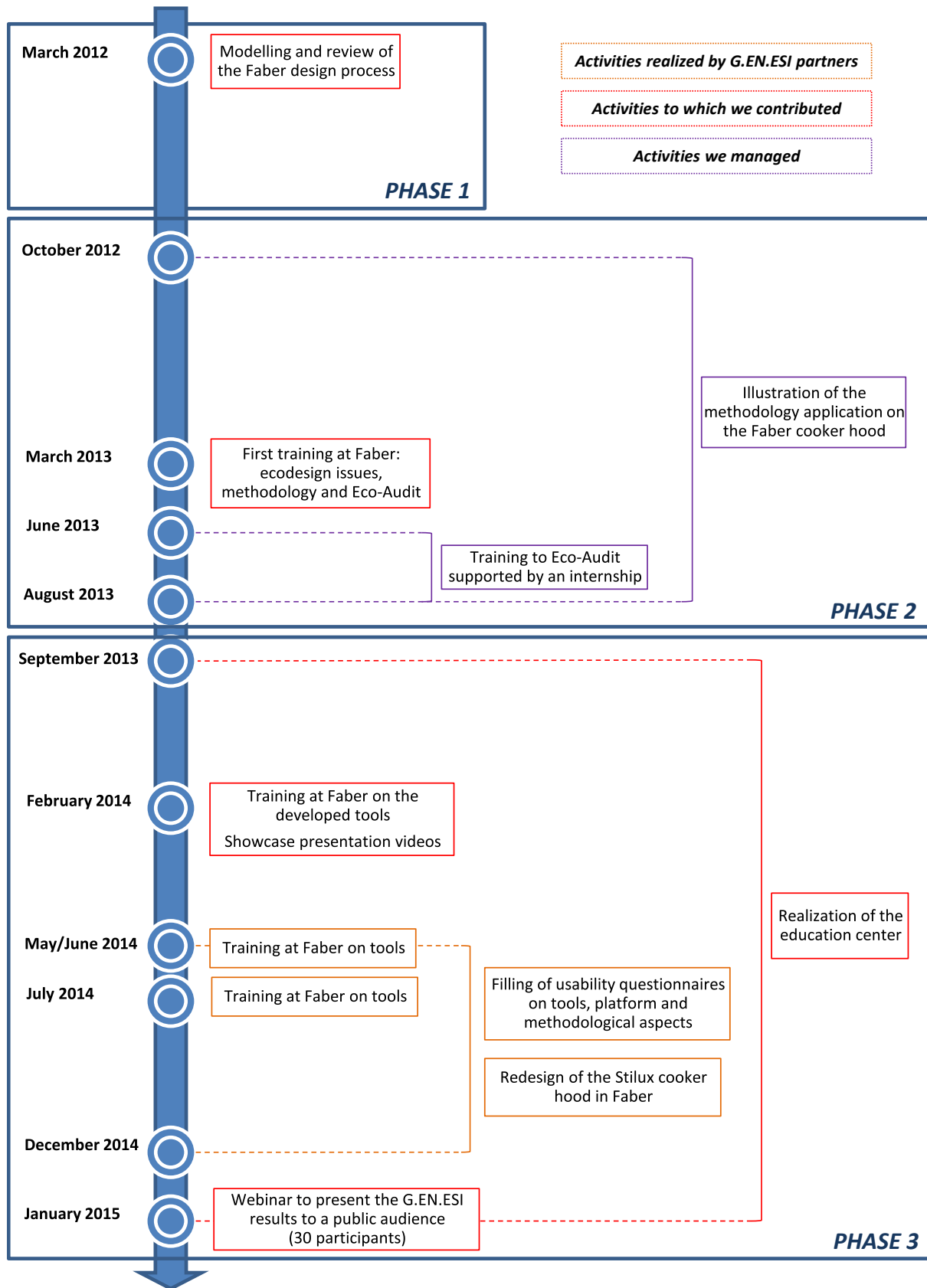

Figure 36: Activities realized during the G.EN.ESI project in order to implement the methodology and the software platform in Faber

2.4. PHASE 1: The current Faber product design process

Understanding the current design process is a necessary step to know how to introduce the solution to the team and to implement it in the design process. This is why, in the G.EN.ESI project we decided to model Faber design process. Partners from the Department of Industrial Engineering of the Università Politecnica delle Marche in Ancona, Italy realized interviews and the design process schematization in March 2012. We reviewed then this work during our first meeting in Faber in April 2012. The description and modelling of the design process is presented in the first deliverable of the G.EN.ESI project (D.1.1: State of the art of ecodeign tools applicability in different product design stages, 2012).

The IDEF formalism (Integrated DEFinition) was used to represent the design process. The analysis of the design process presented in this part describes the main activities performed by the design team to design a new cooker hood. As shown in Figure 37, activities realized during the design process are represented with its interfaces: input, output, controls, resources and tools.

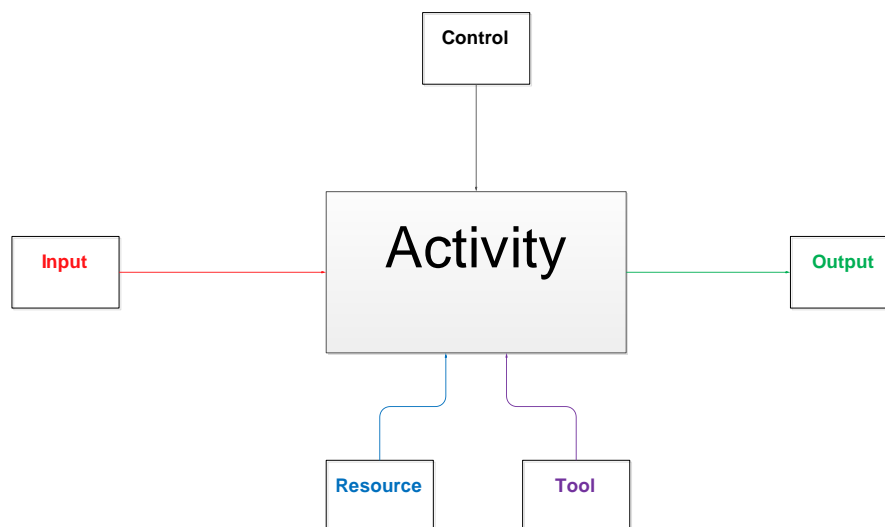

Figure 37: Activity box and interface arrows used in the analysis

As for the IDEF method, the activity box can be decomposed into lower activities to form a hierarchical set. Figure 38 illustrates the decomposition principle of an IDEF model.

Figure 39 represents the first level diagram; it shows all controls influencing the global activity of the design process in Faber, resources or the different members of the design team and the main tools used during the design.

The design team includes in Faber:

- Mechanical Design manager,
- Mechanical designer,
- Packaging designer,
- Functional Design manager,
- Electrical designer,
- Laboratory,

- Electronic Design manager,
- Electronic designer,
- Documentation manager,
- BOM,
- Documentation,
- Equipment manager,
- Workshop and woodwork (Prototype),
- Manufacturing and assembly (Prototype),
- Industrialization,
- Quality,
- Industrial accounting,
- Supplier.

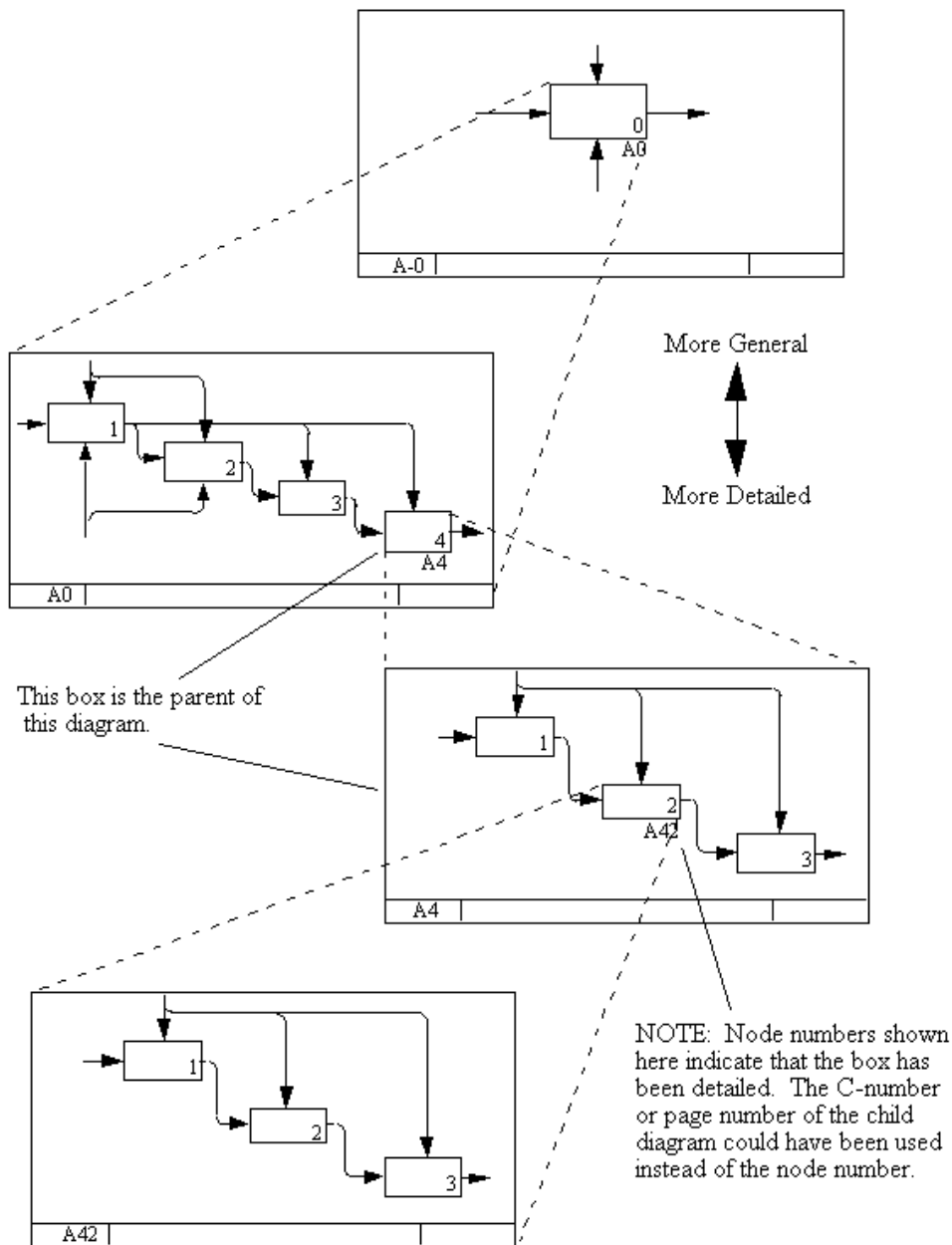

Figure 38: IDEF0 "Parental Diagram" structure

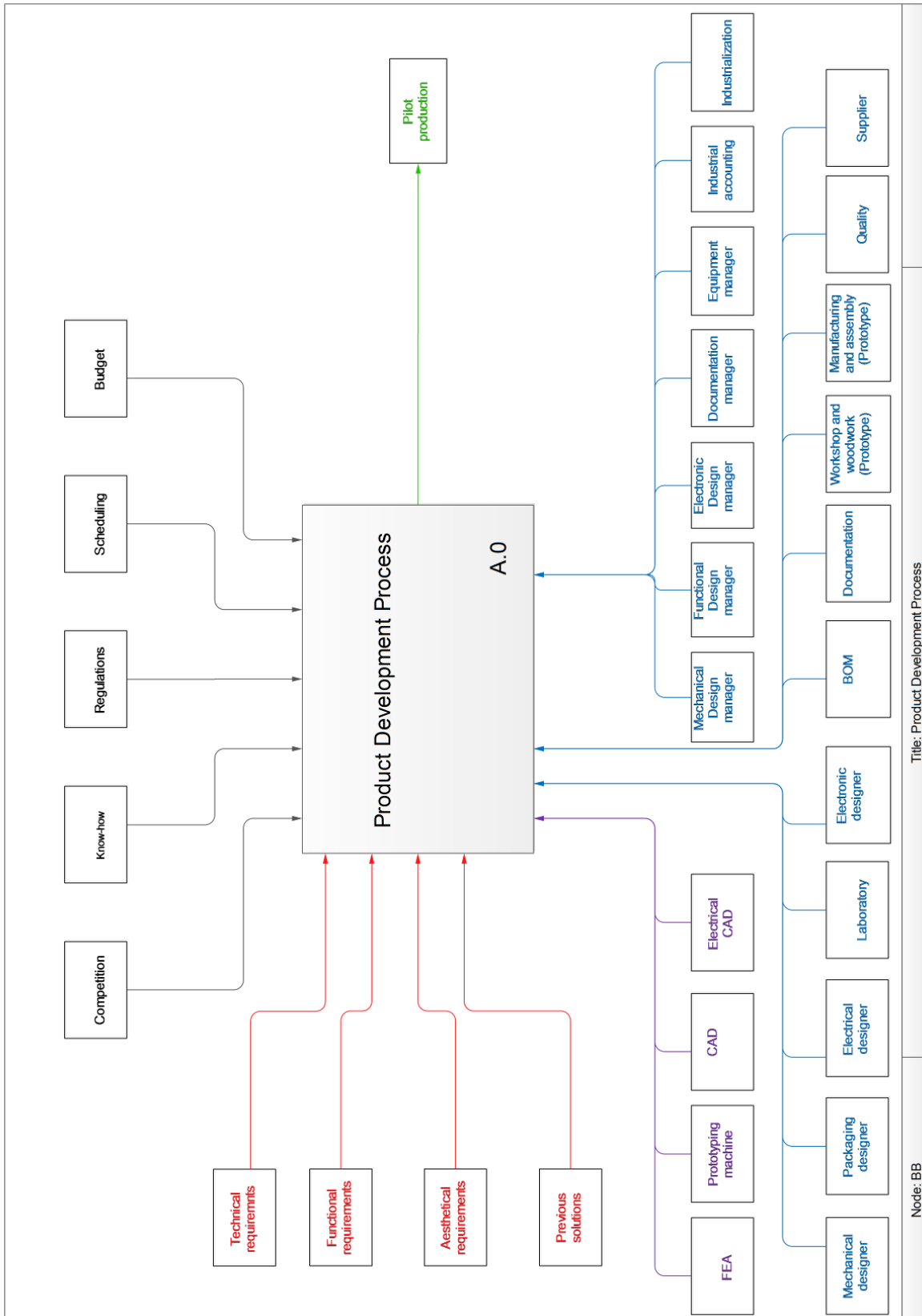

Figure 39: Level BB _ Product Development Process global activity

In Figure 39, only general inputs and outputs are represented to not overload the diagram. The inputs represent mainly the requirements: technical, functional and aesthetical requirements. Previous solutions descriptions are also inputs of the project because some existing design or part of the design can be reused in a new project. Controls of the project, which can be seen as constraints to respect or aspects to take into consideration, are:

- Competition,
- Know-how,
- Regulations,
- Scheduling,
- Budget.

Figure 40 depicts the four main phases of Faber design process that we can compare with the classical design process described in Chapter 3:

- Feasibility, which combines Planning and Conceptual design,
- Development, which corresponds to the Detailed design and the first tests,
- Industrialization, which corresponds to the Detailed design for the last iterations,
- Production start-up.

For ease of reading, resources and tools are not represented in the figure.

Figure 41 and Figure 42 show respectively activities of the Feasibility phase and of the Development phase. Building all these diagrams enables to map, on the one hand, activities and their interfaces, and on the other hand interactions between the different members of the team. For example, the first step to begin the development of a product is the organization of a kick-off meeting (box A.1.1) between the mechanical design manager, the functional design manager and the electronic design manager. Thus we know that these stakeholders met and worked together to establish the project plan which is the output of the box A.1.1.

As we already described phases of a classical design process, we will not detail here activities made during these two phases but only the main outputs. Thus, the feasibility phase leads to the establishment of different documents:

- A project plan,
- Preliminary mechanical models,
- An investment estimation,
- A cost estimation documentation.

The main result of the development phase is the realization of a soft tool; this is the first operational prototype. Other outputs of the development phase are:

- Mechanical and packaging models,
- Electronic documentation and components,
- Engineering BOM,
- FEA simulation results,
- FMEA documentation
- Certification documents,
- Cost estimation documentation.

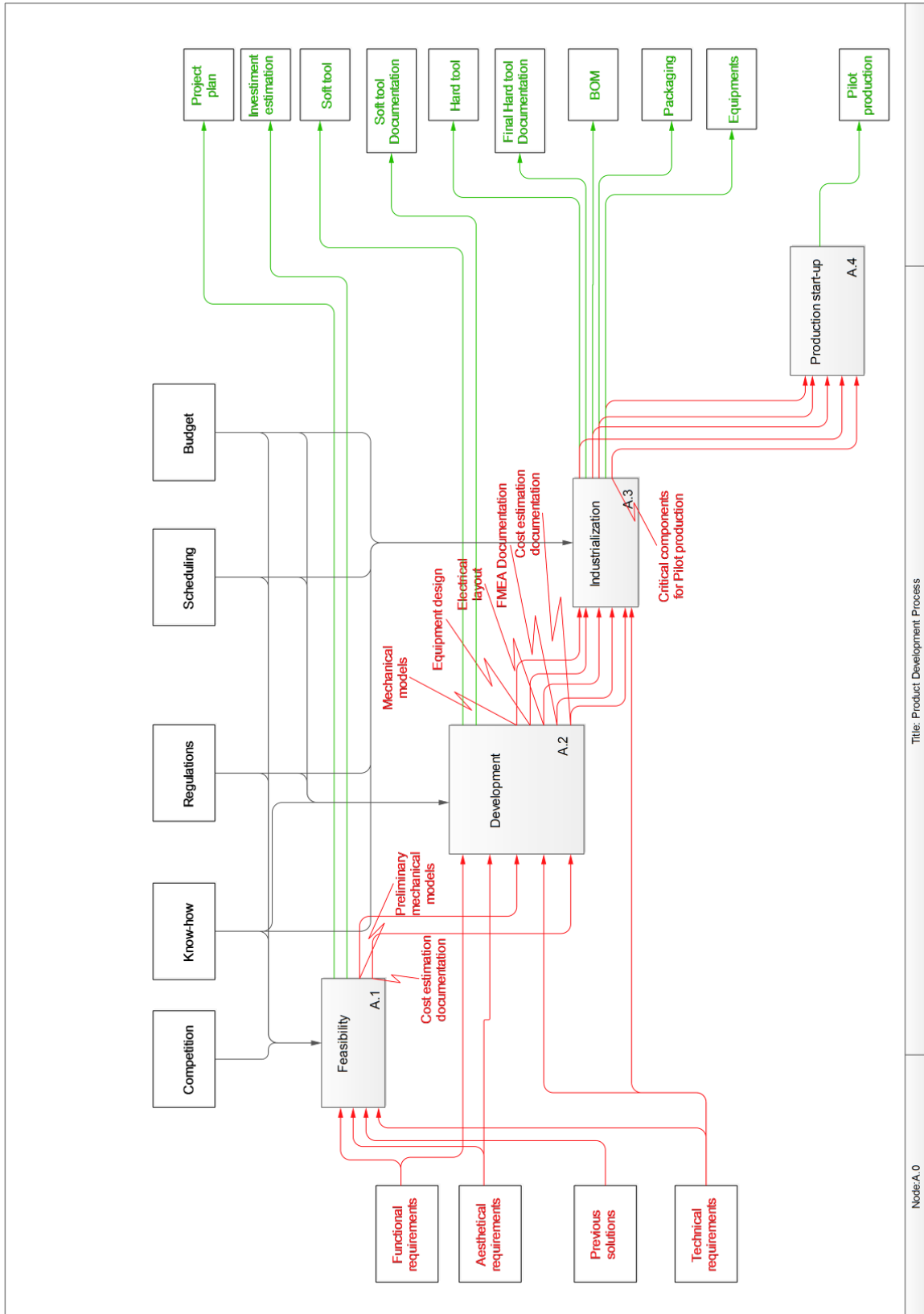

Figure 40: Level A.0 _ The four major phases of the Product Development Process

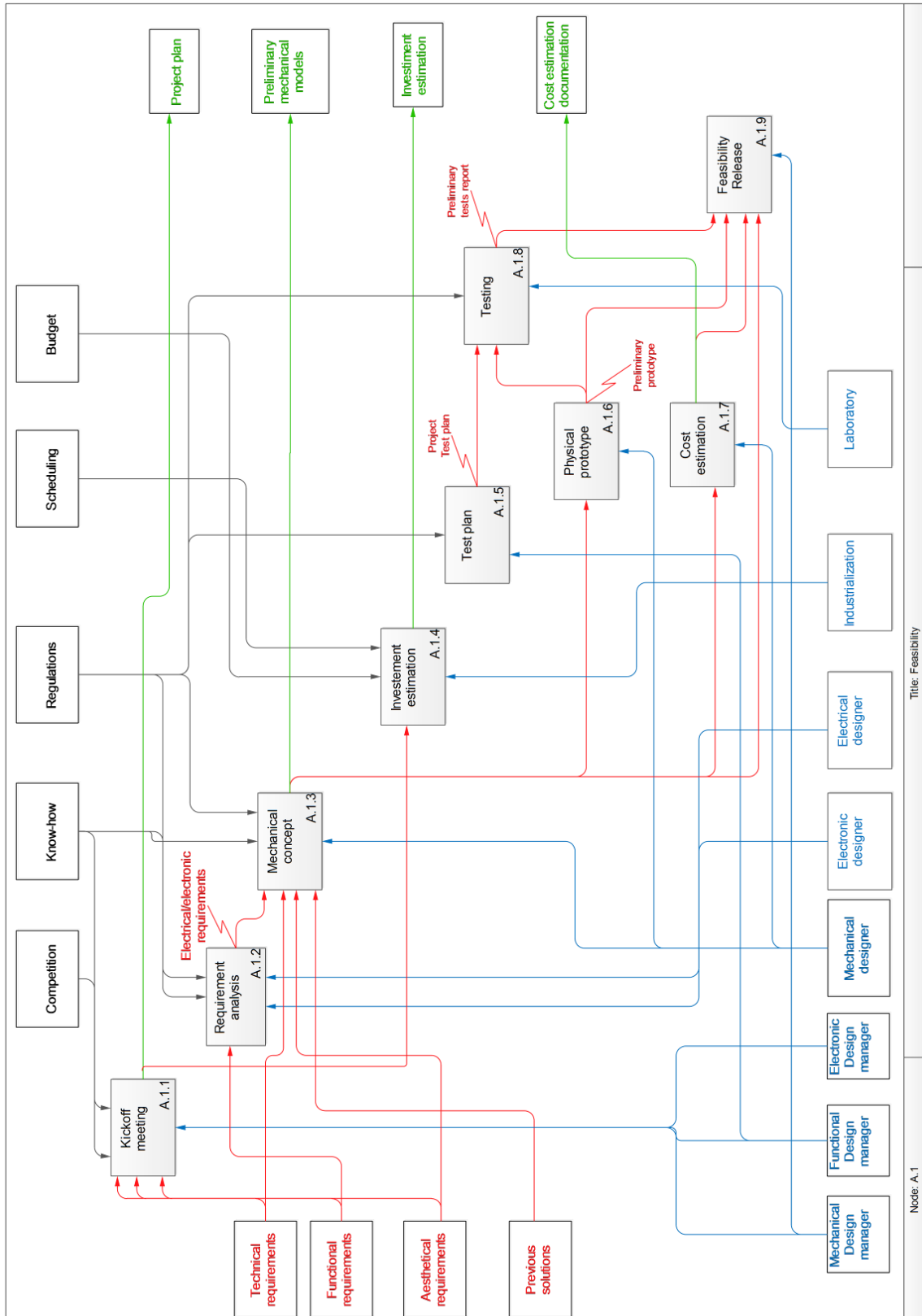

Figure 41: Level A.1 _ Feasibility phase

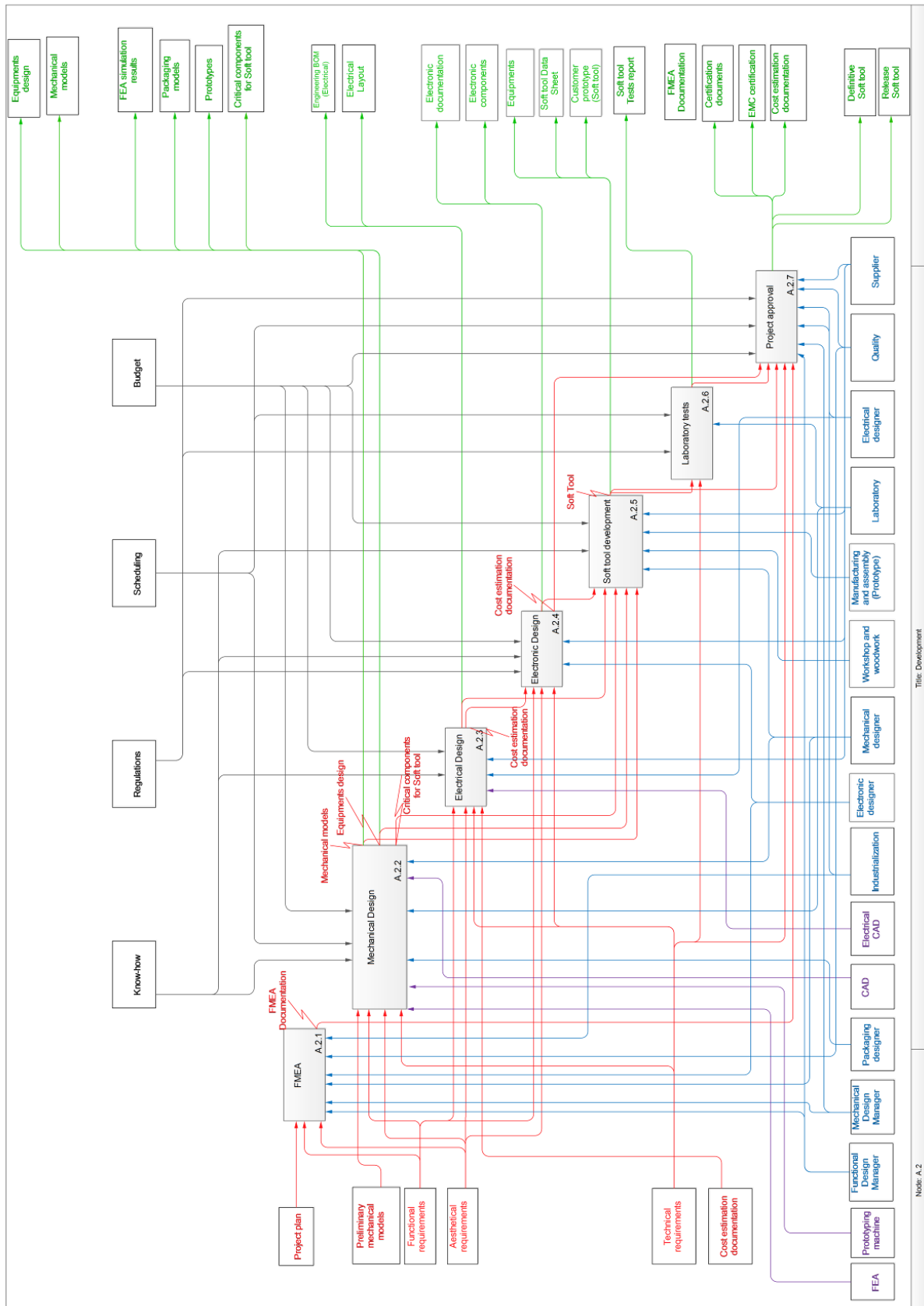

Figure 42: Level A.2 _ Development phase

2.5. PHASE 2: Illustration of the application of the methodology and the associated platform in Faber design process

This section aims at illustrating the integration of the ecodesign methodology and the associated platform into Faber traditional design process. We realized a study where the methodology was applied for the redesign of a cooker hood. To achieve that, we used the combined solution described in chapter 4, the design process presented in the previous subsection and data from Faber. Changes required to implement ecodesign are highlighted and the solution is illustrated with a running project for the redesign of a cooker hood.

The studied product is the Stilux cooker hood, a classical cooker hood with a T-shape which represents the chimney of the cooker hood. Figure 43 shows the cooker hood and its functional groups with the standard components.

FUNCTIONAL GROUP	STANDARD COMPONENT
Motor + Impeller	Electric Motor
	Capacitor
	Motor Impeller
Blower	Blower (to the right)
	Blower (to the left)
Cover	Chimney
	Cover
	Aesthetic Panel
Electricity Supply	Transformer
Electronic Control Board	Electronic Board
Filters	Grease Filter
	Carbon Filter
Lamps	Lamps
Support	Supports
Others	Plastic Parts
	Metal Parts
	Wiring & Connectors
	Packaging



Figure 43: Functional groups and standard components for cooker hoods (left) _ Image of the Stilux cooker hood (right)

Changes and adaptations required to take into consideration environmental issues into the design process are multiple and diverse in nature. We will explain in the following subsections the changes needed to be operated in the design process.

2.5.1. Changes before the start of the new design project

The aim of the changes is to design and produce thanks to ecodesign a greener product, a product which limits its impacts on the environment. Figure 44 illustrates extra inputs, resources and controls necessary to implement ecodesign. The boxes relative to environmental issues are orange.

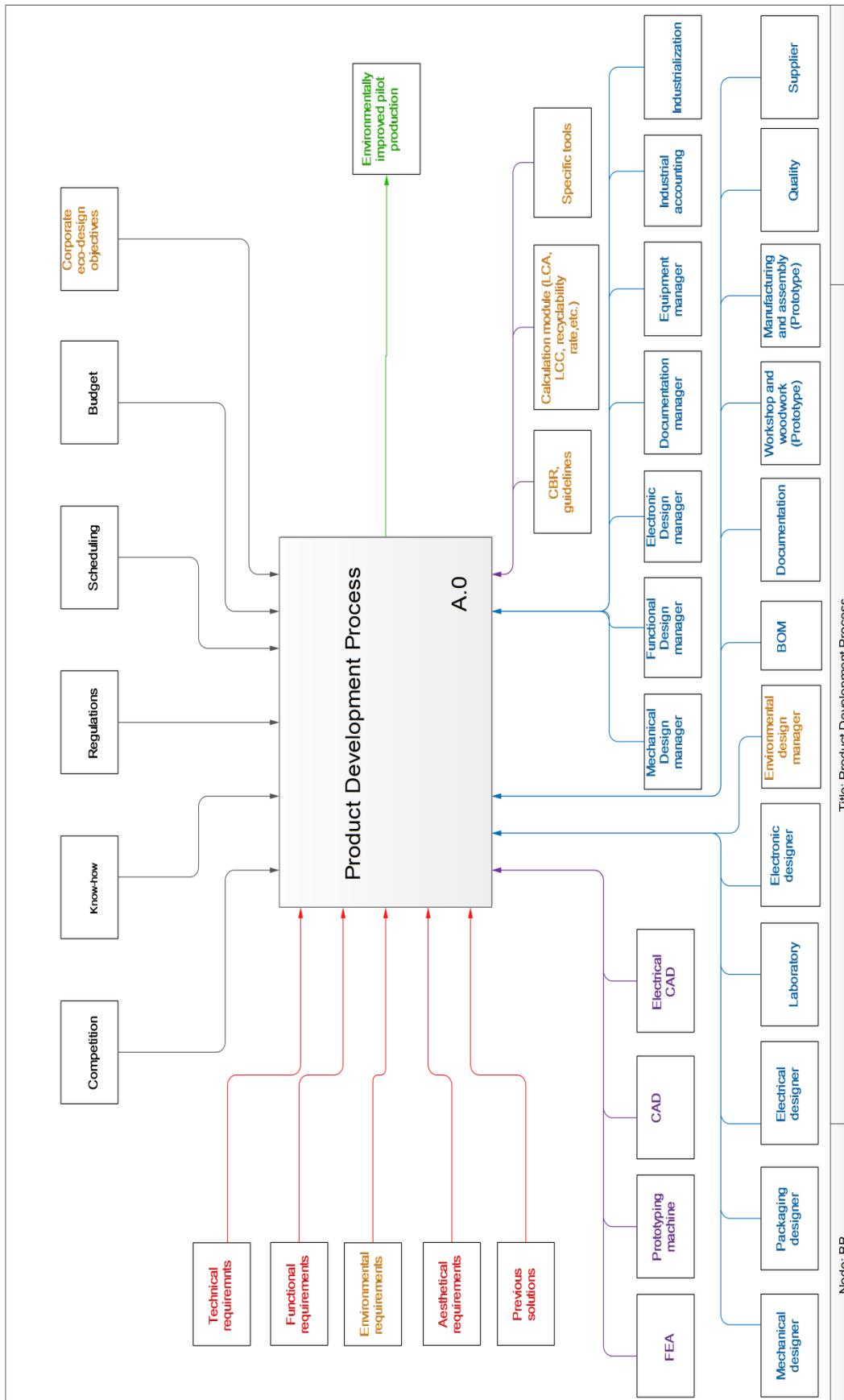

Figure 44: Level BB _ General product development process with the elements of the methodology

Resources: Environmental Design Manager

In Faber different types of designers contribute to the product development process: mainly mechanical designers, packaging designers, electrical designers and electronic designers. Each field has its manager and together they constitute the management team.

Faber needs to appoint an environmental design manager to take care of the introduction and the integration of environmental issues within the design process. This individual may come from the existing design team following intensive training or from outside the company, either as a new employee or a consultant. That will depend upon available man resources and budget, but Faber should also consider the likelihood of acceptance (of this new person) by the wider design team, as some members may be resistant to changes. The Environmental Design Manager will be also included in the management team.

This manager is required to understand the environmental perspective of the product and development process and he should have knowledge about LCA and costing processes. His primary role would be to support the introduction of environmental issues throughout the design development team. This would be achieved by working alongside existing management and design teams, representing and discussing relevant environmental issues with each department. This would include helping management in the definition of environmental requirements, particularly during a company's first environmental design project; participating in project kick-off meetings; working alongside design teams to perform assessments and develop concepts; and communicating the environmental needs of the product and design process to those outside the design development team.

In the long term the aim would be for this role to be removed once environmental awareness has reached a level suitable for sharing responsibility regarding these previous tasks. At this point designers would be able to integrate environmental considerations into their daily activities without assistance.

Resources: Tools

As part of the introduction of the methodology and the platform, members of Faber design team will need to familiarize themselves with software tools designed to help streamline ecodesign application and learning. In 2012, the entire G.EN.ESI platform was not yet developed but we used the Eco Audit software tool: a tool developed by the company GRANTA Design and included into the G.EN.ESI platform. Eco Audit is a simplified life cycle assessment tool which is directly plugged into the CAD tool (Creo® in our case). Data from the bill of materials (BoM) are thus directly usable in the Eco Audit module, which facilitates the manufacturing phase inventory.

We had to train ourselves on Eco Audit to realize the S-LCA of the current cooker hood. A trainee supports us in the spring of 2013 in this task. On these aspects, he was in charge of learning how to use Eco Audit and to realize the S-LCA of the cooker hood on Eco Audit.

Faber provided him with their cooker hood CAD file and sent us a Stilux cooker hood that the intern has dismantled in order to get the necessary data for the S-LCA.

Controls: Corporate ecodesign objectives

Corporate ecodesign objectives reflect the environmental strategy adopted by the management team to take into consideration environment in the company. In Faber, the environmental strategy of the company comes from two main aspects. Firstly, from 2015 the cooker hoods must bear an energy label displaying their energy efficiency. Thus the energy consumption, in particular in use, will be an indicator to control during the design. Secondly, Faber is part of the Franke Group and since 2010 sustainability is becoming a strategic topic. In particular, Franke Group is following targets related to energy and water consumption, CO₂ emissions and occupational health & safety.

Inputs: Environmental Requirements

The environmental requirements for a new product will embody the environmental business objectives set by the company management team. For the first environmental project within the company, the environmental expert will help the management team to set objectives and define requirements. This process would be helped through the use of the case-based-reasoning tool, which will contain information related to existing LCA's and best practice approaches within the relevant industries.

Once the company has completed their first environmental design process they will be able to draw on this experience, and the understanding it has given them, to set requirements for the second generation of ecodesigned products.

2.5.2. Changes in the design process through the application of the methodology

Steps of the methodology are described in chapter 4. In this part, we illustrate the application of the methodology to the redesign of the Stilux cooker hood and the number corresponding to the steps of the methodology are reminded here to highlight the activities linked to ecodesign.

1. The first step of the methodology consists in the determination of the project environmental objectives considering the environmental weaknesses of the cooker hood, its environmental performance, costs and legislation compliance. To determine these objectives, the team can use information on previous projects on electrical appliances, explanations on European directives, eco-labelling, etc., present in the guidance tool that contains a database on existing products of the company. These environmental objectives are translated into environmental requirements which are an integral part of the specifications. In this study we chose to focus on CO₂ emissions and energy consumption as these are targets from the company strategy.

Figure 49 reminds the four phases of the product development process with the extra interfaces. Feasibility phase and development phase are detailed in the following paragraphs.

Feasibility Phase (A.1)

Figure 50 shows the different activities of the feasibility phase. Some of these activities are developed below.

Kick-off meeting (A.1.1)

Design managers and environmental design manager meet to discuss the new development project. The inclusion of the environmental design manager ensures that environmental issues are addressed from the start of a project.

Preliminary design (A.1.3)

Figure 51 illustrates changes we prescribed in Faber design process to apply the methodology.

Preliminary design (A.1.3.1): Design team and environmental design manager conduct initial concept development with regards to all design requirements including environmental requirements. In our study, as we illustrate the redesign of a product, the preliminary design phase is not relevant: the product is already developed.

2.

Data extraction (A.1.3.2): Collection of the relevant design data from initial concepts and, where computational collection is unavailable, manual input of these data into the platform. This data collection enables the initial assessment. This would require contribution from the design team, environmental design manager and BOM manager. The environmental design manager (ourselves in this case) determines the functional unit of the cooker hood which is “drawing air at 600 m³/ h two hours a day and illuminating a surface at 1600lux three hours a day for 10 years”. The collection work has been realized by the trainee, through information coming from files exchanges, from the dismantled cooker hood and from direct contacts with Faber.

3.

Preliminary assessment and determination of environmental hot spots (A.1.3.3): The calculation module is used to perform a low detailed assessment (S-LCA and S-LCC) of the preliminary design and compare this to previous generations where data is available. The S-LCA is in this case realized with the Eco Audit tool. It enables to calculate, for each life cycle phases, CO₂ emissions and energy uses, the two indicators we decided to follow at the first step of the methodology according to the environmental strategy of the company. Figure 45 and Figure 46 shows the results given by the software tool. The results of this assessment need to be visually displayed to the design team and captured in the first environmental and cost reports. The environmental design manager (ourselves in this case) identifies then the most environmental critical points. The realization of sensitivity analysis can be necessary at this step. The identified hot spots for the cooker hood are: the use phase due to the energy consumption and the raw material extraction phase.

Translation of the results into targets (A.1.3.4): The environmental design manager and design team work together to understand the design implications of the preliminary assessment and translate these into design targets for the next stages of development.

The targets are defined according to environmental hot spots, company objectives, product market, and legislation. For the cooker hood study here, we fixed the following environmental target: to drop by 30 per cent the CO₂ emissions of the product life cycle. A report on this preliminary analysis needs to be sent to all the members of the project team and stored in the CBR database.

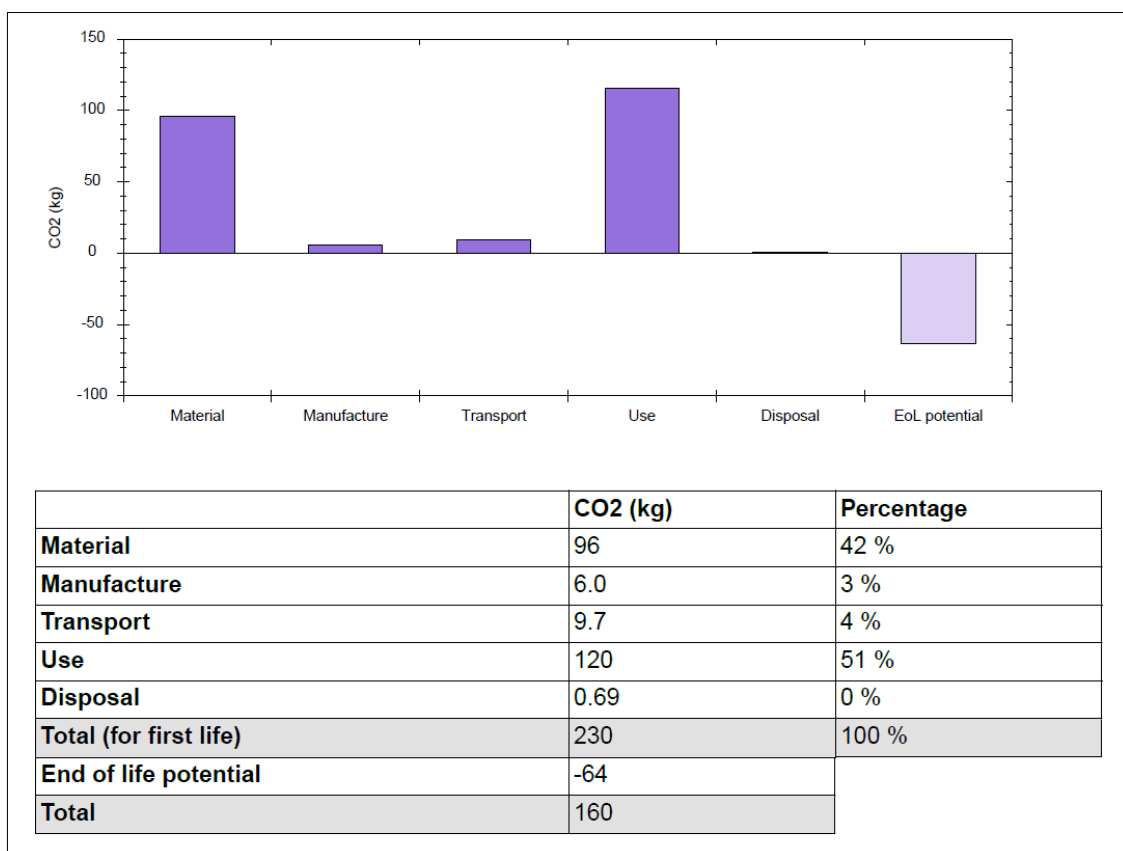

Figure 45: CO₂ emissions of the cooker hood for each life cycle phase

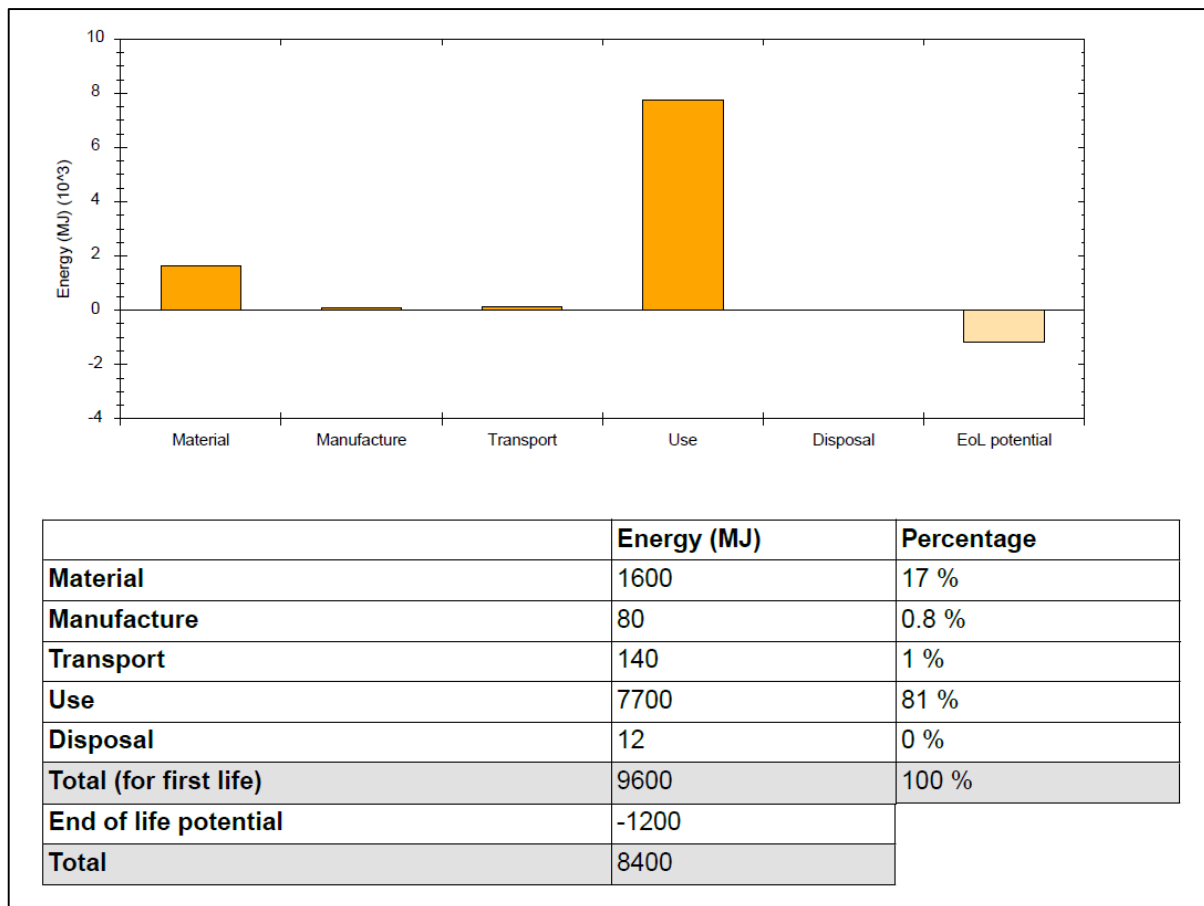

Figure 46: energy uses of the cooker hood for each life cycle phase

Design Changes (A.1.3.5): The design team and environmental design manager have to work together to improve the environmental performance of the design concepts based on the design targets defined in the previous steps (A.1.3.4). This is supported by inputs from the CBR tool and ecodesign guidelines contained within the platform.

Check (A.1.3.6): Environmental and cost implications of design changes are dynamically represented to the design team allowing them to check against targets. This is likely to result in iterative changes and checks until the team is happy with the concept. The final concept on which the team agreed is captured in the first environmental and cost reports.

It should be noted that although these steps are described distinctly, in reality they relate to a dynamic and fluid process that takes place between the design team and the software tools. As the tools would provide instant feedbacks and comparison to previous generations, the design team is likely to repeat these steps, or at least a collection of them, several times within one product development project.

Development (A-2)

Figure 52 shows the different activities of the development phase. Some of these activities are developed below.

4. Concepts are detailed in this phase. Mechanical design (A.2.2), Electrical Design (A.2.3) and Electronic Design (A.2.4) activities are realized. Figure 47 shows the CAD model of the product. The product is optimized according to the priorities and targets established in the previous steps. Ecodesign guidelines, included in the guidance tool can be consulted by designers to help redesigning the cooker hood. For each rule (i.e. “Prefer high efficiency motors and lamps”), some possible technical solutions are associated (alternative motors, lamps, etc.).

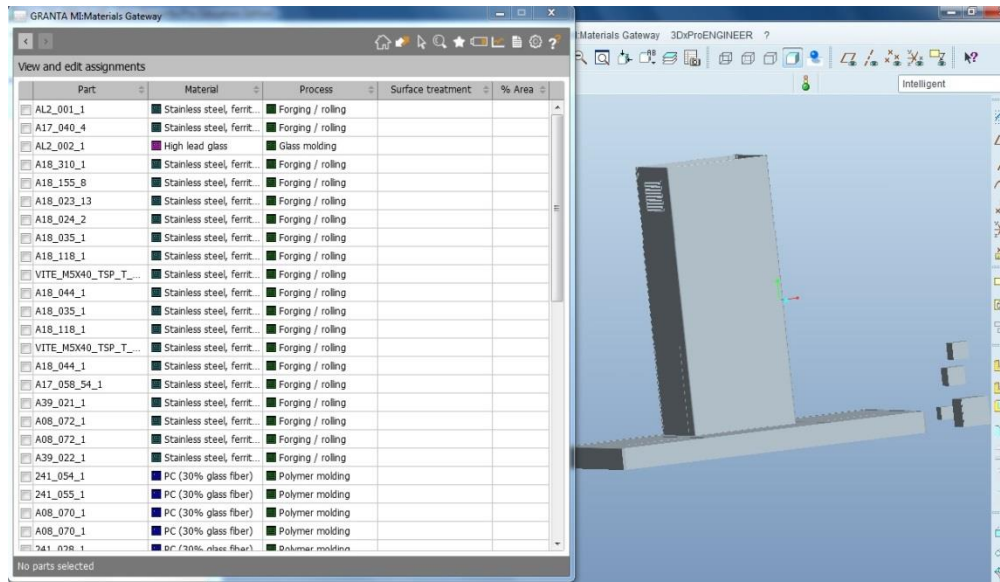

Figure 47: CAD model of the cooker hood

Detailed Environmental Development (A.2.5)

Figure 53 illustrates the changes we prescribed in the design process to apply the methodology.

5. *Data extraction (A.2.5.1)*: Extraction of relevant design data from each department, design models and outputs from the low level LCA and LCC. This should be achieved automatically by the platform software.

Detailed assessment and determination of future environmental hot spots (A.2.5.2): The calculation module is used to perform a high detailed environmental assessment of the design and compare it to previous targets. The results of this assessment would be visually displayed to the design team and captured in the final environmental and cost reports.

Translation of the results in targets (A.2.5.3): The environmental design manager and design team work together to understand the design implications of the detailed assessment. They translate these into small design targets (those involving simple and easy design changes) for the current design project and more complex design targets to be carried through to the next product generation. It would be the environmental design manager’s job to

communicate these larger targets to higher management level; those who set the environmental design objectives.

Design Change (A.2.5.4): When possible, the design team and the environmental design manager work together to improve the environmental performance of the detailed design. This can be supported by inputs from the CBR tool including ecodesign guidelines contained within the platform.

The designer optimizes his technical solution. If the objective for the global CO₂ emissions reduction is not realized, he tries to act on the product under development (i.e. new material, new use scenario or end-of-life scenario), but he can also ask the buyer to try to change the supplier for a less impacting material or less material transportation. In our case, the electric motor supplier was consulted to optimize the energy consumption of the motor. An energy efficient motor was proposed as well as LEDs. Environmental impacts from the transportation are decreased by the change of suppliers for a local one. At the same time, the project management team controls all environmental indicators on the dashboard and sends an alert if there is unacceptable impacts transfers.

Check (A.2.5.5): The project management team is in charge of carrying out the final check. Environmental and cost implications of design changes are dynamically represented to the design team allowing them to check against targets. This is likely to result in iterative changes and checks until the team is happy with the final design.

In our case study, the results of the S-LCA for the redesigned cooker hood (modelling the change of the motor and of the lamps) show a decrease of 42 per cent of the CO₂ emissions and no major impact transfer are noticed in this case. The targeted objective is reached. Reports are generated to collect the different changes operated during the redesign of the product. The outputs of this step are captured in the final environmental and cost reports.

Knowledge Feedback Loop

6.

The final step aims to capitalize experience for the future. It consists in thinking about the long term company objectives. The project management team assesses the impacts of the previous decisions on the long term environmental position of the company to systematize and improve the consideration of environmental aspects. The use of energy efficient components or the changes of suppliers for local ones are some aspects which could become long-term company strategies.

This product development process aims to support a gradual learning process within a company. This is done through capturing environmental development between generations of a product. This allows assessments of completed designs to set targets for the next generations of a product. It also ensures that knowledge developed within the design team are communicated to a management level and integrated into design specifications. This

knowledge feedback loop is seen as essential to support a continual reduction in environmental impacts. This feedback loop is represented in Figure 48.

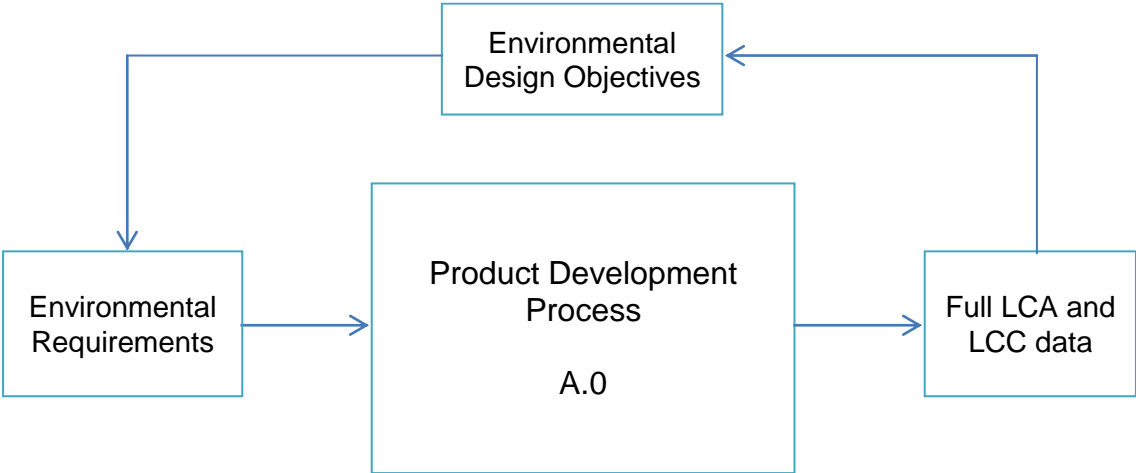
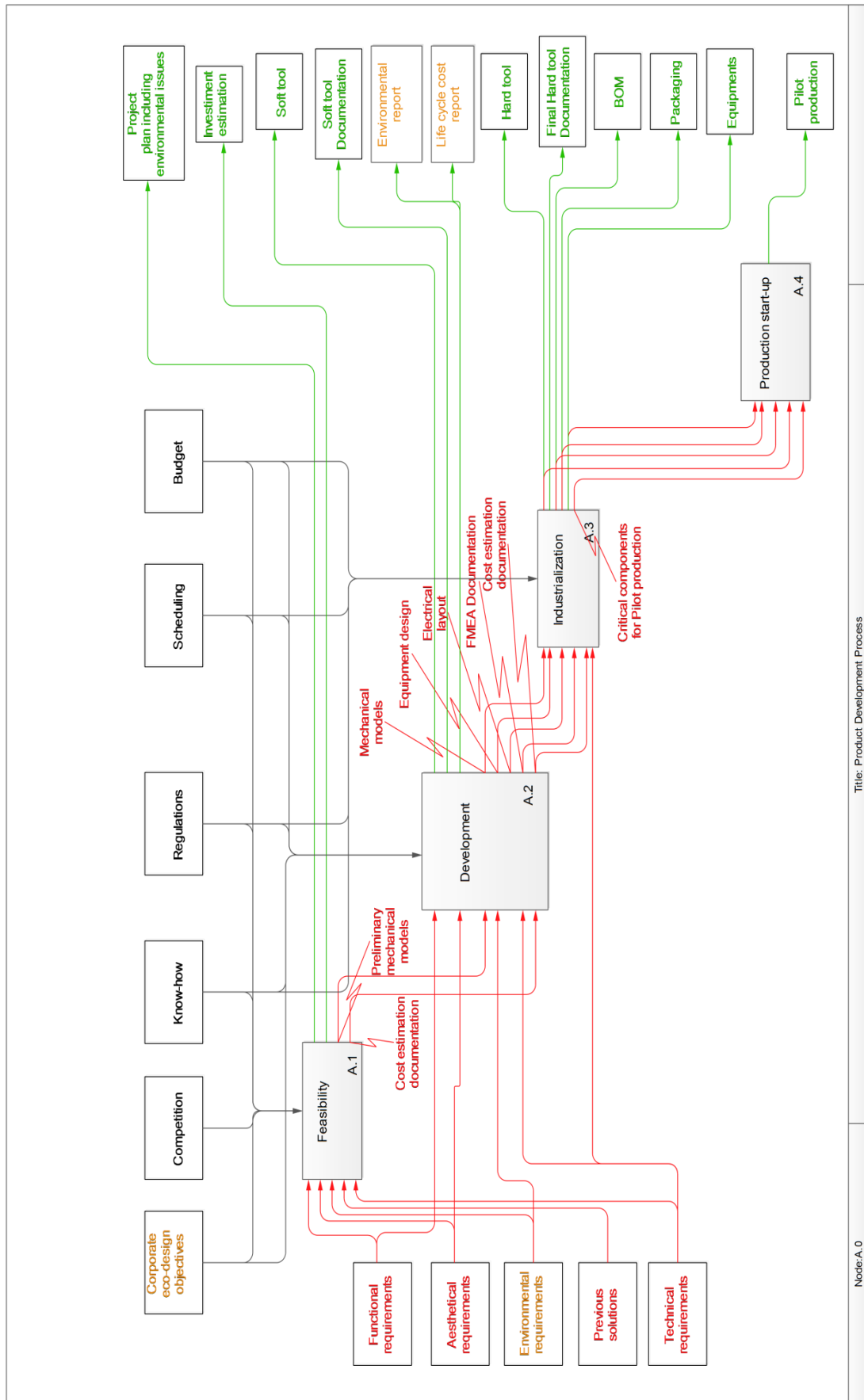

Figure 48: Environmental Knowledge Feedback Loop



Title: Product Development Process

Node: A.0

Figure 49: Level A.0 _ Product development process with the four major phases and with the elements of the methodology

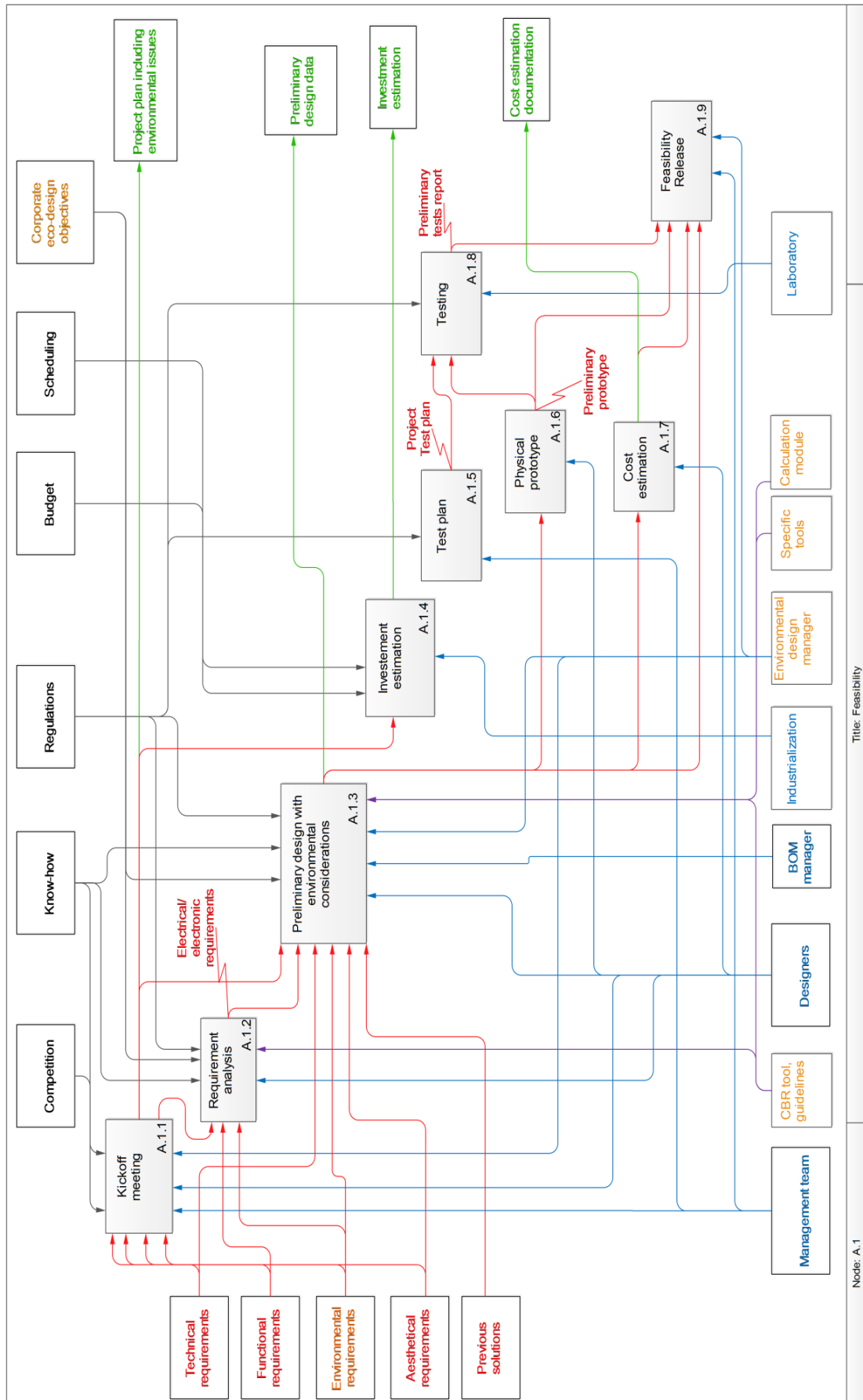

Figure 50: Level A.1 _ Feasibility phase with the elements of the methodology

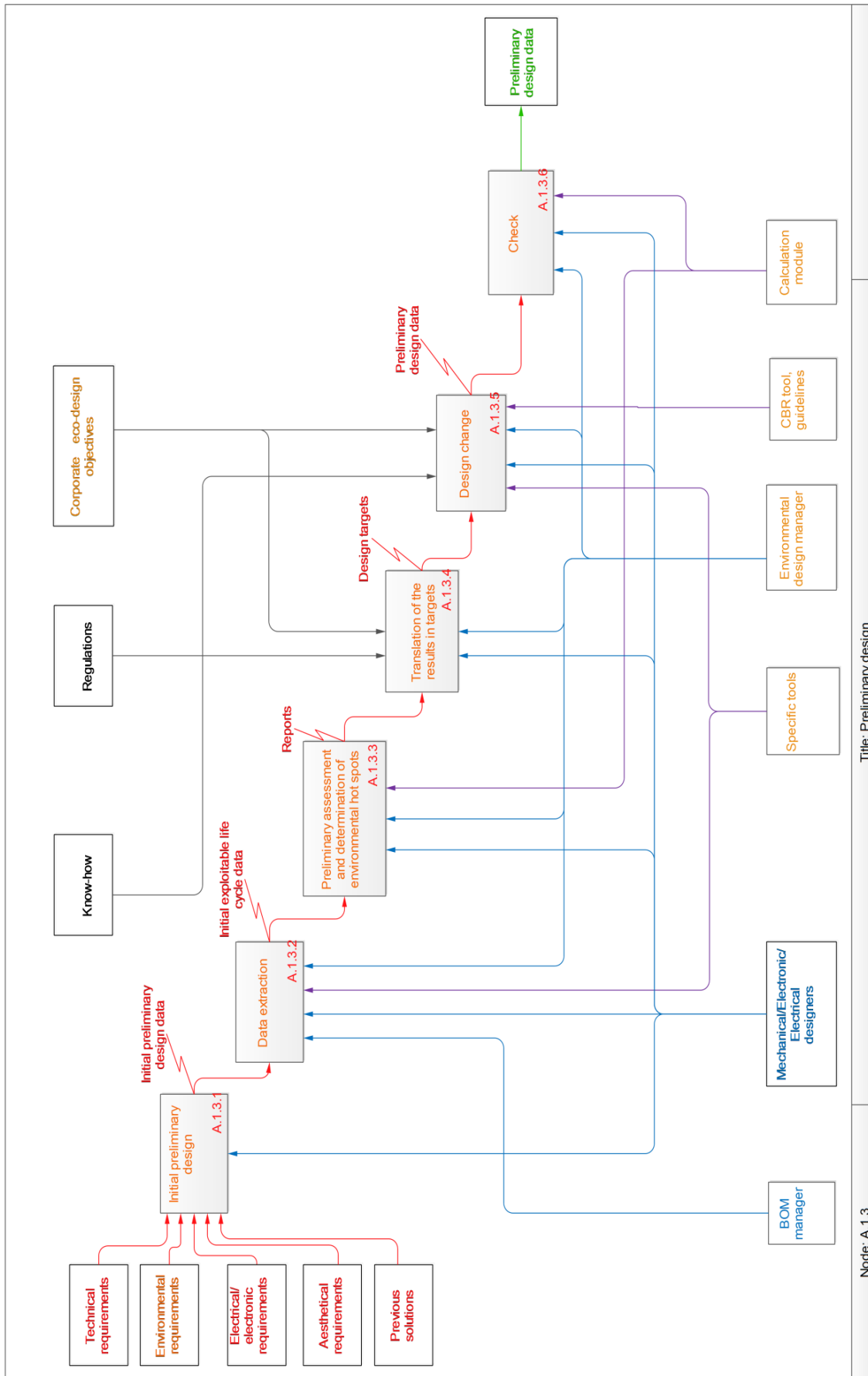

Figure 51: Level A.1.3 _ Preliminary design with the elements of the methodology

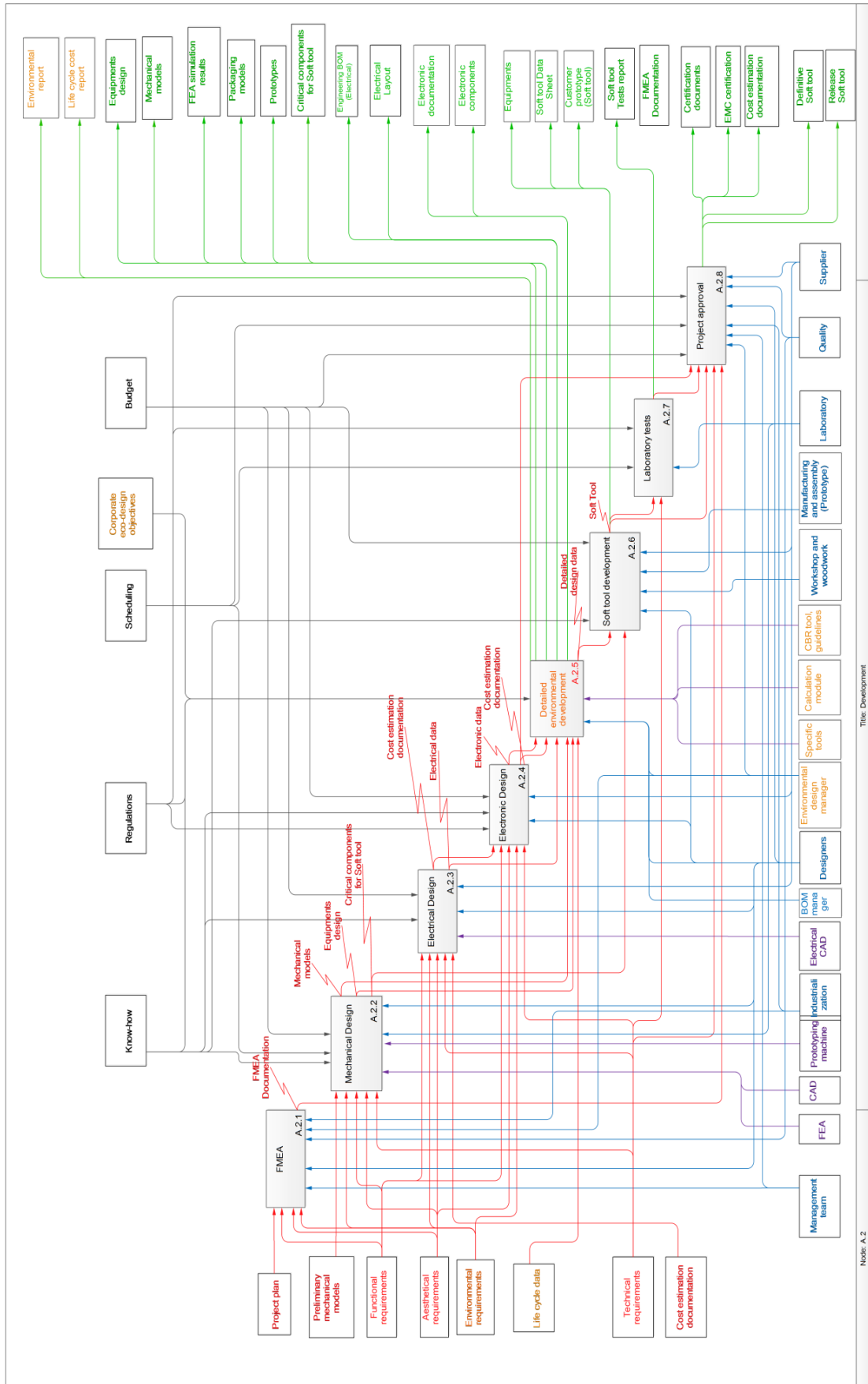

Figure 52: Level A.2 _ Development process with the elements of the methodology

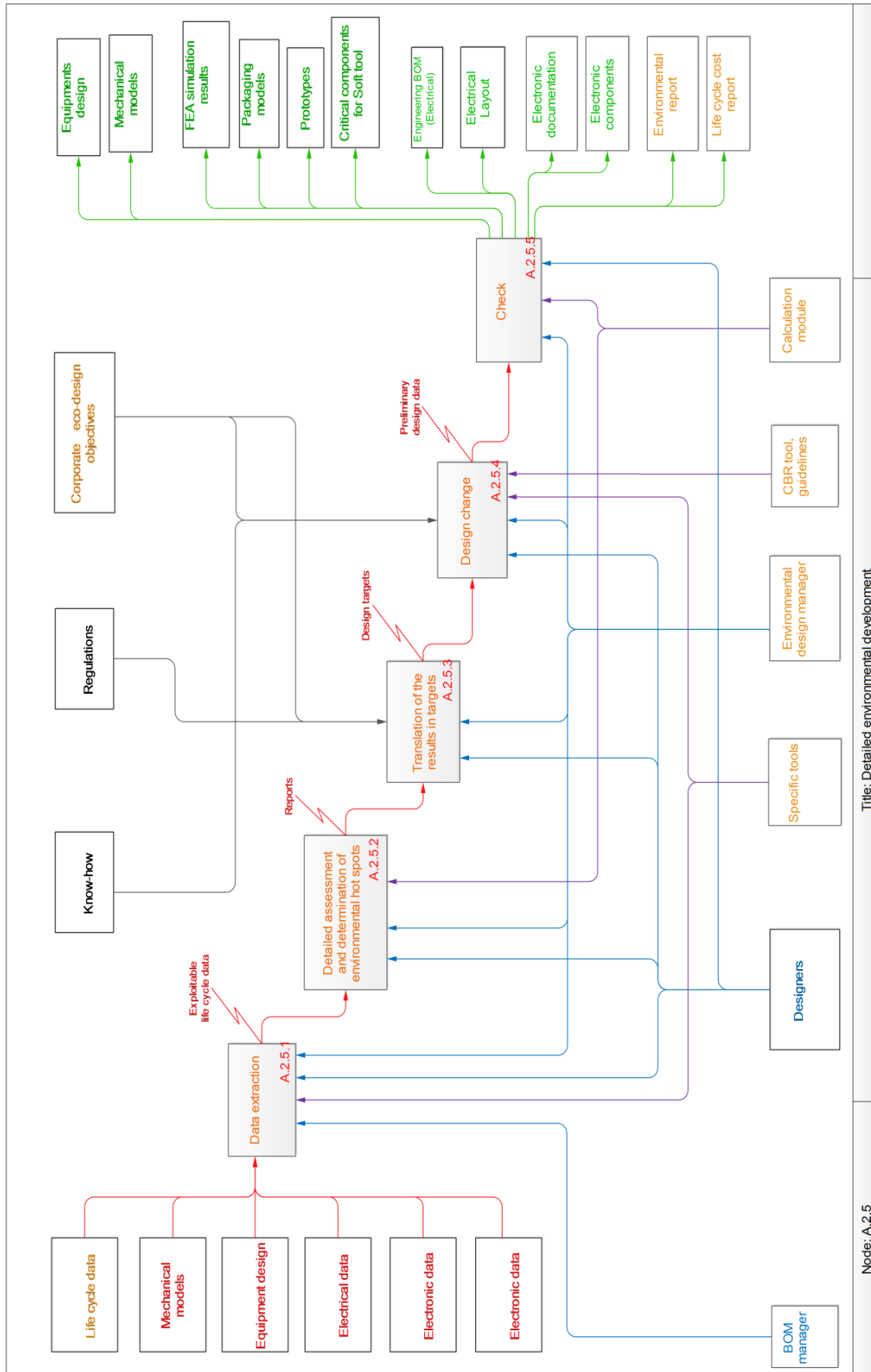

Figure 53: Level A.2.5 _ Detailed environmental development

2.6. PHASE 3: Necessary steps for a full integration of the methodology and the platform in Faber design process

2.6.1. Training sessions

Realizing the first phase of reviewing the design process modelling enables us to identify lacks, and particularly in term of integrated design and ecodesign. Moreover the illustration of the application of the methodology realized in phase 2 also shows us that the current design teams were not ready for the changes we expected. We identified thus a real need of training to improve the knowledge of the design team. A training program for the designers has therefore been developed together with partners of the project.

The first training for Faber took place in March 2013 at the company's premises. It was a half day training on ecodesign principles, on the methodology and on Eco Audit. We were in charge of developing presentation materials for a section on ecodesign principles (the end-of-life phase) and for the whole pack related to the methodology.

The second training session in February 2014 aimed at training designers on the different software tools of the platform. Two others sessions were held to train Faber on the tools and on the platform in June and July 2014. These sessions were mainly organized by software developers.

Six designers tested at least one tool and the entire platform for some of them. They were thus able to answer usability questionnaires (developed by the G.EN.ESI partners) concerning the tools, the platform and some methodological aspects.

2.6.2. Other training materials

In February 2014 after the training session, some of the G.EN.ESI partners met each other in order to realize recorded presentations on different topics linked to ecodesign. These presentations are available on the website of the G.EN.ESI project at <http://genesi-fp7.eu/education-centre/research-showcase-1/>. Our presentation is entitled "Integration of ecodesign activities into the design process using a methodology and an engineering platform".

A serious game was developed to enable participants to understand the principles of ecodesign and of the methodology playing a game and thus being actors. This game was adapted from the one we developed for the workshop at the DESIGN conference (described in Experiment N°3).

An education center has been developed, led by the partners of the University of Bath, and to which we contributed. It contains different documents and modules on the different aspects of ecodesign. This education center is available online at <http://genesi-fp7.eu/education-centre-library-2/>.

All the training materials are available online and thus can be consulted at any time.

2.6.3. The redesign of the Stilux cooker hood by Faber

Further to the trainings, Faber design team redesigned the cooker hood based on the model described in phase 2. The person who was the technical reference for the G.EN.ESI project was appointed as the environmental design manager. He is currently the manager for innovation projects and he already had a background in life cycle assessment. He managed the redesign project.

After the realization of the LCA by the environmental design manager and the G.EN.ESI team, Faber design team focused on improving the energy consumption during the use phase and on improving the recyclability rate of the product. They used the different tools of the platform to get the necessary data, redesign the product and realize the new LCA. They particularly used the DfEE tool (specific tool for optimizing the use phase) and LeandDfD (specific tool for optimizing the end-of-life phase). They had a lot of exchanges with their motors supplier in order to choose a new motor for the Stilux cooker hood. Thus they changed the motor and the lamps on the product to reduce the energy consumption. They also optimized other components by selecting appropriate materials, reducing the level of plastic contaminants and introducing new types of connections and of rotating quick-release screws. These changes have halved the life cycle Energy consumption and the estimated life cycle costs of the cooker hood. They also have increased the recyclability index by 6 percentage points and reduced the disassembly times for almost all the considered components.

At the end of the redesign process, they developed a prototype to prove the feasibility of the redesigned product.

2.7. Conclusion and validation of assumption

2.7.1. Conclusion

The establishment of the solution in Faber design process involved different changes. Here are summarized the most important ones: a new actor in the design team, the use of new tools by the design team, involvement of the strategy in environmental issues, consideration of environmental requirements from the specifications for an early integration, and finally changes in the design process to take into account the different steps necessary to ecodesign. As a first step, this example via the redesign of a product shows that the methodology enables a good adaptation to the current design process. However, the need of training should not be neglected. Indeed, we observed that several training sessions were necessary for the design team for whom environmental considerations were totally new. Indeed, before using the software tools and platform and applying the methodology a strong training on the ecodesign concepts were necessary.

2.7.2. Validation of the assumption

The implementation of the methodology and the platform in Faber design process was a success which leads to a good integration of environmental issues. At the end of the redesign

phase, the objective was reached: the product was ecodesigned. We observed therefore that it was easy to realize the LCA, to identify the hotspots, to make changes in the design model and so to observe the impacts of the changes in the environmental evaluation. This was possible due to different aspects explained in the following paragraphs.

Creation of data and connection of the design team stakeholders

Using the different tools of the platform creates data which are notably used to fill in the life cycle model of the product. These data are useful to realize the life cycle assessment of the product but some data may lack. In this case, the environmental design manager has to get back the information to the concerned person or department. When he interprets the graphs and that he gives some recommendations to the designers, he may have to interlink different stakeholders from the same department of the company or from different departments to let them work together in order to improve the product and reduce its environmental impacts.

Moreover the stakeholders have been involved via the tools they had to use. For example, the supplier of electric motors has been solicited, as well as the electrical engineer of Faber in order to fill in the tool for the use phase. These actors have been highlighted by the platform.

This means that the platform is more than a calculator because in addition to facilitate data transfer between tools, the platform strongly encourages the involvement and the connection of people in the design project. These observations validate the assumptions (N1) and (N4) of the hypothesis concerning respectively the involvement of stakeholders and the creation of data via the different tools.

Use of new tools and new indicators

Faber design team had to use new tools. In this case study, the environmental design manager realized the LCA and decided to monitor the project with two indicators: the energy consumption and the recyclability rate. Designers had then to use specific life cycle tools and in particular those for the use phase and the end-of-life phase to improve the environmental performance of the product. These observations validate the assumptions (N2) and (N3) of the assumption, concerning respectively the use of life cycle tools and the use of environmental indicators.

Creation of knowledge

Designers are facing new tools, new indicators and new tasks in their classic activities. All these changes lead to the creation of new environmental skills and knowledge within the company. This knowledge is then translated into guidelines and stored in the case-based reasoning tool to be available for next projects. Other guidance documents like checklists can be created from department constraints. This observation validates the assumption (N4) of the assumption, concerning knowledge building and management.

Steps to follow

During the experiment, ecodesign was implemented in the process through the activities defined in the steps of the methodology. Following the methodology was adapted and enabled a good coordination between the stakeholders and the steps. This validates the assumption (N5).

The five assumptions have been validated in the context of this company. The deployment of the solution promotes a strong integration of ecodesign in the design process and in the different departments of the company. It brings new elements in the design process and thus in the activity of the different stakeholders. Indeed, stakeholders of the design process are much more connected than before because they need to exchange data or to work together to find a common solution in order to reduce the environmental impacts of a component or of a part of the product. Moreover designers acquire knowledge and skills through projects and therefore their awareness and their understanding of environmental issues increase.

3. Experiment N°2: Implementation of the approach in the design of a new range of public benches

The first experiment showed that identification of environmental hot spots is easier when designers use connected tools because changes in the CAD software are instantly transferred in the environmental evaluation. Moreover, the experiment showed also that the methodology is compatible with classic design processes, such as Faber's. We would like now to carry out a second experiment which aims to design a new product instead. This experiment takes place in another company for different reasons explained in the section dealing with the choice of the case study. The company designs and manufactures urban furniture and lighting columns for public and private sectors. The methodology was implemented in the design process during a new design project for public benches.

As a first step, we remind the objective of the experiment. Then we present briefly the company Aubrilam and we explain why this company was interesting as a case study. Next we present the different steps of our work in Aubrilam and the associated results. We conclude then on the case study and on the hypothesis validation.

3.1. Objective of the experiment in Aubrilam

The industrial case study realized in the company Aubrilam aims at verifying in a second company, it means in another context, the thesis hypothesis, reminded here:

The methodology supported by the software platform facilitates the identification of environmental hot spots and the development of ecodesigned products through the connection between the stakeholders (N1), the use of classic tools and life cycle parameters (N2), the use of environmental indicators (N3), the creation of new data and new knowledge and their management (N4) and the procedure to follow (N5).

3.2. Aubrilam

Aubrilam is a French SME designing and producing urban furniture and lighting columns in wood. The company includes 75 employees. The head office of the company is located in Clermont-Ferrand and the manufacturing plant is in Brioude, 70km far away from the head office. About 30 people are in the head office and between 30 and 40 in the factory.

3.3. Choice of the case study

We choose to work with Aubrilam on their new project to limit the environmental impacts of the new product. The company is already committed in an environmental approach. The next

paragraph summarizes the different actions and facts of the company about environmental implication and strategy.

Since 2000, the company Aubrilam invested in a sustainable development process to develop what we called “greener products”, that are more environmentally friendly products. One objective was to communicate their environmental improvements to their customers. They contacted a consultant to realize some life cycle assessment on their products. Then the technical manager trained himself to ecodesign and developed some environmental actions. He used the software EIME to realize life cycle assessments of lighting columns and worked with the Bureau Veritas Group to create new modules. He also created an “eco-comparator”, an Excel sheet to compare environmental profiles of lighting columns. When he left the company, the company loosed his knowledge and no one in the company had the skills to pursue his actions. In 2011, the company was certified ISO 14001 thanks to the supervision of the quality, safety, and environment (QSE) manager. In 2012 they hired an engineer to take the responsibility of environmental aspects. She evaluated the situation, realized life cycle assessments for the Environmental Product Declaration (EPD), and initiated the integration of ecodesign in the design process. She also left the company one year after being hired and after that ecodesign was still setting aside. The QSE manager was motivated to continue ecodesign actions but due to her job she had not a lot of time to work on ecodesign implementation.

The situation of the company was thus ideal for our case study because some actions have already been done but environmental issues were not yet fully integrated in the design process. Moreover the marketing department already communicates a lot on environment but it seems to have a wall between the marketing department and the design office. Indeed, as a first approach, we interviewed Aubrilam designers in order to understand their vision of ecodesign management in the company and when we asked the following questions to designers, answers showed that they were not really taking into account environmental issues. Five people constitute the design office and all the persons were present when we asked the questions.

[QUESTIONS] Are you doing ecodesign in Aubrilam? Are you considering environmental requirements in the design of your products?

[ANSWERS OF DESIGNERS]

“We have practices like material optimization but for economic reasons”

“We (Aubrilam) communicate on the environmental profiles of our products but nothing appears in the product specifications”

“We are not doing design iteration based on environmental criteria”

“We have a marketing approach but not an ecodesign approach”

“The problem is that customers are not really interested in environmental criteria and this is not the priority”

Designers of the design office were trained by the last environmental manager for half a day on ecodesign so they had some kind of awareness of what ecodesign is but as they do not have environmental objectives they have no reason to practice it.

We therefore chose to work with Aubrilam on a new design project because they were in a situation where they already have some knowledge about ecodesign but the integration in the company does not work. Moreover there appears to be walls between the different departments of Aubrilam on the environmental issue. Our methodology could propose solutions to these issues.

3.4. Implementation of the methodology in Aubrilam

Figure 54 summarizes the collaboration with the company. In the left column are listed the dates of the face to face meetings with the topic of the meetings. The middle column shows Aubrilam designer's actions between the meetings. The right column presents documents and models we created during each period.

Different phases have been observed in the implementation of the methodology in Aubrilam. The first phase consisted in the first contact with the company where the methodology was exposed and the general objectives of the collaboration were discussed. The second phase aimed for us, people implementing the methodology, to know and understand the design process, the general operation of the company, and its position on ecodesign activities. The third phase, phase 3A, consisted in following the project design in applying the different steps of the methodology. In parallel, in phase 3B, a mapping of the activities of the different departments was realized. The fourth phase was an exchange phase where feedbacks and recommendations were proposed to improve ecodesign integration.

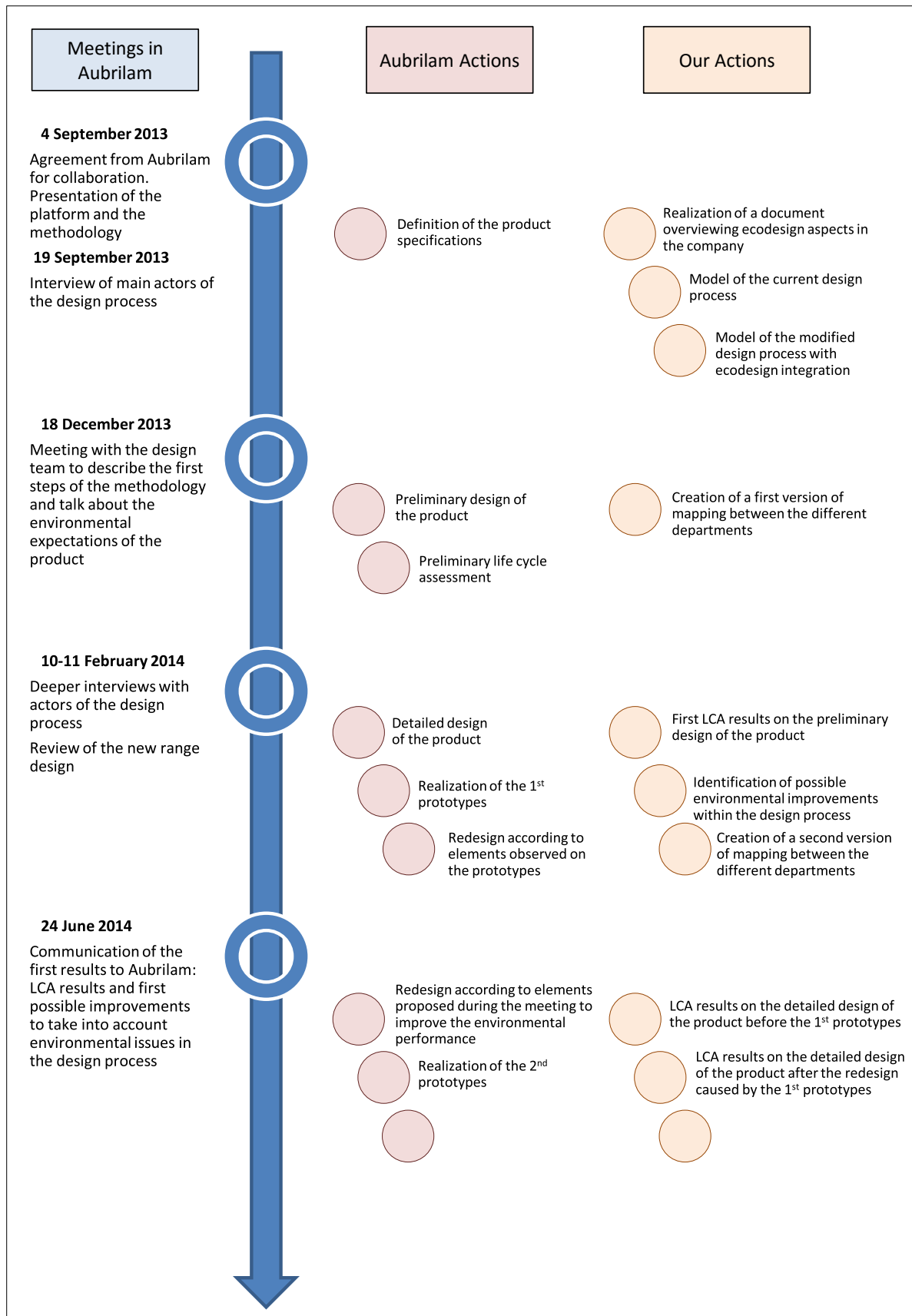

Figure 54: Meetings in Aubrilam and main actions realized

3.4.1. PHASE 1: First contact with the company, setting up of the general objectives of the collaboration

In September 2013, during the first meeting the Aubrilam industrial manager introduced us to the concept of the new products range they planned to design and produce. They would like to take into account environmental considerations during the design of the new project. Then, we presented the methodology and the platform to the QSE manager and to the designers' office.

3.4.2. PHASE 2: Interviews with the different departments to establish the modelling of the design process

Interviews with some employees from different departments have been organized to establish the modelling of the design process and to have an overview of ecodesign aspects in the design process. Interviews enable to collect information on Aubrilam design process, involved people, data fluxes, and software used. They therefore aimed at drawing an ecodesign picture of the company. As a first step, seven interviews were conducted:

- The manager of the design office,
- A designer, in charge of the new range of products,
- The product and marketing manager,
- The QSE manager,
- A logistic manager,
- The workshop manager,
- The industrial manager.

Their activities, their roles in the design process, their position in relation to ecodesign, and tools they use have been detailed with the interview.

The working process

Annex 1 presents the modelling of Aubrilam design process following the type of formalism chosen in the experiment N°1. Boxes referring to ecodesign activities and resources are colored in orange. A synthesis of the main steps with some of the output documents has been realized below (Figure 55).

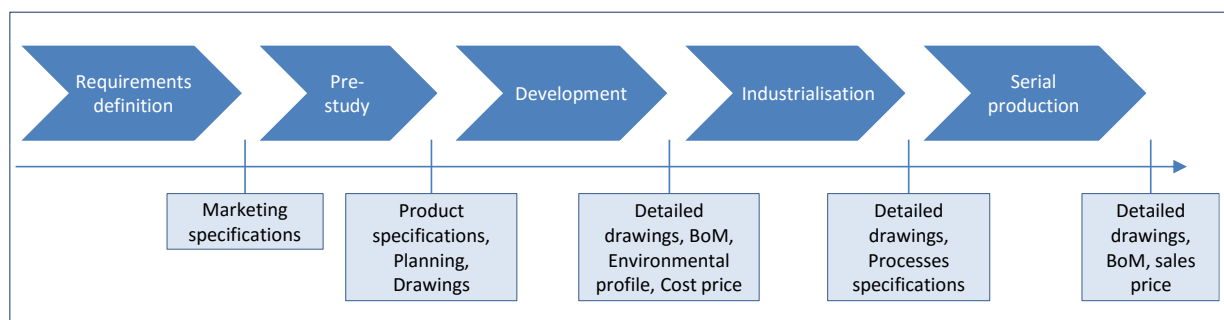

Figure 55: Main steps of the Aubrilam design process with the main outputs after each step

The description done below provides a general idea of the company working process.

Step1: Requirements definition

A marketing study is realized by the marketing department, the procurement and development manager and the sales department. The objective is to create the product marketing specifications which have to be validated by the Executive Committee.

Step 2: Pre-study

From the product marketing specifications, the design office realizes a pre-study to define the product design specifications. During this step, design objectives are reviewed and a technical and economic feasibility study is carried out by the design office. The main outputs are the product specifications, the planning, generic drawings and cost estimations. The pre-study is validated by the Executive Committee

Step 3: Development

The design office designs the products according to the requirement and then generates detailed drawings and bill of materials (BoM). Suppliers are then evaluated and the supply chain is qualified. At this stage, the environmental assessment should be done by the QSE manager with EIME software tool but this is often not the case because of time pressure. Economic costs are also estimated. The development step is validated by the Executive Committee.

Step 4: Industrialization

During the industrialization step, the workshop manager, the procurement department and the methods technician industrialize the product and create process specifications, purchase specification and production plan. During this step, some feedbacks can be given to the design office to adjust the product design. Final drawings are validated by the Executive Committee.

Step5: Serial production

The final step is the serial production. The sales price is fixed. The factory and the design office update drawings, BoM, and other design related documents which are then stored in the company database. The marketing team is finally in charge of the product commercial launch. The product environmental profile is sometimes calculated to be included in the product datasheet.

The ecodesign working process

From the expertise acquired with experiment N°1 and the current design process of the company, we modelled adaptive and incremental changes necessary in a first step in the design process to implement ecodesign. Annex 2 gathers the different models developed. Again, the boxes colored in orange refer to ecodesign activities and resources or to activities now involving the consideration of environmental issues. This is a theoretical approach to implement the ecodesign methodology to their design process.

In this model we assume that the QSE manager of that company will be enough qualified and aware to support ecodesign activities. That is why we do not recommend to hire a new manager. Moreover, in this first project, we will assume the role of environmental design manager to support the QSE manager. The QSE manager needs thus to be involved in more decisions and meetings, starting with the marketing specifications.

Environmental requirements linked to the environmental policy of the company have to be added and taken into account for the realization of the product marketing specifications and then to the product specifications. During the pre-study step, design objectives need to be considered as well as ecodesign objectives and the technical feasibility study requires to realize a preliminary environmental assessment to identify critical points. Then during the development step, designers carry out the detailed design of the product taken into consideration environmental issues (via a deeper environmental assessment). Others annex design activities are concerned by environmental issues as procurement activities for the choice of the new suppliers for example. Finally, for the market launch, sales managers need to be better trained about the product environmental performance in order to raise awareness of ecodesign among the customers.

Overview of the current ecodesign aspects in the company

Applying the methodology and simulating the platform in Aubrilam is the objective to improve their ecodesign approach. However, the company has already an environmental awareness. In June 2013, the Auvergne chamber of commerce and industry has realized an ecodesign review of the company, highlighting in an action plan proposal the current positive aspects and other aspects to improve for better ecodesign integration. Analyzing the interviews also allowed us to write a document overviewing the ecodesign situation in the company (Annex 3). The document is a table where positive points and negative points are highlighted on different topics: general remark, company strategy, site approach, environmental assessments, consideration of the product life cycle during the design, and communication between the departments on design and ecodesign. Main important positive and negative aspects are summarized in Table 6.

Table 6: Overview of the current ecodesign aspects in the company

Topics	Positive points	Negative points
General remarks		Ecodesign is not well integrated among the different departments; there is often a wall between the QSE manager and the other departments that we called “green wall”.
Company strategy	The company strategy consists of four axes, one specifying three characteristics for the products: market price, product design and low environmental impact.	There is no clear target concerning environmental issues and nothing appears in the specifications regarding environment.
Site approach	The company is certified ISO 14001 since 2011.	During the steps of wood manufacturing in the factory, there is a lot of wood waste. There is also a lot of packaging wastes with the suppliers packaging and their own packaging.
Environmental assessments	They have a LCA software tool, EIME, and use it to realize product environmental profile (PEP) of some of their products.	The LCA tool is not used at all during the design process but after. Moreover, PEPs are not systematically realized.
Consideration of the product life cycle during the design	Designers have some good design reflexes in line with ecodesign principles as material optimization.	The life cycle of the product are not really taken into consideration by the designers.
Communication between the departments on design and ecodesign	The factory has a document to collect design and manufacturing anomalies on existing products and to communicate the information to the design office. Design teams have a project review document to follow the product design and manufacturing.	The anomalies document is poorly used during the design. The project review document is not really used as this is a SME and there is no environmental milestone in the document.

The project review document is a document recently created by the QSE manager for the formalization of the steps and of the design advances; however the document is not really used. Indeed, design teams find easier to communicate informally. We still improved the document in order to add environmental milestones. This document is thus ready if they

would like to use it. We think that this document could help always having a thought for ecodesign, even if the team does not respect all the milestones.

3.4.3. PHASE 3A: Application of the methodology during the range design process

As ecodesign consultant, we applied the methodology to the new design project but as the platform was not still developed, we “played” ourselves the role of the platform in order to link necessary data and to establish the required assessments of the on-going project. All the environmental assessments were done with the LCA tool EIME v5.3.0.10. Eleven environmental impacts indicators are calculated by this software tool:

- Air Acidification Potential Indicator (AA),
- Air Toxicity Indicator (AT),
- Energy Depletion Indicator (ED),
- Global Warming Potential Indicator (GWP),
- Hazardous Waste Production Indicator (HWP),
- Stratospheric Ozone Depletion Potential Indicator (ODP),
- Photochemical Ozone Creation Indicator (POC),
- Natural Resources Depletion Indicator (RMD),
- Water Depletion Indicator (WD),
- Water Eutrophication Indicator (WE),
- Water Toxicity Indicator (WT).

Meanwhile we modelled the design process and realized an ecodesign overview, the design team worked on the new project in order to define the specifications. The new project consisted in realizing a new range of public benches with two types of materials: wood and stone (symbolized for example by concrete). The company Aubrilam worked in collaboration with a “design” company for the products aesthetic.

During the design project, we attended three design meetings (Figure 54). The topic of the first one in December 2013 was the product specifications. The two other meetings were design meetings in February 2014 and June 2014 to review the design advances and talk about possible directions to improve the environmental performance of the product.

1. Define Environmental and Business Objectives

During the first meeting, no quantified environmental target was established for this first project but we raised awareness about different ecodesign challenges. Problematic on processes were raised by the workshop manager. He talked in particular about manufacturing and quality constraints. This discussion led us to realize a mapping between the different departments of Aubrilam in order to collect department links and constraints which can have an influence on the product design. This task was realized in parallel with the project review on ecodesign topics and is thus described in PHASE 3B.

2. Establish a life cycle perspective for your product

After the designer realized the preliminary design, we collected data to realize the first LCA of the product. The defined functional unit is “to enable the seat of three persons with an average weight of 75 kg with a certain comfort and aesthetic during 10 years”. The framework of the study has been defined: the different LCAs realized during the design process aimed at guiding the design in finding the hotspots, looking at the possible actions and then trying to reduce the environmental impacts of the product. As the design project was the realization of a new range of public benches with modular fashion design, we focused the LCA on one type of bench with wooden slats and a concrete seat.

As this is a simplified LCA with rough data and as the product is neutral in the use phase, we focused the first LCA on the manufacturing phase. Figure 56 shows the contribution of the different components of the product to the LCA of the manufacturing phase. The wooden slats, the bench legs and the steel structure are the main contributors to all the environmental indicators. The critical indicators for the wooden slats are HWP, ODP, POCP and WT where the contribution of the slats is between 60% and 95%. The concrete seat has a low contribution to the global assessment (less than 4% for all the indicators). The screws also have a low contribution except on the ODP indicator where the contribution rises almost 20%.

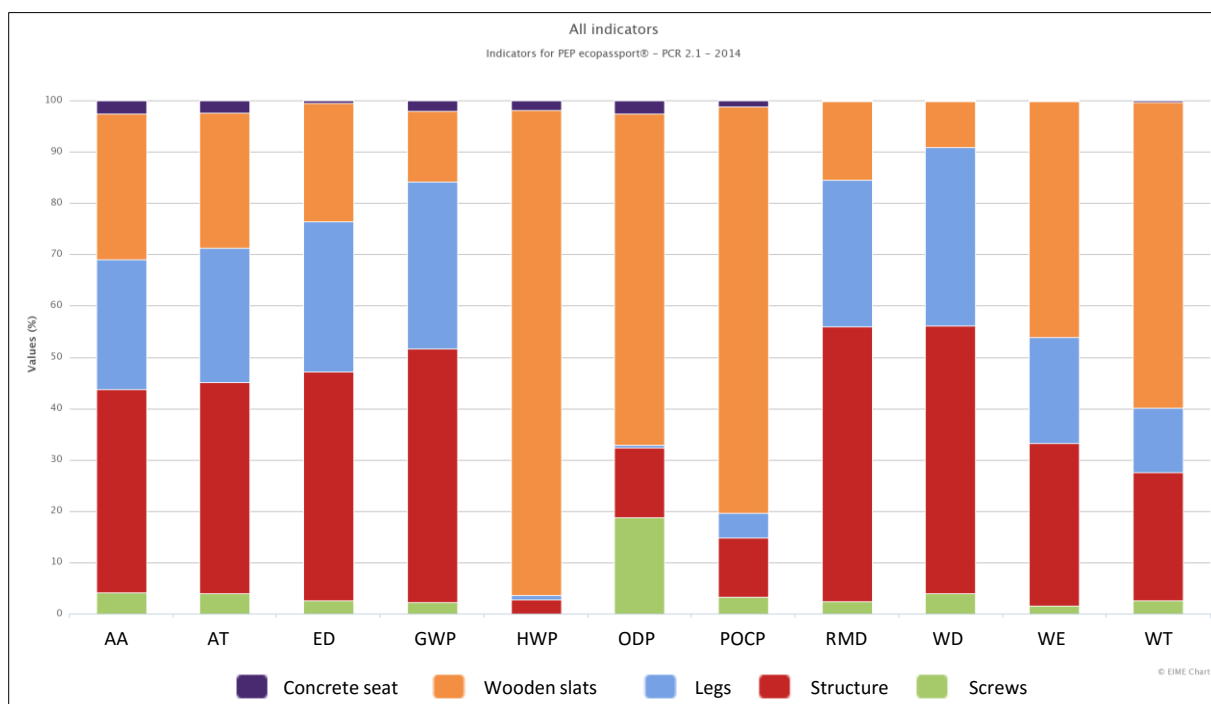

Figure 56: Contribution of the different components to the LCA of the manufacturing phase

To identify the hot spots in detail, it was necessary to deepen the assessment in analyzing the wooden slats and the structure. Indeed, the legs and the structure are realized by the same supplier and so they are constituted with the same material (steel) and are processed with quite the same processes; that is why we can analyze only the structure to have an idea of the contributors to this kind of product.

Figure 57 shows the detailed contribution of the wooden slats to the manufacturing phase life cycle analysis. Wood is an observable contributor but coating is mainly responsible for the impacts.

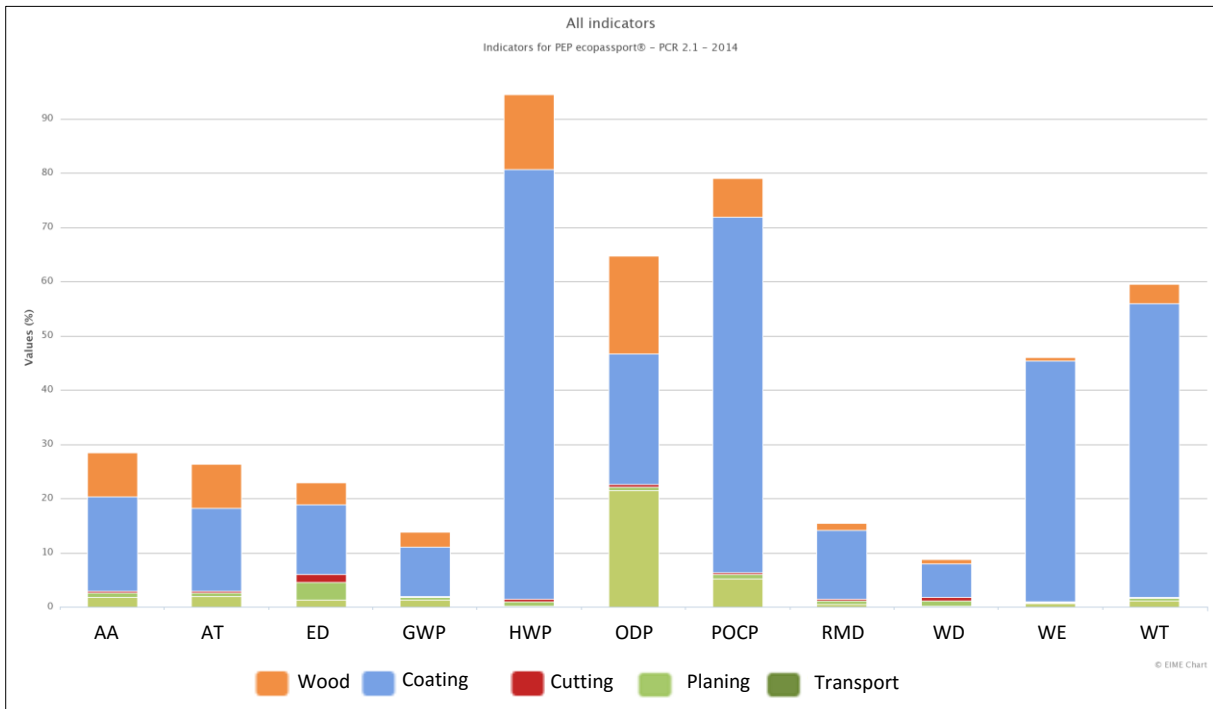

Figure 57: Detailed contribution of the wooden slats to the LCA of the manufacturing phase

Figure 58 shows the detailed contribution of the steel structure to the manufacturing phase analysis. The impact of the steel is the major contributor to the structure. Paint is also remarkable on the RMD and the WT indicators. The steel upstream transport represents the majority of impacts on the ODP indicator.

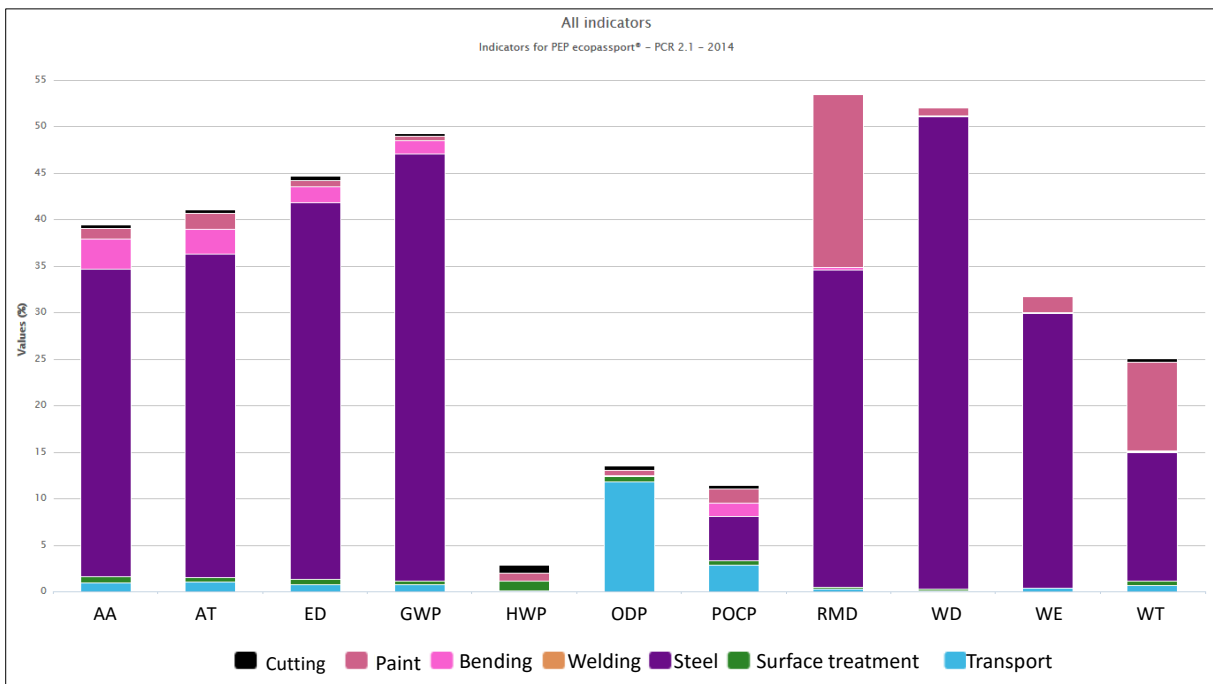

Figure 58: Detailed contribution of the steel structure to the LCA of the manufacturing phase

To sum up, the hot spots of the product are the wood coating and the steel and, to a lesser extent, the wood and the steel paint.

3. Align hotspots and business context and determine relevant indicators to guide the design

At this stage, the design team did not know how far the preliminary design was from the final design. Moreover, the preliminary assessment is a simplified LCA and all data could not be collected. However, this study is useful to have a first overview and shows us the hotspots. Data quality of the wood coating is difficult to estimate but seems to have a certain influence of the impact contribution of the wooden slats. Aubrilam is already aware of this problem and is currently using more and more water based paint instead of solvent based paint. They also try to use paint booth instead of brush when possible because it enables to use less paint.

For this experiment, all indicators were considered to guide the design. Moreover, according to the results, steel quantity is a data to monitor.

4. Conduct design development activities

Design development phase take a long time, in particular because of the collaborative work with the aesthetic designers. Some of the concepts developed during the preliminary design phase were then reviewed to better fit with the specifications.

5. Incorporate LCA throughout development process

After the development phase, data were collected to realize the second LCA. The other life cycle phases were taken into consideration and especially the distribution phase and the use phase as very few data are available for the company to characterize the end-of-life phase.

The repartition of the different life cycle phases are represented in Figure 59. Manufacturing phase is the dominating phase in term of environmental impacts (between 40% and more than 90%) but the distribution phase has also a great influence (between 5% and more than 50%). Half of the potential impacts for ODP and POCP come from the distribution phase. The impacts of the distribution phase are not directly due to the packaging materials but are due to the transport of the packaged product by lorry.

The preliminary designed product weighed about 87kg and the first detailed product weighed about 126 kg. The design team realized in April prototypes to test the design and have a visual feedback. Two bench structures with two different widths were presented. The narrowest structure did not fit with the aesthetic requirements; that is why only the second one was kept for the design.

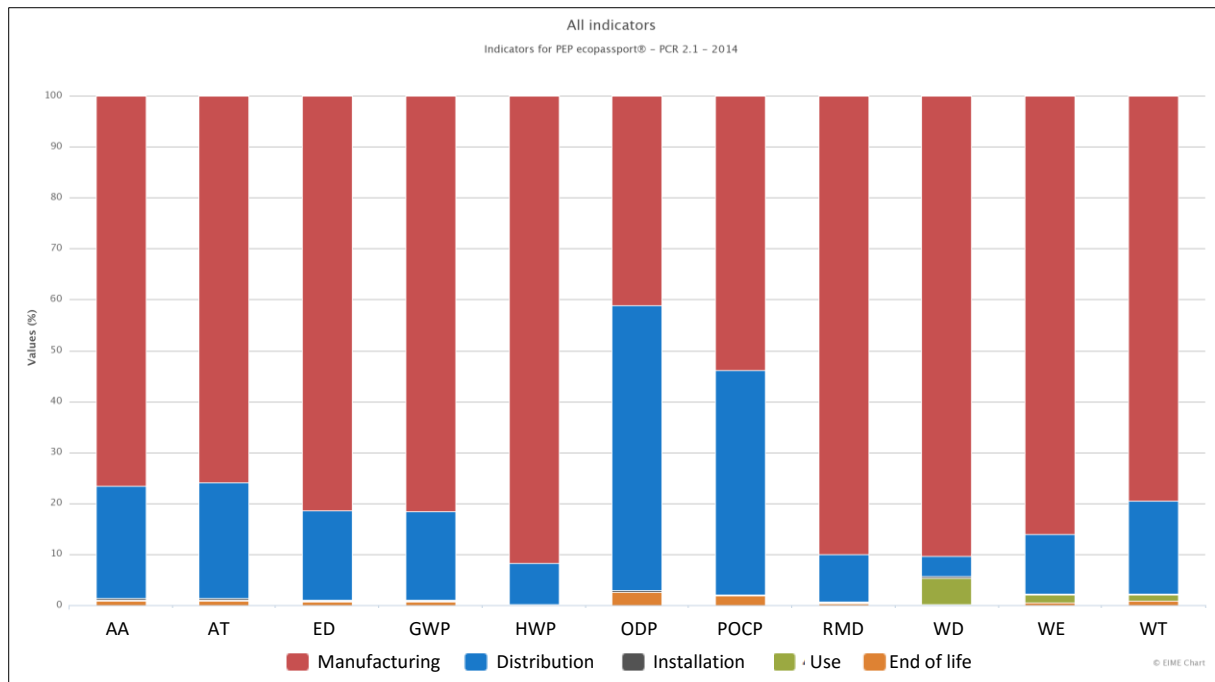

Figure 59: LCA of the first detailed version of the bench

The weight of the product was really too high so efforts had to be done in this direction. The designer made the following choices to improve the environmental impacts of the product:

- Reduction of the weight of the structure and thus used less steel.
- Design of a standard structure and a standard reinforcement to enable different modular configurations for the complete products range.
- Change of a component in order to work with the same supplier and thus avoid having an additional supplier.
- Limitation of the welds.
- Limitation of the number of screws to fix the wooden slats on the structure thanks to the tests on the prototypes.
- Use of the same wooden slats than for the previous products range in order to make the production more efficient.

With this modification, the product reaches a weight of 110kg; it means that these changes enable a reduction of 13% of the total mass of the product.

All these actions were beneficial for environmental reasons but also for economic reasons, which is a motor for the design team. The LCA of the second version of the detailed design is represented in Figure 60. The graph has a similar aspect to the previous one. Indeed, the repartition between the manufacturing phase and the distribution phase are quite the same ones. This can be explained by the fact that reducing the mass of steel involves a change on the impacts of the manufacturing phase but reduces also the weight of the product which positively influences the impacts of the transport.

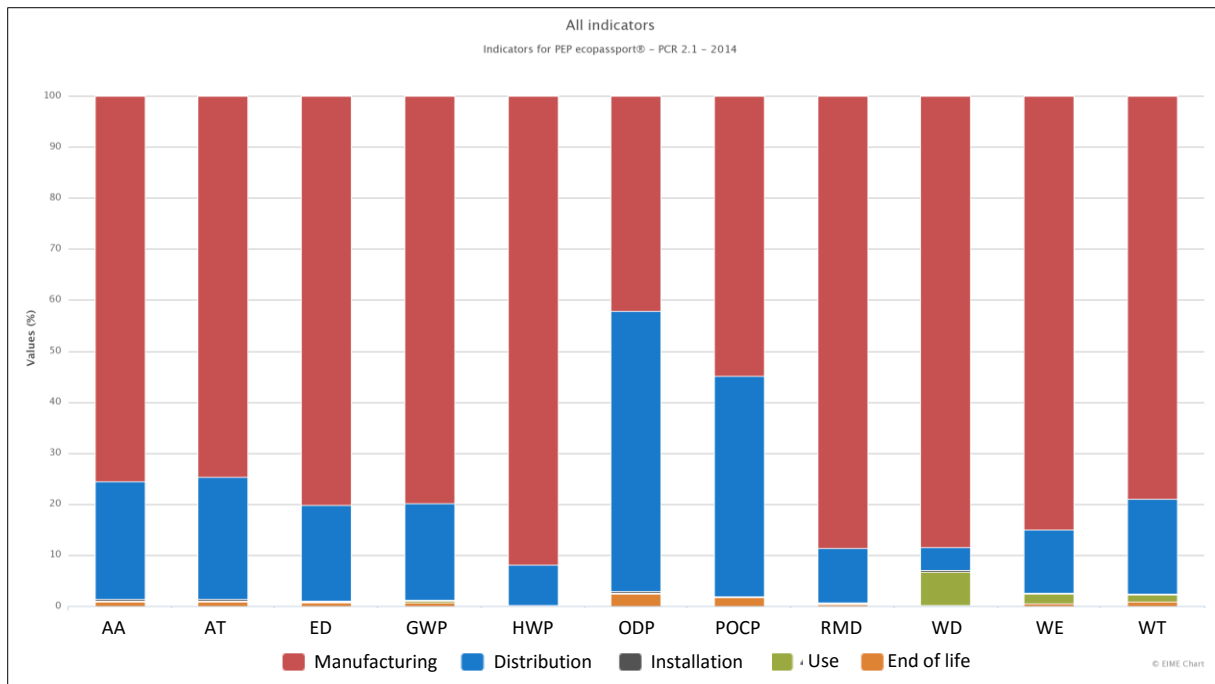

Figure 60: LCA of the second version of the bench after the first prototype

Figure 61 shows the comparison between the first detailed version of the bench and the second detailed version after design improvements. We observe a reduction of the impacts from 2% on the HWP indicator to 20% on the RMD and WD indicators with an average reduction of 13%.

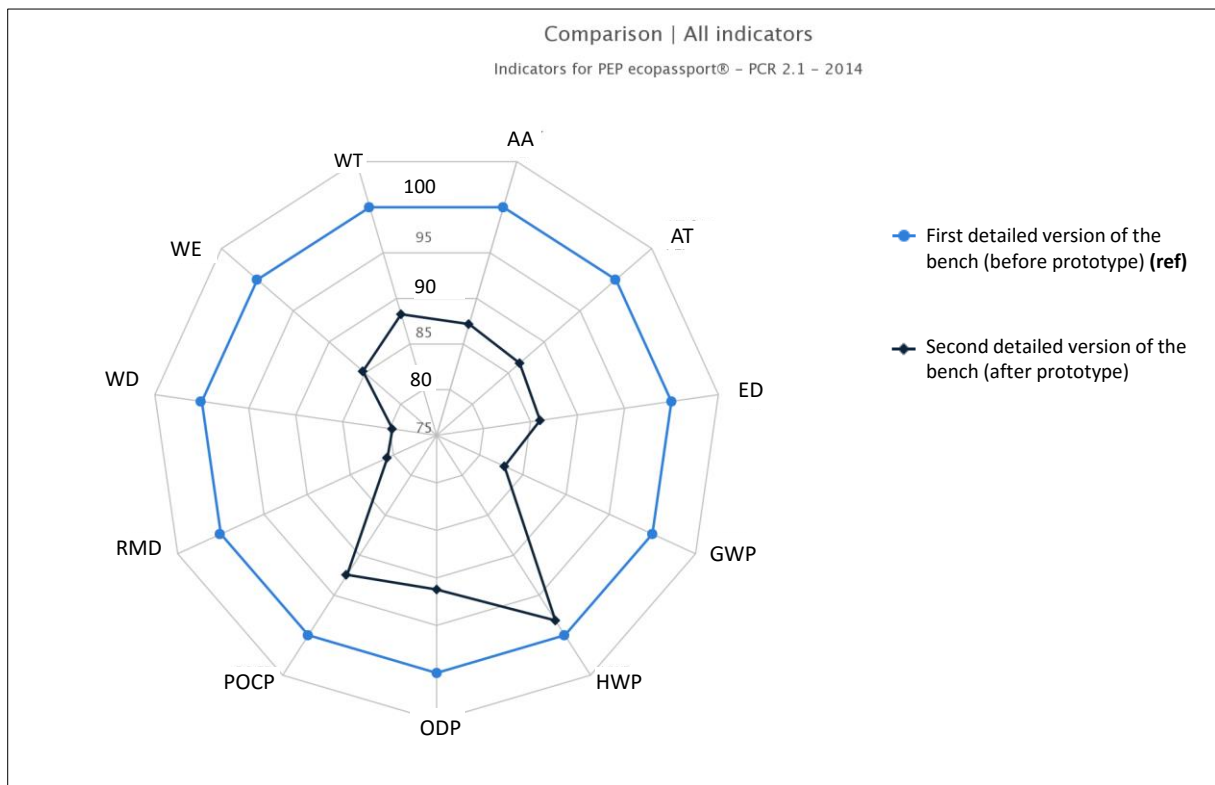

Figure 61 Comparison of the two versions of the bench

6. Review design process and outcomes and revise long term strategy

The designed product is represented on the following picture¹²; the range with the seven configurations of the product is visible on the bottom of the picture (Figure 62).

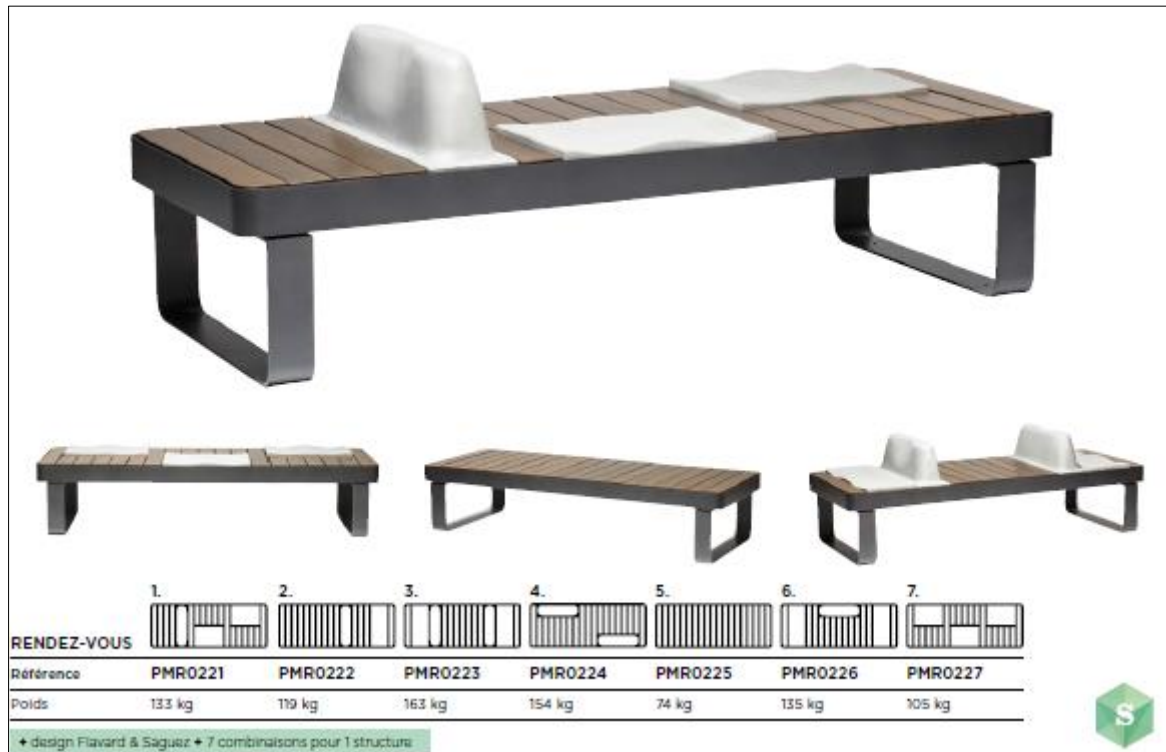

Figure 62: Aubrilam new range called “Rendez-vous”

The design iteration made during the development phase enables to improve significantly the environmental performance of the product that was one of the objectives in implementing the methodology in this project. With this project, the design team and in particular the involved designer saw the steps to implement ecodesign and also the type of questions and discussions necessary to think about or rethink all the product life cycle.

Secondly, Aubrilam also realized tests on the wooden slats in order to try to reduce the thickness of the slats and thus use less resources. Moreover a work with the procurement department was planned to look at new wood batches in order to reduce the wood waste as highlighted in the ecodesign overview document. Connections between the design office, the procurement department and the wood workshop are necessary to ensure the best decisions, taking into consideration the constraints of the different departments.

¹² Picture from the Aubrilam catalogue for 2015-2016 available online <http://www.aubrilam.fr/documentation.htm>

Limit of the platform

Thanks to the interviews we had at the beginning of our collaboration, we knew which departments had to meet in order to discuss about potential improvements solutions during the different redesign steps. In our case, we did not use the platform to obtain this type of information and we are aware that the platform could not provide it. We highlighted through this case study, a limit of the platform.

We were able to bring together the right concerned persons to address each hotspot due to our knowledge about the company. We observed thus that if the environmental design manager is a consultant, he does not know all the links and the influences between the departments. Therefore, its feedbacks for the redesign cannot be ideally appropriate because some stakeholders would not be consulted. The approach would not be optimal. That is why we decided to establish a big picture of the company by mapping the interrelations between the different departments that the stakeholders themselves do not know necessarily. Thus the lack of the platform should probably be solved if the mapping is then included in the guidance tool. The realization of the mapping is described in the following section.

3.4.4. PHASE 3B: Realization of the mapping between the different departments

The first wave of interviews and design meetings we attended showed us that some aspects were not so well integrated in the company. Indeed, constraints of the different departments are not necessarily known by designers and have sometimes resulted into problems after the production. For example, a product was wider than the lorry width; it was impossible to transport the product. These aspects can have economic repercussions but also environmental repercussions. That is why we realized a mapping between the different departments of Aubrilam in order to collect department links and constraints which can have an influence on the product ecodesign. The company has different kinds of product but as we worked on a bench project, we decided to focus our mapping on this type of product.

A second set of interviews has been realized in Aubrilam in February 2014 to collect data on the organizational aspects of the company and to understand particularly their roles on the life cycle of the bench. Ten persons were interviewed:

- Two persons from sales department,
- The designer in charge of the new range,
- The installation, after-sales service and maintenance manager,
- A logistic manager,
- The workshop manager,
- The wood workshop foreman
- The finishing workshop foreman,
- The methods technician,
- The QSE manager.

The mapping principle consists in realizing a table which collects the links between the lifecycle parameters in lines and the company departments in columns. The objective is to

know if and how each department is influenced or has an influence on the concerned parameters in order to take into account all the constraints during life cycle design.

Table 7 illustrates the idea with only few departments and few life cycle parameters and Table 8 and Table 9 show the global vision we had of the links in the company.

Table 7: Illustration of the mapping realized between the life cycle parameters and the company departments

Life cycle model	Departments linked to elements of the life cycle model			
	Design office	Wood workshop	...	Top Management
Wooden slats				
Material	X			X Require aesthetic aspects and a smooth finish of the bench to respect the image of the company
Dimensions	X	X Plane the beams but observe a lot of wood waste		
...				
Steel structure				
Material	X			X Require aesthetic aspects and a smooth finish of the bench to respect the image of the company
Dimensions	X			
...				

Table 8: Mapping between lifecycle parameters and company departments (Part 1)

Bench life cycle model	Departments influencing or influenced by the life cycle elements										Number of indicators where the environmental impacts are upper to 15% of total environmental impacts of the product (/11)
	Design office	Methods office	Wood workshop	Wood finishing workshop	Logistics department	Installation/Maintenance	Quality department	Strategy/ Top Management	Marketing	Procurement department	
Wooden slats											
Material	X		The wood workshop is concerned by the wooden slats parameters because they produce them.			The choice of wood species is linked to its durability. The maintenance service is influenced by this parameter because it maintains the product and could have to change the slats.	The choice of wood species is linked to its durability and have therefore an influence on the product quality.	The marketing and the top management have an influence on the aesthetic aspects of the product because of the image of the company.	The procurement department have an influence on the material choice. In particular for the wood, according to the purchased lots, the wood workshop will have to adapt the beams.		2
Number	X										2
Dimensions	X	X							X		9
Shaping processes	X	X									0
Shape finishing processes	X			X				aspects "esthétiques"			0
Aspect finishing processes	X			X				aspects "esthétiques"			9
Mass of a slat	X								X		1
Concrete seats											
Material	X					The concrete material is not really known in the company. This choice influence the installation work because the parts could break according to their vulnerability to shocks.		aesthetic reasons		X	0
Number	X										0
Dimensions	X										0
Shaping processes											0
Mass of a seat	X					The mass of concrete parts can be a nuisance for the installation service that will handle the parts.					0
Structure											
Material	X							aesthetic reasons		X	8
Dimensions	X										2
Forming processes											0
Shape finishing processes	X							aesthetic reasons			0
Aspect finishing processes	X					This item is related to the quality because it guarantees the lifetime of the chosen material (steel in this case).		aesthetic reasons			1
Mass of the structure	X										1

Table 9: Mapping between lifecycle parameters and company departments (Part 2)

Departments influencing or influenced by the life cycle elements											Number of indicators where the environmental impacts are upper to 15% of total environmental impacts of the product (√/11)
Bench life cycle model	Design office	Methods office	Wood workshop	Wood finishing workshop	Logistics department	Installation/Maintenance	Quality department	Strategy/Top Management	Marketing	Procurement department	
Legs									aesthetic reasons	X	7
Material	X										7
Number	X										0
Dimensions	X										0
Shaping processes											0
Shape finishing processes	X								aesthetic reasons		0
Aspect finishing processes	X						This item is related to the quality because it guarantees the lifetime of the chosen material (steel in this case).		aesthetic reasons		0
Mass of a leg	X										0
Screws											
Material	X	The methods office assembles the prototypes and is thus concerned by the mounting method. Feedbacks could be done to the design office.		X		The installation service sometimes assembles the products on site and is thus concerned by the mounting method. Provide as much as possible the settings / cushioning systems (eg slotted hole, etc.) to allow a range of adjustment.					1
Number	X	X		X		X					1
Assembled product											
Dimensions of the assembled product	X			The dimensions can be a nuisance for the installation service that will handle the products and prepare them for the distribution.	These elements can affect the work of the logistics department that organizes truck deliveries. If the dimensions of the assembled product do not meet the "constraints" of this department, that leads to poor optimization.	The product volume can be a nuisance for the installation service that will handle the products and install them.					0
Total mass of the product	X		The mass can be a nuisance for the installation services that will handle the products and prepare them for the distribution.	These elements can affect the work of the logistics department that organizes truck deliveries. If the dimensions of the assembled product do not meet the "constraints" of this department, that leads to poor optimization.	The product mass can be a nuisance for the installation service that will handle the products and install them.						0
Packaging											
Material											0
Shaping processes											0
Mass											0
Installation											
Material	X				X	X					0
Shaping processes											0
Mass											0

The links were identified from the interviews realized. It can be completed as the different projects move forward. This mapping enables anyway to highlight some design constraints not really known the designers because nobody formalizes them. This map will help supporting integrated design and therefore considering all the departments' viewpoints in the design process.

Our objective then, was to add to this mapping environmental information or assessment. To do this we realized a demonstrator explained in section 3.5. The results are displayed in the last column of Table 8 and Table 9. We proposed to display the number of indicators where the environmental impacts are higher than 15% of total environmental impacts of the product. Therefore, in a redesign process, the design team can then use the table to organize a working meeting with departments concerned by the critical life cycle parameters. The redesign process is then focused and more efficient.

3.4.5. PHASE 4: Feedbacks and recommendations to improve ecodesign integration

We also realized from the interviews a design constraints checklist for the design office. Recommendations have also been proposed to change organizational aspects in the working process in order to improve the collaboration between the actors. These changes aim notably at improving the efficiency.

Creation of environmental checklist from department constraints

This is something that the environmental expert is doing before a new development phase. The objective is to create check-lists for designers to be sure they respect certain rules which will limit environmental impacts and then decrease associated environmental indicators. These check-lists must be updated each time something is changing in the different departments.

The first thing to do is to collect the different company departments' constraints linked to their specific work. Then these constraints are associated to design parameters in order to calculate their environmental impacts. Sensitivity analyses are then done to evaluate their influences on environmental indicators.

This information is translated into checklists that must be respected by designers during the design process. For example, a checklist could contain some recommendations like:

“The product should not be larger than 1.5m because it would generate packaging problems which would increase environmental impacts of the CO₂ emissions indicator by about 20% in average.”

The recommendations and the checklist we realized are gathered in Annex 4. An extract from the recommendations (R) and an extract from the checklist (C) are given below:

(R) Some special shapes in the wood parts are difficult to realize in the wood workshop because some curves have to be manually done. We recommend to the

design and to the wood workshop to work together on the shapes in order to study the manufacturing feasibility. They can also work on some shapes standardization.

(C) To be easily transportable, products dimensions should not exceed the lorry dimensions, it means 13.6m * 2.4m * 2.6m.

This document has been presented to the QSE manager in June 2014 as well as the mapping. She welcomed the proposed documents (Mapping and Annex 4):

“It enables to see when the designer changes a parameter which departments will be influenced. It encourages people to communicate to their colleagues to know for example if an idea is viable or not because it is useless to deepen a reflection if the workshop cannot produce it or if the procurement department cannot purchase it. This is a good decision-support matrix.”

3.5. Development of a demonstrator tool

In order to add an environmental dimension to the mapping, we developed a demonstrator tool in an Excel file. The tool is based on LCA results so we exported from the EIME software tool all the data necessary to realize a simplified LCA of the bench. The example is based on the data of the preliminary design of the bench.

3.5.1. General structure

The tool is divided into 13 sheets where the names are given below:

Operating mode	General info	Database	Manufacturing	Distribution	Installation	Use	EoL
	Results	Mapping	Allocation	Pivot tables	Computation		

The first sheet of the file gives the procedure to use the tool as a user. Figure 63 shows the operating mode with the different steps to follow in order to fill in the tool as a user.

Operating mode

- 1** **Fill out the sheet called "*General information*"**
- 2** **Realise the life cycle inventory of the product in the sheets corresponding to the different lifecycle phases. **Fill in only the yellow cells; the other cells are automatically filled in.****
 - 2.1 Fill out the sheet called "*Manufacturing*"
 - 2.2 Fill out the sheet called "*Distribution*"
 - 2.3 Fill out the sheet called "*Installation*"
 - 2.4 Fill out the sheet called "*Use*"
 - 2.5 Fill out the sheet called "*EoL*"
- 3** **Go to the "Results" sheet, choose the life cycle phase you would like to study and you will be automatically redirected to Mapping_Manufacturing or Mapping_Distribution.**

NB : The "Database" sheet correspond to the database available to realise the life cycle inventory, it could be broaden in exporting other EIME modules.
 In the "Pivot tables" sheets, only the reference threshold (currently 10%) from which it is considered that an item is impacting can be changed by the user.
 The "*Allocation*" and "*Computation*" sheets are not useful for the user.

Figure 63: Operating mode to use the demonstrator tool as a user

The second sheet is a table with general information on the product and the functional unit that the user has to fill out. The third sheet contains the environmental database with the elements extracted from EIME necessary to model the bench life cycle.

The five following sheets correspond to the five life cycle phases of the product modelled in EIME.

The 'Results' sheet gives the LCA results by life cycles phases and a graph showing the life cycle phases contributions. The sheet contains also 2 buttons: a first one to actualize the results if the user made changes in the inventory, a second to display the 'Mapping' sheet.

The last three sheets, 'Allocation', 'Pivot tables' and 'Computation' are the sheets necessary to calculate the results displayed in the 'Mapping' sheet.

3.5.2. General use

After completing the general information about the project, the user has to realize the life cycle inventory of the product in filling out the yellow cells of the five life cycle sheets.

The architecture of the product has been defined according to the bench life cycle model established previously in the mapping. Thus to enter a new data, the user has to define a new part. He chooses from a drop-down menu a part of the product's architecture and then he

chooses from another drop-down menu the type of element he wants to add. Table 10 shows the current lists of the two drop-down menus. This information is summarized in the “Allocation” sheet.

Table 10: Content of the drop-down menus

ARCHITECTURE	TYPE
Wooden slats	Material
Concrete seat	Shaping processes
Structure	Shape finishing processes
Legs	Aspect finishing processes
Screws	Transport
Assembled product	
Packaging	
Installation	

The user chooses then the EIME module from the data list and enters the corresponding value (as in a classic LCA software tool). Figure 64 shows an extract of the ‘Manufacturing’ sheet. For each phase, environmental indicators are then automatically calculated and contribution graphs with the different elements of a phase are displayed.

When the inventory is finished, the user can go to the ‘Results’ sheet and click on the button ‘Refresh’ in order to update the data if changes have been made. A table and a graph showing the life cycle phases contributions are available. The user can then click on the ‘Display the links’ button in order to display the ‘Mapping’ sheet. Figure 65 shows the content of the ‘Results’ sheet.

The ‘Mapping’ sheet contains as a support the mapping between the bench life cycle elements and the company departments presented in section 3.4.4 and illustrated in Table 8 and Table 9. In addition, in the demonstrator tool, the lines where the value of at least one indicator is higher than 15% of total environmental impacts are highlighted in yellow and the number of indicators concerned is written in the last columns. For readability, Table 8 and Table 9 are not shown with the highlighted lines in this document. The link with environmental indicators is built from the life cycle inventory and the choices made in the drop-down menus.

Manufacturing

Fill in only the yellow cells

Quantity		Architecture	Type	Architecture Elements	1st Parameter
					Value 1 Unit 1
16	Wooden slats	Material	Scots pine wood; to manufacturing site; RER		1,5 kg
16	Wooden slats	Shaping processes	Electricity mix AC; consumption mix, at power plant; FR		0,593 MJ
16	Wooden slats	Shaping processes	Electricity mix AC; consumption mix, at power plant; FR		1,186 MJ
16	Wooden slats	Aspect finishing processes	Painting with water based paint; for all materials; technology mix, at plant; FR		0,2 m2
1	Wooden slats	Transport	Small lorry transport; for freight transport; 3,5-7,5t; technology mix; RER		4,07 t*km
1	Concrete seat	Material	Concrete; production mix, at plant; 2200 kg/m3 average density; RER		20 kg
2	Legs	Shaping processes	Bending of steel parts; from pre-shaped materials; technology mix, at plant; NE		8,5 kg
2	Legs	Shaping processes	Laser cutting of steel parts; technology mix, at plant; RER		1,5 m
2	Legs	Aspect finishing processes	Painting with powder based paint; for all materials; technology mix, at plant; FR		0,25 m2
2	Legs	Material	Steel finished cold rolled; without surface treatment; 47% recycled; production mix, at plant; GLO		8,5 kg
2	Legs	Aspect finishing processes	Zinc phosphating of steel; for surface treatment; technology mix, at plant; RER		0,25 m2
1	Structure	Shaping processes	Bending of steel parts; from pre-shaped materials; technology mix, at plant; NE		25 kg
1	Structure	Shaping processes	Laser cutting of steel parts; technology mix, at plant; RER		9 m
1	Structure	Aspect finishing processes	Painting with powder based paint; for all materials; technology mix, at plant; FR		1,8 m2
1	Structure	Material	Steel finished cold rolled; without surface treatment; 47% recycled; production mix, at plant; GLO		25 kg
1	Structure	Shaping processes	Welding of steel parts; metal active gas (MAG); using argon gas; technology mix, at plant; RER		0,5 m
1	Structure	Aspect finishing processes	Zinc phosphating of steel; for surface treatment; technology mix, at plant; RER		1,8 m2
1	Structure	Transport	Small lorry transport; for freight transport; 3,5-7,5t; technology mix; RER		2,222 t*km
1	Screws	Material	Steel stainless; 15% chromium content, primary production; production mix, at plant; RER		0,96 kg
1	Screws	Transport	Small lorry transport; for freight transport; 3,5-7,5t; technology mix; RER		0,194 t*km

Figure 64: Part of the sheet for the manufacturing phase inventory

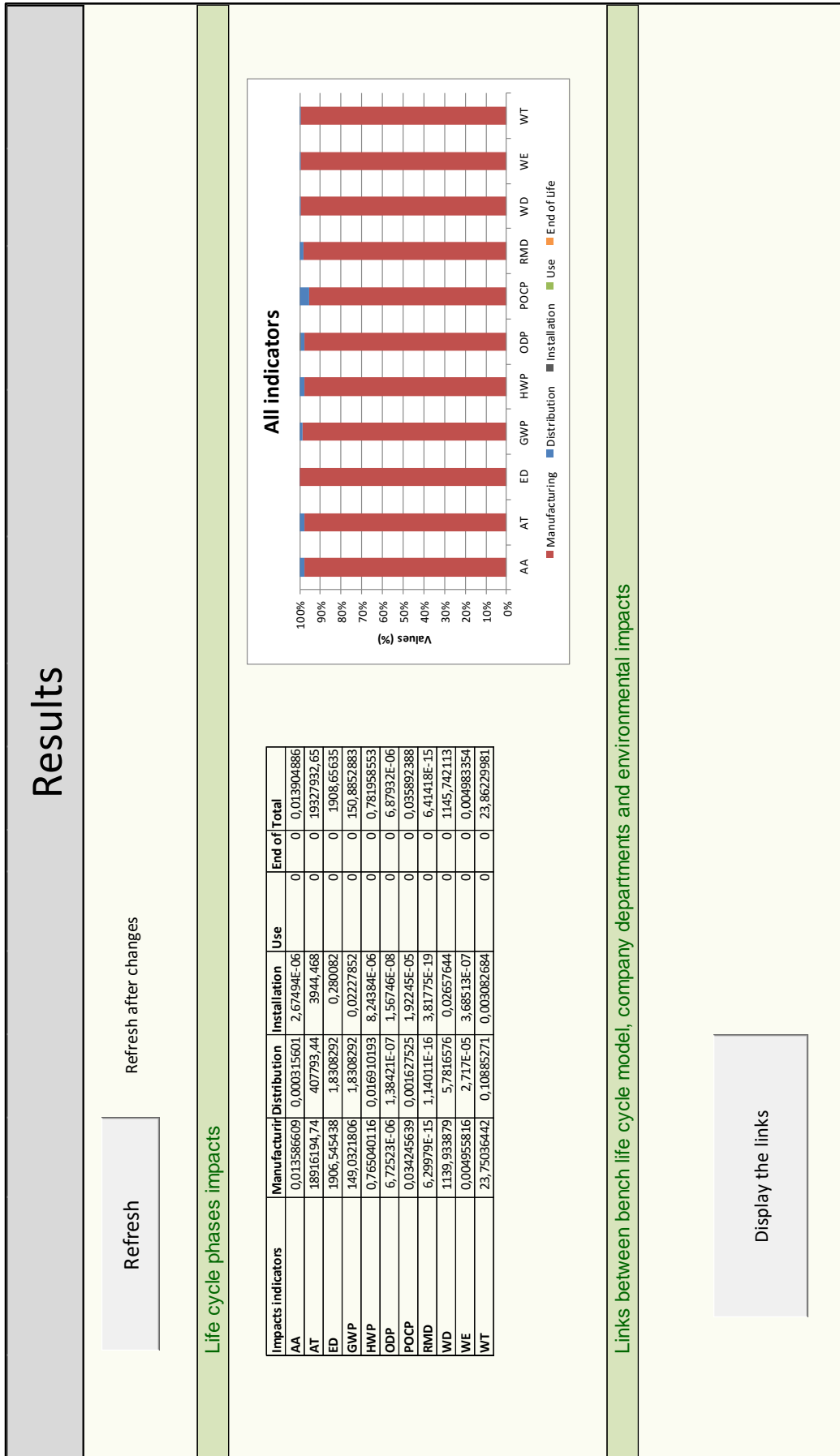

Figure 65: Content of the ‘Results’ sheet

Thus, even if the LCA is realized by the environmental design manager, the mapping with the highlighted lines can be presented to designers to give them some environmental feedbacks on the product. Moreover, in a redesign process, the design team can then use the table to organize a working meeting with departments concerned by the critical life cycle parameters. Even if more detailed environmental information is useful and necessary for the environmental analysis, this interface enables to focus on the critical points and proposes a support easy to understand for the design team. Moreover for each design change realized, an update of the product inventory induces a direct evolution of the indicators and of the highlighted lines. Sensitivity analysis can be easily realized and exploited.

3.6. Synthesis and perspective

Interviewed were realized at Aubrilam to collect information and model the current design process. We also proposed a modified version of the design process with ecodesign integration. Realizing an ecodesign overview and assisting to design meetings showed us that some design aspects and constraints were not really integrated in the company. Some lacks or problems have been identified on both design and ecodesign aspects. We realized that the platform has a limit on the information it provides to redesign a product. This led us to realize a mapping based on the bench example between the different Aubrilam departments in order to collect departments' links and constraints which can have an influence on the product design. Then, we added an environmental dimension to the mapping in order to highlight the critical points and show the usefulness of the tool. Indeed, once critical points have been identified, the design team could organize a meeting with the concerned departments and therefore optimize the redesign. The mapping acts as a decision-support matrix.

The discussion with the QSE manager opens some perspectives to this approach. Indeed, one direction will be to make the mapping generic for all the Aubrilam types of products. For example, the table could have categories with wood material, metal and assembly principles. The QSE manager would like to “de-dramatize” ecodesign in all the departments. The table could be a support to adjust the different visions of people and therefore discuss about the roles and the exchanges between them. This confrontation will enable to complete and improve the mapping.

The QSE manager raises a problem about the resistance to change in the design office. Indeed, applying a new procedure or follow new methods is quite difficult in this SME because things already works and changes are more seen as a constraint than as an evolution. Therefore creating tailored checklists or tools for each department is a challenge to succeed in the ecodesign integration in this company.

3.7. Conclusion and validation of the thesis hypothesis

The deployment of the methodology in Aubrilam design process enables to design a bench with improved environmental performance. This has been possible through the connections of

the departments (N1), the management of life cycle parameters (N2), the monitoring of the EIME environmental indicators (N3), creation of new data and new knowledge (N4)., and the following of the methodology steps (N5). The five assumptions have been validated in the context of this case study.

However, we observed that if the environmental design manager does not know the influence networks between the different departments of the company, the feedbacks he will make from the LCA results will not be the most suitable. This happens more in particular if the environmental design manager is external to the company and the platform does not provide this information.

In Chapter 4, we talk about the needs to provide feedbacks from the environmental analysis to the designers for them to make environmentally informed design choices. We proposed an approach summarized in Figure 66.

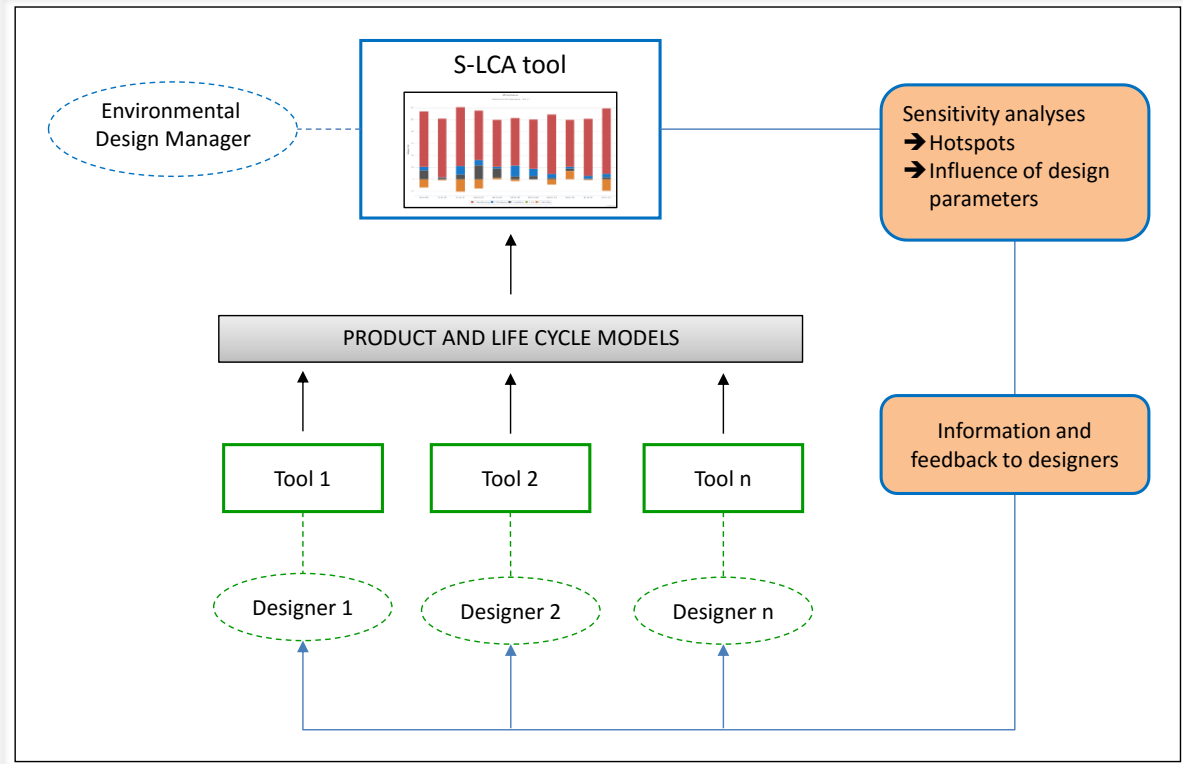

Figure 66: Process of feedback to designers from LCA results

The platform described in the proposal aims at making easy the building of the product and life cycle models via different tools, classic design tools and specific tools, and also at making easy the LCA realization. However, the influence of design parameters and the possible feedbacks to designers were not so detailed (orange boxes in the figure). The experiment in Aubrilam enables to create a demonstrator tool in Excel and to link life cycle parameters, company departments and information on environmental impacts. The example has been implemented from data of a bench but can be extended to other products. Thus the company can have a database of generic products and use the tool for any kind of project. Linking these information enables to give feedbacks from the LCA to the designers. The identification of hotspots is easy with the highlighted lines and working meetings with concerned departments

can be organized to redesign the product according to the results coming from this tool. Connections between the departments are thus necessary for an efficient redesign. The mapping is “living” and “evolutionary” and must be updated and completed by the teams to be always useful.

4. Experiment N°3: A serious game for a workshop

We validated in the previous sections of this chapter the concept of the methodology and the platform in two companies. However, we observed that some redesign choices did not come from outputs of the platform and that others aspects, linked to an intrinsic knowledge of the company, needed to be considered. These are the knowledge about the company, the knowledge of the interrelations between the company departments. Indeed, this knowledge is necessary to optimize the redesign process in bringing together the appropriate stakeholders to address each hotspot. If the environmental design manager is external to the company, he does not have this knowledge.

We proved that when the environmental design manager is internal (Experiment N°1) or when he is external but really mobilized and involved in the project (Experiment N°2), the ecodesign process works and is efficient. However in other cases, we asked ourselves whether or not it counters our initial hypothesis and we conclude that assumptions 1 and 4, about the connections between the departments and the information management, can be difficult to realize.

We wonder whether a complementary ‘tool’ could support the design team and in particular the environmental design manager. The case of the company Aubrilam enables to establish a mapping between the departments and the product life cycle parameters. We would like now to test the influence of having this mapping on the design process. To do that, the results of the Aubrilam case study were adapted in order to develop a serious game. This experiment was then tested during a workshop during a design conference.

In this section, the objective of the experiment is firstly reminded. Second, the context and the content of the workshop are presented. Then, results of the game are described and feedbacks from the participants are summarized. Finally we conclude on the experiment N°3.

4.1. Objective of the experiment during the workshop

The objective of the experiment realized during a workshop during an international conference is to verify that the mapping between the different company departments makes easier and efficient the redesign process by providing to the environmental design manager relevant information about the interrelations between the departments.

4.2. Context of the workshop

This workshop was held at the DESIGN Conference the 19th May 2014 in Cavtat, Croatia. This workshop was realized in the framework of the G.EN.ESI project in order to disseminate information about the project, the goals and the expected results. The workshop was co-organized with two members of the University of Bath, Mendy Mombeshora and Elies Dekoninck, as they are partner of the European project. We took this opportunity to design, in

collaboration with Bath, a serious game, that we called “The Bench Game”, to fully integrate the audience. The Bench Game is an interactive game-based workshop that combines product design, environmental and supply chain issues with the aim of introducing participants to both the practical aspects of ecodesign and the wider business considerations necessary in the implementation of environmental product development. Thus people during the workshop have to work on two parts, the usefulness of the connections between the different company departments, life cycle parameters and environmental indicators (work managed by ourself), and the importance of the links with the supply chain (work managed by Mendy). The second part is not addressed in this document.

The workshop was attended by 28 participants from 16 universities and 2 industries. They were representing 11 different countries.

4.3. Proceedings of the session

During the workshop, the participants were introduced to the G.EN.ESI methodology before the commencement of the game. Exercising the knowledge gained through the prior presentation and reflections on their own experiences of industry based ecodesign implementation, the participants are involved in The Bench Game. To kick-start the game, the participants were divided into groups, with each group representing a complete design team in a manufacturing company. After being split into groups, the facilitator commissioned a re-design of a bench, based on a provided base-model, which has particular environmental performance improvements. Each team member assumes a pre-defined role, to successfully redesign the bench and to ensure an improved environmental profile based on the LCA results of the base-model. The team members must work in close cooperation within their own group.

During the game, the participants have the control of the entire re-design process in a real time interactive environment; this exercise simulate the real life complexities of ecodesign within a product design team in a modern business environment.

Following the game, a discussion session was held to reflect upon the methodology and the interactive exercise.

4.4. Content of the serious game



Figure 67: Bench to redesign

During the game, the participants have to organize, from data on an existing bench, the redesign process in order to implement ecodesign aspects.

Figure 67 shows the product the teams had to redesign.

4.4.1. Building design teams

At the beginning of the session, each person received a post-it with the colour corresponding to their level of ecodesign knowledge and skills. Teams were then built in a way people are mixed according to their level. Teams were composed of 4 to 5 people and represented a design team. In each group, the following roles were assigned:

- A project manager,
- A design engineer,
- A quality manager,
- A purchasing manager,
- A production manager.

4.4.2. Materials

To organize the redesign process in order to improve the environmental performance of the product, the team had different materials available in Annex 5.

For each group:

- ✓ **A sheet of A3 paper** with the recap of the GENESI methodology and the instructions of the play
- ✓ **Material 1:** Information needed to start the game: the LCA report of the bench
- ✓ **Material 2:** A meeting planning to fill in, in order to organize the redesign process
- ✓ **Material 3:** A document to record ecodesign ideas for the redesign of the bench
- ✓ **Material 4:** A project review document with a team survey

For each person:

- ✓ An individual role card explaining the general skills of the person
- ✓ A set of ‘Actions Cards’ representing the possible actions or strategies the person can do: this is what we called the resources of the company

4.4.3. Aim of the game

The aim of the game for the teams is to redesign a product by improving its environmental performance and by optimizing the resources of the company. The teams need to balance the eco-effectiveness of their actions against the resources/company effort. They have to work efficiently during the given time to tackle as many environmental hotspots as possible.

4.4.4. How to play the game

Each group is invited to follow the steps of the methodology via the A3 paper. Each step of the methodology is reminded. Associated to each step, some instructions to realize are provided to the teams to guide them. These instructions are summarized below.

1. Define Strategic Environmental Objectives.

In this case, the company's strategic objective is already defined: the company wishes to design and produce greener products. As a first project, the top management chooses to redesign a bench. They aim to optimize the resources to meet the objective.

2. Determine Initial Environmental Analysis

A streamlined-LCA of the bench was performed by the environmental expert of the company. Main streamlined-LCA results are provided in Material 1.

3. Determine Environmental 'Hotspots' and Relevant Design Indicators

Participants have to use the information and graphs given in Material 1 to analyze the streamlined-LCA results and determine the product's hotspots (the most environmentally critical features of the product). The identified hotspots have to be written in the first column of Material 2.

4. Conduct Design Development Activities

The redesign process: for each hotspot, the teams plan a meeting between the persons they think are concerned by the hotspot. For such needs, each person must look his personal role card to know if he feels concerned by the hotspot. They report this information in Material 2.

Then, they conduct the hotspots redesign meetings. During each meeting, persons will discuss ecodesign ideas for the product and thus actions and resources to mobilize for the redesign. They write in Material 3 potential ecodesign ideas they could have for the bench. At the end of each discussion, decisions must be taken about the actions to realize. The team selects the actions cards necessary to redesign the product and improve the hotspot. Figure 68 shows two examples of action cards for the purchasing manager. Each action involves a resource load for the company on a scale of 1 to 5 written on the card and enables an environmental benefit on a scale of 1 to 4, not revealed to the participants. The code in the bottom left side is specific to each action card.

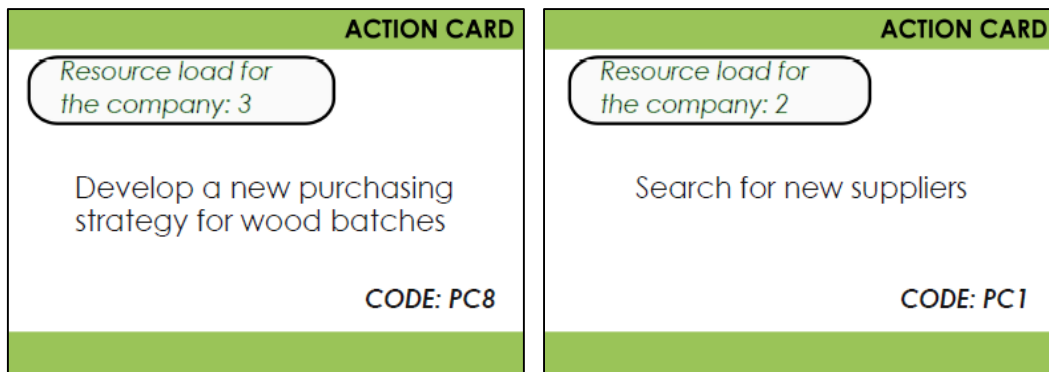

Figure 68: Example of two actions cards for the purchasing manager

The teams record in Material 2 the code of the selected cards corresponding to the actions to do to improve the environmental performance of the product.

5. Check Design's Environmental Performance

In this workshop, as the focus is more on the redesign organization than on the redesign itself, it is not asked to calculate the new environmental profile of the product.

6. Review Design Process Outcomes and Revise Strategy

The teams review the design process and write their comments on the game in Material 4 document.

Summary:

The teams follow the steps of the methodology from the instructions sheets. They identify the environmental hotspots from the LCA results provided in Material 1. For each hotspot, they mark in the meeting planning (Material 2) the persons needed at each hotspot redesign meeting. Each person must look his role card to know if he feels concerned by the hotspot. The teams conduct all the hotspot redesign meetings (and record any ideas in Material 3). For each meeting, they write the code of the action cards that the team selects to enable the redesign of that hotspot (for each meeting, they can use only the action cards of the persons marked present). Figure 69 illustrates the game proceedings.

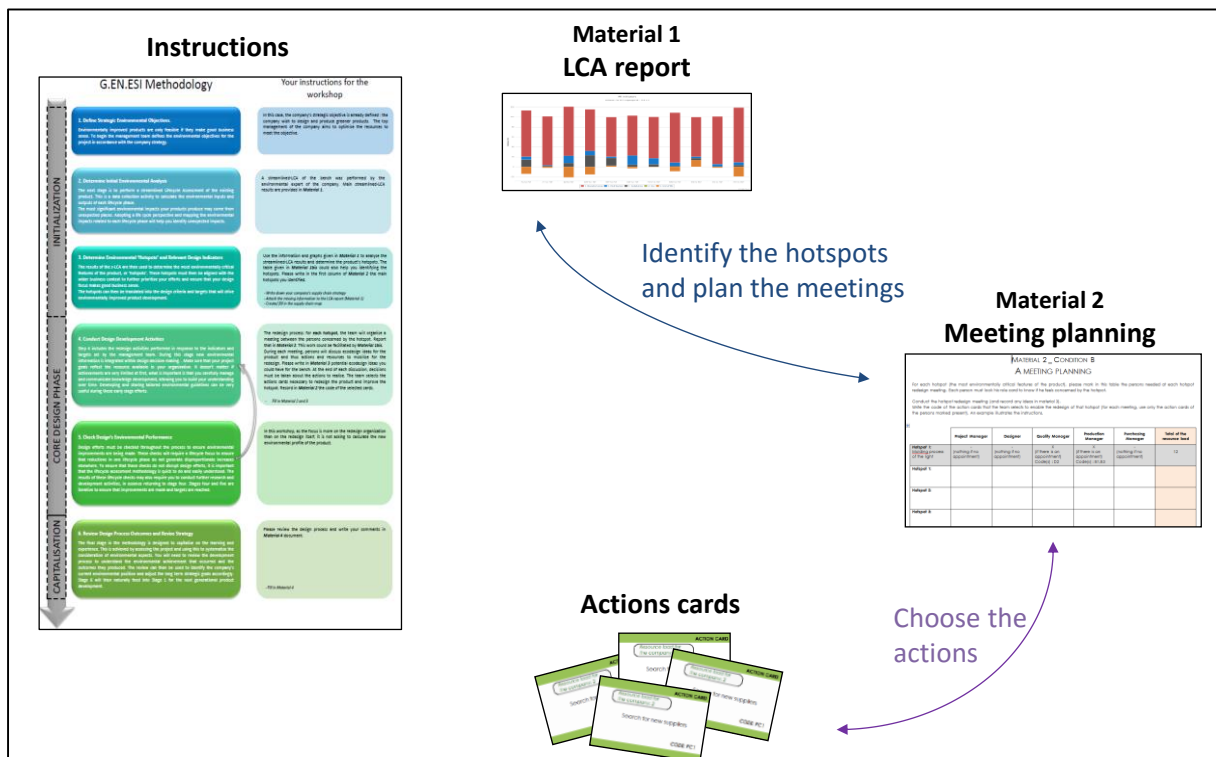

Figure 69: Illustration of the game proceedings

4.5. Exploitation of the results

At the end of the session, we asked the teams to reference how many hotspots they had time to tackle, the total potential environmental benefits they get, and the total resource loads they mobilized.

Indeed, each action card is associated to a resource load for the company (written on the card) but also to a potential environmental benefit (revealed to the participants at the end of the game). In the simulation for the game, the resources loads and the environmental benefits were evaluated respectively on a scale of 1 to 5 and on a scale of 1 to 4. In real life, for example, the resources loads could be assessed in person-month or in money and the environmental benefits could be assessed in percentage gained on the different environmental indicators or in mPts gained on the ponderation graph with the method Eco-indicator 99.

These data were estimated in collaboration with an environmental expert having industrial experience. To calculate the total potential environmental benefit, they had to sum up the potential environmental benefit of all the action cards used to improve all the tackled hotspots. Idem for the resources loads.

In terms of environmental concerns, the objectives for the companies was to maximize the number of hotspots improved and to maximize the total environmental benefits realized, while at the same time making sure that this does not involve impacts transfers. However, the objective for companies, in a strong competitive context, was also to try to maximize these two parameters by minimizing the total resources loads. Thus the notion of prioritization of the activities to realize in order to improve the critical environmental features of a product is important regarding potential environmental benefits and resource loads.

Table 11 shows the results of the six groups playing the game at the workshop.

Table 11: Results of the six teams

Teams	Numbers of hotspots	Total environmental benefits	Total resource loads
A	9	90	84
B	2	30	25
C	5	37	29
D	4	50	39
E	4	51	33
F	3	59	36

The results are disparate but what was important was the redesign process itself. We would like to put people in a situation where they could face ecodesign issues by organizing the steps and the meetings necessary to redesign the product according to the environmental hotspots in order to obtain their feedback.

4.6. Feedback of the participants

At the end of the session, we presented to the participants the mapping between the life cycle parameters and the company departments (Figure 70). We explained its role and we showed that if the methodology and the platform are not implemented by internal persons in the company, realizing this mapping in parallel to the implementation could be necessary to ease the ecodesign process. This information needs to be capitalized and can then be stored in the platform.

We asked the teams to fill in the survey of Material 4. The objective was to have general feedbacks and feedbacks on the table mapping lifecycle parameters, company departments and environmental information.

We analyzed the responses of the six teams and we summarized the comments in the following paragraphs.

General recommendations for format improvements

There were a lot of information maybe a synthesis version can be developed to make the game easier. A better definition of the rules will help to save time and to handle all the information.

The actions cards are quite limited and so the game does not provide support for radical innovation.

Feedback regarding the ecodesign approach provided by the game

The teams liked the principles of the game and found it very useful to introduce ecodesign principles and to illustrate ecodesign activities.

Concerning the proposed mapping, all of the teams recognized the benefits to link environmental impacts, life cycle models and company departments during the ecodesign process. Different reasons have been cited:

- Linking these three elements provides a holistic approach to ecodesign.
- It provides a way to break through the 'green wall'.
- The consideration of environmental impacts by different departments during the early stages avoids problems in the later stages.

This mapping enables therefore to have a global vision of the company and eases the organization of the design process.

However, a team wonder if the proposed approach is enough robust to take into consideration design contradictions, the fact that changing a parameter could has positive consequence for a department and negative for another.

Finally, the mapping seems to be very useful for an efficient organization of the redesign process through the management of information about interrelations between the departments but we should take care of potential design contradictions.

Life cycle model	Departments linked to elements of the life cycle model							Number of indicators where the environmental impacts are upper to 15% of total environmental impacts of the product (/11)		
	Design office	Wood workshop	Wood finishing workshop	Logistics department	Quality department	stratégie/ Top Management	Marketing department		Purchasing department	
Wooden slats										
Material	X				X	X	Require aesthetic aspects and a smooth finish of the bench to respect the image of the company	Influences the choice of material	X	5
Dimensions	X	X Plans the beams but observes a lot of wood waste						Purchases varying sizes of wood beams according to best price list	X	-
Forming processes	X	X							X	0
Finishing processes	X		X Coats the wood with solvent base coatings		X	X	Require aesthetic aspects and a smooth finish of the bench to respect the image of the company		X	6
Mass of a slat	X									-
Steel structure										
Material	X						X	Require aesthetic aspects and a smooth finish of the bench to respect the image of the company	X	5
Dimensions	X									-
Forming processes	X					X			X	0
Finishing processes	X					X	Checks these elements because they have an influence on the lifetime of the product		X	1
Mass of the structure	X									-
Screws										
Material	X		X						X	0
Quantity	X		X Assembly the different parts of the bench							-
Packaging										
Material				X						0
Mass				X						-
Packaged product										
Dimensions of packaged product	X			X Adapts the means of transportation to the volume of the product						-
Total mass	X			X Adapts the means of transportation to the mass of the product						-

Figure 70: Illustration of the interrelations between the company departments showed to the participants

4.7. Conclusion of this experiment

This experiment was held during a workshop at an international design conference. The participants were divided into teams in order to organize the redesign process of a public bench.

The workshop was multi-objective in the sense that:

- It aims at introducing the participants to both the practical aspects of ecodesign and the wider business considerations, as collaboration inside and outside the company, necessary in the implementation of environmental product development.
- We wanted to know if having the mapping between the different company departments would support people in the redesign process of the bench.

Overall, we received positive reviews from the participants, along with constructive criticisms and viable ideas on how to improve the workshop. Moreover, they all said that having the mapping would enlighten them in the ecodesign process. Thus, this approach needs to be deepened in future researches.

5. Conclusion of the three experiments

This chapter aimed to present the three experiments established to test the validity of the proposal. Three experiments have been carried out in three distinct contexts. We confirmed with two industrial case studies the validity of our proposal. Both experiments were completed successfully with the development of ecodesigned products. The five assumptions defined for the validity of this thesis were demonstrated in both companies. The contexts of these two companies were different.

Experiment N°1 validated the hypothesis in the context of the company Faber:

- A company not aware of ecodesign.
- The role of the environmental design manager performed by an internal person.

The design team has been trained to ecodesign in order to redesign a cooker hood.

Experiment N°2 validates the hypothesis in the context of the company Aubrilam:

- A company already aware of some ecodesign aspects.
- The role of the environmental design manager performed by an external person (myself).

In the first experiment, we validated the methodology and the platform through the redesign of a cooker hood. We illustrated the application of the solution and then the solution has been implemented in the company via training sessions. The design team of the company could then use the platform to redesign their cooker hood.

In the second experiment, a public bench has been ecodesigned. As external environmental design manager, we observed that we did not know the influence networks between the different departments. This could lead to an inefficient ecodesign process. Indeed, this knowledge is necessary to optimize the redesign process in bringing together the appropriate stakeholders to address each hotspot. The proposed platform does not provide this information but makes the user questioning on these aspects. To solve the problem, we created a mapping of the interrelations between the departments by collecting the information through interviews.

We wondered whether or not our initial hypothesis would be countered if the environmental design manager would be an external person, for example a consultant. We concluded that assumptions 1 and 4, about the connections between the departments and the information management, can be difficult to consider without the mapping.

According to our experience in Aubrilam, the mapping can help to identify which stakeholder or department was in charge of such critical aspect or such component. Therefore, the feedbacks for the redesign would be the most appropriate because the relevant stakeholders would be consulted. Having in mind all these links enables to make effective the redesign process and to reduce the number of iterative steps.

Then, we wanted to test this complementary tool on another audience to collect more feedbacks about it. We organized thus a workshop during a design conference. The results of Aubrilam case study were adapted in order to develop a serious game. We asked participants to coordinate the redesign process of a product. Then we introduced them the mapping: all participants were convinced that with the mapping it should be easier to support the design team and to develop environmental knowledge. This will lead to further researches.

Chapter 7

Conclusions and perspectives

The competitive pressure, regulations, and customer demands for green products are pushing companies to better consider environmental issues. Ecodesign aims at integrating environmental aspects into product design and development. However, the environmental aspect as a viewpoint is not easy to integrate and specific considerations have to be focused on.

In this thesis, we highlighted the different challenges of ecodesign integration, from basic ecodesign principles to the needs for ecodesign tools and ways to manage data and information through organizational issues. Then we showed that integrated design by its definition and its principles met some of the challenges. However a lot of them still need other solutions. We then realized a state-of-the-art about the interoperability trials between ecodesign and integrated design approaches. We demonstrated that the current methodological and software solutions do not provide a complete solution to meet all the specificities of ecodesign integration.

We developed our problematic on these gaps and we identified the key elements required for a good integration of ecodesign in a design team. According to our literature review, we made the following five assumptions. Ecodesign integration needs:

- The involvement of all design stakeholders, with a particular need for an environmental design manager.
- Tools for the design of products and their life cycles.
- Indicators and guidance tools to manage environmental information.
- Means for data and information management.
- A procedure taking into account the methodological needs to be in line with the design process.

Our contribution is the formalization of the needs for a good integration of ecodesign in the design process in a strong integrated design environment. Our detailed contributions are:

- A methodology which guides the design team for the introduction of ecodesign steps in the design process.
- The structure of a software platform aiming at supporting the methodology. The platform gathers the necessary tools to manage ecodesign activities: from tools for the design of the product life cycle, to evaluation tool, guidance tool, monitoring tool, and databases. The tools users and the necessary links between the tools are also specified.
- The validation of this approach in two industrial case studies.
- The training of industrials on this approach.

Thus, the methodology describes at each step the necessary interactions between the stakeholders and the different tools. We promote the necessity for the design team to consider a complete life cycle model with environmental indicators in addition to design indicators.

We tested the validity of our proposal in two industrial case studies. Their main characteristics are reminded below.

The first experiment took place in a company:

- Where ecodesign and environmental issues were new for the design team.
- With an environmental design manager internal to the company and involved in the G.EN.ESI project.

We illustrated the application of the platform on the redesign of the Stilux cooker hood and we participated to the training sessions of the designers. Then, the design team managed by their environmental design manager redesigned themselves the hood with the G.EN.ESI software platform. The experiments were successfully carried out with an ecodesigned product and the validation of the five thesis assumptions.

In the second case, the situation was as follows:

- Ecodesign and environmental issues had been included in the company strategy for years but was not well integrated in the design team.
- We followed the new design project as environmental design manager.

As external environmental design manager, we observed that it was difficult to organize the redesign process according to the hotspots we identified because we did not know the interrelations and the influence between the activities of the different departments of the company. Thus, we developed the mapping of the links between the departments in order to better organize the redesign process. The realization of the mapping was possible through interviews with the different design stakeholders. So, we established a global view of the interrelations in the company that the stakeholders themselves do not necessarily have. In this project we also link the interrelations with environmental information through the product life cycle parameters. Having in mind all these links enables to make effective the redesign process and to reduce the number of iterative steps.

We thus contribute to improve the feedbacks given to the design team through the development of a system of links between the different stakeholders of the design process to show how their constraints influence design parameters and the product environmental profile.

At the end of the project, the product was ecodesigned and we validated the five assumptions.

This second experiment highlighted a limit to the proposed platform. Although the platform does not provide the interrelations, it can lead us to raise questions on these relations. Moreover, once the mapping is realized, it could be stored in the platform, for example in the guidance tool in order to capitalize the information for future projects.

Following these two experiments, we organized a workshop where participants were asked to coordinate the redesign process of a product. Then we introduced them the mapping and its advantages. All participants agreed that with the mapping it is easier to help the design team and to develop environmental knowledge. This will lead to further research.

Perspectives

The improvements and the perspectives of our work are presented in the following paragraphs.

Different industrial situations

We demonstrated the application of our proposal on two particular cases studies only. It would be interesting to test and validate the methodology and the platform in other industrial situations to identify the potential lacks or weaknesses of the tools and the overall platform. Other industrial situations mean different types of user or different use objectives. We can give some examples:

- The platform could be used for the ecodesign of strongly innovative products in order to test the viability of the solution and to identify potential lacks. For example, the guidance tool could need to be enhanced with eco-innovation guidelines and other useful information to be transferred to designers.
- The solution could be deployed in large companies with a dedicated environmental department.
- Finally, the platform could be implemented by a consultant who has to set up the solution in companies.

The results of these experiments would probably lead to adapt and improve the methodology and the platform but also to create specific training or implementation materials to support the different user types and the different use situations.

Different possible software implementations of the platform

The software platform developed within the framework of the G.EN.ESI project is just an example of implementation of the architecture we proposed but others implementations are possible. In the G-SCOP laboratory, the ecodesign team would like to create its own platform gathering different tools and approaches previously developed in the lab. For example, this platform could include:

- Synergico: a contribution to the design for energy efficiency of electr(on)ic equipments focusing on the use phase (Domingo, Mathieux, et al. 2011) (Domingo, Evrard, et al. 2011). Synergico is a methodology helping designers to better consider the energy consumption of electrical and electronic equipment during its design and to facilitate the integration of this criterion as any other design criteria. The methodology is based on three tools, namely the In-Use Energy consumption tool (IUE), the guidelines, and the lifecycle check tool. Design data are used to calculate an In-Use Energy consumption indicator for several use scenarios and to monitor the compliance

with the objectives defined earlier. Guidelines can then be used to obtain a list of strategies in order to converge towards an objective. Eight criteria help the designers to select the guidelines according to their needs. Finally, Synergico includes a simplified lifecycle check tool to compare the environmental impacts of the product along its lifecycle with a reference product to verify that a solution improving energy efficiency in use does not entail impacts in the other phases.

- A simplified environmental assessment usable during the preliminary design stage based on "Design for Environment" rules (DfE rules). Alhomsy developed an approach which integrates DfE rules early in the product design while proposing a method that translates these rules into DfE indicators (Alhomsy 2012). This approach has been implemented in a tool in 2013. Moreover the collected DfE rules could be a basis for a guidance tool.

Moreover, the consideration of products end-of-life aspects needs to be strengthened. That is why the platform could also contain:

- Resicled: a software tool dedicated to the end of life phase developed for designers. This tool is based on the method developed by Mathieux et al. (Mathieux et al. 2008). Resicled enables to calculate the recyclability rate of products, to identify weaknesses of the design and to propose redesign strategies according to the results.
- Repro2 - REmanufacturing with the aid of PROduct PROfiles. Repro2 is a tool developed to support the design of remanufacturable products (Zwolinski et al. 2006). Indeed, designers assisted with this tool make early design by product profiling. It gives specific information to improve the internal technical definition of the product under study from a remanufacturing point of view.
- Cloée - Closed LOop Environmental Evaluations. This tool propose a product model that allows to consider the recovery strategies for components taking into account several usage phases. It helps the designer to create different life scenarios for products under design and provide the comparisons between the environmental impacts for the different designed life cycles.

To have an efficient consideration of the end of life aspects, an analysis of these tools would be necessary before merging them. A single tool for end of life would be necessary to avoid contradictions and to simplify the work for designers.

Furthermore, we could also consider to extent this platform by including other tools of the French ecodesign community. The EcoSD Network is a French association whose purpose is to promote knowledge sharing between academic and industrial researchers in the ecodesign fields. Within the EcoSD Network, a Collaborative Research Project is currently underway to inventory ecodesign tools. This inventory could be used to evaluate the relevance of each tool in the platform.

The implementation of those tools will require to furthermore developing their interoperability (model unification, federation, etc.).

Mapping of the interrelations between the departments of a company

Realizing the mapping of the interrelations between the departments of a company can really be a heavy task, especially in big companies. A method to model the links should be developed to facilitate the building of the mapping. Moreover, the mapping we realized should be improved because for the moment it is adapted for redesign. Indeed, in case of radical changes information could be missing or not suitable.

We can imagine integrating the mapping to the platform in order to “automate” the feedbacks to the design team. As a first step, an easy solution could be to add it to the guidance tool in order to make it available for everyone. The mapping could then be updated if there are changes or evolutions in the companies. It enables to capitalize information.

Moreover, the approach could be deepened. Our platform manages data and information flows but the cognitive aspects of stakeholders also need to be considered. Indeed, using the tools, receiving feedbacks, taking part to projects, or exchanging with other stakeholders lead designers to collaborate together, or to wonder and therefore build their own knowledge. Thus, our platform also generates flows coming from human interactions. In order to manage these flows, Baouch proposed to support the ecodesign processes with a knowledge-sharing platform (Baouch et al. 2014). This collaborative platform in parallel to our platform would support knowledge creation and knowledge sharing between actors, as shown in Figure 71. This work is still in progress.

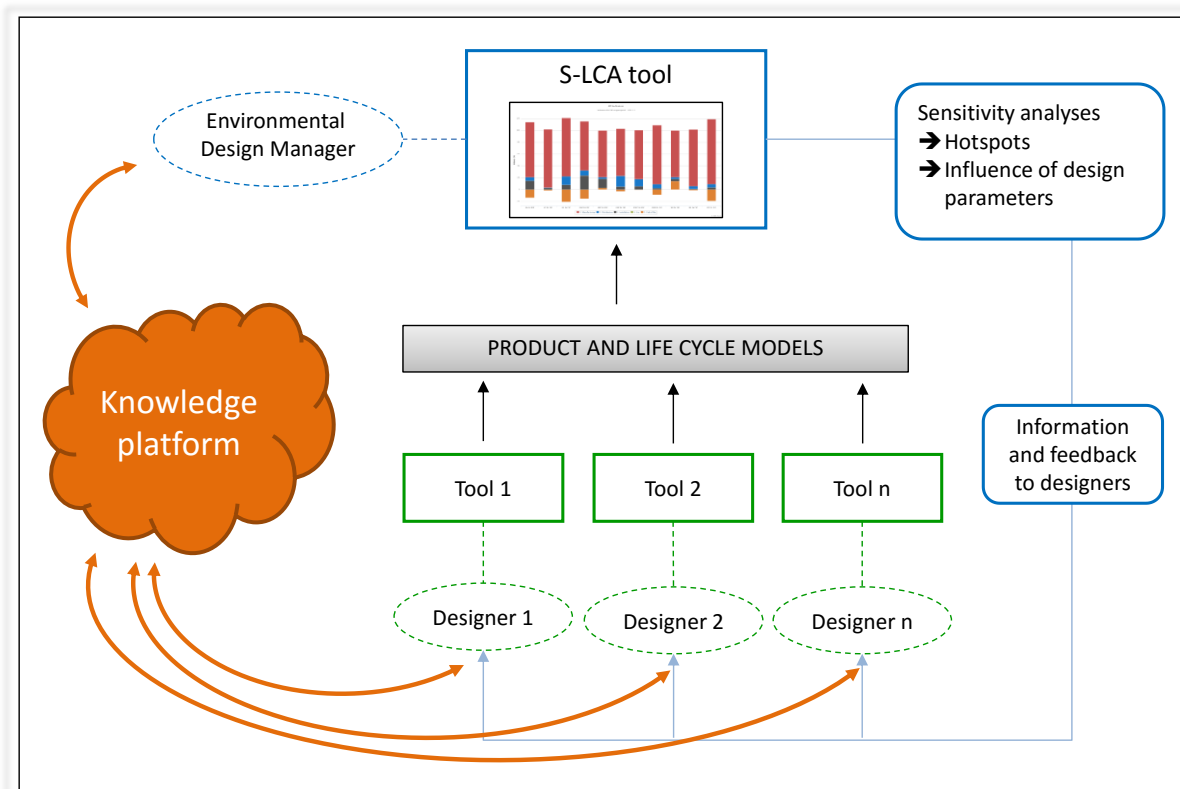

Figure 71: Framework for a knowledge-sharing platform

Educational perspective for ecodesign

Vallet showed the importance of training the future design engineers on ecodesign (Vallet 2012). Ilgin and Gupta concluded that:

“With stricter environmental regulations and increased environmental awareness in society, firms must educate their employees in environmental aspects of manufacturing to increase their competitive edge. Moreover, Environmentally Conscious Manufacturing principles should be incorporated into engineering curriculums at universities.” (Ilgin & Gupta 2010)

Our experience of training students in engineering school leads us to the same observation. We gave ecodesign classes in integrated design training modules. These courses aimed at making students aware of the different viewpoints and we talked about the integration of environmental issues. We observed that students prefer to practice in order to better understand and learn the concepts. Our experience of training industrial people to ecodesign showed us the same thing.

The workshop realized during the Design conference 2014 was based on a serious game based on a real case study. According to the participants’ feedbacks, this game could be really suited to educational purposes both in universities to teach ecodesign to students and in industry to illustrate what ecodesign on a product is.

We think that this serious game could be a good way to train people from both universities and industries. Moreover this approach combined to the use of a software platform could provide an illustration of what ecodesign should be in companies.

Circular economy

The linear approach, ‘Take, Make, Dispose’, meets its limits today due to natural resources depletion. This has a direct influence on industry:

“Recently, many companies have also begun to notice that this linear system increases their exposure to risks, most notably higher resource prices and supply disruptions.” (Ellen MacArthur Foundation 2012)

A new economic model is thus needed to face these statements. Some businesses have already started to change their approaches in reusing or recycling products or their components, in producing energy efficiency products, in promoting renewables energy, etc. This ‘circular’ concept must be deepened to meet the challenges that lie ahead.

A circular economy aims to undertake a paradigm shift from a linear economy by avoiding resources wastes and limiting environmental impact, and by enhancing resource use efficiency at every stage of products economy. In 2012, the European Commission published

a “Manifesto for a resource-efficient Europe”. The memo deals with the necessary transition to a circular economy model:

*“In a world with growing pressures on resources and the environment, the EU has no choice but to go for the transition to a resource-efficient and ultimately regenerative circular economy.”*¹³

A circular economy reduces the consumption of natural resources by reusing these resources in a continuous loop. Therefore, besides ecodesign, companies will need new means of action in order to consider circular economy approaches in their design process. This thesis proposal is valid in the framework of a routine design process but it will certainly assist the product development in a transition towards circular models. The structure of the platform will be suitable either if some adaptations or additional tools will be necessary to manage the circular approach.

¹³ Manifesto for a Resource Efficient Europe. Memo of the European Commission. 2012.

References

- Alhomsy, H., 2012. *Intégration de règles “DfE” (Design for Environment) pour la conception de produits, process et cycles de vie propres*. PhD Thesis, Université de Grenoble.
- Altshuller, G., 1996. *And Suddenly the Inventor Appeared: TRIZ, the Theory of Inventive Problem Solving*, Technical Innovation Center, Inc, Worcester.
- Asquin, A., Garel, G. & Picq, T., 2010. When project-based management causes distress at work. *International Journal of Project Management*, 28(2), pp.166–172.
- Baouch, Y. et al., 2014. Identifying the Requirements for a Knowledge-sharing Platform in Ecodesign. In *Proceedings of the 24th CIRP Design Conference*. Milan, Italy, pp. 427–431.
- Baumann, H., Boons, F. & Bragd, A., 2002. Mapping the green product development field: engineering, policy and business perspectives. *Journal of Cleaner Production*, 10(5), pp.409–425.
- Bhamra, T. & Lofthouse, V., 2007. *Design for Sustainability: A Practical Approach*, Gower Publishing, Ltd.
- Bhamra, T.A. et al., 1999. Integrating Environmental Decisions into the Product Development Process: Part 1 The Early Stages. In *EcoDesign '99: First International Symposium On Environmentally Conscious Design and Inverse Manufacturing*. Tokyo, Japan, pp. 329–333.
- Blessing, L.T.M. & Chakrabarti, A., 2009. *DRM, a Design Research Methodology*, London: Springer London.
- Blondaz, L., 1999. *Prise en compte de la fabricabilité, en conception intégrée de produits mécaniques*. PhD Thesis, Université Joseph Fourier, Grenoble.
- Boks, C., 2006. The soft side of ecodesign. *Journal of Cleaner Production*, 14(15–16), pp.1346–1356.
- Bovea, M.D. & Pérez-Belis, V., 2012. A taxonomy of ecodesign tools for integrating environmental requirements into the product design process. *Journal of Cleaner Production*, 20(1), pp.61–71.
- Bovea, M.D. & Wang, B., 2007. Redesign methodology for developing environmentally conscious products. *International Journal of Production Research*, 45(18-19), pp.4057–4072.
- Brezet, H., Van Hemel, C. & Böttcher, H., 1997. *Ecodesign: a promising approach to sustainable production and consumption*, Eds. Harriët Böttcher, and Robin Clarke. UNEP.

- Brissaud, D., 1992. *Système de conception automatique de gammes d'usinage pour les industries manufacturières*. PhD Thesis, Institut National Polytechnique de Grenoble.
- Brissaud, D. & Tichkiewitch, S., 2001. Product models for life-cycle. *CIRP Annals - Manufacturing Technology*, 50(1), pp.105–108.
- Brissaud, D. & Zwolinski, P., 2004. End-of-Life-Based Negotiation Throughout the Design Process. *CIRP Annals - Manufacturing Technology*, 53(1), pp.155–158.
- Cappelli, F., Delogu, M. & Pierini, M., 2006. Integration of LCA and EcoDesign guideline in a virtual CAD framework. In *Proceedings of the 13th CIRP International Conference on Life Cycle Engineering*. Leuven, Belgium, pp. 185–188.
- Chapa, E., 1997. *Outils et structure pour la coopération formelle et informelle dans un contexte de conception holonique*. PhD Thesis, Institut National Polytechnique de Grenoble.
- Choo, H.J. et al., 2004. DePlan: a tool for integrated design management. *Automation in Construction*, 13(3), pp.313–326.
- Cramer, J.M. & Stevels, A.L.N., 1997. Strategic environmental product planning within Philips sound & vision. *Environmental Quality Management*, 7(1), pp.91–102.
- Dassault Systèmes, D., 2011. *SolidWorks Sustainability data sheet*, http://www.solidworks.com/sw/docs/SW_Sustainability_2011.pdf.
- Deutz, P., McGuire, M. & Neighbour, G., 2013. Eco-design practice in the context of a structured design process: an interdisciplinary empirical study of UK manufacturers. *Journal of Cleaner Production*, 39, pp.117–128.
- Dewulf, W. & Duflou, J., 2004. The ecodesign knowledge system - Supporting ecodesign education as well as ecodesign knowledge management. In *Proceedings of DESIGN 2004, the 8th International Design Conference*. Dubrovnik, Croatia, pp. 1509 – 1514.
- Domingo, L., Evrard, D., et al., 2011. Synergico: a new “Design for Energy Efficiency” Method enhancing the Design of more environmentally friendly Electr(on)ic Equipments. In *Proceedings of the 18th CIRP International Conference on Life Cycle Engineering*. Braunschweig, Germany, p. pp 148–153.
- Domingo, L., Mathieux, F. & Brissaud, D., 2011. A new “in-use energy consumption” indicator for the design of energy-efficient electr(on)ics. *Journal of Engineering Design*, 23(3), pp.217–235.
- Ellen MacArthur Foundation, 2012. *Towards the Circular Economy 1: Economic and Business Rationale for an Accelerated Transition*, <http://www.ellenmacarthurfoundation.org/business/reports>.
- Etienne, A. et al., 2011. Specifications and development of interoperability solution dedicated to multiple expertise collaboration in a design framework. *International Journal of Product Lifecycle Management*, 5(2 - 4).

- Fargnoli, M. & Kimura, F., 2007. The Optimization of the Design Process for an Effective Use in Eco-Design. *Advances in Life Cycle Engineering for Sustainable Manufacturing Businesses*, 5, pp.59–64.
- Favi, C. et al., 2012. Innovative software platform for eco-design of efficient electric motors. *Journal of Cleaner Production*, 37, pp.125–134.
- Favre, J.-M., Estublier, J. & Blay-Fornarino, M., 2006. *L'ingénierie dirigée par les modèles : au-delà du MDA*, Hermes Science publications.
- Fine, L., Remondini, L. & Leon, J.-C., 2000. Automated generation of FEA models through idealization operators. *International Journal for Numerical Methods in Engineering*, 49(1-2), pp.83–108.
- Gaha, R., Yannou, B. & Benamara, A., 2014. A new eco-design approach on CAD systems. *International Journal of Precision Engineering and Manufacturing*, 15(7), pp.1443–1451.
- Gehin, A., Zwolinski, P. & Brissaud, D., 2009. Integrated design of product lifecycles—The fridge case study. In *CIRP Journal of Manufacturing Science and Technology*. pp. 214–220.
- Germani, M., Mandolini, M., et al., 2013. A Case-Based Reasoning Approach to Support the Application of the Eco-Design Guidelines. In A. Y. C. Nee, B. Song, & S.-K. Ong, eds. *Proceedings of the 20th CIRP International Conference on Life Cycle Engineering*. Singapore: Springer Singapore, pp. 81–86.
- Germani, M., Dufrene, M., et al., 2013. Integrated Software Platform for Green Engineering Design and Product Sustainability. In *Proceedings of the 20th CIRP International Conference on Life Cycle Engineering, Singapore 17-19 April, 2013*. Singapore, pp. 87–92.
- Gondran, N., 2001. *Système de diffusion d'information pour encourager les PME-PMI à améliorer leurs performances environnementales*. PhD Thesis, INSA Lyon & Ecole des Mines Saint Etienne.
- Gottberg, A. et al., 2006. Producer responsibility, waste minimisation and the WEEE Directive: case studies in eco-design from the European lighting sector. *The Science of the total environment*, 359(1-3), pp.38–56.
- Gorauskiene, I. & Varžinskas, V., 2006. Eco-design Methodology for Electrical and Electronic Equipment Industry. *journal of Environmental research, engineering and management*, 3(37), pp.43–51.
- Hauschild, M., Wenzel, H. & Alting, L., 1999. Life Cycle Design – a Route to the Sustainable Industrial Cultur? *CIRP Annals - Manufacturing Technology*, 48(1), pp.393–396.
- Hauschild, M.Z., Jeswiet, J. & Alting, L., 2004. Design for Environment — Do We Get the Focus Right? *CIRP Annals - Manufacturing Technology*, 53(1), pp.1–4.

- Haveman, M. & Dorfman, M., 1999. Breaking down the “Green Wall” (part one): Early efforts at integrating business and environment at SC Johnson. *Corporate Environmental Strategy*, 6(1), pp.5–13.
- Van Hemel, C. & Cramer, J., 2002. Barriers and stimuli for ecodesign in SMEs. *Journal of Cleaner Production*, 10(5), pp.439–453.
- Hernandez Pardo, R.J. et al., 2011. Contribution to the characterisation of eco-design projects. *International Journal of Sustainable Engineering*, 4(4), pp.301–312.
- Howell, K.E., 2014. *An Introduction to the Philosophy of Methodology*, London: SAGE Publications Ltd.
- Hunkeler, D. & Rebitzer, G., 2003. Life Cycle costing — paving the road to sustainable development? *The International Journal of Life Cycle Assessment*, 8(2), pp.109–110.
- Ilgin, M.A. & Gupta, S.M., 2010. Environmentally conscious manufacturing and product recovery (ECMPRO): A review of the state of the art. *Journal of environmental management*, 91(3), pp.563–91.
- Ishii, K., 1993. Modeling of Concurrent Engineering Design. In A. Kusiak, ed. *Concurrent Engineering, Automation, Tools and Techniques*. Wiley inter-science publication.
- ISO 14062, 2002. ISO/TR 14062. Environmental management – integrating environmental aspects into product design and development; 2002.
- ISO 14258, 1998. ISO 14258 Systèmes d’automatisation industrielle -- Concepts et règles pour modèles d’entreprise.
- Jacqueson, L., 2002. *Intégration de l’environnement en entreprise : proposition d’un outil de pilotage du processus de création de connaissances environnementales*. PhD Thesis, ENSAM, Paris.
- Janin, M., 2000. *Démarche d’éco-conception en entreprise Un enjeu : construire la cohérence entre outils et processus*. PhD Thesis, ENSAM Chambéry, France.
- Jansen, A.J. & Stevels, A.L.N., 1998. the E-Pass Method, a systematic approach for Env. Product Assessment. In *CARE Innovation Conference*. Vienna, Austria.
- Janthong, N., Brissaud, D. & Butdee, S., 2010. Combining axiomatic design and case-based reasoning in an innovative design methodology of mechatronics products. *CIRP Journal of Manufacturing Science and Technology*, 2(4), pp.226–239.
- Johansson, G., 2002. Success factors for integration of ecodesign in product development: A review of state of the art. *Environmental Management and Health*, 13(1), pp.98–107.
- Karlsson, R. & Luttrupp, C., 2006. EcoDesign: what’s happening? An overview of the subject area of EcoDesign and of the papers in this special issue. *Journal of Cleaner Production*, 14(15-16), pp.1291–1298.

- Kloepffer, W., 2008. Life Cycle Sustainability Assessment of Products. *International Journal of Life Cycle Assessment*, 13(2), pp.89–95.
- Knight, P. & Jenkins, J.O., 2009. Adopting and applying eco-design techniques: a practitioners perspective. *Journal of Cleaner Production*, 17(5), pp.549–558.
- Kobayashi, H., 2006. A systematic approach to eco-innovative product design based on life cycle planning. *Advanced Engineering Informatics*, 20(2), pp.113–125.
- Kolodner, J., 1993. *Case-Based Reasoning*, Morgan Kaufmann Publishers.
- Lagerstedt, J., 2003. *Functional and environmental factors in early phases of product development - Eco functional matrix*. Maskinkonstruktion.
- Lenox, M., Jordan, B. & Ehrenfeld, J., 1996. The Diffusion of Design for Environment : A Survey of Current Practice. In *Proceedings of the 1996 IEEE International Symposium on Electronics and the Environment*. Dallas, USA.
- Lindahl, M., 2005. Designers' Utilization of and Requirements on Design for Environment (DfE) Methods and Tools. In *Eco Design 2005: Fourth International Symposium on Environmentally Conscious Design and Inverse Manufacturing*. Tokyo, Japan, pp. 224 – 231.
- Lindahl, M., 1999. E-FMEA-a new promising tool for efficient design for environment. In *EcoDesign '99: First International Symposium On Environmentally Conscious Design and Inverse Manufacturing*. Tokyo, Japan: IEEE, pp. 734–739.
- Lindahl, M., 2006. Engineering designers' experience of design for environment methods and tools – Requirement definitions from an interview study. *Journal of Cleaner Production*, 14(5), pp.487–496.
- Lofthouse, V., 2006a. Ecodesign tools for designers: defining the requirements. *Journal of Cleaner Production*, 14(15–16), pp.1386–1395.
- Lofthouse, V., 2006b. Ecodesign tools for designers: defining the requirements. *Journal of Cleaner Production*, 14(15-16), pp.1386–1395.
- Luttrupp, C. & Lagerstedt, J., 2006. EcoDesign and The Ten Golden Rules: generic advice for merging environmental aspects into product development. *Journal of Cleaner Production*, 14(15-16), pp.1396–1408.
- Masui, K., Sakao, T. & Inaba, A., 2001. Quality function deployment for environment: QFDE (1st report)-a methodology in early stage of DfE. In *EcoDesign 2001: Second International Symposium on Environmentally Conscious Design and Inverse Manufacturing*. Tokyo, Japan: IEEE, pp. 852–857.
- Mathieux, F. et al., 2007. Connecting CAD and PLM Systems With Ecodesign Software: Current Experiences and Future Opportunities. In *ICED07: 16th International Conference of Engineering Design*. Paris.

- Mathieux, F., Froelich, D. & Moszkowicz, P., 2008. ReSICLED: a new recovery-conscious design method for complex products based on a multicriteria assessment of the recoverability. *Journal of Cleaner Production*, 16(3), pp.277–298.
- Millet, D. et al., 2007. Does the potential of the use of LCA match the design team needs? *Journal of Cleaner Production*, 15(4), pp.335–346.
- Millet, D. et al., 2003. *Intégration de l'environnement en conception*. Ed. Hermes., Paris.
- Morbidoni, A. et al., 2012. Environmental evaluation from cradle to grave with CAD-integrated LCA tools. In *Acta Technica Corvininensis - Bulletin of Engineering; Jan-Mar 2012, Vol. 5(1), p109*.
- Navarro, G. et al., 2005. Ecodesign Function and Form. Classification of Ecodesign Tools According to Their Functional Aspects. In *ICED 05: 15th International Conference on Engineering Design: Engineering Design and the Global Economy*. pp. 1–15.
- Noël, F. & Roucoules, L., 2008. The PPO design model with respect to digital enterprise technologies among product life cycle. *International Journal of Computer Integrated Manufacturing*, 21(2), pp.139–145.
- Nonaka, I., Toyama, R. & Konno, N., 2000. SECI, Ba and Leadership: a Unified Model of Dynamic Knowledge Creation. *Long Range Planning*, 33(1), pp.5–34.
- Papanek, V.J., 1984. *Design for the Real World: Human Ecology and Social Change*, Chicago: Academy Chicago Publishers.
- Paviot, T., 2010. *Méthodologie de résolution des problèmes d'interopérabilité dans le domaine du Product Lifecycle Management*. Ph.D Thesis, Ecole Centrale Paris.
- Pigosso, D. & Sousa, S., 2011. Life Cycle Assessment (LCA): Discussion on Full-Scale and Simplified Assessments to Support the Product Development Process. *3rd International workshop on advances in cleaner production: Cleaner production initiatives and challenges for a sustainable world*.
- Pigosso, D.C.A., Rozenfeld, H. & McAloone, T.C., 2013. Ecodesign maturity model: a management framework to support ecodesign implementation into manufacturing companies. *Journal of Cleaner Production*, 59, pp.160–173.
- Platcheck, E.R. et al., 2008. Methodology of ecodesign for the development of more sustainable electro-electronic equipments. *Journal of Cleaner Production*, 16(1), pp.75–86.
- Le Pochat, S., 2005. *Intégration de l'éco-conception dans les PME: Proposition d'une méthode d'appropriation de savoir-faire pour la conception environnementale des produits*. PhD Thesis, ENSAM Chambéry.
- Le Pochat, S., Bertoluci, G. & Froelich, D., 2007. Integrating ecodesign by conducting changes in SMEs. *Journal of Cleaner Production*, 15(7), pp.671–680.

- Poole, S. et al., 1999. Integrating Environmental Decisions into the Product Development Process : Part 2 The Later Stages. In *EcoDesign '99: First International Symposium On Environmentally Conscious Design and Inverse Manufacturing*. Tokyo, Japan, pp. 334–337.
- Poveda, O., 2001. *Pilotage technique des projets d'ingénierie simultanée, modélisation des processus, analyse et instrumentation*. PhD Thesis, Institut National Polytechnique, Grenoble.
- Prudhomme, G., 1999. *Le processus de conception mécanique et son enseignement*. PhD Thesis, Université Joseph Fourier, Grenoble.
- Ramani, K. et al., 2010. Integrated Sustainable Life Cycle Design: A Review. *Journal of Mechanical Design*, 132(9), pp.091004–15.
- Rejneri, N., 2000. *Détermination et simulation des opérations d'assemblage lors de la conception de systèmes mécaniques*. PhD Thesis, Institut National Polytechnique de Grenoble.
- Rio, M., 2012. *A l'interface de l'ingénierie et de l'analyse environnementale, fédération pour une éco-conception proactive*. PhD Thesis, Université de Technologie de Troyes.
- Rio, M., Reyes, T. & Roucoules, L., 2013. Toward proactive (eco)design process: modeling information transformations among designers activities. *Journal of Cleaner Production*, 39, pp.105–116.
- Robin, V., 2005. *Evaluation de la performance des systèmes de conception pour la conduite de l'ingénierie des produits ; prototype logiciel d'aide aux acteurs*. PhD Thesis, Université Bordeaux I.
- Roucoules, L. & Tichkiewitch, S., 2000. CoDE: A Cooperative Design Environment-- A New Generation of CAD Systems. *Concurrent Engineering*, 8(4), pp.263–280.
- Sakai, T. & Takata, S., 2012. Reconfiguration management of remanufactured products for responding to varied user needs. *CIRP Annals - Manufacturing Technology*, 61(1), pp.21–26.
- Sarkis, J., 2003. A strategic decision framework for green supply chain management. *Journal of Cleaner Production*, 11(4), pp.397–409.
- Schank, R.C. & Abelson, R.P., 1977. *Scripts, Plans, Goals, and Understanding: An Inquiry Into Human Knowledge Structures*, Lawrence Erlbaum Associated, Hillsdale N.J.
- Shelton, R.D. & Shopley, J.B., 1997. Beyond the Green Wall: Rethinking the Environment for Business Advantage. *Greener Management International*, (15), p.53.
- Sherwin, C., 2004. Design and sustainability. *The Journal of Sustainable Product Design*, 4(1-4), pp.21–31.

- Sherwin, C. & Bhamra, T., 2001. Early Ecodesign Integration. Experiences from a Single Case. *Journal of Design Research*, 1(2).
- Simon, M. et al., 2000. Environmental priorities in strategic product development. *Business Strategy and the Environment*, 9(6), pp.367–377.
- Sohlenius, G., 1992. Concurrent Engineering. *CIRP Annals - Manufacturing Technology*, 41(2), pp.645–655.
- Stevens, A., 2001. Application of EcoDesign: ten years of dynamic development. In *Proceedings Second International Symposium on Environmentally Conscious Design and Inverse Manufacturing*. Tokyo, Japan: IEEE Comput. Soc, pp. 905–915.
- Sutherland, J.W., Jenkins, T.L. & Haapala, K.R., 2010. Development of a cost model and its application in determining optimal size of a diesel engine remanufacturing facility. *CIRP Annals - Manufacturing Technology*, 59(1), pp.49–52.
- Swarr, T.E. et al., 2011. Environmental life-cycle costing: a code of practice. *The International Journal of Life Cycle Assessment*, 16(5), pp.389–391.
- Tang, D. et al., 2000. Re-engineering of the design process for concurrent engineering. *Computers & Industrial Engineering*, 38(4), pp.479–491.
- Teulon, H. & Canaguier, B., 2012. Seeds4Green - Free collaborative internet platform for LCA studies. *Electronics Goes Green 2012+ (EGG)*, pp.1–4.
- Theret, J.-P., Zwolinski, P. & Mathieux, F., 2011. Integrating CAD, PLM and LCA: a new architecture & integration proposal. In *International Conference on Renewable Energy and Eco-Design in Electrical Engineering*. Lille, France, pp. 1–6.
- Tichkiewitch, S., 1996. Specification on integrated design methodology using a multi - view product model. In *ESDA Proceeding of the 1996 System Design and Analysis Conference, PD-Vol 80*.
- Tichkiewitch, S. & Brissaud, D., 2003. *Methods and tools for co-operative and integrated design*, Springer.
- Tichkiewitch, S., Radulescu, B. & Drăgoi, G., 2008. Mechatronic Co-Operative Design Modeller (MECA-CoDeMo) – A tool for the development of mechatronic products. *The Romanian Review Precision Mechanics, Optics & Mechatronics*, 18(33), pp.55–59.
- Umeda, Y. et al., 2012. Toward integrated product and process life cycle planning—An environmental perspective. *CIRP Annals - Manufacturing Technology*, 61(2), pp.681–702.
- UNEP, 2011. *Towards a Life Cycle Sustainability Assessment: Making informed choices on products*,

- Vallet, F., 2012. *Caractérisation des bonnes pratiques en éco-conception pour la formation des ingénieurs-concepteurs : synthèse des dimensions, méthodes, activités et outils*. PhD Thesis, Université de Technologie de Compiègne.
- Vezzoli, C. & Sciama, D., 2006. Life Cycle Design: from general methods to product type specific guidelines and checklists: a method adopted to develop a set of guidelines/checklist handbook for the eco-efficient design of NECTA vending machines. *Journal of Cleaner Production*, 14(15-16), pp.1319–1325.
- White, C. et al., 2008. *Aligned for Sustainable Design: An A-B-C-D Approach to Making Better Products*,
- Van Wijk, D., 2011. *Contribution à l'amélioration de la collaboration PLM dans la chaîne de sous-traitance aéronautique*. PhD Thesis, Université de Technologie de Troyes.
- Wimmer, W., Züst, R. & Ch, S., 2002. The Application of the ECODESIGN PILOT and Methodical Support for the Implementation of ECODESIGN in Products. In *Proceedings of the 7th International Design Conference*. Dubrovnik, Croatia, pp. 1357–1364.
- Yang, C.J. & Chen, J.L., 2011. Accelerating preliminary eco-innovation design for products that integrates case-based reasoning and TRIZ method. *Journal of Cleaner Production*, 19(9-10), pp.998–1006.
- Zhang, Y., Wang & Zhang, 1999. Green QFD-II: A life cycle approach for environmentally conscious manufacturing by integrating LCA and LCC into QFD matrices. *International Journal of Production Research*, 37(5), pp.1075–1091.
- Zwolinski, P., 1999. *La simulation de l'activité comme outil d'aide à la conception et à l'innovation : application à la conception du poste de conduite des TGV futurs*. PhD Thesis, Institut National Polytechnique de Lorraine.
- Zwolinski, P., Lopez-Ontiveros, M.-A. & Brissaud, D., 2006. Integrated design of remanufacturable products based on product profiles. *Journal of Cleaner Production*, 14(15-16), pp.1333–1345.
- Zwolinski, P., Prudhomme, G. & Brissaud, D., 2004. Environment and Design. Toward Methods and Tools for Integration and Co-operation. In *Methods and tools for cooperative and integrated design*, Kluwer Academic Publishers. Springer Netherlands, pp. 223–232.

Résumé en français

Note : Le résumé en français ne donne qu'un aperçu de la thèse. Pour plus de précisions, merci de se référer au document en anglais.

INTRODUCTION

La lutte contre l'épuisement des ressources naturelles et le changement climatique est un enjeu majeur de ce siècle. Dans son quatrième rapport d'évaluation, le Groupe Intergouvernemental d'Experts sur le Climat (GIEC) a indiqué que les scientifiques étaient certains à plus de 90% que les émissions de gaz à effet de serre produites par les activités humaines étaient en majeure partie responsables du réchauffement climatique. Le secteur industriel et notamment les industries manufacturières y jouent un rôle fondamental.

Les approches telles que la conception pour l'environnement ou l'éco-conception, qui prônent l'intégration systématique des considérations environnementales dans la conception de produits, sont proposées dans la littérature comme des solutions potentielles. Nos recherches se positionnent dans le domaine de l'éco-conception de produits.

L'éco-conception a un rôle majeur à jouer dans la réduction des impacts environnementaux des produits. En effet, la phase de conception est primordiale car il est estimé que 80% des impacts environnementaux d'un produit sont prédéfinis lors de sa phase de conception. Des moyens d'actions sont nécessaires pour aider les entreprises et notamment les concepteurs dans cette démarche d'éco-conception. Un grand nombre d'outils et de méthodes d'éco-conception ont été développés pour aider les concepteurs à toutes les étapes du processus de développement de produits (Navarro et al. 2005). Cependant leur utilisation est encore limitée (Lindahl 2005) et différentes causes peuvent l'expliquer. Certains de ces outils, en raison des connaissances qu'ils requièrent, sont dédiés à des experts (Le Pochat et al. 2007). Il existe un manque d'informations sur la manière de les utiliser (Fagnoli & Kimura 2007). De plus, la compatibilité entre les outils n'est pas garantie (Le Pochat et al. 2007). Par conséquent, ces outils ont une pénétration très limitée en industrie.

Le challenge réside donc plus dans l'intégration des outils existants et dans une réelle implémentation de l'éco-conception dans le processus de conception que dans le développement de nouveaux outils. C'est pourquoi nous nous sommes intéressés au domaine de la conception intégrée. La conception intégrée supporte l'intégration des différents points de vue d'experts (Tichkiewitch & Brissaud 2003). Ces points de vue sont la vision et l'expertise d'experts participants à des groupes de conception : ils doivent être considérés simultanément pour faire émerger la solution finale. L'éco-conception résulte alors de l'introduction d'une nouvelle perspective dans les équipes de conception intégrée : le point de vue environnemental. Cependant un manque de méthodes et d'outils d'intégration a été observé.

L'objectif de cette thèse n'est donc pas de développer un nouvel outil d'éco-conception mais de **proposer une solution pour favoriser l'éco-conception et donc l'intégration du point de vue environnemental**. L'objectif final est de prendre en compte les enjeux environnementaux dans une démarche de conception intégrée. Nous proposons pour cela une méthodologie d'éco-conception couplée à une plateforme logicielle pour assurer une cohérence entre les outils d'éco-conception. Nous décrivons la structure d'une telle plateforme

et nous analyserons son implémentation logicielle au sein du projet européen G.EN.ESI. Des expérimentations ont été menées pour la validation de l'approche proposée. La thèse se conclut avec un résumé des contributions et des perspectives.

CONTEXTE ET ETAT DE L'ART

1. L'éco-conception et ses spécificités

La première section a pour objectif de définir ce qu'est l'éco-conception et de mettre en avant les spécificités de son adoption en entreprise.

1.1. Définition de l'éco-conception

La norme ISO/TR 14062 définit l'écoconception comme « l'intégration des aspects environnementaux dans la conception et le développement de produit ». On trouve dans la littérature beaucoup de termes répondant à cette définition, et notamment : le développement environnemental de produits (Baumann et al. 2002), la conception verte, l'éco-conception (van Hemel & Cramer 2002; Gottberg et al. 2006), la conception environnementale, la conception pour l'environnement (Lenox et al. 1996), la conception du cycle de vie (Vezzoli & Sciama 2006), et la conception durable (Ramani et al. 2010).

Selon les auteurs, la définition donnée par la norme ISO/TR 14062 est agrémentée d'une caractéristique ou d'un point de vue spécifique. Hauschild et al (Hauschild et al. 2004) ajoute la notion d'amélioration de la performance environnementale du produit. Van Hemel and Cramer (van Hemel & Cramer 2002) expriment cette notion mais la complètent avec la notion de pensée cycle de vie. D'autres auteurs tels que Johansson insistent sur le fait que l'intégration des considérations environnementales doit se faire sans compromettre les exigences traditionnelles de conception comme la performance ou le coût : *"The term ecodesign refers to actions taken in product development aimed at minimising a product's environmental impact during its whole life cycle, without compromising other essential product criteria such as performance and cost"* (Johansson 2002). Cependant l'éco-conception ne se réduit pas à des activités de conception du bureau d'études mais est plutôt incluse dans une démarche plus globale de management (Pigosso & Sousa 2011).

De nombreuses définitions existent donc pour l'éco-conception et nous allons développer ses principaux concepts dans la partie suivante.

1.2. Les principes de base de l'éco-conception

Selon Bovea et Pérez-Belis, trois facteurs clés sont requis pour optimiser le processus de conception en termes de performance environnementale (Bovea & Pérez-Belis 2012) :

- Une intégration au plus tôt et tout au long du processus de conception,
- La prise en compte du cycle de vie du produit,
- La prise en compte d'une approche multicritère.

La fonctionnalité du produit est également un paramètre important à prendre en compte en éco-conception. Ces quatre facteurs sont détaillés dans les paragraphes suivants.

Une intégration au plus tôt et tout au long du processus de conception

L'intégration des aspects environnementaux dès les premières étapes de conception du produit est nécessaire pour avoir la possibilité d'influencer la conception. En effet, au début, aucune décision n'a encore été prise et les concepteurs ont une large liberté d'actions sur la définition des produits (Luttrupp & Lagerstedt 2006). La connaissance du produit est encore faible mais cela offre une flexibilité nécessaire pour faire des changements et apporter des améliorations au produit (Bovea & Pérez-Belis 2012).

La prise en compte du cycle de vie du produit et d'une approche multicritère

La prise en compte du cycle de vie est un principe de base de l'éco-conception. Il faut donc considérer pendant le processus de conception et de développement du produit les aspects environnementaux pendant tout le cycle de vie du produit. La Figure 72 représente le cycle de vie du produit avec les étapes suivantes : extraction des matières premières, conception et production, emballage et distribution, utilisation et maintenance, et la fin de vie.

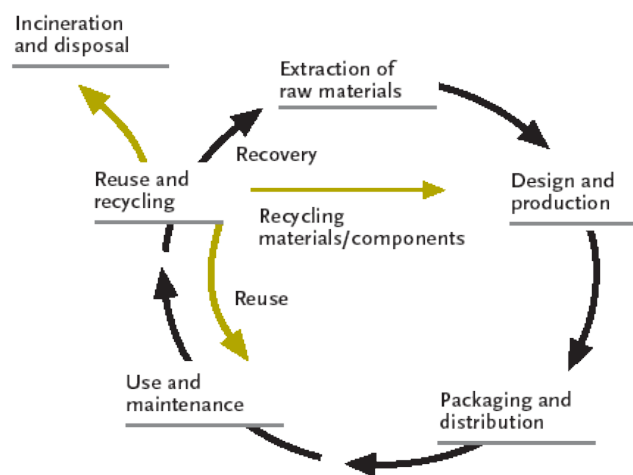

Figure 72: Product life cycle

Contrairement à une approche locale, une approche cycle de vie permet d'éviter les transferts d'impacts entre les phases du cycle de vie (Millet et al. 2003).

A chaque phase du cycle de vie, le produit génère des impacts environnementaux. Il existe une variété d'impacts qui ont des échelles temporelle et spatiale différentes. Une approche multicritère est donc requise pour éviter les transferts d'impacts entre les différentes échelles.

La fonctionnalité du produit

L'éco-conception d'un produit est très liée à sa fonctionnalité. En effet, la plupart des recherches dans ce domaine se focalise sur la manière de réduire les impacts environnementaux du produit sur tout son cycle de vie tout en gardant les mêmes

fonctionnalités (Lagerstedt 2003). L'objectif de l'éco-conception est donc de réduire et d'optimiser les ressources sans diminuer les performances du produit.

1.3. Les spécificités de l'intégration de l'éco-conception aux différents niveaux de l'entreprise

La mise en place de l'éco-conception présente différentes spécificités et implique certains changements résumés et présentés ci-dessous.

- Eviter le green wall,
- Le besoin d'un engagement au niveau stratégique de l'entreprise,
- La difficulté de la collecte des données environnementales,
- La gestion de nouvelles connaissances et compétences,
- La considération d'une vision élargie du produit.

Le « green wall »

Le « green wall » représente la séparation qu'on peut observer entre le service environnement ou éco-conception avec les autres entités de l'entreprise. Une double déconnexion est observée : une séparation avec tous les autres services de l'entreprise (Le Pochat 2005) mais aussi au sein même de l'équipe de conception (Millet et al. 2003). Dans sa thèse, Le Pochat met en avant le fait que les aspects environnementaux doivent être structurellement intégrés à tous les départements de l'entreprise.

Deux enjeux majeurs ressortent de ces observations. Premièrement, il est nécessaire de créer un réseau d'acteurs interne et externe à l'entreprise pour les impliquer dans les projets d'éco-conception. Deuxièmement, les relations entre l'acteur environnement et l'équipe de conception doivent être améliorées.

Un engagement au niveau stratégique de l'entreprise

L'engagement de l'ensemble de l'entreprise est nécessaire pour la prise en compte des aspects environnementaux mais l'implication de la direction de l'entreprise est particulièrement importante pour soutenir des initiatives et avoir un fil conducteur tout au long des différents projets.

Collecte des données environnementales

Dewulf et Duflou montrent que ce qui est difficile à propos de l'intégration de l'éco-conception, c'est la complexité et la quantité de nouvelles informations comprises dans les aspects environnementaux et qui s'ajoutent à un processus déjà lourd en informations (Dewulf & Duflou 2004). En effet, une large variété de données est nécessaire pour mener les évaluations environnementales et pour apporter des conseils pour l'amélioration des produits.

De plus, ces données vont provenir à la fois de l'intérieur et de l'extérieur de l'entreprise du fait de la considération du cycle de vie.

Cela implique de prendre des nouvelles décisions stratégiques qui vont affecter l'organisation de l'entreprise et ses relations avec clients et fournisseurs.

1.4. Les enjeux de l'intégration de l'éco-conception

La nature multidisciplinaire de l'éco-conception et l'importance de l'intégrer au plus tôt dans le processus de conception ont poussé beaucoup d'auteurs à élargir le champ de leurs recherches en s'intéressant à la structure organisationnelle de l'entreprise pour soutenir l'éco-conception (White et al. 2008; Johansson 2002). Le succès du développement de produit est depuis longtemps associé à une approche transdisciplinaire, à une bonne communication entre les départements et à la gestion de connaissances. Ce qui change avec l'introduction de nouveaux enjeux complexes, tels que les considérations environnementales, c'est l'importance de ces caractéristiques (White et al. 2008; Johansson 2002).

Nous avons vu la nécessité d'impliquer tous les services de l'entreprise et même si possible d'avoir une vision élargie de celle-ci en considérant l'ensemble de la chaîne logistique. Une analyse des méthodes et outils d'éco-conception a été réalisée. Lofthouse conclut que les outils doivent apporter inspiration, information, éducation et conseils (Lofthouse 2006b). Cet état de l'art a mis en avant les enjeux de l'intégration de l'éco-conception résumés en Figure 73.

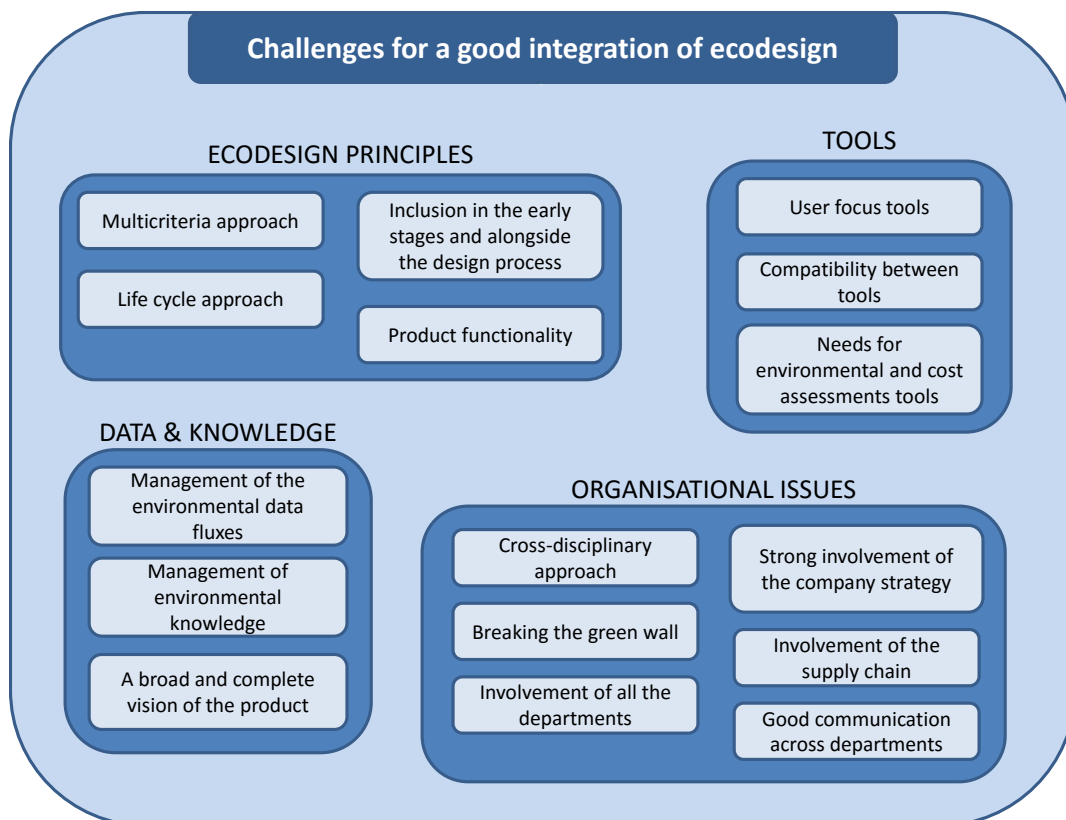

Figure 73: les enjeux de l'intégration de l'éco-conception

2. La conception intégrée pour répondre aux enjeux de l'éco-conception

Pour développer un produit, une équipe de concepteurs cherche à générer et évaluer des solutions permettant de satisfaire à la fois les exigences et les contraintes (Janthong et al. 2010). Le processus de conception consiste en une série d'actions réalisées par les différents acteurs de la conception. Chaque acteur a sa propre juridiction mais l'équipe travaille ensemble. Pour améliorer le travail des équipes, les entreprises mettent en place des processus de conception plus intégrés. Cette partie présente la conception intégrée et examine dans quelle mesure la conception intégrée peut-être répondre aux spécificités de l'intégration de l'éco-conception.

2.1. Définition de la conception intégrée

Dans une approche de conception intégrée, une équipe de conception a pour objectif d'intégrer les contraintes des différents domaines d'expertise au plus tôt dans le processus de conception. L'objectif est de mettre en place une approche orientée produit à la place d'une approche séquentielle. Le produit n'évolue plus à travers les actions successives des concepteurs, mais est plutôt central (Poveda 2001). Pour être capable de considérer tous les aspects du cycle de vie du produit, les concepteurs doivent comprendre les enjeux spécifiques relatifs au produit pour chacune des phases du cycle de vie. Ainsi les différents points de vue des acteurs du cycle de vie doivent être considérés ; un point de vue étant l'expression par un expert de ses connaissances, des contraintes liées à son domaine d'expertise et des objectifs spécifiques pour optimiser le produit.

2.2. La conception intégrée pour l'éco-conception

Dans quelle mesure la conception intégrée répond aux spécificités de l'intégration de l'éco-conception ?

Une approche de conception intégrée nécessite de réunir une équipe multidisciplinaire pour prendre en compte simultanément toutes les caractéristiques du cycle de vie. Tous les acteurs de cycle de vie sont donc impliqués dans le processus de conception. Dans cette configuration, on peut donc imaginer que l'expert environnement est partie prenante dans l'équipe de conception, ce qui permet d'éviter le « green wall », la séparation entre le service environnement et les autres services. De plus, la conception intégrée prône une meilleure communication entre les acteurs ce qui est essentiel pour la mise en place de l'éco-conception.

D'après la définition de l'éco-conception, on peut admettre que l'éco-conception se résume à l'introduction d'une nouvelle perspective dans l'équipe de conception : c'est le point de vue environnement. Cependant la particularité de ce point de vue est qu'il est transversal à tous les services de l'entreprise et a donc des conséquences dans tous les domaines.

Le chef de projet a donc un rôle clé pour gérer les contraintes des différents acteurs. De même la direction de l'entreprise a un rôle majeur pour diffuser une stratégie claire en matière d'environnement.

Le modèle produit inclus dans les logiciels de gestion du cycle de vie des produits (Product Life cycle management PLM) facilite la gestion des données. En effet si un lien peut être fait entre les logiciels d'analyse du cycle de vie (ACV) and les logiciels de PLM, cela faciliterait la collecte des données pour l'évaluation environnementale. Néanmoins, un lien automatique entre outils PLM et outils ACV n'est pas si évident et un système classique de PLM ne contient pas toutes les données nécessaires à la réalisation d'une ACV. Le modèle produit actuel doit donc évoluer vers un modèle complet du cycle de vie.

Le succès d'une approche de conception intégrée réside dans la capacité à fournir aux concepteurs des outils capables de soutenir la production de connaissances dans leurs domaines et de faire en sorte que cette connaissance soit directement utilisable dans les champs d'application des autres concepteurs. C'est un réel défi pour l'éco-conception au sens où sa mise en place va influencer directement les activités de nombreux acteurs.

Selon Le Pochat, les transformations suivantes doivent être opérées dans le processus de conception pour mettre en place l'éco-conception dans un environnement de conception intégrée (Le Pochat et al. 2007):

- L'utilisation de nouveaux outils
- La création de nouveaux indicateurs pour évaluer le produit en cours de conception d'un point de vue environnementale
- La création de nouvelles données
- La mise en place de nouvelles procédures pour permettre la prise en compte des contraintes environnementales dans le cahier des charges du produit.

La Figure 74 résume les enjeux de l'intégration de l'éco-conception auxquels une approche de conception intégrée peut répondre (cases mises en valeur en blanc).

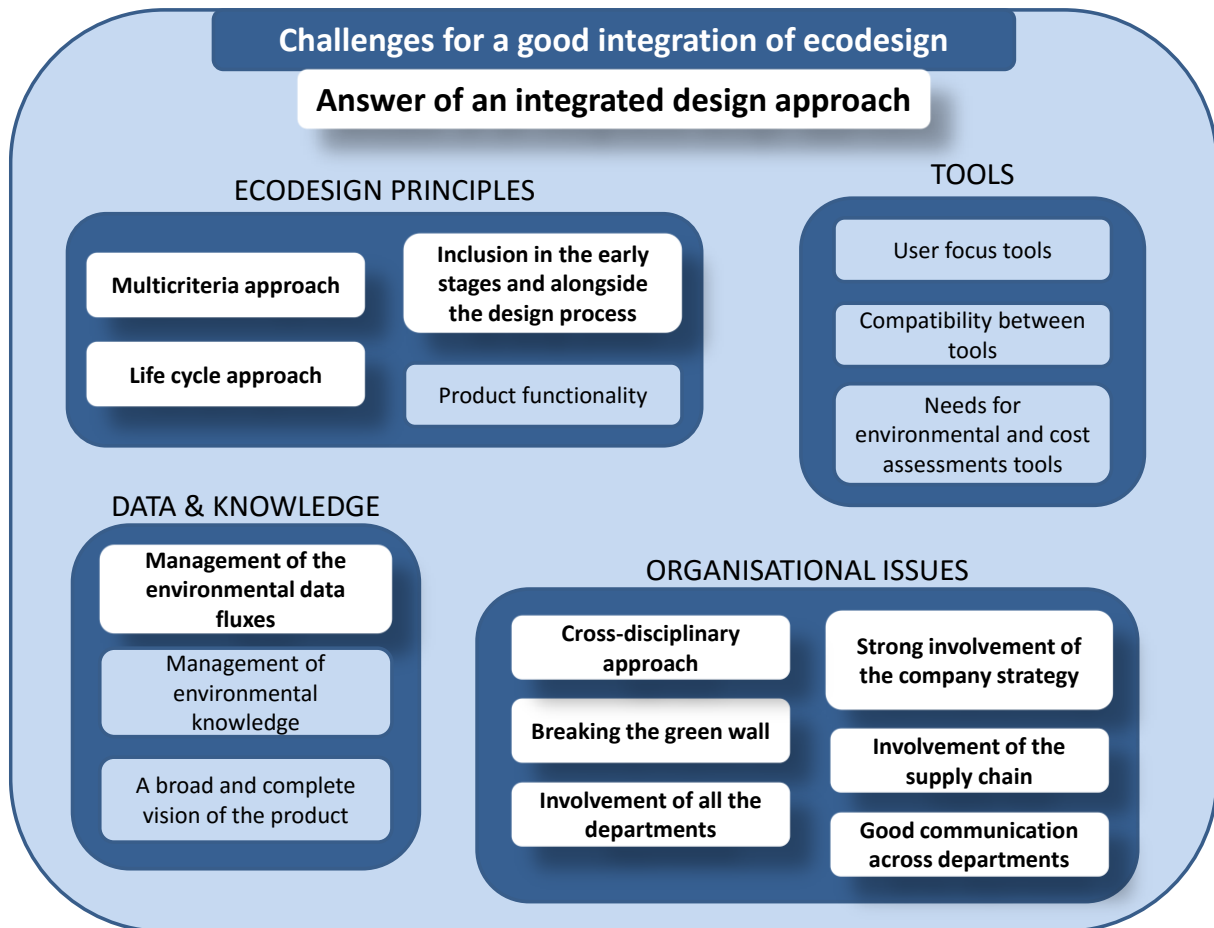

Figure 74: Les enjeux de l'intégration de l'éco-conception et réponse de la conception intégrée à certains de ces enjeux (en blanc)

Ainsi la conception intégrée peut être vue comme l'approche la plus adéquate pour atteindre les objectifs environnementaux et s'adapter aux spécificités de l'éco-conception. Mais il y a des limites. En effet, certains aspects comme la gestion des connaissances environnementales, ou les problèmes liés aux outils d'éco-conception ne peuvent être résolus directement par la conception intégrée. Un environnement commun à tous les acteurs est nécessaire pour gérer l'échange de connaissances et aider les gens à coopérer au sein de l'équipe de conception. La question est maintenant de savoir quelles sont les solutions pour combiner une approche intégrée avec les besoins de l'éco-conception.

3. Essais d'interopérabilité entre approches de conception intégrée et d'éco-conception

Une revue des méthodologies, des outils connectés et des plateformes d'éco-conception a été réalisée.

Conclusion de l'étude menée sur les méthodologies :

Une méthodologie d'éco-conception doit inclure les informations suivantes pour aider au mieux les entreprises et leurs équipes de conception :

- Des objectifs managériaux
- Des étapes pour réaliser l'implémentation
- Le séquençage des actions dans le processus de conception
- Des outils pour mener les actions.

Seules quelques méthodologies rassemblent toutes ces caractéristiques (ISO 14062 2002; Brezet et al. 1997; Pigosso et al. 2013). Cependant, même si elles considèrent tous ces aspects, il reste des zones d'ombre liées à leurs usages. En effet, il n'y a pas d'indications sur le rôle particulier des acteurs : quelles actions doivent-ils faire et à quels moments dans le processus de conception. De plus, certaines méthodologies recommandent des types d'outils spécifiques mais aucune d'entre elles, à notre connaissance, n'apportent une solution pour faciliter la collecte et la gestion des données et connaissances environnementales à chaque étape de la méthodologie, ni la connexion avec les outils traditionnels de conception.

Conclusion de l'étude menée sur les outils connectés et les plateformes :

Premièrement, la connexion entre les outils ACV et CAO (et/ou PLM) semble nécessaire pour obtenir automatiquement les données pour mener des ACV, gagner du temps et accompagner le projet de conception (Theret et al. 2011). Cette connexion permet de récupérer des données sur la structure du produit, sur les procédés et sur la phase de fabrication en générale. Cependant pour réaliser une ACV, il est nécessaire de recueillir des données sur toutes les phases du cycle de vie, c'est pourquoi une solution plus complète est requise (Mathieux et al. 2007).

De plus, les approches connectant les outils ACV et CAO sont dédiées aux technologues et s'il y en a un, à l'expert environnement mais elles n'impliquent pas toute l'équipe de conception et les aspects multidisciplinaires ne sont pas couverts.

D'autres auteurs, notamment (Mathieux et al. 2007; Theret et al. 2011; Favi et al. 2012), vont plus loin et ont développé des plateformes rassemblant différents types d'outils pour fournir aux utilisateurs un environnement de travail commun et complet. Cela permet à plusieurs acteurs d'interagir via la plate-forme. Cependant, on observe que certains aspects de l'éco-conception ne sont pas pris en compte.

D'autres types de plateformes, sous forme d'interfaces web telles que Sustainable Minds¹⁴, Seeds4Green¹⁵ ou P2I¹⁶, présentent des solutions d'éco-conception plus complète avec par exemple : un outil ACV, des guides d'éco-conception, des bases de données sur des cas existants, une estimation des coûts, etc. Ces plateformes mettent en avant le besoin de conseils des concepteurs pour améliorer les performances environnementales du produit. L'avantage de ces approches est l'accès facile sur le web ; l'inconvénient est qu'elles ne sont pas reliées aux autres outils classiques de conception et donc l'utilisateur doit entrer manuellement toutes les données.

¹⁴ Sustainable Minds: <http://www.sustainableminds.com/>, March 2015

¹⁵ Seeds4Green: <http://seeds4green.net/>, March 2015

¹⁶ P2I: <http://www.clustercreer.com>, March 2015

D'autres auteurs (Favi et al. 2012; Gaha et al. 2014) ont mis en avant l'importance de traduire les connaissances environnementales, principalement les résultats d'ACV aux concepteurs. Cet aspect doit être étudié pour améliorer l'efficacité du processus d'éco-conception.

Pour conclure, les solutions logicielles examinées ont permis de mettre en avant les besoins importants pour l'intégration de l'éco-conception mais nous n'avons pas trouvé de solution prenant en compte tous ces aspects.

4. Conclusion

Pour répondre aux besoins de l'éco-conception dans une approche de conception intégrée, les chercheurs ont développé différents types de solutions. Certains ont structuré des méthodologies qui présentent les étapes successives à réaliser pendant le processus de conception et d'autres se sont portés sur le développement de solutions logicielles pour interconnecter différents outils. Cette revue de la littérature nous a permis de lister les différents besoins, à la fois méthodologiques et logiciels, nécessaires pour construire une solution complète afin d'intégrer l'éco-conception dans le processus de conception. Les principaux besoins logiciels sont les suivants :

- Un environnement commun de travail (par exemple sous la forme d'une plate-forme).
- La connexion entre les outils classiques de conception, notamment entre un outil CAO et un outil ACV (via un système PLM ou un autre système de management des données).
- Une solution pour récupérer des données sur toutes les phases du cycle de vie.
- Un outil fournissant des conseils aux concepteurs pour les aider à améliorer les performances environnementales du produit.
- Un moyen pour traduire les résultats environnementaux aux concepteurs.

PROBLEMATIQUE

1. Problématique détaillée

Cette section a pour but de formuler la problématique à partir des observations que nous avons faites à propos de l'éco-conception et de son intégration dans le processus de conception. L'état de l'art réalisé a permis de soulever des enjeux et des manques. Notre question générale de recherche est :

Comment améliorer la prise en compte de l'éco-conception de produits en entreprise ?

Suite à la revue de la littérature, nous avons la problématique suivante :

Comment gérer tous les challenges de l'éco-conception dans un environnement de conception intégrée ?

Et plus particulièrement :

Comment soutenir l'intégration des activités d'éco-conception dans une équipe de conception sachant que de nombreuses expertises sont concernées par ces préoccupations environnementales ?

Quels sont les éléments clés nécessaires à une bonne intégration de l'éco-conception dans les équipes de conception ?

La section suivante résume les besoins à prendre à compte pour une bonne intégration de l'éco-conception dans une équipe de conception et dans le processus de conception de produits conformément à l'état de l'art.

2. Description des hypothèses de travail

D'après notre état de l'art, nous avons développé une hypothèse rassemblant en quatre points les besoins pour une meilleure intégration de l'éco-conception. Ces besoins sont liés :

- Aux rôles des acteurs : besoin d'un responsable éco-conception et de l'implication de tous les acteurs du cycle de vie du produit.
- A des outils pour la conception des produits et de leur cycle de vie.
- A des indicateurs et à un outil d'aide pour gérer les informations environnementales.
- A la gestion des données et des informations.

2.1. Le rôle des acteurs : implication de tous les acteurs du cycle de vie

Un des principes majeur de l'éco-conception est la considération du cycle de vie complet du produit. Par conséquent, chaque acteur du cycle de vie du produit a une influence sur le profil

environnemental du produit et peut contribuer dans son contexte et à son échelle à améliorer les performances environnementales du produit.

Par ailleurs pour gérer les questions environnementales en entreprise, nous pensons qu'il est nécessaire, au moins dans un premier temps, d'avoir une personne dédiée. Le responsable éco-conception doit être impliqué dans la stratégie de l'entreprise afin de prendre part aux décisions concernant la politique environnementale de celle-ci. Il doit également être au cœur de l'équipe de conception pour suivre et agir lors du processus de développement de produits.

2.2. Des outils pour la conception des produits et de leur cycle de vie

Dans la revue de la littérature, nous avons mis en avant le besoin d'outils spécifiques au cycle de vie du produit. Au moins un outil par phase du cycle de vie doit exister : extraction des matières premières, fabrication, distribution, utilisation et fin de vie. L'objectif est au minimum de pouvoir collecter les données pour l'analyse du cycle de vie mais ces outils peuvent être plus complets en proposant une optimisation des paramètres de conception pour chacune des phases.

Les outils classiques de conception et ces outils spécifiques doivent être connectés pour éviter de saisir des données qui existent déjà. Lier ces outils permet donc de construire un modèle produit ainsi qu'un modèle cycle de vie pour stocker toutes les données relatives au produit.

2.3. Des indicateurs et un outil d'aide pour gérer les informations environnementales

Les concepteurs sont encore actuellement trop peu formés à l'éco-conception. Des sessions de formation sont donc nécessaires ainsi qu'un outil de conseils permettant de gérer les connaissances environnementales afin d'aider les concepteurs pendant le processus de conception. Les règles et les guides d'éco-conception pourraient y être stockés.

Un module d'évaluation du produit est indispensable pour évaluer à la fois les performances environnementales du produit et son coût. Les indicateurs environnementaux doivent être considérés en même temps que les indicateurs traditionnels de conception pour répondre aux exigences du produit et faire les bons compromis. Il est donc nécessaire d'avoir un moyen de contrôler les indicateurs environnementaux.

2.4. La gestion des données et des informations

Les concepteurs vont augmenter les connaissances en éco-conception à chaque nouveau projet. Ces nouvelles connaissances doivent pouvoir être stockées pour être utilisées dans des projets futurs ou être disponibles pour d'autres concepteurs.

Réaliser une analyse de cycle de vie demande une grande quantité de données ; c'est pourquoi le module d'évaluation doit être lié au modèle cycle de vie du produit. Cela permet d'économiser du temps et des efforts aux concepteurs et au responsable éco-conception.

Les systèmes existants de bases de données de l'entreprise doivent être enrichis afin d'avoir des nouvelles bases de données pour stocker les modèles cycle de vie du produit, les règles d'éco-conception, les ACV des produits, les décisions prises dans les projets, etc.

Les fournisseurs doivent être impliqués dans la démarche d'éco-conception pour qu'ils puissent communiquer les informations nécessaires à l'ACV. Cela signifie qu'un véritable partenariat est créé entre l'entreprise et ses fournisseurs et ce partenariat implique la création d'un outil support pour permettre l'échange de données.

3. Conclusion

Nous avons identifié les différents besoins pour une bonne intégration de l'éco-conception. Nous décrivons dans le chapitre suivant les spécifications liées à une plateforme logicielle qui rassemble toutes les exigences mises en avant dans cette section. De plus, nous associons à cette plate-forme une méthodologie d'éco-conception décrivant les étapes nécessaires à une bonne intégration des préoccupations environnementales dans le processus de conception.

PROPOSITION

Ces recherches ont été menées dans le cadre du projet européen G.EN.ESI. Nous avons contribué à ce projet à travers le développement d'une méthodologie et les spécifications d'une plateforme pour intégrer les préoccupations environnementales dans les processus de conception. Une implémentation logicielle de cette plateforme a été développée dans ce projet par trois partenaires du consortium.

La première section décrit la structure de la plateforme et la seconde, la méthodologie. La troisième section présente l'implémentation logicielle de la plateforme dans le projet G .EN.ESI.

1. Structure de la plateforme proposée

Les éléments choisis pour soutenir la méthodologie et la plateforme sont d'abord présentés : les acteurs concernés, les outils d'aide à la gestion de projet, les outils pour réaliser les activités de conception et les flux d'informations environnementales. Les interactions entre les différents outils et les parties prenantes seront ensuite décrites en section 2 à travers la description de la méthodologie.

La Figure 75 représente les principaux outils de la plate-forme, leurs liens et les liens avec les acteurs.

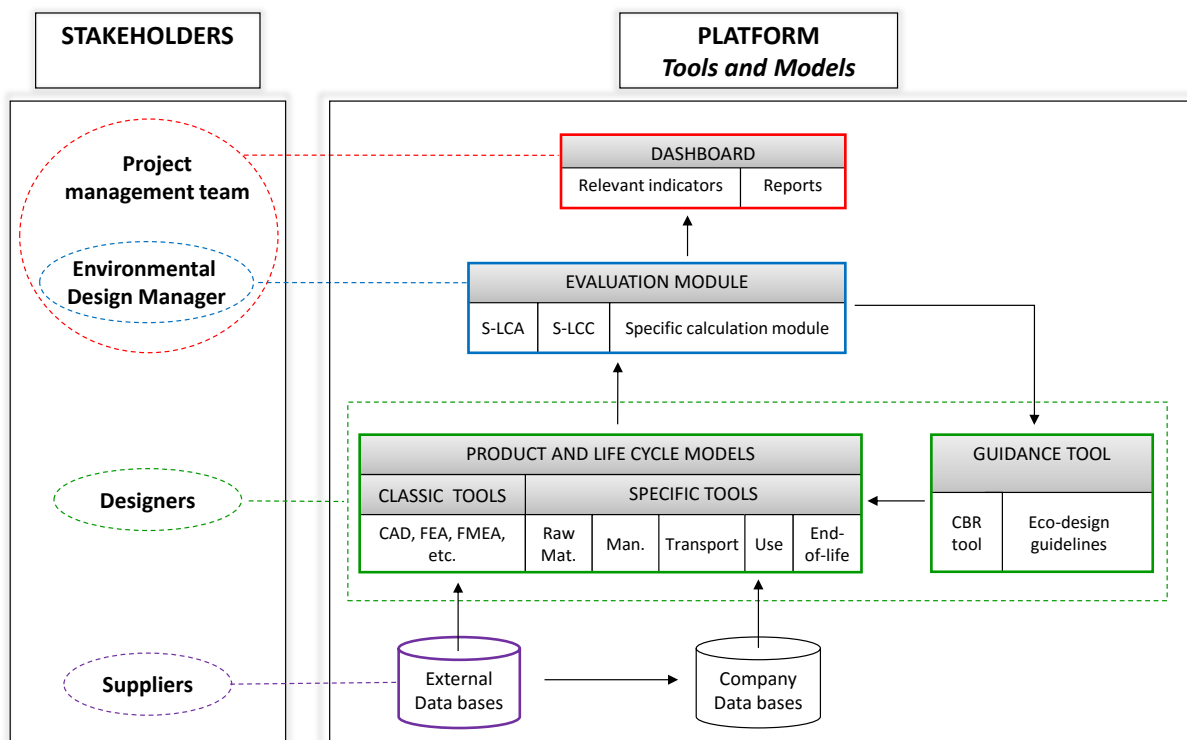

Figure 75: Structure de la plateforme proposée et liens avec les acteurs

La couleur rouge est dédiée aux éléments liés à l'équipe de gestion de projet. La couleur bleue est dédiée aux éléments liés au responsable éco-conception. La couleur verte est dédiée aux éléments liés aux concepteurs. La couleur pourpre est dédiée aux éléments liés aux fournisseurs.

1.1. Les acteurs concernés

L'équipe de conception est constituée de concepteurs du bureau d'études mais dans ce document, nous élargissons l'équipe de conception à tous les acteurs et départements, ayant un rôle dans la conception de produits : la R&D, la production, le département des achats, la qualité, etc. Cette équipe est dirigée par un chef de projet. Il est assisté par un responsable écoconception pour gérer les aspects environnementaux dans le processus de développement. Les fournisseurs peuvent être sollicités pour fournir des informations sur leurs produits.

1.2. Les outils d'aide à la gestion de projet

Les modèles produits et leur cycle de vie sont les éléments au cœur du processus de conception. Ils sont créés au fur et à mesure que les utilisateurs des outils entrent des données sur le produit.

Le module d'évaluation est composé de trois outils : un outil d'ACV simplifié, un outil simplifié d'analyse des coûts du cycle de vie et un outil spécifique de calcul pour des indicateurs nécessaires à un projet ou à une norme en particulier. Ce module est géré par le responsable éco-conception.

Pour faire face au problème de visualisation et de priorisation entre les critères de conception et d'écoconception, nous proposons un tableau de bord adaptable en fonction des objectifs du projet. Le chef de projet en accord avec le responsable écoconception choisira les indicateurs à afficher dans le tableau de bord pour chaque projet.

1.3. Les outils pour réaliser les activités de conception

L'écoconception est basée sur des activités de conception c'est pourquoi les outils classiques sont au minimum reliés voir compris dans la plateforme. Des outils spécifiques à chaque phase du cycle de vie sont également inclus.

La plateforme contient également un outil de conseils pour assister les concepteurs dans l'amélioration des performances environnementales du produit.

1.4. Les flux d'informations environnementales

Les indicateurs du module d'évaluation ainsi que les rapports générés par la plateforme sont les principaux flux d'informations environnementales.

2. La méthodologie proposée

Notre méthodologie reprend les étapes nécessaires pour intégrer l'éco-conception dans le processus de développement de produits. Pour cette raison, la méthodologie présente des aspects similaires avec d'autres méthodologies déjà développées (ISO 14062, NF X30-264, etc.). La nouveauté de cette approche réside dans l'association des étapes méthodologiques avec les outils intégrés de la plate-forme et leurs utilisateurs. La méthodologie proposée est développée en trois phases principales: initialisation, phase de conception et capitalisation. Ces trois phases comprennent six étapes, comme le montre la Figure 76.

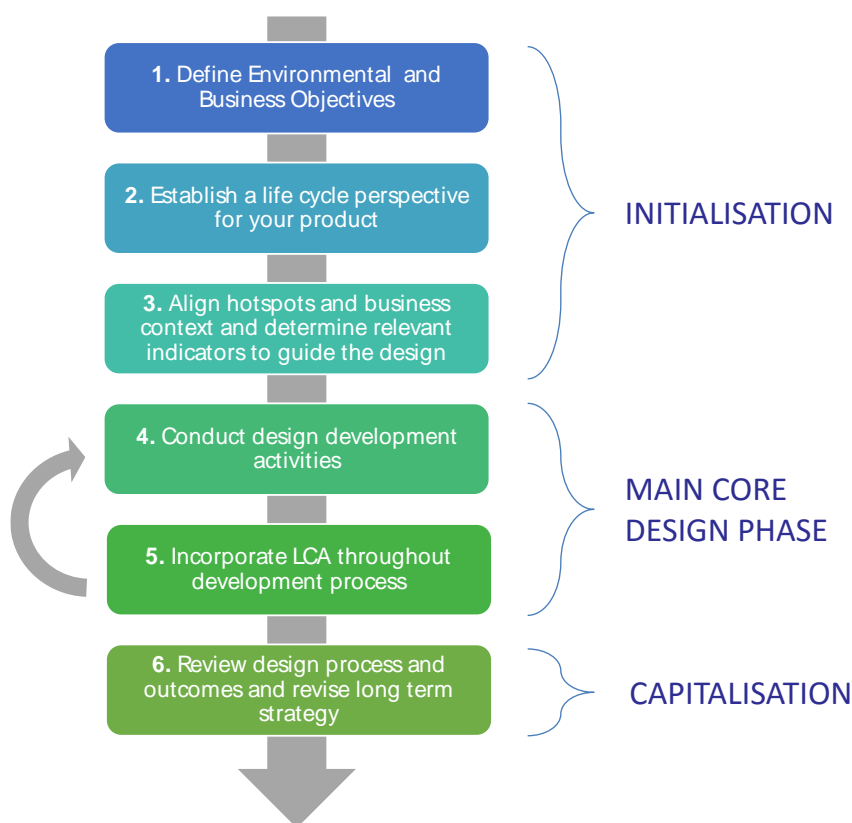

Figure 76: La méthodologie proposée

INITIALISATION

Après la mise en place de l'équipe de conception, le chef de projet détermine les objectifs du projet tout en tenant compte des contraintes, des délais, des ressources et du budget disponible. Il définit également avec le responsable écoconception les objectifs environnementaux du projet conformément à la stratégie de l'entreprise.

1. Définir les objectifs environnementaux

L'établissement de ces objectifs permet d'intégrer dès le début les aspects environnementaux dans le processus de développement de produits. Les objectifs peuvent être traduits en indicateurs spécifiques à surveiller pour le projet. Ces indicateurs seront ensuite inclus dans le tableau de bord ainsi le chef de projet pourra suivre ces indicateurs tout au long du projet.

A partir des objectifs, l'équipe définit la planification du projet et les spécifications du produit à partir des exigences fonctionnelles (Deutz et al. 2013). C'est une étape nécessaire parce que l'éco-conception vise à maintenir les fonctionnalités du produit tout en minimisant ses impacts environnementaux. Les premiers concepts du produit sont ensuite élaborés.

2. Etablir une perspective cycle de vie du produit

Le responsable écoconception réalise une première évaluation environnementale et économique du produit grâce au module d'évaluation d'impacts.

3. Aligner les points environnementaux critiques avec le contexte et les objectifs du projet afin de déterminer les indicateurs pertinents pour guider la conception

A partir des résultats de l'évaluation initiale, la troisième étape, réalisée par le responsable écoconception, consiste à identifier les points critiques environnementaux, appelés "environmental hot spots" (Hauschild et al. 2004) au cours du cycle de vie du produit. Ces hot spots sont ensuite mis en relation avec le contexte de l'entreprise afin de prioriser les actions. Le responsable écoconception fait alors un compte rendu aux concepteurs pour leur donner les voies d'amélioration des performances environnementales du produit.

PHASE DE CONCEPTION

4. Réaliser les activités de conception

La prochaine étape du processus de conception est la phase de conception détaillée. Les concepts sont développés pour répondre aux spécifications. Les matériaux, les procédés et toutes les caractéristiques du produit sont déterminés en tenant compte des différentes contraintes. C'est un processus itératif où les différents services impliqués dans le processus de conception doivent travailler en étroite collaboration. C'est l'approche classique pour un processus de conception traditionnel et nous proposons maintenant quelques changements pour intégrer les questions environnementales à cette étape cruciale.

5. Introduire l'ACV dans le processus de développement

Le produit est conçu et optimisé selon les priorités et les objectifs établis par le chef de projet dans les étapes précédentes (Hauschild et al., 2004). Les concepteurs suivent les instructions données par le responsable écoconception et ils peuvent ensuite utiliser l'outil de conseils pour trouver comment agir grâce à des règles, des guides et à des exemples de solutions précédentes.

Les changements de conception doivent être vérifiés grâce au module d'évaluation tout au long du processus pour s'assurer que des améliorations environnementales sont faites. C'est

une phase continue et itérative d'actions, d'évaluation et de conseils. En parallèle, le chef de projet et le responsable contrôlent tous les indicateurs du tableau de bord.

Il faut savoir que la phase d'interprétation des résultats de l'ACV pose parfois problème. En effet, il est souvent difficile de faire un lien direct entre les hot spots et les paramètres de conception et c'est une tâche cruciale que le responsable écoconception doit réaliser pour aiguiller au mieux les concepteurs dans la reconception.

A la fin du processus itératif, le chef de projet et le responsable écoconception vérifient que tous les objectifs sont atteints et qu'il n'y a pas eu de transfert d'impacts.

CAPITALISATION

6. Réviser le processus de conception, les résultats et la stratégie long terme de l'entreprise

La dernière étape de la méthodologie a pour objectif de capitaliser les connaissances apprises lors du projet. Le but est de systématiser la prise en compte des aspects environnementaux dans la conception de produit. En fonction des résultats et du bilan du projet, les objectifs stratégiques à long terme de l'entreprise peuvent être ajustés. Un rapport final peut être créé et stocké dans la base de données de l'outil de conseils.

3. Illustration d'une implémentation logicielle de la plate-forme : La plateforme G.EN.ESI

Le projet G.EN.ESI a été cofinancé par la Commission Européenne et a été rendu possible grâce au 7^{ième} programme-cadre. Ce projet de trois ans avait pour objectif de développer une méthodologie et une plateforme associée pour soutenir les activités d'écoconception des produits mécatroniques. Nous avons contribué à ce projet via la proposition de la méthodologie et la structure de la plateforme. La plateforme a été développée notamment grâce à trois des partenaires du projet : Granta Design (Royaume Uni), Università Politecnica delle Marche (Italie), et ENEA (Italie) _ l'Agence nationale italienne pour les nouvelles technologies, l'énergie et le développement durable.

La plateforme G.EN.ESI consiste en une série d'outils intégrés qui peuvent échanger des informations. La plateforme peut être interfacée avec un outil CAO (conception assistée par ordinateur) et un système PLM (product lifecycle management).

4. Conclusion

Ce chapitre résume les concepts clés que nous avons identifiés pour intégrer une approche d'écoconception dans le processus de conception. Nous avons décrit les différents éléments de la plateforme et développé les différentes étapes de la méthodologie. Un exemple d'implémentation de la plateforme via le projet G.EN.ESI a également été présenté.

CAS D'ETUDES

Dans le chapitre précédent, nous avons décrit la solution proposée associant une méthodologie d'éco-conception avec une plate-forme pour répondre aux enjeux soulevés dans la problématique. Ce chapitre présente les études de cas réalisées pour tester et valider la proposition.

1. Hypothèse et programme d'expérimentations

Pour valider notre solution, nous devons vérifier les quatre points de notre hypothèse.

« La solution associant une méthodologie et une plateforme facilite l'identification des hot spots et le développement de produits éco-conçus en favorisant :

- La connexion entre les acteurs du processus de conception (P1).
- L'utilisation d'outils pour la conception des produits et de leur cycle de vie (P2).
- L'utilisation d'indicateurs (P3).
- La gestion des données et des connaissances environnementales (P4). »

Trois expérimentations ont ensuite été menées pour obtenir la meilleure validation de notre proposition.

Expérimentation N°1 : Un cas d'étude industriel dans l'entreprise italienne Faber.

L'expérimentation N ° 1 a pour objectif de valider les quatre points de l'hypothèse dans l'entreprise Faber. Nous avons testé la méthodologie et certains des outils de la plate-forme sur la reconception d'un produit afin d'illustrer les différentes étapes de la méthodologie et pour identifier les problèmes et les faiblesses possibles de notre approche. Nous avons également analysé le processus de reconception géré par l'entreprise elle-même après avoir été formée par l'équipe du projet G.EN.ESI.

Expérimentation N°2 : Un cas d'étude industriel dans la PME française Aubrilam.

L'expérimentation N ° 2 vise également à valider les quatre éléments de l'hypothèse dans un contexte différent. La méthodologie a été mise en œuvre dans le processus de conception au cours d'un nouveau projet de conception. Comme la plate-forme n'était pas encore développée lorsque l'expérimentation a été menée, nous avons donc joué le « rôle de plateforme » afin de relier les données nécessaires.

Expérimentation N°3 : organisation d'un workshop pendant la conférence DESIGN 2014, Croatie.

Suite à une observation faite dans l'expérimentation N°2, le but de l'expérimentation N ° 3 est de montrer que connaître les interrelations entre les différents départements d'une entreprise permet de donner des instructions plus efficaces aux concepteurs lors du processus de conception. L'atelier a été co-organisé avec deux membres de l'Université de Bath.

Les expérimentations et les résultats sont brièvement décrits dans les sections suivantes.

2. Expérimentation N°1 : illustration du déploiement de la solution à travers la reconception d'une hotte de cuisine

Cette partie illustre la mise en place de la solution proposée dans le processus de conception de l'entreprise Faber. C'est une entreprise italienne qui conçoit et fabrique des hottes aspirantes. Faber est un partenaire du projet G.EN.ESI et c'est dans ce cadre que nous avons travaillé ensemble. Notre objectif était de valider nos hypothèses de recherche.

Mettre en place une nouvelle procédure en entreprise est souvent un processus long et difficile et l'intégration des considérations environnementales n'y échappe pas. Nous présentons dans les paragraphes suivants les trois phases principales qui ont été nécessaires au déploiement de la méthodologie et de la plateforme logicielle dans le processus de conception de Faber.

PHASE 1 : le processus de conception actuel de Faber

La première phase vise à comprendre comment les équipes de conception travaillent chez Faber. Nous avons examiné le processus de conception modélisé par nos partenaires industriels. Pour cela, nous nous sommes entretenus avec le responsable des projets d'innovation et le responsable stratégique R & D et innovation du groupe Faber. Cela nous a aidés à déterminer la meilleure façon d'intégrer l'éco-conception dans leur processus de conception, illustré lors de la phase 2.

PHASE 2 : Illustration de l'application de la méthodologie et de la plateforme associée dans le processus de conception de Faber

A partir de notre compréhension du processus de conception de Faber, la deuxième phase montre comment l'éco-conception peut être mise en œuvre à travers l'exemple de la reconception d'une hotte Faber. Nous avons montré comment les étapes de la méthodologie peuvent être liées aux étapes du processus de conception actuel. Nous avons illustré ainsi la reconception d'une hotte en utilisant la méthodologie et l'outil Eco Audit développé par Granta Design. Eco Audit a été utilisé pour réaliser l'ACV simplifiée du produit existant.

PHASE 3 : Les étapes essentielles pour une intégration complète de la méthodologie et de la plateforme et pour leurs utilisations en autonomie.

La troisième phase détaille les sessions de formation qui ont été nécessaires pour transmettre les bases de l'écoconception et former l'équipe de conception de Faber (principalement des concepteurs et le responsable des projets d'innovation) sur les outils logiciels G.EN.ESI et la plate-forme complète. Nous avons participé à des séances de formation et à l'élaboration de différents supports réalisés par l'équipe du projet G.EN.ESI.

La Figure 77 résume à l'aide d'une frise chronologique les principales activités réalisées. Les activités ont été divisées en trois catégories: celles que nous avons menées, celles auxquelles nous avons contribué et celles réalisées par les partenaires G.EN.ESI pour la mise en œuvre de la solution combinée (méthodologie et plate-forme logicielle).

ACTIVITÉS RÉALISÉES PENDANT LE PROJET G.EN.ESI POUR METTRE EN PLACE LA MÉTHODOLOGIE ET LA PLATEFORME LOGICIELLE DANS L'ENTREPRISE FABER

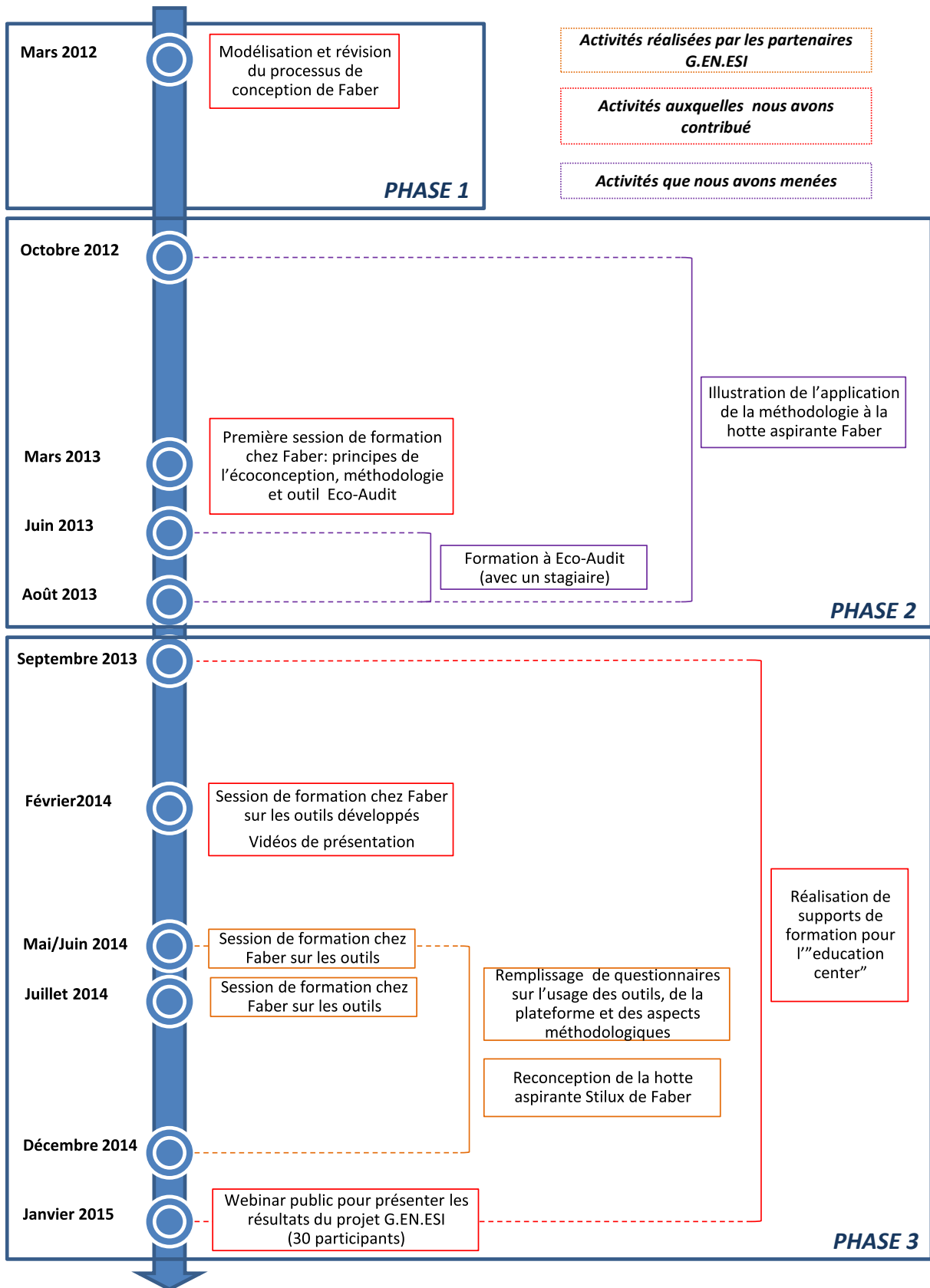

Figure 77: Activités réalisées pendant le projet G.EN.ESI pour mettre en place la méthodologie et la plateforme logicielle dans l'entreprise Faber

Conclusion de l'expérimentation N°1

La mise en place de la solution dans le processus de conception de Faber a impliqué différents changements dont les plus importants sont : - un rôle nouveau dans l'équipe de conception, l'utilisation de nouveaux outils, l'implication de la stratégie pour les enjeux environnementaux, - la prise en compte des exigences environnementales dans les spécifications du produit pour une intégration au plus tôt, - des changements dans le processus de conception pour prendre en compte les étapes nécessaires à l'écoconception. La reconception d'une hotte existante a montré que la méthodologie permettait une bonne adaptation au processus de conception actuel. Toutefois, le besoin de formation des équipes ne doit pas être négligé. En effet, nous avons observé que plusieurs sessions de formation avaient été nécessaires à l'équipe de conception, pour qui les considérations environnementales étaient totalement nouvelles. En effet, avant d'appliquer la méthodologie et d'utiliser la plate-forme, une solide formation en éco-conception est essentielle.

Validation de l'hypothèse de travail

La mise en œuvre de la méthodologie et de la plate-forme dans le processus de conception de Faber a conduit à une bonne intégration de l'environnement. Grâce à la reconception, l'objectif a été atteint : le produit a été éco-conçu. Cela a été rendu possible grâce aux différents aspects expliqués dans les paragraphes suivants.

Création de données et connexion des acteurs de l'équipe de conception :

Utiliser les différents outils de la plate-forme crée des données qui sont notamment utilisées pour remplir le modèle cycle de vie du produit. Ces données sont alors utiles pour réaliser l'analyse du cycle de vie du produit, mais certaines données peuvent encore manquer. Dans ce cas, le responsable écoconception doit récupérer les informations manquantes auprès des personnes concernées. Quand il interprète les résultats d'ACV et qu'il donne des recommandations aux concepteurs, il peut avoir à mettre en relation des acteurs du même service ou de services différents pour les faire travailler ensemble afin d'améliorer le produit et de réduire ses impacts environnementaux.

De plus, les acteurs sont impliqués via les outils qu'ils ont à utiliser. Par exemple, le fournisseur de moteurs électriques a été sollicité, ainsi que l'ingénieur en électricité de Faber afin de remplir l'outil dédié à la phase d'utilisation.

Cela signifie que la plate-forme est plus qu'une calculatrice car en plus de faciliter le transfert de données entre les outils, elle encourage fortement la connexion des acteurs de la conception. Ces observations valident les points (P1) et (P4) de l'hypothèse qui concernent respectivement l'implication des acteurs et la création de données via les différents outils.

L'utilisation de nouveaux outils et de nouveaux indicateurs

L'équipe de conception de Faber a dû utiliser de nouveaux outils. Dans cette étude de cas, le responsable écoconception a réalisé l'ACV et a choisi deux indicateurs pour suivre le projet : la consommation d'énergie et le taux de recyclabilité. Les concepteurs ont ensuite utilisé les

outils spécifiques du cycle de vie et en particulier ceux de la phase d'utilisation et de la phase de fin de vie pour améliorer la performance environnementale du produit. Ces observations valident les points (P2) et (P3) de l'hypothèse, concernant respectivement l'utilisation des outils du cycle de vie et l'utilisation d'indicateurs environnementaux.

Création de connaissances

Les concepteurs ont été confrontés à de nouveaux outils, à de nouveaux indicateurs et à de nouvelles tâches dans leurs activités classiques. Tous ces changements ont conduit à la création de nouvelles compétences et de nouvelles connaissances environnementales dans l'entreprise. Ces connaissances peuvent ensuite être stockées dans l'outil de conseils pour être disponibles pour les projets à venir. Ces observations valident le point (P4) de l'hypothèse, concernant la création et la gestion des connaissances.

Les quatre points de l'hypothèse ont donc été vérifiés dans le contexte de cette entreprise. Le déploiement de la solution a favorisé une forte intégration de l'écoconception dans le processus de conception et dans les différents départements de l'entreprise. Les acteurs du processus de conception sont plus connectés car ils ont besoin d'échanger des données ou de travailler ensemble pour trouver une solution commune afin de réduire les impacts environnementaux d'un composant ou d'une partie du produit. Les concepteurs améliorent leur compréhension des questions environnementales.

3. Expérimentation N°2 : implémentation de l'approche lors de la conception d'une nouvelle gamme de bancs publics

L'expérimentation N°2 a pour objectif de tester la méthodologie lors de la conception d'une nouvelle gamme de produits dans l'entreprise Aubrilam. Cette entreprise conçoit et fabrique du mobilier urbain et des lampadaires pour des secteurs publics et privés. Le contexte d'Aubrilam est particulier car l'entreprise est déjà très sensibilisée aux questions environnementales mais sans que l'écoconception soit intégrée à part entière dans leur processus de conception.

La Figure 78 résume les différentes étapes de notre collaboration avec Aubrilam. Dans la colonne de gauche sont résumées les dates des réunions en face à face. La colonne du milieu montre les actions que les concepteurs d'Aubrilam ont réalisées dans le cadre de l'application de la méthodologie. La colonne de droite liste les documents et les modèles que nous avons créés pendant chaque période. La mise en œuvre de la méthodologie s'est déroulée en plusieurs étapes que nous décrivons brièvement dans les paragraphes suivants.

PHASE 1 : Premiers contacts avec l'entreprise, mise en place des objectifs de la collaboration

La collaboration a commencé en septembre 2013 lorsque nous nous sommes mis d'accord avec Aubrilam pour mettre en œuvre la méthodologie proposée lors d'un projet de conception d'une nouvelle gamme de bancs publics.

PHASE 2 : Entretiens avec les différents services pour établir la modélisation du processus de conception d'Aubrilam

Nous avons réalisé des entretiens avec des employés de différents services afin de modéliser le processus de conception actuel et de dresser le bilan des actions d'écoconception.

PHASE 3A : Application de la méthodologie lors de la conception d'une nouvelle gamme de produits

J'ai donc joué le rôle du responsable écoconception dans le nouveau projet et j'ai également joué le « rôle de la plateforme » (échanges de données, réalisation des ACV, etc.) car la plateforme G.EN.ESI n'était pas encore développée. Les différentes analyses de cycle de vie ont été réalisées avec le logiciel EIME. Suite aux différentes étapes de la méthodologie, une réduction des impacts environnementaux de 13% en moyenne a été observée entre la première version détaillée du banc et la seconde version (après les changements de conception effectués par le concepteur).

Grâce aux entretiens que nous avons eus au début de la collaboration, nous savions quels services devaient se rencontrer, pendant la phase de reconception après analyse des résultats d'ACV, pour discuter des solutions d'amélioration potentielles sur tel ou tel aspect. Nous avons donc mis en avant une limite de la plateforme car nous savons que cette dernière ne peut pas nous fournir ces informations en détail.

Ainsi grâce à notre connaissance de l'entreprise (acquise lors des entretiens), nous avons pu, pour chaque hot spot, mettre en relation les services concernés. Nous avons fait l'observation suivante : si le responsable écoconception est un consultant, il ne connaît pas tous les liens, toutes les influences qui existent entre les différents services de l'entreprise. Les retours aux concepteurs ne sont donc pas optimaux. Nous avons donc établi une cartographie des interrelations entre les services pour avoir une vision complète de l'entreprise, que les acteurs eux-mêmes n'ont pas toujours.

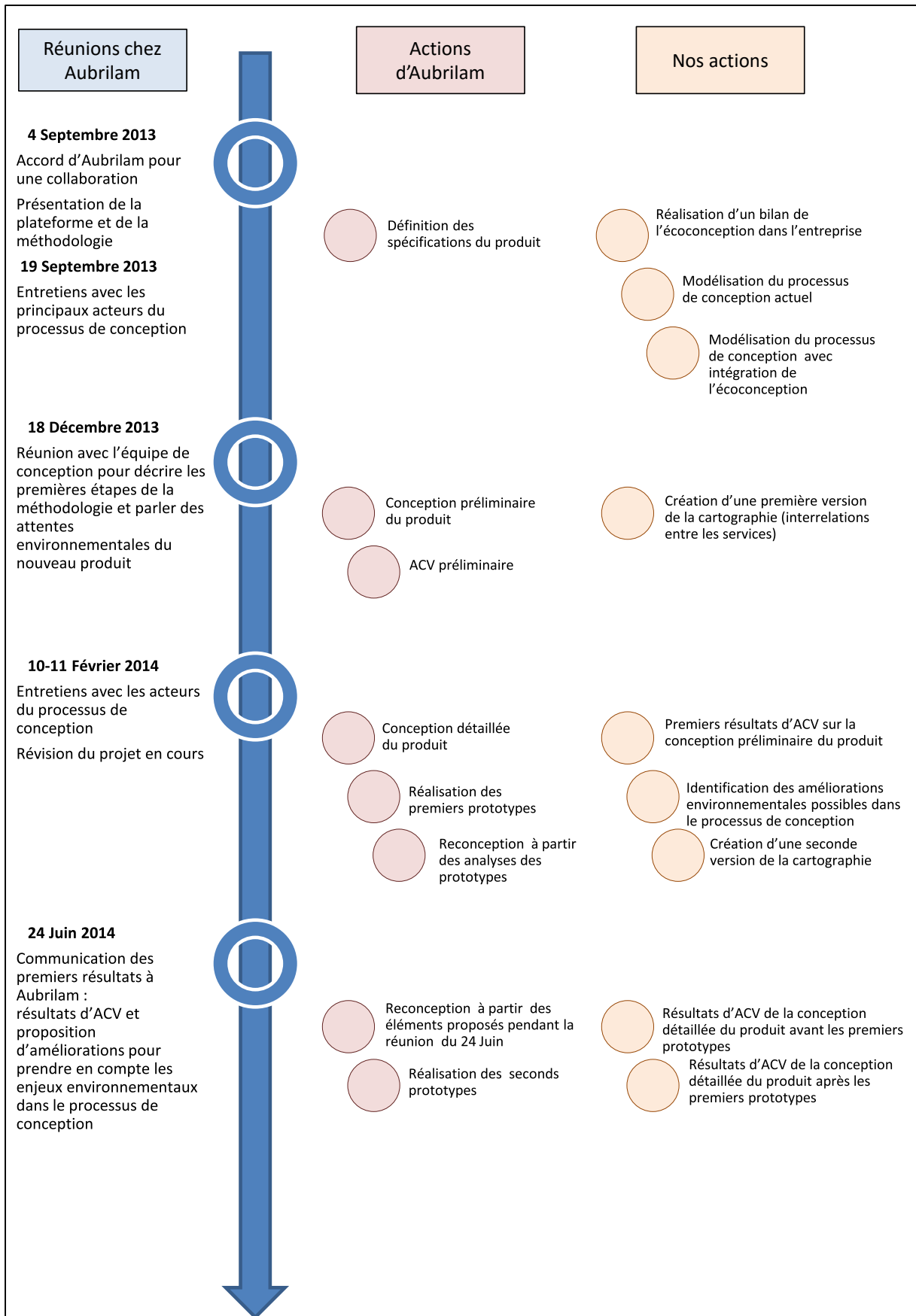

Figure 78: Chronologie des actions et des réunions réalisées avec Aubrilam

PHASE 3B : Réalisation de la cartographie entre les services

D'autres entretiens ont donc été réalisés pour collecter les contraintes et les liens existants entre les services afin d'établir une cartographie. La cartographie consiste à réaliser un tableau qui collecte les liens entre les paramètres du cycle de vie du produit en ligne et les services de l'entreprise en colonne. Nous nous sommes basés sur les éléments d'un banc pour les paramètres du cycle de vie. L'objectif est de savoir si et comment chaque département a une influence ou est influencé par les paramètres du cycle de vie pour prendre en compte toutes les contraintes pendant la conception du cycle de vie. La Figure 79 montre un extrait de la cartographie que nous avons réalisée.

Modèle cycle de vie du banc	Métiers influençant ou influencés par les éléments concernés							Nombre d'indicateurs concernés
	Bureau d'études	Atelier bois	Pose/Maintenance	Qualité	Stratégie/Management	Marketing	Achats	
Lattes de bois								
Matériaux	X	L'atelier bois va être concerné par ces éléments car ils sont relatifs au bois.	Le choix de l'essence du bois est très important pour le vieillissement du bois et de ce fait le service maintenance est influencé par ce paramètre car ils vont être amenés à changer les lattes en cas de besoin.	Le choix de l'essence du bois est lié sa tenue dans le temps et va donc avoir une influence sur la qualité (et vice versa).	Le marketing et la stratégie peuvent avoir une influence sur les aspects "esthétiques" du produit		Le service achat va avoir une influence sur le choix des matériaux. En particulier pour le bois, suivant les lots qui sont achetés, l'atelier bois devra adapter les poutres.	2
Procédés_Mise en forme								0
Procédés de finitions	X	X			aspects "esthétiques"			9
Poids d'une latte	X							1

Figure 79: Extrait de la cartographie

La cartographie peut être complétée au fur et à mesure des projets. Par ailleurs, elle permet de souligner des contraintes de conception pas toujours connues par les concepteurs parce que personne ne les a jamais formalisées. Elle est donc un support à la conception intégrée.

Notre objectif a ensuite été d'ajouter à cette cartographie des informations provenant de l'évaluation environnementale. C'est ce que nous avons fait via le développement d'un outil de démonstration qui affiche en face de chaque paramètre, dans la dernière colonne du tableau, le nombre d'indicateurs où les impacts environnementaux représentent plus de 15% du total des impacts environnementaux du produit (cf. Figure 79). L'équipe de conception peut ainsi facilement organiser la reconception du produit car elle sait quels services sont concernés par les paramètres critiques du point de vue environnemental.

PHASE 4 : Retours et recommandations pour améliorer l'intégration de l'écoconception

A partir des entretiens, nous avons également réalisé des checklists avec les contraintes de conception et fait des recommandations pour changer certains aspects organisationnels afin d'augmenter la collaboration entre les acteurs et d'améliorer l'efficacité du processus de conception.

Conclusion et validation de l'hypothèse de travail

Le déploiement de la méthodologie dans le processus de conception d'Aubrilam a permis de concevoir un banc avec de meilleures performances environnementales. Cela a été possible grâce à la connexion entre les services (P1), la gestion des paramètres du cycle de vie (P2), le

suivi des indicateurs environnementaux dans EIME (P3), et la création de nouvelles données et connaissances (P4). Les quatre points ont été validés dans le contexte d'Aubrilam.

Cependant, nous avons observé que si le responsable écoconception ne connaît pas le réseau d'influence entre les services, les retours qu'il fait à partir des résultats d'ACV ne sont pas toujours bien ciblés. C'est notamment le cas si le responsable écoconception est extérieur à l'entreprise. De plus, la plateforme dans sa version actuelle ne fournit pas ce genre d'informations. Nous avons donc réalisé une cartographie des liens existants entre les services afin de solutionner ce problème.

4. Expérimentation N°3 : un jeu sérieux pour un atelier

Suite au travail fait lors de la seconde expérimentation, nous nous sommes demandés si la cartographie pourrait être un outil complémentaire pour aider les équipes de conception et en particulier les responsables écoconception. Les résultats du cas d'étude d'Aubrilam ont donc été adaptés pour développer un « serious game » ou jeu sérieux. Cette expérimentation a été réalisée lors d'un atelier à la conférence DESIGN 2014 in Croatia.

Les participants du workshop ont été brièvement formés à la méthodologie avant le début du jeu. Ils ont été divisés en groupe représentant chacun une équipe de conception. Chaque membre d'un groupe avait un rôle prédéfini dans l'équipe de conception. L'objectif de chaque équipe était d'organiser la reconception du banc dont on leur avait donné toutes les informations.

A la fin de la session de jeu, nous avons présenté aux participants la cartographie réalisée lors de l'expérimentation N°2. Les retours des participants ont été très positifs. Toutes les équipes ont reconnu l'intérêt de la cartographie qui permet d'avoir une vision globale de l'entreprise et faciliter l'organisation du processus de conception.

5. Conclusions des trois expérimentations

Ce chapitre a présenté les trois expérimentations établies pour tester la validité de la proposition. Ces expérimentations ont été menées dans trois contextes distincts. Nous avons démontré les quatre points de notre hypothèse dans les deux études de cas industriels. Ces deux expérimentations se sont achevées avec succès par le développement de produits éco-conçus. Les contextes de ces deux sociétés étaient différents.

Lors de l'expérimentation N °1, l'hypothèse a été validée dans le contexte de Faber :

- Une société qui n'a pas ou peu de connaissances en écoconception.
- Le rôle du responsable écoconception a été tenu par une personne en interne.

L'équipe de conception a été formé à l'éco-conception en vue de la reconception d'une hotte aspirante.

Lors de l'expérimentation N °2, l'hypothèse a été validée dans le contexte d'Aubrilam :

- Une entreprise déjà sensibilisé à l'écoconception.
- Le rôle du responsable écoconception a été tenu par une personne extérieure (moi-même).

Dans la première expérimentation, nous avons illustré l'application de la solution, puis celle-ci a été implémentée dans l'entreprise via notamment des sessions de formation. L'équipe de conception a alors pu utiliser la plate-forme par elle-même pour la reconception d'une hotte.

Dans la deuxième expérimentation, un banc public a été éco-conçu. En tant que responsable écoconception externe à l'entreprise, nous avons constaté que nous ne connaissions pas les réseaux d'influence entre les différents départements. Cela peut conduire à un processus d'écoconception inefficace. En effet, connaître l'entreprise (les interrelations entre les services) est nécessaire pour optimiser le processus de reconception en réunissant les acteurs appropriés pour répondre à chaque hot spot. La plateforme proposée ne fournit pas ces informations. Pour résoudre le problème, nous avons créé une cartographie des interrelations entre les services en recueillant les informations lors d'entrevues.

Nous avons donc voulu tester cette cartographie pour avoir des retours. Nous avons organisé un atelier lors de la conférence DESIGN 2014 visant à éprouver cette idée de cartographie d'acteurs. Les résultats de l'étude de cas Aubrilam ont été adaptés afin de développer un serious game. Ainsi, les participants devaient organiser le processus de reconception d'un banc. Nous leur avons ensuite présenté la cartographie: les participants étaient unanimes sur le fait qu'avec la cartographie il serait plus facile de guider l'équipe de conception.

CONCLUSIONS

La prise en compte des enjeux environnementaux est aujourd'hui un point essentiel dans la stratégie de développement durable des entreprises. La revue de la littérature montre que l'écoconception n'est pas simple à intégrer du fait de ses spécificités. En effet, malgré le nombre important d'outils et de méthodes existantes, les entreprises rencontrent encore souvent des difficultés à adopter cette approche dans la conception de leurs solutions.

Notre contribution est la formalisation des besoins pour une bonne intégration de l'écoconception dans le processus de conception dans un environnement de conception intégrée. Nos contributions détaillées sont les suivantes :

- Une méthodologie qui guide l'équipe de conception à travers des étapes à réaliser dans le processus classique de conception.
- La structure d'une plate-forme logicielle qui vise à supporter la méthodologie. La plateforme rassemble les outils nécessaires pour gérer les activités d'éco-conception.
- La validation de cette approche lors de deux cas d'études industriels.
- La formation des industriels à cette approche.

Pour gérer les activités d'écoconception, nous avons défini la structure d'une plateforme logicielle rassemblant les outils nécessaires à l'équipe de conception : des outils pour la conception du cycle de vie du produit, un outil d'évaluation des impacts coût et environnement, un outil d'aide à base de règles de conception et d'études de cas, un outil de suivi des indicateurs projet et des bases de données en relation avec le modèle produit et son cycle de vie.

Les résultats de deux expérimentations industrielles démontrent la validité de notre proposition. Cependant, lors de la seconde expérimentation où j'ai joué le rôle du responsable éco-conception, j'ai observé que certains choix de reconception n'étaient pas forcément faits grâce aux « outputs » de la plateforme et que d'autres aspects rentraient en jeu. Ces aspects, ce sont les relations et les influences qui existent entre les différents services d'une entreprise. Une limite de la plateforme a donc été identifiée car si c'est un consultant extérieur à l'entreprise qui met en place la plateforme, ne connaissant pas les interrelations entre les services, il ne va pas forcément renvoyer les informations aux bonnes personnes. Grâce à des entretiens passés avec les différents acteurs d'Aubrilam, j'ai pu développer la cartographie des liens entre les départements. Avoir à l'esprit tous ces liens rend plus efficace le processus de reconception et réduit le nombre d'itérations.

Une troisième expérimentation a alors été réalisée lors d'un atelier pendant une conférence internationale pour valider en partie ce point. Nous avons organisé un jeu sérieux au cours duquel les participants ont dû coordonner le processus de reconception d'un produit. La cartographie leur a ensuite été présentée. Tous les participants ont montré leur intérêt pour cette cartographie qui permet, en entreprise, de faciliter les retours aux différents services afin d'améliorer les performances environnementales du produit.

Perspectives

Différentes situations industrielles

Nous avons démontré l'application de notre proposition avec seulement deux cas d'études industriels. Il serait intéressant de tester la méthodologie et la plateforme dans d'autres situations industrielles pour identifier les faiblesses potentielles. Par d'autres situations industrielles, nous entendons différents types d'utilisateurs (ex : consultant) ou différents objectifs d'utilisation (ex : produit plus innovant). La méthodologie et la plateforme seront amenées à évoluer en fonction des résultats.

Différentes possibilités pour l'implémentation logicielle de la plateforme

La plateforme développée au sein du projet G.EN.ESI est juste un exemple d'implémentation de l'architecture que nous avons proposée, mais d'autres développements sont possibles. L'équipe éco-conception du laboratoire G-SCOP a pour objectif de créer sa propre plateforme à partir notamment d'outils déjà développés auparavant dans l'équipe. Par ailleurs, nous pouvons aussi envisager d'étendre cette plateforme en incluant des outils développés par la communauté française en écoconception, à travers le réseau Eco-SD.

La cartographie des interrelations entre les services d'une entreprise

Réaliser la cartographie des relations entre les départements d'une entreprise peut devenir une lourde tâche, notamment dans les grandes entreprises. Une méthode pour modéliser ces liens pourrait être développée afin de faciliter la construction de la cartographie. De plus, nous pouvons imaginer intégrer la cartographie à la plateforme pour automatiser les retours à l'équipe de conception après la réalisation de l'ACV.

Par ailleurs, notre plateforme génère des flux provenant d'interactions humaines. Nous pouvons imaginer une autre plateforme, en parallèle de la nôtre, pour supporter la création et l'échange de connaissances entre les acteurs.

Perspective pédagogique pour l'enseignement de l'éco-conception

Notre expérience en enseignement, ainsi que l'atelier réalisé lors de la conférence Design 2014 nous ont montré que pratiquer, à travers des mises en situation, était un vrai atout pour la compréhension de l'éco-conception. Nous pensons donc que le jeu sérieux pourrait être un bon moyen pour former à l'éco-conception à la fois des étudiants et des industriels.

Vers une économie circulaire

L'approche linéaire « extraire, fabriquer, jeter » atteint ses limites à cause de l'épuisement des ressources naturelles. Un nouveau modèle économique est donc nécessaire face à ce constat. L'économie circulaire réduit la consommation de ressources naturelles en réutilisant ces ressources en boucle. En plus de l'éco-conception, les entreprises vont avoir besoin de nouveaux moyens d'actions afin de prendre en compte les approches circulaires dans leurs processus de conception. La plateforme proposée devrait être encore valide sous réserve d'adaptation ou d'ajout de nouveaux outils.

Annex

ANNEX 1. AUBRILAM CURRENT PRODUCT DEVELOPMENT PROCESS	241
ANNEX 2. AUBRILAM PRODUCT DEVELOPMENT PROCESS WITH ECODESIGN CONSIDERATION.....	249
ANNEX 3. ECODESIGN OVERVIEW IN AUBRILAM	259
ANNEX 4. RECOMMENDATIONS FOR A BETTER INTEGRATED DESIGN AND ECODESIGN CONSIDERATION.....	264
ANNEX 5. WORKSHOP MATERIALS	268

Annex 1. Aubrilam Current Product Development Process

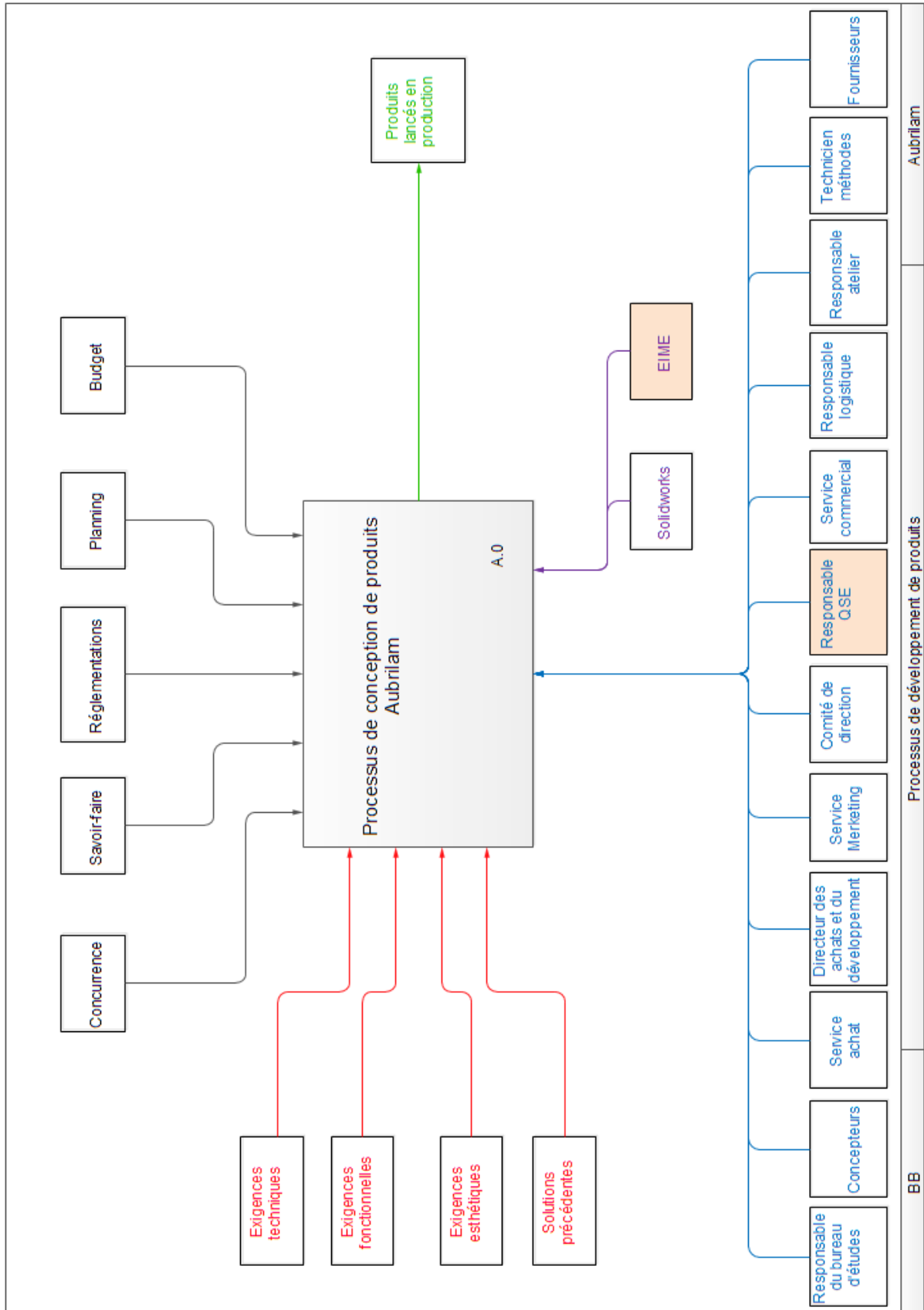

Figure A-1: Aubrilam product development process _ level BB

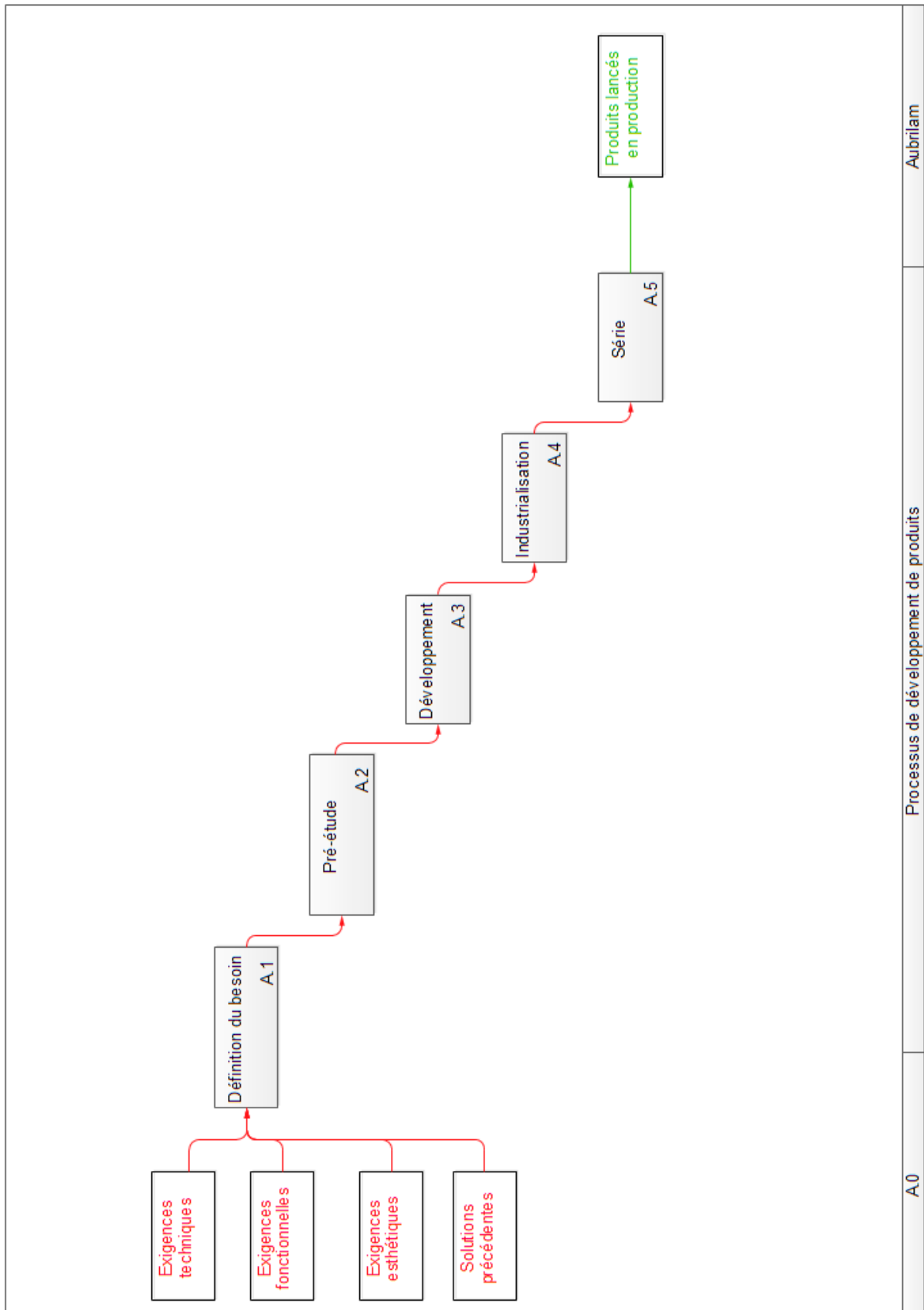

Figure A-2: Aubrilam product development process _ level A0

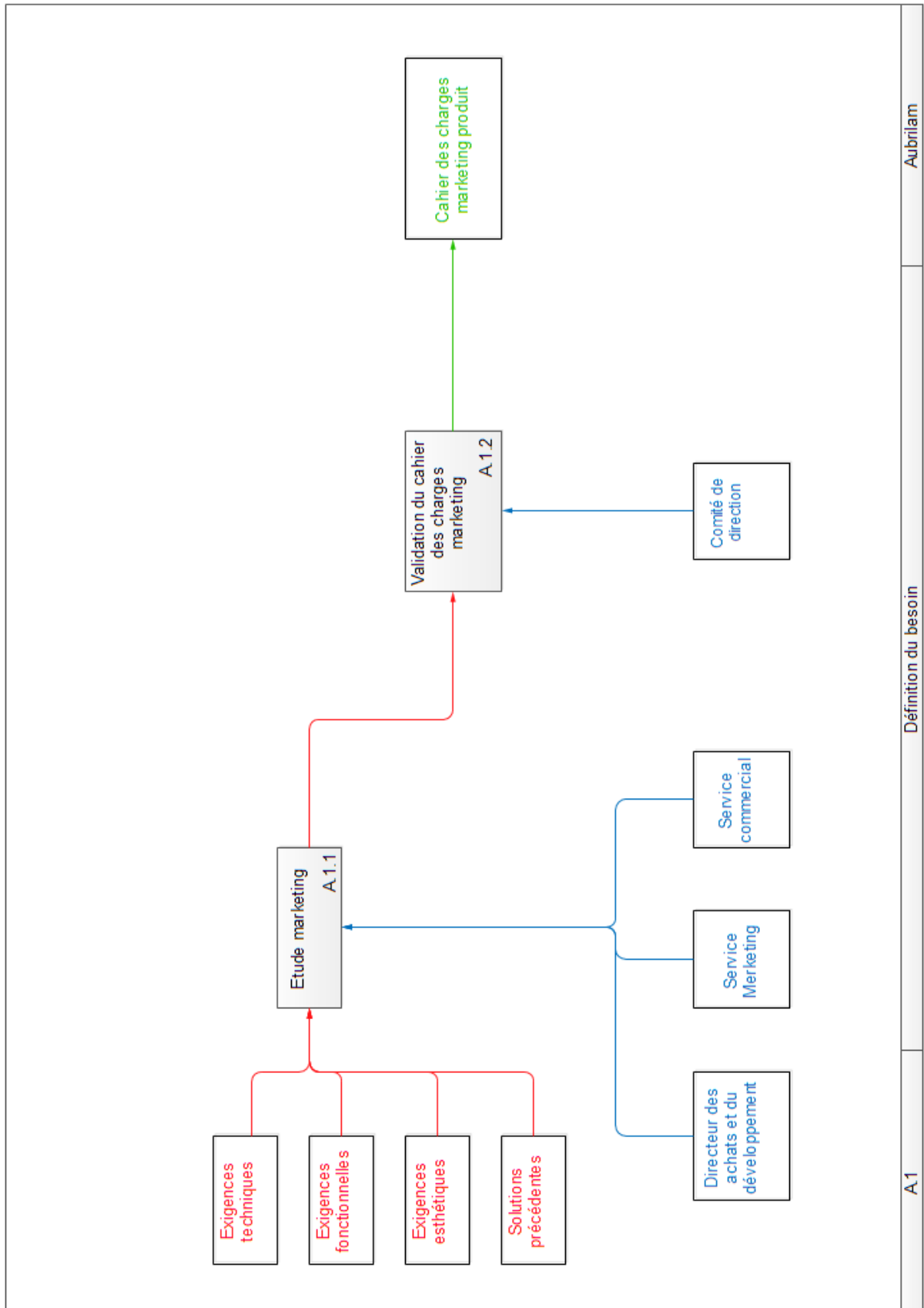

Figure A-3: Aubrilam product development process _ level A1

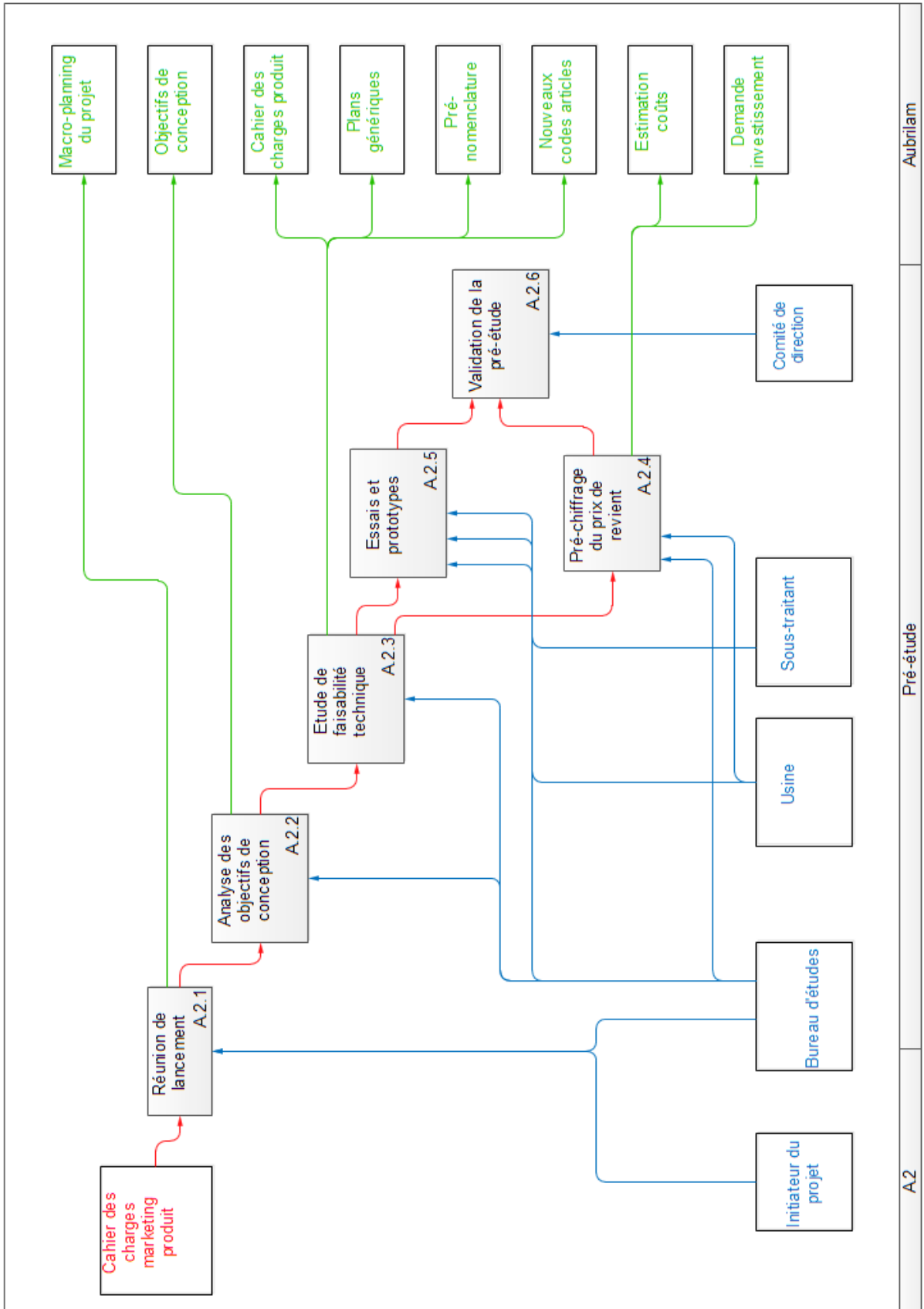

Figure A-4: Aubrilam product development process _ level A2

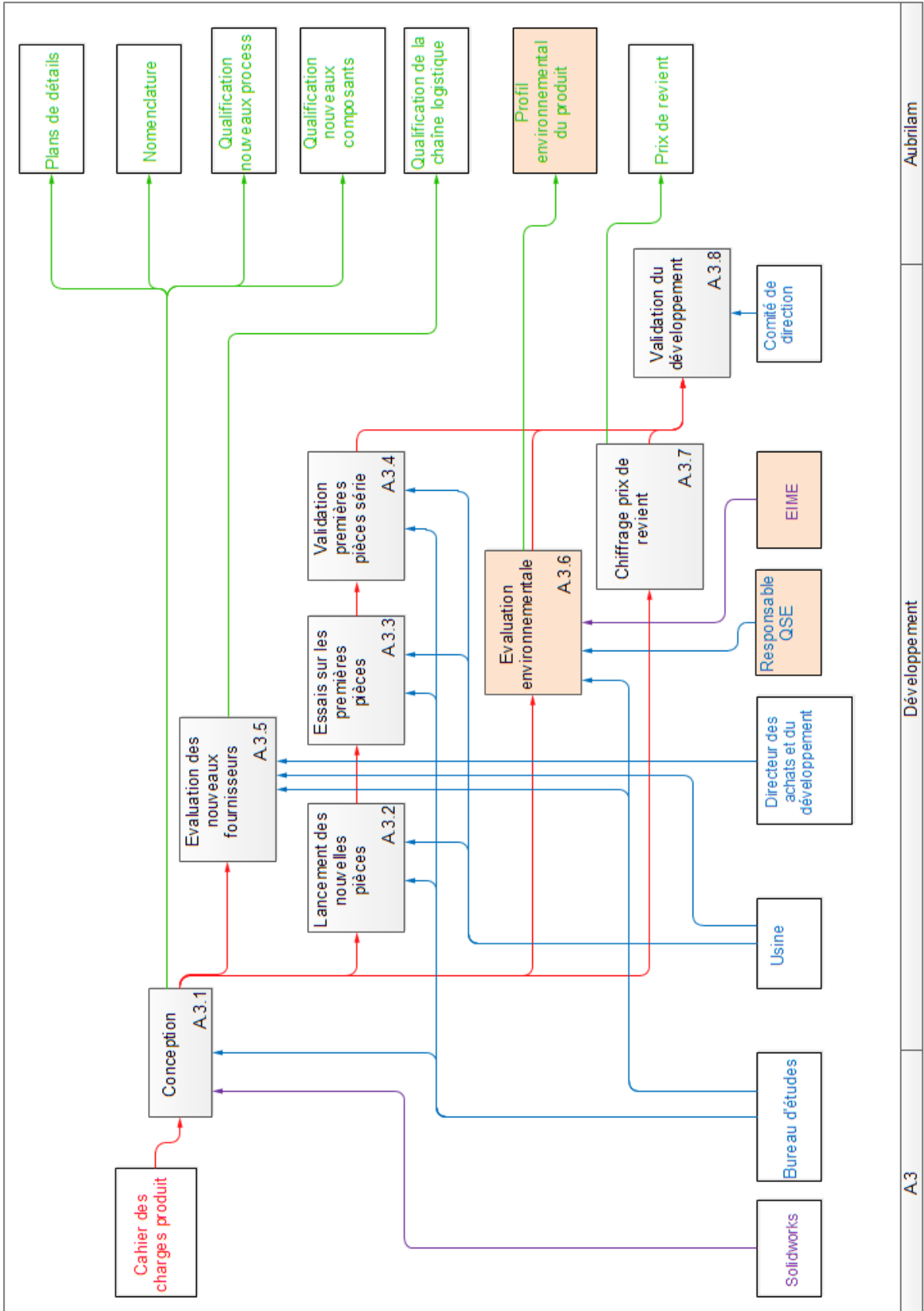

Figure A-5: Aubrilam product development process _ level A3

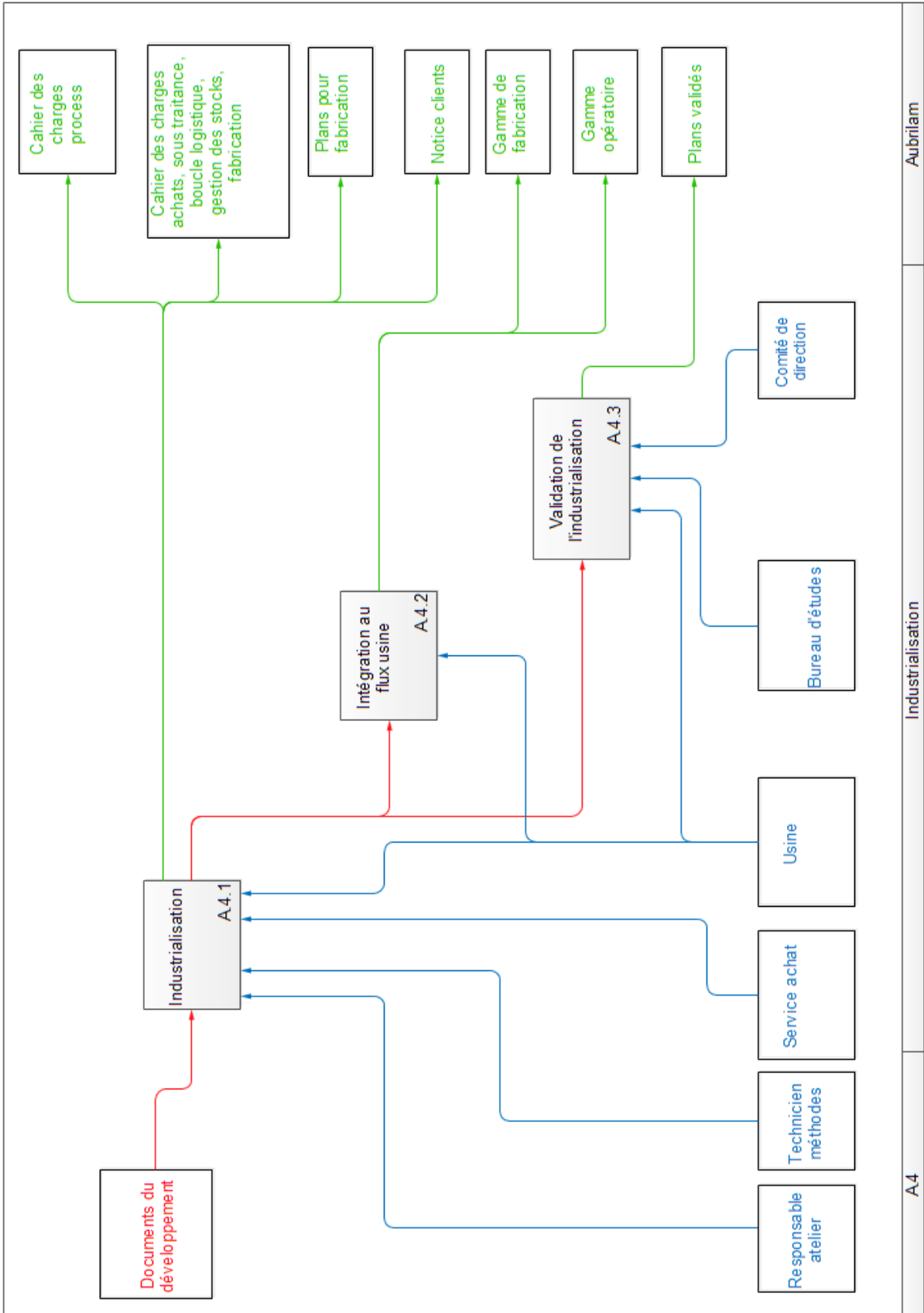

Figure A-6: Aubrilam product development process _ level A4

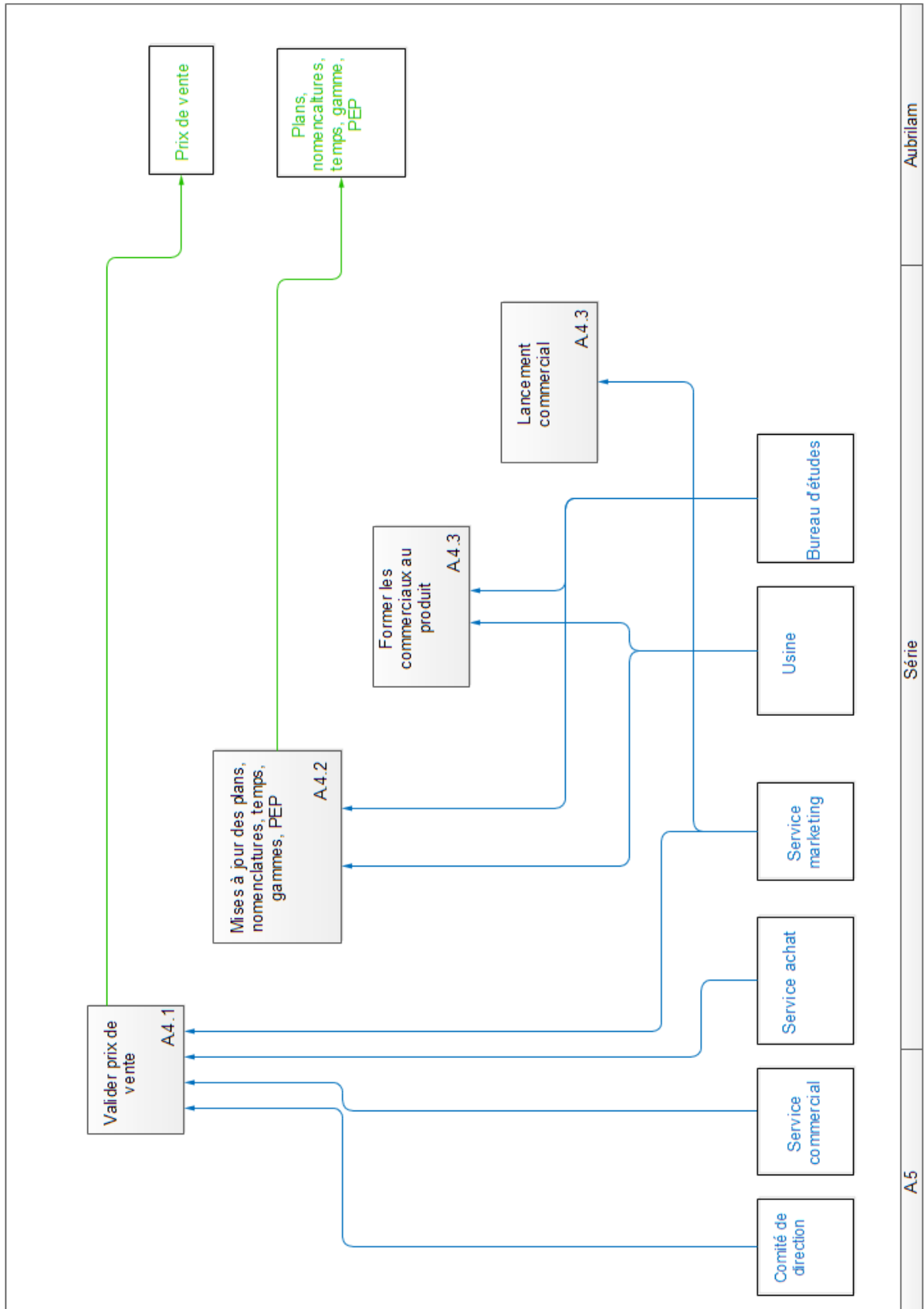

Figure A-7: Aubrilam product development process _ level A5

Annex 2. Aubrilam Product Development Process with Ecodesign Consideration

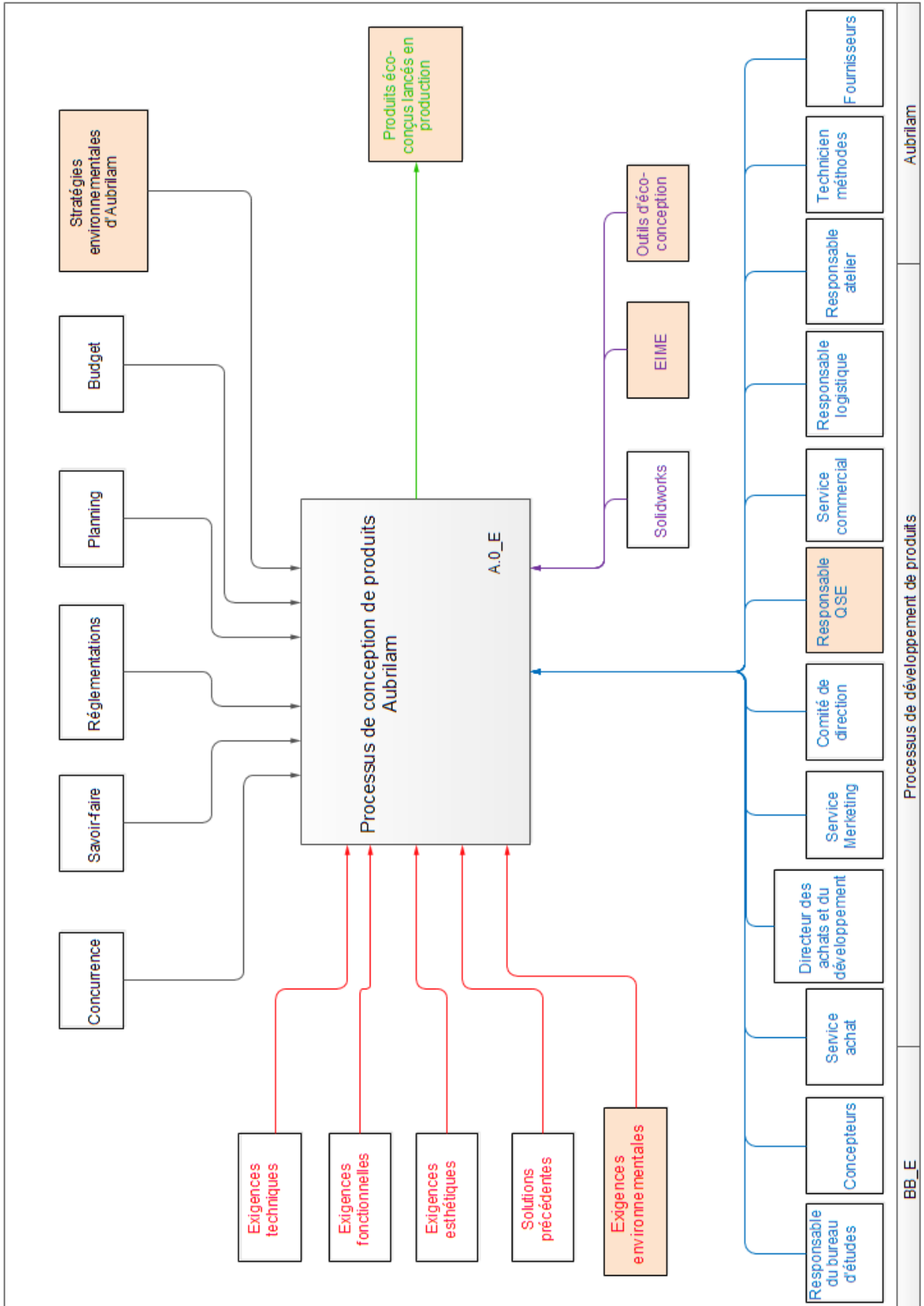

Figure A-8: Aubrilam ecodesign process _ level BB_E

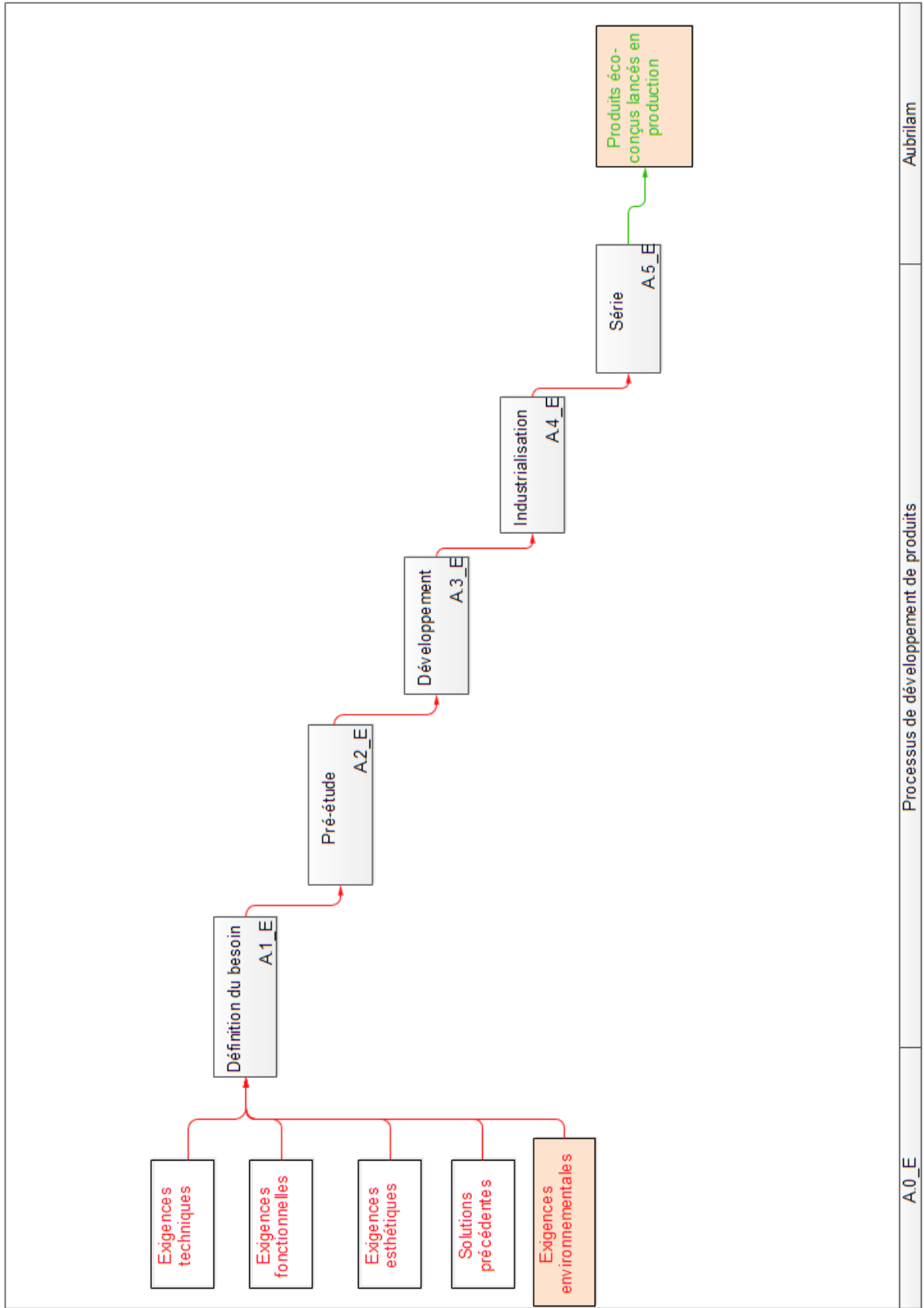

Figure A-9: Aubrilam ecodesign process _ level A0_E

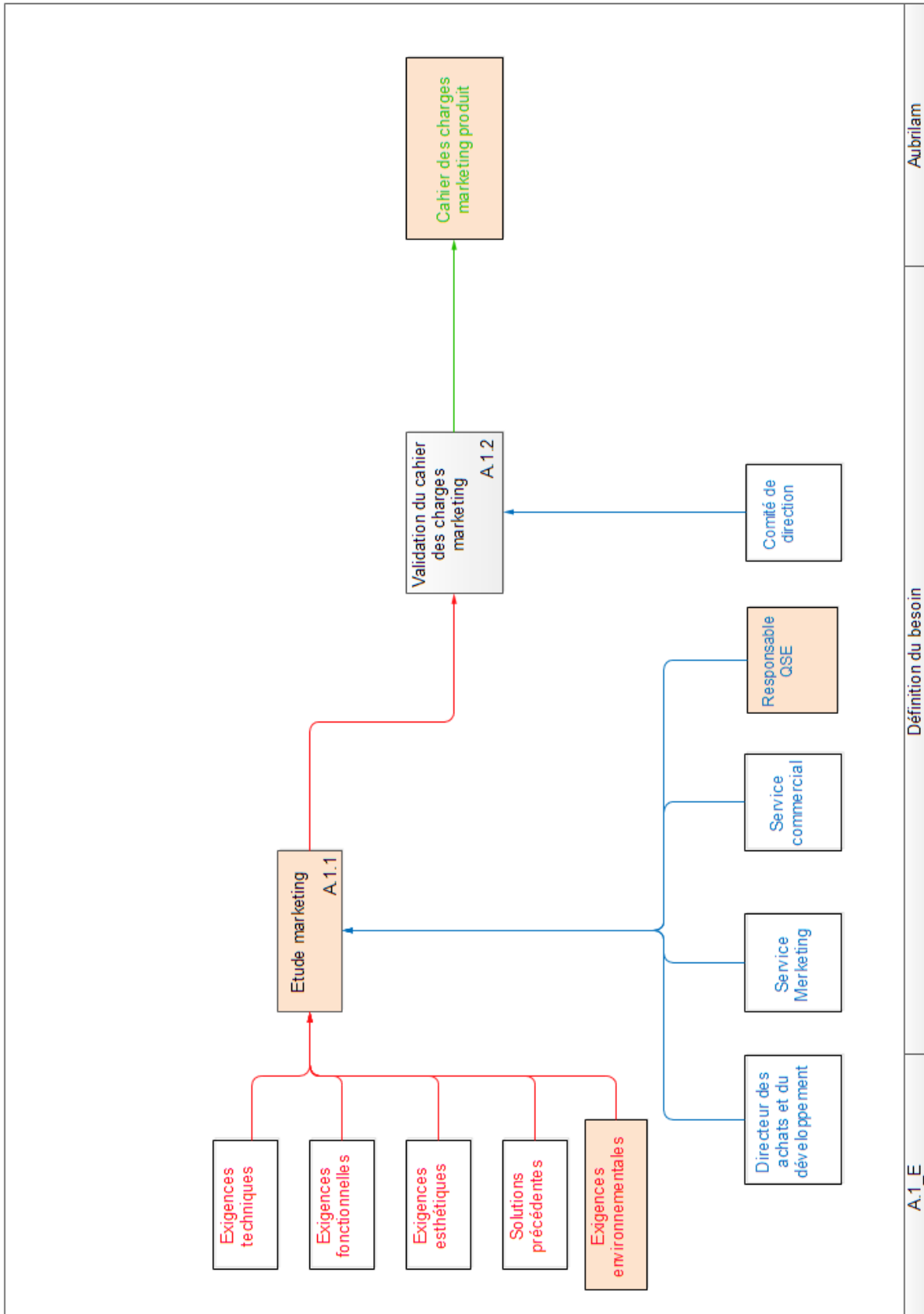

Figure A-10: Aubrilam ecodesign process _ level A1_E

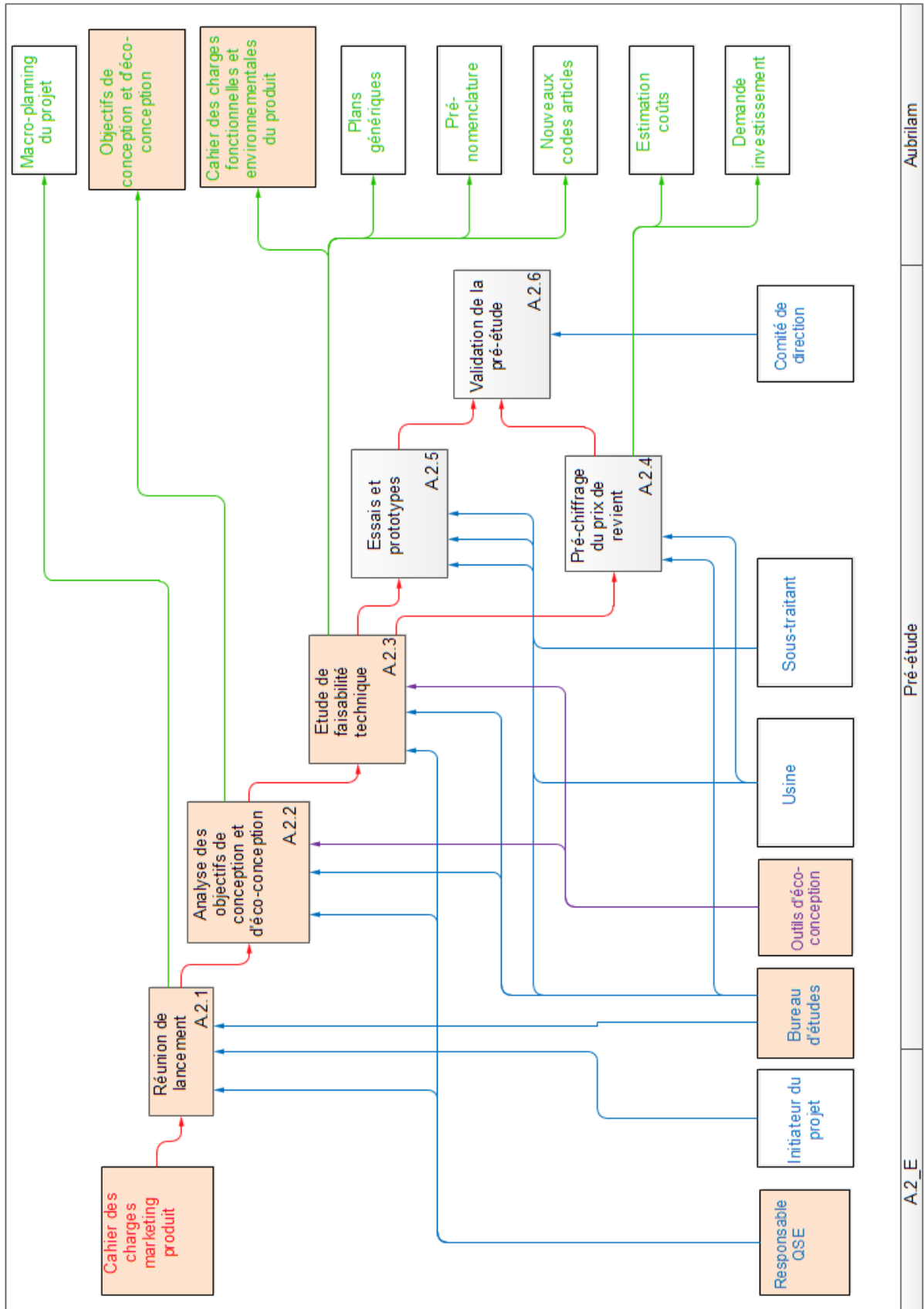

Figure A-11: Aubrilam ecodesign process _ level A2_E

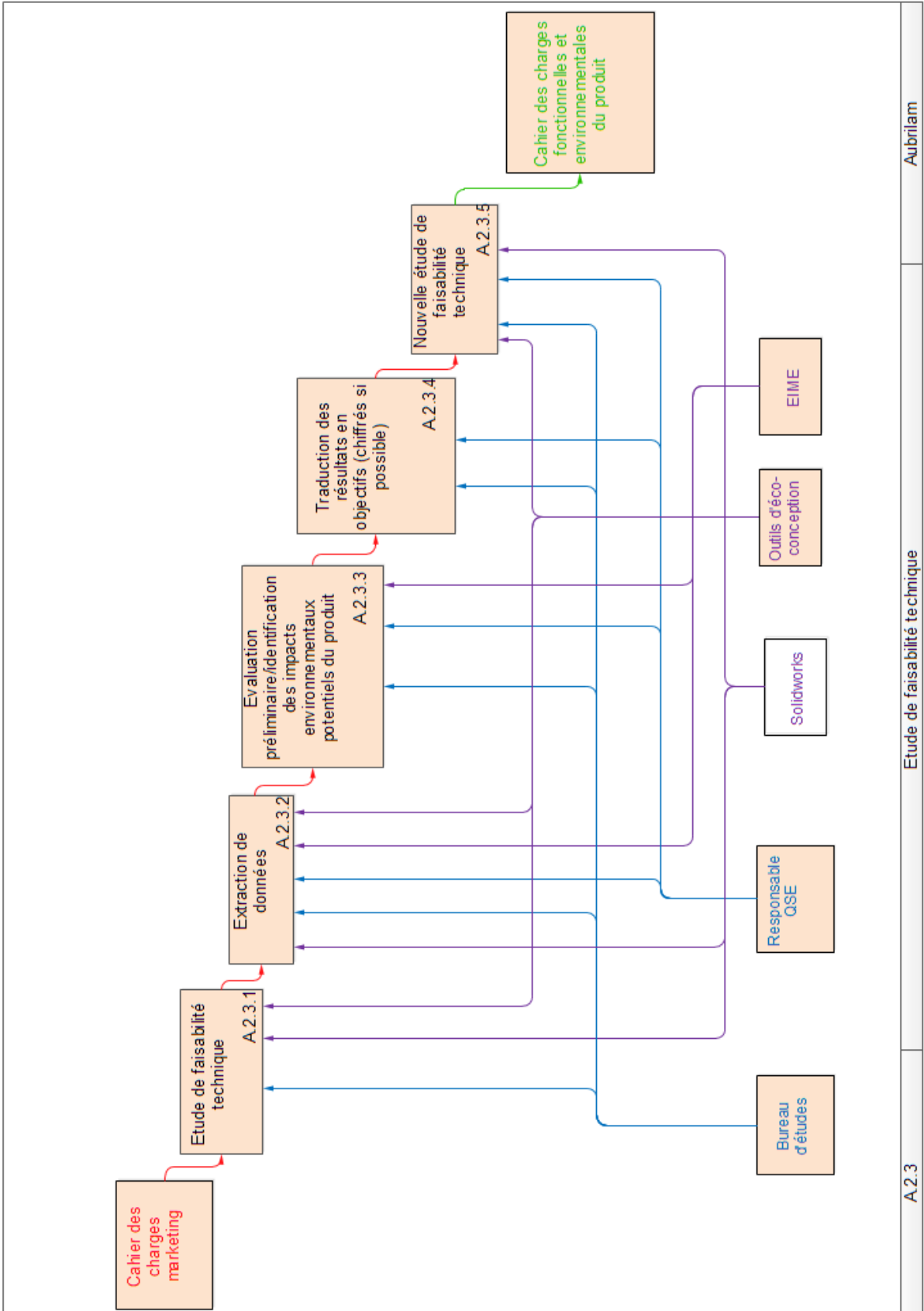

Figure A-12: Aubrilam ecodesign process _ level A2.3_E

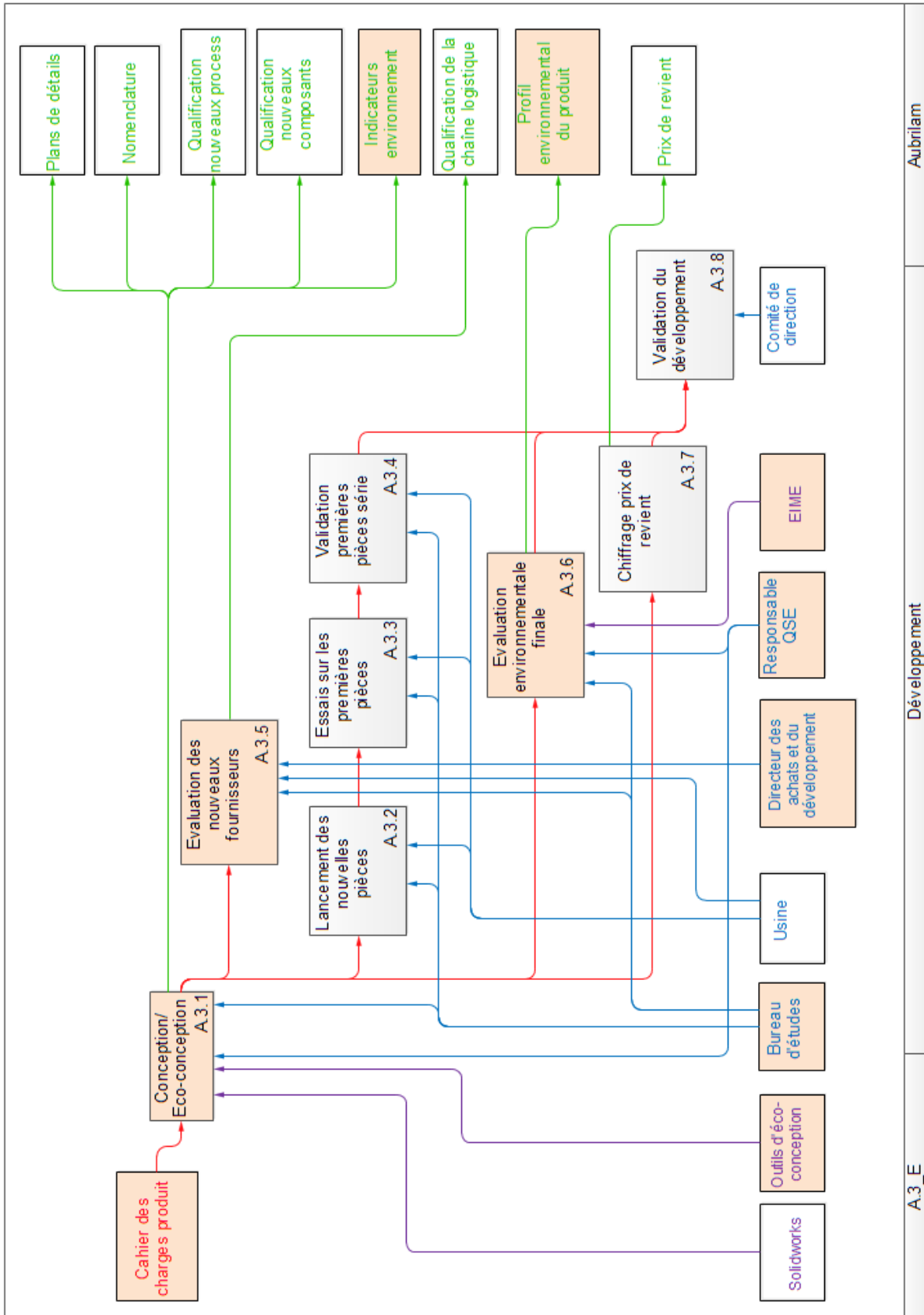

Figure A-13: Aubrilam ecodesign process _ level A3_E

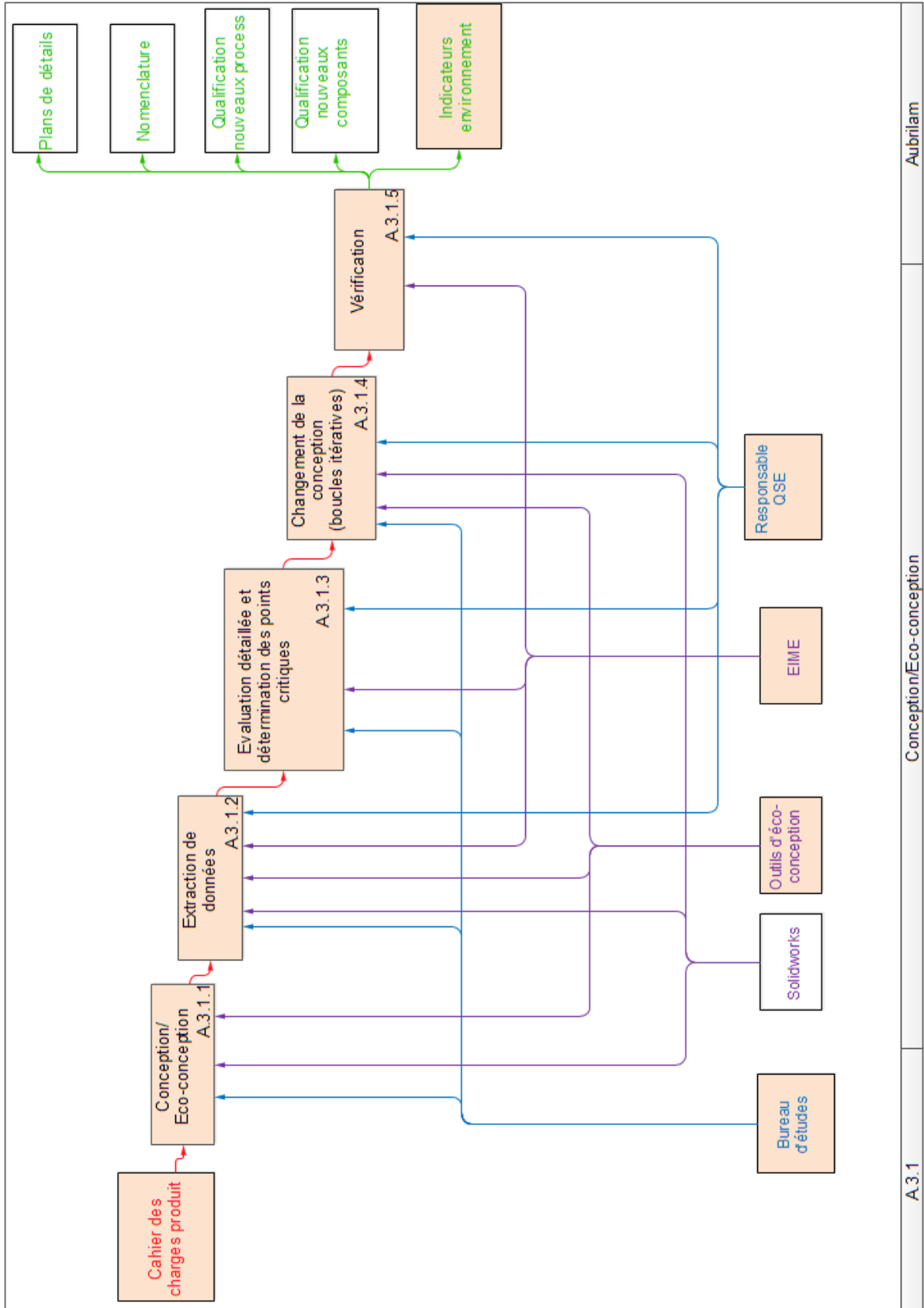

Figure A-14: Aubrilam ecodesign process _ level A3.1_E

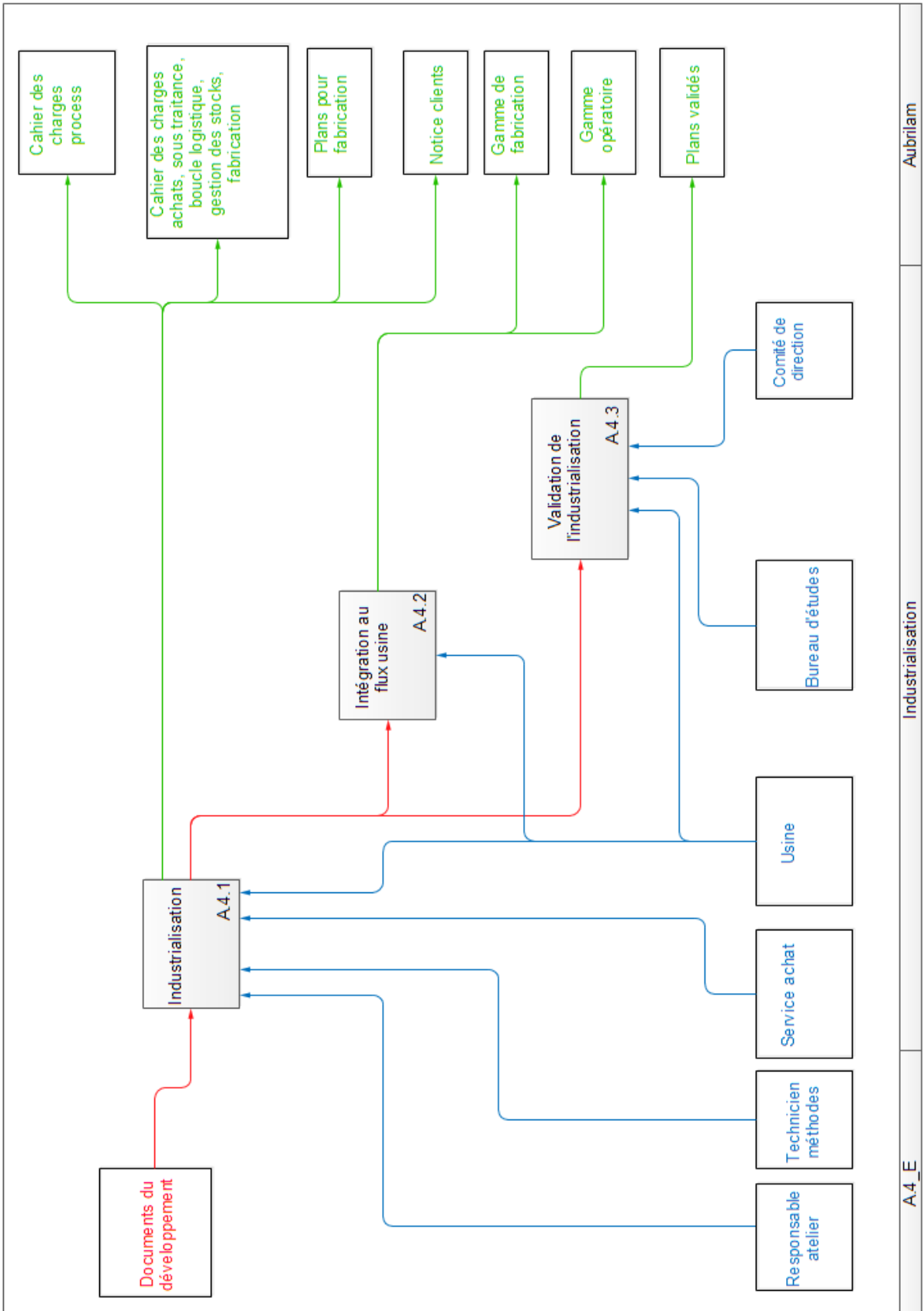

Figure A-15: Aubrilam ecodeign process _ level A4_E

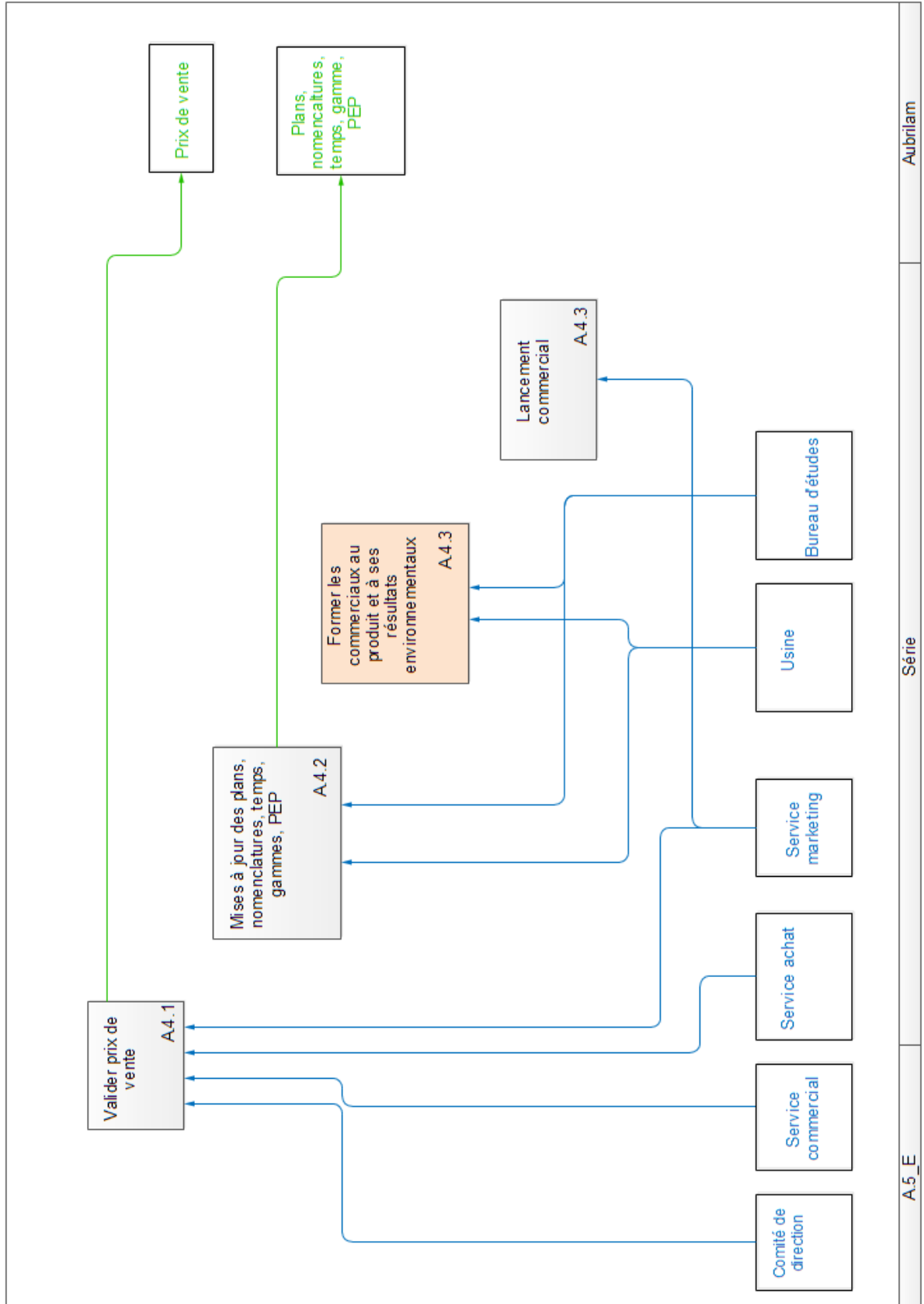

Figure A-16: Aubrilam ecodeign process _ level A5_E

Annex 3. Ecodesign Overview in Aubrilam

BILAN ENVIRONNEMENT D'AUBRILAM

Maud Dufrene, Octobre 2013

L'objectif de ce document est de faire un bilan de la situation d'Aubrilam vis-à-vis de l'éco-conception. Les points positifs et négatifs sont listés sur différents sujets et sous-parties.

Sujet	Sous-partie	Points positifs	Points négatifs
GENERAL		Un état des lieux éco-conception a été réalisé par la CCI Auvergne en Juin 2013.	L'éco-conception n'est pas intégrée au sein des différents services. Il semble y avoir comme une barrière entre la responsable QSE et les autres services sur le sujet éco-conception (sorte de « greenwall »).
STRATEGIE D'AUBRILAM APPELEE STRATEGIE TREFLE		Dans la stratégie d'Aubrilam parmi d'autres points, il est noté concernant les produits: « le plus faible impact environnemental ».	Cependant aucun objectif chiffré n'apparaît. Il n'y a pas de cahier des charges environnement ou de critères environnement dans le cahier des charges produit.
		Objectifs : - utiliser l'éco-comparateur sur les mâts - réaliser le profil environnemental de tous les produits	Ces objectifs ne sont pas réalisés (repris en détail dans la catégorie ACV).
APPROCHE SITE		Certification ISO 14001 depuis 2011. Autres points sur lesquels Aubrilam veut s'améliorer : - Réduire les déchets de bois de 50%	Une idée pour limiter les pertes bois en production est de modifier les procédés de fabrication,

		<p>- Réduire les déchets d'emballage venant des fournisseurs.</p>	<p>mais cela implique de refaire le marquage CE → Aubrilam ne semble pas prêt à le refaire (en termes de ressources humaine et de coûts).</p> <p>Pas encore de démarche réellement engagée sur le sujet.</p>
ANALYSE ENVIRONNEMENTALE DES PRODUITS	Analyse de Cycle de Vie (ACV)	<p>Une licence d'accès à un logiciel d'ACV (EIME) est disponible au sein de l'entreprise.</p> <p>La responsable QSE bénéficie ponctuellement de documentation et de formation à l'ACV en suivant des webinars organisés par CODDE.</p>	<p>Peu de personnes savent utiliser le logiciel d'ACV (2 personnes)</p> <p>Peu de personnes sont formées à l'ACV et la pratiquent régulièrement (2-3 personnes formées, 1 personne qui pratique)</p> <p>Les évaluations environnementales ne sont pas systématiquement faites. Lorsqu'elles sont faites, elles sont toujours faites a posteriori donc il n'y a pas d'améliorations lors de la conception.</p> <p>Toutes les phases du cycle de vie ne sont pas prises en compte dans l'analyse.</p> <p>Pas de ciblage des phases et des composants critiques du cycle de vie des produits</p>
		<p>Des documents Excel permettant de faire la liaison entre Solidworks et EIME ont été développés.</p>	<p>Ces documents Excel sont peu utilisés car ils ne sont pas à jour.</p>
	Profil Environnemental Produit (PEP)	<p>Dans le catalogue, les PEPs apparaissent comme une fiche technique.</p>	<p>Les PEPs ne sont pas toujours faits.</p> <p>Pour les mâts, il faudrait peut-être mettre en place</p>

		Facilité pour sortir les PEP pour les mâts.	<p>les PEPs pour le point lumineux complet.</p> <p>Pour le mobilier, peu de PEPs ont été réalisés.</p> <p>Lecture des PEPs compliquée pour le service commercial.</p>
	Eco-comparateur	Développement d'un éco-comparateur pour les mâts.	<p>Les données ne sont pas complètes (concerne uniquement les mâts standards.)</p> <p>Pas de comparateur pour le mobilier</p>
PRISE EN COMPTE DU CYCLE DE VIE DURANT LA CONCEPTION	Phase 1 du cycle de vie : extraction de matières premières et fabrication	Travail sur l'optimisation matière pendant la conception.	Les concepteurs utilisent les matériaux qu'ils connaissent, peu de recherche sur d'autres solutions.
	Phase 2 du cycle de vie : distribution		<p>Pas ou peu de liens faits entre la conception et les contraintes logistiques. (Ex : la longueur des camions)</p> <p>Pas ou peu d'optimisation de la conception de l'emballage : la conception de l'emballage est faite par plusieurs personnes, pas de capitalisation sur le sujet.</p>
	Phase 3 du cycle de vie : utilisation		
	Phase 4 du cycle de vie : fin de vie		Pas de retour d'information sur la fin de vie des produits Aubrilam

COMMUNICATION ENTRE LES SERVICES SUR LA CONCEPTION ET L'ECO-CONCEPTION	Echange d'information entre l'usine (la responsable QSE) et le BE	Il existe un fichier recensant les anomalies de fabrication sur les produits existants pour faire remonter les informations au BE.	Pas encore au point. Peu utilisé pendant la conception d'un produit.
	Revue de projet	Il existe un document de revue de projet.	Pas de point sur les performances environnementales dans la revue de projet.

Annex 4. Recommendations for a better integrated design and ecodesign consideration

Bilan des entretiens passés avec les différents services

Liste des personnes rencontrées :

Florent Madjaris
Sébastien Boyer et Jean-Philippe Le Gloanec
Philippe Mourier
Nicolas Corny
Franck Lassagne
Christophe Navarro
Valérie Jouve
Sonia Duffaud
Olivier Irrmann

Suite aux discussions avec les personnes listées ci-dessus, nous avons pu identifier quelques points critiques au niveau organisationnel, la plupart ayant une influence sur l'environnement. Ces points critiques pourraient être améliorés afin de faciliter le processus de conception et la collaboration entre les différents services.

La partie 1 liste quelques pistes pour l'amélioration du processus de conception.

La partie 2 propose une liste de contraintes à respecter en conception pour faciliter les activités de certains services.

1. Changements organisationnels pour une meilleure collaboration entre acteurs

1.1. Entre l'usine et le BE

Des problèmes sur les nomenclatures et les plans ont été remarqués à différents niveaux.

- Travailler sur les nomenclatures et leurs mises à jour (travail déjà en cours avec un stagiaire) ainsi que sur la mise à jour des plans pour être sûre que le plan utilisé soit la dernière version.
- Créer une base de données pour archiver les problèmes rencontrés : plans, nomenclatures, problèmes et amélioration de montage (travail déjà prévu).

1.2. Entre la logistique et le BE

Les informations d'embase enfouie ne sont pas clairement inscrites sur les plans du BE et ça engendre parfois quelques surprises au niveau logistique.

- Compléter les plans du BE pour avoir ces informations.

L'évolution et la diversité des gammes conduisent à un stock important de produits variés.

- Travailler sur l'écoulement des stocks et plus particulièrement visseries, chapeau des mâts.
- Standardiser et d'échanger entre concepteurs des mâts et ceux du mobilier.

1.3. Entre la logistique, l'attaché commercial et l'atelier finition

- La création d'une fiche de conditionnement dès la commande permettrait de garder une trace écrite du conditionnement avec en plus du nombre de colis envoyés et de leurs poids, leurs dimensions.

1.4. Entre la logistique et les fournisseurs :

Actuellement il y a beaucoup de gaspillage sur les emballages car ceux des fournisseurs sont jetés alors qu'Aubrilam en achète pour ses produits.

- Engager une démarche commune avec les fournisseurs (au moins ceux avec qui Aubrilam travaille toujours) à propos des emballages.

1.5. Entre l'atelier, les achats et le BE

Il y a beaucoup de gaspillage sur le bois car les planches ne sont pas forcément adaptées aux dimensions des produits ce qui engendre des chutes.

- Travailler sur les lots d'approvisionnement en bois (sachant que la marge de coupe est de 5mm et celle pour le galbe des lattes est de 4mm). Il est préférable que les lots de bois soient de même dimension, cela facilite les étapes de coupe et évite les gaspillages de bois.

1.6. Entre l'atelier bois et le BE

Les formes trop spéciales (comme celles de la gamme ALBA) ne sont pas pratiques à réaliser pour l'atelier bois.

- Travailler sur les formes ensemble pour voir ce qui est facilement réalisable par l'atelier.
- Travailler sur la standardisation de certaines formes.

1.7. Entre l'atelier finition et le BE

- Travailler sur des gammes de conditionnement pour les standardiser.

2. Checklist pour le BE

2.1. Contraintes de conception liées à la logistique

- Dimensionner les produits en gardant à l'esprit les dimensions caractéristiques des éléments de transport :
 - Dimensions des palettes [1.2 m*0.8m]. Sur une palette, il faut laisser 10 à 20 cm de marge de chaque côté.
 - Dimensions des semi-remorques [13.6*2.4*2,6m]
 - Si le colis dépasse 13m, un convoi exceptionnel doit être utilisé. Les engins pour charger les éléments ont des capacités limités.
- Penser à l'empilement des éléments pour le transport

2.2. Contraintes de conception liées à l'atelier bois

- Eviter de faire des choix qui impliqueraient du ponçage car c'est une opération manuelle.
- Eviter de choisir des formes trop spéciales, comme celles de la gamme ALBA, qui ne sont pas pratiques à réaliser pour l'atelier bois (lattes courbées, rainurées en bout, etc.). La standardisation des formes serait un atout pour réduire le gaspillage de bois.
- Dimensionner en fonction des capacités des machines de l'atelier bois (fichier déjà existant).

2.3. Contraintes de conception liées à la pose

- Dimensions et volume des produits
- Poids
- Fragilité : sensibilité aux chocs ou à la manipulation. Cela peut engendrer des problèmes de casse, des problèmes pour coliser ce qui implique du transport et des stocks supplémentaires
- L'assemblage (le montage) : nécessité de prévoir le plus souvent possible des systèmes de réglages / de calage (ex : trou oblong, etc.) afin de permettre une plage de réglage la plus large possible pour pallier aux conditions particulières retrouvées sur chantier, qui sont différentes pour chaque cas.

2.4. Contraintes de conception liées à l'atelier et à la maintenance :

- Le choix de l'essence du bois est très important pour le vieillissement du bois.

Annex 5. Workshop materials

INSTRUCTIONS

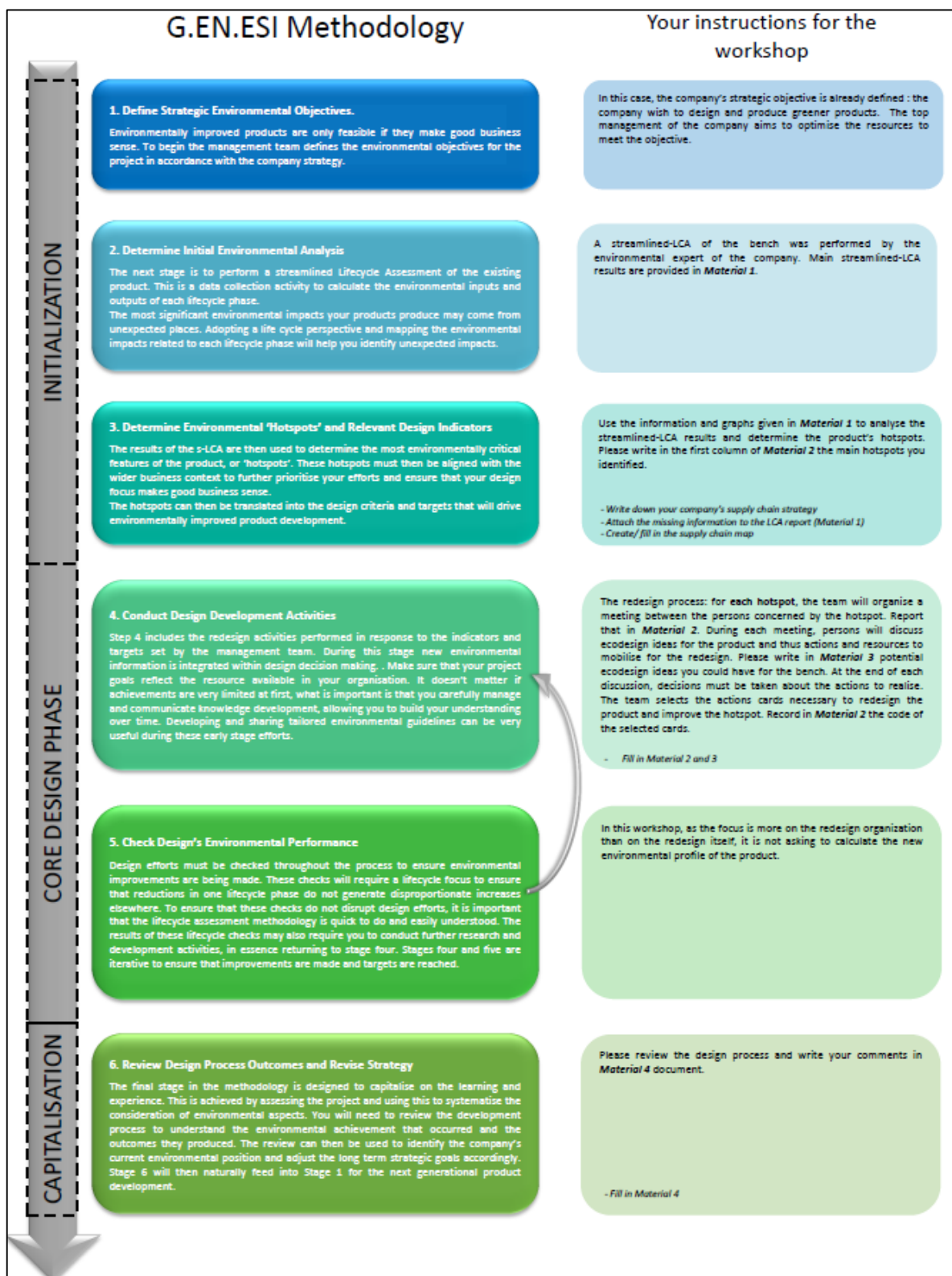

ROLES CARDS

PURCHASING MANAGER

GENERAL ROLE

You are a Purchasing Manager for the manufacturing company. You send drawings and specifications to suppliers to ask about feasibility, costs and timescales. You also request new/updated datasheets for materials and components. Where possible, you source materials and components from a list of known suppliers.

Concerning wood supply, you are currently buying varying sizes of wood beams according to best offer you found on the market (your main driver is cost).

REQUIREMENTS TO THIS PROJECT

You might need to collect specific information on this project from suppliers concerning their products, components, materials, factories and other.

QUALITY MANAGER

GENERAL ROLE

You are the Quality Manager at the company. You aim to ensure that any new product is fit for purpose, is consistent and meets both external and internal requirements. This includes legal compliance and customer expectations.

You are involved in developing the quality goals and targets in the organisation's strategic plan as well as production quality on existing products.

You work closely with purchasing staff to establish supplier quality performance criteria and monitor supplier performance.

You are setting standards for quality as well as health and safety.

REQUIREMENTS TO THIS PROJECT

As bench is an outdoor product, to guarantee the durability of the product, the product must be weather resistant and more generally resistant to external aggression.

You are making sure that the design and production process of the bench meet international and national standards.

PROJECT MANAGER

GENERAL ROLE

You are the Project Manager for the redesign of a bench. You ensure the coordination between the different stakeholders and the integration of their points of view in order to meet all the constraints. You are always under significant pressure from the top management to ensure that projects are delivered on-time and according to the budget.

At the project team level, you represent the company strategy and the marketing service. You ensure that their requirements are followed.

As the new strategic aspect is to provide a greener product to the consumer, you order the environmental expert of the company to conduct a life cycle assessment (LCA) of the current bench. You consult him every time you need environmental information.

In order to reduce environmental impacts of the product, you decided to organise the product redesign process using the results of the LCA.

REQUIREMENTS TO THIS PROJECT

Aesthetic aspects and a smooth finish of the bench are requirements from the marketing department and top management, in order to respect the image of the company; that's why teak was chosen for the previous version of the bench.

DESIGN ENGINEER

GENERAL ROLE

You are a Design Engineer in a manufacturing company. You develop conceptual and detailed designs according to the product specifications the project manager gives you. You spend the majority of your time creating 3D models of new parts and assemblies using CAD: you create the drawings necessary for prototyping and production (both in house components and for sub-contracted components). You follow the product and make requested changes and corrections throughout the life of the product.

Ecodesign will be now part of your mission. You can consult the environmental expert of the company to get from him ecodesign advice and guidelines to increase your knowledge.

REQUIREMENTS TO THIS PROJECT

Your remit is to propose design modifications to the product in order to meet the environmental requirements of the project.

PRODUCTION MANAGER

GENERAL ROLE

You are the Production Manager at the company. You are in charge of the factory, the logistics department, and the maintenance department. The logistics department is in charge of the packaging and of the delivery of products to customer. In the factory, only the wood is processed. The manufacturing of the metal parts of the product is subcontracted. The factory consists of the planing workshop, the wood painting workshop, the assembly workshop of steel and wood parts and the packaging workshop of the whole product.

REQUIREMENTS TO THIS PROJECT

In the framework of the new environmental strategy, you might need to take decisions related to the different activities taking place within the factory. In line with the environmental hotspots raised by the project manager, you have to take decisions concerning the manufacturing workshop of the wood, logistic aspects, and maintenance service. From that aspect, you think reduction of wood losses you observe in the planing workshop could be a part of the strategy. Your aim is to put into action the solutions envisaged for reducing environmental impacts of the product from a manufacturing point of view.

MATERIAL 1

In this information pack you will find the lifecycle assessment (LCA) report of the 13-slat model bench.

THE LCA REPORT

This life cycle analysis has been realised in accordance with the ISO 14044:2006 requirements (Environmental management -- Life cycle assessment -- Requirements and guidelines). The EIME LCA software has been used for this analysis. The indicator set is indicators for PEP ecopassport – PCR 2.1. Information about methods to calculate the indicators are explained in the Indicators Manual of EIME¹⁷.

OBJECTIVE OF STUDY

This study is a simplified LCA realized for pedagogical purpose and aims to identify the environmental hot spots of an element of street furniture: a 13-slats model bench.

THE PRODUCT

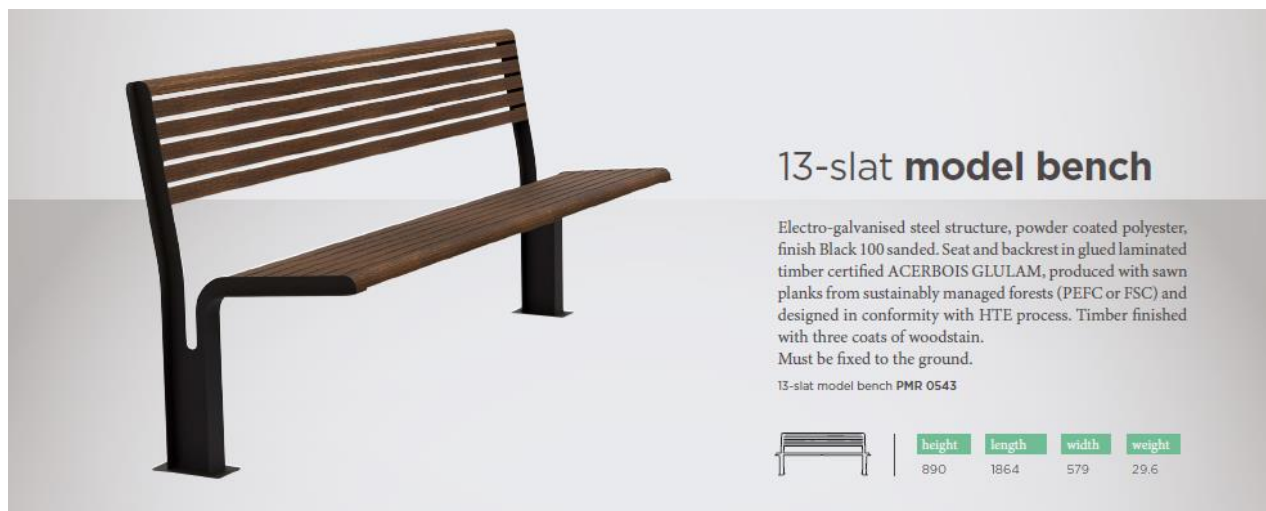

FUNCTIONAL UNIT

Support the weight of 3 persons (80 kg each), 10 hours per day, during 7 years.

SYSTEM BOUNDARIES

The life cycle phases taken into account in this analysis are the followings: Manufacturing phase, Distribution phase, Installation phase, Use phase and End-of-life.

LIFE CYCLE INVENTORY

The life cycle inventory lists the different elements were taken into account during the modelling of the product lifecycle.

¹⁷ http://www.codde.fr/files/EIME%20Manuel%20Indicateurs_Juillet_09_CODDE_BV.pdf

MANUFACTURING PHASE

Three essential parts were considered: wooden slats, steel structure and screws.

WOODEN SLATS

Material

Teak wood: 19.5kg (13 slats of 1.5kg each)

Processes

Cutting: electricity of the machine

Planing: electricity of the machine

Coating: painting with the solvent based paint

Upstream Transport

The transport is calculated per slat.

Lorry in Thailand: 300 km (1.5kg x 300km = 450kg.km)

Container ship from Bangkok to Marseille: 15000 km (1.5kg x 15000km = 22.5tkm)

Lorry in France: 350 km en camion (1.5kg x 350km = 525kg.km)

STEEL STRUCTURE

Material

Steel: 9kg (2 parts of 4.5kg each)

Processes

Bending of steel parts

Laser cutting of steel parts

Painting with powder based paint

Surface treatment: Zinc phosphating of steel

Welding of steel parts

Upstream Transport

Lorry from Romania to France: 2000km [= 2x (4.5kg x 2000km) =2 x (9tkm)]

SCREWS

Material

Stainless steel: 1.1kg

Upstream Transport

Lorry 100km (1.1kg x 100km = 110kg.km)

DISTRIBUTION PHASE

PACKAGING

Material

Plastic film packaging: 0.67kg

Pallet packaging: 2.48kg

Cardboard packaging: 0.2kg

Transport

Calculated per packaged bench.

Lorry 400km in France (29.6kg of product + 3.35kg of packaging =32.95kg) (32.95kg x 400km = 13180kg.km)

INSTALLATION PHASE

CONCRETE BENCH SEALING

Material

Concrete: 80kg

USE PHASE

Nothing appears here because once the bench is installed, there is no use activity.

END-OF-LIFE

Waste Product Collection

Transport of the bench to the waste treatment plant: 50km (29.6kg x 50 km = 1480 kg.km)

Waste Recovery

100% of the steel is recycled

100% of the wood is incinerated to recover energy

LIFE CYCLE IMPACT ASSESSMENT

Below is the life cycle impact assessment of the bench.

Table A1: Environmental profile of the bench

Impact indicator	Unit	Manufact.	Distribution	Installation	Use	End-of-life	Sum
Air Acidification (AA for PEP)	kg H ⁺ eq	1.77E-02	1.17E-03	2.79E-03	0	-2.65E-03	1.90E-02
Air Toxicity (AT for PEP)	m ³	1.64E+08	1.67E+06	3.70E+06	0	-3.06E+06	1.66E+08
Energy Depletion (ED for PEP)	MJ	1.13E+03	1.64E+02	8.87E+01	0	-2.39E+02	1.14E+03
Global Warming Potential (GWP for PEP)	kg CO ₂ eq.	8.29E+01	8.95E+00	2.34E+01	0	-1.54E+01	9.99E+01
Hazardous Waste Production (HWP for PEP)	kg	5.73E-01	1.95E-02	1.12E-01	0	1.84E-02	7.23E-01
Ozone Depletion Potential (ODP for PEP)	kg CFC-11 eq.	2.24E-05	5.15E-06	1.34E-06	0	-8.44E-07	2.80E-05
Photochemical Ozone Creation Potential (POCP for PEP)	kg C ₂ H ₄ eq.	5.29E-02	7.77E-03	3.46E-03	0	-3.19E-04	6.39E-02
Raw Material Depletion (RMD for PEP)	Y-1	3.41E-15	2.36E-16	7.10E-17	0	-2.99E-16	3.42E-15
Water Depletion (WD for PEP)	dm ³	3.89E+02	1.43E+01	1.94E+01	0	6.80E+01	4.91E+02
Water Eutrophication (WE for PEP)	kg PO ₄ ³⁻ eq.	3.05E-03	1.45E-04	3.57E-05	0	-5.14E-05	3.18E-03
Water Toxicity (WT for PEP)	m ³	2.10E+01	1.09E+00	6.75E-01	0	-3.67E+00	1.91E+01

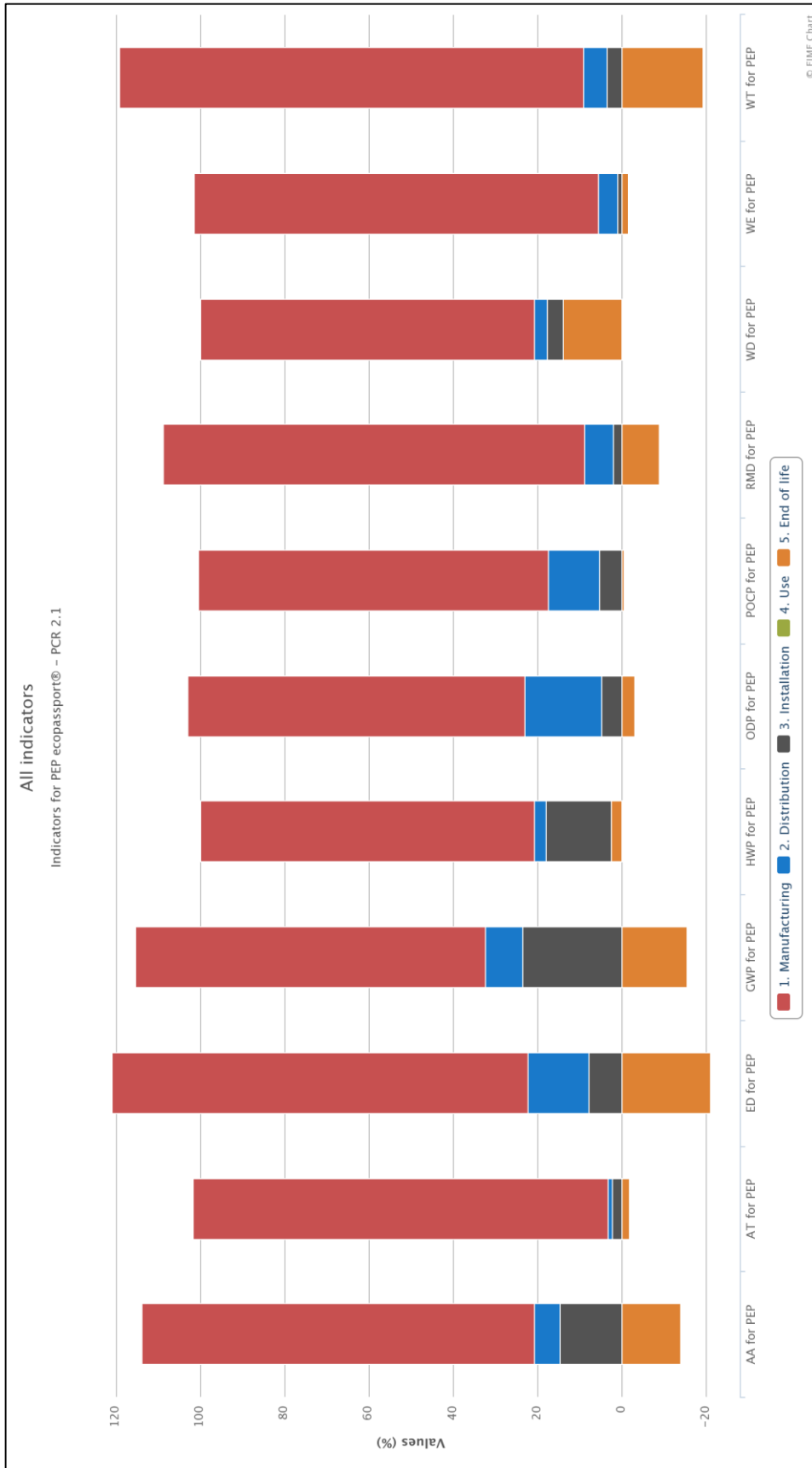

Figure A-16: Impacts of the life cycle of the bench

MANUFACTURING PHASE

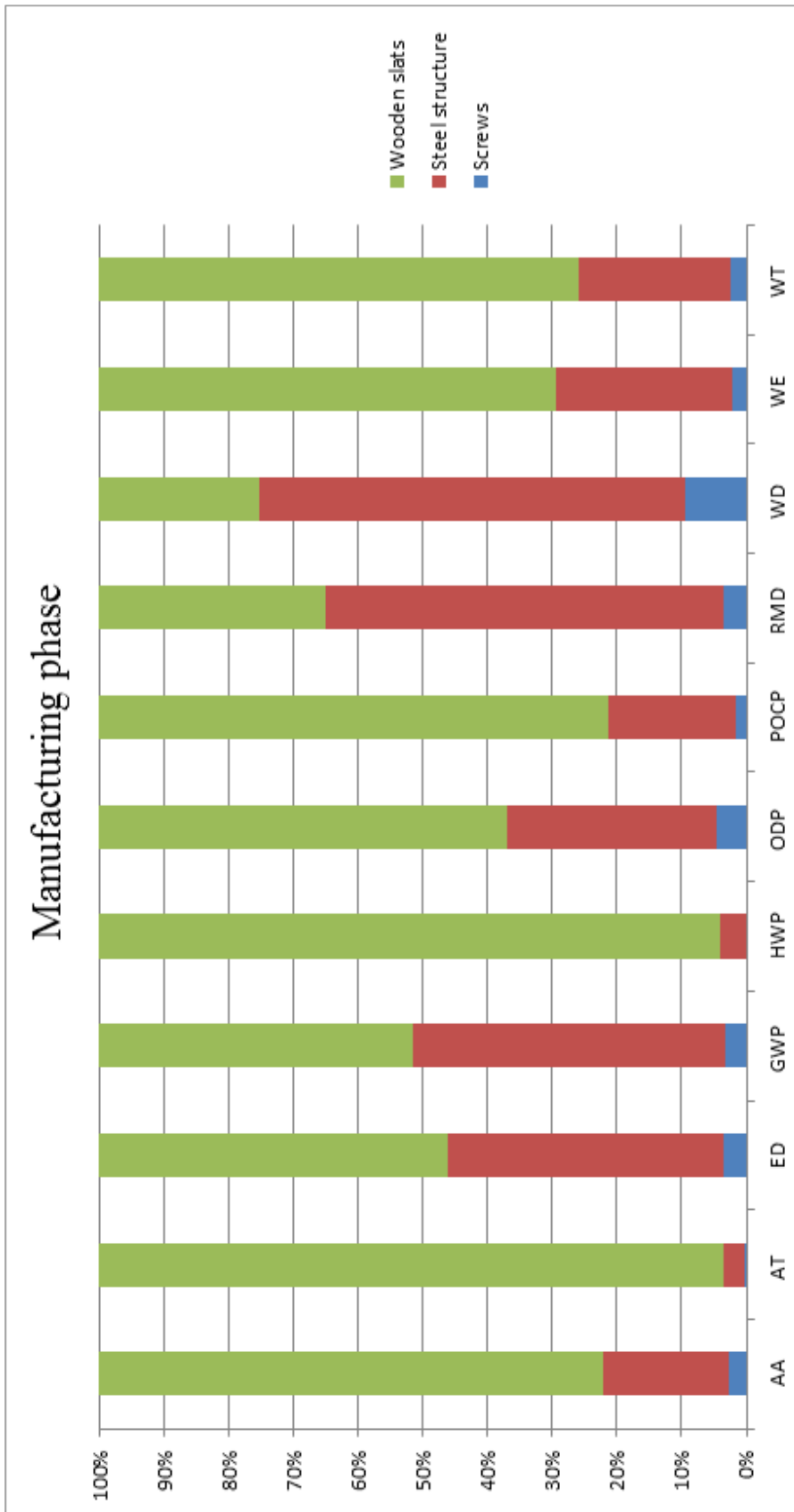

Figure A-17: Contribution to the environmental impacts of the elements of the manufacturing phase

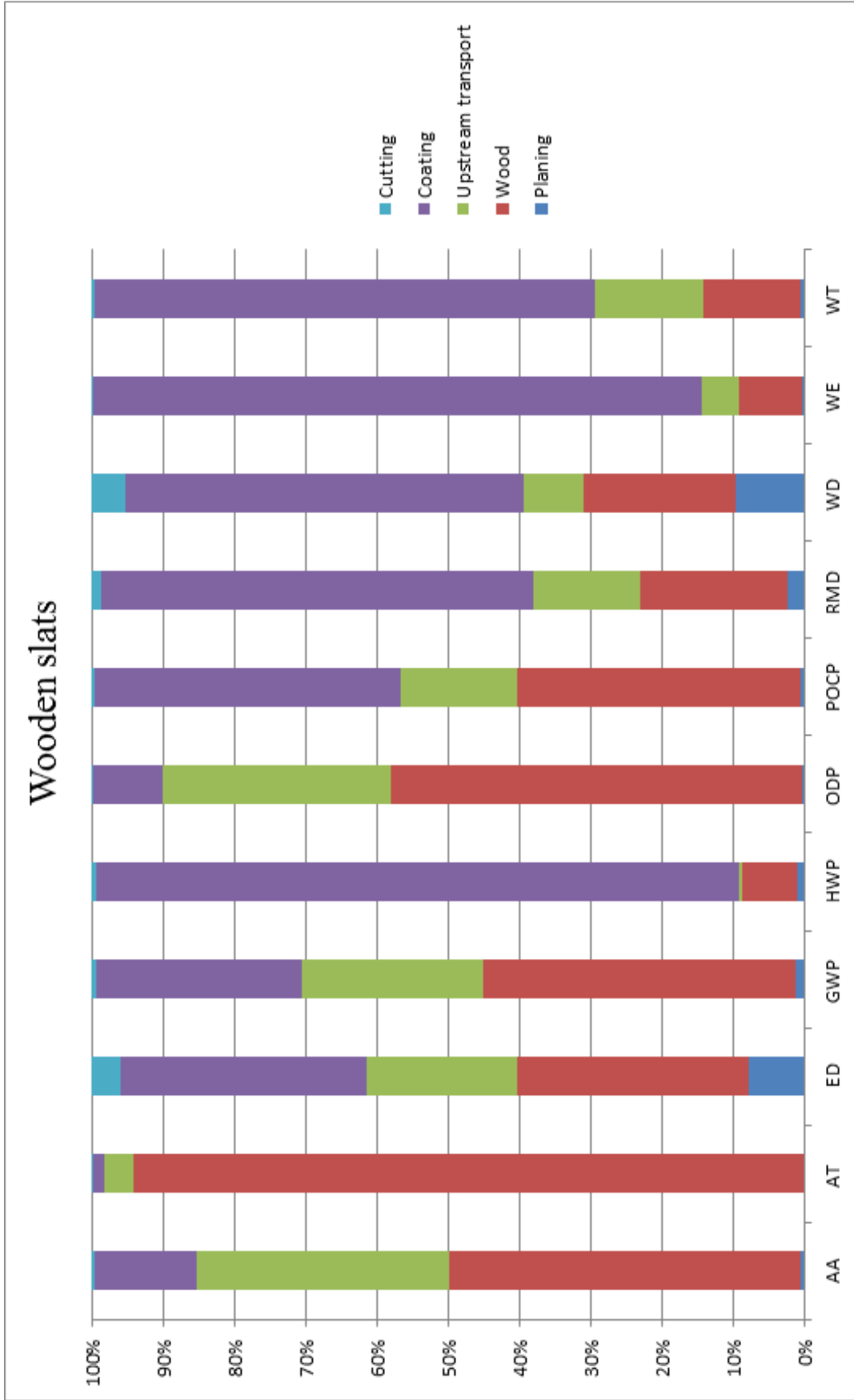

Figure A-18: Contribution to the environmental impacts of the elements of the wooden slats

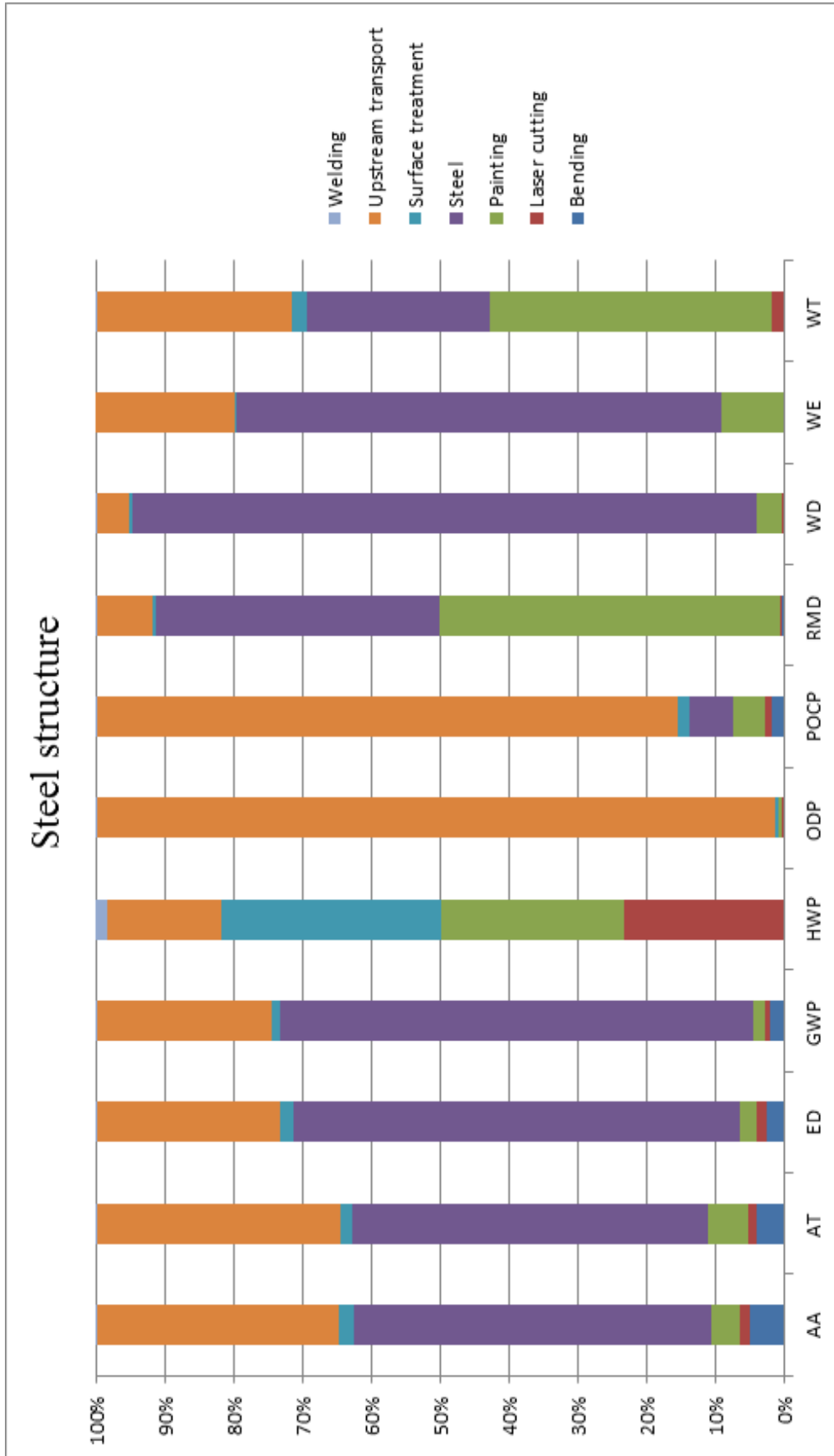

Figure A-19: Contribution to the environmental impacts of the elements of the steel structure

DISTRIBUTION PHASE

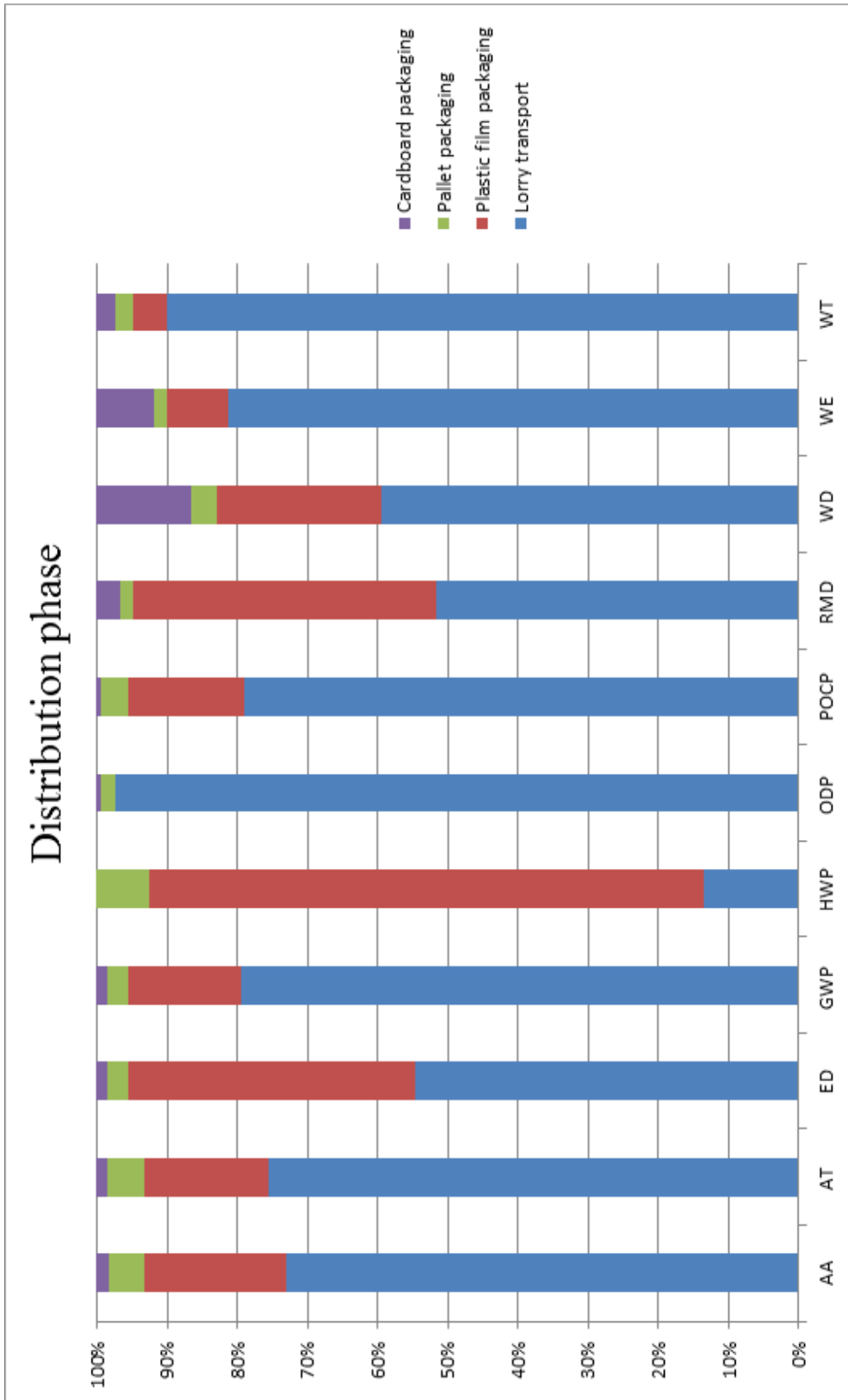

Figure A-20: Contribution to the environmental impacts of the elements of the distribution phase

INTERPRETATION

You will be able to interpret the graphs and identify the most critical aspects of the bench on the environment. Please report in Material 3, hotspots that your team decides to improve.

MATERIAL 2

A MEETING PLANNING

For each hotspot (the most environmentally critical features of the product), please mark in this table the persons needed at each hotspot redesign meeting. Each person must look his role card to know if he feels concerned by the hotspot.

Conduct the hotspot redesign meeting (and record any ideas in material 3).

Write the code of the action cards that the team selects to enable the redesign of that hotspot (for each meeting, use only the action cards of the persons marked present). An example illustrates the instructions.

	Project Manager	Designer	Quality Manager	Production Manager	Purchasing Manager	Total of the resource load
Hotspot N°1: Molding process of the light	- (nothing if no appointment)	- (nothing if no appointment)	X (if there is an appointment) Code(s): D2	X (if there is an appointment) Code(s): B1,B3	- (nothing if no appointment)	12
Hotspot N°1:						
Hotspot N°2:						
Hotspot N°3:						
Hotspot N°4:						
Hotspot N°5:						
Hotspot N°6:						
Hotspot N°7:						

Annex

Hotspot N°8:						
Hotspot N°9:						
Hotspot N°10:						

MATERIAL 3

In this document, you are welcome to write your ecodesign ideas for the redesign of the bench.

Concerned Hotspots	Ecodesign ideas	Comments/Assumptions/Other