



HAL
open science

On the stability by convolution product of some resurgent algebras

Yafei Ou

► **To cite this version:**

Yafei Ou. On the stability by convolution product of some resurgent algebras. Mathematics [math].
Université d'Angers, 2012. English. NNT : 2012ANGE0055 . tel-01277192

HAL Id: tel-01277192

<https://theses.hal.science/tel-01277192>

Submitted on 22 Feb 2016

HAL is a multi-disciplinary open access archive for the deposit and dissemination of scientific research documents, whether they are published or not. The documents may come from teaching and research institutions in France or abroad, or from public or private research centers.

L'archive ouverte pluridisciplinaire **HAL**, est destinée au dépôt et à la diffusion de documents scientifiques de niveau recherche, publiés ou non, émanant des établissements d'enseignement et de recherche français ou étrangers, des laboratoires publics ou privés.

SUR LA STABILITÉ PAR PRODUIT DE CONVOLUTION D'ALGÈBRES DE RÉSURGENCE

THÈSE DE DOCTORAT

Spécialité: Mathématiques

ÉCOLE DOCTORALE D'ANGERS

Présentée et soutenue publiquement le 18 September 2012

à l'Université d'Angers

par

Yafei OU

Devant le jury ci-dessous :

<i>Rapporteurs :</i>	David SAUZIN, Changgui ZHANG,	Dr CNRS Professeur à l'université Lille-1
<i>Examineurs :</i>	Lei TAN Michèle LODAY-RICHAUD Reinhard SCHÄPFKE	Professeur à l'Université d'Angers Professeur à l'Université d'Angers Professeur à l'Université de Strasbourg
<i>Directeur de thèse :</i>	Eric DELABAERE,	Professeur à l'Université d'Angers

LAREMA, Laboratoire de Mathématiques,
2, Bd Lavoisier, 49045 Angers Cedex 01

Yafei OU

**SUR LA STABILITÉ PAR PRODUIT
DE CONVOLUTION D'ALGÈBRES
DE RÉSURGENCE**

Yafei OU

LUNAM Université - Angers, UMR CNRS 6093 LAREMA, 2 Boulevard Lavoisier,
49045 Angers Cedex 01, France.

E-mail : `yafei@math.univ-angers.fr`

2000 Mathematics Subject Classification. — 34M37, 30Hxx.

Key words and phrases. — Convolution product, Resurgent algebra.

25 August 2012

SUR LA STABILITÉ PAR PRODUIT DE CONVOLUTION D'ALGÈBRES DE RÉSURGENCE

Yafei OU

Abstract. — La théorie de la Résurgence fait intervenir différents espaces fonctionnels : des espaces multiplicatifs de séries ou de développements formels qu'il s'agit de sommer; des espaces convolutifs de fonctions analytiques dont les objets se déduisent des premiers par transformations de Borel formelle; des espaces multiplicatifs de fonctions analytiques déduit des objets précédents par transformations de Laplace et qui forment les sommes de Borel-Laplace dont l'asymptotique redonnent les objets formels de départ.

Cette thèse se concentre sur la construction d'algèbres de convolution. Son objectif est de fournir une démonstration originale et complète, aisément compréhensible pour tout chercheur débutant dans le domaine, de la stabilité par produit de convolution de l'espace des fonctions prolongeables sans fin. La deuxième partie de la thèse, consacrée à l'algèbre de convolution des fonctions prolongeables sans fin à singularités simples, explique comment l'utilisation des dérivations étrangères permet de préciser la structure singulière de ces objets. Nous concluons notre travail par un ensemble de problèmes qui selon nous restent ouverts, de grande importance en pratique et pour lesquels nos méthodes doivent selon toute vraisemblance pouvoir s'appliquer.

Résumé (On the stability by convolution product of some resurgent algebras)

Various functional spaces take place in Resurgence theory : multiplicative spaces of formal series expansions that one would like to sum; convolutive spaces of analytic functions, the elements of which coming from the former ones by formal Borel transformations; multiplicative spaces of analytic functions deduced from the previous ones by Laplace transformations, thus giving the Borel-Laplace transforms whose asymptotics give back the formal objects one started with.

This thesis is devoted to the construction of convolution algebras. Our aim is to provide an original and self-contained proof of the stability under convolution products of the space of endlessly continuable functions, in a way understandable by any young searcher in the field. The second part of the thesis concentrates on the convolution space of endlessly continuable functions with simple singularities. We show how the use of the alien derivations bring deep knowlege on the singular structure. We end our work with some problems, still open according to us but of great importance in practice and for which we think that our methods could be applied as well.

REMERCIEMENTS

Tout d'abord, je voudrais dire un grand merci à mon directeur de thèse Eric Delabaere, qui a bien voulu accepter de m'encadrer pendant ces quatre années de thèse. Je tiens à le remercier pour sa grande patience pour toutes les questions que j'ai pu lui poser et ses explications claires, sa gentillesse en toutes circonstances. Il a aussi su me donner la confiance nécessaire pour arriver à la fin de ce travail. Sans ses précieux conseils et commentaires, cette thèse n'aurait jamais vu le jour. Je n'oublierai jamais l'accueil chaleureux que sa famille m'avait réservé quand j'étais arrivée en France. J'exprime donc encore une fois ma profonde gratitude à lui et à toute sa famille.

Je souhaite également remercier très chaleureusement David Sauzin et Zhang Changgui pour avoir accepté d'être rapporteurs, ainsi que pour l'intérêt qu'ils ont porté à mon travail et pour toutes les remarques constructives.

J'adresse aussi mes plus vifs remerciements à Tan Lei qui m'a donné beaucoup d'encouragements pendant toutes ces années ainsi que pour avoir accepté d'être membre de ce jury.

Je tiens aussi à remercier les autres membres du jury, Michèle Loday-Richaud et Reinhard Schaefer d'avoir accepté d'être membres de ce jury.

Je voudrais remercier particulièrement Loïc Chaumont pour son aide et ses précieux conseils.

À ne pas oublier non plus mes compagnes d'études très sympathiques, à savoir Julie, Suzanne, Kanna avec lesquelles je me suis très bien entendue. Merci aussi Jérôme, Alexandre, Irfan, Anastasia, Romain avec eux nous avons partagé le séminaire des doctorants. Un merci aussi à Alexandra et Caroline avec lesquelles j'ai pu passer des moments agréables.

Finalement, aussi un grand merci à Wang Xiaoguang et à Gao Yan pour toutes les discussions et explications qu'ils m'ont fournies à mes questions, sans oublier aussi Richard pour les corrections du texte anglais de ma thèse.

Enfin, je ne serai certainement pas arrivée au bout de ce travail sans le soutien et les permanents encouragements de mes parents, mon frère et tous les autres membres de ma famille. Je leur dis merci pour tout ce qu'ils ont fait et pour tout ce qu'ils continuent de faire.

CONTENTS

1. Introduction	11
1.1. Cadre et objectifs de la thèse	11
1.2. La structure et les résultats principaux de la thèse	16
2. Background on holomorphic functions	27
2.1. Some recalls on holomorphic functions	27
2.2. Riemann surface	30
2.3. Convolution product	33
3. Preparatory lemmas	41
3.1. Some definitions	41
3.2. Heuristic	42
3.3. Preparatory lemmas	43
3.4. Proofs of the preparatory lemmas	45
3.5. Numerical samples	51
4. Convolution algebra : an introduction	57
4.1. The Riemann surface \mathcal{R}_Ω	57
4.2. Symmetrically contractile path and application	61
4.3. The convolution algebra $\mathcal{H}(\mathcal{R}_\Omega)$	63
5. Endless continuability	65
5.1. Discrete filtered set and associated Riemann surface	66
5.2. CNP's endless continuability	71
5.3. Seen and glimpsed singular points	72
5.4. Endless continuability and convolution product	74
5.5. Application : the convolution algebra \mathcal{H}_{end}	84
5.6. Ecalle's endless continuability, continuability without cut	85
6. The resurgence space RES^{simp}	89
6.1. Ecalle's singularities	89
6.2. The convolution algebra RES^{simp}	99
6.3. Alien derivations	104
6.4. Back to the Riemann surface of a convolution product	109
7. Conclusion and related works	121

7.1. An introduction to the weighted products	121
7.2. Some related problems	125
Bibliography	129

CHAPTER 1

INTRODUCTION

1.1. Cadre et objectifs de la thèse

Le cadre dans lequel prend place ce travail est la théorie de la résurgence fondée par Ecalle [Ec81-1, Ec81-2, Ec84, Ec85, Ec93-1, Ec93-2, Ec94, Ec005] et ses élèves [Men97, Men99, Eve99], voir aussi [CNP93-1, CNP93-2, S009]. Cette théorie étend et systématise la théorie classique de sommation de Borel-Laplace [Bor28, Wa65, Din73, Olv74] de séries divergentes et s'applique à de nombreux problèmes naturels: équations différentielles, aux différences, etc..., voir par exemple [Cost98, Cost001, Cost009, DDP93, DDP97, DP97, DR006, GS001, S95, OSS003, S012]. Elle a naturellement des liens étroits avec la théorie de la multi-sommabilité due à Ramis, Sibuya, etc.. [MR94, MR91, R93, Mal91, Sib90, Lod94, Lod95, Lod001, LR011, Bra91, Bal000, Zha99, Zha006] ainsi qu'avec l'hyperasymptotique [BH91, Old96, Old97, Old98, DH002].

Nous faisons ici une présentation extrêmement brève de la sommation de Borel-Laplace, incomplète mais suffisante pour présenter le cadre et l'objectif de notre travail. Nous renvoyons par exemple à [Mal95, S006] pour des exposés pédagogiques plus complets et les détails de démonstration.

1.1.1. Transformation de Borel formelle. — Soit $\tilde{\varphi}(z) = \sum_{n \geq 0} \frac{a_n}{z^n} \in \mathbb{C}[[z^{-1}]]$ une série formelle. On définit sa transformation de Borel formelle par:

$$\mathcal{B} : \tilde{\varphi}(z) = \sum_{n \geq 0} \frac{a_n}{z^n} \rightarrow \sum_{n \geq 1} a_n \frac{\zeta^{n-1}}{(n-1)!} = \hat{\varphi}(\zeta).$$

L'opérateur \mathcal{B} est un opérateur \mathbb{C} -linéaire de $\mathbb{C}[[z^{-1}]]$ sur $\mathbb{C}[[\zeta]]$.

Remarquons que si $\tilde{\varphi}$ est convergente, alors $\hat{\varphi}$ définit une fonction entière. Le cas le plus intéressant est celui où $\hat{\varphi}$ n'est pas entière. On voit facilement que $\hat{\varphi} \in \mathbb{C}\{\zeta\}$ a un rayon de convergence strictement positif si et seulement si $\tilde{\varphi}$ est une série formelle "Gevrey-1", c'est à dire qu'il existe $K > 0$ et $C > 0$, telle que

$$\forall n \in \mathbb{N}, |a_n| \leq KC^n \Gamma(n+1).$$

L'espace des séries formelles "Gevrey-1" est noté $\mathbb{C}[[z^{-1}]]_1$. Cet espace forme une \mathbb{C} -algèbre différentielle.

1.1.2. Transformation de Laplace. — Pour $\theta \in \mathbb{R}/2\pi\mathbb{Z}$, considérons maintenant une fonction analytique à l'origine $\hat{\varphi}(\zeta) \in \mathbb{C}\{\zeta\}$ et supposons que $\hat{\varphi}$ peut être prolongée analytiquement le long de la demi-droite $d_\theta = [0, \infty e^{i\theta}[$ avec une

croissance exponentielle d'ordre au plus un à l'infini sur d_θ , c'est à dire qu'il existe $\tau > 0$ et $C > 0$ tel que pour tout $\zeta \in d_\theta$, $|\widehat{\varphi}(\zeta)| \leq Ce^{\tau|\zeta|}$. Nous définissons la transformation de Laplace dans la direction θ par:

$$\mathcal{L}^\theta \widehat{\varphi}(z) = \int_0^{e^{i\theta}\infty} e^{-z\zeta} \widehat{\varphi}(\zeta) d\zeta.$$

Cette fonction $\mathcal{L}^\theta \widehat{\varphi}$ est analytique dans le demi-plan ouvert $\Pi_\tau^\theta = \{z \in \mathbb{C}, \Re(ze^{i\theta}) > \tau\}$.

Si $\widehat{\varphi}$ peut être prolongée analytiquement le long de l'ensemble des demi-droites d_θ pour $\theta \in [\alpha, \beta]$, $\beta - \alpha < 2\pi$, avec une croissance exponentielle d'ordre au plus un à l'infini sur ces demi-droites, alors les transformées de Laplace $\mathcal{L}^\theta \widehat{\varphi} \in \mathcal{O}(\Pi_\tau^\theta)$ se recollent pour former une seule et même fonction holomorphe notée $\mathcal{L}^{[\alpha, \beta]} \widehat{\varphi} \in \mathcal{O}(\Pi_\tau^{[\alpha, \beta]})$, avec $\Pi_\tau^{[\alpha, \beta]} = \bigcup_{\theta \in [\alpha, \beta]} \Pi_\tau^\theta$ pour un certain $\tau > 0$.

Le cadre naturel pour de tels objets est celui de faisceaux sur $\mathbb{R}/2\pi\mathbb{Z}$ de fonctions holomorphes.

1.1.3. Asymptotique. — Pour un secteur ouvert de la forme $\Sigma = \Pi_\tau^{[\alpha, \beta]}$, nous disons que Σ' est un sous-secteur strict si Σ' est de la forme $\Sigma' = \Pi_{\tau'}^{[\alpha', \beta']}$ avec $\tau' > \tau$ et $[\alpha', \beta']$ strictement inclus dans $[\alpha, \beta]$. Dans ce cas on note $\Sigma' \Subset \Sigma$.

1.1.3.1. Asymptotique de Poincaré. — Soit à présent $\Phi \in \mathcal{O}(\Sigma)$. On dit que Φ est asymptote à la série $\widetilde{\varphi}(z) = \sum_{n=0}^{\infty} \frac{a_n}{z^n}$ à l'infini dans Σ si:

$$\forall \Sigma' \Subset \Sigma, \forall N \in \mathbb{N}, \exists C = C(\Sigma', N) > 0 \text{ tel que } \forall z \in \Sigma', |\Phi(z) - \sum_{n=0}^N \frac{a_n}{z^n}| \leq \frac{C}{|z|^{N+1}}.$$

On note $\bar{\mathcal{A}}(\Sigma)$ l'ensemble des fonctions holomorphes dans Σ et admettant une série asymptotique à l'infini dans Σ . On note

$$T : \bar{\mathcal{A}}(\Sigma) \rightarrow \mathbb{C}[[z^{-1}]]$$

l'application (de Taylor) qui à $\Phi \in \bar{\mathcal{A}}(\Sigma)$ associe sa série asymptotique à l'infini dans Σ .

L'ensemble $\bar{\mathcal{A}}(\Sigma) \subset \mathcal{O}(\Sigma)$ définit une \mathbb{C} -algèbre différentielle, et T est un morphisme de \mathbb{C} -algèbres différentielles. Si $\bar{\mathcal{A}}^{<0}(\Sigma)$ désigne le noyau du morphisme T , alors le Théorème de Borel-Ritt montre que l'application

$$T : \bar{\mathcal{A}}(\Sigma) / \bar{\mathcal{A}}^{<0}(\Sigma) \rightarrow \mathbb{C}[[z^{-1}]]$$

est un isomorphisme.

1.1.3.2. Asymptotique Gevrey-1. — On note $\bar{\mathcal{A}}_1(\Sigma)$ le sous-ensemble des $\Phi \in \bar{\mathcal{A}}(\Sigma)$ tel que, si $T(\Phi) = \sum_{n=0}^{\infty} \frac{a_n}{z^n}$ à l'infini dans Σ , alors:

$$\forall \Sigma' \Subset \Sigma, \exists C = C(\Sigma') > 0, \forall N \in \mathbb{N}^*, \forall z \in \Sigma', |\Phi(z) - \sum_{n=0}^{N-1} \frac{a_n}{z^n}| \leq \frac{C^N \Gamma(N+1)}{|z|^N}$$

L'ensemble $\bar{\mathcal{A}}_1(\Sigma) \subset \bar{\mathcal{A}}(\Sigma)$ forme une \mathbb{C} -algèbre différentielle appelée l'algèbre des fonctions Gevrey-1 dans Σ .

En notant par $\bar{\mathcal{A}}^{\leq -1}(\Sigma)$ le noyau du morphisme

$$T : \bar{\mathcal{A}}_1(\Sigma) \rightarrow \mathbb{C}[[z^{-1}]]_1,$$

le caractère Gevrey implique que ce noyau est constituée de fonctions à décroissance exponentielle d'ordre 1 à l'infini.

Par ailleurs le morphisme

$$T : \bar{\mathcal{A}}_1(\Sigma) \rightarrow \mathbb{C}[[z^{-1}]]_1$$

est injectif si Σ est un secteur d'ouverture $> \pi$ (ce qui est le cas de notre présentation) par le théorème de Watson.

1.1.4. Sommation de Borel-Laplace, 1-sommation. — Le théorème de Watson permet de définir sans ambiguïté ce qu'il est courant d'appeler la 1-sommation: si $\tilde{\varphi}$ est une série Gevrey-1 et s'il existe une fonction $\Phi \in \bar{\mathcal{A}}_1(\Sigma)$ telle que $T(\Phi) = \tilde{\varphi}$, alors Φ est unique (si Σ est un secteur d'ouverture $> \pi$).

Le lien avec la transformation de Borel-Laplace nous est donné par le résultat suivant:

Theorem 1.1.1 (Somme de Borel-Laplace). — *Une série formelle Gevrey-1, $\tilde{\varphi}(z) = \sum_{n \geq 1} \frac{a_n}{z^n} \in \mathbb{C}[[z^{-1}]]_1$ est sommable dans la direction $\theta \in \frac{\mathbb{R}}{2\pi\mathbb{Z}}$ si et seulement si sa transformée de Borel formelle $\hat{\varphi}$:*

- se prolonge analytiquement dans un secteur de la forme $\Sigma(J) = \{\zeta \in \mathbb{C}, \arg(\zeta) \in [\theta - \varepsilon, \theta + \varepsilon]\}$.
- est à croissance exponentielle d'ordre au plus 1 à l'infini le long des demi-droites de ce secteur.

Alors, la somme de Borel $\mathfrak{L}^\theta \mathfrak{B} \tilde{\varphi}$ de $\tilde{\varphi}$ dans la direction θ est donnée par

$$\mathfrak{L}^\theta \mathfrak{B} \tilde{\varphi}(z) = \int_0^{\infty e^{i\theta}} \hat{\varphi}(\zeta) e^{-z\zeta} d\zeta.$$

De plus, si

$$\Phi(z) = \mathcal{L}^{[\theta - \varepsilon, \theta + \varepsilon]} \mathfrak{B} \tilde{\varphi} \in \mathcal{O}(\Pi_r^{[\theta - \varepsilon, \theta + \varepsilon]})$$

alors $\Phi \in \bar{\mathcal{A}}_1(\Pi_r^{[\theta - \varepsilon, \theta + \varepsilon]})$ et $T(\Phi) = \tilde{\varphi}$.

Nous avons donc le diagramme suivant

$$\tilde{\varphi}(z) \xrightarrow{\mathfrak{B}} \hat{\varphi}(\zeta) \xrightarrow{\mathfrak{L}^\theta} \mathfrak{L}^\theta \mathfrak{B}(\tilde{\varphi})(z) \xrightarrow{T} \tilde{\varphi}(z).$$

Remarquons que dans le Théorème précédent nous avons considéré des séries formelles $\tilde{\varphi}(z) = \sum_{n \geq 1} \frac{a_n}{z^n}$ de valuation ≥ 1 , c'est à dire que $a_0 = 0$. On peut étendre la construction en introduisant la transformée de Borel de 1, $\mathfrak{B}(1) = \delta$ de façon cohérente.

1.1.5. Transport de structures - le produit de convolution. — Les structures d'algèbres différentielles des espaces $\mathbb{C}[[z^{-1}]]$ ou $\bar{\mathcal{A}}(\Sigma)$ se transportent aisément par transformation de Borel \mathfrak{B} . La dérivation $\partial = \frac{d}{dz}$ se transporte en la dérivation $\partial = (\text{multiplication par } -\zeta)$ tandis que le produit devient le produit de convolution : pour deux séries formelles Gevrey-1 $\tilde{\varphi}, \tilde{\psi} \in z^{-1}\mathbb{C}[[z^{-1}]]_1$,

$$\mathfrak{B} : \tilde{\varphi} \tilde{\psi}(z) \rightarrow \hat{\varphi} * \hat{\psi}(\zeta)$$

où $*$ est le produit de convolution de deux germes analytiques en 0 qui défini par:

$$(1) \quad \varphi * \psi(\zeta) = \int_0^\zeta \varphi(\eta)\psi(\zeta - \eta)d\eta$$

où on intègre sur le segment $[0, \zeta]$ pour $\zeta \in \mathbb{C}$ proche de 0. (Cette formule dérive très simplement des propriétés de la fonction Beta d'Euler).

Illustrons cela par un exemple classique, celui de l'équation d'Euler [CNP93-1, Del94, GS001]:

$$(2) \quad \frac{\partial}{\partial z}\varphi - \varphi = -\frac{1}{z}.$$

La recherche d'une solution formelle dans $\mathbb{C}[[z^{-1}]]$ mène facilement vers l'unique solution

$$\tilde{\varphi}(z) = \sum_{n \geq 1} \frac{(-1)^{n-1}(n-1)!}{z^n}.$$

Cette séries est Gevrey-1 puisque sa transformée de Borel

$$(\mathfrak{B}\tilde{\varphi})(\zeta) = \hat{\varphi}(\zeta) = \sum_{n \geq 0} (-1)^n \zeta^n$$

converge, de somme $\hat{\varphi}(\zeta) = \frac{1}{\zeta + 1}$ (avec l'abus de notation de confondre un élément de $\mathbb{C}\{\zeta\}$ avec sa somme). On notera qu'on peut déduire ce résultat en transportant l'équation (2) par transformation de Borel:

$$(3) \quad -\zeta\hat{\varphi} - \hat{\varphi} = -1.$$

Si φ est solution de (2) et définissant $\psi = \varphi^2$, il vient que

$$(4) \quad \frac{\partial}{\partial z}\psi = 2\varphi^2 - \frac{2}{z}\varphi$$

dont l'unique solution formelle $\tilde{\psi} = \tilde{\varphi}^2 \in \mathbb{C}[[z^{-1}]]$ admet une transformation de Borel de la forme

$$(5) \quad \hat{\psi}(\zeta) = \hat{\varphi} * \hat{\varphi}, \quad -\zeta\hat{\psi} = 2\hat{\varphi} * \hat{\varphi} - 2(1 * \hat{\varphi}).$$

1.1.6. Phénomène de Stokes et algèbres de convolution. — Le phénomène de Stokes [Sto] et son analyse sont des questions centrales en théorie asymptotique complexe. Ce problème peut-être abordé de diverses manières. En se plaçant dans le cadre de la (multi)-sommabilité, il est réglé de façon satisfaisante par le théorème de Ramis-Sibuya [Mal95]. En théorie de la Résurgence, on l'aborde par une analyse des singularités des transformées de Borel, dans un esprit somme toute plus proche de celui de Stokes.

L'exemple d'Euler précédent illustre la question. La somme de Borel relative à la direction $\theta = \pi$ prête à ambiguïté du fait du pôle en $\zeta = -1$ de $\hat{\varphi}$. Dans un tel cadre, en théorie de la résurgence, on définit la sommation "droite" et la sommation "gauche" suivant que pour l'intégrale de Laplace on évite la singularité "par la gauche" ou "par la droite". Ces deux sommes peuvent être comparées : elles diffèrent d'un élément de $\bar{\mathcal{A}}^{\leq -1}(\Pi_\tau^\pi)$, c'est à dire d'une "petite exponentielle", en l'occurrence une solution de l'équation homogène $\frac{\partial}{\partial z}\varphi - \varphi = 0$.

Plus généralement en Résurgence, on est donc amené à une analyse dans le “plan de Borel”, les objets centraux à y définir devenant les algèbres de convolution de fonctions analytiques convenables.

Prenons maintenant l'exemple classique du produit de convolution de deux pôles simples, comme l'exemple (5). Posons $\widehat{\varphi}(\zeta) = \frac{1}{\zeta - \omega}$, $\widehat{\psi}(\zeta) = \frac{1}{\zeta - \omega'}$ où $\omega, \omega' \in \mathbb{C}^*$, $\omega + \omega' \neq 0$ (disons). Un calcul immédiat nous donne

$$\widehat{\varphi} * \widehat{\psi}(\zeta) = \frac{1}{\zeta - (\omega + \omega')} \left(\ln\left(1 - \frac{\zeta}{\omega}\right) + \ln\left(1 - \frac{\zeta}{\omega'}\right) \right).$$

Il est alors facile de constater avec [CNP93-1, CNP93-2] que

1. le germe de fonctions holomorphes $\widehat{\varphi} * \widehat{\psi}$ se prolonge dans le domaine étoilé vu de l'origine privé des demi-droites $\{r\omega, r \geq 1\}$ et $\{r\omega', r \geq 1\}$.
2. le germe $\widehat{\varphi} * \widehat{\psi}$ se prolonge analytiquement sur le revêtement universel de $\mathbb{C} \setminus \{\omega, \omega', \omega + \omega'\}$.

La structure des singularités peut être précisée (singularités logarithmiques au-dessus de ω et ω' , pôle simple au-dessus de $\omega + \omega'$). Ce qui nous importait dans cet exemple était de faire observer le processus de création de nouvelles singularités par convolution.

1.1.7. La question du prolongement analytique du produit de convolution.

1.1.7.1. Le cas d'un semi-groupe. — Les exemples les plus simples d'algèbres de convolution sont fournis par l'espace des germes de fonctions holomorphes à l'origine se prolongeant analytiquement en dehors d'un ensemble fermé discret Ω . La demande que Ω soit un semi-groupe est légitime vu l'exemple qui précède et c'est ce que nous faisons ici.

C'est grosso modo le cadre où se place Ecalle dans [Ec81-1]. Même dans ce cadre simplifié, la démonstration n'est pas triviale, elle nécessite avant tout de préciser comment on prolonge analytiquement une intégrale singulière⁽¹⁾ du type (1), ce que Ecalle fait par le biais de chemins “symétriquement contractiles”.

Supposons donc que Φ et Ψ sont deux fonctions holomorphes à l'origine se prolongeant analytiquement en dehors d'un même semi-groupe discret fermé Ω . De manière équivalente, Φ et Ψ peuvent être vues comme fonctions holomorphes sur une surface de Riemann (\mathcal{R}, p) pointée ($p(0) = 0$) qu'on peut considérer être le revêtement universel de $\mathbb{C} \setminus \Omega$.

$$\begin{array}{ccc} & \mathcal{R} & \\ \Lambda \nearrow & & \searrow p \\ [0, 1] & \longrightarrow & \mathbb{C} \setminus \Omega \\ & \lambda & \end{array}$$

Le point essentiel dans ce cadre est la propriété de relèvement: puisque p réalise un revêtement, tout chemin λ de $\mathbb{C} \setminus \Omega$ se relève de manière unique par rapport à p en un chemin Λ sur \mathcal{R} à partir d'un point de base. Il en va de même des homotopies.

⁽¹⁾Pour ce concept “d'intégrale singulière”, voir par exemple [Ph005, Del010].

L'analyse est alors la suivante : soit $\gamma : t \in [0, 1] \mapsto \gamma(t) \in \mathbb{C} \setminus \Omega$ un chemin de classe \mathcal{C}^1 symétrique issu de l'origine, i.e., $\gamma(t) + \gamma(1 - t) = \gamma(1)$, soit Γ son relevé par rapport à p à partir de 0, alors l'intégrale

$$(6) \quad \int_0^1 \Phi(\Gamma(t))\Psi(\Gamma(1 - t))\gamma'(t)dt$$

est bien définie. Elle coïncide par ailleurs avec le produit de convolution (1) si γ est un petit segment proche de l'origine. Pour prolonger le produit de convolution, il suffit donc de travailler "en famille", c'est à dire de construire une homotopie convenable Γ_t pour tout chemin de $\lambda : t \in [0, 1] \mapsto \lambda(t) \in \mathbb{C} \setminus \Omega$ le long duquel on cherche à prolonger.

En pratique, il est souvent préférable de travailler en supposant que Ω est un groupe additif. Ceci pose la question du statut un peu spécial qu'est alors l'origine. Dans ce cadre, la surface de Riemann (\mathcal{R}, p) cesse d'être un revêtement mais un espace étalé sur $\mathbb{C} \setminus \Omega^*$ où $\Omega^* = \Omega \setminus \{0\}$. Néanmoins ce cadre n'est pas beaucoup plus contraignant et nous renvoyons par exemple à [OU010, S012] et à la présente thèse pour diverses démonstrations avec des approches qui diffèrent de celle d'Ecalte [Ec81-1].

1.1.7.2. Le cas d'un filtré discret. — Les problèmes "naturels" obligent en pratique à élargir le cadre précédent. On débouche de ce fait sur le concept de "fonctions holomorphes prolongeables sans fin" dont la définition prend diverses formes suivant les auteurs [CNP93-1, Ec85, Ec93-1]. Dans tous les cas de figure, ce sont là des objets surprenants pour un géomètre puisque la surface de Riemann (\mathcal{R}, p) d'une telle fonction est, certes, un espace étalé sur \mathbb{C} mais, dont l'ensemble des singularités peut très bien être un ensemble dense de \mathbb{C} .

A notre connaissance, la seule preuve existante publiée à ce jour de la stabilité par convolution de fonctions holomorphes prolongeables sans fin est celle de [CNP93-1]. Cependant cette preuve est difficile à comprendre, de l'avis des spécialistes. L'un de nos objectifs dans cette thèse (et *in fine* le seul) était de préciser les termes de cette démonstration et d'en compléter les parties omises. C'est pourquoi nous avons adopté - à peu de choses près - la définition de [CNP93-1] de la prolongeabilité sans fin par la donnée d'un filtré discret, suite croissante d'ensembles finis Ω_L indexés par les $L > 0$. La surface de Riemann associée est alors définie par les classes d'homotopies de chemins de longueurs $< L$ évitant Ω_L ([CNP93-1] considère également les "variations de cap").

Ce faisant, force est d'avouer que nous avons été incapable de comprendre certains des arguments de [CNP93-1]. Ce travail aboutit finalement à une preuve que nous pensons originale de la stabilité par produits de convolution de fonctions holomorphes prolongeables sans fin, tout en étant largement redevable des idées développées dans les articles de J. Ecalte et de F. Pham *et al*, ainsi qu'aux articles éclairants de D. Sauzin sur la Résurgence.

1.2. La structure et les résultats principaux de la thèse

Le cadre étant posé, nous présentons à présent la structure de la thèse et nos principaux résultats. Sur certains résultats présentés ici, nous nous sommes permis d'être moins précis que dans le corps de la thèse, afin de favoriser clarté et concision.

1.2.1. Contenu du chapitre 2. — Pour une bonne part, le chapitre 2 pose les notations et outils nécessaires à la thèse. Plutôt que de penser le prolongement analytique d'une fonction en terme de section d'un faisceau, le point de vue que nous adoptons avec [CNP93-1] est celui de surface de Riemann vue comme espace étalé sur \mathbb{C} . Ceci nous paraît mieux adapté à la notion essentielle de ce travail, celui du prolongement analytique le long d'un chemin.

Ceci fait, nous nous intéressons au prolongement analytique le long d'un chemin d'un produit de convolution de deux germes de fonctions analytiques, sous hypothèses convenables. Nous démontrons comment l'existence d'une homotopie convenable de ce chemin permet de répondre à cette question : c'est l'objet de la Proposition 2.3.2 qui forme le point de départ de nos analyses des chapitres ultérieurs. Nous décrivons cette Proposition en posant auparavant quelques notations.

Définition 1. — Soit $U \subset \mathbb{C}$ un ensemble ouvert, nous notons $\mathcal{O}(U)$ l'espace des fonctions analytiques sur U . Pour $\zeta_0 \in \mathbb{C}$, nous notons \mathcal{O}_{ζ_0} l'ensemble des germes de fonctions analytiques en ζ_0 .

Dans cette thèse, un chemin λ est une application continue $\lambda \in \mathcal{C}^0([0, 1], \mathbb{C})$. Quelques fois nous aurons besoin de plus de régularité et travaillerons avec des chemins de classe \mathcal{C}^1 , en utilisant les propriétés de densité classiques.

Définition 2. — Nous notons \mathfrak{R} l'ensemble des chemins $\lambda : [0, 1] \rightarrow \mathbb{C}$ d'origine $0 \in \mathbb{C}$.

On note \mathfrak{R}^{sym} le sous-ensemble de \mathfrak{R} formé par les chemins symétriques: $\gamma \in \mathfrak{R}^{sym}$ ssi

$$\forall t \in [0, 1], \gamma(t) = \gamma(1) - \gamma(1 - t).$$

Venons en à la Proposition mentionnée.

Proposition 1 (Proposition 2.3.2). — Soient $\varphi, \psi \in \mathcal{O}_0$ et $\lambda \in \mathfrak{R}$. On suppose qu'il existe une application continue $\Gamma : (s, t) \in [0, 1] \times [0, 1] \mapsto \Gamma(s, t) = \Gamma_t(s) \in \mathbb{C}$ telle que :

- $\forall s \in [0, 1], \Gamma_0(s) = 0,$
- $\forall t \in [0, 1], \Gamma_t(0) = 0, \Gamma_t(1) = \lambda(t),$
- $\forall t \in [0, 1],$ le germe φ se prolonge analytiquement le long du chemin $\Gamma_t : s \in [0, 1] \mapsto \Gamma_t(s),$
- $\forall t \in [0, 1],$ le germe ψ se prolonge analytiquement le long du chemin $\Gamma_t^* : s \in [0, 1] \mapsto \Gamma_t^*(s) = \Gamma_t(1) - \Gamma_t(1 - s).$

Alors, le germe de fonctions analytiques $\varphi * \psi \in \mathcal{O}_0$ se prolonge analytiquement le long du chemin λ .

1.2.2. Contenu du chapitre 3. — Le troisième chapitre est consacré à l'élaboration des outils nécessaires pour construire l'homotopie Γ_t de la Proposition 1 pour un chemin donné $\lambda_0 \in \mathfrak{R}$. Ces outils sont une formalisation "continue" d'idées développées dans notre article [OU010].

En pratique, travaillant sur des compacts des surfaces de Riemann des (germes de) fonctions holomorphes φ et ψ , nous n'aurons qu'à éviter un nombre fini de singularités A de φ et B de ψ . Nous construisons l'homotopie Γ_t par déformation de λ_0 sous l'action du flot d'un champ de vecteurs (non autonome) construit à l'aide de 2

fonctions régulières, f_A et f_B , à valeurs dans $[0, 1]$ et s'annulant respectivement au voisinage des points de A et des points de B , typiquement de la forme suivante:

Proposition 2 (Proposition 3.1.1). — *Soit C un sous-ensemble fini de \mathbb{C} et $0 < r < R$ assez petit. Alors pour tout $p \in \mathbb{N} \cup \infty$, il existe une fonction $f_C : \mathbb{C} \mapsto [0, 1]$ de \mathcal{C}^{p+1} telle que*

$$\forall \zeta \in \mathbb{C}, f_C(\zeta) = \begin{cases} 0, & \text{si } \exists \omega \in C, |\zeta - \omega| \leq r \\ g(|\zeta - \omega|), & \text{si } \exists \omega \in C, r \leq |\zeta - \omega| \leq R \\ 1, & \text{sinon.} \end{cases}$$

où $g : [r, R] \rightarrow [0, 1]$ est une fonction croissante \mathcal{C}^∞ , $g(r) = 0$ et $g(R) = 1$.

L'homotopie recherchée est alors construite de la manière suivante:

Lemme 1 (Lemme 3.3.1 et suivants). — *On suppose que $\lambda_0 \in \mathfrak{R}$ s'écrit comme un produit $\lambda_0 = \gamma\lambda$ et que pour $p \in \mathbb{N} \cup \infty$:*

- λ est un chemin non constant de classe \mathcal{C}^{p+1} .
- $\gamma \in \mathfrak{R}$ est un (petit) chemin rectiligne tel que $\gamma(1) = \lambda(0)$.
- $f_A, f_B : \mathbb{C} \rightarrow [0, 1]$ sont dans la classe de \mathcal{C}^{p+1} , de la forme donnée par la Proposition 2.

Alors il existe une unique homotopie $\Gamma : (s, t) \in [0, 1] \times [0, 1] \mapsto \Gamma(s, t) = \Gamma_t(s) \in \mathbb{C}$ de classe \mathcal{C}^{p+1} telle que pour $(s, t) \in [0, 1] \times [0, 1]$,

$$(7) \quad \begin{cases} \frac{d\Gamma}{dt}(s, t) = \frac{d\lambda}{dt}(t) \left[s f_A(\Gamma(s, t)) + (1-s) \left[1 - f_B(\Gamma^\circ(1-s, t)) \right] \right] \\ \Gamma(s, 0) = \gamma(s), \quad \text{où } \Gamma^\circ(1-s, t) = \lambda(t) - \Gamma(s, t) \end{cases}$$

De plus si λ_0 évite le lieu $A+B = \{\omega + \omega'; \omega \in A, \omega' \in B\} \cup A \cup B$, alors pour tout $t \in [0, 1]$, Γ_t évite A et Γ_t° évite B pour f_A et f_B convenablement choisis.

1.2.3. Contenu du chapitre 4. — Dans le chapitre 4, nous supposons que Ω est un sous-ensemble fermé, discret de \mathbb{C} . Nous nous intéressons aux germes de fonctions holomorphes à l'origine se prolongeant analytiquement le long de tout chemin de \mathfrak{R} évitant le lieu Ω . Dans le cas où $0 \notin \Omega$, une surface de Riemann commune à l'ensemble de fonctions est le revêtement universel de $\mathbb{C} \setminus \Omega$. Pour des raisons pratiques qui apparaissent par la suite, il est préférable de supposer en fait que 0 appartient à Ω . Nous travaillons donc dans ce cadre et construisons une surface de Riemann ad hoc:

Définition 3. — *Supposons que $0 \in \Omega$ et notons $\Omega^* = \Omega \setminus \{0\}$. Nous notons $\mathfrak{R}_\Omega^* \subset \mathfrak{R}$ l'ensemble des chemins λ qui évitent l'ensemble Ω sauf pour leur origine:*

$$\mathfrak{R}_\Omega^* = \{\lambda \in \mathfrak{R} \text{ tel que } \exists t \in [0, 1], \lambda([0, t]) = \{0\} \text{ et } \lambda([t, 1]) \subset \mathbb{C} \setminus \Omega\}.$$

Pour $\lambda \in \mathfrak{R}_\Omega^*$, nous notons $\text{cl}(\lambda)$ sa classe d'homotopie dans \mathfrak{R}_Ω^* , les extrémités restant fixées. Nous notons

$$\mathcal{R}_\Omega = \{(\zeta, \text{cl}(\lambda)), \lambda \in \mathfrak{R}_\Omega^*, \zeta = \lambda(1)\}.$$

Par la suite nous considérons \mathcal{R}_Ω comme un espace pointé par l'élément $0 = (0, \text{cl}(0))$.

Nous définissons une topologie sur \mathcal{R}_Ω et, munissant \mathcal{R}_Ω de la projection $\pi : (\zeta, \alpha) \in \mathcal{R}_\Omega \mapsto \zeta \in \mathbb{C} \setminus \Omega^*$, l'espace \mathcal{R}_Ω devient la surface de Riemann qui nous intéresse. Nous étudions les propriétés de cette surface de Riemann, dont la simple connexité. C'est là un résultat qui n'est pas automatique puisque $(\mathcal{R}_\Omega, \pi)$ n'est pas un revêtement mais un simple espace étalé.

Nous en venons ensuite à l'objet de ce chapitre, à savoir la stabilité par produit de convolution. Auparavant, quelques définitions s'imposent.

Définition 4. — On note $\mathfrak{X}_\Omega \subset \mathfrak{X}$ l'ensemble des chemins de \mathfrak{X} qui se relèvent sur \mathcal{R}_Ω à partir de $0 \in \mathcal{R}_\Omega$ relativement à π .

Egalement:

Définition 5. — Un chemin $\lambda \in \mathfrak{X}_\Omega$ est dit symétriquement contractile si λ appartient à \mathfrak{X}^{sym} et s'il existe une application continue

$$\Gamma : t \in [0, 1] \mapsto \Gamma_t \in \mathfrak{X}_\Omega \cap \mathfrak{X}^{sym}$$

telle que $\Gamma_1 = \lambda$ and $\Gamma_0 \equiv 0$.

Nous utilisons alors les outils mis en place dans le chapitre 3 afin de démontrer le théorème suivant d'Ecalé [Ec81-1], §4.2.

Théorème 1 (Theorem 4.2.1). — Soit Ω un semi-groupe additif discret de \mathbb{C} . Alors chaque point $z \in \mathcal{R}_\Omega$ est l'extrémité d'un chemin symétriquement contractile.

Une application facile de ce résultat avec la Proposition 1 donne de ce fait:

Théorème 2 (Theorem 4.3.1). — Soit Ω un semi-groupe additif discret de \mathbb{C} . Notons $\mathcal{H}(\mathcal{R}_\Omega)$ l'ensemble des germes de fonctions holomorphes à l'origine se prolongeant analytiquement sur la surface de Riemann \mathcal{R}_Ω . Alors, l'espace $\mathcal{H}(\mathcal{R}_\Omega)$ est un algèbre de convolution.

Ce résultat est aussi démontré dans notre article [OU010]. Une démonstration différente est aussi présentée dans [S012] en utilisant une méthode différente.

Néanmoins, nous remarquons que $\mathcal{H}(\mathcal{R}_\Omega)$ n'est plus stable par le produit de convolution quand le sous-ensemble fermé et discret Ω cesse d'être un semi-groupe. Cette difficulté sera surmontée au chapitre 5 par l'introduction de la notion de prolongement sans fin.

1.2.4. Contenu du chapitre 5. — Le chapitre 5 constitue la partie centrale de la thèse.

Avec [CNP93-1], §Rés II, notre définition de fonctions prolongeables sans fin s'appuie sur la notion d'ensembles filtrés discret.

Définition 6 (Definition 5.1.1). — Un ensemble filtré discret Ω_\star (de centre $0 \in \mathbb{C}$) est une suite croissante (pour l'inclusion) d'ensembles finies $\Omega_L \subset \mathbb{C}$, $L > 0$, telle que:

- $\forall L > 0$, Ω_L appartient au disque ouvert de rayon L centré à l'origine;
- si $L_1 \leq L_2$ alors $\Omega_{L_1} \subseteq \Omega_{L_2}$;
- pour $L > 0$ assez petit, $\Omega_L = \{0\}$.

Pour $L > 0$, nous notons $\Omega_L^\star = \Omega_L \setminus \{0\}$.

A cette définition est associée la notion de chemins permis au sens suivant.

Définition 7 (Definition 5.1.4). — Supposons que Ω_\star est un filtré discret. Nous notons $\mathfrak{R}_{\Omega_L}^\star$ l'ensemble des chemins $\lambda \in \mathfrak{R}$ tels que :

- λ est \mathcal{C}^1 par morceaux.
- il existe $t \in [0, 1]$ tel que $\lambda([0, t]) = \{0\}$ et $\lambda(]t, 1]) \subset D(0, L) \setminus \Omega_L$,
- et la longueur \mathcal{L}_λ de λ est $< L$, où $\mathcal{L}_\lambda = \int_0^1 |\lambda'(t)| dt$.

Un chemin λ est dit Ω_\star -permis si $\lambda \in \mathfrak{R}_{\Omega_L}^\star$ pour un certain $L > 0$. Nous notons $\mathfrak{R}_{\Omega_\star}^\star = \bigcup_{L>0} \mathfrak{R}_{\Omega_L}^\star$ l'ensemble des chemins Ω_\star -permis.

Cette notion donne lieu à la définition importante dans notre contexte de Ω_\star -homotopie.

Définition 8 (Definition 5.1.5). — Soit Ω_\star un ensemble filtré discret. Une application continue

$$\Gamma : (s, t) \in [0, 1]^2 \mapsto \Gamma_t(s) \in \mathbb{C}$$

est un Ω_\star -homotopie si $\forall t \in [0, 1]$ le chemin Γ_t est Ω_\star -permis.

Deux chemins Ω_\star -permis λ_0 et λ_1 sont Ω_\star -homotopes s'il existe une Ω_\star -homotopie $\Gamma : (s, t) \in [0, 1]^2 \mapsto \Gamma_t(s) \in \mathbb{C}$ telle que $\lambda_0 = \Gamma_0$ et $\lambda_1 = \Gamma_1$.

Si λ un chemin Ω_\star -permis, nous notons $\text{cl}(\lambda)$ sa classe de Ω_\star -homotopie à extrémités fixées.

Plus que ne le fait [CNP93-1], §Rés II, nous insistons sur la construction d'une surface de Riemann associée à un ensemble filtré discret. Ce faisant, nous avons introduit certaines nuances dans nos définitions par rapport à celles de [CNP93-1].

L'objet géométrique central est maintenant formé par l'ensemble de classes de Ω_\star -homotopies:

Définition 9 (Definition 5.1.6). — Soit Ω_\star un ensemble filtré discret. Nous notons

$$\mathcal{R}_{\Omega_\star} = \{(\zeta, \text{cl}(\lambda)), \lambda \in \mathfrak{R}_{\Omega_\star}^\star, \zeta = \lambda(1)\}.$$

Nous considérons cet espace comme un espace pointé par le point $0 = (0, \text{cl}(0))$.

Les propriétés essentielles de cet espace sont concentrées dans la Proposition suivante.

Proposition 3 (Proposition 5.1.1 et suivantes). — L'espace pointé $\mathcal{R}_{\Omega_\star}$ peut être muni d'une topologie séparée pour laquelle $\mathcal{R}_{\Omega_\star}$ est connexe par arc et simplement connexe. Avec la projection $\pi : (\zeta, \alpha) \in \mathcal{R}_{\Omega_\star} \mapsto \zeta \in \mathbb{C}$, l'espace $\mathcal{R}_{\Omega_\star}$ est un espace étalé sur \mathbb{C} . Cette surface de Riemann est la surface de Riemann associée à l'ensemble filtré discret Ω_\star et elle est dite "sans fin".

Ceci nous amène finalement à la définition de prolongeabilité sans fin que nous utilisons dans notre travail:

Définition 10 (Definition 5.2.2). — Un germe de fonction analytique $\varphi \in \mathcal{O}_0$ est dite prolongeable sans fin sur \mathbb{C} s'il existe un ensemble filtré discret Ω_\star tel que φ est prolongeable analytiquement le long de tout chacun chemin Ω_\star -permis. Cela est équivalent à la propriété pour φ de se prolonger analytiquement sur la surface de Riemann $\mathcal{R}_{\Omega_\star}$.

On note \mathcal{H}_{end} l'espace des germes de fonctions analytiques à l'origine qui sont prolongeables sans fin sur \mathbb{C} .

Définition 11. — On note $\mathfrak{R}_{\Omega_\star} \subset \mathfrak{R}$ l'ensemble des chemins de \mathfrak{R} qui se relèvent sur $\mathcal{R}_{\Omega_\star}$ à partir de $0 \in \mathcal{R}_{\Omega_\star}$ relativement à π .

Les outils développés dans le chapitre 3 et une analyse des relèvements de chemins sur les surfaces de Riemann “sans fin” nous mènent au théorème suivant, pierre angulaire de nos constructions.

Théorème 3 (Theorem 5.4.2). — Soient Ω_\star et Ω'_\star deux ensembles filtrés discrets de centre 0, nous notons $(\mathcal{R}_{\Omega_\star}, \pi)$, $(\mathcal{R}_{\Omega'_\star}, \pi')$ leur surfaces de Riemann. Alors, si σ est une classe de $(\Omega + \Omega'_\star)_\star$ -homotopie de chemins dans $\mathfrak{R}_{(\Omega + \Omega'_\star)_\star}^\star$, il existe $\lambda_0 \in \mathfrak{R}_{(\Omega + \Omega'_\star)_\star}^\star$, $\sigma = \text{cl}(\lambda_0)$, et une application continue $F : (s, t) \in [0, 1] \times [0, 1] \mapsto F(s, t) = F_t(s) \in \mathbb{C}$ telle que

- $F_0 \equiv 0$,
- $\forall t \in [0, 1], F_t(1) = \lambda_0(t)$,
- $\forall t \in [0, 1], F_t \in \mathfrak{R}_{\Omega_\star}$,
- $\forall t \in [0, 1], F_t^\circ \in \mathfrak{R}_{\Omega'_\star}$ où $F_t^\circ(s) = \lambda_0(t) - F_t(1 - s)$.

De plus, λ_0 et F_1 sont homotopes dans l'espace $\mathfrak{R}_{\Omega_\star}$ tandis que λ_0 et F_1° sont homotopes dans l'espace $\mathfrak{R}_{\Omega'_\star}$.

Dans ce théorème, la somme de deux ensembles filtrés discrets est définie de la manière suivante:

Définition 12 (Definition 5.1.3). — La somme de deux filtrés discrets Ω_\star et Ω'_\star $(\Omega + \Omega'_\star)_\star$ est le filtré discret défini par : pour tout $L > 0$,

$$(\Omega + \Omega'_\star)_L = \{\Omega_L + \Omega'_L\} \cap D(0, L).$$

Une conséquence directe du théorème précédent est le résultat suivant de stabilité par convolution.

Théorème 4 (Theorem 5.5.1). — L'espace \mathcal{H}_{end} est une algèbre de convolution: si Ω_\star et Ω'_\star sont deux filtrés discrets, si $\varphi \in \mathcal{H}(\mathcal{R}_{\Omega_\star})$ et $\psi \in \mathcal{H}(\mathcal{R}_{\Omega'_\star})$, alors $\varphi * \psi \in \mathcal{H}(\mathcal{R}_{(\Omega + \Omega'_\star)_\star})$.

Ce théorème est similaire au résultat de [CNP93-1], Chap. Rés I, §1.5 et Chap. Rés II, Appendix, à ceci près que la définition de la somme de deux filtrés discrets de [CNP93-1] est plus fine que la notre. La définition de [CNP93-1] autorise en particulier à construire une surface de Riemann “sans fin” sur laquelle l'ensemble de tous les itérés de convolution φ^{*n} , $n \in \mathbb{N}$, se prolongent analytiquement. C'est là une propriété essentielle dans les problèmes d'analyse en théorie de la Résurgence.

Nous retrouvons de notre côté la “finesse” du résultat de [CNP93-1] si on se concentre sur les singularités entrevues au sens suivant:

Proposition 4 (Proposition 5.3.1). — On considère un ensemble filtré discret Ω_\star et une direction $\theta \in \frac{\mathbb{R}}{2\pi\mathbb{Z}}$. Alors, il existe un ensemble fermé discret $\text{Sing}_{\Omega_\star}^\star(\theta) \subset \bigcup_{L>0} \Omega_{L,\theta}^\star$ tel que si $\text{Sing}_{\Omega_L}^\star(\theta) = \text{Sing}_{\Omega_\star}^\star(\theta) \cap D(0, L) \subset \Omega_{L,\theta}^\star$ pour $L > 0$, alors:

- Pour tout $L > 0$, tout chemin λ de \mathfrak{R} de longueur $< L$ qui évite l'ensemble $\text{Sing}_{\Omega_L}^\star(\theta)$ par la droite ou par la gauche, se relève sur la surface de Riemann $(\mathcal{R}_{\Omega_\star}, \pi)$ par rapport à π à partir de $(0, \text{cl}(0))$.
- si on ôte de $\text{Sing}_{\Omega_\star}^\star(\theta)$ ne fût-ce qu'un point, les propriétés précédentes ne sont plus vérifiées.

Si $\varphi \in \mathcal{H}(\mathcal{R}_{\Omega_*})$, on note $\text{Sing}_\varphi^*(\theta) = \text{Sing}_{\Omega_*}^*(\theta)$.

Alors:

Corollaire 1 (Corollary 5.5.1). — Soient $\varphi, \psi \in \mathcal{H}_{end}$. Alors

$$\text{Sing}_{\varphi*\psi}^*(\theta) \subseteq (\text{Sing}_\varphi(\theta) + \text{Sing}_\psi(\theta)) \setminus \{0\}.$$

Nous démontrerons au chapitre 6 que les résultats obtenus au chapitre 5 suffisent pour retrouver le résultat “fin” de [CNP93-1], par l’utilisation d’informations supplémentaires fournies par les dérivations étrangères d’Ecalte.

1.2.5. Contenu du chapitre 6. — Nous avons déjà montré que \mathcal{H}_{end} est une algèbre (non-unitaire) convolutive. Dans ce chapitre, nous introduisons l’espace des fonctions résurgentes simples RES^{simp} pour laquelle on peut définir la dérivation étrangère de façon simple.

Nous insistons sur le fait que les résultats de ce chapitre sont connus depuis [Ec81-1]. Notre seul but est de s’assurer que l’ensemble des constructions peut se faire à partir des résultats que nous avons démontré au chapitre précédent.

Rappelons quelques définitions classiques [Ec81-1].

Définition 13 (Definition 6.2.1). — Soit $\varphi \in \mathcal{O}(U)$ une fonction analytique dans un ensemble ouvert connexe $U \subset \mathbb{C}$. Nous supposons que $\omega \in \mathbb{C}$ est un point adhérent à U . Nous disons que φ a “une singularité simple en ω ” s’il existe $C_\omega \in \mathbb{C}$ et deux fonctions analytiques Φ_ω et Reg_ω au voisinage de ω telles que

$$\varphi(\omega + \zeta) = \frac{C_\omega}{2\pi i \zeta} + \frac{1}{2\pi i} \Phi_\omega(\zeta) \log(\zeta) + \text{Reg}_\omega(\zeta)$$

pour $\zeta + \omega$ avec $|\zeta|$ assez petit.

Nous notons

$$\text{sing}_\omega \varphi = C_\omega \delta + \varphi_\omega \in \mathbb{C}\delta \oplus \mathcal{O}_0$$

où $\varphi_\omega \in \mathcal{O}_0$ est le germe de fonction analytique à l’origine qui est représenté par $\Phi_\omega = \text{var}_\omega(\varphi)$ avec

$$\text{var}_\omega \varphi(\omega + \zeta) = \varphi(\omega + \zeta) - \varphi(\omega + \zeta e^{-2\pi i}),$$

et $\varphi(\omega + \zeta e^{-2\pi i})$ représente le prolongement analytique de φ le long du lacet $t \in [0, 1] \mapsto \omega + \zeta e^{-2\pi i t}$ pour ζ proche de 0.

Définition 14 (Definition 6.2.3). — Nous notons \mathcal{H}_{end}^{simp} l’espace des germes prolongeables sans fin $\varphi \in \mathcal{H}_{end}$ tels que tout prolongement analytique $\lambda.\varphi$ de φ ne rencontre que des singularités simples.

L’espace RES^{simp} qui nous intéresse est alors le suivant:

Définition 15 (Definition 6.2.4). — On appelle $\text{RES}^{simp} = \mathbb{C}\delta \oplus \mathcal{H}_{end}^{simp}$ l’espace des fonctions résurgentes simples.

Le Théorème 3, notre analyse développée dans le §5.4.4, ainsi que l’analyse “locale” que nous faisons en début du chap. 6 nous permettent de démontrer, par des arguments analogues à ceux de [S006], que:

Théorème 5 (Theorem 6.2.1). — L’espace RES^{simp} est une algèbre de convolution unitaire.

Nous sommes alors en mesure d'introduire les dérivations étrangères d'Ecalé. Nous introduisons auparavant l'opérateur Δ^+ .

Définition 16 (Définition 6.3.1). — Nous fixons une direction $\theta \in \frac{\mathbb{R}}{2\pi\mathbb{Z}}$ et prenons $\omega_0 = 0$. Nous considérons un ensemble des points distincts $\omega_i \in]0, e^{i\theta}\infty[$, $i = 1, 2, \dots, n$ qui satisfait $0 < |\omega_1| < |\omega_2| < \dots < |\omega_n|$. A cet ensemble de points nous associons une suite de signes $+$ ou $-$, $\varepsilon = (\varepsilon_1, \varepsilon_2, \dots, \varepsilon_{n-1}) \in \{+, -\}^{n-1}$. Alors, nous notons γ_ε tout chemin $\gamma \in \mathfrak{R}$ avec $\gamma(1) \in]\omega_{n-1}, \omega_n[$ qui longe le segment $[0, \omega_n[$ sans retour en arrière en contournant chaque ω_i par la droite si $\varepsilon_i = +$ et par la gauche si $\varepsilon_i = -$.

L'opérateur Δ^+ est défini de la façon suivante:

Définition 17 (Définition 6.3.2). — Soit $f = C\delta + \varphi \in \text{RES}^{\text{simp}}$, $\varphi \in \mathcal{H}_{\text{end}}^{\text{simp}}$. Nous considérons une direction $\theta \in \frac{\mathbb{R}}{2\pi\mathbb{Z}}$ et soit $\text{Sing}_\varphi^*(\theta) = \{\omega_i, |\omega_1| < |\omega_2| < \dots\} \in]0, e^{i\theta}\infty[$ l'ensemble des singularités entrevues de φ . Pour $n \in \mathbb{N}^*$ nous considérons un point $\omega_n \in \text{Sing}_\varphi^*(\theta)$ et un chemin $\gamma_\varepsilon = (+, \dots, +) \in \{+\}^{n-1}$ aboutissant à ω_n et contournant $\omega_1, \dots, \omega_{n-1}$ par la droite. Alors,

$$\Delta_{\omega_n}^+ f = \text{sing}_{\omega_n} \gamma_\varepsilon \cdot \varphi \in \text{RES}^{\text{simp}}.$$

On prolonge cette définition à un point quelconque $\omega \in \mathbb{C}^*$ en imposant

$$\Delta_\omega^+ f = 0$$

quand ω n'est pas une singularité entrevue pour la direction $\theta = \text{ph}(\omega) \in \frac{\mathbb{R}}{2\pi\mathbb{Z}}$.

Ces opérateurs Δ^+ ont des propriétés agréables par rapport au produit de convolution. Ceci sera mieux formalisé par les dérivations étrangères. Encore plus intéressante pour notre propos sera la propriété que les opérateurs Δ^+ permettent de "faire du prolongement analytique" par itérations:

Proposition 5 (Proposition 6.3.2). — Nous supposons que $\varphi \in \mathcal{H}_{\text{end}}^{\text{simp}}$ et

$$\text{Sing}_\varphi^*(\theta) = \{\omega_i, |\omega_1| < \dots < |\omega_n| < |\omega_{n+1}| < \dots\} \in]0, e^{i\theta}\infty[$$

pour $\theta \in \frac{\mathbb{R}}{2\pi\mathbb{Z}}$. Pour tout $n \geq 2$ et tout $\varepsilon = (\varepsilon_1, \dots, \varepsilon_{n-1}) \in \{+, -\}^{n-1}$,

$$\text{sing}_{\omega_n} \gamma_\varepsilon \cdot \varphi = \Delta_{\omega_n}^+ \varphi + \sum_{1 \leq r \leq q(\varepsilon)} (-1)^r \sum_{\substack{|\omega_{i_1}| < \dots < |\omega_{i_r}| < |\omega_n| \\ \varepsilon_{i_1} = \dots = \varepsilon_{i_r} = -}} \Delta_{\omega_n - \omega_{i_r}}^+ \cdots \Delta_{\omega_{i_2} - \omega_{i_1}}^+ \Delta_{\omega_{i_1}}^+ \varphi$$

où $q(\varepsilon)$ est le numéro des signes $'-'$ dans la séquence ε .

Cette propriété peut être généralisée au moyen de la notion de "chemins optimisés" déjà présent dans [CNP93-1]. Nous démontrons en effet que:

Lemme 2 (Lemme 6.4.1). — Pour tout filtré discret donné Ω_\star , tout chemin Ω_\star -permis γ est Ω_\star -homotope à un chemin géodésique γ_ε de longueur minimale qui se décompose sous la forme d'un produit de segments et de petits lacets autour des points du filtré discret.

Alors, pour ce type de chemins γ_ε , nous démontrons le résultat suivant:

Proposition 6 (Proposition 6.4.1). — Soit Ω_\star un filtré discret. On considère $\varphi \in \mathcal{H}_{end}^{simpl}$ qu'on suppose prolongeable analytiquement sur $\mathcal{R}_{\Omega_\star}$. Pour $L > 0$ on considère un chemin Ω_\star -permis dans $\mathfrak{A}_{\Omega_L}^\star$ et on le suppose optimisé, de type $\gamma_{\underline{\epsilon}}$. On suppose de plus que ce chemin aboutit proche d'une point $\omega \in \Omega_L$. Alors le prolongement analytique $\text{sing}_\omega \gamma_{\underline{\epsilon}} \cdot \varphi$ de φ le long de $\gamma_{\underline{\epsilon}}$ peut s'écrire sous la forme:

$$(8) \quad \text{sing}_\omega \gamma_{\underline{\epsilon}} \cdot \varphi = \Delta_\omega^+ \varphi + \sum_{r \geq 1} \sum_{\substack{(\omega_1, \dots, \omega_r) \in \mathfrak{P}_L(\gamma_{\underline{\epsilon}})^r \\ |\omega_1| + \dots + |\omega_r| < L}} a_{(\omega_1, \dots, \omega_r)} \Delta_{\omega - \omega_r}^+ \cdots \Delta_{\omega_2 - \omega_1}^+ \Delta_{\omega_1}^+ \varphi$$

où les $a_{(\omega_1, \dots, \omega_r)}$ appartiennent à \mathbb{Z} .

Nous rappelons enfin la définition des dérivations étrangères d'Ecalte et leurs liens avec les opérateurs précédents.

Définition 18 (Definition 6.3.3). — Pour tout $\omega \in \mathbb{C}^\star$, $\text{ph}(\omega) = \theta \in \frac{\mathbb{R}}{2\pi\mathbb{Z}}$, nous définissons l'opérateur linéaire

$$\Delta_\omega : \text{RES}^{simpl} \rightarrow \text{RES}^{simpl}$$

par:

$$(9) \quad \Delta_\omega = \sum_{r \in \mathbb{N}^\star} \frac{(-1)^{r-1}}{r} \sum_{\substack{(\omega_1, \dots, \omega_r) \in]0, e^{i\theta} \infty[^r \\ \omega_1 + \dots + \omega_r = \omega}} \Delta_{\omega_r}^+ \cdots \Delta_{\omega_1}^+.$$

On appelle l'opérateur Δ_ω la dérivation étrangère en ω .

Proposition 7 (Propositions 6.3.3 and 6.3.4). — Pour tout $\omega \in \mathbb{C}^\star$, l'opérateur $\Delta_\omega : \text{RES}^{simpl} \rightarrow \text{RES}^{simpl}$ est une dérivation, c'est à dire que Δ_ω satisfait la règle Leibniz :

$$(10) \quad \Delta_\omega f * g = (\Delta_\omega f) * g + f * (\Delta_\omega g), \quad f, g \in \text{RES}^{simpl}.$$

Par ailleurs, pour tout $f \in \text{RES}^{simpl}$,

$$\Delta_{\omega_n}^+ f = \Delta_{\omega_n} f + \sum_{1 \leq r \leq n-1} \frac{1}{(r+1)!} \sum_{|\omega_{i_1}| < \dots < |\omega_{i_r}| < |\omega_n|} \Delta_{\omega_n - \omega_{i_r}} \cdots \Delta_{\omega_{i_2} - \omega_{i_1}} \Delta_{\omega_{i_1}} f.$$

L'ensemble de ces outils nous permettent de préciser la surface de Riemann d'un élément de $\mathcal{H}_{end}^{simpl}$. Notre raisonnement est le suivant. Si $\varphi \in \mathcal{H}_{end}^{simpl}$ est prolongeable analytiquement sur la surface de Riemann $\mathcal{R}_{\Omega_\star}$ associée à l'ensemble filtré discret Ω_\star , alors, pour $L > 0$ et tout $\omega \in \Omega_L$ donné,

- soit il existe qu'une suite $\omega_1, \omega_2, \dots, \omega_n \in \Omega_L$ telle que $\Delta_{\omega - (\omega_{n-1} + \dots + \omega_1)}^+ \cdots \Delta_{\omega_2 - \omega_1}^+ \Delta_{\omega_1}^+ \varphi \neq 0$ avec $|\omega - (\omega_{n-1} + \dots + \omega_1)| + \dots + |\omega_2 - \omega_1| + |\omega_1| < L$ et dans ce cas ω est une "vraie" singularité,
- soit ω est une "fausse" singularité et donc peut être retirée de Ω_L par le théorème de prolongement de Riemann.

Ceci nous amène à la notion de "filtré discret fin" associé à un élément de RES^{simpl} .

Proposition 8 (Proposition 6.4.2). — Pour $f = C\delta + \varphi \in \text{RES}^{simpl}$ et $L > 0$, nous considérons l'ensemble Ω_L^\star des points $\omega \in \mathbb{C}$ tel qu'il existe $n \in \mathbb{N}^\star$ et une suite $(\omega_1, \dots, \omega_n) \in (\mathbb{C}^\star)^n$ tel que

- $\omega = \omega_1 + \dots + \omega_n$,
- $\Delta_{\omega_n}^+ \cdots \Delta_{\omega_1}^+ f \neq 0$,
- $|\omega_1| + \dots + |\omega_n| < L$.

Alors, la suite $\Omega_L = \Omega_L^* \cup \{0\}$, $L > 0$ forme un ensemble filtré discret Ω_* et φ prolonge analytiquement sur la surface de Riemann \mathcal{R}_{Ω_*} .

On appelle ce filtré discret le “filtré discret fin” associé à $f \in \text{RES}^{\text{simp}}$.

Nous sommes maintenant en mesure de préciser le Théorème 4 en utilisant les Propositions 7 et 6.

Théorème 6 (Theorem 6.4.2). — Si $\varphi, \psi \in \mathcal{H}_{\text{end}}^{\text{simp}}$ et si Ω_* et Ω'_* sont leur ensembles filtrés discrets fins, alors $\varphi * \psi \in \mathcal{H}(\mathcal{R}_{(\Omega \tilde{+} \Omega')_*})$ où $(\Omega \tilde{+} \Omega')_*$ est la somme fine des deux ensembles filtrés discrets.

La “Somme fine” dont il est question ici est la somme d’ensembles filtrés discrets définie dans [CNP93-1]:

Définition 19 (Definition 5.4.1). — Si Ω_{1*} et Ω_{2*} sont deux filtrés discrets, on définit leur somme “fine” $(\Omega_1 \tilde{+} \Omega_2)_*$ comme étant le filtré discret défini par: pour tout $L > 0$,

$$(\Omega_1 \tilde{+} \Omega_2)_L = \{\omega_1 + \omega_2 / \omega_1 \in \Omega_{1L_1}, \omega_2 \in \Omega_{2L_2} \text{ avec } L_1 + L_2 = L\}.$$

Cette sommation “fine” d’ensembles filtrés discrets est associative et autorise un passage à la limite: pour un ensemble filtré discret donné Ω_* et pour $L > 0$, l’ensemble

$$\Omega_L^\infty = \bigcup_{n \geq 1} (\sum_n \tilde{\Omega})_L, \quad \text{avec} \quad (\sum_n \tilde{\Omega})_L = \underbrace{(\Omega \tilde{+} \dots \tilde{+} \Omega)}_{n \text{ times}}_L$$

est un ensemble fini. Ceci donne du sens à la définition qui suit.

Définition 20 (Definition 6.4.3). — Pour un ensemble filtré discret Ω_* on note Ω_*^∞ l’ensemble filtré discret qui est défini par

$$\Omega_L^\infty = \bigcup_{n \geq 1} (\sum_n \tilde{\Omega})_L, \quad L > 0.$$

Cet ensemble filtré discret Ω_*^∞ est appelé l’ensemble filtré discret “saturé” de Ω_* .

Nous concluons alors par le Corollaire suivant.

Corollaire 2 (Corollary 6.4.2). — Si φ appartient à $\mathcal{H}_{\text{end}}^{\text{simp}}$ et si Ω_* est son ensemble filtré discret, alors

$$\forall n \in \mathbb{N}, \varphi^{*n} = \underbrace{\varphi * \dots * \varphi}_{n \text{ fois}} \in \mathcal{H}(\mathcal{R}_{\Omega_*^\infty}).$$

Nous terminons ce chapitre par quelques commentaires sur la façon probable de généraliser nos résultats au cadre général de la Résurgence. Également, quelques remarques sont faites sur la manière d’estimer les normes (du sup) $\|\varphi^{*n}\|$ sur tout compact de la surface de Riemann de $\mathcal{R}_{\Omega_*^\infty}$ afin de faire de nos résultats des outils pratiques d’analyse dans le cadre résurgent. Faute de temps nous n’avons pas poussé plus loin notre analyse au-delà d’un exemple particulier.

1.2.6. Contenu du chapitre 7. — Nous nous sommes attachés dans cette thèse à comprendre le produit de convolution “classique” de fonctions analytiques puis à formaliser une preuve que nous croyons originale de la stabilité par convolution de l'espace \mathcal{H}_{end} et son sous-espace \mathcal{H}_{end}^{simp} .

Nous pensons que ce travail préalable - qui nous a pris finalement plus de temps que nous le pensions - était indispensable avant de poursuivre sur ce qui étaient nos motivations originelles: l'étude des produits pondérés d'Ecalles.

Dans son article [Ec94], J. Ecalle fait le lien entre ce qu'il appelle “résurgence équationnelle” et “résurgence coéquationnelle” en construisant un ensemble de monômes de résurgence.

Du côté “résurgence équationnelle”, ces monômes sont de la forme $\sec^{\mathbf{A}}$, $\text{sem}^{\mathbf{A}}$ et $\widehat{\text{sem}}^{\mathbf{A}}$. Décrivons ici $\sec^{\mathbf{A}}$:

Définition 21 (Définition 7.1.1). — Nous considérons une suite quelconque $\mathbf{A} = (A_1, \dots, A_r)$ de paires $A_i = \begin{pmatrix} \omega_i \\ g_i \end{pmatrix}$ telles que $g_i \in \text{RES}^{simp}$, $\omega_i \in \mathbb{C}$ et supposons que pour chaque $0 < i \leq r$, $\check{\omega}_i = \omega_1 + \dots + \omega_i \in \mathbb{C}^*$. On définit $\sec^{\mathbf{A}}(\zeta)$ par récurrence:

1. $\sec^{\emptyset}(\zeta) = \delta$,
2. $\sec^{\mathbf{A}.A_{r+1}}(\zeta) = (\partial + \omega_1 + \dots + \omega_r + \omega_{r+1})^{-1} [g_{r+1} * \sec^{\mathbf{A}}](\zeta)$, où $\mathbf{A}.A_{r+1} = (A_1, \dots, A_r, A_{r+1})$ est la concaténation.

Les monômes $\sec^{\mathbf{A}}$ sont appelés des produits pondérés dans le cadre équationnel.

De par leur définition, il est immédiat de voir que ces $\sec^{\mathbf{A}}$ appartiennent à RES^{simp} . Ecalle dans [Ec94] va plus loin en détaillant leur structure résurgente. (Il se place d'ailleurs dans un cadre plus général que celui de RES^{simp}).

Plus intéressant ici est le “dual coéquationnel” $\text{soc}^{\mathbf{B}}$ de ces objets que nous définissons maintenant:

Proposition 9 (Proposition 7.1.1). — Nous considérons une suite quelconque $\mathbf{B} = (B_1, \dots, B_r)$ de paires $B_i = \begin{pmatrix} \omega_i \\ g_i \end{pmatrix}$ telles que $g_i \in \mathcal{H}_{end}^{simp}$, $\omega_i \in \mathbb{C}$ et supposant que pour chaque $0 < i \leq r$, $\check{\omega}_i = \omega_1 + \dots + \omega_i \in \mathbb{C}^*$. On définit $\text{soc}^{\mathbf{B}}(\xi, z)$ par récurrence:

1. $\text{soc}^{\emptyset}(\xi, z) = \delta$,
2. $\text{soc}^{\mathbf{B}.B_{r+1}}(\xi, z)$ est la solution unique dans $\mathbb{C}\{\xi, z\}$ du problème de Cauchy

$$(\partial_z + (\omega_1 + \dots + \omega_{r+1})\delta + (\omega_1 + \dots + \omega_{r+1})\partial_\xi)\text{soc}^{\mathbf{B}.B_{r+1}} = g_{r+1}(-z)\text{soc}^{\mathbf{B}}.$$

Les monômes $\text{soc}^{\mathbf{B}}$ sont appelés des produits pondérés dans le cadre coéquationnel.

Pour ces monômes, s'il est facile d'obtenir leurs propriétés locales comme objets de $\mathbb{C}\{\xi, z\}$, leur analyse globale s'avère bien plus ardue et pose de nouvelles questions : nous les soulevons au chapitre 7. Il nous semble cependant que le cadre que nous avons développé dans notre thèse forme un socle conceptuel pour une analyse de ces monômes et, finalement, pour aborder le vaste cadre de la résurgence paramétrique.

CHAPTER 2

BACKGROUND ON HOLOMORPHIC FUNCTIONS

This chapter is merely devoted to fixing notations that will be used throughout the paper. In §2.1 we consider germs of holomorphic functions and their analytic continuations along paths. In §2.2 the necessary background on Riemann surfaces is given. In §2.3 we define the convolution product of germs of holomorphic functions and state the problem of their analytic continuations.

2.1. Some recalls on holomorphic functions

In this section, we recall some properties on holomorphic functions, in a way suitable for our purpose. For the very classical results hereafter see, e.g., [For81],[JS87],[Eb007].

2.1.1. The space of germs of holomorphic functions. —

Definition 2.1.1. — If $U \subset \mathbb{C}$ is an open set, we note as usual $\mathcal{O}(U)$ the space of holomorphic functions on U .

For $\zeta_0 \in \mathbb{C}$ we note \mathcal{O}_{ζ_0} the set of all germs of holomorphic functions at ζ_0 .

We shall freely identify \mathcal{O}_{ζ_0} with $\mathbb{C}\{\zeta - \zeta_0\}$, which is the space of convergent series expansions at ζ_0 . If $\Phi \in \mathcal{O}(U)$ and if ζ_0 belongs to the open set U , then the germ Φ_{ζ_0} of Φ at ζ_0 can be identified with the Taylor series expansion of Φ at ζ_0 .

Definition 2.1.2. — If $\Phi_{\zeta_0}(\zeta) = \sum_{n \geq 0} a_n(\zeta - \zeta_0)^n$ is a germ of holomorphic functions at ζ_0 , the radius of convergence of the series expansion is denoted by $\rho(\Phi_{\zeta_0})$ and will be called the radius of convergence of the germ Φ_{ζ_0} .

Definition 2.1.3. — We denote by $\mathcal{O} = \bigsqcup_{\zeta \in \mathbb{C}} \mathcal{O}_{\zeta}$ the set of all germs of holomorphic functions. The space \mathcal{O} is equipped with the topology defined by the following base $\mathfrak{B}(\mathcal{O}) = \{\mathcal{O}_{U,\Phi}\}$ of open sets : for $U \subset \mathbb{C}$ a connected open set and $\Phi \in \mathcal{O}(U)$,

$$\mathcal{O}_{U,\Phi} = \bigsqcup_{\zeta \in U} \{\Phi_{\zeta} \in \mathcal{O}_{\zeta}, \text{ where } \Phi_{\zeta} \text{ is the germ of } \Phi \text{ at } \zeta\} \subset \mathcal{O}.$$

Indeed the base $\mathfrak{B}(\mathcal{O})$ provides a topology on \mathcal{O} : if $\mathcal{O}_{U,\Phi}, \mathcal{O}_{V,\Psi} \in \mathfrak{B}(\mathcal{O})$ and if $\sigma_{\zeta} \in \mathcal{O}_{U,\Phi} \cap \mathcal{O}_{V,\Psi}$ then by the principle of analytic continuity, Φ and Ψ coincide on a connected component W of $U \cap V$ containing ζ . If we note $\sigma = \Phi|_W = \Psi|_W$, then

$\mathcal{O}_{W,\sigma} \subset \mathcal{O}_{U,\Phi} \cap \mathcal{O}_{V,\Psi}$ and $\sigma_\zeta \in \mathcal{O}_{W,\sigma} \in \mathfrak{B}(\mathcal{O})$.

We remark that

$$\forall \mathcal{O}_{U,\Phi}, \mathcal{O}_{V,\Psi} \in \mathfrak{B}(\mathcal{O}), \quad \mathcal{O}_{U,\Phi} \subset \mathcal{O}_{V,\Psi} \Leftrightarrow U \subset V \text{ and } \Phi = \Psi|_U.$$

Proposition 2.1.1. — *With the projection $p : \begin{array}{c} \mathcal{O} \rightarrow \mathbb{C} \\ \Phi_\zeta \in \mathcal{O}_\zeta \mapsto \zeta \in \mathbb{C} \end{array}$ which associates to a germ its support, the space \mathcal{O} becomes an étalé space, that is p is a local homeomorphism.*

Proof. — For $\mathcal{O}_{U,\Phi} \in \mathfrak{B}(\mathcal{O})$ we consider the restriction of p to $\mathcal{O}_{U,\Phi}$,

$$p|_{\mathcal{O}_{U,\Phi}} : \begin{array}{c} \mathcal{O}_{U,\Phi} \rightarrow U \\ \Phi_\zeta \in \mathcal{O}_{U,\Phi} \mapsto \zeta \in U. \end{array}$$

Obviously $p|_{\mathcal{O}_{U,\Phi}}$ is a homeomorphism. \square

Proposition 2.1.2. — *\mathcal{O} is a topologically separated, locally arc-connected and locally compact space.*

Proof. — We show that \mathcal{O} is a separated space. We consider $\Phi_\zeta, \Psi_\xi \in \mathcal{O}, \Phi_\zeta \neq \Psi_\xi$. Either $\zeta \neq \xi$. If $D(z, r) \subset \mathbb{C}$ is the open disc centered on z and of radius $r > 0$, then $D(\zeta, r) \cap D(\xi, r) = \emptyset$ if $r < \min\{\rho(\Phi_\zeta), \rho(\Psi_\xi), |\zeta - \xi|/2\}$, so that $\mathcal{O}_{D(\zeta, r), \Phi|_{D(\zeta, r)}} \cap \mathcal{O}_{D(\xi, r), \Psi|_{D(\xi, r)}} = \emptyset$.

Or $\zeta = \xi$. We introduce $r < \min\{\rho(\Phi_\zeta), \rho(\Psi_\xi)\}$. Then Φ_ζ , resp. Ψ_ξ , is the germ at $\zeta = \xi$ of $\Phi \in \mathcal{O}(D(\zeta, r))$, resp. $\Psi \in \mathcal{O}(D(\xi, r))$. But $\Phi \neq \Psi$ by the principle of analytic continuity so that $\mathcal{O}_{D(\zeta, r), \Phi} \cap \mathcal{O}_{D(\xi, r), \Psi} = \emptyset$.

The fact that \mathcal{O} is locally arc-connected and locally compact is a consequence of Proposition 2.1.1. \square

2.1.2. Analytic continuation of a germ of holomorphic functions. —

2.1.2.1. Analytic continuation of a germ. — An analytic continuation of a germ φ is a connected subset of \mathcal{O} containing φ .

2.1.2.2. Path. —

Definition 2.1.4. — *In the paper, a path λ is any continuous map $\lambda \in \mathcal{C}^0([0, 1], \mathbb{C})$. We equip the space of paths with the uniform norm topology :*

$$\forall \lambda_1, \lambda_2 \in \mathcal{C}^0([0, 1], \mathbb{C}), \quad \|\lambda_1 - \lambda_2\| = \max_{t \in [0, 1]} |\lambda_1(t) - \lambda_2(t)|.$$

Definition 2.1.5. — *We denote by \mathfrak{R}_ζ the set of paths $\lambda : [0, 1] \rightarrow \mathbb{C}$ starting from $\zeta \in \mathbb{C}$.*

We usually simply write \mathfrak{R} for \mathfrak{R}_0 .

The topology on these spaces \mathfrak{R}_ζ is that induced by that of $\mathcal{C}^0([0, 1], \mathbb{C})$.

Definition 2.1.6. — *We say that λ_1 is a path deduced from the path λ_0 by reparametrization if there exists a continuous increasing function h from $[0, 1]$ onto itself such that $\lambda_1 = \lambda_0 \circ h$.*

Note that a reparametrization is a homotopy : just consider the mapping $(s, t) \in [0, 1]^2 \mapsto \lambda_s(t) = \lambda_0[(1-s)t + sh(t)]$.

2.1.2.3. *Analytic continuation along a path.* —

Definition 2.1.7. — *Let $\lambda : [0, 1] \rightarrow \mathbb{C}$ be a path starting from $\zeta_0 = \lambda(0)$. If the analytic continuation of the germ $\varphi \in \mathcal{O}_{\zeta_0}$ along λ exists, then the analytic continuation is the image of a unique path $\lambda \diamond \varphi : [0, 1] \rightarrow \mathcal{O}$ such that $\lambda \diamond \varphi(0) = \varphi$ and whose projection by p is λ :*

$$\begin{array}{ccc} & \mathcal{O} & \\ \lambda \diamond \varphi \nearrow & & \searrow p \\ [0, 1] & \longrightarrow & \mathbb{C} \\ & \lambda & \end{array}$$

In the paper:

- we note $\lambda \diamond \varphi(t) \in \mathcal{O}_{\lambda(t)}$ the analytic continuation along λ of the germ $\varphi \in \mathcal{O}_{\lambda(0)}$ at $\lambda(t)$,
- we write $\varphi(\lambda(t) + \xi) = \lambda \diamond \varphi(t)(\lambda(t) + \xi)$ for ξ close to 0,
- we write $\lambda.\varphi \in \mathcal{O}_{\lambda(1)}$ in place of $\lambda \diamond \varphi(1)$.

In other words, one can define a subdivision $0 = t_0 < t_1 < \dots < t_{n-1} < t_n = 1$ of the interval $[0, 1]$, open sets $U_j \subset \mathbb{C}$ with $\lambda([t_{j-1}, t_j]) \subset U_j$, and holomorphic functions $\Phi_j \in \mathcal{O}(U_j)$ whose germ at $\lambda(t_{j-1})$ is given by $\lambda \diamond \varphi(t_{j-1}) \in \mathcal{O}_{\lambda(t_{j-1})}$, $j = 1, \dots, n$, such that :

- (i) $\lambda \diamond \varphi(t_0) = \varphi$
- (ii) $\Phi_j = \Phi_{j+1}$ on the connected component V_j of $\lambda(t_j)$ in $U_j \cap U_{j+1}$, $j = 1, \dots, n - 1$.

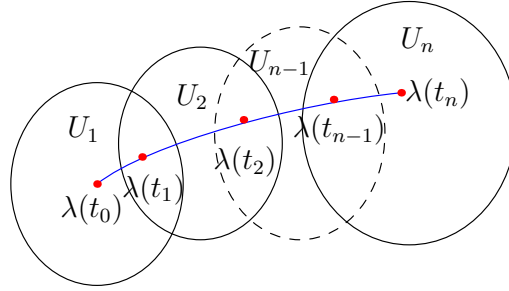

FIGURE 1

Obviously :

Lemma 2.1.1. — *We assume that $\varphi \in \mathcal{O}_{\zeta_0}$ can be continued analytically along a path λ_1 starting from $\zeta_0 = \lambda_1(0)$. Let λ_2 be a path deduced from λ_1 by reparametrization. Then φ can be continued analytically along λ_2 and $\lambda_2.\varphi = \lambda_1.\varphi$.*

Definition 2.1.8. — *For a given $\varphi \in \mathcal{O}_{\zeta}$ we note*

$$\mathfrak{R}(\varphi) = \{\lambda \in \mathfrak{R}_{\zeta} / \varphi \text{ can be continued analytically along } \lambda\}.$$

Lemma 2.1.2. — *For a given $\varphi \in \mathcal{O}_{\zeta}$, the set $\mathfrak{R}(\varphi)$ is open in \mathfrak{R}_{ζ} .*

More precisely, if $\lambda \in \mathfrak{R}(\varphi)$, then there exists a neighborhood $V \subset \mathfrak{R}_{\zeta}$ of λ such that every path $\lambda' \in V$ belongs to $\mathfrak{R}(\varphi)$, and for every $t \in [0, 1]$ the germs $\lambda \diamond \varphi(t)$ and $\lambda' \diamond \varphi(t)$ at $\lambda(t)$ and $\lambda'(t)$ respectively belong to the same open set of $\mathfrak{B}(\mathcal{O})$.

Proof. — Suppose the radius of convergence of the germ $\varphi \in \mathcal{O}_\zeta$ is finite, consider the mapping $f : t \in [0, 1] \mapsto \rho(\lambda \diamond \varphi(t)) \in \mathbb{R}^{+\ast}$ where $\rho(\lambda \diamond \varphi(t))$ stands for the radius of convergence of the germ $\lambda \diamond \varphi(t) \in \mathcal{O}_{\lambda(t)}$. This map f is clearly continuous. Set $r = \min_{[0,1]} f > 0$. Then one just has to assume that V is the open ball $\{\lambda' \in \mathfrak{A}_\zeta, \|\lambda - \lambda'\| < r\}$. \square

2.2. Riemann surface

2.2.1. Étale space and Riemann surface. — We remind the following definition (see, e.g., [For81]):

Definition 2.2.1. — *A Riemann surface is a connected one-dimensional complex manifold.*

In the paper we shall only encounter the following kind of Riemann surface : we assume that \mathcal{R} is a topologically connected separated space and that (\mathcal{R}, π) is an étale space on \mathbb{C} . Then \mathcal{R} becomes a Riemann surface by pulling back by π the complex structure of \mathbb{C} : if $V_1, V_2, V_1 \cap V_2 \neq \emptyset$ are two open sets of \mathcal{R} such that $\pi|_{V_1} : V_1 \rightarrow p(V_1) \subset \mathbb{C}$ and $\pi|_{V_2} : V_2 \rightarrow p(V_2) \subset \mathbb{C}$ are two homeomorphisms, then the chart transition $\pi|_{V_1} \circ (\pi|_{V_2})^{-1} : p(V_1 \cap V_2) \rightarrow p(V_1 \cap V_2)$ is nothing but the identity map, thus is biholomorphic. Therefore :

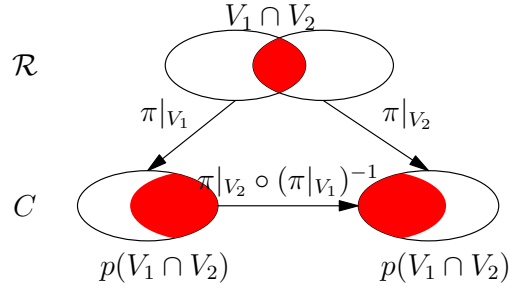

FIGURE 2

Proposition 2.2.1. — *If \mathcal{R} is a topologically connected separated space such that (\mathcal{R}, π) is an étale space on \mathbb{C} , then \mathcal{R} becomes a Riemann surface by pulling back by π the complex structure of \mathbb{C} .*

2.2.2. Example. — We note $\mathbb{H} = \{z = r + i\theta, r > 0, \theta \in \mathbb{R}\}$ the open right-half complex plane with its usual topology. We introduce $p : z = r + i\theta \in \mathbb{H} \mapsto p(z) = re^{i\theta} \in \mathbb{C}^*$. Obviously (\mathbb{H}, p) is an étale space on \mathbb{C} (even $p : \mathbb{H} \rightarrow \mathbb{C}^*$ is the universal covering space of \mathbb{C}^*), thus (\mathbb{H}, p) is a Riemann surface.

2.2.3. The Riemann surface of a germ of holomorphic functions. — For a given $\varphi \in \mathcal{O}_\zeta$ we consider the set

$$\mathcal{R}(\varphi) = \{\lambda \cdot \varphi \in \mathcal{O}_{\lambda(1)}, \lambda \in \mathfrak{A}(\varphi)\} \subset \mathcal{O}.$$

By Lemma 2.1.2 the set $\mathcal{R}(\varphi)$ is open in \mathcal{O} . We endow $\mathcal{R}(\varphi)$ with the topology induced by that of \mathcal{O} . By its very definition, $\mathcal{R}(\varphi)$ is (arc)connected. Now, again by

Lemma 2.1.2, the projection $p : \mathcal{R}(\varphi) \rightarrow \mathbb{C}$ is a local homeomorphism, thus $\mathcal{R}(\varphi)$ becomes a Riemann surface by pulling back by p the complex structure of \mathbb{C} .

Conversely, from the uniqueness of lifting (see [For81]), if one considers the étalé space $\mathcal{R}(\varphi)$ and the base point $\varphi \in \mathcal{R}(\varphi)$ one can recover the set $\mathfrak{R}(\varphi)$: for every path $\lambda \in \mathfrak{R}_\zeta$, λ belongs to $\mathfrak{R}(\varphi)$ iff there exists a lifting Λ of λ from φ with respect to p .

$$\begin{array}{ccc} & \mathcal{R}(\varphi) & \\ \Lambda \nearrow & & \searrow p \\ [0, 1] & \longrightarrow & \mathbb{C} \\ & \lambda & \end{array}, \quad \Lambda(0) = \varphi.$$

Definition 2.2.2. — For $\varphi \in \mathcal{O}_\zeta$ we set

$$\mathcal{R}(\varphi) = \{\lambda.\varphi \in \mathcal{O}_{\lambda(1)}, \lambda \in \mathfrak{R}(\varphi)\} \subset \mathcal{O},$$

The pointed étalé space $((\mathcal{R}(\varphi), \varphi), p)$ is called the Riemann surface of φ .

We add the following remark which will be useful in some circumstances : we know that if $\lambda \in \mathfrak{R}(\varphi)$ and if $\lambda' \in \mathfrak{R}_\zeta$ is close enough to λ for the uniform norm topology with $\lambda(1) = \lambda'(1)$ then $\lambda'.\varphi(1) = \lambda.\varphi(1)$. Since every $\lambda \in \mathfrak{R}_\zeta$ can be uniformly approached by paths λ' of $\mathfrak{R}_\zeta \cap \mathcal{C}^\infty$ with $\lambda(1) = \lambda'(1)$, we obtain that:

Proposition 2.2.2. — The Riemann surface $((\mathcal{R}(\varphi), \varphi), p)$ of $\varphi \in \mathcal{O}_\zeta$ can be described as:

$$\mathcal{R}(\varphi) = \{\lambda.\varphi \in \mathcal{O}_{\lambda(1)}, \lambda \in \mathfrak{R}(\varphi) \cap \mathcal{C}^\infty\}.$$

2.2.4. Analytic continuation on a Riemann surface. — The complex structure of Riemann surfaces allows us to define analytic functions on them. In particular:

Definition 2.2.3. — We assume that (\mathcal{R}, π) is a Riemann surface defined as an étalé space on \mathbb{C} .

One says that $F : \mathcal{R} \rightarrow \mathbb{C}$ is analytic if for every open set $V \subset \mathcal{R}$ such that $\pi|_V : V \rightarrow U = \pi(V) \subset \mathbb{C}$ is a homeomorphism, the mapping $F \circ (\pi|_V)^{-1} : U \rightarrow \mathbb{C}$ is holomorphic.

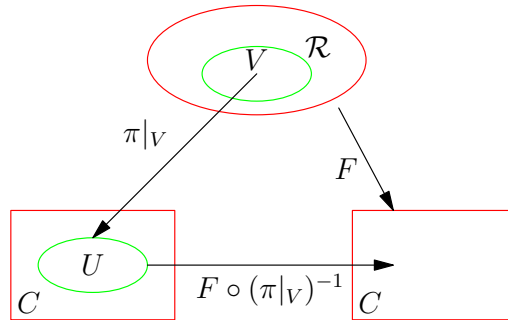

FIGURE 3

We note $\mathcal{H}(\mathcal{R})$ the space of analytic function on the Riemann surface \mathcal{R} .

Definition 2.2.4. — We consider a pointed Riemann surface $((\mathcal{R}, z_0), \pi)$, $\pi(z_0) = \zeta_0$, defined as an étalé space on \mathbb{C} . We also assume that $\pi|_V : (V, z_0) \subset \mathcal{R} \rightarrow (U, \zeta_0) = (\pi(V), \pi(z_0)) \subset \mathbb{C}$ where (V, z_0) is a connected neighborhood of z_0 and we consider $\Phi_0 \in \mathcal{O}_{\zeta_0}$ such that $\Phi_0 \in \mathcal{O}_{U, \Phi}$.

If the mapping

$$f : z \in (V, z_0) \subset \mathcal{R} \mapsto f(z) = \Phi_0 \circ \pi(z) \in \mathbb{C}$$

continues analytically on \mathcal{R} , one says that the germ Φ_0 continues analytically on the pointed Riemann surface $((\mathcal{R}, z_0), \pi)$. In that case we note $\Phi_0 \in \mathcal{H}(\mathcal{R})$ (with some abuse of notations).

2.2.5. Example. — We go back to the example discussed in §2.2.2 and we consider the pointed Riemann surface $((\mathbb{H}, 1), p)$, $p(1) = 1$. Consider the usual \ln function,

$\ln(\zeta) = \int_1^\zeta \frac{1}{\eta} d\eta$, $\zeta \in \mathbb{C} \setminus]0, -\infty[$, that we view here as a germ of holomorphic functions at $1 \in \mathbb{C}$. Then the mapping

$$\text{Log}(z) = \ln(r) + i\theta, \quad z = r + i\theta \in \mathbb{H},$$

makes an analytic continuation of \ln on the Riemann surface $((\mathbb{H}, 1), p)$. This justify to consider this pointed Riemann surface as the Riemann surface of the \ln function.

2.2.6. Cases of simply connected Riemann surface. — In the above example, the Riemann surface (\mathbb{H}, p) is simply connected. This is a quite important property in order to avoid working with “multi-valued” functions. We mention the following easy result :

Proposition 2.2.3. — We assume that the pointed Riemann surface $((\mathcal{R}, z_0), \pi)$, $\pi(z_0) = \zeta_0$, is simply connected. We note $\widehat{\mathfrak{R}}_{z_0}$ the set of paths on \mathcal{R} starting from z_0 . We consider $\psi \in \mathcal{O}_{\zeta_0}$. Then $\psi \in \mathcal{H}(\mathcal{R})$ iff $\pi(\widehat{\mathfrak{R}}_{z_0}) \subset \mathfrak{R}(\psi)$.

Proof. — We assume that $\psi \in \mathcal{H}(\mathcal{R})$. We consider a path $\lambda \in \pi(\widehat{\mathfrak{R}}_{z_0})$ and its unique lifting Λ from z_0 with respect to π . Since $\psi \in \mathcal{H}(\mathcal{R})$, $\psi \circ p$ can be continued analytically along Λ , thus ψ continues analytically along λ . This show that $\pi(\widehat{\mathfrak{R}}_{z_0}) \subset \mathfrak{R}(\psi)$.

Conversely we now assume that $\pi(\widehat{\mathfrak{R}}_{z_0}) \subset \mathfrak{R}(\psi)$, that is ψ can be continued analytically along every path $\lambda \in \pi(\widehat{\mathfrak{R}}_{z_0})$. If Λ is the lifting of λ on \mathcal{R} from z_0 with respect to π , then $\psi \circ p$ can be continued analytically along Λ . Since \mathcal{R} is simply connected, this implies that $\psi \in \mathcal{H}(\mathcal{R})$. \square

2.2.7. Homotopies. — The following Proposition will be useful in Chapter 5.

Proposition 2.2.4. — We consider a Riemann surface $((\mathcal{R}, z_0), \pi)$, $\pi(z_0) = \zeta_0$ and a continuous mapping $\Gamma : (s, t) \in [0, 1]^2 \mapsto \Gamma(s, t) \in \mathbb{C}$ such that:

- $\forall s \in [0, 1], \Gamma(s, 0) = \zeta_0$,
- $\forall t \in [0, 1], \Gamma(0, t) = \zeta_0$,
- $\forall s \in [0, 1]$, the path $\Gamma^s : t \in [0, 1] \mapsto \Gamma(s, t)$ can be lifted on \mathcal{R} from z_0 with respect to π .

Then $\forall t \in [0, 1]$, the path $\Gamma_t : s \in [0, 1] \mapsto \Gamma(s, t)$ can be lifted on \mathcal{R} from z_0 with respect to π .

Proof. — By hypotheses, $\forall s \in [0, 1]$, the path Γ^s can be lifted into a path $\widehat{\Gamma}^s : t \in [0, 1] \mapsto \widehat{\Gamma}^s(t) \in \mathcal{R}$,

$$\forall s \in [0, 1], \quad \begin{array}{ccc} & \mathcal{R} & \\ \widehat{\Gamma}^s \nearrow & & \searrow \pi \\ [0, 1] & \longrightarrow & \mathbb{C} \\ & \Gamma^s & \end{array}, \quad \widehat{\Gamma}^s(0) = z_0, \quad \pi \circ \widehat{\Gamma}^s(t) = \Gamma^s(t) = \Gamma(s, t).$$

This allows to consider the mapping

$$\widehat{\Gamma} : (s, t) \in [0, 1]^2 \mapsto \widehat{\Gamma}^s(t) \in \mathcal{R}$$

which is continuous from the lifting theorem for homotopies. (See, e.g, [For81]).

Now defining

$$\forall t \in [0, 1], \quad \widehat{\Gamma}_t : s \in [0, 1] \mapsto \widehat{\Gamma}^s(t) \in \mathcal{R}$$

one obtains a lifting of the path Γ_t . □

2.3. Convolution product

Throughout the paper, we will be concerned with the following definition of convolution products of germs of holomorphic functions and their main properties.

2.3.1. Convolution product of germs. —

Definition 2.3.1. — For $\varphi, \psi \in \mathcal{O}_0$ two germs of holomorphic functions at the origin, we define their convolution product by

$$(11) \quad \varphi * \psi(\zeta) = \int_0^\zeta \varphi(\eta)\psi(\zeta - \eta) d\eta$$

where the integral is taken along the segment $[0, \zeta]$ for ζ close enough to the origin.

Precisely if $\varphi \in \mathcal{O}_{D(0,r),\Phi}$ and $\psi \in \mathcal{O}_{D(0,r),\Psi}$ where $D(0, r)$ is the open disc of radius $r > 0$ centered at 0, then for $|\zeta| < r$,

$$\varphi * \psi(\zeta) = \int_0^1 \Phi(\zeta t)\Psi(\zeta(1 - t)) \zeta dt$$

and the classical Lebesgue type theorems ensure that the convolution product $\varphi * \psi$ defines a germ of holomorphic functions at the origin.

We mention the following obvious properties:

Proposition 2.3.1. — The space $(\mathcal{O}_0, *)$ is an algebra. Introducing the operator

$$\partial : \varphi \in \mathcal{O}_0 \mapsto \partial\varphi(\zeta) = -\zeta\varphi(\zeta)$$

then $(\mathcal{O}_0, *)$ becomes a differential algebra.

One can extend $(\mathcal{O}_0, *)$ into a unitary differential algebra $(\mathcal{O}_0 \oplus \mathbb{C}\delta, *)$ where the unit δ satisfies:

- $\delta * \varphi = \varphi * \delta = \varphi$;
- $\delta * \delta = \delta$;
- $\partial\delta = 0$.

2.3.2. Analytic continuations of a convolution product. —

Definition 2.3.2. — For $\lambda \in \mathfrak{R}$ we define $\lambda^* \in \mathfrak{R}$ by

$$\lambda^* : t \in [0, 1] \mapsto \lambda^*(t) = \lambda(1) - \lambda(1 - t).$$

We consider $\varphi, \psi \in \mathcal{O}_0$ and $\lambda_{\zeta_0} \in \mathfrak{R}$ a path ending at $\zeta_0 = \lambda_{\zeta_0}(1)$. We assume that

- the germ φ is analytically continuable along the path λ_{ζ_0} , that is $\lambda_{\zeta_0} \in \mathfrak{R}(\varphi)$,
- the germ ψ is analytically continuable along the path $\lambda_{\zeta_0}^*$, that is $\lambda_{\zeta_0}^* \in \mathfrak{R}(\psi)$.

According to lemma 2.1.2, these properties are still satisfied by small variations of the path. This allows to assume that λ_{ζ_0} is \mathcal{C}^1 by part and furthermore we can consider instead the nearby family of paths

$$\lambda_{\zeta} : t \in [0, 1] \mapsto \lambda_{\zeta_0}(t) + t(\zeta - \zeta_0)$$

for $|\zeta - \zeta_0|$ small enough. Under these conditions, the integral

$$I(\zeta) = \int_{\lambda_{\zeta}} \varphi(\eta)\psi(\zeta - \eta) d\eta = \int_0^1 \varphi(\lambda_{\zeta}(t))\psi(\lambda_{\zeta}^*(1 - t)) \frac{d\lambda_{\zeta}}{dt}(t) dt$$

is well defined and $I(\zeta)$ defines a germ of analytic function at ζ_0 (by holomorphic dependance of λ_{ζ} with ζ and applying classical results in integration theory).

However, it should be noted that $I(\zeta)$ has no reason to be the analytic continuation along λ_{ζ_0} of the germ of analytic function at the origin defined by the convolution product $\varphi * \psi(\zeta)$. For that other conditions are necessary. The following lemma gives sufficient conditions.

Proposition 2.3.2. — One considers $\varphi, \psi \in \mathcal{O}_0$ and $\lambda \in \mathfrak{R}$. We assume that there is a continuous map $\Gamma : (s, t) \in [0, 1] \times [0, 1] \mapsto \Gamma(s, t) = \Gamma_t(s) \in \mathbb{C}$ such that :

- $\forall s \in [0, 1], \Gamma_0(s) = 0$,
- $\forall t \in [0, 1], \Gamma_t(0) = 0, \Gamma_t(1) = \lambda(t)$,
- $\forall t \in [0, 1]$, the germ φ is analytically continuable along the path $\Gamma_t : s \in [0, 1] \mapsto \Gamma_t(s)$, that is $\Gamma_t \in \mathfrak{R}(\varphi)$,
- $\forall t \in [0, 1]$, the germ ψ is analytically continuable along the path $\Gamma_t^* : s \in [0, 1] \mapsto \Gamma_t^*(s) = \Gamma_t(1) - \Gamma_t(1 - s)$, that is $\Gamma_t^* \in \mathfrak{R}(\psi)$.

Then the germ of analytic functions $\varphi * \psi \in \mathcal{O}_0$ is analytically continuable along the path λ , in other words $\lambda \in \mathfrak{R}(\varphi * \psi)$, with:

$$\varphi * \psi(\lambda(t) + \xi) = \int_{\Gamma_t} \varphi(\eta)\psi(\lambda(t) + \xi - \eta) d\eta, \quad \xi \text{ close to } 0.$$

Proof. — The map $\Gamma : (s, t) \in [0, 1] \times [0, 1] \mapsto \Gamma(s, t) \in \mathbb{C}$ is continuous on a compact thus, by regularization, it can be uniformly approached by means of \mathcal{C}^∞ functions : for every $\varepsilon > 0$, there exists $\Gamma^\varepsilon : (s, t) \in [0, 1] \times [0, 1] \mapsto \Gamma^\varepsilon(s, t) = \Gamma_t^\varepsilon(s) \in \mathbb{C}, \Gamma^\varepsilon \in \mathcal{C}^\infty$ such that

1. $\forall s \in [0, 1], \Gamma_0^\varepsilon(s) = 0$,
2. $\forall t \in [0, 1], \Gamma_t^\varepsilon(0) = 0$,
3. $\max_{(s,t) \in [0,1]^2} |\Gamma^\varepsilon(s, t) - \Gamma(s, t)| < \varepsilon$.

Indeed, we can introduce a sequence of mollifiers $(\rho_n)_{n \in \mathbb{N}}$,

$$\rho_n \in \mathcal{D}(\mathbb{R}^2), \text{supp}(\rho_n) = B(0, \frac{1}{n}), \int_{\mathbb{R}^2} \rho_n = 1, \rho_n \geq 0 \text{ on } \mathbb{R}^2.$$

For every $\varepsilon > 0$, there exists $\delta > 0$ such that $\forall (s, t) \in [0, 1]^2, \forall (s', t') \in B(0, \delta)$,

$$|\Gamma(s - s', t - t') - \Gamma(s, t)| < \frac{\varepsilon}{4}.$$

Thus

$$\rho_n * \Gamma(s, t) - \Gamma(s, t) = \int_{\mathbb{R}^2} [\Gamma(s - s', t - t') - \Gamma(s, t)] \rho_n(s', t') ds' \otimes dt'$$

that is, for $n > 1/\delta$,

$$\rho_n * \Gamma(s, t) - \Gamma(s, t) = \int_{B(0, 1/n)} [\Gamma(s - s', t - t') - \Gamma(s, t)] \rho_n(s', t') ds' \otimes dt',$$

then

$$|\rho_n * \Gamma(s, t) - \Gamma(s, t)| < \frac{\varepsilon}{4} \int_{\mathbb{R}^2} \rho_n$$

and finally

$$\forall (s, t) \in [0, 1]^2, |\rho_n * \Gamma(s, t) - \Gamma(s, t)| < \frac{\varepsilon}{4}.$$

We have $\rho_n * \Gamma \in \mathcal{C}^\infty$ and it remains to define

$$\Gamma^\varepsilon(s, t) = \rho_n * \Gamma(s, t) - \rho_n * \Gamma(s, 0) - \rho_n * \Gamma(0, t) + \rho_n * \Gamma(0, 0)$$

to end the construction.

Also, using the same notations used in the proof of Lemma 2.1.2, we consider the mappings $f : t \in [0, 1] \mapsto \min_{s \in [0, 1]} \rho(\Gamma_t \diamond \varphi(s)) \in \mathbb{R}^{+*}$ and $g : t \in [0, 1] \mapsto \min_{s \in [0, 1]} \rho(\Gamma_t^* \diamond \psi(s)) \in \mathbb{R}^{+*}$. Since Γ_t depends continuously on t , both f and g are continuous. We note $r = \min\{\min_{[0, 1]} f, \min_{[0, 1]} g\} > 0$.

Assuming $0 < \varepsilon < r$ we deduce that

4. $\forall t \in [0, 1], \Gamma_t^\varepsilon \in \mathfrak{A}(\varphi)$
5. $\forall t \in [0, 1], \Gamma_t^{\varepsilon*} \in \mathfrak{A}(\psi)$.

We note

$$\lambda^\varepsilon : t \in [0, 1] \mapsto \lambda^\varepsilon(t) = \Gamma_t^\varepsilon(1)$$

so that

$$(12) \quad \|\lambda^\varepsilon - \lambda\| < \varepsilon.$$

Now for every $t \in [0, 1]$ the integral

$$\begin{aligned} I(\lambda^\varepsilon(t)) &= \int_{\Gamma_t^\varepsilon} \varphi(\eta) \psi(\lambda^\varepsilon(t) - \eta) d\eta \\ &= \int_0^1 \varphi(\Gamma_t^\varepsilon(s)) \psi(\Gamma_t^{\varepsilon*}(1 - s)) \frac{\partial \Gamma_t^\varepsilon}{\partial s}(s) ds \end{aligned}$$

is well defined by virtue of conditions 4 and 5. Furthermore, by conditions 1, 2, $I(\lambda^\varepsilon(t))$ coincides with $\varphi * \psi(\lambda^\varepsilon(t))$ for t close to 0. By the arguments discussed

above, $\varphi * \psi$ is therefore analytically continuable along λ^ε (assume that $0 < \varepsilon < r/2$ and consider

$$I(\lambda^\varepsilon(t) + \xi) = \int_{s \mapsto \Gamma_t^\varepsilon(s) + s\xi} \varphi(\eta)\psi(\lambda^\varepsilon(t) + \xi - \eta) d\eta.$$

for $|\xi| < r/2$. This defines a germ of holomorphic functions at $\lambda^\varepsilon(t)$ and the map $t \in [0, 1] \mapsto I(\lambda^\varepsilon(t) + \xi) \in \mathcal{O}_{\lambda^\varepsilon(t)}$ provides the analytic continuation of $\varphi * \psi$ along λ^ε . Taking $\varepsilon > 0$ small enough, we conclude that $\varphi * \psi$ is analytically continuable along λ . \square

2.3.3. Example. — We illustrate Proposition 2.3.2 with Figure 5. We assume that $\varphi \in \mathcal{O}_0$, resp. $\psi \in \mathcal{O}_0$, can be analytically continued along every path avoiding ω_1 , resp. ω_1, ω_2 . We choose a path $\lambda \in \mathfrak{R}$ and on pictures A_1, \dots, A_5 we represent $\lambda([0, t])$ for various times $t = t_1 < t = t_2 < \dots < t = t_5$. On pictures B_1, \dots, B_5 we represent the paths $\Gamma_t \in \mathfrak{R}(\varphi)$, $\Gamma_t(1) = \lambda(t)$, while on pictures C_1, \dots, C_5 we have drawn the paths $\Gamma_t^* \in \mathfrak{R}(\psi)$.

Clearly on Figure 5, the homotopy Γ satisfies the conditions of Proposition 2.3.2, so that the germ of analytic functions $\varphi * \psi \in \mathcal{O}_0$ can be analytically continued along λ .

On pictures D_1, \dots, D_5 we have represented the way we get the deformed paths Γ_t , by adding to the “fixed singular point” ω_1 (the singular point of $\varphi(\eta)$) the “movable” ones $\lambda(t) - \omega_2$ and $\lambda(t) - \omega_3$ (the singular points of $\psi(\lambda(t) - \eta)$).

Pictures A_5, B_5, C_5 suggest that some troubles may occur when the path λ reaches the point $w_1 + \omega_3$: on picture D_5 this translates to the fact that the path Γ_t becomes “pinched” (twice) between the fixed singular point ω_1 and the movable singular point $\lambda(t) - \omega_3$. We return to this point latter on.

2.3.4. Convolution product and symmetric path. — The following definition will be used in the sequel.

Definition 2.3.3. — A path $\gamma \in \mathfrak{R}$ is called a symmetric path if it is symmetric with respect to its mid-point $\frac{\gamma(1)}{2}$ (see Fig. 4). In other words,

$$(13) \quad \forall t \in [0, 1], \quad \text{we have} \quad \gamma^*(t) = \gamma(t) \quad \text{where} \quad \gamma^*(t) = \gamma(1) - \gamma(1 - t).$$

We denote by $\mathfrak{R}^{\text{sym}}$ the subset of symmetric paths of \mathfrak{R} .

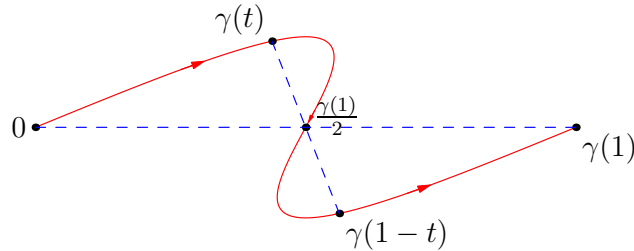

FIGURE 4

With this definition, Proposition 2.3.2 has an obvious Corollary.

Corollary 2.3.1. — *One considers $\varphi, \psi \in \mathcal{O}_0$ and $\lambda \in \mathfrak{R}$. We assume that there is a continuous map $\Gamma : (s, t) \in [0, 1] \times [0, 1] \mapsto \Gamma(s, t) = \Gamma_t(s) \in \mathbb{C}$ such that :*

- $\forall s \in [0, 1], \Gamma_0(s) = 0,$
- $\forall t \in [0, 1], \Gamma_t \in \mathfrak{R}^{sym}$ and $\Gamma_t(1) = \lambda(t),$
- $\forall t \in [0, 1], \Gamma_t \in \mathfrak{R}(\varphi) \cap \mathfrak{R}(\psi).$

*Then the germ of analytic functions $\varphi * \psi \in \mathcal{O}_0$ is analytically continuable along the path λ , in other words $\lambda \in \mathfrak{R}(\varphi * \psi).$*

2.3.5. Example. — We illustrate Proposition 2.3.1 with Figure 6. The hypotheses are the same as those used in Example 2.3.3 but this time the paths Γ_t are symmetric.

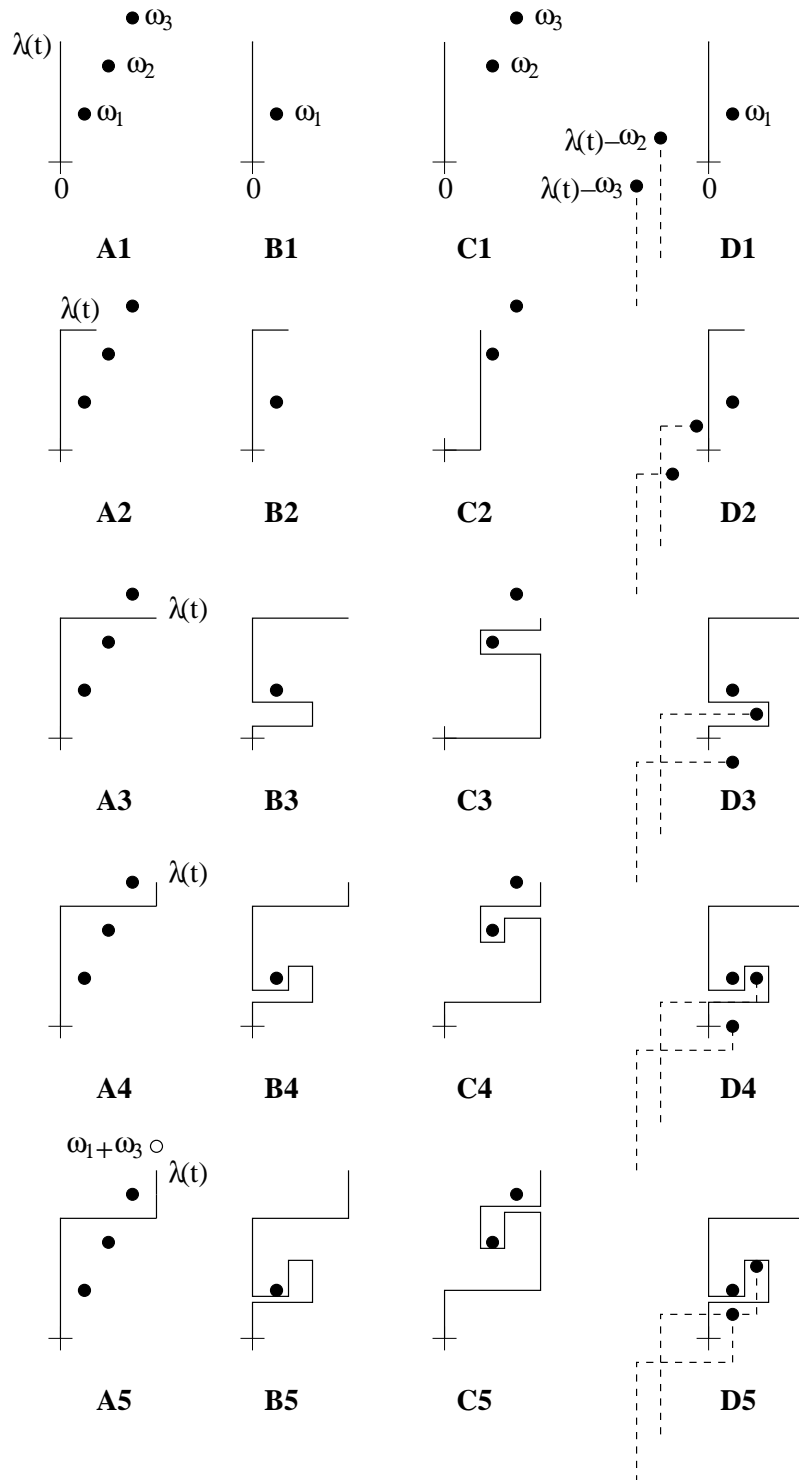

FIGURE 5

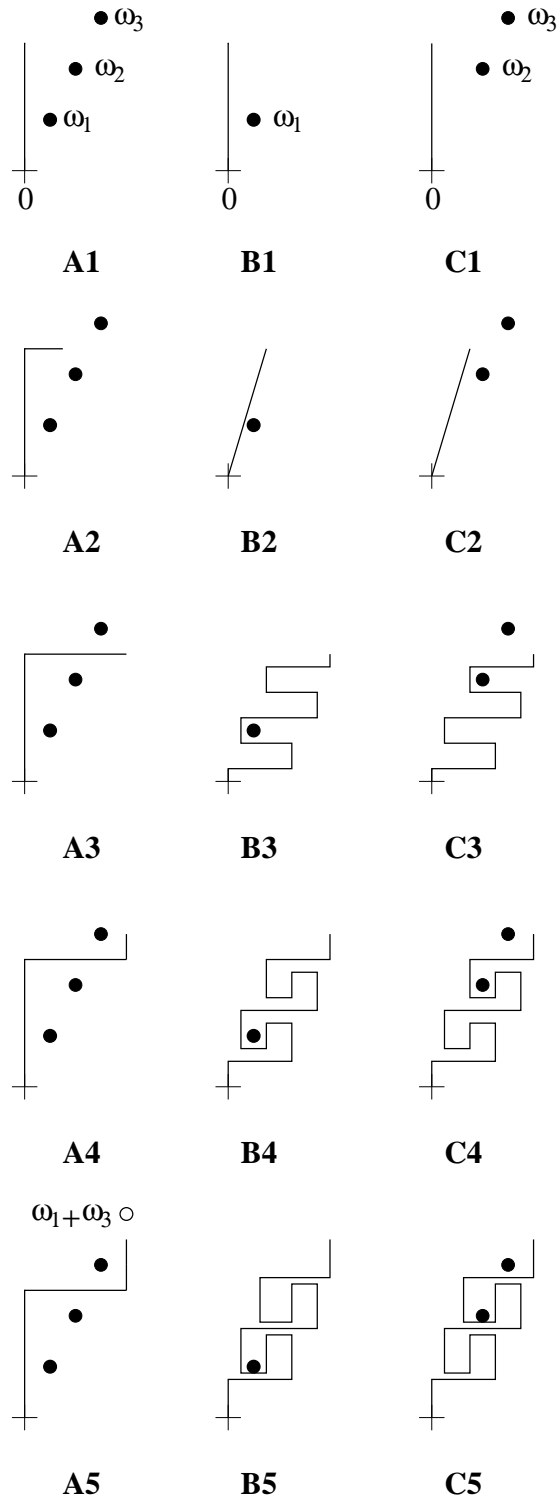

FIGURE 6

CHAPTER 3

PREPARATORY LEMMAS

In the next chapters we shall investigate the analytic continuation of the convolution product of germs of analytic functions and will provide convolution algebras.

In practice our analysis will be based on Proposition 2.3.2. However, in order to apply this Proposition one has to construct a homotopy map Γ for a given path λ , under convenient hypotheses on the space of analytic functions under consideration. Our analysis will be based on some preparatory lemmas essentially based on ideas from [OU010] that we detail in this chapter.

This chapter is organized as follows : after some useful definitions and a heuristic section, we formulate our preparatory lemmas in §3.3. Their proofs are given in the next section §3.4. Since our method is based on an explicit construction of the homotopy map, we end this chapter with numerical samples in §3.5.

3.1. Some definitions

Definition 3.1.1. — We assume that $\lambda : t \in [0, 1] \mapsto \lambda(t) \in \mathbb{C}$ is a path of class \mathcal{C}^1 by part. Then :

- we note \mathcal{L}_λ the length of the path λ : $\mathcal{L}_\lambda = \int_0^1 |\lambda'(t)| dt$, where λ' is the derivative of λ .
- for $0 \leq t_1 \leq t_2 \leq 1$, we note $\mathcal{L}_{\lambda, t_1, t_2}$ the length of the path $\lambda|_{[t_1, t_2]}$: $\mathcal{L}_{\lambda, t_1, t_2} = \int_{t_1}^{t_2} |\lambda'(t)| dt$

Definition 3.1.2. — If $A, B \subset \mathbb{C}$, we note

$$A + B = \{\omega + \omega', \text{ with } \omega \in A, \omega' \in B\} \subset \mathbb{C}.$$

Proposition 3.1.1. — We assume that C is a discrete subset of \mathbb{C} such that there exists $\kappa > 0$ so that

$$\forall \omega, \omega' \in C, \omega \neq \omega' \Rightarrow |\omega - \omega'| \geq \kappa.$$

We consider $R : C \rightarrow \mathbb{R}^{+\star}$, $r : C \rightarrow \mathbb{R}^{+\star}$ such that

$$0 < 2R < \kappa, \quad 0 < r < R.$$

Then there exists $f_{C,R,r} : \mathbb{C} \mapsto [0, 1]$, a C^∞ function such that

$$\forall \zeta \in \mathbb{C}, f_{C,R,r}(\zeta) = \begin{cases} 0 & \text{if } \exists \omega \in C, |\zeta - \omega| \leq r(\omega) \\ g_\omega(|\zeta - \omega|) & \text{if } \exists \omega \in C, r(\omega) \leq |\zeta - \omega| \leq R(\omega) \\ 1 & \text{else.} \end{cases}$$

where $g_\omega : [r(\omega), R(\omega)] \rightarrow [0, 1]$ is an increasing C^∞ function, $g_\omega(r(\omega)) = 0$ and $g_\omega(R(\omega)) = 1$.

Proof. — One easily constructs $f_{C,R,r}$ by using a C^∞ partition of unity. \square

Notation : In what follows and for such a C^p function $f(\zeta) = f_{C,R,r}(\zeta)$, $f'(\zeta)$ will stand for $\left(\frac{\partial f}{\partial x}(\zeta), \frac{\partial f}{\partial y}(\zeta)\right) \in \mathbb{C}^2$ where $\zeta = x + iy$, we shall write $f'(\zeta) \cdot (u + iv) = u \frac{\partial f}{\partial x}(\zeta) + v \frac{\partial f}{\partial y}(\zeta)$ and $|f'| = \left|\frac{\partial f}{\partial x}\right| + \left|\frac{\partial f}{\partial y}\right|$ so that $|f'(\zeta) \cdot (u + iv)| \leq |f'| \cdot |u + iv|$ (this is used in §3.4).

Notice also that $\sup_{\mathbb{C}} |f'_{C,R,r}| = \sup_{\omega \in C} \sup_{\mathbb{R}} g'_\omega$.

3.2. Heuristic

The lemmas discussed in the next section are based on the following considerations. We assume that A is the set of singular points of an analytic function φ and B is the set of singular points of another analytic function ψ . For a given path $\lambda_0 \in \mathfrak{A}$ one wants to construct the deformation paths Γ_t as in Proposition 2.3.2. For doing that we introduce (with Proposition 3.1.1) a function f_1 which vanishes at the points of A , otherwise $f_1 = 1$. Similarly f_2 vanishes at the points of B and is equal to 1 otherwise.

To realize what we have drawn on pictures D_1, \dots, D_5 of Figure 5, we can consider the map $\Gamma : (s, t) \in [0, 1]^2 \mapsto \Gamma(s, t)$ such that

$$(14) \quad \begin{cases} \frac{d\Gamma}{dt}(s, t) = s\lambda'_0(st)f_1(\Gamma(s, t)) + [\lambda'_0(t) - s\lambda'_0(st)] [1 - f_2(\lambda_0(t) - \Gamma(s, t))] \\ \Gamma(s, 0) = 0. \end{cases}$$

As a rule, $f_1 = f_2 = 1$, so that by integration,

$$\Gamma(s, t) = \int_0^t s\lambda'(st') dt' = \lambda(st).$$

The term $f_1(\Gamma(s, t))$ is added in (14) so as to avoid the set of singular points A . In the same manner from the property of f_2 , when $\Gamma(s, t)$ becomes close to a movable singular point for some s , that is $\lambda(t) - \Gamma(s, t) \simeq \omega \in B$, then $\frac{d\Gamma}{dt}(s, t) \simeq \lambda'(t)$, that is $\Gamma(s, t)$ is pushed forward in the direction given by $\lambda'(t)$, thus away from the movable singular point. Of course this does not work when at the same time $\Gamma(s, t)$ becomes close to a fixed singular point (“pinching” case).

In what follows, instead of considering (14), we shall rather consider the mapping Γ given by the Cauchy problem (15). One follows the same ideas as previously, but (15) has the virtue to “tighten” the paths. This simplifies here and there some reasonings. Some technicalities come from the fact that the origin will have a rather special status in the next chapters.

3.3. Preparatory lemmas

In what follows A and B are two discrete subsets of \mathbb{C} and there exist $\kappa_A > 0$, $\kappa_B > 0$ so that

$$\forall \omega, \omega' \in A, \omega \neq \omega' \Rightarrow |\omega - \omega'| \geq \kappa_A, \quad \forall \omega, \omega' \in B, \omega \neq \omega' \Rightarrow |\omega - \omega'| \geq \kappa_B.$$

We also note the functions $R_A : A \rightarrow \mathbb{R}^{+\ast}$, $r_A : A \rightarrow \mathbb{R}^{+\ast}$ and similarly $R_B : B \rightarrow \mathbb{R}^{+\ast}$, $r_B : B \rightarrow \mathbb{R}^{+\ast}$ such that

$$0 < 2R_A < \kappa_A, \quad 0 < r_A < R_A \quad \text{and} \quad 0 < 2R_B < \kappa_B, \quad 0 < r_B < R_B.$$

Lemma 3.3.1. — *We assume that :*

- $p \in \mathbb{N} \cup \infty$.
- $\lambda : t \in [0, 1] \mapsto \lambda(t) \in \mathbb{C}$ is a (nonconstant) path of class \mathcal{C}^{p+1} . We note $M = \max_{t \in [0, 1]} |\lambda'(t)| > 0$ where λ' is the derivative of λ .
- $\gamma : s \in [0, 1] \mapsto \gamma(s) \in \mathbb{C}$ belongs to $\mathfrak{R}^{\text{sym}} \cap \mathcal{C}^{p+1}$ and $\gamma(1) = \lambda(0)$. We note $N = \max_{s \in [0, 1]} |\gamma'(s)|$, where γ' is the derivative of γ .
- $f_1, f_2 : \mathbb{C} \rightarrow [0, 1]$ are of class \mathcal{C}^{p+1} .

Then :

1. There exists a unique map $\Gamma : (s, t) \in [0, 1] \times [0, 1] \mapsto \Gamma(s, t) \in \mathbb{C}$ of class \mathcal{C}^{p+1} such that for $(s, t) \in [0, 1] \times [0, 1]$,

$$(15) \quad \begin{cases} \frac{d\Gamma}{dt}(s, t) = \frac{d\lambda}{dt}(t) \left[s f_1(\Gamma(s, t)) + (1-s) \left[1 - f_2(\Gamma^\circ(1-s, t)) \right] \right] \\ \Gamma(s, 0) = \gamma(s), \quad \text{where} \quad \Gamma^\circ(1-s, t) = \lambda(t) - \Gamma(s, t) \end{cases}$$

Moreover

$$\forall s \in [0, 1], \forall t_1, t_2 \in [0, 1], |\Gamma(s, t_2) - \Gamma(s, t_1)| \leq M|t_2 - t_1|$$

2. If Γ solves the Cauchy problem (15), then equivalently Γ° solves the Cauchy problem

$$(16) \quad \begin{cases} \frac{d\Gamma^\circ}{dt}(s, t) = \lambda'(t) \left[s f_2(\Gamma^\circ(s, t)) + (1-s) \left[1 - f_1(\Gamma^{\circ\circ}(1-s, t)) \right] \right] \\ \Gamma^\circ(s, 0) = \lambda(0) - \Gamma(1-s, 0) = \gamma(s), \quad \Gamma^{\circ\circ}(1-s, t) = \lambda(t) - \Gamma^\circ(s, t) = \Gamma(1-s, t) \end{cases}$$

3. The map Γ satisfies :

$$\forall (s, t) \in [0, 1] \times [0, 1], |\Gamma(s, t) - \gamma(s)| \leq \mathcal{L}_{\lambda, 0, t} \leq Mt,$$

$$\forall (s, t) \in [0, 1] \times [0, 1], |\Gamma^\circ(s, t) - \gamma(s)| \leq \mathcal{L}_{\lambda, 0, t} \leq Mt.$$

In particular,

$$\forall (s, t) \in [0, 1]^2, |\Gamma(s, t)| \leq \mathcal{L}_{\gamma, 0, s} + \mathcal{L}_{\lambda, 0, t} \leq \mathcal{L}_\gamma + \mathcal{L}_\lambda \leq N + M,$$

$$\forall (s, t) \in [0, 1]^2, |\Gamma^\circ(s, t)| \leq \mathcal{L}_{\gamma, 0, s} + \mathcal{L}_{\lambda, 0, t} \leq \mathcal{L}_\gamma + \mathcal{L}_\lambda \leq N + M.$$

4. If $f_1 = f_2$, then for every $t \in [0, 1]$,

$$\forall (s, t) \in [0, 1] \times [0, 1], \Gamma^\circ(s, t) = \Gamma(s, t).$$

5. For every $s \in [0, 1]$, the paths $\Gamma^s : t \in [0, 1] \mapsto \Gamma^s(t) = \Gamma(s, t)$ and $\Gamma^{\circ s} : t \in [0, 1] \mapsto \Gamma^{\circ s}(t) = \Gamma^\circ(s, t)$ satisfy

$$\mathcal{L}_{\Gamma^s} \leq \mathcal{L}_\lambda, \quad \mathcal{L}_{\Gamma^{\circ s}} \leq \mathcal{L}_\lambda.$$

6. If $k = \max_{|\zeta| \leq N+M} \{|f'_1(\zeta)|, |f'_2(\zeta)|\}$, then $\forall (s_1, s_2) \in [0, 1]^2, \forall t \in [0, 1]$,

$$|\Gamma(s_1, t) - \Gamma(s_2, t)| \leq |s_1 - s_2| \left[Ne^{kMt} + \frac{e^{kMt} - 1}{k} \right].$$

7. For every $t \in [0, 1]$, the path $\Gamma_t : s \in [0, 1] \mapsto \Gamma_t(s) = \Gamma(s, t)$ satisfies:

$$\mathcal{L}_{\Gamma_t} \leq (\mathcal{L}_\gamma + \mathcal{L}_{\lambda, 0, t}) e^{k\mathcal{L}_{\lambda, 0, t}}$$

with $k = \max_{|\zeta| \leq N+M} \{|f'_1(\zeta)|, |f'_2(\zeta)|\}$.

8. Assume that there exist $\theta_0 \in \mathbb{R}$ and $\alpha \in \mathbb{R}$ such that

$$\forall t \in [0, 1], \lambda'(t) \neq 0 \Rightarrow \arg \lambda'(t) \in] - \alpha + \theta_0, \theta_0 + \alpha[.$$

Then $\forall (s, t) \in [0, 1]^2$, either $\Gamma(s, t) - \gamma(s) = 0$ or

$$\arg(\Gamma(s, t) - \gamma(s)) \in] - \alpha + \theta_0, \theta_0 + \alpha[.$$

Lemma 3.3.2. — We assume the conditions of lemma 3.3.1. Then:

- if $f_1 = f_{A, R_A, r_A}$ and if λ satisfies

$$\forall \omega \in A, \inf_{t \in [0, 1]} d(\lambda(t), \omega) > R_A(\omega),$$

then the map Γ satisfies:

$$\forall t \in [0, 1], \Gamma(1, t) = \lambda(t) \quad \text{and equivalently} \quad \Gamma^\circ(0, t) = 0.$$

- if $f_2 = f_{B, R_B, r_B}$ and if λ satisfies

$$\forall \omega \in B, \inf_{t \in [0, 1]} d(\lambda(t), \omega) > R_B(\omega),$$

then the map Γ satisfies:

$$\forall t \in [0, 1], \Gamma^\circ(1, t) = \lambda(t) \quad \text{and equivalently} \quad \Gamma(0, t) = 0.$$

- if $A = B = C$, $f_1 = f_2 = f_{C, R_C, r_C}$ and if λ satisfies :

$$\forall \omega \in C, \inf_{t \in [0, 1]} d(\lambda(t), \omega) > R_C(\omega),$$

then the map Γ satisfies:

$$\forall t \in [0, 1], \Gamma(1, t) = \lambda(t), \quad \Gamma(0, t) = 0$$

and $\forall t \in [0, 1]$, the path $\Gamma_t : s \in [0, 1] \mapsto \Gamma_t(s) = \Gamma(s, t)$ belongs to \mathfrak{A}^{sym} .

Lemma 3.3.3. — We assume the conditions of lemma 3.3.1. Furthermore we assume that the path λ is so that $\forall \omega \in A, \forall \omega' \in B$,

$$d_\lambda(\omega + \omega') = \inf_{t \in [0, 1]} d(\lambda(t), \omega + \omega') > \sup\{r_A(\omega) + R_B(\omega'), R_A(\omega) + r_B(\omega')\}$$

and that

$$\forall \omega \in A, \delta(\omega) = \inf_{\omega' \in B} d_\lambda(\omega + \omega') - (r_A(\omega) + R_B(\omega')) > 0,$$

$$\forall \omega' \in B, \delta(\omega') = \inf_{\omega \in A} d_\lambda(\omega + \omega') - (R_A(\omega) + r_B(\omega')) > 0.$$

We note $M = \max_{t \in [0, 1]} |\lambda'(t)|$. Then for every $T_0 \in [0, 1]$ and for a given $s \in [0, 1]$:

– if

$$\exists \omega \in A, \exists T \in [T_0, T_0 + \varepsilon], |\Gamma(s, T) - \omega| \leq r_A(\omega),$$

with $0 < \varepsilon \leq \frac{\delta(\omega)}{2M}$, then

$$\forall \omega' \in B, \forall T \in [T_0, T_0 + \varepsilon], |\Gamma^\circ(1 - s, T) - \omega'| \geq R_B(\omega').$$

– if

$$\exists \omega' \in B, \exists T \in [T_0, T_0 + \varepsilon], |\Gamma^\circ(1 - s, T) - \omega'| \leq r_B(\omega'),$$

with $0 < \varepsilon \leq \frac{\delta(\omega')}{2M}$, then

$$\forall \omega \in A, \forall T \in [T_0, T_0 + \varepsilon], |\Gamma(s, T) - \omega| \geq R_A(\omega).$$

Lemma 3.3.4. — We assume the conditions of lemma 3.3.3. Furthermore we assume that :

- 0 belongs to $A \cap B$.
- $f_1 = f_{A, R_A, r_A}$, $f_2 = f_{B, R_B, r_B}$ as defined by Proposition 3.1.1 and $r_A(0) = r_B(0) = r$.
- there exists $0 < s_0 \leq 1$ such that

$$\forall s \in [0, s_0[, |\gamma(s)| < r.$$

Then the map Γ satisfies:

$$\forall (s, t) \in [0, s_0] \times [0, 1], \Gamma(s, t) = \Gamma^\circ(s, t) = \gamma(s).$$

Lemma 3.3.5. — We assume the conditions of lemma 3.3.3. Furthermore we assume that :

- $f_1 = f_{A, R_A, r_A}$, $f_2 = f_{B, R_B, r_B}$ as defined by Proposition 3.1.1.
- there exists $0 < s_0 \leq 1$ such that

$$\forall s \in [s_0, 1], \forall \omega \in A, |\gamma(s) - \omega| \geq r_A(\omega) \quad \text{and} \quad \inf_{\omega \in A} \delta(\omega) > 0,$$

resp.

$$\forall s \in [s_0, 1], \forall \omega \in B, |\gamma(s) - \omega| \geq r_B(\omega) \quad \text{and} \quad \inf_{\omega \in B} \delta(\omega) > 0.$$

Then the map Γ satisfies:

$$\forall (s, t) \in [s_0, 1] \times [0, 1], \forall \omega \in A, |\Gamma(s, t) - \omega| \geq r_A(\omega),$$

resp.

$$\forall (s, t) \in [s_0, 1] \times [0, 1], \forall \omega \in B, |\Gamma^\circ(s, t) - \omega| \geq r_B(\omega).$$

3.4. Proofs of the preparatory lemmas

3.4.1. Proof of the preparatory lemma 3.3.1. —

1. The differential equation (15) reads

$$(17) \quad \begin{cases} \frac{d\Gamma}{dt} = \mathfrak{F}(\Gamma, s, t), & \mathfrak{F} : (\Gamma, s, t) \in \mathbb{C} \times [0, 1] \times [0, 1] \mapsto \mathfrak{F}(\Gamma, s, t) \in \mathbb{C} \\ \mathfrak{F}(\Gamma, s, t) = \frac{d\lambda}{dt} [s f_1(\Gamma) + (1 - s)(1 - f_2(\lambda - \Gamma))] . \end{cases}$$

We note that \mathfrak{F} is of class \mathcal{C}^p and has its partial derivative $\frac{\partial \mathfrak{F}}{\partial \Gamma}$ of class \mathcal{C}^p . The Cauchy-Lipschitz theorem can thus be applied : for every $(s_0, t_0) \in [0, 1] \times [0, 1]$, for every $H : s \in [0, 1] \mapsto H(s) \in \mathbb{C}$ of class \mathcal{C}^{p+1} , the Cauchy problem

$$(18) \quad \begin{cases} \frac{d\Gamma}{dt} = \mathfrak{F}(\Gamma, s, t) \\ \Gamma(s, t_0) = H(s) \end{cases}$$

has a unique local solution $\Gamma(s, t)$ for (s, t) in a neighborhood of (s_0, t_0) , and Γ is of class \mathcal{C}^{p+1} .

One easily gets that

$$\|\mathfrak{F}\| \leq M, \quad M = \max_{t \in [0, 1]} |\lambda'(t)|$$

where $\|\cdot\|$ is the sup norm. This has the following consequences by the Grönwall lemma : for every $s \in [0, 1]$, the Cauchy problem (18) has a unique maximal solution, it is defined globally for $t \in [0, 1]$ and furthermore

$$\forall s \in [0, 1], \forall t_1, t_2 \in [0, 1], |\Gamma(s, t_2) - \Gamma(s, t_1)| \leq M|t_2 - t_1|.$$

2. The fact that the Cauchy problem (15) for Γ is equivalent to the Cauchy problem (16) for Γ° is a consequence of the fact that $\lambda(0) = \gamma(1)$ and that $\gamma \in \mathfrak{R}^{sym}$.
3. From (15) one has for $(s, t) \in [0, 1] \times [0, 1]$,

$$\Gamma(s, t) = \gamma(s) + s \int_0^t f_1(\Gamma(s, t')) \lambda'(t') dt' + (1-s) \int_0^t [1 - f_2(\Gamma^\circ(1-s, t'))] \lambda'(t') dt'$$

so that

$$|\Gamma(s, t) - \gamma(s)| \leq \int_0^t |\lambda'(t')| dt' \leq \mathcal{L}_{\lambda, 0, t} \leq Mt.$$

One easily deduces that $\forall (s, t) \in [0, 1] \times [0, 1]$,

$$|\Gamma(s, t)| \leq |\gamma(s)| + |\Gamma(s, t) - \gamma(s)| \leq \mathcal{L}_{\gamma, 0, s} + \mathcal{L}_{\lambda, 0, t} \leq \mathcal{L}_\gamma + \mathcal{L}_\lambda \leq N + M.$$

Comparing (16) and (15) one sees that Γ° has the same properties than Γ .

4. When $f_1 = f_2 = f$, one observes by (15) and (16) that Γ and Γ° solve the same Cauchy problem. Thus $\Gamma^\circ = \Gamma$ by unicity of the solution.
5. For every $s \in [0, 1]$, if $\Gamma^s : t \in [0, 1] \mapsto \Gamma^s(t) = \Gamma(s, t)$, then

$$\begin{aligned} \mathfrak{L}_{\Gamma^s} &= \int_0^1 \left| \frac{d\Gamma^s}{dt}(t) \right| dt \\ &= \int_0^1 \left| \lambda'(t) \left[s f_1(\Gamma(s, t)) + (1-s) \left[1 - f_2(\Gamma^\circ(1-s, t)) \right] \right] \right| dt \\ &\leq \int_0^1 |\lambda'(t)| dt \\ &\leq \mathfrak{L}_\lambda. \end{aligned}$$

The proof is the same for $\Gamma^{\circ s}$.

6. Let Γ be the maximal (thus global as we saw), solution of

$$(19) \quad \begin{cases} \frac{d\Gamma}{dt} = \mathfrak{F}(\Gamma, s, t), & (s, t) \in [0, 1] \times [0, 1] \\ \Gamma(s, 0) = \gamma(s). \end{cases}$$

We observe that $\forall(s, t) \in [0, 1] \times [0, 1]$,

$$|\Gamma(s, t)| \leq |\Gamma(s, 0)| + |\Gamma(s, t) - \Gamma(s, 0)| \leq N + M$$

with $N = \max_{s \in [0, 1]} |\gamma'(s)|$, where γ' is the derivative of γ .

We now note $\overline{D(0, N + M)} \subset \mathbb{C}$ the close disc of radius $N + M$, centered at 0, and

$$k = \max_{\zeta \in \overline{D(0, N + M)}} \{|f_1'(\zeta)|, |f_2'(\zeta)|\}.$$

By the mean value theorem, $\forall(s, t) \in [0, 1] \times [0, 1]$, $\forall \Gamma_1, \Gamma_2 \in \overline{D(0, N + M)}$,

$$|\mathfrak{F}(\Gamma_1, s, t) - \mathfrak{F}(\Gamma_2, s, t)| \leq kM|\Gamma_1 - \Gamma_2|$$

while $\forall(s_1, s_2) \in [0, 1]^2$, $\forall t \in [0, 1]$, $\forall \Gamma \in \overline{D(0, N + M)}$,

$$|\mathfrak{F}(\Gamma, s_1, t) - \mathfrak{F}(\Gamma, s_2, t)| \leq M|s_1 - s_2|$$

so that $\forall(s_1, s_2) \in [0, 1]^2$, $\forall t \in [0, 1]$, $\forall \Gamma_1, \Gamma_2 \in \overline{D(0, N + M)}$,

$$|\mathfrak{F}(\Gamma_1, s_1, t) - \mathfrak{F}(\Gamma_2, s_2, t)| \leq kM|\Gamma_1 - \Gamma_2| + M|s_1 - s_2|.$$

For $(s_1, s_2) \in [0, 1]^2$, if $\Gamma_1(t)$ *resp.* $\Gamma_2(t)$ is the global solution of

$$(20) \quad \begin{cases} \frac{d\Gamma_1}{dt} = \mathfrak{F}(\Gamma_1, s_1, t) \\ \Gamma_1(0) = \gamma(s_1) \end{cases}, \text{ resp. } \begin{cases} \frac{d\Gamma_2}{dt} = \mathfrak{F}(\Gamma_2, s_2, t) \\ \Gamma_2(0) = \gamma(s_2) \end{cases}$$

and if $\Gamma(t) = \Gamma_1(t) - \Gamma_2(t)$ one thus has

$$\left| \frac{d\Gamma}{dt} \right| \leq kM|\Gamma| + M|s_1 - s_2|, \quad |\Gamma(0)| \leq N|s_1 - s_2|.$$

We deduce from the Grönwall lemma that

$$\forall t \in [0, 1], \quad |\Gamma(t)| \leq N|s_1 - s_2|e^{\int_0^t kM ds} + \int_0^t M|s_1 - s_2|e^{\int_s^t kM ds'} ds$$

that is

$$\forall t \in [0, 1], \quad |\Gamma(t)| \leq |s_1 - s_2| \left[Ne^{kMt} + \frac{e^{kMt} - 1}{k} \right].$$

7. We note

$$F(s, t) = \frac{\partial \Gamma}{\partial s}(s, t)$$

By (15) we have

$$(21) \quad \begin{cases} \frac{dF}{dt}(s, t) = \lambda'(t) \left\{ f_1(\Gamma(s, t)) - 1 + f_2(\Gamma^\circ(1 - s, t)) \right. \\ \quad \left. + s f_1'(\Gamma(s, t)) \cdot F(s, t) + (1 - s) f_2'(\Gamma^\circ(1 - s, t)) \cdot F(s, t) \right\} \\ F(s, 0) = \gamma'(s) \end{cases}$$

For $(s, t) \in [0, 1]^2$ we have

$$|f_1(\Gamma(s, t)) - 1 + f_2(\Gamma^\circ(1 - s, t))| \leq 1$$

and

$$|s f_1'(\Gamma(s, t)) + (1 - s) f_2'(\Gamma^\circ(1 - s, t))| \leq k$$

where

$$k = \frac{\max}{\zeta \in D(0, N+M)} \{ |f'_1(\zeta)|, |f'_2(\zeta)| \}.$$

We deduce that for $(s, t) \in [0, 1]^2$,

$$(22) \quad \begin{cases} \left| \frac{dF}{dt}(s, t) \right| \leq k |\lambda'(t)| |F(s, t)| + |\lambda'(t)| \\ |F(s, 0)| = |\gamma'(s)| \end{cases}$$

By the Grönwall lemma we deduce that

$$\forall (s, t) \in [0, 1]^2, |F(s, t)| \leq |\gamma'(s)| e^{k \int_0^t |\lambda'(t')| dt'} + \int_0^t |\lambda'(t')| e^{k \int_{t'}^t |\lambda'(\tau)| d\tau} dt'$$

that is

$$\forall (s, t) \in [0, 1]^2, \quad \left| \frac{\partial \Gamma}{\partial s}(s, t) \right| \leq |\gamma'(s)| e^{k \mathcal{L}_{\lambda, 0, t}} + \int_0^t |\lambda'(t')| e^{k \mathcal{L}_{\lambda, t', t}} dt'.$$

Thus for every $t \in [0, 1]$, the path $\Gamma_t : s \in [0, 1] \mapsto \Gamma(s, t)$ satisfies:

$$\mathcal{L}_{\Gamma_t} \leq (\mathcal{L}_{\gamma} + \mathcal{L}_{\lambda, 0, t}) e^{k \mathcal{L}_{\lambda, 0, t}}$$

8. Assume that there exist $\theta_0 \in \mathbb{R}$ and $\alpha \in]0, \frac{\pi}{2}]$ such that

$$\forall t \in [0, 1], \lambda'(t) \neq 0 \Rightarrow \arg \lambda'(t) \in]-\alpha + \theta_0, \theta_0 + \alpha[.$$

We introduce

$$\Sigma := \{0\} \cup \{ \zeta \in \mathbb{C}^* \mid \arg \zeta \in]\theta_0 - \alpha, \theta_0 + \alpha[\}.$$

This can be written as

$$\Sigma = \{0\} \cup (\Pi^+ \cap \Pi^-), \quad \Pi^\pm := \{ \zeta \in \mathbb{C} \mid \Re e(\zeta e^{-i(\theta_0 \pm \beta)}) > 0 \}$$

with $\beta := \frac{\pi}{2} - \alpha$. Since $\Gamma(s, t) - \gamma(s) = \int_0^t g(t') \lambda'(t') dt'$ where $g \geq 0$ is a continuous function on $[0, 1]$, we can write

$$\Gamma(s, t) - \gamma(s) = \int_{U_t} g(t') \lambda'(t') dt'$$

with $U_t := \{t' \in [0, t] \mid g(t') > 0\}$. From the hypothesis on λ' we obtain that for $\theta = \theta_0 \pm \beta$,

$$\Re e\left((\Gamma(s, t) - \gamma(s)) e^{-i\theta} \right) = \int_{U_t} g(t') \Re e(\lambda'(t') e^{-i\theta}) dt' \geq 0.$$

Moreover this vanishes only when:

- either $U_t = \emptyset$. In this case, $g = 0$ on $[0, t]$ and $\Gamma(s, t) - \gamma(s) = 0$;
- or $U_t \neq \emptyset$ and $\Re e(\lambda'(t') e^{-i\theta}) = 0$ on U_t . In this case, $\lambda'(t) = 0$ on U_t and $\Gamma(s, t) - \gamma(s) = 0$.

We thus get that $\Gamma(s, t) - \gamma(s) \in \{0\} \cup (\Pi^+ \cap \Pi^-)$.

3.4.2. Proof of the preparatory lemma 3.3.2. —

– Assume that $f_1 = f_{A,R_A,r_A}$ and that λ satisfies

$$\forall \omega \in A, d_\lambda(\omega) = \inf_{t \in [0,1]} d(\lambda(t), \omega) > R_A(\omega).$$

We consider the equation

$$(23) \quad \begin{cases} \zeta'(t) = \mathfrak{F}(\zeta, 1, t) \\ \zeta(0) = \gamma(1), \end{cases}$$

where $\mathfrak{F}(\zeta, 1, t) = \lambda'(t)f_1(\zeta)$ is defined as in equation (17). By the hypotheses made on λ , we get that $\forall t \in [0, 1]$, $f_1(\lambda(t)) = 1$. Thus, $t \in [0, 1] \mapsto \lambda(t)$ is the solution of the Cauchy problem (23). By the unicity of the solution, we deduce that $\Gamma(1, t) \equiv \lambda(t)$.

– When $f_2 = f_{B,R_B,r_B}$ and when λ satisfies

$$\forall \omega \in B, d_\lambda(\omega) = \inf_{t \in [0,1]} d(\lambda(t), \omega) > R_B(\omega)$$

then by (16) the above result translates to Γ° .

– When $A = B = C$, $f_1 = f_2 = f_{C,R_C,r_C}$, then we already know from Lemma 3.3.1 that

$$\forall (s, t) \in [0, 1] \times [0, 1], \Gamma(s, t) = \Gamma^\circ(s, t) = \lambda(t) - \Gamma(1 - s, t).$$

If furthermore λ satisfies :

$$\forall \omega \in C, d_\lambda(\omega) = \inf_{t \in [0,1]} d(\lambda(t), \omega) > R_C(\omega),$$

the above results apply so that $\Gamma(1, t) = \lambda(t)$. Thus

$$\forall (s, t) \in [0, 1] \times [0, 1], \Gamma(s, t) = \Gamma(1, t) - \Gamma(1 - s, t)$$

that is $\forall t \in [0, 1]$, the path $\Gamma_t : s \in [0, 1] \mapsto \Gamma_t(s) = \Gamma(s, t)$ belongs to \mathfrak{R}^{sym} .

3.4.3. Proof of the preparatory lemma 3.3.3. — We assume that for a given $\omega \in A$,

$$\delta(\omega) = \inf_{\omega' \in B} d_\lambda(\omega + \omega') - (r_A(\omega) + R_B(\omega')) > 0$$

and we introduce $0 < \varepsilon \leq \frac{\delta(\omega)}{2M}$ with $M = \max_{t \in [0,1]} |\lambda'(t)|$. We also assume that

$$\exists T_1 \in [T_0, T_0 + \varepsilon], |\Gamma(s, T_1) - \omega| \leq r_A(\omega)$$

and that

$$\exists \omega' \in B, \exists T_2 \in [T_0, T_0 + \varepsilon], |\Gamma^\circ(1 - s, T_2) - \omega'| < R_B(\omega').$$

On the one hand one has

$$|\Gamma(s, T_1) + \Gamma^\circ(1 - s, T_2) - (\omega + \omega')| < r_A(\omega) + R_B(\omega').$$

On the other hand,

$$\begin{aligned} \Gamma(s, T_1) + \Gamma^\circ(1 - s, T_2) &= [\Gamma(s, T_1) - \Gamma(s, T_0)] + [\Gamma^\circ(1 - s, T_2) - \Gamma^\circ(1 - s, T_0)] \\ &\quad + [\Gamma(s, T_0) + \Gamma^\circ(1 - s, T_0)]. \end{aligned}$$

We have $\Gamma(s, T_0) + \Gamma^\circ(1 - s, T_0) = \lambda(T_0)$ while by Lemma 3.3.1

$$|\Gamma(s, T_1) - \Gamma(s, T_0)| \leq M\varepsilon, \quad |\Gamma(1 - s, T_2) - \Gamma(1 - s, T_0)| \leq M\varepsilon.$$

Also by hypothesis,

$$|\lambda(T_0) - (\omega + \omega')| \geq d_\lambda(\omega + \omega').$$

Since ε is so that $0 < 2M\varepsilon \leq \delta(\omega)$,

$$\begin{aligned} |\Gamma(s, T_1) + \Gamma^\circ(1-s, T_2) - (\omega + \omega')| &\geq |\lambda(T_0) - (\omega + \omega')| - 2M\varepsilon \\ &\geq d_\lambda(\omega + \omega') - \delta(\omega) \\ &\geq r_A(\omega) + R_B(\omega'). \end{aligned}$$

We thus get a contradiction. The same reason for the other case.

3.4.4. Proof of the preparatory lemma 3.3.4. — We assume that there exists $0 < s_0 \leq 1$ such that

$$\forall s \in [0, s_0[, |\gamma(s)| < r, \quad r = r_A(0) = r_B(0).$$

We remind that by (15) and (16),

$$\forall s \in [0, 1], \Gamma(s, 0) = \Gamma^\circ(s, 0) = \gamma(s).$$

Consider the Cauchy problem

$$(24) \quad \begin{cases} \frac{d\Gamma}{dt} = \lambda'(t)(sf_1(\Gamma) + (1-s)(1-f_2(\lambda(t) - \Gamma))) \\ \Gamma(0) = \gamma(s), \end{cases}$$

We say that the constant map $t \in [0, 1] \mapsto \gamma(s)$ is the solution of this Cauchy problem (24). Indeed we have that

- $f_1(\gamma(s)) = 0$, since $|\gamma(s)| \leq r_A(0)$, $\forall s \in [0, s_0]$;
- $f_2(\lambda(t) - \gamma(s)) = 1$, since $|\lambda(t) - \gamma(s) - \omega| \geq R_B(\omega)$ for all $\omega \in B$ (because $0 \in A$, $|\lambda(t) - \omega| \geq d_\lambda(0 + \omega) > r_A(0) + R_B(\omega)$).

Thus, $\forall (s, t) \in [0, s_0] \times [0, 1]$, $\Gamma(s, t) = \gamma(s)$ by the unicity of solution.

The same reasoning can be done for Γ° , by (16).

3.4.5. Proof of preparatory lemma 3.3.5. — Assume that there exists $0 \leq s_0 \leq 1$ such that

$$\forall s \in [s_0, 1], \forall \omega \in A, |\gamma(s) - \omega| \geq r_A(\omega), \quad \delta = \inf_{\omega \in A} \delta(\omega) > 0,$$

where

$$\delta(\omega) = \inf_{\omega' \in B} d_\lambda(\omega + \omega') - (r_A(\omega) + R_B(\omega')).$$

Consider the flow $\Phi_s^{t_1, t_2}$ associated to the vector field

$$X_s(\zeta, t) := \lambda'(t) \left[sf_1(\zeta) + (1-s)(1-f_2(\lambda(t) - \zeta)) \right]$$

where $X_s(\zeta, t) = \mathfrak{F}(\zeta, s, t)$ is defined as in equation (17). We remark that

$$\Gamma(s, t) = \Phi_s^{0, t}(\gamma(s)).$$

Writing $\mathcal{A} := \bigcup_{\omega \in A} D(\omega, r_A(\omega))$, the above hypothesis translates into the fact that $\gamma(s) \in \mathbb{C} \setminus \mathcal{A}$ for $s \in [0, s_0]$. Moreover,

$$\zeta \in \mathcal{A} \Rightarrow \forall s, t, X_s(\zeta, t) = 0$$

because:

- for such a $\zeta \in \mathcal{A}$, there exists $\omega \in A$ such that $|\zeta - \omega| < r_A(\omega)$ and therefore $f_1(\zeta) = 0$;
- for every $\omega' \in B$, according to the hypothese made on λ , we get that

$$|\lambda(t) - \zeta - \omega'| \geq |\lambda(t) - (\omega + \omega')| - |\zeta - \omega| > R_B(\omega').$$

This implies that $1 - f_2(\lambda(t) - \zeta) = 0$.

We thus have that for any s, t_1, t_2 ,

$$\zeta \in \mathcal{A} \Rightarrow \Phi_s^{t_1, t_2}(\zeta) = \zeta.$$

and since $\Phi_s^{t_2, t_1} \circ \Phi_s^{t_1, t_2} = \text{Id}$,

$$\Phi_s^{t_1, t_2}(\zeta) \in \mathcal{A} \Rightarrow \zeta \in \mathcal{A}.$$

Hence, by contraposition,

$$\zeta \in \mathbb{C} \setminus \mathcal{A} \Rightarrow \Phi_s^{t_1, t_2}(\zeta) \in \mathbb{C} \setminus \mathcal{A}$$

and therefore, if $s \in [s_0, 1]$, $\Gamma(s, t) = \Phi_s^{0, t}(\gamma(s)) \in \mathbb{C} \setminus \mathcal{A}$.

By (16) one sees that a similar reasoning works for Γ° . This ends the proof of Lemma 3.3.5.

3.5. Numerical samples

Our method to build the convenient homotopies that will be used in Chapter 4 (§4.2) and Chapter 5 (§5.4.2.2 and §5.4.3) is based on the idea of considering deformations of a given path along the flow of the non-autonomous vector field detailed in Lemma 3.3.2. This flow can be numerically computed and this is what we have done in this section, with a simple Euler's difference numerical scheme, in order to produce the following samples.

In what follows, $A = \{0, 1, 2, 3, 2.5 + 0.6i\}$ and $B = \{0, 1, 2, 3, 2 + i, 3 - i\}$ are two finite sets such that $0 \in A \cap B$. We have applied Lemma 3.3.2 with $f_1 = f_{A, R_A, r_A}$, $f_2 = f_{B, R_B, r_B}$, where $R_A(= R)$, $r_A(= r)$, $R_B(= R)$, $r_B(= r)$ are constant maps. We have chosen $R = 0.2$ and $r = 0.1$.

On Fig. 7, we have drawn with dashed lines a path $\lambda_0 = \gamma\lambda$ while the points represent the locus $A + B$ for some given set of points A and B . The path λ_0 has been chosen so $d(\lambda, A + B) > R + r$ so that the lemmas of this chapter 3 apply.

On Fig. 8 we have drawn the corresponding final deformed path Γ_1 theoretically studied in Lemma 3.3.2. On that picture we have also drawn the “fixed singular points” A and the “movable ones” $\lambda_0(1) - B$.

On Fig. 9, we choose another path $\tilde{\lambda}_0 = \gamma\tilde{\lambda}$ which is, from a homotopy viewpoint, the product of λ_0 with a clockwise loop around the point $\omega_0 = 3$ which, at the same time, belongs to A , to B and for which some “pinching” occur.

Figures 10, 11, 12 detail the paths $\tilde{\Gamma}_t$ for different intermediary times $t \in]0, 1[$. We have drawn the fixed singular points A and the movable ones $\tilde{\lambda}_0(t) - B$. The final path $\tilde{\Gamma}_1$ is drawn on Fig. 13. These pictures shows that $\tilde{\Gamma}_1$ is symmetrically contractile (in the sense of §4.2) : this is due to the particular choice of singular points which are involved here and to the choice of f_1, f_2 .

Finally Fig. 14 compares the two end paths Γ_1 and $\tilde{\Gamma}_1$ on the same picture.

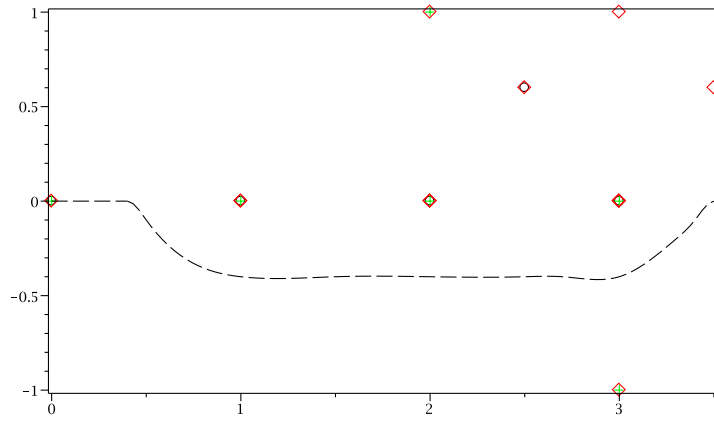

FIGURE 7. In dashed lines the path λ_0 and the singular locus $A + B$.

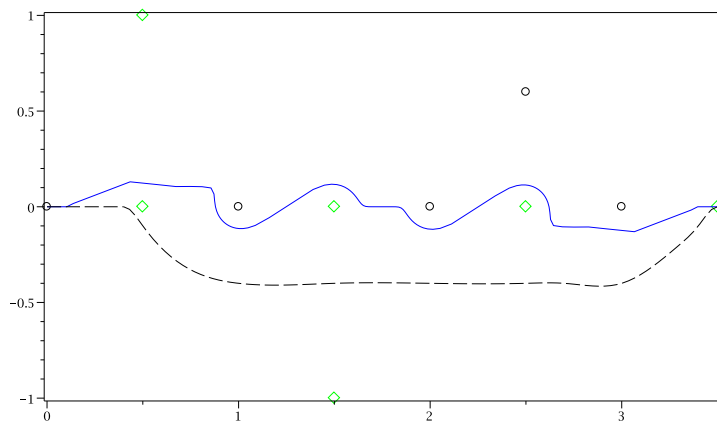

FIGURE 8. The final path Γ_1 associated with λ_0 and the fixed (circles) and movable (diamonds) singular points.

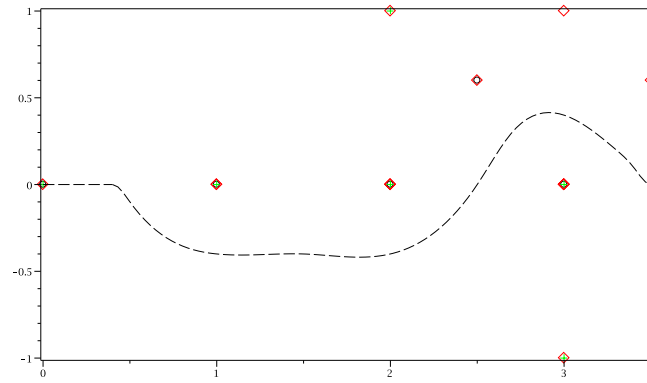

FIGURE 9. The path $\tilde{\lambda}_0$ drawn with dashed lines and the singular locus $A + B$

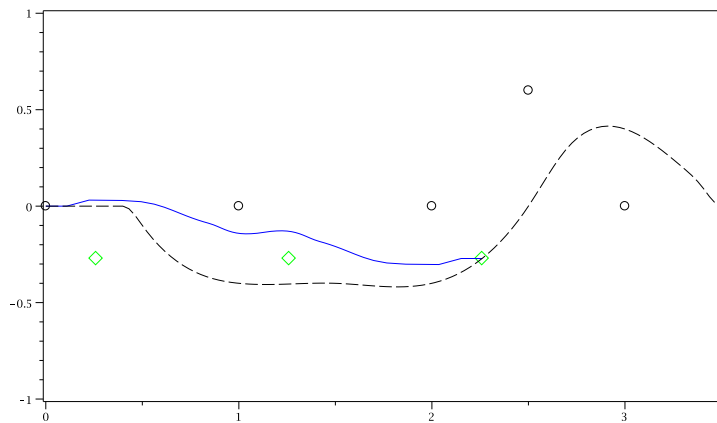

FIGURE 10. The path $\tilde{\Gamma}_t$ corresponding to $\tilde{\lambda}_0$ for some $0 < t < 1$, the fixed points A and the movable singular points $\tilde{\lambda}_0(t) - B$.

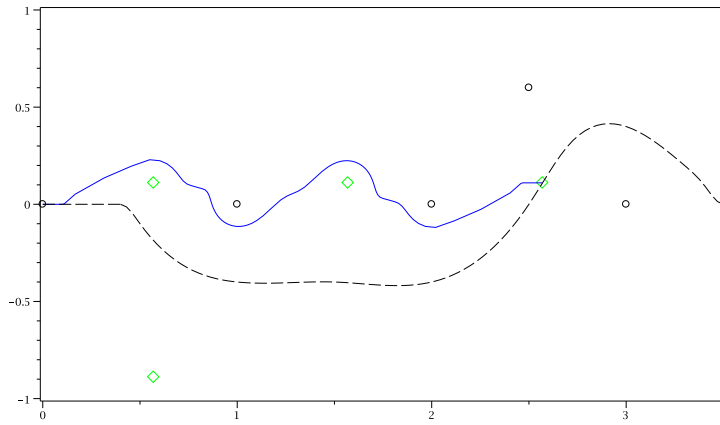

FIGURE 11. The path $\tilde{\Gamma}_t$ corresponding to $\tilde{\lambda}_0$ for some $0 < t < 1$, the fixed points A and the movable singular points $\tilde{\lambda}_0(t) - B$.

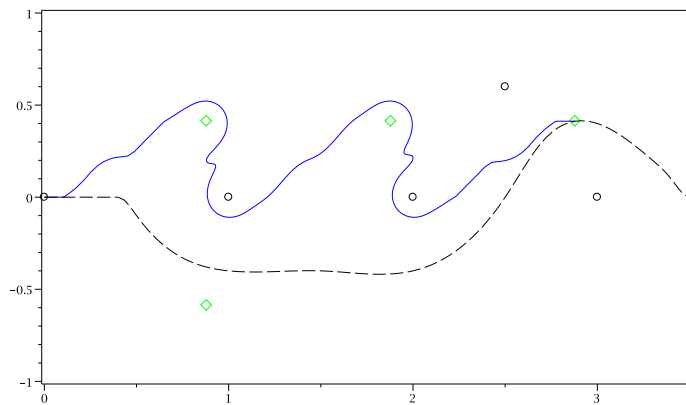

FIGURE 12. The path $\tilde{\Gamma}_t$ corresponding to $\tilde{\lambda}_0$ for some (further) $0 < t < 1$, the fixed points A and the movable singular points $\tilde{\lambda}_0(t) - B$.

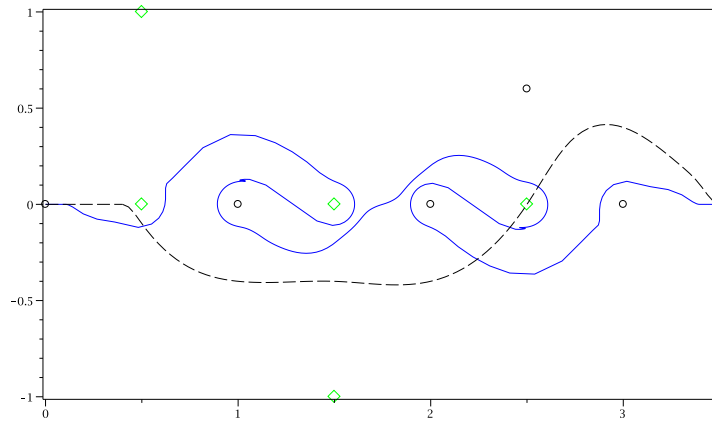

FIGURE 13. The final path $\tilde{\Gamma}_1$ associated with $\tilde{\lambda}_0$, the fixed singular points A and the movable singular ones $\tilde{\lambda}_0(1) - B$

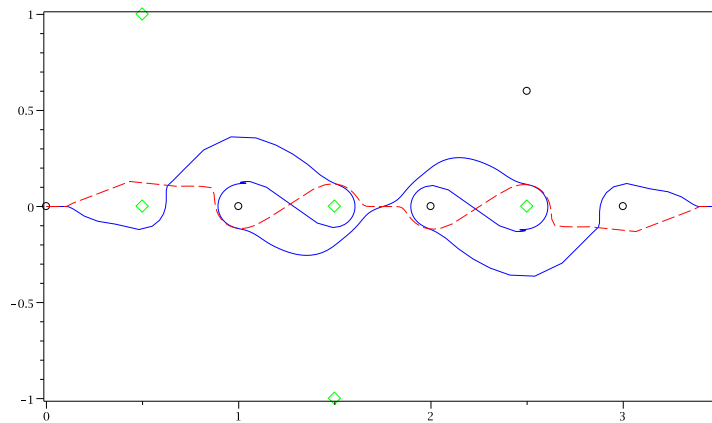

FIGURE 14. On the same picture, the path Γ_1 with dashed lines and the path $\tilde{\Gamma}_1$. We have also indicated the fixed (circles) singular points A and the movable (diamonds) singular points $\lambda_0(1) - B = \tilde{\lambda}_0(1) - B$.

CHAPTER 4

CONVOLUTION ALGEBRA : AN INTRODUCTION

This chapter essentially aims at introducing the reader to Chapter 5. Here we assume that Ω is a closed and discrete subset of \mathbb{C} , so that Ω has no accumulation point and the intersection of Ω with any compact set provides a finite set.

In section 4.1 we construct a Riemann surface \mathcal{R}_Ω defined as the homotopy classes of paths starting from 0 and avoiding Ω . When $0 \notin \Omega$, \mathcal{R}_Ω is nothing but the universal covering of $\mathbb{C} \setminus \Omega$. The usual construction works as well when $0 \in \Omega$ but this time the Riemann surface obtained is no more a covering space. However the main properties that are needed can be demonstrated as well.

In section 4.2 we formulate a theorem (Thm. 4.2.1) due to Ecalle [Ec81-1] and we prove it as an application of the tools developed in chapter 3.

This chapter ends with section 4.3 with a direct consequence of Thm. 4.2.1 : the space of holomorphic functions on \mathcal{R}_Ω is a convolution algebra.

4.1. The Riemann surface \mathcal{R}_Ω

4.1.1. The Riemann surface \mathcal{R}_Ω when $0 \notin \Omega$. — This case is well-known, allowing us to be short.

Definition 4.1.1. — We assume that $0 \notin \Omega$. We note $\mathfrak{R}_\Omega \subset \mathfrak{R}$ the set of paths λ avoiding Ω :

$$\mathfrak{R}_\Omega = \{\lambda \in \mathfrak{R} \text{ such that } \lambda([0, 1]) \subset \mathbb{C} \setminus \Omega\}.$$

For $\lambda \in \mathfrak{R}_\Omega$, we note $\text{cl}(\lambda)$ its homotopy class in \mathfrak{R}_Ω with fixed extremities. We note

$$\mathcal{R}_\Omega = \{(\zeta, \text{cl}(\lambda)), \lambda \in \mathfrak{R}_\Omega, \zeta = \lambda(1)\}.$$

We refer to [For81], Thm 5.3 for the following result:

Proposition 4.1.1. — The pointed space $(\mathcal{R}_\Omega, 0)$ is a topologically (arc)connected separated space and is simply connected. Moreover the projection $\pi : (\zeta, \alpha) \in \mathcal{R}_\Omega \mapsto \zeta \in \mathbb{C} \setminus \Omega$ is a covering map and makes \mathcal{R}_Ω a Riemann surface.

In other words, $\pi : \mathcal{R}_\Omega \rightarrow \mathbb{C} \setminus \Omega$ is the universal covering of $\mathbb{C} \setminus \Omega$.

4.1.2. The Riemann surface \mathcal{R}_Ω when $0 \in \Omega$. — We shall spend more time on this case, since this will be generalized in Chapter 5.

4.1.2.1. *The spaces \mathfrak{R}_Ω^* and \mathcal{R}_Ω . —*

Definition 4.1.2. — *We assume that $0 \in \Omega$ and we note $\Omega^* = \Omega \setminus \{0\}$. We note $\mathfrak{R}_\Omega^* \subset \mathfrak{R}$ the set of paths λ avoiding the set Ω except for its origin:*

$$\mathfrak{R}_\Omega^* = \{\lambda \in \mathfrak{R} \text{ such that } \exists t \in [0, 1], \lambda([0, t]) = \{0\} \text{ and } \lambda([t, 1]) \subset \mathbb{C} \setminus \Omega\}.$$

For $\lambda \in \mathfrak{R}_\Omega^*$, we note $\text{cl}(\lambda)$ its homotopy class in \mathfrak{R}_Ω^* with fixed extremities. We note

$$\mathcal{R}_\Omega = \{(\zeta, \text{cl}(\lambda)), \lambda \in \mathfrak{R}_\Omega^*, \zeta = \lambda(1)\}.$$

In the sequel we usually note 0 for the homotopy class of the constant path. We also usually note 0 instead of $(0, 0) \in \mathcal{R}_\Omega$.

4.1.2.2. *The Riemann surface \mathcal{R}_Ω and the space \mathfrak{R}_Ω . —* On the space \mathcal{R}_Ω we now define a topology. Let us consider $(\zeta, \alpha) \in \mathcal{R}_\Omega$.

- Assume that $(\zeta, \alpha) = 0$. If $U \subset \mathbb{C} \setminus \Omega^*$ is a simply connected neighborhood of 0 , we denote by $[U, \alpha] \subset \mathcal{R}_\Omega$ the set of $(\xi, \sigma) \in \mathcal{R}_\Omega$ such that $\xi \in U$ and $\sigma = \text{cl}(\lambda_1 \lambda_2)$ where $\lambda_1 \lambda_2$ is the product⁽¹⁾ of λ_1 and λ_2 , $\lambda_1 \in \mathfrak{R}_\Omega^*$ such that $\text{cl}(\lambda_1) = 0$ while $\lambda_2 \in \mathfrak{R}_\Omega^*$ is any path whose image is contained in U and ends at ξ . One can notice that (ξ, σ) is independent of the choice of λ_2 since U is simply connected.
- Assume that $(\zeta, \alpha) \neq 0$. If $U \subset \mathbb{C} \setminus \Omega$ is a simply connected neighborhood of ζ , we denote by $[U, \alpha] \subset \mathcal{R}_\Omega$ the set of $(\xi, \sigma) \in \mathcal{R}_\Omega$ such that $\xi \in U$, $\sigma = \text{cl}(\lambda_1 \lambda_2)$ where $\lambda_1 \in \mathfrak{R}_\Omega^*$ so that $\alpha = \text{cl}(\lambda_1)$ while λ_2 is a path starting from ζ and ending at ξ and whose image is contained in U .

It is then easy to show that the system \mathfrak{B} of all such sets $[U, \alpha]$ is a basis for a topology on \mathcal{R}_Ω . Then :

Proposition 4.1.2. — *The pointed space $(\mathcal{R}_\Omega, 0)$ is a topologically (arc)connected separated space. With the projection $\pi : (\zeta, \alpha) \in \mathcal{R}_\Omega \mapsto \zeta \in \mathbb{C} \setminus \Omega^*$, the space \mathcal{R}_Ω is an étalé space on $\mathbb{C} \setminus \Omega^*$. Thus \mathcal{R}_Ω is a Riemann surface by pulling back by π the complex structure of \mathbb{C} .*

Proof. — The proof follows that of Thm 5.3 in [For81]. In particular, for every $[U, \alpha] \in \mathfrak{B}$, the mapping $\pi|_{[U, \alpha]} \rightarrow U$ is a homeomorphism. \square

From the very definition, every path $\lambda \in \mathfrak{R}_\Omega^*$ can be lifted on \mathcal{R}_Ω with respect to π from 0 : indeed, define $\lambda_t : s \in [0, 1] \mapsto \lambda_t(s) = \lambda(ts)$ for $t \in [0, 1]$. Then $\lambda_t \in \mathfrak{R}_\Omega^*$ and the mapping

$$\Lambda : t \in [0, 1] \mapsto \Lambda(t) = (\lambda(t), \text{cl}(\lambda_t))$$

is continuous and is a lifting of λ from 0 . (This lifting is unique thanks to the uniqueness of lifting [For81]).

Definition 4.1.3. — *We note $\mathfrak{R}_\Omega \subset \mathfrak{R}$ the set of paths which can be lifted from $0 \in \mathcal{R}_\Omega$ with respect to π .*

⁽¹⁾We define the product as usual by $\lambda_1 \lambda_2(t) = \begin{cases} \lambda_1(2t), & t \in [0, 1/2] \\ \lambda_2(2t - 1), & t \in [1/2, 1] \end{cases}$.

We note that \mathfrak{R}_Ω is a space larger than \mathfrak{R}_Ω^* . For instance, if $U \subset \mathbb{C} \setminus \Omega^*$ is a simply connected neighborhood of 0, then every loop $\lambda \in \mathfrak{R}$ contained in U belongs to \mathfrak{R}_Ω since $\pi|_{[U,0]} \rightarrow U$ is a homeomorphism. Meanwhile, we remark that $\pi : \mathcal{R}_\Omega \rightarrow \mathbb{C} \setminus \Omega^*$ is not a covering map : the curve lifting property is not satisfied since, as a rule, a path starting and ending at 0 cannot be lifted on \mathcal{R}_Ω with respect to π . Nevertheless:

Proposition 4.1.3. — *The Riemann surface \mathcal{R}_Ω described in Proposition 4.1.2 is simply connected.*

Proof. — We want to show that every closed curve in \mathcal{R}_Ω is null-homotopic. Since \mathcal{R}_Ω is arc-connected, one can concentrate on closed curves starting and ending at $0 \in \mathcal{R}_\Omega$.

Consider $\lambda_1 \in \mathfrak{R}_\Omega^*$ and $\lambda_t : s \in [0, 1] \mapsto \lambda_t(s) = \lambda_1(ts)$ for $t \in [0, 1]$. Note Λ_t the lifting of λ_t . Then the homotopy $(2) t \in [0, 1] \mapsto \lambda_t \lambda_t^{-1}$ lifts on $t \in [0, 1] \mapsto \Lambda_t \Lambda_t^{-1}$ and both $\lambda = \lambda_1 \lambda_1^{-1}$ and $\Lambda = \Lambda_1 \Lambda_1^{-1}$ are homotopic to the constant path. This can be generalized : if $\lambda_1, \lambda_2 \in \mathfrak{R}_\Omega^*$ are in the same homotopy class and if Λ_1, Λ_2 are their lifting from 0, then the product $\Lambda = \Lambda_1 \Lambda_2^{-1}$ is a closed curve on \mathcal{R}_Ω and thus $\pi(\Lambda) = \lambda_1 \lambda_2^{-1}$ belongs to \mathfrak{R}_Ω . From the fact that $\text{cl}(\lambda_1 \lambda_2^{-1}) = \text{cl}(\lambda_2 \lambda_2^{-1})$ and that $\lambda_2 \lambda_2^{-1}$ is homotopic to the constant path, one gets that Λ is homotopic to the constant path by lifting the homotopy.

Conversely, assume that Λ is a closed curve on \mathcal{R}_Ω starting and ending at 0. To simplify, assume also that $\Lambda = \Lambda_1 \Lambda_2^{-1}$ with both $\pi(\Lambda_1) = \lambda_1$ and $\pi(\Lambda_2) = \lambda_2$ in \mathfrak{R}_Ω^* (that is we assume that Λ reach 0 only at its starting and end points). Since Λ_1 and Λ_2 end at the same point, this means that $\text{cl}(\lambda_1) = \text{cl}(\lambda_2)$ so that $\lambda_1 \lambda_2^{-1}$ is homotopic to the constant path. Therefore Λ is homotopic to the constant path by lifting the homotopy. \square

4.1.3. Distance of a path to Ω . — We consider a point $z = (\zeta, \alpha) \in \mathcal{R}_\Omega$. Then for $r > 0$ small enough, $[D(\zeta, r), \alpha]$ is a neighbourhood of z and

$$\pi|_{[D(\zeta, r), \alpha]} : [D(\zeta, r), \alpha] \rightarrow D(\zeta, r)$$

is a homeomorphism. (As usual $D(\zeta, r)$ is the open disc centred at ζ with radius r). This comes directly from the topology considered on \mathcal{R}_Ω .

Definition 4.1.4. — *For every $z = (\zeta, \alpha) \in \mathcal{R}_\Omega$ we note*

$$\rho(z) = \sup\{r > 0 \text{ such that } [D(\zeta, r), \alpha] \text{ is a neighbourhood of } z\}.$$

We call $\rho(z)$ the distance of z to Ω .

The map $\rho : z \in \mathcal{R}_\Omega \mapsto \rho(z) \in \mathbb{R}^{*+}$ is continuous and this allows to define the distance of a path $\lambda \in \mathfrak{R}_\Omega$ to Ω . Indeed, consider its lifting Λ with respect to π from 0. Then map

$$t \in [0, 1] \mapsto \rho(\Lambda(t))$$

is continuous so that, by compactness,

$$\inf_{t \in [0, 1]} \rho(\Lambda(t)) > 0.$$

⁽²⁾The path λ^{-1} is the inverse path, $\lambda^{-1}(s) = \lambda(1 - s)$.

Definition 4.1.5. — For $\lambda \in \mathfrak{R}_\Omega$ we define its distance to Ω as

$$d(\lambda, \Omega) = \inf_{t \in [0,1]} \rho(\Lambda(t)) > 0$$

where Λ is the lifting of λ from 0 with respect to π .

Remark : quite obviously, when $0 \notin \Omega$, then the distance $d(\lambda, \Omega)$ is the usual one, namely

$$d(\lambda, \Omega) = \inf_{t \in [0,1]} d(\lambda(t), \Omega).$$

4.1.4. Analytic continuation on \mathcal{R}_Ω : some remarks and examples. —

4.1.4.1. *Some remarks.* — We consider the Riemann surface $(\mathcal{R}_\Omega, \pi)$ given by Proposition 4.1.2. We assume that $\varphi \in \mathcal{O}_0$. Then φ can be analytically continued on \mathcal{R}_Ω if :

1. φ can be analytically continued along every path in \mathfrak{R}_Ω . This comes from Proposition 2.2.3, since \mathcal{R}_Ω is simply connected.
2. φ can be analytically continued along every path in \mathfrak{R}_Ω^* . This comes from the definition of the Riemann surface $(\mathcal{R}_\Omega, \pi)$ itself : every point of \mathcal{R}_Ω is the endpoint of a path Λ obtained as the lifting from 0 of a path $\lambda \in \mathfrak{R}_\Omega^*$. Note that $\lambda \cdot \varphi$ depends only on the homotopy class $\alpha = \text{cl}(\lambda)$ of λ in \mathfrak{R}_Ω^* as it has to be, because \mathcal{R}_Ω is simply connected.
3. for every $\lambda \in \mathfrak{R}_\Omega^*$ there exists λ' with $\text{cl}(\lambda) = \text{cl}(\lambda')$ such that φ is analytically continuable along λ' : this follows from the previous arguments.

Also, if $\varphi \in \mathcal{H}(\mathcal{R}_\Omega)$, then for every

$$\forall \lambda \in \mathfrak{R}_\Omega, \rho(\lambda \diamond \varphi(t)) \geq \rho(\Lambda(t))$$

where Λ is the lifting of λ from 0 with respect to π .

4.1.4.2. *Some examples.* — We now provide some examples of germs of analytic functions at the origin which can be considered in our frame.

Assume that Ω is a closed and discrete subset of \mathbb{C} . For $\omega \in \Omega^*$ consider the germ of analytic functions at the origin φ_ω defined by $\varphi_\omega(\zeta) = \frac{1}{\zeta} \ln(1 - \frac{\zeta}{\omega})$, $\varphi_\omega(0) = -\frac{1}{\omega}$.

Then $\varphi_\omega \in \mathcal{H}(\mathcal{R}_\Omega)$. Note that φ_ω cannot be analytically continued along a loop λ if its index with respect to ω is nonzero.

We now note $\Gamma = \omega_1\mathbb{Z} + \omega_2\mathbb{Z}$ the lattice spanned by $\omega_1, \omega_2 \in \mathbb{C}^*$ where ω_1 and ω_2 are linearly independent over \mathbb{R} . We consider the Weierstrass elliptic function

$$\wp_\Gamma(\zeta) = \frac{1}{\zeta^2} + \sum_{\omega \in \Gamma^*} \frac{1}{(\zeta - \omega)^2} - \frac{1}{\omega^2}$$

where $\Gamma^* = \Gamma \setminus \{0\}$. This doubly periodic function is holomorphic in $\mathbb{C} \setminus \Gamma$ and has double poles at each point of Γ . Assume that $\omega \notin \Gamma$ and define

$$\varphi(\zeta) = \wp_\Omega(\zeta - \omega) \quad \text{and} \quad \Omega = \omega + \Gamma.$$

Then φ belongs to $\mathcal{H}(\mathcal{R}_\Omega)$ (when φ is considered as defining a germ of holomorphic functions at the origin).

It is known that \wp_Γ has, modulo Γ , only two simple zeros or one double zero : $\omega'_1 + \Gamma$ and $\omega'_2 + \Gamma$ (in case of double zero, assume $\omega'_1 = \omega'_2$). We assume that $\omega \notin \{\omega'_1, \omega'_2\}$ and we note

$$\Omega' = (\omega + \Gamma) \cup (\omega + \omega'_1 + \Gamma) \cup (\omega + \omega'_2 + \Gamma).$$

Then $\ln(\varphi)$ belongs $\mathcal{H}(\mathcal{R}_\Omega)$.

4.2. Symmetrically contractile path and application

In this section we heavily refer to [Ec81-1], [Tou90], [S006].

4.2.1. Symmetrically contractile path. —

Definition 4.2.1. — We note $\widehat{\mathfrak{R}}_\Omega$ the set of paths on \mathcal{R}_Ω starting from $0 \in \mathcal{R}_\Omega$.

When $0 \in \Omega$, we note $\mathfrak{R}_\Omega^* \subset \widehat{\mathfrak{R}}_\Omega$ the set of paths deduced from \mathfrak{R}_Ω^* by lifting from 0 with respect to π .

We remark that $\mathfrak{R}_\Omega = \pi(\widehat{\mathfrak{R}}_\Omega)$.

Definition 4.2.2. — A path $\Lambda \in \widehat{\mathfrak{R}}_\Omega$ is said to be symmetric if $\pi(\Lambda)$ belongs to \mathfrak{R}^{sym} . We note $\widehat{\mathfrak{R}}_\Omega^{sym}$ the set of such symmetric paths.

The space $\mathfrak{R}_\Omega^{sym} = \pi(\widehat{\mathfrak{R}}_\Omega^{sym}) = \mathfrak{R}_\Omega \cap \mathfrak{R}^{sym}$ is the space of \mathcal{R}_Ω -symmetric paths.

When $0 \in \Omega$, we note $\widehat{\mathfrak{R}}_\Omega^{*sym} = \widehat{\mathfrak{R}}_\Omega^{sym} \cap \widehat{\mathfrak{R}}_\Omega^*$ and $\mathfrak{R}_\Omega^{*sym} = \mathfrak{R}_\Omega^* \cap \mathfrak{R}^{sym}$.

Definition 4.2.3. — A path $\Lambda \in \widehat{\mathfrak{R}}_\Omega$ is symmetrically contractile if Λ is symmetric and if there exists a continuous map

$$\widehat{\Gamma} : t \in [0, 1] \mapsto \widehat{\Gamma}_t \in \widehat{\mathfrak{R}}_\Omega^{sym}$$

such that $\widehat{\Gamma}_1 = \Lambda$ and $\widehat{\Gamma}_0 \equiv 0$.

Similarly, a path $\lambda \in \mathfrak{R}_\Omega$ is \mathcal{R}_Ω -symmetrically contractile if λ is \mathcal{R}_Ω -symmetric and if there exists a continuous map

$$\Gamma : t \in [0, 1] \mapsto \Gamma_t \in \mathfrak{R}_\Omega^{sym}$$

such that $\Gamma_1 = \lambda$ and $\Gamma_0 \equiv 0$.

We remark that if $\Lambda \in \widehat{\mathfrak{R}}_\Omega$ is symmetrically contractile, then $\lambda = \pi(\Lambda)$ is \mathcal{R}_Ω -symmetrically contractile. Conversely, a \mathcal{R}_Ω -symmetrically contractile path λ gives rise to a symmetrically contractile path Λ since we can lift the homotopy.

4.2.2. Application. — In [Ec81-1], p. 58-59 and [Tou90] Chap V. p. 2, the following Theorem 4.2.1 is given, see also [S012]. This Theorem is illustrated by Fig. 6). We show how our method, which differs from theirs, can be applied to demonstrate this result.

Theorem 4.2.1. — We assume that the closed and discrete subset Ω of \mathbb{C} is a semi-group,

$$\omega, \omega' \in \Omega \Rightarrow \omega + \omega' \in \Omega.$$

Then every point $z \in \mathcal{R}_\Omega$ is the end point of a symmetrically contractile path.

Proof. — We assume here that $0 \in \Omega$ (the other case is left to the reader).

We consider $z = (\xi, \sigma) \in \mathcal{R}_\Omega$. We want to show that there exists a \mathcal{R}_Ω -symmetrically contractile path whose class is σ .

We can assume that $z \neq 0$ (since in that case the result is obvious) and that:

- $\sigma = \text{cl}(\gamma\lambda)$,
- the path $\gamma \in \mathfrak{R}_\Omega^{*sym}$ is the line segment $[0, \zeta]$ (that is $\gamma(s) = s\zeta$ for $s \in [0, 1]$) with ζ close enough to 0 . We note $N = \max |\gamma'| = |\zeta|$.

- λ is a (nonconstant) path of class \mathcal{C}^1 starting from ζ and ending at ξ such that $\lambda([0, 1]) \in \mathbb{C} \setminus \Omega$. (Here we use the fact that every path can be uniformly approached by \mathcal{C}^∞ paths). We note $M = \max |\lambda'|$.

We introduce

$$d = d(\gamma\lambda, \Omega)$$

and we note

$$(25) \quad A = \Omega \cap \overline{D(0, N + M + d)} \subset \Omega.$$

A is a finite set so that one can find $\kappa > 0$ such that $\kappa \leq d$ and

$$\forall \omega, \omega' \in A, \omega \neq \omega' \Rightarrow |\omega - \omega'| \geq \kappa.$$

We introduce $R > 0$ such that

$$0 < 2R < \kappa \leq d.$$

In particular

$$R < 2R < \inf_{t \in [0, 1]} d(\lambda(t), A).$$

Now for every $r > 0$ small enough, one can find $s_0 = s_0(r) \in]0, 1]$ such that

$$(26) \quad \forall s \in [0, s_0[, |\gamma(s)| < r \text{ and } \forall s \in [s_0, 1], \forall \omega \in \Omega, |\gamma(s) - \omega| \geq r.$$

In what follows we fix such an $r > 0$ under the condition

$$0 < r < R.$$

We are now ready to apply the preparatory lemmas of Chapter 3 with $B = C = A$, where A is given by (25).

1. We consider the map $\Gamma : (s, t) \in [0, 1] \times [0, 1] \mapsto \Gamma(s, t) \in \mathbb{C}$ given by Lemma 3.3.1, with $f_1 = f_2 = f_{A, R, r}$ defined by Proposition 3.1.1. In particular, Γ is of class \mathcal{C}^1 , $\Gamma^\circ = \Gamma$ and

$$\forall (s, t) \in [0, 1] \times [0, 1], |\Gamma(s, t)| \leq N + M.$$

2. By definition of $f_{A, R, r}$ we know that

$$\forall \zeta \in \mathbb{C}, d(\zeta, A) \geq R \Rightarrow f_{A, R, r}(\zeta) = 1.$$

Since moreover $R < \inf_{t \in [0, 1]} d(\lambda(t), A)$, Lemma 3.3.2 can be applied : $\forall t \in [0, 1]$, the path $\Gamma_t : s \in [0, 1] \mapsto \Gamma_t(s) = \Gamma(s, t)$ belongs to \mathfrak{R}^{sym} and $\Gamma(1, t) = \lambda(t)$.

3. The path λ satisfies

$$\inf_{t \in [0, 1]} d(\lambda(t), \Omega) > 2R.$$

Moreover $A \subset \Omega$ and Ω is a semi-group, thus $A + A \subset \Omega$. Therefore

$$\inf_{t \in [0, 1]} d(\lambda(t), A + A) > 2R$$

and Lemma 3.3.3 can be applied to Γ .

4. The hypotheses made ensure that Lemma 3.3.4 can be applied, that is: the map Γ satisfies:

$$\forall (s, t) \in [0, s_0[\times [0, 1], \Gamma(s, t) = \gamma(s).$$

5. Finally, Lemma 3.3.5 can be applied as well : the map Γ satisfies:

$$\forall (s, t) \in [s_0, 1] \times [0, 1], \forall \omega \in A, |\Gamma(s, t) - \omega| \geq r.$$

But by 1. one has $|\Gamma(s, t)| \leq N + M$ and one concludes by the very definition of A that:

$$\forall (s, t) \in [s_0, 1] \times [0, 1], \forall \omega \in \Omega, |\Gamma(s, t) - \omega| \geq r.$$

Putting these things together, we conclude that the map Γ satisfies: Γ is a map of class \mathcal{C}^1 such that

$$\Gamma : t \in [0, 1] \mapsto \Gamma_t \in \mathfrak{R}_\Omega^{\text{sym}}$$

with $\Gamma_0 = \gamma$ and $\forall t \in [0, 1], \Gamma_t(1) = \lambda(t)$.

We note that γ is \mathcal{R}_Ω -symmetrically contractile, thus by composition of homotopies, one deduces that the path Γ_1 is \mathcal{R}_Ω -symmetrically contractile. Moreover $\text{cl}(\Gamma_1) = \text{cl}(\gamma\lambda)$: the map

$$H : (s, t) \in [0, 1]^2 \mapsto H_t(s) = \begin{cases} \Gamma((2-t)s, t) & \text{for } s \in [0, \frac{1}{2-t}] \\ \Gamma(1, (2-t)s + t - 1) & \text{for } s \in [\frac{1}{2-t}, 1] \end{cases}$$

realises a homotopy between $H_0 = \gamma\lambda$ and Γ_1 in \mathfrak{R}_Ω^* . Therefore $z = (\zeta, \sigma) = (\zeta, \text{cl}(\Gamma_1))$. \square

4.3. The convolution algebra $\mathcal{H}(\mathcal{R}_\Omega)$

Theorem 4.2.1 has the following consequences on the convolution product, see also [OU010, S012].

Theorem 4.3.1. — *We assume that the closed and discrete subset Ω of \mathbb{C} is a semi-group. Then the space $\mathcal{H}(\mathcal{R}_\Omega)$ is a convolution algebra.*

Proof. — We consider two germs of analytic functions $\varphi, \psi \in \mathcal{O}_0$ and we assume that $\varphi, \psi \in \mathcal{H}(\mathcal{R}_\Omega)$. We take a point on $z = (\zeta, \alpha) \in \mathcal{R}_\Omega$. We know from Theorem 4.2.1 that there exists a \mathcal{R}_Ω -symmetrically contractile path γ such that $\text{cl}(\gamma) = \alpha$. Precisely, there exists a continuous map

$$\Gamma : t \in [0, 1] \mapsto \Gamma_t \in \mathfrak{R}_\Omega^{\text{sym}}$$

such that $\Gamma_1 = \gamma$ and $\Gamma_0 \equiv 0$.

We now consider the path $\lambda : t \in [0, 1] \mapsto \Gamma_t(1)$. This path belongs to \mathfrak{R}_Ω and is homotopic to γ . Thus $\text{cl}(\lambda) = \alpha$. Applying Corollary 2.3.1, the convolution product $\varphi * \psi$ is analytically continuable along the path λ .

Since \mathcal{R}_Ω is simply connected, this property implies that $\varphi * \psi \in \mathcal{H}(\mathcal{R}_\Omega)$. \square

When the closed, discrete subset Ω is not a semi-group, then $\mathcal{H}(\mathcal{R}_\Omega)$ is not stable by convolution product. This difficulty will be overcome with the notion of endless continuability. This is the aim of the next chapter.

CHAPTER 5

ENDLESS CONTINUABILITY

In Resurgence theory, one has to deal with holomorphic functions which are “endlessly continuable”. Intuitively, a holomorphic function Φ , defined in some open subset of \mathbb{C} , is endlessly continuable if Φ is analytically continuable on a Riemann surface (defined as an étalé space on \mathbb{C}) *apart from a discrete set of singular points* of this Riemann surface. However, when projected on \mathbb{C} , *this set may be everywhere dense*.

There exist various definitions of “endless continuability”. For all of them, what is required is that :

- the definition allows us to define convenient convolution algebras ;
- the definition allows us to define alien derivatives.

The more general approach is certainly that of Ecalle [Ec85], [Ec93-1]. Nevertheless we have chosen in this paper to follow in a self-contained - and somewhat different - way an approach due to Pham *et al.* in [CNP93-2] and especially [CNP93-1] where all proofs are given. Meanwhile in [CNP93-1], some arguments are sometimes lacking for key-results (e.g., Thm. 1.5 of Chap. Rés I, Prop. 3.1.5 of Chap. Rés II, some arguments in the appendix of Chap. Rés II) and this Chapter 5 (and finally the paper itself) should be seen as our attempt to fill in the missing arguments and write the proofs in an understandable manner for a graduate student. In doing so, we have to confess that we have been unable to show (at least directly) some of the properties of [CNP93-1] so that some definitions, results and methods differ from that in [CNP93-1]. This will be mentioned in the paper. For completeness we shall also recall another approach due to Ecalle with available references.

This chapter is organized as follows.

In §5.1, we introduce the notion of “discrete filtered set” and its associated Riemann surface. Our starting point is [CNP93-1], §Rés II, though our notion of Ω_\star -allowed path and thus Ω_\star -homotopy, slightly differs from theirs. We then consider the space $\mathcal{R}_{\Omega_\star}$ of all Ω_\star -homotopy classes of Ω_\star -allowed paths. We make precise the topology considered on $\mathcal{R}_{\Omega_\star}$ and its main properties (this is not developed in [CNP93-1]).

In §5.2 we define endless Riemann surfaces and endlessly continuable germs of holomorphic functions. In §5.3 we define glimpsed singular points. Nothing new in this section, apart from the presentation we make.

The main theorems we were looking for (Theorems 5.4.2 and 5.4.3) are formulated and proved in §5.4 and compared with that of Theorem 5.4.1 from [CNP93-1].

In section §5.5 we draw some consequences of the previous section and define the convolution space of endlessly continuable germs of holomorphic functions. We end in §5.6 with a brief Ecalle's viewpoint.

5.1. Discrete filtered set and associated Riemann surface

The following definitions are adapted from [CNP93-1].

5.1.1. Discrete filtered sets. —

Definition 5.1.1. — A discrete filtered set Ω_\star centred at $\omega \in \mathbb{C}$ is an increasing sequence of finite sets $\Omega_L \subset \mathbb{C}$, $L > 0$, such that :

- $\forall L > 0$, Ω_L belongs to the open disc centred at ω with radius L ;
- if $L_1 \leq L_2$ then $\Omega_{L_1} \subseteq \Omega_{L_2}$;
- for $L > 0$ small enough, $\Omega_L = \{\omega\}$.

For $L > 0$, we note $\Omega_L^\star = \Omega_L \setminus \{\omega\}$.

Definition 5.1.2. — We consider two discrete filtered sets Ω_\star and Ω'_\star centred at $\omega \in \mathbb{C}$. Then their union $(\Omega \cup \Omega')_\star$ is the discrete filtered set defined by : for every $L > 0$, $(\Omega \cup \Omega')_L = \Omega_L \cup \Omega'_L$.

We mention that the following definition differs from that of [CNP93-1], §Rés II, 3.1.

Definition 5.1.3. — We consider two discrete filtered sets Ω_\star and Ω'_\star centred at 0. Their sum $(\Omega + \Omega')_\star$ is the filtered set centred at 0 and defined by : for $L > 0$,

$$(\Omega + \Omega')_L = \{\Omega_L + \Omega'_L\} \cap D(0, L).$$

The sum of two discrete filtered sets centred at $\omega \in \mathbb{C}$ is defined as well by translation.

If Ω_\star is a discrete filtered set, we remark that $\bigcup_{L>0} \Omega_L$ can be dense in \mathbb{C} as it is shown in the following example.

5.1.2. Example. — Assume that $\omega_1 \in \mathbb{C}^\star$ and define

- $\forall L \in]0, |\omega_1|]$, $\Omega_L = \{0\}$,
- for every $n \in \mathbb{N}^\star$, $\forall L \in]n|\omega_1|, (n+1)|\omega_1|]$, $\Omega_L = \{0, \pm\omega_1, \dots, \pm n\omega_1\}$.

This define a discrete filtered set $\Omega_{1\star}$ centred at 0.

Assume now that $\omega_1, \omega_2, \omega_3 \in \mathbb{C}^\star$ are rationally independent, that is linearly independent over \mathbb{Z} . We consider the three discrete filtered sets $\Omega_{1\star}$, $\Omega_{2\star}$ and $\Omega_{3\star}$ centred at 0 defined as above. We note $\Omega_\star = (\Omega_1 + \Omega_2 + \Omega_3)_\star$ their sum. Then $\bigcup_{L>0} \Omega_L$ is everywhere dense in \mathbb{C} .

5.1.3. Ω_\star -allowed path, Ω_\star -homotopy. —

5.1.3.1. *Definitions.* — The following definitions follows that of [CNP93-2] but slightly differs from that of [CNP93-1], §Rés II, 3.1. We mention that, like in [CNP93-1], we could have added a control of the so-called “variation of direction” of the paths under consideration. We have refrained from doing that only for a matter of simplicity.

Definition 5.1.4. — We assume that Ω_\star is a discrete filtered set centred at $\omega \in \mathbb{C}$. We note $\mathfrak{R}_{\Omega_L}^\star$ the set of paths $\lambda : [0, 1] \rightarrow \mathbb{C}$ starting from ω and such that :

- λ is \mathcal{C}^1 by parts.
- λ is the constant path or there exists $t \in [0, 1]$ such that $\lambda([0, t]) = \{\omega\}$ and $\lambda(]t, 1]) \subset D(\omega, L) \setminus \Omega_L$,
- and the length \mathcal{L}_λ of λ is $< L$, where $\mathcal{L}_\lambda = \int_0^1 |\lambda'(t)| dt$.

A path λ is said to be Ω_\star -allowed if $\lambda \in \mathfrak{R}_{\Omega_L}^\star$ for some $L > 0$. We note $\mathfrak{R}_{\Omega_\star}^\star = \bigcup_{L>0} \mathfrak{R}_{\Omega_L}^\star$ the set of Ω_\star -allowed paths.

Definition 5.1.5. — We assume that Ω_\star is a discrete filtered set centred at $\omega \in \mathbb{C}$. A continuous map

$$\Gamma : (s, t) \in [0, 1]^2 \mapsto \Gamma_t(s) \in \mathbb{C}$$

is a Ω_\star -homotopy if $\forall t \in [0, 1]$ the path Γ_t is Ω_\star -allowed and the map $t \in [0, 1] \mapsto \mathcal{L}_{\Gamma_t}$ is continuous.

Two Ω_\star -allowed paths λ_0 and λ_1 are Ω_\star -homotopic if there exists a Ω_\star -homotopy $\Gamma : (s, t) \in [0, 1]^2 \mapsto \Gamma_t(s) \in \mathbb{C}$ such that $\lambda_0 = \Gamma_0$ and $\lambda_1 = \Gamma_1$.

The homotopy class with fixed extremities of a Ω_\star -allowed path λ is denoted by $\text{cl}(\lambda)$.

Obviously, the notion of Ω_\star -homotopy is an equivalence relation between Ω_\star -allowed paths.

5.1.3.2. *Remark.* — It is quite important to understand what is the Ω_\star -homotopy and we make the following remark that we formulate as a Lemma:

Lemma 5.1.1. — If Γ is a Ω_\star -homotopy, there exist $0 = t_0 < t_1 < \dots < t_n < t_{n+1} = 1$ and some positive numbers L_0, L_1, \dots, L_n such that:

$$\forall i = 0, \dots, n, \forall t \in [t_i, t_{i+1}], \Gamma_t \in \mathfrak{R}_{\Omega_{L_i}}^\star.$$

Proof. — From the properties of a discrete filtered set, one can define an increasing sequence $0 < l_0 < l_1 < l_2 < \dots$ such that $\Omega_{l_0} = \{\omega\}$ and $\forall i \geq 1, \Omega_{l_{i-1}} \subset \Omega_{l_i}$ strictly while $\forall L \in]l_{i-1}, l_i], \Omega_L = \Omega_{l_i}$. Take some $t_0 \in [0, 1]$ and assume that $\mathcal{L}_{\Gamma_{t_0}} \in [l_{i-1}, l_i[$. Since Γ_{t_0} is Ω_\star -allowed one has $\Gamma_{t_0} \in \mathfrak{R}_{\Omega_{l_i}}^\star$ necessarily and this remains true for every Γ_t for t in a vicinity of t_0 in $[0, 1]$: here we use both the continuity of the map $t \in [0, 1] \mapsto \mathcal{L}_{\Gamma_t}$ and the continuity of Γ itself when $\mathcal{L}_{\Gamma_{t_0}} = l_{i-1}$. This way one gets an open covering of $[0, 1]$ from which one deduces a finite open covering by compactity. One then easily deduces the result. \square

From this remark, observe that if $L_2 > L_1$, a path $\lambda_1 \in \mathfrak{R}_{\Omega_{L_1}}^\star$ can be Ω_\star -homotopic to another path $\lambda_2 \in \mathfrak{R}_{\Omega_{L_2}}^\star$ and at the same time λ_1 not homotopic to λ_2 in the usual way, when both are seen as paths in $\mathfrak{R}_{\Omega_{L_2}}^\star$. Even, we may have $\lambda_1 \notin \mathfrak{R}_{\Omega_{L_2}}^\star$! See Fig. 15.

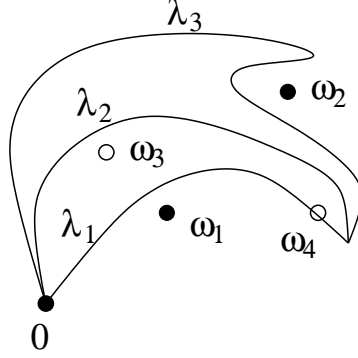

FIGURE 15. We assume that Ω_\star is a discrete filtered set centred at 0. For $0 < L_1 < L_2$, $\Omega_{L_1} = \{0, \omega_1, \omega_2\}$, $\Omega_{L_2} = \Omega_{L_1} \cup \{\omega_3, \omega_4\}$. The paths $\lambda_1, \lambda_2 \in \mathfrak{R}_{\Omega_{L_1}}^\star$ are Ω_\star -homotopic, the paths $\lambda_2, \lambda_3 \in \mathfrak{R}_{\Omega_{L_2}}^\star$ are Ω_\star -homotopic, thus λ_1 and λ_3 are Ω_\star -homotopic despite the fact that $\lambda_1 \notin \mathfrak{R}_{\Omega_{L_2}}^\star$.

5.1.4. Riemann surface associated to a discrete filtered set. —

Definition 5.1.6. — If Ω_\star is a discrete filtered set centred at $\omega \in \mathbb{C}$, We note

$$\mathcal{R}_{\Omega_\star} = \{(\zeta, \text{cl}(\lambda)), \lambda \in \mathfrak{R}_{\Omega_\star}^\star, \zeta = \lambda(1)\}.$$

In what follows we usually note $\text{cl}(\omega)$ or even simply ω for the Ω_\star -homotopy class of the constant path.

5.1.4.1. *Topology on $\mathcal{R}_{\Omega_\star}$.* — On the space $\mathcal{R}_{\Omega_\star}$ we now define a topology. Let us consider $(\zeta, \alpha) \in \mathcal{R}_{\Omega_\star}$.

- Assume that $(\zeta, \alpha) = (\omega, \text{cl}(\omega))$. For some $L > 0$ we consider $U \subset D(\omega, L) \setminus \Omega_L^\star$ a star-shaped domain with respect to ω . We note $[U, \alpha] = \{(\xi, \text{cl}(\lambda_1 \lambda_2)), \xi \in U\} \subset \mathcal{R}_{\Omega_\star}$ where $\text{cl}(\lambda_1) = \omega$ and for a given $\xi \in U$, $\lambda_2 \in \mathfrak{R}_{\Omega_L}^\star$ is any path ending at ξ and whose image is the line segment $[\omega, \xi]$. (The length of these paths is $|\xi| < L$ and all these paths belong to the same Ω_\star -homotopy class).
- Assume that $(\zeta, \alpha) \neq (\omega, \text{cl}(\omega))$. We choose a path $\lambda_1 \in \mathfrak{R}_{\Omega_L}^\star$ such that $\text{cl}(\lambda_1) = \alpha$. We note \mathcal{L}_{λ_1} the length of λ_1 . For some $L_2 > 0$ such that $\mathcal{L}_{\lambda_1} + L_2 < L$, we consider $U \subset D(\zeta, L_2) \setminus \Omega_{L_2} \subset D(\omega, L) \setminus \Omega_L$ such that U is a star-shaped domain with respect to $\zeta = \lambda_1(1)$. For $\xi \in U$, consider a path λ_2 starting from ζ , ending at ξ and whose image is the line segment $[\zeta, \xi]$. Then the product $\lambda_1 \lambda_2$ belongs to $\mathfrak{R}_{\Omega_L}^\star$ and we consider its Ω_\star -homotopy class $\text{cl}(\lambda_1 \lambda_2)$. We note $[U, \alpha] = \{(\xi, \text{cl}(\lambda_1 \lambda_2)), \xi \in U\} \subset \mathcal{R}_{\Omega_\star}$ the set of such points.

We show that the system \mathfrak{B} of all such sets $[U, \alpha]$ is a basis for a topology on $\mathcal{R}_{\Omega_\star}$:

- Obviously, every element $(\xi, \gamma) \in \mathcal{R}_{\Omega_\star}$ belongs to at least one $[U, \alpha]$.
- Assume that $(\xi, \gamma) \in [U, \alpha] \cap [V, \beta]$.
 - if $(\xi, \gamma) = (\omega, \text{cl}(\omega))$, then necessarily $\alpha = \beta = \omega$ and U and V are two star-shaped domains with respect to ω , U is a subset of $D(\omega, L_1) \setminus \Omega_{L_1}^\star$ and V is a subset of $D(\omega, L_2) \setminus \Omega_{L_2}^\star$. Set $L = \max\{L_1, L_2\}$. Then $U \cap V \subset D(\omega, L) \setminus \Omega_L^\star$ is also a star-shaped domain with respect to ω and

$$(\xi, \gamma) \in [U \cap V, \gamma] \subset [U, \alpha] \cap [V, \beta].$$

- otherwise $\xi \neq \omega$ and $\xi \in U \cap V$. To simplify we assume that $\omega \notin U \cup V$.

Thus :

- * for some $L > 0$, $U \subset D(\zeta_1, L_2) \setminus \Omega_L$ is a star-shaped domain with respect to $\zeta_1 = \lambda_1(1)$ where $\lambda_1 \in \mathfrak{R}_{\Omega_L}^*$ satisfies $\alpha = \text{cl}(\lambda_1)$ and $\mathcal{L}_{\lambda_1} + L_2 < L$. Also we have $\gamma = \text{cl}(\lambda_1 \lambda_2)$ where λ_2 starts from ζ_1 , ends at ξ and is such that $\lambda_2([0, 1]) = [\zeta_1, \xi]$.

- * for some $L' > 0$, $V \subset D(\zeta'_1, L'_2) \setminus \Omega_{L'}$ is a star-shaped domain with respect to $\zeta'_1 = \lambda'_1(1)$ where $\lambda'_1 \in \mathfrak{R}_{\Omega_{L'}}^*$ satisfies $\beta = \text{cl}(\lambda'_1)$ and $\mathcal{L}_{\lambda'_1} + L'_2 < L'$. Also $\gamma = \text{cl}(\lambda'_1 \lambda'_2)$ where λ'_2 starts from ζ'_1 , ends at ξ and is such that $\lambda'_2([0, 1]) = [\zeta'_1, \xi]$.

Now choose $L''_2 > 0$ such that $\mathcal{L}_{\lambda_1 \lambda_2} + L''_2 < L$ and $\mathcal{L}_{\lambda'_1 \lambda'_2} + L''_2 < L'$. Consider $W \subset U \cap V \cap D(\xi, L''_2)$ a star-shaped domain with respect to ξ . Then obviously $[W, \gamma] \in \mathfrak{B}$ is well-defined and

$$(\xi, \gamma) \in [W, \gamma] \subset [U, \alpha] \cap [V, \beta].$$

The topology thus defined by \mathfrak{B} is Hausdorff. We consider two points (ζ, α) and (ζ', α') in $\mathcal{R}_{\Omega_\star}$. Clearly if $\zeta \neq \zeta'$, then (ζ, α) and (ζ', α') have disjoint neighbourhoods. Thus assume that $\zeta = \zeta'$ ($\neq \omega$, say) but $\alpha \neq \alpha'$. Assume that $[U, \alpha] \in \mathfrak{B}$ is a neighbourhood of (ζ, α) , that $[U', \alpha'] \in \mathfrak{B}$ is a neighbourhood of (ζ, α') and that $[U, \alpha] \cap [U', \alpha'] \neq \emptyset$. Then there exists $(\xi, \beta) \in [U, \alpha] \cap [U', \alpha']$, that is:

- $\beta = \text{cl}(\lambda_1 \lambda_2)$, $\alpha = \text{cl}(\lambda_1)$, while λ_2 starts from ζ , ends at ξ and maps on the line segment $[\zeta, \xi] \subset U$;
- $\beta = \text{cl}(\lambda'_1 \lambda'_2)$, $\alpha' = \text{cl}(\lambda'_1)$, while λ'_2 starts from ζ , ends at ξ and maps on the line segment $[\zeta, \xi] \subset U'$.

This implies that λ_1 and λ'_1 are in the same class, that is $\alpha = \alpha'$.

One easily shows that $\mathcal{R}_{\Omega_\star}$ is (arc)connected. Furthermore, for every $[U, \alpha] \in \mathfrak{B}$, the mapping $\pi_{[U, \alpha]} : (\zeta, \alpha) \rightarrow \zeta \in U$ is a homeomorphism. Thus :

Proposition 5.1.1. — *The (pointed) space $\mathcal{R}_{\Omega_\star}$ is a topologically (arc)connected separated space. With the projection $\pi : (\zeta, \alpha) \in \mathcal{R}_{\Omega_\star} \mapsto \zeta \in \mathbb{C}$, the space $\mathcal{R}_{\Omega_\star}$ is an étalé space on \mathbb{C} .*

When pulling back by π the complex structure of \mathbb{C} , $\mathcal{R}_{\Omega_\star}$ becomes a Riemann surface.

Definition 5.1.7. — *$(\mathcal{R}_{\Omega_\star}, \pi)$ is called the Riemann surface associated to the discrete filtered set Ω_\star .*

5.1.4.2. Remark. — From its very definition, if $(\mathcal{R}_{\Omega_\star}, \pi)$ is the Riemann surface associated to a discrete filtered set Ω_\star centred at $\omega \in \mathbb{C}$, then every Ω_\star -allowed path can be lifted with respect to π to a path on $\mathcal{R}_{\Omega_\star}$ with initial point $(\omega, \text{cl}(\omega))$. Indeed, assume that $\lambda \in \mathfrak{R}_{\Omega_L}^*$ and define $\lambda_t : s \in [0, 1] \mapsto \lambda_t(s) = \lambda(ts)$ for $t \in [0, 1]$. Then $\lambda_t \in \mathfrak{R}_{\Omega_L}^*$ and the mapping

$$\Lambda : t \in [0, 1] \mapsto \Lambda(t) = (\lambda(t), \text{cl}(\lambda_t))$$

is continuous and is a lifting of λ from $(\omega, \text{cl}(\omega))$. This lifting is unique thanks to the uniqueness of lifting [For81].

We would like to point out a consequence of the topology considered on these Riemann surfaces. On Fig. 16 we consider a discrete filtered set Ω_\star centred at 0 such that, for $0 < L_1 < L_2$, $\Omega_{L_1} = \{0, \omega_1, \omega_2\}$, $\Omega_{L_2} = \Omega_{L_1} \cup \{\omega_3, \omega_4\}$. We have

drawn two paths $\lambda_1, \lambda_2 \in \mathfrak{R}_{\Omega_{L_1}}^*$ ending at the same point ζ and Ω_* -homotopic, $\text{cl}(\lambda_1) = \text{cl}(\lambda_2)$. Also we have drawn a path λ_3 starting at ζ and ending at ξ such that the product path $\lambda_2\lambda_3$ belongs to $\mathfrak{R}_{\Omega_{L_2}}^*$. We remark that $\lambda_1\lambda_3 \notin \mathfrak{R}_{\Omega_{L_2}}^*$.

The path λ_1 , *resp.* λ_2 , can be lifted with respect to π to a path Λ_1 , *resp.* Λ_2 , on \mathcal{R}_{Ω_*} with initial point $(0, \text{cl}(0))$ and end point $(\zeta, \text{cl}(\lambda_1) = \text{cl}(\lambda_2))$. From that point, λ_3 can be lifted with respect to π to a path Λ_3 ending at $(\xi, \text{cl}(\lambda_1\lambda_3) = \text{cl}(\lambda_2\lambda_3))$. At the same time, the path $\Lambda_1\Lambda_3$ is well defined and $\pi(\Lambda_1\Lambda_3) = \lambda_1\lambda_3$. Thus $\lambda_1\lambda_3$ can be lifted on \mathcal{R}_{Ω_*} with respect to π from $(0, \text{cl}(0))$ despite the fact that $\lambda_1\lambda_3$ is not Ω_* -allowed. We say that ω_3 is a “removable singular point” for $\lambda_1\lambda_3$.

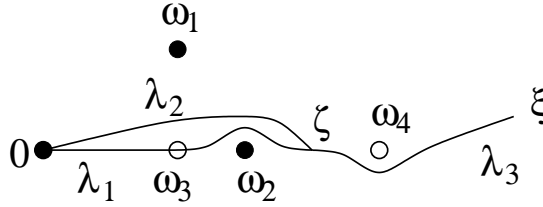

FIGURE 16

5.1.4.3. *Distance of a path to Ω_* .* — We consider a point $z = (\zeta, \alpha) \in \mathcal{R}_{\Omega_*}$. Since a disc is a star-shaped domain with respect to its origin, then for $r > 0$ small enough, $[D(\zeta, r), \alpha]$ is a neighbourhood of z and

$$\pi_{|[D(\zeta, r), \alpha]} : [D(\zeta, r), \alpha] \rightarrow D(\zeta, r)$$

is a homeomorphism.

Definition 5.1.8. — *For every $z = (\zeta, \alpha) \in \mathcal{R}_{\Omega_*}$ we note*

$$\rho(z) = \sup\{r > 0 \text{ such that } [D(\zeta, r), \alpha] \text{ is a neighbourhood of } z\}.$$

We call $\rho(z)$ the distance of z to Ω_ .*

Definition 5.1.9. — *We assume that Ω_* is a discrete filtered set centred at $\omega \in \mathbb{C}$. For every $\lambda \in \mathfrak{R}_{\Omega_*}^*$ we define its distance to Ω_* as*

$$d(\lambda, \Omega_*) = \inf_{t \in [0, 1]} \rho(\Lambda(t)) > 0$$

where Λ is the lifting of λ from ω with respect to π .

5.1.4.4. *Some properties of the Riemann surface \mathcal{R}_{Ω_*} .* — We consider the Riemann surface $(\mathcal{R}_{\Omega_*}, \pi)$ associated to a discrete filtered set Ω_* centred at $\omega \in \mathbb{C}$. Take $z = (\zeta, \alpha) \neq (\omega, \text{cl}(\omega)) \in \mathcal{R}_{\Omega_*}$ and assume that $\alpha = \text{cl}(\lambda_0)$, $\lambda_0 \in \mathfrak{R}_{\Omega_{L_0}}^*$ for some $L_0 > 0$. We consider a path λ starting from ζ and we note \mathcal{L}_λ its length.

If \mathcal{L}_λ is small enough, then obviously λ can be lifted from z with respect to π : this is just a consequence of the topology considered on \mathcal{R}_{Ω_*} .

Assume now that λ satisfies, for some $L > 0$: there exists $t \in [0, 1]$ such that $\lambda([0, t]) = \{\zeta\}$, $\lambda([t, 1]) \subset \mathbb{C} \setminus \Omega_{L_0+L}$ and that $\mathcal{L}_\lambda < L$. For $\varepsilon > 0$ small enough, one can find a Ω_* -homotopy

$$\Gamma : t \in [0, 1] \mapsto \Gamma_t \in \mathfrak{R}_{\Omega_*}^*$$

such that

$$- \Gamma_0 = \lambda_0,$$

- $\forall t \in [0, \varepsilon] \Gamma_t \in \mathfrak{R}_{\Omega_{L_0}}^*$ and $\Gamma_t(1) = \lambda(t)$,
- $\Gamma_\varepsilon \in \mathfrak{R}_{\Omega_{L_0}}^* \cap \mathfrak{R}_{\Omega_{L_0+L}}^*$,
- $\forall t \in [\varepsilon, 1], \Gamma_t \in \mathfrak{R}_{\Omega_{L_0+L}}^*$ and $\Gamma_t(1) = \lambda(t)$.

(For $t \in [0, \varepsilon]$), Γ_t is just a small deformation of λ_0 so as to avoid the points of Ω_{L_0+L} , cf. Remark 5.1.4.2. For $t \in [\varepsilon, 1]$, Γ_t is for instance the product of Γ_ε with $\lambda|_{[\varepsilon, t]}$ up to reparametrisation).

This Ω_* -homotopy can be lifted with respect to π into a homotopy

$$\widehat{\Gamma} : t \in [0, 1] \mapsto \widehat{\Gamma}_t$$

where $\forall t \in [0, 1], \widehat{\Gamma}_t : [0, 1] \rightarrow \mathcal{R}_{\Omega_*}$ is a path starting at $(w, \text{cl}(\omega))$. Then the path $\Lambda : t \in [0, 1] \mapsto \widehat{\Gamma}_t(1) \in \mathcal{R}_{\Omega_*}$ is a lifting of λ starting from z .

This has the following consequences. There exists a discrete filtered set $\Omega_*(z)$ centred at ζ :

- for $L > 0$ small enough, $\Omega_L(z) = \{\zeta\}$,
- for $L > 0$ large enough, $\Omega_L(z) = (\Omega_{L_0+L} \cap D(\zeta, L)) \cup \{\zeta\}$

such that every path $\Omega_*(z)$ -allowed path can be lifted on \mathcal{R}_{Ω_*} from z with respect to π .

To summarize :

Proposition 5.1.2. — *Assume that $(\mathcal{R}_{\Omega_*}, \pi)$ is the Riemann surface associated to a discrete filtered set Ω_* . Then, for every $z = (\zeta, \alpha) \in \mathcal{R}_{\Omega_*}$, there exists a discrete filtered set $\Omega_*(z)$ centred at ζ such that every $\Omega_*(z)$ -allowed path starting from ζ can be lifted on \mathcal{R}_{Ω_*} from z with respect to π .*

We end this subsection with the following property :

Proposition 5.1.3. — *The Riemann surface \mathcal{R}_{Ω_*} associated to the discrete filtered set Ω_* is simply connected.*

Proof. — Just adapt the proof of Proposition 4.1.3. □

5.2. CNP's endless continuability

5.2.1. Endless Riemann surface. —

Definition 5.2.1 (Endless Riemann surface). — *A Riemann surface (\mathcal{R}, π) , given as an étalé space on \mathbb{C} , is said to be endless if for every $z \in \mathcal{R}$, $\omega = \pi(z)$, there exists a discrete filtered set $\Omega_*(z)$ centred at ω such that : every $\Omega_*(z)$ -allowed path λ starting from ω can be lifted on \mathcal{R} from z with respect to π .*

5.2.2. Example. — We consider the example discussed in §4.1 : we assume that Ω is a closed discrete subset of \mathbb{C} and we look at the Riemann surface $(\mathcal{R}_\Omega, \pi)$ (see Proposition 4.1.2). It is a simple exercise to show that \mathcal{R}_Ω is endless.

5.2.3. Endless continuability. —

Definition 5.2.2 (Endless continuability). — A germ of analytic functions $\varphi \in \mathcal{O}_0$ at $0 \in \mathbb{C}$ is said to be endlessly continuable on \mathbb{C} if there exists a discrete filtered set Ω_\star centred at 0 such that φ is analytically continuable along every Ω_\star -allowed path.

We note \mathcal{H}_{end} the space of germs of analytic functions at the origin which are endlessly continuable on \mathbb{C} .

Proposition 5.2.1. — A germ of analytic functions $\varphi \in \mathcal{O}_0$ is endlessly continuable on \mathbb{C} if and only if φ is analytically continuable on an endless Riemann surface.

Proof. — This is a direct consequence of the definitions and of Proposition 5.1.2. \square

5.3. Seen and glimpsed singular points

Definition 5.3.1. — For $L > 0$, $\theta \in \frac{\mathbb{R}}{2\pi\mathbb{Z}}$ and for $\alpha \in]0, \frac{\pi}{2}[$, we note $\Sigma_{L,\theta,\alpha}$ the following open sector adherent to zero:

$$\Sigma_{L,\theta,\alpha} = \{\zeta \in \mathbb{C}, 0 < |\zeta| < L, -\alpha < \arg(\zeta) - \theta < \alpha\}.$$

We now assume that Ω_\star is a discrete filtered set centred at $0 \in \mathbb{C}$ and we fix a direction $\theta \in \frac{\mathbb{R}}{2\pi\mathbb{Z}}$. For every $L > 0$, Ω_L is a finite set, so that for $\alpha \in]0, \frac{\pi}{2}[$ small enough,

$$\Omega_L \cap \Sigma_{L,\theta,\alpha} = \Omega_L \cap]0, e^{i\theta}L[.$$

Definition 5.3.2. — For a given $\theta \in \frac{\mathbb{R}}{2\pi\mathbb{Z}}$ and $L > 0$ one says that $\alpha \in]0, \frac{\pi}{2}[$ is (θ, L) - Ω_\star -allowed if

$$\Omega_L \cap \Sigma_{L,\theta,\alpha} = \Omega_L \cap]0, e^{i\theta}L[= \Omega_{L,\theta}^\star.$$

Definition 5.3.3. — We assume that Ω_\star is a discrete filtered set centred at $0 \in \mathbb{C}$. For $\theta \in \frac{\mathbb{R}}{2\pi\mathbb{Z}}$ and $L > 0$.

We note $\mathfrak{R}(\Omega_\star, L, \theta)$ the set of paths $\lambda \in \mathfrak{R}$ so that :

- λ is \mathcal{C}^1 by parts,
- $\mathcal{L}_\lambda < L$,
- there exists $\alpha \in]0, \frac{\pi}{2}[$ which is (θ, L) - Ω_\star -allowed such that⁽¹⁾

$$\forall t \in [0, 1], \arg(\lambda'(t)) \in]-\alpha + \theta, \theta + \alpha[\text{ or } \lambda'(t) = 0.$$

We remark that, apart from its origin, a path $\lambda \in \mathfrak{R}(\Omega_\star, L, \theta)$ stays in an open sector $\Sigma_{L,\theta,\alpha}$ with a (θ, L) - Ω_\star -allowed α . Moreover λ always moves forward in that sector.

Proposition 5.3.1. — We consider a discrete filtered set Ω_\star centred at 0 and a direction $\theta \in \frac{\mathbb{R}}{2\pi\mathbb{Z}}$. Then there exists a discrete and closed set $\text{Sing}_{\Omega_\star}^\star(\theta) \subset \bigcup_{L>0} \Omega_{L,\theta}^\star$ such that $\text{Sing}_{\Omega_L}^\star(\theta) = \text{Sing}_{\Omega_\star}^\star(\theta) \cap D(0, L) \subset \Omega_{L,\theta}^\star$ for $L > 0$ and:

- For every $L > 0$, every path λ in $\mathfrak{R}(\Omega_\star, L, \theta)$ that circumvents to the right or the left the set $\text{Sing}_{\Omega_L}^\star(\theta)$, can be lifted on the Riemann surface $(\mathcal{R}_{\Omega_\star}, \pi)$ with respect to π from $(0, \text{cl}(0))$.

⁽¹⁾For the point where λ is not \mathcal{C}^1 , λ' should of course be understood as the left or right derivative.

- when at least one point is removed from $\text{Sing}_{\Omega_\star}^*(\theta)$, then the above property is no more satisfied.

Proof. — We show Proposition 5.3.1 by constructing $\text{Sing}_{\Omega_\star}^*(\theta)$ by iteration, under the hypothesis that $\bigcup_{L>0} \Omega_{L,\theta}^* \neq \emptyset$ (in such a case $\text{Sing}_{\Omega_\star}^*(\theta) = \emptyset$).

From the property of Ω_\star , one can define an increasing sequence $0 < L_0 < L_1 < L_2 < \dots$ such that $\Omega_{L_0,\theta}^* = \emptyset$ and $\forall i \geq 1$, $\Omega_{L_{i-1},\theta}^* \subset \Omega_{L_i,\theta}^*$ strictly while $\forall L \in]L_{i-1}, L_i]$, $\Omega_{L,\theta}^* = \Omega_{L_i,\theta}^*$.

- Since $\Omega_{L_0,\theta}^* = \emptyset$ and for every $L \leq L_0$, every $\lambda \in \mathfrak{R}(\Omega_\star, L, \theta)$ is Ω_\star -allowed and therefore can be lifted on $\mathcal{R}_{\Omega_\star}$. We thus set $\text{Sing}_{\Omega_L}^*(\theta) = \emptyset$ for $L \leq L_0$.
- From this property and using the arguments of Remark 5.1.4.2, every $\omega \in \Omega_{L_1,\theta}^*$ such that $|\omega| < L_0$ is a “removable” singular point for every path $\lambda \in \mathfrak{R}(\Omega_\star, L, \theta)$, $L \leq L_1$. Since $\forall L \in]L_0, L_1]$, $\Omega_{L,\theta}^* = \Omega_{L_1,\theta}^*$,
 - either $\omega = L_0 e^{i\pi\theta} \in \Omega_{L_1,\theta}^*$. In that case we have to set $\text{Sing}_{\Omega_L}^*(\theta) = \text{Sing}_{\Omega_{L_0}}^*(\theta) \cup \{\omega\}$ for $L_0 < L \leq L_1$ so as to ensure that for every $L \leq L_1$, every path $\lambda \in \mathfrak{R}(\Omega_\star, L, \theta)$ that circumvents $\text{Sing}_{\Omega_L}^*(\theta)$ to the right or the left can be lifted on $\mathcal{R}_{\Omega_\star}$.
 - or $\omega \notin \Omega_{L_1,\theta}^*$. We set $\text{Sing}_{\Omega_L}^*(\theta) = \text{Sing}_{\Omega_{L_0}}^*(\theta) = \emptyset$ for $L_0 < L \leq L_1$, since in that case, for every $L \leq L_1$, every path in $\mathfrak{R}(\Omega_\star, L, \theta)$ can be lifted on $\mathcal{R}_{\Omega_\star}$.
- Assume that for some $i \geq 1$ one has:
 - for every $1 \leq j \leq i$, $\text{Sing}_{\Omega_L}^*(\theta) = \text{Sing}_{\Omega_{L_j}}^*(\theta) \subset \Omega_{L,\theta}^*$ for every $L_{j-1} < L \leq L_j$,
 - for every $1 \leq j \leq i$, $\text{Sing}_{\Omega_{L_j}}^*(\theta) \cap]0, e^{i\theta} L_{j-1}[= \text{Sing}_{\Omega_{L_{j-1}}}^*(\theta)$
 - for every $L \leq L_i$, every path $\lambda \in \mathfrak{R}(\Omega_\star, L, \theta)$ that circumvents the set $\text{Sing}_{\Omega_L}^*(\theta)$ to the right or the left, can be lifted on $\mathcal{R}_{\Omega_\star}$.

From these properties and using again the arguments of Remark 5.1.4.2, every $\omega \in \Omega_{L_{i+1},\theta}^* \setminus \text{Sing}_{\Omega_{L_i}}^*(\theta)$ such that $|\omega| < L_i$ is a “removable” singular point.

From the fact that $\forall L \in]L_i, L_{i+1}]$, $\Omega_{L,\theta}^* = \Omega_{L_{i+1},\theta}^*$,

- either $\omega = L_i e^{i\pi\theta} \in \Omega_{L_{i+1},\theta}^*$. In that case one defines $\text{Sing}_{\Omega_L}^*(\theta) = \text{Sing}_{\Omega_{L_i}}^*(\theta) \cup \{\omega\}$ for $L_i < L \leq L_{i+1}$ so that for every $L \leq L_{i+1}$, every path $\lambda \in \mathfrak{R}(\Omega_\star, L, \theta)$ that circumvents the set $\text{Sing}_{\Omega_L}^*(\theta)$ to the right or the left, can be lifted on $\mathcal{R}_{\Omega_\star}$.
- or $\omega \notin \Omega_{L_{i+1},\theta}^*$ and one concludes like previously with $\text{Sing}_{\Omega_L}^*(\theta) = \text{Sing}_{\Omega_{L_i}}^*(\theta)$ for $L_i < L \leq L_{i+1}$.

This ends the proof. \square

Definition 5.3.4. — We consider a discrete filtered set Ω_\star centred at 0 and $\theta \in \frac{\mathbb{R}}{2\pi\mathbb{Z}}$. Then the discrete and closed set $\text{Sing}_{\Omega_\star}^*(\theta) = \{\omega_i, |\omega_1| < |\omega_2| < \dots\} \in]0, e^{i\theta} \infty[$ defined by Proposition 5.3.1 is the set of glimpsed singular points in the direction θ . The glimpsed singular point ω_1 is the seen singular point in the direction θ .

We note $\text{Sing}_{\Omega_\star}(\theta) = \text{Sing}_{\Omega_\star}^*(\theta) \cup \{0\}$.

We will see in Definition 5.6.1 that the set $\text{Sing}_{\Omega_\star}^*(\theta)$ can be defined (and generalized) in a simpler way. However the presentation we have made here is more fitted to the methods we develop in the paper.

We end this section by translating the above definition for an endlessly continuable germ of analytic functions at the origin.

Proposition 5.3.2. — *If $\varphi \in \mathcal{H}_{end}$ is an endlessly continuable germ of analytic functions at $0 \in \mathbb{C}$ and for a direction $\theta \in \frac{\mathbb{R}}{2\pi\mathbb{Z}}$, there exists a discrete and closed set $\text{Sing}_\varphi^*(\theta) = \{\omega_i, |\omega_1| < |\omega_2| < \dots\} \in]0, e^{i\theta}\infty[$ such that:*

- φ is analytically continuable along every path that closely follows the half-line $]0, e^{i\theta}\infty[$ in the forward direction, while circumventing (to the right or to the left) each point of the set $\text{Sing}_\varphi^*(\theta)$.
- this property is no more valid if at least one point is removed from $\text{Sing}_\varphi^*(\theta)$.

Definition 5.3.5. — *The element $\text{Sing}_\varphi^*(\theta)$ defined by Proposition 5.3.2 are called the glimpsed singular point in the direction θ for φ . Specifically, ω_1 is the seen singular point in the direction θ for φ .*

We note $\text{Sing}_\varphi(\theta) = \text{Sing}_\varphi^*(\theta) \cup \{0\}$.

5.4. Endless continuability and convolution product

5.4.1. A theorem from CNP. — We start with the following definition⁽²⁾ from [CNP93-1], which differs from our own Definition 5.1.3.

Definition 5.4.1. — *We consider two discrete filtered sets centred at 0, $\Omega_{1\star}$ and $\Omega_{2\star}$. Their “fine” sum $(\Omega_1 \tilde{+} \Omega_2)_\star$ is the filtered set centred at 0 and defined by : for $L > 0$,*

$$(\Omega_1 \tilde{+} \Omega_2)_L = \{\omega_1 + \omega_2 / \omega_1 \in \Omega_{1L_1}, \omega_2 \in \Omega_{2L_2} \text{ with } L_1 + L_2 = L\}.$$

In [CNP93-1], the following property is announced:

Theorem 5.4.1 ([CNP93-1], Chap. Rés I, §1.5). — *If $\varphi, \psi \in \mathcal{O}_0$ are endlessly continuable on \mathbb{C} , then their convolution product $\varphi * \psi$ is endlessly continuable. More precisely, if $\Omega_\star(\varphi)$ and $\Omega_\star(\psi)$ are two discrete filtered sets centred at 0 such that φ , resp. ψ , is analytically continuable along every $\Omega_\star(\varphi)$ -allowed path, resp. $\Omega_\star(\psi)$ -allowed path, then $\varphi * \psi$ is analytically continuable along every $(\Omega(\varphi) \tilde{+} \Omega(\psi))_\star$ -allowed path where $(\Omega(\varphi) \tilde{+} \Omega(\psi))_\star$ is the filtered sum of $\Omega_\star(\varphi)$ and $\Omega_\star(\psi)$.*

We sketch the main arguments given in [CNP93-1], (Chap. Rés I, §1.5 and Chap. Rés II, Appendix for an extension) for proving this Theorem. For some $L > 0$, consider a path $\lambda \in \mathfrak{R}$ of length $< L$ and $\varphi, \psi \in \mathcal{O}_0$ which are assumed to be endlessly continuable. The analytic continuation of $\varphi * \psi$ along λ is

$$\forall t \in [0, 1], \varphi * \psi(\lambda(t)) = \int_{\Gamma_t} \varphi(\eta) \psi(\lambda(t) - \eta) d\eta$$

where the path Γ_t is a convenient deformation of $\lambda|_{[0,t]}$ as detailed in Proposition 2.3.2.

To construct the homotopy Γ , one distinguishes two types of singularities for the integrand $\eta \mapsto \varphi(\eta) \psi(\lambda(t) - \eta)$. The *fixed* singularities, which are those of

⁽²⁾The sum as defined by Definition 5.4.1 has the following enjoyable property. if Ω_\star is a discrete filtered sets centred at 0, then the infinite sum $(\Omega \tilde{+} \Omega \tilde{+} \Omega \tilde{+} \dots)_\star$ still define a discrete filtered sets centred at 0. This is not the case with our Definition 5.4.1.

(the analytic continuations of) φ . The *movable* singularities, that is those of $\eta \mapsto \psi(\lambda(t) - \eta)$: they move in parallel with $\lambda(t)$.

The analysis is now as follows : different types of accidents may occur, making impossible to keep on deforming λ into a convenient integration path Γ :

- boundary type accidents : the boundary $\Gamma_t(1) = \lambda(t)$ meets a fixed singularity or a movable singularity meets one of the boundary $\Gamma_t(0) = 0$ or $\Gamma_t(1) = \lambda(t)$;
- pinching type accidents : Γ_t is “pinched” between a movable singularity and a fixed singularity.

Then according to [CNP93-1] :

- to avoid the boundary type accidents, the path λ has to be $\Omega_\star(\varphi)$ and $\Omega_\star(\psi)$ -allowed;
- a pinching type accident occurs only when (at least) a couple of fixed/movable singularities $\omega, \lambda(t) - \omega'$ pinches the integration path Γ_t , that is $\omega = \lambda(t) - \omega' = \Gamma_t(s)$ for some $s \in]0, 1[$ and in this case, necessarily, one has $\omega \in \Omega_l(\varphi)$, $\omega' \in \Omega_{l'}(\psi)$ with $l + l' \leq L$.

These arguments are illustrated by Example 2.3.3 and Figure 5 : on that figure, we have drawn on pictures D_1, \dots, D_5 the fixed singularities $\{\omega_1\}$ and the movable singularities $\{\lambda(t) - \omega_2, \lambda(t) - \omega_3\}$. On D_5 , one can guess that a pinching occurs when $\lambda(t)$ reaches $\omega_1 + \omega_3$, the integration path Γ_t being pinched between the fixed singularity ω_1 and the movable singularity $\lambda(t) - \omega_3$.

However that example shows that the deformations and thus the “pinching case” can be rather complicated and we must confess that the arguments of [CNP93-1] to get the conclusions for the pinching case is not that clear for us. To clarify this point was one of the purpose of this paper and this is our aim in the sequel with our own methods.

5.4.2. A CNP’s like theorem. — The definitions and properties discussed in §. 4.2 can be adapted in the frame of an endless Riemann surface.

5.4.2.1. Some definitions. — We assume that Ω_\star is a discrete filtered set centred at 0.

Definition 5.4.2. — We note $\widehat{\mathfrak{R}}_{\Omega_\star}$ the set of paths on $\mathcal{R}_{\Omega_\star}$ starting from $0 \in \mathcal{R}_{\Omega_\star}$. We define $\mathfrak{R}_{\Omega_\star} = \pi(\widehat{\mathfrak{R}}_{\Omega_\star})$.

We note $\widehat{\mathfrak{R}}_{\Omega_\star}^\star \subset \widehat{\mathfrak{R}}_{\Omega_\star}$ the set of paths deduced from $\mathfrak{R}_{\Omega_\star}^\star$ by lifting from 0 with respect to π .

Definition 5.4.3. — A path $\Lambda \in \widehat{\mathfrak{R}}_{\Omega_\star}$ is said to be symmetric if $\pi(\Lambda)$ belongs to \mathfrak{R}^{sym} . We note $\widehat{\mathfrak{R}}_{\Omega_\star}^{sym}$ the set of such symmetric paths.

The space $\mathfrak{R}_{\Omega_\star}^{sym} = \pi(\widehat{\mathfrak{R}}_{\Omega_\star}^{sym}) = \mathfrak{R}_{\Omega_\star} \cap \mathfrak{R}^{sym}$ is the space of $\mathcal{R}_{\Omega_\star}$ -symmetric paths.

We note $\widehat{\mathfrak{R}}_{\Omega_\star}^{\star sym} = \widehat{\mathfrak{R}}_{\Omega_\star}^{sym} \cap \widehat{\mathfrak{R}}_{\Omega_\star}^\star$ and $\mathfrak{R}_{\Omega_\star}^{\star sym} = \mathfrak{R}_{\Omega_\star}^\star \cap \mathfrak{R}^{sym}$.

5.4.2.2. The main theorem. — The following Theorem which is illustrated by Fig. 5 (see also §3.5) is analogous to Theorem 5.4.1 of [CNP93-1]. It is our masterpiece result so as to demonstrate the stability by convolution of endlessly continuable functions.

Theorem 5.4.2. — We assume that Ω_\star and Ω'_\star are two discrete filtered set centred at 0 and we note $(\mathcal{R}_{\Omega_\star}, \pi), (\mathcal{R}_{\Omega'_\star}, \pi')$ their associated Riemann surfaces. Then if

σ is a $(\Omega + \Omega')_*$ -homotopy class of paths in $\mathfrak{R}_{(\Omega + \Omega')_*}^*$, there exists $\lambda_0 \in \mathfrak{R}_{(\Omega + \Omega')_*}^*$, $\sigma = \text{cl}(\lambda_0)$, and a continuous map $F : (s, t) \in [0, 1] \times [0, 1] \mapsto F(s, t) = F_t(s) \in \mathbb{C}$ such that

- $F_0 \equiv 0$,
- $\forall t \in [0, 1], F_t(1) = \lambda_0(t)$,
- $\forall t \in [0, 1], F_t \in \mathfrak{R}_{\Omega_*}$,
- $\forall t \in [0, 1], F_t^\circ \in \mathfrak{R}_{\Omega_*}^\circ$ where $F_t^\circ(s) = \lambda_0(t) - F_t(1 - s)$.

Moreover λ_0 and F_1 are homotopic in the space \mathfrak{R}_{Ω_*} while λ_0 and F_1° are homotopic in the space $\mathfrak{R}_{\Omega_*}^\circ$.

Proof. — We can assume that σ is not the $(\Omega + \Omega')_*$ -homotopy class of the constant path (otherwise the result is obvious) and that $\sigma = \text{cl}(\lambda_0)$ with:

- $\lambda_0 \in \mathfrak{R}_{(\Omega + \Omega')_L}^*$ for some $L > 0$, $\mathcal{L}_{\lambda_0} < L$.
- $\lambda_0 = \gamma\lambda$,
- the path $\gamma \in \mathfrak{R}_{(\Omega + \Omega')_L}^{*sym}$ is the line segment $[0, \zeta]$, that is $\gamma(s) = s\zeta$ for $s \in [0, 1]$ with ζ close enough to 0.
- λ is a (nonconstant) path of class \mathcal{C}^1 starting from ζ and ending at ξ such that $\lambda([0, 1]) \in \mathbb{C} \setminus (\Omega + \Omega')_L$.

Note that $(\Omega + \Omega')_L$ is a finite set. We have by hypothesis that

$$\inf_{t \in [0, 1]} d(\lambda(t), (\Omega + \Omega')_L) > 0$$

and moreover

$$(27) \quad \forall \omega \in (\Omega_L + \Omega'_L) \setminus (\Omega + \Omega')_L, \quad \inf_{t \in [0, 1]} d(\lambda(t), \omega) \geq L - \mathcal{L}_{\lambda_0} > 0.$$

We introduce $\kappa > 0$ such that

$$\forall \omega, \omega' \in \Omega_L, \omega \neq \omega' \Rightarrow |\omega - \omega'| \geq \kappa, \quad \forall \omega, \omega' \in \Omega'_L, \omega \neq \omega' \Rightarrow |\omega - \omega'| \geq \kappa.$$

For latter purpose, it will be useful to examine the case where the end point $\lambda_0(1) = \lambda(1)$ comes close to some $\omega_0 \in (\Omega + \Omega')_L$. This why we introduce here $(r_0, R_0) \in (\mathbb{R}^{++})^2$ and $(r_1, R_1) \in (\mathbb{R}^{++})^2$, subject to the conditions

$$0 < 2R_0 \leq 2R_1 < \kappa, \quad 0 < r_0 < R_0, \quad 0 < r_1 < R_1, \quad r_0 \leq r_1.$$

We add also the condition that

$$(28) \quad r_0 + R_0 \leq r_1 + R_1 < L - \mathcal{L}_{\lambda_0}.$$

The functions $R_{\Omega_L} : \Omega_L \rightarrow \mathbb{R}^{++}$, $r_{\Omega_L} : \Omega_L \rightarrow \mathbb{R}^{++}$, $R_{\Omega'_L} : \Omega'_L \rightarrow \mathbb{R}^{++}$, $r_{\Omega'_L} : \Omega'_L \rightarrow \mathbb{R}^{++}$ are given as follows:

- $R_{\Omega_L}(0) = R_{\Omega'_L}(0) = R_0$ and $r_{\Omega_L}(0) = r_{\Omega'_L}(0) = r_0$.
- if $(\omega, \omega') \in \Omega_L \times \Omega'_L$ is such that $\omega_0 = \omega + \omega'$, then $R_{\Omega_L}(\omega) = R_{\Omega'_L}(\omega') = R_0$, $r_{\Omega_L}(\omega) = r_{\Omega'_L}(\omega') = r_0$.
- otherwise $R_{\Omega_L} = R_{\Omega'_L} = R_1$, $r_{\Omega_L} = r_{\Omega'_L} = r_1$.

Now, adjusting (r_0, R_0) and (r_1, R_1) if necessary, we can assume that :

- λ satisfies:

$$(29) \quad \inf_{t \in [0, 1]} d(\lambda(t), \omega_0) > r_0 + R_0 \quad \text{and}$$

$$(30) \quad \inf_{t \in [0, 1]} d(\lambda(t), \omega + \omega') > r_1 + R_1 \quad \text{when} \quad \omega + \omega' \neq \omega_0, \quad (\omega, \omega') \in \Omega_L \times \Omega'_L.$$

(This is possible from the property (27) under the condition (28)).

- For the line segment $\gamma \in \mathfrak{R}_{(\Omega+\Omega')_L}^{*sym}$, there exists $0 < s_0 < 1$ (s_0 depends on r_0) such that

$$(31) \quad \forall s \in [0, s_0[, |\gamma(s)| < r_0.$$

Furthermore we can assume that

$$\forall \omega \in \Omega_L, \inf_{s \in [s_0, 1]} d(\gamma(s), \omega) \geq r_{\Omega_L}(\omega), \quad \forall \omega' \in \Omega'_L, \inf_{s \in [s_0, 1]} d(\gamma(s), \omega') \geq r_{\Omega'_L}(\omega').$$

We are now in position to apply the preparatory lemmas of Chapter 3 with $A = \Omega_L$ and $B = \Omega'_L$.

1. We consider the map $\Gamma : (s, t) \in [0, 1] \times [0, 1] \mapsto \Gamma(s, t) \in \mathbb{C}$ given by Lemma 3.3.1, with $f_1 = f_{\Omega_L, R_{\Omega_L}, r_{\Omega_L}}$ and $f_2 = f_{\Omega'_L, R_{\Omega'_L}, r_{\Omega'_L}}$ defined by Proposition 3.1.1.

In particular, Γ is of class \mathcal{C}^1 and

$$\forall (s, t) \in [0, 1] \times [0, 1], |\Gamma(s, t)| \leq \mathcal{L}_{\lambda_0} < L$$

and

$$\forall (s, t) \in [0, 1] \times [0, 1], |\Gamma^\circ(s, t)| \leq \mathcal{L}_{\lambda_0} < L$$

where $\Gamma^\circ(s, t) = \lambda(t) - \Gamma(1-s, t)$.

2. By the definition of f_1 and f_2 and using the conditions (29) and (30), one can apply Lemma 3.3.2 to get :
 - $\forall t \in [0, 1]$, the path $\Gamma_t : s \in [0, 1] \mapsto \Gamma_t(s) = \Gamma(s, t)$ belongs to \mathfrak{R} and $\Gamma(1, t) = \lambda(t)$ while $\Gamma_0 = \gamma$.
 - $\forall t \in [0, 1]$, the path $\Gamma_t^\circ : s \in [0, 1] \mapsto \Gamma_t^\circ(s) = \Gamma^\circ(s, t)$ belongs to \mathfrak{R} and $\Gamma^\circ(1, t) = \lambda(t)$ while $\Gamma_0^\circ = \gamma$.
3. Conditions (29) and (30) imply that Lemma 3.3.3 can be applied to Γ .
4. We know that $r_{\Omega_L}(0) = r_{\Omega'_L}(0) = r_0$ and that $\forall s \in [0, s_0[, |\gamma(s)| < r_0$. These hypotheses allow us to apply Lemma 3.3.4, that is the map Γ satisfies:

$$(32) \quad \forall (s, t) \in [0, s_0] \times [0, 1], \Gamma_t(s) = \Gamma_t^\circ(s) = \gamma(s)$$

and in particular

$$\forall (s, t) \in]0, s_0[\times [0, 1], \Gamma_t(s) = \Gamma_t^\circ(s) \in \mathbb{C} \setminus (\Omega_L \cup \Omega'_L).$$

5. Finally, Lemma 3.3.5 can be applied as well : the map Γ satisfies:

$$(33) \quad \forall (s, t) \in [s_0, 1] \times [0, 1], \forall \omega \in \Omega_L, |\Gamma_t(s) - \omega| \geq r_{\Omega_L}(\omega)$$

and

$$(34) \quad \forall (s, t) \in [s_0, 1] \times [0, 1], \forall \omega \in \Omega'_L, |\Gamma_t^\circ(s) - \omega| \geq r_{\Omega'_L}(\omega).$$

Putting things together, we conclude that the map Γ satisfies:

1. Γ is a map of class \mathcal{C}^1 such that $\forall t \in [0, 1], \Gamma_t \in \mathfrak{R}, \Gamma_t^\circ = \Gamma_t^* \in \mathfrak{R}$ with $\Gamma_0 = \gamma$ and $\forall t \in [0, 1], \Gamma_t(1) = \lambda(t)$.
2. for every $t \in [0, 1], \Gamma_t$ is such that

$$\forall s \in]0, 1], \Gamma_t(s) \in D(0, L) \setminus \Omega_L.$$

Symmetrically, for every $t \in [0, 1], \Gamma_t^\circ$ satisfies :

$$\forall s \in]0, 1], \Gamma_t^\circ(s) \in D(0, L) \setminus \Omega'_L.$$

We note that we may have $\mathcal{L}_{\Gamma_t} \geq L$, so that Γ_t does not belong to $\mathfrak{R}_{\Omega_L}^*$ as a rule, despite the above properties. Nevertheless, what follows will allow us to conclude with the help of Proposition 2.2.4.

3. By Lemma 3.3.1, for every $s \in [0, 1]$, the maps

$$\Gamma^s : t \in [0, 1] \mapsto \Gamma^s(t) = \Gamma(s, t), \quad \Gamma^{\circ s} : t \in [0, 1] \mapsto \Gamma^{\circ s}(t) = \Gamma^\circ(s, t),$$

satisfy

$$\mathcal{L}_{\Gamma^s} \leq \mathcal{L}_\lambda, \quad \mathcal{L}_{\Gamma^{\circ s}} \leq \mathcal{L}_\lambda.$$

We know that $\Gamma^s(0) = \Gamma^{\circ s}(0) = \gamma(s)$, thus for every $s \in [0, 1]$ the paths

$$(35) \quad F^s : t \in [0, 1] \mapsto F^s(t) = \begin{cases} \gamma(2ts) & \text{for } t \in [0, \frac{1}{2}] \\ \Gamma^s(2t-1) & \text{for } t \in [\frac{1}{2}, 1] \end{cases}$$

and

$$F'^s : t \in [0, 1] \mapsto F'^s(t) = \begin{cases} \gamma(2ts) & \text{for } t \in [0, \frac{1}{2}] \\ \Gamma^{\circ s}(2t-1) & \text{for } t \in [\frac{1}{2}, 1] \end{cases}$$

are well defined and satisfy:

- F^s and F'^s are \mathcal{C}^1 by parts,
- $F^s(0) = F'^s(0) = 0$ and $\forall t \in]0, 1]$, $F^s(t) \in D(0, L) \setminus \Omega_L$, $F'^s(t) \in D(0, L) \setminus \Omega'_L$,
- $\mathcal{L}_{F^s} \leq \mathcal{L}_\gamma + \mathcal{L}_\lambda$ thus $\mathcal{L}_{F^s} \leq \mathcal{L}_{\lambda_0} < L$. In the same way, $\mathcal{L}_{F'^s} \leq \mathcal{L}_{\lambda_0} < L$.

This implies that $F^s \in \mathfrak{R}_{\Omega_L}^*$ and $F'^s \in \mathfrak{R}_{\Omega'_L}^*$ for every $s \in [0, 1]$. In particular each F^s , *resp.* F'^s , can be uniquely lifted on $\mathcal{R}_{\Omega_\star}$ with respect to π , *resp.* $\mathcal{R}_{\Omega'_\star}$ with respect to π' , into a path \widehat{F}^s , *resp.* \widehat{F}'^s , starting from $0 \in \mathcal{R}_{\Omega_\star}$, *resp.* $0 \in \mathcal{R}_{\Omega'_\star}$. Since moreover the maps

$$F : (s, t) \in [0, 1]^2 \mapsto F^s(t), \quad F' : (s, t) \in [0, 1]^2 \mapsto F'^s(t)$$

are continuous, the maps $s \in [0, 1] \mapsto \widehat{F}^s$, *resp.* $s \in [0, 1] \mapsto \widehat{F}'^s$, give rise to two continuous maps

$$\widehat{F} : (s, t) \in [0, 1]^2 \mapsto \widehat{F}(s, t) = \widehat{F}^s(t) \in \mathcal{R}_{\Omega_\star}$$

resp.

$$\widehat{F}' : (s, t) \in [0, 1]^2 \mapsto \widehat{F}'(s, t) = \widehat{F}'^s(t) \in \mathcal{R}_{\Omega'_\star}.$$

4. What we have obtained can be translated as follows : we have two continuous family of paths $\widehat{F}_t \in \widehat{\mathfrak{R}}_{\Omega_\star}$ and $\widehat{F}'_t \in \widehat{\mathfrak{R}}_{\Omega'_\star}$ depending on $t \in [0, 1]$ defined by

$$\widehat{F}_t : s \in [0, 1] \mapsto \widehat{F}_t(s) = \widehat{F}(s, t), \quad \widehat{F}'_t : s \in [0, 1] \mapsto \widehat{F}'_t(s) = \widehat{F}'(s, t).$$

Therefore $\pi(\widehat{F}_t) = F_t \in \mathfrak{R}_{\Omega_\star}$ and $\pi'(\widehat{F}'_t) = F'_t \in \mathfrak{R}_{\Omega'_\star}$.

5. We observe that $\lambda_0 = \gamma\lambda$ is defined by

$$\lambda_0 : t \in [0, 1] \mapsto \lambda_0(t) = \begin{cases} \gamma(2t) & \text{for } t \in [0, \frac{1}{2}] \\ \lambda(2t-1) & \text{for } t \in [\frac{1}{2}, 1] \end{cases}$$

so that, using the hypothesis made on γ , that is γ is a line segment,

$$F'(s, t) = \begin{cases} \gamma(2t) - \gamma(2t(1-s)) = \lambda_0(t) - \gamma(2t(1-s)) & \text{for } t \in [0, \frac{1}{2}] \\ \lambda(2t-1) - \Gamma(1-s, 2t-1) = \lambda_0(t) - \Gamma(1-s, 2t-1) & \text{for } t \in [\frac{1}{2}, 1] \end{cases}$$

Therefore, $F' = F^\circ$.

6. We now show that λ_0 and F_1 are homotopic in the space $\mathfrak{R}_{\Omega_\star}$. For doing that we consider the continuous map

$$\widehat{H} : (s, t) \in [0, 1]^2 \mapsto \widehat{H}_t(s) = \begin{cases} \widehat{F}((2-t)s, t) & \text{for } s \in [0, \frac{1}{2-t}] \\ \widehat{F}(1, (2-t)s + t - 1) & \text{for } s \in [\frac{1}{2-t}, 1] \end{cases}$$

and its projection $H = \pi(\widehat{H})$,

$$(36) \quad H : (s, t) \in [0, 1]^2 \mapsto H_t(s) = \begin{cases} F((2-t)s, t) & \text{for } s \in [0, \frac{1}{2-t}] \\ F(1, (2-t)s + t - 1) & \text{for } s \in [\frac{1}{2-t}, 1] \end{cases}$$

By construction $t \in [0, 1] \mapsto H_t \in \mathfrak{R}_{\Omega_\star}$ and we observe that $H_1 = F_1$ while $H_0 = \lambda_0$ up to reparametrization, precisely:

$$H_0(s) = \begin{cases} \gamma(0) & \text{for } s \in [0, \frac{1}{2-t}] \\ \gamma(2u), u = 2s - 1 \in [0, \frac{1}{2}] & \text{for } s \in [\frac{1}{2}, \frac{3}{4}] \\ \Gamma(1, 2u - 1) = \lambda(2u - 1), u = 2s - 1 \in [\frac{1}{2}, 1] & \text{for } s \in [\frac{3}{4}, 1] \end{cases}$$

In the same way, the map

$$H^\circ : (s, t) \in [0, 1]^2 \mapsto H_t^\circ(s) = \lambda_0(t) - H_t(1-s)$$

provides a homotopy in the space $\mathfrak{R}_{\Omega'_\star}$ between $H_1^\circ = F_1^\circ$ and H_0° while $H_0^\circ = \lambda_0$ up to reparametrization. □

5.4.3. Seen and glimpsed singular points. — The ideas develop in the proof of Theorem 5.4.2 can be easily adapted so as to get the following information on seen and glimpsed singular points, cf. §5.3.

Theorem 5.4.3. — *We assume that Ω_\star and Ω'_\star are two discrete filtered sets centred at 0. We note $\text{Sing}_{\Omega_\star}^\star(\theta)$ and $\text{Sing}_{\Omega'_\star}^\star(\theta)$ the set of glimpsed singular points associated to Ω_\star and Ω'_\star for a given direction $\theta \in \frac{\mathbb{R}}{2\pi\mathbb{Z}}$ (see Definition 5.3.4).*

Then for every path λ_0 in \mathfrak{R} that closely follows the half-line $[0, e^{i\theta}\infty[$ in the forward direction and circumvents to the right or the left the set $(\text{Sing}_{\Omega_\star}(\theta) + \text{Sing}_{\Omega'_\star}(\theta)) \setminus$

$\{0\}$, there exists a continuous map $F : (s, t) \in [0, 1] \times [0, 1] \mapsto F(s, t) = F_t(s) \in \mathbb{C}$ such that

- $F_0 \equiv 0$,
- $\forall t \in [0, 1], F_t(1) = \lambda_0(t)$,
- $\forall t \in [0, 1], F_t \in \mathfrak{R}_{\Omega_\star}$,
- $\forall t \in [0, 1], F_t^\circ \in \mathfrak{R}_{\Omega_\star'}^{\circ}$ where $F_t^\circ(s) = \lambda_0(t) - F_t(1 - s)$.

Proof. — We use the notations of §5.3 and we adapt the proof of Theorem 5.4.2, allowing us a sketchy manner. We can assume that λ_0 is so that:

- $\lambda_0 \in \mathfrak{R}(\Omega_\star, L, \theta) \cap \mathfrak{R}(\Omega_\star', L, \theta)$ for some $L > 0$.
- $\lambda_0 = \gamma\lambda$ and λ_0 avoids the set $(\text{Sing}_{\Omega_\star}(\theta) + \text{Sing}_{\Omega_\star'}(\theta)) \setminus \{0\}$.
- the path γ is the line segment $[0, \zeta]$ for $\zeta \in]0, e^{i\theta}\infty[$ close enough to 0.
- λ is a (nonconstant) path starting from ζ such that for $\alpha > 0$ small enough

$$\forall t \in [0, 1], \arg(\lambda'(t)) \in]-\alpha + \theta, \theta + \alpha[\quad \text{or} \quad \lambda'(t) = 0.$$

In the proof of Theorem 5.4.2, we now replace Ω_L by $\text{Sing}_{\Omega_L}(\theta)$ and Ω_L' by $\text{Sing}_{\Omega_L'}(\theta)$. In this way, one gets a map Γ which satisfies:

1. Γ is a map of class \mathcal{C}^1 such that $\forall t \in [0, 1], \Gamma_t \in \mathfrak{R}, \Gamma_t^\circ = \Gamma_t^\star \in \mathfrak{R}$ with $\Gamma_0 = \gamma$ and $\forall t \in [0, 1], \Gamma_t(1) = \lambda(t)$.
2. for every $t \in [0, 1], \Gamma_t$ is such that

$$\forall s \in]0, 1], \Gamma_t(s) \in D(0, L) \setminus \text{Sing}_{\Omega_L}(\theta).$$

Symmetrically, for every $t \in [0, 1], \Gamma_t^\circ$ satisfies :

$$\forall s \in]0, 1], \Gamma_t^\circ(s) \in D(0, L) \setminus \text{Sing}_{\Omega_L'}(\theta).$$

3. By Lemma 3.3.1, for every $s \in [0, 1]$, the maps

$$\Gamma^s : t \in [0, 1] \mapsto \Gamma^s(t) = \Gamma(s, t), \quad \Gamma^{\circ s} : t \in [0, 1] \mapsto \Gamma^{\circ s}(t) = \Gamma^\circ(s, t),$$

satisfy

$$\mathcal{L}_{\Gamma^s} \leq \mathcal{L}_\lambda, \quad \mathcal{L}_{\Gamma^{\circ s}} \leq \mathcal{L}_\lambda.$$

and moreover

$$\forall t \in [0, 1], \arg\left(\frac{d\Gamma^s}{dt}(t)\right) \in]-\alpha + \theta, \theta + \alpha[\quad \text{or} \quad \frac{d\Gamma^s}{dt}(t) = 0.$$

A similar property works for $\Gamma^{\circ s}$. We introduce the paths

$$(37) \quad F^s : t \in [0, 1] \mapsto F^s(t) = \begin{cases} \gamma(2ts) & \text{for } t \in [0, \frac{1}{2}] \\ \Gamma^s(2t - 1) & \text{for } t \in [\frac{1}{2}, 1] \end{cases}$$

and its symmetric $F^{\circ s}$. One observes that:

- F^s and $F^{\circ s}$ are \mathcal{C}^1 ,
- $F^s(0) = F^{\circ s}(0) = 0$, F^s avoids the $\text{Sing}_{\Omega_L}^\star(\theta)$, $F^{\circ s}$ avoids the set $\text{Sing}_{\Omega_L'}^\star(\theta)$,
- $\mathcal{L}_{F^s} \leq \mathcal{L}_{\lambda_0} < L$ and $\mathcal{L}_{F^{\circ s}} \leq \mathcal{L}_{\lambda_0} < L$.
- $\forall t \in [0, 1], \arg\left(\frac{dF^s}{dt}(t)\right) \in]-\alpha + \theta, \theta + \alpha[$ or $\frac{dF^s}{dt}(t) = 0$ and a similar property for $F^{\circ s}$.

This means that $F^s \in \mathfrak{R}(\Omega_\star, L, \theta)$ and avoids $\text{Sing}_{\Omega'_L}^\star(\theta)$, similarly $F^{\circ s} \in \mathfrak{R}(\Omega'_\star, L, \theta)$ and avoids $\text{Sing}_{\Omega_L}^\star(\theta)$. One can apply Proposition 5.3.1 to get that each F^s , *resp.* $F^{\circ s}$, can be uniquely lifted on $\mathcal{R}_{\Omega_\star}$ with respect to π , *resp.* $\mathcal{R}_{\Omega'_\star}$ with respect to π' .

Arrived at this stage, one then concludes like in the proof of Theorem 5.4.2. \square

5.4.4. Monodromy. — We go back to the proof of Theorem 5.4.2. With the terminology used in the Example 2.3.3 and exemplified by Figure 5 (see also §3.5), we want to translate what we have obtained into how the paths Γ_t avoid both the “fixed singular points” $\omega \in \Omega_L$ and the “movable singular points” $\lambda(t) - \omega'$, $\omega' \in \Omega'_L$. In other words, one considers the path Γ_t as:

$$(38) \quad \Gamma_t : s \in [0, 1] \mapsto \begin{cases} 0 & \text{if } s = 0 \\ \Gamma_t(s) \in \mathbb{C} \setminus (\Omega_L \cup \{\lambda(t) - \Omega'_L\}) & \text{if } s \neq 0 \end{cases}$$

This will help us to examine the behavior of these paths when the end point $\lambda_0(1)$ of λ_0 comes close to a point $\omega_0 \in (\Omega + \Omega')_L$.

To fix our mind, we assume that $\omega_0 = \omega'_0 \in A \cup B$ for some $n \in \mathbb{N}$ and that there exists a set of $n + 1$ distinct couples $(\omega_i, \omega'_{n-i}) \in \Omega_L \times \Omega'_L$, $i = 0, \dots, n$, $n \in \mathbb{N}$, such that $\omega_0 = \omega_i + \omega'_i$ (thus $\omega'_n = 0 = \omega_n$).

We remind that $\Gamma_t^\circ(s) = \lambda(t) - \Gamma_t(1 - s)$.

- Formulas (31) and (32) provide informations near the end points of $\Gamma_t : \Gamma_t(s) = \gamma(s)$ for $s \in [0, s_0]$ and $\Gamma_t(s) = \lambda(t) - \gamma(1 - s)$ for $s \in [1 - s_0, 1]$. In particular, for $\forall t \in [0, 1]$,

$$(39) \quad \forall s \in [0, s_0], \forall \omega \in \Omega_L \setminus \{0\}, \quad |\Gamma_t(s) - \omega| > R_1$$

because $|\Gamma_t(s)| \leq r_0$ and $r_0 + R_1 < 2R_1 < \kappa$. Also, using (29) and (30),

$$(40) \quad \forall s \in [1 - s_0, 1], \forall \omega' \in \Omega'_L, \quad \begin{aligned} |\Gamma_t(s) - (\lambda(t) - \omega')| &> R_0 & \text{if } \omega' = \omega'_0 \\ |\Gamma_t(s) - (\lambda(t) - \omega')| &> R_1 & \text{when } \omega' \neq \omega'_0. \end{aligned}$$

- Otherwise, by (33) and $\forall t \in [0, 1]$

$$(41) \quad \forall s \in [s_0, 1], \forall \omega \in \Omega_L, \quad \begin{aligned} |\Gamma_t(s) - \omega| &\geq r_0 & \text{if } \omega = \omega_i, i = 0, \dots, n \\ |\Gamma_t(s) - \omega| &\geq r_1 & \text{else.} \end{aligned}$$

Now using (34), $\forall t \in [0, 1]$

$$(42) \quad \forall s \in [0, 1 - s_0], \forall \omega' \in \Omega'_L, \quad \begin{aligned} |\Gamma_t(s) - (\lambda(t) - \omega')| &\geq r_0 & \text{if } \omega' = \omega'_i, i = 0, \dots, n \\ |\Gamma_t(s) - (\lambda(t) - \omega')| &\geq r_1 & \text{else.} \end{aligned}$$

- Going back to (35), one sees that $\Gamma_1 = F_1$ and we know from (36) that F_1 and λ_0 are homotopic in the space of paths $\mathfrak{R}_{\Omega_\star}$. This translate into the fact that the path Γ_1 and λ_0 are homotopic as paths in $\mathbb{C} \setminus \Omega_L$ (apart from their origin). Symmetrically, Γ_1° and λ_0 are homotopic in the space of paths $\mathfrak{R}_{\Omega'_\star}$, thus Γ_1° and λ_0 as paths in $\mathbb{C} \setminus \Omega'_L$ (apart from their origin). This translate into the property that Γ_1 is homotopic to the path λ_0^\star in the space of paths in $\mathbb{C} \setminus \{\lambda(1) - \Omega'_L\}$. (We remind that $\lambda_0^\star(s) = \lambda_0(1) - \lambda_0(1 - s)$).

We are ready to see what happens when $\lambda_0(1) = \lambda(1)$ approaches ω_0 , that is $\lambda(1) = \omega_0 + \xi$, ξ close enough to zero. Following condition (29), we thus take $|\xi| \gtrsim r_0 + R_0$ and we assume that $R_0 \simeq 0$ (and thus $r_0 \simeq 0$ and $s_0 \simeq 0$ as well), while r_1 and R_1 can be kept fixed. We distinguish:

- the boundary type singularity : since $\Gamma_1(1) = \lambda(1)$, the end point $\Gamma_1(1)$ meets the singular point ω_0 at the same time than $\lambda(1)$ when $\xi \rightarrow 0$. Symmetrically, the starting point $\Gamma_1(0) = 0$ meets the movable singular point $\lambda(1) - \omega'_0$ (in formula (42), this corresponds to the case $\omega' = \omega'_0$).
- the pinching type singularity : we see by (41) that for some $s \in [s_0, 1]$, $\Gamma_1(s)$ may approach a singular point ω_i . At the same time, by (42), $\Gamma_1(s)$ may be close to a movable singular point $\lambda(1) - \omega'_j$. If $j = n - i$, that is $\omega_i + \omega'_j = \omega_0$, then the path Γ_1 is “pinched” between ω_i and $\lambda(1) - \omega'_j$ when $\xi \rightarrow 0$, provided that Γ_1 intersects the line segment $[\omega_i, \lambda(1) - \omega'_j]$.

We now make a soft “Picard-Lefschetz”-like analysis [Ph005, AVG88]. We complete λ with a clockwise loop $\ell_{\omega_0}(= \ell_{\omega'_0})$ around $\omega_0(= \omega'_0)$, that is

$$\ell_{\omega_0}(t) = \omega_0 + \xi e^{-2i\pi t}.$$

In other words we introduce

$$\tilde{\lambda} = \lambda \ell_{\omega_0} : t \in [0, 1] \mapsto \tilde{\lambda}(t) = \begin{cases} \lambda(2t), & t \in [0, \frac{1}{2}] \\ \ell_{\omega_0}(2t - 1), & t \in [\frac{1}{2}, 1] \end{cases}$$

(It is needless to say that we still assume that $\mathcal{L}_{\gamma\tilde{\lambda}} < L$).

If Γ_t is the deformation paths obtained from λ and if $\tilde{\Gamma}_t$ is that obtained from $\tilde{\lambda}$, one observes from their very definitions and from (32) that

$$(43) \quad \begin{cases} \tilde{\Gamma}_t = \Gamma_{2t} & \text{for } t \in [0, \frac{1}{2}] \\ \Gamma_1(s) = \tilde{\Gamma}_1(s) = \gamma(s) & \text{for } s \in [0, s_0] \\ \Gamma_1(s) = \tilde{\Gamma}_1(s) = \omega_0 + \xi - \gamma(1 - s) & \text{for } s \in [1 - s_0, 1]. \end{cases}$$

We would like to compare $\Gamma_1 = \tilde{\Gamma}_{1/2}$ and $\tilde{\Gamma}_1$.

- By Lemma 3.3.1,

$$\forall s \in [0, 1], |\tilde{\Gamma}_1(s) - \tilde{\Gamma}_{1/2}(s)| \leq \pi|\xi|.$$

- From what we have previously seen, the product⁽³⁾ $\tilde{\Gamma}_{1/2}\tilde{\Gamma}_1^{-1}$ is a loop in $\mathbb{C} \setminus (\Omega_L \cup \{\omega_0 + \xi - \Omega'_L\})$.
- *Variation near a boundary type singular point.* Seen as paths in $\mathbb{C} \setminus \Omega_L$ (apart from their origin), $\tilde{\Gamma}_{1/2}$ is homotopic to λ_0 while $\tilde{\Gamma}_1$ is homotopic to $\lambda_0 \ell_{\omega_0}$. Thus $\tilde{\Gamma}_{1/2}\tilde{\Gamma}_1^{-1}$ is homotopic in $\mathbb{C} \setminus \Omega_L$ to the loop $\ell_{\omega_0}^{-1}$, like on Fig. 17.

Symmetrically, seen as paths in $\mathbb{C} \setminus \{\omega_0 + \xi - \Omega'_L\}$, $\tilde{\Gamma}_{1/2}$ is homotopic to λ_0^* while $\tilde{\Gamma}_1$ is homotopic to $(\lambda_0 \ell_{\omega_0})^*$. Thus $\tilde{\Gamma}_{1/2}\tilde{\Gamma}_1^{-1}$ is homotopic in $\mathbb{C} \setminus \{\omega_0 + \xi - \Omega'_L\}$ to the loop $\omega_0 + \xi - \ell_{\omega_0}$, that is a clockwise loop around $\xi = \omega_0 + \xi - \omega'_0$. See Fig. 18.

- *Variation near a pinching type singular point.* Assume that $\tilde{\Gamma}_{1/2}$ intersects (may be several times) the line segment $[\omega_i, \lambda(1) - \omega'_{n-i}]$, $\omega_i + \omega'_{n-i} = \omega_0$, $\omega_i \in \Omega_L$, $\omega'_{n-i} \in \Omega'_L$. When one completes λ with the loop ℓ_{ω_0} , the movable singular point $\tilde{\lambda}(t) - \omega'_{n-i}$ turns clockwise around w_i . Locally near the pinching point,

⁽³⁾We remind that the path $\tilde{\Gamma}_1^{-1}$ is the inverse path, $\tilde{\Gamma}_1^{-1}(s) = \tilde{\Gamma}_1(1 - s)$.

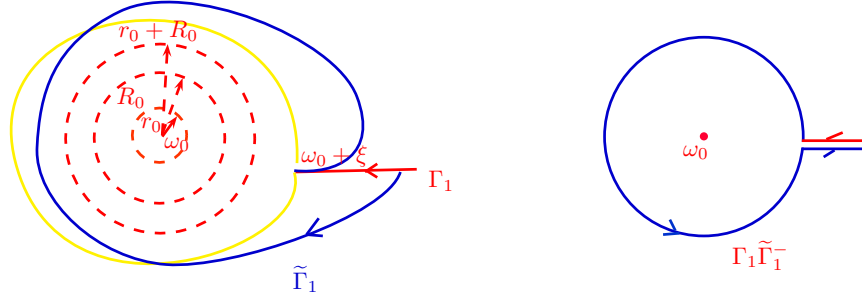

FIGURE 17

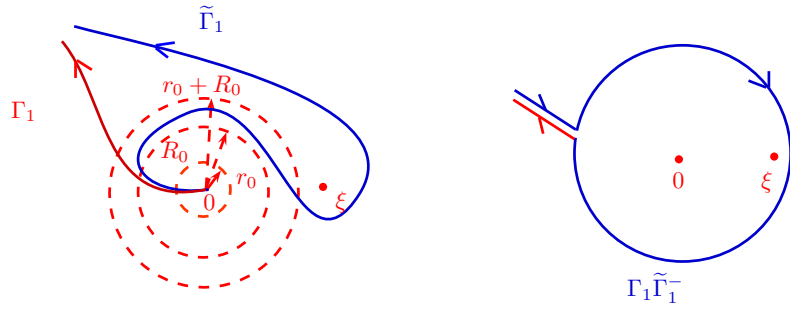

FIGURE 18

the behavior of $\tilde{\Gamma}_{1/2} \tilde{\Gamma}_1^{-1}$ is thus homotopic to the path drawn on Fig. 19 (up to multiplicity if $\tilde{\Gamma}_{1/2}$ intersects several times the line segment $[\omega_i, \lambda(1) - \omega'_{n-i}]$).

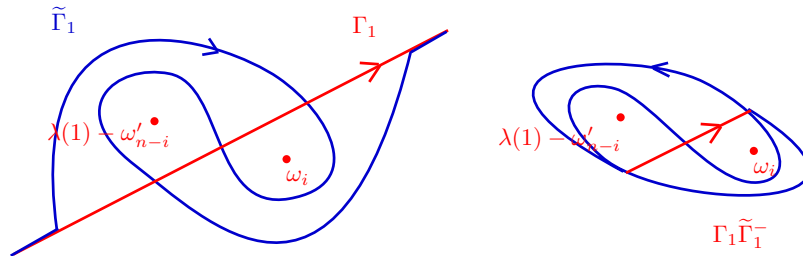

FIGURE 19

The above analysis will be used in the next chapter.

5.5. Application : the convolution algebra \mathcal{H}_{end}

Theorem 5.4.2 provides one of the main result of the paper :

Theorem 5.5.1. — *The space \mathcal{H}_{end} of endlessly continuable germs of analytic functions at the origin makes a convolution algebra. More precisely, if Ω_\star and Ω'_\star are two discrete filtered sets centred at 0, if $\varphi \in \mathcal{H}(\mathcal{R}_{\Omega_\star})$ and $\psi \in \mathcal{H}(\mathcal{R}_{\Omega'_\star})$, then $\varphi * \psi \in \mathcal{H}(\mathcal{R}_{(\Omega+\Omega')_\star})$.*

Proof. — Assume that Ω_\star and Ω'_\star are two discrete filtered sets centred at 0. Consider a homotopy class of paths σ in $\mathfrak{R}_{(\Omega+\Omega')_\star}^\star$. From Theorem 5.4.2, there exists a continuous map $F : (s, t) \in [0, 1] \times [0, 1] \mapsto F(s, t) = F_t(s) \in \mathbb{C}$ such that

- $F_0 \equiv 0$,
- $\forall t \in [0, 1], F_t(1) = \lambda_0(t)$,
- $\forall t \in [0, 1], F_t \in \mathfrak{R}_{\Omega_\star}$,
- $\forall t \in [0, 1], F_t^\circ \in \mathfrak{R}_{\Omega'_\star}$ where $F_t^\circ(s) = \lambda_0(t) - F_t(1 - s)$.
- $\text{cl}(\lambda_0) = \sigma$.

Proposition 2.3.2 can be applied, which shows that the convolution product $\varphi * \psi$ can be analytically continued along λ_0 . Since $\mathcal{R}_{(\Omega+\Omega')_\star}$ is simply connected, one concludes that $\varphi * \psi \in \mathcal{H}(\mathcal{R}_{(\Omega+\Omega')_\star})$. \square

We mention that Theorem 5.5.1 is less precise than Theorem 5.4.1 announced in [CNP93-1] which we have been unable to obtain directly by our method. However in Chap. 6 (see Proposition 6.4.2) we shall recover Theorem 5.4.1 from Theorem 5.5.1 when adding considerations on alien derivatives and from the following Corollary.

Corollary 5.5.1. — *Assume that $\varphi, \psi \in \mathcal{H}_{end}$. For a given direction $\theta \in \frac{\mathbb{R}}{2\pi\mathbb{Z}}$ we note $\text{Sing}_\varphi^\star(\theta)$ and $\text{Sing}_\psi^\star(\theta)$ the sets of their glimpsed singular points in the direction θ (cf. Definition 5.3.5). Then*

$$\text{Sing}_{\varphi*\psi}^\star(\theta) \subseteq (\text{Sing}_\varphi(\theta) + \text{Sing}_\psi(\theta)) \setminus \{0\}.$$

Proof. — Just like the proof of Theorem 5.5.1, using Theorem 5.4.3. \square

Remark : Defining the discrete filtered sets $\text{Sing}_\varphi(\theta)_\star$, resp. $\text{Sing}_\psi(\theta)_\star$, by $\text{Sing}_\varphi(\theta)_L = \text{Sing}_\varphi(\theta) \cap [0, e^{i\theta}L[$, resp. $\text{Sing}_\psi(\theta)_L = \text{Sing}_\psi(\theta) \cap [0, e^{i\theta}L[$, one sees that the discrete filtered sum $(\text{Sing}_\varphi(\theta) + \text{Sing}_\psi(\theta))_\star$ coincides both with Definition 5.1.3 as well as with Definition 5.4.1, because $\text{Sing}_\varphi(\theta)$ and $\text{Sing}_\psi(\theta)$ are both subsets of the half-line $[0, e^{i\theta}\infty[$: this is the fact that is quite interesting when comparing Theorem 5.5.1 and Corollary 5.5.1.

We end this section with the following corollary which provides (by the way rather bad) estimates for a convolution product.

Definition 5.5.1. — *If Ω_\star is a discrete filtered set centred at 0, for every $L > 0$ and every $r > 0$ small enough we denote by $K_{\Omega_\star, L, r} \subset \mathcal{R}_{\Omega_\star}$ the bounded set defined by*

$$K_{\Omega_\star, L, r} = \{z = (\zeta, \text{cl}(\lambda)) \in \mathcal{R}_{\Omega_\star} \text{ with } \lambda \in \mathfrak{R}_{\Omega_\star}^\star, d(\lambda, \Omega_\star) \geq r\}.$$

For $\varphi \in \mathcal{H}(\mathcal{R}_{\Omega_\star})$ we note

$$\|\varphi\|_{K_{\Omega_\star, L, r}} = \sup_{z \in K_{\Omega_\star, L, r}} |\Phi(z)|$$

where Φ stands for the analytic continuation of φ on $\mathcal{R}_{\Omega_\star}$.

Corollary 5.5.2. — *If Ω_\star and Ω'_\star are two discrete filtered set centred at 0, then for every $L > 0$, for every $0 < r < R$ small enough⁽⁴⁾, for every $\nu > 1$ and every $\varphi \in \mathcal{H}(\mathcal{R}_{\Omega_\star})$ and $\psi \in \mathcal{H}(\mathcal{R}_{\Omega'_\star})$,*

$$\|\varphi * \psi\|_{K_{(\Omega+\Omega')_L, R+r}} \leq L e^{\frac{\nu}{R-r}L} \|\varphi\|_{K_{\Omega_L, r}} \|\psi\|_{K_{\Omega'_L, r}}.$$

Proof. — We go back to the proof of Theorem 5.4.2 with $R_0 = R_1 = R$ and $r_0 = r_1 = r$. For some $L > 0$ we take $\lambda_0 \in \mathfrak{A}_{(\Omega+\Omega')_L}^*$ with $d(\lambda, (\Omega + \Omega')_\star) \geq r + R$, thus $(\lambda_0(1), \text{cl}(\lambda_0)) \in K_{(\Omega+\Omega')_L, R+r}$. The path F_1 belongs to $\mathfrak{A}_{\Omega_\star}$ and by construction its lifting \widehat{F}_1 satisfies the property that :

$$\forall s \in [0, 1], \widehat{F}_1(s) \in K_{\Omega_L, r}.$$

Similarly,

$$\forall s \in [0, 1], \widehat{F}_1^\circ(s) \in K_{\Omega'_L, r}.$$

Furthermore $F_1(s) = \Gamma_1(s)$ and using the preparatory lemma 3.3.1,

$$\mathcal{L}_{\Gamma_1} \leq \mathcal{L}_{\lambda_0} e^{k\mathcal{L}\lambda_0} < L e^{kL}$$

where $k = \max |f'_{\Omega_L, R, r}| = \max |f'_{\Omega'_L, R, r}|$. Examining Proposition 3.1.1, one easily gets that for every $\nu > 1$ one can choose $f_{\Omega_L, R, r}$ and $f_{\Omega'_L, R, r}$ so that $k \leq \frac{\nu}{R-r}$. We thus get:

$$|\varphi * \psi(\lambda_0(1))| = \left| \int_{\Gamma_1} \varphi(\eta) \psi(\lambda_0(1) - \eta) d\eta \right| \leq L e^{\frac{\nu}{R-r}L} \|\varphi\|_{K_{\Omega_L, r}} \|\psi\|_{K_{\Omega'_L, r}}.$$

□

5.6. Ecalle's endless continuability, continuability without cut

We complete this chapter with a brief viewpoint of Ecalle.

5.6.1. Continuability without cut. — In [Ec85], §1.3.a, the following definition is given :

Definition 5.6.1 (Riemann surface without cut). — *A Riemann surface (\mathcal{R}, π) , given as an étalé space on \mathbb{C} , is said to be without cut if for every $z \in \mathcal{R}$, $\omega = \pi(z)$, there exists a closed and discrete set $\text{sing}(z) \subset \mathbb{C}$ which satisfies the following properties :*

1. *if the line segment $[\omega, \omega'] \subset \mathbb{C}$ does not meet $\text{sing}(z)$, then $[\omega, \omega']$ can be lifted homeomorphically on \mathcal{R} by π from z .*
2. *for every line segment $[\omega, \omega'] \subset \mathbb{C}$ which meets the points $\omega_1, \dots, \omega_r$ of $\text{sing}(z)$, there exists an open rectangle W neighborhood of $[\omega, \omega']$ such that each of the 2^r simply connected open sets W_j deduced from W by making lateral cuts at $\omega_1, \dots, \omega_r$ (see Fig. 20) can be lifted homeomorphically on \mathcal{R} by π to an open set $\mathcal{W}_j \subset \mathcal{R}$ containing z .*
3. *if at least one point is removed from $\text{sing}(z)$, then properties 1-2 are no more satisfied.*

⁽⁴⁾One must have $2R < \min\left\{ \inf_{\omega, \omega' \in \Omega_L, \omega \neq \omega'} |\omega - \omega'|, \inf_{\omega, \omega' \in \Omega'_L, \omega \neq \omega'} |\omega - \omega'| \right\}$

One says that the singular point $\omega_1 \in \text{sing}(z)$ is seen from z if $[\omega, \omega_1] \cap \text{sing}(z) = \{\omega_1\}$. Otherwise the singular points $\omega_j \in \text{sing}(z)$ are glimpsed from z .

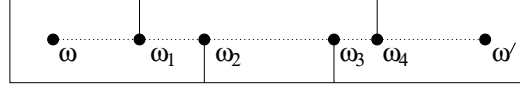

FIGURE 20

We note that in Definition 5.6.1, condition 3 is added so as to define the seen and glimpsed singular points.

This definition provides another definition of what can be the “endless continuability” :

Definition 5.6.2 (Continuability without cut). — *A germ of analytic functions $\varphi \in \mathcal{O}_0$ at $0 \in \mathbb{C}$ is said to be analytically continuable without cut on \mathbb{C} if its Riemann surface is without cut.*

Proposition 5.6.1. — *We consider a Riemann surface (\mathcal{R}, π) . If \mathcal{R} is endless in the sense of Definition 5.2.1, then \mathcal{R} is without cut.*

Proof. — We assume that the Riemann surface (\mathcal{R}, π) is endless. We consider $z \in \mathcal{R}$, $\omega = \pi(z)$: there exists a discrete filtered set Ω_\star centred at ω such that every Ω_\star -allowed path $\lambda \in \mathfrak{R}_{\Omega_\star}^\star$ starting from ω can be lifted on \mathcal{R} from z with respect to π . We consider the line segment $[\omega, \omega'] \subset \mathbb{C}$ and $L > l > 0$ where $l = |\omega' - \omega|$.

1. Assume that the line segment $[\omega, \omega']$ does not meet Ω_L apart from ω . Then the path $\lambda : t \in [0, 1] \mapsto \omega + t(\omega' - \omega)$ belongs to $\mathfrak{R}_{\Omega_L}^\star$ and thus can be lifted by π from z .
2. Assume that the line segment $[\omega, \omega']$ meets the points $\omega, \omega_1, \dots, \omega_r$ of Ω_L . Consider an open rectangle W centred on (and thus neighborhood of) $[\omega, \omega']$ of length $l + 2l'$ and width $2l'$ where $l' > 0$ satisfies $l + 2l' > L$. For l' small enough one has $W \cap \Omega_L = \{\omega, \omega_1, \dots, \omega_r\}$ and $\forall \zeta \in W \setminus \{\omega_1, \dots, \omega_r\}$, there exists a path $\lambda \in \mathfrak{R}_{\Omega_L}^\star$ such that $\lambda([0, 1]) \subset W \setminus \{\omega_1, \dots, \omega_r\}$, $\lambda(0) = \omega$ and $\lambda(1) = \zeta$.

Now assume that W_j is one of the 2^r simply connected open sets W_j deduced from W by making lateral cuts at $\omega_1, \dots, \omega_r$ (see Fig. 20). Then $\forall \zeta \in W_j$, there exists a path $\lambda \in \mathfrak{R}_{\Omega_L}^\star$ such that $\lambda([0, 1]) \subset W_j$, $\lambda(0) = \omega$ and $\lambda(1) = \zeta$. This path can be lifted with respect to π into a path starting from z and ending at a point y such that $\pi(y) = \zeta$. We note \mathcal{W}_j the set of these points y .

By its very definition, \mathcal{W}_j is an open arcconnected subset of \mathcal{R} such that $\pi(\mathcal{W}_j) = W_j$. Moreover $\pi|_{\mathcal{W}_j}$ is injective. Indeed, if one considers two paths $\lambda_0, \lambda_1 \in \mathfrak{R}_{\Omega_L}^\star$ such that $\lambda_1([0, 1]) \subset W_j$ and $\lambda_2([0, 1]) \subset W_j$ and ending at the same point $\zeta \in W_j$, one can easily construct a homotopy $\Gamma : t \in [0, 1] \mapsto \Gamma_t \in \mathfrak{R}_{\Omega_L}^\star$ between λ_0 and λ_1 (because W_j is simply connected). Finally, since π is a local homeomorphism, $\pi|_{\mathcal{W}_j}$ is a homeomorphism between \mathcal{W}_j and W_j .

□

5.6.2. Additional remark. — Just for completeness, we mention the following result and definition.

In [Ec85], §1.3.a, the following property is mentioned. We do not know if our methods can be used to show this result which, according to Ecalle (private communication, May 2011), can be derived by extending the method used in [Ec81-1] (as far as we understand).

Theorem 5.6.1 ([Ec85], §1.3.a). — *If $\varphi, \psi \in \mathcal{O}_0$ are analytically continuable without cut on \mathbb{C} , then their convolution product $\varphi * \psi$ is analytically continuable without cut.*

Also, we end with the following definition, from [Ec93-1], §1.3.

Definition 5.6.3 (Endless continuability - second definition)

A germ of analytic functions $\varphi \in \mathcal{O}_0$ at $0 \in \mathbb{C}$ is said to be endlessly continuable along \mathbb{R}^+ if it may be continued along any path that closely follows \mathbb{R}^+ in the forward direction, while circumventing (to the right or to the left) a discrete sequence $0 < \omega_1 < \omega_2 < \omega_3 \cdots$ of singular points.

More generally, $\varphi \in \mathcal{O}_0$ is endlessly continuable on \mathbb{C} if φ is analytically continuable along any discretely punctured broken lines on \mathbb{C} and issued from 0.

CHAPTER 6

THE RESURGENCE SPACE RES^{simp}

In Chapter 5 we defined the space \mathcal{H}_{end} (Definition 5.2.2) and we have shown that \mathcal{H}_{end} is a (non unitary) convolution algebra (Theorem 5.5.1). In this chapter we work in the space of the so-called simple resurgent functions RES^{simp} , which will allow us to introduce the alien derivatives in a simple way.

Apart from the help of Theorem 5.5.1 and the analysis made in §5.4.4, this part does not pretend to any originality and we shall essentially follow ideas from Ecalle [Ec81-1, Ec81-2, Ec85, Ec93-1], Pham *et al.* [CNP93-1, CNP93-2]. We are specially indebted to Sauzin [S006, S009] apart from our notations and possible (but hopefully not !) own mistakes.

This being made, we shall employ the fact that the alien derivatives can be used in return so as to analyze the analytic continuations of endlessly continuable functions. This information will allow us to derive a proof of Theorem 5.4.1 from Theorem 5.4.2 in the case of simple resurgent functions.

6.1. Ecalle's singularities

In this section we follow the viewpoint and notations of Ecalle [Ec93-1] and Sauzin [S006] rather than those of Pham *et al.*⁽¹⁾ in [CNP93-1]. However, we shall make a rather limited use of the definitions that we introduce here since we shall quickly limited ourself to simple singularities⁽²⁾.

6.1.1. Singularities. — We first fix some notations. On the one hand, we have introduced in §2.2.2 and §2.2.5 what we called the Riemann surface of the \ln function, considering the right-half complex plane $\mathbb{H} = \{z = r + i\theta, r > 0, \theta \in \mathbb{R}\}$ and the mapping $p : z \in \mathbb{H} \mapsto p(z) = re^{i\theta} \in \mathbb{C}^*$. This has allowed us to analytically continued $\ln(\zeta)$ into a holomorphic function $\text{Log}(z)$ on \mathbb{H} through the relation

$$\text{Log}(r + i\theta) = \ln(r) + i\theta.$$

⁽¹⁾Instead of the quotient space ANA, [CNP93-1] works with the sheaf on the circle \mathbb{S}^1 of Satos's microfunctions in dimension 1. The link between the two viewpoints is done by considering the étalé space made by the union of the fibers of this sheaf.

⁽²⁾The singularities of Ecalle [Ec93-1] as developed in §6.1.1 or equivalently the microfunctions as in [CNP93-1] are the natural (local) objects to consider in Resurgence theory in its general frame.

On the other hand, it is usual to think of the logarithm function as a “multivalued” function through the definition

$$\log(re^{i\theta}) = \ln(r) + i\theta.$$

In particular the “monodromy” reads $\log(\zeta e^{2i\pi}) = \log(\zeta) + 2i\pi$ which in our viewpoint should be written as $\text{Log}(z + 2i\pi) = \text{Log}(z) + 2i\pi$ which may be perturbing. This is why that, following [Ec93-1] and [S006], we shall identify $z = r + i\theta \in \mathbb{H}$ with a point $\zeta = re^{i\theta}$ on a Riemann surface thought of as a “spiralling space”.

Definition 6.1.1. — We note \mathbb{C}_{\bullet} the Riemann surface of the logarithm,

$$\mathbb{C}_{\bullet} = \{\zeta = re^{i\theta}, r > 0, \theta \in \mathbb{R}\}, \quad \pi : \zeta \in \mathbb{C}_{\bullet} \mapsto \dot{\zeta} = re^{i\theta} \in \mathbb{C}^*.$$

$$\begin{array}{ccc} \mathbb{H} & \xrightarrow{\approx} & \mathbb{C}_{\bullet} \\ p \searrow & & \swarrow \pi \\ & & \mathbb{C}^* \end{array} \quad \begin{array}{ccc} z = r + i\theta & \longrightarrow & \zeta = re^{i\theta} \\ p \searrow & & \swarrow \pi \\ & & \dot{\zeta} \end{array}$$

Definition 6.1.2. — One defines the space ANA as the space of germs of holomorphic functions $\Phi(\zeta) \in \mathcal{H}(V)$ in a “spiralling” domain of the form $V = \{\zeta = re^{i\theta}, 0 < r < h(\theta)\} \subset \mathbb{C}_{\bullet}$ where $h : \mathbb{R} \rightarrow]0, +\infty[$ is a continuous function.

It is worth mentioning that a “spiralling” domain is a connected and simply connected open set of \mathbb{C}_{\bullet} .

In the following Definition, we consider the space \mathcal{O}_0 of germs of holomorphic functions at 0 as a subspace of ANA,

$$\varphi \in \mathcal{O}_0 \mapsto \hat{\varphi} \in \text{ANA}, \quad \hat{\varphi}(\zeta) = \varphi(\dot{\zeta}).$$

Definition 6.1.3. — One defines $\text{SING} = \text{ANA}/\mathcal{O}_0$. The elements of this quotient space are called “singularities”. One denotes by sing_0 the canonical projection,

$$\text{sing}_0 : \begin{cases} \text{ANA} & \rightarrow \text{SING} \\ \check{\varphi} & \mapsto \check{\varphi} \end{cases}$$

If $\text{sing}_0(\check{\varphi}) = \check{\varphi}$, then $\check{\varphi}$ is called a “major” of the singularity $\check{\varphi}$.

One defines the “variation map”⁽³⁾ by

$$\text{var} : \begin{cases} \text{SING} & \rightarrow \text{ANA} \\ \check{\varphi} = \text{sing}_0(\check{\varphi}) & \mapsto \hat{\varphi}, \quad \hat{\varphi}(\zeta) = \check{\varphi}(\zeta) - \check{\varphi}(\zeta e^{-2i\pi}) \end{cases}$$

and $\hat{\varphi} = \text{var}(\check{\varphi})$ is called the “minor” of the singularity $\check{\varphi}$.

6.1.2. Simple singularities. —

⁽³⁾Notice that when working in \mathbb{H} rather than in \mathbb{C}_{\bullet} , the variation map reads $\hat{\varphi}(z) = \check{\varphi}(z) - \check{\varphi}(z - 2i\pi)$.

6.1.2.1. *Simple singularities.* — With the notations of Definition 6.1.3, we introduce the notion of “simple singularities”:

Definition 6.1.4. — We note $\delta = \text{sing}_0 \left(\frac{1}{2i\pi\zeta} \right)$ and ${}^b\widehat{\varphi} = \text{sing}_0 \left(\frac{1}{2i\pi} \widehat{\varphi}(\zeta) \log(\zeta) \right)$ when $\widehat{\varphi} \in \mathcal{O}_0$. Then the linear combinations of the type $C_1\delta + C_2{}^b\widehat{\varphi} \in \text{SING}$, $C_1, C_2 \in \mathbb{C}$, are called “simple singularities”. The space of simple singularities is denoted by $\text{SING}^{\text{simp}}$

We remark that if $\widehat{\varphi} \in \mathcal{O}_0$ then $\text{var}({}^b\widehat{\varphi}) = \widehat{\varphi}$. This to justify the above notation. On $\text{SING}^{\text{simp}}$ one can introduce a convolution product in a natural way,

$$(f, g) = (C_1\delta + {}^b\widehat{\varphi}, C_2\delta + {}^b\widehat{\psi}) \mapsto f * g := C_1C_2\delta + {}^b(C_1\widehat{\psi} + C_2\widehat{\varphi} + \widehat{\varphi} * \widehat{\psi}),$$

which makes $\text{SING}^{\text{simp}}$ an algebra. In what follows we shall recover this convolution product with two type of integral formula:

- in Lemma 6.1.1, an integral for the “minor” $\widehat{\varphi}$ of f and a “major” of g (assuming $C_1 = 0$),
- in Lemma 6.1.2 an integral for a “major” of f and a “major” of g .

These two Lemmas will be key-point results in the proof of Theorem 6.2.1 in the next section.

6.1.2.2. *Boundary type simple singularities.* — In this subsection we examine convolution-like products of the type

$$(44) \quad \overset{\vee}{\Phi}(\zeta) = \int_{\zeta_0}^{\zeta} \overset{\vee}{\phi}(\eta) \widehat{\varphi}(\zeta - \eta) d\eta$$

for some $\overset{\vee}{\phi} \in \text{ANA}$ and $\widehat{\varphi} \in \mathcal{O}_0$. As usual in this paper, when writing (44) one identifies a germ with one of their representative, that is $\overset{\vee}{\phi}$ and $\widehat{\varphi}$ are seen as holomorphic functions on some “spiralling” domain V of \mathbb{C} , $\pi(V) \subset D(0, r)^* \subset \mathbb{C}^*$, and more-

over $\widehat{\varphi}(\zeta) = \varphi(\dot{\zeta})$ with $\varphi \in \mathcal{O}(D(0, r))$. The integral $\int_{\zeta_0}^{\zeta}$ is taken along a path γ in V starting from an arbitrary chosen ζ_0 and ending at ζ and (44) is unambiguously defined as

$$(45) \quad \overset{\vee}{\Phi}(\zeta) = \int_{\zeta_0}^{\zeta} \overset{\vee}{\phi}(\eta) \varphi(\dot{\zeta} - \dot{\eta}) d\eta.$$

as far as $\dot{\zeta} - \dot{\eta}$ is kept inside the disc $D(0, r)$.

Therefore (44) defines a singularity and, being only interested in $\text{sing}_0 \overset{\vee}{\phi}$ rather than in $\overset{\vee}{\phi}$ itself, one can forget the choice of ζ_0 and this is what we do in what follows.

Lemma 6.1.1. — We assume that $\widehat{\varphi}, \widehat{\psi} \in \mathcal{O}_0$. Then:

1. $\text{sing}_0 \left(\int^{\zeta} \frac{1}{2i\pi} \frac{\widehat{\varphi}(\zeta - \eta)}{\eta} d\eta \right) = {}^b\widehat{\varphi}(\zeta)$.
2. $\text{sing}_0 \left(\int^{\zeta} \frac{\widehat{\psi}(\eta)}{2i\pi} \log(\eta) \widehat{\varphi}(\zeta - \eta) d\eta \right) = {}^b(\widehat{\varphi} * \widehat{\psi})(\zeta)$.

Proof. — 1. Just write $\widehat{\varphi}(\zeta - \eta)$ under the form $\varphi(\dot{\zeta} - \dot{\eta}) = \varphi(\dot{\zeta}) + \dot{\eta}\varphi_1(\dot{\zeta} - \dot{\eta})$ with $\varphi_1 \in \mathcal{O}_0$ and concludes.

2. For any compact subset K of \mathbb{C} (of course K is chosen so that $\widehat{\varphi}, \widehat{\psi}$ are holomorphic and bounded in K), one first observes that

$$\overset{\vee}{\phi}(\zeta) = \int_0^\zeta \frac{1}{2i\pi} \widehat{\varphi}(\eta) \log(\eta) \widehat{\psi}(\zeta - \eta) d\eta$$

is bounded (since \ln is integrable at 0). We now examine the variation of $\text{sing}_0(\overset{\vee}{\phi})$: since $\widehat{\varphi} \in \mathcal{O}_0$ one easily obtains that

$$\overset{\vee}{\phi}(\zeta) - \overset{\vee}{\phi}(\zeta e^{-2i\pi}) = \int_0^\zeta \widehat{\psi}(\eta) \widehat{\varphi}(\zeta - \eta) d\eta = \widehat{\varphi} * \widehat{\psi}(\zeta) \quad (= \varphi * \psi(\dot{\zeta})).$$

Therefore by classical arguments, $\text{sing}_0(\overset{\vee}{\phi}) = \text{sing}_0\left(\frac{1}{2i\pi} \widehat{\varphi} * \widehat{\psi}(\zeta) \log(\zeta)\right)$. \square

6.1.2.3. Pinching type simple singularities. — Here one would like to consider convolution-like products of the type

$$(46) \quad \overset{\vee}{\Phi}(\zeta) = \int_{\zeta_1}^{\zeta_2} \overset{\vee}{\varphi}(\eta) \overset{\vee}{\psi}(\zeta - \eta) d\eta$$

for a given path from ζ_1 to ζ_2 in \mathbb{C} while $\overset{\vee}{\varphi}$ and $\overset{\vee}{\psi}$ are two majors in ANA. We first define (46) properly.

In what follows we fix some $R > r > 0$ and $\dot{\zeta}_0 \in D(0, r)^*$.

We note γ a non constant path in $D(0, R)^*$ with extremities $\gamma(0) = \dot{\zeta}_1$ and $\gamma(1) = \dot{\zeta}_2$ on the boundary $\mathbb{S} = \partial D(0, R)^*$ of $D(0, R)^*$ in \mathbb{C}^* ,

$$\gamma : [0, 1] \rightarrow \mathbb{C}^*, \quad \gamma([0, 1]) \subset D(0, R)^*, \quad |\gamma(0)| = |\gamma(1)| = R.$$

Choosing a point ζ_1 above $\dot{\zeta}_1$ (that is $\pi(\zeta_1) = \dot{\zeta}_1$), we note $\widehat{\gamma}$ the lifting of γ from ζ_1 on \mathbb{C} with respect to π . This defines the path from ζ_1 to $\zeta_2 = \widehat{\gamma}(1)$, $\pi(\zeta_2) = \dot{\zeta}_2$.

We shall now assume that γ avoids the point $\dot{\zeta}_0 \in D(0, r)^*$,

$$(47) \quad \dot{\zeta}_0 \notin \gamma([0, 1]),$$

and thus $\widehat{\gamma}$ avoids the fiber $\pi^{-1}(\dot{\zeta}_0)$.

We define

$$(48) \quad \gamma_{\dot{\zeta}_0}^\circ : s \in [0, 1] \mapsto \dot{\zeta}_0 - \gamma(s) \in D(0, r + R)^*,$$

which is a path starting from $\dot{\xi}_1 = \dot{\zeta}_0 - \dot{\zeta}_1$ and ending at $\dot{\xi}_2 = \dot{\zeta}_0 - \dot{\zeta}_2$. Notice that condition (47) implies that

$$(49) \quad 0 \notin \gamma_{\dot{\zeta}_0}^\circ([0, 1])$$

and thus $\gamma_{\dot{\zeta}_0}^\circ$ can be lifted on \mathbb{C} with respect to π into a path $\widehat{\gamma}_{\dot{\zeta}_0}^\circ$ starting from a chosen point ξ_1 above $\dot{\xi}_1$, see Fig. 21.

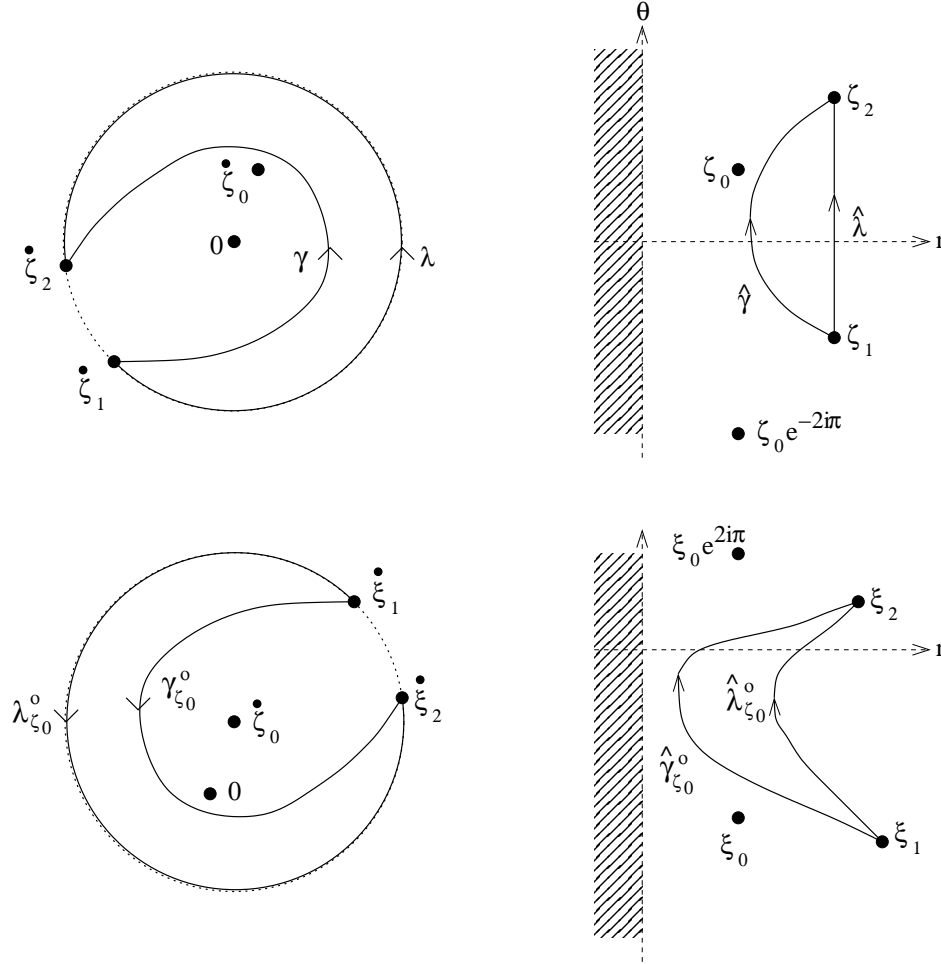

FIGURE 21. On the upper-left picture, the path γ is homotopic to the path λ in $D(0, R)^* \setminus \{\zeta_0\}$. On the upper-right picture, their liftings on \mathbb{H} . On the lower-left picture, the path $\gamma_{\zeta_0}^\circ = \zeta_0 - \gamma$ is homotopic to the path $\lambda_{\zeta_0}^\circ = \zeta_0 - \lambda$ in $D(0, r + R)^*$. On lower-right picture, their liftings on \mathbb{H} where ξ_0 and $\xi_0 e^{2i\pi}$ are above ζ_0 . No pinching occurs when $\zeta_0 \rightarrow 0$

When γ is deformed by homotopy (with fixed extremities) in $D(0, R)^*$, then $\hat{\gamma}$ is deformed as well in \mathbb{C} by lifting the homotopy. When the homotopy preserves condition (47), that is when one considers the homotopy class of γ in $D(0, R)^* \setminus \{\zeta_0\}$, then this homotopy translates into an homotopy for the path $\hat{\gamma}_{\zeta_0}^\circ$ in \mathbb{C} as well. In such case we shall say here that the homotopy is allowed.

We assume that the two majors $\check{\varphi}$ and $\check{\psi}$ in ANA can be represented by functions holomorphic in a spiralling domain of the form $V_{r+R} = \{\zeta = \tau e^{i\theta}, 0 < \tau < r+R, \theta \in \mathbb{R}\}$ and continuous on the closure \bar{V} of V in \mathbb{C} . With the above conditions and notations, the integral

$$(50) \quad \Phi(\zeta_0) = \int_{\hat{\gamma}} \check{\varphi}(\eta) \check{\psi}(\zeta_0 - \eta) d\eta, \quad \zeta_0 - \eta = \hat{\gamma}_{\zeta_0}^\circ(s) \text{ when } \eta = \hat{\gamma}(s),$$

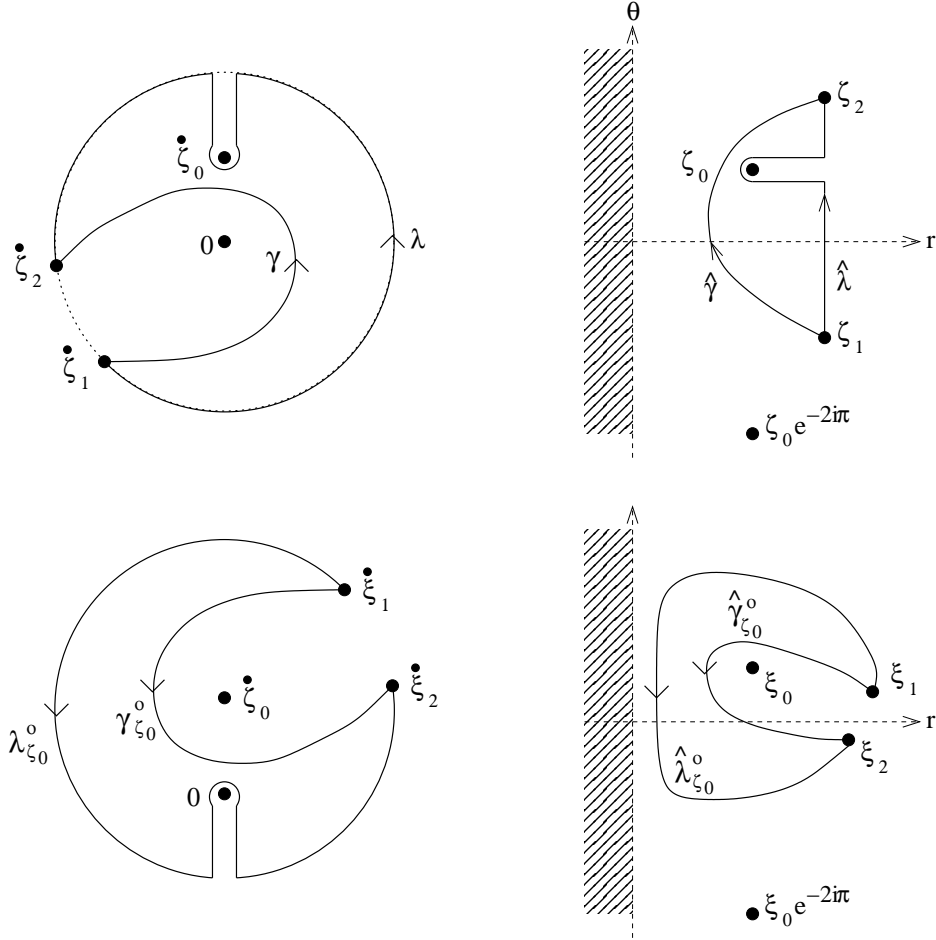

FIGURE 22. The same Fig. than Fig. 21 but this time the the segment $[0, \dot{\zeta}_0]$ intersects γ transversally. A pinching occurs when $\dot{\zeta}_0 \rightarrow 0$.

is well defined and only depends on the allowed homotopy class of $\hat{\gamma}$. One can even make $\dot{\zeta}_0$ varying in a neighbourhood of its initial point, thus defining a holomorphic function near $\dot{\zeta}_0$,

$$(51) \quad \Phi(\dot{\zeta}) = \int_{\hat{\gamma}} \check{\varphi}(\eta) \check{\psi}(\zeta - \eta) d\eta, \quad \dot{\zeta} \text{ near } \dot{\zeta}_0.$$

We now distinguish two cases:

1. **case 1** : either γ is homotopic in $D(0, R)^* \setminus \{\dot{\zeta}_0\}$ to a path which follows the boundary \mathbb{S} , see Fig. 21. In that case, one can analytically continued Φ in the open disc $D(0, r)$ and Φ gives rise to an element $\check{\Phi} \in \mathcal{O}_0 \subset \text{ANA}$ so that $\text{sing}_0 \check{\Phi} = 0$.
2. **case 2** : or, up to deforming γ so as to put it in a general position, the segment $[0, \dot{\zeta}_0]$ intersects transversally γ may be several times, see Fig. 22. In that case

one can analytically continued Φ in the open disc $D(0, r)^*$ as a multivalued function, which gives rise to a non trivial singularity $\check{\Phi} \in \text{ANA}$.

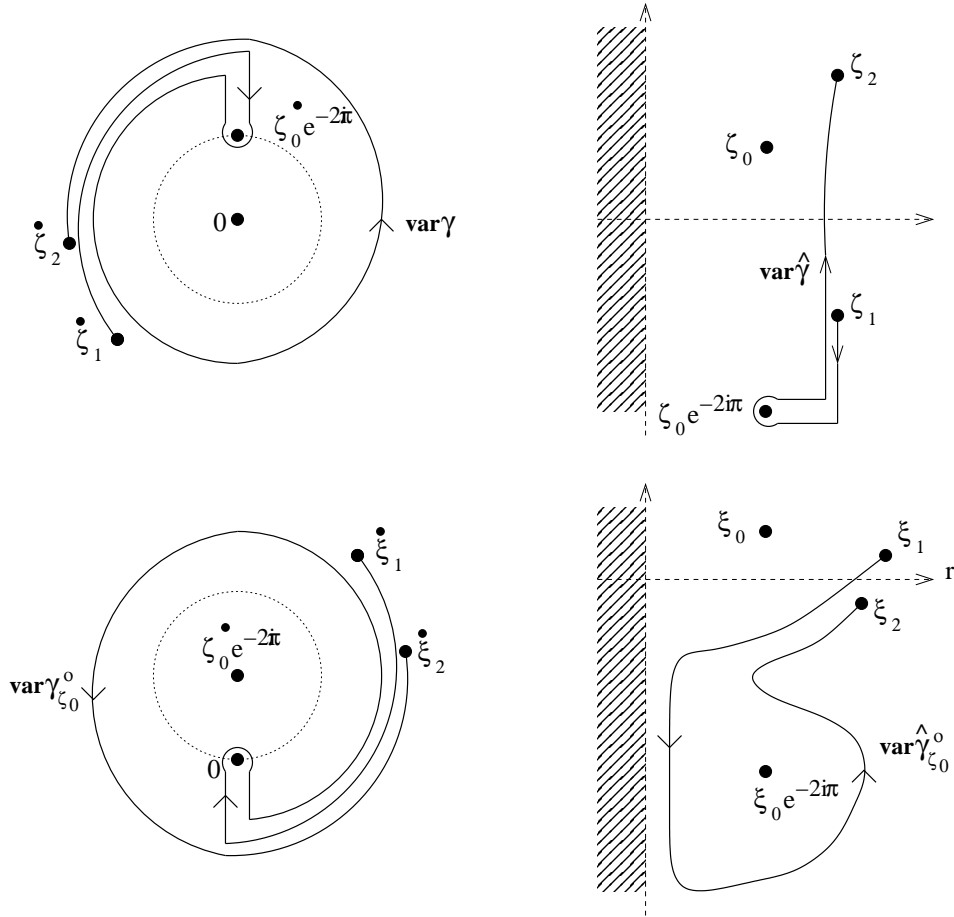

FIGURE 23. Effect of the monodromy on the paths drawn on Fig. 22, up to homotopy : the paths $\text{var } \gamma$, $\text{var } \hat{\gamma}$, $\text{var } \gamma_{\zeta_0}^o$ and $\text{var } \hat{\gamma}_{\zeta_0}^o$.

We thus concentrate on this second case, assuming a “simple pinching”, that is the (oriented) path γ intersects transversally the (oriented) segment $[\dot{\zeta}_0, 0]$ only once. Moreover we shall assume that the orientation between γ and $[\dot{\zeta}_0, 0]$ coincides with the canonical one like in on our figures.⁽⁴⁾

For doing this analysis, we need to precise the variation of $\text{sing}_0 \check{\Phi}$, that is to precise

$$\hat{\Phi}(\zeta_0) = \check{\Phi}(\zeta_0) - \check{\Phi}(\zeta_0 e^{-2i\pi}).$$

⁽⁴⁾One can assume that at the intersection point $\gamma(s)$ is smooth and non constant. Thus its derivative $\gamma'(s) \in \mathbb{C}^*$ is well defined. Here we assume that the orientation given by the couple of vectors $(\gamma'(s), -\dot{\zeta}_0)$ coincides with the usual orientation for the vector space \mathbb{C} .

To get $\check{\Phi}(\zeta_0 e^{-2i\pi})$, one only has to deform continuously γ in $D(0, R)^* \setminus \{\dot{\zeta}_0\}$ (allowed homotopy) when $\dot{\zeta}_0$ makes a clockwise loop around the origin, and analyse this deformation on $\hat{\gamma}$ by lifting. This is what we have done on Fig. 23 where the resulting paths are called $\text{var } \gamma$ and $\text{var } \hat{\gamma}$ respectively. This homotopy translates to the paths $\gamma_{\zeta_0}^\circ$ and $\hat{\gamma}_{\zeta_0}^\circ$. That provides the paths $\text{var } \gamma_{\zeta_0}^\circ$ and $\text{var } \hat{\gamma}_{\zeta_0}^\circ$ respectively. See Fig. 23.

Notice that both $\hat{\gamma}$ and $\text{var } \hat{\gamma}$ (*resp.* $\hat{\gamma}_{\zeta_0}^\circ$ and $\text{var } \hat{\gamma}_{\zeta_0}^\circ$) are paths with the *same* end points ζ_1 and ζ_2 (*resp.* ξ_1 and ξ_2). As a consequence, the product path $\hat{\gamma}(\text{var } \hat{\gamma})^{-1}$ (*resp.* $\hat{\gamma}_{\zeta_0}^\circ(\text{var } \hat{\gamma}_{\zeta_0}^\circ)^{-1}$) is a loop in the space \mathbb{C} which avoids the two points ζ_0 and $\zeta_0 e^{-2i\pi}$ (*resp.* ξ_0 and $\xi_0 e^{-2i\pi}$) of the fiber $\pi^{-1}(\dot{\zeta}_0)$. See Fig. 24.

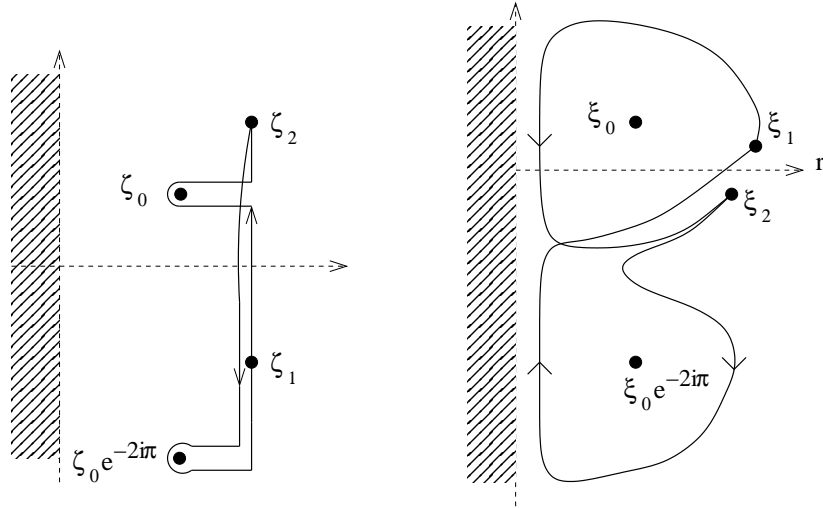

FIGURE 24. Up to homotopy, the paths $\hat{\gamma}(\text{var } \hat{\gamma})^{-1}$ (left picture) and $\hat{\gamma}_{\zeta_0}^\circ(\text{var } \hat{\gamma}_{\zeta_0}^\circ)^{-1}$ (right picture) corresponding to the paths drawn on Fig. 22 and Fig. 23. When considering their (free) homotopy classes, the base points ζ_1 (*resp.* ξ_1) and ζ_2 (*resp.* ξ_2) can be forgotten. Compare with Fig. 19 and Fig. 14.

To summarize,

$$(52) \quad \check{\Phi}(\zeta_0) = \int_{\hat{\gamma}} \check{\varphi}(\eta) \check{\psi}(\zeta_0 - \eta) d\eta, \quad \zeta_0 - \eta = \hat{\gamma}_{\zeta_0}^\circ(s) \text{ when } \eta = \hat{\gamma}(s),$$

$$\check{\Phi}(\zeta_0 e^{-2i\pi}) = \int_{\text{var } \hat{\gamma}} \check{\varphi}(\eta) \check{\psi}(\zeta_0 - \eta) d\eta, \quad \zeta_0 - \eta = \text{var } \hat{\gamma}_{\zeta_0}^\circ(s) \text{ when } \eta = \text{var } \hat{\gamma}(s).$$

and with similar conventions,

$$(53) \quad \check{\Phi}(\zeta_0) - \check{\Phi}(\zeta_0 e^{-2i\pi}) = \int_{\hat{\gamma}(\text{var } \hat{\gamma})^{-1}} \check{\varphi}(\eta) \check{\psi}(\zeta_0 - \eta) d\eta$$

where the integral depends only on the homotopy class of $\hat{\gamma}(\text{var } \hat{\gamma})^{-1}$ in $\mathbb{C} \setminus \pi^{-1}(\dot{\zeta}_0)$.

The above considerations were quite general. Now we specialize the study for simple singularities, see also [S006], §2.3, Lemma 4.

Lemma 6.1.2. — We assume that $\widehat{\varphi}, \widehat{\psi} \in \mathcal{O}_0$. In the following integrals one assume that a simple pinching occurs with the canonical orientation. Then:

1. $\text{sing}_0 \left(\int_{\widehat{\gamma}} \frac{1}{2i\pi\eta} \frac{\widehat{\varphi}(\zeta - \eta)}{2i\pi(\zeta - \eta)} d\eta \right) = \widehat{\varphi}(0)\delta.$
2. $\text{sing}_0 \left(\int_{\widehat{\gamma}} \frac{\widehat{\psi}(\eta)}{2i\pi\eta} \frac{\widehat{\varphi}(\zeta - \eta)}{2i\pi} \log(\zeta - \eta) d\eta \right) = \widehat{\psi}(0) {}^b\widehat{\varphi}.$
3. $\text{sing}_0 \left(\int_{\widehat{\gamma}} \frac{\widehat{\psi}(\eta)}{2i\pi} \log(\eta) \frac{\widehat{\varphi}(\zeta - \eta)}{2i\pi} \log(\zeta - \eta) d\eta \right) = {}^b(\widehat{\varphi} * \widehat{\psi})(\zeta).$

Also, changing the orientation induces the multiplication by a $-$ sign in the above formulas.

Proof. — 1. Since $\widehat{\varphi} \in \mathcal{O}_0$, the integral can be analyzed by projection on \mathbb{C}^* . Thanks to the orientation of the path γ , one decomposes by homotopy the path $\gamma = \pi(\widehat{\gamma})$ into an anticlockwise loop δ around 0 and another path which is no more pinched. Then by the classical residue theorem,

$$\int_{\delta} \frac{1}{2i\pi\dot{\eta}} \frac{\varphi(\dot{\zeta} - \dot{\eta})}{2i\pi(\dot{\zeta} - \dot{\eta})} d\dot{\eta} = \frac{\varphi(\dot{\zeta})}{2i\pi\dot{\zeta}} = \frac{\varphi(0)}{2i\pi\dot{\zeta}} \pmod{\mathcal{O}_0}.$$

We one changes the orientation, the loop δ becomes a clockwise loop around 0, so that the sign of the final result is changed.

2. The same trick works as well for the integral $\int_{\widehat{\gamma}} \frac{\widehat{\psi}(\eta)}{2i\pi\eta} \frac{\widehat{\varphi}(\zeta - \eta)}{2i\pi} \log(\zeta - \eta) d\eta$. One decomposes by homotopy the path $\widehat{\gamma}$ into a small (anticlockwise) loop⁽⁵⁾ $\widehat{\delta}$ and a path for which the pinching does not occurs. For $\dot{\zeta}$ large enough, $\zeta - \eta$ stays in a neighbourhood of ξ (ξ being a lifting of $\dot{\zeta}$) in which $\frac{\widehat{\varphi}(\zeta - \eta)}{2i\pi} \log(\zeta - \eta)$ is holomorphic. Thus applying the residue formula,

$$\int_{\widehat{\delta}} \frac{\widehat{\psi}(\eta)}{2i\pi\eta} \frac{\widehat{\varphi}(\zeta - \eta)}{2i\pi} \log(\zeta - \eta) d\eta = \psi(0) \frac{\widehat{\varphi}(\xi)}{2i\pi} \log(\xi).$$

We end by remarking that $\text{sing}_0 \left(\psi(0) \frac{\widehat{\varphi}(\xi)}{2i\pi} \log(\xi) \right) = \text{sing}_0 \left(\psi(0) \frac{\widehat{\varphi}(\zeta)}{2i\pi} \log(\zeta) \right)$ because $\pi(\xi) = \pi(\zeta)$, thus $\log(\xi) = \log(\zeta) \pmod{[2i\pi]}$, while $\widehat{\varphi} \in \mathcal{O}_0$.

3. By integrability at the origin of the logarithmic function, one gets that $\check{\Phi}(\zeta) = \int_{\widehat{\gamma}} \frac{\widehat{\psi}(\eta)}{2i\pi} \log(\eta) \frac{\widehat{\varphi}(\zeta - \eta)}{2i\pi} \log(\zeta - \eta) d\eta$ remains bounded when $\dot{\zeta} \rightarrow 0$.

We now consider the variation given by formula (53) (with $\zeta = \zeta_0$). Using the integrability of $\log(\zeta - \eta)$ when $\dot{\zeta} - \dot{\eta} \rightarrow 0$, we collapse the path $\widehat{\gamma}(\text{var } \widehat{\gamma})^{-1}$ onto the points above $\dot{\zeta}$ like on Fig. 25. Always like on Fig. 25 one decomposes the resulting path into the product of 6 paths, ①, ②, ..., thus,

$$\int_{\widehat{\gamma}} = \int_{\textcircled{1}} + \int_{\textcircled{2}} + \cdots + \int_{\textcircled{6}}.$$

⁽⁵⁾On Fig. 22 think of δ as the path γ drawn on that picture - resp. $\widehat{\gamma}$ - with $\dot{\zeta}_1 = \dot{\zeta}_2$ close to the origin - resp. $\zeta_1 = \zeta_2 e^{-2i\pi}$ close to the θ -axis -

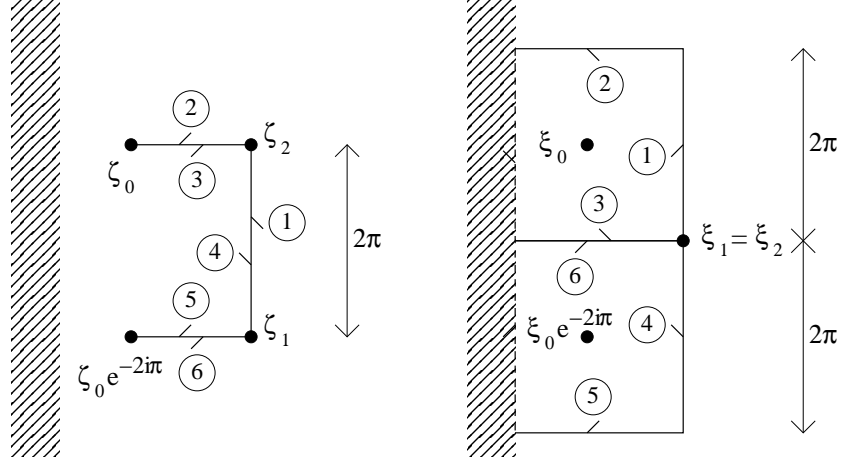

FIGURE 25. Up to homotopy, the paths $\widehat{\gamma}(\text{var } \widehat{\gamma})^{-1}$ (left picture) and $\widehat{\gamma}_{\zeta_0}^{\circ}(\text{var } \widehat{\gamma}_{\zeta_0}^{\circ})^{-1}$ (right picture) deduced from those drawn on Fig. 24 by collapsing onto the points above ζ_0 and decomposed as the product of the paths ①, ②, ... The half-arrows indicate the orientations of the paths.

We analyze these 6 integrals. The integral $\int_{\textcircled{2}}$, which reads

$$\int_{\textcircled{2}} = \int_{\zeta_2}^{\zeta} \frac{\widehat{\psi}(\eta)}{2i\pi} \log(\eta) \frac{\widehat{\varphi}(\zeta - \eta)}{2i\pi} \log(\zeta - \eta) d\eta,$$

can be compared with $\int_{\textcircled{3}}$ which can be written as

$$\int_{\textcircled{3}} = - \int_{\zeta_2}^{\zeta} \frac{\widehat{\psi}(\eta)}{2i\pi} \log(\eta) \frac{\widehat{\varphi}(\zeta - \eta)}{2i\pi} (\log(\zeta - \eta) - 2i\pi) d\eta.$$

(On Fig. 25, right picture, see the translation of $-2i\pi$ between ② and ③). Thus

$$(54) \quad \int_{\textcircled{2}} + \int_{\textcircled{3}} = \int_{\zeta_2}^{\zeta} \frac{\widehat{\psi}(\eta)}{2i\pi} \log(\eta) \widehat{\varphi}(\zeta - \eta) d\eta.$$

For the same reasons,

$$\int_{\textcircled{5}} + \int_{\textcircled{6}} = - \int_{\zeta_1}^{\zeta e^{-2i\pi}} \frac{\widehat{\psi}(\eta)}{2i\pi} \log(\eta) \widehat{\varphi}(\zeta - \eta) d\eta.$$

(On Fig. 25, right picture, see the translation of $+2i\pi$ between ⑤ and ⑥). This reads also as

$$(55) \quad \int_{\textcircled{5}} + \int_{\textcircled{6}} = - \int_{\zeta_2}^{\zeta} \frac{\widehat{\psi}(\eta)}{2i\pi} (\log(\eta) - 2i\pi) \widehat{\varphi}(\zeta - \eta) d\eta$$

so that using (54) and (55),

$$\int_{\textcircled{2}} + \int_{\textcircled{3}} + \int_{\textcircled{5}} + \int_{\textcircled{6}} = \int_{\zeta_2}^{\zeta} \widehat{\psi}(\eta) \widehat{\varphi}(\zeta - \eta) d\eta.$$

Finally, the integrals $\int_{\textcircled{1}}$ and $\int_{\textcircled{4}}$ provides “regular singularities”⁽⁶⁾, that is elements of \mathcal{O}_0 .

The lemma is thus shown. \square

6.2. The convolution algebra RES^{simp}

6.2.1. Simple singularity. —

Definition 6.2.1. — We consider a holomorphic function $\varphi \in \mathcal{O}(U)$ where $U \subset \mathbb{C}$ is a connected open set. We assume that $\omega \in \mathbb{C}$ is adherent to U . One says that φ has “a simple singularity at ω ” if there exist $C_\omega \in \mathbb{C}$ and two holomorphic functions Φ_ω and Reg_ω near the origin such that

$$(56) \quad \varphi(\omega + \zeta) = \frac{C_\omega}{2\pi i \zeta} + \frac{1}{2\pi i} \Phi_\omega(\zeta) \log(\zeta) + \text{Reg}_\omega(\zeta)$$

for $\zeta + \omega \in U$ with $|\zeta|$ small enough.

If φ has a simple singularity at ω in the sense of Definition 6.2.1, then (56) allows an analytic continuation of $\zeta \mapsto \varphi(\zeta + \omega)$ on a “spiralling” domain of \mathbb{C} (see Definition 6.1.2) of the form $V = \{\zeta = re^{i\theta}, 0 < r < r_0\}$ with $r_0 > 0$ small enough. Defining $\check{\varphi} \in \text{ANA}$ by $\check{\varphi}(\zeta) = \varphi(\zeta + \omega)$, formula (56) shows that $\check{\varphi}$ is a simple singularity in the sense of Definition 6.1.4. Namely,

$$\text{sing}_0(\check{\varphi}) = C_\omega \delta + {}^b \widehat{\varphi}_\omega$$

where

$$\widehat{\varphi}_\omega(\zeta) = (\text{var } \check{\varphi})(\zeta) = \check{\varphi}(\zeta) - \check{\varphi}(\zeta e^{-2i\pi}) = \Phi_\omega(\zeta).$$

This justifies the following notations:

Definition 6.2.2. — In the conditions of Definition 6.2.1, one notes

$$(57) \quad \text{sing}_\omega \varphi = C_\omega \delta + \varphi_\omega \in \mathbb{C} \delta \oplus \mathcal{O}_0.$$

In (57), $\varphi_\omega \in \mathcal{O}_0$ stands for the germ of analytic functions at the origin represented by $\Phi_\omega = \text{var}_\omega \varphi$ with

$$\text{var}_\omega \varphi(\omega + \zeta) = \varphi(\omega + \zeta) - \varphi(\omega + \zeta e^{-2\pi i}),$$

where $\varphi(\omega + \zeta e^{-2\pi i})$ stands for the analytic continuation of φ along the clockwise loop $t \in [0, 1] \mapsto \omega + \zeta e^{-2\pi i t}$ for ζ close enough to 0.

6.2.2. The convolution algebra RES^{simp} . —

⁽⁶⁾Explicitly, $\int_{\textcircled{1}} + \int_{\textcircled{4}} = \int_{\zeta_1}^{\zeta_2} \frac{\widehat{\psi}(\eta)}{2i\pi} \log(\eta) \widehat{\varphi}(\zeta - \eta) d\eta$.

6.2.2.1. The space $\mathcal{H}_{\text{end}}^{\text{simp}}$. —

Definition 6.2.3. — One denotes by $\mathcal{H}_{\text{end}}^{\text{simp}}$ the subspace of endlessly continuable germs $\varphi \in \mathcal{H}_{\text{end}}$ such that the analytic continuations $\lambda.\varphi$ of φ along every $\lambda \in \mathfrak{R}(\varphi)$ encounter only simple singularities.

Proposition 6.2.1. — For every φ in $\mathcal{H}_{\text{end}}^{\text{simp}}$ and for every $\lambda \in \mathfrak{R}(\varphi)$ with $\lambda(1) = \omega + \zeta$ close to $\omega \in \mathbb{C}$, if

$$\text{sing}_{\omega}\lambda.\varphi = C_{\omega}\delta + \varphi_{\omega} \in \mathbb{C}\delta \oplus \mathcal{O}_0$$

then φ_{ω} belongs to $\mathcal{H}_{\text{end}}^{\text{simp}}$.

Proof. — We mention that in the proposition, the germ $\lambda.\varphi$ is thought of as one of its representatives. This being said, φ_{ω} is deduced from $\lambda.\varphi$ by the variation map var_{ω} so that the hypothesis made on φ translates obviously to φ_{ω} . \square

The elements of the space $\mathcal{H}_{\text{end}}^{\text{simp}}$ enjoy the following property which will be useful in a moment. Assume that φ in $\mathcal{H}_{\text{end}}^{\text{simp}}$ and consider a path $\lambda_1 \in \mathfrak{R}(\varphi)$ with $\lambda_1(1) = \omega + \zeta$ close to a (simple) singular point $\omega \in \mathbb{C}$. Introduce δ_{ω} a small anticlockwise loop starting from and ending at $\lambda_1(1)$. Then

$$\lambda_1.\varphi(\omega + \zeta) - \lambda_1\delta_{\omega}^{-}.\varphi(\omega + \zeta e^{-2\pi i}) = \text{var}_{\omega}\lambda_1.\varphi(\omega + \zeta) = \varphi_{\omega}(\zeta).$$

Since ω is a simple singular point, $\varphi_{\omega}(\zeta)$ belongs to \mathcal{O}_0 so that one has also:

$$\forall n \in \mathbb{Z}, \lambda_1\delta_{\omega}^n.\varphi(\omega + \zeta e^{2\pi i n}) - \lambda_1\delta_{\omega}^{n-1}.\varphi(\omega + \zeta e^{2\pi i(n-1)}) = \varphi_{\omega}(\zeta).$$

Notice that the above considerations work as well when ω is not singular : in that case $\varphi_{\omega} = 0$!

This has the following consequences : assume that $\lambda_1\lambda_2 \in \mathfrak{R}(\varphi)$ and $\lambda_1\delta_{\omega}^{-}\lambda_2 \in \mathfrak{R}(\varphi)$, then $\forall n \in \mathbb{Z}$,

$$\lambda_1\lambda_2.\varphi - \lambda_1\delta_{\omega}^{-}\lambda_2.\varphi = \lambda_2.[(\lambda_1 - \lambda_1\delta_{\omega}^{-1}).\varphi] = \lambda_2.[(\lambda_1\delta_{\omega}^n - \lambda_1\delta_{\omega}^{n-1}).\varphi].$$

We have therefore the following lemma:

Lemma 6.2.1. — For every φ in $\mathcal{H}_{\text{end}}^{\text{simp}}$, if $\lambda_1\lambda_2 \in \mathfrak{R}(\varphi)$ and $\lambda_1\delta_{\omega}^{-}\lambda_2 \in \mathfrak{R}(\varphi)$ where δ_{ω} is a small anticlockwise loop around some point $\omega \in \mathbb{C}$, then

$$\forall n \in \mathbb{Z}, \lambda_2.[(\lambda_1\delta_{\omega}^n - \lambda_1\delta_{\omega}^{n-1}).\varphi] = \lambda_1\lambda_2.\varphi - \lambda_1\delta_{\omega}^{-}\lambda_2.\varphi$$

is a well defined germ of holomorphic functions that does not depend on n .

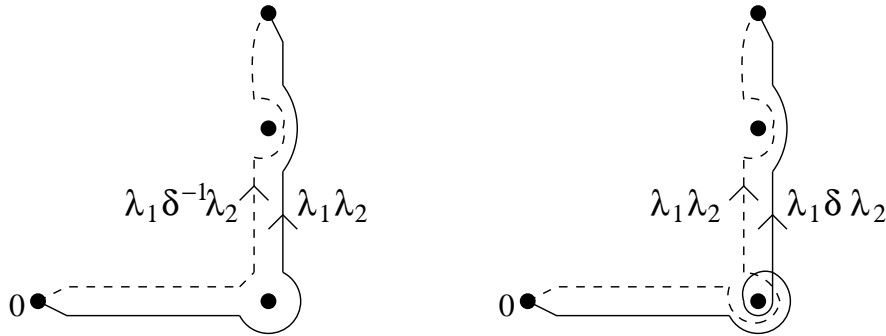

FIGURE 26. Examples of paths of type $\lambda_1\delta_{\omega}^n\lambda_2$.

Remark : under the hypotheses of Lemma 6.2.1, it would be meaningless to write

$$\lambda_1 \lambda_2 \cdot \varphi - \lambda_1 \delta_\omega^- \lambda_2 \cdot \varphi = \lambda_1 \delta_\omega^n \lambda_2 \cdot \varphi - \lambda_1 \delta_\omega^{n-1} \lambda_2 \cdot \varphi$$

since it is not guaranteed that $\lambda_1 \delta_\omega^n \lambda_2$ belongs to $\mathfrak{R}(\varphi)$ for $n \neq 0, -1$.

6.2.2.2. *The convolution algebra RES^{simp} .* —

Definition 6.2.4. — *The space $\text{RES}^{\text{simp}} = \mathbb{C}\delta \oplus \mathcal{H}_{\text{end}}^{\text{simp}}$ is called the space of simple resurgent functions⁽⁷⁾.*

Theorem 6.2.1. — *The space RES^{simp} is an unitary convolution algebra. Moreover for $\varphi, \psi \in \mathcal{H}_{\text{end}}^{\text{simp}}$ and for a path $\lambda \in \mathfrak{R}(\varphi * \psi)$ with $\lambda(1)$ close to a singular point ω_0 , there exists a finite set of “pinching” couples $(\omega, \omega') \in \mathbb{C}^2$, $\omega + \omega' = \omega_0$ and associated couples of paths $(\lambda_\omega, \lambda_{\omega'}) \in \mathfrak{R}(\varphi) \times \mathfrak{R}(\psi)$ such that $\text{sing}_{\omega_0} \lambda.(\varphi * \psi)$ is of the form*

$$(58) \quad \begin{aligned} \text{sing}_{\omega_0} \lambda.(\varphi * \psi) &= \psi * \text{sing}_{\omega_0} \lambda.\varphi + \varphi * \text{sing}_{\omega_0} \lambda.\psi \\ &\pm \sum_{\omega + \omega' = \omega_0} \text{sing}_\omega \lambda_\omega.\varphi * \text{sing}_{\omega'} \lambda_{\omega'}.\psi. \end{aligned}$$

Proof. — (Adpated from [S006], §2.3, proof of Lemma 4 in §2.3). We show Theorem 6.2.1 with the help of Theorem 5.4.2, the analysis made in §5.4.4 and Lemmas 6.1.1 and 6.1.2.

We assume that $f = a\delta + \varphi$ and $g = b\delta + \psi$ belong to RES^{simp} , $\varphi, \psi \in \mathcal{H}_{\text{end}}^{\text{simp}}$. Since

$$f * g(\zeta) = ab + a\psi(\zeta) + b\varphi(\zeta) + \varphi * \psi(\zeta),$$

what remains to show is that $\varphi * \psi \in \text{RES}^{\text{simp}}$.

By definition, there exist two discrete filtered sets Ω_\star and Ω'_\star centred at 0 such that $\varphi \in \mathcal{H}(\mathcal{R}_{\Omega_\star})$ and $\psi \in \mathcal{H}(\mathcal{R}_{\Omega'_\star})$. By Theorem 5.5.1 we know that $\varphi * \psi \in \mathcal{H}(\mathcal{R}_{(\Omega + \Omega')_\star})$. We thus assume that the path λ belongs to $\lambda \in \mathfrak{R}_{(\Omega + \Omega')_L}^\star$ for some $L > 0$ and that its endpoint $\lambda(1) = \omega_0 + \zeta$ is close to $\omega_0 \in (\Omega + \Omega')_L$. From Theorem 5.4.2, the analytic continuation of $\varphi * \psi$ along λ is well defined and reads

$$(59) \quad \lambda.(\varphi * \psi)(\omega_0 + \zeta) = \int_0^{\omega_0 + \zeta} \varphi(\eta) \psi(\omega_0 + \zeta - \eta) d\eta, \quad \eta = \Gamma(s), s \in [0, 1],$$

where the integral is taken along a convenient path Γ such that:

- the paths $\widehat{\lambda}$ and $\widehat{\Gamma}$ are homotopic on the Riemann surface $\mathcal{R}_{\Omega_\star}$, where $\widehat{\lambda}, \widehat{\Gamma}$ stand for the liftings of λ, Γ from the origin on $\mathcal{R}_{\Omega_\star}$.
- if $\Gamma^\circ(s) = \lambda(1) - \Gamma(1 - s)$ for $s \in [0, 1]$, then the paths $\widehat{\lambda}$ and $\widehat{\Gamma}^\circ$ are homotopic on the Riemann surface $\mathcal{R}_{\Omega'_\star}$, where $\widehat{\lambda}, \widehat{\Gamma}^\circ$ stand for the liftings of λ, Γ° from the origin on $\mathcal{R}_{\Omega'_\star}$.

1. **Boundary type singular point.** Assume that the germ $\lambda.\varphi$ represents a holomorphic function with a simple singularity at ω_0 , that we note by:

$$(60) \quad \text{sing}_{\omega_0} \lambda.\varphi = C_{\omega_0} \delta + \varphi_{\omega_0} \in \mathbb{C}\delta \oplus \mathcal{O}_0.$$

⁽⁷⁾According to, e.g., [Ec93-1, Ec005, S006, S009], we should note $\widehat{\text{RES}}^{\text{simp}}$ this space. Since most of the paper is devoted to a study in the convolution space, we have decided to remove the hat.

To analyze the effect of this singularity on the behavior of $\lambda.(\varphi * \psi)$, the analysis made in §5.4.4 (see Fig. 17) shows that one can localize the study near that singular point. In (59) we thus truncate the path of integration and we consider

$$\Phi_1(\omega_0 + \zeta) = \int_{\omega_0 + \zeta_1}^{\omega_0 + \zeta} \varphi(\eta) \psi(\omega_0 + \zeta - \eta) d\eta = \int_{\zeta_1}^{\zeta} \lambda.\varphi(\omega_0 + \eta) \psi(\zeta - \eta) d\eta$$

for some ζ_1 close to 0. The germ $\zeta \mapsto \lambda.\varphi(\omega_0 + \zeta)$, *resp.* $\zeta \mapsto \psi(\zeta)$, can be analytically continued into an element $\check{\varphi}(\zeta) = \lambda.\varphi(\zeta + \omega_0)$ of ANA, *resp.* $\check{\psi}(\zeta) = \psi(\zeta) \in \mathcal{O}_0$, and by (60), $\text{sing}_0(\check{\varphi}) = C_{\omega_0} \delta + {}^b \widehat{\varphi}_{\omega_0}$.

Applying Lemma 6.1.1, $\check{\Phi}(\zeta) = \Phi_1(\zeta + \omega_0)$ is analytically continuable as an element of ANA with

$$\text{sing}_0(\check{\Phi}) = C_{\omega_0} {}^b \widehat{\psi} + {}^b(\widehat{\psi} * \widehat{\varphi}_{\omega_0}) = {}^b(\widehat{\psi} * (C_{\omega_0} \delta + \widehat{\varphi}_{\omega_0})).$$

Returning to the notations of Definition 6.2.2, this means that Φ_1 has a simple singularity at ω_0 given by

$$(61) \quad \text{sing}_{\omega_0} \Phi_1 = \psi * (C_{\omega_0} \delta + \varphi_{\omega_0}) = \psi * \text{sing}_{\omega_0} \lambda.\varphi.$$

We mention that when ω_0 is not a singular point for $\lambda.\varphi$, that is $\text{sing}_{\omega_0} \lambda.\varphi = 0$, then $\text{sing}_{\omega_0} \Phi_1 = 0$ as well.

Symmetrically, assume that $\lambda.\psi$ represents a holomorphic function with a simple singularity at ω_0 . This time the analysis made in §5.4.4 (see Fig. 18) shows that one has to localize the study near the origin so as to analyze the effect of that singularity on the behavior of $\lambda.(\varphi * \psi)$. In (59) we thus truncate the path of integration and we consider⁽⁸⁾

$$\Phi_0(\zeta) = \int_0^{\zeta_1} \varphi(\eta) \psi(\omega_0 + \zeta - \eta) d\eta = \int_{\zeta_1}^{\zeta} \varphi(\eta) \lambda.\psi(\zeta - \eta) d\eta$$

for some ζ_1 close to 0. The previous analysis provides that

$$(62) \quad \text{sing}_{\omega_0} \Phi_0 = \varphi * \text{sing}_{\omega_0} \lambda.\psi.$$

2. Pinching type singular point. We now analyze the effect of a simple pinching on the behavior of $\lambda.(\varphi * \psi)$. That corresponds to the analysis made in §5.4.4 and illustrated by Fig. 19 (see also Fig. 14). We thus assume that

- there exist $\omega \in \Omega_L$ and $\omega' \in \Omega'_L$ such that $\omega_0 = \omega + \omega'$;
- the integration path Γ intersects transversally the segment $[\omega, \omega_0 + \zeta - \omega']$ at $\Gamma(s_0) = \omega + \xi$ for some $s_0 \in [0, 1]$ and thus Γ is pinched when $\zeta \rightarrow 0$.
To fix the orientation, we shall assume that the pinching occurs with the canonical orientation⁽⁹⁾.

In the vicinity of the the pinching point, the analytic continuation of φ along Γ behave like

$$(63) \quad \text{sing}_{\omega} \Gamma_1.\varphi = C_{\omega} \delta + \varphi_{\omega} \in \mathbb{C} \delta \oplus \mathcal{O}_0$$

⁽⁸⁾We can also use the commutativity of the convolution product and the result is simply a consequence of the previous analysis.

⁽⁹⁾Thus, at the intersection point between Γ and $[\omega, \omega_0 + \zeta - \omega'] = [\omega, \omega + \zeta]$, the couple of vectors $(\Gamma'(s_0), -\zeta)$ provides the canonical orientation of \mathbb{C} .

where we have denoted by Γ_{\downarrow} the restriction of Γ to $[0, s_0]$. Similarly near the pinching point the analytic continuation of ψ along Γ° behave like

$$(64) \quad \text{sing}_{\omega'} \Gamma_{\downarrow}^{\circ} \cdot \psi = D_{\omega'} \delta + \psi_{\omega'} \in \mathbb{C}\delta \oplus \mathcal{O}_0.$$

where we have denoted by $\Gamma_{\downarrow}^{\circ}$ the restriction of Γ° to $[0, 1 - s_0]$, $\Gamma^{\circ}(1 - s_0) = \omega' + \zeta - \xi$.

In (59) we now truncate the path of integration near the pinching point, that is we consider

$$\Phi_{\omega, \omega'}(\omega_0 + \zeta) = \int_{\omega_0 + \xi_1}^{\omega_0 + \xi_2} \varphi(\eta) \psi(\omega_0 + \zeta - \eta) d\eta = \int_{\xi_1}^{\xi_2} \Gamma_{\downarrow} \cdot \varphi(\omega + \eta) \Gamma_{\downarrow}^{\circ} \cdot \psi(\omega' + \zeta - \eta) d\eta$$

for some ξ_1, ξ_2 close to 0, the (oriented) path (ξ_1, ξ_2) intersecting transversally once the (oriented) segment $[\zeta, 0]$ with the canonical orientation.

The germ $\xi \mapsto \Gamma_{\downarrow} \cdot \varphi(\omega + \xi)$, *resp.* $\xi \mapsto \Gamma_{\downarrow}^{\circ} \cdot \psi(\omega' + \xi)$, can be analytically continued

into an element $\overset{\vee}{\varphi}(\xi) = \Gamma_{\downarrow} \cdot \varphi(\overset{\bullet}{\xi} + \omega)$ of ANA, *resp.* $\overset{\vee}{\psi}(\xi) = \Gamma_{\downarrow}^{\circ} \cdot \psi(\overset{\bullet}{\xi} + \omega') \in \text{ANA}$,

and by (63), $\text{sing}_0(\overset{\vee}{\varphi}) = C_{\omega} \delta + {}^b \widehat{\varphi}_{\omega}$, *resp.* by (64), $\text{sing}_0(\overset{\vee}{\psi}) = D_{\omega'} \delta + {}^b \widehat{\psi}_{\omega'}$.

Applying Lemma 6.1.2, $\overset{\vee}{\Phi}(\zeta) = \Phi_{\omega, \omega'}(\overset{\bullet}{\zeta} + \omega_0)$ is analytically continuable as an element of ANA with

$$\text{sing}_0(\overset{\vee}{\Phi}) = {}^b((C_{\omega} \delta + \widehat{\varphi}_{\omega}) * (D_{\omega'} \delta + \widehat{\psi}_{\omega'}))$$

Returning to the notations of Definition 6.2.2, this means that $\Phi_{\omega, \omega'}$ has a simple singularity at ω_0 given by

$$(65) \quad \text{sing}_{\omega_0} \Phi_{\omega, \omega'} = \text{sing}_{\omega} \Gamma_{\downarrow} \cdot \varphi * \text{sing}_{\omega'} \Gamma_{\downarrow}^{\circ} \cdot \psi.$$

Of course, when the pinching is realized with an orientation which differs from the canonical one, then the result becomes

$$(66) \quad \text{sing}_{\omega_0} \Phi_{\omega, \omega'} = -\text{sing}_{\omega} \Gamma_{\downarrow} \cdot \varphi * \text{sing}_{\omega'} \Gamma_{\downarrow}^{\circ} \cdot \psi.$$

3. **Conclusion.** Being interested in $\text{sing}_{\omega_0} \lambda.(\varphi * \psi)$, that is working modulo germs of holomorphic functions at ω_0 , one sees from (61), (62), (66) that $\lambda.(\varphi * \psi)$ is a (germ of) holomorphic functions with a simple singularity at ω_0 given by:

$$\begin{aligned} \text{sing}_{\omega_0} \lambda.(\varphi * \psi) &= \psi * \text{sing}_{\omega_0} \lambda.\varphi + \varphi * \text{sing}_{\omega_0} \lambda.\psi \\ &\pm \sum_{\omega + \omega' = \omega_0} \text{sing}_{\omega} \Gamma_{\downarrow} \cdot \varphi * \text{sing}_{\omega'} \Gamma_{\downarrow}^{\circ} \cdot \psi \end{aligned}$$

where the finite \sum is made over the couples $(\omega, \omega') \in \Omega_L \times \Omega'_L$, $\omega + \omega' = \omega_0$ for which the integration path defining the convolution product Γ is pinched. \square

6.2.3. Example. — We illustrate Theorem 6.2.1 with the example discussed in §2.3.3 with the help of Fig. 27 (part of Fig. 5). We assume that $\varphi \in \mathcal{H}_{\text{end}}^{\text{simp}}$, *resp.* $\psi \in \mathcal{H}_{\text{end}}^{\text{simp}}$, can be analytically continued along every path avoiding ω_1, ω_2 . We have chosen a path λ drawn on Fig. 27-A5, which ends close to $\omega_1 + \omega_3$ and is so that a pinching occurs twice at different times (Fig. 27-D5), due to the couple

(ω_1, ω_3) . The first pinching occurs with the canonical orientation but not for the other pinching. We get

$$\text{sing}_{\omega_1+\omega_3} \lambda.(\varphi * \psi) = \text{sing}_{\omega_1} \lambda_{\omega_1} \cdot \varphi * \text{sing}_{\omega_3} \lambda_{\omega_3}^1 \cdot \psi - \text{sing}_{\omega_1} \lambda_{\omega_1} \cdot \varphi * \text{sing}_{\omega_3} \lambda_{\omega_3}^2 \cdot \psi,$$

where the paths $\lambda_{\omega_3}^1$ and $\lambda_{\omega_3}^2$ are different (on Fig. 27-C5 we are on two different sheets of the Riemann surface of ψ).

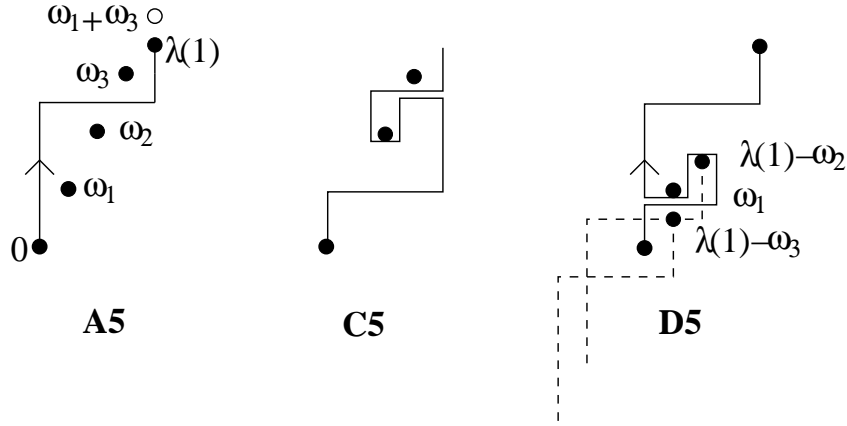

FIGURE 27. An example of a “double” pinching.

6.3. Alien derivations

We have shown in Theorem 6.2.1 that RES^{simp} is a convolution algebra. Nevertheless, formula (58) remains too vague and the aim of the so-called alien derivatives is to make it precise.

6.3.1. The Δ^+ -operator. —

6.3.1.1. *Definitions.* —

Definition 6.3.1. — We fix a direction $\theta \in \frac{\mathbb{R}}{2\pi\mathbb{Z}}$ and we set $\omega_0 = 0$. We consider a set of $n \in \mathbb{N}^*$ distinct points $\omega_i \in]0, e^{i\theta}\infty[$, $i = 1, 2, \dots, n$ ordered so that $0 < |\omega_1| < |\omega_2| < \dots < |\omega_n|$. We associate to these points a sequence of + or - signs, $\varepsilon = (\varepsilon_1, \varepsilon_2, \dots, \varepsilon_{n-1}) \in \{+, -\}^{n-1}$.

Then one denotes by γ_ε any path $\gamma \in \mathfrak{R}$ with end point $\gamma(1) \in]\omega_{n-1}, \omega_n[$ that closely follows the segment $[0, \omega_n[$ in the forward direction while circumventing the points ω_i , $i = 1, 2, \dots, n-1$, to the right when $\varepsilon_i = +$ and to the left⁽¹⁰⁾ when $\varepsilon_i = -$, see Figure 28. When ε is the null sequence ($n = 1$), then γ_ε lie on the segment $[0, \omega_1[$.

Definition 6.3.2. — We consider $f = C\delta + \varphi \in \text{RES}^{\text{simp}}$, $\varphi \in \mathcal{H}_{\text{end}}^{\text{simp}}$. We consider a direction $\theta \in \frac{\mathbb{R}}{2\pi\mathbb{Z}}$ and we assume that the set of glimpsed singular points $\text{Sing}_\varphi^*(\theta) = \{\omega_i, |\omega_1| < |\omega_2| < \dots\} \in]0, e^{i\theta}\infty[$ is non empty (see Definition 5.3.5).

For some $n \in \mathbb{N}^*$ we consider a point $\omega_n \in \text{Sing}_\varphi^*(\theta)$ and a path $\gamma_\varepsilon = (+, \dots, +) \in$

⁽¹⁰⁾that is someone standing at 0 and looking in the direction θ will see the path γ avoiding the point ω_i by swerving in the direction of his right hand when $\varepsilon_i = +$, of his left hand when $\varepsilon_i = -$.

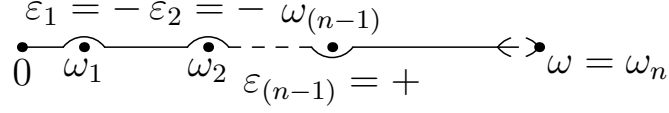
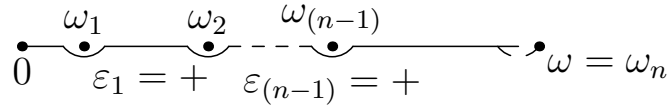
FIGURE 28. Example of path of type γ_ε for $\varepsilon \in \{+, -\}^{n-1}$.FIGURE 29. Example of path of type γ_ε for $\varepsilon \in \{+\}^{n-1}$.

$\{+\}^{n-1}$ ending close to ω_n and avoiding $\omega_1, \dots, \omega_{n-1}$ to the right, see Fig. 29. Then we set

$$\Delta_{\omega_n}^+ f = \text{sing}_{\omega_n} \gamma_{\varepsilon} \cdot \varphi \in \text{RES}^{\text{simp}}.$$

One extends this definition to any point $\omega \in \mathbb{C}^*$ by imposing

$$\Delta_{\omega}^+ f = 0$$

when ω is not a glimpsed singular point for the direction $\theta = \text{ph}(\omega) \in \frac{\mathbb{R}}{2\pi\mathbb{Z}}$.

We mention that it is possible for a glimpsed singularity ω to be a “removable” singular point for $\gamma_{\varepsilon} \cdot \varphi$ and in that case $\Delta_{\omega}^+ f = 0$ from the very definition of sing_{ω} . Cf. Example 6.3.1.2.

Lemma 6.3.1. — We assume that $f = C\delta + \varphi \in \text{RES}^{\text{simp}}$, $\varphi \in \mathcal{H}_{\text{end}}^{\text{simp}}$ and that

$$\text{Sing}_{\varphi}^*(\theta) = \{\omega_i, |\omega_1| < \dots < |\omega_n| < |\omega_{n+1}| < \dots\} \in]0, e^{i\theta}\infty[$$

for some $\theta \in \frac{\mathbb{R}}{2\pi\mathbb{Z}}$. Then if $\Delta_{\omega_n}^+ f = C_{\omega_n}\delta + \varphi_{\omega_n}$ for some $n \in \mathbb{N}^*$, one has

$$\text{Sing}_{\varphi_{\omega_n}}^*(\theta) \subset \{\omega_{n+1} - \omega_n, \omega_{n+2} - \omega_n, \dots\} = \tau_{-\omega_n} \left(\text{Sing}_{\varphi}^*(\theta) \cap]\omega_n, e^{i\theta}\infty[\right)$$

where $\tau_{-\omega_n}$ stands for the translation operator of vector $-\omega_n$.

Proof. — Just a direct consequence of the definitions. □

6.3.1.2. *Example.* — We consider

$$\varphi(\zeta) = \frac{\varphi_1(\zeta+1)}{2i\pi(\zeta+1)} + \frac{\varphi_2(\zeta+2)}{\zeta+2} \left(\frac{\ln(\zeta+1)}{2i\pi} - \frac{1}{2} \right) + \frac{\varphi_4(\zeta+4)}{2i\pi} \ln(\zeta+4) \in \mathcal{H}_{\text{end}}^{\text{simp}}$$

where $\varphi_1, \varphi_2, \varphi_4 \in \mathcal{O}(\mathbb{C})$. Obviously $\text{Sing}_{\varphi}^*(\pi) \subset \{-1, -2, -4\}$ and

$$1. \text{sing}_{-1} \gamma_{()} \cdot \varphi = \Delta_{-1}^+ \varphi = \varphi_1(0)\delta + \frac{\varphi_2(\zeta+1)}{\zeta+1}, \text{ since for } \xi \in D(0, 1),$$

$$\varphi(-1 + \xi) = \frac{\varphi_1(0)}{2i\pi\xi} + \frac{\varphi_2(\xi+1)}{2i\pi} \frac{1}{\xi+1} \ln(\xi) + \text{Reg}(\xi).$$

2. $\text{sing}_{-2}\gamma_{(+)}\cdot\varphi = \Delta_{-2}^+\varphi = 0$, since for $\xi \in D(0, 1)$,

$$\begin{aligned}\gamma_{(+)}\cdot\varphi(-2 + \xi) &= \frac{\varphi_2(\xi)}{\xi} \left(\frac{\log(e^{i\pi} + \xi)}{2i\pi} - \frac{1}{2} \right) + \text{Reg}(\xi) \\ &= \frac{\varphi_2(\xi)}{\xi} \left(\frac{i\pi + \ln(1 + \xi e^{-i\pi})}{2i\pi} - \frac{1}{2} \right) + \text{Reg}(\xi) = \text{Reg}(\xi).\end{aligned}$$

Note that obviously $\Delta_{-1}^+\Delta_{-1}^+\varphi = 2i\pi\varphi_2(0)\delta$. Returning to the very definition of the sing operator one gets

$$\Delta_{-1}^+\Delta_{-1}^+\varphi = \text{sing}_{-2}(\gamma_{(+)}\cdot\varphi - \gamma_{(-)}\cdot\varphi) = 2i\pi\varphi_2(0)\delta.$$

Comparing the two results we get that

$$\text{sing}_{-2}\gamma_{(-)}\cdot\varphi = \Delta_{-2}^+\varphi - \Delta_{-1}^+\Delta_{-1}^+\varphi = -2i\pi\varphi_2(0)\delta.$$

3. $\text{sing}_{-4}\gamma_{(+,+)}\cdot\varphi = \Delta_{-4}^+\varphi = \varphi_4(\zeta)$, since for $\xi \in D(0, 2)$,

$$\gamma_{(+,+)}\cdot\varphi(-4 + \xi) = \frac{\varphi_4(\xi)}{2i\pi} \ln(\xi) + \text{Reg}(\xi).$$

Notice that $0 = \Delta_{-2}^+\Delta_{-2}^+\varphi = \text{sing}_{-4}(\gamma_{(+,+)}\cdot\varphi - \gamma_{(+,-)}\cdot\varphi)$ so that

$$\text{sing}_{-4}\gamma_{(+,-)}\cdot\varphi = \Delta_{-4}^+\varphi - \Delta_{-2}^+\Delta_{-2}^+\varphi = \varphi_4(\zeta).$$

Similarly $0 = \Delta_{-3}^+\Delta_{-1}^+\varphi = \text{sing}_{-4}(\gamma_{(+,+)}\cdot\varphi - \gamma_{(-,+)}\cdot\varphi)$, thus

$$\text{sing}_{-4}\gamma_{(-,+)}\cdot\varphi = \Delta_{-4}^+\varphi - \Delta_{-3}^+\Delta_{-1}^+\varphi = \varphi_4(\zeta).$$

Finally one has also

$$0 = \Delta_{-2}^+\Delta_{-1}^+\Delta_{-1}^+\varphi = \text{sing}_{-4}([\gamma_{(+,+)}\cdot\varphi - \gamma_{(-,+)}\cdot\varphi] - [\gamma_{(+,-)}\cdot\varphi - \gamma_{(-,-)}\cdot\varphi])$$

from which we deduce that

$$\text{sing}_{-4}\gamma_{(-,-)}\cdot\varphi = \Delta_{-4}^+\varphi - \Delta_{-3}^+\Delta_{-1}^+\varphi - \Delta_{-2}^+\Delta_{-2}^+\varphi + \Delta_{-2}^+\Delta_{-1}^+\Delta_{-1}^+\varphi = \varphi_4(\zeta).$$

This exemplifies how the operator Δ^+ and its iterations can be used to precise the structure of the Riemann surface of an endlessly continuable germ of holomorphic functions with simple singularities. We formalize in Proposition 6.3.2 below this idea.

6.3.1.3. *Some properties.* —

Proposition 6.3.1. — *For every $\omega \in \mathbb{C}^*$, $\text{ph}(\omega) = \theta \in \frac{\mathbb{R}}{2\pi\mathbb{Z}}$, the operator*

$$\Delta_{\omega}^+ : \text{RES}^{\text{simp}} \rightarrow \text{RES}^{\text{simp}}$$

is \mathbb{C} -linear and satisfies: for every $f = C\delta + \varphi \in \text{RES}^{\text{simp}}$ and $g = D\delta + \psi \in \text{RES}^{\text{simp}}$,

$$(67) \quad \Delta_{\omega}^+(f * g) = (\Delta_{\omega}^+ f) * g + \sum_{\omega_1 + \omega_2 = \omega} (\Delta_{\omega_1}^+ f) * (\Delta_{\omega_2}^+ g) + f * (\Delta_{\omega}^+ g)$$

where the sum runs over all $(\omega_1, \omega_2) \in]0, \omega]^2$ such that $\omega_1 + \omega_2 = \omega$ with $\omega_1 \in \text{Sing}_{\varphi}^(\theta)$ and $\omega_2 \in \text{Sing}_{\psi}^*(\theta)$.*

Proof. — The fact that Δ_ω^+ is a linear operator is obvious. Otherwise, we have seen in Corollary 5.5.1 that for two endlessly continuable germs $\varphi, \psi \in \mathcal{H}_{end}$, the set of glimpsed singular points in the direction $\theta \in \frac{\mathbb{R}}{2\pi\mathbb{Z}}$ of $\varphi * \psi$ satisfies

$$\text{Sing}_{\mathcal{G}\varphi*\psi}^*(\theta) \subseteq (\text{Sing}_\varphi(\theta) + \text{Sing}_\psi(\theta)) \setminus \{0\}.$$

Thus formula (58) of Theorem 6.2.1 translates into

$$\Delta_\omega^+(f * g) = (\Delta_\omega^+ f) * g + \sum \pm (\Delta_{\omega_1}^+ f) * (\Delta_{\omega_2}^+ g) + f * (\Delta_\omega^+ g)$$

where the sum extends to the pinching couples $(\omega_1, \omega_2) \in]0, \omega]^2$ such that $\omega_1 + \omega_2 = \omega$ with $\omega_1 \in \text{Sing}_\varphi^*(\theta)$ and $\omega_2 \in \text{Sing}_\psi^*(\theta)$. What remains to show is to precise the sign in the above formula, which depends on whether the pinching occurs with the canonical orientation (+ sign) or not (− sign), which is obviously determined for paths of the type $\gamma_\varepsilon = (+, \dots, +) \in \{+\}^{n-1}$ (the integral defining the convolution product is made along γ_ε up to small deformations due to the movable singular points, all of them coming from “the right” in direction of the fixed singular points, see Fig. 8). \square

Proposition 6.3.2. — *We assume that $f = C\delta + \varphi \in \text{RES}^{simp}$, $\varphi \in \mathcal{H}_{end}^{simp}$ and that*

$$\text{Sing}_\varphi^*(\theta) = \{\omega_i, |\omega_1| < \dots < |\omega_n| < |\omega_{n+1}| < \dots\} \in]0, e^{i\theta}\infty[$$

for some $\theta \in \frac{\mathbb{R}}{2\pi\mathbb{Z}}$. For every $n \geq 2$ and every $\varepsilon = (\varepsilon_1, \dots, \varepsilon_{n-1}) \in \{+, -\}^{n-1}$,

$$\text{sing}_{\mathcal{G}\omega_n \gamma_\varepsilon} \varphi = \Delta_{\omega_n}^+ f + \sum_{1 \leq r \leq q(\varepsilon)} (-1)^r \sum_{\substack{|\omega_{i_1}| < \dots < |\omega_{i_r}| < |\omega_n| \\ \varepsilon_{i_1} = \dots = \varepsilon_{i_r} = -}} \Delta_{\omega_n - \omega_{i_r}}^+ \dots \Delta_{\omega_{i_2} - \omega_{i_1}}^+ \Delta_{\omega_{i_1}}^+ f$$

where $q(\varepsilon)$ denotes the number of ‘−’ signs in the sequence ε . For each $r \geq 1$, the right-hand sum has exactly $\binom{q(\varepsilon)}{r}$ terms where $\binom{\cdot}{\cdot}$ is the binomial coefficient.

Proof. — In what follows, for two sequences $\mathbf{a} = (a_1, \dots, a_m)$ and $\mathbf{b} = (b_1, \dots, b_n)$ we note by $\mathbf{a}.\mathbf{b} = (a_1, \dots, a_m, b_1, \dots, b_n)$ their concatenation.

For some $n \geq 2$ and some $1 \leq i \leq n-1$, consider the sequences

$$\varepsilon = (\varepsilon_1, \dots, \varepsilon_{i-1}) \in \{+, -\}^{i-1}$$

and

$$\varepsilon' = (+, \dots, +) \in \{+\}^{n-i}, \quad \varepsilon'' = (-, +, \dots, +) \in \{+, -\}^{n-i}.$$

It is an easy exercise (stemming from the very definition of the operator sing) that

$$(68) \quad \Delta_{\omega_n - \omega_i}^+ \text{sing}_{\mathcal{G}\omega_i \gamma_\varepsilon} \varphi = \text{sing}_{\mathcal{G}\omega_n \gamma_{\varepsilon.\varepsilon'}} \varphi - \text{sing}_{\mathcal{G}\omega_n \gamma_{\varepsilon.\varepsilon''}} \varphi$$

where the sequences $\varepsilon.\varepsilon'$ and $\varepsilon.\varepsilon''$ only differ from the sign of their i -th element.

Let us now consider the case of a sequence containing only + signs except for one − sign at the i -th position: we set $\varepsilon = (\varepsilon_1, \dots, \varepsilon_{n-1}) \in \{+\}^{n-1}$, $\varepsilon_i = (\varepsilon_1, \dots, -\varepsilon_i, \dots, \varepsilon_{n-1})$, one deduces from (68) that

$$(69) \quad \Delta_{\omega_n - \omega_i}^+ \Delta_{\omega_i}^+ f = \Delta_{\omega_n}^+ f - \text{sing}_{\mathcal{G}\omega_n \gamma_{\varepsilon_i}} \varphi.$$

We thus obtain the desired formula for $\text{sing}_{\mathcal{G}\omega_n \gamma_{\varepsilon_i}} \varphi$. Now replacing n with any $j \in]i, n-1]$ and applying again (68),

$$\begin{aligned} \Delta_{\omega_n - \omega_j}^+ \Delta_{\omega_j - \omega_i}^+ \Delta_{\omega_i}^+ f &= \Delta_{\omega_n - \omega_j}^+ \left(\Delta_{\omega_j}^+ f - \text{sing}_{\mathcal{G}\omega_j \gamma_{(\varepsilon_1, \dots, -\varepsilon_i, \dots, \varepsilon_{j-1})}} \varphi \right) \\ &= \Delta_{\omega_n - \omega_j}^+ \Delta_{\omega_j}^+ f - \text{sing}_{\mathcal{G}\omega_n \gamma_{\varepsilon_i}} \varphi + \text{sing}_{\mathcal{G}\omega_n \gamma_{\varepsilon_{(i,j)}}} \varphi \end{aligned}$$

where $\varepsilon_{(i,j)}$ is the sequence deduced from ε by changing the signs of ε_i and ε_j from $+$ to $-$. Now using (69) one gets that

$$\Delta_{\omega_n - \omega_j}^+ \Delta_{\omega_j - \omega_i}^+ \Delta_{\omega_i}^+ f = \Delta_{\omega_n - \omega_j}^+ \Delta_{\omega_j}^+ f + \Delta_{\omega_n - \omega_i}^+ \Delta_{\omega_i}^+ f - \Delta_{\omega_n}^+ f + \text{sing}_{\omega_n} \gamma_{\varepsilon_{(i,j)}} \cdot \varphi$$

The final result is shown that way by (finite) induction. \square

6.3.2. Alien derivations. — All the machinery is now in place to introduce the alien derivations of Ecalle.

6.3.2.1. *Alien derivations - Definition.* —

Definition 6.3.3. — For every $\omega \in \mathbb{C}^*$, $\text{ph}(\omega) = \theta \in \frac{\mathbb{R}}{2\pi\mathbb{Z}}$, we define the linear operator

$$\Delta_\omega : \text{RES}^{\text{simp}} \rightarrow \text{RES}^{\text{simp}}$$

by:

$$(70) \quad \Delta_\omega = \sum_{r \in \mathbb{N}^*} \frac{(-1)^{r-1}}{r} \sum_{\substack{(\omega_1, \dots, \omega_r) \in]0, e^{i\theta} \infty[^r \\ \omega_1 + \dots + \omega_r = \omega}} \Delta_{\omega_r}^+ \cdots \Delta_{\omega_1}^+.$$

The operator Δ_ω is called the alien derivation at ω .

Notice a consequence of Lemma 6.3.1 : for $f = C\delta + \varphi \in \text{RES}^{\text{simp}}$, $\varphi \in \mathcal{H}_{\text{end}}^{\text{simp}}$, $\Delta_{\omega_r}^+ \cdots \Delta_{\omega_1}^+ f$ vanishes as a rule except, eventually, when

- $\omega_1 \in \text{Sing}_\varphi^*(\theta)$,
- $\omega_2 \in \tau_{-\omega_1}(\text{Sing}_\varphi^*(\theta) \cap]\omega_1, e^{i\theta} \infty[)$,
- \vdots
- $\omega_r \in \tau_{-(\omega_1 + \dots + \omega_{r-1})}(\text{Sing}_\varphi^*(\theta) \cap]\omega_1 + \dots + \omega_{r-1}, e^{i\theta} \infty[)$

with $\omega_1 + \dots + \omega_r = \omega$. Thus the sums in (70) are finite.

6.3.2.2. *Example.* — We go back to the example discussed in §6.3.1.2. Applying formula (70) one gets:

1. $\Delta_{-1}\varphi = \Delta_{-1}^+\varphi = \text{sing}_{-1}\gamma_{(-)} \cdot \varphi$.
2. One has

$$\begin{aligned} \Delta_{-2}\varphi &= \Delta_{-2}^+\varphi - \frac{1}{2}\Delta_{-1}^+\Delta_{-1}^+\varphi \\ &= \frac{1}{2}\text{sing}_{-2}\gamma_{(+)} \cdot \varphi + \frac{1}{2}\text{sing}_{-2}\gamma_{(-)} \cdot \varphi. \end{aligned}$$

Conversely, noticing that

$$\Delta_{-1}\Delta_{-1}\varphi = \Delta_{-1}^+\Delta_{-1}^+\varphi,$$

one obtains:

$$\Delta_{-2}^+\varphi = \Delta_{-2}\varphi + \frac{1}{2}\Delta_{-1}\Delta_{-1}\varphi$$

3. One has

$$\begin{aligned} \Delta_{-4}\varphi &= \Delta_{-4}^+\varphi - \frac{1}{2}(\Delta_{-3}^+\Delta_{-1}^+\varphi + \Delta_{-2}^+\Delta_{-2}^+\varphi) + \frac{1}{3}\Delta_{-2}^+\Delta_{-1}^+\Delta_{-1}^+\varphi \\ &= \frac{1}{3}\text{sing}_{-4}\gamma_{(+,+)} \cdot \varphi + \frac{1}{6}\text{sing}_{-4}\gamma_{(+,-)} \cdot \varphi + \frac{1}{6}\text{sing}_{-4}\gamma_{(-,+)} \cdot \varphi + \frac{1}{3}\text{sing}_{-4}\gamma_{(-,-)} \cdot \varphi \end{aligned}$$

6.3.2.3. *Alien derivations - Some properties.* — We shall refer to [S006], §2.4 (see also [S006], [CNP93-1], §Rés II and [Ec81-1]) for the proofs of the following Propositions 6.3.3 and 6.3.4. We stress that these proofs require only materials developed in this paper⁽¹¹⁾.

Proposition 6.3.3. — *We assume that $f = C\delta + \varphi \in \text{RES}^{\text{simp}}$, $\varphi \in \mathcal{H}_{\text{end}}^{\text{simp}}$ and that*

$$\text{Sing}_{\varphi}^*(\theta) = \{\omega_i, |\omega_1| < \dots < |\omega_n| < \dots\} \in]0, e^{i\theta} \infty[$$

for some $\theta \in \frac{\mathbb{R}}{2\pi\mathbb{Z}}$. Then

$$(71) \quad \Delta_{\omega_n} f = \sum_{\varepsilon=(\varepsilon_1, \dots, \varepsilon_{n-1}) \in \{+, -\}^{n-1}} \frac{p(\varepsilon)!q(\varepsilon)!}{n!} \text{sing}_{\omega_n} \gamma_{\varepsilon} \cdot \varphi,$$

where $p(\varepsilon)$ - resp. $q(\varepsilon) = n - 1 - p(\varepsilon)$ - denotes the number of '+' signs - resp. '-' signs - in the sequence ε , while the 2^{n-1} paths γ_{ε} avoid $\omega_1, \dots, \omega_{n-1}$ to the right or to the left according to ε (Definition 6.3.1) and end close to ω_n . Also,

$$\Delta_{\omega_n}^+ f = \Delta_{\omega_n} f + \sum_{1 \leq r \leq n-1} \frac{1}{(r+1)!} \sum_{|\omega_{i_1}| < \dots < |\omega_{i_r}| < |\omega_n|} \Delta_{\omega_n - \omega_{i_r}} \cdots \Delta_{\omega_{i_2} - \omega_{i_1}} \Delta_{\omega_{i_1}} f$$

where for each $r \geq 1$, the right-hand sum has exactly $\binom{n-1}{r}$ terms.

Of course the main properties for the alien derivations of Ecalle is precisely that their are derivations !

Proposition 6.3.4. — *For every $\omega \in \mathbb{C}^*$, the operator $\Delta_{\omega} : \text{RES}^{\text{simp}} \rightarrow \text{RES}^{\text{simp}}$ is a derivation, that is Δ_{ω} satisfies the Leibniz rule:*

$$(72) \quad \Delta_{\omega} f * g = (\Delta_{\omega} f) * g + f * (\Delta_{\omega} g), \quad f, g \in \text{RES}^{\text{simp}}.$$

6.4. Back to the Riemann surface of a convolution product

We have shown in Proposition 6.3.2 that considering the analytic continuations of an endless germ of holomorphic function with simple singularities along a path γ_{ε} that closely follows a direction, is equivalent to consider a linear combination of operators of the type $\Delta_{\omega_n}^+ \cdots \Delta_{\omega_1}^+$ (or $\Delta_{\omega_n} \cdots \Delta_{\omega_1}$ if one likes, by Proposition 6.3.3). Arrived at the end point of γ_{ε} , one can then choose another direction by and examine that direction along a new path of type γ_{ε} . This is just equivalent to consider products of type $\Delta_{\omega_n}^+ \cdots \Delta_{\omega_1}^+$ (or $\Delta_{\omega_n} \cdots \Delta_{\omega_1}$ if one likes) where now the phases of $\omega_1, \dots, \omega_n$ may differ.

This is this idea that we use in this section. Notice that this way of exploring the Riemann surface is closely related with Definition 5.6.3 of Ecalle [Ec93-1]. See also [CNP93-1], §Rés II-2. We start with some examples and remarks.

⁽¹¹⁾As a matter of fact one can show Proposition 6.3.3 by starting from formula (71) and finding formula (70) using Proposition 6.3.2. In the same way, Proposition 6.3.4 is a consequence of Proposition 6.3.1. This pedestrian way of thinking hides an important fact : to the collection of Δ_{ω}^+ , $\omega \in]0, e^{i\theta} \infty[$, one can associate an automorphism Δ^+ , the logarithm of which being the directional alien derivation - with respect to the direction θ -. The automorphism Δ^+ allows to analyze the Stokes phenomena in practice.

6.4.1. Examples and remarks. —

6.4.1.1. *First example.* — We consider the situation of Fig. 30. We assume that $\varphi \in \mathcal{H}_{\text{end}}^{\text{simp}}$ has an associated discrete filtered set Ω_\star centered at 0 such that $\Omega_{L_0} = \{2, 1+i, 1+1.5i, 2+3i\}$ for $L_0 = 6$ (say). We would like to illustrate how the Δ^+ operators can be used so as to precise the nature of these points.

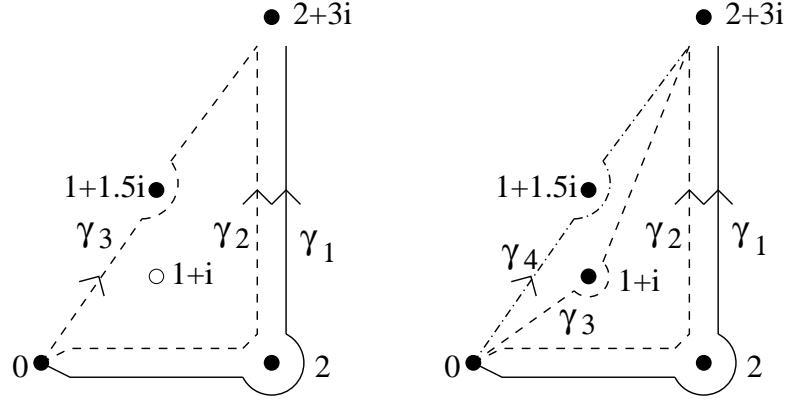

FIGURE 30. Left picture : the paths γ_2 and γ_3 are Ω_\star -homotopic. Right picture : γ_2 and γ_3 are Ω_\star -homotopic but not with γ_4 .

– **First case, Fig. 30, left picture.** We assume here that $\Delta_{1+i}^+\varphi = 0$. We concentrate on the point $2+3i$.

Starting with the identity $\Delta_2^+\varphi = \text{sing}_2\gamma_0 \cdot \varphi$, one deduces that $\Delta_{3i}^+\Delta_2^+\varphi = \text{sing}_{2+3i}(\gamma_1 \cdot \varphi - \gamma_2 \cdot \varphi)$.

On Fig. 30, left picture, the paths γ_2 and γ_3 are seen to be Ω_\star -homotopic, thus $\gamma_2 \cdot \varphi = \gamma_3 \cdot \varphi$. But since γ_3 is of type $\gamma_{(+)}$, one has $\text{sing}_{2+3i}\gamma_3 \cdot \varphi = \Delta_{2+3i}^+\varphi$.

As a conclusion, one gets the following knowledge about the nature of the point $2+3i$:

1. since $\text{sing}_{2+3i}\gamma_2 \cdot \varphi = \text{sing}_{2+3i}\gamma_3 \cdot \varphi = \Delta_{2+3i}^+\varphi$, then $2+3i$ is an actual singular point for $\gamma_3 \cdot \varphi$ iff $\Delta_{2+3i}^+\varphi \neq 0$. In that case, $2+3i$ belongs to Ω_L for $L > |2+3i|$. The same conclusion when $\Delta_{1+1.5i}^+\Delta_{1+1.5i}^+\varphi \neq 0$.
2. When $\Delta_{1+1.5i}^+\Delta_{1+1.5i}^+\varphi = \Delta_{2+3i}^+\varphi = 0$ and since $\text{sing}_{2+3i}\gamma_1 \cdot \varphi = \Delta_{3i}^+\Delta_2^+\varphi + \Delta_{2+3i}^+\varphi$, then $2+3i$ is an actual singular point for $\gamma_1 \cdot \varphi$ iff $\Delta_{3i}^+\Delta_2^+\varphi \neq 0$. In that case, $2+3i$ belongs to Ω_L *only* for $L > |2| + |3i|$.

Second case, Fig. 30, right picture. We assume here that $\Delta_{1+i}^+\varphi \neq 0$, thus $1+i$ belongs to Ω_L for $L > |1+i|$. We again concentrate on the point $2+3i$.

Of course we still have $\Delta_{3i}^+\Delta_2^+\varphi = \text{sing}_{2+3i}(\gamma_1 \cdot \varphi - \gamma_2 \cdot \varphi)$. We now introduce

$\Delta_{1+2i}^+\Delta_{1+i}^+\varphi = \text{sing}_{2+3i}(\gamma_3 \cdot \varphi - \gamma_4 \cdot \varphi)$ and we remark that $\gamma_2 \cdot \varphi = \gamma_3 \cdot \varphi$ (because γ_2 and γ_3 are Ω_\star -homotopic) while $\text{sing}_{2+3i}\gamma_4 \cdot \varphi = \Delta_{2+3i}^+\varphi$.

To summarize,

1. since $\text{sing}_{2+3i}\gamma_4 \cdot \varphi = \Delta_{2+3i}^+\varphi$, then $2+3i$ is an actual singular point for $\gamma_4 \cdot \varphi$ iff $\Delta_{2+3i}^+\varphi \neq 0$. In that case, $2+3i$ belongs to Ω_L for $L > |2+3i|$. Same conclusion when $\Delta_{1+1.5i}^+\Delta_{1+1.5i}^+\varphi \neq 0$.
2. When $\Delta_{1+1.5i}^+\Delta_{1+1.5i}^+\varphi = \Delta_{2+3i}^+\varphi = 0$ and since $\text{sing}_{2+3i}\gamma_3 \cdot \varphi = \Delta_{1+2i}^+\Delta_{1+i}^+\varphi + \Delta_{2+3i}^+\varphi$, then $2+3i$ is an actual singular point for $\gamma_3 \cdot \varphi$ iff $\Delta_{1+2i}^+\Delta_{1+i}^+\varphi \neq 0$. In that case, $2+3i$ belongs to Ω_L *only* for $L > |1+i| + |1+2i|$.

3. When $\Delta_{1+1.5i}^+ \Delta_{1+1.5i}^+ \varphi = \Delta_{2+3i}^+ \varphi = \Delta_{1+2i}^+ \Delta_{1+i}^+ \varphi = 0$, since $\text{sing}_{2+3i} \gamma_1 \cdot \varphi = \Delta_{3i}^+ \Delta_2^+ \varphi + \Delta_{1+2i}^+ \Delta_{1+i}^+ \varphi + \Delta_{2+3i}^+ \varphi$, then $2 + 3i$ is an actual singular point for $\gamma_1 \cdot \varphi$ iff $\Delta_{3i}^+ \Delta_2^+ \varphi \neq 0$. In that case, $2 + 3i$ belongs to Ω_L *only* for $L > |2| + |3i|$.

6.4.1.2. *Second example.* — We now consider the situation of Fig. 31 where we use the notations of Lemma 6.2.1 with $\delta = \delta_2$ (see also Fig. 26) : $\varphi \in \mathcal{H}_{end}^{simp}$ has an associated discrete filtered set Ω_\star centered at 0 such that $\Omega_{L_0} = \{2, 2 + 3i\}$ for $L_0 = 6$ (say). Here we would like to analyze the effect of a rotation at a singular point, here at 2.

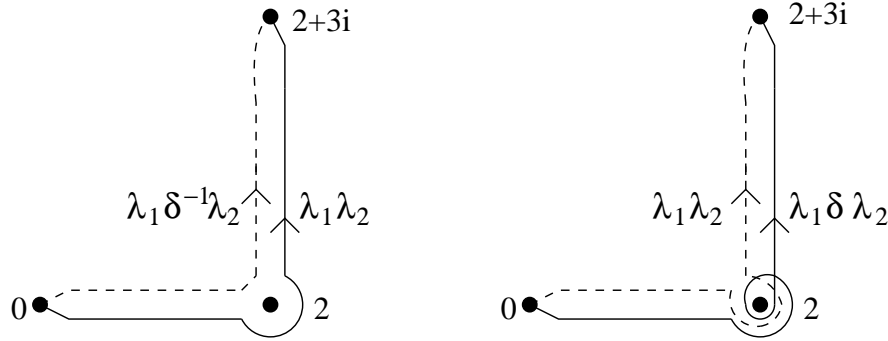

FIGURE 31. Left picture : the paths $\lambda_1 \delta^{-1} \lambda_2$, $\lambda_1 \lambda_2$, $\lambda_1 \delta \lambda_2$.

From the previous analysis we know that $\Delta_{2+3i}^+ \varphi = \text{sing}_{2+3i} \lambda_1 \delta^{-1} \lambda_2 \cdot \varphi$ but also, using Lemma 6.2.1, that $\Delta_{3i}^+ \Delta_2^+ \varphi = \text{sing}_{2+3i} (\lambda_1 \lambda_2 \cdot \varphi - \lambda_1 \delta^{-1} \lambda_2 \cdot \varphi) = \text{sing}_{2+3i} (\lambda_1 \delta \lambda_2 \cdot \varphi - \lambda_1 \lambda_2 \cdot \varphi)$. Therefore

1. $\text{sing}_{2+3i} \lambda_1 \delta^{-1} \lambda_2 \cdot \varphi = \Delta_{2+3i}^+ \varphi$,
2. $\text{sing}_{2+3i} \lambda_1 \lambda_2 \cdot \varphi = \Delta_{3i}^+ \Delta_2^+ \varphi + \Delta_{2+3i}^+ \varphi$,
3. $\text{sing}_{2+3i} \lambda_1 \delta \lambda_2 \cdot \varphi = 2 \Delta_{3i}^+ \Delta_2^+ \varphi + \Delta_{2+3i}^+ \varphi$
4. more generally, $\text{sing}_{2+3i} \lambda_1 \delta^n \lambda_2 \cdot \varphi = (n + 1) \Delta_{3i}^+ \Delta_2^+ \varphi + \Delta_{2+3i}^+ \varphi$ for $n \in \mathbb{Z}$.

This allows to conclude as in the first example whether a point belongs to Ω_L or not for $L < L_0$ and we see that adding some small loops δ has no effect in the conclusion.

6.4.1.3. *Conclusion.* — The above examples clearly show the way to precise the rather rough information given by a discrete filtered set Ω_\star one started with: if $\varphi \in \mathcal{H}_{end}^{simp}$ is analytically continuable on the Riemann surface $\mathcal{R}_{\Omega_\star}$ associated with the discrete filtered set Ω_\star , then for some $L > 0$ and a given $\omega \in \Omega_L$,

- either there exists a sequence $\omega_1, \omega_2, \dots, \omega_n \in \Omega_L$ such that $\Delta_{\omega - (\omega_{n-1} + \dots + \omega_1)}^+ \dots \Delta_{\omega_2 - \omega_1}^+ \Delta_{\omega_1}^+ \varphi \neq 0$ with $|\omega - (\omega_{n-1} + \dots + \omega_1)| + \dots + |\omega_2 - \omega_1| + |\omega_1| < L$ and in that case ω is not a “removable” singular point of $\omega \in \Omega_L$,
- either ω can be removed from Ω_L .

6.4.2. Preparatory results. — A property was underlying in our first example §6.4.1.1, namely the fact that the path γ_2 was homotopic to γ_3 , a product of segments and of curves following the boundary of small discs centred to singular points. We need to generalize this result. This is equivalent to look for geodesics.

We first recall the following well-known result for compact Riemannian manifold, see e.g. [Jos95]:

Theorem 6.4.1. — *If M is a compact Riemannian manifold, then for every two points $a, b \in M$, there exists a geodesic in every homotopy class of curves from a to b and this geodesic may be chosen as a shortest curve in the homotopy class.*

In this theorem, a geodesic is a locally shortest path for the metric, or equivalently a path that satisfied the Euler-Lagrange equations (when M has no boundary).

When M is not compact, Theorem 6.4.1 remains valid only if M is complete⁽¹²⁾ (as a metric space or equivalently for its underlying topology).

In our problem, we consider paths in \mathfrak{R} of length $< L$ which have to avoid a finite set of points Ω_L for some $L > 0$. Thus we define small discs centred at each point of Ω_L and we define a space M as the complement in \mathbb{C} of these discs. The space M is a complete (real) 2-dimensional Riemannian manifold with smooth boundary embedded in the 2-dimensional euclidean space⁽¹³⁾ : in the interior a geodesic is a straight line otherwise one just follows the boundary ∂M , see, e.g., [AB91] and references therein. We thus have the following result (see also [CNP93-1]§Rés II-2):

Lemma 6.4.1. — *For a given discrete filtered set Ω_\star centred at 0, every Ω_\star -allowed path is Ω_\star -homotopic to a geodesic path of shortest length which can be decomposed as the product of segments and small curves around points of the discrete filtered set.*

From this Lemma, every Ω_\star -allowed path ending close to a singular point is Ω_\star -homotopic to a path of type γ_ε according to the following Definition and Fig. 32.

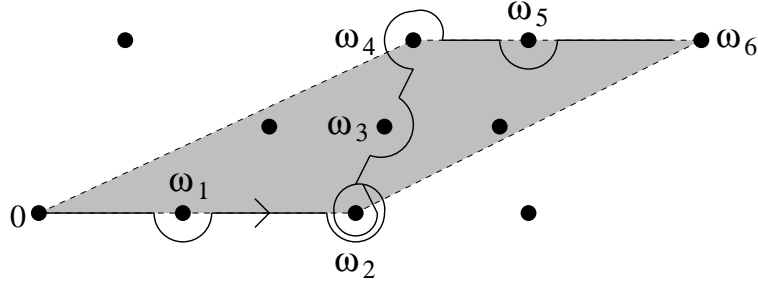

FIGURE 32. An example of path of type $\gamma_{(+;\delta^1;+;\delta^{-1};+)}$ and its associated convex hull.

Definition 6.4.1. — *We assume that Ω_\star is a discrete filtered set centred at 0. For $L > 0$ and $n > 0$ we consider a sequence $\omega_1, \dots, \omega_n$ of points of Ω_L such that there exists a sequence $0 = n_0 < n_1 < n_2 < \dots < n_k < n_{k+1} = n$ so that:*

- $\omega_0 = 0$,
- for every $0 \leq i \leq n-1$, $\omega_i \neq \omega_{i+1}$,
- for every $0 \leq j \leq k$, $\forall i \in [n_j, n_{j+1}]$, $\omega_i \in [\omega_{n_j}, \omega_{n_{j+1}}]$,
- $|\omega_1| + \dots + |\omega_n| < L$.

We note

- for every $0 \leq j \leq k$, $\varepsilon_j = (\varepsilon_{n_{j+1}}, \dots, \varepsilon_{n_{j+1}-1}) \in \{+, -\}^{n_{j+1}-n_j-1}$,
- $(m_1, m_2, \dots, m_k) \in \mathbb{Z}^k$.

⁽¹²⁾Theorem of Hopf-Rinow, [Jos95].

⁽¹³⁾Here we identify \mathbb{C} as \mathbb{R}^2 with its usual scalar product $\langle \cdot, \cdot \rangle$. To keep the complex structure one can of course rather consider the Hermitian form $\langle z, z' \rangle = z\bar{z}'$ which induces a Riemann metric as well.

Finally for $\underline{\varepsilon} = (\varepsilon_0; \delta_{n_1}^{m_1}; \dots; \varepsilon_{n_{k-1}}; \delta_{n_k}^{m_k}; \varepsilon_{n_k})$ we denote by $\gamma_{\underline{\varepsilon}}$ any path $\gamma \in \mathfrak{R}_{\Omega_L}^*$ with end point $\gamma(1)$ close to $]\omega_{n-1}, \omega_n[$ and so that:

- $\gamma_{\underline{\varepsilon}}$ closely follows each segment $]\omega_{n_j}, \omega_{n_{j+1}}[$, $0 \leq j \leq k$, in the forward direction while circumventing the points $\omega_{n_{j+1}}, \dots, \omega_{n_{j+1}-1}$ to the right or to the left according to the sequence ε_j ,
- $\gamma_{\underline{\varepsilon}}$ avoids each point ω_{n_j} , $1 \leq j \leq k$, to the right if $\delta_{n_j}^{m_j} = \delta_{n_j}^0$ or to the left times $\delta_{n_j}^{m_j}$ where δ_{n_j} stands for a small anticlockwise loop around ω_{n_j} .

We shall say that the points ω_{n_j} are corner points for the path $\gamma_{\underline{\varepsilon}}$.

The convex hull associated to $\gamma_{\underline{\varepsilon}}$ is the convex hull $\mathcal{P}(\gamma_{\underline{\varepsilon}})$ in \mathbb{C} of the set $\{0, \omega_1, \dots, \omega_n\}$.

One defines $\mathfrak{P}(\gamma_{\underline{\varepsilon}})$ as

$$\mathfrak{P}_L(\gamma_{\underline{\varepsilon}}) = \mathcal{P}(\gamma_{\underline{\varepsilon}}) \cap \Omega_L.$$

Proposition 6.4.1. — We assume that Ω_* is a discrete filtered set centred at 0. We consider that $\varphi \in \mathcal{H}_{\text{end}}^{\text{simp}}$ is analytically continuable on \mathcal{R}_{Ω_*} . For some $L > 0$ one considers a path in $\mathfrak{R}_{\Omega_L}^*$ of type $\gamma_{\underline{\varepsilon}}$ ending close to $\omega \in \Omega_L$. Then $\text{sing}_{\omega} \gamma_{\underline{\varepsilon}} \cdot \varphi$ can be decomposed as

$$(73) \quad \text{sing}_{\omega} \gamma_{\underline{\varepsilon}} \cdot \varphi = \Delta_{\omega}^+ \varphi + \sum_{r \geq 1} \sum_{\substack{(\omega_1, \dots, \omega_r) \in \mathfrak{P}_L(\gamma_{\underline{\varepsilon}})^r \\ |\omega_1| + \dots + |\omega_r| < L}} a_{(\omega_1, \dots, \omega_r)} \Delta_{\omega - \omega_r}^+ \cdots \Delta_{\omega_2 - \omega_1}^+ \Delta_{\omega_1}^+ \varphi$$

where the $a_{(\omega_1, \dots, \omega_r)}$ belong to \mathbb{Z} .

Proof. — The proof is presented by the following algorithm.

We consider a path $\gamma_{\underline{\varepsilon}} \in \mathfrak{R}_{\Omega_L}^*$ where $\underline{\varepsilon} = (\varepsilon_0; \delta_{n_1}^{m_1}; \dots; \varepsilon_{n_{k-1}}; \delta_{n_k}^{m_k}; \varepsilon_{n_k})$ is like in Definition 6.4.1.

- **Step-1** : if $\gamma_{\underline{\varepsilon}}$ is of type γ_{ε_0} , then applies Proposition 6.3.2 to get

$$\text{sing}_{\omega_{n_1}} \gamma_{\varepsilon_0} \cdot \varphi = \Delta_{\omega_{n_1}}^+ + \sum_{r \geq 1} (-1)^r \sum \Delta_{\omega_{n_1} - \omega_{i_r}}^+ \cdots \Delta_{\omega_{i_2} - \omega_{i_1}}^+ \Delta_{\omega_{i_1}}^+$$

and this ends the construction.

Otherwise go to **Step-2**.

- **Step-2** (“corner point”) : Assume that $\gamma_{\underline{\varepsilon}} = \gamma_{(\varepsilon_0; \delta_{n_1}^{m_1}; \dots; \varepsilon_{n_{j-1}}; \delta_{n_j}^{m_j}; \dots)}$ with $\gamma_{(\varepsilon_0; \delta_{n_1}^{m_1}; \dots; \varepsilon_{n_{j-1}})}$ a path ending close to ω_{n_j} and so that $\text{sing}_{\omega_{n_j}} \gamma_{(\varepsilon_0; \delta_{n_1}^{m_1}; \dots; \varepsilon_{n_{j-1}})} \cdot \varphi$ is given by a formula like (73).

Formula (68) can be applied and gives

$$(74) \quad \Delta_{\omega_{n_j+1} - \omega_{n_j}}^+ \text{sing}_{\omega_{n_j}} \gamma_{(\varepsilon_0; \dots; \varepsilon_{n_{j-1}})} \cdot \varphi = \text{sing}_{\omega_{n_j+1}} \gamma_{(\varepsilon_0; \dots; \varepsilon_{n_{j-1}}; \delta_{n_j}^0)} \cdot \varphi - \text{sing}_{\omega_{n_j+1}} \gamma_{(\varepsilon_0; \dots; \varepsilon_{n_{j-1}}; \delta_{n_j}^{-1})} \cdot \varphi$$

Using Lemma 6.2.1, this means that

$$\begin{aligned} \text{sing}_{\omega_{n_j+1}} \gamma_{(\varepsilon_0; \dots; \delta_{n_j}^{m_j})} \cdot \varphi &= \text{sing}_{\omega_{n_j+1}} \gamma_{(\varepsilon_0; \dots; \delta_{n_j}^0)} \cdot \varphi + m_j \Delta_{\omega_{n_j+1} - \omega_{n_j}}^+ \text{sing}_{\omega_{n_j}} \gamma_{\varepsilon_0; \dots; \varepsilon_{n_{j-1}}} \cdot \varphi \\ &= \text{sing}_{\omega_{n_j+1}} \gamma_{(\varepsilon_0; \dots; \delta_{n_j}^{-1})} \cdot \varphi + (m_j + 1) \Delta_{\omega_{n_j+1} - \omega_{n_j}}^+ \text{sing}_{\omega_{n_j}} \gamma_{\varepsilon_0; \dots; \varepsilon_{n_{j-1}}} \cdot \varphi \end{aligned}$$

At least one of the two paths $\gamma_{(\varepsilon_0; \dots; \delta_{n_j}^0)}$ or $\gamma_{(\varepsilon_0; \dots; \delta_{n_j}^{-1})}$ is homotopic in $\mathbb{C} \setminus \Omega_L$ to a geodesic path of shortest length. Say it is $\gamma_{(\varepsilon_0; \dots; \delta_{n_j}^{-1})}$ to fix the idea and

consider the second equality.

For $\text{sing}_{\omega_{n_j+1}} \gamma_{(\varepsilon_0; \dots; \delta_{n_j}^{-1})} \cdot \varphi$ go to **Step-3**. Otherwise keep on with **Step-4**.

- **Step-3** : $\gamma_{(\varepsilon_0; \dots; \delta_{n_j}^{-1})}$ is homotopic to a path of *shortest length* of type $\gamma_{\underline{\varepsilon}} \in \mathfrak{R}_{\Omega_L}^*$ which necessarily involves only points of Ω_L belonging to the convex hull $\mathcal{P}(\gamma_{\underline{\varepsilon}})$. To decompose $\text{sing}_{\omega_{n_j+1}} \gamma_{(\varepsilon_0; \dots; \delta_{n_j}^{-1})} \cdot \varphi$, return to **Step-1**.

- **Step-4** (“forward point”): If $\gamma_{\underline{\varepsilon}} = \gamma_{(\varepsilon_0; \delta_{n_j}^{m_j}; \delta_{n_{j+1}}^{m_{j+1}}, \dots)}$, that is $n_j + 1 = n_{j+1}$, then go to **Step-2** to decompose $\text{sing}_{\omega_{n_j+1+1}} \gamma_{(\varepsilon_0; \dots; \delta_{n_j}^{m_j}; \delta_{n_{j+1}}^{m_{j+1}})} \cdot \varphi$.

If not, that is if $\gamma_{\underline{\varepsilon}} = \gamma_{(\varepsilon_0; \dots; \delta_{n_j}^{m_j}; \varepsilon_{n_j}; \dots)}$, then apply the method used in the proof

of Proposition 6.3.2 and in Step-2 and consider the terms of type $\Delta_{\omega_{n_j+2}-\omega_{n_j}}^+ \text{sing}_{\omega_{n_j}} \gamma_{\varepsilon_0; \dots; \varepsilon_{n_j-1}} \cdot \varphi$, $\Delta_{\omega_{n_j+2}-\omega_{n_j+1}}^+ \Delta_{\omega_{n_j+1}-\omega_{n_j}}^+ \text{sing}_{\omega_{n_j}} \gamma_{\varepsilon_0; \dots; \varepsilon_{n_j-1}} \cdot \varphi$, etc...

Each step produces paths that are homotopic in $\mathbb{C} \setminus \Omega_L$ to geodesic paths of shortest length that are treated by **Step-3**.

Otherwise return to **Step-1**.

It is easy to see that the algorithm stop after a finite number of steps because one minimizes the length of the paths under consideration. \square

6.4.2.1. *Remarks.* — Using Proposition 6.3.3, one can change the Δ^+ operators into alien derivations in Proposition 6.4.1, that is $\text{sing}_{\omega} \gamma_{\underline{\varepsilon}} \cdot \varphi$ can be decomposed as

$$(75) \quad \text{sing}_{\omega} \gamma_{\underline{\varepsilon}} \cdot \varphi = \Delta_{\omega} \varphi + \sum_{r \geq 1} \sum_{\substack{(\omega_1, \dots, \omega_r) \in \mathfrak{P}_L(\gamma_{\underline{\varepsilon}})^r \\ |\omega_1| + \dots + |\omega_r| < L}} b_{(\omega_1, \dots, \omega_r)} \Delta_{\omega-\omega_r} \cdots \Delta_{\omega_2-\omega_1} \Delta_{\omega_1} \varphi$$

where the $b_{(\omega_1, \dots, \omega_r)}$ belong to \mathbb{Z} and are of course related to the integers $a_{(\omega_1, \dots, \omega_r)}$.

It is difficult to give more precisely statements on these coefficients, since they highly depend on the geometry of the path $\gamma_{\underline{\varepsilon}}$ one started with and on the Ω_L . In [CNP93-1], §Rés II-2, the link between (an analogous of) Proposition 6.3.3 and the Moulds of Ecalle is alluded. We do not know if the frame of Moulds [Men97, Men99, Eve99, Ec005, S009] can be used so as to precise Proposition 6.3.3. This could be helpful for instance to consider the inverse problem : to a given set of integers $\{a_{(\omega_1, \dots, \omega_r)}\}$ or $\{b_{(\omega_1, \dots, \omega_r)}\}$, construct a path $\gamma_{\underline{\varepsilon}}$ related to those integers by (73) or (75).

6.4.3. “Fine” discrete filtered set associated with an element of RES^{simp} .

—

Proposition 6.4.2. — For some given $f = C\delta + \varphi \in \text{RES}^{\text{simp}}$ and for every $L > 0$ one considers the set Ω_L^* of points $\omega \in \mathbb{C}$ such that there exists $n \in \mathbb{N}^*$ and a sequence $(\omega_1, \dots, \omega_n) \in (\mathbb{C}^*)^n$ so that

- $\omega = \omega_1 + \dots + \omega_n$,
- $\Delta_{\omega_n}^+ \cdots \Delta_{\omega_1}^+ f \neq 0$,
- $|\omega_1| + \dots + |\omega_n| < L$.

Then the sequence $\Omega_L = \Omega_L^* \cup \{0\}$, $L > 0$ makes a discrete filtered set Ω_* and φ is analytically continuable on the associated Riemann surface \mathcal{R}_{Ω_*} .

Proof. — Since $f = C\delta + \varphi \in \text{RES}^{\text{simp}}$, φ is endlessly continuable : there exists a filtered set Ω'_* such that φ is analytically continuable along every allowed path. According to Proposition 6.3.2, the condition $\Delta_{\omega_n}^+ \cdots \Delta_{\omega_1}^+ f \neq 0$ implies that $\omega'_1 = \omega_1$,

$\omega'_2 = \omega_1 + \omega_2, \dots, \omega'_n = \omega = \omega_1 + \dots + \omega_n$ belong to $\Omega'_{L'}$ for some $L' > 0$. The condition $|\omega_1| + \dots + |\omega_n| < L$ implies more precisely that $\{\omega'_1, \dots, \omega'_n\} \subset \Omega'_L$. From the fact that Ω'_L is finite and to the one-to-one correspondance between the ω_i and the ω'_i (namely $\omega_1 = \omega'_1, \omega_2 = \omega'_2 - \omega'_1, \dots$), one deduces that $\Omega_L \subset \Omega'_L$. Thus Ω_\star is a discrete filtered set. We end the proof with Proposition 6.4.1. \square

Definition 6.4.2. — *The discrete filtered set Ω_\star defined by Proposition 6.4.2 is called the “fine” discrete filtered set associated to $f \in \text{RES}^{\text{simp}}$.*

6.4.4. The Riemann surface of convolution products. —

6.4.4.1. *Back to convolution product.* — We are now in position to precise Theorem 5.5.1.

Theorem 6.4.2. — *If φ, ψ belong to $\mathcal{H}_{\text{end}}^{\text{simp}}$ and if Ω_\star and Ω'_\star are their associated (fine) discrete filtered sets centered at 0, then $\varphi * \psi \in \mathcal{H}(\mathcal{R}_{(\Omega \tilde{+} \Omega')_\star})$ where $(\Omega \tilde{+} \Omega')_\star$ is the fine sum of the two discrete filtered sets (see Definition 5.4.1).*

Proof. — Assume that φ, ψ belong to $\mathcal{H}_{\text{end}}^{\text{simp}}$. From Proposition 6.4.2, the fine discrete filtered set Ω''_\star associated to $\varphi * \psi$ is defined by : for every $L > 0$, Ω''_L is the set of points $\omega \in \mathbb{C}$ such that

- $\omega = \omega_1 + \dots + \omega_n$, with $\forall i, \omega_i \in \mathbb{C}^\star$
- $\Delta_{\omega_n}^+ \dots \Delta_{\omega_1}^+ \varphi * \psi \neq 0$,
- $|\omega_1| + \dots + |\omega_n| < L$.

From Proposition 6.3.1, for every $\omega_i \in \mathbb{C}^\star$, $\Delta_{\omega_i}^+ \varphi * \psi$ reads as

$$\Delta_{\omega_i}^+(\varphi * \psi) = (\Delta_{\omega_i}^+ \varphi) * \psi + \sum (\Delta_{\omega_{i_1}}^+ \varphi) * (\Delta_{\omega_{i_2}}^+ \psi) + \varphi * (\Delta_{\omega_i}^+ \psi)$$

where in the (finite) sum, $\omega_{i_1} + \omega_{i_2} = \omega_i$, $|\omega_{i_1}| + |\omega_{i_2}| = |\omega_i|$. This means that $\Delta_{\omega_n}^+ \dots \Delta_{\omega_1}^+(\varphi * \psi)$ is a (finite) sum of terms of the type

- $(\Delta_{\omega_{n_1}}^+ \dots \Delta_{\omega_{11}}^+ \varphi) * (\Delta_{\omega_{n_2}}^+ \dots \Delta_{\omega_{12}}^+ \psi)$,
- $\omega = \omega_1 + \omega_2$ with $\omega_1 = \omega_{11} + \dots + \omega_{n_1}, \omega_2 = \omega_{12} + \dots + \omega_{n_2}$,
- $|\omega_{11}| + \dots + |\omega_{n_1}| + |\omega_{12}| + \dots + |\omega_{n_2}| = |\omega_1| + \dots + |\omega_n| < L$.

Thus $\Delta_{\omega_n}^+ \dots \Delta_{\omega_1}^+(\varphi * \psi) \neq 0$ only if at least one of such terms $(\Delta_{\omega_{n_1}}^+ \dots \Delta_{\omega_{11}}^+ \varphi) * (\Delta_{\omega_{n_2}}^+ \dots \Delta_{\omega_{12}}^+ \psi)$ is non zero, that is $\omega_1 \in \Omega_{L_1}$ and $\omega_2 \in \Omega'_{L_2}$ with $L_1 + L_2 \leq L$. This implies that $\Omega''_L \subset (\Omega \tilde{+} \Omega')_L$. \square

One can also refine Corollary 5.5.2 as well. We remind (Definition 5.5.1) that if Ω_\star is a discrete filtered set centred at 0, for every $L > 0$ and every $r > 0$ small enough, we note

$$K_{\Omega_\star, r} = \{z = (\zeta, \text{cl}(\lambda)) \in \mathcal{R}_{\Omega_\star} \text{ with } \lambda \in \mathfrak{R}_{\Omega_\star}^*, d(\lambda, \Omega_\star) \geq r\}.$$

For $\varphi \in \mathcal{H}(\mathcal{R}_{\Omega_\star})$ we note

$$\|\varphi\|_{K_{\Omega_\star, r}} = \sup_{z \in K_{\Omega_\star, r}} |\Phi(z)|$$

where Φ stands for the analytic continuation of φ on $\mathcal{R}_{\Omega_\star}$.

Corollary 6.4.1. — *If Ω_\star and Ω'_\star are two discrete filtered set centered at 0, then for every $L > 0$, for every $r > 0$ small enough, for every $\nu > 1$, for every $\varphi \in \mathcal{H}(\mathcal{R}_{\Omega_\star})$ and $\psi \in \mathcal{H}(\mathcal{R}_{\Omega'_\star})$,*

$$\|\varphi * \psi\|_{K_{(\Omega \dot{+} \Omega')_L, r}} \leq L \exp\left(\frac{3\nu}{r}L\right) \|\varphi\|_{K_{\Omega_L, r/3}} \|\psi\|_{K_{\Omega'_L, r/3}}.$$

Proof. — From Corollary 5.5.2 we know that for every $0 < r < R$ small enough, for every $\nu > 1$,

$$\|\varphi * \psi\|_{K_{(\Omega + \Omega')_L, R+r}} \leq L e^{\frac{\nu}{R-r}L} \|\varphi\|_{K_{\Omega_L, r}} \|\psi\|_{K_{\Omega'_L, r}}$$

when $\varphi * \psi$ is seen to be analytically continuable on $\mathcal{R}_{(\Omega + \Omega')_\star}$. We want to show that these estimates are still valid near the removable singular points by the maximum principle. Assume that $z = (\zeta, \text{cl}(\lambda)) \in K_{(\Omega + \Omega')_L, R+r}$ is so that $d(\lambda(1), \omega) = R + r$ with $\omega \in (\Omega + \Omega')_L \setminus (\Omega \dot{+} \Omega')_L$. Thus $\lambda.(\varphi * \pi)$ can be represented by a holomorphic function Φ in the closed disc $\overline{D}(\omega, R + r)$ and by the maximum principle, $\sup_{D(\omega, R+r)} |\Phi| = \sup_{\partial D(\omega, R+r)} |\Phi|$. But $\sup_{\partial D(\omega, R+r)} |\Phi| \leq \|\varphi * \psi\|_{K_{(\Omega + \Omega')_L, R+r}}$ provided that the product $\lambda\delta \in \mathfrak{R}_{(\Omega + \Omega')_L}^\star$ where δ is a loop which follows $\partial D(\omega, R + r)$. This is true eventually taking a larger L and a smaller $R + r$. Finally, to simplify, we take $R = 2r$ in the formula and make a rescaling. \square

6.4.4.2. Saturated discrete filtered set. — We now remark with [CNP93-1] that fine sums of discrete filtered sets is an associative operation with the following property. For a given discrete filtered set Ω_\star centered at 0 and for some $L > 0$, consider the set

$$\Omega_L^\infty = \bigcup_{n \geq 1} \left(\sum_n \tilde{\Omega} \right)_L, \quad \text{with} \quad \left(\sum_n \tilde{\Omega} \right)_L = \underbrace{(\Omega \dot{+} \dots \dot{+} \Omega)}_{n \text{ times}}_L.$$

Then Ω_L^∞ is a finite set. Indeed, by definition of the fine sum,

$$\left(\sum_n \tilde{\Omega} \right)_L = \{\omega = \omega_1 + \dots + \omega_n, \omega_i \in \Omega_{L_i}, L_1 + \dots + L_n = L\}.$$

From the fact that there exists $L_0 > 0$ such that $\Omega_L = \{0\}$ for every $0 < L \leq L_0$, one deduces that $(\sum_n \tilde{\Omega})_L = (\sum_{n_0} \tilde{\Omega})_L$ for $n \geq n_0$, where $n_0 = \lfloor L/L_0 \rfloor$ is the entire part of L/L_0 . Thus the increasing sequence of sets Ω_L^∞ makes a discrete filtered set.

Definition 6.4.3. — *For a given discrete filtered set Ω_\star one notes Ω_\star^∞ the discrete filtered set defined by*

$$\Omega_L^\infty = \bigcup_{n \geq 1} \left(\sum_n \tilde{\Omega} \right)_L, \quad L > 0.$$

This discrete filtered set Ω_\star^∞ is called the “saturated” discrete filtered set of Ω_\star .

The following result is now obvious result from Theorem 6.4.2, Corollary 6.4.1 and Definition 6.4.3.

Corollary 6.4.2. — *If φ belongs to $\mathcal{H}_{\text{end}}^{\text{simp}}$ and if Ω_\star is its associated fine discrete filtered set centered at 0, then*

$$\forall n \in \mathbb{N}, \varphi^{*n} = \underbrace{\varphi * \dots * \varphi}_{n \text{ times}} \in \mathcal{H}(\mathcal{R}_{\Omega_\star^\infty}).$$

Moreover, for every $L > 0$, for every $r > 0$ small enough and every $\nu > 1$,

$$(76) \quad \forall n \in \mathbb{N}, \|\varphi^{*n}\|_{K_{\Omega_L^\infty, r}} \leq L \exp\left(3^n \frac{\nu}{r} L\right) \|\varphi\|_{K_{\Omega_L, r/3^{n-1}}}^n.$$

6.4.4.3. *Comments.* — It is worth remarking that Theorem 6.4.2, Corollary 6.4.1 and Corollary 6.4.2 are consequences of:

- our main Theorem 5.5.1 which are valid without any information about the kind of singular points,
- the properties of the alien derivations (or rather the Δ^+ operators) which we have construct starting from hypotheses on the type of singularities.

From the fact that the alien derivations can be extended without any information about the singular points, we think that our method for proving Theorem 6.4.2 and its Corollaries can be extended as well.

Now some comments about the estimates (76) which are bad⁽¹⁴⁾ and cannot be used to analyze for instance series expansions like $\sum_{n \geq 0} a_n \varphi^{*n}$ with $\sum_{n \geq 0} a_n z^n$ an entire function.

In order to get more precise estimates, it is possible to use again the informations given by the Δ^+ operators or the alien derivations in the spirit of [GS001, OSS003]: if a given φ is represented by the holomorphic function Φ in the star-shaped domain from 0, every analytic continuations of φ along a path can be compared to Φ up to a finite linear combinations of terms of type $\Delta_{\omega_{n_1}}^+ \cdots \Delta_{\omega_{11}}^+ \varphi$ or $\Delta_{\omega_{n_1}} \cdots \Delta_{\omega_{11}} \varphi$ (modulo translations). On the one hand, for these terms the action of the convolution is known thanks to Proposition 6.3.1 or simply by the Leibniz rule, on the other hand the estimates for convolution of type $\Phi * \Phi$ is the star-shaped domain where Φ is defined is straightforward. However, we have replaced the problem by another one of combinatorial nature.

Let us precise our mind by the way of an example. Consider $\varphi \in \mathcal{H}_{end}^{simp}$ such that $\varphi \in \mathcal{H}(\mathcal{R}_\Omega)$ with $\Omega = \omega\mathbb{Z}$ for some $\omega \in \mathbb{C}^*$. We note $\omega_n = n\omega$ for $n \in \mathbb{Z}$. We introduce the star-shaped domain $U = \mathbb{C} \setminus \{\pm r\omega, r \geq 1\}$ and we define:

1. $\Phi_0 \in \mathcal{O}(U)$ is the representative in $\mathcal{O}(U)$ of φ ,
2. for every $\mathbf{i} = (i_1, \dots, i_n) \in (\mathbb{N}^*)^n$, $\Phi_{\mathbf{i}} \in \mathcal{O}(U)$ is the representative in $\mathcal{O}(U)$ of $\Delta_{\omega_{i_n} - \omega_{i_{n-1}}} \cdots \Delta_{\omega_{i_2} - \omega_{i_1}} \Delta_{\omega_{i_1}} \varphi$.

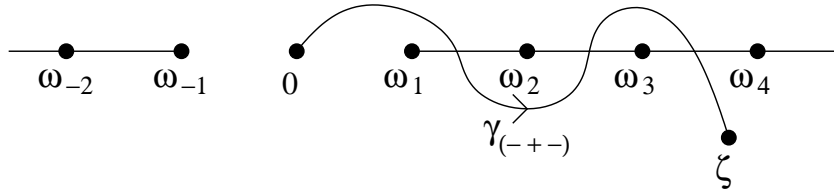

FIGURE 33. The star-shaped domain U and the path $\gamma_{(-,+, -)}$.

⁽¹⁴⁾This traces back to Proposition 3.1.1 and the estimates of the length of Γ_i . We remark that these estimates are linked to the behaviour of the derivative of functions of type $f_{C,R,r}$ - Proposition 3.1.1 - which vanishes apart from the vicinity of the singular points, but we have been unable to use this fact.

We consider a path in \mathfrak{R}_Ω^* of type $\gamma_{(-,+,-)}$ with end point in U , like on Fig. 33. Proposition 6.3.2 can be applied and gives for every $n \in \mathbb{N}^*$:

$$(77) \quad \text{sing}_{\omega_4} \gamma_{(-,+,-)} \varphi^{*n} = \Delta_{\omega_4}^+ \varphi^{*n} - \Delta_{\omega_4 - \omega_1}^+ \Delta_{\omega_1}^+ \varphi^{*n} - \Delta_{\omega_4 - \omega_3}^+ \Delta_{\omega_3}^+ \varphi^{*n} + \Delta_{\omega_4 - \omega_3}^+ \Delta_{\omega_3 - \omega_1}^+ \Delta_{\omega_1}^+ \varphi^{*n}.$$

We remark that $\omega_3 - \omega_1 = \omega_2$. By Proposition 6.3.3,

1. $\Delta_{\omega_1}^+ = \Delta_{\omega_1}$,
2. $\Delta_{\omega_2}^+ = \Delta_{\omega_2} + \frac{1}{2!} \Delta_{\omega_1} \Delta_{\omega_1}$,
3. $\Delta_{\omega_3}^+ = \Delta_{\omega_3} + \frac{1}{2!} (\Delta_{\omega_2} \Delta_{\omega_1} + \Delta_{\omega_1} \Delta_{\omega_2}) + \frac{1}{3!} \Delta_{\omega_1} \Delta_{\omega_1} \Delta_{\omega_1}$.

We now use the Leibniz rule for the alien derivations to get:

1. $\Delta_{\omega_1}^+ \varphi^{*n} = n \varphi^{*(n-1)} * \Delta_{\omega_1} \varphi$,
2. $\Delta_{\omega_2}^+ \Delta_{\omega_1}^+ \varphi^{*n} = n(n-1) \varphi^{*(n-2)} * \Delta_{\omega_2} \varphi * \Delta_{\omega_1} \varphi + n \varphi^{*(n-1)} * \Delta_{\omega_2} \Delta_{\omega_1} \varphi + \frac{1}{2!} \left[n(n-1)(n-2) \varphi^{*(n-3)} * (\Delta_{\omega_1} \varphi)^{*3} + n(n-1) \varphi^{*(n-2)} * \Delta_{\omega_1} \varphi * \Delta_{\omega_1} \Delta_{\omega_1} \varphi + n \varphi^{*(n-1)} * \Delta_{\omega_1} \Delta_{\omega_1} \Delta_{\omega_1} \varphi \right]$,
3. $\Delta_{\omega_3}^+ \varphi^{*n} = n \varphi^{*(n-1)} * \Delta_{\omega_3} \varphi + \frac{1}{2!} \left[2n(n-1) \varphi^{*(n-2)} * \Delta_{\omega_2} \varphi * \Delta_{\omega_1} \varphi + n \varphi^{*(n-1)} * (\Delta_{\omega_2} \Delta_{\omega_1} \varphi + \Delta_{\omega_1} \Delta_{\omega_2} \varphi) \right] + \frac{1}{3!} \left[n(n-1)(n-2) \varphi^{*(n-3)} * (\Delta_{\omega_1} \varphi)^{*3} + n(n-1) \varphi^{*(n-2)} * \Delta_{\omega_1} \varphi * \Delta_{\omega_1} \Delta_{\omega_1} \varphi + n \varphi^{*(n-1)} * \Delta_{\omega_1} \Delta_{\omega_1} \Delta_{\omega_1} \varphi \right]$.

Plugging these identities in (77), then removing the sing_{ω_4} operator on the left-hand side of the equality and equivalently on its right-hand side removing the last (left-hand side) Δ^+ -operator, one obtains after some reductions:

$$(78) \quad \begin{aligned} & \gamma_{(-,+,-)} \cdot \varphi^{*n}(\zeta) = \\ & \Phi_0^{*n}(\zeta) - n \Phi_0^{*(n-1)} * \Phi_1(\zeta - \omega_1) - n \Phi_0^{*(n-1)} * \Phi_3(\zeta - \omega_3) + \frac{1}{2} \left[n \Phi_0^{*(n-1)} * (\Phi_{1,2} - \Phi_{2,1}) \right] (\zeta - \omega_3) \\ & + \frac{1}{3} \left[n(n-1)(n-2) \Phi_0^{*(n-3)} * \Phi_1^{*3} + n(n-1) \Phi_0^{*(n-2)} * \Phi_1 * \Phi_{1,1} + n \Phi_0^{*(n-1)} * \Phi_{1,1,1} \right] (\zeta - \omega_3) \end{aligned}$$

Thus getting some estimates for $|\gamma_{(-,+,-)} \cdot \varphi(\zeta)|$ reduces to getting estimates for $\Phi_0, \Phi_1, \Phi_3, \Phi_{1,1}, \Phi_{1,2}, \Phi_{2,1}, \Phi_{1,1,1}$. Indeed, assume for instance that Σ_R is a bounded star-shaped domain from 0 where $R = \sup_{\zeta \in \Sigma_R} |\zeta|$ is its “radius”. Take a $\Sigma'_R \subset \Sigma_R$ another star-shaped domain such that

$$\forall \zeta \in \Sigma'_R, \zeta - 1, \zeta - 3 \in \Sigma_R.$$

Then for $f \in \mathcal{O}(U)$ define $\|f\|_{\Sigma_R} = R \sup_{\zeta \in \Sigma_R} |\Phi(\zeta)|$. One easily gets from the very definition of the convolution product that $\|f * g\|_{\Sigma_R} \leq \|f\|_{\Sigma_R} \|g\|_{\Sigma_R}$ for $f, g \in \mathcal{O}(U)$. Now take

$$K = \sup \{ \|\Phi_0\|_{\Sigma_R}, \|\Phi_1\|_{\Sigma_R}, \dots, \|\Phi_{1,1,1}\|_{\Sigma_R} \}$$

and define Φ as the analytic continuation in Σ'_R of $\gamma_{(-,+,-)} \cdot \varphi^{*n}(\zeta)$. Then by (78) and using the previous considerations,

$$\|\Phi\|_{\Sigma'_R} \leq \left(1 + 3n + \frac{n}{3}(n^2 - 2n + 2) \right) K^n.$$

This to be compared to what we obtained in (76).

What we have done on an example can be extended in principle, using the decomposition given by Proposition 6.4.1 and an appeal to Proposition 6.3.3 so as to use the Leibniz rule. We shall not try to pursue in that direction in this paper.

CHAPTER 7

CONCLUSION AND RELATED WORKS

In the paper we have studied the space \mathcal{H}_{end} of endlessly continuable functions and we have shown how the general frame in Resurgence theory can be used so as to “master” the convolution product. In particular we have demonstrated that RES^{simp} makes a convolution algebra.

Our initial goal in the thesis was in fact to study a kind of generalisation of the convolution product, namely the convolution weighted products [Ec94] which have strong links with the so-called semi-classical resurgent theory [Ec84, DDP93, DDP97, DP97, DP98, DP99, DT000, S95]. Unfortunately it took more time than we planned to work on the usual convolution itself, so that the analysis of these convolution weighted products have to be postponed to further study. In this chapter we shall only briefly describe what kind of problems are encountered.

7.1. An introduction to the weighted products

This part follows [Ec94], see also [S009]. We shall use the notations of Chap. 1 - Introduction.

7.1.1. Equational resurgence. —

7.1.1.1. Euler’s like equation. — Assume that $\omega \in \mathbb{C}^*$ and consider the Euler’s like differential equation

$$(79) \quad (\partial + \omega)f(z) = g(z) \quad \text{where } \partial = \partial_z.$$

We note that the operator $\partial + \omega : \tilde{f} \in \mathbb{C}[[z^{-1}]]_1 \mapsto (\partial + \omega)\tilde{f} \in \mathbb{C}[[z^{-1}]]_1$ is invertible and we note $(\partial + \omega)^{-1}$ its inverse operator.

By Borel transformation $\mathfrak{B}(z \rightarrow \zeta)$ the operator $\partial + \omega$ becomes

$$\partial + \omega : a_0\delta + \hat{f} \in \mathbb{C}\delta \oplus \mathbb{C}\{\zeta\} \mapsto a_0\omega\delta + (\partial + \omega)\hat{f} \in \mathbb{C}\delta \oplus \mathbb{C}\{\zeta\} \quad \text{where } \partial = -\zeta.$$

It is invertible as well and we still denote by $(\partial + \omega)^{-1}$ its inverse operator.

Assume now that $g \in \tilde{\mathcal{A}}_1(\Pi_7^{[\theta-\varepsilon, \theta+\varepsilon]})$ for some $\theta \in \frac{\mathbb{R}}{2\pi\mathbb{Z}}$ and note $T(g) = \tilde{g} \in \mathbb{C}[[z^{-1}]]_1$ where T stands for the Taylor expansion. Then:

- equation (79) can be solved formally by defining $\tilde{f}(z) = (\partial + \omega)^{-1}\tilde{g}(z) \in \mathbb{C}[[z^{-1}]]_1$.
- Next, working by Borel transformation, one can define

$$(\mathfrak{B}\tilde{f})(\zeta) = (\partial + \omega)^{-1}(\mathfrak{B}\tilde{g})(\zeta) \in \mathbb{C}\delta \oplus \mathbb{C}\{\zeta\}.$$

– finally considering its Laplace transform for $\theta' \in [\theta - \varepsilon, \theta + \varepsilon]$,

$$f(z) = \mathfrak{L}^{\theta'} \mathfrak{B} \tilde{f}(z) = \mathfrak{L}^{\theta'} \left[(\partial + \omega)^{-1} \mathfrak{B} \tilde{g} \right] (z).$$

Depending on ω , this defines a unique element $f \in \bar{\mathcal{A}}_1(\Pi_r^{[\theta-\varepsilon, \theta+\varepsilon]})$ or two holomorphic functions solution of (79). For this or those functions, $T(f) = \tilde{f}$.

7.1.1.2. *Equational resurgent monomials.* — In the convolution space and for every $\omega \in \mathbb{C}^*$ the operator $\partial + \omega$ naturally extends as an *invertible* operator

$$\partial + \omega : \text{RES}^{\text{simp}} \rightarrow \text{RES}^{\text{simp}}.$$

This allows to make the following considerations. First define

$$\text{sec}^{\emptyset}(\zeta) = \delta$$

then for a pair $A_1 = \begin{pmatrix} \omega_1 \\ g_1 \end{pmatrix}$ with $\omega_1 \in \mathbb{C}^*$ and $g_1 \in \text{RES}^{\text{simp}}$ introduce

$$\text{sec}^{A_1}(\zeta) = (\partial + \omega_1)^{-1} g_1(\zeta) = (\partial + \omega)^{-1} \left[g_1 * \text{sec}^{\emptyset} \right] (\zeta)$$

and iterate the construction as follows : for a pair $A_2 = \begin{pmatrix} \omega_2 \\ g_2 \end{pmatrix}$ with $\omega_1 + \omega_2 \in \mathbb{C}^*$ and $g_2 \in \text{RES}^{\text{simp}}$, define

$$\text{sec}^{A_1, A_2}(\zeta) = (\partial + \omega_1 + \omega_2)^{-1} \left[g_2 * \text{sec}^{A_1} \right] (\zeta).$$

More generally:

Definition 7.1.1. — Consider any sequence $\mathbf{A} = (A_1, \dots, A_r)$ of pairs $A_i = \begin{pmatrix} \omega_i \\ g_i \end{pmatrix}$ such that $g_i \in \text{RES}^{\text{simp}}$, $\omega_i \in \mathbb{C}$ and assume the “non-singularity” of the weightages, that is for every $0 < i \leq r$, $\check{\omega}_i = \omega_1 + \dots + \omega_i \in \mathbb{C}^*$. One defines $\text{sec}^{\mathbf{A}}(\zeta)$ by recursion:

1. $\text{sec}^{\emptyset}(\zeta) = \delta$,
2. $\text{sec}^{\mathbf{A}.A_{r+1}}(\zeta) = (\partial + \omega_1 + \dots + \omega_r + \omega_{r+1})^{-1} \left[g_{r+1} * \text{sec}^{\mathbf{A}} \right] (\zeta)$, where $\mathbf{A}.A_{r+1} = (A_1, \dots, A_r, A_{r+1})$ is the concatenation.

These elements $\text{sec}^{\mathbf{A}}$ of RES^{simp} are called the equational weighted convolution monomials.

One defines the equational weighted multiplication formal monomials $\widetilde{\text{sec}}^{\mathbf{A}}$ by inverse Borel transform : $\widetilde{\text{sem}}^{\mathbf{A}} = \mathfrak{B}^{-1} \text{sec}^{\mathbf{A}}$.

Adding some Borel-summability assumptions, one defines the equational weighted multiplication geometric monomials $\text{sem}^{\mathbf{A}}$ of direction $\theta \in \frac{\mathbb{R}}{2\pi\mathbb{Z}}$ by Laplace transform:

$$\text{sem}^{\mathbf{A}}(z) = (\mathfrak{L}^{\theta} \text{sec}^{\mathbf{A}})(z).$$

These equational monomials enjoy interesting properties. One of them is the so-called “Symmetrality”, that is:

$$\text{sec}^{\mathbf{A}^1} * \text{sec}^{\mathbf{A}^2} = \sum \text{sh} \begin{pmatrix} \mathbf{A}^1, \mathbf{A}^2 \\ \mathbf{A} \end{pmatrix} \text{sec}^{\mathbf{A}}$$

where $\text{sh} \begin{pmatrix} \mathbf{A}^1, \mathbf{A}^2 \\ \mathbf{A} \end{pmatrix}$ denotes the number of ways in which \mathbf{A} may be obtained by "shuffling" \mathbf{A}^1 and \mathbf{A}^2 , see [Ec93-1, Ec005, S009]. For instance

$$\text{sec}^{A_1} * \text{sec}^{A_1, A_2} = 2\text{sec}^{A_1, A_1, A_2} + \text{sec}^{A_1, A_2, A_1}.$$

Of course this property translates to $\widetilde{\text{sem}}^{\mathbf{A}}$ and $\text{sem}^{\mathbf{A}}$ where convolution product becomes multiplication.

Another interesting property lie on their behaviour under alien derivations, see [Ec93-1, Ec005, S009].

7.1.2. Co-equational resurgence, exact semi-classical analysis. —

7.1.2.1. Euler's like equation : singular perturbation viewpoint. — Following Ecalle [Ec94], we now consider the Euler's like equation adding a parameter of singular perturbation. Namely we consider the differential equation

$$(80) \quad (\partial_z + x\omega)f(x, z) = g(-z)$$

where x is a complex parameter and g holomorphic near the origin. (The minus sign in $g(-z)$ is only there for a matter of simplification in what follows).

We are interested in the behaviour of the solutions f of (80) when $|x|$ goes to infinity.

In perturbation theory it is usual to tackle these kind of problems by looking for formal "WKB" solutions, that is expansions of the form

$$\tilde{f}(x, z) = \sum_{n \geq 1} f_n(z)x^{-n} \in \mathbb{C}\{z\}[[x^{-1}]].$$

We observe that $f_0 = 0$ necessarily and persuing in that direction, we consider the Borel transformation $\mathfrak{B}(x \rightarrow \xi)$. If

$$(\mathfrak{B}\tilde{f})(\xi, z) = \hat{f}(\xi, z) = \sum_{n \geq 1} f_n(z) \frac{\xi^{n-1}}{(n-1)!} \in \mathbb{C}\{z\}[[\xi]],$$

equation (80) becomes

$$(81) \quad (\partial_z + \omega\delta + \omega\partial_\xi)\hat{f}(\xi, z) = g(-z)\delta$$

which is equivalent to the following Cauchy problem for a 1-d transport equation:

$$\begin{aligned} (\partial_z + \omega\partial_\xi)\hat{f}(\xi, z) &= 0 \\ \omega\hat{f}(0, z) &= g(-z) \end{aligned}$$

This problem is easily solved by the method of characteristics and provides

$$(82) \quad \hat{f}(\xi, z) = \frac{1}{\omega}g\left(\frac{\xi}{\omega} - z\right) \in \mathbb{C}\{z, \xi\}.$$

When z is kept constant close to zero and assuming that $g \in \mathcal{H}_{end}^{simp}$, then $\hat{f}(\xi, z)$ belongs to \mathcal{H}_{end}^{simp} as well (for z fixed). Thus, assuming a Borel-summability assumption, we get by Laplace transform $f(x, z) = (\mathfrak{L}^\theta \hat{f})(x, z)$ an analytic solution of (80) such that $Tf(x, z) = \tilde{f}(x, z)$.

7.1.2.2. *Coequational resurgent monomials.* — The purpose of Ecalle in [Ec94] was at the same time to construct “elementary blocks” in the frame of coequational resurgence and to be able to compare and make links between equational and coequational resurgence. We now provide the coequational resurgent monomials, the convolution ones $\text{soc}^{\mathbf{B}}$ and their multiplication formal $\widetilde{\text{som}}^{\mathbf{B}}$ and geometric $\text{som}^{\mathbf{B}}$ counter parts.

We start with

$$\text{soc}^{\emptyset}(\xi, z) = \delta, \quad \widetilde{\text{som}}^{\emptyset}(x, z) = 1.$$

For a given pair $B_1 = \begin{pmatrix} \omega_1 \\ g_1 \end{pmatrix}$ with $\omega_1 \in \mathbb{C}^*$ and $g_1 \in \text{RES}^{\text{simp}}$ we have already seen that the problem

$$(\partial_z + x\omega_1)\widetilde{\text{som}}^{B_1} = g_1(-z)\widetilde{\text{som}}^{\emptyset}$$

has a unique solution in the “Gevrey-1”-space $\mathbb{C}\{z\}[[x^{-1}]]_1$ whose Borel transform soc^{B_1} through $\mathfrak{B}(x \rightarrow \xi)$ is the unique solution of the Cauchy problem

$$\begin{aligned} (\partial_z + \omega_1\partial_\xi)\text{soc}^{B_1}(\xi, z) &= 0 \\ \omega_1\text{soc}^{B_1}(0, z) &= g_1(-z). \end{aligned}$$

and reads

$$(83) \quad \text{soc}^{B_1}(\xi, z) = \frac{1}{\omega_1}g_1\left(\frac{\xi}{\omega_1} - z\right) \in \mathbb{C}\{\xi, z\}.$$

Keeping on that way, it is straightforward to see that the problem

$$(\partial_z + x(\omega_1 + \omega_2))\widetilde{\text{som}}^{B_1, B_2} = g_2(-z)\widetilde{\text{som}}^{B_1}$$

associated to a new pair $B_2 = \begin{pmatrix} \omega_2 \\ g_2 \end{pmatrix}$ with $\omega_1 + \omega_2 \in \mathbb{C}^*$ and $g_2 \in \text{RES}^{\text{simp}}$, has a unique solution in $\mathbb{C}\{z\}[[x^{-1}]]_1$. By Borel transformation $\mathfrak{B}(x \rightarrow \xi)$, its Borel transform $\text{soc}^{B_1, B_2}(\xi, z)$ solves

$$(\partial_z + (\omega_1 + \omega_2)\partial_\xi)\text{soc}^{B_1, B_2}(\xi, z) = g_2(-z)\text{soc}^{B_1}(\xi, z)$$

which is equivalent to the Cauchy problem

$$\begin{aligned} (\partial_z + (\omega_1 + \omega_2)\partial_\xi)\text{soc}^{B_1, B_2}(\xi, z) &= g_2(-z)\text{soc}^{B_1}(\xi, z) \\ (\omega_1 + \omega_2)\text{soc}^{B_1, B_2}(0, z) &= 0. \end{aligned}$$

Solving this problem by the method of characteristics, one gets:

$$(84) \quad \text{soc}^{B_1, B_2}(\xi, z) = \frac{1}{\omega_1} \int_0^{\xi_3} g_2(\eta_2 - z)g_1(\eta_1 - z) d\eta_2 \in \mathbb{C}\{\xi, z\},$$

$$\xi_3 = \frac{\xi}{\omega_1 + \omega_2}, \quad \omega_1\eta_2 + \omega_2\eta_2 = \xi.$$

This construction can be generalized. Since what we have written is enough for our purpose, we refer to [Ec94] for the following Proposition-Definition⁽¹⁾.

Proposition 7.1.1. — *Consider any sequence $\mathbf{B} = (B_1, \dots, B_r)$ of pairs $B_i = \begin{pmatrix} \omega_i \\ g_i \end{pmatrix}$ such that $g_i \in \mathcal{H}_{\text{end}}^{\text{simp}}$, $\omega_i \in \mathbb{C}$ and assume the “non-singularity” of the weights : for every $0 < i \leq r$, $\check{\omega}_i = \omega_1 + \dots + \omega_i \in \mathbb{C}^*$. One defines $\text{soc}^{\mathbf{B}}(\xi, z)$ by recursion:*

⁽¹⁾Ecalle in [Ec94] makes $z = 0$ for the definition of the monomials $\text{soc}^{\mathbf{B}}$.

1. $\text{soc}^\emptyset(\xi, z) = \delta$,
2. $\text{soc}^{\mathbf{B}.B_{r+1}}(\xi, z)$ is the unique solution in $\mathbb{C}\{\xi, z\}$ of the Cauchy problem

$$(\partial_z + (\omega_1 + \cdots + \omega_{r+1})\delta + (\omega_1 + \cdots + \omega_{r+1})\partial_\xi)\text{soc}^{\mathbf{B}.B_{r+1}} = g_{r+1}(-z)\text{soc}^{\mathbf{B}}.$$

These elements $\text{soc}^{\mathbf{B}}$ are called the coequational weighted convolution monomials. One defines the coequational weighted multiplication formal monomials $\widetilde{\text{soc}}^{\mathbf{B}}$ by inverse Borel transform : $\widetilde{\text{soc}}^{\mathbf{B}} = \mathfrak{B}^{-1}\text{soc}^{\mathbf{B}}$. Adding some Borel-summability assumptions, one defines the coequational weighted multiplication geometric monomials $\text{som}^{\mathbf{B}}$ of direction $\theta \in \frac{\mathbb{R}}{2\pi\mathbb{Z}}$ by Laplace transform:

$$\text{som}^{\mathbf{B}}(x, z) = (\mathfrak{L}^\theta \text{soc}^{\mathbf{B}})(x, z).$$

Here again, the $\text{soc}^{\mathbf{B}}$ monomials enjoy the property of being symetral:

$$\text{soc}^{\mathbf{B}^1} * \text{soc}^{\mathbf{B}^2}(\xi, z) = \sum \text{sh} \begin{pmatrix} \mathbf{B}^1, \mathbf{B}^2 \\ \mathbf{B} \end{pmatrix} \text{soc}^{\mathbf{B}}(\xi, z)$$

where of course the convolution product is made with respect to the ξ -variable.

7.2. Some related problems

7.2.1. Endless continuability. —

7.2.1.1. General problem. — In Proposition 7.1.1, we made the hypothesis that the g_i 's belong to $\mathcal{H}_{\text{end}}^{\text{simp}}$. However in our conclusion we only says that the $\text{soc}^{\mathbf{B}}(\xi, z)$ monomials are holomorphic near $(0, 0) \in \mathbb{C}^2$. Even when making $z = 0$ for simplicity, *the question is whether the $\text{soc}^{\mathbf{B}}(\xi, 0)$ belong to RES^{simp} or not.*

In [Ec94], Ecalle gives the answer in a larger resurgent algebra (when making $z = 0$). The monomials $\text{soc}^{\mathbf{B}}(\xi, 0)$ are indeed endlessly continuable. Moreover their resurgent structure is governed by beautiful closed formulas including another set of monomials $\text{loc}^{\mathbf{B}}(\xi)$.

Meanwhile, and up to our knowledge, there is no written proof showing that $\text{soc}^{\mathbf{B}}(\xi, 0)$ are endlessly continuable. So we state the following problem:

Problem: prove that the monomials $\text{soc}^{\mathbf{B}}$ belong to $\mathcal{H}_{\text{end}}^{\text{simp}}$ when all the g_i 's belong to this space.

7.2.1.2. Example. — It is worth here to consider a simple situation. In [S95], the monomials $\text{soc}^{\mathbf{B}}(\xi, 0)$ were considered for homogenous weights, precisely every weights are equal to 1. We thus consider $\text{soc}^{\mathbf{B}}(\xi, 0)$ for sequences of the form $\mathbf{B} = \begin{pmatrix} 1, \cdots, 1 \\ g_1, \cdots, g_r \end{pmatrix}$ and we denote them by $\text{soc}^{\mathbf{B}}(\xi, 0) = \mathcal{S}^{g_1, \cdots, g_r}(\xi)$. From their very definition one gets that:

- if $r = 0$, then $\mathcal{S}^\emptyset(\xi) = \delta$,
- if $r = 1$, then $\mathcal{S}^{g_1}(\xi) = g_1(\xi)$,
- if $r = 2$, then $\mathcal{S}^{g_1, g_2}(\xi) = \int_0^{\frac{\xi}{2}} g_1(\eta)g_2(\xi - \eta)d\eta$,

– if $r \geq 3$, then $\mathcal{S}^{g_1, \dots, g_r}(\xi) = \int g_1(\eta_1) \dots g_r(\eta_r) d\eta_2 \dots d\eta_r$ where the integral domain is given by

$$\begin{cases} \eta_r \in \left[0, \frac{\xi}{r}\right], \\ \eta_k \in \left[\eta_{k+1}, \frac{\xi - (\eta_{k+1} + \dots + \eta_r)}{k}\right], \quad \forall k \in \{2, 3, \dots, r-1\} \\ \eta_1 + \eta_2 + \dots + \eta_r = \xi. \end{cases}$$

Let us concentrate now on \mathcal{S}^{g_1, g_2} for which we can use a rather fortunate situation.

Lemma 7.2.1. — *Assume that Ω is a closed, discrete and additive semi-group. Take g_1 and g_2 in the space $\mathcal{H}(\mathcal{R}_\Omega)$. Then \mathcal{S}^{g_1, g_2} belongs to $\mathcal{H}(\mathcal{R}_\Omega)$ as well as to RES^{simp} .*

Proof. — By Theorem 4.2.1, we know that every point of the Riemann surface \mathcal{R}_Ω is the end point of a symmetrically contractile path. We now copy part of the proof of Theorem 4.3.1. We take a point (ξ, α) on \mathcal{R}_Ω : there exists a \mathcal{R}_Ω -symmetrically contractile path γ such that $\text{cl}(\gamma) = \alpha$. More precisely, there exists a continuous map

$$\Gamma : t \in [0, 1] \mapsto \Gamma_t \in \mathfrak{R}_\Omega^{\text{sym}}$$

such that $\Gamma_1 = \gamma$ and $\Gamma_0 \equiv 0$.

Define the path $\lambda : t \in [0, 1] \mapsto \Gamma_t(1)$. This path belongs to \mathfrak{R}_Ω and is homotopic to γ . Thus $\text{cl}(\lambda) = \alpha$. Moreover the integral

$$\forall t \in [0, 1], I(\lambda(t)) = \int_0^{\frac{1}{2}} g_1(\Gamma_t(s)) g_2(\Gamma_t^*(1-s)) \frac{\partial \Gamma_t}{\partial s}(s) ds$$

is well defined and provides the analytic continuation of \mathcal{S}^{g_1, g_2} along λ because $\Gamma_t \in \mathfrak{R}_\Omega^{\text{sym}}$ for every $t \in [0, 1]$. \square

7.2.2. The singular case. — The definition and properties we mentioned in Proposition 7.1.1 are given under a “non-singularity” assumption for the weightages : for every $0 < i \leq r$, $\overset{\vee}{\omega}_i = \omega_1 + \dots + \omega_i$ are nonzero. As Ecalle mention in [Ec94], the singular case is harder but of great importance in practice for problems stemming from the so-called “exact semi-classical” analysis [Ec84, S95, DDP93, DDP97, DP97, DP98, DP99, DT000]. This leads to the following question.

Problem: Extend the construction and the resurgent analysis of the monomials $\text{soc}^{\mathbf{B}}$ for singular weightages and show that they belong to $\mathcal{H}_{\text{end}}^{\text{simp}}$ when the g_i ’s belong to the same space.

7.2.3. Parametric resurgence. — As we saw, the weighted products $\text{soc}^{\mathbf{B}}$ or their by-products $\widetilde{\text{soc}}^{\mathbf{B}}$ and $\widetilde{\text{som}}^{\mathbf{B}}$, are naturally functions of *two* variables or, more precisely, functions of ξ depending on the parameter z . Concentrating on $\text{soc}^{\mathbf{B}}(\xi, z)$, this means considering subalgebras of RES^{simp} as local systems⁽²⁾ depending on

⁽²⁾Consider for instance that $\text{soc}^{B_1}(\xi, z) = \frac{1}{\omega_1} g_1\left(\frac{\xi}{\omega_1} - z\right)$ and assume that $g \in \mathcal{H}(\mathcal{R}_\Omega)$. Then as far as $z \notin \Omega$, $\text{soc}^{B_1}(\xi, z)$ belongs to $\mathcal{H}(\mathcal{R}_\Omega)_z = \mathcal{H}(\mathcal{R}_{\omega_1(z+\Omega)})$. Thus the disjoint union $\tilde{\mathcal{H}} := \coprod_{z \in \mathbb{C} \setminus \Omega} \mathcal{H}(\mathcal{R}_\Omega)_z$

with its natural projection $p : \varphi_z \in \mathcal{H}(\mathcal{R}_\Omega)_z \mapsto p(\varphi_z) = z$ makes an étalé space. We thus get a sheaf and soc^{B_1} can be seen as a section of this sheaf.

$z \in \mathbb{C}$. This general question is approached in [DP99] and [SS96] in various ways, see also [S95, Zha96]. But no doubt that much remains to be done in this area.

BIBLIOGRAPHY

- [AB91] F. Albrecht, I.D. Berg, *Geodesics in Euclidean space with analytic obstacle*. Proc. Amer. Math. Soc. **113** (1991), no. 1, 201-207.
- [AVG88] V. Arnold, A. Varchenko, S. Gussein-Zadé, *Singularities of differentiable maps. Vol. II. Monodromy and asymptotics of integrals*. Monographs in Mathematics, 83. Birkhäuser Boston, Inc., Boston, MA (1988).
- [Bal000] W. Balser, *Formal power series and linear systems of meromorphic ordinary differential equations*. Universitext. Springer-Verlag, New York, 2000.
- [Bor28] E. Borel, *Leçons sur les séries divergentes*. Gauthier-Villars, 1928. Réimpression de 1988, éditions J.Gabay (1988).
- [Bra91] B. L. J. Braaksma, *Multisummability and Stokes multipliers of linear meromorphic differential equations*. J. Differential Equations **92** (1991), no. 1, 45-75.
- [BH91] M.V. Berry, C.J. Howls, *Hyperasymptotics for integrals with saddles*. Proc. Roy. Soc. Lond. A, Vol 434, 657-675 (1991).
- [CNP93-1] B. Candelpergher, C. Nosmas, F. Pham, *Approche de la résurgence*, Actualités mathématiques, Hermann, Paris (1993).
- [CNP93-2] B. Candelpergher, C. Nosmas, F. Pham, *Premiers pas en calcul étranger*, Ann. Inst. Fourier (Grenoble) **43** (1993) 201-224.
- [Cost98] O. Costin, *On Borel summation and Stokes phenomena for rank-1 nonlinear systems of ordinary differential equations*, Duke Math. J. **93** (1998), no. 2, 289-344.
- [Cost001] O. Costin, R.D. Costin *On the formation of singularities of solutions of nonlinear differential systems in antistokes directions*, Invent. Math. **145** (2001), no. 3, 425-485.
- [Cost009] O. Costin, *Asymptotics and Borel summability*, Chapman & Hall/CRC Monographs and Surveys in Pure and Applied Mathematics, 141. CRC Press, Boca Raton, FL, 2009.

- [Del94] E. Delabaere, *Introduction to the écalles theory*, in Computer algebra and differential equations, London Math. Soc., Lecture Note Ser., 193(1994), 59-102.
- [Del010] E. Delabaere, *Singular integrals and the stationary phase methods*. Algebraic approach to differential equations, 136-209, World Sci. Publ., Hackensack, NJ, 2010.
- [DDP93] E. Delabaere, H. Dillinger, F. Pham, *Résurgence de Voros et périodes des courbes hyperelliptiques*, Annales de l'Institut Fourier **43** (1993), no. 1, 163-199.
- [DDP97] E. Delabaere, H. Dillinger, F. Pham, *Exact semi-classical expansions for one dimensional quantum oscillators*, Journal Math. Phys. **38** (1997), 12, 6126-6184.
- [DP97] E. Delabaere, F. Pham, *Unfolding the quartic oscillator*, Ann. Physics **261** (1997), no. 2, 180-218.
- [DP98] E. Delabaere, F. Pham, *Eigenvalues of complex Hamiltonians with PT-symmetry*, Phys. Lett. A **250** (1998), no. 1-3, 25-32.
- [DP99] E. Delabaere, F. Pham, *Resurgent methods in semi-classical asymptotics*, Ann. Inst. Henri Poincaré, Sect. A **71** (1999), no 1, 1-94.
- [DH002] E. Delabaere, C. J. Howls, *Global asymptotics for multiple integrals with boundaries*. Duke Math. J. **112** (2002), no. 2, 199-264.
- [DR006] E. Delabaere, J.M. Rasoamanana, *Resurgent deformation of an ordinary differential equation of order 2*, Pacific Journal of Mathematics, **223** (2006), no 1, 35-93.
- [DT000] E. Delabaere, D.T. Trinh, *Spectral analysis of the complex cubic oscillator*, J.Phys. A: Math. Gen. **33** (2000), no. 48, 8771-8796.
- [Din73] R.B. Dingle, *Asymptotic expansions : their derivation and interpretation*. Academic Press, Oxford (1973).
- [Eb007] W. Ebeling, *Functions of several complex variables and their singularities*. Graduate studies in mathematics, Vol. 83. Amer. Math. Soc., Providence, 2007.
- [Ec81-1] J. Écalles, *Les algèbres de fonctions résurgentes*, Publ. Math. D'Orsay, Université Paris-Sud, 1981.05 (1981).
- [Ec81-2] J. Écalles, *Les fonctions résurgentes appliquées à l'itération*, Publ. Math. D'Orsay, Université Paris-Sud, 1981.06 (1981).
- [Ec84] J. Écalles, *Cinq applications des fonctions résurgentes*, preprint 84T 62, Orsay, (1984).
- [Ec85] J. Écalles, *L'équation du pont et la classification analytique des objets locaux*, Publ. Math. D'Orsay, Université Paris-Sud, 1985.05 (1985).

- [Ec90] J. Écalle, *Finitude des cycles limites et accélero-sommation de l'application de retour*. Bifurcations of planar vector fields (J.P.Françoise & J.C.Roussarie ed.), Lecture Notes in Maths N°1455, Springer (1990).
- [Ec92] J. Écalle, *Singularités non abordables par la géométrie*. Annales de l'Institut Fourier, Tome 42, Fascicule 1 et 2, 73-164 (1992).
- [Ec93-1] J. Écalle, *Six lectures on transseries, Analysable functions and the Constructive proof of Dulac's conjecture*, Bifurcations and periodic orbits of vector fields (Montreal, PQ, 1992), 75-184, NATO Adv. Sci. Inst. Ser. C Math. Phys. Sci., 408, Kluwer Acad. Publ., Dordrecht, 1993.
- [Ec93-2] J. Écalle, *Fonctions analysables et preuve constructive de la conjecture de Dulac*. Actualités mathématiques, Hermann, Paris (1993).
- [Ec94] J. Écalle, *Weighted products and parametric resurgence*, "Analyse algébrique des perturbations singulières I : Méthodes résurgentes", Travaux en cours, Hermann, Paris (1994), 7-49.
- [Ec005] J. Écalle, *Twisted resurgence monomials and canonical-spherical synthesis of local objects*. Analyzable functions and applications, 207-315, Contemp. Math. **373**, Amer. Math. Soc., Providence, RI, 2005.
- [EM96] J. Écalle, F. Menous, *Well-behaved convolution averages and the non-accumulation theorem for limit-cycles*. The Stokes phenomenon and Hilbert's 16th problem (Groningen, 1995), 71-101, World Sci. Publishing, River Edge, NJ, 1996.
- [Eve99] C. Even, *Etude d'une fonction remarquable associée aux moyennes de convolution*. Ann. Inst. Fourier (Grenoble) **49** (1999), no. 2, 687-705.
- [For81] O. Forster, *Lectures on Riemann Surfaces*, Graduate texts in mathematics; 81, Springer, New York (1981).
- [GS001] V. Gelfreich, D. Sauzin, *Borel summation and splitting of separatrices for the Hénon map*, Ann. Inst. Fourier (Grenoble) **51** (2001), no 2, 513-567.
- [Jos95] J. Jost, *Riemannian geometry and geometric analysis*. Universitext. Springer-Verlag, Berlin, 1995
- [JS87] G. Jones, D. Singerman, *Complex functions*, Cambridge University Press, United Kingdom, (1987).
- [Lod94] M. Loday-Richaud, *Stokes phenomenon, multisummability and differential Galois groups*. Ann. Inst. Fourier (Grenoble) **44** (1994), no. 3, 849-906.
- [Lod95] M. Loday-Richaud, *Solutions formelles des systèmes différentiels linéaires méromorphes et sommation*. Exposition. Math. **13**, no. 2-3, 116-162 (1995).
- [Lod001] M. Loday-Richaud, *Rank reduction, normal forms and Stokes matrices*. Expo. Math. **19** (2001), no. 3, 229-250.
- [LR011] M. Loday-Richaud, P. Remy, *Resurgence, Stokes phenomenon and alien derivatives for level-one linear differential systems*. J. Differential Equations **250** (2011), no. 3, 1591-1630.

- [Mal85] B. Malgrange, *Introduction aux travaux de J. Écalle*, Enseign. Math. **31** (1985) 261-282.
- [Mal91] B. Malgrange, *Equations différentielles à coefficients polynomiaux*, Progress in Mathematics, Volume 96, Birkhäuser, Basel (1991).
- [Mal95] B. Malgrange, *Sommation des séries divergentes*. Expositiones Mathematicae **13**, 163-222 (1995).
- [MR94] J. Martinet, J.P. Ramis, *Théorie de Galois différentielle et resommation. Computer Algebra and Differential Equations (E.Tournier ed.)*, Acad.Press (1984).
- [MR91] J. Martinet, J.P. Ramis, *Elementary acceleration and multisummability*. Ann. Inst. H. Poincaré, Physique théorique **54**, 331-401 (1991).
- [Men97] F. Menous, *The well-behaved Catalan and Brownian averages and their applications to real resummation*. Proceedings of the Symposium on Planar Vector Fields (Lleida, 1996). Publ. Mat. **41** (1997), no. 1, 209–222.
- [Men99] F. Menous, *Les bonnes moyennes uniformisantes et une application à la resommation réelle*. Ann. Fac. Sci. Toulouse Math. (6) **8** (1999), no. 4, 579–628.
- [Old96] A.B. Olde Daalhuis, *Hyperterminants I*. J. Comput. Appl. Math. **76**, 255-264 (1996).
- [Old97] A.B. Olde Daalhuis, *Hyperterminants II*. J. Comput. Appl. Math. **89**, 87-95 (1997).
- [Old98] A.B. Olde Daalhuis, *Hyperasymptotic solutions of higher order linear differential equations with a singularity of rank one*. Proc. R. Soc. Lond. A **445**, 1-29 (1998).
- [Olv74] F.W.J. Olver, *Asymptotics and special functions*. New York, Academic Press (1974).
- [OSS003] C. Olivé, D. Sauzin, T. Seara, *Resurgence in a Hamilton-Jacobi equation*. Proceedings of the International Conference in Honor of Frédéric Pham (Nice, 2002). Ann. Inst. Fourier (Grenoble) **53** (2003), no. 4, 1185-1235.
- [OU010] Y. Ou *On the stability by convolution product of a resurgent algebra*. (English, French summary) Ann. Fac. Sci. Toulouse Math. (6) **19** (2010), no. 3-4, 687-705.
- [Ph005] F. Pham, *Intégrales singulières*. Savoirs actuels, EDP Sciences/CNRS Editions (2005).
- [R93] J.-P. Ramis, *Séries divergentes et théories asymptotiques*, Suppl. au bulletin de la SMF, Panoramas et Synthèses **121** (1993), Paris : Société Mathématique de France.
- [S95] D. Sauzin, *Résurgence paramétrique et exponentielle petitesse de l'écart des séparatrices du pendule rapidement forcé*. Ann. Inst. Fourier (Grenoble) **45** (1995), no. 2, 453-511.

- [S006] D. Sauzin, *Resurgent functions and splitting problems*, RIMS Kokyuroku 1493 (31/05/2006) 48-117
- [S009] D. Sauzin, *Mould expansions for the saddle-node and resurgence monomials*. In Renormalization and Galois theories, 83-163, IRMA Lect. Math. Theor. Phys., 15, Eur. Math. Soc., Zürich, 2009.
- [S012] D. Sauzin, *On the stability under convolution of resurgent functions*, arXiv:1201.1073, submitted.
- [Sib90] Y. Sibuya, *Linear differential equations in the complex domain: problems of analytic continuation*. Translated from the Japanese by the author. Translations of Mathematical Monographs, 82. American Mathematical Society, Providence, RI, 1990.
- [SS96] B. Sternin, V. Shatalov *Borel-Laplace transform and asymptotic theory. Introduction to resurgent analysis*. CRC Press, Boca Raton, FL, 1996.
- [Sto] G.G. Stokes, *On the Discontinuity of arbitrary constants which appear in divergent developments*. Transactions of the Cambridge Philosophical Society, Vol.X, Part.I (1857).
- [Tou90] J.C. Tougeron, *An introduction to the theory of Gevrey expansions and to the Borel-Laplace transform with some applications*. Preprint University of Toronto, Canada (1990).
- [Wa65] W. Wasow, *Asymptotic expansions for ODE*. Interscience pub. (1965).
- [Zha96] C. Zhang, *Confluence et phénomène de Stokes*. J. Math. Sci. Univ. Tokyo **3** (1996), no. 1, 91-107.
- [Zha99] C. Zhang, *Développements asymptotiques q -Gevrey et séries Gq -sommables*. Ann. Inst. Fourier (Grenoble) **49** (1999), no. 1, vi-vii, x, 227-261.
- [Zha006] C. Zhang, *Solutions asymptotiques et méromorphes d'équations aux q -différences*. In Théories asymptotiques et équations de Painlevé, 341-356, Sémin. Congr., 14, Soc. Math. France, Paris, 2006.