



HAL
open science

Design methodology and technology assessment for high-density 3D technologies

Hossam Sarhan

► **To cite this version:**

Hossam Sarhan. Design methodology and technology assessment for high-density 3D technologies. Micro and nanotechnologies/Microelectronics. Université Grenoble Alpes, 2015. English. NNT: 2015GREAT134 . tel-01279053

HAL Id: tel-01279053

<https://theses.hal.science/tel-01279053v1>

Submitted on 25 Feb 2016

HAL is a multi-disciplinary open access archive for the deposit and dissemination of scientific research documents, whether they are published or not. The documents may come from teaching and research institutions in France or abroad, or from public or private research centers.

L'archive ouverte pluridisciplinaire **HAL**, est destinée au dépôt et à la diffusion de documents scientifiques de niveau recherche, publiés ou non, émanant des établissements d'enseignement et de recherche français ou étrangers, des laboratoires publics ou privés.

THÈSE

Pour obtenir le grade de

DOCTEUR DE L'UNIVERSITÉ GRENOBLE ALPES

Spécialité : **Nano électronique et nano technologies**

Arrêté ministériel : 7 août 2006

Présentée par

Hossam SARHAN

Thèse dirigée par **Fabien CLERMIDY**

préparée au sein du **Laboratoire Intégration Silicium des Architectures Numériques**
dans l'**École Doctorale Electronique, Electrotechnique, Automatique et Traitement du Signal (EEATS)**

**Design Methodology and
Technology Assessment for
High-Density 3D Technologies**

Thèse soutenue publiquement le « **23 Novembre 2015** »,
devant le jury composé de :

Mme Lorena, ANGHEL

Pofesseur, Univ. Grenoble Alpes, TIMA, Président

M. Amara, AMARA

Pofesseur, ISEP, Rapporteur

M. Jacques-Olivier, KLEIN

Pofesseur, Univ. Paris Sud, Rapporteur

M. Sung Kyu, LIM

Pofesseur, Georgia Institute of Technology, Membre

M. Fabien, CLERMIDY

HDR, CEA-LETI, Directeur de thèse, Membre

M. Sebastien, THURIES

Ingenieur de recherche, CEA-LETI, Membre



DOCTORAL THESIS

**Design Methodology and Technology
Assessment for High-Density 3D
Technologies**

Hossam SARHAN

November 2015

Abstract

Scaling limitations of advanced technology nodes are increasing and the BEOL parasitics become more dominant. This has led to an increasing interest in 3D technologies to overcome such limitations and continue the scaling predicted by Moore's Law. 3D technologies vary according to the fabrication process which creates a wide spectrum of technologies including Through-Silicon-VIA (TSV), Copper-to-Copper (CuCu) and Monolithic (or sequential) 3D (M3D). TSV and CuCu provide 3D contacts of pitch around $5\text{-}10\mu\text{m}$ while M3D scales down 3D via pitch extremely to $0.11\mu\text{m}$. Such high-density capability of Monolithic 3D technology creates new design paradigms. In this context, our objective is to propose innovative design methodologies to well utilize M3D technology and introduce a technology assessment framework to evaluate different M3D technology parameters from design perspective.

This thesis can be divided into three main contributions. As creating 3D standard cells becomes achievable thanks to M3D technology, a new 3D standard cell approach called '3D Cell-on-Buffer' (3DCoB) has been introduced. 3DCoB cells are created by splitting 2D cells into functioning gates and driving buffers stacked over each other. The simulation results show gain in timing performances compared to 2D. By applying an additionally Multi-VDD low-power approach, iso-performance power gain has been achieved. Afterwards cell-on-cell design approach has been explored where a partitioning methodology is required to distribute cells between different tiers, i.e. determine which cell should be placed on which tier. A physical-aware partitioning methodology has been introduced which improves power-performance-area results compared to state-of-the-art partitioning techniques. Finally a full high-density 3D technology assessment study is presented to explore the trade-offs between different 3D technologies, block complexities and partitioning methodologies.

Acknowledgements

Here I am reaching the end of this journey. This work would not have been accomplished without the efforts of many inspiring people. I would like to acknowledge all of their contributions. Above all, I am indebted to my thesis director Fabien Clermidy and my thesis supervisors Sebastien Thuries and Olivier Billoint. I have had the honor and pleasure of working with such smart and inspiring people. Fabien, Sebastien and Olivier are great mentors from whom I have learned a lot on the personal and technical levels. They helped me a lot throughout all my work.

Even though a great effort has been put into this thesis, it would not have been with any value without the approval of a great jury. First of all, I would like to express my gratitude to Prof. Jacques-Olivier and Prof. Amara Amara for being the reporters and for their suggestions. I would also like to thank Prof. Sung Kyu Lim and Prof. Lorena Anghel for accepting to be part of the thesis jury. It was my pleasure to defend and discuss my thesis work with such technical experts.

During this work, I have worked in collaboration with many researchers from whom I have had the chance to learn a lot. I would like to especially thank and acknowledge the effort of Synopsys/Atrenta SpyGlass team; Vladimir Pasca, Claudia Rusu and Ravi Varadarajan for their intensive support of SpyGlass Physical tool within a common lab during my PhD.

I would like to acknowledge as well Perrine Batude for her support and contributions regarding Monolithic 3D Integration Technology process, Maud Vinet for directing the research effort in 3D Technologies, Meycene Toumi for his support on SpyGlass 3D tool flow, Bartosz Boguslawski for his collaboration and great effort in the 3D neural cliques contribution, Fabien Deprat and Alexandre Ayres for their support and contribution in the process characterization of Monolithic 3D technology, Edith Beigne for taking the responsibility of coaching us as PhD students and Pascal Vivet for his fruitful discussions and guidance. I would also like to thank Marc Belleville, Denis Dutoit, Gérald Cibrario, Guillaume Berhault, Frédéric Heitzmann, Cristiano Lopes Dos Santos, Ogun Turkylimaz, Lilia Zaourar, Bilel Belhadj, Simone Bacles-Min, Houcine Oucheikh, David Coriat, Thiago Rappu Da Rosa, Yassine Fkih, Santhosh Onkaraiah and Natalija Jovanovic with whom I have exchanged many ideas and have had technical discussions. I really appreciate their contribution which shaped my thesis research substantially.

I feel privileged for the chance to conduct research in such a dynamic and enriching workplace as CEA where I have met wonderful people. Especially, I would like thank

the members of my laboratory: Olivier Thomas, Bastien, Jérôme, Jean-Frédéric, Alexander, Yvain, Ivan, Romain, Pierre-Yves, Michel, Yves, Anthony and my friends Ismail, Vincent, Brahim, Oussama, Florent, Adam, Alex, Soundous, Emilie, Jolie, Mélanie, Sébastien Bernard, Marie-Sophie, Nour, Mai, Alexandra, Julien, Lionel, Grégory for making the life in CEA even more enjoyable. I would also like to thank Catherine Bour and Jumana Boussey for being very helpful during my administrative struggles. I also want to thank the laboratory secretaries Caroline and Armelle for being kind and patient even with my limited French. I would like to deeply thank Haykel Ben-Jamaa without whom my path would have never crossed with CEA; as he was the one to invited me to this PhD position.

My most thanks, appreciation, and gratitude go to my family. First my wife Nesma who was part of this journey. She has endured my working late so may times and continuously encouraged me to continue through all the hard times that I have had. My son Yusuf whom I have been blessed with during my PhD journey and who has made my life a lot more joyful. My father Hassan, my mother Nawal, my father-in-law Mokhtar and my brother Mohamed have all been a source of motivation and strength. Without their constant encouragement, I would not have been able to get this far. I dedicate this dissertation to each and every one of my family and my friends for their unconditional love and generous support.

Hossam Sarhan

Contents

Abstract	i
Acknowledgements	ii
Contents	iv
List of Figures	viii
List of Tables	x
Abbreviations	xii
1 Introduction	1
1.1 Context	1
1.2 Motivation	3
1.3 Contributions	4
1.4 Thesis Organization	5
2 Overview on 3D Technologies and Design Space	7
2.1 Why 3D ICs?	7
2.2 3D Design Space	8
2.3 3D Technology Spectrum	8
2.3.1 Integration Schemes	9
2.3.1.1 2.5D Interposer	9
2.3.1.2 3D Configurations: Face-to-Back and Face-to-Face	10
2.3.2 3D Through-Silicon-VIA Technology	11
2.3.3 3D Copper-to-Copper Technology	11
2.3.4 Monolithic 3D (3DVLSI) Technology	13
2.3.5 Summary: Comparing different 3D technologies	13
2.4 Partitioning Granularity: Stacking from ‘Coarse-grain’ to ‘Fine-grain’	14
2.4.1 Memory-on-logic integration	15
2.4.2 Core-level and block-level integration	16
2.4.3 Gate-level integration (Cell-on-Cell)	17
2.4.4 Transistor-level integration (N/P)	17
2.4.5 Logic-on-Logic stacking: Fine vs. Coarse grain Partitioning	18
2.4.5.1 Coarse-Grain: Architecture-level Partitioning	18
2.4.5.2 Fine-Grain: Gate-level Partitioning	19

2.4.6	Summary: 3D partitioning granularity spectrum	21
2.5	3D CAD Tools: Issues and Perspectives	23
2.5.1	Issues of CAD tools for 3DICs	23
2.5.1.1	3D Standard Cell Placement	23
2.5.1.2	3D-VIA Placement	24
2.5.1.3	3D Clock Tree Synthesis	24
2.5.2	3D Implementation based on 2D Commercial Tools	26
2.5.3	Using Fast Prototyping Implementation Tool	26
2.6	Conclusion: Work positioning and Design Framework	28
3	Cell-on-Buffer: A New Design Approach for Monolithic 3D	30
3.1	Introduction	30
3.2	3D Cell-on-Buffer (3DCoB) Approach	32
3.2.1	3DCoB cell structure	32
3.2.2	3DCoB input gate capacitance	33
3.2.3	Results of input gate capacitance effect	34
3.3	3DCoB Implementation Framework	34
3.3.1	.LEF file generation	36
3.3.2	.LIB file generation	37
3.3.2.1	Validating .LIB generation methodology	38
3.4	3DCoB Performance-Power Results	40
3.5	Low-Power Multi-VDD CoB (MV-CoB) Approach	44
3.6	Power Optimization Results MV-CoB Performance-Power-Area Results	46
3.7	Summary and Conclusion	48
4	Gate-Level 3D Partitioning	51
4.1	Introduction: 3D Partitioning	51
4.2	Previous Gate-Level Partitioning Techniques	53
4.3	Physical-Aware Partitioning (PAP) Methodology	54
4.4	Bi-Directional Partitioning (BDP) Algorithm	57
4.5	Un-Balancing Area Ratio Concept	60
4.6	Performance-Power-Area Results	62
4.6.1	PAP Methodology Implementation	62
4.6.2	Performance Results	64
4.6.3	Power Results	66
4.7	Summary and Conclusion	67
5	Intermediate BEOL process influence for M3D	68
5.1	Introduction: Effect of Intermediate-BEOL for M3D	68
5.2	The need for W/SiO ₂ I-BEOL	69
5.3	SiO ₂ I-BEOL PPA Evaluation Framework	70
5.3.1	Framework definition	70
5.3.2	I-BEOL parasitics extraction focus	72
5.4	Power-Performance-Area Results	73
5.5	Summary and Conclusion	77
6	3D Technologies Assessment	78
6.1	Introduction	78

6.2	Design Exploration Framework	79
6.2.1	Framework Overview	79
6.2.2	Partitioning Methodologies	80
6.3	3D Area Overhead analysis	81
6.3.1	3D Contact Area Overhead Model	81
6.3.2	Area Results comparing M3D vs CuCu vs TSV	82
6.3.3	Discussion: Partitioning Effect for 3D-C Area	83
6.4	Power-Performance Results for M3D vs CuCu	84
6.4.1	Discussion I: 3D Technology Results Comparison	88
6.4.2	Discussion II: Partitioning Results Comparison	89
6.4.3	Discussion III: Block Type Results Comparison	89
6.5	Summary and Conclusion	89
7	Conclusion and Perspective	92
7.1	Summary and Conclusion	92
7.2	Perspectives and Future work	95
7.2.1	Architecture-Level Partitioning	95
7.2.2	Congestion Analysis for Decreasing Number of Metal Layers	96
7.2.3	3D Thermal Analysis and PDN design	96
7.2.4	Further Aspects	97
A	Architecture-Level Partitioning: Case Study “3D Neural Cliques”	98
A.1	Introduction: Neural Cliques Network Architecture	98
A.2	3D neural cliques network architecture	101
A.3	Simulation model	102
A.4	Simulation results using different partitioning	103
A.4.1	General study	103
A.4.2	Case Study: Power management for LTE receiver	107
A.5	Conclusion: 3D Neural Network	109
B	Résumé en Français	111
B.1	Introduction et Contexte	111
B.2	L’état de l’art: Technologie 3D	113
B.2.1	Le besoin de 3D !	113
B.2.2	Spectre de la technologie 3D	114
B.2.2.1	Schémas d’intégration	114
B.2.2.2	Through-Silicon-VIA technologie 3D (TSV)	115
B.2.2.3	Technologie 3D Cuivre–cuivre	115
B.2.2.4	Technologie 3D Monolithique	116
B.2.3	Granularité de Partitionnement 3D	118
B.2.4	Positionnement de travail et méthodologie de conception	118
B.3	Méthodologie de conception: 3DCoB	120
B.3.1	Introduction	120
B.3.2	Configuration des cellules 3DCoB	120
B.3.3	Cadre de conception 3DCoB	121
B.3.4	Résultats de la simulation	122

B.3.5	3D CoB Multi-VDD	124
B.4	Méthodologie de partitionnement	125
B.4.1	Les techniques de partitionnement précédentes	125
B.4.2	Partitionnement proposé	126
B.4.3	Résultats d'implémentation du partitionnement	127
B.5	Évaluation des technologies 3D	129
B.5.1	Introduction: La nécessité d'une évaluation de la technologie	129
B.5.2	Evaluation et résultats	130
B.6	Conclusion	130
 List of Publications		133
 Bibliography		136

List of Figures

1.1	More-Moore and More-than-Moore Concepts	2
1.2	BEOL scaling effect	2
1.3	Thesis framework	5
2.1	High-Density 3D Design Space	9
2.2	3D integration configuration schemes	10
2.3	3D-Through-Silicon-Via	12
2.4	Copper-to-Copper Integration Technology	12
2.5	Monolithic 3D Technology	14
2.6	3D Granularity spectrum from coarse- to fine- grain	15
2.7	3D openSPARC block-level integration	16
2.8	Gate-level partitioning effect	19
2.9	3D Partitioning Granularity Spectrum	22
2.10	3D placement techniques based on 2D placement	27
2.11	2D/3D Design Implementation Framework.	28
3.1	3D Cell-on-Buffer library set of cells	32
3.2	3DCoB partitioning of a non-min cell	33
3.3	Input gate capacitance results for 2D and 3DCoB cells	35
3.4	3DCoB implementation framework	36
3.5	Effective area for 3DCoB LEF life modification	37
3.6	3DCoB standard cell creation procedure.	38
3.7	Validating .LIB generation methodology using cell-by-cell comparison	39
3.8	Power-Performance tradeoff for 2D and 3DCoB implementations	42
3.9	Standard cell drive distribution for FFT implementation using 2D vs. 3DCoB.	43
3.10	Different connectivity schemes for Multi-VDD 3DCoB approach	45
3.11	Power-Performance tradeoff for 2D and 3DCoB implementations	49
4.1	Physical-Aware-Partitioning methodology framework	55
4.2	Gate netlist to HyperGraph conversion	57
4.3	Bi-Directional Partitioning (BDP) diagram	60
4.4	3D hybrid floor-planning	61
4.5	Snapshot of LDPC implementation prototyping	63
4.6	Power-Performance results for different partitioning techniques	66
5.1	CoolCube TM process for Monolithic 3D technology	70
5.2	Implementation prototype methodology for I-BEOL evaluation	72
5.3	3DCoB standard cell creation procedure.	73

5.4	I-BEOL effect results for 3D blocks	76
6.1	Design-Technology Exploration Framework	80
6.2	Area penalty effect of increasing block size for different 3D technologies.	84
6.3	Power-performance curves for 2D, CuCU and M3D technologies.	88
6.4	High Density 3D Design Space.	90
A.1	The network general structure and notation. Different shapes (circles, squares) represent fanals belonging to different clusters.	100
A.2	2D neural network example. Different shapes (circles, squares) represent fanals belonging to different clusters	101
A.3	3D neural network (folded network)	101
A.4	Total wire length gain compared to 2D in function of the number of clusters in each direction	104
A.5	Maximal RC delay gain compared to 2D in function of the number of clusters in each direction	104
A.6	Total wire length gain and maximal RC delay gain in function of the total number of fanals for different network dimensions	105
B.1	les différentes directions de miniaturisation pour améliorer les performances du système	112
B.2	L'effet pour les différents nœuds CMOS	112
B.3	Schématique de l'interposition active	114
B.4	La configuration de 3D Face-à-dos et face-à-face	115
B.5	3D-Through-Silicon-Via	116
B.6	Cuivre-à-cuivre 3D technologie	117
B.7	Monolithique 3D technologie	117
B.8	Résumé du précédent état de l'art montrant à la fois la technologie 3D et partitionnement spectre de granularité	119
B.9	Cadre de l'implémentation de 2D/3D IC	120
B.10	3D Cellule-sur-Amplificateur cellules.	121
B.11	Cadre complet de l'implémentation de l'approche 3DCoB	122
B.12	Résultats Power-performance pour 2D et 3DCoB implémentations	124
B.13	Résultats Power-performance pour 2D, 3DCoB et Multi-VDD 3DCoB implémentations	125
B.14	Flot de partitionnement.	127
B.15	Partitionnement bidirectionnel	128
B.16	Puissance-performance résultats pour 2D, hMetis 3D partitionnement et notre partitionnement 3D	129
B.17	Résultats Puissance-performance pour un BEOL différent pour la couche de fond de M3D	131

List of Tables

2.1	Comparison between different 3D technologies	14
2.2	Comparison between ‘Architecture-level’ and ‘Gate-level’ partitioning methodologies	20
2.3	A comparison of different partitioning 3D designs showing the granularity spectrum	21
2.4	A qualitative comparison between different 3D clock tree synthesis techniques	25
3.1	Comparison between transistor-level (N/P), Cell-on-Buffer and Cell-on-Cell approaches for M3D technology	31
3.2	Validating .LIB generation methodology with a full block implementation. A comparison of implementation results of 128-bit AES block using both .LIB files: the original foundry .LIB file and our generated .LIB file	40
3.3	Performance optimization results using 3DCoB compared to 2D implementations for openMSP, FFT and AES blocks	41
3.4	Power optimization results using Multi-VDD 3DCoB ($\beta=0.9$) implementations for openMSP, FFT and AES blocks	47
3.5	Full power-performance comparison between transistor-level (N/P), Cell-on-Buffer and Cell-on-Cell approaches for M3D technology	50
4.1	Comparison between parasitics of M3D-VIA and M2 line of a 28nm CMOS technology node.	52
4.2	Comparing the conventional balanced top/bottom area ratio versus the proposed Unbalanced top/bottom area ratio design techniques for 3D blocks	61
4.3	Results comparison between 2D and 3D cases (hMetis and PAP partitioning) for openMSP, Reconf-FFT and LDPC blocks	65
5.1	IBEOl flavours power-performance-area results for FFT, FPU and LDPC blocks	75
6.1	High-density 3D-Connections parameters	79
6.2	3D connections area penalty for HD-TSV, Cu-Cu and M3D using 28nm FDSOI CMOS technology	84
6.3	Power-Performance results comparison between implementations of 2D and 3D using M3D and Cu-Cu technologies for openMSP, Reconf-FFT blocks, FPU and LDPC blocks	86
A.1	Total wire length gain in percentage compared to 2D for a given number of clusters in x and y direction	107

A.2	Maximal RC delay gain in percentage compared to 2D for a given number of clusters in x and y direction	107
A.3	The gains obtained for 3D neural cliques used as power management controller. The results are normalized to 2D circuit	109
B.1	Résultats puissance-performance pour les approches 2D et 3DCoB pour les blocs openMSP, FFT et AES	123

Abbreviations

3DCoB	3D Cell on Buffer
3DIC	3D Integrated Circuits
BDP	Bi Directional Partitioning
BEOL	Back End Of Line
CAD	Computer Aided Design
CMOS	Complementary Metal Oxide Semiconductor
CuCu	Copper-to-Copper
EDA	Electronic Design Automation
M3D	Monolithic 3D
PAP	Physical Aware Partitioning
PPA	Power Performance Area
SEM	Scanning Electron Microscope
TEM	Transmission Electron Microscope
TSV	Through Silicon Via

Chapter 1

Introduction

1.1 Context

Scaling limitations and cost of fabrication of advanced CMOS technology nodes are increasing, resulting in increasingly interest in new technologies to overcome such limitations and continue scaling predicted by Moore's law [1]. Moore's law predicts doubling the number of components, i.e. transistors, per integrated circuit every 1.5-2 years [2]. However continuously scaling and integrating more transistors per chip raise several issues for advanced technology nodes beyond 14nm. New concepts are needed to overcome the technology limitations for CMOS scaling. ITRS discussed the technology scaling roadmap in [3]. Figure 1.1 shows the different scaling directions to enhance system performances. "More-Moore" concept was raised to show the continuous miniaturization of digital functions while the "More-than-Moore" concept has been raised to show functional diversification by including add-on to the already existing technologies to enhance the overall chip performances.

The most important impact of technology scaling is the effect of Back-End-Of-Line (BEOL). By advancing in CMOS node, the gap between delay of the interconnect and that of transistor is increasing where at 16nm CMOS node delay of interconnect reached 1000x transistor delay [4]. Figure 1.2 illustrates that effect for different CMOS nodes.

One way to overcome technology scaling limitations is to integrate "vertically" by stacking different dies on each other providing a third dimension of scaling. This technique is

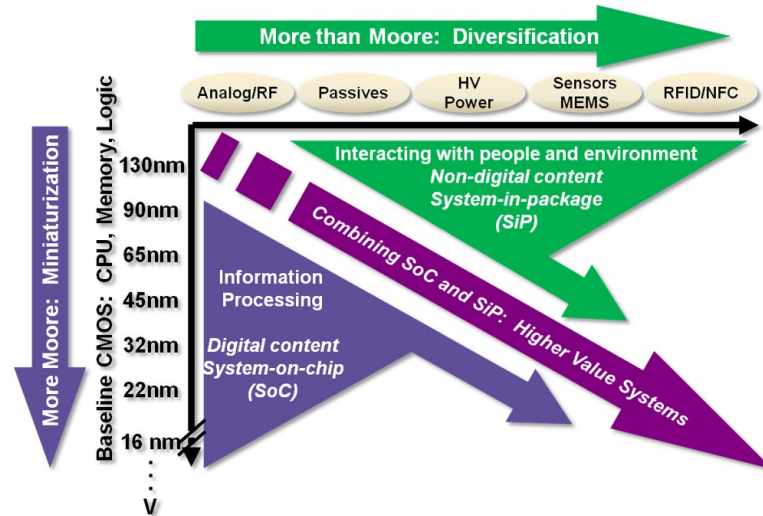

FIGURE 1.1: More-Moore and More-than-Moore concepts describing scaling trends [3]

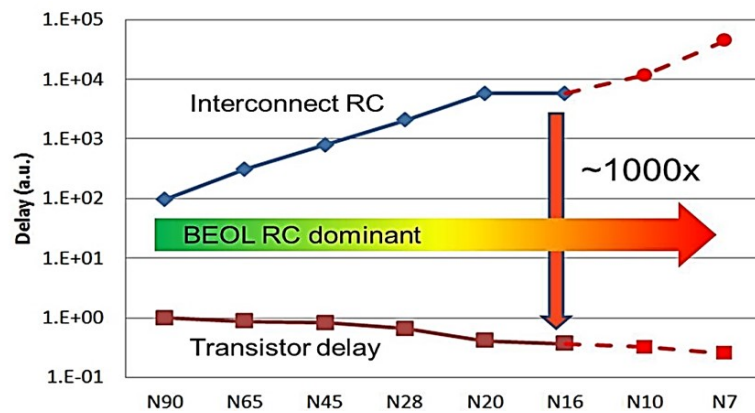

FIGURE 1.2: BEOL scaling effect compared to transistor delay [4].

called “3D Integrated Circuits” (3DICs). 3DICs can provide higher performances and lower-power compared to conventional 2D ICs thanks to footprint reduction and shortening wiring interconnects.

3DICs are fabricated using different integration technologies which provide different size and pitch of the 3D contacts (3D-VIAs) between the stacked dies. As integration technology advances, the size of 3D VIAs scales down providing higher density of 3D-VIAs.

In this work we focus mainly on three different technologies of high-density 3DICs:

1. High-Density Through-Silicon-Vias (HD-TSVs)[5, 6].
2. Copper-to-Copper Contacts (Cu-Cu)[5, 7].

3. CoolCubeTM Monolithic 3D Technology (M3D)[8, 9].

The size and pitch of 3D contacts vary for each technology. HD-TSVs technology affords 3D-VIAs of pitch 1.75-10 μm [5, 6], Cu-Cu 3D contact pitch is 2.4-10 μm [5, 7] while M3D technology scales 3D-VIA pitch down to 0.11 μm in 28nm technology node [8]. Detailed discussion on the different 3D technologies is presented in Chapter 2.

1.2 Motivation

As high-density TSV, Cu-Cu and M3D are advanced technologies, there is a need for a technology assessment framework by implementing 3D designs and evaluating different technology parameters. CAD tools are well-adapted for 2D place and route, however there are some issues and limitations using them for 3D implementation. Thus the first challenge for us is how to create a design methodology to implement blocks using high-density 3D technologies.

Another important challenge is how to design a 3D block. High-density 3D technologies affords up to 10^8 3D vias per mm^2 [8]. However each 3D via has resistance and capacitance parasitics which lead to power/delay costs. Thus there is an important need to create a smart partitioning technique to design a 3D block with maximum power and performance gains.

By having an implementation framework and design methodology, we can create a design framework to assess different technology parameters from a design perspective. The technology assessment framework is crucial to be able to provide design-guidelines to the technology developers, especially for very advanced technologies such as Monolithic 3D.

All the previous points motivate us to introduce a new methodology for 3D technologies assessment and propose innovative design approaches to highly utilize high-density 3D technologies.

1.3 Contributions

As mentioned previously high-density 3D technologies raise the need of new design paradigms. This thesis covers several design perspectives to efficiently utilize the 3D technologies, which can be divided into three main contributions:

i. **3D Cell-on-Buffer Standard Cell.**

Creating 3D standard cells become achievable thanks to M3D technology. 3D Cell-on-Buffer (3DCoB) is a novel 3D standard cell using M3D at which 2D standard cells are split into functioning gates and driving buffers stacked over each other. Additionally a Multi-VDD 3DCoB approach is presented as low-power application on 3DCoB approach.

ii. **3D Partitioning Methodologies.**

3D partitioning is the way to distribute cells between different tiers, i.e. determine which cell is placed on which tier. Previous 3D partitioning methodologies tend to minimize number of interconnects between tiers (min-cut). In our work, we have introduced a physical-aware partitioning (PAP) methodology. PAP is a performance-driven partitioning which uses multi-criteria to optimize partitioning. Additionally an architecture-level partitioning case study is discussed as well.

iii. **3D Technologies Assessment.**

Different 3D technologies have different specifications and provide different advantages. The first part of this study is exploring the effect of using non-copper Intermediate Back-End-Of-Line (I-BEOL), as well as showing the congestion analysis for decreasing number of metal layers for M3D. In the second part of this study, we compare the usage of different 3D technologies on different designs using different partitioning methodologies. The target is to define which 3D technology is the most suitable to which design from power, performance and area perspectives.

Figure 1.3 shows the full framework of the thesis, showing the context and summary of the main contribution.

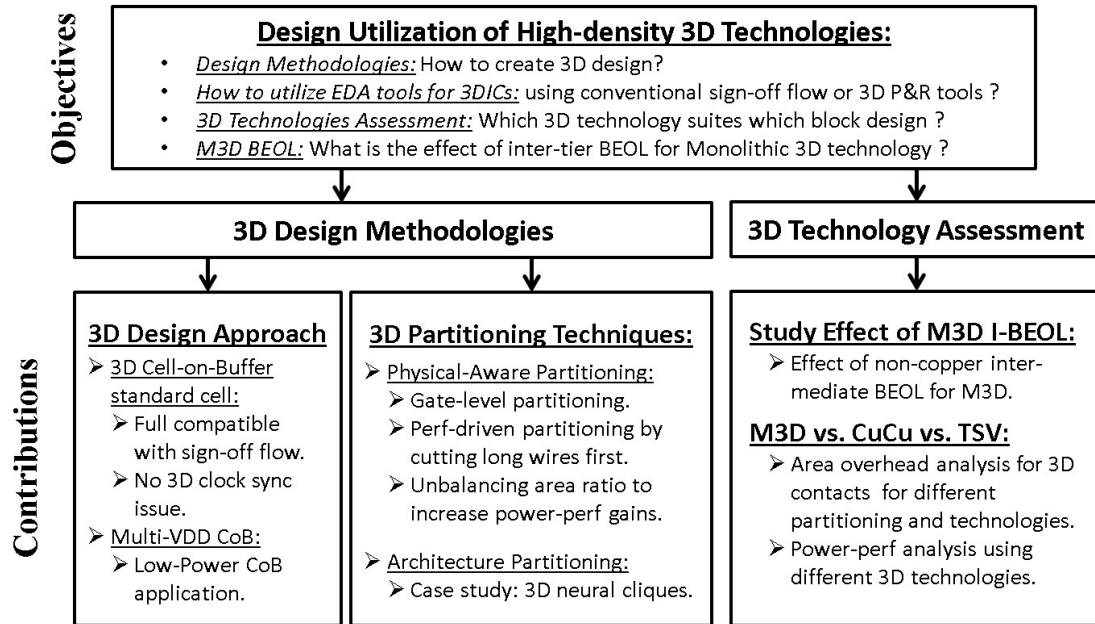

FIGURE 1.3: The full framework of the thesis.

1.4 Thesis Organization

This thesis is organized in six chapters. An introduction with thesis context, organization, and contributions is shown in chapter 1. Chapter 2 summarizes the related state of the art background for 3D technologies and 3D design space at which different issues and opportunities are discussed.

Chapter 3 introduces the 3D Cell-on-Buffer design approach with a full implementation flow and results. Additionally a low-power application is introduced using Multi-VDD CoB with a full power-performance-area results and a comparison with 2D implementations.

Chapter 4 introduces 3D partitioning methodologies. This chapter focuses on gate-level partitioning where a performance-driven Physical-Aware-Partitioning (PAP) methodology is introduced. A full analysis and implementation results are discussed with a comparison with conventional minimum-cut partitioning methodology. On the other hand an architecture partitioning has been explored in Appendix A at which a case study of 3D neural clique is discussed with analytical analysis and results.

Chapter 5 presents a full study of the effect of non-copper metal lines with SiO₂ dielectric used for the Intermediate Back-End-Of-Line (I-BEOL) needed by Monolithic 3D technology using CoolCubeTM process. This study shows effect of increasing resistance and capacitance of the I-BEOL on power-performance metrics with a comparison with conventional Copper metal lines with low-k dielectric I-BEOL.

Chapter 6 introduces a framework for different 3D technologies assessment. In the chapter a comparison is performed between Monolithic 3D, copper-to-copper and TSV technologies with (i) area overhead analysis of 3D contacts and (ii) full power-performance-area results analysis for different implementations. A full discussion of the effect of different 3D technologies, block designs and partitioning techniques is shown to determine which 3D technology suites which block design at which partitioning conditions.

A full list of publications is mentioned at the end of this dissertation (Page 133).

Chapter 2

Overview on 3D Technologies and Design Space

3D design space is large with different parameters from 3D technology, design configuration and CAD tool perspectives. In this chapter we discuss an overview of the state-of-the-art from these three major aspects; (i) 3D technology spectrum, (ii) stacking granularity, and (iii) issues with 3D CAD tools.

2.1 Why 3D ICs?

Technology scaling faces significant difficulties to keep on following Moore's law. As discussed in the introduction, one of the main limitations is the increasing delay of wiring compared to the delay of transistors [1, 4]. Moreover number of Back End Of Line (BEOL) design rules is increasing exponentially. One solution to tackle the planar scaling is to scale vertically by stacking integrated circuits.

3D Integrated Circuits (3D IC) is an emerging technology to stack dies. A direct advantage of such technology is to decrease the wire length by connecting cells in three dimensions, as well as: (i) Decreasing area footprint, (ii) Increasing timing performances by shortening wiring and consequently decreasing the delay of interconnects, (iii) Decreasing power consumption by decreasing the total wire length, and (iv) Achieving

heterogeneous integration by stacking different technologies such as memory, digital circuits, analog circuits, sensors or image display.

3D technology varies with a wide spectrum of capabilities and applications. As we discussed in the previous chapter, continue technology scaling with Moore's law, i.e. More-Moore concept, requires higher density of interconnects. Increasing interconnects density faces difficulties in the advanced nodes beyond 16nm, such as the need of double patterning and Extreme Ultra-Violet (EUV) lithography. One way to scale down the interconnects and increase their density is by adding a new 'vertical' dimension for routability by using high density 3D technologies. Thanks to high-density 3D technologies, a very small size of 3D interconnects is achievable which provides the capabilities of increasing interconnect density. Hence in the following section different 3D technologies are explored with the focus on the high-density 3D technologies.

2.2 3D Design Space

3D design space is large and controlled by different aspects from different areas. Design and implementation using 3D high-density technology is affected by the following three main different areas:

- i. Different 3D technology technologies.
- ii. 3D μ Architecture depending on partitioning granularity level.
- iii. 3D CAD implementation tools.

Figure 2.1 is a circle-diagram showing the different parameters for each area in the whole 3D design space. In the following sections we will explore each area, highlighting the main limitations and opportunities of using high-density 3D technologies.

2.3 3D Technology Spectrum

3DICs are achieved using different technologies; Through-Silicon-VIAs, Copper-to-Copper contacts and Monolithic 3D, and also with different integration schemes; interposer,

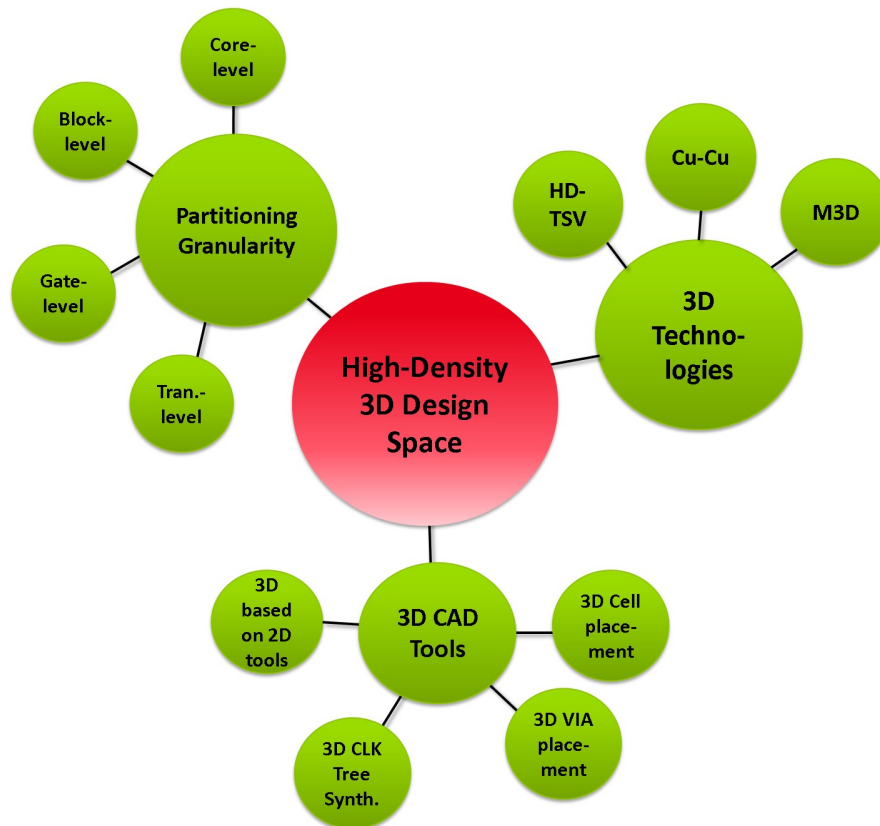

FIGURE 2.1: High-Density 3D Design Space.

face-to-back and face-to-face configurations. This section summarizes the 3D technology spectrum where the first subsection introduces different 3D integration schemes and the subsections after explore the different 3D technologies.

2.3.1 Integration Schemes

2.3.1.1 2.5D Interposer

Interposer is an intermediate step between 2D IC and full 3D IC. This technology is achieved by adding different dies on a common silicon layer called an Interposer [10, 11, 12]. Interposer can be either (i) passive interposer or (ii) active interposer.

In passive interposer, the interposer layer has just wires which connect different dies with no active regions, i.e. no transistor. While in active interposer, the interposer layer has some active components such as driving buffers or communication blocks (e.g. network-on-chip). Figure 2.2(a) shows a schematic of an active interposer configuration.

Interposer technology is mainly targeting by big circuits such as micro-servers and communication chips. The motivation is to reduce the silicon area by splitting the chip into chiplets integrated on an interposer which can increase yield, reduce costs, and enable heterogeneous integration by having different CMOS technology node for each chiplet.

2.3.1.2 3D Configurations: Face-to-Back and Face-to-Face

3D integration can be either face-to-face (F2F) or face-to-back (F2B). In this context we are considering each die has a face and a back, where the face of a die is the top metal layer and the back of a die is the silicon substrate. Consequently the dies can be stacked in a F2F configuration so that the top metal layers are facing each other. Each integration scheme requires different 3D technology to connect the top and bottom dies as we will explain in the next sections. Figure 2.2(b) and (c) show F2B and F2F configuration respectively.

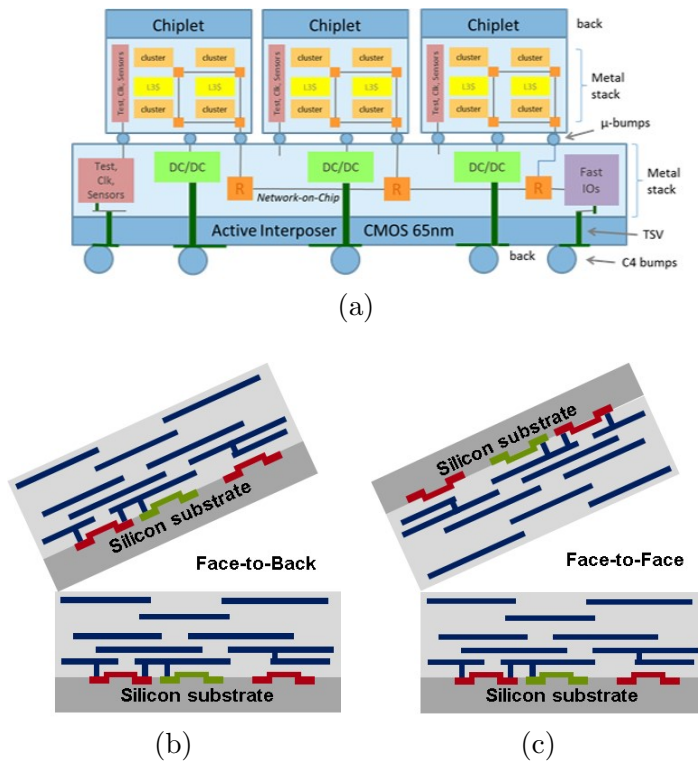

FIGURE 2.2: Different integration schemes, (a) 2.5D active interposer schematic [10], (b) 3D Face-to-Back configuration, (c) 3D Face-to-Face configuration.

2.3.2 3D Through-Silicon-VIA Technology

Through silicon vias (TSV) is a 3D technology at which the 3D via is used for connections through the silicon substrate. One application for TSVs is to connect metal layers of the bottom die to the top die for a face-to-back configuration. Another usage can be connecting metal layers with substrate μ bumps for IO and Power connections.

The diameter and pitch of TSVs determine the density limit of 3D connections that can be achieved. However, the dimensions of TSV are controlled by the assembly process used to stack the dies over each others. Conventional 3D TSV technologies have TSVs with a diameter of 10-20 μm . With the advances of assembly process, 3D TSVs diameter can scale down to 3 μm [13, 6]. Figure 2.3 shows a schematic of face-to-back stacking configuration using TSV connection with a SEM cross-section picture of a 3 μm diameter TSV [14].

The constraints of TSV technology at Design level are the spacing needed for the TSV on the top die which will increase the area overhead and can affect the resultant wire length. To illustrate this area overhead effect, we can mention that High-density TSVs with 5 μm and 10 μm pitches have an equivalent area of 5 and 20 Flip Flops, respectively, in 28nm Technology. Another constraint is the routing on the bottom die where the routing congestion will increase due to the presence of TSVs which cut vertically the bottom metal layers.

2.3.3 3D Copper-to-Copper Technology

Copper-to-copper (CuCu) contact is another 3D integration technology where the two dies are fabricated separately (in parallel) and then assembled together, which is similar to the TSV technology. However CuCu technology is used in F2F stacking configuration. The 3D connections are achieved by direct bonding of top and bottom dies using copper contacts on top of each metal layer stack. The pitch between CuCu 3D contacts can be scaled down to 3.4-5 μm [5, 7]. Figure 2.4 (a) shows a schematic for face-to-face configuration using CuCu integration technology, where (b) shows a fabricated SEM

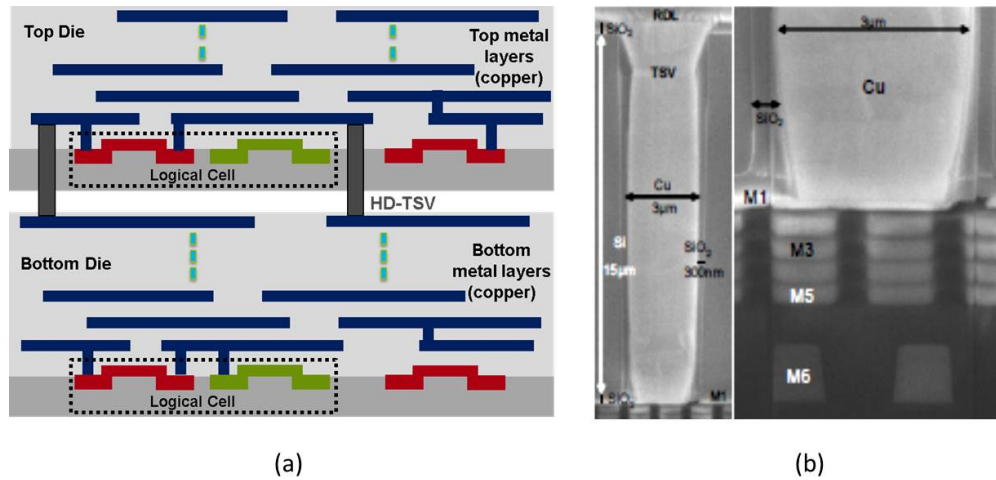

FIGURE 2.3: 3D-TSV (a) configuration schematic and (b) SEM cross-section picture with diameter of $3\mu\text{m}$ [14].

cross-section picture of a CuCu contact with dimensions of $3\times 3\mu\text{m}$ and pitch of $5\mu\text{m}$ [7].

CuCu technology overcomes the issue of TSV technology regarding the area overhead needed by TSVs and increasing congestion on the bottom die. However, the F2F configuration of CuCu limits the number of stacking dies to only two. So that in case of stacking more than two dies, TSV contacts are needed.

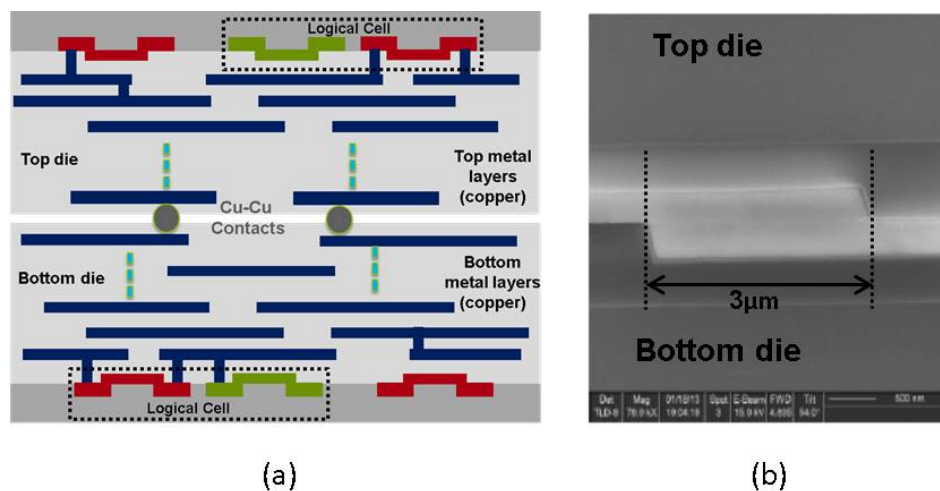

FIGURE 2.4: CuCu integration technology (a) face-to-face configuration schematic, and (b) SEM cross-section picture with dimension of $3\times 3\mu\text{m}$ and pitch of $5\mu\text{m}$ [7].

2.3.4 Monolithic 3D (3DVLSI) Technology

Monolithic 3D (M3D), also known as 3DVLSI, is an emerging technology using sequential 3D integration based on CoolCubeTM process providing very high density of 3D vertical interconnects [15]. In M3D technology a top die is fabricated directly, sequentially, on top of the bottom die in a F2B configuration. The sequential process allows high alignment precision between both dies and consequently very small size of 3D VIAs. In this process the diameter and pitch of M3D-VIAs depend only on lithography alignment capability of the stepper which scales with the scaling of CMOS node [9, 16]. This is different compared to TSV and CuCu technologies where the alignment depends on the assembly process. Consequently M3D scales the diameter of 3D VIAs down to $0.05\mu\text{m}$ with a pitch of $0.11\mu\text{m}$ for 28nm CMOS node.

CoolCubeTM process requires fabrication of top die at low temperature -below 500-550°C- to preserve the bottom die from any degradation. This leads to difficulty of using low-k and copper in the BEOL for the bottom die. One solution is to use SiO₂ with Tungsten metal lines which are stable at high temperature and contamination compatible [8]. In chapter 5 a full study is presented to show the effect of such technology parameters from design perspective.

Figure 2.5 (a) shows a schematic for M3D with standard cells over each others (cell-on-cell), while (b) and (c) show a TEM picture and the process flow for CoolCube process respectively. M3D opens the need for new design methodologies which will be discussed in details in the next chapters.

2.3.5 Summary: Comparing different 3D technologies

As shown previously 3DICs can be achieved using different 3D technologies which can be divided into two main categories: (a) parallel integration, such as TSV-based and CuCu technologies, and (b) sequential integration, such as M3D technology. The size and density of 3D interconnects in parallel integration technologies depend on the assembly process, while in sequential integration technologies 3D interconnects depend on

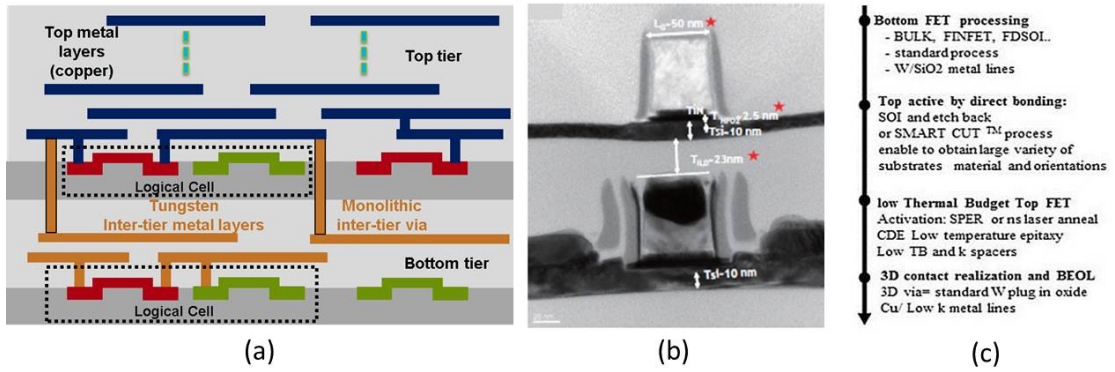

FIGURE 2.5: CoolCubeTM process for M3D technology [8]: (a) configuration schematic, (b) TEM cross-section picture and (c) process flow.

the CMOS process. This is the main difference which affords smaller size and better scaling for M3D-VIAs.

Table 2.1 summarizes a comparison between the different 3D technologies. In the following section an overview of the different design techniques is presented to take advantage of each 3D technology.

TABLE 2.1: Comparison between different 3D technologies

		TSV [14]	CuCu [7]	M3D [8]
Configuration		F2B	F2F	F2B
3DVIA	Diameter	3 μm	1.7-3 μm	0.040 μm
	Pitch	5 μm	5 μm	0.110 μm
	Density (per mm²)	2*10 ⁴	2*10 ⁴	10 ⁸
Integration Process		Parallel	Parallel	Sequential
Top and Bottom BEOL		Same	Same	Different
Scaling is controlled by		Assembly	Assembly	CMOS node

2.4 Partitioning Granularity: Stacking from ‘Coarse-grain’ to ‘Fine-grain’

The variety of 3D technologies allows different 3D connections densities which consequently affords different stacking granularities. Stacking granularity can be coarse-grain such as memory-on-logic and core-level integration, or fine-grain such as gate-level and transistor-level integration. As stacking granularity increases, more 3D connections are

needed to connect top and bottom dies which requires higher density 3D technology to be used. Figure 2.6 shows granularity scaling from coarse-grain to fine-grain [17].

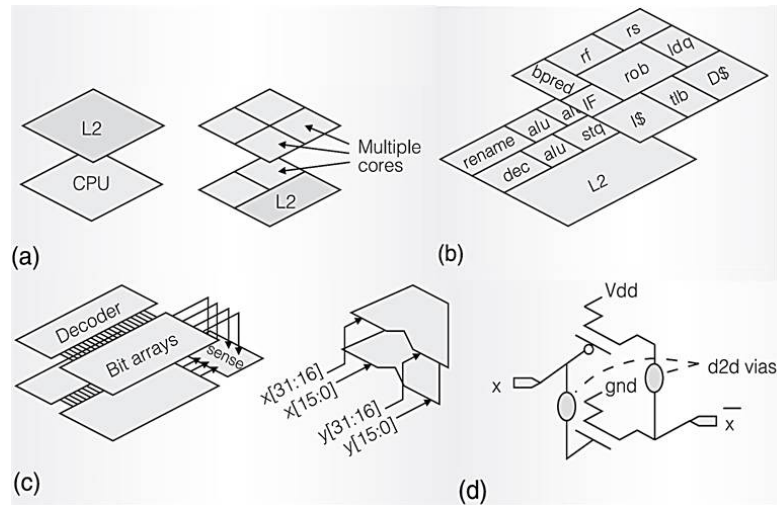

FIGURE 2.6: Granularity spectrum for 3D technologies [17]: (a) memory-on-logic or core-level, (b) block-level, (c) gate-level, (d) transistor-level.

2.4.1 Memory-on-logic integration

Stacking integration can be as coarse as stacking memory over logic-cores. In this case high-density 3D technology is not mandatory due to (i) low number of interconnections between memory and logic cores, and (ii) large area of both memory and logic cores. TSV and CuCu technologies are suitable for such coarse-grain applications.

Reference [18] shows a demonstration of eDRAM cache memory over a processor core where TSV technology is used for stacking. A WideIO memory stacking over logic core using 3D Network-on-Chip (NoC) is demonstrated in [10]. CuCu has been used as well in memory-on-logic integration such as in [19] and [20].

Memory-on-logic is considered as an example of heterogeneous integration where the memory die can be fabricated in a different process node comparing to the logic die. This is interesting to improve the overall system-on-chip performances and continue

with More-than-Moore trend, however, our interest is to use high-density 3D technologies for logic-on-logic stacking to be able to integrate more transistors and continue miniaturization with More-Moore trend.

2.4.2 Core-level and block-level integration

Logic-on-logic integration can be achieved as well at different granularities. A coarse-grain can be achieved by stacking logic cores over each other. Reference [21] discussed the extension of memory-on-logic 3DICs to several layers 3DICs including core-level integration. References [22, 23] discussed different design aspects for core-level integration.

A finer grain stacking can be achieved by splitting a specific core and integrate its internal blocks over each other, which is called ‘block-level integration’. References [17] and [24] discuss two case studies for block-level integration of Intel Pentium 4 and openSPARC T2 processors respectively. Figure 2.7 shows the detailed block-level integration of an openSPARC T2 processor using 2979 TSVs [24].

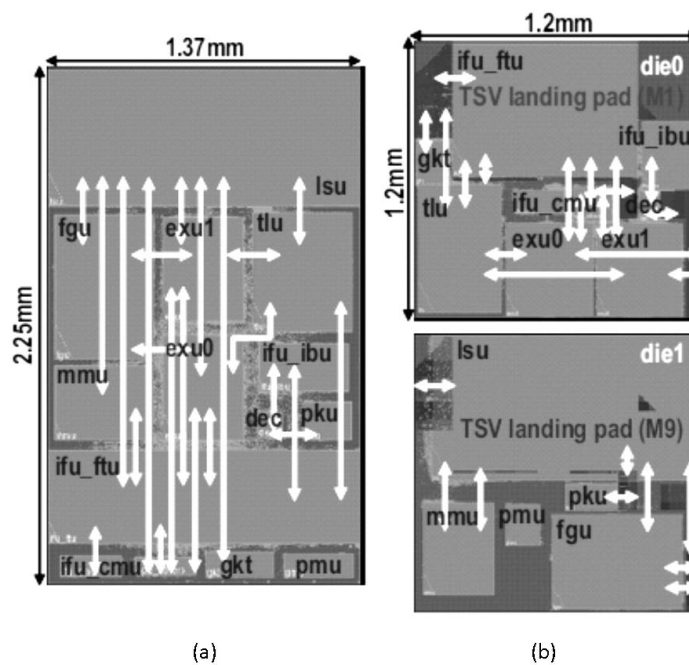

FIGURE 2.7: openSPARC T2 placement [24] in (a) 2D and (b) 3D with block-level integration using 2979 TSVs.

2.4.3 Gate-level integration (Cell-on-Cell)

Gate-level integration, or Cell-on-Cell, is achieved by stacking standard cells over each others. As the density of connections between standard cells is much higher than that between blocks or cores, a high-density 3D technology is needed for cell-on-cell integration.

Cell-on-Cell raises the need for a proper partitioning methodology to determine which standard cell is assigned to which die. A min-cut partitioning algorithm is proposed in [25] to minimize number of connections between dies, and has been used in [26] to demonstrate the stacking of a DSP block using CuCu technology. A placement-driven partitioning algorithm has been proposed in [27] to increase the benefits of M3D technology. A detailed discussion on the gate-level partitioning algorithm is shown in Chapter 4.

Additionally the gate-level integration granularity increases the need for a 3D clock tree synthesis and an optimized 3D cell placement. These two aspects are needed for block-level as well however they become more critical for finer granularities. Both issues will be discussed in details in the next section (sec.2.5).

2.4.4 Transistor-level integration (N/P)

Transistor-level integration is the finest stacking approach in the granularity spectrum. It is achieved by splitting each CMOS gate in two parts, so that NMOS and PMOS transistors are placed in different layers (N/P). A very high density 3D technology, such as M3D, is needed to achieve N/P approach. The main advantages of N/P approach are:

1. (+) Perform process optimization for each transistor layer separately.
2. (+) Minimize number of metal layers of the bottom die as all cell routing is done in the top die.
3. (+) By designing libraries of new 3D standard cells, conventional 2D EDA tool flow can be used.

On the other hand, N/P approach has some drawback such as:

1. (-) N/P approach requires insertion of 3DVIA in each cell which increase the internal resistance and capacitance parasitics of standard cells.
2. (-) The need to re-design and characterize all the 2D design kit libraries to create new 3D standard cells.
3. (-) Limited to two-tiers only. If more than two tiers are used, a cell-on-cell approach is needed.

Reference [28, 29] discuss the benefits and challenges of N/P approach using Monolithic 3D technology for logic blocks (e.g. AES, FFT, JPEG).

Creating a 3D SRAM cell using transistor-level stacking is another design paradigm which has been explored in [30, 31].

2.4.5 Logic-on-Logic stacking: Fine vs. Coarse grain Partitioning

As we illustrated, partitioning techniques differ according to the stacking granularity used. Logic-on-Logic stacking can be divided into two main categories: (i) Architecture-level Partitioning for a coarse-grain stacking, and (ii) Gate-level partitioning for fine-grain stacking.

2.4.5.1 Coarse-Grain: Architecture-level Partitioning

Coarse grain stacking is used for technologies with large 3D-VIA diameter and pitch. In this case an ‘Architecture-level partitioning’ is needed where the global interconnects are cut and converted into 3D connections. These global interconnects can be between memories and logic blocks, or between cores in a many-core architectures, or even between main functional parts of a logic block.

Architecture-level partitioning approach requires the designer to have a preliminary good knowledge and understanding of the 2D architecture, and consequently it takes long time that is not compatible with complex and large-scale designs. Memory-on-logic partitioning has been demonstrated in [18, 19, 20, 21], while logic-on-logic stacking using architecture-level partitioning has been demonstrated in [17, 32, 24, 33, 34].

2.4.5.2 Fine-Grain: Gate-level Partitioning

As 3D technology advances, diameter and pitch of 3D-VIA decrease which allow higher density 3D contacts. Fine grain partitioning is achievable thanks to such high-density 3D technology. The partitioning granularity can be as fine as cell-on-cell stacking, i.e. gate-level.

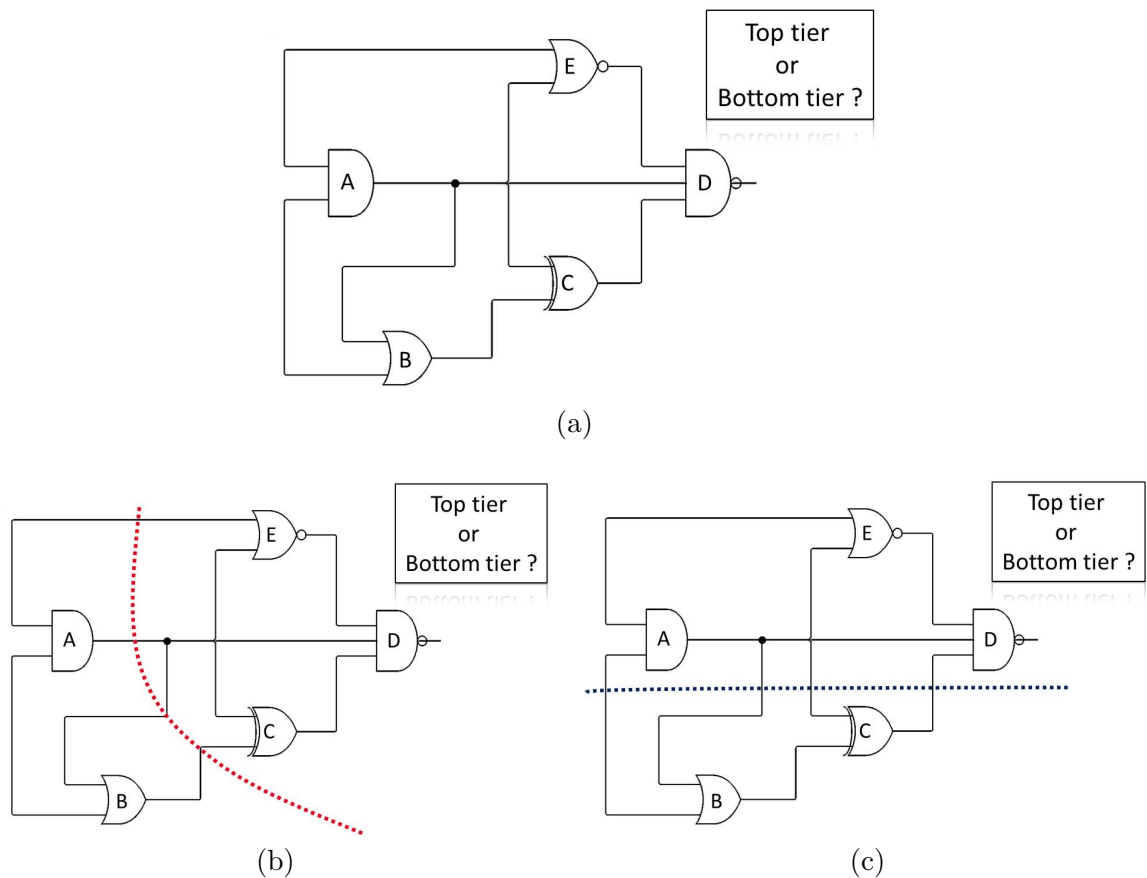

FIGURE 2.8: An example of 5 standard cell netlist where a gate-level partitioning is needed to decide which gate (standard cell) is assigned to the top tier and which to the bottom. The objective is to determine which partition gives better power-performance-area results (b) or (c) ?

Using such high-density technology, a ‘Gate-level partitioning’ technique is needed to distribute the standard cells across top and bottom tiers which creates a cell-on-cell 3D stacking. Gate-level partitioning produces large number of 3D contacts (order of tens/hundreds of thousands) per mm^2 . Conventional architecture-level partitioning has two issues with high-density technology: (i) long design time due to the fine-grain stacking which increases the time-to-market cycle (ii) limiting the gains of such high-density 3D technologies due to limiting number of 3D contacts by cutting only global 2D interconnects.

To show the effect of gate-level 3D partitioning, let's take partitioning case of a small circuit with just 5 gates (standard cells). Figure 2.8(a) shows the standard cell connectivity of that example. To convert this circuit to 3D, we need to decide which cell is to be assigned on which tier. Two possible ways to partition the circuit are shown in Figure 2.8 (b) and (c), however there are 8 other possible partitioning ways! The objective of our study is to perform the partitioning which gives the best performances in terms of power, timing, area and number of 3D contacts.

Previous gate-level partitioning techniques can be divided into two main categories:

- (i) minimum cut partitioning [25, 26], and
- (ii) performance-driven partitioning [27, 35, 24].

In the following section (4.2), a detailed discussion of these techniques is presented.

Table 2.2 shows the main differences between coarse-grain architecture-level partitioning and fine-grain gate-level partitioning methodologies.

Through the rest of this chapter we will focus on the gate-level partitioning methodologies to show the previous state-of-the-art techniques and introduce our physical-aware partitioning methodology, while a case study of architecture-level partitioning for a network of neural cliques is presented and discussed as in Chapter 6.5.

TABLE 2.2: Comparison between ‘Architecture-level’ and ‘Gate-level’ partitioning methodologies

	Architecture-Level Partitioning	Gate-Level Partitioning
Granularity	Coarse-grain	Fine-Grain
Wires to be cut to 3D	Global interconnects between cores, memory or main logic blocks	Local interconnects between standard cells
No. of 3DVIAs	Few	Many
Partitioning Methodology	Designer (Manual by hand)	CAD tool (using automated algorithms)
Drawbacks	(i) Architecture dependent (ii) Long time to market	Partitioning algorithm is needed (CAD tool)

2.4.6 Summary: 3D partitioning granularity spectrum

In the previous section, we show that partitioning granularity varies resulting in a broad spectrum from coarse grain to fine grain 3D integration. Table 2.3 summarizes a comparison between different partitioning granularity levels from design and technology perspectives.

TABLE 2.3: A comparison of different partitioning 3D designs showing the granularity spectrum

	Memory-on-Logic	Core-Level	Block-Level	Gate-Level	Transistor-Level
Partitioning	Coarse-Grain	Coarse-Grain	Medium-Grain	Fine-Grain	Fine-Grain
3DVIA density needed	Low	Low	Medium	High	High
Architecture re-design	No	Yes	Yes	No	No
Using 2D standard cells	Yes	Yes	Yes	Yes	No
Usage of 3D VIAs for	connect memory & logic	connecting cores	connecting blocks within same core	connecting standard cells	connections in every standard cell
Design examples	Cache-on-Processor [18]	3D many-core using 3DNoC [22]	3D openSPARC T2 processor [24]	DES-3, FFT, LDPC [27]	DES-3, FFT, LDPC [28]

Several previous works in the literature have discussed different aspects of each granularity level using different technologies. Figure 2.9 summarizes the most recent published work showing the spectrum of different 3D technologies (i.e. 3DVIA diameter) and different stacking granularity. From the plot we can notice how wide the partitioning spectrum according to 3D technologies and how variant the applications can be.

As we explore the design capabilities of high-density 3D technologies in this dissertation, the fine-grain gate-level and transistor-level will be our main focus. Transistor-level partitioning is achieved by splitting each standard cell into NMOS layer over PMOS layer (N/P), consequently it provides possibilities to optimize separately each layer from

fabrication process perspective. N/P approach has another advantage of using the conventional 2D place and route tool flow as the pins of all N/P standard cells stay on the same tier (top). However using N/P approach inserts 3DVIA between transistor in each standard cell which decreases its interest due to the resistance and capacitance parasitics associated with 3DVIA. Additionally N/P approach requires a complete new design platform including re-designing standard cells and re-generating the design kit libraries.

On the other hand, gate-level partitioning is achieved by assigning each 2D standard cell either to the top tier or the bottom tier (cell-on-cell). Consequently the same design kit libraries can be used with inserting 3DVIA only to connect top and bottom cells. However cell-on-cell approach requires an innovative partitioning technique to determine which cell placed on which tier. Moreover inter-tier metal layers are needed to route standard cells in the bottom tier. Other CAD issues need to be addressed as well for cell-on-cell approach, such as 3D clock tree and the need for special 3D place and route tool flow. The 3D CAD tools issues are explored in the next section.

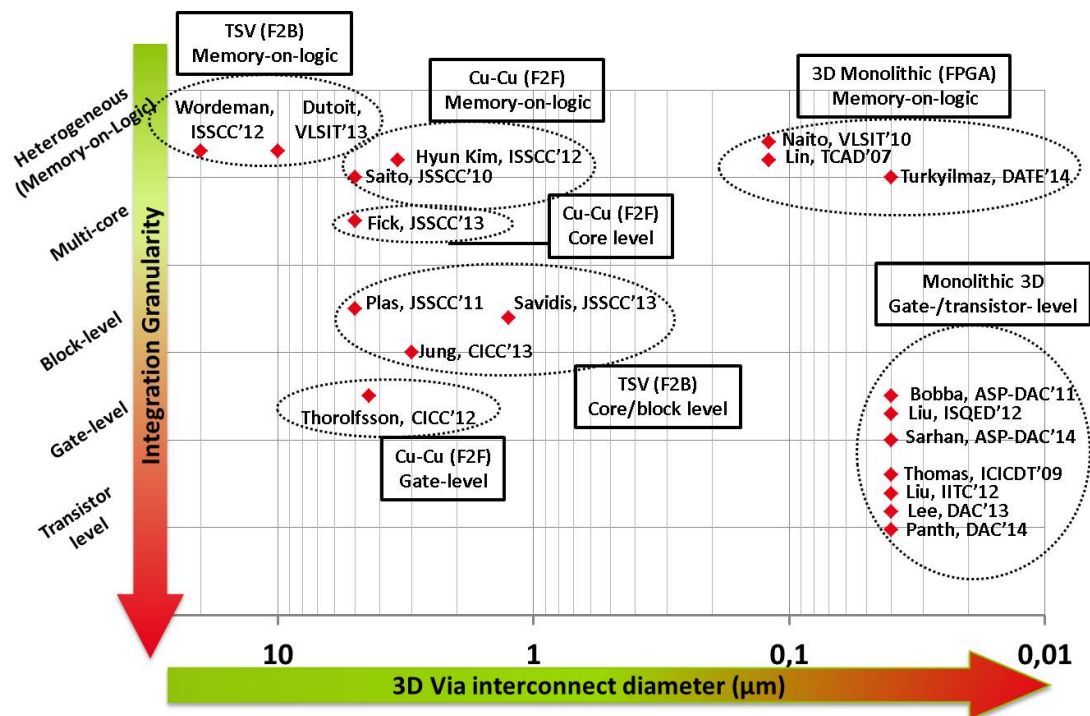

FIGURE 2.9: Summary of previous state-of-the-art showing both 3D technology and partitioning granularity spectrum

2.5 3D CAD Tools: Issues and Perspectives

In the previous two sections 3D technologies and stacking granularity spectrum have been explored. To complete the design cycle CAD tools suited for 3D are needed to implement 3D designs using the proper technology. CAD tools have different requirements for 3D ICs than for 2D ICs, and these requirements vary according to the design granularity. Several previous works have addressed different issues of CAD tools for 3D.

In this section we will first discuss the issues for 3D CAD tools with previous solutions and then we will show some techniques to use 2D commercial tool flow to implement a 3D design.

2.5.1 Issues of CAD tools for 3D ICs

EDA design and implementation flow is mature for 2D ICs using several commercial CAD tools however for 3D there are different issues compared to 2D. In the following subsections 3D cell placement, 3DVIA placement and 3D clock tree synthesis are discussed.

2.5.1.1 3D Standard Cell Placement

Generally standard cell placement is a critical phase in a design implementation. Due to the increasing complexity of integrated circuits, placement is divided into three phases: (i) global placement; where the standard cells are placed within a relaxed overlap constraint, (ii) placement legalization; where any cell overlapping is removed and cell placement is legalized, (iii) detailed placement; where placement is further improved with a non-overlapping constraint using cell swapping and re-arrangement techniques.

For 3D standard cell placement, references [36, 37, 38] proposed analytical full 3D global placement algorithms. These algorithms are based on generating an optimization function in three-dimensions (x, y, z) which targets minimizing wire length and number of 3D vias (TSVs). These techniques are effective to compromise between decreasing number of 3D vias and achieving minimum wire length.

Number of 3D vias is a constraint for TSV and CuCu technologies however it is no longer valid for high-density 3D technology, such as M3D. Consequently M3D placement problem is not constrained with number of M3D-VIA and it can be built based on a 2D placer. References [39, 27] have demonstrated M3D placement based on 2D placer. A detailed discussion of this work is shown in section 2.5.2

2.5.1.2 3D-VIA Placement

3DVIA placement depends on the partitioning granularity. For coarse-grain partitioning, VIA placement is done in association with the 3D floor-planning phase. The reason is that for coarse-grain partitioning number of 3DVIA is small and those VIAs need to be placed in specific positions, such as the case in [10].

On the other hand for fine-grain partitioning, 3DVIA placement is associated with the 3D cell placement. The reason is that for fine-grain case number of 3DVIA is too large (order of thousands) and each 3DVIA location needs to be optimized between the connected top and bottom blocks/gates.

Thermal-aware 3DVIA placement has been addressed as well for coarse-grain partitioning to reduce thermal effect on different tiers [40].

2.5.1.3 3D Clock Tree Synthesis

3D Clock Tree Synthesis (CTS) is another important aspect raised by decreasing the stacking granularity. The main issues of 3D clock tree design are (i) symmetry in the clock tree, (ii) clock skews and (iii) power consumption. In coarse grain integration, a communication scheme, such as 3D NoC, can be used between top and bottom. However for finer grain integration this solution is not affordable due to the high-density of vertical interconnects and the area overhead of such communication scheme.

Custom 3D clock tree synthesis and analysis have been discussed in [41, 42, 43]. [41] shows the effect of the count and parasitics of 3D VIAs inserted in the clock tree, where an optimum number of TSV insertion is determined.

However a full 3D clock synthesis lacks the support of CAD tools. Some techniques have been proposed to avoid synthesizing a 3D clock tree. One technique is to create two clock trees on each die, separately, with a Digital Locked Loop (DLL) for synchronization and skew removal. The cost of this technique is the extra area overhead for implementing DLLs on each die [44]. Another technique is to create shorted-clock-tree to remove the skew between top and bottom at the cost of extra power [44]. Reference [45] shows a demonstration of different conventional clock topologies implemented in 3-layers 3D chip including; H-tree over H-tree, H-tree over global-rings and H-tree over local-rings.

Targeting fine-grain gate-level partitioning using high-density 3D technology opens a new technique to avoid 3D CTS issue. The method is to place all flip-flops only on one die. However a dedicated gate-level partitioning algorithm is needed for that. This technique has been used in [26].

Table 2.4 shows a qualitative comparison between the different 3D clock tree techniques.

TABLE 2.4: A qualitative comparison between different 3D clock tree synthesis techniques

	H-Tree/ H-Tree [45]	DLL- Based [44]	Short- Circuit [44]	Custom 3D CTS [41, 42, 43]	CLK tree only on one tier [26]
3DVIA count	High	Low	High	Depends on CTS alg.	0
3D CLK Skew	Low	Med (DLL)	Low	Low	-NA-
3D CLK Power	High	Med (DLL)	High	Low	-NA-
Design Overhead	No	DLL	No	3D CTS alg.	3D Parti- tioning
Suitable Stacking Granularity	All	All*	All	All	Gate-level

* Shared DLL is needed for block-/gate- level granularity to minimize DLL overhead

2.5.2 3D Implementation based on 2D Commercial Tools

With the lack of mature 3D implementation tools and the need for implementation results using sign-off flow, several work used conventional 2D tool flow to implement 3D designs, which takes advantage of using mature tools and makes integrating 3D placement into conventional flow much easier.

For 3D placement, some simple techniques can be used to convert a 2D placement to a 3D one as shown in Figure 2.10. One straight-forward technique is 2D folding as used in [46, 47]. Another way is by local stacking transformation and window-based stacking transformation [46, 39, 27]. In 2D folding technique, the long wires are shortened by stacking the far cells over each others, while in local stacking technique; close cells are stacked over each other.

To achieve local stacking technique, ‘CELONCEL’ approach [39] is introduced where a 3D placement technique is performed by three steps: (i) transforming each standard cell to half its size, (ii) these cells are placed using regular 2D placer, and then (iii) restore the standard cells to their original size. ‘Shrunk2D’ is a similar technique to provide a placement-driven partitioning for M3D which has been proposed in [27].

2.5.3 Using Fast Prototyping Implementation Tool

As we have illustrated partitioning techniques are needed to distribute the standard cells across top and bottom tiers. However for complex designs, several 3D partitioned and micro-architecture options require evaluation which takes long run time by using conventional place and route as a full sign-off physical implementation tools. Hence the need for a fast prototyping tool is increasing to explore the different design variabilities within acceptable short run time. For example, an FFT block takes 4.5x run time by using a full place and route tool comparing to a SpyGlass Physical fast prototyping tool. This difference increases by increasing the block complexity.

By using a fast prototyping tool with 3D cell placement and routing capabilities, an XML description is needed to define the technology parameters and configuration for the 3D technology used. Using such XML configuration file allows the tools to create

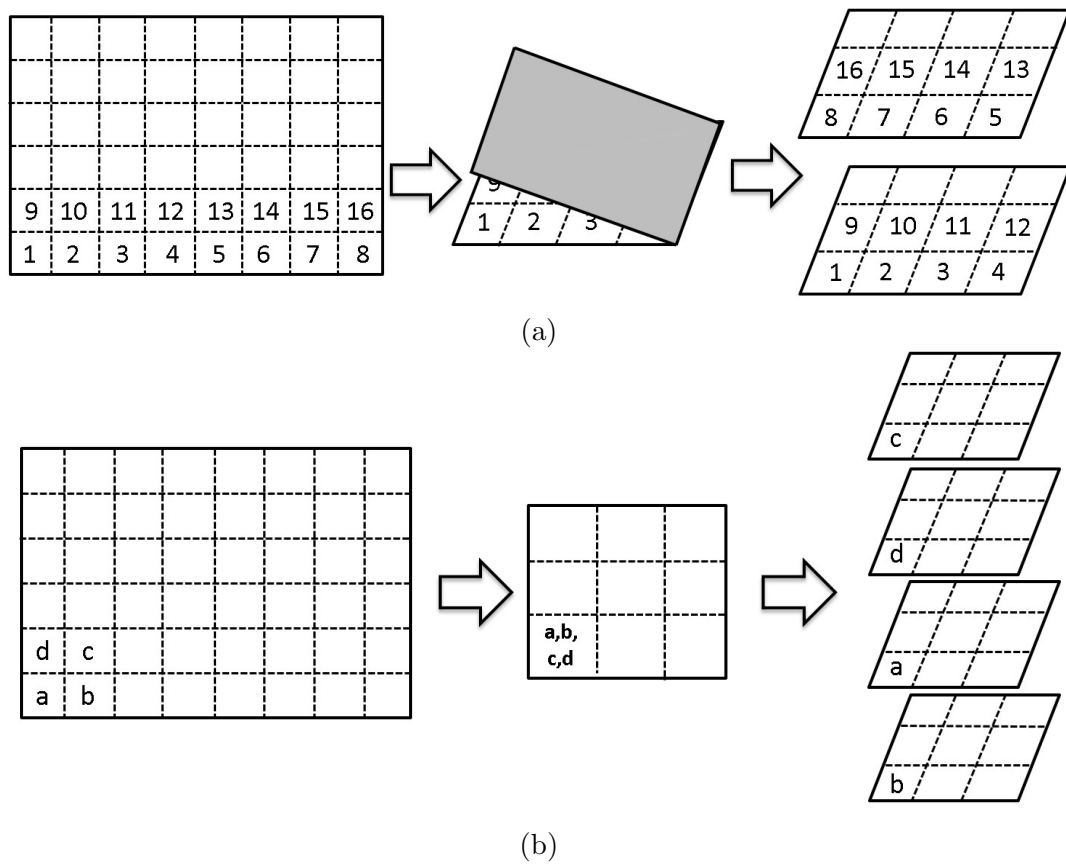

FIGURE 2.10: 3D placement techniques based on an initial 2D placement. (a) 3D placement using folding techniques [46, 47] and (c) 3D placement using local stacking technique [46, 39, 27].

components for 3D vias with the corresponding diameter, pitch and technology parameters.

In our work, we have used a 3D fast prototyping tool to explore different partitioning techniques where the tool is performing 3D placement, 3D global routing, 3D parasitics extraction, 3D timing analysis and 3D power estimation. This methodology has been used in Chapters 4, 5 and 6.

By increasing the design complexities on one hand and having more partitioning, micro-architecture and design parameters to explore on the other hand, the usage of a fast implementation tool is crucial to give some guidelines of the sign-off place and route implementation phase.

2.6 Conclusion: Work positioning and Design Framework

In this dissertation we studied different options in the 3D design space. First from 3D technology perspective, we have implemented the three high-density technologies (CuCu, TSV and M3D), showing a full technology assessment under different design conditions.

Second from partitioning granularity perspective, this work addresses main gate-level fine grain stacking. We have proposed as well a finer grain approach which is ‘cell-on-buffer’ which lies between gate-level and transistor-level granularity.

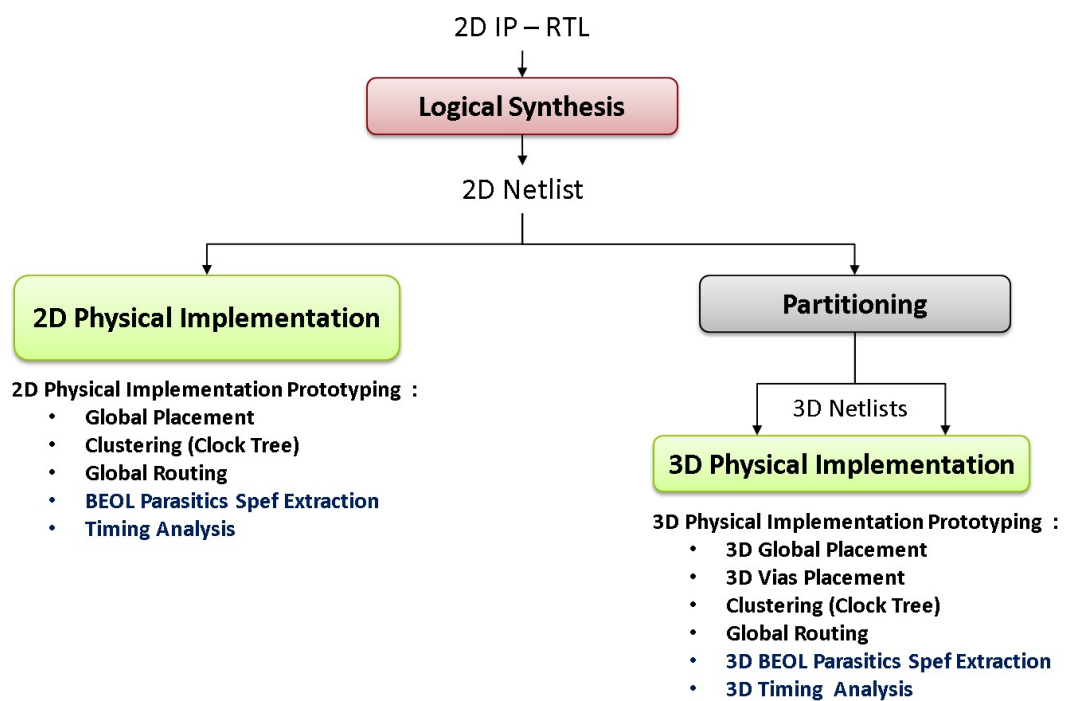

FIGURE 2.11: 2D/3D Design Implementation Framework.

Finally from 3D CAD tools, we have used two different tools; (i) Atrenta SpyGlass Physical 3D (SGP-3D) tool [48] has been used as a fast prototyping tool to get power-performance-area evaluation for different 3D designs. The main advantage of SGP-3D is the capability of physical 3D cell placement, 3D global routing, 3D timing/power analysis within a short run time.

(ii) Cadence Encounter 2D flow for cell-on-buffer approach. In this case we modified the technology libraries to include the 3D effect using conventional 2D sign-off flow.

Regarding the 3D clock tree synthesis, we have used the separation of flip flops on

one tier using our proposed partitioning algorithm as we will discuss later.

Figure 2.11 shows the general 2D/3D design framework starting from the IP RTL, then logic synthesis using Cadence RTL compiler, then 2D and 3D physical implementation using SGP prototyping tool to get full evaluation on a power-performance-area metrics. This design flow has been used in Chapters 4, 5 and 6.

Chapter 3

Cell-on-Buffer: A New Design Approach for Monolithic 3D

3.1 Introduction

Stacking granularity varies depending on 3D technology used. As discussed in chapter 2, granularity spectrum starts from coarse-grain core-level stacking down to fine-grain transistor-level stacking, where our focus in this work is the fine-grain partitioning thanks to capabilities of high-density 3D technologies.

In this chapter we introduce a 3D Cell-on-Buffer (3DCoB) approach. 3DCoB consists in splitting non-minimum drive standard cells into two stages: (i) a logic stage and (ii) a buffering stage. The logic stage is being implemented by its equivalent minimum-drive cell, while the buffering stage is implemented by a driving buffer with the same drive as the original cell. The min-drive cell and the driving buffer is then stacked vertically. Using this approach, the minimum-drive logic cell provides the same logical function as the original cell, while the driving buffer guarantees the same driving capability.

3DCoB approach can be considered as a subset of Cell-on-Cell approach as it uses the 2D cells and no need to redesign the standard cells. Additionally, 3DCoB provides advantages for performance improvement thanks to decreased input gate capacitances, no need to clock synchronization between the two tiers as well as partitioning step. As

a result, full compatibility with conventional 2D digital implementation tools is kept. Moreover, 3DCoB provides a separation between logic functionality and driving capabilities, which can be used to introduce power optimization techniques as we will discuss in section 3.5.

Consequently the 3DCoB approach provides:

- i. Overall performance improvement.
- ii. Full compatibility with the conventional sign-off physical implementation flow.
- iii. No clock synchronization issue between the two tiers.
- iv. No inter-tier routing metal layers between bottom cells.
- v. Separation between logic functionality and driving capabilities.

Table 3.1 summarizes the differences between transistor-level, cell-on-cell and the proposed cell-on-buffer approaches.

TABLE 3.1: Comparison between transistor-level (N/P), Cell-on-Buffer and Cell-on-Cell approaches for M3D technology

	N/P	Cell-on-Buffer	Cell-on-Cell
Using 2D standard cells	No	Yes	Yes
Using inter-tier routing metal layers	No	No	No
2D Design flow compatibility	Yes	Yes	No
Usage of inter-tier VIAs	In every cell	Only in 3D cells	Between cells (if req.)

In the following sections the full design flow, implementation and results for 3DCoB approach are presented. Afterwards, a low-power approach is introduced using Multi-VDD 3DCoB, with a full design flow.

3.2 3D Cell-on-Buffer (3DCoB) Approach

3.2.1 3DCoB cell structure

As we mentioned the main idea of 3DCoB approach is to split the non-minimum drive 2D cells into a logical functioning tier and a driving tier. To have a full set of standard cells, the min-drive cells will be kept in 2D. Figure 3.1 shows the set of cells in case of applying 3DCoB approach, where the min-drive cells are kept as in 2D, and the non-min drive cells are split in 3D.

The input pin of the 3DCoB cell is connected directly to the input of the minimum-drive gate, while the 3DCoB output is taken from the output of the driving buffer. as shown in Figure 3.1(b).

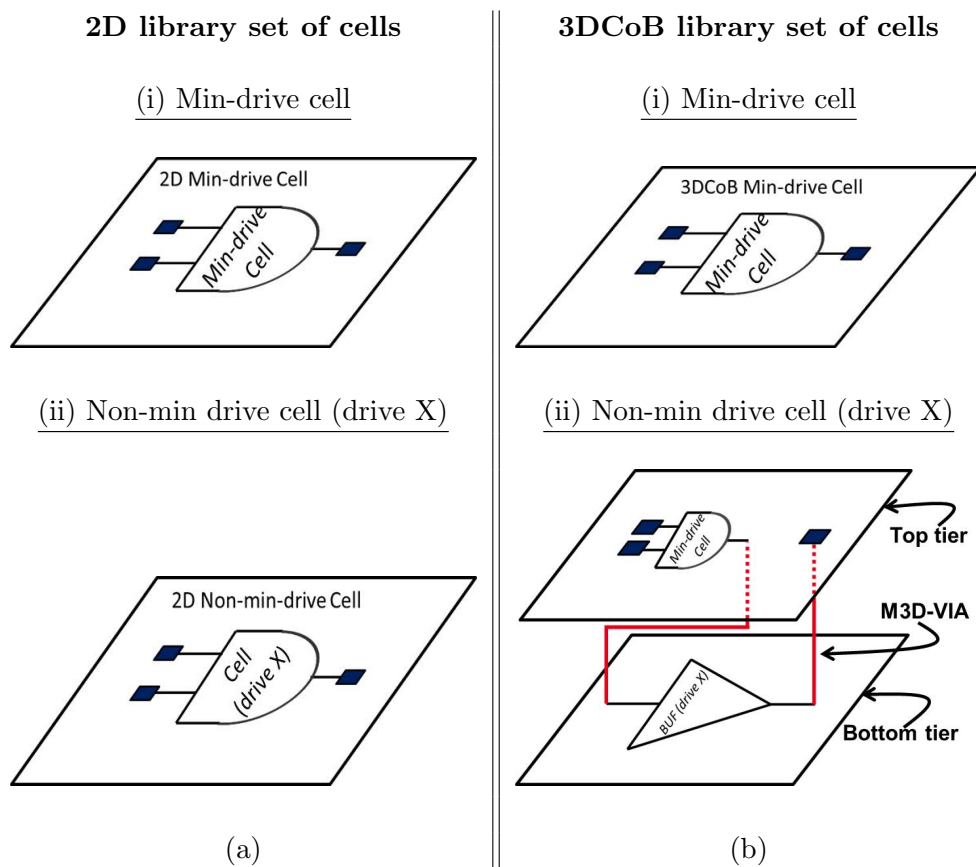

FIGURE 3.1: 3D Cell-on-Buffer library set of cells. (a) conventional 2D set of cells, (b) the equivalent 3DCoB library set of cells (for 2D non-min drive cells, equivalent 3DCoB cells will be min-drive cell stacked over its equivalent drive buffer).

The 3DCoB cell has internally two inter-tier M3D vias. The first via is connecting the minimum-drive gate output to the driving-buffer input. The second via is connecting the output of the driving-buffer to the global output pin of the 3DCoB cell to be on the same tier (i.e. top tier) as the global input pin. As the pins of the 3DCoB cells are located on the same tier, 3DCoB can be used by the conventional 2D place and route tools.

Figure 3.2 shows a schematic of a 2-input AND gate with size of 42 implemented with 3DCoB approach, where a min-drive 2-input AND gate is placed on the top for functionality and a buffer of size 42 is placed on the bottom for driving capabilities.

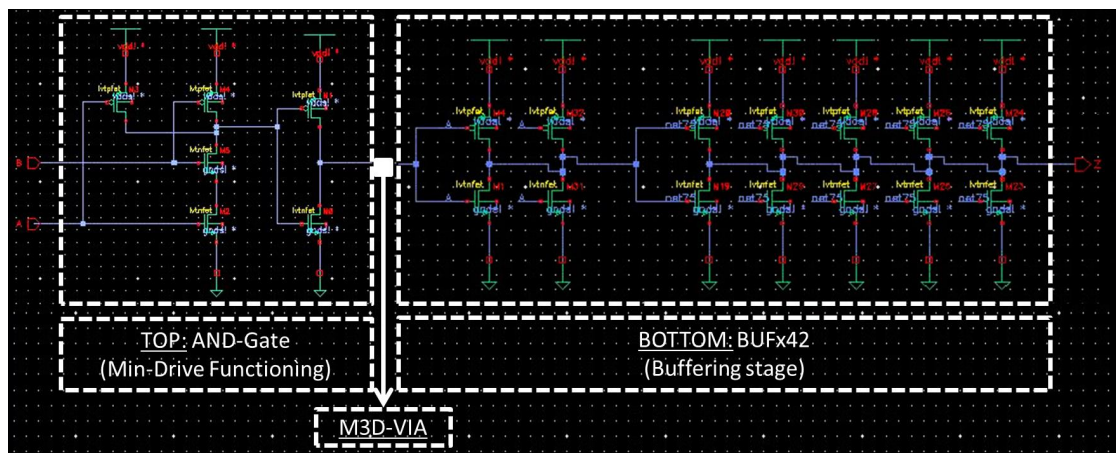

FIGURE 3.2: 3DCoB partitioning of a non-min cell of a 2-input AND gate of driving size 42; where the top part is the min-drive 2-input AND gate and the bottom part is the buffer of size 42.

3.2.2 3DCoB input gate capacitance

Additional advantage of the 3DCoB approach is decreasing the input gate capacitance of the cells. As the input of the 3DCoB cell is connected to the input of the minimum-drive gate instead of the original-drive gate, the input gate capacitance is less than that of the 2D cells.

For example, in case of AND2x33 2D cell, its 3DCoB equivalent cell is the min-drive gate, for instance AND2x8, connected to the equivalent driving buffer BUFx33. In this case, the input of the AND2x33 3DCoB cell is connected to the input capacitance of AND2x8 instead of AND2x33 which affords low input capacitance.

3.2.3 Results of input gate capacitance effect

An experiment has been setup to evaluate the effect of the input gate capacitance for 3DCoB cells. Standard cells of the core library of a 28nm FDSOI design kit have been used. A comparison has been developed between the input capacitance of the 2D cells and their 3DCoB equivalent cells.

Figure 3.3(a) shows the results for the 2-input AND gate cell at different drives. As the global input of 3DCoB is connected to the min-drive gate, the input capacitance of the 3DCoB cells are kept the same across the different drives. This curve shows the increasing difference between the input capacitance of the 2D cells compared to that of the 3DCoB cells. Such difference in the input gate capacitance for the 2D cell can reach up to 2.5 times compared to that of 3DCoB cell.

Figure 3.3(b) shows results for the input gate capacitances of different cells at both 2D and 3DCoB implementations. The difference of the input capacitance varies from one cell to another as it depends on both cell type and drive.

Two parameters decrease the signal path delay which increases the overall performance for 3DCoB approach (i) this reduction of the input gate capacitance and (ii) the reduction of cell area which allows the placement tool to optimize the cells for better performance. The full implementation results will be discussed in section 3.4.

3.3 3DCoB Implementation Framework

To accurately evaluate the potential of 3DCoB approach using M3D technology, a 3D digital implementation flow has been developed. One main advantage of 3DCoB approach is the compatibility with conventional place and route tools. However new design kit libraries are needed to include 3DCoB set of cells. Contrary to N/P approach, 3DCoB cell libraries can be generated directly from the 2D cell library using simple scripts with no need to re-create every standard cell in the library.

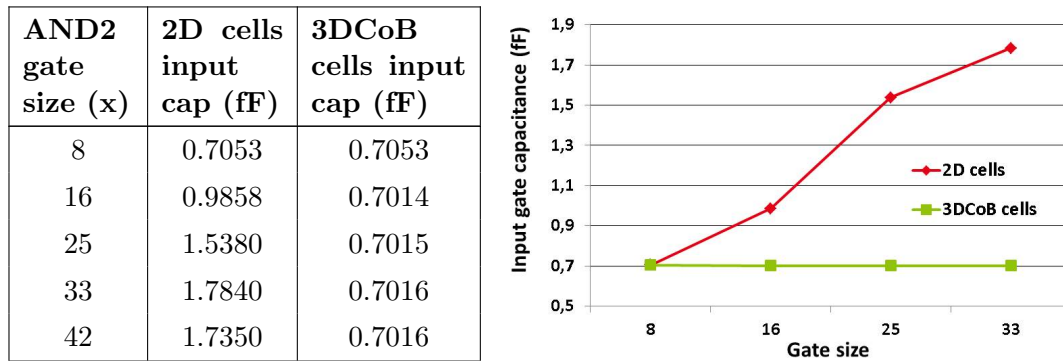

(a)

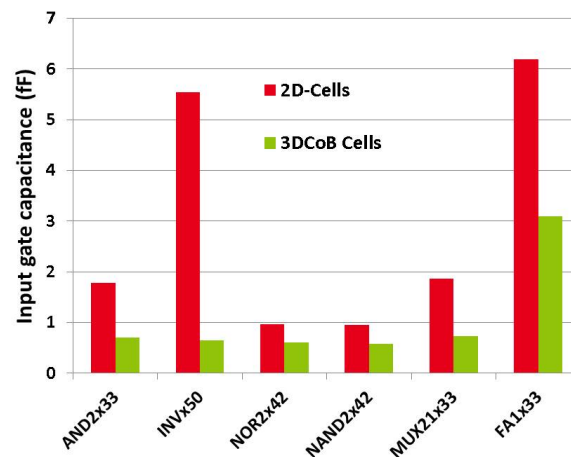

(b)

FIGURE 3.3: Input gate capacitance results for 2D and 3DCoB cells (in fF), where (a) shows input cap of one gate as an example ‘2-input AND’ at different driving, and (b) shows different cell types and drives.

Figure 3.4 shows the whole design flow where the 3DCoB libraries generation is integrated to the conventional 2D digital implementation flow. The flow starts using the original 2D standard cell libraries to generate 3DCoB libraries and then uses the generated 3DCoB libraries a conventional 2D place and route flow in order to generate area, power and timing results. The input files required by the flow are Library Exchange Format file (.LEF) which contains all area, dimensions and layer information for standard cells and Liberty Timing File (.LIB) which contains all timing, power, capacitance information for standard cells.

In the following subsections the generation of 3DCoB .LIB and .LEF libraries is presented in details.

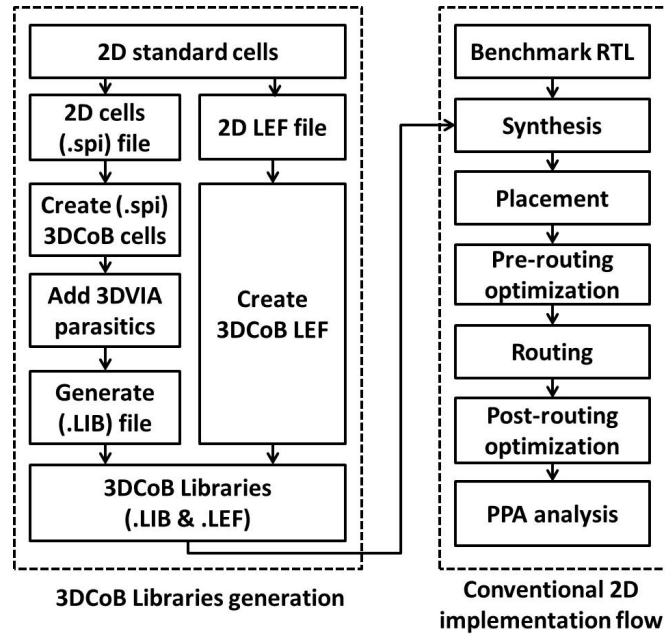

FIGURE 3.4: Full implementation framework for 3DCoB approach

3.3.1 .LEF file generation

.LEF file contains the physical area, dimensions, pin placement, and layer information for each standard cell. Adapting .LEF files for 3DCoB standard cells requires modifying the cell dimensions by extending the cell on the X-axis and adding one metal polygon in order to emulate the inter-tier 3D via contact.

Figure 3.5 shows 3DCoB cell area in different cases depending on the size ratio between min-drive cell and driving buffer. Inter-tier via needs a space to be connected between the top and bottom active regions. This inter-tier via pitch depends on the technology process constraints.

Consequently, when the buffer is equal or smaller than the top cell, an additional area is needed for these vertical inter-tier vias. Contrary, when the buffer is larger than the top cell by equal or more than the inter-tier via pitch, the new 3DCoB cell area will be the same as the buffer area.

Equation 3.1 shows the calculation of the area of the 3DCoB cell.

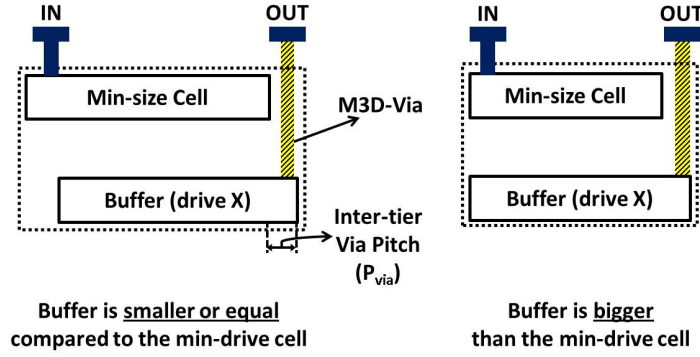

FIGURE 3.5: Different types 3DCoB cells of the same drive X, showing cell area and pin locations depending on cell type.

$$Area_{3DCoB} = \begin{cases} A_{BUF} & (A_{Min-Cell} + P_{via}) < A_{BUF} \\ \max(A_{Min-Cell}, A_{BUF}) & (A_{Min-Cell} + P_{via}) \geq A_{BUF} \end{cases} \quad (3.1)$$

Where, $Area_{3DCoB}$ is the area of the new 3DCoB cell, $A_{Min-Cell}$ is the area of the top cell, A_{BUF} is the area of the bottom buffer cell, and P_{via} is the pitch needed to place the Monolithic 3D VIA.

As these modifications are done for only non-minimum drive cells, the area needed for bottom tier is smaller than the area of the top tier as well as the original 2D area.

3.3.2 .LIB file generation

Liberty timing (.LIB) file contains the timing and power characterization of each standard cells in the form of lookup tables. A .LIB file is generated by characterizing a SPICE netlist (.SPI) of the standard cells. The spice netlist for a 3DCoB cell can be created from the 2D spice netlists using a simple script by generating a new sub-circuits with a gate, a buffer and RC interconnect model, as described in the procedure shown in Figure 3.6. These generated 3DCoB spice netlists are then characterized using the proper resistance and capacitance parasitic values for M3D technology. Using this procedure, a 3DCoB .lib file can be generated.

Procedure 1: 3DCoB cell generation

```

1  foreach cell of the library do
2  get current_cell_drive;
3  get current_cell_type;
4  if (current_cell is the min_drive cell)
5  skip this current_cell;
6  else
7  Cellx = min_drive_cell (current_cell_type);
8  BUFx = select_buffer (current_cell_drive);
9  3DCoB_cell = Cellx and BUFx in series;
10 add inter-tier via parasitics to 3DCoB_cell;
11 end
12 end

```

FIGURE 3.6: 3DCoB standard cell creation procedure.

3.3.2.1 Validating .LIB generation methodology

To validate our .LIB generation methodology, a 2D .LIB file is generated with our proposed methodology using the 2D spice netlists. Then new generated .LIB file is compared to an existing foundry .LIB file. The validation process is achieved by comparing each 2D cell from the new .LIB file with its equivalent 2D cell from the original foundry .LIB file (cell-by-cell comparison). The comparison is done on different parameters such as hold and setup time, delay, transition time and power. The results of that comparison are shown in Figure 3.7, The point of the 45° line ($y=x$) represents the ideal results where both the original and the new .LIB files give the exactly same results. Any deviations around that 45° line represent the mismatch error in the file generation methodology.

To provide an additional validation at a full block level, we have run two implementations of the same block (128-bit AES) using both libraries: the foundry 2D .LIB and our generated 2D .LIB files. Table 3.2 shows the results from Cadence Encounter for timing, gate count and area reports using both files. The mismatch error between our generated 2D .LIB file and the foundry 2D .LIB is maximum 2.2%.

From the aforementioned results we can infer that the proposed .LIB generation methodology is consistent and can be extended to 3D Cell-on-Buffer standard cells .LIB generation in order to enable a full digital implementation flow.

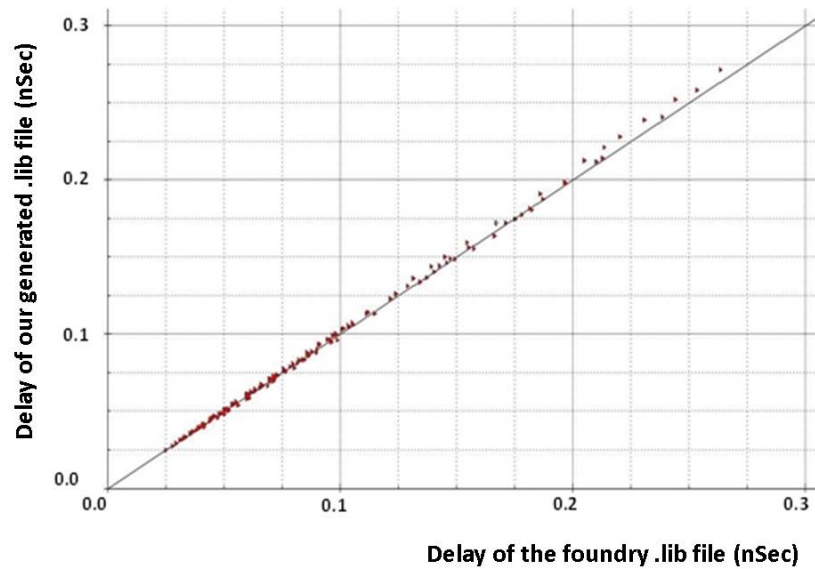

(a)

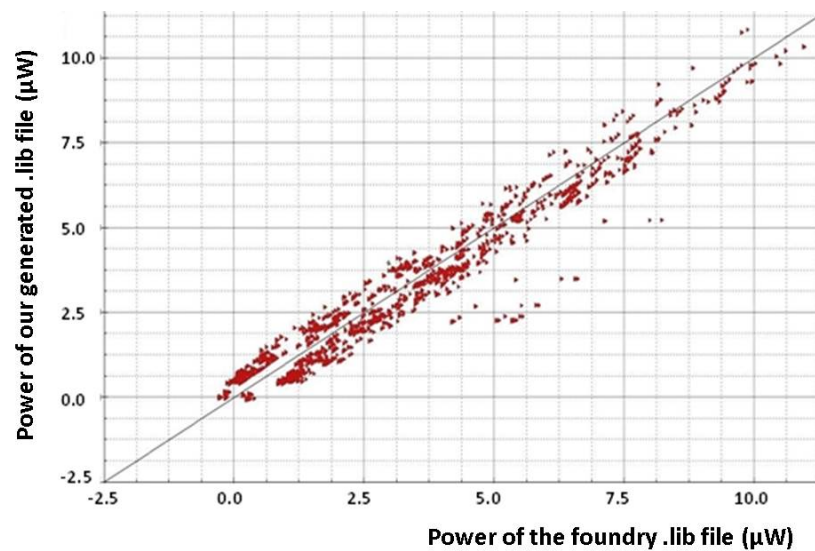

(b)

FIGURE 3.7: Validating .LIB generation methodology by a cell-by-cell comparison between the original foundry .LIB file (x-axis) and our generated .LIB file (y-axis). The 45° line represents the ideal results where both values are equal. This comparison represents cell values of (a) delay in nSec and (b) power in (μW).

TABLE 3.2: Validating .LIB generation methodology with a full block implementation. A comparison of implementation results of 128-bit AES block using both .LIB files: the original foundry .LIB file and our generated .LIB file

	Foundry Libraries	Generated Libraries	Mismatch Error
Timing slack	0 ps	0 ps	0%
No. of cells	130086	129113	0.75%
No. of FlipFlops	5568	5568	0%
No. of INVs	10973	11091	+1.1%
No. of Buffers	91	93	+2.2%
No. of Logic gates	113454	112361	-1.0%
Cell Area	99860	99562	-0.3%

3.4 3DCoB Performance-Power Results

To evaluate the proposed approach, selected benchmark blocks are implemented in 2D and 3DCoB using 28nm FDSOI technology and Monolithic 3D integration technology demonstrated in [8]. We used a sign-off physical implementation flow using CADENCE Encounter place and route tool. The 3DCoB libraries are generated as shown in Figure 3.4. We select a set of growing complexity benchmark blocks consists of: openMSP, Fast Fourier Transform (FFT) and 128-bit Advanced Encryption System (AES) decoder.

Table 3.3 summarizes the physical implementation results for the openMSP, FFT and AES blocks at different target clock frequency. The performance is measured as the effective clock frequency (the target clock period without the slack time). The power results are obtained from the place and route power reports, and then they are scaled to the max performance frequency for fairly comparison. The results are obtained at the same footprint area for each block.

At the same target frequency, 3DCoB approach improves performances by 20.5% and 9.6% compared to 2D for the AES (at 2.5GHz) and FFT (at 1.67GHz) blocks, respectively. OpenMSP block shows no gain in performances due to its small size and low number of standard cells.

To show the maximum achievable frequency at the same block area, we vary the target clock frequency of each block till reach the max performance point that can be achieved.

TABLE 3.3: Performance optimization results using 3DCoB compared to 2D implementations for openMSP, FFT and AES blocks

		Target Freq (GHz)	No. Std Cells	Cell Density	Total Wire Length (μm)	Power @2D max perf (mW)			Setup Slack reg2reg (ns)	Max Perf. (GHz)	Perf. Gain (%)
						Leakage	Dynamic	Total			
openMSP Area= 8163 μm^2	2D	1.25	7328	93.5%	82434	0.14	15.16	15.3	-0.032	1.20	-NA-
	3DCoB		7784	93.2%	86115	0.14	15.36	15.5	-0.041	1.19	-0.8%
FFT Area= 27498 μm^2	2D	1.67	25325	95.1%	274960	0.45	84.05	84.5	-0.089	1.45	-NA-
	3DCoB		27783	93.4%	284766	0.44	81.76	82.2	-0.028	1.59	+9.65%
AES Area= 119266 μm^2	2D	2.5	164174	89.0%	1542019	1.57	198.23	199.8	-0.100	2.00	-NA-
	3DCoB		166749	90.0%	1674193	1.76	209.07	210.8	-0.015	2.41	+20.5%
	3DCoB	3.33	159026	92.0%	1801557	2.29	219.63	221.9	-0.071	2.70	+34.7%

Figure 3.8 shows the power-performance trade-off for, openMSP, FFT and AES blocks with area 0.008 mm², 0.027 mm² and 0.119 mm² respectively. 3DCoB improves the max-performance frequency by 9.7% and 35%, compared to 2D cases, for FFT and AES blocks respectively. However, OpenMSP block doesn't show gain in power-performance, compared to 2D, due to the small size of the block, and low number of its min-cells.

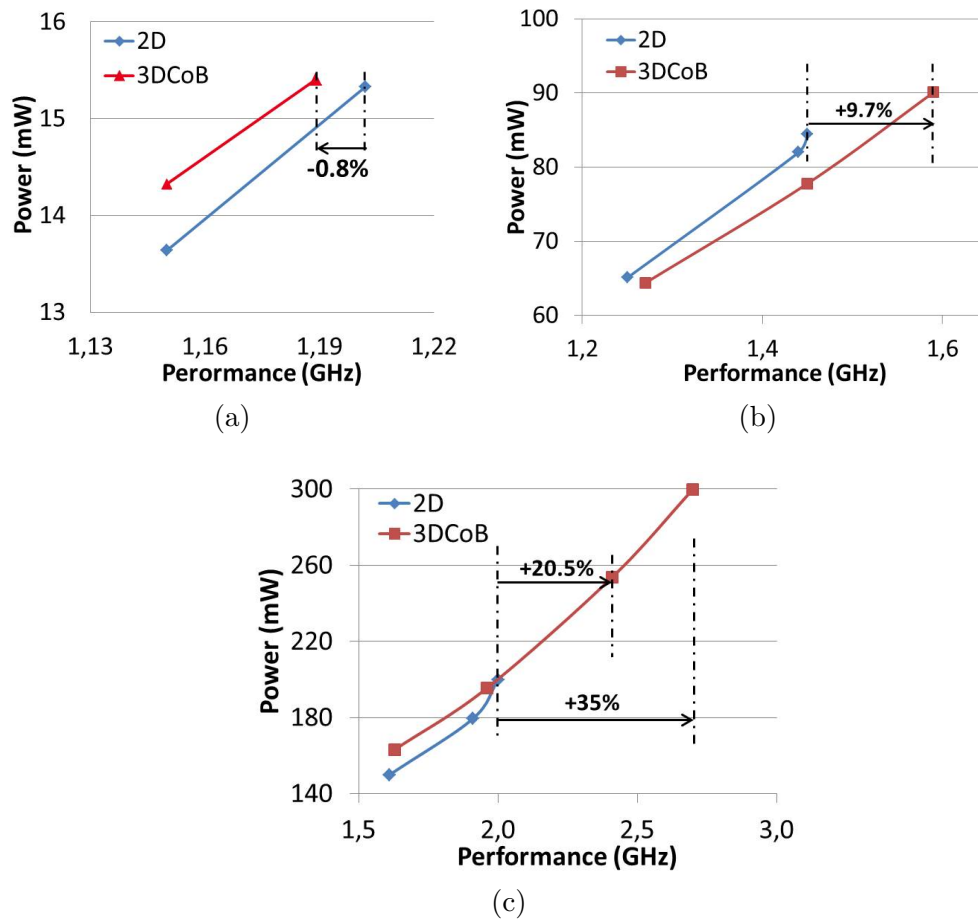

FIGURE 3.8: Power-Performance tradeoff for 2D and 3DCoB implementations for: (a) openMSP, (b) FFT and (c) AES, blocks.

AES block can be implemented using 3DCoB in a higher target frequency (3.33 GHz) compared to 2D implementation (2.5 GHz), at the same block area. As the performance improvement causes power increment, power optimization technique for 3DCoB approach is introduced in the next section.

The performance gain of 3DCoB approach depends on: (1) block complexity, i.e. number of standard cells, and (2) number of non-min cells in the design. Number of non-min cells increases by increasing the implementation constraint, i.e. target frequency.

To show the block complexity effect, we use openMSP, FFT and AES blocks with increasing block complexities which lead to increase number of non-min cells. For small blocks like openMSP, no performance gain can be achieved using 3DCoB approach. However FFT (at 1.67GHz) and AES (at 2.5GHz) blocks show number of non-min cells equals to 6338 and 32984 respectively. As the block complexity increases, 3DCoB performance gain increases. The higher number of non-min cells in the AES block leads to higher performance gain using 3DCoB approach, which is up to 35%, on the cost of power increase.

High performance implementation increases the utilization of non-min drive cells. To show the effect of 3DCoB approach on the cell type and size, we analyze the full cell distribution for the FFT block as an example block for both 2D and 3DCoB implementations.

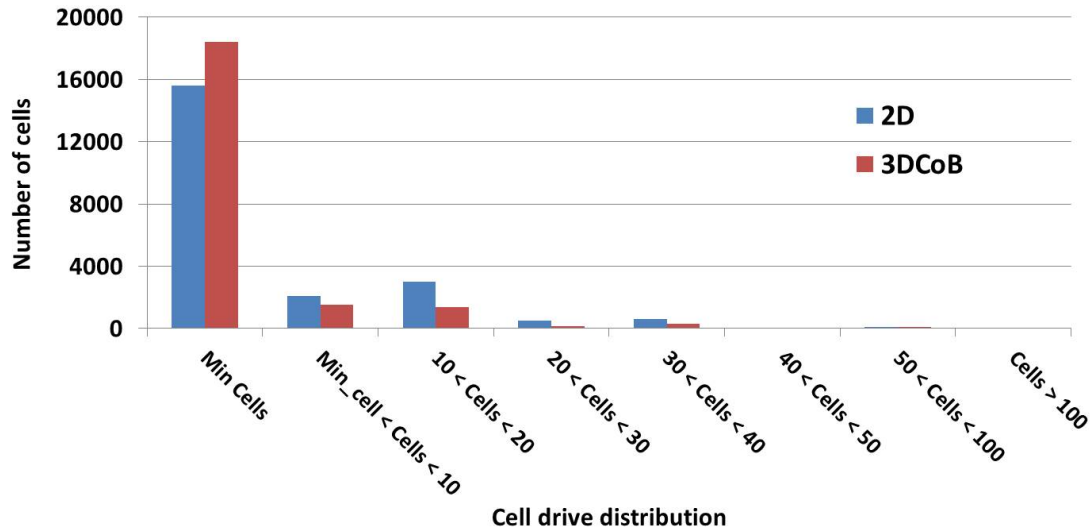

FIGURE 3.9: Comparison of standard cell driving size distribution for the FFT block implementation at target frequency = 1.67GHz for both 2D and 3DCoB libraries.

Figure 3.9 shows the full distribution of the FFT standard cells. The total number of standard cells has been slightly increased from 21942 cells in the 2D implementation to 21960 cells in the 3DCoB implementation. However, the important notice is that number of min-drive cells has been increased from 15604 in 2D (71% of total cells) to 18417 in 3DCoB (83.8% of total cells).

Consequently the 3DCoB implementation has 13% decreasing of non-min-drive cells usage. This is due to: (i) the performance improvement offered by 3DCoB cells so the implementation tool remove several non-min cell drive and (ii) free space appears due

to 3D stacking area reduction which allows the tool to insert more buffers on the critical paths to reach higher performances.

3.5 Low-Power Multi-VDD CoB (MV-CoB) Approach

Different low-power techniques have been developed such as Digital Voltage and Frequency Scaling (DVFS) and VDD-Hopping [49, 50]. To apply power optimization for 3DCoB approach, multiple-VDD has been used as a low power technique. In this section we introduce a new methodology to develop a low-power Multiple-VDD 3DCoB (MV-3DCoB) approach.

One of the main advantages of the 3DCoB is separating the driving capabilities from the logic functionality. Our multi-VDD 3DCoB methodology aims to decrease the supply voltage only for the logic functionality and keep the original supply voltage for the driving buffers. By this way, the driving capability of the multi-VDD 3DCoB cells is kept the same as the original single-VDD 3DCoB cells. Consequently, the power consumption decreases without much degradation of the performance.

For example, if the single-VDD cells with a supply of ' V_{DD} ', the multi-VDD 3DCoB cells will have a top voltage supply equals to ' $\beta * V_{DD}$ ' for the logic functionality where (β less than 1) and a bottom voltage supply equals to ' V_{DD} ' for driving buffer.

Figure 3.10 shows the different connectivity for 3DCoB where; the first scheme is connecting two min-drive cells directly, the second scheme is the inter-cell connection between the min-drive gate and its driving buffer, the third signals are connecting the outputs of the driving buffers and the inputs of the next min-drive gates.

Using these different connectivity schemes, the MV-3DCoB power consumption can be estimated as shown in equation 3.2:

$$P_{MultiVDD} = \alpha * f * V_{DD}^2 [\beta^2 (C_{gmin} N_{min} + C_{gBUF} N_{non-min}) + C_{gmin} N_{non-min}] \quad (3.2)$$

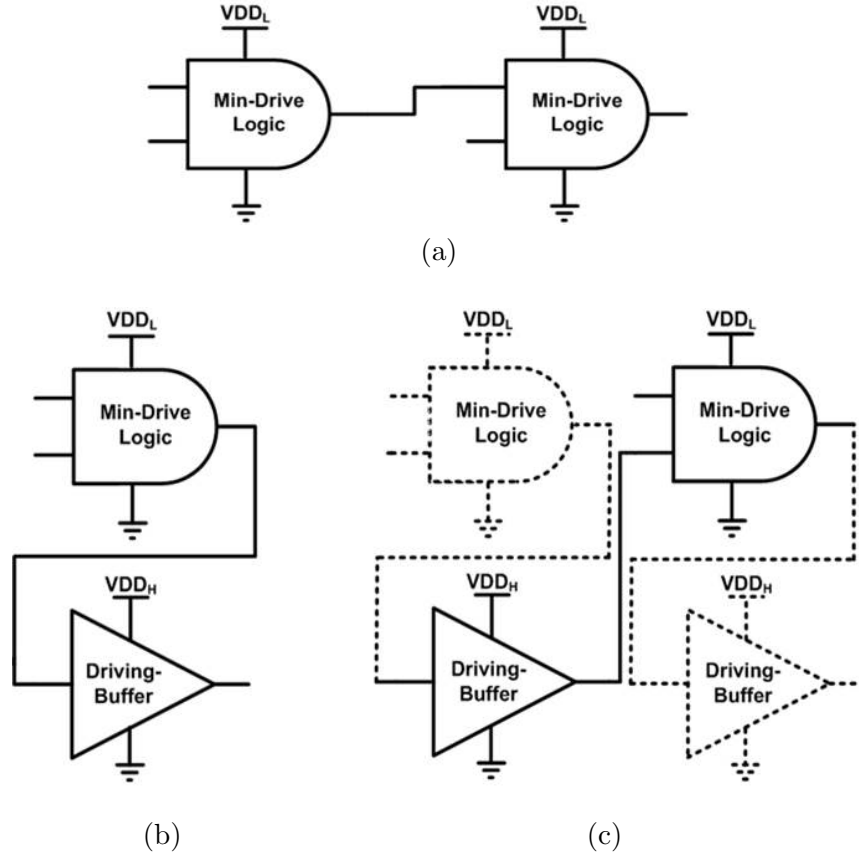

FIGURE 3.10: Different connectivity schemes for Multi-VDD 3DCoB approach; (a) connection between two min-drive cells, (b) inter-cell connectivity from the min-drive gate to the driving buffer, (c) connection between the driving buffer and the min-drive cells.

where β is the supply voltage ratio ($\beta = V_{DDL}/V_{DD}$). N_{min} and $N_{non-min}$ are the number of the min-drive and non-min drive cells, and C_{gmin} and $C_{gnon-min}$ are the average gate capacitances of the min-drive and non-min drive cells respectively. C_{gBUF} is the average gate capacitance of the buffer cells.

The number of the min-drive and non-min cells can be known from the synthesized netlist. As shown from the derived equation, the power gain of the multi-VDD 3DCoB is function of the number of the cells and the technology used (gate capacitances).

Using 3DCoB approach will decrease the leakage power that to decreasing the supply voltage of the bottom tier, i.e. half of the 3DCoB cell. However a short-circuit power may be introduced due to the internal connectivity between the low-voltage bottom buffer and the high-voltage top gate. As a resultant, the total power decreases by applying 3DCoB approach as we will show in the next section.

Creating a Power Distribution Network (PDN) is an important phase for 3D design flow. Using M3D technology, PDN can create more routing obstruction on the bottom tier due to the vias connected the top PDN network with the bottom one. One way is by implementing level shifters or DC-DC converters, such as Digital Low-Drop-Out (D-LDO) or switched capacitor voltage regulator, to lower the voltage supply. As 3DCoB approach converts only the non-min drive cells, the bottom tier is not fully occupied and has free silicon space. Such free space depends on the ratio between number of min-drive cells and the non-min drive cells.

Another way is by controlling the number of M3D vias used for PDN connections. The parasitics of these M3D vias control the voltage drop and the current supply required at the bottom tier. The number of M3D vias used for PDN connections is determined according to the current required for the bottom tier.

3.6 Power Optimization Results MV-CoB Performance-Power-Area Results

To fully implement the Multi-VDD 3DCoB (MV-3DCoB) approach, we use the same design flow methodology introduced in section 3.3. MV-3DCoB cells are re-characterized to include the effect of decreasing the top voltage supply on both delay and power of the cells. The MV-3DCoB .LIB and .LEF files are generated and used in a full place and route flow using 28nm FDSOI technology. The top-tier functioning supply voltage (VDD_L) is set to 0.9V, while the bottom-tier buffering supply voltage (VDD_H) is set to 1V.

Table 3.4 summarizes the MV-3DCoB results compared to: (i) 2D and (ii) single-VDD 3DCoB implementations. The supply voltage in both 2D and single-VDD 3DCoB cases is set to 1V. To achieve a faire comparison, the same set of benchmarks is implemented using the same design frame work as 2D and single-VDD 3DCoB.

In case of AES block at 1.42GHz target frequency, MV-3DCoB reduces power by 21.8% with only performance reduction of 2% compared to 2D. For the FFT block at 1.25GHz,

TABLE 3.4: Power optimization results using Multi-VDD 3DCoB ($\beta=0.9$) implementations for openMSP, FFT and AES blocks

	Target Freq (GHz)	No. Std Cells	Cell Density	Total Wire Length (μm)	Setup Slack reg2reg (ns)	Max Perf. (GHz)	Power @ achieved perf (mW)			Power Gain (%)
							Leakage	Dynamic	Total	
openMSP Area= 8163 μm^2	2D	7306	93%	82107	0.033	1.15	0.14	13.56	13.7	-NA-
	3DCoB	8010	91%	83949	0.002	1.11	0.13	13.77	13.9	-1.4%
	MV3DCoB	7709	93%	80944	-0.070	1.03	0.12	10.0	10.1	26.3%
FFT Area= 27498 μm^2	2D	30831	89%	281083	0.002	1.25	0.37	65	65.1	-NA-
	3DCoB	31716	86%	284959	0.012	1.27	0.35	64	64.4	1.1%
	MV3DCoB	29067	93%	299885	-0.004	1.24	0.28	53.3	53.6	17.7%
AES Area= 119266 μm^2	2D	200907	82%	1659585	0.024	1.48	1.65	139	140.2	-NA-
	3DCoB	196722	83%	1706638	0.009	1.45	1.74	137	138.6	1.1%
	MV3DCoB	185431	86%	1709728	0.011	1.45	1.28	108	109.6	21.8%

MV-3DCoB reduces power by 17.7% with only performance degradation by 0.8% compared to 2D. However, in case of openMSP block at 1.11GHz, MV-3DCoB reduces power by 26.3% but with performance degradation of 10.4% compared to 2D. This is due to the small size effect of the block.

Figure 3.11 shows the power-performance results for the benchmark circuits. As shown, MV-3DCoB provides lower power compared to both 2D and 3DCoB implementations by 26%, 18% and 22% for openMSP, FFT and AES blocks respectively.

For the leakage power, decreasing the top-tier supply voltage in the Multi-VDD 3DCoB decreases the leakage compared to the original 2D design. For example, in case of FFT (with 1.25GHz target clock frequency), the leakage power for the 2D equals 0.37mW while for the MV-3DCoB equals 0.28mW, as shown in Table 3.4. As shown, MV-3DCoB power gain depends on the number of non-min cells in the design which increases by increasing block complexity, or by changing the constraints applied in the place and route tool such as increasing target clock frequency.

3.7 Summary and Conclusion

In this chapter we propose 3D Cell-on-Buffer (3DCoB) as a design approach for M3D. The main idea for 3DCoB is to split the conventional 2D cells into two stages; logical stage (min-drive cells) and driving stage (same-drive buffer). The logical cell is stacked over the driving buffer using the advantage of the M3D technology. The implementation results show up to 35% performance improvement of 3DCoB compared to the same 2D design. The performance gain highly depends on the block complexity and architecture.

Taking the advantage of logic and buffering separation, we presented Multi-VDD 3DCoB (MV-3DCoB) as a power optimization technique to the 3DCoB. For MV-3DCoB, the min-drive logic gates have a low supply voltage while the driving buffers have the normal supply voltage to maintain the original driving capability. The implementation results using MV-3DCoB cells show power gain of 21.8% compared to the 2D results on the cost of 2% performance degradation for the AES block at the same footprint area.

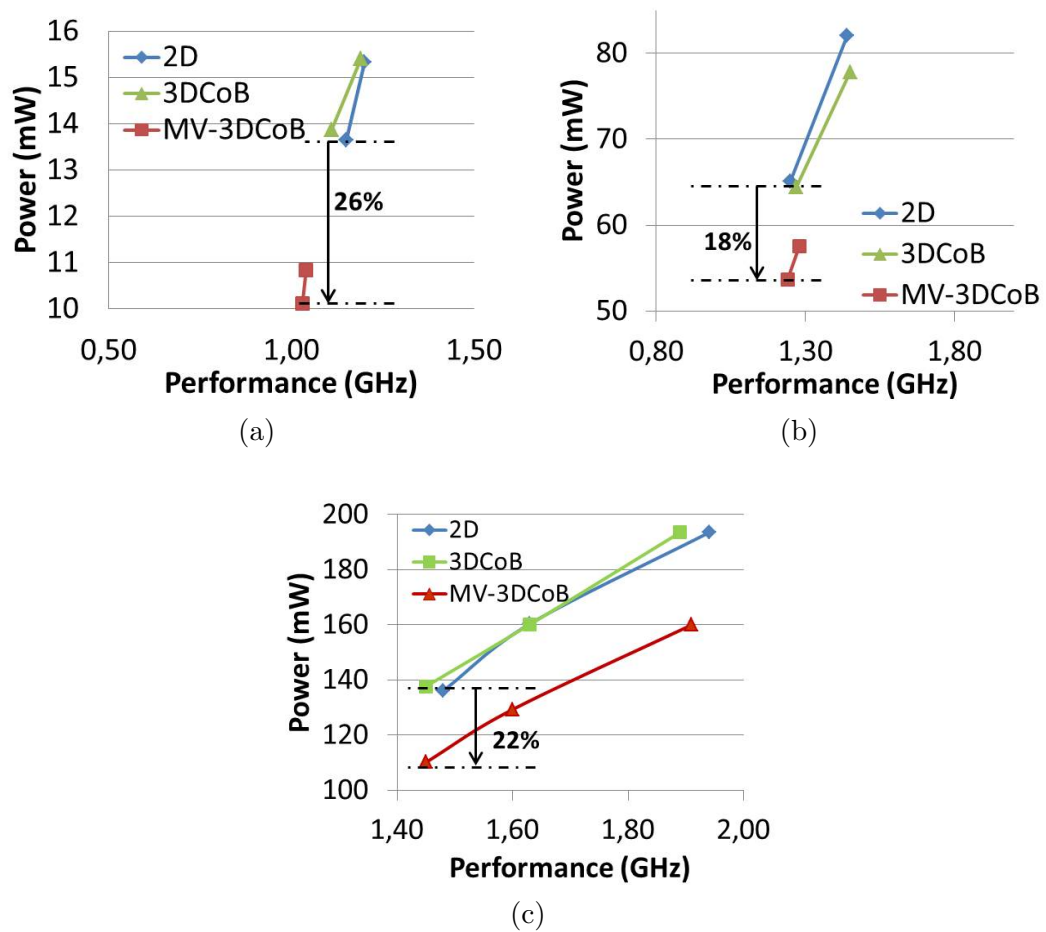

FIGURE 3.11: Power-Performance tradeoff for 2D and 3DCoB implementations for: (a) openMSP, (b) FFT and (c) AES, blocks.

Table 3.5 summarizes the full comparison between transistor-level NMOS-on-PMOS (N/P) approach [28], gate-level Cell-on-Cell approach [35], and the proposed Cell-on-Buffer approach. Comparing to 2D implementation, Cell-on-Cell approach offers gain in performance from 1.7% to 7.3%. For the power, Cell-on-Cell and N/P approaches achieve up to 16% and 32% power reduction, respectively, compared to 2D.

As we demonstrated 3DCoB approach provides better performance and lower power compared to 2D and other 3D techniques. However, the shortage of 3DCoB is in the area gain. The area utilization of bottom tier depends on the percentage of 3DCoB cells in the design which is relatively low (10%-20% depending on block architecture and implementation constraints). Consequently, 3DCoB can be an interesting approach to boost the 3D performance but the partitioning solution. So, there is still a need for a partitioning technique to be used with a cell-on-cell approach to achieve the expected

TABLE 3.5: Full power-performance comparison between transistor-level (N/P), Cell-on-Buffer and Cell-on-Cell approaches for M3D technology

	N/P	Cell-on-Buffer	Cell-on-Cell
Using 2D standard cells	No	Yes	Yes
Using inter-tier routing metal layers	No	No	No
2D Design flow compatibility	Yes	Yes	No
Usage of inter-tier VIAs	In every cell	Only in 3D cells	Between cells (if req.)
Performance gain compared to 2D	iso-performance	0% to 35%	1.7% to 7.3%
Power gain (iso-perf) compared to 2D	4% to 32%	16.3% to 21.8%*	6.6% to 16%
CMOS technology node (for standard cells)	Nangate 45nm	FDSOI 28nm	Nangate 45nm

*Iso-performance power gain using Multi-VDD 3DCoB technique

area gain from 3D IC (around 50%). Cell-on-cell design approach and partitioning methodologies are demonstrated in the next chapter.

Chapter 4

Gate-Level 3D Partitioning

4.1 Introduction: 3D Partitioning

Area gain is one of the main advantages of 3D technologies. In the previous chapter we present a 3D cell-on-buffer approach which shows power and performance improvements. However the need for gate-level cell-on-cell integration is crucial to achieve high area gain, i.e. around 50%. Considering complex designs of several thousands to millions gates (K-Gate to M-Gates) with high-density M3D technology offering up to 10^8 vias/mm² [8], there is an important question is raising of how to distribute cells efficiently on top and bottom tiers.

To create a 3D design, part of the circuit should be placed on one die and the other part should be placed on a second die, that's what we call "Partitioning". Conventionally for two-layers 3DIC, half of the design is assigned to one die and the another half is assigned to the second die. The question is how to partition a 2D design to create a 3D design.

Partitioning is the process to distribute logical cells of a design on different stacked 3D layers. This step is critical in the 3D design flow as it affects the power-performance-area gain of the new 3D design. As 3D power-performance gains are achieved thanks to cutting long wires to 3D connections (3D VIA), different partitioning techniques will give different results due to the different wires have been cut. The ratio of RC parasitics between a 3D VIA and the 2D wire is important to determine the power-performance

gain by going to 3D.

To illustrate the effect of RC parasitics ratio between 2D and 3D, let's discuss Monolithic 3D technology (M3D) parasitics values comparing to the CMOS node. By using M3D technology with a VIA of 5Ω resistance and 0.2 fF capacitance [35, 51], the replaced 2D wire length should had a higher RC values to achieve gain by going 3D. Table 4.1 shows a comparison between M3D-VIA and Metal 2 line of a 28nm CMOS technology node. From the table we can notice that a $22.39 \mu\text{m}$ wire length of metal line gives the same RC delay value of 1 M3D-VIA. This means that cutting 2D wire length less than $22.39 \mu\text{m}$ using M3D technology with such parasitics can degrade or limit the overall performance gain for the 3D design.

TABLE 4.1: Comparison between parasitics of M3D-VIA and M2 line of a 28nm CMOS technology node.

	M3D-VIA	M2 line
Resistance	5Ω	$0.00947 \Omega/\mu\text{m}$
Capacitance	0.2 fF	0.21 fF/ μm
RC delay	1 f <i>sec</i>	$2\text{e-}3$ f <i>sec</i> / μm^2
To get the same delay	1 VIA	$22.39\mu\text{m}$

Also from another point-of-view, different block designs give different wire length distribution. For example, an LDPC block provides total wire length of $4620931 \mu\text{m}$ with a max wire length of $6974 \mu\text{m}$ and an average wire length of $54.4 \mu\text{m}$ in 2D 28nm FDSOI technology. While an FFT block provides total wire length of $334058 \mu\text{m}$ with a max wire length of $2970 \mu\text{m}$ and an average wire length of $14.2 \mu\text{m}$. These values show that a critical cut threshold is needed for partitioning to maximize power and performance gain, especially with blocks like FFT block which have a shorter average wire length ($14.2 \mu\text{m}$) compared to the 3D cut threshold ($22.39 \mu\text{m}$).

Another example from the literature to illustrate the importance of partitioning. Reference [52] shows two different partitioning techniques of the same block, a dynamic instruction scheduler block. The first technique is an Entry partitioning where half of the entry ports are placed on the top and the other half are placed on the bottom tier. While the second one is Tag partitioning where half of the global tag ports are placed on the top and the other half are placed on the bottom tier. The results show that the Entry partitioning can achieve up to 15% latency reduction compared to 2D while the

Tag partitioning can achieve up to only 3.4%.

From these results, we can emphasize that different partitioning of the same block under the same technology parameters and the same implementation framework can achieve different 3D power-performance results.

4.2 Previous Gate-Level Partitioning Techniques

As illustrated there are two main approaches for designing 3D blocks in the literature. The first one is the architecture-level approach which takes long time that is not compatible with complex and large-scale designs. The second approach consists in partitioning the 2D netlist to get the 3D netlists using a partitioning algorithm which is gate-level partitioning. In this chapter, we will focus on the gate-level partitioning.

Gate-level partitioning has two different approaches:

i. **Min-cut partitioning technique.**

In this technique the partitioning algorithm targets to minimize the number of 3D contacts for a certain area ratio between top and bottom tiers, typically the balanced (equal) area ratio.

ii. **Performance-driven partitioning technique.**

In this technique the partitioning algorithm targets to maximize the performance gain of 3D regardless the number of 3D contacts.

A hyper-graph partitioning tool named ‘hMetis’ was presented in reference [25] as a min-cut partitioning algorithm. Reference [26] demonstrates a 3D Digital Signal Processor (DSP) with a gate-level partitioning using hMetis partitioning tool. In this case, the hMetis tends to minimize number of 3D contacts with equal area ratio between top and bottom tiers. Copper-to-Copper technology has been used in that work with a $5\mu\text{m}$ pitch of 3D contacts.

However Monolithic 3D technology offers very high density 3D contacts with a pitch scaled down to $0.11\mu\text{m}$ for 28nm technology. This technology breaks the limitation in

terms of number of 3D connections which opens new paradigm of partitioning to improve performance and power results.

In 2007, Cong et al [53] introduces the concept of Local Stacking Transformation (LST) and it was fully explained in [46]. LST technique assume starting with an optimized 2D placement then shrink placement area with K factor, where K is the number of stacked layers. Then a legalized phase is performed to distribute bin the close cells and distribute them on the different stacked dies. LST was introduced for TSV-based implementation. Similarly, CELONCEL placer was introduced based on the same concept but for Monolithic 3D technology [39]. CELONCEL shrinks all standard cells (deflating phase) then doing the 2D placement optimization then 3D distribution of standard cells and finally restoring the standard cell sizes (inflating phase).

Similar technique was used by Reference [27] as a placement-driven partitioning methodology for monolithic 3D technology with preserving the black boxes of the design. Placement-drive partitioning technique starts either with initial 3D placement or 2D optimized placement.

Although the first two techniques (LST[53] and CELONCEL[39]) are introduced as 3D placers but they are actually performing gate-level 3D partitioning. 3D placement is how to place standard cells in 3D dimensions (x, y, z) instead of only two dimensions. This process includes optimizing the cell placement vertically in z-direction which solves the same problem as 3D standard cell partitioning (cell-on-cell).

4.3 Physical-Aware Partitioning (PAP) Methodology

Previous 3D partitioning techniques are constrained by minimizing number of 3D contacts and targeting to achieve balanced area ratio between top and bottom tiers. These techniques are achieved without taking into consideration performance of the obtained partitioning design. Also as we are focusing on gate-level cell-on-cell partitioning, tens of thousands of gates need to be assigned either on top or on bottom layer to achieve the partitioning. Consequently an automated framework is needed to perform the whole partitioning methodology for different blocks with a physical-aware parameters.

The proposed automated Physical-Aware Partitioning (PAP) methodology consists of 4 main steps which lead to partition a 2D netlist into two 3D netlists. Figure 4.1 shows the main framework of the PAP methodology.

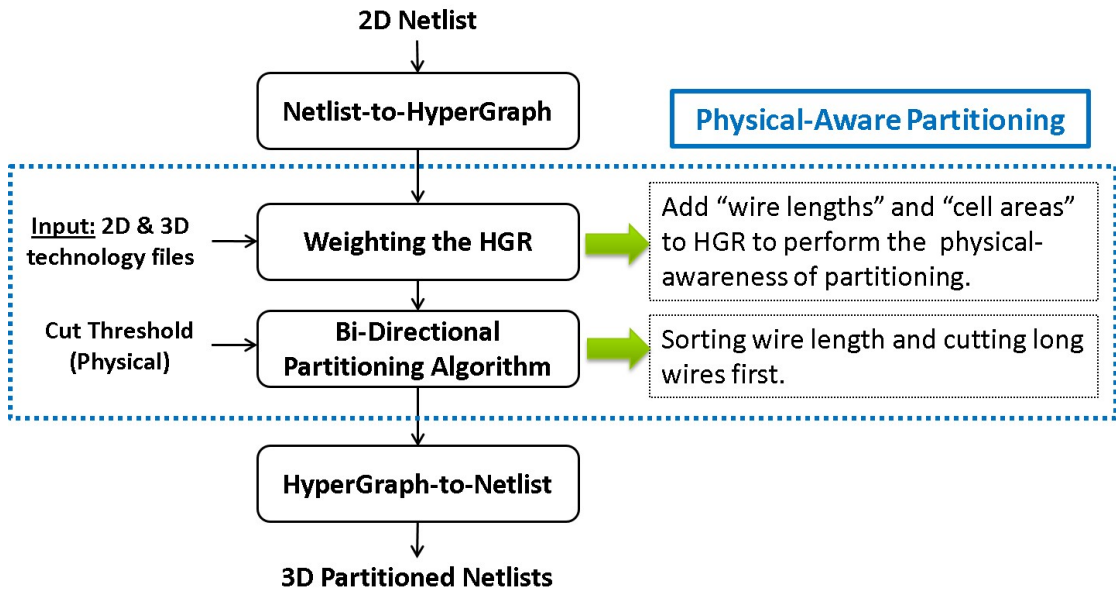

FIGURE 4.1: Design framework of the automated Physical-Aware-Partitioning (PAP) methodology starting from 2D netlist and getting out 3D partitioned netlists.

At the beginning the 2D gate netlist is obtained by a conventional synthesis process. In our study we used 28 nm FDSOI CMOS technology to perform the synthesis. The 2D gate netlist is important for the next steps because (i) it includes all standard cells not a behavior model like the RTL, and (ii) it includes the connectivity between those standard cells.

2D netlist is then passed through the following steps: netlist-to-hypergraph conversion, weighting the hypergraph, hypergraph partitioning, and finally hypergraph to netlist conversion.

a) Netlist-to-HyperGraph Conversion.

3D partitioning flow starts with a netlist-to-hypergraph conversion. This step converts the netlist into a graph representation where each standard cell is represented as a vertex node and these nodes are connected with each other using hyper-edges which represent the wiring interconnections between the cells.

Figure 4.2 shows an example of a gate netlist conversion to hyper-graph representation of a small circuit.

b) **Weighting the HyperGraph.**

The second step is weighting the hypergraph. HGR weighting is the procedure at which every cell and wire takes a numerical value representing its weight in the partitioning algorithm. These numerical values represent the physical parameters of the design.

Each standard cell is represented by its physical cell area to control the area ratio between top and bottom die of the 3D design. While each interconnection is represented by its 2D wire length, so that the partitioning algorithm starts to cut the longest wires first. The wire length values can be obtained using a wire length model, such as the half-perimeter wire length (HPWL) model. These wire length values are then used in the partitioning flow to arrange wiring interconnects from the longest to the shortest one.

Weighting phase is important as it add the physical awareness to the netlist. The HGR shown in Figure 4.2 includes an arbitrary weight values for both gates (vertices) and wires (edges).

c) **Partitioning Algorithm.**

The third step is the partitioning algorithm. In this step, the core of partitioning is performed at which the weighted HGR is partitioned into two (or more) HGRs. In our study we used the min-cut hMetis tool as a reference partitioning algorithm and we proposed a Bi-Directional Partitioning (BDP) algorithm to improve performance and power of the 3D design.

As the BDP algorithm is the main core of the partitioning work flow, it will be discussed in details in the following section (4.4).

d) **HyperGraph-to-Netlist Conversion and Generate 3D Netlists.**

The final step is a hyper-graph to netlist conversion. In this step the partitioned HGRs are converted back to a gate netlist from which we can get two (or more) netlists representing top and bottom layers. A further step is done using some scripts to include the top and bottom netlists into one hierarchical netlist for the 3D design where top and bottom netlists are internal modules.

This 3D netlist is then used in the implementation tool to perform the power-performance-area analysis.

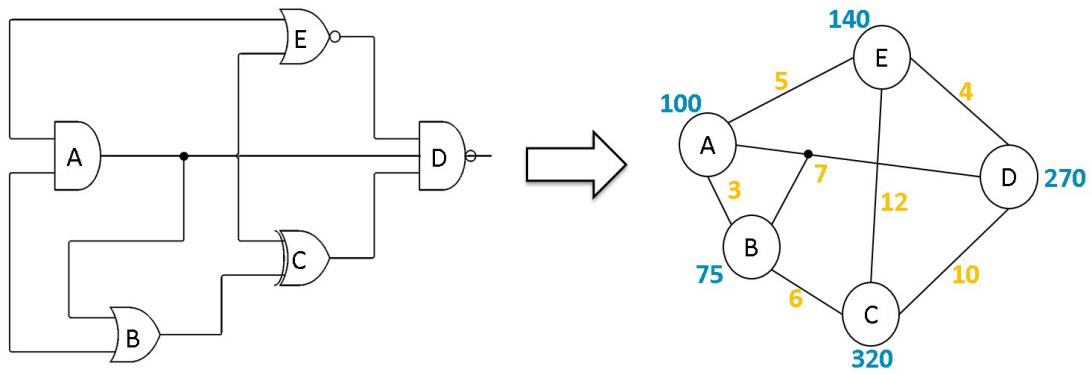

FIGURE 4.2: Gate netlist (left) to weighted HyperGraph (right) conversion, where each gate is represented by a vertex and each interconnect is represented by an edge. The number on the hypergraph represents gate area and wire length of the interconnects.

4.4 Bi-Directional Partitioning (BDP) Algorithm

The main step of the PAP methodology is the partitioning phase of the 2D hypergraph. For the partitioning, a bi-directional partitioning algorithm has been introduced which targets cutting long wires first. Algorithm 1 shows the detailed procedure of the partitioning algorithm.

The first step in the hypergraph partitioning phase is to generate a ‘fixed-cell’ list. This fixed-cell list is generated according to the user specifications to fix some standard cells and avoid them from partitioning. For example, in case of having all the design ports in one die then a list of all the standard cells connected to the design ports is generated as a fixed-cell list. Another example, in case of targeting a clock tree only in one die, then a list of all the clocked standard cells (flip-flops) is generated as a fixed-cell list. The generated fixed-cell list is accompanied with an indication to the fixing die, so that those standard cells are fixed either to the top tier or the bottom tier.

After generating the fixed cells, the main partitioning algorithm is applied. First, all the wires are arranged from the longest to the shortest one. Then all the fixed cells are marked using the list generated in the previous step.

After sorting all wires, each wire is being cut starting from the longest to the shortest ones, by order. After each cut process, some of the standard cells are moved to the another die which can create additional M3D via unintentionally.

Algorithm 1: Bi-directional partitioning algorithm

```

1  Arrange all the interconnect wires from the longest
   interconnect to the shortest interconnect ;
2  get (fixed_cells) ;
3  get (dont_cut_nets) ;
4  Area_Ratio_target = get (Area_Ratio) ;
5  critical_length = get (critical_length) ;
6  3Dvia_number_target = get (3Dvia-number_) ;
7  cut_long_interconnects (Area_Ratio_target, criti-
   cal_length, 3Dvia_number_target) ;
8  fix_short_interconnects();
9  fix_3DVIA_count();
10 fix_area_ratio();
11 end

```

This cutting process is stopped either if it reaches a given critical length as a cut threshold, or reaching a given surface area of the bottom die. The critical length is a threshold to avoid cutting a 2D wire and replace it with a 3D VIA with equal or higher RC parasitics. Replacing a 2D wire with a higher RC parasitics of the 3DVIA will simply degrade the overall performances. Consequently the critical length threshold is a technology depending parameter.

The critical length value is calculated as a function of the resistive and capacitive of the 2D wiring compared to the resistance and capacitance of the M3D. The target is to have, at least, the same RC delay of 2D wire (Eq. 4.1) and that of 3DVIA (Eq. 4.2).

$$Delay_{2D_wire} = r_w c_w L^2; \quad (4.1)$$

$$Delay_{3DVia} = R_{3DVia} C_{3DVia}; \quad (4.2)$$

By equating the equations we can get the wire length to have equal delays. This wire length is the minimum critical length threshold to cut. Equation 4.3 shows the formula of the minimum critical length value to avoid higher RC delay due to the inserted 3DVIA.

$$Critical_Length = \sqrt{(R_{3DVia} C_{3DVia}) / (r_w c_w)}; \quad (4.3)$$

After finishing cutting the long wires, three fixing steps are needed according to the user criteria given.

1. First, **fix_short_interconnects()**. As each standard cell is connected to several wires, not only one, moving one cell which is connected to a long wire from one tier to another will cut several wires, not only the long wire. Consequently a step is needed to restore any short wire (below than a certain threshold) that has been unintentionally cut due to moving cells to the second tier.
2. Second, **fix_3DVIA_count()**. Similar as the first step, number of the 3D-VIAs can be more than intentionally cut. Normally for a high-density technology like Monolithic 3D, this is not an issue. However this will be an issue if other 3D technology is used where a specific 3DVia number is required. Consequently if resultant number of the M3D-VIAs is greater to a given value, then the shortest cut wires are restored. Fixing number of M3D-VIAs is done from shortest cut wires to the longest (the opposite direction of cutting wires).
3. Finally, **fix_area_ratio()**. In case of requiring a given area ratio between partitioned parts. If the moved cell area is less than that given value, then the standard cells connected to the shortest uncut wire will be moved to the bottom die. The direction of fixing the area ratio is from the shortest to the longest wire till the given area ratio is met (the opposite direction of cutting wires).

Figure 4.3 shows the arranged wires of the design. The direction of the partitioning, i.e. cutting wires, is performed from the longest wires to the shortest ones, while the direction of fixing the resultant number of M3D-VIA and surface area ratio is performed by restoring wires from the shortest to the longest ones. Consequently cutting and restoring steps are done in opposite directions, that's why we call it Bi-Directional algorithm. By using this cutting and restoring procedure, each standard cell is placed either on the top tier or the bottom tier.

The order of complexity of the partitioning algorithm is $O(n^2)$ which depends on number of standard cells and consequently wiring interconnects of the block. We have tested the partitioning algorithm for designing different 3D blocks of complexity up to 100K gates.

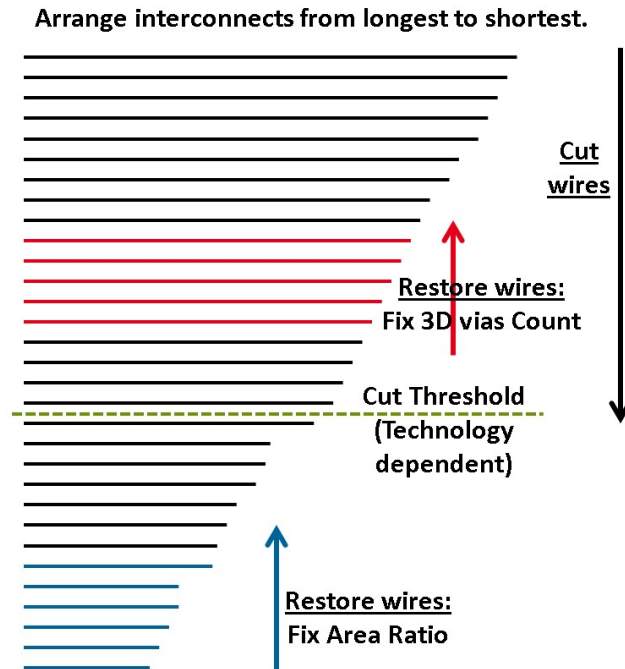

FIGURE 4.3: Bi-Directional Partitioning (BDP) diagram showing the design nets arranged from the longest net to the shortest net where the cut wires is performed from the longest to the shortest one (down arrow) till a certain Cut Threshold, and restore wires is performed from the shortest to the longest (up arrows).

4.5 Un-Balancing Area Ratio Concept

Balancing the area ratio between top and bottom tiers has been always used as it minimizes the 3D footprint area. This argument is true for the whole chip, however by dealing with block-level (each block separately) the need for equal area between top and bottom layers (balanced area ratio) is no longer a constraint. In this case a smart hybrid 3D floor-planning is needed for the whole chip (SoC) to place different blocks properly and get the minimum footprint area by having equal top and bottom areas. Also having equal top and bottom area is important to avoid impact on die packaging.

Figure 4.4 showing different blocks where each block has a different area ratio between top and bottom layers, and even some blocks can be in 2D, while the whole chip have balanced area to minimize the chip footprint area. Using such floor-planning avoids any extra area in the whole chip packaging due to the unbalanced blocks. The concept of having a 3D SoC with both 2D and balanced area ratio 3D blocks has been introduced in [54]. Our proposal is to extend this concept so that the 3D SoC can include 2D blocks, balanced 3D blocks and unbalanced 3D blocks.

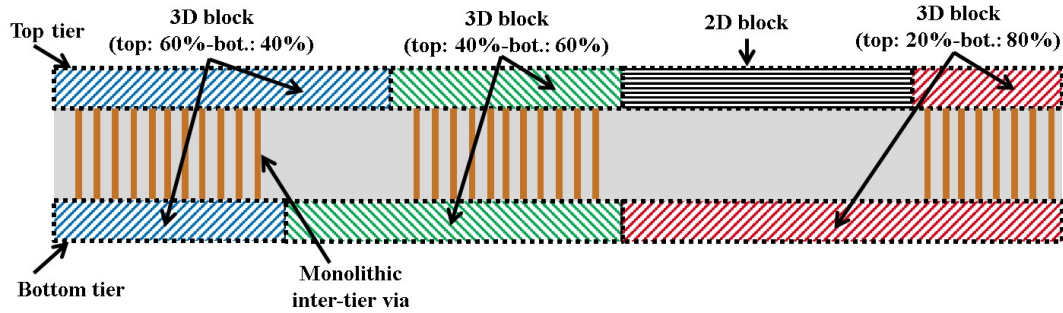

FIGURE 4.4: 3D hybrid floor-planning showing different blocks where each block has a different area ratio between top and bottom layers, and even some blocks can be in 2D, while the whole chip have balanced area to minimize the chip footprint area

The motive of unbalancing top/bottom area ratio of 3D blocks is that in case of balancing the area ratio the main objective of partitioning procedure is to get balanced top/bottom areas which may force cutting short wires. However if the target of partitioning a block is to cut only long wires even if the resultant is getting unbalanced top/bottom area ratio, that can increase the power and performance gain. Cutting a short wire and replacing it with a 3D contact with higher resistance and capacitance parasitics will degrade the 3D power and performance. Consequently our proposal is to cut only long wires and get unbalanced area ratio 3D block to achieve higher power and performance gains.

Table 4.2 summarizes the main two differences between balanced and unbalanced top/bottom area ratio for 3D block design. In the results section (4.6), we will show the power/performance/area results between unbalanced and balanced area ratio 3D blocks.

TABLE 4.2: Comparing the conventional balanced top/bottom area ratio versus the proposed Unbalanced top/bottom area ratio design techniques for 3D blocks

	Balanced Area Ratio	Un-Balanced Area Ratio
Objective	Get equal top & bottom areas	Partition only long wires
Advantage	Minimize area footprint	Avoid cutting short wires

4.6 Performance-Power-Area Results

4.6.1 PAP Methodology Implementation

To evaluate our approach, we have implemented a min-cut partitioning case with balanced area ratio (50%-50%) using hMetis tool [25] and set it as our reference case. Our proposed physical-aware partitioning (PAP) methodology has been implemented with unbalancing the area ratio and relaxing the number of M3D vias. We have explored as well the cases of balanced area ratio using PAP methodology, however to be focus, we will discuss only unbalancing area ratio PAP case with the best performance gain. A comparison is set between our performance-drive partitioning methodology and the hMetis reference points. Our scope in this chapter is gate-level partitioning, so no comparison is performed with Architecture-level cases.

Our benchmark circuits are composed of growing complexity blocks: open-MSP micro-controller, Reconfigurable Fast Fourier Transform (Reconf-FFT), Floating Point Unit (FPU) and Low-Density Parity Check (LDPC) decoder.

To validate our different partitioning cases with timing and power results, we have decided to prototype the physical implementation of our test-bench blocks using Atrenta SpyGlass Physical 3D (SGP-3D) as a commercial 3D tool with FDSOI 28nm CMOS technology node and M3D technology parameters extracted from the work demonstrated in [8].

The SGP-3D prototyping tool used is fully aware of physical implementation floor-planning of both tiers, placement of both standard cells and M3D vias, global routing and parasitic extraction. Figure 4.5 shows a snapshot for the physical implementation of one of our benchmarks, the LDPC block, in hMetis balanced case (50%-50%) and PAP unbalanced case (top: 75%, bottom: 25%). All the results presented are directly outputted by the tool including routing report, Total Wire Length (TWL), time slack (i.e. Performance) and Power.

In all test cases, we use M3D-VIA with a resistance of 2Ω and a capacitance of $0.1fF$ [35]. For the 3D design partitioning, we have converted the resistance and capacitance

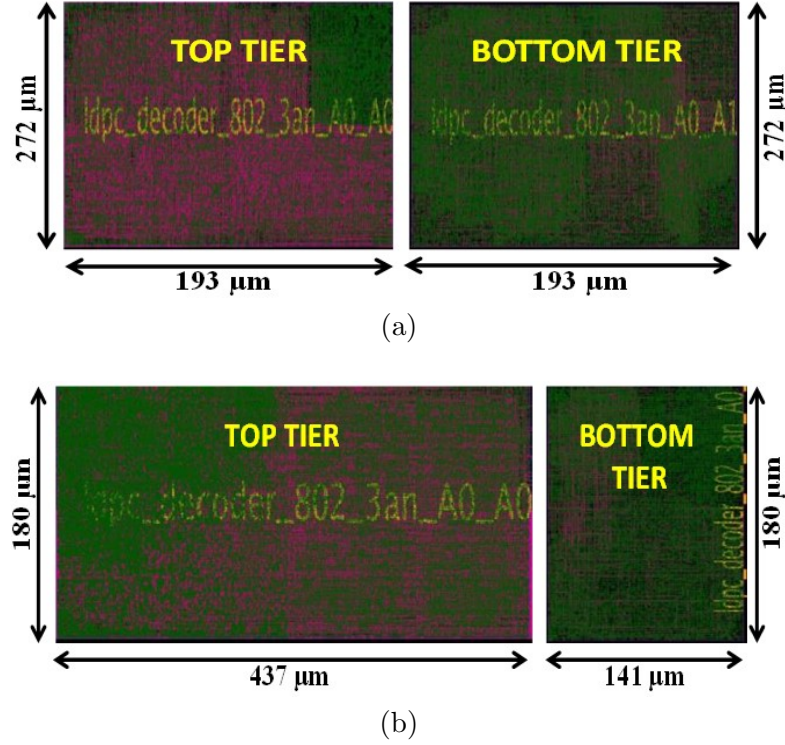

FIGURE 4.5: Snapshot of LDPC implementation prototyping for two cases, (a) balanced area ratio case (50%-50%) using hMetis tool and (b) un-balanced area ratio case (75%-25%) using our PAP methodology.

parasitics (RC) of the M3D-VIA to an equivalent 2D wire length on the targeted FD-SOI 28nm technology, and then apply this wire length as the cut threshold to our PAP methodology as we previously explained in equation 4.3. By applying this critical length, no wire can be replaced by a M3D-VIA with a higher RC delay to guarantee gaining in performances.

For clock tree synthesis, we set parameters of the partitioning algorithm to keep all the clocked cells (flip-flops) on the top tier to avoid clock issues on both tiers. By this way, no need to create a 3D clock tree.

The density of 3DVIA for each test case is calculated to ensure that its value is within the technology 3DVIA density limitations. For Monolithic 3D based on CoolCube process, 3D via can be used up to 10^8 via/mm^2 which represents density limit for our cases. Consequently increasing number of 3DVIA for the PAP cases has no technology violation, thanks to the very high density 3DVIA provided by the M3D technology.

Table 4.3 summarizes the power, performance and area results for different benchmark blocks. A comparison of three implementation cases is set: (i) 2D implementation, (ii) 3D with balanced area ratio using hMetis tool and (iii) 3D with unbalanced area ratio using our PAP methodology.

4.6.2 Performance Results

PAP approach highlights that better performances can be obtained at unbalanced area ratio. The unbalancing area ratio varies depending on the block design, i.e. the ratio between number of long wires and short wires. In case of openMSP better performance is obtained at (35-65) area ratio, while the area ratio is better at (40-60) for the Reconfigurable-FFT, and (25-75) for the LDPC blocks. However PAP with balanced area ratio results better performance than the balanced area ratio using hMetis.

The performance, shown in Table 4.3, is calculated by removing the positive time slack to the frequency max of the clock used. The frequency max is the highest clock frequency we target in the trial before getting high congestion effect.

For control-oriented block like openMSP, we can observe that increasing the number of M3D-VIAS and un-balancing the area ratio by 31% can bring 17.4% better performance than the 2D design but also 15% more performance than classical min-cut balanced area ratio using hMetis. Similarly for the Reconfigurable-FFT block, unbalancing the area ratio by 40% can achieve 24% better performance than 2D where hMetis increases the performance only by 9%. It appears that the control-oriented blocks offer better performance gains by unbalancing area ratio due to the presence of long control wiring interconnects which is difficult to be optimized in 2D.

On the other hand, for the computing-oriented blocks like the LDPC, we show that unbalancing area ratio with our PAP methodology can increase performances by 11.5% compared to 2D which is slightly better than the hMetis.

TABLE 4.3: Results comparison between 2D and 3D cases (hMetis and PAP partitioning) for openMSP, Reconf-FFT and LDPC blocks

		Area (μm^2)		Foot-print Area Gain (%)	No. M3D VIA	Max Perf. (GHz)	Perf Gain (%)	Power @2D max perf (mW)	Power Gain (%)
		Top	Bottom						
openMSP	2D	11390		NA	NA	1.21	NA	11.54	NA
	hMetis (50-50)	6000	6000	47.3%	1110	1.24	2.5%	11.53	0.1%
	PAP (69-31)	7875	4050	30.8%	3775	1.42	17.5%	11.74	-1.7%
Reconf-FFT	2D	27600		NA	NA	1.33	NA	35.50	NA
	hMetis (50-50)	13583	13583	50.7%	1158	1.45	9%	30.87	13%
	PAP (60-40)	16656	10902	39.6%	13894	1.64	24%	28.75	19%
LDPC	2D	134400		NA	NA	1.58	NA	103.5	NA
	hMetis (50-50)	52496	52496	60.9%	12511	1.74	9.9%	98.3	5.2%
	PAP (75-25)	78660	25380	41.5%	26917	1.76	11.5%	100.7	3.0%

* Standard cell number normalized to the smallest block, i.e. openMSP.

** Ratio between total wire length and number of standard cells (WL/Cell) for 2D implementation.

4.6.3 Power Results

For the power analysis, we have compared the iso-performance power results, i.e. at the same 2D max-performance point. The results shown in Table 4.3 highlight that going into M3D can reduce the power consumption up to 40% using hMetis methodology and up to 45% using PAP unbalanced methodology for a complex block like FFT compared to 2D implementation. However, applying hMetis or PAP methodology for a low complex block like openMSP does not guarantee any reduction of power consumption. The block is too small to gain by cutting long wires as we can see with the number of standard cells.

Figure 4.6 shows the power-performance curves for openMSP, Reconf-FFT and LDPC blocks. The curves show that going to 3D always guarantee reaching better performances compared to 2D.

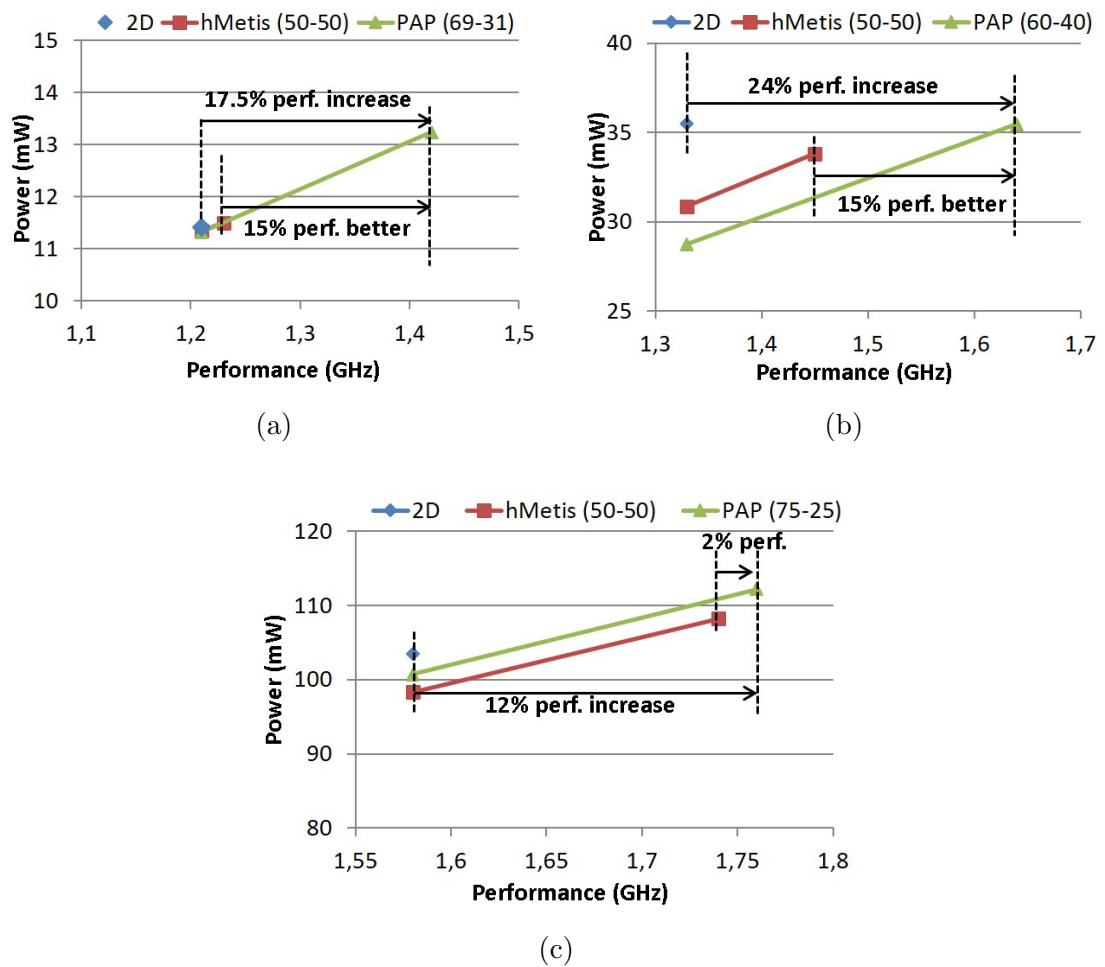

FIGURE 4.6: Power-Performance results for 2D, 3D hMetis partitioning with balanced area ratio (50/50) and 3D PAP with un-balanced area ratio using M3D for (a) openMSP, (b) Reconf-FFT, and (c) LDPC blocks.

4.7 Summary and Conclusion

In this chapter we have demonstrated that partitioning the design with M3D integration technology involves a trade-off between number of M3D-VIAS, area ratio, power consumption and overall performance of the 3D design.

Minimizing number of M3D-VIA and targeting balanced area ratio are no longer efficient as the main constraints to partition designs for high density 3D technologies. We have setup a physical-aware partitioning (PAP) methodology based on a Bi-Directional Partitioning (BDP) algorithm to decide which wire has to be cut and which cell is assigned to which tier.

Additionally We have proposed an unbalanced area ratio technique integrated in the physical-aware partitioning methodology. Unbalanced area ratio concept tends improve the performance gain by partitioning only long wires of the design without taking into account achieving area balance as a constraint. A hybrid floor-planning for different blocks is shown to avoid any extra space in the whole chip area.

We have applied PAP methodology on a set of different growing complexity benchmarks. The physical implementation results show that we can gain in performance up to 24% compared to 2D design and up to 15% more compared to area balanced and min-cut 3D design. On the other hand for iso-performance cases, we show that 3D blocks with unbalanced area ratio reduce power consumption up to 22% compared to 2D and up to 12% more compared to area balanced and min-cut 3D designs.

Chapter 5

Intermediate BEOL process influence for M3D

5.1 Introduction: Effect of Intermediate-BEOL for M3D

Monolithic 3D (3DVLSI) technology based on CoolCubeTM process offers ultra-high density of integration with up to 10^8 3D Vias (3D-V) per mm^2 offering gate level 3D integration capability [8]. As CoolCubeTM process is an advanced technology, there is a need to perform technology assessment to give guidelines at design level to the process and technology teams.

One of the important questions is the effect of Intermediate Back-End-Of-Line (I-BEOL). I-BEOL is the metal layer stack of the bottom tier, so it is an intermediate layer between top and bottom tiers. For process stability and wide range of temperature compliance, Intermediate Back End of Line (I-BEOL) is targeted to be made with Tungsten (W) lines with a SiO_2 dielectric ($k=3.9$), which increase the equivalent resistivity by 6 and capacitance by 1.6 compared to standard Back End of Line (BEOL), i.e. Copper (Cu) lines in low-k dielectrics.

In this chapter a study is performed to show the impact in Power and Performance by using W/ SiO_2 compared to Cu/low-k I-BEOL.

5.2 The need for W/SiO₂ I-BEOL

CoolCubeTM process flow requires fabrication of top transistors at low temperature –below 500-550⁰C- to preserve bottom transistors from any degradation [8]. This leads to fabrication difficulty of using standard Cu/low-k in the I-BEOL as both Copper and the low-k dielectric are unstable at that thermal budget. A simple solution would be to use SiO₂ with Tungsten lines, which are stable at higher thermal budget and contamination compatible.

Since bottom metal layers are made of non-copper (Tungsten) without low-k dielectric, resistance and capacitance of these layers are higher than the standard BEOL (Cu/Low-k dielectric) which may lead to degraded the overall performance and increase power of the resulted 3D IC compared to full copper one [47]. Previous works presented the effect of tungsten resistivity of I-BEOL [35]. Hence, there is a motivation to study as well the effect of varying both resistance and capacitance parameters on PPA metrics due to using of SiO₂ dielectric with Tungsten metal lines for the bottom tier BEOL.

Figure 5.1 describes fabrication process with a Transmission Electron Microscope (TEM) cross-section picture. The main steps of CoolCubeTM process are; first, the fabrication of the bottom FET within BULK, FINFET or FDSOI standard process using W/SiO₂ metal lines (SiO₂ dielectric coefficient of $k = 3.9$). Second step consists in bonding a wafer substrate to the bottom transistor layer following by a low thermal budget top FET. Finally, 3D vias are then realized, which consist in standard Tungsten plug process that is a contact in an oxide, and top BEOL made of copper metallization with low-k dielectric is performed. This process allows up to 10⁸ 3D vias per mm² with a 14nm technology providing ultra-high density of integration and offering 3D stacking at gate level granularity (cell-on-cell) allowing promising gains in area, performance and power as we have explored in the previous chapters.

In our study we implement the effect of W/SiO₂ I-BEOL as 6x resistivity and 1.6x capacitance compared to copper with low-k dielectric as presented in [8, 55]. An intermediate point with 3x resistivity and 1.3x capacitance is implemented as well. Also in this study, four inter tier metal layers have been chosen and we focus only on functional

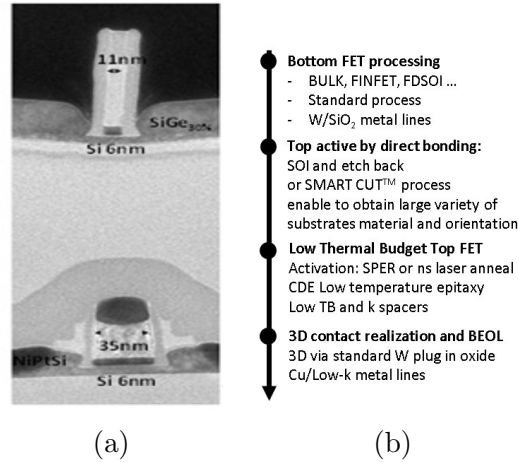

FIGURE 5.1: CoolCubeTM process for Monolithic 3D technology demonstrated with 3.9 SiO₂ dielectric [8]. (a) TEM cross-section and (b) process flow.

signals as we assume top and bottom tiers are supplied ideally and with same power and ground supply.

5.3 SiO₂ I-BEOL PPA Evaluation Framework

To study the effect of W/SiO₂ instead of standard BEOL (Cu/low-k), we propose to set up a full framework to prototype different designs using Monolithic 3D technology to monitor the performance, power and area metrics.

5.3.1 Framework definition

Three benchmarks of growing complexity have been implemented in 2D with 28nm FDSOI technology and implemented in Monolithic 3D technology with three different cases of I-BEOL (Cu/low-k, W/SiO₂ and intermediate case). Benchmarking blocks are composed of a reconfigurable Fast Fourier Transform 1024 bits (Reconf-FFT) based on regular butterfly micro-architecture and a control part managing the reconfiguration capability with about 20 K Gates complexity. A Floating Point Unit 64-bits (FPU) for computing floating point data is about 36 K Gates. Finally, Low Density Parity Checks 2048 bits (LDPC) block is studied for its wire dominated micro-architecture with a bigger complexity, about 68 K Gates.

Benchmarks are first synthesized with 28-nm FDSOI technology to obtain a 2D logical netlist of each block. Partitioning 2D netlist into two 3D netlists is then performed in order to get top and bottom netlists which is expected by the implementation prototyping tool. HMetis tool [25] has been used to partition 2D netlist and consequently generate 3D netlists with equal cell area between top and bottom layers. Partitioning step is performed after synthesis which presents an advantage of using 2D block gate-netlist without updating the micro-architecture and the RTL code which is important from time-to-market perspective.

Afterwards, physical implementation prototyping is performed with Atrenta SpyGlass Physical (SGP) tool [48] as a commercial tool to get early performance, power and area results for 2D and M3D implementations. As Monolithic 3D technology offers ultra-high density of integration with the capability of stacking cells over cells, this feature is not supported well in common place and route tool. That is why we have chosen to prototype physical implementation to bypass limitations in place and route tool, taking advantage of the capability of the tool to perform 3D floor-planning, clustering and macro placement of cells, creating 3D vias based on 3D stack configuration XML file and finally applying global routing. After each step the tool provides optimization capabilities leading to put 3D via on an optimal coarse grain position and place standard cells around, offering global 3D placement optimization.

The SGP tool can extract parasitics at the end of the flow in line with resistivity and capacitance of metallization lines contained in technology files and thus it can perform timing analysis and power estimation based on 28 nm FDSOI gates timing libraries (.lib) with top and bottom BEOL parasitics extraction.

Physical implementation prototyping is done in 2D with copper BEOL extraction then in 3D as illustrated in Figure 5.2 still with copper BEOL and I-BEOL. W/SiO₂ effect is applied by updating SPEF extraction file with resistivity and capacitance values defined for intermediate and W/SiO₂ cases. The next section explains overall focuses on updating the parasitics file with tungsten and SiO₂ dielectric values.

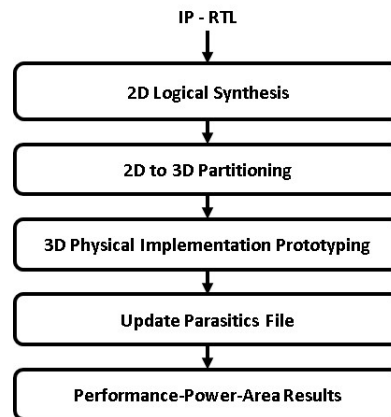

FIGURE 5.2: PPA implementation prototype methodology to compare different bottom metal layers effect.

5.3.2 I-BEOL parasitics extraction focus

In this section we focus on updating the parasitics to reflect the effect of I-BEOL with different flavours. After 3D placement and routing, the tool generates a SPEF file which is composed of top and bottom Cu/low-k BEOL parasitics without 3D vias contributions.

Two different steps are needed to be done here: (i) take into account the 3D via resistance and capacitance contributions and (ii) update I-BEOL parasitics with intermediate and W/SiO₂ parasitics instead of the copper/low-k.

Procedure 2 shows the algorithm used to update SPEF file with 3D via parasitics and different I-BEOL parasitics. First step is to add the 3D via resistance (*Res_3Dvia*) and capacitance (*Cap_3Dvia*) as introduced previously. For this, a script parses the SPEF file to find all 3D connections going from one tier to another, and add values for *Res_3Dvia* and *Cap_3Dvia*. Once the SPEF file is updated, it re-inserted in the tool so that timing analysis and power estimation are performed back in the tool to obtain results including the effect of 3D via.

The second step is to update the SPEF file with the contribution of intermediate BEOL. The original BEOL used is Copper with low-k dielectric. Tungsten BEOL with SiO₂ dielectric has 6x resistance and 1.6x capacitance compared to Cu/low-k. An intermediate case has been selected with 3x resistivity and 1.3x capacitance compared to Cu/low-k BEOL. To achieve that, a script parses the SPEF file to find the bottom connections and multiply resistance and capacitance to include the effect of I-BEOL. Similar to the

Procedure 2: SPEF file parsing to include the IBEOL effect

```

1  read .SPEF file
2  foreach NET do
3      get NET top/bottom position;
4      if (NET is 3D_NET)
5          add  $Res_{3Dvia}^*$  to total NET resistance;
6          add  $Cap_{3Dvia}^*$  to total NET capacitance;
7      end
8      if (NET is BOTTOM.NET)
9          multiply NET resistance by  $Res_{W\_Scaling\_factor}^{**}$ ;
10         multiply NET capacitance by  $Cap_{W\_Scaling\_factor}^{**}$ ;
11     end
12 end

```

* Res_{3Dvia} and Cap_{3Dvia} are the resistance and capacitance values of 3D vias

** $Res_{W_Scaling_factor}$ and $Cap_{W_Scaling_factor}$ are resistance and capacitance scaling factors between conventional Cu/low-k I-BEOL and another I-BEOL case (W/SiO₂).

FIGURE 5.3: 3DCoB standard cell creation procedure.

first step, the updated SPEF is then re-inserted to the tool to perform timing analysis and power estimation based on the updated parasitics. All the results are presented in the next section.

5.4 Power-Performance-Area Results

Table 5.1 shows all Power, Performance and Area results obtained to study the effect of different I-BEOL flavours.

From timing and area perspectives, results show that going to 3D using M3D technology provides up to 60.9% area reduction in case of LDPC block and up to 21.67% better performance in case of FPU block compared to 2D implementation with ideal IBEOL (Cu/low-k) lines.

For all 3D cases, positive Critical Path Slack (CPS) is higher than 2D CPS for the same targeted frequency of each block. This highlights the optimization done by the tool to reach targeted frequency and thus better performance achievable in 3D compared

to 2D. The full analysis and results for 2D versus 3D (Cu/low-k BEOL case) have been presented in the previous chapter(4).

Afterwards, we compare different I-BEOL flavors impact within intermediate case and W/SiO₂ by updating the SPEF parasitics file as explained earlier. The ratio between the Total Wire Length and number of cells (WL/Cell) is used to represent the wire dominance of each block. For blocks that are not wire dominated, we expect insignificant impact on performance for both intermediate and W/SiO₂ cases. Reconf-FFT and FPU that present WL/Cell ratio respectively of 15.6 and 16.2 show performance degradation less than 1% for W/SiO₂ IBEOL compared to Cu/low-k case.

But for LDPC block, the performance degraded down to around 2% by using tungsten I-BEOL (W/SiO₂) compared to the Cu/low-k case. The WL/Cell ratio of the LDPC block equal to 55.9 and it shows 1.8x higher number of cells compared to FPU, means that total wire length is 6.28 wider due to larger number of cells. Consequently tungsten I-BEOL starts to show effect on wire dominated blocks but still within very limited percentage for performance.

Power estimation is performed for 3D blocks to monitor the effect of using W/SiO₂ I-BEOL. Similar to the performance trend, the non-wire-dominant blocks shows insignificant power degradation, i.e. less than 1% for FFT and FPU blocks. For the LDPC block, only 1.4% power increase is shown by using Tungsten with SiO₂ I-BEOL compared to the Copper with low-k dielectric.

Another important result is number of 3D vias used for each block and their impact in term of area overhead. For instance 12511 3D vias are used for the LDPC block, which is the biggest block, leading to a density of 2.38×10^5 per mm² with only area overhead of 0.29% compared to the block footprint area. This number of 3D vias is used for functional signals, however additional 3D vias is needed for power distribution network (PDN) which can be up to 10^3 3D vias per mm². Limited area overhead and large number of 3D vias is due to the very small pitch of Monolithic 3D technology using CoolCube process.

Figure 5.4 shows the power-performance results for FFT, FPU and LDPC blocks using

TABLE 5.1: IBEOL flavours power-performance-area results for FFT, FPU and LDPC blocks

	I-BEOL		3D Vias		Area (μm^2)			Power @2D max perf (mW)	Critical Path Slack (nSec)	Max Perf. (GHz)	Perf Gain (%)
	Res.	Cap.	No.	Density (/mm ²)	Top/Bottom	Footprint Gain (%)	3DV overhead (%)				
Reconf-FFT 21429 cells WL/Cell=15.6*	2D	-NA-	-NA-			37730		-NA-	0.038	1.312	-NA-
	Cu/low-k	1x	1x	1158	6x10 ⁴	18988	49.7%	35.77	0.105	1.439	9.68%
	inter-k	3x	1.3x	1158	6x10 ⁴	18988	49.7%	35.83	0.102	1.433	9.22%
	W/SiO ₂	6x	1.6x	1158	6x10 ⁴	18988	49.7%	35.89	0.099	1.427	8.77%
FPU 36771 cells WL/Cell=16.2*	2D	-NA-	-NA-			46400		-NA-	0.013	1.02	-NA-
	Cu/low-k	1x	1x	587	2x10 ⁴	29260	36.9%	52.02	0.194	1.241	21.67%
	inter-k	3x	1.3x	587	2x10 ⁴	29260	36.9%	52.16	0.191	1.236	21.18%
	W/SiO ₂	6x	1.6x	587	2x10 ⁴	29260	36.9%	52.29	0.189	1.233	20.88%
LDPC 82532 cells WL/Cell=55.9*	2D	-NA-	-NA-			134400		-NA-	0.001	1.536	-NA-
	Cu/low-k	1x	1x	12511	2.38x10 ⁵	52496	60.9%	107.56	0.083	1.764	14.84%
	inter-k	3x	1.3x	12511	2.38x10 ⁵	52496	60.9%	108.25	0.077	1.745	13.61%
	W/SiO ₂	6x	1.6x	12511	2.38x10 ⁵	52496	60.9%	109.06	0.072	1.730	12.63%

*Ratio between total wire length and number of standard cells (WL/Cell) for 2D implementation.

different I-BEOL flavors for 3D implementations. Performance degradation and power increase are shown by going from Cu/low-k to W/SiO₂ I-BEOL cases due to the increase of resistance and capacitance parasitics of the W/SiO₂. However this performance degradation and power increase is limited to few percentages in the worst case wire-dominant block.

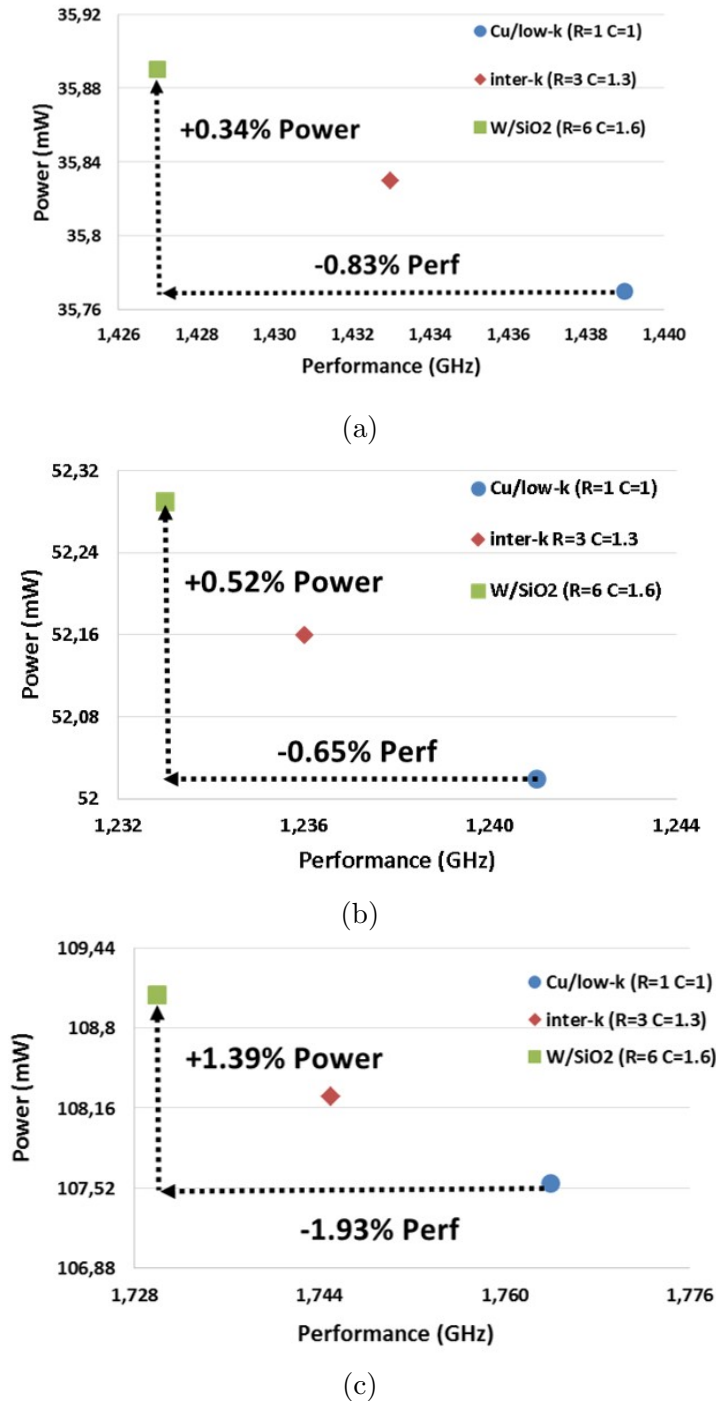

FIGURE 5.4: Different I-BEOL effect on Performance and Power results using M3D for (a) Reconf-FFT, (b) FPU and (c) LDPC blocks.

5.5 Summary and Conclusion

In this chapter we have presented a framework to evaluate the effect of non-copper I-BEOL (Tungsten with SiO₂ dielectric) needed for CoolCubeTM process. The power and performance results show limited effect of such W/SiO₂ I-BEOL compared to conventional Cu/low-k I-BEOL, i.e. below 2% performance degradation and below 1.5% power increase. These results are function of block complexity, partitioning used, implementation framework and the CMOS technology node used.

Due to the presence of different high-density 3D technologies, a full framework is still needed to perform technology assessment for these different 3D technologies. Such technology assessment is important to give us a guideline to use which technology with which block complexity using which partitioning technique. Consequently, a 3D technology assessment is presented in the next chapter.

Chapter 6

3D Technologies Assessment

“There is no one-size-fits-all”, so, Which 3D technology fits your design?

6.1 Introduction

The variety of 3D technology spectrum requires an exploration framework to determine which technology fits which design. In the previous section, a design evaluation is performed to show the effect of the I-BEOL process for Monolithic 3D. In this section, a comprehensive assessment is performed to explore which high density 3D technology among High-Density Through-Silicon-Via (HD-TSV), Copper-to-Copper contact (Cu-Cu) and Monolithic 3D (M3D) provides best Performance, Power and Area (PPA).

We introduce a design frame work to determine quickly and efficiently which 3D technology brings up best PPA considering partitioning algorithm, complexity and type of block (wire oriented, computation ...) for CMOS 28nm technology at 3D IC exploration and architecture definition.

HD-TSV and Cu-Cu technologies are based on post-fabrication assembly process of both tiers. Silicon demonstrators of full chips have already fabricated using these technologies in [10, 20, 26] which show major gains compared to 2D. Monolithic 3D is an

emerging technology based on CoolCubeTM process which is based on a full sequential process presenting ultra-high density 3D contacts. Silicon proof-of-concept has been demonstrated in [8] however no full chip has been demonstrated yet. That is why there is a motivation to explore efficiently PPA gains possible with these high density 3D technologies with respect to process maturity.

Table 6.1 summarizes the technological parameters of each 3D process with 3D contacts diameter, pitch and density data. A full comparison of these three technologies was presented in Chapter 2.

TABLE 6.1: High-density 3D-Connections parameters

		HD-TSV [13]	Cu-Cu [13]	M3D CoolCube [8]
3D Contacts	Diameter (μm)	0.85	1.7	0.05
	Pitch (μm)	1.7	2.4	0.11
	Density (per mm^2)	$\sim 7 \cdot 10^5$	$\sim 10^5$	$\sim 10^8$

6.2 Design Exploration Framework

The problem that is addressed in this work is to select the high density 3D technology which provides best PPA for a specific 3D IC.

6.2.1 Framework Overview

The proposed framework is shown in Figure 6.1, which is composed of three main steps:

i. **3D Area Overhead Analysis.**

Although high density 3D technologies offer small pitches for 3D contacts, an area overhead analysis should be explored to determine the max applicable number of 3D contacts depending on the block area and 3D technology used.

ii. **Partitioning Methodology.**

To create a 3D IC, a partitioning is needed to determine the placement of each cell on which tier. Selection of the partitioning methodology affects the number of 3D contacts needed.

iii. Physical Implementation.

To evaluate the power-performance-area metric, a 3D physical implementation prototype is done including floorplanning, standard cell and 3D contact placement, clustering, global routing and 3D power/time/area reporting.

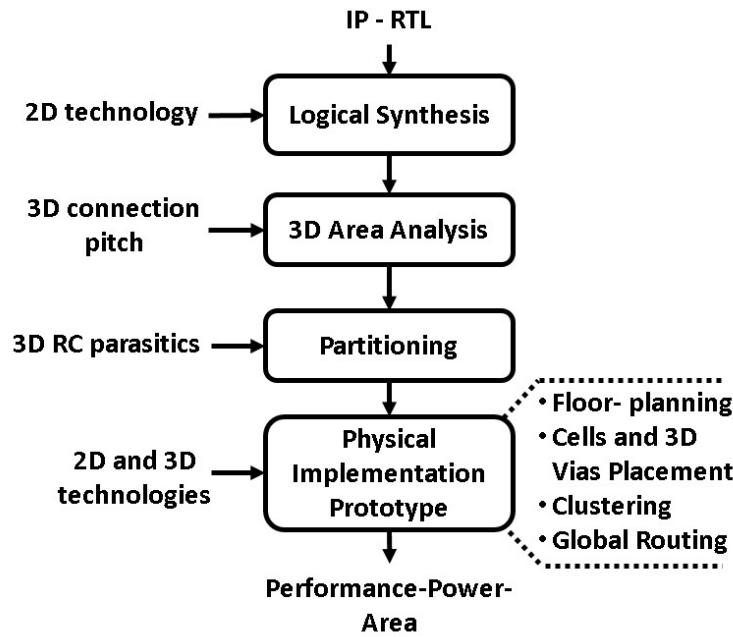

FIGURE 6.1: Design-Technology Exploration Framework to determine best PPA using different 3D technologies and different partitioning methodologies.

6.2.2 Partitioning Methodologies

At gate-level integration, partitioning methodology is critical to determine which standard cell is placed on which tier. Partitioning methodology affects number of 3D contacts needed to connect the stacked tiers, and consequently affects Power, Performances and Area (PPA) of the 3D design.

There are two main types in the literature of gate-level partitioning methodologies dedicated to 3D IC: (i) minimizing number of 3D-VIAs and (ii) performance-driven partitioning. In chapter 4 a full exploration of partitioning techniques is discussed with proposing a new Physical-Aware Partitioning (PAP) methodology.

In this chapter we have explored two partitioning techniques, hMetis [25] is taken as

an example of min-cut partitioning and our PAP methodology is taken as an example of performance-driven partitioning.

HMetis tool is a min-cut partitioning which optimizes number of interconnects between two partitions. In reference [26], hMetis has been used as a min-cut partitioning algorithm to achieve 50-50 area ratio for DSP block based on Cu-Cu technology of $5\mu\text{m}$ 3D contact pitch.

On the other hand, PAP methodology breaks the idea of min-cut partitioning by using a multi-criteria optimization algorithm; i.e. area ratio between stacked tiers, critical length threshold, and number of 3D contacts. By applying performance-driven partitioning, number of 3D-VIAs can exceed that of the min-cut partitioning algorithm to achieve better power-performance results.

6.3 3D Area Overhead analysis

Area and density of 3D contacts affects the decision of using the proper partitioning methodology; either targets minimizing number of 3D contacts or increasing performance with no constraints on 3D contacts count.

To show the area cost of 3D count, an early exploration study is introduced using growing complexity blocks based on different high density 3D technologies.

6.3.1 3D Contact Area Overhead Model

3D contact area penalty is the extra area needed by vertical connections exceeding the ideal 3D area footprint, '*Area_3D_ideal*'. The ideal 3D area is defined as the area occupied by standard cells and routing without taking into consideration the area of 3D contacts. It can be estimated by dividing the 2D area by number of stacked layers, i.e. 2.

Consequently 3D contact area overhead penalty can be calculated as shown in equation 6.1.

$$Penalty_{3DC}\% = (3DC_Overhead)/(Area_3D_{ideal}) * 100\%. \quad (6.1)$$

Where ‘3DC_Overhead’ is the overhead area needed by 3D contacts exceeding the ideal 3D area ‘Area_3D_ideal’.

The ‘3DC_Overhead’ value differs according to the 3D technology, so it can be calculated as presented in equation 6.2.

$$3DC_Overhead = \begin{cases} A_{3DC}, & HD_TSV \text{ or } M3D \\ 0, & CuCu \text{ and } (A_{3DC} < Area_3D_{ideal}) \\ (A_{3DC} - Area_3D_{ideal}), & CuCu \text{ and } (A_{3DC} \geq Area_3D_{ideal}) \end{cases} \quad (6.2)$$

Where ‘A_{3DC}’ is the area occupied by certain number of 3D contacts which can be calculated as:

$$A_{3DC} = (N_x + 1) (N_y + 1) P^2 \quad (6.3)$$

‘N_x’ and ‘N_y’ are number of 3D contacts in both x- and y- directions, ‘P’ is the pitch needed between 3D contacts. The pitch value depends on the 3D technology used as shown in table 6.1.

6.3.2 Area Results comparing M3D vs CuCu vs TSV

Equations (6.1)-(6.3) are used to build a full exploration study of 3D-C area cost for different 3D technologies. As an example, the synthesis results of FPU block in 28 nm technology is 46400 μm². An extra space of 30% is applied to estimate the routing, i.e. 60320 μm². This area is divided by 2 to obtain the ideal 3D area, ‘Area_3D_ideal’ i.e. 30160 μm². Then the pitch of 3D contact ‘P’ is applied according to the 3D technology used based on values shown in table 6.1.

Using this methodology two parameters have been examined to show the effect of 3D

contacts area overhead;

- (i) increasing number of 3D contacts for a specific block, and
- (ii) increasing block complexity at certain number of 3D contact.

Table 6.2 shows the Area overhead effect of increasing density of 3D contacts per gate count. Number of 3D contact is calculated for a 15K gates block as an example. As expected, 3D contacts area overhead penalty increases as number of 3D contact increases. The 100% area overhead means that the total block area, i.e. both gates and 3D contact areas, will reach the original 2D area.

Consequently exceeding the 100% limit, removes any area gain by 3D design. We can notice that HD-TSV and Cu-Cu exceed the original 2D area at 26% 3D-C density (i.e. 4000 3D contacts for 15K gate block). However Monolithic 3D overhead is almost within 1% from the ideal 3D area.

Figure 6.2 shows the effect of growing block complexity at certain 3D contacts count. As number of block gates increases, the block area increases which decrease the area overhead of 3D contacts. For HD-TSV case, 3D contacts area penalty reduced from 164% to 68.4% by doubling block complexity from 15K to 30K gates at 5000 3D contacts.

In all cases, M3D provides insignificant area penalty but for big circuits and 28nm FDSOI technology CuCu has limited area overhead. HD-TSV can be an alternative only for big circuits (more than hundred thousands of gates).

6.3.3 Discussion: Partitioning Effect for 3D-C Area

From the aforementioned results we can notice that using HD-TSV and Cu-Cu technologies for small blocks, number of 3D contacts creates an area overhead penalty and affects the total area of the 3D block. Consequently using min-cut partitioning algorithm is mandatory to minimize number of 3D contacts needed. For larger blocks that area penalty decreases but still 3D block can exceeds the area of the 2D block for large number of 3D contacts.

TABLE 6.2: 3D connections area penalty for HD-TSV, Cu-Cu and M3D using 28nm FDSOI CMOS technology

3DC/ gates (%)	No. of 3DC @15K gates	HDTSV Via Overhead (μm^2)	CuCu contact Overhead (μm^2)	M3D Via Overhead (μm^2)	HDTSV Area penalty (%)	CuCu Area penalty (%)	M3D Area penalty (%)
6%	1000	3063	5760	12	32.79%	0.00%	0.13%
13%	2000	6125	11520	24	65.57%	23.33%	0.26%
20%	3000	9188	17280	36	98.36%	85.00%	0.39%
26%	4000	12250	23040	48	131.15%	146.67%	0.52%
33%	5000	15313	28800	61	163.94%	208.33%	0.65%
66%	10000	30625	57600	121	327.87%	516.67%	1.30%

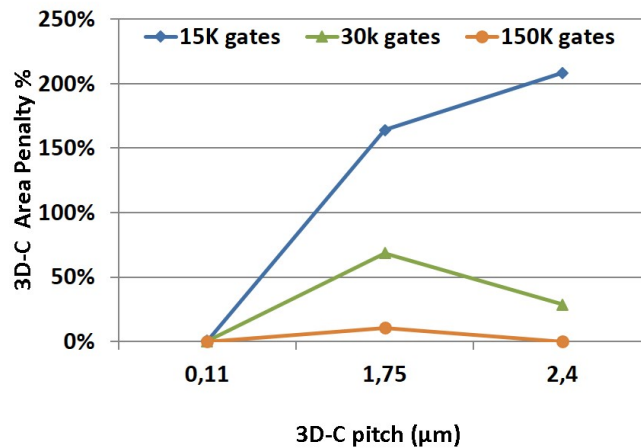

FIGURE 6.2: Area penalty effect of increasing block size for the same number of 3D-Cs (5000 contacts) using 28nm technology and different 3D technologies.

On the other hand, Monolithic 3D presents a very aggressive pitch that is why the results show a negligible area penalty whatever the complexity, even for small block and large number of 3D contacts. Consequently no need to minimize number of 3D contacts in the partitioning algorithm, and consequently the importance of a performance-driven partitioning algorithm increases.

6.4 Power-Performance Results for M3D vs CuCu

The objective of this section is to validate which 3D technology with which partitioning methodology provides better quality of results in terms of Performance, Power, and

Area. Four growing complexity benchmarks have been used; openMSP, Reconfigurable-FFT, FPU and LDPC. We focused on using Cu-Cu and Monolithic 3D technologies as HD-TSV requires more area overhead for most of the blocks compared to the other two technologies. 28nm FDSOI has been used as CMOS technology node for standard cells.

The physical implementation methodology as a part of the whole design framework is shown in Figure 6.1. A logical synthesis is processed to obtain the logical 2D netlist which is passed through each partitioning methodology that outputs 3D partitioned gate netlists.

Atrenta SpyGlass Physical (SGP) is used as a commercial 3D tool to implement the place and route step. SGP is a prototype tool uses 3D and 2D LEF technology files and cell timing LIB files as input with the netlist. SGP tool provides 2 active layers floor-planning capabilities, cells placement on both tiers, clustering with timing constraints file and global routing. 3D contacts are placed to minimize the routing needed for both top and bottom cells depending on cell placement. Routing congestion analysis is performed to validate the implementation.

To include 3D effect in the implementation results, 3D connection technology model parameters are needed. For Monolithic 3D, 3D-VIA of resistance = 5 Ohms and capacitance = 0.2fF is used, while for Cu-Cu implementation, we used copper contact with resistance of 0.17 Ohm and capacitance of 3.89 fF from internal data.

A .SPEF file is extracted with all the parasitics of the 3D design including the M3D-VIA to be included in the power calculations.

Table 6.3 summarizes the results for different cases, where each benchmark block is implemented in 2D, M3D and Cu-Cu. Each 3D test case has one implementation with hMetis partitioning and two implementations with PAP partitioning (using balanced and un-balanced area ratios). For unbalanced area ration PAP cases, the larger area footprint is considered to estimate the footprint area gain compared to 2D. The power results are calculated at 2D maximum performances. Figure 6.3 shows the power-performance curves for these different cases.

TABLE 6.3: Power-Performance results comparison between implementations of 2D and 3D using M3D and Cu-Cu technologies for openMSP, Reconf-FFT blocks, FPU and LDPC blocks

	Area (μm^2)		Foot-print Area Gain (%)	No. M3D VIA	Max Perf. (GHz)	Perf Gain (%)	Power @2D max perf (mW)	Power Gain (%)	
	Top	Bottom							
openMSP 6122 cells norm.=1**	2D		NA	NA	1.21	NA	11.54	NA	
	M3D	hMetis	6000	47.3%	1110	1.24	2.5%	11.53	0.1%
		PAP (50-50)	6000	47.3%	2983	1.29	6.6%	11.56	0.2%
		PAP (69-31)	7875	4050	3775	1.42	17.5%	11.74	-1.7%
	CuCu	hMetis	6400	43.8%	1110	1.21	0.0%	11.53	0.1%
		PAP (50-50)	17182	-50.8%	2983	1.17	-3.3%	11.56*	0.2%*
PAP (69-31)		21744	21744	3775	1.18	-2.0%	11.74*	-1.7%*	
Reconf-FFT 21429 cells norm.=3.5**	2D		NA	NA	1.33	NA	35.50	NA	
	M3D	hMetis	13583	50.7%	1158	1.45	9%	30.87	13.0%
		PAP (50-50)	13583	50.7%	14073	1.49	12%	31.67	10.7%
		PAP (60-40)	16656	10902	13894	1.64	24%	28.75	19.0%
	CuCu	hMetis	13583	50.7%	1158	1.46	10%	30.8	13.2%
		PAP (50-50)	81060	-193%	14073	1.25	-6%	35.56*	-0.17%*
PAP (60-40)		88159	88159	15305	1.25	-6%	35.59*	-0.25%*	

* Performance doesn't meet the 2D max performance, and power value is calculated for comparison.

** Standard cell number normalized to the smallest block, i.e. openMSP.

Continue: Power-Performance results comparison between implementations of 2D and 3D using M3D and Cu-Cu technologies for openMSP, Reconf-FFT blocks, FPU and LDPC blocks

		Area (μm^2)		Foot-print Area Gain (%)	No. M3D VIA	Max Perf. (GHz)	Perf Gain (%)	Power @2D max perf (mW)	Power Gain (%)	
		Top	Bottom							
FPU	2D	46400		NA	NA	0.97	NA	49.19	NA	
		M3D	hMetis	29260	29260	587	1.25	28.8%	40.00	18.7%
			PAP (50-50)	29260	29260	15738	1.23	26.8%	42.30	14.0%
	CuCu	PAP (85-15)	49005	28875	-5.6%	11429	1.25	28.8%	41.60	15.4%
		hMetis	29260	29260	36.9%	587	1.25	28.4%	40.25	18.2%
		PAP (50-50)	90650	90650	-95.3%	15738	1.22	25.8%	46.87	4.7%
16.2	PAP (85-15)	65831	65831	-41.9%	11429	1.24	27.6%	44.78	9.0%	
LDPC	2D	134400		NA	NA	1.58	NA	103.5	NA	
		M3D	hMetis	52496	52496	12511	1.74	9.9%	98.3	5.2%
			PAP (50-50)	52496	52496	24971	1.70	7.6%	102.9	0.6%
	CuCu	PAP (75-25)	78660	25380	41.5%	26917	1.76	11.5%	100.7	3.0%
		hMetis	72065	72065	46.4%	12511	1.54	-2.8%	118.5*	-1.4%*
		PAP (50-50)	143835	143835	-7.0%	24971	1.40	-11%	140.9*	-36%*
55.9	PAP (75-25)	155045	155045	-15.4%	26917	1.37	-13%	148.1*	-43%*	

* Performance doesn't meet the 2D max performance, and power value is calculated for comparison.

** Standard cell number normalized to the smallest block, i.e. openMSP.

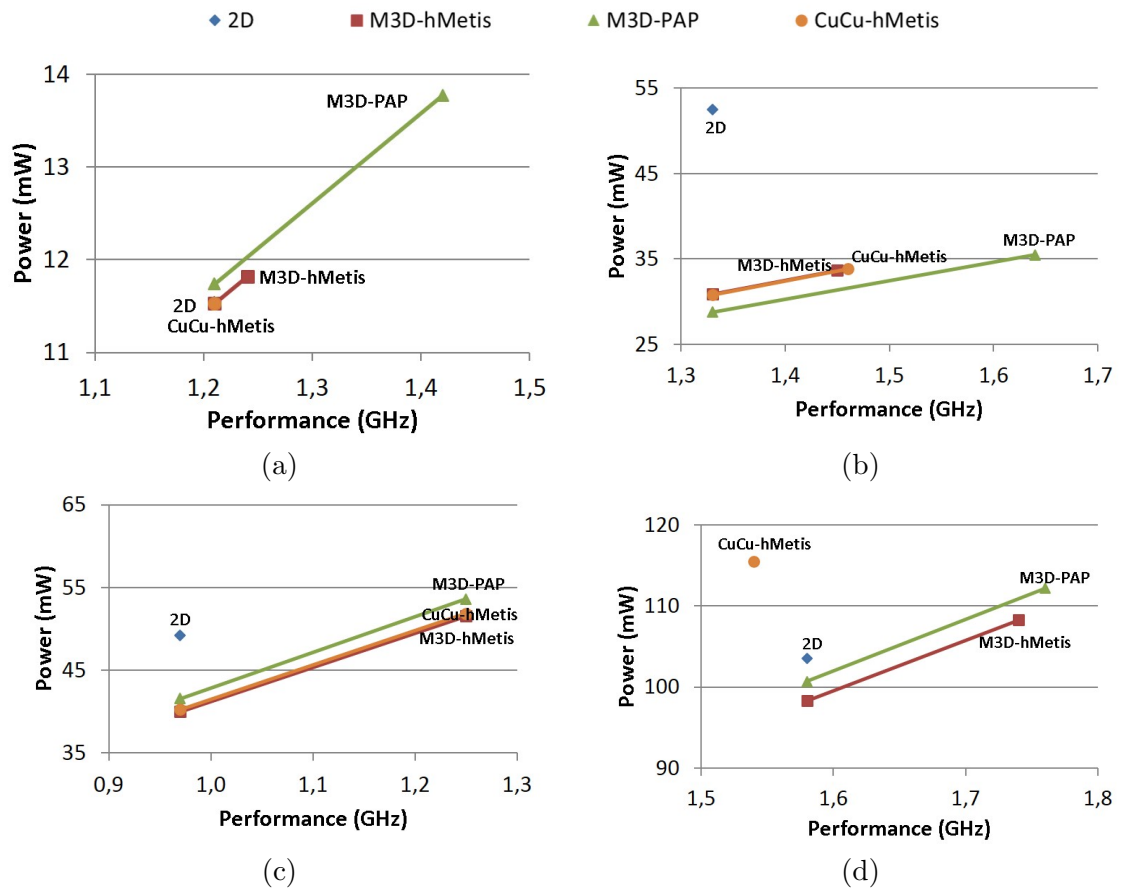

FIGURE 6.3: Power-Performance for 2D and 3D using M3D and Cu-Cu technologies for (a) openMSP, (b) Reconf-FFT, (c) FPU and (d) LDPC blocks.

A full discussion of the results is mentioned below from three different perspectives: (i) 3D Technology comparison, (ii) Partitioning comparison and (iii) Block Type comparison.

6.4.1 Discussion I: 3D Technology Results Comparison

Figure 6.3 shows that going into M3D provides best PPA whatever the block type and complexity with up to 28.8% higher performance and 45% reduced power and 50.7% reduced area compared to 2D IC. On the other hand, even if Cu-Cu cannot afford such high gains, it appears that for FPU block it provides 28.4% better performance, 18.2% reduced power and 36.9% reduced area compared to 2D, with -0.4% less performance and -0.5% reduced power and no area waste compared to M3D.

For small block and wire dominated, results show that Cu-Cu is not suitable for 3D

IC. But even if M3D provides best PPA it has to be noticed that partitioning methodology used has major impact.

6.4.2 Discussion II: Partitioning Results Comparison

As mentioned before, M3D provides best PPA using performance-driven partitioning (PAP) except for LDPC that is a special wire dominated block. We can observe that PAP provides for OpenMSP, Reconf-FFT and FPU better performances and reduced power than hMetis but with unbalanced area ratio, meaning that trade-off exists between area and performance-power.

For example, going into 60-40 area ratio with PAP for Reconf-FFT provides 15% better performance and 4% reduced power but with a waste of 11.1% area compared to hMetis partitioning solution.

6.4.3 Discussion III: Block Type Results Comparison

Table 6.3 highlights that Cu-Cu is killer for small block (less than 30 K-Gates) and wire dominated block because of its large 3D-C pitch compared to M3D which affects the resulted 3D area. As mentioned previously, it makes sense to consider Cu-Cu when the complexity is big enough like for FPU block.

LDPC block is interesting to study because of its big ratio of wire length over number of standard cell which highlights that the block is a wire dominated. In that case, going into M3D brings better PPA than 2D but with limited gains compared to others type of block. As a consequence, putting a 3D contacts on a constrained wire in 28nm FDSOI technology has no guaranty of very high gains.

6.5 Summary and Conclusion

In this chapter we have presented a full framework to early estimate gains affordable by three different high density 3D technologies based on first area penalty involved by the topology of the high density 3D technology and then by performance and power gains

we can expect regarding partitioning methodology used. M3D provides best gains, up to 28.8% more performance and 45% reduced power compared to 2D IC but also than others high density 3D depending on partitioning methodology used as well.

Using HD-TSV technology with a pitch of $1.7 \mu\text{m}$ for 28nm requires extra area overhead for 3D contact placement which degrades the overall block performances. Similarly for Cu-Cu with a pitch of $2.4 \mu\text{m}$ which can be killer for very small blocks and for wire dominated blocks like LDPC. However Cu-Cu can brings high gains compared to 2D and almost the same as M3D if reduced number of 3D contact is applied at the partitioning level with up to 28.4% better performance and 18.2% reduced power than 2D with -0.4% performance and -0.5% reduced power compared to M3D with an assembly process that is more mature than M3D.

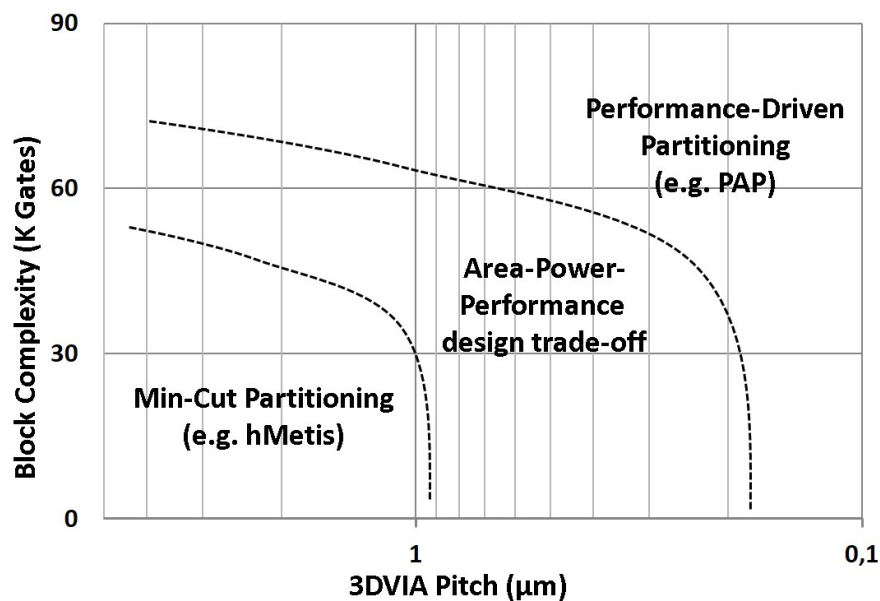

FIGURE 6.4: High Density 3D Design Space including 3D-C pitch, on x-axis, and block complexity, on y-axis, and suitable partitioning technique for each region.

That is why early estimating power performance and area gains depending on the 2D IC of the high density 3D technology targeted accordingly to dedicated partitioning methodology is mandatory to design efficiently 3D IC.

Figure 6.4 presents a qualitative representation for the regions recommended to use either min-cut or performance-driven partitioning. For large 3D contact pitch and small

blocks, min-cut algorithm is mandatory to minimize the number of 3D contact and limit its 3D contact area overhead. As the 3D contact pitch decreases and the block area increases, performance-driven partitioning becomes more needed to increase 3D overall performances with no constraints on number of 3D contact.

Chapter 7

Conclusion and Perspective

7.1 Summary and Conclusion

As we have discussed, More's scaling becomes more and more complex due to increasing technology limitations, where parasitics of the interconnects (i.e. Back-End-of-Line (BEOL)) increases significantly compared to that of transistors (i.e. the Front-End-of-Line). One way to decrease the effect of BEOL is by stacking die vertically which is called 3D Integrated Circuits (3D ICs). Thanks to the advanced 3D technologies, size and pitch of 3D contacts have been decreased which offers a high-density integration capabilities. Through-Silicon-Vias (TSVs) and Copper-to-Copper (CuCu) technologies achieve 3D contact pitch around 3-10 μ m. However a new 3D technology called Monolithic 3D (M3D) can scale down the 3D contact pitch to 0.11 μ m. Monolithic 3D is a sequential integration technology based on CoolCube process, where a second active layer is fabricated directly (sequentially) on top of the first layer. This integration technique gives the capability to use the lithography stepper of the process node which scales down drastically the size and pitch of 3D contacts. Monolithic 3D contact size for 28nm technology has nearly the same size of Via2 (via between metal 2 and metal 3).

Monolithic 3D and high-density TSV/CuCu technologies creates new design paradigm at which we can use such advanced technologies to continue CMOS scaling following More-Moore trend. In this thesis we explored new design methodologies and technology assessments for different high density 3D technologies, where a full 3D design space has

been explored based on the following aspects; First creating new M3D design methodology which is compatible with 2D conventional place and route sign-off flow, (ii) As each 3D via has a delay/power cost due its resistance and capacitance parasitics, a smart partitioning algorithm is needed to cut long wires and maximize the 3D power-performance gains, and (iii) creating a technology assessment framework to evaluate different technological parameters from a design perspective.

Chapter 2 explores the design space for high density 3D technologies, showing different 3D technology varieties where each 3D technology can be used for a different application. The full 3D design space consists in three main aspects: 3D technologies, partitioning granularity and 3D CAD tools. First a suitable 3D technology is selected depending on the application. We have discussed TSV, CuCu and M3D technologies to show the advantages and limitations of each technology. Another important aspect is the partitioning granularity which determines how to distribute a design into different 3D stacked layers. In this thesis, our focus was on fine-grain partitioning, meaning gate-level cell-on-cell and transistor-level integrations. The last aspect is 3D CAD tools which are needed to perform the whole 3D cell placement, 3D via placement, 3D routing, 3D timing and power analysis.

Chapters 3 and 4 introduce new design methodologies using M3D. In Chapter 3 we introduced a new 3D standard cells named 3D Cell-on-Buffer (3DCoB). 3DCoB is based on splitting 2D cells into a functioning part (cell) stacked over a driving part (buffer). This approach shows up to 35% performance gain compared to 2D implementation with a full compatibility with conventional sign-off 2D place and route CAD flow. Additionally, a low-power multi-VDD technique was applied on 3DCoB at which 21% power reduction can be obtained with only 2% performance degradation compared to 2D.

In Chapter 4 we explored different partitioning techniques for gate-level cell-on-cell design approach. Partitioning is the way to distribute standard cells in different tiers. A physical-aware partitioning methodology has been introduced where we showed two important aspects for M3D: (i) minimizing number of 3D vias is no longer a constraint for 3D design, and (ii) unbalancing area ratio between top and bottom tiers improves power and performance results without paying extra silicon area. Our physical-aware partitioning methodology showed performance gain up to 24% compared to 2D and

up to 15% compared to state-of-the-art 3D partitioning technique. Also for the power we showed that our partitioning reduces power consumption, at iso-performances, up to 22% compared to 2D and up to 12% more compared to other 3D partitioning techniques.

A technology assessment is needed for high-density 3D technologies. Chapters 5 and 6 show full studies of different technological parameters for different 3D technologies. In Chapter 5 we studied the effect of non-copper Intermediate BEOL (I-BEOL) for M3D technology. M3D technology requires a temperature of 500-550°C to fabricate the top active layer sequentially over the bottom one. The conventional BEOL of copper metal line with ultra-low-k dielectric is unstable at that temperature. Consequently there is a need to use Tungsten lines with SiO₂ dielectric which are stable at that thermal budget. Tungsten has a 6x resistivity compared to Copper, and using SiO₂ dielectric increase wire capacitance by 1.6x compared to ultra-low-k dielectric. We studied this effect on the whole power-performance results using different benchmark block. Our study showed limited impact of using Tungsten/SiO₂ I-BEOL where we got a performance degradation up to 2% and power increase up to 1.5% compared to the Copper/ultra-low-k I-BEOL.

In Chapter 6 we presented a full framework to compare different high-density 3D technologies to decide which technology is suitable for each design. Different aspects have been taken into consideration; (i) 3D technology used, (ii) block complexity and μ -architecture design and (iii) different partitioning techniques. Our framework is based on first area analysis to calculate the area overhead needed by 3D contacts. Then a power-performance analysis is performed to show the 3D gains. M3D technology provides up to 28% performance improvement compared to 2D. High-density TSV and CuCu provide bigger 3D contacts compared to M3D. Consequently using TSV and CuCu technologies require extra area overhead to insert 3D contacts. This extra area overhead degrade significantly power-performance-area results and can be killer for very small blocks or wire-dominant blocks like LDPC. Therefore a min-cut partitioning technique is needed for TSV and CuCu technologies to minimize number of 3D contacts.

As an overview, the main guidelines for designing using high density 3D technologies can be summarizes as:

1. Minimizing number for 3D-VIA is no longer a limitation for Monolithic 3D technology.
2. New 3D standard cell approaches can be achieved such as 3D cell-on-buffer to provide better power-performance results.
3. 3D unbalanced area ratio blocks can provide better power-performance results with no extra silicon usage.
4. Physical-aware partitioning methodology is needed to increase 3D PPA gains.
5. Technology assessment framework is needed to evaluate different technology parameters specially for Monolithic 3D.

7.2 Perspectives and Future work

7.2.1 Architecture-Level Partitioning

High density 3D technologies afford the capabilities of fine-grain integration; cell-on-cell and transistor-on-transistor which requires a fine-grain ‘gate-level’ partitioning techniques. In Chapter 4, gate-level partitioning algorithms have been discussed with the introduction of a physical-aware un-balanced area-ratio partitioning methodology. However, coarse-grain ‘Architecture-level’ partitioning is still needed for TSV and Cu-Cu technologies.

Similar to gate-level partitioning, architecture-level partitioning needs to be efficient in order to increase the power-performance 3D gains. Appendix A presents simulation framework and results for a case study of architecture-level partitioning for a 3D neural cliques network. The different partitioning configurations of a 3D neural clique network are evaluated to show the effect in terms of interconnects power and timing performances.

The simulation results show that different partitioning lead to different power and performance 3D gains compared to 2D. Total wire length gain in 3D compared to 2D varies from 25% up to 45% depending on the partitioning configuration. Similarly for RC delay gain which varies from 45% up to 72% compared to 2D depending as well on

the partitioning configuration. These results show the importance of partitioning in architecture-level grain.

7.2.2 Congestion Analysis for Decreasing Number of Metal Layers

Generally, one of the main advantages of 3D technologies is footprint area reduction. By decreasing area, the space allowed for metal routing decreases which can create routing congestion. Moreover, Monolithic 3D technology affords limited number of metal layers on the bottom tier, while the full metal stack is kept for the top tier. Thus studying congestion analysis is crucial for Monolithic 3D technology using different number of metal layers to know the minimum number of bottom metal layers after which the congestion increases and becomes impossible to implement the design.

7.2.3 3D Thermal Analysis and PDN design

Thermal analysis has been always one of the main questions raised for 3D technologies. As stacking more tiers, the power density increases and the thermal dissipation starts to be more difficult. Power Distribution Network (PDN) design is as well important aspect for 3D IC, especially by using high-density 3D technologies. PDN is needed to provide voltage supply to the different stacked tiers, however the 3D contacts (TSV, CuCu contacts or M3DVIA) has an IR voltage drop due to its parasitics. An IR drop analysis is needed to design the 3D PDN with the awareness of the thermal impact.

PDN design with thermal analysis for Monolithic 3D has been studied and presented in [56, 57]. The work in [56] shows the capability of using the metal lines of the PDN as a cooling factor and reduce the thermal effect, while [57] presents PDN design guidelines for M3D taking into consideration total wire length, number of M3D-Vias, routing congestion, IR drop and thermal effect of PDN. Thermal compact models have been introduced in [58, 59], where [58] introduces a thermal model for face-to-back and face-to-face 3D while [59] focuses on Monolithic 3D technology with introducing thermal 3D floorplanning for M3D.

However more studies are needed to illustrate the effect of non-conventional Intermediate BEOL (Tungsten metal line with SiO₂ dielectric) on the PDN design including IR drop analysis and thermal impact.

7.2.4 Further Aspects

The 3D design space is huge and there are even more aspects to be explored. Below we mention briefly some of these points:

- Cost and yield analysis for designing using high-density 3D technology.
- Including thermal analysis into the design framework, to create a thermal-aware partitioning methodology for M3D technology.
- Exploring the design methodologies by applying 3D Design for Testability (DFT) and 3D Design for Manufacturability (DFM).
- Exploring the design and implementation of memories using M3D technology.
- Studying the effect of low-thermal budget ($500^{\circ}C$) on the top active layer for M3D technology.
- Studying other advanced 3D technologies, such as 3D carbon nano-tubes.

Appendix A

Architecture-Level Partitioning: Case Study “3D Neural Cliques”

High density 3D technologies afford the capabilities of fine-grain integration; cell-on-cell and transistor-on-transistor which requires a fine-grain ‘gate-level’ partitioning techniques. In Chapter 4, gate-level partitioning algorithms have been discussed with the introduction of a physical-aware un-balanced area-ratio partitioning methodology. However, coarse-grain ‘Architecture-level’ partitioning is still needed for TSV and CuCu technologies. Similar to gate-level partitioning, architecture-level partitioning needs to be efficient in order to increase the power-performance 3D gains. In this appendix, we present simulation and results of a case study for 3D neural cliques network where different partitioning configurations are evaluated to show the effect in terms of interconnects power and timing performances.

A.1 Introduction: Neural Cliques Network Architecture

The brain’s capabilities of learning, processing a large amount of information, and taking decision have always interested scientists from various domains. More specifically, engineers are interested in brain because of its: a) distributed structure enabling massive parallelism [60], b) capability to deal with unreliability and uncertainty [60], c) energy efficiency [61] and d) the ease of solving associative tasks so difficult to solve with traditional algorithmic approaches [62]. However, the aforementioned characteristics come

with a huge number of neurons (elementary processing units) and synapses (connections allowing communication between the neurons). In fact, the capabilities of brain are the sum of simple, but numerous, operators.

Due to the number of elements that are interconnected, neural networks are wire-dominated systems, *i.e.* this entails challenges in hardware implementation - wiring problems, high latency, energy consumption and large memory requirements among others. One way to overcome these issues is to use a shared, multiplexed communication medium as bus or Network on Chip (NoC). Nevertheless, this approach comes with performance reduction and strongly limits the application field. To obtain high-performance neural networks, physical connections are needed for all the synapses. That is why first neural networks in 3D technology are arising. In [63] a 3D Spiking Neural Network (SNN) based accelerator is proposed. The authors report 52% energy savings and 64% bandwidth improvement. The authors of [64] study a two-layer neural network for objects recognition in a video stream and demonstrate that the total connections' length is reduced three times.

Recently Gripon and Berrou proposed a new family of neural networks [65]. It relies on a neural clique which is an assembly of neurons representing an information stored in the neural network. The elementary part of the information is called message and is associated with the clique. The network is able to store a large number of cliques-messages and can be used either to check if a given information is known by the network (an exemplary application is an intrusion detection system) or an associative memory. The principle of the associative memory is that the retrieval of the message from the memory is accomplished presenting a part (possibly small and even partly incorrect) of it to the memory. Then, the memory outputs the remaining part of the message. Associative memories are used for example in processing units' caches [66] or routers [67]. This type of neural networks showed a huge gain in performance compared to state-of-the-art neural networks [65].

The clique that represents a piece of information stored in the network is strongly redundant, *i.e.* it contains more information than the necessary minimum. That is why it allows the retrieval based on partial and/or noisy information. Consequently, the hardware implementation is wire-dominated. The long wires impact the energy consumption

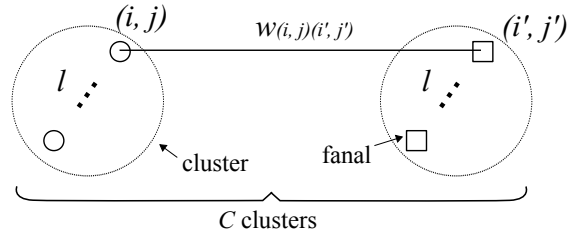

FIGURE A.1: The network general structure and notation. Different shapes (circles, squares) represent fanals belonging to different clusters.

and time response since all the neurons in the clique have to exchange some signals between them. For that reason, it is interesting to organize the neurons in 3D so that they create 3D cliques with shorter connections, and therefore lower energy consumption and time response.

In order to store messages, a network that consists of binary neurons called *fanals* and binary connections is used. The authors of [65], use the term *fanal* (which means lantern or beacon) instead of neuron for two reasons: a) at a given moment, in normal conditions, only one fanal within a group of them can be active and b) for biological inspirations, fanals do not represent neurons but microcolumns [68]. Figure A.1 represents the general structure of the network and the notation. All of the n fanals are organized in C disjoint groups called *clusters*. Fanals belonging to specific clusters are represented with different shapes. Each cluster groups $\ell = n/C$ fanals. Note that the number of clusters is equal to the number of segments and the number of fanals within each cluster is equal to the number of values possible on each segment. The connections (synapses) are allowed only between fanals belonging to different clusters. Contrary to classical neural networks the connections do not have weights, the connection exists or not. Hence, the weight (or adjacency) matrix of such a network consists of values $\{0, 1\}$ where 1 indicates the connection between two fanals, and 0 the lack of connection. In this paper, the connection w between two fanals is identified by their coordinates (i, y) and (i', y') where the first one is the row number and the second one the column number of the fanal on an xy plane. Figure A.2 shows an example of a network with $C = 4$ and $\ell = 4$.

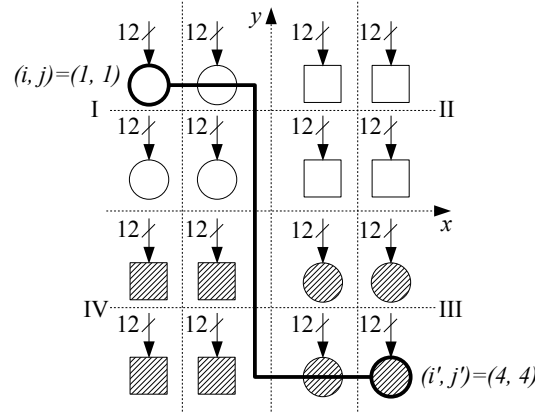

FIGURE A.2: 2D network example. Different shapes (circles, squares) represent fanals belonging to different clusters. Each fanal has 12 synapses to connect to other fanals. The thick line represents the wire necessary to connect two fanals.

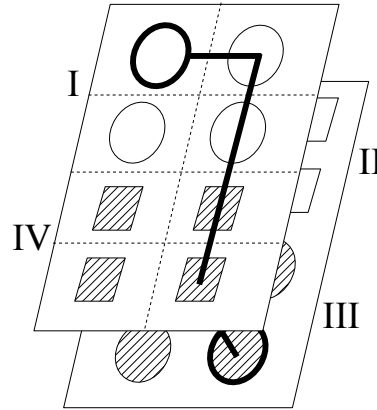

FIGURE A.3: 3D network (folded network from Figure A.2). Different shapes (circles, squares) represent fanals belonging to different clusters. The thick line represents the wire necessary to connect two fanals.

A.2 3D neural cliques network architecture

Since the clique is created by interconnecting the fanals from distinct clusters, the wires span all over the network. Moreover, the performance of the system depends on the longest wire in the clique since all the fanals activated in the retrieval process exchange the signals through their connections. Therefore, in such a wire-dominated structure, it is beneficial to reduce the length of the connections in the clique to reduce the delays and the energy consumption due to the signals exchanged between the fanals. This can be obtained by folding the network. Figure A.2 shows an exemplary network. The network is made of four clusters with four fanals each. Fanals belonging to specific clusters are represented with different shapes. Each fanal has 12 synapses to provide all the possible connections. For the simplicity, the length of the wires is measured with the number of

hops between the fanals in terms of the Manhattan distance. In the presented example the fanal $(i, j) = (1, 1)$ in the cluster I is connected with the fanal $(i', j') = (4, 4)$ in the cluster III. This connection represents the longest possible distance that equals six (the number of dotted lines that have to be crossed). Figure A.3 shows the same network after folding. One can see that the clusters II and III are moved to another layer and put below the clusters I and IV. To realize the connection from Figure A.2, a wire of length four is used. The connection to the layer below is ensured by the TSV. Depending on the size and arrangement of the clusters the folding can be done either in x or y direction.

A.3 Simulation model

Since the clique is created by interconnecting the fanals from distinct clusters, the wires span all over the network. Moreover, the performance of the system depends on the longest wire in the clique since all the fanals activated in the retrieval process exchange the signals through their connections. Therefore, in such a wire-dominated structure, it is beneficial to reduce the length of the connections in the clique to reduce the delays and the energy consumption due to the signals exchanged between the fanals. This can be obtained by folding the network as shown in Figure A.3.

To analyze the gains introduced by using 3D technology the lengths of all the possible connections have to be calculated.

First, the elementary distance between two fanals has to be calculated. This distance depends on the space occupied by the fanal and all its synapses. The area A_{f+s} occupied by one fanal and all its synapses is calculated as:

$$A_{f+s} = A_{fanal} + N_s A_{synapse} \quad (\text{A.1})$$

where A_{fanal} is the area of the fanal, $A_{synapse}$ is the area of the synapse, N_s is the number of the synapses connected to one fanal and is calculated as:

$$N_s = (C - 1)\ell. \quad (\text{A.2})$$

In accordance with the aforementioned model each fanal can be connected to any fanal in a different cluster.

Second, the Manhattan distance $d_{(i,j)(i',j')}$ between two fanals with coordinates (i, j) and (i', j') is (cf. Figure A.2):

$$d_{(i,j)(i',j')} = |i - i'| \sqrt{A_{f+s}} + |j - j'| \sqrt{A_{f+s}}. \quad (\text{A.3})$$

Knowing the distance, the unitary resistance and capacitance for the targeted technology, one can obtain the RC delay τ as:

$$\tau_{2D} = r_{per \ \mu m} c_{per \ \mu m} d_{(i,j)(i',j')}^2 \quad (\text{A.4})$$

where $r_{per \ \mu m}$ and $c_{per \ \mu m}$ are the resistance and capacitance per unit length. In case of a 3D circuit, the resistance and capacitance of the TSV are added to the RC delay:

$$\tau_{3D} = \tau_{2D} + r_{TSV} c_{TSV}. \quad (\text{A.5})$$

A.4 Simulation results using different partitioning

To evaluate the proposed 3D architecture, the gains obtained by using the 3D technology are explored for different configurations of the network. This includes scaling the number of clusters C and the cluster's size ℓ . Later, after the general study, an applicative test-case is presented and the gains resulting from the 3D technology are analyzed as well. The results are based on physical implementation using 65nm technology and 3D technology with TSV of resistance and capacitance equal to $2\text{m}\Omega$ and 5fF , respectively. These values have been included in the 3D results to count the TSV vertical effects.

A.4.1 General study

In the beginning, the size of the cluster ℓ is fixed to four (each cluster is square - two by two fanals) and the number of clusters C is scaled. Figure A.4 shows the gain of the 3D technology in terms of total wire length compared to the conventional 2D circuit. The gains reach 45% when the network is strongly non-rectangular. For a given network size

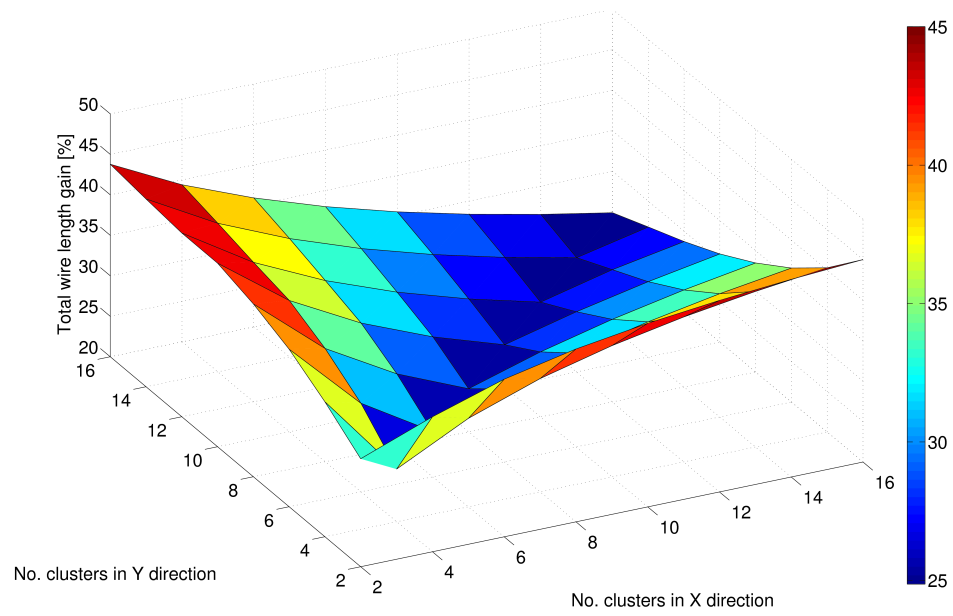

FIGURE A.4: Total wire length gain compared to 2D in function of the number of clusters in each direction. Square cluster of size two by two is used. The numbers of clusters are given for 2D. For 3D the network is split in two equal parts in such a way to cut its longest dimension.

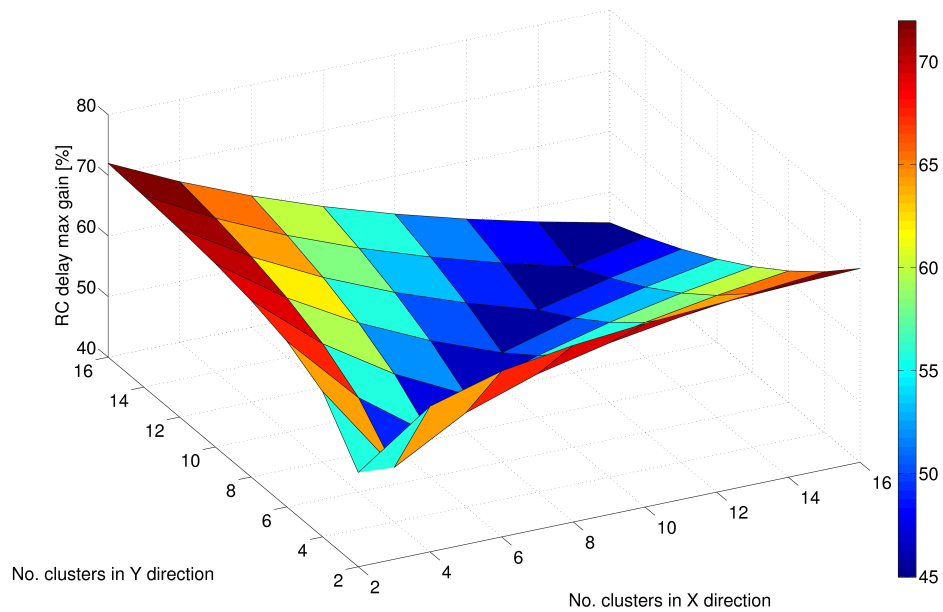

FIGURE A.5: Maximal RC delay gain compared to 2D in function of the number of clusters in each direction. Square cluster of size two by two is used. The numbers of clusters are given for 2D. For 3D the network is split in two equal parts in such a way to cut its longest dimension.

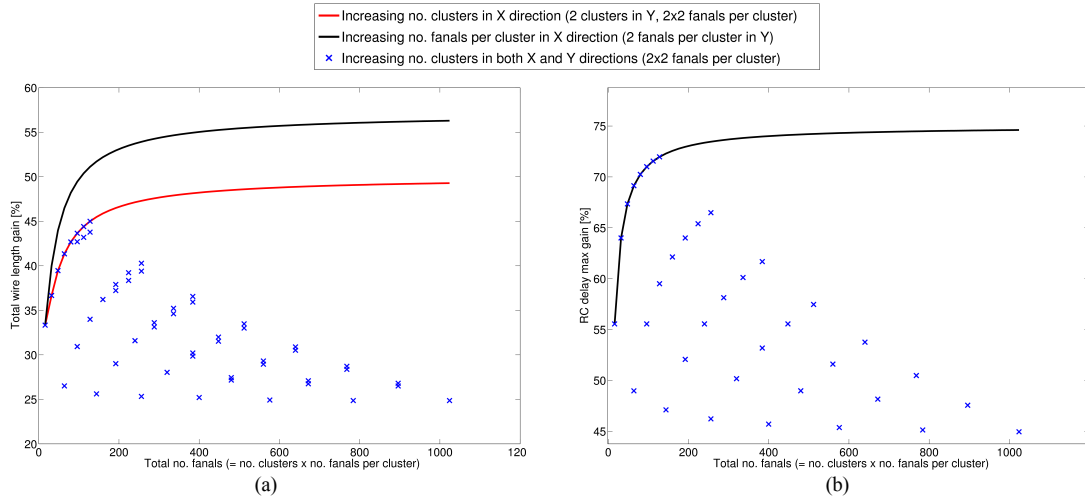

FIGURE A.6: (a) Total wire length gain (b) maximal RC delay gain in function of the total number of fanals n for different network dimensions.

it is therefore better to organize the clusters in a rectangle. For instance, for $C=16$, the gain is 41% when the network is organized in eight by two clusters compared to 27% for four by four clusters. The square networks are clearly distinguished on the surface by their lower gains. Note that it is possible to use few rectangular networks to organize them in a square. Similar trends can be observed in Figure A.5 that shows the gains in terms of maximal RC delay τ . In this case the maximal gains reach 72%. It is important to note that the time response of the neural cliques is determined by the longest path in the clique.

As shown in Figure A.4 and Figure A.5, one can notice that by increasing the number of clusters equally in both x- and y- directions, the 3D gain is higher for smaller numbers of clusters (2x2) than bigger ones (16x16). The reason is that 3D cut partitioning is done in only one direction and, consequently, the 3D gain is achieved in one direction. Therefore, in case of increasing number of clusters equally in both directions, the effect of long interconnects will not be reduced in one of the two directions which will reduce the overall 3D gain.

Figure A.6 (a) shows the total wire length gain. The cluster size is kept the same as in Figure A.4 and Figure A.5. The red curve shows the evolution of the total wire length gain when the number of clusters in one direction is fixed to two and the network is scaled in another direction. The gain increases quickly for smaller numbers of fanals, then it saturates. It reaches 90% of the maximal value for $n=112$ fanals which corresponds to $C=28$ clusters. Blue crosses show the gains when the number of clusters is

scaled in both directions, resulting in a network that is less rectangular. The obtained gains are never bigger than when scaling in only one direction. Therefore, it is more beneficial to scale the network in one direction. The black curve presents the gain when C is fixed to four (two by two clusters) and the number of fanals in the cluster ℓ is scaled.

Now the gains are higher than in the former case for the same total number of fanals. Again, the same trend is observed. After the fast increase in the gain for smaller numbers of fanals, there comes a saturation. 90% of the maximal gain is reached for $n=128$ fanals which corresponds to $\ell=32$. Comparing these two curves leads to the conclusion that for a given total number of fanals n from the 3D point of view it is more beneficial to have bigger clusters. This is consistent with [65] where authors state that from the storage capacity point of view for a given total number of fanals n it is better to have bigger clusters since the density of the connections established in the network grows slower.

Figure A.6 (b) shows the similar analysis for the gains in terms of maximal RC delay τ_{max} . The gains, reaching 74%, are bigger than for total wire length. There is no difference between the maximal RC delay when increasing the number of clusters C or the number of fanals per cluster ℓ because in both cases the length of the longest connection is the same. Similarly, it is beneficial to scale the network only in one direction.

To give more insight in the gains represented by the blue crosses (when the number of clusters is increased in both x and y directions), Table A.1 shows the gains obtained for total wire length (*cf.* Figure A.6 (a)). The table gives the number of clusters in each direction (x or y) and the corresponding gain compared to 2D. For instance, when $x=2$ and the clusters are added only in y direction, the gain compared to 2D increases from 33 to 45%. If a network of 16 clusters is considered, for two clusters in x direction and eight clusters in y direction, one obtains 41% gain whereas for four clusters in x and y direction one obtains only 27%. This shows once again, that it is more beneficial to organize the clusters in a rectangle rather than in a square. Similar analysis is shown in Table A.2 for the maximum RC delay.

TABLE A.1: Total wire length gain in percentage compared to 2D for a given number of clusters in x and y direction

$y-x$	2	4	6	8	10	12	14	16
2	33	37	40	41	43	44	44	45
4	37	27	31	34	36	38	39	40
6	40	31	26	29	32	34	35	37
8	41	34	29	25	28	30	32	34
10	43	36	32	28	25	27	29	31
12	44	38	34	30	27	25	27	29
14	44	39	35	32	29	27	25	27
16	45	40	37	34	31	29	27	25

TABLE A.2: Maximal RC delay gain in percentage compared to 2D for a given number of clusters in x and y direction

$y-x$	2	4	6	8	10	12	14	16
2	56	64	67	69	70	71	72	72
4	64	49	56	60	62	64	65	67
6	67	56	47	52	56	58	60	62
8	69	60	52	46	50	53	56	58
10	70	62	56	50	46	49	52	54
12	71	64	58	53	49	45	48	51
14	72	65	60	56	52	48	45	48
16	72	67	62	58	54	51	48	45

Additionally, the power of the interconnects is directly proportional to the total wire length d_{total} :

$$P_{interconnects} \propto d_{total}. \quad (\text{A.6})$$

Consequently, in case of reducing the total wire length d_{total} by 55%, as shown in Figure A.6 (a), the power of the interconnects is reduced by the same percentage.

A.4.2 Case Study: Power management for LTE receiver

In this subsection, a real-world test-case is used to obtain the dimensions of the neural cliques and explore the gains of using 3D technology. In the considered application

the time response of neural cliques is of first importance. Therefore, high-performance communication structure is essential.

The considered test-case is a neural cliques-based power management controller for a Multiprocessor-System-on-Chip (MPSoC) firstly proposed in [69]. An MPSoC is built of multiple Processing Elements (PE) that can work in parallel. Each PE or set of PEs form a Voltage/Frequency Island (VFI), *i.e.* they work within the same power domain. The supply voltage V_{dd} and frequency f are set by dedicated switching circuits allowing Dynamic Voltage and Frequency Scaling (DVFS). By decreasing the speed of the PEs with lower performance requirements the energy consumption is reduced. The controller decides on (V_{dd}, f) , or power modes, based on latency constraint, current workload and temperature among others.

Nowadays, DVFS switching circuits allow switching between two different power modes in time of the order of tens of nanoseconds [70, 71, 72]. It has been shown in [73] that providing a controller with time response of the same order of magnitude as DVFS switching circuits, allows for 60% energy savings compared to 38% in case of a controller with time response of some μs . That is why neural cliques with high-performance connections for all the synapses need to be used so that the power management controller does not limit the power management reactivity.

Here, MAGALI MPSoC platform is considered [74]. The application mapped on the platform is the LTE receiver [75]. Six PEs are used in the test-case, each PE can choose from 256 frequencies. The speed of each processor is determined by a global latency constraint and an operating mode offering different data rates. The global latency constraint has 51 possible values, there are 5 different operating modes. Based on the optimization problem defined in [73], the frequencies corresponding to each of the possible latency and operating mode combination are obtained. Then, neural cliques are used to store messages containing all the latency and operating mode combinations and the associated six frequencies. During the system operation, latency and operating mode are input to the network and the corresponding frequencies are retrieved. These frequencies are applied to PEs by the DVFS actuators (the DVFS actuator is able to adjust the necessary V_{dd} upon the given frequency). Additionally, in each message a global estimation of the energy consumed by all the PEs is included. Thanks to that, when the energy consumption is the main constraint (*e.g.* low battery level), the

TABLE A.3: The gains obtained for 3D neural cliques used as power management controller. The results are normalized to 2D circuit

	2D	3D		Gain	
		Case 1	Case 2	Case 1	Case 2
Total wire length	1	0.65	0.83	35%	17%
RC delay max	1	0.43	0.69	57%	31%

maximum affordable energy is used as the input to the network and the frequencies and the corresponding latency are retrieved. This kind of flexible controller is of high interest in low-power systems.

The aforementioned parameters of the application allow to obtain the dimensions of the network of neural cliques. The network is made of six clusters of 256 fanals to store all the possible frequency values, one cluster of 255 fanals to store all the possible latency and operating mode values (51 latencies times 5 operating modes), and one cluster of 255 fanals to store all the corresponding energies. For 2D, the network is organized in four clusters in X direction, two clusters in Y direction. In each cluster 16 fanals are placed in each direction. For 3D, there are two possible cases: 1) network is cut in X direction (two clusters in each direction on each die), 2) network is cut in Y direction (four clusters in X direction and one cluster in Y direction on each die).

The gains in terms of total wire length and RC maximum delay compared to the conventional 2D circuit are summarized in Table A.3. Case 1 gives better results. In this application, using 3D technology allows for 35% total wire length reduction and, consequently, the same reduction in terms of the power of the interconnects. Furthermore, the maximum RC delay is reduced by 57%.

A.5 Conclusion: 3D Neural Network

In this work the gains of using 3D technology for a high-performance implementation of networks of neural cliques are explored. Since the neural clique is strongly redundant, *i.e.* it contains more information than the necessary minimum, its hardware implementation is wire-dominated. The results show that using 3D technology allows important gains in terms of total interconnect length, power and delay. It is also shown that dimensioning the network in a way to obtain the highest storage capacity is consistent

with dimensioning the network in a way to obtain the maximal gains coming from 3D technology. This means that optimizing the gains coming from the theoretical model and hardware 3D implementation is not contradictory.

Appendix B

Résumé en Français

L'objectif de cette thèse est de proposer une méthodologie et des outils permettant d'évaluer l'impact des technologies 3D sur les préformantes des architectures numériques.

B.1 Introduction et Contexte

La miniaturisation et le coût de fabrication des technologies CMOS avancées évoluent selon la prédiction de la loi de Moore [1], ce qui nécessite de trouver des solutions technologiques pour remédier à ces limitations. En effet, la loi de Moore prédit de doubler le nombre de transistors, par circuit intégré tous les 1.5-2 ans [2]. Cependant, la miniaturisation et le fait d'intégrer plusieurs transistors sur un même circuit posent des problèmes pour les technologies en 14nm et au delà. De nouveaux concepts sont nécessaires pour surmonter ces limites. ITRS a discuté de la feuille de route de la miniaturisation [3]. Figure B.1 montre les différentes directions de miniaturisation pour améliorer les performances du système. Le concept de "More-Moore" a été soulevé pour montrer la miniaturisation continue des fonctions numériques tandis que le concept "More-than-Moore" a été soulevée pour montrer la diversification fonctionnelle pour les technologies déjà existantes afin d'améliorer les performances globales des puces.

L'impact le plus important de la miniaturisation de la technologie est l'effet Back-End-Of-Line (BEOL). En réduisant la taille des nœuds CMOS, l'écart entre le délai

de l'interconnexion et du transistor augmente [4]. Figure B.2 illustre cet effet pour les différents nœuds CMOS.

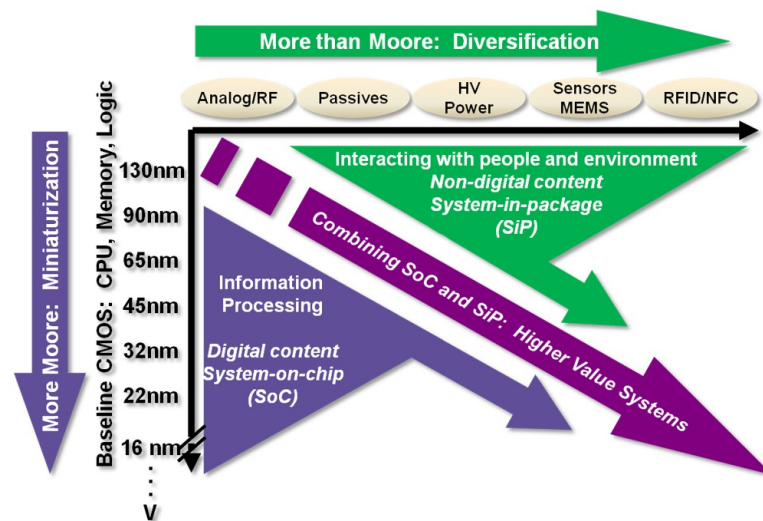

FIGURE B.1: Les différentes directions de miniaturisation pour améliorer les performances du système [3]

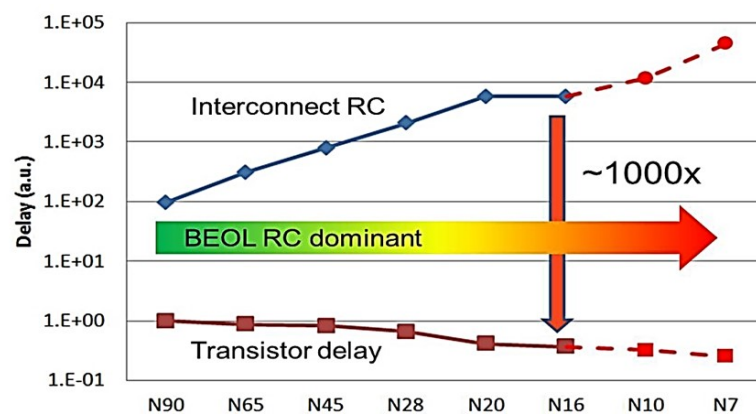

FIGURE B.2: L'effet pour les différents nœuds CMOS [4].

Cela a motivé l'intérêt des technologies d'empilement 3D afin de réduire l'effet des interconnexions sur les performances des circuits. Les technologies d'empilement 3D varient suivant différents procédés de fabrication d'où l'on mettra en avant la technologie Through Silicon Via (TSV) - Collage Cuivre-Cuivre (Cu-Cu) et 3D Monolithique.

TSV et Cu-Cu présentent des diamètres d'interconnexions 3D de l'ordre de $10\mu\text{m}$, mais le diamètre d'une interconnexion de Monolithique 3D est $0.1\mu\text{m}$, c'est-à-dire cent fois plus petit. Un tel diamètre d'interconnexion crée de nouveaux challenges en matière de conception de circuits intégrés numérique.

Dans ce contexte, notre objectif est de proposer des méthodologies innovantes de conception de circuits 3D afin d'utiliser au mieux la densité d'intégration possible et d'évaluer efficacement les gains en performance, puissance et surface de ces différentes technologies d'empilement par rapport à la conception de circuit 2D.

B.2 L'état de l'art: Technologie 3D

B.2.1 Le besoin de 3D !

La miniaturisation de la technologie rencontre des difficultés importantes pour continuer à suivre la loi de Moore. Comme indiqué dans l'introduction, l'une des principales limitations est le délai croissant des fils par rapport au délai de transistors [1, 4]. De plus, le nombre des règles de conception du Back End Of Line (BEOL) augmente de façon exponentielle résultant un cout de fabrication plus important. Une solution pour lutter contre la miniaturisation planaire est de miniaturiser verticalement en empilant les circuits intégrés. Les circuits intégrés 3D sont une technologie émergente qui consiste à empiler les couches. Un avantage direct de cette technologie est de diminuer la longueur des fils en connectant les cellules sur trois dimensions, ainsi que:

- (i) diminution de la surface,
- (ii) augmenter les performances du système en raccourcissant les fils et en diminuant par conséquent les délais d'interconnexions,
- (iii) Diminution de la consommation de puissance en diminuant la longueur totale des fils, et
- (iv) réalisation une intégration hétérogène par l'empilement de différentes technologies telles que la mémoire, des circuits numériques, des circuits analogiques, des capteurs ...

La technologie 3D varie avec un large éventail de capacités et d'applications. Une façon de réduire les interconnexions et d'augmenter leur densité est en ajoutant une nouvelle dimension "verticale" pour la routabilité en utilisant les technologies 3D haute densité. Grâce aux technologies 3D à haute densité, une très petite taille d'interconnexions 3D est réalisable, ce qui fournit les capacités d'augmentation de la densité d'interconnexion.

B.2.2 Spectre de la technologie 3D

B.2.2.1 Schémas d'intégration

i. 2.5D/3D Interposer

L'interposer est une étape intermédiaire entre un circuit 2D et un circuit purement 3D. Cette technologie est obtenue en ajoutant les différentes couches "dies" sur une couche de silicium appelé un interposer [10, 11, 12]. Un interposer peut-être soit (i) passif (ii) soit actif.

L'Interposer passif contient seulement des fils qui relient les différentes couches "dies" sans régions actives, c'est à dire sans transistor. Alors que dans l'interposer actif, la couche de l'interposer a des composants actifs tels que des mémoires tampons ou des blocs de communication (par exemple, réseau sur puce "NoC"). La figure B.3 montre un schéma-bloc d'un interposer actif. La motivation de la technologie interposer est de réduire la surface du silicium en divisant la puce en deux puces intégrées sur un interposer qui peut augmenter le rendement, réduire les coûts et permettre l'intégration hétérogène en ayant différents technologies CMOS pour chaque puce.

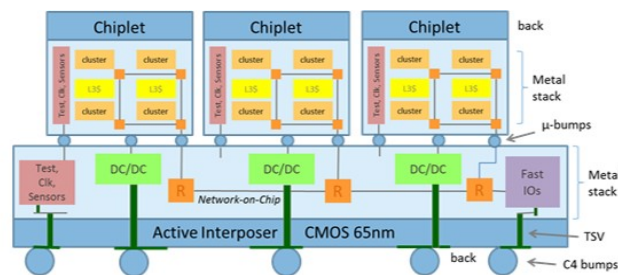

FIGURE B.3: Schématique de l'interposition active

ii. Circuit 3D: face-à-dos et face-à-face

L'intégration 3D peut être soit en face-à-face (face-to-face F2F), soit en face-à-dos (face-to-back F2B). Dans ce contexte, nous considérons que chaque puce a une face et un dos, où la face est le niveau haut de la couche métal et le dos de la puce est le substrat de silicium. Par conséquent, les puces peuvent être empilés dans une configuration de face-à-face de telle sorte que les couches métalliques supérieures soient en face l'une à l'autre.

Chaque schéma d'intégration nécessite une technologie 3D différente pour relier la couche "die" supérieure à la couche "die" inférieure. Les figures B.4(a) et (b) montrent les schéma de configurations F2B et F2F respectivement.

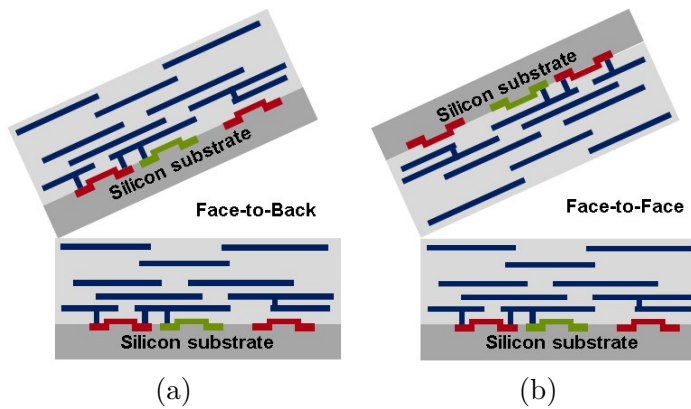

FIGURE B.4: (a) la configuration de 3D Face-à-dos, (b) la configuration de 3D face-à-face.

B.2.2.2 Through-Silicon-VIA technologie 3D (TSV)

Le TSV est une technologie 3D dans laquelle le substrat de silicium est percé pour laisser passer un contact 3D de type métallique. Une application pour TSV est de connecter une puce à une puce supérieure pour une configuration en face-à-dos. Une autre utilisation peut être de relier les couches de métal avec ‘ μ -bumps’ de substrat pour les connexions IO et de puissance.

Le diamètre du TSV est déterminé par la limite de densité des connexions 3D qui peut être atteint. Cependant, les dimensions de TSV sont commandées par le processus d’assemblage utilisé pour empiler les autres puces. Aujourd’hui les TSV présentent un diamètre de 10 à $20\mu\text{m}$. Avec les progrès de processus d’assemblage, le diamètre peut se réduire à $3\mu\text{m}$ [13, 6]. Figure B.5 montre un schéma de configuration face-à-dos utilisant la connexion de TSV et un SEM d’un TSV de $3\mu\text{m}$ diamètre [14].

B.2.2.3 Technologie 3D Cuivre–cuivre

Le contact de type Cuivre–cuivre (CuCu) est une autre technologie d’intégration 3D où les deux puces sont fabriquées séparément (en parallèle), puis assemblées dans la

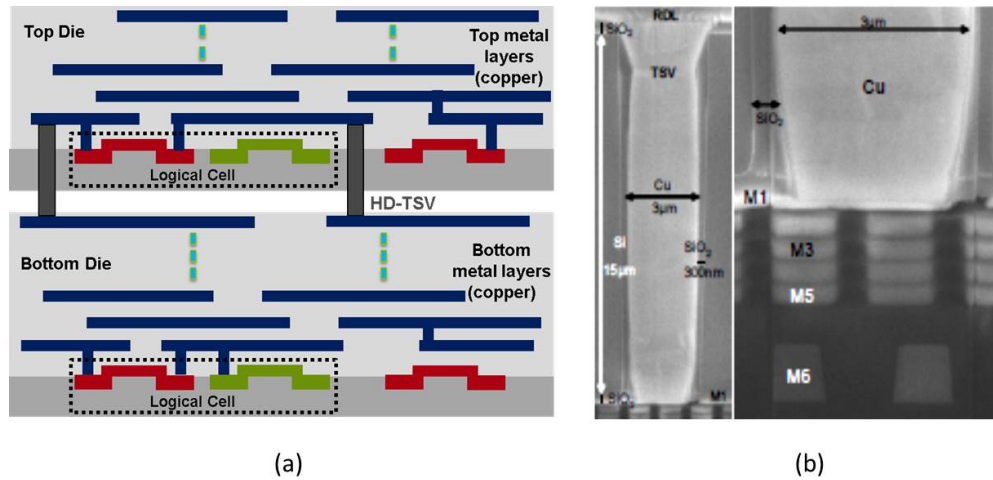

FIGURE B.5: TSV 3D (a) la configuration schématique et (b) l'image avec un diamètre de $3 \mu\text{m}$ [14].

configuration d'empilage face-à-face. Les connexions 3D sont réalisées par collage direct de métal entre la puce du haut et la puce du bas.

L. Le pas entre contacts CuCu 3D est aujourd'hui entre $3.4\text{-}5 \mu\text{m}$ [5, 7]. Figure B.6 (a) montre un schéma pour le face-à-face configuration en utilisant la technologie d'intégration CuCu, et (b) représente une SEM d'un contact avec des dimensions de CuCu $3 \times 3 \mu\text{m}$ [7]. La technologie CuCu surmonte la question de la technologie TSV concernant le surcoût en surface nécessaire par TSV et augmentation de la congestion sur la puce inférieure. Cependant, la configuration de F2F CuCu limite le nombre des puces à empilement seulement deux. Alors que dans le cas d'empiler plus de deux puces, contacts TSV sont nécessaires.

B.2.2.4 Technologie 3D Monolithique

La technologie 3D Monolithique (3DM), aussi connue comme 3DVLSI, est une technologie émergente utilisant l'intégration 3D séquentielle basée sur le processus CoolCubeTM fournissant une densité très élevée d'interconnexions verticales [15]. Dans la technologie 3MD une puce supérieure est fabriquée directement, de façon séquentielle, sur la puce inférieure dans une configuration de face-à-dos. Le processus séquentiel permet une précision d'alignement élevée entre les deux puces.

Dans ce processus, le diamètre et la hauteur de 3DM-Vias ne dépendent que de la

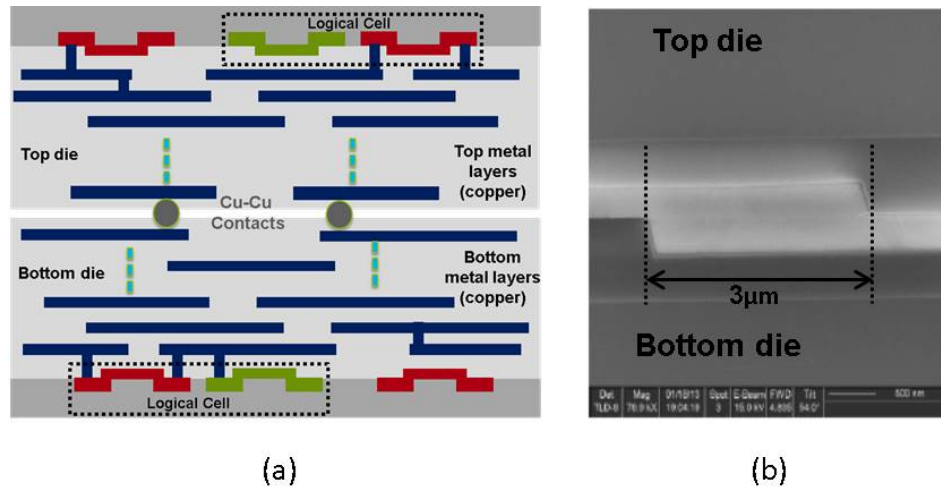

FIGURE B.6: La technologie d'intégration Cu-Cu (a) face-à-face configuration simplifiée, et (b) SEM section photo avec dimension de $3 \times 3 \mu\text{m}$ et la hauteur de $5 \mu\text{m}$ [7].

capacité d'alignement de lithographie du pas qui évolue avec la mise à l'échelle du nœud CMOS [9]. C'est différent par rapport aux technologies TSV et CuCu où l'alignement dépend du processus d'assemblage. Par conséquent, le diamètre du VIA 3D atteint jusqu'à $0.05 \mu\text{m}$.

Le processus CoolCubeTM nécessite la fabrication de haute filière à basse température ($500\text{-}550^\circ\text{C}$) pour préserver la puce de bas de toute dégradation. Figure B.7 (a) montre un schéma pour M3D, tandis que (b) et (c) montrent une photo fabriquée et le cadre du processus pour CoolCubeTM. M3D ouvre le besoin de nouvelles méthodes de conception qui seront discutées en détail cette thèse.

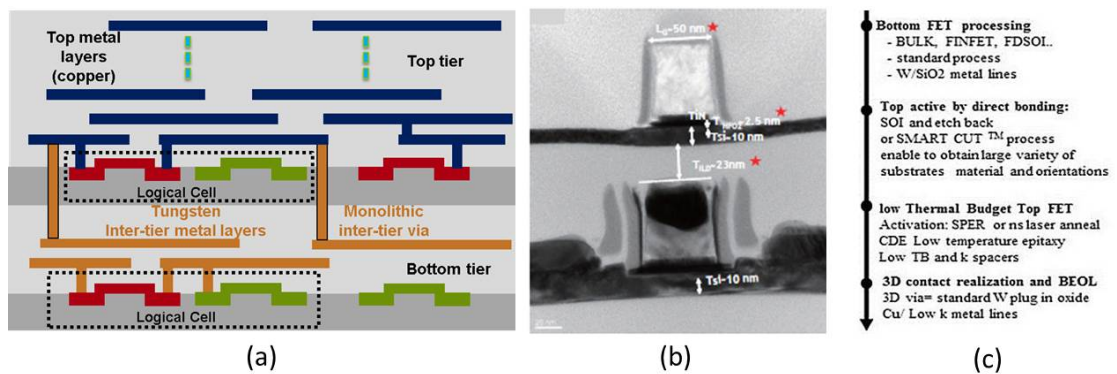

FIGURE B.7: Monolithique 3D technologie [8].

B.2.3 Granularité de Partitionnement 3D

La granularité du partitionnement varie en raison du large spectre des technologies 3D. Plusieurs travaux antérieurs ont étudié des aspects différents de chaque niveau de granularité en utilisant différentes technologies. La figure B.8 liste les derniers travaux publiés en montrant le spectre des différentes technologies 3D.

Étant donné que dans cette thèse nous explorons les capacités de conception des technologies 3D à haute densité, nous allons considérer principalement les niveaux fine-grain gate-level et transistor-level. Le partitionnement au niveau transistor est obtenu en divisant chaque cellule en une couche de NMOS sur une couche de PMOS (N/P). Par conséquent, cette approche offre des possibilités d'optimiser séparément chaque couche selon la perspective du processus de fabrication. Un autre avantage de l'approche N/P est la possibilité d'utiliser les outils 2D classique de placement et routage. Cependant, elle nécessite l'insertion de 3DVIA entre les transistors dans chaque cellule standard ce qui diminue son intérêt en raison des résistances et de capacités parasites associées au 3DVIA. En outre, l'approche N/P demande une nouvelle plateforme de conception complète.

D'autre part, le partitionnement au niveau gate-level est réalisé en attribuant chaque cellule 2D standard soit la séparation de cellules standard est réalisée en plaçant chaque cellule 2D soit à l'étage haut ou à l'étage bas (cellule-sur-cellule). Cependant, l'approche cellule-sur-cellule nécessite une technique de partitionnement innovante pour déterminer sur quel étage placer chaque cellule.

B.2.4 Positionnement de travail et méthodologie de conception

Dans cette thèse, nous avons étudié différentes options pour la conception 3D. D'abord, d'un point de vue technologie 3D, nous avons mis en œuvre les trois technologies à haute densité (CuCu, TSV et M3D), montrant une évaluation complète de la technologie dans des conditions de conception différentes. Ensuite, d'un point de vue granularité de partitionnement, ce travail aborde l'empilement à grain fin au niveau porte. Nous avons proposé ainsi l'approche " Cellule-sur-Amplificateur " de grain plus fin qui se situe entre la granularité des niveaux porte et transistor.

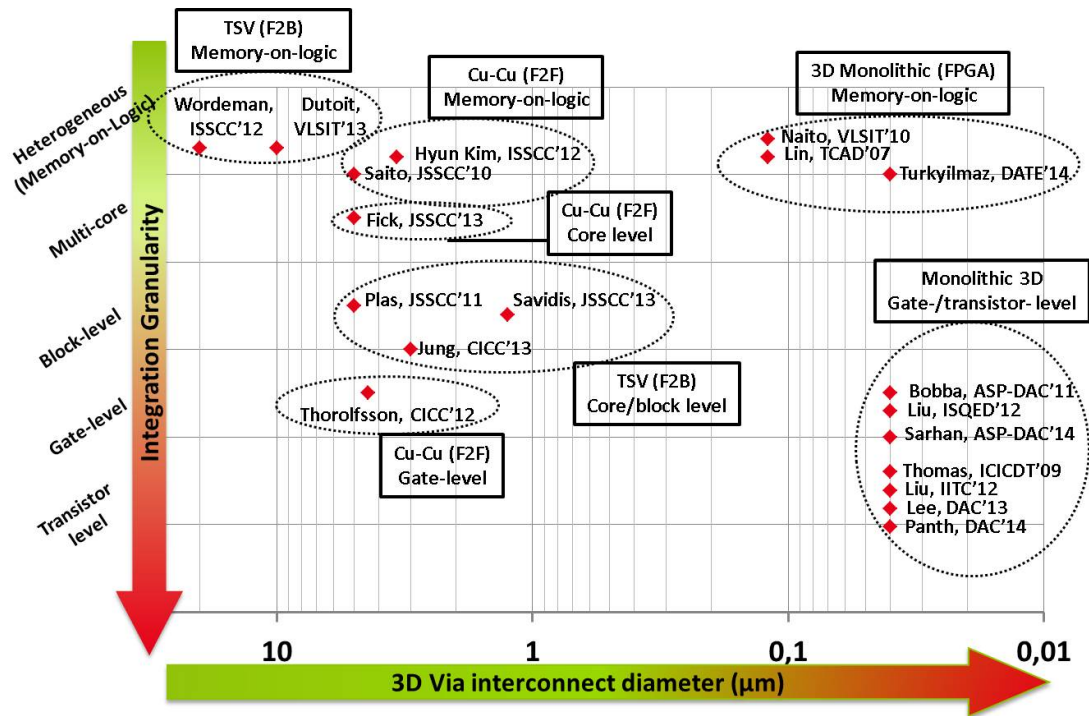

FIGURE B.8: Résumé du précédent état de l'art montrant à la fois la technologie 3D et partitionnement spectre de granularité

Enfin, à partir des outils de CAO 3D, nous avons utilisé deux outils différents ; (i) l'outil Atrenta SpyGlass Physical 3D (SGP-3D) [48] a été utilisé comme un outil de prototypage rapide pour obtenir l'évaluation puissance-performance-surface pour différentes architecture 3D. Le principal avantage de SGP-3D est la capacité de placement physique de cellules 3D, le routage global 3D et l'analyse temps/puissance. (ii) l'outil Cadence Encounter 2D pour l'approche "Cellule-sur-Amplificateur". Dans ce cas, nous avons modifié la librairie de de la technologie afin d'inclure l'effet 3D en utilisant le flux conventionnel sign-off 2D.

La figure B.9 montre le framework de conception 2D/3D en commençant par le RTL, en passant par la synthèse logique en utilisant le compilateur Cadence RTL et enfin l'implémentation physique 2D/3D en utilisant l'outil de prototypage SGP pour obtenir une évaluation complète puissance-performances-surface.

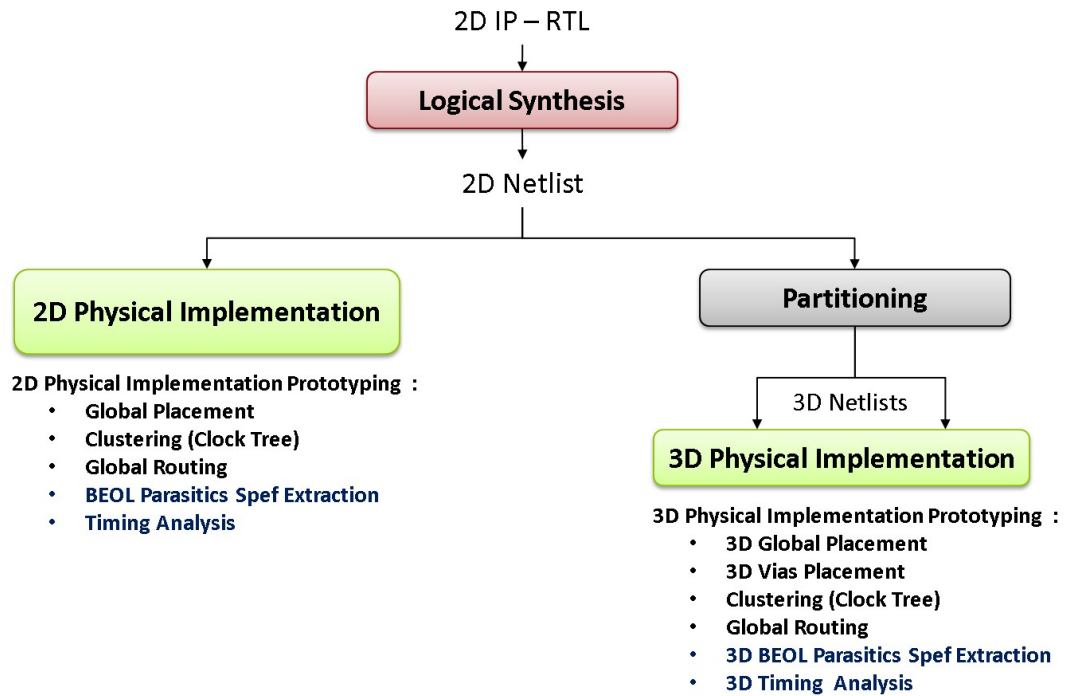

FIGURE B.9: Cadre de l'implémentation de 2D/3D IC.

B.3 Méthodologie de conception: 3DCoB

B.3.1 Introduction

La première approche est “Cellule 3D sur Amplificateur” (Cell-on-Buffer ; CoB). L’approche 3DCoB sépare la logique de fonctionnement d’une cellule standard de l’étage d’amplification. La logique est implémentée par sa cellule minimum-drive équivalente, tandis que l’étage d’amplification est implémenté par un amplificateur de même excitation que la cellule d’origine. La cellule min-drive et l’amplificateur sont ensuite empilés verticalement.

B.3.2 Configuration des cellules 3DCoB

En utilisant cette approche, l’étage logique fournit la même fonction que la cellule d’origine, tandis que l’étage d’amplification garantit la même taille que la cellule d’origine. L’approche 3DCoB peut être considérée comme un sous-ensemble de l’approche Cellule-sur-Cellule car elle utilise les cellules 2D et n’a pas besoin reconcevoir les cellules standard. L’avantage de la 3DCoB est la compatibilité complète avec les outils de placement-et-routage numérique 2D classique.

La cellule 3DCoB possède deux vias M3D. Le premier via connecte la sortie de la porte minimum-drive à l'entrée de l'amplificateur. Le deuxième via connecte la sortie de l'amplificateur à la sortie de la cellule 3DCoB pour quel soit sur le même étage que les entrées de la cellule (c'est à dire l'étage haut). Comme les pins de la cellule 3DCoB se trouvent sur le même étage, cette cellule peut être utilisée par les outils de placement et routage 2D classique. La figure B.10 montre la configuration de la cellule 3DCoB.

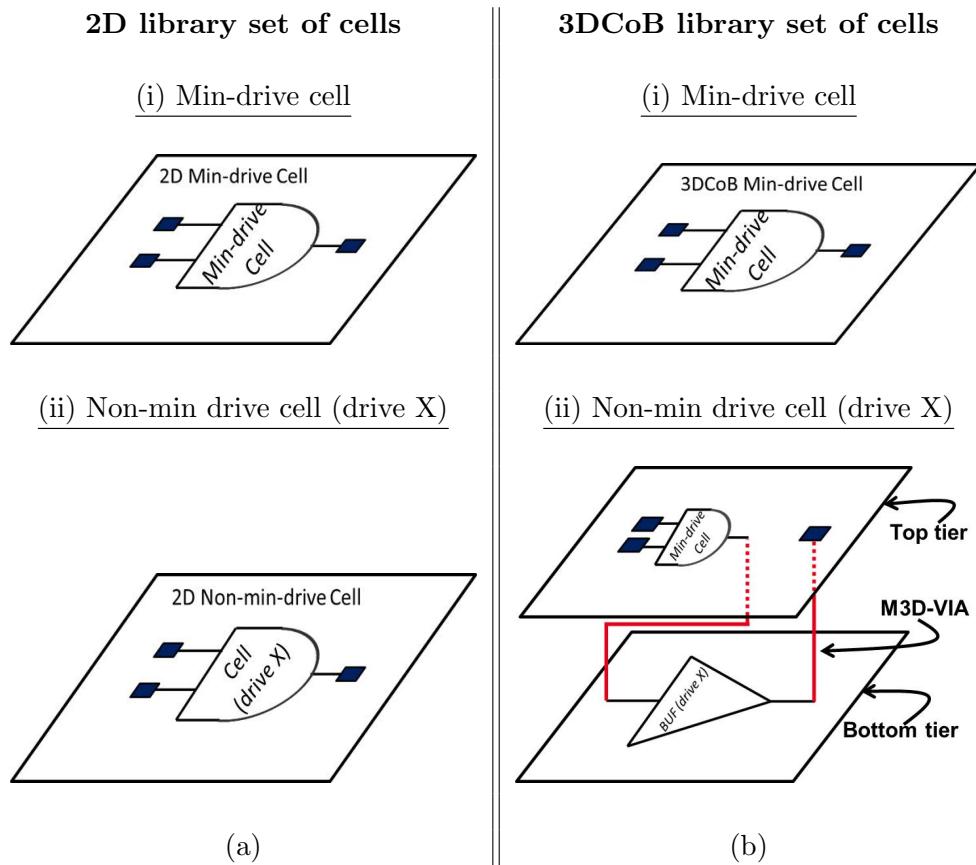

FIGURE B.10: 3D Cellule-sur-Amplificateur cellules. (a) ensemble classique 2D cellules, (b) l'équivalent ensemble 3DCoB cellules.

B.3.3 Cadre de conception 3DCoB

Pour évaluer avec précision le potentiel de l'approche 3DCoB utilisant la technologie M3D, un flux de placement et routage 3D a été développé. Un avantage principal de l'approche 3DCoB est la compatibilité avec les outils de placement et de routage classiques. La figure B.11 montre l'ensemble du flot. On commence par utiliser les cellules 2D standard pour générer des cellules 3DCoB. Les fichiers d'entrée requis par le flot sont le fichier LEF qui contient toutes les superficies, les dimensions et la couche

d'informations pour les cellules standard et le fichier LIB qui contient les informations de timing, de puissance et de capacité pour les cellules standard.

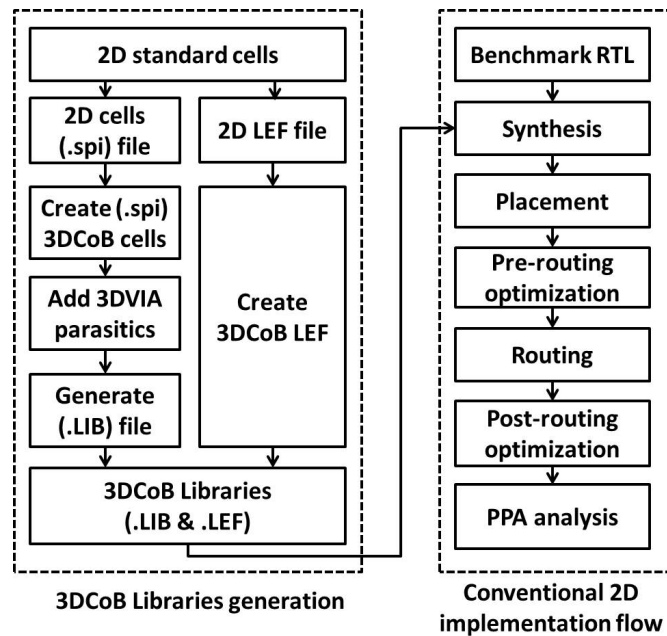

FIGURE B.11: Cadre complet de l'implémentation de l'approche 3DCoB

B.3.4 Résultats de la simulation

Pour évaluer l'approche proposée, des blocs de référence sont implémentés en 2D et 3DCoB en utilisant la technologie 28nm FDSOI et la technologie d'intégration monolithique 3D. Nous avons sélectionné un ensemble de blocs à complexité croissante : OpenMSP, Transformée de Fourier rapide et un décodeur de cryptage AES à 128 bits. Le tableau B.1 montrent les résultats de l'implémentation physique pour différentes fréquences d'horloge. Les performances sont mesurées par la fréquence d'horloge effective. Les résultats de puissance sont obtenus à partir du rapport de placement et routage et sont échelonnés à la fréquence max pour avoir une comparaison juste.

La figure B.12 montre le compromis puissance-performance pour les blocs openMSP, FFT et AES blocs avec les surfaces 0.008 mm², 0.027 mm² et 0.119 mm² respectivement. L'approche 3DCoB améliore la fréquence à maximum de performance de 9.7% et 35%, par rapport à l'approche 2D, pour les blocs FFT et AES respectivement.

TABLE B.1: Résultats puissance-performance pour les approches 2D et 3DCoB pour les blocs openMSP, FFT et AES

	Target Freq (GHz)	No. Std Cells	Cell Density	Total Wire Length (μm)	Power @2D max perf (mW)			Setup Slack reg2reg (ns)	Max Perf. (GHz)	Perf. Gain (%)
					Leakage	Dynamic	Total			
openMSP Area= 8163 μm^2	2D	7328	93.5%	82434	0.14	15.16	15.3	-0.032	1.20	-NA-
	3DCoB	7784	93.2%	86115	0.14	15.36	15.5	-0.041	1.19	-0.8%
FFT Area= 27498 μm^2	2D	25325	95.1%	274960	0.45	84.05	84.5	-0.089	1.45	-NA-
	3DCoB	27783	93.4%	284766	0.44	81.76	82.2	-0.028	1.59	+9.65%
AES Area= 119266 μm^2	2D	164174	89.0%	1542019	1.57	198.23	199.8	-0.100	2.00	-NA-
	3DCoB	166749	90.0%	1674193	1.76	209.07	210.8	-0.015	2.41	+20.5%
	3DCoB	159026	92.0%	1801557	2.29	219.63	221.9	-0.071	2.70	+34.7%

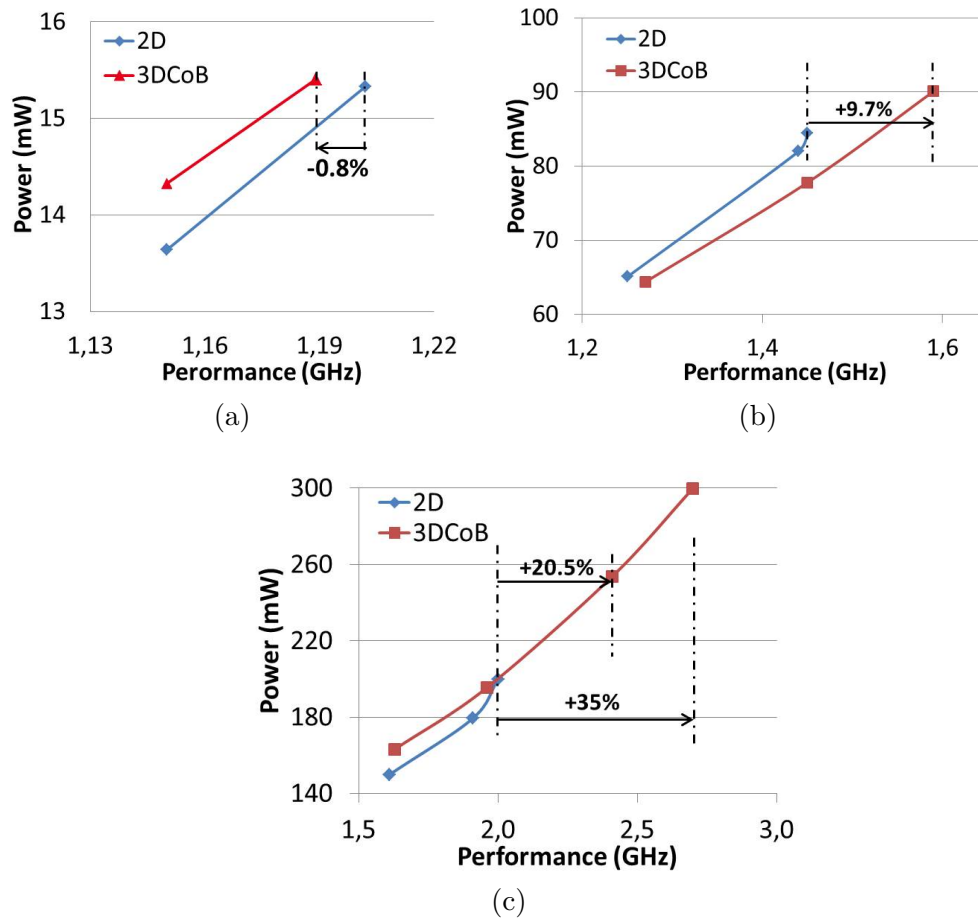

FIGURE B.12: Résultats Power-performance pour 2D et 3DCoB implémentations pour: (a) openMSP, (b) FFT et (c) AES blocs

B.3.5 3D CoB Multi-VDD

Nous avons imaginé par la suite de séparer les niveaux d'alimentation de chaque tranche afin de créer une technique de Multi-VDD adaptée à l'empilement 3D pour réduire encore plus la consommation des circuits 3D. Pour mettre en œuvre l'approche multi-VDD 3DCoB (MV-3DCoB), nous utilisons la même méthodologie de conception où la tension d'alimentation de la couche supérieure de fonctionnement (VDD_L) est fixée à 0.9 V, et la tension de la couche inférieure d'amplification (VDD_H) est maintenue à 1V. La figure B.13 montre les résultats de puissance-performance pour les circuits de référence. Nous constatons que l'approche MV-3DCoB fournit une puissance inférieure par rapport aux approches 2D et 3DCoB (26% pour le bloc openMSP, 18% pour le bloc FFT, et 22% pour le bloc AES).

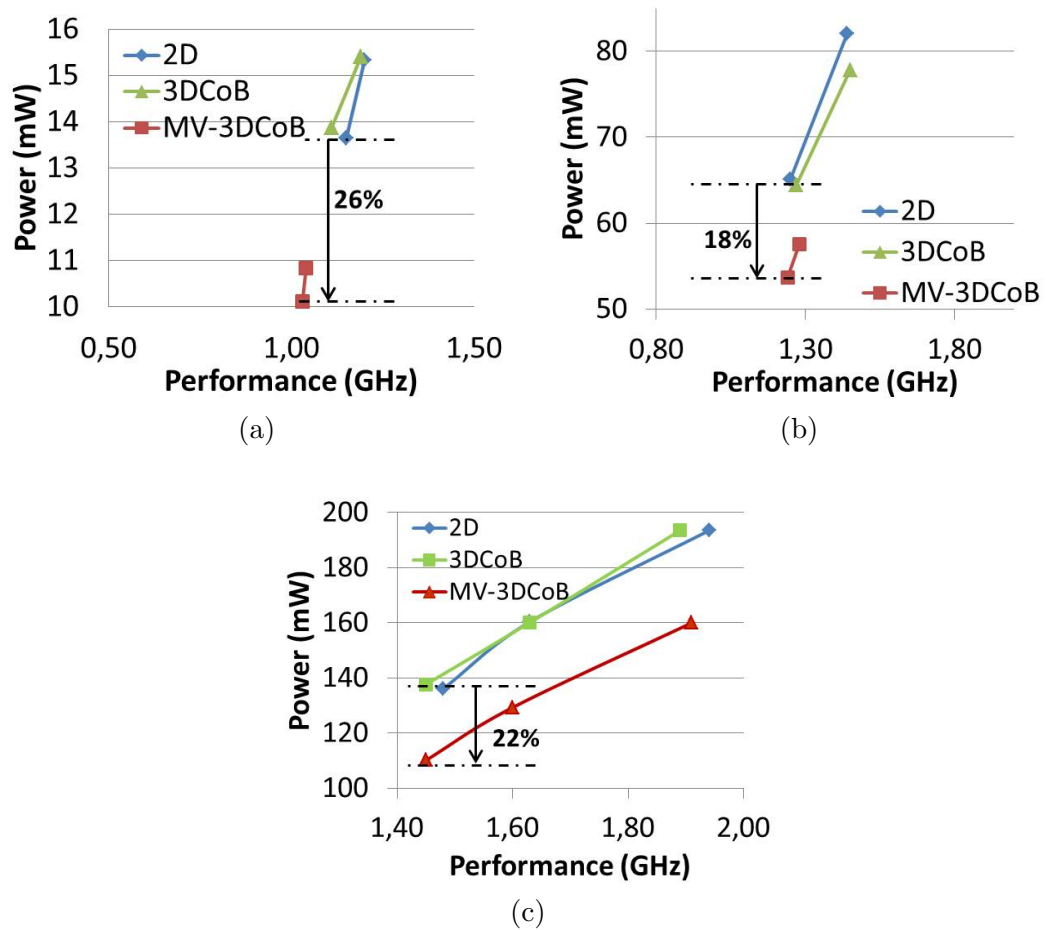

FIGURE B.13: Résultats Power-performance pour 2D, 3DCoB et Multi-VDD 3DCoB implémentations pour: (a) openMSP, (b) FFT et (c) AES blocs.

B.4 Méthodologie de partitionnement

Dans un deuxième temps, le partitionnement à grain fin des cellules a été étudié. En effet, l'intégration à grande échelle, des circuits de plusieurs milliers voir des millions de cellules standards en 3D soulève la question de l'attribution de telle ou telle cellule sur la tranche haute ou basse du circuit 3D afin d'accroître au mieux les performances et consommation du circuit. Une méthodologie de partitionnement physique est proposée pour répondre à cette question.

B.4.1 Les techniques de partitionnement précédentes

Le partitionnement de cellule standard dispose de deux approches différentes dans l'état de l'art :

i. **Technique de coupes minimisées.**

L'objectif de cet algorithme de partitionnement est de minimiser le nombre des contacts 3D à un certain rapport de surface entre les niveaux supérieur et inférieur, typiquement le rapport équilibré de la surface.

ii. **Technique de partitionnement guidée par les performances.**

Dans cette technique, l'algorithme de partitionnement tend à optimiser les performances en gain de 3D indépendamment du nombre de contacts 3D.

Un outil de partitionnement hyper-graphe nommé “ hMetis ” a été présenté dans la référence [25] comme un algorithme de partitionnement en coupes minimisées. La Référence [26] montre un processeur de traitement de signal en 3D (DSP en 3D) avec le partitionnement de cellules standards en utilisant l'outil hMetis. Dans ce cas, hMetis tend à minimiser le nombre de contacts 3D avec un rapport de superficie équilibrée entre le niveau haut et les niveaux d'en bas. La technologie à cuivre a été utilisée dans ce travail avec un pas de $5 \mu\text{m}$ de contact 3D.

Cependant la technologie 3DM propose des contacts 3D de très haute densité avec un pas réduit à $0.11 \mu\text{m}$ pour la technologie 28nm. Cette technologie résout le problème de la limitation du nombre de connexions 3D et ouvre la porte à des nouvelles techniques de partitionnement offrant des meilleurs résultats en termes de performance et consommation.

B.4.2 Partitionnement proposé

La méthodologie de partitionnement proposée se compose de 4 principales étapes qui mènent à partitionner une netlist 2D en deux netlists 3D. La Figure B.14 montre les principales étapes de la méthode proposée.

La netlist 2D de départ est obtenue par une phase de synthèse classique. Dans notre étude, nous avons utilisé la technologie FDSOI CMOS 28nm pour l'étape de synthèse. La netlist 2D est ensuite passée à travers les étapes suivantes : conversion netlist-à-hypergraphe, pondération et partitionnement de l'hypergraphe, et enfin conversion de l'hypergraphe à une nouvelle netlist.

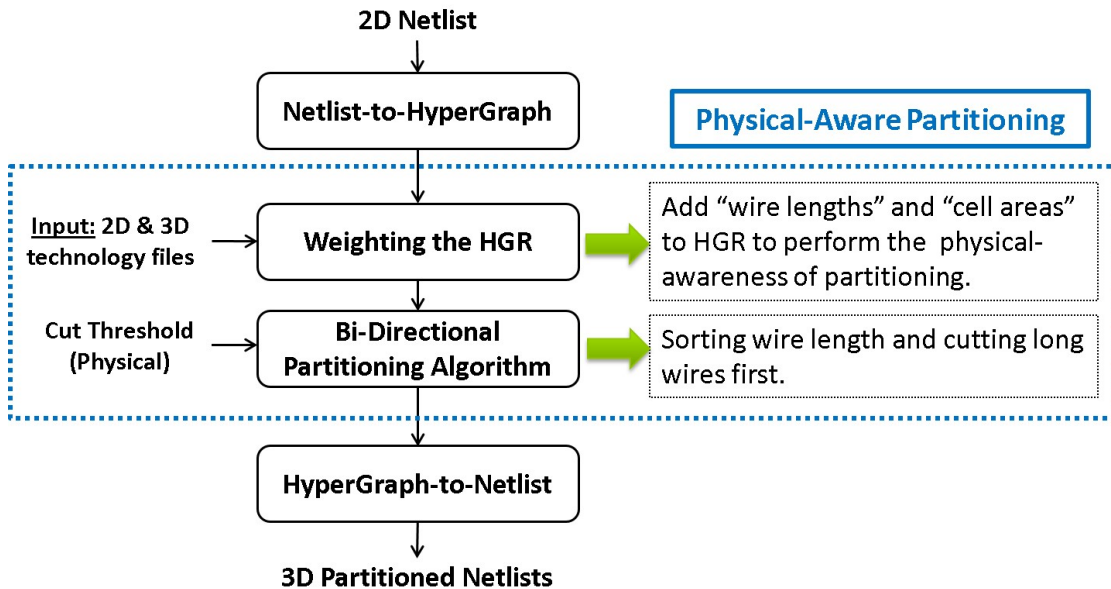

FIGURE B.14: Flot de partitionnement.

L'étape clé de la méthodologie est le partitionnement d'hypergraphe. Un algorithme de partitionnement bidirectionnel a été employé pour couper les longs fils en premier.

Premièrement, les fils sont triés du plus long au plus court. Ensuite, les fils sont coupés un par un dans l'ordre du tri.

L'algorithme s'arrête quand on atteint le seuil de longueur critique d'un fil. Par définition, la longueur critique d'un fil est obtenue lorsque les parasites causés par la résistance et la capacité du fil deviennent inférieures à ceux d'une via M3D.

Figure B.15 montre la technique de partitionnement en coupant les fils longs en premier.

B.4.3 Résultats d'implémentation du partitionnement

Pour évaluer notre approche, nous avons mis en place (i) un cas de course minimisée de fil en utilisant l'outil hMetis [25] et (ii) notre méthodologie de partitionnement.

Nos circuits de référence sont composés de blocs d'une complexité croissante : openMSP microcontrôleur, Fast Fourier Transform (FFT), Floating Point Unit (FPU) et Low

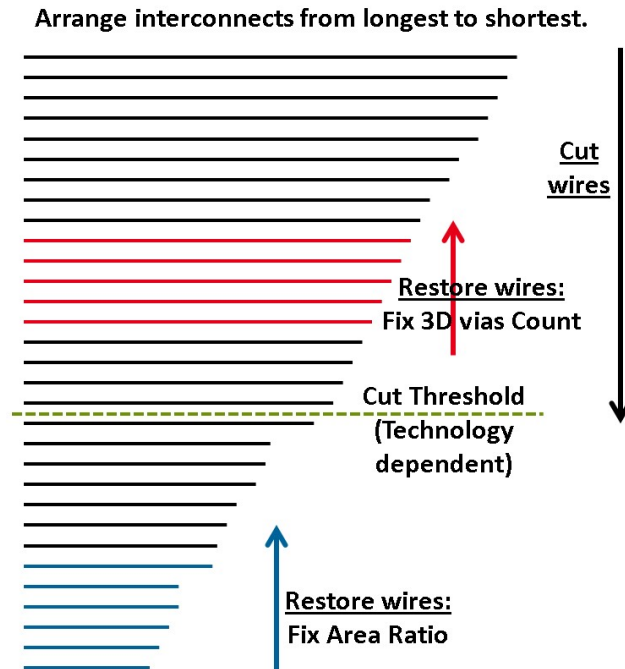

FIGURE B.15: Partitionnement bidirectionnel.

Density Parity Check (LDPC) décodeur. Pour valider nos différents cas de séparation avec la performance et la consommation de puissance, nous avons décidé de prototyper nos blocs en utilisant Atrenta SpyGlass 3D physique (SGP-3D) comme un outil de 3D commerciale.

Figure B.16 montre les résultats de puissance-performance des blocs openMSP, FFT et LDPC. Les résultats montrent que la 3D va toujours garantir les meilleures performances par rapport à la 2D.

En ce qui concerne le partitionnement, les résultats montrent que notre technique de partitionnement apporte un gain considérable qui peut atteindre jusqu'à 24% des performances par rapport à la 2D et de plus de 15% par rapport à l'état d l'art de la technique de la coupe minimisée.

Pour les mêmes performances, notre technique de partitionnement permet de réduire la consommation de puissance de 22% par rapport à la 2D et plus de 12% par rapport à l'autre technique de partitionnement.

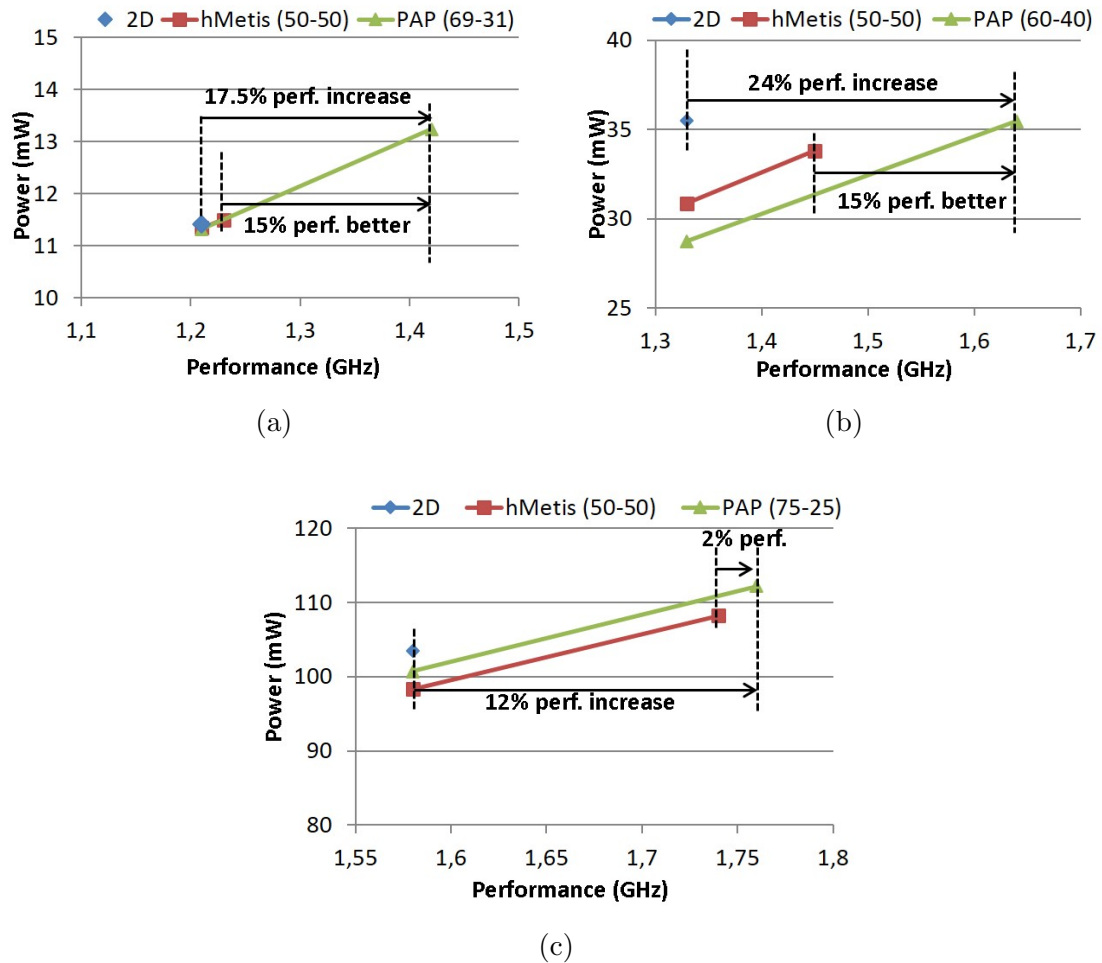

FIGURE B.16: Puissance-performance résultats pour 2D, hMetis 3D partitionnement et notre partitionnement 3D pour (a) openMSP, (b) FFT et (c) LDPC blocs.

B.5 Évaluation des technologies 3D

B.5.1 Introduction: La nécessité d'une évaluation de la technologie

Un environnement d'évaluation des performances et de la consommation des technologies 3D est présenté afin de tester les gains possibles de chaque technologie 3D tout en donnant des directives quant à l'impact des certains paramètres technologiques. Par exemple, l'étude de l'effet du métal de tungstène sur les couches du bas.

La procédure M3D CoolCubeTM nécessite la fabrication des transistors de la couche supérieure à basse température (500-550°C) pour préserver les transistors de la couche de base de toute dégradation [8]. Le cuivre et le low-k diélectrique sont instables à ce budget thermique. Cela conduit à une difficulté lors de la fabrication BEOL du cuivre

et du low-k diélectrique de la couche du bas. Une solution simple serait d'utiliser SiO_2 avec des lignes de tungstène (W) qui sont stables à un budget thermique supérieur.

Dans notre étude, l'effet de W/ SiO_2 est égal à 6x la résistivité et 1.6x la capacité du cuivre et du low-k diélectrique [8, 55], d'où n l'intérêt d'étudier cet effet au niveau de la conception.

B.5.2 Evaluation et résultats

L'implémentation physique se fait en 2D et en 3D avec l'extraction du cuivre BEOL selon le flot d'évaluation introduit au chapitre précédent. Nous extrayons le fichier SPEF qui contient tous les parasites au niveau de la conception. Ensuite, l'effet W/ SiO_2 est appliquée en mettant à jour le fichier SPEF avec les valeurs de la résistivité et de la capacité relatives au W/ SiO_2 . La section suivante se concentre sur la mise à jour du fichier des parasites avec du tungstène (W/ SiO_2).

La figure B.17 montre les résultats de puissance-performance pour les blocs FFT, FPU et LDPC en utilisant différentes I-BEOL pour les implémentations 3D. La dégradation des performances et l'augmentation de la puissance sont présentées de Cu/low-k à W/ SiO_2 en raison de l'augmentation de la résistance et de la capacité parasites de la W/ SiO_2 .

Les résultats de la puissance et de la performance montrent un effet limité du tungstène W/ SiO_2 BEOL par rapport au cuivre Cu/low-k I-BEOL ; au-dessous de 2% des performances se dégradent, et en dessous de 1.5% la puissance augmente. Ces résultats sont en fonction de la complexité des blocs, du partitionnement utilisé, du cadre de l'implémentation physique et du nœud technologique CMOS utilisé.

B.6 Conclusion

L'impact des interconnexions d'un circuit intégré sur les performances et la consommation est de plus en plus important à partir du nœud CMOS 28 nm et au-delà, ayant pour effet de réduire les effets bénéfiques de la loi de Moore. Cela a motivé l'intérêt

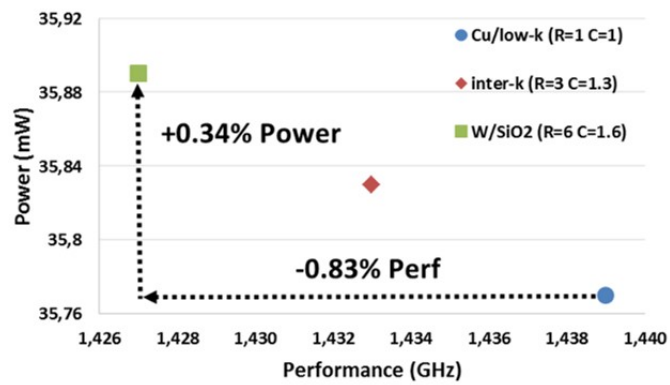

(a)

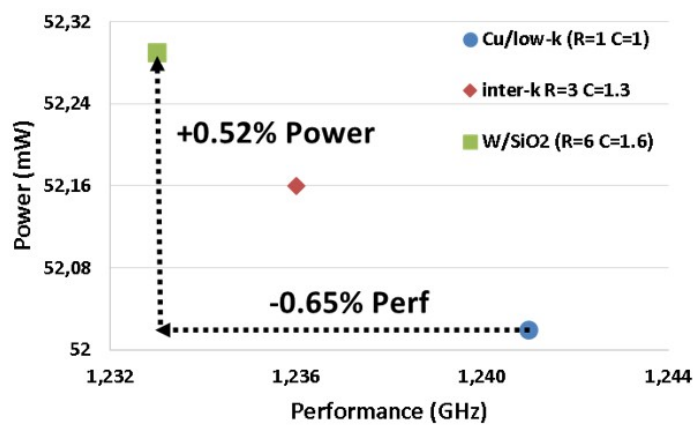

(b)

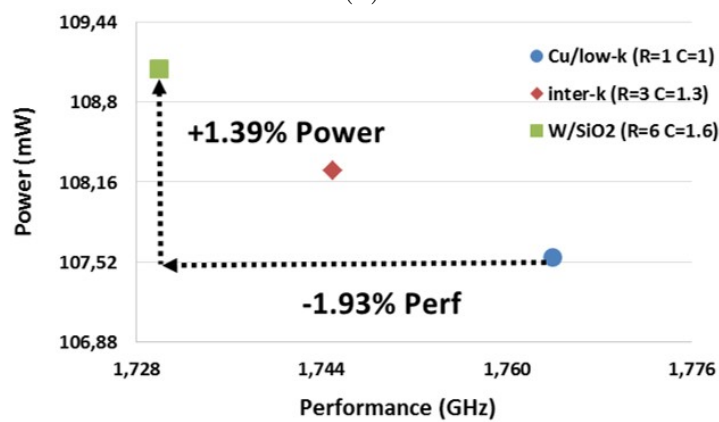

(c)

FIGURE B.17: Résultats Puissance-performance pour un BEOL différent pour la couche de fond de M3D

des technologies d'empilement 3D pour réduire l'effet des interconnexions sur les performances des circuits. Les technologies d'empilement 3D varient suivant différents procédés de fabrication d'où l'on mettra en avant la technologie Through-Silicon-Via (TSV) - Collage Cuivre-Cuivre (Cu-Cu) et 3D Monolithique. TSV et Cu-Cu présentent des diamètres d'interconnexions 3D de l'ordre de $10\ \mu\text{m}$ tandis que le diamètre d'une interconnexion 3D Monolithique est $0.1\ \mu\text{m}$, c'est-à-dire cent fois plus petit. Un tel diamètre d'interconnexion crée de nouveaux challenges en matière de conception de circuits intégrés numérique.

Trois contributions principales constituent cette thèse :

La densité d'intégration offerte par les technologies d'empilement étudiées laisse la possibilité de revoir la topologie des cellules de base en les concevant directement en 3D. C'est ce qui a été fait dans l'approche Cellule sur Amplificateur (Cell-on-Buffer – CoB), en empilant la fonction logique d'une cellule sur l'étage d'amplification. Les simulations montrent des gains substantiels par rapport aux circuits 2D. On a imaginé par la suite désaligner les niveaux d'alimentation de chaque tranche afin de créer une technique de Multi-VDD adaptée à l'empilement 3D pour réduire encore plus la consommation des circuits 3D. Dans un deuxième temps, le partitionnement grain fin des cellules a été étudié. En effet au niveau VLSI, quand on conçoit un circuit de plusieurs milliers voire million de cellules standard en 3D, se pose la question de l'attribution de telle ou telle cellule sur la tranche haute ou basse du circuit 3D afin d'accroître au mieux les performances et consommation du circuit 3D. Une méthodologie de partitionnement physique est introduite pour cela. Enfin un environnement d'évaluation des performances et consommation des technologies 3D est présenté avec pour objectif de rapidement tester les gains possibles de chaque technologie 3D tout en donnant des directives quant à l'impact des certains paramètres technologiques sur les performances et la consommation.

List of Publications

Patents:

1. **Hossam Sarhan**, Olivier Billoint, Fabien clermidy, Sebastien Thuries. 2014. **3D Circuit Design Method**. FRANCE. N° E.N.: 14 60962. Filing date 13/11/2014.

Conference Papers:

2. **H. Sarhan**, S. Thuries, O. Billoint, F. Clermidy, “**3DCoB: A new design approach for Monolithic 3D Integrated Circuits**”, Asia and South Pacific Design Automation Conference (ASP-DAC), IEEE, 2014.
3. **H. Sarhan**, S. Thuries, O. Billoint, F. Clermidy, “**An Un-Balanced Area Ratio Study for High Performance Monolithic 3D Integrated Circuits**”, ISVLSI, IEEE Computer Society Annual Symposium on. (ISVLSI), 2015.
4. **H. Sarhan**, S. Thuries, O. Billoint, F. Clermidy, “**A Power-Performance Study For Monolithic 3D Integrated Circuit Design Using Un-Balanced Area Ratio Approach**”, Design Automation Conference, Work in Progress session (DAC, WIP), 2015.
5. **H. Sarhan**, S. Thuries, O. Billoint, F. Depart, A. Sousa, P. Batude, C. Fenouillet-Beranger, F. Clermidy, “**Intermediate BEOL process influence on Power and Performance For 3DVLSI**”, 3D System Integration, 2015. (3DIC). IEEE International Conference on. IEEE, 2015.

6. O. Billoint, **H. Sarhan**, Iyad Rayane, M. Vinet, P. Batude, et al., “**A Comprehensive Study of Monolithic 3D Cell on Cell Design Using Commercial 2D Tool**”, Design Automation and Test in Europe (DATE), 2015.
7. O. Billoint, **H. Sarhan**, Iyad Rayane, M. Vinet, P. Batude, et al., “**From 2D to Monolithic 3D: Design Possibilities, Expectations and Challenges**”, Proceedings of the 2015 Symposium on International Symposium on Physical Design, (ISPD) ACM, 2015.
8. F. Clermidy, O. Billoint, **H. Sarhan**, S. Thuries, “**Technology scaling: the CoolCube TM paradigm**”, SOI-3D-Subthreshold Microelectronics Technology Unified Conference (S3S), IEEE ,2015.
9. B. Boguslawski, **H. Sarhan**, F. Heitzmann, F. Seguin, S. Thuries, O. Billoint, F. Clermidy, “**Compact Interconnect Approach for Networks of Neural Cliques Using 3D Technology**”, Proceedings of the IFIP/IEEE International Conference on Very Large Scale Integration (VLSI-SoC), 2015.
10. Batude, P.; Fenouillet-Beranger, C.; Pasini, L.; Lu, V.; Deprat, F.; Brunet, L.; Sklenard, B.; Piegas-Luce, F.; Casse, M.; Mathieu, B.; Billoint, O.; Cibrario, G.; Turkyilmaz, O.; **Sarhan, H.**; Thuries, S.; Hutin, L.; Sollier, S.; Widiez, J.; Hortemel, L.; Tabone, C.; Samson, M-P; Previtali, B.; Rambal, N.; Ponthenier, F.; Mazurier, J.; Beneyton, R.; Bidaud, M.; Josse, E.; Petitprez, E.; Rozeau, O.; Rivoire, M.; Euvard-Colnat, C.; Seignard, A.; Fournel, F.; Benaissa, L.; Coudrain, P.; Leduc, P.; Hartmann, J-M.; Besson, P.; Kerdiles, S.; Bout, C.; Nemouchi, F.; Royer, A.; Agraffeil, C.; Ghibaud, G.; Signamarcheix, T.; Haond, M.; Clermidy, F.; Faynot, O.; Vinet, M., “**3DVLSI with CoolCube process: An alternative path to scaling,**” in VLSI Technology (VLSI Technology), 2015 Symposium on , vol., no., pp.T48-T49, 16-18 June 2015.
11. Batude, P.; Sklenard, B.; Fenouillet-Beranger, C.; Previtali, B.; Tabone, C.; Rozeau, O.; Billoint, O.; Turkyilmaz, O.; **Sarhan, H.**; Thuries, S.; Cibrario, G.; Brunet, L.; Deprat, F.; Michallet, J.-E.; Clermidy, F.; Vinet, M., “**3D sequential integration opportunities and technology optimization,**” in Interconnect Technology Conference / Advanced Metallization Conference (IITC/AMC), 2014 IEEE International , vol., no., pp.373-376, 20-23 May 2014.

-
12. Vinet, M.; Batude, P.; Fenouillet-Beranger, C.; Clermidy, F.; Brunet, L.; Rozeau, O.; Hartmann, J.; Billoint, O.; Cibrario, G.; Previtali, B.; Tabone, C.; Sklenard, B.; Turkyilmaz, O.; Ponthenier, F.; Rambal, N.; Samson, M.; Deprat, F.; Lu, V.; Pasini, L.; Thuries, S.; **Sarhan, H.**; Michallet, J.-E.; Faynot, O., “**Monolithic 3D integration: A powerful alternative to classical 2D scaling,**” in SOI-3D-Subthreshold Microelectronics Technology Unified Conference (S3S), 2014 IEEE , vol., no., pp.1-3, 6-9 Oct. 2014.

Bibliography

- [1] Semiconductor Industry Association. “The International Technology Roadmap for Semiconductors (ITRS)”. 2011 Edition.
- [2] Gordon E Moore et al. Cramming More Components onto Integrated Circuits. *Proceedings of the IEEE*, 86(1):82–85, 1998.
- [3] Wolfgang Arden, Michel Brillouët, Patrick Cogez, Mart Graef, Bert Huizing, and Reinhard Mahnkopf. Morethan-Moore white paper.
- [4] Geoffrey Yeap. Smart mobile socs driving the semiconductor industry: Technology trend, challenges and opportunities. In *Electron Devices Meeting (IEDM), 2013 IEEE International*, pages 1–3. IEEE, 2013.
- [5] Tezzaron Semiconductor. 2013.
- [6] Hamed Chaabouni, M Rousseau, P Leduc, A Farcy, R El Farhane, Aurélie Thuaire, G Haury, A Valentian, G Billiot, M Assous, et al. Investigation on TSV impact on 65nm CMOS devices and circuits. In *Electron Devices Meeting (IEDM), 2010 IEEE International*, pages 35–1. IEEE, 2010.
- [7] L Sanchez, L Bally, B Montmayeul, F Fournel, J Dafonseca, E Augendre, L Di Cioccio, V Carron, T Signamarcheix, R Taibi, et al. Chip to wafer direct bonding technologies for high density 3D integration. In *Electronic Components and Technology Conference (ECTC), 2012 IEEE 62nd*, pages 1960–1964. IEEE, 2012.
- [8] P Batude, C Fenouillet-Beranger, L Pasini, V Lu, F Deprat, L Brunet, B Sklenard, F Piegas-Luce, M Casse, B Mathieu, et al. 3DVLSI with CoolCube process: An alternative path to scaling. In *VLSI Technology (VLSI Technology), 2015 Symposium on*, pages T48–T49. IEEE, 2015.

- [9] M Vinet, P Batude, C Fenouillet-Beranger, F Clermidy, L Brunet, O Rozeau, J Hartmann, O Billoint, G Cibrario, B Previtali, et al. Monolithic 3d integration: a powerful alternative to classical 2d scaling. In *SOI-3D-Subthreshold Microelectronics Technology Unified Conference (S3S), 2014 IEEE*, pages 1–3. IEEE, 2014.
- [10] Denis Dutoit, Christian Bernard, Severine Cheramy, Fabien Clermidy, Yvain Thonnart, Pascal Vivet, Christian Freund, Vincent Guerin, Stéphane Guilhot, Stéphane Lecomte, et al. A 0.9 pJ/bit, 12.8 GByte/s WideIO memory interface in a 3D-IC NoC-based MPSoC. In *VLSI Technology (VLSIT), 2013 Symposium on*, pages C22–C23. IEEE, 2013.
- [11] Matt Wordeman, Joel Silberman, Gary Maier, and Michael Scheuermann. A 3D system prototype of an eDRAM cache stacked over processor-like logic using through-silicon vias. In *Solid-State Circuits Conference Digest of Technical Papers (ISSCC), 2012 IEEE International*, pages 186–187. IEEE, 2012.
- [12] S.W. Ho, Mian Zhi Ding, Pei Siang Lim, D.I. Cereno, G. Katti, Tai Chong Chai, and S. Bhattacharya. 2.5D through silicon interposer package fabrication by chip-on-wafer (CoW) approach. In *Electronics Packaging Technology Conference (EPTC), 2014 IEEE 16th*, pages 679–683, Dec 2014. doi: 10.1109/EPTC.2014.7028352.
- [13] B. Patti. Implementing 2.5D and 3D Devices. In *AIDA workshop*. Tezzaron Semiconductor.
- [14] Hamed Chaabouni, M Rousseau, P Leduc, A Farcy, R El Farhane, Aurélie Thuaire, G Haury, A Valentian, G Billiot, M Assous, et al. Investigation on TSV impact on 65nm CMOS devices and circuits. In *Electron Devices Meeting (IEDM), 2010 IEEE International*, pages 35–1. IEEE, 2010.
- [15] P Batude, B Sklenard, C Fenouillet-Beranger, B Previtali, C Tabone, O Rozeau, O Billoint, O Turkyilmaz, H Sarhan, S Thuries, et al. 3D sequential integration opportunities and technology optimization. In *Interconnect Technology Conference/Advanced Metallization Conference (IITC/AMC), 2014 IEEE International*, pages 373–376. IEEE, 2014.

- [16] F Clermidy, O Billoint, H Sarhan, and S Thuries. Technology scaling: The coolcube tm paradigm. In *SOI-3D-Subthreshold Microelectronics Technology Unified Conference (S3S), 2015 IEEE*, pages 1–4. IEEE, 2015.
- [17] Gabriel H Loh, Yuan Xie, and Bryan Black. Processor Design in 3D Die-Stacking Technologies. *Micro, IEEE*, 27(3):31–48, 2007.
- [18] Matt Wordeman, Joel Silberman, Gary Maier, and Michael Scheuermann. A 3D system prototype of an eDRAM cache stacked over processor-like logic using through-silicon vias. In *Solid-State Circuits Conference Digest of Technical Papers (ISSCC), 2012 IEEE International*, pages 186–187. IEEE, 2012.
- [19] Hideaki Saito, Masayuki Nakajima, Takumi Okamoto, Yusuke Yamada, Akira Ohuchi, Noriyuki Iguchi, Toshitsugu Sakamoto, Koichi Yamaguchi, and Masayuki Mizuno. A chip-stacked memory for on-chip SRAM-rich SoCs and processors. *Solid-State Circuits, IEEE Journal of*, 45(1):15–22, 2010.
- [20] Dae Hyun Kim, Krit Athikulwongse, Michael Healy, Mohammad Hossain, Moon-gon Jung, Ilya Khorosh, Gokul Kumar, Young-Joon Lee, Dean Lewis, Tzu-Wei Lin, et al. 3D-MAPS: 3D Massively parallel processor with stacked memory. In *Solid-State Circuits Conference Digest of Technical Papers (ISSCC), 2012 IEEE International*, pages 188–190. IEEE, 2012.
- [21] David Fick, Ronald G Dreslinski, Bharan Giridhar, Gyouho Kim, Sangwon Seo, Matthew Fojtik, Sudhir Satpathy, Yoonmyung Lee, Daeyeon Kim, Nian Liu, et al. Centip3De: A cluster-based NTC architecture with 64 ARM Cortex-M3 cores in 3D stacked 130 nm CMOS. *Solid-State Circuits, IEEE Journal of*, 48(1):104–117, 2013.
- [22] Geert Van der Plas, Paresh Limaye, Igor Loi, Abdelkarim Mercha, Herman Oprins, Cristina Torregiani, Steven Thijs, Dimitri Linten, Michele Stucchi, Guruprasad Katti, et al. Design issues and considerations for low-cost 3-D TSV IC technology. *Solid-State Circuits, IEEE Journal of*, 46(1):293–307, 2011.
- [23] Ioannis Savidis, Selcuk Kose, and Eby G Friedman. Power noise in tsv-based 3-d integrated circuits. *Solid-State Circuits, IEEE Journal of*, 48(2):587–597, 2013.
- [24] Moongon Jung, Taigon Song, Yang Wan, Young-Joon Lee, Debabrata Mohapatra, Hong Wang, Gareth Taylor, Devang Jariwala, Vijay Pitchumani, Philip Morrow,

- et al. How to reduce power in 3D IC designs: A case study with OpenSPARC T2 core. In *Custom Integrated Circuits Conference (CICC), 2013 IEEE*, pages 1–4. IEEE, 2013.
- [25] George Karypis, Rajat Aggarwal, Vipin Kumar, and Shashi Shekhar. Multilevel hypergraph partitioning: applications in VLSI domain. *Very Large Scale Integration (VLSI) Systems, IEEE Transactions on*, 7(1):69–79, 1999.
- [26] T. Thorolfsson, S. Lipa, and P.D. Franzon. A 10.35 mW/GFlop stacked SAR DSP unit using fine-grain partitioned 3D integration. In *Custom Integrated Circuits Conference (CICC), 2012 IEEE*, pages 1–4, Sept 2012. doi: 10.1109/CICC.2012.6330589.
- [27] Shreepad Panth, Kambiz Samadi, Yang Du, and Sung Kyu Lim. Placement-driven partitioning for congestion mitigation in monolithic 3D IC designs. *Computer-Aided Design of Integrated Circuits and Systems, IEEE Transactions on*, 34(4):540–553, 2015.
- [28] Young-Joon Lee, Patrick Morrow, and Sung Kyu Lim. Ultra high density logic designs using transistor-level monolithic 3D integration. In *Proceedings of the International Conference on Computer-Aided Design*, pages 539–546. ACM, 2012.
- [29] Chang Liu and Sung Kyu Lim. A design tradeoff study with monolithic 3D integration. In *Quality Electronic Design (ISQED), 2012 13th International Symposium on*, pages 529–536. IEEE, 2012.
- [30] O Thomas, M Vinet, O Rozeau, P Batude, and A Valentian. Compact 6T SRAM cell with robust Read/Write stabilizing design in 45nm Monolithic 3D IC technology. In *IC Design and Technology, 2009. ICICDT'09. IEEE International Conference on*, pages 195–198. IEEE, 2009.
- [31] Chang Liu and Sung Kyu Lim. Ultra-high density 3D SRAM cell designs for monolithic 3D integration. In *IEEE International Interconnect Technology Conference*, pages 1–3, 2012.
- [32] Yuan Xie. Processor architecture design using 3D integration technology. In *VLSI Design, 2010. VLSID'10. 23rd International Conference on*, pages 446–451. IEEE, 2010.

- [33] Amr G Wassal, Hossam H Sarhan, and Amr ElSherief. Novel 3D memory-centric NoC architecture for transaction-based SoC applications. In *Electronics, Communications and Photonics Conference (SIECPC), 2011 Saudi International*, pages 1–5. IEEE, 2011.
- [34] Jubee Tada, Ryusuke Egawa, Kazushige Kawai, Hiroaki Kobayashi, and Gensuke Goto. A middle-grain circuit partitioning strategy for 3-D integrated floating-point multipliers. In *3D Systems Integration Conference (3DIC), 2011 IEEE International*, pages 1–6. IEEE, 2012.
- [35] Shreepad Panth, Kambiz Samadi, Yang Du, and Sung Kyu Lim. Power-performance study of block-level monolithic 3D-ICs considering inter-tier performance variations. In *Design Automation Conference (DAC), 2014 51st ACM/EDAC/IEEE*, pages 1–6. IEEE, 2014.
- [36] Guojie Luo, Yiyu Shi, and Jason Cong. An Analytical Placement Framework for 3-D ICs and Its Extension on Thermal Awareness. *Computer-Aided Design of Integrated Circuits and Systems, IEEE Transactions on*, 32(4):510–523, 2013.
- [37] Jason Cong and Guojie Luo. A multilevel analytical placement for 3D ICs. In *Proceedings of the 2009 Asia and South Pacific Design Automation Conference*, pages 361–366. IEEE Press, 2009.
- [38] Meng-Kai Hsu, Yao-Wen Chang, and Valeriy Balabanov. TSV-aware analytical placement for 3D IC designs. In *Design Automation Conference (DAC), 2011 48th ACM/EDAC/IEEE*, pages 664–669. IEEE, 2011.
- [39] Shashikanth Bobba, Ashutosh Chakraborty, Olivier Thomas, Perrine Batude, Thomas Ernst, Olivier Faynot, David Z Pan, and Giovanni De Micheli. CELON-CEL: Effective design technique for 3-D monolithic integration targeting high performance integrated circuits. In *Proceedings of the 16th Asia and South Pacific Design Automation Conference*, pages 336–343. IEEE Press, 2011.
- [40] Jason Cong, Guojie Luo, Jie Wei, and Yan Zhang. Thermal-aware 3D IC placement via transformation. In *Design Automation Conference, 2007. ASP-DAC'07. Asia and South Pacific*, pages 780–785. IEEE, 2007.
- [41] Xin Zhao, J. Minz, and Sung Kyu Lim. Low-Power and Reliable Clock Network Design for Through-Silicon Via (TSV) Based 3D ICs. *Components, Packaging and*

- Manufacturing Technology, IEEE Transactions on*, 1(2):247–259, Feb 2011. ISSN 2156-3950. doi: 10.1109/TCPMT.2010.2099590.
- [42] Tak-Yung Kim and Taewhan Kim. Resource allocation and design techniques of prebond testable 3-D clock tree. *Computer-Aided Design of Integrated Circuits and Systems, IEEE Transactions on*, 32(1):138–151, 2013.
- [43] Xin Zhao, Jacob Minz, and Sung Kyu Lim. Low-power and reliable clock network design for through-silicon via (TSV) based 3D ICs. *Components, Packaging and Manufacturing Technology, IEEE Transactions on*, 1(2):247–259, 2011.
- [44] Liang-Teck Pang, Phillip J Restle, Matthew R Wordeman, Joel A Silberman, Robert L Franch, and Gary W Maier. A shorted global clock design for multi-GHz 3D stacked chips. In *2012 Symposium on VLSI Circuits (VLSIC)*, 2012.
- [45] Vasilis F Pavlidis, Ioannis Savidis, and EbyG Friedman. Clock distribution networks for 3-D ictegrated Circuits. In *Custom Integrated Circuits Conference, 2008. CICC 2008. IEEE*, pages 651–654. IEEE, 2008.
- [46] Yuan Xie, Jason Cong, and Sachin S Sapatnekar. *Three-dimensional integrated circuit design*. Springer, 2010.
- [47] O Billoint, H Sarhan, I Rayane, M Vinet, P Batude, C Fenouillet-Beranger, O Rozeau, G Cibrario, F Deprat, A Fustier, et al. A comprehensive study of monolithic 3D cell on cell design using commercial 2D tool. In *Proceedings of the 2015 Design, Automation & Test in Europe Conference & Exhibition*, pages 1192–1196. EDA Consortium, 2015.
- [48] Atrenta Inc. www.atrenta.com.
- [49] Kihwan Choi, Ramakrishna Soma, and Massoud Pedram. Fine-grained dynamic voltage and frequency scaling for precise energy and performance tradeoff based on the ratio of off-chip access to on-chip computation times. *Computer-Aided Design of Integrated Circuits and Systems, IEEE Transactions on*, 24(1):18–28, 2005.
- [50] John Howard, Saurabh Dighe, Yatin Hoskote, Sriram Vangal, David Finan, Gregory Ruhl, Devon Jenkins, Howard Wilson, Nitin Borkar, Gerhard Schrom, et al. A 48-core IA-32 message-passing processor with DVFS in 45nm CMOS. In *Solid-State*

- Circuits Conference Digest of Technical Papers (ISSCC), 2010 IEEE International*, pages 108–109. IEEE, 2010.
- [51] Hossam Sarhan, Sebastien Thuries, Olivier Billoint, Fabien Deprat, Alexandre Ayres De Sousa, Perrine Batude, Claire Fenouillet-Beranger, and Fabien Clermidy. Intermediate BEOL process influence on Power and Performance For 3DVLSI. In *3D Systems Integration Conference (3DIC), 2015 IEEE International*. IEEE, 2015.
- [52] Kiran Puttaswamy and Gabriel H Loh. Dynamic instruction schedulers in a 3-dimensional integration technology. In *Proceedings of the 16th ACM Great Lakes symposium on VLSI*, pages 153–158. ACM, 2006.
- [53] Jason Cong, Guojie Luo, Jie Wei, and Yan Zhang. Thermal-aware 3D IC placement via transformation. In *Design Automation Conference, 2007. ASP-DAC'07. Asia and South Pacific*, pages 780–785. IEEE, 2007.
- [54] Yuchun Ma, Yongxiang Liu, Eren Kursun, Glenn Reinman, and Jason Cong. Investigating the effects of fine-grain three-dimensional integration on microarchitecture design. *ACM Journal on Emerging Technologies in Computing Systems (JETC)*, 4(4):17, 2008.
- [55] C. Fenouillet-Beranger and et al. W and Copper interconnection stability for 3D VLSI CoolCube integration. *International Conference on Solid State Devices and Materials (SSDM)*, 2015.
- [56] Hai Wei, Tony F Wu, Deepak Sekar, Brian Cronquist, R Fabian Pease, and Subhasish Mitra. Cooling three-dimensional integrated circuits using power delivery networks. In *Electron Devices Meeting (IEDM), 2012 IEEE International*, pages 14–2. IEEE, 2012.
- [57] Sandeep Kumar Samal, Kambiz Samadi, Pratyush Kamal, Yun Du, and Sung Kyu Lim. Full chip impact study of power delivery network designs in monolithic 3d ics. In *Computer-Aided Design (ICCAD), 2014 IEEE/ACM International Conference on*, pages 565–572. IEEE, 2014.
- [58] Mehdi Saeidi, Kambiz Samadi, Arpit Mittal, and Rajat Mittal. Thermal implications of mobile 3d-ics. In *3D Systems Integration Conference (3DIC), 2014 International*, pages 1–7. IEEE, 2014.

- [59] Sandeep Kumar Samal, Shreepad Panth, Kambiz Samadi, Mehdi Saedi, Yang Du, and Sung Kyu Lim. Fast and accurate thermal modeling and optimization for monolithic 3d ics. In *Proceedings of the 51st Annual Design Automation Conference*, pages 1–6. ACM, 2014.
- [60] Raúl Rojas. *Neural Networks: A Systematic Introduction*. Springer-Verlag New York, Inc., New York, NY, USA, 1996. ISBN 3-540-60505-3.
- [61] Biswa Sengupta and Martin B. Stemmler. Power consumption during neuronal computation. *Proceedings of the IEEE*, 102(5):738–750, 2014. doi: 10.1109/JPROC.2014.2307755.
- [62] Brian Whitworth. Some implications of comparing brain and computer processing. In *HICSS*, pages 1–10. IEEE Computer Society, 2008.
- [63] Bilel Belhadj, Alexandre Valentian, Pascal Vivet, Marc Duranton, Liqiang He, and Olivier Temam. The improbable but highly appropriate marriage of 3D stacking and neuromorphic accelerators. In *Proc. CASES'14*, pages 1–9, 2014.
- [64] Fabien Clermidy et al. Advanced technologies for brain-inspired computing. In *Proc. ASP-DAC'14*, 2014.
- [65] Vincent Gripon and Claude Berrou. Sparse neural networks with large learning diversity. 22(7):1087–1096, July 2011.
- [66] Norman P. Jouppi. Improving direct-mapped cache performance by the addition of a small fully-associative cache and prefetch buffers. In *ISCA '90*, pages 364–373, 1990.
- [67] N.F. Huang et al. Design of multi-field IPv6 packet classifiers using ternary CAMs. In *Proc. IEEE GLOBECOM*, volume 3, pages 1877–1881, 2001.
- [68] Behrooz Kamary Aliabadi et al. Storing sparse messages in networks of neural cliques. *IEEE Trans. Neural Netw. Learn. Syst.*, 25(5):980 – 989, 2014.
- [69] Benoit Larras, Bartosz Boguslawski, Cyril Lahuec, Matthieu Arzel, Fabrice Seguin, and Frédéric Heitzmann. Analog encoded neural network for power management in MPSoC. In *Proc. NEWCAS'13*, pages 1–4, 2013.

-
- [70] Wonyoung Kim, Meeta Sharma Gupta, Gu-Yeon Wei, and David Brooks. System level analysis of fast, per-core DVFS using on-chip switching regulators. In *HPCA*, pages 123–134. IEEE Computer Society, 2008.
- [71] D.N. Truong et al. A 167-processor computational platform in 65 nm CMOS. 2009.
- [72] E. Beigné et al. An asynchronous power aware and adaptive NoC based circuit. *Solid-State Circuits, IEEE Journal of*, 44(4):1167–1177, 2009.
- [73] B. Larras, B. Boguslawski, C. Lahuec, M. Arzel, F. Seguin, and F. Heitzmann. Analog encoded neural network for power management in MPSoC. *AICSP*, 81(3): 595–605, 2014. ISSN 0925-1030.
- [74] Fabien Clermidy et al. A 477mW NoC-based digital baseband for mimo 4G SDR. In *ISSCC*, pages 278–279. IEEE, 2010. ISBN 978-1-4244-6033-5.
- [75] Fabien Clermidy, Romain Lemaire, Xavier Popon, Dimitri Ktenas, and Yvain Thonnart. An open and reconfigurable platform for 4G telecommunication: Concepts and application. In *DSD*, pages 449–456. IEEE Computer Society, 2009. ISBN 978-0-7695-3782-5.