



HAL
open science

Illumination dans les billards polygonaux et dynamique symbolique

Thierry Monteil

► **To cite this version:**

Thierry Monteil. Illumination dans les billards polygonaux et dynamique symbolique. Mathématiques [math]. Université de la Méditerranée, 2005. Français. NNT : . tel-01287369

HAL Id: tel-01287369

<https://theses.hal.science/tel-01287369v1>

Submitted on 12 Mar 2016

HAL is a multi-disciplinary open access archive for the deposit and dissemination of scientific research documents, whether they are published or not. The documents may come from teaching and research institutions in France or abroad, or from public or private research centers.

L'archive ouverte pluridisciplinaire **HAL**, est destinée au dépôt et à la diffusion de documents scientifiques de niveau recherche, publiés ou non, émanant des établissements d'enseignement et de recherche français ou étrangers, des laboratoires publics ou privés.

UNIVERSITÉ DE LA MÉDITERRANÉE
Faculté des sciences de Luminy

Thèse
pour obtenir le grade de
Docteur de l'université de la Méditerranée
Spécialité : Mathématiques

Illumination dans les billards polygonaux et dynamique symbolique

soutenue le 9 décembre 2005 par
Thierry MONTEIL

après avis des rapporteurs :

M. Howard MASUR
M. Jean-Paul THOUVENOT

devant le jury composé de :

M. Sébastien FERENCZI, directeur de thèse
M. Pascal HUBERT, directeur de thèse
M. Jérôme LOS
M. Christian MAUDUIT
M. Jean-Paul THOUVENOT
M. Anton ZORICH

Remerciements

Je voudrais tout d'abord exprimer ma reconnaissance à mes patrons, dealers de voyages, Sébastien Ferenczi et Pascal Hubert. Ils ont su me laisser une grande liberté tant dans le choix de mes thèmes de recherche que dans l'organisation de mon travail tout en s'intéressant sincèrement à son avancement.

Je suis très honoré que Howard Masur et Jean-Paul Thouvenot aient accepté la charge de rapporteur et les remercie de l'attention qu'ils ont apporté à mon travail.

Je remercie vivement Jérôme Los, Christian Mauduit et Anton Zorich pour avoir accepté de faire partie de ce jury.

Concernant ma formation mathématique, je tiens à remercier Michel Alessandri pour la découverte d'une discipline vers laquelle je ne me destinais pas a priori, feu Jean Marie Exbrayat pour le socle en béton armé, Maurice Pouzet pour le brillant dans l'oeil et Aurélien Schoumaker pour les scans.

Plus récemment, diverses discussions avec des mathématiciens que j'ai pu rencontrer lors de mes voyages ont été très enrichissantes, particulièrement avec Jorge Almeida, Solomon Marcus, Howard Masur, Anatoly Vershik, ainsi que Julien Cassaigne lors de ses diverses visites à l'IML. Leurs points de vue qu'ils ont su rendre accessibles sont une source in-tarissable d'imagination et de questions.

Je tiens à saluer l'ensemble des membres de l'équipe Dynamique Arithmétique Combinatoire pour leur gentillesse et l'ambiance décontractée qui règne sur son passage, des couloirs ténébreux jusqu'au sable fin. Je remercie spécialement les thésard-e-s et post-doc qui sont passés par là, Ali, Boris, Nicolas, Mathieu, Julien, Erwan, Samuel, Ryugy, Marion, Xavier, Idrissa ainsi que toutes les λ -pincés qui traînent au fond du couloir. Merci à Aurélia de résoudre si magiquement les problèmes administratifs les plus sérieux.

Pour ces années agréables passées à Marseille ou ailleurs, spéciale dédicace à toute ma famille, Farida, mes voisines, le 218, les punks du Tournez la page, Christian, Antonio Negro, Iris, Djamel, les vampires, Sebélodie, ma mère, la cimade, Sophie, cLx, Mamette, Dominique Lagarde, les jeunz, Vincent, l'écool d'été, Nicolas, Reno, Gwy, Mathieu, Uli, Manu-e, Meyth, le centre de media indépendant de Marseille, Céline, les calanques, les minots du collège Versailles, Nouria, Nawell, Sylvia, Jojo, la mouette, Laurent, les raéliens de Bobo Dioulasso, le cecp, la mer, Hazem, les wikis, Sonia, Pierre, Jérémy, Frotcho, Mélissa, A.A., Etienne, les tanneries, la porte d'Aix, David, Rubik's cube, Delphine, ...

Table des matières

Introduction	5
0.1 Illumination et propriété de blocage fini dans les billards et surfaces de translation	5
0.1.1 Des billards rationnels aux surfaces de translation	5
0.1.2 Illumination	7
0.1.3 Propriété de blocage fini, pure périodicité et revêtements ramifiés du tore	8
0.1.4 Surfaces concrètes	12
0.1.5 Ouverture : regard dynamique sur l'illumination	13
0.2 Dynamique symbolique (topologique)	15
0.2.1 Mesures invariantes	16
0.2.2 Ouverture : un point de vue profini	19
0.2.3 Quasipériodicité et symétrie dans les mots infinis	20
0.2.4 Ouverture : stabilité à la Abramov	22
0.3 Bibliographie thématique	23
0.4 Plan de la thèse	26
1 Un contre-exemple au théorème de Hiemer et Snurnikov	27
1.1 Introduction	27
1.2 The counter-example	28
1.3 Conclusion	30
2 Sur la propriété de blocage fini	33
2.1 Introduction	33
2.2 Definitions and first results	35
2.2.1 Translation surfaces and geodesics	35
2.2.2 Branched coverings	35
2.2.3 Rational billiards <i>vs</i> translation surfaces	36
2.2.4 Action of $GL(2, \mathbb{R})$	37
2.3 Some remarks around Hiemer and Snurnikov's proof	38
2.4 A local lemma	41
2.5 Finite blocking property in the regular polygons	46
2.6 Finite blocking property on Veech surfaces	50
2.7 Further results	51
2.7.1 L-shaped surfaces	51
2.7.2 Irrational billiards	52

2.7.3	A density result	52
2.8	Conclusion	54
3	Propriété de blocage fini vs pure périodicité	57
3.1	Introduction	57
3.2	Background	59
3.2.1	Stability	59
3.2.2	Sufficient conditions	60
3.2.3	Necessary conditions	60
3.2.4	Global point of view: moduli spaces of holomorphic forms	61
3.3	Main result	62
3.4	Some applications	67
3.5	Conclusion	68
4	Une condition homologique pour une caractérisation dynamique et illuminatoire des revêtements ramifiés du tore	71
4.1	Introduction	71
4.2	Background and tools	73
4.2.1	Cylinder decomposition	73
4.2.2	(Translational) holonomy	73
4.2.3	Moduli space and $SL(2, \mathbb{R})$ -action	73
4.2.4	The J -invariant	74
4.3	A homological condition for a purely periodic translation surface to be a torus branched covering	75
4.4	When is the homology generated by periodic orbits?	78
4.4.1	For convex surfaces	78
4.4.2	On a dense open subset of full measure in any stratum	81
4.5	Digression: Two directions do not suffice	82
4.5.1	J -simple translation surfaces	83
4.5.2	Advertising	83
4.6	Conclusion	84
5	Majoration du nombre de mesures ergodiques d'un sous-shift en fonction de la géométrie de ses graphes de Rauzy	89
5.1	Introduction	89
5.2	Landscape	91
5.2.1	Invariant measures	91
5.2.2	Rauzy graphs	92
5.2.3	The tree of left special factors	92
5.3	A clean version	93
5.3.1	Subshifts with linear complexity	95
5.3.2	Arnoux-Rauzy subshifts	96
5.3.3	Multi-scale quasiperiodic subshifts	96
5.4	Transition-discussion: evolution of Rauzy graphs	97
5.5	A condition on the tree of left special factors	99
5.5.1	A blurred version of theorem 1	99

5.5.2	A condition on the tree of left special factors	99
5.6	Conclusion	101
6	Mots quasipériodiques : le cas multiéchelle et propriétés dynamiques	105
6.1	Introduction and notations	105
6.1.1	Background: quasiperiodicity and symmetry	105
6.1.2	The derivation: a change of scale	106
6.1.3	Multi-scale quasiperiodic words	107
6.2	Uniform recurrence and minimality	109
6.3	Complexity and topological entropy	110
6.3.1	Word complexity	110
6.3.2	Topological entropy	111
6.3.3	Kolmogorov complexity	111
6.4	Unique ergodicity and frequencies	112
6.5	Sturmian subshifts are multi-scale quasiperiodic	115
6.6	Conclusion	115

Introduction

Cette introduction est composée de deux parties.

La première partie traite d'illumination dans les billards polygonaux et surfaces de translation, et s'attache plus particulièrement à l'étude des surfaces jouissant de la propriété de blocage fini.

La seconde partie s'intéresse à l'étude de certains systèmes dynamiques symboliques topologiques de faible complexité, et s'attache d'une part aux relations qu'il peut y avoir entre les propriétés combinatoires du langage associé au système et le nombre de ses mesures ergodiques invariantes, et d'autre part à l'étude des sous-shifts quasipériodiques multiéchelle.

Ces deux parties sont largement indépendantes, bien que leurs contextes respectifs ne soient pas si éloignés : l'application de premier retour du flot directionnel d'une surface de translation sur un segment transverse à la direction du flot est un échange d'intervalles. Le codage naturel associé à un échange d'intervalles donne un sous-shift de faible complexité et ce sont exactement ces systèmes symboliques qui sont à l'honneur dans la seconde partie.

0.1 Illumination et propriété de blocage fini dans les billards et surfaces de translation

0.1.1 Des billards rationnels aux surfaces de translation

Considérons une table de billard polygonale \mathcal{P} dans laquelle un point se déplace à vitesse constante et telle que, lorsque le point rencontre le bord de la table, l'angle d'incidence soit égal à l'angle de réflexion.

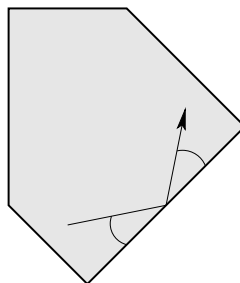

Il est commode de renverser les points de vue par une méthode de dépliage : lorsque la boule de billard rencontre un bord de \mathcal{P} , on reflète la table de billard au lieu de faire rebondir la boule.

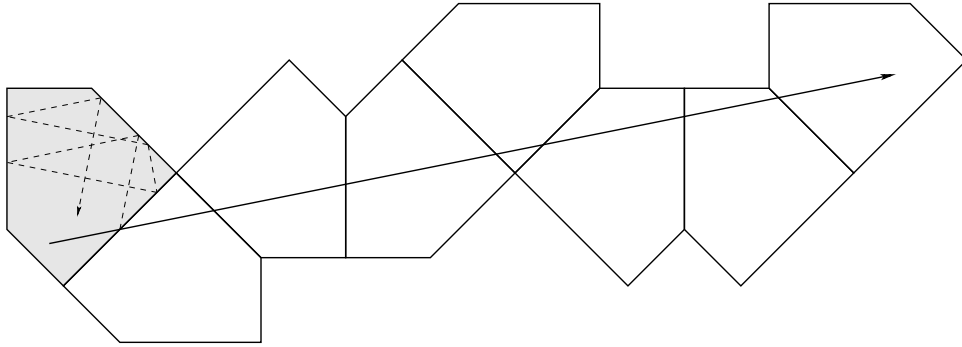

Lorsque les angles formés par les couples d'arêtes du polygone \mathcal{P} sont des multiples rationnels de 2π , le nombre de copies obtenues à translation près est fini (on dit alors que \mathcal{P} est un *polygone rationnel*). On peut dans ce cas considérer que la boule évolue sans changer de direction sur un ensemble fini de copies isométriques de \mathcal{P} , collées le long de leurs arêtes. Ce nouvel espace où évolue la boule est une surface \mathcal{S} compacte sans bord pavée par des copies de \mathcal{P} , et la trajectoire en ligne brisée de la boule de billard dans \mathcal{P} correspond à une ligne droite dans \mathcal{S} .

Prenons comme exemple de table de billard un triangle rectangle dont un angle est égal à $\pi/5$. Le dessin suivant explique la construction de la surface associée : on reflète le triangle jusqu'à obtenir toutes les copies possibles à translation près et on identifie les côtés qui doivent l'être par translation.

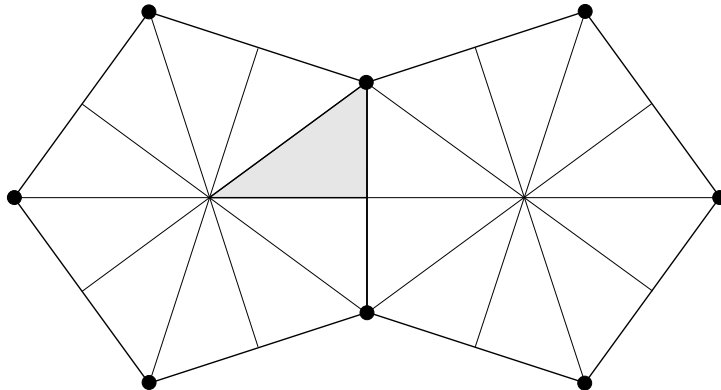

On obtient un double pentagone dont les côtés parallèles sont identifiés deux à deux par translation. On remarque que tous les sommets du double pentagone obtenu sont identifiés et que l'angle conique autour de cette unique singularité est égal à 6π . Partout ailleurs, que ce soit à l'intérieur des copies de \mathcal{P} où au niveau des arêtes, la surface est localement isométrique à un ouvert de \mathbb{R}^2 , et on peut de plus assurer que ces isométries transportent les notions de sens et de direction de façon cohérente sur \mathcal{S} (on peut par exemple définir une direction horizontale sur \mathcal{S}). Toute la courbure est concentrée au niveau de la singularité et le théorème de Gauss-Bonnet nous dit que la surface obtenue est une surface de genre 2.

Un autre exemple fondamental est celui du billard carré :

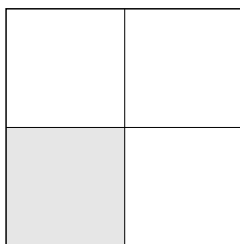

La surface obtenue est un tore plat et la singularité qui provient des coins du carré n'en est pas vraiment une puisque l'angle conique autour d'elle vaut 2π .

On définit une *surface de translation* comme étant un triplet $(\mathcal{S}, \Sigma, \omega)$ où \mathcal{S} est une surface compacte connexe, Σ est une partie finie de \mathcal{S} (l'ensemble des singularités), et ω est un atlas qui recouvre $\mathcal{S} \setminus \Sigma$ et dont les changements de cartes sont des translations. On s'assure que le raccord au niveau des singularités est convenable en demandant de plus que \mathcal{S} soit le complété de $\mathcal{S} \setminus \Sigma$ pour la métrique plate héritée de \mathbb{R}^2 via ω .

Ainsi, l'étude des trajectoires d'une boule de billard dans un polygone rationnel se ramène à l'étude du flot géodésique sur une surface de translation (les singularités stoppent quelques géodésiques, néanmoins ce flot est défini presque partout). Bien sûr, il existe des surfaces de translation qui ne peuvent pas être obtenues à partir d'une table de billard, le fait d'être pavable par un polygone de la façon décrite précédemment impose une certaine symétrie.

0.1.2 Illumination

Le flot géodésique sur une surface de translation \mathcal{S} a pour espace des phases le fibré unitaire tangent $U\mathcal{S}$ (l'ensemble des vecteurs vitesse de norme 1). Le fait que les changements de cartes soient des translations permet de définir sens et direction de façon globale : l'espace des phases se décompose donc globalement en $U\mathcal{S} = \mathcal{S} \times \mathbb{S}^1$.

Ainsi, l'étude du flot géodésique peut se faire à travers deux points de vue selon que l'on fixe la première où la seconde variable :

Dynamique On fixe une direction particulière $\theta \in \mathbb{S}^1$.

Ce choix mène à l'étude du *flot directionnel* $\phi_\theta : \mathcal{S} \times \mathbb{R} \rightarrow \mathcal{S}$. C'est ce point de vue qui est habituellement et largement étudié : on s'intéresse aux propriétés dynamiques du flot selon le choix de θ ou pour des θ génériques (unique ergodicité, minimalité, périodicité, mélange,...).

Illumination On fixe un point de départ $x \in \mathcal{S}$.

Ce choix mène à l'étude du *flot exponentiel* $exp_x : \mathbb{S}^1 \times \mathbb{R} \rightarrow \mathcal{S}$. C'est ce point de vue que nous allons étudier ici. Nous nous intéressons à la façon dont les géodésiques partant de x atteignent les points de \mathcal{S} .

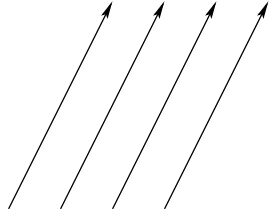

flot directionnel

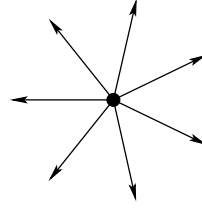

flot exponentiel

0.1.3 Propriété de blocage fini, pure périodicité et revêtements ramifiés du tore

On dit que \mathcal{S} a la *propriété de blocage fini* si pour tout couple de points (O, A) dans \mathcal{S} il existe un nombre fini de points B_1, \dots, B_n (différents de O et A) tels que toute géodésique allant de O à A passe par l'un des B_i (noter qu'il peut exister un nombre infini de géodésiques allant de O à A).

Regardons ce qui se passe lorsque \mathcal{S} est le tore $\mathbb{R}^2/\mathbb{Z}^2$. Soient O et A deux points de \mathcal{S} . Il existe une infinité de géodésiques allant de O à A et pourtant il est possible de bloquer toutes ces géodésiques avec quatre points de \mathcal{S} seulement. En effet, si on représente \mathcal{S} comme le carré $[0, 1] \times [0, 1]$ dont on a identifié les bords parallèles par translation, on écrit en coordonnées $O = (x, y)$ et $A = (x', y')$. Soit γ une géodésique allant de O à A et ne rencontrant pas $\{O, A\}$ en son intérieur. Elle peut être relevée dans \mathbb{R}^2 en un segment allant de $O = (x, y)$ à $A' = (x' + k, y' + l)$ où $(k, l) \in \mathbb{Z}^2$.

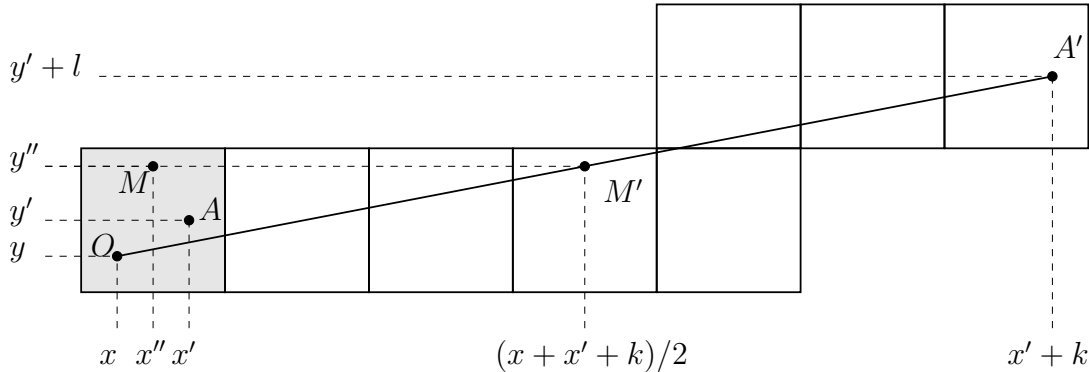

L'idée est de choisir le milieu du segment $[O, A']$ comme point bloquant. Ce point M' se projette sur un point M de \mathcal{S} de coordonnées

$$(x'', y'') = ((x + x' + k)/2, (y + y' + l)/2) \bmod \mathbb{Z}^2$$

Donc $M = ((x + x')/2, (y + y')/2) + \tau \bmod \mathbb{Z}^2$ où $\tau \in \{0, 1/2\}^2$ dépend de la parité de k et l . Il y a donc quatre coordonnées possibles pour les milieux des géodésiques de O à A .

Ce résultat semble apparaître pour la première fois dans un problème posé par Dmitriy Fomin lors des olympiades mathématiques de Leningrad en 1989. La même démonstration marche encore pour un tore plat \mathbb{R}^2/Λ quelconque. Appelons *revêtement ramifié* une application $\pi : \mathcal{S} \rightarrow \mathcal{S}'$ entre deux surfaces de translation qui est un revêtement ramifié

topologique, et qui préserve la structure de translation. La propriété de blocage fini est préservée par revêtement ramifié puisque nous pouvons projeter/relever géodésiques et points bloquants via π . Nous obtenons donc le résultat suivant :

Un revêtement ramifié d'un tore plat a la propriété de blocage fini.

Dans l'espoir de généraliser ce résultat, étudions-en la démonstration : nous avons représenté la surface comme un polygone de \mathbb{R}^2 (un *patron*) dont les côtés parallèles sont identifiés deux à deux par translation. Nous avons ainsi pu "déplier" une géodésique qui joint deux points de \mathcal{S} en un segment du plan. On a "ramené" le milieu de tels segments dans \mathcal{S} au moyen de ce qu'on pourrait appeler le *groupe des dépliages* du patron et l'ensemble obtenu a été notre configuration bloquante.

La construction des rectangles zippés due à William Veech assure que toute surface de translation admet un patron. Par contre, le fait que l'orbite d'un milieu M' sous l'action du groupe des dépliages rencontre le patron en un nombre fini de points n'est assuré que lorsque le groupe des dépliages est discret. Que se passe-t-il dans le cas contraire?

La façon la plus simple d'obtenir un sous-groupe non discret de \mathbb{R}^2 est d'y mettre deux vecteurs colinéaires et rationnellement indépendants. Considérons une surface \mathcal{S} qui contient deux cylindres adjacents dans la même direction (par exemple l'horizontale) et dont les périmètres α et β ne sont pas commensurables. Un patron de \mathcal{S} ressemble localement à :

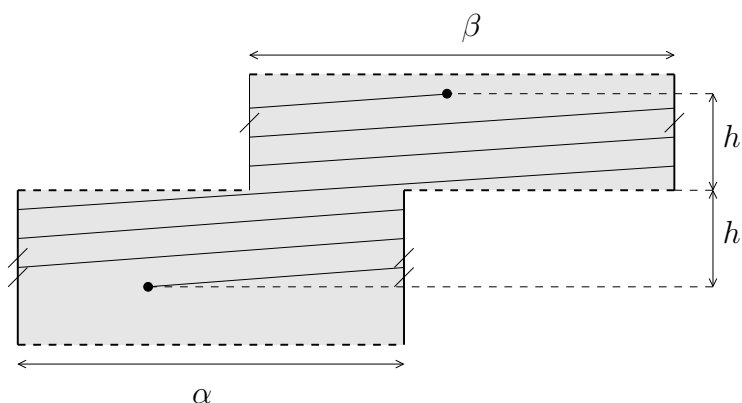

Le groupe des dépliages associé contient donc une copie de $\alpha\mathbb{Z} + \beta\mathbb{Z}$ et n'est pas discret. Dans cette situation, la surface \mathcal{S} n'a pas la propriété de blocage fini. L'idée de la preuve est la suivante : on choisit convenablement un point dans chaque cylindre et on crée des géodésiques entre ces deux points de plus en plus enroulées afin de mesurer de plus en plus précisément le rapport irrationnel qui existe entre α et β . Si la surface a la propriété de blocage fini, il existe un point par lequel passe une infinité de telles géodésiques : les équations de toutes ces droites sont donc liées de sorte que le rapport entre le nombre de tours dans le cylindre du bas et le nombre de tours dans le cylindre du haut est un rationnel fixé, mais ce rapport doit tendre vers α/β .

Moralement, nous avons approché le feuilletage associé au flot directionnel $\phi_{\theta=0}$ par une suite de géodésiques de plus en plus horizontales.

Nous avons donc un critère local assurant qu'une surface n'a pas la propriété de blocage fini, encore faut-il qu'il s'applique dans des situations intéressantes. Un théorème d'Howard

Masur nous dit que pour toute surface de translation, il existe un ensemble dense de directions telles que le flot directionnel associé comporte une orbite périodique. Une telle courbe fermée peut être épaissie en un cylindre. Cela n'est pas suffisant puisque nous désirons avoir deux cylindres adjacents dans une même direction. Kariane Calta a introduit la notion de surface *complètement périodique* : ce sont les surfaces de translation \mathcal{S} telles que pour toute direction θ telle que ϕ_θ admet une orbite périodique, \mathcal{S} se décompose en cylindres dans la direction θ .

Nous avons démontré qu'une surface jouissant de la propriété de blocage fini est complètement périodique. La démonstration de ce résultat est assez longue et on ne peut en donner ici qu'un léger parfum : s'il existe une direction qui contient un cylindre adjacent à une composante non périodique, nous pouvons étaler cette dernière de façon à obtenir des rectangles de plus en plus fins et longs dans la direction du cylindre. Grâce à cette construction, nous construisons des faisceaux de géodésiques entre deux points fixés (l'un dans l'intersection des rectangles, l'autre dans le cylindre). Cette fois-ci, un point peut bloquer une infinité de géodésiques, mais la densité des géodésiques d'un faisceau qui sont bloquées tend vers zéro.

Là encore, nous avons approché le feuilletage associé au flot directionnel dans la direction du cylindre par les faisceaux de géodésiques.

Afin de combiner ce résultat et le critère local précédent, nous définissons une surface *purement périodique* comme étant une surface de translation telle que pour toute direction θ telle que ϕ_θ admet une orbite périodique, \mathcal{S} se décompose dans la direction θ en cylindres dont les périmètres sont commensurables. Nous obtenons donc le résultat suivant :

Une surface qui a la propriété de blocage fini est purement périodique.

Notons qu'une surface est purement périodique si et seulement si pour tout angle θ , ϕ_θ admet une orbite périodique implique qu'il existe $T > 0$ tel que $\phi_\theta^T = Id_{\mathcal{S}}$ presque partout.

Ces deux résultats mettent en rapport géométrie, illumination et dynamique. Nous voulons montrer que les surfaces purement périodiques sont des revêtements ramifiés de tores plats, nous aurons ainsi une équivalence entre les trois notions, revêtement ramifié du tore, propriété de blocage fini, et pure périodicité.

Il existe une caractérisation des revêtements ramifiés des tores plats au moyen de l'*holonomie*. Si $\gamma : [0, 1] \rightarrow \mathcal{S}$ est une courbe continue, elle peut être relevée grâce aux cartes locales en une courbe plane $\bar{\gamma}$ définie à translation près, de sorte que le vecteur d'holonomie $hol(\gamma) = \bar{\gamma}(1) - \bar{\gamma}(0)$ est bien défini. Si on se restreint aux courbes fermées, l'holonomie est constante sur les classes d'homologie et peut être étendue en un morphisme du groupe d'homologie $H_1(\mathcal{S}, \mathbb{Z})$ dans \mathbb{R}^2 . Le groupe des dépliages d'un patron associé à une surface de translation \mathcal{S} n'est autre que $hol(H_1(\mathcal{S}, \mathbb{Z}))$, c'est donc un objet intrinsèque. Une surface de translation est un revêtement ramifié d'un tore si et seulement si $hol(H_1(\mathcal{S}, \mathbb{Z}))$ est discret, il suffit donc de montrer ce fait pour toute surface purement périodique.

Nous avons montré que, si $P(\mathcal{S})$ désigne le sous-groupe de $H_1(\mathcal{S}, \mathbb{Z})$ engendré par les orbites périodiques du flot géodésique d'une surface purement périodique \mathcal{S} , alors $hol(P(\mathcal{S}))$

est discret. L'idée de la preuve est la suivante : Richard Kenyon et John Smillie ont introduit l'invariant J pour les surfaces de translation. C'est un invariant algébrique à valeurs dans le produit alterné $\mathbb{R}^2 \wedge_{\mathbb{Q}} \mathbb{R}^2$ qui se calcule à partir d'une décomposition cellulaire de la surface par des polygones. Si une surface est purement périodique, son invariant J se calcule facilement à partir de décompositions en cylindres dans deux directions différentes. Le fait que l'invariant J ne dépende pas du choix des deux directions nous permet de montrer que trois vecteurs quelconques dans $hol(P(\mathcal{S}))$ sont rationnellement liés. Puis, comme $hol(P(\mathcal{S}))$ est un groupe abélien de type fini, il est isomorphe à \mathbb{Z}^2 , donc discret puisqu'il n'est inclus dans aucune droite de \mathbb{R}^2 .

Nous obtenons donc le résultat suivant :

Lorsque les orbites périodiques du flot géodésique d'une surface \mathcal{S} engendrent son homologie, \mathcal{S} est un revêtement ramifié d'un tore si et seulement si \mathcal{S} a la propriété de blocage fini si et seulement si \mathcal{S} est purement périodique.

Nous avons donc une équivalence soumise à condition. La question naturelle à laquelle nous n'avons pas pu répondre est de savoir si toute surface de translation voit son homologie engendrée par les orbites périodiques de son flot géodésique. Néanmoins, nous avons pu obtenir l'équivalence précédente dans certains cas concrets.

Surfaces convexes Dans son étude des surfaces hyperelliptiques, William Veech a introduit les surfaces *convexes*, ce sont les surfaces de translation qui admettent un patron convexe. Nous avons montré par des moyens de géométrie élémentaire que les orbites périodiques du flot géodésique sur une surface convexe engendrent son homologie. Ainsi l'équivalence a lieu pour de telles surfaces.

Point de vue global L'ensemble des surfaces de translation (ou *espace des modules*) se décompose en *strates* : si $1 \leq k_1 \leq k_2 \leq \dots \leq k_n$ est une suite d'entiers strictement positifs dont la somme est paire, notons $\mathcal{H}(k_1, k_2, \dots, k_n)$ l'ensemble des surfaces de translation qui ont n singularités d'angles coniques respectifs $2(k_i + 1)\pi$ (on néglige donc les singularités d'angle conique 2π). Une surface de translation dans $\mathcal{H}(k_1, k_2, \dots, k_n)$ a un genre $g = 1 + (k_1 + k_2 + \dots + k_n)/2$.

Le groupe $SL(2, \mathbb{R})$ agit sur chaque strate de la façon suivante : si $(\mathcal{S}, \Sigma, \omega)$ est une surface de translation et A un élément de $SL(2, \mathbb{R})$, $A\mathcal{S}$ est la surface définie dans les cartes par $(\mathcal{S}, \Sigma, (U_i, A \circ \phi_i)_{i \in I})$.

On peut définir explicitement une structure de variété topologique sur chaque strate, de sorte que, si on se donne un patron d'une surface, un voisinage de celle-ci est donné par les surfaces obtenues en perturbant légèrement la longueur et l'orientation des arêtes du patron.

On peut aussi définir une mesure $SL(2, \mathbb{R})$ -invariante sur chaque strate $\mathcal{H}(k_1, k_2, \dots, k_n)$, celle-ci est infinie. Si on projette cette mesure sur l'hypersurface $\mathcal{H}_1(k_1, k_2, \dots, k_n)$ des surfaces d'aire 1, Howard Masur et William Veech ont montré que cette nouvelle mesure est finie et que l'action de $SL(2, \mathbb{R})$ est ergodique sur les composantes connexes de chaque strate normalisée (chaque strate comporte au plus trois composantes connexes).

Une construction, due à Maxim Kontsevich et Anton Zorich, d'un ensemble dense dans chaque strate de surfaces à un cylindre nous assure que chaque composante connexe de chaque strate contient au moins une surface convexe. Comme le fait d'être une surface de translation dont l'homologie est engendrée par les orbites périodiques du flot géodésique est une condition ouverte et invariante sous l'action de $SL(2, \mathbb{R})$, on en déduit que les trois notions étudiées coïncident sur un ouvert dense de mesure pleine dans chaque strate normalisée.

Surfaces de Veech Parmi les surfaces de translation, les plus symétriques sont les *surfaces de Veech* i.e. les surfaces \mathcal{S} dont le quotient $SL(2, \mathbb{R})/Stab(\mathcal{S})$ est de volume fini. Le stabilisateur d'une telle surface \mathcal{S} sous l'action de $SL(2, \mathbb{R})$ est si gros qu'il contient nécessairement deux éléments paraboliques (i.e. de trace 2) qui ne commutent pas. Les surfaces qui admettent un tel couple d'éléments paraboliques sont parfois appelées *surfaces bouillabaisse* en allusion à un exposé de John Hubbard sur les travaux de William Thurston à ce sujet lors d'une conférence au CIRM. Un élément parabolique est de la forme

$$M_{\theta,t} = \begin{pmatrix} \cos \theta & -\sin \theta \\ \sin \theta & \cos \theta \end{pmatrix} \begin{pmatrix} 1 & t \\ 0 & 1 \end{pmatrix} \begin{pmatrix} \cos \theta & -\sin \theta \\ \sin \theta & \cos \theta \end{pmatrix}^{-1}$$

et le fait que $M_{\theta,t}.\mathcal{S} = \mathcal{S}$ impose à la surface d'être décomposée en cylindres dans la direction θ et les rapports entre le périmètre et la hauteur de ces cylindres sont commensurables à t . La commensurabilité des périmètres des cylindres d'une surface purement périodique se transmet alors à leurs hauteurs (dans deux directions), et un découpage de la surface en petits parallélogrammes nous permet de dire que les surfaces bouillabaisse (et en particulier les surfaces de Veech) purement périodiques sont des revêtements ramifiés de tores plats.

Eugene Gutkin a montré indépendamment l'équivalence entre la propriété de blocage fini et le fait d'être un revêtement ramifié d'un tore plat pour les surfaces de Veech.

Genre 2 Les travaux de Kariane Calta et de Curtis McMullen concernant les surfaces de genre deux, plus particulièrement les équations liant les divers paramètres associés aux surfaces complètement périodiques, nous ont permis de montrer que l'équivalence a lieu pour les surfaces de genre deux.

0.1.4 Surfaces concrètes

Comme nous l'avons vu précédemment, il est relativement aisé d'obtenir des résultats pour presque toute surface de translation. Certains résultats ne sont pas vrais partout et il n'est généralement pas facile de construire des contre-exemples. Il est aussi difficile de construire une surface ayant tel ou tel comportement générique.

Nous avons par exemple, en utilisant la propriété de blocage fini pour les revêtements ramifiés du tore, construit une surface telle qu'il n'existe pas de géodésique joignant une singularité à elle-même. Nous avons aussi construit une surface dont l'invariant J est celui d'une surface purement périodique mais qui n'est pas purement périodique (cela

montre que l'invariant J ne permet pas de distinguer les surfaces purement périodiques).

Il existe aussi un certain nombre de surfaces concrètes dans la littérature ou le folklore. Citons par exemple les polygones réguliers construits par William Veech (premiers exemples non arithmétiques de surfaces de Veech), les surfaces de Veech qui ont un patron en forme de L construites par Curtis McMullen, les surfaces dont le groupe de Veech contient un élément hyperbolique mais pas d'élément parabolique construites par Pierre Arnoux et Jean-Christophe Yoccoz, la surface de translation dont le groupe de Veech est $SL(2, \mathbb{Z})$ mais qui n'est pas un tore construite par Frank Herrlich et Gabriela Schmithuesen, les surfaces dont le groupe de Veech est infiniment engendré construites par Pascal Hubert et Thomas Schmidt, le triangle obtus dont la surface associée est de Veech mis en évidence grâce au logiciel McBilliards, les billards à mur dont la dimension de Hausdorff des directions non-uniquement ergodiques est égale à $1/2$ (maximum possible) construits par Yitwah Cheung...

Nous pensons qu'il est intéressant d'inventorier de telles surfaces, car une surface construite pour un usage précis est souvent réutilisée à d'autres fins. Vue l'étendue des domaines auxquels est connectée la théorie des surfaces de translation (théorie ergodique, géométrie algébrique, combinatoire, théorie des nombres, analyse complexe), cette tâche ne peut qu'être réalisée en collaboration. Nous tentons de mettre en place un outil pour y parvenir. Techniquement, il s'agit d'un *wiki* i.e. un site web sur lequel tout le monde peut créer ou modifier une page existante à partir d'un simple navigateur. Au delà de l'aspect encyclopédique, ce fonctionnement permettrait aux personnes d'interagir, d'ajouter une surface, de signaler une nouvelle propriété possédée par une surface existante, de proposer une propriété sans posséder d'exemple la vérifiant, d'ajouter simplement un commentaire, une image, une nouvelle preuve. Le site, encore très jeune, se trouve à l'adresse <http://ocarina.ath.cx/~titi/twiki/bin/view/WildSurfaces/WebHome>

0.1.5 Ouverture : regard dynamique sur l'illumination

Il n'existe que peu de travaux relatifs à l'illumination dans les surfaces de translation, et la variable "temps" dans le flot exponentiel n'a jamais vraiment été prise en compte. L'étude de la propriété de blocage fini s'occupe de savoir si on peut joindre deux points d'une certaine façon. Georges Tokarsky s'est demandé si tous les couples de points dans un billard rationnel étaient joints par une géodésique, mais la longueur de celle-ci n'est pas considérée. Ce sont des points de vue qu'on pourrait qualifier de statiques.

Nous souhaitons affiner notre étude dans une direction plus quantitative, en reportant par exemple le modèle dynamique dans ce contexte de l'illumination. On peut se demander à quoi ressemble le "cercle" $C_t(x) = \{exp_x(\theta, t) \mid \theta \in \mathbb{S}^1\}$ lorsque t tend vers l'infini. Nous pouvons imaginer l'évolution de $C_t(x)$ au cours du temps comme la propagation sur la surface d'une "onde de choc" qui part du point x . Un analogue de la minimalité serait que pour tout $\varepsilon > 0$, cette onde devienne ε -dense pour des t suffisamment grands (une partie de \mathcal{S} est dite ε -dense si la distance de tout point de \mathcal{S} à la partie est inférieure à ε). On peut aussi se demander si, asymptotiquement, cette onde de choc se répartit uniformément sur la surface.

A titre d'illustration, montrons que le flot exponentiel sur $\mathcal{S} = \mathbb{R}^2/\mathbb{Z}^2$ est minimal. Soit x un point quelconque de \mathcal{S} (cela importe peu puisque \mathcal{S} est homogène), et soit ε un réel strictement positif. Choisissons une direction θ de pente irrationnelle. La direction $\theta' = \theta + \pi/2$ a elle aussi une pente irrationnelle donc le flot $\phi_{\theta'}$ dans cette direction est uniquement ergodique. Il existe donc $L > 0$ tel que toute géodésique de direction θ' et de longueur L soit $\varepsilon/2$ -dense dans \mathcal{S} . La courbure d'un cercle de \mathbb{R}^2 de rayon T tend vers 0 lorsque T tend vers l'infini. Il existe donc T tel que pour tout $t \geq T$, tout segment de longueur L tangent à un cercle de rayon t est $\varepsilon/2$ -proche de ce cercle.

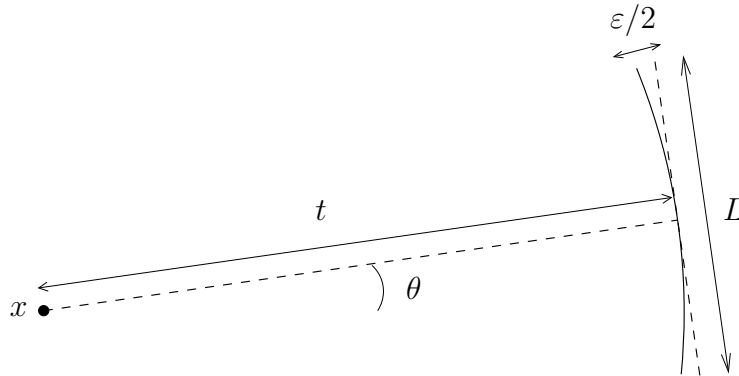

En projetant sur $\mathbb{R}^2/\mathbb{Z}^2$, nous en déduisons que pour de tout $t \geq T$, $C_t(x)$ est ε -dense dans \mathcal{S} , puisque $\phi_{\theta'}(\exp_x(\theta, t), [-L/2, L/2])$ est à la fois $\varepsilon/2$ -dense dans \mathcal{S} et $\varepsilon/2$ -proche de $C_t(x)$.

Ce raisonnement ne peut pas s'appliquer aux surfaces de genre supérieur car le cercle $C_t(x)$ va être découpé en arcs de cercles lorsqu'il rencontrera des singularités. Il est donc nécessaire de trouver d'autres approches.

0.2 Dynamique symbolique (topologique)

Si A est un ensemble fini (appelé *alphabet*), considérons l'application de *décalage* :

$$S = \left(\begin{array}{ccc} A^{\mathbb{N}} & \longrightarrow & A^{\mathbb{N}} \\ x = (x_0, x_1, \dots, x_n, \dots) & \longmapsto & (x_1, x_2, \dots, x_{n+1}, \dots) \end{array} \right)$$

Nous nous intéressons aux systèmes dynamiques (X, S) où X est une partie de $A^{\mathbb{N}}$ qui est fermée, non vide et stable par S . De tels systèmes sont appelés *sous-shifts*.

Ces systèmes symboliques apparaissent comme des codages de systèmes géométriques d'entropie finie : si (Y, T) est un système dynamique et \mathcal{A} est une partition finie de Y , nous pouvons suivre les atomes de la partition rencontrés par une orbite, et créer ainsi un mot infini sur l'alphabet \mathcal{A} . Cette procédure établit, lorsque la partition est convenablement choisie, un dictionnaire entre Y et un sous-ensemble de $\mathcal{A}^{\mathbb{N}}$, et l'application T correspond, à travers ce dictionnaire, au décalage sur les mots infinis.

Concernant les systèmes dynamiques mesurés, nous pouvons toujours établir un isomorphisme entre un système ergodique et un sous-shift. En revanche, certaines obstructions apparaissent dans le cas des systèmes dynamiques topologiques, puisqu'un sous-shift est une application expansive sur un espace totalement discontinu. Néanmoins, il est souvent possible d'établir une semi-conjugaison topologique avec un sous-shift pour certains systèmes géométriques, c'est par exemple le cas lorsque l'application T est un échange d'intervalles ou un homéomorphisme pseudo-Anosov d'une surface compacte. Cela est généralement suffisant pour préserver la plupart des propriétés dynamiques du système, comme le mélange, l'entropie ou l'unique ergodicité.

Les systèmes symboliques permettent aussi de donner un cadre théorique précis pour l'étude de la transmission et de la compression de données numériques (théorie de l'information). Ils ont aussi un intérêt propre puisqu'ils constituent une source importante d'exemples et de contre-exemples.

Nous considérons ici des sous-shifts en tant que systèmes dynamiques topologiques et nous supposons qu'ils sont minimaux dans cette catégorie. Cette hypothèse de *minimalité* est équivalente au fait que toutes les orbites du système (X, S) sont denses dans X .

Nous ne pouvons pas effectivement manipuler les éléments de X qui sont des mots infinis, nous allons donc appréhender ce système grâce au *langage* qui lui est associé, c'est à dire l'ensemble $L(X)$ des mots finis qui apparaissent comme sous-mots des mots de X . Les sous-shifts minimaux sont entièrement déterminés par leur langage.

Une première information combinatoire que nous pouvons tirer de ce langage est sa *fonction de complexité*, qui à tout entier n associe le nombre de mots de longueur n de $L(X)$: $p_n(X) = \text{card}(L_n(X))$ où $L_n(X) = L(X) \cap A^n$.

Par ailleurs, le langage associé à un sous-shift est *factoriel*, c'est à dire qu'il est stable par passage aux sous-mots. Ainsi, un mot de longueur $n + 1$ dans $L(X)$ est naturellement rattaché à deux mots de longueur n dans $L(X)$: son préfixe et son suffixe. Une façon de représenter cette structure factorielle est l'emploi des *graphes de Rauzy* : pour tout entier n , on fabrique un graphe $G_n(X)$ dont les sommets sont les éléments de $L_n(X)$ et il y a une arête orientée d'un mot u à un mot v (tous deux dans $L_n(X)$) s'il existe un mot w dans

$L_{n+1}(X)$ qui commence par u et finit par v . Ces graphes ont été définis formellement par Gérard Rauzy mais ils transparaissent aussi dans les travaux de Michael Boshernitzan relatifs aux échanges d'intervalles qui datent à peu près de la même période.

0.2.1 Mesures invariantes

Nous pouvons apprécier la diversité des comportements des orbites d'un système (X, S) à travers l'ensemble $\mathcal{M}(X, S)$ des mesures de probabilité qui sont invariantes par S . Grâce au théorème de représentation de Riesz, cet ensemble peut être vu comme une partie convexe compacte non vide du dual topologique de $C^0(X, \mathbb{R})$ muni de la topologie faible-étoile.

Une mesure invariante $\mu \in \mathcal{M}(X, S)$ est dite *ergodique* si les boréliens B de X tels que $S^{-1}(B) = B$ ont mesure 0 ou 1. Une telle mesure satisfait le théorème de Birkhoff :

$$\forall f \in L^1(X, \mathbb{R}) \quad \frac{1}{n} \sum_{k=0}^{n-1} f \circ S^k \xrightarrow[n \rightarrow \infty]{\mu\text{-p.p.}} \int_X f d\mu$$

L'ensemble $\mathcal{E}(X, S)$ des mesures ergodiques invariantes est l'ensemble des points extrémaux de $\mathcal{M}(X, S)$, de sorte que toute mesure invariante peut s'écrire comme une moyenne de mesures ergodiques. Les mesures ergodiques sont mutuellement singulières. Le cardinal de $\mathcal{E}(X, S)$ (qui peut être infini) représente donc le nombre de comportements typiques des orbites de (X, S) .

Un cas extrême se produit lorsqu'il n'y a qu'une mesure invariante (le système est dit *uniquement ergodique*) : il y a convergence uniforme dans le théorème de Birkhoff pour les fonctions f continues : toutes les orbites se répartissent de la même façon.

Nous avons étudié les relations qui peuvent exister entre des objets combinatoires associés au langage d'un sous-shift minimal et le simplexe de ses mesures invariantes. Dans cette direction, Christian Grillenberger a construit des sous-shifts uniquement ergodiques de complexité exponentielle. Michael Boshernitzan a donné une majoration du nombre de mesures ergodiques invariantes pour les sous-shifts de complexité linéaire (un sous-shift est dit de complexité linéaire s'il existe une constante C telle que pour tout n , $p_n(X) \leq Cn$). Il montre que si (X, S) est un sous-shift minimal tel que $\liminf_{n \rightarrow \infty} \frac{p_n(X)}{n} \leq K$, alors (X, S) admet au plus K mesures ergodiques invariantes.

Nous pouvons majorer le nombre de mesures invariantes d'un sous-shift en fonction de la géométrie de ses graphes de Rauzy, et plus précisément la facilité avec laquelle on peut les "déconnecter" : disons qu'un sous-shift est *K-déconnectable* s'il existe un entier K' tel que, pour une infinité d'entiers n , il existe un ensemble $D_n \subset L_n(X)$ de cardinal K tel que tout chemin dans $G_n(X) \setminus D_n$ a une longueur inférieure à $K'n$ (en particulier, $G_n(X) \setminus D_n$ ne contient pas de cycle). Nous avons démontré le résultat suivant :

Un sous-shift K-déconnectable admet au plus K mesures ergodiques invariantes.

Pour démontrer ce résultat nous construisons K candidats possibles et montrons que ce sont les seuls. Ces candidats sont obtenus en approximant (X, S) par les systèmes périodiques engendrés par les mots $d^\omega = dddd\dots$ où d appartient à D_n .

Plus formellement, nous considérons les mesures atomiques $\mu_{d,n} = \frac{1}{n} \sum_{k=0}^{n-1} \delta_{S^k(d^\omega)}$. Si μ est une mesure ergodique, un élément de X générique pour μ peut être vu, à n fixé, comme un chemin infini dans le graphe $G_n(X)$. L'hypothèse de déconnectabilité impose une certaine récurrence sur l'ensemble D_n : nous choisissons l'élément d_n de D_n rencontré le plus souvent par le chemin infini de sorte que $\mu_{d_n,n}$ converge à extraction près vers μ , ce qui limite le nombre de tels μ à K .

Ce résultat généralise le théorème de Michael Boshernitzan pour les sous-shifts de complexité linéaire. En effet, puisque que $p_{n+1}(X)$ compte les arêtes de $G_n(X)$ et que $p_n(X)$ compte ses sommets, $p_{n+1}(X) - p_n(X)$ majore le nombre de sommets de $G_n(X)$ de degré entrant supérieur à deux (un tel mot de $L_n(X)$ est appelé *facteur spécial à gauche* de (X, S)). L'ensemble $LS_n(X)$ des spéciaux à gauche de (X, S) déconnecte $G_n(X)$ et, pour une infinité d'entiers n , il est de cardinal inférieur à K .

Ce résultat s'applique pour certaines classes de sous-shifts définis combinatoirement. Par exemple, les sous-shifts Arnoux-Rauzy minimaux et les sous-shifts quasipériodiques multiéchelle sont 1-déconnectables donc uniquement ergodiques, puisque leurs graphes de Rauzy ont infiniment souvent l'allure suivante :

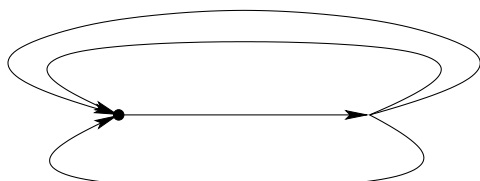

Arnoux-Rauzy

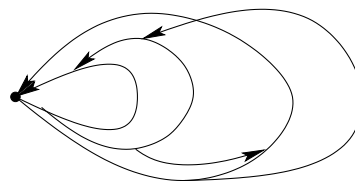

quasipériodique multiéchelle

Nous étudierons les sous-shifts quasipériodiques multiéchelle en détail dans un prochain paragraphe, mais nous pouvons déjà signaler qu'il existe de tels sous-shifts dont la complexité n'est pas linéaire.

Nous avons vu comment utiliser les facteurs spéciaux à gauche comme ensemble déconnectant pour les sous-shifts de complexité linéaire. Une étude fine de l'évolution des graphes de Rauzy $G_n(X)$ lorsque n croit, due à Julien Cassaigne, explique comment des facteurs spéciaux peuvent apparaître ou disparaître. Notons que cette "dynamique" des graphes de Rauzy ne correspond pas à l'évolution au cours du temps dans (X, S) , mais est plutôt un zoom progressif dans la structure de (X, S) , une approximation de (X, S) par des sous-shifts de type fini.

Imaginons qu'à une échelle n , le nombre de spéciaux à gauche passe de K à $K + 1$, et qu'à l'échelle $n + 1$, il passe de $K + 1$ à K , et que ce phénomène apparaisse pour une infinité d'entiers n . Nous obtenons une borne égale à K pour le nombre de mesures ergodiques invariantes. Imaginons maintenant la situation inversée où, pour une infinité d'entiers n , le nombre de spéciaux à gauche passe de K à $K - 1$ à l'échelle n , et qu'à l'échelle $n + 1$ il passe de $K - 1$ à K . Vues depuis l'échelle $n + 2$, les deux situations sont semblables puisque dans les deux cas, il y a eu apparition et disparition d'un spécial à gauche : ce petit défaut de synchronisation ne devrait pas influencer sur le nombre de mesures ergodiques invariantes des sous-shifts associés.

Afin de négliger ce problème de mauvaise synchronisation, nous allons grouper les événements qui se produisent à des échelles “comparables”, c’est à dire des échelles comprises entre un entier n et $n + o(n)$.

Un préfixe d’un facteur spécial à gauche est encore un facteur spécial à gauche. L’ensemble $LS(X)$ des facteurs spéciaux à gauche possède donc une structure d’arbre. Nous pouvons dessiner cet arbre dans $[0, 1] \times \mathbb{R}_+$ de sorte que les sommets qui sont dans $LS_n(X)$ ont une ordonnée égale à n et que les arêtes sont des segments qui ne se chevauchent pas.

Nous appelons *coupe* une fonction continue de $[0, 1]$ dans \mathbb{R}_+ .

Nous avons obtenu le résultat suivant :

Si (X, S) est un sous-shift de complexité linéaire tel qu’il existe une suite (f_n) de coupes telles que :

- *le minimum de f_n tend vers l’infini avec n*
- *$\max(f_n) = \min(f_n) + o(\min(f_n))$*
- *un dessin de l’arbre des facteurs spéciaux à gauche de (X, S) rencontre le graphe de f_n en moins de K points (pour tout entier n)*

Alors, (X, S) admet au plus K mesures ergodiques invariantes.

Sur le dessin suivant, nous avons représenté une coupe qui intersecte l’arbre des facteurs spéciaux à gauche en trois points alors que pour toutes les échelles représentées, le nombre de facteurs spéciaux à gauche est supérieur à six.

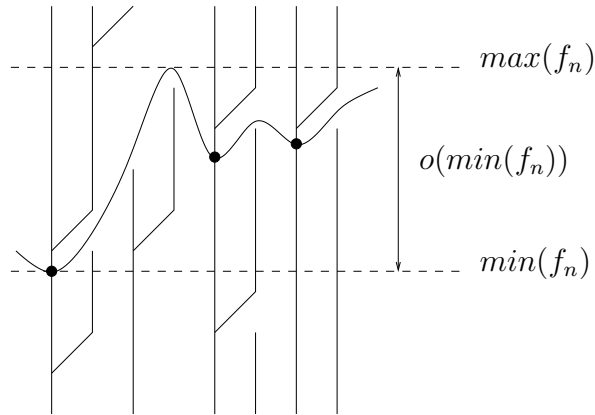

La démonstration repose sur un raffinement du résultat sur les sous-shifts K -déconnectables : au lieu de demander que les graphes de Rauzy soient déconnectés en enlevant K sommets, nous nous permettons de déconnecter les graphes de Rauzy en enlevant K boules de rayon $o(n)$ (la distance entre deux sommets est la longueur minimale d’un chemin non orienté les joignant). Lorsqu’un facteur spécial de longueur n se dédouble, les deux spéciaux à gauche restent proches pendant une gamme d’échelles de longueur $o(n)$: nous pouvons les mettre dans une même petite boule.

Anatoly Katok et William Veech ont démontré qu’un échange de K intervalles admet au plus $K/2$ mesures ergodiques invariantes, et cette borne est optimale. Le codage naturel d’un tel système est de complexité inférieure à $(K - 1)n + 1$, donc la borne donnée par

Michael Boshernitzan peut presque être divisée par deux. Peut-on retrouver la borne optimale d'après la géométrie des graphes de Rauzy (le fait que le sous-shift provient d'un échange d'intervalles, et notamment le fait qu'un échange d'intervalles est croissant par morceaux contraint la géométrie des graphes de Rauzy associés)?

0.2.2 Ouverture : un point de vue profini

Nous avons tenté, à l'aide de l'arbre des spéciaux à gauche, de nous affranchir de certains problèmes de synchronisation qui peuvent apparaître dans l'utilisation du résultat sur les sous-shifts K -déconnectables.

Nous pouvons voir un sous-shift minimal comme la limite projective de ses graphes de Rauzy :

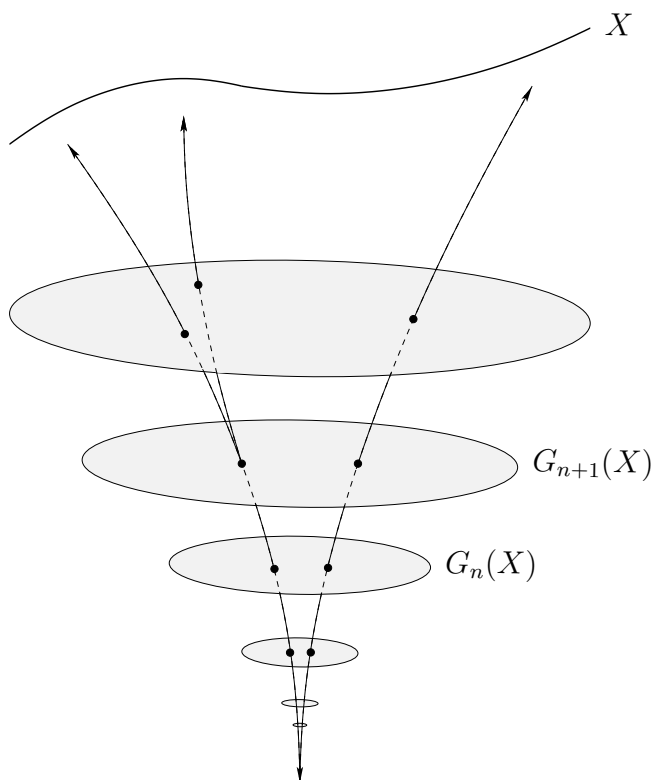

Avec cette présentation, les graphes de Rauzy sont des tranches horizontales, et l'arbre des spéciaux à gauche peut être interprété comme la colonne vertébrale de cet espace (au moins pour les mots de complexité linéaire). Graphes de Rauzy et arbre des spéciaux à gauche sont en quelque sorte des objets combinatoires transverses, et les deux résultats précédents peuvent être reformulés dans cet espace : pouvons-nous énoncer un résultat plus général qui donnerait une majoration du nombre de mesures ergodiques invariantes d'un sous-shift minimal en fonction de la géométrie de cet espace? Cet espace a été utilisé par Jorge Almeida dans son étude d'un invariant algébrique pour les sous-shifts minimaux. Y a-t-il un lien entre le groupe qu'il a introduit et le simplexe des mesures invariantes?

Un sous-shift est dit *sturmien* s'il est infini et de complexité minimale, c'est à dire que pour tout entier n , $p_n(X) = n + 1$. Nous avons montré le résultat suivant :

Les sous-shifts sturmiens sont quasipériodiques multiéchelle.

L'arbre des spéciaux à gauche d'un sous-shift sturmien est filiforme, nous montrons que ce mot particulier est quasipériodique multiéchelle.

Les dessins suivants résument le "gain de symétrie" obtenu en considérant les sous-shifts quasipériodiques multiéchelle plutôt que les mots quasipériodiques :

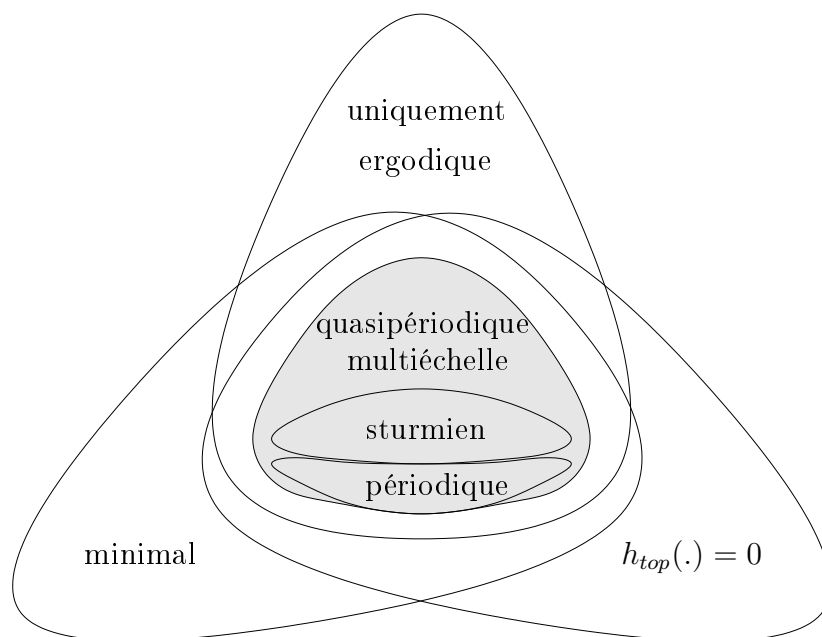
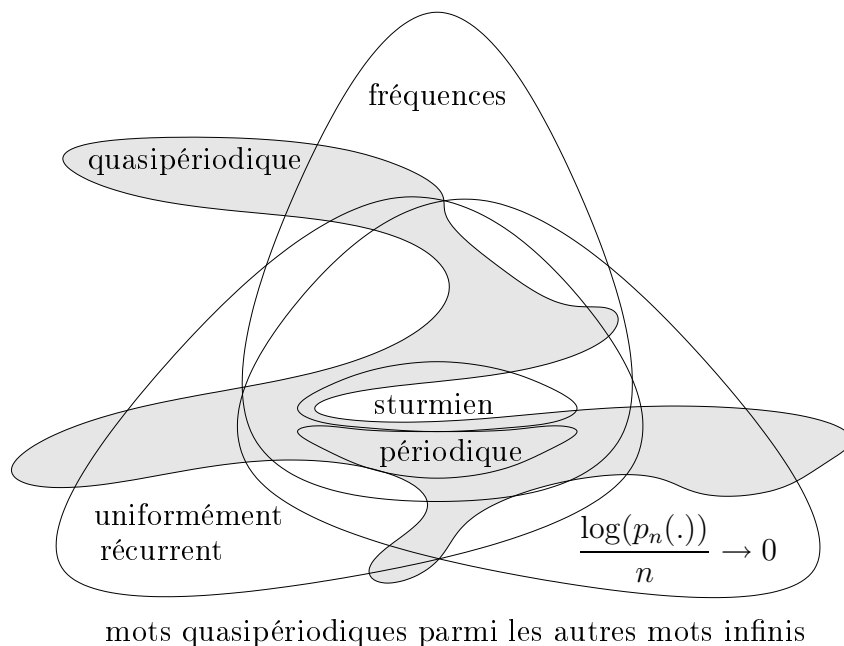

sous-shifts quasipériodiques multiéchelle parmi les autres sous-shifts

0.2.4 Ouverture : stabilité à la Abramov

Nous avons constaté qu'une caractéristique des notions mesurant la régularité dans les mots infinis ou les sous-shifts est qu'elles sont stables par changement d'échelle ; l'analogie de la dérivation des mots infinis pour les systèmes dynamiques est l'induction.

Dans le cadre des systèmes dynamiques mesurés, la formule d'Abramov nous dit que si (Y, T, μ) est un système dynamique ergodique d'entropie finie, et si A est une partie mesurable de Y de mesure strictement positive, alors

$$h(A, T_A, \mu_A) = h(Y, T, \mu) / \mu(A)$$

où h désigne l'entropie métrique et (A, T_A, μ_A) est la transformation induite de T sur A . Ainsi, lorsque l'entropie métrique d'un système mesuré est nulle, il en est de même pour ses transformations induites.

Cette formule peut être vue comme une version quantifiée de la stabilité par changement d'échelle, elle lie le degré de symétrie d'un système, celui du système induit et celui du sous-ensemble où nous induisons.

Peut-on trouver un analogue de la formule d'Abramov pour les notions classiques de symétrie? Par exemple, si X est un sous-shift de faible complexité de Kolmogorov, si A est une partie de X qui peut être décrite par un court programme informatique (par exemple une union finie de cylindres), il devrait être possible d'écrire un programme court qui décrit le système induit, puisque l'induction peut être comprise comme une boucle "repeat – until". Pouvons-nous donner un cadre formel à cette remarque?

0.3 Bibliographie thématique

Illumination dans les billards et surfaces de translation

Textes introductifs sur les billards rationnels et surfaces de translation

- H. MASUR, S. TABACHNIKOV, *Rational billiards and flat structures*, Handbook on dynamical systems, Vol. 1A, p 1015–1089, North-Holland, Amsterdam, (2002).
- Y. VOROBETS, *Planar structures and billiards in rational polygons: the Veech alternative*, Russian Math. Surveys 51 (1996), no. 5, 779–817.
- A. ZORICH, *Flat Surfaces*, Frontiers in Number Theory, Physics and Geometry. Volume 1: On random matrices, zeta functions and dynamical systems, Ecole de physique des Houches, France, March 9-21 2003, Springer-Verlag, Berlin, (2006) 1–149.

Textes fondateurs

- A. KATOK, A. ZEMLJAKOV, *Topological transitivity of billiards in polygons*, Mat. Zametki 18 (1975), no. 2, 291–300.
- S. KERCKHOFF, H. MASUR, J. SMILLIE, *Ergodicity of billiard flows and quadratic differentials*, Ann. Math. 124 (1986), no. 2, 293–311.
- H. MASUR, *Interval exchange transformations and measured foliations*, Ann. of Math. (2) 115 (1982), no. 1, 169–200.
- W. VEECH, *Gauss measures for transformations on the space of interval exchange maps*, Ann. of Math. (2) 115 (1982), no. 1, 201–242.
- W. VEECH, *Teichmüller curves in moduli space, Eisenstein series and an application to triangular billiards*, Invent. Math. 97 (1989), no. 3, 553–583.

Illumination

- D. FOMIN, *ЗАДАЧИ ЛЕНИНГРАДСКИХ МАТЕМАТИЧЕСКИХ ОЛИМПИАД*, Leningrad (1990), 77.
- P. HIEMER, V. SNURNIKOV, *Polygonal billiards with small obstacles*, J. Statist. Phys. 90 (1998), no. 1-2, 453–466.
- V. KLEE, *Is every polygonal region illuminable from some point?*, Amer. Math. Monthly 76(80) (1969).
- G. TOKARSKY, *Polygonal rooms not illuminable from every point*, Amer. Math. Monthly 102 (1995), no. 10, 867–879.

Surfaces de translation concrètes

- P. ARNOUX, J.C. YOCCOZ, *Construction de difféomorphismes pseudo-Anosov*, C. R. Acad. Sci. Paris Sér. I Math., 292 no. 1, (1981) 75–78.
- Y. CHEUNG, *Hausdorff dimension of the set of nonergodic directions*, Ann. of Math. (2) 158 (2003), no. 2, 661–678.
- F. HERRLICH, G. SCHMITHUESEN *An extraordinary origami curve*, preprint arXiv math.AG/0509195.
- P. HOOPER, *Another Veech Triangle*, preprint <http://www.math.sunysb.edu/~pat/>
- P. HUBERT, T. SCHMIDT, *Infinitely generated Veech groups*, Duke Math. J. 123 (2004), no. 1, 49–69.

- C. MCMULLEN, *Billiards and Teichmüller curves on Hilbert modular surfaces*, J. Amer. Math. Soc. 16 (2003), no. 4, 857–885.

Textes sur les wikis

- <http://c2.com/cgi/wiki> (premier site de type wiki)
- <http://fr.wikipedia.org/wiki/Wiki> (encyclopédie de type wiki)

Dynamique symbolique

Textes introductifs

- M. DENKER, C. GRILLENBERGER, K. SIGMUND, *Ergodic theory on compact spaces*, Lect. Notes Math. 527 (1976).
- P. SHIELDS, *The ergodic theory of discrete sample paths*, Graduate Studies in Mathematics, 13. American Mathematical Society, Providence, RI, 1996.

Exemples de codages pour des systèmes dynamiques topologiques

- R. ADLER, *Symbolic dynamics and Markov partitions*, Bull. Amer. Math. Soc. (N.S.) 35 (1998), no. 1, p 1–56.
- M. KEANE, *Interval exchange transformations*, Math. Z. 141 (1975), p 25–31.

Evolution des graphes de Rauzy

- P. ARNOUX, G. RAUZY, *Représentation géométrique de suites de complexité $2n+1$* , Bull. Soc. Math. France 119 (1991), no. 2, p 199–215.
- J. CASSAIGNE, *Complexité et facteurs spéciaux*, Bull. Belg. Math. Soc. Simon Stevin 4 (1997), p 76–88.
- G. RAUZY, *Suites à termes dans un alphabet fini*, Séminaire de Théorie des Nombres de Bordeaux, (1983), p 25-01–25-16.

Survols des différentes classes de complexité

- J.P. ALLOUCHE, *Sur la complexité des suites infinies*, Bull. Belg. Math. Soc. Simon Stevin 1 (1994), no. 2, 133–143.
- S. FERENCZI, *Complexity of sequences and dynamical systems*, Discrete Math. 206 (1999), no. 1-3, 145–154.

Simplexe des mesures invariantes, unique ergodicité

- N. BOGOLIUBOFF, N. KRYLOFF, *La théorie générale de la mesure dans son application à l'étude des systèmes dynamiques de la mécanique non linéaire*, Ann. of Math. (2) 38 (1937), no. 1, 65–113.
- M. BOSHERNITZAN, *A unique ergodicity of minimal symbolic flows with linear block growth*, J. Analyse Math. 44 (1984/85), p 77–96.
- M. BOSHERNITZAN, *A condition for unique ergodicity of minimal symbolic flows*, Ergodic Theory Dynam. Systems 12 (1992), no. 3, 425–428.
- C. GRILLENBERGER, *Constructions of strictly ergodic systems. I. Given entropy*, Z. Wahrscheinlichkeitstheorie und Verw. Gebiete 25 (1972/73), p 323–334.

Mots infinis quasipériodiques

- F. LEVÉ, G. RICHOMME, *Quasiperiodic infinite words: some answers*, Bull. Eur. Assoc. Theor. Comput. Sci. EATCS No. 84, (2004), p 128–138.
- S. MARCUS, *Quasiperiodic infinite words*, Bull. Eur. Assoc. Theor. Comput. Sci. EATCS No. 82, (2004), p 170–174.
- S. MARCUS, *Symmetry phenomena in infinite words, with biological, philosophical and aesthetic relevance*, Symmetry, culture and science, 2004.

Entropie et complexité de Kolmogorov

- A.A. BRUDNO, *Entropy and the complexity of the trajectories of a dynamic system*, Trudy Moskov. Mat. Obshch. 44 (1982), p 124–149.
- H. WHITE, *Algorithmic complexity of points in dynamical systems*, Ergodic Theory Dynam. Systems 13 (1993), no. 4, 807–830.

0.4 Plan de la thèse

Chaque chapitre correspond à un article (publié, soumis, voire simplement prépublié ou en cours de relecture). Le texte comporte donc inévitablement des redondances (notamment lors des paragraphes introductifs), mais nous avons choisi de conserver ce point de vue chronologique, de ne pas retoucher les premiers papiers afin de ne pas trahir l'évolution des idées et de leur perception au cours de la recherche. Les quatre premiers chapitres traitent d'illumination dans les billards polygonaux, les deux derniers traitent de dynamique symbolique.

Le premier chapitre est un contre-exemple au théorème de Philipp Hiemer et Vadim Snurnikov qui affirmait que tout billard rationnel jouit de la propriété de blocage fini. Il correspond à un papier publié en 2004 dans *The Journal of Statistical Physics*.

Le deuxième chapitre reprend la construction du premier pour établir le critère local sur les périmètres des cylindres adjacents. Il permet de montrer que les seules surfaces bouillabaissees (et donc aussi les seules surfaces de Veech) qui possèdent la propriété de blocage fini sont des revêtements ramifiés d'un tore. Nous montrons aussi directement que les seuls polygones réguliers qui ont la propriété de blocage fini sont le triangle équilatéral, le carré et l'hexagone régulier. Il correspond à un papier publié en 2005 aux *Annales de l'Institut Fourier*.

Dans le troisième chapitre, nous montrons que les surfaces de translation qui ont la propriété de blocage fini sont purement périodiques et nous en déduisons la caractérisation de ces surfaces pour le genre 2. On montre aussi que presque aucune surface de translation n'a la propriété de blocage fini.

Dans le quatrième chapitre, nous montrons que les surfaces purement périodiques dont l'homologie est engendrée par les orbites de son flot géodésique sont des revêtements ramifiés d'un tore. Nous en déduisons l'équivalence entre les notions de revêtement ramifié du tore, propriété de blocage fini, et pure périodicité pour les surfaces convexes (ainsi que pour une classe de surfaces dites *face-à-face*) ainsi que sur un ouvert dense de mesure pleine dans chaque strate normalisée. Nous construisons aussi une surface qui a un invariant J de la forme $v_1 \wedge v_2$ mais qui n'est pas purement périodique.

Dans le cinquième chapitre, nous donnons des majorations du nombre de mesures ergodiques invariantes d'un sous-shift en fonction de la géométrie de deux objets combinatoires associés à son langage : les graphes de Rauzy et l'arbre des spéciaux à gauche.

Dans le sixième chapitre, nous étudions les mots infinis quasipériodiques et introduisons les sous-shifts quasipériodiques multitéchelle : nous montrons qu'ils sont uniquement ergodiques, de complexité de Kolmogorov et d'entropie topologique nulles. Nous montrons aussi que tous les sous-shifts sturmiens sont quasipériodiques multitéchelle.

Chapitre 1

Un contre-exemple au théorème de Hiemer et Snurnikov

1.1 Introduction

A planar polygonal billiard \mathcal{P} is said to have the finite blocking property if for every pair (O, A) of points in \mathcal{P} there exists a finite number of “blocking” points B_1, \dots, B_n (different from O and A) such that every billiard trajectory from O to A meets one of the B_i ’s.

In [HS], Hiemer and Snurnikov tried to prove that any rational polygonal billiard has the finite blocking property. The aim of this paper is to construct a family of rational billiards that lack the finite blocking property.

1.2 The counter-example

Let α be a positive irrational number and \mathcal{P}_α be the polygon drawn in Figure 1.1 (L_1 and L_2 can be chosen arbitrarily, greater than 1).

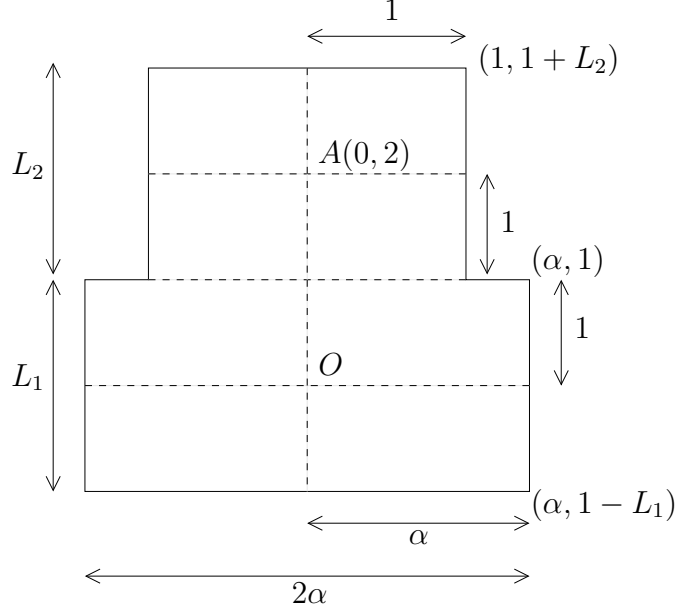

Figure 1.1: The polygon \mathcal{P}_α .

Let $(p_n, q_n)_{n \in \mathbb{N}}$ be a sequence in \mathbb{N}^{*2} such that:

- q_n is strictly increasing
- $|p_n - q_n \alpha| < 1$

For example, we can take $q_n = n + 1$ and $p_n = [q_n \alpha]$.

For $n \in \mathbb{N}$, let γ_n be the billiard trajectory starting from O to A with slope

$$\frac{1}{p_n + q_n \alpha} = \frac{1}{2q_n \alpha + \lambda_n} = \frac{1}{2p_n - \lambda_n}$$

where $\lambda_n = p_n - q_n \alpha \in]-1, 1[$.

So, we can check (with the classical unfolding procedure shown in Figure 1.2) that γ_n hits q_n walls, passes through $(\lambda_n, 1)$, hits p_n walls and then passes through $A(0, 2)$.

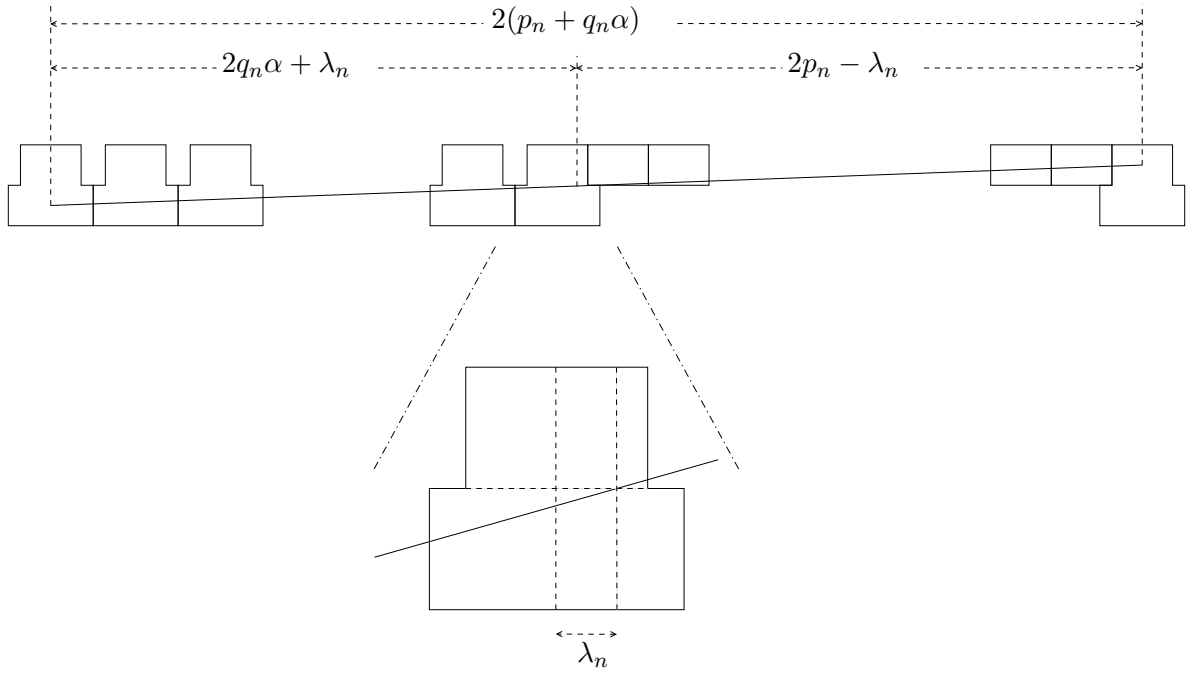

Figure 1.2: The unfolding procedure.

The fact that $\lambda_n \in]-1, 1[$ enables us to avoid the banana peel shown in Figure 1.3.

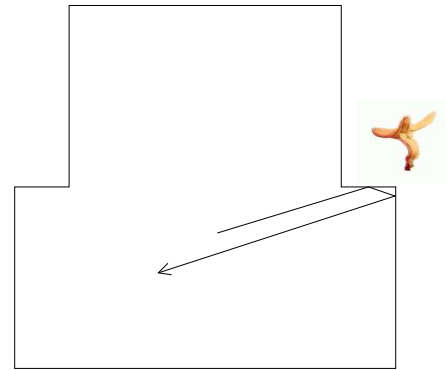

Figure 1.3: The banana peel.

Now, we assume by contradiction that there is a point $B(x, y)$ in \mathcal{P}_α distinct from O and A such that infinitely many γ_n pass through B . Hence, there is a subsequence such that for all n in \mathbb{N} , γ_{i_n} passes through B .

There are two cases to consider:
 First case: $y \in]0, 1]$. By looking at the unfolded version of the trajectory (Figure 1.2), we see that $x = \varepsilon_{i_n} y(p_{i_n} + q_{i_n} \alpha) \pmod{2\alpha}$ where $\varepsilon_{i_n} \in \{-1, 1\}$ depends on the parity of the number of bounces of γ_{i_n} from O to B .
 So, there exists a sequence $(k_n)_{n \in \mathbb{N}}$ in \mathbb{Z} such that $x = \varepsilon_{i_n} y(p_{i_n} + q_{i_n} \alpha) + 2k_n \alpha$.

Taking a further subsequence, we can consider $\varepsilon \circ i$ to be constant with value ε .

We have $x = \varepsilon y(p_{i_0} + q_{i_0}\alpha) + 2k_{i_0}\alpha = \varepsilon y(p_{i_1} + q_{i_1}\alpha) + 2k_{i_1}\alpha$.

Hence, $(p_{i_1} - p_{i_0}) + (q_{i_1} - q_{i_0})\alpha = \frac{\varepsilon 2\alpha}{y}(k_{i_0} - k_{i_1}) \neq 0$.

So, $\frac{\varepsilon 2\alpha}{y}$ can be written as $r + s\alpha$ where r and s are rational numbers.

Now, if $n \geq 1$, we still have $(p_{i_n} - p_{i_0}) + (q_{i_n} - q_{i_0})\alpha = (r + s\alpha)(k_{i_0} - k_{i_n})$.

Because $(1, \alpha)$ is free over \mathbb{Q} , we have

- $(p_{i_n} - p_{i_0}) = r(k_{i_0} - k_{i_n})$
- $(q_{i_n} - q_{i_0}) = s(k_{i_0} - k_{i_n}) \neq 0$ (remember that q_n is strictly increasing)

Thus, by dividing,

$$\frac{r}{s} = \frac{p_{i_n} - p_{i_0}}{q_{i_n} - q_{i_0}} = \frac{p_{i_n}}{q_{i_n}} \left(1 - \frac{p_{i_0}}{p_{i_n}}\right) \left(\frac{1}{1 - \frac{q_{i_0}}{q_{i_n}}}\right) \xrightarrow[n \rightarrow \infty]{} \alpha \in \mathbb{R} \setminus \mathbb{Q}$$

leading to a contradiction.

For the second case, if $y \in [1, 2[$, it is exactly the same (take the point $A(0, 2)$ as the origin and reverse Figure 1.2).

Thus, the billiard \mathcal{P}_α lacks the finite blocking property.

1.3 Conclusion

In [M], we study Hiemer and Snurnikov's proof: it works for rational billiards with discrete translation group (such billiards are called *almost integrable*). Then we generalize the notion of finite blocking property to translation surfaces (see [MT] for precise definitions). With an analogous construction to the one described above, we obtain the following results:

Theorem 1. *Let $n \geq 3$ be an integer. The following assertions are equivalent:*

- *the regular n -gon has the finite blocking property.*
- *the right-angled triangle with an angle equal to π/n has the finite blocking property.*
- $n \in \{3, 4, 6\}$.

Theorem 2. *A translation surface that admits cylinder decomposition of commensurable moduli in two transversal directions has the finite blocking property if and only if it is a torus branched covering.*

Corollary 1. *A Veech surface has the finite blocking property if and only if it is a torus branched covering.*

Note that torus branched coverings are the analogue (in the vocabulary of translation surfaces) of almost integrable billiards.

We also provide a local sufficient condition for a translation surface to fail the finite blocking property: it enables us to give a complete classification for the L-shaped surfaces and a density result in the space of translation surfaces in every genus $g \geq 2$.

References

- [HS] P. HIEMER, V. SNURNIKOV, *Polygonal billiards with small obstacles*, Journal of Statistical Physics, Vol 90 (1998), p 453–466.
- [MT] H. MASUR, S. TABACHNIKOV, *Rational billiards and flat structures*, Handbook on dynamical systems, Vol. 1A, p 1015–1089, North-Holland, Amsterdam, (2002).
- [M] T. MONTEIL, *On the finite blocking property*, preprint.

Chapitre 2

Sur la propriété de blocage fini

2.1 Introduction

When studying the motion of a point-mass in a polygonal billiard \mathcal{P} , we work on the phase space $X = \mathcal{P} \times \mathbb{S}^1$ suitably quotiented: we identify the points (p_1, θ_1) and (p_2, θ_2) if $p_1 = p_2$ is on the boundary of \mathcal{P} and if the angles θ_1 and θ_2 are such that the Descartes law of reflection is respected (see Figure 2.1).

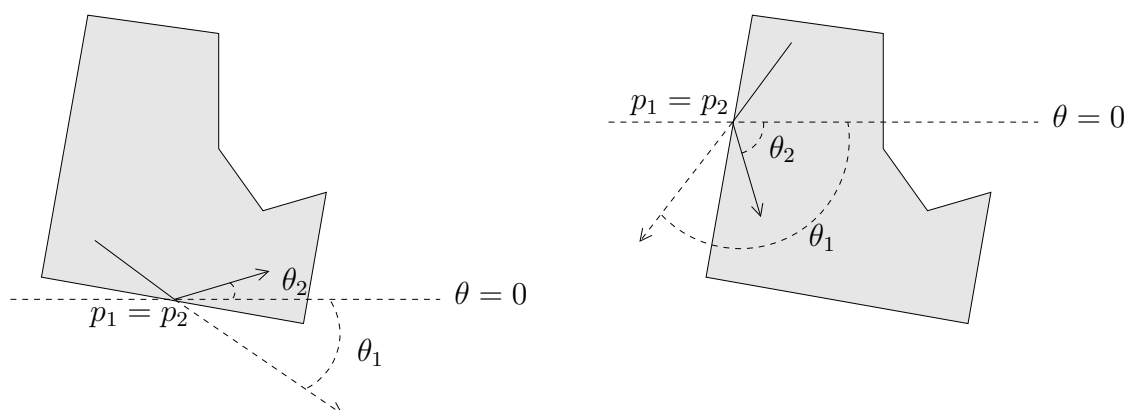

Figure 2.1: The Descartes law: *the incidence angle equals the angle of reflection.*

The phase space enjoys also such a global decomposition in the study of the dynamics on a translation surface.

There are essentially two points of view depending on whether the variable is the first or the second projection:

1. We can fix one (or a finite number of) particular direction: this corresponds for rational billiards to the study of the directional flow in a translation surface (we are interested by the ergodic properties depending on whether θ is a saddle connection direction or not) (see [KMS], [Ve], [MT], [Vo]). It is also useful for finding periodic trajectories in irrational billiards by starting perpendicularly to an edge (see [ST]). This point of view is the most studied.

2. We can also fix one (or a finite number of) point in \mathcal{P} and look at which points we can reach when we let θ move. This class of problems is called “illumination problems”. The first published question seems to appear in [Kl] (see [KW] for a more precise story). The first published result in this direction seems to be the paper of George W. Tostaky (see [To]) who finds a polygon that is not illuminable from every point. Independently, Michael Boshernitzan constructed such an example in a correspondence with Howard Masur (see [Bos]).

We are interested here in an illumination problem called the finite blocking property.

A planar polygon (resp. translation surface) \mathcal{P} is said to have the *finite blocking property* if for every pair (O, A) of points in \mathcal{P} , there exists a finite number of points B_1, \dots, B_n (different from O and A) such that every billiard trajectory (resp. geodesic) from O to A meets one of the B_i 's.

In this paper we will primarily focus on translation surfaces. The paper is organized as follows: in section 2.2, we will give some definitions and prove that the finite blocking property is stable under branched covering, stable under the Zemljakov-Katok's construction, and stable under the action of $GL(2, \mathbb{R})$. Section 2.3 is devoted to the study of Hiemer and Snurnikov's proof, leading to some comments about the finite property in the torus $\mathbb{R}^2/\mathbb{Z}^2$. In section 2.4, we prove a local sufficient condition for a translation surface to fail the finite blocking property (Lemma 1). The aim of the next two sections is to prove the following theorems:

Theorem 1. *Let $n \geq 3$ be an integer. The following assertions are equivalent:*

- *the regular n -gon has the finite blocking property.*
- *the right-angled triangle with an angle equal to π/n has the finite blocking property.*
- *$n \in \{3, 4, 6\}$.*

Theorem 2. *A Veech surface has the finite blocking property if and only if it is a torus covering, branched at only one point.*

The last section is devoted to some other applications of Lemma 1, such as

Proposition 10. *Let a and b be two positive real numbers. Then the L-shaped surface $L(a, b)$ has the finite blocking property if and only if $(a, b) \in \mathbb{Q}^2$.*

Theorem 3. *In genus $g \geq 2$, the set of translation surfaces that fail the finite blocking property is dense in every stratum.*

Acknowledgement: I would like to thank Martin Schmoll for introducing me to the subject, Kostya Kokhas and Serge Troubetzkoy for historical comments, Anton Zorich for helpful discussions and Pascal Hubert for encouragements to write this paper.

2.2 Definitions and first results

2.2.1 Translation surfaces and geodesics

A *translation surface* is a triple $(\mathcal{S}, \Sigma, \omega)$ such that \mathcal{S} is a topological compact connected surface, Σ is a finite subset of \mathcal{S} (whose elements are called *singularities*) and $\omega = (U_i, \phi_i)_{i \in I}$ is an atlas of $\mathcal{S} \setminus \Sigma$ (consistent with the topological structure on \mathcal{S}) such that the transition maps (i.e. the $\phi_j \circ \phi_i^{-1} : \phi_i(U_i \cap U_j) \rightarrow \phi_j(U_i \cap U_j)$ for $(i, j) \in I^2$) are translations. This atlas gives to $\mathcal{S} \setminus \Sigma$ a Riemannian structure; we therefore have notions of length, angle, measure, geodesic... We assume moreover that \mathcal{S} is the completion of $\mathcal{S} \setminus \Sigma$ for this metric. We will sometimes use the notation (\mathcal{S}, Σ) or simply \mathcal{S} to refer to $(\mathcal{S}, \Sigma, \omega)$. A singularity $\sigma \in \Sigma$ is said to be *removable* if there exists an atlas $\omega' \supset \omega$ such that $(\mathcal{S}, \Sigma \setminus \{\sigma\}, \omega')$ is a translation surface.

There are many conventions about what happens if a geodesic γ meets one singularity $\sigma \in \Sigma$. Some people want to stop γ here; some other people want to extend γ with a multi-geodesic path; other people want to extend γ after σ if and only if σ is an removable singularity. *The finite blocking property does not depend on the convention* since, for every pair (O, A) of points in \mathcal{S} , we can always add the set $\Sigma \setminus \{O, A\}$ (that is finite) to a blocking configuration. Therefore, if (S, Σ) is a translation surface, if \mathcal{E} is a finite subset of \mathcal{S} that we want to add in Σ as removable singularities, then (S, Σ) has the finite blocking property if and only if $(S, \Sigma \cup \mathcal{E})$ has it.

2.2.2 Branched coverings

A *branched covering* between two translation surfaces is a mapping $\pi : (\mathcal{S}, \Sigma) \rightarrow (\mathcal{S}', \Sigma')$ that is a topological branched covering that locally preserves the translation structure.

Proposition 1. *Let $\pi : (\mathcal{S}, \Sigma) \rightarrow (\mathcal{S}', \Sigma')$ be a covering of translation surfaces branched on a finite set $\mathcal{R}' \subset \mathcal{S}'$. Then \mathcal{S} has the finite blocking property if and only if \mathcal{S}' has.*

Proof: \Rightarrow : Suppose that \mathcal{S} has the finite blocking property. Let (O', A') be a pair of points in \mathcal{S}' . Let O be a point chosen in $\pi^{-1}(\{O'\})$. If $A \in \pi^{-1}(\{A'\})$, there exists a finite set \mathcal{B}_A of points in $\mathcal{S} \setminus \{O, A\}$ such that every geodesic in \mathcal{S} from O to A meets \mathcal{B}_A . Let

$$\mathcal{B}' \stackrel{\text{def}}{=} \left(\bigcup_{A \in \pi^{-1}(\{A'\})} \pi(\mathcal{B}_A) \cup \mathcal{R}' \right) \setminus \{O', A'\}.$$

Let $\gamma' : [a, b] \rightarrow \mathcal{S}'$ be a geodesic from O' to A' . Up to a restriction, we can suppose that $\gamma'([a, b]) \cap \{O', A'\} = \emptyset$. Suppose by contradiction that $\gamma'([a, b]) \cap \mathcal{B}' = \emptyset$. In particular, $\gamma'([a, b]) \cap \mathcal{R}' = \emptyset$. So, γ' can be lifted to a geodesic $\gamma : [a, b] \rightarrow \mathcal{S}$ from O to some $A \in \pi^{-1}(\{A'\})$ such that $\pi \circ \gamma = \gamma'$. Then, there exists $t \in]a, b[$ such that $\gamma(t) \in \mathcal{B}_A$. Hence $\gamma'(t) \in \mathcal{B}'$, leading to a contradiction. So, \mathcal{B}' is a finite blocking configuration and \mathcal{S}' has the finite blocking property.

\Leftarrow : Suppose that \mathcal{S}' has the finite blocking property. Let (O, A) be a pair of points in \mathcal{S} . Let $O' \stackrel{\text{def}}{=} \pi(O)$ and $A' \stackrel{\text{def}}{=} \pi(A)$. There exists a finite set $\mathcal{B}' \subset \mathcal{S}' \setminus \{O', A'\}$ such that

every geodesic in \mathcal{S}' from O' to A' meets \mathcal{B}' . Let

$$\mathcal{B} \stackrel{\text{def}}{=} \pi^{-1}(\mathcal{B}') \subset \mathcal{S} \setminus \{O, A\}.$$

Let $\gamma : [a, b] \rightarrow \mathcal{S}$ be a geodesic from O to A . γ can be pushed to a geodesic $\gamma' \stackrel{\text{def}}{=} \pi \circ \gamma : [a, b] \rightarrow \mathcal{S}'$ from O' to A' . Then, there exists $t \in]a, b[$ such that $\gamma'(t) \in \mathcal{B}'$. Hence $\gamma(t) \in \mathcal{B}$. So, \mathcal{B} is a finite blocking configuration and \mathcal{S} has the finite blocking property. \square

2.2.3 Rational billiards vs translation surfaces

Let \mathcal{P} denote a polygon in \mathbb{R}^2 , whose set of vertices is denoted by V . Let $\Gamma \subset O(2, \mathbb{R})$ be the group generated by the linear parts of the reflections in the sides of \mathcal{P} . When Γ is finite, we say that \mathcal{P} is a *rational polygonal billiard*. When \mathcal{P} is simply connected, \mathcal{P} is rational if and only if all the angles between edges are rational multiples of π .

A classical construction due to Zemljakov and Katok (see [ZK], [MT]) allows us to associate to each rational billiard \mathcal{P} a translation surface $ZK(\mathcal{P})$ as follows:

Let $(P_\gamma)_{\gamma \in \Gamma}$ be a family of $|\Gamma|$ disjoint copies of \mathcal{P} , each $P_\gamma = \gamma(\mathcal{P})$ being rotated by the element $\gamma \in \Gamma$. If $\gamma \in \Gamma$, if e is an edge of P_γ , let $\delta \in \Gamma$ be the linear part of the reflection in e ; we identify $e \in P_\gamma$ with $\delta(e) \in P_{\delta\gamma}$. We set:

$$ZK(\mathcal{P}) \stackrel{\text{def}}{=} \bigsqcup_{\gamma \in \Gamma} P_\gamma / \sim$$

where \sim is the relation above. The translation structure of each $\overset{\circ}{P}_\gamma \in \mathbb{R}^2$ can be extended to an atlas of $\bigcup_{\gamma \in \Gamma} P_\gamma \setminus \gamma(V)$, that gives to $ZK(\mathcal{P})$ a translation structure whose set of singularities is $\Sigma = \bigcup_{\gamma \in \Gamma} \gamma(V)$.

In other terms, \mathcal{P} tiles $ZK(\mathcal{P})$ which can be written as $ZK(\mathcal{P}) = \bigcup_{\gamma \in \Gamma} \psi_\gamma(\mathcal{P})$ where the ψ_γ 's are isometries. Let

$$\psi \stackrel{\text{def}}{=} \left(\begin{array}{ccc} ZK(\mathcal{P}) & \longrightarrow & \mathcal{P} \\ x & \longmapsto & (\psi_{\gamma|_{\psi_\gamma(\mathcal{P})}})^{-1}(x) \quad \text{if } x \in \psi_\gamma(\mathcal{P}) \end{array} \right).$$

ψ is well defined since if $x \in \psi_\gamma(\mathcal{P}) \cap \psi_\delta(\mathcal{P})$, then $(\psi_{\gamma|_{\psi_\gamma(\mathcal{P})}})^{-1}(x) = (\psi_{\delta|_{\psi_\delta(\mathcal{P})}})^{-1}(x)$ (this is just the compatibility with \sim). Moreover, ψ is a piecewise isometry.

Proposition 2. *Let \mathcal{P} be a rational polygonal billiard. Then $ZK(\mathcal{P})$ has the finite blocking property if and only if \mathcal{P} has.*

Proof: it is very similar to the proof given in subsection 2.2.2 (ψ plays the role of π). Indeed, for the direction \Rightarrow , if (O', A') is a pair of points in \mathcal{P} , if O is chosen in $\psi^{-1}(\{O'\})$, then for each A in $\psi^{-1}(\{A'\})$, there exists a finite set \mathcal{B}_A of points in $ZK(\mathcal{P}) \setminus \{O, A\}$ such that every geodesic in $ZK(\mathcal{P})$ from O to A meets \mathcal{B}_A . Then

$$\mathcal{B}' \stackrel{\text{def}}{=} \left(\bigcup_{A \in \psi^{-1}(\{A'\})} \psi(\mathcal{B}_A) \cup V \right) \setminus \{O', A'\} = \left(\bigcup_{\gamma \in \Gamma} \psi(\mathcal{B}_{\psi_\gamma(A')}) \cup V \right) \setminus \{O', A'\}$$

is a finite blocking configuration between O' and A' , thus \mathcal{P} has the finite blocking property.

For the direction \Leftarrow , if (O, A) is a pair of points in $ZK(\mathcal{P})$, there exists a finite set \mathcal{B}' of points in $\mathcal{P} \setminus \{\psi(O), \psi(A)\}$ such that every billiard path in \mathcal{P} from $\psi(O)$ to $\psi(A)$ meets \mathcal{B}' . Then

$$\mathcal{B} \stackrel{\text{def}}{=} \psi^{-1}(\mathcal{B}') \subset ZK(\mathcal{P}) \setminus \{O, A\}$$

is a finite blocking configuration between O and A , thus $ZK(\mathcal{P})$ has the finite blocking property. □

Unfolding a billiard table: combining propositions 1 and 2, we have (see [MT]) the:

Proposition 3. *Let \mathcal{P} and \mathcal{P}' be two rational polygonal billiards such that \mathcal{P} is obtained by reflecting \mathcal{P}' at its edges finitely many times, without overlapping (we allow some barriers along parts of some sides of copies of \mathcal{P}' inside \mathcal{P}). Since there exists a branched covering from $ZK(\mathcal{P})$ to $ZK(\mathcal{P}')$, then \mathcal{P} has the finite blocking property if and only if \mathcal{P}' has.*

2.2.4 Action of $GL(2, \mathbb{R})$

If $A \in GL(2, \mathbb{R})$, we can define the translation surface

$$A \cdot (\mathcal{S}, \Sigma, (U_i, \phi_i)_{i \in I}) \stackrel{\text{def}}{=} (\mathcal{S}, \Sigma, (U_i, A \circ \phi_i)_{i \in I});$$

hence we have an action of $GL(2, \mathbb{R})$ on the class of translation surfaces. We classically consider only elements of $SL(2, \mathbb{R})$ (see [MT]), but we do not need to preserve area here.

Proposition 4. *Let \mathcal{S} be a translation surface and A be in $GL(2, \mathbb{R})$. Then \mathcal{S} has the finite blocking property if and only if $A \cdot \mathcal{S}$ has.*

Proof: such an action sends geodesic to geodesic. □

To summarize this section, we can say that the finite blocking property enjoys many properties of *stability*. As an illustration, it suffices to apply successively propositions 2, 1, 4, 2, 3 and to follow a construction of [Mc], to reduce the problem of the finite blocking property for the billiard in the regular pentagon to the problem in the \perp -shaped billiard studied in [Mo] with parameters $\alpha = 1 + 2 \cos(2\pi/5)$, $L_1 = 1$, $L_2 = 2 \cos(2\pi/5)$. It is proved there that this billiard table fails the finite blocking property ($\alpha \in \mathbb{R} \setminus \mathbb{Q}$).

2.3 Some remarks around Hiemer and Snurnikov's proof

In their article [HS], Philipp Hiemer and Vadim Snurnikov tried to prove that any rational billiard \mathcal{P} has the finite blocking property.

For this, they use the subgroup $G_{\mathcal{P}}$ of $Isom(\mathbb{R}^2)$ generated by the reflections at the edges of the polygon \mathcal{P} . In the proof of their theorem 5, they construct a finite number of points in \mathbb{R}^2 called the $P_{i,\lambda}$'s and *choose* a blocking point arbitrarily in each orbit of the $P_{i,\lambda}$'s under the action of the group $G_{\mathcal{P}}$ on \mathbb{R}^2 (the (i, λ) 's belong to $G_{\mathcal{P}}/T_{\mathcal{P}} \times \{0, 1/2\}^{\dim_{\mathbb{Q}} T_{\mathcal{P}}}$).

The polygon \mathcal{P} drawn on Figure 2.2 is a rational one but the subgroup $T_{\mathcal{P}}$ of $G_{\mathcal{P}}$ consisting of translations is dense in \mathbb{R}^2 (identified with the group of all translations of \mathbb{R}^2), since $\mathbb{Z} + \sqrt{2}\mathbb{Z}$ is dense in \mathbb{R} . Hence the orbit of any point of the plane under $G_{\mathcal{P}}$ is dense in the plane and therefore in \mathcal{P} (which is the closure of an open set).

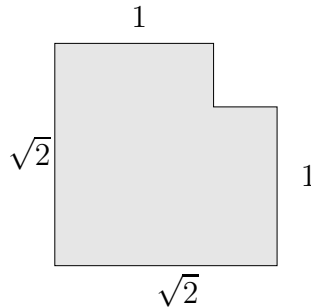

Figure 2.2: A rational polygonal billiard whose translation group is dense in \mathbb{R}^2 .

Now, if we take two points O and A in \mathcal{P} such that the segment $[O, A]$ is included in \mathcal{P} , we can *choose* all the blocking points in a small open set $U \subset \mathcal{P}$ which does not intersect $[O, A]$. Such points cannot block the direct path from O to A (see Figure 2.3).

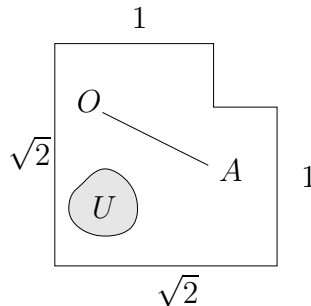

Figure 2.3: The direct path from O to A does not meet the points in U .

Hence the proof in [HS] does not work. In fact, we have shown in [Mo] that the billiard table drawn in Figure 2.2 fails the finite blocking property. Meanwhile, the proof given

in [HS] (theorem 5) works for rational polygons \mathcal{P} such that $T_{\mathcal{P}}$ is discrete (hence lattice) (such billiards are called *almost integrable*). Indeed, instead of choosing one point in each orbit of the $P_{i,\lambda}$'s in \mathcal{P} , it suffices to take *all* the points of the orbits of the $P_{i,\lambda}$'s that lie in \mathcal{P} (and that are distinct from O and A).

We can bound (badly but uniformly) the number of such points as follows:

Proposition 5. *If \mathcal{P} is an almost integrable rational polygonal billiard with angles of the form $\pi \frac{p_i}{q}$ ($1 \leq i \leq n$), if the diameter of \mathcal{P} is D , if (v_1, v_2) is a basis of $T_{\mathcal{P}}$ (that is a lattice), then for every pair (O, A) in \mathcal{P} , there exist a set of at most $8q \left[\frac{\pi \left(\frac{D}{\sqrt{3}} + \frac{\|v_1\| + \|v_2\|}{2} \right)^2}{\det(v_1, v_2)} \right]$ blocking points.*

Proof: include \mathcal{P} in a disk of radius $\frac{D}{\sqrt{3}}$, enlarge this disk by $\frac{\|v_1\| + \|v_2\|}{2}$ and look at the area ($8q$ is larger than $\text{card}(G_{\mathcal{P}}/T_{\mathcal{P}} \times \{0, 1/2\}^{\{v_1, v_2\}})$). □

In fact, the conditions of this proposition (the fact of being an almost integrable billiard) work only for the polygons constructed by reflecting \mathcal{C} at its edges finitely many times (we can add barriers along interior edges), where \mathcal{C} is one of the following elementary polygons:

- the right-angled isosceles triangle with angles $(\pi/2, \pi/4, \pi/4)$
- the half-equilateral triangle with angles $(\pi/2, \pi/3, \pi/6)$
- any rectangle

This fact is a direct consequence of the theory of reflection groups and chamber systems (see [Bou] for an extensive study or [Car] for a brief introduction). The three elementary polygons correspond to the types \tilde{C}_2 , \tilde{G}_2 and $\tilde{A}_1 \times \lambda \tilde{A}_1$ ($\lambda > 0$).

For example, the equilateral triangle, the square and the regular hexagon have the finite blocking property.

Note that the translation surface associated to the square is a (flat) torus. We can notice that the translation surface associated to an almost integrable polygon is a torus branched covering (this is easy for one of the elementary polygons, the rest follows by reflecting). As we have seen in subsection 2.2.2, the finite blocking property is preserved by branched covering and, since 4 points suffice to block every geodesic between 2 fixed points in the torus, we have another bound for the number of blocking points for such billiards that depends on the degree of the covering.

With this remark, we can see that Proposition 5 can be seen as a consequence of the only fact that the square billiard (or equivalently the translation surface $\mathbb{R}^2/\mathbb{Z}^2$) has the finite blocking property. This last result seems to appear for the first time in the Leningrad's Olympiad in 1989 selection round, 9th form (see [Fo]). The problem was the following:

“Professor Smith is standing in the squared hall with mirror walls. Professor Jones wants to place in the hall several students in such a way that professor Smith could not see from his place his own mirror images. Is it possible? (Both professors and students are points, the students can be placed in corners and walls).”

The author of this problem was Dmitriy Fomin. None of the school students solved it. The booklet of the olympiad contains an answer: 16 students, and an example of this arrangement in coordinates.

Another consequence of the fact that the torus $\mathbb{R}^2/\mathbb{Z}^2$ has the finite blocking property is the

Proposition 6. *There exists a translation surface with the property that every geodesic going from a singularity to itself has to meet first another singularity. In other words, this surface does not have any saddle connection going from a singularity to itself.*

Proof: let \mathcal{S} be the translation surface drawn in Figure 2.4.

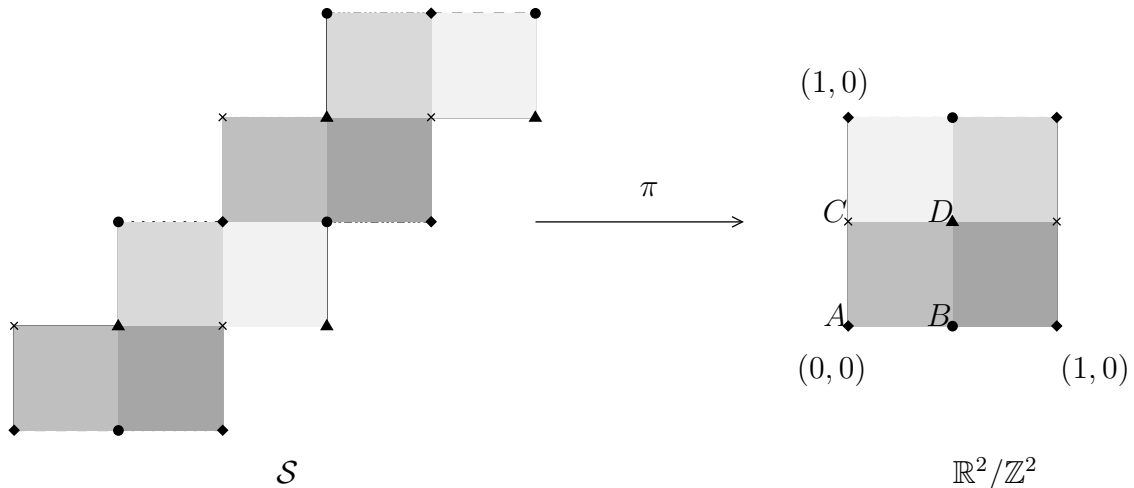

Figure 2.4: Covering between \mathcal{S} and $\mathbb{R}^2/\mathbb{Z}^2$ (the opposite vertical lines are identified by horizontal translation, the vertical lines with the same style are identified).

The coloring allows us to see how to construct a covering $\pi : \mathcal{S} \rightarrow \mathbb{R}^2/\mathbb{Z}^2$ of degree 2, branched at the points $A = (0, 0)$, $B = (1/2, 0)$, $C = (0, 1/2)$, $D = (1/2, 1/2)$. The singularities of \mathcal{S} are located at the preimages of those four points.

The finite blocking property in the square says that three points in $\{A, B, C, D\}$ block every geodesic from the fourth point to itself. Hence, by lifting, every geodesic from the singularity $\pi^{-1}(A)$ to itself in \mathcal{S} has to meet one of the other singularities $\pi^{-1}(B)$, $\pi^{-1}(C)$ or $\pi^{-1}(D)$, and by symmetry it works for the three other singularities. \square

2.4 A local lemma

A *subcylinder* \mathcal{C} is an isometric copy of $\mathbb{R}/w\mathbb{Z} \times]0, h[$ in a translation surface \mathcal{S} ($w > 0$, $h > 0$). w and h are unique and called the *width* and the *height* of \mathcal{C} .

The images in \mathcal{S} of $\mathbb{R}/w\mathbb{Z} \times \{0\}$ and $\mathbb{R}/w\mathbb{Z} \times \{h\}$ (which are well-defined if we extend the isometry, which is uniformly continuous, by continuity in \mathcal{S}) are called the *sides* of \mathcal{C} . The *direction* of \mathcal{C} is the direction of the image of $\mathbb{R}/w\mathbb{Z} \times \{h/2\}$ (which is a closed geodesic).

A *cylinder* is a maximal subcylinder (for the inclusion). By maximality, each side of a cylinder must contain at least one singularity and is a finite union of saddle connections. Let \mathcal{C}_1 and \mathcal{C}_2 be two cylinders with width w_1 (resp. w_2) and height h_1 (resp. h_2) in a translation surface \mathcal{S} .

\mathcal{C}_1 and \mathcal{C}_2 are said to be *parallel* if their directions are parallel.

\mathcal{C}_1 and \mathcal{C}_2 are said to be *commensurable* if the ratios w_1/h_1 and w_2/h_2 are commensurable.

We will study the case where \mathcal{C}_1 and \mathcal{C}_2 are two different parallel cylinders whose closures have a nontrivial (i.e. not reduced to a finite set) intersection. The situation can be described as in Figure 2.5.

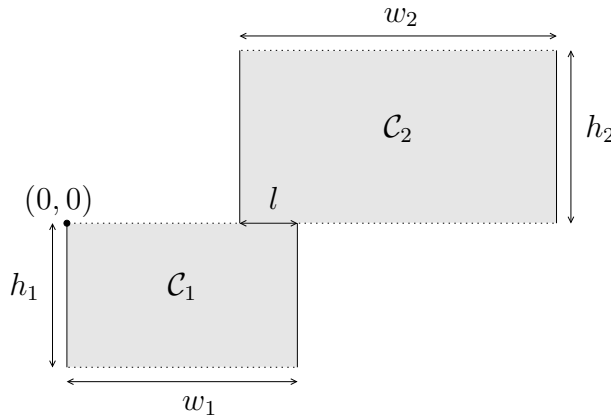

Figure 2.5: The opposite vertical sides are identified by translation while the dotted horizontal ones are glued with the rest of the surface; we take $(0, 0)$ as the origin; $l > 0$.

Lemma 1. *Let \mathcal{S} be a translation surface that contains two different parallel cylinders \mathcal{C}_1 and \mathcal{C}_2 whose closures have a nontrivial intersection. If their widths are uncommensurable, then \mathcal{S} fails the finite blocking property.*

Proof: Up to a vertical dilatation, we can assume that h_1 and h_2 are greater than 1. In the system of coordinates given in Figure 2.5, we set $O = (w_1 - l/2, -1)$ and $A = (w_1 - l/2, 1)$.

Since $\frac{w_1}{w_2}$ is a positive irrational number, $\mathbb{N}^* - \frac{w_1}{w_2}\mathbb{N}^*$ is dense in \mathbb{R} so there exists two positive integer sequences $(p_n)_{n \in \mathbb{N}}$ and $(q_n)_{n \in \mathbb{N}}$ such that:

- q_n is strictly increasing
- $p_n w_2 - q_n w_1 \in]-l, l[$

For $n \in \mathbb{N}$, let γ_n be the geodesic starting from O with slope

$$\frac{2}{q_n w_1 + p_n w_2} = \frac{1}{q_n w_1 + \lambda_n} = \frac{1}{p_n w_2 - \lambda_n}$$

where $\lambda_n = (p_n w_2 - q_n w_1)/2 \in]-l/2, l/2[$.

So, we can check by unfolding the trajectory in the universal cover of \mathcal{S} (see Figure 2.6) that γ_n passes q_n times through the line $\{0\} \times]-h_1, 0[$, passes through $(w_1 - l/2 + \lambda_n, 0) \in]w_1 - l, w_1[\times \{0\}$, passes p_n times through the line $\{w_1 - l\} \times]0, h_2[$ and then passes through A . So, γ_n lies completely in $\mathcal{C}_1 \cup \mathcal{C}_2 \cup]w_1 - l, w_1[\times \{0\}$.

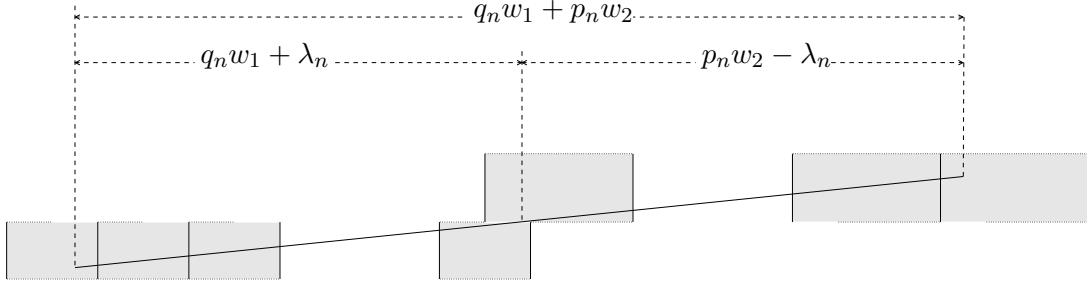

Figure 2.6: The unfolding procedure.

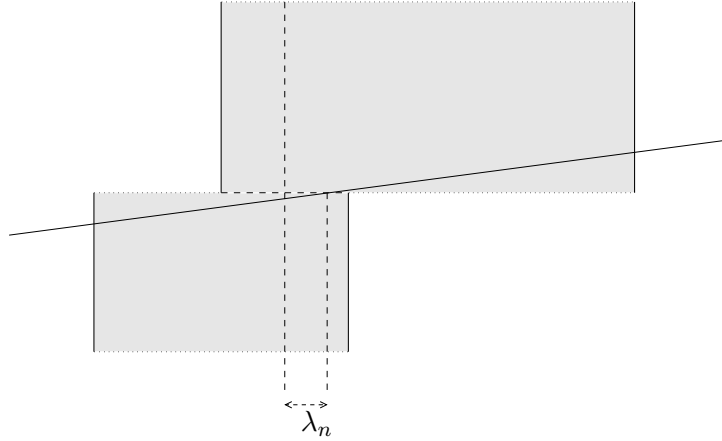

Figure 2.7: Zoom on Figure 2.6.

Now, we assume by contradiction that there is a point $B(x, y)$ in \mathcal{S} distinct from O and A such that infinitely many γ_n pass through B . Hence, there is a subsequence such that for all n in \mathbb{N} , γ_{i_n} passes through B . There are two cases to consider:

First case: $y \in]-1, 0[$. By looking at the unfolded version of the trajectory (Figure 2.6), we see that, if k_{i_n} denotes the number of times that γ_{i_n} pass through the line $\{0\} \times]-h_1, 0[$ before hitting B , then (by calculating the slope of γ_{i_n} from O to B)

$$\frac{y + 1}{(x + k_{i_n} w_1) - (w_1 - l/2)} = \frac{2}{q_n w_1 + p_n w_2}.$$

So,

$$x - w_1 + l/2 = (q_{i_n} w_1 + p_{i_n} w_2)(y + 1)/2 - k_{i_n} w_1.$$

In particular,

$$\begin{aligned} x - w_1 + l/2 &= (q_{i_0} w_1 + p_{i_0} w_2)(y + 1)/2 - k_{i_0} w_1 \\ &= (q_{i_1} w_1 + p_{i_1} w_2)(y + 1)/2 - k_{i_1} w_1. \end{aligned}$$

Hence,

$$(p_{i_1} - p_{i_0})w_2 + (q_{i_1} - q_{i_0})w_1 = \frac{2w_1}{y + 1}(k_{i_1} - k_{i_0}) \neq 0.$$

So, $\frac{2w_1}{y+1}$ can be written as $rw_2 + sw_1$ where r and s are rational numbers.

Now, if $n \geq 1$, we still have

$$(p_{i_n} - p_{i_0})w_2 + (q_{i_n} - q_{i_0})w_1 = (rw_2 + sw_1)(k_{i_n} - k_{i_0}).$$

Because (w_2, w_1) is free over \mathbb{Q} , we have

- $(p_{i_n} - p_{i_0}) = r(k_{i_n} - k_{i_0})$
- $(q_{i_n} - q_{i_0}) = s(k_{i_n} - k_{i_0}) \neq 0$ (remember that q_n is strictly increasing)

Thus, by dividing,

$$\frac{r}{s} = \frac{p_{i_n} - p_{i_0}}{q_{i_n} - q_{i_0}} = \frac{p_{i_n}}{q_{i_n}} \left(1 - \frac{p_{i_0}}{p_{i_n}}\right) \left(\frac{1}{1 - \frac{q_{i_0}}{q_{i_n}}}\right) \xrightarrow{n \rightarrow \infty} \frac{w_1}{w_2} \in \mathbb{R} \setminus \mathbb{Q}$$

leading to a contradiction.

For the second case, if $y \in [0, 1[$, it is exactly the same (just reverse Figure 2.6).

Thus, (O, A) is not finitely blockable, and \mathcal{S} fails the finite blocking property.

□

In the proof of Lemma 1, we have chosen the points $O \in \mathcal{C}_1$ and $A \in \mathcal{C}_2$ in such a way that the calculus was easy. In fact, *almost all* pair $(O, A) \in \mathcal{C}_1 \times \mathcal{C}_2$ is not finitely blockable. More precisely, we have the

Proposition 7. *In the system of coordinates given in Figure 2.5, if $\alpha \stackrel{\text{def}}{=} w_1/w_2 \in \mathbb{R} \setminus \mathbb{Q}$, if $A_i(x_i, y_i) \in \mathcal{C}_i$ ($i \in \{1, 2\}$), if $\beta \stackrel{\text{def}}{=} -y_1/y_2$ is uncommensurable to α , then (A_1, A_2) is not finitely blockable.*

Proof: it is very similar to the proof of Lemma 1; the introduction of many parameters just makes it heavier to read.

Let $R \stackrel{\text{def}}{=} -y_2l + y_2w_1 - y_2x_1 + x_2y_1 - w_1y_1 + y_1l$ (it is just an offset).

Let

$$I \stackrel{\text{def}}{=}]\frac{-R}{w_2y_2}, \frac{l(y_2 - y_1) - R}{w_2y_2}[.$$

I is a non empty open set since $l(y_2 - y_1) > 0$.

Since $\frac{\alpha}{\beta}$ is a positive irrational number, $\mathbb{N} - \frac{\alpha}{\beta}\mathbb{N}$ is dense in \mathbb{R} so there exists two positive integer sequences $(p_n)_{n \in \mathbb{N}}$ and $(q_n)_{n \in \mathbb{N}}$ such that:

- q_n is strictly increasing
- $\alpha q_n - \beta p_n \in I$

Let

$$\lambda_n \stackrel{\text{def}}{=} \frac{y_2w_1q_n + y_1w_2p_n + R}{y_2 - y_1} \in]0, l[\quad (n \in \mathbb{N}).$$

For $n \in \mathbb{N}$, let γ_n be the geodesic starting from A_1 with slope

$$\frac{y_2 - y_1}{w_1q_n + w_2p_n + x_2 - x_1} = \frac{-y_1}{w_1q_n + w_1 - x_1 - l + \lambda_n} = \frac{y_2}{w_2p_n - w_1 + x_2 + l - \lambda_n}.$$

So, we can check that γ_n passes q_n times through the line $\{0\} \times]y_1, 0[$, passes through $(x_1 - l + \lambda_n, 0) \in]x_1 - l, x_1[\times \{0\}$, passes p_n times through the line $\{x_1 - l\} \times]0, y_1[$ and passes through A_2 . Stop γ_n here (see Figure 2.8). So, γ_n lies completely in $\mathcal{C}_1 \cup \mathcal{C}_2 \cup]x_1 - l, x_1[\times \{0\}$.

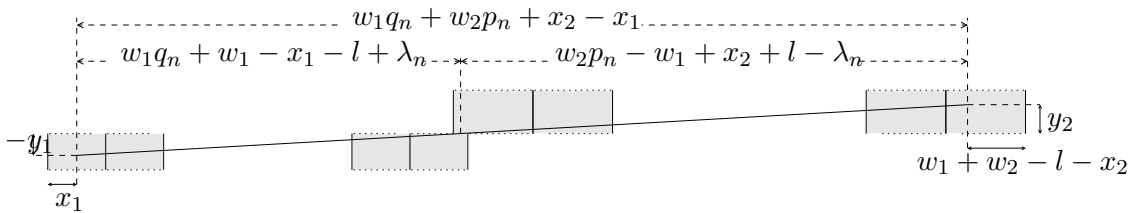

Figure 2.8: The unfolding procedure.

Now, assume by contradiction that there is a point $B(x, y)$ in \mathcal{S} distinct from A_1 and A_2 such that infinitely many γ_n pass through B . Let $i \in \uparrow(\mathbb{N}, \mathbb{N})$ be an extraction such that, for all n in \mathbb{N} , γ_{i_n} pass through B . There are two cases to consider:

First case: $y \in]y_1, 0]$. By looking at the unfolded version of the trajectory (Figure 2.8), we see that if k_{i_n} denotes the number of times that γ_{i_n} pass through the line $\{0\} \times]y_1, 0[$ before hitting B , then

$$\frac{y_1 - y}{x_1 - (x + k_{i_n} w_1)} = \frac{y_2 - y_1}{w_1 q_n + w_2 p_n + x_2 - x_1}.$$

So, $x - x_1 = (w_1 q_{i_n} + w_2 p_{i_n} + x_2 - x_1)(y - y_1)/(y_2 - y_1) - k_{i_n} w_1$.

In particular,

$$\begin{aligned} x - x_1 &= (w_1 q_{i_0} + w_2 p_{i_0} + x_2 - x_1)(y - y_1)/(y_2 - y_1) - k_{i_0} w_1 \\ &= (w_1 q_{i_1} + w_2 p_{i_1} + x_2 - x_1)(y - y_1)/(y_2 - y_1) - k_{i_1} w_1. \end{aligned}$$

Hence, $(p_{i_1} - p_{i_0}) + (q_{i_1} - q_{i_0})\alpha = \alpha \frac{y_2 - y_1}{y - y_1} (k_{i_1} - k_{i_0}) \neq 0$.

So, $\alpha \frac{y_2 - y_1}{y - y_1}$ can be written as $r + s\alpha$ where r and s are rational numbers.

Now, if $n \geq 1$, we still have $(p_{i_n} - p_{i_0}) + (q_{i_n} - q_{i_0})\alpha = (r + s\alpha)(k_{i_n} - k_{i_0})$.

Because $(1, \alpha)$ is free over \mathbb{Q} , we have

- $(p_{i_n} - p_{i_0}) = r(k_{i_n} - k_{i_0})$
- $(q_{i_n} - q_{i_0}) = s(k_{i_n} - k_{i_0}) \neq 0$ (remember that q_n is strictly increasing)

Thus, by dividing,

$$\frac{r}{s} = \frac{p_{i_n} - p_{i_0}}{q_{i_n} - q_{i_0}} = \frac{p_{i_n}}{q_{i_n}} \left(1 - \frac{p_{i_0}}{p_{i_n}}\right) \left(\frac{1}{1 - \frac{q_{i_0}}{q_{i_n}}}\right) \xrightarrow{n \rightarrow \infty} \frac{\alpha}{\beta} \in \mathbb{R} \setminus \mathbb{Q}$$

leading to a contradiction.

For the second case, if $y \in [0, y_2[$, it is exactly the same (just reverse Figure 2.8).

Thus, (A_1, A_2) is not finitely blockable. □

2.5 Finite blocking property in the regular polygons

Theorem 1. *Let $n \geq 3$ be an integer. The following assertions are equivalent:*

- *the regular n -gon has the finite blocking property.*
- *the right-angled triangle \mathcal{T}_n with an angle equal to π/n has the finite blocking property.*
- $n \in \{3, 4, 6\}$.

Proof: according to propositions 3 and 5, it suffices to prove that the second assertion implies the third one.

Suppose first that n is odd. $ZK(\mathcal{T}_n)$ can be described as two regular n -gons P and P' symmetric one to each other, with identifications along the sides (see Figure 2.9).

We number the vertices of P (resp. P') counterclockwise (resp. clockwise) from s_0 to s_{n-1} (resp. from s'_0 to s'_{n-1}) (see Figure 2.9).

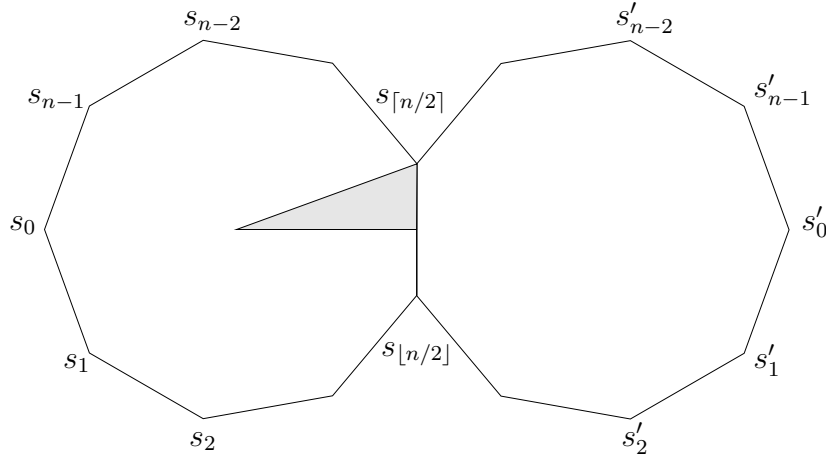

Figure 2.9: The translation surface associated with the right-angled triangle with an angle equal to $\pi/9$ (identify the opposite sides).

Now, look at Figure 2.10.

In $P \cup P'$, $(s_0, s_{[n/2]})$ is parallel to $(s_1, s_{[n/2]} - 1)$, to $(s_2, s_{[n/2]} - 2)$, \dots , to $(s_{n-1}, s_{[n/2]} + 1)$, to $(s_{n-2}, s_{[n/2]} + 2)$, \dots , and by axial symmetry with respect to $(s_{[n/2]}, s_{[n/2]})$, it is parallel to $(s'_0, s'_{[n/2]})$, to $(s'_1, s'_{[n/2]} - 1)$, to $(s'_2, s'_{[n/2]} - 2)$, \dots , to $(s'_{n-1}, s'_{[n/2]} + 1)$, to $(s'_{n-2}, s'_{[n/2]} + 2)$, \dots .

Let us call this common direction the dashed one.

Do the same for the direction $(s_0, s_{[n/2]})$ and call it the dotted one.

This leads to a triangulation of the surface, each triangle having an edge dashed, an edge dotted and an edge that is an edge of P or P' .

Now, take P as the base and glue all the triangles that lie in P' to the ones that lie in P , thanks to the identification between the edges of P and the edges of P' (this can be done in an unique way) (this is the cut and paste operation).

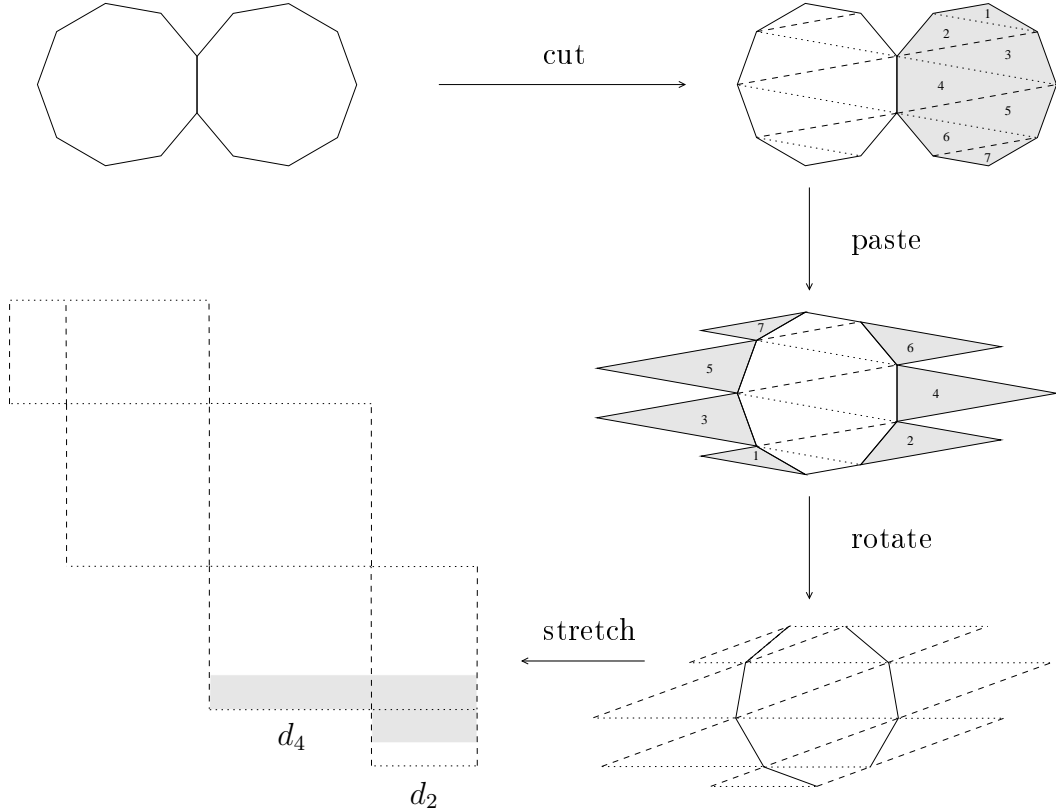

Figure 2.10: From the surface associated to \mathcal{T}_n to a more exploitable one in the same orbit under $GL(2, \mathbb{R})$ (n odd).

We have now a new representation of the surface associated to \mathcal{T}_n , by a planar polygon with identifications along its sides that are only dashed or dotted sides.

Since those two directions are not parallel, it is easy to find an element A of $GL(2, \mathbb{R})$ that put the dotted direction to the horizontal, the dashed one to the vertical and that preserves the lengths in those two directions (this is the rotate and stretch operation).

The surface \mathcal{S} obtained by the action of A to the surface associated to \mathcal{T}_n is more exploitable for our purpose.

For $1 \leq i \leq n - 1$, we denote $d_i \stackrel{\text{def}}{=} \|s_0 - s_i\|_2$.

We can remark that exactly one edge of P is dashed. Starting from this edge in \mathcal{S} , it is easy to recognize the shape of the Figure 2.5 with $w_1 = l = d_2$, $w_2 = d_2 + d_4$, $h_1 = d_1$ and $h_2 = d_3$.

We have $w_2/w_1 = 1 + d_4/d_2 = 1 + 2 \sin(4\pi/n)/2 \sin(2\pi/n) = 1 + 2 \cos(2\pi/n)$ which is irrational if $n \geq 5$. Hence, \mathcal{S} and therefore \mathcal{T}_n lacks the finite blocking property if $n \neq 3$.

For the even case, the translation surface $ZK(\mathcal{T}_n)$ is constituted by only one regular n -gon with opposite sides identified. The construction is very similar, but the role of P is played by the lower-half of the polygon, and the role of P' is played by its upper-half (see Figure 2.11). In this case, $w_2/w_1 = 1 + 2 \cos(2\pi/n)$ is irrational if $n \notin \{4, 6\}$.

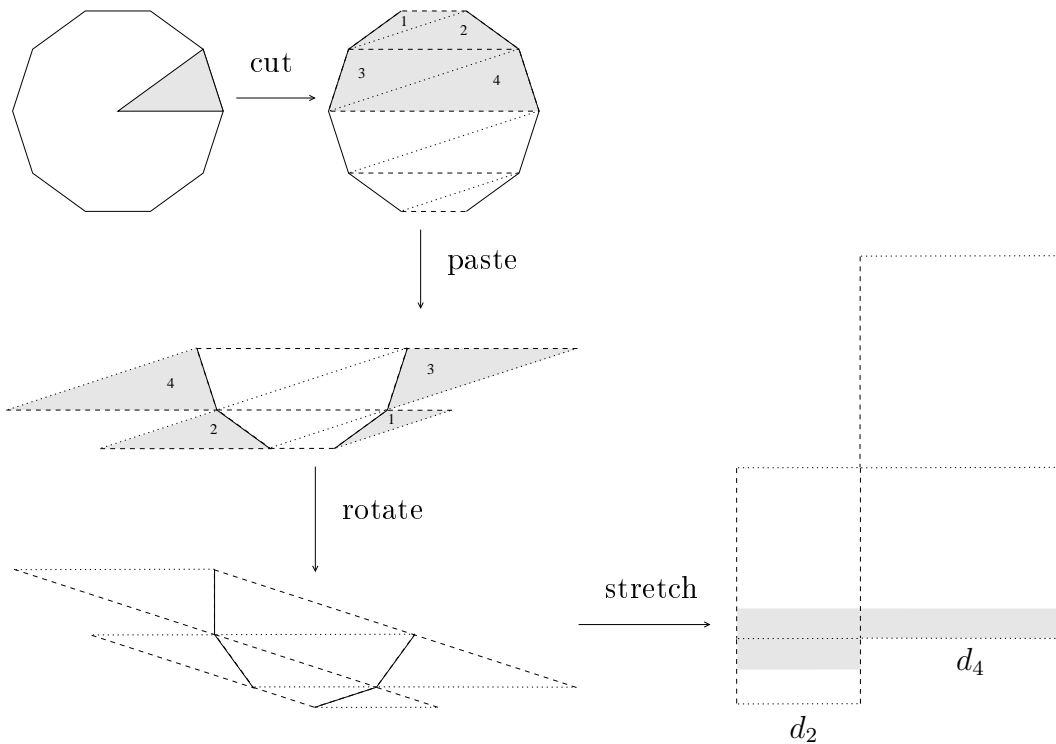

Figure 2.11: The even case ($n = 10$).

□

Nevertheless, we can notice that the situation is *not homogenous* among different pairs of points:

Proposition 8. *For every regular n -gon (n even), there exists a finite set of points that blocks every billiard path from the center O to itself.*

Proof: the set \mathcal{B} consisting in the centers of the edges and the vertices is a (finite) blocking configuration. Indeed, suppose by contradiction that γ is a billiard path from O to O that does not meet \mathcal{B} : it can be folded into a billiard path in the triangle \mathcal{T}_n from the vertex with angle π/n to himself. This contradicts [To], Lemma 4.1. page 871 (a nice argument on angles, measured modulo $2\pi/n$ makes this fact impossible).

□

This proposition is not so clear if n is odd, since a billiard path γ in \mathcal{T}_n starting from O with angle $\pi/2n$ is coming back to O after n bounces (see Figure 2.12).

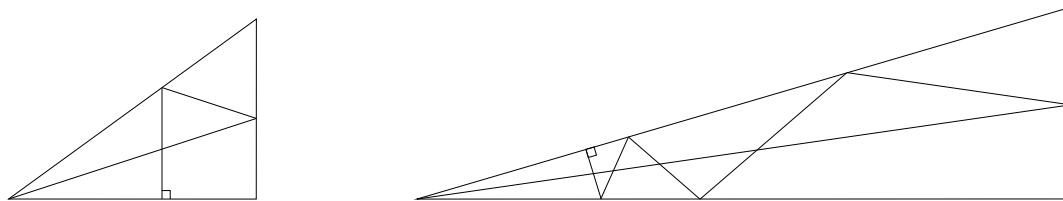

Figure 2.12: By starting with an angle $\pi/2n$, we are coming back in O ($n \in \{5, 11\} \subset 2\mathbb{N} + 3$).

It would be interesting to find a rational polygonal billiard table \mathcal{P} with the property that no pair of points in \mathcal{P} can be finitely blocked.

2.6 Finite blocking property on Veech surfaces

Proposition 9. *Suppose that a translation surface \mathcal{S} is decomposable into commensurable parallel cylinders, in at least two different directions.*

Then \mathcal{S} has the finite blocking property if and only if \mathcal{S} is a torus covering, branched over only one point.

Proof: Let $(\mathcal{C}_i)_{i=0}^n$ be a decomposition of \mathcal{S} into parallel commensurable cylinders, with heights h_i and weights w_i ($i \leq n$).

Starting from \mathcal{C}_0 , by applying Lemma 1 step by step, we can see that all the w_i 's are commensurable (recall that \mathcal{S} is assumed to be connected).

Since, for all $i \leq n$, w_i/h_i is a rational number, we can deduce that all the h_i 's are commensurable. So, there exists $h > 0$ and $(k_i)_{i=0}^n \in \mathbb{N}^{n+1}$ such that for $i \leq n$, $h_i = k_i h$. Then, each \mathcal{C}_i is decomposed into k_i subcylinders $(\mathcal{C}_{i,j})_{j=1}^{k_i}$ of height h ($\mathcal{C}_{i,j}$ is the image of $\mathbb{R}/w_i\mathbb{Z} \times](j-1)h, jh[$). Note that the singularities of \mathcal{S} lie in the sides of the $\mathcal{C}_{i,j}$'s.

By hypothesis, we have the same kind of decomposition of \mathcal{S} into parallel subcylinders $(\mathcal{C}'_{i,j})_{i \leq n', j \leq k'_i}$ of height h' in another direction, with the property that each singularity of \mathcal{S} lies in a side of $\mathcal{C}'_{i,j}$.

$$(\mathcal{P}_i)_{i \leq l} \stackrel{\text{def}}{=} (\mathcal{C}_{i,j})_{i \leq n, j \leq k_i} \bigvee (\mathcal{C}'_{i,j})_{i \leq n', j \leq k'_i}$$

is a decomposition of \mathcal{S} into parallel isometric parallelograms glued edge to edge.

This leads to a covering from \mathcal{S} to \mathcal{P}_0 whose opposite edges are identified, i.e. from \mathcal{S} to a torus. Note that all the singularities of \mathcal{S} lie in a vertex of some \mathcal{P}_i , so they are sent to a common point in the torus (the image of a vertex of \mathcal{P}_0).

□

Theorem 2. *A Veech surface has the finite blocking property if and only if it is a torus covering, branched over only one point.*

Proof: If the surface is a torus, there is nothing to prove (both statements are true). Otherwise, the genus of the surface is greater than two, and then the surface has at least one singularity and therefore many saddle connection directions. In each saddle connection direction, a Veech surface admits a decomposition into commensurable cylinders.

□

2.7 Further results

The aim of this section is to see how Lemma 1 can be used in different contexts.

First, recall that Lemma 1 can be applied in the non-Veech context since:

- \mathcal{C}_1 and \mathcal{C}_2 do not need to be commensurable (there is no condition on the heights)
- the result is *local*: if the configuration of Figure 2.5 appears somewhere in a surface \mathcal{S} with $w_1/w_2 \in \mathbb{R} \setminus \mathbb{Q}$, then \mathcal{S} lacks the finite blocking property (see example on Figure 2.13).

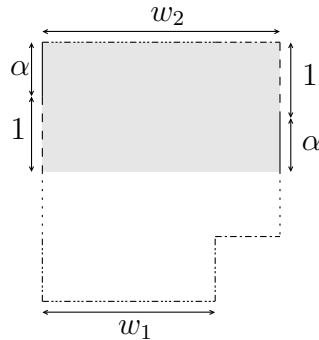

Figure 2.13: The surface cannot be fully decomposed into cylinders in the horizontal direction (the grey zone is a minimal component for the horizontal flow); identify the lines with the same style, $\alpha \in \mathbb{R} \setminus \mathbb{Q}$, $w_1/w_2 \in \mathbb{R} \setminus \mathbb{Q}$.

2.7.1 L-shaped surfaces

Let \mathcal{S} be a L-shaped translation surface; it is in the same $GL(2, \mathbb{R})$ -orbit than some $L(a, b)$ (see Figure 2.14). Lemma 1 allows us to decide whether \mathcal{S} has the finite blocking property (we do not need \mathcal{S} to be a Veech surface (such surfaces were characterized in [Mc] and [Cal])).

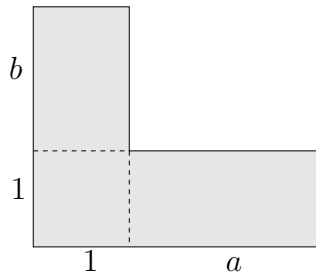

Figure 2.14: The L-shaped translation surface $L(a, b)$ (identify the opposite sides by translation).

Proposition 10. *Let a and b be two positive real numbers. Then $L(a, b)$ has the finite blocking property if and only if $(a, b) \in \mathbb{Q}^2$.*

Proof: If $L(a, b)$ has the finite blocking property, applying Lemma 1 in both horizontal and vertical direction leads to $(1 + a)/1 \in \mathbb{Q}$ and $(1 + b)/1 \in \mathbb{Q}$, so $(a, b) \in \mathbb{Q}^2$. □

2.7.2 Irrational billiards

The construction of Zemljakov and Katok is also possible when the angles of a polygon \mathcal{P} are not rational multiples of π ; in this case, the group Γ is infinite and the surface is not compact. However, periodic trajectories can appear; we can even meet the situation of lemma 1:

Proposition 11. *There exists a non rational polygonal billiard that fails the finite blocking property.*

Proof: consider the billiard drawn in Figure 2.15 and apply Lemma 1 on the pair of cylinders defined by the grey zone.

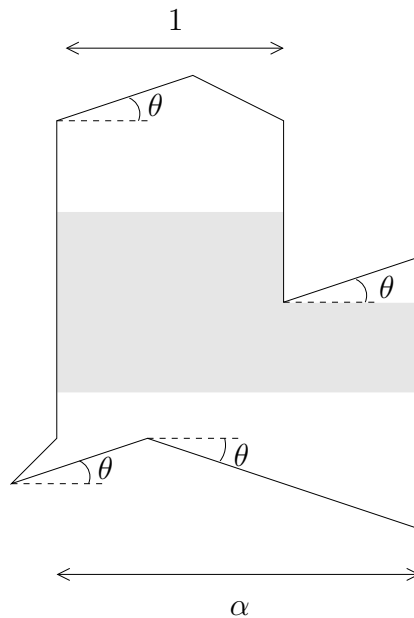

Figure 2.15: A non rational billiard whose associated surface contains the configuration of Lemma 1; $\theta \in \mathbb{R} \setminus \mathbb{Q}\pi$, $\alpha \in \mathbb{R} \setminus \mathbb{Q}$. □

2.7.3 A density result

A singularity $\sigma \in \Sigma$ has a conical angle of the form $2k\pi$, with $k \geq 1$; we say that σ is of multiplicity $k - 1$. If $1 \leq k_1 \leq k_2 \leq \dots \leq k_n$ is a sequence of integers whose sum is even, we denote $\mathcal{H}(k_1, k_2, \dots, k_n)$ the stratum of translation surfaces with exactly n singularities

whose multiplicities are k_1, k_2, \dots, k_n . A translation surface in $\mathcal{H}(k_1, k_2, \dots, k_n)$ has genus $g = 1 + (k_1 + k_2 + \dots + k_n)/2$.

Each stratum carries a natural topology that is for example defined in [Ko].

Theorem 3. *In genus $g \geq 2$, the set of translation surfaces that fail the finite blocking property is dense in every stratum.*

Sketch of the proof: The proof of this requires some material that is too long to describe here (like the precise definition of the topology on such a stratum (for this we have to see each translation surface as a Riemann surface with an abelian differential)). It suffices to prove that the translation surfaces that satisfy the hypothesis of Lemma 1 are dense in each stratum. For this, we begin to prove that translation surfaces that admit a cylinder decomposition in the horizontal direction, with at least two non homologous horizontal cylinders, are dense (see [EO], [KZ], [Zo]). Using the local coordinates given by the period map, we have the possibility to perturb the perimeters of two such “consecutive” non homologous cylinders in order to let them non commensurable. We postpone the precise proof for a further paper (see [Mo2]).

□

In fact, we will prove in [Mo2] that the translation surfaces that fail the finite blocking property is of full measure in each stratum. Moreover, we will prove that finite blocking property implies complete periodicity; we will also give the classification of the surfaces that have the finite blocking property in genus 2.

Of course, the notion of finite blocking property and the results presented in this paper can be translated in the vocabulary of quadratic differentials.

2.8 Conclusion

One can define a stronger property: a planar polygonal billiard or a translation surface \mathcal{P} is said to have the *bounded blocking property* if the number of blocking points can be chosen independently of the pair (O, A) . Does it exist polygonal billiard tables with the finite blocking property but without the bounded blocking property?

Is it true that for general translation surfaces, the fact of being a torus covering is a necessary and sufficient condition to have the finite blocking property (resp. bounded blocking property)? Is it true that for rational billiards, the fact of being almost integrable is a necessary and sufficient condition to have the finite blocking property (resp. bounded blocking property)?

Note that for piecewise smooth billiard tables, the study of the finite blocking property seems very difficult, since for an ellipse, even a countable number of points do not suffice to block every path from a focus to the other one.

References

- [Bos] M. BOSHERNITZAN, *Correspondence with Howard Masur (unpublished)* (1986).
- [Bou] N. BOURBAKI, *Groupes et algèbres de Lie*, Ch 4, 5 et 6 (1981), Masson.
- [Cal] K. CALTA, *Veech surfaces and complete periodicity in genus 2*, J. Amer. Math. Soc., to appear.
- [Car] D. CARTWRIGHT, *A brief introduction to buildings*, Harmonic functions on trees and buildings, Contemp. Math., 206, Amer. Math. Soc., Providence, RI, (1997), 45–77.
- [EO] A. ESKIN, A. OKOUNKOV, *Asymptotics of numbers of branched coverings of a torus and volumes of moduli spaces of holomorphic differentials*, Invent. Math. 145 (2001), no. 1, 59–103.
- [Fo] D. FOMIN, *ЗАДАЧИ ЛЕНИНГРАДСКИХ МАТЕМАТИЧЕСКИХ ОЛИМПИАД*, Leningrad (1990), 77.
- [HS] P. HIEMER, V. SNURNIKOV, *Polygonal billiards with small obstacles*, J. Statist. Phys. 90 (1998), no. 1-2, 453–466.
- [Kl] V. KLEE, *Is every polygonal region illuminable from some point?*, Amer. Math. Monthly 76(80) (1969).
- [KW] V. KLEE, S. WAGON, *Old and new unsolved problems in plane geometry and number theory*, Mathematical association of America (1991).
- [KMS] S. KERCKHOFF, H. MASUR, J. SMILLIE, *Ergodicity of billiard flows and quadratic differentials*, Ann. Math. 124 (1986), no. 2, 293–311.
- [Ko] M. KONTSEVICH, *Lyapunov exponents and Hodge theory*, The mathematical beauty of physics (Saclay, 1996), p 318–332, Adv. Ser. Math. Phys., 24, World Sci. Publishing, River Edge, NJ, 1997.
- [KZ] M. KONTSEVICH, A. ZORICH, *Connected components of the moduli spaces of Abelian differentials with prescribed singularities*, Invent. Math. 153 (2003), no. 3, 631–678.
- [MT] H. MASUR, S. TABACHNIKOV, *Rational billiards and flat structures*, Handbook on dynamical systems, Vol. 1A, 1015–1089, North-Holland, Amsterdam, (2002).
- [Mc] C. MCMULLEN, *Billiards and Teichmüller curves on Hilbert modular surfaces*, J. Amer. Math. Soc. 16 (2003), 857–885.
- [Mo] T. MONTEIL, *A counter-example to the theorem of Hiemer and Snurnikov*, J. Statist. Phys. 114 (2004), no. 5-6, 1619–1623.
- [Mo2] T. MONTEIL, *Finite blocking property vs pure periodicity*, preprint.

- [ST] J. SCHMELING, S. TROUBETZKOY, *Inhomogeneous Diophantine Approximation and Angular Recurrence for Polygonal Billiards*, Mat. Sb. 194 (2003), no. 2, 129–144.
- [To] G. TOKARSKY, *Polygonal rooms not illuminable from every point*, Amer. Math. Monthly 102 (1995), no. 10, 867–879.
- [Ve] W. VEECH, *Teichmüller curves in moduli space, Eisenstein series and an application to triangular billiards*, Invent. Math. 97 (1989), no. 3, 553–583.
- [Vo] Y. VOROBETS, *Planar structures and billiards in rational polygons: the Veech alternative*, Russian Math. Surveys 51 (1996), no. 5, 779–817.
- [ZK] A. ZEMLJAKOV, A. KATOK, *Topological transitivity of billiards in polygons*, Mat. Zametki 18 (1975), no. 2, 291–300.
- [Zo] A. ZORICH, *private communication* (2003).

Chapitre 3

Propriété de blocage fini *vs* pure périodicité

3.1 Introduction

A *translation surface* is a triple $(\mathcal{S}, \Sigma, \omega)$ such that \mathcal{S} is a topological compact connected surface, Σ is a finite subset of \mathcal{S} (whose elements are called *singularities*) and $\omega = (U_i, \phi_i)_{i \in I}$ is an atlas of $\mathcal{S} \setminus \Sigma$ (consistent with the topological structure on \mathcal{S}) such that the transition maps (i.e. the $\phi_j \circ \phi_i^{-1} : \phi_i(U_i \cap U_j) \rightarrow \phi_j(U_i \cap U_j)$ for $(i, j) \in I^2$) are translations. This atlas gives to $\mathcal{S} \setminus \Sigma$ a Riemannian structure; therefore, we have notions of length, angle, measure, geodesic... Moreover, we assume that \mathcal{S} is the completion of $\mathcal{S} \setminus \Sigma$ for this metric.

A translation surface can also be seen as a holomorphic differential h on a Riemann surface (the singularities correspond to the zeroes of the differential, and in an admissible atlas ω , h is of the form $h = dz$). This point of view is useful to give coordinates (and therefore a topology and a measure) to the moduli space of all translation surfaces, while the first one allows to make pictures in the plane.

Translation surfaces provide one of the main tool for the study of rational polygonal billiards.

Since the unit tangent bundle of \mathcal{S} enjoys a canonical global decomposition $U\mathcal{S} = \mathcal{S} \times \mathbb{S}^1$, the study of the geodesic flow on \mathcal{S} can be done through two points of view depending on whether the variable is the first or the second projection:

1. We can fix one particular direction $\theta \in \mathbb{S}^1$: this corresponds to the study of the *directional flow* $\phi_\theta : \mathcal{S} \times \mathbb{R} \rightarrow \mathcal{S}$. We are usually interested in the ergodic properties of this flow depending on whether θ is a saddle connection direction or not, or on the way θ can be approximated by such saddle connections (see [KMS], [Ve], [MT], [Vo], [Ma], [MS], [Ch]). This class of problems is called *dynamical problems*. This point of view is the most studied by mathematicians.
2. We can also fix one point in $x \in \mathcal{S}$: this corresponds to the study of the *exponential flow* $exp_x : \mathbb{S}^1 \times \mathbb{R} \rightarrow \mathcal{S}$. We are usually interested in looking at which points we can reach when we let the second variable move, or at the statistics of the return

to (or near) x (see [Kl], [To], [Mo1], [Mo2], [BGZ], [CG]). This class of problems is called *illumination problems*. This point of view is connected with computer science (computational geometry, ray tracing, art gallery).

Note that those two flows are defined on a dense G_δ -set of full measure but not everywhere because the singularities don't allow some (few) geodesic to be defined on \mathbb{R} .

We are interested here by the connection between an illumination problem called the finite blocking property, and a dynamical one named the pure periodicity.

A translation surface \mathcal{S} is said to have the *finite blocking property* if for every pair (O, A) of points in \mathcal{S} , there exists a finite number of points B_1, \dots, B_n (different from O and A) such that every geodesic from O to A meets one of the B_i 's.

A translation surface \mathcal{S} is said to be *purely periodic* if for any $\theta \in \mathbb{S}^1$, the existence of a periodic orbit in the direction θ implies that the directional flow ϕ_θ is periodic (i.e. there exists $T > 0$ such that $\phi_\theta^T = Id_{\mathcal{S}}$ a.e.). This notion is a stronger version of the complete periodicity defined in [Ca].

The paper is organized as follows :

In the first section, we recall some background and known results about the finite blocking property. The second one is devoted to the proof of the following result :

Theorem 1. *Let \mathcal{S} be a translation surface with the finite blocking property. Then \mathcal{S} is purely periodic.*

The third section is devoted to some applications of this theorem. First, we give an improvement of [Mo2], Theorem 3 :

Theorem 2. *In genus $g \geq 2$, the set of translation surfaces that fail the finite blocking property is of full measure in every stratum.*

Then, we give the complete classification in genus 2 :

Theorem 3. *Let \mathcal{S} be a translation surface of genus 2. Then \mathcal{S} has the finite blocking property if and only if \mathcal{S} is a torus branched covering.*

3.2 Background

In this section, we present some results about the finite blocking property that were proven in [Mo2].

3.2.1 Stability

The finite blocking property is stable under some classical operations on translation surfaces:

Singularities We have used the convention that a geodesic stops when it reaches a singularity. This convention is not restrictive for the study of the finite blocking property since we can add those singularities in any blocking configuration. Moreover the finite blocking property is not perturbed when we add or remove removable singularities (a singularity $\sigma \in \Sigma$ is said to be *removable* if there exists an atlas $\omega' \supset \omega$ such that $(\mathcal{S}, \Sigma \setminus \{\sigma\}, \omega')$ is a translation surface).

Branched covering A *branched translation covering* between two translation surfaces is a map $\pi : (\mathcal{S}, \Sigma) \rightarrow (\mathcal{S}', \Sigma')$ that is a topological branched covering that locally preserves the translation structure. A *torus branched covering* is a translation surface \mathcal{S} such that there exists a branched translation covering from \mathcal{S} to a flat torus.

Proposition 1. *Let $\pi : (\mathcal{S}, \Sigma) \rightarrow (\mathcal{S}', \Sigma')$ be a translation covering branched on a finite set $\mathcal{R}' \subset \mathcal{S}'$. Then \mathcal{S} has the finite blocking property if and only if \mathcal{S}' has.*

Rational billiards Let \mathcal{P} denote a polygon in \mathbb{R}^2 . Let $\Gamma \subset O(2, \mathbb{R})$ be the group generated by the linear parts of the reflections in the sides of \mathcal{P} . When Γ is finite, we say that \mathcal{P} is a *rational polygonal billiard table*. When \mathcal{P} is simply connected, \mathcal{P} is rational if and only if all the angles between edges are rational multiples of π . A classical construction due to Zemljakov and Katok (see [ZK], [MT]) allows us to associate to each rational billiard table \mathcal{P} a translation surface $ZK(\mathcal{P})$ (as an example, the translation surface associated to the square billiard table is the torus $\mathbb{T}^2 = \mathbb{R}^2/\mathbb{Z}^2$).

Proposition 2. *Let \mathcal{P} be a rational polygonal billiard table. Then $ZK(\mathcal{P})$ has the finite blocking property if and only if \mathcal{P} has.*

Action of $GL(2, \mathbb{R})$ If $A \in GL(2, \mathbb{R})$, we can define the translation surface

$$A.(\mathcal{S}, \Sigma, (U_i, \phi_i)_{i \in I}) \stackrel{\text{def}}{=} (\mathcal{S}, \Sigma, (U_i, A \circ \phi_i)_{i \in I});$$

hence we have an action of $GL(2, \mathbb{R})$ on the class of translation surfaces. We classically consider only elements of $SL(2, \mathbb{R})$ (see [MT]), but area is not assumed to be preserved here.

Proposition 3. *Let \mathcal{S} be a translation surface and A be in $GL(2, \mathbb{R})$. Then \mathcal{S} has the finite blocking property if and only if $A.\mathcal{S}$ has.*

3.2.2 Sufficient conditions

Proposition 4 (Fomin [Fo]). *The square billiard table has the finite blocking property.*

Hence, combining propositions 1, 2, 3 and 4, we have :

Proposition 5. *Any torus branched covering has the finite blocking property.*

3.2.3 Necessary conditions

We first give some definitions and conventions concerning isometries and cylinders. In this paper, “isometry” means “orientation-preserving local isometry”. Since an isometry i from an open subset U of \mathbb{R}^2 to a translation surface \mathcal{S} can be uniquely extended by continuity to \overline{U} (it is uniformly continuous), we will also denote by i this extension (that is also an isometry). In this process, we may lose the injectivity of i .

A *subcylinder* \mathcal{C} is an isometric copy of $\mathbb{R}/w\mathbb{Z} \times]0, h[$ in a translation surface \mathcal{S} ($w > 0$, $h > 0$). w and h are unique and called the *width* and the *height* of \mathcal{C} . The *direction* of \mathcal{C} is the direction of the image of $\mathbb{R}/w\mathbb{Z} \times \{h/2\}$ (which is considered here as an oriented closed geodesic); it is defined modulo 2π . The images in \mathcal{S} of $\mathbb{R}/w\mathbb{Z} \times \{0\}$ and $\mathbb{R}/w\mathbb{Z} \times \{h\}$ are called the *sides* of \mathcal{C} . The side $\mathbb{R}/w\mathbb{Z} \times \{h\}$ is called the *upper side*.

A *cylinder* is a maximal subcylinder (for the inclusion). Any periodic trajectory for ϕ_θ can be thickened to obtain a cylinder in the direction θ . Whenever \mathcal{S} is not a torus, each side of a cylinder contains at least one singularity and is a finite union of saddle connections (a *saddle connection* is a geodesic joining two singularities). We say that \mathcal{S} admits a *cylinder decomposition* in the direction θ if the (necessarily finite) union of cylinders whose direction is θ is dense in \mathcal{S} (then, the complement of this union is the union of the sides of those cylinders).

Let \mathcal{C}_1 and \mathcal{C}_2 be two cylinders with width w_1 (resp. w_2) and height h_1 (resp. h_2) in a translation surface \mathcal{S} . We suppose that \mathcal{C}_1 and \mathcal{C}_2 are two different cylinders in the same direction whose closures have a nontrivial (i.e. not reduced to a finite set) intersection. The situation is described in Figure 3.1.

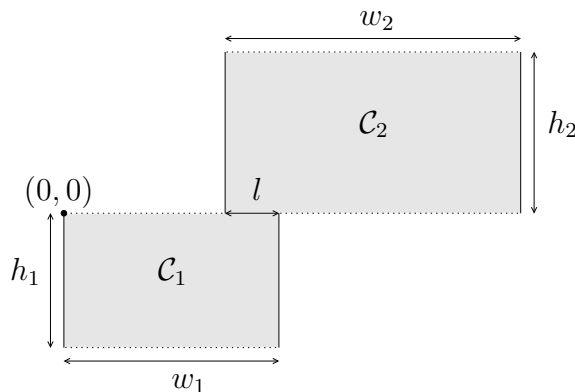

Figure 3.1: The opposite vertical sides are identified by translation while the dotted horizontal ones are glued with the rest of the surface; $l > 0$.

Lemma 1. *Let \mathcal{S} be a translation surface that contains two different cylinders \mathcal{C}_1 and \mathcal{C}_2 in the same direction whose closures have a nontrivial intersection. If their widths are uncommensurable, then \mathcal{S} fails the finite blocking property.*

This lemma implies all the remaining results of section 3.2 and will be useful in the proof of Theorem 1.

Proposition 6. *The only regular polygons (considered as billiard tables) with the finite blocking property are the equilateral triangle, the square and the regular hexagon.*

Proposition 7. *A Veech surface has the finite blocking property if and only if it is a torus covering, branched over only one point.*

In other terms, arithmetic surfaces are exactly the Veech surfaces with the finite blocking property. Note that proposition 7 was proven independently by Eugene Gutkin, and is the main result of [Gu].

3.2.4 Global point of view: moduli spaces of holomorphic forms

A singularity $\sigma \in \Sigma$ has a conical angle of the form $2(k+1)\pi$, with $k \geq 0$; we say that σ is of *multiplicity* k . Removable singularities are the singularities of multiplicity 0. In terms of holomorphic differentials, it is equivalent to say that there is a chart around σ such that $h = z^k dz$ (i.e. σ is a zero of order k of h).

If $1 \leq k_1 \leq k_2 \leq \dots \leq k_n$ is a sequence of integers whose sum is even, we denote by $\mathcal{H}(k_1, k_2, \dots, k_n)$ the *stratum* of translation surfaces with exactly n singularities whose multiplicities are k_1, k_2, \dots, k_n (we consider only surfaces without removable singularities). A translation surface in $\mathcal{H}(k_1, k_2, \dots, k_n)$ has genus $g = 1 + (k_1 + k_2 + \dots + k_n)/2$. Each stratum carries a natural topology and an $SL(2, \mathbb{R})$ -invariant measure that are for example defined in [Ko].

Proposition 8. *In genus $g \geq 2$, the set of translation surfaces that fail the finite blocking property is dense in every stratum.*

In fact, we proved in [Mo2] that the hypotheses of Lemma 1 are satisfied on a dense subset of each stratum. Unfortunately, those hypotheses are valid only on a set of zero measure. Proposition 8 will be considerably improved by Theorem 2.

3.3 Main result

A translation surface is said to be *completely periodic* if the following property holds (see [Ca]): if there exists a periodic orbit in the direction θ , then the surface admits a cylinder decomposition in the direction θ .

Proposition 9. *Let \mathcal{S} be a translation surface with the finite blocking property. Then \mathcal{S} is completely periodic.*

Proof: Let θ be a direction that contains a periodic orbit. Up to a rotation, we assume that this direction is the horizontal one (defined by $\theta = 0 \pmod{2\pi}$). We can thicken all of such horizontal periodic orbits to obtain a finite number of cylinders. Assume by contradiction, that \mathcal{S} is not fully decomposed into cylinders in the horizontal direction: there exists a cylinder \mathcal{C} and singularities σ and σ' (possibly equal) that lie on the upper side of \mathcal{C} such that the horizontal geodesic γ (whose length is denoted by $l(\gamma)$ and image by $|\gamma|$) from σ to σ' exists (the singularities are consecutive for the cyclic order on the upper side of \mathcal{C}) and is not a part of a side of any other cylinder. To be more precise, there exists $s > 0$ (by compactness of $|\gamma|$ and by finiteness of the number of horizontal cylinders) such that there is an injective isometry $i :]0, l(\gamma)[\times]0, s[\rightarrow \mathcal{S}$ such that $i([0, l(\gamma)] \times \{0\}) = |\gamma|$ and $i(]0, l(\gamma)[\times]0, s[)$ doesn't meet any horizontal cylinder. Up to a dilatation (that belongs to $GL^+(2, \mathbb{R})$), we assume that the width of \mathcal{C} is 1 and that its height is 2. The situation is described in Figure 3.2.

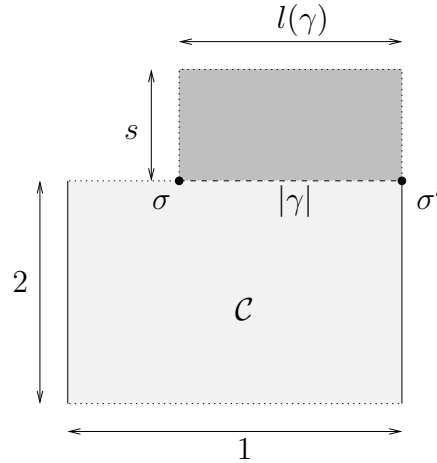

Figure 3.2: The opposite vertical black sides are identified by translation; the dotted ones are glued with the rest of the surface; the dark zone doesn't meet any horizontal cylinder.

The heart of the proof is organised into three steps. A summary concludes each of them.

Step 1 *Construction of certain thin rectangles in \mathcal{S} that contain a common point A .*

Let $\varepsilon > 0$ be smaller than s .

Let T_ε be the supremum of all $t > 0$ such that there exists an injective isometry $j_t :]0, t[\times]0, \varepsilon[\rightarrow \mathcal{S}$ that coincides with γ on $]0, \min(l(\gamma), t)[\times \{0\}$. T_ε is greater than or equal to $l(\gamma)$ and therefore strictly positive. \mathcal{S} has finite area hence T_ε is

finite. Moreover T_ε is a maximum (indeed, if $0 < t \leq t' < T_\varepsilon$, then $j_{t'}$ extends j_t): there exists an injective isometry $j_{T_\varepsilon} :]0, T_\varepsilon[\times]0, \varepsilon[\rightarrow \mathcal{S}$ that coincide with γ on $]0, l(\gamma)[\times \{0\}$.

There are only three possibilities depending on what happens on $j_{T_\varepsilon}(\{T_\varepsilon\} \times]0, \varepsilon[)$ (if $j_{T_\varepsilon}(\{T_\varepsilon\} \times]0, \varepsilon[)$ does not meet a singularity, then j_{T_ε} can be extended to an isometry that fails to be injective, hence $I_\varepsilon = j_{T_\varepsilon}(\{T_\varepsilon\} \times]0, \varepsilon[)$ and $J_\varepsilon = j_{T_\varepsilon}(\{0\} \times]0, \varepsilon[)$ intersect each other):

1. I_ε meets a singularity denoted by σ_ε .
2. $I_\varepsilon = J_\varepsilon$: we just have constructed a cylinder where it is forbidden, so this case does not occur.
3. The vertical intervals I_ε and J_ε intersect each other but we are neither in the first nor in the second case. Since $\sigma = j_{T_\varepsilon}(0, 0)$ is a singularity, $I_\varepsilon \cap J_\varepsilon$ is a subinterval of J_ε that hits the extremity of J_ε that is not σ (i.e. $j_{T_\varepsilon}(0, \varepsilon)$) (see Figure 3.3).

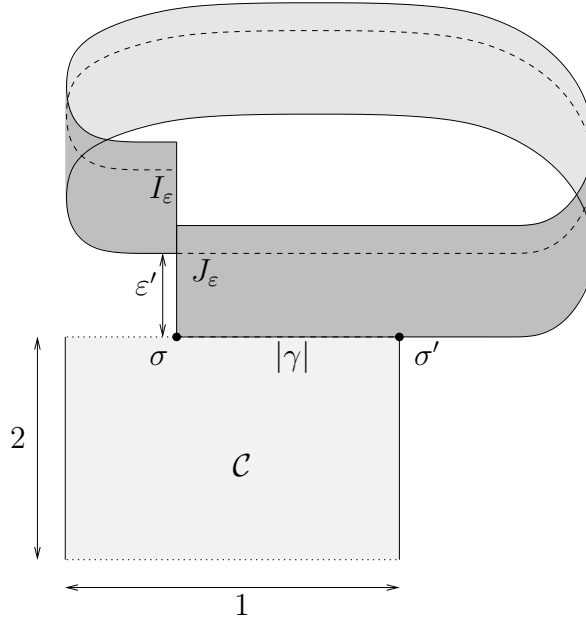

Figure 3.3: The dark zone is the image of j_{T_ε} .

So, there exists $0 < \varepsilon' \leq \varepsilon$ such that $J_\varepsilon \setminus I_\varepsilon = j_{T_\varepsilon}(\{0\} \times]0, \varepsilon']$. Now, the same three possibilities are offered to $j_{T_{\varepsilon'}}$, but the third case can't happen. Indeed, otherwise there is $0 < \varepsilon'' < \varepsilon'$ such that $j_{T_{\varepsilon'}}(0, \varepsilon') = j_{T_{\varepsilon'}}(T_\varepsilon, 0) = j_{T_{\varepsilon'}}(T_{\varepsilon'}, \varepsilon' - \varepsilon'')$ is not a singularity but has a conical angle greater than 2π .

So, up to reducing the size of ε (by replacing ε by ε' whenever we are in the third case), we can consider that we are in the first case, and, since Σ is finite, there exists a sequence $(\varepsilon_n)_{n \in \mathbb{N}}$ of strictly positive numbers that converges to 0 and a singularity $\sigma_\infty \in \Sigma$ such that for all n in \mathbb{N} , $\sigma_{\varepsilon_n} = \sigma_\infty$. If $n \in \mathbb{N}$, there exists $0 < y_n < \varepsilon_n$ such that $\sigma_\infty = j_{T_{\varepsilon_n}}(T_{\varepsilon_n}, y_n)$. Let $A = j_{T_{\varepsilon_n}}(T_{\varepsilon_n} - l(\gamma)/2, y_n)$ (A does not depend on $n \in \mathbb{N}$ and is in the image of every $j_{T_{\varepsilon_n}}$).

To sum up this step and fix notations, we proved that there exists $A \in \mathcal{S}$ such that for all $\varepsilon > 0$ there exists $l_\varepsilon \geq l(\gamma)$ and $0 < h_\varepsilon \leq \varepsilon$ such that there exists an injective isometry i_ε from $]0, l_\varepsilon[\times]0, h_\varepsilon[$ to \mathcal{S} that coincides with γ on $]0, l(\gamma)[\times \{0\}$ and whose image contains A .

The situation is summarized in Figure 3.4. Let O be the point drawn on this Figure. We denote $A = i_\varepsilon(x_\varepsilon, y_\varepsilon)$.

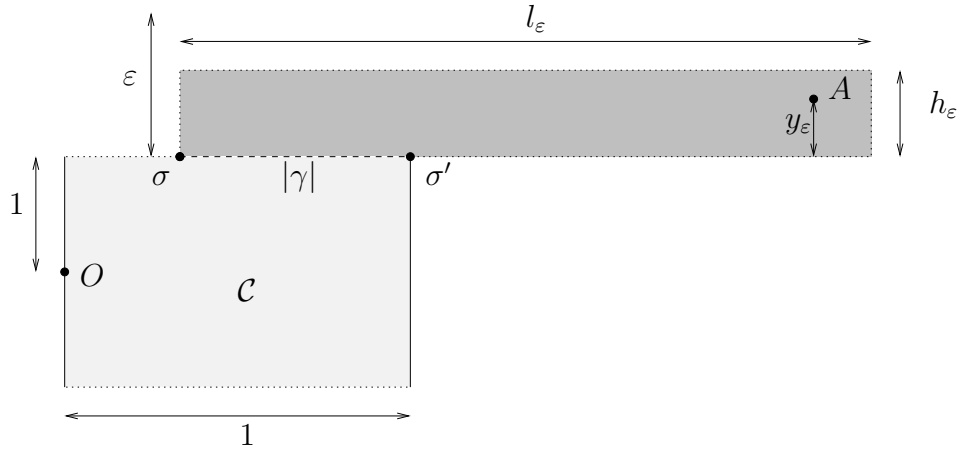

Figure 3.4: Summary of Step 1.

Step 2 Construction of “teepees” of more and more geodesics between O and A .

Let $\varepsilon > 0$. The unfolding of \mathcal{C} allows us to define an extension of i_ε as in Figure 3.5: we get an isometry $i_\varepsilon :]0, l_\varepsilon[\times [0, h_\varepsilon[\cup \mathbb{R} \times]-2, 0[\rightarrow \mathcal{S}$. In \mathbb{R}^2 , we denote without ambiguity $\sigma = (0, 0)$, $\sigma' = (l(\gamma), 0)$ and $A = (x_\varepsilon, y_\varepsilon)$.

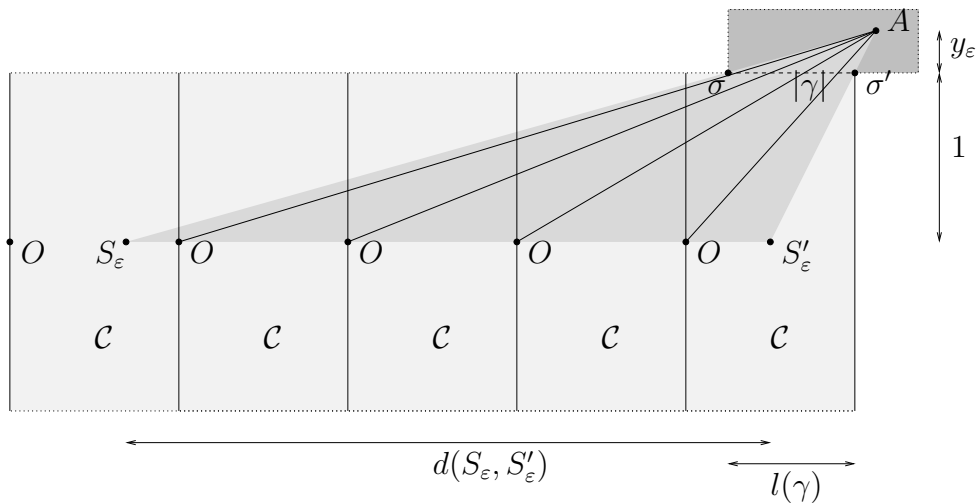

Figure 3.5: First (topological) application of the theorem of Thales.

Let S_ε (resp. S'_ε) be the point of the line that passes through A and σ (resp. σ') whose ordinate is -1 . Since (σ, σ') and $(S_\varepsilon, S'_\varepsilon)$ are parallel, the theorem of Thales

asserts that

$$\frac{d(S_\varepsilon, S'_\varepsilon)}{(1 + y_\varepsilon)} = \frac{l(\gamma)}{y_\varepsilon},$$

where d stands for the euclidean distance of \mathbb{R}^2 . Let $\mathcal{O}_\varepsilon = i_\varepsilon^{-1}(\{O\}) \cap]S_\varepsilon, S'_\varepsilon[$. We have

$$\text{card } \mathcal{O}_\varepsilon \geq d(S_\varepsilon, S'_\varepsilon) - 1 = l(\gamma)(1 + y_\varepsilon)/y_\varepsilon - 1 \xrightarrow{\varepsilon \rightarrow 0} \infty.$$

Since the open triangle $(A, S_\varepsilon, S'_\varepsilon)$ is included in the source of i_ε , we define a set \mathcal{T}_ε (called a *teepee*) of geodesics in \mathcal{S} from O to A by taking the images by i_ε of the segments joining an element of \mathcal{O}_ε to A . Of course,

$$\text{card } \mathcal{T}_\varepsilon = \text{card } \mathcal{O}_\varepsilon \xrightarrow{\varepsilon \rightarrow 0} \infty.$$

To sum up this step, we constructed, for all $\varepsilon > 0$, a set \mathcal{T}_ε of more and more geodesics from O to A whose images are included in $\mathcal{C} \cup |\gamma| \cup i_\varepsilon(]0, l_\varepsilon[\times]0, h_\varepsilon[)$.

Step 3 *The density of the geodesics of a teepee that are blocked by a fixed point vanishes.*

Let B be a fixed point in \mathcal{S} that is different from O and A . For $\varepsilon > 0$, let $\mathcal{T}_\varepsilon(B)$ be the set of elements of \mathcal{T}_ε that are blocked by B (i.e. that pass through B).

- Suppose that B is not in \mathcal{C} . Let $\varepsilon > 0$. If B is not in the image of i_ε , then $\mathcal{T}_\varepsilon(B)$ is empty. Otherwise, B is in $i_\varepsilon(]0, l_\varepsilon[\times]0, h_\varepsilon[)$, then the cardinal of $\mathcal{T}_\varepsilon(B)$ is at most 1 (indeed, the elements of \mathcal{T}_ε are disjoint on $i_\varepsilon(]0, l_\varepsilon[\times]0, h_\varepsilon[) \setminus \{A\}$). Hence, $\text{card } \mathcal{T}_\varepsilon(B) / \text{card } \mathcal{T}_\varepsilon \xrightarrow{\varepsilon \rightarrow 0} 0$.
- Suppose that B is in \mathcal{C} . Let $-h$ be the ordinate of any preimage of B by any i_ε . We can assume that $h \in]0, 1[$, otherwise $\mathcal{T}_\varepsilon(B)$ is empty for any $\varepsilon > 0$. Let $\varepsilon > 0$. Let β_1 and β_2 be two distinct elements of $\mathcal{T}_\varepsilon(B)$: for $i \in \{1, 2\}$, there exists O_i in \mathcal{O}_ε and B_i in $i_\varepsilon^{-1}(B)$ such that B_i lies in the segment $[O_i, A]$ whose image by i_ε is β_i (see Figure 3.6).

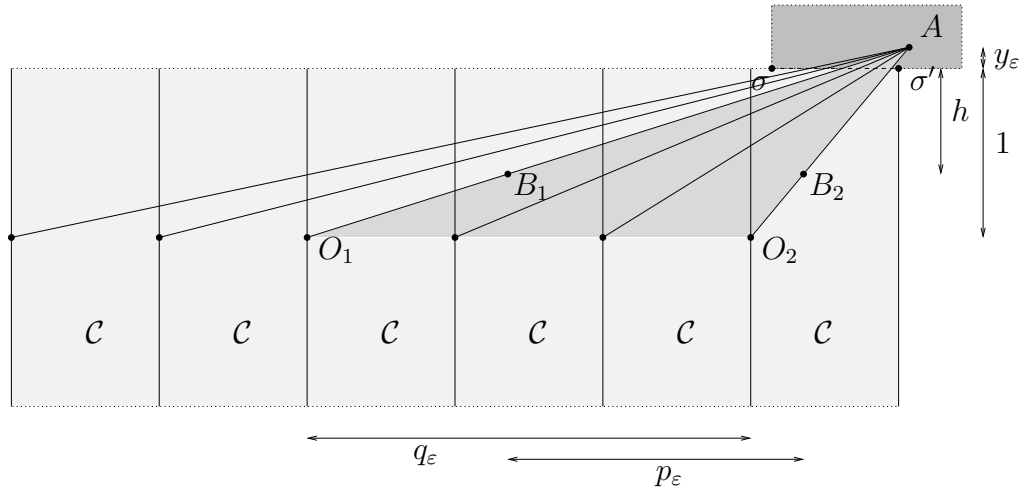

Figure 3.6: Second (arithmetic) application of the theorem of Thales.

We choose β_1 and β_2 such that $d(O_1, O_2)$ is minimal, and set $p_\varepsilon = d(B_1, B_2)$ and $q_\varepsilon = d(O_1, O_2)$. By minimality,

$$\text{card } \mathcal{T}_\varepsilon(B) \leq \frac{\text{card } \mathcal{T}_\varepsilon}{q_\varepsilon} + 1.$$

Since $i_\varepsilon(B_1) = i_\varepsilon(B_2) = B$ and $i_\varepsilon(O_1) = i_\varepsilon(O_2) = O$, p_ε and q_ε are integers. Since (B_1, B_2) and (O_1, O_2) are parallel, the theorem of Thales asserts that

$$\frac{p_\varepsilon}{q_\varepsilon} = \frac{(h + y_\varepsilon)}{(1 + y_\varepsilon)}.$$

The map $\left(\begin{array}{ccc} \mathbb{R}_+^* & \longrightarrow &]h, \infty[\\ \varepsilon & \longmapsto & (h + y_\varepsilon)/(1 + y_\varepsilon) \end{array} \right)$ converges to h when ε converges to 0 but never takes the value h , hence $q_\varepsilon \xrightarrow{\varepsilon \rightarrow 0} \infty$ (indeed, any set of rational numbers whose denominators are bounded is a closed discrete subset of \mathbb{R} , hence it cannot have an accumulation point).

Hence,

$$\frac{\text{card } \mathcal{T}_\varepsilon(B)}{\text{card } \mathcal{T}_\varepsilon} \leq \frac{1}{q_\varepsilon} + \frac{1}{\text{card } \mathcal{T}_\varepsilon} \xrightarrow{\varepsilon \rightarrow 0} 0.$$

To sum up this step, we proved that for any point B in \mathcal{S} that is different from O and A , the density of the geodesics of \mathcal{T}_ε that are blocked by B tends to 0 when ε tends to 0.

Now, we assumed that \mathcal{S} has the finite blocking property, so there exists a finite set $\{B_1, \dots, B_n\}$ in $\mathcal{S} \setminus \{O, A\}$ that blocks any geodesic from O to A .

Let $\varepsilon > 0$ be small enough such that $\sum_{i=1}^n \text{card } \mathcal{T}_\varepsilon(B_i) / \text{card } \mathcal{T}_\varepsilon < 1$: there exists a geodesic in $\mathcal{T}_\varepsilon \setminus \bigcup_{i=1}^n \mathcal{T}_\varepsilon(B_i)$ from O to A that doesn't meet any B_i , leading to a contradiction. So, \mathcal{S} is completely periodic. □

Theorem 1. *Let \mathcal{S} be a translation surface with the finite blocking property. Then \mathcal{S} is purely periodic.*

Proof: Let θ be a direction that contains a periodic trajectory. By virtue of Proposition 9, \mathcal{S} admits a cylinder decomposition $(\mathcal{C}_i)_{i=1}^n$ in the direction θ . Starting from one of those cylinders and applying Lemma 1 step by step, we show that all the widths of those cylinders are commensurable (remember that \mathcal{S} is connected). Hence there exists $w > 0$ such that the width of \mathcal{C}_i is equal to $p_i w$ with $p_i \in \mathbb{N}^*$. Setting $T = w p_1 \dots p_n > 0$, we have $\phi_\theta^T = Id_{\mathcal{S}}$ a.e. □

3.4 Some applications

Theorem 2. *In genus $g \geq 2$, the set of translation surfaces that fail the finite blocking property is of full measure in every stratum.*

Proof: It is known that completely periodic translation surfaces form a set of null measure in every stratum (in genus $g \geq 2$) ([Zo]). □

Theorem 3. *Let \mathcal{S} be a translation surface of genus 2. Then \mathcal{S} has the finite blocking property if and only if \mathcal{S} is a torus branched covering.*

Proof:

By Proposition 5, if \mathcal{S} is a torus branched covering, then \mathcal{S} has the finite blocking property. Conversely, suppose that \mathcal{S} has the finite blocking property. By Proposition 9, \mathcal{S} is completely periodic. Such surfaces of genus 2 were classified in [Ca]. If \mathcal{S} is in $\mathcal{H}(2)$, then \mathcal{S} is a Veech surface and by Proposition 7, \mathcal{S} is a torus branched covering. If \mathcal{S} is in $\mathcal{H}(1, 1)$, we assume by contradiction that \mathcal{S} is not a torus branched covering. A direct consequence of Theorem 1.2 of [Ca] is that after rescaling \mathcal{S} , there exists a square-free integer $d > 0$, four positive numbers w_1, w_2, s_1, s_2 in $\mathbb{Q}(\sqrt{d})$ and a direction $\theta \in \mathbb{S}^1$ such that:

- \mathcal{S} is decomposed into cylinders $\mathcal{C}_1, \mathcal{C}_2$ (and sometimes \mathcal{C}_3) in the direction θ
- w_1 (resp. w_2) is the width of \mathcal{C}_1 (resp. \mathcal{C}_2)
-

$$\frac{w_1}{w_2}\bar{s}_1 + \bar{s}_2 = 0$$

Since w_1, w_2, s_1, s_2 are in $\mathbb{Q}(\sqrt{d})$, there exists two rational numbers r_1 and r_2 such that

$$\frac{w_1}{w_2}s_1 + s_2 = r_1 + r_2\sqrt{d}.$$

The addition of those two equalities gives $\frac{w_1}{w_2}(s_1 + \bar{s}_1) + (s_2 + \bar{s}_2) = r_1 + r_2\sqrt{d}$. Theorem 1 asserts that \mathcal{S} is purely periodic, so $\frac{w_1}{w_2}$ is rational, so $\frac{w_1}{w_2}(s_1 + \bar{s}_1) + (s_2 + \bar{s}_2)$ is rational, so $r_2 = 0$. The subtraction of the two equalities leads to $r_1 = 0$.

Hence, $\frac{w_1}{w_2}s_1 + s_2$ is both null and positive, which is impossible: \mathcal{S} is a torus branched covering. □

Of course, the notion of finite blocking property and the results presented in this paper can be translated in the vocabulary of quadratic differentials.

3.5 Conclusion

We conclude this paper by the following open question :

Does pure periodicity imply being a torus branched covering?

It was positively answered in [Mo2] for Veech surfaces and in the present paper for surfaces of genus two. Proving that in full generality would provide an equivalence between the following assertions :

1. \mathcal{S} is a torus branched covering
2. there exists $A \in GL(2, \mathbb{R})$ such that $hol(H_1(A.\mathcal{S}, \mathbb{Z})) = \mathbb{Z} + i\mathbb{Z}$
3. $Vect_{\mathbb{Q}}(hol(H_1(\mathcal{S}, \mathbb{Z})))$ has dimension 2
4. \mathcal{S} has the finite blocking property
5. \mathcal{S} has the bounded blocking property: there exists $n \in \mathbb{N}$ such that for every pair (O, A) of points in \mathcal{S} , there exists n points B_1, \dots, B_n (different from O and A) such that every geodesic from O to A meets one of the B_i 's
6. \mathcal{S} has the middle blocking property: For every pair (O, A) of points in \mathcal{S} , the set of the midpoints of the geodesics from O to A is finite
7. \mathcal{S} has the bounded middle blocking property: there exists $n \in \mathbb{N}$ such that the set of the midpoints of the geodesics from O to A has cardinal less than n
8. \mathcal{S} is purely periodic: in every direction θ that contains a periodic orbit, the directional flow ϕ_{θ} is periodic (i.e. there exists $T > 0$ such that $\phi_{\theta}^T = Id_{\mathcal{S}}$ a.e.)
9. in every direction that contains a periodic orbit, \mathcal{S} is decomposable into cylinders whose widths are commensurable

Properties 1, 2 and 3 are geometric, whereas properties 4, 5, 6, 7 are exponential and properties 8 and 9 are dynamic.

If \mathcal{C} denotes the subgroup of $H_1(\mathcal{S}, \mathbb{Z})$ generated by the periodic orbits, it is already possible to prove that if \mathcal{S} is purely periodic, then $Vect_{\mathbb{Q}}(hol(\mathcal{C}))$ has dimension 2. Consequently, when $\mathcal{C} = H_1(\mathcal{S}, \mathbb{Z})$, then the nine previous assertions are equivalent.

References

- [BGZ] F. BOCA, R. GOLOGAN, A. ZAHARESCU, *The statistics of the trajectory of a certain billiard in a flat torus*, Comm. Math. Phys. 240 (2003), p 53–76.
- [Ca] K. CALTA, *Veech surfaces and complete periodicity in genus 2*, J. Amer. Math. Soc., to appear.
- [Ch] Y. CHEUNG, *Hausdorff dimension of the set of nonergodic directions*, Ann. Math., 158 (2003), 661–678.
- [CG] N. CHERNOV, G. GALPERIN, *Search light in billiard tables*, Regul. Chaotic Dyn. 8 (2003), no. 2, 225–241.
- [Fo] D. FOMIN, *ЗАДАЧИ ЛЕНИНГРАДСКИХ МАТЕМАТИЧЕСКИХ ОЛИМПИАД*, Leningrad (1990), 77.
- [Gu] E. GUTKIN, *Blocking of orbits and the phenomenon of (in)security for the billiard in polygons and flat surfaces*, preprint (2003).
- [HS] P. HIEMER, V. SNURNIKOV, *Polygonal billiards with small obstacles*, J. Statist. Phys. 90 (1998), no. 1-2, 453–466.
- [Kl] V. KLEE, *Is every polygonal region illuminable from some point?*, Amer. Math. Monthly 76(80) (1969).
- [KMS] S. KERCKHOFF, H. MASUR, J. SMILLIE, *Ergodicity of billiard flows and quadratic differentials*, Ann. Math. 124 (1986), no. 2, p 293–311.
- [Ko] M. KONTSEVICH, *Lyapunov exponents and Hodge theory*, The mathematical beauty of physics (Saclay, 1996), p 318–332, Adv. Ser. Math. Phys., 24, World Sci. Publishing, River Edge, NJ, 1997.
- [Ma] H. MASUR, *Hausdorff dimension of the set of nonergodic foliations of a quadratic differential*, Duke Math. J. 66 (1992), no. 3, p 387–442.
- [MS] H. MASUR, J. SMILLIE, *Hausdorff dimension of sets of nonergodic measured foliations*, Ann. Math. 134 (1991), no. 3, 455–543.
- [MT] H. MASUR, S. TABACHNIKOV, *Rational billiards and flat structures*, Handbook on dynamical systems, Vol. 1A, 1015–1089, North-Holland, Amsterdam, (2002).
- [Mo1] T. MONTEIL, *A counter-example to the theorem of Hiemer and Snurnikov*, J. Statist. Phys. 114 (2004), no. 5-6, 1619–1623.
- [Mo2] T. MONTEIL, *On the finite blocking property*, Ann. Inst. Fourier, to appear.
- [To] G. TOKARSKY, *Polygonal rooms not illuminable from every point*, Amer. Math. Monthly 102 (1995), no. 10, 867–879.
- [Ve] W. VEECH, *Teichmüller curves in moduli space, Eisenstein series and an application to triangular billiards*, Invent. Math. 97 (1989), no. 3, 553–583.

- [Vo] Y. VOROBETS, *Planar structures and billiards in rational polygons: the Veech alternative*, Russian Math. Surveys 51 (1996), no. 5, 779–817.
- [ZK] A. ZEMLJAKOV, A. KATOK, *Topological transitivity of billiards in polygons*, Mat. Zametki 18 (1975), no. 2, 291–300.
- [Zo] A. ZORICH, *private communication*.

Chapitre 4

Une condition homologique pour une caractérisation dynamique et illuminatoire des revêtements ramifiés du tore

4.1 Introduction

A *translation surface* is a triple $(\mathcal{S}, \Sigma, \omega)$ such that \mathcal{S} is a topological compact connected surface, Σ is a finite subset of \mathcal{S} (whose elements are called *singularities*) and $\omega = (U_i, \phi_i)_{i \in I}$ is an atlas of $\mathcal{S} \setminus \Sigma$ (consistent with the topological structure on \mathcal{S}) such that the transition maps (i.e. the $\phi_j \circ \phi_i^{-1} : \phi_i(U_i \cap U_j) \rightarrow \phi_j(U_i \cap U_j)$ for $(i, j) \in I^2$) are translations. This atlas gives to $\mathcal{S} \setminus \Sigma$ a Riemannian structure; therefore, we have notions of length, angle, measure, geodesic... Moreover, we assume that \mathcal{S} is the completion of $\mathcal{S} \setminus \Sigma$ for this metric.

A translation surface can also be seen as a holomorphic differential h on a Riemann surface (the singularities correspond to the zeroes of the differential, and in an admissible atlas ω , h is of the form $h = dz$).

Translation surfaces provide one of the main tool for the study of rational polygonal billiards.

Since the unit tangent bundle of \mathcal{S} enjoys a canonical global decomposition $U\mathcal{S} = \mathcal{S} \times \mathbb{S}^1$ (the rotational holonomy is trivial), the study of the geodesic flow on \mathcal{S} can be done through two points of view depending on whether the variable is the first or the second projection:

Dynamics We can fix one particular direction $\theta \in \mathbb{S}^1$.

This corresponds to the study of the *directional flow* $\phi_\theta : \mathcal{S} \times \mathbb{R} \rightarrow \mathcal{S}$.

In that context, we say that a translation surface \mathcal{S} is *purely periodic* if for any $\theta \in \mathbb{S}^1$, the existence of a periodic orbit in the direction θ implies that the directional flow ϕ_θ is periodic (i.e. there exists $T > 0$ such that $\phi_\theta^T = Id_{\mathcal{S}}$ a.e.).

Illumination We can also fix one point in $x \in \mathcal{S}$.

This corresponds to the study of the *exponential flow* $\exp_x : \mathbb{S}^1 \times \mathbb{R} \rightarrow \mathcal{S}$.

In that context, we say that a translation surface \mathcal{S} has the *finite blocking property* if for every pair (O, A) of points in \mathcal{S} , there exists a finite number of points B_1, \dots, B_n (different from O and A) such that every geodesic from O to A meets one of the B_i 's.

A *torus branched covering* is a translation surface \mathcal{S} such that there exists a branched translation covering from \mathcal{S} to a flat torus (a *branched translation covering* between two translation surfaces is a map $\pi : (\mathcal{S}, \Sigma) \rightarrow (\mathcal{S}', \Sigma')$ that is a topological branched covering that locally preserves the translation structure.). This is a global geometric property.

In [Mon1] and [Mon2], the three notions of torus branched covering, finite blocking property and pure periodicity have been proved to be equivalent for Veech surfaces and surfaces of genus two. Gutkin proved independently that the notions of torus branched covering and finite blocking property are equivalent for Veech surfaces [Gut].

In this paper, we prove that the equivalence is true for any surface whose homology is generated by the periodic orbits of the geodesic flow.

In particular, the three notions are equivalent for convex surfaces and on a dense open subset of full measure of any stratum.

The paper is organized as follows : in section 4.2, we recall some background and useful tools. The second one is devoted to the proof of the following results :

Theorem 1. *Let \mathcal{S} be a purely periodic translation surface. Then $\text{hol}(\mathcal{P}(\mathcal{S}))$ is a lattice of \mathbb{R}^2 .*

Theorem 2. *Let \mathcal{S} be a translation surface whose homology is generated by the periodic orbits of the geodesic flow on \mathcal{S} . Then the following assertions are equivalent:*

1. \mathcal{S} is a torus branched covering
2. \mathcal{S} has the finite blocking property
3. \mathcal{S} is purely periodic

In section 4.4, we try to see to what extent does this result applies. In particular, we prove

Proposition 1. *Let \mathcal{S} be a convex surface, then the periodic orbits of \mathcal{S} generate $H_1(\mathcal{S}, \mathbb{Z})$.*

Proposition 2. *In any stratum $\mathcal{H}_1(k_1, \dots, k_n)$, the set of translation surfaces whose homology is generated by the periodic orbits is an open dense subset of full measure.*

The last section is a discussion about the tools we used, particularly the J -invariant (in the proof of Theorem 1) and the existence of two transverse parabolic elements (for the proof of the result about Veech surfaces), and the fact that in general one needs to find periodic orbits in more than two directions to generate the homology of a translation surface. We take the opportunity to introduce the class of translation surface whose J -invariant is of the simplest form, and present a collaborative encyclopedia of concrete translation surfaces.

4.2 Background and tools

4.2.1 Cylinder decomposition

Let \mathcal{S} be a translation surface. A *cylinder* \mathcal{C} of \mathcal{S} is a maximal isometric copy of $\mathbb{R}/w\mathbb{Z} \times]0, h[$ in \mathcal{S} ($w > 0$, $h > 0$). The parameters w and h are unique and called the *width* (or *perimeter*) and the *height* of \mathcal{C} . The *direction* of \mathcal{C} is the direction of the image of $\mathbb{R}/w\mathbb{Z} \times \{h/2\}$ (which is considered here as an oriented closed geodesic); it is defined modulo 2π .

We say that \mathcal{S} admits a *cylinder decomposition* in the direction θ if the (necessarily finite) union of cylinders in that direction is dense in \mathcal{S} . The remaining is a finite union of saddle connections (a *saddle connections* is a geodesic $\gamma : [0, 1] \rightarrow \mathcal{S}$ joining two singularities and such that $\gamma]0, 1[$ does not contain any singularity).

Any periodic trajectory for ϕ_θ can be thickened to obtain a cylinder in the direction θ . Thus, saying that \mathcal{S} is purely periodic is equivalent to say that in each direction θ that admits a periodic orbit, \mathcal{S} admits a cylinder decomposition whose cylinders have commensurable perimeters. This property is stronger than the notion of complete periodicity introduced by Calta [Cal].

4.2.2 (Translational) holonomy

Let \mathcal{S} be a translation surface. Let $\gamma : [0, 1] \rightarrow \mathcal{S}$ be a continuous curve. Thanks to local charts, γ can be lifted on \mathbb{R}^2 (or \mathbb{C}) to a curve $\bar{\gamma}$ defined up to translation. Hence, $hol(\gamma) \stackrel{\text{def}}{=} \bar{\gamma}(1) - \bar{\gamma}(0)$ is well defined and is called the *holonomy* of γ . If h is the holomorphic form that defines \mathcal{S} , we have $hol(\gamma) = \int_\gamma h$.

If γ' is homologous to γ , then $hol(\gamma') = hol(\gamma)$. If we are looking to closed curves, hol can be extended by formal sum to a morphism $hol : H_1(\mathcal{S}, \mathbb{Z}) \rightarrow \mathbb{R}^2$.

4.2.3 Moduli space and $SL(2, \mathbb{R})$ -action

A singularity $\sigma \in \Sigma$ has a conical angle of the form $2(k+1)\pi$, with $k \geq 0$; we say that σ is of *multiplicity* k . In terms of holomorphic forms, it is equivalent to say that there is a chart around σ such that $h = z^k dz$ (i.e. σ is a zero of order k of h).

If $1 \leq k_1 \leq k_2 \leq \dots \leq k_n$ is a sequence of positive integers whose sum is even, we denote by $\mathcal{H}(k_1, k_2, \dots, k_n)$ the *stratum* of translation surfaces with exactly n singularities whose multiplicities are k_1, k_2, \dots, k_n (we consider only surfaces without *removable* singularities i.e. singularities of multiplicity 0). A translation surface in $\mathcal{H}(k_1, k_2, \dots, k_n)$ has genus $g = 1 + (k_1 + k_2 + \dots + k_n)/2$.

For any translation surface \mathcal{S} and any $A \in SL(2, \mathbb{R})$, we can define the translation surface

$$A.(\mathcal{S}, \Sigma, (U_i, \phi_i)_{i \in I}) \stackrel{\text{def}}{=} (\mathcal{S}, \Sigma, (U_i, A \circ \phi_i)_{i \in I})$$

hence we have an action of $SL(2, \mathbb{R})$ on the moduli space of translation surfaces.

Each stratum carries a natural topology and a $SL(2, \mathbb{R})$ -invariant measure that are for example defined in [Kon]. Let \mathcal{S} be an element of some $\mathcal{H}(k_1, k_2, \dots, k_n)$ and let \mathcal{B} be a basis of the *relative* homology of \mathcal{S} : it is just the concatenation of a basis of the first topological homology group $H_1(\mathcal{S}, \mathbb{Z})$ with a set of $n - 1$ curves from a singularity to the other ones. If \mathcal{S}' is another translation surface (built on the same topological surface), let us denote by $hol_{\mathcal{S}'}$ the associated holonomy. The map

$$\Phi \stackrel{\text{def}}{=} \left(\begin{array}{ccc} \mathcal{H}(k_1, k_2, \dots, k_n) & \longrightarrow & \mathbb{C}^{2g+n-1} \\ \mathcal{S}' & \longmapsto & (hol_{\mathcal{S}'}(\gamma_1), \dots, hol_{\mathcal{S}'}(\gamma_{2g+n-1})) \end{array} \right)$$

is named the *period map* and is a local homeomorphism in a neighbourhood of \mathcal{S} and in this system of coordinates, the former measure is absolutely continuous relatively to Lebesgue.

In each stratum $\mathcal{H}(k_1, k_2, \dots, k_n)$, let $\mathcal{H}_1(k_1, k_2, \dots, k_n)$ denotes the real hypersurface defined by the equation $area(\mathcal{S}) = 1$. The topology can be induced and the measure can be pushed from $\mathcal{H}(k_1, k_2, \dots, k_n)$ to $\mathcal{H}_1(k_1, k_2, \dots, k_n)$ that is stable under $SL(2, \mathbb{R})$. Masur [Mas] and Veech [Vee1] proved that the volume of any such (normalized) stratum is finite, and that the action of $SL(2, \mathbb{R})$ is ergodic on any connected component of any normalized stratum.

4.2.4 The J -invariant

In [KenSmi], Kenyon and Smillie define an algebraic invariant for translation surfaces: the J -invariant. It takes values in the alternating product of \mathbb{R}^2 by itself denoted here by $\mathbb{R}^2 \wedge_{\mathbb{Q}} \mathbb{R}^2$ (note that \mathbb{R}^2 is considered here as an infinite dimensional \mathbb{Q} -vector space). If (β, \leq) is a totally ordered basis of \mathbb{R}^2 , then $\{u \wedge v \mid (u, v) \in \beta^2 \text{ and } u < v\}$ is a basis of $\mathbb{R}^2 \wedge_{\mathbb{Q}} \mathbb{R}^2$.

First, they define it for planar polygons: if P is a polygon of \mathbb{R}^2 with vertices v_1, \dots, v_n in counterclockwise order around the boundary of P , then

$$J(P) \stackrel{\text{def}}{=} v_1 \wedge v_2 + v_2 \wedge v_3 + \dots + v_n \wedge v_1$$

If P is a parallelogram, we have $J(P) = 2e_1 \wedge e_2$, where $e_1 = v_2 - v_1$ and $e_2 = v_3 - v_2 = v_4 - v_1$ are two consecutive edges of P (for the same counterclockwise order).

Then, if a translation surface \mathcal{S} admits a cellular decomposition into planar polygons $\mathcal{S} = P_1 \cup \dots \cup P_n$, they define

$$J(\mathcal{S}) \stackrel{\text{def}}{=} J(P_1) + \dots + J(P_n)$$

Any translation surface admits such a decomposition and $J(\mathcal{S})$ is independent of the choice of the decomposition of \mathcal{S} into polygons (see [KenSmi]). Note that the singularities of \mathcal{S} have to be located at the vertices of the P_i 's.

We have to notice that for any translation surface \mathcal{S} , $J(\mathcal{S})$ cannot be equal to zero since if φ denotes the linear map from $\mathbb{R}^2 \wedge_{\mathbb{Q}} \mathbb{R}^2$ to \mathbb{R} such that for any u and v in \mathbb{R}^2 $\varphi(u \wedge v) = \det(u, v)$, then $\varphi(J(\mathcal{S})) = 2 \cdot \text{area}(\mathcal{S}) \neq 0$.

4.3 A homological condition for a purely periodic translation surface to be a torus branched covering

Thanks to Hopf-Rinow theorem, since \mathcal{S} is a complete surface, any closed curve γ on \mathcal{S} can be tightened to give a closed geodesic in the same homology class. Therefore, $H_1(\mathcal{S}, \mathbb{Z})$ is generated by the closed geodesics of \mathcal{S} . Among them, are the periodic orbits for the geodesic flow. But they are not the only ones since there are also closed unions of “consecutive” saddle connections. Let $P(\mathcal{S})$ denotes the set of periodic orbits, and let $\mathcal{P}(\mathcal{S})$ denotes the subgroup of $H_1(\mathcal{S}, \mathbb{Z})$ generated by $P(\mathcal{S})$.

Theorem 1. *Let \mathcal{S} be a purely periodic translation surface. Then $\text{hol}(\mathcal{P}(\mathcal{S}))$ is a lattice of \mathbb{R}^2 .*

Proof:

Step 1: We prove that $\dim_{\mathbb{Q}}(\text{Vect}_{\mathbb{Q}}(\text{hol}(P(\mathcal{S})))) = 2$.

Let V and W be two non-colinear elements of $\text{hol}(P(\mathcal{S}))$. Up to let $SL(2, \mathbb{R})$ act on \mathcal{S} , we can suppose that V is horizontal whereas W is vertical.

Now, assume by contradiction that there is an element V' in $\text{hol}(P(\mathcal{S}))$ that is not in the \mathbb{Q} -vector sapce generated by V and W .

V' can be neither parallel to V nor W since \mathcal{S} is purely periodic.

We write the real combination $V' = \alpha V + \beta W$.

We have supposed that α or β is in $\mathbb{R} \setminus \mathbb{Q}$. There is no loss of generality to assume that both α and β are positive and that α is irrational (see Figure 4.1, the positivity of α and β is just here to avoid confusions in the computation of $J(\mathcal{S})$).

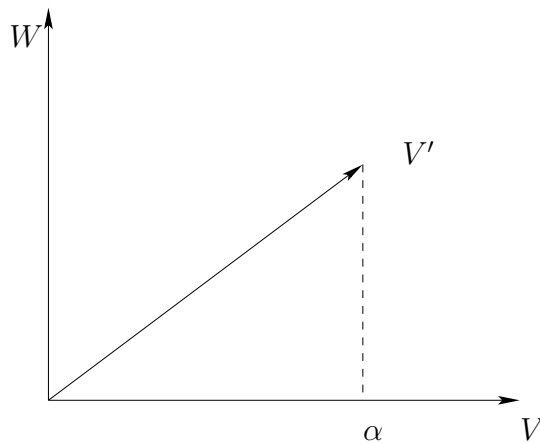

Figure 4.1: Three vectors in $\text{hol}(P(\mathcal{S}))$ that are free over \mathbb{Q} .

We will now calculate $J(\mathcal{S})$ in two different manners, along the couple of directions (V, W) , and then along (V', W) .

Since \mathcal{S} is purely periodic, we can decompose \mathcal{S} into parallel horizontal and vertical cylinders $(\mathcal{C}_i)_{i=0}^p$ and $(\mathcal{D}_j)_{j=0}^q$.

For $i \leq p$ and $j \leq q$, $\mathcal{C}_i \cap \mathcal{D}_j$ is the reunion of a family of disjoint open parallelograms (rectangles) $(P_{i,j,k})_{k=0}^{r(i,j)}$. Let us denote $v_{i,j,k}$ and $w_{i,j,k}$ for the sides of $P_{i,j,k}$ along directions V and W .

Note that $w_{i,j,k}$ does not depend on j nor k since it represents the height of \mathcal{C}_i along the direction W , so we can write $w_{i,j,k} = w_i$. Hence, $J(P_{i,j,k}) = 2v_{i,j,k} \wedge w_i$.

Since \mathcal{S} is purely periodic, for any $i \leq p$, the holonomy of a periodic orbit along \mathcal{C}_i is equal to $r_i V$, where r_i is a rational number. Hence $\sum_{j=0}^q \sum_{k=0}^{r(i,j)} v_{i,j,k} = r_i V$.

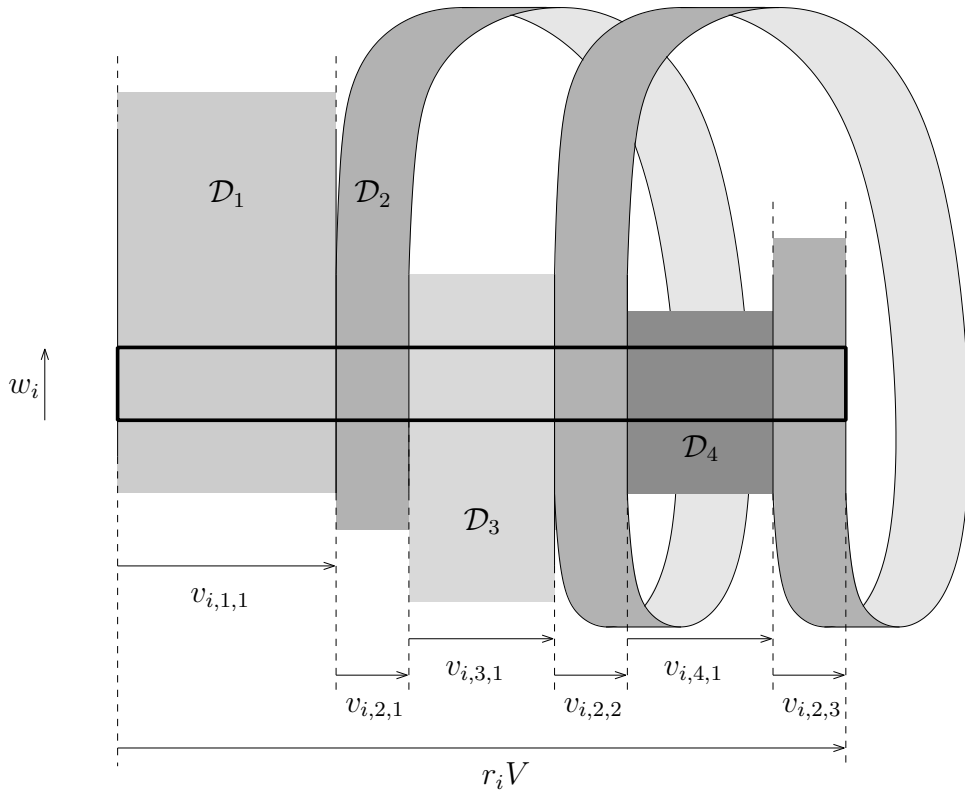

Figure 4.2: Situation around \mathcal{C}_i .

Since the closures of all the $P_{i,j,k}$'s form a cellular decomposition of \mathcal{S} (note that the singularities of \mathcal{S} are located at the vertices of some $P_{i,j,k}$'s), we have

$$J(\mathcal{S}) = \sum_{i=0}^p \sum_{j=0}^q \sum_{k=0}^{r(i,j)} J(P_{i,j,k}) = \sum_{i=0}^p 2r_i V \wedge w_i = 2V \wedge \sum_{i=0}^p r_i w_i = V \wedge Z$$

where Z is a vector colinear to W that stands for $2 \sum_{i=0}^p r_i w_i$.

The same computation holds if we replace (V, W) by (V', W) , so we have also $J(\mathcal{S}) = V' \wedge Z'$ for some vector Z' colinear to W .

So, we have $V \wedge Z = V' \wedge Z'$ hence (V, V', Z, Z') cannot be free over the rationals. Hence, there exists $(a, b, c, d) \in \mathbb{Q}^4 \setminus \{(0, 0, 0, 0)\}$ such that $aV + bV' + cZ + dZ' = 0$.

Projecting on the x -axis along the y -axis, we have $aV + b\alpha V = 0$ so $a = b = 0$ as $\alpha \notin \mathbb{Q}$. Therefore, we have $cZ + dZ' = 0$ with $(c, d) \neq (0, 0)$ and (Z, Z') is not free over \mathbb{Q} . So, there exists a rational number q such that $Z = qZ'$ (Z and Z' are different from 0 since $J(\mathcal{S})$ cannot be null).

Then $V \wedge qZ' = V' \wedge Z'$, so $(qV - V') \wedge Z' = (q - \alpha)V \wedge Z' = 0$.

Therefore, $(q - \alpha)V$ is colinear to Z' , a contradiction.

Step 2: We prove that $hol(\mathcal{P}(\mathcal{S}))$ is a lattice of \mathbb{R}^2 .

Step 1 asserts that $dim_{\mathbb{Q}}(Vect_{\mathbb{Q}}(hol(\mathcal{P}(\mathcal{S})))) = 2$, and since translational holonomy is a morphism, we have $Vect_{\mathbb{Q}}(hol(\mathcal{P}(\mathcal{S}))) \simeq \mathbb{Q}^2 \subset \mathbb{R}^2$.

Since $H_1(\mathcal{S}, \mathbb{Z})$ is a free abelian group of finite type (it is isomorphic to \mathbb{Z}^{2g} where g denotes the genus of \mathcal{S}), so is $\mathcal{P}(\mathcal{S})$ as a subgroup.

Any subgroup of finite type of \mathbb{Q}^2 is discrete in \mathbb{R}^2 . Since there are periodic orbits in at least two directions, $hol(\mathcal{P}(\mathcal{S}))$ is a lattice of \mathbb{R}^2 .

□

Theorem 2. *Let \mathcal{S} be a translation surface whose homology is generated by the periodic orbits of the geodesic flow on \mathcal{S} . Then the following assertions are equivalent:*

1. \mathcal{S} is a torus branched covering
2. \mathcal{S} has the finite blocking property
3. \mathcal{S} is purely periodic

Proof: Since (1) \Rightarrow (2) \Rightarrow (3) is already known [Mon2], it suffice to prove that a purely periodic translation surface \mathcal{S} whose homology is generated by $\mathcal{P}(\mathcal{S})$ is a torus branched covering. By Theorem 1, $\Lambda \stackrel{\text{def}}{=} hol(H_1(\mathcal{S}, \mathbb{Z})) = hol(\mathcal{P}(\mathcal{S}))$ is a lattice of \mathbb{R}^2 .

Now, let us fix a point x_0 in \mathcal{S} . For each point x in \mathcal{S} , we can chose a curve γ_x from x_0 to x . If γ'_x is another such curve, then $hol(\gamma_x) - hol(\gamma'_x) \in \Lambda$.

Hence, the map

$$\left(\begin{array}{ccc} \mathcal{S} & \longrightarrow & \mathbb{R}^2/\Lambda \\ x & \longmapsto & hol(\gamma_x) \pmod{\Lambda} \end{array} \right)$$

is well defined and realizes a branched covering from \mathcal{S} to the torus \mathbb{R}^2/Λ that preserves the translation structure (see [Zor1]). □

This leads to the following general question:

Is the homology of any translation surface generated by its periodic orbits?

Note that for our purpose, it is sufficient to prove that periodic orbits generate a subgroup of finite index of the homology to conclude.

4.4 When is the homology generated by periodic orbits?

4.4.1 For convex surfaces

Let \mathcal{P} be a simply connected polygon of \mathbb{R}^2 whose edges are grouped in pairs such that two edges in a same pair have the same length and direction but opposite orientation (\mathcal{P} gets the canonical orientation coming from \mathbb{R}^2 and transmits it to its boundary). Note that a “geometrical” side of \mathcal{P} can be decomposed into more than one edge (for example a rectangle can have more than four edges). We say that \mathcal{P} is a *pattern* of \mathcal{S} if \mathcal{S} can be obtained from \mathcal{P} by identifying the edges in each pair by translation (the singularities of \mathcal{S} are therefore located at some vertices of \mathcal{P}). The Veech construction of zippered rectangles ensures that any translation surface admits a pattern. A *convex* translation surface is a translation surface that admits a convex pattern [Vee2].

Proposition 1. *Let \mathcal{S} be a convex surface, then $P(\mathcal{S})$ generates $H_1(\mathcal{S}, \mathbb{Z})$.*

Proof: Let \mathcal{P} be a convex pattern of \mathcal{S} . Let us begin with the following observation:

Strolling round a singularity Let σ be a singularity of \mathcal{S} and let v be a vertex of \mathcal{P} that represents σ . v is surrounded by two consecutive edges in the counterclockwise order around \mathcal{P} : the first one is called the *left* edge and the second one is called the *right* edge around v (see Figure 4.3).

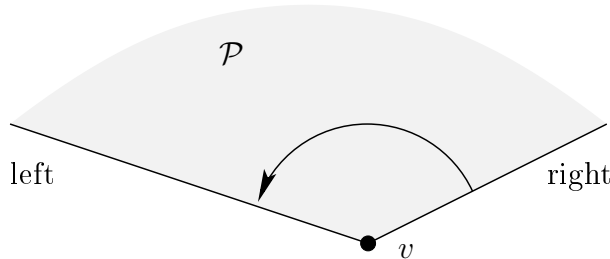

Figure 4.3: A piece of lap around σ .

The left edge around v is identified to the right edge around another vertex v_1 that also represents σ in \mathcal{S} . The left edge around v_1 is identified to the right edge around another vertex v_2 that also represents σ in \mathcal{S} . And so forth until we get a left edge around some v_k that is identified to the right edge around v (see Figure 4.4).

Viewed from \mathcal{S} , we circled in the counterclockwise order around σ (see Figure 4.5). Hence, we passed around *every* vertex of \mathcal{P} that corresponds to σ , and this stroll gives a cyclic order on the vertices of \mathcal{P} that represent σ .

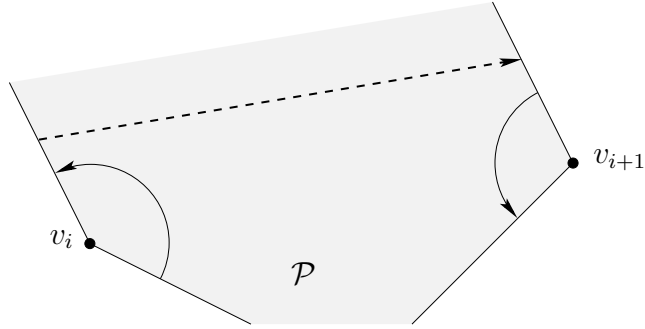

Figure 4.4: From the left edge around v_i to the right edge around v_{i+1} .

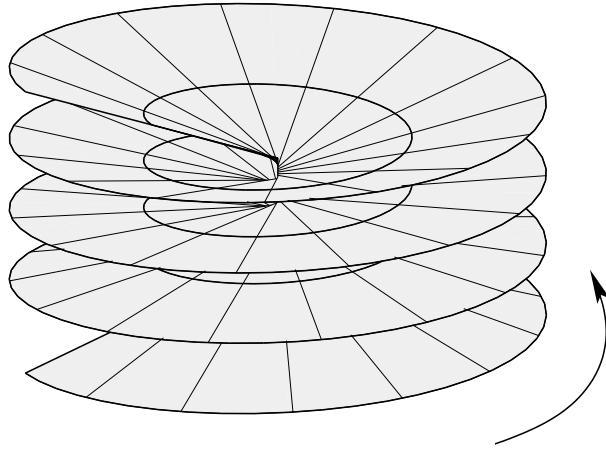

Figure 4.5: A whole lap around σ in counterclockwise order.

The observation is the following: the straight line from some v_i to v_{i+1} corresponds to an element of $\mathcal{P}(\mathcal{S})$: indeed, viewed as a closed curve of \mathcal{S} , it is homologous to the closed curve in \mathcal{S} associated to the straight line joining the middle of the left edge of v_i to the right edge of v_{i+1} that is a periodic orbit.

Hence, if v and v' are two vertices of \mathcal{P} that represent the same singularity σ , the straight line from v to v' in \mathcal{P} corresponds in \mathcal{S} to an element of $\mathcal{P}(\mathcal{S})$, since it is homologous to the sum of the elementary closed curves associated to the straight lines from a v_i to v_{i+1} (v' is one of the v_j 's).

Now, let γ be a closed curve in \mathcal{S} . Up to a tightening, we can assume that it is a closed geodesic. If it is a periodic orbit, then we are done. Otherwise, it is a union of saddle connections c_1, c_2, \dots, c_n , where c_1 goes from a singularity σ_1 to a singularity σ_2 , c_2 goes from σ_2 to σ_3 , and so forth, c_n goes from σ_n to σ_1 (the c_i 's belong to the relative homology and their sum belongs to the absolute homology of \mathcal{S}).

Viewed in \mathcal{P} , c_i is a finite union of segments $[a_{i,1}, b_{i,1}], [a_{i,2}, b_{i,2}], \dots, [a_{i,m_i}, b_{i,m_i}]$, where

- $a_{i,1}$ is a vertex of \mathcal{P} that represents σ_i

- $b_{i,j} \sim a_{i,j+1}$ for $1 \leq j \leq m_i - 1$ (note that the endpoints of the segments belong to the boundary of \mathcal{P})
- b_{i,m_i} is a vertex of \mathcal{P} that represents σ_{i+1} (with the convention that $n + 1 = 1$)

For $1 \leq i \leq n$ and $1 \leq j \leq m_i - 1$, let $\lambda_{i,j}$ denotes the straight line in \mathcal{P} between $b_{i,j}$ and $a_{i,j+1}$: it corresponds in \mathcal{S} to a periodic orbit denoted by $\bar{\lambda}_{i,j}$.

For $1 \leq i \leq n$, let μ_i denote the straight line in \mathcal{P} between b_{i,m_i} and $a_{i+1,1}$ (with the convention that $n + 1 = 1$): since b_{i,m_i} and $a_{i+1,1}$ represent the same singularity σ_{i+1} , we observed in the beginning of the proof that μ_i corresponds in \mathcal{S} to an element $\bar{\mu}_i$ of $\mathcal{P}(\mathcal{S})$. Hence, viewed in $H_1(\mathcal{S}, \mathbb{Z})$, the sum

$$\gamma + \sum_{i=1}^n \sum_{j=1}^{m_i-1} \bar{\lambda}_{i,j} + \sum_{i=1}^n \bar{\mu}_i$$

is homologous to zero: indeed, it is homologous to the image under the continuous projection $\mathcal{P} \rightarrow \mathcal{S}$ of a closed path in the simply connected space \mathcal{P} (see Figure 4.6). Hence, γ can be expressed as a sum of elements of $\mathcal{P}(\mathcal{S})$ and the result is proved.

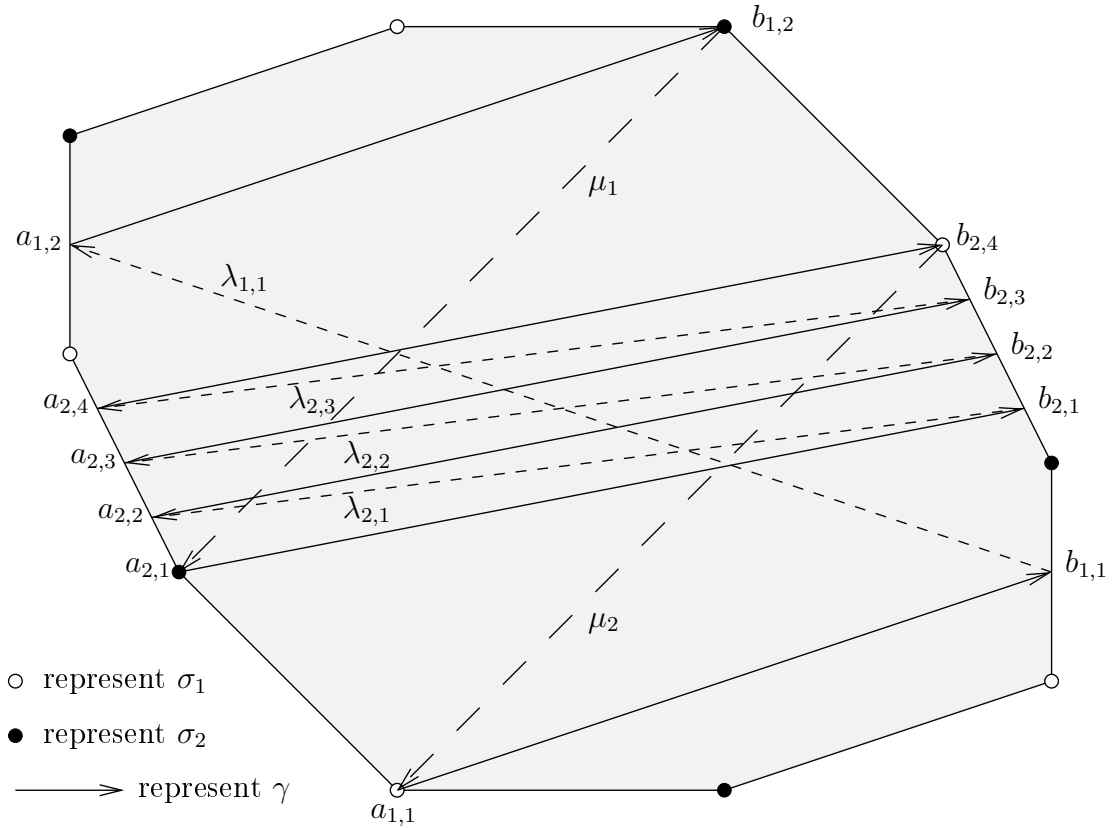

Figure 4.6: We can add (dashed) elements of $\mathcal{P}(\mathcal{S})$ to γ and obtain a closed curve homologous to zero in \mathcal{S} .

□

Corollary 1. *Any purely periodic convex translation surface is a torus branched covering.*

Note that we proved in fact the result for *face-to-face* translation surfaces i.e. translation surfaces that admit a pattern \mathcal{P} such that for each pair of identified edges $e \sim e'$, there exists two identified points x resp. x' in e resp. e' such that the line between x and x' belongs to the interior of \mathcal{P} (see Figure 4.7). Note that there exists non convex translation

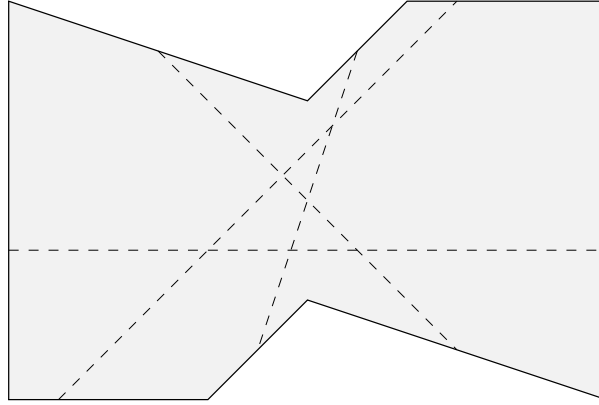

Figure 4.7: A face-to-face surface (identify parallel sides by translation).

surfaces [Vee2], but we do not know if there exists non face-to-face translation surfaces.

4.4.2 On a dense open subset of full measure in any stratum

Proposition 2. *In any stratum $\mathcal{H}_1(k_1, \dots, k_n)$, the set of translation surfaces whose homology is generated by the periodic orbits is an open dense subset of full measure.*

Proof: Let \mathcal{C} be a connected component of a normalized stratum and let \mathcal{G} denotes the subset of surfaces whose homology is generated by the periodic orbits.

In [KonZor], Kontsevich and Zorich proved that there exists a translation surface that admits a cylinder decomposition in the horizontal direction with only one cylinder in \mathcal{C} . Such surfaces are convex (the horizontal cylinder can be unrolled to a rectangle of \mathbb{R}^2) so $\mathcal{G} \neq \emptyset$.

Let \mathcal{S} be an element of \mathcal{G} . So, there exists a finite number of periodic orbits $\gamma_1, \dots, \gamma_N$ in \mathcal{S} that generate $H_1(\mathcal{S}, \mathbb{Z})$. Each γ_i can be thickened to obtain a cylinder of positive height. Those cylinders survive under a small perturbation of \mathcal{S} , so \mathcal{G} is open in the stratum and therefore in \mathcal{C} .

Hence, \mathcal{G} has positive measure, and since it is $SL(2, \mathbb{R})$ -invariant, it is of full measure in \mathcal{C} (recall that the action of $SL(2, \mathbb{R})$ is ergodic on \mathcal{C}). It is also dense in \mathcal{G} .

The result follows since the stratum is the finite union of its connected component. □

We have to notice that Zorich proved the same result using the asymptotic cycle, and looking to the evolution of the shape of Veech zippered rectangles of a generic surface along Rauzy inductions (see [Zor2]).

We also obtained another result that is not exploited yet: if \mathcal{S} is a translation surface and \mathcal{C} is a cylinder of \mathcal{S} then there exists $H > 0$ such that for any $h \geq H$ the homology of the surface obtained by replacing \mathcal{C} by a cylinder of height h and the same perimeter as \mathcal{C} is generated by its periodic orbits. Up to a renormalization of the area of those surfaces, the “flow” obtained when we let h tend to infinity corresponds to a path from \mathcal{S} to the boundary of its normalized stratum in a manner that remains to study.

4.5 Digression: Two directions do not suffice

Recall that a surface is called *bouillabaisse* if its Veech group contains two transverse parabolic elements (Veech surfaces are particular bouillabaisse surfaces). Such surfaces admit cylinder decomposition in two directions (and the moduli are commensurable). In [Mon1], we proved the equivalence of the three assertions of theorem 2 for such surfaces.

This lets us think that it is sufficient to control cylinders in two directions to control the surface. Indeed if V and W are two purely periodic directions (directions that admit a cylinder decomposition with commensurable perimeters), then the subgroup of \mathbb{R}^2 generated by the holonomy of periodic orbits of those two directions is a lattice and one might be tempted to apply the reasoning of theorem 2 to conclude.

We want to insist on the fact that two such directions are not generally sufficient to generate the homology, the following example should convince us:

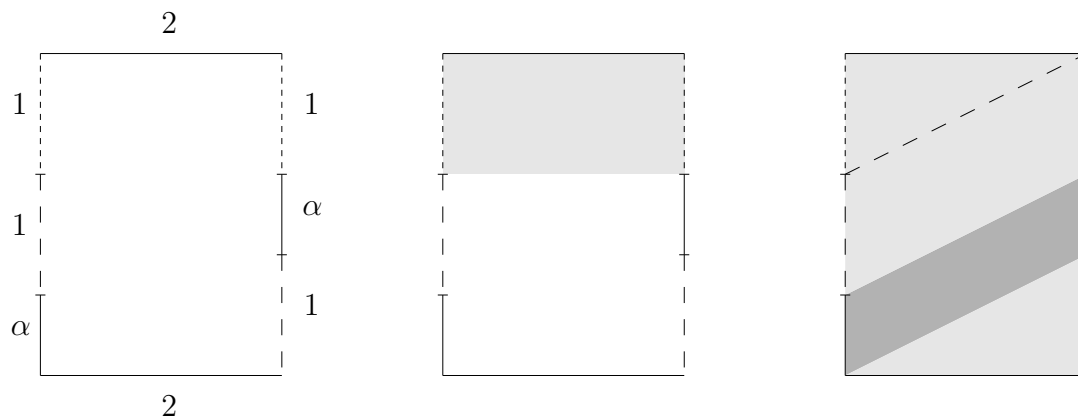

Figure 4.8: A strange surface; parallel lines with the same style are identified by translation, $\alpha \in \mathbb{R} \setminus \mathbb{Q}$.

Indeed, this surface is purely periodic in the vertical direction and in the direction $(2, 1)$ (third picture). But there are in all three cylinders in those two directions, whereas the homology is a free abelian group on four generators. It is also not completely periodic, since the horizontal direction contains one cylinder and one minimal component (second picture).

Anyway, this surface is convex so its homology is generated by its periodic orbits, but one needs more than two directions to succeed.

4.5.1 J -simple translation surfaces

In the proof of theorem 1, we used a particular property: let us call a translation surface J -simple if its J -invariant can be written $v \wedge w$ for some vectors v and w in \mathbb{R}^2 . Purely periodic translation surfaces are J -simple, but there exists non purely periodic J -simple translation surface, like the one described by Figure 4.8. Note that it is sufficient to have two transverse purely periodic directions to be J -simple.

Question: *is it necessary to have two transverse purely periodic directions to be J -simple? can we describe J -simple translation surfaces?*

4.5.2 Advertising

We viewed in proposition 2 that is it not hard to obtain generic results about translation surfaces. Most of those results do not hold everywhere, and to construct counter-examples is not an easy task. For example, this section asked for J -simple translation surfaces without two periodic directions, and surfaces whose homology cannot be generated by periodic orbits in only two directions. We want to propose here a tool to inventory all such constructions, an evolutive encyclopedia of *concrete* translation surfaces that satisfy some particular properties.

Since the existing litterature and the folklore are quite fat already, and since the theory of translation surfaces is connected with many other fields (ergodic theory, algebraic geometry, combinatorics, number theory, complex analysis,...), this objective can only be reached in an open and collaborative way.

Technically, we set up a *wiki* i.e. a website where anyone can freely create or modify any page using any web browser. It is fully featured and lets the possibility to write L^AT_EX formulas, to draw and add pictures, to add easily links to other pages, to be automatically contacted when some new example is added, to follow the evolution of the web pages... The website can be found at

<http://ocarina.ath.cx/~titi/twiki/bin/view/WildSurfaces/WebHome>

For example, we can inventory the Veech's regular n -gons, a surface whose Veech group is $SL(2, \mathbb{Z})$ but that is not a torus constructed by Herrlich and Schmithuesen, McMullen's Veech L -shaped surfaces, some translation surfaces with non generic Siegel-Veech constants, a J -simple surface without any purely periodic direction, Veech obtuse triangular billiards of McBilliards, a non face-to-face translation surface, a translation surface whose Hasudorff dimension of its non-uniquely ergodic directions is $1/2$ constructed by Cheung, a translation surface whose Veech group is infinitely generated constructed by Hubert and Schmidt, the Arnoux-Yoccoz surface whose Veech group contains an hyperbolic element but no parabolic element, a surface that satisfies the Veech alternative but whose Veech group is not a lattice, or whatever you want. You can add new surfaces, but also ask

for surfaces satisfying certain property, find new properties to an existing surface, simply add a comment, a new proof, a picture...

You will find on that website nothing more than what you will contribute.

4.6 Conclusion

To sum up, the assertions

- \mathcal{S} is a torus branched covering (global geometric property)
- \mathcal{S} has the finite blocking property (illuminatory property)
- \mathcal{S} is purely periodic (dynamical property)

have been proved to be equivalent

- for bouillabaisse surfaces, in particular Veech surfaces [Mon1],
- in genus two [Mon2],
- for convex surfaces,
- on a dense open subset of full measure in any stratum.

Who is next?

References

- [Cal] K. CALTA, *Veech surfaces and complete periodicity in genus two*, J. Amer. Math. Soc. 17 (2004), no. 4, 871–908.
- [Gut] E. GUTKIN, *Blocking of billiard orbits and security for polygons and flat surfaces*, Geom. Funct. Anal. 15 (2005), no. 1, 83–105.
- [KenSmi] R. KENYON, J. SMILLIE, *Billiards on rational-angled triangles*, Comment. Math. Helv. 75 (2000), no. 1, 65–108.
- [Kon] M. KONTSEVICH, *Lyapunov exponents and Hodge theory*, The mathematical beauty of physics (Saclay, 1996), p 318–332, Adv. Ser. Math. Phys., 24, World Sci. Publishing, River Edge, NJ, 1997.
- [KonZor] M. KONTSEVICH, A. ZORICH, *Connected components of the moduli spaces of Abelian differentials with prescribed singularities*, Invent. Math. 153 (2003), no. 3, p 631–678.
- [Mas] H. MASUR, *Interval exchange transformations and measured foliations*, Ann. of Math. (2) 115 (1982), no. 1, 169–200.
- [Mon1] T. MONTEIL, *On the finite blocking property*, Ann. Inst. Fourier, 55 (2005), no. 4, 1195–1217.
- [Mon2] T. MONTEIL, *Finite blocking property vs pure periodicity*, submitted.
- [Vee1] W. VEECH, *Gauss measures for transformations on the space of interval exchange maps*, Ann. of Math. (2) 115 (1982), no. 1, 201–242.
- [Vee2] W. VEECH, *Geometric realizations of hyperelliptic curves*, Algorithms, fractals, and dynamics (Okayama/Kyoto, 1992), 217–226, Plenum, New York, 1995.
- [Zor1] A. ZORICH, *How Do the Leaves of a Closed 1-form Wind Around a Surface?*, Pseudoperiodic topology, 135–178, Amer. Math. Soc. Transl. Ser. 2, 197, Amer. Math. Soc., Providence, RI, 1999. preprinted version.
- [Zor2] A. ZORICH, *private communication*.

Appendix: Why is the action of $SL(2, \mathbb{R})$ on the moduli space of abelian differential so much studied?

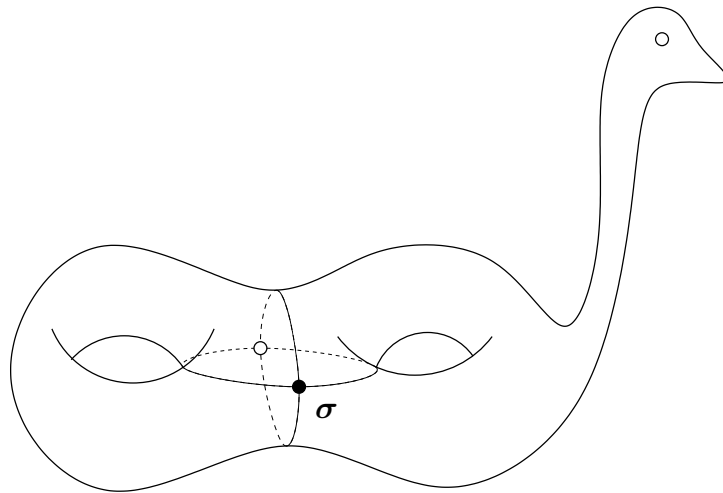
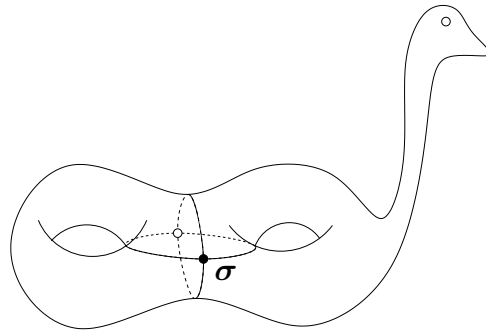
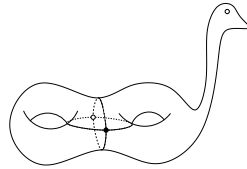

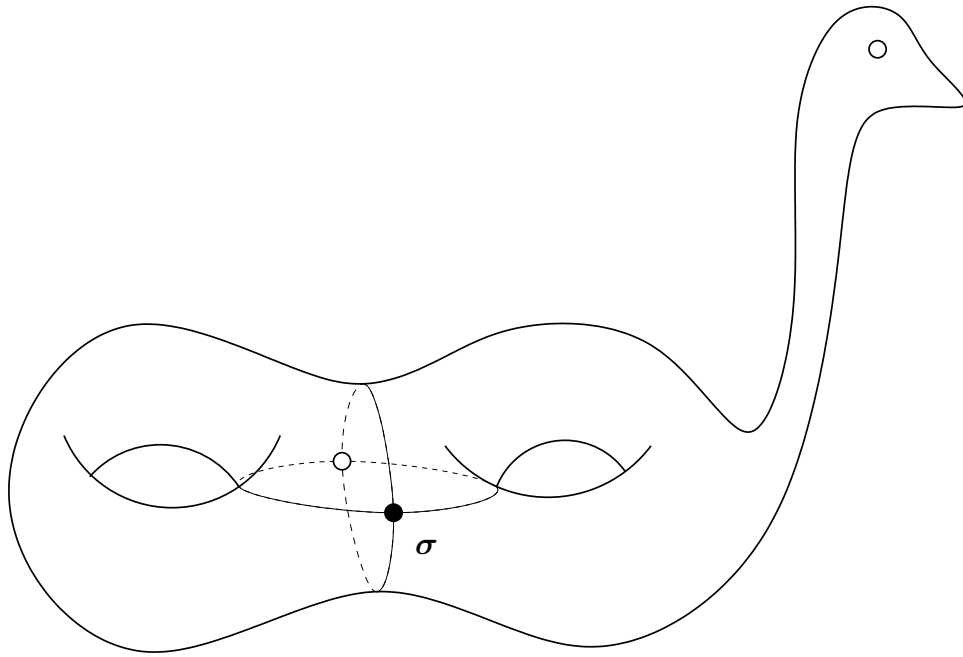

Because the one of $GL(2, \mathbb{R})$ is not optimal!

Chapitre 5

Majoration du nombre de mesures ergodiques d'un sous-shift en fonction de la géométrie de ses graphes de Rauzy

PROVISIONAL VERSION TO BE ENLARGED LATER.

5.1 Introduction

Symbolic dynamics naturally appear as codings of dynamical systems with finite entropy: given a suitable finite partition \mathcal{P} of the underlying space X of such a system, we can follow the atoms of the partition encountered by each orbit to create infinite words on the alphabet \mathcal{P} . Whenever the partition is well chosen, this establishes a “dictionary” between the dynamical system and a subshift that helps to find computable informations. For ergodic measurable dynamical systems, we can always get an isomorphism between the system and a subshift [Kri]. For topological dynamical systems, there are some obstructions since any nontrivial subshift is an expansive map on a Cantor space (this seldom corresponds to what we consider as a geometrical dynamical system). Anyway, a topological semi-conjugacy can be obtained for particular geometrical dynamical systems, like interval exchange transformations [Kea] or pseudo-Anosov homeomorphisms on a compact surface (the measurable Markov partitions constructed in [FaLaPo] are studied in the topological context in [Adl]). This is usually sufficient to preserve most of the dynamical properties, like mixing, entropy, unique ergodicity...

We are interested here in topological dynamics of minimal subshifts and especially in the estimation of the number of their ergodic invariant measures. In that direction, Grillenberger constructed uniquely ergodic minimal subshifts of any given entropy [Gri].

For null entropic ones, complexity refines the notion of entropy. Boshernitzan gave a bound on the number of ergodic invariant measures for subshifts of linear complexity [Bos1]. He also gave a sufficient condition for such systems to be uniquely ergodic [Bos3]

that leads to an elegant symbolic proof of the well known theorem of Masur [Mas] and Veech [Vee2] about interval exchange transformations. In some such calm flows, dynamical properties appear to depend highly on dipohantine approximation (see for example [Rau2] [Tij] [Dur] [Che] [McM] [BeFeZa]) and precise combinatorial tools have been used to keep track of those.

This paper is situated somewhere around there, and tries to understand possible relations between those combinatorial objects and the simplex of invariant measure of a minimal subshift.

The paper is organized as follows: in section 5.2, we give some basic definitions and introduce the simplex of invariant measures as well as two combinatorial objects associated to a minimal subshift that are transverse to eachother: the Rauzy graphs and the tree of left special factors. Section 5.3 is devoted to give a bound of the number of ergodic invariant measures that depends on the geometry of the Rauzy graphs [Rau1]: we prove the following theorem and give some applications.

Theorem 1. *A K -deconnectable minimal subshift has at most K S -invariant ergodic measures.*

See section 5.3 for a definition of K -deconnectable. Section 5.4 explains the limits of such an approach. We discuss the evolution of Rauzy graphs and synchronization problems that appear in their study. Section 5.5 tries to solve this and provides a bound based on the tree of left special factors:

Theorem 3. *Let (X, S) be a minimal subshift of linear complexity such that there exists a positive integer K and a sequence (f_n) of cuts such that*

- $h(f_n) \xrightarrow[n \rightarrow \infty]{} \infty$
- $osc(f_n) \in o(h(f_n))$
- *a representation of $T(X)$ meets the graph of f_n at at most K points ($n \in \mathbb{N}$).*

Then (X, S) admits at most K ergodic invariant measures.

See sections 5.2.3 and 5.5 for definitions.

5.2 Landscape

Let A be a finite set (called an *alphabet*), endowed with the discrete topology.

We note $S \stackrel{\text{def}}{=} \left(\begin{array}{ccc} A^{\mathbb{N}} & \longrightarrow & A^{\mathbb{N}} \\ x = x_0x_1\dots x_n\dots & \longmapsto & x_1x_2\dots x_{n+1}\dots \end{array} \right)$ for the shift.

Let X be a nonempty closed subset of $A^{\mathbb{N}}$ (endowed with the product topology) stable under S and that is minimal for those properties: we say that (X, S) is a *minimal subshift* (we still note S for $S|_X$). We assume moreover that (X, S) is aperiodic i.e. X is infinite.

5.2.1 Invariant measures

A way to describe a minimal subshift (X, S) or more generally a topological dynamical system, is to study the set $\mathcal{M}(X, S)$ of Borel probability measures on X that are invariant under S . Thanks to Riesz representation, this set can be identified to a nonempty compact convex subset of $C^0(X, \mathbb{R})'$ endowed with the weak-star topology.

A S -invariant measure $\mu \in \mathcal{M}(X, S)$ is said to be *ergodic* if the only Borel sets $A \subset X$ such that $S^{-1}(A) = A$ have measure $\mu(A) = 0$ or 1 . Such a measure satisfies Birkhoff's theorem:

$$\forall f \in L^1(X, \mathbb{R}) \quad \frac{1}{n} \sum_{k=0}^{n-1} f \circ S^k \xrightarrow[n \rightarrow \infty]{\mu\text{-a.e.}} \int_X f d\mu$$

Let $\mathcal{E}(X, S)$ denote the set of ergodic invariant measures: it is the set of extremal points of $\mathcal{M}(X, S)$ and it is therefore nonempty. Two different elements of $\mathcal{E}(X, S)$ are mutually singular.

A minimal subshift is said to be *uniquely ergodic* if $\text{card}(\mathcal{M}(X, S)) = 1$. One advantage of such a situation is that, the unique invariant measure μ is ergodic, moreover the convergence in Birkhoff's theorem is uniform for continuous functions.

For more details on this subsection, see [DeGrSi].

5.2.2 Rauzy graphs

A way to grasp a minimal subshift (X, S) is to look at the finite words that appear as subwords of some word x of X . A *finite word* is an element u of A^n , for some integer n that is called the *length* of u and is denoted by $l(u)$.

If x is a word (finite or not) and $0 \leq i \leq j$, then $x_{i \rightarrow j}$ denotes $x_i x_{i+1} x_{i+2} \dots x_j$.

If u and v are two finite words, we note $\#(u, v)$ the number of occurrences of u in v :

$$\#(u, v) \stackrel{\text{def}}{=} \text{card}\{k \leq l(v) - l(u) \mid u_{0 \rightarrow l(u)-1} = v_{k \rightarrow k+l(u)-1}\}$$

If $u = u_0 \dots u_{n-1} \in A^n$ is a finite word, we can define the *cylinder*

$$[u] \stackrel{\text{def}}{=} \{x \in X \mid (\forall i \leq n-1)(x_i = u_i)\}$$

The cylinders are clopen sets and form a basis of the topology of X .

For any integer n , $L_n(X)$ denotes the set of finite words of length n occurring in some (equivalently, any) infinite word x of X .

$$L_n(X) \stackrel{\text{def}}{=} \{u \in A^n \mid [u] \neq \emptyset\}$$

Any word in $L_{n+1}(X)$ is naturally linked to two words in $L_n(X)$ (prefix and suffix).

A way to keep track of this factorial structure of $L(X) \stackrel{\text{def}}{=} \bigcup_{n \in \mathbb{N}} L_n(X)$ is the use of Rauzy graphs (see [Rau1] [Bos2]). For any integer n , we define the n^{th} *Rauzy graph* $G_n(X)$ as follows :

- the set of vertices of $G_n(X)$ is $L_n(X)$.
- there is an (oriented) edge from u to v in $G_n(X)$ if there exists w in $L_{n+1}(X)$ such that w begins with u and ends with v .

The knowledge of all $G_n(X)$ allows to reconstruct X in a profinite manner.

5.2.3 The tree of left special factors

A word u in $L(X)$ is called a *left special factor* if there exist two different letters a and b in A such that au and bu are in $L(X)$. Let $LS_n(X)$ denote the set of left special factors of length n . Viewed in the Rauzy graph, left special factors of length n are the vertices of $G_n(X)$ with incoming degree greater than 1. We can define right special factors in the same way.

Since any prefix of a left special factor is still a left special factor, they form a tree $T(X)$ whose root is the empty word ϵ :

- the vertices of $T(X)$ are the elements of $LS(X) \stackrel{\text{def}}{=} \bigcup_{n \geq 0} LS_n(X)$.
- there is an edge from u to v if u is a prefix of v and $l(u) = l(v) - 1$.

Such a tree can be embedded in $[0, 1] \times \mathbb{R}_+$ in such a way that vertices in $LS_n(X)$ have second coordinate n and edges are non overlapping segments. Such a representation of $T(X)$ will still be denoted by $T(X)$ when there is no possible confusion.

For more details on Rauzy graphs and the tree of left special factors, see [Cas].

5.3 A clean version

We will provide a bound of $\text{card}(\mathcal{E}(X, S))$ that depends on the fragility of the $G_n(X)$: If $K \geq 1$, a minimal subshift (X, S) is said to be K -deconnectable if there exists an extraction (i.e. a strictly increasing integer sequence) $\alpha \in \uparrow(\mathbb{N}, \mathbb{N})$ and a constant $K' \geq 1$ such that for all $n \geq 1$ there exists a subset $D_{\alpha(n)} \subset L_{\alpha(n)}(X)$ of at most K vertices such that every path in $G_{\alpha(n)}(X) \setminus D_{\alpha(n)}$ is of length less than $K'\alpha(n)$ (in particular it does not contain any cycle).

This means that we can disconnect (in a specific way) infinitely many Rauzy graphs by removing at most K vertices.

Theorem 1. *A K -deconnectable minimal subshift has at most K S -invariant ergodic probability measures.*

Proof: We will first construct at most K possible candidates and then prove that they are the only ones.

Step 1: *We construct the candidates to be the only ergodic invariant probability measures.*

For any integer n , let $d_{1,\alpha(n)}, d_{2,\alpha(n)}, \dots, d_{K,\alpha(n)}$ be an enumeration of $D_{\alpha(n)}$ (there is no loss of generality to consider that all the $D_{\alpha(n)}$ have exactly K elements).

For this, we approximate X from the outside by K sequences of periodic subshifts as follows: for $i \leq K$ and $n \in \mathbb{N}$, let

$$\mu_{i,\alpha(n)} \stackrel{\text{def}}{=} \frac{1}{\alpha(n)} \sum_{k=0}^{\alpha(n)-1} \delta_{S^k(d_{i,\alpha(n)}^\omega)}$$

($d_{i,\alpha(n)}^\omega$ denotes $d_{i,\alpha(n)}d_{i,\alpha(n)}d_{i,\alpha(n)}\dots$ and δ stands for the one-point Dirac's measure).

$\mu_{i,\alpha(n)}$ is the only element of $\mathcal{M}(A^{\mathbb{N}}, S)$ that gives measure 1 to the periodic subshift generated by the periodic word $d_{i,\alpha(n)}^\omega$.

By compactity of $\mathcal{M}(A^{\mathbb{N}}, S)^K$, there exists an extraction β such that for each $i \leq K$,

$$\mu_{i,\alpha \circ \beta(n)} \xrightarrow[n \rightarrow \infty]{} \mu_i$$

for some μ_i in $\mathcal{M}(A^{\mathbb{N}}, S)$.

Note that if X is aperiodic, the $\mu_{i,\alpha(n)}$ give measure 0 to X . Anyway,

Step 2: *We show that for $i \leq K$, $\mu_i(X) = 1$.*

Since X is closed in $A^{\mathbb{N}}$, we have the following approximation by open sets:

$$X = \overline{X} = \bigcap_{n \in \mathbb{N}} \bigcup_{u \in L_n(X)} [u]$$

($[u]$ is considered here as a cylinder in the current dynamical system: $A^{\mathbb{N}}$).

Let $n \geq 1$ and $k \geq n$. For $i \in \{0, \dots, \alpha \circ \beta(k) - n\}$, $(d_{i,\alpha \circ \beta(k)}^\omega)_{i \rightarrow i+n-1} \in L_n(X)$ (it is a subword of $d_{i,\alpha \circ \beta(k)}^\omega$). Hence $\mu_{i,\alpha \circ \beta(k)}(\bigcup_{u \in L_n(X)} [u]) \geq (\alpha \circ \beta(k) - n + 1)/\alpha \circ \beta(k)$.

Letting k tend to infinity, since the characteristic function of $\bigcup_{u \in L_n(X)} [u]$ is continuous, we have $\mu_i(\bigcup_{u \in L_n(X)} [u]) = 1$. By countable intersection (n is arbitrary), we have $\mu_i(X) = 1$.

Hence, we can still denote by μ_i for the restriction of μ_i to X .

Step 3: Let μ be an ergodic measure on X . We show that μ is one of the μ_i . By Birkhoff's theorem, there is x in X such that for any u in $L(X)$,

$$\mu([u]) = \lim_{n \rightarrow \infty} \frac{1}{n} \#(u, x_{0 \rightarrow n+l(u)-2}) = \lim_{n \rightarrow \infty} \frac{1}{n} \#(u, x_{0 \rightarrow n-1})$$

Let n be a fixed positive interger. We decompose x into blocks of length $(K'+1)\alpha \circ \beta(n)$: $x = B_0.B_1.B_2.B_3.B_4 \dots$ with $B_j = x_{(K'+1)\alpha \circ \beta(n)j \rightarrow (K'+1)\alpha \circ \beta(n)(j+1)-1}$. By hypothesis, any B_j contains an occurrence of one of the $d_{i, \alpha \circ \beta(n)}$ (B_j can be viewed as a path of length $K'\alpha \circ \beta(n)$ in $G_{\alpha \circ \beta(n)}(X)$). So there exists some $i_{\alpha \circ \beta(n)}$ such that the upper density of the set $\{j \in \mathbb{N} \mid \#(d_{i_{\alpha \circ \beta(n)}, \alpha \circ \beta(n)}, B_j) \geq 1\}$ is at least $1/K$. Let γ be an extraction such that $i_{\alpha \circ \beta \circ \gamma(\cdot)}$ is constant with value denoted by i . We note $\tilde{\alpha}$ for $\alpha \circ \beta \circ \gamma$

We will show that $\mu = \mu_i$. Let u be a finite word in $L(X)$. Let n be an integer greater than $l(u)$. There is an extraction δ such that for any integer m ,

$$\text{card}\{j < \delta(m) \mid \#(d_{i, \tilde{\alpha}(n)}, B_j) \geq 1\} \geq \delta(m)/2K$$

Therefore

$$\#(u, B_0.B_1 \dots B_{\delta(m)-1}) \geq \frac{\delta(m)}{2K} \#(u, d_{i, \tilde{\alpha}(n)})$$

Hence

$$\mu([u]) = \lim_{m \rightarrow \infty} \frac{1}{(K'+1)\tilde{\alpha}(n)\delta(m)} \#(u, B_0.B_1 \dots B_{\delta(m)-1}) \geq \frac{1}{2K(K'+1)\tilde{\alpha}(n)} \#(u, d_{i, \tilde{\alpha}(n)})$$

Moreover, we can control the frequency of occurrences of u in $d_{i, \tilde{\alpha}(n)}^\omega$ by counting separately the occurrences of u that fall in some $d_{i, \tilde{\alpha}(n)}$ and the occurrences of u that appear between two consecutive occurrences of $d_{i, \tilde{\alpha}(n)}$ (boundary effect):

$$\mu_{i, \tilde{\alpha}(n)}([u]) = \frac{1}{\tilde{\alpha}(n)} \sum_{k=0}^{\tilde{\alpha}(n)-1} \delta_{S^k(d_{i, \tilde{\alpha}(n)}^\omega)}([u]) \leq \frac{1}{\tilde{\alpha}(n)} (\#(u, d_{i, \tilde{\alpha}(n)}) + l(u))$$

Therefore,

$$\mu_{i, \tilde{\alpha}(n)}([u]) \leq \frac{1}{\tilde{\alpha}(n)} \#(u, d_{i, \tilde{\alpha}(n)}) + \frac{l(u)}{\tilde{\alpha}(n)} \leq 2K(K'+1)\mu([u]) + \frac{l(u)}{\tilde{\alpha}(n)}$$

Letting n tend to infinity, we have $\mu_i([u]) \leq 2K(K'+1)\mu([u])$, so μ_i is absolutely continuous relatively to μ .

Since μ_i is S -invariant and μ is ergodic, we have $\mu_i = \mu$ and there are at most K S -invariant ergodic measures. □

We will now see how this result can be effectively used.

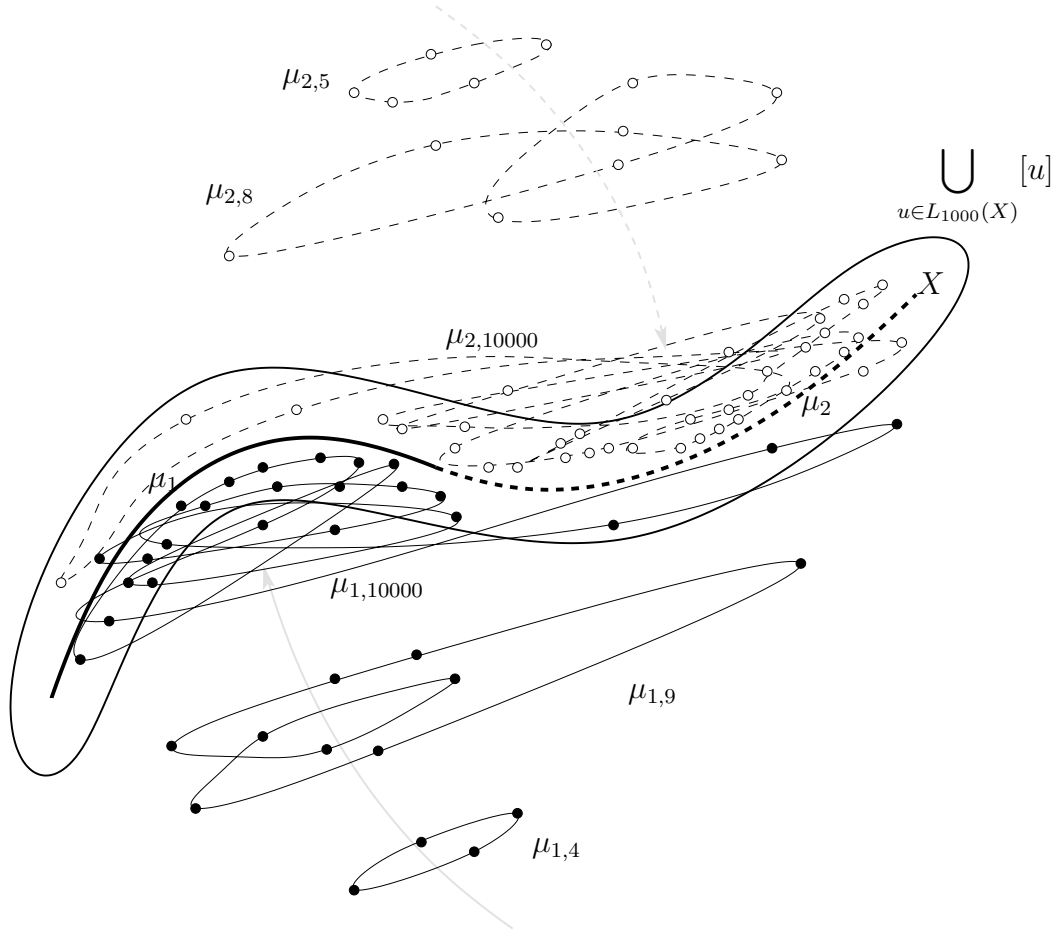

Figure 5.1: Approximation of a 2-deconnectable subshift with two ergodic measures by periodic orbits.

5.3.1 Subshifts with linear complexity

Let X be a minimal subshift. We define the *complexity* of X as the sequence defined by $p_n(X) \stackrel{\text{def}}{=} \text{card}(L_n(X))$. X is said to be of *linear complexity* if there exists an integer K such that

$$\limsup_{n \rightarrow \infty} \frac{p_n(X)}{n} \leq K$$

Since $p_{n+1}(X)$ counts the edges of $G_n(X)$ and $p_n(X)$ counts the vertices of $G_n(X)$, we have the majoration:

$$\text{card}(LS_n(X)) \leq p_{n+1}(X) - p_n(X)$$

We have the following result

Theorem 2. [Bos1]

Let (X, S) be a minimal subshift such that

$$\liminf_{n \rightarrow \infty} \frac{p_n(X)}{n} \leq K$$

then X admits at most K ergodic invariant measures.

Proof: There is an extraction $\alpha \in \uparrow(\mathbb{N}, \mathbb{N})$ such that for all integer n , $p_{\alpha(n)}(X) \leq (K + 1)\alpha(n)$ and $p_{\alpha(n)+1}(X) - p_{\alpha(n)}(X) \leq K$. For n in \mathbb{N} , let $D_{\alpha(n)} = LS_n(X)$, whose cardinal is not greater than K .

Let $n \in \mathbb{N}$. Any loop \mathcal{O} in $G_{\alpha(n)}(X)$ must contain a left special factor: since X is aperiodic, there exists a finite word u in $L_n(X) \setminus \mathcal{O}$, and since X is minimal, there exists a path from u to any vertex of \mathcal{O} , so the first vertex of \mathcal{O} that this path meets is a left special factor. Therefore, $G_{\alpha(n)}(X) \setminus D_{\alpha(n)}$ does not contain any loop.

So, a path in $G_{\alpha(n)}(X) \setminus D_{\alpha(n)}$ is necessarily injective and cannot be of length greater than $\text{card}(L_{\alpha(n)}(X)) \leq (K + 1)\alpha(n)$. □

Hence, theorem 1 can be understood as a geometric interpretation of Boshernitzan's result. Anyway, it is also fruitful for subshift that are not of linear complexity.

5.3.2 Arnoux-Rauzy subshifts

A minimal subshift (X, S) on an alphabet A is said to be *Arnoux-Rauzy* [ArnRau] if for any n in \mathbb{N} :

- $p_n(X) = (\text{card}(A) - 1)n + 1$.
- $G_n(X)$ admits exactly one left special factor and one right special factor.

In particular we get the following proposition for free:

Proposition 1. *A minimal Arnoux-Rauzy subshift is 1-deconnectable and therefore uniquely ergodic.*

5.3.3 Multi-scale quasiperiodic subshifts

Let x be an infinite word on A . A finite word q is said to be a *quasiperiod* of x if x is covered by the occurrences of q (in particular, q is a prefix of x) [Mar]. A minimal subshift (X, S) is said to be *multi-scale quasiperiodic* if it contains an element x that admits infinitely many quasiperiods [Mon].

Proposition 2. *[Mon] A multi-scale quasiperiodic subshift X is 1-deconnectable, and therefore uniquely ergodic.*

Proof: Let x be an element of X that admits infinitely many quasiperiods, and let q be a quasiperiod of x . For each u in $L_{l(q)}(X)$, let $\varphi(u)$ denotes the length of the longest prefix of u that is also a suffix of q . If $u \rightarrow v$ in $G_{l(q)}(X)$, then either $v = q$ or $1 \leq \varphi(v) < \varphi(u) \leq l(q)$.

Hence, $G_{l(q)}(X) \setminus \{q\}$ does not contain any path of length greater than $l(q)$, and since we can reproduce this for infinitely many q , X is 1-deconnectable. □

We have to notice that there exist multi-scale quasiperiodic subshifts that are *not* of linear complexity [Mon].

5.4 Transition-discussion: evolution of Rauzy graphs

To introduce the problematic of synchronization, let us see how do Rauzy graphs evolve with n . The following analysis is due to Rauzy [ArnRau] for bursting and splitting and Cassaigne [Cas] for the description of bispecial factors. For convenience, we restrict to the case where $\text{card}(A) = 2$, therefore incoming and outgoing degree are not bigger than two. The vertices of $G_{n+1}(X)$ correspond to the edges of $G_n(X)$ and the edges of $G_{n+1}(X)$ will be described now. Let us look locally around the vertices of $G_n(X)$:

Simple extension A word in $L_n(X)$ that is not a special factor has incoming and outgoing degree 1, so this will lead in $G_{n+1}(X)$ to two vertices connected with an edge.



Splitting of a common special factor A left special factor that is not a right special factor has incoming degree 2 and outgoing degree 1, so this will lead in $G_{n+1}(X)$ to two vertices connected to a third one with two edges. We can understand this phenomenon as a slit of $G_n(X)$.

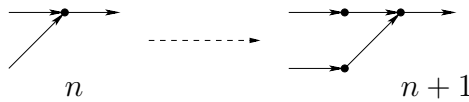

The same phenomenon appears for right special factors that are not left special factors. Hence a path between such a left and a right factor becomes shorter and shorter, until a...

Bursting of a bispecial factor A *bispecial factor* is a word that is both left and right special factor: it has incoming and outgoing degree 2, so this will lead in $G_{n+1}(X)$ to four vertices, but the edging between them is not entirely determined by $G_n(X)$:

Death Only two edges connect those vertices, no special factor remain after the burst. Such a bispecial factor is called *weak bispecial factor*.

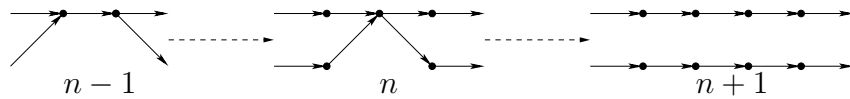

Through Three edges connect those vertices, the left and right special factors do survive. Such a bispecial factor is called *ordinary bispecial factor*.

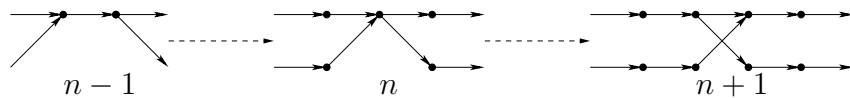

Mitose Four edges connect those vertices, the left and right special factors are duplicated. Such a bispecial factor is called *strong bispecial factor*.

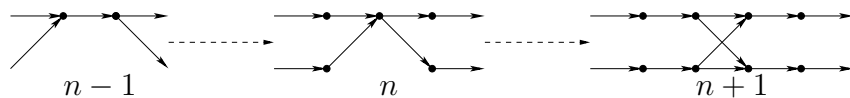

Hence, strong bispecial factors correspond to forks of $T(X)$ and weak bispecial factors correspond to leaves of $T(X)$. Ordinary bispecial factors and nonbispecial left special factors are not distinguished by $T(X)$, since they both correspond to non-branching nodes.

We have to keep in mind that the “dynamics” we just described between the Rauzy graphs do not correspond to the evolution along the time in (X, S) , but has something more linked to the space, letting n increase corresponds much more to a continuous zoom into the structure of (X, S) , it is an approximation of (X, S) by subshifts of finite type.

For subshifts whose complexity grows slowly, we saw the importance of left special factors, since they form disconnecting sets and are linked to the complexity.

So, take a minimal subshift of linear complexity such that for some n , $LS_n(X)$ has cardinal K , and suppose that one of them is a strong bispecial factor. Then $LS_{n+1}(X)$ will have cardinal $K + 1$. Imagine that one of those left special factors is weak bispecial, then $LS_{n+2}(X)$ will have cardinal K , so if such a phenomenon appears infinitely often, Theorem 1 will allow us to conclude that the subshift has at most K ergodic invariant measures.

Then, imagine the swapped situation, where the weak bispecial factor appears at the scale n and the strong bispecial factor appears at the scale $n + 1$: Theorem 1 will give us at most $\text{card}(LS_{n+1}(X)) = K - 1$ ergodic invariant measures.

Wiewed from the scale $n + 2$, those two situations are quite the same, and there shouldn't be such a big difference as the number of ergodic invariant measures in the resulting subshifts. Hence, the problem is that, although the phenomena do all appear through Rauzy graphs, they do not necessarily appear with a good synchronization.

In order to avoid such a problem of small missynchronisation, we should group events that appear at “comparable” scales i.e. scales between some n and $n + o(n)$. Such a grouping of events will be done in the next section thanks to the notion of cuts on $T(X)$. Hence, the n should be considered as arbitrary microscales one has to group in order to form scales, the gap between two consecutive scales will depend on the dynamical system.

5.5 A condition on the tree of left special factors

5.5.1 A blurred version of theorem 1

Let us begin by a small improvement of theorem 1, that will allow us not to care about local phenomenons and then to consider only as a detail the small missynchronisation described before.

The set of vertices of $G_n(x)$ becomes a metric space as follows:

$$d_n(v_1, v_2) \stackrel{\text{def}}{=} n - \max\{l(w) \mid \#(w, v_1) \geq 1 \text{ and } \#(w, v_2) \geq 1\}$$

Note that if u is a finite word, then $|\#(u, v_1) - \#(u, v_2)| \leq d_n(v_1, v_2)$.

Another classical distance between two vertices of an oriented graph is the length (number of vertices) of the shortest *not necessarily oriented* path between them. The distance we are considering is smaller than that distance since if $v_1 \rightarrow v_2$ in $G_n(X)$, then $d(v_1, v_2) \leq 1$.

If $K \geq 1$, a minimal subshift (X, S) is said to be *o - K -deconnectable* if there exists a positive sequence (ρ_n) in $o(n)$, an extraction $\alpha \in \uparrow(\mathbb{N}, \mathbb{N})$ and a constant $K' \geq 1$ such that for all $n \geq 1$ there exists a subset $D_{\alpha(n)} \subset L_{\alpha(n)}(X)$ of at most K vertices such that every path in $G_{\alpha(n)}(X) \setminus V(D_{\alpha(n)}, \rho_{\alpha(n)})$ is of length less than $K'\alpha(n)$. Note that $V(D, \varepsilon) \stackrel{\text{def}}{=} \{v \in L_n(X) \mid (\exists d \in D)(d(d, v) \leq \varepsilon)\}$ denotes the tubular neighborhood of radius ε around $D \subset L_n(X)$.

Proposition 3. *A o - K -deconnectable minimal subshift has at most K S -invariant ergodic measures.*

This means that we can replace the K disconnecting vertices of theorem 1 by K small balls around them to disconnect the Rauzy graphs.

Proof: It is just a hack in the proof of theorem 1.

The construction of the K possible measures in step 1 and 2 is the same. We can notice that any sequence $d'_{i, \alpha(n)} \in V(\{d'_{i, \alpha(n)}\}, \rho_{\alpha(n)})$ will lead to the same limit μ_i .

We need to be more precise in the step 3: we have the *uniform* bound

$$|\#(u, d_{i, \alpha(n)}) - \#(u, d)| \leq \rho_{\alpha(n)}$$

for any $i \leq K$, $n \in \mathbb{N}$, $u \in L(X)$ and $d \in V(\{d_{i, \alpha(n)}\}, \rho_{\alpha(n)})$.

The result in the upper bounds follows since $\rho_{\alpha(n)}/\alpha(n) \xrightarrow[n \rightarrow \infty]{} 0$.

□

Note that a similar result holds if we consider the Hamming \bar{d} -distance instead of d , but we don't need it in this paper (in fact the bound we used in the proof won't be uniform anymore, but will depend on the length of the finite word u , so we have to be a little bit more careful).

5.5.2 A condition on the tree of left special factors

A *cut* is a continuous function from $[0, 1]$ to \mathbb{R}_+ .

The *height* of a cut f is $h(f) \stackrel{\text{def}}{=} \min(f)$ and its *oscillation* is $osc(f) \stackrel{\text{def}}{=} \max(f) - \min(f)$.

Theorem 3. Let (X, S) be a minimal subshift of linear complexity such that there exists a positive integer K and a sequence (f_n) of cuts such that

- $h(f_n) \xrightarrow{n \rightarrow \infty} \infty$
- $osc(f_n) \in o(h(f_n))$
- a representation of $T(X)$ meets the graph of f_n at at most K points ($n \in \mathbb{N}$).

Then (X, S) admits at most K ergodic invariant measures.

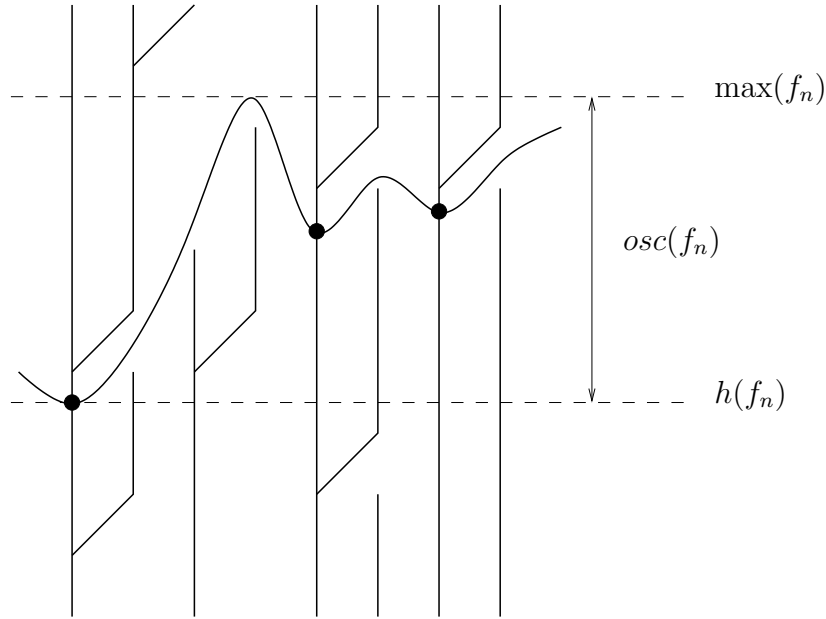

Figure 5.2: A cut of the tree of the left special factors.

Proof: We will show that (X, S) is o - K -deconnectable.

Up to consider only some of the f_n 's, we can assume that the sequence $\alpha(n) \stackrel{\text{def}}{=} \lceil \max(f_n) \rceil$ is an extraction.

Since (X, S) has linear complexity, there exists K' such that for any positive integer n , $p_n(X) \leq K'n$, hence $G_n(X) \setminus LS_n(X)$ does not contain any path of length greater than $K'n$.

Let n be a positive integer.

We group the elements of $LS_{\alpha(n)}(X)$ as follows: to each $v \in LS_{\alpha(n)}(X)$ we choose a point $p(v)$ of $T(X)$ that intersects the graph of f_n . Then we set $v_1 \simeq v_2$ if and only if $p(v_1) = p(v_2)$ (i.e. there are not separated by the cut).

If $v_1 \simeq v_2$, they have a common prefix of length at least $\min(f_n)$, hence $d(v_1, v_2) \leq osc(f_n) \leq o(\alpha(n))$.

By construction, $\text{card}(LS_{\alpha(n)}/\simeq) \leq \text{card}(\text{Graph}(f_n) \cap T(X)) \leq K$.

A choice of a representative in any class is a $o(\alpha(n))$ -deconnecting set.

Therefore (X, S) is o - K -deconnectable and admits at most K ergodic invariant measures.

□

Note that Boshernitzan's result corresponds to the case where the cuts are constant functions with integer values, since the intersection of $T(X)$ with such a cut has cardinal $LS_{f(0)}(X)$. For example, if the situation of Figure 5.2 appears infinitely often, Theorem 3 will give 3 invariant ergodic measures whereas Boshernitzan's theorem will give 6 invariant ergodic measures.

5.6 Conclusion

So, since Theorem 1 depends too much on microscales, Theorem 3 is an attempt to mix different Rauzy graphs in order to synchronize some events that appear at comparable scales.

We can see a minimal subshift as the projective limit of its Rauzy graphs (see picture page 19). Such a profinite representation was used by Almeida [Alm] to study algebraic invariants associated to minimal subshifts. With that presentation, Rauzy graphs are horizontal slices whereas the tree of left special factors can be understood as its vertebral column (at least for subshifts of small complexities), so those two objects are in some sense transversal to each other. Hence, the results presented here can be reformulated in that space and we can hope for a much general version of those that will depend on the geometry of that whole space.

For example can we prove in such a symbolic way the result of Katok [Kat] and Veech [Vee1] which asserts that a minimal interval exchange transformation on K intervals admits at most $K/2$ ergodic invariant measures (Boshernitzan's theorem gives a bound equal to $K - 1$)?

References

- [Adl] R. ADLER, *Symbolic dynamics and Markov partitions*, Bull. Amer. Math. Soc. (N.S.) 35 (1998), no. 1, p 1–56.
- [Alm] J. ALMEIDA, *Profinite structures and dynamics*, CIM Bulletin 14 (2003), p 8–18.
- [ArnRau] P. ARNOUX, G. RAUZY, *Représentation géométrique de suites de complexité $2n + 1$* , Bull. Soc. Math. France 119 (1991), no. 2, p 199–215.
- [BeFeZa] V. BERTHÉ, S. FERENCZI, L. ZAMBONI, *Interactions between dynamics, arithmetics, and combinatorics: the good, the bad, and the ugly*, Algebraic and Topological Dynamics S. Kolyada, T. Manin, and T. Ward eds., Contemporary Mathematics (CONM), AMS, American Mathematical Society, 385 (2005).
- [Bos1] M. BOSHERNITZAN, *A unique ergodicity of minimal symbolic flows with linear block growth*, J. Analyse Math. 44 (1984/85), p 77–96.
- [Bos2] M. BOSHERNITZAN, *A condition for minimal interval exchange maps to be uniquely ergodic*, Duke Math. J. 52 (1985), no. 3, 723–752.
- [Bos3] M. BOSHERNITZAN, *A condition for unique ergodicity of minimal symbolic flows*, Ergodic Theory Dynam. Systems 12 (1992), no. 3, 425–428.
- [Cas] J. CASSAIGNE, *Complexité et facteurs spéciaux*, Bull. Belg. Math. Soc. Simon Stevin 4 (1997), p 76–88.
- [Che] Y. CHEUNG, *Hausdorff dimension of the set of nonergodic directions*, Ann. of Math. (2) 158 (2003), no. 2, p 661–678.
- [DeGrSi] M. DENKER, C. GRILLENBERGER, K. SIGMUND, *Ergodic theory on compact spaces*, Lect. Notes Math. 527 (1976).
- [Dur] F. DURAND, *Linearly recurrent subshifts have a finite number of non-periodic subshift factors*, Ergodic Theory Dynam. Systems 20 (2000), no. 4, p 1061–1078.
- [FaLaPo] A. FATHI, LAUDENBACH, POENARU, *Travaux de Thurston sur les surfaces*, Astérisque, 66-67 (1979), SMF Paris.
- [Gri] C. GRILLENBERGER, *Constructions of strictly ergodic systems. I. Given entropy*, Z. Wahrscheinlichkeitstheorie und Verw. Gebiete 25 (1972/73), p 323–334.
- [Kat] A. KATOK, *Invariant measures of flows on orientable surfaces (Russian)*, Dokl. Akad. Nauk SSSR 211 (1973), p 775–778.
- [Kea] M. KEANE, *Interval exchange transformations*, Math. Z. 141 (1975), p 25–31.
- [Kri] W. KRIEGER, *On entropy and generators of measure-preserving transformations*, Trans. Amer. Math. Soc. 149 (1970) p 453–464.
- [Mar] S. MARCUS, *Quasiperiodic infinite words*, Bull. Eur. Assoc. Theor. Comput. Sci. EATCS No. 82, (2004), p 170–174.

- [Mas] H. MASUR, *Interval exchange transformations and measured foliations*, Ann. of Math. (2) 115 (1982), no. 1, p 169–200.
- [McM] C. MCMULLEN, *Teichmüller geodesics of infinite complexity*, Acta Math. 191 (2003), no. 2, p 191–223.
- [Mon] T. MONTEIL, *Quasiperiodic words : multi-scale case and dynamical properties*, preprint.
- [Rau1] G. RAUZY, *Suites à termes dans un alphabet fini*, Séminaire de Théorie des Nombres de Bordeaux, (1983), p 25-01–25-16.
- [Rau2] G. RAUZY, *Rotations sur les groupes, nombres algébriques, et substitutions*, Séminaire de Théorie des Nombres de Bordeaux, (1988), p 21-01–21-12.
- [Tij] R. TIJDEMAN, *On the minimal complexity of infinite words*, Indag. Math. (N.S.) 10 (1999), no. 1, p 123–129.
- [Vee1] W. VEECH, *Interval exchange transformations* J. Analyse Math. 33 (1978), p 222–272.
- [Vee2] W. VEECH, *Gauss measures for transformations on the space of interval exchange maps*, Ann. of Math. (2) 115 (1982), no. 1, p 201–242.

6.1.2 The derivation: a change of scale

Derivation

Let $x = x_0x_1x_2\dots$ be a quasiperiodic word, and q be a quasiperiod of x . Let $(i_n)_{n \in \mathbb{N}}$ be the sequence as defined before. We can define $\frac{\partial x}{\partial q}$ to be the infinite word on the alphabet $\{0, \dots, l(q) - 1\}$ whose k^{th} letter is $l(q) - i_{k+1} + i_k$ ($k \geq 0$). In other terms, the k^{th} letter of $\frac{\partial x}{\partial q}$ is the length of the overlap between the k^{th} and the $(k+1)^{\text{th}}$ occurrence of q in x .

For example, if $x = ababaabaabaababababaabababaabaabaabaaba\dots$ is quasiperiodic with aba as a quasiperiod, then $\frac{\partial x}{\partial aba} = 100011101100010\dots$

Integration

In some sense, the $\frac{\partial}{\partial q}$ operator removes exactly the information contained in q since the knowledge of $\frac{\partial x}{\partial q}$ and q is sufficient to reconstruct x .

Indeed, we can consider the reverse operation : the integration. If x is an infinite word on a finite alphabet $A \subset \mathbb{N}$ and if w is a finite word whose length is greater than $\max A$, then we can define the word $\int_w x$ as the image of x under the substitution σ_w that replaces the occurrences of $i \in A$ by the $l(w) - i$ first letters of w .

For example, if $x = 01121010201\dots$ and $w = aabcaa$, then $\int_w x = aabcaaaabcaaaabcaaaabcaaaabcaaaabcaaaabcaaaabcaaaabcaaaabcaaaabcaaa\dots$

If w is such that for each n in A , w is a prefix of $\sigma_w(n).w$, then $\int_w x$ is quasiperiodic with w as a quasiperiod, no matter how x is random. This is the case for example if $A \subset \{0, \dots, n\}$ and $w = a^nba^n$ ($n \geq 0$).

Quasiperiodicity is spread everywhere

Recurrence An infinite word x is said to be *recurrent* if any finite word u appearing in x appears infinitely often in x . It is said to be *uniformly recurrent* if moreover for each finite word u appearing in x , the gap between two consecutive occurrences of u in x is bounded.

To construct a non recurrent quasiperiodic word, just take a non recurrent word x on the alphabet $\{0, 1\}$ and consider $\int_{aba} x$. Do the same to construct a uniformly recurrent quasiperiodic word.

Minimality is the analogue of uniform recurrence in the vocabulary of topological dynamical systems (see section 6.2).

Complexity For any infinite word x and any integer n , $L_n(x)$ denotes the finite words of length n that occur in x and we define $L(x) \stackrel{\text{def}}{=} \bigcup_{n \in \mathbb{N}} L_n(x)$.

The function that sends an integer n to $p_n(x) \stackrel{\text{def}}{=} \text{card}(L_n(x))$ is called the *word complexity* of x .

We can define an equivalence relation on the set of infinite words through the asymptotic behaviour of their complexity function: two words x and y are said to be *complexity equivalent* if there exists a positive integer K such that for all $n \geq 1$, $p_n(x) \leq Kp_{Kn}(y)$ and $p_n(y) \leq Kp_{Kn}(x)$. Hence, bounded, linear, quadratic, polynomial or exponential growths are preserved under complexity equivalence.

Theorem 1. *There are quasiperiodic words in any class of complexity equivalence.*

Proof: Let x be an infinite word on an alphabet A . There is no restriction to suppose that $A = \{0, \dots, k\}$. Let $y \stackrel{\text{def}}{=} \int_{a^k b a^k} x$. We check that y is a quasiperiodic word in the class of complexity equivalence of x . \square

The non ultimately periodic words with the smallest word complexity are the sturmian words: an infinite word is said to be *sturmian* if for any integer n , $p_n(x) = n+1$. In [LevRic1], Florence Levé and Gwénaél Richomme proved that there exists sturmian words that are not quasiperiodic.

Entropy is the exponent of the complexity function in the vocabulary of topological dynamical systems (see section 6.3).

Frequencies If u and v are finite words, let $\#(u, v)$ denotes the number of occurrences of u in v . An infinite word x is said to have *frequencies* if for any finite word w , $\frac{1}{n}\#(w, x_{0 \rightarrow n-1})$ admits a limit when n tends to infinity.

By integration, there exists quasiperiodic words that do not have frequencies: if x is an infinite word such that 0 does not appear with frequencies, then $\int_{aba} x$ is a quasiperiodic word such that bab does not appear with frequencies.

Unique ergodicity is a strong analogue of having frequencies in the vocabulary of topological dynamical systems (see section 6.4).

Hence the notion of quasiperiodicity does not insert well among other notions of symmetry.

6.1.3 Multi-scale quasiperiodic words

We have to notice that all classical notions of symmetry are invariant under such a renormalization procedure (derivation corresponds to induction if we are studying dynamical properties like entropy [Abr]). Therefore, if we want that a notion says something about symmetry, we should ensure that it is stable under such a change of scale. As we saw with the derivation procedure, the existence of a quasiperiod q in a word x just imposes rigidity at the scale around $l(q)$ but does not impose anything at larger scales.

This leads to the following definition : an infinite word is said to be *multi-scale quasiperiodic* if the set $Q(x)$ of its quasiperiods is infinite.

The easiest non-periodic multi-scale quasiperiodic words we can construct, are the fixed points for some particular integration operators. For example, the fixed point of \int_{010} is multi-scale quasiperiodic, it is known as the Fibonacci word (a precise description of the

quasiperiods of this word can be found in [LevRic1]). There exists much wilder multi-scale quasiperiodic words (see Theorem 4 in section 6.3).

In the next section we will prove that multi-scale quasiperiodic words are uniformly recurrent. This will allow us to study the subshift generated by them (section 6.2). Concerning the complexity, we will prove that multi-scale quasiperiodic subshifts have zero topological entropy as well as zero Kolmogorov complexity (section 6.3). We will also prove that sturmian subshifts are multi-scale quasiperiodic (section 6.5). Concerning frequencies, we will prove that multi-scale quasiperiodic subshifts are uniquely ergodic (section 6.4).

6.2 Uniform recurrence and minimality

An infinite word $x \in A^{\mathbb{N}}$ is said to be *uniformly recurrent* if any finite word $u \in L(x)$ occurs infinitely many times in x and the gap between two consecutive occurrences of u in x is bounded, equivalently

$$\forall u \in L(x) \quad \exists n \geq 1 \quad \forall v \in L_n(x) \quad \#(u, v) \geq 1$$

Theorem 2. *Any multi-scale quasiperiodic word x is uniformly recurrent.*

Proof: Let u be a finite word that occurs in x . Since every quasiperiod of x is a prefix of x , one of them must contain an occurrence of u (they have unbounded length). Let q be such a quasiperiod. Any word in $L_{2l(q)}$ contains at least an occurrence of q and therefore at least an occurrence of u . \square

This property of multi-scale quasiperiodic words allows us to deal with the dynamical system generated by a multi-scale quasiperiodic word as follows:

We endow A with the discrete topology and $A^{\mathbb{N}}$ with the product topology. This makes $A^{\mathbb{N}}$ a metrisable compact space.

We note

$$S \stackrel{\text{def}}{=} \left(\begin{array}{ccc} A^{\mathbb{N}} & \longrightarrow & A^{\mathbb{N}} \\ x = x_0x_1 \dots x_n \dots & \longmapsto & x_1x_2 \dots x_{n+1} \dots \end{array} \right)$$

for the shift. It is a continuous map.

If x is a multi-scale quasiperiodic word, we define

$$X \stackrel{\text{def}}{=} \overline{\{S^k(x) \mid k \in \mathbb{N}\}}$$

and we still note S for the restriction of S to X , making (X, S) a topological dynamical system.

Theorem 2 is equivalent to say that (X, S) is a *minimal subshift* i.e. X is a nonempty closed subset of $A^{\mathbb{N}}$ stable under S and that is minimal for those properties.

A minimal subshift generated by a multi-scale quasiperiodic word is called a *multi-scale quasiperiodic subshift*.

If u is a finite word, we define the *cylinder*

$$[u] \stackrel{\text{def}}{=} \{x \in X \mid (\forall i \leq n-1)(x_i = u_i)\} \quad (u = u_0 \dots u_{n-1} \in A^n \quad (n \in \mathbb{N}))$$

We can notice that the derivation of a multiscaled quasiperiodic word over the quasiperiod q corresponds to the induction of the subshift (X, S) on the cylinder $[q]$.

We extend the notion of language and complexity to minimal subshifts:

$$L_n(X) \stackrel{\text{def}}{=} \{u \in A^n \mid [u] \neq \emptyset\} \quad \text{and} \quad p_n(X) = \text{card}(L_n(X)) \quad (n \in \mathbb{N})$$

$$L(X) \stackrel{\text{def}}{=} \bigcup_{n \in \mathbb{N}} L_n(X)$$

If y is in X , we have $L(y) = L(X)$ and $p.(y) = p.(X)$.

6.3 Complexity and topological entropy

6.3.1 Word complexity

Theorem 3. *Let x be a multi-scale quasiperiodic word. Then*

$$\liminf_{n \rightarrow \infty} \frac{p_n(x)}{n^2} \leq 1 < \infty$$

Proof: Let $q \in Q(x)$ and $u \in L_{l(q)}(x)$. Since q is a quasiperiod of x , u is a subword of some $v.q$ where v is nonempty prefix of q . u is determined by the choice of v and his position in $v.q$. There are $l(q)$ prefixes of q and for such a prefix v , there are $l(v) \leq l(q)$ available positions for u (we do not count q several times). Finally, there are only $l(q)^2$ possibilities for u and $p_{l(q)}(x) \leq l(q)^2$. The result follows since $\{l(q) \mid q \in Q(x)\}$ is not bounded. \square

Theorem 4. *For each positive function $f : \mathbb{N} \rightarrow \mathbb{R}_+^*$ that converges to zero, there exists a multi-scale quasiperiodic subshift (X, S) such that $\frac{1}{n} \log(p_n(X)) \geq f(n)$ for infinitely many n . In particular, we can ask to $p_n(X)$ to grow faster than any polynomial on a subsequence.*

Proof: Let $\varphi : \mathbb{N} \rightarrow \mathbb{N}^*$ be an increasing sequence such that $2nf(2n\varphi(n)) \leq 1$ for any n . Let $A = \{0, 1\}$ be the alphabet. For $n \geq 1$, let w_n be a finite word on A such that

- w_n begins and ends with the letter 0,
- every word w of length $2n$ such that $\#(0, w) = \#(1, w) = n$ appears as a subword of w_n .

Now, let us define by induction a sequence of finite words over A :

- $u_0 = 010$
- $u_{n+1} = \int_{u_n} w_{\varphi(l(u_n))}$

which is well defined since for any n , u_n begins and ends with the letter 0.

Since $u_n = \int_{u_n} 0$, u_n is a prefix of u_{n+1} : let x be the unique infinite word over A such that u_n is a prefix of x for any n .

If $k \leq l$, u_l is covered by occurrences of u_k , so all the u_n are quasiperiods of x and x is multi-scale quasiperiodic. Let (X, S) denote the associated minimal subshift.

Let n be a positive integer. u_{n+1} and therefore x contain an occurrence of $\int_{u_n} w$, where w is any word of length $2\varphi(l(u_n))$ such that $\#(0, w) = \#(1, w) = \varphi(l(u_n))$. There are at least $2^{\varphi(l(u_n))}$ such different words and each of them has length $\varphi(l(u_n))(l(u_n) + (l(u_n) - 1))$.

Hence,

$$p_{2\varphi(l(u_n))l(u_n)}(X) \geq p_{\varphi(l(u_n))(l(u_n)+(l(u_n)-1))}(X) \geq 2^{\varphi(l(u_n))}$$

So,

$$\frac{1}{2\varphi(l(u_n))l(u_n)} \log(p_{2\varphi(l(u_n))l(u_n)}(X)) \geq \frac{\varphi(l(u_n))}{2\varphi(l(u_n))l(u_n)} = \frac{1}{2l(u_n)} \geq f(2\varphi(l(u_n))l(u_n))$$

\square

We can notice that for the infinite words constructed here, the scales controlled by the quasiperiods are very sparse.

6.3.2 Topological entropy

If (X, S) is a minimal subshift, then the limit

$$h_{top}(X) \stackrel{\text{def}}{=} \lim_{n \rightarrow \infty} \frac{1}{n} \log(p_n(X))$$

exists and is named the *topological entropy* of X .

Corollary 1. *Any multi-scale quasiperiodic subshift has zero topological entropy.*

6.3.3 Kolmogorov complexity

Let U be a fixed universal Turing machine and for each finite word $u \in A^*$, let $K_U(u)$ denotes the Kolmogorov complexity associated to u , i.e. the length of the shortest binary word p such that $U(p) = u$ (see [Bru]). For a minimal subshift (X, S) , we can define

$$K(X) \stackrel{\text{def}}{=} \sup_{x \in X} \limsup_{n \rightarrow \infty} \frac{K_U(x_{1 \rightarrow n})}{n}$$

(this number is independant of the choice of U since if U' is another universal Turing machine, there is a constant C such that for any finite word u , $K_U(u) - C \leq K_{U'}(u) \leq K_U(u) + C$).

Corollary 2. *For any multi-scale quasiperiodic subshift (X, S) , $K(X) = 0$.*

Indeed, [Bru] Theorem 3.1 asserts that $K(X) \leq h_{top}(X)$.

But we can also give a more direct argument : if q is a fixed quasiperiod of a multi-scale quasiperiodic subshift (X, S) and if x is in X , then $\limsup_{n \rightarrow \infty} \frac{K_U(x_{1 \rightarrow n})}{n} \leq \frac{4 \log(l(q))}{l(q)}$. To prove this, it suffices to remark that the integration algorithm can be coded in $O(1)$.

Then, if n is bigger than $4l(q)$, there exists three finite words u , w and v such that $x_{1 \rightarrow n} = u.w.v$, the lengths of u and v are uniformly bounded by $l(q)$, and w begins and ends with q (and can therefore be derivated).

The remaining problem is the control of the length of $\partial w / \partial q$: if the occurrences of q overlap each other deeply, $\partial w / \partial q$ can be rather long. To solve this, we decide to replace recursively an occurrence of $n_1.n_2$ in $\partial w / \partial q$ by $n_1 + n_2$ if n_1 and n_2 are smaller than $n/2$. This operation consists in omitting some useless occurrences of q in $x_{1 \rightarrow n}$. Then at least half of the numbers appearing in the new form of $\partial w / \partial q$ are bigger than $l(q)/2$, so the length of this new $\partial w / \partial q$ will be less than $4n/l(q)$.

Since the coding of each letter of $\partial w / \partial q$ costs $\log(l(q))$, we have a total cost less than a constant (to code the integration algorithm, q , u and v) plus $\log(l(q))4n/l(q)$ (to code the new form of $\partial w / \partial q$).

6.4 Unique ergodicity and frequencies

For a multi-scale quasiperiodic subshift (X, S) , we will now study the set $\mathcal{M}(X, S)$ of Borel probability measures on X that are invariant under S . This set can be identified with a nonempty compact convex subset of $C^0(X, \mathbb{R})'$ endowed with the weak-star topology.

A S -invariant measure $\mu \in \mathcal{M}(X, S)$ is said to be *ergodic* if the only Borel sets $A \subset X$ such that $S^{-1}(A) = A$ have measure $\mu(A) = 0$ or 1 . Such measures are the extremal points of $\mathcal{M}(X, S)$ and satisfies Birkhoff's theorem :

$$\forall f \in L^1(X, \mathbb{R}) \quad \frac{1}{n} \sum_{k=0}^{n-1} f \circ S^k \xrightarrow[n \rightarrow \infty]{\mu\text{-a.e.}} \int_X f d\mu$$

A minimal subshift is said to be *uniquely ergodic* if $\text{card}(\mathcal{M}(X, S)) = 1$.

One interest of such a situation is that, the unique invariant measure μ is ergodic, moreover the convergence in Birkhoff's theorem is uniform for continuous functions.

Theorem 5. *Any multi-scale quasiperiodic subshift (X, S) is uniquely ergodic.*

Proof:

We will first construct a S -invariant probability measure on X and then prove that it is the only one.

Step 1: We construct a candidate to be the unique measure. For this, we will approximate X by periodic subshifts generated by the $q^\omega = qq\bar{q}\bar{q}\dots$ for $q \in Q(X)$.

For q in $Q(X)$, let

$$\mu_q \stackrel{\text{def}}{=} \frac{1}{l(q)} \sum_{k=0}^{l(q)-1} \delta_{S^k(q^\omega)}$$

(δ stands for the one-point Dirac's measure).

μ_q is the only element of $\mathcal{M}(A^\mathbb{N}, S)$ that gives measure 1 to the periodic subshift generated by the periodic word q^ω . By compactity we can find an infinite subset $Q' \subset Q(X)$ such that

$$\mu_q \xrightarrow[l(q) \rightarrow \infty, q \in Q']{\longrightarrow} \mu$$

for some μ in $\mathcal{M}(A^\mathbb{N}, S)$.

Note that if X is aperiodic the μ_q 's give measure 0 to X . However μ will give strictly positive measure to X (as we will see in Step 2) : it shouldn't be surprising since the characteristic function of X is not continuous.

Step 2: Let us show that $\mu(X) = 1$. Since X is closed, we have the following approximation by clopen sets:

$$X = \bar{X} = \bigcap_{n \geq 1} \bigcup_{u \in L_n(X)} [u].$$

Let $n \geq 1$ and let $q \in Q'$ such that $l(q) \geq n$. For $i \in \{0, \dots, l(q) - n\}$, we have $q_{i \rightarrow i+n-1}^\omega \in L_n(X)$ (as a subword of q). Hence $\mu_q(\bigcup_{u \in L_n(X)} [u]) \geq (l(q) - n + 1)/l(q)$.

Letting $l(q)$ tending to infinity, since the characteristic function of $\bigcup_{u \in L_n(X)} [u]$ is continuous, we have $\mu(\bigcup_{u \in L_n(X)} [u]) = 1$. By countable intersection (n is arbitrary), we have

$\mu(X) = 1$. Hence, we can still denote by μ for the restriction of μ to X .

Step 3: Let ν be an ergodic measure on X . We will show that $\nu = \mu$
By Birkhoff's theorem, there is x in X such that for $u \in L(X)$,

$$\nu([u]) = \lim_{n \rightarrow \infty} \frac{1}{n} \#(u, x_{0 \rightarrow n+l(u)-2}) = \lim_{n \rightarrow \infty} \frac{1}{n} \#(u, x_{0 \rightarrow n-1})$$

Let q in Q' such that $l(q) \geq l(u)$. We decompose x into blocks of length $2l(q)$: $x = B_0.B_1.B_2.B_3.B_4 \dots$ with $B_i = x_{2l(q)i \rightarrow 2l(q)(i+1)-1}$. Since each B_i is in $L_{2l(q)}(X)$, it contains at least one occurrence of q , hence $\#(u, B_0.B_1.B_2 \dots B_i) \geq (i+1)\#(u, q)$ for each i in \mathbb{N}^* . We have

$$\nu([u]) = \lim_{i \rightarrow \infty} \frac{1}{2l(q)i} \#(u, B_0.B_1.B_2 \dots B_i) \geq \lim_{i \rightarrow \infty} \frac{i+1}{2l(q)(i+1)} \#(u, q) = \frac{1}{2l(q)} \#(u, q)$$

Moreover, we can control the frequency of occurrences of u in q^ω by estimating the occurrences of u in q and bounding the number of occurrences of u that appear between two consecutive occurrences of q in q^ω :

$$\mu_q([u]) = \lim_{n \rightarrow \infty} \frac{1}{n} \#(u, q_{0 \rightarrow n+l(u)-2}^w) \leq \frac{1}{l(q)} (\#(u, q) + l(u)) = \frac{1}{l(q)} \#(u, q) + \frac{l(u)}{l(q)}$$

Therefore,

$$\mu_q([u]) \leq \frac{1}{l(q)} \#(u, q) + \frac{l(u)}{l(q)} \leq 2\nu([u]) + \frac{l(u)}{l(q)}$$

Letting $l(q)$ tend to infinity, we have $\mu([u]) \leq 2\nu([u])$. So, μ is absolutely continuous relatively to ν . It is well known that this implies $\mu = \nu$, but for sake of completeness, we include a short proof here. There exists a measurable function $f \in L^1(X, \mathbb{R}_+)$ such that for each borel set $A \subset X$, $\mu(A) = \int_A f d\nu$. Since μ is S -invariant, we have $\int_A f d\mu = \int_{S^{-1}A} f d\mu$ for each borel set $A \subset X$.

Let us show that f is constant almost everywhere. Assume by contradiction that the measure of set $A \stackrel{\text{def}}{=} \{x \in X / f(x) \geq \int_X f d\nu\}$ is in $]0, 1[$. Since ν is S -ergodic, A is not S -invariant, so $\nu(S^{-1}(A) \setminus A) = \nu(A \setminus S^{-1}(A)) > 0$.

Hence $\nu(A \setminus S^{-1}(A)) \int_X f d\nu \leq \int_{A \setminus S^{-1}(A)} f d\nu = \int_A f d\nu - \int_{A \cap S^{-1}(A)} f d\nu = \int_{S^{-1}(A)} f d\nu - \int_{A \cap S^{-1}(A)} f d\nu = \int_{S^{-1}(A) \setminus A} f d\nu < \nu(A \setminus S^{-1}(A)) \int_X f d\nu$ which is absurd.

Hence f is constant with value $\nu(X) = 1$, so $\mu = \nu$ and μ is the only S -invariant measure. \square

Corollary 3. *Let x be a multi-scale quasiperiodic word. Then each finite word u occurring in x has frequencies i.e. $\frac{1}{n} \#(u, x_{0 \rightarrow n-1})$ converges when $n \rightarrow \infty$.*

Proof: Let μ be the unique S -invariant measure for the associated subshift (X, S) . The characteristic function $\chi_{[u]}$ of $[u]$ is continuous, so we have a uniform and therefore a pointwise convergence in Birkhoff's theorem :

$$\frac{1}{n} \#(u, x_{0 \rightarrow n-1}) = \frac{1}{n} \sum_{k=0}^{n-1} \chi_{[u]}(S^k(x)) \xrightarrow{n \rightarrow \infty} \mu([u])$$

\square

We can remark that this proof has the same flavour as the the main result of [Bos] that asserts that every subshift with subaffine complexity has only a finite number of ergodic measures. In fact, Theorem 5 and Boshernitzan's result can both be deduced from a more general statement that involves the geometry of Rauzy graphs associated to a minimal subshift:

To each minimal subshift (X, S) we can associate a sequence $(G_n)_{n \geq 1}$ of oriented graphs as follows: the vertices of G_n is $L_n(X)$ and there is an edge from u to v if and only if there exists w in $L_{n+1}(X)$ such that u is a prefix of w and v is a suffix of w .

Those graphs are named the *Rauzy graphs* associated to (X, S) .

If $K \geq 1$, (X, S) is said to be *K-deconnectable* if there exists an extraction $\alpha \in \uparrow(\mathbb{N}^*, \mathbb{N}^*)$ and a constant $K' \geq 1$ such that for all $n \geq 1$ there exists a subset $D_{\alpha(n)} \subset L_{\alpha(n)}(X)$ of at most K vertices such that every path in $G_{\alpha(n)}(X) \setminus D_{\alpha(n)}$ is of length at most $K'\alpha(n)$ (in particular it do not contains any cycle). This means that, up to extraction, we can disconnect (in a specific way) the Rauzy graphs by removing at most K vertices.

Theorem 6 ([Mon]). *A K-deconnectable minimal subshift has at most K S-invariant ergodic measures.*

This result implies Boshernitzan's one, by taking for D_n the set of right special factors (i.e. the set of vertices having outgoing degree strictly greater than one). It also implies Theorem 5 since every multi-scale quasiperiodic subshift is 1-deconnectable. Indeed, if q is in $Q(X)$, $G_{l(q)}(X) \setminus \{q\}$ does not contain any path of length greater than $l(q)$.

6.5 Sturmian subshifts are multi-scale quasiperiodic

In [LevRic1], Florence Levé and Gwénaél Richomme proved that there exists sturmian words that are not quasiperiodic. In terms of complexity, sturmian words are the more symmetric words after periodic ones, so this result do not confirm that quasiperiodicity fits well with other notions of symmetry.

The dynamical point of view will allow us to solve the problem:

Theorem 7. *Sturmian subshifts are multi-scale quasiperiodic.*

Proof: Let (X, S) be a sturmian subshift. Since $p_1(X) = 2$, we can consider that X is defined on the alphabet $\{a, b\}$.

A word $u \in L_n X$ is said to be *left special* if au and bu are in $L_{n+1}(X)$. Since $p_{n+1}(X) - p_n(X) = 1$, there exists exactly one left special word l_n of length n ($n \geq 0$). A prefix of a left special word is still a left special word, so l_{n+1} begins with l_n : let us denotes by x the infinite word that begins by l_n for any integer n . Since $L(x) \subset L(X)$, x is in X (remember that X is closed). We will prove that x is multi-scale quasiperiodic.

The evolution of the Rauzy graphs of sturmian subshifts is described by Rauzy (see [ArnRau]): for infinitely many n (named “bursts”), the Rauzy graph $G_n(X)$ is eight shaped i.e. $G_n(X)$ is the union of two disjoint loops from l_n to l_n . By minimality, the minimal size of the two loops tends to infinity with n , in particular, it is positive for n big enough. Since the sum of the lengths of the two loops is equal to $p_n(X) = n + 1$, then each loop has size less or equal than n .

So, for infinitely many n , any path in $G_n(X)$ of length n starting from l_n has to meet l_n again i.e. l_n is a quasiperiod of x (x can be viewed as an infinite path in $G_n(X)$ starting from l_n). Therefore, (X, S) is a multi-scale quasiperiodic subshift. □

Recently, Florence Levé and Gwénaél Richomme gave a precise description of the quasiperiodic sturmian words ([LevRic2]).

6.6 Conclusion

The gain of fitting with other symmetry classes obtained by considering multi-scale quasiperiodic subshifts instead of quasiperiodic words is summarized by the picture page 21.

References

- [Abr] L.M. ABRAMOV, *The entropy of an induced transformation*, Doklady Akad. Nauk SSSR 128 (1959), p 647–650
- [ApoEhr] A. APOSTOLICO, A. EHRENFEUCHT, *Efficient detection of quasiperiodicities in strings*, Theoret. Comput. Sci. 119 (1993), no. 2, p 247–265.
- [ArnRau] P. ARNOUX, G. RAUZY, *Représentation géométrique de suites de complexité $2n + 1$* , Bull. Soc. Math. France 119 (1991), no. 2, p 199–215.
- [Bos] M. BOSHERNITZAN, *A unique ergodicity of minimal symbolic flows with linear block growth*, J. Analyse Math. 44 (1984/85), p 77–96.
- [Bru] A.A. BRUDNO, *Entropy and the complexity of the trajectories of a dynamic system*, Trudy Moskov. Mat. Obshch. 44 (1982), p 124–149.
- [CrIlRa] T. CRAWFORD, C. S. ILIOPOULOS, R. RAMAN, *String Matching Techniques for Musical Similarity and Melodic Recognition*, Computing in Musicology, vol. 11, p 73–100, 1998.
- [KMGL] S. KARLIN, M. MORRIS, G. GHANDOUR, M. LEUNG, *Efficient algorithms for molecular sequence analysis*, Proc. National. Acad. Sci U.S.A. 85 (1988), p 841–845.
- [LevRic1] F. LEVÉ, G. RICHOMME, *Quasiperiodic infinite words: some answers*, Bull. Eur. Assoc. Theor. Comput. Sci. EATCS No. 84, (2004), p 128–138.
- [LevRic2] F. LEVÉ, G. RICHOMME, *Private communication, april 2005*.
- [Mar1] S. MARCUS, *Quasiperiodic infinite words*, Bull. Eur. Assoc. Theor. Comput. Sci. EATCS No. 82, (2004), p 170–174.
- [Mar2] S. MARCUS, *Symmetry phenomena in infinite words, with biological, philosophical and aesthetic relevance*, Symmetry, culture and science, 2004.
- [MilJur] A. MILOSAVLJEVIC, J. JURKA, *Discovering simple DNA sequences by the algorithmic significance method*, Comput. Appl. Biosci., 9, (1993), p 407–411.
- [Mon] T. MONTEIL, *Estimating the number of ergodic measures of a minimal subshift knowing the geometry of its Rauzy graphs*, preprint.

Résumé :

La première partie de cette thèse traite d'illumination dans les billards polygonaux et les surfaces de translation. Nous étudions les relations entre la propriété de blocage fini (propriété d'illumination), la pure périodicité (propriété dynamique) et le fait d'être un revêtement ramifié d'un tore plat (propriété géométrique). Nous montrons que ces trois notions sont équivalentes pour les surfaces de Veech, pour les surfaces de translation de genre 2, pour les surfaces dont l'homologie est engendrée par les orbites périodiques du flot géodésique et en particulier sur un ouvert dense de mesure pleine dans chaque strate de l'espace des modules des surfaces de translation.

La deuxième partie traite de dynamique symbolique topologique. Nous majorons le nombre de mesures de probabilité ergodiques invariantes d'un sous-shift en fonction de la géométrie d'objets combinatoires associés à son langage : les graphes de Rauzy et l'arbre des spéciaux à gauche. Puis nous introduisons et étudions une classe particulière de sous-shifts : les sous-shifts quasipériodiques multiéchelle. Nous montrons qu'ils sont uniquement ergodiques, de complexité de Kolmogorov et d'entropie topologique nulles.

Mots clefs : Billard polygonal, surface de translation, différentielle quadratique, surface de Veech, revêtement ramifié du tore, illumination, propriété de blocage fini.

Mot infini, dynamique symbolique, entropie nulle, graphe de Rauzy, unique ergodicité, minimalité, complexité, substitution, sous-shift quasipériodique multiéchelle.

English title: Illumination in polygonal billiards and symbolic dynamics.

Abstract:

The first part of this thesis deals with illumination on polygonal billiards and translation surfaces. We study the relationships between the finite blocking property (illumination property), pure periodicity (dynamical property) and being a torus branched covering (geometrical property). We show that those three properties are equivalent for the Veech surfaces, for the translation surfaces of genus 2, for the surfaces whose homology is generated by the periodic orbits of the geodesic flow and therefore on a dense open subset of full measure in every stratum of the moduli space of translation surfaces.

The second part deals with symbolic dynamics. We give some bounds of the number of invariant ergodic probability measures of a subshift that depend on the geometry of combinatorial objects associated to its language : the Rauzy graphs and the tree of left special factors. Then, we then introduce and study a particular class of subshifts: the multi-scale quasiperiodic subshifts. We prove that they are uniquely ergodic and that their Kolmogorov complexity and their topological entropy vanish.

Keywords: Polygonal billiard, translation surface, quadratic differential, Veech surface, torus branched covering, illumination, blocking property.

Infinite word, symbolic dynamics, zero entropy, Rauzy graph, unique ergodicity, minimality, complexity, substitution, multi-scale quasiperiodic subshift.

Adresse du laboratoire: Institut de Mathématiques de Luminy.

CNRS UMR 6206 – 163 avenue de Luminy, Case 907 – 13288 Marseille cedex 9 – France.