



HAL
open science

Allocation des ressources fondée sur la qualité du canal pour la voie descendante des systèmes LTE

Fan Huang

► **To cite this version:**

Fan Huang. Allocation des ressources fondée sur la qualité du canal pour la voie descendante des systèmes LTE. Réseaux et télécommunications [cs.NI]. Université Paris Saclay (COMUE), 2015. Français. NNT : 2015SACLS250 . tel-01293080

HAL Id: tel-01293080

<https://theses.hal.science/tel-01293080>

Submitted on 24 Mar 2016

HAL is a multi-disciplinary open access archive for the deposit and dissemination of scientific research documents, whether they are published or not. The documents may come from teaching and research institutions in France or abroad, or from public or private research centers.

L'archive ouverte pluridisciplinaire **HAL**, est destinée au dépôt et à la diffusion de documents scientifiques de niveau recherche, publiés ou non, émanant des établissements d'enseignement et de recherche français ou étrangers, des laboratoires publics ou privés.

THESE DE DOCTORAT
DE L'UNIVERSITE PARIS-SACLAY,
préparée à l'Université Paris Sud

ÉCOLE DOCTORALE STIC
Sciences et Technologies de l'Information et de la Communication
(LABORATOIRE DES SIGNAUX ET SYSTÈMES, UMR8506)

Spécialité de doctorat : Réseaux Information et Communications

Par

M. Fan HUANG

Allocation des Ressources fondée sur la Qualité du Canal
pour la Voie Descendante des Systèmes LTE

Soutenance prévue à CentraleSupélec, le 16 décembre 2015
Composition du Jury :

M. Marceau Coupechoux	Maître de Conférences HDR, Télécom ParisTech	Rapporteur
Mme. Megumi Kaneko	Assistant Professor, Kyoto University, Japan	Rapporteur
M. Djamal ZEGHLACHE	Professeur, Télécom SudParis	Examineur
M. André-Luc Beylot	Professeur, ENSEEIHT	Examineur
M. Steven Martin	Professeur, Université Paris Sud	Examineur
M. Jean-Christophe Schiel	Ingénieur, Airbus DS	Examineur
Mme. Véronique Vèque	Professeur, Université Paris Sud	Directrice de thèse
Mme. Joanna Tomasik	Professeur, CentraleSupélec	Codirectrice



I would like to dedicate this thesis to my loving parents ...

Declaration

I hereby declare that except where specific reference is made to the work of others, the contents of this dissertation are original and have not been submitted in whole or in part for consideration for any other degree or qualification in this, or any other university. This dissertation is my own work and contains nothing which is the outcome of work done in collaboration with others, except as specified in the text and Acknowledgements. This dissertation contains fewer than 65,000 words including appendices, bibliography, footnotes, tables and equations and has fewer than 150 figures.

Fan HUANG
January 2016

Acknowledgements

And I would like to acknowledge my PhD supervisor Professor Véronique Vèque and Professor Joanna Tomasik, thanks for their hard work and taking care of me during the past three years.

I much appreciate the help of the people who work in the laboratory, and thank them for their great welcome providing good work environment for us, namely Maryvonne Giron, Celine Labrude, Frederic Desprez, and Myriam Baverel. It is also highly fortunate to work in the same office with my colleagues, Changyou LI and Ming XU. We started our Ph.D topics same year and we have stayed in the same lab during the three years. They all are enthusiastic and nice people.

I also want to thank my parents and I am sorry to leave them alone in my hometown for six years since I left home in 2010.

Finally, I would like to thank very much the members of the jury for the precious time which they have taken from their busy schedule in order to evaluate and give feedback to my thesis.

Summary

This research takes place in the context of Private Mobile Radio networks evolution which aims at designing a new LTE based PMR technology dedicated to public security services. As the frequency bands dedicated to this service is scarce and the need of public safety forces is different, we have revisited the Resource Allocation problem in this thesis with two main objectives: designing new allocation algorithms which outperform the spectrum efficiency and serving fairly the users instead of maximizing the global network throughput. This thesis proposes new Resource Block (RB) allocation strategies in LTE downlink systems. Instead of the well-known resource allocation algorithms, which work on the condition that the RB capacity is already estimated, our RB allocation schemes can improve the potential of the channel capacity, using Beamforming cooperation and game-theoretical problems

1. With the MIMO (Multiple-Input-Multiple-output) antennas, the Beamforming technique improves the received signal in order to increase the SINR (Signal-to-Interference-plus-Noise-Ratio), but the improved signal may also influence the inter-cell interference in the neighbouring cells. As inter-cell interference is the main interference in the OFDMA system, a smart scheduling can choose UEs (User Equipment) in adjacent cells to control interference increment caused by Beamforming.

In traditional methods, the scheduler allocates RBs to UEs depending on the RB capacities and other parameters, the system then applies the Beamforming technique to these chosen UEs. After the Beamforming, the RB capacity varies but the scheduler keeps the same allocation.

Our scheme allocates the RBs and chooses Beamforming vectors at the same time to enhance the performance of the Beamforming technique. It increases the average throughput by increasing the RB's average capacity. Because more parameters are taken into account, the complexity also increases exponentially. In the thesis we find an iterative method to reduce the complexity. From the simulations, our iterative method also has good performance and improves more than 10% of throughput on the cell edge.

2. In contrast to the performance first algorithms, game theoretic allocation schemes maximize the UEs' utility function from the economical point of view. The NBS (Nash Bargaining Solution) offers a Pareto optimal solution for the utility function.

The traditional NBS allocation in an OFDMA system is to optimize the subcarrier allocation at each time slot, but in the OFDMA system, the subcarriers are composed of Resource Blocks (RB) in time series. We propose an RB NBS approach, which is more efficient than the existing subcarrier NBS allocation scheme.

We analyze the fast-fading channels and compare them without the path-loss influence. Because of the great path-loss in cell edge, the edge UE always has lower RB capacity than the cell center UE. Our idea is to bring in a compensating factor to overcome this path-loss influence, and the compensating factors are carefully chosen to maximize the NBS function. However, the computation of these factors has a high complexity and we develop four approximated solutions which give same performance and accuracy. The performance evaluation confirms that our method and its approximated solutions are able to spread resources fairly over the entire cell.

Résumé

La recherche effectuée dans cette thèse a pour cadre les réseaux radio privés dédiés aux forces de sécurité civile. En effet, doté actuellement d'un service bande étroite, ils doivent évoluer pour faire face à de nouveaux besoins comme la vidéo ou le multimédia. L'objectif est donc d'adapter la technologie LTE aux contraintes et propriétés de ces réseaux particulier. Ainsi, la bande réservée se trouve dans les 400 MHz mais avec une largeur réduite, le nombre d'utilisateurs est limité mais le service doit toujours être disponible et des priorités peuvent être mises en œuvre.

Dans ce contexte, l'allocation des ressources de communication est un problème important avec des prérequis différents des réseaux d'opérateurs. Notre conception d'algorithmes d'allocation a donc été menée avec deux objectifs principaux : maximiser l'efficacité du spectre et servir équitablement les utilisateurs au lieu de maximiser le débit global du réseau. Cette thèse propose des nouvelles stratégies de l'allocation des blocs de ressources (RB) dans les systèmes LTE sur le lien descendant. Au contraire des algorithmes classiques d'allocation des ressources qui se basent sur la capacité de RB déjà estimée, nos stratégies d'allocation des RB cherchent à améliorer le débit utilisateur, en utilisant la coopération à base de Beamforming et les modèles de la théorie des jeux.

1. L'interférence inter-cellulaire est le principal problème des systèmes OFDMA. Grâce aux antennes MIMO (Multiple-Input-Multiple-Output), la technique de Beamforming améliore le signal reçu afin d'augmenter le SINR (Signal-to-Interference-plus-Noise-Ratio), mais le signal amélioré peut également influencer l'interférence inter-cellulaire dans les cellules voisines. Dans les méthodes traditionnelles, le contrôleur alloue les RBs aux UEs (User Equipment) en fonction de la capacité des RB et d'autres paramètres, le système applique alors la technique de Beamforming aux équipements utilisateurs choisis. Après la formation des faisceaux, la capacité des RB varie mais l'ordonnanceur conserve la même allocation. Au contraire, notre système alloue les RBs et choisit les vecteurs de Beamforming conjointement pour améliorer les performances de la technique de Beamforming. Il accroît le débit moyen en augmentant la capacité moyenne du RB. Comme plusieurs paramètres sont pris en compte, la complexité augmente exponentiellement aussi. Dans cette thèse, nous avons développé une méthode itérative pour réduire la complexité. Notre méthode

itérative a également de bonnes performances étudiées par simulation. Notamment, elle améliore de plus de 10% le débit des utilisateurs en bord de la cellule.

2. Contrairement aux performances des algorithmes qui maximisent le débit global du réseau, les approches d'allocation de ressources à base de théorie des jeux maximisent la fonction d'utilité des UE du point de vue économique. Si le modèle a une solution NBS (Nash Bargaining Solution) il offre une solution optimale de Pareto de la fonction d'utilité. L'allocation traditionnelle dans un système OFDMA est d'optimiser l'allocation de sous-porteuses à chaque intervalle de temps, mais dans le système OFDMA, les sous-porteuses sont formées de blocs de ressources (RB) dans le temps. Nous proposons une approche RB NBS, qui est plus efficace que les schémas existants. Nous analysons les canaux de fast-fading et les comparons sans l'influence de l'atténuation. En raison de la grande atténuation de signal en bordure de la cellule, l'utilisateur dans ces cellules a toujours des RB de plus faible capacité que celui au centre de la cellule. Notre idée est d'ajouter un facteur de compensation pour combattre l'influence de la perte de propagation. Les facteurs de compensation sont soigneusement choisis afin de maximiser la fonction NBS. Cependant, le calcul de ces facteurs a une grande complexité et nous développons quatre solutions approchées qui donnent les mêmes performances avec une bonne précision. L'évaluation des performances de notre approche confirme que notre méthode et ses solutions approchées sont capables de partager équitablement les ressources sur toute la cellule.

Table of contents

List of figures	xvii
List of tables	xix
1 Introduction	3
1.1 Background and Motivation	3
1.2 Thesis Objective	5
1.3 Basic Assumptions	5
1.4 Thesis Outline	6
2 Technical Background and Mathematical Concepts	9
2.1 Wireless Communication Characteristics	9
2.1.1 Frequency Band	10
2.1.2 Fading Channel	10
2.1.3 Interference	11
2.1.4 Spectrum Sharing and Multiple Access Techniques	11
2.1.5 Antenna Techniques	12
2.2 Cellular Wireless Communication	13
2.2.1 LTE Network Element	13
2.2.2 LTE Radio Protocol Architecture	15
2.2.3 Radio Resource Management	17
2.3 Radio Resource in LTE	18
2.4 LTE for PMR	21
2.4.1 Introduction of Professional Mobile Radio (PMR)	21
2.4.2 3GPP LTE in PMR	22
2.5 Wireless Channel	22
2.5.1 Fading Channel	22
2.5.2 Path-loss	24

2.5.3	Signal-to-Interference-plus-Noise-Ratio	26
2.6	Multi-cell System	26
2.6.1	System Model	26
2.6.2	Coordinated Multipoint	28
2.7	Beamforming Techniques	29
2.7.1	Selfish Beamforming	30
2.7.2	Greedy Beamforming	30
2.7.3	Minimum Generated Interference Beamforming	30
2.7.4	Maximum Signal-to-Leakage-Interference-plus-Noise-Ratio Beamforming	31
2.8	Conclusion	31
3	Resource Allocation Algorithms	33
3.1	Resource Allocation Schemes Classification	33
3.2	Throughput and Fairness Balancing	35
3.2.1	Maximum Throughput Algorithm	35
3.2.2	Round Robin Algorithm	35
3.2.3	Max-min Algorithm	36
3.2.4	Proportional Fair Algorithm	36
3.2.5	Coordinated Proportional Fair Algorithm	37
3.2.6	Conclusion	37
3.3	UE State Optimal Algorithm	38
3.3.1	The Maximum Largest Weighted Delay First (M-LWDF)	38
3.3.2	Exp-Rule	39
3.3.3	Log-Rule	40
3.3.4	Frame Level Scheduler (FLS)	41
3.3.5	Conclusion	42
3.4	Economical Optimization	43
3.4.1	Elements of the Game Theory	43
3.4.2	Nash Bargaining Solution	44
3.4.3	Dynamic Subcarrier Assignment	45
3.4.4	NBS for Subcarrier Allocation	47
3.4.5	Conclusion	48
3.5	Chapter Conclusions	49

4	Complexity Reduction in Cooperative Allocation Framework	51
4.1	Introduction	51
4.2	Problem Definition	52
4.3	Framework for Two-User Case	56
4.3.1	Exhaustive Solution	56
4.3.2	Numerical Results	57
4.4	Heuristic Method	59
4.5	Application of Cooperative Framework on Other QoS Service	63
4.5.1	Throughput Optimal with Finite Buffer	63
4.5.2	Delay Optimal	65
4.6	Numerical Results	65
4.6.1	Multi-cell MT Algorithm Results	66
4.6.2	Results for Multi-cell Log Rule and Exp Rule	68
4.7	Conclusions and Perspectives	69
5	Channel Oriented Algorithms	71
5.1	Introduction	71
5.2	System Model	72
5.3	Best Channel Algorithm	73
5.4	NBS in RB Allocation	74
5.5	NBS Solution	77
5.5.1	Exact Solution	79
5.5.2	Proposed RB NBS Algorithm	79
5.5.3	Parallel RB NBS Algorithm	84
5.5.4	Log Scale RB NBS Algorithm	86
5.5.5	Mixed RB NBS Algorithm	87
5.6	Evaluation Methodology	88
5.6.1	Simulation Setup	88
5.6.2	Performance Criteria	88
5.6.3	Design of Experiments	89
5.7	Confrontation of Proposed Methods	91
5.7.1	Exhaustive and Iterative RB NBS	91
5.7.2	Conjecture Validation	93
5.7.3	Influence of Parallel Treatment and Linear Approximation	94
5.7.4	Conclusion	94
5.8	Comparison of Mixed RB NBS with Reference Algorithms	95
5.8.1	Throughput Evaluation	95

5.8.2	Fairness Index	97
5.8.3	Conclusion	99
5.9	Conclusions and Perspectives	99
6	Conclusion and Perspectives	101
6.1	Conclusions	101
6.2	Future	103
	References	105
	Appendix A Simulator Programming	113
A.1	Introduction	113
A.2	LTE-Sim Package	114
A.3	Modification of Multiple Channel Model	114
A.3.1	Path-loss	114
A.3.2	MIMO Channel	115
A.4	Interference and Beamforming Technique	116
A.5	Simulation Settings	117

List of figures

2.1	LTE network architecture [DPSB08]	14
2.2	LTE Radio Protocol Architecture	16
2.3	Subcarrier in OFDMA	19
2.4	RB in LTE Downlink system	19
2.5	The OFDMA Resource Block [3GP10]	20
2.6	MIMO Channel Models [SPSH04]	23
2.7	Cellular model for multi-cell environments [SLA11]	27
4.1	RB allocation with Beamforming: the worst case	53
4.2	RB allocation with Beamforming: the best case	53
4.3	CS/CB Diagram	54
4.4	Multi-cell organizations	58
4.5	Average throughput in cell center	59
4.6	Average throughput on the cell edge	59
4.7	Multi Cell Enumeration Schemes	60
4.8	Modified Algorithm Diagram	62
4.9	Average throughput per UE	67
4.10	Allocation scheme efficiency in function of the number of iteration	67
4.11	Average output-input ratio on the cell edge	68
4.12	Average packet delay on the cell edge	69
5.1	Two-user illustrative example of the subcarrier NBS allocation	75
5.2	Two-user illustrative example of our RB NBS approach	75
5.3	Group concatenation made on Step 4 of Parallel RB NBS Algorithm	85
5.4	Log Scale linear approximation of compensation factors groups for the Log Scale RB NBS Algorithm	86
5.5	Geometric mean throughput vs number of UEs	92
5.6	Arithmetic mean throughput vs number of UEs	92

5.7	Throughput for RB NBS methods and channel oriented methods depending on the UE path-loss (a higher UE index indicates a higher path-loss)	93
5.8	Log scale approximation of compensation factors in cell edge group (Team 3 and 4)	93
5.9	Comparison of proposed methods: geometric mean throughput in function of the number of UEs	95
5.10	Comparison of our proposed methods with the other algorithms: geometric mean throughput performance in function of the number of UEs	95
5.11	Comparison of geometric throughput for Team 1	96
5.12	Comparison of geometric throughput for Team 2	96
5.13	Comparison of geometric throughput for Team 3	97
5.14	Comparison of geometric throughput for Team 4	97
5.15	Fairness index of different algorithms	98

List of tables

2.1	Typical Parameters for Downlink OFDMA Transmission [SBL14]	20
3.1	Throughput and fairness trade-off	38
3.2	UE state allocation algorithm enumeration	42
5.1	Algorithm enumeration	89
5.2	Channel oriented algorithm development: decision criterion	89

Nomenclature

ACM/TDM	Adaptive Modulation and Coding and Time Division Multiplexing
AMC	Adapting Modulation and Coding
ARQ	Automatic Repeat Request
ARP	Allocation and Retention Priority
BDM	Bandwidth Division Mechanisms
BS	Base Station
BPSK	Binary Phase Shift Keying modulation
CBR	Constant Bit Rate
CB/CS	Coordinated Scheduling and Coordinated Beamforming
CC	Component Carrier
CSI	Channel State Information
CoMP	Coordinated Multipoint
CP	Cyclic Prefix
CQI	Channel Quality Indicator
DL	Downlink
e-NodeB	Enhanced Node B
EPC	Evolved Packet Core
EPS	Evolved Packet System
E-UTRAN	Evolved UTRAN
PF	Proportional Fairness
FDD	Frequency Division Duplexing
FRM	Frequency Reuse Mechanisms
GBR	Guaranteed Bit-Rate
HDR	High Data Rate
HOL	Head of Line
ISI	Inter Symbol Interference
JT	Joint Communication
LOS	Line of Sight
LTE	Long Term Evolution
MAC	Medium Access Control
MBR	Maximum Bit Rate
MCS	Modulation and Coding Scheme

MIMO	Multiple Input Multiple Output
M-LWDF	Modified-Largest Weighted Delay First
MME	Mobility Management Entity
NBS	Nash Bargaining Solution
OFDM	Orthogonal Frequency Division Multiplexing
OFDMA	Orthogonal Frequency-Division Multiple Access
PF	Proportional Fairness
PHY	Physical Layer
PLR	Packet Loss Ratio
QAM	Quadrature Amplitude Modulation
QCI	QoS Class Identifier
QoS	Quality of Service
QPSK	Quadrature Phase Shift Keying
RB	Resource Block
RLC	Radio Link Control
RL	Reinforcement Learning
RR	Round Robin
SC-FDMA	Single-Carrier Frequency-Division Multiple Access
SINR	Signal to Interference plus Noise Ratio
SNR	Signal to Noise Ratio
TIN	Treat Interference as Noise
TPS	Transmission Point Selection
TTI	Transmission Time Interval
UE	User Equipment
UL	Uplink
UTRAN	Universal Terrestrial Radio Access Network
UMTS	Universal Mobile Telecommunications System
VoLTE	Voice over LTE

Chapter 1

Introduction

1.1 Background and Motivation

The LTE (Long Term Evolution) is known as the 4G (4th generation) wireless cellular system, which is a standard for wireless communication of high-speed data for mobile phones and data terminals. The LTE systems are well deployed in the major economies region, such as Europe, North America and East Asia.

LTE utilizes UE (User Equipment) categories or classes to define the performance specifications to make base stations enable to communicate effectively with them knowing their performance levels. Classes like LTE UE Category 3 (cat.3) or LTE UE Category 4 (cat.4) are widely used and quoted. In its new Category 6 (cat.6) version, the peak downlink data-rate has reached 300 Mbps [AGER10]. Its main principle is to combines two bandwidths at 20 MHz each to achieve a double speed of cat.4 [GRM⁺10]. The frequency peak of the spectrum efficiency does not increase much, which increase stays at 7.5 bps/Hz/cell when passing from cat.4 to cat.6.

In the narrow band PMR (Personal Mobile Radio) network using LTE technique, whose band varies from 1.4 MHz to 5 MHz, the peak data rate is under 37.5 Mbps, and edge rate which is understood as 5% of the maximum rate is the worst data rate that a UE can reasonably expect to receive when in range of the network. The edge rate is an important metric and has a concrete engineering meaning. Before the deployment of 5G systems which provide higher system spectral efficiency [ABC⁺14], the edge rate of PMR networks is not high enough to meet the demands of high quality multimedia service.

When the radio resource is limited to support most of the UEs' demand in service, well designed allocation algorithms are necessary to increase the utilization of frequency.

The resource allocation is a general challenge in the human's production and life, and the allocation in the wireless communication is a specific subset of the general allocation problem.

In contrast to the allocation in the wired communication networks whose channel quality is always constant, the allocation in wireless network is a dynamic problem because the wireless channel varies like the fast fading does.

To find the solution of the dynamic problem, the first important thing is to find the objective of the allocation.

Our work is to design a resource allocation scheme of a Private Mobile Radio (PMR) network in the project SOAPS [oSp12], to meet the different Quality of Service (QoS) demands in this PMR . There are two ideas to design allocation algorithms:

1. the resource allocation is based on the the specific parameter (throughput, delay or other) optimization,
2. the resource allocation is based on the utility function optimization.

Concerning the first axis, there is a great number of algorithms solving the optimal parameterization problem. These algorithms use, however, the power control which is unavailable on the downlink in LTE systems. Our idea is to use the Beamforming technique as an indirect power control. The allocation is based on the Resource Block (RB) capacity (which equals to the channel capacity in LTE Downlink systems), a cooperative beamforming can increase the capacity by balancing the interference.

The traditional allocation algorithms, the RB capacity are considered as a dynamic parameter, its value is given (according to the given channel SINR) and we use it as the base of the channel assignment.

We intend to create a resource and beamforming assignment framework to improve the channel's SINR and increase the RB capacity, which offers a higher total throughput of the system.

The second axis is to represent the resource allocation in terms of an economical problem. The goal of the LTE communication is to optimize the data service revenue of the operators. Initially, the use of economic tools is justified by the fact that network operators want to find the solution to find the maximum revenue with a certain quality of service (QoS). Making abstraction of the initial motivation of this approach, it may be used to ensure the best possible compromise between users' demands and network resources available. Economic mathematical tools can be applied in this sub-domain to solve this problem. The game theory provides means to find the best strategy of resource allocation to UEs, we therefore call for them in the context of PMR networks.

The RB can be seen as goods in our theory, we trade the RBs between the UEs and increase the UEs' channel capacity according to the trading outcome.

The thesis focuses on both the above mentioned aspects. We aim to provide the positive feedback on the RB capacity, according to the cooperating assignment with Beamforming vector and to perform RB trading. We want to achieve a better performance than in the traditional algorithms and a higher profit in the game theoretic allocations.

1.2 Thesis Objective

To address aspects we enumerated above, we formulate a list of objectives we identified at the beginning of our work:

- understand the fundamentals of the LTE downlink system, as well as the channel state variation, the channel enhancement tools such as Beamforming technique, the game theory as well as the optimization theory namely a formal definition of a game problem and an optimization problem.
- improve the Resource Block (RB) capacity thanks to the cooperation of Beamforming and RB allocation.
- model the Resource Block allocation problems in LTE downlink networks as Beamforming cooperation problems and game theoretical problems.
- evaluate the LTE downlink network performance in terms of system throughput and fairness with the simulator LTE-Sim for algorithmic methods we advanced.
- propose the heuristic methods as the exact solutions of our problems require an unacceptable computing time due to the complexity of exact methods.

1.3 Basic Assumptions

Before starting, we discuss and detail the assumptions that are made through out this thesis.

- Resource Block Allocation per transmission time slot (TTI): We assume that the wireless channel state stays constant over the least one TTS (usually 1ms) which equals to twice of the RB's duration. The RB allocation needs to be updated every TTI.

- **Power Control:** The traditional power control is not available in the LTE downlink system because of the subcarrier in the RB is not adjacent on the frequency. Instead of the direct power control, we apply the Beamforming technique to modify the received signal power and interference power.
- **Chanel State Information:** We assume that the complete and perfect CSI (Channel State Information) is available at both the transmitters and receivers. We assume all the channels are the fast fading channels which means the quality of the channel changes every TTI. More precisely speaking in Chapter 5, we suppose that the variation of the channel follows a Gaussian distribution.
- **Path-loss:** The path loss is dependent on the channel quality, it is a function of the distance between the UE and e-NodeB. We assume that the path loss is known by the e-NodeB.
- **Rationality:** One of the most common assumptions made in the game theory is rationality. This means that every player always maximizes his payoff, thus being able to perfectly calculate the probabilistic result of every action. However, in reality this assumption can only be reasonably approximated since rationality of individuals is limited by the information they have, the cognitive limitations of their minds, and the finite amount of time they have to make decisions.

1.4 Thesis Outline

In general terms, the focus of this thesis is on the channel capacity improvement with the design of resource allocation in wireless channels. The outline of all chapters is as follows.

After the present chapter (Chapter 1) gives the motivation, outline, and contributions of this thesis. We start with the outline of the state of the art.

Chapter 2 overviews the technical background in wireless systems considered in this thesis, such as wireless channel models, path-loss models, i.e., multiple access channels and interference channels, Orthogonal Frequency Division Multiplexing Access (OFDMA) technology in the LTE downlink system.

Chapter 3 summarizes the classic RB allocation schemes, game-theoretic resource allocation algorithms, they are introduced as the reference algorithms of the thesis's main work. It also introduces the fundamentals of game theory, and explains a specific game theoretic bargaining solution - NBS (Nash Bargaining Solution).

The next two chapters cover our original work.

Chapter 4 starts with a proposition of an RB allocation framework to allocate the RB and chooses the Beamforming vector at the same time. We use the Beamforming technique to modify the received signal power and the inter-cell interference in the neighbouring cells, which offers the indirect power control to increase the RB's capacity potential. It secondly apply this framework to the different kinds of RB allocation algorithms which are designed for different Quality of Service (QoS) demands. The exact solution may be found in polynomial time, as a polynomial degree is equal to the number of symbols in the code book, a time required to run the exact method becomes too long to consider this algorithm as worth implementing in practical. For this reason, the chapter introduces the approximated method to reduce the complexity of the proposed algorithm. It introduces the iterative method to reduce the complexity of the exhaustive solution for our framework. In the end of this chapter, we compare the performance of our approximated methods and the original algorithms.

Chapter 5 defines a model of allocation problem, and discusses the difference with existing works that we presented in Chapter 3. This chapter contains our contribution concerning two algorithms: Best Channel algorithm which is a more efficient version of Round-Robin algorithm; RB NBS, which is to solve the NBS allocation problem in in the LTE downlink networks. We present four variants of our RB NBS algorithm: iterative method, parallelization computing, log-scale approximation, and mixed method. These variants are adaptations of the principle algorithm to different conditions, for instance, the possibility of parallel computations, the computation acceleration thanks to the linear approximation of the path loss, etc. We evaluate our game theoretic algorithms and its approximated methods with the reference algorithms we have introduced in Chapter 3.

Chapter 7 summarizes the main results of this thesis and looks into the perspectives of future researches.

Chapter 2

Technical Background and Mathematical Concepts

Nowadays, the wireless communication becomes a topic of study since the Motorola created the first cellphone and the past two decades have seen a surge of research activities in this area. This is mostly given credit to the great demands of the mobile Internet industry. Apple, Google, Facebook, Twitter, Instagram and Snapchat, a lot of giants develop their business on the handsets and billions of customers use their mobile phone to deal with their life and work instead of the computers.

Since the success of 2G (second generation) [MP92] digital wireless standards and techniques, the research thrust in the past two decades has led to a much richer set of perspectives on how to communicate over wireless channels. Based on these perspectives, many new standards such as 3G/HSPA [HT00], CDMA [Vit95], Wi-Fi [Wal01], WiMAX [GWAC05] and 3GPP LTE [DPSB08] have been developed to cope with the explosive demand for wireless connectivity. Now, this evolution is still going on.

We will introduce the general architecture of the cellular wireless communication and main techniques in the next sections.

2.1 Wireless Communication Characteristics

Providing a broadcast and multi-point channel, the radio wireless communication uses the frequency band and electromagnetic wave as the signal carrier while no physical protector like envelope or shielding isolate the signal from interference. Interference is caused by other communication signals or propagation impairments.

Because the signals can be received by all the equipment in a certain area, a **spectrum sharing access** is needed among the users of the wireless communication. Even though the electromagnetic wave can be created variously, a good **antenna technique** can improve the quality of the electromagnetic signal.

In the next subsections, we will introduce them briefly.

2.1.1 Frequency Band

The wireless communication transmits the information as signals on a certain frequency, which is always dedicated to a communication service to avoid interference.

The 2.4GHz and 5GHz bands are usually allocated to the Wi-Fi service, the band of 800–900MHz, 1.8–2.2GHz are mainly used for cellular wireless communication [3GP11a]. Most of bands are free for public service but the band of mobile service are usually auctioned.

Because the bands are licensed and limited, the operators need an efficient radio resource allocation scheme to support more business service in the band. For this reason, we begin with studying the characteristics of the wireless channel which have to be taken into account in the channel assignment policy.

2.1.2 Fading Channel

When the transmitted signal travels from transmitter to receiver, the wireless environment may cause fluctuations in amplitude, phase and angle of arrival of the received signal, we define this phenomenon as fading, and channels that exhibit these properties are known as fading channels [EDHH98].

There are two independent fading effects:

- Multipath delay spread leads to time dispersion and frequency-selective fading.
- Doppler spread leads to frequency dispersion and time-selective fading.

When the delay spread by multi-path delay spread or coherence time of Doppler effect is less than the received symbol period, this causes **fast fading** which means the channel characteristics change quickly.

When the delay spread by multi-path delay spread or coherence time of Doppler effect is much more than the received symbol period, it causes the **slow fading** [Sk197].

In this dissertation, we use the fast-fading as the default configuration because the UE speed is not too high and the coherence time is less than the duration of a symbol.

2.1.3 Interference

Wireless communication from a sender to a receiver is significantly affected by the interference generated by other devices. If devices in the vicinity of the receiver transmit at the adjacent time and on the adjacent frequency, their signals interfere at the receiver with the intended signal from the sender and thus impede proper reception.

Because user can not distinguish the signals on the same frequency at the same time, the multiple access is designed to share these radio channels for the communication.

2.1.4 Spectrum Sharing and Multiple Access Techniques

The spectrum radio resource contains three degrees of freedom: the frequency, the time and the code. The common multiple access techniques are designed on sharing these degrees of freedom:

- **FDMA**

Frequency Division Multiple Access (FDMA) [CS94] is a channel access method which gives each user an individual allocation of one or several frequency sub-bands (or sub-channels).

With FDMA, the sub band can be assigned to only one user at a time. However, FDMA imposes guard bands between two adjacent sub channels to avoid the co-channel interference and its spectrum efficiency is low.

- **TDMA**

In Time Division Multiple Access (TDMA) [Pro91], it makes use of the same frequency spectrum but allows more users on the same band of frequencies by dividing the time into slots and shares the channel between users by assigning them different time slots.

The TDMA can use narrow band because a user can use the full band at the same time, but this technique imposes a strict synchronization between the distributed users in order to transmit exactly in their time slot.

- **CDMA**

Code division multiple access (CDMA) [Vit95] uses a spectrum technique which sends information simultaneously over a single communication channel and several UEs share a band of frequencies. Using a code allocated to each other, several communication are sent over a same band, seeing the other communication as interference.

CDMA is used in 3G/UMTS systems and its limitation is the level of interference introduced by several users using the same band.

- **OFDMA**

Orthogonal Frequency-Division Multiple Access (OFDMA) [YA06] is a multiple access of the Orthogonal Frequency-Division Multiplexing (OFDM) digital modulation scheme. In OFDMA, the band is divided into orthogonal subcarriers which are used to transmit messages. The orthogonal property means the product of two different subcarriers is zero. After the signal is received, the OFDMA technique applies a matched filter to decode the information, because all the subcarriers are orthogonal, the signals of other subcarriers applied by the filter become zero.

OFDMA has many advantages: the most important one is less interference because of the interference from the neighbouring subcarriers is negligible; and its subcarriers are coded independently, so the system complexity does not increase with the number of users.

Because of the advantages on channel capacity, the OFDMA is chosen as the multiple access of the LTE downlink system and we design the allocation scheme to assign the subcarriers for the communication.

2.1.5 Antenna Techniques

The purpose of an antenna is to collect and convert electromagnetic waves to electronic signals.

Different forms of antenna technology refer to single or multiple input transmitters and output receivers. Depending on the radio link, different forms of single/multiple antenna links are defined as below:

- SISO - Single Input Single Output
- SIMO - Single Input Multiple output [SS08]
- MISO - Multiple Input Single Output [Vu11]
- MIMO - Multiple Input multiple Output [PGNB04]

Electronic miniaturization allows to put more than one antenna on a mobile terminal and MIMO can be used to provide improvements in both channel robustness as well as channel throughput [ZT03].

After the presentation of the general wireless network, we will introduce the specific knowledge of the cellular wireless communication in the next section.

2.2 Cellular Wireless Communication

All the communication system are composed by three basic elements: two sides of the communication and the channel between them.

The core characteristic of the cellular communication system is that the users in cellular network does not exchange the information with the other side directly but through a communication node which is called the Base Station (BS).

The communication between the Base Stations are belonging to the traditional wire communication and we focus on the wireless communication in this thesis.

The cellular wireless communication develops from the analogical mode (1G: first generation) [Rap96] to digital mode (after 2G) where more and more User Equipment (UE) are supported in the wireless network. From the GPRS (2.5G) communication, it begins to support the data service. In the 3G service, the voice service and data service can work simultaneously by separating the data channel from the voice channel. Because of the high throughput and low latency in 4G service, we begin to treat the voice service as a kind of data service, which is called - VoLTE (Voice over LTE) [CC11].

For this reason, we just study the data service under a given QoS (Quality of Service) during the allocation of radio resources in this dissertation.

2.2.1 LTE Network Element

The high-level network architecture of LTE is comprised of the following three main components (Fig. 2.1):

- The User Equipment (UE).
- The Evolved UMTS Terrestrial Radio Access Network (E-UTRAN).
- The Evolved Packet Core (EPC).

User Equipment

The UE (user equipment) includes all the wireless terminal that can exchange information with the E-UTRAN network, such as cellphone, data card, Mi-Fi, and other devices. The radio interface between the UE and the e-NodeB is called LTE-Uu.

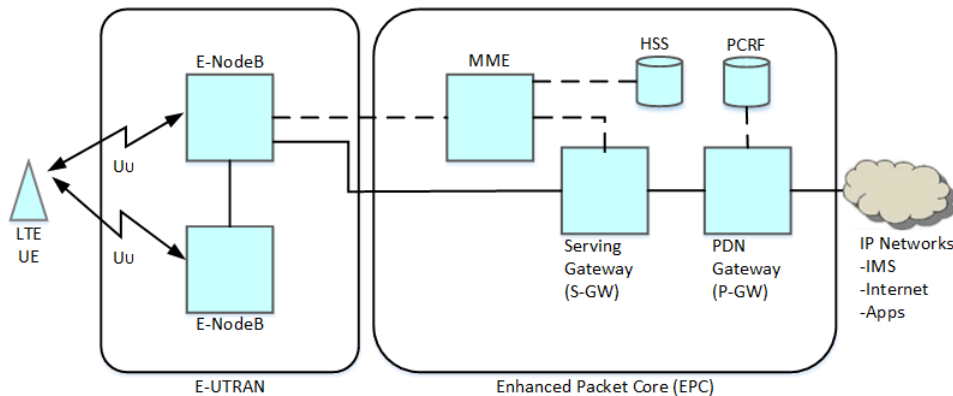

Fig. 2.1 LTE network architecture [DPSB08]

Evolve Packet Core

EPC (Evolved Packet Core) provides the user with IP connectivity to a PDN (Packet Data Network) for accessing the Internet [GZAM10a], as well as for running services such as VoLTE (Voice over IP). The bearer services are the physical communications between the UE and the base station (e-NodeB). An EPC bearer is typically associated with a quality of service (QoS). To quantitatively measure QoS, several related aspects of the network service are often considered, such as error rates, bit rate, throughput, transmission delay. Differing from the 2G/3G service, the EPC considers all the wireless communication as a specific bearer and separates the user data (also known as the **user plane**) and the signalling (also known as the **control plane**) to make the scaling independent [3GP11c]. Multiple bearers can be established for a user in order to provide different QoS streams or connectivity to different PDNs. For example, a user might be engaged in a voice (VoLTE) call while at the same time performing web browsing or FTP download. A VoIP bearer would provide the necessary QoS for the voice call, while a best-effort bearer would be suitable for the web browsing or FTP session.

The E-UTRAN Access Network

The E-UTRAN [3GP11b] handles the radio communications between the UE and the EPC and has just one component, the evolved base station, called eNodeB or e-NodeB. Each e-NodeB is a base station that exchanges the information with UEs. The wireless connection between the e-NodeB and the UE is called the downlink and uplink, while the downlink is used to transmit the information from the e-NodeB to the UE and the uplink is from UE to e-NodeB. In FDD-LTE system [DPSB08], the downlink and uplink use different bands

but in TDD-LTE network, the downlink and uplink share the same band. In the Evolved UMTS Terrestrial Radio Access Network (E-UTRAN), the UMTS is the radio network in the WCDMA system, and in LTE, it evolves to the Long Term Evolution (LTE), so we can update the WCDMA network to a 4G network without too much cost.

2.2.2 LTE Radio Protocol Architecture

As we described in the previous subsection, the protocol usually contains two parts in LTE radio protocols [YCL⁺12]:

- **Control Plane:** allows one device to control how works the other one.
- **User Plane:** sends just raw data from one device to another

At user plane side, the application creates data packets that are processed by protocols such as TCP, UDP and IP, while in the control plane, the Radio Resource Control (RRC) protocol [LL06] writes the signaling messages that are exchanged between the base station and the mobile. In both cases, the information is processed by the Packet Data Convergence Protocol (PDCP), the Radio Link Control (RLC) protocol and the Medium Access Control (MAC) protocol, before being passed to the physical layer for transmission.

The protocol architecture is shown in Fig. 2.2 and explain the two planes in detail in the next two subsections.

User Plane

As shown in Fig. 2.2, the user plane deals with the data flow at the UE side and it is composed of three components:

- **Packet Data Convergence Protocol (PDCP):** This layer processes Radio Resource Control (RRC) messages in the control plane and Internet Protocol (IP) packets in the user plane. Depending on the radio bearer, the main functions of the PDCP layer are header compression, security (integrity protection and ciphering), and support for reordering and retransmission during handover. For radio bearers which are configured to use the PDCP layer, there is one PDCP entity per radio bearer. A UE may experience many kinds of service, so it can build several PDCP with the e-NodeB.
- **Radio Link Control (RLC):** The main functions of the RLC layer are segmentation and reassembly of upper layer packets in order to adapt them to the size which can actually be transmitted over the radio interface. For radio bearers which need

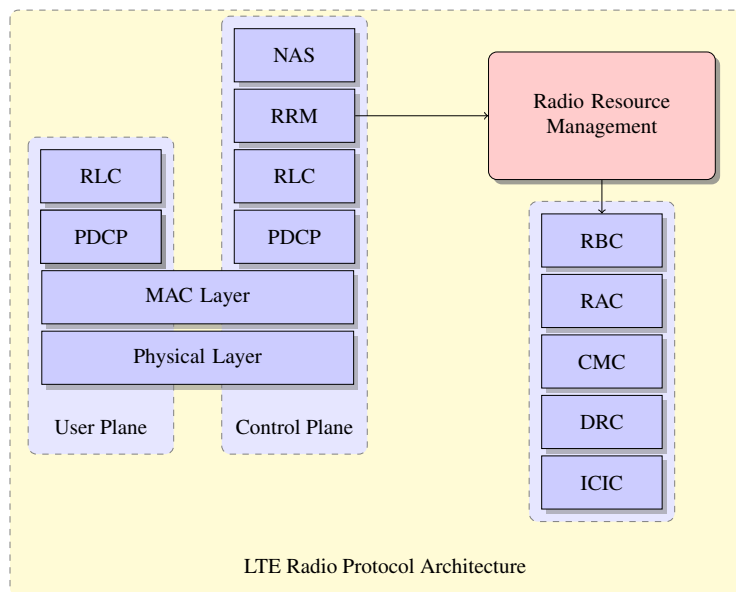

Fig. 2.2 LTE Radio Protocol Architecture

error-free transmission, the RLC layer also performs retransmission to recover from packet losses. Additionally, the RLC layer performs reordering to compensate for out-of-order reception due to Hybrid Automatic Repeat reQuest (HARQ) operation in the layer below. There is one RLC entity per radio bearer.

- **Media Access Control (MAC):** This layer performs the multiplexing of data for a variety of radio carriers. . Determining the amount of data that can be transmitted from each radio bearer layer, the size of the packet, RLC and instructing on the MAC layer to achieve negotiated Quality of Service (QoS) for each radio bearer.

The UE plane focus on the data transmission and it has no idea about how to transmit the data flow, and this is the objective of the control plane.

Control plane

Comparing to the user plane, control plane contains two additional components, Radio Resource Control (RRC) and Non-Access Stratum (NAS). The NAS control protocols handle Public Land Mobile Network1 (PLMN) selection, tracking area update, paging, authentication and EPS bearer establishment, modification and release [Eks09].

The control plane largely depends on the Radio Resource Control (RRC) state of the User Equipment (UE), which handles the control plane between the UE and the e-NodeBs.

With the help of NAS, the UEs exchange the state information and header files with the e-NodeBs, and with RRC protocol, it transmits the private messages with the E-UTRAN.

RRC contains two sub protocols, RRC_IDLE and RRC_CONNECTED. A UE in RRC_IDLE performs cell selection and reselection – in other words, it decides on which cell to camp.

In RRC_CONNECTED, the E-UTRAN allocates radio resources to the UE to facilitate the transfer of data via shared data channels. To support this operation, the UE monitors an associated control channels used to indicate the dynamic allocation of the shared transmission resources in time and frequency. The UE provides the network with reports of its buffer status and of the downlink channel quality, as well as neighbouring cell measurement information to enable E-UTRAN to select the most appropriate cell for the UE.

In this dissertation, we will study the RRC_CONNECTED protocol and study the resource radio management (RRM).

2.2.3 Radio Resource Management

When the RRC controls the radio resource, the strategy of the allocation belongs to the Radio Resource Management (RRM). To allocate the radio resource, the LTE standard designs a specific RR mechanism which are composed of two parts, the configuration and core data transmission. The core part transmits the private messages, but the configuration part guarantees the messages can be transmitted correctly.

- Resource management on configuration:
 1. Radio Bearer Control (RBC): The establishment, maintenance and release of Radio Bearers involve the configuration of radio resources associated with them.
 2. Radio Admission Control (RAC): The task of radio admission control (RAC) is to admit or reject the establishment requests for new radio bearers.
 3. Connection mobility control (CMC) is concerned with the management of radio resources in connection with idle or connected mode mobility. In idle mode, the cell reselection algorithms choose the best cell and/or determine when the UE should select a new cell. In connected mode, it decides the Handover based on UE and e-NodeB measurements. (Handover means refers to the process of transferring an ongoing call or data session from one e-NodeB to another because of the UEs' position movement)
- Resource allocation on core data transmission:

1. The task of dynamic resource allocation or packet scheduling is to allocate and de-allocate resources (including buffer and processing resources and resource blocks) to user and control plane. Dynamic resource allocation involves several sub-tasks, including the selection of radio bearers whose packets are to be scheduled and the managing the necessary resources (e.g. the power levels or the specific resource blocks used). Packet scheduling typically takes into account the QoS requirements associated with the radio bearers, the channel quality information for UEs, buffer status, interference situation, etc. Dynamic resource allocation may also take into account restrictions or preferences on some of the available resource blocks or resource block sets due to inter-cell interference coordination considerations. DRA is located in the e-NodeB.
2. Inter-cell Interference Coordination (ICIC): Inter-cell interference coordination [GJD⁺11] has the task to manage radio resources such that inter-cell interference is kept under control. ICIC mechanism both includes a frequency domain component and a time domain component. ICIC is inherently a multi-cell RRM function that needs to take into account information (e.g. the resource usage status and traffic load situation) from multiple cells. The preferred ICIC method may be different in the uplink and downlink. The frequency domain ICIC manages radio resource, notably the radio resource blocks.

The dynamic resource allocation and the interference management are two independent parts of the RRM, but we find these two processes have interaction. In this dissertation, we propose a cross-layer RB allocation algorithm cooperated with interference management to improve the system performance.

2.3 Radio Resource in LTE

OFDMA meets the LTE requirement for spectrum flexibility and enables cost-efficient solutions for very wide carriers with high peak rates. But the OFDMA in LTE downlink network is different from the standard OFDMA.

In general subcarrier, the radio spectrum is divided into narrow orthogonal subcarriers but in LTE downlink, the subcarriers make the Resource Block (RB) which is the basic resource unit used by UEs to transmit information with e-NodeBs.

To increase the channel efficiency, LTE uses Orthogonal Frequency Division Multiple Access (OFDMA) [NP00] for the downlink transmission.

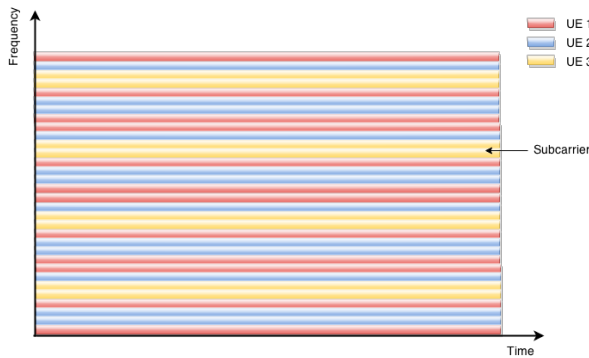

Fig. 2.3 Subcarrier in OFDMA

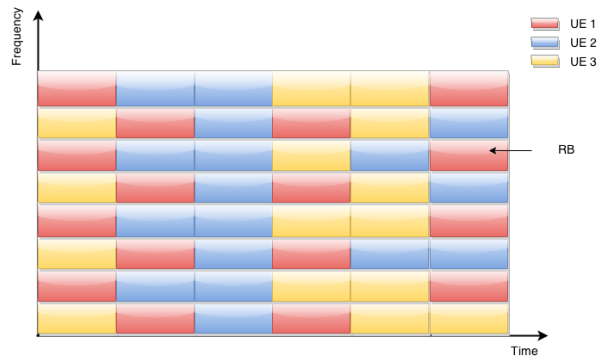

Fig. 2.4 RB in LTE Downlink system

The difference of the general OFDMA system and LTE downlink OFDMA network is the number of available orthogonal units as shown in Fig. 2.3 and 2.4.

- The general OFDMA radio resource is divided into many sub-carriers which can be allocated to UEs (one or many subcarriers to a same UE's communication). The allocation method is applied to optimize the objective at each time-slot.
- The LTE downlink OFDMA bandwidth is divided in the temporal space into Resource Blocks whose time length is equal to a half of the TTI (Time Transmission Interval). Because each RB is composed of 12 subcarriers, the number of RBs available during a TTI may be smaller than the number of UEs, even if it may happen that certain UEs do not have any RB allocated in a TTI. During a transmission time period (100–1000 ms), however, the number of RBs is great enough to allocate resource to all the UEs.

In contrast to the traditional OFDMA technique, the basic LTE downlink physical resource can be seen as a time-frequency grid, as illustrated in Figure 2.5:

A Resource Block (RB) contains 12 orthogonal subcarriers and the duration time is 0.5 ms.

We first describe the frame structure in the time domain, which is a common element shared by both downlink and uplink.

In LTE specifications, the size of elements in the time domain is expressed as a number of time units $T_s = 1/(15000 \times 2048) = 1/(15000 \times 2048)$ seconds. As the normal subcarrier spacing is defined to be $\Delta f = 15\text{KHz}$, T_s can be regarded as the sampling time of an FFT-based (Fast Fourier Transform) OFDM transmitter/receiver implementation with FFT size $N_{\text{FFT}} = 2048$.

Note that this is just for notation purpose, as different FFT sizes are supported depending on the transmission bandwidths. A set of parameters for typical transmission bandwidths

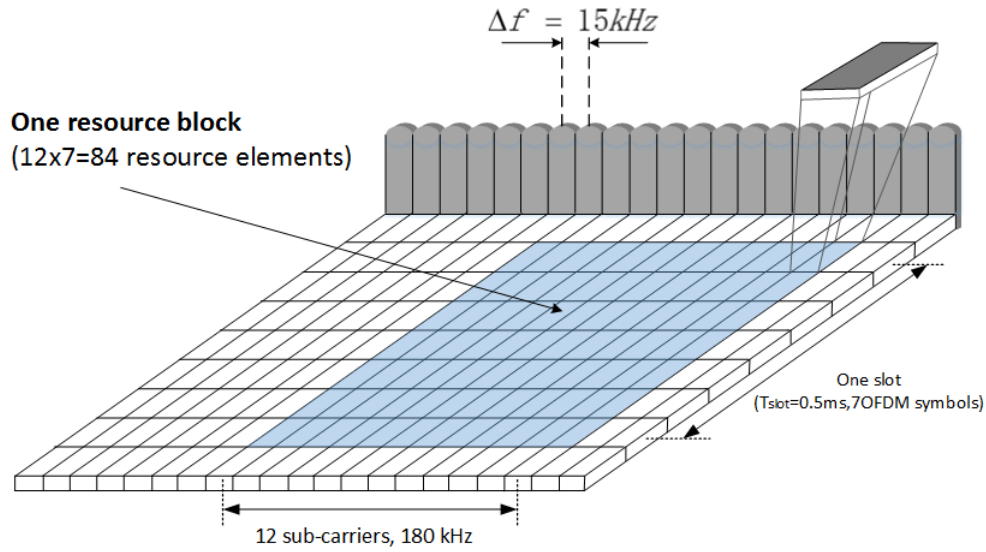

Fig. 2.5 The OFDMA Resource Block [3GP10]

for LTE in the downlink is shown in Table 2.1, where the subcarrier spacing is $\Delta f = 15kHz$. The FFT size increases with the transmission bandwidth, ranging from 128 to 2048.

Transmission bandwidth [MHz]	1.4	3	5	10	15	20
Occupied bandwidth [MHz]	1.08	2.7	4.5	9.0	13.5	18.0
Guardband [MHz]	0.32	0.3	0.5	1.0	1.5	2.0
Guardband, % of total	23	10	10	10	10	10
FFT size	128	256	512	1024	1536	2048
Number of occupied subcarriers	72	180	300	600	900	1200
Number of Resource Blocks	6	15	25	50	75	100
Number of CP samples (normal)	9×610	18×620	36×640	72×680	108×6120	144×6160
Number of CP samples (extended)	32	64	128	256	384	512

Table 2.1 Typical Parameters for Downlink OFDMA Transmission [SBL14]

In the time domain, the downlink and uplink multiple TTIs are organized into radio frames with duration $T_f = 307200 \times T_s = 10ms$. For flexibility, LTE supports both FDD and TDD modes [DPSB08]. Most of the design parameters are common to FDD and TDD in order to reduce the terminal complexity and maximize reuse between the designs of FDD and TDD systems. Accordingly, LTE supports two kinds of frame structures: frame structure type 1 for the FDD mode and frame structure type 2 for the TDD mode. In this thesis, we do not analyze the frame structure type 2 because we just consider the RB allocation in FDD mode.

For FDD, uplink and downlink transmissions are separated in the frequency domain. In half-duplex FDD operation, the UE cannot transmit and receive at the same time while

there are no such restrictions in full-duplex FDD. However, full-duplex FDD terminals need high quality and expensive RF duplex-filters to separate uplink and downlink channels, while half-duplex FDD allows hardware sharing between the uplink and downlink, which offers a cost saving at the expense of reducing data rates by half. Half-duplex FDD UEs are also considered a good solution if the duplex separation between the uplink and downlink transmissions is relatively small. In such cases, the half-duplex FDD is the preferable approach to mitigate the cross-interference between the transmit and receive chains [GZAM10b].

2.4 LTE for PMR

My PhD work has taken place in the context of the SOAPS project [oSp12]. This project targets the professional mobile radio (PMR) communication systems for the Public Safety services of France. Currently as purely voice-based and low data rate systems, they must now be adapted to the changing society and to the new demands from end-users. These new services require new high speed data transfer radio technology. From an economical point of view, it is interesting to leverage the technology evolution coming from commercial domain, so we choose the 3GPP LTE technique to build this network.

2.4.1 Introduction of Professional Mobile Radio (PMR)

PMR are field radio communications systems which use portable, mobile, base station, and dispatch console radios. When private- or professional-mobile-radio (PMR) first started the systems simply consisted of a single base station with a number of mobiles that could communicate with this single base station. These systems are still in widespread use today with police or army for safety reasons.

Because the antenna may be mounted on a high tower, coverage may extend up to distances of fifty kilometres. This is helpful especially when there is no signal in a mobile phone.

Licenses are allocated for operation on a particular channel or channels. The user can then have use of these channels to contact the mobile stations in their fleet. The base station may be run by the user themselves or it may be run by an operating company who will hire out channels to individual users. In this way a single base station with a number of different channels can be run by one operator for a number of different users and this makes efficient use of the base station equipment. The base station site can also be located at a position that will give optimum radio coverage, and private lines can be provided to

connect the users control office to the transmitter site. As there is no incremental cost for the transmissions that are made, individual calls are not charged, but instead there is a rental for overall use of the system. For those users with their own licences they naturally have to pay for the licence and the cost of purchase and maintenance of that equipment.

2.4.2 3GPP LTE in PMR

To apply the LTE technique in PMR network, some modifications are to satisfy the specific demands of features:

- Point to multi-point communications: The broadcast channel become more important than the public service because more messages are transformed to a group not to a single UE in the PMR network. When LTE technique is applied, the specific UE can be used as the e-NodeB.
- Good frequency: Because the Public Safety Service can use the band of 450 MHz, the propagation loss decreases and the coverage area is larger than the commercial version LTE.
- Narrow Band: Because the band around 450 MHz is limited, the SOAPS needs to build a network with narrow band less than 5 MHz, so it needs a good resource allocation scheme to satisfy the data demands of all the UEs. **We use this value in our dissertation.**
- Closed User Group: Only employees of certain organizations can use this network, the safety level of the network is more strictly than the LTE commercial operators.

2.5 Wireless Channel

In this section, we will introduce the channel model we use in our Radio Resource Allocation strategies.

2.5.1 Fading Channel

The transmitted electromagnetic wave can propagate directly from the transmit to the receive antenna, however it can also be reflected by objects like buildings, trucks, etc. In addition, it can be scattered at trees, mountains, etc. This has the effect, that at the

receive antenna we have a superposition of several delayed and attenuated copies of the transmitted signal. The consequence of this is fading and inter-symbol interference (ISI).

Fading means that the superposition of the waves add to a very small value which implies that almost no signal power can be detected. ISI is due to the fact that a discrete symbol has a finite duration T and if the propagation delay due to a detour of the signal is larger than T - even if there is no fading - the waves which are added during a time interval T represent different symbols. The corresponding channel model is called the multi-path Fading Channel which is generated by the different transmitting and receiving antennas. We use the matrix H to describe the whole channel system. In the Fig. 2.6, the signals transmit through the certain channel such as h_{11}, \dots, h_{22} which are the elements of the matrix.

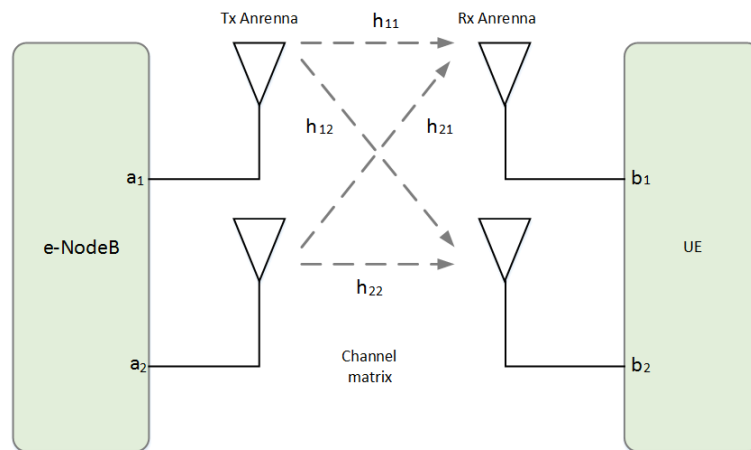

Fig. 2.6 MIMO Channel Models [SPSH04]

The radio channel is composed of two parts:

1. the fading part, it means the signal's phase and amplitude vary when it pass through the channel, we denote it as g_i , it usually satisfies the normal distribution $\mathbb{N}(0, 1)$;
2. the path-loss, it means the strength of the signal decreases with the distance, it can be estimated by some physical models, and it can be express by L_i , so we have $h_i = g_i/L_i$.

We will explain the path-loss models in the next subsection.

2.5.2 Path-loss

When the wireless signal transmits in the space, the electromagnetic wave's power density reduces with distance. The path-loss is mainly depending on the environment and distance, and it leads to bad channel quality when a UE is far from the e-NodeB.

A good feature of the path-loss is that it does not vary with time, so we can consider it as a constant part.

The simplest path-loss model is the free space line of sight channel with no objects between the receiver and the transmitter. This free space path-loss channel has very limited applicability in the propagation environment as it requires a purely unobstructed Line of Sight (LOS) path without any other component. Thus, more sophisticated path-loss models are required that take into account several other parameters such as antenna heights, propagation environment type, building heights terrain type and so on. When the UEs are in the free space or in the building, the electromagnetic environments are totally different.

Actual environments are too complex to model accurately. In practice, most simulation studies use empirical models that have been developed based on measurements taken in various real environments. In this section we describe a number of commonly used empirical models.

Rural area in a macro cell

In 1968, Okumura conducted extensive measurements of base station to mobile signal attenuation throughout Tokyo and developed a set of curves giving median attenuation relative to free space path-loss. To use this model one needs to use the empirical plots given in his paper. This is not very convenient to use. So in 1980, Hata [[Hat80](#)] developed closed-form expressions for Okumura's data. According to Hata model the path-loss in an urban area at a distance d is:

$$L(d) = 69.55 + 26.16 \log_{10} f - 13.82 \log_{10} h_t + (44.9 - 6.55 \log_{10} h_t) \log_{10} d - 4.78 (\log_{10} f)^2 + 18.33 \log_{10}(f) - 40.94 \quad [\text{in dB}] \quad (2.1)$$

where d is the e-NodeB UE separation in kilometres, f is the carrier frequency in MHz, h_t is the base station antenna height above ground in metres.

Considering a carrier frequency of 450 MHz and 2 GHz and a e-NodeB antenna height of 45 meters above ground the propagation model is given by the following formula [3GP09]

$$\begin{aligned} L(d) &= 85.6 + 34.1 \log_{10} d \quad [\text{dB}] \quad \text{when } f = 450\text{MHz} \\ L(d) &= 100.5 + 34.1 \log_{10} d \quad [\text{dB}] \quad \text{when } f = 2\text{GHz} \end{aligned} \quad (2.2)$$

Macro cell propagation model for urban area is applicable for scenarios in urban and suburban areas outside the high rise core where the buildings are of nearly uniform height

Urban and suburban in a macro cell

Macro cell propagation model for urban area is applicable for scenarios in urban and suburban areas outside the high rise core where the buildings are of nearly uniform height:

$$L = 40 + (1 - 4 \cdot 10^{-3} h_t) \log_{10} d - 18 \log_{10} h_t + 21 \cdot \log_{10} f + 80 \text{ dB} \quad (2.3)$$

Considering a carrier frequency of 450MHz and 2GHz and a e-NodeB antenna height of 15 meters above ground the propagation model is given by the following formula:

$$\begin{aligned} L(d) &= 114.5 + 37.6 \log_{10} d \quad [\text{dB}] \quad \text{when } f = 450\text{MHz} \\ L(d) &= 128.1 + 37.6 \log_{10} d \quad [\text{dB}] \quad \text{when } f = 2\text{GHz} \end{aligned} \quad (2.4)$$

Micro Cell Model

Micro Cell model is to be used for spectrum efficiency evaluations in urban environments modelled through a Manhattan-like structure, in order to properly evaluate the performance in microcell situations that will be common in European cities at the time of UMTS deployment [FBR⁺94].

The proposed model is a recursive model that calculates the path-loss as a sum of LOS and NLOS segments. The shortest path along streets between the e-NodeB and the UE has to be found within the Manhattan environment [HXB99].

The path-loss in dB is given by the well-known formula [3GP09]

$$L = 24 + 45 \log_{10}(d + 20). \quad (2.5)$$

In contrast to the macro cell model, the frequency is not a main factor of the path-loss, the signals on the different frequency experience the same path-loss model.

2.5.3 Signal-to-Interference-plus-Noise-Ratio

After the study of the channel, we need to get the SINR before the estimation of the RB capacity. As the definition, the SINR can be expressed as:

$$\Gamma = \frac{P_{Recv}}{I + \sigma_0}, \quad (2.6)$$

where P_{Recv} represents the received signal power at the UE side, I presents the received interference power, which is from the same frequency signals from the neighbouring cells, and σ_0 presents the white noise.

The received signal experiences the fading channel and attenuates because of the path-loss. We present the transmitting signal by x , and the received signal is Hx , where H presents the corresponding fading channel, where the channel H contains the fading part G and the path-loss L ($H = G/\sqrt{L}$). We decode this signal with a matched filter at the UE side, so the received signal power is $\|H\|^2 x^2$. Because the transmitting power $P = x^2$, we have $P_{Recv} = P\|H\|^2$. The received signal power is expressed by:

$$P_{Recv} = P\|H\|^2, \quad (2.7)$$

The interference is generated by the the signal from the neighbouring cells on the same frequency. Denote the interference channel as H_k , their path-loss as L_j , because the UE uses the matched filter to maximize the received power, the received interference is in the form of $P\|H^*H_k\|$, where $*$ signifies the transposition and conjugation of a matrix. The interference comes from all the neighbouring cells, so it equals:

$$I = \sum_j P\|H^*H_k\|, \quad (2.8)$$

Putting Eq. (2.7) (2.8) into (2.6), we can get a completed SINR formula:

$$\Gamma = \frac{P\|H\|^2}{\sum_j P\|H^*H_k\| + \sigma_0}. \quad (2.9)$$

2.6 Multi-cell System

2.6.1 System Model

We consider a multi-cell network made up of a central cell and $J - 1$ neighbouring cells with the same assigned frequency. Fig. 2.7 illustrates a system model in this work. There are K

UEs in each cell which are randomly placed within their corresponding cells.. Let j denote any of these J cells, and i_j denotes a UE in the j th cell. The working frequency contains M RBs. The e-NodeB in each cell is located at the centre and contains N_T transmitting antennas, each UE has N_R receiving antennas.

In a multi-cell system, there exists two kinds of interference: the inner-cell interference and inter-cell interference.

The inner-cell interference comes from the UEs in the same cellular, the user may not distinguish the adjacent band signals because all the signals are not constant during their propagation, their frequency may vary by the Doppler effect and their arriving order may disorganize by the multiple signal path.

The inter-cell interference comes from the communication in the neighbouring cells, because the bandwidth in the wireless network is limited, and the neighbouring cells signal spreads to the receiver through the free space.

As all the sub-carriers are orthogonal, we can thus suppose the inner-cell interference is zero. During the reception of the desired downlink signal from the self-eNodeB, UEs experience inter-cell interference from their neighboring cells. Here, only neighboring cells in the first-tier are counted as interfering sources.

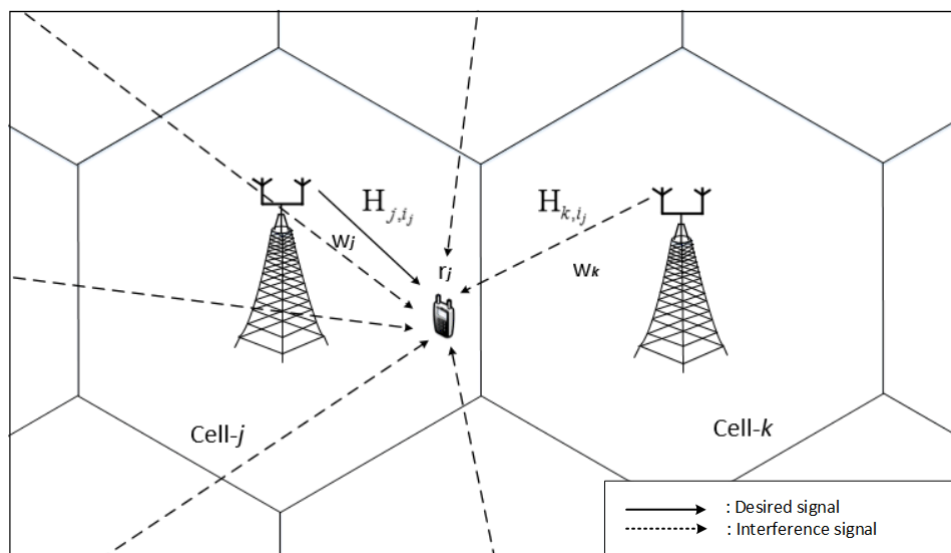

Fig. 2.7 Cellular model for multi-cell environments [SLA11]

SINR is influenced by the beamforming vectors on the same frequency in neighbouring cells, and expressed as in [SLA11]:

$$\Gamma_{i_j}^m = \frac{P \|H_{j,i_j} \omega_j^m\|^2}{\frac{P}{\|H_{j,i_j} \omega_j^m\|^2} \sum_{k \in \Phi(j)} |\omega_j^{m*} H_{j,i_j}^* H_{k,i_j} \omega_k^m| + \sigma_0}, \quad (2.10)$$

where $H_{k,i_j} \in \mathbb{C}^{N_R \times N_T}$ denotes the communication channel matrix between the e-NodeB in the k th cell and the UE i_j , $\omega_j^m \in \mathbb{C}^{N_T}$ denotes a transmit beamforming vector of the e-NodeB in the j th cell on the frequency of RB m , $\Phi(j)$ indicates a group of neighbouring cells around the j th cell, and σ_{i_j} represents a white Gaussian noise vector at UE i_j with the power of each entry σ_0 . The average signal power is noted as P . We assume that each UE perfectly knows the CSI value of its communication channel H_{j,i_j} and interference channel H_{k,i_j} , $k \in \Phi(j)$ based on the feedback channel.

According to the Formula. (2.10), we can conclude that the channel is mainly based on the communication channel and interference channel.

2.6.2 Coordinated Multipoint

The trend of increasing demand for high quality of service at the UE, coupled with the shortage of wireless spectrum, requires more advanced wireless communication techniques to mitigate inter-cell interference and increase the cell edge throughput. Coordinated Multipoint (CoMP) transmission and reception techniques utilize multiple transmit and receive antennas from multiple antenna site locations, which may or may not belong to the same physical cell, to enhance the received signal quality as well as decrease the received spatial interference [LSC⁺12].

These types of CoMP are generally classified by three types [LSC⁺12]:

- **Coordinated Scheduling and Coordinated Beamforming (CB/CS)**

CS (Coordinated Scheduling) divides the entire network in clusters and apply centralized scheduling within each cluster in order to determine which eNodeB/TP in the cluster should transmit in each time slot and to which UE. CB (Coordinated Beamforming) is to choose the beamforming vector in a multi-cell system with the shared CSI (channel state information), this part of work is presented in Section 2.7.

- **Joint Transmission (JT)**

Joint transmission transmits the data to a UE simultaneously from multiple cooperating cells. With the cost of highly synchronization between the eNodeBs and information multicast to the cooperating cells. As an advantage, it allows to improve

the channel cell edge performance by converting as interference signal into a desired signal.

- **Transmission Point Selection (TPS)**

The UE reports the SINR of all the neighbouring cells and transmits the information with its preferred eNodeB/TP. The transmitted eNodeB can dynamically change from a TTI (Time Transmit Interval), which is the minimum signal transmit time unit.

We focus on the CB/CS type of CoMP in this dissertation. In LTE-Advanced, approaches of jointly combining CS and CB have been proposed to increase the system throughput with the cost of higher complexity and requirements in terms of CSI feedback and CSI sharing [YKS13, LSC⁺12].

In their CB/CS schemes, the existed RB allocation algorithms (presented in Section 3.2) can be modified to a combing CS/CB scheme. The coordinated Beamforming is applied in the next step after the coordinated scheduling [YKS13] and we will introduce some coordinated Beamforming schemes in the next section.

2.7 Beamforming Techniques

Beamforming is a signal processing technique used in sensor arrays for directional signal transmission or reception. This is achieved by combining elements in a phased array in such a way that signals at particular angles experience constructive interference while others experience destructive interference. Beamforming can be used at both the transmitting and receiving ends in order to achieve spatial selectivity. The improvement compared with omnidirectional reception/transmission is known as the receive/transmit gain (or loss) [ZCA⁺09].

In the multi-cell network, the choice of beamforming vectors are based on two factors: the received power and the neighbouring cells' interference [BH07]. Some beamforming schemes are introduced in [SLA11] to find a trade-off between increasing the received signal power and reducing interference.

After the Resource Block is chosen, the Beamforming technique is applied to maximize the total system throughput.

The Beamforming techniques introduced in Subsection 2.7.2, 2.7.3 and 2.7.4 all need the CSI information from the neighbouring cells so they are defined as Coordinated Beamforming.

2.7.1 Selfish Beamforming

The simplest solution is an egoistic strategy [LJ08]. Each BS greedily chooses the transmit beamforming vector which maximizes the desired signal power without regards to the generated interference power to neighboring cells. The transmit Beamforming vector is chosen as:

$$\omega_j^{m*} = \arg \max_{\omega_j^m} \|H_{j,i_j} \omega_j^m\|^2. \quad (2.11)$$

which is referred to as selfish Beamforming.

2.7.2 Greedy Beamforming

We first consider an ideal case where all CSI of every e-NodeBs in the network is shared [YG06]. A centralized genie can find the optimal configuration for transmit beamforming vectors $\{\omega_1^{m*}, \omega_2^{m*}, \dots, \omega_j^{m*}\}$ by solving the following global optimization problem:

$$\{\omega_1^{m*}, \omega_2^{m*}, \dots, \omega_j^{m*}\} = \arg \max_{\omega_j^m} R(\{\omega_1^m, \omega_2^m, \dots, \omega_j^m\}). \quad (2.12)$$

Unfortunately, the function given by Eq. (2.12) is a non-convex combinatorial optimization problem, which is in general computationally intractable. The exact solution can be found with an exhaustive search over all possible configurations of $\{\omega_1^m, \omega_2^m, \dots, \omega_j^m\}$, the computational complexity of which grows exponentially with the number of e-NodeBs in the network. Nonetheless, this genie-aided beamforming achieves the optimal performance of cooperative MIMO cellular networks providing an upper bound.

2.7.3 Minimum Generated Interference Beamforming

An altruistic approach is to apply zero-forcing beamforming (ZFBF) developed for multiuser MIMO [LHS03] to cooperative MIMO cellular networks [AYL07]. The rationale behind this is to increase cell throughput by selecting transmit beamforming vectors which minimize the total generated interference power to neighboring cells. Specifically, transmit beamforming vectors are computed as:

$$\omega_j^{m*} = \arg \min_{\omega_j^m} \sum_{k \in \Phi(j)} \|H_{k,i_j} \omega_j^m\|^2. \quad (2.13)$$

which is referred to as minimum generated interference (MIN-GI) beamforming strategy.

2.7.4 Maximum Signal-to-Leakage-Interference-plus-Noise-Ratio Beamforming

In the MIN-GI beamforming, only the generated interference to neighboring cells is considered, which is suboptimal since desired signal power is ignored [NEHA08]. Thus, a metric called signal-to-leakage-interference-plus-noise-ratio (SLINR) is proposed in [LJSL09], [ZHG09] and [STS07] to consider both desired signal and generated interference. The transmit Beamforming vector based on the SINR metric is chosen as [SLA11]:

$$\omega_j^{m*} = \arg \max_{\omega_j^m} \frac{P \|H_{j,i_j} \omega_j^m\|^2}{P \sum_{k \in \Phi(j)} \|H_{k,i_j} \omega_j^m\|^2 + \sigma_0}. \quad (2.14)$$

which is referred to as maximum SLINR (MAX-SLINR) beamforming. It has been shown that this strategy provides a balanced solution between increasing desired signal power and decreasing generated interference power to neighboring cells.

These Beamforming techniques are applied after the RB are allocated, so the channel H is constant. These algorithms do not consider that the channel matrix may change during the application of Beamforming, a more suitable UE matrix may increase the system total throughput. In the next chapters, we will increase the freedom of Beamforming and combine the RB assignment process with it.

2.8 Conclusion

This chapter introduced the main technical issues in RB allocation for LTE systems. Firstly, it introduces basic concepts of wireless communication and the architecture of LTE networks. Then we focus on a specific scenario for PMR network.

After the general presentation of the wireless systems, we continue to analyze the radio channel and the channel improvement techniques – Beamforming.

In the next chapter, we will introduce the well-known allocation algorithms and mathematical elements of game theory.

Chapter 3

Resource Allocation Algorithms

As we described in Chapter 1, the frequency band is limited in the cellular wireless communication network. Even the peak data-rate reaches 300 Mbps in the most recent category of LTE network, the transmission quality depends on spatial factor due to fading attenuation. Thus the cell edge UEs have difficulties to get enough resource for the communication.

To illustrate this fact we give the following example. We consider the worst channel condition in which the cell UEs may obtain 5% of the peak data rate, equal to 15 Mbps. If there are 15 active UEs in this cell, which is actually probable in the urbane or suburban areas, the average data rate, which may be attributed to a UE is less than 1 Mbps. This data rate is not sufficient to satisfy the UE's demand.

The communication channels are dynamic and vary randomly, a bad channel to a certain UE may be good for another UE. If the radio resource can be allocated to a UE when it experiences a good channel quality, the radio resource is utilized more effectively and more data can be transmitted.

The data demand of a UE is bounded, according to the economic theory which can also be applied to cellular networks, very high data rate UEs and low data rate UEs make it difficult to design a efficient allocation scheduler.

For the three reasons above, a good resource allocation scheme is necessary to balance the resource allocation among the UEs in order to improve the network performance.

3.1 Resource Allocation Schemes Classification

The goal of achieving a good network performance can be reached by an appropriate design of the resource allocation scheme.

The performance is described numerous quantifiable measures, such as total and average throughput, delay, operator's data service revenue in commercial networks, etc.

We classify the performance parameters into three categories. We enumerate them below, the number of the sections in which we discuss it in more detail.

1. **throughput and fairness balancing** (Section 3.2)

The explicit objective of resource allocation is to maximize the throughput of the network. This is not necessarily a fair scheme because the bad condition UEs may not get enough radio resource to complete the basic communication. The cellular network has to meet the basic demands of the communication, and then develop allocation schemes to find a trade off between the fairness and the optimal individual data rate. This aspect is crucial in public security cellular networks.

2. **UE state optimization** (Section 3.3)

According to another criterion, meeting the UEs' demand, as customers, is the main objective of the communication system. The data transmission demand is presented by the UE's state, such as the packet delay, the length of the buffer, etc. The cellular network has to meet the basic demands of the communication, and they provide allocation schemes which optimize the UEs' state. In the context of the public security networks, this means that the commanding officers can always have an access to the network.

3. **economic utility maximization** (Section 3.4)

In the review of economical theory, the telecommunication operators provide the mobile services for the profit. Because of the diminishing marginal utility, the revenue from a UE is not linear with its data-rate and maximization of the money paid by the consumers is not equivalent to the maximization of the sum data rate. We use the utility function to qualify the economical benefits, and the performance objectives of this evaluation are to maximize the relevant utility function. Despite the fact that we address in this thesis the public security network, this approach allows us to consider the network allocation from the global point of view.

Corresponding to these three aspects of the performance objectives, the former mobile network designers have created three kinds of allocation algorithms.

In Section 3.2, we introduce the allocation algorithms to balance the UE's throughput and fairness, these algorithms are classical and easy to apply on the system.

In Section 3.3, we present the algorithms which are designed to optimize the UE's interest. The algorithms take the UE's delay or buffer's length into account, and deal them with the channel condition in order to increase the spectrum efficiency.

The last section of this chapter introduces the economical resource allocation algorithms which have been proposed to maximize the economical benefits under different conditions. The scientists try to solve this kind of optimal problem by Game Theory whose recent work on resource allocation is introduced here.

3.2 Throughput and Fairness Balancing

The performance of the first category of the allocation algorithms aim at maximizing of the global network throughput. The maximum throughput (MT) [Tsy02] is the most representative algorithm in this group. Other algorithms have been designed from MT taking into account the fairness factor.

3.2.1 Maximum Throughput Algorithm

The maximum throughput (MT) algorithm always selects the UE with the highest reported instantaneous downlink SINR value. This algorithm efficiently utilizes system resource as UE's packets are transmitted on a radio resource with a good channel condition. On the other hand, a UE with low instantaneous downlink SINR value will never get access to the available radio resource using the MT principle. This UE is deprived from using the radio resource unless the UE's channel condition improves. This situation results in low fairness performance of the MT algorithm. This algorithm performs the maximization:

$$i_j^* = \arg \max_{i_j} \Gamma_{i_j}. \quad (3.1)$$

The MT algorithm maximizes the throughput but it does not take the fairness into account. The following algorithms include the fairness factor in their operation mode.

3.2.2 Round Robin Algorithm

Given that fairness has not been an issue in the MT algorithm, the Round-Robin algorithm [Hah91] was developed to address this problem. The Round-Robin copes with the fairness by allocating an equal amount of packets transmission RBs to each UE. If a system have K UEs, the probability of a UE having allocated an RB is $\frac{1}{K}$. However, throughput performance degrades significantly as the algorithm does not rely on the current channel quality when determining the number of bits to be transmitted. The drawback of the Round-Robin is that the efficiency is lower than the other algorithms.

We propose a best channel algorithm which offers the UE the equal probability to get the radio resource in Chapter 5.3, but the algorithm we designed leads to higher throughput for all the UEs.

3.2.3 Max-min Algorithm

Instead of offering the same opportunity to get the radio resource, the max-min algorithm [RC00] guarantees the same throughput for each UE.

The scheduler detects all the UEs' throughput and allocates the RB to the UE whose data-rate is the minimum. The policy can be expressed as: the RB will be allocated to the UE i_j when

$$i_j^* = \arg \min_{i_j} r^{i_j}. \quad (3.2)$$

There are two kinds of fairness: equality of opportunity and equality of outcome. Rond-Robin leads to first equality and max-min stands for the second.

Moreover, since the max-min approach deals with the worst-case scenario, it penalizes UEs with better channels and thus reduces the overall system's efficiency. In addition, most of the existing solutions have a high computation complexity, which prohibits their practical implementations.

The fairness algorithms dismiss the channel efficiency because the scheduler does not allocate the RB to the best channel UE and other algorithms have been proposed to fix this problem.

3.2.4 Proportional Fair Algorithm

To provide a balance between throughput and fairness, the proportional fair (PF) algorithm was proposed to make up the deficiency concerning the fairness of the first category of algorithms and the throughput of the second one. PF was originally developed to support the NRT (Non Real Time) service in Code Division Multiple Access High Data Rate (CDMA-HDR) system, and can also be applied in the LTE downlink system. Assuming $C_{i_j}^m$ as the RB m 's capacity of UE i_j , $\overline{r^{i_j}}$ is the average data rate of this UE which is counted by the e-NodeB, and the PF algorithm selects a UE with the highest metric defined as follows [RBSP09]:

$$i_j^* = \arg \max_{i_j} \frac{C_{i_j}^m}{r^{i_j}}. \quad (3.3)$$

The PF scheduler is effective in reducing variations in UE bit rates with little average bit rate degradation relative to the MT throughput as long as UEs average SINRs are fairly uniform.

3.2.5 Coordinated Proportional Fair Algorithm

The PF algorithm can be modified to a coordinated version, with the instantaneously shared channel information, the PF algorithms can cooperate with Beamforming and/or power allocation to improve the system performance.

In [LSC⁺12], the authors propose a coordinated joint scheduling with coordinated Beamforming scheme. The scheme contains a repeated process:

- **Step 1:** According to the PF algorithm, choose the UE under a given Beamforming vector who can maximize

$$i_j^* = \arg \max_{i_j} \frac{C_{i_j}^m}{r_{i_j}^{i_j}} \quad (3.4)$$

where $C_{i_j}^m$ is a function of the system Beamforming vector given by Eq. (2.10):

$$C_{i_j}^m = WT \log(1 + \text{SINR}_{i_j}) = WT \log \left(\frac{P \|H_{j,i_j} \omega_j^m\|^2}{\frac{p}{\|H_{j,i_j} \omega_j^m\|^2} \sum_{k \in \Phi(j)} |\omega_j^{m*} H_{j,i_j}^* H_{k,i_j} \omega_k^m| + \sigma_0} \right), \quad (3.5)$$

in this equation, W and T represent respectively the bandwidth and time length of an RB.

- **Step 2:** Apply the multi-cell version Zero-Forcing Beamforming technique introduced in Subsection 2.7.3 to choose the Beamforming vector.
- **Step 3:** Repeat Step 1 and 2 until the total system throughput converges.

In the author's opinion, the scheduling in Step 1 can be replaced by any other effective resource allocation algorithms (such as MT algorithm) and they can create a new CB/CS allocation scheme.

3.2.6 Conclusion

The classical algorithms are simple as they just compare the RB capacity. They mainly differ in their ability to provide a given fairness. We compare these algorithms in Table 3.1 in terms of decision formula, throughput, fairness. The MT algorithm, the base of these

Algorithm	Formula	Throughput Factor	Fairness Factor
MT	$\max \Gamma_{i_j}$	Γ_{i_j}	0
Round-Robin	$\frac{1}{K}$	0	$\frac{1}{K}$
Max-min	$\min r^{i_j}$	Γ_{i_j}	r^{i_j}
PF	$\max \frac{C_{i_j}^m}{r^{i_j}}$	$C_{i_j}^m$	$\overline{r^{i_j}}$

Table 3.1 Throughput and fairness trade-off

algorithms, allocates a RB to the UEs who has the highest capacity on this RB, this scheduler can maximize the channel efficiency. The cell center UEs, however, may have higher SINR which is equivalent to the higher capacity of RBs. In contrast, the cell edge UEs do not have good channel capacity.

The fairness algorithms are designed to increase the throughput of UE with bad channel conditions as they choose a fairness factor to increase the low SINR UE's assigned RBs.

All these algorithms shown in Table 3.1 can also be modified to a coordinated version with the same method introduced in Subsection 3.2.5.

3.3 UE State Optimal Algorithm

Classical approaches based on MT, Round Robin, max-min, PF are not strictly applicable to handle real-time multimedia services. In fact, it is difficult to demonstrate their ability to satisfy strong requirements of UEs' state on Packet Loss Ratio (PLR), delay and waiting buffer's length in a general network setting. The buffer stores the data which the e-NodeB has not sent to the UE yet.

For this reason, several recent contributions propose channel-aware schemes that privilege flows having head-of-line packets approaching a target deadline [AKR⁺04], [AKR⁺00], [SS02] and [SBdV11]. They mainly differ from the weighting functions adopted to optimize fairness in bandwidth allocation and timeliness in packet delivery. In general, to meet QoS (Quality of Service) constraints, it is not sufficient to provide guarantees on the average packet delay, but it is necessary to enforce guarantees on the upper bound of packet delays.

3.3.1 The Maximum Largest Weighted Delay First (M-LWDF)

The maximum-largest weighted delay first (M-LWDF) method [AKR⁺04] is an algorithm designed to support multiple real time data UEs in CDMA-HDR system but can also be

applied to the OFDMA system. A UE obtaining an RB is selected based on the following equation:

$$i_j^* = \arg \max_{i_j} \gamma_{i_j} W_{i_j}(t) \frac{C_{i_j}^m}{r_{i_j}^m} \quad (3.6)$$

where $W_{i_j}(t)$ is the head of line (HOL) packet delay (time difference between the current time and the arrival time of a packet) of UE i_j at time t and γ_{i_j} s are arbitrary positive constants, as in Eq. (3.3), $C_{i_j}^m$ signifies the capacity of RB m for UE i_j and $\bar{r}_{i_j}^m$ is the average data rate of this UE. M-LWDF algorithm achieves a relatively low packet loss ratio (PLR) with a good throughput and fairness performance since it incorporates HOL packet delay together with PF properties (e.g. the ratio of achievable data rate to the average data rate) when determining UEs' priority.

The key feature of this algorithm is that a scheduling decision depends on both current channel conditions and the states of the queues. The M-LWDF scheme is very easy to implement. The scheduler only needs to time-stamp arriving data packets of all UEs to keep track of the current queue length. This simple algorithm is throughput optimal: it is able to handle all the offered traffic, unless it is not feasible at all. In addition, a choice of parameters γ_{i_j} s allows one to control packet delay distributions for different UEs. Increasing the parameter γ_{i_j} s for UE i_j , while keeping γ_{i_j} s of other UEs unchanged, reduces packet delays for this flow at the expense of a delay increase for other flows [AKR⁺04].

This algorithm maximizes the number of UEs that can be supported with the desired QoS. It provides QoS differentiation between different UEs and guarantees minimum throughput.

3.3.2 Exp-Rule

Despite the fact that M-LWDF is firstly proved to be a throughput optimal algorithm, it does not consider the buffers in the UEs' flow. The authors of [SS02] proposed an algorithm to maximize the throughput when the UE's buffer is variable. Such an approach differs from the previous algorithm, because there is an exception that when a UE's allocated RB capacity is greater than the amount of data waiting in the buffer, a part of its bit transmission redundancy is wasted. We rewrite the objective function as

$$\min \sum_{j=1}^J \sum_{i_j=1}^{i_j=I} [Q_{i_j} - \sum_{m=1}^{m=M} C_{i_j}^m \mathbb{1}_{i_j}^m]^+, \quad (3.7)$$

where

$$[x]^+ = \begin{cases} x, & \text{if } x > 0, \\ 0, & \text{otherwise.} \end{cases}$$

$$\mathbb{1}_{i_j}^m = \begin{cases} 1, & \text{if RB } m \text{ is allocated to UE } i_j, \\ 0, & \text{otherwise.} \end{cases}$$

and Q_{i_j} represents the waiting data of UE i_j in the eNodeB.

In [SS02], we find a prove that the Exp Rule can offer an optimal solution to Eq. (3.7). The authors gave the solution considering different priorities of UEs in the equation:

$$i_j^* = \arg \max_{i_j} \frac{1}{\bar{r}_{i_j}} \exp\left(\frac{a_{i_j} Q_{i_j}}{1 + \sqrt{a_j Q_j}}\right) C_{i_j}^m, \quad (3.8)$$

where

$$\overline{a_j Q_j} = \frac{1}{K} \sum_{i_j=1}^{i_j=I} a_{i_j} Q_{i_j},$$

in which \bar{r}_{i_j} denotes UE i_j 's average data rate, a_{i_j} is a fixed positive constant, called UE i_j 's workload contribution, which guarantees the leader of a PMR network can have better quality of service. In our case, we think it as 1 because all the UEs have the same priority. $\overline{a_j Q_j}$ thus denotes the average workload of cell j 's UEs weighted priority.

3.3.3 Log-Rule

Based on the simulation results provided in [RBSP09], we observe that when UEs see heterogenous channels, policies such as Exp Rule that aims at minimizing the exponential decay rate of delay distribution tail of the worst UE may excessively compromise the average delay, in some cases penalizing the tail distributions of many of the UEs. In other words, the Exp Rule algorithm does not perform well when some UEs (not necessarily numerous) significantly exceed the data rate of other UEs.

The authors of [SBdV11] proposed a multi-user opportunistic packet schedulers for UEs sharing a time-varying wireless channel from performance and robustness points of view. This Log Rule can achieve better mean delays (overall and on a per UE basis) and comparable or better distribution tails for large scale UEs' case. The objective of the

minimization of average delay is expressed as:

$$\min \sum_{j=1}^J \sum_{i_j=1}^{i_j=I} W_{i_j}. \quad (3.9)$$

where W_{i_j} denotes the waiting time of the head-of-line packet in UE i_j 's buffer at the e-NodeB.

A UE is scheduled based on the following priority metric:

$$\max_{i_j} \frac{1}{r_{i_j}} \log(1 + a_{i_j} W_{i_j}) C_{i_j}^m \quad (3.10)$$

The a_{i_j} denotes the priority of a UE, the leader of a group has higher a_{i_j} which leads to more assigned RBs. In our case, all the a_{i_j} equals to 1 because they have the same priority.

The Log Rule algorithm is proved as the delay-optimal algorithm in [SBdV11] and it achieves the minimum average delay in all the delay first algorithms.

3.3.4 Frame Level Scheduler (FLS)

The dynamic algorithms discussed above only work on the MAC layer of the LTE network, Frame Level Scheduler (FLS) is a two-level scheduling strategy where the two distinct levels (upper level and lower level) interact with each other to dynamically allocate RBs to the UEs [PGB⁺11b]. At upper level, a resource allocation scheme (namely FLS), which utilizes a Discrete-Time (DT) linear control loop, is implemented. FLS specifies the amount of data packets that a RT source should transmit frame by frame to satisfy its delay constraint. At lower level, in every TTI, RBs are allocated to the UEs using Proportional Fair (proposed in [RBSP09]) scheme with taking into consideration the bandwidth requirements of FLS. Particularly, the scheduler at the lower layer defines the number of TTIs/RBs through which each RT source will send its data packets. The amount of data to be transmitted is given by the following equation:

$$v_{i_j}(k_j) = h_{i_j}(k_j) * q_{i_j}(k_j). \quad (3.11)$$

where $v_{i_j}(k_j)$ is an amount of data to be transmitted by the i -th flow in k -th LTE frame in cell j . Operator $*$ is the discrete convolution operator, $q_{i_j}(k_j)$ is the queue level. The above equation says that $v_{i_j}(k_j)$ obtained by filtering the signal $q_{i_j}(k_j)$ through a time-invariant linear filter with pulse response $h_{i_j}(k_j)$.

Algorithms	Formula	Feature
M-LWDF	$\max_{i_j} \gamma_{i_j} W_{i_j}(t) \frac{C_{i_j}^m}{r_{i_j}^m}$	Takes delay into account
EXP Rule	$\max_{i_j} \frac{1}{r_{i_j}} \exp\left(\frac{a_{i_j} Q_{i_j}}{1 + \sqrt{a_{i_j} Q_{i_j}}}\right) C_{i_j}^m$	Throughput-Optimal
Log Rule	$\max_{i_j} \frac{1}{r_{i_j}} \log(1 + a_{i_j} W_{i_j}) C_{i_j}^m$	Delay Optimal
FLS	$v_{i_j}(k_j) = h_{i_j}(k_j) * q_{i_j}(k_j)$	Frame Optimal

Table 3.2 UE state allocation algorithm enumeration

The data are grouped by packets and the UE can decode the message after receiving a whole packet. If a UE receives only a part of the packet, it can not get any useful information, and it has to wait for the rest part of the packet. This algorithm aims at maximizing the completed sending packets instead of maximizing the sending data.

Compared to the other algorithms, it has more practical value because we sends the data in packets in the LTE system. We can explain the advantage with a simple example, a UE receives 1.8 packets and another receives 1.7 packets, each UE can only get 1 packet of useful information; if a UE get 2 packets and another get 1, maybe the sum data rate is less than the previous case, but the received information is more than before.

3.3.5 Conclusion

In this section, we presented the most important algorithms for the multimedia demand, these algorithms does not only take the RB capacity into account, but also the packet delay and buffer. The principle of these algorithms are introduced in Table 3.2, they evaluate the UEs by the given formulas and assign the RBs to the maximum or minimum one.

Among these previous work, EXP and Log rule have been presented as the most promising approaches for downlink scheduling in LTE systems with delay-sensitive applications.

We remark that all the aforementioned approaches cannot offer any strict guarantees on packet delivery delay, which plays a major role in the end-UE satisfaction.

In general, to meet QoS constraints, it is not sufficient to provide guarantees on the average packet delay, but it is necessary to enforce guarantees on the upper bound of packet delays. It is worth to note that only in [WGM07] a generic scheduling for channel-adaptive wireless networks has been proposed to provide absolute delay guarantees to real-time flows, but this scheme presents a very high computational complexity and it is hard to adopt in the LTE radio interface. In our thesis, we build a resource allocation framework

cooperating with the Beamforming technique to reduce the interference and increase the channel capacity.

Furthermore, another important limitation is that the channel utilization is far from the optimal state. In the following section, we will introduce game theoretic algorithm which optimize the radio resource utilization and satisfy the UEs' QoS demand at the same time.

3.4 Economical Optimization

In the previous two sections we described two kinds of algorithm are designed to maximize the UE's performance in a single cell. However, in multi-cell OFDMA systems, the co-channel UE's interaction leads to variable interference level which is assumed to be fixed or ignored in single-cell scenarios. Hence the resource allocation problem becomes more complicated in multi-cell systems. On the other hand, the UEs in different cells do not have the knowledge of other UEs' conditions and cannot cooperate with each other, they are more likely to act selfishly to maximize their own performance in a distributed way.

Such facts motivate us to adopt the game theory, which is a mathematical tool to provide a formal modeling approach for analyzing an interactive decision process. Game theory allows us to investigate the existence, uniqueness and convergence to a steady state operating point when network nodes perform independent distributed adaptations.

To be more important, telecommunication operators want to maximize the economical benefit on the conditions of meeting the UE's QoS demands. Their goal is not maximize the throughput of a UE but the Average Revenue Per UE (ARPU) of a UE.

The game theoretic algorithms propose the economically optimal solution for the cellular wireless communication operators and find a compromise for two key points:

1. satisfy the basic communication demands for the UE,
2. optimize the utility function instead of the UE's performance

3.4.1 Elements of the Game Theory

The basic framework of game theory was introduced in the book "*Theory of Games and Economic Behavior*" by John von Neumann and Oskar Morgenstern (1944) [NM44]. Until now it is widely used in the many fields, primarily in economics (in order to model competition between companies), as well as computer science, biology, politics and many other areas. But David Ricardo is the first one to propose the idea that the trade of products

or service can improve the utility of all the participants [Ric21]. He did it almost 200 years ago while working on taxation.

Game theory is an effective description of strategic interactions. It attempts to mathematically capture behavior of individuals in strategic situations, in which an individual's success in making choices depends on the choices of others. Game theory enhances the understanding of conflict by devising theories, mathematical models and abstractions that serve to explain nature and results of conflicts.

In game theory, there are some basic assumptions which are often utilized to facilitate the construction of tractable models for real situations. First, it is assumed that each individual in the game has a definite ordering of preferences over all outcomes of a given situation [He10]. These preferences take the form of a utility function or a payoff. Second, the participants in games are sometimes considered to be rational. This means that they always act in a way that maximizes their payoffs, they will always be capable of thinking through all possible outcomes and choosing the action which will result in the best possible outcome.

In a cooperative game, players bargain with each other before the game is played [SDHM07]. If an agreement is reached, players act according to the agreement reached, otherwise players act in a non-cooperative way. Note that the agreements reached must be binding, so players are not allowed to deviate from what is agreed upon. John Nash wrote in his seminal paper on cooperative games that to understand the outcome of a bargaining game, we should not focus on trying to model the bargaining process itself, but instead, we should list the properties, or axioms, that we expect the outcome of the bargaining process to exhibit. This way of analyzing cooperative games is called **axiomatic bargaining game theory**.

3.4.2 Nash Bargaining Solution

A bargaining solution is a map that assigns a solution to a given cooperative game. Following is the bargaining solution proposed by Nash in [Nas53], which is called Nash Bargaining Solution (NBS).

Let $\mathbf{K} = \{1, \dots, i, \dots, K\}$ be the players (UEs), \mathbf{S} be a closed and convex subset of \mathbb{R}^K which is the set of feasible payoff allocations that the players can get if they all work together. Let R_{\min}^i be the minimum payoff that the i th player would expect out of the cooperation. Suppose $\{R_i \in S | R_i \geq R_{\min}^i, \forall i \in K\}$, is a nonempty bounded set. If \mathbf{R}_{\min} is defined as $(R_{\min}^1, \dots, R_{\min}^K)$, then by $(\mathbf{S}, \mathbf{R}_{\min})$ we define that the K -person bargaining problem is to find a solution set \mathbf{S} under the condition of \mathbf{R}_{\min} . With the feasible set S , we define the notion of Pareto optimal as a selection criterion for bargaining solutions.

Definition 1. The point (R_1, \dots, R_K) is said to be **Pareto optimal**, if and only if there is no other allocation R'_i on the condition that $\forall i, R'_i > R_i$, and $\exists i R'_i > R_i$, i.e., there exists no other allocation that leads to superior performance for some UEs without inferior performance for some other UEs. There might be an infinite number of Pareto optimal points.

We need further criteria to select a bargaining result.

Definition 2. Let $\mathbf{r} = f(\mathbf{S}, \mathbf{R}_{\min})$ be an NBS in the solution set \mathbf{S} , if the following axioms are satisfied

1. **Pareto Optimal:** See Definition 1.
2. **Independence of Linear Transformations:** Let $y(\cdot)$ be any positive affine transformation, then $y(\mathbf{r}) = f(y(\mathbf{S}), y(\mathbf{R}_{\min}))$.
3. **Symmetry:** For any UE i_1 and UE i_2 where $R_{\min}^{i_1} = R_{\min}^{i_2}$, $f_{i_1}(\mathbf{S}, \mathbf{R}_{\min}) = f_{i_2}(\mathbf{S}, \mathbf{R}_{\min})$.
4. **Independence of Irrelevant Alternatives:** For any $\mathbf{r}' \in \mathbf{S}'$ where $\mathbf{r}' = f(\mathbf{S}', \mathbf{R}_{\min})$, if $\mathbf{S}' \subset \mathbf{S}$, $f(\mathbf{S}, \mathbf{R}_{\min}) = \mathbf{r}'$.

According to [HJL05], the unique condition that satisfying Definition 2 exists:

$$f(\mathbf{S}, \mathbf{R}_{\min}) \in \arg \max \prod_{i=1}^K (r^i - R_{\min}^i), \text{ where } \mathbf{r} \in \mathbf{S}, \forall i r^i > R_{\min}^i. \quad (3.12)$$

We consider cooperative games where the UEs exchange Channel State Information (CSI) with the base station. Their objective is to find an NBS: to maximize the product of the excesses of the transmitter data rates over their own minimum demands r^k . The NBS guarantees each UE to achieve its own demand, thus providing an individual rationality to the resource allocation. The important result of applying an NBS is that the final rate allocation vector is Pareto optimal. From the point of view of the game theory, our objective is the maximization of the system utility [HJL05]. Song [SL05a] [SL05b] and Han [HJL05] proposed the game theoretic OFDM(A) subcarriers allocation algorithms. Later on we refer to this method as the subcarrier NBS allocation.

3.4.3 Dynamic Subcarrier Assignment

Song et al. investigated DSA (Dynamic Subcarrier Assignment) scheme to improve the performance of an OFDM-based network [SL05a].

Their work concerned the maximization of the sum of the utility function $U(r^i) = 0.16 + 0.8 \ln(r^i - 0.3)$, when r^i is very high in 4G LTE downlink network, $U(r^i) = 0.8 \ln(r^i - 0.3)$, his goal is to maximize:

$$\max U(r^i) = 0.8 \sum \ln(r^i - 0.3) = 0.8 \ln \prod (r^i - 0.3)$$

Their objective is equivalent to the Nash Bargaining Solution in Eq. (5.4).

They firstly propose a solution with two UEs and then extend to general networks. His idea is to allocate a subcarrier to a UE whose marginal utility is larger than the other UE, this thought is a classical method in economical field. Its pseudo code is given by Algorithm 1.

The algorithm computes the marginal utility of a UE: $U'_i(r) = \frac{dU_i(r)}{dr}$, then it uses an iterative method to allocate the subcarriers.

Algorithm 1: Two-UE algorithm for utility maximization.

Data: Subcarrier Capacity Estimation – $c_i(f)$

Result: Subcarrier Allocation – f

```

1 initialization:   Initialize the subcarrier assignment by subcarrier capacity
                    $c_i(f)$ , estimate data-rate  $r^1$  and  $r^2$ . ;
2 while  $U_1(r) + U_2(r)$  increases do
3   for Subcarrier  $f \leftarrow 1$  to  $M$  do
4     if  $\frac{c_2(f)}{c_1(f)} \leq \frac{U'_2(r)}{U'_1(r)}$  then
5       | allocate subcarrier  $f$  to UE 1;
6     else
7       | allocate subcarrier  $f$  to UE 2;
8     end
9   end
10 end
```

For $N > 2$ UEs, the algorithm may be summarized as an allocation of frequency f to UE i , if this frequency satisfies:

$$\max U'_i(r)c_i(f) \tag{3.13}$$

The difficulty of the algorithm is that the r_i changes after the subcarrier assignment. As marginal utility $U'_i(r)$ varies with data rate r_i , so the allocation is a dynamic process. Its computational complexity is too high, in $\mathcal{O}(K^4)$, where K is the number of UEs.

Due to these properties, the implementation of this algorithm in practice is problematic.

Another problem of Song's method is that the subcarrier can be seen as continuous and infinite, but in LTE downlink network, the number of RBs is limited and the allocation is defined in a discrete domain.

3.4.4 NBS for Subcarrier Allocation

Han et al. [HJL05] developed an algorithm to reach the Nash bargaining solution. As with bargaining in a real market, the idea is to allow two UEs to negotiate and exchange their subcarriers for mutual benefits. The main challenge is to determine how to optimally exchange subcarriers, which can be considered a complex integer programming problem. To solve this problem, all subcarriers are initially assigned and, for each UE i , a positive weight factor ϱ_i is computed as follows (ϵ_i is a small positive number):

$$\varrho_i = \begin{cases} \frac{1}{r^i - R_{\min}^i}, & \text{if } r^i > R_{\min}^i + \epsilon_i \\ \frac{1}{\epsilon_i}, & \text{otherwise.} \end{cases} \quad (3.14)$$

Firstly, Han created an algorithm for two-UE case (see Algorithm 2), then he expanded it to K UEs case. The subcarriers are sorted and a two-band partition algorithm is applied for them to negotiate the exchange of subcarriers. To achieve the Nash bargaining solution, an intermediate parameter $g_i^{\varrho_i}$ needs to be updated for every iteration.

In the algorithm, the factor g_i is defined as the channel gain to noise ratio of a channel: $g_i = \frac{\|H\|^2}{\sigma_0}$, where $\|H\|^2$ presents the channel gain and σ_0 presents the white noise of a channel.

The process of the allocation is presented in the table below:

Algorithm 2: Two-UE algorithm for finding the NBS.

Data: Subcarrier Capacity Estimation – $c_i(f)$
Result: Subcarrier Allocation – ordered list of RBs

```

1 initialization:   Initialize the subcarrier assignment with the minimum rate
                  requirements. ;
2 while Nash Product  $(r^1 - R_{min}^2)(r^2 - R_{min}^1)$  increases do
3   Arrange the indices from largest to smallest:  $\frac{g_1^{\varrho_1}}{g_2^{\varrho_2}}$ ;
4   for Subcarrier  $j \leftarrow 1$  to  $M$  do
5     UE 1 occupies and water-fills subcarriers 1 to  $j$  ;
6     UE 2 occupies and water-fills subcarriers  $j + 1$  to  $K$ .
7   end
8   Estimate  $r^1$ , and  $r^2$  by Shannon formula;
9   update  $\varrho_1 = 1/(r^1 - R_{min}^1)$  and  $\varrho_2 = 1/(r^2 - R_{min}^2)$ .
10 end

```

For the case in which $K > 2$, the computational complexity for allocating the subcarriers is quite high, in $\mathcal{O}(N^4)$, where N is the number of subcarriers. For this reason most researchers have approached the problem from a centralized perspective. To treat the problem in a distributed manner, we can use an iterative scheme, based on the following steps:

1. The UEs are grouped into pairs.
2. For each pair, Algorithm 2 is applied for the two UEs to negotiate and improve their performance by exchanging subcarriers.

After the two steps are completed, the UEs are regrouped and they renegotiate again and again until convergence. The remaining key question is how to group UEs into pairs. One straightforward approach is to form pairs randomly and let the UEs bargain in an arbitrary manner.

3.4.5 Conclusion

We introduced the conception of game theory and a Pareto optimal solution, NBS, and introduced two highly cited NBS solutions applied to the OFDMA network.

For the subcarrier NBS allocation, as numerous subcarriers are available, a UE always finds a certain good quality subcarrier. The subcarrier allocation is optimized at each time-slot. For the RB allocation problem, as the number of RBs is limited, the optimization

does not match very well when a UE's channel quality always obeys a Gaussian distribution. In Chapter 5, we propose a new NBS RB allocation algorithm that solves this problem.

3.5 Chapter Conclusions

In this chapter, we studied three kinds of allocation schemes. In the Section 3.2, we studied the traditional performance-oriented allocation algorithm - Maximum Throughput (MT) algorithm, then we explain that the fairness is necessary in the allocation mechanism because some bad channel UEs may not get the RB with this algorithm. In Table 3.1, we showed the fairness factor's proportion in the algorithms, we made observe that taking fairness into account (like the Round Robin mechanism) leads to a system which is not efficient from throughput point of view.

In the LTE network, the voice and video calls are seen as data service, for these multi-media service, the delay and buffer is more important. In Section 3.3, we presented the algorithms that optimize the UE's state. Table 3.2 lists some highly cited algorithms which are designed to optimize a specific UE state – such as delay or buffer.

In Section 3.4, we reviewed the subcarrier NBS allocation algorithms it gives a solution that has two meanings:

1. give a trade-off between the throughput and fairness that meets the demands of Pareto optimal
2. optimize the economical utility function of each UE which is equivalent to maximize the revenue of the cellular network operators.

The algorithms discussed in Section 3.2 and 3.3 do not take the interference management into account, and in Chapter 4 we build a framework cooperated with Beamforming technique that can improve their performance.

Han and Song proposed NBS allocation algorithms for OFDMA system and have good performance, but their algorithms are just for subcarrier assignment. We will analyze the difference of subcarrier allocation and LTE downlink in Chapter 5.

Chapter 4

Complexity Reduction in Cooperative Allocation Framework

4.1 Introduction

Numerous RB allocation algorithms [YA06, KLL03, LL06, NLS12] have been proposed to allocate Resource Blocks (RBs) among Users Equipment (UEs) which aim at satisfying a specific parameter like delay or throughput while considering the single cell point of view. In these algorithms, the allocation decision is taken either on UEs' state (number of packets in their buffer, service priority) or the channel capacity. The capacity of each channel is mainly determined by the UE communication channels (received power) and inter-cell interference on the cell edge, commonly represented as the Signal to Interference and Noise Ratio (SINR).

To reduce the inter-cell interference, neighbouring cells should be considered in our system. We study a multi-cell system to analyze the relation between the RB allocation and interference. In the Multiple Input Multiple Output (MIMO) system, many techniques, such as spatial multiplexing (precoding) and Beamforming [Blu03], are applied to increase the channel capacity independently. The Beamforming technique varies the phase of the signals emitted by different antennas to increase the received signal power in the cell centre and to decrease interference on the cell edge.

We propose an iterative method to allocate an RB and to find the best Beamforming parameter at the same time.

We focus on the guarantee of the QoS requirements specific to the professional cellular networks PMR, *Private Mobile Radio*, as our work has been done within the project SOAPS [oSp12]. In such networks a UE having a high priority has to be connected regardless of

its localization. Keeping this strong constraint in mind, we are particularly interested in increasing RB capacity for UEs being on the cell edge.

For the reason mentioned above, we consider that, contrary to any other interference management technique, when Beamforming is applied the RB allocation model has to be modified on the cell edge. When an RB is attributed to the UE, the corresponding Beamforming parameter, called a beamformer, applied to the frequency of this RB does not only change the UE's received signal power, but also affects the interference in its neighbouring cells [RBSP09]. This means that the SINR, which may be seen as equivalent to the capacity of the RB, changes on this frequency on the edge of the neighbouring cells, which consequently influences the RB allocation of these neighbouring cells. In this way, the RB allocation in all the cells interacts with the Beamforming-OFDMA system [YKS11].

The RB allocation is determined by the UE's capacity, but the capacities are also influenced by the Beamforming technique. The decision of RB allocation and Beamforming should be determined jointly to improve the performance of multi-cell networks.

In this chapter, we firstly propose a method to allocate RBs and to find the best Beamforming parameter at the same time. Our method is to allocate the RB and apply the Beamforming technique in one process, this means the RB allocation in neighbouring cells needs to cooperate in order to decrease inter-cell interference. This framework improves the channel capacity but increases the complexity at the same time.

In a few UEs' case, the exhaustive method enumerates all the possible allocation schemes and choose the best one, but when the number of UE increases, the complexity increases polynomially but with very high rate, which makes this method useless for practical applications. So we propose a heuristic method to solve the computation problem and apply our framework to cooperate with the other existing allocation schemes.

4.2 Problem Definition

In Subsection 2.6.2, we observed that the coordinated Beamforming technique can improve the performance of a multi-cell system. In coordinated Beamforming techniques, the RB allocation and the Beamforming procedure are performed separately in different entities:

- Step 1: RBs are allocated to UEs.
- Step 2: The centralized system find the optimal Beamforming vector for the fixed active UE set.

We give an example to explain the relationship between the resource block allocation and the Beamforming technique.

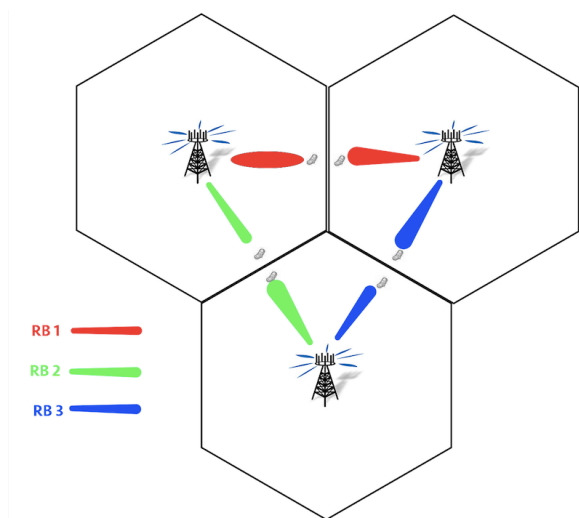

Fig. 4.1 RB allocation with Beamforming: the worst case

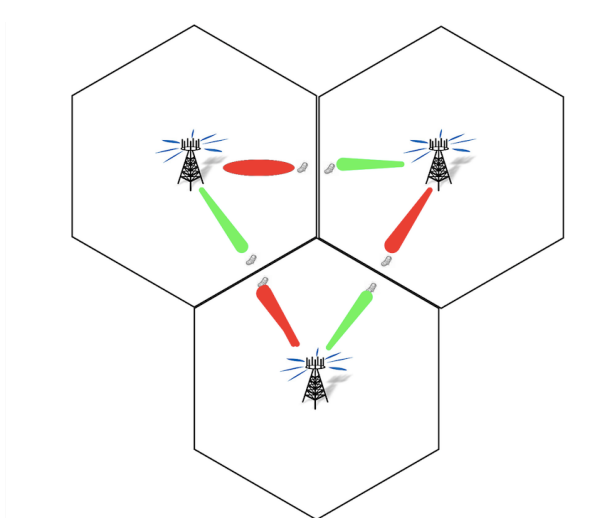

Fig. 4.2 RB allocation with Beamforming: the best case

We start by giving an instructive example in Figures 4.1 and 4.2, the RBs in the same colour represent the RBs on the same frequency in different cells. Three pairs UEs in the neighbouring cells are allocated to RB on the same frequency. For these pairs of UEs, a better beamer for a UE will increase the interference of the other one.

Figure 4.1 shows the worst limiting case for the Beamforming in which each pair UEs is allocated to the same frequency RB. Because all the RBs are orthogonal in OFDMA system, the inter-cell interference on the same frequency introduces the strongest interference, in Fig. 4.1, when the Beamforming technique improves the received signal power, it also increases interference power, so we can not conclude that the Beamforming technique improves the channel quality. Figure 4.2 shows the best limiting case in which all pairs of UEs are assigned to different RBs, all the UEs can use Beamforming technique to improve the received signal power without increasing neighbouring cells interference.

In the real world environment, the real channels are not as simple as the examples in the two figures mentioned above, but the idea is consistent:

- an intelligent RB allocation can improve the effect of Beamforming.
- the neighbouring cells RB assignment can decrease the interference with the Beamforming.

Authors of [LSC⁺12] improved the coordinated Beamforming technique by proposing a Coordinated Scheduling / Coordinated Beamforming technique. They developed it starting from the two-step resource block allocation transformed into a three step process:

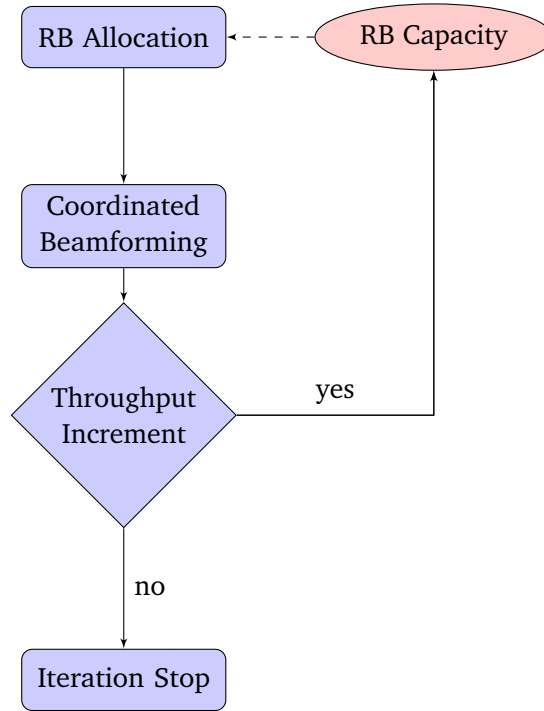

Fig. 4.3 CS/CB Diagram

- Step 1: RBs are allocated to UEs on the condition of given Beamforming vectors.
- Step 2: The centralized system find the optimal Beamforming vector for the fixed active UE set.
- Step 3: Repeat Step 1 and 2 until the system throughput converges (stops increasing).

Figure 4.3 presents the general process of the CS/CB algorithm, it repeats the traditional steps until the system throughput stops increasing, a particular implementation of this general scheme may be found in [YKS13].

In our dissertation, we want to propose a scheme to combine the CS and CB steps together to create a cross-layer scheme that combine the two independent step together (RB allocation and Beamforming configuration).

We consider a multi-cell network made up of a central cell and $J - 1$ neighbouring cells with the same assigned frequency. There are K UEs in each cell. Let j denote any of these J cells, and i_j denote a UE in the j th cell. The working frequency band contains M RBs. The eNode-B in each cell is located at the centre and contains N_T transmitting antennas, each UE has N_R receiving antennas. As all the sub-carriers are orthogonal, we can thus suppose the inner-cell interference is negligible. SINR of UE i_j on frequency m , $\Gamma_{i_j}^m$, is influenced by the Beamforming vectors on the same frequency in neighbouring cells and expressed as in

[SLA11]:

$$\Gamma_{i_j}^m = \frac{P \|H_{j,i_j} \omega_j^m\|^2}{\frac{P}{\|H_{j,i_j} \omega_j^m\|^2} \sum_{k \in \Phi(j)} |\omega_j^{m*} H_{j,i_j}^* H_{k,i_j} \omega_k^m| + \sigma_0}, \quad (4.1)$$

We provide a detailed description of variables found in this equation. Matrix $H_{k,i_j} \in \mathbb{C}^{N_R \times N_T}$ denotes the communication channel matrix between the e-NodeB in the k th cell and the UE i_j . It is calculated from the equation $H = \frac{G}{\sqrt{L(d)}}$, which says that it is a function of the MIMO fading channel G with the path loss L depending on the distance d , and all the elements of G obey the Gaussian distribution.

$\omega_j^m \in \mathbb{C}^{N_T}$ denotes a transmit Beamforming vector of the e-NodeB in the j th cell on the frequency of RB m , $\Phi(j)$ indicates a group of neighbouring cells around the j th cell, and σ_{i_j} represents a white Gaussian noise vector at UE i_j with the power of each entry σ_0 , $*$ signifies the transposition and conjugation of a matrix. The average signal power is noted as P . We assume that each UE perfectly knows the CSI value of its communication channel H_{j,i_j} and interference channel H_{k,i_j} , $k \in \Phi(j)$ based on the feedback channel. Each e-NodeB selects its transmit Beamforming vector ω_j^m according to the same codebook \mathbb{F} which is defined in [SLA11]. With 2 transmit antennas, the codebook is represented in Appendix A.4. Hence the SINR at the UE side in the j th cell on the frequency of RB m depends on the transmit Beamforming vectors in each cell.

When the SINR is confirmed, the RB capacity is estimated by the function of SINR $R(\text{SINR})$ [RBSP09]. The throughput available for a UE is the sum of all its allocated RB capacities. At the same time, it should be less than the amount of data waiting in the UE's buffer. We use r_{i_j} to denote the throughput of UE i_j in a time-slot T_L .

With these mathematical expression, we will build a cooperation framework to model the problem consisting in allocating the RB and choosing the Beamforming vectors at the same time. The problem objective is to maximize the network throughput.

Definition 3. Optimization Objective

Input: Communication channel matrices H_{i_j} and interference channel matrices H_{k,i_j} , the Beamforming vector code book \mathbb{F}

Output: Best UE i_j^* and the corresponding Beamforming vector ω_j^m on RB m .

Objective: The system total throughput $\sum r^{i_j}$ is determined by the channel matrices H_{i_j} , interference channel matrices H_{k,i_j} and the Beamforming vector ω_j^m , see Eq. (4.1). We want to find the best UE i_j^* (which decides the H_{i_j} and H_{k,i_j}) and best ω_j^m to maximize $\sum r^{i_j}$.

4.3 Framework for Two-User Case

In the conventional RB allocation methods, the Beamforming vectors are chosen after the RB allocation. In our optimization problem, the RB choice is also a function of Beamforming vectors $i_j(\omega_1^m, \dots, \omega_J^m)^*$. When Beamforming vectors change, the allocation is different because the UE's capacity varies as a result of SINR, according to Eq. (4.1).

On the other hand, the Beamforming vectors are also determined by the UEs' channel quality, because the vectors $\{\omega_1^*, \omega_2^*, \dots, \omega_J^*\}(i_1, \dots, i_J)$ are a function of UE's channel matrix H .

The classical solution based on the greedy approach is to allocate the RB having the highest capacity to a UE [Tsy02]. Put differently, we find the UE with the highest SINR in each cell, and we make an allocation decision for them on RB m : $\mathbb{K}_0^m = (i_1, \dots, i_J)$ a group of UEs which gets this RB in each cell. After the RB allocation, we apply the Beamforming to the antennas to increase the channel capacity for each chosen UE. Using the commonly admitted notation \mathbb{W}_0^m stands for a set of $(\omega_1^m(0), \dots, \omega_J^m(0))$. With the allocation decision and Beamforming vectors, we can estimate the total system throughput R_0^m on RB m .

Because the scheduler in each cell will influence the neighbouring cell interference, the sum of each cell's maximum throughput is not necessarily equivalent to the maximum of the total network throughput.

4.3.1 Exhaustive Solution

In a J cell system, we suppose there are only 2 UEs in each cell, we can search all the RB allocation the Beamforming vector combinations to find a maximum for the formula defining the total capacity of all RBs on frequency m :

$$\max_{i_j, \mathbb{W}^m} \sum_{j=1}^J R \left(\frac{P \|H_{j,i_j} \omega_j^m\|^2}{I_{i_j}(\mathbb{W}^m) + \sigma_0} \right), \quad (4.2)$$

To keep the notation simple, we introduce the factor I_{i_j} which takes into account interference existing between all the neighbouring cells. Which is weakened by the influence of Beamforming vectors [HVT14].

$$I_{i_j}(\mathbb{W}^m) = \sum_{k \in \Phi(j)} \frac{P |\omega_j^{m*} H_{j,i_j}^* H_{k,i_j} \omega_k^m|}{\|H_{j,i_j} \omega_j^m\|^2}, \quad (4.3)$$

Equation 4.3 represents the interference of UE i_j which has been introduced in Eq. (4.1), it contains the interference from all the neighbouring cells.

We should enumerate over all combinations of the UE channels and Beamforming vectors to maximize the total network throughput. The computation complexity is thus polynomial, $\mathcal{O}(K^{|\mathbb{F}|})$, where $|\mathbb{F}|$ is the number of elements in the Beamforming codebook \mathbb{F} [SLA11]. For this reason, when $|\mathbb{F}| \geq 4$, the computational effort becomes unacceptable.

For two UE case, the complexity is not too much, we can calculate in a short time, but the UEs are increasing, an approximated method is needed to decrease the complexity to find the allocation and Beamforming vectors in the network.

In this section we limit ourselves to present the simplest two-user case, to explain in detail the idea of our solution. The extension of our approach to a multi-user case together with the reduction of its numerical complexity is described in Section 4.4.

4.3.2 Numerical Results

In this section, we compare the performance of the cooperative resource allocation - Beamforming application framework with the traditional two-step method (Step 1: allocate the resource block, Step 2: apply the Beamforming technique [YKS13]).

With the simulator LTE-Sim presented in Appendix A, we build a multi-cell scenario for the simulation. There are J cells with the same configuration in our simulation settings. The radius of the cell is 1 km. The number of cells increased from 3 to 7, the cells' organization is shown in Fig. 4.4. In each cell, there are a cell centre UE ($d < 500\text{m}$) and a cell edge UE, the location of the UE is randomly settled by the seed function of LTE-Sim.

In our simulation setup, the bandwidth of the LTE network is 5 MHz and 25 RBs are available at the same time, which corresponds to the constraints of the PMR network under study in the SOAPS project [oSp12].

In the simulations, we propose to confront our solution with a reference one in order to show the improvement of our framework. The algorithm to be a reference one is formulated as follows. We allocate the RB to the UE and then choose the Beamforming vectors for each UE: we allocate the RBs to the UEs in a cell who has the highest SINR, with the chosen RBs, the e-NodeB applies the best cooperation Beamforming vector with the algorithm proposed in [SLA11].

Our method is a cooperative method that chooses the RB and the corresponding vector at the same time, we iterate all the possible RB assignment and the Beamforming vectors, choose the best channel matrix H and Beamforming vector ω .

We compare our cooperating framework with the independent RB allocation and Beamforming application, in Fig. 4.5 and 4.6, we can see find that our modification improves

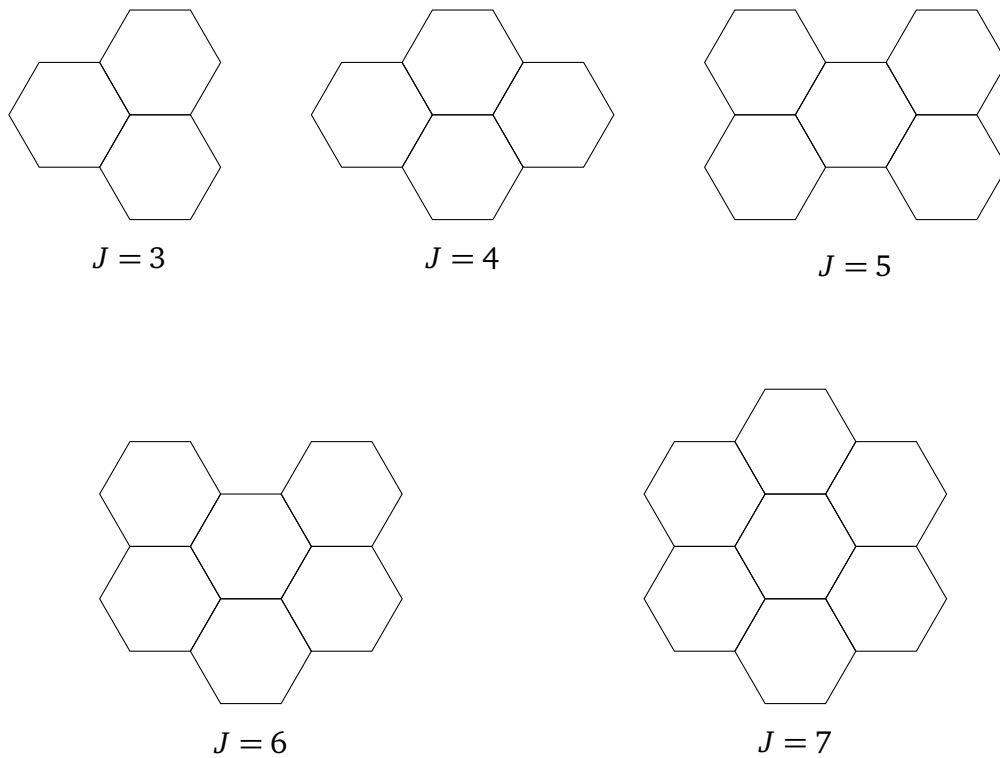

Fig. 4.4 Multi-cell organizations

the throughput for both cell center and cell edge UEs but the improvement in the cell edge is larger than the cell center.

In the cell center, the average throughput of the cell center is 8 – 9 times of the cell edge because the path loss of cell UEs in cell center is much smaller than the cell edge.

On the cell edge, UE's distance to the corresponding e-NodeB is not much less than the neighbouring cell's e-NodeB, so the received message signal power is not too much larger than the interference signal power. As inter-cell interference is the main cause of the low SINR for cell edge UEs, and our framework decreases this interference, the improvement of our algorithm is significant significantly higher than the traditional method.

In Fig. 4.6, we see that our performance improvement obtained thanks to our approach increases with the number of cells, because the source of interference increases when the number of cells increases. Our scheme minimizes interference so its effect becomes more and more important.

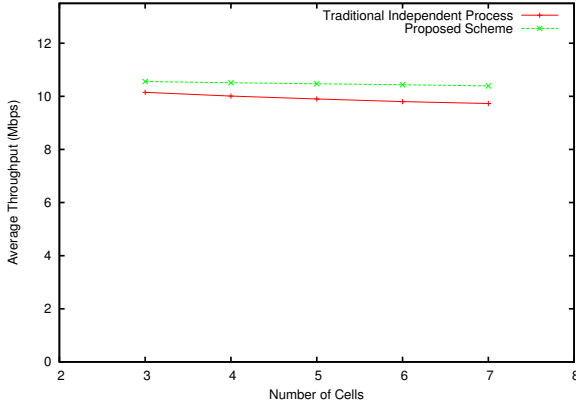

Fig. 4.5 Average throughput in cell center

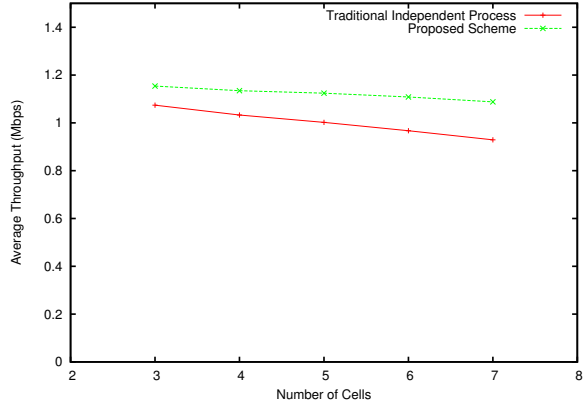

Fig. 4.6 Average throughput on the cell edge

4.4 Heuristic Method

From our analysis and the simulations in the previous section, we conclude that our cooperative framework can improve the channel capacity and increase the average throughput for all the UEs.

The weakness of the scheme is that the complexity, despite being polynomial, may be unacceptably high, as the exponent is a number of elements in the code book. For this reason, we propose a heuristic algorithm to whose complexity has a much lower polynomial degree.

There is a certain similarity between the scheme proposed in [YKS13] which is based upon the scheme in Fig. 4.3. However, in contrast to [YKS13], which performs Beamforming and allocation sequentially, we do these two actions at the same time.

We propose a heuristic method of complexity in $\mathcal{O}(K \cdot |\mathbb{F}|)$. To compute interference occurring between neighbouring cells we use two different schemes which introduce an order between cells. They both depicted in Fig. 4.7. Scheme 1 in this figure allows us to compute cell interference more efficiently than Scheme 2 which represents the traditional cell numbering. We use both these schemes in our algorithms and the difference between their performance will be analyzed and compared in Section 4.6.

The heuristic algorithm performing the allocation with Beamforming cooperation contains two nested loop. In the internal loop, we allocate the RBs in J cells, starting from cell 1 until J ; in the external loop, we repeat the internal loop to improve the allocation. The process of our cooperation allocation scheme is presented in Fig. 4.8 [HTV14].

Algorithm 3 presents the general structure of our method. We comment all element of the algorithm in detail.

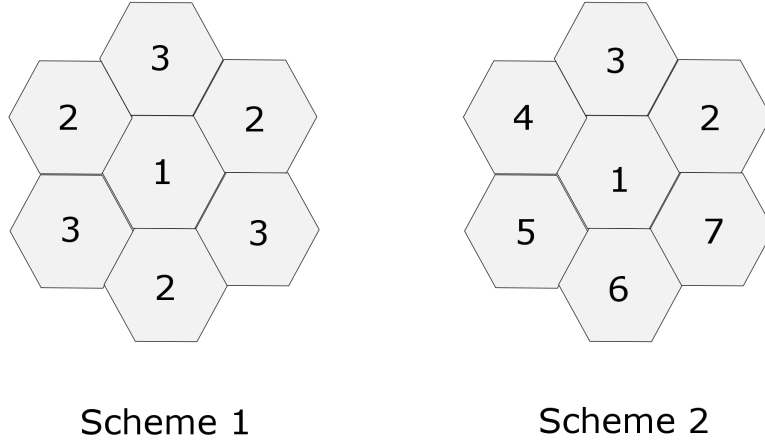

Fig. 4.7 Multi Cell Enumeration Schemes

As we defined in Section 4.3, we repeat the notation of some important parameters. ω_j^{m*} represents the chosen Beamforming vector in cell j on the frequency of RB m , i_j^* represents the UE who is assigned the RB m in cell j . \mathbb{W}^m denotes the set of chosen Beamforming vectors, and $\mathbb{W}_j^m(l)$ represents the set of Beamforming vectors updated in the j th cell of l th loop in Algorithm 3. $\mathbb{K}_j(l)$ denotes the set of assigned UEs on RB m updated in the j th cell of l th loop. $R_j^m = \sum r^{i_j}(\mathbb{K}_j^m(l), \mathbb{W}_j^m(l))$ denotes the estimated system throughput on the RB m with the set of $\mathbb{K}_j^m(l)$ and $\mathbb{W}_j^m(l)$.

Algorithm 3: Heuristic multi-cell maximum throughput algorithm.

```

input : Communication channel matrix  $H_{ij}$ ;
          interference channel matrix  $H_{k,i_j}$ ;
          Beamforming vector code book  $\mathbb{F}$ 
output: Best UE set  $\mathbb{K}^{m*}$ ;
          Beamforming vector set  $\mathbb{W}^{m*}$  on RB  $m$ ..

1 /* initialization: */
2 /* RB allocation set  $\mathbb{K}^m \leftarrow \mathbb{K}^m(0)$ , Beamforming vector set
    $\mathbb{W}^m \leftarrow \mathbb{W}^m(0)$  */
3 while  $\sum r^{i_j}(l) < \sum r^{i_j}(l+1)$  do
4   /* estimate  $\sum_{j=1}^J r^{i_j}$  by  $\sum_{i_j=1}^J R(\Gamma_{i_j}^*)$  */
5   for  $j \leftarrow 1$  to  $J$  do
6      $i_j^*, \omega_j^{m*}(l) \leftarrow \text{find\_best\_radio}(i_j, \mathbb{W}^m)$ ;
7      $\mathbb{W}_j(l) \leftarrow \mathbb{W}_{j-1}(l)$ , update the new Beamforming vector  $\omega_j^{m*}$ 
8   end
9 end

```

Algorithm 4: Internal loop: find_best_radio

input : All the active UEs i_j ;
 Beamforming vector code book \mathbb{F}

output : Best UE i_j^* ;
 corresponding Beamforming vector ω_j^{m*} on RB m .

1 **find_best_radio**(i_j, \mathbb{W}^m):
 2 **for all** (i_j, ω_j^m), $i_j \leftarrow 1$ **to** K , $\omega_j^m \leftarrow 1$ **to** $|F|$ **do**
 3 **if** $R_j^m(i_j, \omega_j^m) > R_j^m(i_j^*, \omega_j^{m*})$ **then**
 4 $i_j^* \leftarrow i_j$, $\omega_j^{m*} \leftarrow \omega_j^m$
 5 **end**
 6 **end**

Before our iteration, we firstly allocate the RB in each cell with the MT algorithm described in Subsection 3.2.1, get an initialization RB assignment policy $\mathbb{K}^m(0)$, then choose the Beamforming vectors for all the cells with coordinated Beamforming technique described in Subsection 2.7.3, and denote the set of Beamforming vectors as $\mathbb{W}^m(0)$.

Internal Loop (“for” over cells and find_best_radio function)

The allocation of RBs is made sequentially cell after cell according to an appropriate cell order (as those in Fig. 4.7). In the 1st cell, our only objective is to maximize the SINR on RB m which is equivalent to find the maximized UE’s data-rate :

$$\max_{i_j, \omega_j^m(l)} R \left(\frac{P \|H_{j,i_j} \omega_j^m(l)\|^2}{I_{i_j}(\mathbb{W}_{j-1}^m(l)) + \sigma_0} \right), \quad (4.4)$$

where $i = 1$ and

$$I_{i_j}(\mathbb{W}_{j-1}^m(l)) = \sum_{\omega_k^m(l) \in \mathbb{W}_{j-1}^m(l)} \frac{P |\omega_j^{m*}(l) H_{j,i_j}^* H_{k,i_j} \omega_k^m(l)|}{\|H_{j,i_j} \omega_j^m(l)\|^2}, \quad (4.5)$$

$I_{i_j}(\mathbb{W}_{j-1}^m(l))$ expresses the interference of UE i_j which is estimated upon the set of Beamforming vectors $\mathbb{W}_{j-1}^m(l)$.

We apply the find_best_radio (see Line 6 in Algorithm 3) to find the UE i_1^* and Beamforming vector $\omega_1^{m*}(l)$, denote the new allocation decision on RB m as $\mathbb{K}_1^m(l) = (i_1^*, i_2, \dots, i_j)$ and Beamforming set as $\mathbb{W}_1^m(l) = (\omega_1^{m*}(l), \omega_2^m(l-1), \dots, \omega_j^m(l-1))$, where l is the number of the external loop executions. At the l th loop, we estimate the total system throughput $R_1^m(l)$, compare it with traditional system throughput R_0^m . If step $R_1^m(l) \geq R_0^m$, we apply the

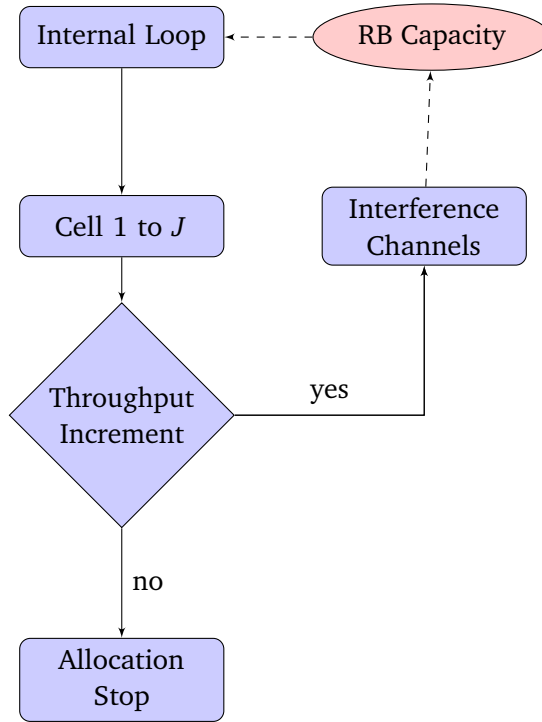

Fig. 4.8 Modified Algorithm Diagram

new allocation policy and Beamforming vectors in the 1st cell. If $R_1^m(l) < R_0^m$, we keep the traditional solution: $\mathbb{K}_1^m(l) = \mathbb{K}_0^m$ and $\mathbb{W}_1^m(l) = \mathbb{W}_0^m$.

For the j th cell ($j = 2, 3, \dots, J$), we consider the Beamforming vectors of the former $j - 1$ cells. Thanks to Eq. (4.4) we can obtain the allocation policy $\mathbb{K}_j^m(l)$ and Beamforming set $\mathbb{W}_j^m(l)$. As before, we compare the estimated data rate $R_j^m(l)$ and $R_{j-1}^m(l)$, if $R_j^m(l) \geq R_{j-1}^m(l)$, the final allocation policy is $\mathbb{K}_j^m(l)$ and Beamforming set is $\mathbb{W}_j^m(l)$. Otherwise we continue to use the former allocation policy $\mathbb{K}_{j-1}^m(l)$ and Beamforming vector $\mathbb{W}_{j-1}^m(l)$.

External Loop (“while” over throughput)

When the internal loop terminates at cell J , we get a new RB allocation policy \mathbb{K}_J^m and Beamforming vector \mathbb{W}_J^m . Based on the new Beamforming vectors in the neighbouring cells, we may allocate this RB to another UE and the corresponding Beamforming vector to increase the system throughput. So we repeat the internal loop.

After the external loop, we get the final allocation policy $\mathbb{K}_J^m(l)$ and Beamforming vector $\mathbb{W}_J^m(l)$. we give below a proof that our method converges.

Proof of Convergence: From the definition of the algorithm, we can conclude that the system throughput is not decreasing in each loop:

$$R_j^m(l) \geq R_{j-1}^m(l), R_j^m(l) \geq R_j^m(l-1), \quad (4.6)$$

The RB capacity function $R(\Gamma)$ is a step function [RBSPO9] so the system throughput function $R_j^m(l)$ is also a step function. The property of the step function is: if $R_j^m(l) > R_j^m(l-1)$, $R_j^m(l) - R_j^m(l-1) > \Delta$, where Δ is the minimum difference between two neighbouring steps of $R(\Gamma)$.

Because the white noise is always presented, we can estimate an upper bound R_{upper}^m for the system throughput on this frequency by ignoring the interference:

$$R_{\text{upper}}^m = \max_{\mathbb{K}, \mathbb{W}} \sum_{j=1}^J \frac{P \|H_{j,i_j} \omega_{j(j)}^m\|^2}{\sigma_0}, \quad (4.7)$$

Thus the number of loops L satisfies:

$$L < \frac{R_{\text{upper}}^m - R_0^m}{\Delta} \quad (4.8)$$

From Eq. (4.6) and (4.8), we can conclude that our multi-cell maximum throughput algorithm is convergent [HTV14].

4.5 Application of Cooperative Framework on Other QoS Service

Service

As we have explained in Chapter 3, the MT algorithm is not applicable in all the scenarios and there are other well designed allocation schemes which were proven as optimal algorithm on different conditions. Our framework can also be applied to these algorithms and improve the overall performance by increasing the average RB capacity.

4.5.1 Throughput Optimal with Finite Buffer

When the buffer of all the UEs is finite, we rewrite the function of data-rate, taking into account data waiting buffer Q_{i_j} of UE i_j :

$$\min \sum_{j=1}^J \sum_{i_j=1}^{i_j=K} [Q_{i_j} - \sum_{m=1}^{m=M} R(\Gamma_{i_j}^m) \mathbb{1}_{i_j}^m]^+ \quad (4.9)$$

$$[x]^+ = \begin{cases} x, & \text{if } x > 0, \\ 0, & \text{otherwise.} \end{cases}$$

$$\mathbb{1}_{i_j}^m = \begin{cases} 1, & \text{if RB } m \text{ is allocated to UE } i_j, \\ 0, & \text{otherwise.} \end{cases}$$

and Q_{i_j} represents the waiting data of UE i_j in the eNodeB.

An approach of this optimization problem from a single cell point of view is EXP-Rule [SS02], which has been explained in Subsection 3.3.2. For a cell j :

$$\max_{i_j} \frac{1}{\bar{r}_{i_j}} \exp\left(\frac{a_{i_j} Q_{i_j}}{1 + \sqrt{a_j Q_j}}\right) R(\Gamma_{i_j}), \quad (4.10)$$

where

$$\overline{a_j Q_j} = \frac{1}{K} \sum_{i_j=1}^{i_j=K} a_{i_j} Q_{i_j},$$

in which \bar{r}_{i_j} denotes UE i_j 's average data rate, a_{i_j} is a fixed positive constant, called UE i_j 's workload contribution, which may be expressed as 1 when all the UEs have the same priority. $\overline{a_j Q_j}$ thus denotes the average workload of cell j 's UEs weighted priority. Γ_{i_j} is given by the LTE downlink control channel.

As we have already said previously, this allocation algorithm does not consider the influence of interference from neighbouring cells RB allocation and we add the similar iterative method. In the first cell, the interference is ignored; in the j th cell, we consider the interference of the former $j - 1$ cells:

$$\max_{i_j, \omega_j^m} \frac{1}{\bar{r}_{i_j}} \exp\left(\frac{a_{i_j} Q_{i_j}}{1 + \sqrt{a_j Q_j}}\right) \times R\left(\frac{P \|H_{j,i_j} \omega_j^m\|^2}{\|H_{j,i_j} \omega_j^m\|^2 \sum_{k=1}^{j-1} |\omega_j^{m*} H_{j,i_j}^* H_{k,i_j} \omega_k^m| + \sigma_0}\right) \quad (4.11)$$

Similarly, UE i_j^* and the corresponding Beamforming vector ω_j^{m*} are chosen according to Eq. (4.11). For each cell, the computation complexity is $\mathcal{O}(K \cdot |\mathbb{F}|)$.

4.5.2 Delay Optimal

When dealing with the Real-Time service class, a delay constraint has to be respected. The objective of this minimization is:

$$\min \sum_{j=1}^{j=J} \sum_{i_j=1}^{i_j=K} W_{i_j}, \quad (4.12)$$

where W_{i_j} denotes the waiting time of the head-of-line packet in UE i_j 's buffer at the e-NodeB.

An approach to this optimization problem is Log Rule [BS09], which we have discussed in Subsection 3.3.2:

$$\arg \max_{i_j} \left(\frac{1}{r_{i_j}} \log(1 + a_{i_j} W_{i_j}) \times R(\Gamma_{i_j}) \right). \quad (4.13)$$

The choice of UE i_j^* given by Eq. (4.13) cannot be proven as optimal on the network level because this equation does not consider the inter-cell interference.

To find a minimum for Eq. (4.13) we proceed in an iterative way as done in Sections 4.5.1. We start with the first cell for which we do not consider any interference.

For the j th cell, we consider the interference of the former $j - 1$ cells:

$$\max_{i_j, \omega_j^m} \frac{1}{r_{i_j}} \log(1 + a_{i_j} W_{i_j}) \times R \left(\frac{P \|H_{j,i_j} \omega_j^m\|^2}{\frac{P}{\|H_{i_j} \omega_j^m\|^2} \sum_{k=1}^{j-1} |\omega_j^{m*} H_{j,i_j}^* H_{k,i_j} \omega_k^m| + \sigma_0} \right). \quad (4.14)$$

With this process, we can improve the upper bound of function given by (4.14) by the Beamforming technique. With higher throughput, more packets can be sent in limited time so the average waiting tie of the packets are also decreasing.

In this section, we apply our cooperation framework to the throughput-optimal and delay-optimal algorithm and we will compare its performance with its original version in the next simulation parts.

4.6 Numerical Results

In this section, we compare the performance of our iterative multi-cell RB allocation algorithm with their single cell version. The performance evaluation is made using LTE-Sim

[PGB⁺11a], a simulation package which we have introduced in Appendix A. We modified the source code of the simulator and added the MIMO channel model to complete our simulation.

The average UE throughput, O-I ratio (Output-to-Input Ratio: the average quotient of sending and receiving data rate at the e-NodeB) and the average packets delay are chosen as performance criteria. In our simulation setup, the bandwidth of the LTE network is 5 MHz and 25 RBs are available at the same time, which corresponds to the constraints of the PMR network under study in the SOAPS project [oS_p12]. There are 7 cells with the same configuration in our simulation settings. The radius of the cell is 1 km and the UEs are uniformly distributed in the cell by the distribution function of LTE-Sim [PGB⁺11a]. They are divided into two groups, the centre group includes 50% of the UEs which are the nearest to the e-NodeB, the edge group is made up of the rest of the UEs. The Transmission Time Interval (TTI) is fixed to 1ms, and an individual simulation time run lasts 100s. We perform a series of simulation runs in order to obtain results with confidence level $\alpha = 0.05$. We repeat simulations 100 times, which is sufficient to get the confidence level assumed and calculate the average value and variance of each performance criterion. Because the channel is fast-fading and simulation time is long, the confidence intervals are very small and for this reason we do not mark them on the figures below. As we mentioned before, the complexity of exact optimal allocation for RB and Beamforming is too high, so we cannot perform the comparison between our proposed scheme with the optimal enumeration method.

4.6.1 Multi-cell MT Algorithm Results

We simulate the MT algorithm with the infinite buffer service because this method is to dedicated to maximize the system throughput.

We firstly compare the throughput improvement obtained thanks to our modified algorithms. Fig. 4.9 shows that the average individual throughput decreases with the number of UEs because the average number of RBs allocated to UEs reduces as the number of UEs increases. Our method benefits from the effect of Beamforming so the RB capacity is higher than in the conventional algorithm, the average throughput per UE increases about 8% to 11% on the cell edge.

Our modification increases the throughput in two ways:

1. Choosing the best $|H_{j,i_j} \omega_j^m|$ to increase the received signal power.
2. Adjusting the inter-cell interference channels $\sum_{k \in \Phi(j)} |\omega_j^{m*} H_{j,i_j}^* H_{k,i_{j,h}} \omega_k^m|$ to limit interference. In Scheme 1 (Fig. 4.7) we consider the interference channel information

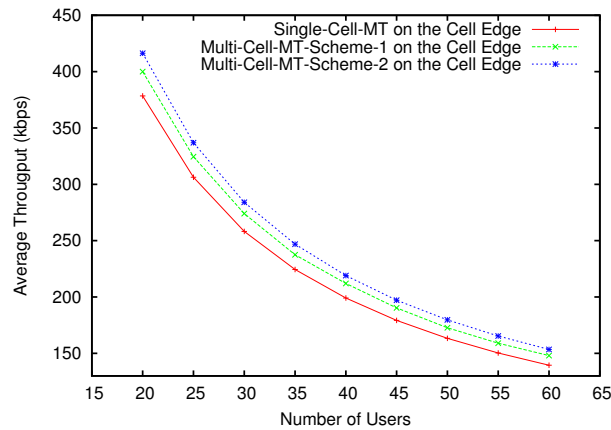

Fig. 4.9 Average throughput per UE

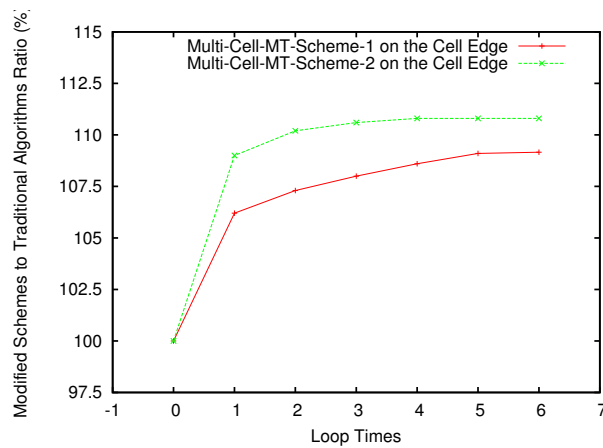

Fig. 4.10 Allocation scheme efficiency in function of the number of iteration

from fewer cells than in Scheme 2. For this reason the interference management effect in Scheme 1 is weaker compared to that obtained with the enumeration according to Scheme 2. This effect leads to less significant improvement in the large interference area, namely on the cell edge.

Fig. 4.10 presents the average improvement of each external loop in our modified algorithm. The throughput improves greatly in the first passage of the external loop. The further loop executions do not increase the throughput significantly. Simulation makes us observe that the algorithm converges quickly and throughput stabilizes after 5 or 6 repetitions.

Compared to the coordinated Beamforming algorithms introduced in Section 2.7, each iteration of our algorithm shares the same CSI process. We can conclude that the exchange

information is only a few times longer than the one of the traditional coordinated Beamforming technique. This multiplication is equal to the number of iterations performed by our algorithm.

Because all the coordinated systems work under the assumption that the cells share the same information system in a multi-cell cluster, and only hundreds of bits are exchanged in each iteration, we confirm that the cost of the sharing CSI in our schemes is acceptable.

4.6.2 Results for Multi-cell Log Rule and Exp Rule

Exp and Log Rule modified algorithms are simulated with Finite Buffer and Video service: in the Finite Buffer service, UEs download data with a Poisson distribution, the arrival data per second for a UE is distributed according to $P(X = k) = \frac{e^{-\bar{r}} \bar{r}^k}{k!}$, where \bar{r} is the average data rate in the infinite buffer service; the Video service packets arrive according to the H.264 standard streaming format, and its average data rate is $k = 128$ Kbps.

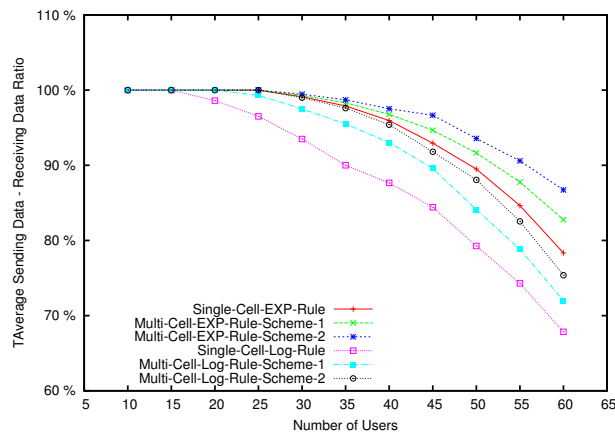

Fig. 4.11 Average output-input ratio on the cell edge

Because of the throughput improvement of our multi-cell version, Fig. 4.11 shows that the sending — receiving data ratio of multi-cell algorithms is greater than in its single cell version. Our modified algorithms increase the RB capacity and more data could be sent in the same duration. As in the previous analysis, our multi-cell Scheme 2 obtains higher throughput on the cell edge and it leads to better performance than Scheme 1 in this area. Exp Rule is designed for throughput-optimal [SS02], so its output-input ratio is higher than Log Rule.

Fig. 4.12 presents the average packet delay of video service. We compare the delay of all the packets, so the delay limitation in the LTE-Sim platform [PGB⁺11a] is cancelled to avoid packet loss. The simulator estimates the average duration of the packet generating

time and UE receiving time. Our multi-cell algorithm improves the RB capacity, and the packets need less time to be transmitted, so the average delay is shorter than with the single cell version. The simulation shows that our multi-cell version decreases the cell delay by 8-10%. With more considerable improvement on the cell edge, the average delay decreases more in this area. The delay improvement depends on the way with which cells are enumerated. Scheme 2 is more efficient in terms of this improvement. Log Rule is a delay-optimal algorithm, hence its average packet delay is much lower than Exp Rule.

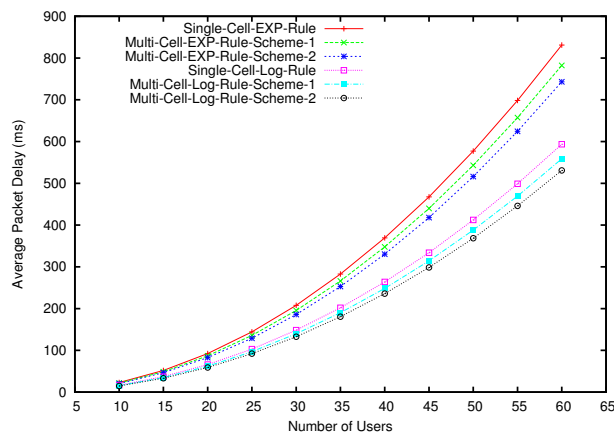

Fig. 4.12 Average packet delay on the cell edge

From the simulation results, we conclude, once again that the performance of multi-cell algorithms is better than their single cell version. Log Rule and Exp Rule are proven to be optimal for different scenarios [SS02] and [BS09], Exp Rule has better throughput and Log Rule benefits from a shorter average delay. Our multi-cell algorithm guarantees a better performance than the reference methods.

4.7 Conclusions and Perspectives

We presented algorithms of RB allocation working with the Beamforming technique for multi-cell networks. We took into account the interference resulting from the RB allocation realized in the neighbouring cells. This increases the channel's efficiency by adjusting the interference of each cell. It should be pointed out that Beamforming is not the only technique to limit interference, the other MIMO techniques like spatial multiplexing can also be applied independently to increase network performance.

We proposed an iterative method to which allocate RBs taking advantage of the Beamforming technique. Our method has a reasonable numerical complexity. We proved that our

iterative method is convergent in a few number of steps which has the additional advantage to reduce CSI exchange between cells. Compared to traditional scheduling algorithms that cooperated with coordinated Beamforming technique, more control channel information should be shared among all the cells. With a polynomial complexity with low degree, the network considerably benefits from our mechanism on the cell edge which is obviously the most prone to suffer from interference. This feature is particularly important in security wireless infrastructures because they must meet very high QoS (Quality of Service) requirements.

We analyzed different cell ordering according to which Beamforming control messages are transmitted. We kept the reduction of this overhead in mind. Comparing between enumeration schemes 1 and 2, more sharing of channel information leads to better performance. Scheme 2 has better improvement on the cell edge because it has more neighbouring cell information to reduce interference. To extend the J -cell network to the one with an infinite number of cells, scheme 1 is more workable because it needs less neighbouring cell Beamforming information. Perspectives of our work will be to apply these both schemes to other interference management techniques like pre-coding and multiplexing.

Moreover, our future work is to incorporate cooperation among cells during the RB allocation to enhance performance without increasing complexity.

Chapter 5

Channel Oriented Algorithms

5.1 Introduction

Considering the different UEs' channel qualities and the discrete nature of the channel-assignment problem, it is difficult to assign the RBs to different UEs in a multi-user environment. To allocate these RBs to UEs, the formulated problem and solutions to it are focused on the efficiency issue [AKR⁺04, SS02, SBdV11], these algorithms are all introduced in Section 3.3. The fairness issue is mostly ignored in such approaches as they are clearly oriented towards the allocation of RBs whose quality is the best for UEs. In other words, the UEs, which are close to the e-NodeB and have less power path-loss than others clearly benefit from these allocation schemes. There is a consistent thread running through this dissertation that is to improve the performance of these bad radio condition UEs. On the other hand, when the fairness of the UEs' treatment is important, some trade-off algorithms have been considered for channel allocation in multi-user orthogonal frequency-division multiplexing (OFDM) systems in Section 3.2. However, advancing this trade-off does not make it easy to take into account the notion that UEs might have different requirements in terms of the throughput demanded. Moreover, since the fairness algorithms deal with the worst-case scenario, they penalize UEs with better channels and thus reduce the system's efficiency. In addition, most of the existing solutions have a high computation complexity, which prohibits their practical implementation. Therefore, it is necessary to develop an approach that considers the fairness of resource allocation, system efficiency, and numerical complexity altogether.

In this study we are inspired by an economics theory concerning goods exchange. In everyday life, a global goods market serves as a central gathering point, where people exchange goods and negotiate transactions, so they can be satisfied through bargaining. Similarly, in multi-user OFDMA systems, the e-NodeB can serve as a function of the market.

The distributed UEs can negotiate via the e-NodeB to cooperate in making the decisions on the RB utilization, such that each of them can operate with others and common agreements are made about their operating points. Such a fact motivates us to apply the cooperative game theory, which can achieve the crucial notion of fairness and maximize the overall system data rate.

In a multi-user LTE system, according to the trading theory [Ric21], each UE has the opportunity to get RBs despite the fact that some UEs always have lower RB capacities because of path-loss or indoor attenuation. For UEs whose channel quality is poor, the capacity of available RBs also varies in function of time and frequency. These bad channel UEs also have higher and lower capacities on these RBs at different times because of the properties of fast fading. The efficient allocation scheme allocates the RB to the UE for which the capacity of this RB is the highest.

Motivated by the above reasons, we apply the cooperative game theory for resource allocation in OFDMA systems and use the comparative advantage to solve the problem. The goal is to maximize the overall system data rate, under the constraints of each UE's minimal rate requirement. Our idea is to counterbalance the channel determination due to the path-loss by compensation factors in order to increase the probability of having an RB by UEs suffering from the poor channel quality [HVT15].

5.2 System Model

We consider a single-cell LTE system with M RBs, and an e-NodeB. The distance between a UE i and e-NodeB is d_i . The channel between UE i and e-NodeB on RB m is denoted by matrix G_i^m , whose elements g are independent, zero-mean complex Gaussian random variables with unit variance. UE i 's received signal power P_i is expressed by

$$P_i = \frac{P \|G_i^m\|^2}{L_i(d_i)}, \quad (5.1)$$

where P denotes the average transmit power and $L_i(d_i)$ presents the path-loss with distance d_i .

With the Treating Interference as Noise (TIN) model, we can consider the interference as a kind of noise and simplify the Signal-plus-Interference-to-Noise-Ratio (SINR) as in [CSHP12]:

$$\Gamma = \frac{P \|G_i^m\|^2}{L_i(d_i) \sigma_0} = \|G_i^m\|^2 \cdot \frac{1}{L_i(d_i)} \cdot \frac{P}{\sigma_0}. \quad (5.2)$$

We observe that $\|G_i^m\|^2$ is time-varying as it depends on channel quality, the second term $\frac{1}{L_i(d_i)}$ is identical for all RBs and all UEs being at distance d_i from the e-NodeB. σ_0 represents the general noise which equals that the white noise adds the interference which is considered as another kind of noise. The last term $\frac{P}{\sigma_0}$ is statistically equal for all the UEs of a given cell.

According to the Shannon Theory, the capacity of RB m for UE i could be seen as $C_i^m = WT \log(1 + \Gamma)$, where W is the bandwidth of an RB and T is the TTI (Time Transmission Interval):

$$C_i^m = WT \log\left(1 + \|G_i^m\|^2 \cdot \frac{1}{L_i(d_i)} \cdot \frac{P}{\sigma_0}\right) \approx WT (\log \|G_i^m\|^2 + \log \frac{1}{L_i(d_i)} + \log \frac{P}{\sigma_0}). \quad (5.3)$$

The only factor varying in time is actually $\log \|G_i^m\|^2$ because of fast-fading. The path-loss factor $\log \frac{1}{L_i(d_i)}$ can be approximated by a constant in a short time window for low speed UEs. In a given time-slot, a total capacity which a UE can obtain is a sum of its allocated RB capacities.

5.3 Best Channel Algorithm

In Subsection 3.2.2, we have introduced the Round-Robin algorithm which provides an equal opportunity to get the RB for the communication. But with the same opportunity but without taking the channel quality into account,

When we analyze the channel into two parts, channel quality G_i and the path-loss $L_i(d)$. The path-loss is independent with the UE and the channel quality varies with the time. For all the UEs, their channel distribution experience the same pdf (probability distribution function).

Theorem 5.3.1. X_i are N random variables with the same distribution $p(X)$, the probability of $P(X_i > X_j, \forall j \neq i) = \frac{1}{N}$.

Proof. The probability that the X_i is greater than the other variables is:

$$P_{X_i} = P(X_i > X_j, \forall j \neq i) = \int_{-\infty}^{\infty} p(X_i) \int \int \int_{-\infty}^{X_i} P(X) dX_1 \dots dX_N$$

For UE i from 1 to N , because the formula of all the X_i are the same, we have:

$$P_{X_1} = P_{X_i} = \dots = P_{X_N}.$$

There is always a variable greater than the other variables, so we get $\sum_{i=1}^N P_{X_i} = 1$, then we get $P_{X_i} = \frac{1}{N}$. \square

From Theorem 5.3.1, we can conclude that, if we allocate the RB to the UE on the condition of $\max \|G_i\|^2$, each UE has the equal probability to get the RB.

Compared to the Round-Robin algorithm in Subsection 3.2.2, the UE's opportunity is as same as the Round-Robin, but each UE can transmit the signal when its channel quality is the best, this leads to a higher Resource Block capacity.

5.4 NBS in RB Allocation

Because of the lack of fairness for performance-optimal algorithms and the worst channel utilization efficiency of the fairness algorithms, the game theoretic framework proposes good tradeoff between the fairness and the overall system performance. Numerous allocation schemes based upon a game theoretic solution have been proposed. Most of the previous approaches [WCLM99, YL00, YC02, RC00] study how to efficiently maximize the total transmission rate or minimize the packet delay under some constraints.

In [WCLM99], the authors studied the dual problem, which consists in finding the optimal subcarrier allocation to minimize the total transmitted power and satisfy a minimum rate constraint for each user. This dual problem is formulated in terms of an integer programming problem, and a sub-optimal solution was found by using a continuous relaxation.

In [YL00], a low-complexity sub-optimal algorithm is proposed. It decouples the problem into two sub-problems, finds the required power and the number of sub-carriers for each user, and determines the corresponding subcarrier and rate allocation.

In [YC02], the discrete subcarrier allocation problem is relaxed into a constrained optimization problem with continuous variables, thus the optimal assignment can be solved with numerical methods.

We briefly remind the reader of basic concepts and theorems of the NBS that we have introduced in Subsection 3.4.1. The bargaining problem of the cooperative game theory can be described as in [HJL05].

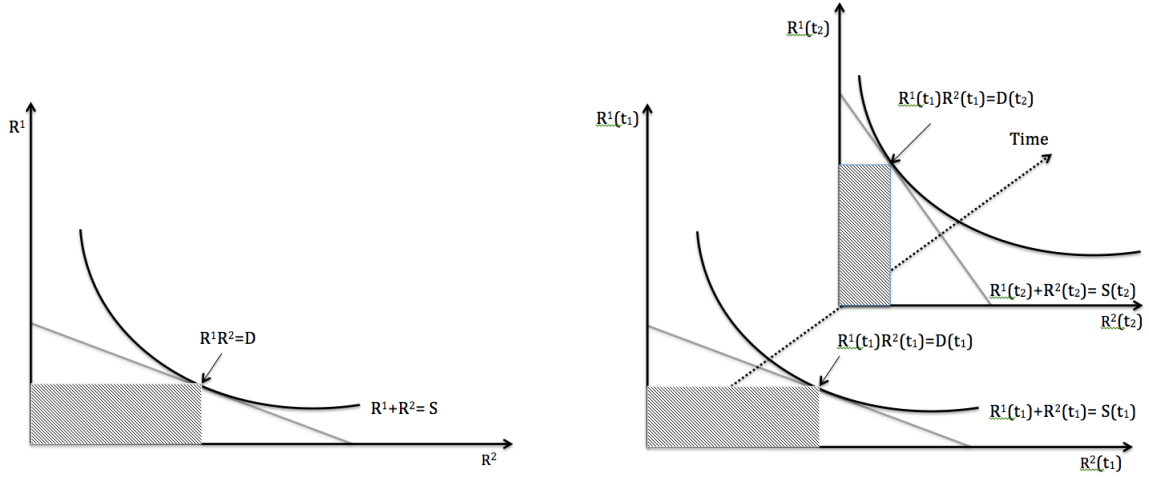

Fig. 5.1 Two-user illustrative example of the subcarrier NBS allocation

Fig. 5.2 Two-user illustrative example of our RB NBS approach

In [HJL05], the authors have introduced the Pareto optimal which is equivalent to the economical optimization and a game theoretic solution – NBS (Nash Bargaining Solution):

$$\arg \max \prod_{i=1}^K (r^i - R_{\min}^i), \text{ where } \mathbf{r}_i \in \mathbf{S}, \forall i r^i > R_{\min}^i. \quad (5.4)$$

Their OFDMA allocation is based on the subcarrier channels in the OFDM(A) where all the subcarriers are orthogonal, in the LTE downlink network, because the RB are composed by the subcarriers, we apply the same scheme for the RBs. But the difference of the general OFDMA system and LTE downlink OFDMA network is the number of available orthogonal units.

- The general OFDMA radio resource is divided into many sub-carriers which can be allocated to UEs (one or many subcarriers to a same UE’s communication). The allocation method is applied to optimize the objective at each time-slot.
- The LTE downlink OFDMA bandwidth is divided in the temporal space into Resource Blocks whose time length is equal to a half of the TTI (Time Transmission Interval). Because each RB is composed of 12 subcarriers, the number of RBs available during a TTI may be smaller than the number of UEs, it may happen that certain UEs do not have any RB allocated in a TTI. During a transmission time period (100–1000 ms), however, the number of RBs is great enough to allocate resource to all the UEs.

Fig. 5.1 illustrates a two-user example of the subcarrier allocation where R_{\min} is assumed to be zero. The triangle $R^1 + R^2 = S$ is the feasible range for the NBS cost function, the

optimal point is at $(\tilde{R}^1, \tilde{R}^2)$ with $R^1 R^2 = \tilde{D}$, where \tilde{D} is the largest constant for the feasible set \mathbb{S} .

In our approach through the RB allocation we add one more dimension to 2-D curves, the time, and translate them into a 3-D model, shown in Fig. 5.2. It is clear that at different time slots t_1 and t_2 , the optimization allocation is different. This 3-D figure shows that the optimization of the RB NBS is to maximize the volume of all the shadow part in a period: $\max \int_{t_1}^{t_2} R_1(t)R_2(t)dt$.

To find a best allocation to maximize the NBS, we use an economic approach. From this point of view, the RBs are seen as goods and different capacities on all the RBs are seen as the gain of these goods.

According to this theory, the cell edge UEs' SINR is always less than centre UEs' because of the larger path-loss $L_i(d_i)$, but these edge UEs' capacities also benefit from good and bad channel quality. When we allocate the RBs depending on their capacity, the central UEs have a position advantage. With some other allocation algorithms, these RBs may be allocated to a UE when the channel quality is not good, and in such a case channel efficiency is wasted. We remain in the economic context to determine the relative quality of an RB for a UE. We need to allocate more RBs to edge UEs to satisfy the formula (5.4), so it is better to allocate RBs to a given UE when their capacity is good [Ric21].

A cooperative theory tool is presented in the following example: a country's choice of goods production is not based on its cost compared with other countries, but on their own cost among different goods. For instance, a developed country produces a machine at a cost of 3 thousand euros and wheat at a cost of 4 thousand euros, whereas a developing country produces a machine at a cost of 30 thousand euros and wheat at a cost of 5 thousand euros. The production costs of the developing country are higher than those of a developed country for all goods, but if it only produces wheat, and the developed country only produces machines, the sum of the two countries' production is maximized [Ric21].

How to judge whether the capacity of an RB is good enough for a UE? We have three parts in the RB capacity formula (5.3), in which only the first part $\|G_i^m\|^2$ is variable. We compare this part with those of other UEs, the UE with maximum $\|G_i^m\|^2$ has the highest efficiency on this RB. Thus our main idea consists in determining the RB allocation in function of $\|G_i^m\|^2$. The reader might have already noticed that its straightforward use would lead to favor UEs localized in the cell center. Such an unwanted phenomenon would take place because all RBs pick up an RB with the same probability. Consequently, the centrally situated UEs would benefit from the higher average RB capacity because of less path-loss.

This is the main idea of our allocation mechanism, but we cannot get the optimal solution directly by comparing the $\|G_i^m\|^2$: Each UE has the same opportunity to get the UEs so the numbers of their allocated RBs will be equal after a long time, the centre UEs will have higher data-rate because their average RB capacities are higher by the reason of less path loss.

5.5 NBS Solution

To maximize the gain of NBS of Eq. (5.4), we should avoid allocating the RBs to the differently positioned UEs with the same probability. A fair allocation scheme will increase the probability of allocating an RB for UEs being on the cell edge and diminish this probability for UEs being close to the e-NodeB. By doing so the scheme will smooth the data rate over the cell. Thus we propose to weigh the channel quality by a compensation factor a_i to balance out the poor channel quality of UEs on the cell edge. A factor a_i is obviously an increasing function of path-loss $L_i(d_i)$. The decision of the allocation of RB m to UE i will be taken according to $a_i\|G_i^m\|^2$.

We point out that in the real world, an e-NodeB always has at its disposal Z historical SINR values from which we can estimate the average path-loss $L(d_i)$, under the assumption that the channel is defined by the Rayleigh model (in SISO channels). We thus have:

$$\sum_{\text{TTI}=1}^Z \Gamma_{\text{TTI}} = \sum_{\text{TTI}=1}^Z \frac{P\|G_{\text{TTI}}\|^2}{L(d_i)\sigma_i^2} = \frac{P}{L(d_i)\sigma_0} \sum_{\text{TTI}=1}^Z \|G_{\text{TTI}}\|^2, \quad (5.5)$$

which gives us in the presence of the Rayleigh assumption allowing us to say that the mean of $\|G\|^2$ is equal to 1:

$$L(d_i) = \frac{ZP}{\sigma_0 \sum_{\text{TTI}=1}^Z \Gamma_{\text{TTI}}}. \quad (5.6)$$

We can compute the probability that a UE can get an RB. All the UEs have the same distribution of the fast fading channels, the probability density function (pdf) of the channel $\|G_i\|^2$ is denoted as $p(\|G_i\|^2)$. Using the notation $\|G_i\|^2 = x_i$, the probability that UE i gets the RB, \mathbb{P}_i , is expressed by

$$\mathbb{P}_i = \int_0^{+\infty} p(x_i) \left(\prod_{k \neq i} \int_0^{\frac{a_i x_i}{a_k}} p(x_k) dx_k \right) dx_i, \quad (5.7)$$

with normalization $\sum_{i=1}^K \mathbb{P}_i = 1$.

For SISO (Single-Input-Single-Output) channel condition, the distribution of $\|G_i\|$ follows a Rayleigh distribution, and $\|G_i\|^2$ follows an exponential distribution, $p(x_i) = \exp(-x_i)$.

The average data rate of UE i is $r^i = \mathbb{P}_i M \overline{C}_i$, where \overline{C}_i is the average RB capacity found thanks to Eq. (5.3) and M is the number of available RBs at the same time. We put it into Eq. (5.4), and omit the R_{\min} because we consider it as very small, a new objective for the NBS is:

$$N = \prod \mathbb{P}_i M W \left(\overline{\log x_i} + \log \frac{1}{L_i(d_i)} + \log \frac{P}{\sigma_0} \right). \quad (5.8)$$

The value of $\overline{\log x_i}$ is expressed by:

$$\overline{\log x_i} = \frac{\int_0^{+\infty} \log x_i p(x_i) \left(\prod_{k \neq i} \int_0^{\frac{a_i x_i}{a_k}} p(x_k) dx_k \right) dx_i}{\mathbb{P}_i}. \quad (5.9)$$

Because all the RBs of a UE are in the same environment, they have the same channel distribution, and N given by NBS equation (5.8) depends on values of a_1, \dots, a_K only. We can achieve its maximum value when for all i :

$$\frac{\partial N}{\partial a_i} = 0. \quad (5.10)$$

We get:

$$\frac{\partial \mathbb{P}_i}{\partial a_i} \left(\overline{\log x_i} + \log \frac{1}{L_i(d_i)} + \log \frac{P}{\sigma_0} \right) + \mathbb{P}_i \frac{\partial \overline{\log x_i}}{\partial a_i} = 0. \quad (5.11)$$

K independent equations with $K - 1$ variables a_1, a_2, \dots, a_K . Eq. (5.11) can thus be solved.

The channel quality matrix G_i^m can be obtained through control channels, the position and path-loss for each UE are also known by the e-NodeB. With this information, we can compute a suitable compensation factor a_i for each UE to maximize the NBS function.

At each time-slot, we allocate the RB m to the UE i in order to satisfy:

$$\arg_{i \in K} \max a_i \|G_i^m\|^2. \quad (5.12)$$

Eq. (5.12) ensures the RB allocation satisfying the NBS model. An algorithm performing such an allocation must have an acceptable complexity. As the reader might have already noticed, computing efficiently compensation factors a_i is a real challenge.

In the remainder of this section, we present our principal algorithmic contribution – the RB NBS method, together with its variants.

5.5.1 Exact Solution

To find the average throughput $r^i = P_i M \bar{C}_i$, we start with Eq. (5.7):

$$\begin{aligned} \mathbb{P}_i = & 1 + (-1)^2 \sum_{u=1, \neq i}^K \frac{1/a_i}{1/a_i + 1/a_u} + (-1)^2 \sum_{u=1, \neq i}^K \sum_{v=1, \neq i, u}^K \frac{1/a_i}{1/a_i + 1/a_u + 1/a_v} \\ & + \dots + (-1)^{K-1} \frac{1/a_i}{\sum_{u=1}^K 1/a_u} \end{aligned} \quad (5.13)$$

According to the Binomial theorem, the expansions of Eq. (5.13) has $\sum \binom{K-1}{k} = 2^{K-1}$ terms, the complexity of the solution to Eq. (5.11) is in $\mathcal{O}(2^{K-1})$.

Similarly to Eq. (5.7), Eq. (5.9) can also be expressed by an expansion with 2^{K-1} terms, but it is not possible to have an analytic solution of the function $\int x \log x dx$. We can use the Newton method to compute a numerical solution of Eq. (5.7). Although the result of Eq. (5.9) is a numerical solution, it is obtained with machine precision not an approximated result.

Computation of factors a_i can be done from Eq. (5.11) through solving a system of first-order partial differential equations. This can be done for a small number of UEs only, because of the exponential complexity. Therefore the exact method can be used for networks with very few UEs. We call it *exhaustive RB NBS* in the rest of the dissertation.

5.5.2 Proposed RB NBS Algorithm

The numerical complexity of an exact algorithm makes it impossible to be implemented in practice. To tackle this obstacle we propose a heuristic algorithm, called (*iterative*) *RB NBS*, which treats the allocation in a greedy manner, UE by UE. Compensation factors are computed one by one, iteratively [HTV15].

We start by sorting UEs in increasing order of their path-loss: $L_1(d_1) < L_2(d_2) < \dots < L_K(d_K)$. Then we use a following method:

Suppose all compensation factors a_i equal to 1 at first. It means that we allocate the RB to a UE whose channel condition is the best, as a conventional allocation algorithm would do. In order to find out the influence of the channel quality upon the allocation, we assign for UE i , $i = 2, 3, \dots, K$ factor a_i whose value is greater than 1. We start with the computation of an approximate value of a_2^* and then use the iterative method to find the value of compensation factor for the next UE, one by one.

Step 1: We only consider first two UEs, UE₁ and UE₂. Assuming that $L_1 < L_2$. Obviously, to maximize product of $r^1 r^2$, we need to have $a_1 < a_2$. The solution of Eq. (5.7) for UE 1

and UE 2 gives $\mathbb{P}_1 = \frac{a_1}{a_1+a_2}$, $\mathbb{P}_2 = \frac{a_2}{a_1+a_2}$. Eq. (5.9) can be rewritten in this as:

$$\overline{\log x_i} = \frac{\int_0^{+\infty} \log x_i p(x_i) \left(1 - e^{-\frac{a_k}{a_i} x_i}\right) dx_i}{\mathbb{P}_i}, \quad (5.14)$$

where $i = 2$ and $k = i - 1 = 1$.

As an integral of type $\int x \log x dx$ presented in Eq. (5.14) cannot be solved analytically, we use the Newton's method to solve the Eq. (5.9) to get a new optimal value of a_2^* . It should be already obvious that the factor a_i for UE i , $i > 2$ must be greater than a_2 because its path-loss is greater. Caring about the simplicity of the convergence proof we note here that for a while $a_3 = \dots = a_K$ are equal to a_2^* .

Step 2: Putting a_1^* and a_2^* in the Eq. (5.7), we find the formula for \mathbb{P}_3 in which a_3 remains unknown. Eq. (5.9) allows us to express $\overline{\log x_3}$ in function of a_3 . Combining \mathbb{P}_3 and $\overline{\log x_3}$ into Eq. (5.11) we obtain a_3^* .

Step 3: We pursue computing a_{i+1}^* , $i = 3, \dots, K-1$, from the \mathbb{P}_{i+1} and $\overline{\log x_{i+1}}$ according to the scheme given on the previous step.

The process of the algorithm is expressed in the Table of Algorithm 5.

Algorithm 5: Proposed RB NBS algorithm.

Data: Channel Matrix G_i , Path loss $L_i(d)$

Result: Factor a_i

- 1 initialization: $a_i = 1$;
 - 2 Calculate a_1 and a_2 by Eq. (5.11) and (5.14);
 - 3 **for** UE $i \leftarrow 3$ **to** K **do**
 - 4 Put a_{i-1} and a_{i-2} in the Eq. (5.7) to express the \mathbb{P}_i by a_i ;
 - 5 express $\overline{\log x_i}$ in function of a_i by Eq. (5.9);
 - 6 take $\mathbb{P}_i(a_i)$ and $\overline{\log x_i}(i)$ into Eq. (5.11) and make it a single function of a_i ;
 - 7 solve this function and get the value of a_i .
 - 8 **end**
-

Our algorithm produces approximate compensation factors a_1^*, \dots, a_K^* . Let us observe that computations of a_i rely upon \mathbb{P}_i and $\overline{\log x_i}$, and require $i - 1$ operations. For all UEs we have $\sum_{i=1}^K K$ operations which leads us to the complexity in $\mathcal{O}(K^2)$.

We prove now that our algorithm converges:

We first prove that the NBS formula $N = \prod r^i(a_i)$ is a monotonic function in the set of $a_i \in (a_{i-1}^*, a_i^*)$:

In iteration i of this algorithm, we have $a_i = a_{i+1}$,

$$\frac{\partial N}{\partial a_i} = r^1 \dots r^{i-1} r^{i+2} \dots r^K \left(r^{i+1} \frac{\partial r^i}{\partial a_i} + r^i \frac{\partial r^{i+1}}{\partial a_i} \right) + \sum_{u=1, u \neq i, i+1}^K \prod_{v=1, v \neq u}^K r^v \frac{\partial r^u}{\partial a_i}; \quad (5.15)$$

$$\frac{\partial N}{\partial a_{i+1}} = r^1 \dots r^{i-1} r^{i+2} \dots r^K \left(r^i \frac{\partial r^{i+1}}{\partial a_{i+1}} + r^{i+1} \frac{\partial r^i}{\partial a_{i+1}} \right) + \sum_{u=1, u \neq i, i+1}^K \prod_{v=1, v \neq u}^K r^v \frac{\partial r^u}{\partial a_{i+1}}; \quad (5.16)$$

In iteration i , obviously we have $\frac{\partial N}{\partial a_i} |_{a_i=a_i^*} = 0$. We will show that $\frac{\partial N}{\partial a_{i+1}} > 0$ when $a_{i+1} = a_i^*$.

Let us firstly study two partial expressions in them: $\frac{\partial r^i}{\partial a_i}$ and $\frac{\partial r^u}{\partial a_i}$, where $u \neq i, i+1$.

Because $r^i = \mathbb{P}_i M \overline{C}_i$ and M is constant, we have:

$$\frac{\partial r^i}{\partial a_i} = M \frac{\partial}{\partial a_i} (\mathbb{P}_i \overline{C}_i) = M \left(\overline{C}_i \frac{\partial \mathbb{P}_i}{\partial a_i} + \mathbb{P}_i \frac{\partial \overline{C}_i}{\partial a_i} \right) \quad (5.17)$$

$$\frac{\partial r^u}{\partial a_i} = M \frac{\partial}{\partial a_i} (\mathbb{P}_u \overline{C}_i) = M \left(\overline{C}_u \frac{\partial \mathbb{P}_u}{\partial a_i} + \mathbb{P}_u \frac{\partial \overline{C}_u}{\partial a_i} \right) \quad (5.18)$$

To analyze Eq. (5.17) and (5.18), we find from the Eq. (5.3), (5.7) and Eq. (5.9) with notation $\|G_i^m\| = x_i$ that:

$$\frac{\partial \mathbb{P}_i}{\partial a_i} = \frac{\partial \mathbb{P}_{i+1}}{\partial a_{i+1}}, \quad (5.19)$$

$$\frac{\partial \mathbb{P}_u}{\partial a_i} = \frac{\partial \mathbb{P}_u}{\partial a_{i+1}}, \quad (5.20)$$

$$\frac{\partial \overline{C}_i}{\partial a_i} = \frac{\partial \overline{C}_{i+1}}{\partial a_{i+1}}, \quad (5.21)$$

$$\frac{\partial \overline{C}_u}{\partial a_i} = \frac{\partial \overline{C}_u}{\partial a_{i+1}}, \quad (5.22)$$

when $a_i = a_{i+1}$ and $u \neq i$.

Because the UE i has higher probability to get the RB when its corresponding a_i increases, and other UEs have lower probability to be allocated an RB at the same time, we conclude that:

$$\frac{\partial \mathbb{P}_i}{\partial a_i} > 0, \quad (5.23)$$

$$\frac{\partial \mathbb{P}_u}{\partial a_i} < 0, \quad (5.24)$$

Equations (5.15) and (5.16) have two terms, and we will analyze these two terms in the next two paragraphs.

Comparison $r^{i+1} \frac{\partial r^i}{\partial a_i} + r^i \frac{\partial r^{i+1}}{\partial a_i}$ **and** $r^i \frac{\partial r^{i+1}}{\partial a_{i+1}} + r^{i+1} \frac{\partial r^i}{\partial a_{i+1}}$

$$r^{i+1} \frac{\partial r^i}{\partial a_i} = r^{i+1} \left(\overline{C}_i \frac{\partial \mathbb{P}_i}{\partial a_i} + \mathbb{P}_i \frac{\partial \overline{C}_i}{\partial a_i} \right) \quad (5.25)$$

$$r^i \frac{\partial r^{i+1}}{\partial a_{i+1}} = r^i \left(\overline{C}_{i+1} \frac{\partial \mathbb{P}_{i+1}}{\partial a_{i+1}} + \mathbb{P}_{i+1} \frac{\partial \overline{C}_{i+1}}{\partial a_{i+1}} \right) \quad (5.26)$$

When $a_i = a_{i+1}$, $\overline{\log x_i} = \overline{\log x_{i+1}}$. Because $L_i < L_{i+1}$, according to Eq. (5.3) we have:

$$\overline{C}_i > \overline{C}_{i+1}, \quad (5.27)$$

so we get:

$$r^i > r^{i+1}. \quad (5.28)$$

With Eq. (5.19), we have:

$$\frac{r^i}{r^{i+1}} = \frac{\mathbb{P}_i \overline{C}_i}{\mathbb{P}_{i+1} \overline{C}_{i+1}} = \frac{\overline{C}_i}{\overline{C}_{i+1}}, \quad (5.29)$$

So we have:

$$r^{i+1} \overline{C}_i \frac{\partial \mathbb{P}_i}{\partial a_i} = r^i \overline{C}_{i+1} \frac{\partial \mathbb{P}_{i+1}}{\partial a_{i+1}} \quad (5.30)$$

Because of Eq. (5.21) and taking advantage of the fact that $P_i = P_{i+1}$ as $a_i = a_{i+1}$ for i th iteration, we have:

$$\mathbb{P}_i \frac{\partial \overline{C}_i}{\partial a_i} = \mathbb{P}_{i+1} \frac{\partial \overline{C}_{i+1}}{\partial a_{i+1}}; \quad (5.31)$$

$$\Leftrightarrow r^{i+1} \mathbb{P}_i \frac{\partial \overline{C}_i}{\partial a_i} < r^i \mathbb{P}_{i+1} \frac{\partial \overline{C}_{i+1}}{\partial a_{i+1}}; \quad (5.32)$$

From Eq. (5.30) and (5.32), we conclude that:

$$r^{i+1} \frac{\partial r^i}{\partial a_i} < r^i \frac{\partial r^{i+1}}{\partial a_{i+1}} \quad (5.33)$$

Comparison $r^i \frac{\partial r^{i+1}}{\partial a_i}$ **and** $r^{i+1} \frac{\partial r^i}{\partial a_{i+1}}$

The expression can be represented as:

$$r^i \frac{\partial r^{i+1}}{\partial a_i} = r^i \left(\overline{C}_{i+1} \frac{\partial \mathbb{P}_{i+1}}{\partial a_i} + \mathbb{P}_i \frac{\partial \overline{C}_{i+1}}{\partial a_i} \right) \quad (5.34)$$

$$r^{i+1} \frac{\partial r^i}{\partial a_{i+1}} = r^{i+1} \left(\overline{C}_i \frac{\partial \mathbb{P}_i}{\partial a_{i+1}} + \mathbb{P}_{i+1} \frac{\partial \overline{C}_i}{\partial a_{i+1}} \right) \quad (5.35)$$

Similarly to the proof of Eq. (5.30), we have:

$$r^i \overline{C}_{i+1} \frac{\partial \mathbb{P}_{i+1}}{\partial a_i} = r^{i+1} \overline{C}_i \frac{\partial \mathbb{P}_i}{\partial a_{i+1}} \quad (5.36)$$

According to Eq. (5.24), we have:

$$\frac{\partial \mathbb{P}_{i+1}}{\partial a_i} = \frac{\partial \mathbb{P}_i}{\partial a_{i+1}} < 0; \quad (5.37)$$

$$(5.38)$$

According to Eq. (5.22) and $r^i > r^{i+1}$, we have:

$$r^i \mathbb{P}_i \frac{\partial \overline{C}_{i+1}}{\partial a_i} < r^{i+1} \mathbb{P}_{i+1} \frac{\partial \overline{C}_i}{\partial a_{i+1}} < 0 \quad (5.39)$$

According to Eq. (5.33) and (5.39), we can conclude that:

$$r^{i+1} \frac{\partial r^i}{\partial a_i} + r^i \frac{\partial r^{i+1}}{\partial a_i} < r^i \frac{\partial r^{i+1}}{\partial a_{i+1}} + r^{i+1} \frac{\partial r^i}{\partial a_{i+1}} \quad (5.40)$$

Comparison $\frac{\partial r^u}{\partial a_i}$ and $\frac{\partial r^u}{\partial a_{i+1}}$

Represent the formulas of $\frac{\partial r^u}{\partial a_i}$ and $\frac{\partial r^u}{\partial a_{i+1}}$:

$$\frac{\partial r^u}{\partial a_i} = \overline{C}_u \frac{\partial \mathbb{P}_u}{\partial a_i} + \mathbb{P}_u \frac{\partial \overline{C}_u}{\partial a_i} \quad (5.41)$$

$$\frac{\partial r^u}{\partial a_{i+1}} = \overline{C}_u \frac{\partial \mathbb{P}_u}{\partial a_{i+1}} + \mathbb{P}_u \frac{\partial \overline{C}_u}{\partial a_{i+1}} \quad (5.42)$$

According to Eq. (5.20) and (5.22), all the terms of the two expressions above (Eq. (5.41) and (5.42)) are equal, so we conclude that:

$$\frac{\partial r^u}{\partial a_i} = \frac{\partial r^u}{\partial a_{i+1}} \quad (5.43)$$

According to Eq. (5.40) and (5.43), we have:

$$\frac{\partial N}{\partial a_i} < \frac{\partial N}{\partial a_{i+1}} \quad (5.44)$$

Because in each iteration, we compute the a_i by Eq (5.10) $\frac{\partial N}{\partial a_i} = 0$, so

$$0 = \frac{\partial N}{\partial a_i} < \frac{\partial N}{\partial a_{i+1}}$$

From $0 = \frac{\partial N}{\partial a_i} < \frac{\partial N}{\partial a_{i+1}}$, we thus conclude that $a_i^* < a_{i+1}^*$.

Because we start by sorting UEs in increasing order of their path-loss: $L_1(d_1) < L_2(d_2) < \dots < L_K(d_K)$, a_i is increased with the path-loss.

When a_{i+1} varies from a_i^* to a_{i+1}^* , $\forall k > i$: we have

$$\begin{aligned} N(a_1^*, \dots, a_i^*, a_{i+1} = a_{i+1}^*, a_{i+2} = a_i^*, \dots, a_K = a_i^*) &\geq \\ N(a_1^*, \dots, a_i^*, a_{i+1} = a_i^*, a_{i+2} = a_i^*, \dots, a_K = a_i^*), & \end{aligned} \quad (5.45)$$

as a harmful impact of the path-loss of UE $_{i+1}$ is reduced better by a greater compensation factor.

Because $0 \leq \frac{\partial N}{\partial a_{i+1}} \leq \frac{\partial N}{\partial a_{i+2}} \leq \dots \leq \frac{\partial N}{\partial a_K}$ in the interval $[a_i^*, a_{i+1}^*]$, we can also conclude that

$$\begin{aligned} N(a_1^*, \dots, a_i^*, a_{i+1} = a_{i+1}^*, a_{i+2} = a_{i+1}^*, \dots, a_K = a_{i+1}^*) &\geq \\ N(a_1^*, \dots, a_i^*, a_{i+1} = a_i^*, a_{i+2} = a_i^*, \dots, a_K = a_i^*). & \end{aligned} \quad (5.46)$$

This proves that our NBS product increases on each iteration of the algorithm. As we deal with an heuristic method, we evaluate its performance via simulation whose results we will discuss in Section 5.7 and 5.8.

5.5.3 Parallel RB NBS Algorithm

As shown above, the numerical complexity of the serial approach is in $\mathcal{O}(K^2)$, which might lead to a long computation time when K , the number of UEs, is very large. It would be thus interesting to have our serial algorithm parallelized. Indeed, our algorithm compares the values of $a_i \|G_i^m\|^2$, the allocation does not change as long as the ratio of $a_i/a_k (i \neq k)$ stays constant. Therefore it is possible to compute compensation factors a_i by groups in which this ratio remains constant and make a normalization in the same quantitative system. This variant will be called *parallel RB NBS*.

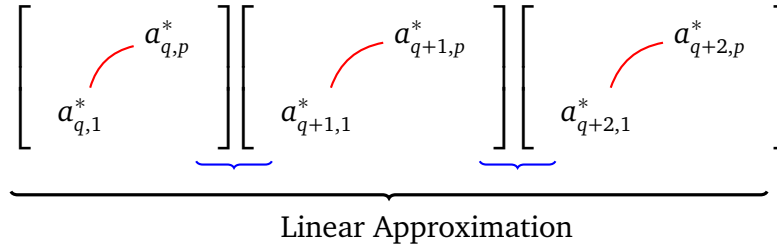

Fig. 5.4 Log Scale linear approximation of compensation factors groups for the Log Scale RB NBS Algorithm

Step 5: For the $(q + 1)$ th group, we repeat the Step 3 and 4 to find the ratio of compensation factors for the UEs between adjacent groups $= \lambda_q \frac{a_{q+1,1}^{**}}{a_{q,p}^*}$. By doing this we compute $a_{q+1,i}^{**} = \lambda_q a_{q,p}^{**} a_{q+1,i}^*$.

Step 6: The iteration process of computing $a_{q+1,i}^{**}$ stops after reaching the last group.

Each group has $\frac{K}{Q}$ members. The algorithm of square complexity (see Subsection 5.5.2) is run for each group. What gives us the numerical complexity $\mathcal{O}(\frac{K^2}{Q})$.

5.5.4 Log Scale RB NBS Algorithm

The parallel algorithm described above may be speed up when in some groups the knowledge of compensation factors for the UEs on the group border only is sufficient to estimate these factors for all UEs inside a group.

Observe the expression for the data-rate r^i :

$$r^i = \mathbb{P}_i MW \left(\overline{\log x_i} + \log \frac{1}{L_i(d_i)} + \log \frac{P}{\sigma_0} \right). \quad (5.47)$$

Thanks to this formula, we conclude that, when all the UEs experience the same channel distribution $\|G\|$, the other components of the formula are constant, the only variable part of different UEs being $\log L_i(d_i)$.

On the cell edge, because the path-loss increases slowly, the rate of increment between the first UE and the last UE in the group may be small. We profit from this fact in our estimation.

According to the Taylor formula, we state:

Conjecture 5.5.1. *When the range of path-loss is relatively narrow in the group, we can suppose that the values of a_i have a linear relationship with $\log L_i$.*

This conjecture will be a subject of the experimental validation (see Subsection. 5.7.2).

Having this conjecture in our disposal, we can estimate the value of compensation factors for these groups of UEs in which the variability of path-loss is negligible.

In a group $\{\text{UE}_{q,1}, \dots, \text{UE}_{q,p}\}$ with a weak path-loss variability, we just calculate the relative value of the first $a_{q,1}$ and last $a_{q,p}$, then use the linear approximation to estimate all the factors.

Step 1: The objective function for this approximation is $N_p = r^{q,1} r^{q,p}$.

Step 2: We express $r^{q,1}$ and $r^{q,p}$ in function of $a_{q,1}$ and $a_{q,p}$.

Step 3: We put them into Eq. (5.11) to get the linear relation s_q in group q : $s_q = \frac{a_{q,p}^*}{a_{q,1}}$.

The algorithm's main idea is presented in Fig. 5.4.

Step 4: For the i th UE in this group, its estimated value is: $a_{q,i}^* = \frac{\log L_{q,i} - \log L_{q,1}}{\log L_{q,p} - \log L_{q,1}} (a_{q,p} - a_{q,1}) + a_{q,1} = \left(\frac{\log L_{q,i} - \log L_{q,1}}{\log L_{q,p} - \log L_{q,1}} s_q + \frac{\log L_{q,p} - \log L_{q,i}}{\log L_{q,p} - \log L_{q,1}} \right) a_{q,1}$

In this fourth method, called *Log scale RB NBS*, the part of computation only has to be done in parallel — for these groups which are close to an e-NodeB in which a rapid growth might be observed, and for this reason compensation factors of all group members have to be computed in iterative way with the RB NBS algorithm. We remind to a reader that it needs time $\mathcal{O}(K^2)$ for each group.

As the path-loss increase rate slows down with a distance separating a group from an e-NodeB, we may benefit from simpler computation when finding compensation factors for groups relatively far from the cell center. These computation can be done in serial way as their complexity is in $\mathcal{O}(K)$.

5.5.5 Mixed RB NBS Algorithm

In the cell center, as $L_i \propto d^\alpha$, $\alpha \approx 3.7$, the path-loss increases quickly with the distance d . For this reason, the path-loss difference among the UEs in the center is very large. The log scale approximated method is not in favor of center UEs. Thus, it is better to use the iterative method described in Subsection 5.5.2 to compute the accurate a_i in this area.

We then propose the fifth method called *Mixed RB NBS* (Table 5.1) which combines the methods proposed above to obtain the suitable solutions for each area while keeping the numerical complexity as low as possible even for cells with a large number of UEs. The mixed RB NBS operates as follows. First, we treat separately these UEs which are in the cell center using the iterative method. We obtain for these UEs accurate computation factors. Second, UEs being on the cell edge are divided into groups in which the use of the Log Scale RB NBS approach is possible. The compensation factors computed for the edge groups are next concatenated according to the scheme illustrated in Fig. 5.4.

In this section, we have discussed four heuristic methods (one of them being a mix) to solve the fair RB allocation problem and to reduce the computation complexity. In the following sections, we provide an exhaustive performance analysis.

5.6 Evaluation Methodology

We proposed heuristic algorithms to find a Pareto optimal solution to our allocation problem. We also proved their convergence and formulated a conjecture which facilitates computation when a certain hypothesis concerning the path-loss variability is taken.

As our algorithmic results require an experimental validation, this section provides its framework. We start by giving a description of the simulation tool used together with its parameterization we choose. Next, we give the performance measures, relevant in our study. The design of experiments follows. We propose two main axis of performance analysis: comparison with channel oriented methods and comparison with reference algorithms aiming throughput or fairness.

We draw reader's attention to the fact that we propose an especially designed channel oriented method which is dedicated to assess a gain obtained by the introduction of compensation factors.

5.6.1 Simulation Setup

The performance evaluation is made using LTE-Sim [PGB⁺11a], a simulation package which provides a library of all LTE functions and architectures. We developed our methods with this package and enriched the simulator to model our methods and perform simulation runs. The detailed description of the modification we introduced in LTE-Sim is given in Appendix A.

5.6.2 Performance Criteria

Throughput Evaluation: As performance throughput criteria we choose the average throughput of an entire cell (the arithmetic mean) and the geometric mean throughput for a UE. The arithmetic mean throughput per UE is expressed as $\frac{\sum_{i=1}^K r^i}{K}$ and it is used to evaluate the channel efficiency. The geometric mean throughput per UE is $\sqrt[K]{\prod_{i=1}^K \bar{r}_i}$. This indicator is proposed to compare the product of all the UE's throughput which is equivalent to the NBS objective function ($\prod_{i=1}^K r^i$).

Fairness Index: Except the mean throughput, another criterion to evaluate the allocation policy is the fairness index. It is used to present the data-rate difference among the UEs. The fairness can also be explained that the UE do not want the other UEs have higher data rate than itself. We use the Jain's fairness index [JCH84] to evaluate the fairness for UEs. It is expressed as:

$$\tau(r^1, r^2, \dots, r^K) = \frac{(\sum_{i=1}^K r^i)^2}{K \sum_{i=1}^K (r^i)^2}. \quad (5.48)$$

A fairness index value ranges from $\frac{1}{K}$ (worst case) to 1 (best case). It reaches the maximum when all UEs have the same throughput.

5.6.3 Design of Experiments

In Section 5.7, we show that our RB NBS algorithms have better performance than other channel oriented algorithms and our approximated methods reduce the complexity but do not affect too much accuracy. Subsection 5.8 covers fairness related results and we introduce the reference algorithms which we use.

Channel oriented algorithms

Algorithms	Subsection	Complexity
Exhaustive RB NBS	Subsection 5.5.1	$\mathcal{O}(2^{K-1})$
(Iterative) RB NBS	Subsection 5.5.2	$\mathcal{O}(K^2)$
Parallel RB NBS	Subsection 5.5.3	$\mathcal{O}(K^2/Q)$
Log Scale RB NBS	Subsection 5.5.4	$\mathcal{O}(K)$
Mixed RB NBS	Subsection 5.5.5	the best $\mathcal{O}(K)$, the worst $\mathcal{O}(K^2/Q)$

Table 5.1 Algorithm enumeration

Algorithms	Criterion
Maximum Throughput (MT)	$\max_i \text{SINR}_i$
Best Channel (BC)	$\max_i \ G_i\ ^2$
Proposed RB NBS	$\max_i a_i \ G_i\ ^2$

Table 5.2 Channel oriented algorithm development: decision criterion

As we were inspired by the Maximum Throughput (MT) algorithm (Subsection 3.2.1). What we stress here is a difference between its approach and the one of our algorithms. The core idea of the series of channel oriented algorithms is to use the highest capacity RB to transmit data. The MT allocates RBs according to their SINR Value. Our RB NBS method makes description allocation according to the channel matrix norm weighted by compensation factors a_i which are introduced to counterbalance a harmful influence of path-loss upon the channel quality.

Naturally, the beneficial impact of those factors upon the RB NBS method performance poses into question. For this reason we propose a reference algorithm based exclusively upon the channel quality, the Best Channel (BC) method (Section 5.3). In other words, the BC method works as it is the RB NBS algorithm with all compensation factors set to one. Table 5.2 gives the decision criteria for the three algorithms mentioned, the two reference ones being discussed below in a more detailed way.

The MT algorithm allocates the RBs to the UE whose SINR is the highest and always favors the center UEs. Indeed, our RB NBS algorithm was derived from MT but with consideration not only to the channel quality but also path-loss as well, which are both components of SINR.

To be able to judge the positive impact of compensation factors, we confront our algorithm with its simplified version, BC algorithm. To increase the channel efficiency for the cell edge UEs whose path-loss is exponentially increasing, the BC algorithm allocates the RBs to these UEs which benefit from the highest $\|G_i\|^2$. Nevertheless, this condition is not sufficient to guarantee a satisfactory throughput for UEs on the cell edge. Compared the RB NBS based algorithms with the BC, the edge UEs have the same probability to get the RBs (i.e. all $a_i = 1$), but their average RB capacity is much lower than that of center UEs. On the other hand, our channel oriented algorithms perform a balanced RB allocation by weighting the channel quality by a compensation factor a_i . We remind to the reader that the decision of the allocation of RB m to UE i will be taken according to $a_i\|G_i^m\|^2$. Table 5.2 summarizes the decision parameter taken by each of these algorithms. We show that in simulations the computation cost of a_i brings an excellent performance of our RB NBS algorithm.

Reference algorithms for throughput and fairness validation

We compare the proposed RB NBS algorithms with the other well-known optimal algorithms focusing upon throughput and fairness.

In Chapter 3, we have introduced the EXP Rule algorithm [SS02], the game theoretic algorithm max-min [RC00], and subcarrier NBS algorithm [HJL05] in the general OFDMA system. The well known EXP Rule is proven to be throughput-optimal [SS02]. With the use of simulations, we confirm that it has the best arithmetic mean throughput among the non-game theory algorithms.

The max-min algorithm is the best fairness algorithm because the higher data-rate UEs will transfer its allocated RB to the lower data-rate UEs to increase the minimum throughput UE. This leads all the UEs to have the same level of data-rate.

The subcarrier NBS algorithm works very well in the subcarrier allocation problem [HJL05]. We explained the difference of subcarrier allocation in a general system and the RB allocation in the LTE downlink in Section 5.4. Actually, the general OFDMA system offers a large number of subcarriers and every UE is allocated to some subcarriers in order to satisfy the algorithm's demand at each time-slot. In contrast, the LTE downlink channel is made up of limited number of RBs and the optimization of the RB allocation algorithm's objective is not done for each time-slot separately but for a period which contains hundreds of time-slots.

To have a relevant reference in the LTE downlink system, we modify the Han's NBS algorithm to make it allocate the RB instead of subcarriers. This algorithm optimizes the product of all UEs' instantaneous data-rate in each TTI.

Our goal is to show that our RB NBS algorithm offers a geometric throughput as good as that obtained with throughput-optimal algorithms and guarantees an excellent fairness factor at the same time.

5.7 Confrontation of Proposed Methods

The exact method (Exhaustive RB NBS) gives the optimal result but does it at an excessive complexity cost. In other words, the heuristic methods (Subsections 5.5.2, 5.5.3, 5.5.4) reduce the complexity but their results are sub-optimal.

First, we compare the exhaustive and the iterative RB NBS algorithms. To offer a wider outlook of our algorithm's performance, we also use in our experiments two other channel oriented allocation schemes, the classical MT algorithm and the BC algorithm which we developed especially for evaluation purposes.

As comparisons with results obtained with the exact method are limited to instances whose size is small, we pursue by comparing our algorithms between them. Before doing this we note that our conjecture concerning a linear approximation of compensation factors can be observed in simulations.

5.7.1 Exhaustive and Iterative RB NBS

The exact method obviously has the best theoretical performance, but because of its high complexity, we cannot use it for instances with many UEs. We thus compare its results with the iterative RB NBS method proposed in Subsection 5.5.2 for instances with several UEs only. This iterative method converges on each iterative step and reduces the complexity without losing too much accuracy.

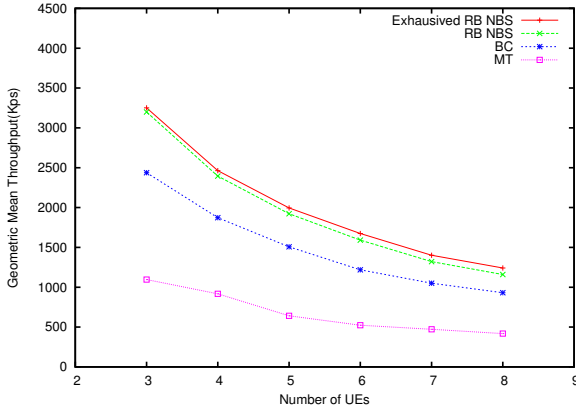

Fig. 5.5 Geometric mean throughput vs number of UEs

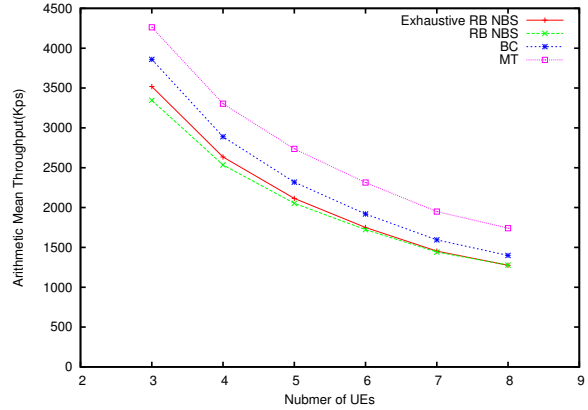

Fig. 5.6 Arithmetic mean throughput vs number of UEs

Fig. 5.5 compares the geometric mean throughput for the MT and BC algorithms with our proposed exhaustive and iterative RB NBS methods, depending on the number of UEs. From this figure we can conclude that our exact and iterative RB NBS algorithms have nearly the same performance when the number of UE grows from 3 to 8. On the other hand, their average geometric mean throughput is much better than that of the BC and MT (see in Section 5.6.3) algorithms. This shows that:

1. as our proposed methods were designed to optimize NBS, the geometric mean throughput they achieve is better than the one of the reference algorithms,
2. the iterative RB NBS method has good performance compared with the exhaustive method as the geometric mean throughput is only 1–2% less than the exact results.

Looking at Fig. 5.6 we naturally find that the MT and BC algorithms have a higher arithmetic mean throughput because they can allocate more RBs to the highest SINR UEs which have lower path-loss. Our algorithm does not aim at maximizing the throughput but finds a trade-off between the channel efficiency and the NBS.

We now compare the throughput obtained for each UE with these four algorithms. Fig. 5.7 gives the geometric throughput depending of UE index indicating the path-loss. It shows that both exhaustive and iterative RB NBS methods give lower throughput to the cell center UEs but higher throughput to the cell edge UEs. This is the main thrust of our methods: to allocate more RBs to the edge UEs in order to increase the product of each UE's throughput. Both the MT and BC schemes give obviously better throughput to the cell center UEs because they have a better SINR which means higher probability to get the RB. In contrast, they give a very poor throughput to the cell edge UEs which have less opportunity to get the RB.

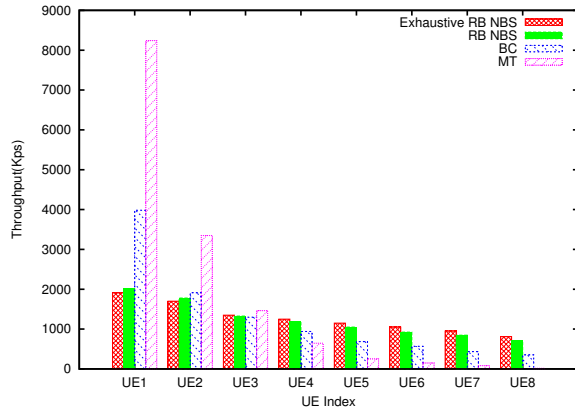

Fig. 5.7 Throughput for RB NBS methods and channel oriented methods depending on the UE path-loss (a higher UE index indicates a higher path-loss)

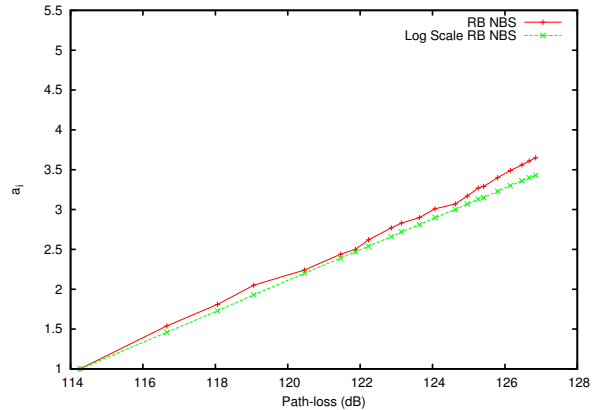

Fig. 5.8 Log scale approximation of compensation factors in cell edge group (Team 3 and 4)

From the results exhibited in the confrontation of our methods with the reference algorithms, we conclude that our objective is achieved as cell edge UEs obtain a highest throughput at the cost of a lower but reasonable global throughput.

According to the simulations, the MT algorithm finds the RB with the highest capacity, which leads to allocate more RBs to the cell center UEs, because they have lower path-loss and thus, higher average SINR. The BC algorithm does not care about the path-loss and offers the same opportunity of RB allocation for each UE, but the edge UEs get RB of lower capacity than the centrally situated UEs because of the path-loss. For this reason, the center UEs have higher average throughput than the edge UEs. Our NBS RB algorithm also allocates the RBs to the best channel quality UEs as the MT and BC algorithms do, but compensation factors introduced make the edge UEs' probability to get the RB increase in order to guarantee their throughput.

5.7.2 Conjecture Validation

In Subsection 5.5.4, we formulated Conjecture 5.5.1 that the values of compensation factors a_i are in a linear relationship with $\log L_i$. To validate it experimentally, we will firstly estimate the factor a_i with the approximation method we formulated in Subsection 5.5.4, and compare the results with their values computed by the iterative method in Subsection 5.5.2. We verify below that Conjecture 5.5.1, which allows us to simplify the computations, may be observed in simulations for these UEs groups for which a path-loss range is narrow.

We divide UEs in a cell into four teams, the population of 25% UEs who have the lowest path-loss are noted as Team 1, the 25%–50% UEs are Team 2, the 50%–75% are Team 3, the rest 25% UEs are Team 4. We name the first two teams as the cell center groups, the Teams 3 and 4 as the cell edge groups. In the edge groups the path-loss gradient is already small. After doing this we compare compensation factors a_i obtained in the cell edge groups with the iterative and our log scale approximation RB NBS methods.

In Fig. 5.8, the x axis represents the path-loss L_i expressed in dB , which is equal to the relative relation of $\log L_i - 10 \log_{10} L_i = \frac{10 \log L_i}{\log 10}$. The y axis represents the computed a_i values. We put in this figure compensation factors a_i computed with the iterative and log scale methods. We observe that the difference between approximated and exact compensation factors is small. Indeed, the relative difference between them is in the range of [0.5%, 3%], the average difference being less than 2%.

We conclude that Conjecture 5.5.1 holds in our experiments and argue that the log scale approximation offers a very satisfying solution when the range of path-loss is narrow.

5.7.3 Influence of Parallel Treatment and Linear Approximation

We consider a scenario with a large number of UEs in order to compare parallel group and log scale approximation algorithms with the iterative RB NBS method.

Using the same setup of UEs in Section 5.7.2, we will first compute compensation factors a_i with the iterative RB NBS method. Second, we compute these factors with the log scale approximation method only. Finally, we use the parallel computation method to find factors a_i in the cell center group and the log scale approximation for the cell edge group (mixed RB NBS algorithm).

Fig. 5.9 shows that these methods have same performance in terms of average geometric throughput. The throughput for iterative method is only nearly 1–2% higher than the mixed method which has much smaller complexity.

5.7.4 Conclusion

Our RB NBS algorithms experience higher geometric mean throughput than the classical channel oriented scheme, MT, and the reference BC algorithms. Because our RB NBS algorithms increase the edge UEs throughput to improve the fairness, a part of the RB capacity is lost for the reason of edge UE's path-loss. This leads to lower the arithmetic mean throughput below the one obtained with the MT and BC algorithms.

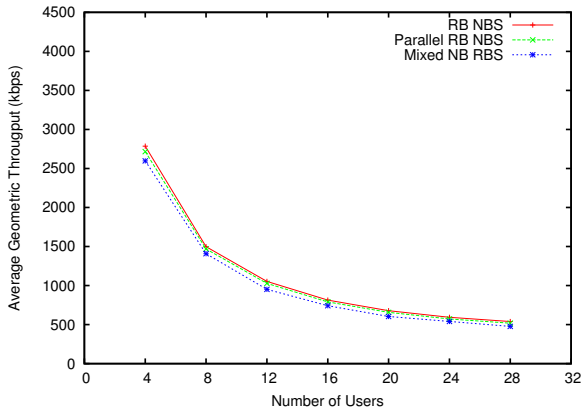

Fig. 5.9 Comparison of proposed methods: geometric mean throughput in function of the number of UEs

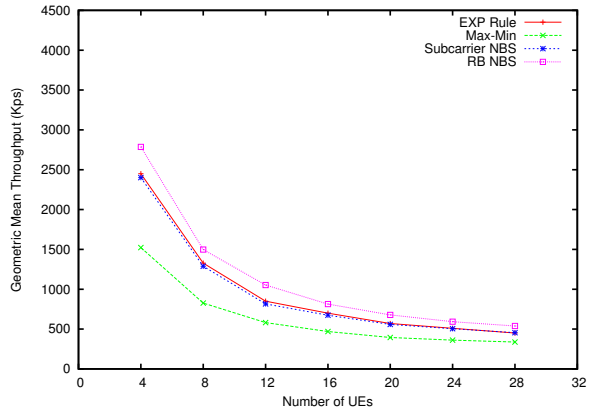

Fig. 5.10 Comparison of our proposed methods with the other algorithms: geometric mean throughput performance in function of the number of UEs

On the other hand, with the computation of compensation factors, the RB NBS family algorithms have much higher geometric throughput than the BC algorithm which may be seen as the RB NBS with trivial compensation factors, $a_i = 1$.

From the result of Section 5.7.2 and 5.7.3, we conclude that the approximated solutions of our algorithm have also very good performance and Conjecture 5.5.1 may be applied to estimate the compensation factors.

5.8 Comparison of Mixed RB NBS with Reference Algorithms

Our intention is to study the behavior of the proposed methods compared to the EXP Rule and other game theory algorithms in order to bring out properties like reached fairness and throughput (see Subsection 5.6.3).

5.8.1 Throughput Evaluation

Fig. 5.10 compares the geometric mean throughput obtained for EXP Rule, max-min, subcarrier NBS and one of our RB NBS schemes. Among the different variants we developed, we use here the iterative method to compute the a_i factors when the number of UEs is less than 20, and for more UEs, we apply the parallel computation in the center groups and the log scale approximation in the cell edge groups (the mixed RB NBS method).

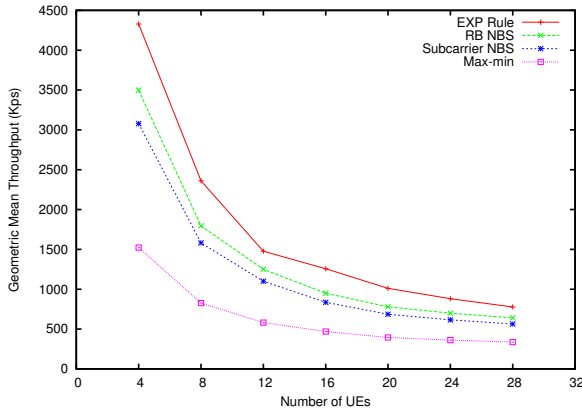

Fig. 5.11 Comparison of geometric throughput for Team 1

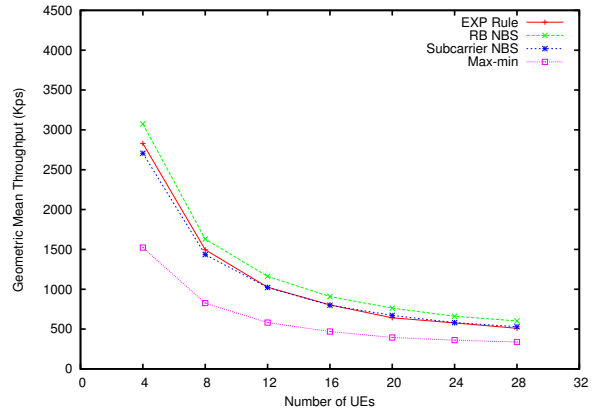

Fig. 5.12 Comparison of geometric throughput for Team 2

The reader may observe this figure that the geometric mean throughput of our scheme is more than 10% higher than the one of EXP rule, 12–15 % higher than the subcarrier NBS algorithm, and much higher than the max-min method.

In contrast to the subcarrier NBS algorithms, our work expands the allocation from a time-slot to several time-slots. This property is adapted to the characteristics of the limited number of available RBs. Because a UE's data transmission is not restricted in each time-slot, it can stop transmitting in some time-slots (a few milliseconds) and transmit the data when the channel returns to a good condition — this return does not last too long in the fast-fading channels. This kind of allocation improves the channel efficiency, so the RB allocation improves channel capacity compared with the subcarrier's allocation method. As we analyzed in Subsection 3.2.3, the max-min is an algorithm which focuses more on the fairness than the channel efficiency, which leads to lower data-rate.

We now compare the performance of our proposed scheme with the reference algorithm in the four teams which are described in Section 5.5. Fig. 5.11–5.14 present performance of the UEs with different listed algorithms in the cell center and on the cell edge.

In Team 1, the EXP Rule must allocate the RBs depending on their capacity. As the central UEs have lowest path-loss and highest SINR, their RB capacity is highest. For this reason, the EXP Rule traditional algorithm gives the highest average throughput as illustrated in Fig. 5.11.

Because the objective of our scheme is to find an approximated solution for the NBS, our geometrical mean throughput per UE has a more significant improvement. For the EXP Rule, because the edge UEs' RB capacity is obviously lower than the centre one, their data rate is much lower. For this reason, the product of all UEs' average throughput is less than that the ones obtained by the other algorithms. When all compensation factors α_i are equal,

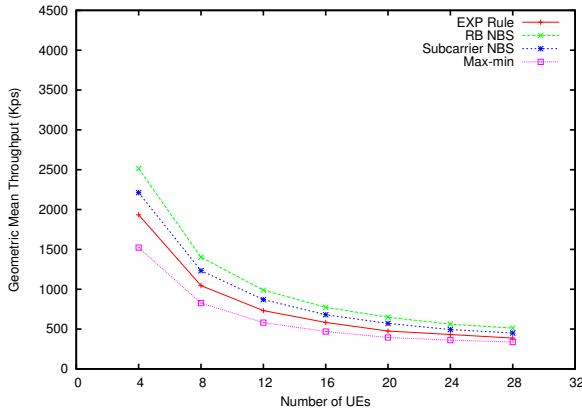

Fig. 5.13 Comparison of geometric throughput for Team 3

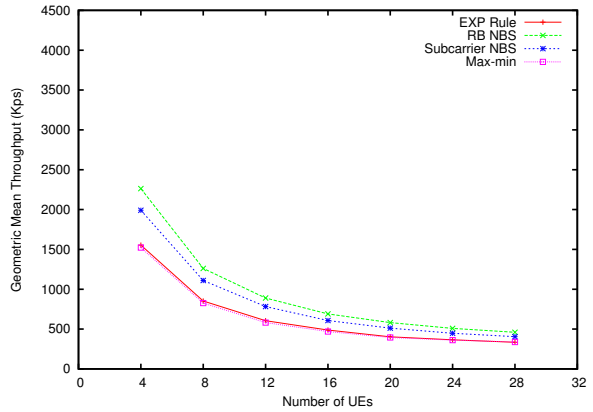

Fig. 5.14 Comparison of geometric throughput for Team 4

our algorithm means to choose the UEs who has the best channel quality $\|G_i\|^2$ as the BC algorithm does.

In Figs 5.11–5.14, we observe throughput obtained for different teams. When the UEs are farther from the cell center, their RB capacity is lower but our proposed algorithm guarantees the allocation chance of higher path-loss UEs, so the average throughput does not decrease significantly.

On the contrary, the EXP Rule allocates the RB on the basis of RB capacity which decreases with path-loss, so the UE's performance is not as good as our proposed scheme when the distance to the e-NodeB is large.

The max-min throughput algorithm has the same average throughput from the cell center to the cell edge, because its mechanism guarantees that all the UEs have the same throughput. When a UE has higher throughput, we can allocate some of its allocated RBs to the other UEs to increase the group's minimum throughput.

From Figs. 5.10–5.14 we can conclude that our RB NBS scheme's performance is the best among other algorithms because it is proven as a global optimal. Simulations show that our algorithms have a very good channel efficiency and guarantee fairness at the same time. Indeed, the UE gets the RB when its channel is good and a distance compensating factor a_i increases the cell edge UE's throughput to maximize the NBS product.

5.8.2 Fairness Index

Our RB NBS algorithms have better performance in terms of throughput than the other algorithms. Now we look at them from a fairness point of view.

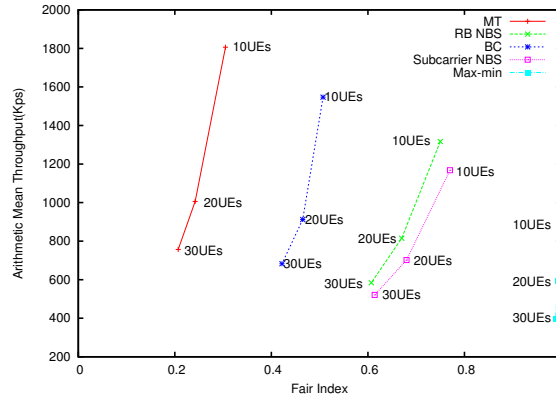

Fig. 5.15 Fairness index of different algorithms

Fig. 5.15 presents the fairness index of the MT algorithm, subcarrier NBS and RB NBS algorithms. The MT algorithm does not consider fairness but only the channel efficiency (see Section 5.7.3). It represents a category of efficiency oriented algorithms. The max-min mechanism is to allocate the RB to UE whose data-rate is less than the others, so the different UE's data-rate converges to the same value. According to the Eq. (5.48), we naturally find that its fairness index converges to 1.

The subcarrier NBS algorithm has the same fairness index as our RB NBS algorithm, because both of them all have the same objective function. As we increase the available allocated resource from the subcarrier in each time-slot to the RBs in hundreds of time-slots, this means that the UEs can pick up the highest capacity RBs in these TTIs. For this reason, the average RB capacity increases in our NBS RB allocation scheme. Fig. 5.15 confirms that the MT algorithm the best average throughput but it suffers from a poor fairness index. This means that some UEs are allocated more RBs and some UEs do not have enough chance to get the transmitted RBs. We observe that the max-min algorithm have the highest fairness index (≈ 1) and this fact guarantees that all the UEs converge to the same average data-rate.

For the RB NBS algorithm, we find an excellent balance between the fairness and the achieved throughput. They allocate more RB to the cell edge UEs to increase their throughput, but every UEs get its allocated RBs when its channel is in the best condition. Its average throughput does not decrease significantly while its fairness is not far from the max-min algorithm.

5.8.3 Conclusion

From the comparison of the geometric mean throughput with the reference algorithms, our RB NBS algorithms have an excellent performance. In the zone close to the e-NodeB, the EXP Rule algorithm may have higher throughput but in the other areas, our RB NBS algorithms obviously benefits from a higher throughput.

The max-min throughput algorithm is the most fair algorithm but it loses too much channel efficiency. Our algorithms give higher throughput and a good fairness index compared to the other channel oriented algorithms.

5.9 Conclusions and Perspectives

In this dissertation, we focus on the downlink resource block allocation problem for LTE systems.

Traditional algorithms propose a resource block allocation algorithm based on the RB capacity in order to optimize the overall system data rate and highly unfair as UEs with bad channel condition achieve very low data rates. In contrast, the fairness algorithms balance the throughput between UEs either without taking into account the channel quality or without maximizing efficiency. Our resource allocation proposition consists in maximising the overall system throughput while ensuring the fair resource allocation among UEs. It is based on the cooperative game theory, more precisely speaking, on the Nash Bargaining Solution (NBS).

The main principle of our method, called RB NBS algorithm, is to counterbalance the channel determination due to the path-loss by *compensation factors* in order to increase the probability of having an RB by UEs suffering from the poor channel quality. To obtain an optimal result for the NBS perspective, the other algorithms allocate more RB to a UE when its average data rate is low, and the channel quality is not so important on this condition. Our solution chooses another approach. The edge UEs have a higher probability to get RBs as the procedure comparing the channel quality takes into account the compensation factors we introduced.

Because the exact computation of compensation factors cannot be done due to their exponential complexity, we propose four heuristic schemes instead. The first heuristic, called (*iterative*) RB NBS, treats the allocation in a greedy manner with a square complexity, and gives similar results as the exact method for a small number of UEs. To reduce the numerical complexity of the iterative approach, we propose to compute the compensation factors a_i by group of UEs in which the ratio of $a_i/a_k (i \neq k)$ remains constant. For this third

variant *parallel RB NBS*, the complexity is thus divided by the number of groups. Finally, in the fourth method, called *Log scale RB NBS*, we observe in the data-rate expression, only $\log L_i(d_i)$ and we make the conjecture that the values of a_i have a linear relationship with $\log L_i$. This simplifies the a_i computation as only the first and last factors have to be computed and the complexity becomes linear. The last method called *mixed RB NBS* is the combination of the two last one depending on the UE position in the cell. Compensation factors are computed either with iterative method for center group of UEs or with Log Scale approach for edge groups.

As we proposed several heuristics to compute the solution and reduce the numerical complexity, a particular attention was paid to their experimental evaluation. We established two main axis of performance analysis: comparison with channel oriented methods and comparison with reference algorithms aiming throughput or fairness. Three performance criteria were evaluated in simulations: arithmetic throughput, geometric throughput seen as the NBS objective function and fairness index.

In this dissertation we hypothesized that channels are of SISO type. With this assumption, $\|G\|^2$ verifies the exponential distribution model. With MIMO (Multiple-input Multiple-output) channel, it would be a real challenge as $\|G\|^2$ is distributed according to a χ^2 law whose complexity is too high to be computed efficiently. Its complexity increases exponentially with the number of MIMO antennas, we will introduce the statistic method inspired by the econometric to find the approximated solutions with good accuracy. Let us notice that the estimation of $L(d_i)$ from the SINR history is not compromised as the mean of $\|G\|^2$ equals to number of elements of G .

Our solution is also able to be applied in the LTE uplink system which utilizes SC-FDMA (Single-Carrier Frequency-Division Multiple Access) technique, therefore, we will modify our method to incorporate it in the distributed NBS system.

Chapter 6

Conclusion and Perspectives

6.1 Conclusions

The core of the RB allocation schemes proposed in this dissertation is to increase the channel efficiency. We reached this goal by exploiting the following directions.

- **Interference Management:** an RB allocation scheme cooperating with the Beamforming technique.
- **Equal Opportunity:** the BC (Best Channel) algorithm which may be seen an advanced version of Round-Robin.
- **Economical Utilization Maximization:** the RB NBS allocation algorithm which can maximize the product of each UE's data rate.

We summarize our results concerning these three axes.

Interference Management

In the existing allocation solutions, the algorithm designers always assumed that the channel capacity is a given parameter and the allocation scheme is based upon this hypothesis. We believe, however, the channel capacity is a feedback of the resource allocation, because when the channel is allocated, a lot of signal process techniques are applied on the communication channels and interference channels, and this process obviously changes the channel capacity.

As we have shown in Chapter 4 this dissertation, a smart allocation policy can increase the channel (or RB) capacity by improving the effect of Beamforming technique. If we allocate the RBs on the same frequency to a "good" group of UEs, the improvement of

Beamforming technique can increase the average RB capacity significantly (more than 10% in our simulations).

Equal Opportunity

Traditionally, the attribution of RBs to UEs is made upon the channel quality basis only: an RB is allocated to a UE for which this RB has the highest SINR. This solution favours the cell center UEs as they always have a high SINR because of a low path loss. Cell edge UEs' path loss may be ten thousand times of a cell center UE. In our work we take advantage of the fact that the channel quality is composed of two parts: the fading part (a varying in time part) and the path loss (a part which does not depend on time).

The fast fading channel obeys a random distribution which is characterized by a high variability in time. Our idea is to compare the various part of the channel, not the path loss part.

According to the Round-Robin allocation algorithm, its principle is to allocate the RBs to a UE with the same share because every UE pays the same for the radio resource and they have equal rights to use the RB. Our modified version in Section 5.3 respects this rule. Consequently, all UEs have the equal opportunity to get the RB, and all the UEs transmit the messages when they reach their best channel condition.

Economical Utilization Maximization

After discussing the performance-first and fairness-first allocation algorithms, we designed an RB allocation algorithm to maximize the economical utility in Chapter 5. This work is developed from the idea of the BC algorithm, we compare the channel's various part with a compensation factor, and this factor is calculated to maximize the value of NBS function.

Differing with the BC algorithm, complexity of computing the compensation factors is an NP hard problem, we propose four heuristic methods to reduce the complexity. From the simulations we can find that the improvement is significant.

In most algorithms, a trade-off is found to improve a part of the performance, for example, decrease the throughput to reduce the delay, decrease the throughput of some UEs to increase the throughput of the other UEs. Our work improves the performance of all the UEs by increasing the average RB capacity.

6.2 Future Work

- **Computational Improvement**

As we address an NP-hard problem, algorithms which may solve it in reasonable time are heuristic algorithms. In this thesis we worked on the channel represented by the Rayleigh model. We would like to pursue our algorithmic work by proposing heuristic methods to solve our problem with more realistic channel model (χ^2 distribution model) dedicated to the MIMO architecture in the game theoretic resource allocation schemes.

- **Distributed Allocation**

We work on the centralized algorithm and the e-NodeB has the CSI information for all the UEs. As the channel information for the entire network can be unknown by the system, we plan to develop a distributed game theoretic algorithm to maximize the system economical utility.

- **Uplink Allocation Schemes**

In the LTE uplink system, the network uses the SC-FDMA protocol and this protocol introduces one more constraint upon the frequency allocation: RBs allocated to a UE have to be on adjacent frequencies. The algorithm we proposed in this thesis can be modified to satisfy this supplementary constraint. One of the possibilities which could be considered here is a modification of the Hungarian method.

References

- [3GP09] 3GPP FDD Base Station (BS) classification. TR 25.951, 3rd Generation Partnership Project (3GPP), 12 2009.
- [3GP10] 3GPP Evolved Universal Terrestrial Radio Access (E-UTRA); Physical layer procedures. TS 36.213, 3rd Generation Partnership Project (3GPP), 10 2010.
- [3GP11a] 3GPP Evolved Universal Terrestrial Radio Access (E-UTRA); User Equipment (UE) radio transmission and reception. TS 36.101, 3rd Generation Partnership Project (3GPP), 06 2011.
- [3GP11b] 3GPP Technical Specifications and Technical Reports for a UTRAN-based 3GPP system. TS 21.101, 3rd Generation Partnership Project (3GPP), 06 2011.
- [3GP11c] 3GPP Technical Specifications and Technical Reports for an Evolved Packet System (EPS) based 3GPP system. TS 21.201, 3rd Generation Partnership Project (3GPP), 06 2011.
- [ABC⁺14] Jeffrey G. Andrews, Stefano Buzzi, Wan Choi, Stephen V. Hanly, Angel E. Lozano, Anthony C. K. Soong, and Jianzhong (Charlie) Zhang. What will 5g be? *IEEE Journal on Selected Areas in Communications*, 32(6):1065–1082, 2014.
- [AGER10] Ian F. Akyildiz, David M. Gutierrez-Estevez, and Elias Chavarria Reyes. The evolution to 4G cellular systems: LTE-advanced. *Phys. Commun.*, 3(4):217–244, December 2010.
- [AKR⁺00] M. Andrews, K. Kumaran, K. Ramanan, A. L. Stolyar, R. Vijayakumar, and P. Whiting. CDMA data QoS scheduling on the forward link with variable channel conditions. Technical report, Bell Laboratories Technical Report, April 2000.
- [AKR⁺04] Matthew Andrews, Krishnan Kumaran, Kavita Ramanan, Alexander Stolyar, Rajiv Vijayakumar, and Phil Whiting. Scheduling in a queuing system with asynchronously varying service rates. *Pro. Eng. Inf. Sci.*, 18(2):191–217, April 2004.
- [AYL07] Chun Kin Au-Yeung and D.J. Love. On the performance of random vector quantization limited feedback beamforming in a miso system. *IEEE Transactions on Wireless Communications*, 6(2):458–462, Feb 2007.

- [BH07] F. Boccardi and H. Huang. Limited downlink network coordination in cellular networks. In *IEEE 18th International Symposium on Personal, Indoor and Mobile Radio Communications PIMRC 2007*, pages 1–5, Sept 2007.
- [BIPR11] J. Blumenstein, J.C. Ikuno, J. Prokopec, and M. Rupp. Simulating the long term evolution uplink physical layer. In *2011 Proceedings ELMAR*, pages 141–144, Sept 2011.
- [Blu03] R.S. Blum. MIMO capacity with interference. *IEEE Journal on Selected Areas in Communications (JSAC)*, 21(5):793–801, June 2003.
- [BS09] Gustavo de Veciana Bilal Sadiq, Seng JunBaek. Delay-optimal opportunistic scheduling and approximations : The log rule. *IEEE INFOCOM*, 22(3):1931–1948, 2009.
- [CC11] R. Copeland and N. Crespi. Modelling multi-MNO business for MVNOs in their evolution to LTE, VoLTE amp; advanced policy. In *2011 15th International Conference on Intelligence in Next Generation Networks (ICIN)*, pages 295–300, Oct 2011.
- [CS94] J.C.-I. Chuang and N.R. Sollenberger. Performance of autonomous dynamic channel assignment and power control for TDMA/FDMA wireless access. *IEEE Journal on Selected Areas in Communications (JSAC)*, 12(8):1314–1323, Oct 1994.
- [CSHP12] M.A. Charafeddine, A. Sezgin, Zhu Han, and A. Paulraj. Achievable and crystallized rate regions of the interference channel with interference as noise. *IEEE Trans. Comm.*, 11(3):1100–1111, March 2012.
- [DPSB08] Erik Dahlman, Stefan Parkvall, Johan Skold, and Per Beming. *3G Evolution, Second Edition: HSPA and LTE for Mobile Broadband*. Academic Press, 2 edition, 2008.
- [EDHH98] T. Eyceoz, A. Duel-Hallen, and H. Hallen. Deterministic channel modeling and long range prediction of fast fading mobile radio channels. *IEEE Communications Letters*, 2(9):254–256, Sept 1998.
- [Eks09] H. Ekstrom. QoS control in the 3GPP evolved packet system. *IEEE Communications Magazine*, 47(2):76–83, February 2009.
- [FBR⁺94] M.J. Feuerstein, K.L. Blackard, T.S. Rappaport, S.Y. Seidel, and H. Xia. Path loss, delay spread, and outage models as functions of antenna height for microcellular system design. *IEEE Transactions on Vehicular Technology*, 43(3):487–498, Aug 1994.
- [GJD⁺11] I. Guvenc, Moo-Ryong Jeong, I. Demirdogen, B. Kecioglu, and F. Watanabe. Range expansion and inter-cell interference coordination (ICIC) for picocell networks. In *2011 IEEE Vehicular Technology Conference (VTC Fall)*, pages 1–6, Sept 2011.
- [gpl07] Gnu general public license, June 2007. <http://www.gnu.org/licenses/gpl.html>.

- [GRM⁺10] A. Ghosh, R. Ratasuk, B. Mondal, N. Mangalvedhe, and T. Thomas. Lte-advanced: next-generation wireless broadband technology [invited paper]. *IEEE Wireless Communications*, 17(3):10–22, June 2010.
- [GWAC05] A. Ghosh, D.R. Wolter, J.G. Andrews, and Runhua Chen. Broadband wireless access with WiMax/802.16: current performance benchmarks and future potential. *IEEE Communications Magazine*, 43(2):129–136, Feb 2005.
- [GZAM10a] Arunabha Ghosh, Jun Zhang, Jeffrey G. Andrews, and Rias Muhamed. *Fundamentals of LTE*. Prentice Hall Press, Upper Saddle River, NJ, USA, 1st edition, 2010.
- [GZAM10b] Arunabha Ghosh, Jun Zhang, Jeffrey G. Andrews, and Rias Muhamed. *Fundamentals of LTE*. Prentice Hall Press, Upper Saddle River, NJ, USA, 1st edition, 2010.
- [Hah91] Ellen L. Hahne. Round-robin scheduling for max-min fairness in data networks. *IEEE JSAC*, 9:1024–1039, 1991.
- [Hat80] M. Hata. Empirical formula for propagation loss in land mobile radio services. *IEEE Transactions on Vehicular Technology*, 29(3):317–325, August 1980.
- [He10] Gaoning He. *A game theoretical approach to resource allocation in wireless networks*. PhD thesis, Thesis, 01 2010.
- [HJL05] Zhu Han, Z. Ji, and K.J.R. Liu. Fair multiuser channel allocation for OFDMA networks using nash bargaining solutions and coalitions. *IEEE Trans. Comm.*, 53(8):1366–1376, Aug 2005.
- [HT00] Harri Holma and Antti Toskala. *WCDMA for UMTS: Radio Access for Third Generation Mobile Communications*. John Wiley & Sons, Inc., New York, NY, USA, 1st edition, 2000.
- [HTV14] Fan Huang, Joanna Tomasik, and Véronique Vèque. Improvement of cell edge performance by coupling rb allocation with beamforming. In *2014 IEEE International Conference on Communication Systems (ICCS)*, pages 333–338, Nov 2014.
- [HTV15] Fan Huang, Joanna Tomasik, and Véronique Vèque. A channel oriented resource block nbs allocation scheme for LTE downlink systems. *IEEE Transactions on Wireless Communications*, 2015. submitted for publication.
- [HVT14] Fan Huang, Véronique Vèque, and Joanna Tomasik. Multi-cell resource block allocation framework. In *Information Sciences and Systems 2014 - Proceedings of the 29th International Symposium on Computer and Information Sciences, ISCIS 2014*, pages 21–31, 2014.
- [HVT15] Fan Huang, Véronique Vèque, and Joanna Tomasik. A pareto-optimal approach for resource allocation in LTE downlink systems. In *IEEE International Conference on Communications, ICC 2016*, 2015. submitted for publication.

- [HXB99] D. Har, H. Xia, and Henry L. Bertoni. Path-loss prediction model for microcells. *IEEE Transactions on Vehicular Technology*, 48(5):1453–1462, Sep 1999.
- [IWR10] J.C. Ikuno, M. Wrulich, and M. Rupp. System level simulation of lte networks. In *Vehicular Technology Conference (VTC 2010-Spring), 2010 IEEE 71st*, pages 1–5, May 2010.
- [JCH84] Rajendra K. Jain, Dah-Ming W. Chiu, and William R. Hawe. A quantitative measure of fairness and discrimination for resource allocation in shared computer systems. Technical report, DEC, September 1984.
- [KLL03] D. Kivanc, Guoqing Li, and Hui Liu. Computationally efficient bandwidth allocation and power control for ofdma. *IEEE Transactions on Wireless Communications*, 2(6):1150–1158, Nov 2003.
- [LHS03] D.J. Love, R.W. Heath, and T. Strohmer. Grassmannian beamforming for multiple-input multiple-output wireless systems. *IEEE Transactions on Information Theory*, 49(10):2735–2747, Oct 2003.
- [LJ08] E.G. Larsson and E.A. Jorswieck. Competition versus cooperation on the miso interference channel. *IEEE Journal on Selected Areas in Communications*, 26(7):1059–1069, September 2008.
- [LJSL09] Byong Ok Lee, Hui Je, Oh-Soon Shin, and Kwang Bok Lee. A novel uplink MIMO transmission scheme in a multicell environment. *IEEE Transactions on Wireless Communications*, 8(10):4981–4987, October 2009.
- [LL06] Guoqing Li and Hui Liu. Downlink radio resource allocation for multi-cell OFDMA system. *IEEE Transactions on Wireless Communications*, 5(12):3451–3459, December 2006.
- [LSC⁺12] Daewon Lee, Hanbyul Seo, B. Clerckx, E. Hardouin, D. Mazzaresse, S. Nagata, and K. Sayana. Coordinated multipoint transmission and reception in lte-advanced: deployment scenarios and operational challenges. *IEEE Communications Magazine*, 50(2):148–155, February 2012.
- [MP92] Michel Mouly and Marie-Bernadette Pautet. *The GSM System for Mobile Communications*. Telecom Publishing, 1992.
- [MWI⁺09] C. Mehlhüner, M. Wrulich, J.C. Ikuno, D. Bosanska, and M. Rupp. Simulating the long term evolution physical layer. In *Signal Processing Conference, 2009 17th European*, pages 1471–1478, Aug 2009.
- [MWIB09] Christian Mehlhüner, Martin Wrulich, Josep Colom Ikuno, and Dagmar Bosanska. Simulating the long term evolution physical layer. *Proc. of the 17th European Signal Processing Conf.*, 2009.
- [Nas53] John Nash. Two-person cooperative games. *Econometrica*, 21(1):pp. 128–140, 1953.

- [NEHA08] Boon Loong Ng, J.S. Evans, S.V. Hanly, and D. Aktas. Distributed downlink beamforming with cooperative base stations. *IEEE Transactions on Information Theory*, 54(12):5491–5499, Dec 2008.
- [NLS12] D.W.K. Ng, E.S. Lo, and R. Schober. Energy-efficient resource allocation in OFDMA systems with large numbers of base station antennas. *IEEE Transactions on Wireless Communications*, 11(9):3292–3304, September 2012.
- [NM44] John Von Neumann and Oskar Morgenstern. *Theory of Games and Economic Behavior*. Princeton University Press, 1944.
- [NP00] Richard van Nee and Ramjee Prasad. *OFDM for Wireless Multimedia Communications*. Artech House, Inc., Norwood, MA, USA, 1st edition, 2000.
- [oSp12] Partners of SOAPS.2 project. Self-adaptive frequency resource allocation. Technical report, Cassidian, 2012. <http://soaps2.fr>.
- [PGB⁺11a] G. Piro, L.A. Grieco, G. Boggia, F. Capozzi, and P. Camarda. Simulating LTE cellular systems: An open-source framework. *IEEE Trans. Vehi. Tech.*, 60(2):498–513, Feb 2011.
- [PGB⁺11b] G. Piro, L.A. Grieco, G. Boggia, R. Fortuna, and P. Camarda. Two-level downlink scheduling for real-time multimedia services in lte networks. *IEEE Transactions on Multimedia*, 13(5):1052–1065, Oct 2011.
- [PGNB04] A.J. Paulraj, D.A. GORE, R.U. Nabar, and H. Bolcskei. An overview of mimo communications - a key to gigabit wireless. *Proceedings of the IEEE*, 92(2):198–218, Feb 2004.
- [Pro91] J.G. Proakis. Adaptive equalization for tdma digital mobile radio. *IEEE Transactions on Vehicular Technology*, 40(2):333–341, May 1991.
- [Rap96] Theodore S. Rappaport. *Wireless Communications: Principles and Practice*. IEEE Press, Piscataway, NJ, USA, 1st edition, 1996.
- [RBSP09] H.A.M. Ramli, R. Basukala, K. Sandrasegaran, and R. Patachaianand. Performance of well known packet scheduling algorithms in the downlink 3GPP LTE system. In *MICC*, pages 815–820, Dec 2009.
- [RC00] Wonjong Rhee and J.M. Cioffi. Increase in capacity of multiuser OFDM system using dynamic subchannel allocation. In *IEEE VTC*, volume 2, pages 1085–1089 vol.2, 2000.
- [Ric21] David Ricardo. *On the Principles of Political Economy and Taxation*. Number ricardo1821 in History of Economic Thought Books. McMaster University Archive for the History of Economic Thought, 1821.
- [SBdV11] B. Sadiq, Seung Jun Baek, and G. de Veciana. Delay-optimal opportunistic scheduling and approximations: The log rule. *IEEE/ACM Trans. Net.*, 19(2):405–418, April 2011.

- [SBL14] Farshad Shams, Giacomo Bacci, and Marco Luise. A survey on resource allocation techniques in OFDM(A) networks. *Computer Networks*, 65(0):129–150, 2014.
- [SDHM07] Juan E. Suris, Luiz A. DaSilva, Zhu Han, and Allen B. MacKenzie. Cooperative game theory for distributed spectrum sharing. *International Conference on Communications*, pages 5282 – 5287, June 2007.
- [SGMJ06] Juan J. Sánchez, G. Gómez, D. Morales-Jiménez, and J. T. Entrambasaguas. Performance evaluation of OFDMA wireless systems using wm-sim platform. In *Proceedings of the 4th ACM International Workshop on Mobility Management and Wireless Access, MobiWac '06*, pages 131–134, New York, NY, USA, 2006. ACM.
- [Skl97] B. Sklar. Rayleigh fading channels in mobile digital communication systems .i. characterization. *IEEE Communications Magazine*, 35(7):90–100, Jul 1997.
- [SL05a] Guocong Song and Ye Li. Cross-layer optimization for OFDM wireless networks-part i: theoretical framework. *IEEE Transactions on Wireless Communications*, 4(2), Mar 2005.
- [SL05b] Guocong Song and Ye Li. Cross-layer optimization for OFDM wireless networks-part ii: algorithm development. *IEEE Transactions on Wireless Communications*, 4(2), Mar 2005.
- [SLA11] Illsoo Sohn, Sang Hyun Lee, and J.G. Andrews. Belief propagation for distributed downlink beamforming in cooperative MIMO cellular networks. *IEEE Trans. Wire. Comm.*, 10(12):4140–4149, December 2011.
- [SPSH04] Q.H. Spencer, C.B. Peel, A.L. Swindlehurst, and M. Haardt. An introduction to the multi-user MIMO downlink. *IEEE Communications Magazine*, 42(10):60–67, Oct 2004.
- [SS02] Sanjay Shakkottai and Alexander L. Stolyar. Scheduling for multiple flows sharing a time-varying channel: The exponential rule. *American Mathematical Society Translations*, 207, 2002.
- [SS08] C. Steger and A. Sabharwal. Single-input two-way SIMO channel: diversity-multiplexing tradeoff with two-way training. *IEEE Transactions on Wireless Communications*, 7(12):4877–4885, December 2008.
- [STS07] M. Sadek, A. Tarighat, and A.H. Sayed. A leakage-based precoding scheme for downlink multi-user mimo channels. *IEEE Transactions on Wireless Communications*, 6(5):1711–1721, May 2007.
- [Tsy02] B. Tsybakov. File transmission over wireless fast fading downlink. *IEEE Transactions on Information Theory*, 48(8):2323–2337, Aug 2002.
- [Vit95] Andrew J. Viterbi. *CDMA: Principles of Spread Spectrum Communication*. Addison Wesley Longman Publishing Co., Inc., Redwood City, CA, USA, 1995.

- [Vu11] Mai Vu. MISO capacity with per-antenna power constraint. *IEEE Transactions on Communications*, 59(5):1268–1274, May 2011.
- [Wal01] Bernhard H. Walke. *Mobile Radio Networks: Networking and Protocols*. John Wiley & Sons, Inc., New York, NY, USA, 2nd edition, 2001.
- [WCLM99] Cheong Yui Wong, Roger S. Cheng, Khaled Ben Letaief, and Ross D. Murch. Multiuser OFDM with adaptive subcarrier, bit, and power allocation. *IEEE JSAC*, 17:1747–1758, 1999.
- [WGM07] Xin Wang, G.B. Giannakis, and A.G. Marques. A unified approach to qos-guaranteed scheduling for channel-adaptive wireless networks. *Proceedings of the IEEE*, 95(12):2410–2431, Dec 2007.
- [YA06] Hujun Yin and S. Alamouti. OFDMA: A broadband wireless access technology. In *2006 IEEE Sarnoff Symposium*, pages 1–4, March 2006.
- [YC02] Wei Yu and J.M. Goffi. FDMA capacity of gaussian multiple-access channels with isi. *IEEE Trans. Comm.*, 50(1):102–111, Jan 2002.
- [YCL⁺12] SeungJune Yi, SungDuck Chun, YoungDae Lee, SungJun Park, and SungHoon Jung. *Radio Protocols for LTE and LTE-Advanced*. Wiley Publishing, 1st edition, 2012.
- [YG06] Taesang Yoo and A. Goldsmith. On the optimality of multiantenna broadcast scheduling using zero-forcing beamforming. *IEEE Journal on Selected Areas in Communications (JSAC)*, 24(3):528–541, March 2006.
- [YKS11] Wei Yu, Taesoo Kwon, and Changyong Shin. Multicell coordination via joint scheduling, beamforming and power spectrum adaptation. In *2011 Proceedings IEEE INFOCOM*, pages 2570–2578, April 2011.
- [YKS13] Wei Yu, Taesoo Kwon, and Changyong Shin. Multicell coordination via joint scheduling, beamforming, and power spectrum adaptation. *IEEE Transactions on Wireless Communications*, 12(7):1–14, July 2013.
- [YL00] Hujun Yin and Hui Liu. An efficient multiuser loading algorithm for OFDM-based broadband wireless systems. In *IEEE GLOBECOM*, volume 1, pages 103–107 vol.1, 2000.
- [ZCA⁺09] Jun Zhang, Runhua Chen, J.G. Andrews, A. Ghosh, and R.W. Heath. Networked mimo with clustered linear precoding. *IEEE Transactions on Wireless Communications*, 8(4):1910–1921, April 2009.
- [ZHG09] R. Zakhour, Z.K.M. Ho, and D. Gesbert. Distributed beamforming coordination in multicell MIMO channels. In *IEEE 69th Vehicular Technology Conference, VTC Spring 2009*, pages 1–5, April 2009.
- [ZT03] Lizhong Zheng and D.N.C. Tse. Diversity and multiplexing: a fundamental tradeoff in multiple-antenna channels. *IEEE Transactions on Information Theory*, 49(5):1073–1096, May 2003.

Appendix A

Simulator Programming

A.1 Introduction

In this chapter we introduce our further developments on the open source simulator LTE-Sim [PGB⁺11a], we developed the MIMO channel and Beamforming module to complete our simulation.

In the previous chapter, we have introduced some well designed resource allocation algorithms, the scientists and engineers need the experiments to evaluate them which costs too much. The simulation is a low cost tool to evaluate the network and easily compare its performance in different scenarios.

The most important mobile communication equipment vendors have implemented their own business simulators [SGMJ06, MWI⁺09, BIPR11]. Moreover, other simulators, developed in academia-industrial corporations, can be purchased using a commercial license, and their source codes are not available so it is not possible to modify. The Matlab-based LTE simulator has been proposed in [MWIB09], implementing a standard compliant LTE downlink physical layer with Adaptive Modulation and Coding (AMC), multiple UEs, MIMO transmission and scheduler. Unfortunately, it does not consider relevant aspects of LTE simulation, such as realistic applications, a complete LTE protocol stack, and multi-cell environments with uplink flows. In [IWR10], a system level simulator for LTE networks has been proposed as a supplement of the previous one, in order to support cell planning, scheduling, and interference. However, it does not support a complete LTE protocol stack, uplink flows, and bearer management.

LTE-Sim is an open source simulation platform destined to simulate LTE scenarios [PGB⁺11a].

A.2 LTE-Sim Package

LTE-Sim has been conceived to simulate uplink and downlink scheduling strategies in multi-cell/multi-users environments taking into account UE mobility, radio resource optimization, frequency reuse techniques, AMC module, and other aspects very relevant for industrial and scientific communities to test enhanced techniques for improving 4G cellular networks such as new physical functionalities, innovative network protocols and architectures, high performance scheduling strategies and so on. LTE-Sim is freely available under the GPLv3 license [gp107]. LTE-Sim can simulate several types of services such as VoIP, video and CBR (Constant Bit Ratio). More services can be added if necessary. This is an important factor for modeling multi-service scenarios which is indispensable in LTE. The MAC and PHY layers are well structured, they are modeled by following 3GPP specifications.

Because of these advantages, we choose it as the simulator in our work. We also create several scenarios appropriate to validate the method we designed.

The LTE-Sim does not offer, unfortunately, either a model of the physical layer or the Beamforming technique. We thus completed LTE-Sim by implementing the MIMO channel and the Beamforming technique.

We will introduce our modification in the Section [A.3](#) and [A.4](#).

A.3 Modification of Multiple Channel Model

In the original LTE-Sim, the authors focus on the basic structures of the LTE network and the MAC layer, and just develop the SISO (Single-input-single-output) channel. Thanks to the well design of the LTE-Sim, the channel between the e-NodeB and the UEs are independent with the other modules, we can rewrite the model without drastic revision.

When a PHY instance has to send packets on a set of sub-channels, it calls the method `Channel::StartTx` of a proper channel object (i.e., the downlink channel for the e-NodeB and the uplink channel for the UE), passing a list of packet to send and the transmission power. `Channel::StartTx` handles packet transmission in two consecutive steps. It first calculates, for each attached physical device, the channel variation and the path-loss. Then, it forwards packets to all physical devices attached to it and calls the reception procedure.

A.3.1 Path-loss

We have introduced the path-loss in Chapter 2. There are typically three types of signal attenuation which depend on the signal propagation properties for UEs which are located

near the eNodeB (Type 1), or in urban area (Type 2), or in an area full of obstacles (Type 3). To express this diversity in our simulation model, we use these three types of path-loss function available in LTE-Sim [PGB⁺11a] to represent the UEs real condition:

- Type 1: $L(d) = 24 + 45 \log_{10}(d + 20)$
- Type 2: $L(d) = 85.6 + 34.1 \log_{10} d$
- Type 3: $L(d) = 114.5 + 37.6 \log_{10} d$

Following the approach given in [PGB⁺11a], for the cell center UEs, whose d is less than 300 meters, we choose Type 1 as the path-loss function; for the other UEs, half of them are randomly chosen as Type 2 and the other half UEs corresponds to Type 3.

A.3.2 MIMO Channel

Communication Channel

We create a two dimensional vector to save the channel matrix G_{N_r, N_t} , where N_t presents the number of transmit antennas, and its N_r presents the number of received antennas.

As we introduced in Chapter 2, the MIMO channel can be expressed by a matrix, and each element g of the matrix G present a channel from a transmit antenna and a received antenna, the number of the Matrix element presents the the number of MIMO channels from the transmitter and receiver.

Because all the channels have their own path, the value of each element of each element are independent. We suppose all the channels the fast-fading [SLA11] channel in our work, the g is supposed to be a zero-mean complex Gaussian random variable with unit variance.

We use the `std::normal_distribution<double> distribution (0.0,1.0)` to generate the channel factor, and repeat them n_r, n_t times to generate the matrix.

When the signal arrives at the UE side, the receiver uses a Hermitian transpose matrix of the channel G to decode the signal, the decoded signal is $G^*G = ||G||^2$, where we use the G^* to present the conjugate transpose of a matrix G .

The received signal experience the channel variation and path-loss, we can calculate the SINR by the formula:

$$\Gamma = \frac{P_r}{\sigma_0 + I} = \frac{P_t ||G||^2 / L(d)}{\sigma_0 + I} = \frac{P_t ||H||^2}{\sigma_0 + I} \quad (\text{A.1})$$

where P_r is the received signal power and P_t presents is signal power at the transmitter, the H presents the channel factor with path-loss.

As the communication channel between the e-NodeB and the UE is changed into the MIMO mode, the interference channels modules in LTE-Sim are also need to be written.

Interference Channel

As same as the communication channel module, the receiver receives the neighbouring cells signal on the same frequency. The interference channels between the UE and the neighbouring cells are also composed by two parts, the channel variation presented by the channel matrix and the path-loss.

The interference signals come from all the neighbouring cells, when a UE is located in LTE-Sim, we can calculate the distance from the UE and e-NodeBs of all the other cells, and get the interference channel path-loss L_I .

When the neighbouring cell signal is received, it is processed as same as the communication signal computation because it is impossible to distinguish. In our module, the mathematical presentation is that the interference signal equals to $\sum_k \|G^* G_k\|/L_i$, where k stands for all the neighbouring cells and G_k is the interference channel matrix between the UE and the neighbouring cells.

After the SINR is calculated, we store this value for the next step.

A.4 Interference and Beamforming Technique

In our thesis work, we create a cooperation allocation framework associated with RB and beamforming technique in order to limit the interference. As this technique is not available in LTE-Sim, we add the Beamforming module in the PHY instance .

In mathematical presentation, the Beamforming technique is equivalent to multiply a Beamforming vector on the channel matrix which we has explained in Chapter 2. We modify the phase of the received signal to increase the sum of the signal power.

From the the previous subsection, we know the channel factor g is a complex number, the absolute value of g means the signal strength variation and the argument of g means the phase variation of a signal when it transmits through this channel.

The Beamforming technique modifies the phase of the signals, we introduce the Beamforming technique by an example:

Suppose there are two MIMO channel $g_1 = a_1 + b_1 i$ and $g_2 = a_2 - b_2 i$, all the a . and b . are positive. The beamforming technique modify the phase of the received signals, but do not change the absolute value of the channel, we defy four Beamforming vectors:

- $[1, 1]$: does not change the relative phase of two signal, the sum of the two signal is $(a_1 + a_2) + (b_1 - b_2)i$
- $[1, -1]$, changes 180° of the second signal, the sum of the two signal is $(a_1 - a_2) + (b_1 + b_2)i$
- $[1, i]$, changes 90° of the second signal, the sum of the two signal is $(a_1 + b_2) + (b_1 - a_2)i$
- $[1, -i]$, changes -90° of the second signal, the sum of the two signal is $(a_1 - b_2) + (b_1 + a_2)i$

We create the vectors in C++ to reserve the Beamforming vector, after the decoder, the processed signal changes from $\|G\|^2$ to $\|G\omega\|^2$ where ω presents the Beamforming vector, and the interference is also decoded from $\sum_k \|G^*G_k\|$ to $\sum_k |\omega^*G^*G_k\omega_k|$, where ω_k presents the Beamforming vector from the neighbouring cells. Then the SINR formula are written as:

$$\Gamma = \frac{P_t \|G\omega\|^2 / L(d)}{\sigma_0 + \sum_k |\omega^*G^*G_k\omega_k|} \quad (\text{A.2})$$

In our new Beamforming module, the scheduler can choose the beamforming vector during its assignment of the RBs, and the `Channel::StartTx` can return a new SINR after the Beamforming vectors are chosen.

A.5 Simulation Settings

In our simulation setup, the bandwidth of the LTE network is 5 MHz and 25 RBs are available at the same time, which corresponds to the constraints of the PMR network under study in the SOAPS project [oSp12].

The radius of the cell is 1 km and the UEs are uniformly distributed over the surface of the cell by using a distribution function of LTE-Sim [PGB⁺11a].

We perform a series of simulation runs in order to obtain results on a confidence level $\alpha = 0.05$. We repeat simulations 100 times, these repetitions are sufficient to calculate the average value of each performance criterion at the given confidence level.

