



HAL
open science

Cross-layer framework for interference avoidance in cognitive radio ad-hoc networks

Minh Thao Quach

► **To cite this version:**

Minh Thao Quach. Cross-layer framework for interference avoidance in cognitive radio ad-hoc networks. Networking and Internet Architecture [cs.NI]. Université de Bordeaux, 2015. English. NNT : 2015BORD0489 . tel-01293315

HAL Id: tel-01293315

<https://theses.hal.science/tel-01293315>

Submitted on 24 Mar 2016

HAL is a multi-disciplinary open access archive for the deposit and dissemination of scientific research documents, whether they are published or not. The documents may come from teaching and research institutions in France or abroad, or from public or private research centers.

L'archive ouverte pluridisciplinaire **HAL**, est destinée au dépôt et à la diffusion de documents scientifiques de niveau recherche, publiés ou non, émanant des établissements d'enseignement et de recherche français ou étrangers, des laboratoires publics ou privés.

THÈSE PRÉSENTÉE
POUR OBTENIR LE GRADE DE
DOCTEUR DE
L'UNIVERSITÉ DE BORDEAUX
ÉCOLE DOCTORALE DE MATHÉMATIQUES ET INFORMATIQUE DE BORDEAUX
SPÉCIALITÉ : INFORMATIQUE
par
Minh Thao QUACH

**Cross-layer Framework for Interference Avoidance in Cognitive Radio
Ad-hoc Networks**
**Un cadre inter-couches pour la protection contre les interférences dans les
réseaux ad-hoc radio cognitive**

Sous la direction de : Professeur Francine KRIEF
Soutenue le 18 Decembre 2015

Membres du jury:

Sami TABBANE	Professeur SUPCOM Technopôle El Gazala à Tunis (Tunisie)	Rapporteur
Thi Mai Trang NGUYEN	Maître de conférences, HDR Université Pierre et Marie Curie (France)	Rapporteur
Damien MAGONI	Professeur Université de Bordeaux (France)	
Daniel NEGRU	Maître de conférences, HDR Bordeaux INP (France)	
Mohamed Aymen CHALOUF	Maître de conférences IUT Lannion (France)	Co-encadrant
Hicham KHALIFÉ	Research Project Manager Thales Communication and Security, Colombes (France)	Co-encadrant
Francine KRIEF	Professeur Bordeaux INP (France)	Directrice de thèse

Abstract

A fixed spectrum assignment scheme has a problem with resource deficiency in a wireless network. In 2002, the US Federal Communication Commission (FCC) reported that the radio spectrum was 20% to 85% under-utilized. The insufficient use of the spectrum is a critical issue for radio communication; as communication grows, a fixed spectrum becomes more limiting. The FCC then changed its spectrum management policy to make it more flexible by investigating the cognitive radio (CR) approach. Cognitive radio is a type of intelligent radio that explores the radio frequency environment, learns, and decides to use the unused portion of the frequency. The main functions of a CR are sensing, decision making, and sharing. However, these radios have to respect the standard wireless infrastructures by ensuring the least impact with their devices, also known as primary radios. Coexistence between CR systems and primary systems requires dedicated observation processes and interference management.

In this thesis, observation from a CR point of view is presented. The overlapping area between a CR transmitter and primary radio (PR) transmitter is analysed so that it can be taken into account. The impact of this area is learnt by simulation and presented in Chapter 4. As a consequence, potential interference is envisaged. Along with observation, we investigate a proper mechanism to better prevent perturbation on PR devices using the Grey model and Kalman filter as a prediction model for predicting the density of primary receivers.

In addition, we provide a strategy to combine the obtained observations into a metric that can be used in routing design in the context of coexistence between Cognitive Radio Networks (CRNs) and primary networks. The proposed strategy, using fuzzy logic, is presented in Chapter 5. In this chapter, we investigate how the routing layer reacts and makes the right decisions to maximise the spectrum resources, while avoiding interference with the primary receivers. For instance, a CR node can operate in an overlap region if primary receivers are inactive within this area. Also, we propose a routing mechanism based on the DYMO routing protocol that takes into account the observed relative impact. In the same chapter, we provide some practical scenarios illustrating the usefulness of our proposal.

Interconnecting the CR nodes in CRNs is also a critical problem for the establish-

ment of the network. We therefore present a beacon-based dissemination process in Chapter 6. In this chapter, we also describe a practical device designed for cognitive radio experiments. Even though our work affects different protocol layers, the designed framework is cross-layered. Indeed, the different components of the proposed framework access the various layers to retrieve information, process it, and react accordingly. Thus, our work constitutes a cross-layer framework for a local cognitive radio that aims to minimise the interference and maximise the network resources in cognitive radio networks.

Keywords: Cognitive Radio, Overlap Region, Grey Model, Kalman Filter, Fuzzy Logic, Routing Protocol, DYMO, Sensing, Signalling Protocol, Cross-layer.

Résumé en français

Le plan d'attribution du spectre présente un problème de déficit de ressources dans les réseaux sans fil. En 2002, la FCC (Federal Communication Commission) a rapporté que le spectre radioélectrique était de 20% à 85% sous-utilisé. L'utilisation inefficace du spectre est un problème majeur qui doit être résolu si l'on veut que les communications radio se développent. La FCC a ensuite changé la politique de gestion du spectre pour la rendre plus souple en s'intéressant à l'approche radio cognitive (CR). La radio cognitive est un type de radio intelligente qui explore l'environnement de fréquences radio, apprend et décide d'utiliser la partie inutilisée du spectre. Les principales fonctions de la CR sont la détection, la prise de décision, et le partage. Cependant, ces radios doivent respecter les infrastructures sans fil standards en minimisant leur impact sur les appareils prioritaires, également appelés systèmes primaires. La coexistence entre les systèmes CR et les systèmes primaires nécessite des processus d'observation et de gestion des interférences dédiés.

Dans cette thèse, nous nous sommes intéressés à la phase d'observation du point de vue CR. La zone de chevauchement entre un émetteur CR et l'émetteur primaire (PR) est analysée et prise en compte. L'impact de cette zone est appris par simulation et présenté dans le chapitre 4. En conséquence, des interférences potentielles sont envisagées. Durant la phase d'observation, nous étudions un mécanisme permettant de mieux prévenir la perturbation sur les dispositifs PR en utilisant le Grey Model et le filtre de Kalman comme modèle de prédiction de la densité des récepteurs primaires.

En complément à cette observation, nous fournissons une stratégie visant à combiner les observations obtenues en une mesure qui pourra être utilisée par le routage dans le cadre de la coexistence entre réseaux radio cognitive (CRN) et réseaux primaires. La stratégie proposée utilise la logique floue et est présentée dans le chapitre 5. Dans ce chapitre, nous étudions comment la couche réseau réagit et prend les bonnes décisions pour maximiser l'utilisation des ressources du spectre, tout en évitant les interférences avec les récepteurs primaires. Par exemple, un nœud CR peut fonctionner dans une zone de recouvrement, si les récepteurs primaires sont inactifs dans cette zone. Ainsi, nous avons proposé un mécanisme de routage basé sur le protocole de routage DYMO qui prend en compte l'impact relatif observé. Dans ce même chapitre, nous avons également présenté des scénarios pratiques illustrant l'utilité de notre proposition.

L'interconnexion des nœuds CR dans le CRN est aussi un problème crucial pour la mise en place du réseau. C'est pourquoi nous présentons un processus de diffusion par balises au chapitre 6. Dans ce chapitre, nous décrivons également un dispositif pratique conçu pour des expériences en radio cognitive.

Même si notre travail se rapporte à différentes couches de la pile protocolaire, le cadre général que nous avons conçu est multicouches. En effet, les composants accèdent aux différentes couches pour récupérer l'information, la traiter et réagir en conséquence. Ainsi, notre travail constitue un environnement inter-couches pour un dispositif radio cognitive local visant à minimiser les interférences et à maximiser les ressources réseau dans les réseaux radio cognitive.

Mots clés : Radio Cognitif, La zone de chevauchement, Grey Model, Kalman Filter, Logique Floue, Le protocole Routage, DYMO, Sensing, Protocole de Signalling, Inter-couches.

Dedication

...to my parents, parents-in-law, my brothers and sisters, and specially to Yao-ban Chan and Ethan Minh Chan. I love you all!

Acknowledgements

To my family, Mommy and Daddy, thanks for always be there for me. Thanks for giving me a home that is full of laughter and happiness. Your encouragement and faith give me a great start in life. Thanks for everything you have given me. To my dear sister and brother-in-laws, thanks for always looking after our parents when I am away. Thanks for sacrificing your dreams for me. Without you guys, I would not have gone this far.

To my dear husband and son, thanks for your continuous support from thick to thin, from ups to downs. You guys are my motivation that has been helping me go through this hardship.

I would also like to express my sincere gratitude to my supervisor, Professor Francine Krief. Thanks, Dr. Krief for your support, care, and guidance. I believe I would not have been able to finish this thesis without your encouragement, your supports and your patience. I also sincerely appreciate Dr. Mohamed Aymen Chalouf, Dr. Hicham Khalifé for being such great advisors and reviewers for my work.

Thanks, Dr. Thi Mai Trang Nguyen for all your advice and your referral to Labri. You was and always are my great teacher.

To all my Labri's friends and colleagues, Martin Peres, Dramane Ouattara, Lorijn van Rooijen, Wafa Ja, Feten Kedidi, Khaoula Zouari, thanks for being part of my social life in Labri. It was so much fun to work, play, and eat with you.

To all my Vietnamese friends in Bordeaux, thanks for your warm and sweet friendship that you guys gave me from the very first moment I was in Bordeaux.

The work was financially supported by ANR LICoRNe. I would like to acknowledge to the project coordinators and team members for making the project work.

Finally, I would like to thank all the people that I have met, even once, for being part of my Ph.D. journey. It was a great journey.

Contents

1	Introduction	1
1.1	Concept de la radio cognitive	3
1.2	Motivation et Objectifs	8
1.2.1	Motivation	8
1.2.2	Objectifs	9
1.3	Principales Contributions	9
1.4	Structure de la thèse	12
2	Introduction	13
2.1	Cognitive radio concept and inspiration	15
2.2	Motivation and Objectives	19
2.2.1	Motivation	19
2.2.2	Objectives	20
2.3	Main Contributions	20
2.4	Thesis structure	23
3	Cognitive Radio Network	24
3.1	Radio resources mobility and usage overview	25
3.2	Sensing in Cognitive Radio Networks	32
3.2.1	Local spectrum sensing	32
3.2.2	Co-operative spectrum sensing	38
3.2.3	Spectrum sensing design trade-offs	39
3.3	Medium Access Control in Cognitive Radio Networks	40
3.4	Interference Analysis in CRNs design	44
3.5	Routing in Cognitive Radio Networks	46
3.6	Cross-layer Design in CRNs	49
3.7	Conclusion	51
4	Interference Observations and Proposed Approaches	52
4.1	Overlapping and Impact on Primary Receivers	53
4.1.1	Reception Overlapping Definition	53
4.1.2	Overlapping scenarios and computation	56

4.1.3	Overlapping and its Impact on Primary Receivers	60
4.1.4	Propagation modelling and formalizing	61
4.2	Prediction Model Investigation	65
4.2.1	Grey Model GM(1,1)	66
4.2.2	Kalman Filter-based prediction model	68
4.2.3	Comprehensive Node Prediction Model	72
4.3	Preliminary Observation	72
4.3.1	Evaluation of the impact of CRN on Primary networks in the overlapping regions	73
4.3.2	Grey Model GM(1,1) and Kalman filter validation test	80
4.4	Conclusion	82
5	Fuzzy-based Routing Strategy	83
5.1	Fuzzy logic and wireless applications	84
5.1.1	Fuzzy logic and wireless applications	85
5.2	Fuzzy-based routing in wireless network	85
5.3	Fuzzy logic-based routing metrics in CRNs	87
5.3.1	Basic implementation and results	88
5.3.2	Fuzzy processes refining	97
5.4	Routing design propositions	107
5.4.1	DYMO Operation	108
5.4.2	CRN-DYMO routing protocol	113
5.4.3	The routing process of DYMO-CRN routing protocol	115
5.5	Experiment Guidelines in Omnet++	117
5.5.1	Current work in Omnet++	120
5.6	Conclusion	121
6	Practical Cognitive Radio Ad-hoc network platform and Signalling proposal	122
6.1	Platform design challenges	123
6.1.1	Sensing process and challenges	123
6.1.2	Signaling and control messages dissemination	124
6.1.3	Medium Access Mechanism	125
6.1.4	GnuRadio-based framework	126
6.2	PHY design - Spectrum scanning and information extraction	128
6.2.1	Proposed signalling framework	128
6.2.2	Sensing operation overview	128
6.3	Signalling protocol	132
6.3.1	Frequency Hopping Cycle and Beacon Frame disseminating	132
6.3.2	Beacon broadcasting and receiving	136
6.4	Link Layer Design and Operation	137

6.4.1	Protocol Introduction	137
6.4.2	Protocol Operation	141
6.4.3	User Identification collaboration protocol	144
6.5	Conclusion	153
7	Conclusion	154
7.1	Key Results	154
7.2	Future Work	156

List of Figures

1.1	Cycle cognitif simple	4
1.2	Contexte de prise de decision d'un dispositif radio cognitive. [1]	5
1.3	Présentation du cadre de travail	10
1.4	Cadre de conception inter-couche d'un dispositif radio cognitive	11
2.1	Simple cognitive abstract cycle.	16
2.2	Cognitive radio decision making context.[1]	17
2.3	Abstraction of work scope	21
2.4	Cross-layer design framework of a Cognitive Radio device	22
3.1	Spectrum usages and holes	25
3.2	802.19 Architecture work scope [2]	30
3.3	Cognitive Cycle of a CR	31
3.4	Detection of PR receiver issue - Signal of PR_1 is too weak compare to the PR transmitter	36
3.5	Detection of PR receiver issue - Signal of PR transmitter is shadowed by the obstacle, thus CR_1's signal interferes with PR_1	37
4.1	General Cognitive Radio Network Architecture	54
4.2	Overlapping definition	54
4.3	Non overlapping reception zones	57
4.4	Tangent	57
4.5	CR coverage area inscribes PR reception zone	58
4.6	PR coverage area inscribes CR reception zone	58
4.7	General overlap case	59
4.8	Particular overlapping case between PR Transmitter and a CR Node	60
4.9	General overlap case - reminder	61
4.10	Normal distribution series	71
4.11	Poisson distribution series	71
4.12	Experiment on a single channel and various overlap areas	73
4.13	Experiment on multiple channels and various overlap areas	74
4.14	Single Channel - Different Overlap region - Uniform Distribution	76
4.15	Single Channel - Different Overlap region - Poisson Distribution	76

4.16	Single Channel - Different Overlap region, smaller reception zone - Uniform Distribution	77
4.17	Single Channel - Different Overlap region, smaller reception zone - Poisson Distribution	77
4.18	Multi Channel - Different Overlap region - Uniform Distribution	78
4.19	Multi Channel - Different Overlap region - Poisson Distribution	78
4.20	Single Channel - Big Reception Zone - Arbitrary Deployment	79
4.21	Single Channel - Small Reception Zone - Arbitrary Deployment	79
4.22	Received power and PR position prediction with Grey Model GM(1, 1)	81
4.23	Relation of RSSI and distance with Kalman Filter	81
4.24	Relation of RSSI and distance with Grey Model GM(1, 1) - identical series with Kalman Filter	82
5.1	General fuzzy logic system	85
5.2	Membership function of Overlap Ratio	89
5.3	Membership function of Node Density	90
5.4	Membership function of the output Interference Degree	92
5.5	Fuzzy Inference Mapping Diagram	93
5.6	Interference level basic implementation	94
5.7	Extended overlap ratio fuzzy functions following definition in 5.3.2	98
5.8	Fuzzification of overlap ratio from its membership functions	99
5.9	Fuzzification of Node Density from its membership functions	100
5.10	Enhanced interference level fuzzy membership functions	101
5.11	Interference Level Output as function of Overlap and Node Density - Rule set of 16	102
5.12	Overlap ratio fuzzification example	103
5.13	Node Density probability fuzzification example	103
5.14	Aggregated Interference level	104
5.15	DYMO Route Discovery from source A to sink F without PR's existence	110
5.16	DYMO Route error sent from C when there is a broken link. Route Error RERR is generated from C and then sent towards all of C's neighbors including B, G, and D to prevent future data transmission towards link C-F. These nodes had already recorded a path containing F, therefore the RERR is further sent to A and E.	112
5.17	DYMO Route Discovery from source A to sink F with PR's existence. We assume that B is kept in silent as it operates in the area where it overlaps with a PR transmitter.	112
5.18	Abstraction of work scope	114
5.19	DYMO Route Discovery from source A to sink E with a PR's existence.	114
5.20	DYMO Route Discovery from source A to sink E with 2 PRs' existence.	115
5.21	Routing information process	117

5.22	2 Nodes overlapping only	119
5.23	Routing between 3 nodes with overlapping	119
5.24	Ad-hoc Routing with multiple nodes multiple overlapping	120
5.25	DYMO Test with enabling IL metric	120
6.1	GNU radio software architecture	127
6.2	Cognitive Radio node composed of USRP-1 and Gnu radio software	128
6.3	Filling procedure in Radio Events Table.	129
6.4	Noise Power Distribution	130
6.5	The radio spectrum sensing example	131
6.6	Sensing conceptual flowchart	131
6.7	Non-transmission to transmission automaton	132
6.8	Beacon frame format example	133
6.9	Frequency hopping scheduling example	135
6.10	Signaling information is disseminating via beacon sending	136
6.11	Beacon decoding example	137
6.12	Waiting to send frame structure	139
6.13	Ready to receive frame structure	139
6.14	Ready to send frame structure	140
6.15	Spectrum lock table example of each node	141
6.16	WTS sending example	142
6.17	Ready-to-receive sending example	142
6.18	Ready-to-send sending example	143
6.19	Spectrum lock table after A's neighbored CRs received RTR	143
6.20	Established communication between A and B	143
6.21	Spectrum users identification flowchart	145
6.22	Sensing process starts at A	146
6.23	Demodulation and Link-Layer Decoding at A	146
6.24	Collaboration between A and its identified neighbours	146
6.25	Collaboration between A and its identified neighbours - responding process	147
6.26	Information synthesis	147
6.27	Proposed Broadcast Request	148
6.28	Proposed Broadcast Response	149
6.29	Collaboration process example	151
6.30	Transmission identification responding process example	152
6.31	Proposed back-off counter to avoid collision	153

List of Tables

4.1	Notations Table	56
4.2	Computation Parameters of PR and CR	65
4.3	Experiment configuration	75
5.1	Interference Level Rules Table	91
5.2	Overlap Degree Fuzzification Output with 20 random different values of the input of Overlap Ratio	93
5.3	Density Degree Fuzzification Output with 20 random different values in consistent to the overlap ratio	95
5.4	Interference Level Fuzzification Output	96
5.5	Enhanced Interference Rules Table	100
5.6	Overlap degree fuzzification data	105
5.7	Density degree fuzzification data	105
5.8	Interference Level fuzzification data	106
5.9	Routing protocol comparison table	108
6.1	Notations Table	134
6.2	Waiting to send frame structure explanation	139
6.3	Ready to receive frame structure explanation	140
6.4	Ready to send frame structure explanation	141
6.5	Broadcast request message structure explanation	149
6.6	Broadcast response message structure explanation	150

List of Abbreviations

ANR Agence Nationale de la Recherche. 20

BS Base Station. 27, 28

CPE Customer Premise Equipments. 9, 27, 28

CR Cognitive Radio. 1, 3, 8, 10, 13, 15–21, 28

CRN Cognitive Radio Network. 19, 20, 28

DSL Digital Subscriber Line. 27

DSP Digital Signal Processors. 15

DTV Digital TV. 29

FCC Federal Communication Commission. 1, 13, 25, 27

FPGA Field Programmable Gate Arrays. 15

GPP General Purpose Processors. 15

IL Interference Level. 22

MAC Medium Access Control. 27, 28

PHY Physical. 27

PR Primary Radio. 17, 21

QoS Quality of Services. 3, 15

RSSI Received Signal Strength Indicator. 56

SCC Standard Coordinating Committee. 30

SDR Software-defined Radio. 1, 13, 15

SNR Signal-to-Noise. 28

SoC System on Chip. 15

TPC Transmitting Power Control. 27, 28

WRAN Wireless Regional Area Network. 27

Chapter 1

Introduction

The process of scientific
discovery is, in effect, a
continual flight from wonder.

Albert Einstein

Aujourd'hui la demande pour des communications de données haut débit explose et démontre l'insuffisance des assignations de fréquences jusque-là statiques. Il est prévu que le nouveau mode d'assignation devra tenir compte, non seulement de l'infrastructure d'accès sans fil existant, mais aussi des nouveaux équipements mobiles afin de pouvoir profiter au mieux du spectre résiduel. La Federal Communication Commission (FCC) aux Etats Unis a annoncé la première réforme sur la politique et la réglementation du spectre en novembre 2000 [3]. Dans un de ses rapports datant de novembre 2002 [4, 5], elle indiquait que le spectre radio était de 20% à 85% sous-utilisé. L'utilisation insuffisante du spectre devient un problème crucial. Pour répondre à la demande de bande passante des applications/services sans fil émergents, il y a eu une demande à la FCC pour modifier la politique de gestion du spectre afin de la rendre plus flexible. En outre, la FCC a également encouragé les propriétaires de fréquences radio à les sous louer pour permettre un accès opportuniste [6].

Une fois que les termes *Software-defined Radio (SDR)* et *Cognitive Radio (CR)* ont été introduits en 1992 et 1996 respectivement, l'intérêt pour ces technologies a pris une importance considérable. La *radio cognitive* définit un type de radio intelligente qui a la capacité de détecter l'environnement de fréquences radio, de décider, et d'apprendre de manière indépendante [7]. Pour cela, la CR repose sur *la radio logicielle*. La *radio logicielle* permet à la CR d'observer le spectre des fréquences radio avant d'utiliser les fréquences grâce au procédé appelé : Détection du spectre. En 2003, la FCC a défini la *radio cognitive* comme «une radio qui peut changer ses paramètres de transmission en fonction de l'environnement dans lequel elle opère» [8].

Cette thèse présente des évolutions concernant l'observation du médium par des dispositifs radio cognitive coexistant avec des appareils radio conventionnels. Dans ce chapitre, le concept de la radio cognitive est présenté dans la section 1.1. Ensuite, nous introduisons notre motivation et nos objectifs ainsi que nos principales contributions dans les sections 1.2 et 1.3 respectivement. La structure de la thèse est présentée à la fin de ce chapitre.

1.1	Concept de la radio cognitive	3
1.2	Motivation et Objectifs	8
1.3	Principales Contributions	9
1.4	Structure de la thèse	12

1.1 Concept de la radio cognitive

La proposition de Mitola sur la radio intelligente a été introduite en 2002 [7]. L'idée était de concevoir un réseau radio qui puisse explorer et exploiter intelligemment les ressources nécessaires au fonctionnement des équipements. Le sujet était limité aux dispositifs sans fil personnels et à leur capacité de calcul au niveau logiciel. En fait, à l'époque, Mitola introduit le terme *CR* pour identifier comment un assistant personnel sans fil numérique, comme un PDA, et les réseaux à sa portée peuvent tirer parti du partage des ressources courantes du spectre en respectant les besoins en Quality of Services (QoS) de l'application. Cette technique doit satisfaire les fonctions suivantes : (i) détecter les besoins de communications de l'utilisateur qui sont liés au contexte d'utilisation, (ii) et fournir les ressources radio qui sont les plus appropriées aux besoins des services sans fil fournis [7]. Ces définitions sont encore utilisées comme fonctionnalités requises d'un dispositif CR. Pourtant, avec la vitesse actuelle de développement des réseaux sans fil, il y a d'autres fonctionnalités pratiques qu'un véritable dispositif CR doit avoir, comme la capacité de s'adapter aux changements de l'environnement pour éviter d'impacter sur l'infrastructure sans fil courante lorsque qu'il coexiste avec un système sans fil existant. Pour cela, un équipement CR s'appuie sur la radio définie par logiciel comme mentionné plus haut.

La radio définie par logiciel se réfère à un moyen de communication sans fil dans lequel les modulations physiques sont définies et fonctionnent sur une base logicielle. Le Forum SDR travaillant en collaboration avec le groupe IEEE P1900.1, a défini la radio logicielle comme : "une radio dans laquelle tout ou partie de la couche physique est défini de manière logicielle" [9]. Une radio traditionnelle nécessite que du matériel soit mis en place et limite la capacité à supporter différents standards de forme d'onde. Et une fois qu'il est nécessaire de modifier une radio traditionnelle, cela nécessite une intervention matérielle qui coûte du temps, des ressources et de l'argent. Malgré cela, la flexibilité reste encore limitée. En revanche, la radio logicielle peut permettre une intervention via le logiciel. Elle permet aux équipements sans fil multimodes et, ou, multibandes de pouvoir être améliorés à l'aide de mises à niveau logicielles. Cependant, de nombreux travaux doivent être menés sur la radio définie par logiciel en termes de fonctionnalités et d'efficacité. Les technologies bien connues utilisées pour développer la SDR sont les logiciels de traitement modifiables ou programmables ou systèmes reprogrammables comme les FPGA (Field Programmable Gate Arrays), les processeurs traitement du signal DSP (Digital Signal Processors), les processeurs généralistes GPP (General Purpose Processors), les systèmes programmables sur puce SoC (System on Chip) ou d'autres processeurs programmables spécifiques à l'application. Ces technologies permettent l'introduction de nouvelles fonctionnalités et capacités sans fil dans le système radio en cours. Et une CR est une sorte de radio logicielle qui peut tirer parti du système radio en cours, exploiter les ressources résiduelles du spectre radioélectrique,

et ajuster ses comportements en fonction des changements du support radio.

La radio cognitive de base fonctionne selon un cycle appelé cycle cognitif qui comprend l'exploration, l'analyse et l'action. Un dispositif CR observe le support de communication et son état actuel. Il doit ensuite analyser l'environnement actuel pour déterminer quelles parties du spectre sont actuellement disponibles. Un comportement approprié de la part du dispositif CR nécessite de disposer d'informations sur les ressources disponibles et leurs états. Ce cycle simple et les différentes étapes sont illustrés dans la Fig. 1.1.

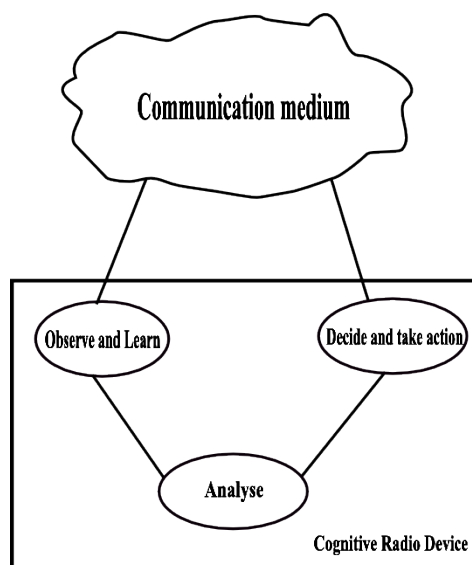

Figure 1.1: Cycle cognitif simple

De façon plus détaillée, Haykin et al. [1] ont illustré le contexte simplifié de décision de la radio cognitive dans la Fig. 1.2. Un émetteur CR doit obtenir l'information adéquate sur l'environnement avant de transmettre quoi que ce soit sur le support. A partir du processus d'observation et d'apprentissage, le module d'analyse du spectre radio fournit des données statistiques sur l'état du trafic actuel dans le voisinage, les trous de spectre, le bruit ambiant. Ainsi le module amont obtient l'état du monde extérieur et transmet cet état au module d'analyse. Le dispositif CR analyse et extrait ensuite les informations utiles telles que la partie du spectre inutilisée, le seuil du bruit de fond et à quoi le trafic ressemble dans ses dimensions temporelle et spatiale. Tout ce processus est appelé détection de spectre dans les CRN. Un processus de détection est un processus dans lequel un dispositif CR surveille, détecte et analyse le spectre radio de l'environnement avant de transmettre. Après l'étape de détection, le médium est évalué. Ce processus d'évaluation vise à estimer les ressources accessibles telles que des bandes de fréquences et la capacité spectrale dont dispose un dispositif CR pour transmettre. Cette partie est la gestion du spectre. Comme un dispositif CR doit aussi être conscient des activités des PR, un modèle de prédiction des activités des PR est nécessaire. Un émetteur CR obtient donc toutes ces informations pour pouvoir ajuster

sa puissance de transmission afin d'éviter les interférences avec les systèmes primaires tant qu'il transmet. Même si un dispositif CR est inactif, il doit toujours collecter des statistiques sur les ressources radio aux alentours, les activités des PR, le trafic, etc.

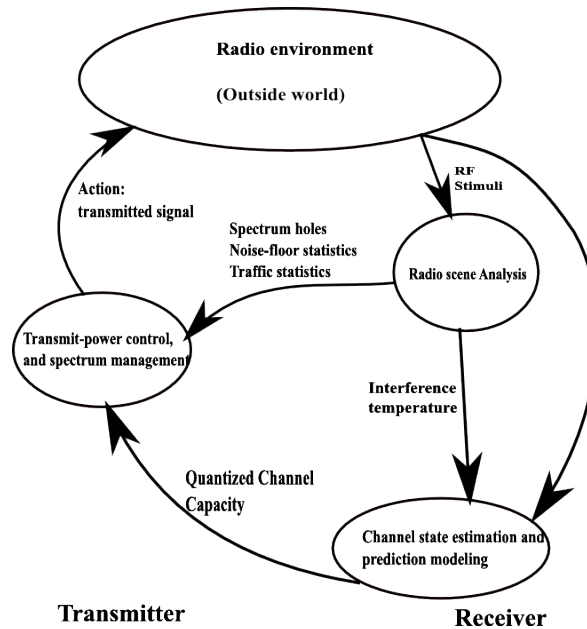

Figure 1.2: Contexte de prise de decision d'un dispositif radio cognitive. [1]

Ainsi un dispositif CR est un nœud mobile qui accède de manière opportuniste aux ressources radio et fonctionne sans interférer avec l'infrastructure sans fil actuelle. Plus précisément, un nœud CR est conscient de son environnement et acquiert une connaissance de transmission préalable avant de réaliser une action. Un nœud CR doit également être en mesure de détecter les autres appareils mobiles sous licence sur la fréquence radio opérationnelle courante afin de leur laisser la place à chaque fois que ces dispositifs veulent communiquer. La capacité de détection du spectre d'un dispositif CR est donc une fonction importante. C'est une fonction locale que chaque nœud CR doit effectuer. En théorie, un nœud CR peut communiquer avec tout type d'appareils mobiles. Cependant, la qualité de la communication est une préoccupation importante. En effet, à chaque fois que le dispositif CR doit quitter une fréquence en cours, la transmission sera retardée ou interrompue. Pourtant, si un nœud CR coopère et travaille avec d'autres nœuds CR, la situation peut être améliorée. Plusieurs nœuds CR travaillant ensemble forment un réseau de radio cognitive (CRN). Ainsi l'avantage de former un CRN est que la performance de détection peut être améliorée en termes de précision de détection de l'information et probabilité de détection grâce à la collaboration entre nœuds CR. En effet, en cas de coexistence avec d'autres nœuds radios, la détection du spectre d'un nœud CR doit traiter divers aspects tels que la surveillance continue du spectre, la détection d'une bande de fréquences de remplacement, et la conscience du type de transmission. Un nœud CR doit donc détecter le spectre régulièrement, ou, pour certaines applications, sans interruption car il fonctionne sur le principe de base de

la non-ingérence avec les utilisateurs primaires. Par conséquent, il doit rester à l'écoute pour s'assurer de détecter les retours d'une radio primaire. Comme un nœud CR doit partir quand un PR veut réutiliser le spectre, la détection du spectre doit permettre de chercher des ressources radio alternatives pour que le nœud CR puisse changer de bande de fréquences lorsque cela est nécessaire. Être conscient du type de transmission permet à un CR d'identifier la transmission d'un PR quand il communique. Puis ces CR peuvent soit arrêter leur transmission ou passer sur d'autres canaux pour reprendre la communication. En général, il existe deux schémas principaux de détection qui ont été explorés dans la littérature : la détection locale et la détection coopérative. Ces types de détection du spectre et les méthodes utilisées sont détaillés plus loin dans le chapitre 3.

Le processus de détection fournit la vue et la connaissance du support radio actuel. Un dispositif CR se doit d'utiliser ces informations avec discernement pour tenir compte de ses propres besoins. Par exemple, quand un dispositif CR a l'intention d'établir une communication avec d'autres équipements radios, il doit choisir les bandes de fréquences appropriées qui sont soit inactives soit partiellement utilisées. En outre, pour s'assurer que la communication peut être établie, le paramètre de configuration des canaux choisis ou des bandes de fréquences doit répondre aux exigences de l'application. Il est nécessaire que le système radio cognitive gère le spectre acquis par le processus de détection pour allouer des ressources appropriées pour fonctionner. En outre, lorsqu'un PR revendique les bandes de fréquences, un CR doit être en mesure de passer sur d'autres plages accessibles pour reprendre la communication en cours. Sinon, la communication est susceptible d'être interrompue. Pour cela, un CR doit disposer d'autres ressources libres. Cette fonction est la gestion du spectre et reste un défi pour la communauté scientifique : comment minimiser les connexions intermittentes lors du passage d'un canal à l'autre. En cas de coexistence avec d'autres équipements radios, y compris les systèmes primaires, l'atténuation des interférences dans les réseaux radio cognitive est également un autre domaine de recherche à explorer. En particulier dans ce travail, nous nous intéressons à la phase d'observation d'un nœud CR pour évaluer l'impact potentiel sur les systèmes primaires dans un scénario de coexistence entre un CRN et un système primaire. Ce travail est présenté au chapitre 4.

Comme tout type de réseaux de communication, les nœuds CR dans les CRN ont également besoin de trouver un chemin pour communiquer les uns avec les autres, qui s'appuie sur un protocole de routage. Cependant, contrairement au réseau sans fil classique, le routage dans les CRN défie la communauté scientifique car il doit considérer le système primaire et traiter les changements de bandes de fréquences. Pour établir un trajet depuis une source vers une cible, à la différence de la radio classique, un nœud CR doit accéder à l'information de détection qui a été collectée et analysée pour déterminer la fréquence à utiliser. En outre, les canaux de communications à utiliser entre une source et sa cible devront être négociés tout au long du chemin avant de

pouvoir échanger des données. En cas de présence de PR tandis que la communication est en cours, la source CR devra être capable de rechercher un autre chemin. Les sélections de canaux, et la récupération de chemin sont deux aspects qu'un protocole de routage doit prendre en compte. En outre, l'atténuation des interférences devient primordiale pour le protocole de routage dans les CRN car un nœud CR doit respecter la présence du système primaire. Ainsi, un protocole de routage existant utilisé dans un réseau sans fil devra être modifié pour s'adapter au CRN. Cette adaptation doit être faite pour répondre aux exigences de l'application aussi bien qu'aux conditions de l'environnement du CRN.

Un autre aspect des réseaux radio cognitive concerne l'échange et le traitement des informations de contrôle. L'information la plus importante qu'un nœud CR doit collecter est l'information de détection. Pourtant, l'essentiel de cette information est obtenue et traitée par la couche physique. Un nœud CR ne peut fonctionner que lorsque l'information de la couche physique est échangée entre les différentes couches supérieures telle que la couche Liaison ou la couche Réseau. Le modèle OSI traditionnel ne fournit pas la flexibilité et l'accès rapide aux informations à travers les couches si elles ne sont pas adjacentes. Par exemple, le routage a besoin d'informations sur les canaux disponibles sur lesquels il peut transmettre la signalisation de routage dans l'environnement pour établir un chemin vers une cible. Avec des informations supplémentaires de la couche physique, telles que les informations d'estimation d'interférence sur un canal spécifique, le routage CR peut sélectionner un chemin qui minimise les interférences pouvant survenir durant le processus de découverte. Par conséquent, l'échange d'informations cross-layers se montre bénéfique pour un accès rapide à l'information.

Pour répondre au développement de ce système sans fil, de nombreux standards de gestion de la réglementation du spectre ont été développés tels que IEEE 802.22 pour les WRAN, IEEE 802.19 pour la coexistence réseau, IEEE 1900.6 pour l'interface de détection, IEEE 802.16e supporter le WiMax. Ces standards sont décrits dans le chapitre 3.

Dans l'ensemble, les CRN ont obtenu une attention considérable et de nombreux efforts de recherche ont été menés par la communauté scientifique. Plusieurs documents ont recensé les travaux existants comme dans [10, 11] ou ont donné des lignes directrices concernant les orientations futures de recherche [12]. Depuis, le domaine a sa propre communauté de chercheurs, et nous avons également souhaité apporter notre contribution à la communauté scientifique. Nous introduisons donc notre motivation et les objectifs de ces travaux de thèse dans la section suivante. Nous espérons que nos résultats contribueront au développement des CRN.

En France notamment, le projet LICoRNe (Leveraging Insurance for services providers cohabitation over Cognitive Radio Networks) avait pour objectif d'étudier la faisabilité

d'offres de services via les réseaux radio cognitive. Le projet va au-delà de la notion de radio cognitive pour s'intéresser à la transmission sur le médium, l'ingénierie de services, et les techniques de gestion sur des radios cognitives avancées. En particulier, les types de services qui peuvent être offerts aux utilisateurs finaux via des réseaux radio cognitive multi-sauts est l'objectif principal. Pour atteindre cet objectif, le projet a dû s'attaquer à divers problèmes allant de la couche physique à la conception de la couche application sur ce nouveau schéma de spectre [13].

1.2 Motivation et Objectifs

1.2.1 Motivation

Comme mentionné, la recherche en radio cognitive émerge du nouveau schéma d'accès réseau qui nécessite une réflexion sur ce que sont les réseaux radio cognitive et comment les réseaux de prochaine génération traiteront des questions relatives à la pénurie du spectre due au schéma de distribution de spectre fixe de la FCC. Une fois que le CRN est déployé, il est essentiel également qu'il permette à divers réseaux sans fil de coexister et de travailler dans un milieu partagé sans perturbations graves sur les autres et également sur eux-mêmes. C'est l'une des fonctions les plus importantes qu'un CRN doit fournir.

Même si la radio définie par logiciel et la radio cognitive sont définies de manière distincte, la CR fonctionne toujours sur la base de la radio définie par logiciel. Nous nous sommes donc intéressés à apprendre et comprendre comment un changement de conception pourrait permettre d'améliorer les techniques de l'infrastructure réseau sans fil actuelle. En particulier, nous avons étudié l'importance des observations de l'environnement radio pour prévenir les interférences potentielles. À partir des observations obtenues, nous avons proposé un mécanisme de routage pour prévenir les interférences. Nous avons également étudié et proposé une conception cross-layer et une métrique de routage qui pourrait tirer parti de la conception d'un protocole de routage actuel pour permettre de surmonter certaines restrictions liées à l'utilisation des CRN.

L'ingénierie de services qui se rapporte au nouveau schéma d'accès sans fil est une tâche critique. Ce travail fait partie du projet ANR LICoRNe. Il adresse le problème de la coexistence entre un CRN et un réseau sans fil existant (WiFi et GSM). Nous espérons que nos résultats contribueront à ce projet en termes de diminution des interférences dans un schéma de coexistence avec des PR.

1.2.2 Objectifs

Nous étudions l'effet possible d'une communication CR dans un réseau radio cognitive dans le contexte de la coexistence avec des PR. Par conséquent, nous nous concentrons sur les points suivants :

- Nous abordons l'impact en termes d'interférences en partant de l'observation et nous proposons une approche permettant de diminuer cet l'impact sur le système primaire. L'observation est exécutée localement sur un dispositif CR en supposant que la localisation des dispositifs est connue. La localisation de ces dispositifs pourrait être obtenue par des techniques de géolocalisation [14] ou des services basés sur la localisation [15]. La relation entre l'impact et les emplacements des PR sont donc extraits et analysés.
- Partant de l'acquisition des résultats, nous proposons une approche de conception cross-layer pour la coexistence potentielle de réseaux primaire et secondaire, afin d'atténuer par exemple l'impact des activités des Customer Premise Equipments (CPE) sur les dispositifs en place dans le spectre de fréquences exploitant les zones blanches de la TV.
- Des modèles de prédiction de la densité de nœuds et d'estimation de l'interférence sont proposés. Les résultats pratiques obtenus à partir de l'observation permettent d'envisager l'impact potentiel, mais pour faire face à la nature changeante du médium, une approche globale et précise de la modélisation du système est également cruciale.
- Le routage dans un réseau multi-saut est essentiel. Nous proposons donc une métrique de routage pour le déploiement des CRN ad hoc en accord avec les impacts observés.
- La signalisation dans un CRN est une question cruciale. Nous nous appuyons sur une solution de signalisation développée au sein de notre équipe [16] pour proposer les extensions nécessaires à notre approche.

1.3 Principales Contributions

Notre champ de recherche se concentre sur la stratégie d'évitement des interférences dans des scénarios de coexistence entre CRN et réseau primaire. Plus précisément, nous avons positionné notre travail par rapport à une structure en couches pour avoir un aperçu de la façon dont les blocs sur lesquels nous nous positionnons, sont interconnectés et reliés au modèle OSI. La figure 1.3 résume le cadre de recherche de ce travail de thèse. Nous nous concentrons sur l'étape d'observation d'un nœud CR. Le contrôleur de gestion (*Management Controller*) stocke les paramètres d'observation tels que les

mouvements et la localisation des nœuds mobiles. Le bloc de calcul de recouvrement (*Overlap Calculation*) peut alors récupérer, calculer et analyser localement la situation actuelle des CR relativement à un émetteur PR. De même, l'estimateur de densité de nœuds (*Node Density Estimator*) obtient l'historique des statistiques du nœud dans une zone spécifique et estime la probabilité de densité de nœuds. Ces blocs produisent des entrées estimées pour l'estimateur d'interférence (*Interference Estimator*). C'est le moteur principal qui prend en considération les entrées des autres blocs dans le cadre de ce travail est qui est présenté sur la Fig. 1.3.

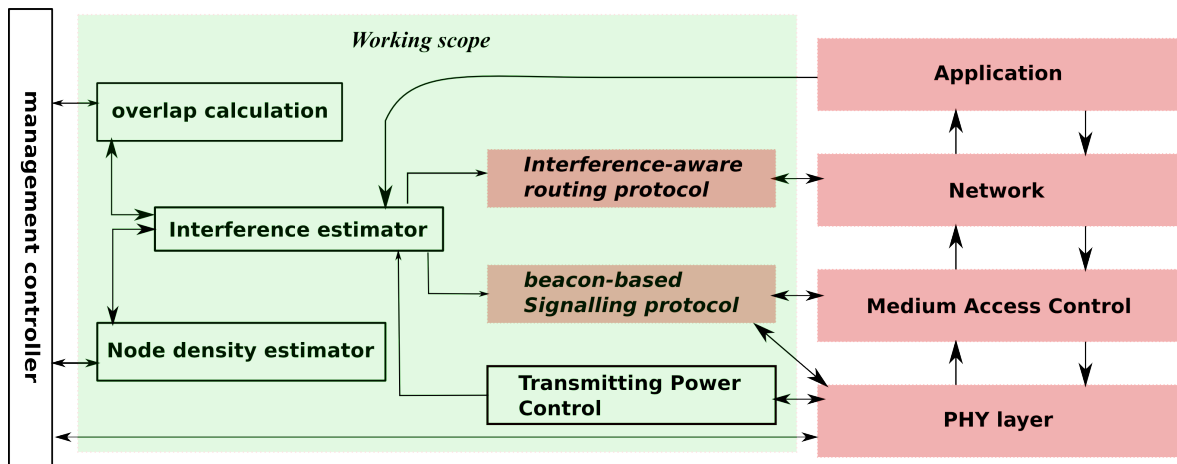

Figure 1.3: Présentation du cadre de travail

Les entrées et sorties de ce framework sont conservées dans la base de données locale de manière à ce qu'un autre moteur puisse accéder à l'information nécessaire ou stocker les résultats calculés (par exemple, le moteur de calcul de recouvrement pourrait récupérer l'emplacement des PR à partir de cette base de données). Le bloc de routage étant conscient de l'interférence (interference-aware routing), notre proposition de protocole de routage, récupère et utilise la valeur estimée de l'interférence comme métrique pour sélectionner les canaux. Le protocole proposé est présenté dans le chapitre 5. En outre, ce framework pourrait travailler en collaboration avec le protocole de signalisation présenté au chapitre 6. La puissance de transmission estimée peut être ajoutée à la balise afin que la destination puisse juger par elle-même de sa propre puissance d'émission. Les blocs en rouge sur la droite représentent les couches OSI pour que nous puissions voir comment l'information est échangée à travers les couches réseau, MAC et physique.

Le framework que nous proposons pour un nœud CR local est décrit dans la Fig. 1.4. Ce cadre qui sera détaillé tout au long de ce manuscrit, vise à minimiser les interférences que pourrait causer un dispositif CR lorsqu'il décide d'émettre. Les données historiques sont stockées et récupérées par les différents moteurs qui appartiennent à différentes couches de protocole. La zone de recouvrement et la densité de nœuds sont calculés

séparément par les moteurs respectifs : *overlap computation engine* et *prediction engine*. Les résultats de ces moteurs sont l'entrée pour le moteur *Fuzzy logic inference engine* qui a pour tâche d'estimer le niveau d'interférence (Interference Level : IL). IL peut être utilisé dans l'estimation de transmission de puissance, ce qui n'a pas été fait dans ce travail mais que nous souhaitons réaliser par la suite. D'autre part, la stratégie de routage que nous proposons accède également à IL comme une nouvelle métrique utilisée pour la sélection de chemin dans le processus de découverte de route. L'utilisation d'IL pourrait également éviter les interférences prévues quand un CRN coexiste avec un réseau primaire une fois que le chemin est établi entre une source et une destination CR. En particulier, nous avons introduit une procédure de contrôle d'accès des messages de diffusion dans laquelle les nœuds CR maintiennent la connaissance de leurs voisins ainsi que de leurs ressources avant de pouvoir commencer à transmettre. Cet établissement prend en charge le protocole de routage de la couche supérieure, qui, dans ce cas, est le protocole de routage de niveau d'interférence. Par ailleurs, les paramètres sont calculés via des accès inter-couches sans aucune restriction. Le protocole de routage que nous proposons peut servir de guide à l'élaboration d'un protocole de routage CR qui minimiserait les interférences sur les réseaux primaires lorsque que les CRNs opèrent.

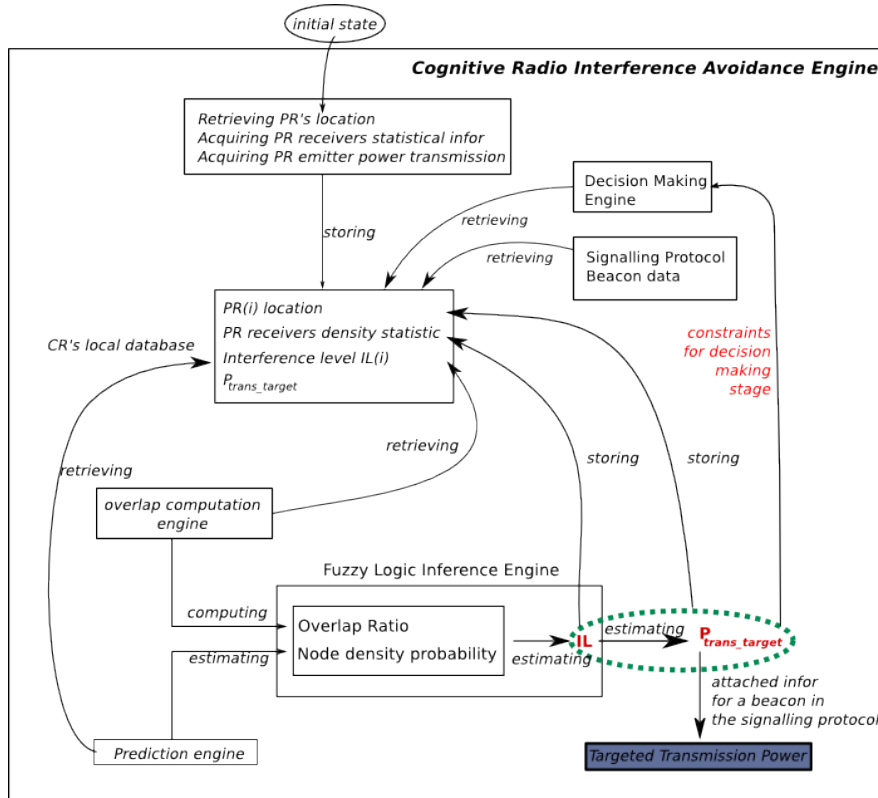

Figure 1.4: Cadre de conception inter-couche d'un dispositif radio cognitive

Ce cadre abstrait peut être développé localement dans un dispositif CR. Généralement, l'accès des données cross-layer par un nœud CR permet (1) d'observer les phénomènes de chevauchement; (2) de prédire la densité des nœuds en utilisant le Grey

Model en combinaison avec un filtre de Kalman; (3) d'estimer le niveau d'interférence prévu.

1.4 Structure de la thèse

Pour rendre le document cohérent, nous présentons les principes et fonctions de base d'un réseau radio cognitive dans le chapitre 3. Nous discutons aussi brièvement du schéma de répartition des ressources spectrales qui a conduit à proposer le concept de radio définie par logiciel. Nous détaillons également certaines techniques de détection, ainsi qu'un mécanisme de contrôle d'accès au support dans un réseau CRN. En outre, l'analyse des interférences et du routage dans un CRN sont discutées. Les lecteurs peuvent également trouver une critique de l'approche de conception inter-couche à la fin de ce chapitre.

Nous étudions ensuite la coexistence entre les systèmes primaires et secondaires et proposons une approche pour pouvoir prendre en considération l'interférence avec les PR dans le chapitre 4. Nous détaillons le calcul de la zone de vulnérabilité, c'est-à-dire lorsque la couverture d'un émetteur CR rencontre la zone de couverture d'un émetteur PR associée au pourcentage d'impact obtenu par simulation. L'importance de cette observation prouve qu'il existe un lien entre l'impact potentiel sur le réseau primaire et la taille de la zone de chevauchement. Plus le chevauchement est important plus l'impact est fort. Cependant, nous avons également constaté d'autres facteurs critiques qui influencent cette conclusion préliminaire.

Les conclusions du chapitre 4 nous ont conduit à proposer une approche permettant de produire une métrique globale de routage qui est détaillée dans le chapitre 5. La logique floue est la technique qui permet de combiner différents facteurs indépendants. Nous présentons également cette technique dans ce chapitre ainsi que les résultats numériques associés.

Nous présentons ensuite brièvement le schéma de signalisation sur lequel nous nous appuyons au chapitre 6. Il s'agit d'un mécanisme de signalisation par balises permettant de localiser les ressources utilisables par le nœud CR afin de pouvoir échanger des informations de contrôle. Le mécanisme vise à tirer parti du protocole CSMA/CA avec prise en compte des nœuds cachés pour allouer des ressources suffisantes afin d'établir une communication au niveau de la couche liaison entre les CR.

Nous concluons notre travail dans le chapitre 7. Dans ce chapitre, nous résumons les contributions de cette thèse. Puis, nous discutons de questions ouvertes que nous avons identifiées durant ce travail, et proposons les futures orientations de recherche qui pourraient permettre de résoudre ces problèmes.

Chapter 2

Introduction

The process of scientific discovery is, in effect, a continual flight from wonder.

Albert Einstein

Nowadays, huge demand for broadband data demonstrates the deficiency of static spectrum assignments. It is envisioned that the new design should accommodate not only the existing wireless access infrastructure but also the new advanced mobile devices to take the advantage of the residual spectrum. The American Federal Communication Commission (FCC) announced the first reform on spectrum policy and regulation in November 2000 [3]. In one of its reports in 2002 [4, 5], FCC confirmed that the radio spectrum was 20% to 85% underutilized. The insufficient use of spectrum became a critical issue for the growth of mobile communications. To meet the spectrum demand of emerging wireless applications/services, FCC requested to change the spectrum management policy to make it more flexible. Moreover, FCC also encouraged the spectrum owners to sublease their spectrum for opportunistic access [6].

Once the terms *Software-defined radio (SDR)* and *Cognitive Radio (CR)* were introduced in 1992 and 1996 respectively, interest in these technologies has become increasingly important. *Cognitive Radio* addresses a type of smart radio that has the ability to sense the radio frequency environment, make a decision, and learn independently [7]. To do so, a CR can rely on a *Software-defined radio*. *Software-defined radio* allows a CR to observe the radio frequency spectrum before it uses the spectrum thanks to the spectrum sensing process. In 2003, the FCC defined a *Cognitive Radio* as “a radio that can change its transmitter parameters based on the environment in which it operates” [8].

This dissertation presents the medium observation perspectives of cognitive radio devices when they coexist with conventional radio devices. In this chapter, cognitive radio is presented in section 2.1. Moreover, we introduce our motivation and objectives as well as our main contributions in sections 2.2 and 2.3 respectively. The thesis's structure is presented at the end of the chapter.

2.1	Cognitive radio concept and inspiration	15
2.2	Motivation and Objectives	19
2.3	Main Contributions	20
2.4	Thesis structure	23

2.1 Cognitive radio concept and inspiration

Mitola's proposal on smart radio was introduced in 2002 [7]. The meaning behind the idea was designing a radio network that intelligently explored and exploited essential resources for the devices' operations. The topic was limited on the intersection of personal wireless devices and the computational capacity at the software level. In fact, at the time, Mitola introduced the term *CR* to identify the point at which a wireless personal digital assistant, a.k.a PDA, and the related networks could leverage the resources of current spectrum while respecting the application's QoS requirements. This technique has to satisfy the following functions: (i) detecting user's communications needs as a function of the use context, (ii) and providing radio resources that are most appropriate to the needs of provided wireless services [7]. These definitions are still used as those of the required functionalities of a CR device. Yet, with the current speed of wireless network development, there are some other practical functionalities that a real CR device must have, such as the ability to adapt to environmental change and to prevent impact to current wireless infrastructure when it coexists with a legacy wireless system. To do so, a CR device can rely on software-defined radio as mentioned above.

Software-defined radio refers to a mean of wireless communication in which the physical modulations are defined and operated in a software base. SDR forum working in collaboration with the IEEE P1900.1 group, has defined software-defined radio as: "a radio in which some or all of the physical layer are software defined" [9]. A traditional radio requires hardware implemented and limits the cross-functionality (the ability to support different waveform standards). And when changes are needed, a traditional radio has to be modified via hardware intervention that costs time, resources and money. Therefore, the flexibility is limited. In contrast, software-defined radio can allow intervention via software. It allows multimode, multi-band and/or multi-functional wireless devices to be enhanced using software upgrades. However, many studies have to be considered on software-defined radio work in terms of functionalities and efficiency. The well-known technologies used to develop SDR are modifiable or programmable processing software or firmware such as, Field Programmable Gate Arrays (FPGA), Digital Signal Processors (DSP), General Purpose Processors (GPP), programmable System on Chip (SoC), or other application specific programmable processors. These technologies allow the introduction of new wireless features and capacities into the current radio system. And CR is a sort of software-defined radios which can leverage the current radio system, exploit the residual radio spectrum resources, and adjust its behaviors according to the changes of the radio medium.

A basic cognitive radio operates in a cycle called cognitive cycle that includes the exploration, analysis, and action. A CR device observes the communication medium and explores the state of the current medium. It then has to analyze the current

environment to determine which parts of the spectrum are currently available. An appropriate behavior is taken into account this information regarding the state and the available resources. This simple cycle and the different stages are illustrated in Fig. 2.1.

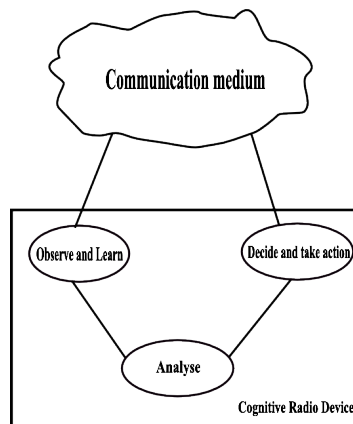

Figure 2.1: Simple cognitive abstract cycle.

In detail, Haykin et al. [1] illustrated the simplified cognitive radio decision-making context as in Fig. 2.2. A CR transmitter has to obtain adequate information from the environment before transmitting anything into the medium. From the observing and learning process, the radio spectrum analysis module provides statistical data regarding the spectrum holes, noise-floor and traffic state of the current surrounding. Thereby, radio front-end obtains the status of the outside world and passes this status to the analysis module. The CR then analyses and extracts useful information such as which part of the spectrum is unused, what the noise-floor threshold is, and how the traffic looks like in time and space dimensions. This whole process is called spectrum sensing in CRNs. A sensing process is a process in which a CR device monitors, senses and analyses the environment radio spectrum before transmitting. After the sensing stage, the medium is evaluated. This evaluation process aims to estimate the accessible resources such as frequency bands and spectral capacity that a CR device can use for transmitting. This part is spectrum management. Besides, since a CR device also has to aware of the PR's activities, a prediction model of PR's activities is necessary. A CR transmitter hence obtains all these information to adjust its transmitting power to prevent interference with the primary systems while its transmission is active. While a CR device is idle, it is still collecting the surroundings statistics regarding the radio spectrum resources, PR's activities, traffic statistic, etc.

Thus, a CR device is a mobile node that opportunistically accesses the radio resources, and operates without interfering with the current wireless infrastructure. Precisely, a CR node is aware of its surroundings and acquires prior transmission knowledge before taking any action. A CR node also has to be able to detect the other licensed mobile devices on the current operating radio frequency to vacate anytime these de-

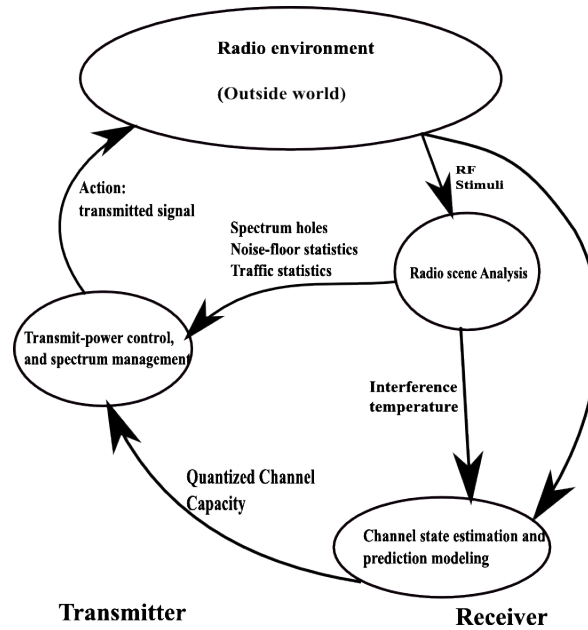

Figure 2.2: Cognitive radio decision making context.[1]

vices claim back the spectrum. Spectrum sensing ability of a CR device is hence an important function. This is a local function that each CR node has to perform. In theory, a CR node can communicate with any mobile devices. However, the communication quality is a concern. Indeed, once the CR device has to vacate from current frequency, the transmission will be delayed or interrupted. However, if a CR cooperates and works with other CR nodes, the situation may be improved. Multiple CR nodes working together forms a Cognitive Radio Networks (CRN). The advantage of forming a CRN is that the sensing performance can be improved in terms of accuracy sensing information and higher detection probability thanks to the cooperation with the other CR nodes.

In fact, in case of coexisting with other radio nodes, spectrum sensing of a CR has to accommodate various aspects such as continuous spectrum monitoring, alternative spectrum detection, and awareness of the type of transmission. A CR node senses the spectrum regularly, or in some application, continuously since a CR device only operates on a spectrum on the basic principle of non-interference with primary users. Hence, it has to keep sensing to ensure detecting the returns of a Primary Radio (PR). As a CR has to vacate when a PR claims back the spectrum, spectrum sensing has to look for alternative spare radio resources to help the CR node to switch when needed. Being aware of the type of transmission helps a CR node to identify the transmission of a PR when it is communicating. Then these CR nodes can either change their transmission to idle or switch to other spare channels to resume the communication. In general, there are two main sensing schemes that have been explored in the literature: local sensing and cooperative sensing. The main spectrum sensing types and methodologies used are detailed in Chapter 3.

When a CR intends to establish a communication with other radio devices, it has to choose an appropriate frequency range that is either idle or partially unused. To ensure the communication can be setup, the setup parameters of the chosen channels or frequency ranges have to meet the application requirements. Therefore, a CR node should be able to manage the spectrum that acquired from the sensing process to allocate proper resources to operate. Furthermore, when a PR device returns to the medium and claims back the frequency ranges, a CR device needs to be able to change to other accessible ranges to resume the current communication. Otherwise, the communication is likely to be interrupted. To do so, a CR node must have other spare resources in-hand. This function is spectrum management, and it remains a challenge for the research community. The main challenge of spectrum management is how to minimise intermittent connections while a CR node switches to other channels. In case of coexisting with other CR nodes, including PR radio devices, mitigating interference in cognitive radio networks is also another topic to explore. Particularly in this work, we are interested in the observation phase of a CR node in order to assess the potential impact on primary systems. This work is presented in Chapter 4.

Alike any communication networks, CR nodes in CRN also need to look for a pathway to communicate with each other. The path exploration process relies on a routing protocol. However, unlike the conventional wireless network, routing in CRNs challenges the research community due to its unique characteristic namely the primary system and frequency bands change. To establish a path from a source to a destination, a CR node has to access the sensing information that has been collected and analysed to determine the available frequency bands. Furthermore, resource allocation of a source and a destination would have to be negotiated and agreed along the way before data transmission. Once PR returns to the medium, the source CR should be able to lookup for an alternate path. Hence, channel selections and path recovery are two aspects that a routing protocol should take into account. Besides, mitigating interference while routing protocol is operating should also be considered since a CR node has to respect the presence of the primary system. In fact, some existing routing protocol in wireless networks can be modified to adapt into CRNs. However, some modifications on the existing routing protocol has to be made to meet the requirements of the CRNs' application as well as the environment's conditions.

Other aspects in cognitive radio networks are the exchanging and processing of control information. Most of the information is obtained and processed at the physical layer. The traditional open system interconnection (OSI) model does not provide the flexibility and fast accessing information across the layers (physical, MAC, and network layers). For instance, the routing layer needs the information about the available channels to transmit the routing information to establish a path to a destination. With extra information from the physical layer such as interference estimation information on a specific channel, a CR routing can select a path that minimises the interference that

may occur during the discovery process. Therefore, exchange cross-layer information allows the fast information accessing from a lower layer to upper layers and vice versa.

Currently, to accommodate to the development of this wireless scheme, many standards of the spectrum regulation management have been developed such as IEEE 802.22 for WRAN, IEEE 802.19 for network coexistence, IEEE 1900.6 for sensing interface or IEEE 802.16e for supporting WiMAX. These standards are presented in Chapter 3.

Overall, research community has been paying attention on cognitive radio technology. Many research efforts have been carrying out from the community. Several papers have surveyed the existing work such as [10, 11], or have given guidelines for the future research directions in [12]. Particularly, we are interested in contributing to the research community. We hence express our motivation and objectives of the work in this dissertation in the following section. We hope that our results contribute to the CRNs' research development.

In France, LICoRNe (Leveraging Insurance for services providers cohabitation over Cognitive Radio Networks) project was formed to investigate the feasibilities of services offerings over an opportunistic spectrum access. The project goes beyond Cognitive Radio concept to investigate media transmission, service engineering, and management techniques over advanced cognitive radios. In fact, the main objective is the identification of the types of services that can be offered to end-users over a multi-hop cognitive radio network. The project has to tackle various challenges from the physical layer to application layer design over this new spectrum regime. This project detailed in [13].

2.2 Motivation and Objectives

2.2.1 Motivation

As stated, Cognitive Radio research emerges from the new network access scheme that requires investigation on certain problems. What are the cognitive radio networks? How the next generation network deals with scarcity spectrum issues due to the traditional fixed spectrum distribution scheme? Essentially, once a Cognitive Radio Network (CRN) is deployed, it should also allow variable wireless networks to coexist and to operate in a shared medium without causing severe impacts to each other. This function is one of the most important function that a CRN must provide.

Even though the software-defined radio and Cognitive Radio are distinctively defined, CR still works on the basis of software-defined radio. We are hence interested in learning and understanding how the change of design could improve the current wireless network infrastructure. Particularly, we study the importance of radio environment observations to prevent the potential interference. From the obtained observations, a

routing mechanism is proposed to deal with the observed interference. We also investigate and suggest a cross-layer signalling design that could leverage the current existing design and overcome the restriction of a cognitive radio network.

The engineering of services that relates to the new wireless access scheme is a critical task. This work is part of the Agence Nationale de la Recherche (ANR) LICoRNe project. It addresses the coexistence between a CRN and a legacy wireless network (WiFi and GSM). We hope our results also contribute to the project in terms of interference reduction in a coexistence scheme with PRs.

2.2.2 Objectives

We investigate the possible effect of CR's communication in coexistence with PRs context. Hence, we focus on the followings.

- We study the observations and hence propose an approach to mitigating the interference impact to the primary system. The observations was performed locally on a CR device, assuming that the devices locations are known. The relation between the impact on PR receivers and their locations are hence extracted and analyzed.
- Node density prediction models and interference estimation methods are alternatively proposed to envisage the impact. Practical results obtained from the observation can be used to identify potential impact on PR systems in coexisting scenarios.
- A routing function in a multi-hop network is required. Thus, we propose a routing metric for ad-hoc CRNs deployments according to the observed impacts. Furthermore, we study the adaptation of existing routing protocols for CRN. We aim to develop a routing protocol that considers interference as one of its criteria for path selection.
- Signalling in a CRN is a crucial issue. We present an adaptive signalling protocol that avoids the hidden node problems as well as allocates proper resources for communication establishment. We rely on the signalling solution developed within our team [16] to propose necessary extensions to our approach.

2.3 Main Contributions

Our working scope, the green block, focuses on interference avoidance strategy for coexistence between CRN and primary network. Precisely, we compare our working scope with a layered structure so that we can take a glance of how the built blocks are

interconnected and correlated to the OSI model. Fig. 2.3 summarizes the scope of our research in this thesis. We focus on observation stage of a CR device. The *Management Controller* stores all environment observation parameters such as mobile nodes' movements and locations. Then, *Overlap Calculation* block can locally retrieve, compute and analyse the current situation of the CR device comparatively to a PR emitter. The *Node Density Estimator* obtains historical statistic of the node within a specific area, and estimates the probability of current node density. These blocks produce estimated inputs for *Interference Estimator*. This is the key engine that produces an important input for the other blocks in the working scope of Fig. 2.3. The beacon-based *Signalling protocol* also retrieves information from the *Interference Estimator* and from the physical layer.

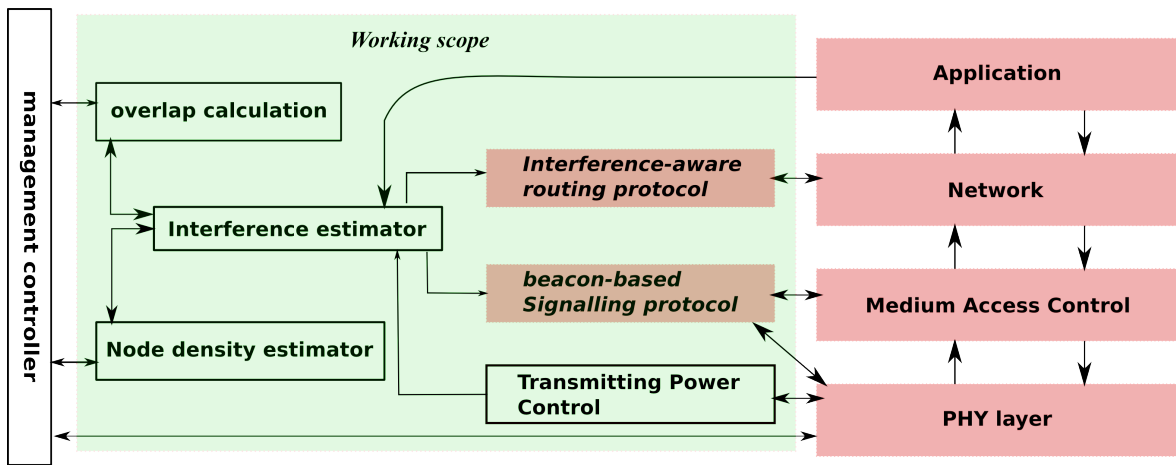

Figure 2.3: Abstraction of work scope

The inputs and outputs of the framework are kept in the local database so as other engines can retrieve necessary information or store computed outcomes (e.g., the overlapping computation engine could retrieve the PR location from this database). The interference-aware routing block retrieves and uses the interference estimated value as a metric for selecting a routing channel. This proposed protocol is detailed in Chapter 5. Furthermore, this framework could work cooperatively with the signalling protocol presented in Chapter 6. The estimated transmission power can be attached into the beacon so that the destination can make a judgment itself on its transmission power. The red blocks are the OSI abstract layers and we can see how information is exchanged through the different layers.

We form an abstract framework for a local CR node as described in Fig. 2.4. This framework accounts for the interference caused by an operating CR. Historical data are stored and retrieved by different engines that belong to different protocol layers. Overlap and node density are computed separately by *overlap computation engine* and *prediction engine* respectively. The results of these engines are the inputs for *Fuzzy*

logic inference engine to estimate the Interference Level (IL). This IL can be used in power transmission estimation that we have not done in this work. But we want to develop this work in the future. On the other hand, our routing strategy also accesses this IL as a new metric for path selection in the route discovery process. The use of IL could prevent the interference when a CRN coexists with a PR network after a path is established between a source and a destination CRs. Essentially, we introduced a medium access control messages dissemination procedure, in which CR nodes maintain the knowledge of their neighbors as well as their resources before they can initiate transmissions. This establishment supports the routing protocol, which, in this case, is the interference level routing protocol. Besides, the retrieving and storing computed parameters are cross-layered without any restriction. Our proposed routing protocol is a guideline for developing a cognitive routing protocol that could prevent potential impact on primary networks when CRNs operate.

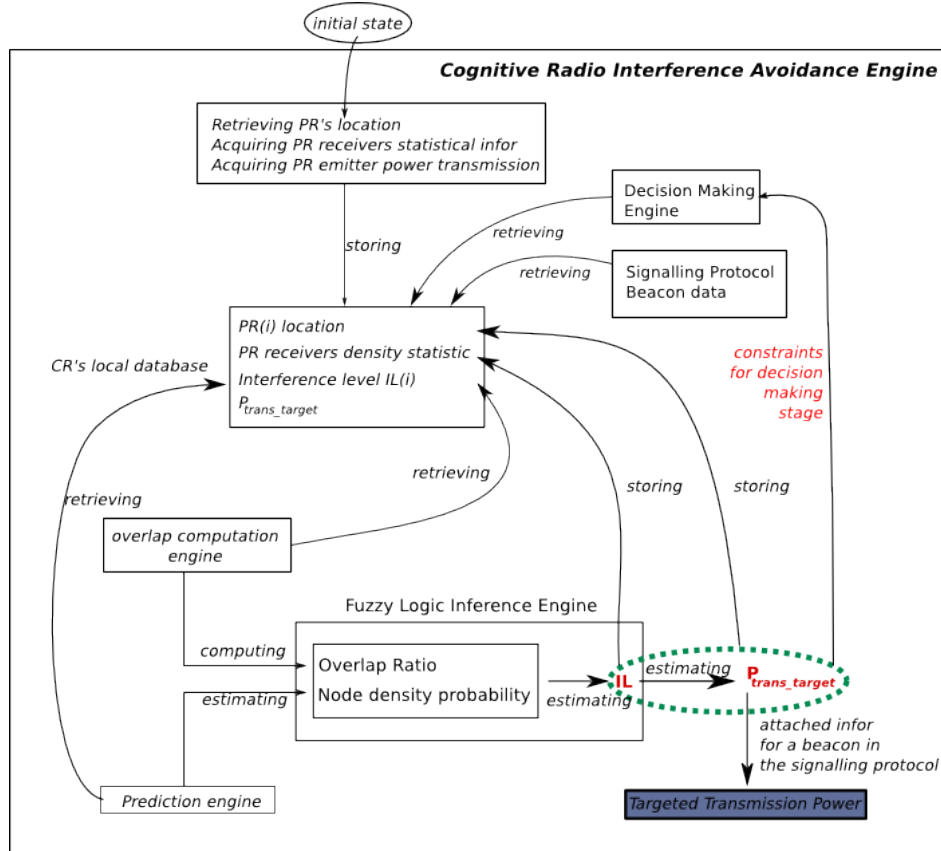

Figure 2.4: Cross-layer design framework of a Cognitive Radio device

This abstract framework can be developed locally in a CR device. Generally, cross-layer data accessing in the framework allows a CR device to (1) observe the overlapping phenomena; (2) predict the node density using Grey model in combination with Kalman filter; (3) estimate the foreseen interference level.

2.4 Thesis structure

To make the document coherent, we present basic principles and functions of a CRN in Chapter 3. We also briefly discuss the current spectrum resource distribution scheme that led to the innovative software-defined radio concept. We also provide a detailed review of some sensing techniques as well as some medium access control mechanisms in CRNs. Additionally, interference analysis and routing in CRNs design are discussed. The readers can also find a review on cross-layer design approach at the end of this chapter.

We then investigate the coexistence between primary and secondary systems and propose an approach to envision the interference to the PRs in Chapter 4. We detail the computation of the vulnerable area where a CR emitter's coverage meets a PR emitter's coverage area associated with the impact percentage obtained by simulation. The importance of this observation proves that there is a connection between the potential impact on primary network and the size of the overlapping. The bigger the overlap is the higher the impact is. However, we also found out other critical factors that influence the preliminary conclusion.

The findings in Chapter 4 inspired an approach to produce a comprehensive metric for routing that is explained in Chapter 5. Fuzzy logic is the core technique that combines different independent factors from the observation. We also give a glimpse of this technique in the same chapter. The detailed proposal and the associated numerical results are also presented.

Furthermore, we briefly discuss the signaling scheme and our proposition in Chapter 6. In this chapter, we also present a beacon-based signaling mechanism to locate the resources that CR node could use for exchanging control information. The mechanism aims to leverage the current CSMA/CA protocol with a modification to prevent the hidden node problems as well as allocating sufficient resources to initiate a connection at MAC layer between CR nodes.

We conclude our work in Chapter 7. In this chapter, we summarize our contributions in this thesis. Besides, we also open related issues that we found from the work and propose the future research direction to resolve these issues.

Chapter 3

Cognitive Radio Network

In this chapter, we present spectrum resource usage and how current technologies respond to this issue via cognitive radio networks (CRNs). Then, we introduce the related issues that we treat in this thesis. We start by describing the spectrum sensing process, before presenting how the access to the medium is achieved in those networks. We put a thought on existing interference avoidance approaches, since it is one of the important properties of CRNs design and deployment. Since routing in Cognitive Radio Networks is considered in this work, a brief review about current interesting routing proposal is also provided. Finally, we review some cross-layer design approaches for fast control information accessing in a CR at the end of the chapter.

3.1	Radio resources mobility and usage overview	25
3.2	Sensing in Cognitive Radio Networks	32
3.3	Medium Access Control in Cognitive Radio Networks	40
3.4	Interference Analysis in CRNs design	44
3.5	Routing in Cognitive Radio Networks	46
3.6	Cross-layer Design in CRNs	49
3.7	Conclusion	51

3.1 Radio resources mobility and usage overview

According to the statistic data from FCC, 25% to 85% is under-utilized due to the frequency allocation scheme. This allocation scheme creates the spectrum holes as illustrated in Fig. 3.1 [17]. This under-use of the spectrum is caused by the existing fix spectrum assignments. Indeed, different technologies/services are assigned to use dedicated bands, called licensed bands, for their transmission, while the other technologies/services occupied the other bands. However, the first type of services is not always in operation. The spare spectrum is hence unused. This problem leads to the question of how these resources should be used efficiently. In 2000, Mitola proposed a scheme where a smart device can “seek” and “leverage” the spare unused resources for its operation. The term “Cognitive Radio” (CR) was then introduced. In the first notice of the proposed rulemaking and order [8], FCC proposed to use CR technology in suggested spectrum range; below 90Mhz, in 3GHz band that relates to TV broadcast frequency ranges (3650–3700MHz), and some additional spectrum for CR devices (5470–5725Mhz). In this proposal, FCC briefly considered technical capacities that were incorporated into CRN and through that they sought for comment from the research community for additional capacities. Besides that, some specific applications of these technologies were added, and it was said that the most beneficial fields of CRNs are the followings:

- Permitting the use of high power by unlicensed devices in rural area,
- Enabling real-time frequency coordination,
- Facilitating interoperability among different radio systems so as more extensive deployment of mesh network could be developed,
- And developing authorization rules.

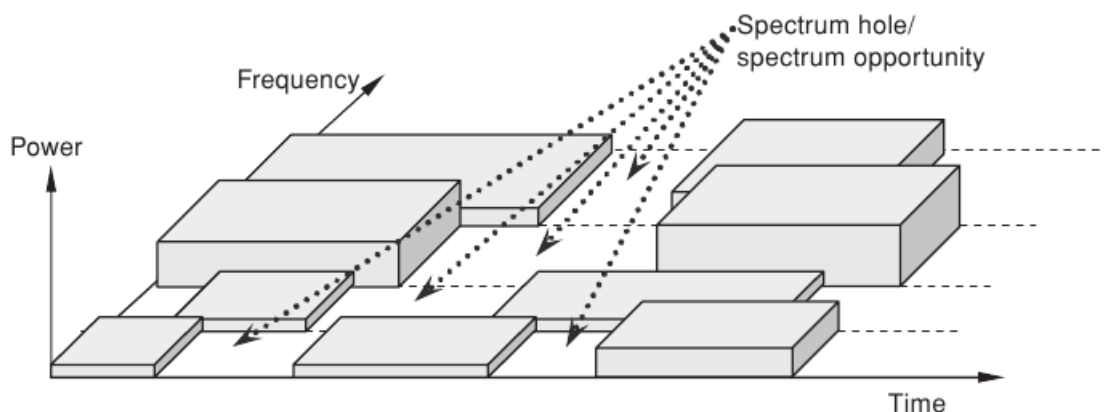

Figure 3.1: Spectrum usages and holes

In February 2015, Cisco visual networking index (VNI) released global mobile data traffic forecast update report [18] confirmed that in 2014, global mobile data traffic grew 69%, and it reached 2.5 exabytes per month by the end of 2014. Almost half a billion (497 million to be precise) mobile devices and connections were added in 2014 in which traffic from smartphones occupied 88% of that growth. On average, smartphones usage grew 45% in 2014. Globally, Cisco forecasted that the number of mobile connected devices (e.g., smartphones, laptops, tablets, wearable mobile devices, etc.) exceeded the world's population in 2014. Therefore, by 2019, there will be nearly 1.5 mobile devices per person, and more than half of all devices connected to the mobile network will be "smart" devices. This is a huge demand for data and resources for this exploded trend of mobile usage and mobile data. Therefore, system infrastructure redesigns to fit the demand by allowing more efficient use of resources is a challenging task.

Relatively to this trend, LICoRNe project explored the CR research area to enable more services and co-habitation between different types of networks. In fact, the project aimed to investigate media transmission, service engineering, and management techniques over CRNs. The work of this thesis contributed to the media transmission perspective of the project. The main idea of the work was exploring the impact of CR on existing primary radios' (PRs) communication via sensitive overlapping area. Learning the impact and trying to access opportunistically the current resources take a considerable part in leveraging the spectrum holes that can be useful for nowadays applications. Enabling the co-habitation among various types of networks is also an important and challenging task. This property allows multiple mobile users/devices/services to work cooperatively and efficiently on the same medium.

Globally, the need for radio resources rises along the side of the standard development to accommodate the trend. Many standards of the spectrum regulation management have been developed such as IEEE 802.22 for WRAN, IEEE 802.19 for co-existence networks, or IEEE 1900.6 for sensing interface or IEEE 802.16e for WiMax support. IEEE 802.22 WRAN working group proposed the first international standard using cognitive radio mechanism for wireless regional area networks. This standard defined a new wireless interface based on cognitive radio to leverage the spectrum holes in TV bands from channels 2 to 69 in the VHF and UHF portions of the radio spectrum. The innovated air interface defined in this standard may operate in any current regulatory regime (Europe, Japan, USA, Canada and Australia).

These channels are 6, 7 or 8 MHz wide, and span over the following frequency ranges: 54–72 MHz, 76–88 MHz, 174–216 MHz, and 470–86 MHz. The physical and medium access control designs suggest using the cognitive radio concept to exploit the available portion of the TV spectrum (the TV white spaces). Formalizing the standard is still on going after it was first introduced and published in July 2007 and 2011 respectively.

In [19] and [20], Cordeiro et al., discussed the IEEE 802.22 WRAN while the work was on progress at that time (2005 and 2006). In [19], the authors gave technical and business perspectives of the standard. An overview of 802.22 architecture (e.g., topology, entities, and connections), requirements (e.g., service capacity, service coverage, Physical (PHY) and Medium Access Control (MAC) layer details), applications, and coexistence issues (e.g., antenna, TV and wireless microphone sensing and protection) were conveyed accordingly. In [20], the authors provided deeper insight of the standard with details on frame and superframe structures dedicatedly designed for IEEE 802.22. To get a more precise idea on the research development of cognitive radio networks, we briefly present the IEEE 802.22 standard in this section.

IEEE 802.22 working group aims to define a new wireless interface based on *Cognitive Radio* technology. This interface is implemented incorporation with the development of a CR-based Wireless Regional Area Network (WRAN) PHY & MAC for license-exempt devices. A license-exempt device is a tested and authorized device by a regulatory body and is allowed to operate according to certain technical specifications without acquiring a spectrum license [21].

The 802.22 WRAN standard focuses on TV white spaces frequency ranges. Indeed, it is suggested that it be applied to wireless broadband access in rural and remote areas with appropriate services. The deployed applications must have good performances to be competitive with the existing fixed broadband access techniques (e.g., Digital Subscriber Line (DSL) and cable modem). In fact, the needs of exploiting internet market to the rural areas have been encouraged by FCC in one of its 2009 report [22]. FCC also reported extensive work on bringing broadband to rural areas in the US [23].

Why does IEEE 802.22 exploit TV bands? Spectrum holes created on TV bands is one of the main reasons. Indeed, a large portion of TV bands are unoccupied in the US, as reported by FCC in 2002, 2004, 2006 and 2010 [5, 24, 25, 26]. On the other hand, since these bands are at low frequency ranges, the coverage area is bigger because of the propagation characteristics of that frequency bands.

In this standard, traditional cellular architecture for the cognitive network was proposed. The architecture composed of a Base Station (BS) and a group of CPE. The IEEE 802.22 WRAN defined an air interface architecture on PHY and MAC layer of a mobile device. The standard suggested a high performance and low complexity physical layer. Moreover, the proposed layer was characterised by its flexibility that facilitates dynamic change and adaption to different modulations and coding of various CPE technologies.

Specifically, an 802.22 device must provide transmission power control and frequency agility functions. Precisely, the device should be able to jump quickly from channel to channel without errors and interference (or self-interference). Effective Transmitting Power Control (TPC) is important and must be considered in any PHY design

using 802.22 standard. IEEE 802.22 WRAN indicated the TPC dynamic range to be at least 30dB with 1dB step to avoid self-interference. At MAC layer, the standard required that an 802.22 device should respond quickly to changes in operating environment, including all different underlying access schemes of the broadcasting spectrum. 802.22 MAC should be able to provide not only traditional services but also robust data delivery services. Moreover, supported device must also provide a set of functions for effective operation in the shared TV bands. The standard identified the critical component of 802.22 MAC layer which was measuring change and adjusting local parameters. These features focus on measurement and channel management issues in CRN with channel bonding, as currently proposed technique [20].

To satisfy the requirements, an 802.22 device has to provide efficient sensing functions. In fact, the standard suggested that CR should be able to operate in-band and out-of-band sensing.

In-band sensing is responsible measuring the channels used by a base station to communicate with CPEs and also the adjacencies while the CPE is not transmitting. Therefore, the BS requires the CPE to be silent when the channels are used for data transmission at the time of sensing. The device would be temporarily inactive during this time, and hence it will be disconnected from the base station. Consequently, the communication may suffer performance degradations at some point. Besides, it is not sure whether or not a CPE has to reconnect to the BS again by starting over the initiating process, and re-transfer local measurement to the BS on the same or different channel. It appears to be a centralized-like approach management scheme. So, the resources expenses for every reinitialising process of each CPE would somehow increase dramatically.

While in-band sensing tends to sense the current in-use channels, out-of-band sensing measures all the other channels in very low Signal-to-Noise (SNR) to acquire the knowledge of the operating environment. The obtained information thanks to out-of-band sensing enriches the local database of CR so that the node internally computes and jumps if necessary to another vacant channel.

With these sensing techniques, minimizing the propagation delay becomes a challenging task. The delay can be up to 300 microseconds for a coverage of 100km. This duration is a long delay that an application may suffer while trying to converge [20].

Another important function of CRN is coexistence function. The design suggested dealing with coexistence using various deployed radios. An 802.22 CPE uses two antennas, one for unidirectional transmitting, and the other one for omni-directional which has gained at 0 or slightly higher for sensing purposes. For instance, for protecting TV and wireless microphones, redundant sensing is employed by BS by using data fusion technique and referendums over all measured data to obtain reliable spectrum occupancy scheme. The sensing threshold at which a device should vacate suggests at

-166dBm over 6 MHz channel to ensure adequate protection for Digital TV (DTV). The emitting signal should not exceed -94 dBm for analog TV and -107 dBm for wireless microphone measured in 200Hz wide range.

In association with IEEE 802.22, IEEE 802.22.1 standard [27] defined a protocol and data formats for a communication device, which offered enhanced protection for low-power and licensed devices. This standard specified how to provide enhanced protection for the devices that legally operate in the TV broadcast bands. The 802.22.1 devices formed a beaconing network that helped to prevent interference with low-power, licensed devices operating in television broadcast bands.

IEEE 802.19.1 standard [28] addressed coexistence between cognitive radio networks and conventional wireless networks, e.g. GSM and WiFi. The standard working group has formed since 2010. The standard specified radio technology independent methods for coexistence among dissimilar or independently operated wireless networks operating in TVWS. This standard addressed coexistence for IEEE 802 networks and devices, and it was said to be useful for non-IEEE 802 networks and TV bands devices [2]. The scope of the standard was defined in Fig. 3.2. According to the specification of the standard, the defined coexistence system has three logical entities (Coexistence Discovery and Information Server, Coexistence Managers, and Coexistence Enabler) and five logical interfaces (Interface A, B, B1, B2, B3 and C) as shown in Fig. 3.2. Precisely, IEEE 802.19.1 intended to leverage the cognitive radio capabilities of the TVWS devices, including geolocation awareness and access to information databases. The coexistence discovery and information server gathers and provides coexistence information regarding TVWS networks. Coexistence managers utilize the information from this server to enhance the coexistence of the TVWS networks. Furthermore, the standard defined common coexistence architecture and protocols, as well as several profiles to enable cost-efficient and flexible deployment of the coexistence system in various scenarios.

In [29], C. Stevenson et al., provided a comprehensive discussion of the IEEE 802.22 WRAN standard in comparison with IEEE 802.16e WiMax standard. WRAN stands for Wireless Rural Area Networks and IEEE 802.22 WRAN aimed to bring the broadband access to the rural area where the signal is hard to reach and the population is much lower than the urban areas. The authors showed more insights of PHY and MAC requirements of the standard in comparison to the other IEEE 802 family, specifically the IEEE 802.16e WiMax standard. For instance, air interface of IEEE 802.22 only supports OFDMA while IEEE 802.16e supports OFDMA, OFDM, and single carriers. IEEE 802.22 allows coexistence with incumbents when IEEE 802.16e does not support this feature. Since 802.22 included cognitive concepts into its architecture, it used dynamic spectrum sharing for self-coexistence while IEEE 802.16e statically uses master frame assignment for the same feature.

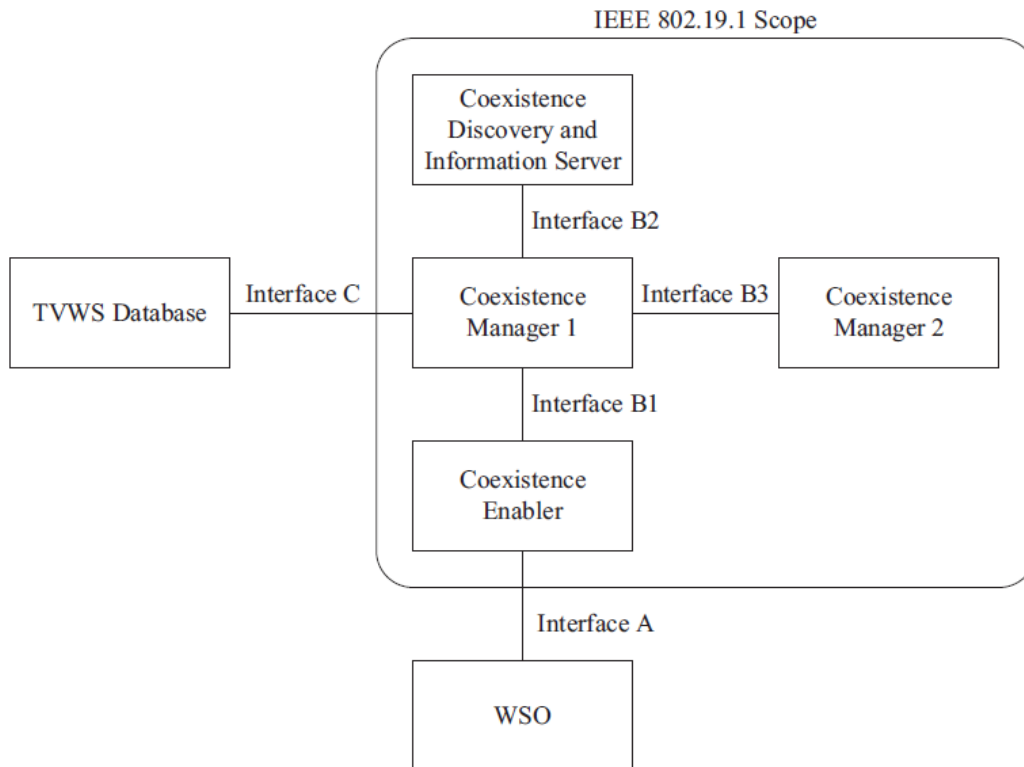

Figure 3.2: 802.19 Architecture work scope [2]

In the other discussion, F. Granelli et al., [30] presented a comprehensive review of the standardization activities in cognitive radio and dynamic spectrum access. The authors focused on the IEEE P1900 and IEEE Standard Coordinating Committee (SCC) 41 for the dynamic spectrum access networks. They also discussed the relationship of IEEE SCC 41 with other standard entities including IEEE 802.22 working group, as well as some open issues (e.g., regulation and testing, system design and networking, and security).

For spectrum sensing, M. Murrioni et al., [31] provided an extensive review of the IEEE 1900.6 standard focusing on the technical details of spectrum sensing interfaces and data structure for dynamic spectrum access. Murrioni et al., also analyzed the relationship of the IEEE 1900.6 standard with other standardization efforts (e.g., CogNeA ECMA 392, ETSI DTR/RRS-01003/02004, and 3GPP-LTE).

In practice, Ettus Research develops a prototype device that could explore the radio environment and be programmable as a CR device, USRP (Universal Software Radio Peripheral).

Regarding the basic concept of a cognitive cycle of a smart radio, a.k.a, the general operation of a CR, we illustrated this cycle in figure Fig. 3.3. Spectrum sensing and spectrum decision are critical components of a CR. These components take into account

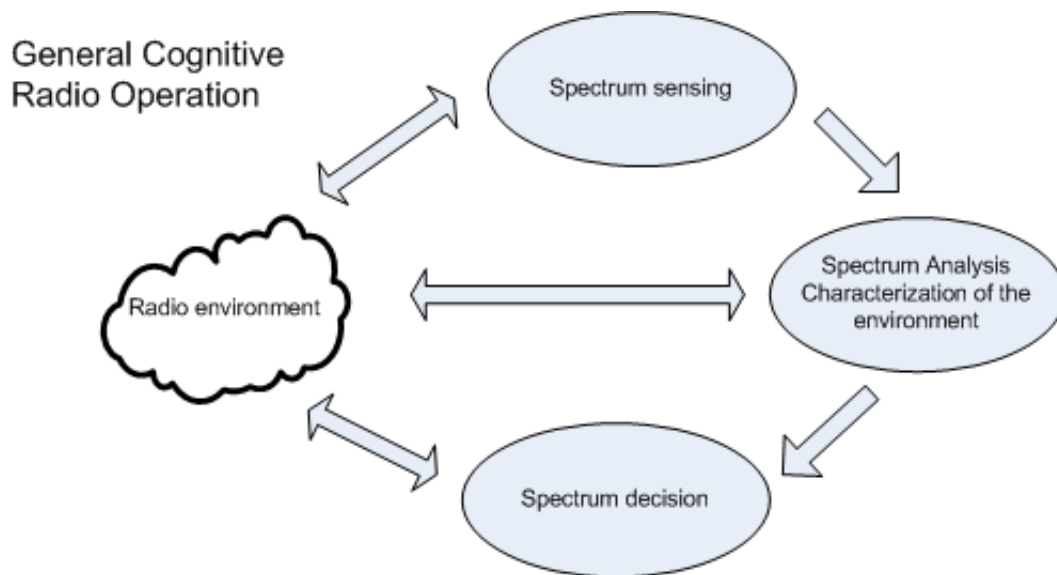

Figure 3.3: Cognitive Cycle of a CR

the information that they acquire from radio environment. This information is then analyzed locally by the node which has to characterize all the properties of its current surrounding. The main output of these processes are the available resources that a CR can use for its operation while ensuring minimal impact to the conventional radio network infrastructure. Since sensing is the most important function of a CR, we provide more details of these processes in the next section. However, the work in this thesis does not involve spectrum sensing or spectrum sharing though it is related.

3.2 Sensing in Cognitive Radio Networks

One of the constraints to open the licensed bands to unlicensed or secondary users is primary system protection. A cognitive radio (CR) therefore has to monitor continuously the activity of the primary radios (PR) to opportunistically access any spectrum hole. This procedure is called spectrum sensing where the CR has to sense all the possible frequency ranges. The process takes place to allow the CR to access the band to use, and to avoid harmful impact to the primary users [32, 33, 1, 34, 35].

3.2.1 Local spectrum sensing

Lu et al. [36] summarized ten years of developments and achievements of spectrum sensing, sharing techniques and the applications of CR systems. In this article, the authors essentially described the fundamental spectrum techniques that included local sensing and cooperative sensing. Besides, several challenges were also pointed out at the current state of the art. A couple of applications of CR were also mentioned to provide deployment perspective in the next generation networks. In the last decade, it is obvious that a lot of research work has been conducted and achieved to boost the development of CRN. Sensing and sharing techniques are always the most attractive topics in cognitive radio networks research area.

Local spectrum sensing is the procedure in which a CR senses the existence of PR users within its transmission range by detecting PR transmitting signals. However, this is a challenging task due to the difficulty to distinguish between PR transmitter's radius and the PR receivers' detection ranges. Most local spectrum sensing techniques are focusing on PR's transmitter detection [10, 37]. Another challenge of local sensing mechanism is the methodology to identify the signal coming from PR and CR devices. These signals cannot be differentiated. The key is considering these signals as one received signal in combination with Gaussian noise. The common formula of the received signal $x(t)$ is expressed as in Eq.3.1. H_0 and H_1 represent the hypotheses of absence and presence of PR signal respectively while $n(t)$ is the additive white Gaussian noise. $x(t)$ is the local observing signal at a CR. In an ideal circumstance where there is not any PR around, only noise is the signal CR could receive. The PR is assumed to be around in other cases when other signals are detected apart from noise $n(t)$.

$$x(t) = \begin{cases} n(t) & H_0, \\ s(t) + n(t) & H_1 \end{cases} \quad (3.1)$$

To evaluate the sensing method efficiency, detection performance can be determined via the detection probability P_d and the false-alarm probability P_f . P_d is the probability of decision for H_1 where the receiving signal contains the signal from other devices

rather than noises. False alarm happens when the decision for H_1 takes place, but there is not any actual radio devices' signal detected. In reality, parameter miss detection P_m is also used to evaluate the sufficiency a spectrum sensing technique. This miss detection probability is computed by the negative of P_d , $P_m = 1 - P_d$.

Sensing functions and requirements for CRNs, in particular, are addressed as follows [35]:

- Different classes of primary users require different sensitivity and rate of sensing for detection (TV broadcast signals are easier to detect than GPS signals because TV receivers' sensitivity is 10dB worse than that of GPS receivers),
- More stress on the cognitive radio sensitivity that it should outperform the primary receivers by a large margin in order to avoid hidden terminal problem (occurs when the CR is shadowed due to multipath fading or inside a building with high penetration loss while it is close to the primary receivers),
- Another function is that the implementation should be flexible to deal with the environment mobility (e.g., different types of primary systems in time domains and space domain, propagation losses and interference). Consequently, the digital signal processing techniques are inevitable research work for spectrum sensing with respect to enhancing wideband amplification, mixing, and converting A/D of over a GHz or more bandwidth, so does the radio sensitivity improve.

Furthermore, some factors need to be noticed in digital signal processing techniques that can improve the radio sensitivity and detect primary users' presence such as energy detection, matched filter, cyclostationary, etc.

Many spectrum techniques have been proposed for local spectrum sensing in the literature. We review some of the common local sensing mechanisms, such as matched filter, energy detector, feature detector and some other sophisticated detecting techniques (e.g., cyclostationary detection, emerging method as eigenvalue-based detector, wavelet-based sensing or co-variance-based and blindly combined energy detection). These techniques are detecting the primary transmitters' signal rather receivers' signal. To detect PR receivers' signal, it requires co-operative and more complicated procedures due to interference and signal uncertainty issues [38, 32].

Matched filtering is a simple spectrum sensing technique [32]. This technique requires some prior knowledge of primary signal characteristics, so that it correlates the known primary signal with the received signal in order to detect the existence of a primary device and thus maximise the signal-to-noise ratio (SNR) [39, 36]. Matched filtering works efficiently during a short sensing period so that it can be early deployed for limited operation of a CR. However, the disadvantage of this technique is that the signal of primary users should be known to the CR. It will be costly to deploy in an area where more primary bands are in use [32]. Furthermore, it may not be applicable

in a deployment that the modulation of transmitted signals by PR users are unknown to CRs [39, 36, 35, 38].

Energy detector can be an option when a CR cannot gather all the information regarding the PR receivers' signal structure. This is the most common spectrum sensing method. It requires a thorough observation of the signal samples, then the decision status of this detector are defined as the average energy of these observed samples (eq. 3.2).

$$Y = \frac{1}{N} \sum_{t=1}^N |x(t)|^2 \quad (3.2)$$

Y is compared to a designated threshold γ . If $Y \geq \gamma$, CR concludes that PR's signal exists in the current band (H_1). Otherwise, it concludes that PR's signal is absent (H_0). However, the performance is susceptible to the uncertainty of noise power [38, 40, 41, 42, 36]. False alarm probability P_f may increase due to the unintended signal while the detector is operating. This could occur since the CR lacks PR's information. Thus, the energy detector is unable to discriminate between sources of received energy. In some cases, if a CR has some information about PR's signal (such as coding type), noise floor, which is basis of the definition of the power threshold, can be mitigated. In chapter 6 of this thesis, we present some experiments to determine the noise floor on our platform.

Feature detector or Cyclostationary detector is more sophisticated. It can be used when some features of the primary signal such as carrier frequency or modulation type are known. The modulated signals are characterized and analyzed to produce a spectral correlation. Hence, the feature of the primary signals can be detected. In principle, feature detector uses the cyclostationary feature of the signals for sensing [43, 44]. In other words, feature detector senses the devices' signal based on its periodicity by analyzing the cyclic autocorrelation function of the received signal. Since the modulated signals are periodic [45] and noise is non-periodic, the detector can detect whether the received signal is noise or not. The drawbacks of this type of detector are the complexity of implementation and deployment. More detail of this method and its mathematical formula can be found in [36, 45]. Several implementations for cyclostationary detector have been proposed in [46, 47, 48, 49, 50].

Some approaches adapted the advantages of energy detector and feature detector to achieve a more efficient and reliable sensing techniques [51, 52]. This type of detector includes two stages: an energy detection stage to capture the uncertainty of the noise and the cyclostationary phase that works when the energy detector fails to distinguish noise and true signal.

In the literature, there are many spin-off practical sensing implementation based on those common detectors that we introduced previously. Cabric et al., introduced one of

these implementations [35]. The authors suggested a spectrum sensing implementation for CRNs that had to tackle several challenges. These challenges included the ability to sense the radio environment, the adaptivity to adjust the transmission parameters to avoid perturbation to the legacy wireless networks. They argued that the critical problem of the sensing design was always the ability to process a wide radio bandwidth and to detect the existence of the other devices, a.k.a., the primary radios. In this article, Cabric et al., investigated the cyclostationary method and shown its advantages in CRN spectrum sensing design. Furthermore, they stressed the importance of having a proper MAC protocol to exploit the co-operation between CR nodes. The advantages and disadvantages of this solution are listed as the following.

- Advantages:
 - The results of the paper motivated the need for sophisticated sensing techniques as well as the signal processing, and sensing should be cross-layered.
 - Cooperation experiment showed that noteworthy point in having a cooperative sensing scheme improved the detecting probability and the interference to the primary receivers. The experiment was done with a simulation in which the primary receivers were digital TV receivers and the SNR at 83dBm with the carrier to noise (CNR) at 15dBm. So if any signal that was effected by the assuming white noise from the CRNs and lower then -83-15=-98dBm, it would cause the signal degradation to the TV receivers. Noted that CRs transmitted at a power of 20dBm, radius equaled to 100m, 10km from the TV while the TV was located at the height of 3m in a building.
 - The authors also pointed a problem of sensing results combining of various CRs that may have different sensitivities and sensing times. Therefore, any co-operation sensing scheme should be aware of synchronization between these CRs.
- Disadvantages:
 - Radio front-end for CR was limited to 400-800mhz (UHF TV bands) and 3-10GHz due to the limitation from FCC at the time the work was introduced.
 - The authors were more interested in the cross-layer design of spectrum sensing.
 - The work did not take into account the sensing trade-off issue that may cause delay and false-alarm at PR detection stage.

Interference-based detection [53, 54] in which a transmitter controls its interference by regulating its output transmission power, and its out-of-band emissions based on its location with respect to other users (both CRs and PRs). This type of detection in CRNs focuses on measuring interference at the receiver. FCC introduced the model

of measuring this interference as interference temperature. An interference limit is associated with the accumulated RF energy from multiple transmissions. This limit is the amount of interference at the receiver can tolerate. Hence, as long as a CR's transmitting signal does not exceed this limit, it can operate over the specific spectrum ranges.

We recall that multi-path fading, time dispersion and shadowing [32, 38] are major issues causing channel uncertainty that is one of the challenges for any spectrum sensing technique. Within an interference range of a PR transmitter, several PR receivers could be operating at the border, where a CR could detect the strong signal from the transmitter. However, this CR may be confused with the weak signal from PR receiver. It causes interference to this specific PR as illustrated in Fig. 3.4. When an obstacle is present between a PR transmitter and a CR transmitter, the CR can observe clearly its surrounding, except the blocking area behind the obstacle as shown in Fig. 3.5. SO, its signal could interfere with PR_1 as in this illustration.

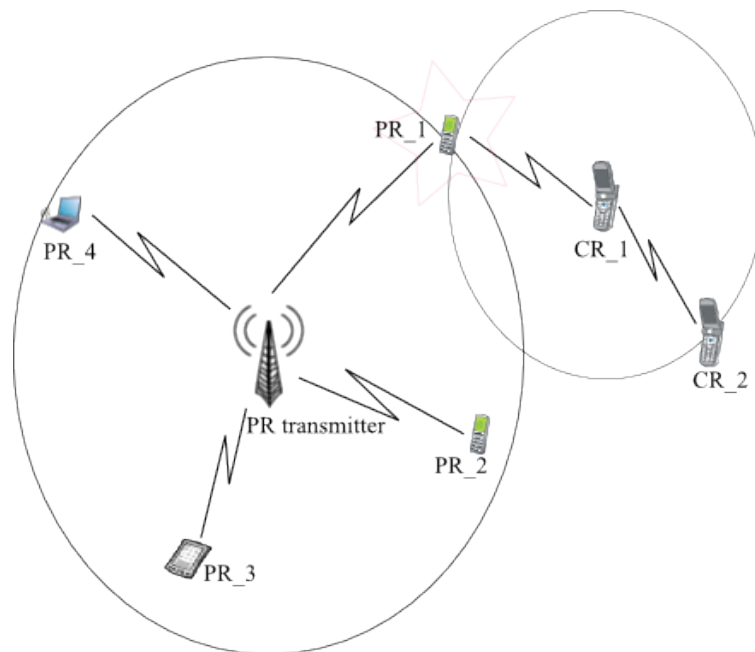

Figure 3.4: Detection of PR receiver issue - Signal of PR_1 is too weak compare to the PR transmitter

Another challenge for spectrum sensing is the noise uncertainty while a CR has to senses and operates in a low SNR environment. This low SNR environment affects the detection sensitivity threshold. Channel fading or shadowing makes the receiving signals weaker than expected, and these signals may be misunderstood as a noise instead of a real signal. Aggregate interference uncertainty and sensing periodicity [32] also affect the sensing performance as well as fluctuate the impact guarantee for the primary receivers. CR devices have to make use of any portion of the widespread spectrum. However, their limitations in energy and data processing [36, 55] obstruct the wideband sensing, needed by the CRs to detect reliably detect spectral across a

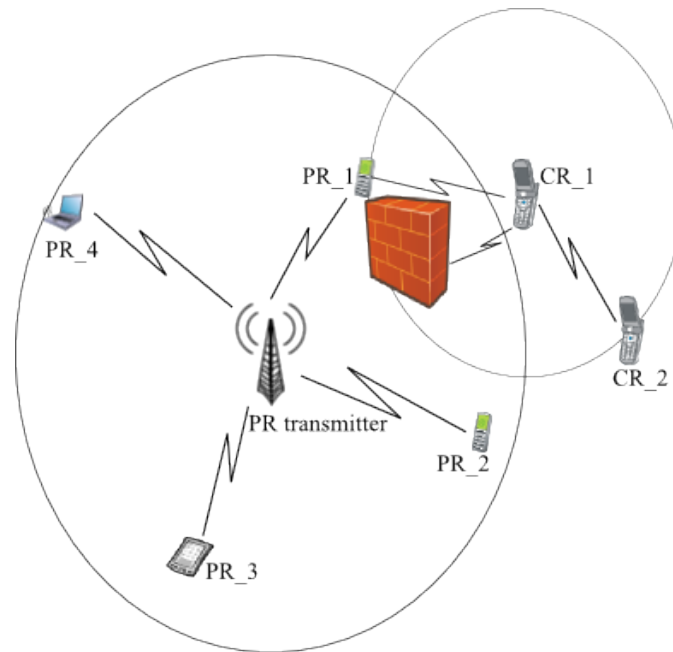

Figure 3.5: Detection of PR receiver issue - Signal of PR transmitter is shadowed by the obstacle, thus CR_1's signal interferes with PR_1

wide frequency range. The mentioned techniques were performed for narrow band sensing, and can not be used to perform wideband sensing directly. These techniques made a single binary decision (signal is used or unused) for the whole spectrum, and thus could not identify individual spectral opportunities that lie within the wideband spectrum [56].

As the spectrum fluctuates and differs from a location to another, Akyildiz et al. [10] were interested in the QoS requirements from the application layers. Indeed, they addressed the main challenges such as interference avoidance, QoS awareness, seamless communications. In this thesis, we pay a particular interest in the interference avoidance challenge by investigating overlap region, receiver density and future position.

Spectrum decision is the ability to decide which is the best spectrum bands among the currently available bands in terms of satisfying the required QoS from the application. Akyildiz et al. also investigated the channel characteristics, decision procedures, and identified the research challenges in the decision process of a CRN. When channel characteristics suggested interference with the primary receivers, what is the permissible power that a CR can adjust? And what is the capacity of the resources that a CR can use? Furthermore, a spectrum decision process should consider the trade-off that a system has to tolerate the pathloss accompany by increasing transmission power and the perturbation on the other users. Combining these conditions, authors inspected how wireless link errors related to the error rate when the resources were changed. Akyildiz et al. [10] suggested a decision model that satisfied difference QoS requirements and adapted well to the spectrum mobility. However, the work was not

mentioning challenges related to multiple transmissions on a single band (which was limited by the current hardware technologies) and on the spectrum handoff procedure.

3.2.2 Co-operative spectrum sensing

Once local spectrum sensing is performed at each CR, to improve the sensing accuracy, the CRs have to share sensing information. They have to work collaboratively with each other to obtain as much information as possible about current radio environment. This process is called cooperative sensing with the cost of additional communication overhead due to the introduction of exchanging control messages between the CRs.

Cooperative or collaborative sensing is the sharing scheme where the interference measurements are disclosed among the CRs within a CRN. This scheme takes into account the effect of a node's communication to the other nodes. Cluster sharing is the basis of the co-operative work between the nodes. Nonetheless, non-cooperative spectrum sharing is a selfish solution and aims to reduce the message exchanges. There are two types of spectrum sharing: inside or outside a CRN, also called intra-network spectrum sharing or inter-network spectrum sharing [10]. Challenges raised in spectrum sharing was local/global common control channel deployment and listening/operating frequency ranges. Since different CRN design uses different spectrum unit in channel definition (in our context we consider frequency ranges instead of a channel), the consistency in channel definition is then a problem to make these CRN work together. Furthermore, having location information of the PR emitters is also a strong assumption that some of the solutions for CRNs deployment considered while this information may not be always available.

Centralized cooperative sensing approach uses a common control channel to share the sensing information among CRs [10]. This dedicated channel is set to be known by all the CRs in the same CRN. In distributed cooperative sensing approach (or cluster-based cooperative sensing) [57, 58, 59], the CRs have to establish their way of communicating with each other by any available/stable channel and this channel is subject to change at anytime. This is the most common classification based on the network architecture. However, some work classified cooperative sensing into underlay and overlay sensing according to designated accessing technology [60]. In the centralized approach, there are two important tasks: designing a common control channel and securing this channel. Whereas, with the distributed approach, the communication scheme between CRs within a cluster has to be well aware of synchronization as well as the overhead of extra control messages. A delay may be introduced during sensing processes, and it may require resources to be reserved for disclosing sensing information between CRs.

We also notice the development of some experimental platforms for spectrum sensing. An experimental design for research purpose on CRN, called Papyrus, was proposed in [61, 62]. Papyrus is a software platform that was implemented using frequency agile wireless transceivers based on software-defined radios (SDRs). Papyrus addressed two key issues at the physical layer. First, SDR devices must be able to sense quickly specific spectrum ranges that are unused. Second, the available spectrum is likely to be in fragments of all sizes. Therefore, to support high bandwidth applications, SDR devices must be able to combine multiple spectrum fragments into a single channel for its data transmission. Moreover, SDR devices must also be able to operate in a decentralized manner without relying on any central control entity.

Regarding processing sensing information, the fuzzy logic approach was introduced in [63] for cooperative sensing. Matinmikko et al. suggested using neural fuzzy logic approach to combining several observations about PR's presence from different CRs, to make the final decision on spectrum sensing in the current environment. The proposed scheme took input decisions from individual co-operative CR and produced an output of combined sensing result, e.g., PR was presence or absence.

3.2.3 Spectrum sensing design trade-offs

As mentioned in the previous session, there is always a trade-off in designing a sensing scheme that best matches the network's needs. The research community is more interested in co-operative processing trade-off. For instance, a good energy detector should ensure the high detection probability and low false alarm. Alternatively, it should optimize the spectrum usage efficiency while the PR receivers are well-protected. However, there exist some challenges for this type of detector due to its low computational and implementation complexity and short detection time.

A spectrum sensing can be reactive or proactive as in the sensing process is triggered on demand (reactive) or setup before needed (proactive). The trade-off between these two designs is again, sensing overhead in time and bandwidth perspective. For instance, the CR does not need to perform spectrum sensing while it does not have any data to transmit. This design reduces the unnecessary processing resources at each CR, but it may produce delay for looking up spare accessible frequency ranges when needed. Proactive sensing, on the other hand, may be able to provide accessible bands for instant usage by maintaining the list of the idle bands as well as looking for more spare resources in its capacity. The drawback of proactive sensing is that the sensing process has to be active all the time. Thus how to define an optimal sensing period can be an issue. The more sensing the node performs, the more energy it uses, and the more information it has to process. For some delay sensitive applications, the proactive sensing scheme may be considered, as the delay spent on looking up for the

spare resource may significantly impact the QoS of the application.

In relation to sensing period, reliability trade-off should be considered to determine a spectrum sensing method. The mandatory constraint of a CR is that it has to vacate immediately when a PR uses its licensed bands. To resume the current transmission, the CR must find another spare band that is also in synchronized with the other peers. Otherwise, the transmission may suffer from huge delay due to the interruption. The data rate and transmission reliability are then unstable in this scenario. Some research work has tried to tackle this issue by distributing the data transmission over multiple channels/ranges, so that the rate was not reduced dramatically [64, 65, 66]. This technique is mostly used for the support of OFDM as the underlay modulation thanks to its inherent flexibility [32].

Co-operation processing in cooperative sensing is also an important issue. Although, with this scheme, the detection sensitivity at each CR may be reduced, the amount of processed information at each CR may be increased thanks to the shared information received from the neighbors. The processing overhead naturally increases while the number of cooperative nodes increases [67, 32].

3.3 Medium Access Control in Cognitive Radio Networks

Media access control in cognitive radio networks can be considered as a policy that controls how a CR should access the spectrum [68]. Akyildiz et al. [10] addressed that designing a proper media access control (MAC) architecture for Cognitive Radio Networks was also a challenging issue. This issue includes allocating the spectrum (or a.k.a., selecting good channels for communication, or accessing techniques). Two schemes were mentioned: distributed (spectrum allocation and access based on local or possibly global policy) and centralized (a central entity took charge of allocating channels and set up the accessing policies) cooperative or non-cooperative spectrum sharing. The work presented in [39] revealed that current distributed solutions were close to the centralized methodologies with the cost of messages exchanging among nodes. For example, one of the CRs will be designated to distribute the information to the others in a CRN.

Stochastic model-based medium access was proposed in [69]. Geirhofer et al. characterized the interaction between the primary system (e.g., multiple parallel WLAN channels system) and the secondary system by measurement. From that, they estimated the interference constraint. Also, a continuous-time Markov chain model was used to predict WLAN's behavior to enhance the coexistence between these two systems. The authors claimed that cognitive medium access can be recast as one of the

constrained Markov decision processes. Regarding channel switching cost, a stochastic selection strategy based on learning automata was proposed by Song et al. in [70]. Indeed, the authors proposed an algorithm to adjust the probability of each available channel, and then select an optimal accessing channel. Another Markov-chain model based medium access mechanism was presented in [71]. This mechanism also took into account the interaction between PR and CR system. Wang et al., [71] prioritized the PR's activities based on a continuous time Markov-chains. Based on this model, they proposed to compensate the throughput degradation due to the interference among secondary users. To do this, the solution computed the optimal access probabilities for the secondary users. This accessing scheme guaranteed that the spectrum access of the secondary users was optimally coordinated.

Doerr et al., [72] proposed a multi-mac protocol to reconfigure cognitively MAC and physical layer properties based on monitoring current network metrics. Precisely, the protocol observed current network properties and chose the alternative MAC layer that allowed achieving the best performance (e.g., selecting the appropriate MAC decoding algorithm for an incoming frame). For instance, a node can use CDMA in low contention periods and switch to TDMA in high contention periods. Besides, from node flow's statistic, the protocol incorporated the decision process to choose the suitable MAC component and intelligently reconfigured MAC and physical layer metrics to respond to the current network conditions. Regarding the signalling between the nodes, the dynamic control channel assignment for medium access in CRNs was later proposed by the same group of authors [73]. Dealing with multi-channel accessing and sharing, a cognitive MAC (C-MAC) was proposed in [74]. The designed protocol divided each channel information into several superframes for synchronization purpose. Hence, only hosts which were using the same channel need to be synchronized while the others (using different channels) do not. Since it operated on many channels, the protocol was capable of dealing with the dynamic channel availability caused by PR's activities. An enhanced solution for C-MAC was presented in the work of Hsu et al. [75]. The authors suggested dynamically adjusting the number of signalling channel slots according to the number of contenders.

Hardware-constraint cognitive MAC approach was introduced in [76, 77]. This approach optimized the spectrum sensing decision by formulating sensing as an optimal stopping problem. It was proposed to deal with the limitation of spectrum sensing and bandwidth due to hardware cost (e.g., single radio, partial spectrum sensing, and spectrum aggregation limit). However, this approach allowed only the node that wanted to transmit, to sense the licensed channels. It meant that under high SNR environment, more sensing points were monitored in the time domain. Consequently, the network throughput may be affected [78]. Mobile devices' spectrum usage is unpredictable and unstable so that a CR needs always to be aware of their current accessing environment. An integrated interference-aware statistical admission control with the aid of

stability-oriented spectrum allocation was introduced in [79]. The solution allowed CR nodes to regulate their spectrum demand proactively to allow efficient statistical multiplexing while minimizing outages. Then, these admitted nodes coordinated to adapt instantaneous spectrum allocation to match time-varying demand.

Protecting PR by optimizing CR network's throughput concerning the power constraint was proposed in [80]. Salameh et al., [80] argued that multi-channel MAC protocols for the typical ad-hoc network did not have any restriction on transmission power while an operating CR may occupy a wide range of frequencies. CR users using different licensed bands have to satisfy different PR-CR interference conditions, and CR's activities have to be vacated out of the current ranges once a PR claims back the ranges for its communication. Salameh et al. proposed a distance-dependent MAC protocol for CRNs to deal with unnecessary blocking of CR transmission under these constraints. This protocol suggested a probabilistic channel assignment algorithm that exploited the dependence between the signal's attenuation model and the transmission distance while considering the traffic profile. On the contrary, location-awareness approach to facilitate spectrum sensing and spectrum sharing was introduced by Wang et al., in [81]. The authors stressed on the energy consumption of a CR when wideband spectrum sensing process took place. They investigated whether the support of location awareness capacity at each CR could improve its energy consumption by reducing its need for spectrum sensing. Meanwhile, the location awareness could enable the capability of identifying the concurrent transmission region in a hybrid infrastructure-based and ad hoc overlaying systems. Celebi et al. [82] also advocated the importance of location information in cognitive wireless networks. Our work in this thesis also considered the location information for mitigating the impact of a CRN on the PR system. In fact, the location of a mobile device can be obtained from geo-location technologies [14]. As mentioned, standard IEEE 802.19.1 also included this information in each mobile node in the design description. Therefore, it placed a foundation for us to investigate the potential impact of the co-existence scenario between CRs and PRs.

Leveraging discontinuous orthogonal frequency division multiplexing (DOFDM) technique, Chen et al. [83] proposed an aggregation spectrum assignment to improve spectrum utilization efficiency in CRNs. The solution aggregated several small spectrum fragments and optimized the spectrum assignment while maximised the number of users in the system. Similar idea, Huang et al., [84] proposed an opportunistic spectrum access in CRNs to improve and mitigate spectrum scarcity. Keeping the constraint that a CR can access only the spectrum vacated by idle PRs, the authors suggested two metrics: collision probability and overlapping time to protect PR users. These metrics were used to guarantee the potential spectrum accessibility for CR users. Their work was carried on, and they proposed an optimal transmission strategy for dynamic spectrum access in another publication [85].

In this work, Huang et al., [85] studied the performance limit on the throughput of CRNs under the PR's packet collision constraint. In the first part of this work, Huang et al., analyzed the impact of the imperfect sensing on the CRs' spectrum access. They concluded that there existed a trade-off between detection performance and CR throughput performance. Precisely, the analysis revealed the greater the sensing time, the more reliable the spectrum sensing, and thus the better the protection on the PR systems. But it meant that the longer sensing time would reduce the transmission time for the CR. The second part of the work, they assumed having a perfect sensing process at CR as well as the generic PR traffic patterns as the initial models to produce an optimal spectrum access strategy. A distributed access scheme was introduced as a result. This scheme enabled multiple CRs to access the spectrum adaptively to PR's change pattern to avoid impacting PRs transmissions. The authors modeled PR's activity pattern as an alternative IDLE-BUSY pattern, and this idle/busy pattern followed a semi-Markov renewal process. With the perfect sensing assumption, they also supposed that the CRs can exploit the idle time and transmit without sensing.

Another approach for dynamic opportunistic spectrum access based on game theory was proposed with multi-channel multi-radio in [86]. Fang et al., investigated an optimization solution for distributed channel selections for CRNs. They proposed two cases to study, such as predicting the channel state and determining the access probability of a CR. On one hand, they use partial observable Markov decision process to predict the channel state; and they argued that it could reduce the collision of CRs with PRs. On the other hand, they suggested using a potential game theoretic framework to produce the access probability of a CR to reduce collision of CRs and other CRs. By alleviating the mutual collision between the networks (CRN and PRs, or CRN and CRN), the authors argued that the proposed scheme can improve the spectrum efficiency.

All in all, there are always a tradeoff among power consumption, sensing time and throughput, a cross-layer approach has been introduced to strike a balance between interference to primary system and performance of the secondary system [87]. Hamdi et al. studied the impact of sensing time and power adaptation on cognitive system performance. Their analysis results suggested that optimizing transmitting power and sensing time can improve the system throughput.

In additional, research community also investigated how a CR would suspend its communication when a PR's communication takes place. To vacate currently used spectrum, a CR performs spectrum handoff to release current spectrum for PR's usage. This is also known as spectrum mobility challenge. Spectrum handoff takes place when a PR changes its transmitting channel or its state from passive to active. It then requires CR to vacate the current bands so that the PR revokes its licensed channel. Calhan et al.,[88] investigated an efficient handoff that satisfied QoS provision in the heterogeneous network and enabled mobile devices to roam seamlessly between wireless

networks. The authors presented a fuzzy-based approach for spectrum handoff in [88]. In fact, they proposed an adaptive fuzzy logic based vertical handoff decision-making algorithm that took and composed data rate, monetary cost and RSSI information as the inputs of the fuzzy logic system. The output was used to choose the best access point for a CR. To avoid intermittent communication while a CR is moving from a channel to another channel, Song et al., [89] suggested an interesting approach. The solution proposed to reserve some spectrum bands that can be used for switching when needed. The proposed framework allowed a CR to perform spectrum handoff before a PR claimed back the frequency ranges. However, the framework required a network coordination of CRs to achieve network rendezvous. A distributed channel selection to avoid collisions was also proposed in this work. The same group of authors studied the performance of spectrum handoff process in CRAHNs under homogeneous primary traffic [90]. Arguing that a common channel was unpractical, they evaluated the spectrum handoff performance via their proposed distributed channel selection in [89]. The impact of different channel selection schemes on the performance of spectrum handoff was studied; an analytical model was proposed to provide new insights on the process of spectrum handoffs.

Overall, the current research on MAC in CRNs mostly focuses on dynamic spectrum access and spectrum handoff. Two signalling mechanisms that are mostly used are common control channel and distributed beacon between the CRs in the network. Furthermore, cross-layer that integrated physical parameter and MAC requirements are also studied. Again, there is not any absolute solution that could satisfy all the aspects of the network; tradeoff between performance and interference always exists in any proposed solutions. Hence, studying interference in CRNs is crucial. When a CRN is in operation, it has to guarantee interference-free to the PR system. Therefore, interference mitigating is required in CRNs design. In the next section, we review some analysis that has been done in CRNs.

3.4 Interference Analysis in CRNs design

To be able to prevent perturbation in a PR system, a CR has to aware of its operation before deciding to use the spectrum. This awareness is a must function. Therefore, analyzing interference in CRNs is necessary to determine the interference level that may occur between these systems. It provides the input for design various network parameters to guarantee certain performance for PR networks [91]. Many studies have been carried out in this context [92, 93, 94, 95, 96].

Interference temperature was proposed to be a metric for dynamic spectrum utilization by FCC [97]. The interference temperature is the total allowable interference on a spectral band. Kolodzy provided the introductory analysis of the interference

temperature metric in [94]. In [92], Clancy et al., examined the relationship between the achieved capacity of a CRN and the interference caused to the PR network. The authors also provided a mathematical analysis of the interference temperature model. They concluded that the achievable capacity was very small while the impact on the licensee could be very large. In another work of Gastpar [93] investigated the capacity of multiple independent networks that shared the same frequency band in spectrum sharing and dynamic spectrum allocation. In this work, the author analyzed the interference constraints at the output signal and concluded that coexistence between different networks can be done via spatial interference power restrictions. And this approach imposed at the network level rather than at the device level. Also considering the interference temperature constraints, Wang et al., proposed an optimal power control model for CRNs in [95]. In another work, Xing et al., [96] investigated the secondary spectrum access with QoS under interference constraints.

Hossain et al. [91] has studied and classified two types of interference configuration, network with beacon and network with primary exclusive regions.

Assuming that in the circular network, when the CRs are uniformly distributed with a constant density λ , the interference generated by these CRs depends on their locations and the random channel fading. This type of configuration causes random interference [98]. **In the network with beacons** where CRs tries to capture and detect beacons transmitted by PRs, the CR tried to avoid transmitting in the next duration after successfully detecting these beacons. The PRs' communication is hence safe from CR's perturbation. However, the channel fading problem could make these CR misdetect the beacons. A beacon detection threshold becomes a crucial parameter for the design of a CRN since it could limit the impact on the PR's operation. **In the network with primary exclusive regions**, the PR transmitter's exclusive region is avoided by any CRs within the area. Since PR receivers within this area are passive devices, they might have interfered if any of the nearby CR operates. Our work in Chapter 4 evaluated the impact in case the CR's transmitter area overlapped with the PR's transmitter area. The parameter for the design of such network is then the diameter of the exclusive zone of a PR transmitter. However, in some cases, the PR receivers are completely inactive or far away from the overlap zone of a CR transmitter. In such cases, it could lead to unnecessary avoidance resources. We raised the issue that avoiding this area may waste the resources for CRN's operation. Instead, we can mitigate the impact so that the CRs can use these resources while the PR system is still protected.

Beside MAC and interference management, routing is also a crucial component of a computer networks. Especially in wireless networks, routing protocol has to consider several aspects of the networks such as the mobility of a node and the change of the environment's conditions. We hence present some research work on routing in CRNs.

3.5 Routing in Cognitive Radio Networks

Apart from physical and data link layer, network layer also plays an important role in computer network communication. The network layer is responsible for establishing a path between a sender and a receiver via a routing protocol. Routing in a wireless network is always an interesting research topic. In cognitive radio networks, routing problem imposes a great challenge due to the dynamic spectrum access nature. Two neighboring nodes do not have a common accessible channel or they have a common channel but do not tune to the same frequency. Then the communication, in this case, is infeasible since there does not exist any path between them. In CRNs, topology construction includes spectrum detection, neighbor discovery, and topology management. In some circumstances, a routing decision also depends on required QoS from upper layers and also from the control information from the lower layers (PHY and MAC).

Due to its unique function, link intermittent could be the first issue that any routing solution needs to overcome. To be specific, routing challenges in CRNs include spectrum awareness, quality route discovery process, and route maintenance/repairation mechanism [99]. Researchers hence have to keep in mind the fact that there will not be any pre-allocated spectrum for the routing module. Thus, the routing algorithm has to accommodate to the change of the environment. However, the algorithm has to satisfy the basic network performance [68]. Nevertheless, an inter-dependence solution between route selection and spectrum management could be an appropriate approach to resolving the spectrum awareness issue [100]. As in, a route selection process depends on some information provided by the spectrum management component.

Routing over the open spectrum environment is a fundamental issue, especially when dealing with the multi-hop cognitive radio networks. Several routing solutions were proposed, but no general routing solution exists [101]. Again, the challenge is how to ensure radio resources for cognitive transmission while guaranteeing the service for all on-going PR communications over the exploited channels on the whole path. From a service point of view, the question is how many possible services can be provided to the end users in the secondary networks. Any routing solution in CRNs should always be aware of the potentially available spectrum that may be provided by the sensing function (either local or global). Cesana et al. [99] classified routing algorithm into two main classes, full spectrum knowledge, and local spectrum knowledge. This classification was based on the nature of the spectrum information which can be global or local.

Cheng et al. [102] proposed a spectrum-aware routing solution that selected route according to the switching delay among channels and backoff delay within a channel based on the provided spectrum information. In Liu et al. [103], another spectrum-aware routing solutions, suggested coupling spectrum sensing and spectrum sharing

into multi-channel for multi-hop routing. Based on the location information and channel statistic, a CR selected the relay hop and adapted its transmission to dynamic spectrum access opportunities in its neighbor. The authors proposed a routing metric that encountered the throughput called Cognitive transport throughput. This metric was used to capture the dynamic changing from sensing information and evaluate potential gain of each relay hop. In term of spectrum awareness solution, Zhu et al. [104] built a spectrum tree based on an on-demand routing solution for CRAHNS. The global sensing and sharing information were utilized to build a tree with distinguished levels of the available spectrum in each band. The work was suggested that this information should be cooperated between spectrum decision and routing selection process to produce a metric and to adapt an on-demand routing protocol for CRAHNS. Another on-demand routing adaptations for CRNs was introduced Cacciapuoti et al., in [105]. They adapted AODV routing protocol into CRNs. Without requiring a dedicated common control channel, the proposed routing protocol avoided the regions of primary users activity during both route formation and packet discovery. To reduce the processing cost, the protocol performed a joint path and channel selection at each forwarder. Furthermore, to improve the overall performances, the authors took advantage of the availability of multiple channels. Unlike this work [105], our routing proposal considered the overlapping regions between PR and CR's transmitters to leverage the potential resources within this vulnerable area.

Some other works that also took into account the cooperation between spectrum sensing and routing module were introduced in [106, 107]. Xin et al. [106] was a graph-based solution that associated spectrum sensing decision with the radio interfaces of each node in the network to assign specific spectrum opportunities to these radio interfaces. While Krishnamurthy et al. [107] modified MAC layer configuration to determine a common set of channels to facilitate communication between the nodes. Then the topology was formed according to this common set of discovered channels. This solution used the global spectrum knowledge to accommodate the routing algorithm. Additionally, the physical location of each node was also disclosed between the nodes to provide the global view of the network topology.

Once the knowledge is partially learned, Guan et al. [108] proposed a prediction-based middleware between the network layer and lower layers. The authors studied topology control and routing issue in CR-MANETs and built a middleware-like cross-layer module to provide cognition capacity for routing in CR-MANETs. The work aimed to capture the dynamic change of topology and potentially construct an efficient and reliable topology. Indeed, the solution was the inter-dependence component as mentioned between MAC layer and routing layer, and this component incorporated sensing statistic to predict and provided information on an available period of a link candidate to routing component. Another solution that dealt with the opportunistic network was opportunistic access routing solution in [101]. In this solution, the routing

metric was based on the needed QoS coupled with the channels' accessing opportunities.

Location awareness is another aspect of CRNs' routing. A geographic forwarding based Spectrum Aware Routing protocol for Cognitive ad-Hoc networks (SEARCH) was a location awareness routing solution proposed in [109]. The solution joined undertaken paths to avoid the PR's region completely. This provided protection for PR devices within this area. Similarly, Habak et al. [110] presented a location-aware routing solution that could provide better protection for PR devices from CRNs' communication. Another routing solution with consideration of overlapping was proposed in [111]. PR receivers protection was studied in this work. The proposed routing mechanism ensured a perfect protection for PRs by selecting routes that avoided any overlap between primary radios and secondary radios coverage. However, the resources of the overlap region may be usable when the PR receivers are inactive or inexistent. This phenomenon may block the co-existence between CRN and PR network. On the contrary, we studied this scenario and proposed a routing mechanism that made use of the usable resources in this overlap region. We investigated the potential impact of the CRs' operation on the PR receivers in Chapter 4. We also took into account the PR receivers density and proposed an approach to predict this density. Accordingly, we incorporated these observations into a routing mechanism in Chapter 5

Even though research community has been spending considerable resources and efforts to resolve routing challenges for CRNs, there is still not existing any routing standards that could overcome all the challenges. Routing issues encountered in CRNs' design could be various. Each hop has its different expectation of available resources (channels, frequency range, power level, interference level, etc.) and allocation time. Therefore, most of the existing solution treated routing designs as a cross-layered problem with the co-operation between lower layers, e.g., to acquire sensing information, extract potential resources and to establish a path through nodes.

In terms of coupling several factors that could effect the routing over CRNs, we also encounter some fuzzy logic based routing [112, 113, 114] where fuzzy logic has been used to compose these factors to produce a routing metric that captures the attributions of a CRN. Also using fuzzy logic, we considered the interference on the PR system when it co-exists with a CRN. Fuzzy logic was efficient to combine the observations on the impact of the CR's transmission on the PR receivers in an overlap area without requiring a complex mathematical formula. As the result, we proposed a routing approach that minimised the interference to the PR receivers, so that they can be protected in a co-existence scenario. Detailed work is presented in Chapter 5.

3.6 Cross-layer Design in CRNs

To benefit from the sensing information, other layers should be able to access this information anytime. However, traditional OSI model does not support fast accessing information between different layers. Generally, inside a protocol stack, exchange of control information takes place only between adjacent protocol layers by the concept of service access point (SAP). This SAP provides access to selected subset protocol functionalities via precisely defined primitive operations. This is the standard paradigm of OSI model. In wireless communication networks, any design that violates the OSI reference model is considered as a cross-layer design. In short, any abstract model that allows the cross-layer interactions from a lower layer to the upper layers to exchange information across the layers' boundaries is a cross-layer design. TCP performance in wireless networks is one of the most commonly cited applications of cross-layer design. Cabric et al. [35] once mentioned that sensing process in CRNs should be treated as a cross-layer problem. Recently, numerous research efforts have used cross-layer design to improve the performance of wireless communications [115]. In CRNs, a CR has to adjust layer parameters according to the spectrum environment and the quality of service requirements. Hence, cross-layer design (CLD) solutions were needed to allow improving and optimizing CRNs performance. In this section, we briefly go through some recent works that consider cross-layer design in CRNs.

Regarding the optimization problem in resource allocation and performance, Chong et al., [116] conducted a cross-layer performance analysis of CSMA/CA protocol under an imperfect sensing condition where the false-alarm and miss detection could happen during the sensing process. The idea of the work was to investigate and identify the possible impact on the system performance when sensing error occurred. The results confirmed that the false alarm error caused an effect of extending the contention window size, and the miss detection error made this window shrunk as well as caused additional collisions. The work also showed that sensing threshold was an important factor that should be chosen carefully to reduce the impact. To recognize the impact of the spectrum sensing on the CSMA/CA protocol, Foukalas et al., suggested a cross-layer design at the MAC layer [117]. The authors used Markov chain to model the spectrum sensing in pair with the exponential backoff of the CSMA/CA. From this pair, transmission and collision probability were obtained. The work confirmed that lower detection probability resulted in higher transmission probability. Accordingly, the collision probability was also higher.

To maximise data rates for a set of user communication sessions in CRNs, Shi et al., [118] proposed a distributed cross-layer optimization algorithm. Power control, scheduling, and routing were the main considered factors. The goal of the work was to optimize network resource allocation under a given rate requirement. The proposed algorithm had routing, minimalist scheduling and power control/scheduling modules.

The authors solved the problem as NP-hard problem and aimed to find an optimal scaling factor for each session so that at least the composition of this factor and the given rate could be transported. The same authors presented another work that studied the capacity of CRNs in the SINR model in [119]. The resource allocation problem was solved using cross-layer approach by joining optimization at physical (for power control), link (for scheduling), and network (for flow routing) layers with the SINR function. The authors derived a mathematical characterization of the relationship between these layers. The authors suggested that the result of this work could offer a performance benchmark for any other optimization algorithms that were developed for practical implementation in CRNs. Another optimization cross-layer design for overlay CRNs was introduced in [120]. This work aimed to improve the performance of a CRN in power control, spectrum allocation, and multi-path routing under the QoS constraints. The authors divided the optimization problem into multiple sub-problems to finally resolve the QoS constrained flow control and routing selection. Each sub-problem, such as spectrum access, spectrum lifetime, and routing, was formulated. Then, these sub-problems were composed of two main factors, the routing selection with flow control at minimal rate requirement, and resource allocation for each pair of CR's communications. The authors introduced a new control flows interface between transport and physical layers to exchange and process the information. Some other work with the similar approach but dedicatedly for channel access and resource allocation were presented in [121, 122].

Using cross-layer approach to deal with channel assignment and routing in Cognitive Radio Networks, Wang et al., proposed a routing metric of minimum cumulative interference and channel switching delay [123]. In short, the work aimed to provide the optimal end-to-end path and channel on each hop by a cross-layer design through the physical layer, MAC layer, and network layer. Sifan et al., [124] introduced a Cross-layer Routing Protocol (CLRP), which considered both the channels that were known to be available at each node, as well as other channels that may be available. From the sensing process, each CR node maintained a list of monitored channels that were either available or non-available. A certain probability of each channel was calculated to determine the quality of a path between a source and a destination. The signalling of the routing (control messages) in this work was done via a common control channel. Besides, the authors assumed that the relay nodes (e.g., in-between nodes) could sense and monitor the set of chosen channel after a path was determined. Some other interesting work in [125, 126] considered the cross-layer approach to boost the throughput in CRNs and to deal with the network security issue in CRNs.

Overall, the cross-layer design approach is mainly used to incorporate the sensing information with the application layer to optimize the local processing time and improve the performance of a node's operation. Due to the mobility of radio resources, a CR node has to be able to switch to any available channel to maintain its operations. This

switching process is one of the reasons for network interruption. From the application point of view, it could be a big issue, especially to a throughput sensitive application. To enforce the fast delivery of sensing information, a cross-layer design becomes a suitable approach. Therefore, our work also considered the exchanging process between the protocol layers that we explained in Chapter 2.

3.7 Conclusion

In this chapter, we provided insights of current research work in cognitive radio networks, from the demand of the wireless network resources to how research community respond to this demand. Firstly, the regulation change made by FCC and the statistical mobile data usage made by Cisco have been proved the huge demand of modern network usage. This demand is predicted to grow dramatically in the near future. The urge to work on making wireless resource usage more efficient is hence essential. Some insights of spectrum sensing, one of the most important function of CRN are provided. Routing and medium access control are also mentioned so as the readers could get a picture on how the research community are working on.

Clearly, cognitive radio network could be a potential solution for the scarcity wireless spectrum problem but research community has to spend a lot of efforts on putting cognitive radio network into practice. This is a wide researching area that requires a lot of efforts and work from the physical aspect to the application aspect. Again, no absolute solution exists for co-existence operating of CRNs and current classical wireless infrastructure. Most of the proposed solutions satisfied some requirements and they always had a tradeoff between interference and performance. We also went through some attempts using cross-layer design approach to improve the network performance. The cross-layer design appeared to be a suitable approach for reducing process delay at each CR while sensing information was retrieved from other application layers. However, we noticed that each abstract model proposed in the literature was applied for a particular scenario instead of a general scenario. In our work, we designed a cross-layer framework for the co-existence network that aimed to mitigate the interference to the primary networks and to make use the resources within the overlapping regions between PR's and CR's transmitters.

Chapter 4

Interference Observations and Proposed Approaches

As we said in the previous chapter, in Cognitive Radio Networks (CRNs), the spectrum resource is limited. A cognitive radio (CR) has to intelligently use the resources without causing any interference to the primary radios (PR). However, in some circumstances, a CR transmitter reception zone may overlap with a PR transmitter reception zone. Here, we discuss the reception overlapping phenomenon, which could cause interference to primary receivers yet spectrum resource can still be useful for CR's communications.

In this chapter, we describe in details the overlapping phenomenon CRNs. From the design perspective, we envision the potential interference that may occur during the secondary communication on the primary receivers. Along with the observation, we investigate a proper mechanism to prevent perturbation on these primary devices. We investigate two prediction models to predict the density of potential primary devices within a specific area. We present our investigation of Grey Model and Kalman filter in section 4.2. We verified the accuracy of these models on a time series data (i.e., the distance related to the RSSI (received signal strength indicator) of a mobile device). We found that the predicted RSSI value are close to the original values.

4.1	Overlapping and Impact on Primary Receivers	53
4.2	Prediction Model Investigation	65
4.3	Preliminary Observation	72
4.4	Conclusion	82

4.1 Overlapping and Impact on Primary Receivers

4.1.1 Reception Overlapping Definition

Due to the limitation of the fixed broadband and frequency range allocation, there are a huge need of enhancing radio resource usage thanks to the Cognitive Radio technologies, especially in the rural areas. The FCC has been collecting data to evaluate the communication needs of rural communities since 2008 in the US [127, 23, 128]. Expanding broadband deployment for rural areas is critical.

As illustrated in Fig. 4.1 [10], CRN infrastructure can coexist with a primary system including the primary transmitter base station and its primary receivers. The impact of this co-existing scheme should be studied since a CR has to avoid interference to the PRs. Therefore, we are interested in studying the reception overlapping between the secondary transmitter and primary transmitter and observing its impact to the primary receivers.

Eliminating interruptions during a communication will enhance the reliability of applications and services. In CRNs, interruptions obviously happen when the transmission of a primary radio forces CRs to vacate the currently used band. On the other hand, when an overlap exists in the coverage area between the CR and PR transmitters, the undesired interference generated by the secondary transmitters on primary radio communications becomes difficult to control. For this reason, it is necessary to characterize accurately this overlap and its effect on every available channel for better spectrum selection.

We define an overlap region as an area where PR emitter's signal meets CR emitter's one. In case of coexistence, this area is vulnerable for the operating primary receivers within the region. To protect PR receivers communication, one of the options is to avoid this vulnerable area. However, these PR receivers are not always operating continuously in this area. Then, the spare spectrum within this area can be exploited and used by CR nodes. Considering Light Of Sight propagation model in rural areas, we define an overlap in CRN context as being a geometrical overlapping area between two circles that were formed by the signal of PR and CR transmitters. As illustrated in Fig. 4.2, PR transmitter overlaps with two other CRs that created two overlap regions, overlap region 1 and overlap region 2 respectively.

We rely on the position of the transmitters and their transmission ranges to identify the encountered overlap situations. Different overlapping cases have different effects on the primary receivers. Therefore, characterising all these cases provides the better

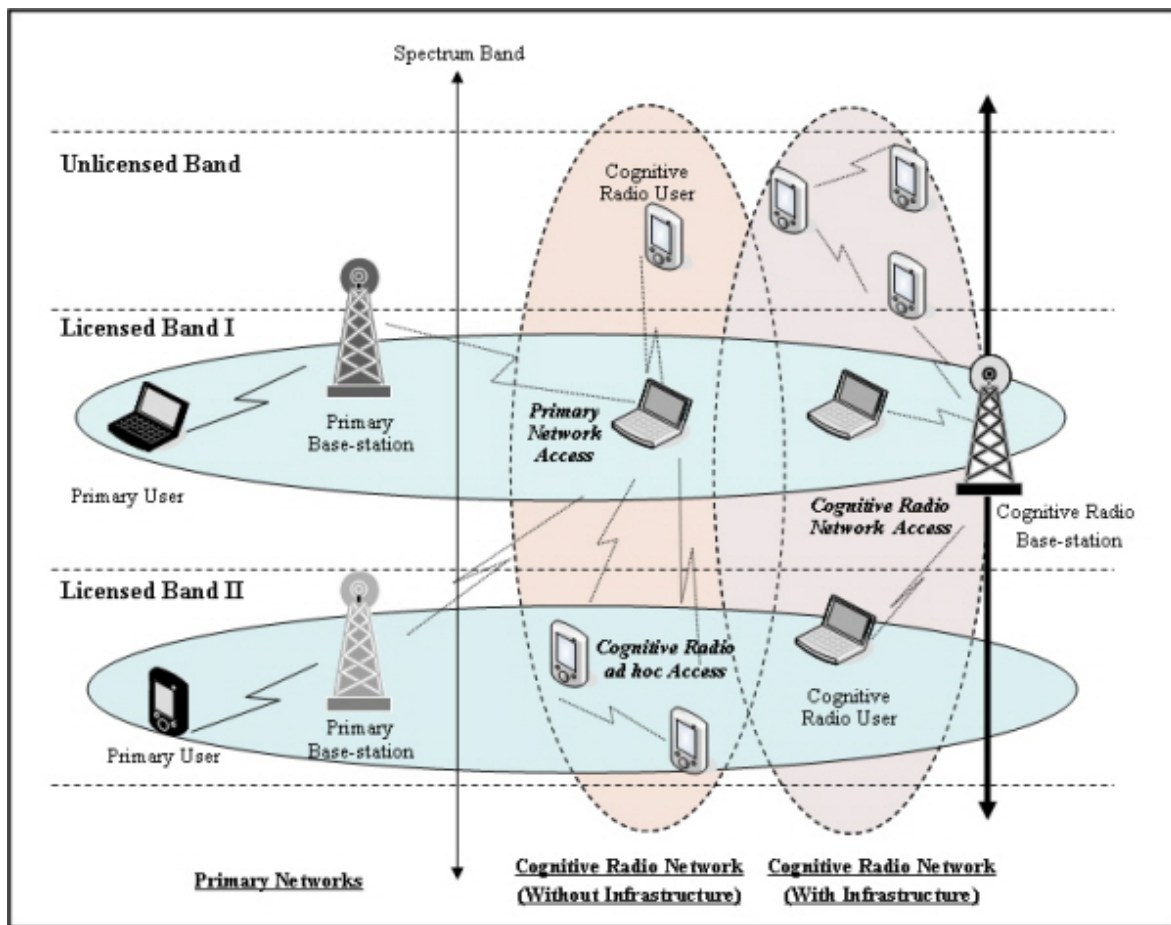

Figure 4.1: General Cognitive Radio Network Architecture

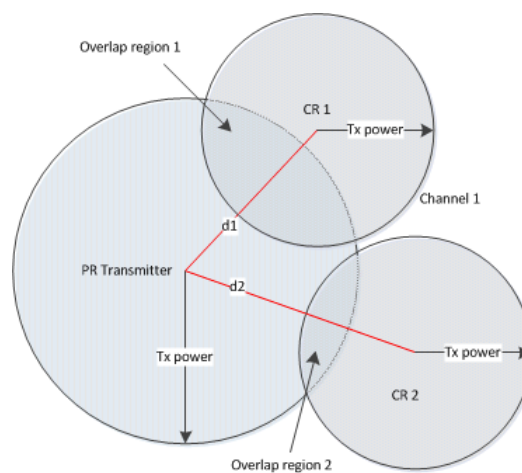

Figure 4.2: Overlapping definition

vision on designing an interference-free CR communication schemes. For instance in a rural area, a CRN overlaps with TV transmission signals; the overlap area size could be variable. Assuming that smaller overlap region leads to less impact on possible TV receivers, this CRN should operate in the area that minimises the overlapping region. The impact on the receivers is foreseen, and hence the interference could be avoided.

Though we have conducted a literature review on CRN research in Chapter 3, we provide some related work that intrigued the work in this Chapter in the next section.

Related Work

First of all, we study some related research that involves the overlap matter in CRNs. Authors in [129, 130] argued that the performance in terms of throughput and delays of a secondary network could equal that of a standalone network by applying scaling laws when primary and secondary systems overlapped. A different overlapping perspective in Cognitive Radio Networks was proposed in [131], where the time overlap during sensing between the CRs was derived. The solution aimed at exploiting the waiting time for sensing while the other CRs report to a fusion center.

Another work on the channel overlapping [132] discussed the partial frequency barrier overlapping when PR and CR coexist over the same frequency. In fact, the authors focused on finding the minimum frequency separation between PR and CR to meet a provided certain average target bit error rate (BER). However, the positions of CR and PR were not clearly mentioned whether these CRs and PRs coexisted geographically within an area or not. Both [131] and [132] addressed the overlapping aspects either in time or frequency that can be encountered in CRNs without a clear description of how PR receivers protection can be achieved.

PR receivers protection was studied in [111], and a routing solution with consideration about overlapping was proposed. The routing mechanism ensured a perfect protection for PRs by selecting routes that avoided any overlap between primary radios and secondary radios coverage. However, the resources of the overlap region could be used when the PR receivers are inactive or inexistent.

In this chapter, we present an exact computation of the vulnerable overlap area to characterize the impact of secondary transmission on a primary radio system. Our technique requires only the coordinate position and the coverage area (the reception zone) of CRs and PRs to calculate the region where these two zones geographically overlap. The size of the obtained area is directly linked to the interference on the existing PR receivers. It means that the smaller overlapping area is, the less interference impact is on on-going PR communications.

We show the practical case in which the ratio of affected nodes is minor because of

the low density of receivers in the overlap region. In this case, few PR receivers are in the overlap region and concerned by the impact of CR emitters. We propose a strategy to refine our computation of the overlap areas using the Grey prediction model. We can use this model to predict the sensitivity limit of each transmitter based on the Received Signal Strength Indicator (RSSI), essential for achieving adaptive transmitting power for CRs and after that getting the nodes' position. Furthermore, to minimise error variation so as the prediction is more accurate, we propose a mechanism to correct the prediction function using Kalman filter.

4.1.2 Overlapping scenarios and computation

The objective of this section is to identify the overlapping regions between primary and cognitive radio networks and to compute the overlapping in the various possible scenarios. The location of these radio devices could be obtained by geo-location technologies [14] or location-based services as described in [15]. We assume that the coverage area of PR and CR transmitters forms a perfect circle whose center is located at the position of the emitter. We denote by O_P of coordinates (x_P, y_P) and O_C with (x_C, y_C) the position of the PR and CR transmitters respectively, d the distance between these two points, R_P and R_C the radius of their coverage disk respectively. Table 4.1 summarizes the used notations. Our goal is to calculate the overlap region and observe the impact of CR transmissions on the primary users within the area.

Symbols	Descriptions
$O_P(x_P, y_P)$	Center and corresponding co-ordination of a Primary Radio (PR) transmitter
$O_C(x_C, y_C)$	Center and corresponding co-ordination of a Cognitive Radio (CR) node
R_P	Radius of the PR power transmission
R_C	Radius of the CR power transmission
d	Distance between the center of a PR transmitter and a CR
θ_P	Angle of the sector created by the intersection of PR
θ_C	Angle of the sector created by the intersection of CR
$A(x_A, y_A) B(x_B, y_B)$	Intersection points of CR and PR
$G(x_G, y_G)$	Inner point and on the boundary of the overlapped region
$W(x_W, y_W)$	Outer point and on the boundary of the overlapped region

Table 4.1: Notations Table

Generally, we consider that the PR and CR positions are known, the radii are fixed and the PR transmitter is located at the origin of the coordinate system.

We list here all possible situations when PR and CR signal overlap. There are several situations where the CRN and the primary radio network coexist, but they do not interfere with each other. When the spectrum of CR is not overlapping with the spectrum of the PR transmitter, no impact is considered. The secondary users or cognitive radios (CRs) do not use the frequency band of the PR transmitter, so

their communication do not interfere with the PR receivers in this range. Likewise, the tangent overlapping circumstance unlikely effect to the receivers of PR transmitter. The cases are illustrated geographically in Fig. 4.3 and Fig. 4.4.

The distance in-between the CR and PR transmitters satisfies the condition in equation 4.1. The impact, in this case, is likely zero.

$$d \leq R_P + R_C \quad (4.1)$$

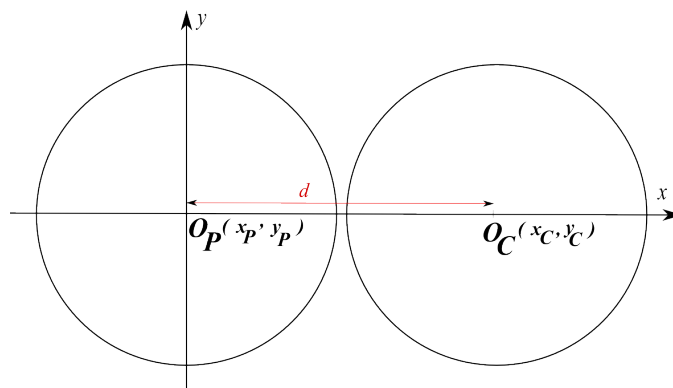

Figure 4.3: Non overlapping reception zones

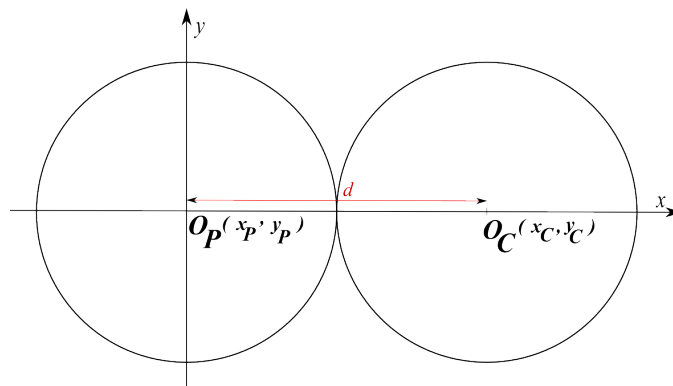

Figure 4.4: Tangent

On the contrary, inscribed situations happen when either CR's or PR's transmitter contains one another. The overlapping area is as big as the inscribed reception zone of the smaller reception area. In Fig. 4.5, CR reception zone covers the whole reception zone of a PR transmitter; the impact is foreseen as maximal since every communication of the primary receivers within this area is severely disturbed. On the other hand, in Fig. 4.6, the contained zone is the CR reception. Due to known primary area, CR devices can not operate. The overlap size is as big as the reception zone of the CR's disk. We do not carry the experiment for both of these cases, either the CR communications are harmful or unable to operate.

$$R_P \leq d \leq R_C \text{ or } R_C \leq d \leq R_P \quad (4.2)$$

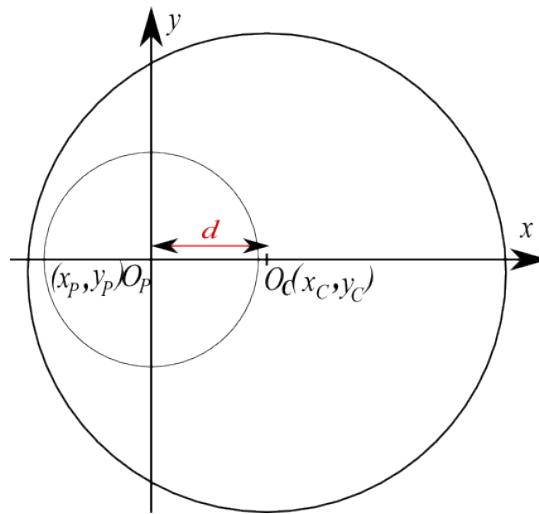

Figure 4.5: CR coverage area inscribes PR reception zone

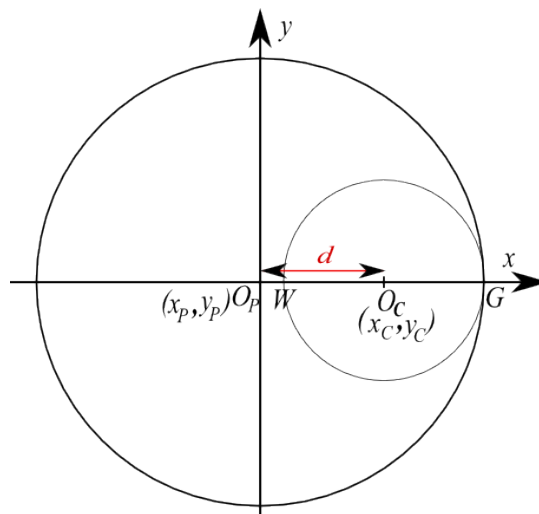

Figure 4.6: PR coverage area inscribes CR reception zone

The realistic overlap case highlighted in Fig. 4.7 and Fig. 4.8 is obtained when the following condition is satisfied (equation 4.3). So, we are mainly interested in the study of the possible impact in these general cases.

$$d < R_P + R_C \text{ and } d > R_P \text{ and } d > R_C. \quad (4.3)$$

Overlapping region is clearly displayed in Fig. 4.7 and Fig. 4.8. Then, using classical geometry, we calculate the general overlap region between PR and CR receptions zones

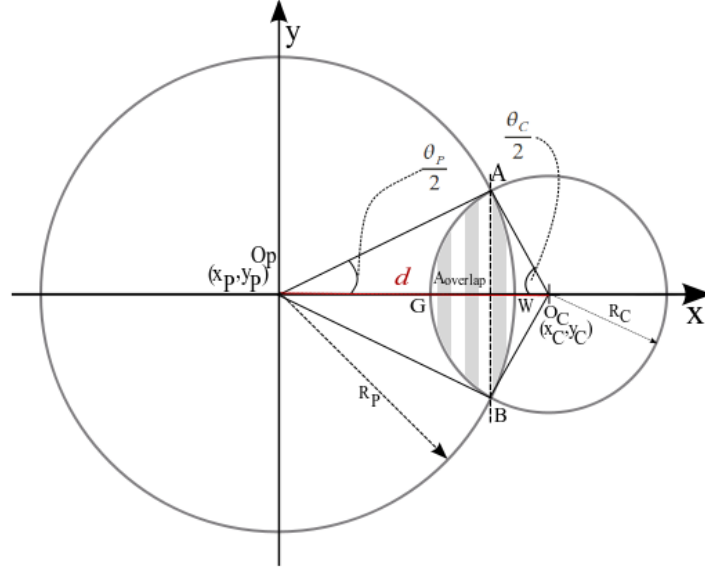

Figure 4.7: General overlap case

for this case (equation 4.4),

$$A_{Overlap} = \frac{\theta_C}{2} R_C^2 - R_C^2 |\cos \beta| \cos \frac{\theta_C}{2} + \frac{\theta_P}{2} R_P^2 - R_C |\cos \beta| R_P \cos \frac{\theta_P}{2}; \quad (4.4)$$

where θ_C and θ_P are the angles formed at O_C and O_P with points A and B respectively, whereas β is an intermediate variable for our computation given,

$$\begin{aligned} \sin \beta &= \frac{R_P^2 - (R_C^2 + x_C^2 + y_C^2)}{2 * R_C * \sqrt{x_C^2 + y_C^2}}; \\ \sin \frac{\theta_C}{2} &= \frac{R_C}{R_P} * |\cos \beta|; \\ \sin \frac{\theta_P}{2} &= |\cos \beta|. \end{aligned}$$

The case where $d < R_C < R_P$ shown in Fig. 4.8 is not included in equation (4.4). Therefore, to make our study complete, this particular situation is considered in equation (4.5).

$$\begin{aligned} A_{Overlap} &= \frac{\theta_P}{2} R_P^2 - R_C R_P |\cos \beta| \cos \frac{\theta_P}{2} \\ &+ \Pi R_C^2 - \frac{\theta_C}{2} R_C^2 \\ &+ R_C^2 |\cos \beta| \cos \frac{\theta_P}{2}. \end{aligned} \quad (4.5)$$

The size of the overlap region depends on how big the reception zone of both the CR and the PR transmitters is on a specific channel. Determining the size of the overlap is

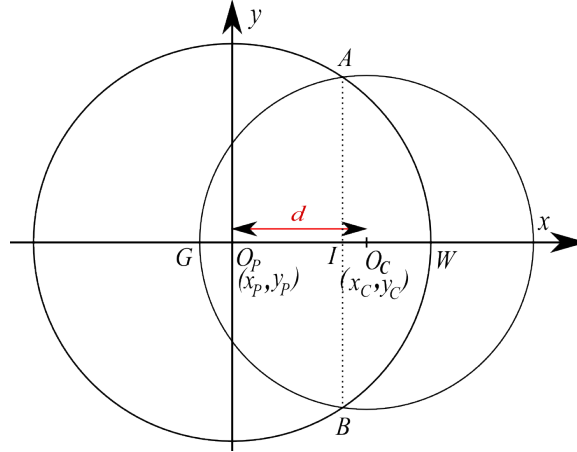

Figure 4.8: Particular overlapping case between PR Transmitter and a CR Node

important to characterize the impact on the primary receivers. The smaller the region is, the less impact there is on the potential PR receivers operating on a given channel.

Once the interference PR receivers is foreseen, the impact that the CRs transmissions have on PR communications can be contained. In some specific cases, it might be interesting to take also into account the PR deployment in the area. For example, a small overlap region might contain a high number of PR receivers. In other words, nodes may not be uniformly distributed in space. All these possible situations will be studied through simulations (section 4.3.1).

4.1.3 Overlapping and its Impact on Primary Receivers

Until the work was taken into account, we found that there was not existing work on evaluating the impact of this phenomena on the primary system or primary receiver in particular. The overlap between these two reception zones was simply ignored or assumed that it does not happen. When no overlapping happens, the secondary communication does not affect the primary system. It is hence safe from CR's operation. We illustrated the cases in Fig. 4.3 and Fig. 4.4. However, in the case of co-existing primary and secondary emitters (Fig. 4.2), the possible impact should be evaluated.

In case of TV-white spaces, the overlapping is more likely happening in deployment. So as evaluating how this overlapping will impact the TV stations provides the needed knowledge for the deployment of the network. However, TV receivers are passive devices and how they are in-use depends on users' need. It is difficult to obtain the information such as when and where these devices operate (i.e., how much would the CR communication cause if the CRN is operating, and an anonymous user turns on his TV?). CRN deployment in these areas needs to consider possible impacts on PR's communications. Thus, overlapping should be studied and taken into account while deploying CRN in such type of area.

To provide a thorough aspect of the work, we consider a well-known propagation model in the free space in which the overlapping phenomenon may happen. The proposed customization path-loss model is hence discussed in the following section.

4.1.4 Propagation modelling and formalizing

In this section, we consider the path-loss propagation model that encounters the overlapping size factor. The signal from CR and PR transmitters is the light-of-sight radio signal. The further it gets, the weaker the signal is. Path loss is the reduction in the power density of an electromagnetic wave when it propagates throughout the space. This power reduction is caused by the various environment effects such as refraction, diffraction, aperture-medium coupling loss or absorption. In our solution, we take into account the loss due to the listed factors as well as the impact of CR's communication when overlapping happens.

Assuming that both PR (at O_P) and CR (at O_C) are transmitting, apart from the path loss caused by the signal fading from the center to the destination, the attenuation caused by the other transmitter is also counted. Therefore, it adds up to the loss of signal at the destination. Recalling the general overlapping in Fig. 4.9, we specify the left-most and right-most points of the overlapping region when it happens (e.g. G and W).

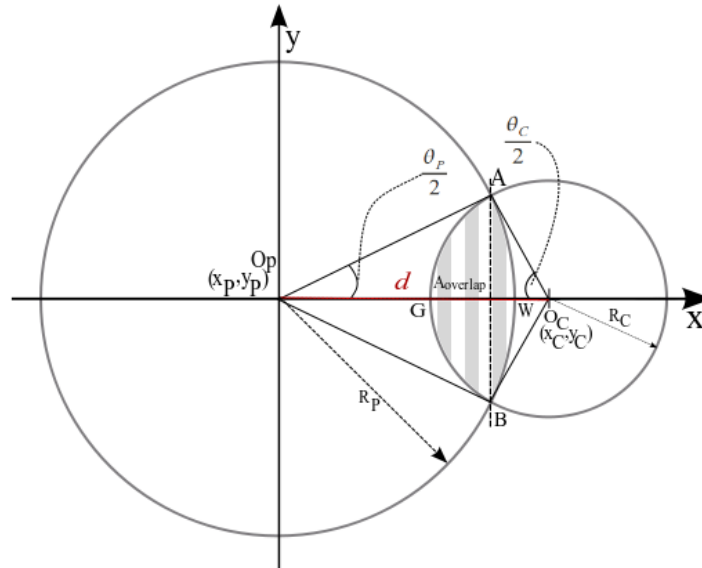

Figure 4.9: General overlap case - reminder

Explicitly, we evaluate the Effective Isotropic Radiated Power (EIRP), attenuation caused by CR's emission signal and the amount of actual receiving signal strength at any points in-between CR and PR transmitter. Since we account for the loss of the signal due to the distance, we chose path loss model.

First of all, considering the attenuation caused by the transmitter at O_C is Att_{O_C} and this value varies from G to W . However, the further the destination to O_C is, the less the attenuation caused by O_C is. For any point i and j in between O_C and O_P , the attention is defined in equation 4.6.

$$Att_{O_C}(atpointi) < Att_{O_C}(atpointj), \quad (4.6)$$

such that $d(O_C, i) < d(O_C, j)$

And the path loss of the signal transmitted from O_P to single point G, A, B, W in Fig. 4.9 is computed using the path loss model of 802.11 in [32] with added attenuation Att_{O_C} , the path loss power yields:

$$P_{loss} = 40 \log d - 20 \log (h_t h_r) + 20 \log f \quad (4.7)$$

where d is the distance between the antenna, h_t and h_r the transmitter and receiver height respectively, and f the transmitting frequency. Therefore, the EIRP at a single point is defined by the general equation:

$$EIRP = P_T - Cable_{loss} + G \quad (4.8)$$

with P_T the power output of the transmitter and G is the antenna gain in dB; cable loss equals to zero.

In terms of calculating the receiving power of a PR receiver, the path Loss will include the Attenuation (interference power) caused by the CR transmitters and the environment loss. For example, the loss at point G would be computed as in equation 4.9

$$P_{Loss} \text{ at } G = 40 \log O_P G + 20 \log f - 20 \log (h_t h_r) + Att_{O_C}(G) \quad (4.9)$$

Where $O_P G$ is the distance between the center of the primary transmitter to point G , and Att_{O_C} is the attenuation caused by CR's transmitting signal.

Whether the receiving signal could be recognized or not depends on the Receiver Sensitivity or the Signal-to-Noise-Ratio (SNR). It is the minimum RF Signal power level required at the input of a receiver for a certain performance. The receiver sensitivity in this case is defined as in equation 4.10. Note that, in this equation, the cable loss is

omitted because of the wireless medium nature.

$$\begin{aligned} \text{Receiver Sensitivity (dBm)} &= \text{EIRP}(\text{from the transmitter}) - P_{\text{loss}} \\ &+ \text{Receiver Antenna Gain} \\ &- \text{Cable loss at the Receiver} \end{aligned} \quad (4.10)$$

or notation-based of the formula is represented:

$$\begin{aligned} \text{SNR(dB)} &= \text{EIRP}(\text{from the transmitter}) - P_{\text{loss}} \\ &+ \text{Receiver Antenna Gain} \end{aligned} \quad (4.11)$$

, with P_{Loss} calculated from equation 4.7.

Note that, we can obtain the antenna gain and the cable loss from the devices' description provided by vendors. From this calculation, it is clear that the loss factor influences the received power. The further the signal goes, the more the EIRP decreases.

Considering an isotropic model, where the transmitting antenna radiates its power uniformly in all directions. The transmitter is the center of a sphere with radius r . The total power density on the sphere (also called the flux density) is expressed in equation 4.12, assuming that cable loss and the antenna gain are equal to 0.

$$\begin{aligned} P_d &= \frac{\text{EIRP}}{4\pi r^2} = \frac{P_{\text{out}}}{4\pi r^2} \\ &\Rightarrow \text{EIRP} = P_{\text{out}} \end{aligned}$$

Then the transmitted power and characteristic of the receive antenna becomes

$$P_r = P_d A_e = \frac{\text{EIRP}}{4\pi r^2} A_e = \frac{A_e P_{\text{out}}}{4\pi r^2} \quad (4.12)$$

where A_e is the effective aperture, the area where the signal spreads and it is related to the overlap area in this work. Therefore, we propose to compute the SNR for the general overlap in this section.

Assume that the Area got from the computation is A_e . The ideal receiving power from O_C to the nodes within area is determined by equation 4.12 which has not taken into account any loss or noise. However, in our scenario, the radiated area of the CR Transmitter and PR transmitter are the 2D circles, the ideal receiving power at a single point in the effective aperture A_e would be adapted:

$$\begin{aligned} P_r &= P_{\text{transmitter}} * \frac{A_e}{\text{CircleArea}} \\ &= P_{\text{transmitter}} * \frac{\text{EIRP}}{4\pi r^2} \end{aligned} \quad (4.13)$$

Consider at an arbitrary point i within the area (e.g. at G or A or B in the figure), we could have the discrete receiving sensitivity from O_C satisfies the path loss propagation model in equation 4.12:

$$P_{receiving\ At\ G} = P_{CR\ emitter} - P_{loss\ from\ O_C\ to\ G} + AntennaGain$$

Hence, the power of the signal transmitted by the CR at a node i in the overlapping area is determined by the equation 4.14.

$$P_{O_C,i} = P_{O_C} * \frac{A_e}{\pi r_C^2} - 40 \log O_C i + 20 \log (h_C h_i) - 20 \log f + AntennaGain \quad (4.14)$$

The power signal received from O_C within the overlap region is considered as the attenuation to the PR receiver within the area. Therefore, this signal power, yielded in equation 4.14, can be seen as an attenuation. Hence, the attenuation caused by CR at O_C at single point i is

$$Att_{O_C\ to\ i} = P_{O_C,i}$$

The Signal-to-Interference-plus-Noise Ratio (SINR) is the power level relative to receiving power level based on the noise being seen. The two main components to calculate SINR are the signal and the noise as expressed in the followings:

$$SINR = \frac{P_{received}}{Noise}$$

$$SINR(dB) = P_{received}(dB) - P_{Noise}$$

At a primary receiver, SINR is the ratio of transmission power P_t and the unwanted signal which is processed by a receiver. Typically, the receiving power at the receiver has to account for the path loss along the distance from the sender to the current location of the receiver. Therefore, we can compute the SINR as in equation 4.15

$$SINR(dB) = P_{out}(dB) - P_{loss} - P_{Noise} \quad (4.15)$$

With P_{out} the transmitting power and P_{loss} computed from equation 4.7.

We have many kinds of noise such as thermal noise coming from the processing unit at receiving device, or weather humidity, or the interference from other signal that weakens the receiving power at the receiver. Therefore, the interference from CR's transmitter is a type of noise, the SINR in dB is computed as follows:

$$SINR(dB) = P_{O_P} * \frac{A_e}{\pi r_P^2} (dB)$$

$$- P_{O_C} * \frac{A_e}{\pi r_C^2} (dB)$$

$$- 40 \log \frac{d_{O_P,i}}{d_{O_C,i}} + 20 \log \frac{h_t h_i}{h_C h_i} (dB) \quad (4.16)$$

In case of omitting the medium noise, we compared the SINR from equation 4.15 and from equation 4.16 with parameters defined in the Table 4.2. These parameters are extracted from the experiments described in Section.4.3. The SINR obtained from equation 4.15 from O_P to I is at -67.86700 dB while the SINR obtained from equation 4.16 is really much higher at -10.61995 dB. The SINR is computed at a node located at I which is $208m$ away from O_C and $356m$ away from O_P , and it locates within the overlap area. This SINR reflects the effect of the attenuation caused by the CR at O_C . However, the SINR at I that only takes into account the signal from a single transmitter (either from the PR transmitter or from the CR transmitter) is really much lower and ignoring the effect of the reciprocal signal from the other side.

Parameters	Descriptions
Transmitting Power at PR Emitter P_R	110mW ~ 20.4143 dB
Transmitting Power at CR Emitter P_C	55mW ~ 17.4036 dB
Overlap area A_e	126157 m^2
CR radius R_C	377 m
PR radius R_P	475 m
Distance from O_C to point I $d_{O_C O_I}$	208 m
Distance from O_P to point I $d_{O_P O_I}$	356 m

Table 4.2: Computation Parameters of PR and CR

Note that only distance factor is not enough to form a metric for routing, there are many other factors that need to be considered when we design a proper hop-by-hop routing in ad-hoc cognitive radio networks. These factors are the obstacles in-between the two reception zones, the number of possible primary receivers operating or hibernating within the overlap region. Hence, we argue that with the proper prediction model we can estimate the potential number of primary receivers with minimal empirical data, so as we have the better view of the probable deployment. In the next section, we discuss these models that we investigated.

4.2 Prediction Model Investigation

A deterministic mathematical model can not thoroughly characterize all the aspects of a physical system, it only reflects some perspectives of what we expect to observe. On the contrary, a physical model is always noise-corrupted since unexpected incidents can always happen. This phenomenon is called uncertainty. Stochastic model, however, combines the advantages of both mentioned models to reflect the physical system relatively while considering all possible uncertainties if any [133]. Therefore,

we used a stochastic model that most fitted our requirements, Grey Model GM(1, 1) and Kalman-filter. These models are presented in the following sections.

4.2.1 Grey Model GM(1,1)

The Grey systems theory [134] is known for the analysis of problems with incomplete or uncertain information. This is an uncertain system of which the information is incomplete, and the existing data is partially accurate. Grey system theory focuses on the uncertainty problems with known samples or inadequate information that challenges probability to handle. Many components of Grey system theory have been built up since the theory was introduced [135]. These components are composed of systems analysis, evaluation, modelling, prediction, decision-making, etc. Our work focuses on the Grey prediction in term of modelling and predicting upon a set of samples.

In the literature, Grey predictor is said to be a robust model which respects to noise and the deficiency of modelling information compared to the other prediction methods [136]. As defined in [136], “Grey models predict the future value of a time series based only on a set of the most recent data depending on the window size of the predictor assuming that all the data used in the models are positive and the sampling frequency of the time series are fixed.”

One of the most efficient Grey model in the real-time applications is GM(1, 1). The model GM(1, 1), pronounced as “Grey Model First Order One Variable”, is the time series forecasting model in which the model is renewed when the new data become available to the prediction model [136].

In the next generation network, e.g., software-defined radio networks or so-called cognitive radio networks (CRNs), the resource exploration process on these devices has very limited information about radio environment. A prediction model that satisfies partial knowledge can be useful. The density of these devices, for example, is one of the important characteristics that a CR needs to estimate to avoid the maximum perturbation on the primary system.

A proposal on the use of Grey Model in [137] defined a function that facilitates the detection of free bands by the mobile cognitive radio equipment dedicated to the real-time patient’s monitoring. This work proposed a predicting strategy that is based on machine learning techniques combined with the Grey Model system for performing a spectral prediction.

Firstly, we are interested in predicting the distribution of the PR receivers within a specific area using the forecasting model $GM(1, 1)$. Let consider the input series for GM(1, 1) is X^0 with n denoted as follows.

1. Input data series in time domain $X^0 = [x^0(1), x^0(2), x^0(3), \dots, x^0(n)]$, $x^0(i) \geq 0$. This series represents the density of the PR receivers in the primary emitter area A_P after n times sampling, assuming that the data is known. For instance, we can obtain this piece of information after a number of transmission detection trials, which is achievable.
2. Generate new sequences using Accumulated Generating Operation (AGO) to reflect the tendency $X^1 = [x^1(1), x^1(2), x^1(3), \dots, x^1(n)]$, with $x^1(k) = \sum_{i=1}^k x^0(i)$, with $k = [1, n]$. For instance, $x^1 = x^0(1); x^1(2) = x^0(1) + x^0(2)$
3. The first order differential equation obtained from X^1 is given by: $\frac{dx^1(t)}{dt} + ax^1(t) = b$
4. The time-coefficient a and the predictive control coefficient b are obtained by applying the least square method

$$[a, b]^T = (B^T B)^{-1} B^T y_N$$
5. matrix B and y_N are obtained as follows:

$$B = \begin{pmatrix} -\frac{1}{2}(x^1(1) + x^1(2)) & 1 \\ -\frac{1}{2}(x^1(2) + x^1(3)) & 1 \\ -\frac{1}{2}(x^1(3) + x^1(4)) & 1 \\ \vdots & \vdots \\ -\frac{1}{2}(x^1(n-1) + x^1(n)) & 1 \end{pmatrix}$$

and $y_N = [x^0(2), x^0(3), x^0(4), \dots, x^0(n)]^T$; n being the size of the sequence

6. The node density at time $t = k$ estimation function becomes: $\hat{x}^1(k) = (x^0(1) - \frac{b}{a})e^{-ak} + \frac{b}{a}$. This is the predictive value solution for $x^1(t = k)$
7. The variation according to time difference or the number of the primary receivers density at time $k+h$ could be obtained by: $\hat{x}^0(k+h) = \hat{x}^1(k+h) - \hat{x}^1(k+h-1) = [x^0(1) - \frac{b}{a}] e^{-a(k+h)}(1 - e^a)$. This is the subtraction from the tendency function using Inverse AGO.

The idea of using least squared method is to find the closest point to the actual value curve/line of the data. In Grey Model, to ensure the accuracy of the predicted value in time domain (that reflects the trend of the series) and prediction control variation (the variance of the predicted value and the actual value), least squared method is applied to calculate these coefficient factors.

In this work, we used GM(1,1) in predicting the number of PR receivers in a specific area if a statistical receivers quantity is known. Assuming that there is a statistical information about the number of active licensed mobiles/devices in a specific area (note that we focus on the rural area since there are fewer obstacles in-between for the current model). Depending on the time unit of data (e.g., per hour or per day), we extract

the statistics into a time series chain of the number of the active licensed device that is named measured PRs \hat{X}^0 . This is the input series of Grey Model GM(1, 1).

To thoroughly ensure the accuracy of the prediction, we investigate another prediction model that was introduced in the 60s, the Kalman-filter described in the next section. The produced results of these two models showed that with the same input of RSSI value, the prediction were close to the actual value. However, there is a difference between the predicted value and the measured value when we performed the verification with a series of real numeric values. The results and observations are discussed in section 4.3.

4.2.2 Kalman Filter-based prediction model

Kalman filter was introduced in the 60s by R.E. Kalman to solve a data linear filtering problem. However, it first attracted the research community via an application research in aerospace of the US military research department. Then, it was applied in navigational and guidance systems, radar tracking, sonar ranging, and satellite orbit determination, aerospace engineering, and in mathematic research (numerical methods and algebra).

Ever since it was introduced, Kalman filter has been called the optimal linear estimator. It is optimal due to its ability to process any types of measurement. Kalman filter incorporates all information that one can provide based on *a*) knowledge of the system and measurement device dynamics; *b*) statistical description of system noise, measurement errors/bias and uncertainty in the models (as much descriptive as better); *c*) a piece of initial value of the variable of interest.

In algebra, Kalman filter can be applied to stationary time series (where the mean and variance do not change over time) or non-stationary time series. However, Kalman filter has a drawback that is its reliance on linearity. Some research has been carried out to solve this issue. For example, an extended version of Kalman filter was proposed by Julier et al. [133].

Furthermore, Kalman filter is characterised by its practical implementation since it does not require all previous data to be stored and preprocessed every time a new measurement is taken. Therefore, a memoryless design can be considered sufficient for implementing a basic Kalman filter-based application. Of course, depending on how complex a system would be, the other factors will be taken into account.

The Kalman-based estimator provides good results in practice due to its optimality (minimises the mean square error of the estimated parameters) [138].

The idea behind Kalman Filter is the recursively correction the estimation function associated with the current measured value, current predicted value and current pre-

dicted measurement value. For example, we have a prediction function of variable x at time t called, \hat{x}_t^- . The current measured value is z_t , the predicted measurement which is yield by the predicted value of x at t is z_t^- , providing that $z_t^- = Hx_t^-$ with H is the related matrix to measured value at time t .

The actual value of x denoted by \hat{x}_t , then the prediction function is corrected as follows:

$$\hat{x}_t = \hat{x}_t^- + K(z_t - H\hat{x}_t^-) \quad (4.17)$$

K is called the Kalman gain that reflects the factor associated with the error from the actual measured value and the prediction measurement value, z_t and z_t^- respectively. As in equation 4.17, the composition after K is the correction for the predicted function for estimation of x - denoted \hat{x}_t^- .

The original version of the Kalman filter is used for estimating a state of a discrete-time in which the controlled process is governed by the linear stochastic difference probability. However, predicting scalar value may be a non-linear problem instead. We can consider using extended Kalman filter instead, since the extended Kalman filter deals with non-linear and discrete-time events/processes.

The object in the model is the number of nodes within a specific area. The velocity will follow the ON-OFF model that reflects the activity of the receivers in the area. To make the ON-OFF model robust, the other statistical model related to the receivers activities can be applied. Sung et al. [139] proposed a power control scheme for CR based on the prediction of the PR activities. The work addressed the temporal spectrum sharing. CR can only access the channel during off period, and it had to vacate immediately or at least some reasonable time before the off period elapsed. The objective of the work was to maximise the spectrum utilization of CR and minimise perceived interference below the threshold to the PR.

CR and PR coexist and operate in the same bands and in the same area. The work aimed to maximise total accessing rate during the OFF periods assuming that the frame length of the CR was shorter than the ON period of the PR. OFF duration was modelled based on any type of distribution in respect with the application requirement. Two types of applications was taken into account: peer to peer and interactive game application with log-normal distribution and extreme-value distribution respectively. The drawback of the solution was that predicting OFF and ON period maximise the total number of timeslots for CR access. However, the frame length was fixed for the sake of synchronization; and that was impractical. The solution considered the cases of false alarm sensing and only coped with the dedicated sensing channel scheme. Whereas the centralized sensing would not be practical due to the security issues and

resources wasting. The proposed model was applied for linear accessing scheme while in this case we can consider the discrete scheme (non-linear). The activity of a CR and PR could be a non-stationary process instead, so it should be non-linear.

Horvath et al. [140] investigated the properties of 2-state Markovian chain for the ON-OFF statistical model through real measurement on 802.11 wireless local area network. They proposed an aggregation model to navigate the primary activities by fitting a partitioned Markov model into this aggregation process. Chowdhury et al. in [109] used predictive Kalman filtering to model node mobility to verify their routing proposition even though the applied technique briefly explained in term of modelling aspect.

Grey Model GM(1, 1) and Kalman Filter comparison

Both Grey GM(1, 1) and Kalman filter could be feasible for building a prediction system. However, to ensure a precise and accurate result from this prediction system, some extra analysis and experiment should be carried out. In this section, we compare the two models with a simple experiment on predicting a constant value to evaluate the accuracy as well as the feasibility of each model.

Qiang et al. [141] reported their preliminary work on object tracking based on GM(1, 1) since they argued that the Kalman filter was limited on motion and noise assumption. The limitation was confirmed as a constant velocity and acceleration at the modelling stage. However, the accuracy of the Kalman filter strongly depends on the bias of the model and its real physical system. The closer the model to the physical system is, the more accuracy is obtained.

A comprehensive comparison among the prediction models was conducted in the report of project SOMA [142]. Time-series based prediction model such as GM(1, 1), discrete Kalman filter, Fast Fourier Transform (FFT), and the particle were tested to verify RSSI fluctuation. The results showed that all the models produced quite an accurate prediction. However, the Grey system tended to overestimate while Kalman filter and FFT accurately follow the actual RSSI.

We conducted a comparison with Grey Model and Kalman filter. In Fig. 4.10 and Fig. 4.11, we generated a series of constant numbers, the iteration was the index of the number in the array. Both models are used to predict the series based on this original series. Clearly, the Kalman filter values bend according to the change in the original series while the Grey Model tends to linearly either increase or decrease.

We verified Kalman filter with the same configuration with the Grey Model RSSI experiment in section 4.3.2. The results showed the consistency regarding the trend of the original signal and the prediction signal. Ten thousand (10000) samples were

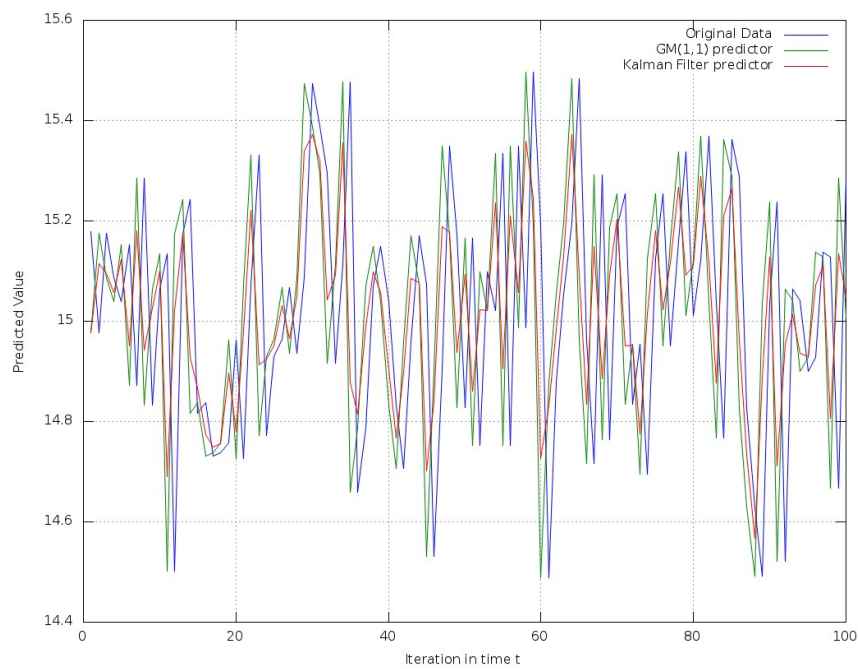

Figure 4.10: Normal distribution series

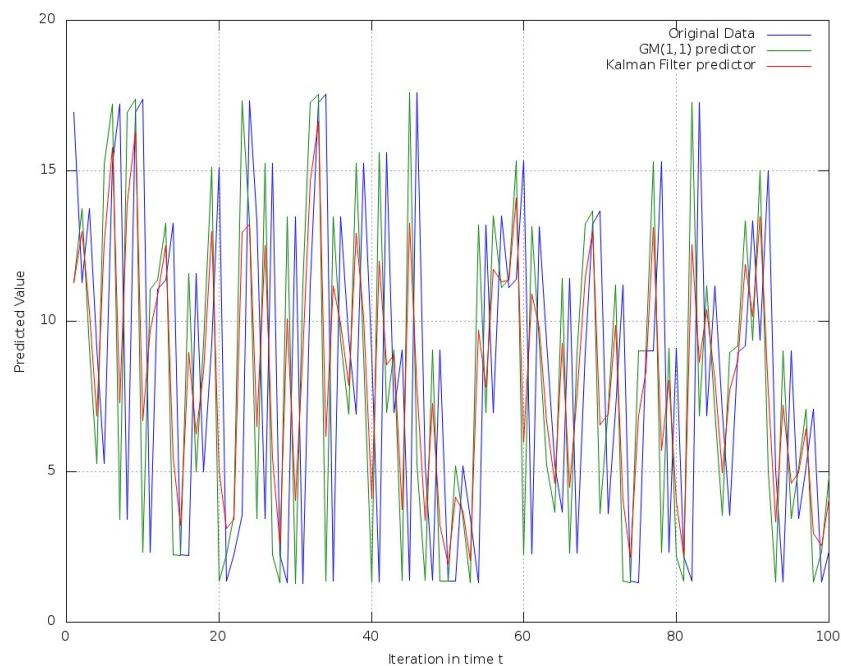

Figure 4.11: Poisson distribution series

considered with 50 iteration steps. However, the fluctuation in the Kalman filter seems slightly bigger than in Grey model plot. In this case, the Grey model seems to show better prediction than the Kalman model does. Details simulation and results are

discussed in section 4.3.2.

4.2.3 Comprehensive Node Prediction Model

The two introduced prediction models yield indifferent, yet the algorithm and the dependency are different. The objects of these models are controversial. Grey model is effective for predicting data series with temporal trends while the Kalman filter is useful for improving the prediction accuracy [143]. Therefore, Wei et al. [143] proposed a potential combination of these two models to earn more accurate prediction value in term of estimation based on a single data series.

We proposed the abstract steps for combining these two models as followings.

1. $predictedVal \leftarrow \hat{x}^0(k)$ extracted from Grey GM(1, 1)
2. $measureVal \leftarrow z_k$

Starts:

1. Measure the real value at $t = k$: z_t ,
2. Apply Kalman filter to correct the estimation
3. Recall and reassign a and b to $\hat{x}^0(k + i)$
4. Back to step 1

4.3 Preliminary Observation

We opted for the use of a discrete-event simulator to verify the hypothesis about the overlap regions and its impact on primary's communication. Omnet++ allows users to modify the events as well as add more components to the simulator. This simulator also supports a framework to simulate a wireless environment with coherent functions and protocols [144]. It is widely used by the research community, especially for wireless networks protocol experimenting. In this section, we describe the experiments we performed to validate our proposals in terms of: evaluating the impact of CR transmissions on PR receivers in the overlap regions and verifying the feasibility of Grey GM(1, 1) and Kalman filter.

4.3.1 Evaluation of the impact of CRN on Primary networks in the overlapping regions

Simulation Scenarios

The relationship between the overlap phenomena and its impact on the PR network is investigated using OMNeT++ simulator with the integrated MiXim framework. MiXim is a mixed framework that supports mobile and wireless simulations and offers detailed models of radio wave propagation, interference estimation, radio transceiver, power consumption and wireless MAC protocols as explained in [144].

The simulation was deployed on a playground size $3000m \times 3000m$, the PR transmitter was a typical 802.11b single channel sender with the maximum transmission power of $110.11mW$ that corresponded to a reception range of $475.8m$. When the transmission was set to $11.11mW$, reception range hence decreases to about $103m$. The number of receivers was kept varying from 10 to 200 nodes within the PR's transmitter reception region.

We deployed the topology that is illustrated in Fig. 4.12. The receivers are represented by laptop icons and are scattered around PR transmitter. We distributed these devices randomly using uniform and Poisson distribution algorithms. CR emitter, denoted by CR 1, overlaps with PR transmitter on channel 1. The location of CR 1 changes from each run, the overlap size is hence changed accordingly. By doing so, we can verify how different the impact is corresponding to different overlap areas.

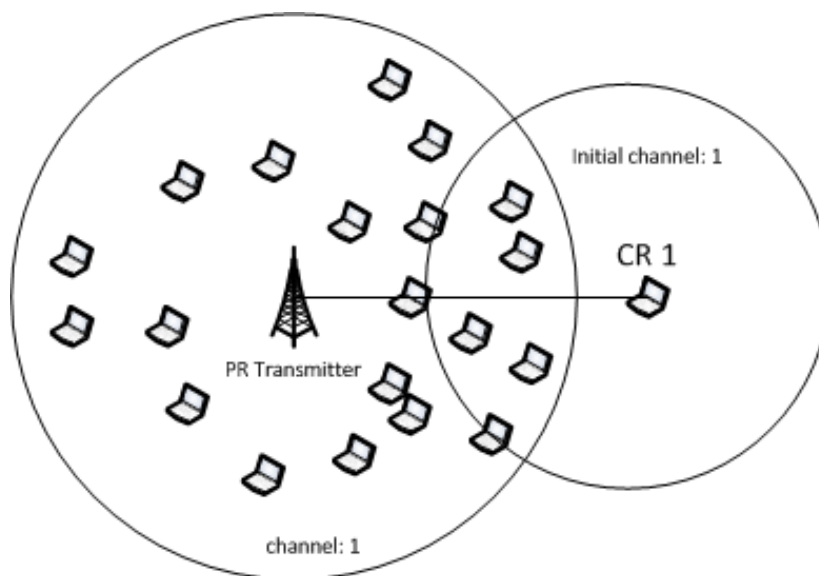

Figure 4.12: Experiment on a single channel and various overlap areas

We developed a CR node on top of an adaptive 802.11 multi-channel implementation that allowed nodes to switch between channels under specific conditions. Note here that the IEEE 802.11 was selected for simplicity reasons. However, our results can

be generalized over any spectrum band. Cognitive radio transmission power was fixed at $55.11mW$ and $5.5mW$ that covered a distance of $377.77m$ and $83.64m$ respectively. This coverage distance was computed according to the maximum transmission power, wavelength, the path loss coefficient and a threshold for the minimal receiving power.

Fig. 4.13 illustrates the deployment for this experiment. We applied the same distribution methods on drawing the PR receivers into PR transmitter's disks. However, CR emitter's location was fixed in this test. We also fixed the size of each overlap region that CR emitter had with the PR transmitters. Providing that the overlap region on channel 1 is bigger than the overlap region on channel 2, we expect to observe less impact on channel 2 than on channel 1.

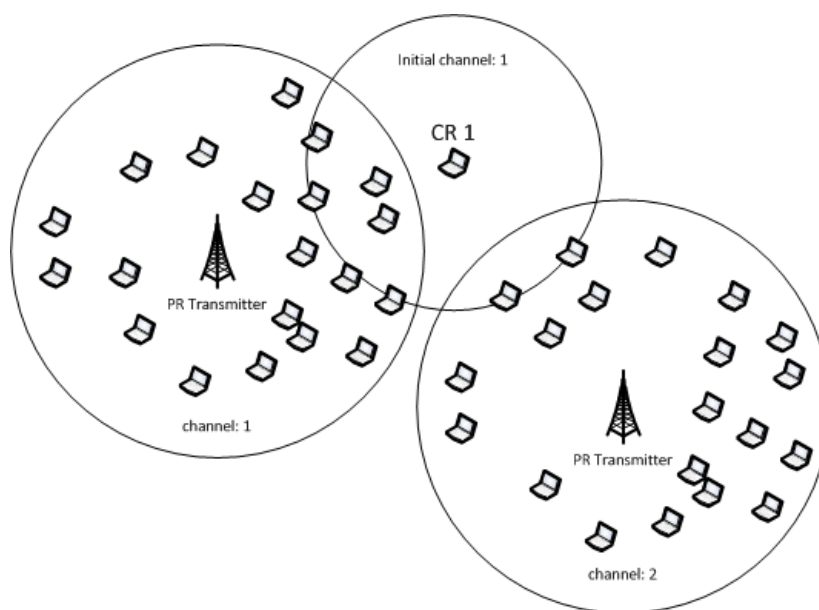

Figure 4.13: Experiment on multiple channels and various overlap areas

The built-in path loss propagation was used with the default path loss coefficient alpha of 3.5. All the physical values were also kept by default as pre-defined in MiXim while the transmission power of the CR node was modified and set to be lower than the PR's transmission power. We placed the PR receivers in the disk area around the PR transmitter following various distributions. Every shown result is the outcome of 27 simulation runs while modifying the number of nodes and PR receivers distribution. Each run was performed in 500s at least. The configuration parameters are summarized in Table 4.3 and the results are claimed in the next section.

Parameters	Configuration
Ground size	3000m x 3000m
PR emitter's transmission power	110.11mW and 55.11 mW
CR emitter's transmission power	11.11mW and 5.5mW
Path loss coefficient	3.5
Reception range R_P	475.8m and 377.77m
Reception range R_C	103m and 83.64ms
Number of PR receivers	10-200
Number of runs per number of receivers	27
Time per run	500s
Distribution	Uniform and Poisson

Table 4.3: Experiment configuration

Numerical results

This section presents the numerical results of the experiments introduced in the previous section. Fig. 4.14 and Fig. 4.15 show results for a scenario where over a single channel network we modify the overlap size and study its impact on PR receivers. We consider Uniform and Poisson distributions to deploy PR receivers around the primary radio emitter. The x-axis presents the size of the overlap obtained from the location of the CR sender and calculated based on equations (4.4) or (4.5); the y-axis shows the ratio of impacted primary nodes. Lower coverage area in Fig. 4.16 and Fig. 4.17 produces almost the similar observed results on the single channel experiments.

Apparently, the ratio of impacted PR receivers by the CRs transmissions grows linearly from 30% to more than 90% when the overlap size increases as observed in Fig. 4.14 and Fig. 4.15. However, our surprise comes from the observation that the ratio of affected PRs is almost independent of the number of PR receivers as a different number of PR receivers are simulated. Decreasing the reception zones of these devices also gave us the same result as seen in Fig. 4.16 Fig. 4.17. This important result may seem intuitive with a uniform distribution where nodes were deployed inside the coverage disk with equal probability. But we show here that with a different probability distribution (i.e. Poisson distribution), this tendency remains somehow similar. This proved that the impact depended on the size of the overlap regions regardless of the distribution method.

Fig. 4.18 and Fig. 4.19 correspond to the second scenario where two channels are available with a PR transmitter observing different overlaps on each channel. In fact, the overlap on channel1 is about $120000m^2$ while on channel2 the intersection between transmitter circles is around $500m^2$. We study in the graphs depicted in Fig. 4.18 and Fig. 4.19, the distinctive ratio of affected nodes while modifying the number of PR

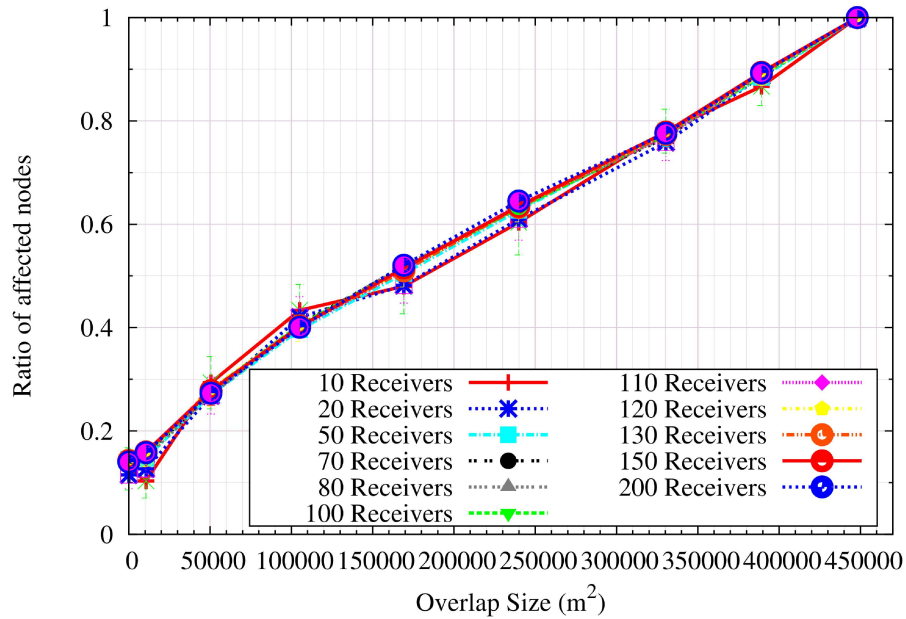

Figure 4.14: Single Channel - Different Overlap region - Uniform Distribution

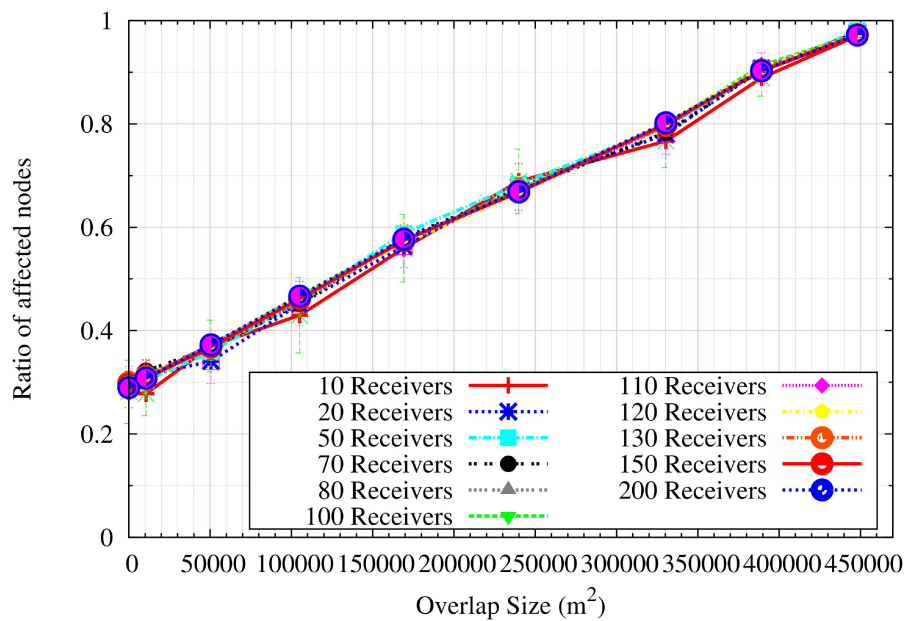

Figure 4.15: Single Channel - Different Overlap region - Poisson Distribution

receivers on both channels.

Again, the experiment was performed with a various number of PR receivers within the PR transmitter's disks on both channels. The x-axis shows the number PR receivers while the y-axis illustrates the ratio of nodes being affected by the CR transmitter's signal. Obviously, this ratio varies from 10% to almost 15% on channel2, and from almost 34% to almost 40% on channel1 when the receivers are distributed uniformly on these disks (as in Fig. 4.18). These results corroborate the previous observation by

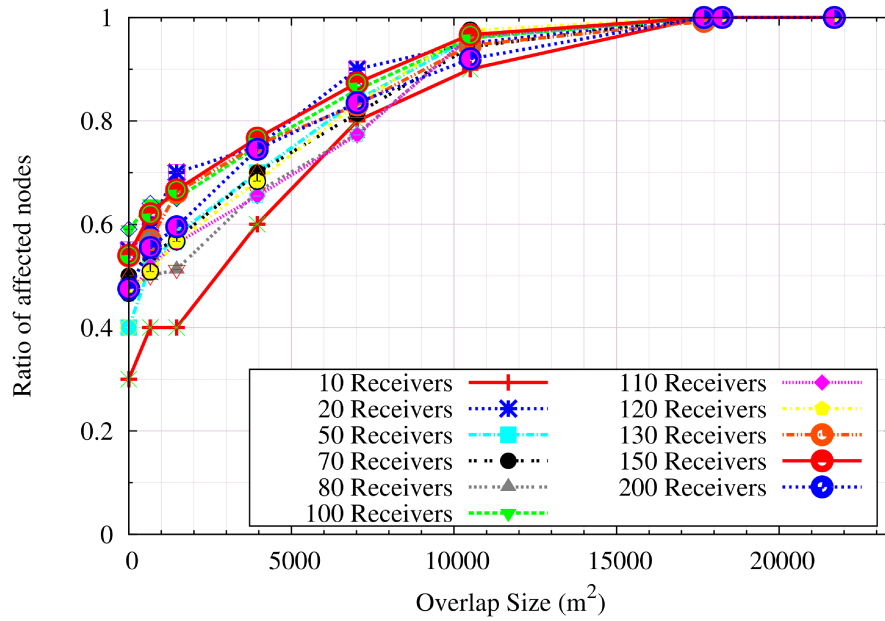

Figure 4.16: Single Channel - Different Overlap region, smaller reception zone - Uniform Distribution

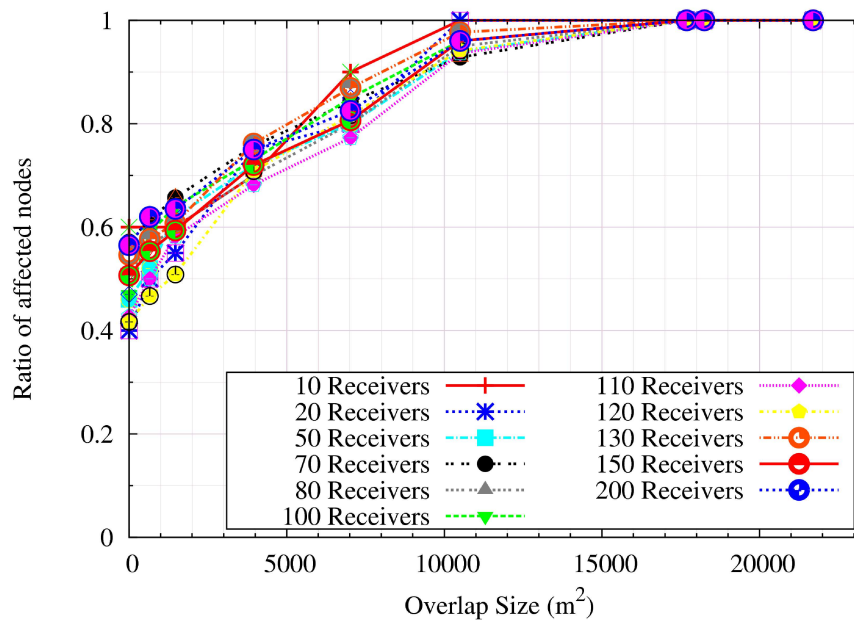

Figure 4.17: Single Channel - Different Overlap region, smaller reception zone - Poisson Distribution

showing again the limited impact of the number of PRs on the ratio of affected PRs for these distributions (i.e. Uniform and Poisson). It confirmed that the bigger the overlap region is the higher impact on the PR receivers is.

Though the relationship between overlap size and the impact is shown, we performed another experiment on a single channel with different overlap size and arbitrary deploy-

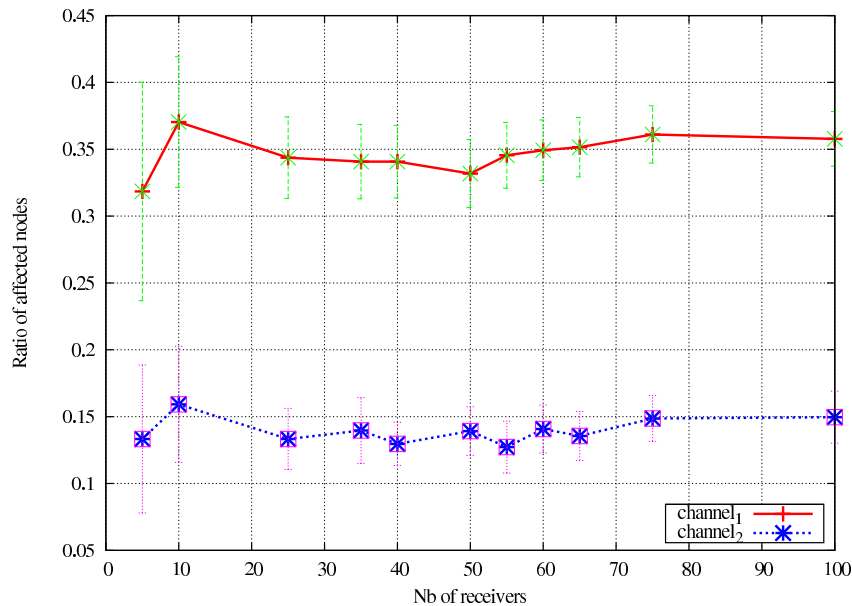

Figure 4.18: Multi Channel - Different Overlap region - Uniform Distribution

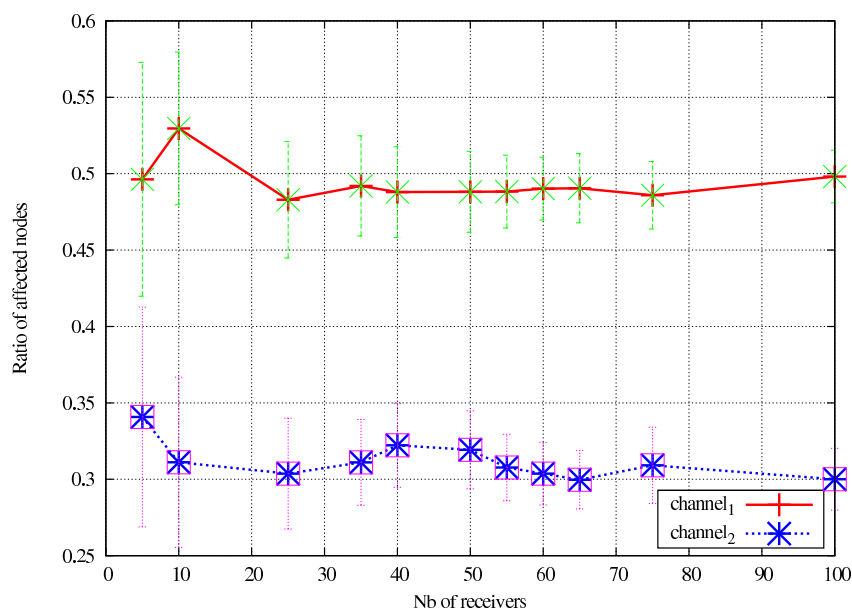

Figure 4.19: Multi Channel - Different Overlap region - Poisson Distribution

ment of PR receivers. As in, the primary users tend to be deployed further from the vulnerable area. For instance, even 200 receivers were deployed, the ratio of affected nodes was lower than the deployment of 80 or 50 receivers in Fig. 4.20 and Fig. 4.21 respectively. Hence, envisaging the distribution over the overlap area and applying the proper prediction model to estimate the density of the receivers could be a new approach to protect the primary receivers in general.

In summary, the simulation results reflect the relationship between the overlap area and the impact on the primary receivers with homogeneous distributions of PR re-

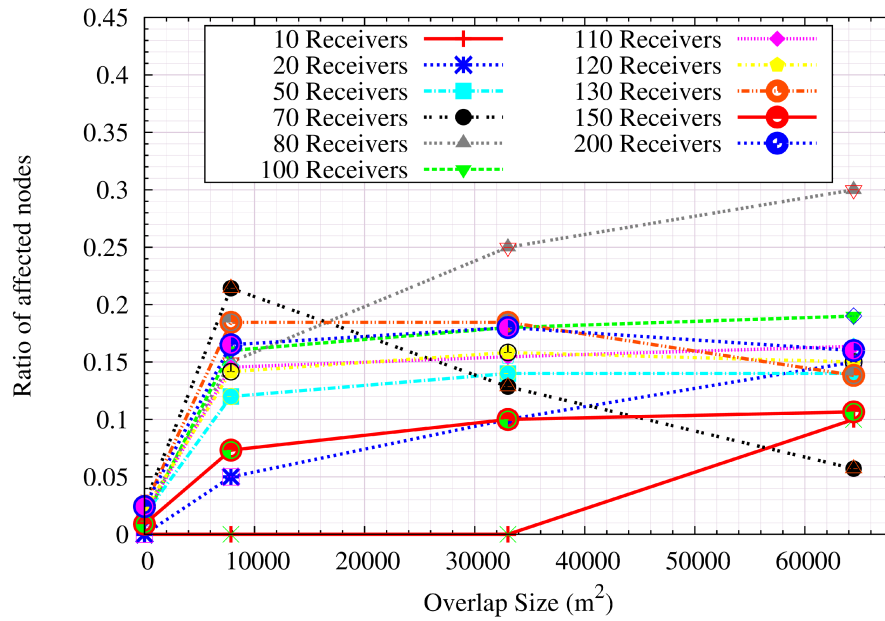

Figure 4.20: Single Channel - Big Reception Zone - Arbitrary Deployment

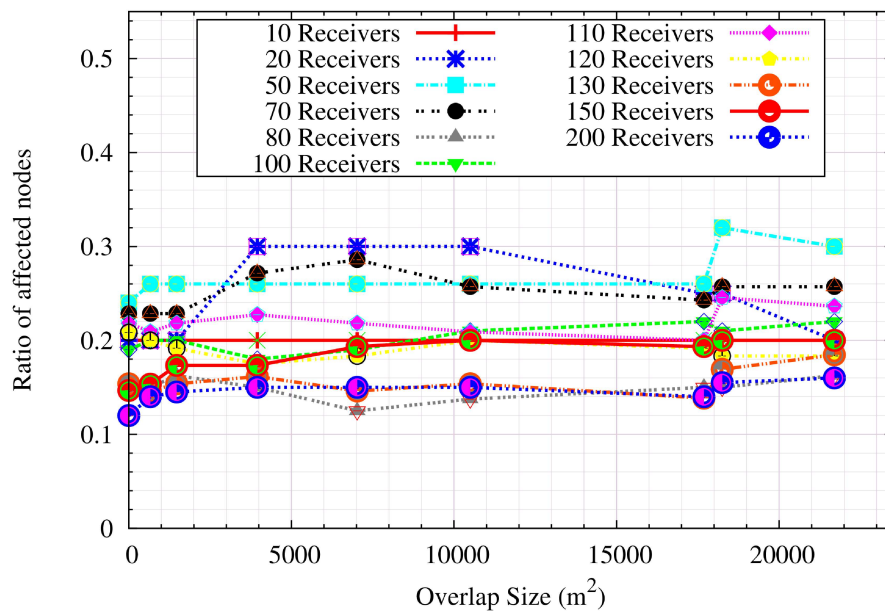

Figure 4.21: Single Channel - Small Reception Zone - Arbitrary Deployment

ceivers. However, positions of PRs may be impacted by practical considerations such as obstacles, buildings, mountains, etc. that prevent regions of the coverage area from containing receivers.

Therefore, a prediction model to estimate the location of these devices is required. The Grey prediction model appears to be an appropriate tool to solve the problem. With Grey model, based on the previous receiver power, we can predict the mobility of the mobile node at time $t+t'$. Hence, we can predict the location where a node may

exist.

4.3.2 Grey Model GM(1,1) and Kalman filter validation test

We present a test to validate the feasibility of two chosen prediction models, Grey GM(1, 1) and Kalman filter. We choose to investigate the estimation via a study case where the location of PR receivers can be predicted assuming that we got the historical location of these PRs. Since GM(1, 1) requires a time series as an input, we consider using the RSSI series associated with the given distance. Then we can obtain the PR position based on their transmitting/receiving power. The relationship between transmission power and reception power in free space can be approximated by [17] as the followings:

$$P_r(d) = \frac{P_t G_t G_r \lambda^2}{(4\pi d)^2 L}$$

Where P_r and P_t are received and transmitted power respectively, G_r and G_t denote the antenna gains of receiver and transmitter, L the system loss factors (a.k.a. filter losses and antenna losses), d the distance between the transmitter and the receiver and λ is the wavelength of the transmit signal in meters. Thus, knowing the PR positions based on their transmitting/received power by the CR node, the system (i.e. Cognitive Radio emitter) could estimate the changes in their position and number of PR receivers from the overlap region. According to this information, CR node could adapt its transmitting parameters (power) to minimise possible impact to PR systems.

First of all, the Grey GM(1, 1) was tested. We generated a random distance series which is a time series alike. Then a series of RSSI is generated according to this distance series using the equation in 4.3.2. Ten thousands (10000) samples were generated as the input series for the Grey GM(1, 1). The output result of the GM(1, 1) reflects the predicted value of the RSSI according to the given distance.

Fig. 4.22 shows the relationship between the received signal and the distance. The predicted values are close to the original values. Hence, the future position was predicted based on this received signal and the current position. This example (Fig. 4.22) allows us to estimate the different positions of the PRs in the overlap region and to characterize the overlap region with PRs mobility. The sensitivity range for this case has a limit that approaches the $-100dBm$. These results can also be the basis for adaptive transmission power selection.

Secondly, we compared the Grey GM(1, 1) and Kalman filter with the same configuration and same input series to investigate the outcome of each model. Again, we generated a random series of distance. Then, the RSSI was generated according to this distances. We took a ten thousands (10000) sample as an input series for the test. The observed results shown that the predicted RSSI were close to the original series

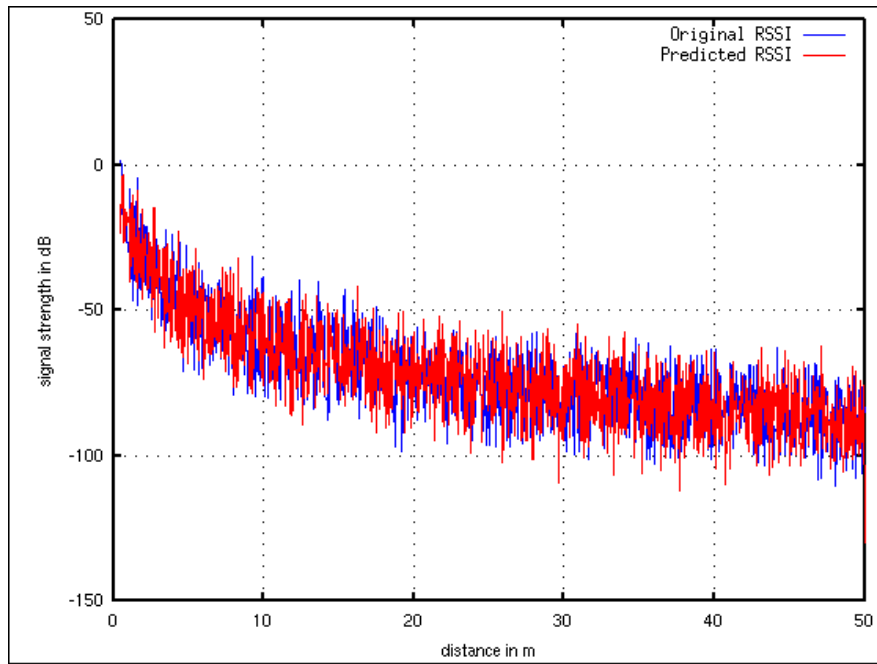

Figure 4.22: Received power and PR position prediction with Grey Model GM(1, 1)

in both models. Besides, since we chose a large sample size for the input series, the bias between the original and predicted the values in the plots (Fig. 4.23 and Fig 4.24) are minor. It meant that the large the size of the sample, the more accurate predicted value can be obtained.

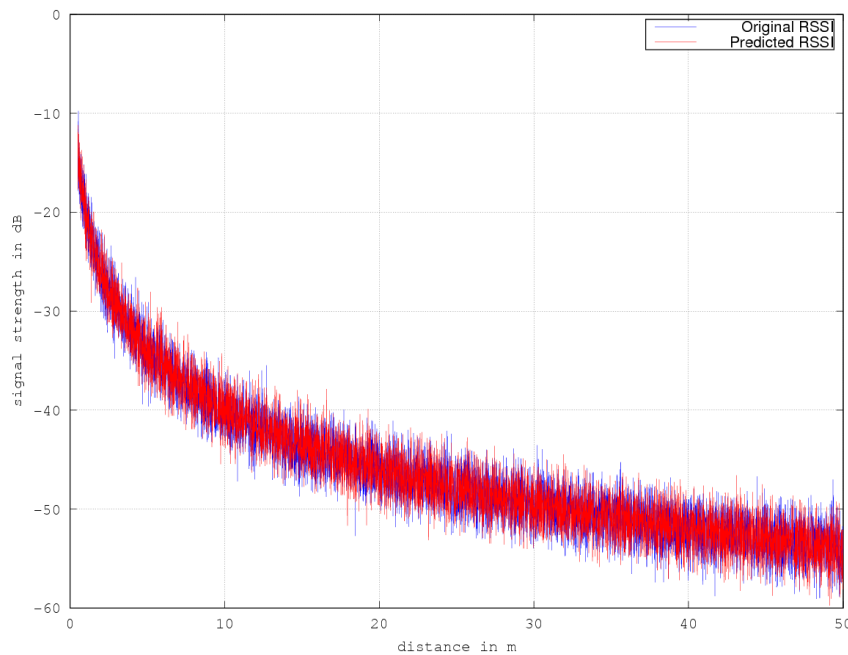

Figure 4.23: Relation of RSSI and distance with Kalman Filter

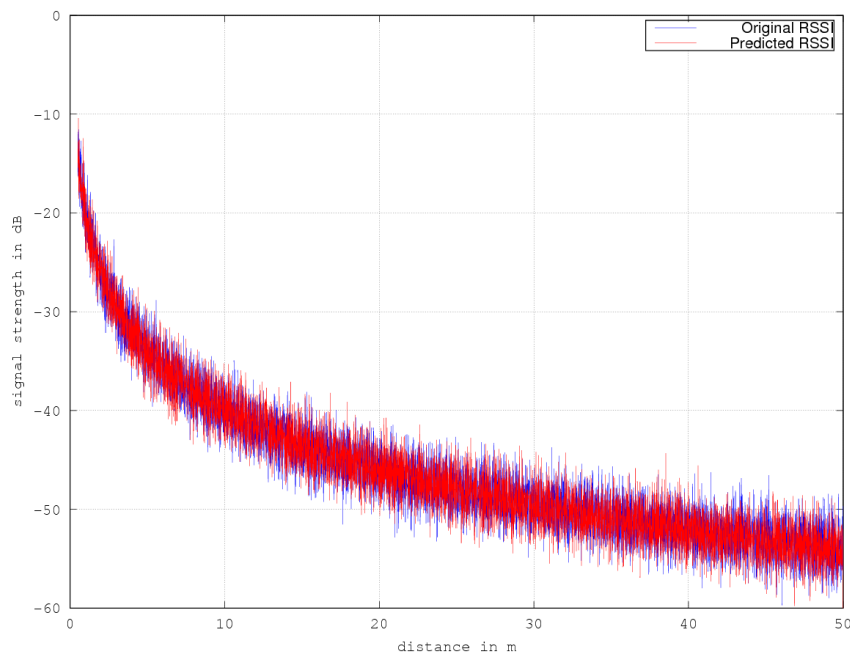

Figure 4.24: Relation of RSSI and distance with Grey Model GM(1, 1) - identical series with Kalman Filter

4.4 Conclusion

In this chapter, we provide an observation of the effect of the CR transmission on the Primary receivers and its relation to the overlap area. All possibilities are characterized with associated computation for overlap regions. The according impact is also observed and evaluated with Omnet++ simulator. The obtaining results clearly illustrated the association of the overlapping phenomenon and possible impact on the primary receivers if CR and PR coexist. On the other hand, the work also considers the other perspective of the coexistence topology between these two systems such as the propagation model of the hypothesis, the receivers density and obstacles in-between the two emitters.

Along with the observation, we also investigate two approaches to predict PR receivers within the reception zone of PR emitter: Grey Model and Kalman Filter. With Grey Model, we presented the feasibility of obtaining the estimation with limited knowledge of the area and its historical node density. The idea of the work can be applied in e-health area, and one of its application was published in Mobile Health 2013 [145]. Our observations provided important inputs to estimate a relative interference to the PR system.

Chapter 5

Fuzzy-based Routing Strategy

In Chapter 4, we focused on the environment observation at CR devices' point of view to detect the possible impact of CR's communications on PR receivers. In this chapter, we will try to answer the following question: How can we benefit from our observations results in order to improve primary receivers' protection and network accessing efficiency? One of the possible solutions consists in the definition of a strategy to combine the overlap size with the PR receivers density into a metric that can be taken into account while routing data in CRN with the presence of primary networks.

The metric that we define is the level of the interference that may occur when overlap happens between a CRN and a primary network. This interference reflects the impact that we have investigated in the Chapter 4. In this chapter, we study how the routing process could react and make the right decisions to maximise the use of the resource while ensuring avoiding interference with the primary receivers. To evaluate the interference level, we propose to use fuzzy logic technique. Indeed, the fuzzy logic engine that we propose will provide an interference level estimation. Then, the obtained estimation of the interference level will be used as a new metric by the routing process in CRNs. Thus, we propose to include that interference level in the routing metrics used by a concrete routing protocol, the DYMO protocol.

5.1	Fuzzy logic and wireless applications	84
5.2	Fuzzy-based routing in wireless network	85
5.3	Fuzzy logic-based routing metrics in CRNs	87
5.4	Routing design propositions	107
5.5	Experiment Guidelines in Omnet++	117
5.6	Conclusion	121

5.1 Fuzzy logic and wireless applications

Fuzzy logic theory was developed to generalize 'true and false' values to any value between 0 and 1 [146]. It also presents the approximate knowledge that may not be expressed by conventional crisp method (i.e. bivalent set theory). This theory is suitable for treating any vague problem that may require complex mathematical solutions. For instance, an application that needs a complex decision-making process but lacks necessary knowledge such as controlling transmitting power or network access selection in wireless networks.

A fuzzy logic system with two inputs and one output is represented in Fig. 5.1. The fuzzy sets are sets of unsharp boundaries objects in which the membership is a matter of degree (in the range of 0 to 1). For instance, a fuzzy set of *weekend* may contain half of Friday, Saturday, and Sunday and a set of *weekdays* may contain from Monday to the first half of Friday. So, Friday can be in both sets with a distinctive degree. To identify the degree of these variables, a membership function is used to reason all the related information. The membership function assigns a value to the interval $[0, 1]$ to a fuzzy variable and denoted as $\mu(\textit{weekend}(\textit{day}))$, where *weekend* is a fuzzy set, and *day* is a fuzzy variable.

Input crisp values are mapped or fuzzified to produce an appropriate linguistic value thanks to corresponding membership functions. Inference engine will then base on defined rules (If-Then-Else) to accommodate to fuzzy outputs. These outputs are fuzzified thanks to the output membership functions and integrated into a single crisp value thanks to the defuzzifier.

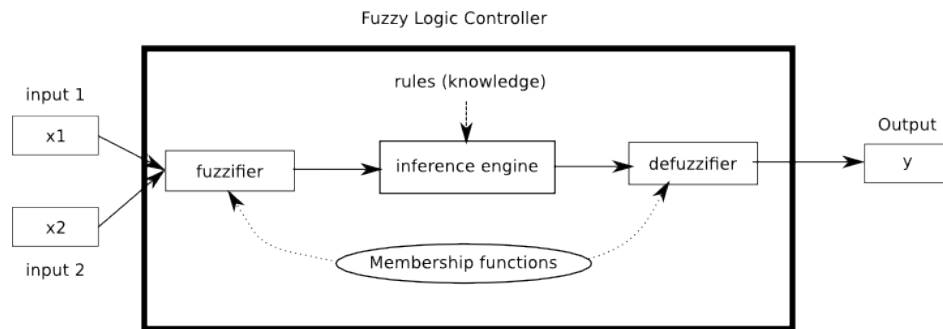

Figure 5.1: General fuzzy logic system

5.1.1 Fuzzy logic and wireless applications

In wireless communication, particularly in ad-hoc networks, choosing the proper routing strategy is a challenging task due to the various factors to take into account. Among these factors, we can cite the environment characteristics, and the application needs.

The purpose of a routing protocol is to establish paths which are stable while ensuring fast recovering after interruptions. In ad-hoc networks, a chosen path must not only produce low interference but also has to adapt to spectrum changing, that is the main reason for intermittent connectivity problem. Cognitive radio technologies with its reconfigurability will allow meeting this need.

Cognitive radio makes a decision based on its environment observation information even though this knowledge may be unclear. In this context, fuzzy logic can yield useful outputs with incomplete, approximate and vague information (low or high interference, acceptable or semi-acceptable available radio resources). In addition, fuzzy logic does not require too complicated computations since it is based on If-Then-Else rules. Hence, we can use fuzzy logic in real-time cognitive radio applications for which the response time is critical for the system performance [147].

5.2 Fuzzy-based routing in wireless network

Fuzzy-decision based routing was introduced in [148] for Mobile Ad-hoc NETWORK (MANET) in 2002. Wong et al., developed a routing protocol on top of the classical Dynamic Source Routing (DSR) protocol. The proposed routing protocol aimed to achieve the fairness of all the routing input metrics and route packets based on QoS priority. They used fuzzy decision engine to support service differentiation and quality of service. Three matrices such as node speed, node loss and end-to-end delay were fuzzified to produce the output that showed how suitable a route was. Their results confirmed that three over five of the study cases outperformed the original routing

protocol for Constant Bit Rate (CBR), real-time Variable Bit Rate (rt-VBR), and non-real-time Variable Bit Rate (nrt-VBR). However, the routing load increased because more controlling messages had to be delivered. Another drawback was that the mobile node required a powerful processor and so higher power consumption.

Gasim et al. [112] applied fuzzy logic to differentiate resource allocation considering traffic importance and network state. They applied fuzzy logic to leverage multiple available paths to carry the packets simultaneously according to the importance of the service type. The goal of applying fuzzy logic was to determine how explored paths are used to carry the traffic from the maximal set of disjoint paths. First of all, a Fuzzy Logic Controller (FLC) was used to determine if a routing request was processed. Then, the precedence message (i.e., routine or priority or immediate or flash message) and the network status were calculated by the probability of available buffer capacity. Finally, an appropriate route discovery process was triggered to handle the request.

Rea et al. [113] used fuzzy logic to instruct route caching during path exploration process to ensure that only the routes with good quality were cached in DSR. The solution also used hop count as one of the metrics similarly to [112]. Furthermore, it used link strength and energy available at a link vertex as fuzzy inputs. The outcome was whether a path in a route request was cached or not, and continued with a route request rebroadcast. Only the request that had high link strength, good node energy, and low hop-count was cached. As a result, route request overhead was reduced thanks to the elimination of the unsuitable paths from the discovery process. The proposed solutions in [148, 112, 113] were not thoroughly dealing with the changes of the wireless environment. However, applying fuzzy theory in ad-hoc routing design is convincing.

Fuzzy logic has been applied in many routing proposals for WSNs. For example, Chiang and Wang [114] used fuzzy logic to optimize routing path in a distributed fashion. In a WSN context, the purpose of the proposed protocol was to minimise the network resource consumption (particularly energy consumption) and lengthen the lifetime of the sensor network.

Recently, Santhi et al. [149] applied Fuzzy Logic to combine different QoS criteria in a routing metric. So, ad-hoc mobile node used this metric to choose the most stable but least cost path. A similar approach can be used in CRNs with consideration of some the environment factors. The factors that may impact the routing decision as well as the routing performance like the resource availability and the interference with the legacy primary systems.

In Cognitive Radio network design, Baldo et al., [150, 151, 152] used Fuzzy Logic for controlling transmitting power of the secondary device when it coexisted with primary devices. Le et al. [153] based the network access in CRN on the Fuzzy Logic. The proposed solution combined multiple feedbacks of a device on network performance such as delay, throughput, and reliability. The authors showed that the output of this

network accessing scheme outperformed conventional scheme.

Another approach that used the Fuzzy Logic method to select an optimal path in CRN was proposed in [154]. Han et al. composed channel utilization and channel perception using the Fuzzy Logic system to select the shortest and low-cost route. The authors used Fuzzy Logic to solve the time changeable allocation problem in CRN as well as to adapt to the limited resources at the CR nodes. The proposed routing protocol was based on Ad-hoc On-demand Distance Vector (AODV) routing protocol. The simulation results proved that the proposed routing selection strategy brought better packet delivery ratio and better throughput compared to native AODV protocol. However, the interference from CRs' operation to PR's network was out of the scope of this solution.

Masri et al. [155] proposed a strategy that used fuzzy logic to compose multiple independent environment parameters for multihop routing in CRNs. They accounted for instantaneous variations of the environment and proved that channel selection must be part of routing decision with MAC layer supports. The outcomes of this proposal was a strategy on cognitive channel selection based on these instantaneous parameters. However, the routing establishment was implicitly done in path evaluation process. To be precise, in path evaluation process, the protocol examined the ability of the route to satisfy the required type of connection of the source. This proposal is well suited for path selection in CRNs. However, it did not take into account the interference caused in case of coexistence of CRN and PR network in the same area. Since this interference, observed and studied in chapter 4, is very important and may prevent the PR's communications in some cases, we will extend this proposal detailed in [155]. So, the extended version will take into consideration the interference level while selecting a routing path. Our solution consists mainly in the definition of a new routing metric that could guarantee the minimal impact on the primary system when it coexists with a CRN.

5.3 Fuzzy logic-based routing metrics in CRNs

In this work, we aim define a routing metric that can be used in CRNs. This metric should allow taking into account the interference caused by CR devices to the primary network. The interference issue was considered in Chapter. 4, where we tried to compute and evaluate it. Our task now is to combine two crucial factors (overlap and node density) into a metric that reflects the interference to the primary network. This metric helps to identify firstly the possible impact of a chosen route to the primary network, and secondly, to select the best route in terms of minimise perturbation to primary network while cognitive radio network operates. In this section, we detail how the value of the routing metric is obtained, before describing how it will be used by a

routing protocol to achieve an efficient path selection (section 5.4).

5.3.1 Basic implementation and results

First of all, we present a preliminary approach using fuzzy logic to combine overlap ratio and node density to estimate the interference level when primary and secondary system coexists. The inputs are the overlap ratio and the node density probability. Each of these two variables consists of two fuzzy sets, i.e., *Low* and *High*. The fuzzy output variable is interference level that is also a fuzzy set containing two fuzzy variables *Low* and *High*. A proper implication would be applied for each rule present in the rules table. Result from implication rule is then aggregated and defuzzified to obtain the final result. This final result is the degree of impact on the primary system. A CR can consider this degree before using a frequency range when overlap happens.

Overlap Ratio Fuzzy Sets

The ratio of an overlap area to reception zone of an emitter is taken as the fuzzy input variable. To make it simple and easy to understand, we first define two simple fuzzy sets *Low* and *High* that represent overlap ratio state. The Low set contains all values that indicate the low overlap ratio. For instance, overlap ratio is considered low when it is less than 50%. Otherwise, it is considered high. Note that, specific low and high boundaries are not precisely defined, since we can have different definitions of low and high. We are declaring the preliminary possibility in this context. It is said to be 100% low when the ratio is exactly between 0 and 20%. From 20% to further (e.g. 50%), the possibility of being low hence decreases while the possibility of being high increases. We describe the membership functions of these sets in trapezoidal or triangular shape. Overlap ratio membership functions are described in equations 5.1 and 5.2.

$$\mu_{Low}(x) = \begin{cases} 1 & 0 \leq x \leq 20\% \\ \frac{50\% - x}{30\%} & 20\% < x \leq 50\% \\ 0 & x \geq 50\% \end{cases} \quad (5.1)$$

$$\mu_{High}(x) = \begin{cases} \frac{x - 25\%}{50\%} & 25\% \leq x \leq 75\% \\ 1 & x \geq 75\% \end{cases} \quad (5.2)$$

To interpret the output of the antecedents (i.e., overlap ratio), we use Mamdani Min Implication [156] rules to extract the final result for Overlap ratio fuzzy set. Mamdani's method is the most commonly used in applications represented by a trapezoid shape in fuzzy logic, due to its simple structure of 'min-max' operations. For instance, at intersection part of two functions, an *or* operator is used to connect two sets, the maximum of two membership functions is evaluated for the antecedent part of the

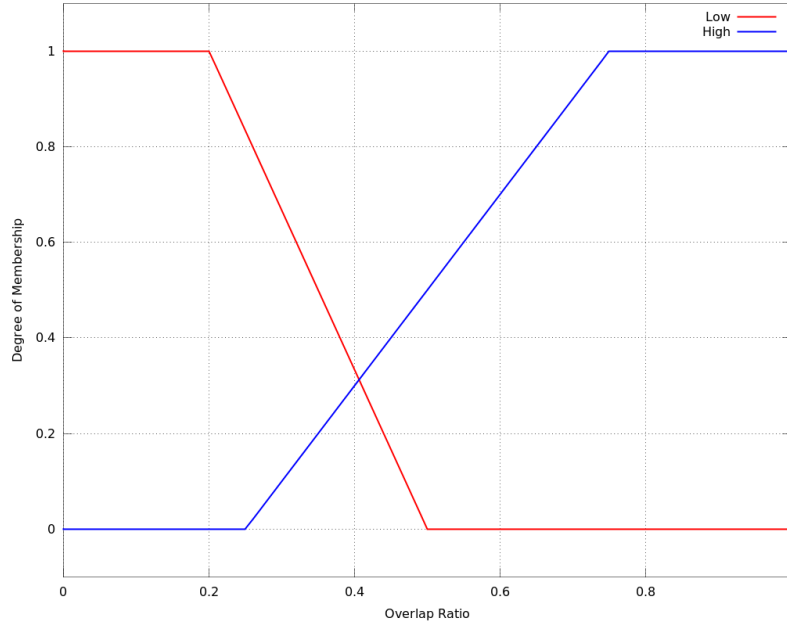

Figure 5.2: Membership function of Overlap Ratio

fuzzy rules. We use this method since synthesizing the set of linguistic control rules obtained from experience human operators. Besides, this is a widespread accepted, intuitive and well-suited for human inputs, as the parameters to consider in our case (overlap ratio and node density).

$$\begin{aligned}\mu_{OverlapRatio}(x) &= \mu_{Low}(x) \vee \mu_{High}(x) \\ &= \max[\mu_{Low}(x), \mu_{High}(x)]\end{aligned}\quad (5.3)$$

Basic Node Density Fuzzy Sets

Although the overlap size was proven to be associated with possible impact on primary receivers, the density of the primary receivers with PR's emitter disk also represents a considerable factor, as mentioned in Chapter. 4. Similarly to Overlap Ratio sets, we define two simple fuzzy sets *Low* and *High* to reflect how PR receivers are scattering within an area unit. The characteristic of the mobile receivers is discrete, independent and randomly distributed. Therefore, the distribution of the nodes in this context is assumed to follow Poisson distribution. The expected density value X yields from Grey Model explained in Chapter. 4. The mutual independent event occurs at a known and constant rate r per unit (time or space). From the historical data (i.e. the input series for Grey Model), we can compute the possible average density m that represents the estimated rate λ . The probability the area has at most X receivers

within an area unit is the Poisson accumulate density function of $P(X \leq x)$

$$P(X \leq x) = \frac{e^{-\lambda} \sum_{i=0}^x \lambda^i}{i!}$$

The higher probability of predicted density is, the higher possibility the receivers get the impact. We consider that the low value of $P(x)$ belongs to fuzzy set Low, while the high value belongs to fuzzy set High. Node density reflects the probability of the number of receivers that may be affected. The membership functions of Node Density are also presented in trapezoid-shape, similarly to Overlap Ratio fuzzy sets, as shown in Fig. 5.3.

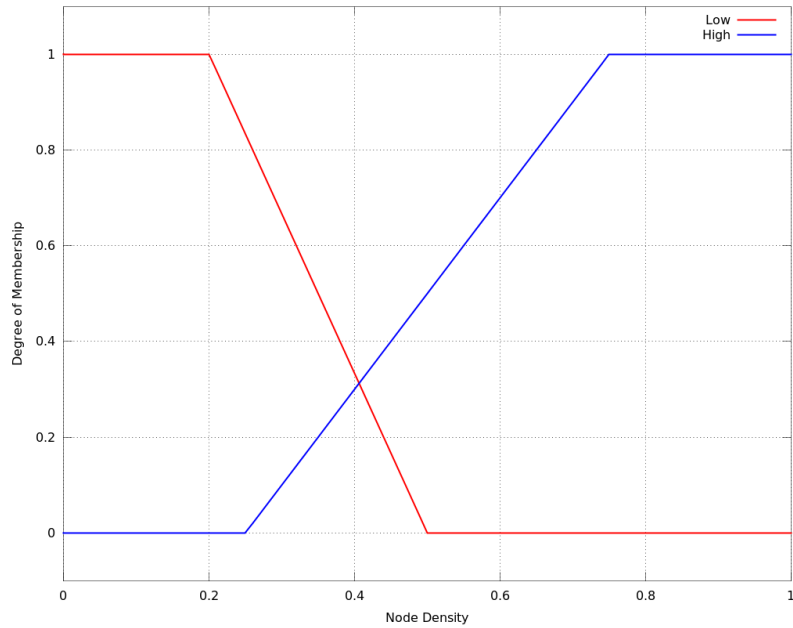

Figure 5.3: Membership function of Node Density

Basic rules table and interference level fuzzy set

Since Overlap ratio and Node Density are two independent parameters with different properties and characteristics, we combine these two sets using a rules table as following. Output of the combination represents the interference level (e.g. Low or High level of interference) to the primary system under particular overlap degree $\mu_{OverlapRatio}(ratio)$ and primary receiver density degree $\mu_{Density}(P_x)$. Interference level is used to foresee how much impact could be caused to the primary receiver. Therefore, the density of these nodes are prioritized in the rules table shown in Table. 5.1.

We used GNU-Octave with plug-in fuzzy logic toolkit to extract the rule statement as follows. With the input we provided into the fuzzy logic toolkit, it produces the followings interpreted rules.

Overlap Degree	Density Degree	Interference Level
Low	Low	Low
High	Low	Low
Low	High	High
High	High	High

Table 5.1: Interference Level Rules Table

- If (overlapRatio is low) and (nodeDensity is low), then (InterferenceLevel is low) (1)
- If (overlapRatio is low) and (nodeDensity is high), then (InterferenceLevel is high) (1)
- If (overlapRatio is high) and (nodeDensity is low), then (InterferenceLevel is low) (1)
- If (overlapRatio is high) and (nodeDensity is high), then (InterferenceLevel is high) (1)

The indicator in the parenthesis of each rule identifies the certainty of the statement or weight [157] of each rule. This weight is relative to the others, e.g., a high overlap ratio combined with a low node density makes the interference low, the certainty of interference is at 100%. This weight is set manually or automatically; it is 1 by default. For each rule, the rule weight is the truth value of the aggregated antecedent multiplied by the degree of support for the rule (for example, the degree support for low overlap ratio is between 0 to 20%). As we could see that this is too simple to make the case. However, to make it coherent, we would like to present how we applied fuzzy logic theory for this study case in this section.

The defined rules table is expressed by the If-Then construct. For instance, if both the overlap ratio and the density are low, interference level is low. The interference level is also low when the overlap ratio is high, and the density is low. This explains the case where we have big overlap and low receivers operating in the emitter's reception zone. The if-part statement of the rule is called *antecedent* or premise, while the then-part is called *consequence* or conclusion. In this context, the premises are the overlap ratio and the density degree, while the consequence would be the interference level. The consequence is also a fuzzy set. We define the fuzzy sets of interference level in Fig. 5.4.

Using plug-in Fuzzy logic toolbox of Octave [158], which is a Matlab-like fuzzy logic toolbox, we verify the design fuzzy inference system of interference level with two inputs: overlap ratio and node density probability. The membership functions of the inputs as well the output are plotted in a trapezoidal or triangular shape. These plots are gradually shown as following in this chapter.

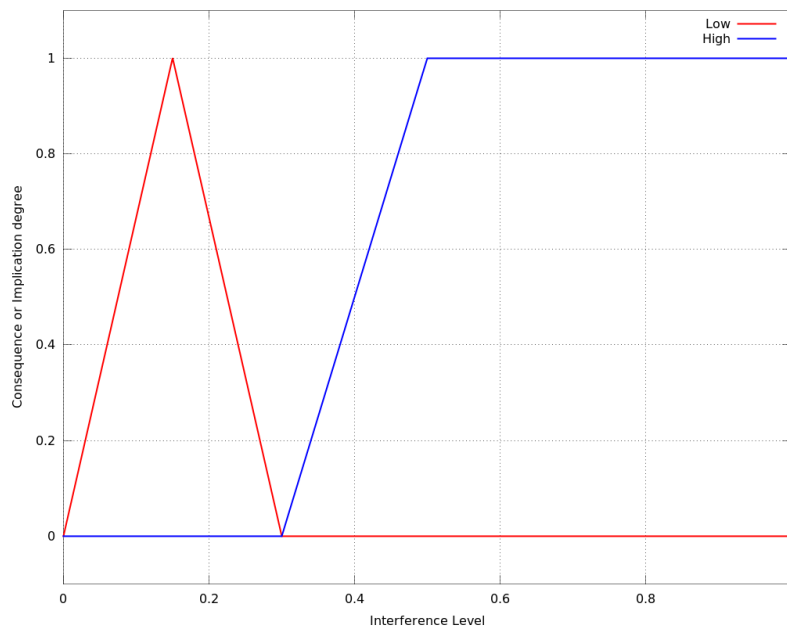

Figure 5.4: Membership function of the output Interference Degree

In general, the inputs of these rules are the current values of overlap ratio degree and density degree. And the output would be the entire fuzzy set of interference level (e.g. *Low* or *High* set). This set is then defuzzified. The defuzzification process assigns a single value to indicate the interference ratio. The mapping is done from left to right as shown in Fig. 5.5 [157].

Numerical results

We can also observe this reflection in the diagram in Fig. 5.6. Unsurprisingly, when overlap ratio is high and receivers density is high; interference level is hence high. Interference level is the same (high) in the case of low overlap ratio and high receivers density. Details on numerical results are shown in Table 5.2 and Table 5.3. Each of the variables presented in Fig. 5.6 reflects both the linguistic and the crisp values. For instance, when the overlap degree and density Degree are zeros, the interference is low (coded with orange) with high probability (more than 50%). When the overlap ratio is high with (over 60% certainty) and the node density degree is low (below 20%), the interference level is low with low probability (the dark blue area). It explains the fact that, the interference level is connected to the 20% degree of node density that might be affected by the big overlap ratio. The higher the node density is, the higher the interference level and the probability are.

Table 5.2 represents the numerical data after fuzzification and defuzzification process of Overlap Ratio fuzzy sets. *Overlap Ratio* is the overlap ratio of the overlap region

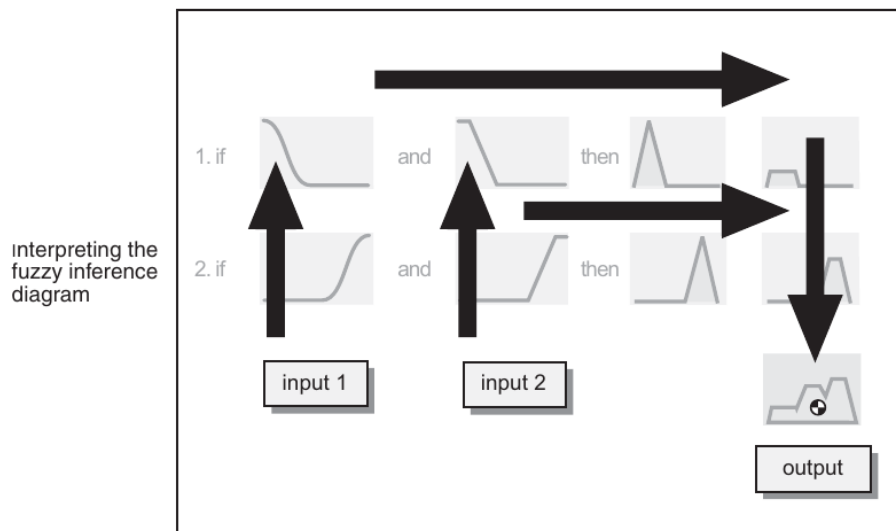

Figure 5.5: Fuzzy Inference Mapping Diagram

Index	Overlap Ratio	$\mu(x)$ Low	$\mu(x)$ High	$\mu(x)$ Overlap Ratio	Overlap Degree
1	0.8685786	0	1	1	High
2	0.7543719	0	1	1	High
3	0.0878475	1	0	1	Low
4	0.7334334	0	0.96687	0.96687	High
5	0.0093621	1	0	1	Low
6	0.1661	1	0.355069377	0.355069377	Low
7	0.0555839	1	0	1	Low
8	0.7621468	0	1	1	High
9	0.0338584	1	0	1	Low
10	0.399828	0.33391	0.29966	0.33391	Low
11	0.8408368	0	1	1	High
12	0.8967195	0	1	1	High
13	0.3182583	0.60581	0.13652	0.60581	Low
14	0.1853683	1	0	1	Low
15	0.462081	0.1264	0.42416	0.42416	High
16	0.32288	0.5904	0.14576	0.5904	Low
17	0.9822648	0	1	1	High
18	0.5146803	0	0.52936	0.52936	High
19	0.5928336	0	0.68567	0.68567	High
20	0.8125646	0	1	1	High

Table 5.2: Overlap Degree Fuzzification Output with 20 random different values of the input of Overlap Ratio

to the PR emitter reception zone. This is the fuzzy input of fuzzification process to map this value to the linguistic variables *Low* and *High*. The fuzzy logic controller

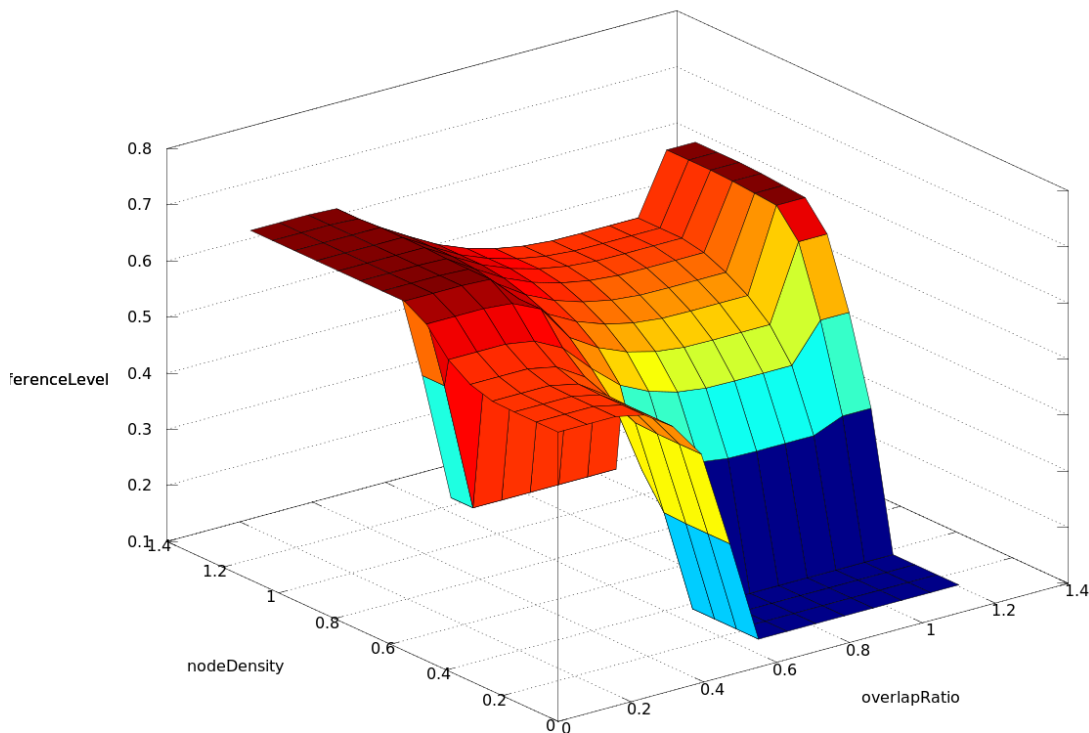

Figure 5.6: Interference level basic implementation

uses the membership functions defined in Fig. 5.2 to fuzzify the input ratio. $\mu(x)_{Low}$ and $\mu(x)_{High}$ present the fuzzified values obtained from equation 5.1 and equation 5.2 respectively. For example, at index 2 (Table 5.2) input ratio that equals 0.7543719 is interpreted as 0% Low and 100% High according to the membership functions defined in Fig. 5.2. These outputs are evaluated as 100% high overlap (e.g. columns μx Overlap Ratio and Overlap Degree) by Mamdani Min Implication in (5.3).

Same processes are done and presented in Table 5.3. We argue that both Density Degree and Overlap Degree are two main factors that affect the level of probable interference. With Mamdani implication, it finds the centroid of this two-dimensional functions to produce the final grade of the Interference Level. Low overlap ratio combined with low density probability would result in a low interference level. The defuzzified value of this outcome is produced by taking the central point in the area under the curve of Overlap Ratio and Node density according to the input values.

Table 5.4 shows the final result output after aggregating the two fuzzy sets: Overlap Degree and Density Degree. We can see that if overlap ratio is low, and density degree is low, interference level is hence low (first row of the table in Table 5.4). Crisp value column represents the defuzzified output of Overlap and Density degree sets. For

Index	Poisson Distribution of Node Density	$\mu(x)$ Low	$\mu(x)$ High	$\mu(x)$ Node Density	Node Density Degree
1	0.428626	0.23791	0.35725	0.35725	High
2	0.628075	0	0.75615	0.75615	High
3	0.304221	0.6526	0.10844	0.6526	Low
4	0.473434	0.08855	0.44687	0.44687	High
5	0.737709	0	0.97542	0.97542	High
6	0.990624	0	1	1	High
7	0.622994	0	0.74599	0.74599	High
8	0.803581	0	1	1	High
9	0.320865	0.59712	0.14173	0.59712	Low
10	0.617651	0	0.7353	0.7353	High
11	0.109057	1	0	1	Low
12	0.547376	0	0.59475	0.59475	High
13	0.38512	0.38293	0.27024	0.38293	Low
14	0.994956	0	1	1	High
15	0.447447	0.17518	0.39489	0.39489	High
16	0.735339	0	0.97068	0.97068	High
17	0.875212	0	1	1	High
18	0.370649	0.43117	0.2413	0.43117	Low
19	0.271246	0.76251	0.04249	0.76251	Low
20	0.029703	1	0	1	Low

Table 5.3: Density Degree Fuzzification Output with 20 random different values in consistent to the overlap ratio

example, (index 1 in Table 5.2), interference level is at 50.757% high when overlap degree is 100% high, and density degree is 35.725% high. The followings indexes are the corresponding outputs of overlap and density degree antecedents in Table 5.2 and Table 5.3.

With this first simple study case, we can see that interference level depends on the predicted density degree. However, it provides the glimpse of considering overlap and density for better protection of primary receivers in CRNs. We found that the binary variable as *Low* and *High* is not sufficient to evaluate how severe the interference level is to the path selection (for example, too high or reasonable low for path selection). An extension of this approach is then introduced below. It is an enhanced version of overlap and density fuzzy sets, which results in a new definition of the rules table.

Index	Overlap Degree	Density Degree	Interference Level	Crisp value
1	High	High	High	0.50757
2	High	High	High	0.59057
3	Low	Low	Low	0.62641
4	High	High	High	0.5348
5	Low	High	High	0.72308
6	Low	High	High	0.72308
7	Low	High	High	0.72308
8	High	High	High	0.61563
9	Low	Low	Low	0.63024
10	Low	High	High	0.64309
11	High	Low	Low	0.15
12	High	High	High	0.56647
13	Low	Low	Low	0.61414
14	Low	High	High	0.72308
15	High	High	High	0.56676
16	Low	High	High	0.68812
17	High	High	High	0.61563
18	High	Low	Low	0.49032
19	High	Low	Low	0.25603
20	High	Low	Low	0.15

Table 5.4: Interference Level Fuzzification Output

5.3.2 Fuzzy processes refining

As stated, the first definition introduced in section 5.3.1 only consisted two subsets (Low and High) for each variable (overlap ratio and node density). The margin of being low or high was hence considerable large. Therefore, it is not sufficient to justify the level of interference after the defuzzification process. For instance, at index 5 on each table (Table 5.2 and Table 5.3) indicated that overlap ratio was extremely low (0.0093621) and the node density was rather high (0.7377), respectively. The interference level in this case should not be too high since the overlap size was really small. However, the result of the our proposed Fuzzy Inference System (FIS) concluded that the IL was high (0.72308 at index 5 on Table 5.4). Consequently, we need to redefine the overlap and node density fuzzy sets to reduce the margin of being high or low to correctly justify the IL.

Extended Overlap Ratio Fuzzy Sets

We consider that the overlap ratio is low when the ratio is from 0 to 10%. The membership function of Low overlap ratio reflects the degree of low overlapping which follows the idea of the possibility of low overlap is lower and lower after 10% of overlap. The possibility of low overlap decreases when the ratio increases. Other possibilities could be medium or high overlap after a specific boundary. For instance, the input value of an overlap ratio is at 25%, the probability of being Low is 25%. And if the probability of being Medium is 33%, we can conclude that the input is at medium overlap degree. We redefine the overlap fuzzy set as following. The fuzzy set of overlap ratio contains four linguistic variables:

$O_{fuzzyset} = \{low, medium, high, veryhigh\}$, in which

- $low : 0 < \frac{A_{overlap}}{A_P} \leq \frac{3}{10}$
- $medium : \frac{2}{10} < \frac{A_{overlap}}{A_P} \leq \frac{5}{10}$
- $high : \frac{4}{10} < \frac{A_{overlap}}{A_P} \leq \frac{7}{10}$
- $veryhigh : \frac{A_{overlap}}{A_P} > \frac{6}{10}$

Extended Node Density Fuzzy Sets

Same principle is applied on Node Density fuzzy sets. Indeed, we define 4 linguistic variables corresponding to 4 fuzzy sets *Low*, *Medium*, *High* and *Very High*. Assume that the density of the receivers is defined as $d_r = \frac{N}{A_P}$ where N , the total number of

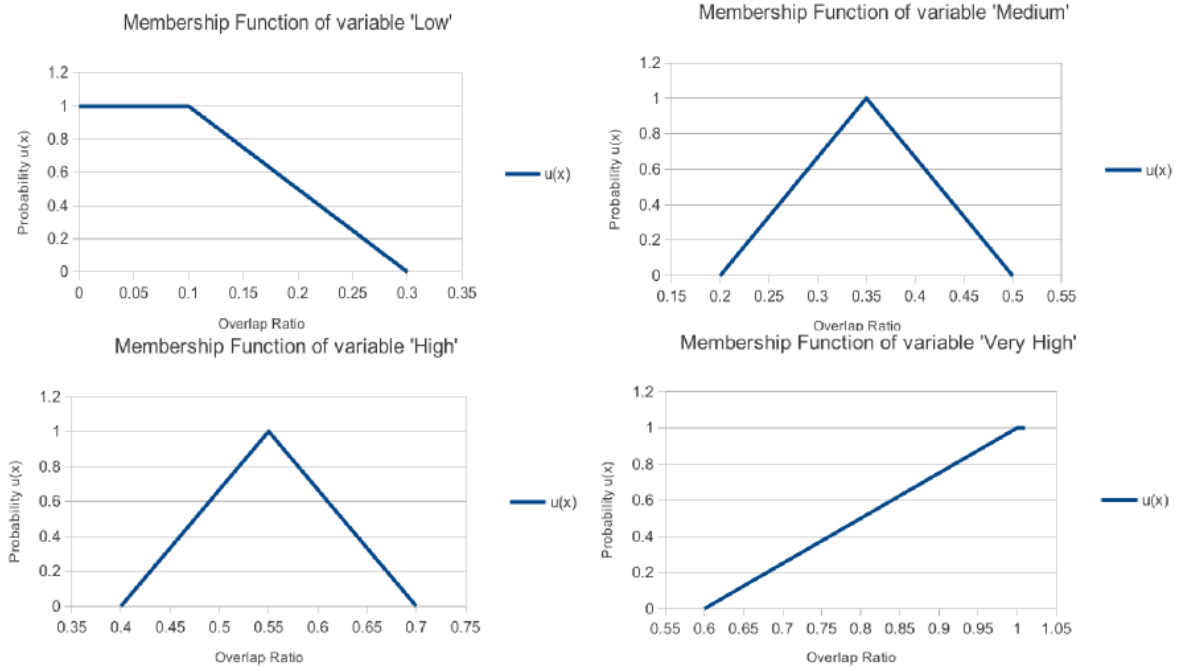

Figure 5.7: Extended overlap ratio fuzzy functions following definition in 5.3.2

receivers within the reception zone of an emitter, A_P the total area size of the zone. Therefore, within a specific area A_0 , the average number of receivers are $n_{avg} = d_r * A_0$

As a node existence is independent from the others within an area, the probability of x nodes which exist within A_0 follows Poisson process with mean $\lambda = n_{avg}$. This probability is given by equation 5.4.

$$f(x) = P(X = x) = \frac{\lambda^x}{x!} e^{-\lambda} \quad (5.4)$$

The probability the area has more than the average number of receivers within A_0 is the Poisson accumulate density function of $P(X \geq x)$ with $x \geq \lambda$ becomes $P(X \geq x) = \frac{e^{-\lambda}(e\lambda)^x}{x^x}$

Since the attributions of node density and overlap ratio are similar, the membership functions for Node Density sets will be defined similarly to those of the overlap ratio.

Interference Level Rules and Outputs

As the inputs are re-defined, the output of this enhanced inference system is re-defined. A proposed rules table for these new fuzzy sets is defined in table 5.5. As we can see that with the first approach (in section 5.3.1), the rules illustrate only two states of the interference level: *low* and *high*. In the enhanced approach, we introduce two more variables to enrich the input fuzzy sets: *medium* and *veryhigh*. The rules should be also adapted to the changes occurring on these variables.

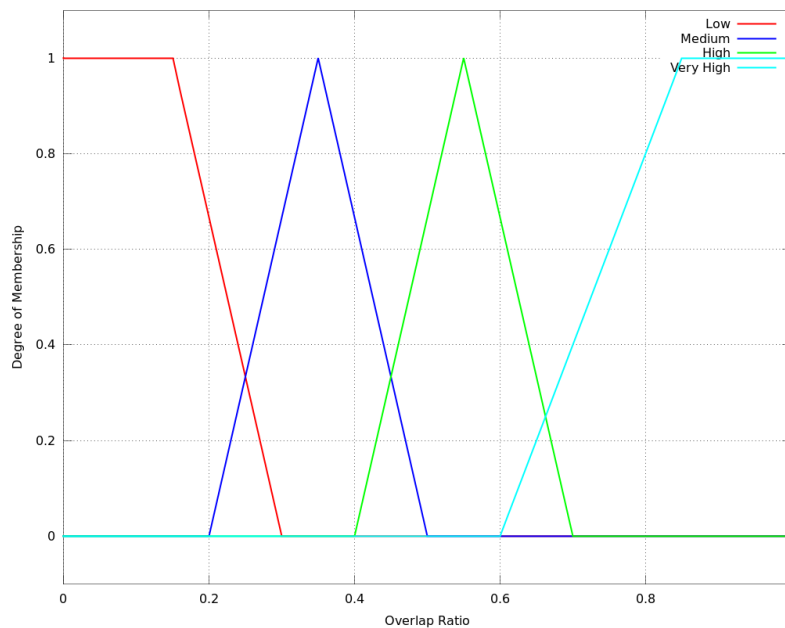

Figure 5.8: Fuzzification of overlap ratio from its membership functions

Practically, the level of interference can be at a reasonable degree (e.g., medium). As we can see, in the first approach the interference level is high even when the overlap ratio is low and the node density is high. Now, a node density of 30% (high level in the first approach) corresponds to the medium level in the new approach. For instance, it can be at 30% high that we redefined it to be medium. The interference level is then adapted to be medium too. It means that the caused interference in this case is not severe.

For instance, the above rules (on Table 5.5) infer the followings by the fuzzy toolkit of GNU-Octave [158]. This toolkit is supporting the boundary which the implication is verbally rendered according to the edge of the defined membership functions. We use built-in boundary with four English terms, "somewhat", "very", "very very", "extremely". They are calculated by the power of $\mu^{1/2}$, μ^2 , μ^3 , μ^4 [158].

- If (Overlap-Ratio is Low) and (Density-Ratio is Low), then (Interference Level is Low) (1)
- If (Overlap-Ratio is Low) and (Density-Ratio is Medium), then (Interference Level isn't Low) (0.5000)
- If (Overlap-Ratio is Low) and (Density-Ratio is High), then (Interference Level is somewhat High) (1)
- If (Overlap-Ratio is Low) and (Density-Ratio is Very High), then (Interference Level is High) (1)

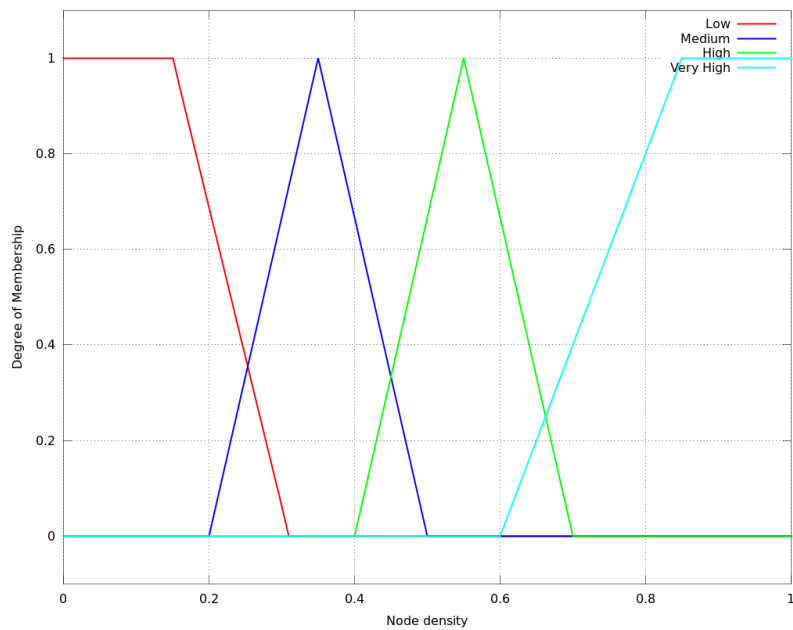

Figure 5.9: Fuzzification of Node Density from its membership functions

Index	Overlap Ratio	Density	Interference Level
1	Low	Low	Low
2	Low	Medium	somewhat Medium
3	Low	High	somewhat High
4	Low	Very High	High
5	Medium	Low	somewhat Low
6	Medium	Medium	Medium
7	Medium	High	High
8	Medium	Very High	Very High
9	High	Low	Medium
10	High	medium	somewhat High
11	High	High	High
12	High	Very High	Very High
13	Very High	Low	Medium
14	Very High	Medium	very High
15	Very High	High	extremely High
16	Very High	Very High	extremely very High

Table 5.5: Enhanced Interference Rules Table

- If (Overlap-Ratio is Medium) and (Density-Ratio is Low), then (Interference Level is somewhat Low) (1)
- If (Overlap-Ratio is Medium) and (Density-Ratio is Medium), then (Interference

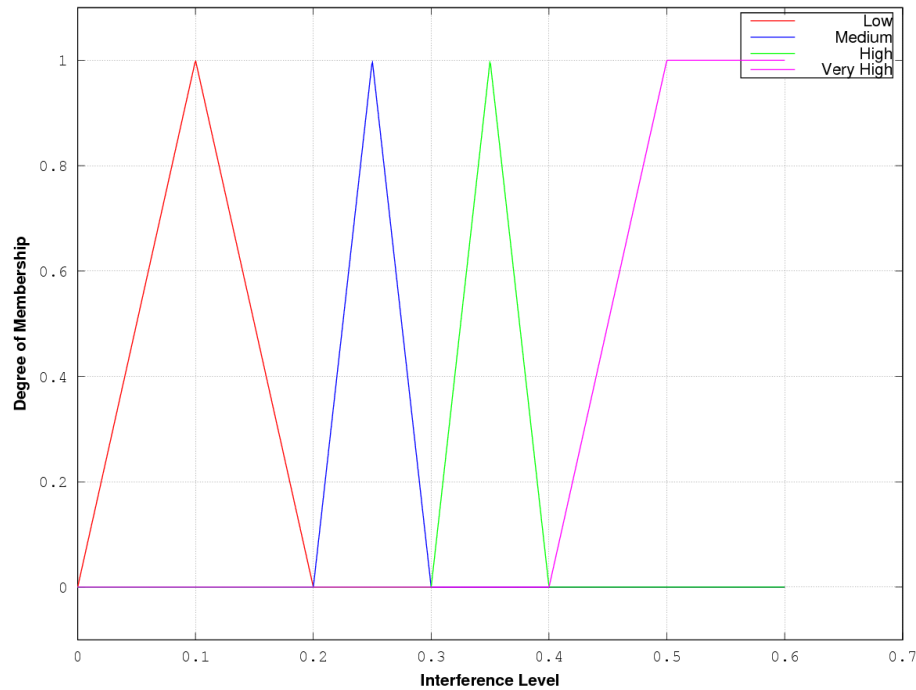

Figure 5.10: Enhanced interference level fuzzy membership functions

Level is Medium) (1)

- If (Overlap-Ratio is Medium) and (Density-Ratio is High), then (Interference Level is High) (1)
- If (Overlap-Ratio is Medium) and (Density-Ratio is Very High), then (Interference Level is Very High) (1)
- If (Overlap-Ratio is High) and (Density-Ratio is Low), then (Interference Level is Medium) (1)
- If (Overlap-Ratio is High) and (Density-Ratio is Medium), then (Interference Level is somewhat High) (1)
- If (Overlap-Ratio is High) and (Density-Ratio is High), then (Interference Level is High) (1)
- If (Overlap-Ratio is High) and (Density-Ratio is Very High), then (Interference Level is very Very High) (1)
- If (Overlap-Ratio is Very High) and (Density-Ratio is Low), then (Interference Level is Medium) (1)
- If (Overlap-Ratio is Very High) and (Density-Ratio is Medium), then (Interference Level is very High) (1)
- If (Overlap-Ratio is Very High) and (Density-Ratio is High), then (Interference Level is extremely High) (1)

- If (Overlap-Ratio is Very High) and (Density-Ratio is Very High), then (Interference Level is extremely Very High) (1)

The ratio of overlap area and the nodes density in the reception zone are the inputs of the fuzzy system. These values activate the rules (basically If-Then-Else statement). The next step is using fuzzy inference engine which combines the rules to obtain the aggregated fuzzy outputs. The outputs are the fuzzy sets of the interference level that are defined in Fig. 5.10. The fuzzy controller has to defuzzify these output into crisp values using centroid method to make the final decisions. The central point of the whole area is extracted to render most average value under the curves. Fig. 5.11 shows the system output as a function of 2 variables, overlap ratio, and node density, with the set of 16 rules.

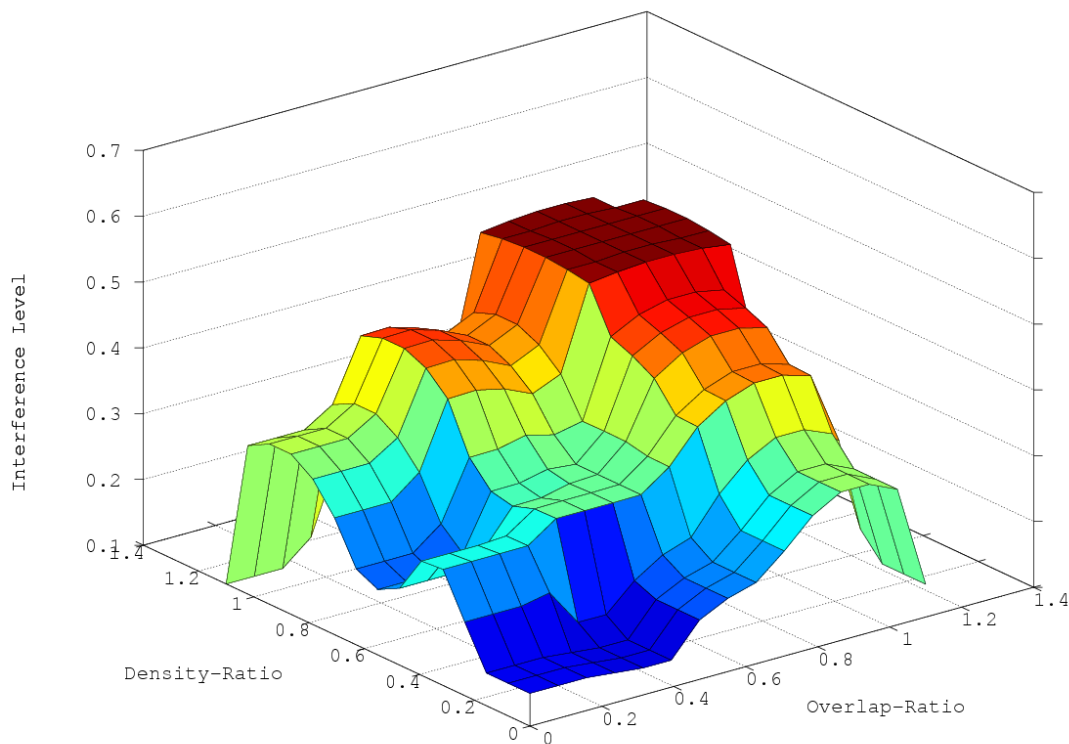

Figure 5.11: Interference Level Output as function of Overlap and Node Density - Rule set of 16

Then, to validate our propose Fuzzy Inference System (FIS), we performed some test with GNU Octave. The obtained results are summarised in Table 5.6, Table 5.7 and Table 5.8. To illustrate how the system interpreted the input values with the provided membership functions, we consider the example shown in Figures 5.12 and 5.13. In this example, let's consider an overlap ratio of 0.2893 and a node density probability

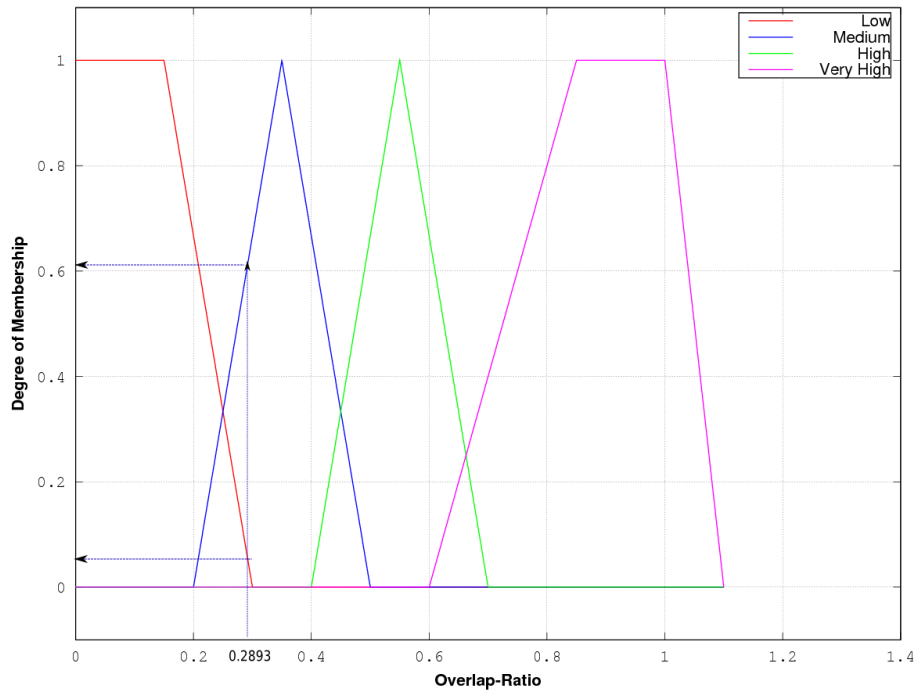

Figure 5.12: Overlap ratio fuzzification example

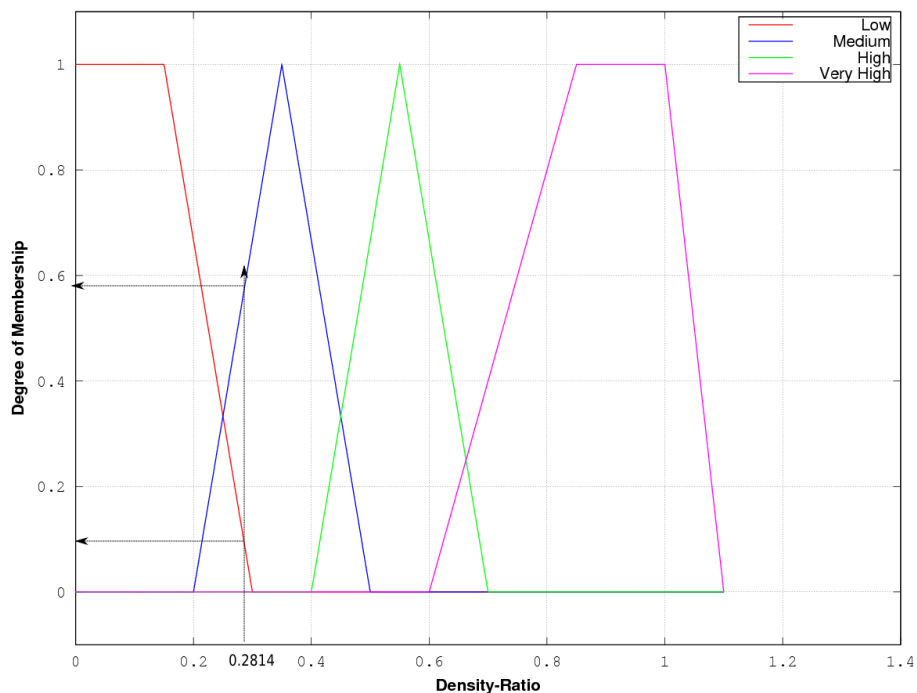

Figure 5.13: Node Density probability fuzzification example

of 0.2814. The inference system estimates the overlap ratio around 5% low and 61% medium (Fig. 5.12). Similarly, node density probability of 0.2814 is fuzzified as 10% low and 58% medium (Fig. 5.13). These values are used to obtain the interference level thanks to the inference system and Interference level membership functions as shown in Fig. 5.14. The blue area below the curves in Fig. 5.14 is the area which was created

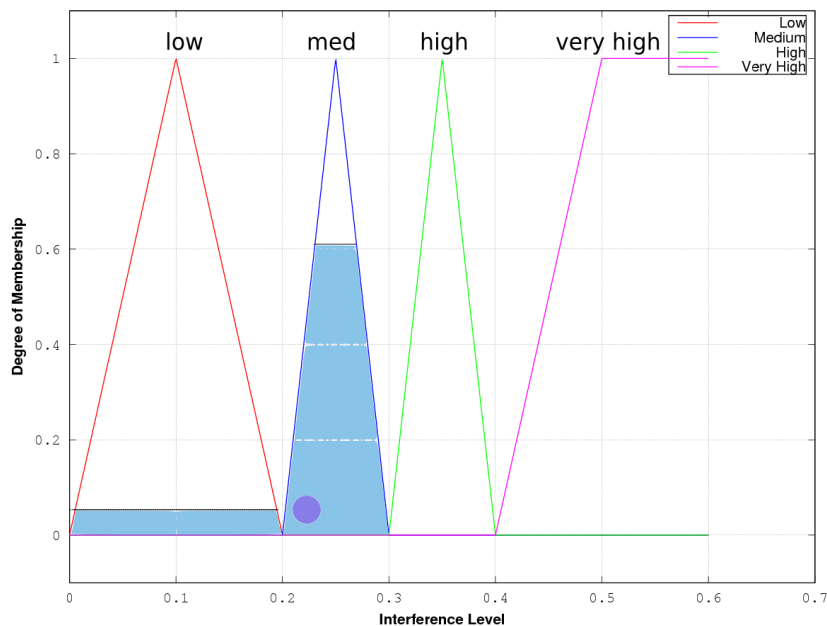

Figure 5.14: Aggregated Interference level

by the outputs of overlap ratio and node density probability in this example. As the result, the interference level in this example is the circle-like dot represented by the centroid computation in this area. It is a medium interference level.

For more detailed results, we performed other tests. In these tests, we try to evaluate the interference level in 16 random cases. In these tested cases, we randomly create the fuzzy system inputs, but the values of these inputs could correspond to real world cases of interference between CRN and primary network.

We presented numerical outputs of the fuzzification process of the inference system with two sets, overlap ratio and node density probability. We randomly generate inputs for our proposed FIS. Table 5.6 and Table 5.7 show the fuzzified data of the inputs based on their defined membership functions. We can observe that the crisp values are converted into linguistic values thanks to the membership functions in Fig. 5.8 and Fig. 5.9. The reversed process is done at the output Table 5.8 where the inputs are fuzzified according to the Interference Membership function in Fig. 5.10. The rules are applied in defuzzification process to produce the final crisp value of the Interference level.

Index	overlap ratio	$\mu(x)$ Low	$\mu(x)$ Medium	$\mu(x)$ High	$\mu(x)$ Very High
1	0.2559572948187629	0.2936180345415806	0.3730486321250859	0	0
2	0.5782854804259209	0	0	0.811430130493861	0
3	0.7796715441449785	0	0	0	0.7186861765799142
4	0.4601201936341917	0	0.2658653757720552	0.4008012908946112	0
5	0.5036098904944681	0	0 0.690732603296454	0	
6	0.4440169557390617	0	0.373220295072922	0.2934463715937444	0
7	0.1916581384025917	0.7222790773160556	0	0	0
8	0.06274811845172305	1	0	0	0
9	0.6656591967473759	0	0	0.2289386883508269	0.2626367869895039
10	0.3990502446735325	0	0.6729983688431165	0	0
11	0.5316290870098186	0	0	0.8775272467321237	0
12	0.7541364572667245	0	0	0 0.6165458290668981	
13	0.5342011732503661	0	0	0.8946744883357737	0
14	0.6568026833433304	0	0	0.2879821110444641	0.2272107333733215
15	0.4033487796932065	0	0.6443414687119563	0.0223251979547101	0
16	0.6545286585070226	0	0	0.3031422766198494	0.2181146340280904

Table 5.6: Overlap degree fuzzification data

The input values are generated randomly using normal distribution in Octave. Overlap degree fuzzification data and Density degree fuzzification data are presented in Table 5.6 and Table 5.7 respectively.

Index	Density probability	$\mu(x)$ Low	$\mu(x)$ Medium	$\mu(x)$ High	$\mu(x)$ Very High
1	0.08048508526618459	1	0	0	0
2	0.1990789828328513	0.6728067811143246	0	0	0
3	0.5748014106920747	0	0	0.8346572620528356	0
4	0.7497027560068379	0	0	0	0.5988110240273516
5	0.3758603099662863	0	0.8275979335580914	0	0
6	0.6676395155576322	0	0	0.2157365629491183	0.270558062230529
7	0.281822668633451	0.1211822091103269	0.5454844575563398	0	0
8	0.6676395155576322	0	0	0.2157365629491183	0.270558062230529
9	0.8184238337367057	0	0	0	0.8736953349468228
10	0.7497027560068379	0	0	0	0.5988110240273516
11	0.7497027560068379	0	0	0	0.5988110240273516
12	0.475608579276362	0	0.1626094714909198	0.5040571951757465	0
13	0.281822668633451	0.1211822091103269	0.5454844575563398	0	0
14	0.3758603099662863	0	0.8275979335580914	0	0
15	0.6676395155576322	0	0	0.2157365629491183	0.270558062230529
16	0.5748014106920747	0	0	0.8346572620528356	0

Table 5.7: Density degree fuzzification data

Table 5.8 describes the aggregate output values of the correspond fuzzy logic controller (FLC). The 2nd and 3rd columns contain respectively the values of the overlap ratio and density probability variables (values extracted from Table 5.6 and 5.7), while the interference level column contains the inferred linguistic value. Then, the crisp value represents the actual value reflecting the corresponding interference level.

Index	Overlap input	Density input	Interference Level	Crisp Value
1	0.2559572948187629	0.08048508526618459	Low	0.142360168203297
2	0.5782854804259209	0.1990789828328513	Medium	0.214644380010403
3	0.7796715441449785	0.5748014106920747	High	0.4709177026154472
4	0.4601201936341917	0.7497027560068379	High	0.4270776509376505
5	0.5036098904944681	0.3758603099662863	High	0.3068306457544435
6	0.4440169557390617	0.6676395155576322	High	0.3949458639936706
7	0.1916581384025917	0.281822668633451	Medium	0.2647142347368112
8	0.06274811845172305	0.6676395155576322	Medium	0.2423137269573083
9	0.6656591967473759	0.8184238337367057	Very High	0.4710294298018818
10	0.3990502446735325	0.7497027560068379	Very High	0.4335945341870531
11	0.5316290870098186	0.7497027560068379	Very High	0.4005290205238545
12	0.7541364572667245	0.475608579276362	Very High	0.4499710602804636
13	0.5342011732503661	0.281822668633451	Medium	0.272725560404169
14	0.6568026833433304	0.3758603099662863	High	0.3582435091685925
15	0.4033487796932065	0.6676395155576322	High	0.3812774816128402
16	0.6545286585070226	0.5748014106920747	High	0.3793001898855203

Table 5.8: Interference Level fuzzification data

More precisely, the fuzzy logic controller infer the fuzzified outputs of the inputs (fuzzified outputs of each linguistic variable of overlap ratio and node density probability) to the associated consequences. The inference engine decomposes an input of overlap ratio at index 1 of 0.255957 into $\mu(\text{low})$ at 0.293618 and input of density probability of 0.080485 into $\mu(\text{low})$ at 1. This composition matches the first rule in Table 5.5 - *If (Overlap-Ratio is Low) and (Density-Ratio is Low), then (Interference Level is Low)*. These following rules match the input values of the overlap ratio and node density probability.

- If (Overlap-Ratio is Low) and (Density-Ratio is Low), then (Interference Level is Low) (1)
- If (Overlap-Ratio is Low) and (Density-Ratio is Medium), then (Interference Level isn't Low) (0.5000)
- If (Overlap-Ratio is Medium) and (Density-Ratio is Low), then (Interference Level is somewhat Low) (1)
- If (Overlap-Ratio is Medium) and (Density-Ratio is Medium), then (Interference Level is Medium) (1)

In fact, the centroid computation is applied to compute the central value of the area under the aggregated area - the light blue area in Fig.5.14. And the interference level is the purple circle under the light blue area in Fig.5.14.

Depending on the method that we defined at the beginning, the consequence of these antecedents is calculated and mapped to the membership functions of the interference level fuzzy set. In this example, *Min* implication method evaluates the outcome, which

computes the interference output (0.04115). However, this is not yet the final result since after matching all the possible fuzzified inputs with the rule knowledge, all the outcomes are decomposed/defuzzified to produce a single crisp value (refers to the diagram in Fig. 5.5). This will be the final output of the whole process.

In this section, we proposed an approach based on fuzzy logic to evaluate the interference level in the case of coexistence of CRN and primary networks. Since the first approach (presented in section 5.3.1) was too simple, we provided a more refined approach with more precision. Each proposed approach was tested using the fuzzy logic toolkit and numerical values were extracted in about 2.8s. We ran the tests on a basic personal computer (processor Intel Core i5 2.5GHz with 8GHz RAM). However, this performance parameter will depend on the used system. Note that, this processing time did not include plotting the membership functions and the 3-dimensional surface showing the FIS outputs.

5.4 Routing design propositions

There exist three types of routing protocol design for mobile networks: proactive, reactive and hybrid. A proactive routing protocol allows a node to establish a route to all destinations regardless applications' demand. On Link State Routing (OLSR) is a well-known proactive routing protocol. As for reactive routing protocol, a node only initiates routing explorations upon applications' demand. Ad-hoc On-Demand Vector (AODV) and Dynamic Source Routing (DSR) are two common reactive routing protocol. Hybrid protocol merges the advantages of both proactive and reactive. DYMO is an example for hybrid routing protocol

Now, the interesting questions are the followings. Which routing protocol can work efficiently in Cognitive Radio Networks? How could these routing protocol be adapted to have an optimal operation? To answer these questions correctly, we must know that routing protocols in CRNs should:

- avoid periodic message since redundant messages are sometimes causing collision and confusing,
- avoid acknowledgment over the CR link, so as the overhead of the protocol is not too big,
- detect primary users' existence so as routing exploration process does not cause severe impact to the primary networks.

In this section, we propose to extend an existing routing protocol to take into account the interference level between CRN and primary network while selecting a route for a communication in the CRN. The protocol we chose is the DYMO (Dynamic MANET

Protocol	Type	Metric	Periodic message	Acknowledgement message	Applicable network
DSR	Reactive	Shortest path	Yes	Yes	Ad-hoc but less dynamic than AODV
OLSR	Proactive	Shortest path	Yes	Yes	MANETs
AODV	Reactive	Hop count	Yes	Yes	MANETs
DYMO	Hybrid	Hop count with alternative metrics	No	Optional	VANETs and MANETs

Table 5.9: Routing protocol comparison table

On-demand) protocol. This choice could be motivated by the suitability of DYMO due to its main features. Indeed, the results of a comparison between some routing protocols for MANETS and VANETS shows that DYMO performs better than OLSR, especially in VANETs where the mobility of nodes is high and the surrounding changes quickly [159]. Another study on DYMO performances was provided in [160, 161]. All these work concluded that DYMO outperformed the existing routing protocol for MANET in terms of packet delivery, delay, and compatible throughput.

5.4.1 DYMO Operation

The DYMO routing protocol has been defined in an IETF specification (Internet draft version 4.0) [162]. This protocol is the successor of the AODV routing protocol. Thus, it has some similarities with AODV such as the activation of route discovery only when a route is needed. Loop prevention is done by including a sequence number in each routing message. A node creates a route only when it has a demand for sending data messages to the target node. Therefore, the intermediate nodes maintain and detect topology changes while listening to these exchanging data messages. No HELLO packets are needed in comparison to AODV. Thus, the change is detected faster, and the overhead caused by extra control messages is lower. However, some requirements of DYMO should be taken into account to guarantee the best performances. The protocol assumes that links are bidirectional. It hence relies on the reliability of the lower layers to provide essential environment state information. This relation will be discussed after the description of the main operations of DYMO in MANET.

Route Discovery

When a mobile node wants to establish a path to communicate to another node in the network, it has to discover a path to reach the destination node. To do so, this node or so-called the source, generates a route request and transmits it to any of its known neighbours. Each of these neighbours including the source and the target node will maintain the active discovered link via a routing table that is created right after the discovery process finished. Each entry contains basic information for routing, such as, addresses of source and destination, sequence number, hop-count, next hop address, next interface, timestamp of last used, expiration time, metric type, and metric route state.

We provide an example in Fig. 5.15 to illustrate the route discovery process of DYMO in MANET. Mobile node A wants to reach the mobile node F. A is the source, and F is the destination in this scenario. A firstly creates its route request RREQ that contains its information such as originator address, target address and also its sequence number. This information will be maintained at the routing table of A. The RREQ is then flooded to B and G, the neighbors of A. The intermediates node B and G verify the information in the RREQ and determine that this RREQ is not a request for them. B and G then increase the sequence number and keep flooding this RREQ to their neighbor C. Unfortunately, C receives both RREQ from both directions with the same sequence number. Here, the path selection will depend on hop count and another alternative metric. If the alternative metric was not pre-set, it does not matter which path will be chosen. In this case, let assume that C records the route involving B and C. C is still not the target mobile node. It then carries on forwarding this RREQ to the next hops, D and F. F is already the target destination while D is not. While F replies the request with its RREP, D records the route and still sends over this RREQ to E. And E again forwards RREQ to F. Of course, the request F received from E will be discarded. The RREP from F will be transferred on the reverse path from F back to C, B and A (the source). The data transmission will then follow.

Upon sending the RREQ, originator node (A) has to wait for a RREQ WAIT TIME for the RREP. In case, there is no RREP received, A will properly attempt to send another RREQ with a different sequence number. This default waiting time is set to 1000 milliseconds. Once the RREP is created and sent back, the flow of traffic of RREP is unicast. Therefore, it heavily relies on the MAC to ensure the bi-directional link underneath the network layer.

An example scenario of a CRN without PR's is provided in Fig. 5.15.

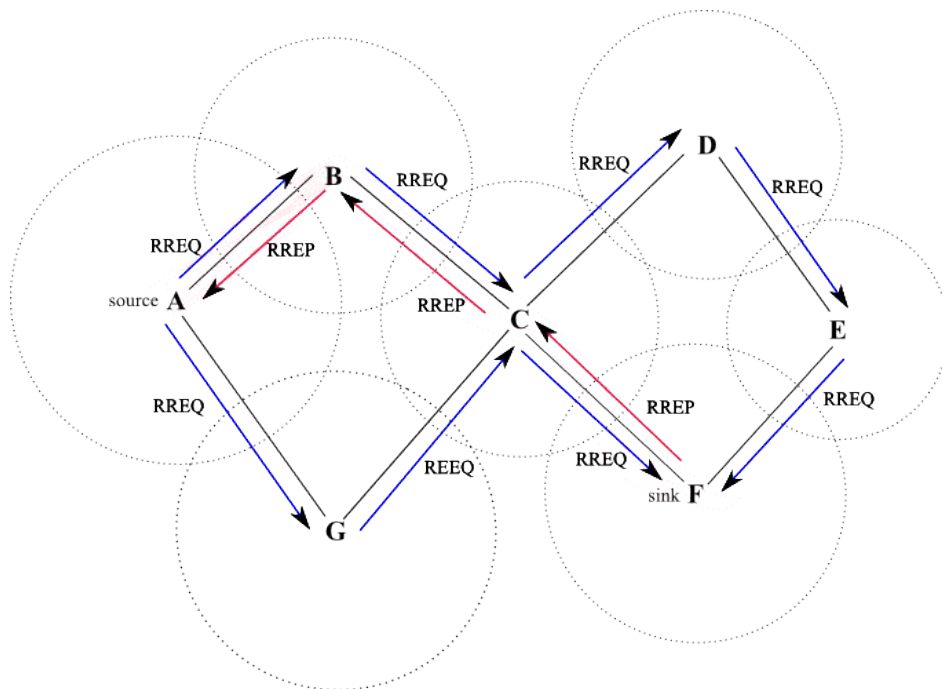

Figure 5.15: DYMO Route Discovery from source A to sink F without PR's existence

Route Maintenance

Each node that has received a route request and a reply has to maintain the active route locally by monitoring the communication exchanging along the path. However, when there is a problem in the network, a route error (RERR) may be generated and transmitted by the detecting nodes to its neighbours. The two most common problems are: broken links on current active route and un-recorded path from a received data packet.

Before using a route to forward a packet, a node must check the status of the route as follows. If the route is marked as Broken, this node will not use this path. Otherwise, if the *Current_Time* is higher than the *Route.ExpirationTime*, the route has expired and cannot be used. However, if the route is currently not in use when $(Current_Time - Route.LastUsed) < (MAX_SEQNUM_LIFETIME)$, this route table entry must be expunged. When generating a RERR, a node creates a list of unreachable destinations including their addresses with associated sequence number and its routing table is updated.

In case of undeliverable packet, the RERR may be multicasting or unicasting to the neighbor from which the data packet was sent. For unicast RERR, the PktSource MsgTLV (Message Type-length-value) is mandatory included in the header. The PktSource MsgTLV contains the source IP address of the undeliverable packet. In case of broken link, the RERR is sent to all neighbors of the node that experience a broken link. After the other intermediate nodes receive the RERR, they verify the information contained in the RERR to react to the event. Figure 5.16 shows an example illustrating the whole process.

Since DYMO allows for including an alternative metric for route selection process, we can modify the protocol to take into account the interference phenomenon considered in chapter 4. An example of the use of DYMO in this context is illustrated in Fig.5.17. In this example, we have a coexistence of a CRN and a primary network. Thus, the alternative routing metric that we propose to use is the interference level.

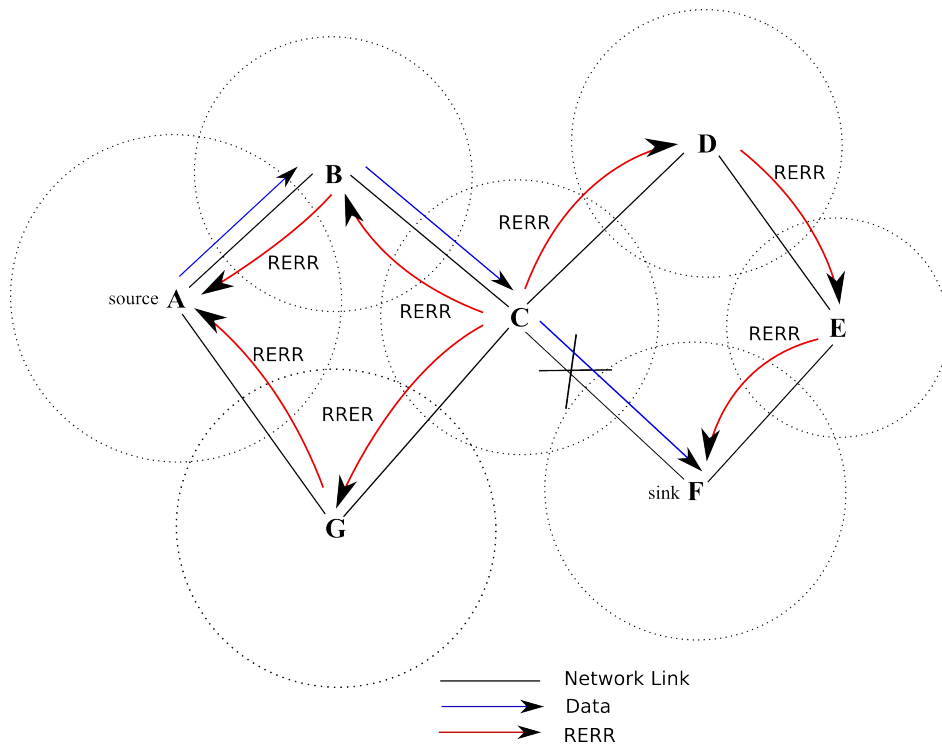

Figure 5.16: DYMO Route error sent from C when there is a broken link. Route Error RERR is generated from C and then sent towards all of C's neighbors including B, G, and D to prevent future data transmission towards link C-F. These nodes had already recorded a path containing F, therefore the RERR is further sent to A and E.

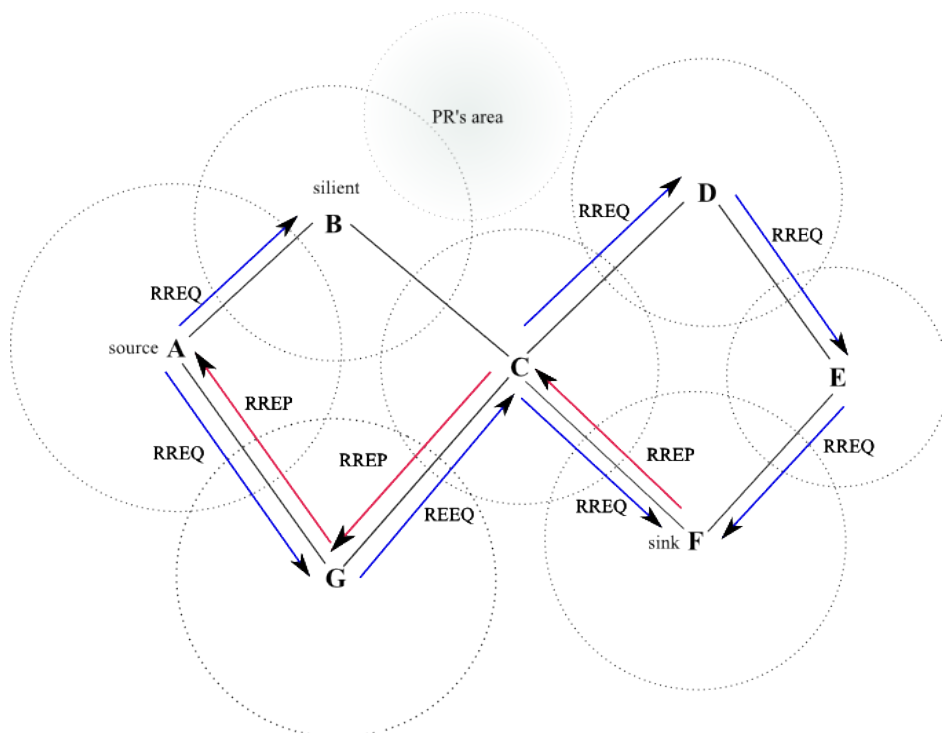

Figure 5.17: DYMO Route Discovery from source A to sink F with PR's existence. We assume that B is kept in silent as it operates in the area where it overlaps with a PR transmitter.

Alternative Metric

The hop Count is traditionally used as the default metric to select a route for a target node. However, some applications may require other metric information because the Hop Count may unfortunately cause the selection of the worst route in some situations. In Cognitive Radio Networks, sometimes, Hop Count metric is not sufficient to choose a route to a target without interfering with the operating primary networks. The authors of AODVv2 [162] have discussed an alternative metric in a draft [163]. An alternative metric measures the "cost" of a route on the basis of various parameters like latency, delay, monetary, or energy.

The protocol specification in [163] provides the abstract function to evaluate the cost of each route; $\text{Cost}(R)$ where R is the route for which the cost is calculated. The route information for R must always include the type of metric by which $\text{Cost}(R)$ is evaluated. Using this alternative metric should guarantee a loop-free environment while the routing engine is operating. Since the work on the specification of DYMO-AODVv2 is still on progress, specific descriptions for some types of alternative metric are provided. In this work, we try to use it to evaluate the efficiency of the use of interference level as an alternative metric in preventing impact on primary networks.

5.4.2 CRN-DYMO routing protocol

Overlap ratio and density factors regarding primary receivers are computed and stored locally at each station. A node will make the decision on which channel it can transmit. So, the modification is mostly at the decision phase of AODV protocol. At the origin, this stage should be done before a routing request is send over the medium. Similarly, the process at intermediate and destination stations is also invoked before any further control messages are sent.

Let's consider the abstraction framework that we mentioned at the beginning of this thesis, Fig. 5.18. The DYMO routing agent can obtain the neighbour's information from the radio-events-table (proposed in Chapter 6) and the interference level from the interference level estimator. The bidirectional link is maintained thanks to the beacon protocol (proposed in Chapter 6).

Customized DYMO-CRN protocol uses the interference level as an alternative metric for route selection as explained in Fig.5.19 and Fig.5.20. In Fig. 5.19, we describe the route discovery, which is initiated by node A to look for a path to node E in presence of an overlap with a PR. We assume that at C, the sequence numbers in the RREQs are the same for both directions, from B to C and from G to C. But the interference levels from B is medium with non-zero probability. Similarly, F is preferred to D. Thus, the selected path is A – G – C – F – E. In Fig. 5.20, we have the same scenario with a second

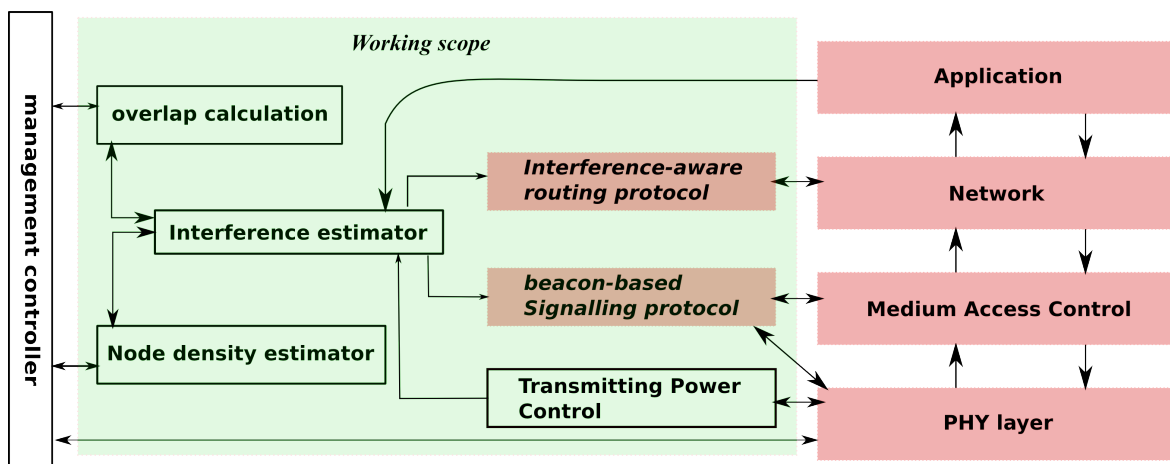

Figure 5.18: Abstraction of work scope

overlap with PR2 on G's and F's side. In this case, the selected route is changed since the interference levels from B and D are medium with non-zero probability, while the interference levels from G and F are high with non-zero probability, and the interference level from C with PR2 is small with non-zero probability. So, the selected path this time is A – B – C – D – E.

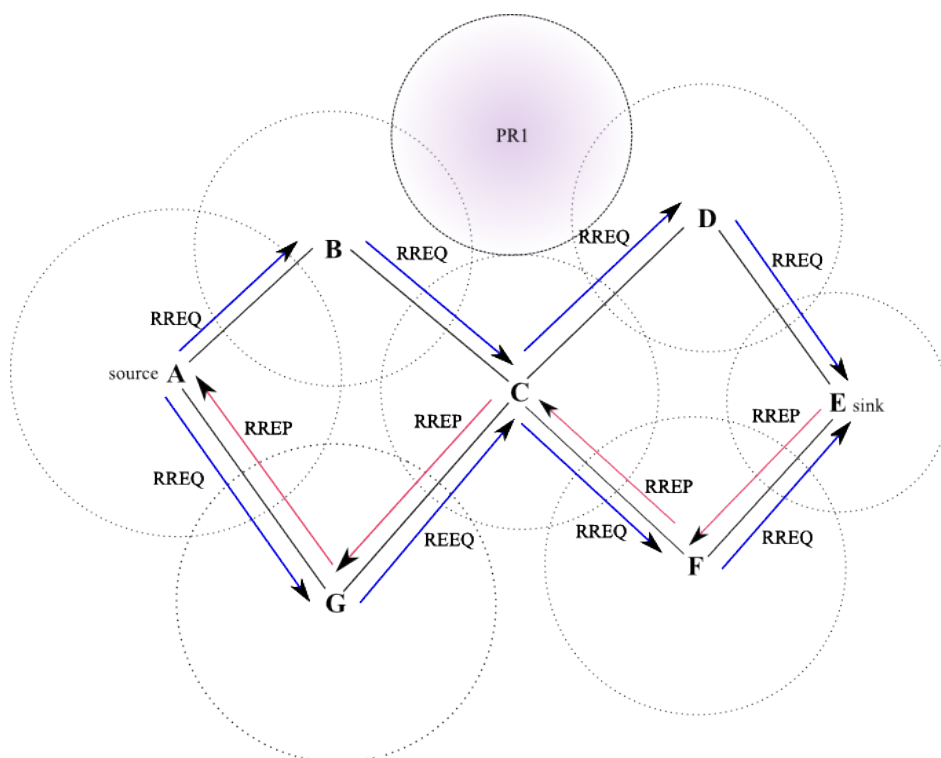

Figure 5.19: DYMO Route Discovery from source A to sink E with a PR's existence.

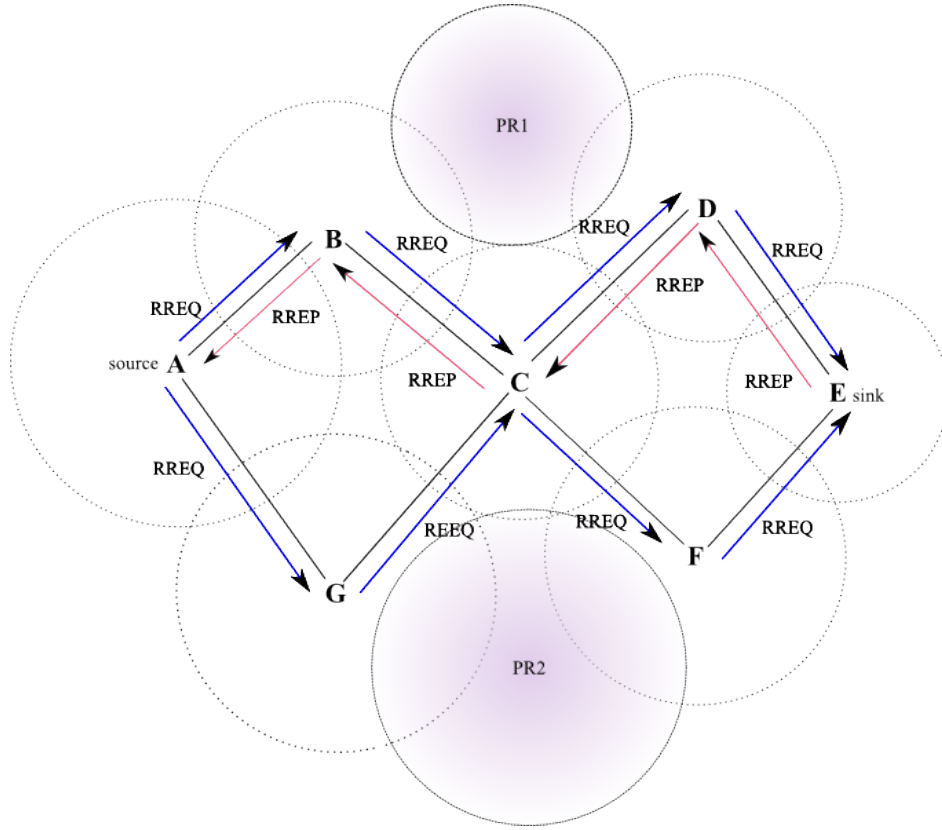

Figure 5.20: DYMO Route Discovery from source A to sink E with 2 PRs' existence.

5.4.3 The routing process of DYMO-CRN routing protocol

Route discovery

Similarly to DYMO specification, the process of sending RREQ and RREP are performed as described in section 5.4.1.

However, the criteria to evaluate an incoming route information are the hop count and the interference level (IL) which is the alternative metric. When a RREQ is received, each node will check, acquire its local interference level on each channel assuming that the node may have more than one available accessible channel. A comparison of its local IL (if it overlaps with more than one PR transmitters) is carried out, and the most optimal IL is chosen as the local $metric_IL$. Accompanying with hop_count , the new_metric and new_metric_IL are recalculated as Eq 5.5 and 5.6. This is the metric of IL for the path from the originator to the current node.

$$new_metric_IL = (metric_IL + last_metric_IL)/2 \quad (5.5)$$

$$new_metric = metric + last_hop_metric \quad (5.6)$$

The information from a received RREQ is handled by a routine call routing handling process (RteHandler) as described in Fig. 5.21. By default, Dymo uses hop count as

the routing metric to handle a route request with metric type 3 [163]. In the context of this work, we define metric type 4 for interference level (IL). A metric type MsgTLV (message TLV defined in [164]) should be hence built and attached to a route message. During the RREQ process, the handler checks and looks up in its routing table for an entry with the extracted metric type, e.g., metric type 4 for IL. Besides, an optimal IL is also acquired locally at the current node to recompute the new metric cost along the path. If the path to the target node exists, the sequence number of the entry is then compared with the sequence number in the received RREQ. The end of the process will return an existing route entry without any update when the sequence number of the RREQ is outdated, or the metric in the RREQ does not improve the cost of the path. In addition, the routing entry needs some updates (sequence number, metric state and value). The merit of enabling metric IL is that we can guarantee the optimal IL. If the current path has the minimum IL, the route from the source CR to the target CR could guarantee the least impact on any PR receivers.

Route maintenance

Route maintenance is performed to avoid prematurely expunging route from the current route table as well as to avoid dropping packets when an active route breaks. Basically, the maintenance process consists of two operations: (i) extending the route lifetimes upon successfully forwarding a packet, (ii) and notifying the upstream nodes when route to a target is broken due to loss of the link to neighbors. In CRNs, breaking the link to neighbors could be due to environment change such as the arrival of a PR. However, thanks to the obtained information from the radio event table, CR nodes can always look up for an alternative route and start notifying their neighbors about the change. The change would result in complete path change (via different channels). The discovery process may be invoked when one of the node is unreachable. This issue is deferred to future work.

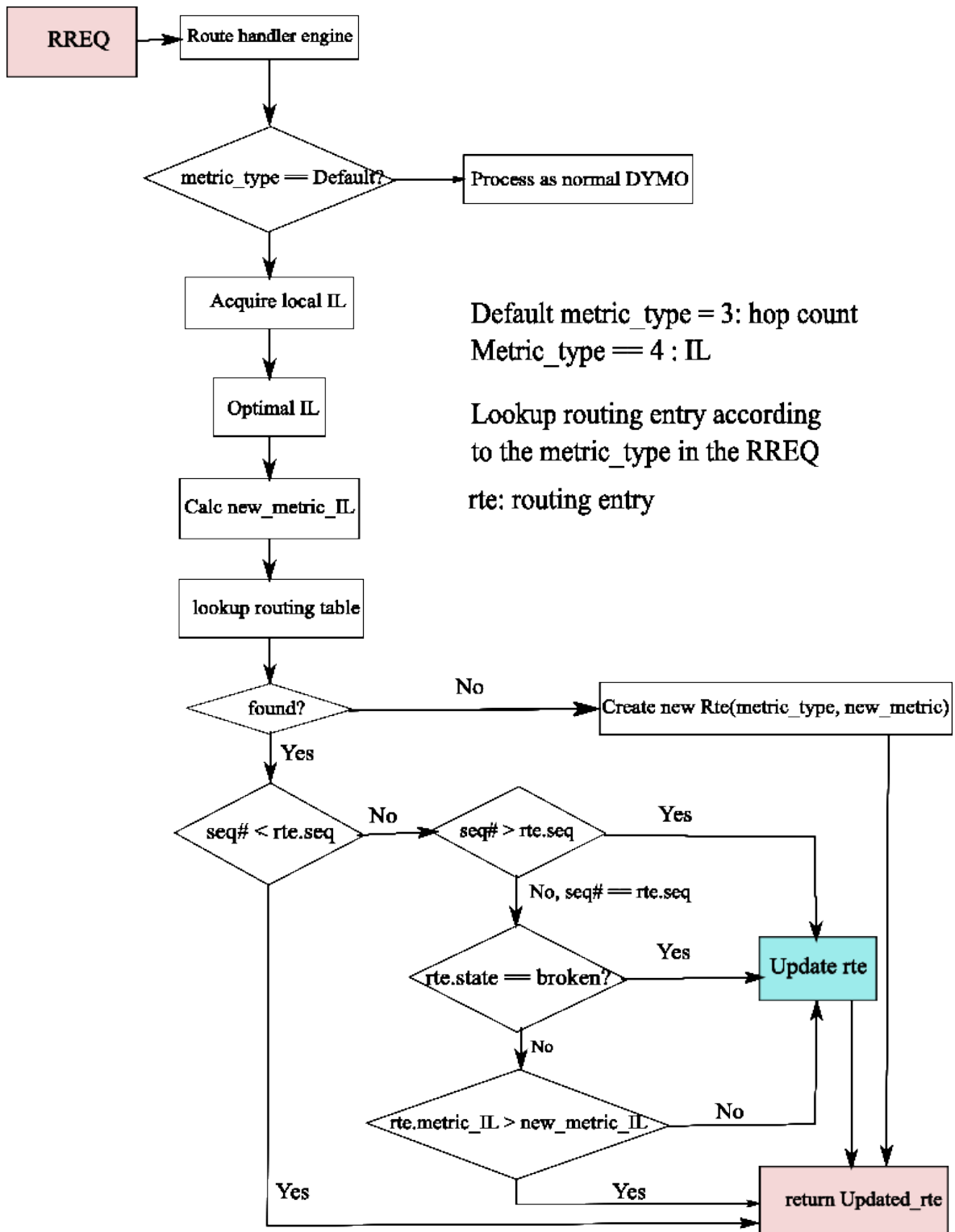

Figure 5.21: Routing information process

5.5 Experiment Guidelines in Omnet++

In this section, we try to validate our proposal using the Omnet++ simulation tool. Omnet++ provides the generic framework that could support multiple MANET

routing protocols including DYMO in Inet plugin. However, DYMO specification is still a work on progress and therefore, DYMO implementation in current Omnet++/Inet version the implementation of the internet draft version 24 (released early 2015). In addition, at the MAC layer, some modifications are needed since Omnet++ does not support cognitive radio yet. The workload to perform all these modifications as well as the implementation of our proposal require more time. Therefore, we would expect to have an implementation in the future with the following suggestions.

Briefly, the components that have to be added into Omnet++ includes:

- A RET module that emulates the radio events table. This table includes the exact information obtained from the sensing process (a pre-defined script). The module can extract the information of signalling as well as resources that are eligible to the control plans (which is used for control messages). This module could then be added into a physical description of a node in Omnet++.
- An observation module which computes the overlapping size. Furthermore, the prediction model described in Chapter 4 should be also included in this module.
- A fuzzy module that represents the fuzzy logic inference system to estimate the IL. This module and the observation module should allow MAC and routing protocol to access the computed outputs.
- An adapted MAC layer which includes channel or frequency ranges information that it is using. This modified MAC layer has also to include the *start_freq* frequency range and the associated bandwidth with the available duration. This MAC layer should implement the mechanism proposed in Chapter 6.

The DYMO routing protocol module is implemented in Inet plugin (module xDymo), under the network layer component. The current implementation (xDymo) can be leveraged with some changes. First of all, a new metric should be defined. For example, metric of type 4 standing for Interference Level (IL). Then we have to develop a function to compute the cost of the route in the discovery process. Furthermore, the discovery process should be modified to implement the algorithm described in section 5.4.2 in this chapter.

Lacking time, we have not been able to finish the implementation of the whole protocol. Thus, we simply describe the scenarios to experiment and the expected results. Fig. 5.22 represents the basic case for verifying how different overlapping produce different ILs. Nodes A and B in Fig. 5.22 locally compute overlap size, node density and the IL using the needed information on the environment as well as our fuzzy modules. In case of an acceptable IL, A should be able to talk to B via the channel on which PR_2 is transmitting.

Another transmission scenario including many nodes is proposed in Fig. 5.24. In

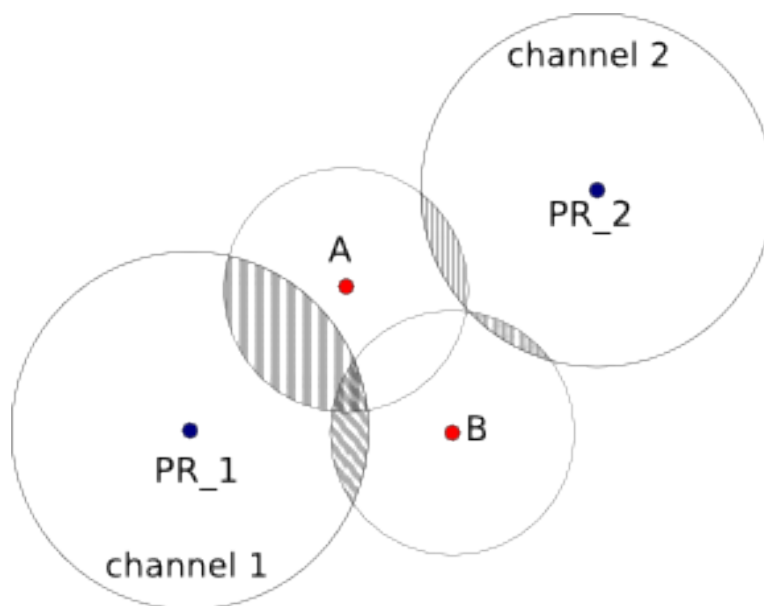

Figure 5.22: 2 Nodes overlapping only

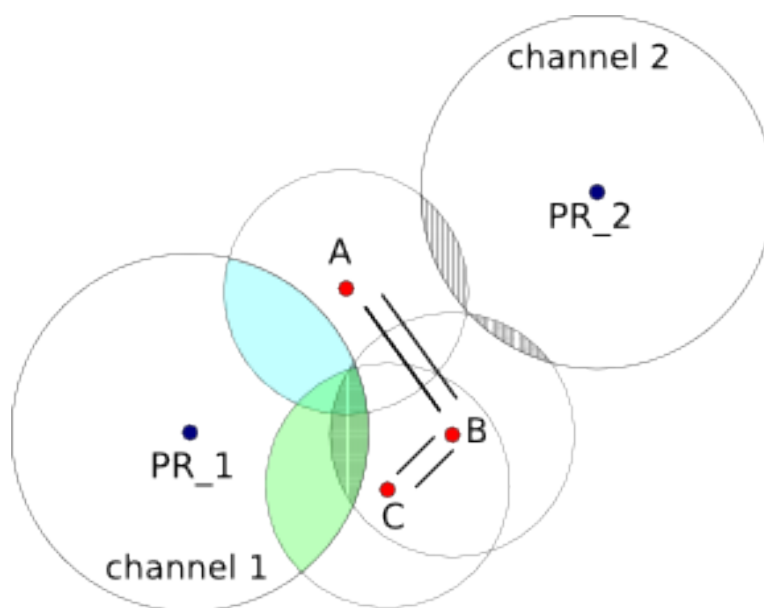

Figure 5.23: Routing between 3 nodes with overlapping

this scenario, A is the source node and D is the target node. During the discovery process, all the nodes have to calculate their own ILs. Following the discovery process suggested in section 5.4.3, the expected result would return the path $A \rightarrow B \rightarrow E \rightarrow C \rightarrow D$. E cannot choose to reach D directly since it should select the path through C with smaller IL. However, A has to pass through B and E even if the iLs, in this case, are not null.

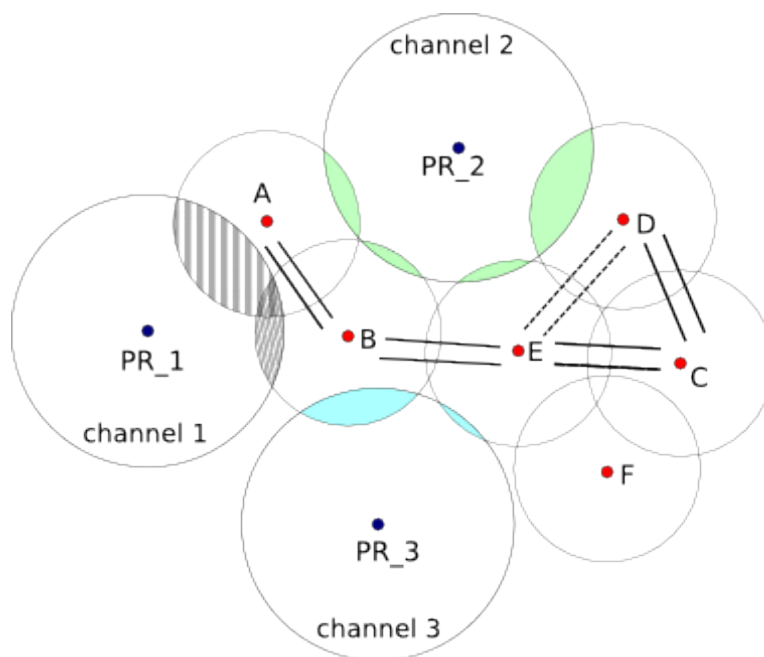

Figure 5.24: Ad-hoc Routing with multiple nodes multiple overlapping

5.5.1 Current work in Omnet++

We added a new metric type into the DYMO protocol in Omnet++ with the Inet framework. The interference level IL is temporarily read from a configuration file, called the ini file in Omnet++. Every node reads this IL at the initialization stage. And this information is attached to the route request in the discovery process of DYMO. We tried to test our proposal in a scenario where we have two equal paths with different IL as shown in Fig.5.25. In this scenario, we haven't yet considered the overlapping with the primary transmitters since the test was to verify the current implementation of DYMO protocol in Omnet++.

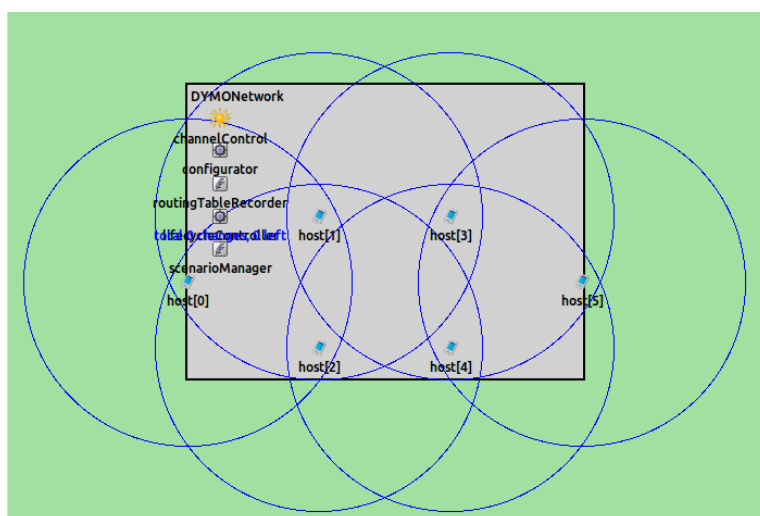

Figure 5.25: DYMO Test with enabling IL metric

The configuration of the hosts are as the following. Host[0] (at 145.236.0.1) tries to ping Host[5] (at 145.236.0.6). Along the path on top of Host[0], Host[1] and Host[3] have IL equals to 0.12 and 0.05 respectively. And the path at the bottom (Host[0], Host[2] and Host[4]) has IL at 0.01. So, expected route would be the path through Host[2]. Accumulated IL of Host[1] and Host[3] is 0.625 while it is 0.01 for the path via Host[2]. This computation is done thanks to the cost equation in 5.5. However, with the current DYMO implementation, the upper path was chosen (through Host[1] and Host[3]) and the combined IL was expected to be (0.0625). Unfortunately, in the routing table, the hopcount and the IL were not calculated correctly. And we found out that the RREQ was messing up around the network and the hopcount and IL kept being added up until the RREQ reached the destination. Since each host typically updates its own routing table when it receives a RREQ, we got a bug. This bug is due to the fact that after updating the routing table, the hopcount and the IL increase.

5.6 Conclusion

In this chapter, we provide an approach to estimate the interference level based on Fuzzy Logic. This estimation is based on overlap radio and node density. The obtained results confirm the usefulness of the fuzzy logic in CRN in terms of estimating interference as well as the validity of our proposal. The decision making process can leverage this information when a cognitive node selects a possible accessing channel that minimises the impact on the primary systems. Otherwise, the estimation can also be used in defining a routing metric that allows selecting a path with minimal interference level. Furthermore, in cross-layer design, this approach can be integrated with other parameters such as transmitting power and application requirements for engineering the traffic flow.

Chapter 6

Practical Cognitive Radio Ad-hoc network platform and Signalling proposal

As mentioned in Chapter 5, our proposed routing protocol DYMO-CRN relies on the medium access control layer to operate. Therefore, a medium access control mechanism is needed. The access of frequency bands in CRN requires two mandatory functions: spectrum sensing and sharing. The sensing process helps a CR device to determine accessible radio spectrum. The sharing process helps a CR device to identify other CRs operating on the same frequency range. So, it can reach the other nodes and form a CRN. Disseminating the environment parameters between CRs is a prerequisite for synchronisation in CRNs. Since detailed spectrum sensing reviews has been provided in Chapter 3, we will focus on the technical aspects of a spectrum sensing process and its development on a practical platform in this chapter. Indeed, we will present our cognitive radio ad-hoc network platform, before detailing our proposal in terms of signalling protocol to enable the rendez-vous channel as well as the initiation of a communication between CRs. A signalling solution that we rely on to solve the problem addressed in this chapter was developed within our platform [165]. Thus, we present the whole signalling solution with a focus on the various extensions that we propose. Some elements (e.g., the hopping sequences) of the signalling protocol have been implemented and tested on our platform. The implementation and the validation of the other components (e.g., medium access mechanism and users identification process) are in progress.

6.1	Platform design challenges	123
6.2	PHY design - Spectrum scanning and information extraction .	128
6.3	Signalling protocol	132
6.4	Link Layer Design and Operation	137
6.5	Conclusion	153

6.1 Platform design challenges

6.1.1 Sensing process and challenges

In this section, we explain the sensing operation implemented on our platform. Since a CR user operates on a shared environment with PR users, it has to be aware of the PR users to avoid perturbing PR's communications.

In [32], Amir et al. defined the "Spectrum sensing" as the ability of cognitive radio to reliably and autonomously identify unused frequency bands. Practically, it consists in listening to specific frequency bands, detecting transmission, and probing for vacant spectrum bands. Sensing takes a considerable role in software-defined radio which allows a CR to observe a window in the radio frequency spectrum. In some circumstances, a CR has to listen to arbitrary bands while detecting the transmission on the currently used band.

Without spectrum sensing, deploying a CRN may require some costly operations such as: data registry for the spectrum usage at a centralised station and dissemination of this information via a beacon broadcasting. It would be costly in practice. Furthermore, spectrum sensing is implemented locally either in the CRN core or in any other CR node [32].

Several spectrum sensing techniques have been proposed such as optimal detection [35] and energy detection [40, 59, 39, 166]. Implementing a sensing technique in CRN is a challenging task. It requires to consider the followings constraints: sensing periodicity and detection sensitivity. While using a frequency range, a CR has to periodically sense the band to detect PR's transmissions. This sensing period determines the maximum time during which a CR will be unaware of a reappearing PR. No matter which type

of sensing method a CR is using, detection sensitivity indicates the threshold which a CR has to consider while performing sensing over a band. This threshold guarantees the minimal interference that may occur to a PR. This threshold depends on the characteristic of the interfering signals.

Spectrum sensing in CRNs faces many challenges by different sources of uncertainty. When a CR senses in a low SNR environment, it has to overcome the noise uncertainty. Another challenge is the multipath fading and time dispersion that leads to channel uncertainty. While several CRs operate on the same band, they may face another challenge so-called aggregate interference uncertainty. This issue is like hidden-node problem in the mobile network. For instance, CR nodes A, B and C are operating nearby a primary transmitter. While A could identify the existence of B but not C. C does not know anything about A and B. The aggregate interference of A and C could cause extra impact on the sensing process at each network as well as on the primary system.

In this work, we describe the basic energy detection which is implemented in our platform. We suggest capturing the activity on several bands and identifying the noise floor to improve the sensing process.

6.1.2 Signaling and control messages dissemination

There are two schemes of disseminating the signalling messages in a CRN: centralised and distributed. Centralized scheme uses a particular common control channel to disseminate the control as well as synchronisation messages to the CRs in the network. This common channel must be known by the CRs, and should be always available. In the distributed scheme, the CRs establish their scheme of locally disseminating information to the neighbour that they have learned about through sensing and identifying processes. Our work focuses on the distributed scheme since it is realistic and does not require any available common control channel which may cause some security issues.

In the literature, we found some interesting work related the distributed scheme. In [167], Lin et al. suggested a rendezvous technique for CRs to access the spare resources without the need of time-synchronization. The algorithm generated a channel hopping sequence in rounds. Each round consisted of a jump-pattern and a stay-pattern where a CR “jumped” on the available channel following a specific pattern, or “stayed” on a specific channel also following a stay-pattern. A time-to-rendezvous and upper-bound of expected time were derived to guarantee the rendezvous for 2-user and multi-user scenarios. This design did not require signalling dissemination between CRs. However, there was a challenge that the same authors addressed in [168]. The pattern was difficult to keep up-to-date. The link may be broken if one of the CR was out of operation.

Also in distributed scheme, Tajer et al. [169] proposed a beacon-assisted approach where signalling messages were initially transmitted by PRs to the CRs to manage spectrum access. Any CR who received this beacon was able to detect the signal from a PR. This CR could then cooperate with the other CRs by disseminating this information to its surrounding neighbours. This proposal was based on the cooperation between a PR and a CR as well as between CRs. This cooperation requires some modifications in the PR configuration and the regulation of access spectrum for opportunistic users.

6.1.3 Medium Access Mechanism

There exist three different approaches in the design of MAC protocols for CRNs: random, time slotted and hybrid access.

The random access approach is similar to the CSMA/CA model. For instance, in [170], Shu et al. proposed an extended 802.11 handshaking between the CR nodes to enable multichannel data transmission without serious impact on PRs transmitter. Sensing information was obtained and updated from an out-of-band common channel, and the list of available channels were kept locally in a free-channel table (FCT) at each CR node. Data transmission would be performed in parallel over several negotiated channels between the source and the sink. The exchange of control messages was similar to the CSMA/CA model with the modification of the Request-To-Send (RTS), Clear-To-Send (CTS) messages and the introduction of a new message Echo CTS (ECTS). The ECTS was used to confirm the agreed parameters before the data transmission. This solution seriously depends on a common control channel which must be allocated and shared by CRs. These CRs have to send and receive control messages on this channel. Therefore, this mechanism helped to prevent collision among other CRs. Multi-channel data transmission along with medium awareness was resolved. However, the sensing process and PR-CR identification were neglected in this protocol.

Another approach using the CSMA/CA scheme in a distributed manner was proposed in [89]. The authors used the Common Hopping coordination scheme described in [171], where channels or frequency ranges were time-slotted and the CR devices worked in a synchronous manner. This means that these devices formed an Ad-Hoc network and opportunistically accessed a known list of channels. These CRs hopped between these channels in identical hopping sequences. A hopping sequence is a cycle where a device either initiated a transmission or switched to the next frequency range. The duration of this cycle, called the “idle dwelling time”, was shared between these CRs. Within this period, if a CR wants to communicate with another CR, it would start exchanging RTS/CTS messages. Consequently, the hopping sequence is temporarily postponed. The transmitted data was divided into frames to suit the hopping sequences. Based on the sensed channels statistics, the CR has to predict whether

or not the current channel is still available to trigger the “channel switching process” at the end of a frame transmission. This process takes place just before the end of the frame transmission to let the other side (i.e., the destination node) know about the next hopping channel. Mo et al. [171], provided an effective switching method although they did not address the problem of detecting and sharing the same list of available channels before forming the network. So, there is a risk of asynchronous hopping sequences if the CR devices had different lists of available channels.

The time-slotted approach needs time synchronisation. The operation duration is divided into slots for both common channel (signalling channel) and data channels.

With the limitations of these approaches for multi-channel sharing, C-MAC protocol [74] was proposed. In C-MAC, each channel was divided into several superframes. Only hosts using the same channel needed to be synchronised. Other hosts using different channels did not need to be synchronized. Hsu, Chen and He [75] proposed an efficient dynamic adjusting MAC (EDA-MAC) protocol for cognitive wireless networks. This proposal was an improvement of the C-MAC protocol. Instead of a fixed number of signaling slots of C-MAC, EDA-MAC dynamically adjusted the number of signalling slots according to the number of estimated contenders. Then, each joined host could inform the others about its transmission intention by a beacon frame. As a result, each communication group contained a leader. This leader was responsible for coordinating the join process, data transmission, transmission rate selection, channel scan, and channel switch of each host in the communication group.

In [172], Doost et al. proposed a power control mechanism with energy detection spectrum sensing for signalling. Concerning channel hopping and neighbours’ exploration in dynamic spectrum access environment, Liu, Hai et al. [173] explored the rendezvous techniques. The CR users had to blindly look up a common channel that they could meet and establish a communication link with other CR users. Some other related rendezvous techniques using Number theory were discussed in [167, 168]. Another approach using quorum system theory was also introduced in [174]. These techniques were said to be efficient, but they also required powerful and complex computations at each CR device.

6.1.4 GnuRadio-based framework

We aimed to use Universal Software Radio Peripheral (USRP) devices for a testbed implementation. Therefore, in this section we present this device which is associated to GNU-radio framework to form a CR node. The hardware platform used for our experiments is composed of USRP-1 devices. USRP-1 can detect and/or send radio signals. This platform implements a function to convert the received signal, using four analog/digital converters up to 64 MHz (12 bits) and four digital/analog converters up

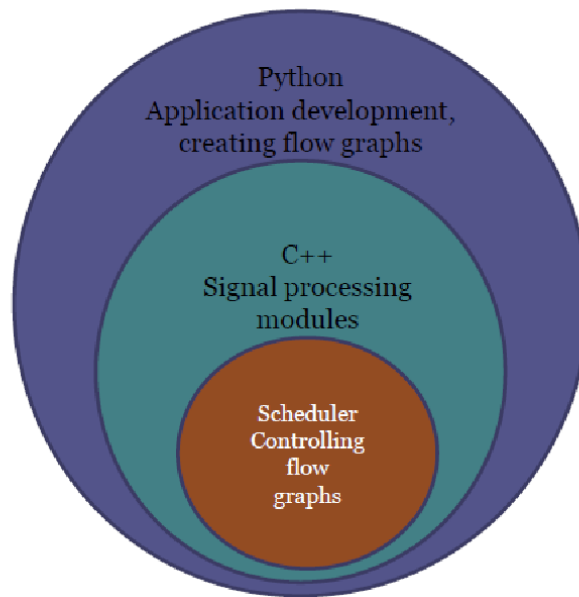

Figure 6.1: GNU radio software architecture

to 128 MHz (14 bits) driven by a FPGA.

The USRP works in coupling with a computer connected via a USB2 bus (theoretical flow 480 Mb/s). The built platform is used to retrieve the converted data and treat them in the GNU Radio framework. A Python application is implemented to detect emitted signals over a channel. It allows us to configure the USRP in the reception of signals. The GNU Radio platform is used to analyze received spectrum and extract useful information (i.e., spectrum holes or spectrum usage statistics).

In summary, a cognitive radio node (Fig. 6.2) is composed of an USRP-1 device connected to a computer via an USB Interface. To communicate with the device, we need to install the GNU radio platform on the computer. It allows us to interact with the device. In this way, we can exploit signals captured by the USRP-1 device and obtain the needed results.

As in Fig. 6.1, the software architecture is the GNU Radio which is composed of [175]:

- The “signal flow graphs” is created using the Python scripting language. A flow graph is a series of interconnected blocks which are written in C++. A block can be a source, a sink, or an intermediate signal processing module. The USRP-1 is either the beginning of the flow graph (signal generator) or the end (as a transmitter or a receiver).
- The scheduler which is using Python’s built-in module threading to control the “starting”, “stopping” or “waiting” operations of the signal flow graph.

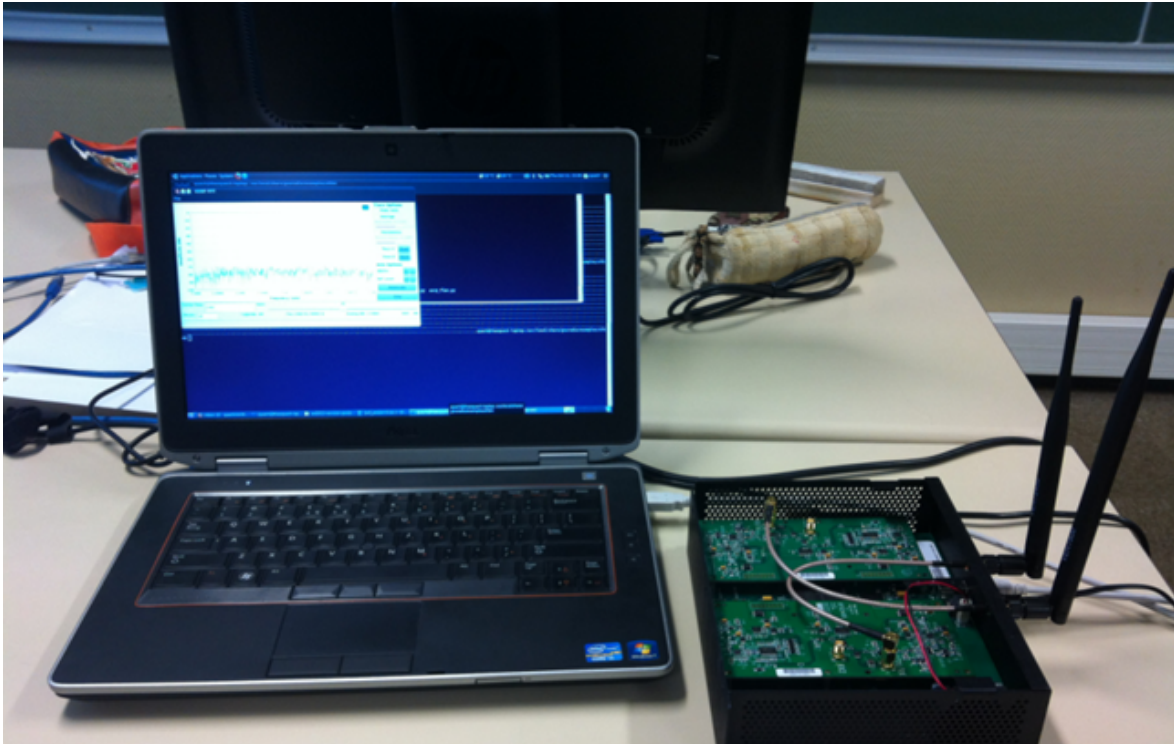

Figure 6.2: Cognitive Radio node composed of USRP-1 and Gnu radio software

6.2 PHY design - Spectrum scanning and information extraction

6.2.1 Proposed signalling framework

As mentioned in Chapter 2, the management controller takes the measurement of the signal from a PR and a CR to infer their characteristics. Then, this information is exploited by the spectrum management module to derive long term statistics. We introduce a physical-layer signalling protocol for CRNs in this section. A CR will use this protocol to inform the other CR nodes about its presence. Also, it allows the other nodes to tell on which frequency bands and at what time they will be available. So, we consider this protocol as a part of the disseminating process of the management plane.

6.2.2 Sensing operation overview

We briefly recall the sensing operation that can be implemented for this platform. Since a CR user operates on a shared environment with PR users, it has to be aware of the PR users presence. In our platform, we use the USRP-1 device to perform signal scanning. USRP devices acquire the signal and transfer the stream of samples to the

signal processing block (a Gnuradio block). This block transforms the time-domain (the samples stream) to the frequency-domain using the Fast-Fourier-Transformation (FFT). The sensing block detects the transmissions in the frequency-domain. Once a transmission is detected, a decoder is instantiated to demodulate the transmission. This transmission is then forwarded to the operating system's network stack. All the information gathered from the frequency domain, and the demodulation is finally stored in the Radio-Events-Table (RET). This procedure is summarized in Fig. 6.3 and the sensing procedure is explained in Fig. 6.6.

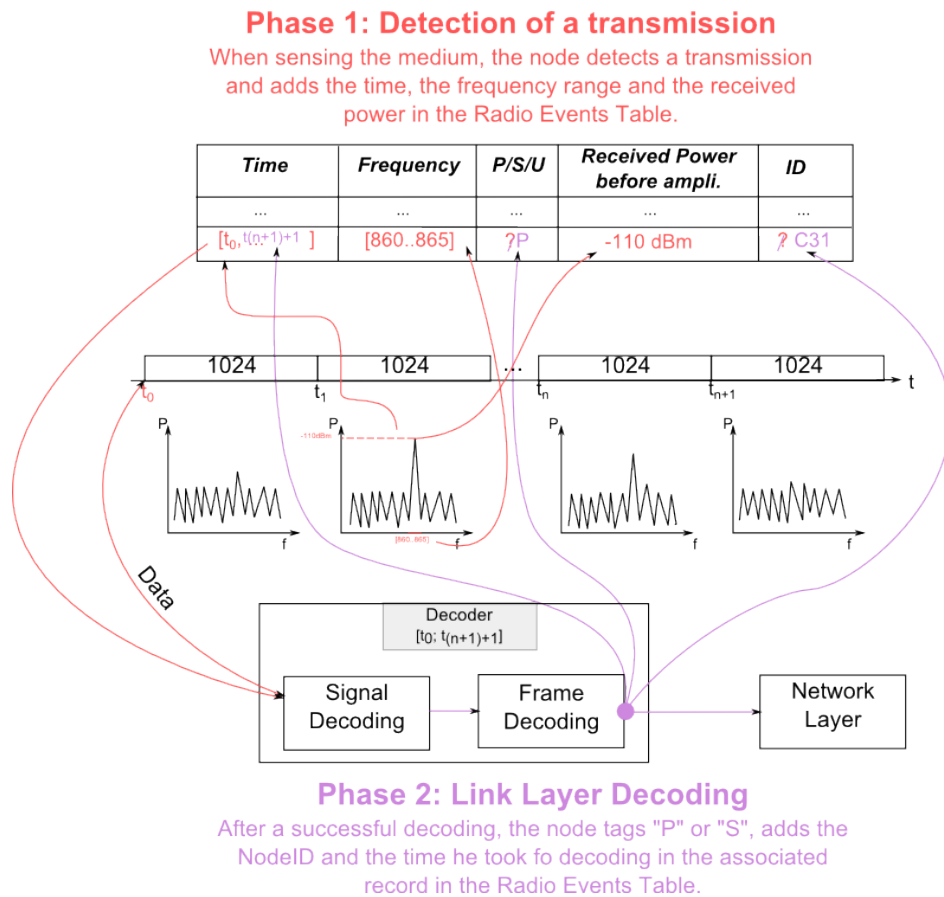

Figure 6.3: Filling procedure in Radio Events Table.

A Rashid et al. [176] developed a practical energy detection model with a decision-making process by applying the Neyman-Pearson formula. They evaluated the sensing performance on USRP and Gnuradio on 2.48GHz with a bandwidth of 4MHz. The evaluation metrics are the probability of false alarm, P_{fa} , and the probability of primary detection, P_d . These metrics are used to obtain medium awareness about the spectrum usage. In our platform, we apply energy detection based sensing in the frequency domain with the hypothesis described in equation 6.1:

$$x(t) = \begin{cases} g(t) \\ g(t) + s(t) \end{cases} \quad (6.1)$$

where $g(t)$ is the Gaussian noise and $x(t)$ is the receiving power at time t . Any

time the signal is read, it always contains noise. From a signal processing point of view, sensing is done by converting the time domain (the stream of voltage samples collected by the USRP) to the frequency domain (decomposition of the signal into a sum of sines with an associated power). From the frequency domain, it is possible to detect some radio transmissions as they are characterized by an increase in the received power over a given frequency range. When a received signal overcomes a certain threshold, the sensing module records this information into a Radio-Events-Table (RET). The threshold is calculated and specified by the QoS and depends on the underlying technology of the frequency ranges that the radio is listening on. We propose a collaborative scheme in which the sensing information is disclosed, and a synchronization method is applied to let the neighbouring CRs be conscious of the surroundings. This protocol is introduced in section 6.4.

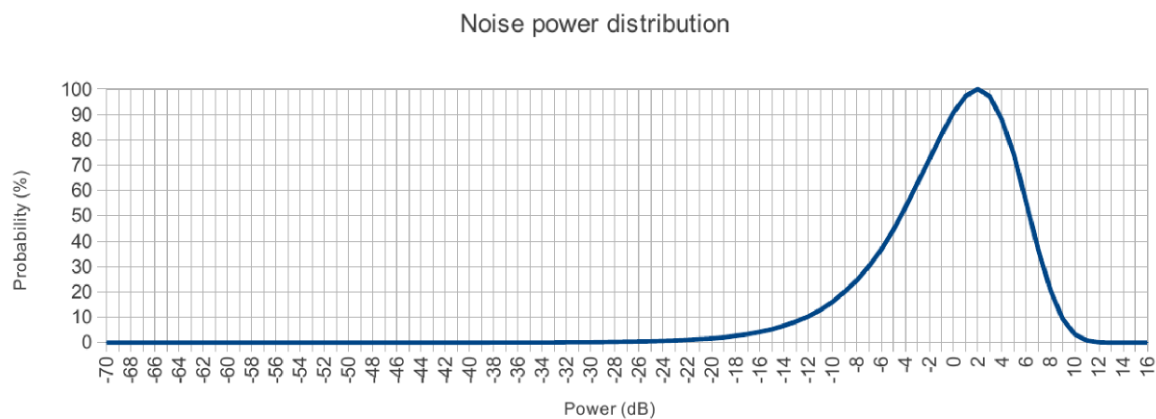

Figure 6.4: Noise Power Distribution

We conduct a preliminary testing to find the lowest possible threshold with a low probability of false alarm. From our observations in Fig. 6.4, the probability that a noise signal would not be more than 13dB is around 99.999%. The primary/secondary identification mechanism is discussed in section 6.4. The process relies on cooperative information from the other CRs and also on the decoding mechanism at the link layer level.

We provide an example of spectrum sensing that extracts the vacant spectrum bands from a listening range in Fig. 6.5. Since the bandwidth of the software radio is usually much smaller than the frequencies it can tune into, looking for spectrum holes requires hopping from a frequency band to other frequency bands. Spectrum sensing on any given band is thus discontinuous. With the given threshold power and specific SNR, we compare the signal strength with the threshold to see if that signal belongs to a transmission. If there is a transmission, the start and the end of the transmission are recorded into the RET. At this point, no decoding is done. The information will then be packed and passed to upper layers to notify them about the transmission in a

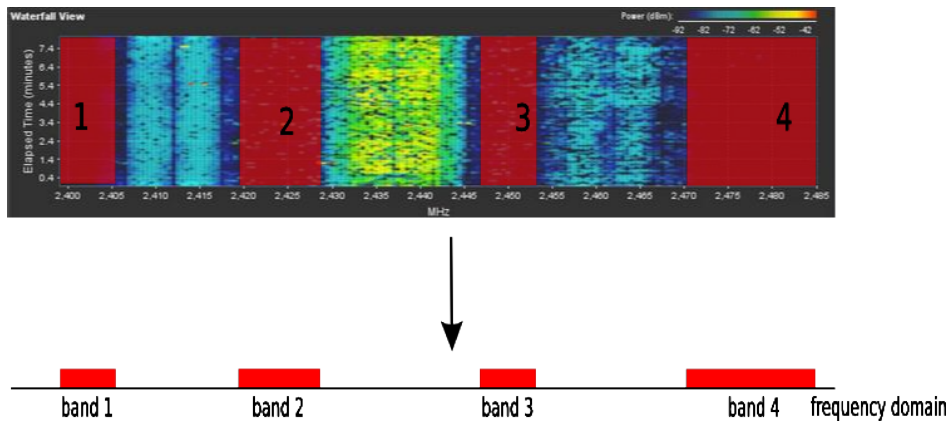

Figure 6.5: The radio spectrum sensing example

particular frequency range. If the node is operating within that range, the transmission will be interrupted immediately.

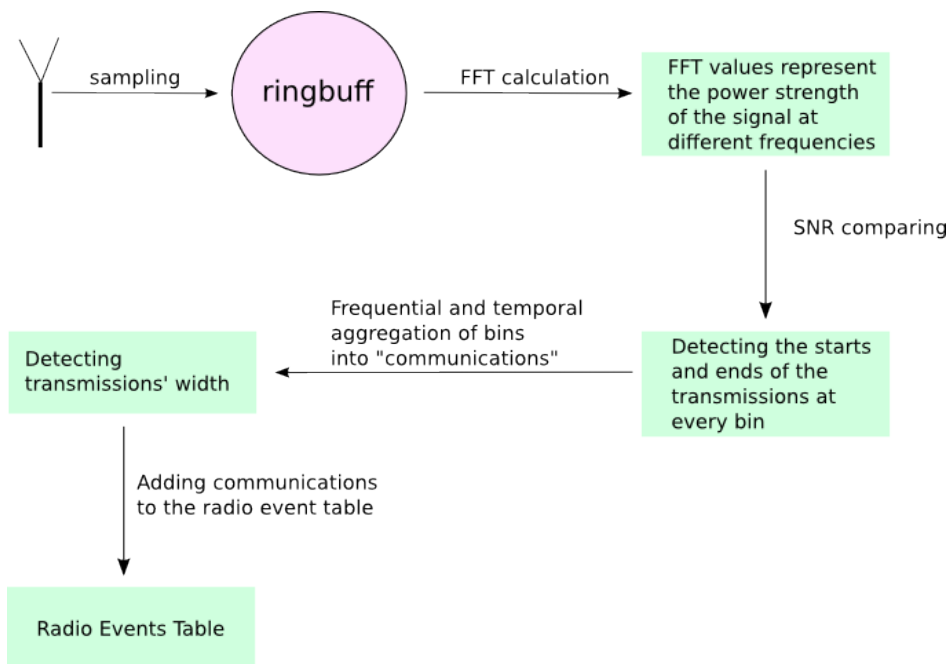

Figure 6.6: Sensing conceptual flowchart

Fig. 6.6 represents the general operation of the sensing module which is implemented on our platform. The signals are sampled and transformed to absolute power values (dBm) in the frequency domain using FFT. A lookup process to identify the transmission (including frequency ranges and starting/ending time of a transmission) is triggered based on the calculated FFT. The formula hypothesis of the signal captured by USRP is described in equation 6.1. The detection is done on the low SNR and is changed according to the QoS and the expected SNR. For instance, if the SNR of the received signal is below the defined minimum SNR (e.g., 20dBm), it would not be considered as a transmission. Starting and ending points of a transmission are detected according to the schema given in Fig. 6.7

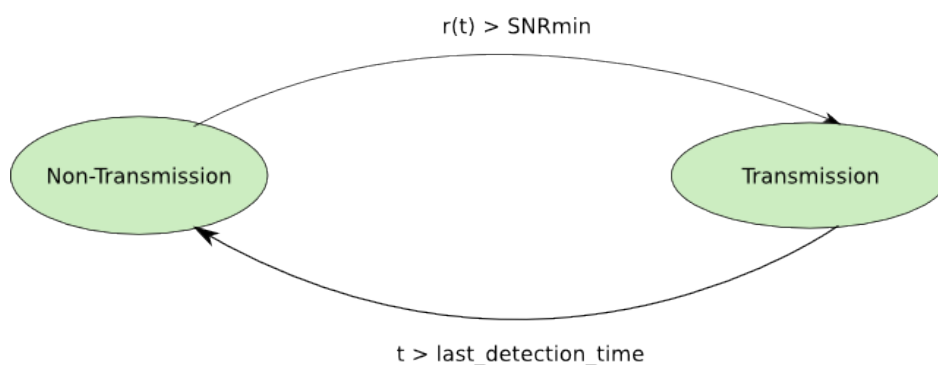

Figure 6.7: Non-transmission to transmission automaton

A CR node with a sensing module can provide the information of the RF-spectrum such as the available frequency bands which a secondary radio may access. This CR explores the neighbours by broadcasting its local knowledge using a beacon frame. We describe in detail the frequency hopping cycle and how a beacon is constructed from the output of the sensing module in section 6.3.1.

6.3 Signalling protocol

We propose a beacon sending with the timing attached in each beacon. This beacon is used for notifying and acknowledging the neighbours' exploration and neighbours' identification in CRN.

6.3.1 Frequency Hopping Cycle and Beacon Frame disseminating

Based on the RET filled by the sensing process, a node knows which bands are generally or potentially available. The node then needs to create a periodical hopping pattern to maximise its availability for the other CR nodes. A suitable hop pattern

should allow the node to be available on as many reasonably-sized bands as possible, so that it increases the probability of being available at any time. On the other hand, the availability of a CR may need to be compromised so that the CR can look for new vacant bands and discover new CR nodes. The hopping pattern could be changed. Indeed, it depends mainly on the currently available bands as well as the desired QoS for the communication with the other CR nodes.

Once the hopping pattern has been created, the node advertises the bands it wants to be available on. This is done by broadcasting a beacon periodically. The beacon contains at least the following information:

- the identification of the node,
- the duration of the hopping cycle,
- the current period offset of the beacon sending time,
- the list of available bands, their period offsets and their available time.

The current period offset is the mean to achieve clock synchronisations between CR nodes. To ensure the optimal operation of the proposed system, nodes need to have loosely synchronized clocks with regards to how often the beacon is sent. The beacon's period offset specifies at what time the node will start being available in this band and the available time specifies for how long it will continue to be. We propose a frame structure for the beacon in Fig. 6.8 along with the fields' explanation in Table 6.1.

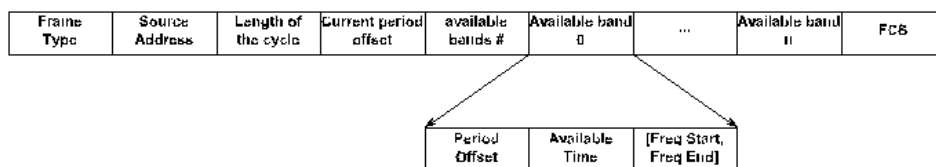

Figure 6.8: Beacon frame format example

The size of the beacon varies from 12 bytes (for $n = 0$) to 2817 bytes (for $n = 255$). For example, the node with ID "23" listens to frequency slot#1 which contains bands 1,2 and 3 at timeslot#1 and listens to frequency slot#2 which contains bands 3 and 4. The beacon frame is presented in ASCII form as in 6.2.

Field	Size	Descriptions
Frame type	8 bits	Signaling Beacon
Source Address	48 bits	Identification, the MAC adders of the node
Length of the cycle	16 bits	Duration of the hopping pattern in <i>ms</i>
Current period offset	8 bits	The node's current normalized period offset
Number of available bands	8 bits	Number of available bands
Available band i:	88 bits	
Period offset	8 bits	Starting from when the band is available
Available Time	16 bits	Available duration of the band in <i>ms</i>
Frequency band start	32 bits	Frequency in Hz
Frequency band end	32 bits	Frequency in Hz
FCS	8 bits	Frame check sequence

Table 6.1: Notations Table

$$\begin{aligned}
\langle \text{beaconframe} \rangle & \{ \text{Frame type} = \text{SignalingMessage}, & (6.2) \\
& \text{Source address} = 23, \\
& \text{Length of a cycle} = 100, \\
& \text{Current period offset} = 0.126, \\
& n = 5, \\
& \{ \text{available time} = 0.39, [\text{Band1}], \text{period offset} = 0 \}, \\
& \{ \text{available time} = 0.39, [\text{Band2}], \text{period offset} = 0 \}, \\
& \{ \text{available time} = 0.39, [\text{Band3}], \text{period offset} = 0 \}, \\
& \{ \text{available time} = 0.59, [\text{Band3}], \text{period offset} = 0.4 \}, \\
& \{ \text{available time} = 0.59, [\text{Band4}], \text{period offset} = 0.4 \} \\
& \}
\end{aligned}$$

An example of frequency hopping and beacon frame is also provided in Fig. 6.9. The CR who sends this beacon frame has to listen to frequency slot #1 containing band #1, #2 and #3 or frequency slot #2 containing bands #3 and #4. So it divides the listening period on frequency slot #1 at timeslot #1 and on frequency slot #2 at timeslot #2. Note that the total length of the listening period should be equal to the total length of the cycle specified in the beacon frame.

In this example (Fig. 6.9), the node is able to send and receive on bands #1, #2 and #3 from *period_offset* = 0 to *period_offset* = 0.39, as indicated in the beacon. The period indicates how long the frequency hopping cycle. In this example, the hop cycle takes 100ms before repeating itself.

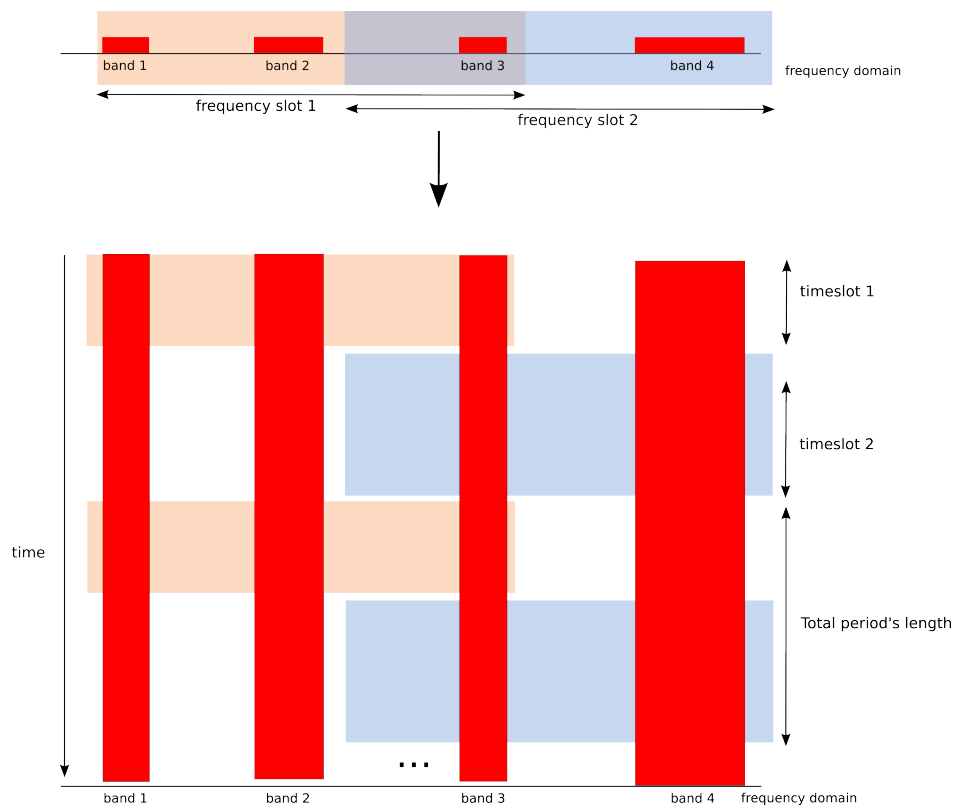

Figure 6.9: Frequency hopping scheduling example

Bands #1, #2 and #3 are available from the beginning of the period ($period_offset = 0$) until 39ms ($period_offset + period * avail_time = 0 + 100ms * 0.39$) after the beginning of the cycle. Bands #3 and #4 will be available from 59ms after the beginning of the cycle until 1ms before the end of the cycle. Band #3 is thus available twice during the frequency hopping cycle with a gap of 1ms needed to tune the software-radio to another band.

The current period offset is the normalized current time offset in the period at the time of the emission of the beacon. In this example, the current period offset is 0.126, which means that time has passed since the beginning of a new cycle equals to $period * cur_period_offset = 0.1s * 0.126 = 0.0126s = 12.6ms$.

Once a beacon has been generated, the node sends it on selected available bands so that the surrounding cognitive radio nodes may be able to receive it. Knowing its own schedule of availability on the spectrum, and having information about surrounding nodes' schedules, each node knows where and when it can reach other nodes. In the next section, we describe how other surrounding CRs can reach each others using this beacon signalling scheme.

6.3.2 Beacon broadcasting and receiving

During its sensing cycle, a node is likely to receive beacons from its surrounding nodes. For illustration, we provide an example in Fig. 6.10. Green-squared and blue-squared dots represent the beacon frames that are sent in the frequency bands available at the corresponding timeslot.

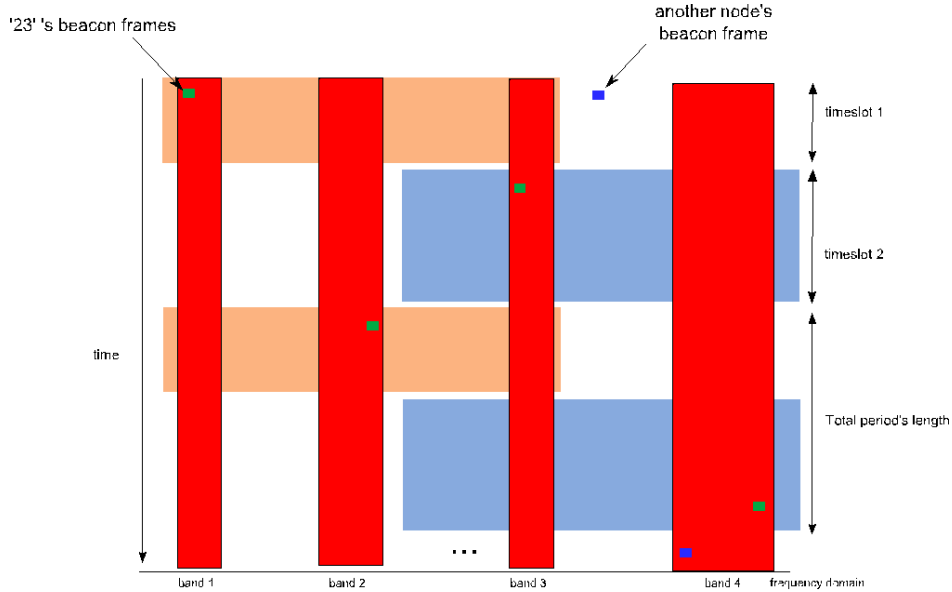

Figure 6.10: Signaling information is disseminating via beacon sending

In Fig. 6.10, the beacons sent by node #23 are represented by the green-squared dots, while those transmitted by the node#10 are represented by the blue-squared dots. Each beacon will be decoded by the receiving node.

When a node receives and decodes the other node's beacon frames, it knows where and when the it can communicate with the others. With this mechanism, signalling channel preset is not needed. The beacon frame sent by the node#10 is shown in 6.3.

$$\begin{aligned}
 < beaconframe > \{ Frame\ type = Signaling\ Message, \\
 & \quad Source\ address = 10, \\
 & \quad Length\ of\ a\ cycle = 133, \\
 & \quad Current\ period\ of\ fset = 0.542, \\
 & \quad n = 2, \\
 & \quad \{ [available\ time = 0.49, [Band1], period\ of\ fset = 0], \\
 & \quad \quad [available\ time = 0.49, [Band2], period\ of\ fset = 0.5] \} \\
 & \quad \}
 \end{aligned} \tag{6.3}$$

When this beacon is received and decoded by node #23 (Fig. 6.10), node #23 obtains the following information about node#10:

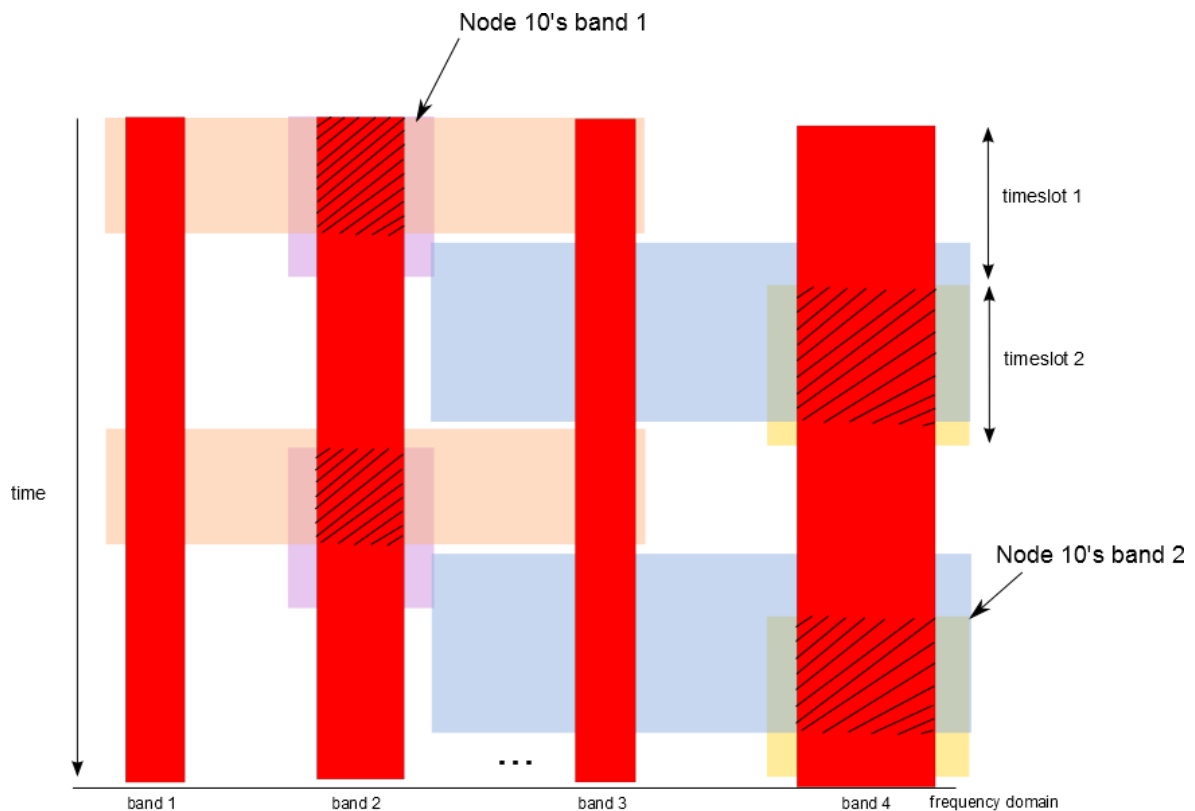

Figure 6.11: Beacon decoding example

- The node identification is 10.
- The length of its frequency hopping cycle is 133 ms and it is currently $0.542 \times 133 = 72ms$ in its own cycle.
- There are two available bands: band#1 is available 49% of the time since the beginning of the cycle and band#2 is available 49% of the time starting from $66.5ms$ that equals to $0,5 \times 133ms$.

6.4 Link Layer Design and Operation

This section details the link-layer protocol that a CR uses to negotiate with another CR to initiate a communication.

6.4.1 Protocol Introduction

The physical layer signalling protocol allows a CR to know when and where it can reach another CRs in the network. However, to avoid the potential collision that may happen when these CR initiate a transmission, CR sender and CR receiver need to

make a reservation in frequency and time. For example, two nodes “A” and “C” want to start a communication with node “B”. They sense the medium, and when it is free, they send their frames on the channel at the same time to “B” which leads to a collision. So they need to reserve the medium before and let the other know that the channel will be reserved for a particular duration.

In 802.11, this problem is solved by using CSMA/CA with CTS/RTS exchange. When a node attempts to send a packet to another node, it first sends a Request To Send (RTS) frame. The RTS can be seen as a lock on the channel, and other nodes should refrain from communicating until the end of the communication. When the receiving node receives the RTS, it will check that no transmission is currently going on the channel. It will then send a Clear To Send (CTS) frame. Just like the RTS, the CTS acts as a lock but on the receiver instead of the transmitter.

This principle can be applied to a cognitive radio network with some modifications. The first one is that CSMA/CA can only be implemented to single-channel networks. In our case, the communication can happen on any frequency. Thus, nodes need to negotiate on a frequency range depending on the state of the spectrum for the emitter and the receiver. To provide a proper transaction that cannot be interrupted, the sender first needs to make a reservation. The real spectrum reservation will happen at the receiver node which can select a frequency from the available frequencies at the sender and its available frequencies. The selection of the band should also consider some of the constraints of the emitter such as the available time on the band.

Logical link control messages

To solve the hidden-node problem, CR nodes need to exchange some control messages and all the neighbouring CRs should receive and interpret these messages. This process is similar to the traditional RTS/CTS exchange explained previously. In this part, we will detail the used frames and their structure.

When a CR emitter wants to establish a communication with a specified destination, it will broadcast a Willing-To-Send (WTS) frame on any available frequency band. If it is for data transmission, this frame will indicate its parameters for the transmission. These parameters are encapsulated into the frame and included the following information:

- The node’s identification and the available frequency bands,
- The data length that the sender wants to transmit,
- The relative limited duration needed for the transmission
- The expected destination the sender wants to reach.

However, if the communication is for voice or video, other parameters will be needed to calculate the reservation time in the destination side, such as: delay and loss probability. We suggest a WTS Frame structure in Fig. 6.12 and the respective fields explanation in Table 6.2.

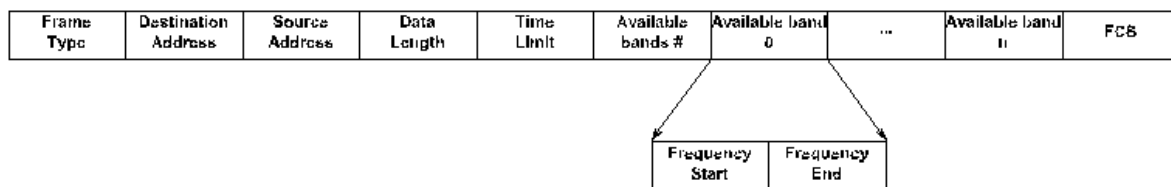

Figure 6.12: Waiting to send frame structure

Field	Size	Descriptions
Frame type	8 bits	Waiting to send
Destination Address	48 bits	Destination MAC's address
Source Address	48 bits	Sender MAC's address
Data length	8 bits	Data size that the sender intends to transmit
Time limit	8 bits	Necessary duration which the transmission takes place in <i>ms</i>
Number of Available bands	8 bits	Number of available frequency bands
Available band i:	64 bits	Available frequency bands at the current time
Frequency band start	32 bits	Frequency in Hz
Frequency band end	32 bits	Frequency in Hz
FCS	8 bits	Frame check sequence

Table 6.2: Waiting to send frame structure explanation

When the WTS reaches the destination, this CR selects one of its available frequency band that satisfies the indicated frequency ranges in the WTS. It then broadcasts a Ready-to-Receive (RTR) frame on any of its available frequency bands. This frame contains the selected frequency, the reservation time, the destination address. The RTR frame structure is shown in Fig.6.13 and fields explanation is provided in Table 6.3.

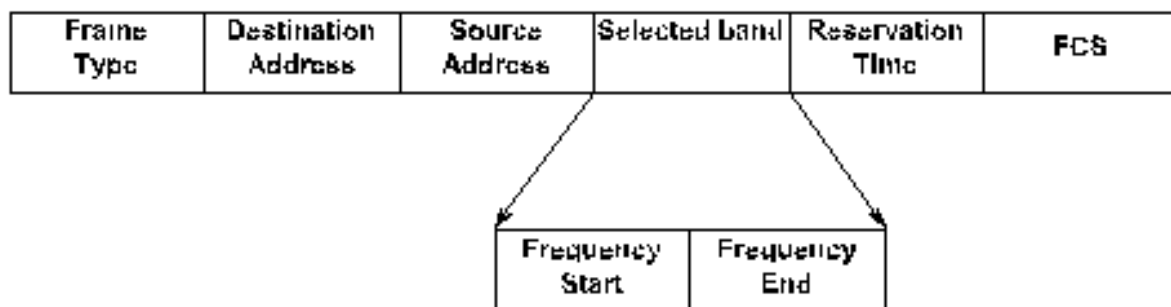

Figure 6.13: Ready to receive frame structure

Field	Size	Descriptions
Frame type	8 bits	Ready to receive
Destination Address	48 bits	Destination MAC's address
Source Address	48 bits	Sender MAC's address
Selected band:	64 bits	Available frequency bands at the current time
Frequency band start	32 bits	Frequency in Hz
Frequency band end	32 bits	Frequency in Hz
Reservation Time	8 bits	Reserved duration for the transmission
FCS	8 bits	Frame check sequence

Table 6.3: Ready to receive frame structure explanation

Following the RTR sending process, the sender acknowledges to the destination that it can reach the destination on a determined frequency range within a specific reserved time. To do so, the CR emitter sends a Ready-to-Send containing the same frequency as a RTR. Similar to WTS and RTR, ReadyTS frames are also broadcast on all the available frequency ranges. The ReadyTS frame basically copies the contents from the received RTR. Therefore, the structure of ReadyTS has the same format as the RTR (Fig.6.14 and Table 6.4). Note that the frame type is different as the sender and the recipient addresses are swapped.

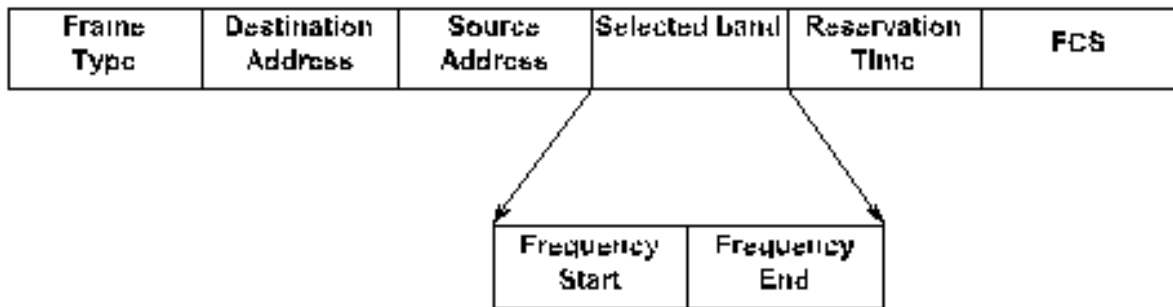

Figure 6.14: Ready to send frame structure

Field	Size	Descriptions
Frame type	8 bits	Ready to send
Destination Address	48 bits	Destination MAC's address
Source Address	48 bits	Sender MAC's address
Selected band:	64 bits	Available frequency bands at the current time
Frequency band start	32 bits	Frequency in Hz
Frequency band end	32 bits	Frequency in Hz
Reservation Time	8 bits	Reserved duration for the transmission
FCS	8 bits	Frame check sequence

Table 6.4: Ready to send frame structure explanation

6.4.2 Protocol Operation

In this section, we explain the various operation phases of the link-layer protocol. The CR broadcasts a WTS to initiate a communication with another CR. This last as well as the other neighbouring CRs also receive the WTS. So, they will be aware of the indicated resources in the WTS frame. A local "Spectrum Lock Table" (SLT) is hence needed to store information about the current used frequency band during a period of time.

After receiving a WTS, surrounding CRs read and update their SLT. The updated information include the sender and destination IDs and the potentially occupied frequency bands. These neighbours hence avoid accessing these bands and wait for the RTS which will tell them about the frequency band that will be occupied and the reservation time. Upon receiving the ReadyTS, the SLT of the surrounding CRs are also updated such as the example in Fig. 6.15.

Spectrum Lock Table Local to each Node

Locked Frequency Bands	Source ID	Destination ID	Lock Duration
[868..869]	A	B	d_{ms}
[870..870,5]	A	B	d_{ms}
[915..917]	A	B	d_{ms}

Figure 6.15: Spectrum lock table example of each node

When the WTS reaches the expected destination, this last selects an available frequency band that satisfies the indicated request in the WTS. The selected frequency band along with the reservation time are encapsulated into a RTR frame and then

sent back to the sender. This RTR also reaches the destination surrounding CRs, so that they can update their SLT accordingly. These CRs avoid accessing these locked spectrum until the reserved time is over. Thus, the hidden node problem is resolved. At this stage, the sender knows that it can reach the destination on a determined frequency band within a specific reserved time. The sender finally emits a ReadyTS frame containing exactly the same information as the RTR. So, its surrounding nodes know that they should not use this band. The following example illustrates the link-layer protocol operation.

In Fig. 6.16, node A, who is available on frequency ranges [868, 869], [870, 870.5] and [915, 917], wants to talk to node B, it sends a WTS on any available channel. In Fig. 6.16, the green and blue nodes are the neighbours of A and B respectively, assuming that B is also one of A's neighbours. The representing table shows the current unavailable frequency ranges after A sent out the WTS and the duration of unavailability for the green and the blue nodes.

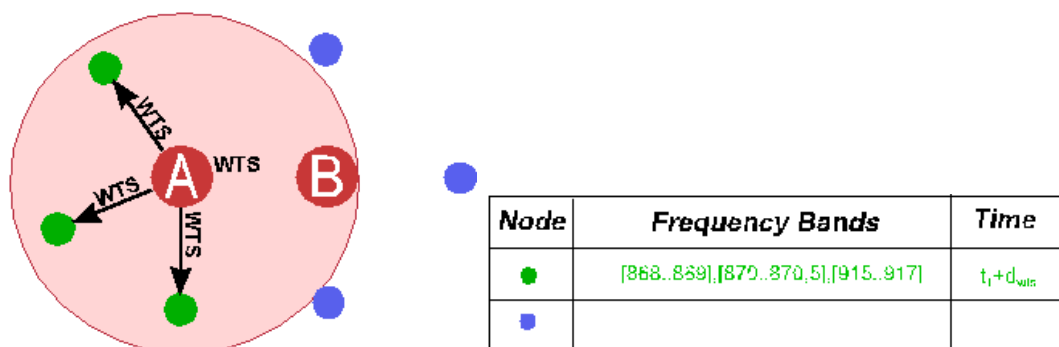

Figure 6.16: WTS sending example

After B receives the WTS from A, it selects a frequency range ([868, 869]) which is available for both A and B and sends back a RTR indicating this selected range as well as the expiration time (10ms for instance). Fig. 6.17 shows the RTR sending process and the corresponding SLT at each A's neighbour CRs.

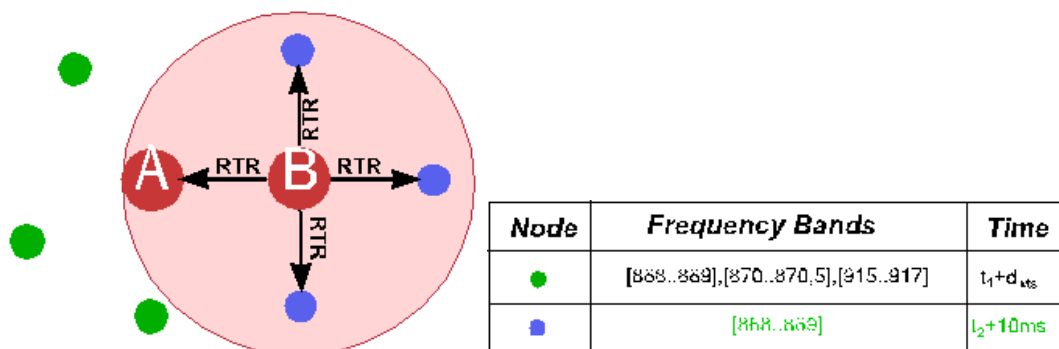

Figure 6.17: Ready-to-receive sending example

A eventually receives B's RTR indicating the agreed parameters of the communication. RTS frames are generated and sent over the medium. Again, the surrounding

green neighbours, including the destination B, are expected to receive this frame. In Fig.6.18, A confirmed that it is ready to start sending data to B via reserved frequency ranges and within the indicated time frame.

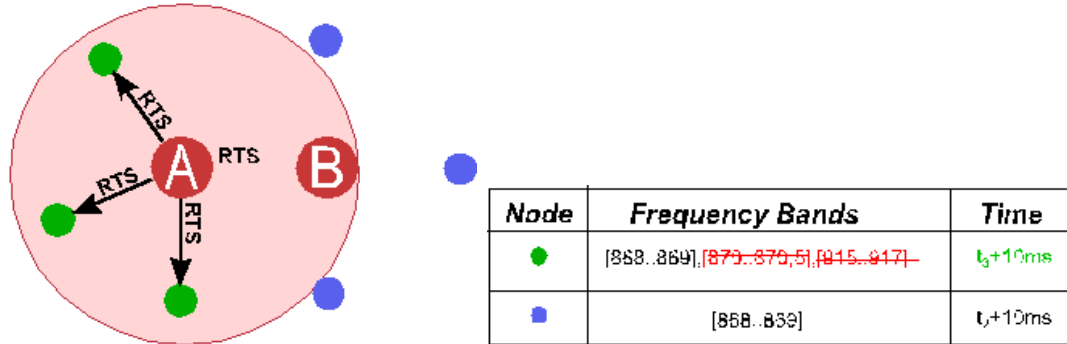

Figure 6.18: Ready-to-send sending example

All the green nodes are able to update the actual occupied frequency band and its expiration duration in their locking table (SLT). A and B are now ready to communicate on range [868, 869], the other unused bands are freed and can be utilized as in Fig. 6.19.

Locked Frequency Bands	Source ID	Destination ID	Lock Duration
[858..869]	A	B	10 ms
[870..870,5]	A	B	0 ms
[915..917]	A	B	0 ms

Figure 6.19: Spectrum lock table after A's neighboured CRs received RTR

Once the communication channel is established, the sender is now able to transmit data to the expected destination as in Fig. 6.20.

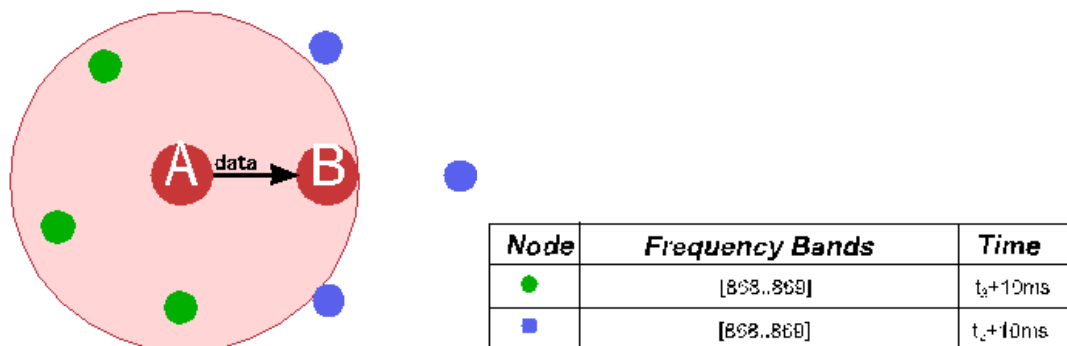

Figure 6.20: Established communication between A and B

6.4.3 User Identification collaboration protocol

Identifying spectrum users over the CRNs

The purpose of the sensing process is to identify the transmissions within the listening frequency ranges (e.g., 8Mhz bandwidth). The process is realized with the CRN framework provided in section 6.2.2 in which the USRP-1 device is used in conjunction with gnuradio block to detect the beginning and the ending of a suspected signal.

First of all, the primary-secondary detection can be pursued by exploring the physical characteristics of the spectrum: underlying technology, frequency bands, modulation, channel width, etc. The extracted information from a MAC frame are the followings:

- If the frame is readable, it means that it is known so it can likely be attributed to a primary or a secondary user.
- Otherwise, the frame comes probably from an unknown CR or a primary device.

Then, the CR collaborates with the surrounding devices to acquire as much useful information as possible (e.g., frequency range on which it is available, relative time, power strength). This means every secondary user needs to store every so-called “radio-event” in a table. Radio Events Table is where the spectrum sensing information is locally recorded by each CR node. Each record in this table contains the transmission information of a concerned transmission with the time, frequency ranges and received power as well as a tag indicating the type of the emitter (primary, secondary or an unknown). The spectrum users identification procedure is summarized in the flowchart provided in Fig. 6.21

To demonstrate how the procedure works, we provide the following study case. Node A senses the medium to find an available frequency range (Fig.6.22). It detects a transmission and adds detected information to the Radio Events Table (Fig.6.22).

In Fig. 6.23, A attempts to read the information from the detected transmission. If it is successful, it forwards the frame to the MAC Layer which tries to decode the frame. After successful decoding, A tags “P” or “S” and adds the NodeID to the associated record in the Radio Events Table. When this transmission ends, its info is stored locally in A’s Radio Events Table.

If A failed to either read information from the detected transmission or decode the frame, it will ask the surrounding nodes for more information about this transmission. To do so, it sends a request which contains frequency, (relative) time range and received power at the antenna. The collaboration between A and the other identified CRs is illustrated in Fig. 6.24.

Flow Chart of Spectrum users identification

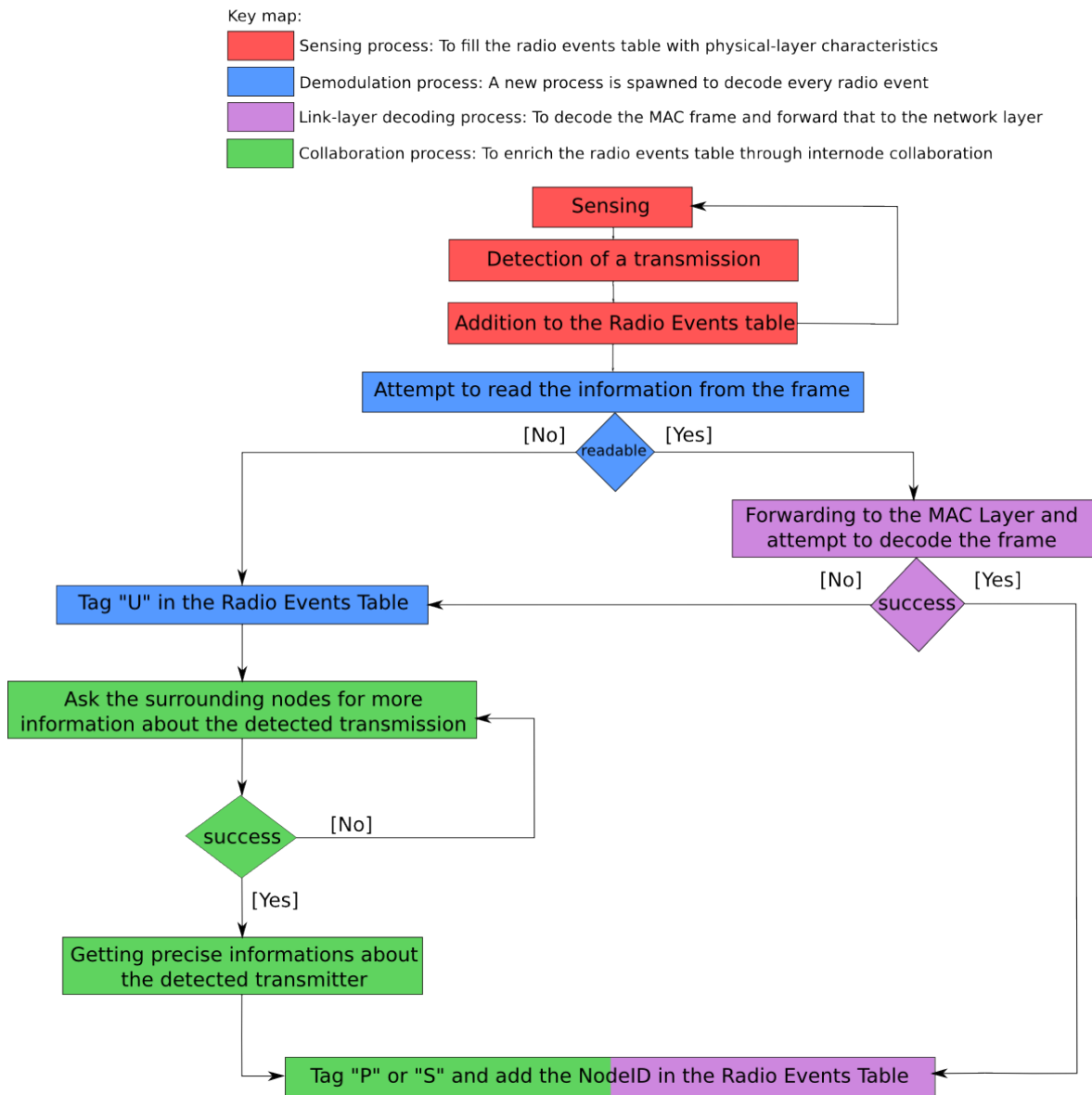

Figure 6.21: Spectrum users identification flowchart

Any surrounding node which gets the request and obtains the information will respond thanks to its own knowledge (Fig. 6.25). A then collects the information from these responses, tags “Unknown”, “P” or “S” and adds the NodeID to the associated input in its the RET.

Now, A has the needed information about the PR (with identification C31) using the band [860..865], and can store this information in a neighbouring PRs’ table (Fig. 6.26). This table contains the node IDs, the frequencies they use to communicate and the maximum power A can use without disturbing these nodes. This allows A to fill a map of the maximum allowed transmission power on every frequency it can emit on without harmfully perturbing the PR.

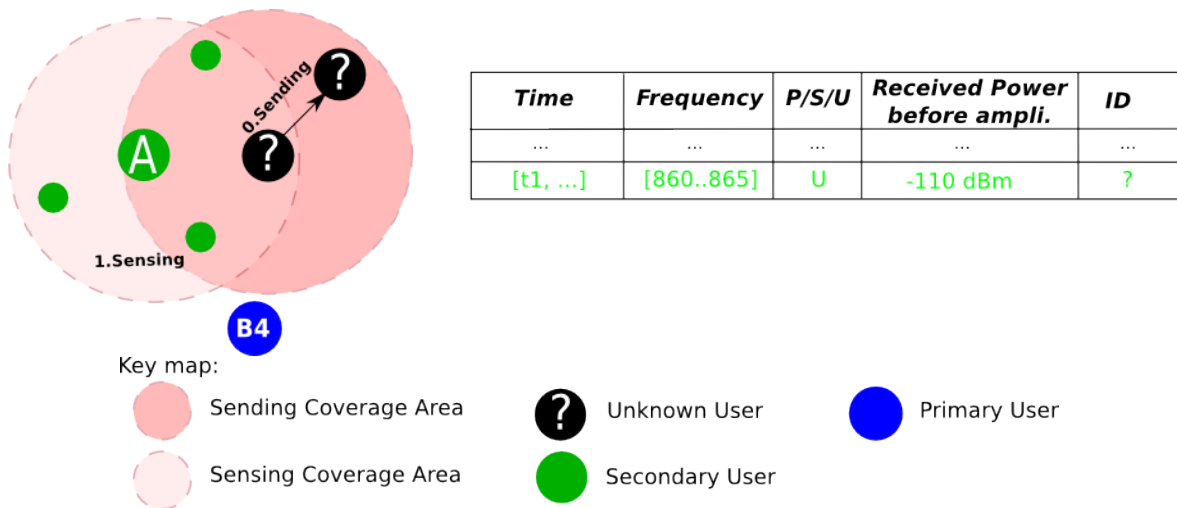

Figure 6.22: Sensing process starts at A

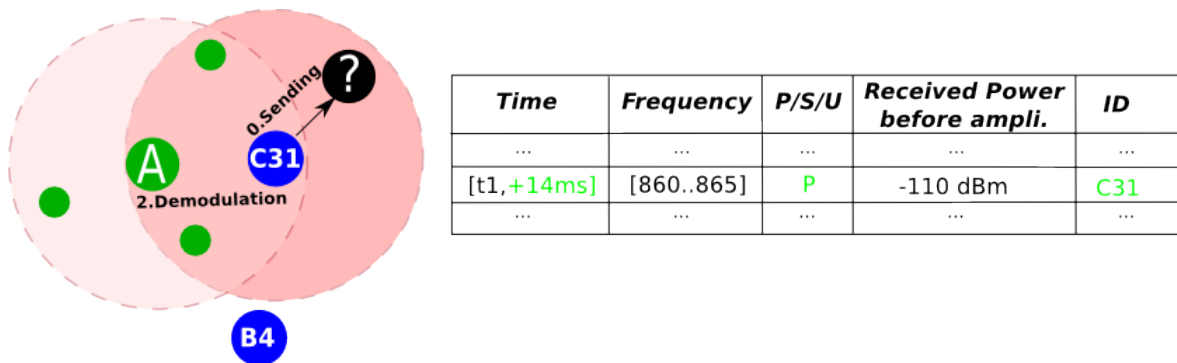

Figure 6.23: Demodulation and Link-Layer Decoding at A

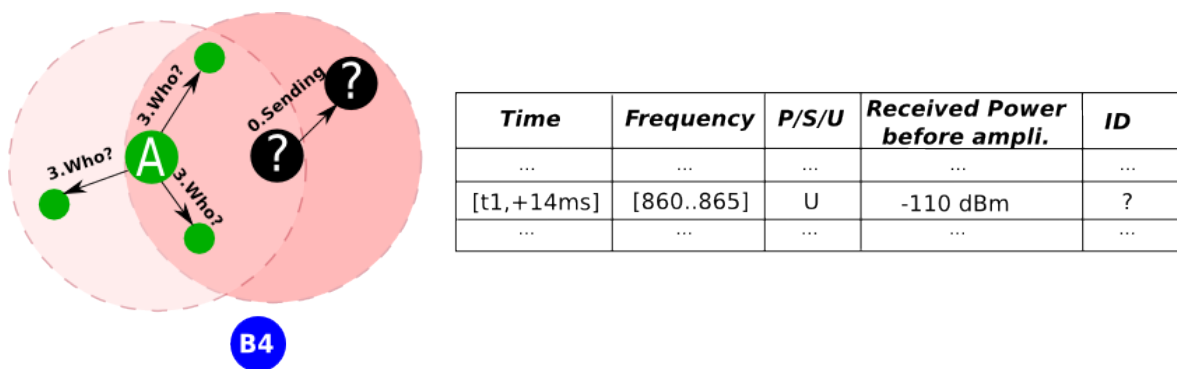

Figure 6.24: Collaboration between A and its identified neighbours

All the information that the Node could obtain from the neighbours, is stored in the Radio Events Table. The stored parameters are:

- The time of the transmission: stored as the beginning and end of the transmission,
- The frequency range used by the transmission,

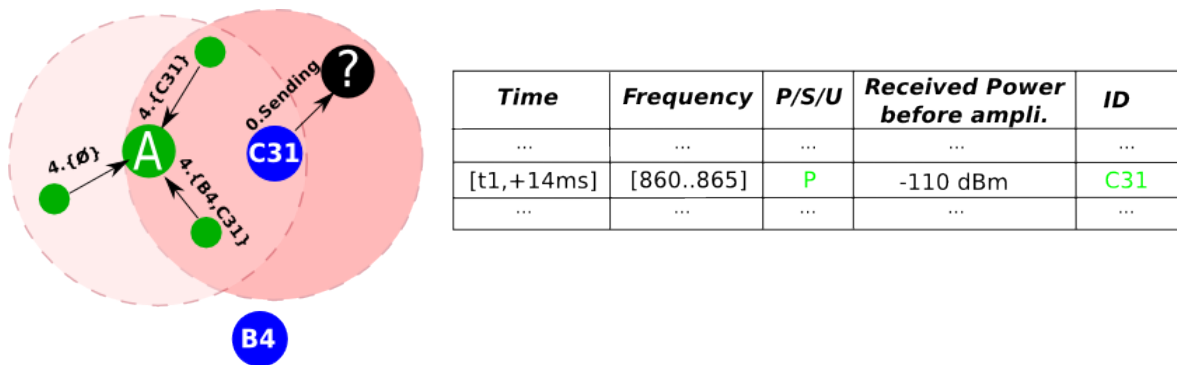

Figure 6.25: Collaboration between A and its identified neighbours - responding process

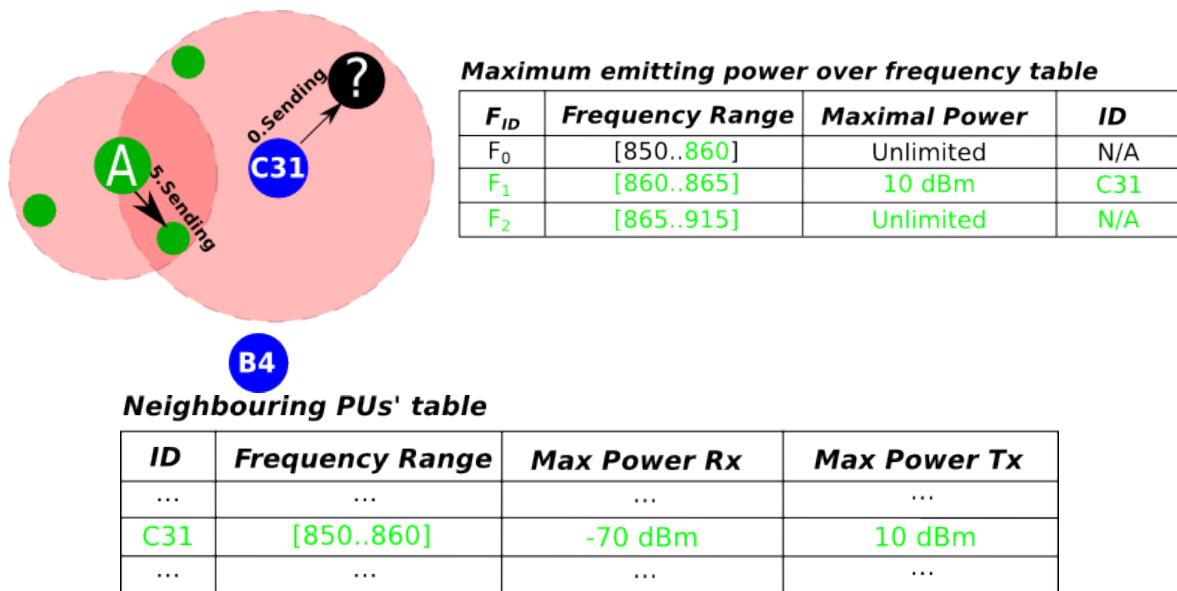

Figure 6.26: Information synthesis

- The received power at the antenna,
- The Primary/Secondary/Unknown users,
- An ID for the node. This ID can be constructed either from the decoding of the MAC layer or from pseudo generated local ID.

Collaboration process

To identify users of spectrum based on their radio-frequency activities, we propose a collaboration scheme between CR nodes. The purpose of this protocol is to provide better view of the current network and hence provide better protection of primary radio users. In this section, we explain why we design this protocol as well as how it works.

As mentioned in previous sections, during the sensing phase, a CR can detect if there is a transmission on a specific band but a CR cannot always identify who occupies it.

From a physical layer point of view, a CR node needs to know several parameters (the underlying technology, signal modulation technique, and bandwidth of a channel) to be able to decode a transmission. When a node senses one communication on the current listening frequency band, it attempts to decode it to see if it comes from a primary or a secondary user. However, decoding a transmission requires that the transmission:

- happens entirely inside the current listening band,
- finishes before the node hops to another frequency band,
- has a sufficient Signal-to-Noise-Ratio for the decoder to distinguish the symbols,
- is modulated using a known modulation,
- is not encrypted at the link-layer.

To determine the origin of an unknown transmission, neighbouring CRs should cooperate to identify this communication. Inherently, this collaboration mechanism works along with the previous proposed signalling protocol and on top of this protocol. Thus, we propose a broadcasting scheme with some modifications to avoid possible collisions. In this section, we present the operation of this collaboration process, i.e., how a node generates a decoding transmission request and how the other CRs respond.

When a node fails to decode a transmission, it will generate a broadcast request that will be sent to the neighbours – which are known thanks to the proposed signalling protocol in section 6.3.

Broadcast request contains the list of the unidentified communications/transmissions. A communication is identified by the relative time at which it happened and its frequency band. To simplify later communication as well as updates the RET, the node generates a locally-unique number. This ID will also be used to create a unique MAC address if none of the nodes is able to decode the transmission. A request ID is also included, so that the CR nodes answering the request can refer to it. Broadcast request format is illustrated in Fig. 6.27.

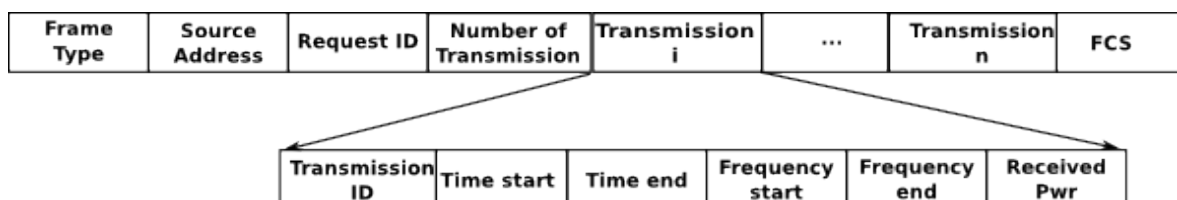

Figure 6.27: Proposed Broadcast Request

CR nodes receiving a request in the collaboration protocol are supposed to look inside their Radio Events Table to find a potential match to every transmission contained in the request. If a match for a communication is found, the node answers by telling

Field	Size	Descriptions
Frame type	8 bits	Collaboration request message
Source Address	48 bits	Sender MAC's address
Request ID	16 bits	Request identification
Number of transmission	8 bits	Number of unidentified transmission(s)
Unidentified transmission i:	120 bits	list of unidentified transmission
ID	16 bits	Local generated transmission ID for current unknown transmission
Time start	16 bits	Time starting point when the transmission is detected
Time end	16 bits	Time ending point when the transmission is detected
Frequency band start	32 bits	Frequency in Hz
Frequency band end	32 bits	Frequency in Hz
Received power	8 bits	Received power before amplified in dBm
FCS	8 bits	Frame check sequence

Table 6.5: Broadcast request message structure explanation

the received power (before amplification). However, if the node manages to decode the transmission and it knows if the transmission was done by a primary or a secondary user, the MAC address of the device is stored in RET and enclosed in the response. Fig. 6.28 represents the Broadcast Response structure.

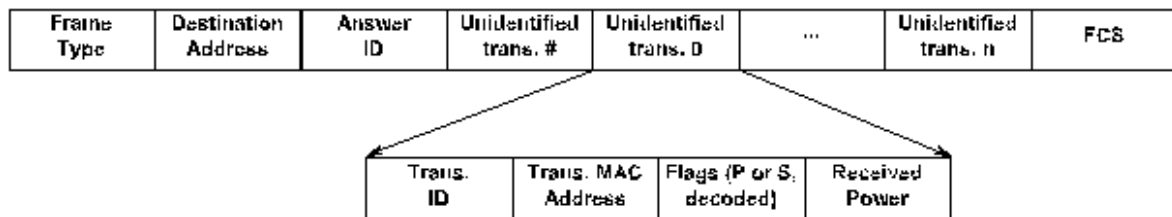

Figure 6.28: Proposed Broadcast Response

Flow chart in Fig. 6.29 summarizes the replying process at a neighbouring CR. Since, the response is all broadcast, other neighbours will also receive it. These neighbours can read these response and stop themselves from generating the same response. Each CR will apply a waiting time before replying to prevent transmitting response at the same time. Duplicated responses are hence avoided. Furthermore, these neighbours can leverage the information included to fill their own knowledge (e.g., the Radio Events Table). If a neighbour node receives a broadcast response, it checks the flag of the response for the requested transmission. A comparison process takes place to see whether this node should update the radio event table or send another response to correct the information of the transmission. If the flag is negative and the node has knowledge of the requested transmission, the node generates another response and broadcasts it. Furthermore, if the flag is negative and the node does not have any knowledge about the transmission, this node has nothing to do with it. By using this indicating flag, we aim to minimise confusing information among the neighbours as well as reducing traffic produced by multiple duplicated broadcasts. Note that, a node

Field	Size	Descriptions
Frame type	8 bits	Collaboration request message
Destination Address	48 bits	The requested senders' MAC address
Answer ID	16 bits	Request identification
Number of transmission	8 bits	Number of enclosed transmission(s)
Unidentified transmission i:	72 bits	list of unidentified transmission
ID	16 bits	Local generated transmission ID for current unknown transmission
Transmission MAC	48 bits	MAC of the detected transmission
Flags (P or S, decoded)	8 bits	Primary or Secondary user indicator
Received power	8 bits	Received power before amplified in dBm
FCS	8 bits	Frame check sequence

Table 6.6: Broadcast response message structure explanation

will generate a local ID for an unknown transmission that is unable to decode after collaboration process. This ID includes a generated MAC with an extra bit for negative flag, telling the MAC address was generated.

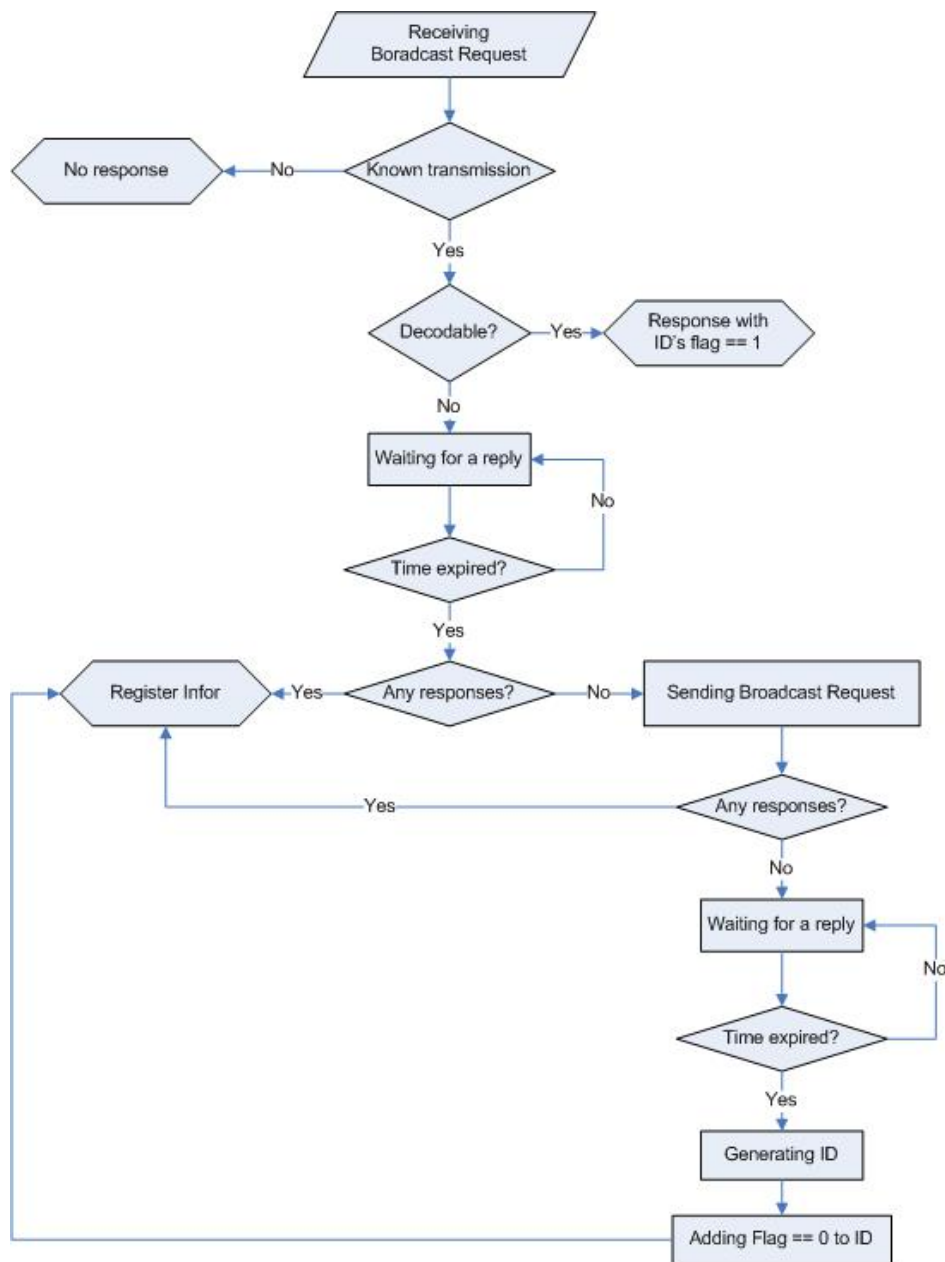

Figure 6.29: Collaboration process example

We demonstrate an example in which a node sends out a response with a negative flag and other node corrects the information by sending out another response with positive flag in Fig. 6.30. In Fig. 6.30(a), A wants to know about the transmission of the blue node (C31) and one of its neighbour answers with an negative flag. It means that user C31 is a local ID (a pseudo identification) generated by its neighbour and C31 is still an unknown user. In this case, the blue node is actually B4 instead of C31. Thank to the flag, other neighbour of A (the green node on the bottom) has information about C31. In Fig. 6.30(b), an update response is then sent over the network. So, all the surrounding nodes could update their own knowledge about the real user's identity (B4).

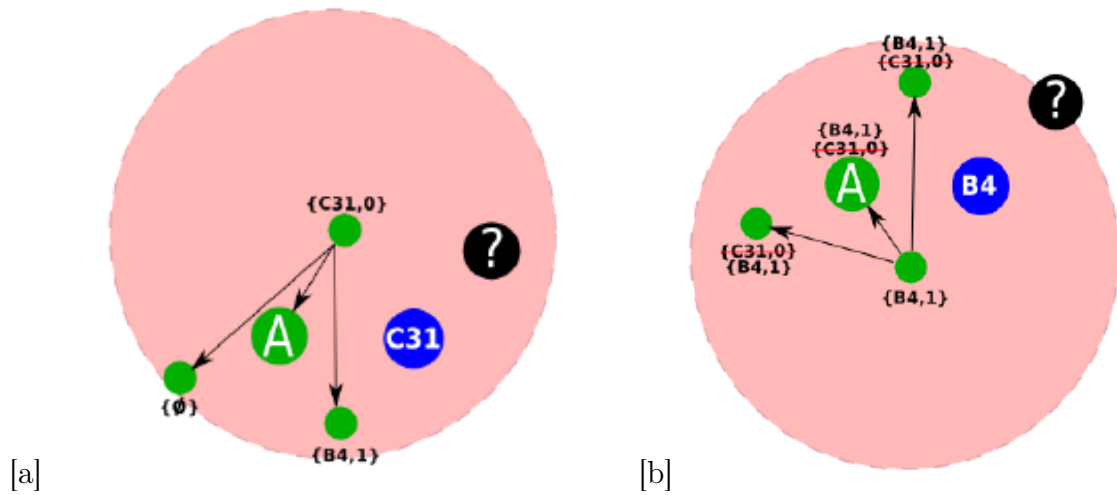

Figure 6.30: Transmission identification responding process example

Since we chose the broadcast scheme in our dissemination model, we also need to avoid potential collisions that occur. Thus, we choose to apply typical back-off counter strategy to prevent collision. Before sending out a broadcast, a node also makes sure the environment is idle to prevent jamming into the medium. If the medium is currently condense , a node generates a back-off counter while keeps checking the medium. This counter is randomly generated depending on the state of the medium. We describe the process in the flowchart in Fig. 6.31.

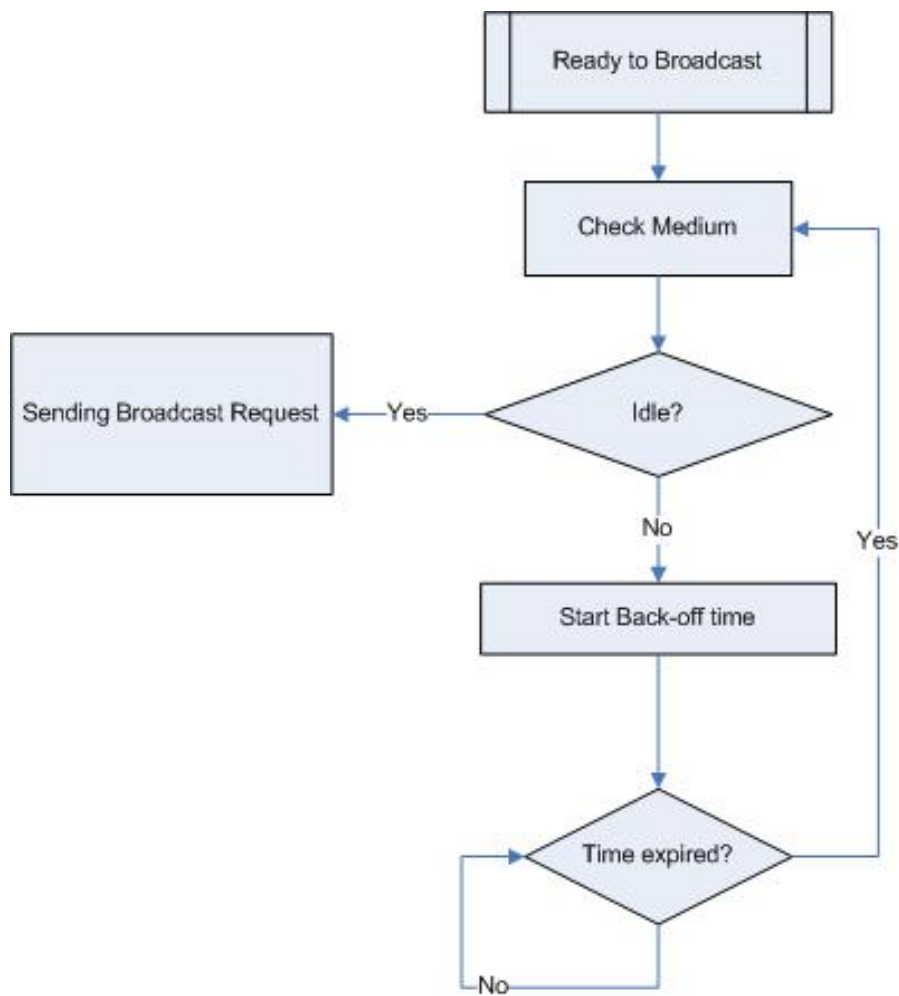

Figure 6.31: Proposed back-off counter to avoid collision

6.5 Conclusion

Knowing that not only the interference avoidance in CRNs is important, our beacon-based signalling protocol deals with resource allocations and avoids hidden node problem in CRNs. In multihop CRNs, the protocol helps to establish the common channel between the nodes so that they can virtually see each other on a designated channel within a specific time frame. These information is broadcast periodically among the CRs to still aware of the change of the environment. The proposed signalling protocol is important to guarantee the accessibility for CRs and also place a solid foundation for our DYMO-CRN. We has provided a practical framework that covered from the physical perspective to the logical perspective, from the physical layer to the medium access control layer. Recall from the drawback of DYMO, DYMO assumes that all the link in the network are bidirectional. It hence strongly depends on the lower layers to ensure the link availability before routing protocol execution. Therefore, with our proposed medium access control mechanism, we can ensure a bidirectional link for DYMO.

Chapter 7

Conclusion

In this chapter, we summarise the key results our various contributions before presenting some interesting perspectives of our work.

7.1 Key Results	154
7.2 Future Work	156

7.1 Key Results

Insufficient radio spectrum usage is still a problem that the research community and international broadband agencies are dealing with, especially with the continuously increasing demand for mobile communication. Cognitive radio technology is a promising approach to improve the scarcity of radio resources. In the context of coexisting PRs and CRs, we have shown that potential resources can be used with a level of tolerable interference while CRs operates within a PR's coverage network. To make use of our findings, we provided an interference estimation technique accompanied with a routing proposal. Since the interference avoidance in CRNs is not the only important problem, we also worked on a beacon-based signalling protocol to deal with resource allocations to avoid hidden node problem in CRNs. In multihop CRNs, this protocol helps to establish the common channel between the nodes so that they can see virtually each other on a designated channel within a particular time frame. This information is

broadcasted periodically among the CRs to monitor changes in the environment. Our main contributions are the following.

We found that not only the size of overlap region was important to make use of residual resources of the current medium, but also the existence of PR nodes in this sensitive area. This observation can be used as a brief assessment of the impact of any kind of CRN deployment in practice, before considering other technical aspects such as modulation or underlying technology. For instance, interference can be evaluated when CRNs and other current devices coexist in TV white spaces. The technique we presented in Chapter 4 can be used to characterise the overlap region between TV emitters and cognitive radio users in TV white spaces. Our simulations showed that the size of the interference region was the key factor in reducing the interference on licensed incumbent users, much more than the number of primary users inside these regions. These results are encouraging since managing the size of the overlap region through the optimisation of CR users transmission power and/or locations is feasible unlike controlling the number of TV receivers. Furthermore, our findings can be used to encourage for the coexistence of licensed and unlicensed users in cognitive radio environments as well as in the infrastructure based TV white spaces deployment.

In addition to these observations, we suggested an approach to estimate the interference level based on fuzzy logic in Chapter 5. Fuzzy logic is a simple but effective method to deal with vague problems that may require complex mathematical solutions. If the provided observations signify the importance of the overlap and node density, the composition of them using fuzzy logic produces a readable interference level. The fuzzification process combines the overlap size and the node density into linguistic parameters that are easy to understand in plain language. Furthermore, we showed that the linguistic variable of interference level comes with a corresponding crisp value. This value indicates the ratio of the interference level, which can be integrated into our proposed DYMO-CRN routing protocol. Thanks to the extension feature of DYMO, which is the alternative metric enabling a subordinate parameter for the route selection, the interference level can be used for the route selection process along with the hopcount. With these two metrics, the protocol can select the most optimal path according to the hopcount with the lowest interference level. Therefore, the established path could be the route with least interference level between the source CR and the destination CR. The PRs are hence protected at a certain probability. So the impact of on-going CRs' operations is known and identified. Interestingly, this information can be accessed by the network layer and incorporated into a path exploration process in the proposed routing solution. Our work highlights the possibility to leverage DYMO routing protocol in CRNs. Thanks to an alternative metric option provided by DYMO, we can incorporate interference metric into path exploration. Even though the simulation is not yet realized, our work offers a guideline for developing a cognitive radio routing protocol that could prevent potential impact on primary networks when CRNs operate.

We developed ideas on how we would like to allocate the radio resources between the CR nodes and how they access the medium in Chapter 6. Indeed, we provide a practical framework from the physical perspective to the logical perspective, and from the physical layer to the medium access control layer. The proposed signalling mechanism combines the work from Chapter 4 and Chapter 5. Identification of the spare resources and determination of the users in the medium are the two most interesting features of our signalling proposal. Moreover, the CRs in our proposed scenarios collaborate and form a distributed spectrum-sharing CRN. Thanks to this MAC design, we can overcome the problem with DYMO due to bidirectional link requirement. In addition, the hidden node problem was also addressed and solved thanks to our MAC protocol. The information collected from the physical RF of the spectrum sensing are locally kept. The MAC protocol accesses this information to extract useful knowledge such as spare frequency ranges, bandwidth, and traffic activities. Even though the information is mainly collected from the physical layer, other layers such as MAC and network layers can always retrieve it in a cross-layer manner. Our design thus allows information to be exchanged between any protocol layers without any boundaries.

As the result of our work, we have presented and published our ideas in several Cognitive Radio conferences such as [177, 178, 179, 180] and a collaboration in [145].

7.2 Future Work

The research in this thesis has highlighted some issues in developing a practical a cognitive radio network, and the following aspects can be extended.

The characterisation of the licensed users activities can be included in the observation described in Chapter 4. The historical information regarding the licensed users' activities can then be analysed and integrated into the prediction models. Currently, only the overlap and node density are considered in the coexistence scenario. With information about primary users activities, the study fulfills the time dimension for the observation. An investigation of overlapping area for more complex cases can be carried out. For the signal processing, work can be done with more precise propagation models where multiple TV broadcasters and secondary senders are active. The accumulating interference in these models should consider not only the CR systems but also the current operating TV broadcasters. Besides, the obstacles between the TV broadcasters and the CRs should also be included when investigating the interference in such a scenario.

Recalling our cross-layer accessing scheme in Chapter 2, we can see that not only the routing protocol benefits from estimating the interference level. Indeed, other components could also use this parameter to determine the appropriate use of current

radio resources. One component that we have not had time to investigate was the power control that satisfies the estimated interference level. This task requires deeper signal processing knowledge. In addition, our proposed guidelines in Chapter 5 can be realized. This would contribute to the open-source community by achieving some of the simulation components for CRNs in Omnet++. It would then help the research community perform verification of CRN functionality. More importantly, the medium access scheme in Chapter 6 can be developed for the Omnet++ simulation as one of its MAC modules for wireless network experimentation.

To achieve a real operational framework for cognitive radio network, the current prediction of experimental data must be improved. Service providers keep the statistical data on nodes' existence and position. Since these data are confidential, they are not open access for the public. Therefore, the bias between the prediction model and real life statistics may be huge. Thus, it would be useful if this data is made available for research community.

List of Publications

Posters

1. **Minh Thao Quach** and Hicham Khalife, ‘The impact of overlap regions in cognitive radio networks’ in *Wireless Days (WD)*, IFIP, IEEE, 2012, pp. 1–3.

In Proceedings

1. **Minh Thao Quach**, Dramane Ouattara, Francine Krief, Hicham Khalifé, and Mohamed Aymen Chalouf, ‘Overlap regions and grey model-based approach for interference avoidance in cognitive radio networks’ in *IEEE 2013 Fifth International Conference on Ubiquitous and Future Networks (ICUFN)*, 2013, pp. 642–647.
2. Dramane Ouattara, **Minh Thao Quach**, Francine Krief, Mohamed Aymen Chalouf, and Hicham Khalifé, ‘Mitigating the Hospital Area Communication’s Interference using Cognitive Radio Networks’, *IEEE International Conference on e-Health Networking, Application & Services (IEEE Healthcom)*, 2013.
3. **Minh Thao Quach**, Francine Krief, Mohamed Aymen Chalouf, and Hicham Khalifé, ‘Fuzzy-based interference level estimation in cognitive radio networks’, in *The Tenth Advanced International Conference on Telecommunications AICT*, IARIA XPS, 2014, Best Paper Award.

Journals

1. **Minh Thao Quach**, Francine Krief, and Mohamed Aymen Chalouf, ‘Interference avoidance routing strategy in cognitive radio networks’, *International Journal on Advances in Telecommunications*, vol. 8, no. 1–2, pp. 84–97, 2015

Bibliography

- [1] S. Haykin, D. J. Thomson, and J. H. Reed, "Spectrum sensing for cognitive radio," *Proceedings of the IEEE*, vol. 97, no. 5, pp. 849–877, 2009.
- [2] IEEE-SA Standards Board, "IEEE standard for information technology telecommunications and information exchange between systems – local and metropolitan area networks – specific requirements – part 19: Tv white space coexistence methods," <http://standards.ieee.org/getieee802/download/802.19.1-2014.pdf>, September 2014, iEEE standard.
- [3] Federal Communications Commission, "In the matter of promoting efficient use of spectrum through elimination of barriers to the development of secondary markets, notice of proposed rule making," WT Docket No. 00-230, 15 FCC Rcd 24203 (2000), November 2000.
- [4] Federal Communications Commission Spectrum Policy Task Force, "Report of the spectrum efficiency group," Technical Report, November 2002.
- [5] Federal Communications Commission, "Federal communications commission: spectrum policy task force report," FCC, ET Docket 02-135, 2002.
- [6] Spectrum Bridge Inc., "Analysis of fcc secondary spectrum markets positions, policies and comments," White Paper, August 2008.
- [7] J. Mitola, "Cognitive radio: An integrated agent architecture for software defined radio," Ph.D. dissertation, Royal Institute of Technology (KTH), Sweden, 2000.
- [8] By the Commission: Chairman Powell, Commissioners Copps, "Notice of proposed rule making and order," ET Docket No. 03-108, December 2003, before the Federal Communications Commission Washington, D.C. 20554.
- [9] S. Forum, "SDRF Cognitive Radio Definitions," Nov. 2007. [Online]. Available: http://www.sdrforum.org/pages/documentLibrary/documents/SDRF-06-R-0011-V1_0_0.pdf
- [10] I. F. Akyildiz, W.-Y. Lee, M. C. Vuran, and S. Mohanty, "Next generation/dynamic spectrum access/cognitive radio wireless network: A survey," in *Computer Networks*, vol. 50, 2006, pp. 2127–2159.

-
- [11] I. F. Alyikdiz, Won-Yeol, and K. R. Chowdhury, "Crahns: Cognitive radio adhoc networks," *AdhocNet*, vol. 7, pp. 810–836, July 2009.
- [12] H. Khalifé, S. Ahuja, N. Malouch, and M. Krunz, "Probabilistic path selection in opportunistic cognitive radio networks," in *IEEE GLOBECOM 2008*, NOV 2008.
- [13] "Leveraging insurance for services providers cohabitation over cognitive radio networks," ANR Project proposal, 2010, project LiCORNe, DOCUMENT B.
- [14] K. F. King, "Geolocation and federalism on the internet: Cutting internet gambling's gordian knot," *The Columbia Science and Technology Law Review*, 2009.
- [15] W. Shu, M. Jungwon, and Y. B. K, "Location based services for mobiles: Technologies and standards," in *IEEE international conference on communication (ICC)*, vol. 19, 2008.
- [16] M. Peres, "A holistic approach to green networking in wireless networks - collaboration among autonomic systems as a mean towards efficient resource-sharing," Ph.D. dissertation, University of Bordeaux, France, 2014.
- [17] D. N. Ekram Hossain and Z. Han, "Dynamic spectrum access and management, cognitive radio networks," Cambridge University Press, 2009.
- [18] Cisco, "Cisco visual networking index: Global mobile data traffic forecast update, 2014–2019," Public White paper, February 2015. [Online]. Available: http://www.cisco.com/c/en/us/solutions/collateral/service-provider/visual-networking-index-vni/white_paper_c11-520862.html
- [19] C. Cordeiro, K. Challapali, D. Birru, and N. Sai Shankar, "Ieee 802.22: the first worldwide wireless standard based on cognitive radios," in *First IEEE International Symposium on New Frontiers in Dynamic Spectrum Access Networks, DySPAN*, Nov 2005, pp. 328–337.
- [20] C. Cordeiro, K. Challapali, D. Birru, S. Shankar N *et al.*, "Ieee 802.22: An introduction to the first wireless standard based on cognitive radios," *Journal of Communications*, vol. 1, no. 1, pp. 38–47, 2006.
- [21] IEEE802.22 Working Group, "IEEE draft standard for information technology -telecommunications and information exchange between systems - wireless regional area networks (wran) - specific requirements - part 22: Cognitive wireless ran medium access control (mac) and physical layer (phy) specifications: Policies and procedures for operation in the tv bands," *IEEE P802.22/D1.0*, December 2010, pp. 1–598, Dec 2010.
- [22] M. J. Copps, "Bringing broadband to rural america: Report on a rural broadband strategy," Federal Communications Commission, Tech. Rep., May 2009.

-
- [23] FCC, “Bringing broadband to rural america: Update to report on a rural broadband strategy,” Federal Communications Commission, Tech. Rep., 2011.
- [24] Federal Communications Commission, “Notice of proposed rules making in the matter of unlicensed operation in the tv broadcast bands,” May 2004, eT Docket 04-186.
- [25] —, “Second report and order and memorandum opinion an order, in the matter of unlicensed operation in the tv broadcast bands additional spectrum for unlicensed devices belows 9000mhz and in the 3ghz bands,” Technical Report, October 2006, eT Docket 08-260.
- [26] —, “Mobile broadband: The benefits of additional spectrum,” Federal Communications Commission, Tech. Rep., 2010.
- [27] IEEE802.22 Working Group, “IEEE draft standard for information technology -telecommunications and information exchange between systems - wireless regional area networks (wran) - specific requirements - part 22.1: Standard to enhance harmful interference protection for low-power licensed devices operating in tv broadcast bands,” *IEEE ASSP Magazine*, Nov 2010.
- [28] S. S. Tuncer Baykas, Mika Kasslin, “IEEE p802.19 wireless coexistence,” <https://mentor.ieee.org/802.19/dcn/10/19-10-0055-03-0001-system-design-document.doc>, March 2010, system Design Document.
- [29] C. R. Stevenson, G. Chouinard, Z. Lei, W. Hu, S. J. Shellhammer, and W. Caldwell, “Ieee 802.22: The first cognitive radio wireless regional area network standard,” *IEEE Communications Magazine*, vol. 47, no. 1, pp. 130–138, 2009.
- [30] F. Granelli, P. Pawelczak, R. V. Prasad, K. Subbalakshmi, R. Chandramouli, J. A. Hoffmeyer, and H. S. Berger, “Standardization and research in cognitive and dynamic spectrum access networks: IEEE SCC41 efforts and other activities,” *IEEE Communications Magazine*, vol. 48, no. 1, pp. 71–79, 2010.
- [31] M. Murrioni, R. Prasad, P. Marques, B. Bochow, D. Noguet, C. Sun, K. Moessner, and H. Harada, “Ieee 1900.6: spectrum sensing interfaces and data structures for dynamic spectrum access and other advanced radio communication systems standard: technical aspects and future outlook,” *IEEE Communications Magazine*, vol. 49, no. 12, pp. 118–127, December 2011.
- [32] A. Ghasemi and E. Sousa, “Interference aggregation in spectrum-sensing cognitive wireless networks,” *IEEE Journal of Selected Topics in Signal Processing*, vol. 2, no. 1, pp. 41–56, 2008.
- [33] J. Ma, G. Y. Li, and B. H. Juang, “Signal processing in cognitive radio,” *Proceedings of the IEEE*, vol. 97, no. 5, pp. 805–823, 2009.

- [34] R. Tandra and A. Sahai, "Fundamental limits on detection in low snr under noise uncertainty," in *International Conference on Wireless Networks, Communications and Mobile Computing*, vol. 1. IEEE, 2005, pp. 464–469.
- [35] D. Cabric, S. Mishra, and R. Brodersen, "Implementation issues in spectrum sensing for cognitive radios," in *Conference Record of the Thirty-Eighth Asilomar Conference on Signals, Systems and Computers*, vol. 1, 2004, pp. 772–776 Vol.1.
- [36] L. Lu, X. Zhou, U. Onunkwo, and G. Li, "Ten years of research in spectrum sensing and sharing in cognitive radio," *EURASIP Journal on Wireless Communications and Networking*, vol. 2012, no. 1, 2012. [Online]. Available: <http://dx.doi.org/10.1186/1687-1499-2012-28>
- [37] Q. Zhao and B. M. Sadler, "A survey of dynamic spectrum access," *Signal Processing Magazine, IEEE*, vol. 24, no. 3, pp. 79–89, 2007.
- [38] I. Akyildiz, W.-Y. Lee, M. C. Vuran, and S. Mohanty, "A survey on spectrum management in cognitive radio networks," *IEEE Communications Magazine*, vol. 46, no. 4, pp. 40–48, 2008.
- [39] A. Sahai and D. Cabric, "Spectrum sensing: fundamental limits and practical challenges," in *IEEE International Symposium on New Frontier in Dynamic Spectrum Access Networks (DySPAN 05)*, November 2005.
- [40] A. Sonnenschein and P. Fishman, "Radiometric detection of spread-spectrum signals in noise of uncertain power," *IEEE Transactions on Aerospace and Electronic Systems*, vol. 28, no. 3, pp. 654–660, Jul 1992.
- [41] R. Tandra and A. Sahai, "Snr walls for signal detection," *IEEE Journal of Selected Topics in Signal Processing*, vol. 2, no. 1, pp. 4–17, Feb 2008.
- [42] W. Jouini, "Energy detection limits under log-normal approximated noise uncertainty," *IEEE Signal Processing Letters*, vol. 18, no. 7, pp. 423–426, July 2011.
- [43] M. Ghozzi, F. Marx, M. Dohler, and J. Palicot, "Cyclostationarity-based test for detection of vacant frequency bands," in *1st International Conference on Cognitive Radio Oriented Wireless Networks and Communications*, June 2006, pp. 1–5.
- [44] P. Sutton, K. Nolan, and L. Doyle, "Cyclostationary signatures in practical cognitive radio applications," *IEEE Journal on Selected Areas in Communications*, vol. 26, no. 1, pp. 13–24, Jan 2008.
- [45] A. Sahai and D. Cabric, "Cyclostationary feature detection," Dyspan 2005 talk, 2005.
- [46] J. Lee, "Blind spectrum sensing techniques for cognitive radio system," 2008.

- [47] M. P. K. Verma and R. L. Dua, "A survey on cyclostationary feature spectrum sensing technique," *International Journal of Advanced Research in Computer Engineering & Technology (IJARCET)*, vol. 1, no. 7, pp. pp-300, 2012.
- [48] S. H. Sohn, N. Han, J. M. Kim, and J. W. Kim, "Ofdm signal sensing method based on cyclostationary detection," in *2nd International Conference on Cognitive Radio Oriented Wireless Networks and Communications, CrownCom*, Aug 2007, pp. 63-68.
- [49] B. Adoum and V. Jeoti, "Cyclostationary feature based multiresolution spectrum sensing approach for dvb-t and wireless microphone signals," in *International Conference on Computer and Communication Engineering (ICCCE)*, May 2010, pp. 1-6.
- [50] H. Saggar and D. K. Mehra, "Cyclostationary spectrum sensing in cognitive radios using FRESH filters," *ACM Computing Research Repository*, vol. abs/1312.5257, 2013. [Online]. Available: <http://arxiv.org/abs/1312.5257>
- [51] Z. Khalaf, A. Nafkha, J. Palicot, and M. Ghozzi, "Hybrid spectrum sensing architecture for cognitive radio equipment," in *Sixth Advanced International Conference on Telecommunications (AICT)*, May 2010, pp. 46-51.
- [52] Y. Yang, Y. L. Ji, H. H. Li, D. Lei, and M. Rui, "Adaptive two-stage sensing based on energy detection and cyclostationary feature detection for cognitive radio systems," *Applied Mechanics and Materials*, vol. 411, pp. 1521-1528, 2013.
- [53] B. Krenik, "Clearing interference for cognitive radio," http://www.eetimes.com/document.asp?doc_id=1271125.
- [54] H. Lance and R. A. D, "Cognitive radio networks: Not your father's wireless network," *Going Green by Using Glass and Air to Reduce Carbon*, pp. 44-54, 2008.
- [55] A. Sahai, R. Tandra, S. M. Mishra, and N. Hoven, "Fundamental design tradeoffs in cognitive radio systems," in *Proceedings of the first international workshop on Technology and policy for accessing spectrum*. ACM, 2006, p. 2.
- [56] H. Sun, A. Nallanathan, C.-X. Wang, and Y. Chen, "Wideband spectrum sensing for cognitive radio networks: a survey," *IEEE Wireless Communications*, vol. 20, no. 2, pp. 74-81, April 2013.
- [57] C. Guo, T. Peng, S. Xu, H. Wang, and W. Wang, "Cooperative spectrum sensing with cluster-based architecture in cognitive radio networks," in *IEEE 69th Vehicular Technology Conference, VTC Spring*, April 2009, pp. 1-5.

- [58] J. Unnikrishnan and V. Veeravalli, "Cooperative sensing for primary detection in cognitive radio," *IEEE Journal of Selected Topics in Signal Processing*, vol. 2, no. 1, pp. 18–27, Feb 2008.
- [59] Y. Zeng, Y.-C. Liang, A. T. Hoang, and R. Zhang, "A review on spectrum sensing for cognitive radio: challenges and solutions," *EURASIP Journal on Advances in Signal Processing*, vol. 2010, p. 2, 2010.
- [60] R. Menon, R. Buehrer, and J. Reed, "Outage probability based comparison of underlay and overlay spectrum sharing techniques," in *First IEEE International Symposium on New Frontiers in Dynamic Spectrum Access Networks, DySPAN*, Nov 2005, pp. 101–109.
- [61] "Papyrus: A software radio platform for dynamic spectrum sharing," <http://link.cs.ucsb.edu/papyrus/detail/design.html>.
- [62] L. Yang, Z. Zhang, W. Hou, B. Y. Zhao, and H. Zheng, "Papyrus: A software platform for distributed dynamic spectrum sharing using sdrs," *SIGCOMM Computing Communications*, vol. 41, no. 1, pp. 31–37, Jan. 2011. [Online]. Available: <http://doi.acm.org/10.1145/1925861.1925866>
- [63] M. Matinmikko, T. Rauma, M. Mustonen, I. Harjula, H. Sarvanko, and A. Mammela, "Application of fuzzy logic to cognitive radio systems," *IEICE transactions on communications*, vol. 92, no. 12, pp. 3572–3580, 2009.
- [64] S. Haykin, "Cognitive radio: brain-empowered wireless communications," *IEEE Journal on Selected Areas in Communications*, vol. 23, no. 2, pp. 201–220, 2005.
- [65] X. Fan and J. Liu, "Mac protocol for distributed relay-assisted cognitive radio networks," in *6th International Conference on Wireless Communications Networking and Mobile Computing (WiCOM)*, Sept 2010, pp. 1–4.
- [66] C. Gao, S. Chu, and X. Wang, "Distributed scheduling in mimo empowered cognitive radio ad hoc networks," *IEEE Transactions on Mobile Computing*, vol. 13, no. 7, pp. 1456–1468, July 2014.
- [67] A. Ghasemi and E. S. Sousa, "Spectrum sensing in cognitive radio networks: the cooperation-processing tradeoff," *Wireless Communications and Mobile Computing*, vol. 7, no. 9, pp. 1049–1060, 2007. [Online]. Available: <http://dx.doi.org/10.1002/wcm.480>
- [68] B. Wang and K. Liu, "Advances in cognitive radio networks: A survey," *IEEE Journal of Selected Topics in Signal Processing*, vol. 5, no. 1, pp. 5–23, Feb 2011.
- [69] S. Geirhofer, L. Tong, and B. Sadler, "Cognitive medium access: Constraining interference based on experimental models," *IEEE Journal on Selected Areas in Communications*, vol. 26, no. 1, pp. 95–105, Jan 2008.

- [70] Y. Song, Y. Fang, and Y. Zhang, "Stochastic channel selection in cognitive radio networks," in *IEEE Global Telecommunications Conference, GLOBECOM*, Nov 2007, pp. 4878–4882.
- [71] B. Wang, Z. Ji, K. Liu, and T. Clancy, "Primary-prioritized markov approach for dynamic spectrum allocation," *IEEE Transactions on Wireless Communications*, vol. 8, no. 4, pp. 1854–1865, April 2009.
- [72] C. Doerr, M. Neufeld, J. Fifield, T. Weingart, D. Sicker, and D. Grunwald, "Multimac - an adaptive mac framework for dynamic radio networking," in *First IEEE International Symposium on New Frontiers in Dynamic Spectrum Access Networks*, Nov 2005, pp. 548–555.
- [73] C. Doerr, D. Sicker, and D. Grunwald, "Dynamic control channel assignment in cognitive radio networks using swarm intelligence," in *IEEE Global Telecommunications Conference, GLOBECOM*, Nov 2008, pp. 1–6.
- [74] *C-MAC: A Cognitive MAC Protocol for Multi-Channel Wireless Networks*, April 2007.
- [75] H. Chih-Shun, Y.-S. Chen, and C.-E. He, "An efficient dynamic adjusting mac protocol for multichannel cognitive wireless networks," in *IEEE International Conference on Wireless Communications, Networking and Information Security (WCNIS)*, June 2010.
- [76] J. Jia and Q. Zhang, "Hardware-constrained multi-channel cognitive mac," in *IEEE Global Telecommunications Conference, GLOBECOM*, Nov 2007, pp. 4653–4658.
- [77] J. Jia, Q. Zhang, and X. Shen, "Hc-mac: A hardware-constrained cognitive mac for efficient spectrum management," *IEEE Journal on Selected Areas in Communications*, vol. 26, no. 1, pp. 106–117, Jan 2008.
- [78] Z. Wang, L. Huang, and Z. Gao, "Research of sensing points and performance about method of energy detection in hc-mac," in *International Conference on Internet Technology and Applications (iTAP)*, Aug 2011, pp. 1–4.
- [79] L. Cao and H. Zheng, "Stable and efficient spectrum access in next generation dynamic spectrum networks," in *The 27th IEEE Conference on Computer Communications, INFOCOM*, April 2008, pp. –.
- [80] H. Salameh, M. Krunz, and O. Younis, "Distance- and traffic-aware channel assignment in cognitive radio networks," in *5th Annual IEEE Communications Society Conference on Sensor, Mesh and Ad Hoc Communications and Networks, SECON*, June 2008, pp. 10–18.

- [81] L.-C. Wang and A. Chen, "Effects of location awareness on concurrent transmissions for cognitive ad hoc networks overlaying infrastructure-based systems," *IEEE Transactions on Mobile Computing*, vol. 8, no. 5, pp. 577–589, May 2009.
- [82] H. Celebi and H. Arslan, "Utilization of location information in cognitive wireless networks," *IEEE Wireless Communications*, vol. 14, no. 4, pp. 6–13, August 2007.
- [83] D. Chen, Q. Zhang, and W. Jia, "Aggregation aware spectrum assignment in cognitive ad-hoc networks," in *3rd International Conference on Cognitive Radio Oriented Wireless Networks and Communications, CrownCom*, May 2008, pp. 1–6.
- [84] S. Huang, X. Liu, and Z. Ding, "Opportunistic spectrum access in cognitive radio networks," in *The 27th IEEE Conference on Computer Communications, INFOCOM*, April 2008, pp. –.
- [85] —, "Optimal transmission strategies for dynamic spectrum access in cognitive radio networks," *IEEE Transactions on Mobile Computing*, vol. 8, no. 12, pp. 1636–1648, Dec 2009.
- [86] H. Fang, L. Xu, and C. Huang, "Dynamic opportunistic spectrum access of multi-channel multi-radio based on game theory in wireless cognitive network," in *IEEE Ninth International Conference on Mobile Ad-hoc and Sensor Networks (MSN)*, Dec 2013, pp. 127–132.
- [87] K. Hamdi and K. Ben Letaief, "Power, sensing time, and throughput tradeoffs in cognitive radio systems: A cross-layer approach," in *IEEE Wireless Communications and Networking Conference, WCNC*, April 2009, pp. 1–5.
- [88] A. Calhan and C. Ceken, "An adaptive neuro-fuzzy based vertical handoff decision algorithm for wireless heterogeneous networks," in *IEEE 21st International Symposium on Personal Indoor and Mobile Radio Communications (PIMRC)*, Sept 2010, pp. 2271–2276.
- [89] Y. Song and J. Xie, "Common hopping based proactive spectrum handoff in cognitive radio ad hoc networks," in *IEEE Global Telecommunications Conference, GLOBECOM*, 2010, pp. 1–5.
- [90] —, "Performance analysis of spectrum handoff for cognitive radio ad hoc networks without common control channel under homogeneous primary traffic," in *IEEE International Conference on Computer Communications, INFOCOM*, 2011, pp. 3011–3019.
- [91] E. Hossain, L. Le, N. Devroye, and M. Vu, "Cognitive radio: From theory to practical network engineering," in *New Directions in Wireless Communications Research*, V. Tarokh, Ed. Springer US, 2009, pp. 251–289.

- [92] T. Clancy, "Achievable capacity under the interference temperature model," in *26th IEEE International Conference on Computer Communications, INFOCOM*, May 2007, pp. 794–802.
- [93] M. Gastpar, "On capacity under receive and spatial spectrum-sharing constraints," *IEEE Transactions on Information Theory*, vol. 53, no. 2, pp. 471–487, Feb 2007.
- [94] P. J. Kolodzy, "Interference temperature: a metric for dynamic spectrum utilization," *International Journal of Network Management*, vol. 16, no. 2, pp. 103–113, 2006.
- [95] W. Wang, T. Peng, and W. Wang, "Optimal power control under interference temperature constraints in cognitive radio network," in *IEEE Wireless Communications and Networking Conference, WCNC*. IEEE, 2007, pp. 116–120.
- [96] Y. Xing, C. Mathur, M. Haleem, R. Chandramouli, and K. Subbalakshmi, "Dynamic spectrum access with qos and interference temperature constraints," *IEEE Transactions on Mobile Computing*, vol. 6, no. 4, pp. 423–433, April 2007.
- [97] Federal Communications Commission Spectrum Policy Task Force, "Notice of inquiry and notice of proposed rule making: In the matter of establishment of an interference temperature metric to quantify and manage interference and to expand available unlicensed operation in certain fixed, mobile and satellite frequency bands," ET Docket No.03-237, November 2003.
- [98] M. Vu, S. Ghassemzadeh, and V. Tarokh, "Interference in a cognitive network with beacon," in *IEEE Wireless Communications and Networking Conference, WCNC*, March 2008, pp. 876–881.
- [99] M. Cesana, F. Cuomo, and E. Ekici, "Routing in cognitive radio networks: Challenges and solutions," *Ad Hoc Networks*, vol. 9, no. 3, pp. 228–248, 2011.
- [100] Q. Wang and H. Zheng, "Route and spectrum selection in dynamic spectrum networks," in *IEEE Consumer Communications and Networking Conference (CNCC)*, 2006, pp. 342–346.
- [101] H. Khalifé, N. Malouch, and S. Fdida, "Multihop cognitive radio networks: To route or not to route," *IEEE/NET, The Magazine of Global Internetworking*, vol. 23, no. 4, July/August 2009.
- [102] G. Cheng, W. Liu, Y. Li, and W. Cheng, "Spectrum aware on-demand routing in cognitive radio networks," in *2nd IEEE International Symposium on New Frontiers in Dynamic Spectrum Access Networks, DySPAN*. IEEE, 2007, pp. 571–574.

- [103] Y. Liu, L. Cai, and X. Shen, "Spectrum-aware opportunistic routing in multi-hop cognitive radio networks," *IEEE Journal on Selected Areas in Communications*, vol. 30, no. 10, pp. 1958–1968, November 2012.
- [104] G.-M. Zhu, I. Akyildiz, and G.-S. Kuo, "Stod-rp: A spectrum-tree based on-demand routing protocol for multi-hop cognitive radio networks," in *IEEE Global Telecommunications Conference, GLOBECOM*, Nov 2008, pp. 1–5.
- [105] A. Cacciapuoti, C. Calcagno, M. Caleffi, and L. Paura, "Caodv: Routing in mobile ad-hoc cognitive radio networks," in *Wireless Days (WD), IFIP*, Oct 2010, pp. 1–5.
- [106] C. Xin, B. Xie, and C.-C. Shen, "A novel layered graph model for topology formation and routing in dynamic spectrum access networks," in *First IEEE International Symposium on New Frontiers in Dynamic Spectrum Access Networks*. IEEE, 2005, pp. 308–317.
- [107] S. Krishnamurthy, M. Thoppian, S. Venkatesan, and R. Prakash, "Control channel based mac-layer configuration, routing and situation awareness for cognitive radio networks," in *IEEE Military Communications Conference, MILCOM*. IEEE, 2005, pp. 455–460.
- [108] Q. Guan, F. Yu, S. Jiang, and G. Wei, "Prediction-based topology control and routing in cognitive radio mobile ad hoc networks," *IEEE Transactions on Vehicular Technology*, vol. 59, no. 9, pp. 4443–4452, Nov 2010.
- [109] K. Chowdhury and M. Felice, "Search: A routing protocol for mobile cognitive radio ad-hoc networks," *IEEE Computer Communications*, vol. 32, no. 18, pp. 1983 – 1997, 2009, <ce:title>Cognitive Radio and Dynamic Spectrum Sharing Systems</ce:title>. [Online]. Available: <http://www.sciencedirect.com/science/article/pii/S0140366409001510>
- [110] K. Habak, M. Abdelatif, H. Hagrass, K. Rizc, and M. Youssef, "A location-aided routing protocol for cognitive radio networks," in *International Conference on Computing, Networking and Communications (ICNC)*, Jan 2013, pp. 729–733.
- [111] K. Chowdhury and I. Akyildiz, "Crp: A routing protocol for cognitive radio ad hoc networks," *IEEE Journal on Selected Areas in Communications*, vol. 29, no. 4, pp. 794–804, 2011.
- [112] G. Alandjani and E. Johnson, "Fuzzy routing in ad hoc networks," in *Proceedings of the IEEE International Performance, Computing, and Communications Conference*, 2003, pp. 525–530.

- [113] S. Rea and D. Pesch, "Multi-metric routing decisions for ad hoc networks using fuzzy logic," in *1st International Symposium on Wireless Communication Systems*, 2004, pp. 403–407.
- [114] S.-Y. Chiang and J.-L. Wang, "Routing analysis using fuzzy logic systems in wireless sensor networks," in *Knowledge-Based Intelligent Information and Engineering Systems*. Springer, 2008, pp. 966–973.
- [115] F. Foukalas, V. Gazis, and N. Alonistioti, "Cross-layer design proposals for wireless mobile networks: A survey and taxonomy," *IEEE Communications Surveys Tutorials*, vol. 10, no. 1, pp. 70–85, Jan 2008.
- [116] J. W. Chong, D. K. Sung, and Y. Sung, "Cross-layer performance analysis for csma/ca protocols: Impact of imperfect sensing," *IEEE Transactions on Vehicular Technology*, vol. 59, no. 3, pp. 1100–1108, March 2010.
- [117] F. Foukalas, G. T. Karetsos, and P. Chatzimisios, "Cross-layer design of csma/ca with spectrum sensing for cognitive radio networks," in *Proceedings of the Tenth International Symposium on Wireless Communication Systems (ISWCS 2013)*. VDE, 2013, pp. 1–5.
- [118] Y. Shi, Y. Hou, H. Zhou, and S. Midkiff, "Distributed cross-layer optimization for cognitive radio networks," *IEEE Transactions on Vehicular Technology*, vol. 59, no. 8, pp. 4058–4069, Oct 2010.
- [119] Y. Shi, Y. Hou, S. Kompella, and H. Sherali, "Maximizing capacity in multihop cognitive radio networks under the sinr model," *IEEE Transactions on Mobile Computing*, vol. 10, no. 7, pp. 954–967, July 2011.
- [120] Y. Teng, H. Xu, V. Schober, and M. Song, "Cross-layer optimization and analysis for overlay cognitive radio," in *IEEE Global Communications Conference, GLOBECOM*, Dec 2014, pp. 870–875.
- [121] G. Saleh, A. El-Keyi, and M. Nafie, "Cross-layer minimum-delay scheduling and maximum-throughput resource allocation for multiuser cognitive networks," *IEEE Transactions on Mobile Computing*, vol. 12, no. 4, pp. 761–773, April 2013.
- [122] Y. Zhang and C. Leung, "Cross-layer resource allocation for mixed services in multiuser ofdm-based cognitive radio systems," *IEEE Transactions on Vehicular Technology*, vol. 58, no. 8, pp. 4605–4619, Oct 2009.
- [123] J. Wang and Y. Huang, "A cross-layer design of channel assignment and routing in cognitive radio networks," in *3rd IEEE International Conference on Computer Science and Information Technology (ICCSIT)*, vol. 7, July 2010, pp. 542–547.

- [124] R. Saifan, A. Kamal, and Y. Guan, "A cross-layer routing protocol (clrp) for cognitive radio network," in *IEEE Global Communications Conference (GLOBECOM)*, Dec 2013, pp. 896–901.
- [125] M. Faisal Amjad, B. Aslam, and C. Zou, "Transparent cross-layer solutions for throughput boost in cognitive radio networks," in *IEEE Consumer Communications and Networking Conference (CCNC)*, Jan 2013, pp. 580–586.
- [126] W. Wang, Y. Sun, H. Li, and Z. Han, "Cross-layer attack and defense in cognitive radio networks," in *IEEE Global Telecommunications Conference (GLOBECOM 2010)*, Dec 2010, pp. 1–6.
- [127] M. J. Copps, "Bringing broadband to rural america: Report on a rural broadband strategy," Federal Communications Commission, Tech. Rep., 2009.
- [128] Genachowski, Clyburn, and Rosenworcel, "Eighth broadband progress report," Federal Communications Commission, Tech. Rep. FCC 12-90, August 2012.
- [129] C. Li and H. Dai, "On the throughput scaling of cognitive radio adhoc networks," in *IEEE International Conference on Computer Communications, INFOCOM*, 2011.
- [130] W. Huang and X. Wang, "Throughput and delay scaling of general cognitive networks," in *IEEE International Conference on Computer Communications, INFOCOM*, 2011.
- [131] H. N. Vu and H. Y. Kong, "Overlap cooperative spectrum sensing with energy comparing in cognitive radio networks," in *International Forum on Strategic Technology (IFOST)*, 2010.
- [132] E. Bedeer, M. Marey, O. Dobre, and K. Baddour, "On partially overlapping coexistence for dynamic spectrum access in cognitive radio," in *IEEE 16th Workshop on Computer Aided Modeling and Design of Communication Links and Network (CAMAD)*, 2011.
- [133] P. S. Maybeck, *Stochastic models, estimation, and control*. Academic press, 1982, vol. 3, chapter 1.
- [134] D. Julog, "The basis of grey theory," Huazhong University of Science and Technology Press, 2002.
- [135] L. Sifeng, J. Forrest, and Y. Yingjie, "A brief introduction to grey systems theory," in *IEEE International Conference on Grey Systems and Intelligent Services (GSIS)*, 2011, pp. 1–9.
- [136] E. Kayacan, B. Ulutas, and O. Kaynak, "Grey system theory-based models in time series prediction," *Expert Systems with Applications*, vol. 37, no. 2, pp. 1784–1789, 2010.

- [137] D. Ouattara, F. Krief, M. A. Chalouf, and O. Ahmdi, "Spectrum sensing improvement in cognitive radio networks for real-time patients monitoring," in *Mobihealth, Paris, France*, 2012.
- [138] G. Welch and G. Bishop, "An introduction to the kalman filter," University of North Carolina at Chapel Hill, Chapel Hill, NC, USA, Tech. Rep., 1995.
- [139] K. W. Sung, S.-L. Kim, and J. Zander, "Temporal spectrum sharing based on primary user activity prediction," *IEEE Transactions on Wireless Communications*, vol. 9, no. 12, pp. 3848–3855, December 2010.
- [140] L. Csurgai-Horvath and J. Bitó, "Primary and secondary user activity models for cognitive wireless network," in *Proceedings of the 11th International Conference on Telecommunications (ConTEL)*, June 2011, pp. 301–306.
- [141] F. Qiang, X. Yunshi, and Y. Huilin, "Object tracking algorithm based on grey innovation model gm (1, 1) of fixed length," in *World Congress on Computer Science and Information Engineering, WRI*, vol. 6. IEEE, 2009, pp. 615–618.
- [142] "Mobility and handover prediction mechanism: a performance comparison exploiting several filters," <http://lia.deis.unibo.it/research/SOMA/MobilityPrediction/filters.shtml>.
- [143] G. Wei, Y. Ling, B. Guo, B. Xiao, and A. V. Vasilakos, "Prediction-based data aggregation in wireless sensor networks: Combining grey model and kalman filter," *Computer Communications*, vol. 34, no. 6, pp. 793 – 802, 2011. [Online]. Available: <http://www.sciencedirect.com/science/article/pii/S0140366410004330>
- [144] K. Wessel, M. Swigulski, A. Köpke, and D. Willkomm, "Mixim the physical layer an architecture overview," in *OMNeT++ 2009: Proceedings of the 2nd International Workshop on OMNeT++ (hosted by SIMUTools 2009)*. ICST, Brussels, Belgium, Belgium: ICST (Institute for Computer Sciences, Social-Informatics and Telecommunications Engineering), 2009.
- [145] D. Ouattara, M. T. Quach, F. Krief, M. A. Chalouf, and H. Khalifé, "Mitigating the Hospital Area Communication's Interference using Cognitive Radio Networks," *IEEE International Conference on e-Health Networking, Application & Services (IEEE Healthcom)*, 2013.
- [146] T. J. Ross, *Fuzzy Logic with Engineering Applications*. John Wiley & Sons, Ltd., 2010.
- [147] E. Hossain, D. Niyato, and Z. Han, *Dynamic spectrum access and management in cognitive radio networks*. Cambridge University Press Cambridge, 2009.

- [148] Y. F. Wong and W. Wong, "A fuzzy-decision-based routing protocol for mobile ad hoc networks," in *10th IEEE International Conference on Networks, ICON*, 2002, pp. 317–322.
- [149] G. Santhi and A. Nachiappan, "Fuzzy-cost based multiconstrained qos routing with mobility prediction in {MANETs}," *Egyptian Informatics Journal*, vol. 13, no. 1, pp. 19 – 25, 2012.
- [150] N. Baldo and M. Zorzi, "Cognitive network access using fuzzy decision making," in *Communications, 2007. ICC '07. IEEE International Conference on*, 2007, pp. 6504–6510.
- [151] —, "Fuzzy logic for cross-layer optimization in cognitive radio networks," *IEEE Communications Magazine*, vol. 46, no. 4, pp. 64–71, 2008.
- [152] —, "Cognitive network access using fuzzy decision making," *IEEE Transactions on Wireless Communications*, vol. 8, no. 7, pp. 3523–3535, 2009.
- [153] H.-S. Le and Q. Liang, "An efficient power control scheme for cognitive radios," in *IEEE Wireless Communications and Networking Conference, WCNC*, March 2007, pp. 2559–2563.
- [154] Q. Han, T. Wang, S. Shang, L. Zeng, and M. Huang, "Fuzzy control method for routing selection in cognitive radio network," *Journal of Computational Information Systems*, vol. 6, no. 13, pp. 4325–4333, 2010.
- [155] A. E. Masri, N. Malouch, and H. Khalife, "A fuzzy-based routing strategy for multihop cognitive radio networks." *International Journal of Computer Network and Information Security (IJCNIS)*, vol. 3, no. 1, 2011.
- [156] E. Mamdani and S. Assilian, "An experiment in linguistic synthesis with a fuzzy logic controller," *International Journal of Man-Machine Studies*, vol. 7, no. 1, pp. 1 – 13, 1975. [Online]. Available: <http://www.sciencedirect.com/science/article/pii/S0020737375800022>
- [157] G. of Authors from the Mathworks., *Fuzzy Logic Toolbox tm - User's Guide*, R2013b, Ed. The Mathworks, Inc., 2013.
- [158] L. Markowsky and B. Segee, "The octave fuzzy logic toolkit," in *IEEE 2011 International Workshop on Open-Source Software for Scientific Computation (OSSC)*, October 2011, pp. 118–125.
- [159] S. Sagar, J. Saqib, A. Bibi, and N. Javaid, "Evaluating and comparing the performance of dymo and olsr in manets and in vanets," in *IEEE 14th International Multitopic Conference (INMIC)*, Dec 2011, pp. 362–366.

- [160] N. Sivakumar and S. K. Jaiswal, "Comparison of dymo protocol with respect to various quantitative performance metrics," *Department of Computer Science, Malardalen University*, 2009.
- [161] S. K. Bisoyi and S. Sahu, "Performance analysis of dynamic manet on-demand (dymo) routing protocol," *Special Issue of IJCCT*, vol. 1, no. 2, p. 3, 2010.
- [162] C. Perkins, Futurewei, S. Ratliff, Cisco, J. Dowdell, and Cassidian, "Dynamic manet on-demand (aodvv2) routing, draft-ietf-manet-aodvv2-04," Internet-Draft, <https://datatracker.ietf.org/doc/draft-ietf-manet-aodvv2/>, July 20 2014.
- [163] I. C. C. Perkins, Futurewei, "Dynamic manet on-demand (aodvv2) routing," Internet-Draft, December 1st 2012.
- [164] T. Clausen, C. Dearlove, J. Dean, and C. Adjih, "Generalized mobile ad hoc network (manet) packet/message format," Internet-Draft, February 2009.
- [165] M. Peres, M. A. Chalouf, and F. Krief, "Phy/mac signalling protocols for resilient cognitive radio networks," in *22nd International Conference on Software, Telecommunications and Computer Networks (SoftCOM)*, Sept 2014, pp. 310–314.
- [166] H. Urkowitz, "Energy detection of unknown deterministic signals," *Proceedings of the IEEE*, vol. 55, no. 4, pp. 523–531, April 1967.
- [167] Z. Lin, H. Liu, X. Chu, and Y.-W. Leung, "Jump-stay based channel-hopping algorithm with guaranteed rendezvous for cognitive radio networks," in *IEEE International Conference on Computer Communications, INFOCOM*, 2011, pp. 2444–2452.
- [168] H. Liu, Z. Lin, X. Chu, and Y.-W. Leung, "Jump-stay rendezvous algorithm for cognitive radio networks," *IEEE Transactions on Parallel and Distributed Systems*, vol. 23, no. 10, pp. 1867–1881, 2012.
- [169] A. Tajer and X. Wang, "Beacon-assisted spectrum access with cooperative cognitive transmitter and receiver," in *IEEE International Conference on Acoustics, Speech and Signal Processing, ICASSP*, April 2009, pp. 2341–2344.
- [170] T. Shu, S. Cui, and M. Krunz, "Medium access control for multi-channel parallel transmission in cognitive radio networks," in *IEEE Global Telecommunications Conference, GLOBECOM*. IEEE, 2006, pp. 1–5.
- [171] J. Mo, H.-S. So, and J. Walrand, "Comparison of multichannel mac protocols," *IEEE Transactions on Mobile Computing*, vol. 7, no. 1, pp. 50–65, 2008.
- [172] R. Doost-Mohammady, P. Paweczak, G. J. M. Janssen, and H. Segers, "Physical layer bootstrapping protocol for cognitive radio networks," in *7th IEEE Consumer Communications and Networking Conference (CCNC)*, 2010, pp. 1–5.

- [173] H. Liu, Z. Lin, X. Chu, and Y.-W. Leung, "Taxonomy and challenges of rendezvous algorithms in cognitive radio networks," in *2012 International Conference on Computing, Networking and Communications (ICNC)*, 2012, pp. 645–649.
- [174] S. Romaszko and P. Mähönen, "Quorum systems towards an asynchronous communication in cognitive radio networks," *Journal of Electrical and Computer Engineering*, vol. 2012, 2012.
- [175] A. Crohas, "Practical implementation of a cognitive radio system for dynamic spectrum access," University of Notre Dame, Indiana 2008, 2008.
- [176] R. A Rashid, M. A. Sarijari, N. Fisal, A. Lo, S. Yusof, S. Kamilah, and N. Mahalin, "Spectrum sensing measurement using gnu radio and usrp software radio platform," in *The Seventh International Conference on Wireless and Mobile Communications, ICWMC*, 2011, pp. 237–242.
- [177] M. T. Quach and H. Khalife, "The impact of overlap regions in cognitive radio networks," in *IEEE Wireless Days (WD), IFIP*, 2012, pp. 1–3.
- [178] M. T. Quach, D. Ouattara, F. Krief, H. Khalife, and M. Chalouf, "Overlap regions and grey model-based approach for interference avoidance in cognitive radio networks," in *IEEE Fifth International Conference on Ubiquitous and Future Networks (ICUFN)*, 2013, pp. 642–647.
- [179] M. T. Quach, F. Krief, M. A. Chalouf, and H. Khalifé, "Fuzzy-based interference level estimation in cognitive radio networks," in *The Tenth Advanced International Conference on Telecommunications, AICT*. IARIA XPS, 2014, best Paper Award.
- [180] M. T. Quach, F. Krief, and M. A. Chalouf, "Interference avoidance routing strategy in cognitive radio networks," *International Journal on Advances in Telecommunications*, vol. 8, no. 1–2, pp. 84–97, 2015.