



HAL
open science

Design and implementation of a new low-power consumption DSRC transponder

Bruno Franciscatto

► **To cite this version:**

Bruno Franciscatto. Design and implementation of a new low-power consumption DSRC transponder. Electronics. Université de Grenoble, 2014. English. NNT : 2014GRENT037 . tel-01293522

HAL Id: tel-01293522

<https://theses.hal.science/tel-01293522v1>

Submitted on 24 Mar 2016

HAL is a multi-disciplinary open access archive for the deposit and dissemination of scientific research documents, whether they are published or not. The documents may come from teaching and research institutions in France or abroad, or from public or private research centers.

L'archive ouverte pluridisciplinaire **HAL**, est destinée au dépôt et à la diffusion de documents scientifiques de niveau recherche, publiés ou non, émanant des établissements d'enseignement et de recherche français ou étrangers, des laboratoires publics ou privés.

THÈSE

Pour obtenir le grade de

DOCTEUR DE L'UNIVERSITÉ DE GRENOBLE

Spécialité: **OPTIQUE ET RADIOFREQUENCES**

Arrêté ministériel: 7 août 2006

Présentée par

Bruno Roberto FRANCISCATTO

Thèse dirigée par **Tan Phu VUONG** et
codirigée par **Jean-Marc DUCHAMP**

préparée au sein du **Institut de Microélectronique
Electromagnétisme et Photonique et le Laboratoire
d'Hyperfréquences et de Caractérisation (IMEP-LAHC)**
dans l'**École Doctorale Electronique, Electrotechnique,
Automatique, Traitement du Signal (EEATS)**

Conception et réalisation d'un nouveau transpondeur DSRC à faible consommation

Thèse soutenue publiquement le 9 juillet 2014,
devant le jury composé de :

Pr. Dr. Ke WU

Ecole Polytechnique de Montréal, Président

Pr. Dr. Laurent CIRIO

Université Paris-Est Marne la Vallée, Rapporteur

Pr. Dr. Mohammed HIMDI

Université de Rennes I, Rapporteur

Pr. Dr. Christian VOLLAIRE

École Centrale de Lyon, Membre

Mr. Christian DEFAY

PDG Multitoll Solutions SA, Membre

Pr. Dr. Tan Phu VUONG

Université de Grenoble, Directeur de thèse

Dr. Jean-Marc DUCHAMP

Maître de Conférences à l'Université Joseph Fourier, Co-directeur de
thèse



*To
my fiancée Diana,
my parents and sister...*

Remerciements

J'exprime ma gratitude et mes remerciements à mon directeur de thèse, Tan Phu Vuong pour sa confiance et son soutien, tout en me laissant une large autonomie et à mon co-encadrant Jean-Marc Duchamp, pour son énergie, ses conseils avisés et pertinents et son professionnalisme qui m'ont été d'une aide précieuse et indispensable, et m'ont motivé à entreprendre cette aventure doctorale. Je tiens aussi à remercier mon co-encadrant Mr. Christian Defay, PDG de la société Multitoll, qui m'a permis de réaliser ma thèse tout en gardant un poste d'ingénieur R&D chez Multitoll.

Cette thèse a été réalisée au laboratoire IMEP-LAHC à Grenoble, où j'ai passé de très bons moments. Je tiens à remercier à tous les permanents du laboratoire qui ont su rendre agréables ces années de thèse, à travers d'échanges techniques, mais aussi de moments très joyeux en dehors du travail. Un grand merci à toute l'équipe technique responsable des plateformes de fabrication et caractérisation, Nicolas Corrao, Antoine Gachon et Gregory Grosa, pas seulement pour leur efficacité au bon fonctionnement des plateformes, mais surtout pour leur précises interventions techniques pendant les différentes réalisations expérimentales de cette thèse. Je remercie également aux différents post-doctorants, doctorants, ingénieurs de recherche et stagiaires que j'ai eu le plaisir de connaître et avec lesquels j'ai pu collaborer pendant ces années dans le laboratoire.

Je tiens également à remercier l'entreprise Multitoll, pour l'opportunité de pouvoir développer ma thèse en ayant un poste d'ingénieur. Ces années d'échanges professionnelles m'ont permis d'acquérir différentes compétences que j'emporterai avec moi. Je remercie le bureau d'études, l'équipe d'installation et tests des systèmes et les ressources humaines pour tout le support. Je tiens à remercier spécialement à Mr. Tan Trinh Trang qui a eu une participation importante dans cette thèse, aussi bien que dans mon parcours professionnel.

Un grand merci tout particulier à ma fiancée Diana Stefan pour tout son support, sa patience et sa compréhension pendant ces années de thèse. J'adresse mes pensées les plus chaleureuses à tous mes amis, qui m'ont supporté avec la thèse, mais aussi qui m'ont permis de vivre de bons moments inoubliables de détente, un grand merci à Vincent, Vitor, Aline, Flora, Bertrand, Mauricio, ...

Enfin, merci du fond du cœur à ma famille, mes parents, ma sœur et notre petite Maria Valentina, pour tout ce que je suis aujourd'hui grâce à vous! Obrigado, amo vocês!

Abstract

To increase the efficiency and safety of the road traffic, new concepts and technologies have been developed in Europe since 1992 for RTTT applications (Road Traffic & Transport Telematics). These applications use the Dedicated Short Range Communications (DSRC) devices at 5.8 GHz (ISM band). In view of the reliability and success of this technology, the use of such equipment is thus extended to the EFC (Electronic Fee Collection) or e-toll and as well in many other application areas such as fleet management, public transport and parking management. Due to the broad applicability, these equipments are subject to various standards CEN/TC 278, CEN ENV (EN) 12253, ETSI, etc.... The DSRC system consists in a transceiver (reader) and transponders (tags). Industrial approaches are oriented to semi-passive transponder technology, which uses the same signal sent by the reader to retransmit, performing a frequency shift and encoding data to be transmitted. This design avoids the use of the local oscillators to generate the RF wave, as in active transponders, and saves electrical energy of batteries. This allows the development of relatively low cost and small size transponders. Despite advances of low-power integrated circuits technology, this concept still requires a lithium battery to operate the transponder for a period of 4-6 years. However, with the expansion of these facilities, it appears that over the years the amount of lithium to destroy has become a crucial problem for the environment. Nowadays designing a completely autonomous DSRC transponder is not feasible, since the amount of energy required is still high (8 mA/3.6 V active mode). Nevertheless, reducing the transponder electrical power consumption, as a solution to at least double the battery life, could be a good start point to improve environment protection.

In this thesis we propose a new DSRC transponder with an original statechart that considerably reduces the power consumption. After validation of the new low-power consumption mode, we have investigated the possibility to recharge the battery of the transponder by means of Wireless Energy Harvesting. The DSRC Toll Collection RF link budget has been carried out in order to estimate the amount of energy available when a car with a transponder passes through a toll system. However, RF link budget at 5.8 GHz presents a low power density, since the car does not remain enough in the DSRC antenna's field to proceed to energy harvesting. Therefore, we have explored another ISM frequency, the 2.45 GHz. Thus the Wireless Energy Harvesting chapter aims to further the state of the art by the design and optimization of a novel RF harvesting board. We have demonstrated that an optimum RF-DC load is required in order to achieve high RF-DC conversion efficiency. Several rectifiers and rectennas have been prototyped in order to validate the numerical studies. Finally, the results obtained in this thesis are in the forefront of the State-of-the-Art of Wireless Energy Harvesting for very low available power density.

Keywords: *DSRC, Wireless Energy Harvesting, antenna, rectenna, transponder, RF-DC conversion*

Résumé

Afin d'augmenter l'efficacité et la sécurité du trafic routier, de nouveaux concepts et technologies ont été développés depuis 1992 en Europe pour les applications RTTT (Road Traffic & Transport Telematics). Ces applications utilisent les équipements DSRC qui supportent les transmissions à courte distance à 5.8GHz. Vues la fiabilité et le succès de cette technologie, l'utilisation de ces équipements est ensuite étendue aux ETC (Electronic Toll Collection) ou Télépéage et aussi dans une multitude d'autres domaines d'application comme la gestion des flottes, le transport public et la gestion des parkings. Le système DSRC se compose d'un émetteur/récepteur (lecteur) et des transpondeurs (badges). En toute logique, l'approche industrielle oriente les développements vers la technologie de transpondeur semi passif qui, pour réémettre un signal utilise le signal transmis par l'émetteur-récepteur, effectue une modulation de phase d'une sous porteuse fréquentielle encodant ainsi les données à transmettre. Cette conception évite l'utilisation des oscillateurs locaux, comme dans les transpondeurs actifs, pour générer l'onde Radio Fréquence (RF). Ceci permet de produire des transpondeurs relativement à faible coût et de petite taille. Cependant ce concept nécessite quand même une batterie au Lithium pour assurer le fonctionnement du transpondeur pour une durée de 4 à 6 ans et ce malgré les progrès des technologies de circuits intégrés à faible consommation. Au fur et à mesure de l'expansion de ces équipements, il s'avère qu'avec les années la quantité des batteries au lithium à détruire deviendrait un problème crucial pour l'environnement. Aujourd'hui, la conception d'un transpondeur DSRC complètement autonome n'est pas faisable, car la quantité d'énergie nécessaire s'avère encore élevée (mode actif 8 mA/3.6 V). Néanmoins, la réduction de la consommation électrique du transpondeur, permet au moins doubler la durée de vie de la batterie et pourrait être un bon point de départ pour améliorer la protection de l'environnement.

Dans cette thèse, nous proposons un nouveau transpondeur DSRC avec un diagramme d'état original qui réduit considérablement la consommation énergétique. Après validation d'un nouvel état de fonctionnement en mode très faible consommation d'énergie, nous avons étudié la possibilité de recharger la batterie du transpondeur à travers de la récupération d'énergie sans fil. Le bilan de liaison énergétique DSRC a été réalisé afin d'estimer la quantité d'énergie disponible quand une voiture avec un transpondeur passe à sous un système de péage. Toutefois, le bilan énergétique à 5.8 GHz présente une faible densité d'énergie RF, puisque la voiture ne reste pas assez sur le lobe de l'antenne DSRC afin de procéder à la récupération d'énergie. Par conséquent, nous avons alors exploré une autre fréquence ISM, le 2.45 GHz dans laquelle la présence d'émetteurs est bien plus grande. Dans le chapitre de récupération d'énergie sans fil nous présentons la conception et l'optimisation d'un nouveau récupérateur d'énergie RF. Après avoir démontré qu'une charge RF-DC optimale est nécessaire afin d'atteindre une haute efficacité de conversion RF-DC. Plusieurs redresseurs et *rectennas* ont été conçus pour valider les études numériques. Parmi, les résultats présentés dans cette thèse les rendement de conversion obtenus sont à l'état de l'art de la récupération d'énergie sans fil pour une très faible densité de puissance disponible.

Mots clés: DSRC, récupération d'énergie sans fil, antenne, rectenna, transpondeur, conversion RF-DC

Contents

Chapter I - Introduction and State-of-the-Art.....	1
I.1. Context.....	1
I.1.1. Transponder architecture	2
I.1.2. Process technology choice	4
I.1.3. RF protocol.....	5
I.1.4. Potential Energy Harvesting techniques.....	7
I.1.4.1. Solar	9
I.1.4.2. Thermoelectric	10
I.1.4.3. Mechanical	11
I.1.4.4. Radio frequency (RF).....	12
I.1.4.4.1. Why Wireless Energy Harvesting?	15
I.1.4.4.2. State-of-the-Art of Wireless Energy Harvesting.....	19
I.2. Problem statement: is it possible to design a completely autonomous DSRC transponder?	22
I.3. Thesis overview.....	23
Chapter II - Low-power DSRC transponder	24
II.1. Introduction	24
II.2. DSRC system.....	24
II.2.1. Literature overview	30
II.2.2. DSRC V2I link budget.....	31
II.2.2.1. Windshield fading	34
II.2.2.2. DSRC V2I link budget results	35
II.3. A new low-power DSRC transponder design	40
II.3.1. Electric power consumption of DSRC transponders on the current market	40
II.3.1.1. Measurement setup.....	41
II.3.1.2. Electric power consumption measurements results	42
II.3.1.3. The importance of a low-power operation mode	44
II.3.2. RF implementation.....	44
II.3.2.1. DSRC transponder chip evaluation board design	44
II.3.2.2. DSRC transponder chip characterization	47
II.3.3. Microcontroller sleep mode + Demod Bloc (FPGA)	51
II.3.4. A new deep-sleep mode	51
II.3.4.1. Vibration sensor evaluation board design	53

II.3.4.2. <i>In-situ</i> deep-sleep tests	55
II.3.5. The energy consumption of the proposed DSRC transponder	56
II.4. Conclusions.....	57
Chapter III - Antenna design.....	59
III.1. Introduction.....	59
III.2. Antenna fundamentals.....	59
III.2.1. How an antenna radiates	59
III.2.2. Fundamental parameters of Antennas	60
III.2.2.1. Radiation pattern (farfield).....	60
III.2.2.2. Beamwidth	61
III.2.2.3. Return loss and reflection coefficient	61
III.2.2.4. Bandwidth	62
III.2.2.5. Antenna efficiency.....	62
III.2.2.6. Gain.....	62
III.2.2.7. Polarization.....	63
III.2.3. Near and Far field regions	64
III.2.4. Different antenna types	66
III.3. Antenna design.....	67
III.3.1. Multitoll antenna specifications	67
III.3.2. Microstrip antenna	67
III.3.3. DSRC antennas.....	69
III.3.3.1. DSRC OBU antenna	69
III.3.3.2. DSRC RSE antennas.....	72
III.3.3.2.1. Patch antenna array with superstrate.....	72
III.3.3.2.2. Patch antenna array with an improved circular polarization.....	77
III.3.3.2.3. DSRC RSE antennas in-situ tests.....	85
III.3.4. Wireless Energy Harvesting antennas	90
III.3.4.1. Antenna design (Rectenna #1)	90
III.3.4.2. Antenna design (Rectenna #2)	92
III.4. Conclusion	93
Chapter IV - Wireless Energy Harvesting.....	95
IV.1. Introduction to Wireless Energy Harvesting	95
IV.2. Zero-bias Schottky Diode modeling	98
IV.3. Analysis of the optimum load impedance to improve the RF-DC conversion efficiency.	104

IV.4. Microstrip line.....	111
IV.5. WEH device design	112
IV.5.1. Design of rectifiers.....	112
IV.5.1.1. Rectifier prototype #1	112
IV.5.1.2. Rectifier prototype #2	118
IV.5.1.3. Rectifier prototype #3	121
IV.5.1.4. Rectifier prototype #4	122
IV.5.1.5. Rectifier prototype #5	125
IV.5.2. Design of the <i>rectennas</i>	127
IV.5.2.1. Rectenna prototype #1	129
IV.5.2.2. Rectenna prototype #2	131
IV.6. Conclusion, comparison with the state of the art and perspectives for future work	133
Chapter V - Conclusion and perspectives	139
V.1. Summary of results	139
V.2. Perspectives	142
References	144
Publications	154

Acronyms

BST	Beacon Service Table
DSRC	Dedicated Short Range Communication
EH	Energy Harvesting
ETC	Electronic Toll Collection
ETSI	European Telecommunications Standards Institute
IC	Integrated Circuit
ISM	Industrial Scientific Medical
ITS	Intelligent Transport Systems
LNA	Low Noise Amplifier
LO	Local Oscillator
OBU	On-Boar Unit
PA	Power Amplifier
RF	Radio Frequency
RFID	Radio-Frequency IDentification
RSE	Road Side Equipment
RTTT	Road Traffic & Transport Telematics
V2I	Vehicle-to-Infrastructure
V2V	Vehicle-to- Vehicle
WEH	Wireless Energy Harvesting
WPT	Wireless Power Transfer
WS	Wireless Sensor
WSN	Wireless Sensor Network

Chapter I - Introduction and State-of-the-Art

I.1. Context

Engineers are often confronted to improve the system functionality and performances objective while simultaneously maximizing the battery life of electronic devices. From the consumer's viewpoint, they are expecting more and more functionality in a smaller device that operates for a long time, whose battery does not need to be changed often. The common point is the battery; the maintenance cost can be very high and in some cases the replacement is really difficult (e.g.: sensors inside the walls of a house). To effectively design electronic devices with a longer battery life, or even without battery, one should consider the power optimization at all levels, from the circuit architecture up to the application layer. Nowadays, Wireless Sensors (WS) are able to realize three activities, with the associated energy cost, Fig. I-1.

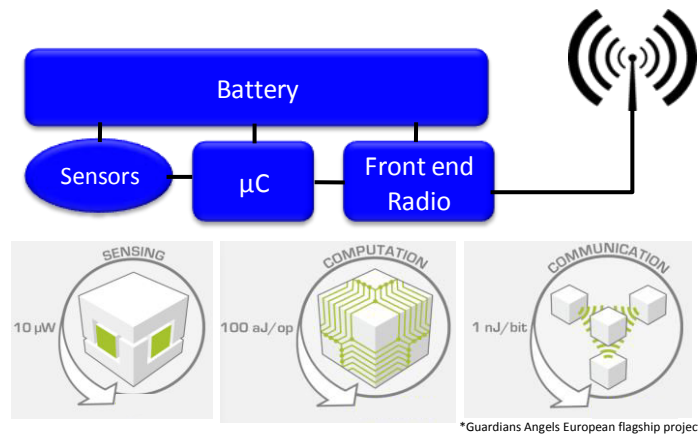

Fig. I-1. Classical WS diagram illustrating the different power consumption for each operation mode.

However, the power consumption for each operation mode, should be observed taking into account the period to accomplish the task, Fig. I-2.

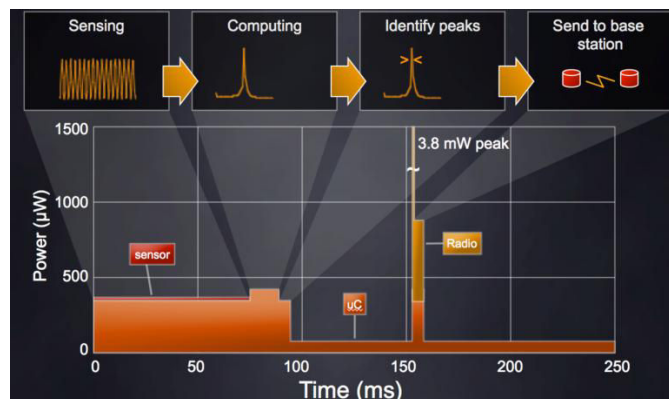

Fig. I-2. WS power consumption for different operation mode.

One first possibility towards maximizing the battery life is by reducing the power consumption. However, we are looking for power reduction not only at an instantaneous time, but over the life of the product. In this case, we introduce the concept of energy, which is the integral of power over a period of time. In general, we may define the total energy consumed by an electronic device as:

$$Energy_{total} = Energy_{standby} + Energy_{active} \quad (I-1)$$

For low-power battery-powered applications (e.g.: sensors), the standby mode is predominant and thus its energy requirement impacts directly the battery life. Therefore, before starting the device design, engineers may interrogate themselves on some hypothetical points about the application:

- What is the statechart of the device and how much time is necessary for each operation mode?
- Reduce functional blocks on the RF front-end, decrease the power consumption. Which ones are really necessary?
- When the microcontroller is not running, in a deep-sleep mode, how is its wake-up induced?
- Which is the microelectronic technology that allows the lowest power consumption (or lowest bias current)?

The answer for these questions may help during the optimization process aiming for energy reduction.

Nowadays, most of the low-powered applications need Radio Frequency (RF) transponders for different reasons: a RF link is necessary to the exchange data between Tx and Rx (e.g.: DSRC), the energy necessary to supply the device may be provided by the RF signal (e.g.: RFID)...

In order to improve the battery life and functionality of the low-powered devices, some approaches may be explored: the optimization of the *transponder architecture*, the energy required by each electronic component should be efficiently shared and each operation mode should be correctly explored; the *process technology* choice, since the microcontroller is a primary power consumer, and the way that energy is used should be carefully considered; the *RF protocol* can be modified (in some cases), saving energy; and finally, new approaches in which is efficiently possible to recharge the battery by means of *energy harvesting* have been reported.

I.1.1. Transponder architecture

With the purpose of exemplifying transponder architectures, let us consider the case of a classical active transponder, where several electronic components are required to provide a correct reception and transmission of signals, as described in Fig. I-3. In active

transponder architecture, the energy is mostly dissipated on the Low Noise Amplifier (LNA), Power Amplifier (PA), Local Oscillator (LO) and microcontroller.

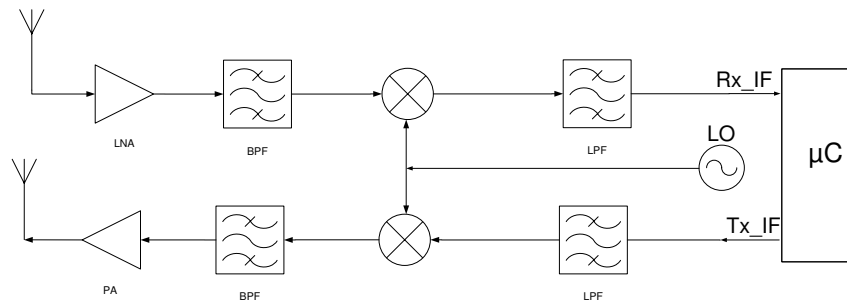

Fig. I-3. Typical active transponder architecture.

Depending on the application, some blocs of the active transponder may be eliminated, e.g., the local oscillator, PA and LNA. Thus, by using a backscattering method, the transponder can recover the incoming carrier to modulate the uplink data stream, and consequently the power is considerably reduced. This architecture is named backscatter transponder, an example of its circuit diagram being described in Fig. I-4.

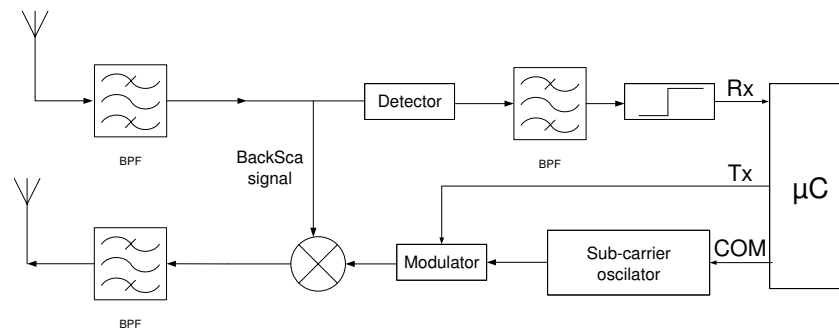

Fig. I-4. Typical backscatter transponder architecture.

However, the backscatter transponder should be ready to reply the reader's request at anytime, i.e., the transponder should be able to leave the standby mode very quickly. In order to reduce the power consumption of a backscatter transponder, a simple approach may be applied, a supplementary wake-up bloc may be added, creating a supplementary very-low-power mode (deep-sleep). As a result, the transponder is active only when the RF transaction is imminent. Evidently, the protocol and statechart should be modified in order to predict the new operation mode.

Owing to advances in integrated low-power circuit technology, nowadays, completely passive transponders are also available. In most of the cases, the energy required by the transponder is provided by a RF wake-up signal (e.g.: RFID tags). Moreover, an important progress has been done in order to reduce the power consumption of RF transponders, thus a new approach is emerging, i.e., low-power devices may be powered by means of Energy Harvesting.

Furthermore, depending on the application, the transponder architecture may be considerably optimized by reducing the energy consumption. Implementing different

operation modes also helps saving energy in a more efficient manner. Nevertheless, to implement a complex statechart, the microcontroller choice should be correctly done.

I.1.2. Process technology choice

The process technology has been improved continuously, and definitely it continues reaching physical limitations. Furthermore, due to the increased demand of faster and smaller, low-power chips, the geometry shrink is an important candidate to manage low-power, Fig. I-5. Currently, 22/16nm chips are already available, and 11nm are very soon coming.

The next graph contains a lot of information, if you take the time to parse it, you can observe interesting points, e.g.: the size of the transistor proposed by Xeonis about half of the size of a HIV virus.

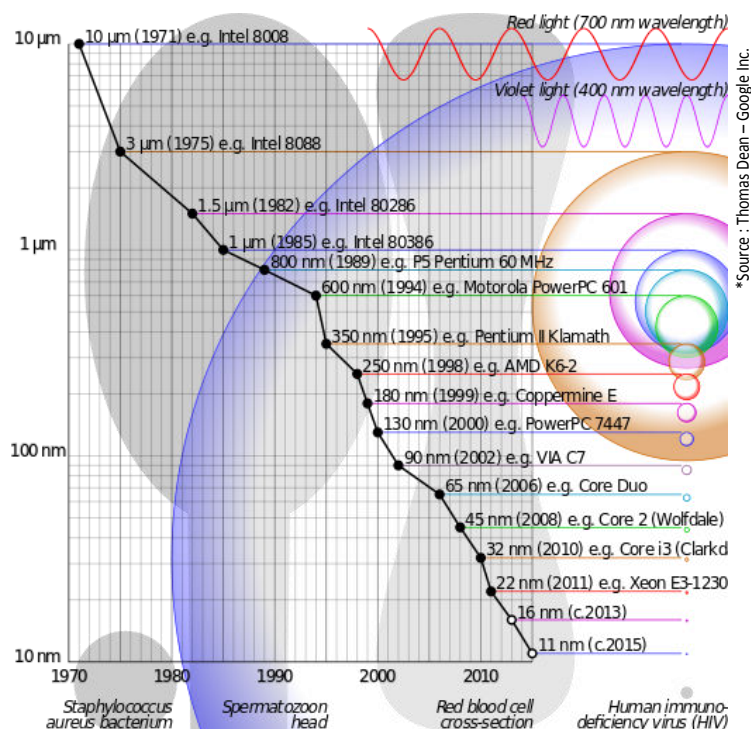

Fig. I-5. Lithography scaling.

The semiconductor technology has been improved and leads to lower power consumption, smaller dimensions of transistors, higher packaging density and faster circuits. From a simple sensor to a complex system, they need at least a chip to take the decisions. Despite the advances in semiconductor technology, the chip is still one of the sources of power dissipation in an electronic device. However, this element does not need to be active or running on the maximum clock frequency at all times. Nowadays, several microcontrollers available on the market have at least three operation modes (deep-sleep, stand-by and active) and, as well, the frequency of the clock can be gradually varied. Reducing power consumption in active mode only saves energy if the time required to accomplish the task does not increase too much. We aim at keeping the statechart in the deep-sleep mode as long as possible.

By understanding the potential in the use of the different operation modes, frequency clock control and the many ways of microcontrollers energy consumption, the functionality and battery life of low-power devices may be improved.

I.1.3. RF protocol

Communication applications range from simple RFID transponders to cell phones and cognitive radios or even systems where security enforcement is necessary to guarantee payment transactions (e.g.: DSRC electronic toll collection). Depending on the application, several protocols are available and in some cases the RF protocol can be modified in order to reduce the energy consumption. A good example of a RF protocol evolution is the RFID, in which first the energy necessary to wake-up the tag is sent and then the tag executes the instructions of reception and transmission.

In indoor applications, Wireless Sensor Network (WSN) appears to be a huge opportunity for protocol development, as energy consumption is a key point for low-power sensors. We could cite as classical RF protocols for indoor applications: WiFi, Bluetooth and ZigBee. However, recently several companies emerged, providing specific RF protocols optimized for very-low-power or completely autonomous sensors integrating a WSN: enOcean, WirelessHart, z-wave, dash7, MyriaNED... In Fig. I-6, we have a comparison of different indoor RF protocols considering the energy required, as well the indoor range. It should be noticed that if the energy requirements decrease, the battery problem can be easily cancelled out, transforming the devices in *battery-less* sensors.

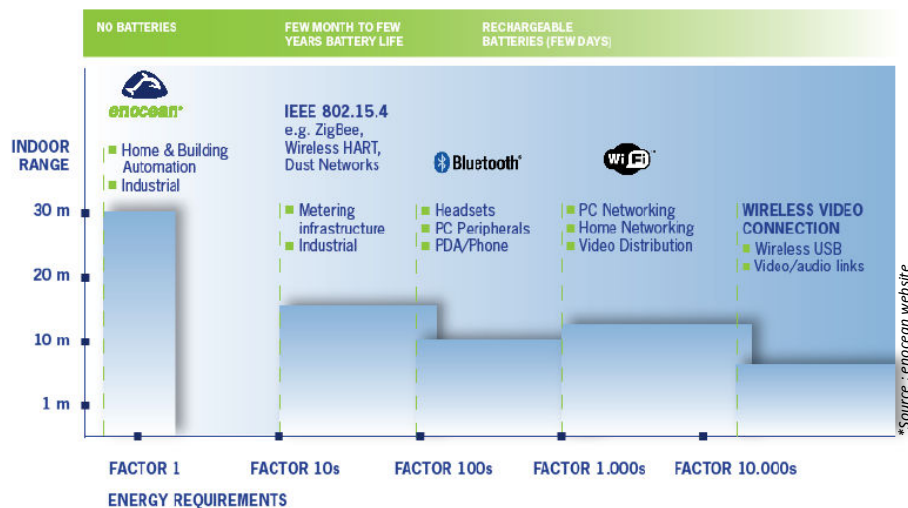

Fig. I-6. Comparison of RF protocols optimized for Wireless Sensor Network.

In outdoor applications, as different RF protocols exist, let us consider as example a particular application, the Electronic Toll Collection (ETC) or *e-toll*, which employs at least two RF protocols: DSRC and RFID. ETC is based on collecting tolls electronically at toll stations, preventing the traffic jam and providing a faster and safer trip for the drivers.

Over the years, for RFID, an important effort has been done in order to transform the RFID tags into completely passive devices. Due to the battery elimination, the fabrication cost was considerably reduced and nowadays for less than \$2, RFID tags are sold all over the world. However, in the case not only the ID is required, and writing information on the tag is necessary, depending on the amount of data, using semi-passive tags is unavoidable. In ETC applications, some countries use RFID as RF protocol for the road fee collection. The advantage is the final cost of the system that is really cheap when compared to DSRC protocols, as passive tags can be used and several are the RFID tags and readers available on the market. On the other hand, the RFID protocol does not provide enough complexity levels in order to guarantee a safe electronic payment and consequently can be easily hacked.

DSRC protocol emerged in Europe and it is a complete system designed for vehicle-to-vehicle (V2V) and vehicle-to-infrastructure (V2I) communications. In a V2I communication, this protocol may be deployed for e-toll applications. The advantage of DSRC protocol is the existence of several layers of complexity that guarantee a safe payment transaction. Moreover, DSRC provides a higher data rate than RFID. Due to the amount of data exchanged in a DSRC transaction, the transponder is semi-passive (has a battery). However, industrial European approaches designed the DSRC transponder based on the backscatter method, which uses the same signal sent by the reader to retransmit, perform a frequency shift and encode data to be transmitted. Due to this improvement the DSRC transponder does not need a local oscillator and the energy consumption is considerably reduced. The DSRC protocol is detailed later on in this thesis.

Choosing the RF protocol, if it is possible, is a key point to guarantee the efficiency of the application, by finding a compromise with power consumption. The combination of authorized radiated power (E.R.I.P), data rate and radio sensitivity provides developers with the flexibility to optimize their implementation for range, cost, operating life and ease of installation. In Table I.1, some RF protocols are compared based on EU standards.

TABLE I.1. RF PROTOCOLS

RF protocol	Radiated power (E.I.R.P.)	Data rate ⁺	Frequency	Radio sensitivity [§]
WiFi [°]	100mW [#]	11-105Mbps	2.45GHz	-80dBm
Bluetooth [°]	1mW [#]	1Mbps	2.45GHz	-70dBm
ZigBee [°]	1mW [#]	250kbps	2.45GHz	-85dBm
RFID	2W [*]	128kbps	868-915MHz	-20dBm
DSRC	2W [*]	500kbps	5.8GHz	-60dBm

[°]Symmetric protocol, [#]indoor, ^{*}outdoor, ⁺downlink(Tx->Rx), [§]Rx

From the RF link budget, the range can be determined by the sensitivity of the transceiver and its maximum authorized radiated power. In Fig. I-7, several RF protocols are presented by finding a compromise between the power consumption, complexity/cost and data rate.

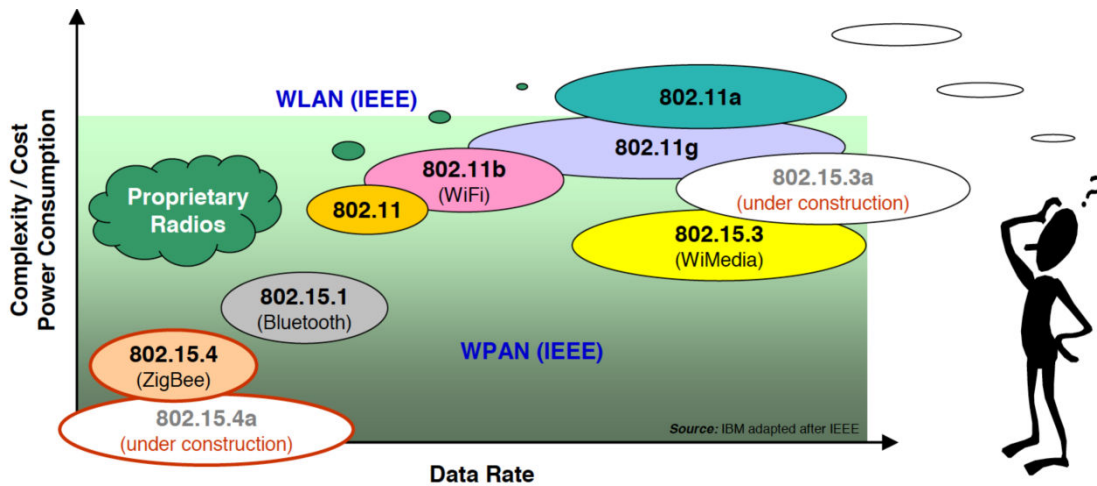

Fig. I-7. RF protocols showing compromise between the power consumption, complexity/cost and data rate.

I.1.4. Potential Energy Harvesting techniques

The effort over the years in reducing the energy consumption of the transponders, by optimizing the architecture, process technology and RF protocol, is being repaid by an emergent concept, that is, the low-power devices can be powered by means of ambient Energy Harvesting (EH). The energy harvesting concept comes at a time when the “compromise point” between energy consumed and harvested may be achieved.

Energy harvesting may be defined as the conversion process of ambient energy into electrical energy. Radiant (solar, infrared, radiofrequency), thermal, mechanical and biochemical are examples of the ambient energy that surrounds us and thus potential candidates for energy harvesting sources, as described in Fig. I-8. Energy harvesting or scavenging becomes an interesting environmental friendly solution regarding the devices batteries. Even if long-life batteries will still be unavoidable, as technologies mature, energy harvesting is creating some shift in battery usage from primary to rechargeable batteries. However, the biggest potential of energy harvesting is creating a new class of electronic devices that do not need battery, i.e., *battery-less*, as they are completely powered by ambient sources. Thus, at same time the device cost is clearly reduced and an alternative is provided for the battery discarding problem.

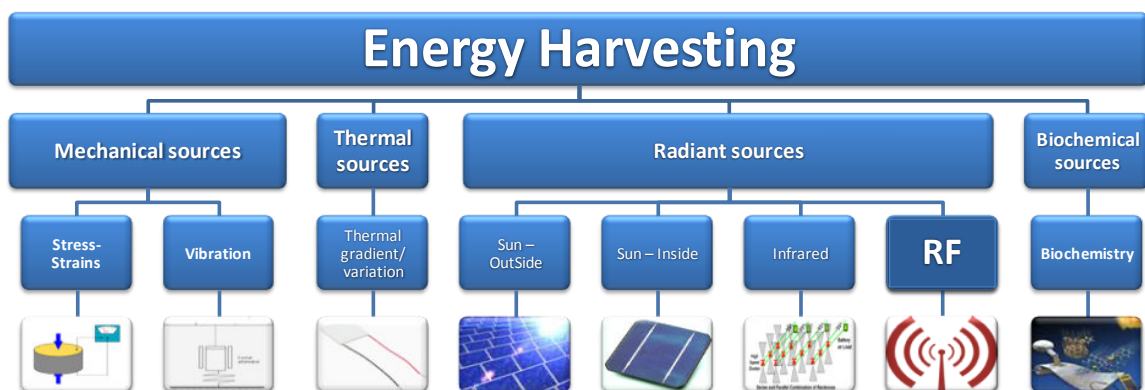

Fig. I-8. Energy harvesting sources.

For each industrial application, there is an optimal energy(-ies) harvesting technology(-ies) to be used. Therefore, there will be no “one size fits all” solution for all applications. The choice of the energy source may be done on different criteria, e.g.:

- How much energy should be provided for the device?
- Is it for an indoor or outdoor application?
- The powered device should just acquire data and store it or it should send the information by wireless link?
- What is the statechart of the device? How much time is it active and in standby mode?

In order to understand what is the useful amount of harvested power, and therefore what level of energy could be harvested depending on the energy source and hence how the battery run time works for different classes of electronics, Fig. I-9 gives a description of these different points.

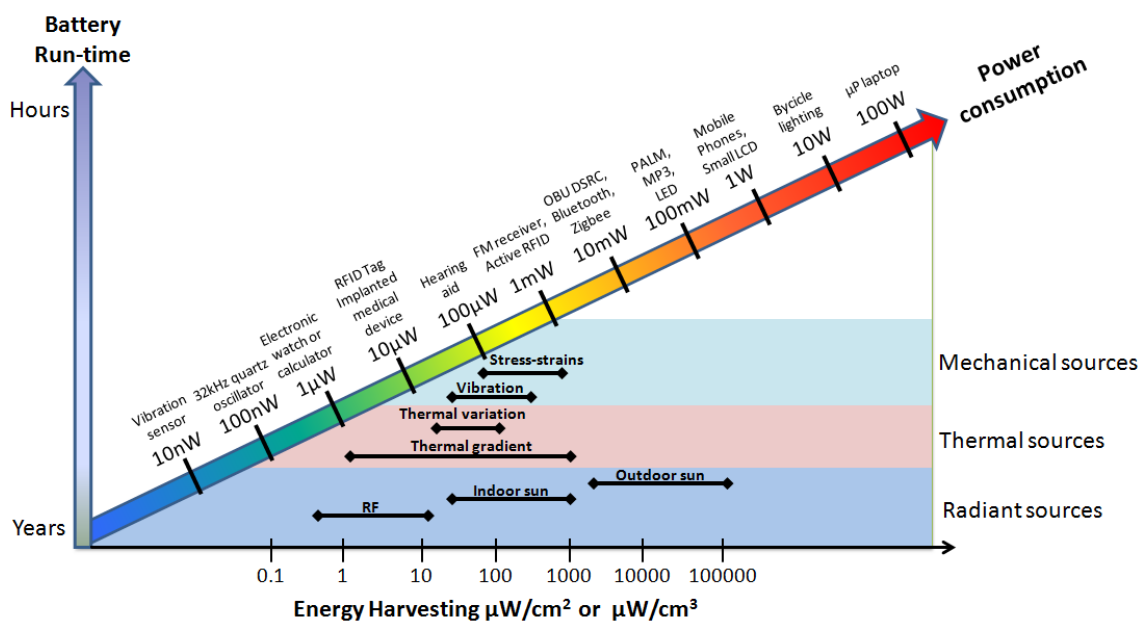

Fig. I-9. Electric power consumption for different electronic devices illustrating that the energy harvesting comes at a time when the power consumption levels of the devices are being reduced. The battery run-time is also exemplified as a function of the electric power consumption.

In Fig. I-9, we describe that depending on the application, a specific(s) energy harvesting source(s) is/are more appropriate than another one. The comparison of the different ambient energy sources is presented as a function of the available power density for each source, i.e., how much power density is available before conversion into electric energy, based on conversion efficiency. Providing a comparison of different energy harvesting sources implies a normalization of the power density units ($\mu\text{W}/\text{cm}^2$ or $\mu\text{W}/\text{cm}^3$). This normalization is sometimes forgotten in the literature, and this issue will be discussed later on in this chapter. From Fig. I-9, an interesting point may be observed;

the energy harvesting comes at a time when the electric power consumption of the modern devices is being reduced, i.e., the “compromise point” between energy consumed and harvested may be achieved.

From Fig. I-9, the outdoor sun is clearly the most powerful source in terms of power density available, however, the conversion efficiency is an important factor and solar panels still present low values. Moreover, solar energy is available just a few times during a day ~12h, if it is a sunny day on the Equatorial line. Thermal energy needs a high constant temperature gradient to provide correct conversion efficiency. Vibration energy needs a specific and constant vibration frequency to have good conversion efficiency. Finally, among all the energy sources, RF comes as an interesting candidate to provide energy to low-power electronic devices, since the system can operate 24h a day and high conversion efficiency values can be achieved.

Given that, in the next section we describe each energy source, presenting some conversion efficiencies reported in the literature and we attempt to convince that Wireless Energy Harvesting could be an interesting candidate as an energy harvesting source.

I.1.4.1. Solar

A photovoltaic system generates electricity by converting light into electricity. Solar energy is one of the most powerful sources, however, it is highly dependent on the weather conditions and the conversion efficiency is still low. Some studies estimate that on the earth we have a solar power density of 1000W/m^2 [1], or 100mW/cm^2 [2]. The amount of harvested power depends on the incident angle of the light, the intensity and spectral content of the light falling on the surface of the solar cell, the size, sensitivity, temperature and type of solar cells used. Therefore, the amount of the solar power density varies with the localization over the earth. A good guideline about how to fix the solar panel, at a given latitude, is reported in [3].

In general solar cell conversion efficiency is not high. In 1883, the first cell that has photoconductive properties was conceived, by Charles Fritts, and had only 1% of conversion efficiency. Nowadays, the efficiency of the commercial solar cells ranges from a low of approximately 8% to State-of-Art values of 20%, with some experimental technologies reaching as high as 35% [4]-[5]. However, some research groups presented electronic devices successfully powered by solar panels: in [6]-[7] a solar charger designed for small devices (e.g., MP3) was presented and, a fully autonomous sensor node (Helimote) was produced by ATLA Labs [8]. Despite the classical calculators which have been powered by solar energy since 1970s, nowadays, other commercial products are available: keyboards, toys, radio/watches [9]-[10].

Regarding indoor applications powered by solar panels, we can expect from an indoor solar cell (active area of 9cm^2 , volume of 2.88cm^3): $\sim 300\mu\text{W}$ from a continuous light intensity of 1000lx [11], thus we can estimate that for ~12h of sun, a power of 3.6mW.h is recovered.

I.1.4.2. Thermoelectric

Thermoelectric energy harvesters, based on the Seebeck effect in semiconductor junctions, are used to convert a temperature gradient into electrical power. Briefly, the thermal harvesting is based on a thermocouple placed between a hot and a cold junction, and when the two junctions are subject to different temperatures, heated electrons flow toward the cooler one. If the pair is connected through an electrical circuit, direct current (DC) flows through that circuit, this phenomenon being known as the Seebeck voltage.

Several commercial thermal generators are available on the market, in Fig. I-10, two examples are presented. The first one, Fig. I-10(a), can provide 4.05W if a maximum continuous operating high temperature of 230°C is guaranteed. The second one is an example of a micro-fabricated device (20mm x 34mm x 2.2mm) with its mounting surface and heat sink, as shown in Fig. I-10(b).

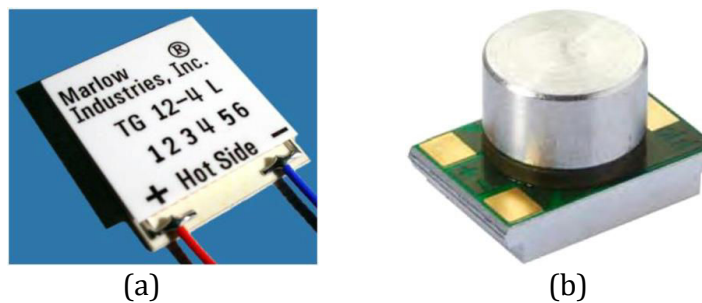

Fig. I-10. (a) Thermoelectric energy harvester from Marlow Industries Inc. and (b) Micro-fabricated TGP 751 thermoelectric device from Micropelt with mounting surface and heatsink.

Volkswagen presented recently an interesting large-scale thermal harvesting solution. Basically, a thermoelectric generator has been conceived for recovering energy dissipated as heat from their vehicles. According to them, the generator is able to obtain about 600W (30% of the car's total electrical consumption), which implies a 5% saving of the fuel consumption [12].

In the literature, interesting thermal generators were reported: in [13], a thermal generator that harvests energy from the room temperature, and provides 250 μ W from 20 μ W/cm², unfortunately the temperature gradient is not provided; in [14], from a 20K of temperature gradient, the thermal generator can provide 20 μ W and in [15], from 10K of delta temperature, a power density of 15 μ W/cm² is converted. In [16], a thermal generator for wireless sensor node applications is presented, 150mW being provided from 34°C of temperature gradient.

Regarding the thermal/electrical conversion efficiency, which is based on the Carnot efficiency in general, it is low for small to modest temperature differences. For a temperature gradient of 10°C, the Carnot efficiency would be only 3%. Furthermore, if the gradient temperature is increased, better conversion efficiency is expected, e.g., 100°C of gradient temperature may provide a 20% of conversion efficiency. However, most of the currently available optimal thermal generators operate below 40%, as reported in [17].

I.1.4.3. Mechanical

From the rumble of a passing truck, a vehicle engines turning, floors (night club, train stations) or even the human body (heartbeat, walking ...), vibrations are an important source of energy surrounding us in our every-day life. There are many opportunities for converting vibrations into electrical power. The amount of electrical energy that can be harvested from mechanical vibration depends on the vibration level, the frequency of vibration and the type, and size, of the harvester.

The mechanical energy harvesting relies on one of the following three transduction mechanisms [18]-[19]: electromagnetic (EM), electrostatic or piezoelectric. Electromagnetic method [20]-[24], sometimes called electromechanical, is based on the induction principle, that is, a conductor moving through a magnetic flux, an example of such apparatus being presented in Fig. I-11(a). Electrostatic transduction [25]-[29] is based on the movement between two isolated charged capacitor plates to generate energy, an example of this mechanism being presented in Fig. I-11(b). Finally, piezoelectric generators [30]-[33] are based on the mechanical stress applied on a piezoelectric material producing energy, the method being described in Fig. I-11(c).

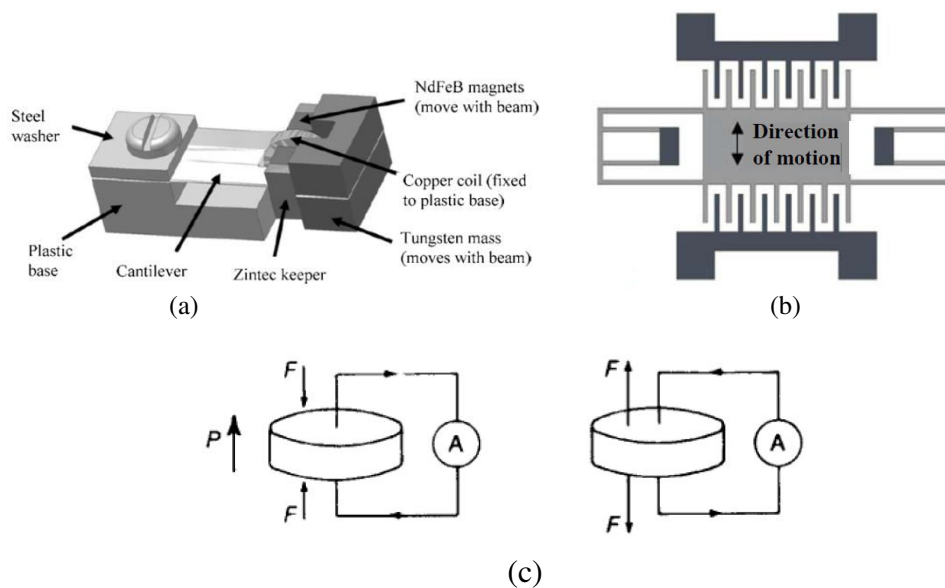

Fig. I-11. Mechanical energy harvesting: (a) moving magnet electromagnetic vibration energy harvester design [20], (b) Electrostatic converter [18] and (c) piezoelectric converter [34].

In [35], a piezoelectric application was demonstrated, where the vibration generator was able to provide 1.53mW and 1.95mW, from a random vibration from 80 to 115 Hz applied to the device. In [36], an electromagnetic micro-generator was presented, and a theoretical output power of $40\mu\text{W}/\text{cm}^3$ was predicted for a frequency of 70Hz. In [37], a different approach for mechanical energy harvesting was presented, where a laser-micromachined springs converting mechanical vibration energy into electric power and the output power density was about $830\mu\text{W}/\text{cm}^3$ for a frequency resonance of 60-100Hz. Recently, in IMEP-LAHC laboratory, the piezoelectric nanowires have been studied and designed, as active transducer element for sensors and mechanical energy harvesters [38]-[40].

I.1.4.4. Radio frequency (RF)

The first wireless power transmission (WPT) using the electromagnetic radiation method can be dated back to many years ago when Nikola Tesla conducted his first successful experiment [41]. His experiment consisted in creating an electromagnetic wave with a conductor excited by an oscillator joined to it, as shown in Fig. I-12. Then different receiver circuit topologies, *a*, *b*, *c* and *d* comprising inductance and/or capacitance were capable to recover the Radio Frequency (RF) energy. For several years, the wireless power transfer was employed for specific high-power applications; e.g., in 1964, a miniature helicopter propelled by microwave power had been demonstrate [42], other application was the high-power beaming using microwaves for the transmission of energy from orbiting solar power satellites to Earth [43]-[44], as well in the opposite direction which a spacecraft leaving in orbit was powered by a high-power beaming from earth [45]. However, in other environments high-power transmissions are not accepted, for example in-door systems, e.g., distributed sensors in complex environments such as aircraft, ships and houses. In this case the radiated power at each frequency will be limited to very low levels.

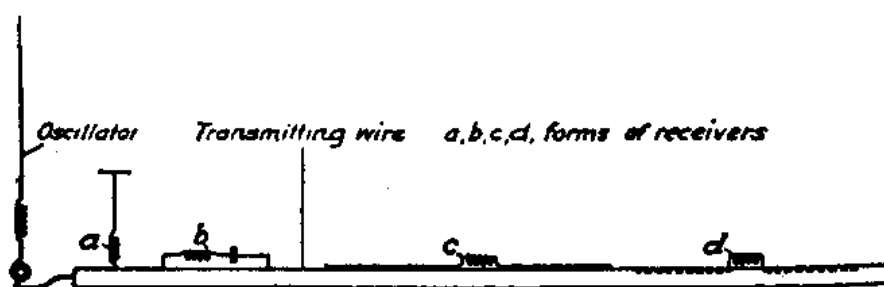

Fig. I-12. Tesla handmade draw of the first WPT apparatus illustrating a typical arrangement for collecting energy in a system of transmission thru a single wire. Figure extract from [41].

In recent times, another term emerged; we are interested in recovering the ambient RF energy, i.e., we explore the RF energy already existent in the air from different applications (television, radio, GSM, GPS, WIFI, Bluetooth, satellite, radar, etc...). This emergent concept is called *Radiofrequency Energy Harvesting* or *Wireless Energy Harvesting (WEH)*. The average power from wireless energy harvesting is typically in the microwatt and nanowatt range based on the radio standard limits or the distance from the transmitter. Due to the radiofrequency development and upcoming technologies, our radio spectrum is filled up by different applications. Each of these frequency bands in the radio spectrum has a standard to control and regulate, which dictates how it is used and shared, how to avoid interference, to set protocol for the compatibility of transmitters/receivers and to determine the amount of RF authorized power to be transmitted. The RF power is a determinant criterion to be taken into account in the RF energy harvesting design.

In a wide wireless communication system, to guarantee the efficiency of the radio link in a broad range site, several base stations and repeaters are need, and as a result the energy density available in the air is increased, certainly under control of the telecommunications regulatory agency. To illustrate the concentration of RF energy

around us, Fig. I-13 shows the emplacement of different (GSM, TV and radio) base stations in Grenoble (157k habitants in a 18km² surface), the city where this thesis was developed in.

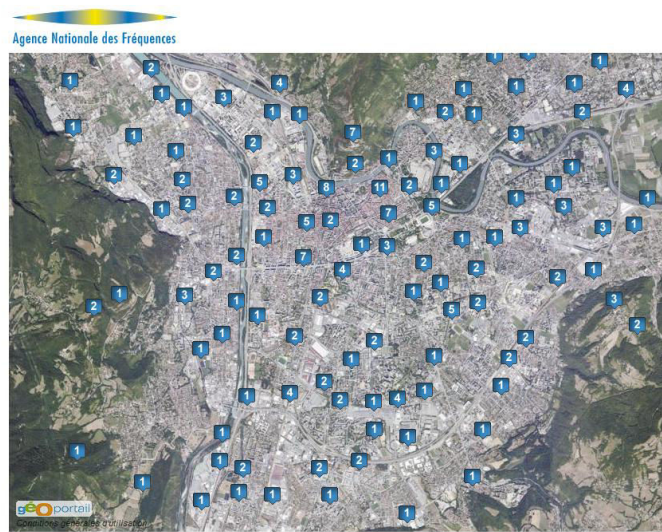

Fig. I-13. Grenoble city map with the emplacement of different base stations (GSM, TV and radio), 2013. Blue flags represents the number of antennas existent in that location.

As WEH concept is quite new, some confusion in the literature is made on the definition of this notion. Fig. I-14 shows an original approach to classify the energy recovery/transfer method based on the source type and the amount of energy available/applied.

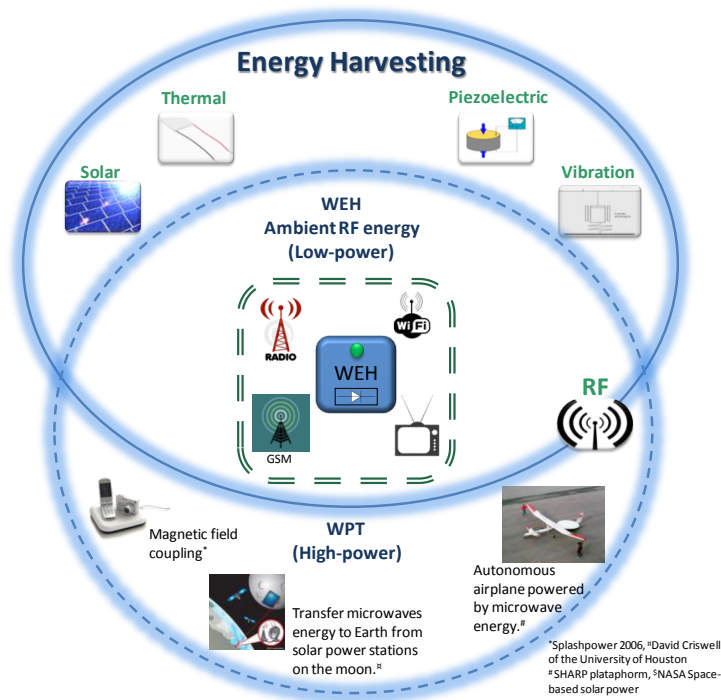

Fig. I-14. Energy recovery/transfer method classification based on the source type and the amount of the energy available. WEH= Wireless Energy Harvesting, WPT = Wireless Power Transfer.

Energy harvesting is the process by which energy is derived from external sources, captured and stored by small wireless autonomous/quasi autonomous devices. In Fig. I-14, the Energy Harvesting cloud included different ambient sources: solar, thermal, mechanical and RF. Inside the RF energy harvesting cloud, two subclasses coexist: Wireless Power Transfer (WPT) and Wireless Energy Harvesting (WEH). *Wireless Power Transfer* consists in the transport of energy by a dedicated RF high-power source (e.g., microwave power beaming or inductive energy transmission). Differently from the high-power wireless power transfer, the *Wireless Energy Harvesting* may be able to recover low-power RF energy already existent in our environment (e.g., outdoor temperature sensors powered by TV signals or autonomous sensors in a smart-house powered by WiFi waves). When the receiving antenna is directly combined with the rectifier, this becomes a *Rectenna* (RECTifier+antENNA). *Rectenna* is an intersection between WEH and WPT, and it can be deployed for both processes, depending on the power level. In this thesis we focus on the design and understanding of high-efficiency wireless energy harvesters for low-power applications.

In wireless energy harvester design some requirements should be considered. First of all, the final application should be defined (performance and functionality required); a simple harvester may provide just the RF-DC conversion for instant utilization and it does not need an embedded power management circuitry and a battery. A more complex harvester should provide a RF-DC conversion and also has the power management circuitry embedded to store the energy. In all RF harvesting cases, the harvester must have a high RF-DC efficiency to convert the maximum of the RF energy into usable electric power. It should have a high sensitivity to be able to harvest ultra-low levels of RF energy. If possible, the WEH device should be able to support a wide range of operating conditions such as input power, load resistance and output voltage. For more complex systems an intelligent power management circuitry is necessary to control and optimize the recovered energy and its use. Finally, the WEH device should be compatible with the standard 50Ω to facilitate measurements and RF connections.

Most of the sensors which need this wireless power supply are located within structures where battery replacement would be complicated or impossible, e.g., in a manufacturing process where the quantity of sensors is elevated, earthquake sensors installed on the bridges or at difficult access places, temperature sensors installed in a nuclear power plant where the radiation exposure level is high. In the biomedical industry, in-body implants that need a power supply could be privileged by this wireless power transfer or RF harvesting prolonging the life and maintenance of the implant while avoiding the possibility of contamination and instability associated with implanted battery.

For indoor applications, several sensors are required to equip a smart-house for example; temperature, humidity, surveillance, light control and others. Most of these sensors are located inside walls or above ceilings; consequently, the battery replacement is unsuitable. Indoor ambient can often have low-light conditions that make solar energy harvesting methods unrealizable. Thermal gradient is not easily available in indoors

scenarios and vibration is suitable to be the lowest possible. Finally, one solution could be a simple WiFi router that could power these sensors.

We can divide the Wireless Energy Harvesting applications in three classes, depending of the RF source [46]:

- Intentional sources: the amount of power and the period can be controlled and engineered for a specific application. The sources can be programmable to supply energy for the device continuously or intermittently on a scheduled basis and the amount of power can be also controllable. Application examples: WiFi routers, RFID and we can also imagine an evolution in the mobile base stations.
- Anticipated ambient sources: the sources are not controlled, but they are predicted, i.e., the engineers can predict that at a certain place for a certain time a RF density power intensification is available (e.g.: stadium during a match, where most all the supporters have a mobile or bus station or airport and other crowded places). These sources include also known radio, television and mobile base station transmitters.
- Unknown ambient sources: the sources are neither controlled nor predicted. The WEH device will act as an “opportunist” (e.g. walk-talk, temporally WiFi cloud, police radio).

I.1.4.4.1. Why Wireless Energy Harvesting?

Energy harvesting has therefore attracted much attention from the research community, because of its potential role as a power supply mainly in two applications: low-power wireless sensor networks and low-power electronic systems. In most of the cases, there is an element that is unavoidable in both applications, the *antenna*. Since, wireless sensors are connected to a remote system and most of the low-power electronic systems need also to be connected to a wireless network (e.g., internet), the wireless channel is unavoidable. As described in detail in Chapter IV, the Wireless Energy Harvesting device is basically composed of an antenna, a diode and a DC load. Therefore, in a wireless sensor the same antenna could be used for the wireless communication and also for the WEH, saving the occupied PCB area.

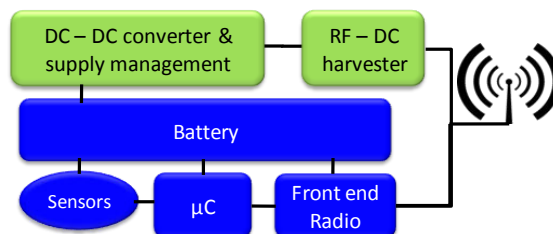

Fig. I-15. Wireless sensor circuit block.

A basic wireless sensor circuit block is described in Fig. I-15, illustrating the coexistence of the wireless communication channel with the wireless energy harvesting.

However, the two operational modes, wireless communication and WEH, should not be activated at the same time, to avoid interference on the protocol signal quality.

Moreover, during a day the wireless sensor is required just a few times, and consequently during the “free” time, the WEH process could be operational, as described in Fig. I-16.

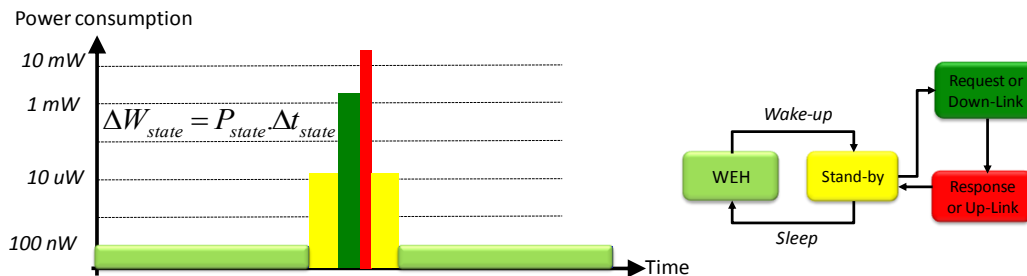

Fig. I-16. Wireless sensor statechart.

Wireless energy harvesting is quasi-independent of weather conditions or time of day, can power remote systems over distance, 24hours per day and there is no required physical effort to charge the remote device. WEH is a unique technology and remains the most promising for use in consumer-oriented portable electronic devices that can provide power to thousands of wireless sensors. Devices built with this wireless power technology can be sealed, easily embedded within structures, or made mobile, and battery replacement can be (quasi) eliminated. As the quantity of transmitting devices is increased, the ambient RF power levels are also boosted.

WEH is suitable for applications where the other sources (e.g., solar, vibration...) are not available or slightly available, for example, building interiors where the amount of light makes solar energy harvesting methods unreliable and in the case the electronic device is inside the wall or on the roof, where solar harvesting is definitely not appropriate. Implanted medical devices already exist and run with batteries which can be recharged using WEH.

However, energy harvesting efforts will be only rewarded if the power consumption of the electronic devices continues to decrease, and, consequently, ambient RF energy harvesting becomes more practical and available in more areas.

- **From an economic point of view:**

Free-battery sensors or with rechargeable battery are an interesting solution to reduce the battery replacement cost or management effort. Fig. I-17 shows how the cost/management effort for wireless sensors with battery powerfully increases with the amount of nodes in a wireless sensor network.

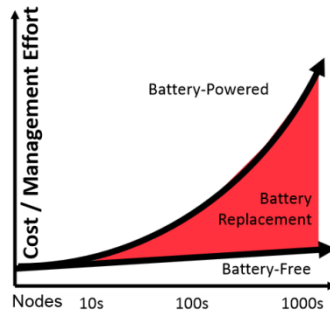

Fig. I-17. Battery replacement cost as a function of the quantity of nodes in a wireless sensor network, [47].

Since the available ambient power density depends on the number of transmitting devices, two promising technologies are at the forefront of Wireless Energy Harvesting sources: GSM and WiFi. In 2012, 87% of the world population (7 billions) had a mobile phone and this number continues to increase, as shown in Fig. I-18. The number of public WiFi access points has been multiplied by 4.5 in the last 5 years (Fig. I-19) and as well some research groups reported that already in some urban environments, one can detect tens of WiFi transmitters from a single location [48].

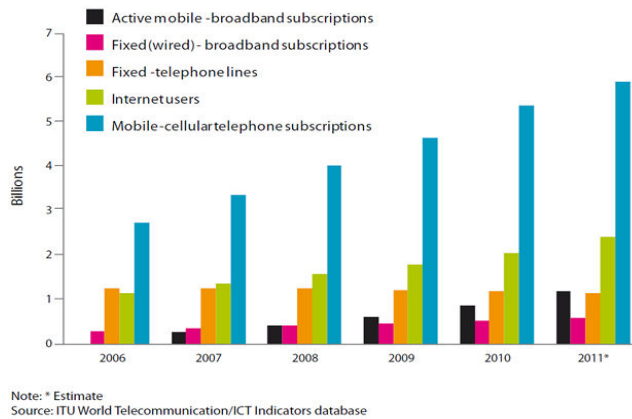

Fig. I-18. Number of subscriptions for different telephony services, 2006-2011.

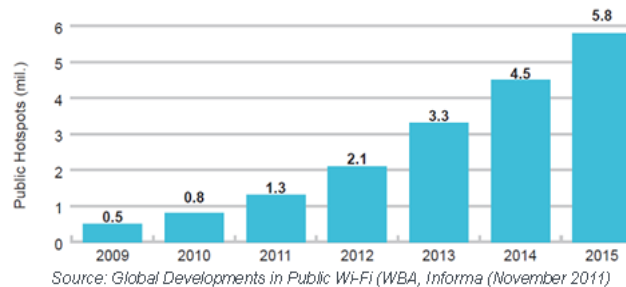

Fig. I-19. Number of public WiFi hotspots in the world, 2009-2015.

Definitely, energy harvesting is a hot topic and there are still several technological barriers to be surpassed. The EETimes magazine in 2011 [49], published an interesting article entitled “EE Times 20 hot technologies for 2012”, where wireless sensor network supplied by energy harvesting was classified as the second hottest technology. Frost &

Sullivan has recently released a report detailing “Top 50 Technologies Reshaping the World” [50], included among them are Wireless Sensors, Energy Harvesting and Wireless Charging. IDTechEx published a motivating review about the amount of money spent on energy harvesters research, and they predicted that it was more than \$0.7B in 2012 , the perspectives for the next years being optimistic, e.g., in 2022, the total market for energy harvesting devices would rise to over \$5 billion, Fig. I-20.

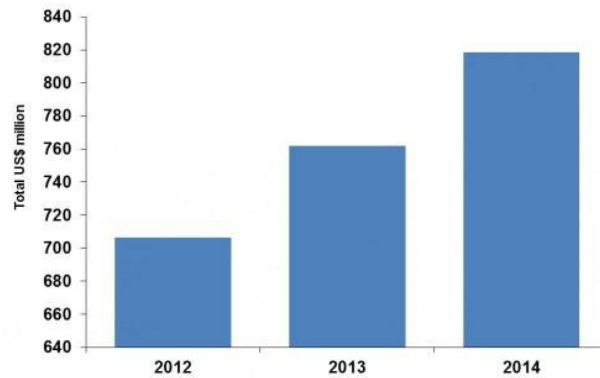

Fig. I-20. The amount of money spent on energy harvesters’ research. Source *IDTechEx* [51].

Since we are talking about money, the audacious companies that are launching the electronic devices powered by means of WEH, have all interest to preserve the intellectual property of their new products. However, since the WEH topic is quite fresh subject, the number of patent applications is still small and first application dated back only few years ago (2004). In Fig. I-21, we have the number of worldwide patent application per year requesting the intellectual property for WEH apparatus. From 2004 to 2014, only 49 worldwide patent applications were provided, it is clear that there is still a lot of work to do in this field. The patent data were acquired from the EPO (European Patent Office) database with the keyword RF energy harvesting.

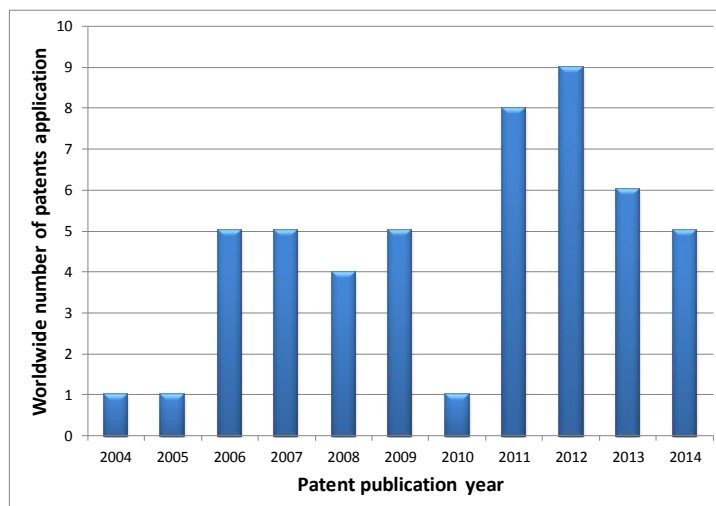

Fig. I-21. Worldwide number of patent application for WEH apparatus, 2004-2014. Data acquired from EPO (European Patent Office).

I.1.4.4.2. State-of-the-Art of Wireless Energy Harvesting

Before beginning the Wireless Energy Harvesting State-of-the-Art description, we would like to introduce this section with a graph illustrating how attractive WEH is becoming to the scientific community compared to others classical Energy Harvesting (EH) sources (solar, vibration, thermal ...). Furthermore, one more time, we would like to clarify that there is a difference between Wireless Energy Transfer (WET) and Wireless Energy Harvesting (WEH). Fig. I-22 shows the number of IEEE published papers per period of years for the three keywords: Energy Harvesting, Wireless Energy Transfer and Wireless Energy Harvesting.

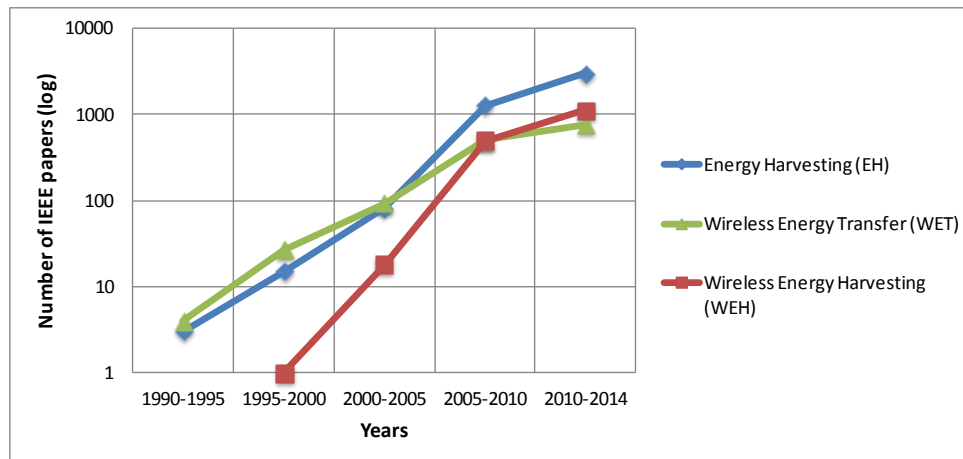

Fig. I-22. Number of IEEE published papers per year with the keywords: Energy Harvesting, Wireless Energy Harvesting and Wireless Energy Transfer (1990-2014).

In the literature, quite a few papers presented high-efficiency rectifiers results for low-power RF input power, but hardly any elucidate in detail how to achieve high efficiencies levels with a single diode and a simple load. For example, [52] clarified the key components of a harvesting system: (a) miniaturized antenna and (b) high-efficiency rectifying circuit. They proposed a novel, compact and efficient design that can harvest very low-level ambient energy (WiFi band). According to this paper, the proposed rectifier has better conversion efficiency than any power harvester on the market (2012). The harvester can provide 1V for -5dBm input level (10k Ω load), and we can deduce the RF-DC efficiency of 31% for this optimal RF input power. Reference [53] successfully developed a RF energy harvester embedded in a low-power transceiver (TRx) front-end, using the same antenna (at 2.4GHz). This prototype has been co-integrated with the low-power TRx in a 130nm CMOS process and achieves a measured peak power conversion efficiency of 15.9% for 0dBm input power. Recently, in [54], a novel rectenna architecture tunable for 900MHz – 2.45GHz operation was presented, its RF-DC conversion efficiency peak is 80% for 25dBm input power. However, for 0dBm input power they achieve only 10% of RF-DC efficiency.

Reference [55] reports a four-band circularly polarized antenna for energy harvesting from ambient sources, designed by exploiting genetic algorithm optimization tools. Special remarks go to the antenna design, as the genetic algorithm was applied and for the broadband matching network. However, a double diode circuit was used and the rectenna

provides a 10% of RF-DC conversion efficiency for a -13dBm RF input power (at 2.45GHz). In [56], a rectenna at 2.45GHz which has 44% RF-DC conversion efficiency for a $25\mu\text{W}/\text{cm}^2$ power density was presented. According to authors, the reported RF-DC efficiency is the highest demonstrated for these power levels (2012). A source-pull method was applied in order to vary the DC load over incident RF power level, to predict the best DC load value. The impedance matching between the antenna and the rectifier was successful, however on the load side the RF impedance analysis was not done, and just the DC aspect was detailed. Differently from the precedent paper, in [57], a higher RF-DC conversion efficiency was reported in the 2.45GHz band for a low RF input signal, 50% of efficiency for a -17.2dBm ($0.22\mu\text{W}/\text{cm}^2$) RF input power. Although the results seem to be hardly achievable in a farfield context, measurements and simulation results are in good agreement as reported in the paper. Special remark goes to the high-gain compact antenna design, which was directly matched to the rectifier, through a coplanar stripline (CPS) technology. Due to the CPS method applied, the rectenna benefits on both sinusoidal wave cycles (positive and negative). As the rectenna is fed by CPS, an interesting double-stub tuning matching circuit was designed to transform the CPS to a 50Ω microstrip in order to allow the antenna measurements. In [58], an interesting 2.45GHz rectenna using a compact dual circularly polarized (DCP) patch antenna was presented. The aperture-coupled feed method was used to excite the antenna through two ports phase shifted of 90° , providing a circular polarization. The rectenna was optimized for 10dBm RF input power, therefore a specific DC load was obtained. The rectenna provides 63% of RF-DC conversion efficiency for an estimated $0.525\text{mW}/\text{cm}^2$ of RF density power. In [59], the 42% efficiency is measured as the ratio of the dc power and the estimated input power to the diode of 0.1mW (-10dBm). The antenna consists in a square aperture coupled patch antenna with a cross shaped slot etched on its surface that permits a patch side reduction of 32.5%. Furthermore, for a low estimated RF input power of -20dBm, the rectenna still provide 16% of efficiency. Reference [60] reports a 52% RF-DC conversion efficiency for an estimated +10dBm ($150\mu\text{W}/\text{cm}^2$) incident power on a four-diode rectifier. The rectifier is integrated with the antenna on the same substrate, and the overall device is compact. However, a modified bridge rectifier with four diodes was applied.

Reference [61] reports a rectifier with two diodes. The optimal RF-DC conversion efficiency was 60% for 10dBm RF input power. In [62], an interesting highly-efficient rectenna is presented. The rectenna is based on a multilayer substrate, which the antenna and rectifier are separated. Matching network in the diode input was designed, as well high-order harmonics issue was analyzed. The rectenna presented an efficiency of 34% for an estimated input power of -10dBm ($17\mu\text{W}/\text{cm}^2$). However, a good didactic method is applied on the paper. In [63], a monolithic rectifier was designed with 45% of RF-DC conversion efficiency for a +10dBm RF input power. In [64], the focus was on present analytical models and closed-form analytical expressions in order to facilitate the rectenna design. Even, an important effort was deployed in the mathematical approach, however, the rectenna layout was not precisely described. Nevertheless, an efficiency of 40% was predicted for a high and estimated RF input power of +20dBm. In [65], a dual-

frequency printed dipole rectenna has been developed for the wireless power transmission at 2.45 and 5.8 GHz. The rectenna design is based on the CPS method, which allows a size reduction of the antenna. An interesting filter co-design was described, blocking the high-order harmonics for both frequencies. The rectenna is compact and original, presenting a high RF-DC efficiency of 84%, but for a high estimated RF input power of +19.5dBm. In [66], through a Harmonic Balance simulation the diode impedance was optimized at the fundamental frequency (2.45GHz) for a specific RF input power (0dBm). The efficiency was calculated by estimating the receiver antenna gain from the simulation results, and then the estimated received power was predicted. The rectenna presents a RF-DC efficiency of 62% for an estimated RF input of 0dBm. Finally, in [67], a 48-element dipole array was designed with a single diode, allowing high input power values at the rectifier input, therefore a 50% efficiency was measured for a +13dBm RF input power.

Nonetheless, to the best of our knowledge, in the literature just a few papers ([56] and [57]) present a precise rectenna measurement, i.e., since the RF-DC conversion efficiency depends on the RF input power, and consequently, for each output voltage measured, the RF input power value should also be measured. In general, most of the papers estimate the RF input power by subtracting the theoretical free-space path loss from the receiver antenna gain. Further in Chapter IV (IV.5.2), we discuss more in detail this.

Additionally to the research results obtained by several groups, recently, numerous companies brought up different products using wireless energy harvesting: Intel has created a WEH device that can recover energy from the TV frequency band (674 and 680 MHz), using a UHF log periodic antenna with 5dB gain connected to a 4 stage charge pump power harvesting circuit [46]. An output voltage of 0.7V was measured across an 8k Ω load that was enough to power up a thermometer/hygrometer and its LCD display, which is usually powered by a 1.5 Volt AAA battery (no information was given about the RF-DC efficiency). Nokia has started using the energy harvesting technology in a prototype mobile phone that recharges itself using only ambient radio waves (GSM, TV, etc...) [68].

Finally, by investigating the Wireless Energy Harvesting literature, it is important to note that due to the multiple efficiency definitions and different prototype technologies existent in the literature, it is quite difficult to compare the efficiency numbers directly. Another critical point is the normalization of the RF-DC conversion efficiency as a function of received power or power density. Nevertheless, the results described and compared in this thesis were extracted exactly as they are reported in the respective papers. Given that, in the conclusion of Chapter IV, we have summarized the different RF-DC conversion efficiencies reported in the literature of 2.45GHz *rectennas* designed for Wireless Energy Harvesting, and we have compared to the results obtained in this thesis.

I.2. Problem statement: is it possible to design a completely autonomous DSRC transponder?

To increase the efficiency and safety of the road traffic, new concepts and technologies have been developed in Europe since 1992 for RTTT applications (Road Traffic & Transport Telematics). These applications use the Dedicated Short Range Communications (DSRC) devices at 5.8GHz (ISM band). The DSRC system consists in a reader or roadside equipment (RSE) and a transponder or on-board unit (OBU).

Industrial European approaches are oriented to semi-passive transponder technology, which uses the same signal sent by the reader to retransmit, performing a frequency shift and encoding the data to be transmitted. This design avoids the use of the local oscillators to generate the RF waves, as in active transponders and save electrical energy of batteries. This allows the development of relatively low cost and small size transponders. Despite advances of integrated low-power circuit technology, this concept still requires a lithium battery to operate the transponder for a period of 4-6 years. However, if this time life seems long, it is not enough and generates important costs for tag providers to replace customers OBU. Moreover, with the expansion of these mobile facilities, it appears that over the years the amount of lithium to destroy has become a crucial problem for the environment.

In this thesis, the initial objective was to conceive a new low-power DSRC transponder powered by means of Wireless Energy Harvesting at the 5.8GHz band. Since in the DSRC protocol, we have already 5.8GHz energy available, we could imagine that during the time that DSRC OBU is in the sleep mode, we could foresee to recharge the battery of the transponder by means of WEH, as illustrated in the circuit block diagram in Fig. I-16. However, during the thesis development, three major points were detected. First, the priority is to establish the DSRC transaction and as in most of the DSRC applications (e.g., Free-flow), the exposure time of the vehicle in the antenna field is short. This obliged to establish at the same time the DSRC protocol and the WEH at 5.8GHz. Therefore, we are not sure that DSRC protocol and WEH could be active at the same time without interferences on the protocol signal quality. Second, from the DSRC V2I link budget modeling results that are described in Chapter II, we observed that RF link budget at 5.8GHz presents a low power density for the OBU, since the car does not remain enough in the DSRC antenna's field to proceed to energy harvesting, as well as the free-space path loss is high at this frequency and the car's windshield attenuation is important. Third, the electric power consumption of the DSRC OBU is still high when compared to the amount of the energy that could be harvested (Chapter II).

Finally, we have decided to first optimize the energy consumption of the DSRC OBU by means of a new operation mode and then we have explored another ISM frequency for WEH. We chose the 2.45GHz band, because first of all is a license-free band (ISM) that can be deployed in different applications. Second, this is one of the most used frequencies for WEH, and consequently allows us to easily compare our results to the State-of-the-Art. Finally, the free-space path loss at 2.45GHz band is lower compared to 5.8GHz.

- **PhD context:**

This thesis was prepared in a collaboration between the IMEP-LAHC laboratory and Multitoll Solutions Company. During the PhD, I have been employed by the company Multitoll Solutions as electronic R&D engineer. So I had to manage and deal with Multitoll priorities based on the requests of new customer projects and my thesis. Subsequently, in this thesis, new results in Wireless Energy Harvesting domain have been reported. Moreover, some industrial research results are as well presented to respond to company requests.

I.3. Thesis overview

The manuscript of this thesis will be organized as follows:

- Chapter II (Low power DSRC transponder) focuses on the DSRC e-toll collection application, and particularly on the design of a new low-power DSRC transponder. The chapter will review the DSRC system. Then, the DSRC V2I link budget modeling will be presented. Further on, we will describe the design of the DSRC transponder with an original operation mode that considerably reduces the power consumption. Finally, we will conclude this chapter, presenting the electric power consumption of the new DSRC transponder.
- Chapter III (Antenna design) will present all the antennas developed in this thesis, DSRC and Wireless Energy Harvesting included.
- Chapter IV (Wireless Energy Harvesting) will present an original rectifier/rectenna design method based on the analysis of the optimal load impedance (RF and DC), improving the RF-DC conversion efficiency. Several rectifiers have been conceived in order to validate the design method and then two rectennas have been developed. Finally, the results obtained in this thesis will be compared to the Wireless Energy Harvesting State-of-the-Art.
- Chapter V will summarize the conclusions drawn from the current work and will present perspectives and future improvements.

Chapter II - Low-power DSRC transponder

II.1. Introduction

In this chapter we focus on the DSRC (Dedicated Short Range Communication) toll collection application, particularly on the design of a new low-power DSRC transponder. We propose a DSRC transponder with an original statechart that considerably reduces the power consumption compared to the existent transponders on the current market.

First of all, the DSRC system is introduced in II.2. A literature overview is presented in II.2.1, showing the different results reported on the Road-Side-Equipment and On-Board-Unit design. Then a DSRC Toll Collection RF link budget was carried out in order to determine the optimum configuration to improve the RF link, as described in II.2.2. Since the electric power consumption of the transponders available on the market is not public-access, we have implemented a measurement setup to estimate the amount of energy needed by these market transponders (2011), the measurement results being presented in II.3.1. Following the electric power consumption measurements, we start the low-power DSRC transponder design with the RF implementation (II.3.2). The microcontroller choice is explained in II.3.3. The low-power DSRC transponder proposed is based on a creative deep-sleep mode, which reduces considerably the power consumption, this new operation mode being detailed in II.3.4. Finally, in II.4 we conclude the low-power DSRC transponder design, and we discuss the feasibility of recharging the battery of the transponder by means of Wireless Energy Harvesting.

II.2. DSRC system

DSRC is a wireless technology for automotive use, either among vehicles (V2V) or between vehicles and infrastructures (V2I), supporting public and private safety operations [69]. DSRC is part of a more complex system, ITS - Intelligent Transport Systems, which include telematics and all types of automotive communications. However, ITS are not restricted to road transport; they also cover for the use of Information and Communication Technologies (ICT) for rail, water and air transport, including navigation systems. Some examples of different ITS are presented in Fig. II-1. Many potential applications for DSRC public safety and traffic management exist such as free-barrier toll system (Free-Flow), automatic-barrier toll system (Stop&Go), intersection collision avoidance, approach a vehicle emergency alert, vehicle safety inspection, transit priority signal or emergency vehicle, electronic parking payment, customs clearance of vehicles and safety inspections, signing of vehicles, warning rolling, sensor data collection, highway-rail intersection warning.

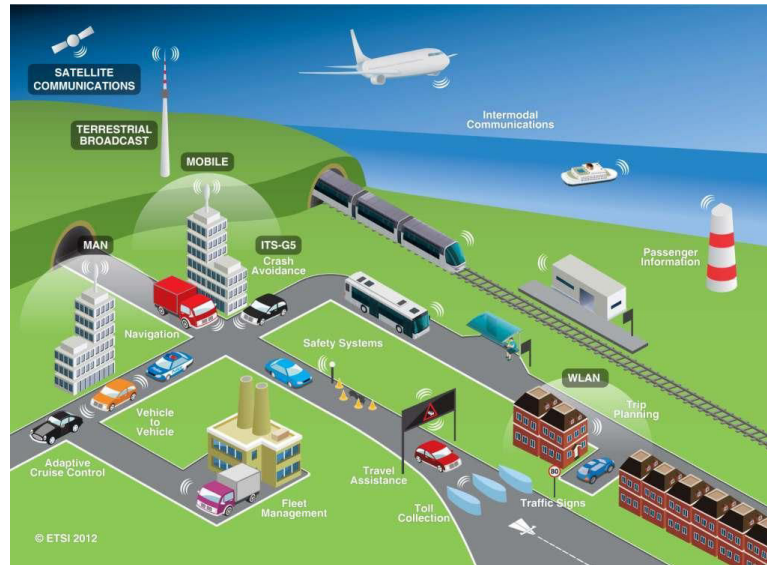

Fig. II-1. ITS - Intelligent Transport Systems. *Source: ETSI.*

Among the ITS applications, and particularly the DSRC systems, the e-toll collection has become an interesting solution for highways toll payments, avoiding traffic jam and providing a fast and safe trip for the drivers. In fact, the idea of electronic tolling using microwave signals dates from some decades ago. In 1959, the Nobel Economics Prize winner, William Vickrey, has been the first to propose a system of electronic tolling for the Washington metropolitan area. He suggested that each car be equipped with a transponder. “The transponder’s personalized signal would be picked up when the car passed through an intersection, and then relayed to a central computer which would calculate the charge according to the intersection and the time of day and add it to the car’s bill” [70]. With this new idea, Vickrey demonstrated an important reduction of traffic congestion at the toll plazas by allowing more vehicles per hour/per lane. Naturally, when Vickrey proposed this idea, it was not well received by the traffic control organisms. Nevertheless, he introduces an interesting argument: “People see it as a tax increase, which I think is a gut reaction. When motorists' time is considered, it's really a savings”.

The world’s pioneer in the widespread implementation of this technology was Norway, in 1986. Nowadays, DSRC for e-toll collection has standards well established in Europe and also in other countries such USA, Japan, Korea and Brazil. In October 1999, the Federal Communications Commission (FCC) allocated to the United States a 75MHz spectrum in the 5.9GHz band for DSRC to be used by intelligent systems in the transport. Similarly, in Europe, the European Telecommunications Standards Institute (ETSI) has allocated 30MHz of spectrum in the 5.8GHz band for ITS, in August 2008. The decision to use frequencies in the range of 5GHz is due to spectral environment and propagation characteristics, which are adapted to environments of vehicles. The waves propagating in this spectrum can provide broadband communications over long distances, if one has good weather.

The DSRC architecture has been developed according to the standards included in: EN 12253 (physical layer) [71], EN 12795 (data link layer) [72], EN 12834 (application layer) [73], EN 13372 (communications profiles) [74] and EN ISO/ETSI 14906 (interface for EFC) [75]. For the work developed in this thesis, the EN 12253 standard is indispensable, since it describes the physical layer using microwaves at 5.8 GHz as applicable in the field of Road Transport and Traffic Telematics and the requirements for the short-medium range communication to be used for exchanges between the infrastructure and the vehicle.

A DSRC e-toll system comprises an On Board Unit (OBU), placed inside the vehicle (windshield) and a fixed unit Road Side Equipment (RSE) placed in a fixed spot of the road, enabling the establishment of RF link between vehicles and infrastructure. For RTTT (Road Traffic & Transport Telematics) applications to be efficient, a high percentage of vehicles must detain an OBU. For OBU perspective, the transponder has to be unobtrusive and cannot impact the vehicle design or its safety. For RSE context, the antenna (reader) must be cost-effective and reliable in all environments. Finally, from the company point of view, for after-market purchase, the antenna and electronics must be easy to install and provide excellent value.

Next, we will introduce two well-known configurations of DSRC e-toll collection.

- **Stop&Go configuration:**

Stop&Go DSRC e-toll collection is characterized by special lanes in a toll plaza where only drivers equipped with a transponder can have access, as shown in Fig. II-2. The vehicle should approach the barrier with a maximum speed of 30km/h, the wireless identification is done automatically between the RSE and OBU, and then, if the transaction is confirmed, the barrier is opened. Typically, these automatic systems are installed in toll plazas where they coexist with the classical toll booths (payment in cash), since the latter is required for the occasional users who do not have a DSRC OBU. The e-toll stations are also equipped with video/image capturing equipment for full-time violation enforcement.



Fig. II-2. Stop&Go toll collection configuration.

- **Free-Flow configuration:**

In the Free-Flow configuration, there is no barrier, no toll booths and no cash lanes, as shown in Fig. II-3(a). Motorists, instead, experience driving on an open (multi lanes) highway with tolls automatically calculated as they drive through an e-tolling point. The only condition is that the vehicles need to have an OBU inside. The users are able to pass through the toll plazas without slowing-down to pay the highway toll. This system reduces significantly the congestion in highway toll plazas, but on the other hand, the toll operator needs to invest more money in order to avoid no-payment by violators (camera, magnetic loops, etc), as shown in Fig. II-3(b).

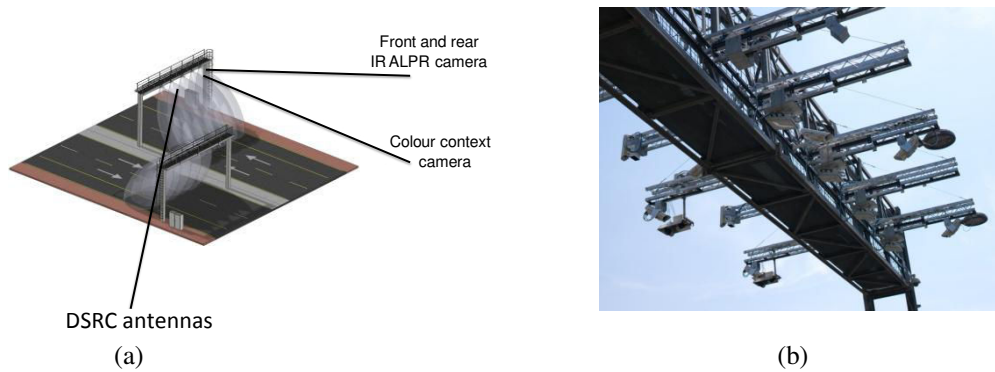

Fig. II-3. DSRC Free-Flow e-toll collection: (a) schema and (b) picture.

As observed in Fig. II-3(b), Free-Flow e-toll stations need a metallic platform in order to mount the DSRC vehicle detection devices (RSE, cameras, laser...). However, recently an innovative DSRC Free-Flow toll collection system was proposed in [76]. The antenna reader is buried under the surface of the highway, and consequently there is no visible structure, providing the driver with a more enjoyable trip without visual pollution caused by the toll systems. This original concept is already protected by a worldwide patent application.

- **DSRC specifications:**

Table II.1 and Table II.2 shows the DSRC protocol specifications for each operation mode.

TABLE II.1. DOWNLINK MODE SPECIFICATIONS

Downlink Mode: RSE -> OBU	
Carrier Frequencies	5.7975GHz, 5.8025GHz, 5.8075GHz, 5.8125GHz.
RSE Transmitter Power	+33dBm E.I.R.P.
Modulation type	ASK
Modulation Index	0.5 - 0.9
Bit Rate	500kbit/s
Data coding	FM0
Power limit for communication	-17dBm (upper) -43dBm (lower)
Polarization	Left hand circular

TABLE II.2. UPLINK MODE SPECIFICATIONS

Uplink Mode: OBU -> RSE	
Sub-carrier frequencies	1.5MHz or 2MHz
Sub-carrier modulation	2-PSK
Bit Rate	250kbit/s
Data coding	NRZI
Polarization	Left hand circular

In an e-toll collection scenario, the DSRC reader sends continuously (each 8ms) a BST (Beacon Service Table) signal waiting for a transponder response. The transponder is generally in the sleep-mode, in order to save energy. When a vehicle with a DSRC transponder enters into the e-toll communication zone (\overline{AB}), as shown in Fig. II-4, the transponder wakes-up and a communication link is opened. In fact, the BST signal is ASK modulated data, that when recognized by the transponder, changes the operation mode from sleep-mode to downlink mode.

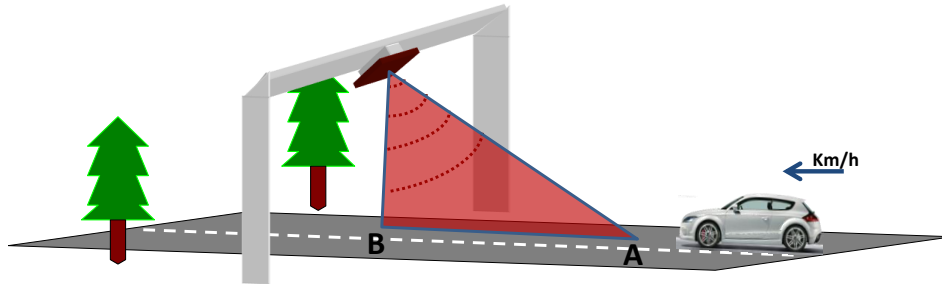

Fig. II-4. DSRC Free-Flow Toll collection detection zone.

The different operation modes of a classical DSRC transponder are described in the statechart in Fig. II-5. Due to the fact that only relatively short distances between the RSE and the OBU have to be covered, very cost-effective semi-passive transponder technology can be used. The signal received from the RSE is used for uplink transmission by retransmitting it after a frequency shift and encoding uplink data. This avoids the usage of local oscillators as in active transceivers and allows to easily design battery powered OBU.

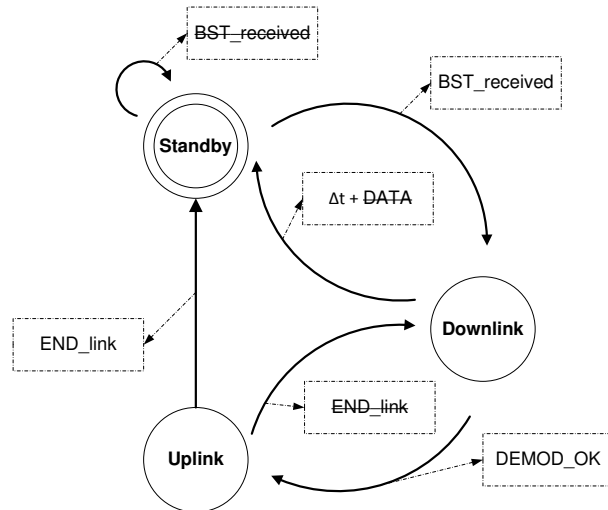

Fig. II-5. Classical DSRC transponder statechart.

During the downlink mode, the OBU receives the ASK-modulated data from the RSE. The demodulation part in the OBU is mainly an envelope detector, as shown in Fig. II-6. The amplitude detection is implemented by means of a Schottky diode that makes a direct conversion from the 5.8GHz ASK modulated carrier to baseband; then this signal is sent to the microcontroller.

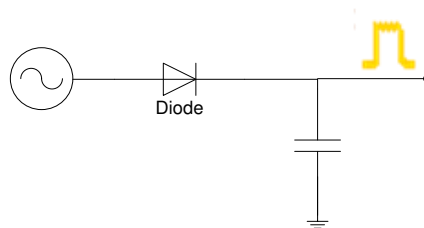

Fig. II-6. Envelope detector – ASK demodulation.

In the uplink mode, the OBU receives an “unmodulated” carrier from the beacon. Then, by applying the backscattering method, the OBU uses this carrier to modulate a subcarrier at 1.5MHz or 2.0MHz which itself is phase modulated with the uplink data stream (250kbit/s). By this type of modulation, two-side bands appear, each containing the same information, as shown in Fig. II-7. After transmission back to the beacon, this signal is converted to the baseband and demodulated. The European DSRC standard established that the OBU should be fully reflective, i.e., the tag does not generate any local frequency.

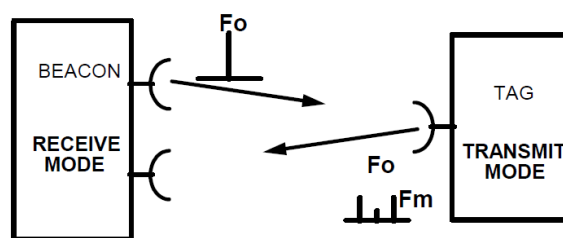

Fig. II-7. DSRC uplink mode.

A typical circuit block diagram of a passive backscatter OBU is presented in Fig. II-8. Through downlink process, the Rx-data is detected (envelope) and then processed by the microcontroller. For the uplink mode, the OBU continuously receives the unmodulated carrier signal from the RSE; this signal is mixed with the Tx-data already modulated with the sub-carrier signal and finally sent back to the RSE.

The circuit block diagram in Fig. II-8 contains two separated antennas, one for transmission and other for reception. The DSRC transponder proposed in this thesis has only one antenna for both operation modes, and will be described later.

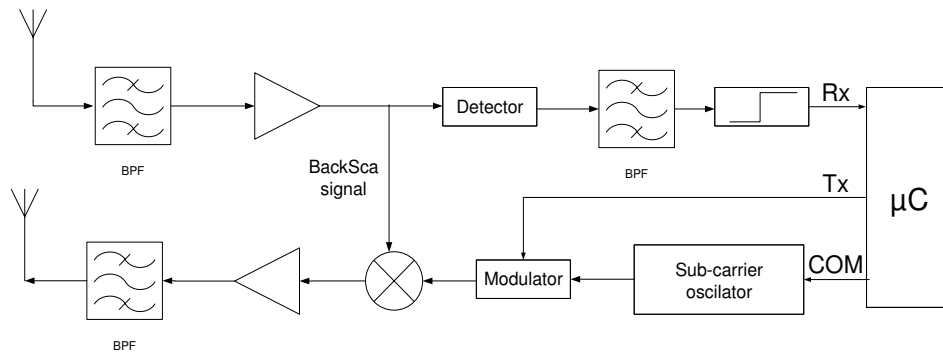

Fig. II-8. Typical circuit block diagram of a classical passive backscatter OBU.

II.2.1. Literature overview

DSRC has broad applicability due to the numerous possible applications that this system may support. However, its initial development did not have a unique standardization. Consequently, nowadays, three different DSRC standards are used: for the USA, Europe and Japan (Asia). In Table II.3, the different DSRC standards are presented, showing the distinctive specifications for each protocol. Even if Europe and Japan DSRC standards have the same operation frequency, they are completely different, starting with the fact the OBU in the Asia standard is active (local oscillator), whereas in the EU the OBUs are completely reflexive.

TABLE II.3. DSRC STANDARDS [77]

Features	JAPAN (ARIB)	EUROPE (CEN)	USA (ASTM)
Communication	Half-duplex(OBU)/Full duplex(RSU)	Half-duplex	Half-duplex
Radio Frequency Band	5.8GHz band 80MHz bandwidth	5.8GHz band 20MHz bandwidth	5.9GHz band 75MHz bandwidth
Channels	Downlink: 7, Uplink: 7	4	7
Channel Separation	5MHz	5MHz	10MHz
Data Transmission rate	Down/Up-link: 1 or 4Mbits/s	Down-link: 500kbits/s Up-link: 250kbits/s	Down/Up-link: 3-27Mbits/s
Coverage	30 meters	15-20 meters	1000 meters (max)
Modulation	2- ASK, 4-PSK	RSU: ASK OBU: 2-PSK	OFDM

Establish a directed comparison from the various DSRC papers existents in the literature is not trivial, due to both the different DSRC standards and the different DSRC

target applications (i.e., V2I or V2V). In the literature, most of the reported results are in regard to the DSRC vehicle-to-vehicle (V2V) communications [78]-[86], since this application is widely requested by different cars manufactures companies and definitely, it is broadly deployed for the smart city concept. An important effort has been done in modeling the vehicle-to-vehicle link budget, since one of the major V2V application is the collision avoidance [87]-[89], and consequently there is no place for prediction error. A common issue of V2V and V2I applications is the multipath interference, especially in a critical case, e.g., inside a tunnel. A wide range of studies addressing the radio channel inside tunnel, both theoretically and experimentally, are available [90]-[93]. Research on narrowband radio propagation inside a tunnel, that focus on signal attenuation and fading characteristics are provided in [94]-[95]. Ray-based models are also used to predict the field pattern inside tunnels for both polarizations [96]-[98].

Regarding the vehicle-to-infrastructure applications, and particularly the Electronic Toll Collection, just a few papers are available in the literature. A good review of the European ETC history is presented in [99]. In [100], an interesting study was reported, analyzing the effectiveness of several vehicle and roadside antenna locations under simulated vertical and horizontal polarization at a frequency of 5.8GHz. They demonstrated that in an ETC scenario many factors can affect the signal level, such as the vehicle and the roadside antenna location, the traffic conditions, the polarization, the windshield effects and the roadway reflections. The DSRC ETC link budget analysis was reported in [101] and [102]. Regarding the commercial aspect of the ETC, in [103], an approach of testing and evaluating DSRC systems is presented, pinpointing that before investing in the installation, the operator has to assess the system functionality, quality and reliability. As detailed in Chapter III, the specifications for the DSRC ETC antennas OBU and RSE are quite rigorous, since they should respect the DSRC physical layer criteria [71]. Some DSRC antennas concepts were reported in the literature: [104]-[107].

Looking forward to the development of future ITS, a recently study for V2V communications was presented in [108]-[109]. The system is based on a multifunctional transceiver that has two operation modes, namely, radar (sensing) mode and radio (communication) mode, which are integrated within a single hardware platform.

II.2.2. DSRC V2I link budget

In many RF applications, a specific period of time is necessary to allow a complete data transfer between Tx and Rx devices. In DSRC toll collection this is not different, however, electronic payment is necessary, so the communication link has to be extremely reliable. Therefore a large quantity of information should be exchanged between RSE and OBU, while the vehicles are rapidly travelling through the communication zone (\overline{AB}), as shown in Fig. II-4. The strength of the RF link budget depends of the mounting configuration of the RSE and OBU. The mounting angles of RSE and OBU, the RSE height and OBU/RSE antenna radiation pattern should be carefully optimized to improve the DSRC link budget.

In DSRC V2I systems, the antenna gain of the RSE is higher than that of the OBU and as presented previously the DSRC transponder is a backscatter device, consequently the uplink communication (OBU \rightarrow RSE) is weaker than the downlink (RSE \rightarrow OBU) communication. Nevertheless, the RF link budget modeling is equivalent for both directions (uplink or downlink). In this thesis we present the modeling of the downlink link budget.

In the literature, to the best of our knowledge, only few papers explored the DSRC mounting configuration. In [110], a study on the optimal configuration for DSRC system is presented, based on the signal strength threshold. The signal strength is calculated from the radiation pattern of the OBU, the receiving pattern of the RSE and the relative location and direction between the OBU and RSE. In [111], a physical model estimating the reliability of the microwave DSRC link for ETC applications was reported. Finally, in [112] an extension of [110] was reported, but using the infrared frequency (wavelength band 780–950nm) instead of microwave. In general, these papers focus on demonstrating the best DSRC mounting configuration which provides a correct RF link. Therefore, we are interested to analyze this point and also predict the amount of energy recovered by the OBU for the two e-toll cases: Free-Flow and Stop&Go. This analysis will be useful to verify the hypothesis of recharging the OBU battery by means of Wireless Energy Harvesting in the DSRC band.

Fig. II-9 shows a DSRC V2I link budget proposed in this thesis. The RSE is mounted at a height, h_{RSE} (in m), above the road lane with an angle α (in degree) relative to the vertical plane. The OBU is placed on the windshield with an angle β (in degree) relative to the horizontal plane and a height, h_{OBU} (in m), from the road lane. Obviously, the angle β depends of the vehicle model, i.e., each windshield has a particular angle of inclination. For this reason, in our model, we assumed that the OBU boresight axis (center of the main lobe) has the same direction as the RSE boresight axis, and consequently, the angle β is not taken into account in the optimization process. The main lobe of the reader antenna has a beamwidth θ (in degree). The vector \overline{CM} is the RSE antenna boresight axis. The distance between the OBU and RSE, r , is variable since the vehicle is moving towards the RSE direction with a speed v (in km/h or m/s). The vector \overline{AB} indicates the detection zone. Outside this region a successful transaction cannot be guaranteed, even if microwave signals are still available, coming directly from the reader or by reflections. P_t and P_r (in W) are the transmitted and received power, respectively.

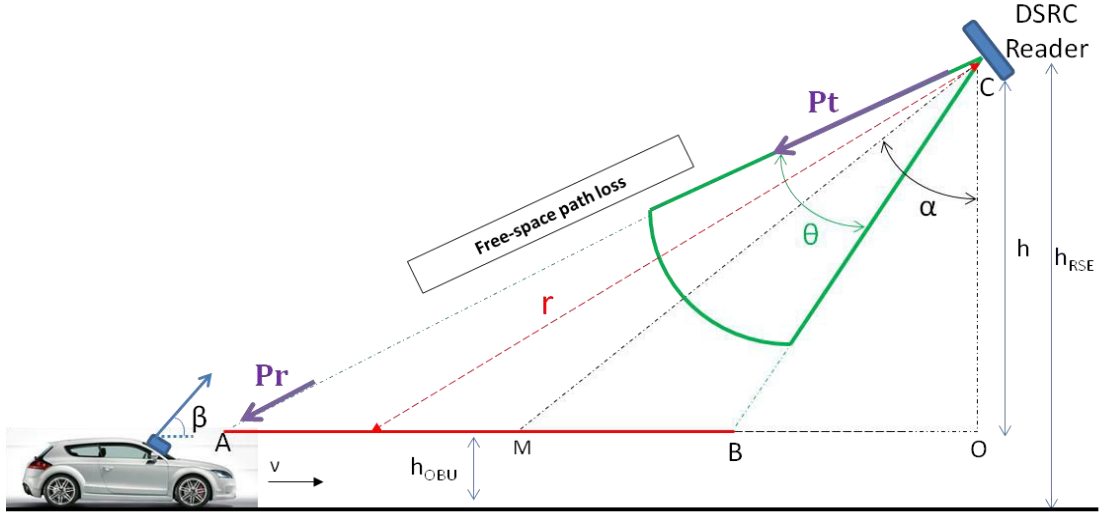

Fig. II-9. DSRC V2I link budget.

The signal quality received by the OBU depends on many parameters, which can attenuate or amplify the signal. Based on Friis transmission equation, (II-1) shows the instantaneous power received by the OBU. In (II-1) all the variables are in dB.

$$P_r[t] = P_t + G_t[\theta] - L_f[r] - L_{win} + G_r \quad (\text{II-1})$$

The P_t is the transmitted RF power (measured before the RSE antenna input), and its value is controlled by the DSRC reader in order to respect the maximum authorized E.I.R.P. (+33dBm), as described in [71]. G_t is the RSE antenna gain, which depends on the antenna beamwidth (θ). Therefore, a mathematical model for the antenna main lobe has been included in our DSRC mounting model, which is described later in this section. The antenna beamwidth is also standardized by [71]. L_f , the free-space path loss parameter, is represented as a function of the distance between RSE and OBU. The effect of windshield fading is also considered here; L_{win} represents this attenuation and, in generally, it is currently modeled as a constant parameter. Its modeling will be described later. Finally, G_r is the OBU antenna gain.

Because of the height of big trucks, in Europe the RSE mounting height should not be lower than 5.5m above the ground. Consequently, in our modeling framework we assumed that h_{RSE} is fixed and equal to 5.5m, but the h_{OBU} can vary with of the vehicle model.

- **RSE radiation pattern model:**

Typically, the RSE antenna has a gain of 16dBi. In this thesis, we have designed also the high-gain RSE antenna, and its development is presented in Chapter III (III.3.3.2). Nevertheless, we have not included yet the RSE antenna results, and we have modeled the antenna radiation pattern from a mathematical estimation.

Since the real antenna main lobe does not have an ideal radiation distribution, the energy varies with angular displacement. The radiation module can be simulated by a

cosine or sinus function, which has been widely used for infrared sources [113]-[114]. Otherwise, standard mathematical models can be as well applied [115]. We estimated the RSE antenna radiation pattern by a sinus function:

$$G_t[\theta] = 37 \left(\frac{\sin\left(\frac{180\theta}{37}\right)}{\frac{180\theta}{37}} \right)^2 \quad (\text{II-2})$$

Fig. II-10 shows the estimated RSE antenna radiation pattern result. The maximum antenna gain in the boresight direction is 16dBi. The antenna beamwidth (θ) is 15° .

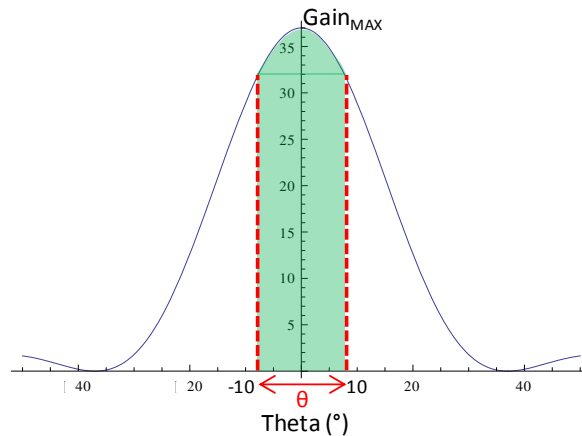

Fig. II-10. Estimated RSE antenna radiation pattern.

II.2.2.1. Windshield fading

Predicting a correct model or estimating a value for the windshield fading is not trivial, since nowadays a large number of vehicle models exist, and each fabricant has its own manufacturing method. In many countries, windshields are made of laminated glass, as required by law. Laminated glass can bend slightly under impact. This quality reduces the risk of injury of the drivers. On the other hand, some athermic heat-reflecting windshields and built-in windshield heaters block the microwave signal reception. In [116], different windshield types from different vehicle manufacturers are presented showing the correct position for the transponder placement. Fig. II-11 shows examples of different windshield types, illustrating the areas where a transponder must be placed to avoid interference. In Fig. II-11, the region named “*epargne*” signifies the right position to place the transponder without attenuation.

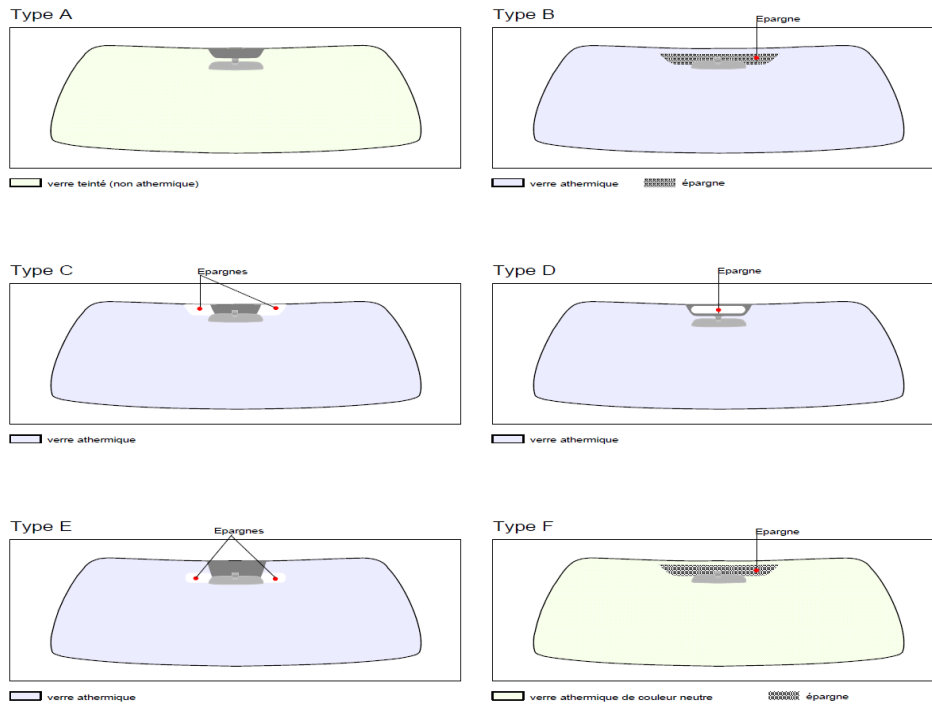

Fig. II-11. Different windshields types showing the zones where a transponder could be placed without interference [116].

In our laboratory, windshield fading characterization has been prepared. The preliminary measurement scenario consisted in two horn antennas placed on the sides of the windshield. The antennas were connected to a VNA and the transmission S parameters were measured. First, the measurement setup was calibrated without the windshield, then the windshield was inserted between the antennas and the S parameters were acquired. A windshield fading of 3dB at 5.8GHz was obtained. Moreover, other measurement scenarios are under analysis. This preliminary windshield fading results are comparable to the one reported in [100].

II.2.2.2. DSRC V2I link budget results

Based on the system configuration presented in Fig. II-9, we have implemented a routine in Matlab to estimate the best mounting configuration for the two DSRC toll collection modes: Free-Flow and Stop&Go.

We are interested in observing two particular parameters: the instantaneous received power and the amount of energy acquired by the transponder. The instantaneous received power is useful in this chapter to check the limit level of power to establish a RF link communication. This is the level above the communication is guaranteed with a specific error bit ratio. The second parameter we analyze is the total amount of RF energy that a vehicle with a transponder is able to collect when passing through a DSRC antenna area. In fact, the importance of this recovered energy is useful for us to introduce Chapter IV – “Wireless Energy Harvesting”.

To establish a correct communication, the minimum received power is -43dBm , as standardized in [71]. Nowadays, the DSRC reader produced by Multitoll can execute a complete DSRC transaction in $50\text{-}80\text{ms}$ (equivalent to 2.89m at maximum speed ϑ of 130km/h), depending on the transaction complexity. This maximum transaction time is important for the estimation of the required communication distance zone as a function of the vehicle speed. For our DSRC RF link budget we use the performance results yielded by the Multitoll DSRC reader.

- **Free-Flow toll configuration:**

As presented in the beginning of this chapter, in a Free-Flow toll configuration no barrier exists, the vehicles move in a multi-lane configuration with a maximum speed of 130km/h (Europe). Since there is no stop or speed reducing and the time needed for a complete transaction is short, the communication zone is narrow. The first mounting configuration to be analyzed is defined by the following parameters:

- RSE antenna beamwidth: $\theta=15^\circ$
- E.I.R.P transmitted RF power: $P_t + G_t[\theta = 0]=+33\text{dBm}$
- Windshield fading: $L_{win}=3\text{dB}$
- OBU antenna gain: $G_r=7\text{dB}$
- RSE height: $h_{RSE}=5.5\text{m}$
- OBU height: $h_{OBU}=1.5\text{m}$
- Vehicle speed: $\vartheta=130\text{km/h}$ (or 36.1m/s)
- **The RSE mounting angle (relative to the vertical plane): $\alpha=$ variable**

Based on the specifications above described, Fig. II-12 shows the received power as a function of the distance between the vehicle and the RSE for different RSE mounting angle.

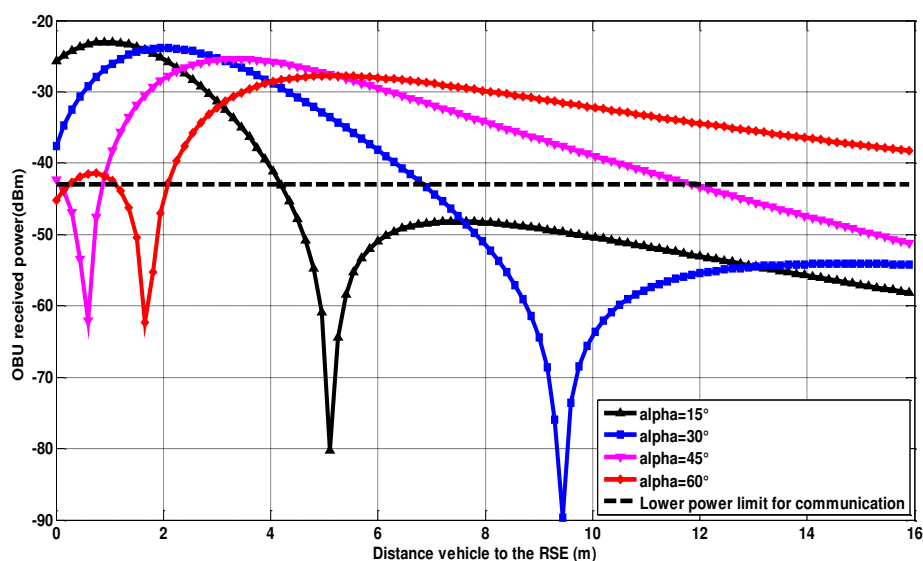

Fig. II-12. OBU received power as a function of the distance between the vehicle and the RSE for different RSE mounting angle. Specifications: $\theta=15^\circ$, $P_t=+33\text{dBm}$, $L_{win}=3\text{dB}$, $G_r=7\text{dB}$, $h_{RSE}=5.5\text{m}$, $h_{OBU}=1.5\text{m}$.

If the inclination of RSE mounting increases, the communication zone enlarges, and conversely, the incident power decreases as shown in Fig. II-12. It is important to notice in Fig. II-12, the lower power limit for establishing a communication (-43dBm).

At a speed of 130km/h we need at least 1.81m to 2.9m as communication zone to complete a simple DSRC transaction (50ms to 80ms). Nevertheless the period necessary to complete a transaction could be higher depending on the transaction complexity and RSE performances. Multitoll requests a minimum detection zone of 10m, based on *in-situ* tests. From Fig. II-12 a RSE mounting angle of 45° provides a sufficient detection zone distance and the received power criterion is respected. As a result, in Fig. II-13 we have confirmed for different OBU heights that the RSE mounting angle of 45° provides a correct detection zone distance and enough incident power. In Fig. II-13, a second configuration is analyzed; now the RSE mounting angle is fixed (45°), but the OBU height vary, since different classes of vehicle are available on the market (e.g. classical cars, sport cars, vans, trucks...). The second mounting configuration is defined by the following parameters:

- RSE antenna beamwidth: $\theta=15^\circ$
- RSE mounting angle (relative to the vertical plane): $\alpha=45^\circ$
- E.I.R.P transmitted RF power: $P_t=+33\text{dBm}$
- Windshield fading: $L_{win}=3\text{dB}$
- OBU antenna gain: $G_r=7\text{dB}$
- RSE height: $h_{RSE}=5.5\text{m}$
- Vehicle speed: $v=130\text{km/h}$
- **OBU height: $h_{OBU}=\text{variable}$**

Based on the specifications described before, we choose three OBU heights. A height of 1.5m is representative for a classical car, 1.9m for a van and 2.5m for a truck. Fig. II-13 shows the received power by the OBU as a function of the distance between the vehicle and the RSE for different OBU heights.

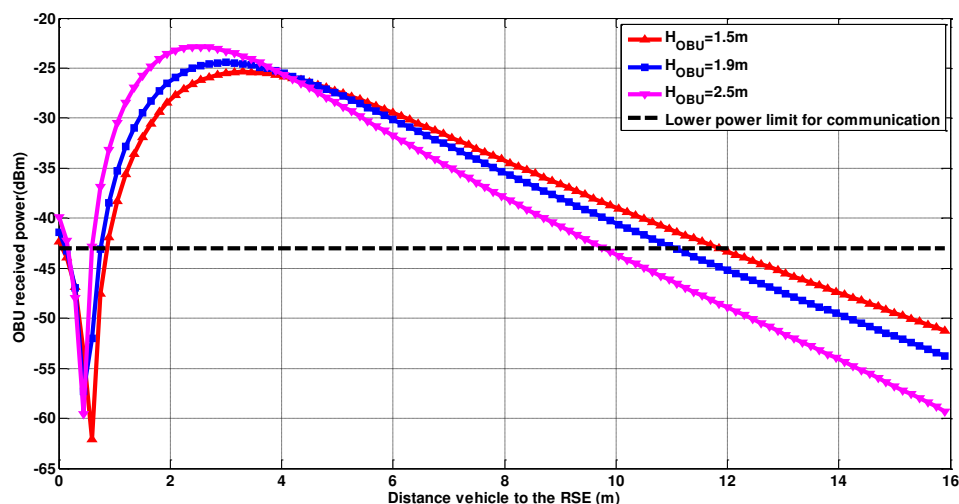

Fig. II-13. OBU received power as a function of the distance between the vehicle and the RSE for different OBU heights. Specifications: $\theta=15^\circ$, $\alpha=45^\circ$, $P_t=+33\text{dBm}$, $L_{win}=3\text{dB}$, $G_r=7\text{dB}$, $h_{RSE}=5.5\text{m}$, $v=130\text{km/h}$.

As expected, the incident power increases with the OBU height. The communication zone distance shrinks, when the OBU height augments. The RSE mounting angle of 45° provides a correct detection zone distance and enough incident power for different OBU heights.

With the received power during the detection zone, it is possible to estimate the DSRC RF energy harvested. This energy is proportional to the surface of the integration bellow:

$$W_r = \frac{1}{v} \int_{x=0}^{x \rightarrow +\infty} P_r[x]. dx \quad (\text{II-3})$$

In Fig. II-14, based on (II-3), the amount of recovered energy by an OBU is plotted as a function of the RSE mounting angle for a constant vehicle speed of 130km/h.

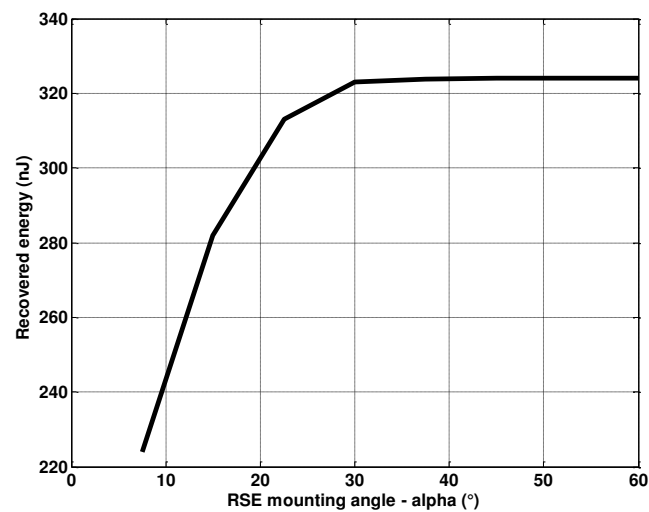

Fig. II-14. OBU recovered energy as a function of the RSE mounting angle for a constant vehicle speed. Specifications: $\theta=15^\circ$, $P_t=+33\text{dBm}$, $L_{win}=3\text{dB}$, $G_r=7\text{dB}$, $h_{RSE}=5.5\text{m}$, $h_{OBU}=1.5\text{m}$, $v=130\text{km/h}$.

For small RSE mounting angles, the amount of recovered energy increases, but around 45° the recovered energy, saturates, as showed in Fig. II-14. A resume of the total DSRC RF energy harvested for Free-flow and Stop&Go configurations is given in Table II.4 and Table II.5.

- **Stop&Go toll configuration:**

Stop&Go configuration resembles to the classical toll plaza, where several lanes are available for the drivers; the only difference is that the automatic lanes are equipped with DSRC systems, and the payment is made automatically as the vehicle approaches. The maximum accepted speed for this configuration is 30km/h (8.33m/s). If the Stop&Go transaction works well, the vehicles should neither stop, nor reduce their speed. The barrier is opened instantly when the transaction is completed.

The instantaneous received power and communication zone are dependent of DSRC mounting configuration parameters. The vehicle speed impacts directly the recovered energy calculus, since the time the transponder is lighted by the reader antenna field is dependent of the vehicle speed, as described in (II-3). Given that for the Stop&Go

mounting optimization the only difference when compared to the Free-Flow configuration is the vehicle speed, the optimal mounting configuration result is the same for both cases, as previously presented in Fig. II-12 and Fig. II-13.

In Table II.4 and Table II.5, the estimated recovered energy is presented for both configurations (Stop&Go and Free-Flow). The Free-Flow results in Table II.4 and in Table II.5 are based on the mounting parameters described in Fig. II-12 and in Fig. II-13, respectively. The Stop&Go results are also based on the mounting parameters previously discussed with a single difference, the vehicle speed.

TABLE II.4. RECOVERED ENERGY BY THE DSRC TRANSPONDER FOR STOP&GO AND FREE-FLOW CONFIGURATION AS FUNCTION OF THE RSE MOUNTING ANGLE.

Recovered Energy / RSE mounting angle	$\alpha=15^\circ$	$\alpha=30^\circ$	$\alpha=45^\circ$	$\alpha=60^\circ$
Free-Flow (130km/h)	282nJ	323nJ	324nJ	324nJ
Stop&Go (30km/h)	1.2 μ J	1.4 μ J	1.4 μ J	1.4 μ J

TABLE II.5. RECOVERED ENERGY BY THE DSRC TRANSPONDER FOR STOP&GO AND FREE-FLOW CONFIGURATION AS FUNCTION OF THE OBU HEIGHT.

Recovered Energy / OBU height	$h_{OBU}=1.5m$	$h_{OBU}=1.9m$	$h_{OBU}=2.5m$
Free-Flow (130km/h)	324nJ	359nJ	431nJ
Stop&Go (30km/h)	1.4 μ J	1.6 μ J	1.9 μ J

From Table II.4 and Table II.5, we assume that the vehicles neither stop nor reduce their speed on the toll plaza. Consequently, a low-power recovered energy is observed, even for the more favorable case, a truck's driver ($h_{OBU}=2.5m$) on a Stop&Go toll.

Nonetheless, the Stop&Go systems are conceived to avoid that the vehicle stops in the DSRC toll lanes. It happens often, that the vehicle is immobilized for at least 2s due to the transaction delay and anti-violation enforcement (capture video/image). If we take this condition into account, the energy recovered will increase considerably. For instance, a transponder on a truck that stops under the maximum RF power, between 3 and 5 μ W, at position around 1.5m and 2m, during 2s in the communication zone, could harvest 10 μ J from the DSRC band. This is the best scenario for the RF energy harvesting in the DSRC band.

In view of the fact that we have available RF energy in the DSRC band, we could foresee recharging the battery of the DSRC transponder by means of Wireless Energy Harvesting, improving the battery lifetime. Nevertheless, two issues arise: first, the priority is to establish the DSRC transaction, we are not sure that DSRC protocol and RF energy harvesting could coexist in the same band, without interferences on the protocol signal quality. Second, the amount of RF energy available becomes significant only for the Stop&Go configuration (stop time>2s). Therefore this assumption goes in the opposite direction of the DSRC toll collection principle, that is, to reduce traffic jam and time spent in highway tolls.

Based on these DSRC V2I link budget results and in the aim of improving the battery lifetime of a DSRC transponder, we decide to look up for a different method than 5.8GHz

Wireless Energy Harvesting. In the next section (0), we present a new low-power DSRC transponder design based on an original operation mode that considerably reduces the power consumption.

II.3. A new low-power DSRC transponder design

In this section we describe the new low-power DSRC transponder design. The DSRC transponder circuit diagram (Fig. II.15) presented in this thesis is greatly simplified compared to the classical structure proposed in the literature, as shown in Fig. II-8. The DSRC transponder specifications requested by Multitoll are: bi-directional transmission architecture, that is, only one antenna Tx/Rx should be deployed, ultra low standby power consumption, high detection sensitivity for downlink, and completely reflective transponder .

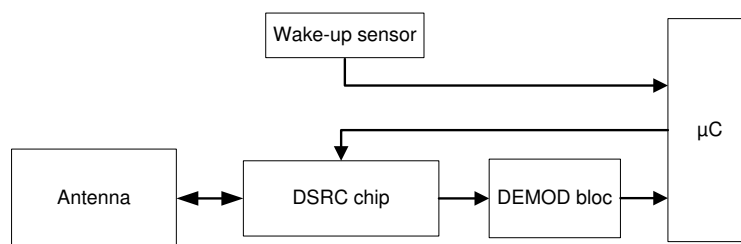

Fig. II-15. General low-power DSRC transponder circuit diagram.

Before starting the transponder design, we have characterized different DSRC transponders available on the current market, in order to acquire an electric power consumption reference, as described in II.3.1. The DSRC chip (Fig. II-15) is detailed in II.3.2, where its performances are tested. In II.3.3 we explain the microcontroller choice and why we need an extra bloc for demodulation (DEMOD bloc). The new deep-sleep mode based on a wake-up sensor is presented in II.3.4. Finally, the total power consumption of the DSRC transponder is presented in II.3.5.

II.3.1. Electric power consumption of DSRC transponders on the current market

The objective of this section is to present an analysis of the electric power consumption of several DSRC transponders existing on the current market (2011). The results obtained on these measurements are used as reference for the low-power DSRC transponder design proposed in this thesis. Three DSRC transponders have been studied, for confidentiality reasons we will name them: T1, T2 and T3. The transponders have a battery and for safety reasons, if this battery is taken off, the memory is deleted. This procedure is important to avoid that toll users try to manipulate the transponders. Voltage battery is equal to 3.6V. Once the measurement setup (II.3.1.1) has been made operational, the DSRC transponder has been excited by a typical DSRC wake-up frame (BST), as described in [121].

To estimate the electric power consumption, we need to measure the current of the transponder for each operation mode of the device. This procedure should be executed without any voltage fluctuation to avoid erasing the transponder memory.

II.3.1.1. Measurement setup

The purpose of this experiment is to succeed with a single amplifier operating in the inverse mode, to transform measured output voltage into current absorbed by the transponder (“*badge*”). The measurement setup is presented in Fig. II-16.

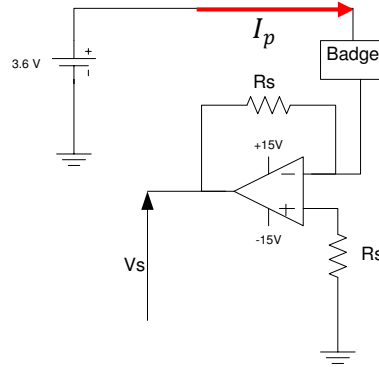

Fig. II-16. Transponder output voltage measurement setup.

The relation between voltage (V_s) and current (I_p) is the following:

$$I_p = -\frac{V_s}{R_s} \quad (\text{II-4})$$

The operational amplifier (op-amp) used is the TL081-ST. The transponder must be placed in series with the amplifier and above all, must be powered at all the times, to prevent data loss. The choice of the resistance R_s requires a compromise between the gain and the bandwidth of the measurement setup. We expect that the current to be measured is around 10mA. To ensure the non-saturation of the op-amp, the resistor R_s is chosen equal to 1k Ω . The real value of the resistor R_s is measured and it is equal to 995 Ω . In Fig. II-17 a picture of the measurement setup is presented.

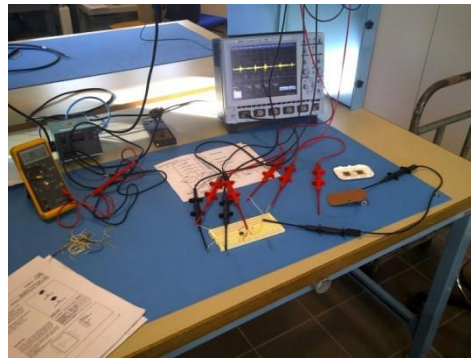

Fig. II-17. Picture of the DSRC transponder electric power consumption measurement setup.

- **Gain-Bandwidth:**

In a DSRC transponder the maximum bit rate is 500kbps with ASK modulation, thus its occupied bandwidth is 1MHz. We have made a simple test in order to verify if the bandwidth of the amplifier circuit is large enough to cover the modulation bandwidth. The setup consisted in injecting a sinusoidal to the inverting input of the op-amp, varying

the frequency of the sinusoidal, and measuring the output voltage saturation. From voltage measurement results, we could check the operating limit frequency. We have observed that the bandwidth limit is around 3MHz. We could therefore conclude that the proposed measurement setup is correct for our requirements.

- **Leakage current:**

To ensure the correctness of all measurement results acquired in this section, the existence of a leakage current should be verified. We can check the current at the inverting and non-inverting inputs of the amplifier, with the purpose to confirm if the leakage current is significant. We expect measured results around $10\mu\text{A}$ with $R_s=995\Omega$ and from the amplifier manufacturer datasheet the input impedance of the amplifier is $10^{12}\Omega$ (Z_{in}). Applying a voltage division rule, the current at the inverting input (I^-) can be deduced from the following equations:

$$V^- = V_s \frac{(Z_{in} + R_s)}{(Z_{in} + 2R_s)} \quad (\text{II-5})$$

From (II-5) we have V^- around 10mV. Consequently we can estimate the inverting current:

$$I^- = \frac{V^-}{Z_{in} + R_s} \quad (\text{II-6})$$

As a result, the current at the inverting input is equal to $1 \times 10^{-14}\text{A}$. The current values that we have acquired during our measurement are around 10mA. Then, we have observed that the inverting input current is 10^{12} times smaller than the output current. Consequently, we have assumed that the measurement setup is acceptable and the results have been considered.

II.3.1.2. Electric power consumption measurements results

- **Transponder T1:**

A high impedance oscilloscope probe has been placed at the output of the amplifier to measure the voltage (V_s).

Standby mode:

The average measured value of the voltage, -13mV, has been recovered directly on the screen of the oscilloscope. From

(II-4), we have deduced the value of the current corresponding to the standby mode. The current of the transponder T1 on the standby mode is $13\mu\text{A}$.

Active mode:

The DSRC transponder switches to the active mode when an AM signal is received. In Fig. II-18 we have shown the output voltage measurement of the transponder for the

active mode. From the measurement results, we have observed that in the active mode, this transponder has three different periods of operation. However, we do not have more information about this particular operation mode for this transponder.

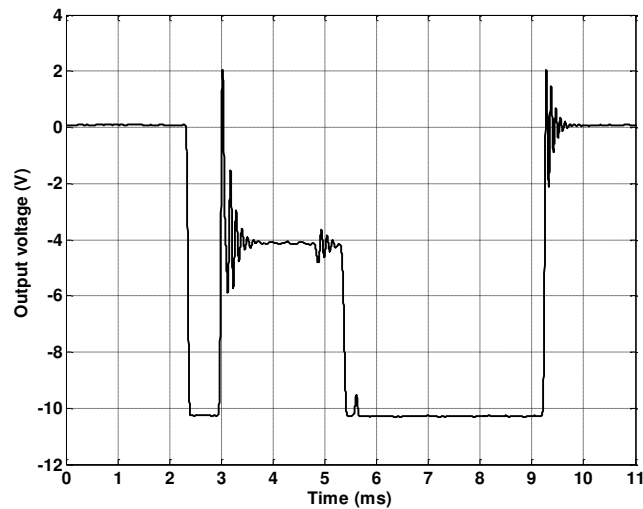

Fig. II-18. Output voltage measurement of the transponder T1 for the active mode.

The transponder T1 has an average current consumption equal to 8.2mA and the protocol window has a duration of 6.97ms. Since the battery voltage is equal to 3.6V, the total energy consumed by the transponder T1 in the active mode is about 206 μ J.

- **Transponder T2:**

Standby mode:

The voltage average value is equal to -11mV. From

(II-4), we have deduced the current value corresponding to this transponder operation mode. The current of the transponder T2 for the standby mode is 11 μ A.

Active mode:

The average current is equal to 9.6mA. The total energy consumed during 6.97ms, for a voltage equal to 3.6V, is 241 μ J.

- **Transponder T3:**

Standby mode:

For transponder T3, the standby mode measurement results could not be exploited, since the average output voltage value for this mode is positive and from the sketch proposed in Fig. II-16, positive values are not in agreement with the measurement setup.

Active mode:

The transponder T3 has an average current consumption equal to 5.25mA. The total energy is equal to 132 μ J (with a voltage of 3.6V).

II.3.1.3. The importance of a low-power operation mode

We have tested three transponders from the current market (year 2011) in order to estimate their electric power consumption. The measurement results have been resumed in Table II.6.

TABLE II.6. TYPICAL TRANSPONDER ELECTRIC POWER CONSUMPTION.

	T1	T2	T3
Current – Standby mode	13 uA	11 uA	--
Current – Active mode	8.2 mA	9.5 mA	5.3 mA

Given that a complete DSRC transaction can be executed in 50 ms, we can deduce the amount of electric charge required for each operation mode. In Table II.7 we have estimated the amount of electric charge of the transponder T1 for each operation mode, during a day.

TABLE II.7. ELECTRIC CHARGE FOR EACH DSRC OPERATION MODE

	Standby mode	Active mode
Duration	~24h [#]	50ms
Average current	13μA	8.2mA
Amount of electric charge requested	312μA.h	0.1μA.h

[#]standbyModeDuration = (24h – ActiveModeDuration*RequestedTimePerDay).

From Table II.7, we can observe that over a day, the duration of the standby mode is predominant compared to the active mode, even if the transponder is active more than one time per day. We can make an estimation of the number of recalls per day as a function of the user's profile. For example:

- Common driver: 2 times per day.
- Truck's driver: 6-8 times per day.

Even if we take as example the case in which the transponder is requested 8 times during a day (truck's driver), the energy demanded for the active mode will not be significant compared to the standby mode. The requested amount of electric charge factor is around 390 times between both modes. Since we are interested to improve the battery lifetime of the DSRC transponder, we should focus on the standby mode optimization.

In the next section, the DSRC transponder design is presented, starting with the RF implementation and then, describing the deep-sleep mode implementation.

II.3.2. RF implementation

II.3.2.1. DSRC transponder chip evaluation board design

Multitoll required the DSRC chip to be integrated in our transponder should be reliable and large scale production tested. For this reason, we have oriented our research towards a DSRC chip available on the market. Nevertheless, in the literature several papers present interesting results of a fully reflexive DSRC transponder. In [117], a compact ETSI compliant DSRC Transponder is reported, based on a RFIC custom chip with two

separated antennas Tx/Rx. In [118], a preliminary study of low-cost transceiver is presented, based on low cost components, however no power consumption information is given. Moreover, an active (but not fully reflexive) DSRC transponder, and more specifically a retrodirective transponder with a local oscillator, is also reported in [119].

We have acquired a GaAs MMIC transponder dedicated to short range communications at 5.8GHz. This RF module embedded the three classical operation DSRC modes: standby, downlink and uplink. The IC, named CHR2244 [120], is produced by UMS. The objective is to implement and characterize this DSRC transponder chip through an evaluation board. Following these measurement results, we have included this transceiver in our transponder development and then improved the total electric power consumption balance, by implementing a new standby mode. In Fig. II-19, the IC chip diagram is presented.

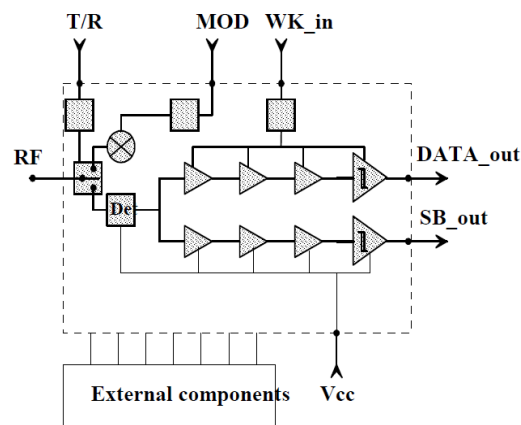

Fig. II-19. DSRC transponder IC diagram.

The selection of each operation mode is made from the control inputs (T/R, WK_in). The RF port can be at a time either reception or emission mode. Two outputs are provided: DATA_out and SB_out; the first output is the demodulated signal and the second output can be used as a flag to inform the microcontroller of the demodulated frame duration. The input MOD is used in the uplink mode, in which the data is modulated with the carrier signal coming from the beacon. This module is driven by a low-power consumption microcontroller.

The package outline and pin connections have been extracted from the manufacturer datasheet [120]. Then, a RF prototype board circuit has been designed with the minimal external components and no active components in order to save energy. In Fig. II-20 the circuit diagram is presented.

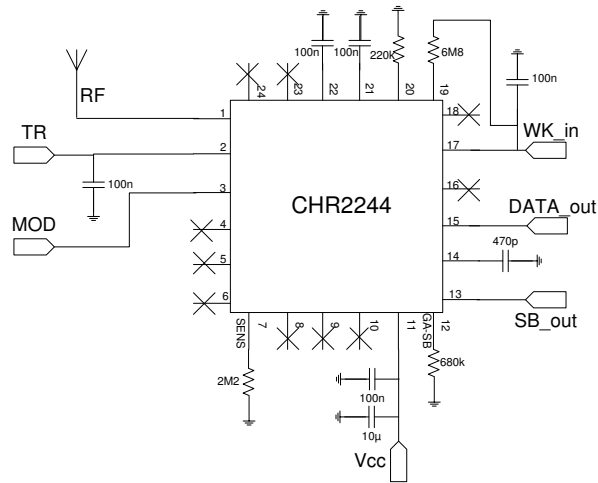

Fig. II-20. RF prototype board circuit diagram of the DSRC transponder chip.

In Fig. II-21, the RF prototype board layout is presented. A flat-ribbon connector has been set up to facilitate the microcontroller interface. An impedance matching network has been implemented at the RF input in order to provide a 50Ω matching.

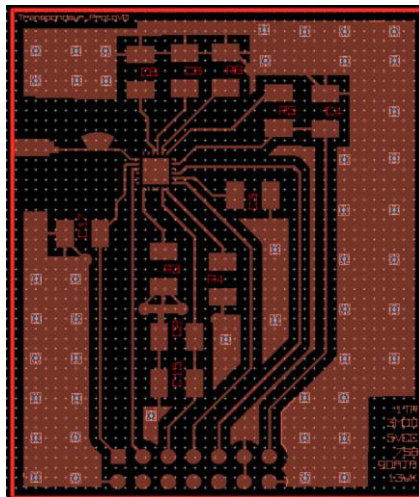

Fig. II-21. DSRC transponder chip RF prototype board layout (top layer).

In Fig. II-22 a picture of the fabricated evaluation board is shown.

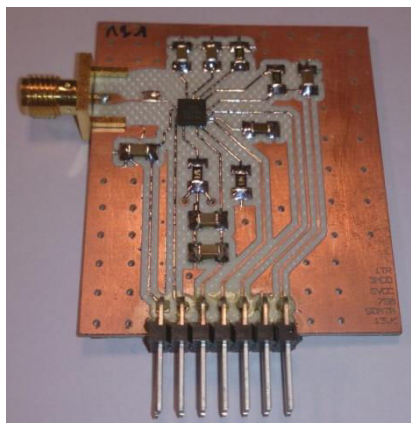

Fig. II-22. Picture of the DSRC transponder chip RF prototype board.

After the RF prototype board design and fabrication, we proceed with the chip characterization, detailed in the next sections.

II.3.2.2. DSRC transponder chip characterization

The chip evaluation board has been tested for the three DSRC operation modes. To verify the limits of DSRC IC, a characterization setup has been carried out, observing in particular the transponder response for the following parameters variation: RF input power signal (power limit communication), modulation bit rate and supply voltage.

- **Standby mode characterization:**

In this mode, an amplitude modulated RF signal is required to produce a DC voltage at the output SB_out which can be used as a flag of the communication beginning. SB_out output is active if and only if an AM modulated signal RF is applied at the RF input. The standby characterization setup is presented in Fig. II-23.

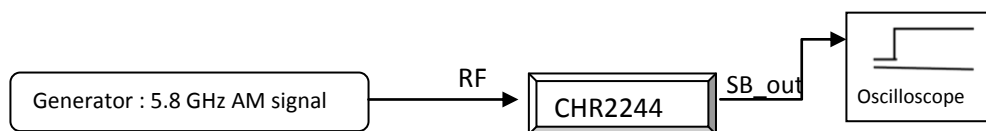

Fig. II-23. Standby characterization setup (control commands: T/R=0 , MOD=0 , WK_in=0).

If the RF input signal is detected by the transponder chip, a DC voltage is produced at the SB_out output during the communication frame, as shown in Fig. II-24.



Fig. II-24. Oscilloscope print screen of the SB_out output during a successive AM signal receiving.

RF input signal variation: for the four DSRC carries frequencies (5.7975GHz, 5.8025GHz, 5.8075GHz, 5.8125GHz) the RF input signal varies from -50dBm to 0dBm, the modulation bit rate is set to 500kbit/s and the supply voltage to 3.1V. The IC transponder has responded well for all RF powers, i.e., a clear DC signal on the SB_out output has been detected. During the measurements, the standby DC current has been found to be approximately 9µA.

Modulation bit rate variation: for this measurement, the RF input signal level is set to -30dBm (typical DSRC RF input power), the carrier frequency equals 5.8025GHz and the supply voltage is 3.1V. The modulation bit rate has been varied from 31.25kbit/s to 530kbit/s and the IC transponder has reacted well, by presenting a clear DC voltage on the SB_out output. For a bit rate of 100kbit/s, which is not of our interest, the result is not stable.

Supply voltage variation: In order to verify the supply voltage limitation of this IC, we have varied the Vcc from 2.7V to 3.6V and set the RF input signal level to -30dBm. The carrier frequency equals 5.8025GHz and the modulation bit rate 500kbit/s. During this variation, the circuit has worked at all voltages (no problems were detected).

- **Downlink mode characterization:**

During the downlink mode, additionally to the SB_out output, we have the DATA_out output active. The received data is demodulated and accessible at the DATA_out. The downlink characterization setup is presented in Fig. II-25.

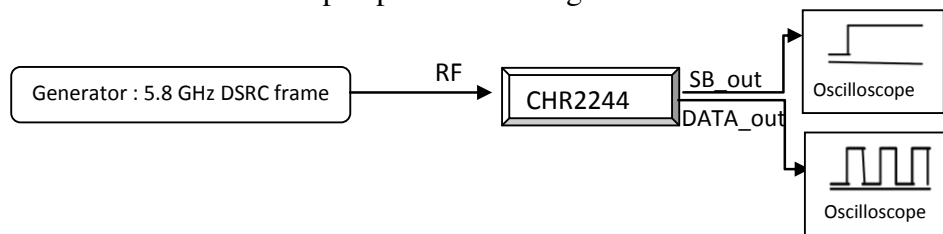

Fig. II-25. Downlink characterization setup (control commands: T/R=0 , MOD=0 , WK_in=Vcc).

The RF input signal applied this time is a typical DSRC frame, as described in [121]. The frame has been sent continuously during the measurements. Fig. II-26 shows the oscilloscope print screen, where the rose curve is the SB_out signal and the yellow curve is the DATA_out signal. We can observe that both outputs are synchronized. The SB_out confirms the frame begin and end.



Fig. II-26. Oscilloscope print screen of the downlink mode setup measurement.

In Fig. II-27, a zoom on a frame is presented. The yellow curve (DATA_out) shows a wake-up preamble before the frame, and then the flag (rose curve, SB_out) presents a rising edge signaling that the frame starts. At the frame end, since there is no amplitude variation on the data, the flag shows a falling edge.

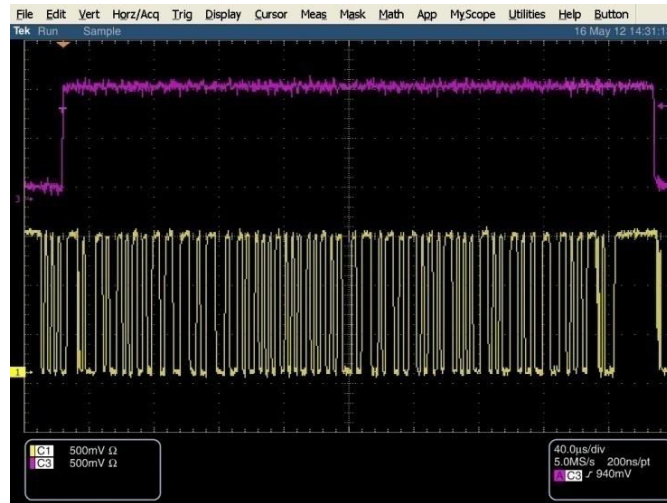

Fig. II-27. Oscilloscope print screen of the downlink mode – frame zoom.

As for the standby mode, a measurement setup has been developed in order to push the IC transponder to its operation limit, by applying the same parameter variation (supply voltage, frequency carrier and bit rate). During the downlink measurements, the IC responded well for the parameter variation, the only difference being that the current consumption evidently increased to $159\mu\text{A}$ due to the operation mode changing (standby->downlink).

- **Uplink mode characterization:**

Uplink mode relies on a backscattering of the incoming carrier 5.8GHz (f_0) multiplied by the modulated data (f_M) at the input MOD. In fact, the ETSI standard recommends the modulation to be made around a sub-carrier f_M . The uplink signal result is a transposition of the carrier around the sub-carrier ($f_0 \pm f_M$), as presented in Fig. II-28.

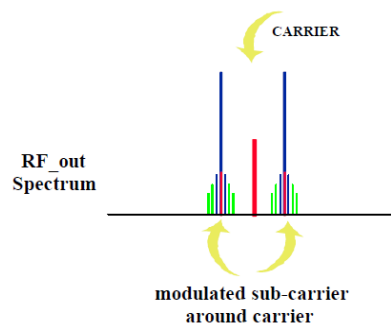

Fig. II-28. Uplink spectrum is a result of a transposition of the carrier around the sub-carrier.

The characterization setup for the uplink mode requires an extra attention, since we need to inject the carrier signal, multiply it with the modulated data and then observe the

spectrum to verify if the modulation is corrected. Fig. II-29 shows the characterization setup for the uplink mode.

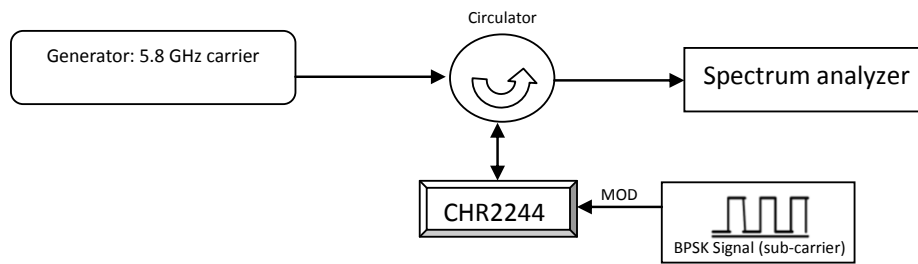

Fig. II-29. Uplink characterization setup.

At the MOD input we should provide the subcarrier at 1.5MHz or 2.0MHz which itself is phase modulated with the uplink data stream (250kbit/s). For this reason, we set up a BPSK modulator based on a synchronization of the sub-carrier (f_M) and the data (BBS) signals in a XOR gate, as described in Fig. II-30.

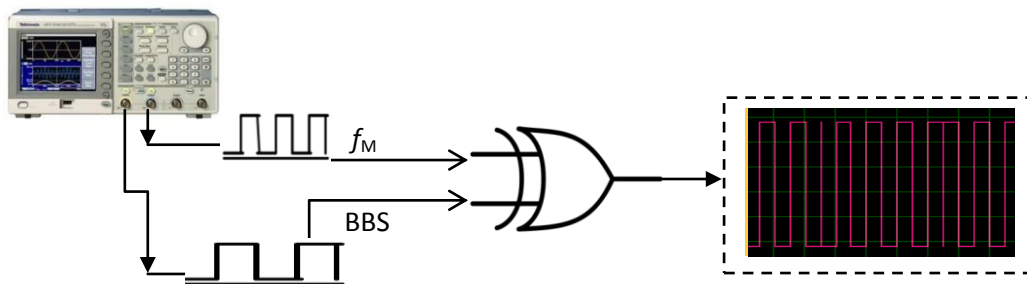

Fig. II-30. BPSK modulator based on a synchronization of the sub-carrier (f_M) and data (BBS) signals through a XOR gate

The signal generator we have use is the Tektronix AFG3011 Arbitrary Function and the XOR gate is the ST HCF4030B. The sub-carrier and data frequencies are 1.5MHz and 250kHz, respectively. In Fig. II-31 a print screen of the BPSK modulator signals is presented.

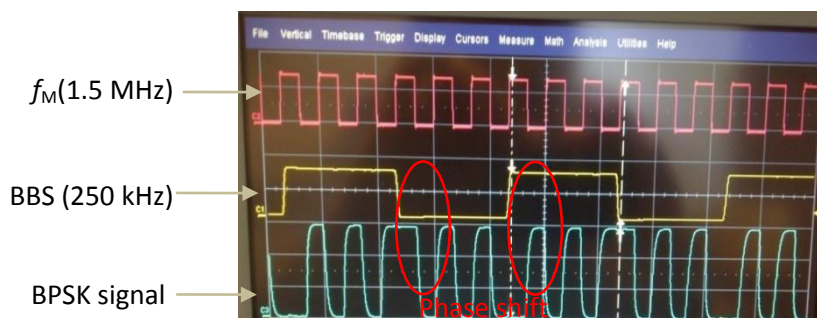

Fig. II-31. Oscilloscope screen picture of the of the BPSK modulator signals.

With the BPSK modulator conceived, we have performed the uplink characterization setup as described in Fig. II-29. In Fig. II-32, we show the uplink spectrum, with the carrier signal (center pick) and the modulation on the sub-carrier signal (two laterals signals).

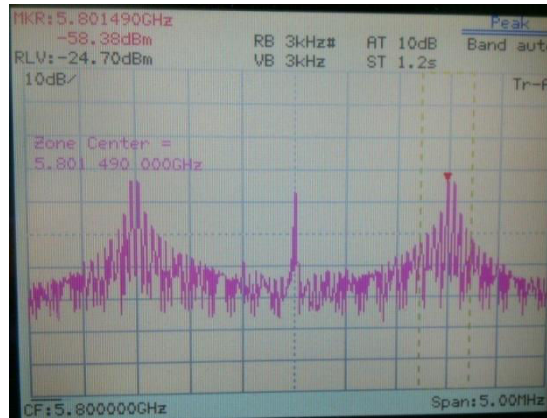

Fig. II-32. Spectrum analyzer screen picture of the uplink spectrum signal.

The DSRC transponder chip characterization has provided corrected results, and therefore, we have decided to integrate this IC in our DSRC transponder.

II.3.3. Microcontroller sleep mode + Demod Bloc (FPGA)

As presented in previous sections, the DSRC chip has three operation modes: standby, downlink and uplink. In general, the transponder remains in standby mode and only when the vehicle is approaching an e-toll plaza, it switches to the active operation mode. A considerable energy saving could be achieved if we could just turn on the DSRC chip when the car starts to move for example. Given that we need an extra operation mode with very low power consumption and from a wake-up flag, the transponder switches on to the classical standby-by mode.

Since the microcontroller supplies and pilots each bloc of the DSRC transponder, choosing a low power microcontroller with a deep-sleep mode is primordial.

Nowadays we can find microcontrollers that provide a deep-sleep mode for very low power consumption. The C8051F91X from Silicom labs provides a deep-sleep mode that consumes 50nA, and an active mode consuming 160 μ A/MHz (24.5MHz clock). Recently, Microchip has presented the nanoWatt microcontroller series providing a very-low-power deep-sleep mode. The PIC1XF182X Microchip family achieves sleep currents as low as 20nA, and a run mode current consumption less than 50 μ A/MHz. Moreover, Microchip has presented the PIC24F16 with deep-sleep mode current down to 20nA and run mode current down to 8 μ A. We choose the PIC24F16 from Microchip for our DSRC transponder design.

Although the very low-power microcontroller was chosen, during the downlink mode, the DSRC transponder needs to demodulate a 500kbit/s AM signal. Given that a potential DEMOD bloc will be need in order to help the low-power μ C to process the received information. This bloc could be implemented by a FPGA. In this thesis, the DEMOD bloc is not analyzed, but it is included in the transponder diagram.

II.3.4. A new deep-sleep mode

To the best of our knowledge, the DSRC transponders currently available on the market have three operations mode: standby, downlink and uplink. From the electric power

consumption results obtained in section II.3.1, we have observed that during a day the operation mode that consumes more energy is the standby mode. In this thesis we thus propose a new low-power standby mode, i.e., a deep-sleep mode.

Depending on the driver’s profile, the vehicle use differs. For instance, highways drivers, often make pauses for rest during the day and, in general, keep their vehicles parked during the night; in a common day-to-day city life, the duration for which the vehicle is parked is bigger. Average number of kilometers per year in France is around 25,000km (about 68.5km/day), so less than 2 hours of use by day and 22 hours of parking. For most DSRC transponders available today, during all this “parking time” the DSRC transponder is running in standby mode (13 μ A/3.6V).

For the DSRC transponder proposed in this thesis, while the vehicle is parked, the transponder is in a (very-low-power) deep-sleep mode and only when the motor is turned on, it switches to the standby mode. This wake-up will be induced by a vibration sensor. The new operation mode for the DSRC transponder is presented in Fig. II-33.

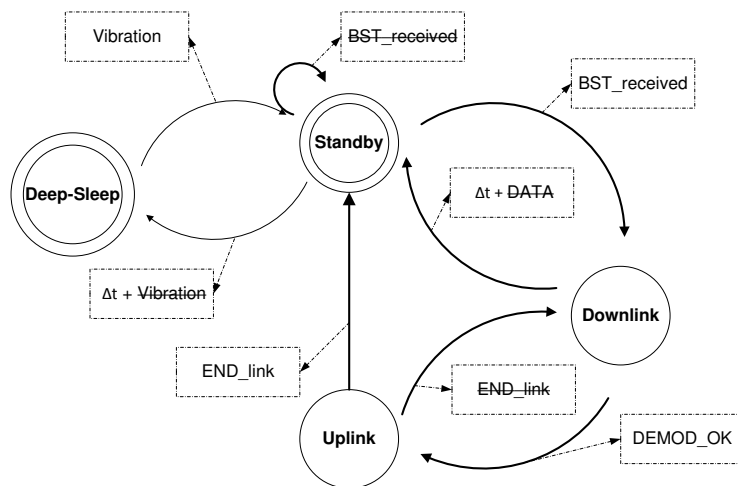

Fig. II-33. The new low-power statechart for the DSRC transponder.

The vibration sensor chosen for our application is the SQ-MIN-200 produced by Signal Quest [122]. The SQ-MIN-200 is an omnidirectional sensor that acts as a closed switch in the rest state and chatters open/closed when it is tilted or vibrated. Hence, we can define our DSRC transponder by a five bloc structure as presented in Fig. II-34. An additional DEMOD bloc is inserted in our diagram in order to help the microcontroller demodulating a 500kbit/s signal.

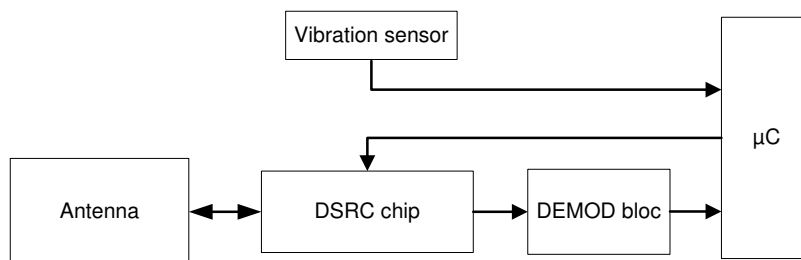

Fig. II-34. Low-power DSRC transponder schema bloc.

A detailed flowchart for the low-power DSRC transponder is presented in Fig. II-35, illustrating each condition for the mode transition and the respective powered blocs.

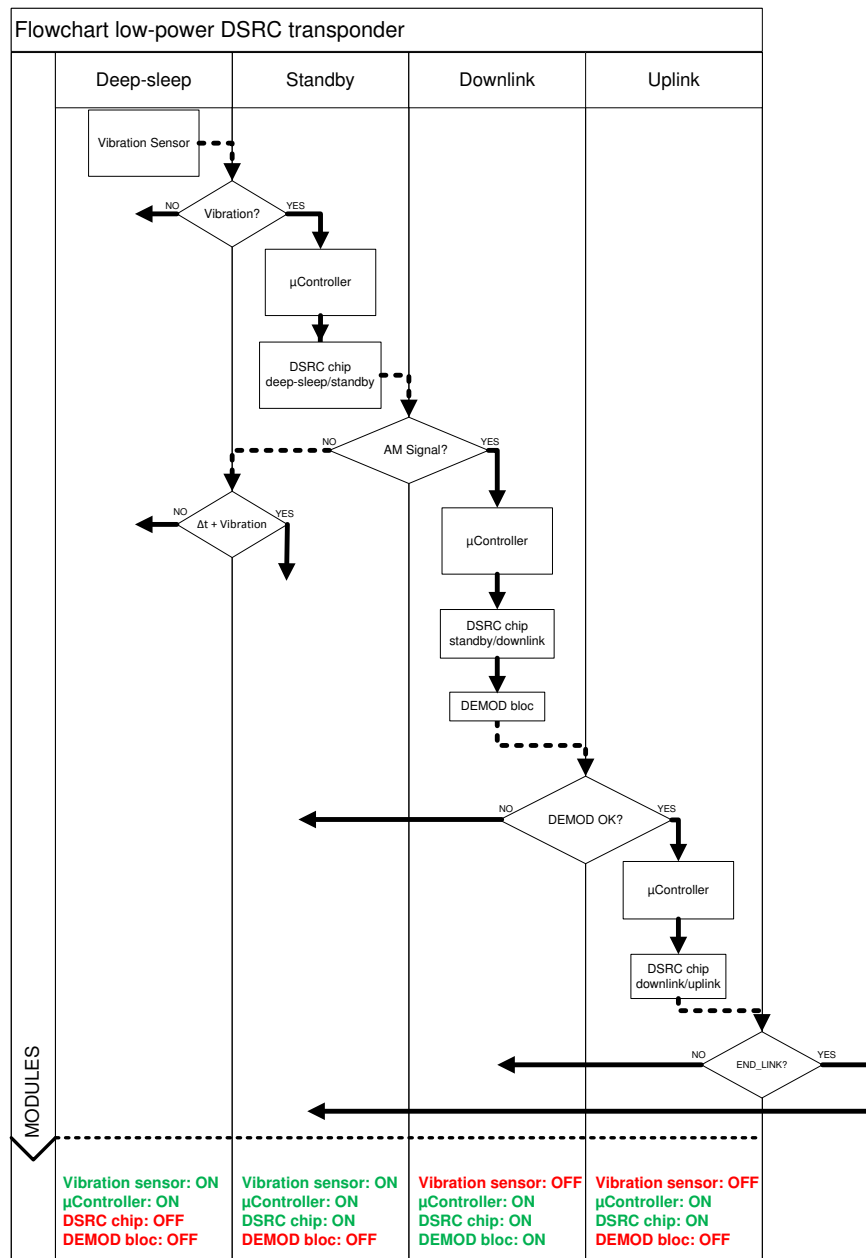

Fig. II-35. Flowchart of the low-power DSRC transponder.

II.3.4.1. Vibration sensor evaluation board design

In a simple configuration, the vibration sensor requires only a resistor to limit current, and is fully passive. For our application, a sensitivity control circuit (or lowpass filter) should be employed to reject light vibration/bumps and to provide a proper trigger; an integrating capacitor is used to determine the integration time. Since the wake-up signal from the vibration sensor goes directly to the microcontroller, it is important to keep a minimum voltage amplitude, in order to ensure the wake-up signal is detected by the μC. Nevertheless, the current consumption of the sensor is proportional to the supply voltage

applied on its terminals. Another important point is that the sensor is sensitive to the mounting position (vertical, horizontal, diagonal ...) and the direction of the excitation.

Based on the above specifications a sensor prototype board has been designed and realized in order to test the sensor sensitivity in an *in-situ* configuration (II.3.4.2). In Fig. II-36, the circuit diagram of the vibration sensor prototype board is presented. Two sensors have been deployed on two perpendicular directions on the evaluation board. At the circuit input, different series resistor values are added to provide a flexible resistance during the tests. An integrator capacitor of 5nF is used. The simplified circuit diagram is presented in Fig. II-36. *Cap_out1* and *Cap_out2* are the outputs interface to the μ C.

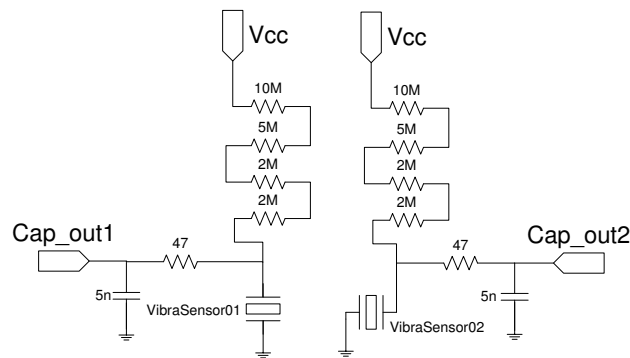

Fig. II-36. Circuit diagram of the vibration sensor prototype board.

For the sensor prototype board layout an interesting assembly has been achieved. Since the evaluation board is controlled by a microcontroller, during the *in-situ* tests, it is interesting to reduce the number of the equipments on board (inside the vehicle). From the already available microcontroller board, we have designed the sensor board in order to match the supply voltages pins of the microcontroller board. To yield a better mobility for the assembly, the supply voltage has been provided by a USB port (+5V) from the laptop used during the measurements. Therefore, at the circuit input a zener diode is required in order to assure +1.8V to the microcontroller supply. Three LEDs have been deployed with the purpose to indicate the output information: one for the supply voltage indication and two others for vibration detections (horizontal and vertical vibration sensors).

In Fig. II-37 the layout of the vibration sensor prototype board is presented. A picture of the assembly (sensor + microcontroller board) is shown in Fig. II-38

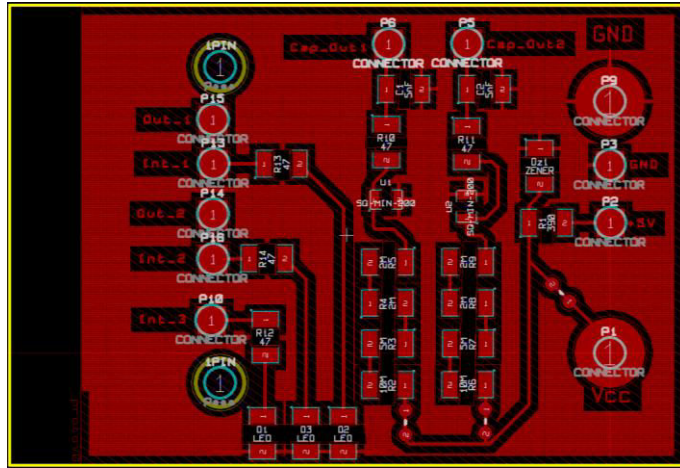

Fig. II-37. Vibration sensor prototype board layout.

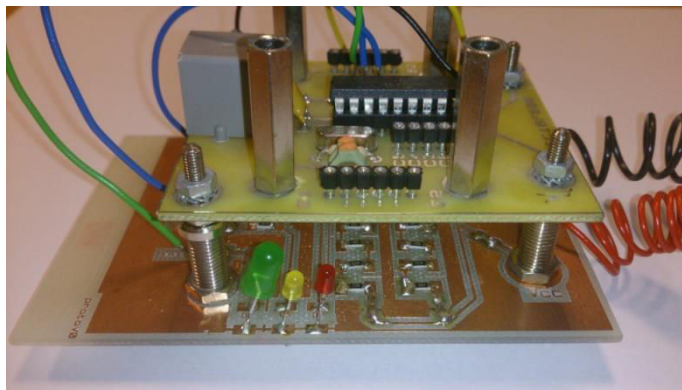

Fig. II-38. Picture of the assembly (sensor + microcontroller board).

II.3.4.2. *In-situ* deep-sleep tests

The aim of the in-situ tests is to verify if the vibrations induced by the vehicle movement could be detected by the vibration sensor. We are also interested in verifying how the vibration sensor responds for different vehicle movements/actions (starting the car, closing the door, acceleration ...).

The assembly (vibration sensor prototype board + μ C board) is fixed on the windshield of the vehicle in a specific position, that is, one of the sensors is in a horizontal position relative to the ground and the other one in a vertical position. To check if the vibration sensor responds correctly, different scenarios have been tested, the vibration detection criterion being based on the LED lighting as following:

- **OK+**: LED lighting was constant, i.e., strong vibration detected.
- **OK**: LED lighting was shortly observed, i.e., light vibration detected.
- **NOK**: No LED lighting observed, i.e., no vibration detected.

The measurement results are presented in Table II.8.

TABLE II.8. VIBRATION SENSOR *IN-SITU* MEASUREMENTS RESULTS.

Actions	Vibration sensor 01 (horizontal)	Vibration sensor 02 (vertical)
Closing the door	OK+	OK+
Starting the car	OK	OK+
Vehicle initial acceleration	OK	OK+
Constant speed in a city	OK	OK+
Constant speed in a high-way (110 km/h)	OK	OK+
Curves	OK+	OK
Vehicle stopped at a traffic light	NOK	NOK

Both sensors are appropriate and sensible for different scenarios and very precise even when the vehicle has stopped at a traffic light. As expected, the mounting position influences the vibration detection. An interesting scenario to exemplify the importance of the mounting position is when the vehicle is in a curve, since the horizontal sensor responds better than the vertical one, as shows Table II.8. Nevertheless, both (vertical/horizontal) mounting positions have provided satisfactory results. The electric power consumption measurements have been also analyzed, but they are described in the next section with total amount of DSRC transponder power consumption.

II.3.5. The energy consumption of the proposed DSRC transponder

From the different blocs proposed for the new DSRC transponder in Fig. II-34, we have the following supply voltage range values accepted, based on the datasheet of the manufactures:

- Vibration sensor: 0.9V - 12V
- DSRC chip: 2.7V – 3.6V
- Microcontroller: 1.8 to 3.6V
- DEMOD bloc: not yet performed

Since the microcontroller provides the V_{cc} for the others blocs, we have decided to supply the microcontroller with +3.3V and thus +3.1V will be available to the other blocs. The microcontroller chosen for our application is the nanoWatt Microchip PIC, which has a very-low-power current in the deep-sleep mode, [123]. Table II.9 shows the total electric power consumption for the low-power DSRC transponder proposed in this thesis.

TABLE II.9. TOTAL POWER ELECTRIC CONSUMPTION FOR THE NEW LOW-POWER DSRC TRANSPONDER.

Module/Operation mode	Deep-sleep	Standby	Downlink	Uplink
Vibration sensor (+3.1V)	164nA*	164nA*	OFF	OFF
DSRC chip (+3.1V)	OFF	9 μ A*	159 μ A*	159 μ A*
μ C (+3.3V)	20nA [#]	2 μ A [#]	8 μ A [#]	8 μ A [#]

*Measured values, [#] theoretic values.

We can take the example of the city driver, who goes to work and needs to use the highway traversing two DSRC toll plazas. We consider that he needs one hour to go to work and one to come back home and that during the night his vehicle is parked.

Following the power electric consumption measurements (Table II.9) and based on the flowchart presented in Fig. II-35, we can estimate the energy required by the DSRC transponder for each operation mode during a day. Table II.10 shows the estimated amount of energy required by the new DSRC transponder during a day.

TABLE II.10. ENERGY REQUIRED BY THE NEW DSRC TRANSPONDER DURING A DAY.

Operation mode	Current	Duration	Energy
Deep-sleep	184nA	~22h	48mJ
Standby	11.2μA	~2h	266mJ
Active (down and up link)	167μA	~200ms (4times e-toll passage)	0.1mJ
TOTAL	0.18mA	24h	314mJ

With the proposed statechart, it is clear that the current consumption can be considerably reduced, by using to the new deep-sleep mode. Since the deep-sleep needs 48mJ during a day and it is the predominant mode, the total power consumption of the transponder is significantly reduced. In the next section, we compare the power consumption of the DSRC transponder proposed in this thesis with the power consumption of others transponders.

II.4. Conclusions

In this chapter we have presented the proposed new DSRC transponder with an original statechart that considerably reduces the power consumption.

First of all, the DSRC system has been introduced and then the RF link budget modeling has been carried out in order to predict the best DSRC mounting configuration. Since we did not have any knowledge about the amount of energy the transponders on the current market consume, we have established our own measurement setup to acquire this information. Based on these measurements, we have designed a low-power DSRC transponder.

The new DSRC transponder design starts with the DSRC chip characterization, for which an evaluation board has been conceived to assist the measurements. Since the IC measured performance corresponds well to our specifications, we have decided to include the DSRC chip in our transponder design. We have implemented a deep-sleep mode based on a vibration sensor, and a mobile evaluation board supplied by a USB port has been conceived. *In-situ* tests have been carried out. By implementing the supplementary operational mode, the electric power consumption has been considerably reduced.

Coming around the example of the driver described previously, that is, spending two hours per day on the road and keeping its vehicle parked during the night, a comparative table between the classical and the proposed DSRC transponder in this thesis is described in Table II.11. Reminding that classical transponders do not have a deep-sleep mode and that the standby mode is predominant during a day, our approach makes major use of a deep-sleep mode.

TABLE II.11. ENERGY CONSUMPTION COMPARISON BETWEEN THE CLASSICAL AND THE PROPOSED DSRC TRANSPONDER IN THIS THESIS

Operation mode	Classical Transponders	Transponder proposed on this thesis
Deep-sleep	---	48 mJ
Standby	4 J	266 mJ
Active (down and up link)	6.5 mJ	0.1 mJ
Total (24 h)	~4 J	~314 mJ

From Table II.11, a factor of 13x concerning the energy consumption per day is identified when comparing classical DSRC transponders and the one proposed in this thesis.

The feasibility of recharging the battery of the DSRC transponder by means of Wireless Energy Harvesting has been discussed in section II.2.2.2. The amount of RF energy harvested by the DSRC transponder for the two DSRC e-toll cases (Free-Flow and Stop&Go) has been estimated using the RF link budget. The RF energy harvesting could become attractive to power the transponder only for Stop&Go configurations (stop time > 2s). An amount of energy of 10 μ J could be recovered if the driver spends 2s in the RSE antenna field. Nevertheless, even if considering the transponder power consumption proposed in this thesis (314mJ), the recovered energy by means of DSRC Wireless Energy Harvesting would not be enough. Moreover, the request that the vehicle should spend more time in front of the antenna counteracts the DSRC toll collection principle, that is, reducing traffic jams and time spent in highway tolls. Based on this analysis, we have decided to explore the Wireless Energy Harvesting for other than the DSRC 5.8GHz frequency, we chose therefore, the 2.45 GHz that is also included in the ISM band (Chapter IV).

Chapter III - Antenna design

III.1. Introduction

Nowadays antennas gain their place everywhere in environments surrounding us. Television, radio, cell phones, WiFi, garage doors opener, car remote locking central, etc, are just a few examples of applications that require antennas for functioning. Antennas are indispensable for any radio receiver or transmitter to couple its electrical connection to the electromagnetic field.

The first antenna was built by the German Heinrich Hertz in 1888. He developed a wireless communication system in which an electrical spark was forced to occur in the gap of a dipole antenna [124]. Nevertheless, we could associate the terminology creation, “*antenna*”, with the Italian Guglielmo Marconi, in 1895, in the Swiss Alps, he conceived an early radio communication between two long wires that he named “aerials”. Marconi uses the word *antenna* that spreads among wireless researchers, and later is adopted by the general public [125]. Antenna or aerial could be defined as “a means for radiating or receiving radio waves”, in IEEE Standard Definitions of Terms for Antennas [126]. In other words the antenna is an interface between free-space and guiding device, as defined in [127]. A good review about major events in the development of antennas is presented in [128].

In this chapter, we describe the fundamentals of antennas, basic definitions, highlighting the different field regions around the antenna. Then, in III.3, we present the Multitoll requirements for the antennas design, followed by the detailed explanation of the antennas developed in this thesis: in III.3.3 for DSRC applications and in III.3.4 for Wireless Energy Harvesting.

As already explained in the introduction of this manuscript, this thesis was realized in collaboration between the IMEP-LAHC laboratory and the Multitoll Solutions SA Company. Consequently some of the antennas have been designed following rigorous specifications from Multitoll, applying to specific practical applications. Nevertheless, an important effort was devoted in order to promote the transfer of knowledge from research to the industry.

III.2. Antenna fundamentals

III.2.1. How an antenna radiates

Let us take the simple case where two conductor wires are connected to an antenna and are excited by a source, as shown in Fig. III-1. Since a voltage is applied across the conductors, an electric field is generated between the conductors. Nevertheless, the radiation occurs if there is a movement of charge, i.e., creation of the current that in turn creates a magnetic field intensity. If there is no motion of charges, no radiation arises. In

order words, due to the time-varying electric and magnetic fields between conductors, the electromagnetic waves travel along the transmission lines and when approaching open space, the radiation occurs, as shown in Fig. III-1(b).

If we assume the voltage source is sinusoidal, electromagnetic waves are created continuously with a period equal to that of the applied source, and these waves travel along the transmission line, throughout the antenna and are radiated into free space. Inside the transmission line and the antenna, the electromagnetic waves are sustained due to the charges, but as soon as they enter the space, they form closed loops and are radiated as described in [127].

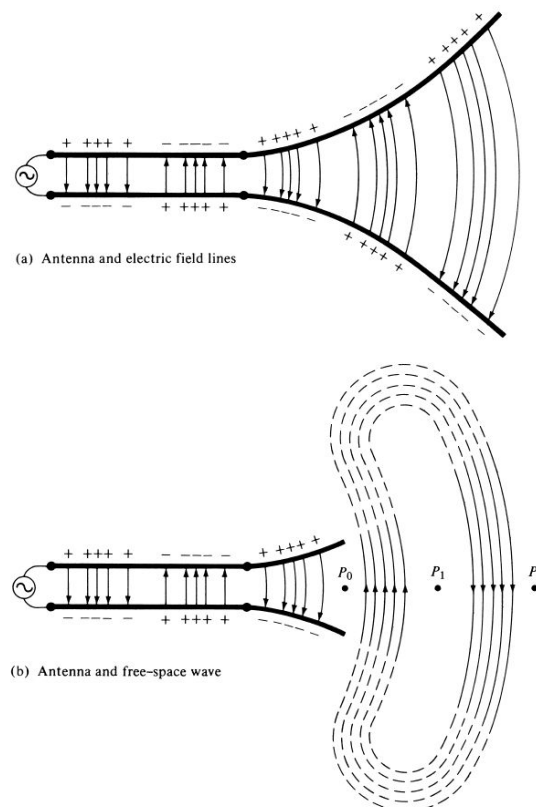

Fig. III-1. Antenna radiation example (source, transmission line, antenna and free-space propagation). (from [127]).

The two-wire conductor is one example of antennas. It is useful to explain the electric and magnetic field variation that generate the radiation.

III.2.2. Fundamental parameters of Antennas

III.2.2.1. Radiation pattern (farfield)

The antenna radiation pattern is defined by IEEE standard as “the spatial distribution of a quantity which characterizes the electromagnetic field generated by the antenna” [129]. In other words, the radiation pattern describes the relative strength of the radiated field in different directions. In general, the radiation pattern is determined in the farfield region. Various plotting formats to represent a radiation pattern exist: Cartesian plot (Fig. III-2), polar (Fig. III-3(a)) and 3D plot (Fig. III-3(b)). A radiation pattern is composed of several *lobes*, which may be classified into main, side and back lobes, as described in Fig.

III-2. The main lobe is the lobe which determines the direction of maximum radiation. The side lobes are the lobes in any direction other than the main lobe, and in general, are adjoining to the main lobe. The back lobe is the symmetric (180°) of the main lobe, i.e., the back lobe is oriented in the opposite direction of the main lobe. In most of applications the requested ratio between the main lobe and the side lobe is around -20dB.

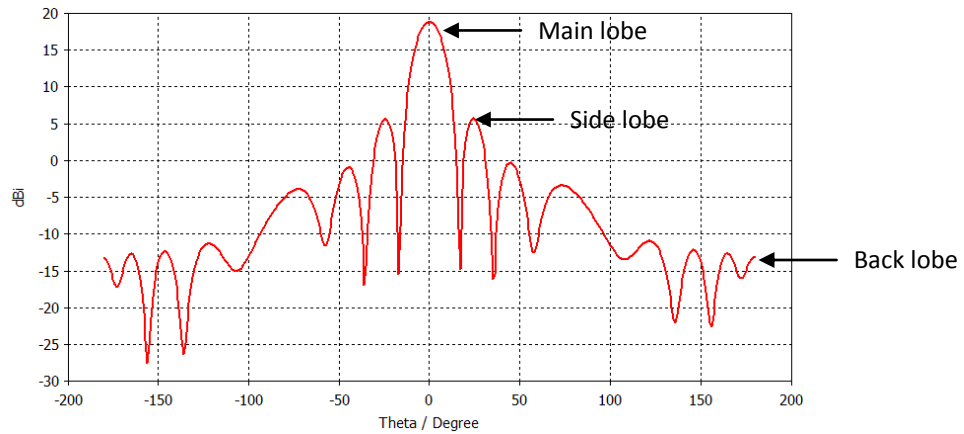

Fig. III-2. Radiation pattern in Cartesian plot.

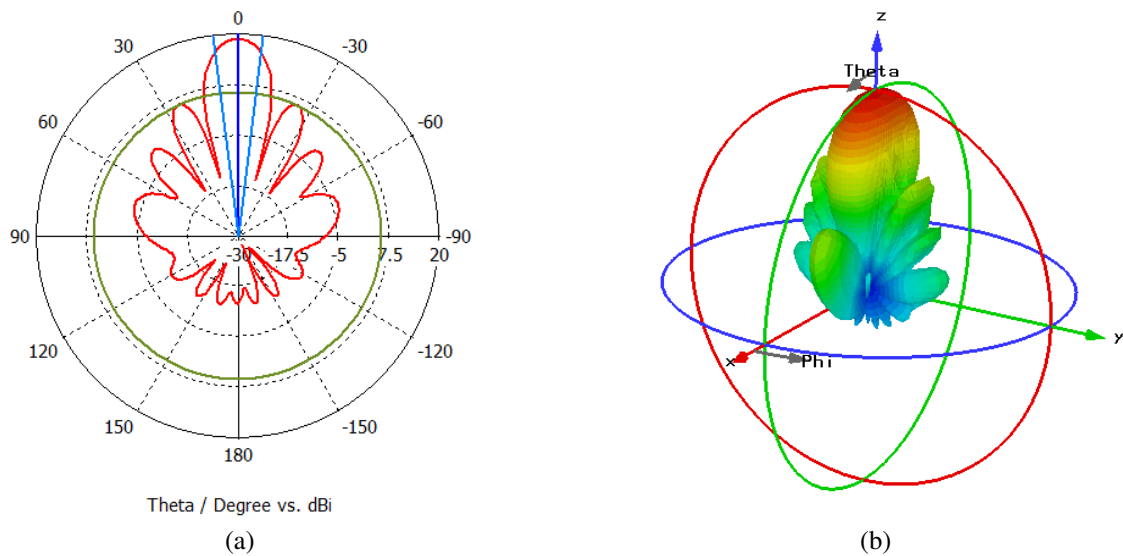

Fig. III-3. (a) Radiation pattern in polar plot. (b) Radiation pattern in 3D plot.

III.2.2.2. Beamwidth

The common definition for the beamwidth is the angular distance created from the main lobe peak to the two points on either side corresponding to the half power (-3dB). For this reason the half power beamwidth (HPBW) is sometimes referred to as the 3dB beamwidth. In Fig. III-3, the beamwidth is represented (blue lines) in polar form. However, we can also present it in Cartesian form.

III.2.2.3. Return loss and reflection coefficient

Return loss is basically a logarithmic ratio of relative magnitudes of input power (P_{in}) and reflected power (P_{ref}):

$$RL (dB) = 10 \log_{10} \left(\frac{P_{in}}{P_{ref}} \right) \quad (III-1)$$

The name “*loss*” comes from the fact that the reflected power cannot exceed the input power; consequently $P_{ref} < P_{in}$, and RL should be a positive number.

The S_{11} parameter, or reflection coefficient, also expressed in dB, is the opposite of RL (negative values)

- **Reflection coefficient:**

Reflection coefficient (Γ) is defined as the ratio of the reflected wave (V_r) to the incident (or forward) (V_f) wave. The quantity of interest (magnitude of the reflected wave) is compared to the initial quantity (magnitude of the forward wave):

$$\Gamma = \frac{V_r}{V_f} \quad (III-2)$$

Since $V_r < V_f$, the reflection coefficient is always $\Gamma < 1$. This coefficient has a link direct with the S_{11} parameter, through the ABCD matrix of S parameters.

III.2.2.4. Bandwidth

The bandwidth of antenna may be defined as “the range of frequencies within which the performance of the antenna, with respect to some characteristics, conforms to a specified standard” [127]. From the center frequency, the range of frequencies which the antenna characteristics (radiation pattern, polarization, input impedance...) are comparable to those of the center frequency, this is the antenna bandwidth. In general, the antenna bandwidth is given in percentage, e.g., a 3% bandwidth indicates the range of frequencies where the antenna performance is still acceptable compared to the center frequency.

III.2.2.5. Antenna efficiency

The *total efficiency* describes how much of the power provided to the antenna is radiated or lost within the antenna. The total efficiency can be expressed as a percentage or in decibels. The total efficiency (e_T) should take into account the dielectric efficiency (e_d) (losses due to dielectric material), conduction efficiency (e_c) and reflection mismatch efficiency (e_r), as follow:

$$e_T = e_d e_c e_r \quad (III-3)$$

III.2.2.6. Gain

The antenna gain describes how much power is transmitted in the direction of peak radiation to that of an isotropic source, and it is in general represented in dBi [127]. The *absolute gain* (G_{abs}) is the total efficiency multiplied by the antenna directivity (D):

$$G_{abs} = e_T D \quad (III-4)$$

All simulation results of the antenna gain presented in this thesis are extracted from the CST Microwave Studio software. However, in this software the antenna gain (“realized gain”) is given in dB.

III.2.2.7. Polarization

The antenna polarization can be defined as the emplacement relation of the traced by the extremity of the time-varying field vectors at a fixed observation point. In other words, it describes the behavior of the field vectors (direction and magnitude) change over time.

Depending on the instantaneous plane wave behavior (electric field vectors position), traveling in a z direction in a farfield zone, the polarization can be classified as linear, circular or elliptical. If the electric field at a point in space as a function of time is always a line, this characterizes a linear polarization. If the X and Y electric field components are 90° out of phase and have the same amplitude, the wave plane seen is a circle, namely a circular polarization. Finally, if electric field vectors are two perpendicular components and out of phase with 90 degrees, but not equal in magnitude, this defines an elliptical polarization. However, in practice there are no perfect linearly or circularly polarized antennas, the antennas are often elliptically polarized.

Fig. III-4 shows an example of the electric field polarization distribution, for an elliptical polarization.

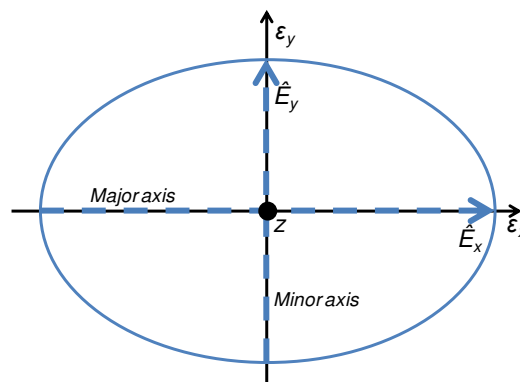

Fig. III-4. Ellipse polarization.

Fig. III-5 shows how the electric field vectors impact the polarization, considering their amplitude ratio and phase delay. The ellipse may be represented by the Axial Ratio (AR), the ratio of the two main axes and its tilt angle. The perfect value of the axial ratio for circularly polarized fields is 0dB, when the components have equal magnitude and are 90 degrees out of phase.

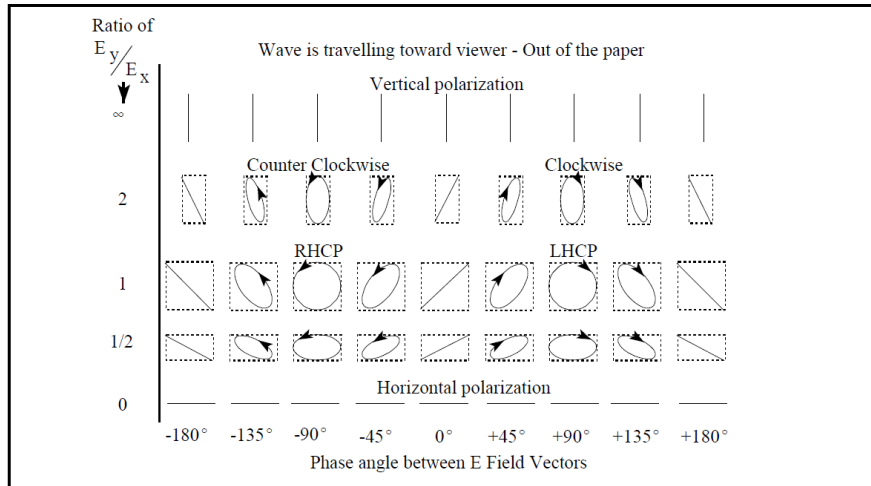

Fig. III-5. Polarization as a function of E_y/E_x magnitude ratio and phase angle. Figure extracted from [130]

In a radio communication link budget between two antennas Rx and Tx (e.g., DSRC, RFID, Television, radio...), the antenna polarization plays an important role. In practice, the polarization of the receiving antenna is rarely exactly the same as the polarization of the incoming wave. This polarization “mismatch” is named the Polarization Loss Factor (PLF) and is defined as follows [127]:

$$PLF = |\hat{p}_w \hat{p}_a|^2 = |\cos(\varphi)|^2 \tag{III-5}$$

where \hat{p}_w is the unit vector of the incoming wave, \hat{p}_a is the polarization vector of the receiving antenna and φ is the angle between the two vectors (E_y/E_x). PLF is dimensionless.

From (III-5), if the antenna is polarization matched, the PLF is equal to one, i.e., the receiving antenna extracts the maximal power from the incoming plane wave. In Table III.1 an interesting comparison of the PLF for different polarization patterns, including different antenna types is presented.

TABLE III.1. POLARIZATION LOSS FOR VARIOUS ANTENNA COMBINATIONS. TABLE EXTRACTED FROM [130]

Transmit Antenna Polarization	Receive Antenna Polarization	Ratio of Power Received to Maximum Power					
		Theoretical		Practical Horn		Practical Spiral	
		Ratio in dB	as Ratio	Ratio in dB	as Ratio	Ratio in dB	as Ratio
Vertical	Vertical	0 dB	1	*	*	N/A	N/A
Vertical	Slant (45° or 135°)	-3 dB	½	*	*	N/A	N/A
Vertical	Horizontal	-∞ dB	0	-20 dB	1/100	N/A	N/A
Vertical	Circular (right-hand or left-hand)	-3 dB	½	*	*	*	*
Horizontal	Horizontal	0 dB	1	*	*	N/A	N/A
Horizontal	Slant (45° or 135°)	-3 dB	½	*	*	N/A	N/A
Horizontal	Circular (right-hand or left-hand)	-3 dB	½	*	*	*	*
Circular (right-hand)	Circular (right-hand)	0 dB	1	*	*	*	*
Circular (right-hand)	Circular (left-hand)	-∞ dB	0	-20 dB	1/100	-10 dB	1/10
Circular (right or left)	Slant (45° or 135°)	-3 dB	½	*	*	*	*

* Approximately the same as theoretical

III.2.3. Near and Far field regions

When measuring antenna radiation pattern or calculating RF link budgets using the Friis power transmission formula, the first underlying criterion is if the Tx and Rx

antennas are sufficiently far enough from each other to be considered in the far-field. In [132]-[133] the distance that Tx/Rx should respect for the farfield region is defined by:

$$d = \frac{2D^2}{\lambda} \quad (\text{III-6})$$

where D is the maximal linear dimension of the antenna and λ is the operating wavelength.

However (III-6) is correct if and only if the following criteria are respected: $d \gg D$ and $d \gg \lambda$, as reported in [134].

The space surrounding an antenna is usually divided into three regions [127]: (a) reactive nearfield, (b) radiating nearfield (Fresnel) and (c) farfield (Fraunhofer), as shown in Fig. III-6.

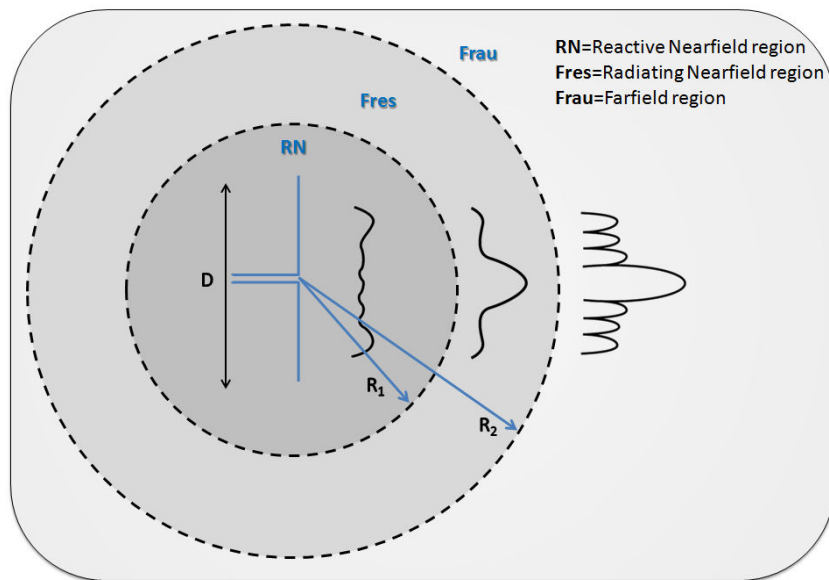

Fig. III-6. Field regions around an antenna showing the typical changes of antenna amplitude pattern.

- **Reactive nearfield:**

In this region, the reactive power density dominates. It is the region that immediately surrounds the antenna. The outermost boundary of this region is at a distance $R_1 = 0.62\sqrt{D^3/\lambda}$ where R_1 is the distance from the antenna surface, D is the largest dimension of the antenna and λ is the wavelength.

- **Radiating nearfield (Fresnel):**

Fresnel region is the transition zone between reactive nearfield region and farfield region. In this region the reactive power density becomes lower than the radiating power density. The field pattern has a conventional shape, i.e., its shape is a function of the radial distance, as described in Fig. III-6. The outermost boundary for this region is at a distance $R_2 = 2D^2/\lambda$ where R_2 is the distance from the antenna surface.

- **Farfield (Fraunhofer):**

This region is defined as “that region of the field of an antenna where the angular field distribution is essentially independent of the distance from the antenna” [127]. The RF power density varies with the inverse square of the radial distance in this zone. The inner boundary is at the radial distance $R_2 = 2D^2/\lambda$ and the outer one at infinity. In the Fraunhofer region, the pattern is well formed and has, in general, a few minor lobes and one, or more, major lobes, as described in Fig. III-6. In the farfield zone, only the radiation fields exist, the reactive fields are absent.

III.2.4. Different antenna types

Many the antenna types are available in the literature, and the choice of the antenna should be made depending on the final application. In addition to the classical role, of receiver and emitter, in advanced wireless systems the antennas could be employed to suppress or accentuate the radiation energy in a specific direction, and in other cases, the antenna would be used as a simple probing device. In this section, some of the commonly used antennas are briefly described.

Let us start with the dipole; it has been widely studied [135]-[138]. In general, dipoles are composed of two branches each one of a size of $\lambda/4$. Consequently the propagating wave in a dipole travels a total of $\lambda/2$ from the initial point. The typical directivity of the dipole is 2.23dB and the bandwidth is of about 10% [134].

Another inexpensive and versatile antenna is the loop antenna. Loop antennas are characterized by a “loop” of wire or other conductor that is connected to a balun [139]-[143]. There are two categories of loop antennas: electrically small when the antenna size is smaller than a wavelength (magnetic loop), and electrically large when the antenna size is approximately equal to a wavelength (resonant loop). Most of the applications for loop antennas are between the HF (3-30MHz) and UHF (300-3000 MHz). Loop antennas can be also used as a “probe” device, as described in [143]. Helical antennas is an easy way to obtain a good circular polarization (excited on axial mode), but they are difficult to fabricate.

The helical antenna was first described by John Daniel Kraus [144], and it is still employed for different applications [145]-[147]. A particular antenna shape gained an important attention last decades, which we call fractal antennas. In fact, the fractals have their in mathematics. First described by Benoît Mandelbrot in 1975 as a way of classifying structures where dimensions are not integer numbers, fractals have a unique geometry that occurs in nature. It can be used to describe tree leaves, plants branching, rough terrain, coastline jaggedness, and many other natural elements. However, lately its potential for antenna design was recognized [148]-[157]. It was observed that the fractals radiate electromagnetic energy in an efficient way and with a multiband behavior, i.e., they can radiate multiple wavebands signals when their properties of impedance are compared with those of the Euclidean antennas having the same total size. In [158] and [159], two different fractal shapes (Koch Island and Sierpinski Gasket) were applied for

the RFID antenna design. Finally, the most deployed antenna type in different applications is the microstrip antenna, which is described in detail in the next section, pinpointing its advantages and disadvantages.

III.3. Antenna design

III.3.1. Multitoll antenna specifications

As Multitoll is one of the worldwide turn-key leaders of e-toll solutions, they provided us with the antenna specifications for the DSRC application. These requirements should be rigorously taken into account, since the antennas developed in this thesis are deployed in real applications under protocol regulations. The specifications were the following:

- Low-cost antenna, easy to fabricate and that may be rapidly tested in a real *in-situ* test.
- Antenna gain: RSE 13-15 dBi and OBU 5-6 dBi
- Antenna bandwidth respecting the DSRC standard: 5.795-5.815 GHz (20MHz)
- A minimum S_{11} parameter of -10dB over all the bandwidth
- Left-hand circular polarization
- Technology should be microstrip

III.3.2. Microstrip antenna

Microstrip radiators were first described by Deschamps in 1953 [160]. However, only some decades later, in 1970, microstrip antennas were fabricated [161]-[173]. This development accelerated due to the availability of good substrates with low loss tangent and attractive thermal and mechanical specifications. Nowadays, microstrip antennas are fully deployed in different fields and frequencies, due to their numerous advantages, e.g., easy large-scale fabrication, compatibility with integrated circuits, simple and inexpensive manufacturing using modern printed-circuit technology, low weight, low cost, and so on. A good review of microstrip antennas can be found in [174]-[186]. Microstrip antennas are attractively versatile, since the radiator elements can be loaded with lumped elements (e.g., pins and varactor diodes), providing a frequency and/or polarization and/or pattern variation [187]-[192].

A microstrip patch antenna consists in a conductor metal shape (rectangular, circular, ellipse, triangle...) on one PCB face and the ground plane on the other side. Typically, a patch antenna has a gain between 5 and 8 dBi and a -3dB beamwidth between 70° and 90°. A good review of the radiation pattern characteristics as a function of the metal shape is presented in [193].

Depending on the application, the feed method has an important role in the antenna design. Several feeding methods have been reported in the literature, and among them: microstrip line, aperture coupling and coaxial probe [194]-[200]. Microstrip line feed is

more appropriate for the integration with RF circuit (front-end), since all the RF parts can be directly printed, as shown in Fig. III-7(a). The microstrip line is easy to fabricate and also to model. Coaxial probe is as well widely used, the inner coaxial conductor is connected to the radiator and the outer coaxial conductor is connected to the ground, Fig. III-7(b). However, this method requires more attention for design and fabrication, since the inner coaxial conductor passes through the substrate, and a parasitic capacitance can be generated between the inner coaxial conductor and the ground plane. Attention should be also given to the soldering point on the radiator connecting the inner coaxial connector, since the radiator surface is sensible to slight electrical modifications. Finally, aperture-coupled feed is the most difficult to design, Fig. III-7(c). An interesting result of a dual-fed aperture-coupled circularly polarized patch antenna was reported in [201], where general practical guidelines for the design of such antennas have been described.

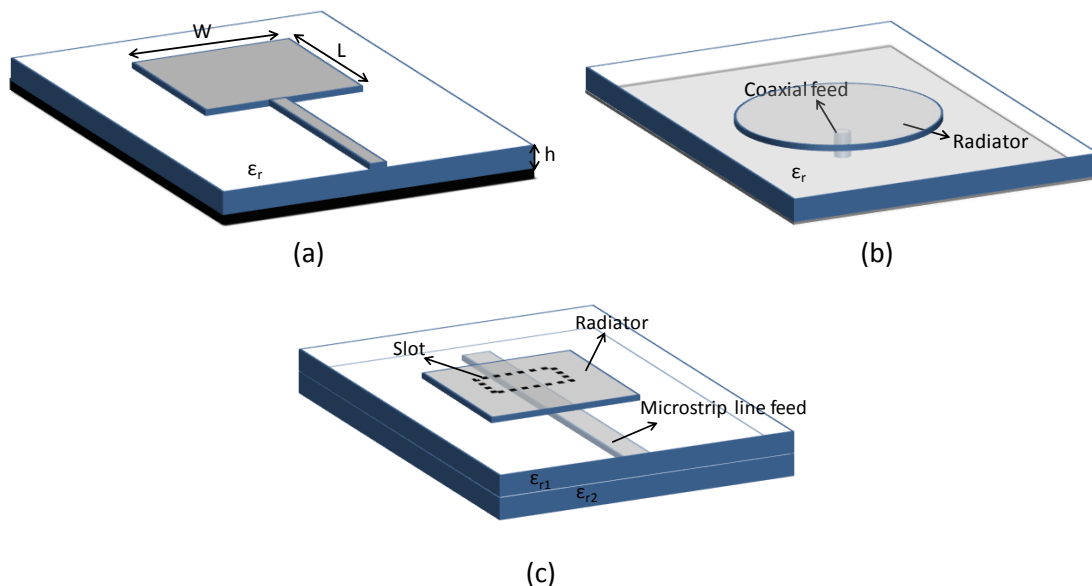

Fig. III-7. Typical feed methods for microstrip antennas: (a) microstrip line, (b) coaxial feed and (c) aperture-coupled feed.

Microstrip antennas have been widely used in different applications due to several advantages intrinsic to their structure. In Table III.2, the most common positive and negative characteristics of the microstrip antennas are resumed.

TABLE III.2. MICROSTRIP ANTENNAS ADVANTAGES AND DISADVANTAGES

Advantages
Easy large-scale mass production using printed circuit technology leads to a low fabrication cost
Easy integration with other microstrip circuits
Low profile and weight
Linear and circular polarization
Versatile characteristic (varactors, diode...)
Disadvantages
Narrow bandwidth
Relative low-gain (~6dB)
Microstrip array need complex feed to achieve high-performances
High mutual coupling within an array environment at high frequencies

Due to these advantages, in this thesis, the different antennas developed are based on microstrip patch antennas, using two feed methods (microstrip line and coaxial probe feed). In III.3.3.1, we present the DSRC transponder patch antenna design, that it is integrated with the DSRC OBU. Then in III.3.3.2, the DSRC reader antenna development is described, where two different topologies are studied, designed and tested. Finally, in III.3.4 the patch antenna array designed for Wireless Energy Harvesting applications are presented.

III.3.3. DSRC antennas

III.3.3.1. DSRC OBU antenna

In Chapter II, the DSRC OBU design is presented, a new low-power mode is described and the RF front-end is studied and implemented. Nevertheless, to complete the OBU front-end circuit, Multitoll requested an OBU antenna with a 6dBi gain, left hand circular polarization, simple to be integrated on the OBU PCB and a maximal occupied area of 20cm². Given this, we have decide to design a patch antenna fed by microstrip line.

The substrate used is ROGERS RT5880, which has a relative dielectric constant of $\epsilon_r=2.2$, a thickness of $h=0.787$ mm and a tangent loss of $\tan\delta=0.0009$. The antenna design has been numerically assisted using the antenna analysis software CST Microwave Studio.

The first step is to match the square patch to the resonant frequency (5.8GHz), by computation of the physical dimensions (W and L). From Fig. III-7(a), to calculate the rectangular microstrip radiating patch dimensions, width W and length L , we will apply the equations (III-7)-(III-10).

The patch width is determined by:

$$W = \frac{c}{2f} \sqrt{\frac{2}{E_r + 1}} \quad (\text{III-7})$$

where c is the speed of light, f is the resonant frequency and E_r is the relative dielectric constant of the substrate.

Due to finite length of this antenna, electromagnetic fields at the edge of the patch undergo fringing. Thus, to account for the fields present in the air (fringing) and in the substrate, the effective dielectric constant (E_{eff}) is introduced.

$$E_{eff} = \frac{E_r + 1}{2} + \frac{E_r - 1}{2} \left[1 + 12 \frac{h}{W} \right]^{-1/2} \quad (\text{III-8})$$

where h is the substrate height.

For the patch length calculus and also due to the fringing effect, the length of the patch increases by a distance of $2\Delta L$:

$$\Delta L = 0.412 h \frac{(E_{eff} + 0.3) \left(\frac{W}{h} + 0.264 \right)}{(E_{eff} - 0.258) \left(\frac{W}{h} + 0.8 \right)} \quad (\text{III-9})$$

Finally, the patch length can be computed as following:

$$L = \frac{1}{2f \sqrt{E_{eff}} \sqrt{\mu_0 \epsilon_0}} - 2\Delta L \quad (\text{III-10})$$

Then an impedance transformer microstrip line is designed at the input of the antenna in order to provide a 50Ω interface. Finally, in order to generate a circular polarization, a well-known method is applied, that consists in trimming the ends of two opposite corners of a square patch [202]. The DSRC OBU antenna is presented in Fig. III-8.

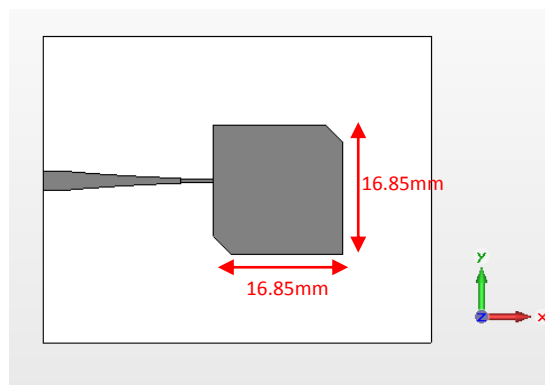

Fig. III-8. DSRC OBU patch antenna.

The S_{11} simulation results of the OBU antenna are presented in Fig. III-9. A good matching at 5.8GHz has been achieved, $S_{11} = -18\text{dB}$.

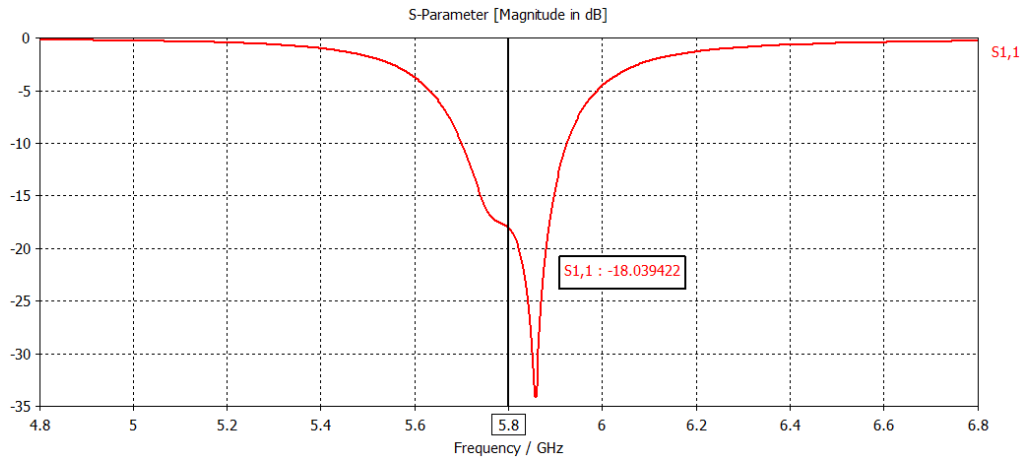

Fig. III-9. S_{11} simulation results of the DSRC OBU antenna

Fig. III-10 shows the simulated radiation pattern of the patch antenna. As can be observed, a simulated 8dB gain has been achieved (Fig. III-10(a)), due to the low loss substrate. The patch antenna has a beamwidth of 68.5° ($\phi=0^\circ$, Fig. III-10(b)) and 75° ($\phi=90^\circ$).

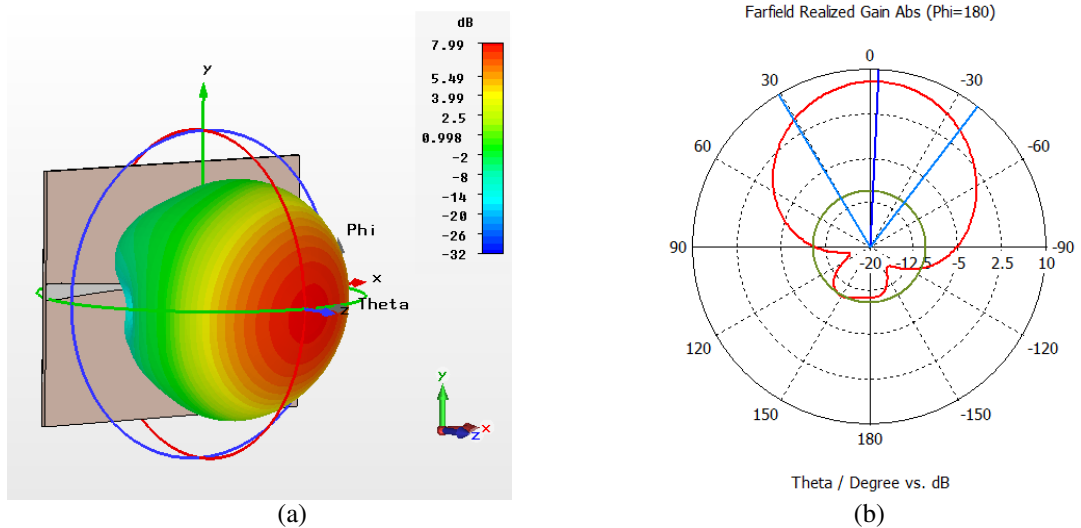

Fig. III-10. Radiation pattern simulation results of the DSRC OBU antenna: (a) 3D plot and (b) polar plot.

The axial ratio of the antenna is presented in Fig. III-11. As requested by Multitoll, the OBU patch antenna has to be LHCP (Left Hand Circular Polarization).

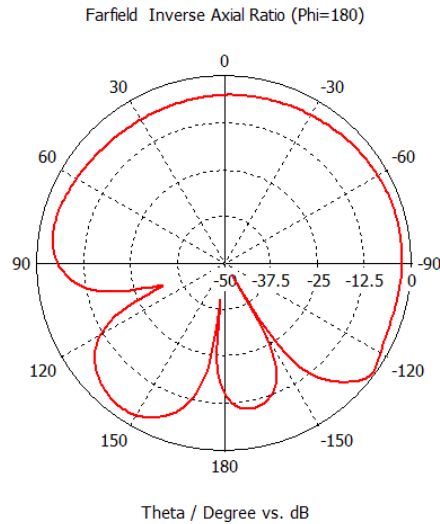

Fig. III-11. Antenna polarization simulation results of the DSRC OBU antenna.

III.3.3.2. DSRC RSE antennas

In Chapter II, the DSRC link budget is presented, showing the best mounting parameters for an efficient DSRC system. Among the mounting parameters described, the RSE radiation pattern has been considered in the RF link budget model. Even though in the downlink mode (RSE->OBU) the RSE gain is limited by the maximum authorized E.I.R.P. (+33dBm), on the uplink mode (OBU->RSE), the RSE gain plays an important role for the receiving signal. Since the OBU is completely reflexive, the uplink signal is very low, the incoming signal on the RSE needs to be captured by a high-gain antenna.

Multitoll requested two different DSRC antennas: the first one for a specific Stop&Go application and the second one for Free-Flow applications. The first antenna is a 1x3 patch array with superstrate layers enhancing the antenna gain. The second antenna is a patch antenna array with 8 elements and an improvement on the circular polarization due to the sequential rotation feeding.

III.3.3.2.1. Patch antenna array with superstrate

The first DSRC reader antenna requested by Multitoll it is used for a specific Stop&Go e-toll application. The antenna should be as small as possible, should have a gain so as to provide a minimum OBU distance detection of 17m from the reader and should be low-weight. Another condition was that the antenna would be installed in a lateral post, 4m from the lane, as described in Fig. III-12. Following Multitoll specification, the antenna gain should be around 14dBi.

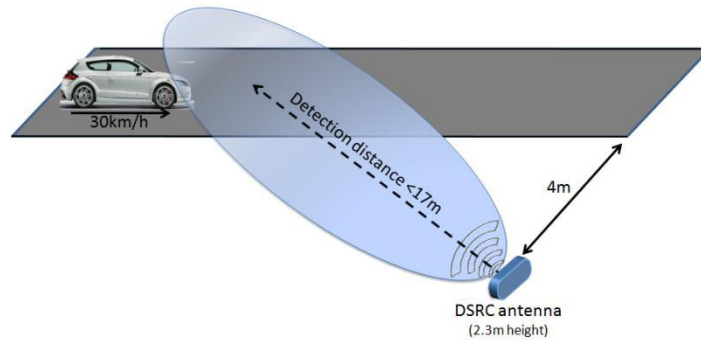

Fig. III-12. DSRC read antenna Stop&Go mounting configuration.

The preliminary antenna has been designed based on the microstrip patch antenna theory. The dimensions of the patch are adjusted to ensure a frequency resonance at 5.8GHz. The Rogers RT/Duroid 5880 was chosen as substrate. Then in order to increase the gain, a 1x3 array has been conceived. The 1x3 patch antenna array is shown in Fig. III-13.

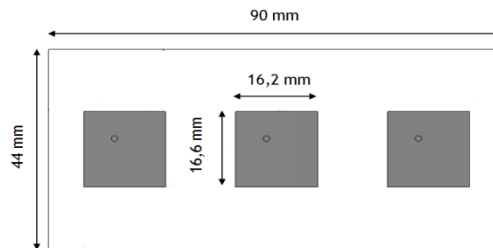

Fig. III-13. 1x3 microstrip patch antenna array.

Microstrip patch antennas can be fed by a variety of methods, as described previously in this section. The feed point position has been optimized in order to provide a circular polarization. The distance between the elements was optimized in order to improve the antenna gain. For this first DSRC antenna, in order to reduce the “visible antenna surface”, we have decided to implement the feed array on a second layer behind the patch substrate and, through via connections join the radiators, as shown in Fig. III-14. The array feeding network has been designed so as provide equal amplitude and phase signal excitation for each radiating element. In Fig. III-15, a lateral view of the multilayer is presented.

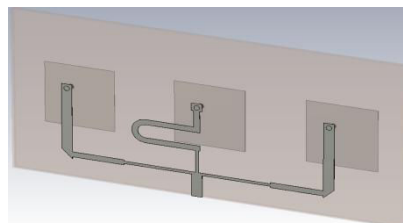

Fig. III-14. Detailed feeding network lines with via.

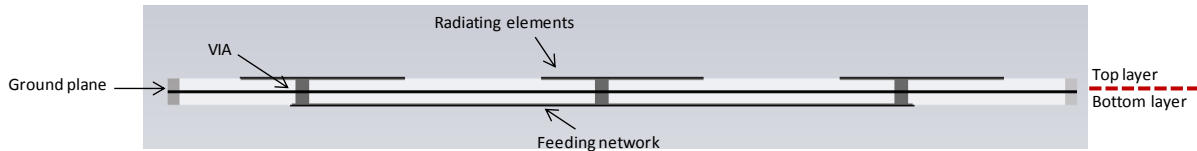

Fig. III-15. Lateral view of the patch antenna array with via.

The effect of the via-hole diameter has been studied; the via-hole dimensions were optimized in order to achieve the more suitable response of the antenna return-loss and circular polarization. The effects of the via-hole radius variation on the antenna performances are resumed in Table III.3.

TABLE III.3. VARIATION OF THE VIA DIAMETER

Via radius (mm)	S_{11} (at 5.8GHz)	Bandwidth (MHz)	Total efficiency (%)	Gain (dB)	AR (dB)
0.5	-18.15dB	206	95	11.45	-2.54
0.64	-20.3dB	210	96	11.49	-1.69
0.75	-22.75dB	220	96	11.51	-0.79

As discussed previously the antenna should be small, nevertheless should present a high-gain ($\sim 14\text{dBi}$) and with a 1×3 patch array we could achieve this condition. Various methods are typically used to improve the gain of antennas [203]-[204]. Among them, superstrate layers method is a useful gain enhancement technique that can be used with several antennas types and not required specials designs to be implemented, [205]-[206].

The superstrate layers are dielectrics that are placed just above the radiated structure in order to guide the radiated waves in a certain direction. This concentrates the energy and increases the directivity. The superstrate layers bend the rays outgoing from the antenna according to Snell's law [203], since that the material has positive electromagnetic properties ($\mu > 0$, $\epsilon > 0$). The dielectric material characteristics used for the superstrate layers are: $\epsilon=2.2$, $\mu=1$ and $\tan\delta=0.025$. The schema of the patch antenna array with superstrate is described in Fig. III-16.

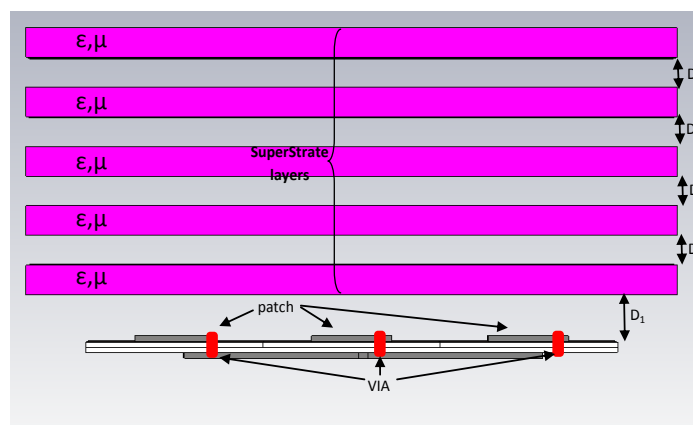

Fig. III-16. Patch antenna array with superstrate layers.

Regarding the superstrate layers design, first of all I have optimized the distance (D_1) between the first superstrate layer and the array, and then the distance between layers

(D_2). Fig. III-17 and Fig. III-18 show the parametric results considering the axial ratio and gain parameters.

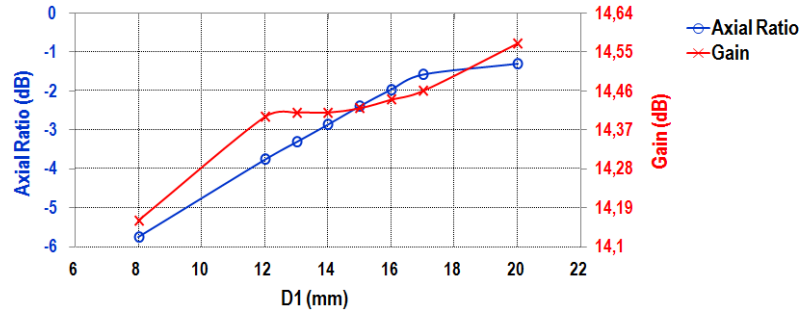

Fig. III-17. Antenna Axial Ratio (AR) and gain based on the D_1 variation.

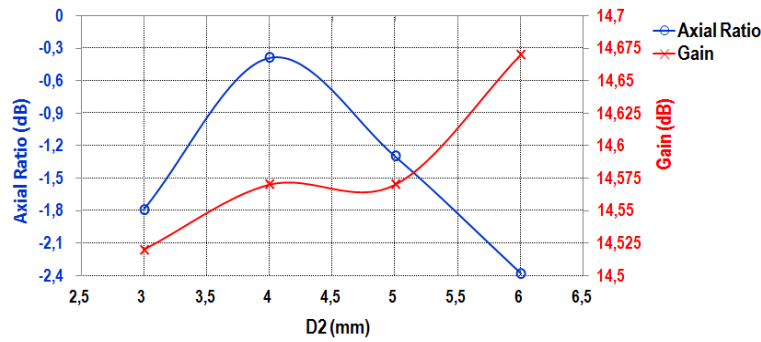

Fig. III-18. Axial ratio and gain based on D_2 variation ($D_1=20$ mm)

Finally from the parametric assessment results, the best result for D_1 is 20mm. For D_2 it was observed that the best value of AR is obtained when $D_2=4$ mm, and conversely the gain best value, when $D_2=6$ mm. We have decided to chose the AR criterion as more important in this case, and consequently we have chosen $D_2=4$ mm.

In order to highlight the gain enhancement due the use of superstrate layers, we have compared the simulated gain of the 1x3 patch antenna array with superstrate to the one of the 1x3 patch antenna array without superstrate; the first is about 13.8dB and second is about 11.3dB. A gain improvement of about 2.5dB is obtained.

- **Measurements results:**

In order to validate the simulation results, several prototypes have been fabricated. Nevertheless in this manuscript we restrain the results to only two prototypes. Unfortunately at the time where we were developing this antenna, IMEP-LAHC laboratory was not yet equipped with a multilayer printed circuit machine, consequently the vias could not be directly fabricated. Two different PCBs were fabricated (patch antennas and feed array), each one with its respective ground plane, and then metallic wires were used to emulate the vias, connecting the two PCB layers. Next we have assembled the antenna PCB with the superstrate layers, and finally we have accommodated the patch antenna array with the superstrate in a mechanical support for the later fixation on a post for the *in-situ* tests. Fig. III-19 shows a picture of the final patch antenna array with superstrate ready for the RF characterization and *in-situ* tests.



Fig. III-19. Final patch antenna array with superstrate: (a) top view and (b) perspective view of the closed box.

We proceed with the RF characterization of the assembly, the S_{11} measurements are presented in Fig. III-20 and compared with the simulation results.

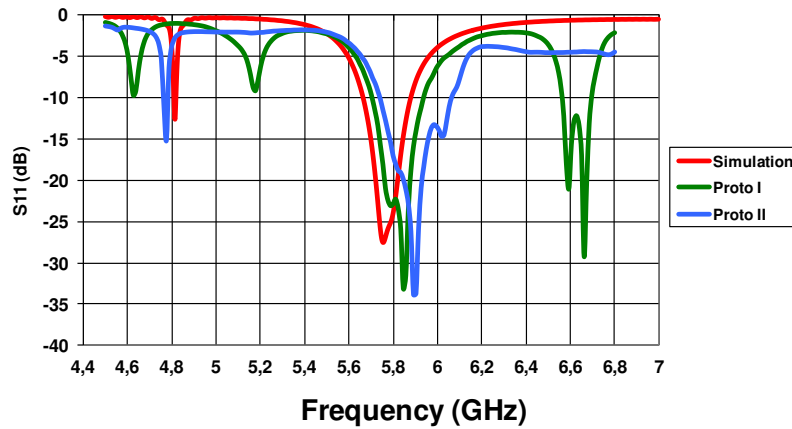

Fig. III-20. S_{11} measurement results of the patch antenna array.

From Fig. III-20, it is clear that the S_{11} are not reproducible for both prototypes when compared with the simulation results.

We pursued the measurements, the maximum gain (boresight) and the AR (polarization) have been measured and they are presented in Table III.4.

TABLE III.4. MEASUREMENTS RESULTS

Version	S_{11} (at 5,8GHz)	Δf (MHz)	Gain (dB)	AR (dB)
Simulation	-24.0dB	220	14	-0.54
Proto I	-22.8dB	230	13.8	-5
Proto II	-17.0dB	320	13.3	-1

From this preliminary DSRC antenna designed, we can already derive some conclusions. The measured gain follows the theoretical result. On the other hand, for the AR and S_{11} results some issues have been identified. From the fabricated antennas, we have observed that because of the hand-made via and consequently the different welding applied, the impedance matching of each prototype is different. The large-scale fabrication feasibility have been also analyzed and we have concluded that the via could

be a problem in the fabrication process. Therefore, we have decided to study another solution for the next DSRC antenna (Free-Flow), which should be easy to fabricate on large-scale and presents a lower margin of error between the different fabricated prototypes.

Nevertheless, after the RF characterization of the 1x3 patch array with superstrate layers, we have proceeded with the *in-situ* tests in order to evaluate the antenna performances with the DSRC reader developed by Multitoll. These results are presented in section III.3.3.2.3.

III.3.3.2.2. Patch antenna array with an improved circular polarization

The second antenna requested by Multitoll, is deployed in Free-Flow e-toll applications. In Free-Flow e-toll configuration, there is no barrier, no toll booths and no cash lanes. Motorists instead experience driving on an open highway (multi lanes) with tolls automatically calculated as they drive through a tolling point, with the only condition of having an OBU inside their vehicles. In generally, in a Free-Flow e-toll sector, each lane is equipped with a RSE. In order to avoid the overlapping zone of the contiguous lobes, the RSE antenna should have a very directional lobe, minimizing the probability of cross-readings and therefore OBU detection misunderstandings.

Moreover, the RSE radiation pattern should also respect other criteria, imposed by DSRC standards and also by Multitoll specifications, e.g., the antenna beamwidth should be 30° (vertical plane) and 15° (Horizontal plane), the side lobe levels should be lower than -13dB in both planes and the antenna gain should be 15dBi. In addition, the antenna PCB should occupy a maximum area of 289 x 241mm (radome thickness already included) since the antenna is further integrated in the DSRC reader box, as shown in Fig. III-21. Another requirement is that the antenna should resist in an outside environment, and consequently a radome should be designed and matched with the antenna. Rogers RT/Duroid 5880 is chosen here as substrate for the antenna.

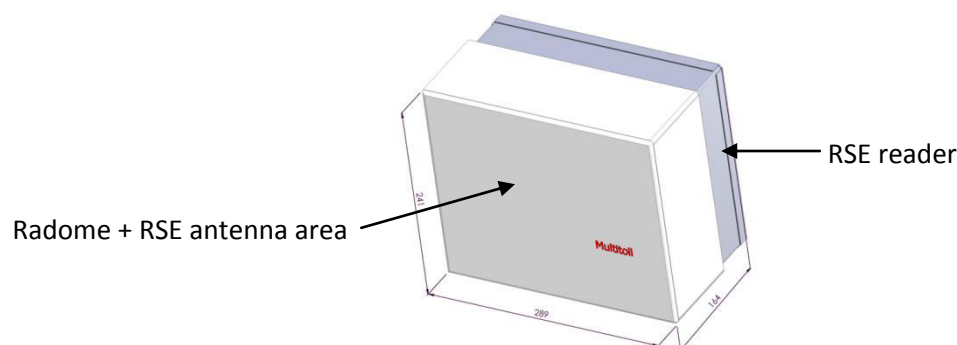

Fig. III-21. RSE box layout.

The RSE antenna array design starts with the patch element construction. In fact, since we have already designed a patch element at 5.8GHz for the OBU (Fig. III-8), we have used this element as start point for this RSE antenna array. The only difference is that for the OBU antenna design, a 50Ω interface (patch element/front-end) has been carried out,

and here, for this RSE antenna array, we conceive the feed network directly connected to the high impedance microstrip feed line at the patch input. As presented for the OBU antenna results, the patch element has already a good LHCP, by truncating the corners of patches. We are interested to preserve and even improve the circular polarization in the array design. We have applied the sequential rotation feeding [207] that consists in enhancing the circular polarization of the array, by applying a specific physical rotation and an electrical delay in each patch element, as described in Fig. III-22. The sequential feeding involves both the rotation of the antenna feed point and its phase feeding. This method has the advantage of improving the axial ratio bandwidth and reducing the mutual coupling between array elements.

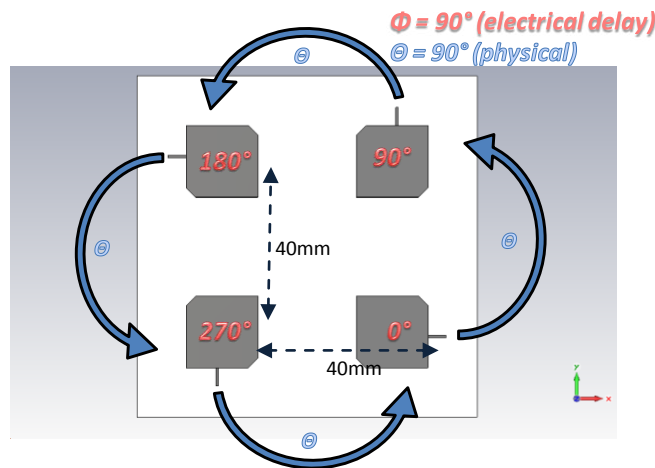

Fig. III-22. Sequential rotation array feeding method.

In Fig. III-22, the distances between the patch elements are optimized in order to obtain lower coupling effects between each element and to improve the antenna gain. For the feed network design we have applied a particular co-simulation method using the CST Studio Suite software, with the purpose of reducing the simulation time. The patch antenna array has been simulated in the 3D CST Microwave Studio environment and the microstrip feed network has been designed in CST Design Studio, as described in Fig. III-23. The simulation routine implemented consisted in: first, optimizing the feed network providing the sequential electrical delay for each patch element and a good impedance matching, and then the co-simulation (3D environment) in order to obtain the results (S_{11} , gain, AR ...) of the complete array.

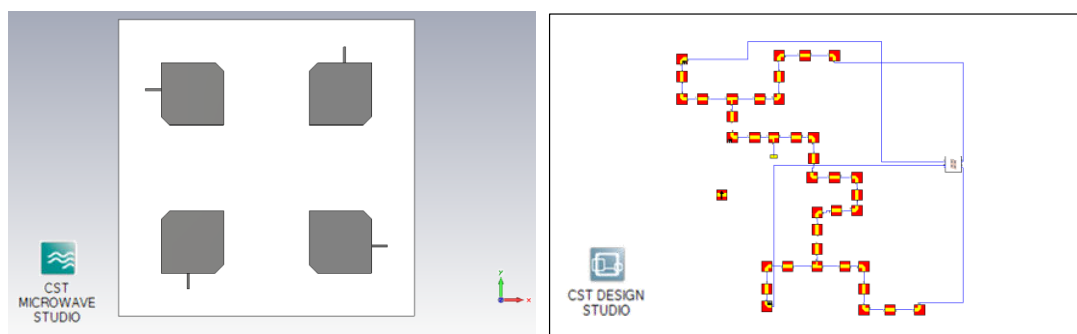

Fig. III-23. Co-simulation method in CST Studio Suite.

As Multitoll specified, we need to achieve a gain of $\sim 15\text{dBi}$ and a beamwidth of $15^\circ \times 30^\circ$. Consequently, from the antenna array theory, we observe that to obtain a beamwidth around 15° , we need 4 elements, and for 30° of beamwidth two elements are sufficient. Finally, we have decided to implement a patch antenna array with 8 elements in the $(2 \times 2) \times 2$ form, as shown in Fig. III-24. It should be noticed that the sequential rotation feeding method is still applied, but this time, the electrical/physical delay is of 180° , as the bloc of patch elements is doubled.

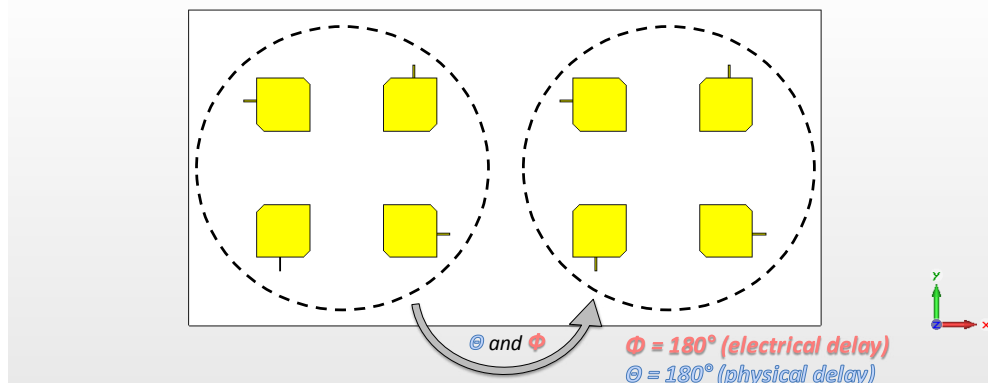

Fig. III-24. RSE patch antenna array with 8 elements in the $(2 \times 2) \times 2$ form.

For the feeding network design, a co-simulation assessment has been also carried out for the final $(2 \times 2) \times 2$ patch antenna array. Finally, after an optimization assessment, the final RSE patch antenna array layout is presented in Fig. III-25. The receiving and transmitting antennas have been already assembled on the same PCB in order to check the coupling effect between the transmission and reception chains. This is a consequence of the fact that the RSE reader produced by Multitoll has two separated chains Tx/Rx, and necessarily, two identical antennas. In Fig. III-25, we can observe that on the PCB border some holes have been done for the fixation.

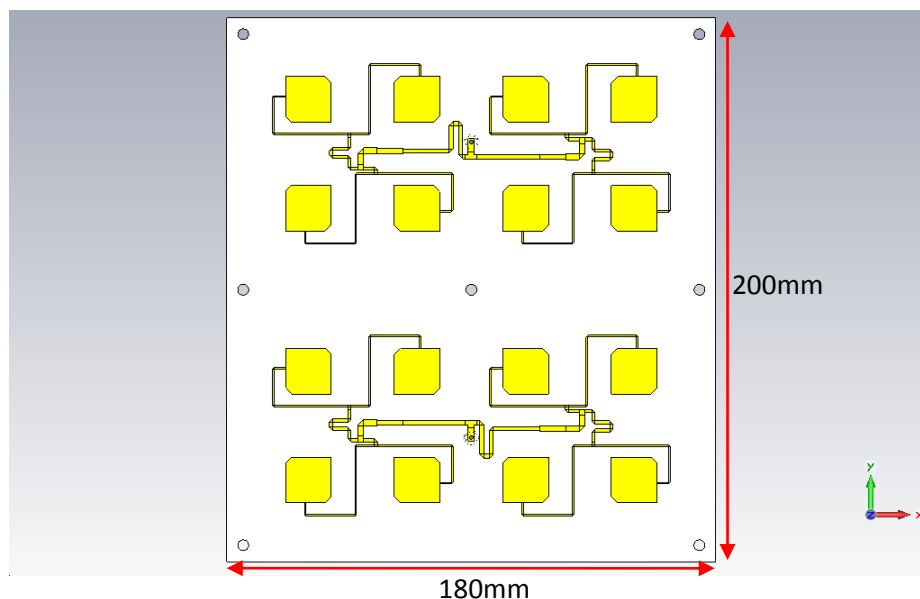

Fig. III-25. The RSE patch antenna array.

The simulated S parameter results of the RSE antenna are presented in Fig. III-26, S_{11} and S_{22} represents the reflection mismatch and the S_{21} represents the coupling between antennas (Tx/Rx). The simulated gain and axial ratio are presented in Fig. III-27. The radiation pattern results being identical for both antennas, we have plotted only once.

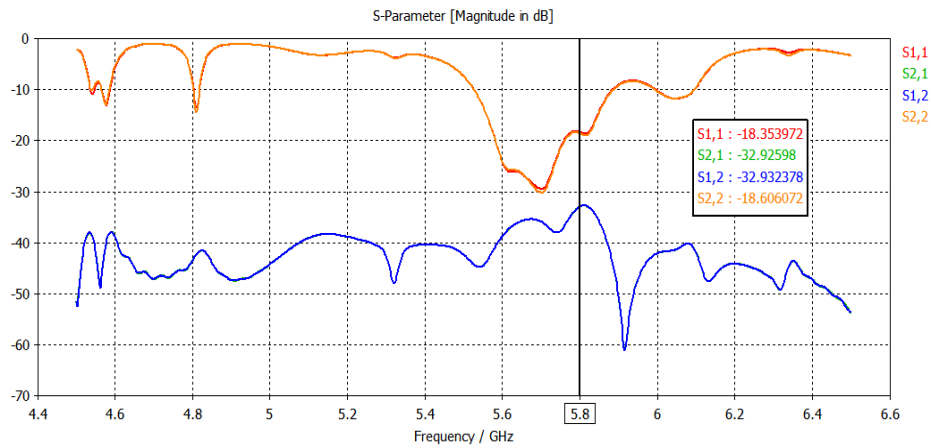
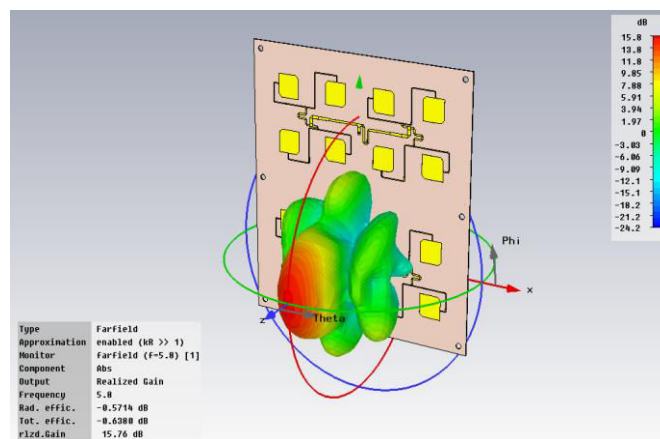
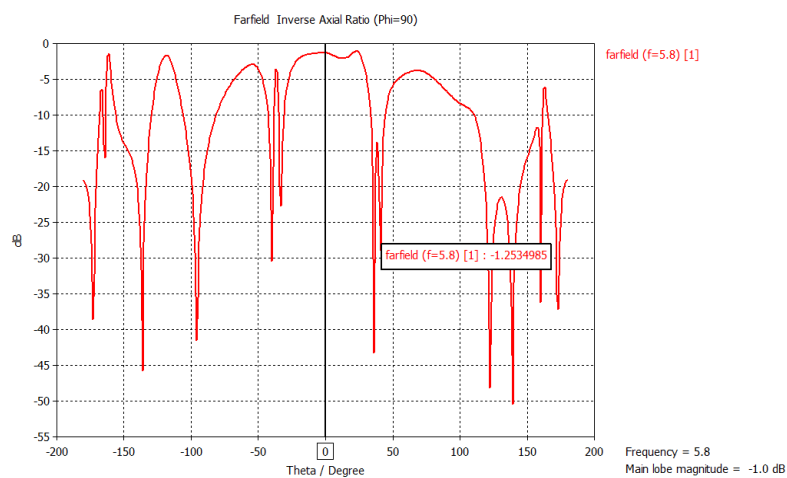

Fig. III-26. Simulated S parameters results of the RSE antenna.



(a)



(b)

Fig. III-27. Simulation results of the RSE antenna: (a) gain and (b) axial ratio.

From Fig. III-26, a good matching of -18dB for the S_{11} and S_{22} is observed as well a low coupling (-33dB) between the Tx/Rx antenna. From Fig. III-27, a high simulated gain of 15.8dB is achieved with a good axial ratio for the circular polarization (-1dB).

As discussed previously the DSRC antenna developed in this thesis is part of a complete DSRC system, and for this reason, some conditions were imposed for the antenna design (physical dimensions, radiation pattern...) as well as for the box where the antenna is inserted (Fig. III-21). The antenna PCB should be inserted in a radome box and the RF sector is isolated from the electronic sector by using a metallic plate, as described in Fig. III-28.

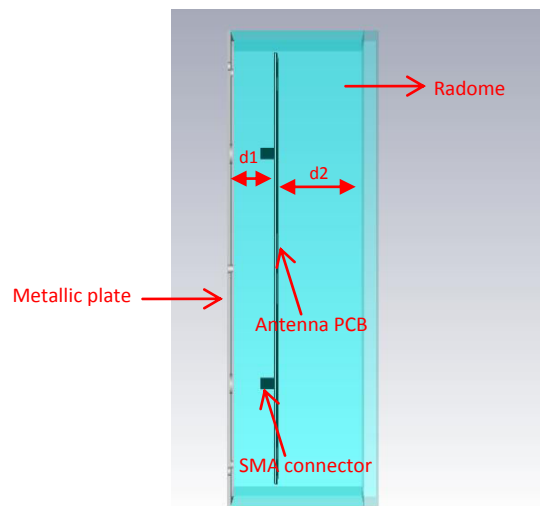

Fig. III-28. Schema of the radome box.

The radome is composed of a material with a dielectric constant of 2.2 and a thickness of 5mm. The distance d_2 separates the antenna PCB from the radome top layer, and the distance d_1 separates the metallic plate from the PCB antenna. A numerical parametric assessment has been carried out in order to determine the optimal distance values. However, each distance variation has been analyzed independently in order to reduce the simulation time. For d_2 variation (10mm to 40mm), a slight S_{11} deviation has been observed around $\Delta S_{11}=0.5\text{dB}$, and on the antenna boresight, the gain fluctuation is around $\Delta G=1\text{dB}$ with the axial ratio variation of $\Delta AR=0.3\text{dB}$. Finally, the optimal d_2 value found is 30mm. For the d_1 variation (0mm to 30mm), the antenna performances are weakly affected, within the observed variation of: $\Delta S_{11}=0.3\text{dB}$, $\Delta G=0.8\text{dB}$ and $\Delta AR=0.6\text{dB}$. Finally, the optimal d_1 value was 15mm.

In order to evaluate the assembly (antenna+radome+metallic plate) and reduce the simulation time, we have conducted an original simulation process in CST software. Since we already have the radiation pattern of the patch antenna array alone (Fig. III-27), by using the import farfield CST tool, we can import the farfield result of the antenna into the box and then run the simulation with the “Integral Equation Solver”, as shown in Fig. III-29. By applying this method we reduce the number of mesh, since we do not have

anymore the antenna PCB with its complex feed network, and we considerably decrease the simulation time (10x).

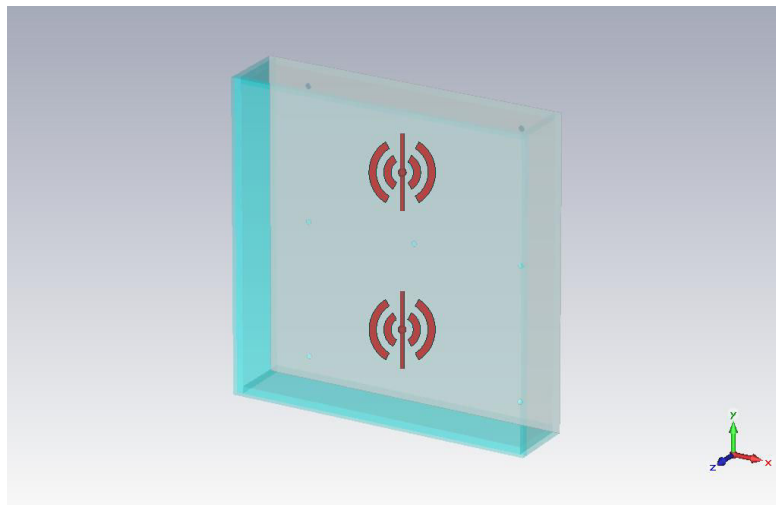

Fig. III-29. CST simulation method that reduces the simulation time by importing the antenna farfield into the box (radome+metallic plate).

Finally, in Fig. III-30 - Fig. III-32 the simulated results of the RSE antenna for Free-Flow e-toll applications are presented.

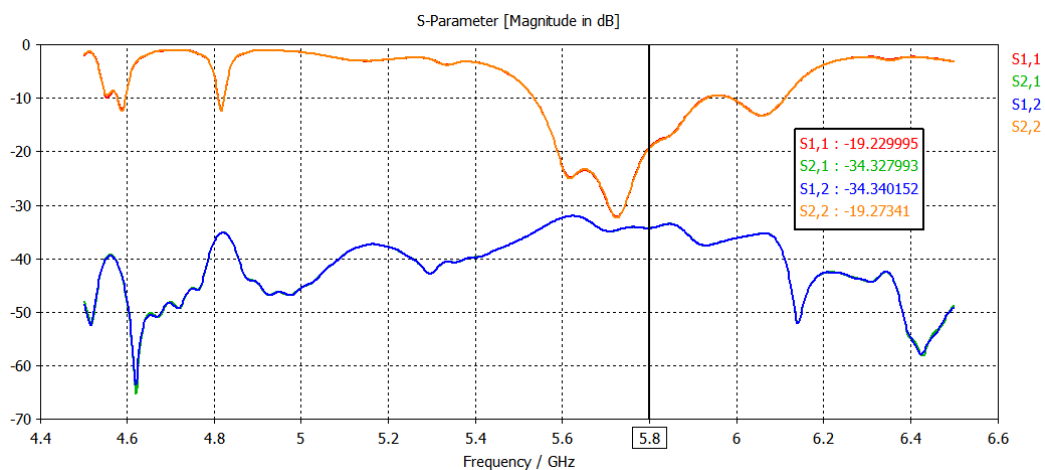

Fig. III-30. S parameters simulation results of the RSE antenna for Free-Flow e-toll applications.

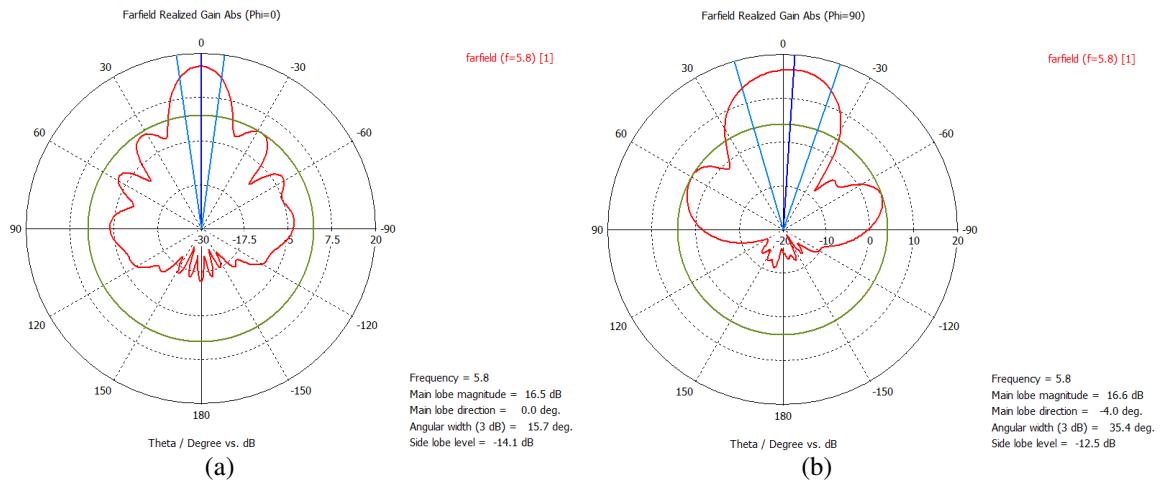

Fig. III-31. Radiation pattern simulation results in polar form of the RSE antenna for Free-Flow e-toll applications: (a) polar with $\phi=0^\circ$ and (b) polar with $\phi=90^\circ$.

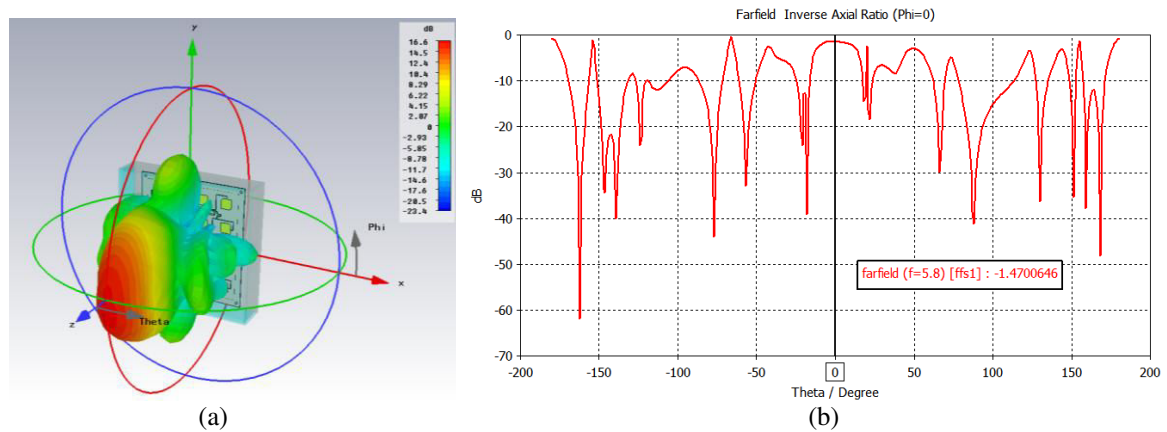

Fig. III-32. Simulation results of the RSE antenna for Free-Flow e-toll applications: (a) 3D gain and (b) polar axial ratio.

From Fig. III-30 a good input matching and a low coupling between the antennas (Tx/Rx) are achieved, of -19dB and -34dB respectively. The simulated radiation pattern (Fig. III-31) is in good agreement with Multitoll specifications: boresight gain of 16.5dB, beamwidth of $15.7^\circ \times 35.4^\circ$ and a side lobe level of -14.1dB and -12.5dB, for $\phi=0^\circ$ and $\phi=90^\circ$ respectively. In Fig. III-32(a) the 3D radiation pattern is presented and in Fig. III-32(b) the polar axial ratio is presented, which has a value of -1.5dB in boresight direction, confirming a circular polarization.

- **Measurements results:**

Several antenna prototypes have been fabricated and characterized. Given that, in general, the measurement results (S parameters, gain, AR) are quite similar between the prototypes, in this manuscript only results for one prototype are presented. Following MultiToll strategy and requirements, I was in charge of measuring the performances of the antenna, without radome and metallic plate. The whole assembly will be characterized and tested in another time. Fig. III-33 shows the measured S_{11} parameters results of both patch antennas array (Tx/Rx).

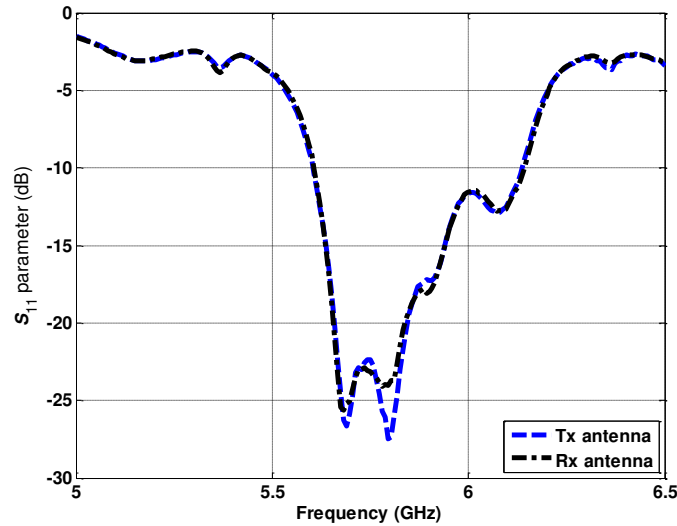

Fig. III-33. Measured S_{11} parameters results of the both antennas patch array (Tx/Rx).

In Fig. III-34, the radiation pattern measurement results are presented for both antennas Tx and Rx on two planes (phi equal to 0° and 90°).

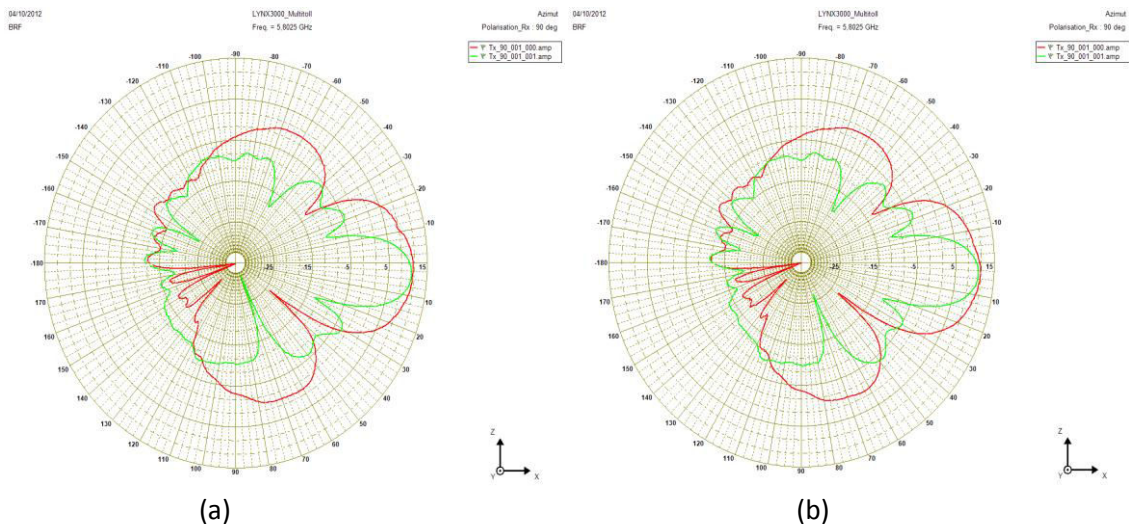

Fig. III-34. Radiation pattern measurement results of both antennas Tx(a) and Rx(b). Red curve is for $\phi=0^\circ$ plane and green curve is for $\phi=90^\circ$ plane.

From Fig. III-33, a good matching at 5.8GHz can be observed for both antennas Tx and Rx, -24dB and -27dB respectively. The slight difference on the measured S_{11} between both antennas comes from the SMA connector soldering, since the inner coaxial conductor is connected to the microstrip feed line through a soldering point, as described in the zoom in Fig. III-35.

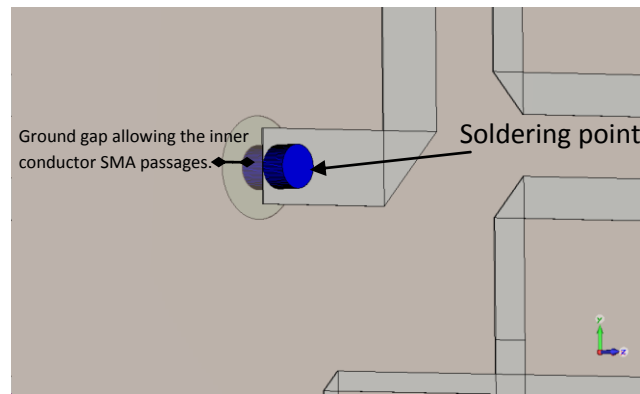

Fig. III-35. Zoom of the soldering point on the microstrip feed line of the antenna array.

In Fig. III-34, the radiation pattern measurement results show good form stability for both antennas (Tx/Rx). A maximum gain of 14.3dB has been detected in the boresight direction. Compared to the expected gain (15dB, without radome and metallic plate), the 0.7dB difference is acceptable for an anechoic chamber measurement setup. In Fig. III-34, the slight inclination of the boresight direction of the radiation pattern measurements comes from the misalignment of the mounting support of the DUT in the anechoic chamber. Regarding the side lobe levels, the measurement results are in good agreement with the side lobe level requested by Multitoll (-13dB). The measured side lobe levels were -17.5dB ($\phi=0^\circ$, horizontal plane) and -14dB ($\phi=90^\circ$, vertical plane).

III.3.3.2.3. DSRC RSE antennas in-situ tests

The RSE antennas developed in this thesis are part of a complete DSRC e-toll system conceived by Multitoll. Once the antenna prototypes have been designed, fabricated and characterized (RF performances) in the IMEP-LAHC laboratory, they were sent to the Multitoll headquarter in Asnières to proceed the *in-situ* tests. Multitoll dedicated an important effort to implement different test scenarios for the validation of the DSRC system. Two emplacements were used for *in-situ* tests: a parking space in Multitoll headquarter for the static tests and the racecourse circuit in Montlhéry for the dynamic tests. During the tests, three detection systems were deployed: RF, camera and magnetic loop. These detection systems are necessary to provide enough information to indentify the vehicle ID. Several parameters have been analyzed, but by far the most important are: the position of the vehicle on the highway lane, the vehicle speed, the type of OBU, the type of vehicle (car, motorcycle, truck), the vehicles in an adjacent lane, the detection and measurement of the static antenna lobe.

In order to present the two DSRC *in-situ* scenarios, we show the patch antenna array with superstrate (III.3.3.2.1) under static test (parking) and the patch antenna array with an improved circular polarization (III.3.3.2.2) under dynamic test (racecourse circuit).

- **Static test (Multitoll parking):**

After the antenna characterization in the IMEP-LAHC laboratory, the first practical tests are done on the parking of the Multitoll headquarter. The objective of these

preliminary tests is to evaluate the antenna performances when connected to DSRC reader. In Fig. III-36, a picture of the static tests site is presented.



Fig. III-36. Parking of the Multitoll headquarter used for the static DSRC tests.

The patch antenna array with superstrate has been developed for a specific Stop&Go application. In order to implement the mounting configuration, described in Fig. III-12, the Multitoll test engineers reproduce the same scenario where the antenna was mounted on a post at 2.3m of height and the OBU moves through a shift axis located 4m from the post. A picture of the static test is shown in Fig. III-37. Fig. III-38 shows in detail how the antenna is connected to DSRC reader.

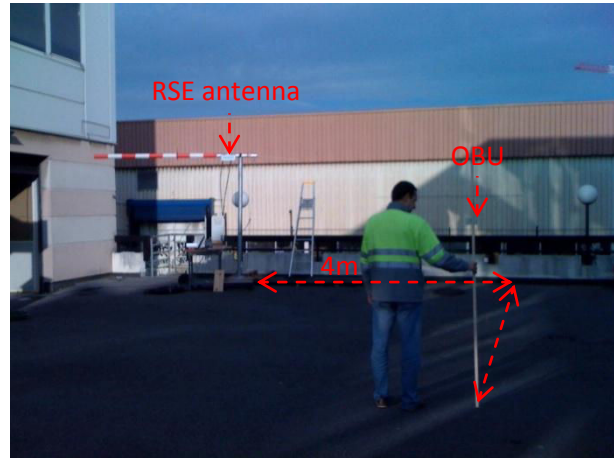

Fig. III-37. Static test of the RSE antenna for a specific Stop&Go application.



Fig. III-38. RSE antenna mounting detail where the antenna is connected by coaxial cables to the DSRC reader.

The test consisted in moving the OBU over a shift axis towards the antenna. The objective is to simulate the passages of a car with an OBU. Three different OBU heights have been analyzed (2m, 1.5m and 1.2m). Two types of static tests have been carried out, one with the OBU mounted in a hand support, as described in Fig. III-37, and a second test where the OBU is placed inside a vehicle (ford Ka). For each OBU height, the detection zone has been measured. The measurement results are presented in Table III.5 and Table III.6.

TABLE III.5. ZONE DETECTION FOR DIFFERENT OBU HEIGHTS PLACED ON A HAND SUPPORT

<i>OBU height (m)</i>	<i>Detection zone (m)</i>
2	6.5 – 22
1.5	6 – 24
1.2	6 – 22

TABLE III.6. ZONE DETECTION FOR OBU PLACED INSIDE A VEHICLE (FORD KA)

<i>OBU height (m)</i>	<i>Detection zone (m)</i>
1.2	6.5 – 22

- **Racecourse circuit (Monthéry):**

In order to evaluate the complete DSRC system, Multitoll had rent a racecourse circuit. Fig. III-39 shows a picture of the dynamic test scenario. Two lanes are available for the test and each of the lanes has one RSE antenna, one camera and a magnetic loop. The back office is installed in a booth. For each vehicle passage the most important parameters acquired are: vehicle ID (OBU), licence plate picture (camera), vehicle speed (magnetic loop).

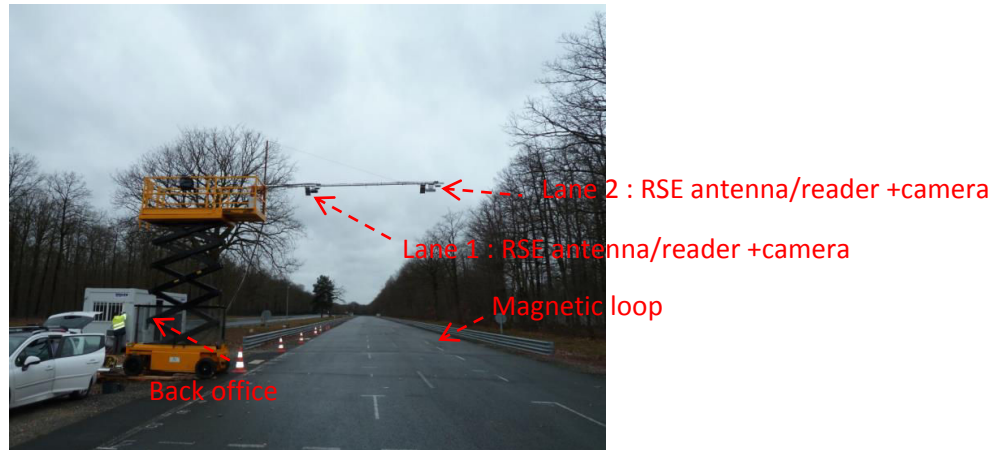

Fig. III-39. Dynamic test of the DSRC system.

In Fig. III-40, we have a picture of the e-toll detection devices installed on the racecourse of Montlhéry, we can thus observe the DSRC RSE (antenna+reader), the camera and the RFID antenna/reader. The RFID antenna has been developed in another project and it is also being used in some countries for e-toll applications.

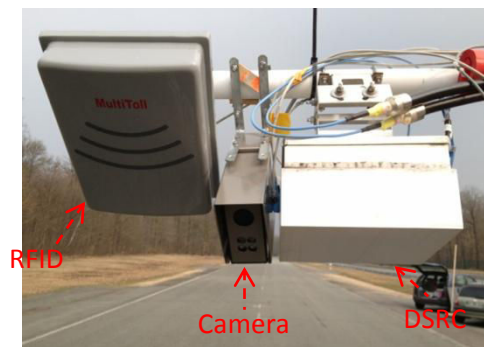

Fig. III-40. Picture of the e-toll system (RFID, camera, DSRC).

Several the DSRC transactions have been tested (wake-up, complete transaction ...) and as well different traffic scenarios, i.e., vehicles may be in any position across the road and may change lane anywhere in the toll charging area, and usually here is more than one vehicle. Some of the different scenarios tested are described in the next tables. For each scenario, the parameter that confirms a complete DSRC transaction is the BIP sound emitted by the OBU.

TABLE III.7. DSRC DYNAMIC TEST, BOTH VEHICLES WITH OBU – SCENARIO 1

Fast lane	Slow lane	Round	Speed (km/h)	Distance between the vehicles	Result
V2 OBU		1	90	≈5m	2 bips (OK)
		2	130	≈15m	2 bips (OK)
		3	130	≈15m	2 bips (OK)
		4	130	≈15m	2 bips (OK)
		5	130	>>15	2 bips (OK)
V1 OBU		6	130	≈10m	2 bips (OK)
		7	130	≈10m	2 bips (OK)

TABLE III.8. DSRC DYNAMIC TEST, THREE VEHICLES WITH OBU – SCENARIO 2

Round	Speed (Km/h)	Distance between the vehicles	Result
1	130	5m	OK (all OBUs)
2	130	5m	OK (all OBUs)
3	60	3m	OK (all OBUs)
4	60	3m	OK (all OBUs)
5	60	3m	OK (all OBUs)
6	26	3m	OK (all OBUs)

Fast lane	Slow lane
V2 OBU	↑
V1 OBU	
V3 OBU	

In Fig. III-41 an example of the picture used to identify the vehicle licence plate is shown. This picture is acquired when the vehicle crosses the e-toll station. The use of cameras in e-toll systems is to enforce the detection rate, complementary to RF detection. A 99.9% detection rate can be achieved.



Fig. III-41. Licence plate picture acquired by the DSRC camera during the dynamic tests.

Recently Multitoll has started to install a DSRC system in Portugal, where the conditions requested are even more challenging, since the e-toll station should be implemented in a highway curve. In Fig. III-42 we have some preliminary pictures of the DSRC systems installed.

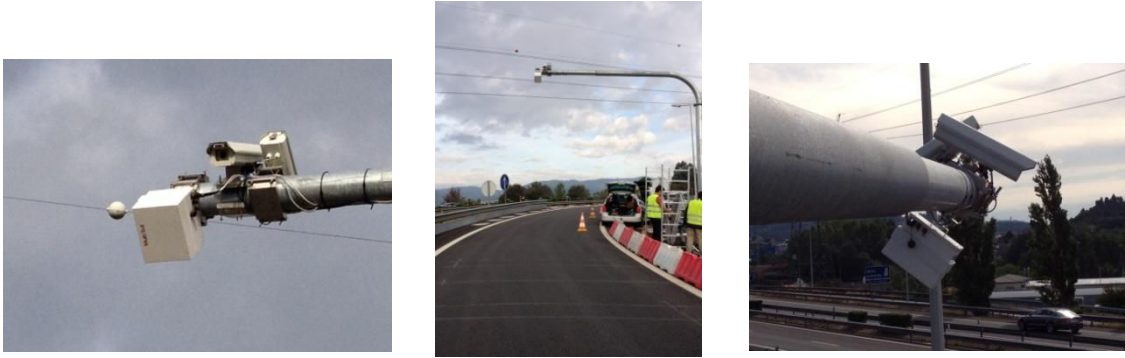

Fig. III-42. Pictures of the Multitoll DSRC system being installed on a Portuguese highway.

III.3.4. Wireless Energy Harvesting antennas

In Chapter IV, two high-efficiency *rectenna* are presented. From the rectifier perspective, we demonstrate that an optimal RF-DC load is required in order to achieve high RF-DC conversion efficiency. From the antenna perspective, two important points should be analyzed: avoiding that the high-order harmonics are radiated by the antenna and matching the antenna input impedance and the input impedance of the rectifier. Both antennas are designed by using ROGERS 4003 substrate ($\epsilon_r=3.55$ and $\tan(\delta)=0.0027$) with a thickness of 0.813 mm.

III.3.4.1. Antenna design (Rectenna #1)

For the first rectenna studied, the antenna and the rectifier design are executed separately, i.e., first of all the high-efficiency rectifier has been created with a 50Ω interface and then the high-orders harmonic-rejection antenna has been conceived also with a 50Ω interface. This section explains the antenna design and in Chapter IV (IV.5.2) we detail the design of the rectifier.

The antenna design starts with the creation of the patch element (as presented before for the OBU antenna at 5.8GHz). A 2.45GHz patch element has been conceived with the detail that the two opposite corners are trunked in an optimization process in order to provide a good circular polarization [202]. Then an 1x2 array has been conceived with the purpose of enhancing the antenna gain. The power divider has been shaped directly on the high impedance microstrip lines (microstrip feed line of the patch element). As detailed in Chapter IV, due to the non-linear behavior of the diode Schottky, harmonics are generated. Since the fundamental frequency is 2.45GHz, the second and third harmonics are at 4.9 and 7.35 GHz. To avoid the radiation of these harmonics by the antenna, two BPF stubs have been implemented at the antenna input, as shown in Fig. III-43. By tuning the size of these stubs, high-order harmonics can be blocked or passed.

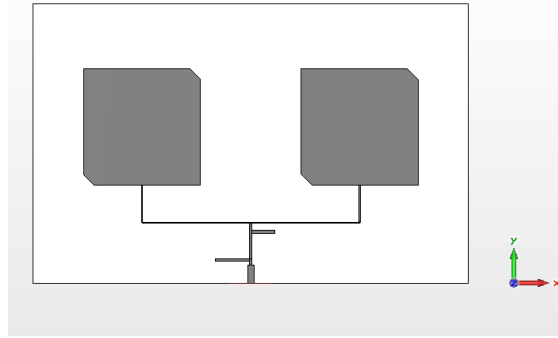

Fig. III-43. 1x2 patch antenna array with BPF stubs (rectenna #1)

In Fig. III-44, we present the S_{11} parameter of the antenna with and without the BPF stubs. Due to the BPF stubs effect, the second (4.9GHz) and third (7.35GHz) harmonics are clearly blocked, as described in Fig. III-44.

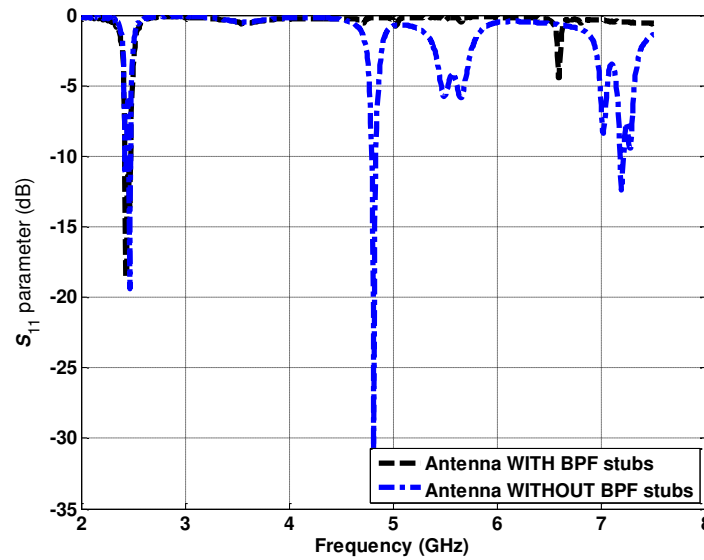

Fig. III-44. Antenna S_{11} parameter results showing the difference with and without the BPF stubs.

The simulated radiation pattern of the 1x2 patch antenna array (rectenna #1) is presented in Fig. III-45. Since we have a 1x2 patch antenna array, with each patch element fed by the same amplitude and phase delay, a 6.7dB gain has been achieved.

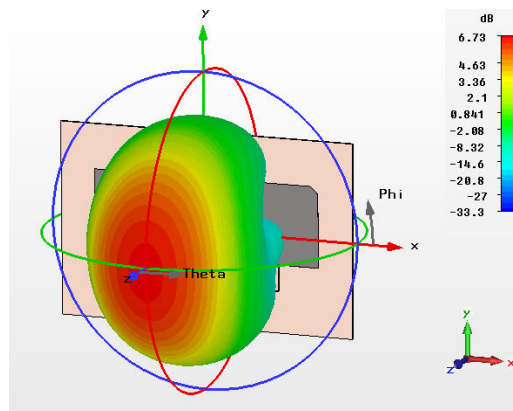

Fig. III-45. Simulated radiation pattern of the antenna (rectenna #1).

Finally, the *rectenna* #1 layout is presented in Fig. III-46 with the patch antenna array connected to the rectifier by using a 50Ω interface.

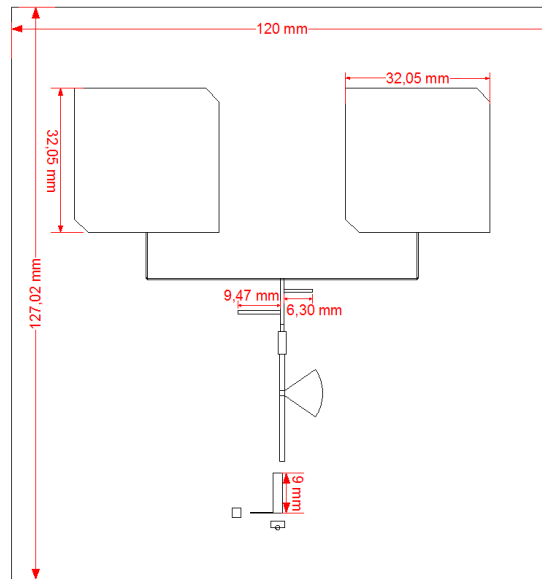

Fig. III-46. Rectenna prototype #1 layout.

III.3.4.2. Antenna design (Rectenna #2)

For the second rectenna development, the rectifier has been co-designed with the patch antenna array. The aim of this co-design is to reduce the rectenna size. First of all, the patch antenna array has been designed, but this time I did not create a 50Ω interface, as described in Fig. III-47. The simulated input impedance of the antenna ($Z_{ant_{in}}$) has been acquired from the CST software and then this value has been imported into the ADS software in order to implement the high-efficiency rectifier considering the antenna impedance. The input matching network of the rectifier has been concatenated with the BPF stubs as can be observed in Fig. III-48. A numerical parametric assessment has been carried out in the ADS interface with the purpose of tuning the BPF stubs in order to reject harmonics.

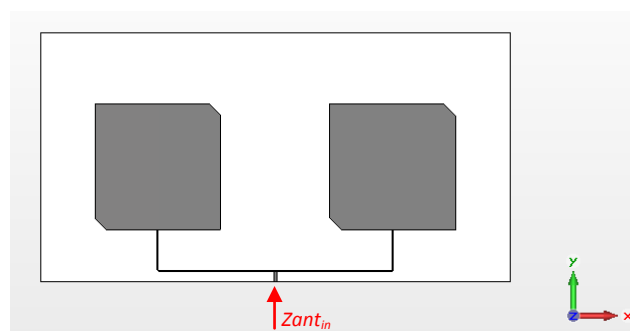

Fig. III-47. Patch antenna array, rectenna #2.

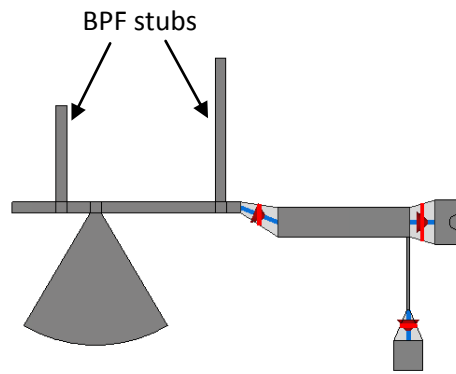

Fig. III-48. Rectifier layout with the co-existing matching network and BPF stubs.

The rectenna#2 final layout is presented in Fig. III-49, where the matching network with the BPF stubs can be observed. Since for the antenna of the rectenna #2 there is no 50Ω interface, the antenna measurements could not be done. Nevertheless, a balun could be designed in order to allow the antenna measurements.

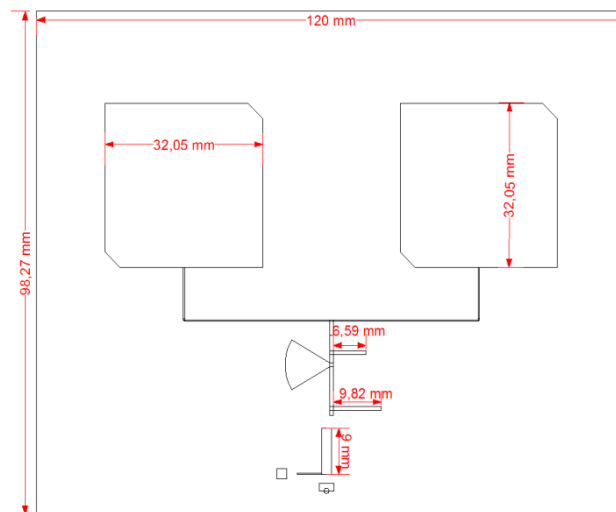

Fig. III-49. Rectenna prototype #2 layout.

III.4. Conclusion

This Chapter introduced the main antenna results obtained in this thesis. We have started with a general introduction of the antenna theory and “classical” antenna fundamentals. In the antenna fundamentals section, an important review of the field regions around the antenna has been described. This knowledge is important for the future work of our team with *rectenna* in a nearfield.

Based on the antenna specifications required by Multitoll, in the antenna design section, we have presented and defended that the microstrip antennas are attractive and versatile for different applications. Consistently, we have widely applied microstrip antennas in our developments.

Due to the special context of this thesis, i.e., at the same time practical and reliable antenna solutions for the Multitoll Company applications, as well as a research

perspective to further the State-of-the-Art on different ideas. As a result, the section on antenna design clearly contains two different applications (DSRC and Wireless Energy Harvesting antennas). This distinction has already been justified and described in Chapter II.

For the DSRC antennas design, since the OBU antenna requirements were simple, we start our development from it. A 5.8GHz patch antenna has been designed and good results have been achieved. This antenna will be integrated in the OBU device produced by Multitoll later. The second studied, fabricated and characterized antenna is the 1x3 patch array with superstrate layers. We have successfully designed this antenna that has a high gain and a small “visible surface” (constraint imposed by Multitoll). Nevertheless, an issue has been detected for the reproducibility of the antenna prototypes due to the vias connections. Therefore we have decided to use a different feeding method for the next antennas, which should be easy to fabricate in large-scale and presents a lower margin of error between the fabricated prototypes.

The third DSRC antenna developed is based on a patch antenna array with 8 elements and has a special sequential rotation feeding that allowed us to considerably improve the antenna polarization. Once the antenna PCB design established, since this antenna should be inserted in a real box with a DSRC reader, we studied and optimized the antenna considering the radome and metallic plate (for RF/electronic separation).

Both DSRC reader antennas have been tested *in-situ* settings as described in section III.3.3.2.3. In general, the detection results have been corrected. A special remark goes to the patch antenna array with 8 elements and an improved circular polarization, due the good *in-situ* results, Multitoll integrated the antenna in the DSRC system deploying this antenna in different countries and applications.

Finally, as described on Chapter IV, high-efficiency rectenna have been developed and good results have been achieved. Since *rectennas* are a combination of a rectifier and an antenna, then in this chapter we have explained the design of the antennas for both rectennas developed in this thesis.

Chapter IV - Wireless Energy Harvesting

IV.1. Introduction to Wireless Energy Harvesting

RF powered circuits have been demonstrated for more than 50 years [208], but only a few have been able to harvest energy from freely available ambient RF sources. It is important to remind that wireless energy transfer is different from wireless energy harvesting, the first one is deployed for high RF power density (e.g., dedicated source) and the second one for low RF power density (e.g., ambient energy), as described in Chapter I.

The aim in a Wireless Energy Harvesting (WEH) framework is to profit the “free” RF energy already existent in the environment around us and by means of a high-efficiency RF-DC conversion to supply low-power devices. Radiofrequency (RF) signals are deliberately radiated by broadcasting station antennas (GSM, radio, television...), but energy can also be simply radiated without license in the Industrial-Scientific-Medical (ISM) applications frequency bands [208]. Harvesting RF energy directly from the base stations could be affected by long-term fluctuations due to radio tower service schedules and human activity patterns, and by short-term variability due to fading and noise [209]-[210]. Mobile phones represent a large source of transmitters and could be used to harvest RF energy and as the number of mobile subscription will definitely continue to increase. Another way of harvesting RF energy is to use RFID for powering electronic devices [211]-[213]. Nowadays, considering the numbers of houses, buildings and even urban environments that are equipped with WiFi routers [214], one can straightforwardly imagine that wireless sensors could be powered by means of WiFi waves. In an *indoor* scenario, WiFi signals have become serious candidates for energy harvesting, since the alternative harvesting sources (solar, wind ...) are not sufficiently available and the RF broadcasting signals (TV, GSM...) are weak inside buildings. In this thesis, several rectifiers/rectenna were designed for Wireless Energy Harvesting, at 2.45 GHz, in the ISM band, that also includes WiFi routers.

In a wireless energy harvester, the amount of power available for the load depends on several factors including the source power, the distance from the source, the receive antenna gain and the conversion efficiencies, as shown in Fig. IV-1.

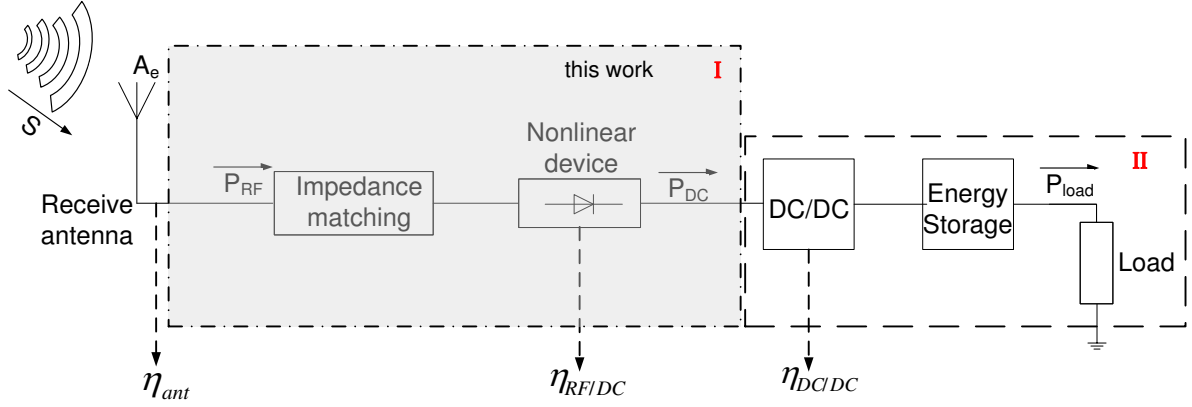

Fig. IV-1. WEH system diagram.

The available power from the receive antenna (P_{RF}) depends on the power density available (S) and on the effective aperture area of the antenna (A_e).

The RF available power is given by:

$$P_{RF} = P_T \eta_{ant} D_{ant} \frac{\lambda^2}{(4\pi d)^2} = S A_e \quad (IV-1)$$

where the power density is defined by:

$$S = \frac{P_T}{4\pi d^2} \quad (IV-2)$$

with P_T , the effective radiated power (EIRP) (in W) and d , the distance from the transmitter (in m).

Finally, the effective aperture area of the antenna is given by:

$$A_e = \eta_{ant} D_{ant} \frac{\lambda^2}{4\pi} \quad (IV-3)$$

In (IV-1), η_{ant} is the rectifier antenna efficiency, D_{ant} is the rectifier antenna directivity and λ is the wavelength (in m).

In this thesis we intend to increase the RF-DC conversion efficiency ($\eta_{RF/DC}$). The development in this work will be restrained to the rectifier design presented in the box I (dashed/dotted box), as shown in Fig. IV-1. The box II (dashed box) will be modeled as a RF load (capacitor and resistor in parallel). Subsequently, the RF-DC conversion efficiency ($\eta_{RF/DC}$) is directly proportional to the DC power (P_{DC}) at the DC load terminals, divided by the RF input power (P_{RF}), as in (IV-4). It is essential to increase the DC power in order to amplify the RF-DC efficiency.

$$\eta_{RF/DC} = \frac{P_{DC}}{P_{RF}} \quad (IV-4)$$

where P_{DC} (in W) is the following:

$$P_{DC} = \frac{V_{DC}^2}{R_l} \quad (IV-5)$$

V_{DC} defines the output voltage (in V) and R_l the load resistor (in Ω). Another definition for the DC output power is available taking into account the RF link:

$$P_{DC} = \eta_{RF/DC} S A_e = \eta_{RF/DC} \left(P_T \eta_{ant} D_{ant} \left(\frac{\lambda}{4\pi d} \right)^2 \right) \quad (IV-6)$$

The amount of power arriving at the load terminals (P_{load}) depends on the different conversion efficiencies included in a WEH description, as shown in Fig. IV-1. In (IV-7) the expression of the power at load terminals is presented.

$$P_{load} = P_T \eta_{ant} D_{ant} \left(\frac{\lambda}{4\pi d} \right)^2 \eta_{RF/DC} \eta_{DC/DC} \quad (IV-7)$$

Depending on the type of the antenna chosen, the efficiency (η_{ant}) may vary from 20% (monopole) to 95% (horn antennas [215]) or 97% (UWB monopole antenna [216]). The DC-DC converter bloc is used to adapt the rectified voltage to a rechargeable battery voltage. A minimum input voltage is required by the DC-DC converter to produce the preset output voltage. In previous studies, several DC-DC converters were reported, e.g., in [217] a 25% DC-DC conversion efficiency was achieved; in [218] a discrete buck-boost converter with an efficiency of 69% is described; and more recently, a DC-DC peak of 72% was reported in [219].

To improve the DC output power one needs to look up for the RF-DC conversion efficiency, to have an important power density available around the WEH device and the WEH's antenna should have a gain as high as physically possible.

For RF-DC conversion efficiency, several research groups have presented different results, quite a few papers introduce high-efficiency rectifiers results, but hardly any elucidate in detail how to achieve high efficiency levels with a single diode and a simple load, as presented in the State-of-the-Art Chapter I (I.1.4.4.2).

The first rectenna (RECTifier + anTENNA) to be designed using a full-wave electromagnetic simulator dates from a few years ago, 1998, [220]. Preceding rectenna devices have been developed using transmission-line models, Touchstone, and others [221] - [222].

Different papers have taken as factor of merit for the WEH design the output voltage (V_{DC}) parameter, [222]-[223]. We believe that this assumption is not really accurate, i.e., the output voltage depends on the load resistor used in the WEH device. It is obvious that we can increase the output voltage by changing the load resistor value and moreover, a high output voltage does not mean the maximum DC power conversion is reached. In our approach, the factor of merit for WEH design is the RF-DC conversion efficiency as defined in (IV-4). We have chosen this parameter as figure of merit to clarify and to standardize the efficiency definitions for various practical applications of RF energy harvesting.

Another important point to smooth the progress of comparison of different energy harvesting sources (solar, thermal, mechanical,..) is the normalization of the recovered power as a function of the available power density, as shown in the Chapter I , i.e., with units of $\mu\text{W}/\text{cm}^2$ or $\mu\text{W}/\text{cm}^3$.

The key component for the RF to DC conversion is the diode, which will be presented in the next section.

IV.2. Zero-bias Schottky Diode modeling

Since nearly the beginning, the Schottky diode has been used to RF/microwave mixing and rectifying circuits. However, for the specific harvesting applications using μW power, obtaining a satisfying RF-DC conversion efficiency is restricted by physical limitations of the diode. A recently good review of low-power microwave-to-dc energy conversion techniques [224], points out the limitations imposed due to diode's high zero-bias junction resistance. The Schottky diode is the principal element of a WEH device, therefore it is important to provide a correct model. Zero-bias diodes are necessary because they have relatively low barrier (high saturation current), which compared to externally biased detector diodes, results in a higher output voltage for low power input levels. The equivalent electrical circuit of a Schottky diode is shown Fig. IV-2.

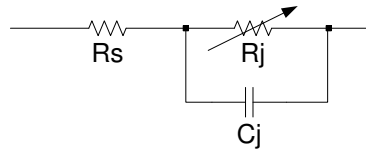

Fig. IV-2. Equivalent circuit of a Schottky diode.

with C_j the junction capacitance (diode voltage dependent) (in Farad), R_s the bulk series resistance (in Ω) and R_j the junction resistance of the diode (in Ω).

In order to obtain the maximum output, all the incoming RF voltage should ideally appear across R_j with no losses over R_s , so for low-power applications we are interested to choose a diode with the smallest series resistance value. The intrinsic diode is modeled as a varistor element that obeys the i-v law, as described in [225]:

$$i = I_s \left[\exp\left(\frac{1}{n} \Lambda v\right) - 1 \right] \quad (\text{IV-8})$$

where I_s is the diode's saturation current and $\Lambda = q/(\kappa T)$ is the reciprocal of the thermal voltage, q is the electronic charge, κ is Boltzmann's constant, T is the physical temperature in Kelvins, and n is the diode ideality factor (emission coefficient).

Therefore the saturation current I_s is given by:

$$I_s(T) = I_s(T_0) \left(\frac{T}{T_0}\right)^{2/n} \exp\left[-\frac{q\psi_{ms}}{k} \left(\frac{1}{T} - \frac{1}{T_0}\right)\right] \quad (\text{IV-9})$$

where T_0 is a reference temperature. The quantity ψ_{ms} is the metal-semiconductor Schottky barrier height (energy gap) at T_0 (e.g., 0.85 eV for Al on GaAs).

The Schottky diodes can be organized in two main classes. The first class consists in a n-type silicon with a high-barrier and low values of series resistance (e.g., mixer applications and detectors where DC bias is available). The second class consists in p-type silicon and is characterized by low barrier and high R_s (e.g., square law detector applications where load resistance is high and DC bias is not available). For WEH applications we are interested to use the second class (p-type diode). Although we have a high series resistance, the higher saturation current of the p-type diode results in a higher output voltage at low power levels compared to a n-type (100 times), as shown in [226].

In Fig. IV-3, the simulated output voltage for two commercial Schottky diodes is presented: HSMS-285X (p-type) and HSMS-8205 (n-type). The diodes are loaded by a 1k Ω load resistor.

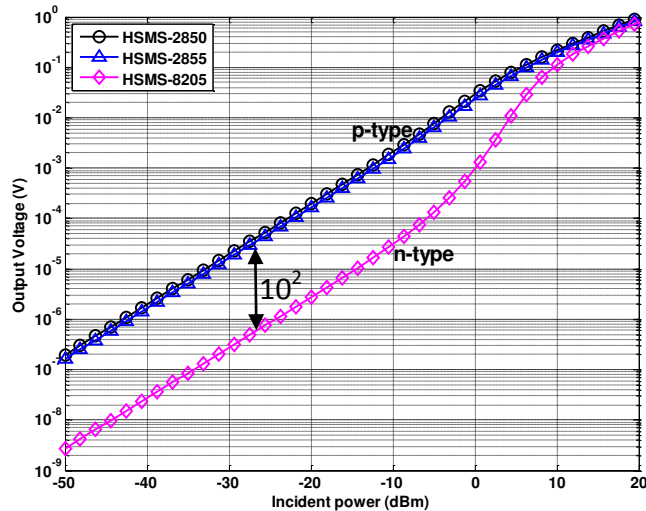

Fig. IV-3. Calculated output voltage as a function of available input power for three commercially available Schottky diodes: Avago HSMS-285X (p-type) and HSMS-8205 (n-type). Diode loaded by a 1k Ω load.

In Fig. IV-3, different voltage profiles can be observed between high and low power levels. In [225] it was demonstrated that diode detectors exhibit true square-law behavior at low power levels, and that at higher power levels there is a gradual change to a linear (peak-detecting) law. From Fig. IV-3 we can also notice that for low incident power applications, e.g., WEH, the p-type Schottky diode is recommended since it provides a higher output voltage when compared to the n-type (10²x).

From (IV-8), the value of R_j of the diode decreases due to the value of circulating current I_b , i.e., the diode impedance being dependent of the RF input power. The junction capacitance has a large impact ahead the output voltage at high frequencies and when the series resistance has high values. The impact of the series resistance on the output DC voltage has been described in [226]. A simple multiplier parameter for the output voltage has been defined (IV-10) related to the 3 components of the equivalent electrical circuit of

a Schottky diode (Fig. IV-2). If the series resistance increases the output voltage is strongly reduced by the multiplier M .

$$M = \frac{1}{1 + \omega^2 C_j^2 R_s R_j} \quad (\text{IV-10})$$

where ω is the angular frequency (in rd/s).

Depending on the final application, the output voltage will be the primary goal of the harvester design. Nevertheless, the RF-DC conversion efficiency explicitly describes how powerful the rectifier is. A compromise should be obtained between a high-efficiency value and a specific output voltage required for a RF energy harvester.

In Fig. IV-4, two typical harvester configurations are presented, a single diode and a voltage doubler. Obviously the voltage doubler provides a higher output than the single diode; however the RF-DC conversion efficiency is lower, as widely demonstrated in the literature [227]-[228]. The doubler puts the Schottky diodes in parallel with respect to the input RF signal, thus lowering the input impedance and reducing the complexity of the impedance matching network.

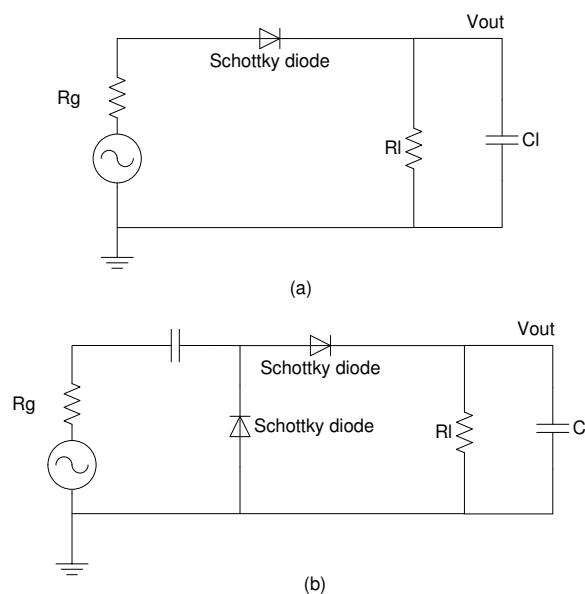

Fig. IV-4. Harvester configurations: (a) single diode, (b) voltage doubler/double diode.

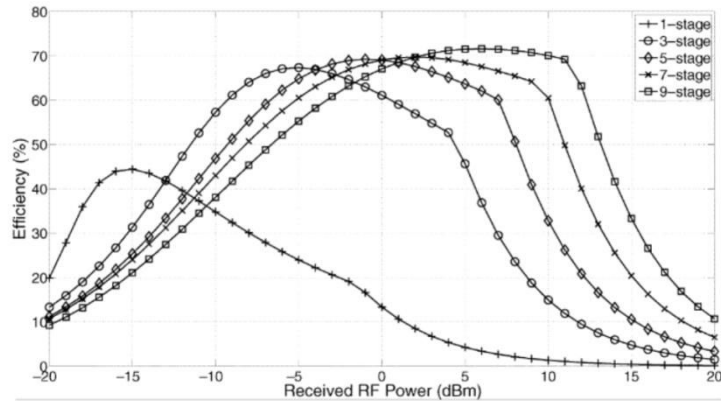

Fig. IV-5. Measured effect of number of stages on the efficiency of energy harvesting Circuit (with HSMS-2852 diodes) [228].

As shown in Fig. IV-5, a single diode converter reaches only 45% of efficiency but it is for the smallest RF power (around -15dBm). This low input power is the main constraint for a WEH converter.

As described before, the diode junction type can be determinant on a WEH device, the HSMS-285X (2850 and 2855) is p-type silicon and the HSMS-8205 is a n-type silicon. For low incident power an important difference on the output voltage can be noticed between both silicon types; the p-type diode presents a higher output voltage for low incident power, when compared to the n-type diode. Moreover, with a single diode, a high efficiency can be reached for low RF input power.

- **Analytical and numerical analysis**

Due to nonlinear behavior it is not trivial to predict a correct model of a Schottky diode. When modeling, one should take into account the presence of the harmonics and the diode input impedance variation as a function of the input power. In general, we need a numerical support to obtain an accurate result.

In Fig. IV-6, the calculated input impedance values for three commercially available Schottky diodes are presented as a function of incident input power. Diodes analyzed: Avago HSMS-2850, HSMS-2855 and HSMS-8205. The diodes are loaded by a short-circuit.

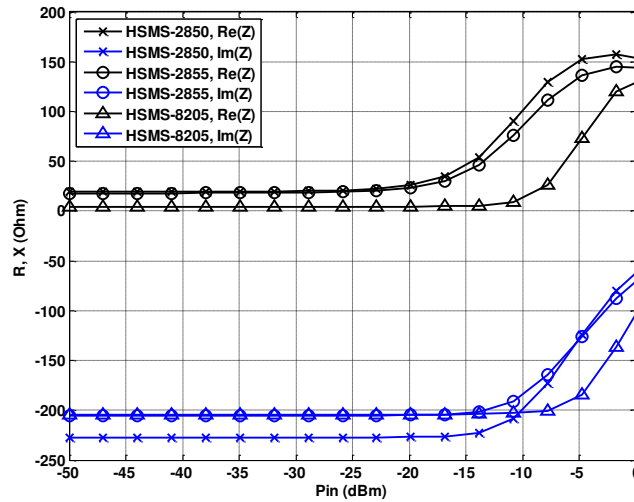

Fig. IV-6. Calculated input impedance values as a function of incident input power for three commercially available Schottky diodes.

In Fig. IV-6, it is important to notice that for low power levels ($< -25\text{dBm}$) the input impedance remains almost constant for all the diodes. From an incident power greater than -25dBm , the input impedance of the HSMS-285X diodes starts to change, because these diodes have been designed and optimized to be used for small signal applications, differently of the HSMS-8205.

- **Schottky diode choice:**

For the all the WEH prototypes developed in this thesis, we employed the AGILENT HSMS-285X zero-bias Schottky p-type detector diode. The diode has a low built-in voltage of 0.35V , a breakdown voltage of 3.8V , a series resistance of 25Ω and a zero-bias junction capacitance of 0.18pF . Its packaging is a surface Mount SOT-23.

First of all a numerical diode model proposed by ADS (Advanced Design System) software was studied and its performances were validated with the S parameter measurements. Initially, I have simulated the HSMS-2855 Schottky diode in ADS software loaded by a 50Ω port for small signal, as shown in Fig. IV-7.

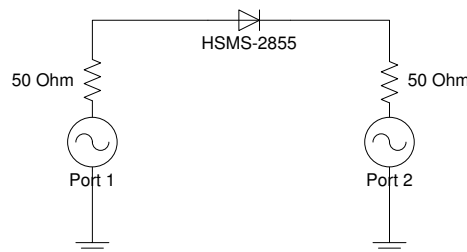

Fig. IV-7. Circuit diagram for the S parameter simulation of the Schottky diode.

I designed and fabricated the DUT (Device Under Test) circuit board for the diodes in series (as described in Fig. IV-7) and the calibration standards circuits (Thru-Reflect-Line), as shown in Fig. IV-8.

Next, I performed the measurement of the S parameters of the diode with the VNA (Vector Network Analyzer HP/AGILENT 8510C). A TRL calibration method (previously described by [229]) has been used to suppress the influence of the access lines.



Fig. IV-8. Picture of the TRL measurement platform with the calibration standards.

Fig. IV-9 shows the measured and simulated S parameters results of the Schottky diode HSMS-2855.

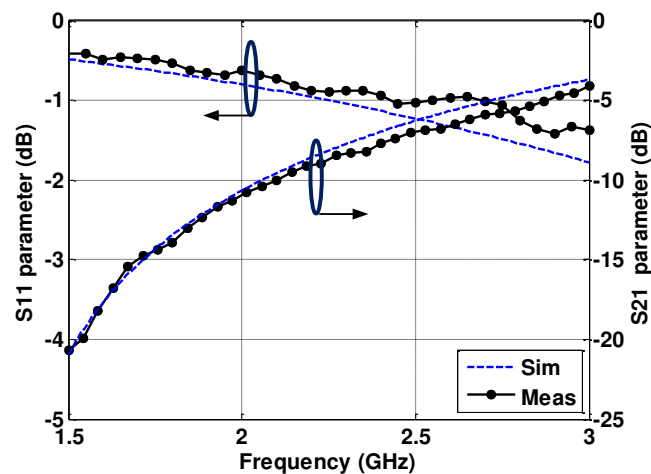

Fig. IV-9. Measured and simulated S parameters results of the AGILENT HSMS-2855 Schottky diode.

The measured and simulated results are in good agreement between 1.5 and 2.5 GHz (around 3 GHz, the value of S_{11} shows a difference of ~ 0.2 dB). We consider that the numerical model of the diode proposed by AGILENT is correct for small signal analysis. An important signal reflexion can be observed in the measurements presented in Fig. IV-9. This is acceptable since there is no impedance matching network in this measurement setup. Given that the HSMS-2855 measurements results are in agreement with the ADS model, we assume that the ADS model for the second diode HSMS-2850 is also correct, as they are part of the same diode series (285X).

For all WEH prototypes developed in this chapter, we consider an operating frequency of 2.45 GHz, which is included in the ISM band, and we decided to use a single diode configuration since we are looking for high RF-DC conversion efficiency. For this frequency, the Federal Communications Commission (FCC) specifies a transmitted power of 1W with up to 6dB antenna gain.

As the diode is not a linear device, when the RF signal reaches the diode, harmonic signals will be generated and as a result this energy could be lost on the DC load or irradiated by the antenna.

The diode impedance should be observed taking into account the RF input power variation. Fig. IV-10 shows the range of the input diode impedance for the fundamental RF signal (f_0), 2nd ($2f_0$) and 3rd ($3f_0$) harmonics from -30dBm to +10dBm input RF power. A color gradient was used to indicate the input power variation; blue corresponds to low input power and red to high input power. The magnitude of the diode impedance decreases with the increasing incident power. The black marker * in Fig. IV-10 corresponds to the diode impedance Z_D for a RF input power of 0dBm; the impedance values (in Ω) are: $Z_D(f_0)=143-j68$, $Z_D(2f_0)=68-j41$ and $Z_D(3f_0)=49+j3.6$ (j is the complex number which corresponds to $j^2 = -1$).

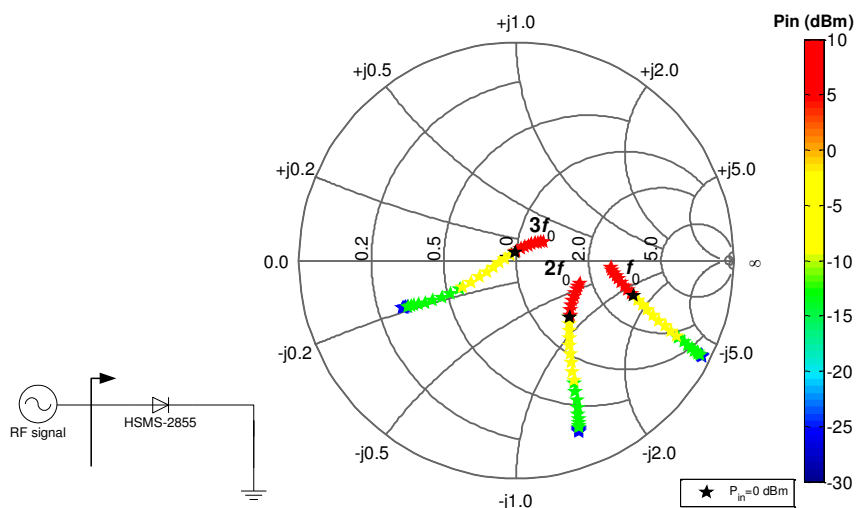

Fig. IV-10. Simulated range of the input diode impedance for the fundamental RF signal (f_0), 2nd ($2f_0$) and 3rd ($3f_0$) harmonics from a -30dBm to +10dBm input RF power. Schottky diode AGILENT HSMS-2855.

IV.3. Analysis of the optimum load impedance to improve the RF-DC conversion efficiency

In the simple case of a detector diode it is possible to show that in the frequency domain the result of a RF signal f_0 passage leads to a continuous (DC) signal, a $2f_0$ signal and other harmonics. The conversion efficiency is maximally 25% accounting for the insertion loss of the diode for a RF input power of 0 dBm, as presented in [226].

To confirm harmonics generation, I have simulated a simple circuit with a diode and a 50 Ω load connected in series (as shown in Fig. IV-11). The RF input power was 0dBm and we have assumed that there is no reflection loss. On DC and on the second harmonic $2f_0$, the difference in the power generated is around -18dBm when compared to the fundamental frequency peak. The DC power conversion is low in these conditions. Moreover, after the RF-DC conversion, considerable power still remains in the fundamental and in the second harmonic $2f_0$, as shown in Fig. IV-11. In a common WEH

circuit this energy would be generally lost: dissipated on the load and in circuit losses or radiated by the antenna.

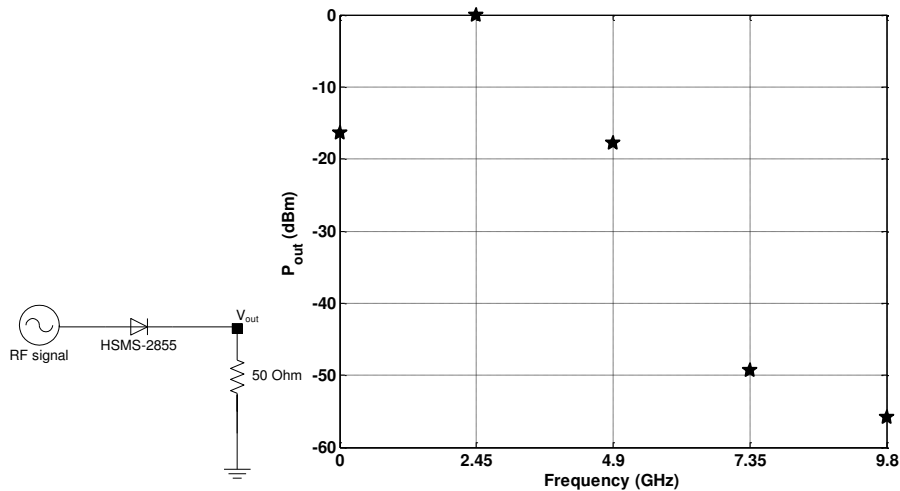

Fig. IV-11. Spectrum of a RF-DC conversion, with Schottky diode excited by a RF signal at 2.45 GHz. As a result of the diode non-linear behavior, a continuous (DC), a second $2f_0$ and the others high harmonics are generated. The amplitudes are normalized with respect to the RF input power value, 0dBm.

To increase the RF-DC conversion efficiency by using a simple Schottky diode, it is necessary to exploit the energy in the fundamental, boosting the DC output power. We can make the analogy of placing a mirror after the diode; this affects the RF signals ($f_0, 2f_0, \dots$) in a particular manner for each frequency, as shown in Fig. IV-12.

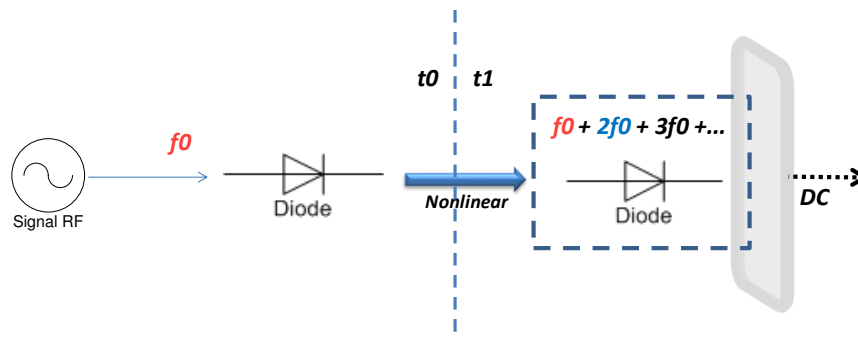

Fig. IV-12. The analogy of placing a mirror in front of the diode; this affects the RF signals ($f_0, 2f_0, etc$) in a particular manner for each frequency, increasing the RF-DC conversion efficiency.

This RF mirror is technically implemented by an optimum load. We have evaluated different load cases, in order to prove that to increase the RF-DC conversion efficiency, an important impedance matching between the Schottky diode and the load is required. Furthermore, the fundamental and second harmonic frequencies have been taken into account.

We have developed an original measurement setup, where different values of the load impedance (capacitive or inductive) were presented at the output terminal of a Schottky diode. This measurement setup consisted in injecting a RF signal on the Schottky diode, varying the RF load impedance, and then acquiring the output voltage to compute the RF-

DC conversion efficiency values for each impedance load. The measurement setup is presented in Fig. IV-13. The RF load impedance variation was implemented with a Computer Controlled Microwave Tuner (CCMT, made by Focus Microwave Corp.). This equipment is able to perform microwave measurements under programmable impedance conditions. The CCMT is an electromechanical instrument that allows precise position of probes in a slotted transmission line, in order to generate repeatable complex microwave reflection factors.

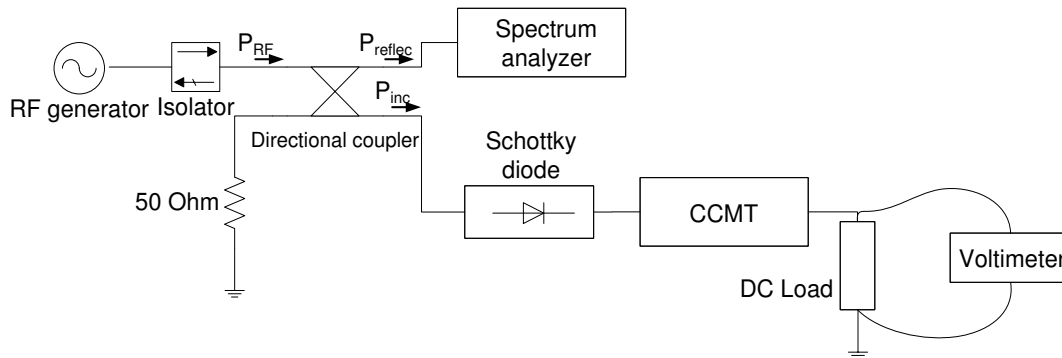

Fig. IV-13. Measurement setup of rectifier circuit with the RF load impedance controlled by a CCMT.

A picture of the measurement setup is presented in Fig. IV-14. The generator that I have used is the Synthesized Signal Generator ANRITSU 68367C and the output voltage has been measured by means of the Digital Multimeter KEITHLEY 2000E. A directional coupler was used to pass on the incident RF power (P_{inc}) to the diode and also to acquire the reflected RF power (P_{reflec}) from the rectifier. We have designed a printed circuit board (PCB) to insert the diode (Fig. IV-15(b)) and two quarter-wavelength microstrip lines provided the access to the diode terminals and facilitated the impedance transformation calculus. The frequency of the RF signal is 2.45GHz. The setup was calibrated in order to supply an incident RF power around 0dBm on the diode anode. The DC load consisted in a resistor (1k Ω) connected in parallel with a capacitor (10pF), as shown in (Fig. IV-15(a)). The Schottky diode is an AGILENT HSMS-2855.

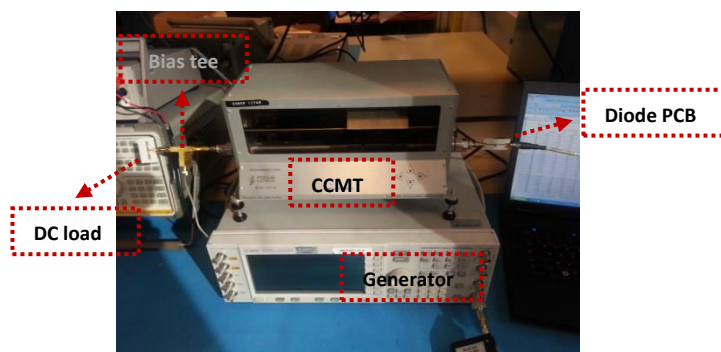

Fig. IV-14. Measurement setup of the rectifier circuit with the RF load impedance controlled by a CCMT.



Fig. IV-15. Zoom of the measurement setup: (a) DC load and Bias Tee, (b) diode PCB with two quarter-wavelength microstrip lines

The first part of our measurements analysis consisted in determining the RF-DC conversion efficiency for different load impedance values. Fig. IV-16 shows the measurement results of the RF-DC conversion efficiency for a Schottky diode loaded with different RF load impedance values. From the output voltage measurements, the RF-DC efficiency was computed for a RF input signal of 0dBm, using (IV-4) and (IV-5). The maximum RF-DC efficiency ($\eta_{RF/DC \max}$) measured in these conditions is approximately 25%. This low value is due to the measurement setup losses, particularly to the CCMT losses.

For the full understanding of the problem, efficiency values were normalized with respect to the maximum measured efficiency value ($\eta_{RF/DC \max}$), since the aim of this measurement is not to achieve a high RF-DC value, but identify the optimum load impedances which improve the RF-DC conversion.

On the Smith chart in Fig. IV-16, four regions are detectable: east side (blue color) where the load impedance values represent a low RF-DC conversion efficiency (<25% of $\eta_{RF/DC \max}$), middle and south/southwest (green color) region where the RF-DC efficiency varies from 25% to 50% of $\eta_{RF/DC \max}$. A small part of the northwest region (yellow color), shows RF-DC efficiency values between 50% and 75%. Finally, a particular part of the north region (red color), illustrates a RF-DC efficiency around the maximum value (>75% of $\eta_{RF/DC \max}$).

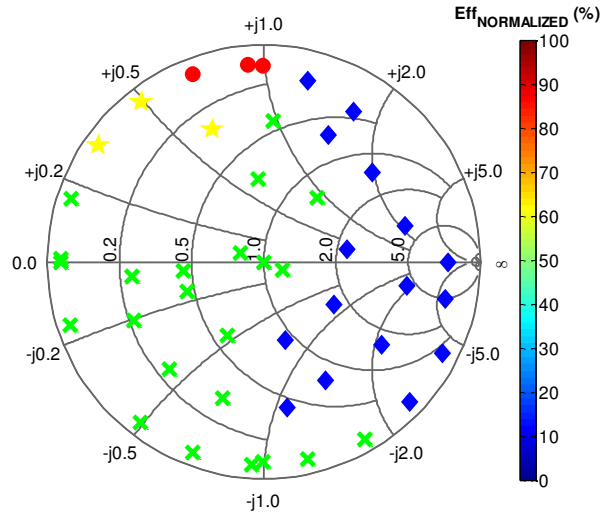

Fig. IV-16. Measurement results of the RF-DC conversion efficiency for a Schottky diode loaded by different RF load impedance values and controlled by a CCMT. The efficiency values were normalized with respect to the maximum efficiency value measured. Operating frequency 2.45 GHz.

It is important to notice that on certain borderlines of the regions, a slight shift in the RF load impedance can change considerably the RF-DC conversion efficiency (e.g., north region red/blue border). The observed strong sensibility will be elucidated in the next sections (rectifiers design).

A second part of the measurement analysis (Fig. IV-13), consisted in discriminating the reflected RF power (f_0 , $2f_0$, $3f_0$) and the DC power level on the DC load terminals for several load impedances. The reflected RF signals were measured directly on the spectrum analyzer due to the directional coupler and the DC power was calculated, (IV-4) and (IV-5), from the output voltage measured on the resistor terminals. The spectrum analyzer I used is the ANRITSU MS2668C.

Fig. IV-17 shows the specific impedance values chosen to be analyzed in more detail at the fundamental frequency (f_0): Z_a and Z_b are near to the optimal efficiency region. These impedances have approximately the same imaginary part (inductive), the real part only being different; Z_c represents a short-circuit, Z_d characterize an open-circuit, Z_e is a 50Ω impedance and finally Z_f is a capacitive impedance.

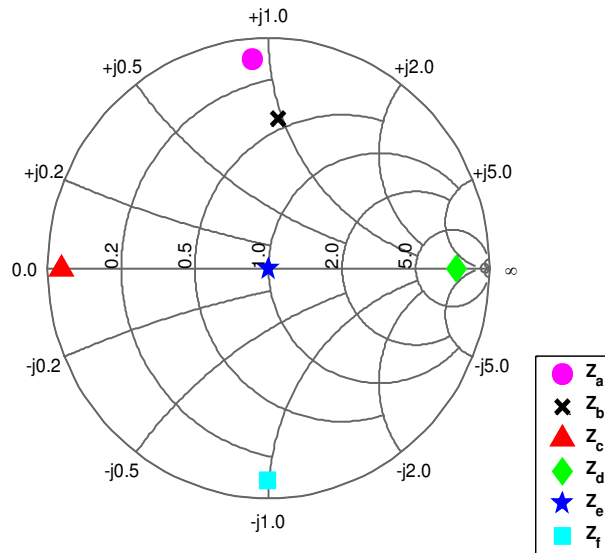

Fig. IV-17. Impedance values chosen to be studied at the fundamental frequency (f_0): Z_a and Z_b have approximately the same imaginary part (inductive), only the real part being different; Z_c represents a short-circuit, Z_d characterizes an open-circuit, Z_e is a 50Ω impedance and finally Z_f is a capacitive impedance.

Fig. IV-18 presents the results of the measurement of the RF reflected power (f_0 , $2f_0$, $3f_0$) and the DC power for the load impedance values reported in Fig. IV-17, taking into accounts the RF-DC conversion efficiency for each case. The different power values P_i (Y-axis) are normalized with respect to the RF input signal (0dBm), since this is the RF power value at the diode input.

For the Z_d case, practically all the f_0 signal (P_{reflec,f_0}) is reflected, just a low DC signal being generated (P_{DC}). Z_f is a capacitive load and has approximately the same imaginary part as the impedance of the Schottky diode (for a RF input power of 0dBm), the reflected power of the $2f_0$ harmonic signal is reduced, and consequently the DC power is increased. For the Z_e case, a 50Ω impedance, the impedance matching affects the f_0 reflected signal, the RF reflected signal is reduced and as a result, the DC power is increased.

Finally, Z_b and Z_a are two impedances, with different real parts, but the same imaginary part. Therefore, an increase in the RF-DC efficiency is induced as a result of the DC power amplification. The Z_a impedance (lower real part) provides the maximum RF-DC conversion efficiency.

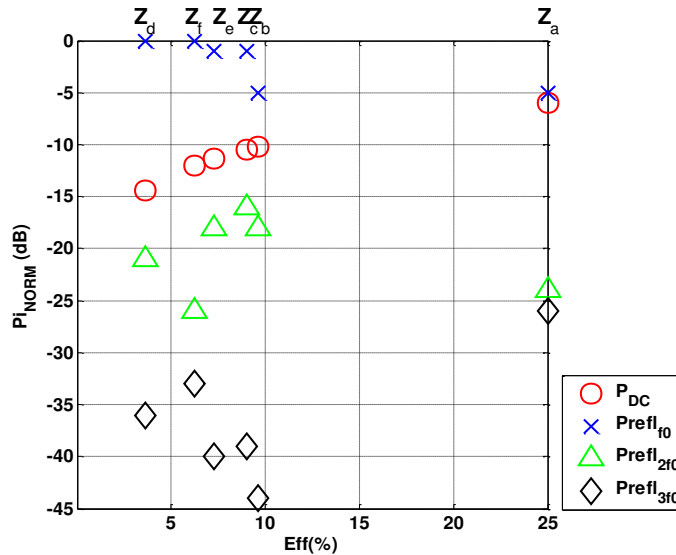

Fig. IV-18. Measurement results of the RF reflected power (f_0 , $2f_0$, $3f_0$) and the DC power for different load impedance values, taking into account the RF-DC conversion efficiency for different load impedance values. The results should be interpreted on columns, for each impedance four measure points are shown.

From Fig. IV-16, the RF-DC conversion efficiency is maximal in a particular region. In Fig. IV-18 the optimum load is presented as a function of the DC power and the reflected power. In order to better understand the correlation between the optimal impedance value and maximum RF-DC conversion efficiency, two case studies were investigated:

- 1) **Case study 1:** *The impedance matching between the diode and the RF load.* The imaginary part of the RF load impedance in the red region (Fig. IV-16) is approximately the opposite of imaginary part of the diode impedance (Z_D) for a RF input power of 0dBm (Fig. IV-10). It seems that the diode impedance is matched by the symmetric imaginary part of the RF load impedance, thus the RF-DC maximum peak appears. In order to detail and verify in-depth this case, three prototypes were developed: rectifier prototypes #1, #2 and #3 (subtopic: IV.5.1).
- 2) **Case study 2:** *The electrical delay created by the RF load for f_0 frequency (and perhaps for the harmonic $2f_0$) could be the origin of the high-efficiency conversion by an optimal diode voltage recombination.* In Fig. IV-16, for the highly efficient RF-DC load (red region), the phase delay created by the RF load for the fundamental signal f_0 is around 45° for one-way propagation and consequently, the f_0 signal will be reflected into the diode terminals with a 90° delay. For the second harmonic ($2f_0$), the optimal RF load is seen as an open-circuit, thus an important amount of the energy of the $2f_0$ will be completely reflected into the diode. For further detailing and investigation of this case, two prototypes were developed: rectifier prototype #4 and #5 (subtopic: IV.5.1).

IV.4. Microstrip line

First described in 1952 [230]-[231], a microstrip line is a wide-band transmission system in which the electro-magnetic waves are propagated through a dielectric medium bonded by a strip conductor on one side and a conducting ground plane on the other side. Using microstrip line, the manufacture of microwave plumbing reduces to a printed circuit technique, susceptible of great accuracy, adaptable to mass production and resulting in great savings in cost, space and weight.

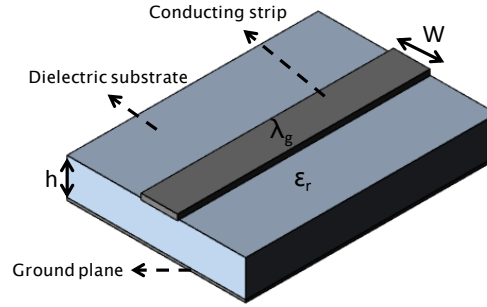

Fig. IV-19. Microstrip line schema.

Since the wave propagation inside the substrate is different from the air, the effective dielectric constant (ϵ_{eff}) should be calculated as follows:

$$\epsilon_{eff} = \frac{\epsilon_r + 1}{2} + \frac{\epsilon_r - 1}{2} \frac{1}{\sqrt{1 + 10 \left(\frac{h}{W}\right)}} \quad (IV-11)$$

where ϵ_r is the substrate dielectric constant, h is the substrate height and W the microstrip line width. Eq. (IV-11) is valid if and only if $\frac{W}{h} \leq 1$.

The characteristic impedance (Z_c) can be computed as follows:

$$Z_c = \frac{60}{\sqrt{\epsilon_{eff}}} \ln \left(\frac{8h}{W} + \frac{W}{4h} \right) \quad (IV-12)$$

Now, if we consider that the microstrip line is loaded by the impedance Z_l and we assume that the microstrip line has only few losses, a good approximation of the input impedance can be calculated by the famous following equation [230]:

$$Z_{in} = Z_c \left(\frac{Z_l + jZ_c \tan(\beta \cdot L)}{Z_c + jZ_l \tan(\beta \cdot L)} \right) \quad (IV-13)$$

with β , the propagation constant and L the length of the physical line.

The propagation constant is defined as:

$$\beta = \frac{2\pi}{\lambda_g} \quad (IV-14)$$

where λ_g is the wavelength inside the transmission line and is given by:

$$\lambda_g = \frac{\lambda_0}{\sqrt{\epsilon_{eff}}} \quad (IV-15)$$

IV.5. WEH device design

In the previous section, two possibilities were evoked to be the underlying reasons to improve the RF-DC conversion efficiency in WEH design. In this section we will test these two concepts by designing different prototypes, in order to verify which assumption is correct.

Five RF-DC prototypes have been designed, each one with particular specifications described in section IV.5.1. Among these rectifiers, the one with the best measured performance was chosen to be integrated to an antenna, thus becoming a *rectenna* (section IV.5.2). For all the WEH devices developed in this thesis, the Schottky diodes used are from the same series AVAGO-HSMS-285X (2850 and 2855), i.e., they have same electrical characteristics, but different packages.

The rectifiers have been designed and optimized using the "Harmonic Balance" (HB) method of AGILENT ADS software, a frequency-domain simulator developed to account for the nonlinear effects of the diode.

The substrate employed is the ROGERS 4003 ($\epsilon_r=3.55$ and $\tan(\delta)=0.0027$) with a thickness of 0.813 mm.

IV.5.1. Design of rectifiers

The first rectifier prototype (#1) has been optimized in order to present for the output diode terminal a particular load, its imaginary part cancelling out the diode imaginary part for a 0dBm RF input power.

The second rectifier prototype (#2) has been designed using the same criteria as the prototype #1, but the RF input power target was of -15dBm.

For the third rectifier prototype (#3), a different impedance matching process has been applied. Nevertheless the objective was the same as for the previous prototypes, that is, to cancel the imaginary part of the diode impedance, but at the input of the diode. The RF input power target was of -15dBm.

The fourth rectifier prototype (#4) has been implemented to reach a particular electrical delay for f_0 frequency (and an open-circuit for the $2f_0$ frequency) by means of a new load design. The RF input power target was of -15dBm.

Finally, the last rectifier prototype (#5) is quite similar to the rectifier #4 with a slight modification in the width (W) of the microstrip line of the load.

IV.5.1.1. Rectifier prototype #1

First of all, we need to recover the simulated input impedance of the diode. From Fig. IV-10, we have $Z_D(f_0)=(143-j68) \Omega$ for a 0dBm RF input power. For the first case study, the imaginary part of the load impedance must cancel the impedance of the diode (Z_D).

The load impedance consists in a microstrip line and a DC load (capacitor in parallel with a resistor). We have chosen a capacitor of 10nF, i.e., seen as a short-circuit at 2.45GHz. Thus we need to add a microstrip line of a length that compensates the imaginary part of the diode impedance. The resistor value does not affect the RF power, because it is short-circuited by the capacitor. Its optimization will be detailed later.

To have at the input of the microstrip line (loaded by a capacitor) an imaginary part equal to a $Z_{in} = j68 \Omega$, the dimensions of the microstrip load line are: length $L=9.23$ mm and width $W=1.24$ mm. Consequently, the effective dielectric constant is equal to 2.694 and the input impedance (microstrip only) is 62Ω .

Fig. IV-20 shows the load impedance (Z_{Load}) for the fundamental RF signal (f_0), and harmonics $2f_0$, $3f_0$, $4f_0$. For the fundamental f_0 , the imaginary part of the load impedance (Z_{Load}) is the symmetric of the imaginary part of $Z_{D(f_0)}$, for the $2f_0$ harmonic the load is considered as an open circuit, for the $3f_0$ harmonic the impedance load has a capacitive behavior and the $4f_0$ harmonic is a short-circuit. Moreover, the load impedance is closer to the region (northern red colored) having the highest RF-DC efficiency (Fig. IV-16).

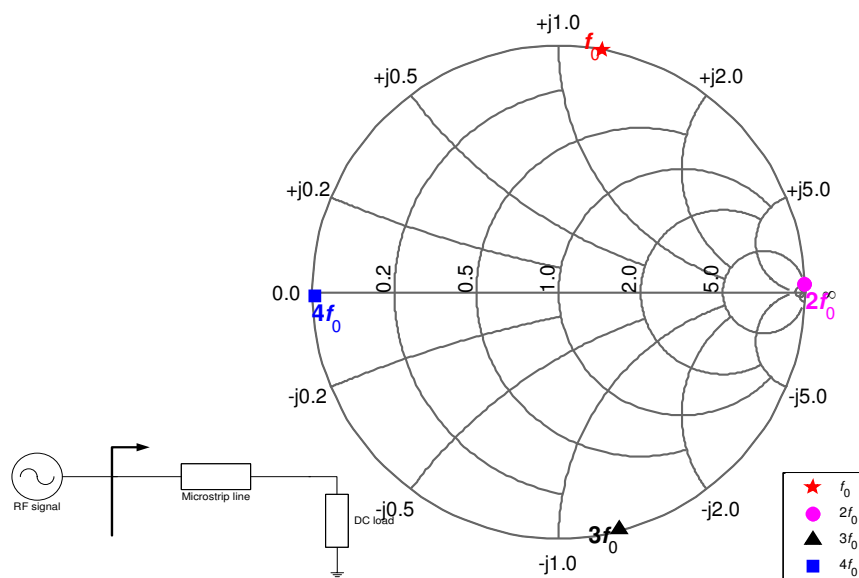

Fig. IV-20: Simulated range of the load impedance (Z_{Load}) for the fundamental RF signal (f_0), harmonics $2f_0$, $3f_0$ and $4f_0$.

A matching network has been implemented, at the input of the diode, in order to guarantee a 50Ω matching. In the circuit input, I have conceived a low-pass filter in order to reflect the harmonics into the diode. For this first prototype, we have decided to design the matching network separately from the filter, in order to analyze the importance of each block independently. For this purpose, Fig. IV-21 shows the RF-DC efficiency for each block combination of this rectifier #1. Each curve is designed by connecting block by block in order to have the complete system.

Combination 1 (named “Di+Lo”) has no impedance matching between the diode and the load, the diode directly connected to a simple DC load (resistor and capacitor), and the efficiency is very low 9% @ 0dBm, as presented in Fig. IV-21 – combination 1.

When the diode is combined with a matching network at the input and the DC load (combination 2 named “Mn+Di+Lo”), a RF-DC efficiency of 47% is achieved, since there is more RF power arriving at the diode input.

For combination 3 (named “Mn+Di+MI+Lo”) an optimized RF load is added, i.e., the imaginary part of $Z_{D(f)}$ is cancelled out. In this case the efficiency increases to 67% @ 0dBm RF input power.

In combination 4 (named “Fi+Mn+Di+MI+Lo”), a low-pass filter is added at the input and we reach an efficiency of 68%.

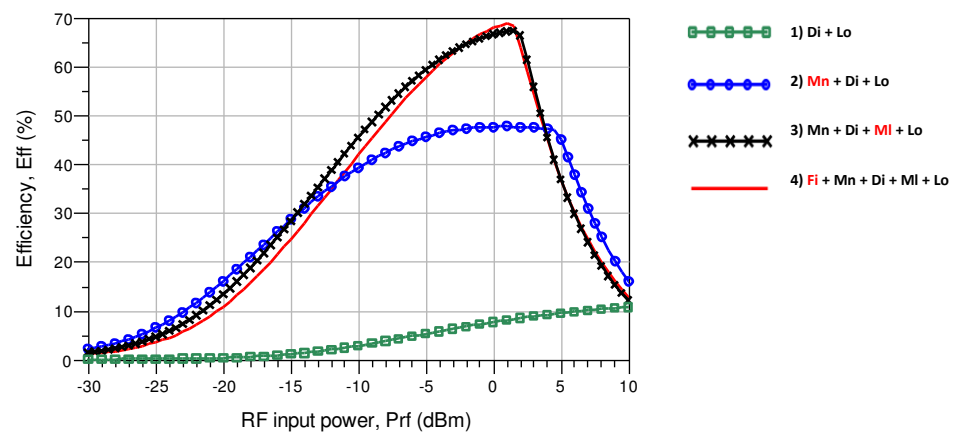

Fig. IV-21. Efficiency by adding block by block in the rectifier #1. *Di= diode, Lo=load, Mn=Matching network, MI=Microstrip line, Fi=filter.

To emphasize the importance of a correct impedance matching between the diode and the load and the sensibility of the RF-DC conversion efficiency with respect to this parameter, I have varied the microstrip line length, i.e., the imaginary part of the microstrip line impedance. Fig. IV-22 shows how the RF-DC efficiency changes with the microstrip line length. A significant sensibility of the RF-DC conversion efficiency value is noticed as a function of the RF load impedance and is confirmed by results shown in Fig. IV-16.

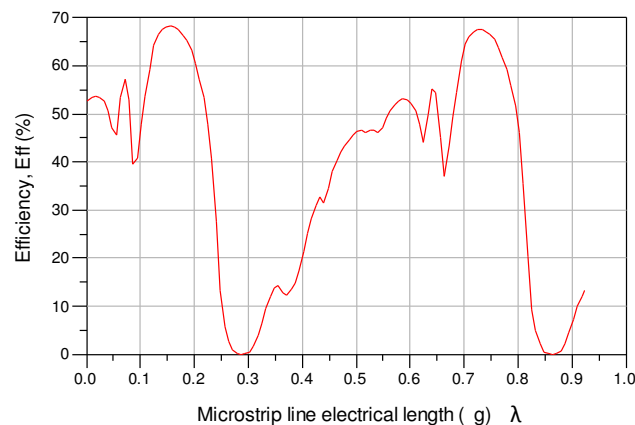

Fig. IV-22. RF-DC conversion efficiency versus the microstrip line length.

Furthermore, to find the optimal load we have investigated the impact of the resistor on the RF-DC conversion efficiency for the prototype #1. Fig. IV-23 shows the RF-DC conversion efficiency versus the RF input power for various DC loadings. The best efficiency, i.e., 70% occurs at a 1.8k Ω loading for 1dBm RF input power (and 68% @ 0dBm). The efficiency gradually decreases as the load resistance increases.

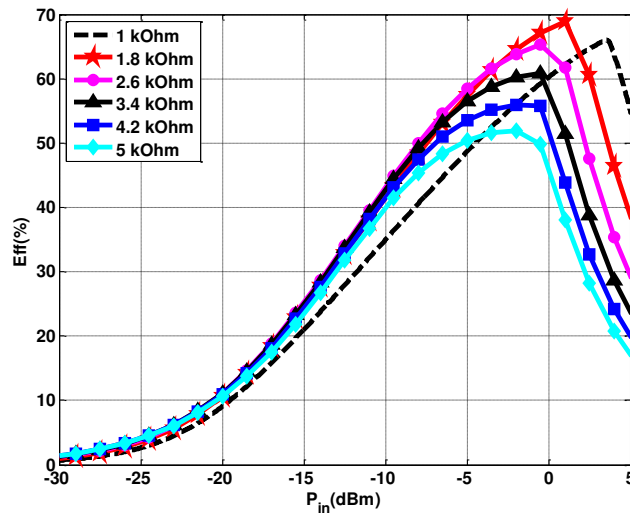

Fig. IV-23. Simulated conversion efficiencies of the rectifier #1 for various DC loadings.

Fig. IV-24 presents the final circuit diagram of the rectifier prototype #1, taking into account all the blocks previously described. The simulated optimal RF-DC efficiency and the output DC voltage of the rectifier are 68% and 1.2V, respectively, for a RF input power of 0dBm. I have fabricated and then characterized the prototype. A picture of the rectifier #1 is presented in Fig. IV-25. A hand-made inductance (RF block) is added at DC load terminals, in order to avoid possible mismatching from the multimeter probe.

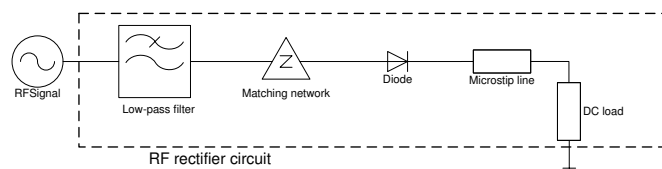

Fig. IV-24. Rectifier #1 circuit diagram.

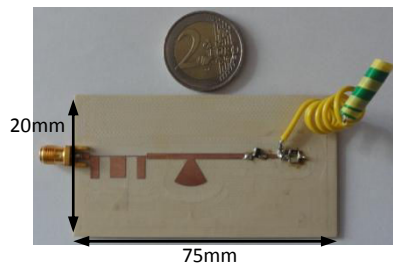

Fig. IV-25. The fabricated rectifier #1.

The measurement setup is presented in Fig. IV-26. The Synthesized Signal Generator ANRITSU 68367C provides the RF input power and allows the power to be varied. In addition, an isolator provides additional protection against the reflected energy. By varying the RF input power (P_{RF}), the DC voltage has been measured across the DC load,

and then the RF-DC conversion efficiency has been calculated. In Fig. IV-27, we compare the simulated and measured results.

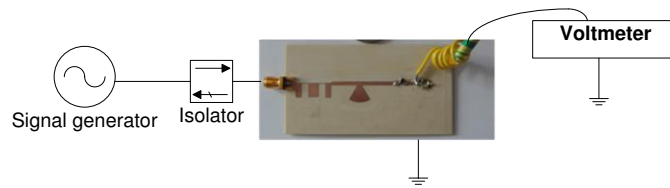

Fig. IV-26. Rectifier #1 measurement setup.

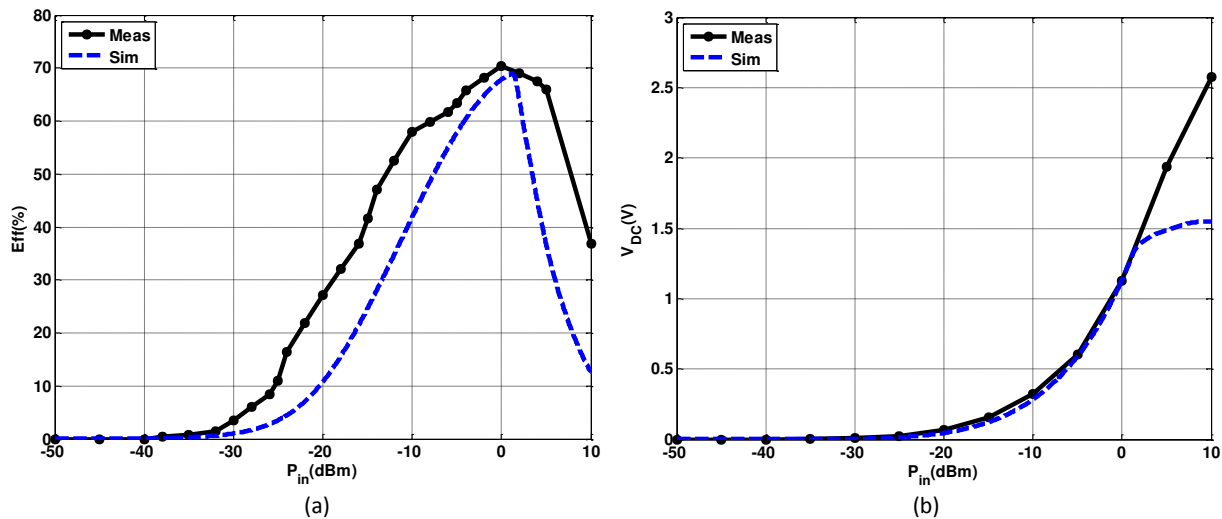

Fig. IV-27. Rectifier #1 simulations and measurements results: a) RF-DC conversion efficiency, (b) output voltage.

First, high efficiency and output voltage of 70% and 1.2V, respectively, were measured for 0 dBm RF input power. Measurements show better results than simulation (Fig. IV-27(a)). It is important to notice that in the design of rectifiers/rectennas, from a certain input power threshold, the efficiency curve decreases considerably, as shown in Fig. IV-27(a). This phenomenon occurs when the reverse peak voltage of the diode becomes larger than the breakdown voltage and the resultants conversion efficiencies begin to decrease [232].

Second, around a specific RF input power equal to 2dBm, a discontinuity on output voltage simulation results can be noticed (Fig. IV-27(b)). Agilent ADS numerical model has a limit parameter (explosion current) for the diode junction current linearization. If the current is linearized, no DC voltage can be obtained, that is why the DC simulated voltage in Fig. IV-27(b) is flat from 2dBm. Nevertheless, the aim of this thesis is to convert a RF input power lower than 0dBm.

Third, the shift between measurement and simulation results, in Fig. IV-27(a), could come from three possible issues. A possibility is that the real quality factor (Q) of the capacitor used was not plausible. Another issue has been observed, because the diode parasitic elements were not specifically taken into account; we will detail this issue in the next paragraphs. Finally, I have detected that a mechanical variation of the hand-made

inductance (RF-block) affected the measurement results. It reinforces the fact that the impedance of the optimal load is sensitive.

To investigate the possible cause of the difference between measurement and simulation results, S_{11} parameter has been studied. Fig. IV-28 shows the simulated and measured S_{11} parameter for the rectifier #1.

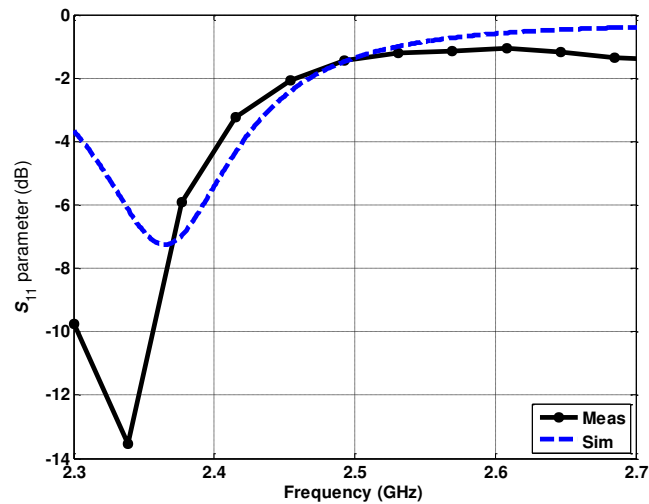

Fig. IV-28. Simulated and measured S parameters of the rectifier prototype #1.

A frequency shift can be observed between the S_{11} simulations and measurements results of the rectifier #1 (Fig. IV-28). After some analyses, we have come to the conclusion that this bias is introduced by the diode parasitic elements. Next, the parasitic elements have been represented by a series inductor (L_p) and parallel capacitor (C_p). The Schottky diode model considering the parasitic elements is presented in Fig. IV-29. Through a numerical assessment we have observed the effect of the HSMS-2855 diode parasitic elements on the rectifier #1 performances; the frequency shift observed in Fig. IV-28 is mainly due to the effect of the series inductor.

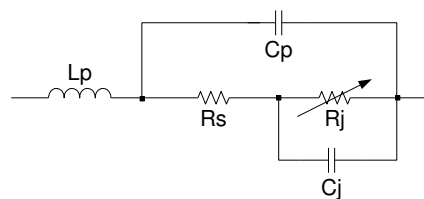

Fig. IV-29. Schottky diode schema model taking into account the parasitic elements.

Fig. IV-30 shows the rectifier #1 S_{11} measurements results compared to the fitted simulation results taking into account the parasitic elements of the diode. The parasitic elements values are: $L_p=1.1$ nH and $C_p=0.01$ pF.

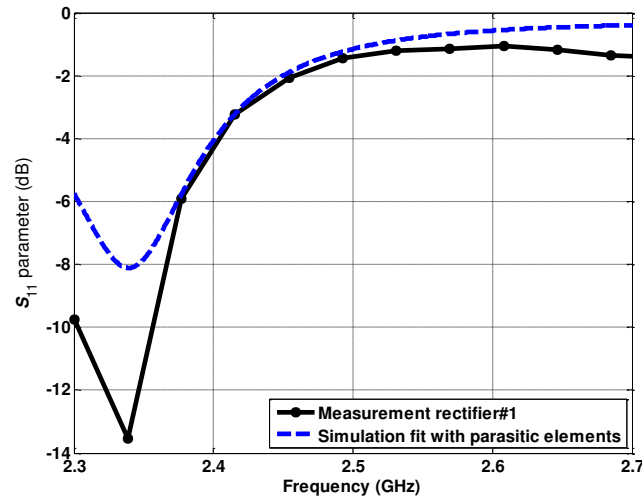

Fig. IV-30. Rectifier #1 S11 parameter comparison results between the measurements and fitted simulation taking into account the parasitic elements of the diode.

From this first high-efficient rectifier design, three important points need to be considered for the design of the next rectifiers:

- Parasitic elements of the Schottky diode.
- Quality factor of capacitor. A correct simulation model of the load capacitor should be applied.
- No hand-made inductor (RF block) is necessary. A high-impedance probe can be used to directly acquire the output voltage.

IV.5.1.2. Rectifier prototype #2

The underlying aim of this rectifier is to check if the concept applied for rectifier #1 is reproducible for different RF input target. The objective is to create a load that would cancel out the imaginary part of the diode impedance, but now with a slightly different specification: the RF input target power is -15dBm.

For this rectifier we have chosen a different Schottky diode, we have selected the HSMS-2850 that is part of the same series of the HSMS-2855. However, the package configuration is different. The HSMS-2850 is a single diode in a package configuration of three leads and the HSMS-2855 is an unconnected pair in a package configuration of four leads.

The diode parasitic elements values were extracted directly from the manufacturer datasheet. The parasitic elements, C_p and L_p , are equal to 0.08pF and 2nH, respectively. The diode model with parasitic elements is presented in Fig. IV-31.

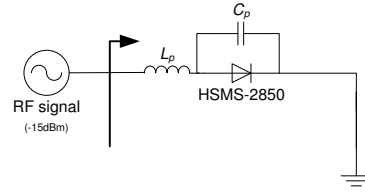

Fig. IV-31. Schottky diode input impedance schema –rectifier #2

Following Fig. IV-31, the HSMS-2850 diode input impedance loaded by a short-circuit is showed in Fig. IV-32 for two cases: with and without parasitic elements.

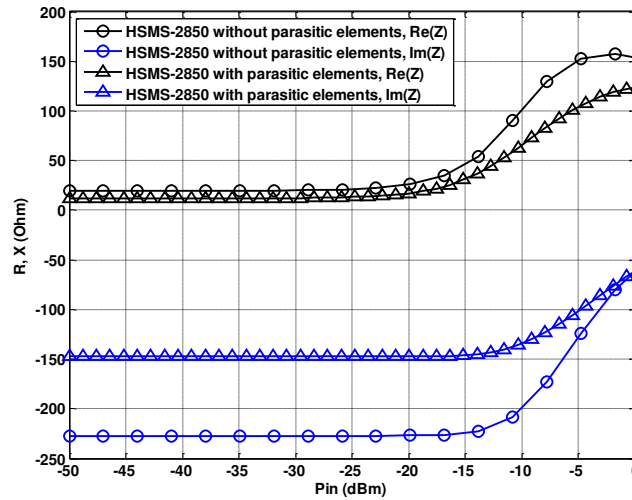

Fig. IV-32. Input impedance of the HSMS-2850 Schottky diode with and without parasitic elements.

The case study 1 highlights that we need a diode input impedance value for a specific RF input power that is for this rectifier design the input power of -15dBm. The diode input impedance with parasitic elements for the chosen RF input power is $Z_D(f_0) = (31 - j145.5)\Omega$, from Fig. IV-32.

Thus, we started the design of the load that cancels out the imaginary part of the diode impedance. The capacitor value was 10pF, but this time an appropriate equivalent circuit model was applied, represented by a capacitor (10pF), a resistor (0.12 Ω) and an inductor (0.16nH) in series. The load resistor value is optimized in order to have the maximum RF-DC conversion, i.e., 2.2k Ω for this rectifier. And finally the microstrip line on the same substrate RO4003 has the dimensions of: $L=15.65\text{mm}$ and $W=2\text{mm}$. Therefore, the effective dielectric constant is equal to 2.804 and the input impedance (microstrip only) is 47 Ω . As a result, the load input impedance obtained is $Z_{load}(f_0) = 1.9 + j145\Omega$, as described in Fig. IV-33. Notice that the imaginary part of the load impedance is the symmetric of the diode impedance.

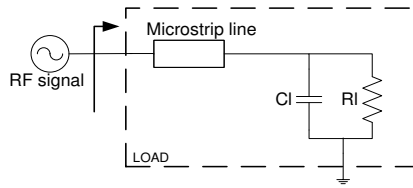

Fig. IV-33. Optimum load schema for rectifier #2.

Next, on the circuit input, I have optimized an impedance matching in order to provide a 50Ω matching at 2.45 GHz, as shown in Fig. IV-34. The rectifier prototype #2 that I have fabricated and characterized is presented in Fig. IV-35.

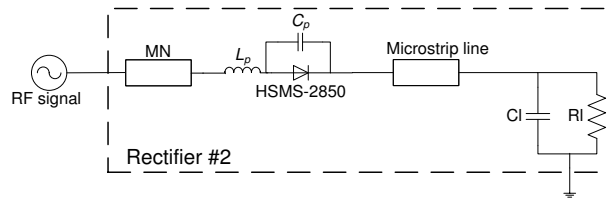

Fig. IV-34. Rectifier #2 final schema.

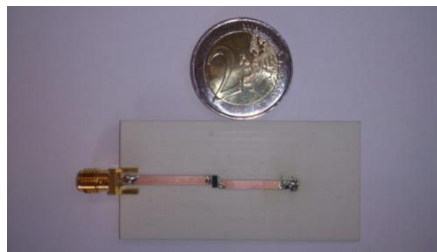

Fig. IV-35. The fabricated rectifier #2.

The measurement results are presented in Fig. IV-36. A very low RF-DC conversion efficiency as well as a low output voltage can be observed.

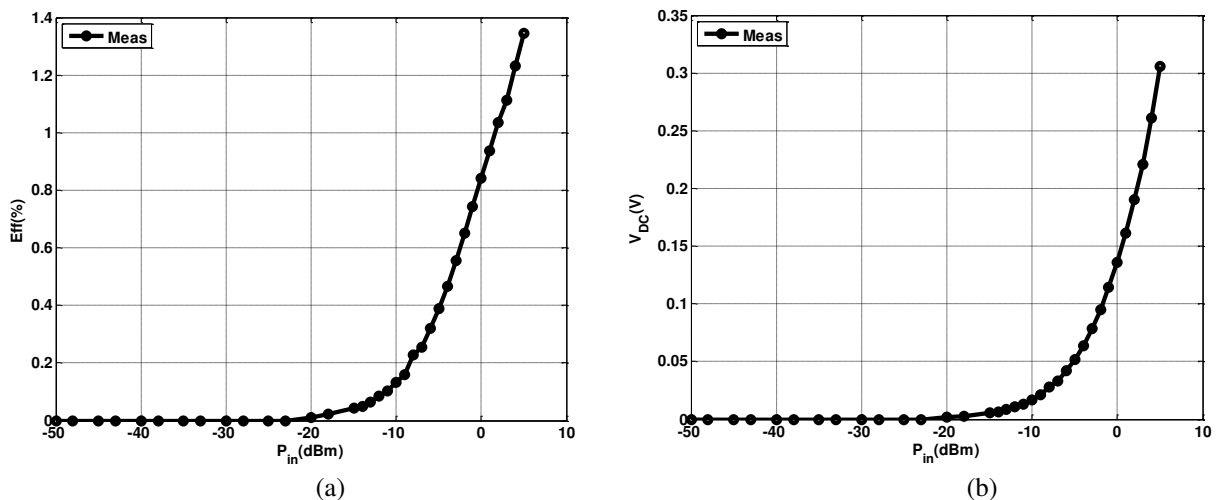

Fig. IV-36. Rectifier #2 simulations and measurements results: a) RF-DC conversion efficiency, (b) output voltage.

From the measurement results of the rectifier#2, the case study 1 does not rely on a correct assumption. Consequently, we decided to design a prototype #3, with the same

concept previously discussed (cancellation of the imaginary impedance part), but now with a different impedance matching process.

IV.5.1.3. Rectifier prototype #3

In the design of rectifier #3 we are interested to cancel out the imaginary part of the impedance seen from the diode input, loaded by an optimized RF load, as described in Fig. IV-37. A numerical parametric assessment was carried out by varying the microstrip line length, seeking for the imaginary part cancellation.

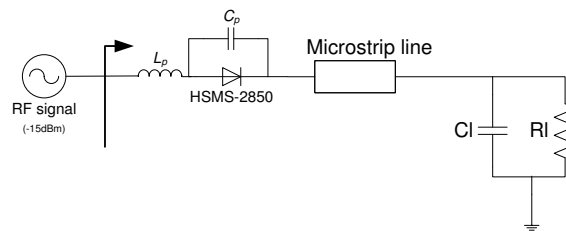

Fig. IV-37. Impedance matching seeking to cancel out of the impedance imaginary part. The microstrip line length is variable.

The optimized microstrip line dimensions are: length $L=16$ mm and width $W=2$ mm on substrate RO4003. The effective dielectric constant is equal to 2.804 and the input impedance (microstrip only) is 47Ω . Thus, the simulated input impedance of diode+load at 2.45GHz is $Z_{load}(f_0)=(29-j0.4)\Omega$ for a RF input power of -15dBm, where the imaginary part of the impedance (diode+load) is almost zero. Then, an impedance matching network was designed in order to provide a good 50Ω matching at the input of the rectifier. The final rectifier #3 circuit is presented in Fig. IV-38. A picture of the fabricated rectifier is presented in Fig. IV-39.

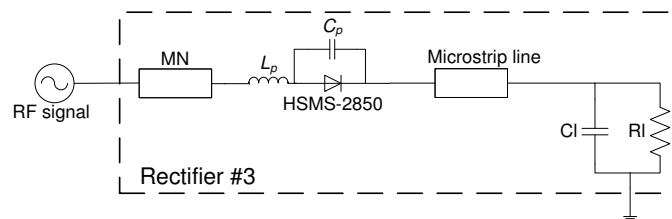

Fig. IV-38. Final rectifier #3 circuit.

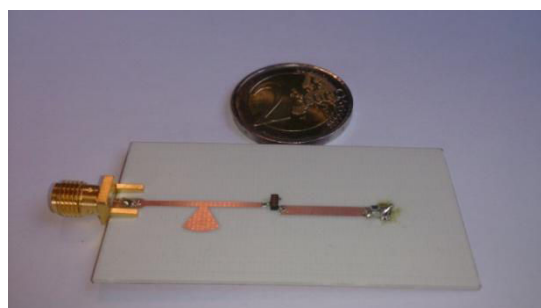

Fig. IV-39. The fabricated rectifier #3.

The measurement results are presented in Fig. IV-40, and once again, a very low RF-DC conversion efficiency and a low output voltage are obtained.

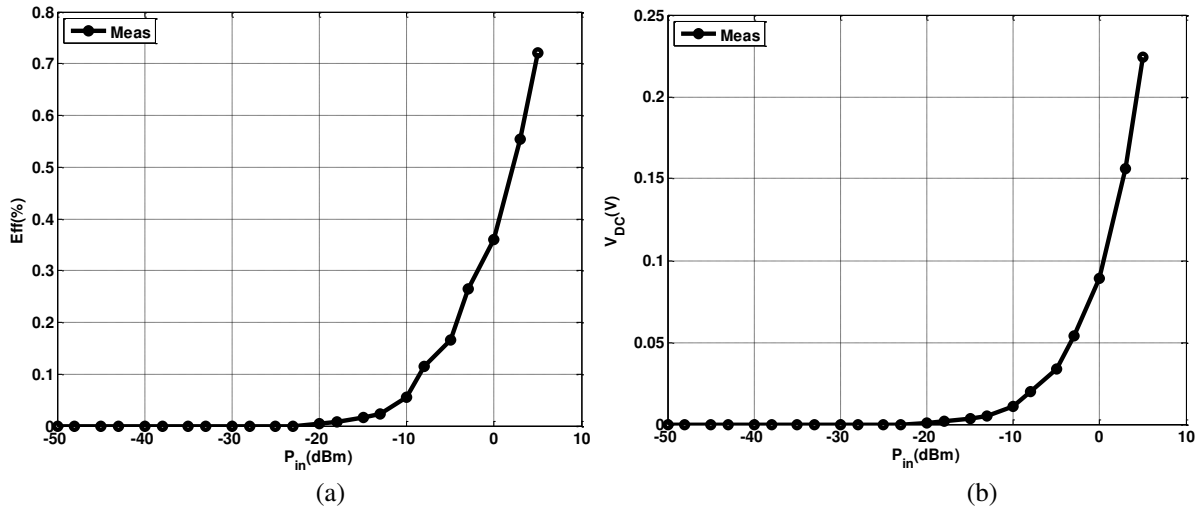

Fig. IV-40. Rectifier #3 simulations and measurements results: a) RF-DC conversion efficiency, (b) output voltage.

While the results of the rectifiers #2 and #3 were not as efficient as expected, the case study 1: “*The impedance matching between the diode and the RF load*” seems not to be the correct assumption for the high RF-DC conversion efficiency. Although the rectifier #1 retrieves good results, a latter estimation of the electrical length of the microstrip line @ 2.45 GHz have given a surprising result for $\beta.L=45^\circ$.

For the design of rectifier #4 and #5, the case study 2 is investigated.

IV.5.1.4. Rectifier prototype #4

In case study 2 the objective was to prove that to achieve a high RF-DC conversion efficiency, we need to design a particular RF load, by creating a phase delay for the fundamental signal f_0 around 45° for one-way propagation. Consequently, the f_0 signal is reflected into the diode terminals with a 90° delay. As well, for the second harmonic ($2f_0$) the optimal RF load is seen as an open-circuit, thus an important amount of the energy from the $2f_0$ will be directly reflected into the diode.

The first step is to estimate the length of the microstrip line that provides a 45° delay at 2.45 GHz. From (IV-13), we deduce that the electrical length of a microstrip line is:

$$\beta.L = \theta \quad (IV-16)$$

with β the propagation constant, L the line physical length and θ the phase delay.

From a simple equation manipulation ((IV-14) and (IV-16)), we can deduce the length of the physical line that provides a 45° phase delay is approximately $0.125\lambda_g$.

As announced previously, the substrate applied has a dielectric constant of $\epsilon_r=3.55$ and a height of $h=0.813$ mm. If we assume a microstrip line width of $W=2$ mm for the RF load, then we can calculate the ϵ_{eff} from (IV-11), then the λ_g from (IV-15) and finally

we can approximate the physical length of the microstrip line, $L=9.1\text{mm}$. The effective dielectric constant is equal to 2.804 and the input impedance (microstrip only) is 47Ω .

To complete the load design, I have added a load capacitor of 10pF . The resistor value has been optimized in order to have the maximum RF-DC conversion, i.e., $2.2\text{k}\Omega$ for this rectifier. Also a slight optimization has been applied on the microstrip line length in order to compensate for the added capacitor. Finally, the dimensions of the microstrip line are $L=9\text{mm}$ and $W=2\text{mm}$.

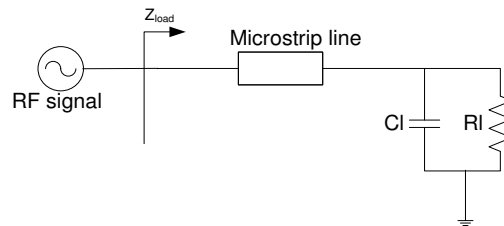

Fig. IV-41. Load schema of the rectifier #4.

Fig. IV-41 shows the load schema of the rectifier #4. Accounting for the effect of the load to the $2f_0$ signal, the load input impedance value is $Z_{load}(2f_0)=(576-j2367)\Omega$, i.e., an open-circuit behavior. Thus, we have expected that a major part of the energy of the $2f_0$ signal will be reflected into the diode.

Finally, I have optimized the impedance matching network in order to provide a good 50Ω matching at 2.45GHz . In Fig. IV-42 the final schema of the rectifier #4 is presented.

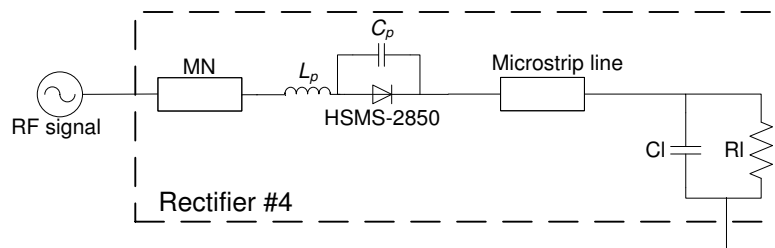

Fig. IV-42. Rectifier #4 final schema.

The rectifier was fabricated and characterized. Fig. IV-43 shows the rectifier fabricated based on the specifications presented previously.

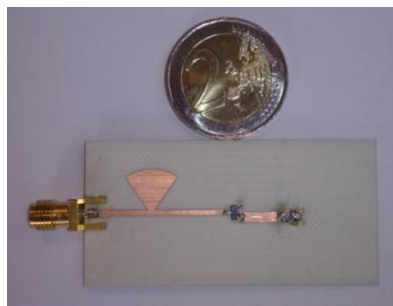

Fig. IV-43. The fabricated rectifier #4 prototype.

The measurement setup consisted in a Synthesized Signal Generator ANRITSU 68367C that provided the RF input power and allowed the power to be varied. In addition, an isolator provides protection against the reflected energy. By varying the RF input power (P_{RF}) the DC voltage was measured across the DC load, and then the RF-DC conversion efficiency was estimated.

The simulated and measured RF-DC conversion and output voltage results are compared in Fig. IV-44.

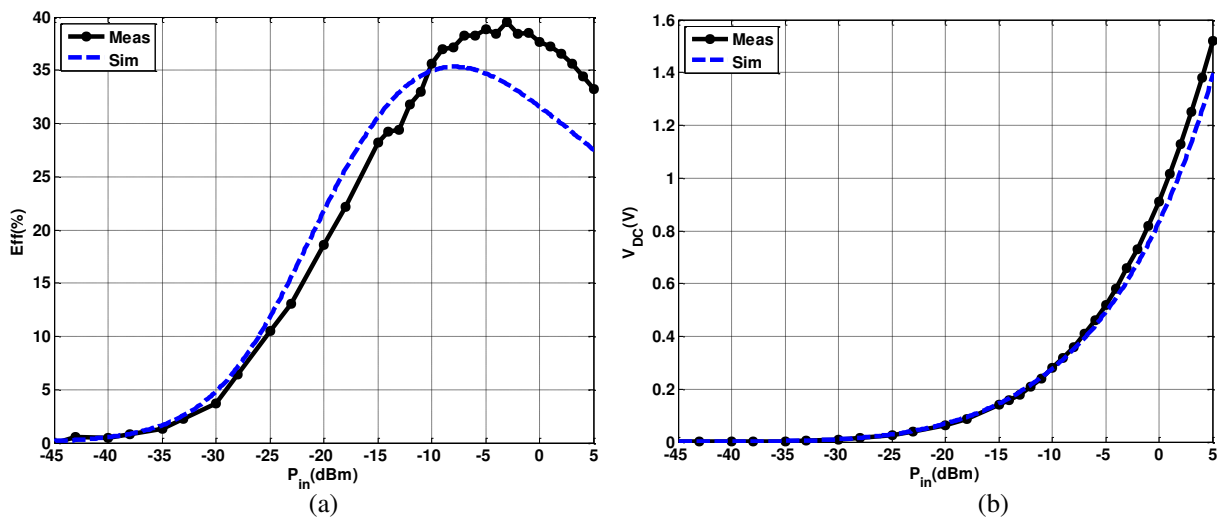

Fig. IV-44. Rectifier #4 simulations and measurements results: a) RF-DC conversion efficiency, (b) output voltage.

The simulated and measured RF-DC conversion efficiency and output voltage are in good agreement, Fig. IV-44 (a) and (b). A high conversion efficiency of 28% was measured for the RF power target (-15dBm), this result is quite good when compared to the literature results. A state-of-the-art comparison table will be presented in the end of this chapter. Concerning the output voltage, at least 1 V can be achieved from 2dBm RF input power.

Fig. IV-45 shows the S_{11} parameter comparison between simulation and measurement. At 2.45GHz we have a measured S_{11} of -13dB. The slight shift of the resonance peak is due to the dispersion of the diode parasitic elements values.

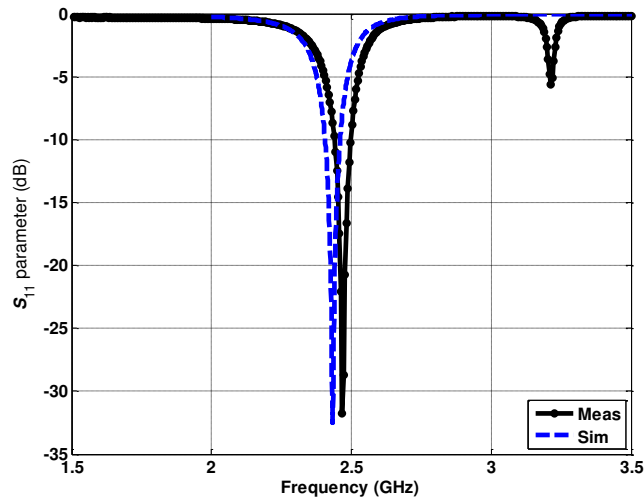

Fig. IV-45. Simulated and measured S_{11} parameter results of the rectifier prototype #4.

IV.5.1.5. Rectifier prototype #5

In order to confirm that the right assumption was correctly identified, we have decided to design a fifth and last rectifier. Rectifier #5 reproduces the same optimal load design described previously for the rectifier #4, but now we change the initial condition (microstrip line width).

The line width is 1mm larger than for prototype #4, i.e., $W=3\text{mm}$. Then, we have calculated the ϵ_{eff} from (IV-11), the λ_g from (IV-15) and finally we have determined the physical approximated length of the microstrip line, $L=8.9\text{mm}$. The effective dielectric constant is equal to 2.908 and the input impedance (microstrip only) is 36Ω .

We have added a capacitor of 10pF. The resistor value was optimized in order to have the maximum RF-DC conversion, i.e., $2.2\text{k}\Omega$ for this rectifier. And a slight optimization was applied on the microstrip line length in order to compensate for the added capacitor. Finally, the final dimensions of the microstrip line are: $L=8.7\text{mm}$ and $W=3\text{mm}$.

Regarding the load input impedance for the $2f_0$ frequency, we have $Z_{load}(2f_0)=(2674-j3261)\Omega$, that characterizes an open circuit impedance. Finally, an impedance matching network was implemented with the purpose of improving the impedance matching at the circuit input for 2.45GHz. The final schema is presented in Fig. IV-46.

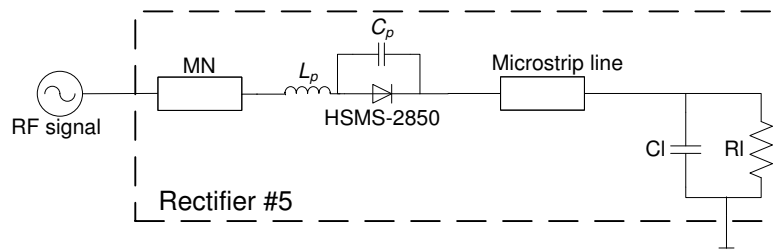

Fig. IV-46. Final schema of the rectifier #5.

The rectifier has been fabricated (Fig. IV-47) and characterized (Fig. IV-48 and Fig. IV-49). The measurement setup consisted in injecting the RF power at the circuit input,

by varying the RF input power (P_{RF}). The DC voltage was measured across the DC load, and then the RF-DC conversion efficiency was calculated.

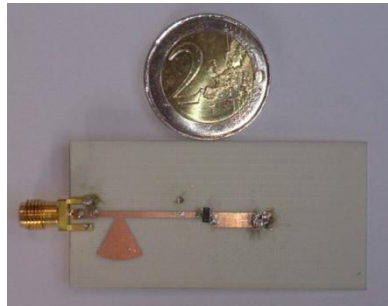

Fig. IV-47. Picture of the rectifier #5 prototype.

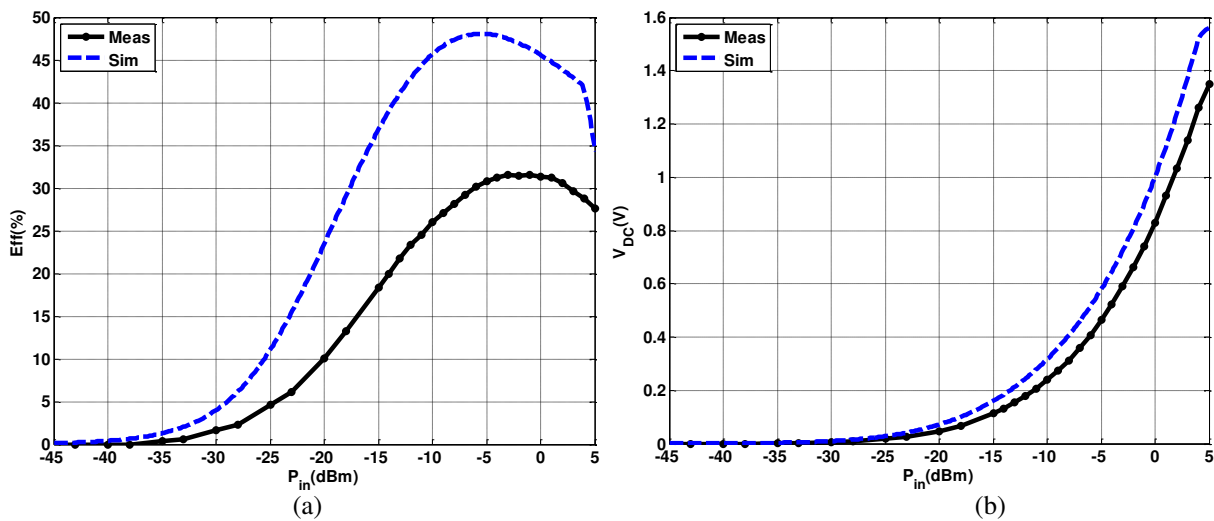

Fig. IV-48. Rectifier #5 simulations and measurements results: a) RF-DC conversion efficiency, (b) output voltage.

Even the simulated and measured curves have the same trend, an important reduction of the efficiency conversion is observed on the measurements results compared to the simulation results, Fig. IV-48(a) and (b). A RF-DC conversion efficiency of 18% was measured for the RF power target (-15dBm). This shift on the measurements results could come from a mismatched detect on the measurements of S_{11} parameter, as described in Fig. IV-49.

Fig. IV-49 shows the S_{11} parameter comparison between simulation and measurement. At 2.45GHz we have a S_{11} measured of -6dB.

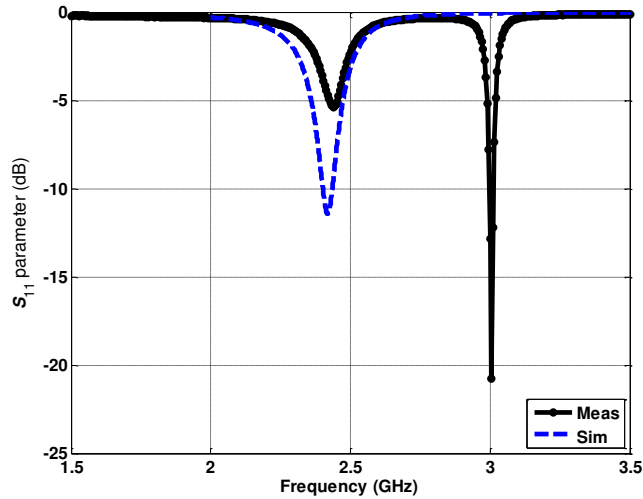

Fig. IV-49. Simulated and measured S_{11} parameter results of the rectifier prototype #5.

At 2.45 GHz, the reflexion measurement shows a mismatch. On the other hand a good matching appears at 3GHz. At present, we do not know exactly the reason of this issue, but we expect a problem of discontinuity between diodes pad and microstrip line on one end and capacitor-resistor pads at the other end.

IV.5.2. Design of the *rectennas*

In this section we propose the design of two microstrip rectennas at 2.45GHz. The first rectenna is composed by the rectifier #4 (IV.5.1.4) and the antenna patch array with high-orders harmonic-rejection through a 50Ω interface. The antenna array design was described in detail in Chapter III (III.3.4). The second rectenna has been developed by a rectifier-antenna co-design. For the rectifier design, the antenna array impedance was taken into account in order to create the impedance matching and on the same time looking for the high-RF-DC conversion efficiency. Both rectenna have been developed with the HSMS-2850 Schottky diode in a single series-mounted configuration.

The rectifier's electrical schematics for both rectenna have been designed and optimized using the ADS software, but the antenna was designed in CST software. The rectennas have been fabricated and characterized in anechoic chamber for a farfield situation.

- **Rectenna measurement setup:**

Special attention should be given to the rectenna measurement setup, since to calculate the RF-DC conversion efficiency, we need to acquire for the same energy density, the RF power on the rectifier input and the output voltage. Interesting methods have been proposed in the literature. For example, a free-space measurement setup using a directional coupler to acquire the transmitted power, and then predict the power density was presented in [233]-[234]. A two-steps system is presented in [57], in which the antenna is placed in a fixed position and the received power is measured. Then, the antenna is replaced by the rectenna in the same position, thus the output voltage is

acquired. Finally in [236], a particular rectenna measurement system based on a waveguide “simulator” is rapidly presented.

In this thesis we propose a bi-modal dynamic rectenna measurement setup (Fig. IV-50.). The measurements have been performed in an anechoic chamber. Tx and Rx circuits are mounted on two axis of movement A_1 and A_2 . The Tx circuit can move in the transmission direction (A_1 axis) and the Rx circuit can execute angular movements (A_2 axis). On the Tx side, the Synthesized Signal Generator ANRITSU 68367C provide the RF signal at 2.45GHz, a coaxial amplifier (ZHL-42W) with a gain of 37dB (15V) at 2.5GHz was used to compensate the free-space path loss and finally a standard horn antenna is employed for transmitting power. On the Rx side, the rectenna is mounted on one mast face, connected to a voltmeter (Digital Multimeter KEITHLEY 2000E) and on the other mast face, a reference patch antenna array is connected to a Single Channel Power Meter (AGILENT E4418B). This method allows to recover a good estimation of the RF input power after the antenna.

For each rectenna prototype the free-space farfield measurement in anechoic chamber has been carried out. Since we are using a Tx horn antenna which has an uniform distribution corresponding to the side lobe suppression of 13dB [237], the border between the far and near field is calculated as:

$$d = \frac{2D^2}{\lambda} \quad (IV-17)$$

where D is the largest antenna dimension.

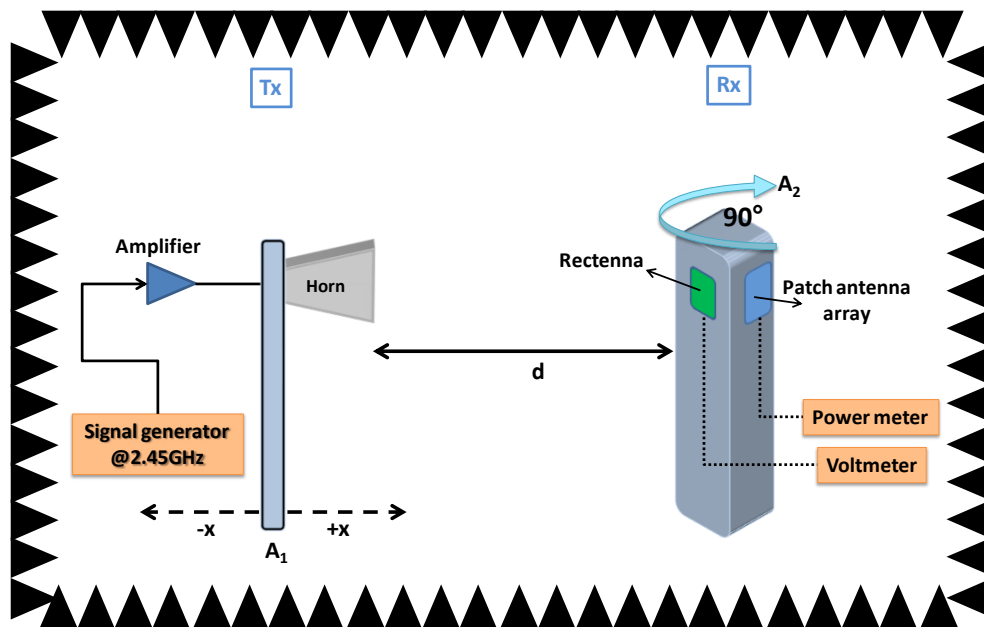

Fig. IV-50. Bi-modal dynamic rectenna measurement setup.

A picture of the bi-modal dynamic rectenna measurement setup is showed in Fig. IV-51.

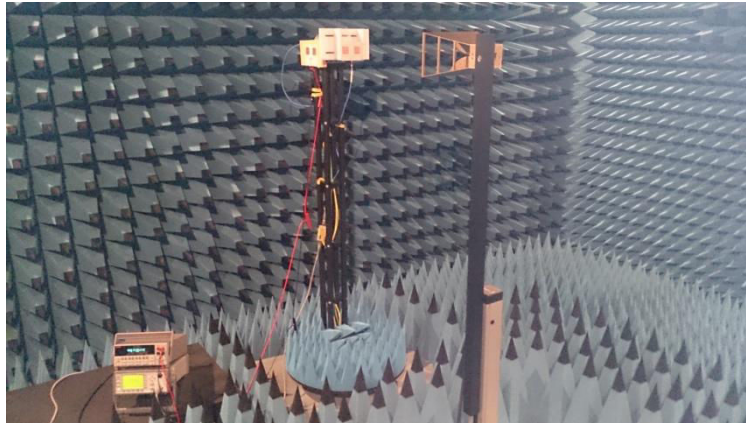

Fig. IV-51. Picture of the bi-modal dynamic rectenna measurement setup.

IV.5.2.1. Rectenna prototype #1

The first rectenna is composed of the rectifier #4 described previously and the antenna patch array with high-orders harmonic-rejection that was described in Chapter III (III.3.4.1). Both circuits have been developed separately with a 50Ω input matching impedance. Then they have been assembled to create the rectenna #1. The rectenna prototype #1 layout is presented in Fig. IV-52 without the lumped elements.

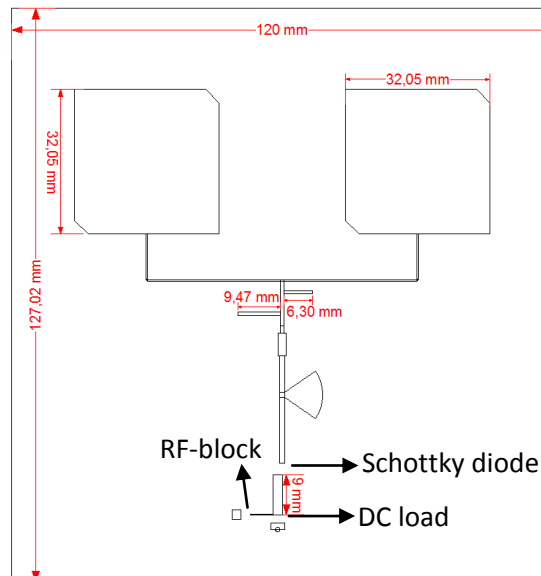

Fig. IV-52. Rectenna prototype #1 layout.

In Fig. IV-52 we can identify the patch antenna array then two high-orders harmonic-rejection stubs, one for the 4.9GHz and the second for 7.35GHz. The 50Ω interface connects the antenna to the rectifier. An improvement on the voltage output measurement process has been implemented in the rectenna design; from the DC load terminals a high-impedance line brings the DC voltage through a RF-block inductor and consequently the probe voltage can acquire the output voltage. Therefore, the measurements results are less sensible to the measurement probe effect.

The rectenna #1 has been fabricated and characterized.

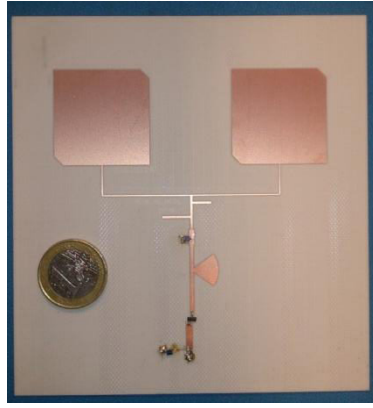

Fig. IV-53. Rectenna prototype #1 picture.

Based on the measurement setup presented in Fig. IV-50, the output voltage and RF-DC conversion efficiency of the rectenna #1 have been acquired for a RF input power from -40dBm to 0dBm. Fig. IV-54 shows the rectenna measurements results when the Tx and Rx circuits respect the farfield constraint (128cm).

A high-RF-DC conversion efficiency of 35% for -15dBm input power is observed. When the input power is decreased to a very-low input power of -30dBm, the rectenna still provides 8% of conversion efficiency. Regarding the output voltage, 0.7V, this can be achieved for a -3dBm RF input power.

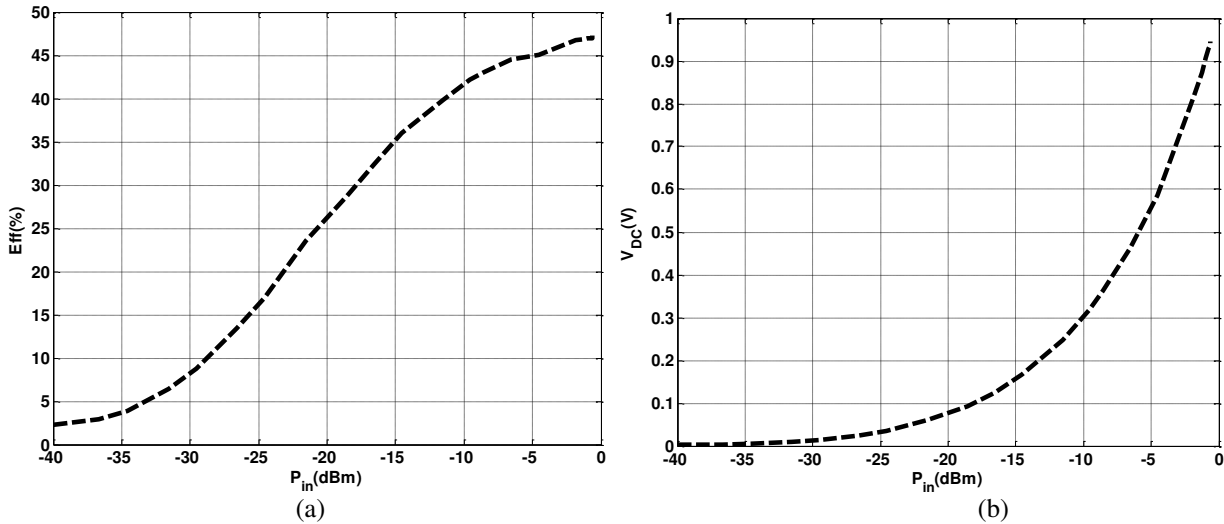

Fig. IV-54. Farfield rectenna #1 measurement results as a function of the RF incident power: a) RF-DC conversion efficiency, (b) output voltage.

As highlighted in Chapter I, to smooth the comparison of different sources of energy harvesting, the conversion efficiency should be normalized with respect to the available power density. Fig. IV-55 shows the RF-DC efficiency and the output voltage as a function of the RF power density. As presented in (IV-1), the power density can be calculated from the measured RF input power divided by the effective aperture area of the antenna. The patch antenna array used in these rectennas has a measured gain of 6.7dB (III.3.4). Thus the power density can be estimated and the measurements results of the

RF-DC efficiency and output voltage are presented in Fig. IV-55. From a low power density of $1\mu\text{W}/\text{cm}^2$, the rectenna #1 already provides 40% of RF-DC efficiency.

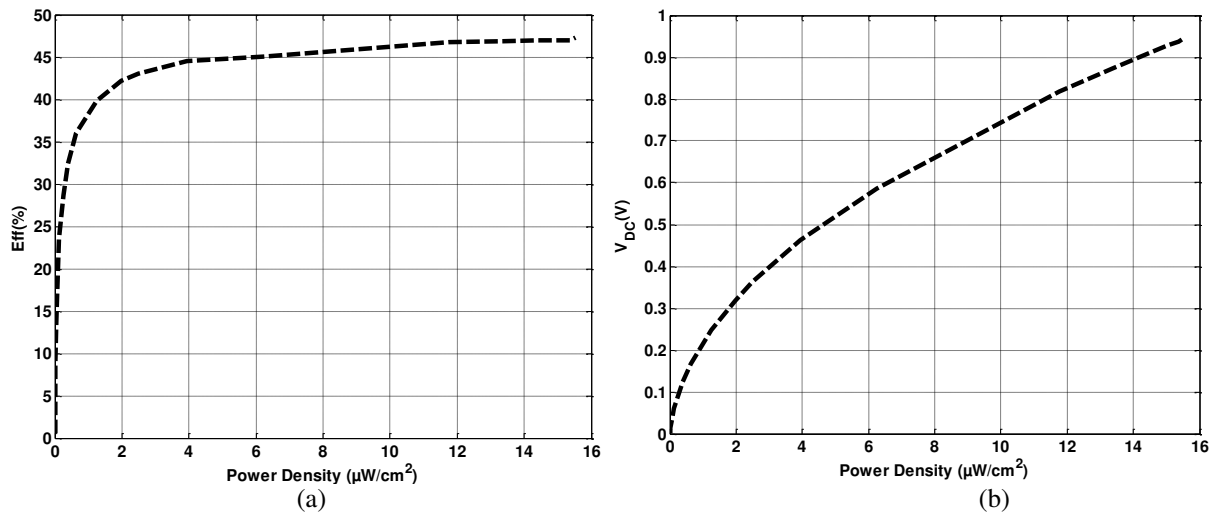

Fig. IV-55. Farfield rectenna #1 measurement results as a function of the RF power density: a) RF-DC conversion efficiency, (b) output voltage.

IV.5.2.2. Rectenna prototype #2

For the development of the second rectenna, the rectifier was co-designed with the patch antenna array. The aim of this co-design is to reduce the rectenna size. First of all, the patch antenna array has been designed (Chapter III.3.4.2), and then, from simulation results, the antenna input complex impedance was acquired. The rectifier has been designed based on the method described previously for the case study 2, i.e., after the Schottky diode a microstrip line length should be carefully designed in order to present a 90° phase delay for the f_0 and an open-circuit behavior for the $2f_0$.

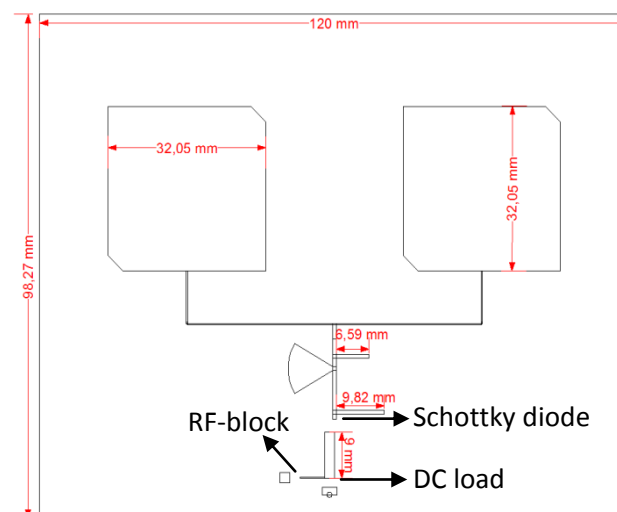

Fig. IV-56. Rectenna prototype #2 layout.

The microstrip line dimensions are: length $L=9\text{mm}$ and width $W=2\text{mm}$. The design of the impedance matching network at the circuit input relies on two criteria: to match the

antenna impedance at 2.45GHz and to eliminate the second and third high-order harmonics. The rectenna #2 layout is presented in Fig. IV-56.

The rectenna #2 has been fabricated (Fig. IV-57) and characterized.

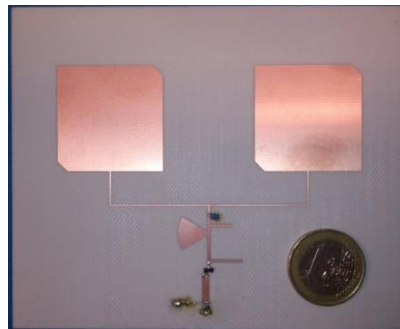

Fig. IV-57. Rectenna prototype #2 picture.

Based on the measurement setup presented in Fig. IV-50, the output voltage and RF-DC conversion efficiency of the rectenna #1 were acquired for a RF input power from -40dBm to 0dBm. Fig. IV-58 shows the rectenna measurements results when the Tx and Rx circuits respect the farfield constraint. A high-RF-DC conversion efficiency of 33% for -15dBm input power was observed. When the input power is decreased to a very-low input power of -30dBm, the rectenna still provides 7% of conversion efficiency. Regarding the output voltage, 1 V can be achieved for a 0 dBm RF input power.

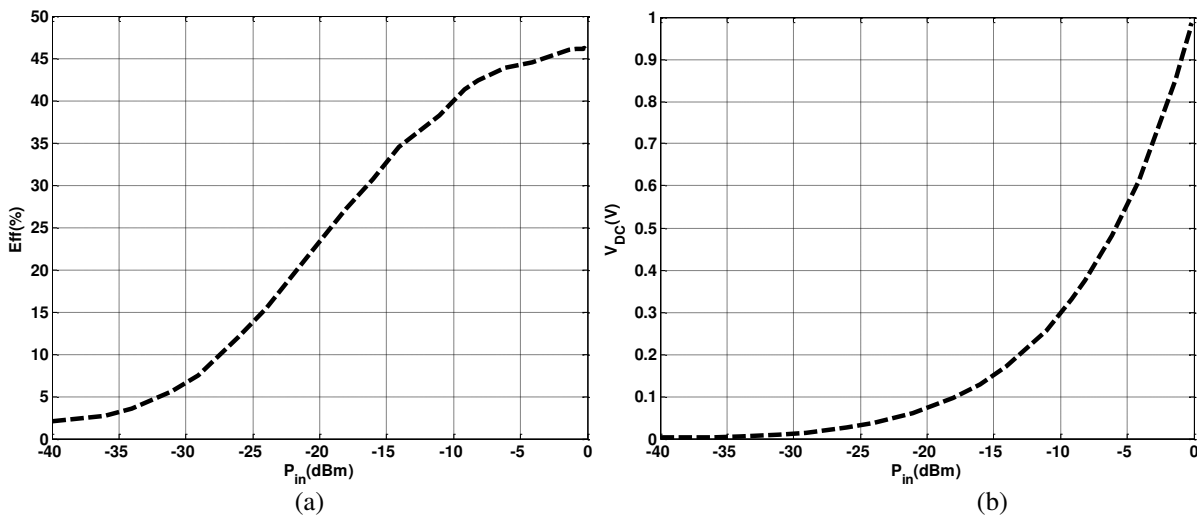

Fig. IV-58. Farfield rectenna #2 measurement results as a function of the RF incident power: a) RF-DC conversion efficiency, (b) output voltage.

Fig. IV-59 shows the RF-DC conversion and output voltage measurements as a function of the RF power density.

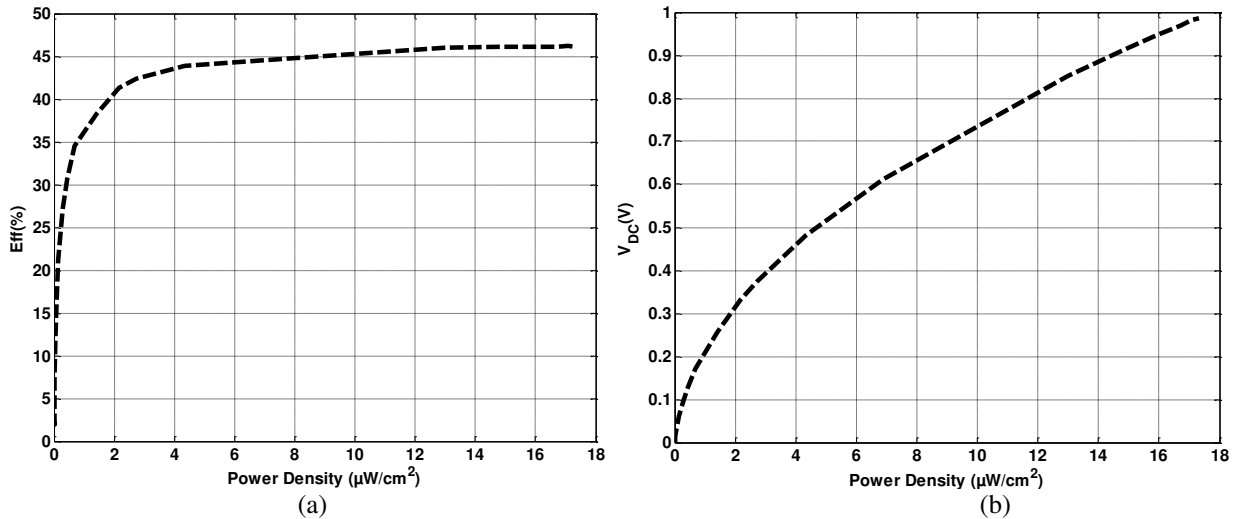

Fig. IV-59. Farfield rectenna #2 measurement results as a function of the RF power density: a) RF-DC conversion efficiency, (b) output voltage.

IV.6. Conclusion, comparison with the state of the art and perspectives for future work

In this chapter, we demonstrated a new approach for the design of highly efficient rectifiers and rectennas for very-low-power applications. An optimum RF-DC load is required in order to achieve high RF-DC conversion efficiency. A careful numerical assessment is important with the aim of predicting a correct Schottky diode model with its parasites, as well as the right models for lumped elements. A thorough and accurate rectenna free-space characterization is mandatory, since small errors in the measurements of the received-power/available-power-density or output voltage have a large effect on the RF-DC conversion efficiency results.

In order to highlight the importance of the RF-DC load, an original method to design a rectifier with the help of Computer Controlled Microwave Tuner (CCMT) was carried out. This method consists in providing different values of the load impedance (capacitive or inductive) at the output terminal of a Schottky diode, preserving the RF-DC conversion efficiency. From the Microwave tuner measurements, a group of optimum load impedances has been identified where the RF-DC conversion efficiency was maximal. Then two possible case studies were put in evidence in order to understand the link between high RF-DC efficiency and these impedance values. Several rectifiers' prototypes have been designed applying the two case studies (subtopic: IV.5.1). Finally, from the rectifiers measurements results, the case study 2 appears as the best assumption, i.e., to improve the RF-DC conversion efficiency, the load should present an open-circuit for the second harmonic ($2f_0$) and a 90° phase delay for the fundamental signal (f_0). The best rectifier prototype (#4) has been chosen for the rectenna design. Two rectennas have been designed and prototyped (subtopic: IV.5.2). An original free-space rectenna characterization was accomplished in an anechoic chamber, where with the help of two axis of movement the RF received power and output voltage could be measured for the same power density. Further, farfield measurements could be performed due to the second movement axis (boresight direction).

At 2.45GHz, included in the industrial-scientific-medical (ISM) band, the expected available power density is around $\mu\text{W}/\text{cm}^2$ level. In [238] the available power density in an indoor WLAN scenario has been presented, following the recommendations of the European Conference on Postal and Telecommunications Administrations (CEPT) [239]; $10\mu\text{W}/\text{m}^2$ power density has been detected from 7m of the WLAN router. In [240], a power density of $125\mu\text{W}/\text{cm}^2$ (ISM band) was enough to power a wireless sensor, which consumes $1\mu\text{A}$ at 2.5V. Recently, E. Falkenstein *et al.* [56] presented a rectenna which has 44% RF-DC conversion efficiency at 2.45GHz for a $25\mu\text{W}/\text{cm}^2$ power density. According to them, the RF-DC efficiency reported in their paper is the highest demonstrated for these power levels. However, we have found two other papers that have reported high-efficiency RF-DC for lower power densities [57] and [62].

Table IV.1 gives an overview of *rectennas* and rectifiers, including the results obtained in this thesis. It is important to note that due to the multiple efficiency definitions and different prototype technologies existent in the literature, it is quite difficult to compare the efficiency numbers directly. As described in Chapter I, another critical point is the normalization of the RF-DC efficiency as a function of received power or power density. Nevertheless, the results listed in this table have been extracted exactly as they are reported in the literature.

TABLE IV.1
OVERVIEW OF RECTENNAS AND RECTIFIERS STATE OF THE ART

Reference	η_{RF-DC}	Incident RF power/ power density	Frequency (GHz)	Single/Multi band	Substrate
[55] - 2013	10%	-13dBm, 0.05mW	2.45	Multiband	RF-60A-Taconic
[56] - 2012	44%	$25\mu\text{W}/\text{cm}^2$	2.45	Single-band	ROGERS 4350B
[57] - 2012	50%	-17.2dBm ($0.22\mu\text{W}/\text{cm}^2$)	2.45	Single-band	RT/Duroid 6002
[58] - 2011	63%	$0.525\text{ mW}/\text{cm}^2$	2.45	Single-band	Duroid 5880
[59] - 2010	16%	-20dBm	2.45	Single-band	Arlon A25N
[60] - 2010	52%	+10 dBm, 10mW ($150\mu\text{W}/\text{cm}^2$)	2.45	Single-band	-
[61] - 2010	25%	0 dBm, 1 mW	2.45	Single-band	Arlon 25N
[62] - 2010	34%	-10 dBm, $100\mu\text{W}$ ($17\mu\text{W}/\text{cm}^2$)	2.45	Single-band	Arlon AD320
[63] - 2006	45%	+10dBm, 10mW	2.45	Single-band	FR4
[64] - 2005	40%	+20 dBm, 100mW	2.45	Single-band	FR4
[65]- 2002	84%	+19.5dBm, 89.84mW	2.45	Dual-band	Duroid5870
[66] - 2000	62%	0dBm, 1mW	2.45	Single-band	RT /Duroid 5870
[67] - 1991	50%	+13dBm, 20mW	2.45	Single-band	-
Rectifier #1	70%	0dBm, 1mW	2.45	Single-band	ROGERS 4003
Rectifier #4	36%	-10dBm, $100\mu\text{W}$	2.45	Single-band	ROGERS

					4003
Rectifier #5	18%	-15dBm, 32 μ W	2.45	Single-band	ROGERS 4003
Rectenna #1	29%	-19dBm, 10 μ W (0.15 μ W/cm ²)	2.45	Single-band	ROGERS 4003
Rectenna #2	41%	-9dBm, 31 μ W (0.33 μ W/cm ²)	2.45	Single-band	ROGERS 4003

For a more clear State-of-the-Art comparison and considering that some papers report the RF-DC efficiency results as a function of the RF incident power (dBm) and others as a function of RF power density (μ W/cm²), we have plotted two graphs for the RF-DC conversion efficiency: Fig. IV-60 (as a function of the RF incident power) and Fig. IV-61 (as a function of the RF power density). It is important to notice that the results (Table IV.1) which have an incident power upper than 0dBm or a power density upper than 30 μ W/cm², are not considered in our comparison, since we focus on the Wireless Energy Harvesting applications (very-low-power available).

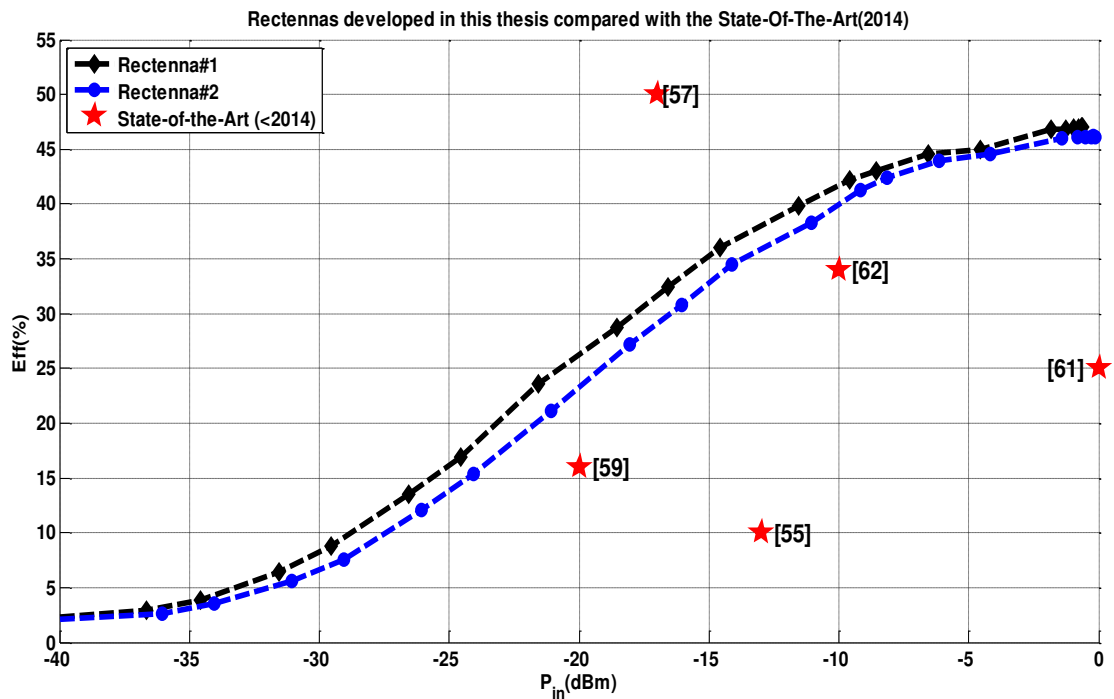

Fig. IV-60. Rectennas state-of-the-Art at 2.45 GHz based on the RF-DC conversion efficiency as a function of incident RF power.

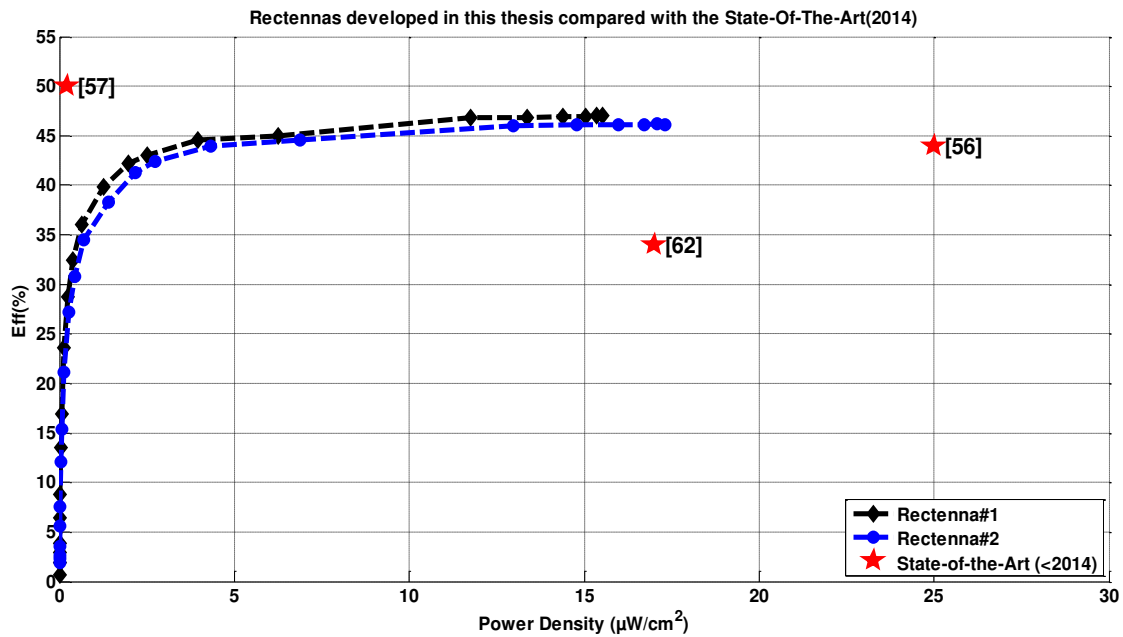

Fig. IV-61. Rectennas state-of-the-Art at 2.45 GHz based on the RF-DC conversion efficiency as a function of RF power density.

Since high-efficiency rectenna has emerged nowadays as an urgent and challengeable issue for low-power RF energy harvesting applications, from state-of-the-art comparison presented in Fig. IV-60 and Fig. IV-61, we can consider the study reported in this thesis as a pointed attempt in this direction.

- **Future work:**

The high-efficient rectifiers and rectennas designed in this thesis, can be employed directly in power wireless sensor, where there is no battery needed, i.e., for instant energy utilization and without any need of an embedded power management circuitry. Nevertheless, due to the rectifier's high efficiency values, it should be interesting to integrate this rectifier in an autonomous wireless sensor powered by RF energy, as described in Fig. IV-1. From (IV-7) we demonstrated that the lowest conversion efficiency in a such autonomous sensor is the RF-DC conversion. Thus, we expect that with the results acquired in this thesis we could to improve the State-of-the-Art of the complete low-power energy harvesting systems (rectenna + super-capacitor storage + load).

A second perspective idea comes from the fact that during the rectennas characterization in the anechoic chamber, farfield measurements, but also preliminary nearfield measurements have been performed, since we were interested to uncover the behavior of the rectenna when closer to the RF source. Since nearfield environment needs a special attention on the formulation and analysis, we are taking these first results carefully. Moreover, the different field regions around an antenna are described in Chapter III (III.2.3)

For both rectennas (#1 and #2), measurements in a nearfield situation were carried out following the measurement setup presented in Fig. IV-50, and for each output voltage value acquired, the received power was effectively measured by means of the reference antenna. The Tx and Rx antennas were separated by 74cm.

Fig. IV-62 shows the rectenna #1 nearfield measurement results as a function of the power density.

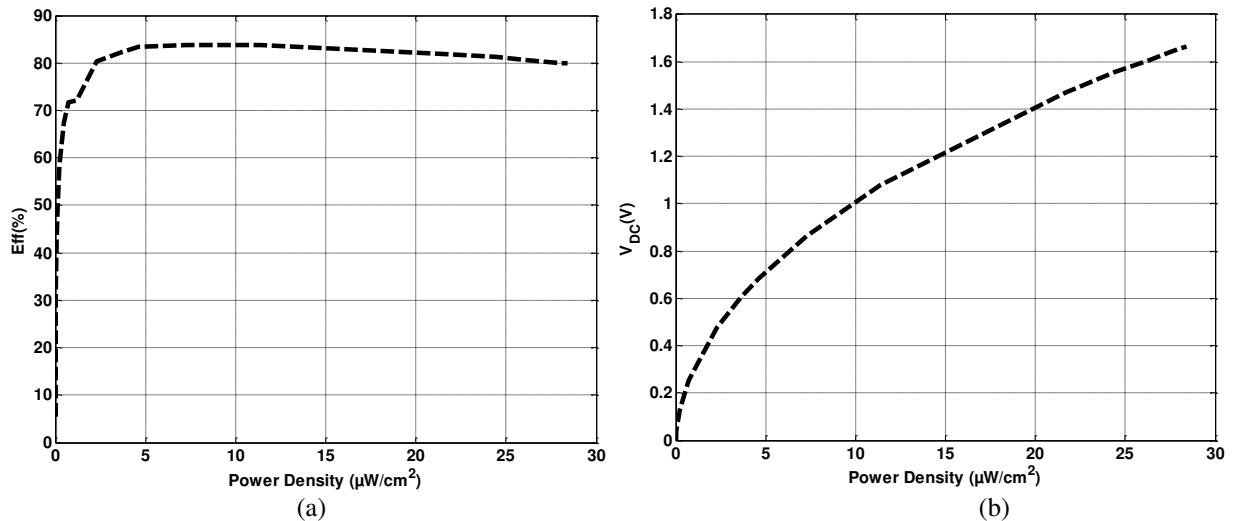

Fig. IV-62. Nearfield rectenna #1 measurement results as a function of the RF power density: a) RF-DC conversion efficiency, (b) output voltage.

Fig. IV-63 shows the rectenna #2 nearfield measurements results as a function of the power density.

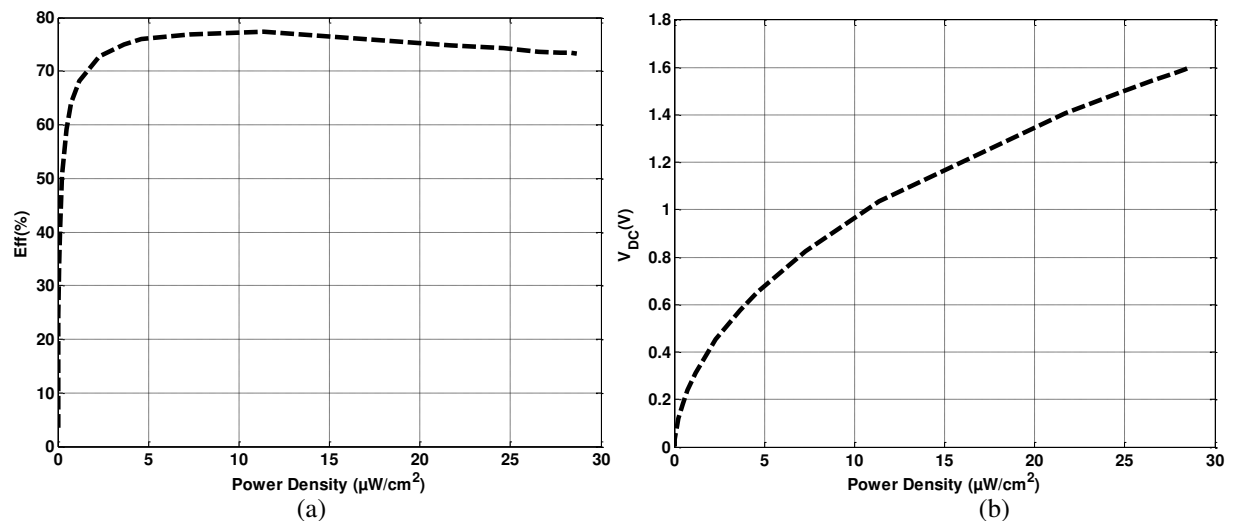

Fig. IV-63. Nearfield rectenna #2 measurement results as a function of the RF power density: a) RF-DC conversion efficiency, (b) output voltage.

From the rectenna measurements results, an important difference is noticed between the near and far field measurements. Thus, we expect to continue in a future work with the near-field analysis in the purpose of understanding the preliminary results observed.

However, in the literature a recent paper seems started to observe the same phenomena in a nearfield zone [241].

Chapter V - Conclusion and perspectives

V.1. Summary of results

DSRC e-toll collection application is a complex and complete system, in which each block should be developed respecting the DSRC standards and practical criteria. Therefore, in this thesis, important DSRC blocks have been developed in order to guarantee the best performance for the whole system.

Regarding the DSRC OBU, since DSRC e-toll system is a broad commercial application, finding references and information about these products is not trivial. Thus, to start our own OBU design, we needed to characterize different DSRC OBU available on the market in order to have access to their electric power consumption. From the measurement results, we observed that the classical DSRC OBUs still demand an important amount of energy per day (4J), this implying a battery life of 4-6 years. Thus, designing a completely autonomous DSRC transponder is not feasible, since the amount of energy required is still high. Nevertheless, reducing the transponder electric power consumption, as a solution to at least double the battery life, could be a good start point to improve environment protection and customer satisfaction. We have proposed a new DSRC transponder with an original statechart that considerably reduces the power consumption. First of all, we have proceeded with the DSRC chip characterization, an evaluation board has been engineered to assist the characterization measurements. We implemented a deep-sleep mode based on a vibration sensor, a mobile evaluation board supplied by a USB port has been engineered. *In-situ* tests have been performed. Due to this supplementary operational mode, the electric power consumption has been considerably reduced. The new DSRC transponder proposed in this thesis consumes 13x less energy compared to the classical DSRC transponder available on the market, regarding the energy consumption per day.

Once the electric power consumption of the new DSRC transponder has been considerably reduced, the feasibility of recharging the battery of the OBU by means of Wireless Energy Harvesting (WEH) has been analyzed. From a friendly environmental and economic point of view, finding a solution for the battery replacement and its discard is an important question nowadays. The amount of RF energy that could be harvested by the OBU for the two DSRC e-toll cases (Free-Flow and Stop&Go) was estimated through the RF link budget. Only for the Stop&Go configuration (stop time > 2s), the RF energy harvesting could become attractive to power the transponder. A recovered energy of 10 μ J could be achieved if the driver spends 2s in the RSE antenna field. Nevertheless, even with the transponder power consumption proposed in this thesis (314mJ), the recovered energy by means of DSRC Wireless Energy Harvesting would not be enough. Based on this analysis, we have decided to explore the Wireless Energy Harvesting for other frequency than the DSRC 5.8GHz frequency. We have chosen the 2.45 GHz as it is part

of the ISM band, many authors described their research on WEH for this frequency and we have been able to compare our results with the state of art.

We have demonstrated a new approach for the design of highly efficient rectifiers and rectennas for very-low-power applications. An optimum RF-DC load is required in order to achieve high RF-DC conversion efficiency. A cautious numerical assessment is important in the aim of predicting a correct Schottky diode model with its parasites, as well as the right models for lumped elements. A thorough and accurate rectenna free-space characterization is mandatory, since small errors in the measurements of the received-power/available-power-density or output voltage have a large effect on the RF-DC conversion efficiency results. With the aim of demonstrating how to achieve high conversion efficiencies values, an original measurement setup was implemented based on a Computer Controlled Microwave Tuner (CCMT), in which different values of the load impedance (capacitive or inductive) have been presented at the output terminal of a Schottky diode. Several rectifiers and rectennas have been designed, fabricated and characterized in order to validate our method. Regarding the rectenna measurement setup, we implemented an appropriate method, since to calculate the RF-DC conversion efficiency, we need to acquire for the same energy density, the RF power at the rectifier input and the output voltage. Finally, the results obtained in this thesis are in the forefront of the State-of-the-Art (45% of RF-DC conversion efficiency) in WEH for very low available power density ($5\mu\text{W}/\text{cm}^2$).

In the special context of this thesis, at the same time Multitoll Company requires practical and reliable antenna solutions for their applications, but also we aim to further the state of the art through different ideas. We provided therefore, several antennas for DSRC and WEH. The first one is the OBU antenna, a 5.8GHz patch antenna has been designed and good results have been achieved (gain value of 8dB and S_{11} value of -18dB). This antenna is integrated with the OBU device produced by Multitoll recently. The second antenna we have studied, fabricated and characterized is the 1x3 patch array with superstrate layers. We have successfully designed this antenna with a high gain (13.8dB) and a small “visible surface” (condition requested by Multitoll). Nevertheless, an issue has been detected in the reproducibility of the antenna prototypes due the VIAs connections. Given this, we have decided to use a different feeding method for the next antennas, which should be easy to fabricate in large-scale and presents a lower margin of error between the different fabricated prototypes. The third DSRC antenna developed is based on a patch antenna array with 8 elements and has a special sequential rotation feeding that allowed us to significantly improve the antenna polarization (AR=-1.5dB with radome). Once the antenna PCB design has been realized and since this antenna should be inserted in a real box with DSRC reader, we have studied and optimized the antenna considering the radome and metallic plate (for RF/electronic separation). As described before, these antennas are part of a complete and complex system, and two different *in-situ* test scenarios have been carried out in order to evaluate the practical antenna performance. Finally, WEH devices need also antennas, since *rectennas* are a combination of rectifier and antenna, then two rectennas have been designed, fabricated

and tested based on microstrip patch antenna array with high-order harmonics rejection. The first rectenna has been directly assembled with the rectifier, however, for the second rectenna a co-design process has been carried out in order to optimize the occupied PCB area.

In this thesis new results on Wireless Energy Harvesting domain have been successfully reported, but also many research technologies have been transferred and adapted to an industrial application of e-toll under the DSRC protocol. All these work results responded to the company requests.

To resume, the main contributions of this thesis are:

- To ensure a correct operation of the DSRC e-toll system, each part of the system should be analyzed, designed and tested as a part of a complete and complex system. Therefore, in this thesis, important DSRC blocks have been developed in order to guarantee the best performances for the whole system:
 - The antennas, both OBU and RSE have been studied, designed and tested in a real DSRC e-toll *in-situ* scenario.
 - The OBU front-end design and implementation have been carried out.
 - A new DSRC OBU deep-sleep mode has been implemented by means of an original wake-up vibration sensor, that allowed a considerable power consumption reduction.
 - The DSRC V2I link budget modeling for e-toll systems has been successfully developed. Several parameters have been taken into account on the link budget modeling, e.g., car's windshield attenuation, RSE antenna specifications and vehicle speed. In the literature, to the best of our knowledge, only quite few papers explored this topic.
- The possibility to recharge electronic devices remotely by means of microwave energy is quite attractive, therefore in this thesis, the Wireless Energy Harvesting has been studied:
 - Our work demonstrates that high-efficient rectifier/rectenna for low input power is feasible.
 - An important effort has been made in order to elucidate in detail how to achieve high efficiencies levels with a single diode and a simple load.
 - In the aim of demonstrating how to achieve high conversion efficiencies values, an original measurement setup has been implemented based on a Computer Controlled Microwave Tuner (CCMT). Different values of the load impedance (capacitive or inductive) were presented at the output terminal of a Schottky diode.

- Several rectifiers and rectennas have been designed, fabricated and characterized in order to validate our method.
- Regarding the *rectenna* measurement setup, we have implemented an appropriate method, since to calculate the RF-DC conversion efficiency, we need to acquire for the same energy density, the RF power on the rectifier input and the output voltage.
- A different approach has been provided regarding the difference between Wireless Power Transfer (WPT) and Wireless Energy Harvesting (WEH). Moreover, we have reminded the difficulty to compare the different results in Energy Harvesting literature due to the lack of standardization on the unit of available power density.
- Finally, the results obtained in this thesis are in the forefront of the State-of-the-Art of Wireless Energy Harvesting for very low available power density.

V.2. Perspectives

DSRC protocol needs complex and reliable RF transactions in order to ensure the payment, as well as the protection of the client's personal information. In this thesis, the high electric power consumption of DSRC protocol has been highlighted. Industrial approaches exist for reducing the electric power consumption of the DSRC protocol (e.g., DSRC OBU completely reflexive, does not need local oscillators to generate the RF wave). However, there is still a lot of work to do in this field. We could imagine the timeline presented in Fig. V-1, where the energy consumption of the DSRC OBU is compared to the energy that could be harvested in the DSRC e-toll scenario.

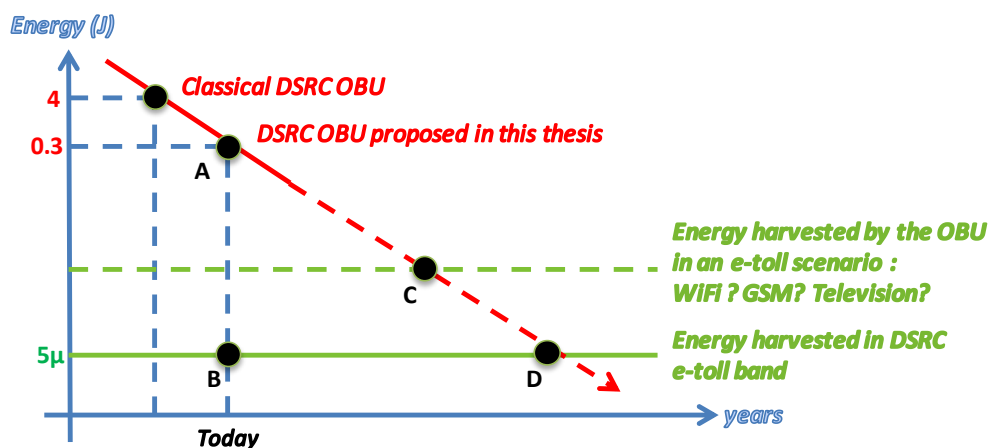

Fig. V-1. Timeline of energy requested by the DSRC OBU compared to the amount of energy that could be harvested by means of WEH.

In this thesis, the points A and B have been well established, a new low-power DSRC transponder have been proposed, and as well, the DSRC RF link budget has been carried out, demonstrating the amount of energy that could be harvested in the DSRC band. An

important observation is that, as discussed in Chapter I, nowadays, the tendency in advances of integrated low-power circuit technology is the reduction of the required energy by the electronic. Thus, WEH arises in an appropriate time, where the key is to find the point-of-compromise between requested energy and energy harvested from ambient sources (point C in Fig. V-1). However, we could also dream on that one day the point D could be reached by DSRC applications, where a completely autonomous DSRC OBU will be available on the market.

References

- [1] K. Sangani, "The sun in your pocket," *IET Engineering and Technology magazine*, pp. 36-38, Aug. 2007.
- [2] S. Roundy, P. Wright, and J.M. Rabaey, "Energy scavenging for wireless sensor networks with special focus on vibrations," 1st ed. London: Kluwer Academic Publishers, 2004.
- [3] T. Markvart and L. Castañer, "Practical Handbook of Photovoltaics: Fundamentals and Applications". 2003.
- [4] J. P. Thomas, M. A. Qidwai, and J. C. Kellogg, "Energy scavenging for small-scale unmanned systems," *Journal of Power Sources*, vol. 159, pp. 1494-1509, 2006.
- [5] A. Reinders, "Options for Photovoltaic Solar Energy Systems in Portable Products," TMCE, 2002.
- [6] M. Veefkind and S. F. J. Flipsen, "Gathering data on the energy to be harvested with portable consumer products, method and equipment," in *Proceedings of the ISES EuroSun Congress*, 2004.
- [7] M. Veefkind, "Industrial design and PV-power, challenges and barriers," in *Proceedings of the ISES Solar World Congress*, 2003.
- [8] ATA LABS. [Online] Available: <http://atllabs.com/>
- [9] Logitech wireless solar keyboard K750. [Online] Available: <http://www.logitech.fr>
- [10] CASIO GW-2000B-1AER solar atomic aviation G-shock watch. [Online] Available: www.casio.co.uk/products
- [11] J. Matiko, N. Grabham, S. Beeby and M. Tudor, "Review of the application of energy harvesting in buildings," Electronics and Computer Science, University of Southampton, UK., 2013.
- [12] International thermoelectric society. Thermoelectric power for automobiles arrives in Europe. [Online] Available: <http://www.its.org/node/5670>
- [13] V. Leonov, T. Torfs, P. Fiorini, and C. Van Hoof, "Thermoelectric Converters of Human Warmth for Self-Powered Wireless Sensor Nodes," *Sensors Journal, IEEE*, vol. 7, no. 5, pp. 650-657, 2007.
- [14] M. Stordeur and I. Stark, "Low power thermoelectric generator – selfsuiet energy supply for micro systems," in *Proceedings of the 16th International Conference on Thermoelectrics*, pp. 575-577, 1997.
- [15] I. Stark and M. Stordeur, "new micro thermoelectric devices based on bismuth telluride-type thin solid," in *Proceedings of the 18th International Conference on Thermoelectronics*, pp. 465-472, 1999.
- [16] X. Lu and S-H. Yang, "Thermal energy harvesting for WSNs", *IEEE Int. Conf. on Systems, Man and Cybernetics*, pp 3045–52, Oct. 2010.
- [17] C. Knight, J. Davidson, and S. Behrens, "Energy Options for Wireless Sensor Nodes," *Sensors*, vol. 8, pp. 8037-8066, 2008.
- [18] S. Beeby, M. Tudor and N. White, "Energy harvesting vibration sources for microsystems applications," *Meas. Sci. Technol.* 17 R175–95, 2006.
- [19] D. Zhu, M. Tudor and S. Beeby, "Strategies for increasing the operating frequency range of vibration energy harvesters: a review," *Meas. Sci. Technol.* 21 022001, 2010.
- [20] R. N. Torah, S. P. Beeby, M. J Tudor, T. O'Donnell, and S. Roy, "Development of a cantilever beam generator employing vibration energy harvesting," in *6th international workshop on micro and nanotechnology for power generation and energy conversion applications (PowerMEMS 2006)*, Dec. 2006.
- [21] M. Mizuno, and D. Chetwynd, "Investigation of a resonance microgenerator", *J. Micromech. Microeng.*, pp. 209-216, 2003.
- [22] C. Shearwood, and R. Yates, "Development of an electromagnetic microgenerator," *Electron. Lett.*, pp. 1883-1884, 1997.
- [23] H. Kulah, and K. Najafi, "An electromagnetic micro power generator for lowfrequency environmental vibrations," *17th IEEE international conference on micro electro mechanical systems (MEMS '04)*, pp. 237-240, Jan. 2004.
- [24] R. Amirtharajah, and A. Chandrakasan, "Self-powered signal processing using vibration-based power generation," *IEEE J. Solid-State Circuit*, pp. 687-695, 1998.
- [25] P. D. Mitcheson, T. C. Green, E. M. Yeatman, and A. S. Holmes, "Architectures for vibration-driven micropower generators," *J. of Microelec- tromechanical Systems*, vol. 13, no. 3, Jun. 2004.
- [26] S. Meninger, J. Mur-Miranda, R. Amirtharajah, A. P. Chandrasakan, and J. H. Lang, "Vibration to electric energy conversion," *IEEE Trans. on VLSI*, vol. 9, no. 1, Feb. 2001.
- [27] S. Roundy, P. Wright, and J. Rabaey, "A study of low level vibrations as a power source for wireless sensor nodes," *Computer Communications*, vol. 26, no. 11, pp. 1131-1144, 2003.
- [28] S. Roundy, B. P. Otis, Y.-H. Chee, J. M. Rabaey, and P. Wright, "A 1.9 GHz rf transmit beacon using environmentally scavenged energy," in *Proceedings of the ISPLED*, 2003.

- [29] S. Roundy, P. Wright, and K. Pister, "Micro-electrostatic vibration-to-electricity converters," in *Proceedings of ASME International Mechanical Engineering Congress and Exposition IMECE2002*, vol. 220, pp. 17-22, Nov. 2002.
- [30] S. Roundy, E. Leland, J. Baker, E. Carleton, E. Reilly, E. Lai, B. Otis, J. Rabaey, P. Wright, and V. Sundararajan, "Improving power output for vibration-based energy scavengers," in *IEEE Pervasive Computing*, vol. 4, no. 1, pp. 28-36, 2005.
- [31] S. Roundy, P. K. Wright, and J. M. Rabaey, "Energy scavenging for wire-less sensor networks with special focus on vibrations," Kluwer Academic Publishers, 2004.
- [32] H. Hu, H. Xue, and Y. Hu, "A spiral-shaped harvester with an improved harvesting element and an adaptive storage circuit," *IEEE Transactions on Ultrasonics, Ferroelectrics and Frequency Control*, vol. 54, no. 6, pp. 1177-1187, Jun. 2007.
- [33] G. Ottman, H. Hofmann, A. Bhatt, and G. Lesieutre, "Adaptive piezoelectric energy harvesting circuit for wireless remote power supply," *IEEE Trans. on Power Electronics*, vol. 17, no. 2, pp. 669-676, Sep. 2002.
- [34] G. Ottman, H. Hofmann, and G. Lesieutre, "Optimized piezoelectric energy harvesting circuit using step-down converter in discontinuous conduction mode," *IEEE Trans. on Power Electronics*, vol. 18, no. 2, pp. 696-703, Mar. 2003.
- [35] W. Wu, Y. Chen, B. Lee, J. He, Y. Peng. "Tunable resonant frequency power harvesting devices". Proc SPIE, 2006.
- [36] C. B. Williams and R. B. Yates, "Analysis of a micro-electric generator for microsystems," Stockholm, Sweden, pp. 369-372, 1995.
- [37] N. N. H. Ching, W. J. Li, P. H. W. Leong, Z. Wen, and H. Y. Wong, "A laser micromachined multi-modal resonating power transducer for wireless sensing systems," Munich, pp. 685-690, 2002.
- [38] Hinchet R., Lee S., Ardila G., Montes L., Mouis M., Wang Z. L., "Performance Optimization of Vertical NW-Based Piezoelectric Nanogenerators", *Advanced Functional Materials*, Oct. 2013.
- [39] R. Hinchet, S. Lee, G. Ardila, L. Montes, M. Mouis and Z-L. Wang, "Design and Guideline Rules for the Performance Improvement of Vertically Integrated Nanogenerator", *Journal of Energy and Power Engineering*, Sept. 2013.
- [40] Ardila G., Hinchet R., Mouis M., Montes L., "Scaling prospects in mechanical energy harvesting with piezo NWs", *The European Physical Journal Applied Physics*, Jul. 2013.
- [41] Nikola Tesla, "Apparatus for the Utilization of Radiant Energy," U.S. Patent No. 685,957, Nov. 5, 1901; and "A Method of Utilizing Radiant Energy," U.S. Patent No. 685-958, Nov. 5, 1901.
- [42] Experimental Airborne Microwave Supported Platform. Descriptive Note : Final rept. Jun 64 – Apr 65
- [43] G. A. Landis, "Applications for Space Power by Laser Transmission," *SPIE Optics, Electro-optics & Laser Conference*, Vol. 2121, 252-255, Jan. 1994.
- [44] W. C. Brown, "The history of power transmission by radio waves," *IEEE Trans. Microwave Theory Tech.*, vol. MTT-32, pp. 1230-1242, Sept. 1984.
- [45] G. Landis, M. Stavnes, S. Oleson and J. Bozek, "Space Transfer With Ground-Based Laser/Electric Propulsion" (AIAA-92-3213) NASA Technical Memorandum TM-106060 (1992).
- [46] Powercast Corp.. (2012). Powercast Overview - RF Energy Harvesting and Wireless Power for Micro-Power Applications. [Online]. Available: <http://www.powercastco.com/>
- [47] The economist Group Corp. (2007). When everything connects. [Online]. Available: <http://www.economist.com/node/9080024>.
- [48] Y.-C. Cheng, Y. Chawathe, A. LaMarca, J. Krumm, "Accuracy characterization for metropolitan-scale Wi-Fi localization", *Proc. Third Int. Conf. on Mobile Systems*, pp. 233-245, Jan. 2005.
- [49] Nicolas Mokhoff. (2011, Juin 12). EE Times' 20 hot technologies for 2012. [Online]. Available: http://www.eetimes.com/author.asp?section_id=36&piddl_msgorder=thrd&doc_id=1266037&page_number=2
- [50] Rajiv Kumar. (2011, October). Top 50 Technologies Reshaping the World. [Online]. Available: [http://www.growthconsulting.frost.com/web/images.nsf/0/A86A27D34190816465257937004BAA06/\\$File/GIL1011_TECHVISION%202020.htm](http://www.growthconsulting.frost.com/web/images.nsf/0/A86A27D34190816465257937004BAA06/$File/GIL1011_TECHVISION%202020.htm)
- [51] Dr Peter Harrop and Raghu Das. (2012, October). Energy Harvesting and Storage for Electronic Devices 2012-2022: Forecasts, Technologies, Players. [Online]. Available: <http://www.idtechex.com/research/reports/energy-harvesting-and-storage-for-electronic-devices-2012-2022-000316.asp?viewopt=desc>
- [52] U. Olgun, C.-C. Chen, and J. Volakis, "Design of an efficient ambient wifi energy harvesting system," *IET Microw. Antennas Propag.*, vol.6, no. 11, pp. 1200-1206, Aug. 2012.
- [53] J. Masuch, M. Delgado-Restituto, D. Milosevic, P. Baltus, "Co-Integration of an RF Energy Harvester Into a 2.4 GHz Transceiver," *Solid-State Circuits, IEEE Journal of*, vol.48, no.7, pp.1565-1574, Jul. 2013.

- [54] V. Marian, B. Allard, C. Vollaire, J. Verdier, "Strategy for Microwave Energy Harvesting From Ambient Field or a Feeding Source," *Power electronics, IEEE Transactions on*, vol.27, no.11, pp.4481-4491, Nov. 2012.
- [55] D. Masotti, A. Costanzo, M. Del Prete, V. Rizzoli, "Genetic-based design of a tetra-band high-efficiency radio-frequency energy harvesting system," *Microwaves, Antennas & Propagation, IET*, vol.7, no.15, pp.1254-1263, Dec. 2013.
- [56] Erez Falkenstein, Michael Roberg, Z. Popovic, "Low-Power Wireless Power Delivery," *Microwave Theory and Techniques, IEEE Transactions on*, vol.60, no.7, pp.2277-2286, Jul. 2012
- [57] Hucheng Sun; Yong-Xin Guo; Miao He; Zheng Zhong, "Design of a High-Efficiency 2.45-GHz Rectenna for Low-Input-Power Energy Harvesting," *Antennas and Wireless Propagation Letters, IEEE*, vol.11, no., pp.929-932, 2012.
- [58] Z. Harouni, L. Cirio, L. Osman, A. Gharsallah, O. Picon, "A Dual Circularly Polarized 2.45-GHz Rectenna for Wireless Power Transmission," *Antennas and Wireless Propagation Letters, IEEE*, vol.10, no., pp.306-309, 2011.
- [59] G. Andia Vera, A. Georgiadis, A. Collado, S. Via, "Design of a 2.45 GHz rectenna for electromagnetic (EM) energy scavenging," *Radio and Wireless Symposium (RWS), 2010 IEEE*, vol., no., pp.61-64, Jan. 2010.
- [60] H. Takhedmit, B. Merabet, L. Cirio, B. Allard, F. Costa, C. Vollaire and O. Picon, "A 2.45-GHz low cost and efficient rectenna," in *Proc. 4th Eur. Antennas Propag. Conf.*, pp. 1–5, 2010
- [61] H. Takhedmit, B. Merabet, L. Cirio, B. Allard, F. Costa, C. Vollaire, O. Picon, "A 2.45-GHz dual-diode RF-to-dc rectifier for rectenna applications," *Microwave Conference (EuMC), 2010 European*, vol., no., pp.37-40, Sept. 2010
- [62] F. A. S. Riviere, A. Douyere, and J.-D. Lan Sun Luk, "A compact rectenna device at low power level," *Progr. Electromagn. Res. C*, vol. 16, pp. 137–146, 2010.
- [63] J. Zbitou, M. Latrach, and S. Toutain, "Hybrid rectenna and monolithic integrated zero-biasmicrowave rectifier," *IEEE Trans. Microw. Theory Tech.*, vol. 54, no. 1, pp. 147–152, Jan. 2006.
- [64] J. Akkermans, M. van Beurden, G. Doodeman, and H. Visser, "Analytical models for low-power rectenna design," *IEEE Antennas Wireless Propag. Lett.*, vol. 4, pp. 187–190, 2005.
- [65] Young-Ho Suh, Kai Chang, "A high-efficiency dual-frequency rectenna for 2.45- and 5.8-GHz wireless power transmission," *Microwave Theory and Techniques, IEEE Transactions on*, vol.50, no.7, pp.1784-1789, Jul. 2002.
- [66] J. Heikkinen, P. Salonen, M. Kivikoski, "Planar rectennas for 2.45 GHz wireless power transfer," *Radio and Wireless Conference, 2000*, vol., no., pp.63-66, 2000.
- [67] W. Brown, "An experimental low power density rectenna," in *IEEE MTT-S Int. Microw. Symp. Dig.*, vol. 1, pp. 197–200, Jul. 1991.
- [68] EE Times (2009, November 11). Nokia working on energy-harvesting handset. *Mag.* [Online]. Available: http://www.eetimes.com/document.asp?doc_id=1253967C.
- [69] Cseh, "Architecture of the Dedicated Short-Range Communications (DSRC) protocol", *Vehicular Technology conference, VTC 98 48th IEEE*, vol. 3 pp 2095-2099, 1998.
- [70] Kelly, Frank (2006): Road Pricing: Addressing congestion, pollution and the financing of Britain's road. Published in "Ingenia" by The Royal Academy of Engineering, volume 39, p. 36-42.
- [71] Dedicated Short-Range Communication (DSRC) - Physical CEN Standard EN 12253, 2004.
- [72] Dedicated Short-Range Communication (DSRC) - Data link layer: Medium Access and Logical Link Control, CEN Standard EN 12795, 2002.
- [73] Dedicated Short Range Communication (DSRC) - DSRC application layer, CEN Standard EN 12834, 2003.
- [74] DSRC profiles for RTTT applications, CEN Standard EN 13372, 2004.
- [75] Interface for EFC – Electronic Fee Collection, CEN, ISO, and ETSI Standard EN ISO/ETSI 14906, 2004.
- [76] B. R. Franciscatto, T.-P. Vuong, T. Trang, C. Defay, "Microstrip-fed quasi-Yagi antenna array for a different DSRC system," *Antenna Technology and Applied Electromagnetics (ANTEM), 2012 15th International Symposium on*, vol., no., pp.1-5, Jun. 2012.
- [77] Kenney and John B., "Dedicated Short-Range Communications (DSRC) Standards in the United States," in *Proceedings of the IEEE*, Vol. 99, Issue: 7, pp. 1162–1182, Jul. 2011.
- [78] D. Tian, H. Luo, J. Zhou, H. Xia, "A Self-Adaptive V2V Communication System with DSRC," *Green Computing and Communications (GreenCom), 2013 IEEE and Internet of Things (iThings/CPSCom), IEEE International Conference on and IEEE Cyber, Physical and Social Computing*, vol., no., pp.1528-1532, Aug. 2013.

- [79] R. Sabouni, R. Hafez, "Performance of DSRC for V2V communications in urban and highway environments," 25th IEEE Canadian Conference *Electrical & Computer Engineering (CCECE)*, vol., no., pp.1-5, Apr. 2012.
- [80] K. Hong, J. Kenney, V. Rai, K. Laberteaux, "Evaluation of Multi-Channel Schemes for Vehicular Safety Communications," *IEEE Vehicular Technology Conference (VTC 2010-Spring)*, vol., no., pp.1-5, May 2010.
- [81] S. Chang, J. Jung, J. Cha, S. Lee, "Implementation of DSRC Mobile MAC for VANET," *Advanced Communication Technology (ICACT)*, 2011 13th International Conference on, vol., no., pp.1502-1505, Feb. 2011.
- [82] V. Kukshya, H. Krishnan, "Experimental Measurements and Modeling for Vehicle-to-Vehicle Dedicated Short Range Communication (DSRC) Wireless Channels," *Vehicular Technology Conference, 2006. VTC-2006 Fall. 2006 IEEE 64th*, vol., no., pp.1-5, Sept. 2006.
- [83] J. Fernandez, K. Borries, L. Cheng, B. Kumar, D. Stancil, F. Bai, "Performance of the 802.11p Physical Layer in Vehicle-to-Vehicle Environments," *Vehicular Technology, IEEE Transactions on*, vol.61, no.1, pp.3-14, Jan. 2012.
- [84] X. Ma, X. Chen, "Delay and Broadcast Reception Rates of Highway Safety Applications in Vehicular Ad Hoc Networks," *2007 Mobile Networking for Vehicular Environments*, vol., no., pp.85-90, May 2007.
- [85] S. Strin, M. Kang, J. Jin, S. Kim, H. Kim, S. Moh, "Vehicle-to-Vehicle emergency message dissemination through the WiBro network," *Networked Computing (INC), 2010 6th International Conference on*, vol., no., pp.1-6, May 2010.
- [86] S. Biswas, R. Tatchikou, and F. Dion, "Vehicle-to-vehicle wireless communication protocols for enhancing highway traffic safety," *IEEE Communications Magazine*, vol. 44, pp. 74-82, Jan. 2006.
- [87] Fan Bai, H. Krishnan, "Reliability Analysis of DSRC Wireless Communication for Vehicle Safety Applications," *Intelligent Transportation Systems Conference*, Page(s): 355-362, 2006.
- [88] Xianbo Chen, H.Refaï, Xiaomin Ma, "A Quantitative Approach to Evaluate DSRC Highway Inter-Vehicle Safety Communication," *Global Telecommunications Conference, 2007. GLOBECOM '07*. Page(s):151–155. Nov. 2007.
- [89] L. Cheng, B. E. Henty, D. D. Stancil, F. Bai, P. Mudalige, "Mobile Vehicle-to-Vehicle Narrow-Band Channel Measurement and Characterization of the 5.9 GHz Dedicated Short Range Communication (DSRC) Frequency Band", *IEEE Journal on Selected Areas in Communications*, Vol. 25, pp. 1501–1516, Oct. 2007.
- [90] A. G. Emslie, R. L. Lagace, and P. F. Strong, "Theory of the propagation of UHF radio waves in coal mine tunnels," *IEEE Trans. Antennas Propag.*, vol. AP-23, pp. 192-205, Mar. 1975.
- [91] Y. Yamaguchi, T. Abe, T. Sekiguchi, and J. Chiba, "Attenuation constants of UHF radio waves in arched tunnels," *IEEE Trans. Microw. Theory Tech.*, vol. MTT-33, no. 8, pp. 714-718, Aug. 1985.
- [92] K. Fujimori and H. Arai, "Propagation characteristics in tunnels including base station antenna," *Electron. and Commun. in Japan (Part I: Commun.)*, vol. 84, iss. 4, pp. 1-10, April 2001.
- [93] K. Uchida, H. Nose, H. Maeda, and T. Matsunaga, "Theoretical and experimental study of propagation in 3D tunnels," *IEICE Trans. Commun.*, vol. E87-B, no. 10, pp. 3044-3049, Oct. 2004.
- [94] D. G. Dudley, and S. F. Mahmoud, "Linear source in a circular tunnel," *IEEE Trans. Antennas Propag.*, vol. 54, no. 7, pp. 2034-2047, July 2006.
- [95] T. S. Wang, and C. F. Yang, "Simulations and measurements of wave propagations in curved road tunnels for signals from GSM base stations," *IEEE Trans. Antennas Propag.*, vol. 54, no. 9, pp. 2577-2584, Sep. 2006.
- [96] C. Briso-Rodriguez, J.M. Cruz, J.I. Alonso, "Measurements and Modeling of Distributed Antenna Systems in Railway Tunnels," *Vehicular Technology, IEEE Transactions on*, vol.56, no.5, pp.2870-2879, Sept. 2007
- [97] D. Didascalou, T. Schafer, F. Weinmann, and W. Wiesbeck, "Ray-density normalization for ray-optical wave propagation modeling in arbitrarily shaped tunnels," *IEEE Trans. Antennas Propag.*, vol. 48, no. 9, pp. 1316-1325, Sep. 2000.
- [98] T. Imai, "Prediction of propagation characteristics in tunnels using raytracing method," *IEICE Trans. Commun. (Japanese Edition)*, vol. J85-B, no. 2, pp. 216-226, Feb. 2002.
- [99] W. Detlefsen, W. Grabow, "Interoperable 5.8 GHz DSRC Systems as Basis for Europeanwide ETC Implementation," *Microwave Conference, 1997. 27th European*, vol.1, no., pp.139-145, Sept. 1997.
- [100] H. Bantli, E. Ring, E. Goff, "Requirements for direct short range, vehicle to roadside communications," *Aerospace Conference, 1997. Proceedings., IEEE*, vol.1, no., pp.41-61, Feb. 1997.
- [101] W.-Y. Shieh, W.-H. Lee, S.-L. Tung, B.-S. Jeng, and C.-H. Liu, "Analysis of the optimum configuration of roadside units and onboard units in dedicated short-range communication systems," *IEEE Trans. Intell. Transp. Syst.*, vol. 7, no. 4, pp. 565–571, Dec. 2006.

- [102] A. Visser, H.H. Yakali, A.-J. van der Wees, M. Oud, G.A. Van der Spek, L.O. Hertzberger, "A hierarchical view on modeling the reliability of a DSRC link for ETC applications," *Intelligent Transportation Systems, IEEE Transactions on*, vol.3, no.2, pp.120-129, Jun. 2002.
- [103] C. Becker, A. Feld, "Pre-installation assessment of DSRC systems," *Intelligent Transportation Systems, 2001. Proceedings. 2001 IEEE*, vol., no., pp.877-882, 2001.
- [104] G. Villino, C. Passmann, D. Mansen, C. Brenzel, T. Wixforth, "Integrated 5.8 GHz phased array antenna, for electronic toll collection," *Microwave Symposium Digest, 1998 IEEE MTT-S International*, vol.3, no., pp.1215-1218, Jun. 1998.
- [105] M. Gatsinzi, F. Jouvie, X. Bunlon, A. Azoulay, "Study of a 5.8 GHz frequency band patch antenna integrated into a vehicle for automotive DSRC applications," *Electromagnetics in Advanced Applications, 2007. ICEAA 2007. International Conference on*, vol., no., pp.543-546, Sept. 2007.
- [106] YingQing Xia, Jia Luo, "RHCP Patch Antenna for Automotive DSRC System," *Wireless Communications Networking and Mobile Computing (WiCOM), 2010 6th International Conference on*, vol., no., pp.1-3, Sept. 2010.
- [107] T. Varum, J. Matos, P. Pinho, "Printed antenna for on-board unit of a DSRC system," *Antennas and Propagation (APSURSI), 2011 IEEE International Symposium on*, vol., no., pp.457-460, Jul. 2011.
- [108] Liang Han, Ke Wu, "Multifunctional Transceiver for Future Intelligent Transportation Systems," *Microwave Theory and Techniques, IEEE Transactions on*, vol.59, no.7, pp.1879-1892, Jul. 2011.
- [109] Liang Han, Ke Wu, "Radar and radio data fusion platform for future intelligent transportation system," *Radar Conference (EuRAD), 2010 European*, vol., no., pp.65-68, Oct. 2010.
- [110] W.-Y. Shieh, W.-H. Lee, S.-L. Tung, B.-S. Jeng, and C.-H. Liu, "Analysis of the optimum configuration of roadside units and onboard units in dedicated short-range communication systems," *IEEE Trans. Intell. Transp. Syst.*, vol. 7, no. 4, pp. 565–571, Dec. 2006.
- [111] A. Visser, H.H. Yakali, A.-J. van der Wees, M. Oud, G.A. Van der Spek, L.O. Hertzberger, "A hierarchical view on modeling the reliability of a DSRC link for ETC applications," *Intelligent Transportation Systems, IEEE Transactions on*, vol.3, no.2, pp.120-129, Jun. 2002.
- [112] W.-Y. Shieh, T. Wang, Y. Chou, C. Huang, "Design of the Radiation Pattern of Infrared Short-Range Communication Systems for Electronic-Toll-Collection Applications," *Intelligent Transportation Systems, IEEE Transactions on*, vol.9, no.3, pp.548-558, Sept. 2008.
- [113] J. M. Kahn and J. R. Barry, "Wireless infrared communications," *Proc. IEEE*, vol. 85, no. 2, pp. 265–298, Feb. 1997.
- [114] W.-Y. Shieh, "The analysis of single-lane OBU and RTU optimum setup configuration in automatic electronic-toll-collection systems," Res. Inst. ChungHwa Telecom, Taoyuan, Taiwan, 89-EC-023, Nov. 2000.
- [115] J. D. Kraus, *Antennas*, 2nd ed. New York: McGraw-Hill, ch. 3, 1988.
- [116] ASFA, "Pare-brise athermiques Bilan 2008 par marque", Annexe au rapport EGIS MOBILITE n° 1A0923D.
- [117] S. Maddio, A. Cidronali, S. Maurri, G. Manes, "Compact ETSI compliant DSRC transponder for vehicular communications at 5.8 GHz," *Microwave Radar and Wireless Communications (MIKON), 2012 19th International Conference on*, vol.1, no., pp.350-353, May 2012.
- [118] N. Almeida, R. Abreu, J. Nuno Matos, N. Borges Carvalho, J. Sales Gomes, "Low cost transceiver for DSRC applications," *Microwave Conference, 2006. APMC 2006. Asia-Pacific*, vol., no., pp.1501-1504, Dec. 2006.
- [119] C. Luxey, J.-M. Laheurte, "A retrodirective transponder with polarization duplexing for dedicated short-range communications," *Microwave Theory and Techniques, IEEE Transactions on*, vol.47, no.9, pp.1910-1915, Sep. 1999.
- [120] UMS Corp. (2009, Jan.). "5.8 GHz one antenna reflective transponder for tag". [Online]. Available: <http://datasheet.eeworld.com.cn>.
- [121] CERTU (1998), "La route intelligente. Les communications dédiées à courte distance". [Online]. Available: <http://lara.inist.fr/>.
- [122] Signal Quest Corp. (2014). "Nano-power tilt and vibration sensor". [Online]. Available: <http://signalquest.com>
- [123] Microchip (2009). "NanoWatt PIC24 Microcontroller Family". [Online]. Available: <http://microchip.com>
- [124] H. Hertz, Ueber Strahlen elektrischer Kraft, Wiedemann Annalen, Annalen der Physik und Chemie, vol. 36, 1888.
- [125] F. Gardiol, y. Fournier. "Salvan: Cradle of Wireless, How Marconi Conducted Early Wireless Experiments in the Swiss Alps". *Microwave Journal*: 124–136. Feb. 2006.
- [126] *IEEE Transactions on Antennas and Propagation*, vols. AP-17, No. 3, May 1969; AP-22, No. 1, January 1974; and AP-31, No. 6, Part II, Nov.1983.

- [127] C.A. Balanis, *Antenna Theory: Analysis and Design*, John Wiley & Sons, Inc, 1997.
- [128] J. Ramsay, "Highlights of antenna history," *Antennas and Propagation Society Newsletter, IEEE*, vol.23, no.6, pp.7-20, Dec. 1981.
- [129] IEEE Standard Definitions of Terms for Antennas," IEEE Std 145-1993, vol., no., pp.1-32, Jul. 1993.
- [130] Granite Island Group (2010). Polarization. [Online]. Available: <http://www.tscm.com>
- [131] T. S. Bird, "Definition and Misuse of Return Loss [Report of the Transactions Editor-in-Chief]," *Antennas and Propagation Magazine, IEEE* , vol.51, no.2, pp.16-167, Apr. 2009.
- [132] D. M. Pozar, "Microwave Engineering", 2nd ed., Wiley, 1998.
- [133] M. Sadiku, "Elements of Electromagnetics", 2nd ed., OUP, 1994.
- [134] W. Stutzman and G. Thiele, "Antenna Theory and Design", 2nd ed., Wiley, 1998.
- [135] D. M. Pozar and D. H. Schaubert, "Scan Blindness in Infinite Phased Arrays of Printed Dipoles," *IEEE Trans. Antennas Propagat.*, Vol. AP-32, No. 6, pp. 602–610, Jun. 1984.
- [136] I. E. Rana and N. G. Alexopoulos, "Current Distribution and Input Impedance of Printed Dipoles," *IEEE Trans. Antennas Propagat.*, Vol. AP-29, No. 1, pp. 99–105, Jan. 1981.
- [137] D. M. Pozar, "Analysis of Finite Phased Arrays of Printed Dipoles," *IEEE Trans. Antennas Propagat.*, Vol. AP-33, No. 10, pp. 1045–1053, Oct. 1985.
- [138] N.K. Uzunoglu, N.G. Alexopoulos, J.G. Fikioris, "Radiation properties of microstrip dipoles," *Antennas and Propagation, IEEE Transactions on*, vol.27, no.6, pp.853-858, Nov. 1979.
- [139] Yun-Wen Chi, Kin-Lu Wong, "Quarter-Wavelength Printed Loop Antenna With an Internal Printed Matching Circuit for GSM/ DCS/PCS/UMTS Operation in the Mobile Phone," *Antennas and Propagation, IEEE Transactions on* , vol.57, no.9, pp.2541-2547, Sept. 2009.
- [140] D.H. Werner, "An exact integration procedure for vector potentials of thin circular loop antennas," *Antennas and Propagation, IEEE Transactions on*, vol.44, no.2, pp.157-165, Feb. 1996.
- [141] K.D. Katsibas, C.A. Balanis, P.A. Tirkas, C.R. Birtcher, "Folded loop antenna for mobile hand-held units," *Antennas and Propagation, IEEE Transactions on*, vol.46, no.2, pp.260-266, Feb. 1998.
- [142] Yun-Wen Chi, Kin-Lu Wong, "Internal Compact Dual-Band Printed Loop Antenna for Mobile Phone Application," *Antennas and Propagation, IEEE Transactions on*, vol.55, no.5, pp.1457-1462, May 2007.
- [143] H. Whiteside, R.W.P. King, "The loop antenna as a probe," *Antennas and Propagation, IEEE Transactions on*, vol.12, no.3, pp.291-297, May 1964.
- [144] John d Kraus, "Antennas", Mcgraw-hill 2nd Ed, 1988.
- [145] T. Imura, H. Okabe, Y. Hori, "Basic experimental study on helical antennas of wireless power transfer for Electric Vehicles by using magnetic resonant couplings," *Vehicle Power and Propulsion Conference, 2009. VPPC '09. IEEE*, vol., no., pp.936-940, Sept. 2009.
- [146] G. Lazzi, O. P. Gandhi, "On modeling and personal dosimetry of cellular telephone helical antennas with the FDTD code," *Antennas and Propagation, IEEE Transactions on*, vol.46, no.4, pp.525-530, Apr. 1998.
- [147] H. Nakano, N. Ikeda, Yu-Yuan Wu, R. Suzuki, H. Mimaki, J. Yamauchi, "Realization of dual-frequency and wide-band VSWR performances using normal-model helical and inverted-F antennas," *Antennas and Propagation, IEEE Transactions on* , vol.46, no.6, pp.788-793, Jun. 1998.
- [148] C. Puente, J. Romeu, R. Pous, and A. Cardama, "On the behavior of the Sierpinski multiband antenna," *IEEE Trans. Antennas Propagat.*, vol. 46, pp. 517–524, Apr. 1998.
- [149] J. Soler and J. Romeu, "Generalized Sierpinski fractal antenna," *IEEE Trans. Antennas Propagation*, vol. 49, pp. 1237–1239, Aug. 2001.
- [150] J. Romeu and Y. Rahmat-Samii, "Fractal FSS: A novel multiband frequencyselective surface," *IEEE Trans. Antennas Propagat.*, vol. 48, pp.713–719, Jul. 2000.
- [151] C. Borja, J.Romeu, "On the behavior of Koch island fractal boundary microstrip patch antenna," *IEEE-AP*, Jun. 2003.
- [152] J. Anguera, "Metalized foams for fractal-shaped microstrip antennas," *IEEE-AP Magazine*, Dec. 2008.
- [153] C. Puente, J. Romeu, R. Pous, X. Garcia and F. Benitez "Fractal Multiband Antenna Based On The Sierpinski Gasket," *Electronics Letters*, Vol 32, Jan. 1996.
- [154] C. Borja, G. Font, S. Blanch, and J. Romeu, "High directivity fractal boundary microstrip patch antenna," *Electron. Lett.*, vol. 36, no. 9, pp. 778–779, Apr. 2000.
- [155] C. Borja: "Fractal Microstrip Patch Antennas with Fractal Perimeter and Self-Affine Properties," Ph.D. thesis, UPC Barcelona, 2001
- [156] C. Borja; C. Puente; A. Medina, "Iterative network model to predict the behaviour of a Sierpinski fractal network [antennas]," *Electronics Letters Volume 34*, pp. 1443 - 1445, Jul. 1998.

- [157] J. Angueraw; C. Borjaw; C. Puente, "Microstrip Fractal-Shaped Antennas," A Review, *Antennas and Propagation*, 2007, EuCAP 2007, *The second European Conference on*, Page(s):1 – 7, Nov. 2007.
- [158] B. R. Franciscatto, G. Fontgalland, F. Ndagijimana and T.P. Vuong, "Design of a directive antenna with fractal geometry for RFID localization applications," *Antennas and Propagation (EuCAP), 2010 Proceedings of the Fourth European Conference on*, vol., no., pp.1,5, 12-16 Apr. 2010.
- [159] B. R. Franciscatto, G. Fontgalland and T.P. Vuong, "High gain Sierpinski Gasket fractal shape antenna designed for RFID," *Microwave & Optoelectronics Conference (IMOC), 2011 SBMO/IEEE MTT-S International*, vol., no., pp.239-243, Nov. 2011.
- [160] G. A. Deschamps, "Microstrip Microwave Antennas," Presented at the Third USAF Symposium on Antennas, 1953.
- [161] W. F. Richards, Y. T. Lo, and D. D. Harrison, "An Improved Theory of Microstrip Antennas with Applications," *IEEE Trans. Antennas Propagat.*, Vol. AP-29, No. 1, pp. 38–46, Jan. 1981.
- [162] R. E. Munson, "Conformal Microstrip Antennas and Microstrip Phased Arrays," *IEEE Trans. Antennas Propagat.*, Vol. AP-22, No. 1, pp. 74–78, Jan. 1974.
- [163] J. W. Howell, "Microstrip Antennas," *IEEE Trans. Antennas Propagat.*, Vol. AP-23, No. 1, pp. 90–93, Jan. 1975.
- [164] A. G. Derneryd, "Linearly Polarized Microstrip Antennas," *IEEE Trans. Antennas Propagat.*, Vol. AP-24, No. 6, pp. 846–851, Nov. 1976.
- [165] L. C. Shen, S. A. Long, M. R. Allerding, and M. D. Walton, "Resonant Frequency of a Circular Disc, Printed-Circuit Antenna," *IEEE Trans. Antennas Propagat.*, Vol. AP-25, No. 4, pp. 595–596, Jul. 1977.
- [166] P. K. Agrawal and M. C. Bailey, "An Analysis Technique for Microstrip Antennas," *IEEE Trans. Antennas Propagat.*, Vol. AP-25, No. 6, pp. 756–759, Nov. 1977.
- [167] A. G. Derneryd, "A Theoretical Investigation of the Rectangular Microstrip Antenna Element," *IEEE Trans. Antennas Propagat.*, Vol. AP-26, No. 4, pp. 532–535, Jul. 1978.
- [168] Proc. of the Workshop on Printed-Circuit Antenna Technology, New Mexico State Univ., Las Cruces, NM, Oct. 1979.
- [169] A. G. Derneryd, "Analysis of the Microstrip Disk Antenna Element," *IEEE Trans. Antennas Propagat.*, Vol. AP-27, No. 5, pp. 660–664, Sep. 1979.
- [170] A. G. Derneryd, "Extended Analysis of Rectangular Microstrip Resonator Antennas," *IEEE Trans. Antennas Propagat.*, Vol. AP-27, No. 6, pp. 846–849, Nov. 1979.
- [171] Y. T. Lo, D. Solomon, and W. F. Richards, "Theory and Experiment on Microstrip Antennas," *IEEE Trans. Antennas Propagat.*, Vol. AP-27, No. 2, pp. 137–145, Mar. 1979.
- [172] S. A. Long and M. D. Walton, "A Dual-Frequency Stacked Circular-Disc Antenna," *IEEE Trans. Antennas Propagat.*, Vol. AP-27, No. 2, pp. 270–273, Mar. 1979.
- [173] N. K. Uzunoglu, N. G. Alexopoulos, and J. G. Fikioris, "Radiation Properties of Microstrip Dipoles," *IEEE Trans. Antennas Propagat.*, Vol. AP-27, No. 6, pp. 853–858, Nov. 1979.
- [174] I. J. Bahl and P. Bhartia, *Microstrip Antennas*, Artech House, Dedham, MA, 1980.
- [175] D. M. Pozar, "Analysis of Finite Phased Arrays of Printed Dipoles," *IEEE Trans. Antennas Propagat.*, Vol. AP-33, No. 10, pp. 1045–1053, Oct. 1985.
- [176] J. R. James, P. S. Hall, and C. Wood, *Microstrip Antenna Theory and Design*, Peter Peregrinus, London, UK, 1981.
- [177] R. E. Munson, "Microstrip Antennas," Chapter 7 in *Antenna Engineering Handbook* (R. C. Johnson and H. Jasik, eds.), McGraw-Hill Book Co., New York, 1984.
- [178] P. Bhartia, K. V. S. Rao, and R. S. Tomar, *Millimeter-Wave Microstrip and Printed Circuit Antennas*, Artech House, Boston, MA, 1991.
- [179] J. R. James, "What's New In Antennas," *IEEE Antennas Propagat. Mag.*, Vol. 32, No. 1, pp. 6–18, Feb. 1990.
- [180] D. M. Pozar, "Input Impedance and Mutual Coupling of Rectangular Microstrip Antenna," *IEEE Trans. Antennas Propagat.*, Vol. AP-30, No. 6, pp. 1191–1196, Nov. 1982.
- [181] D. M. Pozar, "Considerations for Millimeter-Wave Printed Antennas," *IEEE Trans. Antennas Propagat.*, Vol. AP-31, No. 5, pp. 740–747, Sep. 1983.
- [182] E. F. Kuester and D. C. Chang, "A Geometrical Theory for the Resonant Frequencies and Q- Factors of Some Triangular Microstrip Patch Antennas," *IEEE Trans. Antennas Propagat.*, Vol. AP-31, No. 1, pp. 27–34, Jan. 1983.
- [183] W. F. Richards, "Microstrip Antennas," Chapter 10 in *Antenna Handbook: Theory, Applications and Design* (Y. T. Lo and S. W. Lee, eds.), Van Nostrand Reinhold Co., New York, 1988.
- [184] J. R. James and P. S. Hall, *Handbook of Microstrip Antennas*, Vols. 1 and 2, Peter Peregrinus, London, UK, 1989.

- [185] P. B. Katehi and N. G. Alexopoulos, "On the Modeling of Electromagnetically Coupled Microstrip Antennas-The Printed Strip Dipole," *IEEE Trans. Antennas Propagat.*, Vol. AP- 32, No. 11, pp. 1179–1186, Nov. 1984.
- [186] D. M. Pozar, "Microstrip Antennas," *Proc. IEEE*, Vol. 80, No. 1, pp. 79–81, Jan. 1992.
- [187] P. Bhartia and I. J. Bahl, "Frequency Agile Microstrip Antennas," *Microwave Journal*, pp. 67–70, Oct. 1982.
- [188] W. F. Richards and Y. T. Lo, "Theoretical and Experimental Investigation of a Microstrip Radiator with Multiple Lumped Linear Loads," *Electromagnetics*, Vol. 3, No. 3–4, pp. 371–385, Jul.–Dec. 1983.
- [189] W. F. Richards and S. A. Long, "Impedance Control of Microstrip Antennas Utilizing Reactive Loading," *Proc. Intl. Telemetering Conf.*, pp. 285–290, Las Vegas, 1986.
- [190] D. H. Schaubert, F. G. Farrar, A. Sindoris, and S. T. Hayes, "Microstrip Antennas with Frequency Agility and Polarization Diversity," *IEEE Trans. Antennas Propagat.*, Vol. AP-29, No. 1, pp. 118–123, Jan. 1981.
- [191] W. F. Richards and S. A. Long, "Adaptive Pattern Control of a Reactively Loaded, Dual-Mode Microstrip Antenna," *Proc. Intl. Telemetering Conf.*, pp. 291–296, Las Vegas, 1986.
- [192] M. P. Purchine and J. T. Aberle, "A Tunable L-Band Circular Microstrip Patch Antenna," *Microwave Journal*, pp. 80-87, and 88, Oct. 1994.
- [193] J. R. James and P. S. Hall, *Handbook of microstrip antennas*, Peter Peregrinus, London, UK, 1989.
- [194] Keith R. Carver, J. Mink, "Microstrip antenna technology," *Antennas and Propagation, IEEE Transactions on* , vol.29, no.1, pp.2-24, Jan. 1981.
- [195] H.F. Pues, A.R. Van de Capelle, "An impedance-matching technique for increasing the bandwidth of microstrip antennas," *Antennas and Propagation, IEEE Transactions on* , vol.37, no.11, pp.1345-1354, Nov. 1989.
- [196] Y.J. Sung, T.U. Jang, Y. -S Kim, "A reconfigurable microstrip antenna for switchable polarization," *Microwave and Wireless Components Letters, IEEE* , vol.14, no.11, pp.534-536, Nov. 2004.
- [197] Ki-Hak Kim; Seong-Ook Park, "Analysis of the small band-rejected antenna with the parasitic strip for UWB," *Antennas and Propagation, IEEE Transactions on* , vol.54, no.6, pp.1688-1692, Jun. 2006.
- [198] H. G. Oltman and D. A. Huebner, "Electromagnetically Coupled Microstrip Dipoles," *IEEE Trans. Antennas Propagat.*, Vol. AP-29, No. 1, pp. 151–157, Jan. 1981.
- [199] D. M. Pozar, "A Microstrip Antenna Aperture Coupled to a Microstrip Line," *Electronic Letters*, Vol. 21, pp. 49–50, Jan. 1985.
- [200] G. Gronau and I. Wolff, "Aperture-Coupling of a Rectangular Microstrip Resonator," *Electronic Letters*, Vol. 22, pp. 554–556, May 1986.
- [201] M.H.C. Dias, B.R. Franciscatto, E.M.B. Nogueira, Vuong, T.P., "On the design of a dual-fed aperture-coupled circularly polarized microstrip patch antenna," *Microwave & Optoelectronics Conference (IMOC), 2013 SBMO/IEEE MTT-S International* , vol., no., pp.1-5, Aug. 2013.
- [202] Girish Kumar and K.P. Ray, "Broadband microstrip antennas", Artech House, Nov. 2002.
- [203] D.R. Jackson and N.G Alexopoulos, "Gain enhancement methods for printed circuit antennas", *IEEE trans. on antennas and propagation*", vol. AP-33. Sept. 1985.
- [204] H. Iwasaki, T. Nakajima and Y. Suzuki, "Gain Improvement of Circularly Polarized Array Antenna Using Linearly Polarized Elements", *IEEE Transactions on Antennas and Propagation*, vol. 43, no. 6, Jun. 1995.
- [205] H.Y. Yang and N.G. Alexopoulos, "Gain enhancement methods for printed circuit antennas through multiple superstrates", *IEEE trans. on antennas and propagation*, vol. Ap-35, Jul. 1981.
- [206] N.G. Alexopoulos and D.R. Jackson, "Fundamental superstrate effects on printed antennas", *IEEE trans. Antennas propagation*, vol. AP-32, n°8, pp 807-813, Aug. 1984.
- [207] Hall, P.S., "Application of sequential feeding too wide bandwidth, circularly polarized microstrip patch arrays", *Microwaves Antennas and propagation, IEEE proceedings*, Vol. 136, Oct. 1989.
- [208] Documents of the International Radio Conference. Doc. No. 1-100. p.466 (1947, Atlantic City). [Online]. Available: <http://www.itu.int/>
- [209] M. Piñuela, P. D. Mitcheson and S. Lucyszyn, "Ambient RF Energy Harvesting in Urban and Semi-Urban Environments", *IEEE Trans. On Microwave Theory and Techniques*, vol.61, no.7, pp.2715-2726, Jul. 2013.
- [210] A.N. Parks, A.P. Sample, Yi Zhao, J.R. Smith, "A wireless sensing platform utilizing ambient RF energy," *Wireless Sensors and Sensor Networks (WiSNet), 2013 IEEE Topical Conference on* , vol., no., pp.127-129, Jan. 2013.
- [211] D. De Donno, L. Catarinucci, L. Tarricone, "An UHF RFID Energy-Harvesting System Enhanced by a DC-DC Charge Pump in Silicon-on-Insulator Technology," *Microwave and Wireless Components Letters, IEEE* , vol.23, no.6, pp.315-317, Jun. 2013.

- [212] J.-P. Curty, N. Joehl, C. Dehollaini, M. Declercq, "A 2.45 GHz remotely powered RFID system," *Research in Microelectronics and Electronics*, 2005 PhD, vol.1, no., pp.153-156, Jul. 2005.
- [213] J.-P. Curty, N. Joehl, C. Dehollaini, M.J. Declercq, "Remotely powered addressable UHF RFID integrated system," *Solid-State Circuits, IEEE Journal of*, vol.40, no.11, pp.2193-2202, Nov. 2005.
- [214] Y.-C. Cheng, Y. Chawathe, A. LaMarca, J. Krumm, 'Accuracy characterization for metropolitan-scale Wi-Fi localization'. *Proc. Third Int. Conf. on Mobile Systems*, pp. 233–245, Jan. 2005.
- [215] H. Deguchi, M. Tsuji, H. Shigesawa, "Synthesis of a High Efficiency Conical-Horn Antenna: Effect of the Negative Flare Angle," *Microwave Conference, 2001. 31st European*, pp.1,4, 24-26, 2001.
- [216] A.V.S. Lages, M.N. Kawakatsu, V. Dmitriev, "Planar elliptical UWB monopole antenna with high efficiency," *Microwave & Optoelectronics Conference (IMOC), 2011 SBMO/IEEE MTT-S International*, vol., no., pp.208-212, Oct. 2011.
- [217] S-E Adami, V. Marian, N. Degrenne, C. Vollaie, B. Allard, F. Costa, "Self-powered ultra-low power DC-DC converter for RF energy harvesting," *Faible Tension Faible Consommation (FTFC), 2012 IEEE*, vol., no., pp.1-4, Jun. 2012.
- [218] H. J. Visser, V. Pop, B. Op het Veld, and R. J. M. Vullers, "Remote RF battery charging," in *Proc. PowerMEMS*, 2010.
- [219] J. Kim, M. Shim, J. Jung, H. Kim, C. Kim, "A DC-DC boost converter with variation tolerant MPPT technique and efficient ZCS circuit for thermoelectric energy harvesting applications," *Design Automation Conference (ASP-DAC), 2014 19th Asia and South Pacific*, vol., no., pp.35-36, Jan. 2014.
- [220] J.O. McSpadden, L. Fan and K. Chang, "Design and experiments of a high conversion-efficiency 5.8GHz rectenna", *IEEE Trans. On Microwave Theory and Techniques*, vol. 46, no. 12, pp 2053-206, Dec. 1998.
- [221] T. Yoo and K. Chang, "Theoretical and experimental development of 10 and 35 GHz rectennas," *IEEE Trans. Microwave Theory Tech.*, vol. 40, pp. 1259-1266, Jun. 1992.
- [222] S. S. Bharj, R. Camisa, S. Grober, F. Wozniak, and E. Pendleton, "High efficiency C-band 1000 element rectenna array for microwave powered applications," in *IEEE MTT-S Int. Microwave Symp. Dig.*, pp. 301-303, Jun. 1992.
- [223] R.J. Vyas, B.B. Cook, Y. Kawahara, M.M. Tentzeris, "E-WEHP: A Batteryless Embedded Sensor-Platform Wirelessly Powered From Ambient Digital-TV Signals," *Microwave Theory and Techniques, IEEE Transactions on*, vol.61, no.6, pp.2491-2505, Jun. 2013.
- [224] S. Hemour, Y. Zhao, C.H.P. Lorenz, D. Houssameddine, Y. Gui, C.-M. Hu, K. Wu, "Towards Low-Power High-Efficiency RF and Microwave Energy Harvesting," *Microwave Theory and Techniques, IEEE Transactions on*, no. 99, pp. 1-12, 2014.
- [225] R. G. Harrison and X. Polozec, "Nonsquarelaw Behavior of Diode Detectors Analyzed by the Ritz-Galerkin Method," *Microwave Theory and Techniques, IEEE Transactions on*, no. 5, pp. 840-846, 1994.
- [226] Avago technologies Corp. (2010, July). Designing the virtual battery. [Online]. Available: <http://www.avagotech.com/docs/5966-0785E>.
- [227] J. Essel, D. Brenk, J. Heidrich, R. Weigel, "A highly efficient UHF RFID frontend approach," *Wireless Sensing, Local Positioning, and RFID, 2009. IMWS 2009. IEEE MTT-S International Microwave Workshop on*, vol., no., pp.1-4, 24-25, Sept. 2009.
- [228] P. Nintanavongsa, U. Muncuk, D.R. Lewis, K.R. Chowdhury, "Design Optimization and Implementation for RF Energy Harvesting Circuits," *Emerging and Selected Topics in Circuits and Systems, IEEE Journal on*, vol.2, no.1, pp.24-33, Mar. 2012.
- [229] G. F. Engen and C. A. Hoer, "Thru-reflect-line: An improved technique for calibrating the dual six-port automatic network analyzer," *IEEE Transactions on Microwave Theory and Techniques*, Vol. 27, No. 12, 987-993, Dec. 1979.
- [230] F. Assadourian, E. Rimai, "Simplified Theory of Microstrip Transmission Systems," *Proceedings of the IRE*, vol.40, no.12, pp.1651-1657, Dec. 1952.
- [231] D. D. Grieg, H. F. Engelmann, "Microstrip-A New Transmission Technique for the Klilomegacycle Range," *Proceedings of the IRE*, vol.40, no.12, pp.1644-1650, Dec. 1952.
- [232] G. Jiapin and Z. Xinen, "An improved analytical model for RF-DC conversion efficiency in microwave rectifiers," in *IEEE MTT-S Int. Mi-crow. Symp. Dig.*, pp. 1–3, 2012.
- [233] Young-Ho Suh; Kai Chang, "A high-efficiency dual-frequency rectenna for 2.45- and 5.8-GHz wireless power transmission," *Microwave Theory and Techniques, IEEE Transactions on*, vol.50, no.7, pp.1784-1789, Jul. 2002.
- [234] B. Strassner, Kai Chang, "Highly efficient C-band circularly polarized rectifying antenna array for wireless microwave power transmission," *Antennas and Propagation, IEEE Transactions on*, vol.51, no.6, pp.1347-1356, Jun. 2003.

- [235] Hucheng Sun, Yong-Xin Guo, Miao He, Zheng Zhong, "Design of a High-Efficiency 2.45-GHz Rectenna for Low-Input-Power Energy Harvesting," *Antennas and Wireless Propagation Letters, IEEE*, vol.11, no., pp.929-932, 2012.
- [236] Tu Wen-Hua, Shih-Hsun Hsu, Kai Chang, "Compact 5.8-GHz Rectenna Using Stepped-Impedance Dipole Antenna," *Antennas and Wireless Propagation Letters, IEEE*, vol.6, no., pp.282-284, 2007.
- [237] P. Hacker, H. Schrank, "Range distance requirements for measuring low and ultralow sidelobe antenna patterns", *IEEE Transactions on Antennas and Propagation*, Vol. 30, No.5, pp. 956–966, Sept. 1982.
- [238] H.J. Visser, A.C.F. Reniers, J.A.C. Theeuwes, "Ambient RF Energy Scavenging: GSM and WLAN Power Density Measurements," *Microwave Conference, 2008. EuMC 2008. 38th European*, vol., no., pp.721-724, Oct. 2008.
- [239] Electronic Communications Committee, "Measuring Non-Ionising Electromagnetic Radiation (9kHz – 300GHz)", European Conference of Postal and Telecommunications Administrations, Sep. 2002.
- [240] D. Costinett, Erez Falkenstein, R. Zane, Z. Popovic, "RF-powered variable duty cycle wireless sensor," *Microwave Conference (EuMC)*, 2010 European , vol., no., pp.41-44, Sept. 2010.
- [241] H.J. Visser, R.V.D. Linden, "RF Power Transfer Using a Near-Field Focused Array of Directive Radiators", *European Conference on Antennas and Propagation (EuCAP) 2014, to be published*, 2014.

Publications

1) Journal: 1

- M.H.C. Dias, B.R. Franciscatto, H. Adel, and T.P. Vuong, "Dual-band Compact Planar Antenna for a Low-cost WLAN USB Dongle," *International Journal of Antennas and Propagation*, to be published, vol. 2014.

2) International conferences: 8

a) Oral presentation:

- B.R. Franciscatto, H. Adel, M.H.C. Dias and T.P. Vuong, "A Compact IFA-Based Dual-Band Planar Antenna for WiFi USB Dongles," to be published in *European Conference on Antennas and Propagation (EuCAP)*, Apr. 2014.
- B. R. Franciscatto, V. Freitas, J.M. Duchamp, C. Defay and T.P. Vuong, "High-efficiency rectifier circuit at 2.45GHz for low-input-power RF energy harvesting," *Microwave Conference (EuMC), 2013 European*, pp.507-510, Oct. 2013.
- M.H.C. Dias, B.R. Franciscatto, E.M.B Nogueira, T.P. Vuong, "On the design of a dual-fed aperture-coupled circularly polarized microstrip patch antenna," *Microwave & Optoelectronics Conference (IMOC), 2013 SBMO/IEEE MTT-S International*, pp.1-5, Aug. 2013.
- B. R. Franciscatto, A. C. Souza, T.T. Trang, C. Defay and T.P. Vuong, "High gain microstrip patch antenna array using multiple superstrate layers for DSRC applications," *Antennas and Propagation in Wireless Communications (APWC), 2012 IEEE-APS Topical Conference on*, pp.736-739, Sept. 2012.

b) Poster presentation:

- B. R. Franciscatto, V. Freitas, J.M. Duchamp, C. Defay and T.P. Vuong, "A different approach to a highly efficient wireless energy harvesting device for low-power application," *Microwave & Optoelectronics Conference (IMOC), 2013 SBMO/IEEE MTT-S International*, pp.1-5, Aug. 2013. (**Best Student Paper Award**)
- B. R. Franciscatto, T.T. Trang, C. Defay and T.P. Vuong, "Microstrip-fed quasi-Yagi antenna array for a different DSRC system," *Antenna Technology and Applied Electromagnetics (ANTEM), 2012 15th International Symposium on*, pp.1-5, Jun. 2012.
- B. R. Franciscatto, G. Fontgalland and T.P. Vuong, "High gain Sierpinski Gasket fractal shape antenna designed for RFID," *Microwave & Optoelectronics Conference (IMOC), 2011 SBMO/IEEE MTT-S International*, pp.239-243, Nov. 2011.
- B.R. Franciscatto, F. Ndagijimana, G. Fontgalland and T.P. Vuong, "Design of a directive antenna with fractal geometry for RFID localization applications," *Antennas and Propagation (EuCAP), 2010 Proceedings of the Fourth European Conference on*, pp.1-5, Apr. 2010.

3) National conferences: 2

- B. R. Franciscatto, V. Freitas, J.M. Duchamp, C. Defay and T.P. Vuong, “Circuit de conversion RF-DC à 2,45 GHz à fort rendement pour les applications de récupération d’énergie RF,” Journée Nationales de Microondes 2013. 15-17 Mai 2013, Paris – France.
- M. H. C Dias, C. A. Filho, J. C. A. Santos, B. R. Franciscatto, V. Freitas, T. P. Vuong, “Utilisation de parasites et éléments localisés pour l’augmentation de la bande passante d’une antenne monopole,” Journée Nationales de Microondes 2013. 15-17 Mai 2013, Paris – France.