



HAL
open science

Bases comportementales et génétiques des apprentissages aversif et appétitif chez l'abeille, *Apis mellifera*

Pierre Junca

► **To cite this version:**

Pierre Junca. Bases comportementales et génétiques des apprentissages aversif et appétitif chez l'abeille, *Apis mellifera*. Sciences cognitives. Université Paris Sud - Paris XI, 2015. Français. NNT : 2015PA112240 . tel-01293788

HAL Id: tel-01293788

<https://theses.hal.science/tel-01293788>

Submitted on 25 Mar 2016

HAL is a multi-disciplinary open access archive for the deposit and dissemination of scientific research documents, whether they are published or not. The documents may come from teaching and research institutions in France or abroad, or from public or private research centers.

L'archive ouverte pluridisciplinaire **HAL**, est destinée au dépôt et à la diffusion de documents scientifiques de niveau recherche, publiés ou non, émanant des établissements d'enseignement et de recherche français ou étrangers, des laboratoires publics ou privés.

UNIVERSITÉ PARIS-SUD

ÉCOLE DOCTORALE 426 :
GÈNES GÉNOMES CELLULES

Laboratoire : *Evolution, Génome, Comportement et Ecologie*

THÈSE DE DOCTORAT

SCIENCES DE LA VIE ET DE LA SANTÉ

par

Pierre JUNCA

**Bases comportementales et génétiques des apprentissages
aversif et appétitif chez l'abeille, *Apis mellifera***

Date de soutenance : 30/09/2015

Composition du jury :

Directeur de thèse :	Jean-Christophe Sandoz	Directeur de Recherche, (EGCE, Gif-sur-Yvette)
Rapporteurs :	Patricia d'Ettorre Raphael Jeanson	Professeur, (LEEC, Villetaneuse) Chargé de Recherche, (CRCA, Toulouse)
Examineurs :	Pierre Capy (président du jury) Jean-Marc Devaud	Professeur, (EGCE, Gif-sur-Yvette) Maître de Conférence, (CRCA, Toulouse)

Remerciements

Je tiens avant tout à remercier Jean-Christophe Sandoz pour m'avoir fait confiance et soutenu tout au long de cette thèse. Ses conseils et sa sollicitude m'auront permis, je l'espère, de me construire en tant que praticien de la recherche. Les longues discussions que nous avons eues avoir, autour de thèmes scientifiques ou non, auront mis en exergue la sagacité et la pertinence de réflexion d'un modèle pour qui se trouve dans le giron de la science. Un grand merci au capitaine du navire pour avoir maintenu le cap.

Je remercie mes rapporteurs Patrizia d'Ettorre et Raphael Jeanson, d'avoir accepté de juger ce travail.

Un grand merci à Pierre Capy pour m'avoir accueilli au sein du laboratoire, et d'avoir accepté de prendre la présidence du jury.

Merci à mon tuteur et examinateur Jean-Marc Devaud qui m'a suivi tout au long de mon parcours universitaire.

Merci à Lionel Garnery, une vraie rencontre avec un passionné de l'abeille et l'artisan majeur de ma culture apicole et génétique.

Pour leur aide essentielle dans l'univers des microsattellites, merci à Hélène et Sybille.

Merci à mon "co-thésard " Antoine pour tous ces bons moments passés dans le bureau. Merci à Hanna, pour ce sujet que nous avons partagé. Merci à Julie, Florian, Andi et Bénédicte sans qui l'équipe n'aurait pas été la même. Merci aux stagiaires Marie-Anne, Hélène, Nicolas, Alice,... trop nombreux pour tous les nommer, mais individuellement essentiels à la vie de l'équipe.

Merci à Sylvie et Hélène du secrétariat.

Merci à tous les membres du laboratoire qui ont fait de ce lieu un endroit chaleureux : Quentin, Bastien, Frédéric M., Frédéric M.P., Sérafino, Erika, Céline, Florence, Aurélie, Emilie, David, Arnault, Jean-Bernard, Estelle, ... Je prie de m'excuser tous ceux que j'ai oubliés de citer...

Merci à mes amis Toulousains, Parisiens, Lyonnais,... qui se reconnaîtront.

Merci à mes parents pour leur soutien continu, sans eux rien n'aurait été possible.

Et merci aux abeilles.

SOMMAIRE

INTRODUCTION

	p.1
<u>I) Apprentissages associatifs appétitif et aversif</u>	p.2
a) Apprentissage classique et apprentissage opérant	p.2
1) Apprentissage classique	p.2
2) Apprentissage opérant	p.4
b) Apprentissage appétitif et aversif	p.6
c) L'impact de la socialité dans les capacités cognitives hédoniques	p.8
<u>II) L'apprentissage chez un insecte eusocial : l'abeille</u>	p.9
a) Un insecte eusocial	p.9
b) Modèle du polyéthisme d'âge	p.10
c) Les différents types d'apprentissages chez l'abeille	p.12
1) L'apprentissage en vol libre	p.12
2) L'apprentissage appétitif de la réponse d'extension du proboscis (REP)	p.13
3) L'apprentissage aversif de la réponse d'extension du dard (RED)	p.16
<u>III) Bases sociales et génétiques de l'organisation cognitive de la ruche</u>	p.19
a) Seuil de réponse : apprentissage et polyéthisme	p.19
b) Bases génétiques de l'apprentissage de la distributions du travail chez les insectes eusociaux	p.21
<u>IV) Bases nerveuses de l'apprentissage olfactif chez l'abeille</u>	p.24
a) Cerveau de l'abeille et voie olfactive	p.24
b) Systèmes renforçant appétitif et aversif	p.26
c) La température : un possible stimulus inconditionnel ?	p.27
1) La température chez l'abeille	p.27
2) La température dans l'apprentissage chez les insectes	p.28
3) La perception thermique chez les insectes	p.30
d) Réponse mesurée et problème d'interprétation	p.30
<u>V) Objectifs</u>	p.34

<u>CHAPITRES</u>	p.38
Chapitre I : Genotypic influence on aversive conditioning in honeybees, using a novel thermal reinforcement procedure	p.38
Chapitre II : Heat perception and aversive learning in honey bees: putative involvement of the thermal/chemical sensor AmHsTRPA	p.66
Chapitre III : Genotypic trade-off between appetitive and aversive capacities in a cognitive community: the honeybee hive	p.92
Chapitre IV : Appetitive but not aversive olfactory conditioning modifies antennal movements in honey bees	p.118

<u>DISCUSSION</u>	p.151
<u>I) Modèle de travail de la détection de la température et de l'apprentissage aversif thermique</u>	p.154
a) Détection thermique périphérique	p.154
1) Quels neurones sensoriels ?	p.154
2) Quels récepteurs/canaux ?	p.156
b) Traitement central de l'information thermique	p.158
c) Voie motrice entraînant la RED	p.161
d) Formation de l'association odeur / renforcement thermique	p.162
<u>II) Développement de nouveaux protocoles comportementaux pour étudier les apprentissages aversif et appétitif chez l'abeille</u>	p.166
a) Développement d'un conditionnement aversif absolu	p.166
b) Les mouvements antennaires comme reflets de l'apprentissage : une vision plus fine des associations ?	p.169

III) Les capacités appétitive et aversive dans la distribution du travail chez les insectes eusociaux p.172

a) L'implication d'un *trade-off* hédonique dans l'analyse des causes proximales de la division du travail p.172

b) L'implication d'un *trade-off* hédonique dans les causes ultimes de la division du travail p.175

c) Inadéquation du modèle des seuils de réponses chez les butineuses et les gardiennes p.177

Conclusion générale p.179

REFERENCES p.180

ANNEXES p.205

INTRODUCTION

INTRODUCTION

Pour survivre et pouvoir se reproduire, les animaux doivent détecter et intégrer des signaux internes (état physiologique) mais aussi externes (signaux de l'environnement) et ainsi adapter leur comportement de façon adéquate face aux différentes situations auxquelles ils sont confrontés, que celles-ci soient de nature positive (nourriture, partenaire sexuel, etc.) ou négative (danger, prédateur, etc.) (Alcock, 1997). L'aspect potentiellement rédhibitoire d'une mauvaise réponse comportementale dans certaines de ces situations a induit la nécessité pour les animaux de développer au cours de l'évolution des capacités cognitives telles que l'apprentissage et la mémoire (Bindra, 1974 ; Dayan et Balleine, 2002 ; Bouton, 2007). On peut définir l'apprentissage comme tout changement de réponse relativement permanent qui apparait suite à l'acquisition d'expérience (Bitterman, 1979). Ces capacités leur procurent la possibilité de prévoir l'occurrence d'événements particuliers en fonction de la présence de stimuli dans leur environnement ou à la suite du comportement qu'ils manifestent.

I) Apprentissages associatifs appétitif et aversif

L'apprentissage associatif se définit comme la capacité d'apprendre les liens prédictifs existant entre des événements connectés dans l'environnement d'un animal. Il permet d'extraire une structure logique du monde, et en développant des capacités anticipatoires, de réduire l'incertitude des événements futurs (Pearce, 1987; Rescorla, 1988). Deux principaux paradigmes d'apprentissage associatif ont été définis ; l'apprentissage classique et l'apprentissage opérant.

a) Apprentissage classique et apprentissage opérant

1) Apprentissage classique

On peut considérer que l'étude expérimentale de l'apprentissage et de la mémoire naquit avec Ivan Petrovitch Pavlov (1849-1936), médecin et physiologiste russe. L'éthique s'opposant à toute expérimentation humaine sur les troubles de la mémoire, Pavlov établit le chien comme modèle de substitution, et reçut à cet effet le prix Nobel de médecine en 1904. Suite à des observations empiriques du phénomène de conditionnement, il développa expérimentalement en 1898 une étude contrôlée des processus de formation de la mémoire. Il observa que, lors de la distribution de nourriture journalière, les chiens avaient tendance à saliver avant même de rentrer en contact avec la nourriture. Pour mesurer ce phénomène, il équipa un chien de fistules glandulaires, permettant de noter

précisément le moment où commence la sécrétion de salive. Il remarqua alors que lorsque, de manière répétée, la présentation de nourriture était précédée d'un signal sonore, les chiens se mettaient à saliver à la seule présence du signal sonore. Pavlov parle ainsi de « réflexe conditionné ». Comme il l'a écrit lui-même :

"Que voyons-nous? Il suffira de répéter ce bruit seul pour que se reproduise la même réaction : mêmes mouvements de la bouche et même écoulement de salive. (...) Comme le montre l'organisation même de nos expériences, le premier réflexe a été reproduit sans aucune préparation préalable, sans aucune condition (le réflexe inconditionnel), le second a été obtenu à l'aide d'un certain procédé (réflexe conditionné). (...) Il est légitime d'appeler réflexe absolu la liaison permanente de l'agent externe avec l'activité déterminée par lui, et réflexe conditionné, la liaison temporaire."

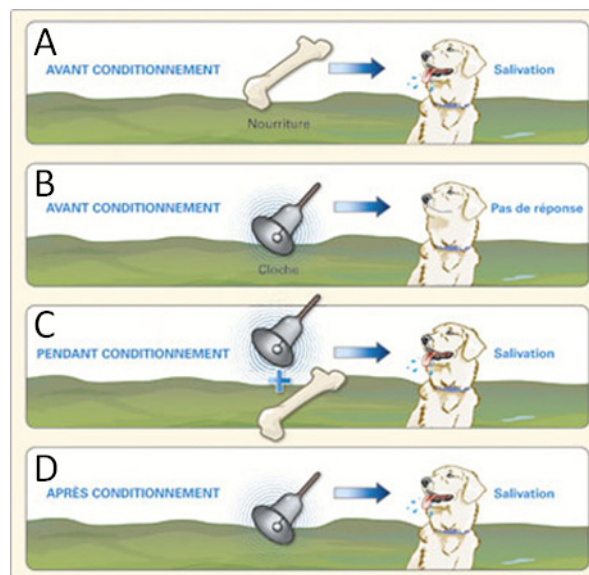

Figure 1 : Déroulement du conditionnement Pavlovien. Le stimulus inconditionnel (SI), la nourriture, déclenche la réponse de salivation (A) tandis que la cloche, le stimulus conditionnel (SC) n'a pas d'effet (B) avant que l'apprentissage commence. La présentation concomitante et répétée, du SC et du SI permet au SC d'acquérir une valence positive (C) puisqu'il déclenche la réponse de salivation (réponse conditionnée) à sa seule présentation (D). *D'après une représentation de Luca Salomon (futurascience.com)*

Pour exposer les concepts expérimentaux sous-jacents à ce protocole (et ainsi fixer une nomenclature utilisée aujourd'hui encore), nous pouvons dire que dans ce type de conditionnement, l'animal devait associer un stimulus conditionnel (SC), originellement neutre (un son dans le cas du chien de Pavlov) avec un stimulus inconditionnel (SI), qui par nature déclenche une réponse contingente de l'animal (par exemple, la nourriture entraînant la salivation). Une fois l'association réalisée, on observera une réponse conditionnée (RC) à la seule présentation du stimulus conditionnel, c'est-à-dire que l'animal répondra (salivera) au son de cloche qu'il aura associé à la présentation de nourriture (**Fig.1**).

Ce paradigme expérimental, nommé indifféremment **conditionnement classique** ou **conditionnement Pavlovien**, a donné naissance à un grand nombre de travaux, au cours desquels les chercheurs ont montré sa validité chez une grande diversité d'espèces animales. En effet, des expériences de conditionnement classique ont été réalisées chez des espèces aussi différentes que les pieuvres (Young, 1960 ; Papini et Bitterman, 1991), l'aplysie (mollusque marin), (Carew *et al.*, 1981, Lechener *et al.*, 2000) ou encore la drosophile (Tully, 1984 ; Mery *et al.*, 2007). Ces différents modèles ont permis de questionner, entre autres, les bases comportementales (Rescorla, 1967, 1988), génétiques (Tully et Quinn, 1985 ; Brembs et Heisenberg, 2000) et neuronales (Klopf, 1988 ; Yu *et al.*, 2004) de l'apprentissage classique.

2) Apprentissage opérant

L'année où Pavlov démontra les composantes de son conditionnement classique (1898), fut publiée la thèse d'Edward Thorndike, précurseur du behaviorisme, qui avait pour objet l'intelligence animale. Par un système ingénieux de « boîtes à problèmes », ce chercheur démontra les capacités d'association d'animaux tels que le chat, le chien, ou encore la poule. Comptant sur le comportement « d'échappement » inné d'animaux affamés, il les plaça dans une boîte dont la porte était fermée par un loquet et positionna de la nourriture visible par les animaux à l'extérieur (**Fig.2**). Les animaux devaient, par tâtonnement, associer une manipulation particulière activant l'ouverture de la porte (selon le type de boîte utilisée) à leur libération et à la nourriture associée (Thorndike, 1898). Il nomma ainsi cet apprentissage, « apprentissage par essais et erreurs ».

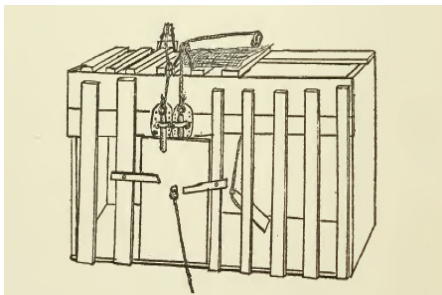

Figure 2 : Boîte à problèmes de Thorndike. Elle comprend différents loquets que l'animal doit activer par tâtonnement pour pouvoir sortir de la boîte. Il s'agit du premier dispositif visant à conditionner le comportement d'un animal (Thorndike, 1898).

Thorndike donne une valeur primordiale aux conséquences du comportement. Ainsi, il formulera en 1913 la « loi de l'effet » selon laquelle, une réponse est d'autant plus susceptible d'être reproduite qu'elle entraîne une satisfaction (renforcement positif) pour l'organisme, et d'être abandonnée qu'il en résulte une insatisfaction (renforcement négatif). Cette loi pose, à elle seule, le principe fondateur du **conditionnement opérant**.

Aujourd'hui, ce que l'on nomme apprentissage opérant prend sa source dans les travaux de Burrhus Frederic Skinner (1904-1990), psychologue américain fortement influencé par les travaux de Thorndike et de Pavlov. Il s'intéressa à la caractéristique de certains stimuli à faire

« augmenter/diminuer la probabilité d'apparition d'un comportement » lors d'un conditionnement (Skinner, 1936). Dans ce paradigme, il s'agit de faire associer à l'animal son propre comportement avec des conséquences particulières (récompense ou punition). En réponse aux pressions exercées par les défenseurs du bien-être animal, Henry Herbert Donaldson introduisit comme modèle expérimental en neurosciences le rat qui déclenchait moins de réactions du public que les chats ou les chiens (King et Donaldson, 1929). Tenant compte de ces considérations, Skinner développa un nouveau type d'épreuve où l'animal (le rat en l'occurrence) obtient nourriture ou décharge électrique, suivant qu'il appuie ou non sur un bouton poussoir, et selon des indications visuelles ou sonore qu'on lui fournit. Ce dispositif sera nommé « Boîte de Skinner » en hommage à son créateur (**Fig.3**). Nombreuses sont les études qui se sont appuyées par la suite sur ce nouveau dispositif expérimental (Rescorla, 1968 ; Feenstra *et al.*, 1999, 2001).

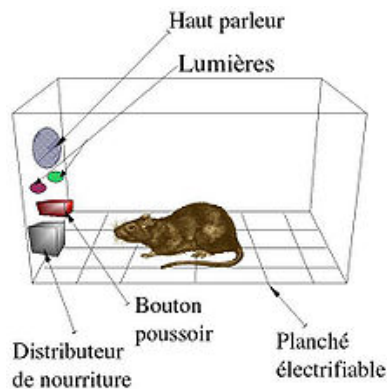

Figure 3 : Boîte de Skinner. Elle rassemble un ensemble de dispositifs permettant, entre autres, d'étudier à la fois les apprentissages appétitif et aversif opérants. La distribution de nourriture ou l'activation du plancher électrifiable peuvent être soit précédées d'un comportement particulier et/ou d'un signal visuel ou sonore. De plus, ces signaux offrent l'opportunité de réaliser des conditionnements classiques (SC-récompense ou punition) ce qui en fait un dispositif à l'interface entre l'apprentissage opérant et l'apprentissage classique. (*image : Yugiz, wikipedia*)

Même si on observe des réponses comportementales des animaux dans les conditionnements classique et opérant, celles-ci ne sont pas de même nature. Dans le conditionnement classique, on mesure une réponse comportementale intrinsèquement liée au stimulus inconditionnel. Lorsque le SC et le SI ont été présentés conjointement, le SC se mettra à déclencher cette réponse comportementale, indice de l'apprentissage. Dans le conditionnement opérant, c'est la réponse comportementale, elle-même, qui est associée à une récompense ou à une punition. Son apparition est alors augmentée ou réduite en fonction de la conséquence associée. On peut ainsi définir l'apprentissage classique, comme l'apprentissage d'une *causalité contextuelle singulière*, et l'apprentissage opérant, comme l'apprentissage d'une *causalité comportementale singulière*. Il faut remarquer que la barrière entre ces deux paradigmes est très fine dans la réalité et ainsi, les apprentissages que les animaux réalisent dans la nature mettent souvent en jeu les deux types de paradigmes.

b) Apprentissage appétitif et aversif

Les capacités d'un organisme à évaluer son environnement sont essentielles à sa survie. Ceci requiert une estimation précise et dynamique de la qualité positive ou négative des stimuli présents dans l'environnement. On appelle stimuli **appétitif** et **aversif** des stimuli particulièrement saillants et possédant des valences intrinsèques respectivement positive et négative pour l'animal. Ils sont supposés déclencher des comportements opposés, respectivement d'approche et d'évitement (Madan, 2013; Bissonette *et al.*, 2014). Ainsi, que ce soit pour un stimulus originellement neutre (couleur, son, odeur,...) (apprentissage classique) ou pour leur propre comportement (apprentissage opérant), les animaux doivent être capables de prédire la survenue de conséquences positives ou négatives, et ainsi de réaliser respectivement des **apprentissages appétitif** ou **aversif**. L'étude de ces apprentissages aux valeurs hédoniques opposées se fait le plus souvent en laboratoire, grâce à des protocoles de conditionnement mimant le plus possible les conditions naturelles dans lesquelles ils interviennent.

Le **conditionnement appétitif** repose majoritairement sur la motivation alimentaire des animaux. Il s'inspire ainsi du contexte environnemental auquel ils font face dans leur recherche de nourriture. Dans ce type de protocole, des comportements d'approche ou des réponses réflexes sont conditionnés. Ainsi, l'étude de l'apprentissage appétitif se réalise aussi bien en conditionnement classique, comme l'a démontré Pavlov sur le chien avec le réflexe de salivation (Pavlov, 1927), qu'en conditionnement opérant dans l'utilisation de labyrinthes (radial, en T, ...) où le déplacement de l'individu dans un bras particulier lui permet de trouver un nourrisseur (Bures et Buresova, 1990 ; Robbins et Everitt, 1996 ; Dudchenko *et al.*, 1997). Selon nos connaissances, un des premiers à avoir établi un protocole de labyrinthe chez le rat fut Tolman, protocole toujours utilisé de nos jours (Tolman et Honzik, 1930). Au fil du temps, ces différentes approches eurent un rôle prépondérant dans la compréhension des systèmes de récompense comme le système limbique et les voies dopaminergiques des mammifères (Hollerman et Schultz, 1998; Berridge et Robinson, 1998; Ikemoto, 2007)

A l'inverse, le **conditionnement aversif** s'intéresse aux comportements de fuite ou de défense des animaux. On peut définir comme stimulus aversif tout stimulus qui déclenche un comportement d'évitement ou une diminution de réponse (Garcia *et al.*, 1985; Carcaud *et al.*, 2009). Les protocoles d'apprentissage cherchent alors à reproduire les comportements d'évitement de dangers tels que des prédateurs ou de la nourriture toxique. Dans les études de laboratoire, différents types de stimuli aversifs, variant par leur nature et leur intensité, ont été utilisés : une solution amère (par exemple la quinine) (Aggleton *et al.*, 1981 ; Swank *et al.*, 1995), un choc électrique (Garcia et Koelling, 1966 ; Li *et al.*, 2008), un puff d'air dans l'œil (Belova *et al.*, 2007; Joshua *et al.*, 2008) , etc. On utilise par exemple des protocoles aversifs gustatifs, dans lesquels un stimulus conditionnel gustatif est associé à

un malaise induit par chlorure de lithium (Garcia *et al.*, 1985 ; Dantzer et Kelley, 2007). En s'appuyant sur le rat comme animal modèle, le substrat neuronal du support de la formation de la mémoire aversive par malaise induit a pu être étudié. On vit ainsi le rôle clef du noyau parabrachial dans ce type d'association aversive (Yamamoto *et al.*, 1994). La composante opérante de l'apprentissage aversif est essentielle à l'animal, lui permettant de se soustraire à des situations périlleuses. Les conditionnements d'évitement (passif/actif) montrent des exemples d'exercices auxquels peuvent être soumis des mammifères pour étudier cette composante opérante de l'apprentissage aversif (**Fig.4**). Ce conditionnement a lieu dans un dispositif contenant deux boîtes jointes, avec une grille pouvant être électrifiée, disposée dans l'un des deux compartiments. Dans le cas de l'évitement passif, une boîte est illuminée et l'autre est maintenue dans l'obscurité. La souris est positionnée dans la boîte illuminée. De par son phototactisme, elle aura préférentiellement tendance à se diriger dans le compartiment sombre (zone de sureté) mais doit apprendre à ne pas y entrer, sous peine de s'exposer à un choc électrique (**Fig.4**). Dans l'évitement actif, l'animal est initialement positionné dans le compartiment avec la grille électrifiable, reçoit un choc pour qu'il en sorte et apprenne à ne plus y revenir. Ces types de protocoles permirent de mettre en évidence le rôle de neurones cholinergiques du néocortex dans ce type d'apprentissage (Friedman *et al.*, 1983).

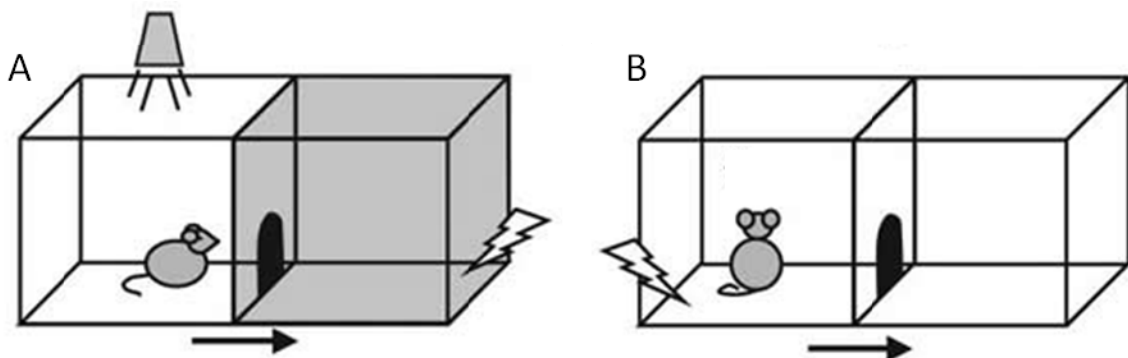

Figure 4 : Dispositifs d'évitement passif et actif. A) Évitemment passif. La souris doit apprendre à ne pas aller dans l'obscurité (ce qu'elle aura tendance à faire) au risque de recevoir un choc électrique. **B)** Évitemment actif. La souris est positionnée dans un compartiment et reçoit un choc électrique. Elle doit sortir du compartiment et apprendre à ne plus s'y rendre. (Friedman *et al.*, 1983). (*photo inspirée de techs.group.yahoo.com*)

Le conditionnement associatif comporte ainsi deux facettes, selon qu'il repose sur une association avec un stimulus à valence positive (conditionnement appétitif) ou à valence négative (conditionnement aversif). Différents protocoles de conditionnements classiques et opérants ont été développés afin d'étudier les règles comportementales et les substrats neuronaux sous-jacents à ces deux apprentissages de natures hédoniques opposées. Cependant, relativement peu d'études cherchent à étudier les relations qui existent entre ces deux facettes indispensables à la survie des espèces animales.

c) L'impact de la socialité dans les capacités cognitives hédoniques

Dans la nature, les animaux possédant un mode de vie solitaire doivent impérativement être performants aussi bien dans les tâches relevant d'apprentissages appétitifs (trouver de la nourriture) que dans les tâches de nature aversive (éviter les dangers potentiels). Une moindre performance dans l'une ou l'autre de ces capacités cognitives pourrait mettre en péril la survie de l'individu. Cependant, sous certaines pressions de sélection, des individus conspécifiques ont pu se réunir et développer des comportements sociaux (Gadau *et al.*, 2009). Ces associations d'individus vivants selon une densité supérieure au reste de l'environnement, peuvent se former dans un but de recherche de nourriture, de soin aux jeunes, ou encore de détection et de défense contre les prédateurs (Camazine *et al.*, 2001). Dans ce cas, la performance individuelle aussi bien dans les tâches aversives qu'appétitives, n'est plus aussi déterminante car, dans une certaine mesure, le groupe pourvoit à l'individu. Par exemple, la taille du groupe permet chez des espèces grégaires, d'augmenter la vigilance pour l'ensemble des individus vis-à-vis des prédateurs (Treisman, 1975). Chez les autruches (*Struthio camelus*), la vigilance du groupe augmente avec la taille du groupe. Lorsqu'un individu se baisse pour se nourrir, un autre prend le relais pour observer un potentiel danger environnant (Bertram, 1980). Chez les maquereaux (*Scomber scombrus*), en réponse à une perturbation externe (comme la présence d'un prédateur), la perception du danger par quelques individus déclenche une modification soudaine du comportement du banc de poisson à l'unisson (Partridge, 1982). Chez les espèces présentant une organisation sociale plus marquée, des spécialisations comportementales pour des tâches de défense et de provision de nourriture apparaissent. Chez les suricates (*Suricata suricatta*) et les méliphages bruyants (*Manorina melanocephala*), certains individus sont alloués à la recherche de nourriture tandis que d'autres sont chargés de la défense contre les prédateurs (Manser, 1999; Arnold *et al.*, 2005). Cette spécialisation comportementale pour des tâches supposées reposer sur des capacités cognitives appétitives ou aversives est encore plus marquée dans les sociétés d'insectes eusociaux comme les fourmis, les termites ou les abeilles. L'allocation des tâches, segmentant le travail de la recherche de nourriture et de la défense de la colonie entre les individus, peut être concomitante avec des modifications morphologiques adaptées à ces différentes activités, comme la macrocéphalie des gardiennes chez certaines espèces de fourmis (Wheeler, 1908) et de termites (Miura et Matsumoto, 1995).

Ainsi une distribution des capacités cognitives, soutenant une spécialisation comportementale, pourrait émerger progressivement dans les processus d'évolution de la socialité. Robert (1964) suggère que l'organisation sociale pourrait être considérée comme une architecture de la cognition à l'échelle de la communauté (Huchtin, 2000). Les déterminants de l'organisation sociale chez les insectes eusociaux ont fait l'objet de nombreux travaux chez l'abeille domestique, *Apis mellifera* (Seeley, 1997; Page *et al.*, 2006; Hunt *et al.*, 2007). Comme nous allons le voir, ce modèle est particulièrement adapté

à l'étude de la spécialisation des individus composant un groupe social entre les capacités cognitives appétitive et aversive.

II/ L'apprentissage chez un insecte eusocial : l'abeille

a) Un insecte eusocial

L'abeille domestique appartient au genre *Apis*, qui comprend les abeilles sociales pourvues d'un dard, toutes mellifères. On compte environ 9 espèces dont la majorité sont endémiques de l'Asie du Sud-Est (Alexander, 1991). Parmi ces espèces, nous avons pris pour modèle dans cette étude l'abeille domestique *Apis mellifera*.

L'abeille *Apis mellifera* est une des espèces d'insectes atteignant le plus haut degré d'organisation sociale, que l'on nomme l'eusocialité. Le terme eusocial, voulant dire « véritablement social » fut introduit par Batra (1966), mais ne prit la définition qu'on lui connaît aujourd'hui que quelques années plus tard, grâce aux travaux de C.D. Michener (Michener, 1969) et de E.O. Wilson (Wilson, 1971). L'eusocialité se définit par les trois caractéristiques suivantes :

- Un chevauchement des générations
- Un soin coopératif apporté à la descendance
- Une division du travail reproducteur

Ce type de socialité (mode d'organisation social), est apparu plusieurs fois de manière indépendante au cours de l'évolution (Wilson et Hölldobler, 2005; Nowak *et al.*, 2010). Ainsi, certaines crevettes du genre *Synalpheus* (Duffy *et al.*, 1996, 2002) ou encore certaines espèces d'abeilles (Woodard *et al.*, 2011), de guêpes (Markiewicz et O'Donnell, 2001), de fourmis (Bourke *et al.*, 1995) ou encore de mammifères (comme le rat taupe glabre, *Heterocephalus glaber* (Jarvis *et al.*, 1994), répondent à toutes les caractéristiques de l'eusocialité.

Chez l'abeille, *Apis mellifera*, on retrouve donc un chevauchement des générations, un soin coopératif apporté au couvain et une division du travail reproducteur reposant sur des individus morphologiquement différents (Winston, 1987, Seeley, 1995). Au sein de la colonie, il existe trois types de castes (**Fig.5**): la reine, les mâles (ou faux-bourdon) (~2500) et les ouvrières (jusqu'à 50 000). La reine est la seule femelle qui se reproduit au sein de la colonie et sa production de phéromone royale empêche le développement ovarien des ouvrières (Butler et Fahey, 1963; Velthuis, 1970 ; Hoover, *et al.* 2003). Elle est reconnaissable à son abdomen hypertrophié en comparaison à celui des ouvrières. De l'autre côté, les mâles sont plus trapus et ne possèdent pas de dard (puisque celui-ci provient chez les Hyménoptères d'une différenciation de l'ovipositeur Snodgrass, 1956). Ils ne sont

présents que transitoirement au sein de la colonie et ce, uniquement en été. Leur rôle semble se limiter à la fécondation de reines vierges lors des vols nuptiaux (Strang, 1970 ; Koeniger, 1990). Plus petites, les ouvrières stériles sont les individus les plus nombreux effectuant les différentes tâches dans la colonie.

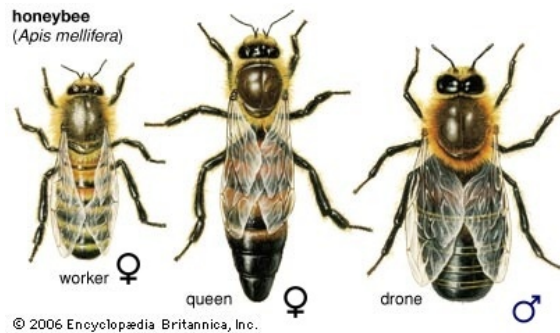

Figure 5 : Différentes caste d'abeilles : ouvrière, la reine et le mâle (de gauche à droite)

L'abeille présente donc un niveau de socialité important avec une distribution du travail reproducteur entre castes morphologiquement différentes. Cependant, au sein des ouvrières, des spécialisations comportementales permettent une distribution des tâches (soin aux larves, nettoyage, recherche de nourriture, défense de la colonie, etc.) entre les individus stériles de la colonie.

b) Modèle du polyéthisme d'âge

Contrairement à certaines espèces de fourmis, chez lesquelles les tâches au sein de la colonie sont assurées par des castes d'ouvrières morphologiquement différentes (polyéthisme de caste), les abeilles possèdent une allocation des tâches reposant sur un polyéthisme d'âge (Calderone et Page, 1988; Harvell, 1994). Ainsi, toutes les ouvrières sont identiques au stade larvaire et émergent au stade *imago* avec la même taille et la même conformation (Winston, 1987).

La première partie de la vie d'une ouvrière se déroule exclusivement à l'intérieur de la colonie. Dans un premier temps, elle participe à la cour de la reine, la nettoyant et la nourrissant. Une étude récente a émis l'hypothèse selon laquelle ce comportement permettrait de créer un lien particulier avec la reine. En effet, la phéromone mandibulaire royale contient du 4-hydroxy-3-méthoxyphényléthanol (alcool homovanillyl ou HVA) entraînant une diminution du taux de dopamine dans le cerveau des ouvrières et ainsi de leur agressivité potentielle envers la reine (Vergoz *et al.*, 2007). De plus, la présence de ces abeilles proches de la reine permettrait, d'individu à individu, de diffuser la phéromone de reine dans toute la colonie (Naumann *et al.*, 1991). Ensuite, les ouvrières deviennent des *nourrices* grâce au développement de leurs glandes hypopharyngiennes, glandes salivaires

céphaliques et glandes mandibulaires, qui leur permettent de produire de la gelée royale (Haydack, 1970 ; Schmitzova *et al.*, 1998). Elles nourrissent alors les larves en leur donnant les nutriments et la gelée royale nécessaires à leur bon développement (Winston, 1987). Les nourrices répondent en fait aux signaux chimiques (phéromones de couvain) émis par les larves, qui réclament ainsi différents types de nourritures en fonction de leur stade de développement (Le Conte *et al.*, 1990). Plus tard, les ouvrières deviennent des *nettoyeuses* luttant contre les parasites, microorganismes, champignons, etc., afin d'éviter la survenue de maladie (Arathi *et al.*, 2000). Le développement des glandes abdominales cirières leur permet ensuite de devenir *bâtisseuses* (Cassier et Lensky, 1995). En utilisant le miel qu'elles transforment au niveau de leurs glandes, elles génèrent de la cire, l'élément de base de construction de la ruche (Blomquist *et al.*, 1980).

La première tâche introduisant un rapport des ouvrières avec l'extérieur de la ruche est celle de *ventileuse* (Winston, 1991). En été, afin de maintenir une température optimale pour le développement larvaire, certaines ouvrières font diminuer la température de la ruche en ventilant l'air à son entrée (Jones *et al.*, 2006). Par la suite, les ouvrières occupent des tâches nécessaires à la défense de la colonie. Les *gardiennes* se postent à l'entrée de la ruche et vérifient l'appartenance à la colonie de tout insecte cherchant à s'y introduire (Moore *et al.*, 1987 ; Breed *et al.*, 2004). En cas d'agression, elles émettront une phéromone d'alarme, produite par la glande de Koshevnikov à la base du dard (Free, 1987). La dernière tâche réalisée par les abeilles est celle de *butineuse*. Il existe au sein de la ruche différents types de butineuses, spécialisées dans la récolte de nectar, de pollen, ou d'eau (Robinson et Page, 1989). Consécutivement à la découverte d'un site de butinage prometteur par une butineuse éclaireuse, d'autres butineuses s'y rendent et y récoltent les ressources requises. Pour ce faire, elles possèdent dans leur répertoire comportemental une "danse". Une fois de retour à la ruche après avoir trouvé une nouvelle source de nourriture, les butineuses se placent sur un cadre au centre de la colonie et commencent à réaliser des mouvements en "huit", que l'on nomme *danse frétillante* (von Frisch, 1974 ; Seeley *et al.*, 2000). Ses congénères se placent autour d'elle et suivent ses mouvements car ils contiennent les informations nécessaires pour retrouver la localisation de la source de nourriture. L'angle formé entre la verticale du cadre et la droite passant par le centre du "huit" fournit l'angle réel existant entre la projection du soleil sur l'horizon et la source de nourriture vue de l'entrée de la ruche (von Frisch, 1967). Durant la danse, l'éclaireur fait vibrer son abdomen pour fournir la notion de distance et de qualité de la nourriture en question (Seeley, 1992).

La progression des ouvrières entre les différentes tâches, est donc très structurée mais reste néanmoins théorique puisque toutes les ouvrières ne passent pas par toutes ces tâches (Sakagami et Fukuda, 1968 ; Seeley, 1982 ; Winston, 1987). De plus, sous diverses contraintes et en fonction des besoins de la colonie, les ouvrières sont susceptibles d'accélérer, de retarder, voire d'inverser leur développement comportemental (Bloch et Robinson, 2001 ; Leoncini *et al.*, 2004). Elles peuvent ainsi

réactiver des glandes devenues inactives si les tâches à occuper le demandent, comme la réactivation des glandes hypopharyngiennes pour les butineuses qui redeviendraient nourrices (Herb *et al.*, 2012).

Compte tenu de la structuration complexe des tâches au sein d'une colonie d'insectes sociaux comme l'abeille, on peut se demander quelles sont les règles qui régissent cette allocation des tâches. Une possibilité serait que cette allocation se fasse selon une sélection de compétences cognitives, qui orienteraient les individus vers telle ou telle tâche. Dans ce contexte, on pourrait poser l'hypothèse que des différences de capacités cognitives de nature aversive ou appétitive puissent induire une allocation vers des tâches de valeur "hédonique" opposée, comme la recherche de nourriture et la défense du lieu de vie. Nous allons voir maintenant comment les capacités cognitives aversive et appétitive peuvent être étudiées chez l'abeille domestique.

c) Les différents types d'apprentissages chez l'abeille

1) L'apprentissage en vol libre

C'est vers la fin du 19^{ème} siècle/début du 20^{ème} siècle que naquirent les premiers questionnements expérimentaux sur les capacités cognitives de l'abeille (Lubbock, 1889 ; Plateau, 1908 ; Forel, 1910). On peut dire cependant que c'est avec Karl von Frisch que débuta réellement l'étude expérimentale des capacités d'apprentissage de l'abeille (von Frisch, 1914, 1919). Les premiers travaux utilisèrent des protocoles de libre vol, laissant à l'abeille toute initiative comportementale. En présentant aux abeilles des fleurs artificielles sous la forme de nourrisseurs posés sur des cartons de couleur, von Frisch réalisa un conditionnement appétitif au cours duquel les butineuses associaient une couleur avec une récompense sucrée. Il parvint ainsi à démontrer l'existence d'une vision des couleurs chez ces insectes (von Frisch, 1914). L'expérimentation en vol libre a toujours cours chez l'abeille de nos jours car elle est considérée comme s'approchant le plus des conditions naturelles. Dans des protocoles de vol d'approche en direction d'une cible visuelle, les abeilles en vol libre peuvent être conditionnées à des stimuli visuels comme des couleurs ou des formes, et même à des stimuli olfactifs (Menzel, 1985 ; Srinivasan *et al.*, 1990 ; Lehrer *et al.*, 1995 ; Laloi *et al.*, 2000). Dans ces expériences de vol libre, on utilise communément des dispositifs de labyrinthe en Y que les abeilles visitent librement (Giurfa *et al.*, 1995, 1996 ; de Ibarra et Giurfa, 2003 ; Srinivasan, 2010). Outre les capacités d'apprentissages olfactif et visuel, ce dispositif a permis de mettre en évidence les capacités cognitives complexes de l'abeille (Giurfa 2007 ; Avarguès-Weber *et al.*, 2014). Ainsi dans des apprentissages non-élémentaires, les abeilles arrivent à extraire des concepts (comme la symétrie, Giurfa *et al.*, 1996) ou des règles communes à des stimuli très différents comme la relation « haut-bas » (Avarguès-Wéber

et al., 2012), l'organisation de repères visuels en visage (Dyer *et al.*, 2005 ; Avarguès-Wéber *et al.* 2010), etc.

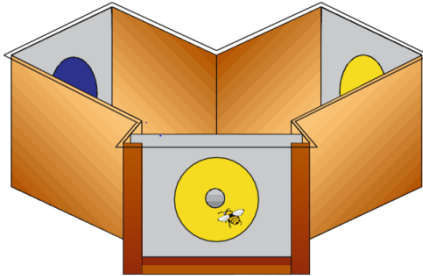

Figure 6 : Labyrinthe en Y. L'abeille positionnée à l'entrée du labyrinthe doit apprendre la règle d'identité ("sameness") pour atteindre la récompense. Elle doit ainsi toujours prendre le bras signalé par le même stimulus visuel que celui présent à l'entrée du labyrinthe (jaune dans le cas présent). *Adapté de Giurfa et al., (2007)*

Par exemple, ce dispositif a permis de montrer que les abeilles sont capables de retenir des règles d'ordre d'apparition de stimuli (« delayed matching-to-sample », Giurfa *et al.*, 2001). Ainsi dans un labyrinthe en Y, les ouvrières apprennent que si un stimulus visuel est présenté à l'entrée du labyrinthe (couleur ou forme particulière), elles devront choisir le couloir présentant le même stimulus pour atteindre la récompense (**Fig.6**). Dans ce cas, ce n'est pas le stimulus qui est renforcé, mais bien la règle d'identité entre un stimulus présenté et le stimulus associé au renforcement. La capacité des abeilles à réaliser ce type d'apprentissage démontre des aptitudes cognitives élevées par rapport à d'autres invertébrés (Giurfa *et al.*, 2001 ; Srinivasan, 2010 ; Avarguès -Wéber *et al.*, 2013).

Bien que très utiles pour la démonstration des capacités d'apprentissage de l'abeille, les protocoles de libre vol permettent difficilement d'atteindre les voies neuronales sous-jacentes, car les individus étudiés sont en mouvement. L'abeille est néanmoins devenue un modèle de choix pour l'étude des bases neuronales de l'apprentissage et de la mémoire (Giurfa, 2007 ; Menzel, 1999, 2012), principalement grâce à l'avènement de protocoles d'apprentissages associatifs en laboratoire, dans lesquels les abeilles sont immobilisées (Giurfa, 2007 ; Menzel, 1999, 2012).

2) L'apprentissage appétitif de la réponse d'extension du probosci (REP)

Certaines espèces d'insectes montrent une extension de leurs pièces buccales à l'application de solution sucrée sur certaines structures de leur corps. Minnich (1921) observa ce phénomène chez les papillons, et montra que l'application de nectar sur les tarse provoquait une extension du proboscis (langue). Ultérieurement à la découverte de cette réponse stéréotypée à l'application d'une solution sucrée sur les antennes de l'abeille (Kunze, 1933 ; Marshall, 1935), une série d'études a montré que cette réponse pouvait être conditionnée dans le cadre d'un protocole de conditionnement associatif classique, avec une odeur comme stimulus conditionnel (Frings, 1944 ; Takeda, 1961 ; Bitterman *et*

al., 1983). Dans ce protocole, l'application d'une stimulation sucrée (stimulus inconditionnel ou SI) au niveau des antennes provoque une réponse comportementale contingente, l'extension du proboscis. Si on présente une odeur (stimulus conditionnel ou SC), initialement neutre, conjointement à cette présentation de solution sucrée, l'abeille formera une association et montrera par la suite une extension du proboscis à la seule présentation de l'odeur (**Fig.7**). Dans le protocole de conditionnement utilisé le plus couramment, le SI est présenté tout d'abord aux antennes, puis au niveau du proboscis, permettant à l'abeille de prélever de la solution sucrée lors de chaque essai renforcé (Bitterman *et al.*, 1983 ; Giurfa et Sandoz, 2012).

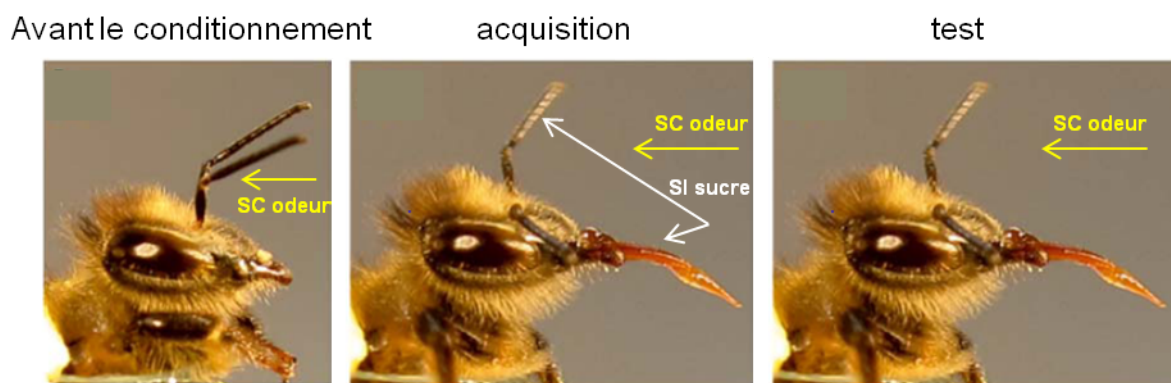

Figure 7 : Protocole de conditionnement appétitif de la Réponse d'Extension du Proboscis (REP). Avant le conditionnement, l'odeur, appliquée au niveau des antennes, constitue un stimulus neutre qui n'entraîne aucune réponse (SC). Durant le conditionnement (acquisition), l'odeur est conjointement présentée à une stimulation sucrée (SI) sur les antennes puis au niveau du proboscis. Une fois l'association réalisée, les abeilles déclenchent leur réponse d'extension du proboscis à la présentation de l'odeur seule (test). *D'après Girling et al. (2013)*

Ce protocole permet aussi de montrer que des stimuli de différentes modalités sensorielles pouvaient être utilisés comme stimulus conditionnel. Kuwabara *et al.* (1957) fit ainsi associer une couleur à la récompense sucrée mais démontra que cette association ne pouvait se réaliser sans que les antennes ne soient préalablement amputées (voir aussi Mota *et al.*, 2011a). Quant à eux, Erber *et al.* (1998) montrèrent qu'un stimulus tactile appliqué au niveau des antennes pouvait être associé avec une récompense sucrée dans un conditionnement de la REP.

Sur la base de ce protocole, Bitterman *et al.* (1983) introduisirent le *conditionnement différentiel*, dans lequel les abeilles doivent différencier une odeur renforcée par la solution sucrée (SC+) d'une autre qui ne l'est pas (SC-). Ce type de procédure permet, entre autres, de confirmer le caractère associatif de cet apprentissage, puisque seule l'odeur associée à la solution sucrée (SC+) déclenche l'extension du proboscis (**Fig.8**).

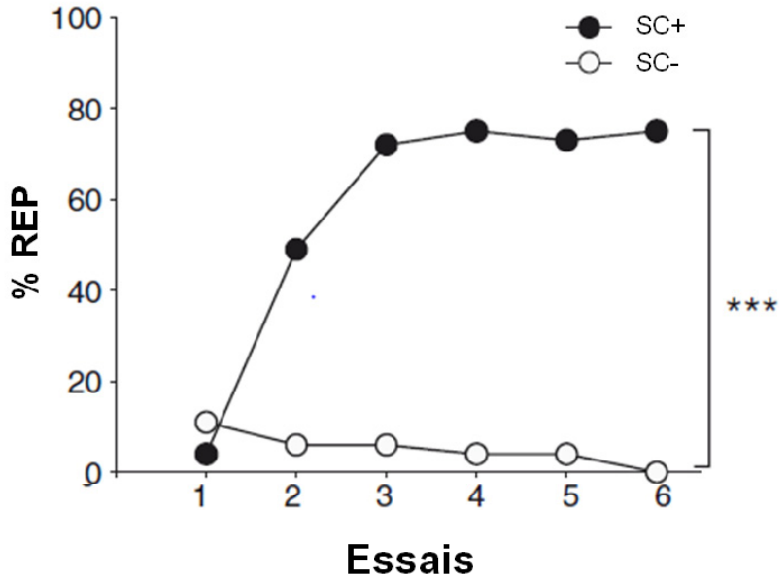

Figure 8 : Courbe d'acquisition d'un conditionnement olfactif différentiel de la REP. Au cours des 6 essais, les abeilles apprennent à répondre par une extension du proboscis à l'odeur renforcée (SC+) par de la solution sucrée et à ne pas répondre à l'odeur non-renforcée (SC-). Elles parviennent ainsi à différencier les deux odeurs durant le conditionnement. *** : $p < 0,001$. Adapté de Carcaud *et al* (2009).

Les protocoles différentiels ont été particulièrement utiles (de manière comparable aux labyrinthes en Y évoqués plus haut) pour étudier en laboratoire les capacités cognitives complexes des abeilles. On peut citer en particulier le *patterning négatif*, dans lequel deux stimuli conditionnels (A et B) se voient renforcés quand ils sont présentés indépendamment et non quand ils le sont conjointement (A+, B+ et AB-). L'abeille doit alors apprendre à ne pas répondre à AB, bien que ce stimulus soit composé de deux stimuli renforcés (Deisig *et al.*, 2001, 2007).

Ce paradigme expérimental (conditionnement de la REP) reproduit en laboratoire la séquence comportementale naturelle des abeilles butinant une fleur (association odeur – nectar) et présente ainsi tous les avantages d'un protocole réalisé en conditions contrôlées sur des individus en contention. Dans cette situation, le cerveau de l'individu est aisément accessible (il suffit de soulever la capsule céphalique pour y accéder), ce qui permet d'effectuer des enregistrements électrophysiologiques (Mauelshagen, 1993, Hammer, 1993 ; Okada *et al.*, 2007 ; Strube-Bloss *et al.*, 2011), ou d'injecter différents composés pharmacologiques pour interférer avec l'apprentissage ou la mémoire (Devaud *et al.*, 2007 ; Matsumoto *et al.*, 2014 ; Boitard *et al.*, 2015). Ces approches ont donné lieu à de nombreuses découvertes sur les voies neuronales sous-tendant l'apprentissage appétitif, et qui seront détaillées plus loin.

En conclusion, le protocole de conditionnement de la REP offre l'opportunité d'étudier les capacités d'apprentissage appétitif sur des individus immobiles. Il semble particulièrement intéressant pour comparer les apprentissages appétitif et aversif chez l'abeille, car son pendant aversif existe.

3) L'apprentissage aversif de la réponse d'extension du dard (RED)

L'étude de l'apprentissage aversif chez l'abeille a pris bien des formes au cours des années, en se basant soit sur la mesure d'un évitement du stimulus appris, soit par une diminution de réponse à ce stimulus. En effet, il faut préciser que d'autres types de conditionnement que celui classique du RED ont été utilisés pour étudier la composante aversive de l'apprentissage chez l'abeille. Par exemple, le conditionnement d'évitement dans lequel l'abeille, positionnée dans une boîte, doit associer un des compartiments ou une odeur avec un choc électrique (Abramson, 1986 ; Wehmann *et al.*, 2015). Nous pouvons aussi citer le conditionnement de rétractation du proboscis de Smith *et al.* (1991) où l'extension du proboscis à une odeur précédemment renforcée par une solution sucrée est punie par un choc électrique.

Dans la nature, l'extension du dard représente une réponse majeure dans les comportements de défense des abeilles (Free, 1961). En effet pour faire cesser une stimulation potentiellement dangereuse pour la colonie, les ouvrières possèdent un dard comme appareil vulnérant (Collins et Kubasek, 1982 ; Breed *et al.*, 1990). L'étude de la réponse d'extension du dard (RED) de l'abeille prend sa source, selon nos connaissances, dans les travaux de Free (1961), qui étudia les stimuli pouvant potentiellement entraîner une extension du dard. Dans le souci de réduire les causes de piqûres chez les apiculteurs, ce criblage de stimuli comprenait des extraits de glandes abdominales, des stimuli de couleurs et de vitesses variables et de la fumée (Free, 1961). Ce travail a montré que les stimulations contrastées et les textures rugueuses avaient tendance à déclencher plus de réponses de pique de la part des ouvrières à l'entrée de la ruche. Par la suite, une série de dispositifs plus ou moins complexes ont été développés.

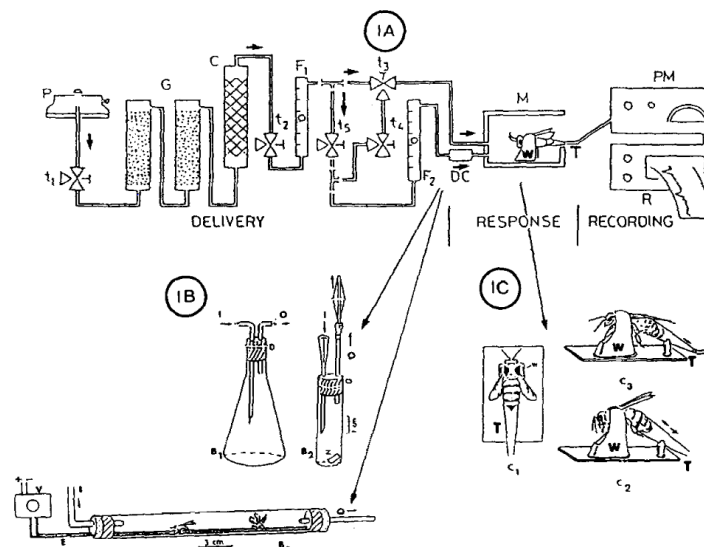

Figure 9 : Dispositif de Tel-Zur et Lensky (1995). L'abeille y est immobilisée et l'abdomen est accroché à un manomètre. Par un enchainement de tuyaux, des stimulations odorantes peuvent être délivrées aux abeilles. Ce procédé permet de plus, d'envoyer des odeurs émises par des individus. L'extension du dard et les mouvements de l'abdomen sont mesurés à l'aide d'un tube contenant les trois derniers segments de l'abdomen de l'abeille où sont enregistrées les variations de pressions.

On peut citer par exemple le dispositif mis en place par Tel-Zur et Lensky (1995) (**Fig.9**) permettant d'enregistrer la réponse d'extension du dard suite à la présentation d'une odeur (dans ce cas la phéromone d'alarme) (Tel-Zur et Lansky, 1995). Cet ingénieux dispositif mesurait l'extension du dard grâce aux variations de pressions dans un tube contenant les trois derniers segments de l'abdomen de l'abeille. Paxton, s'inspirant du travail de Stort (1974), mis en place un système composé d'une grille électrifiée reposant sur une pièce de cuir (**Fig.10**). Ce dispositif enregistre la latence et le nombre de piqures pour une stimulation électrique de l'abeille à un voltage donné (Paxton, 1994). Ce dispositif est toujours utilisé pour des travaux s'intéressant aux différences génotypiques sous-jacentes aux variabilités phénotypiques comportementales (défense, butinage,...) au sein d'une colonie et entre sous-espèces du genre *Apis* (Breed, 2004; Hunt, 2007). En particulier, il a permis de montrer les spécificités du comportement des « abeilles africanisées », issues d'une hybridation entre sous-espèces d'abeilles (Quezada-Euán et Paxton, 1999 ; Uribe-Rubio *et al.*, 2008).

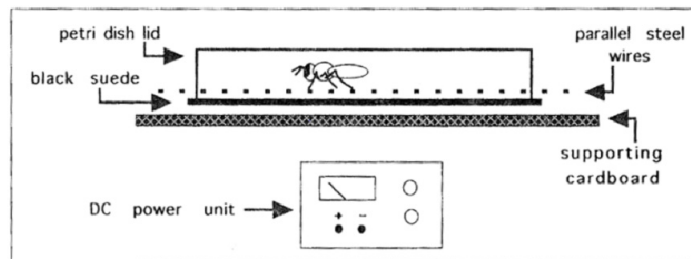

Figure 10 : Dispositif de Paxton (1986). L'abeille se trouve entre une plaque de verre et sur une grille électrifiable. Sous cette grille se situe une pièce de cuir permettant à l'abeille de piquer. Ainsi la latence et le nombre de piqures répondant à un choc électrique sont mesurés visuellement sur la pièce de cuir.

En parallèle des travaux de Paxton (1986), l'idée d'utiliser un choc électrique fut aussi exploitée par Núñez et ses collaborateurs (1983). Ils construisirent le premier dispositif en contention complète permettant de mesurer l'extension du dard en réponse à l'application d'un choc électrique (**Fig.11**). Grâce à ce dispositif, ces auteurs étudièrent, entre autres, l'impact d'analgésiques communément utilisés chez l'homme, tels que la morphine ou la naloxone, sur la RED. Observant une diminution des réponses après injection de ces analgésiques, ils émirent l'hypothèse d'une similarité entre les vertébrés et les invertébrés dans l'inhibition par les opiacés des effets de stimuli nocifs. Grâce à ce système, ils montrèrent de plus que la phéromone d'alarme induit chez l'abeille une analgésie qui pourrait mettre en jeu un tel système (Núñez *et al.*, 1997).

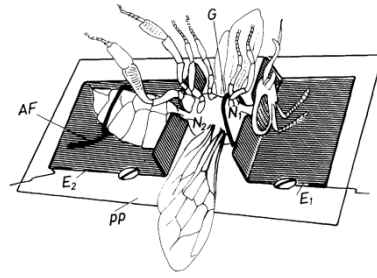

Figure 11 : Dispositif de Núñez *et al.*, (1983). Dans ce dispositif l'abeille se trouve en contention sur le dos entre deux plaques de cuivre. L'expérimentateur peut laisser passer un courant électrique entre les deux plaques.

Consécutivement à ces études sur l'extension du dard comme réponse comportementale *per se*, émergea la volonté de développer un conditionnement associatif aversif chez l'abeille en contention, selon un principe inspiré des travaux sur le conditionnement de la REP. En reprenant le dispositif de Núñez *et al.* (1983), un protocole de conditionnement différentiel utilisant un choc électrique comme stimulus inconditionnel a été développé (Vergoz *et al.*, 2007) (**Fig. 12A**). Dans ce conditionnement, une odeur (SC), neutre au départ, sera présentée conjointement avec le choc électrique (SI). Après plusieurs essais, l'odeur seule se mettra à déclencher la RED (réponse conditionnée). Sur ce principe, les abeilles parviennent à différencier une odeur renforcée négativement (SC+) d'une odeur non-renforcée (SC-) (**Fig.12B**).

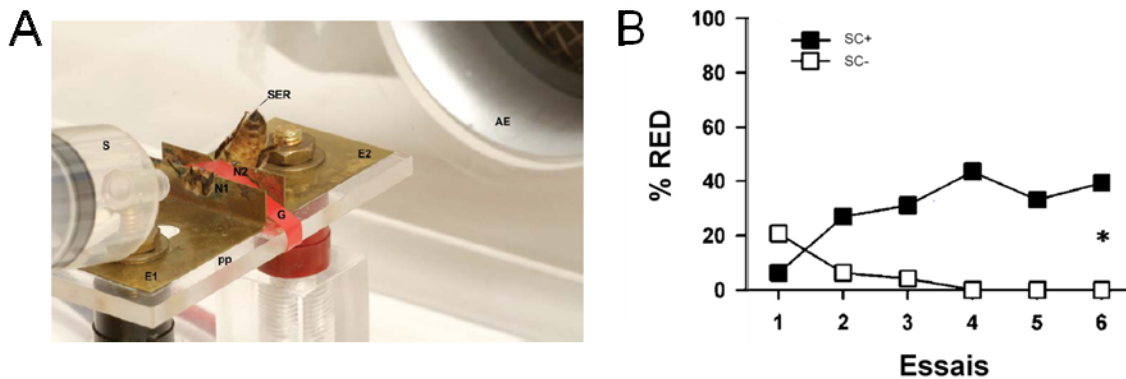

Figure 12 : Conditionnement aversif de la RED utilisant un choc électrique en tant que renforcement. A) Dans ce dispositif, l'abeille est positionnée entre deux éléments de cuivre qui conduisent le courant électrique. Elle reçoit l'odeur, par une seringue (S), associée à un choc électrique auquel elle répond par une extension du dard. B) Au cours des essais, l'abeille apprend à différencier l'odeur renforcée (SC+) par un choc électrique (SI) de l'odeur non-renforcée (SC-). Vergoz *et al.* (2007).

Dans ce protocole, on observe l'augmentation d'une réponse à la présence de l'odeur, ce qui ne correspond pas, en principe, à la définition d'un apprentissage aversif, plutôt étudié sous la forme d'évitements ou de diminutions de réponse (cf. I b). Il n'en reste pas moins que l'abeille associe un SC

à un stimulus aversif (le choc électrique). Afin de démontrer la nature aversive du conditionnement, les abeilles préalablement soumises à un conditionnement différentiel ont été placées dans un labyrinthe en Y présentant les deux odeurs (SC+ et SC-) dans deux bras différents (Carcaud *et al.*, 2009). Dans ce test de rappel, les abeilles évitèrent l'odeur préalablement renforcée et la nature aversive du conditionnement fut confirmée. Le conditionnement olfactif de l'extension du dard est donc bien un conditionnement Pavlovien aversif, dans lequel une réponse de défense de l'animal (la RED) est conditionnée. Depuis une dizaine d'années, ce conditionnement a donné lieu à une dizaine d'études, principalement consacrées à sa description comportementale (Roussel *et al.* 2009, 2012 ; Giurfa *et al.*, 2009 ; Mota *et al.*, 2011 ; Vergoz *et al.*, 2007b, 2009). Par exemple, il a été démontré qu'un stimulus visuel pouvait faire office de SC dans un conditionnement de la RED (Mota *et al.*, 2011b). De plus, un protocole de conditionnement différentiel olfactif comprenant 6 essais renforcés et 6 essais non-renforcés induit une mémoire à long terme (>72h) dépendante de la synthèse de nouvelles protéines (Giurfa *et al.*, 2009). Cependant, à ce jour, on n'a que peu progressé sur les bases neuronales du conditionnement aversif (Tedjakumala et Giurfa, 2013, Tedjakumala *et al.*, 2013). Cet objectif constituera une partie de la présente thèse.

III) Bases sociales et génétiques de l'organisation cognitive de la ruche

a) Seuils de réponses : apprentissage et polyéthisme

La perception des stimuli environnementaux peut varier entre les individus de la ruche. En effet, que ce soit pour le sucre ou pour le choc électrique, l'augmentation de l'intensité de stimulation (appétitive ou aversive) entraîne un accroissement du nombre d'individus montrant qu'ils ont perçu la stimulation par une réponse associée (REP, RED). On observe ainsi des individus plus sélectifs que d'autres qui ne répondront qu'à des stimulations importantes, et inversement des individus plus sensibles aux stimulations (Scheiner *et al.*, 2004 ; Roussel *et al.*, 2009). Dans les protocoles de conditionnement de la REP et de la RED, les capacités d'apprentissage des individus sont fortement influencées par la perception subjective du stimulus inconditionnel. Plus l'animal perçoit le SI comme intense, et plus vite il formera une association entre une odeur (SC) et ce SI. Ainsi, lors de l'apprentissage appétitif, la perception de la récompense sucrée est déterminante dans le succès de l'association (Scheiner *et al.*, 1999; Pankiw et Page, 1999). Il est possible de révéler le seuil de réponse au sucre d'un individu, et donc sa sensibilité, en présentant au niveau de ses antennes une série de solutions sucrées de concentrations croissantes en saccharose (Page *et al.*, 1998). On peut alors démontrer une forte corrélation entre le seuil de réponse au sucre et les performances d'acquisition de

l'association avec le stimulus conditionnel (**Fig. 13**) (Scheiner *et al.*, 2004). Plus un individu possède un seuil de réponse bas (i.e. il répond déjà à de faibles concentrations), plus rapidement il réalisera l'association pendant le conditionnement et *vice versa*.

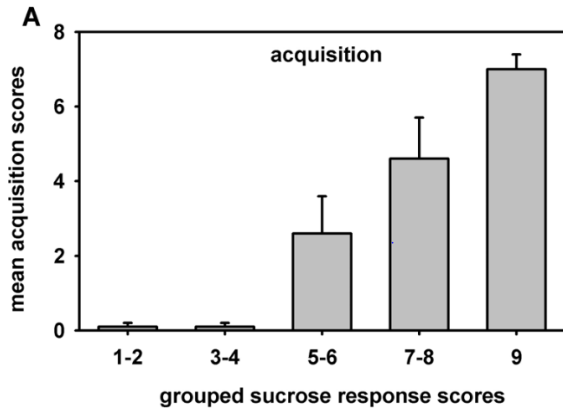

Figure 13 : Corrélation entre la sensibilité au sucre et les performances d'apprentissage des abeilles. Les individus qui présentent les scores de sensibilité au sucre les plus élevés (i.e. qui ont répondu dès les concentrations les plus faibles) possèdent les scores d'acquisition les plus élevés aussi (i.e. ils ont appris dès les premiers essais du conditionnement). D'après Scheiner *et al.*, (2004)

De même que pour l'apprentissage appétitif de la REP, la perception du stimulus inconditionnel aversif (choc électrique) détermine les performances individuelles lors du conditionnement olfactif de la RED. Plus les ouvrières sont sensibles au choc électrique, plus vite elles apprendront à l'associer à l'odeur lors de la phase d'acquisition (Roussel *et al.*, 2009).

Les seuils de réponse n'influencent pas seulement les performances d'apprentissage, ils jouent aussi un rôle dans la spécialisation comportementale des ouvrières. La division du travail parmi les individus stériles de la colonie est une caractéristique fondamentale des sociétés d'insectes (Robinson, 1992 ; Trumbo *et al.*, 1997 ; Duarte *et al.*, 2001). Au niveau proximal, la division du travail est généralement expliquée par le principe de l'auto-organisation basé sur des règles comportementales simples reposant sur des différences de sensibilités inter-individuelles aux stimuli environnementaux (Beshers et Fewell, 2001 ; Duarte *et al.*, 2011). Le *modèle des seuils* semble être particulièrement adéquat pour décrire l'émergence d'une organisation sociale sans avoir recours à des capacités cognitives complexes ou à une centralisation de l'information. Ce modèle émet le postulat que la spécialisation des individus composant un groupe social émerge spontanément de la différence inter-individuelle des seuils de réponses aux stimuli associés aux différentes tâches à accomplir (Bonabeau *et al.*, 1996 ; Page et Mitchell, 1998 ; Jeanson *et al.*, 2007). Lorsque deux ou plusieurs individus interagissent face à une tâche donnée, celui qui possède le seuil de réponse le plus bas pour le stimulus associé à cette tâche (l'individu le plus sensible) l'accomplira. Ce modèle a trouvé une certaine validation dans les observations réalisées chez différentes espèces d'hyménoptères sociaux. Dans les comportements de thermorégulation, par exemple, il a été observé chez les fourmis, les bourdons et les abeilles, qu'un même individu répondait toujours à partir de la même variation de température par rapport à la température ambiante. Cependant, différents individus se lancent dans la tâche de

thermorégulation à partir de niveaux de températures différents, ce qui permet d'avoir une réaction croissante de la colonie en fonction de la température (O'Donnell et Foster 2001; Weidenmüller, 2004; Jones *et al.*, 2004).

Dans cette logique, chez l'abeille, les tâches de butineuse ou de gardienne devraient reposer sur des spécialisations d'individus présentant des sensibilités appétitive ou aversive différentes. Ce n'est cependant pas la théorie qui a été avancée chez cette espèce. En effet, certains auteurs ont proposé que la sensibilité au sucre constituerait le seul déterminant dans l'allocation des tâches (Page *et al.*, 2006). Cette idée était apparue après l'observation de la corrélation de la sensibilité des abeilles au saccharose avec leur sensibilité envers toutes sortes d'autres stimuli sensoriels, comme la lumière (Erber *et al.*, 2006) ou les stimuli tactiles (Scheiner *et al.*, 2001). Cependant, d'autres auteurs ont remarqué que la plupart des stimuli testés étaient liés de près ou de loin à la tâche de butineuse, et ont proposé qu'un deuxième déterminant central soit représenté par la sensibilité des abeilles aux stimuli nociceptifs (Roussel *et al.*, 2009). Cette idée semble pertinente car un *trade-off* (système de compensation) entre l'activité de butinage et les comportements de défense a été révélé en comparant différentes colonies d'abeilles (Rivera-Marchand *et al.*, 2008). Ainsi des colonies montrant une forte activité de butinage tendaient à montrer un comportement de défense moins marqué et *vice versa*. Néanmoins, en Laboratoire, la première étude cherchant à comparer les sensibilités appétitive et aversive des abeilles n'a pas permis d'observer clairement de relation de dépendance entre ces deux sensibilités (Roussel *et al.* 2009). Dans cette étude, cependant, différents aspects expérimentaux peuvent expliquer que le *trade-off* colonial n'ait pas été retrouvé au niveau inter-individuel. D'une part, cette étude a mesuré les RED des abeilles à un choc électrique, stimulus qui n'est pas naturel pour elles. D'autre part, cet effet pourrait provenir de facteurs agissant sur la variabilité comportementale inter-individuelle comme l'âge ou le génotype (Jeanson et Weidenmüller, 2013). Dans l'étude de Roussel *et al.* (2009), l'âge en particulier n'était pas contrôlé, bien qu'il joue un rôle très important dans la trajectoire comportementale des ouvrières d'abeille.

Les performances d'apprentissage et la distribution du travail possèdent donc un déterminant commun dans les seuils de réponses des individus. Cependant, la relation entre les sensibilités appétitive et aversive reste encore peu étudiée. Le contrôle de variables comme l'âge pourrait faire ressortir une structuration des sensibilités hédoniques au sein de la colonie. Cette thèse cherchera à tester cette proposition.

b) Bases génétiques de l'apprentissage et de la distribution du travail

Le substrat génétique des capacités d'apprentissage demeure une question majeure dans la communauté scientifique (Chen et Tonegawa, 1997 ; Waddel et Quinn, 2001 ; Dukas, 2007). La composition génétique particulière de la colonie d'abeilles en fait un modèle particulièrement

intéressant pour ce questionnement. Les abeilles sont monogynes et polyandres et leur système de reproduction est de nature haplo-diploïde. Ainsi, une reine diploïde est fécondée par une quinzaine de mâles haploïdes (Page, 1982 ; Baudry *et al.*, 1998). Il en résulte un découpage de la colonie en fratries différentes, descendant de pères différents et ce bien que toutes les ouvrières héritent de l'ADN maternel (**Fig.14**) (Estoup, 1994). Peu d'études se sont penchées sur l'influence que pouvait avoir l'origine paternelle des individus sur leurs performances d'apprentissages. Dans la modalité appétitive, l'origine paternelle semble expliquer en partie la variation inter-individuelle des performances de conditionnement de la REP (Laloi et Pham-Delègue, 2010). De plus, la sensibilité au sucre varie aussi entre les lignées paternelles (Scheiner et Arnold, 2010). Cependant, dans la modalité aversive, la seule étude réalisée à ce jour a observé une différence entre lignées paternelles de niveau de réponses à un choc électrique d'intensité donnée (Lenoir *et al.*, 2006).

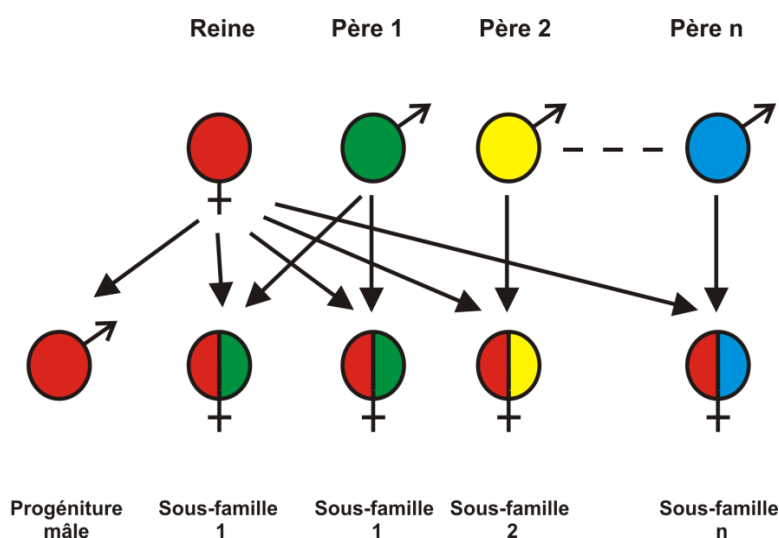

Figure 14 : Représentation du système de reproduction polyandre de l'abeille. La reine est fécondée par une quinzaine de mâles pendant son vol nuptial. Il en découle une division génétique de la colonie en lignées paternelles. Différentes sous-familles issues de pères différents composent l'architecture génétique de la ruche.

L'origine paternelle a aussi un impact sur l'allocation des tâches, les abeilles appartenant à différentes lignées ayant tendance à effectuer des tâches différentes, comme gardienne, butineuse ou nourrice (Robinson et Page, 1989) et aussi à ventiler la colonie à différentes déviations de température par rapport à la température optimale (Jones *et al.*, 2006). Pour apprécier l'influence du génotype sur des comportements de natures appétitive et aversive, des approches de QTL (Quantitative Trait Loci) ont été réalisées. Ces travaux se sont intéressés à des ruches présentant des comportements de collecte de pollen et de défense différents et ont ainsi permis d'isoler des groupes de gènes dans certaines régions chromosomique (des QTL), pouvant expliquer des variations de comportement de butinage entre les individus d'une ruche. Initialement, deux QTL (*pln1* et *pln2*), puis un troisième (*pln3*), ont

été attribués à des traits de butinage à l'échelle individuelle (Hunt *et al.*, 1995, Page *et al.*, 2000). *Pln2* et *pln3* influencent le seuil de sélectivité des butineuses pour la concentration de nectar récolté, tandis que *pln1* agit sur l'âge de l'initiation du butinage (Rueppel *et al.*, 2004). Dans l'entourage direct d'un autre QTL impliqué dans la sensibilité au sucre, *pln4*, on retrouve un gène qui est déterminant pour plusieurs comportements, en particulier en ce qui concerne la recherche de nourriture : le gène *foraging* (Rueppel *et al.*, 2009). Ce gène code pour une PKG (Protéine Kinase dépendant du cGMP). Chez la drosophile, espèce chez laquelle ce gène présente un polymorphisme génétique, il a été observé que les variants *rover* (*for'*) présentant une forte activité de la PKG étaient plus sensibles au sucre que les variants *sitter* (*for^s*) qui ont une faible activité de la PKG. En ce qui concerne l'abeille, l'activité de la PKG augmente avec l'âge, tout comme la sensibilité au sucre (Scheiner *et al.*, 2001 ; Ben Shahr *et al.*, 2002). Contrairement à la drosophile, l'abeille ne présente pas de polymorphisme génétique pour ce locus, mais deux variants d'épissage ont été identifiés (Amfor α et Amfor β). L'expression du variant Amfor α , en particulier, est supérieure dans le cerveau des butineuses que dans celui des nourrices (Thamm et Scheiner, 2014). En ce qui concerne la modalité aversive, certains QTL ont été liés aux comportements de défense. A l'échelle des colonies, *sting1* s'est révélé être le QTL le plus déterminant pour la propension des abeilles à piquer, tandis que *sting 2* et *sting 3* participeraient à l'engagement des individus dans des tâches de défense (Hunt *et al.*, 2007, Lattorff et Moritz, 2013).

Ainsi, si l'on revient à la question de l'interaction entre les capacités cognitives appétitive et aversive, l'étude de Rivera-Marchand *et al.* (2008) soutient que le *trade-off* inter-colonial entre les comportements de butinage et de défense est sous influence génétique (cf. partie précédente). De plus, les seuils de réponses (donc les performances d'apprentissage) et l'allocation des tâches semblent aussi être sous déterminisme génétique. Cependant, jusqu'à présent, les études du déterminisme génotypique de l'apprentissage ont principalement été réalisées indépendamment sur les modalités appétitive et aversive. Une comparaison directe entre les sensibilités appétitive et aversive des mêmes individus, réalisée en contrôlant l'origine paternelle des abeilles, pourrait permettre de révéler une relation de dépendance (et éventuellement un *trade-off*) sous influence génotypique. Un des objectifs de cette thèse sera dédié à cette question.

IV) Bases nerveuses de l'apprentissage olfactif chez l'abeille

a) Cerveau de l'abeille et voie olfactive

La relative simplicité du cerveau des invertébrés comme celui de l'abeille, en fait un modèle de choix pour étudier les substrats neuronaux des apprentissages classiques, bien plus facilement que chez les vertébrés (Menzel et Giurfa, 2001 ; Giurfa, 2003 ; Heisenberg, 2003 ; Gerber *et al.*, 2004 ; Menzel, 2012). Les conditionnements olfactifs de la REP et de la RED mettent tous deux en jeu la voie nerveuse olfactive. Dans la partie suivante, nous aborderons donc les connaissances actuelles sur la manière dont les informations olfactive, appétitive et aversive sont détectées et traitées par le système nerveux de l'abeille.

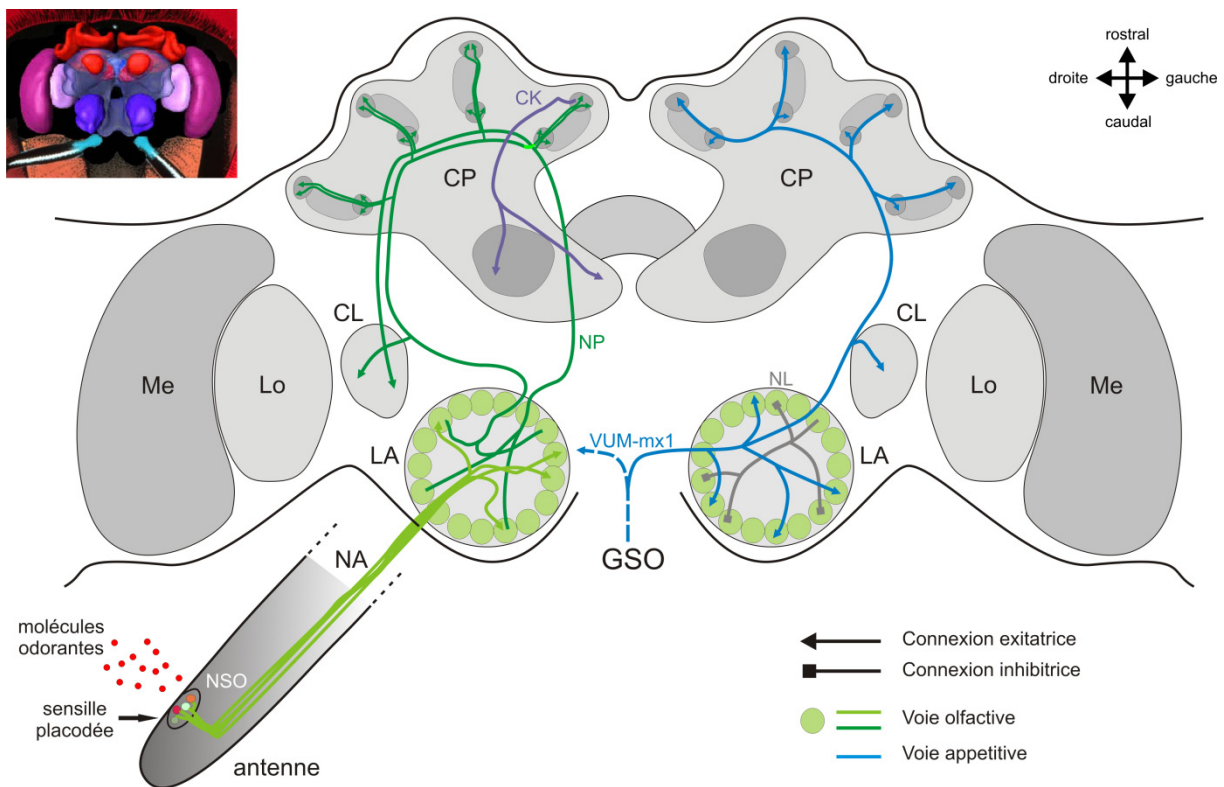

Figure 15 : Voies olfactive et appétitive dans le cerveau de l'abeille. Pour simplifier, les différents types neuronaux sont présentés séparément sur les deux hémisphères. Sur la gauche, la voie olfactive et sur la droite la voie du renforcement appétitif. (**à gauche**) Le lobe antennaire (LA), premier centre de traitement de l'information olfactive, reçoit les afférences de ~60.000 neurones sensoriels olfactifs (NSOs) qui détectent les odeurs au niveau des sensilles placodées de l'antenne. Dans les unités anatomiques et fonctionnelles que sont les 165 glomérules du LA, les NSOs font synapses avec ~4000 neurones locaux (NL) inhibiteurs et ~800 neurones de projection pour relayer l'information traitée vers les centres supérieurs. L'information est ainsi convoyée à la corne latérale (CL) et au niveau des calices des corps pédonculés (CP). Les NP entrent en contact avec les dendrites des cellules de Kenyon (CKs), les 170.000 neurones intrinsèques des CP, et forment les calices. (**à droite**). Le neurone VUM-mx1 (Ventral unpaired median neuron of the maxillary neuromere 1), qui représente le renforcement appétitif dans le cerveau, reçoit les afférences gustatives des récepteurs au sucre au niveau du ganglion sous-œsophagien (GSO). Il se projette et converge avec la voie olfactive au niveau de trois aires du cerveau, le LA, les CP et la CL. *Modifié, d'après Sandoz (2011)*

Le traitement de l'information olfactive suit différentes étapes, de la détection des molécules, en passant par le premier centre de traitement, le lobe antennaire (LA), jusqu'à l'établissement d'une représentation olfactive dans les centres supérieurs du cerveau de l'abeille.

Détection périphérique de l'odeur : l'antenne

La détection périphérique des odeurs commence au niveau des neurones sensoriels olfactifs (NSO) (**Fig.15**) dont l'arborisation dendritique est localisée dans des structures cuticulaires de l'antenne, les sensilles placodés (Snodgrass, 1984; Getz et Akers, 1994). Les molécules odorantes se lient avec les récepteurs olfactifs exprimés au niveau de la membrane des dendrites des NSOs. Les abeilles possèdent un large répertoire de récepteurs olfactifs (RO, environ 163), en comparaison avec d'autres espèces d'insectes comme la drosophile ou les papillons (Robertson et Wanner, 2006).

Premier centre olfactif : le lobe antennaire

Les axones des NSOs forment le nerf antennaire (NA) qui atteint le lobe antennaire (LA), le premier centre de traitement de l'information olfactive du cerveau des insectes (**Fig.15**). Le LA de l'abeille est compartimenté en 165 unités anatomiques et fonctionnelles, les glomérules. D'après la situation observée chez la drosophile (Vosshall *et al.*, 2000), on estime que chaque glomérule reçoit les afférences des NSOs exprimant un même récepteur olfactif. Cette idée est corroborée par le nombre sensiblement identique de glomérules dans le LA et de ROs dans le génome (Robertson et Wanner, 2006). Le LA est principalement composé de deux types de neurones : les neurones locaux (NLs) et les neurones de projection (NPs). Les NLs sont au nombre de ~4000 et leurs connexions synaptiques sont limitées aux glomérules du LA. Ces interneurons, de nature principalement inhibitrice, opèrent à un traitement de l'information provenant des NSOs, permettant de contrôler l'intensité du signal reçu ainsi que d'affiner la représentation olfactive et la discrimination entre odeurs proches (Sachse et Galizia, 2002). L'information olfactive ainsi traitée est ensuite acheminée vers les aires supérieures.

Centres supérieurs olfactifs : les corps pédonculés et la corne latérale

Les neurones intrinsèques des corps pédonculés (CP) sont les cellules de Kenyon (CK). Chaque NP entre en contact avec plusieurs CKs et chaque CK reçoit des afférences de plusieurs NPs (Ganeshina et Menzel, 2001). Les axones des CKs forment les différents lobes des CPs. Les multiples contacts synaptiques entre les NPs et les CKs, ainsi que le haut seuil d'activation des CKs, entraînent un codage dispersé de l'information olfactive, différent de celui observé au niveau du LA (Szyszka *et al.*, 2005). Ainsi, une CK sera très spécifique d'un motif particulier d'activité des NPs, permettant un codage très spécifique des odeurs (Szyszka et Galizia, 2008 ; Sandoz, 2011). La seconde cible majeure

des NPs est la corne latérale (CL), dont l'arrangement neuronal est encore très mal connu. Il semble néanmoins que les odeurs y soient codées de manière analogue avec le LA (Roussel *et al.*, 2014).

b) Systèmes de renforcement appétitif et aversif

La voie olfactive reçoit des apports provenant de différents systèmes modulateurs, impliqués dans les processus d'apprentissage. Tout comme pour l'information olfactive, l'abeille est équipée de systèmes de détection et de traitement qui lui permettent d'intégrer les informations appétitive et aversive.

Voie appétitive

Dans un protocole de conditionnement de la REP, le renforcement appétitif (saccharose) peut être appliqué au niveau de plusieurs structures sensorielles du corps de l'abeille : les antennes, le protarse des pattes antérieures et les pièces buccales (Bitterman *et al.*, 1983 ; Sandoz *et al.*, 2002 ; Scheiner *et al.*, 2005 ; Wright *et al.*, 2007 ; de Brito Sanchez *et al.*, 2008). Ces structures constituent les principaux organes gustatifs de l'abeille (de Brito Sanchez, 2011). De manière analogue à la détection des molécules olfactives, le traitement périphérique du stimulus gustatif au niveau de l'antenne, se réalise par des neurones sensoriels gustatifs (NSG) localisés au niveau de structures cuticulaires, les sensilles *chaetica* et/ou basiconiques (Esslen et Kaissling, 1976). Les NSGs détectent l'information sucrée par l'expression au niveau de leurs dendrites de récepteurs gustatifs, AmGr1 à 3 (de Brito Sanchez *et al.*, 2008; Montell, 2009; Jung *et al.*, 2014).

Le principal centre de traitement de l'information gustative étudié est le ganglion sous-œsophagien (GSO). Cherchant à découvrir un substrat neuronal du stimulus inconditionnel appétitif, Hammer (1993) a réussi à isoler un interneurone ventral et médian, VUM-mx1, qui se projette du GSO de manière ascendante et bilatéralement symétrique dans le cerveau (**Fig.15**). Ce neurone est activé lorsque du sucre est détecté au niveau des pièces buccales, et sa seule dépolarisation peut se substituer à la présentation du stimulus sucré dans un conditionnement de la REP (Hammer, 1993). Il se projette dans les mêmes zones cérébrales que les neurones de la voie olfactive (lobe antennaire, corps pédonculés, corne latérale), en faisant autant de centres potentiels où se formerait l'engramme mnésique (Hammer, 1997). Cet interneurone appartient à un groupe de neurones immunoréactifs à l'octopamine, suggérant que l'octopamine serait le neurotransmetteur du renforcement appétitif. Pour démontrer cette idée, Hammer et Menzel (1998) ont associé la présentation d'une odeur à l'injection d'octopamine localisée dans le LA, les calyces des CP et la CL. Ces auteurs ont obtenu des performances significatives dans les deux premiers cas, mais pas pour la CL, de sorte qu'on pense actuellement que ces deux centres participeraient dans l'apprentissage et la formation de la mémoire olfactive (Menzel, 1999). Notons qu'un second neurone, VUM-md1, possède des caractéristiques

anatomiques très proches de VUM-mx1 et pourrait avoir des propriétés similaires (Schröter *et al.*, 2007).

Voie aversive

Relativement peu d'études ont cherché à comprendre la détection et le traitement de l'information aversive chez l'abeille, de fait on ignore quasiment intégralement les voies nerveuses impliquées, en particulier au niveau périphérique (détection du SI). Il semble néanmoins, que le neurotransmetteur impliqué dans le renforcement aversif soit la dopamine. Par l'injection d'inhibiteurs compétitifs, il a été montré que la dopamine et la sérotonine pouvaient moduler la sensibilité des individus à un choc électrique (Tedjakumala *et al.*, 2014). Cependant, chez plusieurs espèces d'insectes, le système dopaminergique est celui qui semble jouer un rôle central dans la signalisation du renforcement aversif (Drosophile : Schwärzel *et al.*, 2003, Schroll *et al.*, 2006; Grillon : Unoki *et al.*, 2005). Dans le cadre du conditionnement olfactif de la RED chez l'abeille, l'injection de certains antagonistes dopaminergiques (flupentixol) bloque l'acquisition d'une association odeur-choc électrique (Vergoz *et al.* 2007). A ce jour, plusieurs centaines de neurones dopaminergiques ont été décrits chez l'abeille, mais leurs rôles respectifs dans le conditionnement aversif n'ont pas été étudiés (Schäfer et Rehder, 1989 ; Tedjakumala, 2014).

c) La température : un possible stimulus inconditionnel aversif ?

Le peu de données acquises à ce jour sur les voies du renforcement aversif nous amène à nous demander si le choc électrique, utilisé jusqu'à présent comme SI, est vraiment adapté à ce type de recherche. En effet, le choc électrique passant au travers de la majeure partie du corps de l'insecte durant la stimulation, il est peu évident d'isoler les structures périphériques impliquées dans sa détection. Un autre inconvénient du choc électrique (en tant que stimulus) réside dans le fait qu'il est totalement artificiel et n'existe pas dans le milieu naturel de l'abeille. Ainsi, sa détection en conditions de laboratoire se fait par l'intermédiaire d'un système sensoriel dédié à d'autres stimuli, et qui a évolué pour détecter ces autres stimuli. Au vu de ces réflexions, il nous est apparu légitime de rechercher un autre stimulus nociceptif pouvant faire office de renforcement négatif dans le cadre du conditionnement de l'extension du dard. Dans ce contexte émergea l'idée d'utiliser un stimulus thermique. Cette thèse représente notre premier effort dans cette direction.

1) La température chez l'abeille

La température est une variable environnementale qui impacte la vie de la colonie de différentes manières. Comme chez de nombreuses espèces d'hyménoptères sociaux, le développement du couvain dépend d'un environnement thermique contrôlé (Jackelyn, 1992 ; Jones et Oldroyd, 2007).

Chez l'abeille, quand la température dévie trop fortement des $\sim 34^{\circ}\text{C}$ (Seeley, 1989), le couvain développera des malformations et/ou montrera des capacités cognitives restreintes au stade *imago* (Tautz *et al.*, 2003 ; Groh *et al.*, 2004 ; Jones *et al.*, 2005). Pour maintenir une température constante dans la colonie, les abeilles possèdent différentes stratégies. Comme nous l'avons vu (cf. II b), dans le cas d'une augmentation de température, des ouvrières *ventileuses* se positionnent à l'entrée de la ruche, et battent des ailes pour former un courant d'air qui fera diminuer la température (Southwick et Moritz 1987 ; Jones *et al.*, 2004). D'autres individus peuvent aussi rapporter de l'eau de l'extérieur et déposer des gouttelettes à l'intérieur de la colonie, qui par évaporation induiront un refroidissement (Lindauer, 1954 ; Southwick et Heldmaier, 1987). Quand la température diminue, des abeilles peuvent se positionner dans des cellules adjacentes au couvain, et faire augmenter la température en faisant vibrer leurs ailes (Schmaranzer *et al.*, 1988 ; Bujock *et al.*, 2002 ; Kleinhenz *et al.*, 2003). Pendant la période d'hivernage, les abeilles ne sortent plus de la colonie et forment une grappe, au sein de laquelle les ouvrières feront aussi vibrer leur ailes pour maintenir une température minimale, nécessaire à la survie de la reine (Fahrenholz *et al.*, 1989). On observera que la température environnante peut aussi influencer sur des variables physiologiques telles que la respiration. L'augmentation de la température déclenche ainsi une diminution de la respiration des ouvrières et *vice versa* (Allen, 1958). La température est donc une variable environnementale perceptible par les abeilles pouvant déclencher différents comportements.

2) La température dans l'apprentissage chez les insectes

La température est un facteur environnemental omniprésent et crucial pour le développement et la survie de tout être vivant. La *thermotaxie*, ou orientation vers un optimum thermique, est un comportement déterminant pour les animaux (Garrity *et al.*, 2010 ; Ramot *et al.*, 2008). De nombreuses études ont introduit des stimuli thermiques dans les protocoles de conditionnement, soit simplement comme variable environnementale, soit comme stimulus conditionnel ou inconditionnel.

Dans un premier temps, l'intégration de la température au sein de paradigmes déjà établis a permis de s'interroger sur l'influence de l'environnement thermique sur les capacités d'apprentissage. Chez les annélides comme le lombric, la rétention de l'information est améliorée consécutivement à une augmentation de la température, que ce soit dans des protocoles de conditionnement associatif classique, ou dans des protocoles de conditionnement non-associatif comme l'habituation (Applewhite, 1968). Chez le poisson rouge *Carassius auratus* soumis à un conditionnement aversif utilisant un choc électrique dans un protocole d'évitement actif (cf. I 1 a), la formation de la mémoire est inhibée lorsque l'animal est soumis à de fortes températures (Riege et Cherkin, 1972).

Plus tard, la température a été utilisée comme stimulus conditionnel, indice annonçant la survenue de conséquences positives ou négatives. Ainsi, on a pu montrer que les fourmis coupeuses de feuilles *Atta vollenweideri* peuvent apprendre la localisation d'une source de nourriture en utilisant un stimulus thermique comme indice d'orientation (Kleineidam *et al.*, 2007). Chez l'abeille, un stimulus thermique a été utilisé comme SC dans un conditionnement appétitif de la REP (Hammer *et al.*, 2009). Ces auteurs ont ainsi pu faire associer aux abeilles une augmentation de 10 degrés par rapport à la température ambiante ($\sim 31^{\circ}\text{C}$), présentée au niveau des antennes, avec une récompense sucrée (**Fig.16**).

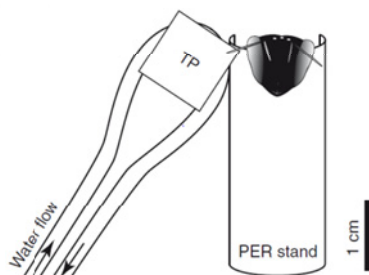

Figure 16 : Système de contention et de stimulation des antennes de l'abeille dans le protocole de conditionnement appétitif de la REP utilisant la température comme stimulus inconditionnel. Ce système utilise un élément Peltier maintenu à température constante par un courant d'eau passant dans un tube de cuivre Hammer *et al.* (2009)

Enfin, la température a été utilisée comme stimulus inconditionnel, positif ou négatif. Ainsi, une étude réalisée chez le bourdon *Bombus terrestris* a montré que dans un protocole d'apprentissage en vol libre, les butineuses pouvaient associer la couleur d'une fleur à la chaleur qu'elle dégageait. La température joue ici un rôle de renforcement positif et entraîne un comportement d'approche (Dyer *et al.*, 2006). A l'inverse, la température peut être perçue comme aversive et entraîner un comportement d'évitement. Ainsi, Foucault *et al.* (2009) ont développé une arène thermique sur le principe de la piscine de Morris, dispositif communément utilisé pour étudier l'orientation et la mémoire spatiale chez la souris (Morris *et al.*, 1982). L'arène thermique est chauffée à une température élevée pour les drosophiles ($\sim 37^{\circ}\text{C}$), à l'exclusion d'un "îlot" conservé au *preferendum* thermique de cet insecte ($\sim 24^{\circ}\text{C}$). En s'appuyant sur des repères visuels placés tout autour de l'arène, les drosophiles apprennent la localisation de la zone "froide" et réduisent ainsi le temps nécessaire pour s'y rendre au cours des essais (Foucaud *et al.*, 2009). En parallèle, chez la drosophile, la température a été introduite comme stimulus renforçant, dans des protocoles d'évitement, dans lequel l'animal apprend à ne pas se rendre dans un compartiment du dispositif sous peine de s'exposer à une forte température (Sitaraman *et al.*, 2008 ; Sitaraman et Zars, 2010). Dans tous ces conditionnements, l'aspect positif ou négatif de la température dépendra de sa déviation par rapport au *preferendum* thermique de l'espèce concernée ainsi que du rôle de la température dans sa biologie. La température peut aussi avoir les deux valeurs, positive et négative, chez le même animal. Ceci a été montré chez la punaise hématophage *Rhodnius prolixus* (Vinauger *et al.*, 2013). Pour ces punaises, une température de 35°C est un stimulus appétitif induisant une extension du proboscis, comme le sucre pour les abeilles. Cependant, si on punit cette réponse par application d'une forte température ($\sim 50^{\circ}\text{C}$), alors la probabilité d'occurrence de cette

réponse diminue. Il se détache de cette dernière étude qu'une forte température, appliquée transitoirement à l'insecte, peut jouer un rôle de renforcement négatif au cours d'un conditionnement, ici opérant.

Nous venons de voir que la température pouvait influencer sur les capacités d'apprentissage en tant que variable environnementale, jouer le rôle de stimulus conditionnel en tant que signal annonçant la survenue d'une récompense, ou de stimulus inconditionnel dans différentes formes de conditionnement. Dans ce cadre, nous nous sommes demandés si, chez l'abeille, une forte température pouvait être utilisée comme renforcement négatif dans un protocole conditionnement aversif de la réponse d'extension du dard. Utiliser un stimulus thermique pourrait offrir l'opportunité d'étudier les voies de perception du stimulus inconditionnel. En effet, il est possible qu'au cours de l'évolution l'abeille ait développé une voie sensorielle dédiée à la détection des températures élevées, un stimulus naturel mais potentiellement létal pour elles.

3) La perception thermique chez les insectes

L'étude de la détection et du traitement de l'information thermique chez les insectes a reçu une attention grandissante dans la dernière décennie. Comme pour l'olfaction, la perception de la température commence par la perception périphérique au niveau de neurones sensoriels exprimant des récepteurs spécifiques. Différents types de sensilles renfermant des neurones thermosensibles ont été mises en évidence sur les antennes des hyménoptères. Les fourmis perçoivent la température au niveau des sensilles coeloconiques (Ruchty *et al.*, 2009). Chez l'abeille, il semblerait que ce soient les sensilles coelocapitulaires qui endossent ce rôle au niveau des antennes (Yokohari *et al.*, 1983). A notre connaissance, la présence de telles sensilles n'a pas été démontrée sur d'autres structures du corps de ces insectes. Cependant, les insectes sont capables de détecter la température sur d'autres parties de leur corps, comme cela a pu être observé dans différents protocoles de conditionnement, au niveau du proboscis (punaise hématophage : Vinauger *et al.*, 2013), des pattes (grillon: Forman, 1984) ou encore du thorax (drosophile : Brembs et Plendl, 2008).

Différentes études ont cherché à définir quels récepteurs pouvaient être impliqués dans la détection thermique (Clapham, 2003 ; Rosenzweig *et al.*, 2005 ; Gallio *et al.*, 2010 ; Tracey *et al.*, 2003). Parmi ces récepteurs les TRP (Transient Receptor Potential) semblent jouer un rôle central. La superfamille des récepteurs TRP est impliquée dans la détection de différentes classes de stimuli environnementaux. Ces canaux cationiques non-sélectifs à six domaines transmembranaires permettent (entre autre) la dépolarisation des membranes des neurones sensoriels périphériques (Clapham *et al.*, 2001 ; Clapham, 2003 ; Voets *et al.*, 2005). Une des premières études sur ce type de récepteur a montré, grâce à des mutants, l'implication du gène *trp* dans la phototransduction au niveau

des ommatidies chez la drosophile (Montell et Rubin, 1989). Depuis lors, une série de canaux de la même famille ont été décrits, dont certains sont impliqués dans la perception thermique, que ce soit chez les mammifères ou les insectes. Le canal TRPV1 a été le premier récepteur identifié à s'activer à de fortes températures chez les mammifères ($>43^{\circ}\text{C}$, Caterina et Julius, 2001 ; Ahern *et al.*, 2005; Pingles *et al.*, 2007). Il a été découvert grâce à la présence d'un agoniste exogène, la capsaïcine, molécule contenue par le piment et qui donne cette sensation de brûlure quand on le consomme. Par la suite, différents TRP impliqués dans la thermosensation ont été décrits, comme TRPV2, pour les chaleurs extrêmes ($>52^{\circ}\text{C}$, Greffrath *et al.*, 2003 ; Woodbury *et al.*, 2004) ou TRPM8 pour les températures froides ($<18^{\circ}\text{C}$), (Bautista *et al.*, 2007 ; Dhaka *et al.*, 2007). Enfin, la sous-famille des TRPA semble jouer un rôle crucial et très conservé dans la perception thermique (Mc Kemy *et al.*, 2007 ; Rosenzweig *et al.*, 2008). En particulier, TRPA1 présente une forte conservation au cours de l'évolution et on le retrouve aussi bien chez les mammifères (Karashima *et al.*, 2009) que chez les reptiles (Saito *et al.*, 2012) et les insectes (Hamada *et al.*, 2007 ; Neely *et al.*, 2011). Il trouve une première implication dans une perception thermotactique *stricto sensu*, c'est-à-dire qu'il est déterminant dans le comportement de recherche d'un *preferendum* thermique (Hamada *et al.*, 2007). De plus, dTRPA1 participe à la perception des fortes températures et à leurs évitements (Neely *et al.*, 2011).

Cependant, il ne semble pas exister de TRPA1 dans le génome des hyménoptères, en particulier de l'abeille (Matsuura *et al.*, 2009). Le seul récepteur de la famille des TRPA à avoir été étudié chez l'abeille est AmHsTRPA (Apis mellifera Hymenoptera-specific Transient Recepteur Potential Ankiryn). Kohno *et al.* (2010) ont démontré que ce récepteur s'active à partir de températures dépassant 34°C (température optimale de la ruche pour le bon développement des larves). Il s'agit d'un récepteur canal cationique qui lors de son activation laisse entrer des cations bivalents tel que le Ca^{2+} entraînant la dépolarisation du neurone sensoriel l'exprimant. En plus de son rôle de détecteur thermique, HsTRPA agit aussi en tant que chimio-récepteur. Il peut être activé par diverses molécules comme l'allyl isothiocyanate (AITC, présent dans la moutarde), le camphre ou encore le cinnamaldéhyde (CA, présent dans la cannelle), qui sont des insecticides naturels produits par les plantes pour se défendre contre les insectes qui leurs sont nuisibles. Enfin, HsTRPA peut être inhibé par le rouge de ruthenium (Rur) et par le menthol (Kohno *et al.*, 2010). L'injection de ces activateurs et inhibiteurs exogènes a permis de démontrer l'implication de HsTRPA dans la perception thermotactique de l'abeille (Kohno *et al.*, 2010).

Ainsi le rôle des TRPA dans la perception de la température semble conservé au cours de l'évolution. HsTRPA étant le seul membre de la sous famille des TRPA décrit jusqu'à présent chez l'abeille, nous pouvons nous demander s'il participe à la détection des fortes températures. L'introduction de telles températures dans un protocole de conditionnement de la RED pourrait

permettre d'initier une recherche des bases neuronales et moléculaires de la détection périphérique du stimulus aversif. Il sera alors intéressant de s'interroger sur le rôle d'HsTRPA dans un tel protocole.

d) REP et RED : réponses mesurées et problèmes d'interprétation

Dans le cas des réponses d'extension du proboscis ou du dard de l'abeille évoquées plus haut, les réponses enregistrées sont très stéréotypées et fonctionnent principalement selon un mode 'tout ou rien', extension ou non du proboscis ou du dard (Bitterman *et al.*, 1983; Vergoz *et al.*, 2007), ce qui empêche de mesurer finement la progression de l'apprentissage. De plus, les associations appétitives et aversives sont étudiées sur la base de deux réponses comportementales distinctes, dont les seuils de déclenchement peuvent être différents. On peut donc se demander s'il serait possible de révéler le contenu d'associations appétitives et aversives grâce à une même réponse comportementale, et si possible, une réponse graduelle permettant de mesurer finement le contenu des associations.

Certains appendices des animaux peuvent montrer une grande mobilité et disposer d'une vaste gamme de mouvements possibles. Ils peuvent donc potentiellement véhiculer des informations riches sur l'état physiologique ou émotionnel des animaux ou sur la valeur intrinsèque positive ou négative de stimuli appris. C'est le cas des mouvements des oreilles chez les moutons (Reefmann *et al.*, 2009) ou de la queue chez les chiens (Siniscalchi *et al.*, 2013) et le cochon (Groffen, 2012). Chez les insectes, certaines structures comme les antennes, montrent des caractéristiques de ce type. Chez la plupart des insectes, les antennes sont fortement mobiles. Elles portent un équipement permettant de détecter un grand nombre de modalités sensorielles, ce qui en fait une interface majeure entre l'individu et son environnement. Ainsi, les antennes possèdent à leur surface des sensilles gustatives et olfactives ainsi que des mécanorécepteurs capables de détecter des stimulations tactiles (Erber *et al.*, 1998). Au niveau du pédicelle, l'organe de Johnston, permettant la perception des ondes vibratoires et constituant ainsi un organe acoustique, est également impliqué dans la proprioception (Ai et Itho, 2012 ; Ai et Hago, 2013). Les mouvements des antennes augmentent activement lors de l'exploration d'un nouvel environnement par les insectes, leur permettant de collecter de nombreuses informations sensorielles (Bell *et al.*, 1995). Ainsi, les mouvements des antennes des criquets sont effectués activement et sont modulés en fonction des caractéristiques des différents stimuli perçus (Yamawaki et Ishibashi, 2014). Chez les blattes, les mouvements antennaires sont même influencés différemment en fonction de la valence (positive ou négative) d'un stimulus, un stimulus aversif provoquant une diminution de l'activité antennaire (Nishiyama *et al.*, 2007).

Les antennes des abeilles, pourvues d'un grand nombre de récepteurs olfactifs, gustatifs, mécano-sensoriels et auditifs (Kirchner *et al.*, 1991 ; Dreller et Kirchner, 1993) sont utilisées dans la ruche pour de nombreuses tâches, comme lors de la trophallaxie (Free, 1956 ; Korst et Velthuis, 1982),

durant le soin au couvain ou lors de la danse d'orientation (Rohrseitz et Tautz, 1999). Les abeilles montrent des mouvements antennaires spécifiques de scannage en réponse à des stimuli visuels, tactiles ou olfactifs (Erber *et al.*, 1993 ; Erber, 2012). Elles utilisent également l'extrémité des antennes pour évaluer gustativement la qualité de la nourriture pendant sa récolte ou sa consommation (Haupt, 2004). Il semble que les mouvements antennaires puissent aussi refléter l'état physiologique de l'abeille, comme son état d'éveil, car des mouvements stéréotypés ont été observés pendant sa phase de sommeil (Sauer *et al.*, 2003 ; Hussaini *et al.*, 2009).

Les connaissances actuelles sur les caractéristiques de la réponse antennaire chez l'abeille sont encore limitées, car dans la plupart des études, les mouvements antennaires n'ont pas été quantifiés précisément et de manière systématique. Parmi les premiers chercheurs à s'intéresser aux mouvements antennaires de l'abeille, Suzuki (1975) a montré par une approche électrophysiologique une augmentation de l'activité du muscle fléchisseur de l'antenne en réponse à une odeur. Il a aussi décrit qualitativement (sans aucune quantification), une "avancée" des antennes en direction d'un stimulus olfactif. L'utilisation d'un électromyogramme s'est cependant avérée problématique car elle nécessite la fixation d'une partie de l'antenne et empêche de mesurer l'activité antennaire naturelle de l'insecte. Erber (1993, 2012) a, quant à lui, utilisé un système de photodiodes afin de détecter le passage des antennes à certaines positions autour de la tête de l'abeille. Il a ainsi pu mesurer des fréquences de passage d'antennes libres en présence de différents types de stimuli. Cet auteur a décrit un comportement de scannage, caractérisé par des mouvements de balayage en réponse à un stimulus sucré, ainsi qu'en réponse à une odeur. Une étude postérieure s'est basée sur une capture vidéo des mouvements antennaires pour montrer que la vitesse angulaire des antennes pouvait représenter un bon indice de la détection d'une odeur (Lambin *et al.*, 2005). Cette technique permet une analyse moins invasive que l'utilisation d'un électromyogramme et plus précise que l'utilisation de diodes. Elle pourrait permettre une étude précise des mouvements antennaires en fonction de l'expérience appétitive ou aversive des abeilles. Cependant, même si de tels systèmes ont été développés récemment (Mujagić *et al.*, 2012) aucune étude sérieuse n'a cherché à mesurer la plasticité des mouvements antennaires après un apprentissage olfactif. Une telle mesure pourrait véritablement apporter une mesure fine des associations appétitives et aversives, ainsi que de leur intégration par l'abeille.

V) Objectifs

Ce travail de thèse vise à mieux comprendre les bases comportementales, nerveuses et génotypiques de l'apprentissage aversif chez l'abeille domestique *Apis mellifera* ainsi que les relations existant entre apprentissages aversif et appétitif. Pour ce faire, nous avons défini quatre objectifs fondamentaux :

- L'étude de l'apprentissage appétitif en contention repose sur un protocole bien établi, le conditionnement de la REP (Bitterman *et al.*, 1983). Récemment, un protocole équivalent a été développé pour étudier l'apprentissage aversif, le conditionnement de la RED (Vergoz *et al.*, 2007). Cependant, dans ce protocole le stimulus inconditionnel consiste en un choc électrique, stimulus peu naturel pour l'abeille, et pour lequel il est peu probable que des voies sensorielles périphériques dédiées existent. **Nous avons donc cherché à développer un nouveau protocole de conditionnement aversif de l'extension du dard utilisant la température comme renforcement.**
- Les bases nerveuses du conditionnement olfactif aversif sont très mal connues chez l'abeille. Le remplacement du choc électrique par la température permettrait de rechercher l'implication de récepteurs thermiques dans la détection périphérique du renforcement aversif. Les travaux récents ont décrit HsTRPA comme candidat crédible pour un tel rôle (Kohno *et al.*, 2010). **Nous avons donc cherché à comprendre la détection périphérique de la température par les abeilles et l'implication potentielle d'HsTRPA.**
- La colonie d'abeilles possède une structure génétique complexe. Il a été démontré que la ruche composait un équilibre génétique permettant aux individus issus de différentes lignées paternelles de s'engager préférentiellement vers différentes tâches (Estoup *et al.*, 1994). Nous avons émis l'hypothèse d'un *trade-off* existant entre les capacités cognitives aversives et appétitives des abeilles. En utilisant des marqueurs génétiques comme les microsatellites, il est possible de définir l'origine paternelle des individus et de relier le génotype au comportement (Garnery *et al.*, 1993). **Nous avons donc cherché à comprendre la dépendance génotypique des performances d'apprentissage aversif et appétitif des abeilles et avons étudié un éventuel *trade-off* dans ces capacités.**
- Les réponses d'extension du proboscis et du dard sont des réponses dichotomiques de type « tout ou rien ». Nous avons cherché si une réponse plus graduelle pouvait refléter la valence hédonique acquise par une odeur. Les antennes représentent une interface majeure entre l'environnement et le milieu interne, et de plus, des modifications de mouvements antennaires

en réponse à une exposition à des odeurs intrinsèquement appétitive et aversive ont été observées chez la blatte (Nishiyama *et al.*, 2007). **Nous avons développé un système d'enregistrement vidéo des mouvements antennaires pour tenter d'estimer dans quelles mesures, les antennes des abeilles pouvaient refléter les performances d'apprentissage aversif et appétitif d'un individu.**

Ces quatre objectifs ont été abordés au sein des quatre chapitres, pour lesquels nous listons ci-dessous les questions précises auxquelles nous avons tenté de répondre :

Chapitre I : Développement d'un conditionnement aversif de la RED utilisant la température comme renforcement

- L'application d'un stimulus thermique sur le corps de l'abeille entraîne-t-elle une réponse d'extension du dard?
- Comment cette réponse évolue-t-elle en fonction de la température présentée ?
- Est-ce qu'une forte température peut être utilisée comme renforcement dans un conditionnement aversif olfactif ?
- Existe-t-il une relation entre la sensibilité des individus à la température et leurs performances d'apprentissage aversif ?
- Cette relation repose-t-elle sur un déterminisme génétique ?

Ces questions sont abordées dans la publication :

Pierre Junca, Julie Carcaud, Sibyle Moulin, Lionel Garnery, Jean-Christophe Sandoz

Genotypic influence on aversive conditioning in honeybees, using a novel thermal reinforcement procedure

PLOS ONE (2014), 9(5), e97333, 1-13. DOI: 10.1371/journal.pone.0097333

Chapitre II : Cartographie de la sensibilité thermique de l'abeille et implication potentielle de HsTRPA

- Comment varie la sensibilité thermique en fonction de la structure du corps de l'abeille ?
- Le conditionnement aversif est-il uniquement réalisable lorsque la stimulation thermique est appliquée sur des organes sensoriels définis, ou bien est-ce un phénomène général indépendant de la zone stimulée ?
- Le récepteur thermique HsTRPA est-il impliqué dans la réponse d'extension du dard déclenchée par un stimulus thermique ?

Ces questions sont traitées dans le manuscrit soumis :

Pierre Junca, Jean-Christophe Sandoz

Heat perception and aversive learning in honey bees: putative involvement of the thermal/chemical sensor AmHsTRPA

Soumis à *Frontiers in Physiology*

Chapitre III : Comparaison entre performances appétitive et aversive à l'échelle individuelle et des lignées paternelles : esquisse d'une communauté cognitive

- Pouvons-nous confirmer la relation corrélative qui existe entre la sensibilité des abeilles au stimulus inconditionnel et leurs performances d'apprentissage au sein de chaque modalité hédonique ?
- Observe-t-on une spécialisation des individus dans leurs capacités cognitives aversive ou appétitive dans la ruche ou bien les individus performant dans un type d'apprentissage le sont-ils aussi dans l'autre ?
- Comment les performances appétitive et aversive sont-elles réparties au sein des lignées paternelles d'une colonie d'abeille ?
- Peut-on mettre en évidence un *trade-off* hédonique au sein de la colonie ?

Ces questions sont abordées dans le manuscrit en préparation :

Pierre Junca, Lionel Garnery, Jean-Christophe Sandoz

Genotypic trade-off between appetitive and aversive capacities in a cognitive community: the honeybee hive

Chapitre IV : Effet des apprentissages appétitif et aversif sur les mouvements antennaires de l'abeille

- Pouvons-nous utiliser la réponse antennaire pour estimer la valence acquise d'un stimulus olfactif?
- Si oui, quelles variables des mouvements antennaires sont pertinentes pour décrire les effets de l'apprentissage ?
- La réponse antennaire acquise suite au conditionnement est-elle le reflet de la réponse dichotomique habituellement utilisée?

Ces questions sont traitées dans le manuscrit soumis :

Hanna Chole, **Pierre Junca**, Jean-Christophe Sandoz

Appetitive but not aversive olfactory conditioning modifies antennal movements in honey bees

Soumis à *Learning and Memory*

Chapitre I

Développement d'un conditionnement
aversif de la RED utilisant la
température comme renforcement

Genotypic influence on aversive conditioning in honeybees, using a novel thermal reinforcement procedure

Pierre Junca, Julie Carcaud, Sibyle Moulin, Lionel Garnery and Jean-Christophe Sandoz

Published in Plos One (2014)

Abstract

In Pavlovian conditioning, animals learn to associate initially neutral stimuli with positive or negative outcomes, leading to appetitive and aversive learning respectively. The honeybee (*Apis mellifera*) is a prominent invertebrate model for studying both versions of olfactory learning and for unraveling the influence of genotype. As a queen bee mates with about 15 males, her worker offspring belong to as many, genetically-different patriline. While the genetic dependency of appetitive learning is well established in bees, it is not the case for aversive learning, as a robust protocol was only developed recently. In the original conditioning of the sting extension response (SER), bees learn to associate an odor (conditioned stimulus - CS) with an electric shock (unconditioned stimulus - US). This US is however not a natural stimulus for bees, which may represent a potential caveat for dissecting the genetics underlying aversive learning. We thus first tested heat as a potential new US for SER conditioning. We show that thermal stimulation of several sensory structures on the bee's body triggers the SER, in a temperature-dependent manner. Moreover, heat applied to the antennae, mouthparts or legs is an efficient US for SER conditioning. Then, using microsatellite analysis, we analyzed heat sensitivity and aversive learning performances in ten worker patriline issued from a naturally inseminated queen. We demonstrate a strong influence of genotype on aversive learning, possibly indicating the existence of a genetic determinism of this capacity. Such determinism could be instrumental for efficient task partitioning within the hive.

Keywords: insect, Pavlovian conditioning, temperature, genetic determinism, patriline.

Introduction

To survive, animals must be able to associate stimuli of their environment with their positive or negative consequences. This leads to two complementary forms of associative learning, termed respectively ‘appetitive’ and ‘aversive’ learning. A major question in the study of the neural bases of cognitive functions is the relationship existing between these two types of associative learning (Benjamin *et al.*, 2000; Paratore *et al.*, 2006; Giurfa, 2006; Ardiel and Rankin, 2010; Norton and Bally-Cuif, 2010). Strongly related to this question is the search for the genetic architecture underlying these two learning types. Do they rely on utterly different ensembles of genes, giving rise to mostly independent neural processes, or do they share essential characteristics, such as for instance the associative machinery?

In this prospect, honeybees (*Apis mellifera*) may represent a valuable asset. In addition to being a well investigated invertebrate model for the study of the behavioral and neuronal basis of associative learning and memory (Menzel, 1999; Sandoz, 2011; Tedjakumala and Giurfa, 2013), the genetic architecture of their colonies is well adapted for studying a possible genotypic influence on cognitive skills. Honeybees possess a haplo-diploid reproduction system. In a honeybee colony, the diploid queen mates on average with fifteen haploid males (Estoup *et al.*, 1994). Therefore, the workers, her daughters, make up about fifteen different patrilines with different genetic backgrounds within the hive. It is currently thought that such genetic diversity is beneficial for the colony’s fitness and survival (Jeanson and Weidenmüller, 2014). Indeed, post-winter survival rate, production of sexuals, resistance and swarming were found to be positively correlated to the number of patrilines (Mattila and Seeley, 2007). Moreover, a high number of patrilines results in an increased performance for thermoregulation, food storage, and even worker communication during foraging (Robinson and Page, 1989; Jones *et al.*, 2004). How can these advantages be explained in terms of task allocation within the hive? An important ensemble of theories, named "threshold theories", consider that the different responsiveness of each individual to environmental stimuli determines this individual's propensity to engage in one or another behavioral task (Page, 1989, Beshers and Fewell, 2001). Thus, the existence of different patrilines with diversified responsiveness within the hive would allow optimal task allocation, in particular concerning foraging (Cox and Myerscough, 2003; Eckholm, 2011) or thermoregulation (Jones *et al.*, 2004). One may thus ask what is the influence of patriline origin on bees’ sensitivity to appetitive and aversive reinforcement and on their learning capacity in these two modalities.

Until now, however, the search for a genetic determinism of associative learning in bees has been limited to appetitive learning, due to the long existence of a well-established laboratory assay: the conditioning of the proboscis extension response (PER) (Bitterman *et al.*, 1983; Giurfa and Sandoz, 2012). The proboscis extension is a reflex triggered by sugar stimulation provided on gustatory

receptors of the antennae, tarsi or mouthparts. In olfactory PER conditioning, an originally neutral odor (conditioned stimulus – CS) is associated with a sugar reward first presented to the antennae and then to the proboscis (unconditioned stimulus – US). Once the association has been established, the bee responds with a proboscis extension to the odor (CS) alone. Thanks to this biological assay, a number of studies have evaluated the relative influence of genetic, developmental and environmental factors on appetitive learning and established its genetic dependency (Brandes, 1991; Brandes *et al.*, 1988, 1990; Bhagavan *et al.*, 1994; Laloï and Pham-Delègue, 2010). This dependency relies in part on bees' responsiveness to the sugar (US), a highly genetically-dependent trait which strongly influences the future role of workers as nectar, pollen or water foragers (Scheiner *et al.*, 2001a; Page *et al.*, 2006). Bees' responsiveness to sugar directly affects appetitive learning performances (Scheiner *et al.*, 1999; Scheiner *et al.*, 2005). Bees with a high response threshold perceive the sugar reward as less intensive, and therefore learn it less efficiently than bees with a lower threshold (Scheiner *et al.*, 2001b). It seems that many behavioral traits of the honeybee are correlated with sugar responsiveness, as for example olfactory sensitivity and phototactic behavior (Erber *et al.*, 2006). As a result, the authors of these studies even suggested that sugar responsiveness could be the *only* determinant of honeybee behavior (Page *et al.*, 2006). However, it was later found that this hypothesis did not take into account types of behaviors that are not related to food search, such as for instance defense behavior or aversive learning (Roussel *et al.*, 2009).

This lack of data on the aversive aspects of honey bee behavior was mainly due to the absence of dedicated protocols for studying aversive learning in controlled laboratory conditions. Recently, the Pavlovian conditioning of the sting extension response (SER) was developed to solve this problem (Vergoz *et al.*, 2007, Tedjakumala and Giurfa, 2013). An electric shock applied to the bee's thorax triggers an extension of the sting (Núñez *et al.*, 1997). Bees can learn to associate an odor CS with this electric shock US and after conditioning will respond to the punished odor with a SER (Vergoz *et al.*, 2007). Since then, it was shown that bees which are more sensitive to the electric shock learn and memorize odor-shock associations more efficiently (Roussel *et al.*, 2009). However, to what extent the observed inter-individual variability in sensitivity to the aversive US and in aversive conditioning capacity relies on a genetic determinism is as yet unknown.

One potential caveat when studying the genetic basis of associative learning could be the unnatural quality of the electric shock as a US. First, the electric shock is applied broadly on the bee's body, which makes it difficult to know which structure(s) has (have) been stimulated. Second, it is still unclear if the electric shock is detected by particular receptors at the periphery, or if it also acts through direct electric activation of peripheral or more central neurons. Using a more natural aversive US, for which the honeybee has evolved dedicated peripheral receptors and neural pathways, may thus

be beneficial for addressing the genetics of aversive learning. We thus first aimed to develop a version of SER conditioning which uses a natural stimulus as US: temperature.

In the honeybee colony, workers maintain a temperature comprised between 32°C and 36°C, mainly because brood development is highly dependent on ambient temperature (Tautz *et al.*, 2003; Groh *et al.*, 2004). At the individual level, honeybees strictly avoid temperatures above 44°C, and reject sucrose solution presented at 45-50°C (Kohno *et al.*, 2010). A high temperature is therefore a naturally aversive stimulus for bees. A thermal stimulus can be applied locally, on particular sensory organs of the bee, using small heated copper probes (see Materials and Methods). In addition, some data are already available on the peripheral detection of temperature in honeybees. The antennae, for instance, contain a specific type of sensilla, the *coelocapitular* sensilla, which detect warmth [36]. Moreover, a honeybee-specific thermal receptor, HsTRPA (Hymenoptera specific Transient Receptor Potential Ankyrin) has been recently identified (Kohno *et al.*, 2010). This receptor is present in many sensory structures, such as the antennae, the proboscis and the legs. However, even if we know that bees actively avoid heat and possess warm sensitive receptors on many of their sensory organs, we do not know if a thermal stimulus can trigger a defensive response of sting extension. We also do not know if this stimulus can play the role of an aversive reinforcement.

The goal of this study was to determine how genotype differences impact aversive olfactory learning in the honey bee, using a natural aversive US. To address this question, we first asked whether local thermal stimulation on the honeybee body can trigger SER. We tested responses to thermal application on the antenna, the mouthparts, the legs and the abdomen, and determined the temperature sensitivity of these structures. Next, we developed a new version of the SER conditioning protocol using a thermal stimulation as US. Then, we compared how sensitivity to temperature and aversive learning performances interact at the individual level. Lastly, we used a genetic analysis based on microsatellites to assess whether a bees' genotype influences this relationship.

Results

Experiment 1: effect of temperature on the sting extension response

In this experiment, we aimed to determine whether controlled temperature stimulation of honeybee sensory structures can trigger a sting extension response (SER). A recent study showed that a temperature-sensitive receptor, the so-called HsTRPA, is present on several sensory structures including the antennae, the mouthparts and the legs (Kohno *et al.*, 2010). We thus chose to study temperature sensitivity on these structures, in combination with other body parts as control. Bees were harnessed in individual holders allowing visual observation of the SER (Fig. 1A).

In a first experiment ($n = 40$), we evaluated the effect caused by a 1 sec stimulation with a copper probe at 65°C applied on the antennae, the mouthparts, the ventral abdomen or the dorsal abdomen (Fig. 1B). As control, an identical stimulation with an unheated probe ('tactile control') was applied on each structure. Stimulations were given at 10 min intervals and their order was randomized across animals. Thermal stimulations induced between 18.5% and 87.5% SER depending on the contacted structure, while tactile controls triggered less than 15% SER on all structures. Responses were significantly higher for thermal stimulation than for tactile control in the case of the antennae (Mc Nemar test, $\text{Chi}^2 = 20.0$, $p < 0.001$), the mouthparts ($\text{Chi}^2 = 33.0$, $p < 0.001$) and the ventral abdomen ($\text{Chi}^2 = 8.10$, $p < 0.01$) but not for the dorsal abdomen ($\text{Chi}^2 = 0.00$, NS). Overall, the effect of thermal stimulations differed according to the contacted structure (Cochran's Q test, $Q = 44.9$, $p < 0.001$, 3 df), while no difference appeared for tactile controls ($Q = 7.33$, NS, 3 df). Antennal and mouthpart stimulation induced significantly higher responses than other areas (Mc Nemar test, $\text{Chi}^2 > 5.88$, $p < \alpha_{\text{corr}} = 0.0167$), but stimulations of these two organs did not differ statistically ($\text{Chi}^2 = 3.5$, NS).

In a second experiment ($n = 37$), we reproduced the previous measures of thermal stimulation of the bees' antennae and mouthparts and compared them with stimulations of the bees' legs (Fig. 1C). With a different holding position, which allowed stimulating the bees' legs with the heated copper probe, it was possible to stimulate selectively the front legs (one after the other) or the middle and hind legs (all together). The four thermal stimulations triggered from 32.4% to 94.6% SER, whereas tactile stimulations induced less than 18.9% responses. In all cases, responses induced by thermal stimuli were significantly higher than responses to tactile controls (Mc Nemar test, $\text{Chi}^2 > 9.09$, $p < 0.01$). Overall, the effect of thermal stimulations differed according to the contacted structure (Cochran's Q test, $Q = 40.5$, $p < 0.001$, 3 df), while no difference appeared for tactile controls ($Q = 7.80$, NS, 3 df). In this experiment, responses to thermal stimulation were equivalent for the antennae, the mouthparts and the front legs (McNemar test, $\text{Chi}^2 < 4.00$, NS), while all three differed with thermal stimulation of the hind legs ($\text{Chi}^2 > 12.0$, $p < \alpha_{\text{corr}} = 0.0167$ in all cases).

These results show several structures on the bees' body are sensitive to temperature and their stimulation triggers a defense response by the extension of the sting. Among the tested structures, the antennae, the mouthparts and the front legs were especially responsive to thermal stimulation.

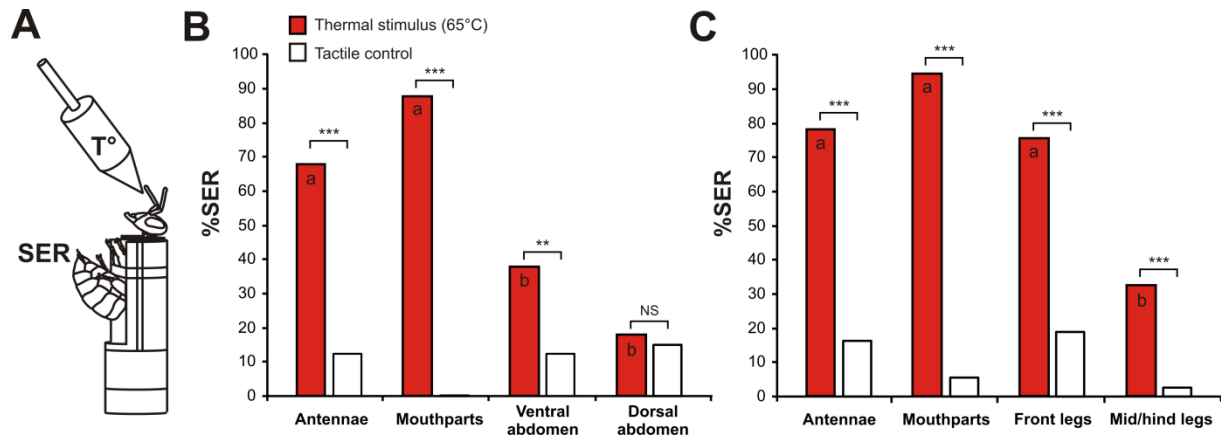

Figure 1: Thermal stimulation on different structures of bee's body. **A)** Bee harnessed in a conditioning tube, leaving the whole abdomen free and allowing observation of sting extension responses (SER). Thermal stimulations were applied using a heated copper probe. As control, tactile stimulations were applied with an identical unheated probe. **B)** Percentage of SER to 1s thermal stimulations (65°C) (red) and to tactile controls (white) on: the antennae, the mouthparts, the ventral abdomen, the dorsal abdomen (n = 40 bees); **C)** Similar experiment but with stimulations of the antennae, the mouthparts, the front legs and the mid-hind legs (n = 37). Thermal stimulation mostly induced stronger responses than tactile controls (Mc Nemar test, ***: $p < 0.001$). Different letters indicate significant differences between structures (Mc Nemar test, $p < 0.0166$).

Experiment 2: honeybees' sensitivity to temperature

The previous experiment showed that stimulation of antennae, mouthparts and front legs with a high temperature (65°C) can trigger strong SER in bees. In the present experiment, we evaluated the effect of increasing temperatures on SER levels, aiming to determine the heat sensitivity of these sensory structures. Thus, temperature of the copper probe was increased from ambient temperature (~25°C) to 75°C in steps of 10°C. Each group of bees was stimulated on the antennae, the mouthparts or the front legs with increasing temperatures, alternating with tactile controls. Intervals between stimulations were 10 min.

We first focused on heat sensitivity of the antennae (Fig. 2A, n = 58). Responses increased significantly with increasing temperature, from 12.1% at ambient temperature to 62.9% at 75°C (repeated measurement ANOVA, $F_{5,285} = 22.0$, $p < 0.001$). In the mean time, bees' responses to tactile stimulation also varied during the experiment, but remained low (below 20%, $F_{5,285} = 3.56$, $p < 0.01$). Accordingly, responses evolved differently along trials for thermal and tactile stimulation (*stimulus x trial* repeated measurement ANOVA, interaction: $F_{5,285} = 13.2$, $p < 0.001$). Thus, thermal stimulation of the antennae induces a gradual increase in SER response with increasing temperature.

Similar observations were made when applying thermal stimulations on the mouthparts (Fig. 2B, $n = 60$) and on the front legs (Fig. 2C, $n = 53$). In both cases, SER increased with increasing temperature (repeated measurement ANOVA, mouthparts: $F_{5,295} = 116.4$, $p < 0.001$; front legs: $F_{5,260} = 37.6$, $p < 0.001$), reaching 100% (65°C) and 84.4% (75°C) for mouthparts and front legs respectively. Responses to the tactile control also varied throughout the experiment (mouthparts: $F_{5,295} = 8.02$, $p < 0.001$; front legs: $F_{5,260} = 3.84$, $p < 0.001$), increasing from 1.7 - 9.4% at the start of the procedure and reaching 23.3% and 20.7% respectively for mouthparts and front legs at the fifth tactile stimulation. This effect is attributable to sensitization due to the temperature stimulations. However, in both cases, responses evolved differently along trials for thermal and tactile stimulation (*stimulus x trial* interaction, mouthparts: $F_{5,295} = 37.6$, $p < 0.001$; front legs: $F_{5,260} = 13.9$, $p < 0.001$).

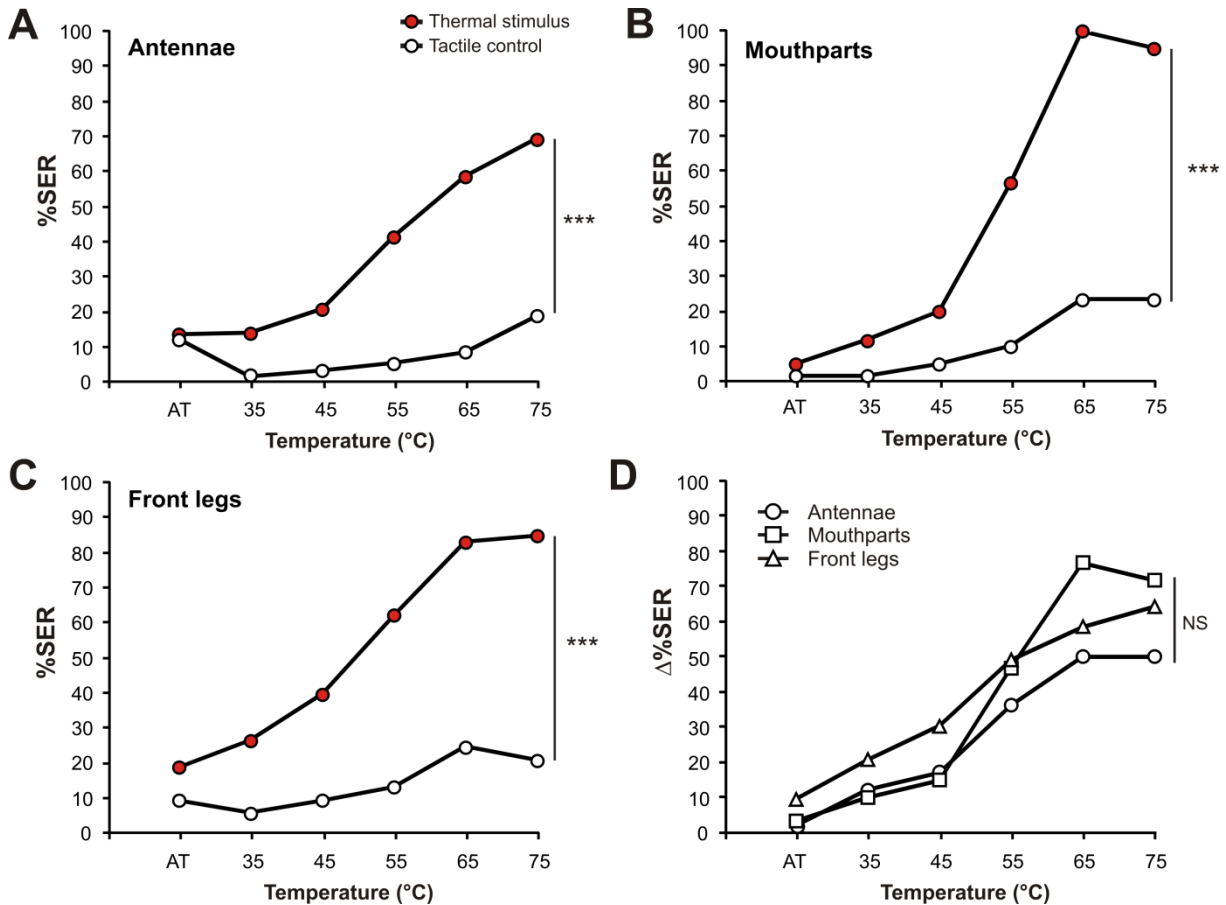

Figure 2: Thermal responsiveness of bees when stimulated on different structures with increasing temperatures. A-C) Percentage of SER to increasing temperatures (red dots, AT: ambient temperature ~25°C, 35°C, 45°C, 55°C, 65°C, 75°C) alternating with tactile controls (white dots). Stimulations were applied on: **A)** the antennae ($n = 58$); **B)** the mouthparts ($n = 60$); **C)** the front legs ($n = 53$). On all three structures, bees respond differently to the thermal stimulus than to the tactile control, as a response increase is observed only with the thermal stimulus (repeated measure ANOVA, *stimulus x trial* effect, ***: $p < 0.001$). **D)** Delta values (Δ SER%) resulting from the difference between the responses to the thermal and to the tactile stimuli for the three tested structures. No difference appeared in the evolution of the three curves with increasing temperature (repeated measure ANOVA, *stimulus x trial* interaction: NS)

To compare thermal responsiveness of the three structures independently of sensitization, we computed for each bee and at each trial a delta value ($\Delta\%$ SER), resulting from the difference between its response to the thermal and to the tactile stimulus. Figure 2D shows the delta values for the antennae, the mouthparts and the front legs. A global analysis of these curves indicated a significant difference among structures (*structure x trial* repeated measure ANOVA, *structure* effect, $F_{2,168} = 3.37$, $p < 0.05$). This effect was probably due to higher delta values for stimulation of the front legs compared that of the antennae, although the posthoc comparison was only near-significant due to multiple comparison correction (Tukey HSD test, $p = 0.047 > \alpha_{\text{corr}} = 0.025$). However, the evolution of responses with increasing temperature was similar as the *stimulus x trial* interaction was not significant ($F_{10,840} = 1.73$, NS).

These results show that thermal stimulation of the antennae, mouthparts or front legs induces a gradual increase in SER response with increasing temperature. This experiment also indicates that 65°C corresponds to an optimum across structures for triggering SER in most individuals. It may thus qualify as an efficient US for aversive conditioning.

Experiment 3: thermal aversive conditioning

Given that a thermal stimulation of the antennae, mouthparts or front legs triggers a SER, we addressed the possible function of such thermal stimulus as an US in aversive SER conditioning. We thus performed a differential conditioning procedure in which an odorant was associated with a stimulation with the copper probe at 65°C (CS+) and another odorant was presented without reinforcement (CS-). Each bee thus received 8 CS+ and 8 CS- trials in a pseudo-randomized order. Three groups of bees were thus conditioned, with the US applied on the antennae, the mouthparts, or the front legs. In each group, half of the individuals received the reinforcement when the odorant 2-octanone was presented and no reinforcement when nonanal was presented, while the reversed combination was used for the other half. The inter-trial interval was 10 min.

For all three structures, the two subgroups did not show any response difference along trials (ANOVA for repeated measurement, antennae: $F_{1,43} = 0.03$, NS; mouthparts: $F_{1,38} = 0.08$, NS; front legs: $F_{1,40} = 0.05$, NS) and, hence, were pooled for the analysis. Figure 3A presents the results for the group receiving the US on the antennae ($n = 45$). Along the trials, bees' responses to the reinforced (CS+) and to the non-reinforced odorant (CS-) developed differently (ANOVA for repeated measurement, *stimulus x trial* interaction: $F_{7,308} = 5.07$, $p < 0.001$). Responses to the CS+ increased (ANOVA for repeated measurement: $F_{7,308} = 2.44$, $p < 0.05$), while responses to CS- decreased (ANOVA for repeated measurement: $F_{7,308} = 3.00$, $p < 0.01$). Thus bees are able to associate an odorant with a thermal US to the antennae. Similarly, we examined aversive conditioning with the thermal US applied to the mouthparts (Fig. 3B, $n = 40$) and to the front legs (Fig. 3C, $n = 42$). In both cases, responses to the CS+ and to the CS- developed differently along trials (*stimulus x trial*

interaction, mouthparts: $F_{7,273} = 7.92$, $p < 0.001$; front legs : $F_{7,287} = 4.93$, $p < 0.001$). Responses to the CS+ increased (mouthparts: $F_{7,273} = 3.47$, $p < 0.01$; front legs: $F_{7,287} = 2,27$, $p < 0.05$) whereas responses to the CS- decreased significantly (mouthparts: $F_{7,273} = 4.51$, $p < 0.001$; front legs: $F_{7,287} = 4.36$, $p < 0.001$). Thus, bees learned to respond to the CS+ and to not respond to the CS-.

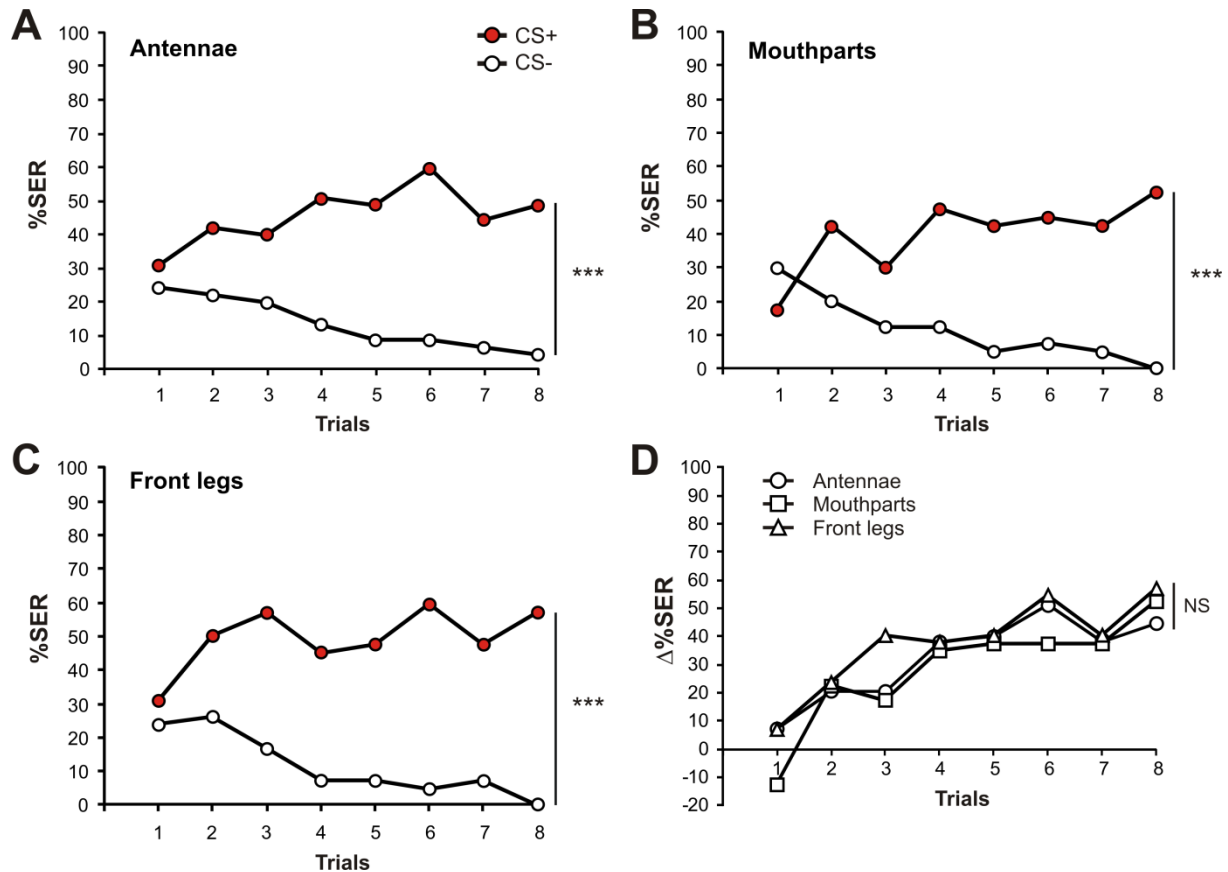

Figure 3: Thermal aversive conditioning with the US applied on different structures. A-C) Percentage of SER to the reinforced odorant (CS+, red dots) and to the non-reinforced odorant (CS-, white dots) along conditioning trials. The thermal unconditioned stimulus (65°C) was applied on : **A)** the antennae ($n = 45$); **B)** the mouthparts ($n = 40$); **C)** the front legs ($n = 42$). Bees learn to respond to the CS+ and not to the CS- when the thermal stimulus is provided on any of the three structures (repeated measurement ANOVA, *stimulus x trial* interaction: ***: $p < 0.001$). **D)** Delta values ($\Delta\%SER$) resulting from the difference between the responses to the CS+ and to the CS- for the US applied on the three tested structures. No difference appeared in the evolution of the three curves along conditioning trials (repeated measure ANOVA, *stimulus x trial* interaction: NS).

To compare the aversive learning performances between the three groups which received the thermal US on different structures, we computed for each bee and at each trial a delta value ($\Delta\%SER$), resulting from the difference between its response to the CS+ and to CS-. Figure 3D shows the delta values for groups reinforced aversively on the antennae, the mouthparts and the front legs. A global analysis of these curves did not show any significant difference among structures (*structure x trial* repeated measure ANOVA, *structure* effect, $F_{2,124} = 1.16$, NS). In addition, the three groups learned as quickly to differentiate the odorants as the *stimulus x trial* interaction was also not significant ($F_{14,868} = 0.74$, NS).

We thus conclude that thermal reinforcement can be used as US in SER aversive conditioning regardless of whether the temperature stimulation is applied on the antennae, the mouthparts or the front legs. Thermal stimulations of the three structures are equally efficient as aversive US.

Experiment 4: Genotypic influence on thermal responsiveness and aversive learning

The previous experiments showed that the percentage of individuals showing a SER to a thermal stimulation increases gradually with the temperature of the stimulation. This observation suggests individual differences in bees' sensitivity to temperature. In addition, although bees as a group learned to associate odorants with a thermal US, their individual performances varied with some bees learning quickly and efficiently and other bees not learning the association at all. Previous work suggested that at the individual level, bees' aversive learning performances depend on their sensitivity to an electric shock US (Roussel *et al.*, 2009). In the present experiment we aimed to confirm this finding with a thermal US. In addition, we aimed to understand the possible genotypic origin of such inter-individual differences in thermal sensitivity and/or aversive learning performance.

In this experiment, we used only 13-14 day-old bees, to avoid any influence of bees' age. Bees were subjected to a thermal responsiveness experiment (as in Experiment 2) followed by an aversive olfactory conditioning protocol (as in Experiment 3). Thermal stimulations were applied to the mouthparts as this showed the strongest SER rate in previous experiments. For assessing the putative genetic dependency of thermal sensitivity and aversive learning performances, all individuals were genotyped based on a set of 14 microsatellite markers, allowing to determine their patriline of origin.

Thermal responsiveness (Fig. 4A, $n = 303$) and aversive conditioning (Fig. 4B, $n = 303$) yielded similar results as in the previous experiments, except that bees in this experiment appeared generally more sensitive to temperature (i.e; they responded at lower temperature) than in Experiment 2. This is probably due to the fact that the two experiments were performed at different periods of the year (Exp. 2: February-March; Exp. 4: May-June). In any case, in the thermal responsiveness experiment (Fig. 4A), responses increased with increasing temperature ($F_{5,1510} = 126.9$, $p < 0.001$) while response to tactile stimulations remained below 18%, but showed significant variations along the procedure ($F_{5,1510} = 2.72$, $p < 0.05$). Responses to thermal and tactile stimuli developed differently along the procedure (*stimulus x trial* repeated-measurement ANOVA, interaction: $F_{5,1510} = 82.0$, $p < 0.001$). In the differential conditioning protocol (Fig. 4B), bees learned to respond to the CS+ ($F_{7,2114} = 12.2$, $p < 0.001$) and to not respond to the CS- ($F_{7,2114} = 23.9$, $p < 0.001$) so that responses to both stimuli developed differently along trials (*stimulus x trial* repeated measurement ANOVA, interaction: $F_{7,2114} = 36.7$, $p < 0.001$).

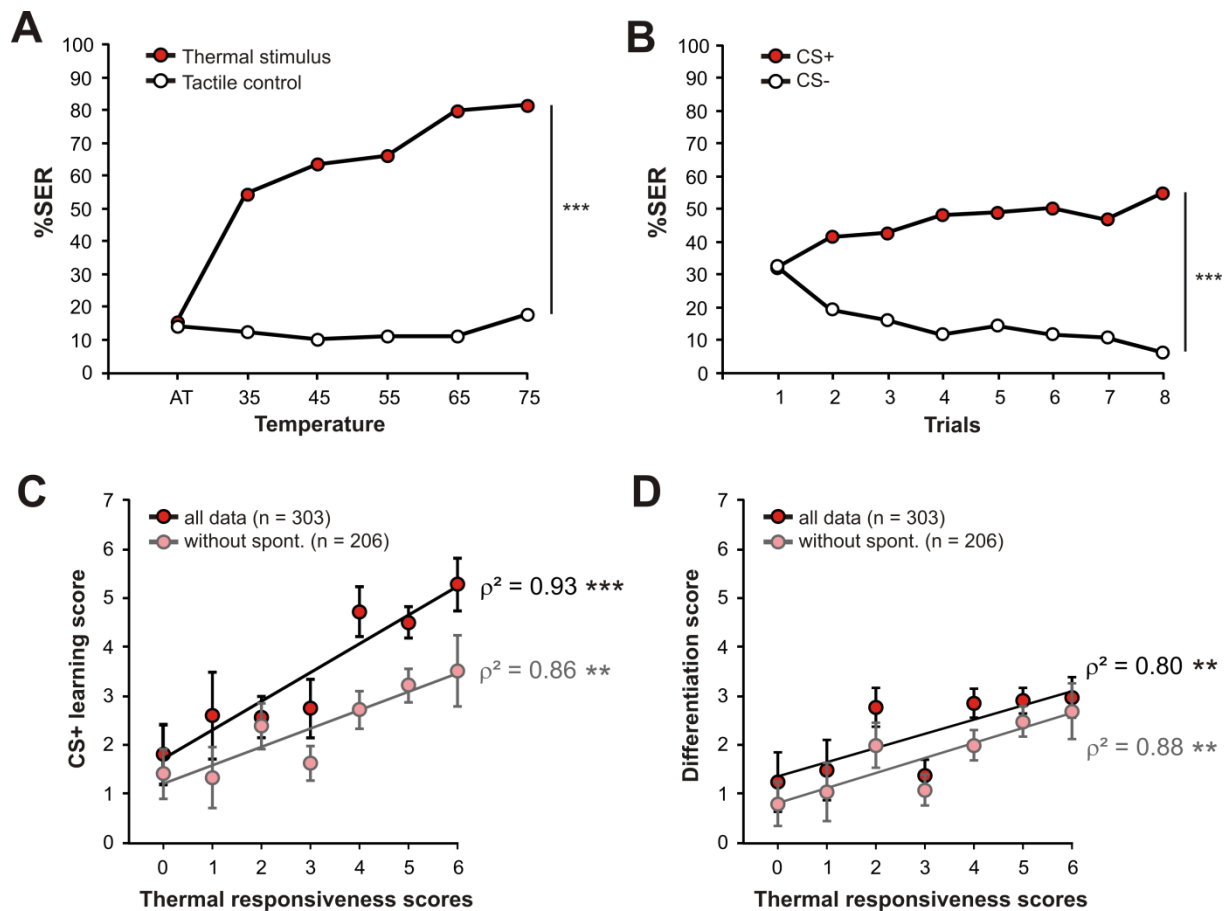

Figure 4: Measure of thermal responsiveness and aversive learning performance on the same bees. A) Thermal responsiveness curve with the temperature stimulus provided on the mouthparts ($n = 303$). Percentage of SER with increasing temperatures (red dots) or with tactile control (white dots). The curves for thermal and tactile stimuli develop differently (repeated measure ANOVA, *stimulus* \times *trial* effect, ***: $p < 0.001$). **B)** Aversive learning performances with thermal reinforcement on the mouthparts ($n = 303$). Percentages of SER to the CS+ (red dots) and to the CS- (white dots). Bees learned to respond to the CS+ and not to the CS- (repeated measure ANOVA, *stimulus* \times *trial* effect, ***: $p < 0.001$). **C)** Relationship between thermal responsiveness and aversive learning performance. The graph shows average response to the CS+ (\pm SEM) for bees with different thermal responsiveness scores ($n = 17$ -81 per score). A significant linear relationship between the two variables is found, both using all data (red dots) or only those from bees that did not respond spontaneously to the CS+ (light red dots) (Spearman correlation, ***: $p < 0.001$; **: $p < 0.01$; 8 df). **D)** Relationship between thermal responsiveness and differentiation performance in the differential conditioning. The graph shows average delta values (responses to the CS+ minus responses to the CS-) \pm SEM for bees with different thermal responsiveness scores (n per score as in C). A significant linear relationship between the two variables is found, both using all data (red dots) or only those from bees that did not respond spontaneously to the CS+ (light red dots) (Spearman correlation, **: $p < 0.01$; 8 df).

Based on these results, we calculated for each bee its *thermal responsiveness score* as the number of responses to the thermal stimuli (from 0 to 6). Thus, a bee with a high score is highly sensitive to temperature, as it would start responding already at rather low temperatures. Likewise, we calculated for each bee its *aversive learning score*, as the number of responses to the CS+ (from 0 to 8). A bee with a high score would be a good aversive learner, which learned quickly to respond to the

reinforced odorant. We then asked whether bees' learning performance can be predicted based on their responsiveness to the thermal US. Figure 4C (black dots) presents the average aversive learning score for bees showing a particular heat responsiveness score. A clear linear relationship can be observed, as the more thermally responsive bees (i.e. more sensitive to temperature) show higher aversive learning scores. Accordingly, aversive learning scores differ among thermal responsiveness score categories (one-way ANOVA, $F_{6,181} = 5.34$, $p < 0.001$) and the linear relationship between both variables is highly significant (Spearman correlation, $\rho^2 = 0.93$, $p < 0.001$, 8 df).

As at the start of conditioning, about one third of the bees responded spontaneously to the CS+ (see Fig. 4B), the previous measure of the *aversive learning score* over all tested individuals could be considered potentially spurious, since individuals that are highly sensitive to the US may also be sensitive to other stimulations and respond spontaneously with a SER to odorants. We thus performed the previous comparison taking into account only bees which did not respond spontaneously to the CS+ ($n = 206$, score 0 to 7). As Fig. 4C (grey dots) shows, without spontaneous responders, the linear relationship between thermal responsiveness and aversive learning is almost fully conserved (Spearman correlation, $\rho^2 = 0.86$, $p < 0.01$, 8 df). Thus, spontaneous responses cannot explain the strong relationship we observed.

As a further verification, we also calculated for each bee a *differentiation score*, as the difference between the number of responses to the CS+ and to the CS- over the course of the experiment. A value of 0 would mean that the animal does not learn to respond to the CS+ and not to the CS-, while increasing positive values indicate increasing levels of differentiation between CS+ and CS-. It is therefore a purely associative measure of aversive learning success, which contains its own control for non-associative responses. Again, there was a highly significant linear relationship between *thermal responsiveness* and the *differentiation score*, both for all bees (black dots, $\rho^2 = 0.80$, $p < 0.01$, 8 df) and for non-spontaneous responders (grey dots, $\rho^2 = 0.88$, $p < 0.01$, 8 df). We thus conclude that bees' responsiveness to the thermal US determines their aversive learning performance with this US.

We next asked what may drive the observed inter-individual differences in thermal responsiveness and learning. Using a microsatellite analysis, which enabled us to determine the patriline origin of each bee, we assessed the impact of genotype on the thermal responsiveness / aversive learning relationship. The 303 individuals tested in this experiment belonged to 22 different patrilines (i.e. were sired by one of 22 drones which mated with the queen). The numbers of bees within each patriline ranged from 1 to 27 individuals. For assessing patriline performance scores accurately, we only used data from the 10 patrilines which contained more than 10 individual bees. Figure 5A presents average thermal responsiveness and aversive learning scores for these 10 patrilines. Among these patrilines, significant differences were observed in both thermal responsiveness (one way ANOVA, $F_{9,138} = 4.37$, $p < 0.001$) and aversive learning scores ($F_{9,138} = 3.59$, $p < 0.001$). Generally, bees from patrilines with a high (resp. low) responsiveness to thermal stimuli also had a high (resp. low) learning score. Accordingly, a strong correlation was observed at the

patriline level (Fig. 5B, $\rho^2 = 0.71$, $p < 0.01$, 8 df). Likewise, when using patrilines' *differentiation score*, measuring the differentiation between CS+ and CS-, a clear and significant correlation was observed (Fig. 5B, $\rho^2 = 0.68$, $p < 0.01$, 8 df). Thus aversive learning performance and sensitivity to the thermal US are under clear genotypic influence and are strongly linked. Within this general trend, however, some deviations could be observed. For instance, while patrilines 3, 4, 5 and 6 display similar thermal responsiveness scores, their aversive learning scores are different. Therefore, in addition to thermal responsiveness, aversive learning performance is also under the influence of other – untested – genetic traits.

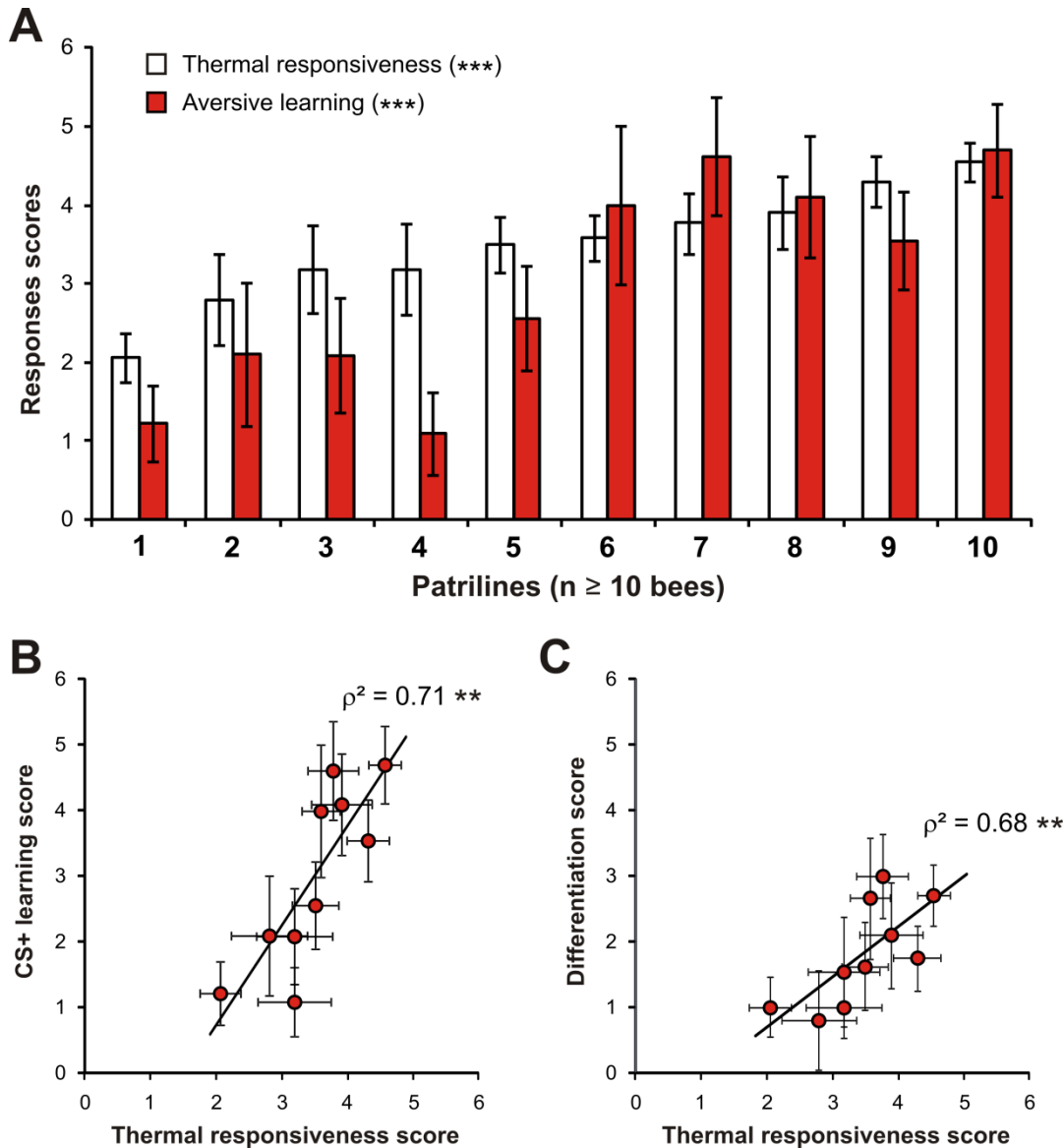

Figure 5: Genotypic influence on thermal responsiveness and aversive learning (patriline effect). **A**) Thermal responsiveness (white bar, average \pm SEM) and aversive learning scores (red bar, average \pm SEM) for the 10 patrilines with the most samples ($n = 10$ -27 bees per patriline). Patrilines are ranked according to increasing thermal responsiveness scores. Significant differences among patrilines are observed for both scores (one way ANOVA, $p < 0.001$). **B**) A strong correlation appears between thermal responsiveness and aversive learning performances at the patriline level (Spearman correlation, **: $p < 0.01$, 8df). **C**) Likewise, a significant correlation appears at the patriline level between the differentiation score (difference between responses to the CS+ and to the CS-) and the thermal responsiveness score (Spearman correlation, **: $p < 0.01$, 8 df).

Discussion

This study first shows that a thermal stimulus applied on different parts of the bee's body can trigger a sting extension response (SER). Most responses were observed when the thermal stimulus was applied on the mouthparts, the antennae or the front legs, suggesting that these structures are the most sensitive to temperature. We then established the use of such thermal stimuli as US in aversive olfactory conditioning of the SER. In a differential conditioning procedure, bees responded more to the CS+ than to the CS- when the thermal US was given to the antennae, the mouthparts or the front legs. Thus thermal stimulation of all three structures can serve as aversive US in SER conditioning. We found a clear correlation between bees' responsiveness to thermal stimuli and aversive learning performance, both at the individual and at the patriline level. Different patrilines within the hive displayed different sensitivities to the US, and accordingly different aversive learning performances. These results establish for the first time a strong genotypic influence for aversive conditioning in honeybees.

Temperature detection in the honey bee

The first important observation of this study is that a thermal stimulus applied on the bee's body triggers SER, which can be interpreted as a defense reaction of the bee towards potentially noxious stimulations. In addition to the advantage of using this stimulus as US in aversive conditioning (see below), this observation provides an interesting means of studying heat sensitivity in honeybees. Thus, in the first part of this work, we measured bees' responses when the thermal stimulus was applied on different sensory structures. Five structures showed significant responses to temperature compared to tactile controls. Among those, three crucial sensory organs of bees (antennae, mouthparts and front legs) induced the strongest SER levels. The antennae are prominent sensory organs (mostly olfactory, tactile and gustatory) in which thermal detection was already known, as they harbor specific thermo-sensitive sensilla (coelocapitular sensilla, Yokohari, 1983). Furthermore, at the behavioral level, the antennae are crucial for the avoidance of high temperatures by freely-walking bees (Kohno *et al.*, 2010). However, thermal sensitivity at the level of the mouthparts and the front legs had not been precisely described before, although heat detection by these organs seems coherent for maintaining the insect's integrity. One can hypothesize that thermal sensitivity at the level of the mouthparts could be adaptive for avoiding food sources at temperatures that could cause internal injury. Thermal sensitivity at the level of the bees' legs could be crucial to avoid landing on hot surfaces during summer months. These ideas are consistent with the recent discovery of the first honeybee thermal receptor within these three sensory organs (Kohno *et al.*, 2010). In contrast to these structures, we did not observe any significant effect of thermal stimulation on the dorsal abdomen. Possibly, thermo-sensitive receptors are not expressed in this region or thermo-sensitive cells are not

linked to motor output leading to SER. Apart from this last case, thermal sensitivity seems however broadly represented on the honeybees' body and SER may allow precisely mapping this sensitivity.

Thermal stimulation as US in olfactory aversive SER conditioning

We show that a thermal stimulus applied to the antennae, the mouthparts or the front legs can act as a US in aversive SER conditioning. Temperature represents an interesting alternative to the electric shock for studying aversive learning, as it is a more natural stimulus for bees and it can be applied more locally on the bees' body. Moreover, prior identification of thermo-sensitive sensilla (Lacher, 1964; Yokohari, 1983) and receptors (Kohno *et al.*, 2010) could be advantageous for building a neural model of aversive conditioning in bees, based on identified sensory structures and neuronal pathways (Tedjakumala and Giurfa, 2013). In theory, associative learning is possible because at one or several locations in the brain, the CS and US pathways converge and neural plasticity takes place at these locations. The olfactory (CS) pathway has been well described in honeybees (Menzel, 1999; Sandoz, 2011; Giurfa, 2007): olfactory receptor neurons located on each antenna project to the antennal lobes where primary olfactory processing takes place. From there, projection neurons convey processed information to higher-order brain centers, the mushroom bodies and the lateral horn. For aversive learning, the US pathway is mostly unknown, but our results may provide some new clues. In the case of conditioning with an antennal temperature US (Fig. 3A), thermo-sensory neurons from coelocapitular sensilla on the antenna are thought to project to the antennal lobe (Yokohari, 1983, Nishino *et al.*, 2009). In another Hymenoptera, the ant *Atta vollenweideri*, an optical imaging study showed that a temperature change in the stimulation airflow induced clear patterns of activity in several glomeruli of the antennal lobe (Ruchty *et al.*, 2010). A first direct convergence between olfactory (CS) and thermal (US) pathways may thus be found in this structure. Successful aversive learning was also observed with a thermal US on the mouthparts (Fig. 3B) and the front legs (Fig. 3C). Data in other insects suggest that putative thermo-sensitive neurons on these structures would first project to the respective ganglia of the ventral nerve cord, respectively to the subesophageal and prothoracic ganglia (Newland and Burrows, 1997). From there, information could be conveyed by interneurons towards the brain, possibly to a thermal integration center, as suggested by several observations. In *Drosophila*, thermal neurons from the arista project to the proximal antennal protocerebrum, a region between the antennal lobe and the sub-esophageal ganglion (Gallio *et al.*, 2010). This structure contains at least two subregions, one responding to cold, and another to warmth. In the bees *Apis cerana*, immediate early gene expression mapping showed that exposure to a high temperature (46°C) induces neural activity in a region of the protocerebrum located between the dorsal and the optic lobe (Ugajin *et al.*, 2012). Neurons from such a putative thermo-sensory center would then activate aversive reinforcement circuits, which would converge with the olfactory pathway and induce learning-associated plasticity. Dopaminergic neurons are thought to mediate aversive

reinforcement in the bee brain because pharmacological blockade of dopamine receptors disrupts aversive learning (Vergoz *et al.*, 2007). Dopamine neurotransmission is also necessary for aversive learning in other insects (*Drosophila*, Schwärzel *et al.*, 2003, Schroll *et al.*, 2006; crickets, Unoki *et al.*, 2005). The bee brain contains a complex arrangement of dopamine-immunoreactive neurons (Schäfer and Rehder, 1989; Schürmann *et al.*, 1989). Among them, three clusters contain processes that project to the mushroom body calyces and lobes (especially the α -lobe), and may thus provide aversive reinforcement information to the olfactory pathway (Tedjakumala and Giurfa, 2013). Neuroanatomical and neurophysiological work (electrophysiology, optical imaging) will be needed to confirm these putative circuits.

Relationship between US sensitivity and aversive learning performance

Associative learning performance usually depends on an animal's sensitivity to both the CS and the US. In honeybees, previous work on appetitive conditioning has established the strong influence of sucrose (US) sensitivity on learning performances. Bees with a low response threshold, i.e. which are highly sensitive to sucrose, learn better than bees with a higher threshold, as they give a higher subjective value to the US performances (Scheiner *et al.*, 1999; Scheiner *et al.*, 2005). Likewise, it was recently demonstrated that a high electric shock sensitivity leads to better aversive learning performances (Roussel *et al.*, 2009). We confirm and extend this relationship. In the former demonstration (Roussel *et al.*, 2009), bees were divided into two groups depending on their sensitivity to the electric shock (low vs high) precluding a true correlative analysis. By dividing bees in 7 thermal responsiveness score groups, we show a clear linear correlation between thermal responsiveness and aversive learning scores, suggesting that the more sensitive a bee is to temperature, the better it can learn to associate an odor with this US. The potentially confounding effect of high spontaneous responses observed in SER conditioning was excluded, as the correlation remained when removing spontaneous responders (Fig. 4C) or when focusing on the response difference between CS+ and CS- (*differentiation score*, Fig. 4D).

Genetic influence on thermal sensitivity and aversive learning

In our study, the relationship between aversive conditioning and US sensitivity was considered with a special emphasis on its genetic determinism. We show here that bees' genotype influences their thermal responsiveness and hence affects their aversive learning performances with a thermal US. Previous work had shown that different patriline react differently to a fixed-intensity aversive stimulus (electric shock; Lenoir *et al.*, 2006). However, no study had evaluated the differential sensitivity of bees from different patriline to a series of aversive stimuli of increasing intensity, nor had aversive learning performances been evaluated as a function of patriline origin. Although we do not know the influence of maternal genotype on aversive responsiveness and learning, the strong

paternal effect we have found is coherent with previous crosses performed between European and Africanized honeybees which showed that drone-inherited genes more strongly determine defensive behavior at the colony level than the queen's genes (Guzman-Novoa *et al.*, 2005). Concerning *appetitive* behavior, the genetic dependency of sucrose responsiveness is well known. For instance, two strains of bees selected for pollen hoarding (amount of pollen stored in the colonies) show a different sucrose responsiveness (PER), and accordingly different tactile and olfactory learning performances with a sucrose US (Scheiner *et al.*, 2001a,b)). In addition, it was recently shown that sucrose responsiveness is different among patrines from the same hive (Scheiner and Arnold, 2010). In the same logic, we found a clear genotypic influence on thermal responsiveness. As aversive and appetitive learning are thought to correspond to two mostly independent modules of honeybees' behavior (foraging and defense respectively, (Roussel *et al.*, 2009)), an important question for future work will be to understand the relative dependency of genes involved in each learning form. At this stage, we know that sucrose responsiveness and electric shock responsiveness tested in the same bees are not correlated (Roussel *et al.*, 2009). It will be important next to extend this finding to thermal sensitivity and to ask how the aversive and appetitive learning performances of bees from different patrines are related.

Genetic differences in thermal sensitivity may arise at multiple levels. First, peripheral thermal receptors may be differentially expressed among patrines. For instance, if we assume that the TRP channel HsTrpA previously identified in bees is responsible for thermal detection in our protocol, it could exist in different allelic forms in different patrines or its expression may be differently regulated. Similarly, in the central nervous system, alleles or expression levels of crucial effectors for heat sensitivity may differ. A possible example would be bees' ortholog of the voltage-gated calcium channel subunit *straight-jacket* of *Drosophila* or *CACNA2D3* ($\alpha 2\delta 3$) of mice, which is implicated in heat pain sensitivity in both animals (Neely *et al.*, 2010). Additionally, dopamine is considered as the neurotransmitter conveying aversive reinforcement information in the insect brain Vergoz *et al.*, 2007, Schwärzel *et al.*, 2003, Schroll *et al.*, 2006, Mizunami and Matsumoto, 2010). Different patrines may produce different levels of this neurotransmitter and/or may express its receptors (AmDop 1, 2 and 3) differentially. Lastly, genetic differences among patrines may induce some epigenetic modifications known to be part of the task allocation process in a bee hive (Herb *et al.*, 2012; Furey and Sethupathy, 2013). DNA methylation can influence some aspects of learning and memory processes in bees (Lockett *et al.*, 2010; Biergans *et al.*, 2012). Enzymes responsible for DNA methylation may be more or less active in different patrines. By altering chromatin structure or regulating transcriptional machinery, differentially methylated regions (DMRs) could potentially influence the expression of genes involved in aversive learning or thermal sensitivity.

Although thermal sensitivity strongly influenced aversive learning performances, it did not explain all the learning differences observed among patrines. For instance, some patrines showed similar thermal sensitivity but different learning performance levels (see Fig. 5A). In this case, genetic

differences may appear due to differences in bees' sensitivity to the odor CS, for instance through differential expression of olfactory receptors (ORs) or through differential wiring at multiple levels within olfactory circuits. However, the observed heterogeneity among patrines with equal thermal sensitivity may reveal 'real' differences in learning ability, which may relate to different alleles or expression levels of CS-US association enzymes, like adenylate cyclases (AC) or other molecular actors of acquisition or memory formation (Müller, 2012; Matsumoto *et al.*, 2014). For this reason, it is important to compare the influence of genetics on these different aspects: sensitivity to the CS, sensitivity to the US, association machinery. The present study shows a strong influence of US sensitivity but suggests a non-negligible role of the other determinants.

General outlook

How may genetic variability in learning and memory abilities influence colony fitness and survival? It has been proposed that a higher genetic variability (for instance, more numerous patrines) within a social insect colony may allow more flexibility and a higher capacity to cope with changes in environmental conditions, by providing different types of genetically-specialized individuals especially efficient for carrying out particular tasks (cleaning, nursing, foraging, defense, etc.)(Jeanson and Weidenmüller, 2014). For instance, a higher number of patrines is beneficial for thermal regulation, as bees from different patrines engage in fanning activity at different deviations from the optimal temperature, thereby providing a gradual and more efficient response to outside temperature changes (Jones *et al.*, 2004). In a social insect colony, the different patrines are not equally involved in the different tasks (Frumhoff and Baker, 1988; Kryger *et al.*, 2000; Chapman *et al.*, 2007) and workers performing different tasks show different associative learning abilities (appetitive modality: Scheiner and Amdam, 2009; Perez *et al.*, 2013 ; aversive modality: Roussel *et al.*, 2009). It will now be important to compare appetitive and aversive learning abilities in different patrines and to relate these differences with the tasks these individuals actually carry out in the hive. Such experiments shall help us understand to which extent task allocation is based on a genetic determinism of aversive or appetitive learning capacities.

Materials and methods

Animals

Experiments were performed on honeybees (*Apis mellifera L.*) captured from outdoor hives located at the CNRS campus of Gif-sur-Yvette, between January and November 2011.

Experiment 1: effect of temperature on the sting extension response

We first aimed to determine whether thermal stimulation of several structures on the bees' body could trigger a SER. Bees were taken from the hive in the morning and chilled on ice until they stopped moving. Then, they were harnessed into individual holders, similar to those usually used for PER conditioning (Bitterman *et al.*, 1983; Matsumoto *et al.*, 2012). The position of the honeybee in the holder was however different from that used in PER conditioning. The bee was placed with its back towards the front of the tube, with a piece of tape placed below the head to the front and at the thorax level (Fig. 1A). Thus, the abdomen could move freely and bees' SER could be observed throughout the experiment. Thermal stimulation was provided by means of a pointed copper cylinder (widest diameter: 6 mm; length: 13 mm), mounted onto the end of a minute soldering iron running at low voltage (HQ-Power, PS1503S). Temperature at the end of the cylinder was controlled, at the beginning and at the end of each experiment, using a contact thermometer (Voltcraft, Dot-150). Thermal stimulations were applied during 1 s on six different areas of the bees' body: the antennae (both flagella simultaneously), the mouthparts (the different articles were stimulated simultaneously, indiscriminately; the proboscis was never extended), the front legs (one after the other, as they were fixated too widely apart for stimulating both simultaneously), the mid- and hind legs (simultaneously), the ventral abdomen (sternites of segments #3 to5), and the dorsal abdomen (tergites of segments 3 to 5).

To avoid any fatigue of the bees, only 4 structures were tested per bee. In one experiment, bees were stimulated on the antennae, the mouthparts, the ventral and the dorsal abdomen. In a second experiment, a new set of bees was stimulated on the antennae, the mouthparts (replications of the former), the front legs and the mid/hind legs. In this last experiment, the front legs were fixated with thin tape strips on each side of the harnessing tube to facilitate stimulation with the copper probes.

We applied tactile controls on the same structures, to insure that sting extension was really a consequence of thermal stimulation. Tactile stimulations were performed with a duplicate copper probe which remained at ambient temperature. For each bee, the order of stimulation of the different structures, as well as whether each stimulation was performed with the heated or with the control probe, were determined randomly prior to starting the experiment. Stimulations were performed at 10 min intervals. In this experiment, two groups of 20 bees were tested each day.

Experiment 2: honeybees' sensitivity to temperature

Honeybees were collected the day before the experiment, and were kept in a plexiglass box containing honey and water *ad libitum*. The day after, they were immobilized on ice and then placed in holders as described above (first harnessing position). Two groups of twelve honeybees were prepared each day. Once mounted, bees were placed in a moist and dark container for two hours to accommodate to the holders. Bees were then stimulated with a succession of six heated stimulations of

increasing temperature (from ambient temperature $\sim 25^{\circ}\text{C}$ to 75°C), in steps of 10°C . Thermal stimulations alternated with tactile controls, provided as above with an identical unheated probe, with 10 min intervals between any two stimulations.

Experiment 3: thermal aversive conditioning

Bees were collected from the hive entrance in the morning. They were chilled on ice and placed in individual holders. They were then fed with $3\mu\text{L}$ sucrose solution (50% w/w) and were placed in a moist and dark container for two hours as above. A group of 16 bees was used every day. Then, bees were subjected to a differential aversive conditioning procedure, in which one odorant (the CS+) was associated with a thermal reinforcement (the US), while another odorant was presented without reinforcement (the CS-). The chosen odors were 2-octanone and nonanal (Sigma Aldrich, Deisenhofen, Germany). Five microliters of pure odorants were applied onto a 1 cm^2 piece of filter paper which was transferred into a 20 ml syringe (Terumo) allowing odorant delivery to the antennae.

Half of the honeybees received thermal reinforcement when 2-octanone (odor A) was presented and no reinforcement when nonanal (odor B) was presented, while the reversed contingency was used for the other half. Both groups were conditioned along 16 trials (8 reinforced and 8 non-reinforced) in which odorants were presented in a pseudo-random sequence (e.g. ABBABAAB) starting with odorant A or B in a balanced way. The inter-trial interval (ITI) was always 10 min. Each conditioning trial lasted 36 s. The bee was placed in the stimulation site in front of the air extractor, and left for 18 s before being exposed to the odorant paired with the US. Each odorant (CS+ or CS-) was delivered manually for 4 s. The thermal stimulus started 3 s after odorant onset and finished with the odorant (1 s temperature stimulation). The bee was then left in the setup for 14 s and was then removed. The temperature of 65°C was chosen for the US because this stimulation induced a high rate of SER in the previous experiments. In this experiment, thermal reinforcement was provided on the antennae, the mouthparts or the front legs, depending on the experimental group. One group of 16 bees was tested daily.

Experiment 4: genotypic influence on thermal responsiveness and aversive learning

Age-controlled honey bees (13-14 days old) were used in this experiment to avoid any impact of age on bees' behavior (Scheiner et al., 2001a)). Every second day, a comb with enough capped brood was placed into an incubator (34°C) during one night. The day after, newly emerged bees were painted with a two-color code (Posca, France) and then placed back into the hive. Thirteen days later, the bees were taken from the hive and used in the behavioral experiments. At this age, honey bees usually start to perform tasks outside the hive such as guarding or foraging (Seeley, 1982).

Thermal responsiveness and aversive learning

To compare heat responsiveness and aversive learning performances at the individual level, both experiments were performed on the same honeybees, one after the other (Roussel *et al.*, 2009). On the first day, bees were subjected to the thermal responsiveness protocol (as above), and on the second day they followed an aversive learning procedure (as above, with 1-hexanol and 1-nonanol as odorants). The interval between the two experiments was 24h. During this time, bees were kept in a dark wet box. As bees' performances in Experiment 3 were high when the thermal US was provided on the mouthparts, this option was chosen in the present experiment. After the behavioral study, bees were placed individually in numbered Eppendorf tubes filled with 90% ethanol for genotyping.

Determination of patriline origin

To characterize the patriline origin of each tested bee, we used a microsatellites locus analysis, using 14 well-characterized loci. DNA was extracted using the 10% Chelex method (Walsh *et al.*, 1991), adapted for squashed bee head tissues (Estoup *et al.*, 1996). Microsatellites amplifications were performed using 3 different multiplexes, which allowed analyzing several loci simultaneously. Multiplex 1 was composed of loci B124, A88, A28, A24, Ap55 and A66. Multiplex 2 was composed of loci A113, A7, Ap43 and Ap81. Multiplex 3 analyzed loci Ap33, A43, A8, Ap36. PCR conditions followed previous studies (Solignac *et al.*, 2003; Miguel *et al.*, 2007). DNA fragments were identified using an ABI 3130 Genetic Analyzer and the Genescan analysis software (version 3.7.1). Allelic sizes were labeled using Genemapper 4.1. Allele nomenclature was standardized using reference samples (Estoup *et al.*, 1995; Franck *et al.*, 1998; Garnery *et al.*, 1998). Once the multilocus genotype of each worker bee was determined, queen genotype was deduced, looking for homozygous genotypes for each locus in the worker data set (queen progeny). The multilocus genotype of the queen was verified, using the Colony 1.2 program (Wang, 2004). The program analyzes haplo-diploid systems based on the expression of codominant genetic markers, such as DNA microsatellites. It calculates the probabilities of all possible queen genotypes, based on the observed allele frequencies in the population. Paternal alleles for each worker were then characterized after subtracting the queen's allele from each worker's genotype. Workers were considered as belonging to the same patriline when the same alleles were shared over all (14) analyzed loci.

Statistical analysis

All recorded data were dichotomous, with a sting extension being recorded as 1 and a non-extension as 0. In the conditioning experiments with the thermal US on different body parts (Experiment 3), bees which did not respond three times to the US (out of 8 CS+ trials) were excluded from the analysis, as they were considered as not aversively motivated enough. They represented less

than 15% of all conditioned bees. When comparing the responses of the same bees to the thermal or tactile stimulation of different structures (Experiment 1), Cochran's Q test was used, followed by pairwise comparisons using a Mc Nemar test. To analyze thermal sensitivity curves (Experiment 2 and 4) or differential conditioning curves (Experiment 3 and 4), we used repeated measure ANOVAs with stimulus (either thermal vs tactile, or CS+ vs CS-) and trial as factors. To evaluate individual sensitivity or learning curves, one-factor repeated measure ANOVAs were used. Monte Carlo studies have shown that it is permissible to use ANOVA on dichotomous data only under controlled conditions, which are met in these experiments (highly similar frequencies and at least 40 degrees of freedom of the error term (Lunney, 1970)).

A correlative approach was chosen to analyze relationships between thermal responsiveness and aversive learning performances at the individual and at the patriline levels (Experiment 4). We calculated for each bee its *thermal responsiveness score* (from 0 to 6) by counting the number of times it responded to the thermal stimulus presented at increasing temperatures. Higher scores indicate bees that started to respond at lower temperatures, and are thus more sensitive to temperature. In the same manner, we calculated two learning performance scores. For the *aversive learning score*, we counted the number of times bees responded to the reinforced odorant (CS+). A higher score indicated a good learner, which quickly associated the CS+ with reinforcement. For the *differentiation score*, we subtracted the number of responses to the non-reinforced odorant (CS-) from the number of responses to the CS+. A high score indicated individuals that learned to respond to the reinforced odorant, but also quickly learned to not respond to a non-reinforced odorant. This score provides a more controlled measure of learning success, as it takes only into account specific responses to the learned odorant.

Since the patriline of each bee was known only weeks after the end of the behavioural experiments, it was not possible to plan in advance the numbers of individuals per patriline or the number of patrilines with enough individuals for analysis ($n > 10$). Due to the high number of patrilines eventually found in the experimental hive ($n = 22$) and in order to encompass the whole variability in honeybees' responsiveness and learning performances within the hive, no drastic selection of individuals based on their response scores was performed. Thus, during the thermal responsiveness procedure, bees that started to respond at one temperature (for instance 45°C) and then failed to respond to a higher temperature (for instance 55°C) were kept in the sample. Such a responsiveness score was lower than expected for bees with this temperature sensitivity. To ensure that this did not affect the results, all analyses were also performed by attributing each bee a score based only on the first temperature they responded to (a score of 6 for bees responding to the lowest temperature, a score of 1 for bees starting to respond at the highest temperature, etc.). This analysis provided exactly the same results as the one presented in the text, showing a significant correlation between thermal responsiveness and aversive learning ($\rho^2 = 0.93$, $p < 0.001$), a significant effect of patrilines on both values (ANOVA, $F_{9,138} = 4.37$, $p < 0.001$ et $F_{9, 138} = 3.44$, $p < 0.001$) and a significant correlation between patrilines' responsiveness and aversive learning ($\rho^2 = 0.76$, $p < 0.01$).

Some bees showed a low thermal responsiveness score (0 or 1) and did not respond to the 65°C temperature on the first day. Previous work discarded such individuals directly on the ground that they do not respond to the US used on the next day for conditioning (Roussel *et al.* 2009). We chose to keep these individuals as they are part of the hive's variability, and subjected them to the conditioning phase, so that they received CS and US stimulations exactly like all other individuals. We found that during conditioning and the repeated US stimulations, these individuals responded to the US at some trials (76% responded more than 4 times to the US during the 8 CS+ trials, $n = 30$), but they showed low learning performances nonetheless (see Fig 4CD) as they perceive the US as a low intensity stimulus.

As usual in SER conditioning, a number of bees (~20-30%) responded already at the first trial to the CS+ (spontaneous responses). While the responses of these individuals cannot unambiguously be attributed to aversive learning, these bees often show that they learned specifically the CS+, as they stop responding to the CS- in the course of training. For this reason, the analyses of the two learning scores were performed twice, once with all individuals, and once taking only into account bees that did not respond at the first CS+ trial. As detailed in the results, both analyses gave the same outcome.

At the individual level, bees were grouped by heat responsiveness score and their average learning performance scores were calculated, thus allowing a clear representation of the relationship between the two variables. Average scores \pm standard error of the mean (SEM) are shown in the figures. A Spearman correlation analysis was then performed on the averaged scores. At the patriline level, bees' thermal responsiveness and aversive learning scores were calculated per patriline and both scores were averaged for the correlation. One way ANOVA was also used to compare the variations of thermal responsiveness and aversive learning performance scores among patrilines. All data were analyzed with STATISTICA V5.5 (StatSoft, Tulsa, USA).

References:

- Ardiel EL, Rankin CH (2010) An elegant mind: learning and memory in *Caenorhabditis elegans*. *Learn Mem* 17: 191-201.
- Benjamin PR, Staras K, Kemenes G (2000) A systems approach to the cellular analysis of associative learning in the pond snail *Lymnaea*. *Learn Mem* 7: 124-131.
- Beshers SN, Fewell JH (2001) Models of division of labor in social insects. *Annu Rev Entomol* 46: 413-440.
- Bhagavan S, Benatar S, Cobey S, Smith BH (1994) Effect of genotype but not of age or caste on olfactory learning performance in the honey bee, *Apis mellifera*. *Anim Behav* 48(6): 1357-1369.
- Biergans SD, Jones JC, Treiber N, Galizia CG, Szyszka P (2012) DNA methylation mediates the discriminatory power of associative long-term memory in honeybees. *PLoS ONE* 7(6): e39349.
- Bitterman ME, Menzel R, Fietz A, Schäfer S (1983) Classical conditioning of proboscis extension in honeybees (*Apis mellifera*). *J Comp Psychol*, 97 (2): 107-119.

- Brandes C (1991) Genetic-differences in learning-behavior in honeybees (*apis-mellifera-capensis*). *Behav Genet* 21(3): 271-294.
- Brandes C, Frisch B, Menzel R (1988) Time-course of memory formation differs in honey bee lines selected for good and poor learning. *Anim Behav* 36: 981-985.
- Brandes C, Sugawa M, Menzel R (1990) High-performance liquid chromatography (HPLC) measurement of catecholamines in single honeybee brains reveals caste-specific differences between worker bees and queens in *Apis mellifera*. *Comp Biochem Physiol C* 97(1): 53-57.
- Chapman NC, Oldroyd BP, Hughes WOH (2007) Differential responses of honeybee (*Apis mellifera*) patriline to changes in stimuli for the generalist tasks of nursing and foraging. *Behav Ecol Sociobiol* 61(8): 1185-1194.
- Cox MD, Myerscough MR (2003) A flexible model of foraging by a honeybee colony: the effects of individual behaviour on foraging success. *J Theor Biol* 223(2): 179-197.
- Eckholm BJ, Anderson KE, Weiss M, DeGrandi-Hoffman G (2011) Intracolony genetic diversity in honeybee (*Apis mellifera*) colonies increases pollen foraging efficiency. *Behav Ecol Sociobiol* 65: 1037-1044.
- Erber J, Hoorman J, Scheiner R (2006) Phototactic behaviour correlates with gustatory responsiveness in honey bees (*Apis mellifera* L.). *Behav Brain Res* 174: 174-180.
- Estoup A, Solignac M, Cornuet JM (1994) Precise assessment of the number of patriline and of genetic relatedness in honeybee colonies. *Proc R Soc Lond B Biol Sci* B258: 1-7.
- Estoup A, Garnery L, Solignac M, Cornuet JM (1995) Microsatellites variation in honey bee (*Apis mellifera* L.) populations: hierarchical genetic structure and test of the infinite allele and stepwise mutation models. *Genetics* 140: 679-695.
- Estoup A, Lagiadère CR, Perrot E, Chourrout D (1996) Rapid One-tube DNA extraction for reliable PCR detection of fish polymorphic markers and transgenes. *Mol Mar Biol Biotechnol* 5: 295-298.
- Franck P, Garnery L, Solignac M, Cornuet JM (1998) The origin of West European subspecies of honeybees (*Apis mellifera*), new insights from microsatellites and mitochondrial data. *Evolution* 52: 1119-1134.
- Frumhoff PC, Baker J (1988) A genetic component to division of labor within honey bee colonies, *Nature* 333(6171): 358-361.
- Furey TS, Sethupathy P (2013) Genetics. Genetics driving epigenetics. *Science* 342: 705-706.
- Gallio M, Ofstad TA, Macpherson LJ, Wang JW, Zuker CS (2010) The coding of temperature in the *Drosophila* brain. *Cell* 144: 614-624.
- Garnery L, Franck P, Baudry E, Vautrin D, Cornuet JM, et al. (1998) Genetic diversity of the west European honey bee (*Apis mellifera* and *A. m. iberica*). II. Microsatellite loci. *Genet Sel Evol* 30 (suppl.1).
- Giurfa M (2006) Associative learning: the instructive function of biogenic amines. *Curr Biol* 16: R892- R895.
- Giurfa M (2007) Behavioural and neural analysis of associative learning in the honeybee: a taste from the magic well. *J Comp Physiol A* 193: 801-824.

- Giurfa M, Sandoz JC (2012) Invertebrate learning and memory: Fifty years of olfactory conditioning of the proboscis extension response in honeybees. *Learn Mem* 19(2): 54-66.
- Groh C, Tautz, J, Rössler W (2004) Synaptic organization in the adult honey bee brain is influenced by brood-temperature control during pupal development. *Proc Natl Acad Sci USA* 101: 4268-4273.
- Guzman-Novoa E, Hunt GJ, Page RE, Uribe-Rubio JL, Prieti-Merlos D, et al. (2005) Paternal effects on the defensive behavior of honeybees. *J Hered* 96(4): 376-380.
- Herb BR, Wolschin F, Hansen KD, Aryee MJ, Langmead B, et al. (2012) Reversible switching between epigenetic states in honeybee behavioral subcastes. *Nat Neurosci* 15: 1371–1373.
- Jeanson R, Weidenmüller A (2014) Interindividual variability in social insects - proximate causes and ultimate consequences. *Biological Reviews*. doi: 10.1111/brv.12074
- Jones JC, Myerscough MR, Graham S, Oldroyd BP (2004) Honey bee nest thermoregulation: diversity promotes stability. *Science* 305: 402-404.
- Kohno K, Sokabe T, Tominaga M, Kadowaki T (2010) Honey bee thermal/chemical sensor, AmHsTRPA, reveals neofunctionalization and loss of transient receptor potential channel genes. *J Neurosci* 30: 12219-12229.
- Kryger P, Kryger U, Moritz RFA (2000) Genotypical variability for the tasks of water collecting and scenting in a honey bee colony. *Ethology* 106(9): 769-779.
- Lacher V (1964) Elektrophysiologische Untersuchungen an einzelnen Rezeptoren für Geruch, Kohlendioxyd, Luftfeuchtigkeit und Temperatur auf den Antennen der Arbeitsbiene und der Drohne (*Apis mellifica* L). *Z Vgl Physiol* 48(6): 587-623.
- Laloi D, Pham-Delègue M (2010) Patriline-level variability in olfactory learning in the honey bee. *Apidologie* 41(4): 436-442.
- Lenoir JC, Laloi D, Dechaume-Moncharmont FX, Solignac M, Pham MH (2006) Intra-colonial variation of the sting extension response in the honeybee *Apis mellifera*. *Insectes Soc* 53: 80-85.
- Lockett GA, Helliwell P, Maleszka R (2010) Involvement of DNA methylation in memory processing in the honey bee. *Neuroreport* 21(12): 812-816.
- Lunney GH (1970) Using analysis of variance with a dichotomous dependent variable: An empirical study. *J Educat Meas* 7: 263–269.
- Matsumoto Y, Menzel R, Sandoz JC, Giurfa M (2012) Revisiting olfactory classical conditioning of the proboscis extension response in honey bees: a step towards standardized procedures. *J Neurosci Meth* 211: 159-167
- Matsumoto Y, Sandoz JC, Devaud JM, Lormant F, Mizunami M, et al. (2014) Cyclic nucleotide-gated channels, calmodulin, adenylyl cyclase and calcium/calmodulin-dependent protein kinase II are required for late but not early long-term memory formation in the honey bee. *Learn Mem* (in press).
- Mattila HR, Seeley TD (2007) Genetic diversity in honeybees colonies enhances productivity and fitness. *Science* 317: 362-364.
- Menzel R (1999) Memory dynamics in the honeybee. *J Comp Physiol A* 185: 323-340.

- Miguel I, Iriondo M, Garnery L, Sheppard WS, Estonba A (2007) Gene flow within the M evolutionary lineage of *Apis mellifera*: role of the Pyrenees, isolation by distance and post-glacial recolonization routes in the western Europe. *Apidologie* 38: 141-155.
- Norton W, Bally-Cuif L (2010) Adult zebrafish as a model organism for behavioural genetics. *BMC Neurosci* 11: 90.
- Mizunami M, Matsumoto Y (2010) Roles of aminergic neurons in formation and recall of associative memory in crickets. *Front Behav Neurosci* 4: 172.
- Müller U (2012) The molecular signalling processes underlying olfactory learning and memory formation in honeybees. *Apidologie* 43(3): 322-333.
- Neely GC, Hess A, Costigan M, Keene AC, Goulas S, et al. (2010) A genome-wide *Drosophila* screen for heat nociception identifies $\alpha 2\delta 3$ as an evolutionarily conserved pain gene. *Cell* 143: 628-638.
- Newland PL, Burrows M (1997) Processing of tactile information in neuronal networks controlling leg movements of the locust. *J Insect Physiol* 43(2): 107-123.
- Nishino H, Nishikawa M, Mizunami M, Yokohari F (2009) Functional and topographic segregation of glomeruli revealed by local staining of antennal sensory neurons in the honeybee *Apis mellifera*. *J Comp Neurol* 515: 161-180
- Núñez J, Almeida L, Balderrama N, Giurfa M (1997) Alarm pheromone induces stress analgesia via an opioid system in the honeybee. *Physiol Behav* 63: 75-80.
- Page RE, Scheiner R, Erber J, Amdam GV (2006) The development and evolution of division of labor, and foraging specialization in a social insect (*Apis mellifera* L.). *Cur Top Dev Biol* 74: 253-286.
- Paratore S, Alessi E, Coffa S, Torrisi A, Mastrobuono F, et al. (2006) Early genomics of learning and memory : a review. *Genes Brain Behav* 5: 209-221.
- Perez M, Rolland U, Giurfa M, d'Ettorre P (2013) Sucrose responsiveness, learning success, and task specialization in ants. *Learn Mem* 20: 417-420.
- Robinson GE, Page RE (1989) Genetic basis for division of labor in an insect society. The genetics of Social Evolution. In : Breed M.D., Page, R.E., (Eds). Boulder, Colorado: Westview Press Inc. pp 61-80.
- Roussel E, Carcaud J, Sandoz JC, Giurfa M (2009) Reappraising social insect behavior through aversive responsiveness and learning. *PloS ONE* 4(1): e4197.
- Ruchty M, Helmchen F, Wehner R, Kleineidam CJ (2010) Representation of thermal information in the antennal lobe of leaf-cutting ants. *Front Behav Neurosci* 4: 174.
- Sandoz JC (2011). Behavioral and neurophysiological study of olfactory perception and learning in honeybees. *Front Syst Neurosci* 5, 98: 1-20.
- Schäfer S, Rehder V (1989) Dopamine-like immunoreactivity in the brain and subesophageal ganglion of the honeybee. *J Comp Neurol* 280(1): 43-58.
- Scheiner R, Erber J, Page RE (1999) Tactile learning and the individual evaluation of the reward in honey bees (*Apis mellifera* L.). *J Comp Physiol A* 185: 1-10.
- Scheiner R, Page RE, Erber J (2001) Responsiveness to sucrose affects tactile and olfactory learning in preforaging honey bees of two genetic strains. *Behav Brain Res* 120: 67-73.

- Scheiner R, Page RE, Erber J (2001) The effects of genotype, foraging role, and sucrose responsiveness on the tactile learning performance of honey bees (*Apis mellifera* L.). *Neurobiol Learn Mem* 76(2):138-150.
- Scheiner R, Kuritz-Kaiser A, Menzel R, Erber J (2005) Sensory responsiveness and the effects of equal subjective rewards on tactile learning and memory of honeybees. *Learn Mem* 12: 626–635.
- Scheiner R, Amdam GV (2009) Impaired tactile learning is related to social role in honeybees. *J Exp Biol* 212(7): 994-1002.
- Scheiner R, Arnold G (2010) Effects of patriline on gustatory responsiveness and olfactory learning in honey bees. *Apidologie* 41(1): 29-37.
- Schroll C, Riemensperger T, Bucher D, Ehmer J, Voller T, et al. (2006) Light-induced activation of distinct modulatory neurons triggers appetitive or aversive learning in *Drosophila* larvae. *Curr Biol* 16: 1741-1747.
- Schürmann FW, Elekes K, Geffard M (1989) Dopamine-like immunoreactivity in the bee brain. *Cell Tissue Res* 256(2): 399-410.
- Schwärzel M, Monastirioti M, Scolz H, Friggi-Grelin F, Birman S, et al. (2003) Dopamine and octopamine differentiate between aversive and appetitive olfactory memories in *drosophila*. *J Neurosci* 23: 10495-10502.
- Seeley TD (1982) Adaptive significance of the age polyethism schedule in honeybee colonies. *Behav Ecol Sociobiol* 11(4): 287-293.
- Solignac M, Vautrin D, Loiseau A, Mougel F, Baudry E, et al. (2003) Five hundred and fifty microsatellite markers for the study of the honeybee (*Apis mellifera* L.) genome. *Mol Ecol Notes* 3(2): 307-311.
- Tautz J, Maier S, Groh C, Rössler W, Brockmann A (2003) Behavioral performance in adult honey bees is influenced by the temperature experienced during their pupal development. *Proc Natl Acad Sci USA* 100: 7343-7347.
- Tedjakumala SR, Giurfa M (2013) Rules and mechanisms of punishment learning in honey bees: the aversive conditioning of the sting extension response. *J Exp Biol* 216 (16): 2985-2997.
- Ugajin A, Kiya T, Kunieda T, Kubo T (2012) Detection of Neural Activity in the Brains of Japanese Honeybee Workers during the Formation of a "Hot Defensive Bee Ball". *Plos ONE* 7(3): e32902.
- Unoki S, Matsumoto Y, Mizunami M (2005) Participation of octopaminergic reward system and dopaminergic punishment system in insect olfactory learning revealed by pharmacological study. *Eur J Neurosci* 22(6): 1409-1416.
- Vergoz V, Roussel E, Sandoz JC, Giurfa M (2007) Aversive learning in honeybees revealed by the olfactory conditioning of the Sting Extension Reflex. *PLoS ONE* 3: e288.
- Walsh PS, Metzger DA, Higuchi R (1991) Chelex® 100 as a medium for simple extraction of DNA for PCR-based typing from forensic material. *Biotechniques* 10: 507.
- Wang J (2004) Sibship reconstruction from genetic data with typing errors. *Genetics* 166: 1963-1979.
- Yokohari F (1983) The coelocapitular sensillum, an antennal hygro- and the thermoreceptive sensillum of the honey bee, *Apis mellifera* L. *Cell Tissue Res* 233: 355-365.

Chapitre II

Cartographie de la sensibilité thermique
de l'abeille et implication potentielle de
HsTRPA

Heat perception and aversive learning in honey bees: putative involvement of the thermal/chemical sensor AmHsTRPA

Pierre Junca and Jean-Christophe Sandoz

Submitted to *Frontiers in physiology*

Abstract:

The recent development of the olfactory conditioning of the sting extension response (SER) has provided new insights into the mechanisms of aversive learning in honeybees. However, until now, very little information has been obtained concerning US detection and perception in this aversive conditioning. In the initial version of SER conditioning, bees learned to associate an odor CS with an electric shock US. Recently, we proposed a modified version of SER conditioning, in which thermal stimulation with a heated probe is used as US (Junca *et al.*, 2014). This procedure has the advantage of allowing topical US applications virtually everywhere on the honeybee body. In this study, we made use of this possibility and mapped thermal responsiveness on the honeybee body, by measuring workers' SER after applying heat on 41 different structures. We then show that bees can learn the CS-US association even when the heat US is applied on body structures that are not prominent sensory organs, here the vertex (back of the head) and the ventral abdomen. Next, we used a neuropharmacological approach to evaluate the potential role of a recently described Transient Receptor Potential (TRP) channel, HsTRPA, on peripheral heat detection by bees. First, we applied HsTRPA activators to assess if such activation is sufficient for triggering SER. Second, we injected HsTRPA inhibitors to ask whether interfering with this TRP channel affects SER triggered by heat. These experiments suggest that HsTRPA may be involved in heat detection by bees, and represent a potential peripheral detection system in thermal SER conditioning.

Keywords: heat sensitivity, , aversive conditioning, HsTRPA, hedonistic responsiveness

Introduction

In associative learning, animals associate sensory stimuli or their own behavioural responses with particular outcomes, possessing a positive or negative hedonic value for the animal. In classical (or Pavlovian) learning, an initially neutral stimulus such as an odor, sound or color (conditioned stimulus – CS) is associated with a salient appetitive or aversive outcome, like the presence of food or of a noxious stimulus (unconditioned stimulus - US) (Pavlov, 1927). Learning success critically depends on the salience of the involved stimuli for the animal, especially on the subjective intensity of the US (Rescorla, 1988; Hammer, 1993; Scheiner *et al.* 2005). Understanding Pavlovian conditioning therefore implies a careful analysis of how a particular US is detected at the sensory level and how its information is processed within the animal brain.

In honeybees, both appetitive and aversive conditioning can be studied in laboratory conditions thanks to two dedicated protocols (Giurfa and Sandoz, 2012; Tedjakumala and Giurfa, 2013). The conditioning of the proboscis extension response (PER), in which bees associate an odor CS with a sucrose US, is a well established assay that has been used for decades for unraveling the neural mechanisms of appetitive learning (Bitterman *et al.*, 1983; Menzel, 1999; Giurfa and Sandoz, 2012). In this paradigm, data are already available about how the sucrose US is detected and processed in the bee brain. Sucrose is detected by dedicated sugar receptors (AmGr1) on gustatory neurons within specific sensilla on the bees' antennae, mouthparts and tarsi (de Brito Sanchez 2011; Jung *et al.* 2014). These neurons project to the subesophageal ganglion, where they are thought to directly or indirectly contact a single octopaminergic neuron, VUM-mx1 (ventral unpaired median neuron 1 of the maxillary neuromere), which represents the appetitive reinforcement in the bee brain (Hammer 1993). It converges at multiple sites with the olfactory pathway, allowing the formation of the odor-sucrose association (Menzel, 1999, 2012).

By contrast, very little information is yet available concerning US detection and perception in aversive conditioning. In the initial version of the conditioning of the sting extension response (SER), bees learn to associate an odor CS with an electric shock US (Vergoz *et al.*, 2007; Roussel *et al.*, 2009). As the electric shock is an unnatural stimulus for bees, a recent study proposed a modified version of SER conditioning, in which the electric shock is replaced by a thermal stimulation with a heated probe as US (Junca *et al.*, 2014). Heat is a natural stimulus for bees and temperature variations play an important role in the life of honeybees. At the colony level, bees strictly regulate the hives' temperature, as deviations from normal brood temperature results in increased mortality as well as in morphological and behavioral defects (Himmer, 1927; Koeniger, 1978; Tautz *et al.* 2003; Groh *et al.* 2004; Jones *et al.* 2005). High temperatures are critical, and in summer, when temperatures rise above the thermal optimum of the hive (~34°C), workers stand at the hive entrance and fan their wings to decrease in-hive temperature. Foragers also bring water inside the hive, thereby cooling air temperature (Lindauer, 1954). At the individual level, bees strictly avoid temperatures above 44°C and

respond with a sting extension to heat stimulations (Junca *et al.* 2014). They thus perceive a high temperature as an aversive stimulus, and can associate an odorant with such a heat stimulus.

Changing the nature of the aversive reinforcement has opened new possibilities for studying US detection and processing. Contrary to the electric shock which requires using EEG gel and does not easily allow topical applications, the heated probe can be used for precisely stimulating particular parts of the bees' body. In the appetitive modality, US perception varies according to which structure is stimulated with sucrose: mouthparts, antennae and foreleg tarsi (Marshall, 1935; Scheiner *et al.*, 2004, de Brito Sanchez *et al.*, 2008). Several studies have dissected the differential contributions of these potential USs in appetitive olfactory learning (Bitterman *et al.* 1983; Sandoz *et al.* 2002; Scheiner *et al.* 2005; Wright *et al.* 2007; de Brito Sanchez *et al.*, 2008). First, these studies showed that all three locations support some level of conditioning, although sucrose solution applied to the proboscis leads to higher acquisition success compared to antennal or tarsal USs. This effect is thought to be related to the mouthparts' higher sensitivity to sucrose compared for instance to the tarsi (de Brito Sanchez *et al.* 2008). In addition, the location of the sucrose US can have an effect on the duration of memory retention and the types of memories produced (Wright *et al.* 2007). PER conditioning with an antenna-only US supports shorter memory retention (< 24 h) than when bees receive the US on the mouthparts (> 96 h) (Wright *et al.* 2007). Thus, different US locations may support different learning and/or retention performances. Sucrose detection is limited to a few structures on the bee body, which have evolved to harbor gustatory sensory organs involved in appetitive behaviors. In aversive learning, by contrast, bees learn to associate an odor with a noxious stimulus, potentially leading to an injury. Contrary to the detection of food stimuli, animals must be able to avoid injuries on their whole body. Until now, we showed that thermal stimulation of the antennae, mouthparts and foreleg tarsi all trigger SER and can act as aversive US, yielding a similar learning success (Junca *et al.*, 2014). In the present study, we asked if in bees, the aversive thermal US must be detected by dedicated sensory organs to act as US (as in appetitive conditioning) or if thermal detection is a more general sensory ability and heat applied anywhere on their body may act as US.

The use of heat as US may also allow searching for the involved peripheral receptors. In the animal kingdom, a wide range of receptors belonging to very different families have been shown to be responsible for temperature detection, from cold to extreme heat (Clapham, 2001). Among them, Transient Receptor Potential (TRP) channels seem to be especially important (Montell *et al.*, 1985, Clapham, 2003; Voets *et al.*, 2005). In invertebrates, *Drosophila* possesses several types of TRP channels involved in high temperature detection. Among them, members of the TRPA subfamily are essential for responding to heat, like Painless and dTRPA1 (Tracey *et al.*, 2003; Hamada *et al.*, 2008; Kwon *et al.*, 2008; Neely *et al.*, 2011). Unfortunately, no TRPA1 receptor is known in honeybees and AmPain is poorly described (Matsuura *et al.*, 2009). However, honey bees express HsTRPA, a Hymenoptera-specific non-selective cationic channel belonging to the TRPA subfamily and activated by temperatures above 34°C (honeybee gene: *AmHsTRPA*, Kohno *et al.* 2010). When expressed in a

heterologous system, this channel's current response increases rather monotonically with increasing temperature without showing any maximum at least until 42°C (it was not tested for higher temperatures). Such response is reminiscent of the SER probability increase observed from room temperature until 65°C in worker bees (Junca *et al.* 2014). To this day, HsTRPA thus represents the best candidate for thermal detection involved in aversive thermal conditioning. This TRP channel is a joint thermal and chemical sensor, being also triggered by exogenous activators like AITC (allyl isothiocyanate), CA (cinnamaldehyde) and camphor (Kohno *et al.* 2010). Two exogenous inhibitors, Ruthenium Red (RuR) and menthol have also been isolated (Kohno *et al.*, 2010). The existence of both activators and inhibitors for this receptor provides us with the opportunity to test whether HsTRPA is necessary and/or sufficient for thermal detection assessed through SER.

In this study, we first mapped thermal responsiveness all over the honeybee body, by measuring workers' SER after applying heat on 41 different structures. We, then, assessed the aversive olfactory conditioning performances of bees when applying the thermal US on body structures that are not prominent sensory interfaces, the vertex (back of the head) and the ventral abdomen. We next used a neuropharmacological approach to evaluate the role of HsTRPA for heat detection. First, we performed topical applications of HsTRPA activators on the bee to assess if it is sufficient for triggering SER. Second, we injected HsTRPA inhibitors to ask whether interfering with this TRP channel affects SER triggered by heat.

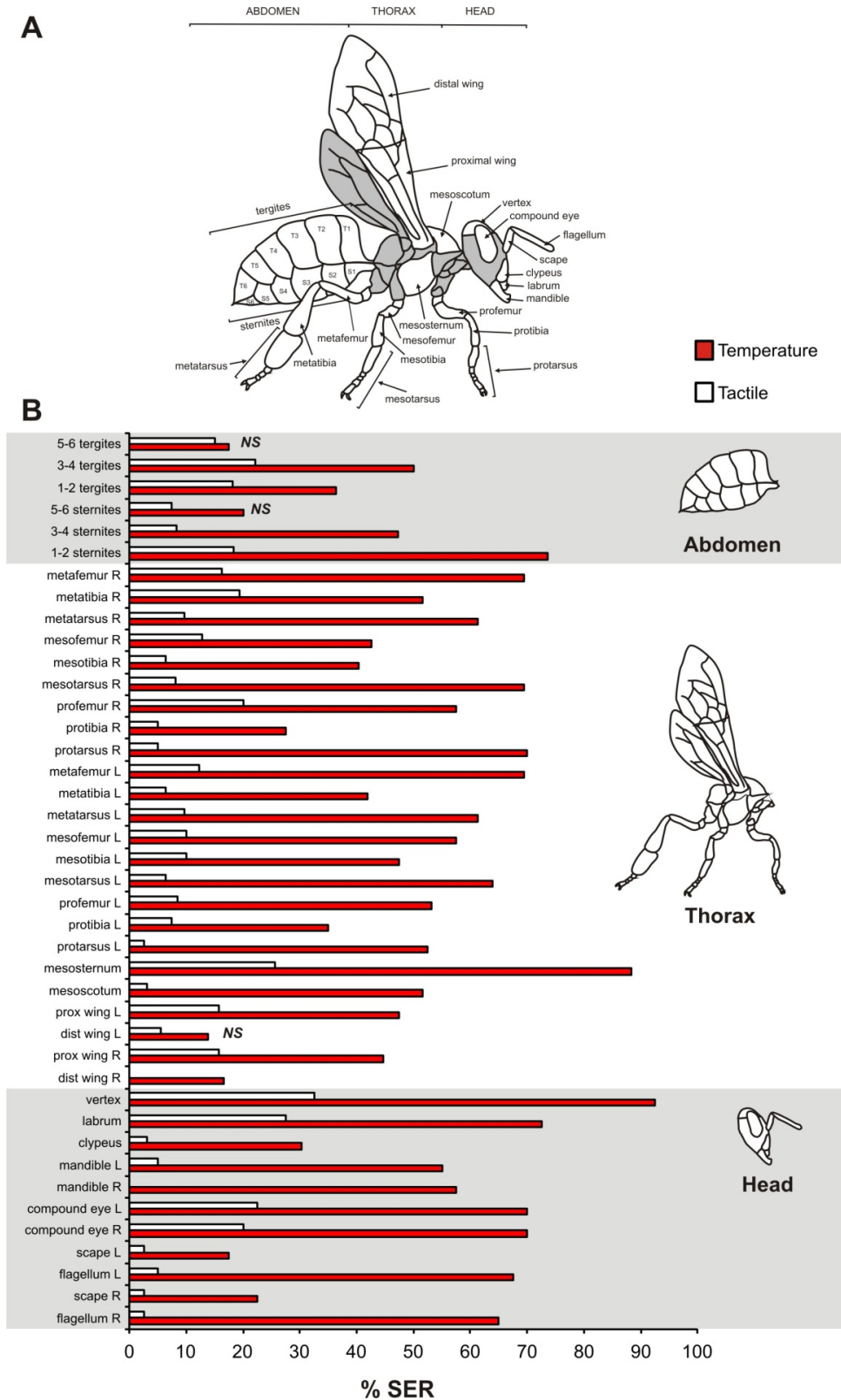

Figure 1: Impact of thermal stimulation of 41 structures of the honeybee body on sting extension responses (SER). **A)** Map of the bee body showing the names of the tested structures. Grey areas were not accessible in our holding setups and were thus not tested. **B)** Percentage of SER observed for thermal stimulations on the 41 different body parts using a heated copper probe ($n = 555$, 4 structures tested per bee). As control, tactile stimulations with an unheated probe were given. Prox: proximal; dist: distal; L: Left; R: Right.

Results

Thermosensory map of the bee body assessed by sting extension

We first aimed to map the heat sensitivity of the different parts of the honeybee body, by applying a heated probe and measuring sting extension responses (SER). Heat was applied for 1 s, and heat stimulations were alternated with tactile controls in a pseudo-randomized order. In total, 41 different structures were tested (Fig 1A, 4 structures tested per bee, $n = 555$ bees). Figure 1B presents the percentage of responses obtained for each structure to heat and to the tactile control. The proportion of SER to heat stimulation varied among tested structures (Chi² test: Chi² = 235.7, $P < 0.001$, 40 df, from 13.9% SER for the left distal wing to 92.5% SER for the dorsal part of the head (vertex)). Likewise, responses to tactile control stimulations varied according to the tested structure (Chi² test: Chi² = 104.8, $P < 0.001$), from 0% SER (right mandible and right distal wing) to 32% SER (vertex). Overall, 38 out of the 41 tested structures exhibited significantly higher responses to heat than to the tactile control (McNemar test: Chi² > 4.17, $p < 0.05$; exceptions: left distal wing, 5.6 sternites, 5.6 tergites: Chi² < 1.78, NS).

Figure 2 presents the same data on a schematic individual, using a color scale from light red (0-10% of SER) to dark red (>50% of SER). This map shows strong variations in the responses of the different body parts to heat stimulations, more so than for tactile stimulations. To evaluate this observation statistically, we next analyzed the responses of different body parts according to their localization (Fig. 3). First, we asked whether bees' tactile and heat sensitivities are lateralized (Fig. 3A). We found that responses to tactile and to heat stimuli were identical between the bees' left and right appendages (tactile: Chi² = 0.10, 1 df, NS; temperature: Chi² = 0.04, 1 df, NS). Second, we asked if a difference in sensitivity exists between the honeybees' body and its different appendages (Fig. 3B). We found that SER were significantly more frequent when stimulating the body than when stimulating the appendages, both for thermal stimulation (Chi² = 10.1, 1 df, $p < 0.01$) and for tactile stimulation (Chi² = 35.4, 1 df, $p < 0.001$). Lastly, we examined tactile and heat sensitivity according to the bees' antero-posterior axis (Fig. 3C). A significant heterogeneity appeared among body parts (head, thorax, abdomen) in the bees' responses to thermal stimuli (Chi² = 14.4, 2 df, $p < 0.001$) but not to tactile stimuli (Chi² = 5.40, 2 df, NS). Thermal responses were highest for the head (56.8% SER) and lowest for the abdomen (40.4% SER), and all body parts differed from the others (head/thorax: Chi² = 5.99, $p < \alpha_{\text{corr}} = 0.025$; head/abdomen: Chi² = 15.9, $p < \alpha_{\text{corr}} = 0.025$; thorax/abdomen: Chi² = 6.39, $p < \alpha_{\text{corr}} = 0.025$). We thus conclude that although the whole honeybee body is sensitive to thermal stimuli, differences in thermal sensitivity appear among body parts.

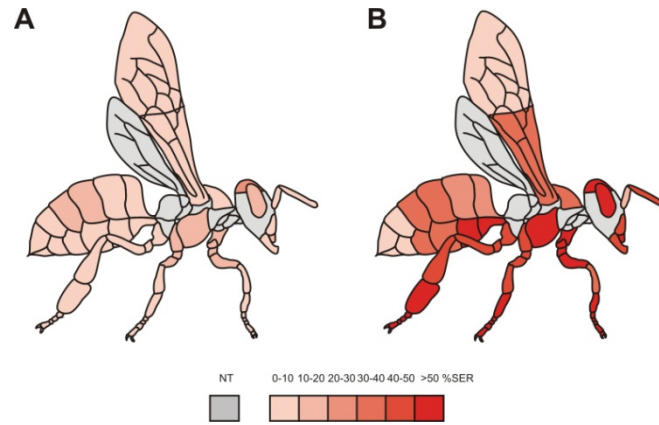

Figure 2: Tactile and heat sensitivity maps obtained by measuring sting extension responses. The maps represent the percentage of SER observed after tactile (A) or thermal (B) stimulation of each structure of the bee body, using a color scale from light red (0-10% of SER) to dark red (>50% of SER). Grey areas were not accessible in our holding setups and were thus not tested (NT). Sting extensions are mainly due to thermal input as seen from the comparison of both maps.

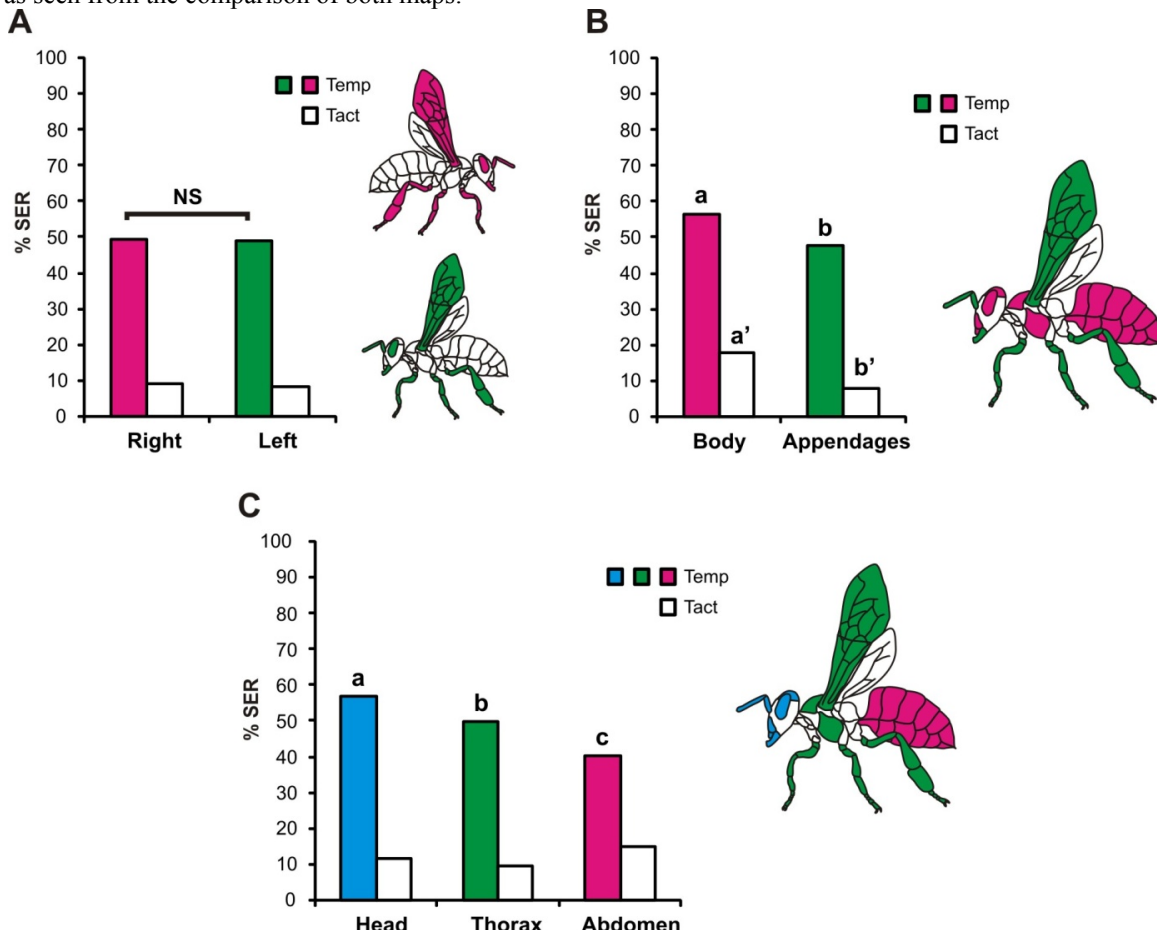

Figure 3: Tactile and heat sensitivity according to the location of the structures. **A)** Bilateral symmetry: responses of left (green) or right (magenta) structures were pooled and compared. Stimulations on both sides induced similar SER rates. **B)** Body/appendages: data were pooled for all appendages (green: antennae, mouthparts, legs, wings) and for main body parts (magenta). Body structures responded significantly more than appendages to both tactile and heat stimulations. **C)** Heat sensitivity according to the antero-posterior axis: data were pooled separately for head (blue), thorax (green), and abdomen (magenta). A gradient of thermal response intensity was found from head to abdomen. Different letters indicate significant differences in χ^2 tests.

Thermal aversive reinforcement on main body structures

If honey bees are able to detect heat on their whole body and to respond with a SER, one may then wonder whether such stimulations may also act as an aversive reinforcement in a conditioning procedure. Our previous work showed that heat application on the antennae, the mouthparts or the front legs may operate as aversive reinforcement in olfactory SER conditioning (Junca et al. 2014). These structures are however all known sensory organs, acting as interfaces between the animal and its environment. Here, we chose two structures, the rear part of the head (vertex) and the ventral abdomen (3-4 sternites), which are not dedicated sensory structures, and asked whether 65°C stimulations of these structures can act as reinforcement in a differential olfactory conditioning procedure. In this protocol, bees had to differentiate between an odor associated with the thermal stimulation (CS+) and an explicitly non-reinforced odor (CS-).

Bees learned the task efficiently in both situations (Fig. 4). When the vertex was stimulated (Fig. 4A, $n = 37$), bees' SER to the CS+ increased significantly (from 6% to 54%, ANOVA for repeated measurements – RM-ANOVA, $F_{7,238} = 4.13$, $p < 0.001$), while their responses to the CS- remained low and stable ($F_{7,238} = 0.27$, NS). Consequently, bees' responses to the CS+ and CS- developed differently in the course of training (*stimulus x trial* interaction: $F_{7,238} = 3.89$, $p < 0.001$). When the 3-4 sternites were stimulated (Fig. 4B, $n = 57$), bees' SER to the CS+ increased along trials (from 9% to 49%, $F_{7,392} = 5.99$, $p < 0.001$) while responses to the CS- did not change throughout the experiment ($F_{7,392} = 1.81$, NS). Accordingly, bees' responses to the CS+ and CS- developed differently in the course of training (*stimulus x trial* interaction: $F_{7,392} = 7.66$, $p < 0.001$). These results, obtained on the vertex and the ventral abdomen, suggest a general ability of bees to associate odorants (CS) with thermal stimulations on their body (US).

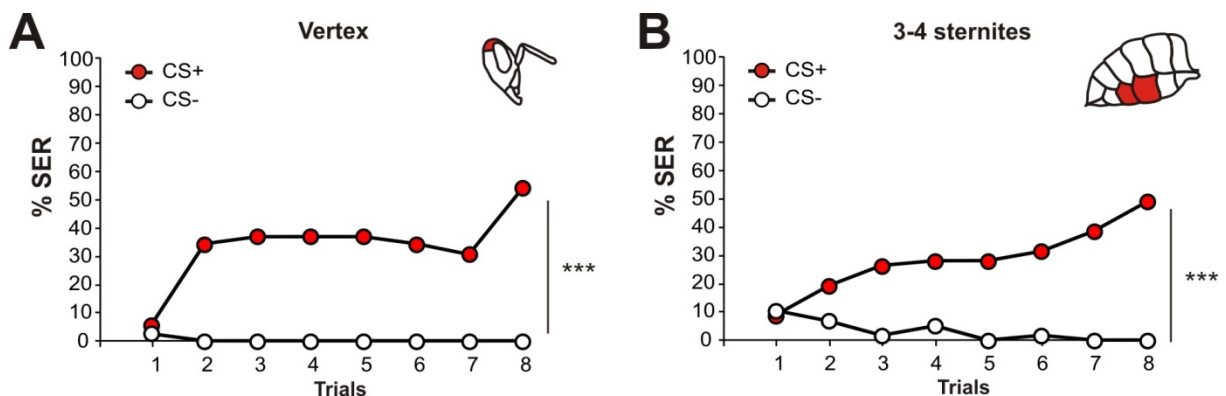

Figure 4: Thermal aversive conditioning with US application on the head and the abdomen. Differential olfactory SER conditioning with a US consisting in thermal stimulation of **A**) the rear of the head (vertex) or **B**) the ventral abdomen (3-4 sternites). In both cases, honey bees managed to differentiate between the CS+ (red dots) and the CS- (white dots) along the 8 trials (***: $p < 0.001$).

Impact on SER of topical applications of HsTRPA activators

The previous experiments showed that bees perceive a heat stimulus on their whole body and can use this information in the context of aversive conditioning. But how does heat detection take place at the peripheral level? We focused on HsTRPA, so far the only well-described thermal receptor in the honey bee. As a previous study isolated chemical activators of this receptor *in vitro* (Kohno et al. 2010), we first wondered if topical application of these chemicals is sufficient for triggering a SER. We thus evaluated the effect caused by the application on the bees' mouthparts of a toothpick soaked with AITC (allyl isothiocyanate), CA (cinnamaldehyde) or camphor, in three groups of animals. We focused here on the mouthparts because thermal stimulation of this structure is routinely used in our aversive conditioning experiments (Junca et al., 2014; Junca et al, in prep). As controls, identical stimulations with a water-soaked toothpick (solvent control) and a heated copper probe (65°C, positive control) were applied. Stimulations were given at 10 min intervals in a randomized order. Two concentrations of each drug were tested.

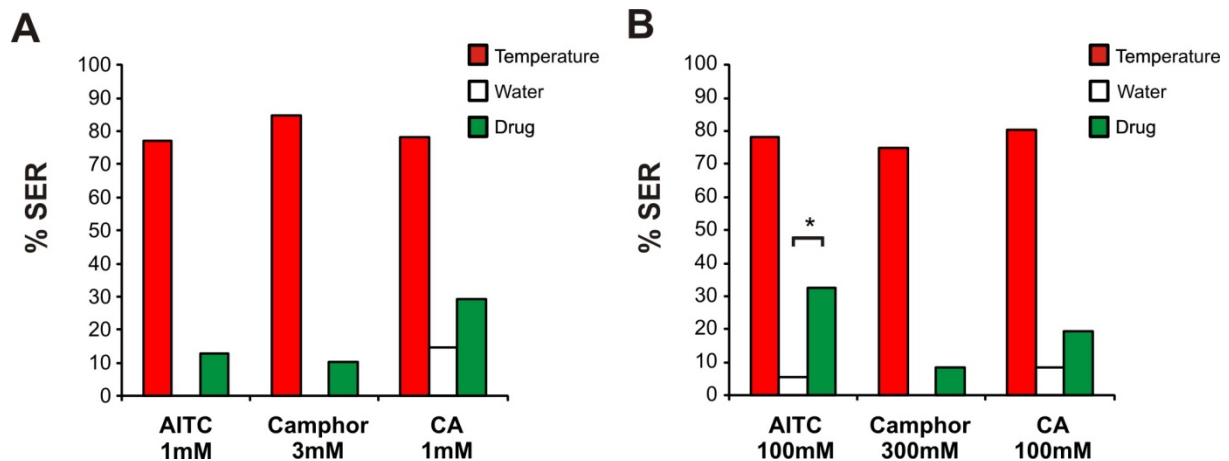

Figure 5: Effect of topical application of HsTRPA activators on sting extension responses. The bees' mouthparts were stimulated with AITC (allyl isothiocyanate), CA (cinnamaldehyde) or camphor at two concentrations, **A**) 1-3 mM or **B**) 100-300 mM (all drugs in green). A thermal stimulation (red) or a water control (white) were used as controls. Only 100 mM AITC led to significant SER compared to the water control (*: $p < \alpha_{\text{corr}} = 0.025$).

At the lower concentrations (Fig. 5A; 1 mM AITC, $n = 39$; 1 mM CA, $n = 39$; 3 mM camphor, $n = 41$), no effect of the drugs was observed. As expected, honey bees exhibited high SER to the heated probe and low responses to the water control stimulation, with a clear difference between both stimulations (Mc Nemar test, $\text{Chi}^2 > 24.04$, $p < \alpha_{\text{corr}} = 0.025$). However, drugs generally induced low response rates, which were not statistically higher than the water control (Mc Nemar test, $\text{Chi}^2 < 3.20$, NS). At the 100 times higher concentrations (Fig. 5B; 100 mM AITC, $n = 37$; 100 mM CA, $n = 36$; 300 mM camphor, $n = 36$), one of the three drugs was effective in triggering SER. As above, in all groups, thermal stimulation led to strong responses but the water control did not (Mc Nemar test, $\text{Chi}^2 > 24.04$, $p < 0.025$). While CA and camphor application did not elicit any clear response (Mc Nemar test, $\text{Chi}^2 < 1.50$, NS), AITC induced 32% SER, which was significantly higher than the water control

(Mc Nemar test, $\text{Chi}^2 = 8.10$, $p < 0.025$). We thus conclude that only one HsTRPA activator was effective when applied topically on the bees' mouthparts, and only at a very high concentration.

Impact of HsTRPA inhibitors on heat sensitivity

We then asked whether HsTRPA is necessary for bees to detect heat and respond with a sting extension. Two chemical inhibitors of HsTRPA have been identified *in vitro* (Kohno *et al.*, 2010), menthol and ruthenium red (RuR). If drug injections provoke a decrease in SER triggered by heat, it would position HsTRPA as a good candidate for high temperature detection. To test this hypothesis, three groups of bees received an injection of 1 μl menthol, RuR, or Ringer (vehicle) as a control, in the median ocellus. After 1h, bees were then subjected to a thermal stimulation (65°C) to the mouthparts and a tactile control at 10 min intervals in a randomized order. Two concentrations of each drug were tested.

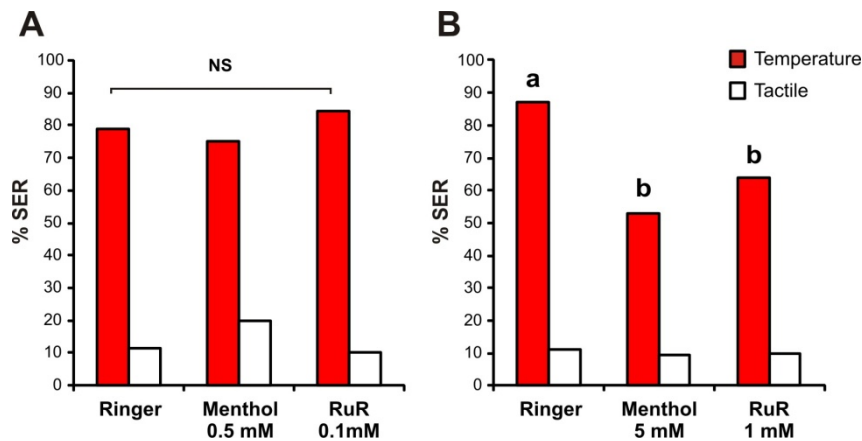

Figure 6: Impact of HsTRPA inhibitors on SER to thermal stimulations. Bees were injected in the median ocellus with menthol, ruthenium red (RuR) or Ringer as control. Sting extensions were recorded in response to 1 sec thermal stimulation (65°C) (red) and tactile stimulation (white). **A)** At low concentration (0.5 mM menthol and 0.1 mM RuR), no effect of the inhibitors appeared. **B)** At 10 times higher concentrations (5 mM menthol and 1 mM RuR) both drugs significantly inhibited SER responses to heat. Different letters indicate significant differences among groups ($p < \alpha_{\text{corr}} = 0.025$).

When the lower concentrations of inhibitors were tested (Fig. 6A; 0.5 mM menthol, $n = 40$; 0.1 mM RuR, $n = 39$; Ringer $n = 43$), no effect was observed. In all three groups, honey bees exhibited high SER to the heated probe and low responses to the tactile control, with a clear difference between these stimulations (Mc Nemar test, $\text{Chi}^2 > 20.0$, $p < 0.001$). No difference was observed among groups in SER to the thermal stimulation ($\text{Chi}^2 = 1.13$, 2 df, NS) or to the tactile control ($\text{Chi}^2 = 1.86$, 2 df, NS). At the 10 times higher concentration (Fig. 6B; 5 mM menthol, $n = 64$; 1 mM RuR, $n = 61$; Ringer $n = 62$), both drugs were effective in blocking SER. Although in all three groups responses induced by thermal stimuli were still significantly higher than responses to tactile controls (Mc Nemar test, $\text{Chi}^2 > 26.0$, $p < 0.001$), SER to the heat stimulus was different among groups ($\text{Chi}^2 = 17.4$, 2 df, $p < 0.001$). In particular, responses to heat were lower in both drug-injected groups compared to the Ringer control group (Fisher's exact test, RuR: $\text{Chi}^2 = 8.95$, $p < \alpha_{\text{corr}} = 0.025$; menthol: $\text{Chi}^2 = 17.3$, $p < 0.025$). RuR- and menthol-injected groups displayed comparable rates of SER to the thermal stimulus

(Fisher's exact test, $\text{Chi}^2 = 1.5$, NS). No difference appeared among groups in SER to the tactile stimulus ($\text{Chi}^2 = 0.14$, 2 df, NS).

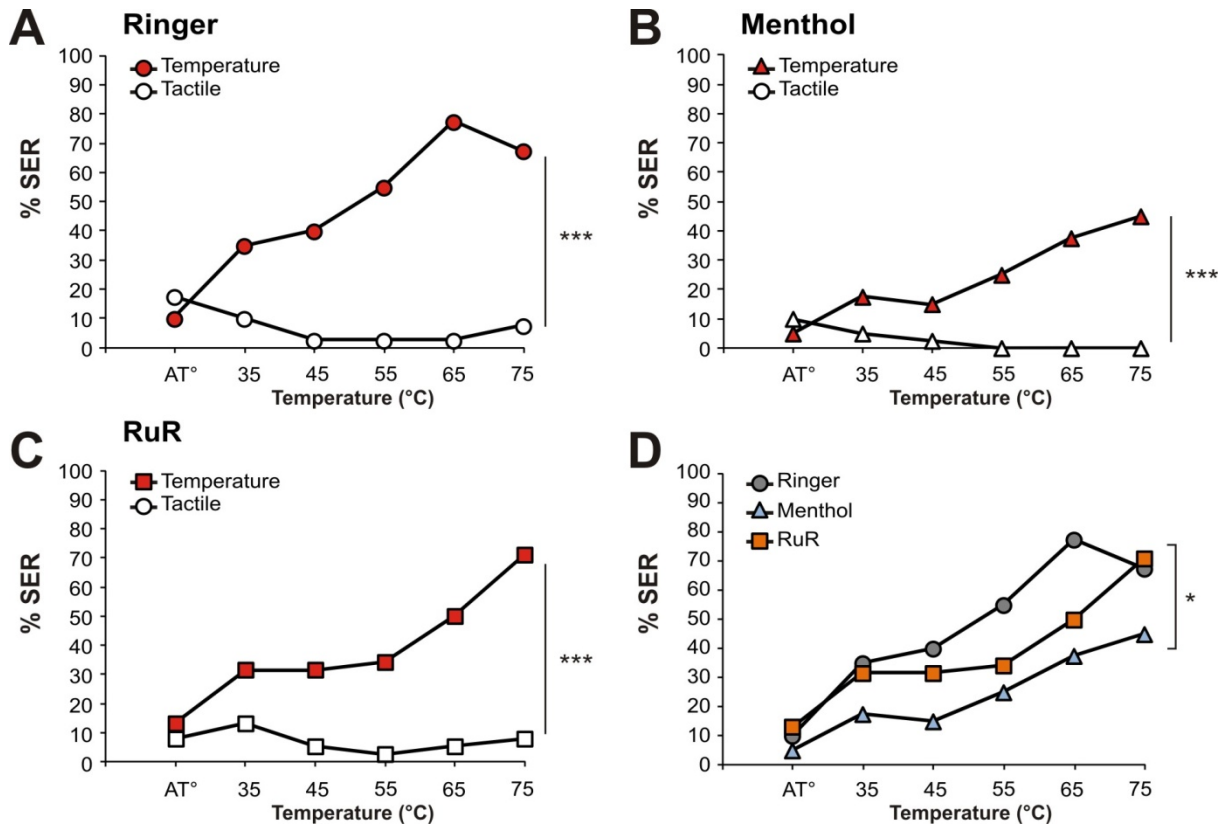

Figure 7: Effect of HsTRPA inhibitors on thermal responsiveness. Different groups of bees were injected with Ringer as control (A) or with an HsTRPA inhibitor, either menthol (5 mM, B) or ruthenium red (RuR, 1 mM, C) SER was measured in response to increasing temperatures (red) alternated with tactile controls (white). D) Comparison of thermal response curves among the three groups (Ringer: grey circles; menthol: light blue triangles; RuR: orange squares). Both inhibitors decreased heat responsiveness (*: $p < 0.05$; ***: $p < 0.001$).

Thus, HsTRPA inhibitors appear to inhibit SER to heat. We next aimed to confirm and expand this result by characterizing the impact of HsTRPA inhibitors on thermal sensitivity along an increasing temperature gradient, as usually tested for measuring bees' aversive responsiveness (Junca et al. 2014; Junca et al., in prep). Bees were thus injected with the higher dose of each inhibitor or with Ringer, as above, but were then subjected to a series of thermal stimulations at increasing temperatures on the mouthparts alternated with tactile controls (Fig. 7A-C). All stimulations were applied at 10 min intervals.

Bees' SER increased significantly with increasing temperature in all three groups (RM-ANOVA, *trial* effect: Ringer: $n = 40$, $F_{5, 195} = 21.6$, $p < 0.001$; RuR: $n = 38$, $F_{5, 185} = 10.8$, $p < 0.001$; menthol: $n = 40$, $F_{5, 195} = 9.84$, $p < 0.001$). By contrast, responses to alternated tactile stimuli did not increase, and even decreased in the Ringer group, throughout the experiment (RM-ANOVA: ringer: $F_{5, 195} = 2.46$, $p < 0.05$; RuR: $F_{5, 185} = 1.22$, NS; menthol: $F_{5, 195} = 1.05$, NS). Accordingly, in all three groups, responses to the temperature stimulus evolved differently from those triggered by tactile

controls (RM-ANOVA, *stimulus* x *trial* interaction: Ringer: $F_{5, 195} = 24.6$, $p < 0.001$; RuR: $F_{5, 185} = 10.2$, $p < 0.001$; menthol: $F_{5, 195} = 9.17$, $p < 0.001$). However, responses to heat were significantly different in the three groups (Fig. 7D, RM-ANOVA, *stimulus* effect: $F_{2,115} = 5.47$, $p < 0.01$; *stimulus* x *trial* interaction: $F_{10, 575} = 2.03$, $p < 0.05$). In particular, weaker responses were observed in the RuR- and menthol-injected groups compared to the Ringer control (RM-ANOVA, *stimulus* x *trial* interaction, Ringer/RuR: $F_{5, 380} = 2.59$, $p < 0.05$; Ringer/menthol: $F_{5, 390} = 2.78$, $p < 0.05$). No difference appeared between the groups injected with HsTRPA inhibitors (RuR/menthol: $F_{5, 380} = 0.73$, NS). Lastly, no difference appeared among groups in the responses to the tactile controls (RM-ANOVA, *stimulus* effect: $F_{2,115} = 1.29$, NS; *stimulus* x *trial* interaction: $F_{10, 575} = 0.74$, NS).*

The previous experiment confirmed that HsTRPA inhibitors affect thermal responsiveness measured by means of SER. Most probably, this result is due to the effect of the inhibitors on HsTRPA receptors. However, theoretically, it could also be due to a non-specific detrimental effect of the drugs on the bees' physiological state, even though no such effect was apparent by simple observation. In the next experiment, we thus checked the possible effect of HsTRPA inhibitors on bees' responsiveness in another hedonic modality – the appetitive modality - by measuring their sucrose responsiveness. After Ringer or HsTRPA inhibitor injections as above, bees were thus subjected to a series of stimulations on the antennae with sucrose solutions at increasing concentrations alternated with water controls, and the bees' PER were measured (Fig. 8A-C). All stimulations were applied at 10 min intervals.

Bees' PER increased significantly with increasing sucrose concentrations in all three groups (RM-ANOVA, *trial* effect: Ringer: $n = 39$, $F_{6, 228} = 21.9$, $p < 0.001$; RuR: $n = 38$, $F_{6, 234} = 24.1$, $p < 0.001$; menthol: $n = 40$, $F_{6, 222} = 21.9$, $p < 0.001$). Responses to the control water stimulations remained stable for Ringer and menthol but slightly increased for RuR (ringer: $F_{6, 228} = 1.63$, NS; RuR: $F_{6, 234} = 2.20$, $p < 0.05$; menthol: $F_{6, 222} = 1.45$, NS). In all groups, sucrose responses evolved differently from responses to water controls (RM-ANOVA, *stimulus* x *trial* interaction: Ringer: $F_{6, 228} = 8.03$, $p < 0.001$; RuR: $F_{6, 234} = 6.50$, $p < 0.001$; menthol: $F_{6, 222} = 10.0$, $p < 0.001$). However responses evolved similarly in the three groups both for sucrose stimulations (Fig.8D; RM-ANOVA, *stimulus* effect: $F_{2, 114} = 1.44$, NS; *stimulus* x *trial* interaction: $F_{12, 684} = 0.68$, NS) and for the water controls (*stimulus* effect: $F_{2, 114} = 0.85$, NS; *stimulus* x *trial* interaction, $F_{12, 684} = 0.68$, NS). We conclude that HsTRPA inhibitors have no effect on sucrose responsiveness.

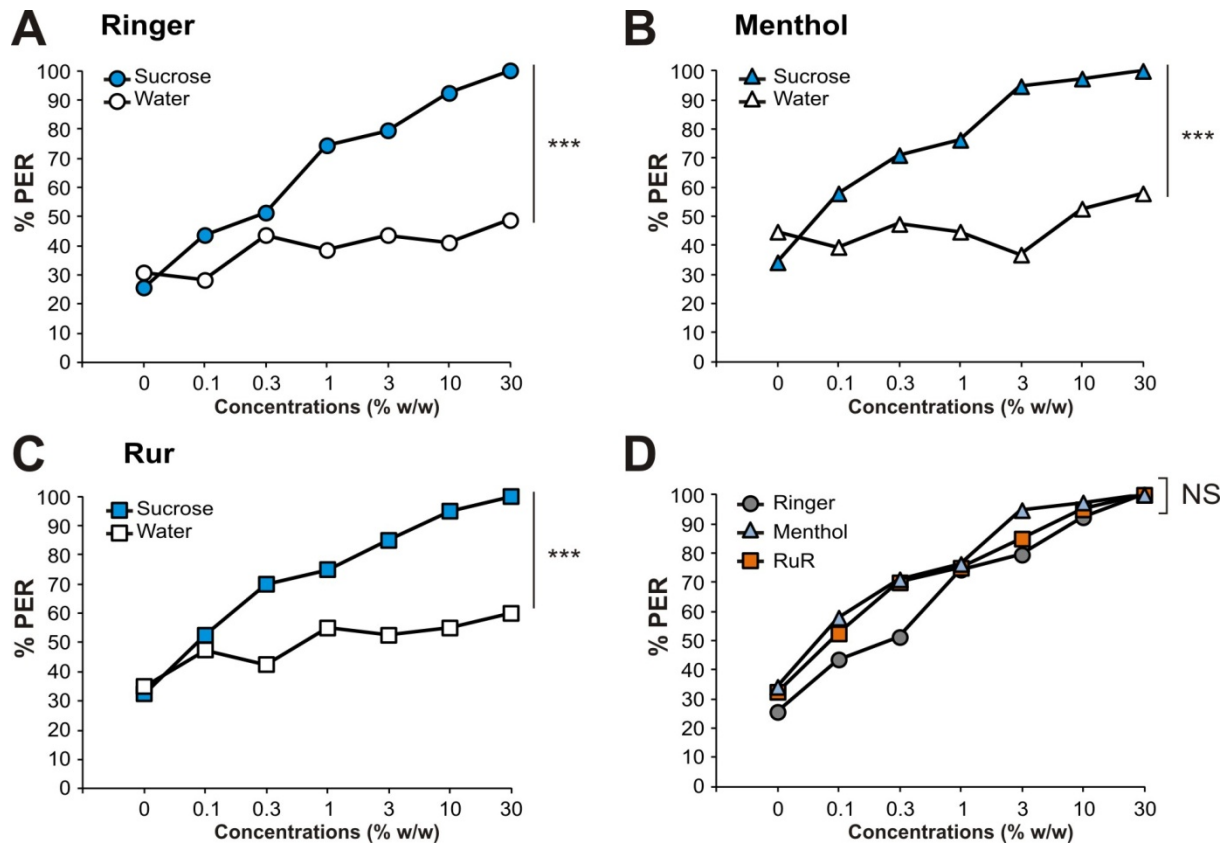

Figure 8: Effect of HsTRPA inhibitors on sucrose responsiveness. Different groups of bees were injected with Ringer as control (A) or with a HsTRPA inhibitor, either B) menthol (5 mM) or C) Ruthenium red (RuR, 1 mM). Proboscis extension responses (PER) were measured in response to sucrose solutions at increasing concentrations (blue) alternated with water controls (white). D) Comparison of sucrose response curves among the three groups (Ringer: grey circles; menthol: light blue triangles; RuR: orange squares). Inhibitor injections did not impact sucrose responsiveness (NS: Non Significant; ***: $p < 0.001$).

Discussion

Our study provides the first heat sensitivity map of the honeybee, measured using heat-induced SER. This map reveals that responses are symmetrical between body sides, that body structures are more sensitive than the appendages and it shows a gradual decrease in thermal sensitivity from the head to the abdomen. We then demonstrated that heat application does not need to be located on specific structures (mouthparts, antennae or protarsi) to serve as an aversive US in SER conditioning. Indeed, bees learned successfully when the US was provided on the vertex or on the ventral abdomen (3-4 sternites). Lastly, we observed that HsTRPA activators (AITC, CA, camphor) applied topically on the bees' mouthparts did not easily induce SER (only AITC at the higher dose) whereas inhibitor injections (RuR, menthol) significantly decreased SER to heat. This impact of HsTRPA inhibitors was specific of SER to heat, since no effect was observed on PER responses to sucrose.

Thermal body map

We observed that bees' heat sensitivity, as measured by the induced SER, varied among body structures. Control tactile stimulations also led to variations in responses among body structures but on a much smaller scale compared to heat-triggered responses. Thus, most of the observed SER were due to heat application. The map showed clearly that heat detection is a general phenomenon and is not restricted to a few dedicated sensory structures, like the antennae, mouthparts or tarsi (Junca *et al.* 2014). A possible explanation for this observation may originate from the high temperature (65°C) used for thermal stimulation, which may have induced activation of nociceptive pathways responsible for preserving the animals' physical integrity. Such system should be differentiated from fine-tuned thermosensory pathways which detect temperatures in the physiological range and employ dedicated thermosensitive sensilla (*coelocapitular sensilla*) on the bee antenna (Lacher, 1964; Yokohari *et al.*, 1982; Yokohari, 1983). The existence of nociceptive pathways in insects has been recently demonstrated in *Drosophila* larvae, in which the detection and avoidance of noxious heat, bright light, or strong mechanical stimuli is operated by class IV multidendritic neurons that express a range of nocisensor proteins (Im and Galko, 2012). These neurons extend their dendrites within the derma and are widely distributed along the body surface (Hwang *et al.* 2007). The wide field heat sensitivity we have found in this study would fit with the existence of an analogous neuron family in honeybees. To this day, however, they have not yet been described. Only a few structures of the bee body did not elicit more SER when they were thermally stimulated than with the tactile control: the tip of the abdomen and the distal part of the forewings. A possible lack of nociceptive neurons in the wings may explain this observation. At the tip of the abdomen, it would seem rather unlikely that nocisensor neurons are utterly absent. Rather, the proximity between the heat stimulus and the sting chamber might have prevented any sting extension, the animal attempting to avoid any internal injuries.

Responses to heat were compared among body parts. First, we did not find any lateralization bias on the paired appendages. The opposite would have been surprising. Indeed, organisms expressing such an asymmetrical perception would suffer from obvious disadvantages (Corballis, 1998). The physical world is indifferent to left and right, and any lateralized deficit might leave an animal vulnerable to attacks on one side or unable to attack prey or competitors appearing on one side (Vallortigara and Rogers, 2005). Generally, peripheral structures appeared less sensitive to tactile and heat stimuli than body structures. For tactile stimuli, sensitivity could be less important than on the body because appendages are more likely to come in contact with mechanical substrates than the body. As for heat, appendages seem to be of minor importance because vital organs (ventral nerve cord, digestive system, circulatory system) are located in the main body. Some insects are even able to undergo appendage autotomy in extreme situations, a process during which an animal improves its survival chances by cutting its own appendages (Eisner and Camazine, 1983; Maginnis, 2008). It would thus seem logical that appendages such as legs are less sensitive to potentially harmful stimuli. Lastly, we observed a gradient of decreasing thermal responsiveness from the head to the abdomen. The brain located in the head capsule contains neuropils essential for processing and integrating information from many sensory modalities (gustatory, olfactory, visual, tactile, etc) as well as for motor control, navigation, learning and memory processes among others (Menzel, 1999; 2012). Therefore, physical integrity of the head is crucial for bees to be able to assess their environment and exhibit adapted behaviors, and noxious simulations located close to the head should trigger stronger responses.

SER learning on the vertex and the ventral abdomen

In a previous study, we demonstrated that thermal SER conditioning is successful with a heat US on the mouthparts, the antennae and the tarsi of the forelegs (Junca et al., 2014). Such structures are well known sensory organs (Hammer, 1993; Giurfa and Sandoz, 2012; Jung et al., 2015; de Brito Sanchez et al., 2008). We show here that heat stimulation on body structures that are not dedicated sensory organs (vertex, ventral abdomen) can also act as US in SER conditioning. This observation supports our current putative neural model of thermal aversive conditioning in honeybees (Fig 9). Associative learning relies on the convergence of CS and US information at one or several locations in the brain. The olfactory (CS) pathway is well known in bees (Menzel 1999; Giurfa et al. 2007; Sandoz, 2011): axons of olfactory receptor neurons (ORN) located on each antenna project to the antennal lobes (AL) where they synapse with approximately 4000 local interneurons (not shown) and 800 projection neurons (PN). Projection neurons then convey processed information to higher-order brain structures, the mushroom bodies (MB) and the lateral horn (not shown). For aversive learning, the US pathway is mostly unknown, but our results may provide some new clues. Except for the case in which an antenna heat US is used (Junca et al. 2014), and for which thermo-sensory neurons from the antenna are thought to project to the antennal lobe (Yokohari et al. 1983; Nishino et al. 2009), all

other heat stimulations probably rely on thermal detection by the above-mentioned putative multidendritic neurons. It is unlikely that this information also projects to the antennal lobe. Rather, it can be expected from neuroanatomical work in other insects (for instance on the mechanosensory system, Pflüger et al. 1988; Newland and Burrow, 1997) that such putative thermo-sensitive/nociceptive neurons would first project to the respective ganglia of the ventral nerve cord, i.e. to sub-esophageal, thoracic or abdominal ganglia depending on the location of the stimulation (SEG, TG and AG in Fig. 9). From there, information could be conveyed by ascending interneurons towards the brain, possibly to a thermal/nociceptive integration center (TNC in Fig. 9), as suggested by several observations. In the Asian bee *Apis cerana*, immediate early gene (*Acks*) expression mapping showed that exposure to a high temperature (46°C) induces neural activity in several brain regions: within the mushroom body, intrinsic neurons (class I and II Kenyon cells), and in a region of the protocerebrum located between the dorsal and the optic lobe (Ugajin et al. 2012). Thus, stimulation with a high temperature presumably induces activity in one thermo-sensitive center and in the mushroom bodies, a well known multimodal integration and association center of the bee brain. Our working hypothesis is that neurons from the putative thermo-sensory center could then activate aversive reinforcement circuits, which would converge with the olfactory pathway and induce learning-associated plasticity, in particular in the mushroom bodies. Previous work on SER conditioning indicated that dopaminergic neurons (dopN in Fig. 9) are involved in aversive reinforcement, because pharmacological blockade of dopamine receptors disrupts aversive learning (Vergoz et al. 2007). Dopamine neurotransmission is also necessary for aversive learning in other insects (*Drosophila*, Schwärzel et al. 2003, Schroll et al. 2006; crickets, Unoki et al. 2005). The bee brain contains a complex arrangement of many dopamine-immunoreactive neurons (Schäfer and Rehder, 1989; Schürmann et al., 1989). Among dopamine neurons, three clusters are especially interesting as they contain processes that project to the mushroom body calyces and lobes (especially the α -lobe), and may thus provide aversive reinforcement information (Tedjakumala and Giurfa, 2013). Co-activation of CS and US pathways could modify the strength of synapses between the specific Kenyon cells representing the learned odorant and mushroom body extrinsic neurons (EN in Fig. 9) feeding onto the sting extension premotor system. After learning, presentation of the odor CS alone would trigger SER thanks to this modification. Further work is needed to confirm the different putative elements of this working model. The present study started this task by evaluating potential receptors detecting temperature at the periphery (see below).

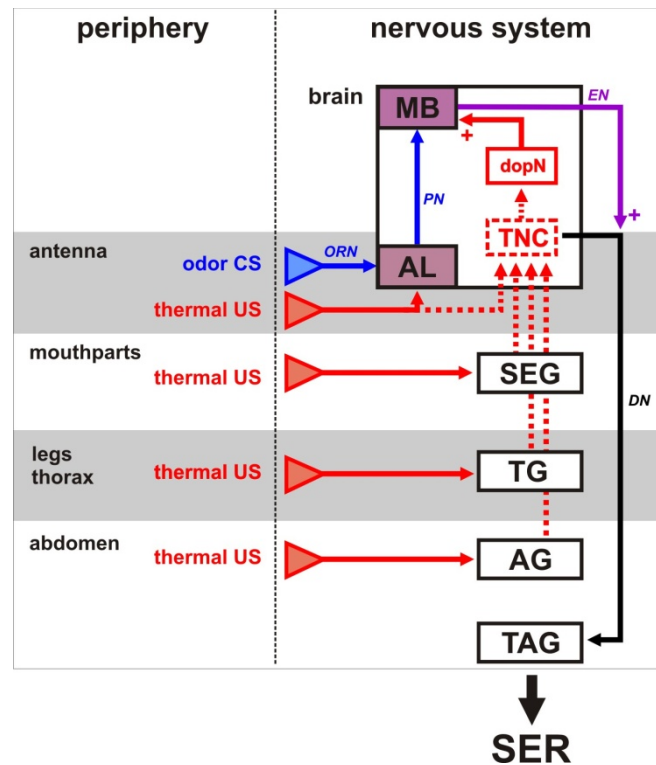

Figure 9: Working model of aversive olfactory conditioning of SER using a thermal US. Putative pathways involved in **A)** the expression of SER after thermal stimulation, **B)** the acquired SER after learning a CS-US association, are shown. **A)** At the periphery, stimulation of the different structures with a high temperature is thought to activate thermosensitive neurons (possibly class IV multidendritic neurons), which would first project to the respective relays on the ventral nerve cord, the subesophageal ganglion (SEG), thoracic ganglia (TG) or abdominal ganglia (AG). As a second step, interneurons would project to a thermal/nociceptive center (TNC) in the brain. Antennal thermal stimulation induces activity in the antennal lobe (AL) but possibly also activates the TNC. Activation of this center would stimulate premotor descending neurons (DN) which would in turn trigger stinging motor patterns in the terminal abdominal ganglion (TAG), producing SER (Ogawa et al. 1995). **B)** Olfactory learning: odorants are detected on the antenna by olfactory receptor neurons (ORNs) projecting to the AL. Then information is prominently conveyed to the mushroom bodies (MB) by projection neurons (PN). Activation of dopaminergic neurons (dopN) by the TNC would inform the olfactory pathway of the aversive thermal reinforcement. Associative plasticity at the level of MB extrinsic neurons (EN) feeding onto the sting premotor descending neurons would allow the CS to elicit SER after learning.

HsTRPA involvement in heat perception

We assessed HsTRPA involvement in SER triggered by heat using topical applications of activators and injections of inhibitors. We observed that topical application of HsTRPA activators is not sufficient for triggering SER, except when a very high concentration (100 mM) of AITC was used as stimulus. This result might appear surprising since all three tested drugs were potent activators of the channel *in vitro* (Kohno et al. 2010). However, if thermosensation is carried out by a similar class of class IV multidendritic neurons as in *Drosophila* (Im and Galko, 2012), it is likely that the thermal channels are located in the epidermis, i.e. below the cuticle, so that direct contact of the activators with the channel is not possible, or at least difficult. Heat could diffuse through the cuticle to activate the channel, but chemical activators would not. In our view, therefore, this result does not invalidate the potential role of HsTRPA in thermal sensitivity and nociception in bees. Concerning the SER increase observed with AITC stimulation, we cannot be sure at this stage that it is not related to a possible

aversive gustatory effect of this compound when presented to the mouthparts, because AITC was found to inhibit PER responses when added to sucrose solution (Kohno et al. 2010). However, in the same study, the effect of AITC was reversed by RuR, suggesting a possible involvement of HsTRPA. Until now no SER in response to bitter or repellent gustatory stimuli has been reported. It will be necessary to test the effect on SER of AITC application on other locations of the bee body, while also checking if known aversive gustatory stimuli (salt or bitter compounds) can trigger SER when applied on the mouthparts. This will be addressed in more details in the future.

Injections of HsTRPA inhibitors produced significant blocking of SER in response to heat. This effect is similar to the reversal of the suppression of PER by heat in previous work (Kohno et al. 2010). In this study, heating a sucrose solution to 70°C was found to decrease bees' PER to sucrose, compared to an unheated solution. Both RuR and menthol restored normal PER responses in the presence of the heated sucrose solution, presumably by blocking HsTRPA activity (Kohno et al. 2010). The effective inhibitor concentrations in our study were about 10 times higher than the concentrations that significantly modified bees' warmth (36.5°C) avoidance in a thermal gradient (0.1 mM RuR and 0.5 mM menthol, Kohno et al. 2010). It is possible that inhibition of the highly-sensitive stinging response requires higher inhibitor concentrations (i.e. more general blocking of HsTRPA channels) than a fine-tuned behavior like warmth avoidance. Alternately, the mode of injection performed in the two studies (ocellar injection in the present study, injection between the antennae in Kohno et al. 2010) might be involved. Performing both experiments in the same conditions may clarify this question. As a control for the effect of the drugs on thermally-induced SER, we tested the effective concentrations on appetitive responsiveness, by measuring bees' PER to solutions containing increasing sucrose concentrations. Neither RuR nor menthol had any effect on sucrose responsiveness. If indeed both compounds act on HsTRPA, as we suppose, such a result could have been expected since responses to sucrose are mediated by dedicated gustatory receptors, mostly *AmGr1* (Jung *et al.*, 2015). This confirms however that RuR and menthol did not reduce SER to heat through a non-specific effect on bees' general responsiveness to stimuli, but rather specifically inhibited their responses to heat.

For the moment, we need to remain cautious about the involvement of HsTRPA in bees' heat sensitivity, as a neuropharmacological approach alone is not sufficient for demonstrating the role of this TRP channel *per se*. Indeed, the chemical activators and inhibitors we have used are also known to be inhibitors/activators of other members of the TRP family in other species. For instance, in mammals, menthol is able to activate TRPM8 (cold, Behrendt et al., 2004), while RuR is a non-specific inhibitor of TRPM8 (Story et al., 2003) and all four TRPV channels (cold to extreme heat, Clapham et al., 2001, 2003). It would thus be especially important in the future to use a technique for blocking HsTRPA more specifically, for instance using RNA interference (Farooqui et al. 2003; Louis et al.

2012), especially because bees express other TRP channels. In invertebrates, channels belonging to the TRPA subfamily are more specifically involved in thermal detection (Matsuura et al., 2009). Most prominently, TRPA1 and Painless have been well described in *Drosophila* and were shown to be crucial for thermal nociception (Tracey et al. 2003; Hamada et al., 2008; Kwon et al., 2008; Neely et al., 2011). In addition, Pyrexia, another TRP channel, plays a significant part in heat detection and tolerance in this species (Lee et al., 2005). The honeybee genome, as that of other Hymenoptera, does not contain any TRPA1 channel. It is thought that HsTRPA, which has evolved from the duplication of an ancestral hygrosensor (*Wtrw*), has gained thermoresponsive properties, which may have resulted in the loss of TRPA1 in Hymenoptera (Matsuura et al. , 2009). Consequently, HsTRPA is considered as a prominent thermosensor in bees and our results suggest it is involved in heat sensitivity leading to SER. However, homologues of the *Drosophila* genes *painless* and *pyrexia* have been described in the honey bee genome, and named *AmPain* and *AmPyr* respectively (Matsuura et al., 2009). It would thus be important to evaluate next the possible involvement of these two channels in heat sensitivity and thermal aversive conditioning. Thanks to the thermal sensitivity map we have established, future studies will be able to compare the relative sensitivity of the different body parts with the expression patterns of *AmHsTRPA*, *AmPain* and *AmPyr* in the bee body. In addition, SER triggered by heat stimulation, coupled to the use of RNA interference will allow testing the involvement of each channel.

In conclusion, this study constitutes a first step for understanding heat perception and aversive SER conditioning in honey bees. Our current results suggest that a RuR- and menthol-sensitive thermal receptor, probably HsTRPA, is involved in heat sensitivity leading to sting extension and may represent the peripheral US detector in our aversive conditioning protocol.

Materials and Methods

Animals

Experiments were performed on honey bees caught on the landing platform of several hives on the CNRS campus of Gif-sur-Yvette, France. After chilling on ice, bees were harnessed in individual holders so that both sting- and proboscis extension could be clearly monitored in the same harnessed position. Bees were fed with 5µl of sucrose solution (50% w/w) every morning to standardize satiety levels and were conserved in a dark and humid box between experiments.

Stimulations

Thermal stimulations were provided for 1 s by means of a pointed copper cylinder (widest diameter: 6 mm; length: 13 mm), mounted onto the end of a minute soldering iron running at low voltage (HQ-Power, PS1503S). Temperature at the end of the cylinder was controlled using a contact thermometer (Votcraft, Dot-150). Sucrose stimulations were provided for 1 sec with a soaked toothpick to the bees' antennae.

Thermal sensitivity map of the bee body

We first aimed at determining whether thermal stimulation of the bees' different body parts triggers a SER and if thermal sensitivity varies among them. Thermal stimulations (65°C) were applied on 41 different areas of the bees' body (see Fig. 1A). Previous work showed that this temperature triggered clear SER responses when applied on the antennae, the mouthparts or the forelegs of the bees, without inducing any long-lasting effect (Junca et al. 2014). Eleven median unpaired structures were tested : labrum, clypeus, back of the head, mesoscutum, mesosternum, 1-2 sternites, 3-4 sternites, 5-6 sternites, 1-2 tergites, 3-4 tergites, 5-6 tergites. Fifteen paired body parts were also tested on the left or right side independently: antenna flagellum, antenna scape, compound eye, mandible, proximal forewing, distal forewing, protarsus, protibia, profemur, mesotarsus, mesotibia, mesofemur, metatarsus, metatibia, metafemur. To avoid any fatigue of the bees, only 4 structures were tested per bee. In addition to thermal stimulations, tactile controls were applied on the same structures to verify that sting extension was a consequence of thermal stimulation. Tactile stimulations were performed with a duplicate copper probe which remained at ambient temperature. For each bee, the order of stimulation of the different structures, as well as whether each stimulation was performed with the heated or with the control probe, were determined randomly prior to starting the experiment. The eight stimulations were performed at 10 min intervals. In this experiment, two groups of 20 bees were tested each day.

SER conditioning with a thermal US on the vertex and the ventral abdomen

To assess whether or not bees are able to perform aversive olfactory conditioning with a thermal US on body parts that do not correspond to sensory organs, SER conditioning experiments were carried out with a thermal stimulus (65°C) on 3-4 sternites or on the back of the head as reinforcement. In a differential aversive conditioning procedure, one odorant (the CS+) was associated with a thermal reinforcement (the US), while another odorant was presented without reinforcement (the CS-). The odor CSs were 2-octanone and nonanal (Sigma Aldrich, Deisenhofen, Germany). Five microliters of pure odorant were applied onto a 1cm² piece of filter paper which was transferred into a 20 ml syringe (Terumo, Guyancourt, France) allowing odorant delivery to the antennae. Half of the honeybees received thermal reinforcement when 2-octanone (odor A) was presented and no reinforcement when nonanal (odor B) was presented, while the reversed contingency was used for the other half of the bees. Both groups were conditioned along 16 trials (8 reinforced and 8 non-reinforced) in which odorants were presented in a pseudo-random sequence (e.g. ABBABAAB) starting with odorant A or B in a balanced way across animals. The inter-trial interval (ITI) was 10 min. Each conditioning trial lasted 36 s. The bee was placed in the stimulation site in front of the air

extractor, and left for 18 s before being exposed to the odorant paired with the US. Each odorant (CS+ or CS-) was delivered manually for 4 s. The thermal stimulus started 3 s after odorant onset and finished with the odorant (1 s temperature stimulation). The bee was then left in the setup for 14 s and was then removed. The temperature of 65°C was chosen for the US because this stimulation induced a high rate of SER in the previous experiments. One group of 16 bees was tested daily.

HsTRPA involvement in thermal Sting Extension Response

We investigated the putative involvement of the thermal/chemical sensor HsTRPA in heat sensitivity as measured by sting extension. To this end, we evaluated the effects of HsTRPA activators and inhibitors. In a first experiment, we asked if topical application of a chemical HsTRPA activator directly triggers SER, as a thermal stimulation does. Kohno et al. (2010) isolated 3 exogenous molecules able to activate this channel: allyl isothiocyanate (AITC), cinnamaldehyde (CA) and camphor (Sigma Aldrich, Deisenhofen, Germany). These compounds were applied with a soaked toothpick on the bees' mouthparts at two concentrations per drug in distilled water: AITC (1 mM and 100 mM), CA (1 mM and 100 mM), camphor (3mM and 300 mM). As controls, thermal stimulation (65°C) as above and a toothpick soaked with distilled water (vehicle) were applied to the mouthparts. Activator solutions and controls were provided in a randomized order with a 10 min interval. Two groups of 18 bees divided in 3 subgroups for each activator were tested each day.

We also evaluated the effect of injections of HsTRPA inhibitors on SER triggered by heat. A small hole was pricked into the cornea of the median ocellus to allow the insertion of a 1µl microsyringe (Hamilton company, Reno, Nevada, USA). Different groups of bees were injected with 1µl Ringer solution, menthol in Ringer, or ruthenium red (RuR) in Ringer (Sigma Aldrich, Deisenhofen, Germany). Two concentrations were tested for each drug: menthol (0.5 mM and 5 mM), RuR (0.1 mM and 1 mM). One hour after the injections (Kohno et al., 2010), bees received a thermal stimulation (65°C) and a tactile control on the mouthparts, in a randomized order for each bee. Stimulations were performed at 10 min intervals.

To further explore the effect of HsTRPA inhibitors on aversive and appetitive responsiveness, bees were injected with the highest inhibitor concentrations (RuR 5 mM; menthol 1 mM) 1h before assessing their thermal or sucrose responsiveness. Thermal responsiveness was measured as in Junca et al. (2014). Bees received a succession of six stimulations of increasing temperature (from ambient temperature ~25°C to 75°C), in steps of 10°C. Thermal stimulations alternated with tactile controls, provided as above with an identical unheated probe. Stimulations were applied during 1 s and the bees' SER was noted. Sucrose responsiveness was measured following the protocol described in Scheiner et al. (2003). Bees were presented sucrose solutions of increasing concentration following an exponential progression (0%, 0.1%, 0.3%, 1%, 3%, 10%, 30% w/w). Sucrose stimulations were alternated with water controls. Sucrose and water stimulations were provided with a soaked toothpick

to the bees' two antennae simultaneously, and the PER (extension or not of the proboscis) was noted. In both thermal and sucrose responsiveness experiments each trial lasted 38 s. The bee was placed in the setup, and left for 20 s before the stimulus application started. The sucrose, thermal or controls stimulation lasted for 1 s to both antennae for sucrose responsiveness or the mouthparts for heat responsiveness. The bee was then left in the setup for 17 s and was then removed. For a given bee, all stimulations were performed at 10 min intervals.

Statistical analysis

All recorded data were dichotomous, with a sting or proboscis extension being recorded as 1 and a non-extension as 0. When comparing the responses of the same bees to thermal and tactile stimulations on the different structures composing the heat sensory map, pairwise McNemar comparisons were used. Differences in thermal or in tactile responses among body structures were assessed using a χ^2 test. When comparing responses to thermal or tactile stimuli across wider areas (lateralization, core/periphery, body parts), χ^2 tests were used. For pairwise comparisons, as body parts were composed of three structures (head, thorax, abdomen), each structure was involved in two comparisons. A Bonferroni correction for multiple comparisons was thus applied, and the significance threshold was $\alpha_{\text{corr}} = 0.05 / 2 = 0.025$. When analyzing within group the effect of topical applications of HsTRPA activators, McNemar tests were used to compare drug application to water control. To compare between groups the responses of bees injected with HsTRPA inhibitors or vehicle, Fisher's exact test were used. As three groups were involved, the significance threshold was corrected for multiple comparisons as $\alpha_{\text{corr}} = 0.025$. To analyze thermal and sucrose responsiveness curves or aversive conditioning curves, we used repeated measure ANOVAs with *stimulus* (thermal vs tactile, sucrose vs water or CS+ vs CS-) and *trial* as repeated factors. For aversive conditioning, following standard procedures, only bees which responded to the US at least 3 times in the course of acquisition were kept for analysis (vertex: 2% ; 3-4 sternites: 29%). To test the effect of inhibitors on *thermal* and *sucrose responsiveness*, thermal or sucrose response curves were compared using repeated measure ANOVAs with *drug* as a between-group factor. Monte Carlo studies have shown that it is permissible to use ANOVA on dichotomous data only under controlled conditions, which are met in these experiments (Lunney 1970). Statistical tests were performed with STATISTICA 5.5 (Statsoft, Tulsa, USA).

References

- Bitterman, M. E., Menzel, R., Fietz, A., & Schäfer, S. (1983). Classical conditioning of proboscis extension in honeybees (*Apis mellifera*). *Journal of Comparative Psychology*, 97(2), 107.
- de Brito Sanchez, M. G., Chen, C., Li, J., Liu, F., Gauthier, M., & Giurfa, M. (2008). Behavioral studies on tarsal gustation in honeybees: sucrose responsiveness and sucrose-mediated olfactory conditioning. *Journal of Comparative Physiology A*, 194(10), 861-869.

- Carcaud, J., Roussel, E., Giurfa, M., & Sandoz, J. C. (2009). Odour aversion after olfactory conditioning of the sting extension reflex in honeybees. *Journal of Experimental Biology*, 212(5), 620-626.
- Clapham, D. E., Runnels, L. W., & Strübing, C. (2001). The TRP ion channel family. *Nature Reviews Neuroscience*, 2(6), 387-396.
- Clapham, D. E. (2003). TRP channels as cellular sensors. *Nature*, 426(6966), 517-524.
- Corballis, M. C. (1998). Cerebral asymmetry: motoring on. *Trends in cognitive sciences*, 2(4), 152-157.
- Eisner, T., & Camazine, S. (1983). Spider leg autotomy induced by prey venom injection: An adaptive response to "pain"? *Proceedings of the National Academy of Sciences*, 80(11), 3382-3385.
- Fredericq, L. (1883). Sur l'autotomie ou mutilation par voie réflexe comme moyen de défense chez les animaux. *Archives de zoologie expérimentale et générale*, 1(2e série), 413.
- Giurfa, M., & Sandoz, J. C. (2012). Invertebrate learning and memory: fifty years of olfactory conditioning of the proboscis extension response in honeybees. *Learning & Memory*, 19(2), 54-66.
- Grueber, W. B., Ye, B., Yang, C. H., Younger, S., Borden, K., Jan, L. Y., & Jan, Y. N. (2007). Projections of Drosophila multidendritic neurons in the central nervous system: links with peripheral dendrite morphology. *Development*, 134(1), 55-64.
- Hamada, F. N., Rosenzweig, M., Kang, K., Pulver, S. R., Ghezzi, A., Jegla, T. J., & Garrity, P. A. (2008). An internal thermal sensor controlling temperature preference in Drosophila. *Nature*, 454(7201), 217-220.
- Hammer, M. (1993). An identified neuron mediates the unconditioned stimulus in associative olfactory learning in honeybees. *Nature*, 366, 59.
- Himmer, A. (1927). Ein Beitrag zur Kenntnis des Wärmehaushalts im Nestbau sozialer Hautflügler. *Journal of Comparative Physiology A: Neuroethology, Sensory, Neural, and Behavioral Physiology*, 5(2), 375-389.
- Hwang, R. Y., Zhong, L., Xu, Y., Johnson, T., Zhang, F., Deisseroth, K., & Tracey, W. D. (2007). Nociceptive neurons protect Drosophila larvae from parasitoid wasps. *Current Biology*, 17(24), 2105-2116.
- Im, S. H., & Galko, M. J. (2012). Pokes, sunburn, and hot sauce: Drosophila as an emerging model for the biology of nociception. *Developmental Dynamics*, 241(1), 16-26.
- Junca, P., Carcaud, J., Moulin, S., Garnery, L., & Sandoz, J. C. (2014). Genotypic Influence on Aversive Conditioning in Honeybees, Using a Novel Thermal Reinforcement Procedure. *PloS one*, 9(5), e97333.
- Jung, J. W., Park, K. W., Ahn, Y. J., & Kwon, H. W. (2015). Functional characterization of sugar receptors in the western honeybee, *Apis mellifera*. *Journal of Asia-Pacific Entomology*, 18(1), 19-26.
- Koeniger N. (1978). Das Wärmeverhalten der Brut bei der Honigbiene (*Apis mellifera* L.). *Apidologie*, 9:305–320.
- Kohno, K., Sokabe, T., Tominaga, M., & Kadowaki, T. (2010). Honey bee thermal/chemical sensor, AmHsTRPA, reveals neofunctionalization and loss of transient receptor potential channel genes. *The Journal of Neuroscience*, 30(37), 12219-12229.

- Kwon, Y., Shen, W. L., Shim, H. S., & Montell, C. (2010). Fine thermotactic discrimination between the optimal and slightly cooler temperatures via a TRPV channel in chordotonal neurons. *The Journal of Neuroscience*, *30*(31), 10465-10471.
- Lee Y., Lee Y., Lee J., Bang S., Hyun S., Kang J., Hong S.T., Bae E., Kaang B.K., & Kim J. (2005) Pyrexia is a new thermal transient receptor potential channel endowing tolerance to high temperatures in *Drosophila melanogaster*. *Nature Genetic*, *37*:305-310.
- Lindauer, M. (1954). Temperaturregulierung und Wasserhaushalt im Bienenstaat. *Zeitschrift für vergleichende Physiologie*, *36*(4), 391-432.
- Lunney, G.H. (1970). Using analysis of variance with a dichotomous dependent variable: an empirical study. *J. Educ. Meas.* *7*, 263–269. doi:10.1111/j.1745- 3984.1970.tb00727.x
- Maginnis, T. L. (2008). Autotomy in a stick insect (Insecta: Phasmida): predation versus molting. *Florida Entomologist*, *91*(1), 126-127.
- Marshall, J. (1935). On the sensitivity of the chemoreceptors on the antenna and fore-tarsus of the honey-bee, *Apis mellifica* L. *Journal of Experimental Biology*, *12*(1), 17-26.
- Matsuura, H., Sokabe, T., Kohno, K., Tominaga, M., & Kadowaki, T. (2009). Evolutionary conservation and changes in insect TRP channels. *BMC evolutionary biology*, *9*(1), 228.
- Menzel, R. (1999). Memory dynamics in the honeybee. *Journal of Comparative Physiology A*, *185*(4), 323-340.
- Montell, C., Jones, K., Hafen, E., & Rubin, G. (1985). Rescue of the *Drosophila* phototransduction mutation *trp* by germline transformation. *Science*, *230*(4729), 1040-1043.
- Neely, G. G., Hess, A., Costigan, M., Keene, A. C., Goulas, S., Langeslag, M., ... & Penninger, J. M. (2010). A genome-wide *Drosophila* screen for heat nociception identifies $\alpha 2\delta 3$ as an evolutionarily conserved pain gene. *Cell*, *143*(4), 628-638.
- Neely, G. G., Keene, A. C., Duchek, P., Chang, E. C., Wang, Q. P., Aksoy, Y. A., ... & Penninger, J. M. (2011). *TrpA1* regulates thermal nociception in *Drosophila*. *PloS one*, *6*(8), e24343.
- Pavlov IP. (1927). Conditioned Reflexes: An Investigation of the Physiological Activity of the Cerebral Cortex. *London: Oxford Univ. Press*
- Rescorla, R. A. (1988). Pavlovian conditioning: It's not what you think it is. *American Psychologist*, *43*(3), 151.
- Roussel, E., Carcaud, J., Sandoz, J. C., & Giurfa, M. (2009). Reappraising social insect behavior through aversive responsiveness and learning. *PLoS One*, *4*(1), e4197.
- Sandoz, J. C., Hammer, M., & Menzel, R. (2002). Side-specificity of olfactory learning in the honeybee: US input side. *Learning & Memory*, *9*(5), 337-348.
- Scheiner, R., Page, R. E., & Erber, J. (2004). Sucrose responsiveness and behavioral plasticity in honey bees (*Apis mellifera*). *Apidologie*, *35*(2), 133-142.
- Tracey, W. D., Wilson, R. I., Laurent, G., & Benzer, S. (2003). *painless*, a *Drosophila* gene essential for nociception. *Cell*, *113*(2), 261-273.

Ugajin, A., Kiya, T., Kunieda, T., Ono, M., Yoshida, T., & Kubo, T. (2012). Detection of neural activity in the brains of Japanese honeybee workers during the formation of a “hot defensive bee ball”. *PloS one*, 7(3).

Vallortigara, G., & Rogers, L. J. (2005). Survival with an asymmetrical brain: advantages and disadvantages of cerebral lateralization. *Behavioral and brain sciences*, 28(4), 575-588.

Vergoz, V., Roussel, E., Sandoz, J. C., & Giurfa, M. (2007). Aversive learning in honeybees revealed by the olfactory conditioning of the sting extension reflex. *PLoS One*, 2(3), e288.

Voets, T., Talavera, K., Owsianik, G., & Nilius, B. (2005). Sensing with TRP channels. *Nature chemical biology*, 1(2), 85-92.

Yokohari, F. (1983). The coelocapitular sensillum, an antennal hygro- and thermoreceptive sensillum of the honey bee, *Apis mellifera* L. *Cell and tissue research*, 233(2), 355-365.

Zhong, L., Hwang, R. Y., & Tracey, W. D. (2010). Pickpocket is a DEG/ENaC protein required for mechanical nociception in *Drosophila* larvae. *Current Biology*, 20(5), 429-434.

Chapitre III

Comparaison entre performances
appétitive et aversive à l'échelle
individuelle et des lignées paternelles :
esquisse d'une communauté cognitive

Genotypic trade-off between appetitive and aversive capacities in a cognitive community: the honeybee hive

Pierre Junca, Lionel Garnery and Jean-Christophe Sandoz

Abstract

In honey bees, two olfactory conditioning protocols allow the study of appetitive and aversive Pavlovian associations. Appetitive conditioning of the proboscis extension response (PER) involves associating an odor, the conditioned stimulus (CS) with a sucrose solution, the unconditioned stimulus (US). Conversely aversive conditioning of the sting extension response (SER) involves associating the odor CS with an electric or thermal shock US. We compared appetitive and aversive learning abilities and found that within hedonic modalities (appetitive or aversive) learning success rely on individual responsiveness to the related stimulus. However, cross modalities comparison revealed antagonistic relationship, the more an individual is efficient in one modality, the less it will be in the other one. More specifically, this relationship is shaped on an hedonistic trade off. The honey bee hive genetic structure, derived from the monogyny polyandrous reproductive system, enable to assess the impact of the fathers genotype on such cognitive abilities distribution. Through microsatellite analysis, we highlighted that a genetic determinism underlie the trade-off between appetitive and aversive capacities. The honey bee hive thus appear as a cognitive community genetically structured.

Keywords: aversive learning, appetitive learning, olfactory learning, genetic determinism

Introduction

Where to find food and how to avoid danger? These are two simple but critical questions animals need to answer for surviving in a wild environment. Individual experience plays a major role in solving these questions, since animals can learn to associate initially neutral environmental stimuli (odors, sounds, colors, etc.) with their upcoming consequences, both beneficial (appetitive) and noxious (aversive). Therefore, an important part of an individual's potential fitness resides in its genetically-determined appetitive and aversive learning abilities. This is particularly true for solitary species, in which individuals must be skilled in both types of tasks since they must provide alone for all of their needs. The emergence of sociality, multiple times in the course of evolution, has fundamentally changed this rule, because in a social group different abilities may be distributed among different members, giving rise to behavioral specialization. Such inter-individual differences are thought to be beneficial for a social groups' ecological success (Jeanson and Weidenmüller, 2014). In meerkats, for instance, particular individuals in the group are dedicated to the surveillance of the surroundings while others take care of the youth and still others forage for the group (Manser, 1999; Madden *et al.*, 2011). In noisy miners, different birds specialize in either defense against predators or in provisioning (Arnold *et al.*, 2005). Such behavioral specialization is even more conspicuous within social insect colonies, where division of labor among non-reproductive individuals is a hallmark of social lifestyle (Robinson *et al.* 1992, Traniello *et al.* 1997; Duarte *et al.*, 2001). At the proximal level, division of labor is commonly explained through self-organization based on individual behavioral rules that rely on inter-individual differences in responses to environmental stimuli (Beshers and Fewell, 2001; Duarte *et al.* 2011). The fixed-threshold model, in particular, assumes that specialization in a social group arises spontaneously from differences among individuals in their response threshold to stimuli associated with specific tasks (Bonabeau *et al.*, 1996; Page and Mitchell, 1998; Jeanson *et al.*, 2007). Generally, individuals with the lowest threshold will engage in the corresponding task, provoking a reduction in the intensity of the task-associated stimulus. Division of labor may thus appear through simple inter-individual differences in the response threshold to different signals.

Response thresholds do not only influence the propensity of individuals to perform a specific task, but they also control associative learning performances within different hedonic modalities, as shown in the honeybee *Apis mellifera*. In the appetitive conditioning of the Proboscis Extension Response (PER - Bitterman *et al.*, 1983; Giurfa and Sandoz, 2012), in which bees have to associate an odor with a sucrose reward, learning performances are strongly under the influence of individual response thresholds to sucrose (Scheiner *et al.*, 2001; Behrends and Scheiner, 2012). Thus, bees that are more sensitive (i.e. show a higher responsiveness) to sucrose display higher learning performances when associating an odor with sucrose. Likewise, in the aversive conditioning of the Sting Extension Response (SER), in which bees have to associate an odor with an electric shock or heat punishment

(Vergoz et al. 2007; Junca et al. 2014), learning performances are directly correlated with an individual's responsiveness to the aversive reinforcer (electric shock: Roussel et al. 2009; heat: Junca *et al.*, 2014). The self-organization theoretical account presented above predicts that within a social group, different individuals should display different response thresholds to appetitive and aversive stimuli, as they are related to different tasks, respectively food-associated tasks and defense-oriented tasks. Interestingly, at the population level, a trade-off has been observed between a hives' foraging activity and its defensive ability (Giray et al. 2000). Hives with a high foraging activity displayed low defense responses and vice versa. As this trade-off is thought to rely on a genetic background, one could expect to find a similar trade-off in individuals' aversive and appetitive abilities. While some individuals would be biased towards appetitive abilities (and would be comparably less skilled for aversive tasks) other individuals would be biased towards aversive abilities. This attractive hypothesis has seldom been tested directly and no demonstration of its validity exists yet.

In honeybees, a plethora of studies on bees' responsiveness to sucrose led to the idea that bees' sensitivity to sucrose was the main determinant of task allocation (Page *et al.*, 1998; Pankiw and Page, 1999; Scheiner *et al.*, 2001; Page *et al.* 2006). Evidence showing that sucrose responsiveness correlates with responsiveness to a number of other sensory stimuli initially supported this idea (e.g. tactile: Scheiner *et al.*, 2004; light: Erber *et al.*, 2006). However, the stimuli tested in these studies were mostly related to foraging-related tasks. More recently, Roussel *et al.* (2009) compared bees' responsiveness to sucrose with responsiveness to a stimulus unrelated to foraging, but rather belonging to the aversive hedonic modality: an electric shock. This study reported that sucrose responsiveness and electric shock responsiveness are not correlated, suggesting the existence of other determinants to bees' behavior (Roussel *et al.*, 2009). This study concluded that appetitive and aversive sensitivities belong to two independent behavioral modules, associated respectively to foraging-related and defense-related tasks. The lack of correlation observed by Roussel *et al.* (2009) could be taken for an invalidation of the hypothesis of a trade-off between appetitive and aversive abilities proposed above. However, these experiments were carried out on individuals of unknown age, which may have added a confounding variable in the analysis. Indeed, the sucrose response threshold varies with the bees' age (Pankiw and Page, 1999; Berhends *et al.*, 2007; Berhends and Scheiner, 2009) as does their sensitivity to aversive stimuli (electric shock: Hunt, 2007; Burrell and Smith, 1994). Therefore, controlling the bees' age may be critical for unraveling potential appetitive vs aversive trade-offs among individuals.

A major question that arises from threshold models of self-organization and the data presented above concerns the genetic substrate underlying such differences in sensory thresholds among individuals. The monogynous and polyandrous reproductive system of honeybees provides a good opportunity for studying this question. In a honeybee colony, the diploid queen mates on average with fifteen haploid males (Estoup et al. 1994). Therefore, the workers, her daughters, belong to about fifteen different patriline with different genetic backgrounds within the hive. Workers' patriline origin

has an impact on task allocation as observed on brood care, foraging and defensive behavior (Page and Robinson, 1989). In addition, it is known to have an impact on sensory responsiveness and learning performances. In the aversive modality, we showed recently that bees from different patriline have different thermal response thresholds and show accordingly different aversive learning performances with this reinforcement (Junca et al. 2014). In the appetitive modality, differences in learning performances among patriline are suspected (Laloi and Pham-Delègue, 2010), especially because sucrose response thresholds vary among them (Scheiner and Arnold, 2010). So far, the study of genotypic determinism on responsiveness and learning has been studied independently within the appetitive or within the aversive modality. Therefore, a possible trade-off in aversive vs appetitive learning abilities among different patriline is utterly unknown.

In the present study, we asked how sensitivity and learning capacity in appetitive and aversive modalities are distributed among individuals composing a honeybee colony, in particular with regards to their patriline of origin. Performing the experiments on age-controlled individuals, we found a clear trade-off between aversive and appetitive abilities at the individual level. This aversive vs appetitive trade-off appeared also when taking into account the bees' patriline. These results suggest that within a eusocial insect colony workers are predetermined to compose an equilibrium of cognitively-specialized individuals, giving rise to a complex but highly-adaptable cognitive community.

Results

To assess how appetitive and aversive sensitivities and learning performances are related, series of four experiments were carried out on age-controlled (two weeks old) honey bee workers. Half of the bees went through an appetitive evaluation day followed by an aversive one, and the other half underwent the reversed schedule. The appetitive evaluation day comprised a *sucrose responsiveness* procedure followed by a *PER conditioning* procedure. Analogously, the aversive evaluation day comprised a *heat responsiveness* procedure followed by a thermal *SER conditioning* procedure. In the *responsiveness* procedures, bees received appetitive (sucrose) or aversive (temperature) stimuli of increasing intensity alternated with control stimulations (water and tactile respectively). In the *conditioning* procedures, bees were subjected to a differential conditioning protocol in which they had to differentiate between a reinforced odor (CS+) and a non-reinforced odor (CS-). For appetitive learning, the CS+ was associated with a sucrose reward and for aversive learning, the CS+ was associated with a temperature punishment. Bees received 8 CS+ and 8 CS- trials in a pseudorandomized order with 10 min inter-trial intervals. For appetitive procedures, the bees' PER were measured, while for aversive procedures, the SER were measured.

Responsiveness to appetitive and aversive stimulations.

In the *heat responsiveness* experiment (Fig. 1A), bees' SER increased significantly with increasing temperature (from 17% to 96%, ANOVA for repeated measurements: $F_{5, 1125}=148.7$, $p<0.001$). In contrast, responses to alternated tactile stimulus applications remained stable throughout the experiment (between 12% and 13%, $F_{5, 1125}=2.07$, NS). Accordingly, responses to heat stimuli increased more quickly than control stimulations throughout the procedure (*stimulus x concentration* interaction, $F_{5, 1125}=106.48$, $p<0.001$). In the *sucrose responsiveness* experiment (Fig. 1B), bees' PER increased significantly with increasing sucrose concentration (from 13% to 95%, $F_{6, 1350}=180.13$, $p<0.001$). A response increase was also noticed in the control water stimulations (from 13% to 38%, $F_{6, 1350}=180.13$, $p<0.001$) but on a smaller scale. Sucrose responses increased more quickly than control stimulations throughout the experiment (*stimulus x concentration* interaction, $F_{6, 1350}=59.5$, $p<0.001$).

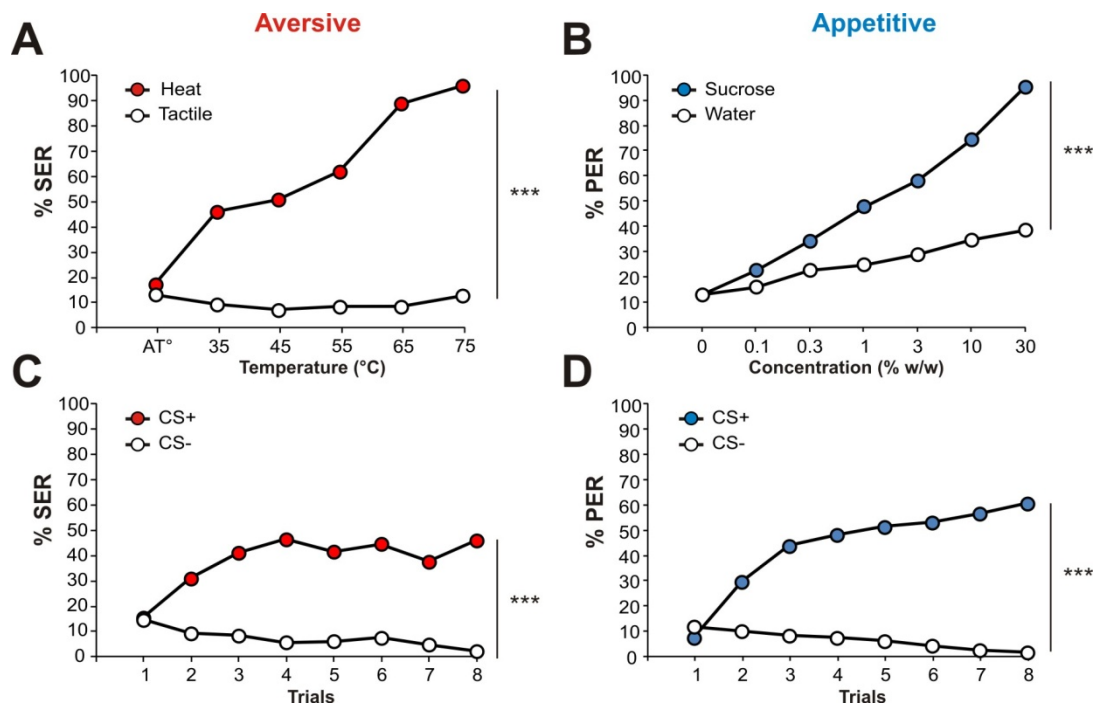

Figure 1: Responsiveness and learning protocols for appetitive and aversive hedonic modalities performed on the same individuals (n = 226). **A)** Heat responsiveness. Red circles, %SER to a series of increasing temperatures; white circles, %SER of the same bees to the presentation of a tactile stimulus (control). **B)** Sucrose responsiveness. Blue circles, %PER to a series of sucrose solutions of increasing concentration; white circles, %PER of the same bees to the presentation of water (control). **C)** Differential aversive conditioning of the SER. Red circles, %SER to the CS+ (reinforced odor) along the 8 trials; white circles, %SER to the CS- (non-reinforced odor). **D)** Differential appetitive conditioning of the PER. Blue circles, %PER to the CS+ along the 8 trials; white circles, %PER to the CS-. (***: $p < 0.001$, AB; *stimulus x concentration* or CD: *stimulus x trial* interaction).

Appetitive and aversive conditioning performances.

Bees learned both appetitive and aversive tasks effectively. In the aversive learning protocol (Fig. 1C), bees' SER to the reinforced (CS+) odorant increased significantly (from 15% to 46%, $F_{7, 1575}=20.8$, $p < 0.001$), while their responses to the non-reinforced odorant (CS-) decreased ($F_{7, 1575}=7.80$, $p < 0.001$). Consequently, bees' responses to the CS+ and CS- developed differently (*stimulus x trial* interaction: $F_{7, 308} = 5.07$, $p < 0.001$). In the appetitive learning protocol (Fig. 1D), bees' PER to the CS+ increased along trials (from 8% to 61%, $F_{7, 1575}=98.7$, $p < 0.001$) while responses to the CS- decreased ($F_{7, 1575}=5.87$, $p < 0.001$). Overall, bees managed to differentiate between the two conditioned stimuli ($F_{7, 1575}=91.1$, $p < 0.001$).

Data obtained in responsiveness and learning experiments for aversive and appetitive modalities were consistent with previous studies performed separately on these two modalities (Scheiner et al., 2003; Junca et al., 2014).

Appetitive and aversive relationships at the individual level

To study the relationships between responsiveness and learning performances within each hedonic modality or between the two modalities, we calculated individual scores (Roussel et al. 2009; Junca et al., 2014). *Responsiveness* scores consisted in the sum of responses to sucrose stimuli or to heat stimuli in each procedure. Similarly, learning scores were calculated as the sum of PER or SER responses to the CS+ along trials for appetitive and aversive learning protocols respectively. Previous work showed clearly that individual learning performance and responsiveness to the reinforcing stimulus are strongly correlated both in the aversive modality (electric shock: Roussel et al., 2009; heat: Junca et al., 2014) and in the appetitive modality (sucrose: Scheiner et al., 1999; Scheiner et al., 2003; Scheiner et al., 2005). But are these relationships noticeable when experiments are performed on the same individuals? In full agreement with previous work, we found strong and significant correlations between heat responsiveness and aversive learning performance (Fig. 2A; Spearman correlation, $\rho = 0.94$, $p < 0.01$) and between sucrose responsiveness and appetitive learning performance (Fig. 2B; $\rho = 0.96$, $p < 0.001$).

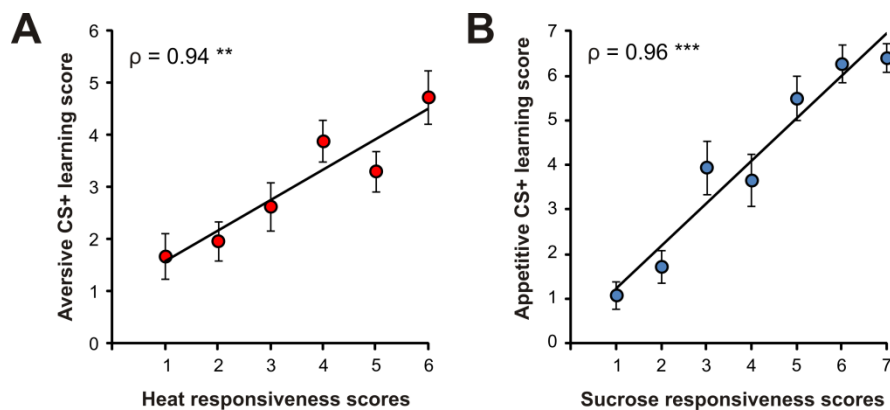

Figure 2: Relationship between responsiveness and learning performances within appetitive and aversive modalities. **A)** Correlation between heat responsiveness scores and aversive learning scores in the same bees. Scores varied from 1 (1 response to stimuli tested in the series) to 6 (responses to all six stimuli of the series) for heat responsiveness scores and from 0 (no response to the CS+ at any trials) to 8 (always respond to the CS+). Individuals were grouped according to their heat responsiveness scores. **B)** Correlation between sucrose responsiveness scores and appetitive learning performance scores in the same bees. Scores varied from 1 (1 response to stimuli tested in the series) to 7 (responses to all six stimuli of the series) for sucrose responsiveness scores and from 0 (no response to the CS+ in any trials) to 8 (always respond to the CS+). Individuals were grouped according to their sucrose responsiveness score (**: $p < 0.01$; ***: $p < 0.001$, $n = 226$).

Measuring appetitive and aversive scores in the same individuals provided us the opportunity to compare responsiveness and learning performances between hedonic modalities. To do that, individual bees can be grouped either according to aversive scores or to appetitive scores. Figure 3 presents both possibilities (aversive grouping: Fig. 3A-C; appetitive grouping: Fig. 3B-D). We found a clear negative correlation between appetitive and aversive *responsiveness* scores, which was present

both when grouping individuals according to heat responsiveness scores (Fig. 3A: $\rho = -0.86$; $p < 0.05$) or to sucrose responsiveness scores (Fig. 3B: $\rho = -0.94$; $p < 0.01$). When comparing appetitive and aversive *learning* scores, we observed a significant negative correlation when grouping individuals according to appetitive learning scores (Fig. 3D: $\rho = -0.77$; $p < 0.05$) but the relation was not significant when grouping bees according to aversive learning scores (Fig. 3C: $\rho = -0.47$; $p = 0.21$). The apparent scattering of appetitive scores in this last graph was due to uneven data distribution among the different aversive scores (from 6 to 90 bees per score). To solve this ambiguity, a Factor Analysis (FA), which does not require grouping data according to one or the other modality, was performed. The four variables (heat responsiveness, sucrose responsiveness, appetitive learning and aversive learning scores) were best explained by 2 main factors (73.1% of overall variance, Fig. 3E). Factor 1 (45.6% overall variance) clearly segregated the hedonic modalities, with appetitive responsiveness and learning scores corresponding to positive values on Factor 1 while aversive scores corresponded to negative values. The coordinates of individual bees on this axis correlated positively with appetitive variables (responsiveness: $\rho = 0.63$; $p < 0.001$; learning: $\rho = 0.60$; $p < 0.001$) and negatively with aversive variables (responsiveness: $\rho = -0.37$; $p < 0.001$; learning: $\rho = -0.30$; $p < 0.001$). Accordingly, the bees that had the lowest loading on Factor 1 (<10th percentile) showed high aversive scores and weak appetitive scores. Conversely, bees that had the highest loading on Factor 1 (>90th percentile) showed high appetitive scores and weak aversive scores. Factor 2 (27.5% variance) was positively correlated with both aversive and appetitive modalities (aversive responsiveness: $\rho = 0.49$; $p < 0.001$; aversive learning: $\rho = 0.55$; $p < 0.001$; appetitive responsiveness: $\rho = 0.24$; $p < 0.001$; appetitive learning: $\rho = 0.27$; $p < 0.001$), and represented the general response magnitude of bees over all scores. Thus, bees below the 10th percentile on Factor 2 showed generally low scores while bees above the 90th percentile displayed high scores. This analysis shows that bees' behavior could be defined primarily as a hedonic bias (Factor 1) and secondarily as a general response magnitude (Factor 2). These data thus demonstrate the opposite relationship existing at the individual level between appetitive and aversive performances. We next evaluated whether these relationships rely on a genotypic determinism.

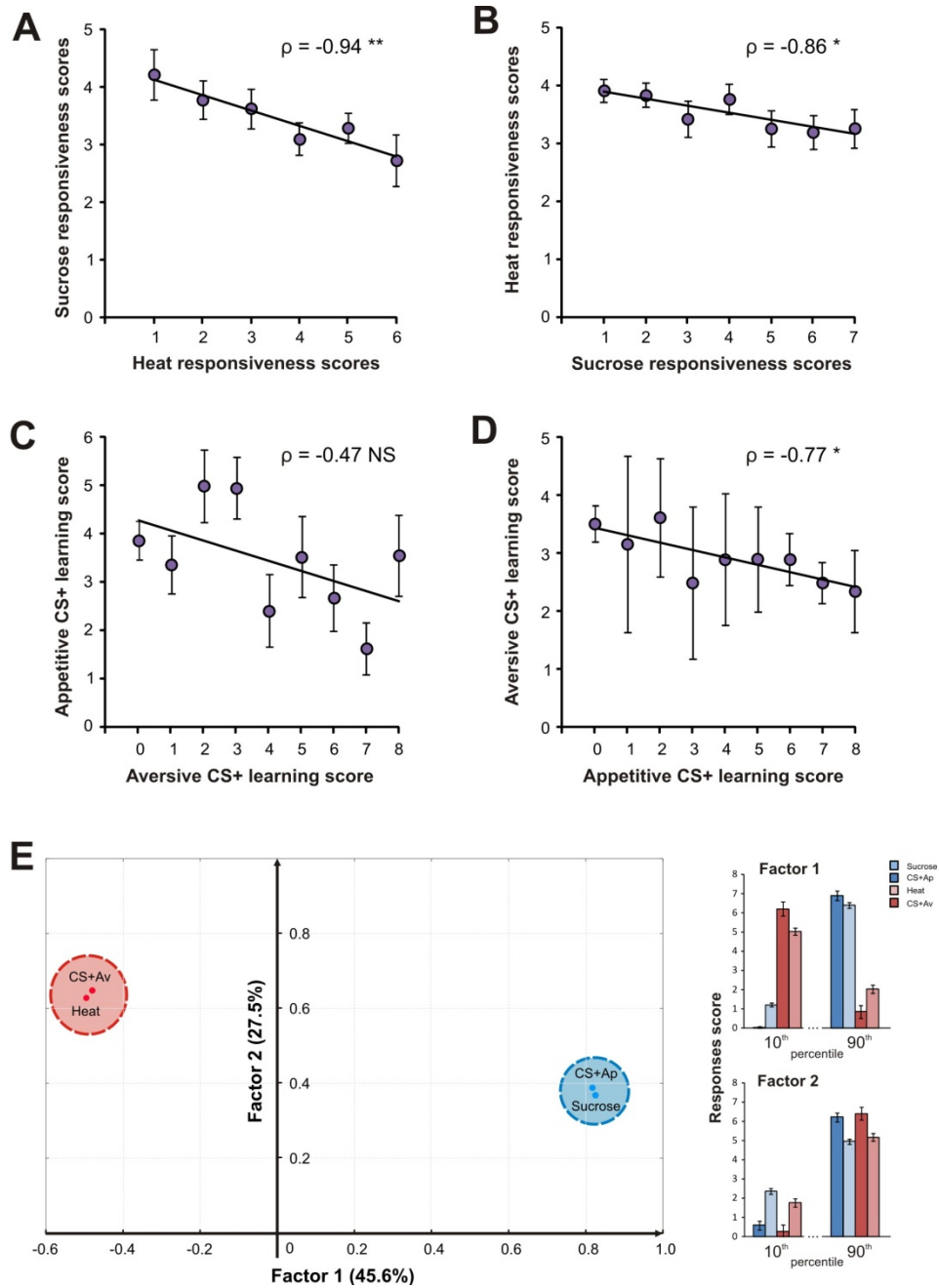

Figure 3 (next page): Relationship between appetitive and aversive performances at the individual level. **A,B)** Relationship between heat responsiveness and sucrose responsiveness scores. Bees were grouped according to either heat responsiveness scores (**A**) or sucrose responsiveness scores (**B**). **C,D)** Relationship between appetitive and aversive learning scores. Bees were grouped according to either aversive learning scores (**C**) or appetitive learning score (**D**). **E)** Left panel: factor analysis on the 4 response scores (sucrose responsiveness, CS+Ap: appetitive learning score, heat responsiveness, CS+Av: aversive learning score) measured in 226 individuals. Two main factors with eigenvalues higher than 1 are extracted. Factor 1 (45.6% variance) shows a clear opposite relationship between appetitive and aversive variables. Factor 2 (27.5% variance) is related to differences in average response magnitude among individuals. Right panel: response scores of the first and last 10% of the distribution of individuals on Factor 1 (top) or Factor 2 (bottom). (*: $p < 0.05$; **: $p < 0.01$, $n = 226$).

Appetitive and aversive learning at the patriline level

To evaluate whether responsiveness and learning performance relationships are influenced by the bees' genotype, we used a microsatellite analysis and determined each worker's patriline. From the initial 226 individuals from 2 colonies, we obtained 25 patrilines containing between 3 and 28 individuals. For assessing patriline performance scores accurately, we only used data from the 11 patrilines which contained more than 8 individual bees. The bees' responsiveness and learning scores in both modalities were pooled according to each worker's patriline (Fig. 4). Within each modality, we found that patrilines that were highly responsive to thermal stimuli also presented high aversive learning performances and *vice versa* (Fig. 4A, $\rho = 0.82$; $p < 0.01$). Similarly, patrilines with a high sucrose responsiveness score presented a high appetitive leaning score and *vice versa* (Fig. 4B, $\rho = 0.65$; $p < 0.05$). This confirms at the genotype level, the relationships observed above between responsiveness and learning within each modality.

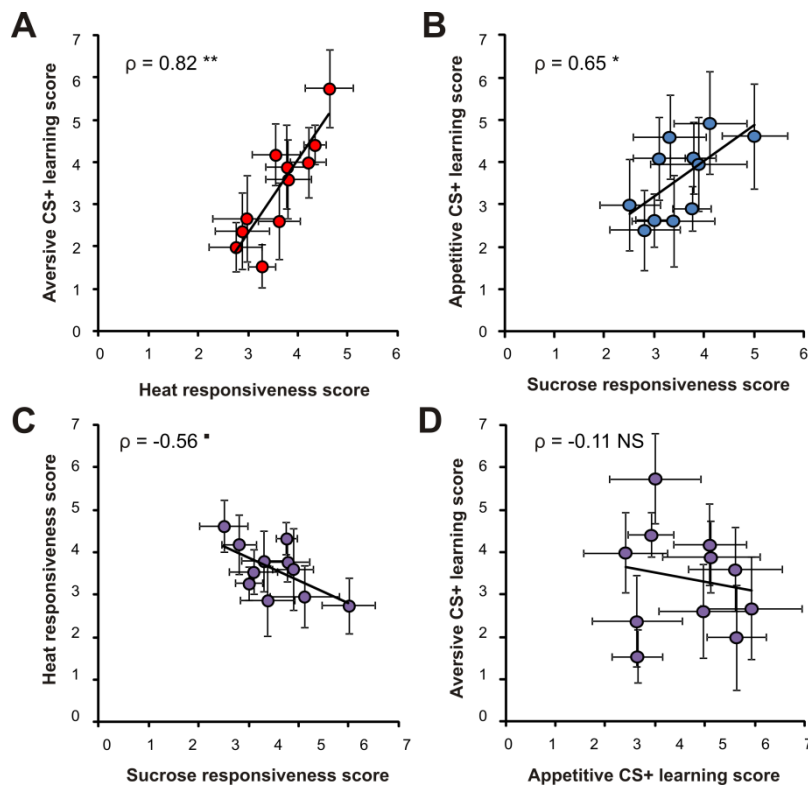

Figure 4: Patriline influence on the relationship between aversive and appetitive performances. Individual scores are grouped according to each worker's patriline. **A)** Correlation between heat responsiveness and aversive learning scores among patrilines. **B)** Correlation between sucrose responsiveness and appetitive learning performance scores among patrilines. **C)** Relationship between heat responsiveness and sucrose responsiveness scores at the patriline level. **D)** Relationship between appetitive and aversive learning performance scores at the patriline level. ((*): $p = 0.07$, *: $p < 0.05$, **: $p < 0.01$; $n = 11$ patrilines).

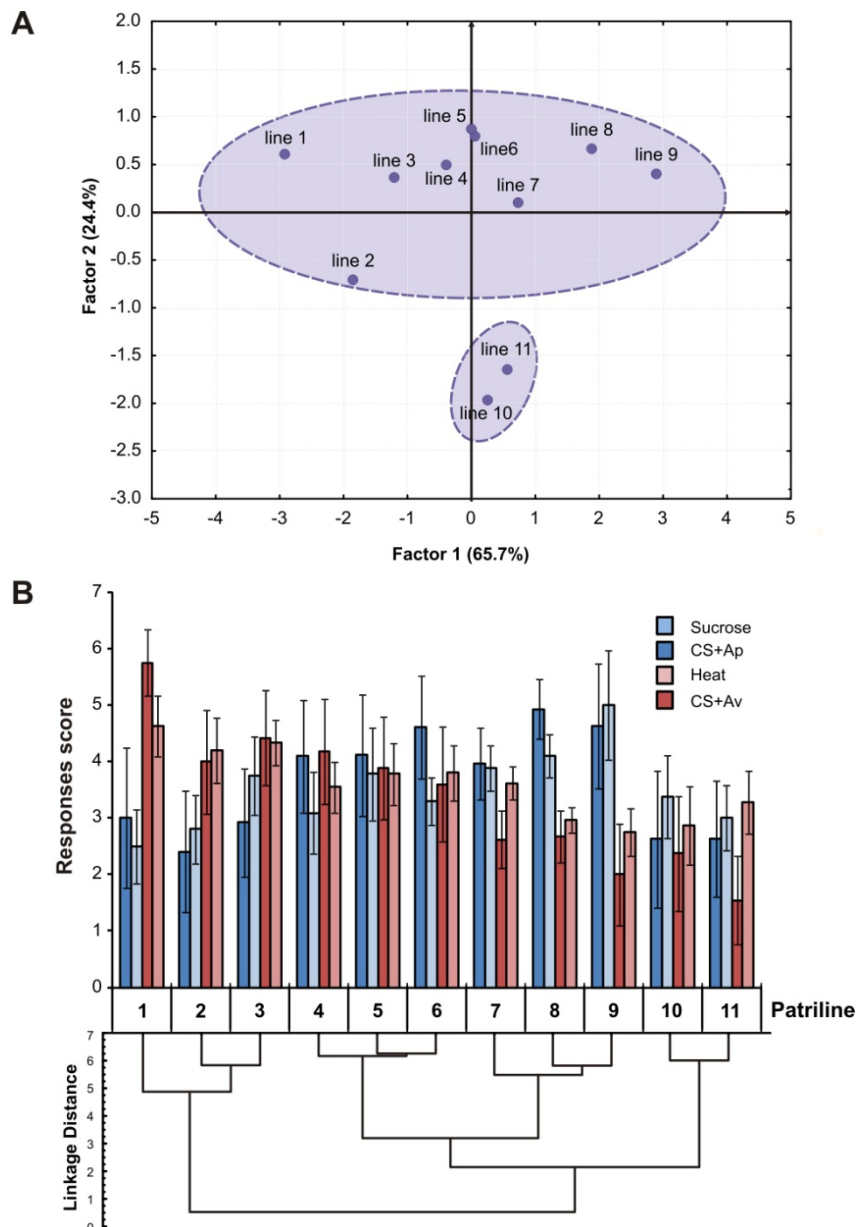

Figure 5: Multivariate analyses of appetitive and aversive performances at the patriline level. A) Factor analysis presenting each patriline according to 2 main factors. Factor 1 is a hedonic bias factor, equivalent to Factor 1 in Figure 3E. Patriline on the left show high responses scores in aversive procedures, while patriline on the right display stronger appetitive performances. Only two patriline contribute significantly to Factor 2 and exhibit weak scores in both appetitive and aversive procedures. **B)** Hierarchical clustering dendrogram (Ward’s method) showing for each patriline its average performance score: sucrose responsiveness (light blue), appetitive learning (CS+Ap, dark blue), heat responsiveness (light red), aversive learning (CS+Av, dark red).

When correlations were performed across aversive and appetitive modalities, we noticed a difference with observations at the individual level (Fig. 3C,D). Thus, the negative relationship between heat responsiveness and sucrose responsiveness scores was only near significant ($\rho=-0.56$, p

= 0.07) (Fig. 4C). Moreover, aversive and appetitive learning showed a rather scattered relationship and the correlation coefficient was not significant ($\rho=-0.11$; NS) (Fig. 4D). In theory, this apparent lack of consistency between data at the individual and at the patriline level (Fig 3CD vs Fig 4CD), could be explained by some patrilines behaving very differently from the rest. To understand this phenomenon, we subjected the data of our patriline data to a factor analysis (FA) and to a cluster analysis (Fig 5).

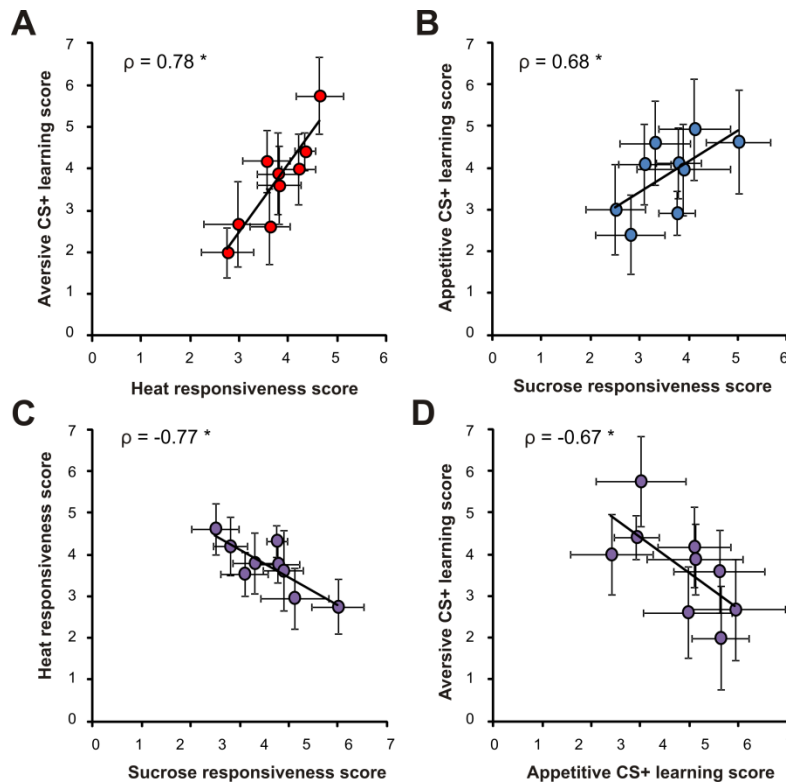

Figure 6: Patriline influence on the relationship between aversive and appetitive performances, without low-score patrilines. Individual scores are grouped according to each worker’s patriline. **A)** Correlation between heat responsiveness and aversive learning performance scores among patrilines. **B)** Correlation between sucrose responsiveness and appetitive learning performance scores among patrilines. **C)** Correlation between heat responsiveness and sucrose responsiveness scores. **D)** Correlation between appetitive and aversive learning performance scores. (*: $p < 0.05$, $n = 9$ patrilines).

These analyses confirmed our hypothesis and indicated the existence of two subgroups. First, the factor analysis extracted two main factors (Fig 5A, 90.1% of overall variance), which were the same factors that appeared at the individual level (Fig 3E). Factor 1 (65.7% variance) represented the hedonic bias, patrilines exhibiting high performances in aversive procedures and weak performances in appetitive procedures being located on the left of this axis and *vice versa* for patrilines located on the right (compare with Fig 5B). As above, Factor 2 (24.4% variance) represented general response magnitude. Two patrilines with generally low scores (lines 10 and 11) contributed 66.7% to this Factor, and were segregated from the other patrilines (lines 1 to 9). These two patrilines were also

clearly segregated by the cluster analysis (Fig 5B). As they did not follow the general response pattern, we further evaluated the relationship between aversive and appetitive scores without the contribution of patriline 10 and 11. This data selection did not modify the strong relationships between responsiveness and learning within each hedonic modality (Fig 6AB, aversive: $\rho = 0.78$; $p < 0.05$; appetitive: $\rho = 0.68$; $p < 0.05$). However, it allowed demonstrating at the patriline level the negative correlation existing between appetitive and aversive modalities. Thus, heat responsiveness was negatively correlated to sucrose responsiveness (Fig 6C, $\rho = -0.77$; $p < 0.05$) and aversive learning performance was negatively correlated to that in appetitive learning (Fig 6D, $\rho = -0.67$; $p < 0.05$). These negative correlations between hedonic modalities support the idea of some genetic specialization of patrilines in either appetitive or aversive abilities.

Discussion

In this study, we assessed responsiveness and learning performance in both appetitive and aversive hedonic modalities on the same, age-controlled, individuals. At the individual level, we confirmed within each modality that responsiveness to a given reinforcement (sucrose or heat) determines learning performance with this reinforcement (PER conditioning or SER conditioning). Moreover, we found a trade-off between appetitive and aversive modalities, so that performances within one modality were negatively correlated with those in the other. Using microsatellite analysis, we confirmed both within-modality and between-modality relationships on a patriline level, thus demonstrating the genetic influence underlying the appetitive / aversive trade-off within the colony. Our data also show however that a low proportion of the patrilines displays generally low scores in both hedonic modalities and do not follow the general trade-off.

A hedonic trade-off within the hive

Among the different models aimed at explaining the origin of division of labor, the response threshold model postulates that individuals differ in their response threshold to task-associated stimuli, and that based on these thresholds they will engage in one or another task (Beshers and Fewell, 2001; Duarte *et al.* 2011). The application of this model in honeybees led to the main postulate that sucrose responsiveness is the key determinant for individuals' task distribution within the hive (Page *et al.* 2006). Evidence showing that sucrose responsiveness correlates with responsiveness to a number of other sensory stimuli initially supported this idea (e.g. tactile: Scheiner *et al.*, 2004; light: Erber *et al.*, 2006). However, the tested stimuli were related to the context of foraging and all these observations described an appetitive behavioral syndrome. A recent comparison of bees' sucrose responsiveness with responsiveness to a stimulus belonging to the aversive hedonic modality (an electric shock) began

to undermine this model. Indeed, a relative independence was found between sucrose and electric shock responsiveness, suggesting the existence of an additional aversive behavioral syndrome within the hive (Roussel *et al.*, 2009). Our results, both at the individual and at the patriline level, go further and demonstrate the existence of a trade-off between bees' appetitive and aversive abilities. This result suggests that the honeybee colony is a cognitive community composed of specialized individuals displaying an appetitive or an aversive bias. The idea of possible interactions between appetitive and aversive skills in worker bees has been suggested early on because opposite tasks like foraging and colony defense are both undertaken by older bees (Breed *et al.*, 1990). Thus, according to the response threshold model, there should be differences among older bees in response thresholds to stimuli associated with each type of task. Our results obtained on 13-day old individuals, an age at which foragers may already engage in foraging or guarding (Seeley, 1982; Winston, 1987), provide explicit support for this idea. Older bees do indeed show widely different response thresholds to appetitive and aversive stimuli. How such differences give rise to actual task allocation within the hive will be the focus of future work. Previous studies already demonstrated that nectar foragers and guards differ in their responsiveness to both sucrose (Pacheco and Breed, 2008) and electric shock (Roussel *et al.*, 2009, equivalent to our heat stimulus). One could thus expect our bees with different hedonic biases to engage in different tasks, for instance foraging and guarding. However, direct predictions are difficult because task allocation is under the control of many environmental variables, including colony size, time of year, climatic conditions or food availability (Robinson, 1992). In addition, the observed relationship between sensory responsiveness and performed task does not appear to be as simple as stated by response threshold models. For instance, contrary to the prediction of these models, nectar foragers were found to be less sensitive to sucrose than guards (Pacheco and Breed, 2008), while guards are less sensitive to the electric shock than foragers (Roussel *et al.*, 2009). Indeed, nectar foragers and guards are particularly selective with regards to the stimulus intensities to which they should respond in nature, instead of being more sensitive. Such high selectivity may be adaptive for honeybees, when taking costs and benefits for the colony into account: nectar foragers would optimize this ratio by compensating the high flying costs by gathering only nectar at the highest sugar concentrations, while guards would optimize this ratio by triggering costly defensive responses only to the strongest aggressions (Page *et al.* 2006; Roussel *et al.* 2009). Given this apparent inconsistency between the predictions of threshold based models and task allocation in honeybees, it will be especially important to relate in future work the hedonic bias we have shown here with the actual propensity of workers to engage in foraging or guarding tasks.

Inter-individual differences in appetitive and aversive sensitivities

Our data show genetically-determined inter-individual differences in the bees' sensitivity to sucrose and thermal stimuli, which translate into differences in learning performances in both modalities. These discrepancies in sensory sensitivity between individuals may be based on neuroanatomical and/or neurophysiological differences and could involve multiple levels of the respective sensory pathways, from receptors at the periphery until neural circuits in the brain. Inter-individual differences in sucrose sensitivity, for instance, could happen because of different numbers and/or affinities of sucrose (AmGr1) receptors within gustatory neurons; different numbers of gustatory neurons present on the bees' antennae; different numbers of synaptic contacts of gustatory neurons with second-order neurons; different intensities of local inhibition in gustatory circuits; or any combination of these processes (De Brito Sanchez, 2011; Jung et al. 2014). For temperature detection, although much less is known at the moment, different sensitivities could also be due to different types/qualities of TRP channels at the periphery (possibly involving HsTRPA, Kohno et al. 2010) or to different neuron/circuit organizations at more central levels. Physiologically, inter-individual differences in appetitive or aversive sensitivities may also arise due to different neuromodulator levels. Biogenic amines, for instance, could be involved, as they play an orchestral role in the modulation of insect behavior (Pflüger and Libersat, 2004), most prominently in social insects (Rhami and Traniello, 2013). The biogenic amines octopamine and dopamine play an *instructive* role in appetitive and aversive learning in bees, by representing respectively the appetitive and the aversive US in the brain (Hammer and Menzel, 1998; Giurfa, 2006; Vergoz et al. 2007). This role is however limited to the associative learning event, but biogenic amines are thought to have wider-ranging roles, including the modulation of bees' responsiveness to sensory stimuli (Scheiner et al. 2002; Tedjakumala and Giurfa, 2014). It has been observed for instance that octopamine, tyramine and dopamine can modulate sucrose responsiveness (Scheiner et al. 2002). While injections of octopamine or tyramine *increase* bees' sucrose responsiveness, injections of dopamine or a dopamine receptor agonist *decrease* it. The effect of biogenic amines on sting responsiveness to thermal stimuli, as used here, has not been tested yet. However, recent data using pharmacological injections of amine receptor antagonists suggested that both serotonin and dopamine can reduce bees' responsiveness to an electric shock, while octopamine has no effect (Tedjakumala et al. 2014). In our case, different individuals may display discrepancies in biogenic amine levels which would translate into differences in their sensitivity to sucrose and to heat stimuli. It would thus be especially interesting in future work to evaluate whether our bees with lower sucrose responsiveness show lower octopamine/tyramine levels, and bees with lower heat responsiveness show higher serotonin levels, as predicted by the studies above (Scheiner et al. 2002; Tedjakumala and Giurfa, 2014).

The appetitive/aversive sensory trade-off

The most important finding of our study is that the sensitivities of bees toward appetitive and aversive stimuli are under the influence of a genotypic trade-off. Bees with a high sensitivity to sucrose tended to show a low sensitivity to thermal stimuli, and vice versa. How does such a trade-off come about? In theory, the hedonic trade-off could follow a monogenic determinism, if the responsible gene displayed a high allelic polymorphism and had pleiotropic effects on both appetitive and aversive sensitivities. In this case, different patrilineages would carry different alleles, giving rise to a continuous distribution of hedonic biases, from aversively-biased to appetitively-biased individuals, as observed here. For instance, a gene that would act positively on both tyramine (or octopamine) and serotonin levels could act on the hedonic bias. Increasing the levels of both amines would give rise to appetitively-biased bees (by increasing sucrose responsiveness and decreasing thermal responsiveness), while decreasing the levels of both amines would favor aversively-biased bees (Scheiner et al. 2002; Tedjakumala and Giurfa, 2014). It is however much more likely that the hedonic trade-off is under polygenic influence, as many quantitative traits actually depend on intricate networks of interacting genes (Chesler 2005; Crow, 2010). The genes responsible for the hedonic trade-off we have described may be related to previous QTL (Quantitative Trait Loci) identified in the honeybee genome and involved in variations of foraging (*pln1-4*, Hunt et al. 1995; Rueppel et al. 2004; Hunt et al. 2007a) or defensive behaviors (*sting1-3*, Hunt et al., 1998, 2007). Interestingly, genes associated with biogenic amine signaling have been identified within these QTL regions (Hunt et al. 2007). Thus, *pln2* contains *AmTyr1*, coding for the honeybee tyramine receptor (Blenau et al. 2000) and *sting3* contains *Am5HT₇*, coding for one of the honeybee serotonin receptors (Schlenstedt et al. 2006). Alternatively or in addition to the hypothesis of different biogenic amine levels mentioned above, bees' appetitive and aversive responsiveness may depend on different allelic forms of tyramine and serotonin receptors respectively. In any case, for the trade-off to appear, the genes supporting appetitive and aversive responsiveness need to engage in epistatic interactions. Genes supporting a high sucrose sensitivity would negatively affect processes involved in heat sensitivity, and vice versa. Such epistasis could happen at several levels, from direct gene interactions by transcription factors (Gerke et al. 2009) or RNA interference processes (Hannon, 2002; Aravin et al. 2004), or more indirectly, from interactions of the products of these genes with biosynthetic pathways and/or developmental processes. Such epistatic interactions are expected to be highly complex and intensive work will be needed for understanding the genotypic trade-off on a functional level. The present study thus paves the way for a long-term exploration of epistatic interactions between aversive and appetitive genetic pathways.

Patriline with low responsiveness in both modalities

We observed that two patriline (number 10 and 11) behaved quite differently from the rest of the colony and exhibited low responsiveness and hence weak learning scores in both appetitive and aversive modalities. One may wonder whether these patriline should be considered as unadapted individuals or on the contrary as another group of specialized individuals. Following the first hypothesis, the low responsiveness and learning performances found in both hedonic modalities could be due to deleterious mutations in the inseminating drones or to genetic incompatibility effects, as observed in the ant *Pogonomyrex rugosus* (Schwander and Keller, 2008). In this species, genetic interactions between maternal and paternal genomes lead to strong differences in the ants' ability to develop as a queen or as a worker. In our case, genetic incompatibilities could induce deleterious effects on bees' responsiveness in both modalities. Conversely, these patriline may correspond to bees playing a specific role in the hive. According to the response threshold models presented above (Bonabeau *et al.*, 1994), individuals that are not responsive to task-related signals will not engage in the respective tasks and may thus remain inactive. Many observations of task allocation within a honeybee hive have shown that a non-negligible proportion of the workers are indeed inactive for long periods of time (Kolmes, 1985; Winston, 1987; Robinson *et al.*, 1992). These bees are thought to stand as adjustment variables for the colony and to perform, when needed, the tasks that are either neglected by other group members or for which an insufficient number of individuals is currently recruited (Lindauer, 1952). Lastly, these patriline may be predetermined to fulfill tasks that require skills that are not related to appetitive or aversive responsiveness and are therefore not assessed with our method. Such individuals may include comb builders, undertakers or cell cleaners (Seeley *et al.*, 1982; Winston, 1987; Huang *et al.*, 1994).

The hedonic trade-off at the evolutionary level

It has been suggested that social insect colonies with a high genetic diversity are more adaptable than low-diversity colonies (Tarpay 2003; Page *et al.* 1995). Similarly, colonies with a high proportion of specialized individuals are thought to be more efficient than homogeneous colonies (Page *et al.*, 1989, Trumbo and Robinson, 1997; Langridge *et al.*, 2008). The hedonic specialization of patriline, as demonstrated here, may be an adaptive mechanism for honeybees, allowing them to respond efficiently to the ecological constraints surrounding the colony, both in terms of food availability and of prevalence of potential predators and parasites. At the individual level, the trade-off suggests that a high sensitivity and high learning performances in one hedonic modality come at the cost of a lower sensitivity and lower learning performances in the other. At the colony level, however, ecological success and fitness may be more related to the simultaneous presence of both strongly appetitively-biased and strongly aversively-biased workers. Therefore, the hedonic trade-off may have been selected over evolutionary times, possibly as a result of group selection (Wade, 1978). The theory of group selection predicts that evolution will favor traits in individuals that aid in maximizing

their group's success — which, in turn, are predicted to increase individuals' long-term evolutionary interests (Wilson, 1975; Wilson and Wilson, 2007). Recently group selection received strong support in a study on social spiders (Pruitt and Goodnight, 2014). In these spiders, colonies display a typical ratio of docile and aggressive individuals. At high-resource sites, small colonies are dominated by docile individuals while at low-resource sites they are dominated by the aggressive phenotype. Artificial colonies covering a wide range of docile / aggressive ratios placed in high- or low-resource sites all displayed within 2 generations the typical site-specific ratios, showing strong local selection pressures on the groups. However, when moved to another environment, colonies always tended to adjust their composition to match the ratio characteristics of their native site. Thus, group selection drove locally-adapted group compositions in these wild populations (Pruitt and Goodnight, 2014). Similarly, in honeybees, one may imagine that different ratios of appetitive-biased / aversive-biased workers may be adapted to different environmental conditions, with for instance a better fitness for a higher proportion of appetitively oriented individuals in high-resource sites and a higher proportion of aversively oriented individuals in low-resource sites. However, the long term interest of the species would be to maintain a good balance of both types of individuals for adapting to local conditions over generations. Honeybees are characterized by a monogynous polyandrous mating system, with typically as many as 15-20 males inseminating a queen (Estoup et al., 1994). This high polyandry increases the probability of sampling alleles from the whole genetic diversity in the population and maintaining rare alleles that may not be currently adapted but may be beneficial in the future (Fuchs and Moritz, 1999). A next step for understanding the evolution of the hedonic trade-off and possible adaptations to local conditions would be to measure the hedonic bias in workers from colonies with a common genetic origin but maintained over generations in high- or low-resource sites. We expect to find in these colonies different proportions of appetitively- and aversively-biased individuals. Such adaptations of the hedonic bias may be a basis for the observation that, at the population level, hives with a high foraging activity display low defense responses and vice versa (Giray et al., 2000).

In conclusion, we found a trade-off in honeybees' sensitivity and learning abilities between appetitive and aversive hedonic modalities, which depends on a genotypic determinism at the paternal level. Such trade-off may be instrumental for efficient task allocation within the colony and for its rapid adaptation to local environmental conditions. On a proximal level, future work will need to focus on the epistatic effects giving rise to this trade-off. On a more distal level, studying how bees adapt this trade-off with local conditions may help understand its possible beneficial effect for bees' ecological success.

Materials and methods

Animals

Bees were taken from two hives over two summers on the CNRS campus of Gif-sur-Yvette, France. Age-controlled honey bees (13-14 days old) were used in this experiment to avoid any impact of age on bees' behavior (Scheiner et al. 2001). To obtain such age-controlled individuals, we selected a comb with capped brood, close to emergence. After removing all adult bees, the comb was placed in a closed box in an incubator at 34°C. The day after, newly emerged bees were painted with a two-color code (Posca, France) and then placed back into the hive. Thirteen days later, the bees were taken from the hive and used in the behavioral experiments. At this age, honey bees usually start to perform tasks outside the hive such as guarding or foraging (Seeley, 1982).

After chilling on ice, 16 individuals were harnessed in a metal holder as described in Junca et al. (2014). With this holding procedure, both sting- and proboscis extension could be clearly monitored. Bees were fed with 5µl of sucrose solution (50% w/w) every morning and evening to keep them in a good condition for the two experimental days and were conserved in dark and humid box between experiments. One group of 16 bees was tested over two days. Four experimental procedures were carried out on these individuals according to the following schedule: for half of the bees were subjected to the measure of *sucrose responsiveness* followed by *appetitive conditioning* on the first day and to the measure of *heat responsiveness* followed by *aversive conditioning* on the second day. For the other half, the two experimental days were swapped. At the end of the second day, all bees were placed in individual Eppendorf tubes filled with 96% ethanol solution for microsatellite analysis.

Bees' responsiveness to temperature and sucrose stimuli

Once mounted, bees were placed in a moist and dark container for two hours to avoid any stress. Thermal responsiveness was measured following the procedure of Junca et al. (2014). Bees received a succession of six stimulations of increasing temperature (from ambient temperature ~25°C to 75°C), in steps of 10°C. Thermal stimulations were provided by means of a pointed copper cylinder (widest diameter: 6 mm; length: 13 mm), mounted onto the end of a minute soldering iron running at low voltage (HQ-Power, PS1503S). Temperature at the end of the cylinder was controlled using a contact thermometer (Voltcraft, Dot-150). Thermal stimulations alternated with tactile controls, provided as above with an identical unheated probe.

Sucrose responsiveness was measured following the protocol described in Scheiner et al. (2003). Bees were presented sucrose solutions of increasing concentration following an exponential progression (0% ; 0.1% ; 0.3% ; 1% ; 3% ; 10% ; 30% w/w). Sucrose stimulations were alternated with water control. Sucrose and water stimulations were provided with a soaked toothpick to the bees' two antennae simultaneously, and the PER (extension or not of the proboscis) was noted.

In both heat and sucrose responsiveness experiments each trial lasted 38 s. The bee was placed in the holding setup, and left for 20 s before stimulus application started. The sucrose or thermal stimulation lasted for 1 s, and was applied to both antennae for sucrose responsiveness or to the mouthparts for heat responsiveness. The bee was then left in the setup for 17 s and was then removed. For a given bee, all stimulations were performed at 10 min intervals.

Bees' aversive and appetitive learning performance

On each day, the learning procedure started 1 h after the responsiveness procedure. Learning procedures were identical for appetitive and for aversive conditioning, except for the US used and the behavioral response measured. During appetitive conditioning, the US was a 30% sucrose solution and PER were measured. During aversive conditioning, the US was a 65°C thermal stimulation to the mouthparts and SER were measured.

Bees were subjected to differential conditioning procedures, in which one odorant (the CS+) was associated with either appetitive or aversive reinforcement (the US), while another odorant was presented without reinforcement (the CS-). Two pairs of odorants were chosen according to Guerrieri et al. (2005), in such a way that all odorants were well differentiated from each other by bees. For each bee, one odorant pair was used for aversive conditioning while the other was used for appetitive conditioning. To avoid producing a high number of subgroups, within each odorant pair, one odorant was used as CS+ while the other was used as CS-. The two pairs of odors were: 1) 1-nonanol (CS+) and 2-heptanol (CS-); 2) hexanal (CS+) and 2-octanone (CS-) (Sigma Aldrich, Deisenhofen, Germany). Five μ l of pure odorant were applied onto a 1 cm² piece of filter paper which was transferred into a 20 ml syringe (Terumo) allowing manual odorant delivery to the antennae. Half of the bees were conditioned with odorant pair 1 for aversive conditioning and odorant pair 2 for appetitive conditioning, and vice versa for the other half.

Each conditioning procedure was composed of 16 trials (8 reinforced and 8 non-reinforced) in a pseudo-random sequence (e.g. ABBABAAB) starting with odorant A or B in a balanced way. The inter-trial interval (ITI) was 10 min. Each conditioning trial lasted 38 s. The bee was placed in the stimulation site in front of the air extractor, and left for 18 s before being exposed to the odorant paired with the US. Each odorant (CS+ or CS-) was delivered manually for 4 s. The thermal stimulus started 3 s after odorant onset and finished with the odorant (1 s temperature stimulation). The bee was then left in the setup for 14 s and was then removed.

Determination of patriline origin

Patriline determination was carried out by genotyping microsatellite areas conserved in the bee's genome. Microsatellites are non-coding DNA fragments, made of repeated pairs (duo) or triplets (or more) of nucleotides. Sizes of microsatellites are conserved in bees' offspring (patrilines) like

alleles. To precisely determine the patriline origin of each bee, 12 loci were amplified (Garnery et al. 1993).

DNA was extracted using the 10% Chelex method (Walsh et al. 1991) adapted for squashed bee head tissues (Estoup et al. 1996). The head of the bee was cut off and placed in an Eppendorf tube with an iron marble. The tube was then placed into a grinder (Retsch MM301). Once the head crushed, 600 μ L of 10% Chelex (warmed at 60°C) (BioRad) were added. Composed of micromarble, the Chelex chelates impurities and ions which could interfere with the following PCR. Then, 18 μ L of proteinase K were added and after 1h digestion at 50°C in a heating block, the tubes were placed 30 min at 90°C to remove proteinase K. The iron marbles were then removed and the solutions centrifugated for 10 min at 12000 rpm. They were then conserved in a freezer (-20°C).

Microsatellites amplifications were performed using 3 different multiplexes, which allowed analyzing several loci simultaneously. Multiplex 1 was composed of loci A88, A28, A24, Ap55 and A66. Multiplex 2 was composed of loci A113, A7, Ap43 and Ap81. Multiplex 3 analyzed loci Ap33, A43, A8. A multiplex contains pure water, buffer (Promega), Bovine serum albumin (BSA; Sigma Aldrich) and Taq polymerase which allows replicating the fragments of interest. In a PCR dish, 1 μ L of non-diluted DNA and 9 μ L of the chosen Plex were deposited. The time spent in the thermocycler (Biometra, UNO-thermobloc) was calibrated for each multiplex, depending on the primers used. For genotyping in the sequencer, a mix of Rox350 and Formamide was added to the PCR product. DNA fragments were identified using an ABI 3130 Genetic Analyzer and the Genscan analysis software (version 3.7.1). Allelic sizes were labeled using Genemapper 4.1. Allele nomenclature was standardized using reference samples (Estoup et al. 1995; Franck et al. 1998; Garnery et al. 1998).

The multilocus genotype of the queen was verified, using the Colony 1.2 program (Wang; 2004). The program analyzes haplo-diploid systems based on the expression of codominant genetic markers, such as DNA microsatellites. It calculates the probabilities of all possible queen genotypes, based on the observed allele frequencies in the population. Paternal alleles for each worker were then characterized after subtracting the queen's allele from each worker's genotype. Workers were considered as belonging to the same patriline when the same alleles were shared over all (12) analyzed loci.

Statistical analysis

All recorded data were dichotomous, with a sting or proboscis extension being recorded as 1 and a non-extension as 0. Over all analyses, bees which did not respond during either one of the responsiveness experiments were excluded from the analysis, as they were considered as not appetitively or aversively motivated enough to learn in the following conditioning experiments.

To analyze *thermal* and *sucrose responsiveness* curves or *appetitive and aversive conditioning* curves, we used repeated measure ANOVAs with stimulus (either thermal (sucrose) vs tactile (water),

or CS+ vs CS-) and trial as repeated factors. Monte Carlo studies have shown that it is permissible to use ANOVA on dichotomous data only under controlled conditions, which are met in these experiments (Lunney 1970).

A correlative approach was chosen to analyze relationships between responsiveness and learning performances within or across hedonic modalities at the individual and at the patriline levels. We calculated for each bee its *thermal responsiveness score* (from 1 to 6) and *sucrose responsiveness score* (from 1 to 7) by counting the number of times it responded to the thermal stimulus presented at increasing temperatures. Higher scores indicate bees that started to respond at lower temperatures or sucrose concentrations, and are thus more sensitive to temperature or sucrose respectively. In the same manner, two learning performance scores were calculated. For the *aversive* and *appetitive learning scores*, we counted the number of times bees responded to the reinforced odorant (CS+). A higher score indicated a good learner, which quickly associated the CS+ with reinforcement. For studying correlations at the individual level, bees were grouped by heat responsiveness score and their average learning performance scores were calculated, thus allowing a clear representation of the relationship between the two variables. At the patriline level, bees thermal and sucrose responsiveness scores and aversive and appetitive learning scores were averaged for each patriline. Correlations were assessed by calculating the Spearman correlation coefficient. To further reveal positive or negative relationships among response scores, Factor Analyses (FA) were used. These analyses were complemented with a cluster analysis based on Euclidian distances between patrilines' behavioral responses in order to highlight putative groupings of patrilines exhibiting similar hedonic biases. All data were analyzed with STATISTICA V5.5 (StatSoft, Tulsa, USA).

References

- Arnold, K. E., Owens, I. P., & Goldizen, A. W. (2005). Division of labour within cooperatively breeding groups. *Behaviour*, *142*(11-12), 1577-1590.
- Behrends, A., & Scheiner, R. (2012). Octopamine improves learning in newly emerged bees but not in old foragers. *The Journal of experimental biology*, *215*(7), 1076-1083.
- Behrends, A., Scheiner, R., Baker, N., & Amdam, G. V. (2007). Cognitive aging is linked to social role in honey bees (*Apis mellifera*). *Experimental gerontology*, *42*(12), 1146-1153.
- Beshers, S. N., & Fewell, J. H. (2001). Models of division of labor in social insects. *Annual review of entomology*, *46*(1), 413-440.
- Bitterman, M. E., Menzel, R., Fietz, A., & Schäfer, S. (1983). Classical conditioning of proboscis extension in honeybees (*Apis mellifera*). *Journal of Comparative Psychology*, *97*(2), 107.
- Bonabeau, E., Theraulaz, G., & Deneubourg, J. L. (1996). Quantitative study of the fixed threshold model for the regulation of division of labour in insect societies. *Proceedings of the Royal Society of London. Series B: Biological Sciences*, *263*(1376), 1565-1569.

- Bonabeau, E., Theraulaz, G., & Deneubourg, J. L. (1998). Fixed response thresholds and the regulation of division of labor in insect societies. *Bulletin of Mathematical Biology*, 60(4), 753-807.
- Breed, M. D., Robinson, G. E., & Page Jr, R. E. (1990). Division of labor during honey bee colony defense. *Behavioral Ecology and Sociobiology*, 27(6), 395-401.
- Burrell, B. D., & Smith, B. H. (1994). Age-but not caste-related regulation of abdominal mechanisms underlying the sting reflex of the honey bee, *Apis mellifera*. *Journal of Comparative Physiology A*, 174(5), 581-592.
- Calderone, N. W., & Page Jr, R. E. (1988). Genotypic variability in age polyethism and task specialization in the honey bee, *Apis mellifera* (Hymenoptera: Apidae). *Behavioral Ecology and Sociobiology*, 22(1), 17-25.
- Cox, M. D., & Myerscough, M. R. (2003). A flexible model of foraging by a honey bee colony: the effects of individual behaviour on foraging success. *Journal of theoretical biology*, 223(2), 179-197.
- Downs, S. G., & Ratnieks, F. L. (2000). Adaptive shifts in honey bee (*Apis mellifera* L.) guarding behavior support predictions of the acceptance threshold model. *Behavioral Ecology*, 11(3), 326-333.
- Duarte, A., Weissing, F. J., Pen, I., & Keller, L. (2011). An evolutionary perspective on self-organized division of labor in social insects. *Annual Review of Ecology, Evolution, and Systematics*, 42, 91-110.
- Erber, J., Hoormann, J., & Scheiner, R. (2006). Phototactic behaviour correlates with gustatory responsiveness in honey bees (*Apis mellifera* L.). *Behavioural brain research*, 174(1), 174-180.
- Estoup, A., Solignac, M., & Cornuet, J. M. (1994). Precise assessment of the number of patriline and of genetic relatedness in honeybee colonies. *Proceedings of the Royal Society of London. Series B: Biological Sciences*, 258(1351), 1-7.
- Eyer, P. A., Freyer, J., & Aron, S. (2013). Genetic polyethism in the polyandrous desert ant *Cataglyphis cursor*. *Behavioral ecology*, 24(1), 144-151.
- Fuchs, S., & Moritz, R. F. A. (1999). Evolution of extreme polyandry in the honeybee *Apis mellifera* L. *Behavioral Ecology and Sociobiology*, 45(3-4), 269-275.
- Giray, T., Guzmán-Novoa, E., Aron, C. W., Zelinsky, B., Fahrbach, S. E., & Robinson, G. E. (2000). Genetic variation in worker temporal polyethism and colony defensiveness in the honey bee, *Apis mellifera*. *Behavioral Ecology*, 11(1), 44-55.
- Giray, T., Huang, Z. Y., Guzmán-Novoa, E., & Robinsons, G. E. (1999). Physiological correlates of genetic variation for rate of behavioral development in the honeybee, *Apis mellifera*. *Behavioral Ecology and Sociobiology*, 47(1-2), 17-28.
- Huang, Z. Y., Robinson, G. E., & Borst, D. W. (1994). Physiological correlates of division of labor among similarly aged honey bees. *Journal of Comparative Physiology A*, 174(6), 731-739.
- Hunt, G. J. (2007). Flight and fight: a comparative view of the neurophysiology and genetics of honey bee defensive behavior. *Journal of insect physiology*, 53(5), 399-410.
- Jeanson, R., Fewell, J. H., Gorelick, R., & Bertram, S. M. (2007). Emergence of increased division of labor as a function of group size. *Behavioral Ecology and Sociobiology*, 62(2), 289-298.
- Jones, J. C., Myerscough, M. R., Graham, S., & Oldroyd, B. P. (2004). Honey bee nest thermoregulation: diversity promotes stability. *Science*, 305(5682), 402-404.

- Julian, G. E., & Fewell, J. H. (2004). Genetic variation and task specialization in the desert leaf-cutter ant, *Acromyrmex versicolor*. *Animal Behaviour*, *68*(1), 1-8.
- Junca, P., Carcaud, J., Moulin, S., Garnery, L., & Sandoz, J. C. (2014). Genotypic Influence on Aversive Conditioning in Honeybees, Using a Novel Thermal Reinforcement Procedure. *PLoS one*, *9*(5), e97333.
- Langridge, E.A., Sendova-Franks, A.B., Franks, N.R. (2008). How experienced individuals contribute to an improvement in collective performance in ants. *Behavioral ecology and sociobiology*, *62*:447-56.
- Madden, J. R., Drewe, J. A., Pearce, G. P., & Clutton-Brock, T. H. (2011). The social network structure of a wild meerkat population: 3. Position of individuals within networks. *Behavioral Ecology and Sociobiology*, *65*(10), 1857-1871.
- Manser, M. B. (1999). Response of foraging group members to sentinel calls in suricates, *Suricata suricatta*. *Proceedings of the Royal Society of London. Series B: Biological Sciences*, *266*(1423), 1013-1019.
- O'Donnell, S. (1998). Genetic effects on task performance, but not on age polyethism, in a swarm-founding eusocial wasp. *Animal behaviour*, *55*(2), 417-426.
- Page Jr, R. E., & Mitchell, S. D. (1998). Self-organization and the evolution of division of labor. *Apidologie*, *29*(1-2), 171-190.
- Page, R. E., & Robinson, G. E. (1991). The genetics of division of labour in honey bee colonies. *Advances in insect physiology*, *23*, 117-169.
- Pankiw, T., & Page Jr, R. E. (1999). The effect of genotype, age, sex, and caste on response thresholds to sucrose and foraging behavior of honey bees (*Apis mellifera* L.). *Journal of Comparative Physiology A*, *185*(2), 207-213.
- Perez, M., Rolland, U., Giurfa, M., & d'Ettorre, P. (2013). Sucrose responsiveness, learning success, and task specialization in ants. *Learning & Memory*, *20*(8), 417-420.
- Pruitt, J. N., & Goodnight, C. J. (2014). Site-specific group selection drives locally adapted group compositions. *Nature*.
- Reeve, H. K. (1989). The evolution of conspecific acceptance thresholds. *American Naturalist*, 407-435.
- Robinson, G. E. (1992). Regulation of division of labor in insect societies. *Annual review of entomology*, *37*(1), 637-665.
- Roussel, E., Carcaud, J., Sandoz, J. C., & Giurfa, M. (2009). Reappraising social insect behavior through aversive responsiveness and learning. *PLoS One*, *4*(1), e4197.
- Rüppell, O., Pankiw, T., & Page, R. E. (2004). Pleiotropy, epistasis and new QTL: the genetic architecture of honey bee foraging behavior. *Journal of heredity*, *95*(6), 481-491.
- Scheiner, R., & Arnold, G. (2010). Effects of patriline on gustatory responsiveness and olfactory learning in honey bees. *Apidologie*, *41*(1), 29-37.
- Scheiner, R., Page, R. E., Jr. and Erber, J. (2001). Responsiveness to sucrose affects tactile and olfactory learning in preforaging honey bees of two genetic strains. *Behav Brain Res* **120**(1): 67-73.

- Scheiner, R., Page, R. E., & Erber, J. (2004). Sucrose responsiveness and behavioral plasticity in honey bees (*Apis mellifera*). *Apidologie*, 35(2), 133-142.
- Schwander, T., & Keller, L. (2008). Genetic compatibility affects queen and worker caste determination. *Science*, 322(5901), 552-552.
- Seeley T.D. (1995) *The wisdom of the hive*. Harvard University Press, Cambridge Mass, London.
- Seeley, T. D. (1982). Adaptive significance of the age polyethism schedule in honeybee colonies. *Behavioral Ecology and Sociobiology*, 11(4), 287-293.
- Seeley, T. D. (1983). Division of labor between scouts and recruits in honeybee foraging. *Behavioral Ecology and Sociobiology*, 12(3), 253-259.
- Slaa, E.J., Chappell, P., & Hughes, W. O. H. (2014). Colony genetic diversity affects task performance in the red ant *Myrmica rubra*. *Behavioral ecology and sociobiology*, 68(6), 903-914.
- Trumbo, S.T., Robinson, G. E. (1997). Learning and task interference by corpse-removal specialists in honey bee colonies. *Ethology*; 103:966-75.
- Vergoz, V., Roussel, E., Sandoz, J. C., & Giurfa, M. (2007). Aversive learning in honeybees revealed by the olfactory conditioning of the sting extension reflex. *PLoS One*, 2(3), e288.
- Wade, M.J. (1978). A critical review of the models of group selection. *Quarterly Review of Biology*, 101-114.
- Weidenmüller, A. (2004). The control of nest climate in bumblebee (*Bombus terrestris*) colonies: interindividual variability and self reinforcement in fanning response. *Behavioral Ecology*, 15(1), 120-128.
- Wilson, D.S. (1975). A theory of group selection. *Proceedings of the national academy of sciences*, 72(1), 143-146.
- Wilson, D.S., & Wilson, E. O. (2007). Rethinking the theoretical foundation of sociobiology. *The Quarterly review of biology*, 82(4), 327-348.
- Winston, M. L. (1987), *Honey bee biology*. Harvard University Press, Cambridge. (In press)

Chapitre IV

Effet des apprentissages appétitif et
aversif sur les mouvements antennaires
de l'abeille

Appetitive but not aversive olfactory conditioning modifies antennal movements in honey bees

Hanna Cholé, Pierre Junca and Jean-Christophe Sandoz

Submitted to *Learning and Memory*

Abstract

In honey bees, two olfactory conditioning protocols allow the study of appetitive and aversive Pavlovian associations. Appetitive conditioning of the proboscis extension response (PER) involves associating an odor, the conditioned stimulus (CS) with a sucrose solution, the unconditioned stimulus (US). Conversely aversive conditioning of the sting extension response (SER) involves associating the odor CS with an electric or thermal shock US. Each protocol is based on the measure of a different behavioral response (proboscis *vs* sting) which both provide binary responses (extension or not of the proboscis or sting). These limitations render the measure of the acquired hedonic value of an odor CS difficult without testing the animals in a freely moving situation. Here we studied the effects of both olfactory conditioning protocols on the movement of the antennae, which are crucial sensory organs for bees. As bees' antennae are highly mobile, we asked whether their movements in response to an odorant change following appetitive or aversive conditioning and if so, do odor-evoked antennal movements contain information about the acquired hedonic value of the CS? We implemented a tracking system for harnessed bees' antennal movements based on a motion capture principle at a high frequency rate. We observed that differential appetitive conditioning had a strong effect on antennal movements. Bees responded to the reinforced odorant with a marked forward motion of the antennae and a strong velocity increase. Conversely, differential aversive conditioning had no associative effect on antennal movements. Rather than revealing the acquired hedonic value of an odorant, antennal movements may represent a novel conditioned response taking place during appetitive conditioning and may provide a possible advantage to bees when foraging in natural situations.

Keywords: Pavlovian conditioning, innate and acquired hedonic value, aversive learning, appetitive learning, olfactory learning, conditioned antennal response

Introduction

In order to survive, animals must detect and integrate environmental signals to adapt their behavior when facing potentially positive (food, sex-mate) or negative (danger, predator) situations (Alcock 1997). These adaptive behaviors are for the most part acquired through experience. Through associative learning, animals learn associations between a particular behavioral response and its consequence (operant learning; Skinner 1936) or between initially neutral environmental (color, sound, odor) stimuli and other meaningful (food, danger, etc.) stimuli (classical or Pavlovian learning; Pavlov 1927).

Classical conditioning has been intensively studied in many species from mammals to invertebrates (Rescorla 1988; Crow 2004; Busto *et al.* 2010). Among invertebrates, the honeybee *Apis mellifera* represents an influential and biologically-relevant model for studying associative learning. Learning is an essential part of their daily behavior, especially while foraging when they must learn and memorize floral odors or colors (Giurfa 2007; Menzel 2012). Pavlovian learning can be effectively studied in the laboratory thanks to the development of two main olfactory conditioning assays performed on restrained individuals. The most prominent learning assay developed for honeybees is the olfactory conditioning of the Proboscis Extension Response (PER), where bees learn to associate an initially neutral odor (conditioned stimulus- CS) with a sucrose reward (unconditioned stimulus - US) applied to the antennae and then to the proboscis (Bitterman *et al.* 1983; Giurfa and Sandoz 2012). Following conditioning, bees extend their proboscis in response to the odor alone (Takeda 1961; Bitterman *et al.* 1983). The odorant thus acquires a positive hedonic value and becomes attractive to bees so that in a free-moving situation, they will orient towards this stimulus (Sandoz *et al.* 2000; Chaffiol *et al.* 2005; Carcaud *et al.* 2009). Another important classical conditioning procedure, the olfactory conditioning of the Sting Extension Response (SER) was developed only recently (Vergoz *et al.* 2007). In this procedure, the odor CS is associated with an aversive US (electric shock: Vergoz *et al.* 2007; thermal shock: Junca *et al.* 2014). Once the association has been made, bees extend their sting to the aversively reinforced odor alone. The odor CS thereby acquires a negative hedonic value and bees clearly avoid it in a freely-moving test (Carcaud *et al.* 2009). Both types of conditioning allow the use of invasive techniques such as electrophysiology, optical imaging and pharmacology enabling us to understand the behavioral, cellular and molecular basis of appetitive and aversive learning respectively (Giurfa and Sandoz 2012; Menzel 2012; Tedjakumala and Giurfa 2013).

In standard PER and SER conditioning procedures, responses are stereotyped and operate in a binary ‘all or nothing’ fashion (extension or not of the proboscis or sting) (Bitterman *et al.* 1983; Vergoz *et al.* 2007). Therefore, they do not allow a graded measure of learning success or a precise measure of the acquired hedonic value of an odorant at the individual level. For this reason, studies using PER or SER conditioning usually discuss individual performances from response proportions in groups of bees, which has been criticized (Pamir *et al.* 2011). Moreover, when using restrained animals,

positive and negative hedonic value have to be studied based on totally different behavioral responses (PER or SER), thereby inducing a potential bias. Therefore we asked whether the movements of other body parts may indeed reveal and integrate both the positive and the negative acquired values of odorants. We focused on honeybee's antennae, which are highly mobile sensory structures displaying a wide range of possible movements around the bees' head.

Many insects use antennal movements to acquire crucial sensory information about their surroundings. As for other insects, the honeybee antenna is a prominent interface between the individual and its environment as it contains complex sensory equipment tuned to different sensory modalities (olfactory, gustatory, thermosensory, mechanosensory, etc.; Lacher and Schneider 1963; Lacher 1964; Vareschi 1971; Esslen and Kaissling 1976; Whitehead and Larsen 1976; Dreller and Kirchner 1993). Honeybees use their antennae in a great variety of behavioral tasks and contexts. Inside the hive, the bees' antennae allow them to probe food, wax or other substrates (Martin and Lindauer 1966; Winston 1987; Nagari and Bloch 2012) and to communicate with conspecifics, during food exchanges (Free 1956; Montagner and Pain 1971; Galliot and Azœuf 1979; Galliot *et al.* 1982; Korst and Velthuis 1982; Crailsheim 1998) or the waggle dance (von Frisch 1967). Outside of the hive, bees use their antennae during foraging allowing them to detect and learn multisensory cues from flowers (olfactory, tactile, gustatory, Kevan and Lane 1985; Menzel 1990; Wright and Schiestl 2009). Therefore, the honey bee antennae are crucial, highly mobile sensory organs, whose movements are essential to their sensory ecology and behavior. One may thus ask whether bees' antennal movements are affected by previous associative experience, and if so, if these movements contain information about the acquired appetitive or aversive value of an odorant.

Previous work used electrophysiological recordings or photodiodes to study honey bees' antennal movements in response to visual, olfactory or tactile stimuli (Suzuki, 1975; Erber and Schildberger, 1980; Erber *et al.* 1993). Typically, bees exhibit an antennal scanning behavior in response to sugar stimulation or to odorants, characterized by sweeping movements from the front to the back of the head (Erber *et al.* 1993). The advent of video capture provided more precise spatial information about antennal movements. The first such study, using marked antenna tips, demonstrated that antennal movements can be operantly conditioned, by rewarding contacts of the antenna with an object with sucrose solution (Erber *et al.* 1997; see also Erber *et al.* 1998, 2000; Kisch and Erber 1999; Haupt 2007). Several studies since then used video means to measure antennal movements but they mostly concentrated on the technical aspects of such recordings (Lambin *et al.* 2005; Mujagić *et al.* 2012) or aimed to monitor bees' sleep state (Sauer *et al.* 2003, 2004; Hussaini *et al.* 2009). Therefore even if honey bees' antennal movements have already been recorded several times and antennal responses to different sensory stimulations are well described, no in-depth study has addressed the plasticity of antennal movements following olfactory Pavlovian conditioning.

In the present study, we thus aimed to determine the influence of an appetitive or an aversive olfactory learning procedure, assigning a positive or a negative hedonic value to an odorant, on bees'

antennal responses. We thus implemented an original antenna tracking system based on a motion capture principle (Erber *et al.* 1997) enabling us to record the antennal movements from harnessed bees, at a high frequency rate (90 Hz). We show that olfactory learning can indeed strongly modify antennal movements to odorants.

Results

Measure of antennal response to odorants

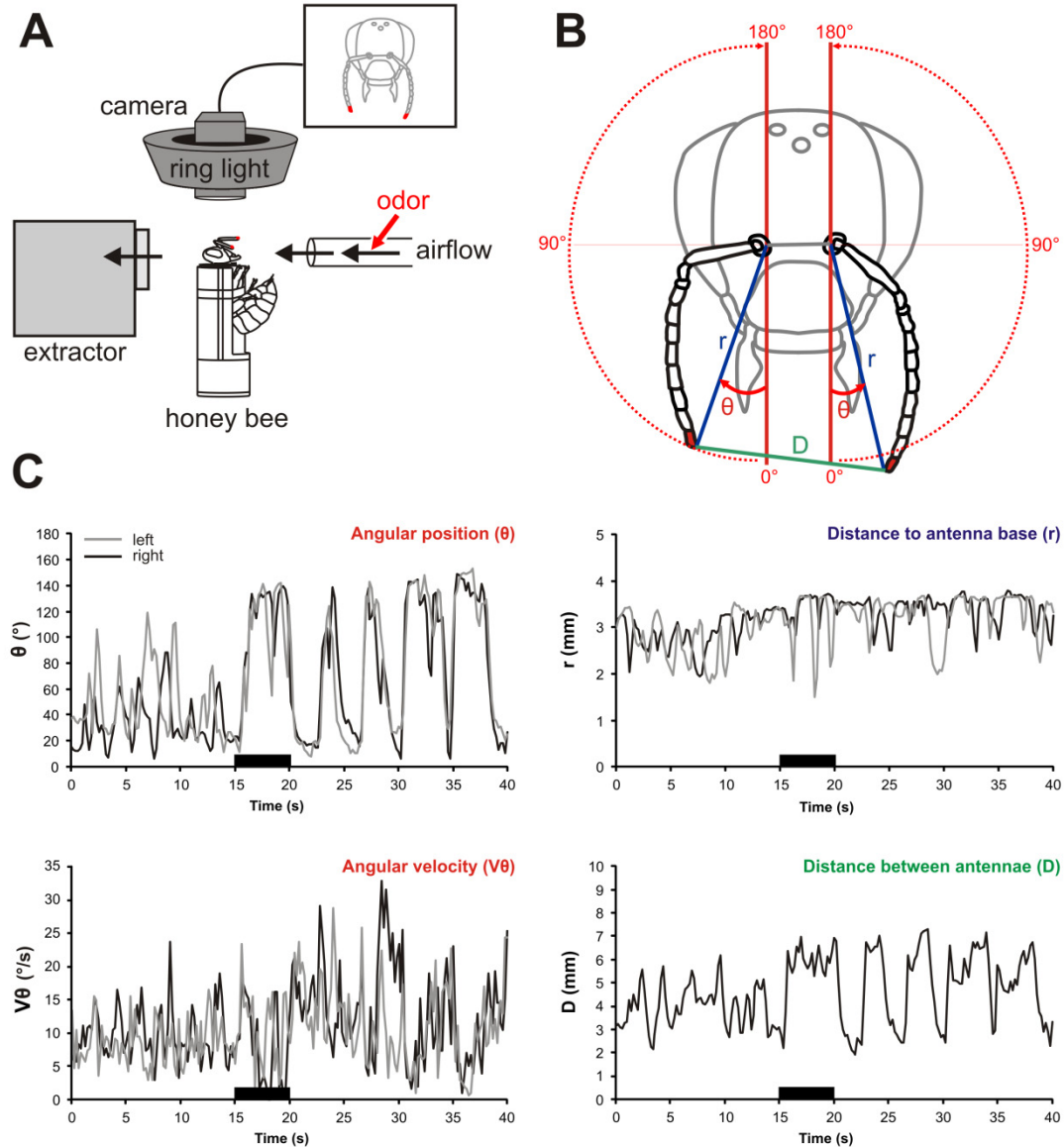

Figure 1. Antennal movement recording. A) Apparatus for recording antennal movements. Harnessed bees were placed in a dark room, under a cold light ring encircling a camera which recorded the coordinates of both antennal tips at a rate of 90 Hz. Olfactory stimulation was delivered to the bee from the front and an air extractor placed behind the animal prevented odorant accumulation. B) Representation of the variables measured from antennal tip positions: blue: distance to antenna base (r); red: angular position (θ); green: distance between both antennal tips (D). C) Recordings taken before conditioning in response to 1-hexanol (black bar) for a typical bee. The same variables as in C are shown for this bee's two antennae (black line, right antenna; grey line, left antenna), with the addition of the angular velocity ($V\theta$) calculated from the angular position (θ).

To monitor antennal movements in harnessed honey bees, a camera-based tracking system using a motion capture principle was placed above the bee's head (Fig. 1A). The upper sides of the bees' antenna tips were marked with small dots of red acrylic paint. The system was tuned to this red color and was able to track the location of both antenna tips at a frequency of 90 Hz. Bees' antennae are highly mobile and can move around their socket (henceforth termed 'antenna base') from the front of their head to the rear on each side (travelling an $\sim 180^\circ$ angle). Therefore, the position of each antenna tip was best described using polar coordinates, i.e. by a radius (r) and an angle (θ) with the center being the antenna base (Fig. 1B). The radius r was defined as the distance between antenna tip and base while the angle θ was measured from the front (0°) to the back of the bee (180°) via the ipsilateral side (90°). From these values, the angular velocity ($V\theta$) as well as the distance between both antenna tips (D) could be calculated. An odor-stimulation trial lasted 40 s. After 15 s of an odorless airflow, a 5 s odorant stimulation was applied. Figure 1C presents the recording of the 4 variables during an odorant stimulation trial in a naïve bee (for average values on groups of bees see Fig. 4C,D, 7C,D and Suppl. Fig. S1 and S2). Typically, bees' antennal movements displayed stronger variations in angle than in radius, their antennae oscillating between the front ($\sim 10^\circ$) and a position at the back of their head (here about 140°). The presentation of a pure odorant usually induced a slight backward motion of the antennae, as shown by an increase in the angle (θ) and in the distance between both antennae (D) during odor delivery.

Olfactory learning performances

To assess how olfactory learning with different reinforcements impacts antennal movements to odorants, bees were subjected either to an appetitive (PER) or to an aversive (SER) differential conditioning procedure. In both cases, bees had to differentiate between a reinforced odorant (CS+) and a non-reinforced odorant (CS-). Bees received 6 CS+ and 6 CS- trials in a pseudorandomized order with 10 min inter-trial intervals. Antennal movements in response to a panel of stimuli were measured 1 h before and 1 h after conditioning. During each of these test sessions, the responses to the CS+, to the CS-, to a novel odorant and to an air control were measured in a randomized order (see Methods).

PER conditioning

Differential conditioning of the PER was performed to evaluate the effect of appetitive learning on bees' antennal movements (Fig. 2A, $N = 44$). In this procedure, bees learned to differentiate between the odorant paired with sucrose reward (CS+) and the non-reinforced odorant (CS-) in the course of training (RM-ANOVA: *trial* \times *stimulus* interaction, $F_{5,215} = 33.5$, $P < 0.001$). Responses to the CS+ increased significantly, from 0% at the first trial to 86% at the 6th trial (RM-ANOVA, *trial* effect, $F_{5,215} = 46.3$, $P < 0.001$), whereas responses to the CS- remained stable, between 5 and 11% (RM-ANOVA,

trial effect, $F_{5,215} = 1.47$, NS). Overall, 75% of the bees (33 out of 44) responded only to the CS+ and not to the CS- at the 6th trial.

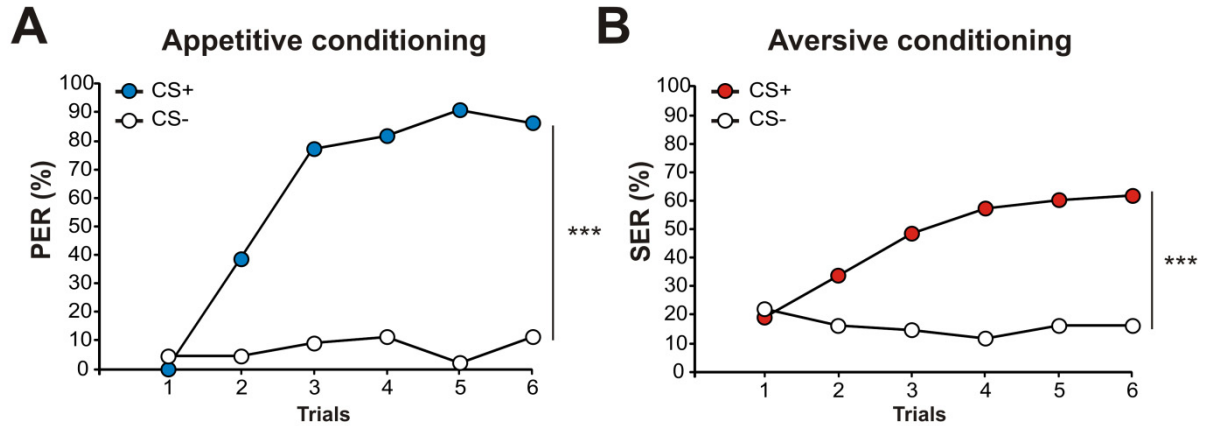

Figure 2. Appetitive and aversive conditioning performances. Acquisition curves are shown for bees trained in A) an appetitive or B) an aversive differential conditioning protocol. The curves show the percentage of individuals eliciting a behavioral response (proboscis extension in A, sting extension in B) to the reinforced odorant (CS+) or the non-reinforced one (CS-) along the trials. All bees learned to discriminate the reinforced odorant from the non-reinforced one, both in appetitive and aversive conditioning (***: $p < 0.001$; appetitive: $N = 44$; aversive: $N = 68$)

SER conditioning

Differential conditioning of the SER was performed to evaluate the impact of aversive learning on bees' antennal movements (Fig. 2B, $N = 68$). In this procedure, bees learned to discriminate the odorant paired with a thermal shock (CS+) from the non-reinforced odorant (CS-) (RM-ANOVA, *trial* \times *stimulus* interaction, $F_{5,335} = 15.2$, $P < 0.001$). The percentage of SER to the CS+ increased significantly, from 19% at the first trial to 60% at the 6th trial (RM-ANOVA, *trial* effect, $F_{5,335} = 18.9$, $P < 0.001$), whereas responses to the CS- did not change and remained between 12 and 22% (RM-ANOVA, *trial* effect, $F_{5,335} = 0.95$, NS). Overall, 44% of bees (30 out of 68) performed correctly at the 6th trial, responding only to the CS+ and not to the CS-.

Bees thus learned to discriminate the reinforced from the non-reinforced odorant in appetitive and aversive conditioning tasks. As observed in previous studies (Vergoz et al. 2007, Carcaud et al. 2009), performances were lower in SER than in PER conditioning.

Effect of appetitive learning on antennal movements

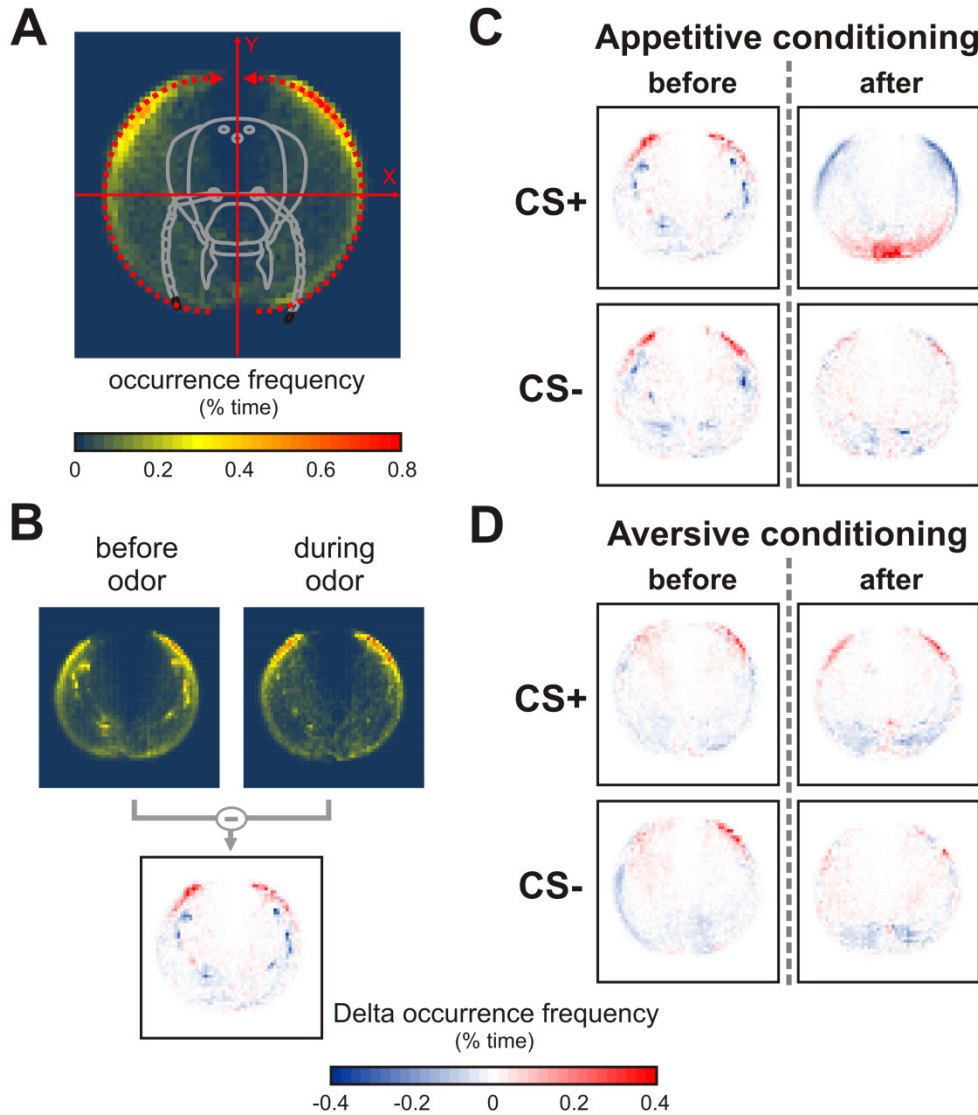

Figure 3. Heatmap of antennal tip occurrence before and after conditioning. A) The space explored by bees' antenna oscillations during odor presentation was calculated by counting the number of times each antennal tip was found at each location. The occurrence frequency at each location is expressed as a percentage of all the recorded occurrences, and displayed following a color scale from dark blue to red. B) Maps of antenna location change are computed by subtracting the map obtained *before* from the map *during* odor. Such maps are color coded, with blue showing a reduction and red showing an increase in frequency respectively. C,D) Heatmaps showing the change in occurrence rate of antennal tips during CS+ and CS- presentation, either 1 h before or 1 h after C) an appetitive (N = 44 bees) or D) an aversive conditioning (N = 68 bees). The space explored during CS+ presentation after appetitive conditioning differed clearly from the one observed before conditioning, high occurrence areas being located mostly forward. Such a modification was not discernible for the CS-, and no clear change was observed for aversive conditioning.

To reveal the effect of olfactory learning on antennal movements, we first computed maps of antennal tip occurrence before and during odor presentations (Fig. 3). In such maps, a color scale from blue to red indicates how often (in % of total time) bees' antenna tips were positioned at each location (Fig. 3A). As the recordings of all tested bees were calculated in the same coordinate system, all the maps obtained for a group of bees could be overlaid. As shown in the map in Fig. 3A, the field of

space covered by antennal movements generally formed two crescents on each side of the bees' head. To observe how antenna tips moved during odor presentations, the map obtained *before* odor presentation was subtracted from the map *during* odor presentation (Fig. 3B). In the resulting maps, red color showed locations where antenna tips were present more often during odor presentation, while blue color coded locations where antenna tips were present less often. Fig. 3C shows such maps for the CS+ and CS- in the recordings performed before and after appetitive conditioning. Before conditioning, the antennae were mostly moving to the rear of the head during odor delivery (for both CS+ and CS-). After appetitive conditioning, a drastic change was observed in the response to the CS+: the bees' antennae were now moving mostly to the front. Such a strong change in antenna location was not discernible for the CS-, although antenna location seemed slightly more evenly distributed after conditioning (Fig. 3C).

This strong modification in antennal movements was also striking when observing the mean angular position (Fig. 4A) and velocity (Fig. 4B) throughout a CS+ or CS- recording (N = 44 bees). Before appetitive training, odor presentations induced a slight increase in the angle, i.e. a slight backward motion of the antennae (Fig. 4A, left) with almost no change in antenna velocity (Fig. 4B, left). After training, antenna angle decreased strongly when the CS+ was presented. Conversely almost no change was observed when the CS- was presented (Fig. 4A, right). This differential effect of CS+ and CS- was significant from the 2nd second after odor onset until 12 s after odor offset (paired t test, $t > 2.59$, $p < 0.05$; except the 8th second, $t = 1.88$, $p = 0.07$). In addition, antenna velocity strongly increased in response to the CS+, but not to the CS- (Fig. 4B, right). This difference in velocity between CS+ and CS- started from the 1st second after odor onset until 13 s after odor offset (paired t test, $t > 3.19$, $p < 0.01$).

To analyze these effects more systematically, we computed $\Delta\theta$ and $\Delta V\theta$, defined as the difference in average angular position and velocity between 5 s *during* and 15 s *before* odorant presentation, for the CS+, the CS-, the novel odorant (NOd) and the air control (Fig. 4CD, N = 44 bees). The change in antennal angular position ($\Delta\theta$) before and after conditioning was significantly affected by the type of stimuli (Fig. 4C, RM-ANOVA, *stimulus* \times *recording* interaction, $F_{3,129} = 16.5$, $p < 0.001$). Before conditioning, the three odorants induced a slight backward motion of the antennae (a positive $\Delta\theta$) which, compared with the air control, fell just short of significance considering the corrected threshold (paired t tests, $t > 2.46$, $0.05 > p > \alpha_{\text{corr1}} = 0.0125$). After conditioning, antennal response to the CS+ was characterized by a 29° forward movement as opposed to a 10° backward movement before conditioning (paired t test, $t = 8.65$, $p < 0.001$). By contrast, the CS- still induced a slight backward movement after conditioning (3°, $t = 1.78$, NS). Interestingly, the angular response to the CS+ generalized to a novel odorant (NOd) but on a smaller scale. NOd led to a 11° forward movement after conditioning compared with a 12° backward movement before conditioning (paired t test, $t = 4.56$, $p <$

0.001). The angular response to the CS+ after conditioning was significantly different from those to the CS- (paired t test, $t = 7.39$, $p < 0.001$) and NOd (paired t test, $t = 4.07$, $p < 0.001$).

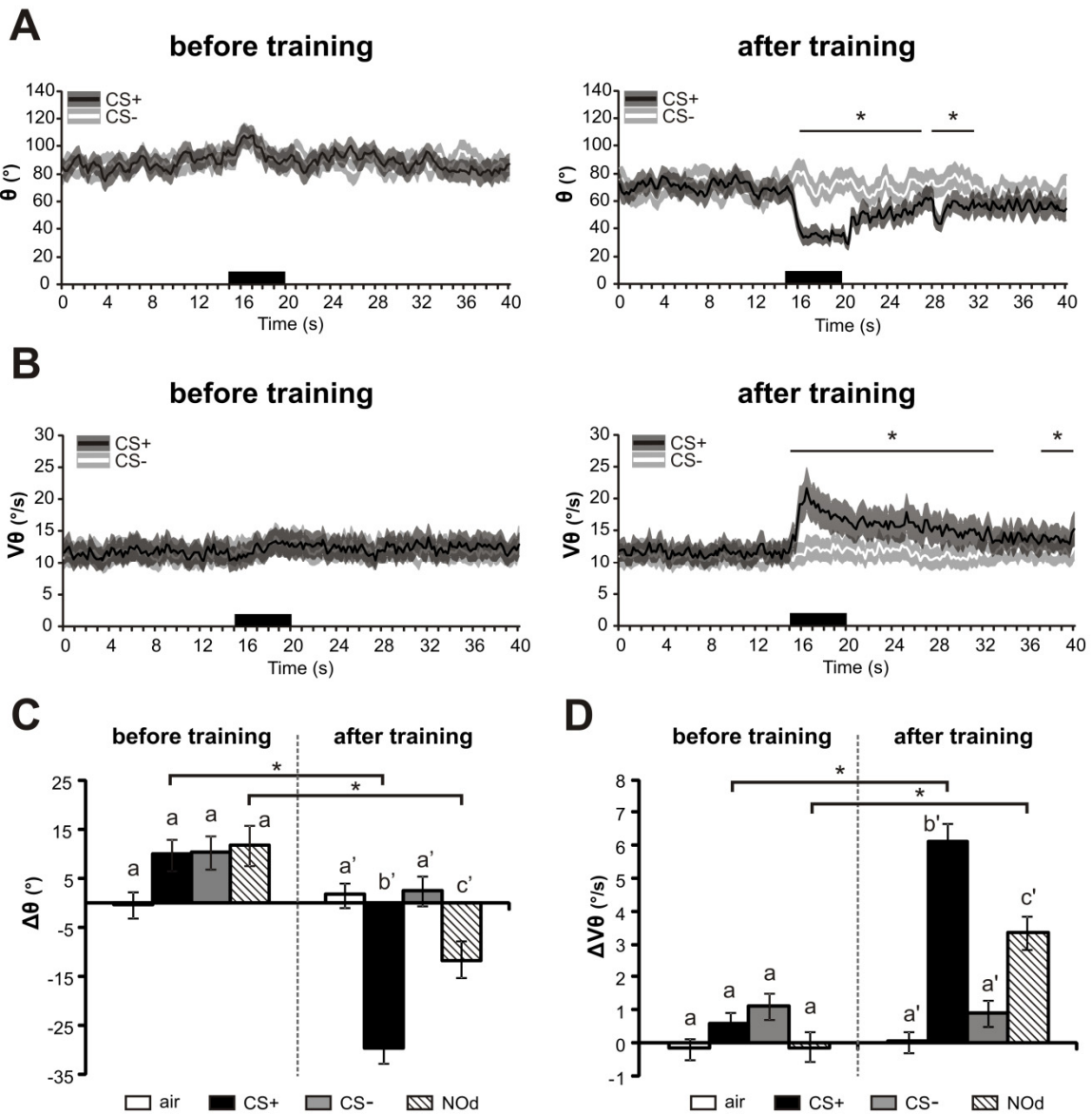

Figure 4. Effect of appetitive conditioning on antennal responses to odors. A,B) Temporal variation curves (averaged every 200 ms) before and after training of A) antenna angular position (θ) and B) angular velocity ($V\theta$). After training appetitive conditioning induced a forward motion of the antennae with an antenna acceleration. Stars indicate significant differences between CS+ and CS- in (paired t test at every second). C,D) Histograms showing the change in C) angular position ($\Delta\theta$) or D) angular velocity ($\Delta V\theta$) during odor presentation (during - before odor) for the air control (white), the CS+ (black), the CS- (light gray) and the novel odorant (NOd, stripes), before and after conditioning. Before conditioning, any olfactory stimulation led to a backward motion of the antennae, whereas after conditioning the CS+ but not the CS- induced a forward motion of the antennae (C, $\Delta\theta$). Conditioning also induced an increase in antenna velocity for the CS+ but no for the CS- (D, $\Delta V\theta$). Both effects generalized to the novel odorant (NOd) but on a smaller scale. Stars and different letters in C and D indicate significant differences in paired t tests including a threshold correction for multiple comparisons ($p < \alpha_{\text{corr1}} = 0.0125$, $N = 44$).

Angular velocity variation ($\Delta V\theta$) followed a similar pattern as angular position variation ($\Delta\theta$), with a differential change for the different odorants between before and after conditioning (Fig. 4D, RM-ANOVA, *stimulus* \times *recording* interaction, $F_{3,129} = 21.0$, $p < 0.001$). Before conditioning, odorants did not induce any significant change in angular velocity compared with the air control (paired t test, $t < 2.51$, $p > 0.0125$). Angular velocity variation ($\Delta V\theta$) during CS+ stimulation increased from 0.57 °/sec before conditioning to 6.09 °/s after conditioning (paired t test, $t = 7.85$, $p < 0.001$). By contrast, velocity variation was stable for the CS- from 1.11 °/s to 0.90 °/s (paired t test, $t = 0.35$, NS). The acceleration effect observed for the CS+ generalized to the novel odorant, with a $\Delta V\theta$ of -0.13 °/s before conditioning and 3.36 °/s after conditioning (paired t test, $t = 5.58$, $p < 0.001$). The velocity increase for the NOd was however significantly smaller than that observed for the CS+ (paired t test, $t = 3.72$, $p < 0.001$).

The data above have shown that appetitive differential conditioning modified the angular position and the angular velocity of the antennae. As antennal movements are characterized by back-and-forth oscillations (see angular position graph in Fig. 1C), we next used a frequency analysis, based on a Fast Fourier Transform (FFT), to explore movement frequency modifications with learning (Fig. 5). When used on the angular position data (θ), this analysis extracts the oscillating power at different frequencies (integrating both number and angular amplitude of oscillations). Figure 5A presents the average frequency spectrum obtained for the CS+ before and during odor presentation (2.84 s each, see Methods), before appetitive conditioning (left panel) or after conditioning (right panel). Firstly, these graphs show that antenna oscillatory movements are best described between 0 and 10 Hz, with most of the oscillating power in this frequency range. Secondly, they show that while odor presentation did not modify the frequency spectrum before conditioning, a strong change was observed after conditioning, with a relative decrease of movements at low frequency and an increase of movements at higher frequencies during odor presentation (see arrow in Fig. 5A). To study this effect statistically, we next compared the change in the power of antennal movements (Delta relative power: during – before odor, in %) at 10 frequency bands from 0.35-1.41 Hz (band 1) to 9.84-10.90 Hz (band 10). Note that the exact frequency values for each band are dependent on the recording frequency, in our case 90 Hz (see Methods). Figure 5B presents the Delta power of antennal movements for the CS+ and for the CS-. The frequency spectrum in response to the CS+ was significantly modified after conditioning, with a dissimilar effect at the different frequency bands (RM-ANOVA, *recording* \times *band* interaction, $F_{9,387} = 21.3$, $p < 0.001$). Thus, after conditioning, antennal movements were significantly reduced at band 1 (paired t test, $t = 5.01$, $p < 0.001$) and increased at bands 4 to 7 and 9 ($t > 3.61$, $p < \alpha_{\text{corr}2} = 0.005$). By contrast, appetitive learning did not modify antenna oscillation frequency for the CS- (RM-ANOVA, *recording* \times *bands* interaction, $F_{9,387} = 1.65$, NS).

Antennal movements being mostly symmetrical, a forward movement as the one observed above for $\Delta\theta$ (Fig. 4A,C) brings both antennae significantly closer to each other during CS+ presentations. Accordingly, variations in the distance between antennae (ΔD) followed the same pattern as the angular position ($\Delta\theta$) (Fig. S1A, RM-ANOVA, interaction *stimulus* \times *recording*, $F_{3,129} = 18.7$, $p < 0.001$). In contrast, as the bees' antennae are mostly extended throughout the experiment, appetitive conditioning had no effect on the variation of the distance to the antenna base (Δr , Fig. S1B, RM-ANOVA, $F_{3,129} = 0.95$, NS).

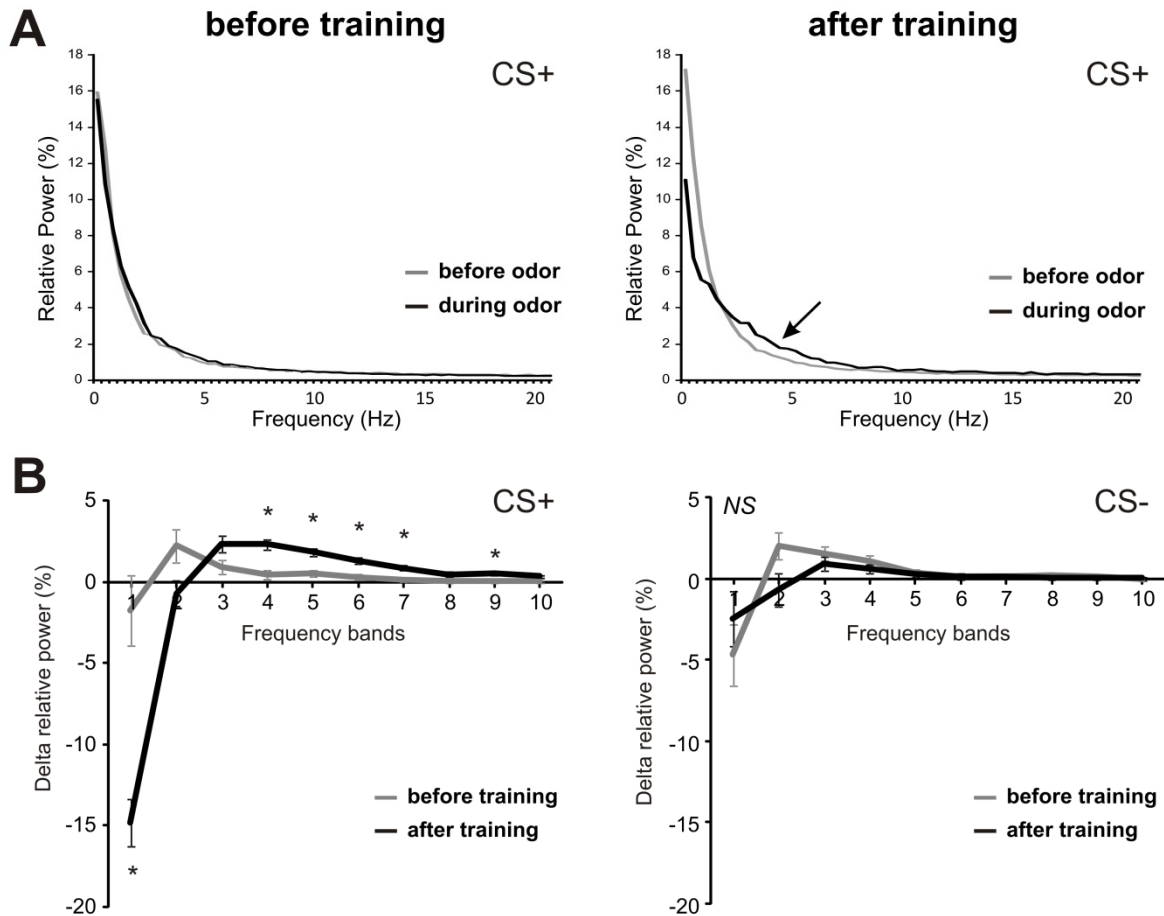

Figure 5. Effect of appetitive conditioning on antennae oscillating frequency. A) Frequency spectrum of antennal movements to the CS+ obtained with a fast Fourier transform (FFT) on angular position (θ), before (grey line) and during (black line) odor presentation, before (left) and after (right) conditioning. After conditioning, the frequency of antenna oscillations changed towards higher frequencies (arrow). B) Change in oscillation frequency (Delta relative power) between during and before odor presentation for the CS+ (left) and CS- (right), before (grey line) and after (black line) conditioning. For statistical analysis, frequencies are grouped in 10 bands from 0.35-1.41 Hz (band 1) to 9.84-10.90 Hz (band 10). Oscillation frequency changed significantly for the CS+ but not for the CS-. In response to CS+, antennal movements at low frequency were reduced (band 1) while movements at higher frequencies (bands 4-7 and 9) were increased (*: $p < \alpha_{\text{corr}2} = 0.005$, $N = 44$).

Co-occurrence of PER and forward antennal movements

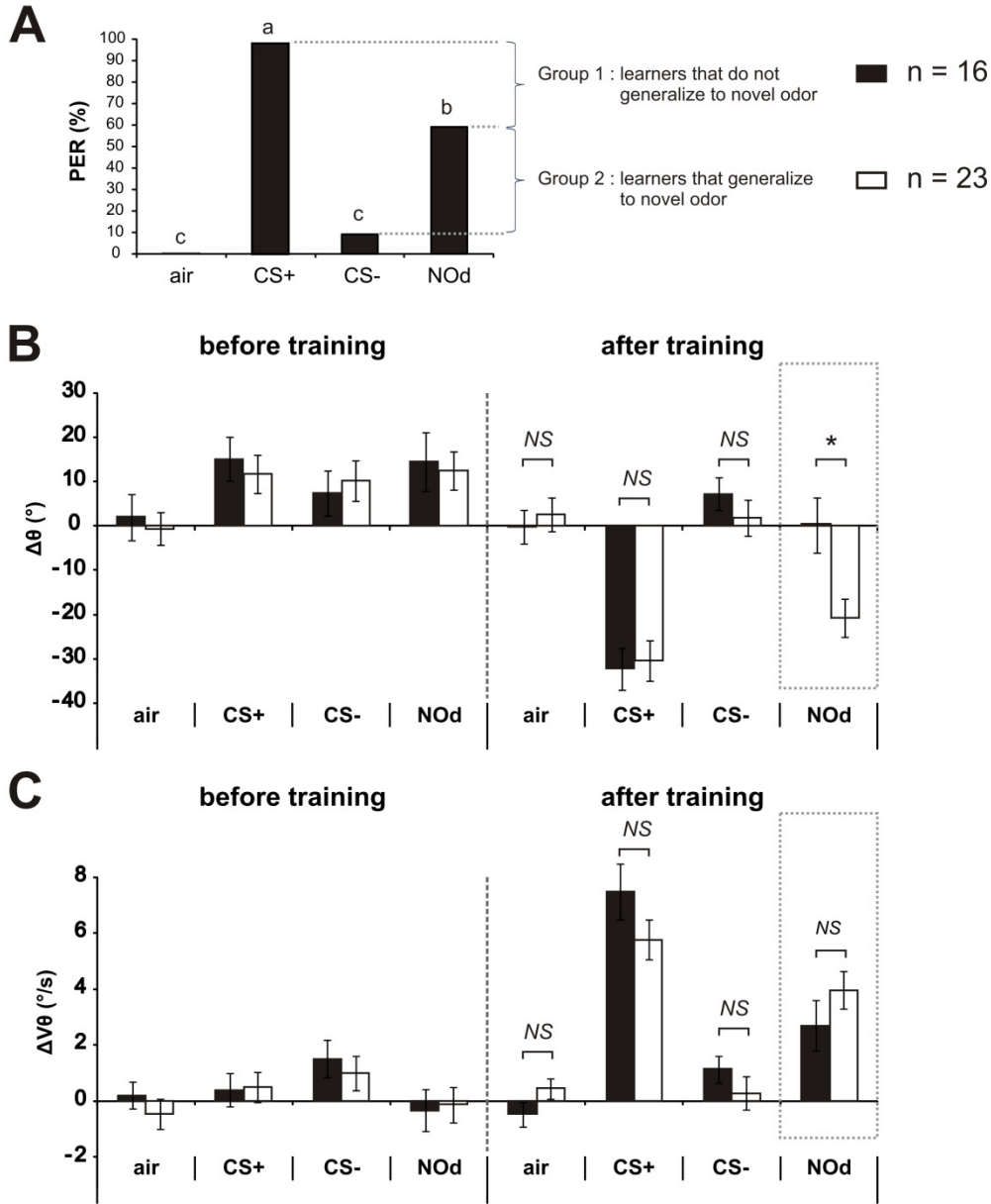

Figure 6. Antennal movement variation as a function of PER generalization to the novel odorant after appetitive conditioning. A) Proportion of PER to the air control, the CS+, the CS- and the novel odorant (NOd) in the test following training. According to learner bees’ responses to the NOd, two subgroups were made: generalizers and non-generalizers. B,C) Histogram showing the change in B) angular position ($\Delta\theta$), and C) angular velocity ($\Delta V\theta$) during odor presentation (during – before odor) for the air control, the CS+, the CS- and the novel odorant (NOd) in individuals that extended their proboscis in response to NOd (generalizers, white, N = 23) and the ones that did not (non-generalizers, black, N = 16). A difference in the angular response appeared between subgroups only for the NOd (t test, $p < 0.05$), not for the CS+, the CS- or the air control. No difference appeared between subgroups for the angular velocity.

Bees show a forward-oriented antenna response to the CS+ and, in some cases, to a novel odorant after appetitive training. This pattern of responses is very similar to that observed with PER (Fig. 6A). We may therefore ask whether the two responses co-occur. To answer this question, we aimed to

compare antennal responses of bees responding or not to an odorant with a PER. Appetitive learning was very effective so that 89% of the bees were learners, responding with a PER to the CS+ and not to the CS- during the tests after conditioning (Fig 5A). The sample sizes for comparing antennal responses of bees responding or not to the CS+ were too unbalanced for proper statistical comparison (Fig 6A, $n = 1$ vs $n = 43$ respectively). However, in learner bees, roughly half of them responded to the novel odorant (NOd) (59%, 23 out of 39, Fig. 5A). This provided a good opportunity to evaluate the possible co-occurrence of PER and antenna response on two similarly-sized groups of animals (Fig. 6B, *PER generalizers*, $n = 23$ vs *PER non-generalizers*, $n = 16$). If PER and antenna responses co-occur, these two groups should show the same antennal behavior for the CS+, the CS- and the air, but not for the NOd. This is exactly what we observed for the angular position. In both subgroups, $\Delta\theta$ strongly decreased for the CS+, but not for the CS- or the air control, without any difference between subgroups for these stimuli after conditioning (t test, $t < 0.92$, NS). By contrast, the PER generalizers showed a strong decrease in $\Delta\theta$ for the NOd, while the PER non-generalizers did not. Accordingly, $\Delta\theta$ for the NOd was different between subgroups after conditioning (t test, $t = 2.85$, $p < 0.01$). A different pattern was however observed when considering the change in angular velocity ($\Delta V\theta$, Fig 6C). As above, no difference between groups was found in the velocity responses to the CS+, CS- and air (t test, $t < 1.60$, NS). Yet, the velocity response was also not significantly different between subgroups for the NOd (t test, $t = 1.15$, NS). Indeed, a significant velocity increase to the NOd with conditioning was observed for PER generalizers (paired t test, $t = 4.56$, $p < 0.001$) and non-generalizers alike (paired t test, $t = 3.06$, $p < 0.01$). We conclude that the acquired forward motion of the antennae to an odorant, but not the acquired velocity increase, co-occur with conditioned PER.

Effect of aversive learning on antennal movements

The general effect of aversive olfactory learning on antennal movements can be observed on the maps showing the changes in antennal tip location for presentations of the CS+ and CS-, before and after conditioning (Fig. 3D). As observed previously (Fig. 3C), before conditioning, the antennae were mostly located at the rear of the head during odor delivery (for both CS+ and CS-). In contrast to appetitive conditioning, no drastic change was observed in the response to the CS+ or CS- after aversive conditioning: the bees' antennae remained at the rear of the head, although for both odorants antenna tips appeared slightly more evenly distributed than before conditioning (Fig. 3D).

These observations were confirmed by the measure of the mean angular position (Fig. 7A) and velocity (Fig. 7B) throughout a CS+ or CS- trial ($N = 68$ bees). Before aversive conditioning, the odorant stimulation induced an increase in the angular position (Fig. 7A, left), as observed before appetitive conditioning (Fig. 4A, left). After aversive conditioning, the same change in angle as before conditioning was observed, for both the CS+ and CS- (Fig. 7A, right). Antenna angular velocity did

not appear to change before conditioning, and only a slight increase during odor presentation was seen after conditioning (Fig. 7B, right). No significant difference in angular position or velocity appeared between CS+ and CS- during or shortly after odor presentation (paired t test, angular position: $t < 1.48$, NS; angular velocity: $t < 1.23$, NS). Only one difference appeared for angular position, but it was long after stimulus offset (18 s, $t = 2.45$, $p < 0.05$).

According to these observations, the variation in angular position ($\Delta\theta$, Fig. 7C) did not show any deviation between stimuli following aversive conditioning (RM-ANOVA, *stimulus* \times *recording* interaction, $F_{3,201} = 1.96$, NS). Indeed, the difference between airflow and odorant stimulations which was observed prior to conditioning (it reached significance for NOd and CS-, paired t tests, $t > 2.08$, $p < 0.0125$) was also prevalent after conditioning (for all odorants, paired t tests, $t > 2.59$, $p < 0.0125$). No change was observed for any of the odorants between before and after conditioning (paired t test, $t < 1.33$, NS).

On the other hand, variation in angular velocity ($\Delta V\theta$) changed during conditioning (RM-ANOVA, *recording* effect, $F_{1,67} = 19.5$, $p < 0.001$) with a different effect for the various stimuli (RM-ANOVA, *stimulus* \times *recording* interaction, $F_{3,201} = 8.59$, $p < 0.001$). Before conditioning, none of the odorants induced any velocity change compared to the air control (paired t test, $t < 1.83$, NS). The three odorant stimuli displayed an increase in the velocity response following conditioning compared to before conditioning (CS+, CS- and NOd, paired t test, $t > 2.69$, $p < 0.0125$). However, no difference appeared between the velocity response to the CS+ and to the CS- after conditioning (paired t test, $t = 1.63$, NS). The *stimulus* \times *recording* interaction was thus attributed to a stronger velocity change for the novel odor compared to the CS- (NOd vs CS-: paired t test, $t = 4.70$, $p < 0.001$). We therefore interpret this effect as a slight non-associative velocity increase after conditioning (see discussion).

We performed a frequency analysis (FFT) on the angular position curves (θ), but again, there was no associative effect of aversive learning on bees' antennal responses. The antennal movement frequency response (Delta relative power, see above) to the CS+ and CS- were similar before and after conditioning (Fig. 8). Consequently, no interaction was observed between *frequency band* and *recording* period, neither for the CS+ (Fig. 8A, RM-ANOVA *recording* \times *band* interaction, $F_{9,603} = 0.63$, NS), nor for the CS- (Fig. 8B, $F_{9,603} = 0.42$, NS).

Variations in the distance between antennae (ΔD) in response to olfactory stimuli showed a differential change throughout conditioning (Fig. S2A, RM-ANOVA, *stimulus* \times *recording* interaction, $F_{3,201} = 3.48$, $p < 0.05$). However, detailed analysis showed that this effect occurred for the NOd and the CS- (paired t test, $t > 3.51$, $p < 0.001$), but not for the CS+ ($t = 1.66$, NS) and again no significant difference appeared between CS+ and CS- ($t = 1.23$, NS). On the other hand, variations in the distance to the antenna base (Δr) did not show any differential change with conditioning (Fig. S2B, RM-ANOVA, *stimulus* \times *recording* interaction, $F_{3,201} = 1.14$, NS).

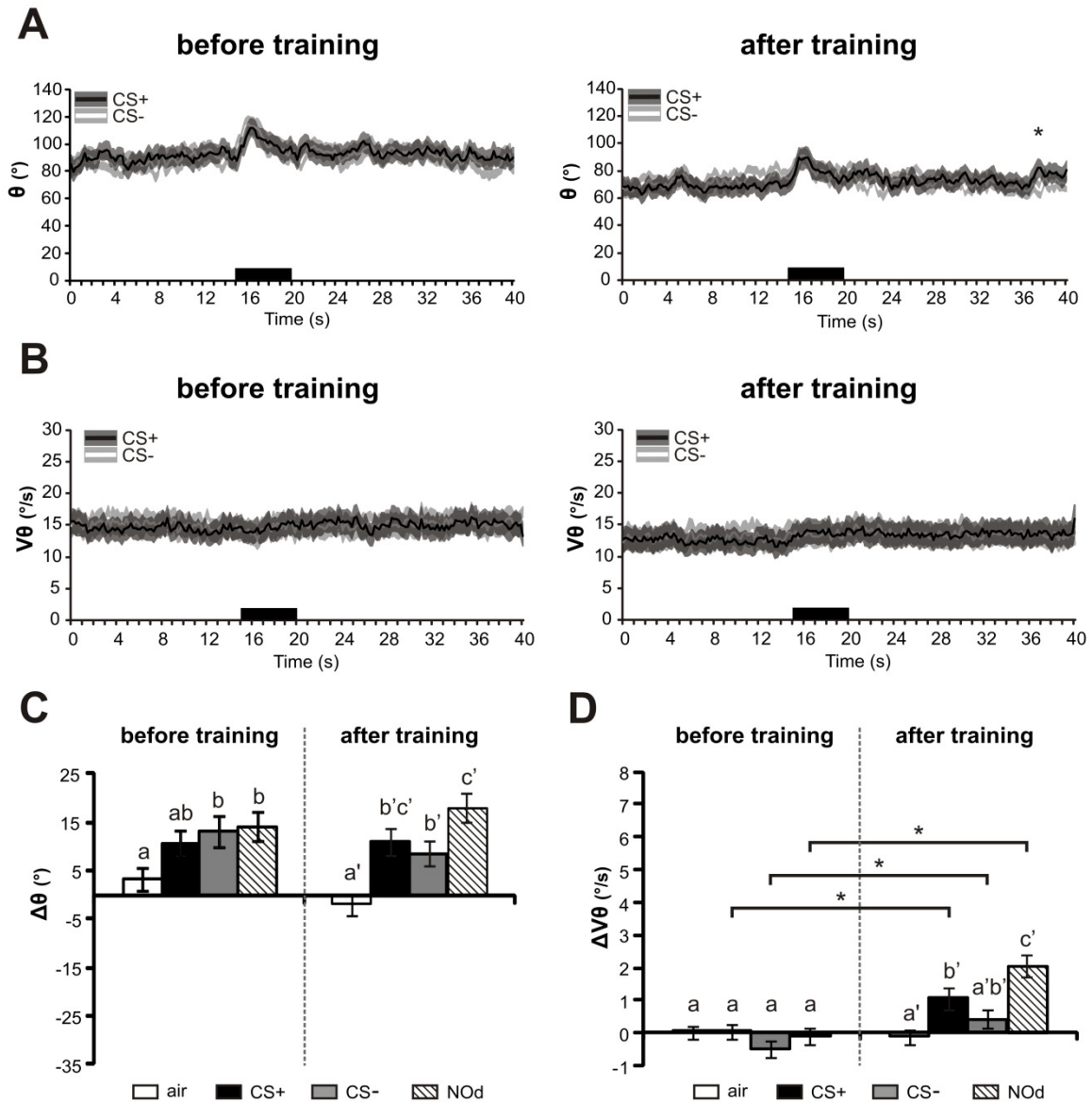

Figure 7. Effect of aversive conditioning on antennal responses to odors. A,B) Temporal variation curves (averaged every 200 ms) before and after training of A) antenna angular position (θ) and B) angular velocity ($V\theta$). No difference appears between CS+ and CS-, except in one instance, long after stimulus of set (star, paired t test at every second). C,D) Histograms showing the change in C) angular position ($\Delta\theta$) or D) angular velocity ($\Delta V\theta$) during odor presentation (during - before odor) for the air control (white), the CS+ (black), the CS- (light gray) and the novel odorant (NOd, stripes), before and after conditioning. All odorants induced a backward antenna motion both before and after training and antenna velocity increased after training for all odorants, especially the NOd. No associative (i.e. CS+ specific) effect of aversive conditioning was observed. Different letters indicate significant differences in paired t tests performed either before or after conditioning ($p < 0.05$). Stars and different letters indicate significant differences in paired t tests ($p < \alpha_{\text{corr1}} = 0.0125$, $N = 68$).

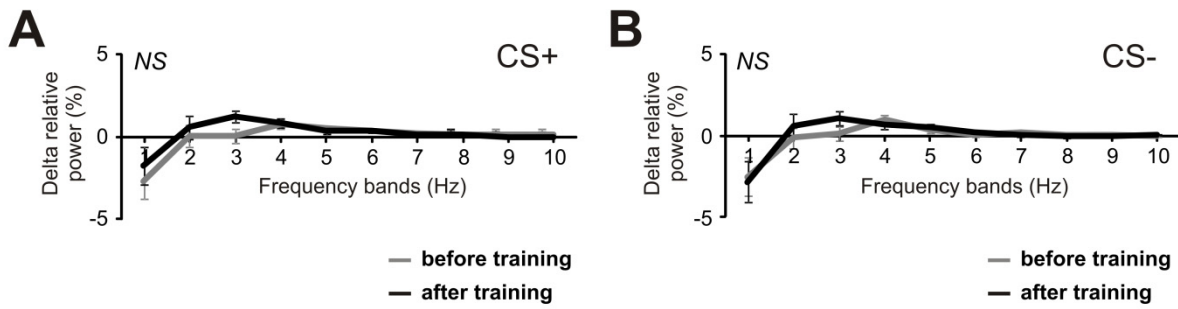

Figure 8. Effect of aversive conditioning on antennae oscillating frequency. A) Change in oscillation frequency (Delta relative power) between during and before odor presentation for the CS+ (A) and CS- (B), before (grey line) and after (black line) training. For statistical analysis, frequencies are grouped in 10 bands from 0.35-1.41 Hz (band 1) to 9.84-10.90 Hz (band 10). Oscillation frequency was neither modified for the CS+ nor for the CS- (NS: non-significant, *band x recording* RM-ANOVA, N = 68).

Is an effect of aversive conditioning on the antennal response hidden by non-learners?

In contrast to PER conditioning, SER conditioning was moderately effective, with 44% of the bees responding to the CS+ and not to the CS- at the end of training (“learners”, Fig. 2B). We thus wanted to verify that a learning effect was not present in learners, which would be hidden by the data of non-learners when analyzed as a whole group. We thus entered the *learning success* as a variable in our analyses, categorizing bees as learners (N = 30) or non-learners (N = 38) based on their performances at the last CS+ and CS- trial of the conditioning phase (see Fig. 2B). We found that this variable had no effect on the results. For the variation in angular position ($\Delta\theta$), we found no effect of *learning success*, nor any interaction with the other variables (*learning success x stimulus x recording* RM-ANOVA, learning success effect: F = 0, NS, all interactions F < 2.3, NS). Likewise, for the change in angular velocity ($\Delta V\theta$), no effect of *learning success* and no significant interaction with other variables were found (*learning success x stimulus x recording* RM-ANOVA, learning success effect: F = 2.24, NS, all interactions F < 1.05, NS). We also verified that learner bees when analyzed alone, did not exhibit a learning-induced change in antennal responses. In this subgroup, response to the CS+ was still not different from that to the CS- after conditioning, neither in terms of angular position ($\Delta\theta$, t = 1.48, NS), nor in terms of angular velocity ($\Delta V\theta$, t = 0.36, NS). In addition, no significant change was observed for any of the tested odorants between before and after conditioning, neither for the angular position (t < 1.79, NS), nor for the angular velocity (t < 2.62, p > $\alpha_{\text{corr1}} = 0.0125$). Thus, no difference in the angular position or in the angular velocity appeared depending on bees’ learning success in the aversive conditioning task. We thus conclude, as above, that aversive conditioning did not have any associative effect on bees’ antennal responses.

Discussion

Using an original motion capture system for recording antenna positions, this study demonstrates important changes in bees' antenna position and velocity following appetitive conditioning. These changes appeared only in response to the reinforced odorant but not in response to the unreinforced one. An intermediate effect was also observed for a novel odorant. By contrast, no clear associative changes were observed following aversive conditioning.

A motion capture principle to measure antennal movements

Our apparatus, based on a motion capture principle, allows recording the position of antenna tips with a very high success rate and at a high frequency (up to 120 Hz). This technique allowed us to monitor the high speed movements of antenna tips, with high temporal resolution. Based on the location of each antenna tip, a number of complementary variables can be calculated, such as its distance from the antenna base, its angular position and its angular velocity, etc. This provides a precise and complete description of antennal movements, which was not achieved in previous studies (Erber *et al.* 1993, 2012; Lambin *et al.* 2005; Hussaini *et al.* 2009; Mujagić *et al.* 2012). As the BipCam system is commercially available (Brain Vision Systems, Paris, France), the implementation of our motion capture system by other researchers should be relatively easy.

A minute drop of paint at the end of each antenna is required for our motion capture system. For optimal monitoring, the drop was placed on the dorsal side at the distal end of each antenna, as in a previous study (Erber *et al.* 1997). One may ask whether such marking affects bees' olfactory or gustatory perceptual capacities. It should be noted that olfactory sensilla are located throughout the flagellum (Esslen and Kaissling 1976; Letzkus *et al.* 2006) and that gustatory sensilla are mostly located on the ventral side of the antenna tip, which was not covered (Esslen and Kaissling 1976; Haupt 2004; de Brito Sanchez 2011). During our experiments, no deleterious effects on the bees' vitality or their behavioral responses were observed as a result of this marking. In particular, marked bees showed olfactory learning performances that are fully consistent with standard performances, both for appetitive (Bitterman *et al.* 1983; Giurfa and Sandoz 2012) and aversive learning (Vergoz *et al.* 2007; Junca *et al.* 2014). Two previous studies in which both appetitive and aversive conditioning were performed, using the same odorants, found highly similar performances to those described in the present work (Vergoz *et al.* 2007; Carcaud *et al.* 2009). It can thus be concluded that antenna marking did not affect the detection of or the responses to odorants, sucrose and temperature.

It should be noted that our system, like all formerly-described systems (Erber *et al.* 1997; Lambin *et al.* 2005; Mujagić *et al.* 2012), can only measure movement variations in two dimensions, here in the frontal plane of the honeybee head. Even if a three-dimensional tracking system would procure finer measurements, close observations show that most of the bees' antennal movements take place in this plane (Fig. 2). We are therefore confident that the changes in antennal movement observed in the

present study represent a prominent part of the bees' antennal behavior during learning. In the future, however our system may be upgraded into a three-dimensional recording system by using two or more motion capture systems placed around the bees' head and by temporally synchronizing their dataflows.

Odor response before conditioning

Bees exhibit specific antennal responses to sensory stimuli (Erber *et al.* 1993). Two previous studies, which were based on a less precise monitoring of antennal movements, suggested that bees tend to orientate the antennae towards an odorant upon olfactory stimulation (Suzuki 1975; Erber *et al.* 1993). In our experiments, odorants had little influence on angular position before conditioning, and even induced a slight – often non-significant - backward movement (Fig. 4 and 7). Such differences could be attributed to different previous experiences with these odorants and/or to differences in the innate values of the tested odorants for bees. Suzuki (1975) described odor responses only qualitatively, providing photographs of a bee responding to an odorant (ethyl methyl ketone, also called 2-butanone). On these photographs, the bee's proboscis is partly extended during odor delivery, suggesting that the odorant might have acquired an appetitive value for this bee before the observation. The behavior of this bee corresponds well to the behavior of our bees *after* appetitive conditioning. In the later study by Erber *et al.* (1993), bees exhibited forward antennal movements to three out of four odorants, but all tested odorants had a strong innate value for bees. Bees oriented their antennae toward geraniol and citral, two main components of the bees' aggregation pheromone (Pickett 1980; Boch 1962a) and to caprylic acid (also called octanoic acid), the major royal jelly volatile (Boch *et al.* 1979; Nazzi *et al.* 2009). By contrast, they did not respond to isopentyl acetate (also known as *iso*-amyl *acetate*), the major component of the alarm pheromone (Boch 1962b). Therefore, all odorants that produced a forward antennal movement already had a strong positive value for bees (aggregation or royal jelly). We thus believe that these previous observations may not represent the general case, and that, as recognized by Erber *et al.* (1993), different odorants may induce different antennal responses. Future work should thus compare antennal responses to a range of pheromonal and non-pheromonal odorants systematically, in naïve bees where prior exposure to test odorants has been carefully controlled. Our recording system is adequate to accomplish this task.

Influence of conditioning on antennal movements – the valence hypothesis

The aim of this study was to compare the effect of two conditioning procedures which convey either an appetitive or an aversive value to an odorant, on odor-evoked antennal movements. Our initial hypothesis posited that these two types of conditioning would induce opposite antennal movement modifications. This idea originated from a study in cockroaches where two odorants with opposite innate values (positive or negative) were tested. Antennal movements were respectively increased by the appetitive odorant and decreased by the aversive odorant (Nishiyama *et al.* 2007). Our results only partly confirmed our initial hypothesis. Appetitive conditioning indeed had a strong

effect on antennal movements to the reinforced odorant. A strong forward motion of the antennae (Fig. 3, 4) and a velocity increase (Fig. 4) associated with a higher scanning activity (antenna oscillation frequency, Fig. 5) were observed. On the contrary, no clear associative effect of aversive conditioning was found on antennal responses (Fig. 7, 8). Therefore, our data suggest that there is a correlation between an odor's acquired positive valence and an increase in the scanning frequency in the direction of the odorant. One possibility is that only appetitively associated odorants can induce such an antennal response. Conversely, our experimental conditions may not have been optimal for measuring a specific response to aversively associated odorants. In particular, we must note that bees tended to place their antennae to the rear of their head during odor delivery, i.e. away from the odorant, before conditioning. Therefore, if a specific antennal response change to aversive conditioning included moving the antennae away from the learned odorant, our conditions may not have been optimal for measuring such response change. However, if such a response existed, we believe that we should have observed it, as the backward motion of the antennae before conditioning covered a small angle ($\sim 10^\circ$) and was short-lived (a few seconds), whereas the acquired response seen in the appetitively conditioned group covered a much wider angle ($\sim 29^\circ$) and lasted longer (until about 10 s after odor delivery). In any case, future experiments should confirm this result. When the systematic study of bees' innate antennal response to a range of odorants is performed, as mentioned above, it will be possible to choose as CSs odorants (or odorant concentrations), which do not induce a backward antennal response prior to conditioning. Use of such an odor in aversive conditioning could clarify whether the absence of any change in antennal response to odorants with a negative acquired valence is a genuine observation, or whether possible backward movements were masked in our study.

Influence of conditioning on antennal movements – a Pavlovian mechanism?

The plasticity of antennal responses we observed after appetitive conditioning can be explained in the context of *classical conditioning*. In this context, the unconditioned response (UR) would be a forward antenna motion with increased scanning activity. This hypothesis is substantiated by previous work demonstrating that a high-concentration sucrose stimulus applied to the bee antennae induces an increased scanning activity and touching frequency of the presented solution (Haupt 2004). This process is thought to involve increased activity of an antenna muscle, the pedicel fast flexor muscle (Pribbenow and Erber 1996; Erber *et al.* 2000; Haupt 2007). Through repeated pairing of the odor CS with the sucrose US, the CS would gain control not only over the PER (Takeda 1961; Bitterman *et al.* 1983), but also over this antennal scanning response (ASR). Thus, appetitively conditioned bees would exhibit a double conditioned response upon CS+ presentation: the PER and the ASR. Like PER, the ASR is not produced for the CS-, but generalization can take place to a novel odor (see Fig. 4, 6).

Double conditioned responses such as this may be an important adaptive advantage under natural conditions. Antennal movements often occur during tasks which involve proboscis extension, for instance during foraging or during trophallactic contacts (Free 1956; Montagner and Pain 1971;

Galliot and Azœuf 1979; Galliot *et al.* 1982; Korst and Velthuis 1982; Crailsheim 1998; Wright *et al.* 2012). One may thus wonder if both responses are part of a common motor pattern and are therefore always co-occurring. In this study we addressed this question by comparing antennal responses in bees that exhibited or not a PER generalization to a novel odorant (Fig. 6). If the two responses were part of a common motor pattern, one would expect ASR generalization to be found only in bees that showed a PER generalization. Our data only partly substantiated this prediction. While antennal angular position clearly correlated with PER responses, antennal angular velocity did not. Bee that did not generalize with a PER to the novel odor still showed an antenna acceleration to this odor (i.e. they generalized this antennal acceleration to the novel odor). This suggests that the two conditioned responses may be in part triggered by the same neural substrate, deciding or not to generalize to a novel odorant and inducing both PER and a forward antenna movement. In addition, an antenna speed increase could still appear, even if bees do not extend their PER, probably because of a higher response threshold for the latter than for the former.

Influence of conditioning on antennal movements – an operant contribution?

Intensive previous work has shown that antennal movements can be subjected to *operant conditioning* (Erber *et al.* 1997, 1998, 2000; Kisch and Erber 1999; Haupt 2007). This applies, for instance, to studies that carried out motor learning by reinforcing high scanning activity (monitoring either antennal contact frequency or muscle activity) with sucrose (Kisch and Erber 1999; Erber *et al.* 2000; Haupt 2007). In our case, the magnitude of the ASR may have been strengthened through an operant process. The bees could have associated their active scanning behavior, caused by the sucrose stimulation applied to the antennae (Haupt 2004) with the subsequent sucrose reward applied to the proboscis. However, even if ASR magnitude was enhanced by operant processes, the core of the response plasticity we found has a Pavlovian nature. It is the quality of the presented odorant that triggers the ASR (CS+) or not (CS-), just as in free-flying conditioning experiments, in which visual stimuli trigger or not an operant approach behavior (Menzel 1999).

Lack of aversive conditioning effect

We did not observe associative effects of aversive conditioning on antennal movements (Fig. 3D, 7). However, we did observe a small increase in angular velocity for all odor stimuli after conditioning (Fig 7B,D). This velocity increase was not significantly different between the CS+ and the CS- (Fig. 7D) suggesting that it may correspond to a non-associative effect of the procedure. Possibly, after aversive training, bees may be in a sensitized state (related to the 6 thermal shocks received) or may display increased attention to external stimuli. A similar effect could also exist in the case of appetitive conditioning with sucrose stimulations, but it would be difficult to observe because of the strong associative effect on antenna velocity. Further experiments comparing bees that received only thermal

shocks, only sucrose stimulations or remained naïve throughout the experiment may help examining this possibility.

Lastly, we used two standard protocols for conditioning bees appetitively (Bitterman *et al.* 1983) or aversively (Junca *et al.* 2014). However it is important to bear in mind that there are differences concerning the application of the US, between the two protocols. In PER conditioning, the US was a compound applied to the antennae and then to the proboscis (Bitterman *et al.* 1983). In SER conditioning, the US was a heated probe applied to the mouthparts (Junca *et al.* 2014). The two protocols thus differ in the mode of delivery and their respective contact with the antennae. It will thus be necessary to consider whether a thermal stimulation on the antennae would induce such classical or operant processes similar to those observed for appetitive conditioning. Following the Pavlovian hypothesis detailed above, bees could show an antennal unconditioned response to such a thermal US, which may then be classically conditioned. Future experiments will test this hypothesis.

Conclusion

In this study, we observed a striking difference in the effects of appetitive and aversive conditioning on odor-induced antennal movements, the former inducing a strong forward-oriented scanning response while the latter had little influence. Our current interpretation of this phenomenon is that the ASR following appetitive conditioning could be linked to a classical conditioning process rather than relating to the positive acquired valence of the odorant.

Materials and methods

Insects

Honeybee workers (*Apis mellifera*) were caught at the entrance of outdoor hives on the CNRS campus of Gif-sur-Yvette, from March to May 2014. The bees were caught in the morning, were fed, and then chilled on ice until they stopped moving. They were then harnessed individually in metal holders, leaving their antennae, abdomen and mouthparts free. The honeybees were positioned with their back toward the front of the tube, allowing both SER and PER conditioning under the same conditions (Fig. 1A, Junca *et al.* 2014).

Antenna monitoring apparatus

The recording apparatus was composed of a camera positioned above the bee holder and an olfactory stimulation apparatus (Fig. 1A). The camera included an integrated processing card allowing adaptive detection (using a motion prediction algorithm) of the two colour dots, up to a rate of 120 Hz (BIPcam, Brain Vision Systems, Paris). The camera managed to follow and record the coordinates of the two color dots on the antenna tips, in real time at a rate of 90 Hz (90 frames per second). In order

to optimise the detection of the colour dots, the apparatus was placed in a room with low light conditions (controlled and kept constant). A cold light illumination ring was placed around the lens of the camera, diffusing homogeneous white light on the bee's head (Leica CLS 150XE, Leica, Jena, Germany). The intensity of the light source was tuned precisely and kept constant for the duration of the experiments.

The olfactory stimulation apparatus was connected to a pump, enabling the constant circulation of an air flow of 52.5 ml/s. This flow, composed of a principal air flow of 50 ml/s and a secondary flow of 2.5 ml/s, was directed to the bee by a glass tube (0.5 cm diameter), at a distance of 2 cm. The secondary air flow could be directed to one of two sub-circuits (one containing an odorant source, and another without any odorant) before being reinjected into the main airflow. Most of the time, air flowed through the odourless sub-circuit. Olfactory stimulation was applied manually inducing a switch of the secondary flow to the odorant sub-circuit for 5 s. The odorant sub-circuit included a Pasteur pipette containing a piece of filter paper (20 × 2 mm) soaked with 5 µl of odorant solution. The other sub-circuit included an identical Pasteur pipette without odorant. An air extractor, placed behind the bee prevented odorant accumulation.

Insect preparation

The aim of this study was to determine the influence of appetitive or aversive learning on antennal responses to an olfactory stimulation. To this aim, antennal movements of each individual were recorded before and after either an appetitive PER (Proboscis Extension response) conditioning procedure or an aversive SER (Sting Extension response) conditioning procedure. Once mounted in a metal holder, each individual was fed with sucrose solution (50% w/w). To maintain a good survival rate throughout the experiment, individuals subjected to appetitive conditioning received 5 µL sucrose solution, while individuals assigned to the aversive conditioning received a higher amount (15 µL). This was to compensate for the fact that these individuals do not receive any sucrose solution during conditioning (by contrast with appetitive conditioning, see below). After feeding, bees were prepared for the motion capture system, by marking their antenna tips with paint. Red colour dots were applied using water-based paint (Posca PC-5M, Mitsubishi Pencil Co., Tokyo, Japan) on the upper surface of the last two flagelomers of each antenna. Once mounted, fed and marked, individuals were placed in a moist, dark polystyrene box for 30 min, before the start of the experiments.

Antennal movement recordings

Antennal movements were recorded 1 h before the beginning of the conditioning procedure and 1 h after the end of the conditioning phase. Before the recording period, each bee was left to acclimatise to the airflow for 20 s. Each recording lasted 40 s: 15 s of airflow, 5 s of olfactory stimulation, and 20 s of airflow. Each bee was recorded four times, three recordings with an olfactory stimulation and one with a constant air flow. These recordings were separated by 1 min and were carried out in a

randomised order. Three odorants were used; 1-hexanol (A) and 1-nonanol (B) were used as conditioned stimuli (CSs) and octanal (C) was used as a novel odor (NOD) (all from Sigma Aldrich). These odorants were chosen because they are easily learned and well discriminated by the bees (Guerrieri et al. 2005). In addition, these CSs have been used in several studies comparing SER and PER conditioning (Vergoz et al. 2007; Carcaud et al. 2009). During these antenna movement recordings, proboscis extensions could be clearly seen and recorded by the experimenter. However, due to the position of the bee and the lighting directed only to the bees' head, sting extensions could not be monitored during these recordings.

Conditioning procedure

Bees were allocated either to an appetitive conditioning group or to an aversive conditioning group. In both groups, the bees were prepared in an identical manner to avoid any potential bias resulting from their position. The bees were thus fixed to the metal tube with a piece of tape placed below the head to the front, leaving the abdomen and the mouthparts free to move. In this position, both SER and PER could be easily observed. The appetitive conditioning of the Proboscis Extension Response (PER) was carried out according to standard procedures (Bitterman *et al.* 1983; Matsumoto *et al.* 2012). For aversive conditioning of the Sting Extension Response (SER), the novel procedure developed by Junca *et al.* (2014) was used. All bees received a differential conditioning procedure in which one odorant (CS+) was associated with the US (i.e. reinforced) and another odorant (CS-) was presented explicitly without US (i.e. non-reinforced). Such a protocol contains an internal control, as animals that efficiently learned the CS-US association will respond to the CS+ but not to the CS- (Matsumoto et al. 2012). If associative learning modifies antennal responses to odorants, we thus expect to observe these modifications for the CS+ but not for the CS-.

For PER conditioning, the unconditioned stimulus (US) was sucrose (50% w/w) applied to the antennae and the proboscis. For SER conditioning, the aversive US was a thermal stimulation (65°C) applied to the mouthparts by means of a pointed copper cylinder (diameter: 6 mm; length: 13 mm), placed on a soldering iron (HQ-Power, PS1503S). The CSs were 5 µl of pure odorant (1-hexanol or 1-nonanol) applied to pieces of filter paper placed into 20 ml syringes. Odor CSs were delivered manually to the antennae of the bee at a distance of 2 cm in a homogeneous flow throughout the 5 s of stimulation.

Each day, half of the individuals received 1-hexanol (A) reinforced and 1-nonanol (B) non-reinforced, and vice versa for the other half of the bees. Conditioning consisted of 12 trials (6 CS+, 6 CS-) with an inter-trial interval of 10 min. Odorants were presented in a pseudo-random sequence of six reinforced and six non-reinforced trials (ABBA BAAB ABBA) starting with the odorant A or B in a balanced manner, so that no effect of a particular odorant could influence the results. Each conditioning trial lasted 35 s (20 s of airflow, 5 s of olfactory stimulation and 10 s of airflow). Each individual was placed on the stimulation site, under a cold light source, in front of the air extractor to

prevent odorant accumulation. In the case of the CS+, the US was applied 3 s after odorant onset, for 2 s. In all experiments, PER or SER responses to the CS were measured during the 3 s in which the bees were exposed to the odour only (before the US).

Antennal movement analysis

The monitoring apparatus recorded at each time point (90 times per second) the location of the two antenna tips of each bee on the camera sensor. Firstly, all the recordings from all bees were recalculated in the same coordinate system (x,y), with the socket of the right antenna as the origin (coordinate 0,0) and the socket of the left antenna as the unit reference on the x axis (coordinate 1,0). Each recording thus resulted in a series of (x,y) coordinates for each antenna at each time-step (1/90 s). This allowed a comparison between the antennal movements of different bees. In addition, heat maps describing the number of times each antenna tip was located at each coordinate could be constructed (Fig. 3). In these heatmaps, the number of occurrences of each data point was normalised with regards to the total number of occurrences on the entire map, to make them comparable in the various conditions. Occurrence frequency is represented on a color scale ranging from dark-blue to red. Maps of antenna location change were computed by subtracting the map obtained *before* odor from that *during* odor. On these new maps, occurrence frequency reduction and increase are shown with blue and red color respectively.

Previous studies (Lambin *et al.* 2005; Hussaini *et al.* 2009) and our preliminary experiments showed that bees' antennal movements are best described using circular coordinates (r, θ), as each antenna moves around its socket (Fig. 1B). Thus, each antenna's movements were described in their own coordinate system, with the antenna socket (base) as the origin (0,0).

- **Angular position (θ):** it was defined as the angle between a line connecting the antenna tips to their base (r) and an anteroposterior line passing through the corresponding antenna base. This variable indicates if the antenna is positioned to the front (0°), to the side (90°) or backwards (180°). Note that the measured angle is symmetrical for the left or the right antenna so that 90° is on the left for the left antenna and on the right for the right antenna.
- **Distance to antenna base (r):** it was defined as the distance between the antenna base and the antenna tip. This variable thus measures whether the antenna is in a stretched or retracted position.

From these, two other variables were computed:

- **Angular velocity ($V\theta$):** it was calculated as the angle θ travelled by each antenna during a frame (1/90 s). It is expressed in $^\circ/s$.
- **Distance between antenna tips (D):** it was the distance in the recording plane between the antennae distal ends. This variable enabled us to detect any variation in terms of the separation or approach of the two antennae.

As explained in the results, θ and $V\theta$ proved to be the most pertinent for measuring changes induced by conditioning and are thus presented in the figures. r and D data are presented in supplementary material.

As antennal movements are mainly composed of back-and-forth scanning motions around the socket with amplitude and frequency variations (Erber *et al.* 1993; Lambin *et al.* 2005; Hussaini *et al.* 2009), we used a Fast Fourier Transform (FFT) to determine the frequency spectrum of these oscillations. Due to mathematical constraints of this analysis (which uses 2^n data points), the FFT was performed on an angular position (θ) data using 256 data points (i.e. 2.84 s) either *during* odor presentation (starting at the first frame of odor presentation) or *before* odor presentation (finishing at the last frame before odor presentation). The obtained frequency spectrum represented the repartition of the oscillating power of antennal movements (integrating both the number and angular amplitude of oscillations) according to 128 different frequency bands from 0 to 45 Hz (half the recording frequency). In the figures, the power at each frequency band was represented as a percentage of total power over the whole frequency range (relative power in %). In order to study the effect of an olfactory stimulation on the antennal movement frequency, the differences between the relative frequency spectrum *before* and *during* the olfactory stimulation was calculated (Δ_{power} in %). As shown in the results, antenna oscillations are best described between 0 and 10 Hz, for which reason further analysis concentrated on this frequency range. Δ_{power} values were thus analyzed according to 10 frequency bands from 0.35-1.41 Hz (band 1) to 9.84-10.90 Hz (band 10). FFT analyses were performed using the analysis toolpack in Microsoft Excel 2007.

Statistical analysis

During conditioning, the occurrence of a proboscis or sting extension (depending on conditioning assay), was recorded as 1 and non-extension as 0. The acquisition curves show the percentage of individuals showing a PER or a SER to each presentation of the CS+ or of the CS-. To analyze learning performances, a repeated measure analysis of variance (RM-ANOVA) was used, with *trial* (from 1 to 6) and *stimulus* (CS+ / CS-) as within-group factors. Monte Carlo simulations demonstrated that it is permissible to use an ANOVA on dichotomous data under controlled conditions (Lunney 1970). For each conditioning type, the two subgroups receiving 1-hexanol (odorant A; PER $n = 21$; SER $n = 33$) and 1-nonanol (odorant B; PER $n = 23$; SER $n = 35$) as CS+ were pooled. No effect of these subgroups or interaction with other variables were found (RM-ANOVA, interaction *stimuli* \times *odours* \times *trials*, PER: $F_{5,210} = 0.72$, $p = 0.61$; SER: $F_{5,330} = 1.57$, $p = 0.17$).

Antennal movements to 4 stimuli (CS+, CS-, Nod and air) were measured before and after conditioning. To analyze possible differences in angular position and angular velocity between the CS+ and the CS- after conditioning, a paired t-test was performed every second throughout the recording. To analyze changes in the different recorded variables (θ , r , $V\theta$ and D) with odor

presentation, we calculated the difference (called $\Delta\theta$, Δr , $\Delta V\theta$ and ΔD) between the average values recorded *during* the stimulation (5 s) and the average values recorded *before the stimulation* (15 s). A RM-ANOVA was used with the *recording* (before or after conditioning) and the *stimulus* (CS+, CS-, NOd or air) as within-group factors. When this analysis was significant, a limited number of planned (*a-priori*) comparisons were carried out, using paired t-tests. Each data point was compared to only 4 other data points. 1) To compare responses between stimuli *within* each recording session, the value observed for each stimulus at each recording session (for instance $\Delta\theta$ for the CS+ *before* conditioning) was compared to the values observed for the three other stimuli within the same recording session (here, $\Delta\theta$ for the CS-, NOd and air *before* conditioning – 3 comparisons). 2) To evaluate the change in the response to each stimulus *between* recording sessions, the value observed for each stimulus at each recording session was compared to the response to the same stimulus in the other recording session (here, $\Delta\theta$ for the CS+ *after* conditioning – 1 comparison). To correct for the multiple use of each data point in these planned contrasts, a Bonferroni correction for multiple comparisons was applied, and the significance threshold for all post hoc comparisons was $\alpha_{\text{corr1}} = 0.05 / 4 = 0.0125$.

The frequency analysis (FFT) concentrated on the change in the frequency spectra of antennal movements observed before and after training for the CS+ and the CS-. A RM-ANOVA was used with the *recording* (before or after conditioning), and the frequency *band* (band 1 to band 10) as within-group factors. A comparison between data obtained before and after training at each of the 10 frequency bands were performed using paired t-tests. The significance threshold was corrected for multiple comparisons as $\alpha_{\text{corr2}} = 0.05 / 10 = 0.005$.

Statistical tests were performed with STATISTICA 5.5 (Statsoft, Tulsa, USA) and R 3.0.2 (Foundation for Statistical Computing, Vienna, Austria).

Acknowledgements

We are indebted to P. Pirim, L. Josselin and G. Havard (Brain Vision Systems, Paris) for their help in software development and to S. Famié for initial tests with the motion capture system. This work was supported by the Agence Nationale de la Recherche (ANR), Paris, France (Project BEE-CHANNELS, ANR-13-BSV7-0010). H.C. and P.J. thank the French Ministère de la Recherche et de l'Enseignement Supérieur for PhD funding. We thank the Evolvee Team for fruitful discussions and A. French and two anonymous referees for helpful comments on the manuscript.

References

- Alcock J. 1997. *Animal Behavior: an evolutionary approach*. Sinauer Associates, Sunderland..
- Bitterman ME, Menzel R, Fietz A, Schäfer S. 1983. Classical conditioning of proboscis extension in honeybees (*Apis mellifera*). *J Comp Psychol* **97**(2): 107-119.
- Boch R. 1962a. Identification of geraniol as the active component in the Nassenoff pheromone of the honey bee. *Nature* **194**: 704-706.
- Boch R. 1962b. Identification of iso-amyl acetate as an active component in the sting pheromone of the honey bee. *Nature* **195**: 1018-1020.
- Boch R, Shearer DA, Shuel RW. 1979. Octanoic and other volatile acids in the mandibular glands of the honeybee and in royal jelly. *J Apicult Res* **18**: 250–252.
- Busto GU, Cervantes-Sandoval I, Davis RL. 2010. Olfactory learning in drosophila. *Physiology* **25**(6): 338-346.
- Carcaud J, Roussel E, Giurfa M, Sandoz JC. 2009. Odor aversion after olfactory conditioning of the sting extension reflex in honeybees. *J Exp Biol* **212**(5): 620-626.
- Chaffiol A, Laloi D, Pham-Delègue MH. 2005. Prior classical olfactory conditioning improves odour-cued flight orientation of honey bees in a wind tunnel. *J Exp Biol* **208**(19): 3731-3737.
- Crailsheim K. 1998. Trophallactic interactions in the adult honeybee (*Apis mellifera* L.). *Apidologie* **29**(1-2): 97-112.
- Crow T. 2004. Pavlovian Conditioning of Hermissenda: Current Cellular, Molecular, and Circuit Perspectives. *Learn Mem* **11**(3): 229-238.
- Dreller C, Kirchner WH. 1993. Hearing in honeybees: localization of the auditory sense organ. *J Comp Physiol A* **173**(3): 275-279.
- de Brito Sanchez MG. 2011. Taste perception in honey bees. *Chem Senses* **36**: 675–692.
- Erber J. 2012. Tactile antennal learning in the honey bee. In *Honeybee Neurobiology and Behavior* (ed. Galizia CG, Eisenhardt D, Giurfa M), pp. 439-455. Springer Netherlands.
- Erber J, Kierzek S, Sander E, Grandy K. 1998. Tactile learning in the honeybee. *J Comp Physiol A* **183**(6): 737-744.
- Erber J, Pribbenow B, Bauer A, Kloppenburg P. 1993. Antennal reflexes in the honeybee: tools for studying the nervous system. *Apidologie* **24**(3): 283-296.
- Erber J, Pribbenow B, Grandy K, Kierzek S. 1997. Tactile motor learning in the antennal system of the honeybee (*Apis mellifera* L.). *J Comp Physiol A* **181**(4): 355-365.
- Erber J, Pribbenow B, Kisch J, Faensen D. 2000. Operant conditioning of antennal muscle activity in the honey bee (*Apis mellifera* L.). *J Comp Physiol A* **186**(6): 557-565.
- Erber J, Schildberger K. 1980. Conditioning of an antennal reflex to visual stimuli in bees (*Apis mellifera* L.). *J Comp Physiol* **135**(3): 217-225.
- Esslen J, Kaissling KE. 1976. Zahl und Verteilung antennaler Sensillen bei der Honigbiene (*Apis mellifera* L.). *Zoomorphol* **83**(3): 227-251.

- Free JB. 1956. A study of the stimuli which release the food begging and offering responses of worker honeybees. *Br J Anim Behav* **4**(3): 94-101.
- von Frisch K. 1967. *The dance language and orientation of bees*. Belknap press, Cambridge.
- Galliot G, Azoëuf P. 1979. Etude quantitative des transferts de nourriture entre ouvrières d'âge connu chez l'abeille domestique (*Apis mellifica mellifica* L.). *Insectes Soc* **26**(1): 39-49.
- Galliot G, Montagner H, Azoëuf P. 1982. Étude quantitative des transferts de nourriture entre ouvrières et mâles chez l'abeille domestique (*Apis mellifica* L.). *Insectes Soc* **29**(2): 268-279.
- Gil M, De Marco RJ. 2010. Decoding information in the honeybee dance: revisiting the tactile hypothesis. *Anim Behav* **80**(5): 887-894.
- Giurfa M. 2007. Behavioral and neural analysis of associative learning in the honeybee: a taste from the magic well. *J Comp Physiol A* **193**(8): 801-824.
- Giurfa M, Sandoz JC. 2012. Invertebrate learning and memory: Fifty years of olfactory conditioning of the proboscis extension response in honeybees. *Learn Mem* **19**(2): 54-66.
- Guerrieri F, Schubert M, Sandoz JC, Giurfa M. 2005. Perceptual and neural olfactory similarity in honeybees. *PLoS Biol* **3**(4): e60.
- Haupt SS. 2004. Antennal sucrose perception in the honey bee (*Apis mellifera* L.): behavior and electrophysiology. *J Comp Physiol A* **190**(9): 735-745.
- Haupt SS. 2007. Central gustatory projections and side-specificity of operant antennal muscle conditioning in the honeybee. *J Comp Physiol A* **193**(5): 523-535.
- Hrnčir M, Barth FG, Tautz J. 2006. Vibratory and Airborne-Sound Signals in Bee Communication (Hymenoptera). In *Insect Sounds and Communication: Physiology, Behaviour, Ecology, and Evolution*, (ed. Drosopoulous S, Claridge MF), pp. 421-436. CRC Press, Boca Raton, FL.
- Hussaini SA, Bogusch L, Landgraf T, Menzel R. 2009. Sleep deprivation affects extinction but not acquisition memory in honeybees. *Learn Mem* **16**(11): 698-705.
- Junca P, Carcaud J, Moulin S, Garnery L, Sandoz JC. 2014. Genotypic influence on aversive conditioning in honeybees, using a novel thermal reinforcement procedure. *PLoS ONE* **9**(5): e97333.
- Kevan PG, Lane MA. 1985. Flower petal microtexture is a tactile cue for bees. *Proc Natl Acad Sci* **82**(14): 4750-4752.
- Kisch J, Erber J. 1999. Operant conditioning of antennal movements in the honey bee. *Behav Brain Res* **99**(1): 93-102.
- Korst PJAM, Velthuis HHW. 1982. The nature of trophallaxis in honeybees. *Insectes Soc* **29**(2): 209-221.
- Lacher V. 1964. Elektrophysiologische Untersuchungen an einzelnen Rezeptoren für Geruch, Kohlendioxyd, Luftfeuchtigkeit und Temperatur auf den Antennen der Arbeitsbiene und der Drohne (*Apis mellifica* L.). *Z vergl Physiol* **48**(6): 587-623.
- Lacher V, Schneider D. 1963. Elektrophysiologischer Nachweis der Riechfunktion von Porenplatten (Sensilla placodea) auf den Antennen der Drohne und der Arbeitsbiene (*Apis mellifica* L.). *Z vergl Physiol* **47**(3): 274-278.

- Lambin M, Déglise P, Gauthier M. 2005. Antennal movements as indicators of odor detection by worker honeybees. *Apidologie* **36**(1): 119-126.
- Letzkus P, Ribi WA, Wood JT, Zhu H, Zhang SW, Srinivasan MV. 2006. Lateralization of Olfaction in the Honeybee *Apis mellifera*. *Curr Biol* **16**(14): 1471-1476.
- Lunney GH. 1970. Using analysis of variance with a dichotomous dependent variable: an empirical study. *J Educ Meas* **7**(4): 263-269.
- Martin H, Lindauer M. 1966. Sinnesphysiologische Leistungen beim Wabenbau der Honigbiene. *Z vergl Physiol* **53**(3): 372-404.
- Matsumoto Y, Menzel R, Sandoz JC, Giurfa M. 2012. Revisiting olfactory classical conditioning of the proboscis extension response in honey bees: a step toward standardized procedures. *J Neurosci Methods* **211**(1): 159-167.
- Menzel R. 1990. Learning, memory, and “cognition” in honey bees. In *Neurobiology of comparative cognition* (ed. Kesner RP, Olton DS), pp. 237–292. Lawrence Erlbaum Associate, Hillsdale.
- Menzel R. 1999. Memory dynamics in the honeybee. *J Comp Physiol A* **185**(4): 323-340.
- Menzel R. 2012. The honeybee as a model for understanding the basis of cognition. *Nat Rev Neurosci* **13**(11): 758-768.
- Montagner H, Pain J. 1971. Étude préliminaire des communications entre ouvrières d’abeilles au cours de la trophallaxie. *Insectes Soc* **18**(3): 177-191.
- Mujagić S, Würth SM, Hellbach S, Dürr V. 2012. Tactile Conditioning And Movement Analysis Of Antennal Sampling Strategies In Honey Bees (*Apis mellifera*. L.). *J Vis Exp* **70**: e50179.
- Nagari M, Bloch G. 2012. The involvement of the antennae in mediating the brood influence on circadian rhythms in “nurse” honey bee (*Apis mellifera*) workers. *J Insect Physiol* **58**(8): 1096-1103.
- Nazzi F, Bortolomeazzi R, Della Vedova G, Del Piccolo F, Annoscia D, Milani N. 2009. Octanoic acid confers to royal jelly varroa-repellent properties. *Naturwiss* **96**(2): 309-314.
- Nishiyama K, Okada J, Toh Y. 2007. Antennal and locomotor responses to attractive and aversive odors in the searching cockroach. *J Comp Physiol A* **193**(9): 963-971.
- Pamir E, Chakraborty NK, Stollhoff N, Gehring KB, Antemann V, Morgenstern L, Felsenberg J, Eisenhardt D, Menzel R, Nawrot MP. 2011. Average group behavior does not represent individual behavior in classical conditioning of the honeybee. *Learn Mem* **18**(11): 733-741.
- Pavlov IP. 1927. *Conditioned Reflexes: An Investigation of the Physiological Activity of the Cerebral Cortex*. Oxford University Press, Oxford.
- Pickett JA, Williams IH, Martin AP, Smith MC. 1980. Nasonov pheromone of the honey bee, *Apis mellifera* L. (Hymenoptera: Apidae). *J Chem Ecol* **6**(2): 425-434.
- Pribbenow B, Erber J. 1996. Modulation of antennal scanning in the honeybee by sucrose stimuli, serotonin, and octopamine: behavior and electrophysiology. *Neurobiol Learn Mem* **66**(2): 109-120.
- Rescorla RA. 1988. Pavlovian conditioning: It’s not what you think it is. *Am Psychol* **43**(3): 151-160.

- Rohrseitz K, Tautz J. 1999. Honey bee dance communication: waggle run direction coded in antennal contacts? *J Comp Physiol A* **184**(4): 463-470.
- Sandoz JC, Laloï D, Odoux JF. 2000. Olfactory information transfer in the honeybee: compared efficiency of classical conditioning and early exposure. *Anim Behav* **59**(5): 1025-1034.
- Sauer S, Kinkelin M, Herrmann E, Kaiser W. 2003. The dynamics of sleep-like behaviour in honey bees. *J Comp Physiol A* **189**(8): 599-607.
- Sauer S, Herrmann E, Kaiser W. 2004. Sleep deprivation in honey bees1. *J Sleep Res* **13**(2): 145-152.
- Skinner BF. 1936. The reinforcing effect of a differentiating stimulus. *J Gen Psychol* **14**(2): 263-278.
- Suzuki H. 1975. Antennal movements induced by odour and central projection of the antennal neurones in the honey-bee. *J Insect Physiol* **21**(4): 831-847.
- Staudacher E, Gebhardt MJ, Dürr V. 2005. Antennal movements and mechanoreception: neurobiology of active tactile sensors. *Adv Insect Physiol* **32**: 49-205.
- Takeda K. 1961. Classical conditioned response in the honey bee. *J Insect Physiol* **6**(3): 168-179.
- Tedjakumala SR, Giurfa M. 2013. Rules and mechanisms of punishment learning in honey bees: the aversive conditioning of the sting extension response. *J Exp Biol* **216**(16): 2985-2997.
- Vareschi E. 1971. Duftunterscheidung bei der Honigbiene — Einzelzell-Ableitungen und Verhaltensreaktionen. *Z vergl Physiol* **75**(2): 143-173.
- Vergoz V, Roussel E, Sandoz JC, Giurfa M. 2007. Aversive Learning in Honeybees Revealed by the Olfactory Conditioning of the Sting Extension Reflex. *PLoS ONE* **2**(3): e288.
- Whitehead AT, Larsen, JR. 1976. Ultrastructure of the contact chemoreceptors of *Apis mellifera* L.(Hymenoptera: Apidae). *Int J Insect Morphol Embryol* **5**(4): 301-315.
- Winston ML. 1987. *The biology of the honey bee*. Harvard University Press, Cambridge.
- Wright GA, Lillvis JL, Bray HJ, Mustard JA. 2012. Physiological state influences the social interactions of two honeybee nest mates. *PLoS ONE* **7**(3): e32677.
- Wright GA, Schiestl FP. 2009. The evolution of floral scent: the influence of olfactory learning by insect pollinators on the honest signalling of floral rewards. *Funct Ecol* **23**(5): 841-851.

Supplementary figures:

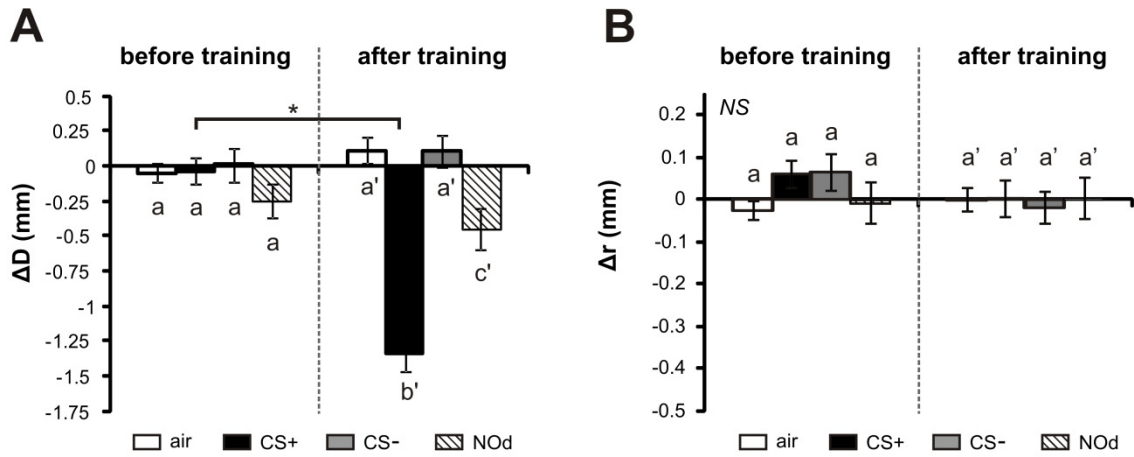

Figure S1. Effect of an appetitive conditioning on antennal movements. A,B) Histogram showing the change in A) the distance between antennae (ΔD), and B) the distance to antenna base (Δr) during odor presentation (during – before odor) for the air control, the CS+, the CS- and the novel odorant (NOd). The antennae moved significantly closer to each other (ΔD) in response to the CS+ but not in response to the CS- after conditioning. This effect was also observed for the novel odorant (NOd), but on a smaller scale. Appetitive conditioning had no significant effect on Δr . Stars and different letters indicate significant differences in paired t tests ($p < \alpha_{\text{corr1}} = 0.0125$, $N = 44$).

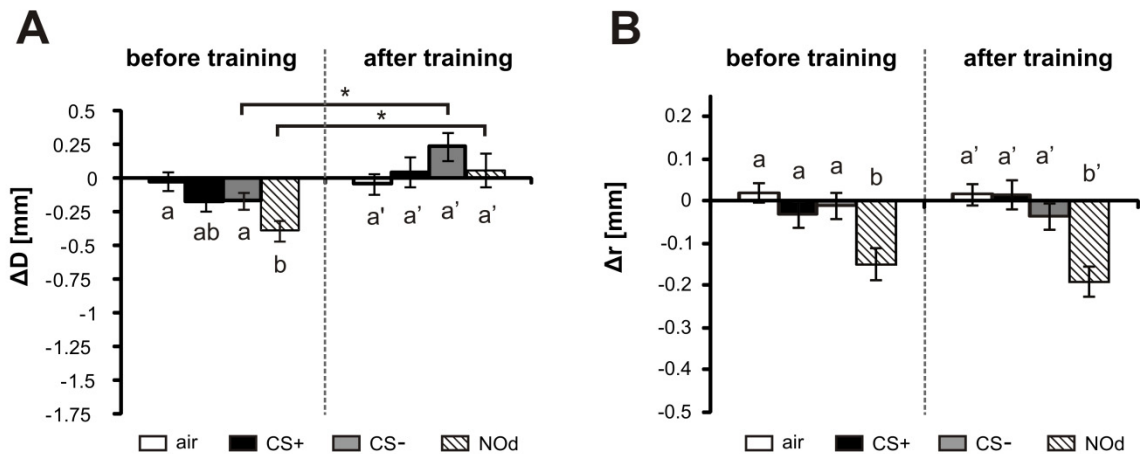

Figure S2. Effect of an aversive conditioning on antennal movements. A,B) Histogram showing the change in A) the distance between antennae (ΔD), and B) the distance to antenna base (Δr) during odor presentation (during – before odor) for the air control, the CS+, the CS- and the novel odorant (NOd). The antennae tended to come closer to each other (ΔD) in response to the NOd and CS- but not to the CS+. Aversive conditioning had no significant effect on Δr . Stars and different letters indicate significant differences in paired t tests ($p < \alpha_{\text{corr1}} = 0.0125$, $N = 68$).

DISCUSSION

DISCUSSION

Au cours de ce travail, nous avons commencé par établir un nouveau protocole de conditionnement de la réponse d'extension du dard, introduisant la température comme stimulus inconditionnel (**Chapitre I**). Nous avons observé que la sensibilité individuelle des abeilles à la chaleur déterminait leurs performances d'apprentissage aversif thermique. Nous avons ensuite montré que la relation entre sensibilité et performance d'apprentissage était sous influence génotypique. Ainsi, la ruche semble contenir des lignées plus sensibles au stimulus thermique, plus performantes en apprentissage aversif, et inversement, des lignées moins sensibles qui apprennent plus lentement.

Dans le protocole de conditionnement aversif utilisé jusqu'alors, (Vergoz *et al.*, 2007 ; Roussel *et al.*, 2009 ; Carcaud *et al.*, 2009), le choc électrique traverse une grande part du corps de l'abeille, ce qui rend difficile l'étude de la détection périphérique et du traitement neuronal du stimulus inconditionnel aversif. De plus, le choc électrique étant un stimulus peu naturel, il est peu probable qu'au cours de l'évolution, une structure ou un réseau neuronal dédié ait été sélectionné pour sa détection. L'utilisation de la température comme stimulus inconditionnel aversif nous a permis d'aborder ces questions relatives à la détection périphérique et aux bases moléculaires (**Chapitre II**). Dans un premier temps, nous avons utilisé la réponse d'extension du dard pour étudier la sensibilité thermique sur le corps de l'abeille et avons démontré l'existence de structures plus sensibles que d'autres. Ensuite, nous avons pu démontrer par une approche neuropharmacologique, que si l'activation d'HsTRPA n'était pas suffisante pour déclencher la réponse d'extension du dard, ce récepteur semblait tout du moins nécessaire pour son expression.

Dans une étude à grande échelle (**Chapitre III**), qui tendait à comparer les performances d'apprentissages appétitif et aversif entre individus de la colonie d'abeilles, nous avons confirmé les corrélations existant entre la sensibilité au renforcement et la capacité de l'individu à réaliser l'apprentissage, que ce soit dans la modalité appétitive, comme déjà démontré par Scheiner *et al.* (2004), ou dans la modalité aversive, pour un stimulus thermique. Ces corrélations ont été observées aussi bien au niveau des individus que des lignées paternelles. En faisant des comparaisons croisées entre modalités hédoniques, nous avons mis en évidence l'existence de corrélations négatives entre les performances des abeilles dans ces deux modalités, que ce soit au niveau des individus ou des lignées composant la colonie. Plus un individu (ou une lignée) est performant(e) dans une modalité, moins elle l'est dans l'autre.

Enfin, nous avons cherché à comparer les performances d'apprentissages appétitif et aversif, sur une même réponse comportementale graduelle (**Chapitre IV**). Nous avons développé un système de capture vidéo, permettant d'observer les réponses antennaires des abeilles à des odeurs, avant et après un conditionnement olfactif appétitif ou aversif. Nos résultats ont montré que les abeilles ayant

subi une procédure de conditionnement appétitif de la REP répondent en positionnant leurs antennes vers l'avant, tandis qu'aucune réponse n'a été enregistrée à la suite d'un conditionnement aversif de la RED.

Dans la section suivante, nous apporterons un éclairage plus général de chaque travail, que celui qui a pu être apporté au sein de chaque chapitre. Nous intégrerons tout d'abord les résultats du chapitre 2 aux données obtenues chez d'autres modèles afin de proposer un modèle de travail des voies potentielles de la détection du stimulus inconditionnel, ainsi que des processus sous-tendant la formation de l'association aversive odeur-température. Ensuite, nous discuterons l'apport de la réponse antennaire dans l'étude de l'apprentissage, et proposerons des perspectives d'étude pour affiner la compréhension de l'apprentissage et de la mémoire aversifs. Enfin, dans une dernière partie, les résultats du chapitre I et du chapitre III seront discutés ensemble, afin de mettre en évidence la relation existant entre les modalités appétitive et aversive au niveau de l'organisation sociale de la colonie d'abeille.

I) Modèle de travail de la détection de la température et de l'apprentissage aversif thermique.

Un des objectifs principaux du développement de ce nouveau conditionnement thermique, était de permettre l'étude des voies neuronales sous-jacentes à la détection, et au traitement de l'information aversive. Le remplacement du choc électrique par un stimulus inconditionnel plus naturel (la chaleur), devait donc permettre d'étudier les composantes moléculaires et neuronales de la détection du stimulus renforçant. Nos travaux ont apporté quelques premiers éléments pour comprendre ces processus chez l'abeille. Cependant, afin de pouvoir proposer un modèle de travail pertinent, il est nécessaire de puiser de nombreux éléments encore inconnus chez l'abeille, chez un autre modèle insecte, la Drosophile, dont la détection thermique (et nociceptive) a été très étudiée. Ces travaux ont fait apparaître de multiples voies, dont nous essayerons de simplifier la description. Comme pour l'olfaction (cf. introduction), le traitement de l'information thermique suit plusieurs étapes, depuis la détection périphérique jusqu'au traitement central de cette information dans le cerveau. Cependant, il faut définir la typologie du message aversif thermique qui nous concerne. En effet, différents systèmes de détection thermique ont été mis en évidence, selon qu'ils soient dédiés aux températures déviants modérément de l'optimum thermique de l'espèce considérée ou qu'ils soient impliqués dans la perception de fortes températures. Dans le conditionnement de la RED, la température utilisée est importante (65°C, approximativement 30 degrés de plus que la température de la ruche), ce qui ferait pencher pour le deuxième système

a) Détection thermique périphérique

Les abeilles répondent par une extension du dard à la stimulation thermique de quasiment toutes les parties de leur corps (Chapitre II), montrant ainsi une sensibilité thermique généralisée. Quels pourraient être les neurones et les récepteurs permettant cette détection ? Les réponses possibles nous viennent de travaux réalisés sur le comportement thermotaxique et sur le comportement nociceptif de la drosophile. Dans chacun des cas, différentes classes de récepteurs ont été identifiées comme potentiellement impliquées dans la détection de la température.

1) Quels neurones sensoriels ?

Voies de la thermotaxie

Une observation générale chez différents insectes montre que la détection fine de variations de températures, proches de la température ambiante, met en jeu les antennes. Chez les hyménoptères, des neurones sensoriels exprimant des récepteurs thermosensibles ont été localisés au sein de sensilles, aspérités cuticulaires de l'antenne. Deux systèmes différents semblent exister chez les fourmis et les abeilles. En effet, chez les premières, Ruchty *et al.* (2009) ont observé que les neurones sensoriels logés dans les sensilles coeloconiques (**Fig.1C**) répondent à des variations de température, tandis que chez l'abeille, ce seraient les sensilles coelocapitulaires (**Fig.1A,B**) qui joueraient ce rôle (Yokohari *et al.*, 1983). Chez la drosophile, deux structures uniques au niveau des antennes, l'arista et le sacculus (**Fig.1D**), contiennent deux classes de neurones thermosensoriels différents : un type neuronal pour le froid, les "*cold cells*" et un type neuronal pour le chaud, les "*hot cells*" (Ni *et al.*, 2013). Ces deux tractus ont montré leur implication dans la détection de températures, descendant jusqu'à 11°C, et augmentant jusqu'à 39°C (Gallio *et al.*, 2011). Les antennes des abeilles ne contiennent pas d'arista ni de sacculus, mais il semble que des neurones analogues aux *hot cells* et aux *cold cells* existent (en particulier dans les sensilles coelocapitulaires, Yokohari, 1983). Quoi qu'il en soit, il ressort que les antennes des insectes contiennent un équipement sensoriel dédié à la détection fine de variations de température. Ces neurones pourraient être impliqués dans la détection de notre stimulus inconditionnel lorsqu'il est présenté aux antennes (Chapitres I et II).

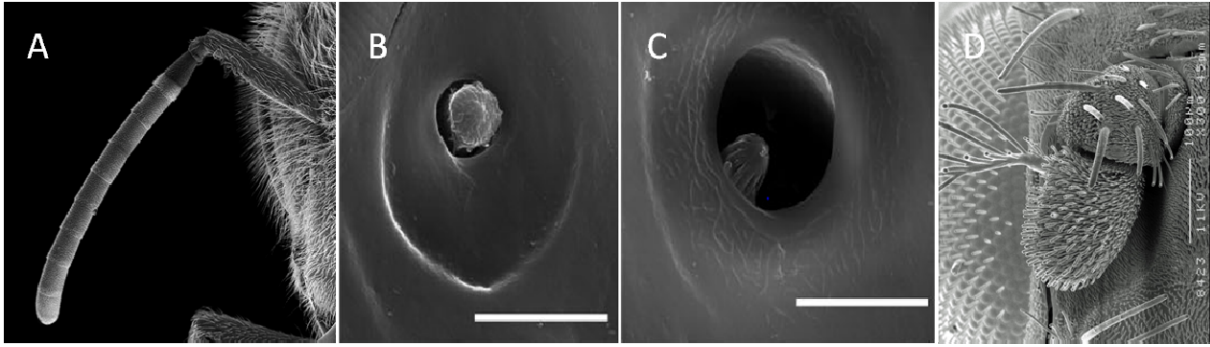

Figure 1 : **A)** Microscopie électronique à balayage (MEB) sur une antenne d'abeille ouvrière. La capture en MEB d'une sensille coelocapitulaire **B)** et d'une sensille coeloconique **C)** montre une claire différence morphologique entre les deux types de sensilles. La sensille coelocapitulaire est reconnaissable à sa protrusion ayant la forme d'un champignon, non perforée, positionnée dans une dépression cuticulaire ovale tandis que la sensille coeloconique possède une protrusion rainurée cachée à l'intérieur d'une cavité. (Nishino *et al.*, 2009). **D)** Antenne de *Drosophila* capturée en MEB. L'arista (dernier segment de l'antenne en forme d'arbre sur la gauche de l'image) loge six neurones thermosensibles (CSIRO Science image) (Gallio *et al.*, 2011). (photo : A : Rose-Lynn Fisher; B,C : Nishino *et al.*, 2009 ; D : Gallio *et al.*, 2011)

Voies de la nociception thermique

D'autres travaux, ciblant précisément la détection des fortes températures, ont mis en évidence d'autres types de neurones sensoriels impliqués dans la nociception thermique chez la drosophile, grâce à la découverte d'un comportement spécifique de la larve en réponse à de fortes températures (Tracey *et al.*, 2003 ; Rosenzweig *et al.*, 2008 ; Neely *et al.*, 2011). Quand la larve de drosophile entre en contact avec une température supérieure à $\sim 38^{\circ}\text{C}$, celle-ci quitte son mode de déplacement péristaltique classique, pour se rouler sur le côté (comportement d'échappement). Une classe de neurones sensoriels périphériques, les neurones multi-dendritiques (MD) de classe IV, a été caractérisée chez ces larves de drosophile, et il a été montré qu'ils s'activent pour différents types de stimulations nociceptives (Tracey *et al.*, 2003 ; Grueber *et al.*, 2007 ; Hwang *et al.*, 2007 ; Xiang *et al.*, 2010). Ces neurones ont la particularité de posséder une large arborisation dendritique dans le derme, sur la totalité du corps de la larve de drosophile. Ils sont impliqués dans la nociception chimique (Xiang *et al.*, 2010), mécanique (Zhong *et al.*, 2010) et thermique (Tracey *et al.*, 2003). L'existence de tels neurones dans le derme de l'abeille permettrait aisément d'expliquer la sensibilité thermique généralisée de l'abeille à de fortes températures, que nous avons démontrée (Chapitres I et II). Chez la drosophile, le récepteur *pickpocket*, un canal DEGENaC (*Degenerine Epithelium Na Channel*), impliqué dans la transduction de l'information nociceptive mécanique, a été utilisé pour cibler directement ces neurones MD (Adams *et al.*, 1998 ; Zhong *et al.*, 2010). L'identification d'un tel récepteur, par analogie de séquence, et le développement d'anticorps, permettraient peut-être de réaliser une étude immunohistochimique, essentielle à la description d'un système nociceptif chez l'abeille.

Il ressort des travaux décrits ci-dessus que plusieurs voies parallèles pourraient être impliquées dans la détection des stimuli thermiques, avec probablement des voies différentes en fonction de la température présentée (proche ou non de la température ambiante), et/ou de la structure stimulée. En particulier, les récepteurs thermiques de l'antenne semblent être différents des récepteurs présents dans les autres parties du corps. On peut alors se demander quels acteurs moléculaires sont exprimés par ces différents types neuronaux et sont impliqués dans la réponse à la température.

2) Quels récepteurs/canaux ?

La super famille des récepteurs TRP (Transient Receptor Potential) comporte un nombre important de thermo-détecteurs, conservés au cours de l'évolution, des invertébrés aux vertébrés. Ce sont des récepteurs canaux ioniques à six domaines transmembranaires, qui agissent dans la perception de différents stimuli sensoriels (Cosens et Manning, 1969 ; Clapham, 2003 ; Montell, 2005). Dans la famille TRPA, TRPA1 est un récepteur majeur pour la détection des variations de température et retrouvé chez les reptiles (Saito *et al.*, 2012), les oiseaux (Saito *et al.*, 2014), les mammifères (Farjado *et al.*, 2008) et les insectes (Kang *et al.*, 2010). L'orthologue du TRPA1 des vertébrés chez la drosophile, dTRPA1, est aussi impliqué dans la détection de température, comme cela a été montré en étudiant la thermotaxie (Rosenzweig *et al.*, 2005). En effet, les drosophiles mutantes, KO pour dTRPA1, n'évitent plus aussi clairement les fortes températures. Cependant, aucun TRPA1 n'a été isolé dans le génome de l'abeille jusqu'à présent (Matsuura *et al.*, 2009). Dans ce contexte, le récepteur canal thermo-sensible HsTRPA (Hymenopteran specific Transient Receptor Potential Akyrine), spécifique aux Hyménoptères, pourrait occuper une place centrale dans la détection de la température chez les abeilles. HsTRPA est un récepteur canal cationique, qui s'active lorsque la température dépasse 34°C, ce qui correspond à l'optimum thermique du développement larvaire dans la ruche (Kohno *et al.*, 2010). Nos résultats suggèrent son implication potentielle dans la perception des fortes températures (chapitre II), même si une approche plus spécifique d'interférence par ARN devrait être utilisée pour confirmer son rôle. HsTRPA semble être exprimé au niveau des neurones sensoriels localisés dans les sensilles coelocapitulaires des antennes (Kohno *et al.*, 2010), mais il est aussi probablement exprimé plus largement dans le corps de l'abeille (dans les pattes, par exemple, Kohno *et al.* 2010). Nos résultats, montrant un blocage pharmacologique des réponses d'extension du dard à la présentation de température sur les pièces buccales, semblent indiquer qu'il serait aussi exprimé à cet endroit. Dans notre modèle de travail, HsTRPA occupe donc une place centrale, et il serait important de cartographier plus généralement son expression sur le corps de l'abeille, grâce à une approche de PCR quantitative. De plus, il nous faudra chercher à isoler les cellules qui l'expriment, grâce à une approche d'hybridation *in situ* ou par l'utilisation d'anticorps, bien que cette dernière technique semble difficile à mettre en place pour ce canal (Kohno *et al.*, 2010).

Cependant, quelques autres thermo-récepteurs candidats ont été isolés chez la drosophile et nos prochains travaux devraient chercher à évaluer leur possible implication dans la détection et l'apprentissage thermique. Ainsi, chez la drosophile, les individus mutants pour le TRPA *ainless* voient augmenter leur latence de réponse à un stimulus nociceptif thermique (Tracey *et al.*, 2003). Par analyse électrophysiologique, on a pu observer que les neurones exprimant *ainless* s'activaient pour des températures dépassant 40°C. De plus, un criblage génétique de mutants défectifs pour les réponses aux fortes températures, a mis en évidence un autre membre de la sous-famille des TRPA, *pyrexia*. Quand celui-ci est exprimé dans des ovocytes de xénope ou dans des cellules HEK, *pyrexia* est activé par des températures dépassant 40°C (Lee *et al.*, 2005 ; Venkatachalam et Montell, 2007). Les neurones sensoriels périphériques exprimant *pyrexia* ont été assez peu décrits, mais ils semblent prendre leur source proche des antennes. Néanmoins, à notre connaissance, aucune étude ne le démontre clairement (Tang *et al.*, 2013). Par analyse phylogénétique, des homologues de *ainless* et *pyrexia* ont été observés dans le génome de l'abeille (nommé *Ampainless* et *Ampyrexia*), mais ces derniers n'ont jamais été étudiés. Toutefois, on estime qu'ils devraient avoir des rôles semblables à ceux de la drosophile (Matsuura *et al.*, 2009). Les neurones multi-dendritiques (MD) de classe IV, bien décrits chez la drosophile, expriment non seulement *ainless* (Grueber *et al.*, 2007) et dTRPA1 (Xiang *et al.*, 2010), mais aussi Gr28B, un paralogue de récepteur gustatif qui permet, lui aussi la détection d'une augmentation de température (Xiang *et al.*, 2010 ; Ni *et al.*, 2013). Dans la Figure 2, nous présentons les différents types neuronaux analogues à ceux décrits chez la drosophile, et potentiellement impliqués dans la détection du stimulus thermique.

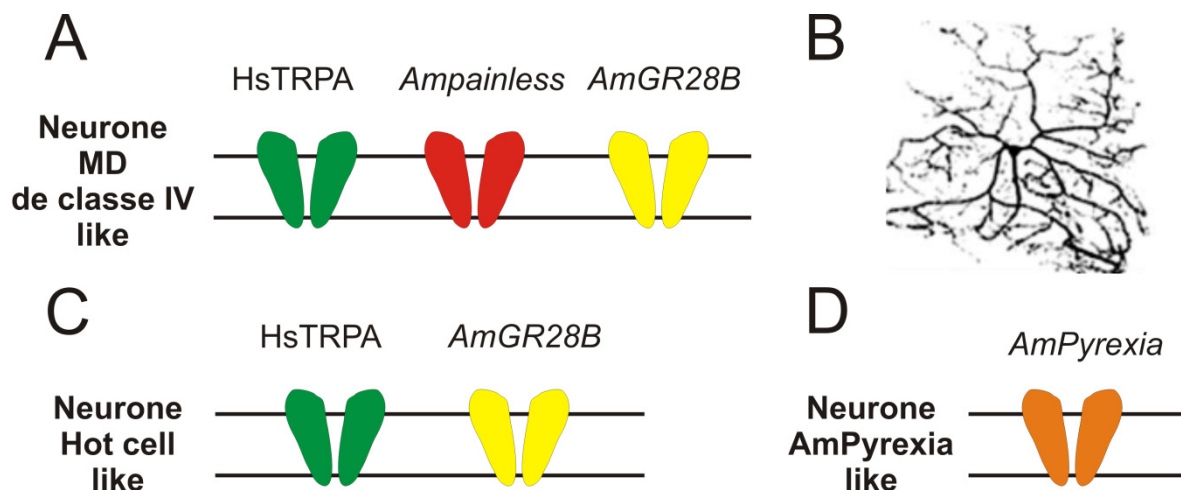

Figure 2 : Représentation des TRPs présents sur la membrane des neurones sensoriels potentiellement impliqués dans la détection de l'information aversive thermique. Si des neurones sensoriels thermiques analogues existent chez l'abeille **A)** La membrane des neurones *Hot cell* ne porterait que HsTRPA et/ou AmGR28B si un paralogue existe aussi chez l'abeille. **B)** Représentation de l'arborisation dendritique des neurones MD de classe IV (Gueber *et al.*, 2007) **C)** La membrane des neurones MD de classe IV porterait HsTRPA, Ampainless, AmGR28B (si il existe chez l'abeille). **D)** La membrane de certains neurones thermosensibles exprimerait Ampyrexia.

Les travaux que nous venons d'exposer démontrent le rôle prépondérant des TRPAs dans la perception thermique chez les insectes, certains spécifiques des fortes températures (*painless*, *pyrexia*) et d'autres pouvant aussi être activés par de faibles variations de température (TRPA1, GR28B). *Painless* et *pyrexia* étant présents dans le génome de l'abeille de futurs travaux devront s'intéresser à étudier leur implication potentielle dans la perception des fortes températures en utilisant une approche d'ARN interférence par exemple.

b) Traitement central de l'information thermique

Une fois l'information thermique détectée au niveau des neurones sensoriels périphériques, elle est convoyée vers des zones de traitement supérieures. Les neurones sensoriels, exprimant les différents récepteurs décrits précédemment, se projettent dans différentes zones du système nerveux central, qu'il s'agisse de la perception de faibles ou de fortes variations thermiques. Chez l'abeille, les zones du cerveau recevant et traitant l'information thermique sont encore presque totalement inconnues. Les principaux travaux existants ont été réalisés chez la drosophile et ils nous serviront à construire notre modèle de travail (**Fig.3**).

Entrée thermique antennaire

Une fois les neurones sensoriels thermo-sensibles de l'antenne (les *hot cells* et les *cold cells*) sélectivement activés, par le chaud ou le froid respectivement, ces deux classes de neurones transmettent, via leurs terminaisons axonales, l'information dans deux zones bien distinctes d'une structure du protocerebron : le lobe antennaire postérieur (LAP) (Gallio *et al.*, 2011, Frank *et al.*, 2015) (**Fig. 3A**). On trouve ainsi dans cette première structure centrale, une zone traitant l'information "froide", et une zone traitant l'information "chaude" (Frank *et al.*, 2015 ; Liu *et al.*, 2015). Des neurones de second ordre, les neurones de projection thermique (NPt), prennent leur source au niveau du LAP, se rassemblent en différents tractus, puis se projettent vers les aires supérieures, dans trois régions distinctes (Frank *et al.* 2015). La principale localisation de ces projections, est le protocérébron latéral, une zone peu étudiée, mais qui reçoit cependant des afférences de plusieurs systèmes sensoriels (Florence et Reiser, 2015). Les deux autres aires innervées sont les corps pédonculés et la corne latérale, deux structures où aboutissent aussi les neurones de projection olfactifs chez l'abeille (cf. introduction), et qui jouent un rôle essentiel dans l'apprentissage olfactif (Menzel, 2001 ; Giurfa et Sandoz, 2012). La mise en évidence de voies analogues du support de l'information thermique chez l'abeille, serait essentielle à la description de la voie de traitement du renforcement thermique. Il n'y a malheureusement que peu de données. Une étude mesurant l'activité d'un gène précoce immédiat (*Acks*), reflet de l'activation des neurones, chez des abeilles asiatiques *Apis cerana* exposées à une température de 46°C, a permis de suggérer l'implication de plusieurs aires cérébrales dans la perception thermique. L'expression de *Acks* était particulièrement importante dans une région située

entre le lobe dorsal et le lobe antennaire (Ugajin *et al.*, 2012). Cette zone pourrait correspondre à une zone analogue au LAP de la drosophile et être un centre de traitement thermique dans le cerveau des abeilles.

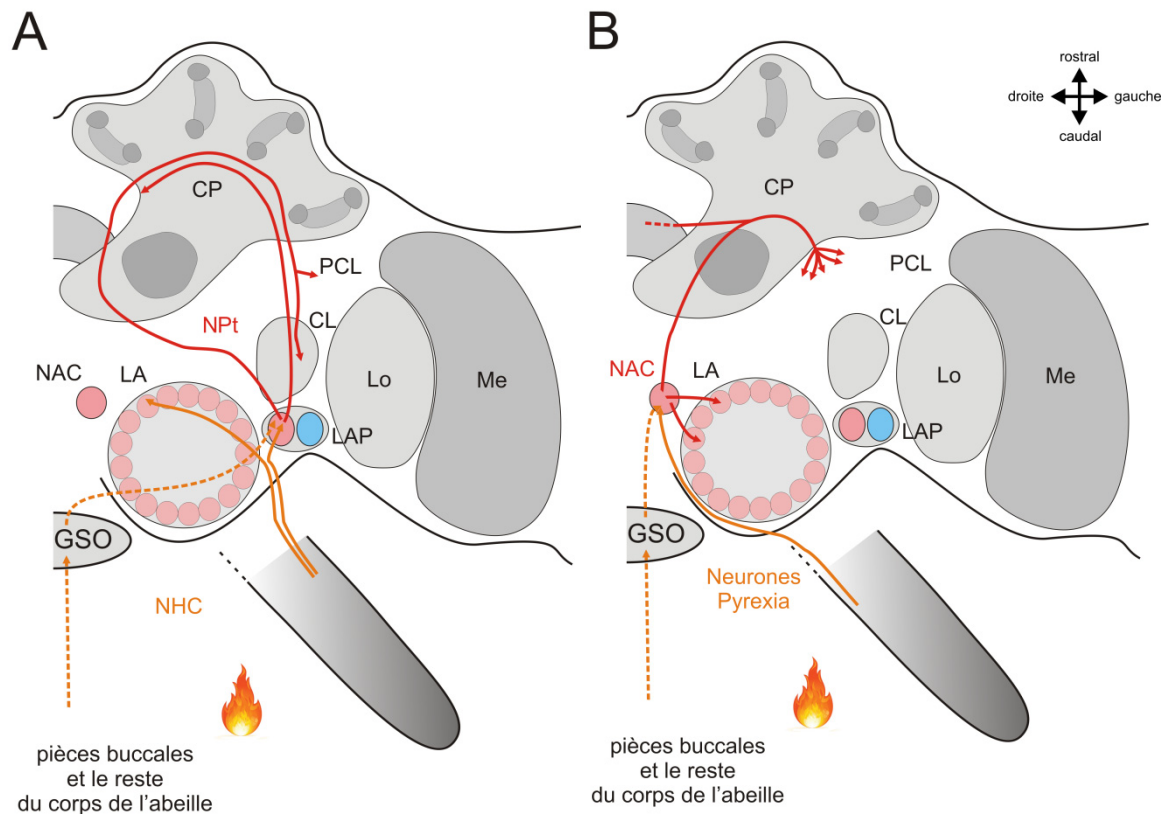

Figure 3: Représentation théorique du traitement de l'information thermique au niveau du système nerveux central de l'abeille. La voie thermique potentiellement impliquée dans la détection du SI dans notre protocole de conditionnement est représentée et découpée entre la voie des *hot cells* (à gauche) et la voie impliquant les *anterior cells* (à droite). Les afférences sensorielles sont représentées en orange tandis que les neurones de projection sont en rouge. En pointillé est représentée une voie sensorielle ascendante, faisant remonter l'information thermique du reste du corps en passant par le ganglion sous-œsophagien (SOG). (à gauche) Les neurones hot cells (NCH), analogues à ceux décrits chez la drosophile, détectent la température et envoient l'information au niveau du lobe antennaire postérieur (LAP) dans la zone dédiée au traitement du chaud. De cette zone, des neurones de projection thermiques (NPt) projettent au niveau de trois aires supérieures, les CP, la corne latérale (CL) et le protocérébron latéral (PCL). (à droite) Des neurones positionnés à proximité de l'antenne exprimant le TRP pyrexia projettent au niveau des neurones anterior cells (NAC) (antérieurement par rapport au lobe antennaire). Les NAC projettent au niveau du protocérébron sous les corps pédonculés (CP). Les NCH et les NAC ont tous les deux des connexions avec certains glomérules du LA.

Chez la drosophile, un autre système que celui du LAP traite, lui aussi, les variations de température. Les neurones exprimant pyrexia (différents des *hot cells*) se projettent au niveau d'un groupe de neurones positionnés dans la partie antérieure du cerveau, les *anterior cells* (AC) (Hamada *et al.*, 2008 ; Tang *et al.*, 2013 ; Galili *et al.*, 2014) (**Fig. 3B**). En plus de recevoir ces afférences thermo-sensorielles des neurones pyrexia, les neurones AC expriment centralement le récepteur

dTRPA1 ce qui permet une perception interne directe de la température (Hamada *et al.* 2008). Les *hot cells* et les neurones AC, innervent tous deux les glomérules VP2 et VP3 du lobe antennaire de la drosophile, ce qui fait du lobe antennaire un troisième lieu potentiel de traitement de l'information thermique (Tang *et al.*, 2013 ; Galili *et al.*, 2014). De manière intéressante, chez les fourmis, l'information thermique, envoyée par les neurones sensoriels logés dans les sensilles coeloconiques, est traitée au niveau du lobe antennaire (Ruchty *et al.*, 2010). Parmi ces trois structures/régions recevant une entrée sensorielle thermique (LAP, NAC et lobe antennaire), seul le lobe antennaire reçoit de manière concomitante l'entrée sensorielle olfactive. Il en découle, que cette structure représente un premier centre potentiel permettant l'association aversive entre une odeur et le renforcement thermique, quand ce dernier est appliqué au niveau des antennes (voir plus bas). Pour soutenir ce propos, une étude récente chez la drosophile a montré que les neurones AC, qui se projettent dans le lobe antennaire, jouent un rôle prépondérant dans l'association odeur-température (température de 34°C, Galili *et al.*, 2014).

Entrée thermique non-antennaire

Nous avons proposé que chez l'abeille, des neurones homologues aux neurones MD de classe IV détectent les fortes variations de température lorsqu'elles sont appliquées sur le corps (et non sur les antennes). Chez la drosophile, les neurones MD de classe IV se projettent dans la partie ventrale et médiale de la corde ventrale, au sein des ganglions relatifs aux organes qu'ils innervent (Grueber *et al.*, 2007). Un ensemble d'interneurones locaux, les neurones bassins et Goro, traitent le signal localement, avant que l'information ne soit convoyée vers le système nerveux central, par des neurones ascendants, les neurones A00c (Ohyama *et al.*, 2015). On peut imaginer que chez l'abeille, des voies similaires permettent à l'information nociceptive thermique de remonter vers le cerveau. Pour l'instant, la région du cerveau de drosophile qui reçoit toutes ces afférences et traite l'information nociceptive thermique reste encore à déterminer. On peut imaginer, mais ceci devrait être étudié précisément, que certaines de ces voies convergent sur les centres thermiques décrits plus hauts.

Traitement de l'information thermique et sensibilité à la température

Que l'information thermique soit détectée au niveau du corps ou des antennes, les centres thermiques du cerveau doivent opérer à un certain traitement de l'information, de sorte que, ce n'est que lorsque l'augmentation de température perçue atteint un certain seuil par rapport à la température ambiante, que des voies induisant la RED sont activées. On peut penser que la sensibilité individuelle des abeilles envers la température, que nous avons mesurée à de multiples reprises (Chapitres I, II et III), dépend de ce traitement local. De précédentes études, s'appuyant sur le choc électrique comme renforcement, ont montré que cette sensibilité au stimulus aversif était sous le contrôle de certaines amines biogènes. Ainsi, l'injection intra-oculaire d'antagonistes des récepteurs à la dopamine et à la

sérotonine, entraîne une augmentation de la sensibilité des individus aux stimulations électriques (Tedjakumala *et al.*, 2013). Ces neurotransmetteurs agissent ainsi comme supprimeurs de la sensibilité aversive. L'implication de ces neurotransmetteurs (dopamine, sérotonine), dans la perception d'autres stimuli aversifs, comme les stimuli thermiques que nous avons utilisés, permettrait de démontrer leur rôle fondamental, dans la transmission de l'information aversive, au sens large du terme. De manière analogue à l'étude de Tedjakumala *et al.* (2013), nous pourrions injecter les abeilles avec du flupentixol, un antagoniste du système dopaminergique, possédant une forte affinité pour les récepteurs de type D1 et D2, et les soumettre, ensuite, à une procédure de sensibilité thermique de la RED (Kokay et Mercer, 1996 ; Vergoz *et al.*, 2007). Des injections de cyproheptadine, un inhibiteur non-compétitif des récepteurs à la sérotonine (Howarth *et al.*, 2002 ; Vleugels *et al.*, 2013; Thamm *et al.*, 2013), permettraient de démontrer l'implication de la sérotonine dans la perception des fortes températures. D'une manière générale, ce pourrait être au niveau de ces centres thermiques qu'un déterminisme génétique puisse influencer la sensibilité individuelle des abeilles, par l'intermédiaire d'une signalisation dopaminergique ou sérotoninergique (voir chapitre III).

Au niveau central, le traitement de l'information thermique semble pouvoir emprunter différentes voies, une voie passant par le LAP et une au niveau des NAC. De futures recherches devront chercher à définir l'existence de ces différentes zones de traitement chez l'abeille et leur implication possible, implication dans le conditionnement aversif thermique du SER. De plus, l'utilisation de chocs électriques a permis de mettre en évidence l'implication d'amines biogènes comme la dopamine et la sérotonine, cependant il nous faudra aussi confirmer son implication dans le traitement d'un stimulus inconditionnel aversif thermique.

c) Voie motrice entraînant la RED

Une fois l'information du renforcement détectée en périphérie, puis traitée au niveau central, une voie motrice descendante doit permettre de déclencher la réponse d'extension du dard, en réponse à la stimulation thermique. En arrivant dans le dernier (7^{ème}) ganglion de l'abdomen, le message est transmis à des motoneurones dédiés, qui activeront un schéma moteur précis, dont résultera l'extension du dard. Ce schéma repose sur l'activité réciproque de muscles homologues, positionnés bilatéralement : les muscles M198 (protracteur) et M199 (rétracteur). Ils sont contrôlés respectivement par 5 et 6 motoneurones émergents du ganglion abdominal terminal (Ogawa *et al.*, 1995).

Nous venons de proposer des voies qui seraient impliquées dans la détection et le traitement de l'information thermique et dont l'activation peut induire une réponse d'extension du dard, en l'absence d'apprentissage. Ces voies restent hypothétiques, et seuls les contrôles précédemment cités, permettront de les vérifier. Par ailleurs, bien que l'information doive obligatoirement passer par le cerveau pour qu'une association odeur / renforcement thermique se fasse, il n'est pas à exclure qu'une

voie court-circuitant le cerveau puisse exister dans le cas de la réponse inconditionnée de RED à la température. On pourrait ainsi imaginer une voie descendante depuis le ganglion recevant l'information nociceptive thermique et allant directement au ganglion abdominal terminal, pour déclencher la RED de manière réflexe.

d) Formation de l'association odeur / renforcement thermique

Les apprentissages associatifs Pavloviens reposent sur la convergence neuronale existant entre les voies du SC (ici l'odeur) et celles du SI (ici la température). Les voies connues ou supposées pour la détection et le traitement des informations olfactives et thermiques étant définies, nous considérerons maintenant différents substrats neuronaux et moléculaires possibles participant à la formation de l'association aversive. Jusqu'à ce jour, ils ont principalement été étudiés en utilisant le choc électrique comme renforcement. De nombreuses similitudes devraient cependant exister avec la procédure que nous avons développée, qui utilise la température comme stimulus inconditionnel.

Les amines biogènes et la 20-E dans la formation de l'association aversive

Une question centrale est celle du neurotransmetteur « instructeur », impliqué dans la signalisation de l'information aversive vers les neurones de la voie olfactive (Giurfa, 2006). De nombreuses études chez plusieurs modèles invertébrés ont démontré le rôle central joué par le système dopaminergique dans l'apprentissage aversif. Chez le grillon, par exemple, l'application d'inhibiteurs des récepteurs à la dopamine, empêche la formation de mémoires aversives, que le SC soit de nature visuelle ou olfactive (Unoki *et al.*, 2005, 2006). De même, chez la drosophile, le blocage neurogénétique de neurones dopaminergiques (DA) réprime l'apprentissage aversif olfactif (Schwaerzel *et al.*, 2003), tandis que l'activation d'autres réseaux de neurones DA spécifiques, peut remplacer le renforcement négatif pendant le conditionnement (Aso *et al.*, 2010, 2012 ; Claridge-Chang *et al.*, 2009). L'activation de neurones DA contingente à la présentation d'une odeur, entraîne aussi un évitement de l'odeur chez la larve de drosophile (Schroll *et al.*, 2006), confirmant que certains réseaux de neurones DA, sont le support du renforcement aversif. L'implication de la dopamine dans le conditionnement de la RED chez l'abeille, a déjà été étudiée dans le cadre du protocole utilisant le choc électrique comme renforcement (Vergoz *et al.*, 2007). Dans une approche neuropharmacologique, les injections de flupentixol et de fluphenazine (inhibiteurs de récepteurs à la dopamine) ont réduit drastiquement la capacité des individus à réaliser l'association odeur-choc électrique. A l'inverse, l'injection d'inhibiteurs des récepteurs à l'octopamine (neurotransmetteur connu pour être l'instructeur de l'apprentissage appétitif, Hammer et Menzel, 1998 ; Farroqui *et al.*, 2003) n'a eu aucun effet sur l'apprentissage aversif. Ainsi, il semblerait que la dopamine soit le support de l'apprentissage aversif, tandis que l'octopamine n'y jouerait pas de rôle particulier. Trois

récepteurs à la dopamine ont été décrits chez l'abeille, AmDOP1 (Blenau *et al.*, 1998 ; Mustard *et al.*, 2003), AmDOP2 (Humphries *et al.*, 2003 ; Mustard *et al.*, 2003) et AmDOP3 (Beggs *et al.*, 2005). AmDOP1 et AmDOP3 semblent être respectivement des analogues des récepteurs dopaminergiques vertébrés de type D1 (provoquant une augmentation de l'AMPc) et de type D2 (diminution de l'AMPc), alors que AmDOP2 semble plutôt relié aux récepteurs octopaminergiques des invertébrés, ce qui en fait un récepteur à part, spécifique des invertébrés. Par l'injection d'inhibiteurs spécifiques des récepteurs de type D1 (SCH23390) et de type D2 (spiperone), Vergoz *et al.* (2007) ont montré que AmDOP1 et AmDOP3 pourraient agir différemment dans l'association aversive. En effet, seule la spiperone, entraînait une réduction des performances d'apprentissage aversif suggérant un rôle prépondérant des récepteurs de type D2.

Plus récemment, il a été montré que la 20-hydroxyecdysone (20-E), un métabolite de l'hormone stéroïde ecdysone, bloquait la mémoire aversive. Son action semble se faire par le biais du récepteur AmGPCR19, récepteur activable à la fois par la dopamine et par la 20-E, et qui est l'orthologue du récepteur dopamine/ecdysone du gène 48 (DmDopEcR), identifié chez la drosophile (Geddes *et al.*, 2013). L'injection de 20-E exogène, entraîne une diminution de AmGPCR19 et des capacités d'apprentissage aversif. Ceci montre que les ecdysones jouent également un rôle central dans la formation de la mémoire aversive chez l'abeille. La 20-E n'a cependant pas d'effet sur la sensibilité au choc électrique ; cela tend à montrer que AmGPCR19 ne jouerait un rôle que dans la formation de l'association. De plus, l'analyse du niveau de transcription des gènes codants pour les récepteurs dopaminergiques, a montré que le blocage de l'apprentissage aversif était associé à une augmentation de l'expression du récepteur AmDOP2 (Geddes *et al.*, 2013). Du fait qu'ils affectent la voie du renforcement aversif très en aval, on peut penser que ces différents neurotransmetteurs, ainsi que leurs récepteurs, auront des rôles analogues dans notre protocole de conditionnement aversif utilisant un renforcement thermique. Il sera néanmoins important dans nos travaux suivants de vérifier leur implication.

Sièges de l'association aversive

Ces neurotransmetteurs peuvent agir à différents endroits le long de la voie olfactive, du lobe antennaire, aux corps pédonculés, en passant par la corne latérale. Afin de déterminer si l'apprentissage aversif pouvait induire une plasticité au niveau de la représentation olfactive dans le lobe antennaire, une étude d'imagerie fonctionnelle *in vivo* (imagerie calcique), a été réalisée pendant un conditionnement différentiel de la RED. Cette étude n'a mis en évidence aucune modification dans l'activation glomérulaire en réponse à l'odeur renforcée ou à l'odeur non-renforcée (Roussel *et al.*, 2010). Il semblerait ainsi que le positionnement de l'engramme se fasse plus en aval sur la voie olfactive, au niveau des corps pédonculés, par exemple (Tedjakumala *et al.*, 2014). Dans une étude immunohistochimique, l'application d'anticorps ciblant la tyrosine hydroxylase, un précurseur de la

dopamine, a permis de mettre en évidence différents réseaux de neurones dopaminergiques, potentiellement impliqués dans l'association aversive (Tedjakumala, 2014). Parmi ces réseaux, on retrouve trois groupes particulièrement intéressants par leurs positionnements : C1 et C2, dont les corps cellulaires se trouvent proches des corps pédonculés, dans la partie inférieure médiale du protocérébron, et qui se projettent au niveau du lobe α (lobe vertical), et C3, dont les corps cellulaires se positionnent sous les calices, et qui se projettent dans le reste des corps pédonculés et dans le protocérébron supérieur médial (**Fig.4**). En accord avec la localisation de leurs corps cellulaires et de leurs innervations, les réseaux C1 et C2 pourraient être analogues au groupe de neurones dopaminergiques PAM (*Protocerebral Anterior Medial*) de la drosophile (Mao et Davis, 2009 ; Tedjakumala, 2014). Les neurones PAM sont impliqués dans différents processus de formation de la mémoire aversive chez la drosophile (Aso *et al.*, 2010). Pour sa part, C3 est supposé être homologue aux réseaux PPL1 et PPL2ab de la drosophile (Liu *et al.*, 2012 ; Mao and Davis, 2009) prenant leurs sources et se projetant dans des zones relativement similaires (Tedjakumala *et al.*, 2014). L'inactivation des zones PPL1 et PPL2ab, bloque la formation de la mémoire aversive chez la drosophile (Aso *et al.*, 2010 ; Claridge-Chang *et al.*, 2009 ; Placais *et al.*, 2012). Ces réseaux neuronaux dopaminergiques (C1-3) proches des corps pédonculés, trouvent ainsi une analogie avec les neurones instructeurs identifiés chez la drosophile, et qui jouent un rôle prépondérant dans la formation de la mémoire aversive. Ainsi, notre hypothèse est que l'association odeur/température aurait lieu au niveau des corps pédonculés selon un schéma similaire à celui décrit chez les drosophiles (Gerber *et al.*, 2004). Les neurones dopaminergiques de type C1-3, activés par le stimulus thermique, induiraient des modifications de la force synaptique entre les cellules de Kenyon (neurones des corps pédonculés représentant l'odeur) et des neurones extrinsèques des corps pédonculés impliqués dans l'activation de voies descendantes comme la voie induisant la RED (voir plus haut). Le cerveau de l'abeille contient de nombreux neurones extrinsèques, dont certains ont montré une grande plasticité au cours d'un apprentissage appétitif (Okada *et al.*, 2007 ; Strube-Bloss *et al.*, 2011). Comme dans ces études, il sera possible de vérifier l'existence d'une plasticité de ces neurones extrinsèques durant un apprentissage aversif grâce à des enregistrements électrophysiologiques.

Outre le lobe antennaire et les corps pédonculés, un troisième site de convergence pourrait exister entre les voies olfactives et thermiques. En effet, les neurones de projection olfactifs et thermiques se projettent tous deux au niveau de la corne latérale. (Kirschner *et al.*, 2006 ; Frank *et al.*, 2015). Il se pourrait donc qu'il existe une convergence entre ces deux voies, mais celle-ci ne mettrait pas en jeu des neurones dopaminergiques en aval des neurones thermiques, car ils n'ont pas été décrits à cet endroit. Une telle hypothèse semble peu probable car la représentation olfactive dans la corne latérale est organisée par grandes catégories d'odeurs (Roussel *et al.* 2014 ; Strutz *et al.* 2014), sans un codage précis de leur qualité chimique. L'apprentissage aversif étant aussi spécifique de l'odeur apprise que l'apprentissage appétitif (Vergoz *et al.* 2007 ; Bos *et al.* 2014 ; Junca *et al.* 2014), un stockage de la mémoire aversive dans la corne latérale semble peu probable.

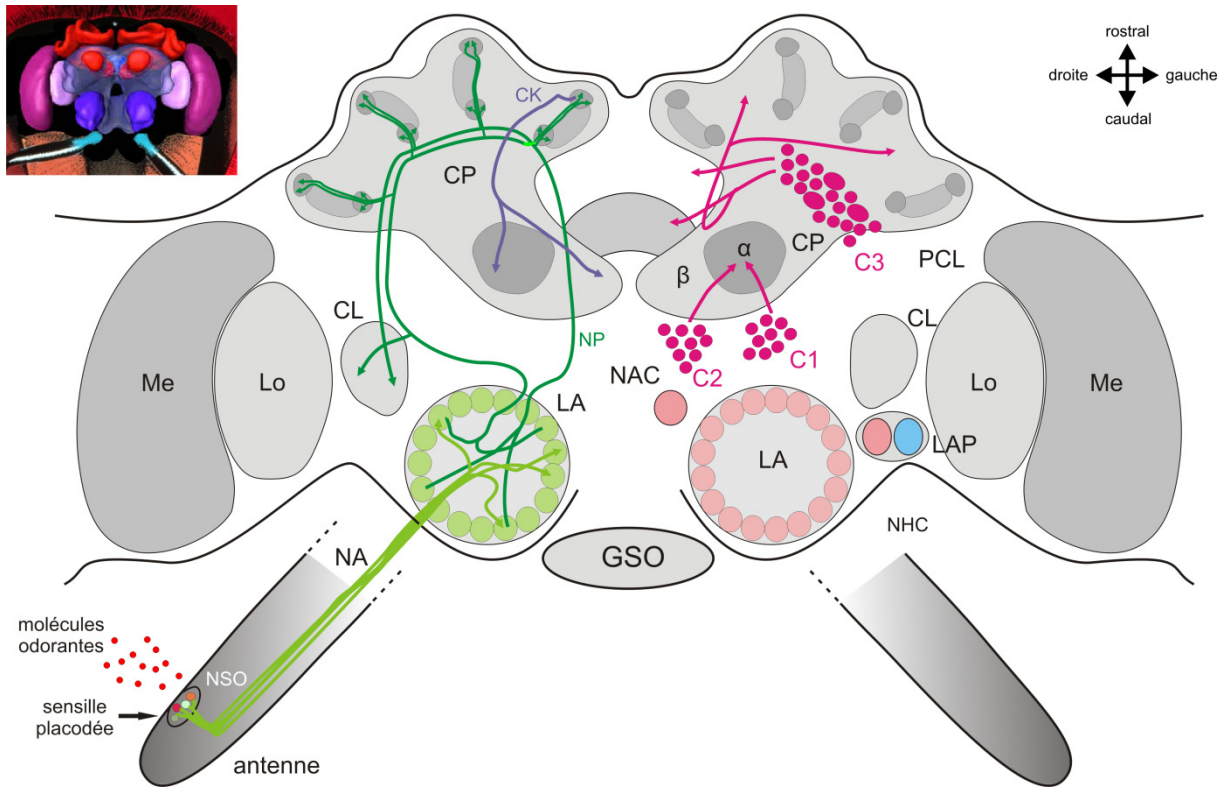

Figure 4: Représentation des neurones dopaminergiques extrinsèques des corps pédonculés (inspiré de Tedjakumala et Giurfa, 2013). Les ensembles de neurones C1-C3 (rose), pourraient être impliqués dans l'association aversive. les flèches représentent les arborisations dendritiques/projections axonales. Les corps pédonculés (CP) sont composés des calices dans leur partie supérieure (synapse entre neurones de projections de différentes modalités sensorielles avec les cellules de Kenyon). Les cellules de Kenyon forment le reste des corps pédonculés qui se divisent en deux lobes, le lobe vertical (α) et le lobe vertical (β). Les neurones C1 sont localisés dans la partie médiale inférieure du protocérébron. Adjacents à ces derniers, les neurones C2 sont positionnés inférieurement par rapport au lobe α . C1 et C2 envoient leurs terminaisons axonales au niveau ventro-médial des corps pédonculés (CP), le lobe α . Le groupe de neurones C3 se trouve à la limite supérieure du protocérébron, sous les calices (CA) des CP. Trois principales voies de projection émergent de C3, une terminant au niveau de la partie antérieure, supérieure et médiale du protocérébron, une deuxième au niveau du corps central (CC), et une troisième passant le long de la limite dorsale du lobe α et bifurquant pour aller innover directement les CA.

Dans le cadre des pistes que nous venons d'esquisser, de nombreuses voies s'ouvrent à nous pour nos futures recherches. Parmi elles, il sera particulièrement important de vérifier l'implication d'HsTRPA ainsi que d'autres types de récepteurs (Pyrexia, GR28B, etc.) dans la détection thermique, d'isoler les voies neuronales impliquées dans le traitement de l'information aversive thermique (LAP, NAC,...) et enfin de comprendre le rôle des différents groupes de neurones dopaminergiques dans la formation de l'association odeur / température.

II) Développement de nouveaux protocoles comportementaux pour étudier les apprentissages aversif et appétitif chez l'abeille

Dans ce travail, nous avons développé deux nouveaux protocoles : le conditionnement aversif thermique, et un nouveau protocole de capture vidéo des mouvements antennaires des abeilles. Certaines améliorations de ces protocoles sont envisageables.

a) Développement d'un conditionnement aversif absolu

L'abeille est un modèle influent dans l'étude des bases moléculaires et cellulaires de la mémoire, qui ont surtout été étudiées grâce au conditionnement olfactif appétitif de la REP (Bitterman *et al.*, 1983 ; Menzel, 1990, 2001 ; Sandoz *et al.*, 1995 ; Matsumoto *et al.*, 2014). On ne sait cependant que très peu de choses concernant la mémoire olfactive établie à la suite d'un conditionnement aversif. Bien que le protocole de conditionnement aversif différentiel que nous avons développé nous ait permis d'étudier différentes composantes de l'apprentissage, aussi bien sur le plan génotypique que comportemental (Chapitres I et III), il ne nous a pas permis de progresser dans la description des différentes phases de la mémoire aversive. Les seuls travaux existant à ce jour ont été réalisés sur la base du protocole utilisant un choc électrique comme stimulus inconditionnel (Giurfa *et al.*, 2009). Les auteurs ont montré que consécutivement à une phase d'acquisition comprenant 6 essais renforcés (SC+) et 6 essais non-renforcés (SC-), les abeilles se souvenaient de l'information apprise jusqu'à 72 h après l'acquisition (mémoire à long terme tardive). De plus, par une approche neuropharmacologique basée sur l'injection d'inhibiteurs de transcription (actinomycine D) et de traduction (anisomycine), ils ont pu observer que cette mémoire dépendait d'une synthèse protéique *de novo*, comme la mémoire équivalente mise en place après un conditionnement appétitif (Giurfa *et al.*, 2009). Cependant, de nombreuses questions restent en suspens, notamment : retrouve-t-on les différentes phases de la mémoire observées avec le protocole de conditionnement de la REP (mémoire à court ou à moyen terme) ? Si oui, quelles en sont les bases neuronales et moléculaires?

Il y a des raisons objectives qui expliquent la difficulté à étudier la mémoire avec les protocoles aversifs (que le renforcement soit un choc électrique ou thermique). Le fort taux de réponses spontanées observé en début de conditionnement (habituellement 20%) ainsi que le faible pourcentage d'individus apprenant spécifiquement l'odeur renforcée obligent à réaliser un conditionnement comprenant un nombre d'essais relativement élevé (Vergoz *et al.*, 2007 ; Roussel *et al.*, 2009 ; Carcaud *et al.*, 2009 ; Giurfa *et al.*, 2009 ; Junca *et al.*, 2014). Ce biais rend très difficile l'étude des limites critiques des phases précoces de la mémoire aversive, qui, dans la modalité appétitive, sont étudiées après un seul essai de conditionnement, c'est-à-dire une seule association odeur-sucre (Menzel 1990 ; Sandoz *et al.*, 1995). De surcroît, l'apprentissage aversif est réalisé le plus

souvent dans le cadre d'un conditionnement différentiel, dans lequel une odeur est présentée associée au renforcement aversif (CS+) alors qu'une autre odeur est présentée explicitement sans ce renforcement (CS-). Les travaux récents suggèrent que dans ce type de conditionnement, deux types de mémoires sont créées. D'une part une mémoire aversive (CS+), l'odeur signalant la présence du renforcement négatif. D'autre part, une mémoire plutôt de type appétitive (CS-), l'odeur signalant l'absence de renforcement négatif (Tanimoto *et al.*, 2004 ; Yarali *et al.*, 2008 ; Carcaud *et al.*, 2009). Nous pensons que la recherche de l'engramme aversif ne peut se réaliser dans des conditions où deux situations antagonistes sont apprises simultanément. Ainsi, pour progresser dans ce domaine, le développement d'un protocole de conditionnement absolu (ne comprenant qu'un stimulus conditionnel renforcé) devrait être envisagé. Afin de comprendre les limites des protocoles utilisés jusqu'à présent et de proposer des améliorations, deux approches sont possibles :

- soit appréhender le conditionnement de la RED comme un calque aversif du conditionnement appétitif de la REP et donc trouver les divergences entre les deux protocoles utilisés et qui pourraient expliquer le faible taux de réussite de l'apprentissage aversif.
- soit comprendre la RED comme une réponse sélectionnée différente de la REP, et donc potentiellement adaptée à d'autres conditions environnementales et qui pourrait répondre à d'autres règles pour être conditionnée efficacement.

Lorsque l'on se positionne dans la première hypothèse, la première différence importante, existant entre les protocoles classiques de conditionnement aversif de la RED et de conditionnement appétitif de la REP, réside dans l'application du stimulus inconditionnel. Si dans le premier cas l'embout conique chauffé est appliqué uniquement au niveau des pièces buccales (Junca *et al.*, 2014 ; Chole *et al.*, *in prep*; Junca *et al.*, *in prep*), dans le second la solution sucrée est d'abord appliquée sur les antennes, stimulation qui déclenche la REP, et est ensuite mise en contact avec le proboscis afin que l'abeille puisse l'ingérer (Bitterman *et al.*, 1983 ; Menzel, 2001 ; Giurfa *et al.*, 2007). Ainsi dans le protocole de la REP, le stimulus inconditionnel est dit « composé » et se présente comme un double renforcement. Dans ce protocole appétitif, les performances sont nettement moindres lorsque la stimulation sucrée est apposée uniquement au niveau des antennes ou du proboscis (Bitterman *et al.*, 1983 ; Sandoz *et al.* 2002) ce qui pourrait expliquer, par analogie, les moindres performances du conditionnement aversif, réalisé avec une application unique du SI. De façon intéressante, le dard pourrait être la cible d'un deuxième renforcement dans le conditionnement aversif, comme le proboscis l'est pour le conditionnement appétitif. La finalité écologique de la RED est de piquer une cible particulière, comme le suggère l'arsenal mécano-sensoriel présent sur le dard. Un ensemble de sensilles campaniformes sont réparties le long du dard et les neurones mécanosensoriels qu'elles renferment envoient un message sensoriel au ganglion abdominal terminal, permettant de contrôler localement l'action du dard (Ogawa *et al.*, 2011). Il est possible que ce système mécano-sensoriel envoie au cerveau l'information selon laquelle le dard a piqué dans un substrat, i.e. un potentiel

deuxième renforcement. Ce système de retour mécano-sensoriel a aussi été observé chez une guêpe parasitoïde, *Ampulex compress*, qui pond dans le cerveau des blattes pour que ses larves s'y développent. En remplaçant le cerveau de la blatte par des cubes d'agarose de concentrations variées (donc plus ou moins denses), Gal *et al.* (2014) ont observé que la guêpe n'acceptait de pondre que dans un milieu dont la solidité se rapprochait d'un vrai cerveau de blatte et donc était capable d'apprécier avec son dard les informations mécano-sensorielles propres au milieu piqué. A l'aune de ces observations, on pourrait compléter le SI thermique par la présentation d'un matériau (cube d'agarose) dans lequel l'abeille piquerait, ce qui pourrait faire office de deuxième renforcement, jusque là absent de la procédure de conditionnement de la RED.

Dans le cadre de la seconde hypothèse, la RED peut être pensée comme une réponse défensive sélectionnée, qui s'exprime dans un contexte particulier et qui ne peut donc pas être apprise dans n'importe quelle situation. Certains auteurs défendent l'idée selon laquelle les capacités d'apprentissage des animaux en Laboratoire découlent des comportements qu'ils réalisent dans leurs niches écologiques et qui sont le fruit de la sélection naturelle. Ils considèrent ainsi les animaux comme "préprogrammés" à apprendre certaines associations, et d'une certaine manière (Bolles, 1970 ; Garcia *et al.*, 1985; Gould, 2002). La nature défensive des comportements "agressifs" déclenchés par des stimulations nocives est remarquable par le fait que la majorité des animaux "attaqués" auront tendance à *éviter* la situation désagréable plutôt que d'*attaquer* la cible disponible (Potegal, 1979). Dans cette vision, ces comportements défensifs pourraient procéder d'un apprentissage opérant (Berkowitz, 1983). En d'autres termes, le comportement défensif verrait sa probabilité d'occurrence croître dès lors que sa manifestation *fait cesser ou diminuer* la stimulation aversive. Knutson *et al.* (1980) soutiennent cette idée en montrant que, lorsqu'un rat, stimulé par un choc électrique, voit ses attaques sur un individu conspécifique faire cesser la stimulation aversive, ses agressions tendent à augmenter. Le dard, en tant qu'appareil vulnérant, joue un rôle primordial dans les comportements défensifs de l'abeille (Free, 1961 ; Núñez *et al.*, 1983 ; Breed *et al.*, 2004). Ainsi concevoir l'apprentissage de la RED comme un conditionnement opérant déclenché par un signal (olfactif, visuel, tactile) pourrait permettre de résoudre les problèmes liés à la faible efficacité du protocole utilisé jusqu'alors, en positionnant la réponse au centre de la procédure. Dans ce cas, le SC serait présenté avant la stimulation thermique, mais cette dernière serait interrompue dès que la RED est déclenchée, afin que l'animal puisse associer son propre comportement (la RED) avec la cessation de la stimulation aversive. La principale difficulté de ce changement de paradigme réside dans l'arrêt à bon escient de la stimulation thermique car la RED peut être une réponse difficile à observer.

Par ailleurs, le contexte environnemental dans lequel l'abeille est susceptible d'exprimer un comportement de RED n'est pas à exclure des considérations. Dans de nombreuses études, les comportements « agressifs » (morsures, piqûres) des abeilles sont étudiés aux abords de la plateforme d'envol des colonies (Free, 1961 ; Millor *et al.*, 1999 ; Giray *et al.*, 2000 ; Hunt *et al.*, 2007).

Lorsqu'un stimulus contrasté est présenté à l'entrée de la ruche, les ouvrières l'attaquent en le piquant, ce qui permet d'évaluer le comportement de défense de la colonie. De tels comportements agressifs sont rarement observés chez les butineuses dans les espaces ouverts éloignés de la colonie. Au contraire, ces ouvrières ont tendance à éviter les zones où un prédateur, comme une Thomise (araignée crabe, *Misumena atia*), a été rencontré auparavant (Dukas et Morse, 2003). Cette différence de comportement des ouvrières dans deux contextes différents pourrait avoir un lien avec le faible rendement obtenu dans le protocole de conditionnement aversif de la RED. Un stimulus contextuel tel qu'une odeur (une phéromone, par exemple) associant le lieu à la colonie (refuge), pourrait avoir été sélectionné comme un élément contextuel permettant de déclencher une réponse de défense optimale. Comme signal olfactif affectant l'apprentissage, la phéromone d'alarme a été observée comme diminuant les performances lors d'un conditionnement appétitif de la REP (Urlacher *et al.*, 2010). Cependant, à notre connaissance, l'impact sur le conditionnement aversif n'a toujours pas été testé. L'ajout de cette odeur pendant (ou avant) un conditionnement aversif pourrait être nécessaire et permettrait d'optimiser les performances d'apprentissages des abeilles. Cette idée est soutenue par le fait que la phéromone d'alarme augmente les comportements défensifs exprimés par les ouvrières postées à l'entrée de la colonie (Boch, 1962). Dans une opposition entre modalités appétitive et aversive, cette phéromone pourrait faire l'objet d'un *trade-off* dont l'intensité (concentration) perçue serait le vecteur. Plus l'individu serait exposé à la phéromone d'alarme plus ses comportements appétitifs seraient inhibés et, à l'inverse, ses comportements aversifs favorisés.

Bien que ces raisonnements puissent paraître exagérés sur certains points, nous pensons qu'ils ont pour avantage de changer le point de vue généralement pris pour aborder l'apprentissage aversif. De ce point de vue différent pourront peut-être apparaître des solutions pour améliorer notre protocole et pouvoir aborder une étude approfondie de la mémoire olfactive aversive.

b) Les mouvements antennaires comme reflets de l'apprentissage : une vision plus fine des associations ?

Les stratégies énoncées plus haut pour améliorer le conditionnement aversif chez l'abeille se sont concentrées sur la mesure de la RED pour révéler l'existence d'une association odeur – renforcement thermique. Une stratégie alternative serait d'utiliser une autre réponse comportementale plastique, réponse qui se modifierait lorsque les abeilles associent une odeur à une conséquence néfaste. Dans le chapitre 4, nous avons étudié les mouvements antennaires, qui ont l'avantage de constituer une réponse graduelle, afin d'estimer si ces mouvements pouvaient révéler la valeur hédonique acquise d'une odeur, associée préalablement avec un renforcement positif ou négatif. Si une plasticité de la réponse antennaire a été clairement démontrée dans le cas du conditionnement appétitif,

les abeilles déplaçant leurs antennes vers l'avant lorsque l'odeur apprise est présentée. A l'inverse, aucune plasticité claire n'a été observée pour le conditionnement aversif. Si les mouvements antennaires révélaient la valeur hédonique d'une odeur, alors nous nous serions attendus à voir les antennes aller vers l'arrière après un apprentissage aversif thermique. Cette impossibilité apparente d'observer un effet du conditionnement aversif sur la réponse antennaire peut provenir du positionnement des antennes vers l'arrière de la tête à la présentation de l'odeur, avant le conditionnement. L'utilisation d'odeurs, initialement perçues comme appétitives (entraînant un mouvement vers l'avant au départ), permettrait peut être d'observer un mouvement vers l'arrière une fois ces odeurs associées à un renforcement négatif (Nishiyama *et al.*, 2007). Pour cette raison, une expérience en cours au Laboratoire consiste à présenter un nombre important de stimuli odorants à des abeilles naïves (stage de N. Henderson, 2015). D'un autre côté, l'absence de stimulation antennaire par le SI pendant le conditionnement de la RED, le différencie de l'apprentissage appétitif de la REP. La mesure antennaire de la valence hédonique acquise d'une odeur pourrait nécessiter un contact entre les antennes et le SI. Dans le contexte du butinage, les antennes des abeilles entrent en contact avec le nectar fourni par les fleurs, ce qui permet à l'abeille d'estimer la qualité de la source de nourriture (Wright and Schiestl, 2009). Dans cette logique, la réponse antennaire procéderait d'un apprentissage opérant dans lequel la récompense augmenterait la probabilité de mouvements des antennes vers l'avant, tandis que la punition entraînerait un évitement qui positionnerait les antennes vers l'arrière. Il sera donc important dans un futur proche de répéter cette expérience i) avec des odeurs ne produisant pas de réponse vers l'arrière avant apprentissage, et/ou ii) en appliquant le renforcement thermique au niveau des antennes de l'abeille.

L'utilisation d'une réponse graduelle, qui procure une mesure plus fine que la REP ou la RED (essentiellement des réponses tout-ou-rien), pourrait se révéler particulièrement avantageuse dans certains contextes d'étude comme l'étude de l'anticipation, ou de phénomènes d'interactions complexes entre associations. Les apprentissages associatifs, classique et instrumental, dépendent de l'association entre des signaux externes ou une réponse comportementale et la représentation interne d'une récompense ou d'une punition (Rescorla, 1987 ; Gil *et al.*, 2007). Dans ce contexte, l'"anticipation" peut se comprendre comme l'activation de la représentation interne de la récompense (ou de la punition) par les événements annonçant celle-ci, en l'absence du renforcement (Tolman, 1959 ; Logan, 1960). L'étude de l'"anticipation" de la récompense est essentielle à la compréhension de l'ontogénie des comportements, au travers de l'apprentissage. Les abeilles adaptant leurs efforts de butinage en fonction de la qualité et de la quantité de nourriture disponible, l'anticipation joue donc un rôle central dans la modulation de ce comportement (Menzel *et al.*, 2006). Dans les études de l'apprentissage appétitif en contention, seule la réponse d'extension du proboscis (REP) était utilisée. Ainsi, le comportement anticipatoire de l'abeille reposait uniquement sur l'observation de la REP pendant la présentation de l'odeur renforcée. Cependant, le contexte expérimental, dans lequel est

effectué le conditionnement, participerait aussi à la formation d'associations appétitives. Ainsi, l'abeille associerait ce contexte expérimental, c'est-à-dire l'ensemble de stimuli multisensoriels présents lors du conditionnement, avec la récompense sucrée. Il est très rare de pouvoir observer des REP manifestées par les abeilles en réponse au contexte expérimental, ce qui rend l'étude de ces associations difficile. Par contre, la réponse antennaire, beaucoup plus fine, devrait permettre de les appréhender, par exemple sous la forme d'une propension plus importante à placer ces antennes vers l'avant lorsqu'on place l'abeille dans le contexte de l'apprentissage. En comparant les mouvements antennaires avant toute présentation du SC+ et du SC-, dans des groupes conditionnés, avant et après apprentissage, avec un groupe contrôle naïf, nous pourrions estimer l'impact de l'attente et des associations contextuelles prédisant la survenue d'une récompense.

Une réponse graduelle serait aussi adéquate pour l'étude d'interactions entre stimuli conditionnels qui sont difficiles à mesurer avec une réponse tout-ou-rien. Par exemple, dans le protocole de *blocking*, deux stimuli A et B sont associés simultanément au SI, après que l'un d'eux (A) a été préalablement associé au SI. Lors d'une phase ultérieure de tests, le stimulus B produit normalement une réponse conditionnelle de moindre amplitude qu'en l'absence d'apprentissage préalable de A : on dit que l'apprentissage préalable de A a « bloqué » l'apprentissage de B (Kamin, 1969). Ce phénomène a beaucoup été étudié chez l'abeille en utilisant le conditionnement appétitif de la REP et a donné lieu à une importante controverse. Certaines études ont pu montrer son existence (Smith et Cobey, 1994, Smith, 1997 ; Hosler and Smith, 2000) mais d'autres n'ont pas réussi à reproduire cet effet (Gerber et Ullrich, 1999 ; Guerrieri *et al.*, 2005) de sorte que le *blocking* est aujourd'hui considéré comme un phénomène difficilement reproductible. Il est possible que cette controverse soit le fruit de l'utilisation d'une réponse trop grossière pour cette question. La réponse antennaire, de par sa nature progressive, pourrait permettre de révéler des interactions négatives subtiles entre stimuli conditionnels, et de s'attaquer aux questionnements des interférences entre stimuli conditionnels.

L'étude de la réponse antennaire, comme reflet de l'apprentissage, apporte ainsi de nombreuses possibilités pour étudier les bases comportementales des apprentissages appétitif et aversif. Les différentes hypothèses que nous avons abordées pourront faire l'objet de futures recherches afin d'améliorer la compréhension des apprentissages hédoniquement opposés.

III) Les capacités appétitive et aversive dans la distribution du travail chez les insectes eusociaux

Une théorie économique d'Adam Smith (1776), chez l'Homme, s'appuyant sur le postulat de l'amélioration de la rentabilité de la production par la répartition des tâches manutentionnaires, fut extrapolée aux colonies d'insectes eusociaux. Chez ces derniers, la distribution du travail se réalise uniquement entre les ouvrières stériles (Oster et Wilson, 1978). Le succès d'une colonie est déterminé par la capacité de ses ouvrières, en tant que groupe, à se répartir efficacement entre les différentes tâches, et de manière adaptée aux conditions environnementales particulières (Gordon, 1996 ; Oster et Wilson, 1978). Comprendre les bases de la distribution des tâches au sein de groupes sociaux, et savoir si elles relèvent d'un avantage sélectif, sont des questionnements majeurs de la sociobiologie (Wilson, 1978 ; Gordon, 1996 ; Chittka et Muller, 2009 ; Duarte *et al.*, 2011). Chez les insectes sociaux, la question a principalement été posée à deux niveaux. D'une part, l'étude des *causes proximales*, correspondant à l'organisation propre de la distribution des tâches, par l'analyse des différences phénotypiques observables entre les individus effectuant différentes tâches (comportement, expression des gènes, etc.) (Dolezal et Toth, 2014). D'autre part, l'étude des *causes distales*, correspondant aux voies évolutives et au maintien de cette organisation au cours des générations (Duarte *et al.*, 2011). Le *trade-off* (système de compensation) hédonique comportemental et génotypique que nous avons observé dans la ruche d'abeille (Chapitre III), peut trouver une explication dans la répartition du travail, aussi bien au niveau proximal que distal.

a) L'implication d'un *trade-off* hédonique dans l'analyse des causes proximales de la division du travail

Les analyses proximales de la division du travail, sont généralement basées sur le concept d'auto-organisation. De ce point de vue, la division du travail est une propriété émergente de l'interactions entre des individus obéissant à des règles comportementales simples (Bonabeau *et al.*, 1997 ; Page et Mitchell, 1998). Ce concept est soutenu par des études comportementales, démontrant que des reines de fourmis moissonneuses de graines ou des halictes (abeilles), normalement solitaires, développent des spécialisations comportementales dès lors qu'elles sont réunies de façon artificielle (Fewell et Page 1999 ; Jeanson *et al.* 2005, 2008). Différents modèles d'auto-organisation ont été développés afin d'expliquer la distribution des tâches chez les individus non-reproductifs des colonies d'insectes sociaux (Duarte *et al.*, 2011). Parmi eux, le modèle des *seuils de* réponse a été particulièrement influent pour comprendre les causes proximales de la distribution des tâches, et a fait

l'objet de nombreuses études (fourmi : Blanchard *et al.*, 2000, Perez *et al.*, 2013 ; abeille : Jones *et al.*, 2004, Page *et al.*, 2006 ; bourdon : Weidenmüller, 2004). Il repose sur l'idée d'une perception subjective des stimuli associés aux différentes tâches par les membres de la colonie. Lorsque deux individus (ou plus) interagissent, l'individu présentant le seuil de sensibilité le plus bas pour le stimulus associé à une tâche à accomplir (donc l'individu le plus sensible), la réalisera (Theraulaz *et al.*, 1998 ; Beshers et Fewel, 2001 ; Nowak *et al.*, 2010). La validité empirique du modèle des seuils de réponse a été soutenue en particulier par des études sur la thermorégulation de colonies d'insectes eusociaux. Chez les fourmis, les bourdons et les abeilles, différents individus déclenchent invariablement des comportements thermorégulateurs à différentes températures au-dessus de la température optimale (O'Donnell et Foster, 2001 ; Jones *et al.*, 2004 ; Weidenmüller, 2004).

Dans notre étude, nous avons observé un *trade-off* hédonique entre les sensibilités des abeilles envers les renforcements appétitif (sucre) et aversif (température). On imagine aisément comment un tel *trade-off* peut donner lieu dans la ruche à une distribution des individus soit dans des tâches appétitives (recherche de nourriture) soit dans des tâches aversives (défense de la colonie) en fonction de leur sensibilité relative aux stimuli associés à ces deux modalités. Dans la majorité des cas, les abeilles âgées de deux semaines (âge que nous avons testé) effectuent des tâches en dehors de la ruche, en tant que butineuses ou gardiennes (Seeley *et al.*, 1982 ; Robinson *et al.*, 1994 ; Breed *et al.*, 2004). La recherche de nourriture (tâche des butineuses) repose principalement sur la perception de stimuli appétitifs, comme le nectar sucré produit par les fleurs. Chez la fourmi *Camponotus aethiops*, qui se nourrit de nectar extra-floral, et possède un polyéthisme d'âge, les individus âgés récoltant le nectar, sont plus sensibles aux solutions de saccharose que les nourrices, qui s'occupent du couvain (Perez *et al.*, 2013). De manière analogue, chez l'abeille, les butineuses, prises dans leur ensemble, sont plus sensibles aux solutions sucrées que les nourrices (Pankiw et Page, 1999 ; Scheiner *et al.*, 2004). Inversement, nous pourrions qualifier les comportements défensifs comme appartenant à la modalité aversive, puisqu'ils ont pour finalité de faire cesser une menace potentielle. Les gardiennes devraient être ainsi plus sensibles aux stimuli reliés à leur tâche, comme elles le sont à la phéromone d'alarme (Breed *et al.*, 2004). Dans cet esprit, il serait donc important d'analyser la relation existant entre les sensibilités aversives ou appétitives étudiées ici et la perception d'autres modalités sensorielles. Pour la modalité appétitive, de nombreuses données ont déjà été obtenues. Ainsi, nous savons déjà que la sensibilité des abeilles au saccharose est corrélée avec leur sensibilité tactile (Scheiner *et al.*, 2001) et avec leur sensibilité à la lumière (comportement phototactique, Erber *et al.*, 2006). Cet ensemble d'observations a donné lieu à l'idée d'un syndrome comportemental appétitif chez les abeilles (Page *et al.*, 2006). Cependant, d'autres stimulations sensorielles, comme la sensibilité au couvain malade (réponse hygiénique) semblent cependant indépendantes de la sensibilité au sucre (Goode *et al.*, 2006). De plus, la sensibilité à la phéromone de couvain, dont on suppose qu'elle serait corrélée à la sensibilité au sucre, reste encore à confirmer (Scheiner *et al.*, 2004). En ce qui concerne la modalité

aversive, on n'a à ce jour que peu de données. Par exemple, on ne sait pas si la sensibilité des abeilles à des stimuli mobiles et contrastés, essentielle aux comportements de défense des abeilles (Free *et al.*, 1961), est corrélée à leur sensibilité aversive, par exemple à la température. Il est donc à ce jour encore difficile de définir un syndrome comportemental aversif (Roussel *et al.* 2009), même si nos données semblent indiquer qu'il pourrait exister. Une étude corrélative à grande échelle des sensibilités des abeilles aux différents stimuli de la ruche devrait être réalisée, afin de consolider le *trade-off* que nous avons observé et définir l'existence de deux syndromes comportementaux antagonistes, permettant de soutenir une base hédonique du polyéthisme chez les insectes eusociaux.

Chez les insectes eusociaux, il est généralement admis que la diversité génétique permet une augmentation de la *fitness* (capacités de s'adapter à un environnement donné et de transmettre cet avantage évolutif à la génération suivante)(Jeanson et Weidenmuller, 2014). Les essaims d'abeilles issus de colonies génétiquement diversifiées fondent des colonies plus rapidement que ceux issus de ruches génétiquement uniformes (Mattila et Seeley, 2007). En effet, en étudiant les différences de croissance de la population, le taux de butinage ainsi que la taille des stocks de nourriture, ces auteurs ont montré que la diversité génétique augmentait le taux de production de mâles et la survie des colonies à l'hivernage, et donc par extension leur *fitness*. Chez de nombreuses espèces eusociales possédant des reines polyandres, les différentes lignées paternelles au sein de la colonie diffèrent dans leur tendance à effectuer certaines tâches (fourmis coupeuses de feuilles: Julian et Fewel, 2004 ; abeilles: Robinson et Page, 1989). Ce phénomène se regroupe sous le terme de *polyéthisme génétique* (Waddington *et al.*, 2010), semblant se combiner au polyéthisme d'âge (cf. introduction) pour déterminer l'allocation des individus aux différentes tâches. Ainsi, l'auto-organisation de la distribution du travail, chez les insectes eusociaux, apparaît aussi sous dépendance génotypique. Avant notre travail, il n'était pas clairement établi que cette diversité génétique, augmentant la *fitness* et participant à la distribution du travail, s'accompagnait aussi d'une spécialisation cognitive (Scheiner et Arnold, 2010). Le *trade-off* hédonique que nous avons observé, et qui contrôle les capacités d'apprentissage aversif et appétitif des abeilles, est clairement sous influence génotypique, puisque nous avons pu le confirmer au niveau des lignées paternelles (Chapitre III). Cependant, le substrat génétique d'un tel déterminisme est encore inconnu. Chez l'abeille, une corrélation négative entre l'intensité des comportements de défense (piqûre, morsure) et de butinage a été observée entre différentes ruches (Rivera-Marchand *et al.*, 2008). Cette observation confirme le caractère génétique d'une telle organisation comportementale. Des analyses de QTL (*Quantitative Trait Loci*) ont montré que certaines régions chromosomiques intervenaient dans les comportements de butinage (*pln1-4*) et que d'autres régions étaient impliquées dans les comportements de défense (*sting1-3*) (Hunt *et al.*, 2007) (Cf. chapitre 3). Il serait donc nécessaire maintenant de réaliser un séquençage du génome des différentes lignées de nos colonies et de réaliser une approche de génétique d'association (GWAS -

Genome Wide Association Study) afin de mettre en évidence des relations de dépendance entre certains gènes et les spécialisations cognitives que nous avons observées.

b) L'implication d'un *trade-off* hédonique dans les causes ultimes de la division du travail

L'augmentation de la variabilité génétique au sein de la colonie peut bénéficier à la colonie de différentes manières. Elle permet une augmentation du spectre de réponses comportementales exprimées par les ouvrières, optimisant l'allocation des tâches en diminuant, par exemple, le coût énergétique associé aux changements de tâche (Goldsby *et al.*, 2012). Dans l'étude que nous avons réalisée, nous avons pu observer que dans la colonie d'abeille, les capacités cognitives hédoniques distribuées entre les ouvrières étaient sous déterminisme génétique et pouvaient être à l'origine de l'orientation des individus vers les différentes tâches. Cette spécialisation cognitive pourrait-elle participer à l'émergence, au maintien et à l'évolution de l'organisation sociale des arthropodes?

En premier, la question de l'émergence des groupes sociaux a fait l'objet de nombreuses études, mais nous ne discuterons que les aspects comportementaux de la division du travail non-reproducteur (Gadau *et al.*, 2009, Camazine *et al.*, 2001). Bien que les agrégations d'individus ne nécessitent pas l'intervention de traits comportementaux typiques des groupes à organisation sociale complexifiée (division du travail reproducteur, chevauchement des générations, etc.), on peut estimer que des préadaptations ou des sélections positives particulières sont nécessaires. Les abeilles du genre *Ceratina*, qui possèdent un mode vie solitaire, peuvent, dans certaines conditions, développer une organisation sociale (Sakagami et Maeta, 1977, 1987, 1989). Dans ce cas, les individus vont mobiliser, ou au contraire occulter, une partie de leur répertoire comportemental, et donner lieu à une réelle distribution du travail au sein de la communauté. Des observations similaires ont été faites chez les halictes, dont certaines espèces se socialisent dans des conditions particulières. La mise en commun de différentes femelles, normalement solitaires, déclenche une division des tâches, certaines déposant des œufs et défendant le nid tandis que d'autres récoltent du pollen (Plateaux-Quénu, 1993). La propension des individus mis en commun à se distribuer entre des tâches de récolte, de nourriture, de ponte et de défense pourrait être imputable à des différences phénotypiques inter-individuelles préexistantes. La comparaison des sensibilités hédoniques de ses individus en fonction de la tâche à laquelle ils sont alloués, nous permettrait de confirmer cette hypothèse.

Ensuite, différents phénomènes ont été décrits comme participant au maintien de la cohésion des groupes sociaux. Parmi les processus permettant la cohésion et l'intégration des individus dans des colonies, la reconnaissance des congénères (*nestmates*) par rapport aux non-congénères (*non-nestmates*) représente une étape essentielle dans la formation d'agrégats durables. Par analyse électrophysiologique, Ozaki *et al.* (2004) ont montré que certaines sensilles répondaient au profil

d'hydrocarbures cuticulaires issu d'individus non-membres de la colonie, tandis qu'elles ne répondaient pas à celui des membres de leur colonie. Ainsi, ces auteurs ont postulé que l'émergence d'une cohésion durable pouvait provenir du fait que les membres d'une même colonie ne pouvaient pas percevoir leur profil d'hydrocarbure et donc ne se considéraient pas comme étrangers. Cependant les travaux que nous avons réalisés offrent une nouvelle approche possible pour expliquer ce phénomène. En effet, outre ces capacités de reconnaissance intraspécifique, la relative dépendance cognitive qu'impose la spécialisation hédonique des individus, pourrait contribuer aussi à la stabilité des sociétés d'insectes. En effet, la spécialisation cognitive appétitive ou aversive des individus composant les colonies implique la perte de certaines aptitudes nécessaires à la survie d'individus ayant un mode de vie solitaire.

Le maintien de cette diversité génétique, nécessaire à la composition cognitive de la colonie, pourrait provenir du mode de reproduction des abeilles. Basé sur une forte polyandrie (15-20 mâles), il permettrait aux reines de récolter un échantillonnage représentatif de la diversité génétique de la population. De même, la forte polyandrie, autorisant le maintien des allèles rares au sein de la population, serait à l'origine de la diversité génétique nécessaire à l'adaptabilité des colonies (Fuchs et Moritz, 1999).

Enfin, les groupes présentant une faible probabilité de dispersion pourraient subir différemment la sélection naturelle. Le passage du mode vie solitaire au mode de vie social correspond à un changement de paradigme de l'unité d'action de la sélection naturelle, de l'individu au groupe (Alexander et Borgia, 1978; Maynard et Szathmáry, 2000). Cette analyse, dans le cadre de la sélection naturelle, correspond à la *sélection de groupe*, formulée par E.O. Wilson (1975). Ainsi l'évolution des comportements sociaux pourrait être soumise à la sélection de groupe. Cette théorie a fait l'objet d'une étude récente sur l'araignée (*Anelosimus studiosus*), qui présente un mode vie sociale rudimentaire (quasi-sociales dans le sens de Wilson (1971): construction coopérative de la toile, capture coopérative des proies, soin au couvain partagé (Brach, 1977)). Les groupes sociaux de cette espèce présentent des ratios d'individus agressifs/dociles variant en fonction de la disponibilité en nourriture dans leur niche écologique. Moins il y a de nourriture, plus les groupes seront composés d'individus agressifs et *vice versa*. La sélection de groupe a pu être observée en perturbant la composition de groupes originaires de différents environnements. Les auteurs ont constaté qu'en peu de générations, les groupes récupéraient leur ratio docile/agressif, adapté à leur lieu d'origine (Pruit et Goodnight, 2014). La persistance de la composition sociale des groupes au cours des générations peut être ainsi expliquée par une sélection de l'environnement (disponibilité de nourriture) sur le groupe. Dans des travaux futurs il faudrait étudier si les types comportementaux *docile* et *agressif* sont respectivement l'expression des sensibilités *appétitive* et *aversive*. Chez l'abeille, un *trade-off* mettant en jeu la disponibilité en nourriture a aussi été observé. Une corrélation négative apparaît entre les comportements de défense et de butinage au sein des colonies sous contrôle génétique (Rivera-

Marchand *et al.*, 2008). Ainsi la sélection de groupe pourrait expliquer l'existence de différents ratios d'individus spécialisés en fonction de la disponibilité en nourriture dans la niche écologique dans laquelle ils évoluent. Cependant, il est peu aisé de confirmer l'aspect évolutif de règles comportementales. Néanmoins, des comparaisons de distributions des capacités cognitives hédoniques, au sein de groupes sociaux d'individus d'une même espèce vivant dans des environnements plus ou moins abondants, permettraient d'acquérir des arguments soutenant l'idée d'une répartition des capacités hédoniques par sélection de groupe.

L'interaction entre le module appétitif et le module aversif (Roussel *et al.*, 2009) constituerait une voie intéressante pour de futures recherches sur l'émergence, l'évolution et le maintien de la socialité. Les études phylogéniques semblent indiquer que le mode de vie solitaire est ancestral, et donc que les animaux sociaux descendent d'un ancêtre solitaire (Wilson, 1971). Ainsi la transition du mode vie solitaire au mode vie social pourrait émerger de l'agrégation d'individus plus aversifs et d'autres plus appétitifs. Dans un environnement induisant certaines pressions de sélection sur l'espèce, la vie en groupe d'individus cognitivement hétérogènes représenterait un avantage adaptatif notable. Pour survivre, les espèces passeraient de l'individu au groupe comme unité de sélection, comme Wilson l'a exprimé dans son modèle de la sélection de groupe. La spécialisation d'individus sur un biais hédonique sélectionné, comme mécanisme participant de la formation des groupes sociaux, si elle était démontrée, représenterait une avancée notable dans la compréhension de la socialité.

c) Inadéquation du modèle des seuils de réponses chez les butineuses et les gardiennes

Dans le modèle des seuils, les individus les plus sensibles pour le stimulus sur lequel repose la tâche à accomplir sont sensés être ceux qui réaliseront cette tâche (Théraulaz *et al.*, 1998 ; Beshers *et al.*, 1999 ; Duarte *et al.*, 2011). Chez l'abeille, cependant, une analyse plus précise des sensibilités aversives et appétitives des gardiennes ou des butineuses de nectar semble contredire cette assertion. En effet, les butineuses de nectar, possèdent un seuil de sensibilité au sucre très haut (elles répondent seulement aux fortes concentrations de saccharose) (Pankiw et Page, 2000 ; Scheiner *et al.*, 2004), tandis que les gardiennes, elles, ne sont sensibles qu'aux fortes stimulations nociceptives (choc électriques, Roussel *et al.*, 2009). Ces observations, qui pourraient paraître contradictoires avec le modèle des seuils de prime abord, peuvent se comprendre si l'on prend en compte certains paramètres sociaux ou concernant l'expérience des individus. En effet, on peut penser qu'à partir d'un certain nombre de membres dans la société, l'allocation de ces individus aux tâches hédoniques (gardiennne, butineuse), par un seuil bas aux stimuli sous-jacents, puisse devenir un handicap du fait du coût énergétique que ces tâches représentent.

D'une manière générale, pour la colonie d'abeilles, il serait plus avantageux d'avoir des butineuses de nectar très sélectives (Roussel *et al.*, 2009). D'une part, le coût énergétique du vol et donc de la recherche de sources florales à l'extérieur de la ruche doit être au moins compensé par le gain énergétique apporté par le nectar récolté. En outre, le miel accumulé (réserve en vue des périodes de pénurie) est le fruit d'une déshydratation du nectar. Plus ce dernier est concentré à son arrivée à la ruche, et moindre sera l'effort pour le transformer. En ce qui concerne les gardiennes, la présence à l'entrée de la ruche d'individus particulièrement sensibles aux stimulations nociceptives aurait un coût important si ceux-ci déclenchent une réponse de défense collective de la colonie pour des menaces insuffisamment importantes (Roussel *et al.*, 2009). En effet, les abeilles pouvant mourir lors de la piqûre d'intrus, toute réaction de défense superflue induit une perte de force de travail pour la colonie. Ces éléments sont susceptibles de revêtir une importance différente en fonction de la taille de la société. Dans des cas de compétitions interspécifiques pour une source de nourriture limitée, l'abeille sans dard *Trigona spinipes* forme des groupes plus ou moins larges pour attaquer les autres espèces présentes sur leur site de butinage. Les individus qui composent les groupes d'attaquants les plus importants montrent un niveau d'agressivité plus faible que les individus composant les groupes plus restreints (Nieh *et al.*, 2005). Ainsi, pour une espèce évoluant en groupes peu nombreux, toute agression peut être fatale et une réponse de défense doit être déclenchée très tôt. A l'inverse, dans des groupes plus nombreux, la colonie a une résilience importante aux agressions de faible intensité et seules les menaces sur le groupe doivent être traitées, seules les menaces suffisamment importantes doivent pouvoir déclencher une réponse collective de défense. La taille du groupe jouerait donc un rôle déterminant dans les comportements des individus, et pourrait être à l'origine de variations dans l'allocation des tâches, hors du modèle des seuils de réponses. Pour tester cette hypothèse, il faudrait mesurer les sensibilités hédoniques des individus effectuant les tâches de récolte, de nourriture et de défense de la colonie, sur des espèces présentant différentes tailles de groupes comme les araignées ou les halictes (cf. partie précédente).

Ainsi, même si on ne peut remettre en question le fait que le modèle des seuils soit avantageux pour orienter au départ des individus vers des tâches particulières, on peut penser que des mécanismes doivent exister pour réguler le nombre d'individus orientés vers les tâches les plus coûteuses. Un de ces mécanismes pourrait mettre en jeu l'expérience des individus concernés. Dans les études de Scheiner (2004) et Roussel (2009), les individus dévolus à de telles tâches (butineuses ou gardiennes) répondaient moins au stimulus central de leur tâche que d'autres ouvrières. Une hypothèse possible serait que ces individus aient changé de sensibilité *au cours de leur activité* de butineuse ou de gardienne, par exemple du fait d'une désensibilisation par un contact très fréquent avec ces stimuli. Dans le cas des butineuses de nectar, les interactions qu'elles ont avec les abeilles receveuses pourraient aussi jouer un rôle important, les receveuses refusant un nectar trop peu concentré, et donc trop coûteux à transformer. Il a été montré que la sensibilité aux solutions sucrées des receveuses variait en fonction de la concentration du nectar qu'elles venaient de recevoir par trophallaxie de la

part des butineuses (Martinez et Farina, 2008). Une faible concentration reçue aura tendance à augmenter la sélectivité des receveuses aux solutions sucrées (i.e. répondent moins aux solutions moins concentrées).

Pour confirmer ces hypothèses, nous pourrions éliminer les butineuses ou les gardiennes d'une colonie et suivre l'évolution au cours du temps des sensibilités hédoniques des individus nouvellement engagés dans ces tâches. De plus, il serait important d'effectuer un suivi de l'évolution des sensibilités appétitive et aversive au cours de la vie des ouvrières, en contrôlant leur âge et les tâches auxquelles elles sont allouées. En plus d'étudier les critères conduisant à l'allocation des individus aux tâches de butinage et de défense, cette expérience nous permettrait de mettre en évidence les dynamiques sensorielles de formation de la spécialisation cognitive, avec l'âge, au sein d'une même ruche.

Conclusion générale

Ce travail constitue une nouvelle étape dans nos connaissances des bases comportementales, génétiques et neurobiologiques de l'apprentissage aversif et de la relation qu'il possède avec l'apprentissage appétitif, chez l'abeille *Apis mellifera*. Au cours de ce travail, nous avons pu démontrer l'intérêt du remplacement du choc électrique par une forte température comme renforcement lors du conditionnement aversif de la RED. Ce nouveau stimulus inconditionnel nous a permis de réorienter l'étude des bases neuronales et moléculaires de la détection périphérique du renforcement aversif. Les recherches devront maintenant se focaliser sur la vérification des voies neuronales et des différents récepteurs/canaux candidats que nous avons proposés sur la base des connaissances obtenues chez la drosophile. Nous avons aussi développé un système de capture vidéo de la réponse antennaire. Les mouvements antennaires reflètent la valeur hédonique acquise, consécutivement à un apprentissage appétitif de la REP, mais pas de la RED. Quoi qu'il en soit, cette nouvelle mesure des performances d'apprentissage des abeilles offre de nombreuses nouvelles possibilités pour de futures recherches sur les interactions fines entre associations. Enfin, l'analyse de la relation entre les capacités appétitive et aversive des abeilles nous a permis d'observer des spécialisations à l'échelle de la colonie. La variabilité génétique, sous le biais des lignées paternelles, nous est apparue comme déterminant une spécialisation sensorielle hédonique des individus composant ainsi une communauté cognitive riche. A la fin de notre travail, une question fondamentale demeure. Cette structuration cognitive de la colonie apporte-t-elle un avantage évolutif à ces insectes sociaux?

REFERENCES

REFERENCES

- Abramson, C. I. (1986). Aversive conditioning in honeybees (*Apis mellifera*). *Journal of Comparative Psychology*, *100*(2), 108.
- Adams, C. M., Anderson, M. G., Motto, D. G., Price, M. P., Johnson, W. A., & Welsh, M. J. (1998). Ripped pocket and pickpocket, novel *Drosophila* DEG/ENaC subunits expressed in early development and in mechanosensory neurons. *The Journal of cell biology*, *140*(1), 143-152.
- Aggleton, J. P., Petrides, M., & Iversen, S. D. (1981). Differential effects of amygdaloid lesions on conditioned taste aversion learning by rats. *Physiology & behavior*, *27*(3), 397-400.
- Ahern, G. P., Brooks, I. M., Miyares, R. L., & Wang, X. B. (2005). Extracellular cations sensitize and gate capsaicin receptor TRPV1 modulating pain signaling. *The Journal of neuroscience*, *25*(21), 5109-5116.
- Ai, H., & Itoh, T. (2012). The Auditory System of the Honey Bee. In *Honeybee Neurobiology and Behavior* (pp. 269-283). Springer Netherlands.
- Ai, H., & Hagio, H. (2013). Morphological analysis of the primary center receiving spatial information transferred by the waggle dance of honeybees. *Journal of Comparative Neurology*, *521*(11), 2570-2584.
- Alcock J. 1997. *Animal Behavior: an evolutionary approach*. Sinauer Associates, Sunderland.
- Alexander, B. A. (1991). Phylogenetic analysis of the genus *Apis* (Hymenoptera: Apidae). *Annals of the Entomological Society of America*, *84*(2), 137-149.
- Alexander, R. D., & Borgia, G. (1978). Group selection, altruism, and the levels of organization of life. *Annual Review of Ecology and Systematics*, 449-474.
- Applewhite, P. B. (1968). Temperature and habituation in a protozoan. *Nature*, *219*, 91 - 92
- Arathi, H. S., Burns, I., & Spivak, M. (2000). Ethology of hygienic behaviour in the honey bee *Apis mellifera* L.(Hymenoptera: Apidae): behavioural repertoire of hygienic bees. *Ethology*, *106*(4), 365-379.
- Arnold, K. E., Owens, I. P., & Goldizen, A. W. (2005). Division of labour within cooperatively breeding groups. *Behaviour*, *142*(11-12), 1577-1590.
- Aso, Y., Herb, A., Ogueta, M., Siwanowicz, I., Templier, T., Friedrich, A. B., ... & Tanimoto, H. (2012). Three dopamine pathways induce aversive odor memories with different stability. *PLoS Genet*, *8*(7), e1002768-e1002768.
- Aso, Y., Siwanowicz, I., Bräcker, L., Ito, K., Kitamoto, T., & Tanimoto, H. (2010). Specific dopaminergic neurons for the formation of labile aversive memory. *Current Biology*, *20*(16), 1445-1451.
- Avarguès-Weber, A., Portelli, G., Benard, J., Dyer, A., & Giurfa, M. (2010). Configural processing enables discrimination and categorization of face-like stimuli in honeybees. *The Journal of experimental biology*, *213*(4), 593-601.
- Avarguès-Weber, A., Dyer, A. G., Combe, M., & Giurfa, M. (2012). Simultaneous mastering of two abstract concepts by the miniature brain of bees. *Proceedings of the National Academy of Sciences*, *109*(19), 7481-7486.

- Avarguès-Weber, A., & Giurfa, M. (2013). Conceptual learning by miniature brains. *Proceedings of the Royal Society of London B: Biological Sciences*, 280(1772), 20131907.
- Avarguès-Weber, A., d'Amaro, D., Metzler, M., & Dyer, A. G. (2014). Conceptualization of relative size by honeybees. *Frontiers in behavioral neuroscience*, 8.
- Batra, S. W. T. (1966). Nests and social behavior of halictine bees of India (Hymenoptera: Halictidae). *Indian Journal of Entomology*, 28(3), 375-393.
- Baudry, E., Solignac, M., Garnery, L., Gries, M., Cornuet, J., & Koeniger, N. (1998). Relatedness among honeybees (*Apis mellifera*) of a drone congregation. *Proceedings of the Royal Society of London B: Biological Sciences*, 265(1409), 2009-2014.
- Bautista, D. M., Siemens, J., Glazer, J. M., Tsuruda, P. R., Basbaum, A. I., Stucky, C. L., ... & Julius, D. (2007). The menthol receptor TRPM8 is the principal detector of environmental cold. *Nature*, 448(7150), 204-208.
- Beggs, K. T., Hamilton, I. S., Kurshan, P. T., Mustard, J. A., & Mercer, A. R. (2005). Characterization of a D2-like dopamine receptor (AmDOP3) in honey bee, *Apis mellifera*. *Insect biochemistry and molecular biology*, 35(8), 873-882.
- Bell, W. J., Kipp, L. R., & Collins, R. D. (1995). The role of chemo-orientation in search behavior. In *Chemical Ecology of Insects 2* (pp. 105-152).
- Belova, M. A., Paton, J. J., Morrison, S. E., & Salzman, C. D. (2007). Expectation modulates neural responses to pleasant and aversive stimuli in primate amygdala. *Neuron*, 55(6), 970-984.
- Ben-Shahar, Y., Robichon, A., Sokolowski, M. B., & Robinson, G. E. (2002). Influence of gene action across different time scales on behavior. *Science*, 296(5568), 741-744.
- Berkowitz, L. (1983). Aversively stimulated aggression: Some parallels and differences in research with animals and humans. *American Psychologist*, 38(11), 1135.
- Berridge, K. C., & Robinson, T. E. (1998). What is the role of dopamine in reward: hedonic impact, reward learning, or incentive salience?. *Brain Research Reviews*, 28(3), 309-369.
- Bertram, B. C. (1980). Vigilance and group size in ostriches. *Animal Behaviour*, 28(1), 278-286.
- Beshers, S. N., & Fewell, J. H. (2001). Models of division of labor in social insects. *Annual review of entomology*, 46(1), 413-440.
- Beshers, S. N., Robinson, G. E., & Mittenthal, J. E. (1999). Response thresholds and division of labor in insect colonies. *Information processing in social insects* (pp. 115-139).
- Bindra, D. (1974). A motivational view of learning, performance, and behavior modification. *Psychological review*, 81(3), 199.
- Bissonette, G. B., Gentry, R. N., Padmala, S., Pessoa, L., & Roesch, M. R. (2014). Impact of appetitive and aversive outcomes on brain responses: linking the animal and human literatures. *Frontiers in systems neuroscience*, 8.
- Bitterman, M.E., Lolordo, V.M., Overmier, J.B., and Rashotte, M.E. (1979). *Animal Learning - Survey and Analysis*. New York, Plenum Press.
- Bitterman, M. E., Menzel, R., Fietz, A., & Schäfer, S. (1983). Classical conditioning of proboscis extension in honeybees (*Apis mellifera*). *Journal of Comparative Psychology*, 97(2), 107.

- Blanchard, G. B., Orledge, G. M., Reynolds, S. E., & Franks, N. R. (2000). Division of labour and seasonality in the ant *Leptothorax albipennis*: worker corpulence and its influence on behaviour. *Animal Behaviour*, *59*(4), 723-738.
- Blenau, W., Erber, J., & Baumann, A. (1998). Characterization of a dopamine D1 receptor from *Apis mellifera*: cloning, functional expression, pharmacology, and mRNA localization in the brain. *Journal of neurochemistry*, *70*(1), 15-23.
- Bloch, G., & Robinson, G. E. (2001). Chronobiology: reversal of honeybee behavioural rhythms. *Nature*, *410*(6832), 1048-1048.
- Blomquist, G. J., Chu, A. J., & Remaley, S. (1980). Biosynthesis of wax in the honeybee, *Apis mellifera* L. *Insect Biochemistry*, *10*(3), 313-321.
- Boch, R. (1962). Identification of iso-amyl acetate as an active component in the sting pheromone of the honey bee. *Nature*, *195*, 1018-1020.
- Boitard, C., Devaud, J. M., Isabel, G., & Giurfa, M. (2015). GABAergic feedback signaling into the calyces of the mushroom bodies enables olfactory reversal learning in honey bees. *Frontiers in Behavioral Neuroscience*, *9*, 198.
- Bolles, R. C. (1970). Species-specific defense reactions and avoidance learning. *Psychological review*, *77*(1), 32.
- Bonabeau, E., Theraulaz, G., & Deneubourg, J. L. (1996). Quantitative study of the fixed threshold model for the regulation of division of labour in insect societies. *Proceedings of the Royal Society of London B: Biological Sciences*, *263*(1376), 1565-1569.
- Bonabeau, E., Theraulaz, G., Deneubourg, J. L., Aron, S., & Camazine, S. (1997). Self-organization in social insects. *Trends in Ecology & Evolution*, *12*(5), 188-193.
- Bos, N., Roussel, E., Giurfa, M., & d'Ettorre, P. (2014). Appetitive and aversive olfactory learning induce similar generalization rates in the honey bee. *Animal cognition*, *17*(2), 399-406.
- Bourke, A. F., Franks, N. R., & Keller, L. (1995). *Social evolution in ants* (1st ed., p. 529). Princeton: Princeton University Press.
- Bouton, M. E. (2007). *Learning and behavior: A contemporary synthesis*. Sinauer Associates.
- Brach, V. (1977). *Anelosimus studiosus* (Araneae: Theridiidae) and the evolution of quasisociality in theridiid spiders. *Evolution*, 154-161.
- Bradya, S. G., Larkinb, L., & Danforthc, B. N. (2009). Bees, ants, and stinging wasps (Aculeata). *The timetree of life*, 264.
- Breed, M. D., Robinson, G. E., & Page Jr, R. E. (1990). Division of labor during honey bee colony defense. *Behavioral Ecology and Sociobiology*, *27*(6), 395-401.
- Breed, M. D., Guzmán-Novoa, E., & Hunt, G. J. 3. (2004). Defensive behavior of honey bees: organization, genetics, and comparisons with other bees. *Annual Reviews in Entomology*, *49*(1), 271-298.
- Brembs, B., & Heisenberg, M. (2000). The operant and the classical in conditioned orientation of *Drosophila melanogaster* at the flight simulator. *Learning & Memory*, *7*(2), 104-115.

- Brembs, B., & Plendl, W. (2008). Double dissociation of PKC and AC manipulations on operant and classical learning in *Drosophila*. *Current Biology*, *18*(15), 1168-1171.
- Bujok, B., Kleinhenz, M., Fuchs, S., & Tautz, J. (2002). Hot spots in the bee hive. *Naturwissenschaften*, *89*(7), 299-301.
- Bures, J., & Buresova, O. (1990). Spatial memory in animals. In *Machinery of the Mind* (pp. 291-310). Birkhäuser Boston.
- Butler, C. G., & Fairey, E. M. (1963). The role of the queen in preventing oogenesis in worker honeybees. *Journal of Apicultural Research*, *2*(1), 14-18.
- Calderone, N. W., & Page Jr, R. E. (1988). Genotypic variability in age polyethism and task specialization in the honey bee, *Apis mellifera* (Hymenoptera: Apidae). *Behavioral Ecology and Sociobiology*, *22*(1), 17-25.
- Camazine, S., Deneubourg, J. L., Franks, N. R., Sneyd, J., Bonabeau, E., & Theraulaz, G. *Self-Organization in Biological Systems* (2001). Princeton University Press
- Carcaud, J., Roussel, E., Giurfa, M., & Sandoz, J. C. (2009). Odour aversion after olfactory conditioning of the sting extension reflex in honeybees. *Journal of Experimental Biology*, *212*(5), 620-626.
- Carew, T. J., Walters, E. T., & Kandel, E. R. (1981). Classical conditioning in a simple withdrawal reflex in *Aplysia californica*. *The Journal of Neuroscience*, *1*(12), 1426-1437.
- Cassier, P., & Lensky, Y. (1995). Ultrastructure of the wax gland complex and secretion of beeswax in the worker honey bee *Apis mellifera* L. *Apidologie*, *26*(1), 17-26.
- Caterina, M. J., & Julius, D. (2001). The vanilloid receptor: a molecular gateway to the pain pathway. *Annual review of neuroscience*, *24*(1), 487-517.
- Chen, C., & Tonegawa, S. (1997). Molecular genetic analysis of synaptic plasticity, activity-dependent neural development, learning, and memory in the mammalian brain. *Annual review of neuroscience*, *20*(1), 157-184.
- Chittka, L., & Muller, H. (2009). Learning, specialization, efficiency and task allocation in social insects. *Communicative & integrative biology*, *2*(2), 151-154.
- Clapham, D. E. (2003). TRP channels as cellular sensors. *Nature*, *426*(6966), 517-524
- Clapham, D. E., Runnels, L. W., & Strübing, C. (2001). The TRP ion channel family. *Nature Reviews Neuroscience*, *2*(6), 387-396.
- Claridge-Chang, A., Roorda, R. D., Vrontou, E., Sjulson, L., Li, H., Hirsh, J., & Miesenböck, G. (2009). Writing memories with light-addressable reinforcement circuitry. *Cell*, *139*(2), 405-415.
- Collins, A. M., & Kubasek, K. J. (1982). Field test of honey bee (Hymenoptera: Apidae) colony defensive behavior. *Annals of the Entomological Society of America*, *75*(4), 383-387.
- Cosens, D. J., & Manning, A. (1969). Abnormal electroretinogram from a *Drosophila* mutant. *Nature* *224*, 285-287
- Dantzer, R., & Kelley, K. W. (2007). Twenty years of research on cytokine-induced sickness behavior. *Brain, behavior, and immunity*, *21*(2), 153-160.

- Dayan, P., & Balleine, B. W. (2002). Reward, motivation, and reinforcement learning. *Neuron*, *36*(2), 285-298.
- de Brito Sanchez, M. G., Chen, C., Li, J., Liu, F., Gauthier, M., & Giurfa, M. (2008). Behavioral studies on tarsal gustation in honeybees: sucrose responsiveness and sucrose-mediated olfactory conditioning. *Journal of Comparative Physiology A*, *194*(10), 861-869.
- de Brito Sanchez, M. G. (2011). Taste perception in honey bees. *Chemical senses*, *36*(8), 675-692.
- de Ibarra, N. H., & Giurfa, M. (2003). Discrimination of closed coloured shapes by honeybees requires only contrast to the long wavelength receptor type. *Animal Behaviour*, *66*(5), 903-910.
- Deisig, N., Lachnit, H., Giurfa, M., & Hellstern, F. (2001). Configural olfactory learning in honeybees: negative and positive patterning discrimination. *Learning & Memory*, *8*(2), 70-78.
- Deisig, N., Sandoz, J. C., Giurfa, M., & Lachnit, H. (2007). The trial-spacing effect in olfactory patterning discriminations in honeybees. *Behavioural brain research*, *176*(2), 314-322.
- Devaud, J. M., Blunk, A., Podufall, J., Giurfa, M., & Grünewald, B. (2007). Using local anaesthetics to block neuronal activity and map specific learning tasks to the mushroom bodies of an insect brain. *European Journal of Neuroscience*, *26*(11), 3193-3206.
- Dhaka, A., Murray, A. N., Mathur, J., Earley, T. J., Petrus, M. J., & Patapoutian, A. (2007). TRPM8 is required for cold sensation in mice. *Neuron*, *54*(3), 371-378.
- Dolezal, A. G., & Toth, A. L. (2014). Honey bee sociogenomics: a genome-scale perspective on bee social behavior and health. *Apidologie*, *45*(3), 375-395.
- Dreller, C., & Kirchner, W. H. (1993). Hearing in honeybees: localization of the auditory sense organ. *Journal of Comparative Physiology A*, *173*(3), 275-279.
- Duarte, A., Weissing, F. J., Pen, I., & Keller, L. (2011). An evolutionary perspective on self-organized division of labor in social insects. *Annual Review of Ecology, Evolution, and Systematics*, *42*, 91-110.
- Dudchenko, P. A., Goodridge, J. P., Seiterle, D. A., & Taube, J. S. (1997). Effects of repeated disorientation on the acquisition of spatial tasks in rats: dissociation between the appetitive radial arm maze and aversive water maze. *Journal of Experimental Psychology: Animal Behavior Processes*, *23*(2), 194.
- Duffy, J. E. (1996). Eusociality in a coral-reef shrimp. *Nature*, *381*(6582), 512-514.
- Duffy, E. J., Morrison, C. L., & Macdonald, K. S. (2002). Colony defense and behavioral differentiation in the eusocial shrimp *Synalpheus regalis*. *Behavioral Ecology and Sociobiology*, *51*(5), 488-495.
- Dukas, R., & Morse, D. H. (2003). Crab spiders affect flower visitation by bees. *Oikos*, *101*(1), 157-163.
- Dukas, R. (2007). Evolutionary biology of insect learning. *Annual Review of Entomology*, *53*, 145-160
- Dyer, A. G., Neumeyer, C., & Chittka, L. (2005). Honeybee (*Apis mellifera*) vision can discriminate between and recognise images of human faces. *Journal of Experimental Biology*, *208*(24), 4709-4714.
- Dyer, A. G., Whitney, H. M., Arnold, S. E., Glover, B. J., & Chittka, L. (2006). Behavioural ecology: bees associate warmth with floral colour. *Nature*, *442*(7102), 525-525.

- Erber, J., Pribbenow, B., Bauer, A., & Kloppenburg, P. (1993). Antennal reflexes in the honeybee: tools for studying the nervous system. *Apidologie*, *24*(3), 283-296.
- Erber, J., Kierzek, S., Sander, E., & Grandy, K. (1998). Tactile learning in the honeybee. *Journal of comparative physiology A*, *183*(6), 737-744.
- Erber, J., Hoormann, J., & Scheiner, R. (2006). Phototactic behaviour correlates with gustatory responsiveness in honey bees (*Apis mellifera* L.). *Behavioural brain research*, *174*(1), 174-180.
- Erber, J. (2012). Tactile antennal learning in the honey bee. In *Honeybee Neurobiology and Behavior* (pp. 439-455). Springer Netherlands.
- Esslen, J., & Kaissling, K. E. (1976). Zahl und Verteilung antennaler Sensillen bei der Honigbiene (*Apis mellifera* L.). *Zoomorphologie*, *83*(3), 227-251.
- Estoup, A., Solignac, M., & Cornuet, J. M. (1994). Precise assessment of the number of patriline and of genetic relatedness in honeybee colonies. *Proceedings of the Royal Society of London B: Biological Sciences*, *258*(1351), 1-7.
- Estoup, A., Garnery, L., Solignac, M., & Cornuet, J. M. (1995). Microsatellite variation in honey bee (*Apis mellifera* L.) populations: hierarchical genetic structure and test of the infinite allele and stepwise mutation models. *Genetics*, *140*(2), 679-695.
- Fahrenholz, L., Lamprecht, I., & Schricker, B. (1989). Thermal investigations of a honey bee colony: thermoregulation of the hive during summer and winter and heat production of members of different bee castes. *Journal of Comparative Physiology B*, *159*(5), 551-560.
- Fajardo, O., Meseguer, V., Belmonte, C., & Viana, F. (2008). TRPA1 channels mediate cold temperature sensing in mammalian vagal sensory neurons: pharmacological and genetic evidence. *The Journal of Neuroscience*, *28*(31), 7863-7875.
- Farooqui, T., Robinson, K., Vaessin, H., & Smith, B. H. (2003). Modulation of early olfactory processing by an octopaminergic reinforcement pathway in the honeybee. *The journal of Neuroscience*, *23*(12), 5370-5380.
- Feenstra, M. G., Teske, G., Botterblom, M. H., & De Bruin, J. P. (1999). Dopamine and noradrenaline release in the prefrontal cortex of rats during classical aversive and appetitive conditioning to a contextual stimulus: interference by novelty effects. *Neuroscience letters*, *272*(3), 179-182.
- Feenstra, M. G. P., Vogel, M., Botterblom, M. H. A., Joosten, R. N. J. M. A., & De Bruin, J. P. C. (2001). Dopamine and noradrenaline efflux in the rat prefrontal cortex after classical aversive conditioning to an auditory cue. *European Journal of Neuroscience*, *13*(5), 1051-1054.
- Fewell, J. H., & Page Jr, R. E. (1999). The emergence of division of labour in forced associations of normally solitary ant queens. *Evolutionary Ecology Research*, *1*(5), 537-548.
- Florence, T. J., & Reiser, M. B. (2015). Neuroscience: Hot on the trail of temperature processing. *Nature*. 519, 296-297
- Forel, A.(1910). *Das Sinnesleben der Insekten*. Reinhardt, Munich.
- Forman, R. R. (1984). Leg position learning by an insect. I. A heat avoidance learning paradigm. *Journal of neurobiology*, *15*(2), 127-140.
- Foucaud, J., Burns, J. G., Mery, F., & Zars, T. (2010). Use of spatial information and search strategies in a water maze analog in *Drosophila melanogaster*. *PLoS One*, *5*(12), e15231-e15231.

- Frank, D. D., Jouandet, G. C., Kearney, P. J., Macpherson, L. J., & Gallio, M. (2015). Temperature representation in the *Drosophila* brain. *Nature*, 519, 358–361
- Free, J. B. (1956). A study of the stimuli which release the food begging and offering responses of worker honeybees. *The British Journal of Animal Behaviour*, 4(3), 94-101.
- Free, J. B. (1961). The stimuli releasing the stinging response of honeybees. *Animal Behaviour*, 9(3), 193-196.
- Free, J.B. (1987). *Pheromones of Social Bees*. pp. 18-21 Chapman and Hall, London
- Friedman, E., Lerer, B., & Kuster, J. (1983). Loss of cholinergic neurons in the rat neocortex produces deficits in passive avoidance learning. *Pharmacology Biochemistry and Behavior*, 19(2), 309-312.
- Frings, H. (1944). The loci of olfactory end-organs in the honey-bee, *Apis mellifera* Linn. *Journal of Experimental Zoology*, 97(2), 123-134.
- Fuchs, S., & Moritz, R. F. A. (1999). Evolution of extreme polyandry in the honeybee *Apis mellifera* L. *Behavioral Ecology and Sociobiology*, 45(3-4), 269-275.
- Gadau, J., Fewell, J., & Wilson, E. O. (2009). *Organization of insect societies: from genome to sociocomplexity*. Harvard University Press.
- Gal, R., Kaiser, M., Haspel, G., & Libersat, F. (2014). Sensory arsenal on the stinger of the parasitoid jewel wasp and its possible role in identifying cockroach brains. *PloS one*, 9(2).
- Galili, D. S., Dylla, K. V., Lüdke, A., Friedrich, A. B., Yamagata, N., Wong, J. Y. H., ... & Tanimoto, H. (2014). Converging circuits mediate temperature and shock aversive olfactory conditioning in *Drosophila*. *Current Biology*, 24(15), 1712-1722.
- Galizia, C. G., & Szyszka, P. (2008). Olfactory coding in the insect brain: molecular receptive ranges, spatial and temporal coding. *Entomologia experimentalis et applicata*, 128(1), 81-92.
- Gallio, M., Ofstad, T. A., Macpherson, L. J., Wang, J. W., & Zuker, C. S. (2011). The coding of temperature in the *Drosophila* brain. *Cell*, 144(4), 614-624.
- Ganeshina, O., & Menzel, R. (2001). GABA-immunoreactive neurons in the mushroom bodies of the honeybee: An electron microscopic study. *Journal of Comparative Neurology*, 437(3), 335-349.
- Garcia, J., & Koelling, R. A. (1966). Relation of cue to consequence in avoidance learning. *Psychonomic science*, 4(1), 123-124.
- Garcia, J., Lasiter, P. S., Bermudez-Rattoni, F., & Deems, D. A. (1985). A General Theory of Aversion Learning. *Annals of the New York Academy of Sciences*, 443(1), 8-21.
- Garnery, L., Solignac, M., Celebrano, G., & Cornuet, J. M. (1993). A simple test using restricted PCR-amplified mitochondrial DNA to study the genetic structure of *Apis mellifera* L. *Experientia*, 49(11), 1016-1021.
- Garrity, P. A., Goodman, M. B., Samuel, A. D., & Sengupta, P. (2010). Running hot and cold: behavioral strategies, neural circuits, and the molecular machinery for thermotaxis in *C. elegans* and *Drosophila*. *Genes & development*, 24(21), 2365-2382.
- Geddes, L. H., McQuillan, H. J., Aiken, A., Vergoz, V., & Mercer, A. R. (2013). Steroid hormone (20-hydroxyecdysone) modulates the acquisition of aversive olfactory memories in pollen forager honeybees. *Learning & Memory*, 20(8), 399-409.

- Gerber, B., & Ullrich, J. (1999). No evidence for olfactory blocking in honeybee classical conditioning. *Journal of experimental biology*, 202(13), 1839-1854.
- Gerber, B., Tanimoto, H., & Heisenberg, M. (2004). An engram found? Evaluating the evidence from fruit flies. *Current opinion in neurobiology*, 14(6), 737-744.
- Getz, W. M., & Akers, R. P. (1994). Honeybee olfactory sensilla behave as integrated processing units. *Behavioral and neural biology*, 61(2), 191-195.
- Gil, M., De Marco, R. J., & Menzel, R. (2007). Learning reward expectations in honeybees. *Learning & Memory*, 14(7), 491-496.
- Giray, T., Guzmán-Novoa, E., Aron, C. W., Zelinsky, B., Fahrbach, S. E., & Robinson, G. E. (2000). Genetic variation in worker temporal polyethism and colony defensiveness in the honey bee, *Apis mellifera*. *Behavioral Ecology*, 11(1), 44-55.
- Girling, R. D., Lusebrink, I., Farthing, E., Newman, T. A., & Poppy, G. M. (2013). Diesel exhaust rapidly degrades floral odours used by honeybees. *Scientific reports*, 3.
- Giurfa, M., Nunez, J., Chittka, L., & Menzel, R. (1995). Colour preferences of flower-naive honeybees. *Journal of Comparative Physiology A*, 177(3), 247-259.
- Giurfa, M., Vorobyev, M., Kevan, P., & Menzel, R. (1996). Detection of coloured stimuli by honeybees: minimum visual angles and receptor specific contrasts. *Journal of Comparative Physiology A*, 178(5), 699-709.
- Giurfa, M., Zhang, S., Jenett, A., Menzel, R., & Srinivasan, M. V. (2001). The concepts of 'sameness' and 'difference' in an insect. *Nature*, 410(6831), 930-933.
- Giurfa, M. (2003). The amazing mini-brain: lessons from a honey bee. *Bee World*, 84(1), 5-18.
- Giurfa, M. (2006). Associative learning: the instructive function of biogenic amines. *Current biology*, 16(20), R892-R895.
- Giurfa, M. (2007). Behavioral and neural analysis of associative learning in the honeybee: a taste from the magic well. *Journal of comparative physiology A*, 193(8), 801-824.
- Giurfa, M., Fabre, E., Flaven-Pouchon, J., Groll, H., Oberwallner, B., Vergoz, V., ... & Sandoz, J. C. (2009). Olfactory conditioning of the sting extension reflex in honeybees: memory dependence on trial number, interstimulus interval, intertrial interval, and protein synthesis. *Learning & Memory*, 16(12), 761-765.
- Giurfa, M., & Sandoz, J. C. (2012). Invertebrate learning and memory: fifty years of olfactory conditioning of the proboscis extension response in honeybees. *Learning & Memory*, 19(2), 54-66.
- Goldsby, H. J., Dornhaus, A., Kerr, B., & Ofria, C. (2012). Task-switching costs promote the evolution of division of labor and shifts in individuality. *Proceedings of the National Academy of Sciences*, 109(34), 13686-13691.
- Goode, K., Huber, Z., Mesce, K. A., & Spivak, M. (2006). Hygienic behavior of the honey bee (*Apis mellifera*) is independent of sucrose responsiveness and foraging ontogeny. *Hormones and Behavior*, 49(3), 391-397.
- Gordon, D. M. (1996). The organization of work in social insect colonies. *Nature*, 380(6570), 121-124.

- Gould, J. L. (2002). Learning instincts. *Stevens' Handbook of Experimental Psychology*.
- Greffrath, W., Binzen, U., Schwarz, S. T., Saaler-Reinhardt, S., & Treede, R. D. (2003). Co-expression of heat sensitive vanilloid receptor subtypes in rat dorsal root ganglion neurons. *Neuroreport*, *14*(17), 2251-2255.
- Groffen, J. (2012). Tail posture and motion as a possible indicator of emotional state in pigs. Second cycle, A2E. Sweden
- Groh, C., Tautz, J., & Rössler, W. (2004). Synaptic organization in the adult honey bee brain is influenced by brood-temperature control during pupal development. *Proceedings of the National Academy of Sciences*, *101*(12), 4268-4273.
- Grueber, W. B., Ye, B., Yang, C. H., Younger, S., Borden, K., Jan, L. Y., & Jan, Y. N. (2007). Projections of Drosophila multidendritic neurons in the central nervous system: links with peripheral dendrite morphology. *Development*, *134*(1), 55-64.
- Guerrieri, F., Schubert, M., Sandoz, J. C., & Giurfa, M. (2005). Perceptual and neural olfactory similarity in honeybees. *PLoS Biol*, *3*(4), e60.
- Guzmán-Novoa, E., Hunt, G. J., Uribe-Rubio, J. L., & Prieto-Merlos, D. (2004). Genotypic effects of honey bee (*Apis mellifera*) defensive behavior at the individual and colony levels: the relationship of guarding, pursuing and stinging. *Apidologie*, *35*(1), 15-24.
- Hamada, F. N., Rosenzweig, M., Kang, K., Pulver, S. R., Ghezzi, A., Jegla, T. J., & Garrity, P. A. (2008). An internal thermal sensor controlling temperature preference in Drosophila. *Nature*, *454*(7201), 217-220.
- Hammer M (1993) An identified neuron mediates the unconditioned stimulus in associative olfactory learning in honeybees. *Nature* 366:59-63
- Hammer, M. (1997). The neural basis of associative reward learning in honeybees. *Trends in neurosciences*, *20*(6), 245-252.
- Hammer, M., & Menzel, R. (1998). Multiple sites of associative odor learning as revealed by local brain microinjections of octopamine in honeybees. *Learning & Memory*, *5*(1), 146-156.
- Hammer, T. J., Hata, C., & Nieh, J. C. (2009). Thermal learning in the honeybee, *Apis mellifera*. *Journal of Experimental Biology*, *212*(23), 3928-3934.
- Harvell, C. D. (1994). The evolution of polymorphism in colonial invertebrates and social insects. *Quarterly Review of Biology*, 155-185.
- Haupt, S. S. (2004). Antennal sucrose perception in the honey bee (*Apis mellifera* L.): behaviour and electrophysiology. *Journal of Comparative Physiology A*, *190*(9), 735-745.
- Haydak, M. H. (1970). Honey bee nutrition. *Annual review of entomology*, *15*(1), 143-156.
- Heisenberg, M. (2003). Mushroom body memoir: from maps to models. *Nature Reviews Neuroscience*, *4*(4), 266-275.
- Herb, B. R., Wolschin, F., Hansen, K. D., Aryee, M. J., Langmead, B., Irizarry, R., ... & Feinberg, A. P. (2012). Reversible switching between epigenetic states in honeybee behavioral subcastes. *Nature neuroscience*, *15*(10), 1371-1373.

- Hollerman, J. R., & Schultz, W. (1998). Dopamine neurons report an error in the temporal prediction of reward during learning. *Nature neuroscience*, *1*(4), 304-309.
- Hoover, S. E., Keeling, C. I., Winston, M. L., & Slessor, K. N. (2003). The effect of queen pheromones on worker honey bee ovary development. *Naturwissenschaften*, *90*(10), 477-480.
- Hosler, J. S., & Smith, B. H. (2000). Blocking and the detection of odor components in blends. *Journal of Experimental Biology*, *203*(18), 2797-2806.
- Howarth, C. J., Prince, R. I., Dyker, H., Lösel, P. M., Seinsche, A., & Osborne, R. H. (2002). Pharmacological characterisation of 5-hydroxytryptamine-induced contractile effects in the isolated gut of the lepidopteran caterpillar *Spodoptera frugiperda*. *Journal of insect physiology*, *48*(1), 43-52.
- Hutchins, E. (2000). Distributed cognition. *International Encyclopedia of the Social and Behavioral Sciences*. Elsevier Science.
- Humphries, M. A., Mustard, J. A., Hunter, S. J., Mercer, A., Ward, V., & Ebert, P. R. (2003). Invertebrate D2 type dopamine receptor exhibits age-based plasticity of expression in the mushroom bodies of the honeybee brain. *Journal of neurobiology*, *55*(3), 315-330.
- Hunt, G. J., Page, R. E., Fondrk, M. K., & Dullum, C. J. (1995). Major quantitative trait loci affecting honey bee foraging behavior. *Genetics*, *141*(4), 1537-1545.
- Hunt, G. J., Amdam, G. V., Schlipalius, D., Emore, C., Sardesai, N., Williams, C. E., ... & Page Jr, R. E. (2007). Behavioral genomics of honeybee foraging and nest defense. *Naturwissenschaften*, *94*(4), 247-267.
- Hussaini, S. A., Bogusch, L., Landgraf, T., & Menzel, R. (2009). Sleep deprivation affects extinction but not acquisition memory in honeybees. *Learning & memory*, *16*(11), 698-705.
- Hwang, R. Y., Zhong, L., Xu, Y., Johnson, T., Zhang, F., Deisseroth, K., & Tracey, W. D. (2007). Nociceptive neurons protect *Drosophila* larvae from parasitoid wasps. *Current Biology*, *17*(24), 2105-2116.
- Ikemoto, S. (2007). Dopamine reward circuitry: two projection systems from the ventral midbrain to the nucleus accumbens-olfactory tubercle complex. *Brain research reviews*, *56*(1), 27-78.
- Jacklyn, P. M. (1992). "Magnetic" termite mound surfaces are oriented to suit wind and shade conditions. *Oecologia*, *91*(3), 385-395.
- Jarvis, J. U., O'Riain, M. J., Bennett, N. C., & Sherman, P. W. (1994). Mammalian eusociality: a family affair. *Trends in Ecology & Evolution*, *9*(2), 47-51.
- Jeanson, R., Kukuk, P. F., & Fewell, J. H. (2005). Emergence of division of labour in halictine bees: contributions of social interactions and behavioural variance. *Animal behaviour*, *70*(5), 1183-1193.
- Jeanson, R., Fewell, J. H., Gorelick, R., & Bertram, S. M. (2007). Emergence of increased division of labor as a function of group size. *Behavioral Ecology and Sociobiology*, *62*(2), 289-298.
- Jeanson, R., Clark, R. M., Holbrook, C. T., Bertram, S. M., Fewell, J. H., & Kukuk, P. F. (2008). Division of labour and socially induced changes in response thresholds in associations of solitary halictine bees. *Animal Behaviour*, *76*(3), 593-602.
- Jeanson, R., & Weidenmüller, A. (2014). Interindividual variability in social insects—proximate causes and ultimate consequences. *Biological Reviews*, *89*(3), 671-687.

- Jones, J. C., Helliwell, P., Beekman, M., Maleszka, R., & Oldroyd, B. P. (2005). The effects of rearing temperature on developmental stability and learning and memory in the honey bee, *Apis mellifera*. *Journal of comparative physiology A*, *191*(12), 1121-1129.
- Jones, J. C., Myerscough, M. R., Graham, S., & Oldroyd, B. P. (2004). Honey bee nest thermoregulation: diversity promotes stability. *Science*, *305*(5682), 402-404.
- Jones, J. C., & Oldroyd, B. P. (2006). Nest thermoregulation in social insects. *Advances in Insect Physiology*, *33*, 153-191.
- Joshua, M., Adler, A., Mitelman, R., Vaadia, E., & Bergman, H. (2008). Midbrain dopaminergic neurons and striatal cholinergic interneurons encode the difference between reward and aversive events at different epochs of probabilistic classical conditioning trials. *The Journal of Neuroscience*, *28*(45), 11673-11684.
- Julian, G. E., & Fewell, J. H. (2004). Genetic variation and task specialization in the desert leaf-cutter ant, *Acromyrmex versicolor*. *Animal Behaviour*, *68*(1), 1-8.
- Junca, P., Carcaud, J., Moulin, S., Garnery, L., & Sandoz, J. C. (2014). Genotypic Influence on Aversive Conditioning in Honeybees, Using a Novel Thermal Reinforcement Procedure.
- Jung, J. W., Park, K. W., Ahn, Y. J., & Kwon, H. W. (2015). Functional characterization of sugar receptors in the western honeybee, *Apis mellifera*. *Journal of Asia-Pacific Entomology*, *18*(1), 19-26.
- Kamin, L. J. (1969). Selective association and conditioning. *Fundamental issues in associative learning*, 42-64.
- Kang, K., Pulver, S. R., Panzano, V. C., Chang, E. C., Griffith, L. C., Theobald, D. L., & Garrity, P. A. (2010). Analysis of *Drosophila* TRPA1 reveals an ancient origin for human chemical nociception. *Nature*, *464*(7288), 597-600.
- King, H. D., & Donaldson, H. H. (1929). Life processes and size of the body and organs of the gray Norway rat during ten generations in captivity. *American Anatomical Memoirs*. American Anatomical Memoirs, *14*
- Kirchner, W. H., Dreller, C., & Towne, W. F. (1991). Hearing in honeybees: operant conditioning and spontaneous reactions to airborne sound. *Journal of Comparative Physiology A*, *168*(1), 85-89.
- Kirschner, S., Kleineidam, C. J., Zube, C., Rybak, J., Grünewald, B., & Rössler, W. (2006). Dual olfactory pathway in the honeybee, *Apis mellifera*. *Journal of comparative neurology*, *499*(6), 933-952.
- Kleineidam, C. J., Ruchty, M., Casero-Montes, Z. A., & Roces, F. (2007). Thermal radiation as a learned orientation cue in leaf-cutting ants (*Atta vollenweideri*). *Journal of insect physiology*, *53*(5), 478-487.
- Kleinhenz, M., Bujok, B., Fuchs, S., & Tautz, J. (2003). Hot bees in empty broodnest cells: heating from within. *The Journal of experimental biology*, *206*(23), 4217-4231.
- Klopf, A. H. (1988). A neuronal model of classical conditioning. *Psychobiology*, *16*(2), 85-125.
- Knutson, J. F., Fordyce, D. J., & Anderson, D. J. (1980). Escalation of irritable aggression: Control by consequences and antecedents. *Aggressive Behavior*, *6*(4), 347-359.
- Koeniger, G. (1990). The role of the mating sign in honey bees, *Apis mellifera* L.: does it hinder or promote multiple mating?. *Animal behaviour*, *39*(3), 444-449.

- Kohno, K., Sokabe, T., Tominaga, M., & Kadowaki, T. (2010). Honey bee thermal/chemical sensor, AmHsTRPA, reveals neofunctionalization and loss of transient receptor potential channel genes. *The Journal of Neuroscience*, *30*(37), 12219-12229.
- Kokay, I. C., & Mercer, A. R. (1996). Characterisation of dopamine receptors in insect (*Apis mellifera*) brain. *Brain research*, *706*(1), 47-56.
- Korst, P. J. A. M., & Velthuis, H. H. W. (1982). The nature of trophallaxis in honeybees. *Insectes Sociaux*, *29*(2), 209-221.
- Kunze G. (1933) Einige Versuche über den Geschmackssinn der Honigbiene, *Zoologische Jahrbücher. Abteilung für allgemeine Zoologie und Physiologie der Tiere*. *52*, 465–512.
- Kuwabara, M. (1957). Bildung des bedingten Reflexes von Pavlovs Typus bei der Honigbiene, *Apis mellifica* (Mit 1 Textabbildung). *北海道大學理學部紀要= Journal of the Faculty of Science Hokkaido University Series V I. zoology*, *13*(1-4), 458-464.
- Laloi, D., Bailez, O., Blight, M. M., Roger, B., Pham-Delègue, M. H., & Wadhams, L. J. (2000). Recognition of complex odors by restrained and free-flying honeybees, *Apis mellifera*. *Journal of chemical ecology*, *26*(10), 2307-2319.
- Laloi, D., & Pham-Delegue, M. H. (2010). Patriline-level variability in olfactory learning in the honey bee. *Apidologie*, *41*(4), 436-442.
- Lambin, M., Déglise, P., & Gauthier, M. (2005). Antennal movements as indicators of odor detection by worker honeybees. *Apidologie*, *36*(1), 119-126.
- Lattorff, H. M. G., & Moritz, R. F. (2013). Genetic underpinnings of division of labor in the honeybee (*Apis mellifera*). *Trends in Genetics*, *29*(11), 641-648.
- Le Conte, Y., Arnold, G., Trouiller, J., Masson, C., & Chappe, B. (1990). Identification of a brood pheromone in honeybees. *Naturwissenschaften*, *77*(7), 334-336.
- Lechner, H. A., Baxter, D. A., & Byrne, J. H. (2000). Classical conditioning of feeding in *Aplysia*: I. Behavioral analysis. *The Journal of Neuroscience*, *20*(9), 3369-3376.
- Lee, Y., Lee, Y., Lee, J., Bang, S., Hyun, S., Kang, J., ... & Kim, J. (2005). Pyrexia is a new thermal transient receptor potential channel endowing tolerance to high temperatures in *Drosophila melanogaster*. *Nature genetics*, *37*(3), 305-310.
- Lehrer, M., Horridge, G. A., Zhang, S. W., & Gadagkar, R. (1995). Shape vision in bees: innate preference for flower-like patterns. *Philosophical Transactions of the Royal Society B: Biological Sciences*, *347*(1320), 123-137.
- Lenoir, J. C., Laloi, D., Dechaume-Moncharmont, F. X., Solignac, M., & Pham, M. H. (2006). Intra-colonial variation of the sting extension response in the honey bee *Apis mellifera*. *Insectes sociaux*, *53*(1), 80-85.
- Leoncini, I., Le Conte, Y., Costagliola, G., Plettner, E., Toth, A. L., Wang, M., ... & Robinson, G. E. (2004). Regulation of behavioral maturation by a primer pheromone produced by adult worker honey bees. *Proceedings of the National Academy of Sciences of the United States of America*, *101*(50), 17559-17564.
- Li, W., Howard, J. D., Parrish, T. B., & Gottfried, J. A. (2008). Aversive learning enhances perceptual and cortical discrimination of indiscriminable odor cues. *Science*, *319*(5871), 1842-1845.

- Lindauer, M. (1954). Temperaturregulierung und Wasserhaushalt im Bienenstaat. *Zeitschrift für vergleichende Physiologie*, 36(4), 391-432.
- Liu, C., Plaçais, P. Y., Yamagata, N., Pfeiffer, B. D., Aso, Y., Friedrich, A. B., ... & Tanimoto, H. (2012). A subset of dopamine neurons signals reward for odour memory in *Drosophila*. *Nature*, 488(7412), 512-516.
- Liu, W. W., Mazor, O., & Wilson, R. I. (2015). Thermosensory processing in the *Drosophila* brain. *Nature*, 519(7543), 353-357.
- Logan, F. A. (1960). Incentive: How the conditions of reinforcement affect the performance of rats. *Yale University Press*
- Lubbock, J. (1889). *On the senses, instincts, and intelligence of animals: with special reference to insects* (Vol. 65). K. Paul, Trench & Company.
- Madan, C. R. (2013). Toward a common theory for learning from reward, affect, and motivation: the SIMON framework. *Frontiers in systems neuroscience*, 7.
- Manser, M. B. (1999). Response of foraging group members to sentinel calls in suricates, *Suricata suricatta*. *Proceedings of the Royal Society of London B: Biological Sciences*, 266(1423), 1013-1019.
- Mao, Z., & Davis, R. L. (2009). Eight different types of dopaminergic neurons innervate the *Drosophila* mushroom body neuropil: anatomical and physiological heterogeneity. *Frontiers in neural circuits*, 3.
- Markiewicz, D. A., & O'Donnell, S. (2001). Social dominance, task performance and nutrition: implications for reproduction in eusocial wasps. *Journal of Comparative Physiology A*, 187(5), 327-333.
- Marshall, J. (1935). On the sensitivity of the chemoreceptors on the antenna and fore-tarsus of the honey-bee, *Apis mellifica* L. *Journal of Experimental Biology*, 12(1), 17-26.
- Martinez, A., & Farina, W. M. (2008). Honeybees modify gustatory responsiveness after receiving nectar from foragers within the hive. *Behavioral Ecology and Sociobiology*, 62(4), 529-535.
- Matsumoto, Y., Sandoz, J. C., Devaud, J. M., Lormant, F., Mizunami, M., & Giurfa, M. (2014). Cyclic nucleotide-gated channels, calmodulin, adenylyl cyclase, and calcium/calmodulin-dependent protein kinase II are required for late, but not early, long-term memory formation in the honeybee. *Learning & Memory*, 21(5), 272-286.
- Matsuura, H., Sokabe, T., Kohno, K., Tominaga, M., & Kadowaki, T. (2009). Evolutionary conservation and changes in insect TRP channels. *BMC evolutionary biology*, 9(1), 228.
- Mattila, H. R., & Seeley, T. D. (2007). Genetic diversity in honey bee colonies enhances productivity and fitness. *Science*, 317(5836), 362-364.
- Mauelshagen, J. (1993). Neural correlates of olfactory learning paradigms in an identified neuron in the honeybee brain. *Journal of neurophysiology*, 69(2), 609-625.
- Maynard Smith, J., & Szathmáry, E. (2000). *Les origines de la vie*. Paris : Dunod
- McKemy, D. D. (2007). Temperature sensing across species. *Pflügers Archiv-European Journal of Physiology*, 454(5), 777-791.

- Menzel, R. (1985). Learning in honey bees in an ecological and behavioral context. *Experimental behavioral ecology*, 31, 55-74.
- Menzel, R. (1990). Learning, memory, and “cognition” in honey bees. *Neurobiology of comparative cognition*, 237-292.
- Menzel, R. (1999). Memory dynamics in the honeybee. *Journal of Comparative Physiology A*, 185(4), 323-340.
- Menzel, R. (2001). Searching for the memory trace in a mini-brain, the honeybee. *Learning & Memory*, 8(2), 53-62.
- Menzel, R., & Giurfa, M. (2001). Cognitive architecture of a mini-brain: the honeybee. *Trends in cognitive sciences*, 5(2), 62-71.
- Menzel, R., De Marco, R. J., & Greggers, U. (2006). Spatial memory, navigation and dance behaviour in *Apis mellifera*. *Journal of Comparative Physiology A*, 192(9), 889-903.
- Menzel, R. (2012). The honeybee as a model for understanding the basis of cognition. *Nature Reviews Neuroscience*, 13(11), 758-768.
- Mery, F., Belay, A. T., So, A. K. C., Sokolowski, M. B., & Kawecki, T. J. (2007). Natural polymorphism affecting learning and memory in *Drosophila*. *Proceedings of the National Academy of Sciences*, 104(32), 13051-13055.
- Michener, C. D. (1969). Comparative social behavior of bees. *Annual review of entomology*, 14(1), 299-342.
- Millor, J., Pham-Delegue, M., Deneubourg, J. L., & Camazine, S. (1999). Self-organized defensive behavior in honeybees. *Proceedings of the National Academy of Sciences*, 96(22), 12611-12615.
- Minnich, D. E. (1921). An experimental study of the tarsal chemoreceptors of two nymphalid butterflies. *Journal of experimental Zoology*, 33, 173-203.
- Miura, T., & Matsumoto, T. (1995). Worker polymorphism and division of labor in the foraging behavior of the black marching termite *Hoplotermes medioflavus*, on Borneo Island. *Naturwissenschaften*, 82(12), 564-567.
- Montell, C. (2005). The TRP superfamily of cation channels. *Science Signaling*, 2005(272), re3-re3.
- Montell, C. (2009). A taste of the *Drosophila* gustatory receptors. *Current opinion in neurobiology*, 19(4), 345-353.
- Montell, C., & Rubin, G. M. (1989). Molecular characterization of the *Drosophila* *trp* locus: a putative integral membrane protein required for phototransduction. *Neuron*, 2(4), 1313-1323.
- Moore, A. J., Breed, M. D., & Moor, M. J. (1987). The guard honey bee: ontogeny and behavioural variability of workers performing a specialized task. *Animal Behaviour*, 35(4), 1159-1167.
- Mota, T., Giurfa, M., & Sandoz, J. C. (2011). Color modulates olfactory learning in honeybees by an occasion-setting mechanism. *Learning & Memory*, 18(3), 144-155.
- Mota, T., Roussel, E., Sandoz, J. C., & Giurfa, M. (2011). Visual conditioning of the sting extension reflex in harnessed honeybees. *The Journal of experimental biology*, 214(21), 3577-3587.

- Mujagić, S., Würth, S. M., Hellbach, S., & Dürr, V. (2012). Tactile conditioning and movement analysis of antennal sampling strategies in honey bees (*Apis mellifera* L.). *Journal of visualized experiments: JoVE*, (70).
- Mustard, J. A., Blenau, W., Hamilton, I. S., Ward, V. K., Ebert, P. R., & Mercer, A. R. (2003). Analysis of two D1-like dopamine receptors from the honey bee *Apis mellifera* reveals agonist-independent activity. *Molecular Brain Research*, 113(1), 67-77.
- Naumann, K., Winston, M. L., Slessor, K. N., Prestwich, G. D., & Webster, F. X. (1991). Production and transmission of honey bee queen (*Apis mellifera* L.) mandibular gland pheromone. *Behavioral Ecology and Sociobiology*, 29(5), 321-332.
- Neely, G. G., Keene, A. C., Duchek, P., Chang, E. C., Wang, Q. P., Aksoy, Y. A., ... & Penninger, J. M. (2011). TrpA1 regulates thermal nociception in *Drosophila*. *PLoS one*, 6(8), e24343.
- Ni, L., Bronk, P., Chang, E. C., Lowell, A. M., Flam, J. O., Panzano, V. C., ... & Garrity, P. A. (2013). A gustatory receptor paralogue controls rapid warmth avoidance in *Drosophila*. *Nature*, 500(7464), 580-584.
- Nieh, J. C., Kruizinga, K., Barreto, L. S., Contrera, F. A. L., & Imperatriz-Fonseca, V. L. (2005). Effect of group size on the aggression strategy of an extirpating stingless bee, *Trigona spinipes*. *Insectes sociaux*, 52(2), 147-154.
- Nishiyama, K., Okada, J., & Toh, Y. (2007). Antennal and locomotor responses to attractive and aversive odors in the searching cockroach. *Journal of Comparative Physiology A*, 193(9), 963-971.
- Nowak, M. A., Tarnita, C. E., & Wilson, E. O. (2010). The evolution of eusociality. *Nature*, 466(7310), 1057-1062.
- Núñez, J., Maldonado, H., Miralto, A., & Balderrama, N. (1983). The stinging response of the honeybee: effects of morphine, naloxone and some opioid peptides. *Pharmacology Biochemistry and Behavior*, 19(6), 921-924.
- Núñez, J., Almeida, L., Balderrama, N., & Giurfa, M. (1997). Alarm pheromone induces stress analgesia via an opioid system in the honeybee. *Physiology & behavior*, 63(1), 75-80.
- O'Donnell, S., & Foster, R. L. (2001). Thresholds of response in nest thermoregulation by worker bumble bees, *Bombus bifarius nearcticus* (Hymenoptera: Apidae). *Ethology*, 107(5), 387-399.
- Ogawa, H., Kawakami, Z., & Yamaguchi, T. (1995). Motor pattern of the stinging response in the honeybee *Apis mellifera*. *The Journal of experimental biology*, 198(1), 39-47.
- Ogawa, H., Kawakami, Z., & Yamaguchi, T. (2011). Proprioceptors involved in stinging response of the honeybee, *Apis mellifera*. *Journal of insect physiology*, 57(10), 1358-1367.
- Ohyama, T., Schneider-Mizell, C. M., Fetter, R. D., Aleman, J. V., Franconville, R., Rivera-Alba, M., ... & Zlatić, M. (2015). A multilevel multimodal circuit enhances action selection in *Drosophila*. *Nature*. 520, 633-63
- Okada, R., Rybak, J., Manz, G., & Menzel, R. (2007). Learning-related plasticity in PE1 and other mushroom body-extrinsic neurons in the honeybee brain. *The Journal of neuroscience*, 27(43), 11736-11747.
- Oster, G. F., & Wilson, E. O. (1978). *Caste and ecology in the social insects*. Princeton University Press.

- Ozaki, M., Wada-Katsumata, A., Fujikawa, K., Iwasaki, M., Yokohari, F., Satoji, Y., ... & Yamaoka, R. (2005). Ant nestmate and non-nestmate discrimination by a chemosensory sensillum. *Science*, *309*(5732), 311-314.
- Page, R. E. (1980). The evolution of multiple mating behavior by honey bee queens (*Apis mellifera* L.). *Genetics*, *96*(1), 263-273.
- Page Jr, R. E., & Metcalf, R. A. (1982). Multiple mating, sperm utilization, and social evolution. *American Naturalist*, 263-281.
- Page, R. E., Robinson, G. E., & Fondrk, M. K. (1989). Genetic specialists, kin recognition and nepotism in honey-bee colonies. *Nature*, *338*(6216), 576-579.
- Page Jr, R. E., Erber, J., & Fondrk, M. K. (1998). The effect of genotype on response thresholds to sucrose and foraging behavior of honey bees (*Apis mellifera* L.). *Journal of Comparative Physiology A*, *182*(4), 489-500.
- Page, R. E., & Mitchell, S. D. (1998). Self-organization and the evolution of division of labor. *Apidologie*, *29*(1-2), 171-190.
- Page, R. E., Fondrk, M. K., Hunt, G. J., Guzman-Novoa, E., Humphries, M. A., Nguyen, K., & Greene, A. S. (2000). Genetic dissection of honeybee (*Apis mellifera* L.) foraging behavior. *Journal of Heredity*, *91*(6), 474-479.
- Page, R. E., Scheiner, R., Erber, J., & Amdam, G. V. (2006). The development and evolution of division of labor and foraging specialization in a social insect (*Apis mellifera* L.). *Current topics in developmental biology*, *74*, 253-286.
- Pankiw, T., & Page Jr, R. E. (1999). The effect of genotype, age, sex, and caste on response thresholds to sucrose and foraging behavior of honey bees (*Apis mellifera* L.). *Journal of Comparative Physiology A*, *185*(2), 207-213.
- Papini, M. R., & Bitterman, M. E. (1991). Appetitive conditioning in *Octopus cyanea*. *Journal of Comparative Psychology*, *105*(2), 107.
- Partridge, B. L. (1982). The structure and function of fish schools. *Scientific american*, *246*(6), 114-123.
- Pavlov, I. P. (1927). Conditioned reflexes. *An Investigation of the physiological activity of the cerebral cortex*.
- Paxton, R. J., Sakamoto, C. H., & Rugiga, F. C. (1994). Modification of honey bee (*Apis mellifera* L.) stinging behaviour by within-colony environment and age. *Journal of Apicultural Research*, *33*(2), 75-82.
- Pearce, J. M. (1987). *Introduction to animal cognition*. Lawrence Erlbaum Associates, Inc.
- Perez, M., Rolland, U., Giurfa, M., & d'Ettorre, P. (2013). Sucrose responsiveness, learning success, and task specialization in ants. *Learning & Memory*, *20*(8), 417-420.
- Pingle, S. C., Matta, J. A., & Ahern, G. P. (2007). Capsaicin receptor: TRPV1 a promiscuous TRP channel. In *Transient Receptor Potential (TRP) Channels* (pp. 155-171). Springer Berlin Heidelberg.
- Plaçais, P. Y., Trannoy, S., Isabel, G., Aso, Y., Siwanowicz, I., Belliard-Guérin, G., ... & Preat, T. (2012). Slow oscillations in two pairs of dopaminergic neurons gate long-term memory formation in *Drosophila*. *Nature neuroscience*, *15*(4), 592-599.

- Plateau, F. (1908). Les insectes ont-ils la mémoire des faits?. *L'année psychologique*, 15(1), 148-159.
- Plateaux-Quenu, C. (1993). Modalités de la socialisation chez les Halictinae (Hymenoptera, Halictidae). I: Biologie des Halictinae. *L'Année biologique*, 32(4), 183-204.
- Potegal, M. (1979). The reinforcing value of several types of aggressive behavior: A review. *Aggressive Behavior*, 5(4), 353-373.
- Pruitt, J. N., & Goodnight, C. J. (2014). Site-specific group selection drives locally adapted group compositions. *Nature*, 514, 359-362
- Quezada-Euán, J. J. G., & Paxton, R. J. (1999). Rapid inter-generational changes in morphology and behaviour in colonies of Africanized and European honey bees (*Apis mellifera*) from tropical Yucatan, Mexico. *Journal of apicultural research*, 38(1-2), 93-104.
- Ramot, D., MacInnis, B. L., Lee, H. C., & Goodman, M. B. (2008). Thermotaxis is a robust mechanism for thermoregulation in *Caenorhabditis elegans* nematodes. *The Journal of Neuroscience*, 28(47), 12546-12557.
- Reefmann, N., Kaszàs, F. B., Wechsler, B., & Gyga, L. (2009). Ear and tail postures as indicators of emotional valence in sheep. *Applied Animal Behaviour Science*, 118(3), 199-207.
- Rescorla, R. A. (1967). Pavlovian conditioning and its proper control procedures. *Psychological review*, 74(1), 71.
- Rescorla, R. A. (1968). Probability of shock in the presence and absence of CS in fear conditioning. *Journal of comparative and physiological psychology*, 66(1), 1.
- Rescorla, R. A. (1987). A Pavlovian analysis of goal-directed behavior. *American Psychologist*, 42(2), 119.
- Rescorla, R. A. (1988). Pavlovian conditioning: It's not what you think it is. *American Psychologist*, 43(3), 151.
- Riege, W. H., & Cherkin, A. (1972). One-trial learning in goldfish: temperature dependence. *Behavioral biology*, 7(2), 255-263.
- Rivera-Marchand, B., Giray, T., & Guzmán-Novoa, E. (2008). The cost of defense in social insects: insights from the honey bee. *Entomologia experimentalis et applicata*, 129(1), 1-10.
- Robbins, T. W., & Everitt, B. J. (1996). Neurobehavioural mechanisms of reward and motivation. *Current opinion in neurobiology*, 6(2), 228-236.
- Robbins, T. W., & Everitt, B. J. (2002). Limbic-striatal memory systems and drug addiction. *Neurobiology of learning and memory*, 78(3), 625-636.
- Robertson, H. M., & Wanner, K. W. (2006). The chemoreceptor superfamily in the honey bee, *Apis mellifera*: expansion of the odorant, but not gustatory, receptor family. *Genome research*, 16(11), 1395-1403.
- Robinson, G. E., & Page Jr, R. E. (1989). Genetic determination of nectar foraging, pollen foraging, and nest-site scouting in honey bee colonies. *Behavioral Ecology and Sociobiology*, 24(5), 317-323.
- Robinson, G. E. (1992). Regulation of division of labor in insect societies. *Annual review of entomology*, 37(1), 637-665.

- Robinson, G. E., Page, R. E., & Huang, Z. Y. (1994). Temporal polyethism in social insects is a developmental process. *Animal Behaviour*, 48(2), 467-469.
- Rohrseitz, K., & Tautz, J. (1999). Honey bee dance communication: waggle run direction coded in antennal contacts?. *Journal of Comparative Physiology A*, 184(4), 463-470.
- Rosenzweig, M., Brennan, K. M., Tayler, T. D., Phelps, P. O., Patapoutian, A., & Garrity, P. A. (2005). The *Drosophila* ortholog of vertebrate TRPA1 regulates thermotaxis. *Genes & development*, 19(4), 419-424.
- Rosenzweig, M., Kang, K., & Garrity, P. A. (2008). Distinct TRP channels are required for warm and cool avoidance in *Drosophila melanogaster*. *Proceedings of the National Academy of Sciences*, 105(38), 14668-14673.
- Roussel, E., Carcaud, J., Sandoz, J. C., & Giurfa, M. (2009). Reappraising social insect behavior through aversive responsiveness and learning. *PLoS One*, 4(1), e4197.
- Roussel, E., Padie, S., & Giurfa, M. (2012). Aversive learning overcomes appetitive innate responding in honeybees. *Animal cognition*, 15(1), 135-141.
- Roussel, E., Carcaud, J., Combe, M., Giurfa, M., & Sandoz, J. C. (2014). Olfactory coding in the honeybee lateral horn. *Current Biology*, 24(5), 561-567.
- Ruchty, M., Romani, R., Kuebler, L. S., Ruschioni, S., Roces, F., Isidoro, N., & Kleineidam, C. J. (2009). The thermo-sensitive sensilla coeloconica of leaf-cutting ants (*Atta vollenweideri*). *Arthropod structure & development*, 38(3), 195-205.
- Ruchty, M., Helmchen, F., Wehner, R., & Kleineidam, C. J. (2010). Representation of thermal information in the antennal lobe of leaf-cutting ants. *Frontiers in behavioral neuroscience*, 4.
- Rüppell, O., Pankiw, T., & Page, R. E. (2004). Pleiotropy, epistasis and new QTL: the genetic architecture of honey bee foraging behavior. *Journal of Heredity*, 95(6), 481-491.
- Rüppell, O. (2009). Characterization of quantitative trait loci for the age of first foraging in honey bee workers. *Behavior genetics*, 39(5), 541-553.
- Sachse, S., & Galizia, C. G. (2002). Role of inhibition for temporal and spatial odor representation in olfactory output neurons: a calcium imaging study. *Journal of Neurophysiology*, 87(2), 1106-1117.
- Saito, S., Nakatsuka, K., Takahashi, K., Fukuta, N., Imagawa, T., Ohta, T., & Tominaga, M. (2012). Analysis of transient receptor potential ankyrin 1 (TRPA1) in frogs and lizards illuminates both nociceptive heat and chemical sensitivities and coexpression with TRP vanilloid 1 (TRPV1) in ancestral vertebrates. *Journal of Biological Chemistry*, 287(36), 30743-30754.
- Saito, S., Banzawa, N., Fukuta, N., Saito, C. T., Takahashi, K., Imagawa, T., ... & Tominaga, M. (2014). Heat and noxious chemical sensor, chicken TRPA1, as a target of bird repellents and identification of its structural determinants by multispecies functional comparison. *Molecular biology and evolution*, 31(3), 708-722.
- Sakagami, S. F., & Fukuda, H. (1968). Life tables for worker honeybees. *Researches on population ecology*, 10(2), 127-139.
- Sakagami, S. F., & Maeta, Y. (1977). Some presumably presocial habits of Japanese *Ceratina* bees, with notes on various social types in Hymenoptera. *Insectes Sociaux*, 24(4), 319-343.

- Sakagami, S. F., & Maeta, Y. (1987). Sociality, induced and/or natural, in the basically solitary small carpenter bees (Ceratina). *Animal societies: theories and facts*, 1-16.
- Sakagami, S., & Maeta, Y. (1989). Compatibility and incompatibility of solitary life with eusociality in two normally solitary bees *Ceratina japonica* and *Ceratina okinawana* (Hymenoptera, Apoidea), with notes on the incipient phase of eusociality. *昆蟲*, 57(2), 417-439.
- Sandoz, J. C., Roger, B., & Pham-Delegue, M. H. (1995). Olfactory learning and memory in the honeybee: comparison of different classical conditioning procedures of the proboscis extension response. *Comptes rendus de l'Academie des sciences. Serie III, Sciences de la vie*, 318(7), 749-755.
- Sandoz, J. C., Galizia, C. G., & Menzel, R. (2002). Side-specific olfactory conditioning leads to more specific odor representation between sides but not within sides in the honeybee antennal lobes. *Neuroscience*, 120(4), 1137-1148.
- Sandoz, J. C., Hammer, M., & Menzel, R. (2002). Side-specificity of olfactory learning in the honeybee: US input side. *Learning & Memory*, 9(5), 337-348.
- Sandoz, J. C. (2011). Behavioral and neurophysiological study of olfactory perception and learning in honeybees. *Frontiers in systems neuroscience*, 5.
- Sauer, S., Kinkelin, M., Herrmann, E., & Kaiser, W. (2003). The dynamics of sleep-like behaviour in honey bees. *Journal of Comparative Physiology A*, 189(8), 599-607.
- Schäfer, S., & Rehder, V. (1989). Dopamine-like immunoreactivity in the brain and suboesophageal ganglion of the honeybee. *Journal of Comparative Neurology*, 280(1), 43-58.
- Scheiner, R., & Arnold, G. (2010). Effects of patriline on gustatory responsiveness and olfactory learning in honey bees. *Apidologie*, 41(1), 29-37.
- Scheiner, R., Erber, J., & Page Jr, R. E. (1999). Tactile learning and the individual evaluation of the reward in honey bees (*Apis mellifera* L.). *Journal of Comparative Physiology A*, 185(1), 1-10.
- Scheiner, R., Page, R. E., & Erber, J. (2001). Responsiveness to sucrose affects tactile and olfactory learning in preforaging honey bees of two genetic strains. *Behavioural brain research*, 120(1), 67-73.
- Scheiner, R., Page, R. E., & Erber, J. (2004). Sucrose responsiveness and behavioral plasticity in honey bees (*Apis mellifera*). *Apidologie*, 35(2), 133-142.
- Scheiner, R., Kuritz-Kaiser, A., Menzel, R., & Erber, J. (2005). Sensory responsiveness and the effects of equal subjective rewards on tactile learning and memory of honeybees. *Learning & Memory*, 12(6), 626-635.
- Schmaranzer, S., Stabentheiner, A., & Heran, H. (1988). Wissenschaftlicher Film: Thermografie bei Bienen. *Mitt Dtsch Ges Allg Angew Entomol*, 6, 136-139.
- Schmitzova, J., Kludiny, J., Albert, Š., Schröder, W., Schreckengost, W., Hanes, J., ... & Šimúth, J. (1998). A family of major royal jelly proteins of the honeybee *Apis mellifera* L. *Cellular and Molecular Life Sciences CMLS*, 54(9), 1020-1030.
- Schroll, C., Riemensperger, T., Bucher, D., Ehmer, J., Völler, T., Erbguth, K., ... & Fiala, A. (2006). Light-induced activation of distinct modulatory neurons triggers appetitive or aversive learning in *Drosophila* larvae. *Current Biology*, 16(17), 1741-1747.
- Schröter, U., Malun, D., & Menzel, R. (2007). Innervation pattern of suboesophageal ventral unpaired median neurones in the honeybee brain. *Cell and tissue research*, 327(3), 647-667.

- Schwaerzel, M., Monastirioti, M., Scholz, H., Friggi-Grelin, F., Birman, S., & Heisenberg, M. (2003). Dopamine and octopamine differentiate between aversive and appetitive olfactory memories in *Drosophila*. *The Journal of neuroscience*, *23*(33), 10495-10502.
- Seeley, T. D. (1982). Adaptive significance of the age polyethism schedule in honeybee colonies. *Behavioral Ecology and Sociobiology*, *11*(4), 287-293.
- Seeley, T. D. (1983). Division of labor between scouts and recruits in honeybee foraging. *Behavioral Ecology and Sociobiology*, *12*(3), 253-259.
- Seeley, T. D. (1989). The honey bee colony as a superorganism. *American Scientist*, 546-553.
- Seeley, T. D. (1992). The tremble dance of the honey bee: message and meanings. *Behavioral Ecology and Sociobiology*, *31*(6), 375-383.
- Seeley, T. D. (1997). Honey bee colonies are group-level adaptive units. *The American Naturalist*, *150*(S1), s22-S41.
- Seeley, T. D., Mikheyev, A. S., & Pagano, G. J. (2000). Dancing bees tune both duration and rate of waggle-run production in relation to nectar-source profitability. *Journal of Comparative Physiology A*, *186*(9), 813-819.
- Seeley, T. D. (2009). *The wisdom of the hive: the social physiology of honey bee colonies*. Harvard University Press.
- Siniscalchi, M., Lusito, R., Vallortigara, G., & Quaranta, A. (2013). Seeing left-or right-asymmetric tail wagging produces different emotional responses in dogs. *Current Biology*, *23*(22), 2279-2282.
- Sitaraman, D., Zars, M., LaFerriere, H., Chen, Y. C., Sable-Smith, A., Kitamoto, T., ... & Zars, T. (2008). Serotonin is necessary for place memory in *Drosophila*. *Proceedings of the National Academy of Sciences*, *105*(14), 5579-5584.
- Sitaraman, D., Zars, M., & Zars, T. (2010). Place memory formation in *Drosophila* is independent of proper octopamine signaling. *Journal of Comparative Physiology A*, *196*(4), 299-305.
- Skinner, B. F. (1936). Conditioning and extinction and their relation to drive. *The Journal of General Psychology*, *14*(2), 296-317.
- Smith, A. (1776). *The wealth of nations*. New York: The Modern Library.
- Smith, B. H., Abramson, C. I., & Tobin, T. R. (1991). Conditional withholding of proboscis extension in honeybees (*Apis mellifera*) during discriminative punishment. *Journal of comparative psychology*, *105*(4), 345.
- Smith, B. H., & Cobey, S. (1994). The olfactory memory of the honeybee *Apis mellifera*. II. Blocking between odorants in binary mixtures. *The Journal of experimental biology*, *195*(1), 91-108.
- Smith, B. H. (1997). An analysis of blocking in odorant mixtures: an increase but not a decrease in intensity of reinforcement produces unblocking. *Behavioral neuroscience*, *111*(1), 57.
- Snodgrass, R. E. (1984). *Anatomy of the honey bee*. Cornell University Press.
- Southwick, E. E., & Heldmaier, G. (1987). Temperature control in honey bee colonies. *Bioscience*, *37*(6), 395-399.

- Southwick, E. E., & Moritz, R. F. (1987). Social control of air ventilation in colonies of honey bees, *Apis mellifera*. *Journal of insect physiology*, 33(9), 623-626.
- Srinivasan, M. V., Lehrer, M., & Horridge, G. A. (1990). Visual figure-ground discrimination in the honeybee: the role of motion parallax at boundaries. *Proceedings of the Royal Society of London B: Biological Sciences*, 238(1293), 331-350.
- Srinivasan, M. V. (2010). Honey bees as a model for vision, perception, and cognition. *Annual review of entomology*, 55, 267-284.
- Stort, A. C. (1974). Genetic study of aggressiveness of two subspecies of *Apis mellifera* in Brazil 1. Some tests to measure aggressiveness. *Journal of Apicultural Research*, 13(1), 33-38.
- Strang, G. E. (1970). A study of honey bee drone attraction in the mating response. *Journal of Economic Entomology*, 63(2), 641-645.
- Strube-Bloss, M. F., Nawrot, M. P., & Menzel, R. (2011). Mushroom body output neurons encode odor-reward associations. *The Journal of neuroscience*, 31(8), 3129-3140.
- Strutz, A., Soelter, J., Baschwitz, A., Farhan, A., Grabe, V., Rybak, J., ... & Sachse, S. (2014). Decoding odor quality and intensity in the *Drosophila* brain. *eLife*, 3, e04147.
- Suzuki, H. (1975). Antennal movements induced by odour and central projection of the antennal neurones in the honey-bee. *Journal of Insect Physiology*, 21(4), 831-847.
- Swank, M. W., Schafe, G. E., & Bernstein, I. L. (1995). c-Fos induction in response to taste stimuli previously paired with amphetamine or LiCl during taste aversion learning. *Brain research*, 673(2), 251-261.
- Szyszkka, P., Ditzen, M., Galkin, A., Galizia, C. G., & Menzel, R. (2005). Sparsening and temporal sharpening of olfactory representations in the honeybee mushroom bodies. *Journal of neurophysiology*, 94(5), 3303-3313.
- Takeda, K. (1961). Classical conditioned response in the honey bee. *Journal of Insect Physiology*, 6(3), 168-179.
- Tang, X., Platt, M. D., Lagnese, C. M., Leslie, J. R., & Hamada, F. N. (2013). Temperature integration at the AC thermosensory neurons in *Drosophila*. *The Journal of Neuroscience*, 33(3), 894-901.
- Tanimoto, H., Heisenberg, M., & Gerber, B. (2004). Experimental psychology: event timing turns punishment to reward. *Nature*, 430(7003), 983-983.
- Tautz, J., Maier, S., Groh, C., Rössler, W., & Brockmann, A. (2003). Behavioral performance in adult honey bees is influenced by the temperature experienced during their pupal development. *Proceedings of the National Academy of Sciences*, 100(12), 7343-7347.
- Tedjakumala, S. R., & Giurfa, M. (2013). Rules and mechanisms of punishment learning in honey bees: the aversive conditioning of the sting extension response. *The Journal of experimental biology*, 216(16), 2985-2997.
- Tedjakumala, S. R., Aimable, M., & Giurfa, M. (2013). Pharmacological modulation of aversive responsiveness in honey bees. *Frontiers in behavioral neuroscience*, 7.
- Tedjakumala, S. R. (2014). *Le rôle des circuits et signalisations dopaminergiques dans l'apprentissage aversif de l'abeille *Apis mellifera** (Doctoral dissertation, Université de Toulouse, Université Toulouse III-Paul Sabatier).

- Tel-Zur, D., & Lensky, Y. (1995). Bioassay and apparatus for measuring the stinging response of an isolated worker honey-bee (*Apis mellifera* L. var. *ligustica* Spin.). *Comparative Biochemistry and Physiology Part A: Physiology*, *110*(4), 281-288.
- Thamm, M., Rolke, D., Jordan, N., Balfanz, S., Schiffer, C., Baumann, A., & Blenau, W. (2013). Function and distribution of 5-HT₂ receptors in the honeybee (*Apis mellifera*). *PloS one*, *8*(12), e82407.
- Thamm, M., & Scheiner, R. (2014). PKG in honey bees: spatial expression, Amfor gene expression, sucrose responsiveness, and division of labor. *Journal of Comparative Neurology*, *522*(8), 1786-1799.
- Theraulaz, G., Bonabeau, E., & Deneubourg, J. N. (1998). Response threshold reinforcements and division of labour in insect societies. *Proceedings of the Royal Society of London B: Biological Sciences*, *265*(1393), 327-332.
- Thorndike, E. L. (1898). "Animal Intelligence". *Nature*, *58*, 390.
- Tolman, E. C., & Honzik, C. H. (1930). Introduction and removal of reward, and maze performance in rats. *University of California Publications in Psychology*.
- Tolman, E. C. (1959). Principles of purposive behavior. (Ed.), *Psychology: A study of science* (pp. 92-157).
- Tracey, W. D., Wilson, R. I., Laurent, G., & Benzer, S. (2003). painless, a *Drosophila* gene essential for nociception. *Cell*, *113*(2), 261-273.
- Treisman, M. (1975). Predation and the evolution of gregariousness. I. Models for concealment and evasion. *Animal Behaviour*, *23*, 779-800.
- Trumbo, S. T., Huang, Z. Y., & Robinson, G. E. (1997). Division of labor between undertaker specialists and other middle-aged workers in honey bee colonies. *Behavioral Ecology and Sociobiology*, *41*(3), 151-163.
- Tully, T. (1984). *Drosophila* learning: behavior and biochemistry. *Behavior genetics*, *14*(5), 527-557.
- Tully, T., & Quinn, W. G. (1985). Classical conditioning and retention in normal and mutant *Drosophila melanogaster*. *Journal of Comparative Physiology A*, *157*(2), 263-277.
- Ugajin, A., Kiya, T., Kunieda, T., Ono, M., Yoshida, T., & Kubo, T. (2012). Detection of neural activity in the brains of Japanese honeybee workers during the formation of a "hot defensive bee ball". *PloS one*, *7*(3).
- Unoki, S., Matsumoto, Y., & Mizunami, M. (2005). Participation of octopaminergic reward system and dopaminergic punishment system in insect olfactory learning revealed by pharmacological study. *European Journal of Neuroscience*, *22*(6), 1409-1416.
- Unoki, S., Matsumoto, Y., & Mizunami, M. (2006). Roles of octopaminergic and dopaminergic neurons in mediating reward and punishment signals in insect visual learning. *European Journal of Neuroscience*, *24*(7), 2031-2038.
- Uribe-Rubio, J. L., Guzmán-Novoa, E., Vázquez-Peláez, C. G., & Hunt, G. J. (2008). Genotype, task specialization, and nest environment influence the stinging response thresholds of individual Africanized and European honeybees to electrical stimulation. *Behavior genetics*, *38*(1), 93-100.

- Urlacher, E., Francés, B., Giurfa, M., & Devaud, J. M. (2010). An alarm pheromone modulates appetitive olfactory learning in the honeybee (*Apis mellifera*). *Frontiers in behavioral neuroscience*, *4*.
- Van Hateren, J. H., Srinivasan, M. V., & Wait, P. B. (1990). Pattern recognition in bees: orientation discrimination. *Journal of Comparative Physiology A*, *167*(5), 649-654.
- Velthuis, H. H. W. (1970). Queen substances from the abdomen of the honey bee queen. *Zeitschrift für vergleichende Physiologie*, *70*(2), 210-221.
- Venkatachalam, K., & Montell, C. (2007). TRP channels. *Annual review of biochemistry*, *76*, 387.
- Vergoz, V., Roussel, E., Sandoz, J. C., & Giurfa, M. (2007). Aversive learning in honeybees revealed by the olfactory conditioning of the sting extension reflex. *PLoS One*, *2*(3), e288.
- Vergoz, V., Schreurs, H. A., & Mercer, A. R. (2007). Queen pheromone blocks aversive learning in young worker bees. *Science*, *317*(5836), 384-386.
- Vergoz, V., McQuillan, H. J., Geddes, L. H., Pullar, K., Nicholson, B. J., Paulin, M. G., & Mercer, A. R. (2009). Peripheral modulation of worker bee responses to queen mandibular pheromone. *Proceedings of the National Academy of Sciences*, *106*(49), 20930-20935.
- Vinauger, C., Lallement, H., & Lazzari, C. R. (2013). Learning and memory in *Rhodnius prolixus*: habituation and aversive operant conditioning of the proboscis extension response. *The Journal of experimental biology*, *216*(5), 892-900.
- Vleugels, R., Lenaerts, C., Baumann, A., Broeck, J. V., & Verlinden, H. (2013). Pharmacological characterization of a 5-HT 1-type serotonin receptor in the red flour beetle, *Tribolium castaneum*.
- Voets, T., Talavera, K., Owsianik, G., & Nilius, B. (2005). Sensing with TRP channels. *Nature chemical biology*, *1*(2), 85-92.
- Von Frisch, K. (1914). *Der farbenninn und formenninn der biene*. Рипол Классик.
- Von Frisch, K. (1919). Über den Geruchssinn der Biene und seine blütenbiologische Bedeutung.
- Von Frisch, K. (1967). *The dance language and orientation of bees*. Harvard University Press
- Von Frisch, K. (1974). Decoding the language of the bee. *Science*, *185*(4152), 663-668.
- Vosshall, L. B. (2001). The molecular logic of olfaction in *Drosophila*. *Chemical senses*, *26*(2), 207-213.
- Waddell, S., & Quinn, W. G. (2001). Flies, genes, and learning. *Annual review of neuroscience*, *24*(1), 1283-1309.
- Waddington, S. J., Santorelli, L. A., Ryan, F. R., & Hughes, W. O. (2010). Genetic polyethism in leaf-cutting ants. *Behavioral Ecology*, arq128.
- Wehmann, H. N., Gustav, D., Kirkerud, N. H., & Galizia, C. G. (2015). The Sound and the Fury—Bees Hiss when Expecting Danger. *PLoS one*, *10*(3), e0118708.
- Weidenmüller, A. (2004). The control of nest climate in bumblebee (*Bombus terrestris*) colonies: interindividual variability and self reinforcement in fanning response. *Behavioral Ecology*, *15*(1), 120-128.

- Wheeler, W. M. (1908). The polymorphism of ants. *Annals of the Entomological Society of America*, 1(1), 39-69.
- Wilson, E. O. (1971). The insect societies. *The insect societies*
- Wilson, D. S. (1975). A theory of group selection. *Proceedings of the national academy of sciences*, 72(1), 143-146.
- Wilson, E. O. (1978). What is sociobiology?. *Society*, 15(6), 10-14.
- Wilson, E. O., & Hölldobler, B. (2005). Eusociality: origin and consequences. *Proceedings of the National Academy of Sciences of the United States of America*, 102(38), 13367-13371.
- Winston, M. L. (1987). Age-related activities of the worker bee. In *The Biology of the Honey Bee* (pp. 89-109). Harvard University Press Cambridge, MA.
- Winston, M. L. (1991). *The biology of the honey bee*. Harvard University Press.
- Woodard, S. H., Fischman, B. J., Venkat, A., Hudson, M. E., Varala, K., Cameron, S. A., ... & Robinson, G. E. (2011). Genes involved in convergent evolution of eusociality in bees. *Proceedings of the National Academy of Sciences*, 108(18), 7472-7477.
- Woodbury, C. J., Zwick, M., Wang, S., Lawson, J. J., Caterina, M. J., Koltzenburg, M., ... & Davis, B. M. (2004). Nociceptors lacking TRPV1 and TRPV2 have normal heat responses. *The Journal of neuroscience*, 24(28), 6410-6415.
- Wright, G. A., & Schiestl, F. P. (2009). The evolution of floral scent: the influence of olfactory learning by insect pollinators on the honest signalling of floral rewards. *Functional Ecology*, 23(5), 841-851.
- Wright, G. A., Mustard, J. A., Kottcamp, S. M., & Smith, B. H. (2007). Olfactory memory formation and the influence of reward pathway during appetitive learning by honey bees. *Journal of Experimental Biology*, 210(22), 4024-4033.
- Xiang, Y., Yuan, Q., Vogt, N., Looger, L. L., Jan, L. Y., & Jan, Y. N. (2010). Light-avoidance-mediating photoreceptors tile the Drosophila larval body wall. *Nature*, 468(7326), 921-926.
- Yamamoto, T., Shimura, T., Sako, N., Yasoshima, Y., & Sakai, N. (1994). Neural substrates for conditioned taste aversion in the rat. *Behavioural brain research*, 65(2), 123-137.
- Yarali, A., Niewalda, T., Chen, Y. C., Tanimoto, H., Duernagel, S., & Gerber, B. (2008). 'Pain relief' learning in fruit flies. *Animal Behaviour*, 76(4), 1173-1185.
- Yokohari, F. (1983). The coelocapitular sensillum, an antennal hygro- and thermoreceptive sensillum of the honey bee, *Apis mellifera* L. *Cell and tissue research*, 233(2), 355-365.
- Young, J. Z. (1960). Unit processes in the formation of representations in the memory of Octopus. *Proceedings of the Royal Society of London B: Biological Sciences*, 153(950), 1-17.
- Yu, D., Ponomarev, A., & Davis, R. L. (2004). Altered representation of the spatial code for odors after olfactory classical conditioning: memory trace formation by synaptic recruitment. *Neuron*, 42(3), 437-449.
- Zhong, L., Hwang, R. Y., & Tracey, W. D. (2010). Pickpocket is a DEG/ENaC protein required for mechanical nociception in Drosophila larvae. *Current Biology*, 20(5), 429-434

ANNEXES



Genotypic Influence on Aversive Conditioning in Honeybees, Using a Novel Thermal Reinforcement Procedure

Pierre Junca, Julie Carcaud, Sibyle Moulin, Lionel Garnery, Jean-Christophe Sandoz*

Evolution, Genomes et Speciation Lab (LEGS – UPR 9034), CNRS, Gif-sur-Yvette, France

Abstract

In Pavlovian conditioning, animals learn to associate initially neutral stimuli with positive or negative outcomes, leading to appetitive and aversive learning respectively. The honeybee (*Apis mellifera*) is a prominent invertebrate model for studying both versions of olfactory learning and for unraveling the influence of genotype. As a queen bee mates with about 15 males, her worker offspring belong to as many, genetically-different patriline. While the genetic dependency of appetitive learning is well established in bees, it is not the case for aversive learning, as a robust protocol was only developed recently. In the original conditioning of the sting extension response (SER), bees learn to associate an odor (conditioned stimulus - CS) with an electric shock (unconditioned stimulus - US). This US is however not a natural stimulus for bees, which may represent a potential caveat for dissecting the genetics underlying aversive learning. We thus first tested heat as a potential new US for SER conditioning. We show that thermal stimulation of several sensory structures on the bee's body triggers the SER, in a temperature-dependent manner. Moreover, heat applied to the antennae, mouthparts or legs is an efficient US for SER conditioning. Then, using microsatellite analysis, we analyzed heat sensitivity and aversive learning performances in ten worker patriline issued from a naturally inseminated queen. We demonstrate a strong influence of genotype on aversive learning, possibly indicating the existence of a genetic determinism of this capacity. Such determinism could be instrumental for efficient task partitioning within the hive.

Citation: Junca P, Carcaud J, Moulin S, Garnery L, Sandoz J-C (2014) Genotypic Influence on Aversive Conditioning in Honeybees, Using a Novel Thermal Reinforcement Procedure. PLoS ONE 9(5): e97333. doi:10.1371/journal.pone.0097333

Editor: Nicolas Chaline, Universidade de São paulo, Brazil

Received: December 12, 2013; **Accepted:** April 17, 2014; **Published:** May 14, 2014

Copyright: © 2014 Junca et al. This is an open-access article distributed under the terms of the Creative Commons Attribution License, which permits unrestricted use, distribution, and reproduction in any medium, provided the original author and source are credited.

Funding: These authors have no support or funding to report.

Competing Interests: The authors have declared that no competing interests exist.

* E-mail: sandoz@legs.cnrs-gif.fr

Introduction

To survive, animals must be able to associate stimuli of their environment with their positive or negative consequences. This leads to two complementary forms of associative learning, termed respectively 'appetitive' and 'aversive' learning. A major question in the study of the neural bases of cognitive functions is the relationship existing between these two types of associative learning [1–5]. Strongly related to this question is the search for the genetic architecture underlying these two learning types. Do they rely on utterly different ensembles of genes, giving rise to mostly independent neural processes, or do they share essential characteristics, such as for instance the associative machinery?

In this prospect, honeybees (*Apis mellifera*) may represent a valuable asset. In addition to being a well investigated invertebrate model for the study of the behavioral and neuronal basis of associative learning and memory [6–8], the genetic architecture of their colonies is well adapted for studying a possible genotypic influence on cognitive skills. Honeybees possess a haplo-diploid reproduction system. In a honeybee colony, the diploid queen mates on average with fifteen haploid males [9]. Therefore, the workers, her daughters, make up about fifteen different patriline with different genetic backgrounds within the hive. It is currently thought that such genetic diversity is beneficial for the colony's fitness and survival [10]. Indeed, post-winter survival rate,

production of sexuals, resistance and swarming were found to be positively correlated to the number of patriline [11]. Moreover, a high number of patriline results in an increased performance for thermoregulation, food storage, and even worker communication during foraging [12–13]. How can these advantages be explained in terms of task allocation within the hive? An important ensemble of theories, named "threshold theories", consider that the different responsiveness of each individual to environmental stimuli determines this individual's propensity to engage in one or another behavioral task [12,14]. Thus, the existence of different patriline with diversified responsiveness within the hive would allow optimal task allocation, in particular concerning foraging [15–16] or thermoregulation [13]. One may thus ask what is the influence of patriline origin on bees' sensitivity to appetitive and aversive reinforcement and on their learning capacity in these two modalities.

Until now, however, the search for a genetic determinism of associative learning in bees has been limited to appetitive learning, due to the long existence of a well-established laboratory assay: the conditioning of the proboscis extension response (PER) [17–18]. The proboscis extension is a reflex triggered by sugar stimulation provided on gustatory receptors of the antennae, tarsi or mouthparts. In olfactory PER conditioning, an originally neutral odor (conditioned stimulus – CS) is associated with a sugar reward first presented to the antennae and then to the proboscis

(unconditioned stimulus – US). Once the association has been established, the bee responds with a proboscis extension to the odor (CS) alone. Thanks to this biological assay, a number of studies have evaluated the relative influence of genetic, developmental and environmental factors on appetitive learning and established its genetic dependency [19–23]. This dependency relies in part on bees' responsiveness to the sugar (US), a highly genetically-dependent trait which strongly influences the future role of workers as nectar, pollen or water foragers [24–25]. Bees' responsiveness to sugar directly affects appetitive learning performances [26–27]. Bees with a high response threshold perceive the sugar reward as less intensive, and therefore learn it less efficiently than bees with a lower threshold [28]. It seems that many behavioral traits of the honeybee are correlated with sugar responsiveness, as for example olfactory sensitivity and phototactic behavior [29]. As a result, the authors of these studies even suggested that sugar responsiveness could be the *only* determinant of honeybee behavior [25]. However, it was later found that this hypothesis did not take into account types of behaviors that are not related to food search, such as for instance defense behavior or aversive learning [30].

This lack of data on the aversive aspects of honey bee behavior was mainly due to the absence of dedicated protocols for studying aversive learning in controlled laboratory conditions. Recently, the Pavlovian conditioning of the sting extension response (SER) was developed to solve this problem [31,8]. An electric shock applied to the bee's thorax triggers an extension of the sting [32]. Bees can learn to associate an odor CS with this electric shock US and after conditioning will respond to the punished odor with a SER [31]. Since then, it was shown that bees which are more sensitive to the electric shock learn and memorize odor-shock associations more efficiently [30]. However, to what extent the observed inter-individual variability in sensitivity to the aversive US and in aversive conditioning capacity relies on a genetic determinism is as yet unknown.

One potential caveat when studying the genetic basis of associative learning could be the unnatural quality of the electric shock as a US. First, the electric shock is applied broadly on the bee's body, which makes it difficult to know which structure(s) has (have) been stimulated. Second, it is still unclear if the electric shock is detected by particular receptors at the periphery, or if it also acts through direct electric activation of peripheral or more central neurons. Using a more natural aversive US, for which the honeybee has evolved dedicated peripheral receptors and neural pathways, may thus be beneficial for addressing the genetics of aversive learning. We thus first aimed to develop a version of SER conditioning which uses a natural stimulus as US: temperature.

In the honeybee colony, workers maintain a temperature comprised between 32°C and 36°C, mainly because brood development is highly dependent on ambient temperature [33–34]. At the individual level, honeybees strictly avoid temperatures above 44°C, and reject sucrose solution presented at 45–50°C [35]. A high temperature is therefore a naturally aversive stimulus for bees. A thermal stimulus can be applied locally, on particular sensory organs of the bee, using small heated copper probes (see Materials and Methods). In addition, some data are already available on the peripheral detection of temperature in honeybees. The antennae, for instance, contain a specific type of sensilla, the *coelocapitular* sensilla, which detect warmth [36]. Moreover, a honeybee-specific thermal receptor, HsTRPA (Hymenoptera specific Transient Receptor Potential Ankyrin) has been recently identified [35]. This receptor is present in many sensory structures, such as the antennae, the proboscis and the legs. However, even if we know that bees actively avoid heat and possess warm sensitive

receptors on many of their sensory organs, we do not know if a thermal stimulus can trigger a defensive response of sting extension. We also do not know if this stimulus can play the role of an aversive reinforcement.

The goal of this study was to determine how genotype differences impact aversive olfactory learning in the honey bee, using a natural aversive US. To address this question, we first asked whether local thermal stimulation on the honeybee body can trigger SER. We tested responses to thermal application on the antenna, the mouthparts, the legs and the abdomen, and determined the temperature sensitivity of these structures. Next, we developed a new version of the SER conditioning protocol using a thermal stimulation as US. Then, we compared how sensitivity to temperature and aversive learning performances interact at the individual level. Lastly, we used a genetic analysis based on microsatellites to assess whether a bees' genotype influences this relationship.

Results

Experiment 1: Effect of Temperature on the Sting Extension Response

In this experiment, we aimed to determine whether controlled temperature stimulation of honeybee sensory structures can trigger a sting extension response (SER). A recent study showed that a temperature-sensitive receptor, the so-called HsTRPA, is present on several sensory structures including the antennae, the mouthparts and the legs [35]. We thus chose to study temperature sensitivity on these structures, in combination with other body parts as control. Bees were harnessed in individual holders allowing visual observation of the SER (Fig. 1A).

In a first experiment ($n = 40$), we evaluated the effect caused by a 1 sec stimulation with a copper probe at 65°C applied on the antennae, the mouthparts, the ventral abdomen or the dorsal abdomen (Fig. 1B). As control, an identical stimulation with an unheated probe ("tactile control") was applied on each structure. Stimulations were given at 10 min intervals and their order was randomized across animals. Thermal stimulations induced between 18.5% and 87.5% SER depending on the contacted structure, while tactile controls triggered less than 15% SER on all structures. Responses were significantly higher for thermal stimulation than for tactile control in the case of the antennae (Mc Nemar test, $\chi^2 = 20.0$, $p < 0.001$), the mouthparts ($\chi^2 = 33.0$, $p < 0.001$) and the ventral abdomen ($\chi^2 = 8.10$, $p < 0.01$) but not for the dorsal abdomen ($\chi^2 = 0.00$, NS). Overall, the effect of thermal stimulations differed according to the contacted structure (Cochran's Q test, $Q = 44.9$, $p < 0.001$, 3 df), while no difference appeared for tactile controls ($Q = 7.33$, NS, 3 df). Antennal and mouthpart stimulation induced significantly higher responses than other areas (Mc Nemar test, $\chi^2 > 5.88$, $p < \alpha_{\text{corr}} = 0.0167$), but stimulations of these two organs did not differ statistically ($\chi^2 = 3.5$, NS).

In a second experiment ($n = 37$), we reproduced the previous measures of thermal stimulation of the bees' antennae and mouthparts and compared them with stimulations of the bees' legs (Fig. 1C). With a different holding position, which allowed stimulating the bees' legs with the heated copper probe, it was possible to stimulate selectively the front legs (one after the other) or the middle and hind legs (all together). The four thermal stimulations triggered from 32.4% to 94.6% SER, whereas tactile stimulations induced less than 18.9% responses. In all cases, responses induced by thermal stimuli were significantly higher than responses to tactile controls (Mc Nemar test, $\chi^2 > 9.09$, $p < 0.01$). Overall, the effect of thermal stimulations differed according

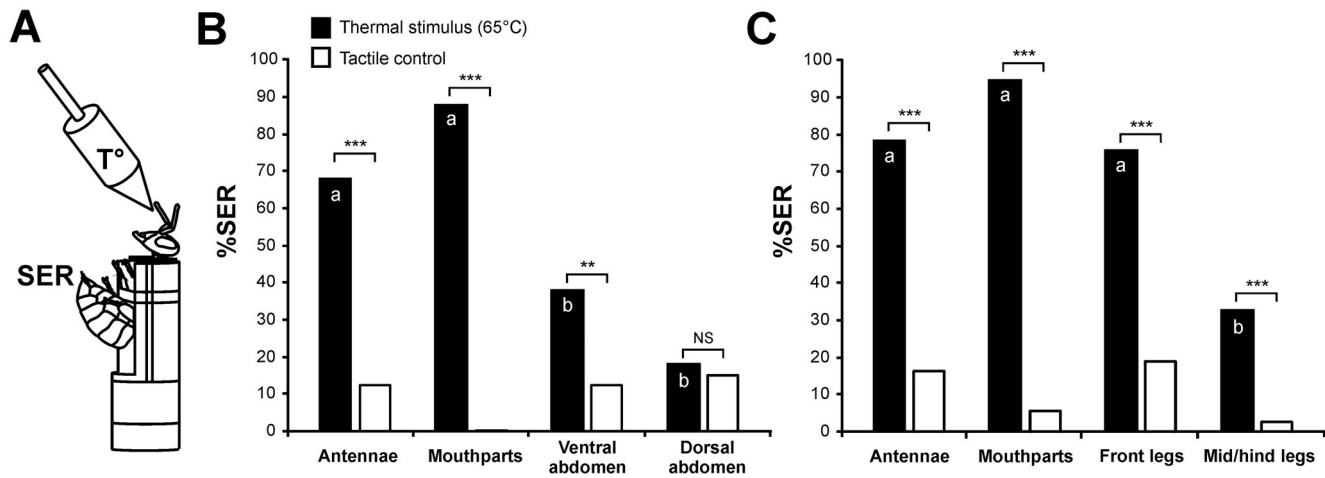

Figure 1. Thermal stimulation on different structures of bee's body. **A)** Bee harnessed in a conditioning tube, leaving the whole abdomen free and allowing observation of sting extension responses (SER). Thermal stimulations were applied using a heated copper probe. As control, tactile stimulations were applied with an identical unheated probe. **B)** Percentage of SER to 1s thermal stimulations (65°C) and to tactile controls on: the antennae, the mouthparts, the ventral abdomen, the dorsal abdomen (n=40 bees); **C)** Similar experiment but with stimulations of the antennae, the mouthparts, the front legs and the mid-hind legs (n=37). Thermal stimulation mostly induced stronger responses than tactile controls (Mc Nemar test, ***: $p < 0.001$). Different letters indicate significant differences between structures (Mc Nemar test, $p < 0.0166$). doi:10.1371/journal.pone.0097333.g001

to the contacted structure (Cochran's Q test, $Q = 40.5$, $p < 0.001$, 3 df), while no difference appeared for tactile controls ($Q = 7.80$, NS, 3 df). In this experiment, responses to thermal stimulation were equivalent for the antennae, the mouthparts and the front legs (McNemar test, $\chi^2 < 4.00$, NS), while all three differed with thermal stimulation of the hind legs ($\chi^2 > 12.0$, $p < \alpha_{\text{corr}} = 0.0167$ in all cases).

These results show several structures on the bees' body are sensitive to temperature and their stimulation triggers a defense response by the extension of the sting. Among the tested structures, the antennae, the mouthparts and the front legs were especially responsive to thermal stimulation.

Experiment 2: Honeybees' Sensitivity to Temperature

The previous experiment showed that stimulation of antennae, mouthparts and front legs with a high temperature (65°C) can trigger strong SER in bees. In the present experiment, we evaluated the effect of increasing temperatures on SER levels, aiming to determine the heat sensitivity of these sensory structures. Thus, temperature of the copper probe was increased from ambient temperature (~25°C) to 75°C in steps of 10°C. Each group of bees was stimulated on the antennae, the mouthparts or the front legs with increasing temperatures, alternating with tactile controls. Intervals between stimulations were 10 min.

We first focused on heat sensitivity of the antennae (Fig. 2A, n = 58). Responses increased significantly with increasing temperature, from 12.1% at ambient temperature to 62.9% at 75°C (repeated measurement ANOVA, $F_{5,285} = 22.0$, $p < 0.001$). In the mean time, bees' responses to tactile stimulation also varied during the experiment, but remained low (below 20%, $F_{5,285} = 3.56$, $p < 0.01$). Accordingly, responses evolved differently along trials for thermal and tactile stimulation (*stimulus x trial* repeated measurement ANOVA, interaction: $F_{5,285} = 13.2$, $p < 0.001$). Thus, thermal stimulation of the antennae induces a gradual increase in SER response with increasing temperature.

Similar observations were made when applying thermal stimulations on the mouthparts (Fig. 2B, n = 60) and on the front legs (Fig. 2C, n = 53). In both cases, SER increased with increasing temperature (repeated measurement ANOVA, mouthparts:

$F_{5,295} = 116.4$, $p < 0.001$; front legs: $F_{5,260} = 37.6$, $p < 0.001$), reaching 100% (65°C) and 84.4% (75°C) for mouthparts and front legs respectively. Responses to the tactile control also varied throughout the experiment (mouthparts: $F_{5,295} = 8.02$, $p < 0.001$; front legs: $F_{5,260} = 3.84$, $p < 0.001$), increasing from 1.7–9.4% at the start of the procedure and reaching 23.3% and 20.7% respectively for mouthparts and front legs at the fifth tactile stimulation. This effect is attributable to sensitization due to the temperature stimulations. However, in both cases, responses evolved differently along trials for thermal and tactile stimulation (*stimulus x trial* interaction, mouthparts: $F_{5,295} = 37.6$, $p < 0.001$; front legs: $F_{5,260} = 13.9$, $p < 0.001$).

To compare thermal responsiveness of the three structures independently of sensitization, we computed for each bee and at each trial a delta value ($\Delta\%SER$), resulting from the difference between its response to the thermal and to the tactile stimulus. Figure 2D shows the delta values for the antennae, the mouthparts and the front legs. A global analysis of these curves indicated a significant difference among structures (*structure x trial* repeated measure ANOVA, *structure* effect, $F_{2,168} = 3.37$, $p < 0.05$). This effect was probably due to higher delta values for stimulation of the front legs compared that of the antennae, although the posthoc comparison was only near-significant due to multiple comparison correction (Tukey HSD test, $p = 0.047 > \alpha_{\text{corr}} = 0.025$). However, the evolution of responses with increasing temperature was similar as the *stimulus x trial* interaction was not significant ($F_{10,840} = 1.73$, NS).

These results show that thermal stimulation of the antennae, mouthparts or front legs induces a gradual increase in SER response with increasing temperature. This experiment also indicates that 65°C corresponds to an optimum across structures for triggering SER in most individuals. It may thus qualify as an efficient US for aversive conditioning.

Experiment 3: Thermal Aversive Conditioning

Given that a thermal stimulation of the antennae, mouthparts or front legs triggers a SER, we addressed the possible function of such thermal stimulus as an US in aversive SER conditioning. We thus performed a differential conditioning procedure in which an

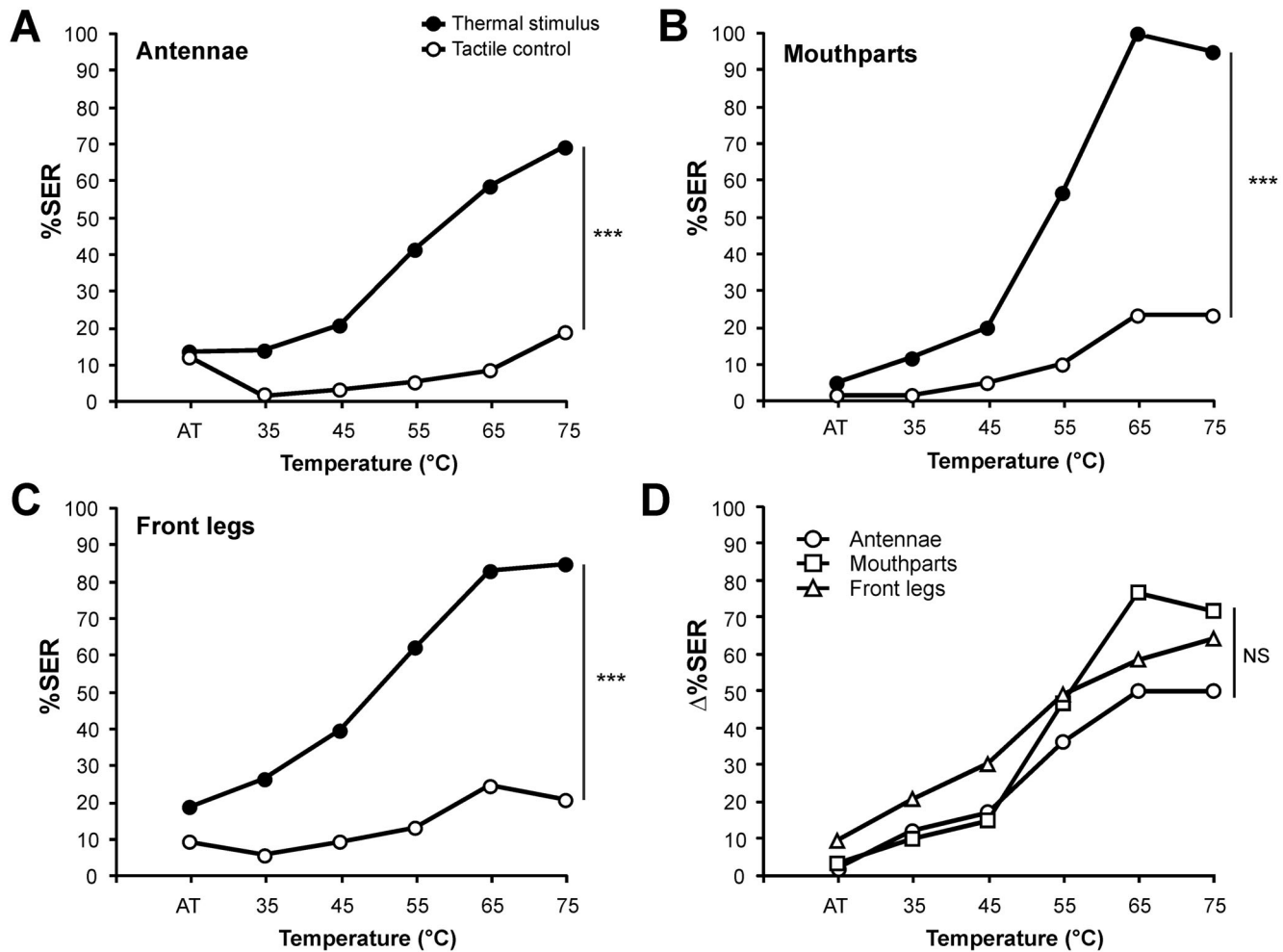

Figure 2. Thermal responsiveness of bees when stimulated on different structures with increasing temperatures. A–C) Percentage of SER to increasing temperatures (black dots, AT: ambient temperature $\sim 25^{\circ}\text{C}$, 35°C , 45°C , 55°C , 65°C , 75°C) alternating with tactile controls (white dots). Stimulations were applied on: **A)** the antennae ($n=58$); **B)** the mouthparts ($n=60$); **C)** the front legs ($n=53$). On all three structures, bees respond differently to the thermal stimulus than to the tactile control, as a response increase is observed only with the thermal stimulus (repeated measure ANOVA, *stimulus* \times *trial* effect, $***: p<0.001$). **D)** Delta values ($\Delta\text{SER}\%$) resulting from the difference between the responses to the thermal and to the tactile stimuli for the three tested structures. No difference appeared in the evolution of the three curves with increasing temperature (repeated measure ANOVA, *stimulus* \times *trial* interaction: NS). doi:10.1371/journal.pone.0097333.g002

odorant was associated with a stimulation with the copper probe at 65°C (CS+) and another odorant was presented without reinforcement (CS-). Each bee thus received 8 CS+ and 8 CS- trials in a pseudo-randomized order. Three groups of bees were thus conditioned, with the US applied on the antennae, the mouthparts, or the front legs. In each group, half of the individuals received the reinforcement when the odorant 2-octanone was presented and no reinforcement when nonanal was presented, while the reversed combination was used for the other half. The inter-trial interval was 10 min.

For all three structures, the two subgroups did not show any response difference along trials (ANOVA for repeated measurement, antennae: $F_{1,43}=0.03$, NS; mouthparts: $F_{1,38}=0.08$, NS; front legs: $F_{1,40}=0.05$, NS) and, hence, were pooled for the analysis. Figure 3A presents the results for the group receiving the US on the antennae ($n=45$). Along the trials, bees' responses to the reinforced (CS+) and to the non-reinforced odorant (CS-) developed differently (ANOVA for repeated measurement, *stimulus* \times *trial* interaction: $F_{7,308}=5.07$, $p<0.001$). Responses to the CS+ increased (ANOVA for repeated measurement: $F_{7,308}=2.44$, $p<$

0.05), while responses to CS- decreased (ANOVA for repeated measurement: $F_{7,308}=3.00$, $p<0.01$). Thus bees are able to associate an odorant with a thermal US to the antennae. Similarly, we examined aversive conditioning with the thermal US applied to the mouthparts (Fig. 3B, $n=40$) and to the front legs (Fig. 3C, $n=42$). In both cases, responses to the CS+ and to the CS- developed differently along trials (*stimulus* \times *trial* interaction, mouthparts: $F_{7,273}=7.92$, $p<0.001$; front legs: $F_{7,287}=4.93$, $p<0.001$). Responses to the CS+ increased (mouthparts: $F_{7,273}=3.47$, $p<0.01$; front legs: $F_{7,287}=2.27$, $p<0.05$) whereas responses to the CS- decreased significantly (mouthparts: $F_{7,273}=4.51$, $p<0.001$; front legs: $F_{7,287}=4.36$, $p<0.001$). Thus, bees learned to respond to the CS+ and to not respond to the CS-.

To compare the aversive learning performances between the three groups which received the thermal US on different structures, we computed for each bee and at each trial a delta value (ΔSER), resulting from the difference between its response to the CS+ and to CS-. Figure 3D shows the delta values for groups reinforced aversively on the antennae, the mouthparts and the front legs. A global analysis of these curves did not show any

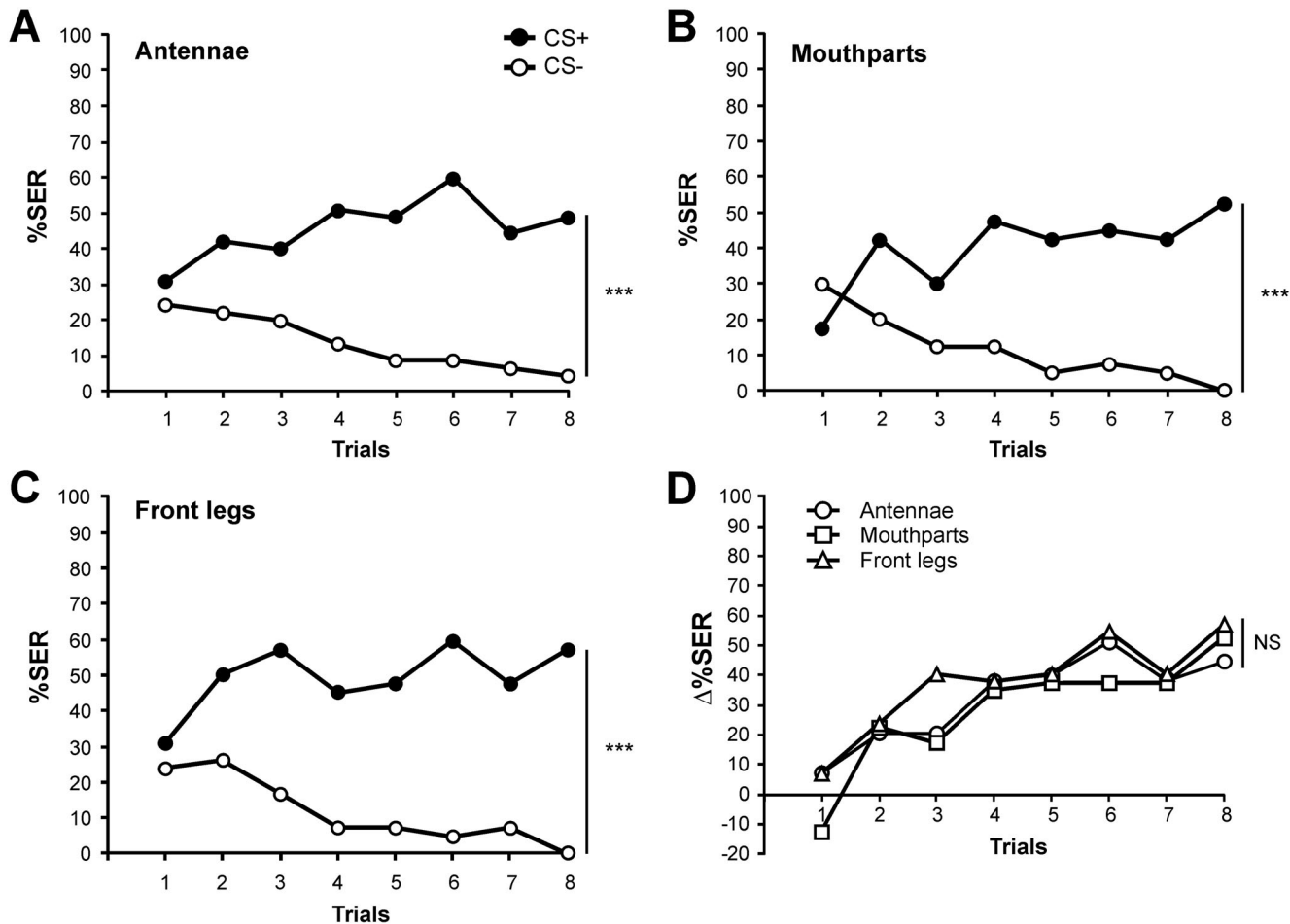

Figure 3. Thermal aversive conditioning with the US applied on different structures. A–C) Percentage of SER to the reinforced odorant (CS+, black dots) and to the non-reinforced odorant (CS–, white dots) along conditioning trials. The thermal unconditioned stimulus (65°C) was applied on: **A)** the antennae ($n = 45$); **B)** the mouthparts ($n = 40$); **C)** the front legs ($n = 42$). Bees learn to respond to the CS+ and not to the CS– when the thermal stimulus is provided on any of the three structures (repeated measurement ANOVA, *stimulus* \times *trial* interaction: ***: $p < 0.001$). **D)** Delta values ($\Delta\%SER$) resulting from the difference between the responses to the CS+ and to the CS– for the US applied on the three tested structures. No difference appeared in the evolution of the three curves along conditioning trials (repeated measure ANOVA, *stimulus* \times *trial* interaction: NS). doi:10.1371/journal.pone.0097333.g003

significant difference among structures (*structure* \times *trial* repeated measure ANOVA, *structure* effect, $F_{2,124} = 1.16$, NS). In addition, the three groups learned as quickly to differentiate the odorants as the *stimulus* \times *trial* interaction was also not significant ($F_{14,868} = 0.74$, NS).

We thus conclude that thermal reinforcement can be used as US in SER aversive conditioning regardless of whether the temperature stimulation is applied on the antennae, the mouthparts or the front legs. Thermal stimulations of the three structures are equally efficient as aversive US.

Experiment 4: Genotypic Influence on Thermal Responsiveness and Aversive Learning

The previous experiments showed that the percentage of individuals showing a SER to a thermal stimulation increases gradually with the temperature of the stimulation. This observation suggests individual differences in bees' sensitivity to temperature. In addition, although bees as a group learned to associate odorants with a thermal US, their individual performances varied with some bees learning quickly and efficiently and other bees not learning the association at all. Previous work suggested that at the

individual level, bees' aversive learning performances depend on their sensitivity to an electric shock US [30]. In the present experiment we aimed to confirm this finding with a thermal US. In addition, we aimed to understand the possible genotypic origin of such inter-individual differences in thermal sensitivity and/or aversive learning performance.

In this experiment, we used only 13–14 day-old bees, to avoid any influence of bees' age. Bees were subjected to a thermal responsiveness experiment (as in Experiment 2) followed by an aversive olfactory conditioning protocol (as in Experiment 3). Thermal stimulations were applied to the mouthparts as this showed the strongest SER rate in previous experiments. For assessing the putative genetic dependency of thermal sensitivity and aversive learning performances, all individuals were genotyped based on a set of 14 microsatellite markers, allowing to determine their patriline of origin.

Thermal responsiveness (Fig. 4A, $n = 303$) and aversive conditioning (Fig. 4B, $n = 303$) yielded similar results as in the previous experiments, except that bees in this experiment appeared generally more sensitive to temperature (i.e.; they responded at lower temperature) than in Experiment 2. This is probably due to the fact that the two experiments were performed at different

periods of the year (Exp. 2: February–March; Exp. 4: May–June). In any case, in the thermal responsiveness experiment (Fig. 4A), responses increased with increasing temperature ($F_{5,1510} = 126.9$, $p < 0.001$) while response to tactile stimulations remained below 18%, but showed significant variations along the procedure ($F_{5,1510} = 2.72$, $p < 0.05$). Responses to thermal and tactile stimuli developed differently along the procedure (*stimulus x trial* repeated-measurement ANOVA, interaction: $F_{5,1510} = 82.0$, $p < 0.001$). In the differential conditioning protocol (Fig. 4B), bees learned to respond to the CS+ ($F_{7,2114} = 12.2$, $p < 0.001$) and to not respond to the CS- ($F_{7,2114} = 23.9$, $p < 0.001$) so that responses to both stimuli developed differently along trials (*stimulus x trial* repeated measurement ANOVA, interaction: $F_{7,2114} = 36.7$, $p < 0.001$).

Based on these results, we calculated for each bee its *thermal responsiveness score* as the number of responses to the thermal stimuli

(from 0 to 6). Thus, a bee with a high score is highly sensitive to temperature, as it would start responding already at rather low temperatures. Likewise, we calculated for each bee its *aversive learning score*, as the number of responses to the CS+ (from 0 to 8). A bee with a high score would be a good aversive learner, which learned quickly to respond to the reinforced odorant. We then asked whether bees' learning performance can be predicted based on their responsiveness to the thermal US. Figure 4C (black dots) presents the average aversive learning score for bees showing a particular heat responsiveness score. A clear linear relationship can be observed, as the more thermally responsive bees (i.e. more sensitive to temperature) show higher aversive learning scores. Accordingly, aversive learning scores differ among thermal responsiveness score categories (one-way ANOVA, $F_{6,181} = 5.34$, $p < 0.001$) and the linear relationship between both variables is

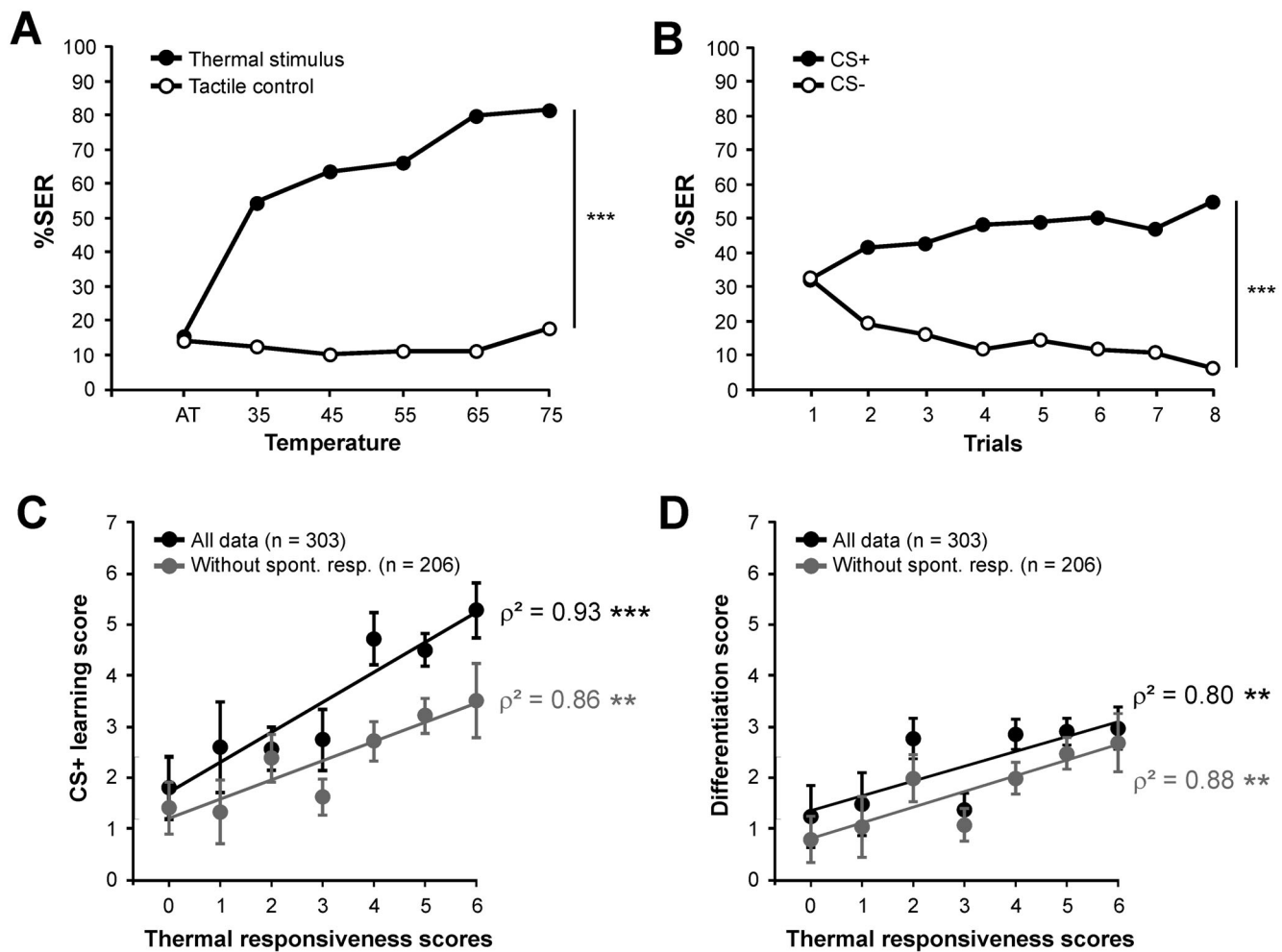

Figure 4. Measure of thermal responsiveness and aversive learning performance on the same bees. **A)** Thermal responsiveness curve with the temperature stimulus provided on the mouthparts ($n = 303$). Percentage of SER with increasing temperatures (black dots) or with tactile control (white dots). The curves for thermal and tactile stimuli develop differently (repeated measure ANOVA, *stimulus x trial* effect, $***$, $p < 0.001$). **B)** Aversive learning performances with thermal reinforcement on the mouthparts ($n = 303$). Percentages of SER to the CS+ (black dots) and to the CS- (white dots). Bees learned to respond to the CS+ and not to the CS- (repeated measure ANOVA, *stimulus x trial* effect, $***$, $p < 0.001$). **C)** Relationship between thermal responsiveness and aversive learning performance. The graph shows average response to the CS+ (\pm SEM) for bees with different thermal responsiveness scores ($n = 17$ – 81 per score). A significant linear relationship between the two variables is found, both using all data (black dots) or only those from bees that did not respond spontaneously to the CS+ (grey dots) (Spearman correlation, $***$, $p < 0.001$; $**$, $p < 0.01$; 8 df). **D)** Relationship between thermal responsiveness and differentiation performance in the differential conditioning. The graph shows average delta values (responses to the CS+ minus responses to the CS-) \pm SEM for bees with different thermal responsiveness scores (n per score as in C). A significant linear relationship between the two variables is found, both using all data (black dots) or only those from bees that did not respond spontaneously to the CS+ (grey dots) (Spearman correlation, $**$, $p < 0.01$; 8 df). doi:10.1371/journal.pone.0097333.g004

highly significant (Spearman correlation, $\rho^2 = 0.93$, $p < 0.001$, 8 df).

As at the start of conditioning, about one third of the bees responded spontaneously to the CS+ (see Fig. 4B), the previous measure of the *aversive learning score* over all tested individuals could be considered potentially spurious, since individuals that are highly sensitive to the US may also be sensitive to other stimulations and respond spontaneously with a SER to odorants. We thus performed the previous comparison taking into account only bees which did not respond spontaneously to the CS+ ($n = 206$, score 0 to 7). As Fig. 4C (grey dots) shows, without spontaneous responders, the linear relationship between thermal responsiveness and aversive learning is almost fully conserved (Spearman correlation, $\rho^2 = 0.86$, $p < 0.01$, 8 df). Thus, spontaneous responses cannot explain the strong relationship we observed.

As a further verification, we also calculated for each bee a *differentiation score*, as the difference between the number of responses to the CS+ and to the CS− over the course of the experiment. A value of 0 would mean that the animal does not learn to respond to the CS+ and not to the CS−, while increasing positive values indicate increasing levels of differentiation between CS+ and CS−. It is therefore a purely associative measure of aversive learning success, which contains its own control for non-associative responses. Again, there was a highly significant linear relationship between *thermal responsiveness* and the *differentiation score*, both for all bees (black dots, $\rho^2 = 0.80$, $p < 0.01$, 8 df) and for non-spontaneous responders (grey dots, $\rho^2 = 0.88$, $p < 0.01$, 8 df). We thus conclude that bees' responsiveness to the thermal US determines their aversive learning performance with this US.

We next asked what may drive the observed inter-individual differences in thermal responsiveness and learning. Using a microsatellite analysis, which enabled us to determine the patriline origin of each bee, we assessed the impact of genotype on the thermal responsiveness/aversive learning relationship. The 303 individuals tested in this experiment belonged to 22 different patrilines (i.e. were sired by one of 22 drones which mated with the queen). The numbers of bees within each patriline ranged from 1 to 27 individuals. For assessing patriline performance scores accurately, we only used data from the 10 patrilines which contained more than 10 individual bees. Figure 5A presents average thermal responsiveness and aversive learning scores for these 10 patrilines. Among these patrilines, significant differences were observed in both thermal responsiveness (one way ANOVA, $F_{9,138} = 4.37$, $p < 0.001$) and aversive learning scores ($F_{9,138} = 3.59$, $p < 0.001$). Generally, bees from patrilines with a high (resp. low) responsiveness to thermal stimuli also had a high (resp. low) learning score. Accordingly, a strong correlation was observed at the patriline level (Fig. 5B, $\rho^2 = 0.71$, $p < 0.01$, 8 df). Likewise, when using patrilines' *differentiation score*, measuring the differentiation between CS+ and CS−, a clear and significant correlation was observed (Fig. 5B, $\rho^2 = 0.68$, $p < 0.01$, 8 df). Thus aversive learning performance and sensitivity to the thermal US are under clear genotypic influence and are strongly linked. Within this general trend, however, some deviations could be observed. For instance, while patrilines 3, 4, 5 and 6 display similar thermal responsiveness scores, their aversive learning scores are different. Therefore, in addition to thermal responsiveness, aversive learning performance is also under the influence of other – untested – genetic traits.

Discussion

This study first shows that a thermal stimulus applied on different parts of the bee's body can trigger a sting extension

response (SER). Most responses were observed when the thermal stimulus was applied on the mouthparts, the antennae or the front legs, suggesting that these structures are the most sensitive to temperature. We then established the use of such thermal stimuli as US in aversive olfactory conditioning of the SER. In a differential conditioning procedure, bees responded more to the CS+ than to the CS− when the thermal US was given to the antennae, the mouthparts or the front legs. Thus thermal stimulation of all three structures can serve as aversive US in SER conditioning. We found a clear correlation between bees' responsiveness to thermal stimuli and aversive learning performance, both at the individual and at the patriline level. Different patrilines within the hive displayed different sensitivities to the US, and accordingly different aversive learning performances. These results establish for the first time a strong genotypic influence for aversive conditioning in honeybees.

Temperature Detection in the Honey Bee

The first important observation of this study is that a thermal stimulus applied on the bee's body triggers SER, which can be interpreted as a defense reaction of the bee towards potentially noxious stimulations. In addition to the advantage of using this stimulus as US in aversive conditioning (see below), this observation provides an interesting means of studying heat sensitivity in honeybees. Thus, in the first part of this work, we measured bees' responses when the thermal stimulus was applied on different sensory structures. Five structures showed significant responses to temperature compared to tactile controls. Among those, three crucial sensory organs of bees (antennae, mouthparts and front legs) induced the strongest SER levels. The antennae are prominent sensory organs (mostly olfactory, tactile and gustatory) in which thermal detection was already known, as they harbor specific thermo-sensitive sensilla (coelocapitular sensilla, [36]). Furthermore, at the behavioral level, the antennae are crucial for the avoidance of high temperatures by freely-walking bees [35]. However, thermal sensitivity at the level of the mouthparts and the front legs had not been precisely described before, although heat detection by these organs seems coherent for maintaining the insect's integrity. One can hypothesize that thermal sensitivity at the level of the mouthparts could be adaptive for avoiding food sources at temperatures that could cause internal injury. Thermal sensitivity at the level of the bees' legs could be crucial to avoid landing on hot surfaces during summer months. These ideas are consistent with the recent discovery of the first honeybee thermal receptor within these three sensory organs [35]. In contrast to these structures, we did not observe any significant effect of thermal stimulation on the dorsal abdomen. Possibly, thermo-sensitive receptors are not expressed in this region or thermo-sensitive cells are not linked to motor output leading to SER. Apart from this last case, thermal sensitivity seems however broadly represented on the honeybees' body and SER may allow precisely mapping this sensitivity.

Thermal Stimulation as US in Olfactory Aversive SER Conditioning

We show that a thermal stimulus applied to the antennae, the mouthparts or the front legs can act as a US in aversive SER conditioning. Temperature represents an interesting alternative to the electric shock for studying aversive learning, as it is a more natural stimulus for bees and it can be applied more locally on the bees' body. Moreover, prior identification of thermo-sensitive sensilla [36–37] and receptors [35] could be advantageous for building a neural model of aversive conditioning in bees, based on identified sensory structures and neuronal pathways [8]. In theory,

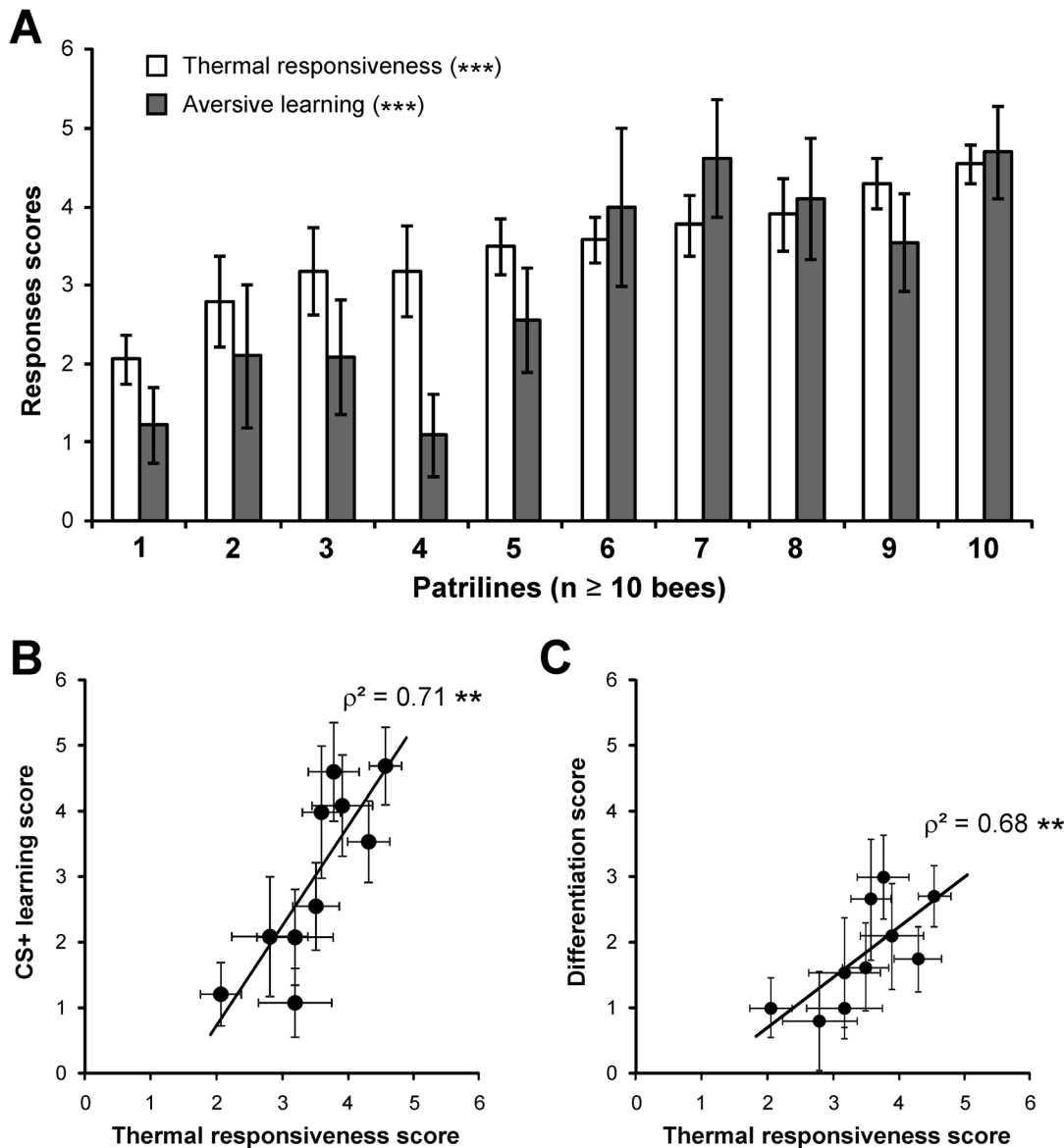

Figure 5. Genotypic influence on thermal responsiveness and aversive learning (patriline effect). **A**) Thermal responsiveness (white bar, average \pm SEM) and aversive learning scores (grey bar, average \pm SEM) for the 10 patriline with the most samples ($n=10-27$ bees per patriline). Patriline are ranked according to increasing thermal responsiveness scores. Significant differences among patriline are observed for both scores (one way ANOVA, $p<0.001$). **B**) A strong correlation appears between thermal responsiveness and aversive learning performances at the patriline level (Spearman correlation, **: $p<0.01$, 8df). **C**) Likewise, a significant correlation appears at the patriline level between the differentiation score (difference between responses to the CS+ and to the CS-) and the thermal responsiveness score (Spearman correlation, **: $p<0.01$, 8 df). doi:10.1371/journal.pone.0097333.g005

associative learning is possible because at one or several locations in the brain, the CS and US pathways converge and neural plasticity takes place at these locations. The olfactory (CS) pathway has been well described in honeybees [6–7,38]: olfactory receptor neurons located on each antenna project to the antennal lobes where primary olfactory processing takes place. From there, projection neurons convey processed information to higher-order brain centers, the mushroom bodies and the lateral horn. For aversive learning, the US pathway is mostly unknown, but our results may provide some new clues. In the case of conditioning with an antennal temperature US (Fig. 3A), thermo-sensory neurons from coelocapitular sensilla on the antenna are thought to project to the antennal lobe [36,39]. In another Hymenoptera, the ant *Atta vollenweideri*, an optical imaging study showed that a

temperature change in the stimulation airflow induced clear patterns of activity in several glomeruli of the antennal lobe [40]. A first direct convergence between olfactory (CS) and thermal (US) pathways may thus be found in this structure. Successful aversive learning was also observed with a thermal US on the mouthparts (Fig. 3B) and the front legs (Fig. 3C). Data in other insects suggest that putative thermo-sensitive neurons on these structures would first project to the respective ganglia of the ventral nerve cord, respectively to the subesophageal and prothoracic ganglia [41]. From there, information could be conveyed by interneurons towards the brain, possibly to a thermal integration center, as suggested by several observations. In *Drosophila*, thermal neurons from the arista project to the proximal antennal protocerebrum, a region between the antennal lobe and the sub-esophageal ganglion

[42]. This structure contains at least two subregions, one responding to cold, and another to warmth. In the bees *Apis cerana*, immediate early gene expression mapping showed that exposure to a high temperature (46°C) induces neural activity in a region of the protocerebrum located between the dorsal and the optic lobe [43]. Neurons from such a putative thermo-sensory center would then activate aversive reinforcement circuits, which would converge with the olfactory pathway and induce learning-associated plasticity. Dopaminergic neurons are thought to mediate aversive reinforcement in the bee brain because pharmacological blockade of dopamine receptors disrupts aversive learning [31]. Dopamine neurotransmission is also necessary for aversive learning in other insects (*Drosophila*, [44–45]; crickets, [46]). The bee brain contains a complex arrangement of dopamine-immunoreactive neurons [47–48]. Among them, three clusters contain processes that project to the mushroom body calyces and lobes (especially the α -lobe), and may thus provide aversive reinforcement information to the olfactory pathway [8]. Neuroanatomical and neurophysiological work (electrophysiology, optical imaging) will be needed to confirm these putative circuits.

Relationship between US Sensitivity and Aversive Learning Performance

Associative learning performance usually depends on an animal's sensitivity to both the CS and the US. In honeybees, previous work on appetitive conditioning has established the strong influence of sucrose (US) sensitivity on learning performances. Bees with a low response threshold, i.e. which are highly sensitive to sucrose, learn better than bees with a higher threshold, as they give a higher subjective value to the US [26–27]. Likewise, it was recently demonstrated that a high electric shock sensitivity leads to better aversive learning performances [30]. We confirm and extend this relationship. In the former demonstration [30], bees were divided into two groups depending on their sensitivity to the electric shock (low *vs* high) precluding a true correlative analysis. By dividing bees in 7 thermal responsiveness score groups, we show a clear linear correlation between thermal responsiveness and aversive learning scores, suggesting that the more sensitive a bee is to temperature, the better it can learn to associate an odor with this US. The potentially confounding effect of high spontaneous responses observed in SER conditioning was excluded, as the correlation remained when removing spontaneous responders (Fig. 4C) or when focusing on the response difference between CS+ and CS− (*differentiation score*, Fig. 4D).

Genetic Influence on Thermal Sensitivity and Aversive Learning

In our study, the relationship between aversive conditioning and US sensitivity was considered with a special emphasis on its genetic determinism. We show here that bees' genotype influences their thermal responsiveness and hence affects their aversive learning performances with a thermal US. Previous work had shown that different patriline react differently to a fixed-intensity aversive stimulus (electric shock; [49]). However, no study had evaluated the differential sensitivity of bees from different patrilines to a series of aversive stimuli of increasing intensity, nor had aversive learning performances been evaluated as a function of patriline origin. Although we do not know the influence of maternal genotype on aversive responsiveness and learning, the strong paternal effect we have found is coherent with previous crosses performed between European and Africanized honeybees which showed that drone-inherited genes more strongly determine defensive behavior at the colony level than the queen's genes

[50]. Concerning *appetitive* behavior, the genetic dependency of sucrose responsiveness is well known. For instance, two strains of bees selected for pollen hoarding (amount of pollen stored in the colonies) show a different sucrose responsiveness (PER), and accordingly different tactile and olfactory learning performances with a sucrose US [24,28]. In addition, it was recently shown that sucrose responsiveness is different among patrilines from the same hive [51]. In the same logic, we found a clear genotypic influence on thermal responsiveness. As aversive and appetitive learning are thought to correspond to two mostly independent modules of honeybees' behavior (foraging and defense respectively, [30]), an important question for future work will be to understand the relative dependency of genes involved in each learning form. At this stage, we know that sucrose responsiveness and electric shock responsiveness tested in the same bees are not correlated [30]. It will be important next to extend this finding to thermal sensitivity and to ask how the aversive and appetitive learning performances of bees from different patrilines are related.

Genetic differences in thermal sensitivity may arise at multiple levels. First, peripheral thermal receptors may be differentially expressed among patrilines. For instance, if we assume that the TRP channel HsTrpA previously identified in bees is responsible for thermal detection in our protocol, it could exist in different allelic forms in different patrilines or its expression may be differently regulated. Similarly, in the central nervous system, alleles or expression levels of crucial effectors for heat sensitivity may differ. A possible example would be bees' ortholog of the voltage-gated calcium channel subunit *straight-jacket* of *Drosophila* or *CACNA2D3* ($\alpha 2\delta 3$) of mice, which is implicated in heat pain sensitivity in both animals [52]. Additionally, dopamine is considered as the neurotransmitter conveying aversive reinforcement information in the insect brain [31,44–45,53]. Different patrilines may produce different levels of this neurotransmitter and/or may express its receptors (AmDop 1, 2 and 3) differentially. Lastly, genetic differences among patrilines may induce some epigenetic modifications known to be part of the task allocation process in a bee hive [54–55]. DNA methylation can influence some aspects of learning and memory processes in bees [56–57]. Enzymes responsible for DNA methylation may be more or less active in different patrilines. By altering chromatin structure or regulating transcriptional machinery, differentially methylated regions (DMRs) could potentially influence the expression of genes involved in aversive learning or thermal sensitivity.

Although thermal sensitivity strongly influenced aversive learning performances, it did not explain all the learning differences observed among patrilines. For instance, some patrilines showed similar thermal sensitivity but different learning performance levels (see Fig. 5A). In this case, genetic differences may appear due to differences in bees' sensitivity to the odor CS, for instance through differential expression of olfactory receptors (ORs) or through differential wiring at multiple levels within olfactory circuits. However, the observed heterogeneity among patrilines with equal thermal sensitivity may reveal 'real' differences in learning ability, which may relate to different alleles or expression levels of CS-US association enzymes, like adenylate cyclases (AC) or other molecular actors of acquisition or memory formation [58–59]. For this reason, it is important to compare the influence of genetics on these different aspects: sensitivity to the CS, sensitivity to the US, association machinery. The present study shows a strong influence of US sensitivity but suggests a non-negligible role of the other determinants.

General Outlook

How may genetic variability in learning and memory abilities influence colony fitness and survival? It has been proposed that a higher genetic variability (for instance, more numerous patriline) within a social insect colony may allow more flexibility and a higher capacity to cope with changes in environmental conditions, by providing different types of genetically-specialized individuals especially efficient for carrying out particular tasks (cleaning, nursing, foraging, defense, etc.) [10]. For instance, a higher number of patriline is beneficial for thermal regulation, as bees from different patriline engage in fanning activity at different deviations from the optimal temperature, thereby providing a gradual and more efficient response to outside temperature changes [13]. In a social insect colony, the different patriline are not equally involved in the different tasks [60–62] and workers performing different tasks show different associative learning abilities (appetitive modality: [63–64]; aversive modality: [30]). It will now be important to compare appetitive and aversive learning abilities in different patriline and to relate these differences with the tasks these individuals actually carry out in the hive. Such experiments shall help us understand to which extent task allocation is based on a genetic determinism of aversive or appetitive learning capacities.

Materials and Methods

Animals

Experiments were performed on honeybees (*Apis mellifera L.*) captured from outdoor hives located at the CNRS campus of Gif-sur-Yvette, between January and November 2011.

Experiment 1: Effect of Temperature on the Sting Extension Response

We first aimed to determine whether thermal stimulation of several structures on the bees' body could trigger a SER. Bees were taken from the hive in the morning and chilled on ice until they stopped moving. Then, they were harnessed into individual holders, similar to those usually used for PER conditioning [17,65]. The position of the honeybee in the holder was however different from that used in PER conditioning. The bee was placed with its back towards the front of the tube, with a piece of tape placed below the head to the front and at the thorax level (Fig. 1A). Thus, the abdomen could move freely and bees' SER could be observed throughout the experiment. Thermal stimulation was provided by means of a pointed copper cylinder (widest diameter: 6 mm; length: 13 mm), mounted onto the end of a minute soldering iron running at low voltage (HQ-Power, PS1503S). Temperature at the end of the cylinder was controlled, at the beginning and at the end of each experiment, using a contact thermometer (Votcraft, Dot-150). Thermal stimulations were applied during 1 s on six different areas of the bees' body: the antennae (both flagella simultaneously), the mouthparts (the different articles were stimulated simultaneously, indiscriminately; the proboscis was never extended), the front legs (one after the other, as they were fixated too widely apart for stimulating both simultaneously), the mid- and hind legs (simultaneously), the ventral abdomen (sternites of segments #3 to5), and the dorsal abdomen (tergites of segments 3 to 5).

To avoid any fatigue of the bees, only 4 structures were tested per bee. In one experiment, bees were stimulated on the antennae, the mouthparts, the ventral and the dorsal abdomen. In a second experiment, a new set of bees was stimulated on the antennae, the mouthparts (replications of the former), the front legs and the mid/hind legs. In this last experiment, the front legs were fixated with

thin tape strips on each side of the harnessing tube to facilitate stimulation with the copper probes.

We applied tactile controls on the same structures, to insure that sting extension was really a consequence of thermal stimulation. Tactile stimulations were performed with a duplicate copper probe which remained at ambient temperature. For each bee, the order of stimulation of the different structures, as well as whether each stimulation was performed with the heated or with the control probe, were determined randomly prior to starting the experiment. Stimulations were performed at 10 min intervals. In this experiment, two groups of 20 bees were tested each day.

Experiment 2: Honeybees' Sensitivity to Temperature

Honeybees were collected the day before the experiment, and were kept in a plexiglass box containing honey and water *ad libitum*. The day after, they were immobilized on ice and then placed in holders as described above (first harnessing position). Two groups of twelve honeybees were prepared each day. Once mounted, bees were placed in a moist and dark container for two hours to accommodate to the holders. Bees were then stimulated with a succession of six heated stimulations of increasing temperature (from ambient temperature ~25°C to 75°C), in steps of 10°C. Thermal stimulations alternated with tactile controls, provided as above with an identical unheated probe, with 10 min intervals between any two stimulations.

Experiment 3: Thermal Aversive Conditioning

Bees were collected from the hive entrance in the morning. They were chilled on ice and placed in individual holders. They were then fed with 3 µL sucrose solution (50% w/w) and were placed in a moist and dark container for two hours as above. A group of 16 bees was used every day. Then, bees were subjected to a differential aversive conditioning procedure, in which one odorant (the CS+) was associated with a thermal reinforcement (the US), while another odorant was presented without reinforcement (the CS-). The chosen odors were 2-octanone and nonanal (Sigma Aldrich, Deisenhofen, Germany). Five microliters of pure odorants were applied onto a 1 cm² piece of filter paper which was transferred into a 20 ml syringe (Terumo) allowing odorant delivery to the antennae.

Half of the honeybees received thermal reinforcement when 2-octanone (odor A) was presented and no reinforcement when nonanal (odor B) was presented, while the reversed contingency was used for the other half. Both groups were conditioned along 16 trials (8 reinforced and 8 non-reinforced) in which odorants were presented in a pseudo-random sequence (e.g. ABBABAAB) starting with odorant A or B in a balanced way. The inter-trial interval (ITI) was always 10 min. Each conditioning trial lasted 36 s. The bee was placed in the stimulation site in front of the air extractor, and left for 18 s before being exposed to the odorant paired with the US. Each odorant (CS+ or CS-) was delivered manually for 4 s. The thermal stimulus started 3 s after odorant onset and finished with the odorant (1 s temperature stimulation). The bee was then left in the setup for 14 s and was then removed. The temperature of 65°C was chosen for the US because this stimulation induced a high rate of SER in the previous experiments. In this experiment, thermal reinforcement was provided on the antennae, the mouthparts or the front legs, depending on the experimental group. One group of 16 bees was tested daily.

Experiment 4: Genotypic Influence on Thermal Responsiveness and Aversive Learning

Age-controlled honey bees (13–14 days old) were used in this experiment to avoid any impact of age on bees' behavior [24]. Every second day, a comb with enough capped brood was placed into an incubator (34°C) during one night. The day after, newly emerged bees were painted with a two-color code (Posca, France) and then placed back into the hive. Thirteen days later, the bees were taken from the hive and used in the behavioral experiments. At this age, honey bees usually start to perform tasks outside the hive such as guarding or foraging [66].

Thermal responsiveness and aversive learning. To compare heat responsiveness and aversive learning performances at the individual level, both experiments were performed on the same honeybees, one after the other [30]. On the first day, bees were subjected to the thermal responsiveness protocol (as above), and on the second day they followed an aversive learning procedure (as above, with 1-hexanol and 1-nonanol as odorants). The interval between the two experiments was 24 h. During this time, bees were kept in a dark wet box. As bees' performances in Experiment 3 were high when the thermal US was provided on the mouthparts, this option was chosen in the present experiment. After the behavioral study, bees were placed individually in numbered Eppendorf tubes filled with 90% ethanol for genotyping.

Determination of patriline origin. To characterize the patriline origin of each tested bee, we used a microsatellites locus analysis, using 14 well-characterized loci. DNA was extracted using the 10% Chelex method [67], adapted for squashed bee head tissues [68]. Microsatellites amplifications were performed using 3 different multiplexes, which allowed analyzing several loci simultaneously. Multiplex 1 was composed of loci B124, A88, A28, A24, Ap55 and A66. Multiplex 2 was composed of loci A113, A7, Ap43 and Ap81. Multiplex 3 analyzed loci Ap33, A43, A8, Ap36. PCR conditions followed previous studies [69–70]. DNA fragments were identified using an ABI 3130 Genetic Analyzer and the Genscan analysis software (version 3.7.1). Allelic sizes were labeled using Genemapper 4.1. Allele nomenclature was standardized using reference samples [71–73]. Once the multilocus genotype of each worker bee was determined, queen genotype was deduced, looking for homozygous genotypes for each locus in the worker data set (queen progeny). The multilocus genotype of the queen was verified, using the Colony 1.2 program [74]. The program analyzes haplo-diploid systems based on the expression of codominant genetic markers, such as DNA microsatellites. It calculates the probabilities of all possible queen genotypes, based on the observed allele frequencies in the population. Paternal alleles for each worker were then characterized after subtracting the queen's allele from each worker's genotype. Workers were considered as belonging to the same patriline when the same alleles were shared over all (14) analyzed loci.

Statistical Analysis

All recorded data were dichotomous, with a sting extension being recorded as 1 and a non-extension as 0. In the conditioning experiments with the thermal US on different body parts (Experiment 3), bees which did not respond three times to the US (out of 8 CS+ trials) were excluded from the analysis, as they were considered as not aversively motivated enough. They represented less than 15% of all conditioned bees. When comparing the responses of the same bees to the thermal or tactile stimulation of different structures (Experiment 1), Cochran's Q test was used, followed by pairwise comparisons using a Mc Nemar test. To analyze thermal sensitivity curves (Experiment 2

and 4) or differential conditioning curves (Experiment 3 and 4), we used repeated measure ANOVAs with stimulus (either thermal vs tactile, or CS+ vs CS−) and trial as factors. To evaluate individual sensitivity or learning curves, one-factor repeated measure ANOVAs were used. Monte Carlo studies have shown that it is permissible to use ANOVA on dichotomous data only under controlled conditions, which are met in these experiments (highly similar frequencies and at least 40 degrees of freedom of the error term [75]).

A correlative approach was chosen to analyze relationships between thermal responsiveness and aversive learning performances at the individual and at the patriline levels (Experiment 4). We calculated for each bee its *thermal responsiveness score* (from 0 to 6) by counting the number of times it responded to the thermal stimulus presented at increasing temperatures. Higher scores indicate bees that started to respond at lower temperatures, and are thus more sensitive to temperature. In the same manner, we calculated two learning performance scores. For the *aversive learning score*, we counted the number of times bees responded to the reinforced odorant (CS+). A higher score indicated a good learner, which quickly associated the CS+ with reinforcement. For the *differentiation score*, we subtracted the number of responses to the non-reinforced odorant (CS−) from the number of responses to the CS+. A high score indicated individuals that learned to respond to the reinforced odorant, but also quickly learned to not respond to a non-reinforced odorant. This score provides a more controlled measure of learning success, as it takes only into account specific responses to the learned odorant.

Since the patriline of each bee was known only weeks after the end of the behavioural experiments, it was not possible to plan in advance the numbers of individuals per patriline or the number of patrilines with enough individuals for analysis ($n > 10$). Due to the high number of patrilines eventually found in the experimental hive ($n = 22$) and in order to encompass the whole variability in honeybees' responsiveness and learning performances within the hive, no drastic selection of individuals based on their response scores was performed. Thus, during the thermal responsiveness procedure, bees that started to respond at one temperature (for instance 45°C) and then failed to respond to a higher temperature (for instance 55°C) were kept in the sample. Such a responsiveness score was lower than expected for bees with this temperature sensitivity. To ensure that this did not affect the results, all analyses were also performed by attributing each bee a score based only on the first temperature they responded to (a score of 6 for bees responding to the lowest temperature, a score of 1 for bees starting to respond at the highest temperature, etc.). This analysis provided exactly the same results as the one presented in the text, showing a significant correlation between thermal responsiveness and aversive learning ($\rho^2 = 0.93$, $p < 0.001$), a significant effect of patrilines on both values (ANOVA, $F_{9,138} = 4.37$, $p < 0.001$ et $F_{9,138} = 3.44$, $p < 0.001$) and a significant correlation between patrilines' responsiveness and aversive learning ($\rho^2 = 0.76$, $p < 0.01$).

Some bees showed a low thermal responsiveness score (0 or 1) and did not respond to the 65°C temperature on the first day. Previous work discarded such individuals directly on the ground that they do not respond to the US used on the next day for conditioning (Roussel et al. 2009). We chose to keep these individuals as they are part of the hive's variability, and subjected them to the conditioning phase, so that they received CS and US stimulations exactly like all other individuals. We found that during conditioning and the repeated US stimulations, these individuals responded to the US at some trials (76% responded more than 4 times to the US during the 8 CS+ trials, $n = 30$), but

they showed low learning performances nonetheless (see Fig. 4CD) as they perceive the US as a low intensity stimulus.

As usual in SER conditioning, a number of bees (~20–30%) responded already at the first trial to the CS+ (spontaneous responses). While the responses of these individuals cannot unambiguously be attributed to aversive learning, these bees often show that they learned specifically the CS+, as they stop responding to the CS– in the course of training. For this reason, the analyses of the two learning scores were performed twice, once with all individuals, and once taking only into account bees that did not respond at the first CS+ trial. As detailed in the results, both analyses gave the same outcome.

At the individual level, bees were grouped by heat responsiveness score and their average learning performance scores were calculated, thus allowing a clear representation of the relationship

between the two variables. Average scores \pm standard error of the mean (SEM) are shown in the figures. A Spearman correlation analysis was then performed on the averaged scores. At the patriline level, bees' thermal responsiveness and aversive learning scores were calculated per patriline and both scores were averaged for the correlation. One way ANOVA was also used to compare the variations of thermal responsiveness and aversive learning performance scores among patrilines. All data were analyzed with STATISTICA V5.5 (StatSoft, Tulsa, USA).

Author Contributions

Conceived and designed the experiments: PJ JC LG JCS. Performed the experiments: PJ. Analyzed the data: PJ JC SM LG JCS. Wrote the paper: PJ JCS.

References

- Benjamin PR, Staras K, Kemenes G (2000) A systems approach to the cellular analysis of associative learning in the pond snail *Lymnaea*. *Learn Mem* 7: 124–131.
- Paratore S, Alessi E, Coffa S, Torrissi A, Mastrobuono F, et al. (2006) Early genomics of learning and memory: a review. *Genes Brain Behav* 5: 209–221.
- Giurfa M (2006) Associative learning: the instructive function of biogenic amines. *Curr Biol* 16: R892–R895.
- Ardiel EL, Rankin CH (2010) An elegant mind: learning and memory in *Caenorhabditis elegans*. *Learn Mem* 17: 191–201.
- Norton W, Bally-Cuif L (2010) Adult zebrafish as a model organism for behavioural genetics. *BMC Neurosci* 11: 90.
- Sandoz JC (2011). Behavioral and neurophysiological study of olfactory perception and learning in honeybees. *Front Syst Neurosci* 5, 98: 1–20.
- Menzel R (1999) Memory dynamics in the honeybee. *J Comp Physiol A* 185: 323–340.
- Tedjakumala SR, Giurfa M (2013) Rules and mechanisms of punishment learning in honey bees: the aversive conditioning of the sting extension response. *J Exp Biol* 216 (16): 2985–2997.
- Estoup A, Solignac M, Cornuet JM (1994) Precise assessment of the number of patrilines and of genetic relatedness in honeybee colonies. *Proc R Soc Lond B Biol Sci* B258: 1–7.
- Jeanson R, Weidenmüller A (2014) Interindividual variability in social insects - proximate causes and ultimate consequences. *Biological Reviews*. doi:10.1111/brv.12074.
- Mattila HR, Seeley TD (2007) Genetic diversity in honeybees colonies enhances productivity and fitness. *Science* 317: 362–364.
- Robinson GE, Page RE (1989) Genetic basis for division of labor in an insect society. *The genetics of Social Evolution*. In: Breed M.D., Page, R.E., (Eds). Boulder, Colorado: Westview Press Inc. 61–80.
- Jones JC, Myerscough MR, Graham S, Oldroyd BP (2004) Honey bee nest thermoregulation: diversity promotes stability. *Science* 305: 402–404.
- Beshers SN, Fewell JH (2001) Models of division of labor in social insects. *Annu Rev Entomol* 46: 413–440.
- Eckholm BJ, Anderson KE, Weiss M, DeGrandi-Hoffman G (2011) Intracolony genetic diversity in honeybee (*Apis mellifera*) colonies increases pollen foraging efficiency. *Behav Ecol Sociobiol* 65: 1037–1044.
- Cox MD, Myerscough MR (2003) A flexible model of foraging by a honeybee colony: the effects of individual behaviour on foraging success. *J Theor Biol* 223(2): 179–197.
- Bitterman ME, Menzel R, Fietz A, Schäfer S (1983) Classical conditioning of proboscis extension in honeybees (*Apis mellifera*). *J Comp Psychol*, 97 (2): 107–119.
- Giurfa M, Sandoz JC (2012) Invertebrate learning and memory: Fifty years of olfactory conditioning of the proboscis extension response in honeybees. *Learn Mem* 19(2): 54–66.
- Brandes C (1991) Genetic-differences in learning-behavior in honeybees (*Apis mellifera-capensis*). *Behav Genet* 21(3): 271–294.
- Brandes C, Frisch B, Menzel R (1988) Time-course of memory formation differs in honey bee lines selected for good and poor learning. *Anim Behav* 36: 981–985.
- Brandes C, Sugawa M, Menzel R (1990) High-performance liquid chromatography (HPLC) measurement of catecholamines in single honeybee brains reveals caste-specific differences between worker bees and queens in *Apis mellifera*. *Comp Biochem Physiol C* 97(1): 53–57.
- Bhagavan S, Benatar S, Cobey S, Smith BH (1994) Effect of genotype but not of age or caste on olfactory learning performance in the honey bee, *Apis mellifera*. *Anim Behav* 48(6): 1357–1369.
- Laloi D, Pham-Delègue M (2010) Patriline-level variability in olfactory learning in the honey bee. *Apidologie* 41(4): 436–442.
- Scheiner R, Page RE, Erber J (2001) The effects of genotype, foraging role, and sucrose responsiveness on the tactile learning performance of honey bees (*Apis mellifera* L.). *Neurobiol Learn Mem* 76(2): 138–150.
- Page RE, Scheiner R, Erber J, Amdam GV (2006) The development and evolution of division of labor, and foraging specialization in a social insect (*Apis mellifera* L.). *Cur Top Dev Biol* 74: 253–286.
- Scheiner R, Erber J, Page RE (1999) Tactile learning and the individual evaluation of the reward in honey bees (*Apis mellifera* L.). *J Comp Physiol A* 185: 1–10.
- Scheiner R, Kuritz-Kaiser A, Menzel R, Erber J (2005) Sensory responsiveness and the effects of equal subjective rewards on tactile learning and memory of honeybees. *Learn Mem* 12: 626–635.
- Scheiner R, Page RE, Erber J (2001) Responsiveness to sucrose affects tactile and olfactory learning in preforaging honey bees of two genetic strains. *Behav Brain Res* 120: 67–73.
- Erber J, Hoorman J, Scheiner R (2006) Phototactic behaviour correlates with gustatory responsiveness in honey bees (*Apis mellifera* L.). *Behav Brain Res* 174: 174–180.
- Roussel E, Carcaud J, Sandoz JC, Giurfa M (2009) Reappraising social insect behavior through aversive responsiveness and learning. *PLoS ONE* 4(1): e4197.
- Vergoz V, Roussel E, Sandoz JC, Giurfa M (2007) Aversive learning in honeybees revealed by the olfactory conditioning of the Sting Extension Reflex. *PLoS ONE* 3: e288.
- Núñez J, Almeida L, Balderrama N, Giurfa M (1997) Alarm pheromone induces stress analgesia via an opioid system in the honeybee. *Physiol Behav* 63: 75–80.
- Tautz J, Maier S, Groh C, Rössler W, Brockmann A (2003) Behavioral performance in adult honey bees is influenced by the temperature experienced during their pupal development. *Proc Natl Acad Sci USA* 100: 7343–7347.
- Groh C, Tautz J, Rössler W (2004) Synaptic organization in the adult honey bee brain is influenced by brood-temperature control during pupal development. *Proc Natl Acad Sci USA* 101: 4268–4273.
- Kohno K, Sokabe T, Tominaga M, Kadowaki T (2010) Honey bee thermal/chemical sensor, AmHsTRPA, reveals neofunctionalization and loss of transient receptor potential channel genes. *J Neurosci* 30: 12219–12229.
- Yokohari F (1983) The coelocapitular sensillum, an antennal hygro- and the thermoreceptive sensillum of the honey bee, *Apis mellifera* L. *Cell Tissue Res* 233: 355–365.
- Lacher V (1964) Elektrophysiologische Untersuchungen an einzelnen Rezeptoren für Geruch, Kohlendioxid, Luftfeuchtigkeit und Temperatur auf den Antennen der Arbeitsbiene und der Drohne (*Apis mellifera* L.). *Z Vgl Physiol* 48(6): 587–623.
- Giurfa M (2007) Behavioural and neural analysis of associative learning in the honeybee: a taste from the magic well. *J Comp Physiol A* 193: 801–824.
- Nishino H, Nishikawa M, Mizunami M, Yokohari F (2009) Functional and topographic segregation of glomeruli revealed by local staining of antennal sensory neurons in the honeybee *Apis mellifera*. *J Comp Neurol* 515: 161–180.
- Ruchty M, Helmchen F, Wehner R, Kleineidam CJ (2010) Representation of thermal information in the antennal lobe of leaf-cutting ants. *Front Behav Neurosci* 4: 174.
- Newland PL, Burrows M (1997) Processing of tactile information in neuronal networks controlling leg movements of the locust. *J Insect Physiol* 43(2): 107–123.
- Gallio M, Ofstad TA, Macpherson LJ, Wang JW, Zuker CS (2010) The coding of temperature in the *Drosophila* brain. *Cell* 144: 614–624.
- Ugajin A, Kiya T, Kunieda T, Kubo T (2012) Detection of Neural Activity in the Brains of Japanese Honeybee Workers during the Formation of a “Hot Defensive Bee Ball”. *PLoS ONE* 7(3): e32902.
- Schwärzel M, Monastirioti M, Scolz H, Friggi-Grelin F, Birman S, et al. (2003) Dopamine and octopamine differentiate between aversive and appetitive olfactory memories in *Drosophila*. *J Neurosci* 23: 10495–10502.

45. Schroll C, Riemsperger T, Bucher D, Ehmer J, Voller T, et al. (2006) Light-induced activation of distinct modulatory neurons triggers appetitive or aversive learning in *Drosophila* larvae. *Curr Biol* 16: 1741–1747.
46. Unoki S, Matsumoto Y, Mizunami M (2005) Participation of octopaminergic reward system and dopaminergic punishment system in insect olfactory learning revealed by pharmacological study. *Eur J Neurosci* 22(6): 1409–1416.
47. Schäfer S, Rehder V (1989) Dopamine-like immunoreactivity in the brain and subesophageal ganglion of the honeybee. *J Comp Neurol* 280(1): 43–58.
48. Schürmann FW, Elekes K, Geffard M (1989) Dopamine-like immunoreactivity in the bee brain. *Cell Tissue Res* 256(2): 399–410.
49. Lenoir JC, Laloï D, Dechaume-Moncharmont FX, Solignac M, Pham MH (2006) Intra-colonial variation of the sting extension response in the honeybee *Apis mellifera*. *Insectes Soc* 53: 80–85.
50. Guzman-Novoa E, Hunt GJ, Page RE, Uribe-Rubio JL, Prieti-Merlos D, et al. (2005) Paternal effects on the defensive behavior of honeybees. *J Hered* 96(4): 376–380.
51. Scheiner R, Arnold G (2010) Effects of patriline on gustatory responsiveness and olfactory learning in honey bees. *Apidologie* 41(1): 29–37.
52. Neely GC, Hess A, Costigan M, Keene AC, Goulas S, et al. (2010) A genome-wide *Drosophila* screen for heat nociception identifies $\alpha 2\delta 3$ as an evolutionarily conserved pain gene. *Cell* 143: 628–638.
53. Mizunami M, Matsumoto Y (2010) Roles of aminergic neurons in formation and recall of associative memory in crickets. *Front Behav Neurosci* 4: 172.
54. Herb BR, Wolschin F, Hansen KD, Aryee MJ, Langmead B, et al. (2012) Reversible switching between epigenetic states in honeybee behavioral subcastes. *Nat Neurosci* 15: 1371–1373.
55. Furey TS, Sethupathy P (2013) Genetics. Genetics driving epigenetics. *Science* 342: 705–706.
56. Lockett GA, Helliwell P, Maleszka R (2010) Involvement of DNA methylation in memory processing in the honey bee. *Neuroreport* 21(12): 812–816.
57. Biergans SD, Jones JC, Treiber N, Galizia CG, Szyszka P (2012) DNA methylation mediates the discriminatory power of associative long-term memory in honeybees. *PLoS ONE* 7(6): e39349.
58. Müller U (2012) The molecular signalling processes underlying olfactory learning and memory formation in honeybees. *Apidologie* 43(3): 322–333.
59. Matsumoto Y, Sandoz JC, Devaud JM, Lormant F, Mizunami M, et al. (2014) Cyclic nucleotide-gated channels, calmodulin, adenylyl cyclase and calcium/calmodulin-dependent protein kinase II are required for late but not early long-term memory formation in the honey bee. *Learn Mem* (in press).
60. Frumhoff PC, Baker J (1988) A genetic component to division of labor within honey bee colonies. *Nature* 333(6171): 358–361.
61. Kryger P, Kryger U, Moritz RFA (2000) Genotypical variability for the tasks of water collecting and scenting in a honey bee colony. *Ethology* 106(9): 769–779.
62. Chapman NC, Oldroyd BP, Hughes WOH (2007) Differential responses of honeybee (*Apis mellifera*) patrilines to changes in stimuli for the generalist tasks of nursing and foraging. *Behav Ecol Sociobiol* 61(8): 1185–1194.
63. Scheiner R, Amdam GV (2009) Impaired tactile learning is related to social role in honeybees. *J Exp Biol* 212(7): 994–1002.
64. Perez M, Rolland U, Giurfa M, d'Ettorre P (2013) Sucrose responsiveness, learning success, and task specialization in ants. *Learn Mem* 20: 417–420.
65. Matsumoto Y, Menzel R, Sandoz JC, Giurfa M (2012) Revisiting olfactory classical conditioning of the proboscis extension response in honey bees: a step towards standardized procedures. *J Neurosci Meth* 211: 159–167.
66. Seeley TD (1982) Adaptive significance of the age polyethism schedule in honeybee colonies. *Behav Ecol Sociobiol* 11(4): 287–293.
67. Walsh PS, Metzger DA, Higuchi R (1991) Chelex 100 as a medium for simple extraction of DNA for PCR-based typing from forensic material. *Biotechniques* 10: 507.
68. Estoup A, Lagiadère CR, Perrot E, Chourrou D (1996) Rapid One-tube DNA extraction for reliable PCR detection of fish polymorphic markers and transgenes. *Mol Mar Biol Biotechnol* 5: 295–298.
69. Solignac M, Vautrin D, Loiseau A, Mougel F, Baudry E, et al. (2003) Five hundred and fifty microsatellite markers for the study of the honeybee (*Apis mellifera* L.) genome. *Mol Ecol Notes* 3(2): 307–311.
70. Miguel I, Iriando M, Garnery L, Sheppard WS, Estonba A (2007) Gene flow within the M evolutionary lineage of *Apis mellifera*: role of the Pyrenees, isolation by distance and post-glacial re-colonization routes in the western Europe. *Apidologie* 38: 141–155.
71. Estoup A, Garnery L, Solignac M, Cornuet JM (1995) Microsatellites variation in honey bee (*Apis mellifera* L.) populations: hierarchical genetic structure and test of the infinite allele and stepwise mutation models. *Genetics* 140: 679–695.
72. Franck P, Garnery L, Solignac M, Cornuet JM (1998) The origin of West European subspecies of honeybees (*Apis mellifera*), new insights from microsatellites and mitochondrial data. *Evolution* 52: 1119–1134.
73. Garnery L, Franck P, Baudry E, Vautrin D, Cornuet JM, et al. (1998) Genetic diversity of the west European honey bee (*Apis mellifera* and *A. m. iberica*). II. Microsatellite loci. *Genet Sel Evol* 30 (suppl.1).
74. Wang J (2004) Sibship reconstruction from genetic data with typing errors. *Genetics* 166: 1963–1979.
75. Lunney GH (1970) Using analysis of variance with a dichotomous dependent variable: An empirical study. *J Educat Meas* 7: 263–269.

Résumé

Dans un monde dynamique, les animaux sont confrontés en permanence à des changements de l'environnement susceptibles de les affecter (Alcock, 1997). Leur survie dépend de leur capacité à intégrer ces signaux afin d'adapter leur comportement à la survenue de conséquences positives (recherche de nourriture) ou négatives (éviter les dangers) c'est-à-dire de leurs capacités d'apprentissages associatifs appétitif et aversif. Au cours de ce travail de thèse, nous nous sommes intéressés aux bases comportementales, moléculaires et génétiques de l'apprentissage aversif et aux relations existant entre apprentissages aversif et appétitif au sein d'un groupe social. L'abeille est un insecte eusocial qui constitue un modèle de choix pour cette étude grâce à l'existence des protocoles de conditionnement appétitif de la réponse d'extension du proboscis (REP) et de conditionnement aversif de la réponse d'extension du dard (RED).

Jusqu'à présent, le renforcement utilisé dans le conditionnement aversif de la RED était un choc électrique. Ce stimulus n'étant pas naturel pour l'abeille, il est peu probable que des voies sensorielles dédiées à la détection de ce stimulus existent. En outre, le choc électrique traversant la majeure partie du corps de l'abeille, il est peu aisé d'étudier les structures responsables de sa détection. Dans un premier chapitre, nous avons donc testé l'effet d'une forte température (65°C), stimulus plus naturel et hautement aversif pour l'abeille, sur la RED. Nous montrons qu'une stimulation thermique au niveau des pièces buccales, des pattes ou des antennes induit une RED. De plus, les abeilles parviennent à associer une odeur à la présentation concomitante d'une forte température, de sorte qu'après apprentissage l'odeur seule déclenche la RED.

Dans un deuxième chapitre, nous avons cartographié la sensibilité thermique du corps des abeilles en mesurant la RED. Ce travail a montré qu'à part quelques exceptions (ailes, bout de l'abdomen), la stimulation de toutes les parties du corps induit une RED. De plus, ces stimulations peuvent jouer le rôle de renforcement aversif lors d'un conditionnement olfactif de la RED. Nous nous sommes ensuite intéressés aux récepteurs périphériques potentiellement impliqués dans la détection des fortes températures, et en particulier à HsTRPA (Hymenoptera specific Transient Receptor Potential A), déjà décrit chez l'abeille. Par une approche neuropharmacologique, nous montrons que l'injection d'inhibiteurs exogènes de HsTRPA réduit les RED à la température, mais n'affecte pas les REP au sucre. Ces résultats suggèrent l'implication possible d'HsTRPA dans la détection de la température chez l'abeille.

Dans un troisième chapitre, nous nous sommes intéressés aux relations existant entre les capacités d'apprentissages aversif et appétitif des abeilles. En nous appuyant sur le protocole aversif thermique, combiné au protocole de conditionnement de la REP existant, nous avons étudié la distribution des capacités hédoniques appétitive et aversive au sein d'une ruche. La reine étant fécondée par 15-20 mâles, la ruche est segmentée génétiquement en autant de lignées paternelles différentes. Nos données montrent que la sensibilité des individus aux renforcements aversif (chaleur) et appétitif (sucre) varie entre individus et détermine leurs performances d'apprentissage au sein de chaque modalité hédonique. Nous montrons de plus l'existence d'un *trade-off*, sous déterminisme génotypique, entre les capacités cognitives appétitive et aversive au sein de la colonie. Ainsi, plus un individu (et donc une lignée paternelle) est performant en apprentissage appétitif moins il le sera en apprentissage aversif, et *vice versa*.

Le quatrième chapitre a étudié la plasticité comportementale induite par les deux types de conditionnement. La REP et la RED sont des réponses de type "tout ou rien" ne permettant pas d'apprécier des variations fines de comportement. Nous nous sommes demandé si les mouvements antennaires des abeilles pouvaient procurer une mesure fine et intégrer des apprentissages appétitif et aversif. Nous avons développé un système de capture vidéo enregistrant les mouvements antennaires à haute vitesse (90 Hz). Nous montrons que les abeilles modifient leur réponse antennaire à une odeur après un apprentissage appétitif mais pas après un apprentissage aversif. Cette réponse antennaire spécifique du conditionnement appétitif pourrait jouer un rôle dans le comportement de butinage.

Durant ce travail de thèse, nous avons ainsi développé deux nouveaux protocoles comportementaux en contention, et avons procuré de nouvelles données sur l'apprentissage aversif chez l'abeille. Nous avons observé un *trade-off* au sein de la ruche entre les capacités hédoniques appétitive et aversive, sous déterminisme génétique. De telles spécialisations cognitives pourraient jouer un rôle prépondérant dans l'évolution des groupes sociaux.