



HAL
open science

Modelling of human reactive and deliberative behaviour using a multi-agent approach for energy management in home settings

Ayesha Kashif

► **To cite this version:**

Ayesha Kashif. Modelling of human reactive and deliberative behaviour using a multi-agent approach for energy management in home settings. Modeling and Simulation. Université de Grenoble, 2014. English. NNT : 2014GRENM030 . tel-01304290

HAL Id: tel-01304290

<https://theses.hal.science/tel-01304290>

Submitted on 19 Apr 2016

HAL is a multi-disciplinary open access archive for the deposit and dissemination of scientific research documents, whether they are published or not. The documents may come from teaching and research institutions in France or abroad, or from public or private research centers.

L'archive ouverte pluridisciplinaire **HAL**, est destinée au dépôt et à la diffusion de documents scientifiques de niveau recherche, publiés ou non, émanant des établissements d'enseignement et de recherche français ou étrangers, des laboratoires publics ou privés.

--	--	--	--	--	--	--	--	--	--

THÈSE

Pour obtenir le grade de

DOCTEUR DE L'UNIVERSITÉ DE GRENOBLE

Spécialité : **Mathématiques-Informatique**

Arrêté ministériel : 7 août 2006

Présentée par

Ayesha KASHIF

Thèse dirigée par **Stéphane PLOIX** et
codirigée par **Julie DUGDALE**

préparée au sein du **Laboratoire G-SCOP** (Laboratoire des Sciences
pour la Conception, l'Optimisation et la Production de Grenoble - UMR5272)
dans l'**École Doctorale MSTII** (Mathématiques, Sciences et Technologies de
l'Information, Informatique)

Modélisation du comportement humain réactif et délibératif avec une approche multi-agent pour la gestion énergétique dans le bâtiment

Thèse soutenue publiquement le **30 Jan, 2014**
devant le jury composé de :

Mr. Patrick REIGNIER

Professeur, Université de Grenoble, France, Président

Mr. Jean-Marc SALOTTI

Professeur, INP Bordeaux, France, Rapporteur

Mr. Darren ROBINSON

Professeur, Université de Nottingham, Royaume-Uni, Rapporteur

Mr. Yvon HARADJI

Chercheur Senior, EDF, France, Examineur

Mr. Benjamin HAAS

Chef de Projet, CSTB, France, Examineur

Mr. René MANDIAU

Professeur Université de Valenciennes, France, Examineur

Mr. Stéphane PLOIX

Professeur, Université de Grenoble - Alpes, France, Directeur de Thèse

Ms. Julie DUGDALE

MCF, Université de Grenoble - Alpes, France, Co-Directrice de Thèse



Preface

I completed my M2R degree (Computer Science) at the ENSIMAG (Ecole Nationale Supérieure d'Informatique et de Mathématique Appliquées de Grenoble) in 2010 and did my research internship at the Laboratoire G-SCOP (Sciences pour la Conception l'Optimisation et la Production) with Professor Stéphane Ploix, from G-SCOP, and Associate Professor Julie Dugdale, from LIG (Laboratoire d'Informatique de Grenoble). I was very fortunate that my internship supervisors offered me a PhD position at Laboratoire G-SCOP in the SUPERBAT project. It exactly matched my objectives to do problem oriented academic research. I started my PhD with the registration at MSTII doctoral school in October, 2010. Three years later, at the end of my PhD it is a good opportunity to look back and reflect on these three years. This PhD has changed my life and gave me an opportunity to dive into an exciting and challenging domain of inhabitants' behaviour modelling and energy management. It is a wonderful experience, where I participated and presented my research articles, that gave me a chance to visit different cities in France and different countries including Italy and the USA.

I would like to express my words of gratitude for my academic supervisors Stephane Ploix and Julie Dugdale for their guidance in developing the present work and also for being so supportive, encouraging, and understanding in good and bad times. My special thanks go to my colleagues at G-SCOP with whom I participated in different case studies and important discussions that helped me in understanding the complex domain of energy management.

This is not the end but the beginning and there is a long way to go...

Acknowledgements

I start *in the name of Almighty God, the most Gracious, the most Merciful*, for providing me with good health and mental state to carry on this research.

I would like to express my deepest and sincerest gratitude and appreciation to my supervisors, Professor Stéphane Ploix and Associate Professor Julie Dugdale for providing me with the opportunity to start my thesis with them. This period of my PhD was a wonderful journey with such knowledgeable, competent, enthusiastic and motivating supervisors. Beyond appreciating their expertise and strong grip on their domain, i also want to express special thanks for being so understanding and supportive all the time. I found them always there for me whenever i asked them and provided me with full support, ideas and suggestions for improvements in the work. I would also like to mention that because they are such perfectionists, it helped me always to improve the quality of work. Besides, their guidance and support in the practical work, they have also rigorously analysed and read all the research papers and this manuscript to be easily understandable and highly useful for others. This lead to multiple re-readings by them and improvements in the documents, not only regarding the structure but also the sentences, phrases and grammar etc. They always encouraged me to participate in the relevant international conferences, schools and courses that improved my knowledge, skills and expertise in my domain and over certain tools. Without their continuous support, guidance and help i would never be able to achieve this reward of completing my PhD. Finally, i feel myself obliged not to forget the most kind, soft and humble part of their personalities, which provided me with an opportunity to learn good manners in life.

I am grateful to the members of jury, who take some time out of their busy schedules and came to my thesis defence. The jury members, Professor Darren Robinson from Univ. of Nottingham, UK, Professor Jean-Marc Salotti from INP, Bordeaux, Professor Patrick Reignier from University of Grenoble, Professor Rene Mandiau from Univ. of Valenciennes, Senior researcher, Yvon Haradji from EDF, France and Project manager Benjamin Haas from CSTB, France, rigorously read the manuscript and provided with their valuable comments and suggestions.

I am also thankful to my research lab G-SCOP, where i got a nice, comfortable and productive environment and all the necessary equipment and tools to carry on my research without any problems. I spend a very good time with my colleagues and participated in healthy discussions with them. I would also like to thank Le Xoa Hoa Binh, the ancient researcher of our team for his support when i started my PhD and even afterwards during our joint work with Vesta Systems, where he is currently employed.

This research work is part of the SUPERBAT project, funded by ANR (French National Research Agency) and EDF (French Electricity Company), so i am greatly thankful to them as this research was made possible with their investment.

My special thank goes to my family for their unconditional love and moral support throughout the completion of this research work and their kind wishes and prays for me. Many thanks to my husband and colleague Kashif for always being there for me.

I end with the pray to Almighty God to enable me to use the knowledge, that i have gained during this research work, in the great interest and betterment of society and humanity.

Modelling of human reactive and deliberative behaviour using a multi-agent approach for energy management in home settings

Ayesha Kashif

University of Grenoble Alpes, 2014

Supervisor: **Professor Stéphane PLOIX**

Co-supervisor: **Associate Professor Julie DUGDALE**

Abstract: Energy consumption in buildings is affected by various factors including its physical characteristics, the appliances inside, and the outdoor environment, etc. However, inhabitants' behaviour that determines the global energy consumption must not be forgotten. In most of the previous works and simulation tools, human behaviour is modelled as occupancy profiles. In this thesis the focus is more on detailed behaviour representation, particularly the cognitive, reactive, and deliberative mechanisms. The inhabitants' dynamic behaviour is modelled and co-simulated together with the physical aspects of a building and an energy management system. The analysis of different household appliances has revealed that energy consumption patterns are highly associated with inhabitants' behaviours. Data analysis of inhabitants' actions and appliances' consumptions is used to derive a model of inhabitants' behaviour that impacts the energy consumption. This model represents the cognitive mechanisms that provide causes that motivate the actions, including the communication with other inhabitants. An approach based on multi-agent systems is developed along with a methodology for parameter tuning in the proposed behaviour model. These tools are used to co-simulate, not only the physical characteristics of the building, the reactive behaviour that is sensitive to physical data, and deliberative behaviour of the inhabitants, but also the building energy management system. The energy management system allows the direct adjustment of the building parameters or simply giving advice to the inhabitants. The impact of different types of inhabitants' behaviours, with and without the inclusion of an energy management system is analyzed. This work opens new perspectives not only in the building simulation and in the validation of energy management systems but also in the representation of buildings in the smart grid where signals can be sent to end users advising them to modulate their consumption.

Keywords: Human behaviour modelling, agent based modelling and simulation, energy management, cognitive systems

Modélisation du comportement humain réactif et délibératif avec une approche multi-agent pour la gestion énergétique dans le bâtiment

Ayesha Kashif

Université de Grenoble Alpes, 2014

Directeur de thèse : **Stéphane PLOIX**

Co-directeur de thèse : **Julie DUGDALE**

Résumé : La consommation énergétique dans le secteur bâtiment dépend de diverses facteurs parmi lesquels ses caractéristiques physique, ses équipements, l'environnement extérieur, etc... mais il ne faut pas oublier le comportement des habitants qui est déterminant pour la consommation énergétique globale. Or, la plupart des travaux et outils représentent les occupants par des profils d'occupation. Cette thèse s'intéresse à la représentation plus détaillée du comportement des occupants, en particulier les mécanismes cognitifs, réactifs et délibératifs. Le comportement dynamique des occupants est modélisé et co-simulé avec les aspects physiques et des éventuels systèmes de gestion énergétique. L'analyse de la consommation de différents équipements électroménagers met en évidence que le consommation énergétique est très dépendante des comportements des occupants. L'analyse des consommations et des actions des habitants permet d'élaborer un modèle du comportement des occupants impactant la consommation énergétique. Le modèle représente des mécanismes cognitifs, qui représente les causes qui motivent les actions, incluant des échange avec d'autres acteurs humains. Une approche à base d'agents logiciels a été développée. Outre les aspects techniques, une méthodologie de réglage des paramètres des modèles de comportement est proposée. Ces outils sont utilisés pour réaliser une co-simulation représentant la physique du bâtiment, le comportement réactif, c'est-à-dire sensible aux données physiques, et délibératif des habitants mais aussi un système de gestion énergétique qui peut ajuster directement la configuration du logement ou simplement conseiller ces occupants. L'impact de différents types de comportements, avec et sans gestionnaire énergétique est analysé. Ces travaux ouvrent de nouvelles perspectives dans la simulation bâtiment, dans la validation de gestionnaires énergétiques mais aussi dans la représentation des bâtiments dans les réseaux d'énergie dits intelligents, dans lesquels des signaux peuvent être envoyés aux utilisateurs finaux pour les inviter à moduler leur consommation.

Mots-clés: simulation bâtiment, modélisation du comportement humain, modélisation et simulation multi-agent, gestion énergétique, systèmes cognitifs.

Table of Contents

List of Tables.....	15
List of Figures	17
List of Acronyms.....	23
CHAPTER 1: INTRODUCTION.....	25
1.1 Energy Control and Management Problem.....	27
1.2 Existing Solutions and Role of Inhabitants' Behaviour	28
1.3 Behaviour Modelling Challenges and Limitations.....	30
1.4 Context and Research Questions.....	32
1.5 Research Methodology.....	33
1.6 Thesis Organization.....	34
CHAPTER 2: LITERATURE REVIEW	37
2.1 Energy Consumption and Occupants' Behaviour: Role and Background	39
2.1.1 Why consider Occupant's Behaviour in Buildings' Energy Management	39
2.1.2 Influence of Behaviour on Energy Consumption: Surveys and Studies	40
2.1.3 Approaches for including Behaviour in Energy Management and Control.....	41
2.1.3.1 Diversity, Occupancy Profiles and Schedules.....	42
2.1.3.2 Energy Simulations and Occupants' Behaviour.....	42
2.2 Household Context and Behaviour Representation.....	44
2.2.1 Human Behaviour Representation (HBR) Models.....	45
2.2.2 Behaviour Modelling with current Energy Simulation Tools	51
2.3 Motivation and Need for Agent Based Modelling and Simulation.....	53
2.3.1 Multi-Agent System based Approaches for Energy Simulations.....	53
2.3.2 Agent Based Modelling and Complexity	54
2.3.3 Structure of Agent Based Models	54
2.3.4 BDI Architecture for Behaviour Modelling	55
2.4 Summary and Conclusions.....	55
CHAPTER 3: DATA COLLECTION AND ANALYSIS	59
3.1 Introduction	61
3.2 Irise Dataset: Structure and Contents	62
3.3 Domestic Appliances: Categories and Impact of Usages.....	63
3.3.1 Low Power Low Energy.....	64
3.3.2 High Power Low Energy.....	66
3.3.3 Low Power High Energy.....	68
3.3.4 High Power High Energy	69

3.4	High Energy Consuming Appliances	70
3.4.1	Impact of Human Behaviour on Heating, Cooling and Window Opening.....	70
3.4.2	High Energy consuming Appliances' Consumption and Inhabitants' Behaviour.....	70
3.4.3	Other Categories of Appliances' Consumption and Inhabitants' Behaviour	72
3.5	Identification of Parameters that affect Energy Consumption	73
3.5.1	The Impact of Environmental Parameters on Consumption (level 1)	74
3.5.2	The Impact of Human Actions on Appliance Consumption (level 2).....	79
3.5.2.1	Complementing the Irise Dataset.....	79
3.5.2.2	Experimental Data Collection and Analysis	80
3.5.3	Relation between Appliance Usages (level 3)	83
3.5.4	Reason behind Actions (level 4).....	83
3.6	Summary and Conclusions	84
CHAPTER 4: INHABITANTS' BEHAVIOUR MODEL		87
4.1	Introduction.....	89
4.2	Inhabitants' Behaviour Representation Modelling.....	89
4.2.1	How Results of Data Analyses are used in the Behaviour Model.....	89
4.2.2	Causal Behaviour Representation	94
4.3	Behaviour and Energy Consumption: A Conceptual Framework	97
4.3.1	H-BDI Agent Based Behaviour Representation Model.....	98
4.4	Summary and Conclusions	105
CHAPTER 5: MODEL IMPLEMENTATION AND CO-SIMULATION		107
5.1	Introduction.....	109
5.2	Brahms as Behaviour Modelling and Simulation Environment.....	109
5.2.1	Brahms Language Constructs	110
5.2.1.1	Agents and Groups (agent-based).....	110
5.2.1.2	Objects	110
5.2.1.3	Activities (subsumption).....	110
5.2.1.4	Attribute, Relations, Facts and Beliefs (mental-state/world-state)	111
5.2.1.5	Workframes (rule-based)	112
5.2.1.6	Detectable (reactive)	113
5.2.1.7	Consequences:.....	113
5.2.1.8	Thoughtframes (inferences)	114
5.2.1.9	Communication.....	114
5.2.1.10	Multi-tasking Agents (rule-based/subsumption)	114
5.2.1.11	Area-definitions, Area, Paths (geo-based).....	114
5.2.2	Brahms Simulation Components	115

5.2.2.1 Agent Model	115
5.2.2.2 Object Model	116
5.2.2.3 Geography Model	117
5.2.2.4 Knowledge Model	118
5.2.2.5 Activity Model	119
5.2.2.6 Communication Model	119
5.2.2.7 Timing Model	121
5.2.3 H-BDI Agent based Behaviour Model Simulation Results	122
5.2.3.1 Scenario Description	122
5.2.3.2 Implementation and Simulation Results	122
5.3 Multi-Simulator Environment	128
5.3.1 Coupling Thermal and User Behaviour Simulators	128
5.3.1.1 Connection between Simulators	128
5.3.1.2 Application Example	131
5.3.2 Coupling the Appliance's Physical Model and the User Behaviour Simulators	134
5.3.2.1 Implementation into Brahms	135
5.4 Summary and Conclusions	137
CHAPTER 6: VALIDATING REPRESENTATIVE BEHAVIOUR MODELS.....	139
6.1 Introduction	141
6.2 4-Step Validation Methodology for Behaviour Model	141
6.2.1 Appliance's Physical Behaviour Modelling (Step-1)	142
6.2.2 Inhabitants' Behaviour Modelling (Step-2)	142
6.2.2.1 Irise Database Preprocessing	143
6.2.2.2 Fridge Freezer On-Cycle Durations Computation	143
6.2.2.3 Impact of Seasons, Day type and Cooking Activity	144
6.3 How the Impact of Cooking Activity on Fridge On-Cycles is Computed	145
6.4 Clustering the Houses with Similar Behaviours	150
6.4.1 Identifying Representative Behaviours	151
6.5 Inhabitants' Behaviour and Appliance Co-Simulation	154
6.5.1 Brahms Simulation with Tuning Parameters (Step-3)	155
6.6 Comparison of Benchmarked and Simulated Distributions (Step-4)	156
6.7 Summary and Conclusions	160
CHAPTER 7: CO-SIMULATION WITH BUILDING ENERGY MANAGEMENT SYSTEM.....	163
7.1 Introduction	165
7.2 Co-Simulation Elements	165
7.2.1 Mozart Building and its Thermal Model	167

7.2.2 Building Energy Management System	168
7.2.3 Inhabitants' Behaviour Simulation	168
7.2.3.1 Fanger's Thermal Comfort Model and Inhabitants' Behaviour	168
7.3 Co-Simulation Environment	172
7.3.1 Co-Simulation with and without BEMS	173
7.3.2 Eco vs Non-Eco Behaviours	175
7.3.3 Eco Agent Controls the Environment without BEMS	178
7.3.4 Eco Agent Controls the Environment with BEMS	184
7.3.5 Non-Eco Agent Controls the Environment without BEMS	189
7.3.6 Non-Eco Agent Controls the Environment with BEMS	190
7.3.7 Eco vs Non-Eco Behaviours with and without BEMS	192
7.4 Summary and Conclusions	194
CHAPTER 8: CONCLUSIONS AND PERSPECTIVES	197
References	203
Appendix A: List of Publications	213

List of Tables

Table 2.1 Comparison of HBR models for mapping to 5W1H and social behaviour	49
Table 2.2 Comparison of agent based modelling and simulation platforms for social behaviour simulation	50
Table 3.1 Selection criteria for different categories of appliances	64
Table 6.1 Iterations for on-cycle duration computation	149
Table 6.2 Similarities in clusters	153
Table 7.1 Colours to represent agents' comfort/discomfort levels.....	178

List of Figures

Figure 1.1(a) Global energy mix	27
Figure 1.1(b) Oil discovery, consumption and International Energy Agency's (IEA) forecast	27
Figure 1.2 GHG emissions 2003-2050	28
Figure 1.3 User behaviour influenced by temperature rise	29
Figure 1.4(a) Energy consuming activities: 2 person houses	30
Figure 1.4(b) Energy consuming activities: 5 person houses.....	30
Figure 1.5 Occupation in a house	31
Figure 1.6 Co-simulating occupants' behaviour with the physical aspects of buildings	32
Figure 1.7 Research schematic and contributions at glance	34
Figure 2.1 5W1H approach to map user behaviour in home context.....	44
Figure 2.2 Generic human behaviour representation	45
Figure 2.3 Typical agent structure [Macal and North, 2010]	55
Figure 3.1 Structure and contents of Irise dataset	62
Figure 3.2 Entity Relation Diagram (ERD) of Irise database	63
Figure 3.3 Irise database after preprocessing	63
Figure 3.4(a) Power consumption of different appliances in Irise database	65
Figure 3.4(b) Energy consumption of different appliances in Irise database.....	65
Figure 3.5 Histograms for low power and low energy consuming appliances	66
Figure 3.6 Histograms for high power and low energy consuming appliances	67
Figure 3.7 Histograms for low power and high energy consuming appliances	68
Figure 3.8 Histograms for high power and high energy consuming appliances	69
Figure 3.9 Residential energy consumption breakdown in Europe.....	69
Figure 3.10 Fridge freezer consumption patterns from the Irise dataset.....	71
Figure 3.11 Water heater yearly energy consumption for all houses in the Irise dataset.....	71
Figure 3.12 Dishwasher yearly energy consumption for all houses in Irise dataset	72
Figure 3.13 Washing machine yearly energy consumption for all houses in Irise dataset	73
Figure 3.14 Microwave oven yearly energy consumption for all houses in Irise dataset	73
Figure 3.15 Parameters considered as important for the model	74
Figure 3.16 Comparison of the fridge freezer consumption for different houses from the Irise dataset.....	75
Figure 3.17 Comparison of the dishwasher for all the houses from the Irise dataset.....	75
Figure 3.18 Consumption of the TV for all the houses from the Irise dataset	76
Figure 3.19 Consumption of the Water heater for all the houses from the Irise dataset	76
Figure 3.20 Consumption of electric cooker averaged over weekdays and weekends	77
Figure 3.21 Consumption of the washing machine averaged over weekdays and weekends	77

Figure 3.22 Cooker consumption during different weather conditions for a house in the Irise database.....	78
Figure 3.23 Total-Lighting consumption during different weather conditions	78
Figure 3.24 The scope of the Irise dataset	79
Figure 3.25 Power consumption pattern of a television	80
Figure 3.26(a) Questionnaire for collecting context and information of inhabitant behaviour.....	80
Figure 3.26(b) Experiments on the fridge freezer and data collection	81
Figure 3.27 Experimental data analysis results	82
Figure 3.28 Effect of cooking activities on the fridge freezer consumption cycles	83
Figure 3.29 What are the reasons behind longer compressor cycles?	84
Figure 3.30 Can the reasons behind actions help to identify the unknown situations?	84
Figure 4.2 Important elements extracted from data to model human behaviour	91
Figure 4.1 Important elements to model human behaviour	92
Figure 4.3(a) Behaviour representation	92
Figure 4.3(b) Social behaviour	93
Figure 4.3(c) Other perceptive elements.....	94
Figure 4.4 Need based causal behaviour.....	94
Figure 4.5 Categorization of needs, actions and events.....	96
Figure 4.6 Causal model of inhabitant behaviour to satisfy a need	96
Figure 4.7 Evolved Causal model of inhabitant behaviour	96
Figure 4.8 Complete causal model of inhabitants' behaviour at home	97
Figure 4.9 Conceptual framework for behaviour simulation.....	98
Figure 4.10 H-BDI dynamic behaviour representation model	99
Figure 4.11 Class diagram for H-BDI model	100
Figure 4.12 Conversion of environmental states to agents' beliefs	101
Figure 4.13 Process for beliefs generation.....	102
Figure 4.14 Process for desire generation.....	103
Figure 4.15 Environmental and social constraints.....	104
Figure 4.16 Intention generation process.....	104
Figure 4.17 Actions on external environment	105
Figure 5.1 Anatomy of a Brahms model: language concepts	110
Figure 5.2 Relation between constructs	112
Figure 5.3 Workframe-Activity hierarchy	112
Figure 5.4 Activity subsumption and multi tasking.....	114
Figure 5.5 Mapping of user behaviour elements onto Brahms.....	115
Figure 5.6 Agent model in Brahms.....	116
Figure 5.7 Object model in Brahms.....	116

Figure 5.8 Geography model in Brahms	117
Figure 5.9 Move activity to change geographic location	117
Figure 5.10 Knowledge model in Brahms	118
Figure 5.11 Activity model in Brahms	119
Figure 5.12 Communication between agents	120
Figure 5.13 Communication between an agent and an object.....	120
Figure 5.14 Workframe broadcasting the timing signals	121
Figure 5.15 Thoughtframe for perceiving time	121
Figure 5.16 Perception of time by an agent to change geographic location.....	122
Figure 5.17 Perception of internal and external environment, and desire generation process	123
Figure 5.18 Social constraints generation process	124
Figure 5.19 Intention generation process	125
Figure 5.20 Plans and actions generation process	126
Figure 5.21 Communication and group reactive/deliberative behaviour	127
Figure 5.22 Interoperability between different modules in a co-simulation environment	128
Figure 5.23 Interaction between the components of the co-simulator	130
Figure 5.24 Combined architecture of Brahms and the thermal simulator	131
Figure 5.25 Movements of inhabitants in different locations in the house	132
Figure 5.26 Communication between inhabitants	133
Figure 5.27 Window's status is not changed, Inhabitant has turned on the air conditioner	133
Figure 5.28 Living room's temperature and setpoint for air conditioner.....	134
Figure 5.29 Living room's temperature and setpoint for heater	134
Figure 5.30 Co-simulation platform for Brahms and physical simulators	135
Figure 5.31 Simulation results against simulated inhabitants' behaviour.....	136
Figure 5.32 Simulated inhabitants' behaviours affecting fridge temperature and compressor cycles.....	137
Figure 6.1 4-Step methodology to validate behaviour model	141
Figure 6.2 Fridge on-cycle durations.....	143
Figure 6.3 Flowchart to compute fridge cycle durations.....	144
Figure 6.4 Selection of houses from Irise database for clustering	145
Figure 6.5 Different trends identified in on-cycle durations	146
Figure 6.7 Impact of cooking activities on fridge cycle durations	150
Figure 6.8 Data preprocessing for clustering	150
Figure 6.9 Fridge consumption during cooking and non cooking activity.....	151
Figure 6.10 Clusters of houses with similar energy consumption behaviour.....	153
Figure 6.11 Brahms scenario simulation results.....	155
Figure 6.12 How to get fridge cycle durations from simulations.....	156

Figure 6.13 Fridge cycles distribution from Irise database.....	157
Figure 6.14 Optimized tuning parameters, simulated consumption patterns and comparison between actual and simulated fitted curves	158
Figure 6.15 Comparison with another member of the same cluster	160
Figure 7.1 Co-Simulation between inhabitant’s behaviour, SIMBAD and BEMS	166
Figure 7.2 MOZART house plan.....	167
Figure 7.3 SIMBAD-MOZART thermal model.....	167
Figure 7.4 PMV and PPD	169
Figure 7.5 Fanger’s model in co-simulation.....	170
Figure 7.6 Clothing index computation module.....	171
Figure 7.7 Metabolic rate assignment module.....	171
Figure 7.8 Temperature receiver module.....	172
Figure 7.9 Thermal comfort (PMV) computation module	172
Figure 7.10 Co-simulation environment.....	173
Figure 7.11 Activity diagram: inhabitants’ behaviour scenario.....	175
Figure 7.12 Brahms simulation: agents’ movements, activities and perception of environment...	176
Figure 7.13 A situation modelled in Brahms	177
Figure 7.14 Brahms simulation: choice of clothes	179
Figure 7.15 Brahms simulation: perception of comfort during watching TV activity	180
Figure 7.16 State of the appliance/object, temperature, and PMV perceived while watching TV.	181
Figure 7.17 Brahms simulation: perception of comfort while talking.....	182
Figure 7.18 State of the appliance/object, temperature, and PMV perceived during talking activity	182
Figure 7.19 Brahms simulation: perception of comfort while cleaning	183
Figure 7.20 State of the appliance/object, temperature, and PMV perceived while cleaning activity	184
Figure 7.21 How energy management system controls the environment.....	185
Figure 7.22 Perception of thermal comfort and behaviour during communication with BEMS....	186
Figure 7.23 State of the appliance/object, temperature, and PMV perceived during simulation with BEMS: case 1	187
Figure 7.24 Brahms simulation: inhabitant’s behaviour and BEMS’s control over environment .	188
Figure 7.25 State of the appliance/object, temperature, and PMV perceived during simulation with BEMS: case 2	189
Figure 7.26 Brahms simulation: watching TV and control by the NonEcoWife of the environment	190
Figure 7.27 State of the appliance/object, temperature, and PMV perceived while NonEcoWife controls the environment without BEMS	190
Figure 7.28 Brahms simulation: NonEcoWife and BEMS controls the environment.....	191

Figure 7.29 State of the appliance/object, temperature, and PMV perceived while NonEcoWife controls the environment with BEMS	192
Figure 7.30 Comfort of agents: with and without the control of BEMS	193
Figure 7.31 Energy consumed during control over environment by different agents with/without BEMS	193
Figure 7.32 PMV perceived by agents while NonEcoWife and BEMS control the environment ..	194

List of Acronyms

ABMS	Agent Based Modelling Systems
ASHRAE	American Society Heating Refrigerating and Air Conditioning Engineers
BRAHMS	Business Redesign Agent Based Holistic Modeling System
BEMS	Building Energy Management System
BDI	Belief Desire Intent
CSV	Comma Separated Files
EU	European Union
EPBD	Energy Performance of Buildings Directive
ERD	Entity Relation Diagram
EDF	Electricité De France
EuroACE	European Alliance of Companies for Energy efficiency in buildings
GHG	Green House Gasses
HBR	Human Behaviour Representation
HVAC	Heating, Ventilation and Air Conditioning
MAS	Multi Agent System
MSE	Mean Squared Error
MPE	Mean Percentage Error
OOP	Object Oriented Programming
PMV	Predicted Mean Vote
REMODECE	Residential Monitoring to Decrease Energy Use and Carbon Emissions in Europe
SCR	Social Corporate Responsibility
TUS	Time Use Survey

CHAPTER 1: INTRODUCTION

The objective of this chapter is to introduce the problem background, research questions and methodology. In the start, an introduction to energy control and management problem is presented that highlights energy efficiency as a key towards addressing the growing energy demand and respective environmental issues. Existing solutions to address these challenges are briefly discussed along with the extent to which inhabitants' behaviour is currently taken into account. The current challenges and limitations in inhabitants' behaviour modelling are further elaborated. Based on this discussion, 3 research questions are formulated followed by a graphical presentation of the research methodology and thesis organization.

CONTENTS

1.1	Energy Control and Management Problem	27
1.2	Existing Solutions and Role of Inhabitants' Behaviour	28
1.3	Behaviour Modelling Challenges and Limitations.....	30
1.4	Context and Research Questions	32
1.5	Research Methodology	33
1.6	Thesis Organization.....	34

1.1 Energy Control and Management Problem

The energy sources depletion and Green House Gasses (GHG) emissions are the established causes for energy and climate crises resulting in global warming, the most defining challenge of our time. Industry, transport and buildings constitute almost 100% of the energy demand. However, a major portion of this energy is needlessly wasted [Van, 2009]. At present 50% (~3.6 billion) of the world’s population is living in urban areas and by the year 2050, 70% (~6.3 billion) will live in urban areas [World Urbanization Prospects, 2011]. Affordable and sustainable housing and increased energy demand for this huge shift is forecasted; hence, associated energy loss from buildings has emerged as a significant concern. The major sources to fulfil these growing energy needs are oil (~34%), coal (~30%) and gas (~24%) whereas sources having minimum impact on the environment are renewable (~1.9%), hydro (~7%) and nuclear (~4.5%) (Figure 1.1(a)) [BP, 2013]. If energy source depletion continued against increasing demand then by the year 2030, our world shall encounter severe energy crises as shown in figure 1.1(b) [ASPO, 2009; Kuehn, 2008].

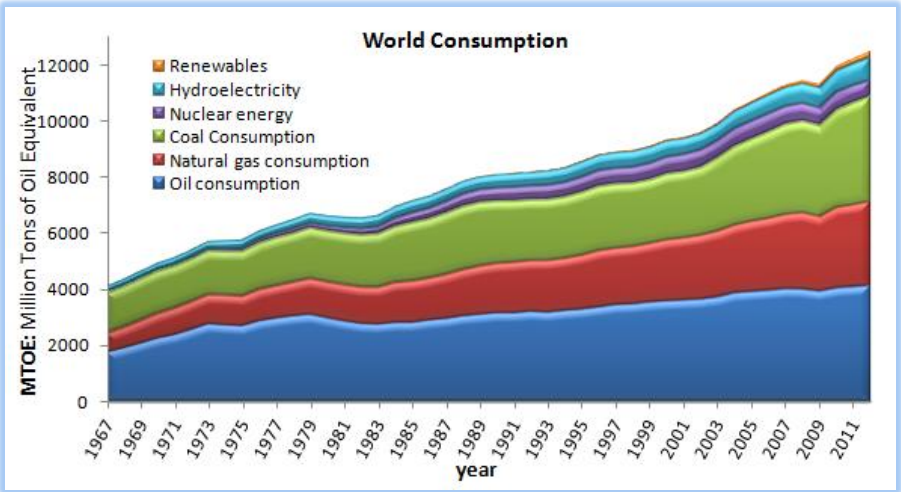

Figure 1.1(a) Global energy mix

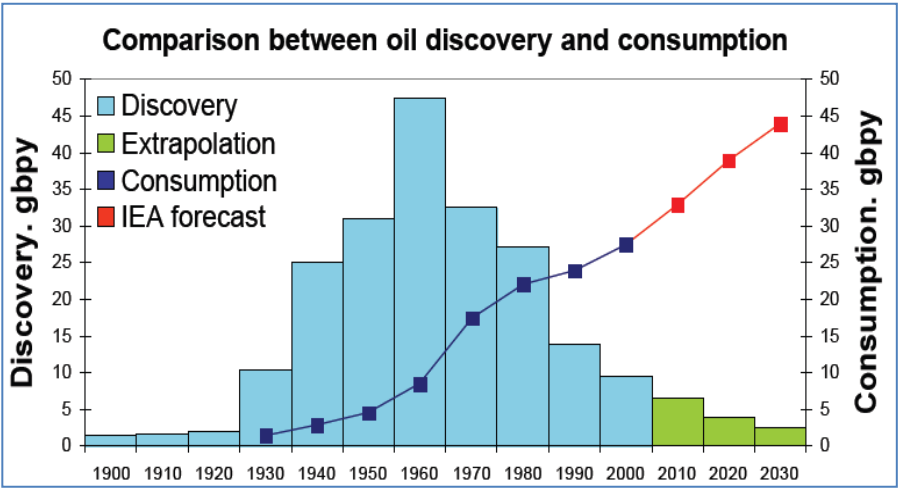

Figure 1.1(b) Oil discovery, consumption and International Energy Agency’s (IEA) forecast

Energy from oil, gas and coal directly contribute to GHG emissions. Europe’s energy consumption in the domestic environment is 40% of the total energy consumption (2/3rd is used in heating and cooling) along with 35% Green House Gas (GHG) emissions [Huovila, 2007; Van, 2009]. If this rate continues until the year 2050, GHG emissions only from buildings will double the total GHG emissions of buildings today as shown in figure 1.2 [Energy Technology

Perspectives, 2010]. The GHG emissions from energy waste in buildings are one principal focus of research today.

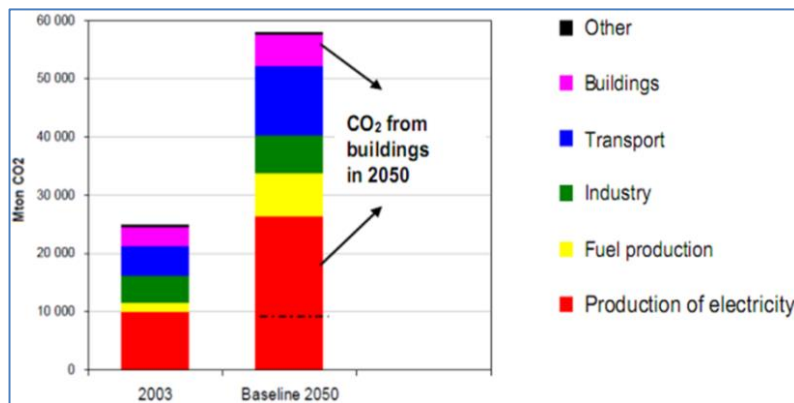

Figure 1.2 GHG emissions 2003-2050

The above discussion highlights optimized building design and energy control and management as an active research area for sustainable excellence that advocates passing natural resources to the next generations with minimum impact. It is an extended concept of Social Corporate Responsibility (SCR) that focuses on fulfilling the growing energy needs while minimizing environmental impact by reducing energy waste. These challenges can be best addressed with energy temperance or by increasing the share of renewable resources (~1.9%). The former US Secretary of Energy, Samuel Bodman, said: “the largest source of immediately available, cost-effective 'new' energy is the energy waste every day and it is the cheapest, most abundant, cleanest, most readily available source of energy we can access” [Ogilvie, 2009].

1.2 Existing Solutions and Role of Inhabitants’ Behaviour

There are some existing solutions and ongoing research to address the problem of energy control and management. The existing solutions include the compliance of new buildings to low energy consumption standards as proposed by the European Alliance of Companies for Energy efficiency in buildings (EuroACE) and European National Strategy, and renovation of buildings to improve energy efficiency [Jensen et al., 2009]. Similarly, ongoing research includes centralized approaches for energy management of living places [Ha et al., 2006a]. In existing approaches, emphasis has been put on modelling and simulating various physical factors related to energy consumption e.g. thermal performance of insulation, energy used by heating and cooling, and other electrical appliances, the outdoor environment, and energy efficient appliances. Modelling represents system elements and their interactions whereas simulation helps to analyze responses of the system to some change which in real life might not be possible. In the work of this thesis, the focus is not only on the physical aspects of the building but also on the inhabitants’ behaviour. Learning ecological behaviours and temperance will empower the energy simulations and will help to reduce energy waste.

Energy waste resulting from inhabitants’ behaviour can be demonstrated using an example as presented in figure 1.3 [Kashif, 2010]. If the number of people increases in a room, shown by the upper curve, the respective energy requirement for heating reduces in the same “time window” shown by the lower curve. In the absence of a feedback control, the temperature will rise in the room causing natural human behaviour to open the window, resulting in energy loss.

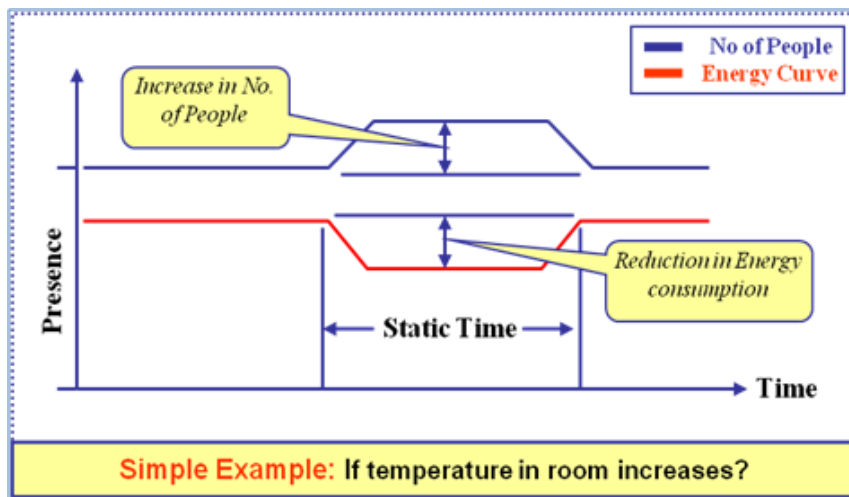
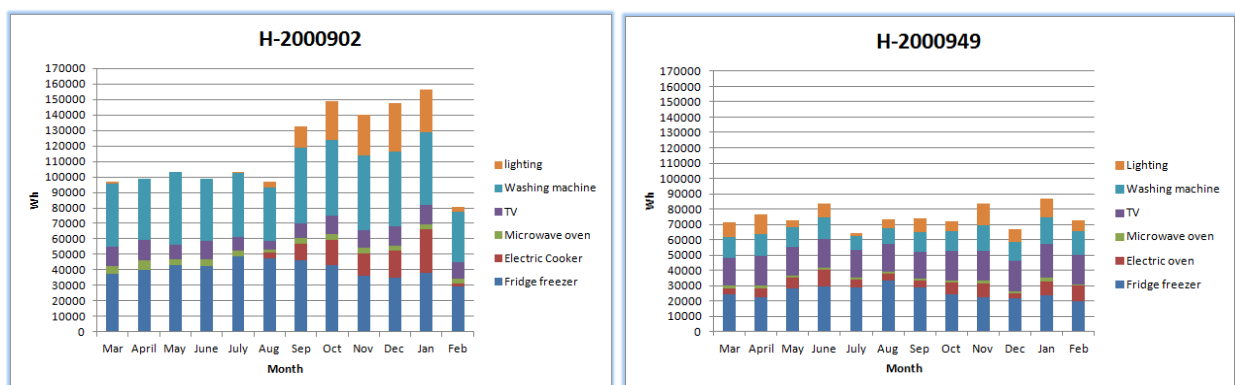

Figure 1.3 User behaviour influenced by temperature rise

The energy waste related to human behaviour has not yet been fully explored for energy efficiency. The literature suggests that behaviour strongly influences energy consumption patterns and is an important factor for energy waste reduction in buildings [Andersen et al., 2009]. There are also a multitude of factors that influence human behaviour and consequently energy consumption. For example, public information on the energy problem, energy related personal interests, economical differences, home characteristics (internal arrangement, decision to insulate), lifestyle consciousness about energy saving, personal values, personality, acceptance of responsibility, social norms, knowledge about energy use and appliances' purchase, usage and maintenance related behaviours [Raaij and Verhallen, 1982; Ouyang and Hokao, 2009]. Hence, in this research, it is argued that understanding inhabitants' behaviour is a key for energy efficiency efforts. Inhabitants' behaviour can either optimize energy utilization, taking into account comfort needs, or it can needlessly waste energy.

In order to understand how inhabitants' behaviour impacts energy consumption, the results from an analysis performed on the Irise dataset¹ are presented below in figure 1.4(a,b). It is performed on two different categories of houses selected based on the number of occupants: 2 person houses in category 1 (Figure 1.4(a)), and 5 person houses in category 2 (Figure 1.4(b)). Also all houses in both categories have almost the same number and type of appliances.



¹ This is part of the European Residential Monitoring to Decrease Energy Use and Carbon Emissions (REMOCEDCE) project. It contains energy consumption data, for each appliance from 98 French houses, recorded at every 10 minutes, over a one year period.

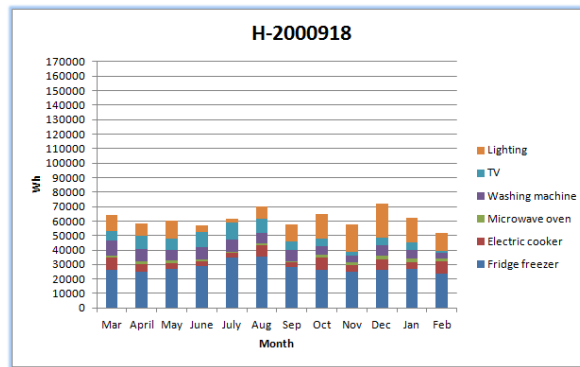

Figure 1.4(a) Energy consuming activities: 2 person houses

It can be seen in the 1st category (Figure 1.4(a)), that inhabitants from the house “H2000902” have the highest consumption for the washing machine as compared to other houses. This may be due to their behaviour of frequently washing a small volume of clothes compared to washing a large volume, less often. In the 2nd category (Figure 1.4(b)), inhabitants from house "H2000945" have the highest consumption for the TV as compared to other houses possibly because of their behavioural differences with the inhabitants in other houses. The above analyses show that the occupants' behaviours vary frequently and have a strong influence on the energy consumption. It also demonstrates that human behaviour is a key factor to be modelled for energy efficiency.

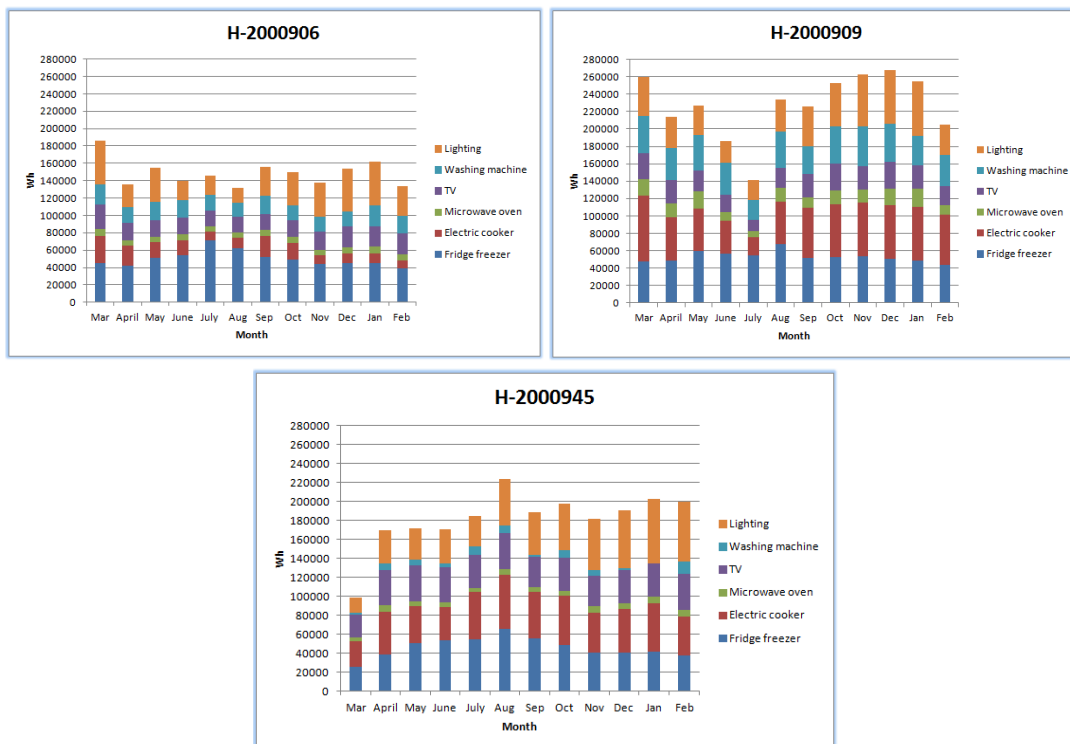

Figure 1.4(b) Energy consuming activities: 5 person houses

1.3 Behaviour Modelling Challenges and Limitations

The majority of works in energy modelling and simulation are based on office buildings using single user and static profiles. This is unrealistic since human behaviour could be far more complex than these profiles. Typically, in building simulators only the thermal heat generated by appliances and occupants is considered. Moreover, the occupants are considered only as being present or

absent, an example from the field studies data is shown in figure 1.5 [Kashif et al., 2013a], without taking into account the way they behave to consume energy.

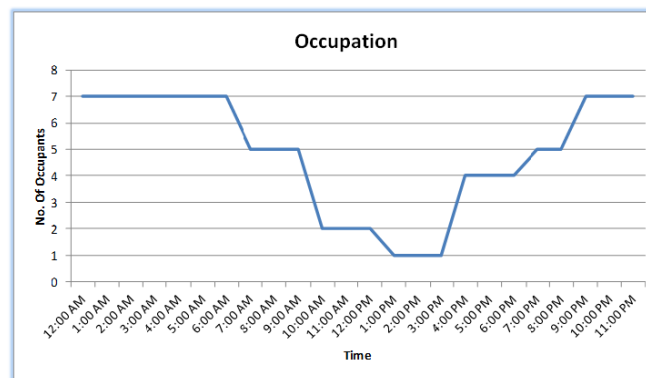

Figure 1.5 Occupation in a house

Simulations based on single user and static profiles are limited in extending the results to real life situations. A better management that coordinates and orchestrates the use of all kinds of energy according to inhabitant’s needs and comfort remains an important progress factor. In this research thesis we focus on the domestic situations to model and simulate dynamic (reactive/deliberative) group behaviours which we believe is a key in reliable simulations for energy efficiency. The objective of this approach is to identify behaviour sensitivity for energy control and management. This will help in developing smart environments as well as testing the design of new buildings that are well suited to human behaviour. A smart environment is one that is able to acquire and apply knowledge about the environment and its inhabitants in order to improve their experience in that environment [Cook and Das., 2007]. The proposed approach for modelling human behaviour would also help to capture inhabitants’ reactive behaviour to the signals coming from the smart grid. These signals include information on the availability of energy, price details and potential energy consumption by different household appliances, etc. As it is difficult for the inhabitants to interpret well these signals, the communication between the smart grid and inhabitants is done through an energy management system.

The simulation of inhabitants’ behaviour in buildings (for energy management, home automation, etc.) has emerged as a focus of recent research. For example, [Reinhart, 2004] used occupancy models to predict the manual and automated control of lights and blinds. [Claridge et al., 2004] compiled a library of schedules and diversity factors based on measured electricity consumption data for energy simulations and peak cooling load calculations in office buildings. [Abushakra and Claridge., 2001] used the occupancy and lighting diversity profiles and found a strong correlation between these two variables through linear regression. [Capasso et al., 1994] applied Monte-Carlo extraction on average daily availability at home to derive the daily presence profiles of inhabitants. [Yamaguchi et al., 2003] used a Markov model to simulate the occupants presence by using a weekly profile of the presence probability as input.

The above mentioned significant efforts to model inhabitants’ behaviour do not take into account complex behaviours and moreover they are primarily focused on office buildings where inhabitants exhibit regular and routine activities likely to be predicted and/or modelled. However, residential buildings involve complex behaviours, where inhabitants spend most of the time and strongly influence the social and group behaviours.

1.4 Context and Research Questions

This research thesis is part of the ANR funded SUPERBAT project (SimUler pour PilotER les BATiments efficaces). The objective of the SUPERBAT project is to improve energy prediction by co-simulating the energy impacting behaviours of inhabitants together with more accurate physical models of buildings and appliances. In this project the stochastic modelling of the occupancy and energy uses is integrated into dynamic simulation tools. The developed models are further adjusted to the real life measurements (power load, temperatures etc.). It will allow designers to study different applications such as the design and energy management of low energy and positive-energy buildings. Interaction between inhabitants and physical aspects can be seen in figure 1.6. The bottom-right corner shows the communication from the power supplier or smart grid to the inhabitants through electrical signals e.g., the peak usage periods, energy tariffs for different hours. Similarly, inhabitants can communicate back their choices. These interactions help in reducing the delivered electricity costs and are beneficial to both the grid and the environment.

Information coming from the grid is becoming more complex, making it difficult for inhabitants to react accordingly. A Building Energy Management System (BEMS) could help to optimize energy consumption and allow inhabitants to make better decisions regarding energy use. The BEMS receives the signals from the grid and informs the inhabitants, in a clearly understandable way, about the availability of energy, the price details, and energy consumption of different household appliances etc. The question is how the inhabitants will react to all these signals coming from the grid. They will actually react by communicating with the BEMS, expressing their energy needs and asking for advice. The co-simulation with inhabitants will make it possible to assess and evaluate the strategies developed by the BEMS.

Similarly, the values for different physical variables, coming from the building envelope or the appliances, are captured by the BEMS and the inhabitants. The inhabitants can interact with appliances either directly, by adjusting the setpoints, or indirectly, through the BEMS. Since the inhabitants play a key role in the energy consumption of home appliances, in this work focus has been put specifically on capturing their reactive behaviours to assess the strategies of the BEMS.

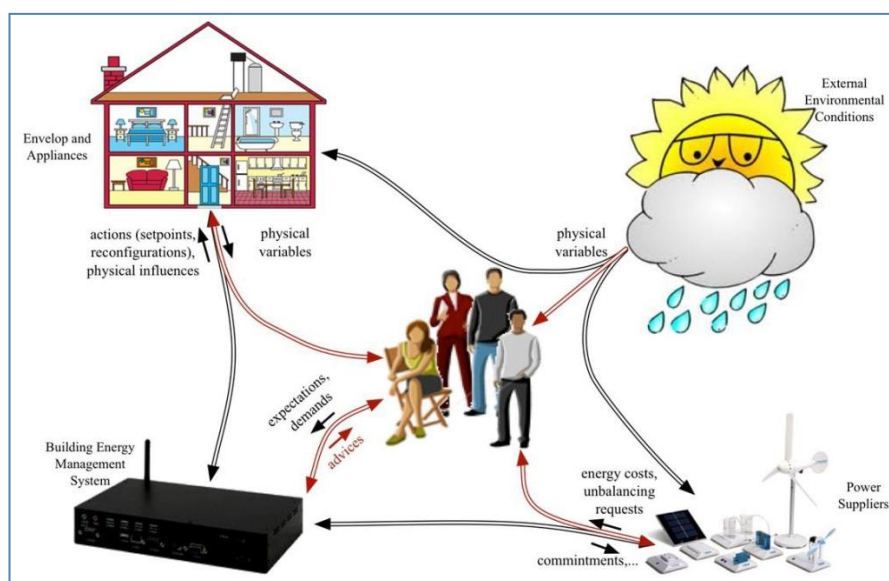

Figure 1.6 Co-simulating occupants' behaviour with the physical aspects of buildings

The first basic research task is to identify the high energy consuming activities and propose a conceptual behaviour model which is capable of taking into account inhabitants' reactive, deliberative, social and group behaviours. Reactive systems "sense internal or external conditions and then respond by producing internal or external state changes (or some combination)". However, "they lack the ability to evaluate and compare actions or the future consequences of those actions". Deliberative systems "provide the opportunity to represent, analyse, compare, evaluate and react to descriptions of hypothetical future scenarios or possible explanations of previously observed phenomena" [Aaron Sloman, 2001].

Q1: *How to identify the energy impacting behaviours?*

A preliminary analysis of energy consumption patterns for different household appliances has revealed that these patterns are highly variable. This variability in consumption patterns is linked with inhabitants' behaviour and the daily activities they perform on appliances. Hence, it is important to analyze both the consumption and behaviour patterns to identify those behaviours that are responsible for high energy consumptions.

Energy simulation using static occupancy profiles are not reliable. Inhabitant's behaviours must be linked to the appliance's consumption patterns, and co-simulated for better energy demand estimations.

Q2: *How can the complex (reactive, deliberative, social and group) behaviour be co-simulated with the thermal model of the building, and physical models of appliances, in residential buildings?*

The modelling and simulation of complex (social and group) behaviours in residential buildings with thermal comfort and physical appliance models is not trivial. Hence, our objective is to propose a co-simulation methodology to facilitate more realistic real time simulation.

Since the purpose of co-simulations is to analyze the inhabitants' complex energy impacting behaviours, we must model realistic behaviours.

Q3: *How can the complex behaviour models be validated to ensure its representativeness?*

The validation and fit of the behaviour model is highly critical to make it a representative model to be used during simulations. Hence, a validation methodology is required prior to use the behaviour model in energy simulations for more accurate results.

Q4: *How to validate BEMS with building system and inhabitants?*

The BEMS makes certain plans and strategies to control the building system based on the signals coming from the grid. However, a mechanism is required in order to assess whether these strategies are efficient or not in the presence of reactive inhabitants.

1.5 Research Methodology

In this section the methodology is graphically presented (Figure 1.7) as a block diagram, summarizing how the research was carried out. The research starts with (A0) literature review on behaviour models to identify the key behaviours influencing the energy consumption patterns. The analyses on the Irise dataset (A1) were performed in parallel to categorize appliances based on their energy consumption patterns. This initial analysis also highlighted the missing information regarding activities data within the Irise dataset. Hence, local field studies (A2) were performed to identify the most likely activities against the energy consumption of appliances. A heuristic algorithm is developed and implemented to restructure and complement the Irise dataset with

additional information. The analyses at this stage resulted in the identification of high energy consuming activities. Further, based on the information generated by the modules A0, A1 and A2, the important elements of behaviour for energy management were identified (A3). An inhabitants' behaviour model that captures the complex and dynamic behaviours was developed; based on this behavioural scenarios were implemented (A5) in Brahms (multi-agent simulation framework). The modules A1 and A2 helped to identify certain parameters and activities that impact an appliance's energy consumption (A4). It lead to development of appliance's physical model to capture the appliance's behaviour. In order to co-simulate the behaviour of an appliance an example of the fridge freezer is chosen because of its complexity and sensitivity to human behaviour. The appliance's physical model (A7) and the thermal model of a house (A6) were then co-simulated together with the inhabitants' behaviour model (A8). Further, the houses with similar energy consumption behaviours were clustered (A9) to find representative behaviours. In order to validate the behaviour model (A11) the inhabitants' behaviour model was co-simulated with the physical model of the appliance (A7). Then a statistical analysis (A10) of the consumption of the selected appliance from the Irise database was performed. The actual consumption distribution from A10 is then compared with the simulated consumption (A8) using the concept of parameter tuning. The simulated consumption is then compared against another member of the cluster to find the representativeness of the behaviour model. Finally, the co-simulation of inhabitants' behaviour and thermal model of the building is done with an energy management system (A12) to analyze its impact on household energy consumption against different types of inhabitants' behaviours (ecological, non ecological behaviours).

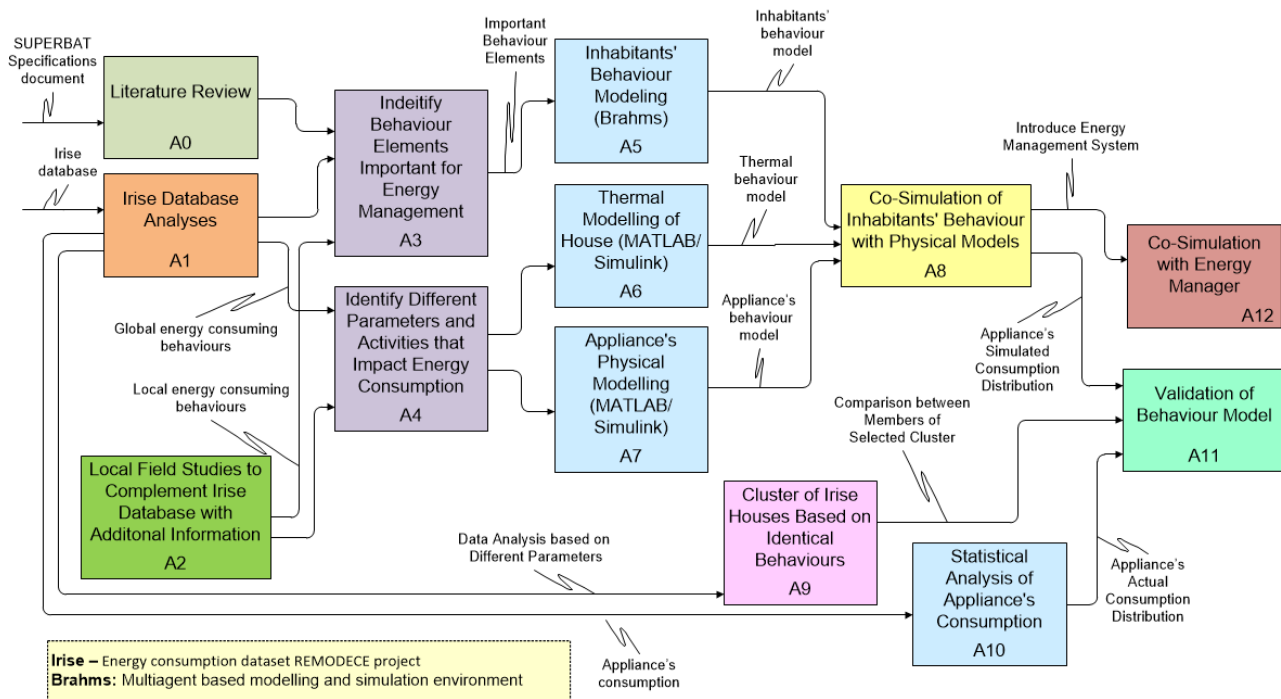

Figure 1.7 Research schematic and contributions at glance

1.6 Thesis Organization

This thesis is divided into 8 chapters:

- **Chapter 2 [Literature Review]:** presents a literature review across three sections (i) energy consumption and occupants' behaviour: role and background (ii) household context and

behaviour representation (iii) motivation and need for agent based modelling and simulation. It also provides an insight to the extent to which Multi Agent System (MAS) approaches have helped the energy management problem. The objective is to provide an overview of the limitations and challenges to clearly place the contributions in this thesis.

- **Chapter 3 [Data Collection and Analysis]:** presents and discusses the impact of human actions on the consumption of different domestic appliances and objects. The structure of the Irise dataset is also explored followed by data preprocessing prior to its formal usage. A categorization of home appliances is made based on their power and energy consumption. The different parameters that impact the energy consumption of home appliances are identified. The objective of this chapter is to find global (Irise dataset) and local (field studies) traces of energy consumption with their respective activities. These traces will serve as input to chapter 4 for developing behaviour models.
- **Chapter 4 [Inhabitants' Behaviour Model]:** The objective of this chapter is to present our first contribution as conceptual behaviour model based on the results from local field studies and global traces identified in Chapter-3. This conceptual model is further used for building and simulating scenarios using the Brahms environment in subsequent chapters.
- **Chapter 5 [Models Implementation and Co-Simulation]:** provides a brief description of Brahms environment components and implements the behaviour models developed in chapter 4. Further, an approach to co-simulate the behaviour and appliance's physical models is proposed and implemented. It helps to analyze the impact of inhabitants' behaviour on the energy consumption that often results in energy waste due to high energy consuming activities. This co-simulator is implemented using Brahms, Matlab and Simulink. These modelling and simulation tools are integrated and synchronized using JAVA.
- **Chapter 6 [Methodology for Validating Representative Behaviour Models]:** presents a methodology to validate the behaviour model as being representative of the respective cluster extracted from the Irise dataset. In this methodology the concept of tuning parameters is used where simulated consumption curves are mapped to the actual consumption curves using curve fitting methods. The tuned model is further validated against other cluster member houses to ensure the model reliability.
- **Chapter 7 [Co-Simulation with Building Energy Management System]:** This chapter describes the co-simulation of the inhabitants' behaviour with the thermal model of a building and a BEMS. The objective is to analyze how a BEMS takes the decisions for better energy control and management in the presence of inhabitants' reactive and dynamic behaviours. Similarly we analyse how the actions of different types of inhabitants, having ecological and non ecological behaviours, impact energy consumption with and without the presence of a BEMS.
- **Chapter 8 [Conclusions and Discussion]:** This chapter discusses the results and draws some conclusions. It also provides an insight into the potential benefits and applications of the proposed models and methodologies. This chapter concludes with a description of future short and long term research directions and evaluates what has been achieved in the light of research questions as presented in section 1.4 of chapter 1.

CHAPTER 2: LITERATURE REVIEW

This chapter highlights challenges associated with the representation and inclusion of inhabitants' behaviour within energy simulations for more realistic energy consumption estimates and predictions. The objective is to clearly position our research questions as presented in chapter 1 in the existing literature. The literature review is divided in three parts: (i) energy consumption and occupants' behaviour: role and background (ii) household context and behaviour representation (iii) motivation and need for agent based modelling and simulation.

CONTENTS

2.1	Energy Consumption and Occupants' Behaviour: Role and Background	39
2.1.1	Why consider Occupant's Behaviour in Buildings' Energy Management	39
2.1.2	Influence of Behaviour on Energy Consumption: Surveys and Studies	40
2.1.3	Approaches for including Behaviour in Energy Management and Control	41
2.1.3.1	Diversity, Occupancy Profiles and Schedules	42
2.1.3.2	Energy Simulations and Occupants' Behaviour	42
2.2	Household Context and Behaviour Representation	44
2.2.1	Human Behaviour Representation (HBR) Models	45
2.2.2	Behaviour Modelling with current Energy Simulation Tools	51
2.3	Motivation and Need for Agent Based Modelling and Simulation	53
2.3.1	Multi-Agent System based Approaches for Energy Simulations	53
2.3.2	Agent Based Modelling and Complexity	54
2.3.3	Structure of Agent Based Models	54
2.3.4	BDI Architecture for Behaviour Modelling	55
2.4	Summary and Conclusions	55

2.1 Energy Consumption and Occupants' Behaviour: Role and Background

In order to address the potential energy crises, the European Union (EU) commission has set a 20-20-20 strategy. The objective is to (i) meet 20% of the existing energy needs with renewable sources and (ii) reduce GHG emissions below 20% (from 1990 levels) by 2020, whereas special emphasis is on (iii) reducing 20% energy consumption of projected levels by 2020 and to reduce GHG emission between 60-80% by 2050 [EU Commission, 2007; EU Commission, 2008]. The European Energy Performance of Buildings Directive (EPBD) revised in 2011 stressed improving energy performance and energy efficiency in buildings, as the greatest energy saving potential lies in buildings [EU Commission, 2011].

The targets set by EU may be met by the year 2020 by introducing solutions as: (i) new buildings' compliance with the low energy consumption standards and (ii) old buildings' renovation [Jensen et al., 2009], depending on the initiatives taken by respective states. Besides these solutions, there are (i) centralized approaches for energy management and (ii) distributed approach with focus on modelling and energy simulations [Hadj et al., 2012; Abras et al., 2010; Ha et al., 2006a]. These approaches can be used to support inhabitants in their day to day life, thanks to relevant advice on energy suitable behaviours [Hadj et al., 2013]. [Janda 2011] argued that building users play a critical role in buildings' performance which is poorly understood and often overlooked. [Vale and Vale, 2010] stated that "*What is essential now is to concentrate on household behaviour, not just the building*", because "*buildings don't use energy: people do*" [Janda, 2011]. Hence the increasing interests in inhabitants' behaviour will result in more accurate and reliable estimates and predictions, besides its potential contribution to the 20-20-20 strategy.

2.1.1 WHY CONSIDER OCCUPANT'S BEHAVIOUR IN BUILDINGS' ENERGY MANAGEMENT

[Norford et al., 1994] were interested to find the causes for discrepancies between actual and predicted energy use. They found that the choices occupants make about the usage of lights and office equipment and the manner in which air conditioning is used has an enormous impact on energy consumption. The significant gap between energy predictions and reality has been shown by [Elzenga et al., 2010] as being attributed to either a difficulty in predicting inhabitants' behaviour and/or the failure of taking into account variations in occupant activities by the building professionals. They compared the energy models built during a building's design phase with that after one year of actual occupancy. The difference between the actual and calibrated models was found to be significant. The case studies on residential buildings fully monitored 1930s replica three bedroom semi-detached houses concluded that besides building performance, human factor is the most influential aspect on energy efficiency since humans control the appliances [Spataru and Gillott, 2011].

[Gill et al., 2010] demonstrated that energy consumption can vary enormously even for neighbours living in the same type of house. They found that energy efficient occupant behaviours account for 51%, 37% and 11% of variance in heat, electricity and water consumptions respectively between dwellings. Energy efficient behaviours can potentially reduce gas consumption by 12% and electricity consumption by 7% [Uitdenbogerd et al., 2007]. Two thirds of energy demand reduction can be achieved by encouraging inhabitants to limit their energy usages whereas one third can be saved from the use of low-carbon technologies [Boardman, 2007]. [Azar and Menassa, 2012] emphasized that the discrepancies between predicted and actual building performance are due to

neglecting the parameters related to energy consumption behaviour of occupants. They performed sensitivity analysis and found that occupancy behavioural parameters have a significant influence on the results of building energy models. Sensitivity analysis is a technique by which the changes in outputs are compared to the changes in inputs.

The gap between predictions and actual consumption, as mentioned above, suggest a lack of understanding of the relationship between inhabitants' behaviour and energy consumption. There are simplistic representations of occupants' behaviour and assumed deterministic rules and schedules that are not rooted in reality. Hence it should be modelled and included during energy simulation for more accurate and reliable estimates and predictions.

2.1.2 INFLUENCE OF BEHAVIOUR ON ENERGY CONSUMPTION: SURVEYS AND STUDIES

There are many factors that affect inhabitants' behaviour and can be used to reduce energy consumption. For example energy related personal interests, lifestyle consciousness about energy saving and environmental problems, social norms etc. [Raaij and Verhallen, 1982; Ouyang and Hokao, 2009]. The EU commission highlighted the lack of consumer/occupants' awareness as one of the main hurdles in achieving the target of reducing energy consumption by 20%. They suggested that member states provide information to occupants on cost-effective and easy to achieve changes in energy use [EU Commission, 2012]. The high energy consuming or energy wasting behaviour can be attributed to "energy unconscious behaviour" [Al-Mumin et al., 2003] and can be strongly influenced by awareness on how the occupants underestimate the energy usage for the activities they perform on household appliances [Attari et al., 2010]. Feedback on energy consumption is another important factor characterized as the reinforce awareness. The immediate and direct feedback through energy monitors is very effective resulting in 5-15% reduction in energy consumption. The indirect feedback through informative billing and energy reports is better for large scale deployment and is attributed to 0-10% savings [Darby, 2006]. However, the sustainability of feedback factor is found to deteriorate with time [Van Dam et al., 2010].

The studies also demonstrate that awareness through information on climate change alone is not sufficient to promote energy efficient behaviour. Instead, more precise information such as latest energy reducing technology etc. is required to promote behaviours [Linden et al., 2006]. Stevenson and Leaman state that "*It is not enough to presume that information from 'smart metering' will encourage people to reduce their energy consumption any more than a car speedometer will reduce speeding, unless the speed limit is made clear along with the severe consequences of breaking it*" [Stevenson and Leaman, 2010]. The studies have also shown that monetary rewards are not necessarily the most prominent factor and can be easily compromised with comfort [McMakin et al., 2002]. The objective should be on changing beliefs otherwise all efforts could be useless [Druckman, 2011].

There are other frequently discussed enabling factors in the literature such as behavioural constraints, financial constraints, technical and organizational resources [Collier et al., 2010], emotional and rational appeals, competitions, changing aspects of inhabitants' environment and goal setting [Bakhaus and Heiskanen, 2009].

[Raaij and Verhallen, 1982] proposed a behavioural model of residential energy use and showed that personal, environmental and behavioural factors are associated to energy use. They suggested important determinants and their interactions for energy consumption in the residential sector like information on the energy problem, energy supply and energy efficiency of appliances,

personal interests, regional/economical differences, home characteristics (degree of insulation etc.). They distinguished between attitudes and behaviours where energy related *attitudes* include *cognitive beliefs and their evaluation*, like energy and its price, environmental concerns, personal health and comfort. Conversely, energy related *behaviour* can be categorized as purchase, usage and maintenance related behaviours towards appliances. Another important factor between attitude and behaviour is the *behavioural cost-benefit trade-off* where behavioural cost (like a decrease in personal comfort by lowering thermostats, closing shutters etc.) may be huge compared to behavioural benefits.

The literature suggests that behaviour strongly influences energy consumption patterns and is an important factor for energy waste reduction in buildings [Raaij and Verhallen, 1982; Andersen et al., 2009]. Various surveys, studies and energy audits have been conducted to analyze how behaviour is affected by certain factors and how it affects energy consumption [Seryak and Kissock, 2000; Ouyang and Hokao, 2009; Masoso and Grobler, 2009]. [Seryak and Kissock, 2000] conducted a study on university residential houses and showed that the same house occupied during 2 academic years by different occupants show different energy consumptions because of behavioural differences. [Ouyang and Hokao, 2009] conducted a study in an urban residential sector and showed that the energy consumption behaviour of inhabitant's has some *relationship with their lifestyle* such as occupant's characteristics, electrical appliances, consciousness about energy saving and environmental problems. They also suggested that energy saving behaviour of occupants can be improved if they are provided with *energy saving education*. [Masoso and Grobler, 2009] conducted an energy audit on six randomly selected commercial buildings in Africa and results showed that more energy is consumed during non working hours than during working hours because of the occupant's behaviour of leaving lights and other equipment on at the end of the day. [Yun and Steemers, 2011] used the path analysis technique to find different factors affecting cooling energy demand in residential buildings. They found that although the physical parameters (climate, house type etc.) and socio-economic aspects (income, household size, etc.) are important in determining the cooling energy demand, the most significant factor of all these is the occupants' behaviour. The occupants' choices regarding how often and where air conditioning is to be used have a strong influence on energy consumption.

[Ueno et al., 2006] proposed an *on-line energy consumption information system* to inform the occupants of the impact of their energy consuming behaviour of different appliances, power and gas consumptions of the whole house, room temperature, comparison with other houses and comparison with past data. The system helped in reducing power consumption of houses by 18% at the end of the study. [Hadj et al., 2013] developed a BEMS for the CANOPEA building. The BEMS is based on the virtual representation of the building and includes information on the building envelope, and domestic and technical appliances. It computes anticipative plans and is able not only to control the appliances for occupants, but also provide them with energy efficient advice when they ask for it. The BEMS helps the occupants to minimize energy cost and maximize comfort without extra cognitive workload.

2.1.3 APPROACHES FOR INCLUDING BEHAVIOUR IN ENERGY MANAGEMENT AND CONTROL

Including behaviour in energy control and management is currently focused on either static profiles or predictive models (sensor based inhabitants' occupancy detection). However current approaches are also based on single user interactions with the environment and *do not include reactive/deliberative decision making* or complex human behaviours. The purpose of work done in

this thesis is to capture the behaviour that not only represents a simple presence or absence of an inhabitant in an environment but also represents a realistic interaction of the human with the environment. This means that the dynamic, reactive, deliberative and social behaviour of inhabitants must also be taken into account in order to fully understand its possible effect on energy consumption. Such an approach considers the inhabitants as reactive, intelligent agents instead of simply "fixed metabolic heat generators passively experiencing the indoor environment" [Newsham, 1994].

2.1.3.1 Diversity, Occupancy Profiles and Schedules

The occupants have previously been included in energy simulations through diversity profiles. These are the hourly equipment usage profiles on weekdays and weekends for different office buildings [Abushakra and Claridge, 2001; Claridge et al., 2004]. These profiles are then used to estimate the impact of internal heat gains, coming from occupants, office equipment and lighting, on the peak cooling load calculations in office buildings. [Abushakra and Claridge, 2001] further used the occupancy and lighting diversity profiles and found a strong correlation between these two variables through linear regression. They suggested that the occupancy profiles can be derived from lighting and electrical socket load profiles which can further be used accurately in building energy models.

[Page et al., 2008] build a time series of presence/absence from the data collected from single person offices and use a Markov chain to predict the presence profiles through simulations. The purpose of generating such profiles was to use them further in occupant behaviour models within building simulation tools. The work conducted for residential buildings in terms of identifying occupancy patterns includes that of [Richardson et al., 2008] who used the Time Use Survey (TUS) data to generate active synthetic occupancy data used in future energy demand simulations. [Capasso et al., 1994] proposed a residential load model where "availability at home" profiles are used for each occupant. Other authors have stressed the importance of occupancy patterns in order to represent diversity [Stokes et al., 2004], and for accurate prediction of energy demand load profiles for home appliances [Yao and Steemers, 2005]. The factors considered important for occupancy patterns include: the number of occupants, time of the first person getting up and the last person going to sleep, and the unoccupied period during the day. In the French thermal regulations 2012 [CSTB, 2012] defined for buildings, the behaviour of occupants is considered as temporal schedules based on weekend/weekdays and holidays. These schedules are used to control the setpoint temperature, lighting and hot water needs in individual and adjoined houses. The presence profiles of occupants are also used to calculate the internal heat and humidity gains differently for adults and children. [Goldstein et al., 2010b] found the algorithms proposed by [Page et al., 2008] on occupancy profiles generation to be simplistic and proposed a mathematical technique for calibrating schedules that uses an arbitrary set of factors to select the activity type, duration and number of participants during simulation.

2.1.3.2 Energy Simulations and Occupants' Behaviour

[Degelman et al., 1999] however suggested that fixed lighting profiles generate misleading information when lights are controlled using occupancy sensors. He and his colleagues modelled the lighting and occupancy in buildings using a Monte Carlo approach based on survey statistics on how people use office spaces. [Newsham, 1994] suggested paying more attention to occupant behaviour in order to bring more accuracy into building thermal models. [Reinhart, 2004] proposed

the stochastic Lightswitch2002 algorithms to predict the manual and automated control of lights and blinds in private and two person offices. In these algorithms the occupants were categorized as active (someone who actively seeks daylight, adjusts blind settings) or passive (relies on artificial lighting, permanently arranges blind settings) users. The lightswitch2002 algorithms were used to demonstrate the impact of manual control on predicted lighting energy requirements. Much more savings were made in the case of artificial lights with active users as compared to the passive users. Reinhart however, did not consider the overall impact of manual lighting control on heating and cooling requirements. [Bourgeois et al., 2006] proposed a sub-hourly occupancy-based control (SHOCC) model taking into account the heating and cooling requirements. They found that the occupants that actively exploit natural daylight reduce energy expenditure by more than 40% as compared to the occupants who rely on artificial lighting. [Hoes et al., 2009] tried to find out the requirements for design solutions for buildings that are more robust to user behaviour. They coupled the user simulation of space utilization (USSU) model, which simulates the movements of users in a building, to a sub-hourly occupancy-based control (SHOCC) model. They found that for an optimized building design, user behaviour should be assessed in more detail for specific buildings. In addition to lighting and air conditioning, the occupant's window opening behaviour is also captured in energy simulations. This is considered important for indoor environmental control and air quality. However, this behaviour is mostly based on some fixed schedules. [Dong and Andrews, 2009] developed an event based pattern detection algorithm for sensor based modelling and prediction of user behaviour. [Lee et al., 2011] generated dynamic schedules of occupancy for office buildings and introduced them into an energy simulation. The decision variables used in this scheduling are the single meeting duration, time of the day, day of the week and number of meetings per week. A stochastic algorithm further assigned probabilities to these variables. A schedule prediction model further gave weights to the schedules for different days. These schedules when simulated in EnergyPlus and compared with a conventional schedule gave a 17% increased energy prediction.

The above approaches were developed for office buildings and hence could not be generalized to home situations. The reason is that in offices the occupants have some restricted interactions with the environment and have more or less the same routines. In home situation however, there could be a variety of interactions and communications involving family norms and certain other factors etc.

[Grandjean, 2013] identified different parameters that influence domestic power demand and calculated household load curve. They developed a stochastic model to reproduce the activation of household appliances by the occupants. Besides the building's and appliance's characterization, the characteristics of households considered are: the composition, socio-economical level and occupation status (active, retired etc.). They calculated the load curves for households at various spatial levels.

In order to visualize how energy use is a part of everyday life [Ellegard, 2011] used the TUS data and arranged them in energy related activity sequences. These sequences use the high level categorization of activities e.g. care for oneself, care for household, movement/travel etc. [Widen, 2009] used the time use data of daily household activities to compute the electricity and hot water demand profiles. They used some conversion schemes to associate activities to power consumption, however, a constant power demand is considered for the activities. [Wilke et al., 2011] used the TUS data to reproduce the activities of occupants. Since the TUS dataset contains information only

about activities and not the energy consumption, it can help to associate the power consumption to high level activities. However, it is not sufficient in identifying the more specific activities that impacts the energy consumption, e.g. the impact of opening the door of fridge or putting hot food etc.

2.2 Household Context and Behaviour Representation

Context is another important factor under which the energy related activities are performed by the occupants. It is important as it represents different situations under which the inhabitants take decisions and impact energy consumption. “The context of a task is the set of circumstances surrounding it, potentially relevant to its completion” [Henricksen, 2003]. [Dey, 2001] defined context as "Context is any information that can be used to characterize the situation of an entity". The context elements that should be considered for energy management in home environments are categorized as [Ha et al., 2006b; Zimmermann et al., 2007]:

- a) **User/Human entity:** The user is the principle entity in the residential area having different characteristics such as age, gender, name etc. and can be classified as family member or visitor. They can interact with each other and with other context elements.
- b) **Object:** This represents any physical object at home such as electric/non electric equipment or other products.
- c) **Home Space/Location:** Since humans and objects are physically situated and change location in order to perform certain tasks, their location is another important context element to consider.
- d) **Time:** This includes the time zone information of the user, current time, working hours, weekends, meal time, sleeping time, year, month, second, etc.
- e) **Environment:** This includes different factors such as temperature, light, humidity etc.
- f) **Activity:** [Zimmerman et al., 2007] introduced activity context which is described by certain goals, tasks and actions and helps to answer the question “what does the entity want to achieve and how?”.

[Ha et al., 2006b; Le et al., 2010] analysed user behaviour through contextual factors including user, time, space, environment and object. These authors presented a user behaviour modelling approach called 5W1H for: what, when, where, who, why and how, which they then mapped to a home context (object, time, space, user and environment).

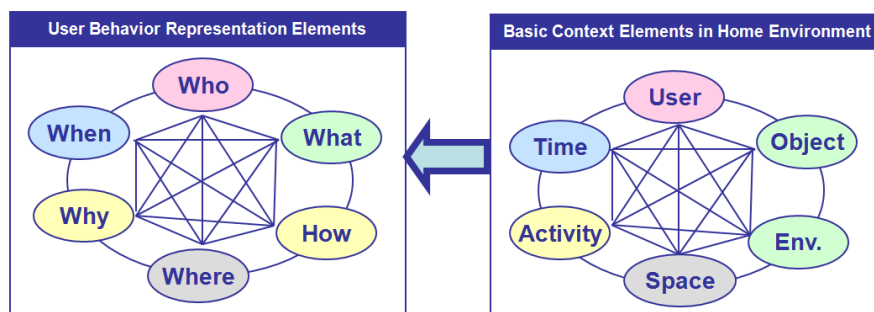

Figure 2.1 5W1H approach to map user behaviour in home context

The context elements in the home environment are interconnected with each other. For example, the users are interacting with some objects, at some instance of time, at a specific location in order to achieve some task. The user or resident is represented by who, object in the environment

by what, location by where, time by when, way of doing the action by how, and the reason/purpose to perform the action is represented by why. In order to gather information about the user's behaviour in the home environment the 5W1H approach is mapped to the home context elements (Figure 2.1). The context elements provide the complete situation in which the inhabitants interact with the environment. However, the most important element is the user/inhabitant that perceives all elements and behaves in a certain way to control the environment.

The term "behaviour" refers to the actions or reactions of an entity, usually in relation to its environment. The basic elements in generic human behaviour representation [Lehman et al., 1996; Sloman, 2001; Sierhuis et al., 2007] are perception (*visualizing, hearing etc.*), decision making (*condition-action production rules*), psychomotor performance (*actions*), memory (*central storage*), learning, cognition (*thought processes*), and social and emotional behaviour. Human behaviour takes perception as input; use existing means (psychomotor, memory, cognition and learning) and controls (emotional, social behaviour and learned beliefs and information) to generate actions as shown below (Figure 2.2):

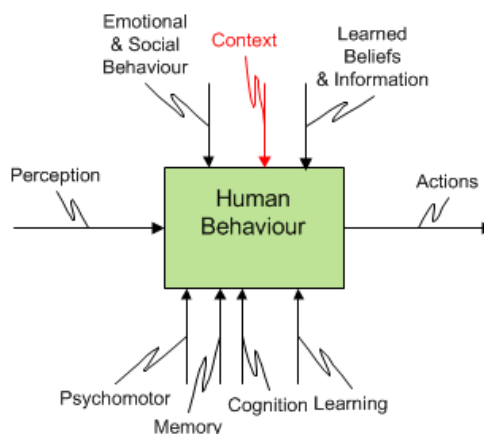

Figure 2.2 Generic human behaviour representation

2.2.1 HUMAN BEHAVIOUR REPRESENTATION (HBR) MODELS

Human Behaviour Representation (HBR) models capture covert (hidden) and overt (open/apparent) human behaviour and represent it in some way using a representation mechanism. Most of the HBR models share the aspects of both cognition and performance. Cognitive models need to have a performance component to simulate human actions resulting from cognition. Similarly, performance models often incorporate cognition to simulate certain mental phenomena, such as decision-making [Morrison, 2003]. Hence in the literature HBR Models are grouped as:

- a) **Cognitive Models:** comprise of the covert mental mechanisms that simulate human cognitive activities, from object perception to abstract problem solving.
- b) **Performance Models:** comprise only the observable outcomes of covert and overt behaviour.

Cognition and the organization of knowledge within humans is captured by many behaviour representation models. [Anderson and Lebiere, 1998] proposed ACT (atomic components of thoughts) in order to represent human behaviour. ACT mainly focuses on human cognition and shows how humans organize their knowledge in order to behave intelligently. It divides the knowledge into declarative and procedural. The *declarative knowledge* refers to the known facts about the word and *procedural knowledge* consists of the production rules. These rules specify how

the declarative knowledge is used to solve problems. [Anderson et al., 2004] included perceptual-motor components to the ACT model to identify objects from the environment and act accordingly based on some *goals and intentions*. [Thibadeau et al., 1982; Just et al., 1999] proposed CAPS (concurrent activation based production system) which is a system whose procedural knowledge consists of production rules, specifying the conditions and their consequent actions. This model has some assumptions about human cognition, like: the system's declarative knowledge base consists of elements called propositions or facts. Each fact has a numerical activation value or confidence value that reflects the degree to which it is believed. A production is fired when the element is matched with the condition component of the production and also the activation value exceeds a specific threshold. Cognitive processing is carried out by production firings, which propagate the activation. The flow of propagation proceeds from one element called the source, multiplied by a factor called the weight to the target. [Zachary et al., 1998] proposed COGNET (cognition as a network of tasks) that mainly focuses on cognitive behaviour of humans, which is modelled by assuming that humans are capable of performing multiple tasks simultaneously. Information is processed serially and tasks can be in various states of completion, but only one of them is actually executing at a current moment. Its internal information processing mechanism perceives information from the external world. Cognition processes this information using the declarative and procedural knowledge and invokes the motor system to perform certain actions accordingly. [Card et al., 1983; Kieras and Polson, 1985] proposed CCT (Cognitive complexity theory) as a model of cognition based on the concept of GOMS, which models human performance as Goals, Operators, Methods and Selection rules. It assumes that humans perform certain actions to reach some specific goals. In order to reach these goals, certain actions needed to be done are called the operators which are further organized into methods. There could be multiple methods to perform the same task so the selection rules exist to select a particular method from the given ones in order to perform a specific task. It is a simple model of cognition as it represents human performance only on the sequential tasks and shows how they use their task knowledge to interact with the devices. [Eggleston et al., 2000] proposed DCOG (distributed cognition) which, argues that cognition is not confined into an individual rather it is distributed across the environment. It assumes that actors adapt different skilful behaviours and use different strategies to accomplish the same task. The environment also affects individual performance and under a low workload, individuals explore the workspace in more detail, whereas under a high workload they prefer to stick to more concrete aspects of work domain.

In addition to human cognition many of the behaviour models also focus on the perceptive and motor processes within humans. [Kieras and Meyer, 1995] proposed EPIC (Executive process/interactive control) model that focuses on the perceptual, cognitive and motor processes. Using EPIC a model can be constructed that represents the procedures required for performing complex tasks in the form of production rules. When the model perceives some external stimulus for some specific task, it will execute the procedures to accomplish it by generating predicted actions and in this way it simulates the human performance. It also captures another important factor of human performance which is multitasking. Its production system fires all the rules whose conditions are matched with the contents of working memory and will execute all of their actions. [Freed, 1998; Firby, 1989] proposed APEX (Architecture for procedure execution), to model human behaviour in a complex and dynamic environment. It makes an abstract sketch of future actions and fills out a plan in the form of procedures as soon as the information is available, and manages the tasks accordingly. It perceives the environment, makes some appropriate decisions by selecting the appropriate procedure and acts accordingly. The order of procedures could be serial, parallel or

based on some priority. [Sloman, 2001] proposed Cogaff (cognition and affect project) which is a human information processing architecture divided into three levels, *reactive*, *deliberative*, and *reflective*. The reactive system senses internal or external conditions and responds to them by making internal or external state changes. However, they lack the ability to evaluate and compare actions or the future consequences of those actions. The deliberative system enables planning by predicting future actions. It does so by explaining past occurrences of actions. The reflective mechanism permits self observation of a wide variety of internal states. The information processing system is further composed of perception, central processing and action. [Lehman et al., 1996] proposed SOAR (State operator and result), according to which behaviour is captured as a search through the problem space at a particular time and a goal state which represents a solution for the problem. The knowledge is modelled in terms of goals, states and operators. Operators are used to change or transform the state of the system. Cognitive behaviour in SOAR includes some important characteristics: it is goal-oriented, it takes place in a rich, complex environment, it requires a large amount of knowledge, it requires the use of symbols and abstractions, it is flexible and a function of the environment, and it requires learning from the environment and experience.

There are many HBR models that take into account the human–system interactions. [Wherry, 1976] proposed HOS (Human operator simulator) which provide a model of human capabilities and limitations to support the design of human-machine systems. To simulate the cognitive, perceptual and motor activities of a human operator, HOS assumes that human performance is described by a network of discrete subtasks. The time to complete a task is calculated as the sum of times required to execute the component subtasks. [Deutsch et al., 1993] proposed OMAR (Operator model architecture), this model takes the assumptions that human behaviour in a complex and interactive environment is proactive and reactive. Humans operate on the basis of some goal oriented agenda but must also respond to the frequent interruptions. Proactive activities require the attention to be focused on the given task whereas reactive activities are demanded when attention is interrupted maybe because of some visual or auditory actions. Another characteristic of OMAR is that tasks occur concurrently within and among multiple operators. Human behaviour is modelled as interactions among independent computational agents. These agents can represent different people or different functions within a single person. But there is no central executive or scheduler that controls these parallel activities.

[Kintsch, 1998] proposed CI (Construction-Integration theory) which was originally developed to handle discourse comprehension tasks but was extended to include the concept of decision cycles to generate the problem solving behaviour. The CI model consists of 2 steps, construction and integration. During construction some propositions or productions rules are made which are weaker rules as they are not the precise ones. As the rules are not precise, some of the associations among the propositions will be closely related to the target meaning and some will be much more remote. During integration however, only the precise propositions or rules are considered and integrated. [Corker and Smith, 1993] proposed MIDAS (Man machine integrated design and analysis system), this model focuses mainly on human system interactions and provides the designers with an environment where the cognitive human functions and intelligent machine functions are taken into account. MIDAS makes an assumption that the “human operator can perform multiple, concurrent tasks, subject to available, perceptual, cognitive and motor resources” [Pew and Mavor, 1998]. [Pritsker et al., 1974] proposed Micro Saint (Micro system analysis of integrated network of tasks), in this model the basic element is a task. Tasks are divided into subtasks until some elemental level is reached. The relationship between the task elements is

established by a precedence relation that indicates which task will precede the next task. In this way SAINT develops a network that comprised of nodes and branches. The nodes represent tasks and the branches of the network represent the precedence relations among nodes. Besides the task oriented concepts, Saint also uses the operator oriented concepts as the operators perform the task assigned to them, taking some time, in order to accomplish the mission. Operators can also work in teams to accomplish some joint tasks. The relationships among nodes help to decide which path to follow in the task network based upon some probabilistic value, some calculated value, or by selecting more than one task at the same time. [Sierhuis et al., 1999; Sierhuis et al., 2007; Clancey et al., 1998] proposed Brahms (Business redesign agent based holistic modeling system) as a modelling and simulation environment for analyzing human work practices in organizations. It is able to represent people, things, places (relevant to the domain), behaviour of people over time, tools and artifacts used, when they are used and it also focuses on the communication between people and in this regard captures their social behaviour. It also focuses on communication between co-located and distributed people to support social behaviour. The key concepts used are thoughtframes and workframes. Thoughtframes are used to model the reasoning behaviour of agents and are represented as production-rules creating new beliefs of agents or objects. Workframes (rule-based) perform the agents and objects activities (simple or composite).

The above studies show that the HBR models capture many characteristics of humans, such as their observable actions, decision making and cognitive abilities and single and group behaviour. Most of the behaviour models discussed above capture the reactive and deliberative behaviour of humans, however, few of them capture the social behaviour as well. The models that capture the social behaviour include MIDAS, OMAR, SOAR, and Brahms. Also keeping in view the context elements important for energy control and management, Brahms modelling and simulation environment is one which is able to simulate the inhabitants as agents. These agents interact not only with the objects and appliances at a particular location and at particular instance of time, but also with other agents in the environment.

Agents in Brahms support social behaviour and are similar to SOAR, MIDAS and OMAR in the sense that they also support social behaviour. Brahms can also represent the multitasking behaviour and in this regard is similar to OMAR, MIDAS, EPIC and COGNET.

In addition to the behaviour models and simulation tools detailed above, there are platforms that support multi agent simulations and behaviour can be modelled inside them. SMACH platform [Haradji et al., 2012], developed in a joint collaboration by *Electricité De France* (EDF) R&D team, Laboratoire d'Informatique de Paris 6 (LIP6), and Institut de Recherche pour le Développement (IRD), allows the multi agent modelling and simulation of inhabitants. Another interesting tool already used in the SUPERBAT project is Anylogic, developed by Anylogic Company that supports the modelling of system dynamics, discrete and multi-agent systems. A comparative study of the HBR models presented above is summarized in table 2.1 according to their possible mapping to 5W1H and social behaviour. The table below clearly indicates that SOAR, OMAR, MIDAS, Brahms, SMACH and Anylogic supports social behaviour as required for dynamic group behaviour simulations. Brahms, SMACH and Anylogic, however, also support 5W1H.

Brahms is a general purpose agent based modelling and simulation environment, free for academic research, and supporting detailed behaviour modelling. It is based on the Belief Desire Intention (BDI) agent architecture and allows coupling of complex external activities and other tools for physical modelling of buildings through Java plug-ins. In comparison, SMACH is an in-

house and customized simulation platform recently developed by EDF to serve their needs for energy based simulations. In SMACH, the granularity for modelling is different from that proposed in this thesis. The actions are considered at a higher level of detail e.g. how the collective actions impact consumption. However, in Brahms the behaviour is explored in the micro level i.e. more specific actions that affect the consumption are considered important while modelling. Similarly, the reasons behind actions are taken into account as detailed cognitive processes. The nature of modelling the agents is also different in both approaches. In SMACH, the agents are task oriented having beliefs and preferences, whereas in Brahms the BDI agent architecture is used. Anylogic is a proprietary tool which limits its free use for academic purposes. The behaviour can be defined using state charts, however, in order to model the cognitive processes, a large number of states will be required that could lead to the increased complexity of the model. GAMA is also a strong candidate for behaviour modelling. However, we selected Brahms because of its strong cognition based decision system as it is based on the BDI agent architecture. GAMA is developed more with the objectives to include GIS data and reduce simulation time with thousands of heterogeneous agents. Taking these considerations into account, Brahms is selected and used as the simulation platform in this thesis.

No.	Human Behaviour Representation Models	5W					1H	Social Behaviour
		What	When	Where	Who	Why	How	
1.	Atomic components of thought (ACT)	×	-	-	-	×	×	-
2.	Cognition and effect project (CogAff)	×	-	-	×	×	×	-
3.	Cognitive complexity theory (CCT)	×	×	-	-	×	×	-
4.	Distributed Cognition (DCOG)	×	-	-	×	×	×	-
5.	Human Operator Simulator (HOS)	×	×	-	×	×	×	-
6.	State operator and result (SOAR)	×	-	-	×	×	×	×
7.	Operator model architecture (OMAR)	×	×	-	×	×	×	×
8.	Construction integration theory (CI)	×	-	-	-	×	×	-
9.	Execution process interactive control (EPIC)	×	×	×	×	×	×	-
10.	Cognition as a network of tasks (COGNET)	×	×	-	-	×	×	-
11.	Architecture for procedure execution (APEX)	×	×	-	×	×	×	-
12.	Concurrent activation based production system (CAPS)	×	-	-	-	×	×	-
13.	Man machine integrated design and analysis system (MIDAS)	×	×	×	×	×	×	×
14.	Micro systems analysis of integrated network of tasks (Micro Saint)	×	×	-	×	×	×	-
15.	Business redesign agent based holistic modeling system (Brahms)	×	×	×	×	×	×	×
16.	Anylogic (Multimethod simulation software)	×	×	×	×	×	×	×
17.	SMACH	×	×	×	×	×	×	×

Table 2.1 Comparison of HBR models for mapping to 5W1H and social behaviour

	Brahms	Anylogic	Smach	Mason	Swarm	Gama
Programming language	Brahms language is an agent oriented language used to program a model	Programming language is java; UML-RT (UML for real time)	Java	Java	Java, Objective C	GAML (modelling) language developed in Java
License	Closed source, free for academic purposes	proprietary	proprietary	Academic Free License (open source)	GPL	GPL
Platform	Can run on, windows, linux, macintosh	Can run on, windows, linux, macintosh	Can run on, windows, linux, macintosh	Java platform	Windows, Linux, Mac	Windows, Linux, Mac
Modelling environment	General Purpose, agent based modelling and simulation environment, main purpose is building multi-agent systems	Is designed for general purpose distributed simulations, can model agent based system, system dynamics, and discrete event simulations	Agent based modelling and simulation environment Specifically designed for modelling the consumption behaviour of families	General purpose agent based platform	General purpose agent based platform with primary specialization in social sciences	spatially explicit agent-based simulations (use complex GIS data as environments for the agents)
Artifacts	People, places inside and outside the house, objects, timing, and activities of people can be modelled.	People, places, objects, timing and actions can be modelled	People, places inside the house, objects, timing, tasks of people can be modelled.	Agents with their positions are modelled	It is based on three artifacts as Space, Time and Objects (agents and places)	Agents, species, population, environment and world are modelled
Priorities	Agents performing certain activities, may have priorities for the activities	No priorities (triggerd events causes the state transitions)	Tasks performed by agents have preferences	Scheduled actions are triggered without priorities	Scheduled one time or repetitive actions are triggered	Priorities are used to change the execution of tasks
Simulation visualization	Simulation has a 2-D representation	Simulation can have a 2-D as well as 3-D representation	Simulation has a 2-D representation	Simulation can have a 2-D as well as 3-D representation	2D and 3D visualization with SwarmVis tool	2D/3D simulation views
Supported Agent architecture	Based on the BDI (belief-desire-intention) agent Architecture, thus strong reasoning capabilities	Is not based on but, can support BDI (agent reasoning)	Close to the BDI (belief-desire-intention) agent Architecture	Is not based on BDI	Is not based on BDI	Is not based on BDI
Social interaction	Agents can communicate with other specific agents and objects as well as broadcast messages to be heard by ell the audience	Agents can communicate with each other and can make social networks	Agents can communicate with other agents	Agents are scheduled to perform actions to manipulate environment	Swarm is particularly useful for simulating the social interactions of agents	Agents can communicate with each other, move and take actions on environment
Activity duration	Activities have a duration	Agent states have a duration	Tasks have a duration	Activities are executed until state changes	Tasks are performed using primitive actions in an activity structure with schedules	Activities have duration with being one time or repeat activity
Behaviour modelling	Agent's behaviour is defined by using the concepts of workframes (condition-action-concequence rules) and thoughtframes (reasoning mechanism)	Agent's behaviour is defined by the main drivers, reactions, memory, states... etc., behaviour can be passive (agents react only to message arrivals) or active (reaction to timeouts or system dynamics)	Behaviour is described by tasks, ordering constraints between tasks and parameters describing the appearance of tasks in time	Behaviour is modelled as rules and focus is on social interactions	Behaviour is composed of activities grouped as activity structures and time or rule based triggering with linear or parallel execution	Behaviour is modelled using task, reflex, ask and event for agents with skills and body and decision system.

Table 2.2 Comparison of agent based modelling and simulation platforms for social behaviour simulation

Table 2.1 shows that Brahms, Anylogic and SMACH are the simulation platforms that support social behaviour modelling along with the 5W1H approach. A detailed comparison of these three tools and some other multi agent environments is presented in the table 2.2.

Brahms is a general purpose agent based modelling and simulation environment, free for academic research, and supporting detailed behaviour modelling. It is based on the BDI agent architecture and allows coupling of complex external activities and other tools for physical modelling of buildings through Java plug-ins. In comparison, SMACH is an in-house and customized simulation platform recently developed by EDF to serve their needs for energy based simulations. In SMACH, the granularity for modelling is different from that proposed in this thesis. The actions are considered at a higher level of detail e.g. how the collective actions impact consumption. However, in Brahms the behaviour is explored in the micro level i.e. specific actions that affect the consumption are considered important while modelling. Similarly, the reasons behind actions are taken into account as detailed cognitive processes. The nature of modelling the agents is also different in both approaches. In SMACH, the agents are task oriented having beliefs and preferences, whereas in Brahms the BDI agent architecture is used. Anylogic is a proprietary tool which limits its free use for academic purposes. The behaviour can be defined using state charts, however, in order to model the cognitive processes, a large number of states will be required that could lead to the increased complexity of the model. GAMA is also a strong candidate for behaviour modelling. However, we selected Brahms because of its strong cognition based decision system as it is based on the BDI agent architecture. GAMA is developed more with the objectives to include GIS data and reduce simulation time with thousands of heterogeneous agents. Taking these considerations into account, Brahms is selected and used as the simulation platform in this thesis.

2.2.2 BEHAVIOUR MODELLING WITH CURRENT ENERGY SIMULATION TOOLS

In this section, we focus on how the approaches and models described in section 2.1.3.2 are implemented in different energy simulation tools. Building energy simulation tools are used to evaluate building designs, energy efficiency, demands, human comfort, emissions and associated costs during design stages and performance predictions. The existing simulation tools exhibit significant differences in predicted and simulated energy consumptions. This is due to the fact that factors influencing energy consumptions in buildings, *(i)* outdoor/indoor climate *(ii)* building characteristics and *(iii)* inhabitants' behaviour; are poorly understood and included only with standard basic assumptions. The role of inhabitants' behaviour as discussed in section 2.1 clearly indicates our inability to properly model inhabitants' complex behaviour, taking into account the reactive and deliberative mechanisms and to better quantify uncertainties in energy efficiency predictions. This section presents a brief summary of the widely used simulation tools which are based on deterministic approaches. The objective is to highlight limitations and inclusion of new dimensions for accurate and reliable energy estimates and predictions.

The energy simulation tools era comprises of three generations. The 1st generation tools included simple methods (mathematical functions) with standard assumptions and indicative results. The 2nd generation tools adopted simple building dynamics for energy efficiency evaluations [Clarke, 2001]. The 3rd generation simulation tools are associated with dynamic methods [Hand, 1998] having capability with GUIs to model and simulate heat flows, electrical appliances, lighting etc. [Swan, 2009]. At present, most widely used 3rd generation tools like ESP-r, TRNSYS, DOE-2, BLAST, Energy Plus, IDA ICE and Virtual Environment are well integrated with heat transfer and

thermodynamic equations. However, in this thesis these tools are evaluated based on their capabilities to model the complex inhabitants' behaviour.

Repetitive inhabitants' actions are included in same simulation tools (e.g. DAYSIM) as intelligent algorithms [Reinhart, 2004; Bourgeois et al., 2006] but they are not representative of the actual behavioural variations. Inclusion of inhabitants' behaviour within energy simulations are discussed in literature across two dimensions: (i) behaviour models based on statistical algorithms [Boergson et al., 2008] and (ii) predefined fixed schedule based behaviour models [Goldstein et al., 2010a]. The statistical behavioural models are based on stochastic processes with probabilities of control events but fixed schedules refer to deterministic, predictable and repeatable behaviours. This is an important limitation in these simulation tools that restricts us to achieve more accurate energy estimates and predictions. The inclusion of a probabilistic discomfort model in addition to a stochastic behavioural model [Clarke et al., 2006] often results in more realistic simulations but occupancy model with only presence and absence profiles is still a challenge. The probabilistic schedules on windows opening/closing behaviours are poorly implemented [Dutton, 2009] in simulation tools; however, probabilistic interactions with windows when combined with ventilation and thermal simulations in EnergyPlus and ESPr, results in improved predictions. The probability of interaction with window based on discomfort levels [Rijal et al., 2007; Haldi and Robinson, 2010] was implemented in ESP-r for more realistic thermal comfort and energy efficiency evaluations [Humphreys and Nicol, 1998]. The ESP-r also offers integrated behaviour models like Hunt [Hunt, 1980] and Lightswitch [Reinhart, 2004] for lights switching and dynamic response to control lights and blinds, respectively, based on occupants presence/absence and arrival/departure profiles. [Bourgeois et al., 2006] integrated SHOCC (Sub-Hourly Occupancy Control) to enable sub-hourly occupancy model across ESP-r domains. In this method the simulation is calibrated using real schedules of presence and absence. If the real schedules tend to include a lunch break around noon, then the time of day factor allows that pattern of behaviour to be reproduced. The COMETH (core for modelling energy and thermal comfort) tool is developed by CSTB [Haas, 2013]. It computes heat and humidity gains of occupants and appliances and offers support for modelling the control of lights, window opening, blinds, systems and heating/cooling seasons. The energy needs are computed based on the presence of occupants in different zones (absence/presence profiles) whereas controls are modelled for manual parameterization. The idea of manual controls is to accurately model energy inefficiencies with an objective to assess and build the profile of energy needs within a building over time.

"In recent years, the number of studies regarding occupants interactions with buildings' environmental control systems has increased, aiming at establishing a link between user control actions (or the state of user controlled devices) and indoor or outdoor environmental parameters. On the other hand, given the complexity of the domain, additional long-term and (geographically and culturally) broader studies are necessary to arrive at more realistic models of control oriented user actions in buildings. Further improvements could be achieved by a deeper definition of the control strategies of the building technical systems and actions by occupants (action scenarios) aimed at improving or maintaining the indoor environmental quality with minimum energy consumption" [Fabi et al., 2011].

2.3 Motivation and Need for Agent Based Modelling and Simulation

One of the main characteristics of MAS is that they are composed of autonomous interacting components, each with their own characteristics and actions. This strong focus on distributed behaviours has made them an ideal candidate for managing the individual elements in energy systems. The approach is also well suited for modelling and simulating inhabitants, since each inhabitant (or a group of inhabitants) can be represented, as having its own characteristics (e.g. age, beliefs, etc) and actions (e.g. turn on appliance). Thus MAS provides a good way to model the behaviour of both inhabitants and household appliances.

2.3.1 MULTI-AGENT SYSTEM BASED APPROACHES FOR ENERGY SIMULATIONS

Recently, the multi-agent systems (MAS) are being used in the domain of energy management within buildings. For example, a MAS approach is used in monitoring and controlling the Heating, Ventilation and Air Conditioning (HVAC) system and lighting in office buildings [Davidsson and Boman, 2005]. In smart homes, the approach has also been used for the anticipatory and reactive control of HVAC and lighting [Joumaa et al., 2011]. Likewise, an agent based control system was used for the optimization of a simulated residential water heating system [Engler and Kusiak, 2010]. The prediction of the mobility patterns and device usage of inhabitants has been done in the MAVHome project in order to satisfy the tradeoff between cost and comfort [Das et al., 2002]. Abras and his colleagues [Abras et al., 2010] gave the control of appliances and sources to the software agents that are used in a home automation system. [Liao and Barooah, 2010] developed a multi agent systems to predict and simulate the occupancy at room and zone level in commercial buildings.

A MAS approach provides a realistic way of modelling inhabitants' behaviour that plays a significant role in the energy consumption. In the above MAS based works however, either the energy system is controlled using agents, or, when agents have been used to represent inhabitants', the level of detail is minimal (e.g. tracking just the displacement of inhabitants in a location). Hence, use of MAS for more accurate energy simulations is not new, but the extent to which they model the complex inhabitants' behaviour is limited.

Most of the energy simulation works in section-2.1 and section-2.2 focus on office buildings where the behaviour of occupants is not as complex as in home situations. So whilst simple presence/absence and/or arrival/departure profiles could be suitable for offices, for example in managing lighting and interacting with windows and blinds, they do not capture the complexity of behaviours found in home situations. If the appliances, other than lighting, are considered, then the way behaviour needs to be captured should also be changed. Behavioural parameters that are sufficient to study the impact on one appliance, such as lighting, might not be sufficient for another. The complexity increases as a shift is made from office buildings to home situations and with the choice of appliance. Cold appliances, such as fridges, are highly sensitive to inhabitants' behaviours (e.g. opening/closing the door and introducing food items) and cannot be modelled using simple presence/absence profiles. In order to take into account such behaviours, it is necessary to move towards more complex and dynamic behaviour profiles that are generated randomly and subsequently used during energy simulations.

The MAS approaches, presented above, are used both to manage and simulate energy systems in buildings with simple behavioural profiles but they do not model, how complex human

behaviour affects the energy consumption patterns of appliances. Thus the work done in this thesis on human behaviour modelling differs from previous approaches since it is concerned with home situations containing complex appliances. In addition, an attempt is also made to analyse and model: how other environmental variables, such as external temperature affects behaviours; what is the relationship between different appliance usage (e.g. fridge and cooker); and what are the underlying reasons behind the inhabitants' actions.

Our research also extends those above by increasing the level of detail on what is modelled about inhabitants. Rather than dealing with simple movements, the model includes the beliefs that an agent has about the world, the facts in the environment, the way these beliefs and facts influence the agents' thought process, and also how they perform various actions. The reason for modelling these levels of details in an energy simulation is to make it closer to a home situation where inhabitants are considered as active, intelligent 'agents'. This complexity of behaviours and increased number of parameters in energy simulations will provide with more reliable results for its subsequent use in energy load/demand estimation and prediction.

2.3.2 AGENT BASED MODELLING AND COMPLEXITY

The history of the development of agent based modelling systems (ABMS) can be traced back to the complex systems [Weisbuch, 1991], complex adaptive systems [Kauffman, 1993; Holland, 1995], and artificial life [Langton, 1989]. The complex adaptive system offers the ability for agents to adapt to changing environment in addition to learning and interaction. It provides the basis for universal principles e.g. self-organization, emergent phenomenon and origins of adaptation in nature, specific for complex system. It led the emergence of ABMS as set of ideas, techniques, and tools to implement complex adaptive systems with computational models [Macal and North, 2010]. The early agent-based models used Swarm modelling software designed by Langton and others to model ALife [Minar et al., 1996] with agents' behaviours as simple rules. The evolution in the ABMS has led the inclusion of exceedingly complex behaviours.

2.3.3 STRUCTURE OF AGENT BASED MODELS

An agent based model has 3 elements: (i) set of agents with attributes and behaviours, (ii) relationship between agents and coordination mechanism and (iii) agents interaction mechanism [Epstein and Axtell, 1996]. A widely accepted definition of an agent describes autonomy as its essential feature [Jennings, 2000]. They can individually assess their situation and make decisions based on the set of rules [Bonabeau, 2001]. The behaviour in this context is characterized from simplistic and reactive "if-then" rules to complex behaviours with AI based adaptive techniques [Macal and North, 2010]. In a new context, the agents must be able to learn and change their behaviours in response to their interactions with other agents and the environment [Casti, 1997]. A typical agent structure is presented below in figure 2.3. The attributes of an agent defines it's characteristics. The overall behaviour emerges from its interactions with other agents and the environment and can be represented from simple rules to neural network or heuristic models. The states of the agents and the environment condition the behaviour of an agent. The social and interactive behaviour are implemented through defined protocols like communication, movement, space contention etc.

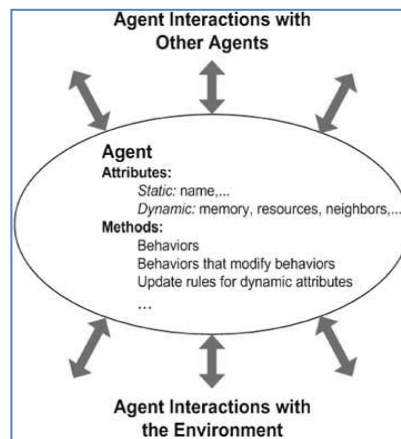

Figure 2.3 Typical agent structure [Macal and North, 2010]

There are multiple research efforts in the literature in cognitive science, focused on enabling social interaction between agents e.g. SOAR, Brahms etc. [Sierhuis et al., 2007; Lehman et al., 1996]. The BDI behavioural framework [Georgeff et al., 1999] is the basis for SOAR and Brahms agent based modelling approaches. There is significant amount of research in machine learning and genetic algorithms that can be effectively used for the agents to improve their active and reactive dynamic interactions [Alpaydin, 2004; Bishop, 2007; Goldberg, 1989; Holland et al., 2000].

2.3.4 BDI ARCHITECTURE FOR BEHAVIOUR MODELLING

The BDI agents have been used for user modelling since long to perform high level management and control tasks such as air traffic control [Rao and Georgeff, 1995; Georgeff et al., 1999]. These agents are characterized by belief, desire and intention as detailed under:

- (a) **Belief** as Information and knowledge: Belief is viewed as the informative component of the system state. In order to act properly the agent needs to select the appropriate actions or procedures to execute, but this selection depends on the context or information about the state of the environment. The perception of the system's state is represented internally to an agent as a belief and is personal to that agent.
- (b) **Desire** as Motivation and Goals: It is also necessary that some agent component has also information about its objectives, priorities and payoffs to be accomplished. This component of agent is called the agent's desires which represent the motivational state of the agent. Desires or somewhat loosely goals represent some desired end state.
- (c) **Intention** as Deliberation and committed plans or procedures: As the actions change with the context (environment), assuming that these changes can be determined, an agent component represent currently chosen action which is called the agent's intention. The committed plans or procedures are called, intentions and represent the third necessary component of the agent state that capture the deliberative component of the agent.

2.4 Summary and Conclusions

In energy simulations, significant gap is observed between predictions and reality. Amongst other things, this is because of the difficulty of taking into account the variations in inhabitants' behaviour by building professionals. Inhabitants' behaviour is highly critical in energy control and management approaches and should be included during energy simulations. This will result in more realistic energy estimates and predictions. Energy consumption is influenced by a multitude of human behaviour factors. For example, public information on the energy problem, energy related

personal interests, economical differences, home characteristics (internal arrangement, decision to insulate), lifestyle consciousness about energy saving, values, personality, acceptance of responsibility, social norms, knowledge about energy use and appliances' purchase, usage and maintenance related behaviours, energy related cognitive beliefs and their evaluation e.g. energy prices, and personal comfort. Feedback on energy consumption through on-line energy consumption information system is also found to be very effective, resulting in energy savings.

Some previous works have already established that inhabitants' behaviour has a significant impact on energy consumption and energy waste reduction. Diversity and occupancy profiles have been used to estimate the impact of internal heat gains, coming from occupants and equipment on peak load calculations, to establish the correlation between lighting and occupancy diversity profiles, to reproduce the presence profiles to be used in energy simulations, and for the prediction of energy demand profiles. The energy prediction models for electrical appliances are mostly based on presence/absence profiles. Such profiles could be helpful for the appliances that are comparatively simple to model e.g. the lights, television. These appliances consume energy, and a constant amount, only when they are turned on. On the contrary, for some appliances, such as a fridge/freezer, simple presence/absence profiles are unsuitable. Furthermore, it is difficult to associate the turn-on or turn-off patterns with consumption. Taking the fridge as an example, the compressor uses continuous energy consumption cycles, which vary considerably depending on what type of human action is performed on the fridge (e.g. opening the door, adding warm food). We argue that in modelling appliances, specifically cold appliances, it is important to consider dynamic human behaviours in order to accurately predict energy consumption. Complexity increases as a shift is made from office buildings to home situations and with the choice of appliance. Similarly, most of the previous works focus on office buildings where the behaviour of occupants is not as complex as in home situations. So whilst simple presence/absence profiles could be suitable for offices, for example in managing lighting, they do not capture the complexity of behaviours seen in home situations.

Thus our work on human behaviour modelling differs from previous approaches since we are concerned with home situations containing complex appliances. In addition we also attempt to analyze and model: how other environmental parameters, such as external temperature affects behaviours; what is the relationship between different appliance usage (e.g. fridge and cooker); and what are the underlying reasons behind the inhabitants' actions.

Human behaviour can range from being very simple to very complex. The purpose of this research is to capture the behaviour that not only represents a simple presence/absence of an inhabitant in an environment but also represents a realistic interaction of the human with the environment. This means that the dynamic, reactive, deliberative and social behaviour of inhabitants needs to be taken into account in order to fully understand its possible effect on energy consumption. This will help to consider the inhabitants as reactive, intelligent agents instead of simply "fixed metabolic heat generators passively experiencing the indoor environment".

Some of the context elements that are identified to be important for energy management in home situations include the inhabitants, objects, home space/location, time, environment and activity. Existing human behaviour representation models capture many characteristics of humans, such as their observable actions, decision making and cognitive abilities and single and group behaviour. Most of the behaviour models capture the reactive and deliberative behaviour of humans; however, few of them capture the social behaviour as well, including HOS, OMAR, SOAR, and Brahms. Also keeping in view the context elements important for energy control and management,

Brahms modelling and simulation environment is one which is able to simulate the inhabitants as agents. These agents interact not only with the objects and appliances at a particular location and at particular instance of time but also with other agents in the environment.

In literature it is found that the studies that take into account inhabitants' interactions with the buildings' control systems are increasing. The aim is to establish the link between the environmental parameters (e.g. the indoor and outdoor temperature) and the actions performed by the inhabitants to control the building system. However, additional studies (e.g. based on geography, culture etc.) are required for more realistic modelling that includes inhabitants' control oriented actions by inhabitants. Further a deeper definition of the control strategies of the building technical systems and actions by occupants (action scenarios) is required. This will lead to the improvements in maintaining the indoor environmental quality with minimum energy consumption.

More recently, the multi-agent systems (MAS) are being used in the domain of energy management within buildings. This is due to the fact that this approach provides a realistic way of modelling inhabitants' behaviour that plays a significant role in the energy consumption. However, in the existing multi-agent works either the energy system is controlled using agents, or, when agents have been used to represent inhabitants', the level of detail is minimal (e.g. tracking just the displacement of inhabitants in a location). Hence, use of MAS for more accurate energy simulations is not new, but the extent to which it models the complex inhabitants' behaviour is limited.

This research extends those above by increasing the level of detail on what is modelled about inhabitants. Rather than dealing with only the movements, we model the beliefs that an agent has about the world, the facts in the environment, the way these beliefs and facts influence agents' thought process, and also how they perform various actions. The reason for modelling these levels of details in an energy simulation is to make it closer to a home situation where inhabitants are considered as active, intelligent 'agents' for better control and energy waste reduction in buildings. This complexity of behaviours and increased number of parameters in energy simulations will provide with more reliable results for its subsequent use in energy load/demand estimation and prediction.

CHAPTER 3: DATA COLLECTION AND ANALYSIS

The objective of this chapter is to collect and analyse data for model development. This is done by using the Irise dataset and complementing the missing data with field studies. In this chapter, the impact of inhabitants' actions on the consumption of different domestic appliances and objects e.g. fridge freezer, windows, etc is presented. The structure of Irise energy consumption dataset is also explored to identify missing data that is required in order to build the model (e.g. missing activities information, weather profile etc.) followed by data preprocessing prior to its formal usage. A categorization of the home appliances is made based on their energy consumption. This will help to identify the appliances with high energy consumption and that are sensitive to human activities. The important parameters that impact inhabitants' energy consuming behaviours are identified through local field studies and experiments. Further, these parameters are presented to show the link between energy consumption and inhabitants' behaviours.

CONTENTS

3.1	Introduction	61
3.2	Irise Dataset: Structure and Contents	62
3.3	Domestic Appliances: Categories and Impact of Usages.....	63
	Table 3.1 Selection criteria for different categories of appliances	64
3.3.1	Low Power Low Energy.....	64
3.3.2	High Power Low Energy	66
3.3.3	Low Power High Energy	68
3.3.4	High Power High Energy	69
3.4	High Energy Consuming Appliances	70
3.4.1	Impact of Human Behaviour on Heating, Cooling and Window Opening	70
3.4.2	High Energy consuming Appliances' Consumption and Inhabitants' Behaviour	70
3.4.3	Other Categories of Appliances' Consumption and Inhabitants' Behaviour	72
3.5	Identification of Parameters that affect Energy Consumption	73
3.5.1	The Impact of Environmental Parameters on Consumption (level 1).....	74
3.5.2	The Impact of Human Actions on Appliance Consumption (level 2).....	79
3.5.2.1	Complementing the Irise Dataset	79
3.5.2.2	Experimental Data Collection and Analysis	80
3.5.3	Relation between Appliance Usages (level 3).....	83
3.5.4	Reason behind Actions (level 4)	83
3.6	Summary and Conclusions	84

3.1 Introduction

The role of data is very important in modelling and validating inhabitants' and appliances behaviour for subsequent use in the energy simulations. The data quality will ensure more accurate estimates and predictions of energy demand. It can be collected from either experiments or standard datasets. Experimental data collection is time consuming and often involves intricate equipment for data collection. Alternatively standard datasets, such as Irise, are readily available. These datasets are rich in information and knowledge.

This research thesis is focused on modelling and co-simulating inhabitants' behaviour with appliances' (physical) and buildings' (thermal) models. The objective is to assess and include the impact of behaviour on energy consumption for more accurate estimates and predictions of energy demands. Many different datasets are available that contains the information about household activities and appliances. These include the Reference Energy Disaggregation Dataset (REDD), PlaceLab Datasets, INRIA Dataset, CASAS (Center for Advanced Studies in Adaptive Systems) project, Irise dataset, and Time Use Survey (TUS) dataset, etc. These datasets are prepared to serve the defined research purpose which ranges from activity recognition (CASAS, TUS, INRIA) to energy consumption (REDD, Irise) modelling and prediction. PlaceLab is a dataset comprising of occupants activities collected for 2.5 months at "live-in-laboratory" in Cambridge at MIT [Intille et al., 2006]. It is the sensor based and video data of activities. The CASAS project uses 21 datasets collected across the world e.g. Japan, Egypt, and Mexico, etc. The data is collected either through sensors or video and is then further processed for its annotation with respective daily life activities. The INRIA dataset comprises of sensor based data annotated with the daily life activities (Brdiczka et al., 2007). The REDD dataset comprises of data collected from 6 houses at every 3-4 minutes over the period of one year [Kolter and Johnson, 2011]. However, these datasets contain the information about the activities of occupants but not the energy consumption of appliances.

The TUS data for France was collected by France's National Institute of Statistics and Economic Studies (INSEE) on household activities through a questionnaire on 8,000 French houses and 15,000 inhabitants (1998-1999). In the questionnaires the respondents have to depict the chronological course of activities selected from a list containing 41 different categories. For example, time spent gardening, time cooking, washing up, time watching TV, time studying etc. This information about the activities has already been used for occupants' displacement predictions and load estimation of certain appliances [Widen et al., 2009; Wilke et al., 2013]. Some conversion schemes are have been used to associate the electrical power to the activities for power demand estimations [Widen et al., 2009]. However, in order to analyze more specific behaviours of inhabitants that leave a high energy consuming impact on household appliances, the consumption data must also be available. For example, the information about the washing dishes activity alone would not be sufficient if the resulting consumption varies for different washings. The higher consumption on one day as compared to the other could be attributed to the program selected by the inhabitant, not scrapping the food off before putting plates in the dishwasher, using the 'rinse hold' function even for a few dirty dishes etc. Since one of the research questions as presented in chapter 1 is to identify the high energy consuming activities, we need a dataset containing the consumption of appliances in order to have a more precise answer to this question. This is why the Irise dataset is selected and further complemented with the information about activities through experiments and field studies.

The dataset used in this thesis is the Irise energy consumption dataset. The reason for using the Irise dataset is the availability of detailed actual energy consumption data, collected at every 10 minutes, against diverse set of appliances for 100 households over one year. However, the Irise dataset lacks inhabitants' activities information. Conversely, other datasets, such as TUS lack energy consumption data against inhabitants' activities. None of the datasets in their current form can be directly used to link activities to appliance's energy consumption. Hence, experimental studies are performed to find a link between high energy consumption activities for selected appliances. The results are then used to complement the Irise dataset which lacks information on behavioural activities. Further detail on the methodology to complement Irise dataset with additional information can be found in chapter 6.

3.2 Irise Dataset: Structure and Contents

The Irise energy consumption dataset is part of the Residential Monitoring to Decrease Energy Use and Carbon Emissions in Europe (REMODECE) project. The objectives of this project are to increase the understanding of energy consumption for different type of appliances and to estimate demand trends for Europe. Using a Java application developed at G-SCOP for easy data extraction, the consumption data is fed into comma separated files (CSV) format (Figure 3.1). This data concerns by a house number, the number of people in the house, location and area of the house. However, further detail of the family e.g. their age groups, profession or the daily life activities are not available. Figure 3.1 shows the snapshot of one of the houses with energy consumption data.

	A	B	C	D	E	F	G	H	I	J
	date	Total site light consumption	Site consumption	Non halogen lamp 1	TV (67cm)	Non halogen lamp 2	Fridge freezer (Kitchen, 325l/75l)	Electric Cooker (hot plate+oven) (1,5kW)	Washing machine	Vertical freezer (Storeroom, 145l)
1										
101	01/30/1998 09:00	0	401	0	14	0	18	0	0	16
102	01/30/1998 09:10	2	350	0	16	0	19	0	0	16
103	01/30/1998 09:20	9	49	0	16	0	18	0	0	2
104	01/30/1998 09:30	2	275	0	16	0	18	0	235	0
105	01/30/1998 09:40	0	350	0	17	0	18	0	311	0
106	01/30/1998 09:50	2	124	0	15	0	18	0	91	0
107	01/30/1998 10:00	0	45	0	0	0	18	0	17	11
108	01/30/1998 10:10	0	44	0	0	0	15	0	13	18
109	01/30/1998 10:20	0	27	0	0	0	3	0	4	17
110	01/30/1998 10:30	0	24	0	0	0	3	0	0	17
111	01/30/1998 10:40	0	27	0	2	0	4	0	0	17
112	01/30/1998 10:50	0	40	0	16	0	3	0	0	16
113	01/30/1998 11:00	0	179	0	16	0	3	140	0	17
114	01/30/1998 11:10	0	298	0	16	0	11	264	0	1
115	01/30/1998 11:20	0	131	0	16	0	21	90	0	0
116	01/30/1998 11:30	0	192	0	16	0	21	153	0	0
117	01/30/1998 11:40	0	253	0	16	0	20	213	0	0
118	01/30/1998 11:50	0	249	0	15	0	19	203	0	9
119	01/30/1998 12:00	0	135	0	9	0	19	87	0	19
120	01/30/1998 12:10	0	216	0	0	0	18	181	0	17
121	01/30/1998 12:20	0	241	0	0	0	19	205	0	18
122	01/30/1998 12:30	0	42	0	0	0	19	5	0	0
123	01/30/1998 12:40	0	37	0	0	0	18	0	0	0
124	01/30/1998 12:50	0	50	0	12	0	0	0	0	0
125	01/30/1998 13:00	0	157	0	16	0	0	0	0	0
126	01/30/1998 13:10	0	285	0	15	0	0	0	0	0

Figure 3.1 Structure and contents of Irise dataset

In order to perform a detailed analysis of energy consuming behaviour based on different criteria e.g. energy consumption for the houses with a specific number of persons, area, or the impact of weekends, holidays, weather etc., a database was designed as shown in figure 3.2. In this database each house has many appliances where each appliance has energy consumption for the whole year at a time stamp of 10 minutes. This energy consumption is complemented with the

holiday schedule and weather profiles for detailed analysis of inhabitants behaviour patterns based on energy consumption.

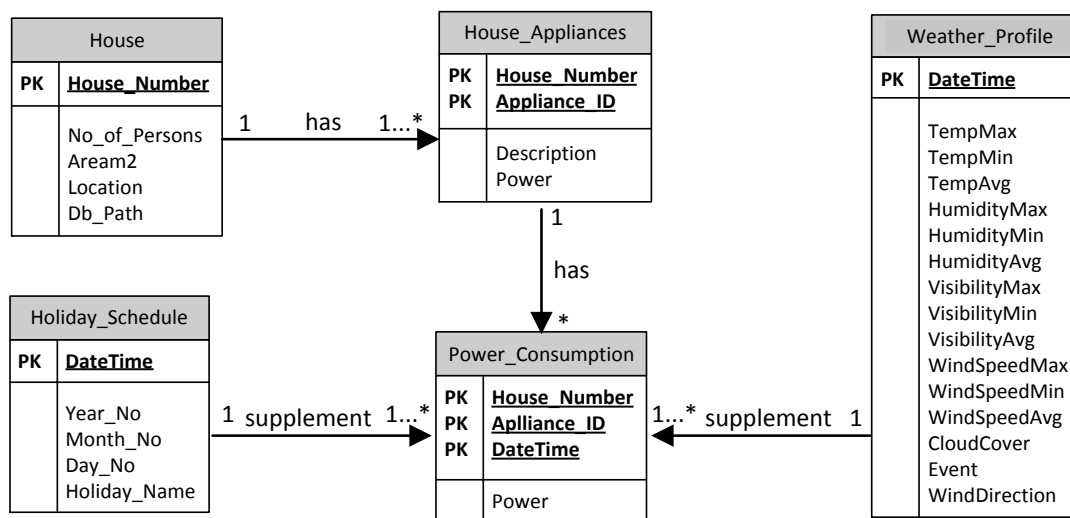

Figure 3.2 Entity Relation Diagram (ERD) of Irise database

The structure and information of one of the house after complementing it with additional information e.g. metrology, holidays, etc. is shown in figure 3.3.

	A	B	C	D	E	F	G	H	I	J	K	L	M	N	O	P	Q	R
	Date	Total site light consumption	Site consumption	Non halogen lamp 1	TV 67cm	Non halogen lamp 2	Fridge freezer Kitchen 325l 75l	Electric Cooker hot plateove	Washing machine	Vertical freezer Storeroom 145l	myYear	myMonth	Day Number	Day Name	DayTime	Holiday	Avg Temperature	W_Event
1																		
2	05/01/1998 17:00	1	73	20	0	0	19	0	0	18 1998	May	1	Friday	AfterNoon	Labor Day		11	Rain
3	05/01/1998 17:10	0	71	19	0	0	20	0	0	17 1998	May	1	Friday	AfterNoon	Labor Day		11	Rain
4	05/01/1998 17:20	0	70	19	0	0	19	0	0	17 1998	May	1	Friday	AfterNoon	Labor Day		11	Rain
5	05/01/1998 17:30	0	71	19	0	0	19	0	0	17 1998	May	1	Friday	AfterNoon	Labor Day		11	Rain
6	05/01/1998 17:40	0	71	18	0	0	20	0	0	17 1998	May	1	Friday	AfterNoon	Labor Day		11	Rain
7	05/01/1998 17:50	0	118	17	0	0	19	49	0	17 1998	May	1	Friday	AfterNoon	Labor Day		11	Rain
8	05/01/1998 18:00	15	393	19	0	0	19	309	0	16 1998	May	1	Friday	Evening	Labor Day		11	Rain
9	05/01/1998 18:10	29	392	17	0	0	19	308	0	2 1998	May	1	Friday	Evening	Labor Day		11	Rain
10	05/01/1998 18:20	36	398	17	0	0	3	309	0	0 1998	May	1	Friday	Evening	Labor Day		11	Rain
11	05/01/1998 18:30	25	583	17	0	0	4	211	0	0 1998	May	1	Friday	Evening	Labor Day		11	Rain
12	05/01/1998 18:40	8	584	17	0	0	3	244	0	3 1998	May	1	Friday	Evening	Labor Day		11	Rain
13	05/01/1998 18:50	25	349	17	0	0	21	250	0	18 1998	May	1	Friday	Evening	Labor Day		11	Rain
14	05/01/1998 19:00	26	720	18	0	0	21	276	0	18 1998	May	1	Friday	Evening	Labor Day		11	Rain
15	05/01/1998 19:10	29	661	18	0	0	20	198	0	18 1998	May	1	Friday	Evening	Labor Day		11	Rain
16	05/01/1998 19:20	31	684	18	0	0	21	235	0	17 1998	May	1	Friday	Evening	Labor Day		11	Rain
17	05/01/1998 19:30	28	661	18	0	0	20	246	0	17 1998	May	1	Friday	Evening	Labor Day		11	Rain
18	05/01/1998 19:40	41	431	17	0	0	20	308	0	16 1998	May	1	Friday	Evening	Labor Day		11	Rain
19	05/01/1998 19:50	61	380	18	0	0	20	251	0	17 1998	May	1	Friday	Evening	Labor Day		11	Rain
20	05/01/1998 20:00	73	467	19	0	0	20	239	0	16 1998	May	1	Friday	Evening	Labor Day		11	Rain
21	05/01/1998 20:10	60	639	17	0	0	20	233	0	16 1998	May	1	Friday	Evening	Labor Day		11	Rain

Figure 3.3 Irise database after preprocessing

3.3 Domestic Appliances: Categories and Impact of Usages

The household energy consumption is determined by the power consumed by each appliance and the duration in which it is used by inhabitants. Before proceeding further, it is very important to classify domestic appliances because their energy consumption patterns are strongly influenced by inhabitants' behaviour and impact demand predictions. [Robinson et al., 2007] proposed 4 categories of appliances as: (a) the use of appliance is independent of occupancy (e.g. refrigerator), (b) the appliance is switched on in the presence of at least one occupant and switched off automatically (e.g. washing machine), (c) the appliance is switched on and off by the occupant, (d) "miscellaneous" appliances which are used occasionally (e.g. mobile phone chargers) and/or have a small power consumption. [Firth et al., 2008] presented 4 categories of domestic appliances based

on the patterns of their use: (i) continuous appliances, (ii) standby appliances, (iii) cold appliances and (iv) active appliances. The continuous appliances consume a continuous constant amount of power e.g. clocks, etc. The standby appliances have three basic modes of operation: standby, in use, and switched off. However, these appliances still continuously consume power when in standby mode [Cogan et al., 2006] e.g. TV. The active appliances consume power only when turned on. However, cold appliances besides their constant use, do not consume constant amount of power e.g. fridge freezer. [Foglar, 2008] defined the energy manageability as the occupants' ability to manage the energy consumption of household appliances. It is because energy consumption is not steady and fluctuates, for example, as a function of time and program performed. They suggested different criteria categorizing domestic appliances as (i) manageable instantaneous consumption where the consumption fluctuates with the thermostat settings or programmed functions. However, this fluctuation is manageable by the end users e.g. fridge freezer, washing machine, dishwasher, (ii) manageable total consumption where the consumption is steady but can be managed by the end users either by programming or through intelligent controls. e.g. TV, lighting and (iii) hardly manageable consumption where the consumption is hardly manageable by the end users due to its dynamic nature e.g. water heater, PC.

In this thesis one of our research questions to find the activities and behaviours that cause high energy consumption of appliances. Hence, the appliances with different energy and power consumptions must first be identified and then their sensitivity to the inhabitants' behaviour should be analyzed. The two categorizations described above are thus not relevant to our research. We propose another categorization based on (i) appliances with high power but low energy consumption (ii) appliances with low power and low energy consumption (iii) appliances with high power and high energy consumption and (iv) appliances with low power but high energy consumption over long periods. The reason for this categorization is to study those appliances that have high energy consumption and are more sensitive to inhabitants' actions.

In Irise database the energy consumption is available every 10 minutes. Each instance of this energy at the 10 minutes time step is assumed to represent the power of the appliance. However when this power is accumulated over the year, it is considered to represent the energy consumption in the categorization below. Table 3.1 shows how the different categories are selected based on maximum power and energy consumption. Details of each of these categories are given in the following sections.

No.	Category	Maximum Power Consumption	Yearly Energy Consumption
i).	high power low energy consumption	$\geq 5\%$	$\leq 7\%$
ii).	low power low energy consumption	$< 5\%$	$\leq 7\%$
iii).	high power high energy consumption	$\geq 5\%$	$> 7\%$
iv).	low power high energy consumption	$< 5\%$	$> 7\%$

Table 3.1 Selection criteria for different categories of appliances

3.3.1 LOW POWER LOW ENERGY

The appliances in this category consume low power and their yearly energy consumption is also low e.g. halogen, non halogen lamps, TV and microwave oven. Figure 3.4(a) shows the yearly power

consumption of these appliances 4%, 1%, 1%, and 4% and the yearly energy consumption (Figure 3.4(b)) 3%, 1%, 3% and 2% respectively, computed against all the houses in Irise.

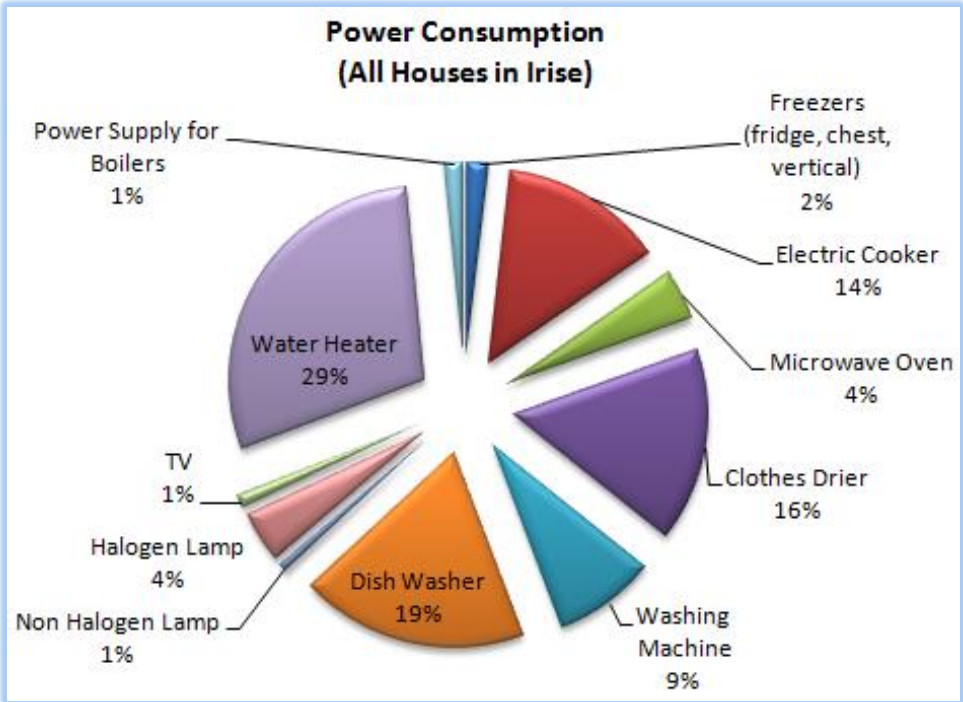

Figure 3.4(a) Power consumption of different appliances in Irise database

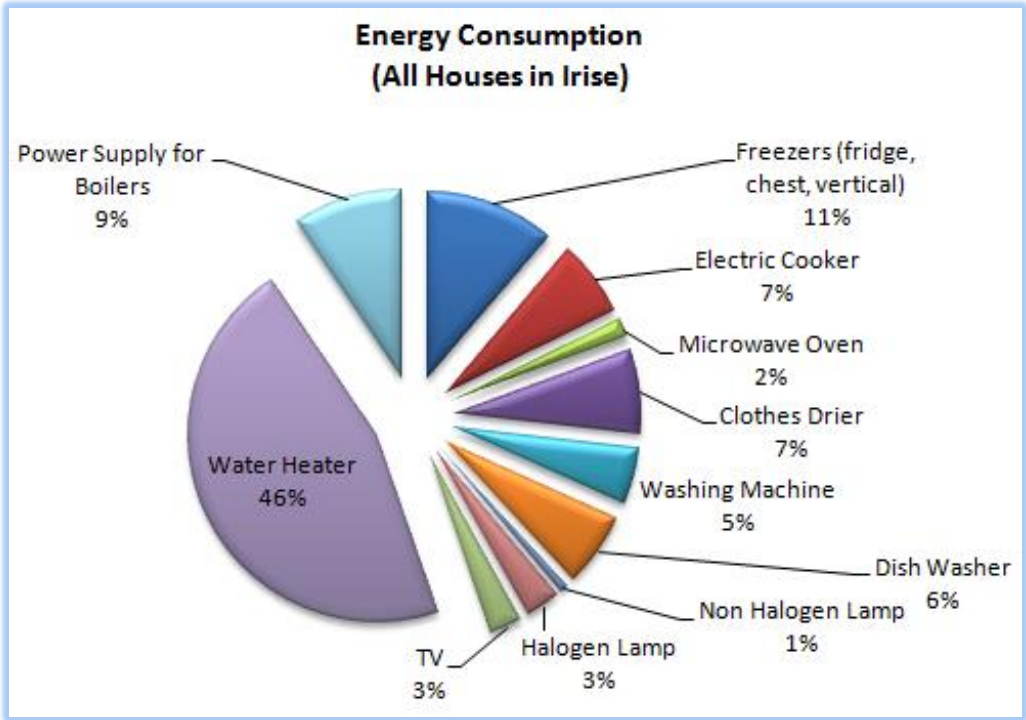

Figure 3.4(b) Energy consumption of different appliances in Irise database

Figure 3.5 shows the histograms for power and energy consumption of these appliances computed against all the houses in the Irise dataset. The x-axis shows the bins (discrete intervals) and the y-axis shows the frequency (count) of for each bin. The energy consumption in Irise is recorded after every 10 minutes which is assumed to represent the power of the appliance. Thus the bins in the histograms are drawn on the data with 10 minutes time difference between each data

point and recorded for the interval of a full year. The average power consumption for these appliances is 44W, 7W, 12W and 43W respectively. Similarly, the average energy consumption is 138069Wh, 35355Wh, 129228Wh and 75278Wh respectively.

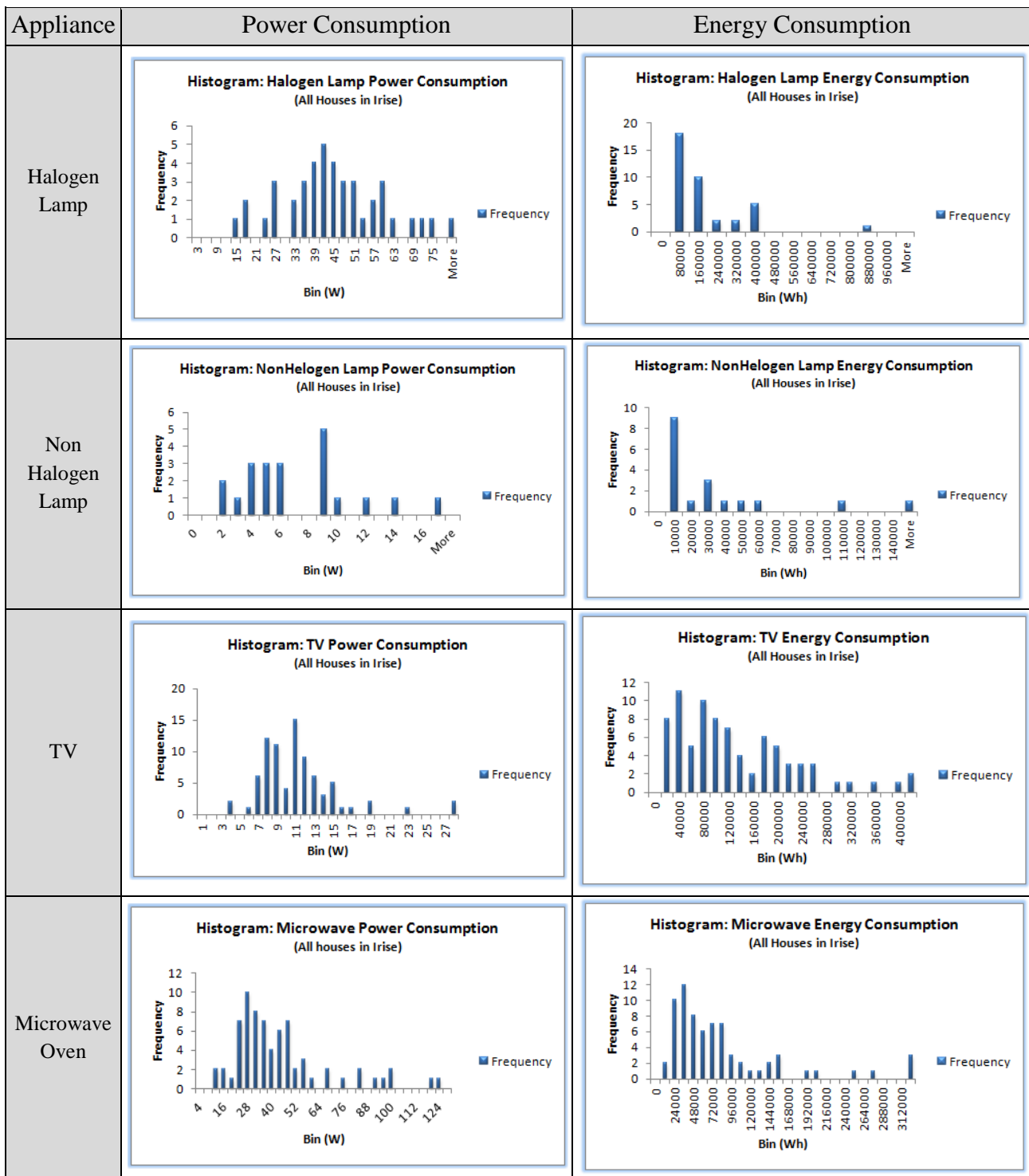

Figure 3.5 Histograms for low power and low energy consuming appliances

3.3.2 HIGH POWER LOW ENERGY

Examples of appliances in this category include the electric cooker (oven+hot plate), dishwasher, washing machine, and clothes drier. Figure 3.4(a) shows the yearly power consumption of these appliances 14%, 19%, 9%, and 16% and yearly energy consumption (Figure 3.4(b)) 7%, 6%, 5% and 7% respectively.

These appliances, when in use, consume a high power as shown by the histograms in figure 3.6 where the average power consumption is 138W, 191W, 86W and 164W respectively. However, they are only turned when inhabitants have to warm up or cook food, wash the dishes, clothes etc, and are not always on.

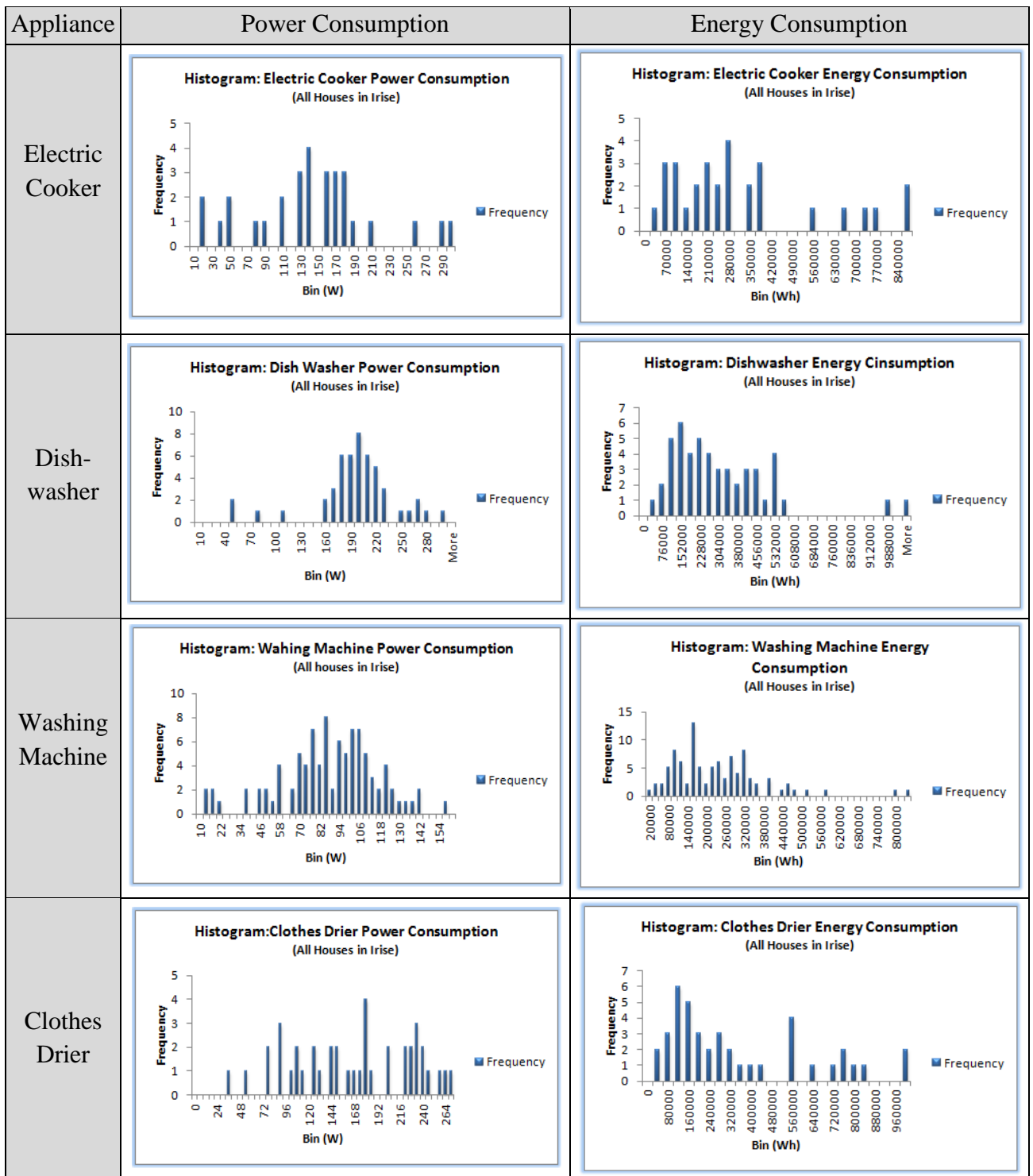

Figure 3.6 Histograms for high power and low energy consuming appliances

The yearly energy consumption for these appliances is not, however, very large as compared to other appliances in the home. This is depicted by the histograms in figure 3.6, that show the yearly energy consumption of these appliances as 301678Wh, 295651Wh, 225271Wh and 295651Wh respectively.

3.3.3 LOW POWER HIGH ENERGY

In this category the appliances have low power consumption but overall energy consumption computed over the whole year is high. Freezers (fridge freezer, chest freezer and vertical freezer) and electric boilers are the examples of appliances in this category. Figure 3.4(a) shows the yearly power consumption of all type of freezers as 2% and electric boilers as 1% and yearly energy consumption (Figure 3.4(b)) 11% and 9% respectively.

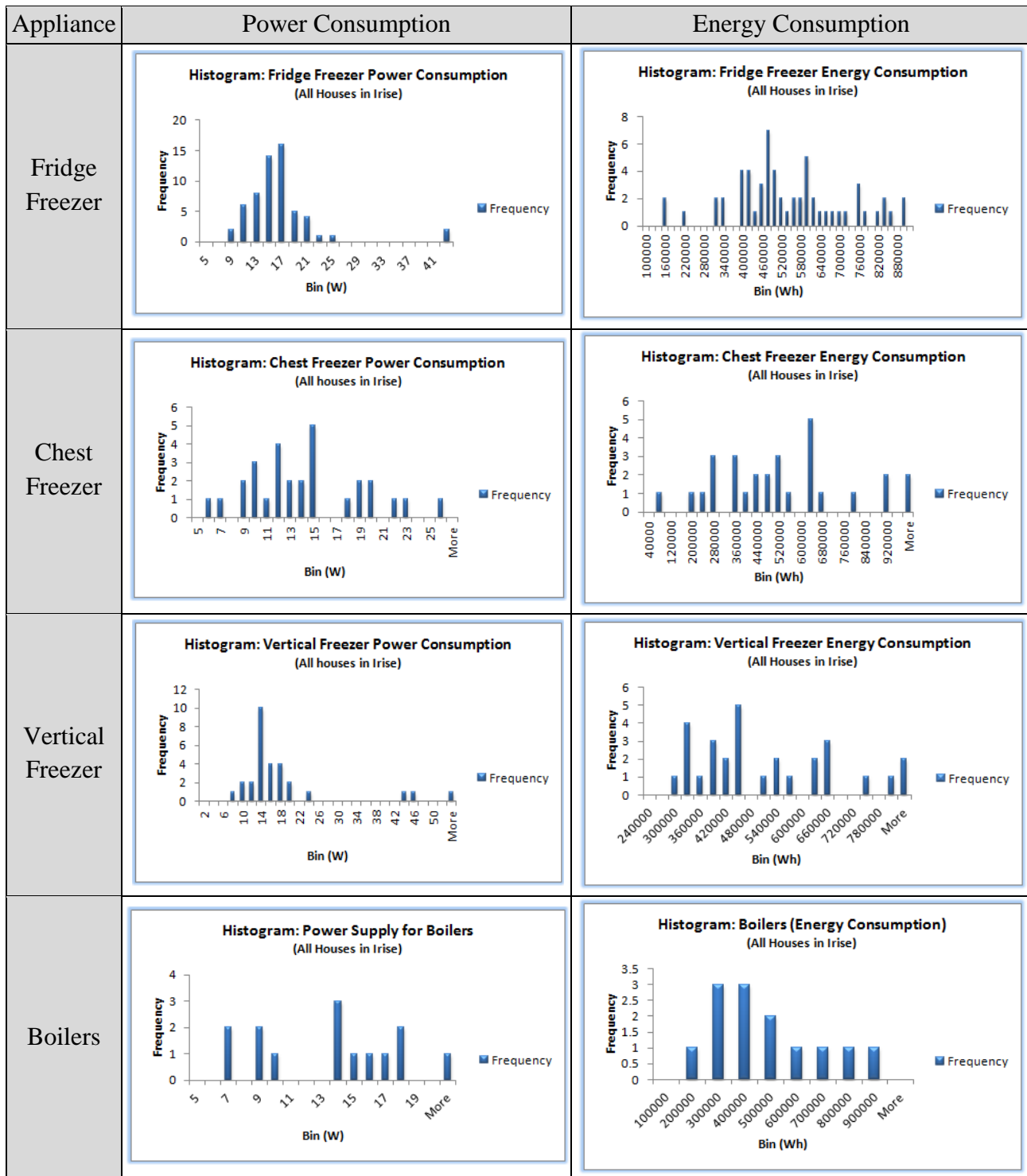

Figure 3.7 Histograms for low power and high energy consuming appliances

Figure 3.7 shows the histograms for yearly power and energy consumptions of different types of freezers and electric boilers. The average power consumption for freezers is 18W and for

electric boilers is 15W respectively. However, the average energy consumption is high, for example for freezers it is 517609Wh and for boilers it is 431748Wh respectively.

3.3.4 HIGH POWER HIGH ENERGY

A water heater is an example of high power and high energy consuming appliances. Figure 3.8 shows that its power and energy consumption are both much higher as compared to other appliances. The power consumption is 29% and energy consumption is 46% of the all other appliances. The average power consumption as shown in the histogram in figure 3.8 is 300W and average energy consumption is 2105296Wh respectively.

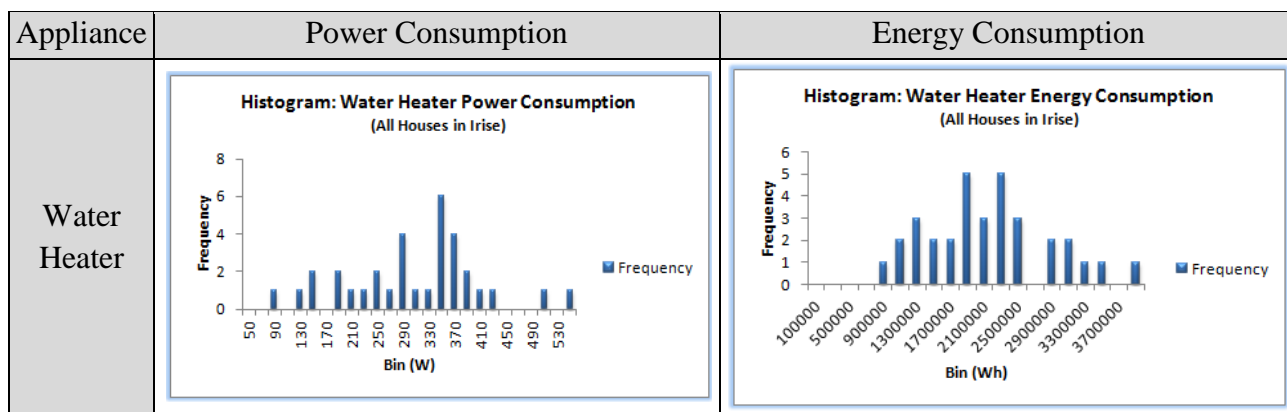

Figure 3.8 Histograms for high power and high energy consuming appliances

The statistics given by the European commission Joint Research Center (JRC) scientific and policy reports [Bertoldi et al., 2012] about residential energy breakdown are given in figure 3.9. For the high energy consuming appliances i.e. cold appliances and heating systems, the overall results are also in-line with those using our categorization (Figure 3.4(b)).

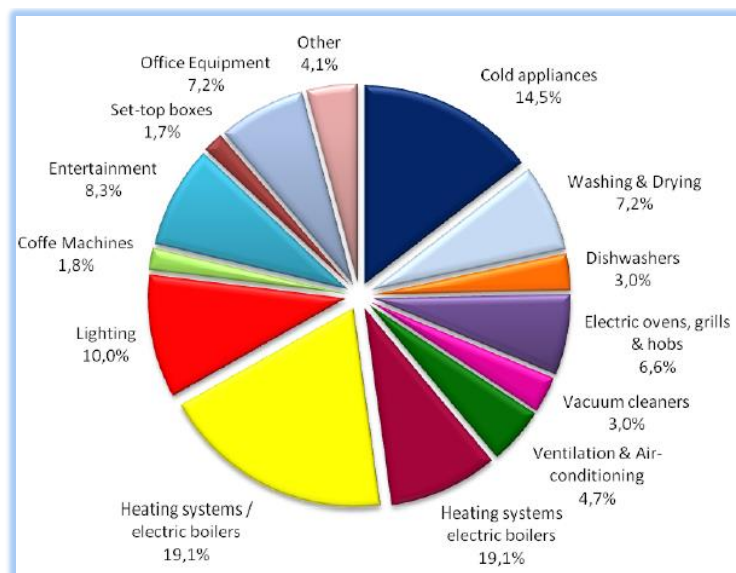

Figure 3.9 Residential energy consumption breakdown in Europe

The different categories used in this section are based on the power and energy consumption of the appliance. Other factors, besides the type of appliance, that impact the energy consumption are the size of the appliance, number of persons in the house, etc. However, the most important of these is the occupants' behaviour. For example, the inhabitants' choice of washing clothes or dishes in smaller loads rather than full load, leaving the curtains and shutters opened at night, leaving the

pans without lids while cooking etc. are some of the examples of inhabitants' high energy impacting behaviours.

3.4 High Energy Consuming Appliances

As shown in figure 3.4(b), section 3.3, the most energy consuming appliances are heating systems, 46% of total energy consumption and cold appliances, 11% of total energy consumption. These appliances have been selected for the co-simulation of inhabitants' behaviour together with physical aspects of building and energy consumption. The impact of behaviour on the energy consumption of these appliances is discussed through a literature review and an analysis of the Irise database in the following sections.

3.4.1 IMPACT OF HUMAN BEHAVIOUR ON HEATING, COOLING AND WINDOW OPENING

The impact of heating/cooling and window opening behaviour on buildings' energy consumption is well documented in the literature [Bourgeois et al., 2006; Haldi and Robinson, 2009]. However, the energy modelling and simulation accuracy ranges from +/- 10 to 40% for non residential buildings. Furthermore, empirical data shows that the energy use of different occupants living in identical residential units can vary by as much as 200-300% [Lutzenhiser, 1987]. This wide fluctuation is attributed to the inhabitants' behaviour involving opening/closing windows and blinds, turning lighting on/off and controlling heating and cooling equipment [Fracastaro and Lyberg, 1983].

New residential buildings are more energy efficient. Nevertheless overall energy consumption still rose by 39% in the last 40 years with 24% share of domestic heating energy. Different studies found changes to thermostat settings, and window opening as the key behavioural aspects which influence energy consumption patterns [Andersen et al., 2009]. However, studies conducted by Shipworth found no evidence of changes in thermostat settings during last 40 years [Shipworth, 2011]. This raises the question that if inhabitants are not requiring higher indoor temperatures then what else is affecting the major increase (24%) of domestic heating needs. Wallace found that window opening behaviour significantly affects the air flow rates [Wallace et al., 2002]. Hence, it is likely to be one of the main reasons for the major increase in energy consumption besides the other factors like population increase, new buildings, etc. This leads to the conclusion that behaviour is an important factor for the increase in heating energy needs.

A comprehensive case study conducted by Karjalainen shows that regarding the thermal environment occupants feel less comfortable in offices than in residential buildings. This is because of the level of adaptive control over heating and cooling sources. In the office, occupants are more restricted in their actions because of the presence of other people, whereas at their residence they are free to manipulate the heating and cooling controls for their thermal comfort [Karjalainen, 2009]. This is referred to as tolerant behaviour, because the thermal comfort variations, acceptable or not, are tolerated by the occupants in office buildings [Humphreys and Nicol, 1998].

3.4.2 HIGH ENERGY CONSUMING APPLIANCES' CONSUMPTION AND INHABITANTS' BEHAVIOUR

After heating and cooling appliances, the other important high energy consuming appliance that is sensible to inhabitants' actions and that has uncertain power consumption is the fridge freezer (Figure 3.4(b)).

In order to assess the sensitivity of these appliances to inhabitants' behaviour, the Irise database is analyzed. The results of this analysis are presented in figure 3.10. The x-axis shows the

size of the fridge freezer in each house and the y-axis shows the energy consumption. Each point in the graph corresponds to the energy consumption of a fridge freezer over the period of a year along with the number of persons in each house represented by different colours. In some cases the energy consumption depends upon the size of the fridge freezer and the number of people in the house, but in others it does not. An example of where the energy consumption does not depend upon the number of people in the house nor on the size of the fridge freezer, is shown with an oval. This shows that the energy consumption of the fridge freezer does not necessarily depend upon the number of people in the house nor on the size of the appliance. Instead it depends on how the inhabitants' use the appliance, i.e. their behaviours. This analysis also provides a good justification that simple presence/absence profiles are insufficient in order to model the household behaviour for cold appliances.

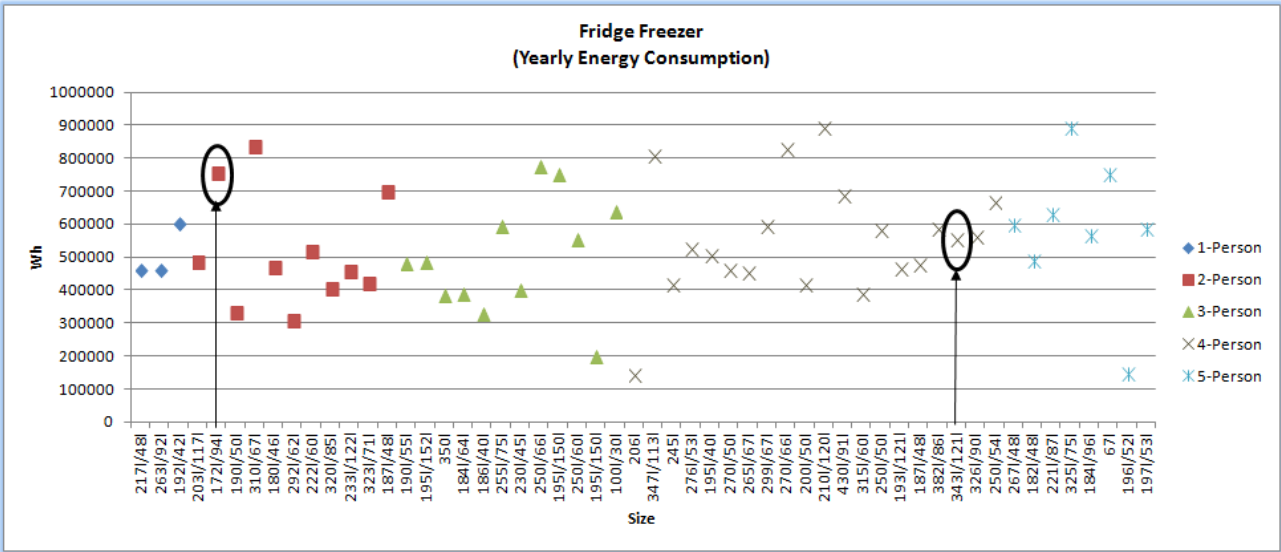

Figure 3.10 Fridge freezer consumption patterns from the Irise dataset

The second example of a high energy consuming appliance is the water heater. The box plot in figure 3.11 shows the overall increase in consumption with the increase in the number of persons. However, there are still cases where there is a much higher consumption in a house where there are only a few persons as compared to a house with more persons. Such an example is shown by the box plots for 2 person and 5 person houses where the heater in a 2-person house (the "Max" value) is consuming more than the one in a 5 person house (the "Min" value).

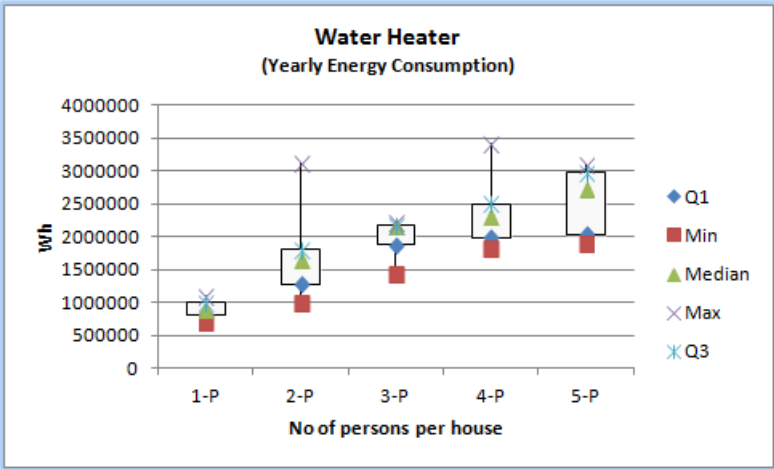

Figure 3.11 Water heater yearly energy consumption for all houses in the Irise dataset

The above energy consumption patterns show that the appliances' consumptions belonging to each category are impacted by occupants' behaviour. Since behaviour is important regarding the energy consumption of most of household appliances, it is important to identify which specific behaviours are high energy consuming. Similarly the impact of certain environmental parameters that could possibly impact the energy consumption patterns needs to be further identified. This will serve as an essential input for the modelling and simulation of human behaviour for energy management.

3.4.3 OTHER CATEGORIES OF APPLIANCES' CONSUMPTION AND INHABITANTS' BEHAVIOUR

The above examples represent the appliances taken from the high energy consuming categories. In order to analyze the sensitivity of appliances belonging to other categories on inhabitants' behaviour, examples from each category are taken and explained below. The analyses performed on other appliances of "High Power Low Energy" category e.g. dishwasher and washing machine show similar results. Figure 3.12 shows the yearly energy consumption of 12 place setting dishwashers for all houses in Irise that have a dishwasher. The box plot shows that the fluctuation of energy consumption among these houses is irrespective of the number of people inside the house. The example of one of the extreme cases is the 1 person house where the dishwasher consumes more than the 5 person houses (the "Median" value) irrespective of the fact that both have a 12 place setting dishwasher.

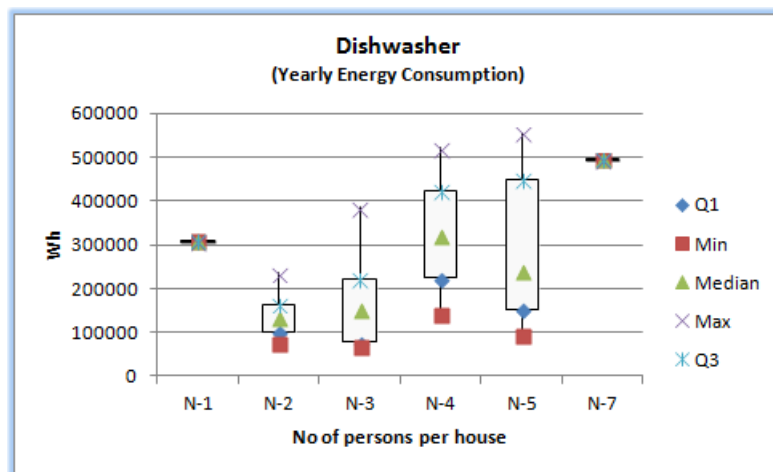

Figure 3.12 Dishwasher yearly energy consumption for all houses in Irise dataset

Figure 3.13 shows the yearly energy consumption of a washing machine for all houses in the Irise database. The consumptions inside the rectangle show that the variations in energy consumption for most of the houses are irrespective of the number of persons inside the house.

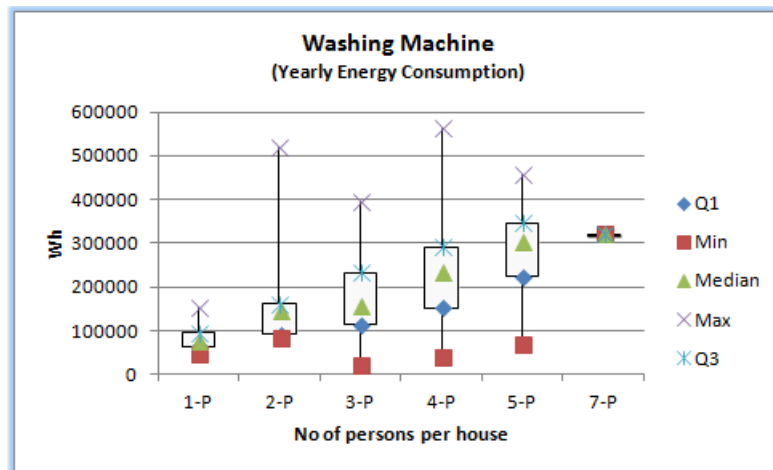

Figure 3.13 Washing machine yearly energy consumption for all houses in Irise dataset

A microwave oven belongs to the category “Low Power Low Energy” and figure 3.14 shows the yearly energy consumption of the microwave ovens of different sizes. In this example also no strict correlation between the number of persons in the house and the size of appliance with the consumption is found. The ovals show the case where a 12kw microwave in a 2 person house is consuming more than a 335kw microwave in a 4 person house. There could be certain reasons e.g. the inhabitants in a 2-person house eat ready meals at home most of the time and those in the 5-person house use the standard cooker every time they want to eat. Similarly, covering the food while warming up, the duration for which the food is warmed up etc. impacts the overall consumption. These factors, however, belongs to inhabitants’ behaviour rather than the size of the appliance or the number of persons in the house and hence are important to be considered in energy simulations and demand predictions.

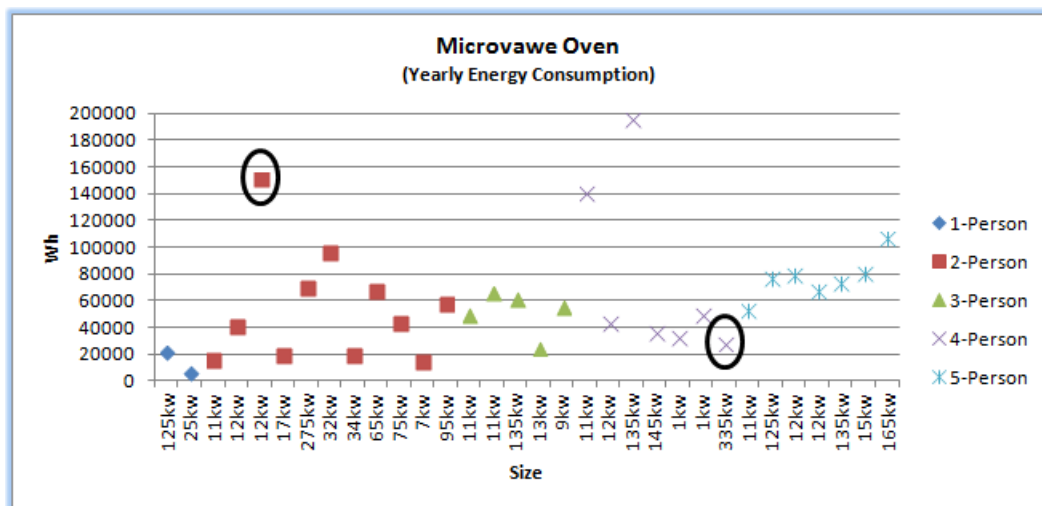

Figure 3.14 Microwave oven yearly energy consumption for all houses in Irise dataset

3.5 Identification of Parameters that affect Energy Consumption

Some of the parameters that impact the energy consumption behaviours are identified through analysing the Irise database and through field studies. These parameters lie at different levels of granularity, from being simple to complex. This means for some of them, they are easy to analyze using only the Irise database, while others need field studies in addition to the Irise database. Figure 3.15, explains how the identification of parameters, from simple to complex, has been made. The

term ‘Global Behaviour’ in the figure is used for those parameters that can be analyzed using the Irise database. Similarly, the term ‘Local Behaviour’ is used for those parameters for which it is necessary to do field studies in order to find their impact on energy consumption. The detail about the different parameters, in figure 3.15, and the reason for performing field studies is given in the following sections.

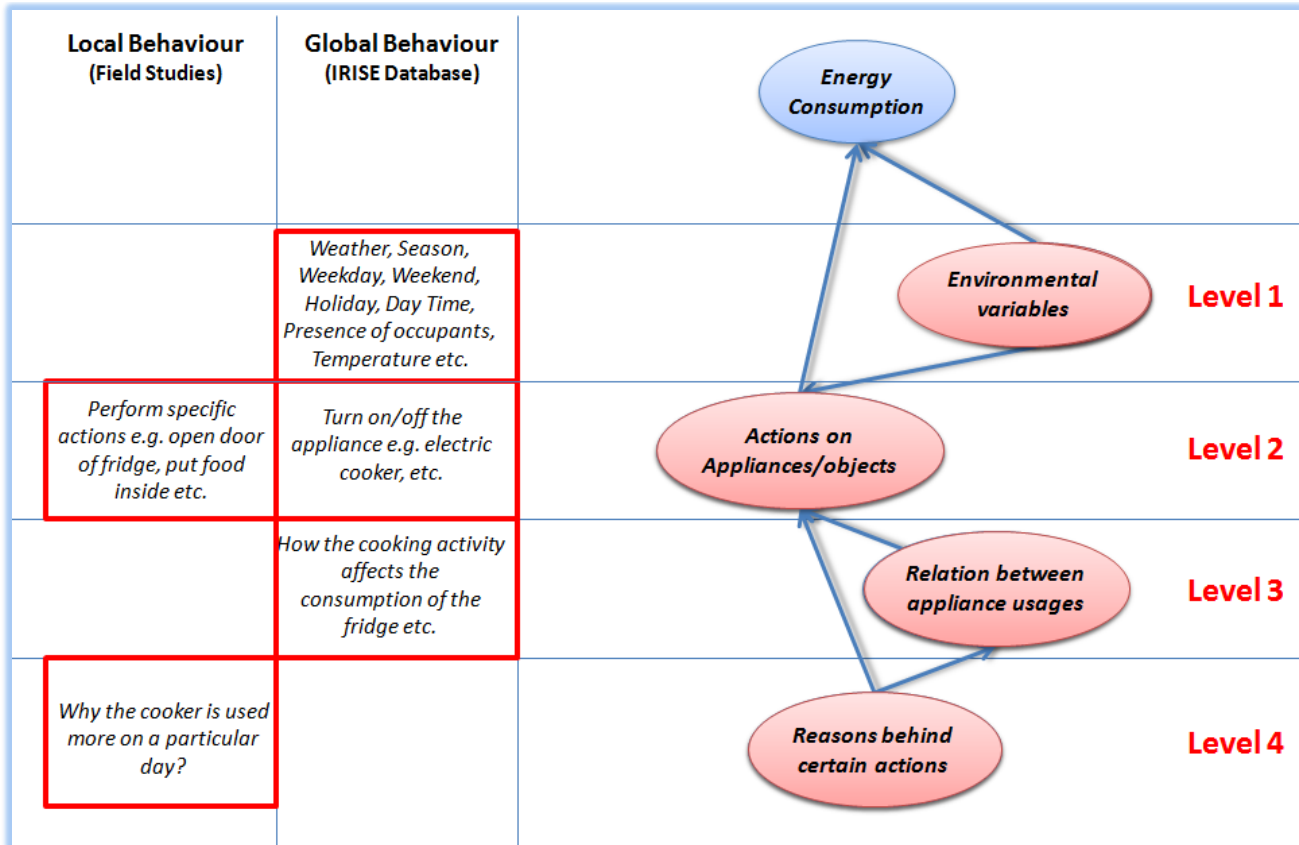
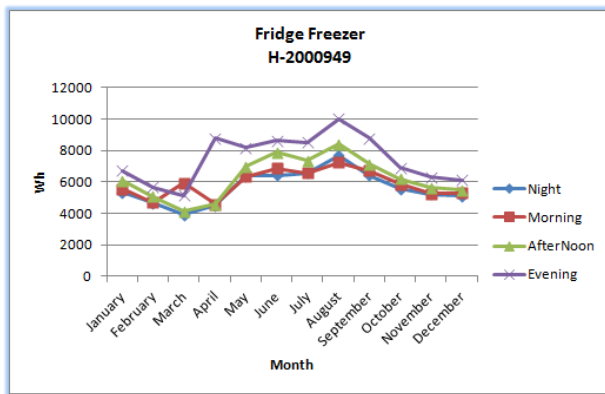

Figure 3.15 Parameters considered as important for the model

3.5.1 THE IMPACT OF ENVIRONMENTAL PARAMETERS ON CONSUMPTION (LEVEL 1)

There are certain environmental parameters that impact the inhabitants’ behaviour regarding energy consumption. These include seasons, day type (weekday, weekend), day time (morning, afternoon, evening, night) and weather conditions (sun, rain, etc). In this section the impact of these parameters on energy consuming behaviours of inhabitants is presented with examples from each category of appliances. In figure 3.16, the monthly consumption of the fridge freezer is computed over the whole year for different houses with different number of persons in the house from the Irise database. It shows that the consumption of the fridge freezer varies with the seasons and also the time of the day. At night, i.e. 0h – 6h (blue curve), the inhabitants’ have very little or almost no interactions with the fridge freezer, so the consumption is smaller compared to the other periods of the day when it is more likely that the appliance consumption is affected by human behaviour. Conversely, in the evenings, i.e. 18h – 24h, (purple curve), the inhabitants are more likely to be at home, cooking, and interacting with the fridge freezer; hence the increased consumption of the fridge freezer. Concerning fridge freezer efficiency, it is likely that the fridge freezer in figure 3.16(a) is very efficient since it is more sensitive to human actions compared to the one in figure 3.16(b,c,d).



(a) 2-person house

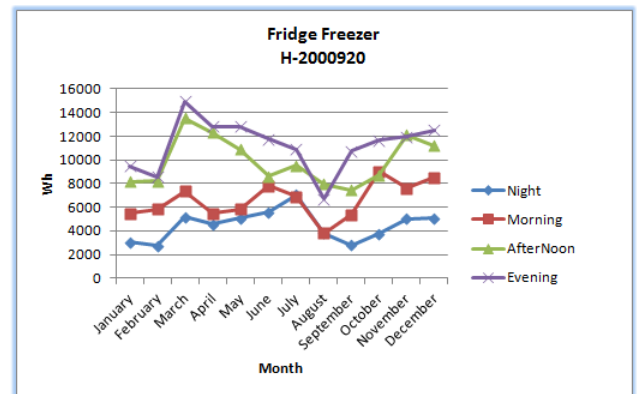

(b) 3-person house

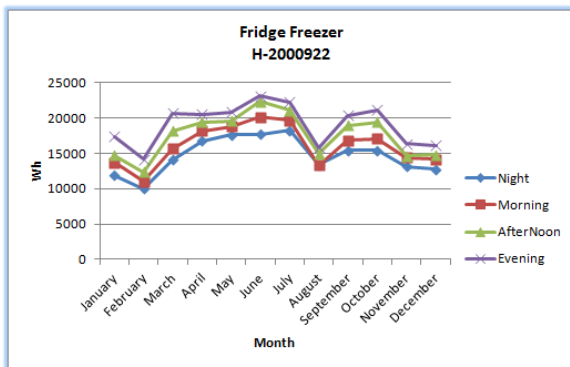

(c) 4-person house

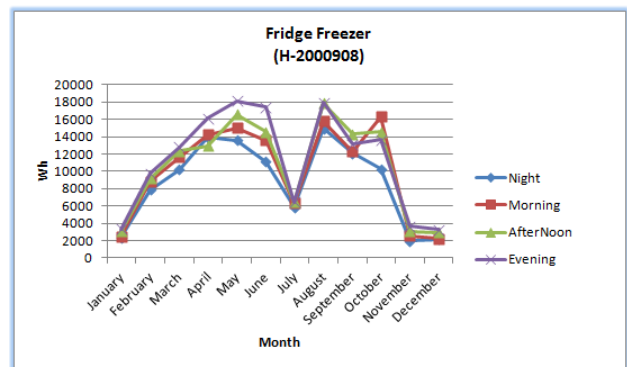

(d) 5-person house

Figure 3.16 Comparison of the fridge freezer consumption for different houses from the Irise dataset

Figure 3.17(a,b) shows the consumption of the dishwasher for all houses having a dishwasher in the Irise database. The power consumption is higher in the evenings (18h – 24h) (Figure 3.17(a)) as mostly all the family members are at home during dinner. The energy consumption in the afternoon (12h – 18h) is less than in evening as mostly the people have their lunch at their workplace rather than at home. It seems that most of the family members in these houses are working and have their lunch at the workplace. On the contrary, the inhabitants in figure 3.17(b) are used to washing their dishes more in the afternoon and morning (06h – 12h) than in the evening. In these houses it seems that most of family members stay at home and prefer to do the dishwashing during the day rather than at night.

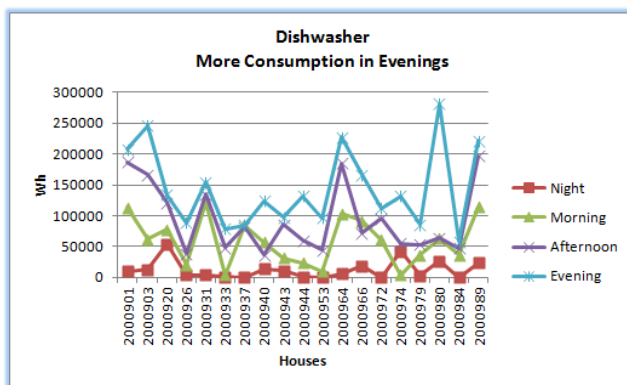

(a) More consumption in the evening

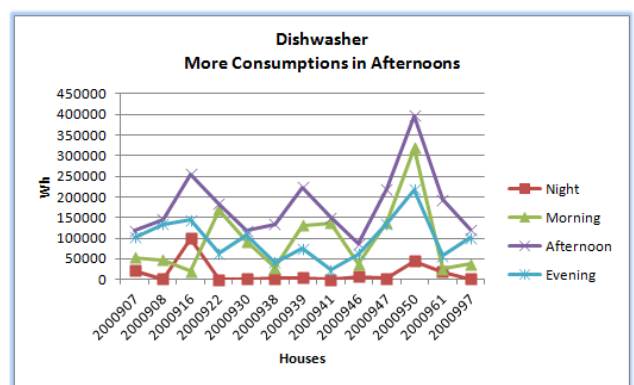

(b) More consumption in the afternoon

Figure 3.17 Comparison of the dishwasher for all the houses from the Irise dataset

Figure 3.18(a,b) shows the energy consumption of the TV in all houses in the Irise database. There is more consumption in the evening (Figure 3.18(a)) as mostly people are at home and like to watch TV during this period. There are however some houses where the inhabitants watch TV mostly in the afternoon (Figure (3.18(b))). In these houses the second most probable time to watch TV is at night. This could be due to the fact that in these houses most of the family members stay at home, perhaps because they are elderly and retired or house wives or kids watching cartoons etc.

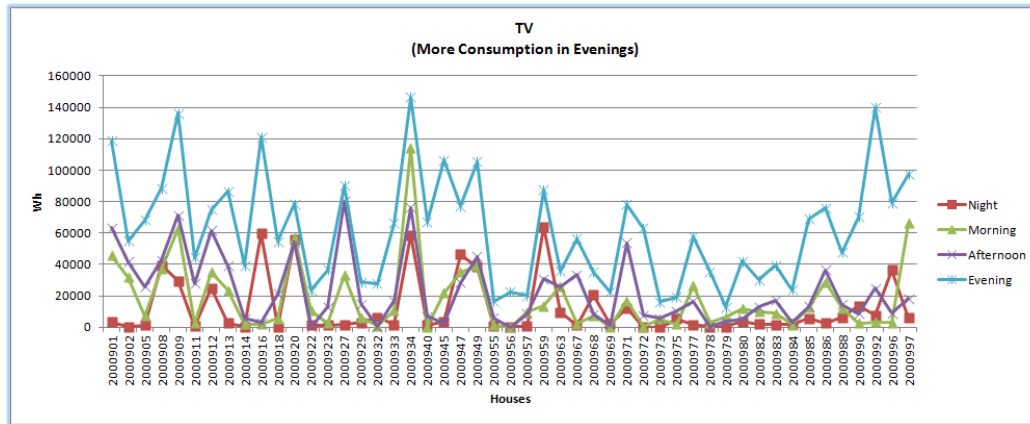

(a) More consumption in the evening

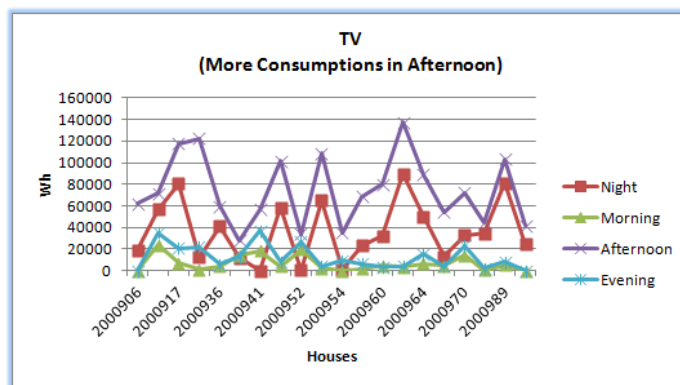

(b) More consumption in the afternoon

Figure 3.18 Consumption of the TV for all the houses from the Irise dataset

The consumption of the water heater in figure 3.19(a,b) is more in the evening and at night as compared to other periods of the day. This is because during these periods inhabitants are mostly at home and interact more with thermostat settings or windows, etc.

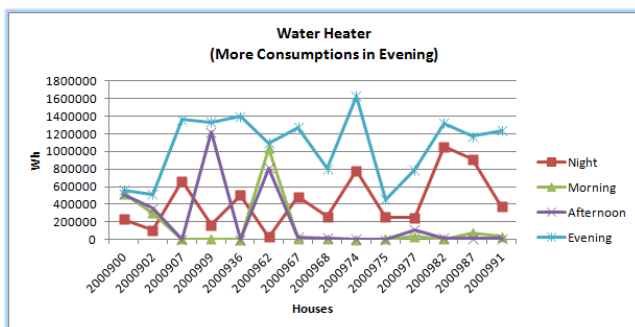

(a) More consumption in the evening

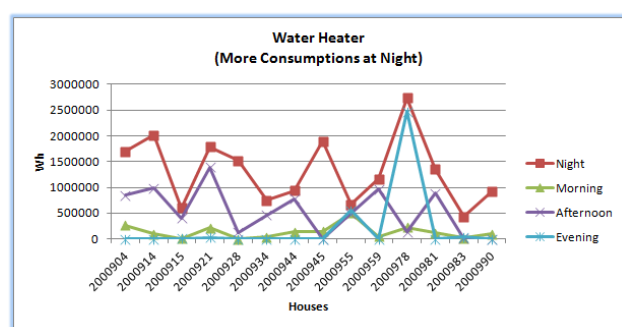

(b) More consumption at night

Figure 3.19 Consumption of the Water heater for all the houses from the Irise dataset

Similarly, in addition to time of the day the type of day also sometimes plays a significant role in the overall energy consumption. Figure 3.20 show the yearly energy consumption of an electric cooker averaged over weekdays and weekends. It shows that the energy consumption for these houses is comparatively more on weekends than weekdays.

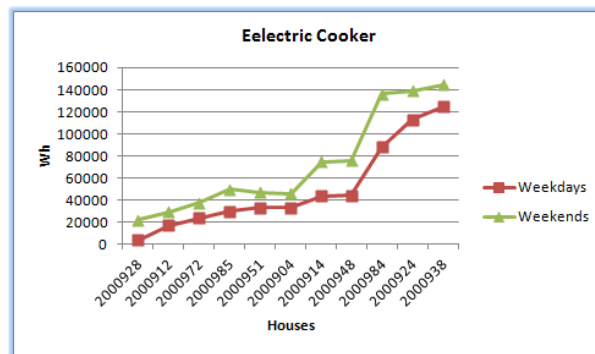
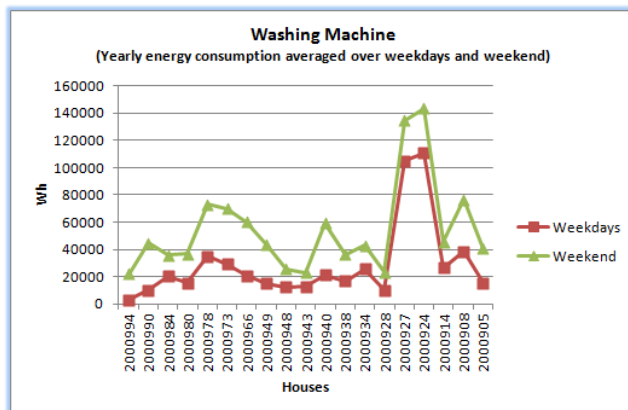
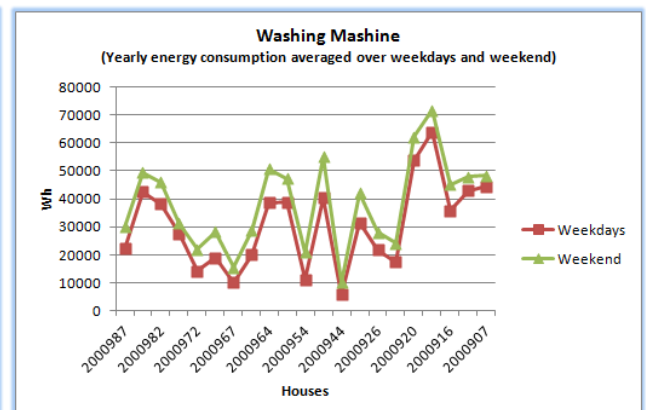

Figure 3.20 Consumption of electric cooker averaged over weekdays and weekends

Figure 3.21(a) shows an example of a washing machine where there is significantly more consumption on weekends than weekdays. Conversely, the houses in figure 3.21(b) do not have a significant difference between the energy consumption on weekdays and weekends. Figure 3.21(c) shows the houses where the washing machine is used more on weekdays than on weekends. Thus high variability is found in the inhabitants' behaviours regarding the weekdays and weekend consumptions.



(a) Significant difference in consumption



(b) Small difference in consumption

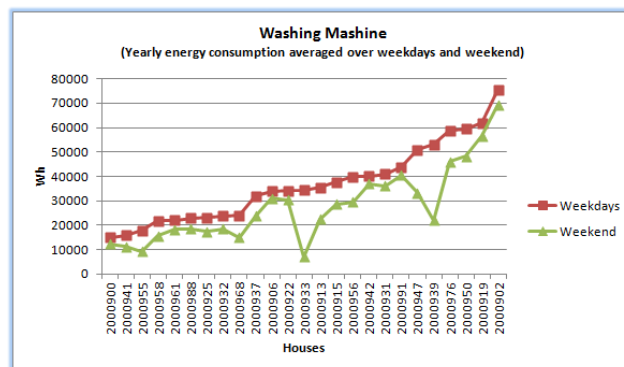

(c) More consumption on weekdays

Figure 3.21 Consumption of the washing machine averaged over weekdays and weekends

In addition to the parameters discussed above, the weather is another important factor that affects inhabitants' way of interacting with some appliances. For example, if the weather is good it may influence the inhabitants' desire to eat out. This behaviour could vary from one family to another based on their norms, culture, region, etc. In order to see the impact of weather on cooking behaviour, an analysis is performed on the houses in the Irise database. In this analysis the consumption of the electric cooker (hotplate+oven) is summed up for each day for the whole year. Also the weather condition for each day during the year is registered. Finally, the consumption is averaged for each of the weather conditions. Figure 3.22 shows an example where the average consumption of the cooker for different weather conditions is averaged over the whole year. It shows that during most of the times when weather is not sunny the consumption is higher compared to when it is sunny. There could be certain reasons behind this consumption behaviour of this family, e.g. the tendency to eat out when the weather is good, or the inhabitants are eating cold food (salads etc.).

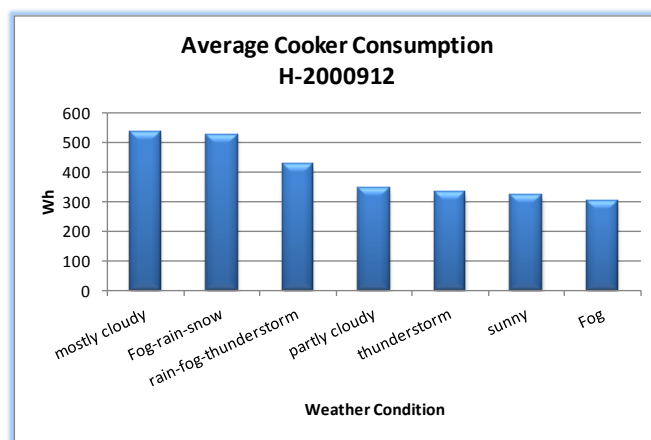

Figure 3.22 Cooker consumption during different weather conditions for a house in the Irise database

In literature weather is found to be one of the most important and influencing factor on energy consumption [Griffin, 2008]. Another analysis is performed to find the impact of different weather conditions on the usage of lights. The experiment is performed on a house in the Irise database where the total lighting consumption is summed for each morning during the period of a month. Then the consumption against each weather condition is summed up. The results shown in figure 3.23 clearly depict that as the weather is getting worse the usage of lights is significantly increased.

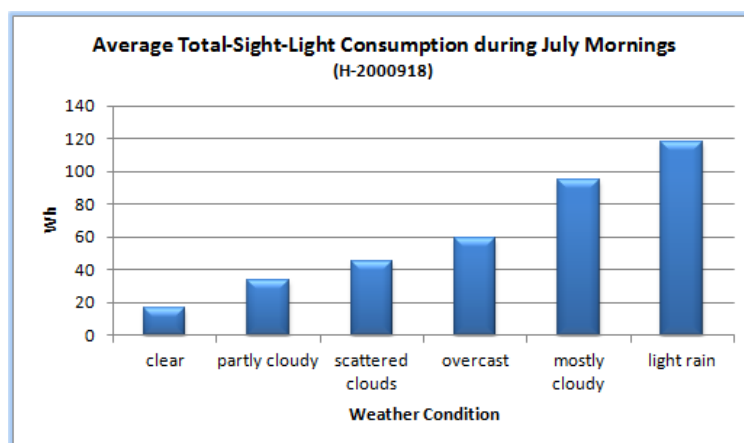

Figure 3.23 Total-Lighting consumption during different weather conditions

3.5.2 THE IMPACT OF HUMAN ACTIONS ON APPLIANCE CONSUMPTION (LEVEL 2)

In section 3.3 we found that fridge freezers consume the highest energy after the heating system. The fridge freezer is chosen as an appliance to be modelled and simulated with the inhabitants' behavioural patterns based on three factors (i) it has a strong impact on energy consumptions, (ii) fridge cycles are highly influenced by inhabitants' behaviour and (iii) it is complex to model the fridge consumption cycles.

3.5.2.1 Complementing the Irise Dataset

In order to co-simulate the inhabitants' behaviour with the physical model of the appliance both the consumption of the appliance and the actions behind these consumption patterns are required. However, the Irise database only contains information about the consumption of electrical appliances. It does not include any information about the activities behind those consumption patterns. Thus this database is used only to study the impact of more generic parameters, such as, when the cooker is on, the weekday/weekend and the information about the weather. This information is insufficient to find the impact of specific actions to which the compressor cycles are sensitive. These specific actions include, for example, the quantity of food introduced into the fridge, etc. These specific actions are related directly to the behaviour of occupants, who may have different behaviours for the achievement of the same goal. Since, specific actions constitute these behaviours, it is important to take into account these types of actions and see the impacting results.

The relationship between the energy consumption data from Irise, and data on inhabitants' activities is shown in figure 3.24 below:

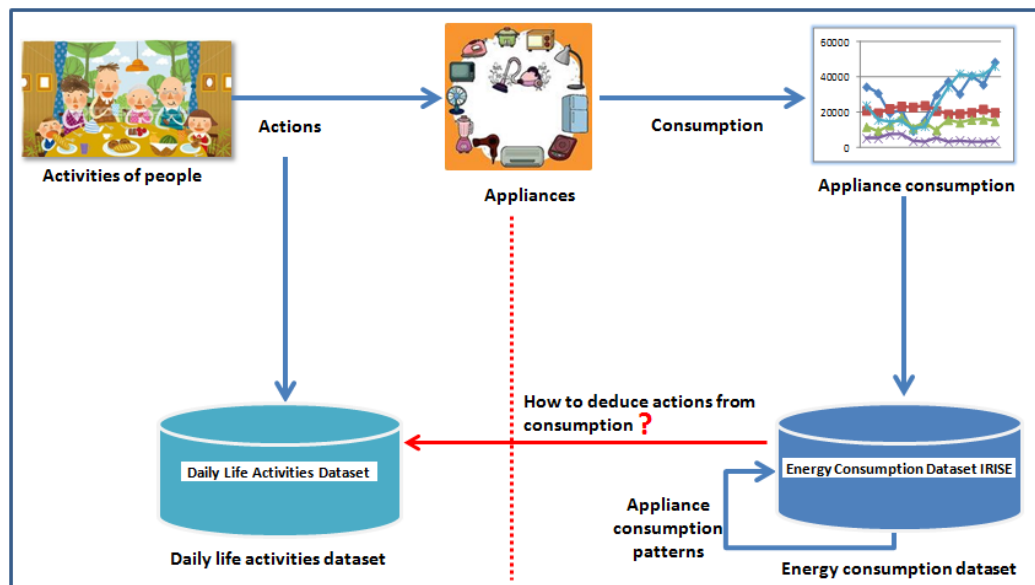

Figure 3.24 The scope of the Irise dataset

The figure 3.24 shows that two datasets, Irise and Daily life activities, are disconnected; the red dotted line is used to show this separation. The inhabitants perform certain actions at home that are registered in the daily life activities dataset. However, this dataset only contains the information about the activities of people. It does not provide any information about how the activities affect the consumption of appliances. Conversely, energy consumption of home appliances is stored in the Irise dataset. The Irise energy consumption dataset is the key in extracting activity specific energy consumption patterns; however, it lacks the information about inhabitants' actions behind certain appliance consumption patterns. Finding a link between these two types of datasets is critical to

capture the influence of inhabitants' behaviour on energy consumption as well as the usage patterns of home appliances. Since, it is critical to complement the structural discrepancy of missing activities information against energy consumption trends in the Irise dataset we performed an experiment on fridge freezer. The goal was to find energy consumption patterns associated with behavioural actions.

For some appliances it is easy to deduce the actions behind consumption patterns. Figure 3.25 shows the power consumption of a television over 3 consecutive days. Here, it is easy to deduce the actions behind these consumptions; when the appliance is turned on it consumes more or less a constant amount of power until it is turned off.

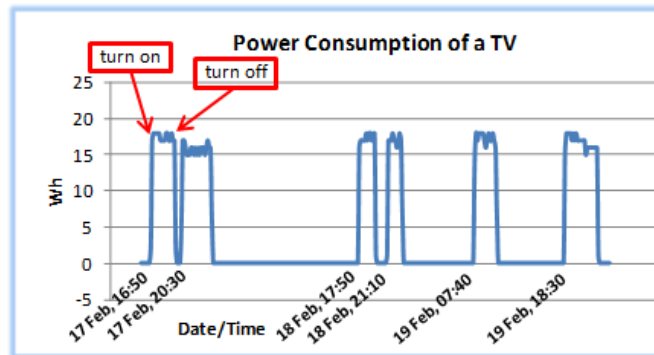

Figure 3.25 Power consumption pattern of a television

However there are other appliances, such as a fridge freezer, for which it is not easy to deduce the actions behind the consumption patterns. Such a situation is shown in figure 3.27, where the compressor cycles of the fridge freezer have different lengths even during the same day. In this case it is not easy to deduce the actions behind the consumption patterns, thus building a model for these types of appliances is more challenging as compared to lamps or televisions. Also, unlike a television or lamp, the impact of some actions on these appliances is not immediate. The impact could not only affect the current cycle, but also subsequent ones depending on the nature of the action being done. That is why the compressor cycles in the figure are quite different.

3.5.2.2 Experimental Data Collection and Analysis

The objective was to identify the reasons behind certain activities and to link these to the consumption data in the Irise database. As detailed in chapter 2, section 2.2, the inhabitants' behaviour is captured through the 5W1H approach; all these elements are considered in the questionnaires used for data collection. The questionnaire proposed and used for this purpose is presented in figure 3.26(a) to collect the context elements and information of inhabitants' behaviour at home.

Activity Journal: to be filled by each family member and insiders

Date :											
Name : Stéphane			Age : 40			Role in family: Father			Profession: Professor		
Movement			Principle Activity				Secondary Activities			With whom	Action on window, blinds, curtains
from	to	time	name	begin	end	type	name and equipment used	Begin	end		
Bedroom	Kitchen	7h30	Breakfast	7h30	7h45	habitual	light	7h15	8h00	wife	Opened window

Figure 3.26(a) Questionnaire for collecting context and information of inhabitant behaviour

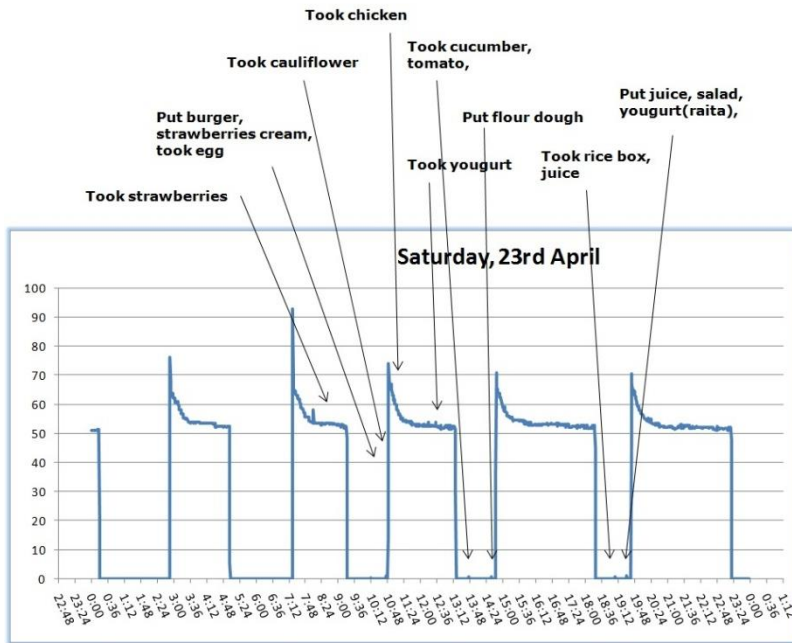

(a)

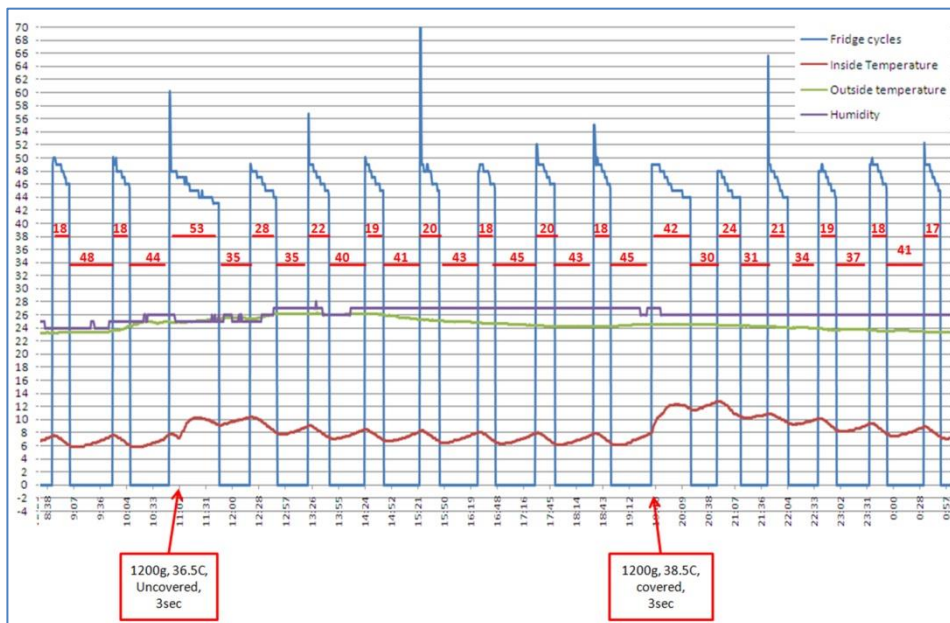

(b)

Figure 3.27 Experimental data analysis results

The normal compressor cycles are regular in figure 3.27(a) during the middle of the day, and during the first two cycles in figure 3.27(b). As there are more interactions with the fridge the cycle durations change according to the type of activity performed, i.e. the amount and temperature of food, the duration of opening the door of the fridge, etc. That is why in figure 3.27(b), when food is put into the fridge at two different times, the cycle durations are different. The cycle where the first time food is introduced is longer than when food is introduced for the second time; this is because the food was uncovered the first time. So even though the temperature was lower in the fridge just before the first food was added, compared to the second time, the compressor cycle duration was longer.

In these experiments it is confirmed that inhabitants' actions have a strong impact on fridge cycles, which leads to high energy consumption. The high energy consuming activities are listed below. However, a low energy consuming activity was also found i.e. putting frozen food into the fridge:

- a) Putting a large quantity of food inside
- b) Food with high temperature
- c) Keeping the door open for a long time
- d) Opening the door more often
- e) Putting in uncovered food

3.5.3 RELATION BETWEEN APPLIANCE USAGES (LEVEL 3)

One of the most interesting heuristics derived from the Irise database analysis is that fridge freezer cycles were larger when the cooker was used (Figure 3.28); hence, cooking activity is strongly related to the actions on the fridge. Also, the use of the cooker affects the average duration cycles of the fridge freezer since the two appliances are often used together in a cooking activity, with the inhabitants' opening the fridge door more often, etc.

This link is exploited to complement Irise database: similar patterns are classified as the cooking activities, whereas the rest of the fridge freezer usage patterns are classified as non cooking activities. These patterns will be used further in the computation of the impact of inhabitants' behaviour on the consumption of the fridge freezer. The complete details about how these patterns are computed and used in the model is detailed in chapter 6.

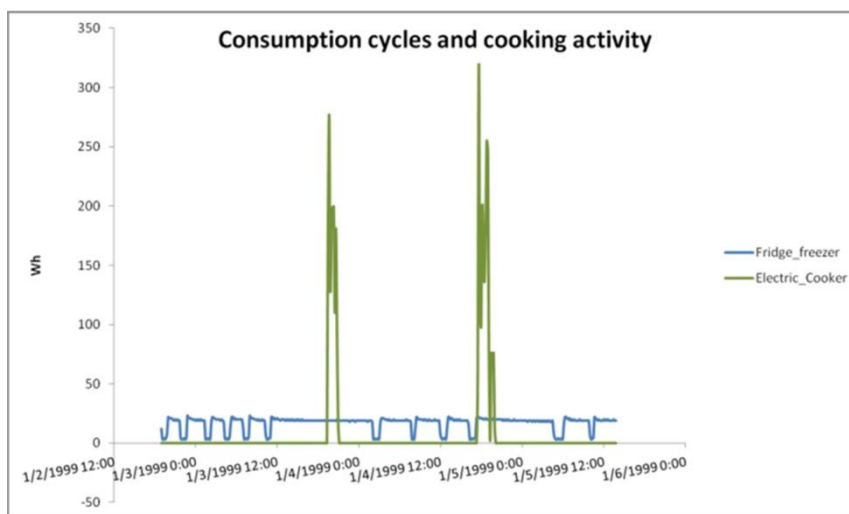

Figure 3.28 Effect of cooking activities on the fridge freezer consumption cycles

3.5.4 REASON BEHIND ACTIONS (LEVEL 4)

In the previous sections we saw that certain parameters affect the consumption patterns. This is shown by experiments on the Irise database and the field studies. There are situations, however, where the appliance consumption is abnormal, without any known reason. Figure 3.29 shows such a situation, where the compressor cycles of a fridge freezer are given for 3 consecutive days. The x-axis shows the time and y-axis the consumption. The compressor cycles are longer than normal cycles. This could be due to certain reasons e.g. more interactions with the fridge, irrespective of the fact that neither a cooking activity is performed, nor is it a weekend or holiday.

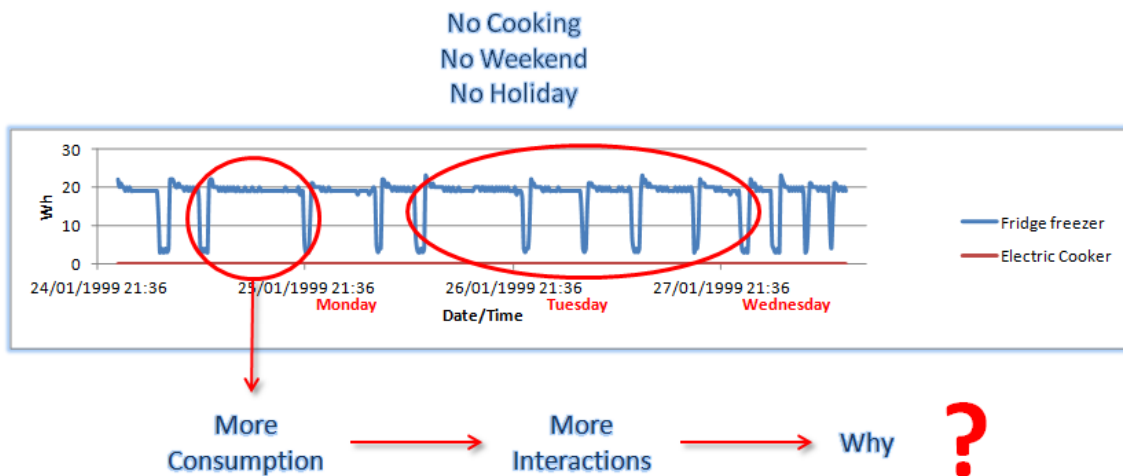

Figure 3.29 What are the reasons behind longer compressor cycles?

In this case, rules are found from the field studies, where the inhabitants' reasons behind certain actions are also recorded. This will help to find some possible reasons behind some abnormal consumption patterns. For example, there are more interactions with the fridge when guests are arriving (Figure 3.30). Since, it is difficult to find all the possible reasons behind actions, some high level categorization for the reasons behind actions is made in chapter 4, section 4.2.2.

DateTime	Item	Amount	Food Temperature	Reasons Behind Actions	Actions
12/6/11 15:22	chicken mea	250g	19C		put inside
12/6/11 15:47	chicken meat			want to cook it now	take out
12/6/11 15:50	bell pepper				take out
12/6/11 20:15	milk			going to prepare drink for my husband	
12/6/11 20:15	yougurt	2			take out
12/6/11 20:54	yougurt	400g	16C	want to make raita	
12/6/11 21:01	vegetable ric	1400g	31C	want to make the cold	put inside
12/6/11 21:14	chicken man	1000g	30C		
12/6/11 23:45	flour dow	2500g	28.5C	because some guests are coming in the morning	
13/6/2011 2:06	rice	small			put inside
13/6/2011 10:54	meat		frozen	take out from freezer because i have to prepare it later	take out
13/6/2011 10:59	butter			take butter for breakfast	take out
13/6/2011 11:01	milk	1l		took little to prepare tea	take out
13/6/2011 11:2	butter				
	khao				
	khao	2500g	65C		

Figure 3.30 Can the reasons behind actions help to identify the unknown situations?

3.6 Summary and Conclusions

The role of data is very important in modelling and validating inhabitants' and appliances behaviour for subsequent use in the energy simulations. It can be collected through experiments, field studies and standard datasets. There are two standard datasets (i) Irise and (ii) TUS that are publically available. None of these datasets alone can be used to support our research as Irise dataset contains the information only about consumption of appliances and not the corresponding actions. Similarly, the TUS data contains the information only about the activities without any information about the corresponding consumption. Since one of the research questions as presented in chapter 1 is to identify the energy impacting behaviours and high energy consuming activities, we need a dataset containing the consumption of appliances in order to get more precise answer to this question. That is why the Irise dataset is selected because it contains comprehensive energy consumption data for

domestic appliances. The Irise database has helped to categorize the appliances based on their power and energy consumption. These categories include, low power low energy, low power high energy, high power low energy, and high power high energy. The heating systems and cold appliances, e.g. refrigerators lie in the *high power high energy* category and are thus the most energy consuming appliances. Further, the energy consumption for appliances in each category is analysed based on the number of persons in the house, the size of the appliance etc. The consumption curves have shown that some of the appliances are highly sensitive to human actions, for example the fridge freezer.

In order to co-simulate the inhabitants' behaviour with the physical model of the appliance both the consumption of the appliance and the actions behind these consumption patterns are required. However, the Irise database only contains information about the consumption of electrical appliances. Local field studies were performed in order to find the activities behind appliances' consumption patterns and to identify the high energy consuming activities. For example, data analysis and field studies on the fridge freezer have revealed that the quantity and temperature of food, and the duration for which the door is opened etc highly impacts the power consumption. Similarly, important parameters that affect the consumption are identified through Irise database analysis and field studies. Parameters at four different levels are identified. The first level includes the environmental parameters (e.g. season, weekdays, weekends etc.), second level includes the actions on appliances (e.g. turn on/off, put food etc.), third level includes the relation between appliance usages (e.g. the impact of cooking activity on the consumption of fridge), and fourth level includes the reasons behind certain actions (e.g. why the cooker is used more on a particular day?). These parameters will serve as important inputs to identify inhabitants' representative energy consuming behaviours from Irise database (chapter 6). These identified behaviours are further used in model building and its validation through co-simulation of inhabitants' and appliances behaviours.

CHAPTER 4: INHABITANTS' BEHAVIOUR MODEL

The objective of this chapter is to present the contribution as causal and H-BDI behaviour models based on the results from local field studies and global traces identified during analyses on Irise dataset, as presented in Chapter 3. The analyses results highlight the relevance of the BDI (belief-desire-intention) architecture for multi agent modelling. Therefore a dynamic behaviour model based on the BDI architecture is presented for energy consumption in domestic settings. This model is further used for building and simulating scenarios using Brahms in subsequent chapters.

CONTENTS

4.1	Introduction	89
4.2	Inhabitants' Behaviour Representation Modelling.....	89
	4.2.1 How Results of Data Analyses are used in the Behaviour Model.....	89
	4.2.2 Causal Behaviour Representation	94
4.3	Behaviour and Energy Consumption: A Conceptual Framework.....	97
	4.3.1 H-BDI Agent Based Behaviour Representation Model	98
4.4	Summary and Conclusions	105

4.1 Introduction

Inhabitant's decisions and actions have a strong impact on the energy consumption and are an important factor in reducing energy consumption and in modelling future energy trends. Energy simulations that take into account inhabitants' behaviour are mostly benchmarked at office buildings using controlled activity profiles and predefined scenarios. Inhabitants' behaviour can range from being very simple to very complex. Since the inhabitants play a key role in the energy consumption of home appliances, our objective is to capture the behaviour that not only represents a simple presence or absence of an inhabitant in an environment but also represents a realistic interaction of the human with the environment. This means that the dynamic, reactive, deliberative and social behaviour of inhabitants must also be taken into account to fully understand its possible effect on energy consumption.

Modelling inhabitants' behaviour in this way will help to create situations in simulations which are closer to what could possibly happen in daily life of inhabitants in home situations. At home the behaviour is quite complex and difficult to predict as compared to at work. Hence modelling and co-simulation of inhabitants' dynamic behaviours with home appliances can provide an opportunity to analyze the impact of these behaviours on energy consumption patterns. In order to study these interactions, it is necessary to model the complex and dynamic aspects of inhabitants' behaviour and how it can be introduced in energy simulations. The physical models for home appliances are also needed that give typical power consumption behaviour of these appliances with and without interactions from inhabitants. This will allow us to identify the impact of specific behaviours on energy consumption of these appliances.

4.2 Inhabitants' Behaviour Representation Modelling

In chapter 2, section 2.2, the context elements that constitute the inhabitants' behaviour were presented by the 5W1H approach (Figure 4.1) that is used in this chapter for behaviour modelling. Since human behaviour is an important factor in energy simulations [Sierhuis et al., 2007; Kashif et al., 2011; 2012], this section looks at the elements that form such behaviours. The elements that are considered important when modelling human behaviour are identified.

4.2.1 HOW RESULTS OF DATA ANALYSES ARE USED IN THE BEHAVIOUR MODEL

The results from field studies (see chapter 3, section 3.5.2.2) used in deriving the behaviour model, are shown in figure 4.2. Here only a part of the results is presented that highlights the different elements required to capture inhabitants' energy related behaviours. The inhabitants filled the information in an activity journal not only about the actions they performed on the household appliances but also the reasons that caused these actions over the period of three weeks. Hence, these results helped us to derive generic rules about how the individual and group behaviours evolve. In the upper part of figure 4.2, the consumption of the fridge freezer is plotted on the y-axis against time on the x-axis. The actions of inhabitants on the fridge freezer are shown in the lower part of the figure with arrows pointing to the time when they were performed. The generic rules and conceptual elements that are derived from these results are divided into different blocks as shown in the lower part of the figure in blocks 1 to 5.

In the evening of day 1 (Figure 4.2) the wife is feeling hungry; however, as she usually eats with her husband, she waits for him. The husband arrives later than usual and the wife waited for

him; note that her hunger was below her hunger threshold level. They used to prepare bread everyday for dinner but as the husband came very late, and the wife became tired and changed her mind to prepare something quick. She takes the already cooked rice and curry out of the fridge. The husband asked her to prepare some fries. She opens the freezer to take out the potatoes, these a pizza and puts it in the fridge to use later. The husband finally asks the wife not to prepare the fries. The generic rules that are derived from this behaviour of inhabitants are shown in blocks 1, 2 and 3. Block 1 shows that the inhabitants set their beliefs based on some perception from the environment, for example, perception of the other inhabitants, objects, location and time, etc. The environment could be the physical surroundings or the inner self of the inhabitant. For example, in order to have the dinner, the perception from the inner self is the feeling of hunger, which now becomes a desire to eat. However, this desire will not be fulfilled by the inhabitant until it reaches a certain threshold level and/or based on some cognitive influence. In this case, if the threshold of one inhabitant for hunger is reached but the other inhabitant has not arrived yet, based on the cognitive influence (family rules, social constraints etc.) a new threshold level will be attained. If, however the threshold has crossed its limit (block5), the inhabitant will either do an alternative or his desire will be converted to an intention and he will achieve the goal, i.e. fulfil hunger. Block 2 shows that the actions caused by the inhabitant's intentions are planned actions, but if there is some new perception from the environment before he fulfilled the intention, it may lead to some unplanned actions. For example the planned actions to fulfil hunger are to open the fridge, take the prepared food out, heat it up and then eat, but the unplanned actions upon the perception of a pizza in the freezer is to prepare it for dinner. How the actions are performed finally constitute the behaviour of the inhabitants [Kashif et al., 2013b]. Block 3 shows that the behaviour could be reactive or deliberative. In reactive behaviour the inhabitants, upon the perception from the environment, react to the situation. Whereas in deliberative behaviour, they pass through some complex cognitive process and decide how to act in a particular situation. For example, the husband reacts to his hunger by requesting the wife for some specific food, but in a situation where he perceives the presence of other food items and the fact that she is tired, he decides not to eat that specific food item. On day 3 the husband asks if the wife would like to have some drink together, the wife agrees and suggests a curd shake. The husband agrees and she takes out the ingredients from the fridge to prepare the drink. This situation is presented in block 4 which highlights the importance of group behaviour while modelling inhabitants' behaviour.

The important states derived from the results include perceptive, cognitive and active states (Figure 4.2). These states include all the basic behaviour elements found in the 5W1H approach (Figure 4.1). The perceptive state includes Who is the inhabitant, Where he/she is, When during the time period, he performs some action, and What are the objects in the environment with which he interacts. The cognitive state represents Why the inhabitant wants to perform some action. Finally, the active state is about How the action is performed after some decision is made by the inhabitant.

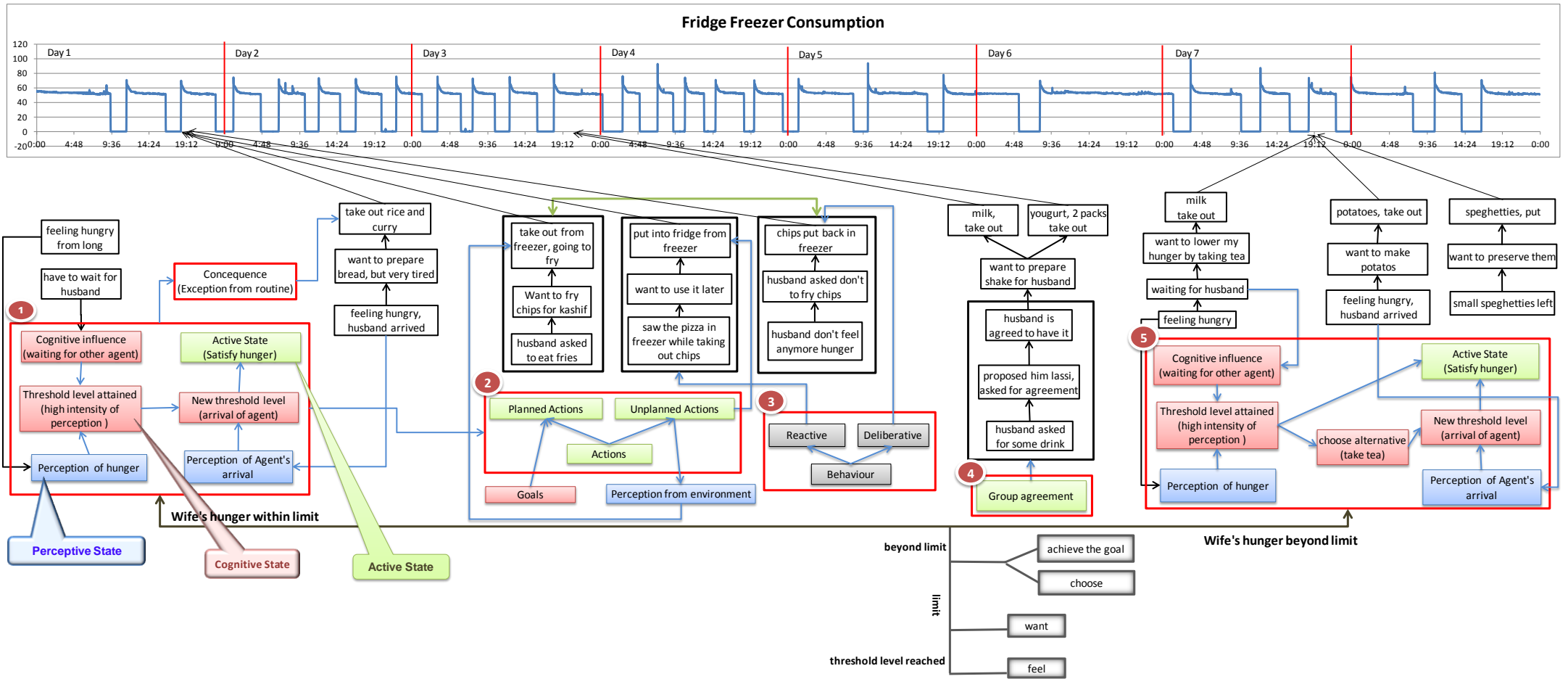

Figure 4.2 Important elements extracted from data to model human behaviour

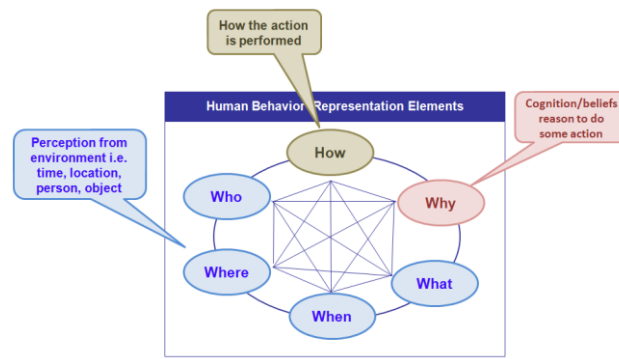

Figure 4.1 Important elements to model human behaviour

Figure 4.3(a) shows a high level representation of the proposed behaviour model where each inhabitant has three different states: (i) perception, (ii) cognition and (iii) action. In chapter 3 different parameters that are important to be considered while modelling the energy consuming behaviour of inhabitants were detailed. All those parameters are captured by different states. In the perceptive state all the environmental variables (level 1 in figure 3.15) are perceived. These include the perception of appliances and objects, season, time of day, weekend and weekday, etc. Since all of these variables belong to the external environment, they are called the outside cause. However, if there is some perception from inside the inhabitant, it is called an inside cause, e.g. feeling of hunger, tiredness etc. The perception of the environment not only includes the physical objects but also the other inhabitants that leads to the constitution of social behaviour e.g. interaction with other inhabitants. Based on these initial beliefs the inhabitant advances to the cognitive state. This cognition constitutes the decision-making process and the reasoning mechanism why the inhabitant should take or avoid taking some decisions. The social norms, family rules, culture, role in family, etc. for example, could be some of the influencing factors on cognition. This state represents the “reasons behind actions” parameter presented in chapter 3 (level 4 in figure 3.15). Following cognitive decision-making, the inhabitant performs certain actions, which may be planned or unplanned. For example, the planned actions to fulfil hunger are to open the fridge, take the food out, cook it and then eat; but the unplanned actions upon the perception of a sudden pleasant change in the weather are to go to the restaurant and eat there. Actions finally constitute the observed behaviour of the inhabitant. The action state includes the “impact of human actions on appliance consumption parameters” as presented in chapter 3 (level 2 in figure 3.15). The cognition block represents the stage where all the properties that have an influence on the behaviour of inhabitants are defined. An inhabitant has a set of attributes and a set of actions; these define different types of agents, or put another way, a profile of a group of agents.

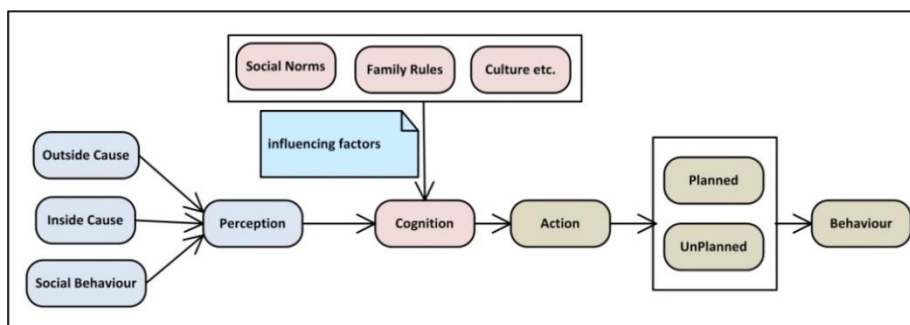

Figure 4.3(a) Behaviour representation

Figures 4.3(b) and 4.3(c) show specific examples of the behaviour model, where the

inhabitant's perception is changed by different parameters. These parameters include the behaviour of the inhabitant upon the perception of: outside weather, communication/interaction with the other inhabitant, whether it is a weekday or weekend, and arrival of some guests. In figure 4.3(a) when inhabitant-1 perceives that it is time to cook, it starts thinking about how to follow the cooking process, e.g. what to cook, use the food items already present in the fridge, etc. this cognitive process finally leads the agent towards the sequence of actions that it performs on household appliances or objects. If, however, the agent perceives some other information from the environment (e.g. the inhabitant-2 suggests to inhabitant-1 to go out to eat based upon its perception of beautiful sunny weather outside), inhabitant-1 will again go through the cognitive process, taking into account other influencing factors, e.g. how the decision of going out instead of cooking at home will affect the other inhabitants in the environment or other actions that it has planned for the day, etc. Taking into account all of the important factors, inhabitant-1 will finally agree or disagree with inhabitant-2. This agreement/disagreement that is communicated by inhabitant-1, will now become the perception of the other inhabitant. The inhabitant-2's cognitive state will then lead the two agents to eat at home or go out to eat.

The example in figure 4.3 (c) shows other elements i.e. the perception of some guests that unexpectedly arrive, and the perception of weekdays and weekends. In the first case, the agent may have to go through the cooking process that it has not already planned or serve them with some other things. In the second case i.e. the perception of weekday/weekend, depending upon the inhabitant's role in the house e.g. principle cook or not, etc., it will start the cooking process based upon the availability of time. All of the above mentioned factors will either increase or decrease the inhabitant's interactions with the household appliances e.g. cooker, fridge etc.

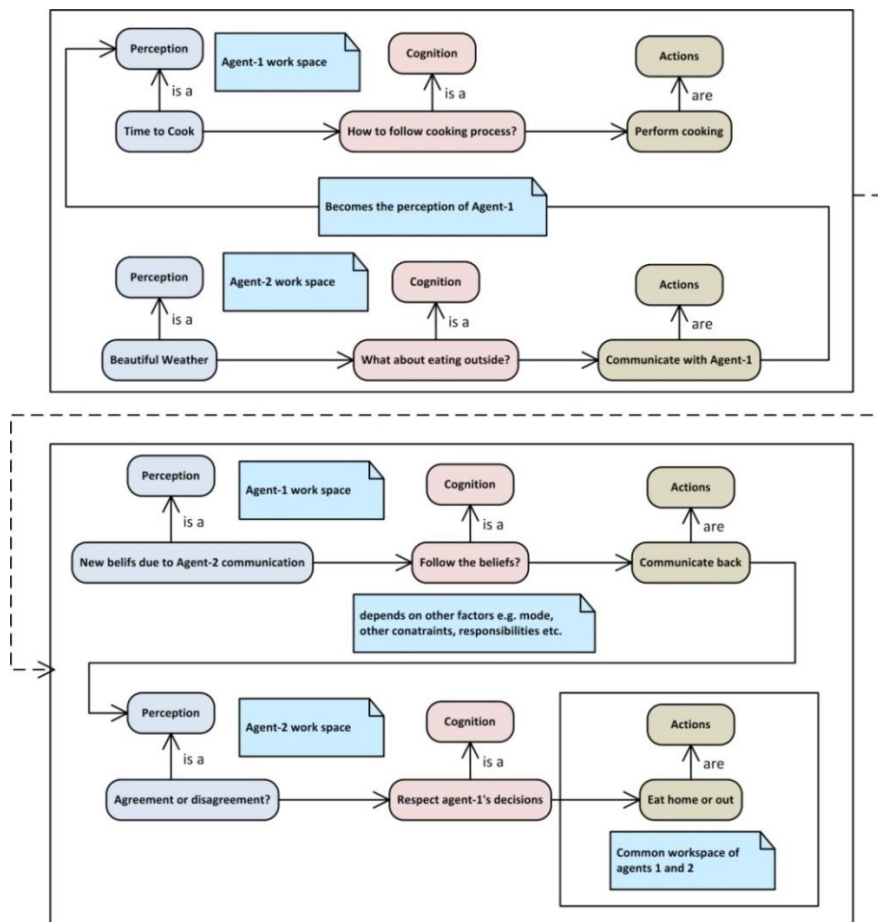

Figure 4.3(b) Social behaviour

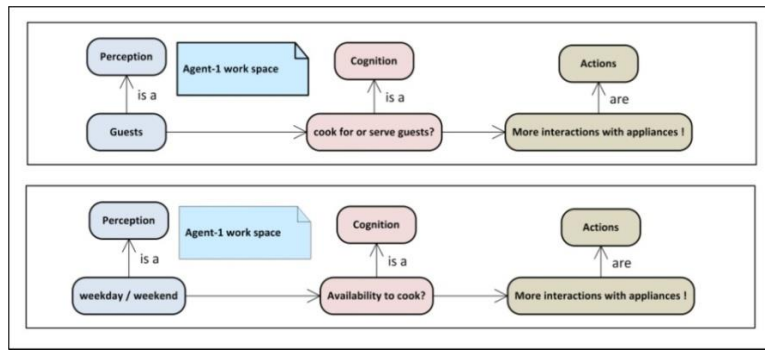

Figure 4.3(c) Other perceptive elements

4.2.2 CAUSAL BEHAVIOUR REPRESENTATION

The behaviour representation in the previous section models inhabitants' actions as a function of perception and cognition. However, in this section the focus is on modelling the actions as a function of needs which are initiated based on the time. The results from the data collection through field studies have led us to the derivation of causality between needs and respective actions. Figure 4.4 presents the partial analyses results that help us to identify various types of behaviour and needs of inhabitants and the way inhabitants use household objects to satisfy their needs. This analysis led us to develop the causal behaviour representation to complement the model proposed in section 4.2.1 for a more realistic inhabitants' behaviour representation.

Name :Anna		Age :12		Role in family: Child				Profession: Student			
Movement			Principle Activity				Secondary Activities			With whom	Action on window, blinds, curtains
from	to	time	name	begin	end	type	name and equipment used	Begin	end		
Bedroom	Kitchen	7h30	Breakfast	7h25	7h40	habitual	light	7h15	8h00	mama	
Kitchen	Bedroom	7h40	dressing				light				
Bedroom	Outdoor		Go to school			habitual				mama	
Washroom	Bedroom		Wash hands	17h00	17h01		Light, water				
Bedroom	Living room		Watch TV	19h00	19h50		TV, light				
Living room	Dining room	19h53	Have dinner	19h53	21h50						
Dining room	Washroom	21h50	Brush teeth	21h50	21h55		Light, water				
Washroom	Bedroom	21h55	sleep	21h55							

Name :Catherine		Age :40		Role in family: Mother				Profession: Medical Assistant			
Movement			Principle Activity				Secondary Activities			With whom	Action on window, blinds, curtains
from	to	time	name	begin	end	type	name and equipment used	Begin	end		
Bedroom	Washroom	7h00	Change Clothes	7h00	7h20	habitual	Water Lamp	7h05 7h00	7h06 7h20		
Washroom	Kitchen	7h20	Breakfast	7h20	7h50	habitual	light Kettle	7h20 7h25	7h50 7h26	Anna	
Kitchen	Anna Room	7h40	Get Anna Dressed	7h40	7h50	habitual	Radio light	7h20 7h40	7h50	Anna	Shutters
Anna Room	Washroom	7h45	Brush teeth	7h45	7h50	habitual	light Water	7h45 7h46	7h50 7h47	Anna	
Outside	Living room	17h00	Used the clothes stand, used PC	17h00	17h10		Light PC	17h00 17h00	20h41	Anna	
Living room	Kitchen	17h10	Arrangements	17h10	17h30	habitual	Espresso Water				Open window + Fridge
Kitchen	Living room	20h45	Prepare shopping list	20h45	21h30	Occasional					
Living room	Kitchen	20h45	Tea	20h45	20h46						
Washroom	Washroom	22h20		22h20	20h55						

Figure 4.4 Need based causal behaviour

In figure 4.4, some physical needs of inhabitants have been identified (e.g. drinking, eating, going to the toilet, sleeping, taking a bath, dressing, etc). Each inhabitant tends to repeat the behaviour that has been successful in satisfying these needs. This repetition becomes a behaviour pattern and forms the daily activities of inhabitants (Who of 5W1H) with a timetable fairly regular.

These behaviours can be modelled and simulated by a stochastic process with an approximated timetable. However, for evaluating possible power management solutions, not only the time (When of 5W1H), duration and location (Where of 5W1H) of the daily activities are necessary but also the detailed information about which and how domestic electric appliances (What of 5W1H) are used in these activities are also important. For example, an inhabitant wants (Why of 5W1H) to have dinner; he goes to the kitchen and prepares the dinner by warming food in the microwave for 30 seconds at 500 Watts, cooking food on hot plate for 10 minutes at its maximal power and then eating the meal in 5 minutes (How of 5W1H); during all this time period, he turns on a 100 Watt light in the kitchen. The information about power consumption in each period of this inhabitants' behaviour is necessary for evaluating power management solutions.

The inhabitants' behaviour for satisfying environmental comfort needs (e.g. thermal comfort, visual comfort, etc.) is also important and has to be considered. These behaviours are not triggered at regular times. They depend solely on the value of some environmental factors, one of the context elements. When the physical state of the environment exceeds the inhabitant comfort tolerances, it causes a psychological state (belief) in the inhabitant. This belief induces the inhabitant to desire to have activities to adjust the environment around him. For example, the inhabitant enters a room; the room's temperature is higher than 30 °C; the inhabitant believes that he is feeling hot and wants to open a window or turn on the ventilator to lower the room temperature. These behaviours can change the power consumption at home, hence, it is necessary to model and simulate these behaviours for evaluating power management solutions. If there are many inhabitants at home, an inhabitant can demand others to perform activities to satisfy his need. For instance, the inhabitant in the above example can ask others in the same room to turn on a ventilator. Such type of behaviours needs to be modelled as well. For modelling these various types of behaviours and needs of inhabitants, a causal model of inhabitants' behaviour is proposed and presented in detail in the next section. A causal model is an abstract model that uses cause and effect logic to describe the behaviour of a system [Anthony, 2006].

The analyses of data collected through field studies (Figure 4.2 and 4.4) resulted in the identification of 4 basic categories of needs and reasons that cause the events on household appliances and objects, as presented in figure 4.5 below. The usual and unusual needs are triggered by time whereas social and occasional needs are the function of environmental factors. This categorization results in some general conclusions that events are modelled as a function of actions whereas actions are modelled as a function of needs and reasons behind actions. The usual/typical needs include basic requirements, e.g. eating, drinking, sleeping etc, hygiene, and planning. Inhabitants are involved in these types of behaviours most of the time. The unusual reasons include the sudden and unknown circumstances e.g. urgency. The occasional reasons include special occasions, arrival of guests, etc. The social interactions between inhabitants become the reasons for some specific behaviour, e.g. going out to restaurant due to group agreement to eat out or fulfilling the demands/requests made by others, etc.

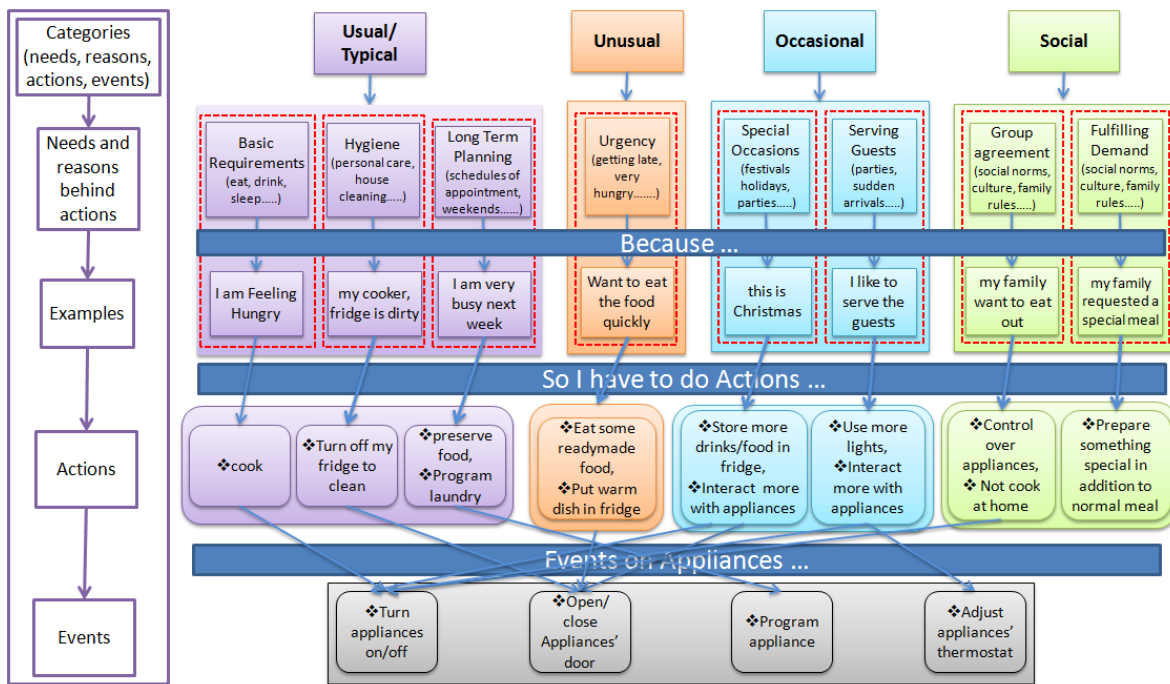

Figure 4.5 Categorization of needs, actions and events

Based on the above analyses (Figure 4.4 and 4.5), the behaviour representation is generalized as a causal model. An inhabitant living at home has some needs. To satisfy his need, he can do one or many activities. To do an activity, he can use none or several household objects. The causal model representing these relations is presented in Figure 4.6.



Figure 4.6 Causal model of inhabitant behaviour to satisfy a need

The above model shows that an activity can cause other activities. An example of this relation is when an inhabitant prepares a meal, he needs to prepare the ingredients and cook the food. These actions cause state changes (e.g. turn on, turn off, open, close, etc.) in household objects or appliances. Through the field studies data analysis the needs are found to be triggered by usual time and environmental factors. When the usual time comes inhabitants' needs are generated, e.g. an inhabitant eats around 12h30 every day and sleeps around 22h00. However, a need to sleep or eat could be generated sooner or later due to some environmental factor e.g. the same inhabitant needs to eat at 11:30 if he didn't take the breakfast. In figure 4.7, two additional causal inputs of inhabitant needs are introduced into the model: usual time and environmental factors.

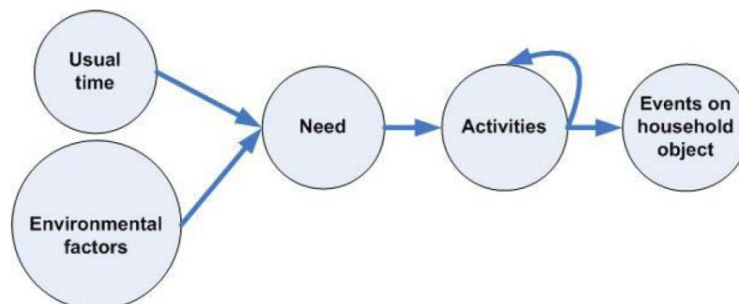

Figure 4.7 Evolved Causal model of inhabitant behaviour

When the usual time for some action arrives, it may cause a need in the inhabitant e.g. to get up, to go to work, to have dinner, to go to sleep, etc. When an environmental factor changes and exceeds the inhabitants' comfort tolerances, it causes an inhabitant comfort need to change. Both the usual time and the environmental factors constitute the inhabitant's context at home. The change of other context elements (inhabitant, space and object) can also cause an inhabitant need to change. For example, when a visitor is present, the inhabitant may need to prepare a meal for the visitor. The context elements are considered as an external cause, coming from the environment, whereas inhabitants' psychological state is considered to be an internal cause that triggers an inhabitants' need. The complete causal model of inhabitants' behaviour is presented in the figure 4.82. The communication between inhabitants is modelled as a demand generated by one inhabitant and received by the other. The inhabitant that receives the demand takes necessary actions.

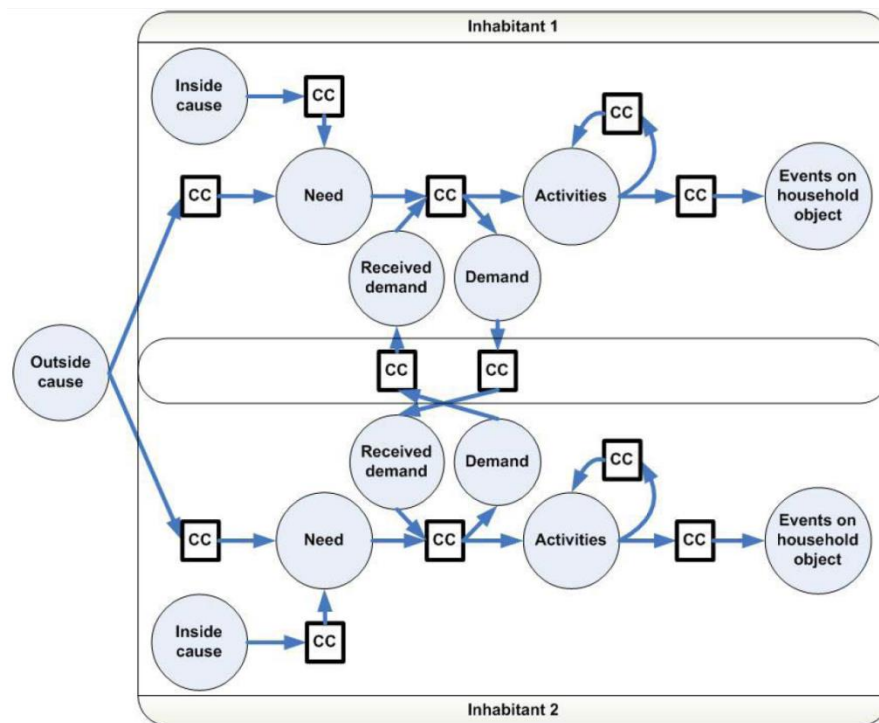

Figure 4.8 Complete causal model of inhabitants' behaviour at home

In the above model, the inside and outside causes represents inhabitants' perception about environment. It successfully captures the social behaviour through communication between inhabitants. However, this model can be made more generic by including cognition and deliberation elements that enable this model to represent decision making process for the selection of some action. Hence, in the next section a conceptual behaviour representation model is presented that captures social behaviour with cognitive and deliberative elements. It will provide a more generic representation of inhabitants' behaviour to analyze its impact on energy consumption patterns.

4.3 Behaviour and Energy Consumption: A Conceptual Framework

In the above section, different aspects of inhabitants' behaviour for modelling purposes are explored and a causal model is built based on the activities of inhabitants. The purpose for modelling

² In Figure 4.5, CC stands for the causal condition: if a cause is satisfied, an effect is created. In the case of many inhabitants, a need of an inhabitant can cause not only personal activities but also activities of other inhabitants. For instance, in a family the parent asks their children to go to the table to have dinner altogether.

inhabitants' behaviour is to explore its impact on the energy consumption and analyze the energy performance against different actions of inhabitants. A high level abstraction of this concept is shown in figure 4.9 with two functions. The function 'A1' simulates the dynamic inhabitants' behaviour whereas the function 'A2' analyzes the impact on energy performance. The inhabitants' behaviour component 'A1' is the core element to simulate reactive/deliberative group behaviour using an agent based approach. The 5W1H (home context) and initial beliefs and facts serve as inputs to this function. It uses the 'Inhabitants' behaviour component and 'Knowledge Base' as its means to perform the dynamic simulation. The 'Knowledge Base' contains changing beliefs and facts about the environment. The output (dynamic inhabitant behaviour) of the function 'A1' serves as input to the function 'A2' for energy performance analyses. Similarly, the 'Analyze Energy Performance' component uses the generated dynamic behaviours, the physical models for appliances (physical component) and the connection between the behavioural and physical components (inhabitants' behaviour/physical component connector) in order to analyze the impact of the simulated dynamic behaviour on energy consumption. The objective is to identify context, beliefs and facts from the simulated inhabitants' dynamic behaviours that influence energy consumption patterns.

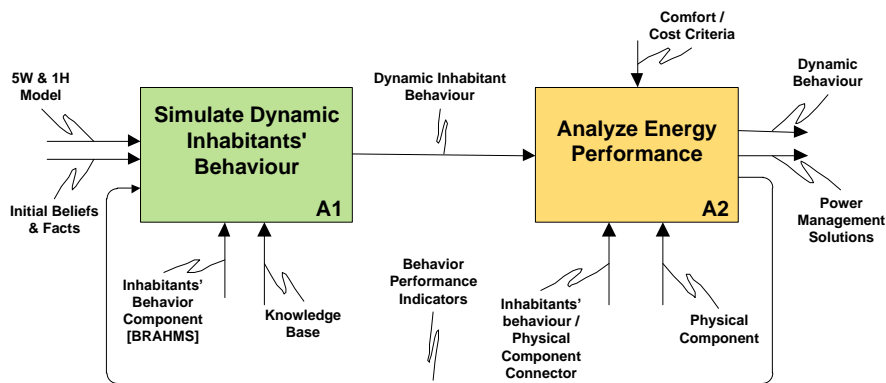

Figure 4.9 Conceptual framework for behaviour simulation

4.3.1 H-BDI AGENT BASED BEHAVIOUR REPRESENTATION MODEL

The actions on household appliances as a result of inhabitants' behaviour are found to be a function of perception and cognition (section 4.2.1). However, in section 4.2 a causal behaviour is identified between the actions and the causes that trigger them. In this causal representation actions are a function of inhabitants' needs. In this section however, all the elements that constitute the inhabitants' behaviour for energy management are combined to build a global H-BDI based model (Figure. 4.10). This model can not only capture the needs but also the other important elements of human behaviour as explained below.

Figure 4.10 shows the cycle of inhabitants' behaviour that starts with perception of the environment, passes through the instinctive and cognitive phases and ends up with actions back on the environment. The outside environment includes the location and physical building models that provides the information about Where the agent is, one of the element in the 5W1H approach. The objects, appliances, other agents, agent belongings, weather and BEMS informs the agent about What are the other things around the agent. The time provides the information about When the agent is perceiving its surroundings or taking actions. All these environmental elements are then perceived by the agent. Upon the perception the agent will translate these elements as its beliefs, shown by the "Beliefs" part of the cycle. Beliefs represent the mental state of the inhabitant and are

the first important concept in BDI architecture. In the model in figure 4.10, however, another concept is introduced in addition to beliefs that relates to the physical state of an inhabitant. Thus the inhabitant has not only perception about the outside environment but also about its internal physical state. The question is why introduce the physical state of the inhabitant, as the agent's physical state also becomes its belief. The reason is that there are some physical phenomena that the agent could not directly perceive. For example, one can perceive the internal physical state of being thermally uncomfortable, but could not directly perceive his metabolism. Metabolism is a physical phenomenon that continues to happen in the body without notifying the person about its value. Similarly, the increase of CO₂ level in the room can impact on a person's mood, but he could not directly perceive the CO₂ level and identify it as a cause of his stress. That is why the physical phenomena taking place inside human body are put under Homeostasis, rather than just beliefs. The agent then has the beliefs about its homeostasis, the outside environment. Based on these beliefs the agent can have certain desires, however, due to the external environmental constraints only one of them is converted to the agent's intention. The intention then leads to the process of generating plans of how to fulfill the intention. Finally, the agent follows this plan to perform actions on the environment.

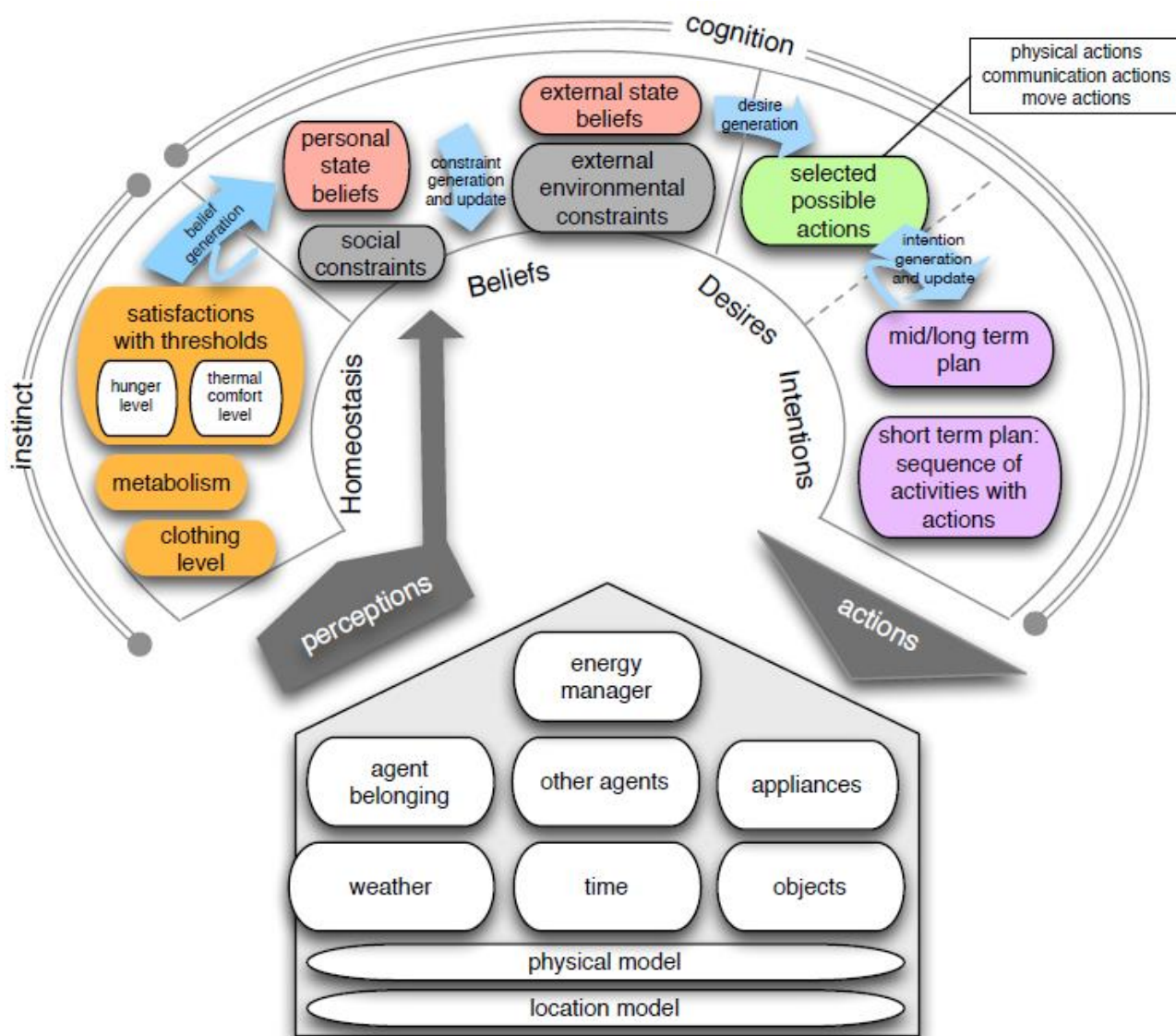

Figure 4.10 H-BDI dynamic behaviour representation model

Figure 4.11 shows the class diagram of the H-BDI model with details of every concept used to build the model. In this model the basic element that leads the inhabitants to take some actions are the beliefs. A belief is a representation of the state of the world which could be a value of an attribute or a variable. The values of these variables could be qualitative e.g. weather is good or quantitative e.g. the result of some mathematical expression etc. The inhabitants' beliefs are generated from some perception from the environment. The perception is represented by an interface in figure 4.11 through which an agent receives the state of the outside environment and converts it into its belief. The outside environment includes the appliances, objects, time, weather, geographical location, the building physics, other agents, and the energy management system.

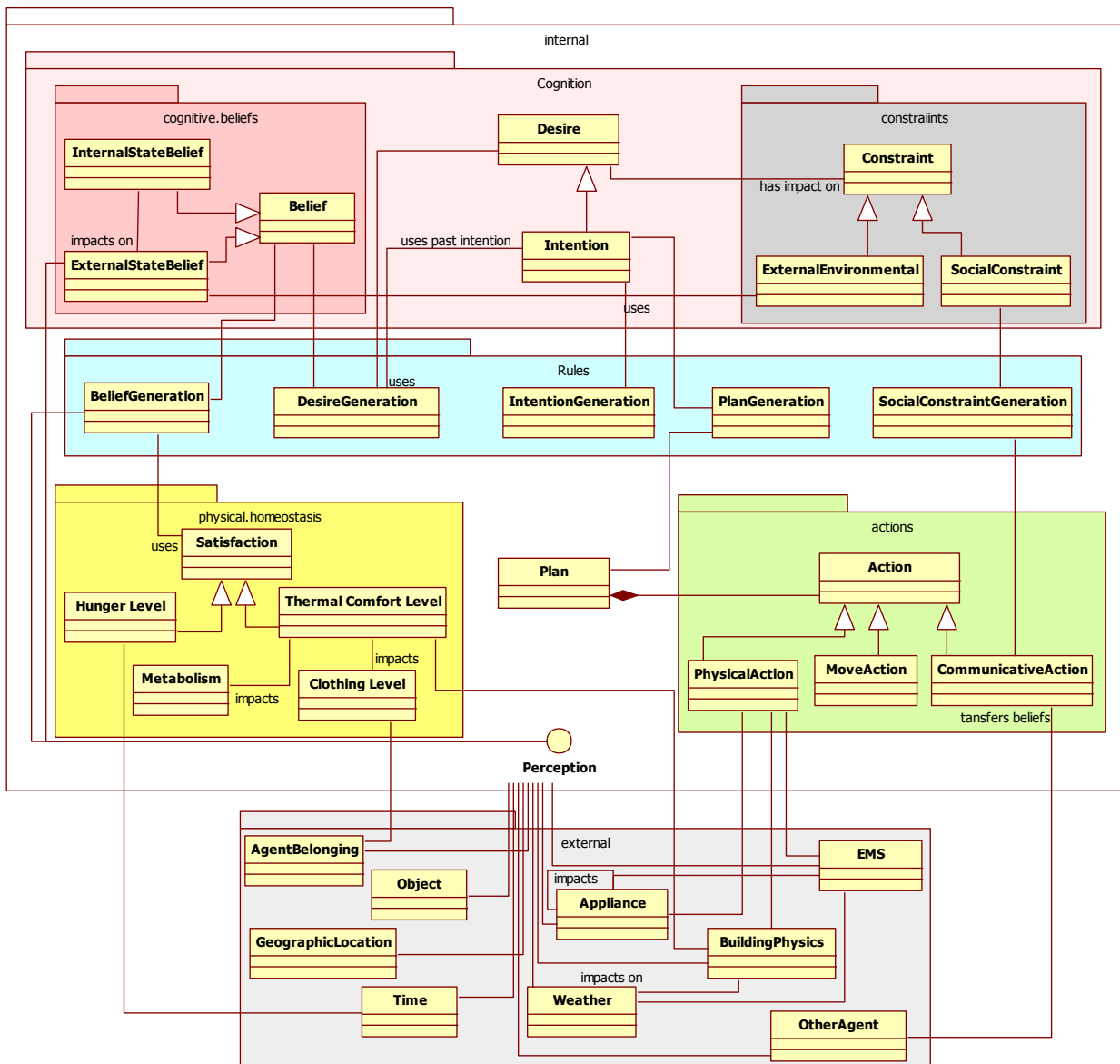

Figure 4.11 Class diagram for H-BDI model

- **Perception → External State Belief:**

When the environmental states pass through the perception interface they become the “ExternalStateBelief” of an agent. The examples of environment states and their conversion to inhabitants' beliefs through perception are shown in figure 4.12. The state of the environment gives information about the facts in the world e.g. the fact is that the heater setpoint is 25°C. This fact,

when perceived by the agent, will be transformed into its belief. This transformation of facts into beliefs however, will be different for different agents. For example the fact that the heater setpoint is 25°C when perceived by agent1 turns into a belief that the setpoint is high and the same fact when perceived by agent2 turns into a belief that the setpoint is medium. Similarly, the fact that the weather is partially cloudy when perceived by different agents will be turned into different beliefs based on whether or not they like partially cloudy weather.

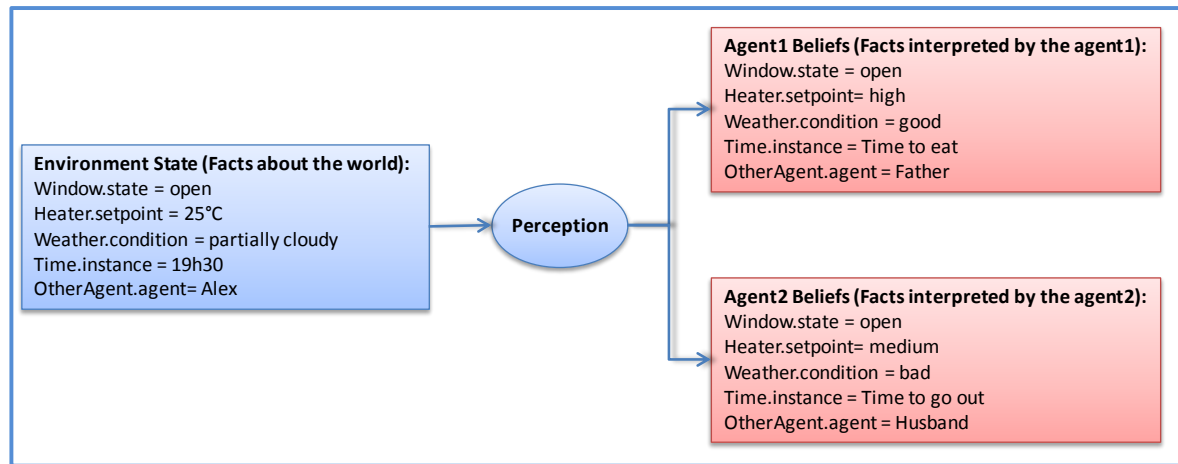

Figure 4.12 Conversion of environmental states to agents' beliefs

- **Homeostasis → Beliefs:**

We have seen that the beliefs generated against the same environmental states may be different for different agents. For example, going back to the heater setpoint, a setpoint of 25°C is high for one agent and medium for the other. This means that one agent may not be satisfied with this temperature whereas the other is satisfied. The package “physical.homeostasis” in figure 4.11 contains this concept of “Satisfaction”. Homeostasis captures the level of equilibrium for all those elements that belong to the physical conditions of the human body. For example, if the agent is feeling cold, its thermal comfort level is low and its satisfaction will also be low. The level of satisfaction will generate the agents' belief about how comfortable it is. These beliefs are generated based on the set of rules that transform the physical homeostasis into agents' beliefs. These rules are defined in the “BeliefGeneration” concept. These beliefs become the personal state beliefs of the agent and are represented by the “Belief” concept in the “cognitive.beliefs” package.

Figure 4.13 shows an example of how the agents' beliefs are generated. The agents perceive the external environment through perception and generate the external state beliefs about the environment. In figure 4.13 the “cognitive.beliefs” block shows that the agent builds his beliefs that the window is closed, air conditioning is off, weather is windy outside, it is physically located in the living room, and another agent, who is his wife, is also present in the living room. The “physical.homeostasis” computes his level of satisfaction or comfort regarding his thermal environment. This thermal comfort for the agent is computed using the Fanger's thermal comfort model. The complete detail of how this model works is given in chapter 7. In the “physical.homeostasis” block only the input parameters to this model are shown. These include the agent's clothing and metabolism levels that are computed on what the agent is wearing and what activity it is doing. Other parameters include the temperature, mean radiant temperature, velocity and humidity that come from the “buildingPhysics”. The comfort value computed by the Fanger model will then become the agents' belief. The process of transformation of thermal comfort value

into agents' beliefs is called the "BeliefGeneration" that defines the set of rules of how these values will be interpreted by the agent. For example if the thermal comfort value is between 0.5 and 1, the agent will feel slightly warm. This will convert to his personal state belief as shown in "cognitive.beliefs" block.

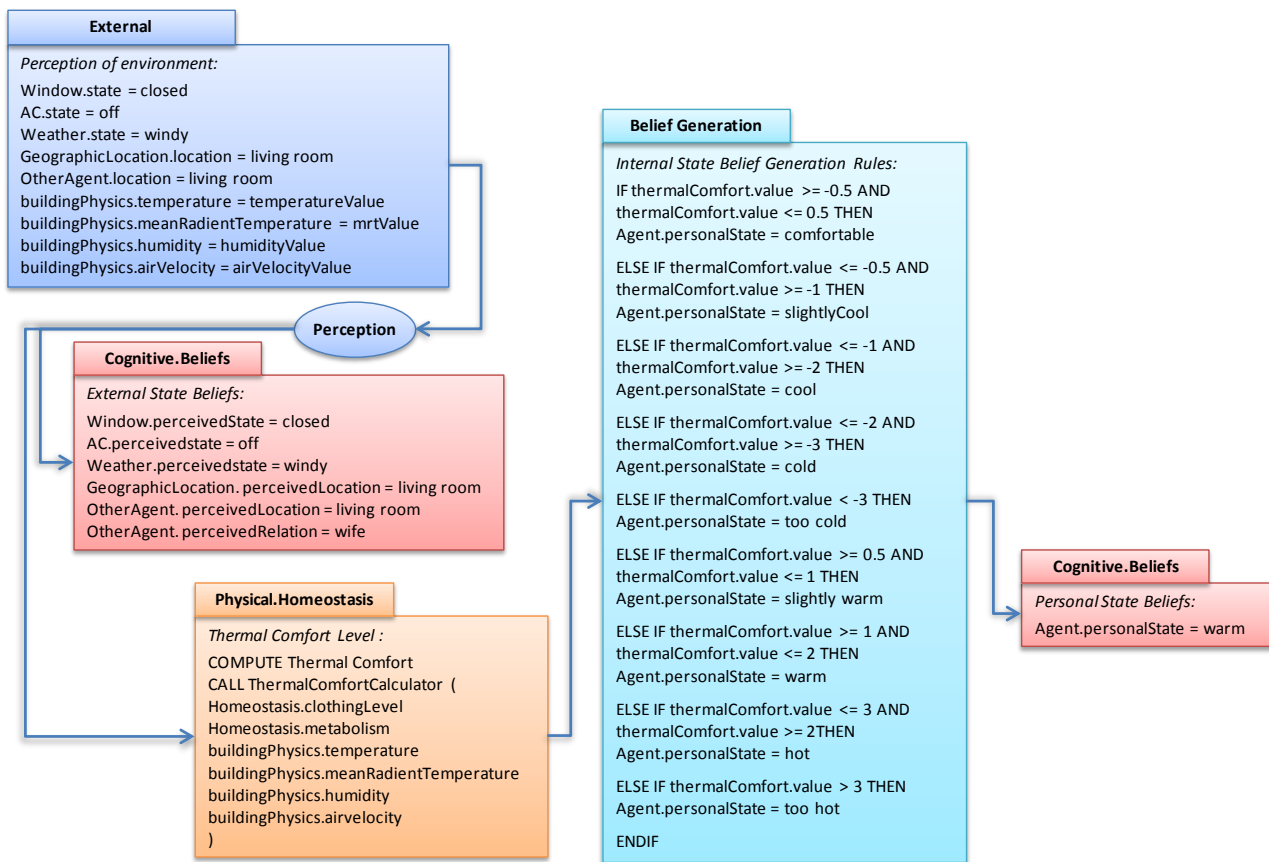

Figure 4.13 Process for beliefs generation

- **Beliefs → Desire:**

The agent's belief of being warm will create a desire to take actions to improve his satisfaction regarding thermal comfort. Figure 4.14 shows the process of desire generation where the agent has all the beliefs about the external and internal states in the "cognitive.belief" block. The rules that will generate a desire in the agent are shown in the "Desire Generation" block. These rules say that if it is feeling warm and the window is closed and air conditioning is off, it will desire to open the window or turn on the air conditioning system.

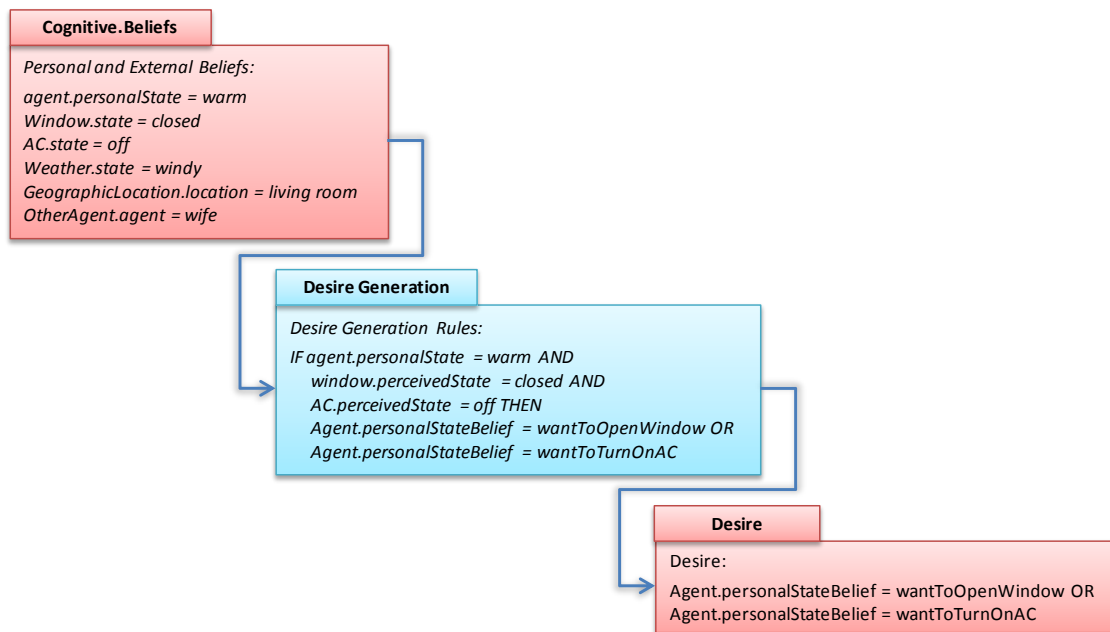

Figure 4.14 Process for desire generation

- **Desire → Intention:**

The desires are possible actions that an agent can do to achieve satisfaction. However, the agent would keep only those desires that would be feasible to be fulfilled if the other agents in the environment are satisfied with the decision as well. This means that the agent has considered all the constraints that could impact the desire selection process. Figure 4.15 shows the process of how the agent comes to know about all constraints. The constraints about the external environment come from the “cognitive.beliefs” where all the beliefs about the external environment are present. Since the agent believes that his wife is in the living room, it will influence his belief about the possible social constraint. The “social constraint generation” block shows the rules of how the social constraint is generated. The husband agent seeks permission from the wife only if it believes that the weather is windy and it wants to open the window. As it already has beliefs about the external environment that the weather is windy and it will lead it to ask for permission from wife. The process of seeking permission is through communication which is a communicative action. The “Action” block shows two communicative actions, one for the agent himself and the other for the “Other agent” i.e. the wife agent with whom it will communicate. The agent sends its desire that it wants to open window as a message that informs the “Other agent” about its desire. Upon the reception of this message, the Wife agent will communicate back through a message transferring her belief about whether it accepts to open the window or not. The message from wife will go to the “social constraint generation” block where depending upon the acceptance value a constraint will be generated or not. Since the wife has not accepted to go along with the agent’s desire of opening the window while the weather is windy, the social constraint is generated. This constraint is shown in the “social constraint” block. The “constraints” block now has all the constraints about the external environment and the social agreement.

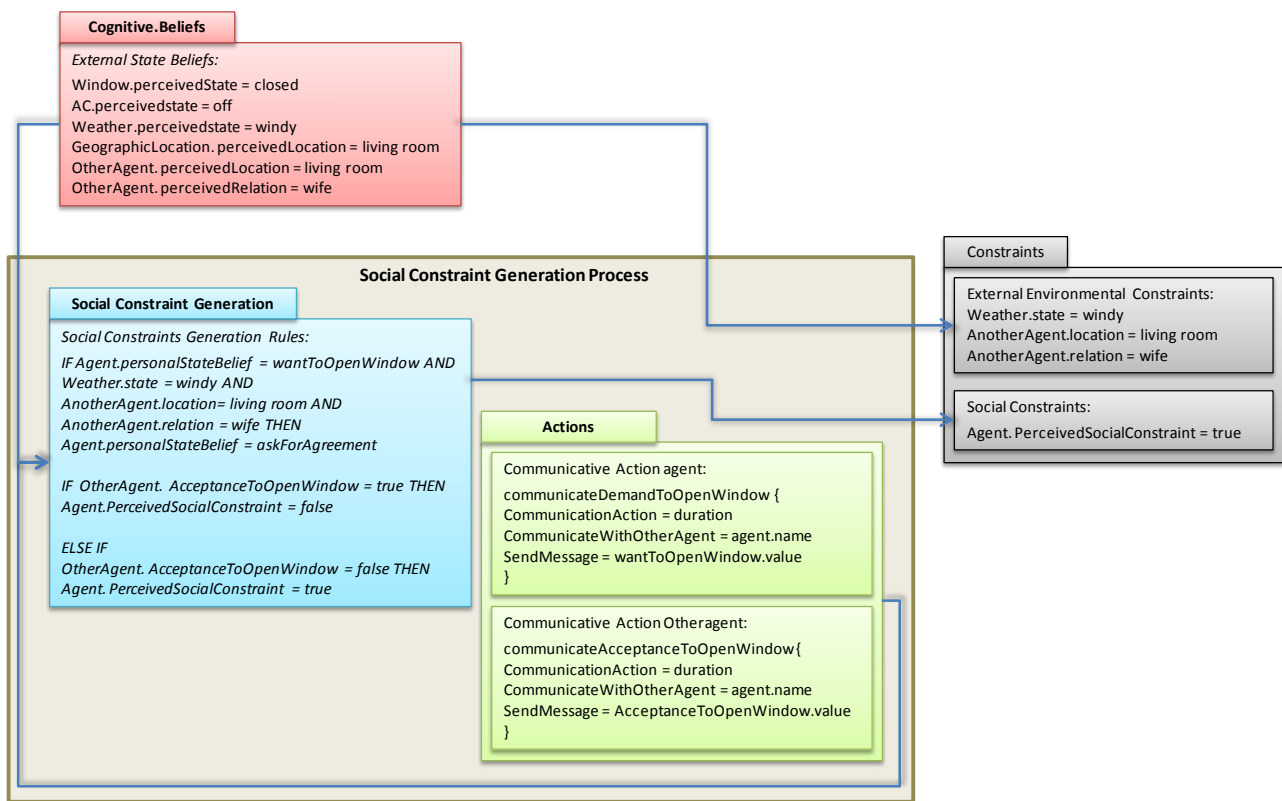

Figure 4.15 Environmental and social constraints

After receiving all the constraints, the agent finally chooses one of its desires to become the intention. Figure 4.16 shows the Intention generation process where the “Intention generation” block list the rules the agent will use to transform his desire into the intention. These rules say that if the agent wants to turn on the air conditioning, the social constraint will not impact his decision. If however, it wants to transform its desire about window opening, it has to take into account the social constraint and that will lead to its intention.

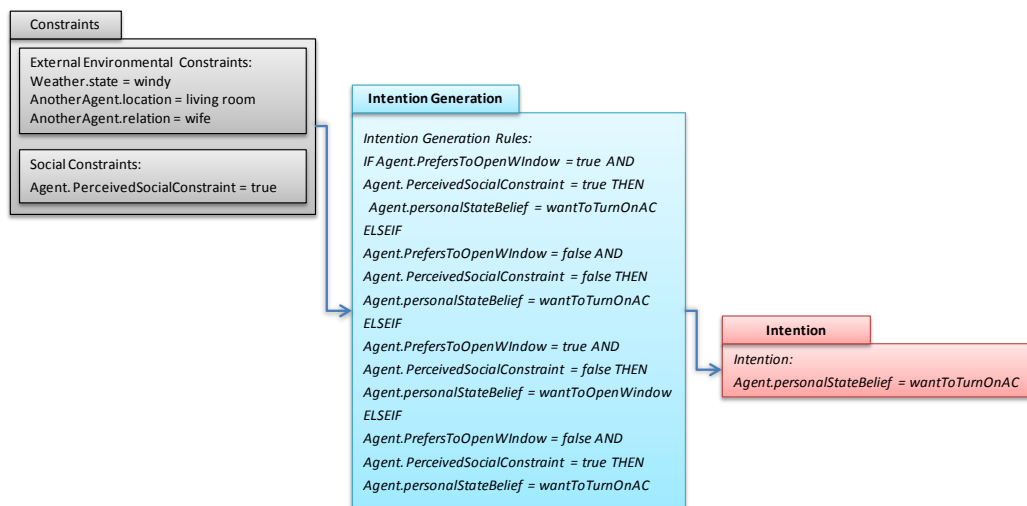

Figure 4.16 Intention generation process

- **Intention → Action:**

Once the agent has the intention of turning on the air conditioning, it will make a plan of how it will perform the desired actions (Figure 4.17). The “plan generation” rules will lead it to the “plan” that consists of simple actions. These set of simple actions will then become a composite

action as shown in the “Activity” block. Finally, the actions when performed on the appliances will change their current state to a new state as shown in the “Appliance state change generation” block.

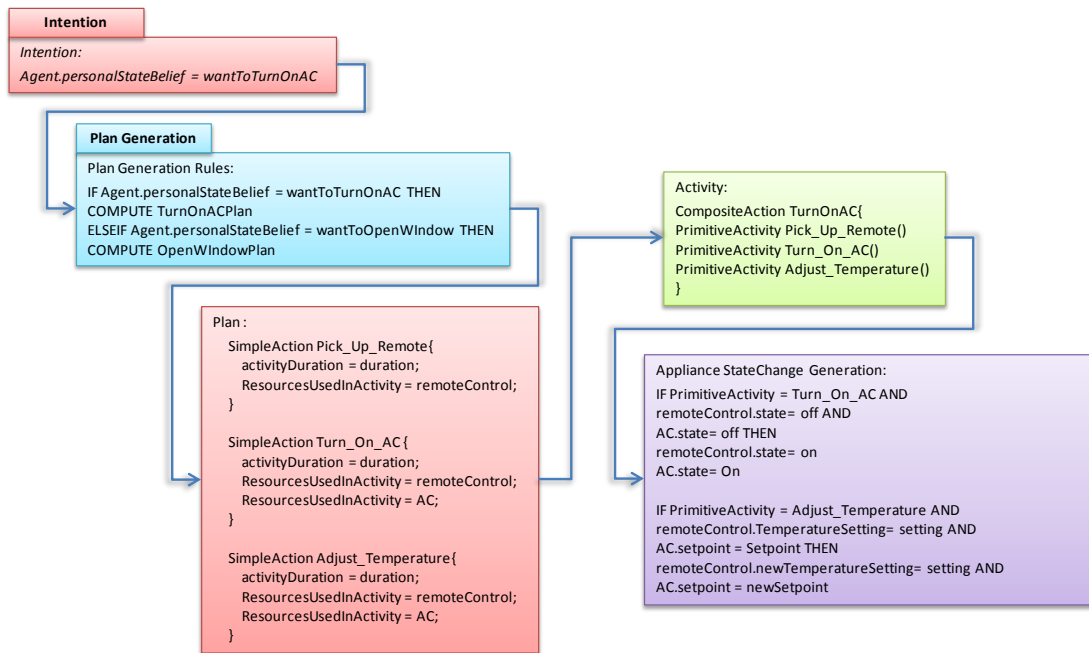

Figure 4.17 Actions on external environment

Similarly, if the agent has not had its meal, it will start feeling hungry. The more it becomes hungry the less it will be satisfied with its current physical condition. The level of satisfaction will generate the agents’ belief about how hungry it is. These beliefs become the personal state beliefs of the agent and are represented by the “PersonalStateBelief” concept in “cognitive.beliefs” package.

4.4 Summary and Conclusions

The inhabitant’s decisions and actions have strong impact on the energy consumption but most of the existing energy simulation tools are benchmarked at office buildings using controlled profiles. The behaviour exhibited by inhabitants in domestic settings is complex and strongly influence the consumption pattern; hence, a behaviour model is needed to take into account dynamic, reactive, deliberative and social behaviour of inhabitants.

In this chapter, data collected through field studies (see chapter 3) was analyzed to identify inhabitants’ behaviour relevant to energy management in domestic settings. The inhabitants completed an activity journal, not only about actions they performed on the household appliances but also the reasons that caused these actions. These analyses results form the basis for a generic inhabitants behaviour model, presented in this chapter, that serves for the scenario and simulation in the subsequent chapters.

The important states derived from the results include perceptive, cognitive and active states; hence, the behaviour (set of actions) is modelled as a function of perception and cognition. These identified states comply with the behaviour representation elements of 5W1H approach (see chapter 2). The perceptive state includes Who is the inhabitant, Where he/she is, When he performs some action and What are the objects in the environment with which he interacts. The cognitive state represents Why the inhabitant wanted to perform some action. Finally, the active state is about How

the action is performed after some decision is made by the inhabitants. The data analyses have also resulted in the identification of 4 categories of the needs, and reasons behind actions as (i) usual, (ii) unusual, (iii) occasional and (iv) social. The usual and unusual needs are triggered by time whereas social and occasional needs are the function of environmental factors. This categorization results in some general conclusions that events are modelled as a function of actions and actions are modelled as a function of needs and reasons behind actions.

The generic model for inhabitants' behaviour, based on a BDI architecture is presented. It includes the internal physical condition of the inhabitant as physical homeostasis e.g. hunger level, comfort level, etc. It also includes the perception of inhabitant about the external environmental. The perceptions are transformed into agent's beliefs. These are both the internal as well as external state beliefs. These beliefs trigger a reasoning mechanism in the inhabitant that generates some desires. Based on certain constraints only some of the desires could be fulfilled and are transformed into an agents' intention. The intention finally leads to the actions performed by the inhabitant on the external environment. This model is used in the subsequent chapter for scenario based behaviour simulation and validation. An important contribution made in this model is the introduction of internal physical state of the inhabitant as physical homeostasis. The physical condition of the inhabitant might not be directly perceived as a belief but it impacts the comfort levels. For example, the change in mood due to an increased CO₂ level in the room where the CO₂ level is not a belief, but nevertheless impacts behaviour. Thus the model is named an H-BDI model based on the introduction of this new concept of physical homeostasis.

CHAPTER 5: MODEL IMPLEMENTATION AND CO-SIMULATION

In this chapter the scenarios based on the behaviour model developed in chapter 4 are implemented and results are presented. A brief description of different Brahms language components is provided with details of how the different concepts in the proposed behaviour model are implemented in the Brahms language. Then a scenario is presented that shows how the inhabitants' behaviour in domestic situations can be implemented and simulated in Brahms, using all the different concepts of proposed behaviour model. Further, an approach to co-simulate inhabitants' behaviour with the thermal models of the building and physical models of appliances is implemented. The proposed approach is implemented using Brahms, Matlab and Simulink. These modelling and simulation tools are integrated and synchronized using Java.

CONTENTS

5.1	Introduction	109
5.2	Brahms as Behaviour Modelling and Simulation Environment.....	109
5.2.1	Brahms Language Constructs.....	110
5.2.1.1	Agents and Groups (agent-based)	110
5.2.1.2	Objects.....	110
5.2.1.3	Activities (subsumption)	110
5.2.1.4	Attribute, Relations, Facts and Beliefs (mental-state/world-state).....	111
5.2.1.5	Workframes (rule-based).....	112
5.2.1.6	Detectable (reactive).....	113
5.2.1.7	Consequences:	113
5.2.1.8	Thoughtframes (inferences).....	114
5.2.1.9	Communication	114
5.2.1.10	Multi-tasking Agents (rule-based/subsumption)	114
5.2.1.11	Area-definitions, Area, Paths (geo-based)	114
5.2.2	Brahms Simulation Components.....	115
5.2.2.1	Agent Model.....	115
5.2.2.2	Object Model.....	116
5.2.2.3	Geography Model.....	117
5.2.2.4	Knowledge Model	118
5.2.2.5	Activity Model	119
5.2.2.6	Communication Model.....	119
5.2.2.7	Timing Model.....	121
5.2.3	H-BDI Agent based Behaviour Model Simulation Results.....	122
5.2.3.1	Scenario Description	122
5.2.3.2	Implementation and Simulation Results.....	122
5.3	Multi-Simulator Environment	128
5.3.1	Coupling Thermal and User Behaviour Simulators	128
5.3.1.1	Connection between Simulators	128
5.3.1.2	Application Example.....	131
5.3.2	Coupling the Appliance's Physical Model and the User Behaviour Simulators.....	134
5.3.2.1	Implementation into Brahms	135
5.4	Summary and Conclusions	137

5.1 Introduction

The Brahms (Business Redesign Agent-based Holistic Modeling System) environment [Sierhuis et al., 2007] has been selected to model the 5W1H approach along with the H-BDI architecture detailed in chapter 4. Brahms environment uses a multi-agent, rule-based, activity programming language. An agent based approach is needed as agents can have needs, they can perform certain activities based on their needs and can also communicate for the fulfilment of various needs. Brahms has similarities to BDI architectures and other agent-oriented languages, but is based on a theory of work practice and situated cognition. The notion of work practice includes how people behave in situations, at specific moments in the real world. Situated cognition claims that "every human thought and action is adapted to the environment, that is, situated, because what people perceive, how they conceive of their activity, and what they physically do develop together" [Clancey, 1997]. Brahms has an activity subsumption architecture which can model an activity that causes other activities. The subsumption architecture decomposes the complex behaviours into simple layered behaviour modules.

In order to co-simulate the inhabitants' behaviour with the physical aspects of the building and the appliances, a tool that implements the physical aspects is required. Matlab/Simulink is used because they have built-in mathematical function libraries for the implementation of physical appliances models. Matlab is an industry standard computing platform with its own proprietary programming language. It is commonly used for developing sophisticated models of engineering phenomena or to perform detailed mathematical or statistical analyses. Simulink is a graphical extension of Matlab, widely used for simulating dynamic control systems. The integration of behaviour and physical models for concurrent simulation is the key to analyze the impact of inhabitants' behaviour on appliances energy consumption. We have used Java to integrate these tools during simulations.

5.2 Brahms as Behaviour Modelling and Simulation Environment

The Brahms is a multi-agent modelling and simulation environment for modelling the behaviour of people [Clancey et al., 1998]. It follows a user-centered system design methodology focused on modelling and simulating work practices and reveals how people interact with each other and with the objects in their environment in different circumstances. It is able to represent people, places, things, behaviour of people and their activities over time, communication among people and is based on the following behavioural and cognitive theories:

- a) Activity theory:** According to this theory [Leont'ev, 1979; Clancey, 1997] the basic unit of analysis is an activity where an activity is some action with a meaningful context. It consists of the subject, object, actions and operations, where subject is the person or group of people engaged in the activity, object is the objective for which this activity is being carried out by the subject. Actions are the processes which must be carried out in order to reach the object.
- b) Situated action:** Following [Suchman, 1987] it states that "every course of action depends in essential ways upon its material and social circumstances" where actions are taken in the context of some specific circumstances and behaviour is not strictly serial from plan to action.

c) **Distributed cognition:** In this theory [Hutchins, 1995] cognition is not confined into an individual; rather it is distributed across objects, individuals, tools and artifacts in the environment. The theory is mainly concerned with how information is represented and how representations are transformed and propagated through the system. It moved the unit of analysis from the individual to the socio-technical system.

5.2.1 BRAHMS LANGUAGE CONSTRUCTS

Important constructs of Brahms modelling/simulation language are as follows:

5.2.1.1 Agents and Groups (agent-based)

An agent is a construct that may represent a person and its behaviour in a modelled setting e.g. home, office, etc. An agent represents the “Who” of the 5W1H approach presented in chapter 4. The agent characteristics include autonomy, social ability, reactivity, pro-activeness, mobility and bounded rationality. Every agent is identified by a name, it has a location and it may or may not belong to some specific group of agents. Members of the group share some common beliefs, facts, activities, attributes, workframes (see section 5.2.1.5), thoughtframes (see section 5.2.1.8) and relations. To specify what an agent does, the modeler defines activities and workframes for the agent. The key properties of agents are group membership, beliefs, workframes, thoughtframes, and location. An agent is able to perceive its environment, make decisions based on its cognitive ability and perform actions.

5.2.1.2 Objects

One of the most important elements of Brahms with which agents interact is the inanimate artifacts/objects. The key properties of objects are facts, workframes, and activities. They together represent the state and causal behaviours of objects. Classes/conceptual classes and objects/conceptual objects are the key concepts inherited from Object Oriented Programming (OOP) (Figure 5.1) [Sierhuis, 2009].

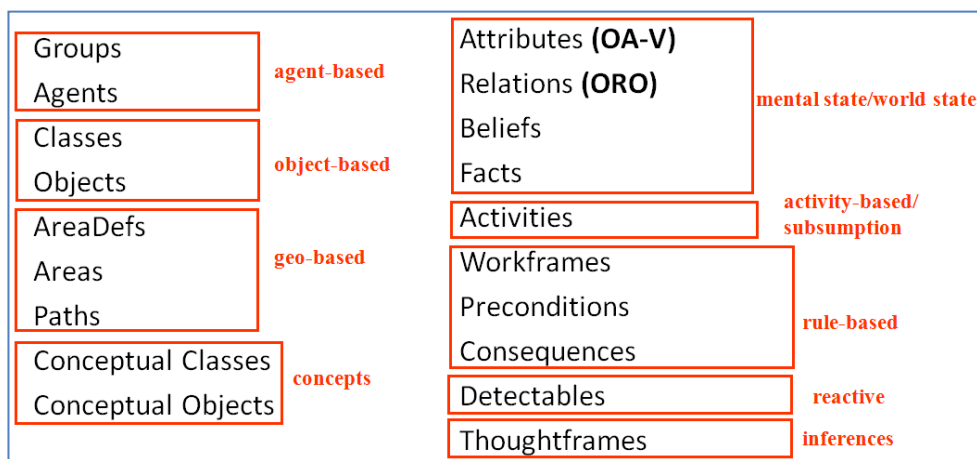

Figure 5.1 Anatomy of a Brahms model: language concepts

5.2.1.3 Activities (subsumption)

Activities in Brahms are key constructs representing actions performed by an individual at certain moments of time. When performing an activity, people might articulate a task they are working on, and the goal they want to accomplish [Clancey, 1997]. Each activity has duration, either fixed or

random, is situated in real world, can be interrupted/resumed, can be decomposed and/or subsumed, and can have a priority.

The behaviour model presented in chapter 4 has the concept of “Actions” after perception and cognition. This concept of actions can be modelled in Brahms using the activities, where the activities are:

- (a) **Primitive activities:** These are the user-defined lowest level activities having time and resources as parameters e.g. eating, sleeping, etc.
- (b) **Predefined activities:** These are the primitive activities with predefined semantics, for example:
 - **Create Agent/Object/Area:** Creates new agents/ objects/areas dynamically
 - **Move:** Moves an agent/object from one area to another area
 - **Communicate:** Communicates agent’s beliefs from/to receiver agent(s)
 - **Broadcast:** Communicates agent’s beliefs from/to all agent(s) in specific areas
- (c) **Composite activities:** These are the user-defined activities that are composed of other activities. For example the activity of preparing lunch would further be composed of cutting the food, putting in the pan, cooking for some time, etc.
- (d) **Java activities:** These are the user-defined primitive activities implemented in a Java class using a Brahms API.

5.2.1.4 Attribute, Relations, Facts and Beliefs (mental-state/world-state)

The attributes represent the context of any agent or object whereas a relation defines inheritance and hierarchy among them. The facts represent the physical state of the world or some attribute of an agent or object and when observed by agents are turned into their beliefs which represent an internal mental state of the agent or object. A belief represents an agent's interpretation of a fact in the world. A belief held by an agent may differ from the corresponding fact. Different agents act differently to the state of the world based on their beliefs. For example, high temperature in a room can be modelled as a fact in the world. An agent feeling hot (detecting the fact) may decide to open the window, while other agents who are also feeling hot might not move to open the window. The relationship between constructs in Brahms is shown in figure 5.2 [Sierhuis et al., 2009]. A group in Brahms represents a collection of agents and is similar to the concept of a template or a class in object oriented programming. Agents have certain beliefs and perform activities based on their beliefs. The activities are defined in a workframe that are defined by the detectables, preconditions and consequences.

GROUPS are composed of
 AGENTS having
 BELIEFS and doing
 ACTIVITIES executed by
 WORKFRAMES defined by
 PRECONDITIONS, matching agents beliefs
 PRIMITIVE ACTIVITIES
 COMPOSITE ACTIVITIES, decomposing the activity
 DETECTABLES, including INTERRUPTS, IMPASSES
 CONSEQUENCES, creating new beliefs and/or facts
 DELIBERATION implemented with
 THOUGHTFRAMES defined by
 PRECONDITIONS, matching agents beliefs
 CONSEQUENCES, creating new beliefs

Figure 5.2 Relation between constructs

5.2.1.5 Workframes (rule-based)

A workframe is a situation-action rule consisting of preconditions (what the agent must believe to be true), actions, detectables (what facts in the world might be noticed, with what probability and when during the actions), and consequences (changes to the world or this agent’s beliefs that result). They are different from production rules in that they take time. Agents with different workframes, performing the same activity, represent individual differences. A Workframe defines when an activity or activities of agent/object may be performed. Activities performed could be simple (just indicating a name, duration, and priority) or composite (another activity), where a composite activity may in turn consist of several workframes (Figure 5.1 and 5.3) [Sierhuis et al., 2007]. Workframes capture the reactive/deliberative behaviour of the agents. When the workframe is executed, conclusions that are facts, beliefs or both, that maybe asserted. Figure 5.3 shows the workframe activity hierarchy where the workframe W_1 has two activities, $A_{1.1}$ is a primitive activity and $A_{1.2}$ is a composite activity since $A_{1.2}$ further has many workframes from $W_{1.2.1}$ to $W_{1.2.n}$. The arrow “current activity” indicates that $A_{1.2}$ is currently executing under workframe W_1 and it is executing the workframe $W_{1.2.1}$. This subsumption goes on until it reaches the primitive activity $A_{1.2.1.1.1.1}$ which is the activity currently in execution.

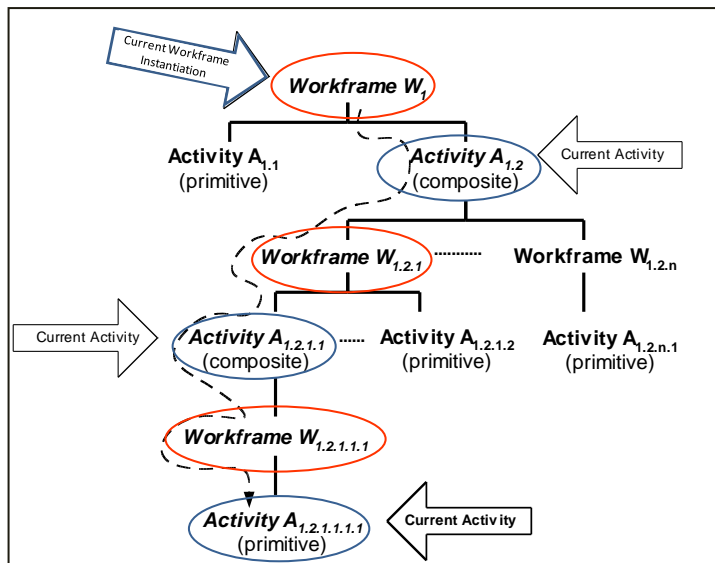

Figure 5.3 Workframe-Activity hierarchy

5.2.1.6 Detectable (reactive)

A detectable is defined as a fact that occurs in the world, an agent may notice it and may stop doing current activities or may finish them. The concept of “perception” proposed in the behaviour model is realized by the detectables. They allow for modelling the reactive behaviour of agents. Whenever an agent detects some fact in the world it is converted into an agent’s belief. Later the agent’s belief is matched with the condition used in the detectable and if it is matched then part of the detectable will be executed.

a) *Detect certainty*

The percentage of chance that a fact will be detected based on the detectable is called “detect certainty”. The detect-certainty is a number ranging from 0 to 100. A detect-certainty of 0% means that the fact will never be detected, basically meaning that the detectable is switched off. A detect-certainty of 100% means that a fact will always be detected.

b) *Detectable action*

As mentioned before the concept of “perception” is modelled through a detectable. After detecting the fact there are 5 different possible detectable actions:

- ***Continue***: Has no effect, only used for having agents or object detect facts and turn them into beliefs.
- ***Impasse***: Blocks the workframe on which the agent or object is working until the impasse is resolved.
- ***Abort***: Immediately terminates the workframe on which the agent or object is working.
- ***Complete***: Immediately terminates the workframe on which the agent or object is working, but still executes all remaining consequences defined in the workframe. All remaining activities are skipped.
- ***End activity***: This action type is only meaningful when used with composite activities. It causes the composite activity on which the agent or object is working to be ended.

5.2.1.7 Consequences:

Consequences are facts, beliefs or both that maybe asserted after the workframe is completed. They represent cognitive state changes for the agent by creating new beliefs, and/or a new state in the world (i.e. a fact) due to the work done in an activity (Figure 5.1 and 5.2).

a) *Fact certainty*

The percentage of chance that a fact will be created based on the consequence is called “fact certainty”. It ranges from 0 to 100. A fact certainty of 0% means that a fact will not be created, 100% means that a fact will always be created at all times.

b) *Belief certainty*

The percentage of chance that a belief will be created based on the consequence is called “belief certainty”. It ranges from 0 to 100. A belief certainty of 0% means that a belief will not be created, whereas, 100% means that a belief will always be created.

5.2.1.8 Thoughtframes (inferences)

These are used to model the reasoning/deliberative behaviour of agents and are represented as production-rules creating new beliefs of agents without executing some activity. As no activity is executed by the thoughtframes, it makes them different from workframes which, in addition to generating new beliefs and facts, also execute some activity.

5.2.1.9 Communication

In Brahms, communication between agents and objects is done by communicating beliefs. The communication of beliefs is done with a communication activity that transfers beliefs to/from one agent to one or several other agents, or to/from an (information carrier) object. These activities are key towards implementing group activities (social behaviour).

5.2.1.10 Multi-tasking Agents (rule-based/subsumption)

An agent may have multiple competing general activities in process: activities 1, 3, and 4 (Figure 5.4) [Sierhuis et al., 2007]. Activity 1 has led the agent (through workframe WF1) to begin a sub-activity, activity 2, which has led (through workframe WF2) to a primitive activity Action X. When activity 2 is complete, WF1 will lead the agent to do other activities. Meanwhile, other workframes are competing for attention in activity 1. Activity 2 similarly has competing workframes. Priority or preference rankings led this agent to follow the path to Action X, but interruptions may occur at any time. Activity 3 has a workframe that is potentially active, but the agent is not doing anything with respect to this activity at this time. The agent is doing Activity 4, but reached an impasse in workframe WF4 and has begun an alternative approach (or step) in this Activity WF5. This produced a sub-activity, Activity 6, which has several potentially active workframes, all having less priority at this time than WF2. This approach has the real-life analogy of people are working on many different activities at the same time, but are active in only one. However, at any moment focus can be changed and they start working on another competing activity, while interrupting others.

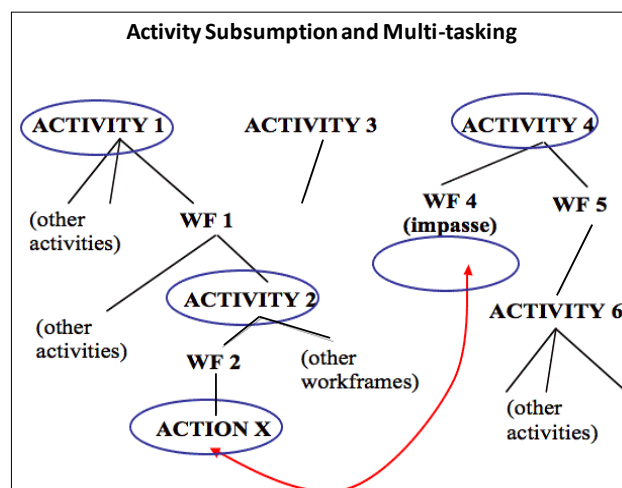

Figure 5.4 Activity subsumption and multi tasking

5.2.1.11 Area-definitions, Area, Paths (geo-based)

Agent and objects are located and they may move from one location to another. Agents know about their location and the location of the other agents/objects around them. Area definitions are the

attributes of geographical places identified within a scenario and used during simulation. Bi-directional paths can be defined from one geographical area to another. These paths are characterized by distance and duration.

5.2.2 BRAHMS SIMULATION COMPONENTS

In addition to the language constructs, Brahms has models that are used in simulation [Clancey et al., 1998]. The reason for selecting the Brahms simulation environment is that all the elements considered important in behaviour representation (chapter 4, section 4.2) can be mapped to Brahms models (Figure 5.5). The behaviour elements When, What, Why, Where, Who and How are mapped to the Timing, Object, Knowledge, Geography, Agent and Activity models respectively. The detail of each model and how the proposed behaviour elements are implemented in each component is given in the section below.

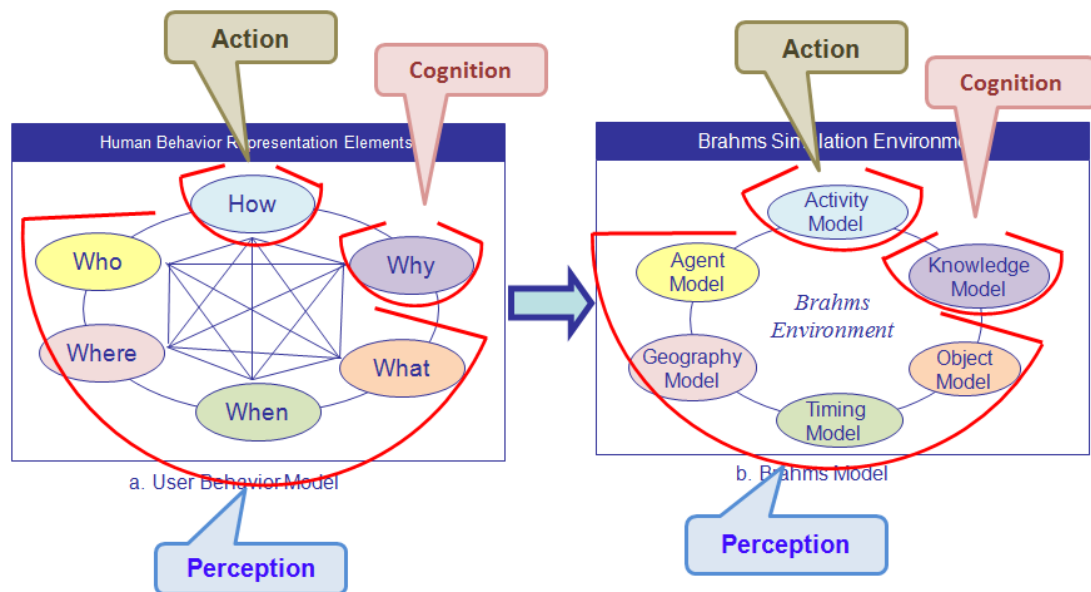

Figure 5.5 Mapping of user behaviour elements onto Brahms

5.2.2.1 Agent Model

This model contains all the agents, the groups to which they belong, and how these groups are related to each other, resulting in a group hierarchy. Facts and beliefs which are common to all the agents can be specified in the group as initial-beliefs and initial-facts. However, if there are some beliefs and facts that are specific to some agents, they are defined in the body of that particular agent. Agents can also have some attributes, where an attribute is a property having some value. Values can be of type Boolean, integer, double, string or some user-defined types. The values of these attributes are specified through facts and beliefs.

Figure 5.6 shows the agent model where the “groupOccupant” is the group that has two members, Husband and Wife agents. These agents have their own specific attributes, beliefs, workframes and thoughtframes, and they also inherit the ones from the “groupOccupants” which are common to both of these agents.

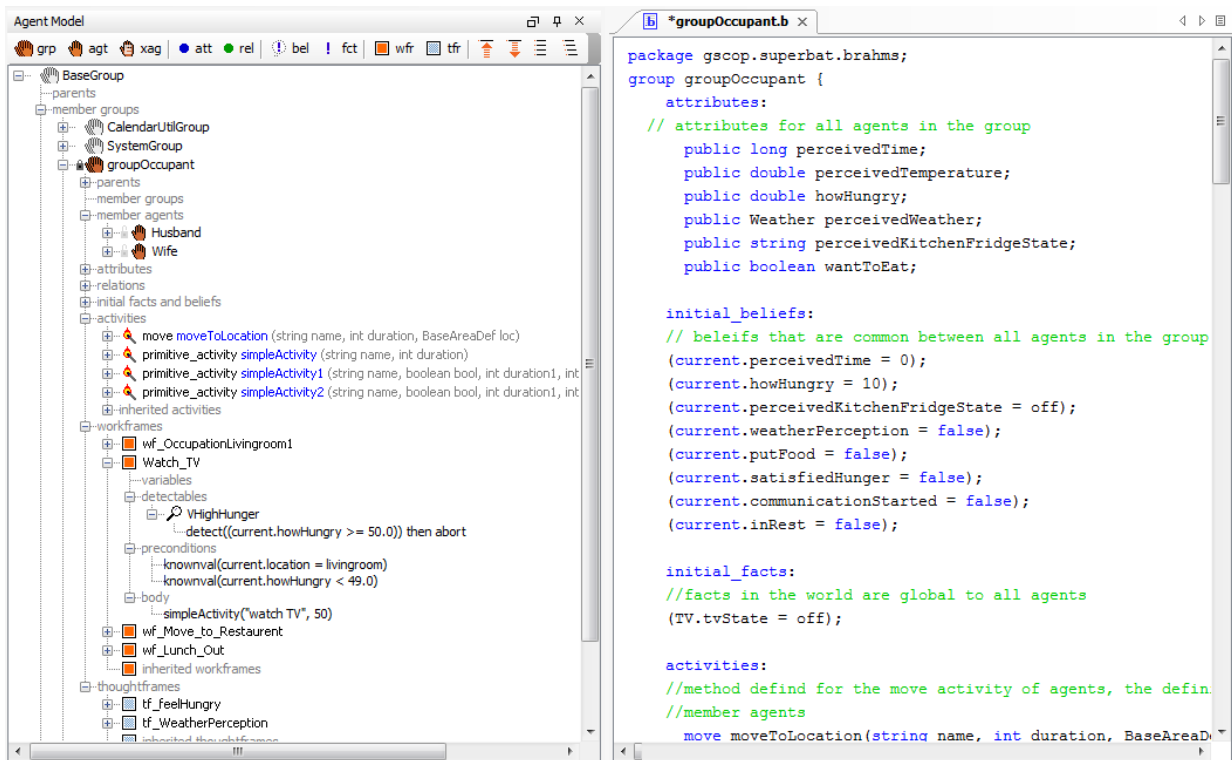

Figure 5.6 Agent model in Brahms

5.2.2.2 Object Model

Figure 5.7 shows the object model containing different objects. Just as a group hierarchy is defined in the agent model, a class hierarchy of all the objects is defined in the Object model. The root class for this class hierarchy is called the Base Class and all other objects and classes are inherited from this Base Class. The objects in this model have certain attributes, facts and beliefs.

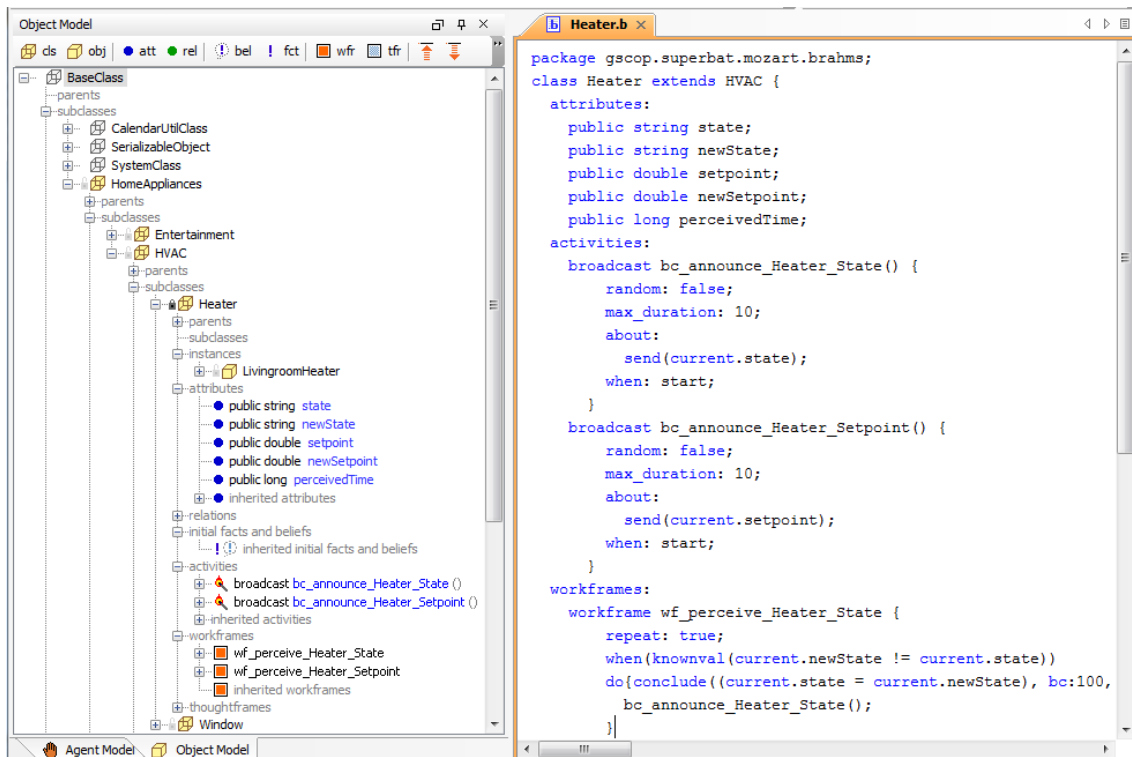

Figure 5.7 Object model in Brahms

In figure 5.7 the class “HomeAppliances” is derived from the “BaseGroup” that contains the “Entertainment” and “HVAC” classes. The “HVAC” class further has a sub class “Heater” that contains the “Livingroom Heater” as an object. The object has its own specific attributes, beliefs, workframes and thoughtframes and it also inherits them from the classes it belongs to.

5.2.2.3 Geography Model

In this model, geography is described through the concepts of area, area definitions and paths. Area definitions are similar to classes and represent different geographical locations ('World', 'City' and 'Building'). Area is an instance of the area definition and can be decomposed into sub-areas using a part-of relationship or 'path' (Figure 5.8).

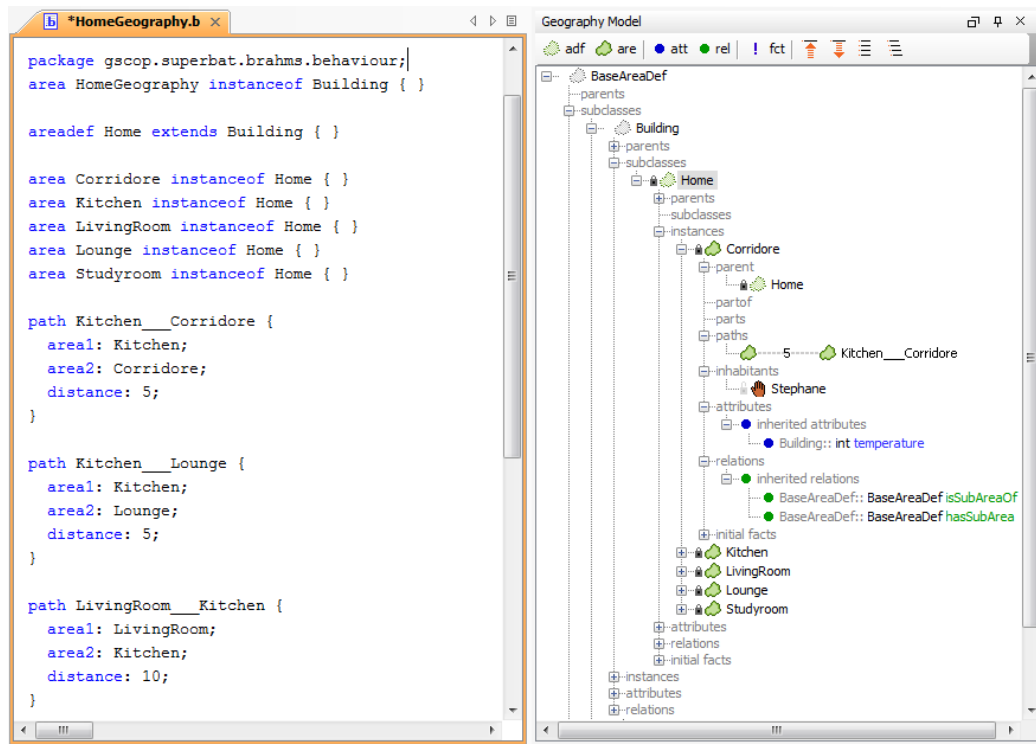

Figure 5.8 Geography model in Brahms

The agents can change their location by moving from one location to another. The movement is modelled using the “move” activity. When the agents or objects move from one area to another their location facts and beliefs are also changed and they become aware of their new location, other agents, and objects in that location. The distance between two locations is measured in time duration. This duration can be mentioned while building the geography model, e.g. the distance between kitchen and corridor is 5 sec, as shown in figure 5.8. This distance can also be mentioned in the move activity as a random duration as shown in figure 5.9.

```

move moveToLocation(string name, boolean randomness, int duration1, int duration2, BaseAreaDef loc) {
  display: name;
  random: true;
  min_duration: duration1;
  max_duration: duration2;
  location: loc;
}
  
```

Figure 5.9 Move activity to change geographic location

5.2.2.4 Knowledge Model

In this model, the agent’s reasoning mechanism is represented as forward chaining production rules, called thoughtframes. Thoughtframes can be represented at group or class levels and can be inherited. Perception is modelled as conditions. These conditions are attached to workframes and are called detectable. Thus observation is dependent on what the agent is doing.



Figure 5.10 Knowledge model in Brahms

Figure 5.10 shows a throughframe “tf_perceive_comfort”, that receives the comfort value from the comfort calculator and changes the agent’s perception of comfort at each simulation time step. The workframe that is attached to this thoughtframe is the “Watch_TV”, where among the other preconditions to watch TV are that the agent’s comfort value lie between 0.5 and -1. If the agents’ perception of comfort lies between these values it will continue watching TV. However, as soon as the value will be out of this range one of the detectable in the detectables list will be triggered. For example if the comfort value goes below -1, the detectable “veryLowComfortVal” will be triggered and the agent will abort the current activity of watching TV. The agent will now take some action to be comfortable, and will search for that workframe where the precondition matches the detectable. In figure 5.10 the “wf_Adjust_Heater_Setpoint” contains this precondition and the agent turns on the heater and adjusts the setpoint to achieve comfort.

5.2.2.5 Activity Model

Figure 5.11 shows the activity model where the activities of agents and objects are represented, these activities can be defined at the group level or they may be specific to certain agents or objects. Activities take some time and may have an associated priority.

Figure 5.11 shows different types of activities, the move, broadcast, primitive, composite and Java activities. Each activity has a set of parameters and belongs to some workframe where it is realized based on the preconditions.

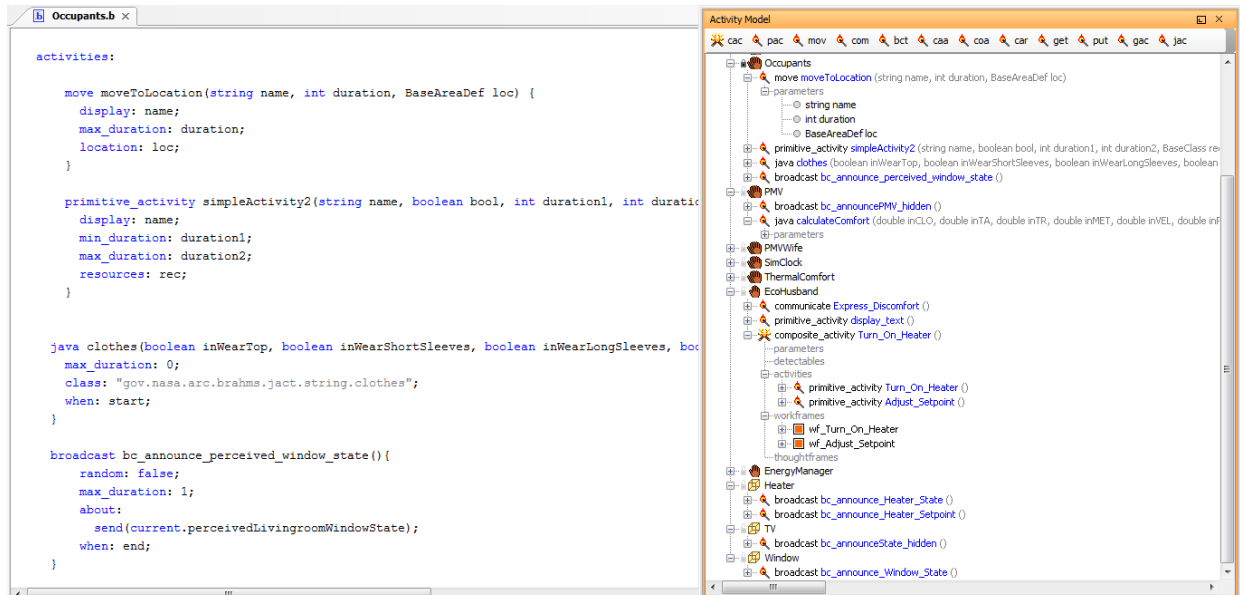

Figure 5.11 Activity model in Brahms

5.2.2.6 Communication Model

This model includes the actions by which agents and objects exchange their beliefs. The communication includes telling someone something or asking a question. Conversation is modelled as an activity with communication actions. Figure 5.12 shows how the communication between two agents is made in order to open the window. The communication activity “communicateDemandToOpenWindow” is realized in the workframe “DemandToOpenWindow”. When the Wife agent perceives the belief of the Husband agent in “AcceptToOPenWindow” workframe, it checks for the other constraints before replying back to the Husband agent. One of the constraints it needs to check for is the weather. The thoughtframe “tf_perceive_weather” collects the information about weather from the “OutsideEnvironment” agent and provides this information to the Wife Agent at each time step. Upon perceiving that the weather is fine, the Wife agent sets its belief “AcceptToOpenWindow” to be true. However, the “bc” (belief certainty) and “fc” (fact certainty) also decide the value for this belief. The value can be between 0 and 100 and defines, how probable it would be, that the Wife agent accepts the Husband agent’s request. Finally, the value of this belief is sent back to Husband agent, where depending upon the value it will perform the desired action.

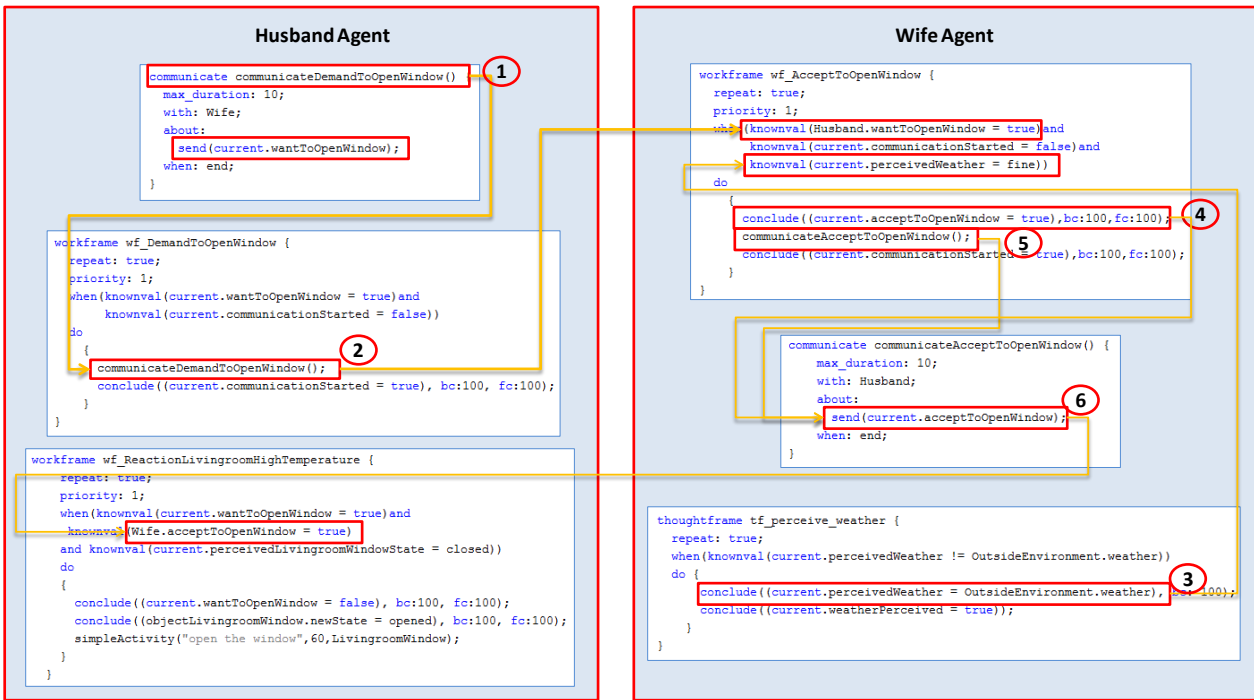

Figure 5.12 Communication between agents

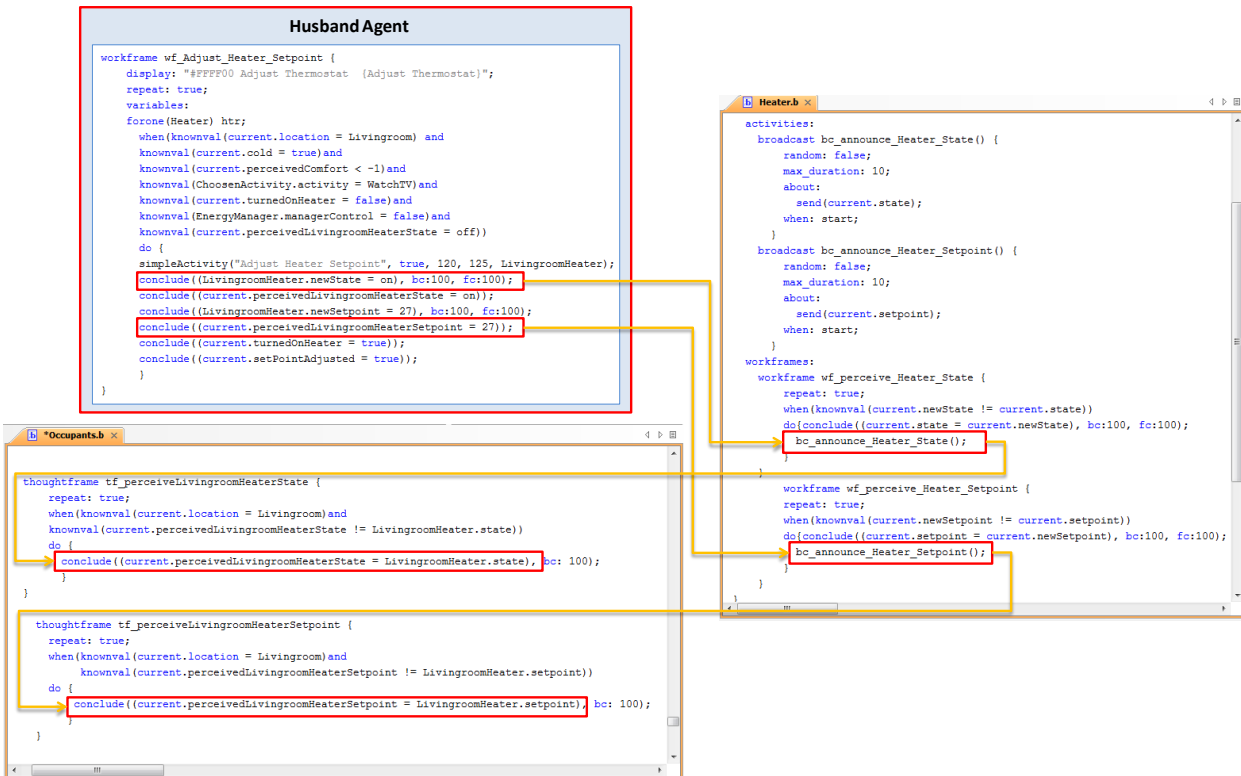

Figure 5.13 Communication between an agent and an object

The transfer of beliefs between agents and objects is also possible, either through communication or broadcasting of messages. In figure 5.13 in the workframe “Adjust_Heater_Setpoint”, Husband agent turns on the heater and adjusts its setpoint. It then corrects its previous beliefs about the state of the heater and its setpoint. This adjustment of state and setpoint is perceived by the heater and as soon as this change happens it broadcasts its state and setpoint to all the other agents and objects, so that they can also correct their beliefs about the heater state and setpoint. The group “Occupants” contains other agents and once the change of state and

setpoint is perceived at the group level, it will automatically be perceived by the other agents belonging to this group due to inheritance.

5.2.2.7 Timing Model

This model enforces the constraints of when activities in the activity model can be performed. This is represented as preconditions of situation-action rules (workframes). Activities take time (predefined duration of primitive actions) and workframes can be interrupted and resumed, making the actual length of an activity situation dependent.

```

package gscop.superbat.mozart.brahms;
group SimClock {
  attributes:
    public long time;
    public long timeStep;
    public long endTime;

  activities:
    broadcast bc_announce_Time(int duration) {
      random: false;
      max_duration: duration;
      about:
        send(current.time);
      when: start;
    }

  workframes:
    workframe wf_asTimeGoesBy {
      repeat: true;
      when(knowval(current.time <= current.endTime) and knowval(current.timeStep = 60))
      do {
        bc_announce_Time(60);
        conclude((current.time = current.time + current.timeStep), bc:100, fc:100);
      }
    }
}

```

Figure 5.14 Workframe broadcasting the timing signals

This model is built in the simulator by first building a clock, and then sending the clock time to every agent and object in the environment. The clock that sends the simulation time can be built as an object or as an agent that broadcasts its timing signals to all the other agents and objects. Figure 5.14 shows the workframe “wf_asTimeGoesBy” that use the broadcast activity “bc_announceTime” to broadcast the time duration in seconds.

The other agents and objects will perceive these signals through their belief about the perception of the environment. The perception of environment is modelled through the concept of thoughtframes in Brahms. The agents update their belief about the time at each time step (Figure 5.15).

```

thoughtframes:
  thoughtframe tf_perceiveTime {
    repeat: true;
    when(knowval(Simulation_Clock.time > current.perceivedTime))
    do {
      conclude((current.perceivedTime = Simulation_Clock.time), bc: 100);
    }
  }
}

```

Figure 5.15 Thoughtframe for perceiving time

The perception of time also helps agents to perform some time based actions, e.g. for example, having breakfast, going to work, going to sleep, etc. If the agents are involved in doing

some other activity and the time to sleep arrives, they will first complete their activity and then will move to the bedroom (Figure 5.16).

```

workframe wf_OccupationBedroom {
  repeat: true;
  priority: 1;
  when(knownval(current.location != Bedroom) and
  knownval(current.perceivedTime >= 24*3600)and
  knownval(current.perceivedTime < 6*3600)) // 24h00-06h00
  do { moveToLocation("Move to bedroom",true,5,10,Bedroom);
    conclude((current.location = Bedroom), bc:100);}
}

```

Figure 5.16 Perception of time by an agent to change geographic location

However, the situations where the agents have to quit their current activity as soon as they perceive that the time for some specific task has come, the time based detectable are used. The timing model is also used to make the synchronization between the Brahms clock and the one used in Matlab/Simulink model.

5.2.3 H-BDI AGENT BASED BEHAVIOUR MODEL SIMULATION RESULTS

In this section, a scenario is implemented based on the BDI agent based behaviour model (chapter 4, section 4.3) in order to capture and simulate cognitive and deliberative aspects in addition to reactive and group behaviours. The following section includes the scenario description, implementation details and simulation results with an explanation.

5.2.3.1 Scenario Description

In order to explain how a more complex behaviour of inhabitants could be represented in a simulation, we use a scenario. The Father, mother, daughter agents move to the living room after having the dinner in Kitchen. The son moves to the study room to study. In the Living room the agents start watching television. The temperature increases slowly due to the presence of many people in the Living room. Father feels hot and wishes to reduce the temperature. It can choose between opening the window, opening the door, and turning on the air conditioning. If it chooses to open the window, it asks the Mother and Daughter agents. If they agree, the Father agent goes to the window and opens it. It realises that there is a storm outside and opening window is not safe, so it evaluates between two options to identify the most comfortable, turn the AC on using the remote control, or open the door linked to the study room.

5.2.3.2 Implementation and Simulation Results

In this section the implementation details are presented that will show how the different concepts presented in the behaviour model in chapter 4, section 4.3.1 are developed in Brahms. Only a part of the simulation results is presented in figure 5.21. The agents move to the living room after having their dinner and start watching TV. They also continuously perceive the environmental variables e.g. the temperature in the room, the presence of other agents, etc. The perception from the environment is then converted to agents' beliefs about the external environment and their physical comfort level, shown by the "Cognitive.beliefs" and "Physical.Homeostasis" blocks in figure 5.17. The thermal comfort of the agent depends on the temperature value and is computed with a thoughtframe that increments the temperature with the passage of time. The "Continue Current Activity" block in figure 5.17 shows the workframe Watch TV, which says that the agent will

continue the watch TV activity until it detects the temperature exceeds his comfort level. The “belief generation” block shows that when the temperature in the living room increases to the threshold level, i.e. 20°C, the agents start feeling uncomfortable. This generates a desire in the Father agent to lower the temperature by either opening the window or the door. Since the agent has multiple desires at one time, one of his desires will be converted to an intention and the others will be ruled out. This can be done by analyzing the constraints that can reduce the agent’s desires for possible actions. In this scenario the constraint is modelled as a group opinion. Thus if the Father agent wants to open the window, due to the presence of other agents in living room, it has to consider their opinion as well. These perceptions and desires that are generated in the Father agent are shown in figure 5.21 as a series of thoughtframes (yellow bulb symbols). They show how the perception of feeling hot triggers a reasoning mechanism in order to lower down the temperature.

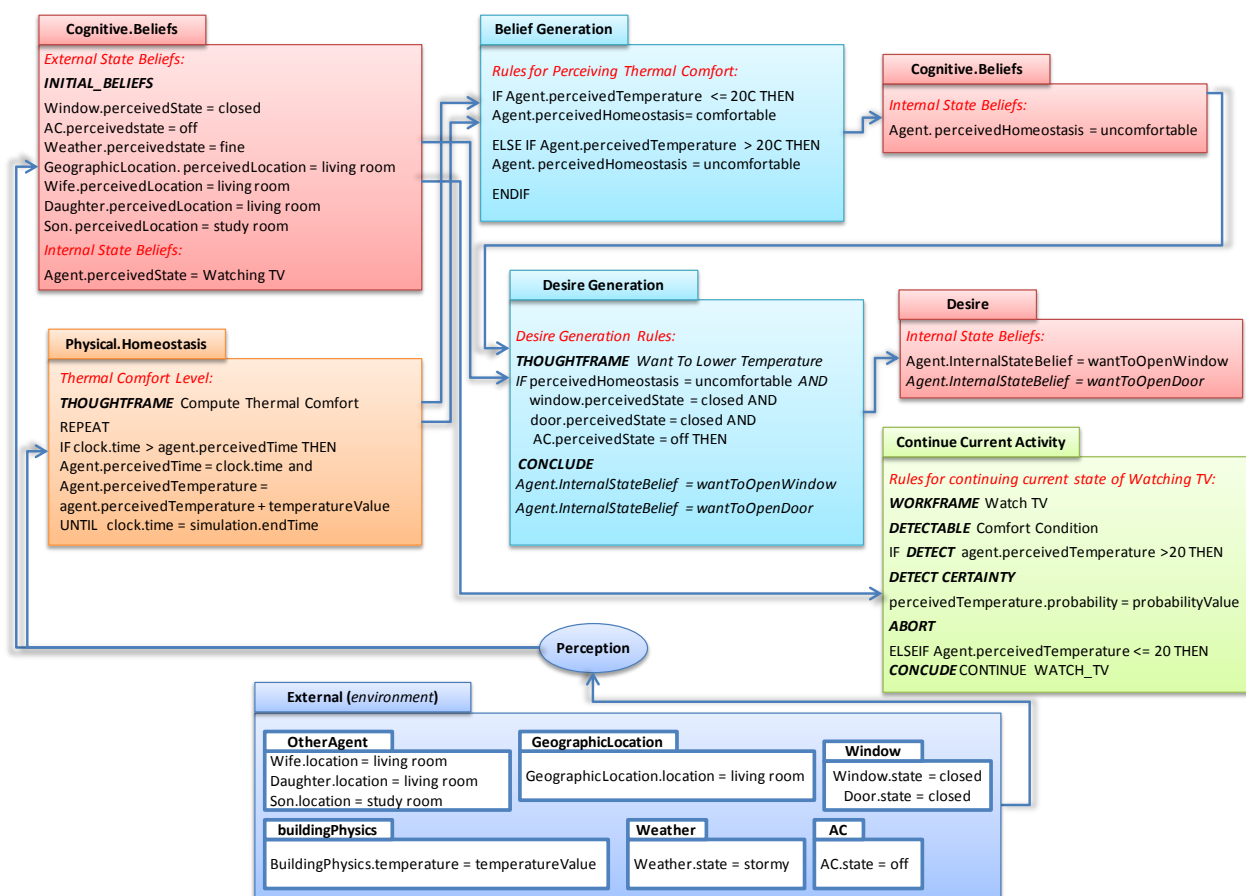

Figure 5.17 Perception of internal and external environment, and desire generation process

The agents, when they have detected that the temperature goes up to the threshold level, abort the current activity i.e. watching TV, in order to first make themselves comfortable. This behaviour is modelled through the concept of detectables in Brahms as detailed in section 5.2.1.6.

Since the agent Father wants to consider the opinion of the Mother and Daughter agents as well, it starts to communicate with them. The communication activities taking place between Father, Mother and Daughter agents are represented by vertical blue lines in figure 5.21. In the communication activity, the Father agent expresses his desire to Mother and Daughter agents. These agents then perceive the agent Father desire. They response with their beliefs of whether they agree with it or not. The “Actions” block in figure 5.18 shows the communication activity between agents through which they send and receive messages to each other and exchange their beliefs. The

agreement or disagreement of agents can be modelled through “belief certainty” that assigns a percentage value to the agreement. Depending on this value the agents will always agree if the value is 1, will never agree if it is 0, or sometimes agree or not if it is in between.

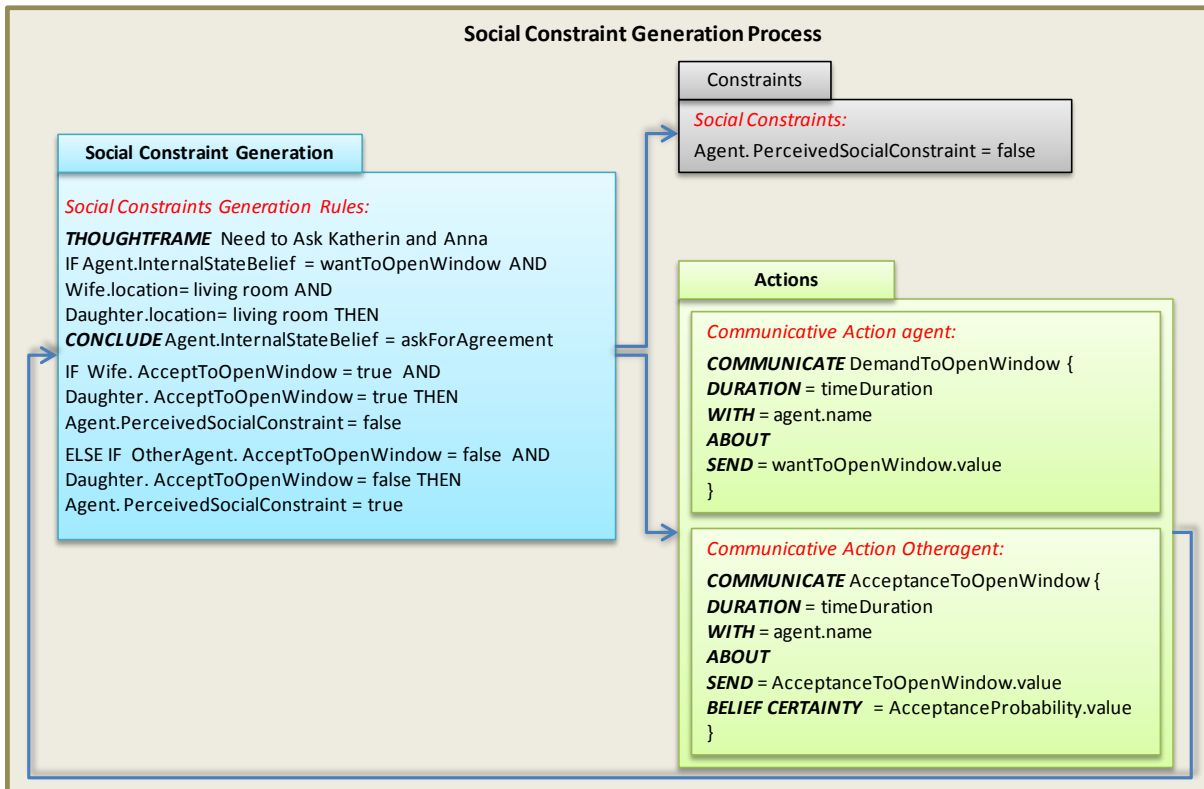

Figure 5.18 Social constraints generation process

If the Wife and Daughter agents do not agree with the Husband agent, one of the agent’s desires i.e. open the window would be ruled out and it could not choose to open the window. However, since the other agents agree with the Father agent to open the window, the agent now has two desires, want to open the window, and want to open the door. The “Intention Generation” process as shown in figure 5.19 further limits the desires by selecting the one based on the “belief certainty” value as the agent’s intention. If both desires have the same “belief certainty” value, one of them will be picked randomly, otherwise, the one with a high "belief certainty" value will be selected. If the desire to open window becomes an intention of the agent, a plan will be generated of how the agent will follow the action to open the window. The agent will then follow this plan by moving to the window, interacting with the window and opening it. The workframe “Open window” in the “Actions” block in figure 5.19 will execute only if the agent does not detect a storm outside. If the agent detects a storm it will not open the window.

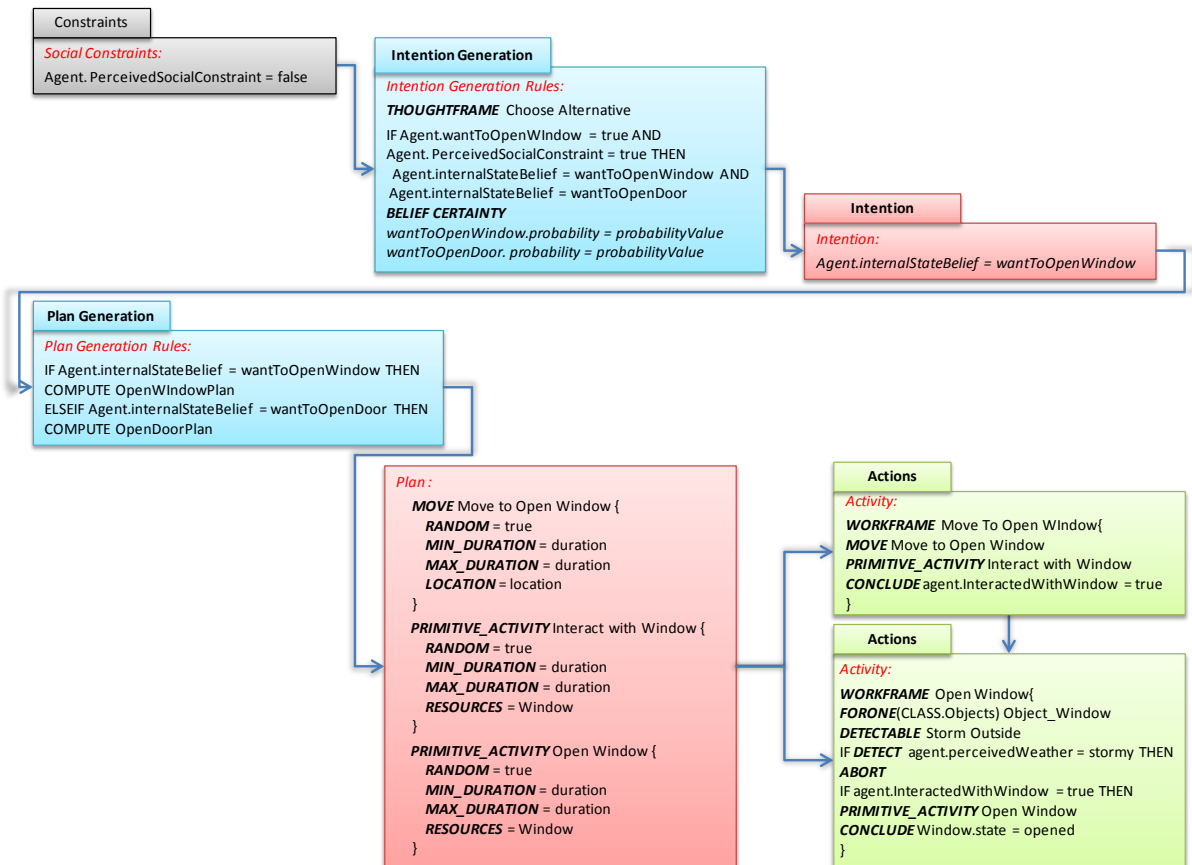

Figure 5.19 Intention generation process

The thoughtframe in the “Cognitive.beliefs” block in figure 5.20 will then change the agents’ external state belief about the weather. At the start, the agent believed that the weather was fine but after detecting the fact from the environment, it corrected its belief about the weather. This belief gives rise to deliberative behaviour of choosing between opening the door or turning on the air conditioner based on Son agent’s presence in the study room. Since the Son agent is in the study room, opening the door might disturb it. Thus, the final choice made is to turn on the air conditioner. Finally, based on these thoughtframes the choice is implemented by workframe (wf) ‘Turn_On_AC’ which consists of the composite activity (ca) of first picking up the remote control and adjusting the temperature. This action will change the appliance state and the change in temperature will lead to new external beliefs by the agent (Figure 5.20). The yellow horizontal lines beneath the primitive activities (pa) in figure 5.21 show the interaction with some appliance/object, in this case the remote control. After turning on the AC, the temperature decreases, which is perceived by the agents, who then resume their activity of watching TV, as shown in figure 5.21.

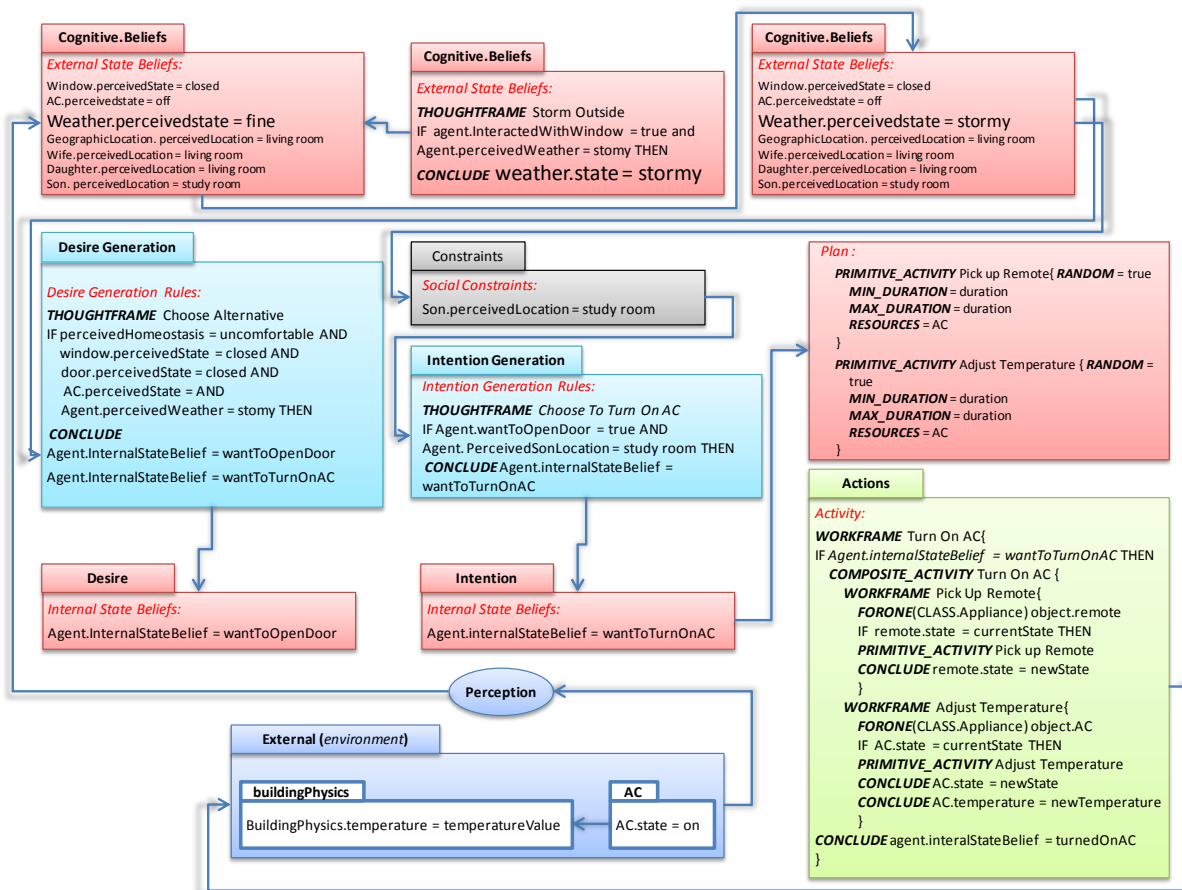

Figure 5.20 Plans and actions generation process

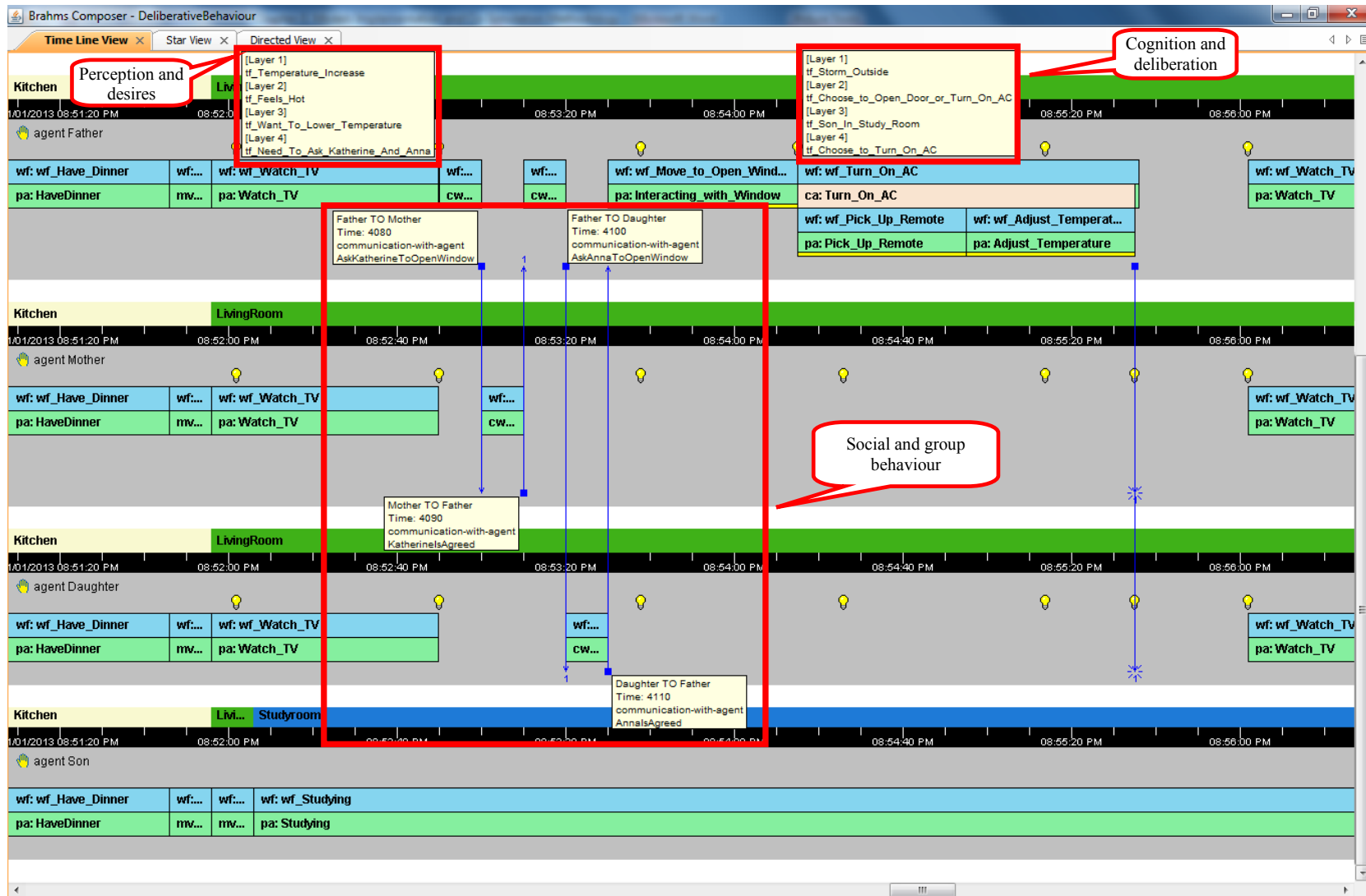

Figure 5.21 Communication and group reactive/deliberative behaviour

5.3 Multi-Simulator Environment

The above sections detail how the behavioural model is implemented in Brahms multiagent environment. However, as already mentioned in previous chapters, the modelling and simulation of these models is to analyze their combined impact on the building. This section describes how a co-simulation environment is established. In this environment, there are five modules: two modules with models describing the thermal (heating and cooling) and electrical aspects (appliances consumptions) in the building; a module dedicated to control algorithms and energy saving policies; a module for the simulation of inhabitants behaviour and a fifth module for predicting the outdoor weather conditions. The interoperability between these modules is presented in figure 5.22.

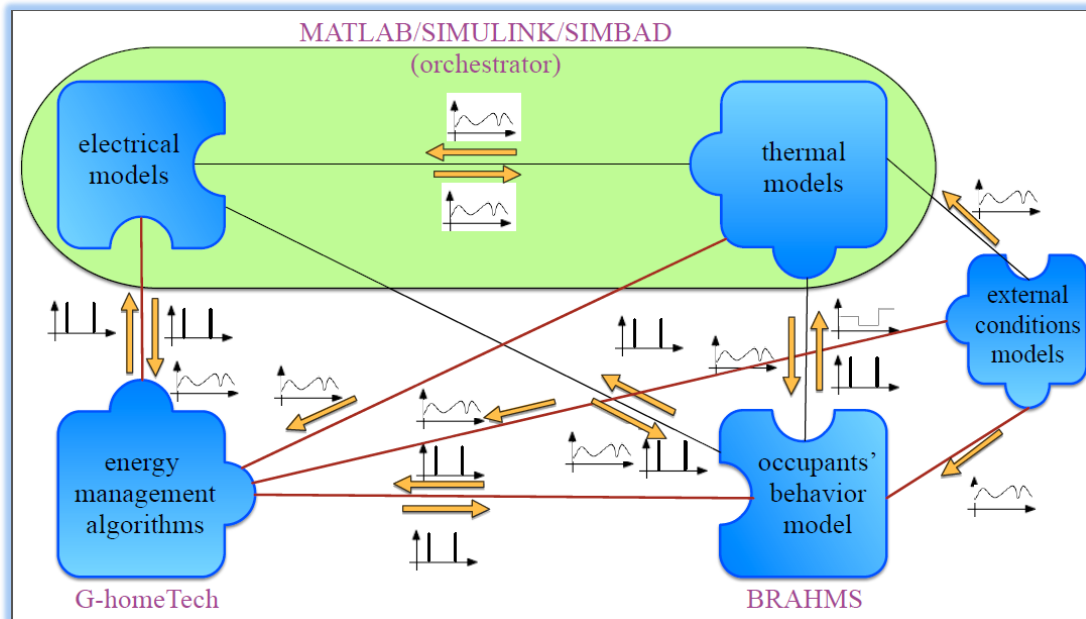

Figure 5.22 Interoperability between different modules in a co-simulation environment

5.3.1 COUPLING THERMAL AND USER BEHAVIOUR SIMULATORS

The activities of inhabitants, their presence at different locations in the house, their control over different appliances and objects, and their communications are modelled in the Brahms simulation environment. However in order to model the environmental variables a physical simulator is required that provides the information about physical aspects, such as temperature inside different parts of the house, humidity and outside weather conditions, etc. The values of these environmental parameters are fed into the Brahms simulation environment, causing the inhabitants to change their beliefs and perform some activity. In order to perform certain activities, the inhabitants change their locations, change the states of different objects (e.g. doors, windows), and different appliances (e.g. heater, air conditioner) in the house. As soon as these state changes happen, this information is sent back to the physical simulator where new setpoints for the environmental parameters, such as the temperature, are adjusted. This process continues in a cycle and impacts the inhabitants' behaviour capturing energy consumption.

5.3.1.1 Connection between Simulators

The connection between the occupant's behaviour simulator (Brahms simulation environment) and the physical simulator, is established through a Java interface. The physical simulator is created in Matlab/Simulink and consists of the thermal model of the house and the controllers for appliances.

This interface actually drives the Brahms virtual machine and manipulates different attributes of the occupant's behaviour model to be simulated. This is done by setting agents and objects attributes and handling the starting time of the simulation. The simulator keeps track of the current location of the agents and of the current values of different attributes of objects. In addition, the interface is also responsible for the synchronization between Brahms and Matlab/Simulink. The interface verifies the termination of a simulation step and advances the Brahms virtual machine to the next step of the simulation and prepares the data to be exchanged between Brahms and Matlab/Simulink (i.e. data to be exchanged between the occupant behaviour simulator and the physical simulator). This interface is utilized in Matlab/Simulink by compiling it into a jar file and giving the path of this file, and then calling its built-in functions in the level-2 Matlab s-function. The thermal model is defined in the Matlab function file which uses: the output of the Brahms simulation, such as presence of occupants and the appliance and window state. Based on the outside temperature and the heating appliance's power it gives the temperature inside the room. The heating appliance's power is calculated by the controller which maintains the setpoint temperature for the room. Figure 5.23 shows how the co-simulation works.

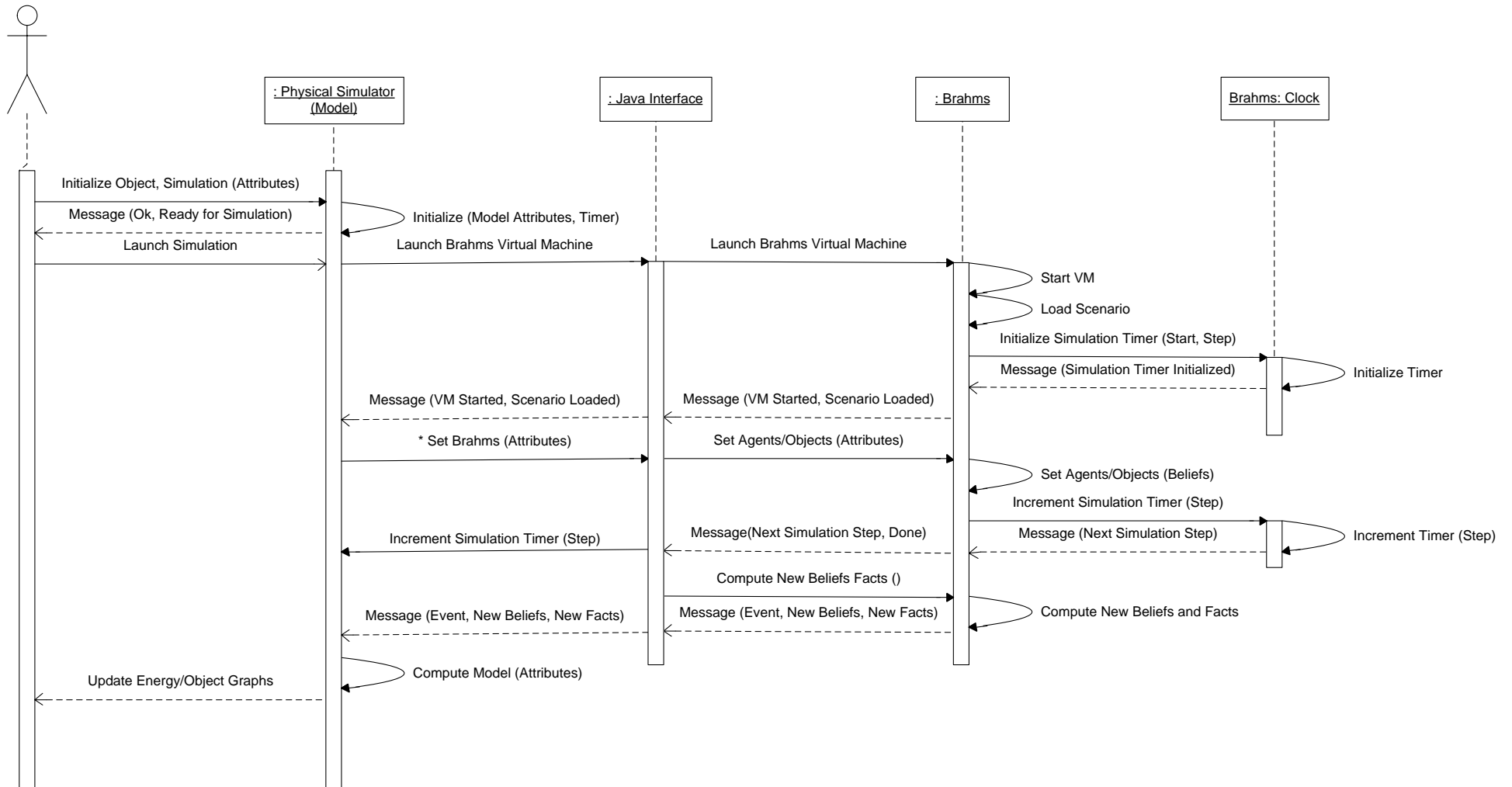

Figure 5.23 Interaction between the components of the co-simulator

5.3.1.2 Application Example

The combined architecture of the physical simulator connected to the Brahms simulation environment is shown in figure 5.24. An example of its application, being run in Matlab/Simulink, and results are shown in figure 5.25 and 5.26. The physical simulator, consisting of the thermal model of the house and the controllers for the air conditioner and heater is connected to the Brahms simulator. In figure 5.24, only the thermal model of the living room is considered. The information about the temperature inside the living room is sent to the Brahms simulator. If an agent is present in the living room, it will continuously perceive the environmental temperature and as soon as the temperature value exceeds or falls below a specific setpoint it will perform the appropriate action. Figure 5.24 shows the physical simulator which stores the values for the environmental variables. In this scenario the environmental variable considered is the temperature in different rooms inside the house. This physical simulator, when connected to Brahms simulation environment, adjusts the temperature in different rooms. The inhabitants are modelled as agents moving throughout the house.

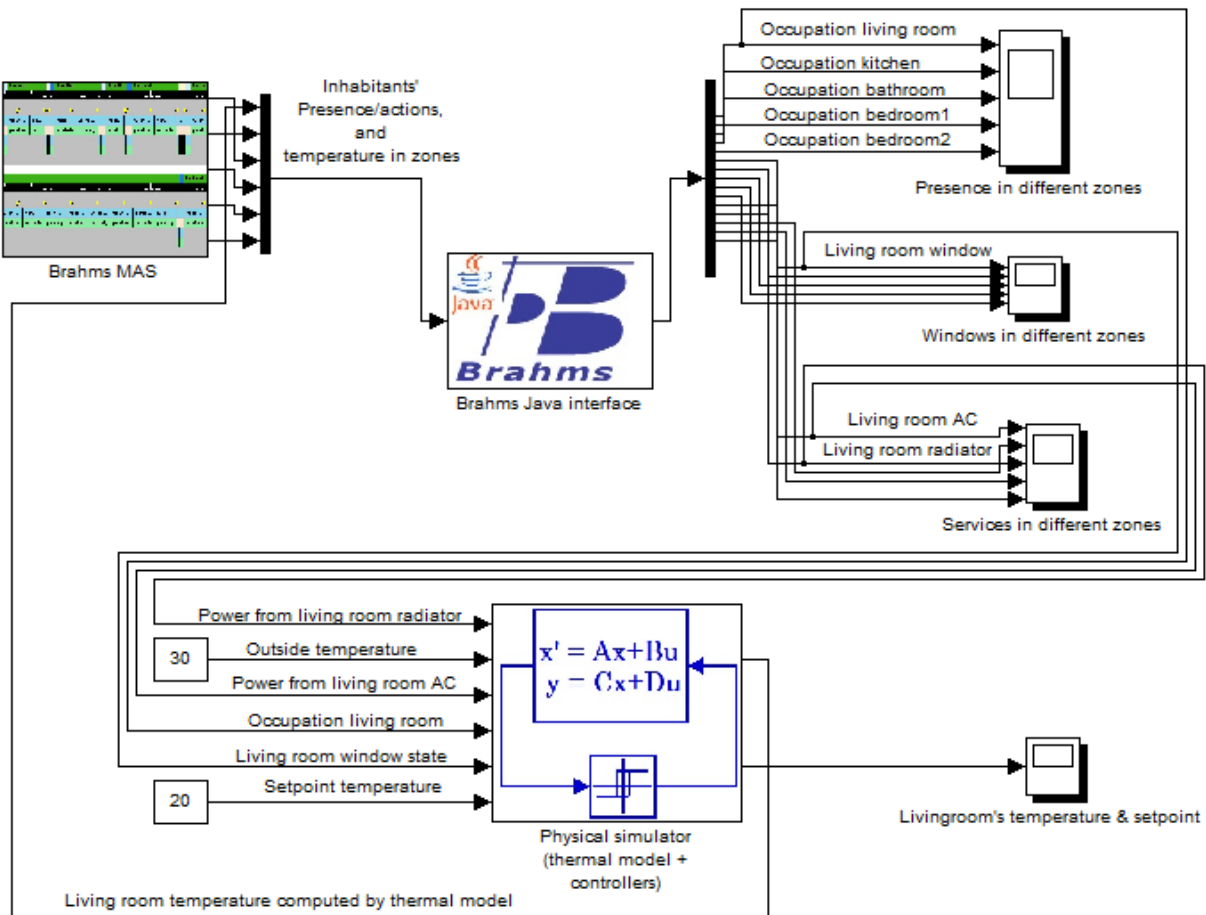

Figure 5.24 Combined architecture of Brahms and the thermal simulator

A simple scenario is described here to see how the co-simulation works and how decisions taken by the inhabitants affect the energy consumption. Consider a scenario with a 4 person house, husband, wife and their 2 children. Figure 5.25 shows that at the start, 2 children are present in bedroom2, husband in bedroom1 and wife in the living room, after some time the husband moves to the bathroom and then to the kitchen and finally to the living room. Inhabitants' beliefs are changed based on perceived environmental values and they perform different activities accordingly. These

activities when performed affect the appliances or objects present in the house. For example, if the temperature in the physical simulator for the living room is adjusted to a value lower than a specific setpoint, say 20°C, the inhabitant will be comfortable with this, but as soon as the temperature value exceeds 20°C, it will start feeling hot (physical homeostasis) and will react in some way or the other to lower the temperature. The husband and wife may have different ways of lowering the temperature. The wife being mindful of cleanliness prefers not to open the window, especially when the weather is windy (constraints on desires). Instead she always prefers turning on the air conditioner (desire generation rules for the wife). On the other hand, the husband, being worried about the electricity bills, prefers opening the window, whatever the outside weather condition (desire generation rules for husband). If however, they both are present in the room and temperature goes up, both of them make certain compromises because of the social influence of the other (social constraints). In this case, the husband, who always prefers opening the window, will take into account the weather and if it is fine (external environment constraints), he will disregard his wife's opinion and open the window (action on objects). However if the weather is windy or stormy, he will not want to annoy his wife and will first ask her permission to open the window (social constraint generation). If she disagrees he will turn on the air conditioner in order to lower the temperature (actions on appliances). In the scenario the temperature outside is 30°C and the weather is windy (agents' external environment belief about weather). The inhabitants in the living room will react as mentioned in the scenario. Since the weather is windy, the wife did not agree to open the window and husband turns on the air conditioner.



Figure 5.25 Movements of inhabitants in different locations in the house

The negotiation between the inhabitants is shown in the Matlab command window in figure 5.26. The husband agent (agentAdult1) is in the kitchen and at 7:30am moves from the kitchen to the livingroom. The fact that the agent is in the kitchen now becomes false, represented by the (F) symbol, and the fact that it is now in the living room becomes true, represented by the (T) symbol. The husband agent (agentAdult1) starts a communication with the wife agent (agentAdult2) at 7:30:01. It takes it 10 seconds to communicate his message to the wife agent. The (S) symbol is for the start of the communication and (E) for the end. As a result of this communication between the 2 agents, the final decision made by the agent is to turn on the air conditioner.

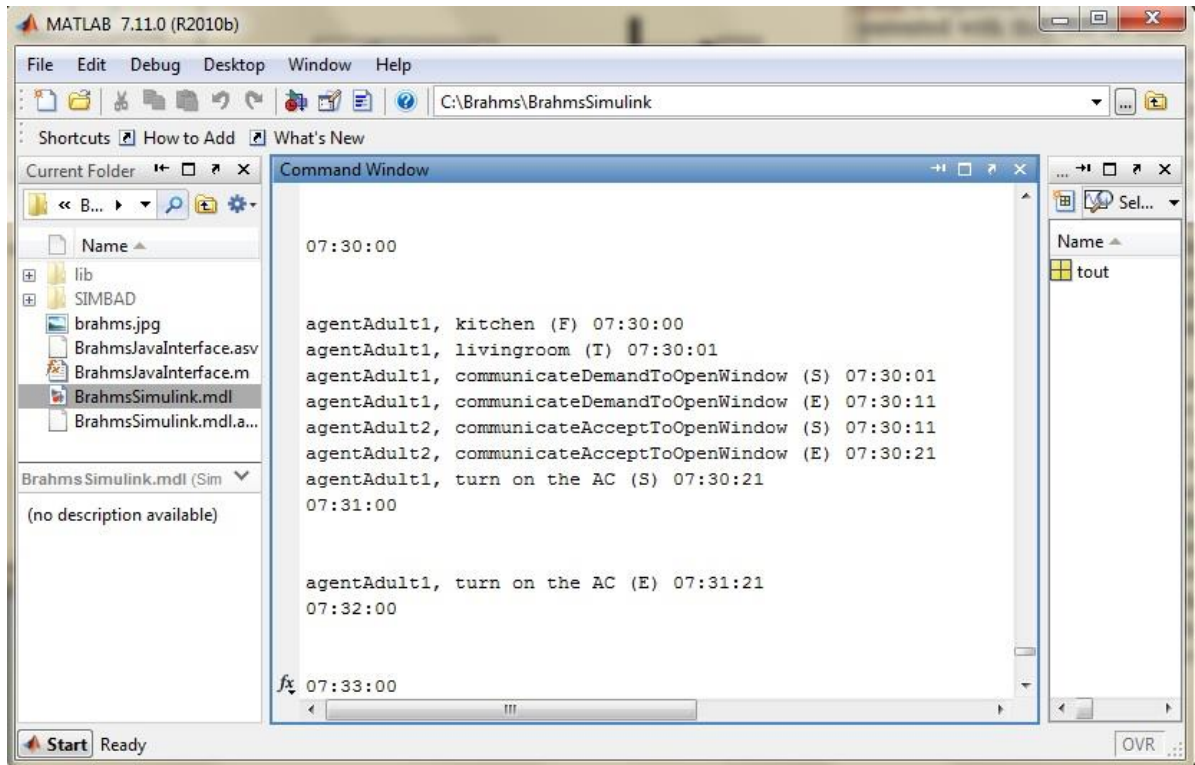

Figure 5.26 Communication between inhabitants

In addition to the occupants' presence in different zones, figure 5.27 shows other outputs of the co-simulator that include the windows and services status in different zones. These outputs are captured in Matlab/Simulink. In figure 5.27, the status of the window and the air conditioner in the living room is shown, it can be seen that the window is closed and the air conditioner is turned on. This is the result of the weather outside and the negotiation between the inhabitants in lowering the living room temperature.

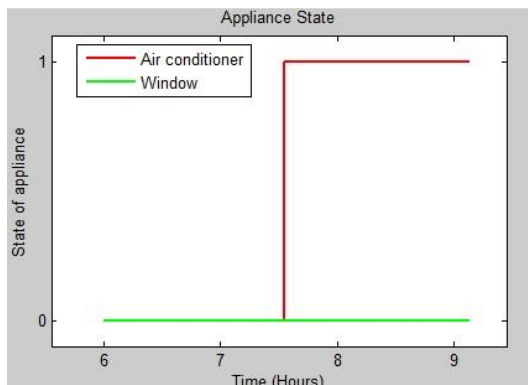

Figure 5.27 Window's status is not changed, Inhabitant has turned on the air conditioner

The output from the simulator (Figure. 5.24) “living room temperature & setpoint” is shown in figure 5.28. It shows how the physical simulator adjusts the temperature inside the room to a value where the inhabitants feel comfortable, 20°C in this scenario.

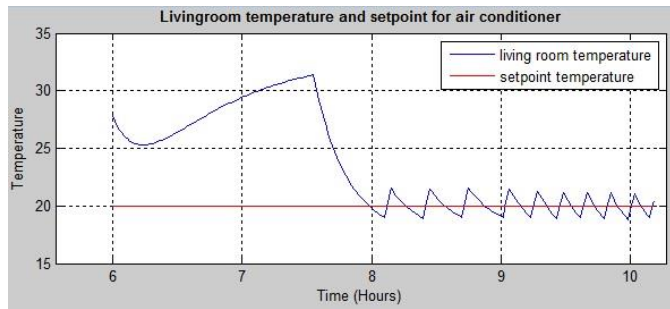

Figure 5.28 Living room's temperature and setpoint for air conditioner

If however, the outside temperature falls below the setpoint, the physical simulator will start using the heater controller to heat the living room to the setpoint temperature as shown in figure 5.29.

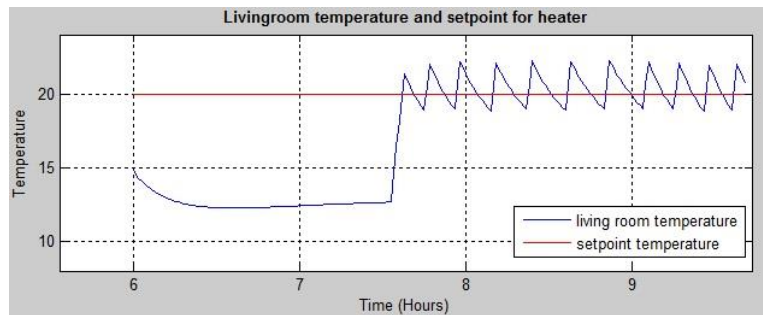

Figure 5.29 Living room's temperature and setpoint for heater

5.3.2 COUPLING THE APPLIANCE'S PHYSICAL MODEL AND THE USER BEHAVIOUR SIMULATORS

In the previous section, the co-simulation of the inhabitants behaviour is done with the thermal aspects of the building. The impact of inhabitants' actions on appliances i.e. the heating and airconditioning system is also detailed. However, as shown in figure 5.22, we are not only interested in co-simulating the impact of thermal aspects but also the electrical impact of home appliances, this second aspect is detailed in this section.

In order to perform certain activities, the inhabitants change their location, perform certain actions on appliances e.g. opening the fridge, putting food inside, etc. As soon as these state changes happen, this information is sent to the physical simulator, where the appliance behaviour is changed and its consumption is computed. The proposed co-simulation platform is presented in figure 5.30 showing 3 distinct elements (i) Brahms MAS, (ii) Brahms Java Interface and (iii) physical simulator (Matlab model of the fridge). The Brahms MAS element simulates the agent behaviour on the fridge. The Brahms Java interface establishes the connection between Brahms and the physical model of the fridge by providing activity information generated during the behavioural simulation to the physical simulator. This interface manages various aspects: it drives the Brahms virtual machine; it manipulates different attributes of the occupant's behaviour model to be simulated, by setting agents and objects attributes and by handling the starting time of the simulation; and it keeps track of the current location of agents and of the current values of different attributes of objects. The physical simulator consists of the model of the fridge and the controllers for appliances. The model of the fridge is defined in a Matlab function file which uses the output of the Brahms simulation (such as opening the fridge, putting food in the fridge) and based on the inside temperature of the fridge it turns the refrigeration cycles on or off. The inside temperature of the fridge is computed by the controller to maintain its setpoint temperature.

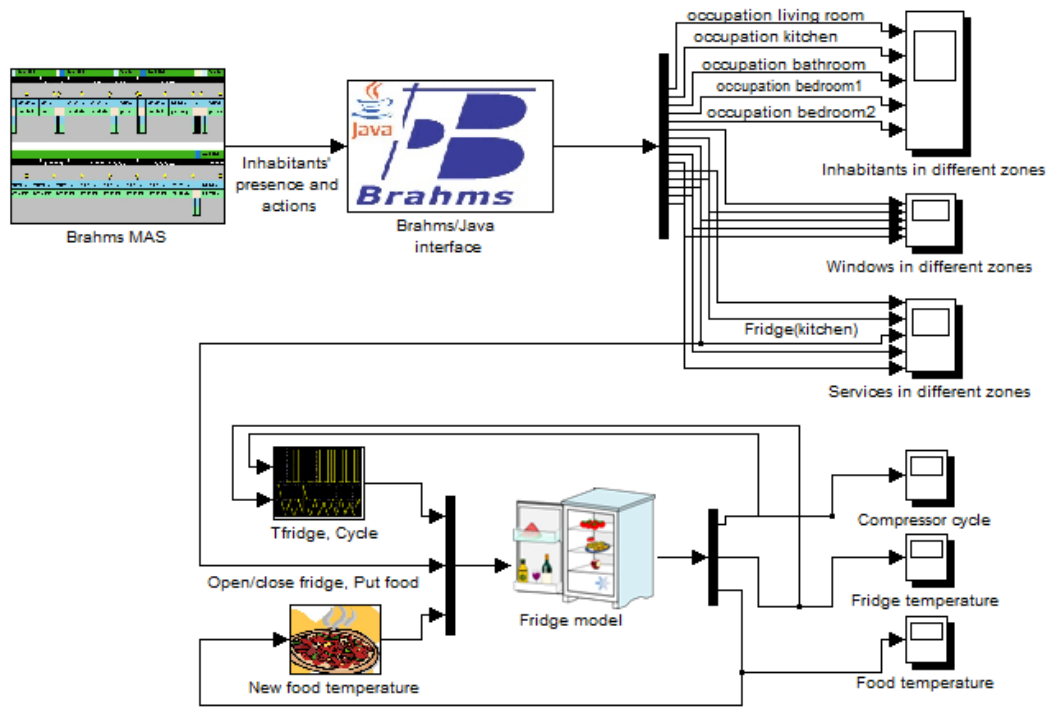

Figure 5.30 Co-simulation platform for Brahms and physical simulators

In figure 5.30, the first block represents the Brahms simulation environment. In the simulation the hunger level is perceived by the agents in Brahms. Based on this perception of hunger, the agents in Brahms perform different actions e.g, opening and closing the fridge to get the food, etc.

5.3.2.1 Implementation into Brahms

A scenario consisting of a 2 person house will be considered where husband and wife are modelled as agents. It will show how the decisions taken by the agents affect the energy consumption. Figure 5.31(a) shows that the husband and wife are sitting in the living room and watching TV (perception of environment). The hunger level for the wife gradually increases with time (physical homeostasis calculation). When it reaches beyond some threshold (internal state belief generation rules), she communicates with the husband to have their meal together (generation of desire in wife and communication activity to convey the husband about desire). The husband usually likes to eat at a restaurant if there is a beautiful weather outside; otherwise he prefers to eat at home (desire generation rules for husband). If the husband agrees based on perception about the weather (social behaviour as a result of external state belief), she moves to the kitchen, opens the fridge, takes the things out and prepares the dining table (plan generation to be followed in dining activity). If however, the husband does not agree to eat at home (social constraint), she puts the warm food, which she had already prepared for their meal into the fridge (action on appliance) and they go out to the restaurant. The simulation results are presented in figure 5.31. The output is generated randomly based on the agents' belief certainty. Belief certainty is the concept used in Brahms which assigns a probability between 0 to 100 to agents' beliefs and the facts in the environment. Beliefs and facts with varying probabilistic values influence agents' actions accordingly. For example, if for the communication between the agents, the husband agrees to eat at home, there is a higher probability that the wife will not put the warm food which she had prepared for the meal into the fridge. Also, if the husband is agrees to eat at home, the duration of the activity of opening the door

of the fridge and taking the things out is a random value between a minimum and maximum duration. Thus, every time the wife opens the fridge door for different durations resulting in varying behaviours of the fridge. In figure 5.31³, the horizontal bar on the top represents the movements of agents to different locations. Below this is the timeline, which shows the simulation time in the agent world. The vertical bars represent the communication between agents and the broadcast activity where the agents transfer their beliefs to each other. For example in figure 5.31(b), the vertical bar coming down from Wife agent to Husband agent at the moment when the Wife agent moves from the kitchen to the living room, represents the Wife agent's belief which she transfers to the husband to go to the restaurant. The bulb symbols are used to represent the thoughtframes or beliefs of agents. Thoughtframes are changed with the passage of the simulation time and on the different perceptions of the agents from their environment.

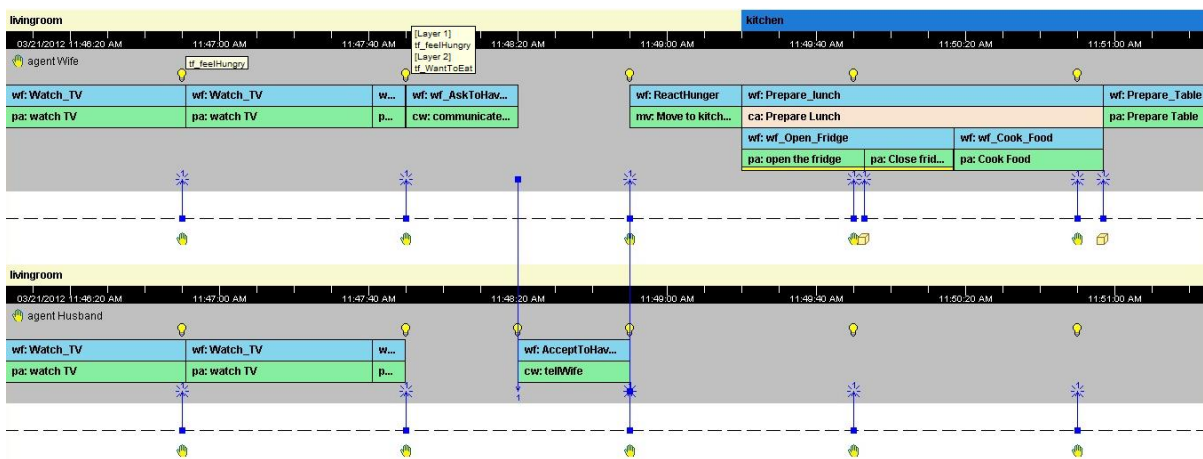

a) Social agreement between agents to have meal at home

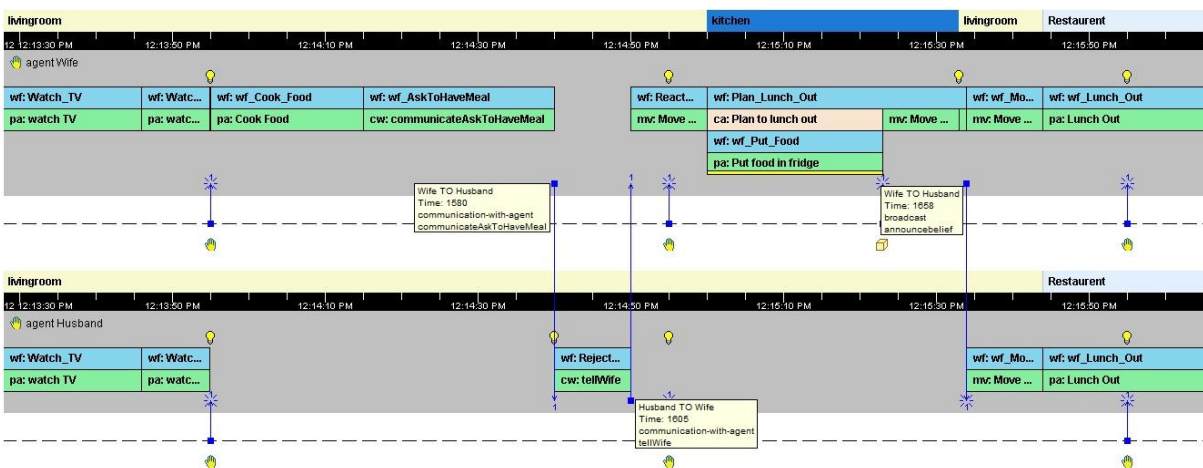

b) Social agreement between agents to eat out

Figure 5.31 Simulation results against simulated inhabitants' behaviour

The figures below show the actions of the agents on the fridge and the resulting effect on the inside temperature and the compressor cycles. Opening the fridge door for different durations affects the compressor cycles accordingly. In figure 5.32(a) the agent opened the door of the fridge for a long period, so the compressor worked for longer and consumed more energy than in figure 5.32(b) where the agent opened the door for a shorter period. In figure 5.32(c) an agent persuades

³ In Figure 5.31 wf stands for workframe, tf for thoughtframe, ca for composite activity, pa for primitive activity, mv for move activity and cw for communication activity.

another agent to eat at a restaurant, meaning that already cooked warm food is put inside the fridge. As a result, the inside fridge temperature increased causing the compressor to work longer than usual to bring the temperature back to the setpoint. The fridge states are represented by three levels 0,1,2 where 0 means that there is no action on the fridge, 1 means the door is opened and closed, and 2 means that new food is added.

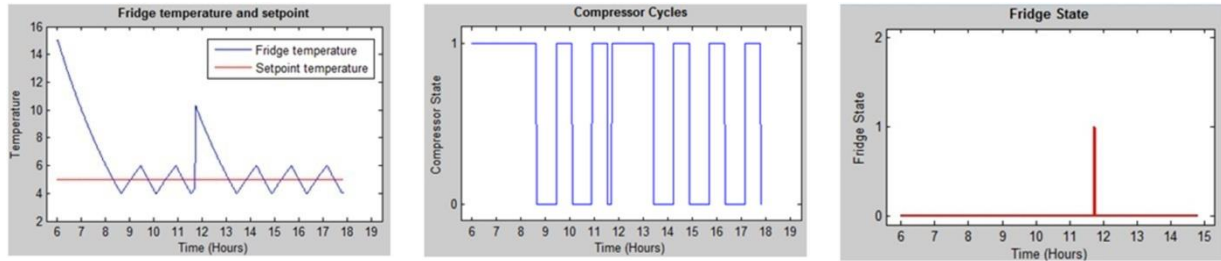

a) Door opened for 100 seconds

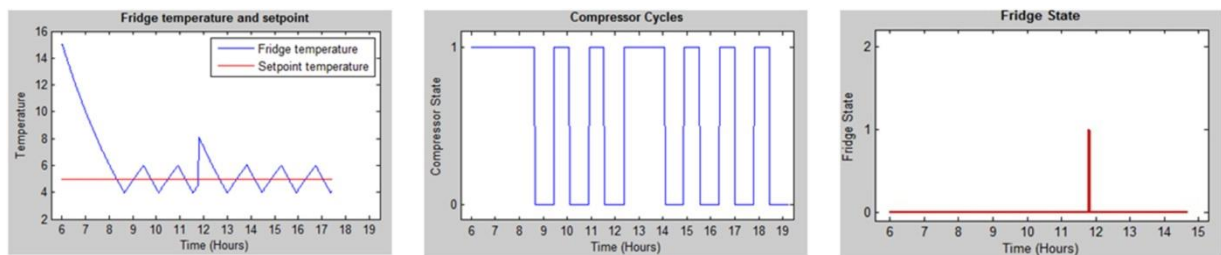

b) Door opened for 60 seconds

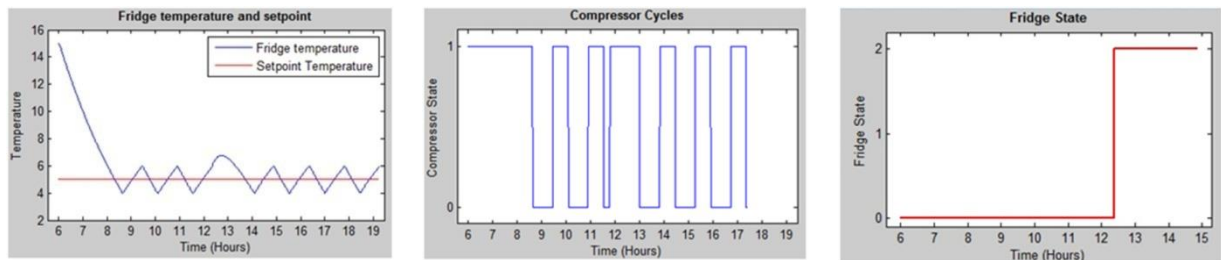

c) New food introduced in the fridge

Figure 5.32 Simulated inhabitants' behaviours affecting fridge temperature and compressor cycles

5.4 Summary and Conclusions

The modelling and simulation tool for the implementation of behaviour models is presented with the co-simulator to integrate these models with the physical models of building and appliances.

The Brahms modelling and simulation environment supports social and behavioural elements necessary for dynamic group behaviour and fulfils need to model dynamic group behaviour. As detailed in chapter 2, Brahms modelling environment is selected after analyzing the different behaviour models on the criteria of whether the 5W1H model and social behaviour can be modelled or not. Another positive point of this environment is that the inhabitants' behaviour can be represented as intelligent agents with perceptive, cognitive and action abilities. Also it is based on the BDI architecture that is used in modelling the behaviour of inhabitants as detailed in chapter 4. Similarly, all the elements of the 5W1H model presented in chapter 4 can be easily implemented in this behaviour modelling environment. Another reason for selecting it is that the agents have strong

reasoning capabilities with which it is easy not only to model the complex and deliberative behaviours but also the reasons behind inhabitants' different energy consuming behaviours. Thus, all the different concepts to capture inhabitants' behaviour, detailed in chapter 4, can be realized in this language. It demonstrates how a multi-agent BDI approach, symbolic cognitive modelling, traditional business process modelling, activity and situated cognition theories are brought together in a coherent approach for analysis and design of human-centered systems. It helps in developing a structural computational model that allows us to observe result of changes in a system as time moves forward.

Brahms is one of the few human behaviour representation models which support social behaviour and group interactions. It provides an integrated development environment to model and simulate BDI agent based complex system. Activities in Brahms does not strictly follow some fixed static duration. This helps to create dynamism in activities by defining the minimum and maximum duration of some ongoing activity and it dynamically change the duration at run time. It was originally developed to model and simulate only work practices but latest release includes an option to develop Java plug-ins for customization. Although, Brahms is developed in Java, it is not an open source development environment; hence, every single customization requires a Java plug-in to be developed separately and used within Brahms during simulations.

The H-BDI behaviour model presented in chapter 4 is implemented in Brahms using its different components. The perceptive elements i.e. "Who" is the other agent in the environment, "What" are the other objects in the environment, "Where" in the geographic location the agent is located, and "When" the agent is perceiving all these beliefs on the time scale are modelled in the Brahms "Agent model", "Object model", "Geographic model" and "Timing model" respectively. Cognition is taken into account in the "Knowledge model" that models agents, current and changing beliefs. Finally the actions are modelled in the "Activity model" using the simple and composite activities.

The objective of work done in this thesis is to analyze the impact of inhabitants' behaviour on energy consumption. This requires that the behaviour model is coupled with the thermal and physical models of the building and the appliances respectively, during simulations. The physical model for the target appliance (Fridge freezer) is developed using Matlab. These three models, i.e. inhabitants' behaviour, thermal and physical models for the appliance, are integrated in a co-simulation approach.

In this chapter and the impact of the inhabitants' behaviour over the physical aspects of the building is modelled and simulated. Inhabitants' energy consuming behaviours identified in chapter 4 through data analysis and the reasons behind certain actions are used to model and implement them. The proposed and implemented co-simulation framework enables its functionality to be extended to energy wizards in smart homes within the context of energy management. In this regard, a co-simulation of behavioural and building's physical models is done with an BEMS management system in chapter 7. The energy management systems provides the inhabitants with the energy saving advice and controls the environments to provide them with better comfort while saving the energy cost. The inhabitants' behaviour must be reactive to be able to accept or not the BEMS's suggestions based on their own reasoning capabilities. The different type of behaviours, e.g. ecological and non ecological etc., would result is different energy consumption patterns and would help to bring improvements in the energy managements systems based on a better understanding of inhabitants' dynamic behaviours.

CHAPTER 6: VALIDATING REPRESENTATIVE BEHAVIOUR MODELS

This chapter presents a 4-step methodology to validate the behaviour model. The inhabitants' behaviour scenario is built based on the behaviour model proposed in chapter 4. This is built for the houses in the Irise database by complementing it with additional information about the inhabitants' behaviour and further clustering the houses with similar energy consumption behaviours. Clustering is a technique where the objects having similar behaviours are put together in a group. Further, the appliance and inhabitants' behaviours are co-simulated based on certain parameters. Then the appliance consumption distributions are drawn for both the actual consumption of the appliance and the one obtained after simulation. In this methodology, the concept of tuning parameters is presented where simulated consumption curves are mapped to the actual consumption curves with curve fitting methods. The tuned model is further validated against other cluster member houses to ensure the reliability of model.

CONTENTS

6.1	Introduction	141
6.2	4-Step Validation Methodology for Behaviour Model	141
6.2.1	Appliance's Physical Behaviour Modelling (Step-1)	142
6.2.2	Inhabitants' Behaviour Modelling (Step-2)	142
6.2.2.1	Irise Database Preprocessing	143
6.2.2.2	Fridge Freezer On-Cycle Durations Computation	143
6.2.2.3	Impact of Seasons, Day type and Cooking Activity	144
6.3	How the Impact of Cooking Activity on Fridge On-Cycles is Computed	145
6.4	Clustering the Houses with Similar Behaviours.....	150
6.4.1	Identifying Representative Behaviours	151
6.5	Inhabitants' Behaviour and Appliance Co-Simulation.....	154
6.5.1	Brahms Simulation with Tuning Parameters (Step-3)	155
6.6	Comparison of Benchmarked and Simulated Distributions (Step-4)	156
6.7	Summary and Conclusions	160

6.1 Introduction

In order to evaluate the inhabitants' behaviour model, we have defined some requirements that the model must satisfy. The model must:

- simulate interdependent individuals that dynamically interact with the physical and behavioural simulators through a BEMS,
- be consistent with the reasons behind inhabitants' actions; these are obtained by questioning or observing the occupants,
- be consistent with long term (month, seasons, etc.) observation data for the representative households.

The inhabitants' dynamic behaviour and co-simulation approach was presented in detail in chapters 4 and 5. In this chapter, the contributions made in subsequent chapters are generalized to propose a validation methodology. It can be used to model inhabitants' behaviour for any appliance within a household for further integration in the BEMS.

6.2 4-Step Validation Methodology for Behaviour Model

The proposed 4-step validation methodology to validate the behaviour models a using multi-agent approach is shown in figure 6.1 below:

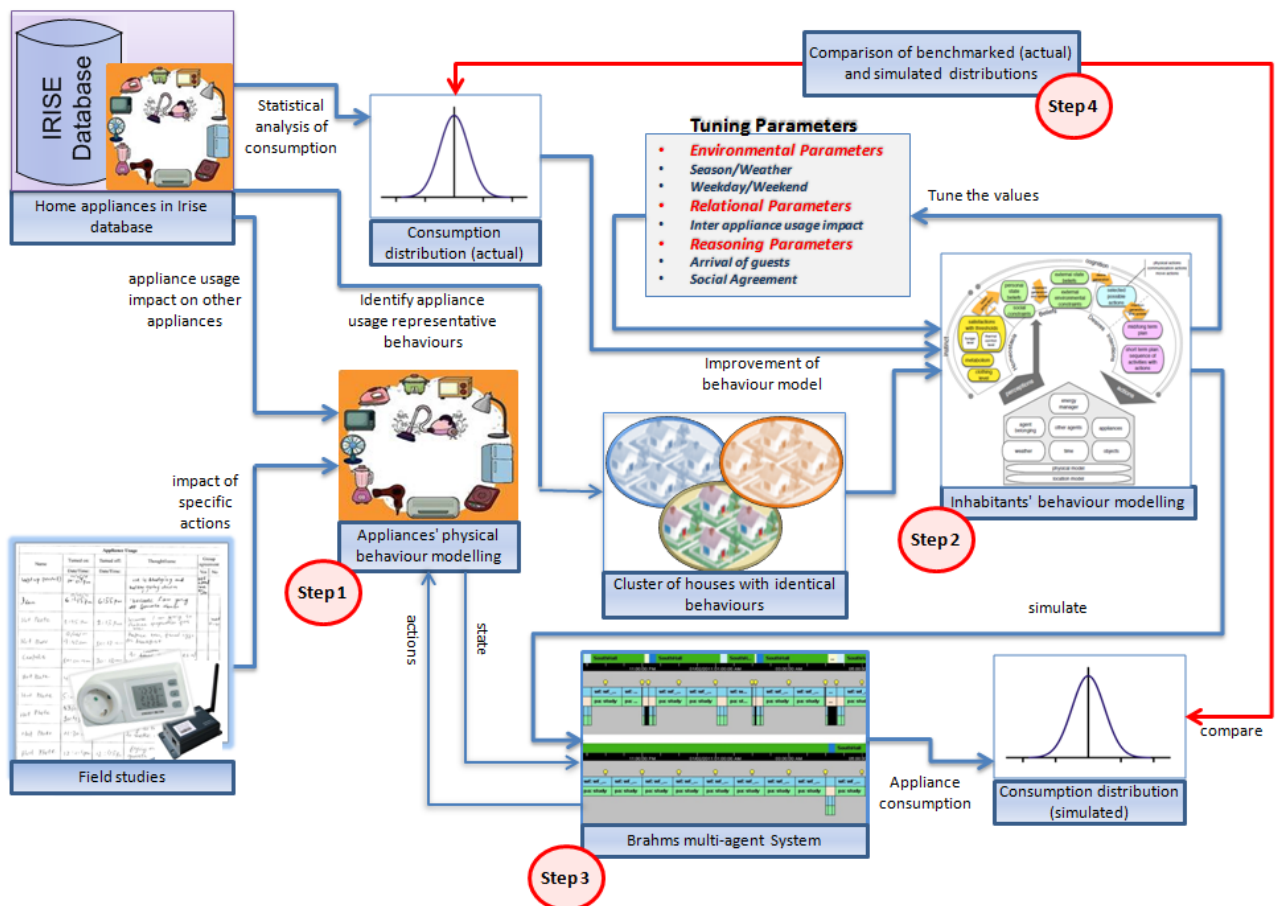

Figure 6.1 4-Step methodology to validate behaviour model

In step-1, the physical model of the appliance is constructed. The important inputs for this step include the data about the household activities and the data about the consumption of appliance. The

impact of the usage of one appliance on another is also important to construct the model of appliances. This impact can be analyzed both from the Irise database and the field studies. However, the impact of specific actions on appliance consumption is analyzed through field studies. In step-2, an analysis of the Irise energy consumption database is performed to find the energy consumption behaviour of the households. The data in Irise is further complemented with some additional information in order to understand the affect of certain other parameters on the energy consumption behaviour of households (section-3.5). This information includes the day of the week (i.e. weekend or weekdays), holidays, the state of the weather, and the parallel usage of other appliances. Based on these parameters, clustering is used to find the houses in Irise with identical behaviours. Further, in order to see the impact of household energy consumption behaviour on the appliances, the probability distributions for the consumption of the appliances used in a particular house are computed. Using our example of a fridge, a complete detail of how this step is performed is given in section-6.6.1. In step-3, the behaviour model has been implemented taking into account different parameters that could possibly affect the consumption distributions of the household appliances. In step-4 the values of these parameters are tuned, such as the probability of certain activities on weekdays, on weekends, the outside weather, etc. The simulation results for the consumption cycles of the fridge are then used to compute the probability distributions. These distributions are then compared to the actual distribution obtained from the Irise database. The purpose of this comparison is to see how close the proposed behaviour model and scenario implemented in Brahms, is to reality. The process of tuning the parameters continues until the actual and simulated error is significantly reduced.

In the following sections we use the fridge freezer as an example to show how the validation methodology works. The fridge freezer is used since it is very sensitive to inhabitants' behaviour.

6.2.1 APPLIANCE'S PHYSICAL BEHAVIOUR MODELLING (STEP-1)

This step involves developing the physical behaviour model for the fridge freezer along with the identification of the impact of different activities on the fridge cycle durations. The local field studies, benchmarked on a 2 person (husband-wife) family, are performed to deduce high energy consuming activities and are presented in section-3.5.2.

6.2.2 INHABITANTS' BEHAVIOUR MODELLING (STEP-2)

As mentioned in section 6.2, the 4th and last step of validation methodology is to compute the consumption distribution of an appliance from the Irise database and then compare it with the simulated consumption distribution. This could be done by modelling and simulating the behaviour of occupants from some house in the Irise database. However, in the Irise database only the consumption of appliances is available and not the activities. In this section, the inhabitants' energy consuming behaviour is extracted by analyzing the appliances' consumption patterns. This is done by first preprocessing the Irise database to enrich it with some additional information. Then, the houses in Irise are clustered based on identical energy consuming behaviours. Further, the representative behaviour for some cluster is co-simulated with the selected appliance and the consumption distribution for that appliance is obtained after simulation. This simulated consumption distribution will be used in the next step where it will be compared with the actual consumption distribution for the house benchmarked for that cluster. Since, the energy consuming behaviour of inhabitants' belonging to a cluster is identical; the same simulated consumption is also compared with the actual consumption of other members of the cluster.

6.2.2.1 Irise Database Preprocessing

In order to identify the energy consuming behaviour of inhabitants we pre-process the Irise database to identify the behaviour of inhabitants based on certain parameters found to be important in chapter 3. These parameters include the consumption behaviours based on seasons, weekend, weekdays, holidays, and the impact of usage of one appliance over another. The sections below provide the detail of how the pre-processing is done to complement Irise database with the inhabitants' behaviour information.

6.2.2.2 Fridge Freezer On-Cycle Durations Computation

The fridge freezer needs a pre-processing step as compared to other appliances. because it consumes power in continuous (on and off) cycles, whereas, other appliances consume only when they are turned on. Thus the cycles of the fridge freezer need to be computed from its consumption. In figure 6.8(a) a snapshot of the data file from the Irise database shows the consumption of the fridge every 10 minutes time stamp. However, these consumption values are not very meaningful in their present form because the compressor works in continuous cycles. Thus, it is important to extract 'on' and 'off' cycle durations from the consumption. The flowchart in figure 6.3 explains the process of how the on and off cycles are actually computed from the Irise database. A list of selected houses is made where both the electric cooker and the fridge freezer are in the kitchen. A new field "Duration" is added to each house table in the Irise database, where the values in minutes for on and off-cycles are stored. Similarly the "Cycle" field tags the computed duration with text "On" and "Off" if the duration corresponds to the 'on' or 'off' fridge cycles respectively (Figure 6.2).

myDate	TV_S1cm	hing_maclave_oven	freezer_Kitcher_with_electr_ov	Fridge_freezer_Kitch	consumptate_3_gaser_12_pl	light_cor	myYear	myMonth	myNum	DayName	DayTime	Holiday	Duration	Cycle
01/02/1998	0	0	0	10	0	0	2 1998	February	1	Sunday	Night	No		
01/02/1998	0	0	0	20	0	0	2 1998	February	1	Sunday	Night	No		
01/02/1998	0	0	0	5	0	0	2 1998	February	1	Sunday	Night	No		
01/02/1998	0	0	0	5	0	0	2 1998	February	1	Sunday	Night	No	90 off	
01/02/1998	0	0	0	21	0	0	2 1998	February	1	Sunday	Night	No		
01/02/1998	0	0	0	9	0	0	2 1998	February	1	Sunday	Night	No		
01/02/1998	0	0	0	0	0	0	2 1998	February	1	Sunday	Night	No		
01/02/1998	0	0	0	20	0	0	2 1998	February	1	Sunday	Night	No		
01/02/1998	0	0	0	14	0	0	2 1998	February	1	Sunday	Night	No		
01/02/1998	0	0	0	0	0	0	2 1998	February	1	Sunday	Night	No		
01/02/1998	0	0	0	15	0	0	2 1998	February	1	Sunday	Night	No	60 On	
01/02/1998	0	0	0	19	0	0	2 1998	February	1	Sunday	Night	No		
01/02/1998	0	0	0	0	0	0	2 1998	February	1	Sunday	Night	No		
01/02/1998	0	0	0	11	0	0	2 1998	February	1	Sunday	Night	No		
01/02/1998	0	0	0	20	0	0	2 1998	February	1	Sunday	Night	No		
01/02/1998	0	0	0	2	0	0	2 1998	February	1	Sunday	Night	No		
01/02/1998	0	0	0	7	0	0	2 1998	February	1	Sunday	Night	No		
01/02/1998	0	0	0	20	0	0	2 1998	February	1	Sunday	Night	No		
01/02/1998	0	0	0	5	0	0	2 1998	February	1	Sunday	Night	No	90 off	
01/02/1998	0	0	0	5	0	0	2 1998	February	1	Sunday	Night	No		
01/02/1998	0	0	0	20	0	0	2 1998	February	1	Sunday	Night	No		
01/02/1998	0	0	0	7	0	0	2 1998	February	1	Sunday	Night	No		
01/02/1998	0	0	0	20	0	0	2 1998	February	1	Sunday	Night	No		
01/02/1998	0	0	0	2	0	0	2 1998	February	1	Sunday	Night	No		
01/02/1998	0	0	0	20	0	0	2 1998	February	1	Sunday	Night	No		
01/02/1998	0	0	0	10	0	0	2 1998	February	1	Sunday	Night	No		
01/02/1998	0	0	0	0	0	0	2 1998	February	1	Sunday	Night	No		
01/02/1998	0	0	0	19	0	0	2 1998	February	1	Sunday	Night	No	70 On	
01/02/1998	0	0	0	14	0	0	2 1998	February	1	Sunday	Night	No		
01/02/1998	0	0	0	0	0	0	2 1998	February	1	Sunday	Night	No		
01/02/1998	0	0	0	0	0	0	2 1998	February	1	Sunday	Night	No		

Figure 6.2 Fridge on-cycle durations

The on-cycles include the consumption values for the fridge that are above 3Wh during 10 min, whereas, when the fridge consumption is less than or equal to 3Wh, this consumption is added to the off-cycle. The reason for putting the values below or equal to 3Wh in the off-cycle is that in some houses the consumption of the fridge never goes to 0 when the compressor is off, but remains at some small value e.g. 1, 2, 3 or occasionally 4 and 5Wh. If this fact is neglected during the computation of the cycle duration, the compressor cycle will never come back to the off state. Further, the difference between the times where the values are either below (off-cycle) or above (on-cycle) 3Wh is used to compute cycle durations respectively.

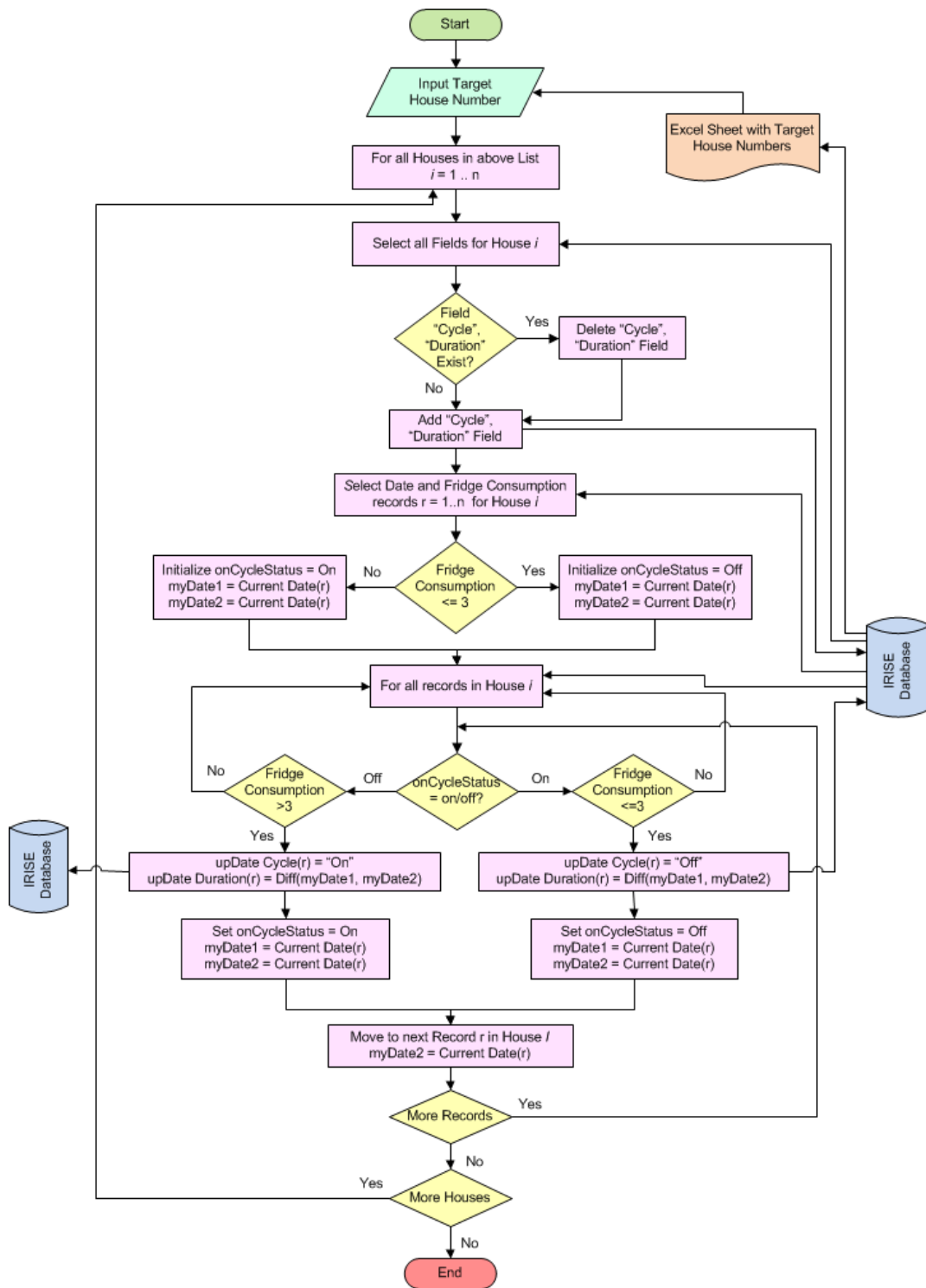

Figure 6.3 Flowchart to compute fridge cycle durations

6.2.2.3 Impact of Seasons, Day type and Cooking Activity

In this analysis the global impact of the different parameters e.g. cooking activity, seasons, day types on both the fridge freezer and fridge consumption cycles is considered. This is achieved by clustering the houses in the Irise database that identify the similarities and differences that exist in the behaviour of inhabitants regarding the usage of appliances. However, it is necessary to pre-process the data for clustering by extracting the information about all the other parameters that impact the consumption. The pre-processing is done not only to complement the Irise database with additional information but also to organize the information in a meaningful way to be input to a

clustering algorithm. Since, one of most important factors that impact the consumption of the fridge is the cooking activity, the houses in Irise database with both a cooker and a fridge are selected for pre-processing. Figure 6.4 shows only those houses where the fridge is located in the kitchen. This selection is made because the impact of the cooking activity on the fridge cycles is not only due to the interactions with the fridge but also due to the temperature change in the kitchen. Thus, the houses with fridges located in other areas e.g. living room or utility room are not included in the experiments.

House Number	Refrigerator Type	House Number	Refrigerator Type	House Number	Refrigerator Type	House Number	Refrigerator Type
2000900	Fridge (Kitchen)	2000926	Fridge (Kitchen) ✓	2000952		2000978	Fridge/Freezer
2000901	Fridge (Kitchen)	2000927	Fridge/Freezer (Kitchen) ✓	2000953	Fridge/Freezer (Kitchen)	2000979	Fridge/Freezer (Kitchen) ✓
2000902	Fridge/Freezer (Kitchen) ✓	2000928	Fridge/Freezer	2000954		2000980	Fridge/Freezer (Kitchen) ✓
2000903		2000929	Fridge/Freezer (Kitchen)	2000955	Fridge/Freezer (Kitchen) ✓	2000981	Fridge (Kitchen)
2000904		2000930	Fridge/Freezer (Kitchen)	2000956	Fridge/Freezer (Kitchen) ✓	2000982	Fridge/Freezer (Kitchen) ✓
2000905	Fridge/Freezer	2000931	Fridge/Freezer (Kitchen) ✓	2000957	Fridge/Freezer (Kitchen)	2000983	Fridge/Freezer
2000906	Fridge/Freezer	2000932	Fridge/Freezer (Kitchen) ✓	2000958	Fridge/Freezer (Kitchen)	2000984	✓
2000907		2000933	Fridge/Freezer (Kitchen) ✓	2000959		2000985	Fridge/Freezer (Kitchen) ✓
2000908	Fridge/Freezer (Kitchen) ✓	2000934	Vertical Fridge	2000960	Fridge/Freezer (Kitchen)	2000986	Fridge/Freezer (Kitchen) ✓
2000909	Fridge/Freezer (Kitchen)	2000935	Fridge/Freezer (Kitchen)	2000961	Fridge/Freezer (Kitchen)	2000987	Fridge/Freezer (Kitchen) ✓
2000910	Fridge/Freezer (Kitchen) ✓	2000936				2000988	Fridge (Kitchen)
2000911	Fridge/Freezer (Kitchen) ✓	2000937				2000989	
2000912	Fridge/Freezer	2000938	Fridge	2000964	Fridge/Freezer (Kitchen) ✓	2000990	Fridge (Kitchen)
2000913	Fridge/Freezer	2000939	Fridge/Freezer (Kitchen) ✓	2000965	Fridge/Freezer (Kitchen)	2000991	Chest/Freezer (Kitchen)
2000914	Fridge (Kitchen) ✓	2000940	Fridge/Freezer (Kitchen)	2000966	Fridge/Freezer (Kitchen) ✓	2000992	Fridge (Kitchen)
2000915		2000941	Fridge (Kitchen) ✓	2000967	Fridge/Freezer	2000993	Fridge/Freezer (Kitchen) ✓
2000916		2000942	Fridge/Freezer (Kitchen)	2000968	Fridge (Kitchen) ✓	2000994	Fridge/Freezer (Kitchen)
2000917	Fridge (Kitchen) ✓	2000943	Fridge (Kitchen)	2000969		2000995	Fridge/Freezer (Kitchen)
2000918	Fridge/Freezer	2000944	Fridge (Kitchen)	2000970	Fridge/Freezer (Kitchen) ✓	2000996	Fridge/Freezer (Kitchen) ✓
2000919	Fridge (Kitchen) ✓	2000945	Fridge/Freezer	2000971	Fridge (Kitchen)	2000997	
2000920	Fridge (Kitchen) Fridge/Freezer (Kitchen)	2000946		2000972	Fridge/Freezer (Kitchen) ✓		
2000921	Fridge (Kitchen) ✓	2000947	Fridge Fridge/Freezer (Kitchen) ✓	2000973	Fridge (Kitchen) ✓		
2000922	Fridge/Freezer	2000948	Fridge	2000974	Fridge/Freezer (Kitchen) ✓		
2000923	Fridge (Kitchen) ✓	2000949	Fridge/Freezer (Kitchen) ✓	2000975	Fridge		
2000924	Vertical Fridge	2000950	Fridge/Freezer	2000976	Fridge/Freezer (Kitchen)		
2000925	Fridge (Kitchen)	2000951	Fridge (Kitchen) ✓	2000977	Fridge		

Figure 6.4 Selection of houses from Irise database for clustering

6.3 How the Impact of Cooking Activity on Fridge On-Cycles is Computed

In order to find the impact of the cooking activity on the consumption of the fridge, the on-cycle duration is computed when the cooker is turned on. The impact of the cooking activity on the fridge cycles is not only considered for the cycles where cooker was on but also on the subsequent fridge cycles as well. There are multiple reasons for this, e.g. the temperature increases in the kitchen affecting the fridge, the inhabitants interact with the fridge often more during the cooking activity, inhabitants can put warm food inside the fridge, etc. This means that the fridge cycles after the cooker has been turned off must be taken into account. Hence, the fridge consumption cycles are considered to be impacted by the cooking activity until they become normal or stable.

Different trends have been observed in the fridge on-cycle durations during the cooking activity. Figure 6.5 shows that as a result of the cooking activity, the on-cycle duration increased compared to the previous on-cycle. Then, the subsequent on-cycle also increased showing an increasing trend in on-cycle durations. Then it started to decrease before increasing again. The decision about which cycles should be considered as being impacted by the cooking activity based on different trends is explained through an example in table 6.1.

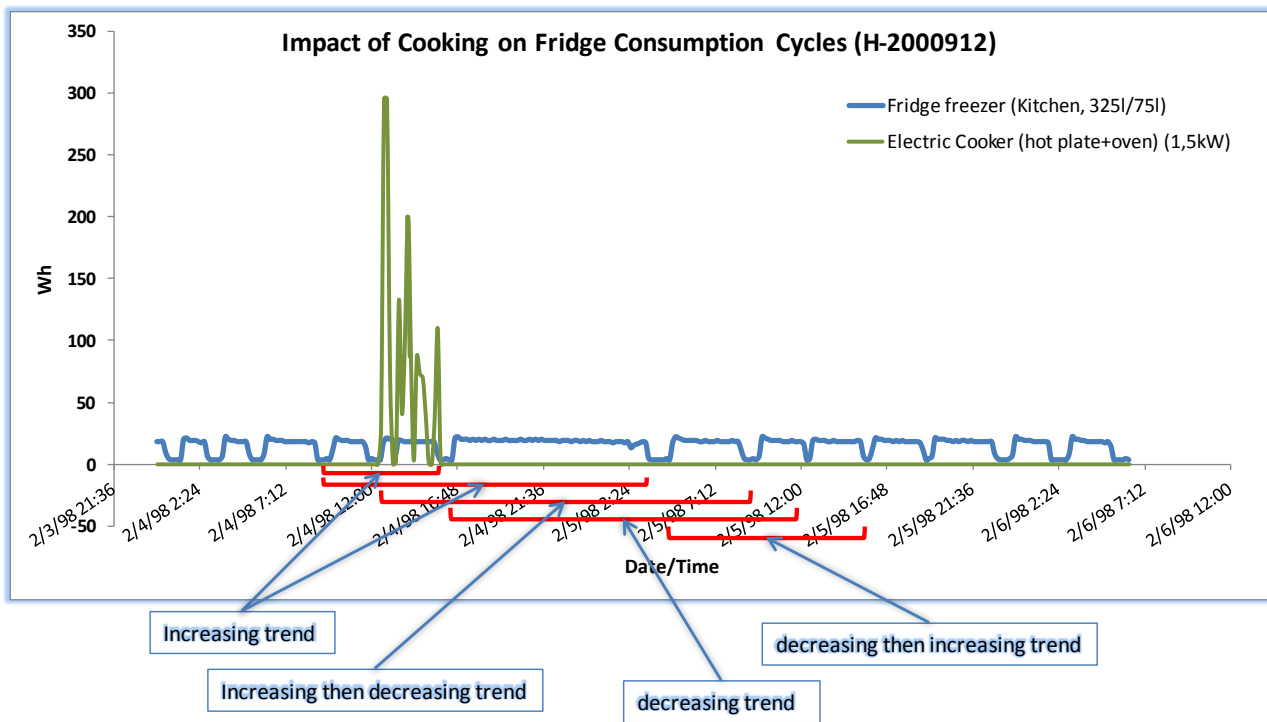

Figure 6.5 Different trends identified in on-cycle durations

Before explaining the example, the flowchart to compute the impact of the cooking activities on the fridge cycle durations is shown in figure 6.6(a,b). It starts by taking as input all the houses where both the fridge and the electric cooker are in the kitchen. Then for every month, for each house, the “normal” compressor cycle durations are computed. “Normal” compressor cycles are those that are not influenced by the cooking activity or some other activity that affects the fridge consumption. These are the cycles where the fridge is assumed to behave in the standard way and are assumed to lie in the first quartile of data. A list of SQL queries is prepared to compute the fridge on-cycle durations based on different criteria i.e. seasons and day types. This step is important as the fridge cycle durations are impacted by not only the cooking activity but also the season and day type (weekday/weekend).

The important variables used in this algorithm are $cVal$, Dc , Dp and $myFlag$. The variable $cVal$ is a pointer that scrolls down in the “OnCycle” field. This field contains the on-cycle durations of the fridge (Figure 6.8(b)). The pointer stores the current value of the on-cycle in the OnCycle field. The Dc and Dp variables corresponds to current and previous differences, computed from three consecutive fridge on-cycle durations. These variables identify the increasing or decreasing trends in the fridge cycles. The $myFlag$ [0,1,2] variable is computed based on the Dc and Dp values to see whether the impact of cooking activity on the subsequent fridge cycles should be included or not. There could be an increasing trend ($myFlag=0$), decreasing trend ($myFlag=1$), increasing then decreasing trend ($myFlag=1$) (the decision criteria is the same in the last two cases, so $myFlag$ is given the same value) and decreasing then increasing trend ($myFlag=2$). These values are further used with cutoff criteria (i.e. whether the normal onCycle is reached) to decide the cooking impact on the next on-cycles. All these trends are shown in table 6.1, with the help of an example taken from house 2000912 in the Irise database. The iterations show for how long the cooker impacts the fridge on-cycle durations. Figure 6.7 shows the graph of the same example; here on-cycles that are included under the impact of cooking activity can be clearly seen. The normal on-cycle duration computed for this house is 140 min. The first row of the table shows the on-cycle duration (190

min) where the cooker was turned on (Table 6.1). This cycle is impacted by the cooking activity. In order to decide whether the next cycle (650 min) should be considered as impacted by the cooking activity as well, the difference between the current cycle duration and the next cycle duration is computed. If the current difference ($D_c = 460$) is larger than the previous difference ($D_p = 0$) and the on-cycle duration is larger than the normal cycle duration it means that the current on-cycle is impacted by the cooking activity. This shows an increasing trend in the on-cycle duration and is represented by $myflag = 0$. The next on-cycle duration is 240 min and in order to decide whether this cycle has to be considered under the impact of cooking activity the same process is repeated, i.e. the difference between current cycle and the previous cycle is computed. The current difference ($D_c = -410$) is less than the previous difference ($D_p = 460$). The trend between the three consecutive cycles is increasing then decreasing, thus $myFlag = 1$. Although the current on-cycle duration has decreased, it needs to be compared with the normal on-cycle duration (cut off criteria). Since the current cycle duration is greater than the normal on-cycle duration, it is considered to be impacted by the cooking activity. The next on-cycle duration is 160 min that again shows a decreasing trend. Now the three consecutive on-cycles have a decreasing trend and the current on-cycle duration is greater than the normal cycle. Thus, it is included under the impact of cooking activity. The next on-cycle duration is 180 min, and the trend between three consecutive cycles is decreasing and then increasing ($myflag = 2$). This cycle will not be considered under the impact of cooking activity. This is because once the cycle durations gradually decrease and then increase again, it is assumed that the inhabitants have performed some activity other than cooking that caused the cycles to become larger. Thus, these cycles are not considered to be impacted by the cooking activity.

If there is no further cooking impact on the on-cycles then the pointer $cVal$ returns to the previous bookmarked on-cycle record i.e. the previous on-cycle duration it has stored. The cooker variable is set to "Off" and all other pointers are initialized to 0. The process is repeated until all the on-cycle durations for the current SQL query are computed and averaged. The process will then start for the next SQL query for the same house, until all the queries have been run. It will then move to the next house in the given list of houses. The figure 6.8(c) shows that the final output of the above process, giving the average fridge cycle durations based on seasons, day type and the cooking activity.

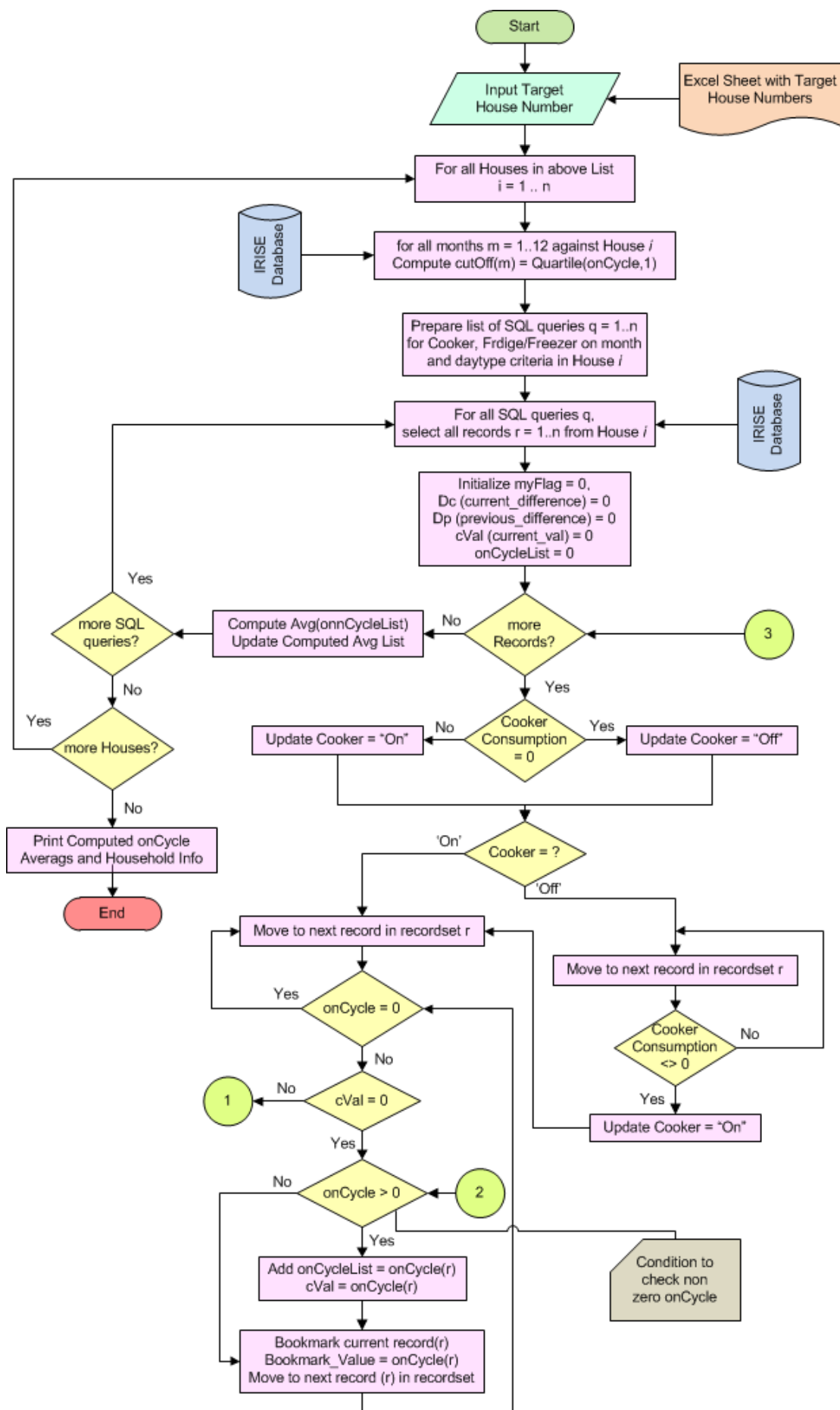

(a)

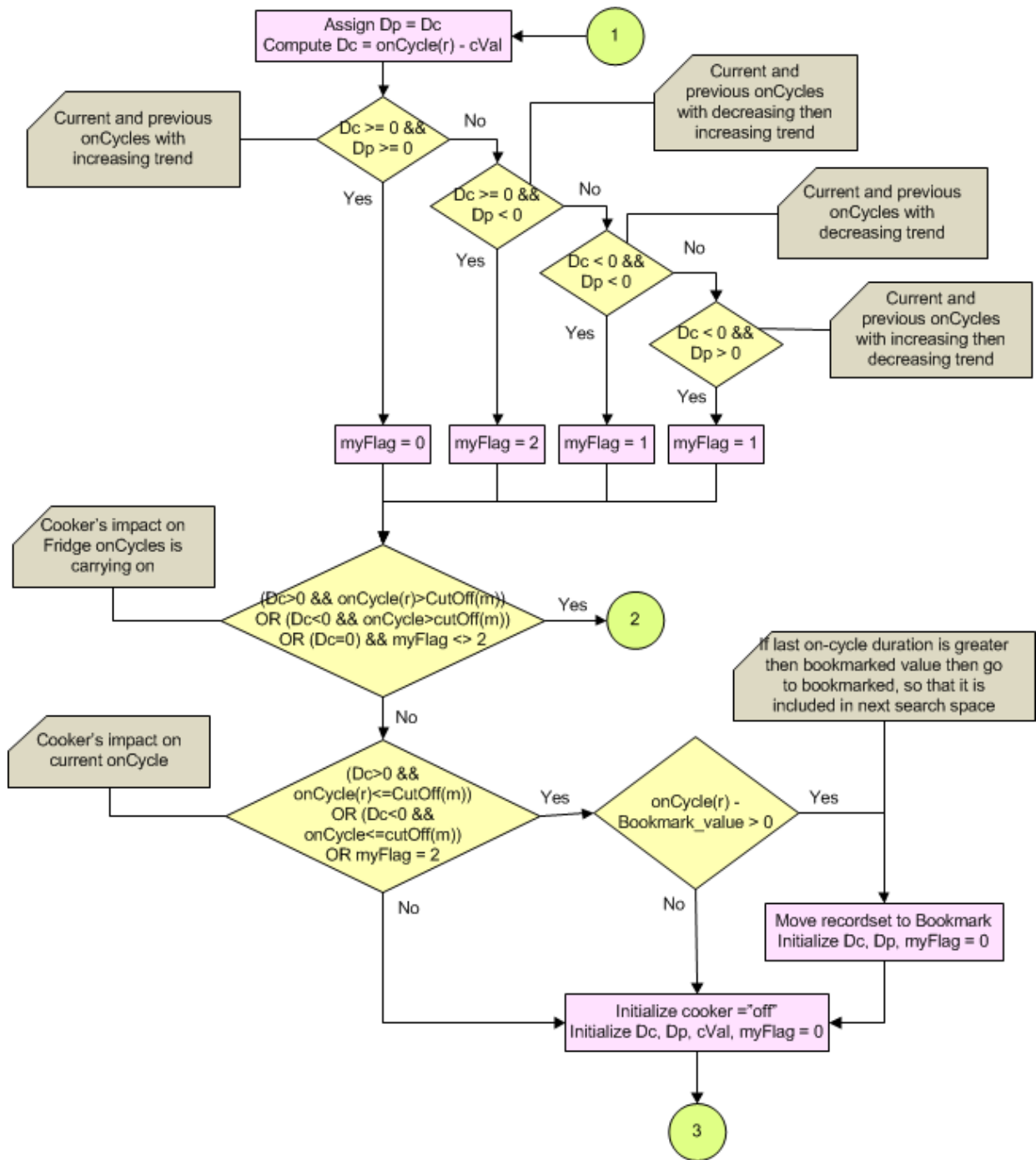

(b)

Figure 6.6 Flowchart for average on-cycle duration computation based on the cooking activity

on-cycle duration computation based on cooking activity					
Date/Time	Cooker_Impact	onCycle_Duration	Dc (Current_Duration)	DP (Previous_Duration)	myFlag
2/4/1998 15:40	true	190	0	0	0
2/5/1998 3:20	true	650	460	0	0
2/5/1998 8:40	true	240	-410	460	1
2/5/1998 12:10	true	160	-80	-410	2
2/5/1998 15:30	false	180	20	-80	2

Table 6.1 Iterations for on-cycle duration computation

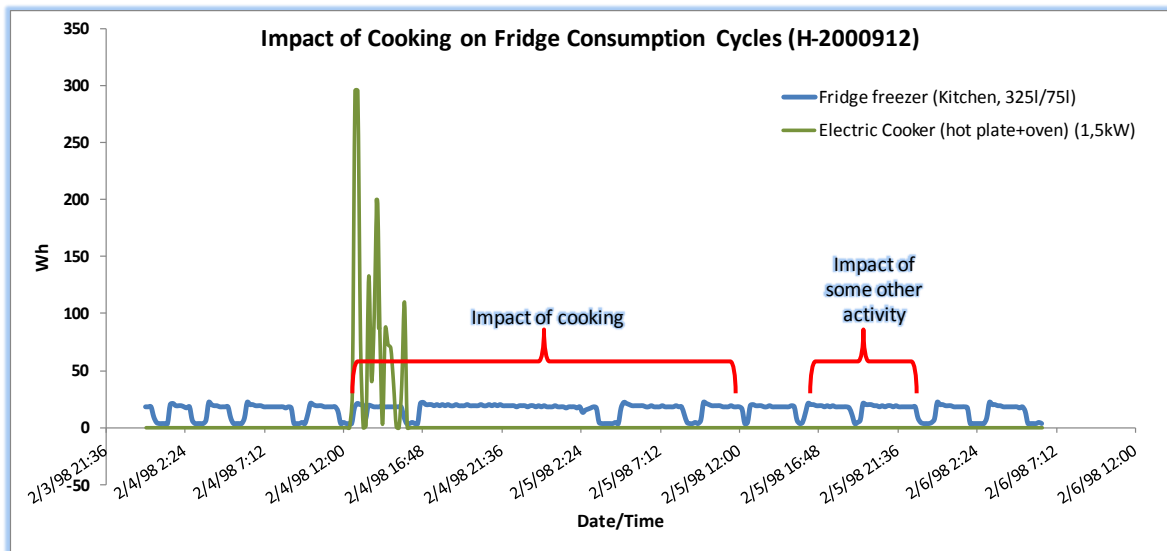

Figure 6.7 Impact of cooking activities on fridge cycle durations

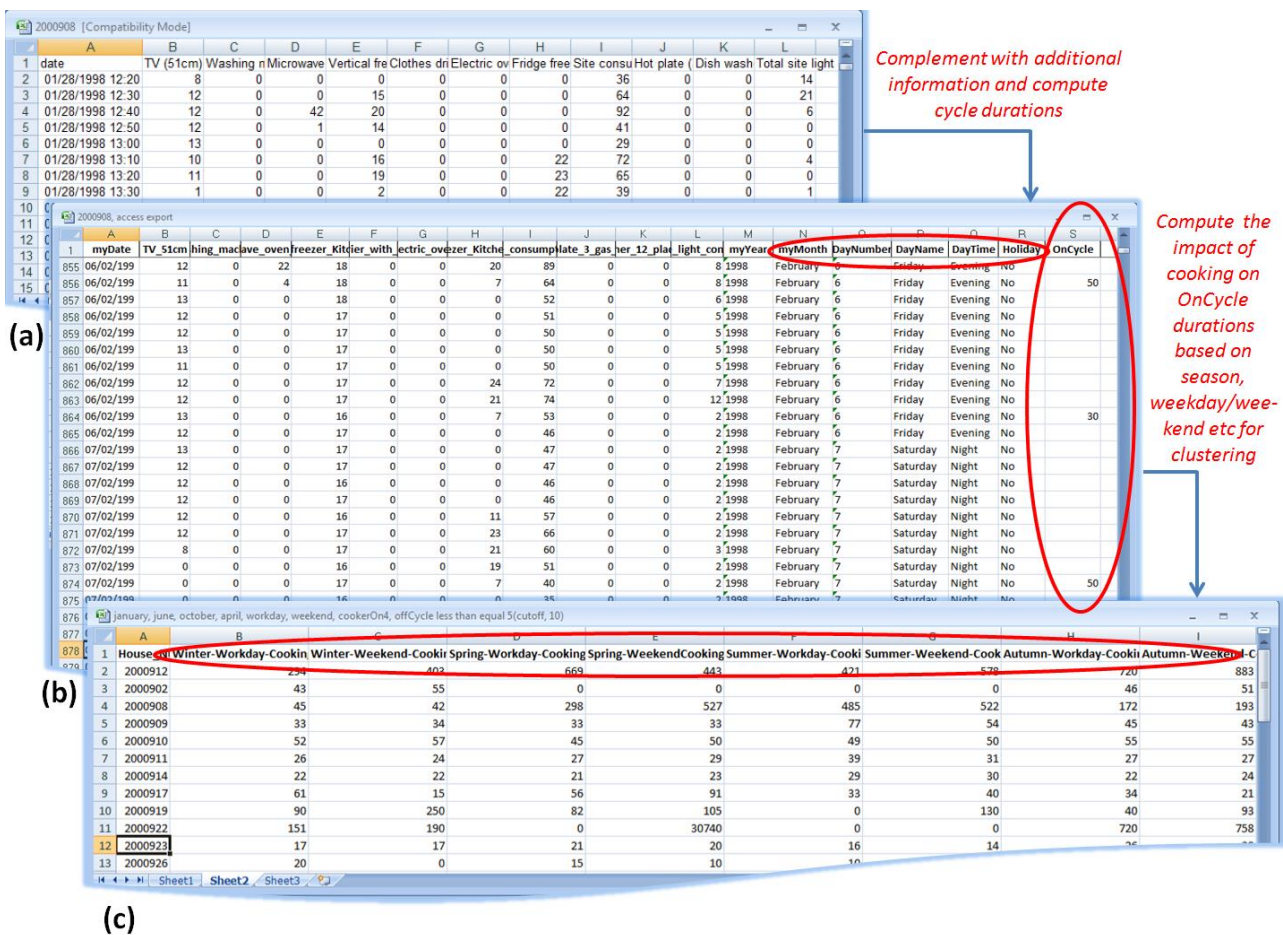

Figure 6.8 Data preprocessing for clustering

6.4 Clustering the Houses with Similar Behaviours

The impact of the cooking activity on the consumption of the fridge due to the inhabitants' behaviour varies with different seasons and day types (weekdays and weekends). The stacked chart for average on-cycle durations for the fridge in all the houses in the Irise database, where both the cooker and fridge are located in the kitchen, is shown in figure 6.9. On the x-axis there is the season

(one month from each season is taken), day type and whether it is cooking activity or not; on the y-axis there is the fridge on-cycle durations in minutes. This graph shows that when the inhabitants are involved in the cooking activity in most of the houses the fridge consumption cycles become longer than when there is no cooking activity.

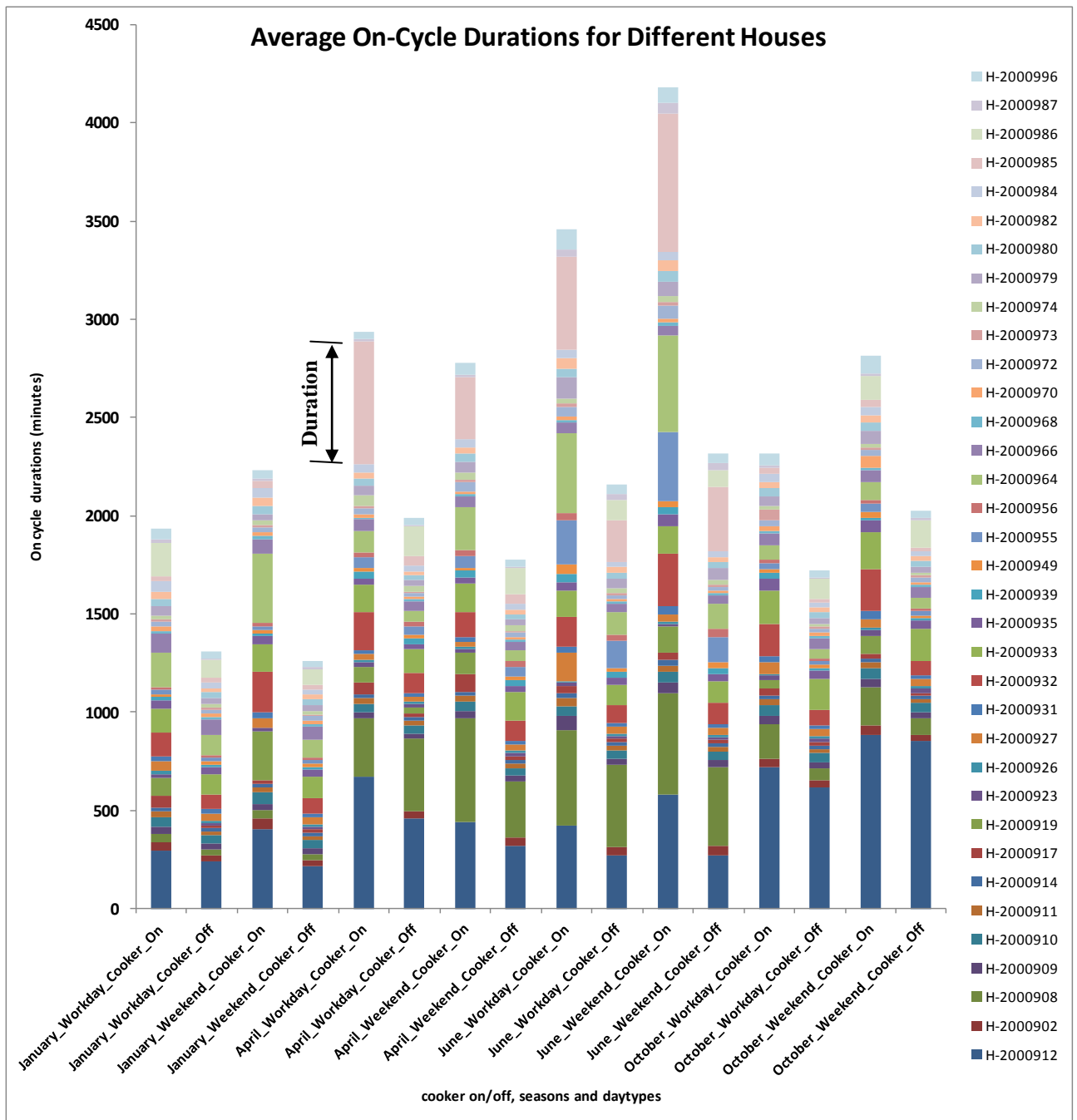
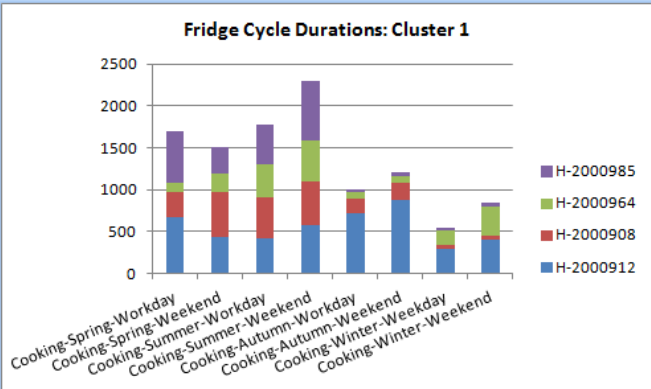
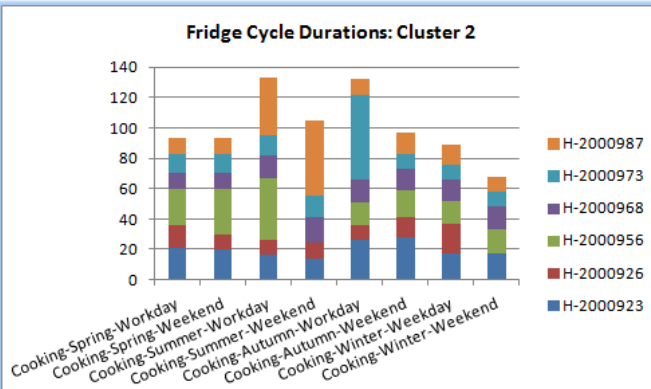
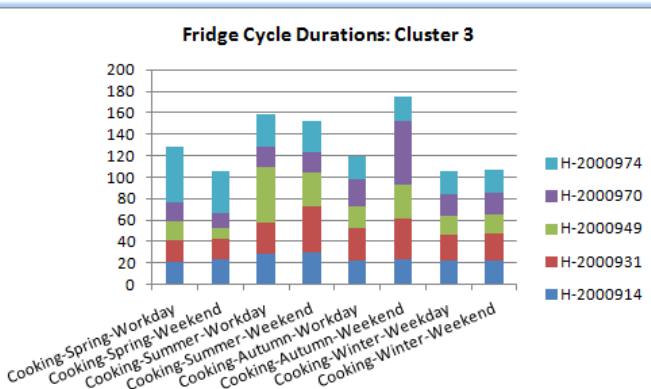
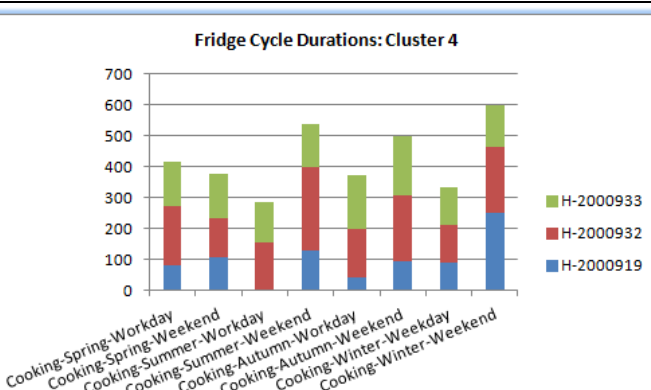

Figure 6.9 Fridge consumption during cooking and non cooking activity

6.4.1 IDENTIFYING REPRESENTATIVE BEHAVIOURS

All the houses in figure 6.4 are further clustered to identify representative behaviours based on their fridge consumption during the cooking activity. The houses are clustered based on how the cooking activity, seasons and day types (weekend/weekdays) affects the fridge consumption. The data file in the figure 6.8(c) is taken as input for k-means clustering. The reason for using k-means clustering is that it gives more accurate clustering results when the data is huge [Abbas, 2008] and is computationally better when the number of variables is large.

Clusters	Cluster Description
	<ul style="list-style-type: none"> • Average fridge cycle durations of the members of this cluster are 340 minutes. • The effect of cooking activity on the fridge cycles is highest in the summer season. • The fridge consumption during cooking is higher at weekends in all the seasons except in Spring where on weekdays there is more consumption.
	<ul style="list-style-type: none"> • Average fridge cycle durations of the members of this cluster are 17 minutes. • The effect of cooking activity on the fridge cycles is highest in the Summer and Autumn seasons. • The fridge consumption during cooking is higher on weekdays in all the seasons except in Spring where the consumptions on weekends and weekdays are the same.
	<ul style="list-style-type: none"> • Average fridge cycle durations of the members of this cluster are 26 minutes. • The affect of cooking activity on the fridge cycles is highest in the Summer and Autumn season. • The fridge consumption during cooking on weekends and weekdays is almost the same in Winter, whereas in Autumn there is more consumption at weekends and in Summer and Spring on weekdays.
	<ul style="list-style-type: none"> • Average fridge cycle durations of the members of this cluster are 50 minutes. • The affect of cooking activity on the fridge cycles is highest in Summer. • The fridge consumption during cooking is higher on weekdays in Spring, whereas in all other seasons it is higher at the weekend.

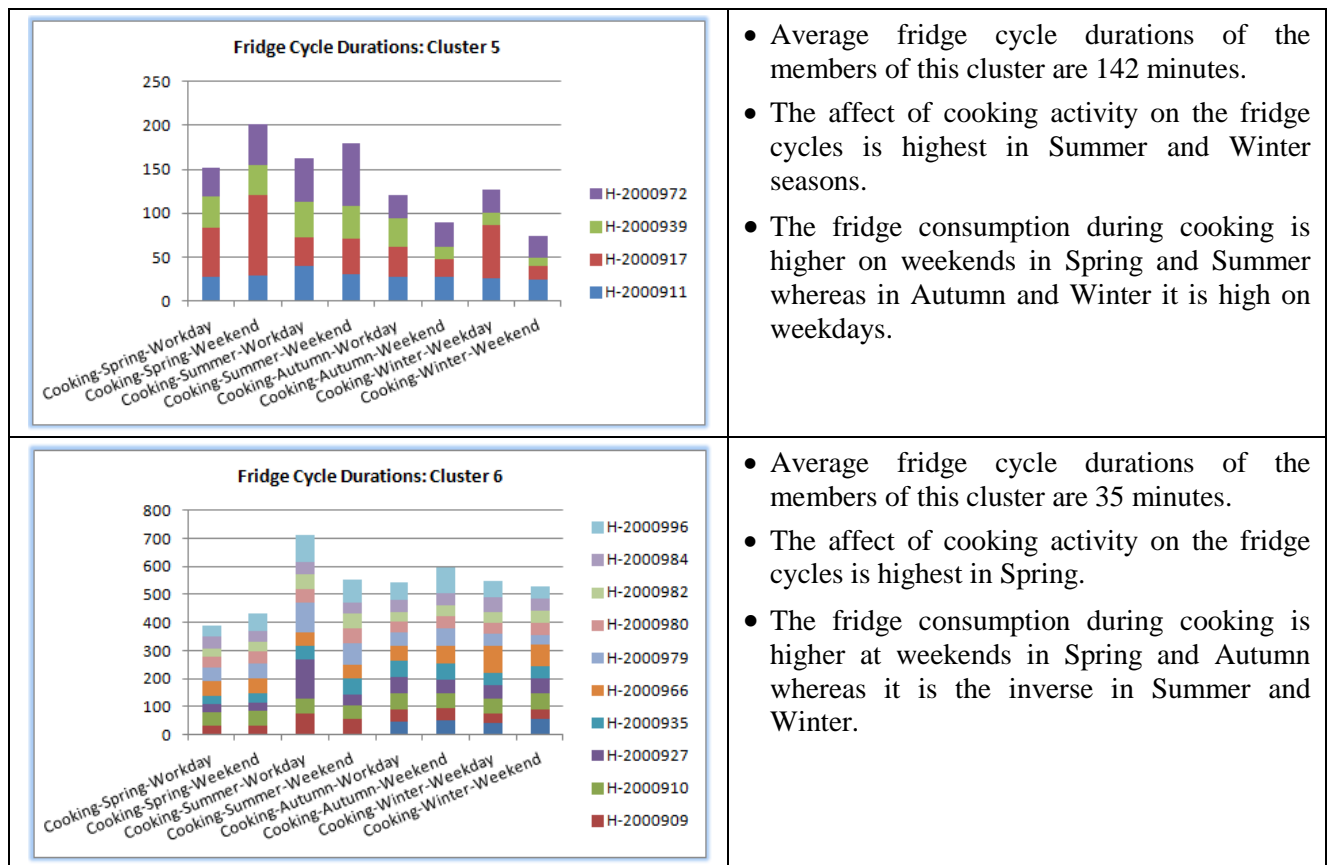

Figure 6.10 Clusters of houses with similar energy consumption behaviour

The different clusters obtained after applying k-means clustering on the data are given in figure 6.10. The seasons and day type is on the x-axes whereas average on-cycle duration of the fridge in minutes is on the y-axes. One month from each season is taken as representative i.e. April for Spring, June for Summer, October for Autumn and January for Winter. Each graph represents a cluster, where the consumption behaviour of the fridge is different based on the season and the day type while the occupants are involved in the cooking activity.

From the above clusters, some general consumption patterns on the population can be seen. These patterns are summarized in the similarity matrix in table 6.2. 50% similarity is observed in inhabitants' consumption behaviours during Winter, Summer and Spring weekdays. The highest similarity (83%) is observed during the Summer season where globally there is more consumption as compared to the other seasons. Similarly on Winter weekends there is 66% similarity in the behaviour of inhabitants.

Season/ Daytype	Globally high consumption	High consumption on weekdays	cluster No.	high consumption on weekends	cluster No.	no difference	cluster No.
Winter	33%	50%	2,6,5	33%	1,4	16%	
Summer	83%	50%	2,3,6	50%	1,4,5	0%	
Spring	0%	50%	1,3,4	33%	5,6	16%	2
Autumn	33%	33%	1,2	66%	1,3,4,6	0%	

Table 6.2 Similarities in clusters

6.5 Inhabitants' Behaviour and Appliance Co-Simulation

In the above section the houses in the Irise database are clustered based on the generic energy consuming behaviour of inhabitants. In this section more specific behaviour of inhabitants will be modelled and simulated. Some of the parameters and their impact on energy consumption e.g. seasons, weekday, weekend, impact of an appliance usage over another (e.g. cooking activity) are already known. However, there are still situations where high consumption is not explained by the above mentioned parameters but some other unknown reason (chapter 3, section 3.5.4). In these situations the results from field studies are used to find the reasons behind these high consumptions. Thus the additional parameters that will be used while modelling and simulating the behaviour of inhabitants from the Irise database are the social behaviour of the family and the arrival of guests. Since there is a combination of parameters, ones that are observed from the Irise database and others from local field studies, their values needs to be tuned during the simulation to see if the simulated behaviour is realistic. This simulated behaviour will generate the consumption distribution of the appliance (in this example a fridge freezer). The consumption distribution obtained from the simulated results will then be compared with the original consumption distribution of the same house to see if they follow the same trend. Further, this simulated distribution will be compared with other members of the same cluster. The proposed tuning parameters are:

- a) ***Weekend and weekday cooking probabilities:*** This defines the probability that the family cooks more during weekends or weekdays. While cooking, the agents interact more with the fridge. If a higher probability is assigned to weekend cooking, then the family will interact more with the fridge during weekends compared to weekdays when they may eat out or use the food they have already cooked during weekends.
- b) ***Weather:*** This defines and controls the perception by agents about the outside weather. It means that if the weather is good, e.g. sunny and warm, then the family might prefer to eat out.
- c) ***Communication based agreement/disagreement over cooking or dining out:*** This involves the social interaction between agents where they agree or disagree on dining out or cooking at home. The purpose of introducing this parameter is to show how the social interactions of agents are interesting to include in simulations in order to make them closer to reality.
- d) ***Guests:*** This is a random parameter that increases the interactions with the fridge resulting in larger fridge cycles, hence large energy consumptions.

Different combinations of values for these parameters result in different consumption simulation results, one of which is shown in figure 6.11. The values of these tuning parameters are first initialized in Brahms simulation environment. These fall between the probabilistic values of 0 and 1 and are randomly selected by the Brahms simulator during simulations. The goal is to find optimal values of these tuning parameters such that they generate the consumption distribution close to the benchmarked distribution.

6.5.1 BRAHMS SIMULATION WITH TUNING PARAMETERS (STEP-3)

Brahms has been used to implement a scenario of a husband and wife concerned with a cooking activity. The scenario is highly dynamic and random because of the probabilistic values of the tuning parameters.



Figure 6.11 Brahms scenario simulation results

Figure 6.11 shows a snapshot of a Brahms simulation over a one month period. The bar with the light-bulb symbols shows the thoughtframes, where the agents reason based on different perceptions (such as time, day of the week, weather) coming from the environment. The colourful vertical bars in the area just behind the thoughtframes show the workframes, where we have the activities of the agents, these may be composite activities or primitive ones. A composite activity is composed of primitive activities, e.g. the “prepare lunch” composite activity can be decomposed into the “open fridge”, “close fridge” and “cook food” primitive activities. The vertical bars going from one agent’s workframe area to another shows the communication between agents or the broadcasting of information (beliefs) that may in turn invoke actions in other agents.

Since there are many random variables in the simulation e.g. the probability of cooking on a weekday and weekend, the probability of how often the inhabitants go out to eat instead of eating at home, the probability of social agreement between inhabitants to eat at home or outside based on the weather, the probability of arrival of guests at home. Based on the combination of these probabilistic values the agents interact with the fridge more or less often, they may put hot food in the fridge; they prepare food at home or not, etc. Also the activities performed by the agents do not always have the same duration, e.g. the cooking activity on one day may take 30 minutes while on another day it could take 50 minutes. This means that every day during the period of simulation run (1 month) not only the agents’ perception about the environment and choice of actions change but also the duration of activities change as well. Thus the probability of occurrence of some random variable along with the duration of activities needs to be averaged. Figure 6.12 explains the process, where, for some particular probability values for each parameter, several simulations are run (20 times) and then the results are averaged. Similarly, the probability values are changed for the next runs and the results are again averaged. The process of changing these probabilities continues until the selected probability values match the observed behaviour of the people and the consumption trends start matching with each other. The next step is to calibrate the simulator by

matching fridge freezer cycle distributions computed from the behaviour simulations with those from the Irise database.

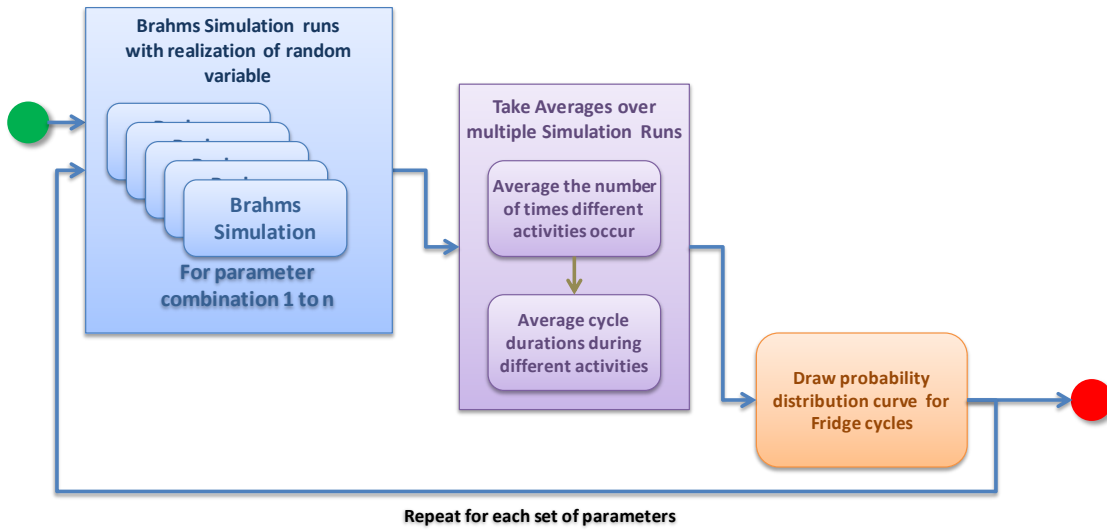

Figure 6.12 How to get fridge cycle durations from simulations

The Brahms simulation results are combined into a text file. A parser was developed to read these files and compute the energy consumption associated with the duration of fridge cycles. The initial results with the initial set of tuning parameters are presented in figure 6.14(a) for the reference. The probabilities for each parameter are set at the start of the simulation. For example if the probability that the inhabitants will cook more on weekdays is set to 40%, they will cook on different days for each simulation run, but not for more or less than 40% of the time.

6.6 Comparison of Benchmarked and Simulated Distributions (Step-4)

Since, only the on-cycles represents the fact that the fridge is consuming energy, these cycles are used to draw the probability distribution for the selected houses. This is done in Matlab through a function that computes the optimal number of bins (discrete intervals) for the histogram from the on-cycle durations. It then uses the Matlab functions to compute the probability distribution that best fits the data. Some of the different probability distributions that are computed by this function include weibull, extreme value, inverse gaussian, gamma, etc. The fridge on-cycle distribution computed for the house 2000912, in the Irise database, for one month is shown in figure 6.13. The duration in minutes of the fridge compressor cycle is shown on the x-axis and its probability density on the y-axis. It shows that on-cycle durations range from 80 to 940 minutes where the most probable durations are 170 minutes. The best fit of the probability densities is an inverse gaussian distribution [Matsuda, 2005]. The probability density function for inverse Gaussian is:

$$f(x|\mu, \lambda) = \sqrt{\frac{\lambda}{2\pi x^3}} \exp\left\{-\frac{\lambda}{2\mu^2 x}(x - \mu)^2\right\}; x > 0$$

Where μ is the scale parameter and λ is the shape parameter

This is the reference distribution computed from the house for which the co-simulation is run in section 6.5.1. This is the actual consumption distribution from the Irise database and it will be

used during the validation step where it will be compared with the distribution results from the simulation.

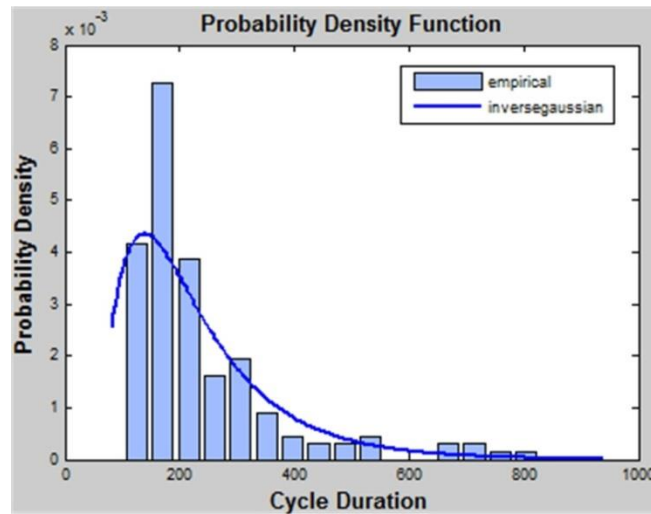
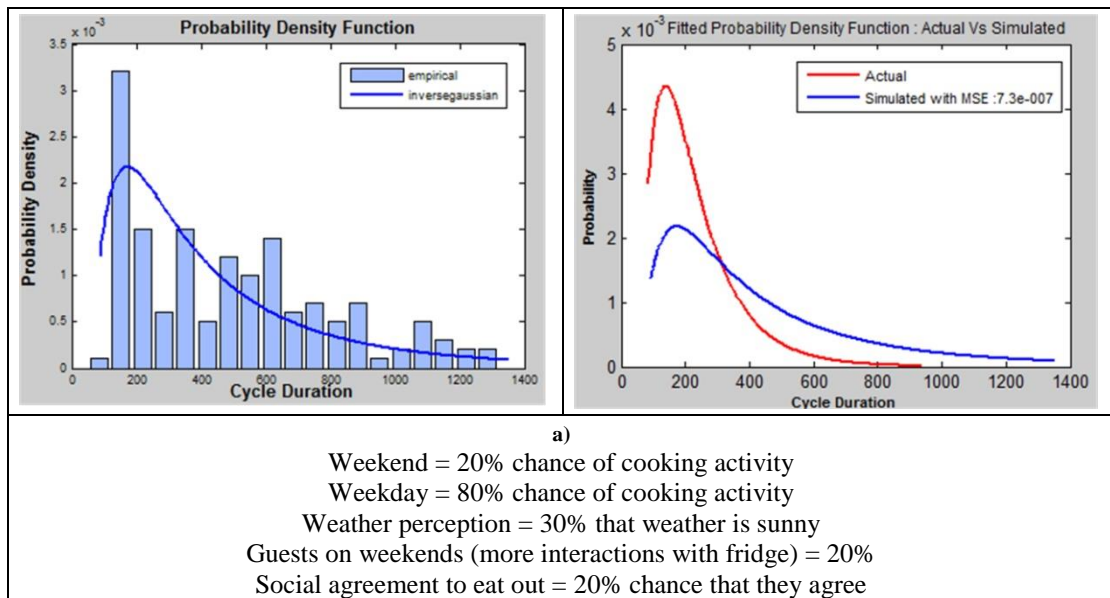

Figure 6.13 Fridge cycles distribution from Irise database

In this section we present the optimization results found by adjusting the set of parameters (Figure 6.14) and averaging the simulations over several(20 simulations) runs. In order to capture the error between the actual and the simulated fitted distributions, the standard Mean Squared Error (MSE) function in Matlab is used. The Mean Percentage Error (MPE) is also computed in order to analyze the error with different values of the tuning parameters. The formula to calculate the mean percentage error is:

$$MPE = 1 / \sum_{i=1}^n ABS(S_i - A_i) / A_i * 100n$$

where, A_i is the actual value and S_i the simulated one.



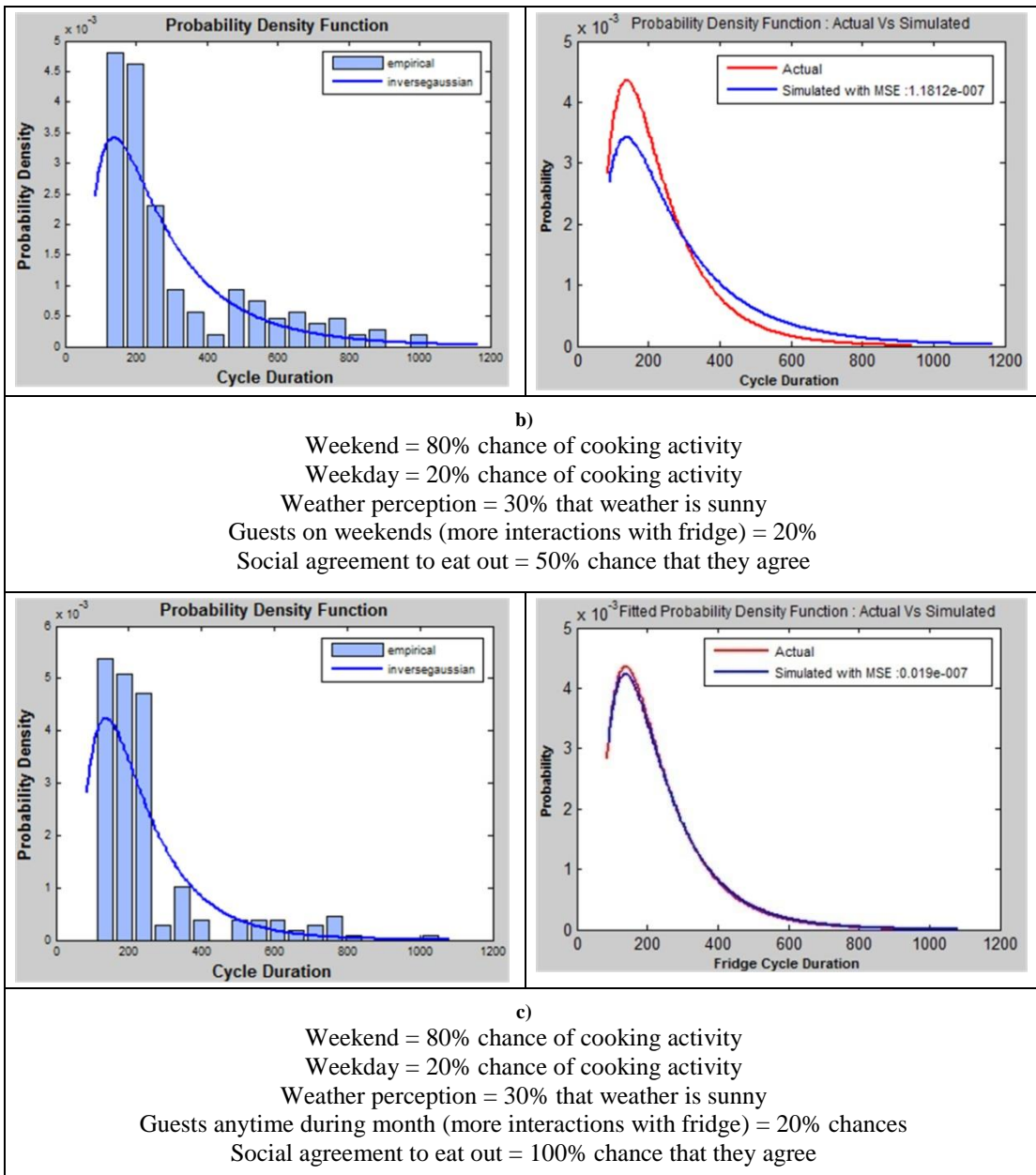

Figure 6.14 Optimized tuning parameters, simulated consumption patterns and comparison between actual and simulated fitted curves

If the above results are analyzed from left to right and top to bottom, it shows a convergence of the simulated distribution towards the benchmarked distribution by successively adjusting the tuning parameters. The final distribution is quite similar to the actual distribution curve. It can be seen in figure 6.14 that the error is gradually reducing by adjusting the parameters such that they are closer to what is observed in the experiments (section-3.5.1 and section 6.4 for weather and weekend, weekday, cooking activity impact). In figure 6.14(a), since the inhabitants are more likely to cook on weekdays, instead of weekends, and the weather is often not sunny, they tend to cook more frequently during the month. However, this is not close to the inhabitants' actual behaviour and is quite far from reality, hence, actual and simulated distributions do not match.

Figure 6.14(b) shows a particular case where the curves are very close, but the behaviours are not in line with what has been observed through Irise database analysis and field studies. Although the inhabitants cook more often during the weekends, the value for the social agreement is inconsistent with reality. The parameter values for figure 6.14(c) are tuned according to the

observations from experiments. In this case the inhabitants cook more often during the weekends as compared to weekdays and there is a 30% chance that the weather will be sunny and warm. Also the parameter for the social agreement between agents to eat out is set to 100%, which seems to be more realistic compared to the previous cases. Here the statistical curves are not only in compliance with the reference distributions, but also the simulated behaviour is realistic.

In figure 6.14, the behaviour model is validated based on the comparison between actual and simulated energy consumption curves for the fridge. However, after clustering the energy consumption behaviour of occupants during cooking activity, the simulated energy consumption of the fridge is compared with another house (2000964) that is a member of the same cluster. Figure 6.15 shows the difference between the consumption distribution for house-2000964 and simulated curves for house-2000912.

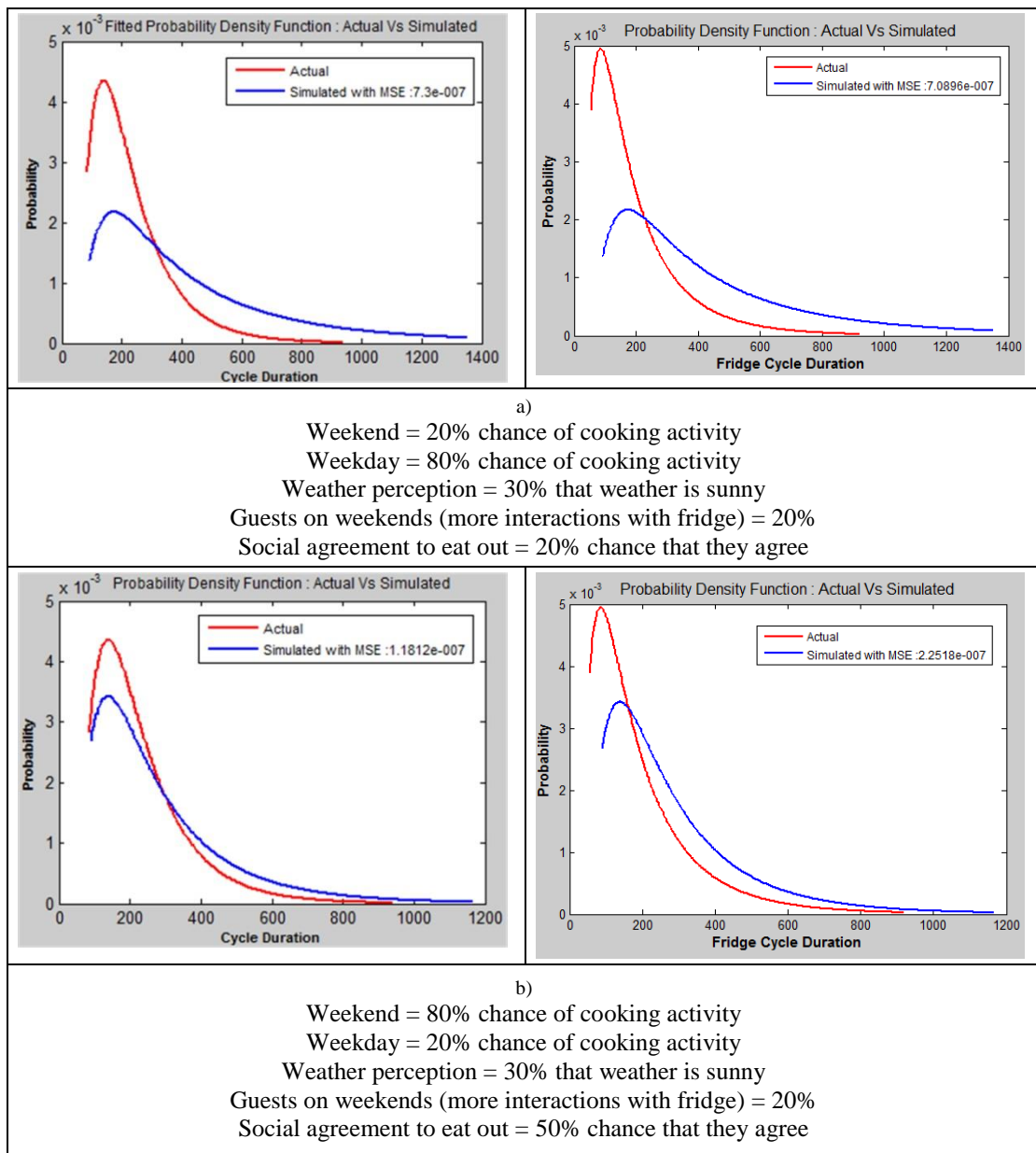

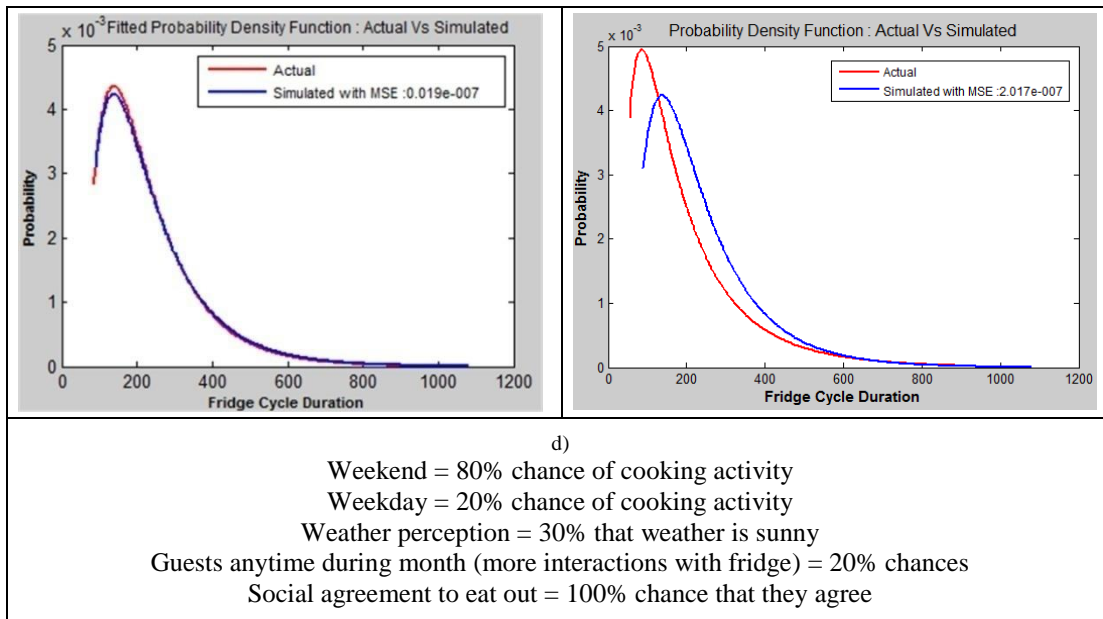

Figure 6.15 Comparison with another member of the same cluster

The difference between these distributions is bigger as compared to the benchmarked house (house-2000912). This is because in figure 6.14 the comparison of simulated distribution was made with the same house for which the simulation was done. But in figure 6.15, the comparison of the same simulated distribution is made with another member of the same cluster (house-2000964) that causes the error to increase but still it is realistic and follows almost the same trend.

6.7 Summary and Conclusions

The proposed 4-step methodology for validation is a generic approach that can be effectively used to analyze the impact of inhabitants' behaviour on household appliances. In this chapter we have benchmarked the fridge freezer as a target appliance. In the proposed methodology, step-1 is to model household appliances followed by the Irise database analysis and local field studies. This step will remain the same even for appliances other than a fridge freezer. Step-2 comprises of modelling the behaviour of inhabitants for the houses in the Irise database. Since the information about the activities of inhabitants is missing in the Irise database, it is complemented with additional information to capture the inhabitants' energy consuming behaviour. In the case of the fridge freezer example, data preprocessing is done to complement the Irise database with the computed fridge on-cycle durations, the impact of cooking activity, seasons, weekdays and weekends. After data preprocessing, clustering is used to group together the houses with identical energy consuming behavioural patterns. Step-2 will also remain the same for other appliances, as the impact of these parameters on all the different kind of appliances has been analyzed in chapter 3. However, the parameter that takes into account the impact of one usage of one appliance over the energy consumption of another has to be analyzed for each appliance separately. For example, in case of a heating system, if there are computers and television usage in the room, the inhabitants might select a low temperature setpoint as these appliances also emit heat. In step-3, the co-simulation of inhabitants' behaviour is done with the appliance (fridge freezer as an example). In order to accomplish this step the important tuning parameters which effect the energy consumption are identified as (i) weekend and weekday, (ii) weather based cooking probabilities, (iii) communication based agreement/disagreement over cooking or eating out activities and (iv) guests parameter to

conclude home cooking or non cooking fridge activities. The values of these tuning parameters fall between the probabilistic values of 0 and 1 and are randomly selected by the Brahms simulator during simulations. The parameters that are used in the case of co-simulating inhabitants' behaviour with the fridge freezer comprises both the global behaviours (behaviour impacted by weekend, weekday, weather, season, etc) and local behaviours (social behaviour and arrival of guests, etc). The global behaviours are identified through analysis of the Irise database whereas the local behaviours are identified through field studies. In case of appliances other than the fridge the parameters concerned with the global behaviours would remain the same (see analyses and experiments done in chapter 3 for all the environmental parameters and against all the different appliances in the Irise database). However, for local behaviours, they could change but most probably would lie in one of the proposed categories for reasons behind actions (chapter 4, section 4.2.2). In step-4 the actual appliance consumption distribution from the house in the Irise database (for which the behaviour is modelled and simulated against some appliance usage) is drawn. Similarly, the appliance consumption distribution resulting from the simulation is also drawn and compared with the actual consumption distribution. Parameter tuning is used to re-run the simulations if there is an error between the actual and simulated appliance consumption distributions. This step is repeated until error is significantly reduced.

The resulting inhabitants' behaviour along with optimized tuning parameters from the above methodology serves as the representative behaviour of the cluster of houses to which the selected house belongs. This hypothesis is further validated by clustering the houses from the Irise database using k-means clustering method. The simulated results from the house 2000912 are further used as reference for the actual consumption curves computed from house 2000964 in the same cluster. The results show that the error is more compared to the actual house, but validate representativeness of the behaviour identified with optimized tuning parameters with similar consumption trends. The representative behaviour identified for each cluster along with tuning parameters can be further used to extend simulation results over the population (i.e. all the houses in France) for realistic estimates and predictions.

CHAPTER 7: CO-SIMULATION WITH BUILDING ENERGY MANAGEMENT SYSTEM

This chapter presents the co-simulation of inhabitants' behaviour with the thermal model, SIMBAD, of a reference building, MOZART and the Building Energy Management System (BEMS) G-HomeTech. This work is part of the SUPERBAT project. The objective is to analyze the impact of building energy management system to save energy in the presence of inhabitants' reactive and dynamic decision making behaviour on household appliances. A comparison is also made to analyze the impact of different behaviours (Eco, Non Eco) on the energy consumption and thermal comfort levels with and without the presence of BEMS.

CONTENTS

7.1	Introduction	165
7.2	Co-Simulation Elements	165
7.2.1	Mozart Building and its Thermal Model	167
7.2.2	Building Energy Management System	168
7.2.3	Inhabitants' Behaviour Simulation	168
7.2.3.1	Fanger's Thermal Comfort Model and Inhabitants' Behaviour	168
7.3	Co-Simulation Environment	172
7.3.1	Co-Simulation with and without BEMS	173
7.3.2	Eco vs Non-Eco Behaviours	175
7.3.3	Eco Agent Controls the Environment without BEMS	178
7.3.4	Eco Agent Controls the Environment with BEMS	184
7.3.5	Non-Eco Agent Controls the Environment without BEMS	189
7.3.6	Non-Eco Agent Controls the Environment with BEMS	190
7.3.7	Eco vs Non-Eco Behaviours with and without BEMS	192
7.4	Summary and Conclusions	194

7.1 Introduction

The advancements in the electric grid technology have led to the concept of a smart grid that uses the information technology to communicate with the suppliers and customers about their energy supply and demand needs. The smart grid helps in improving energy efficiency and sustainability of its production and distribution. The information that can be provided to the inhabitants consists of availability of energy, tariff details and energy consumption by different household appliances etc.

After receiving all the different information from the smart grid, the inhabitants must be intelligent enough to interpret all this information so that they can save energy while maintaining their comfort. This requires a high cognitive workload to make decisions about energy management, and the results depend on how intelligently the information is handled and acted upon. This raises questions of: whether all the inhabitants can interpret the information in the same way, do they all have enough time to make these decisions, and do they all have the same behaviours concerning the energy problem. If the answer to these questions is no, then there is need of an intelligent system that saves the inhabitants time, reduces cognitive workload, and which can make the best decisions on their behalf. The intelligent systems called Building Energy Management System (BEMS) are under development [Doukas et al., 2007]. They control the environmental conditions inside the house such that its less costly and more comfortable for the inhabitants. The inhabitants can also communicate with the BEMS and can express their comfort needs, occupancy plans etc. and can also ask for advice.

In order to assess and evaluate the different strategies that are developed by the BEMS it is important to include the inhabitants' reactive and dynamic interactions with their environment in building energy simulations. It will help to analyze the control of different behaviours over the environment and the resulting impact on energy consumption patterns. Similarly, the role of BEMS in the presence of these reactive behaviours will be more challenging and will lead to improved functionality and energy efficient decision making.

In chapter 5, a co-simulation of inhabitants' behaviour with the thermal aspects of the building was described. However, this simulation does not consider the inclusion of an energy management system. Also, the agents' reaction to the environment is based on the perception of temperature. In this chapter, the co-simulation of inhabitants' dynamic behaviour is done by taking into account the control and advice coming from BEMS. The BEMS used in the co-simulation called G-HomeTech [Ha et al., 2012] has been developed at G-SCOP and commercialized by Vesta System [VestaEnergy, 2011]. Similarly, the perception of environment in this model is based on the thermal comfort model. The SIMBAD thermal model [Husaunndee and Visier, 1997] used in the co-simulation is of a reference house, called MOZART [Noël, 2008] and detailed in the upcoming section.

7.2 Co-Simulation Elements

Figure 7.1 explains the process of how the co-simulation between different modules is performed. The inhabitants in the "Human Agent" module continuously perceive their comfort and react to the environment. The notion of comfort in the inhabitants is introduced using the Fanger's comfort model [Fanger, 1973]. This model computes the thermal comfort conditions for inhabitants based on their clothing, activity, temperature in surroundings and some other parameters detailed in the

upcoming sections. The values of these parameters are computed in separate modules i.e. the “Clothing Index Computation”, “Metabolic Rate Assignment”, and “Mozart Building” modules respectively. In “Mozart Building” module the temperatures (air and radiant temperatures) are calculated by the SIMBAD thermal model and sent back to the “Thermal Comfort (PMV) Computation” module. The inhabitants based on their perceived comfort levels further control the appliances or objects in the environment through the “Control (Setpoint, Appliances and Objects)” module. This control over the environment, however, can also be taken by the “Building Energy Management System” module that maintains the thermal comfort of inhabitants. The detail about the different modules is given in the upcoming sections.

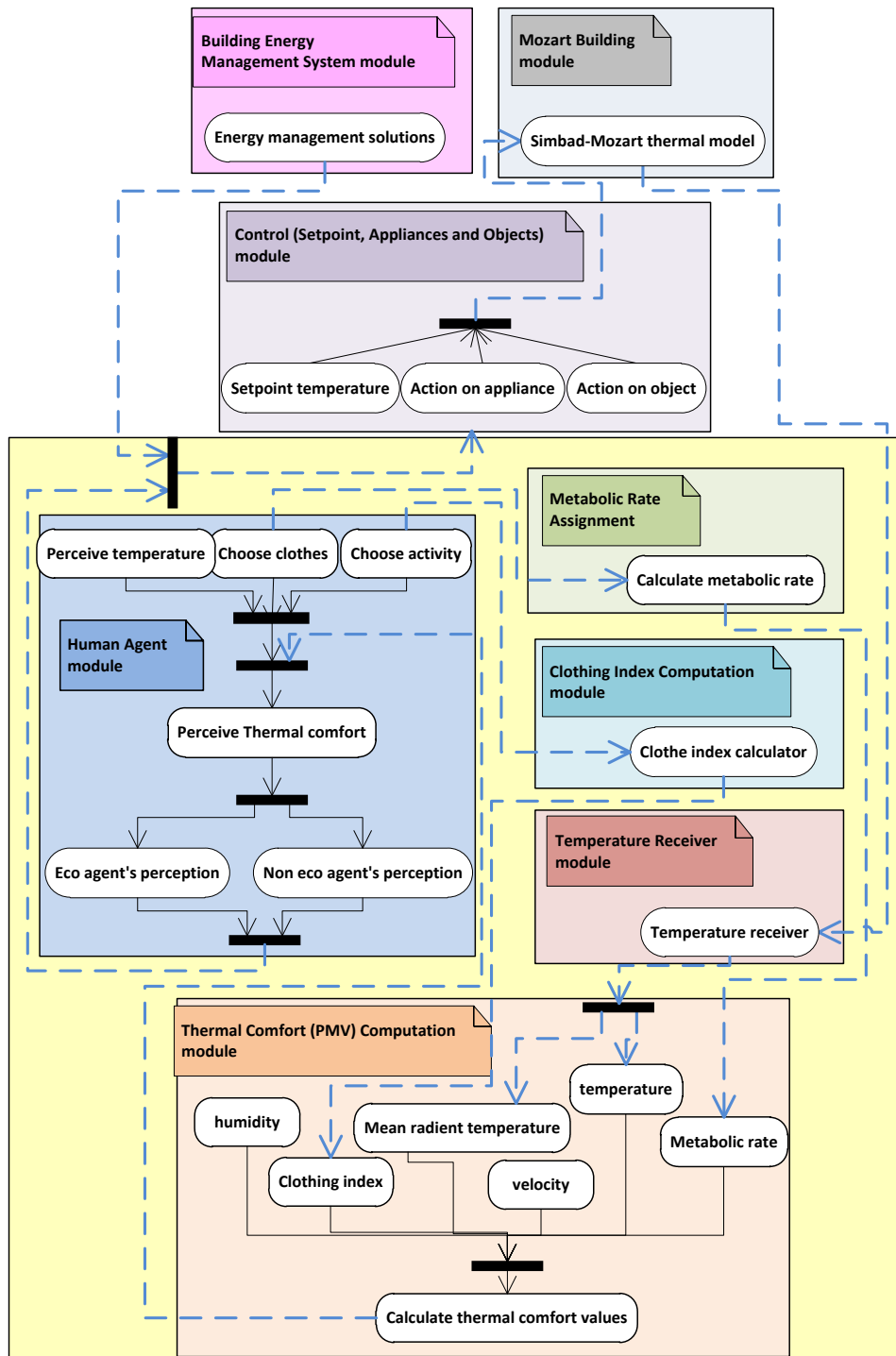

Figure 7.1 Co-Simulation between inhabitant’s behaviour, SIMBAD and BEMS

7.2.1 MOZART BUILDING AND ITS THERMAL MODEL

Mozart is a 99.84m² single story virtual house consisting of 5 rooms, (Figure 7.2) [Noël, 2008]. It has 3 bedrooms, a living room, a kitchen and a bathroom. This house is taken as a reference house in the co-simulation where the agents move around the house, perceive their comfort and act upon the appliances/objects.

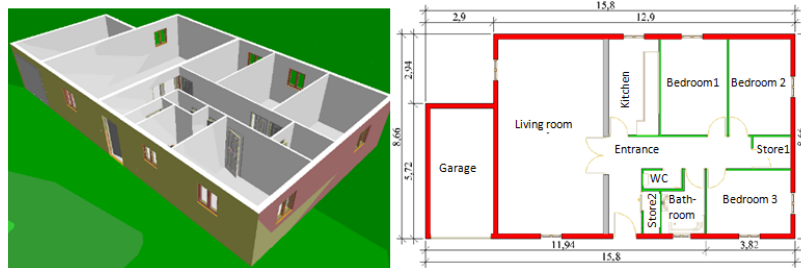

Figure 7.2 MOZART house plan

The thermal model for this house called the SIMBAD-MOZART model (Figure 7.3) as was built in Matlab/Simulink by CSTB (Centre Scientifique et Technique du Bâtiment). SIMBAD-MOZART calculates the temperature in each zone by taking into account various input variables. Some of the most important variables, shown inside the yellow rectangle in figure 7.3, include the power of all the different appliances present in the zone, the position of the blinds e.g. open/closed, number of occupants in the zone, respiration flow rate, weather data, artificial lighting, and ventilation. The impact of window states (opened/closed) is also taken into account through ventilation, i.e. the air mass flow between the inside and outside of the building.

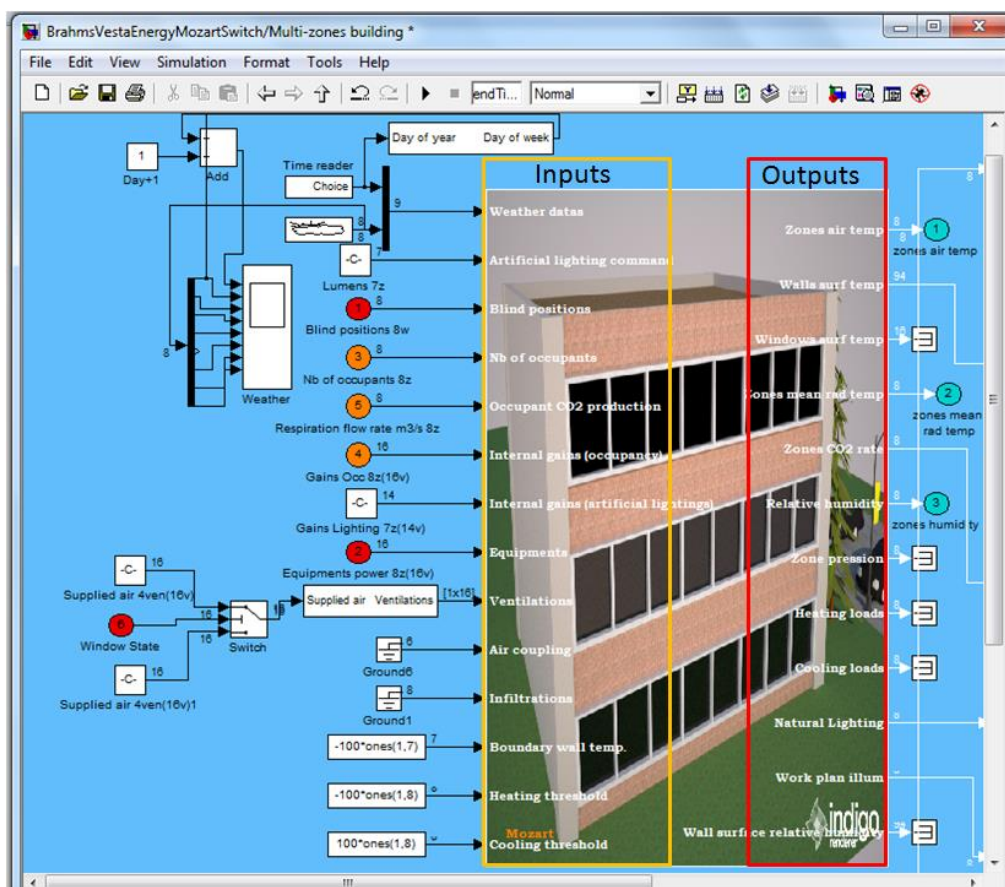

Figure 7.3 SIMBAD-MOZART thermal model

7.2.2 BUILDING ENERGY MANAGEMENT SYSTEM

In the co-simulation, the BEMS provides the inhabitants with a comfortable environment while lowering the energy cost. The self learning algorithms help to anticipate scheduling and make real-time adjustments. The important inputs consist of occupancy, weather forecast, smart grid information etc.

The occupants can also themselves make decisions regarding the control of appliances. However, this requires a high cognitive workload and information about different factors e.g. the distant and local sources of power, equipment consumption, energy price and availability, weather conditions etc. Alternatively, occupants can simply express their energy comfort needs in terms of expectations that are translated by the BEMS into energy choices taking into account the cost and comfort criteria.

The BEMS can either control the equipment itself e.g. the heating system, or it can give advice and let the occupants control the appliances themselves e.g. heater setpoint, washing machine, TV etc.

7.2.3 INHABITANTS' BEHAVIOUR SIMULATION

Since the thermal model used in the simulation is of the reference house MOZART, the same house is used for developing a scenario of inhabitants' presence and their activities. The purpose of modelling the inhabitants' behaviour is to see how their choices and control of household appliances can impact the energy consumption. An important element of this behaviour is the perception of comfort, i.e. how the inhabitants' behaviour will be impacted by the feeling of comfort or discomfort and how it will lead to the choice of certain actions. The comfort is introduced in the agents through the Fanger's thermal comfort model [Fanger, 1970].

7.2.3.1 Fanger's Thermal Comfort Model and Inhabitants' Behaviour

Occupants' comfort is given in the American Society Heating Refrigerating and Air Conditioning Engineers (ASHRAE) Standard Number 55, as "the condition of mind that expresses satisfaction with the thermal environment and is assessed by subjective evaluation". Thermal comfort is ensured by heat conduction, convection, radiation and evaporative heat loss. Thermal comfort is maintained by maintaining thermal equilibrium with the surroundings i.e. there is a balance between heat production and heat loss. Fanger describes his heat balance model as "Since the purpose of the thermoregulatory system of the body is to maintain an essentially constant internal body temperature, it can be assumed that for long exposure to a constant (moderate) thermal environment with a constant metabolic rate a heat balance will exist for the human body, i.e., the heat production will equal the heat dissipation, and there will be no significant heat storage within the body". The heat balance condition is:

$$H - E_d - E_{sw} - E_{re} - L = K = R + C$$

Where

H = the internal heat production in the human body

E_d = the heat loss by water vapour diffusion through the skin

E_{sw} = the heat loss by evaporation of sweat from the surface of the skin

E_{re} = the latent respiration heat loss

L = the dry respiration heat loss

K = the heat transfer from the skin to the outer surface of the clothed body (conduction through the clothing)

R = the heat loss by radiation from the outer surface of the clothed body

C = the heat loss by convection from the outer surface of the clothed body

Based on the heat balance equation, Fanger proposed an index in order to analyze the thermal environment. This gives the Predicted Mean Vote (PMV) of subjects according to the following psycho-physical scale (Figure 7.4(a)):

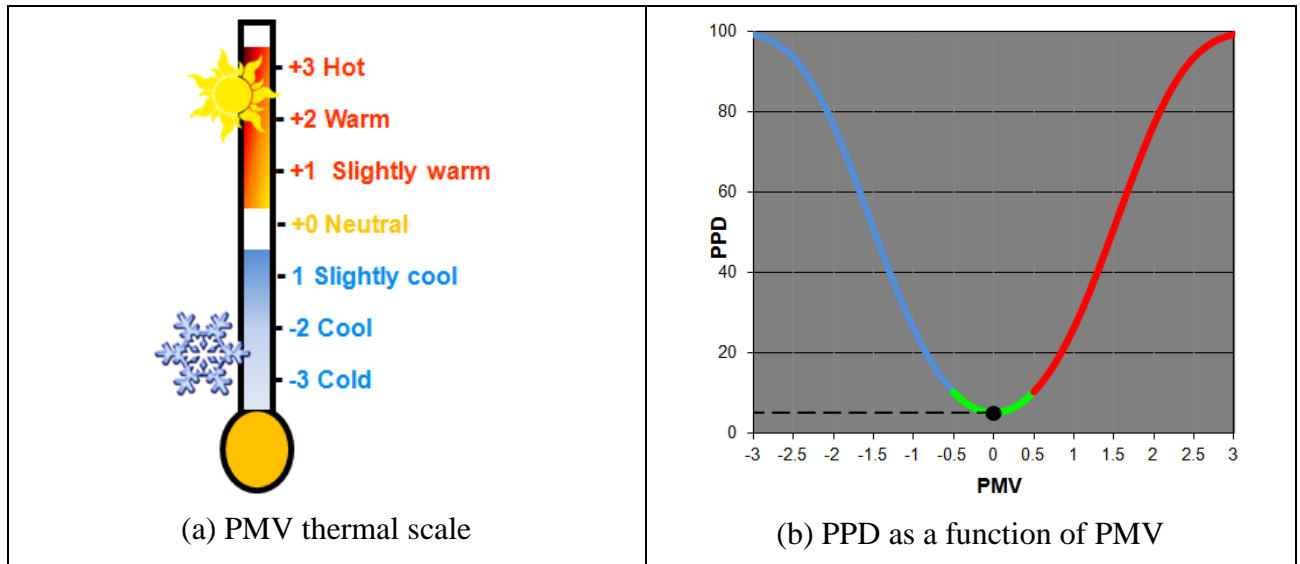

Figure 7.4 PMV and PPD

The PMV value is calculated through the following equation:

$$PMV = (0,303e^{-0.036 \cdot M} + 0,028) \cdot [(M-W) - 3,05 \cdot 10^{-3} \cdot \{5733 - 6,99 \cdot (M-W) - p_a\} - 0,42 \cdot \{(M-W) - 58,15\} - 1,7 \cdot 10^{-5} \cdot M \cdot (5867 - p_a) - 0,0014 \cdot M \cdot (34 - t_a) - 3,96 \cdot 10^{-8} \cdot f_{cl} \cdot \{(t_{cl} + 273)^4 - (t_r + 273)^4\} - f_{cl} \cdot h_c \cdot (t_{cl} - t_a)]$$

M = Metabolism, W/m^2 (1 met = 58.15 W/m^2)

W = External work met. Equal to zero for most metabolisms

l_{cl} = Thermal resistance of clothing, clo (1 clo = 0.155 $m^2 K/W$)

f_{cl} = The ratio of the surface area of clothed body to the surface area of nude body

t_a = Air temperature, $^{\circ}C$

t_r = Mean radiant temperature, $^{\circ}C$

v_{ar} = Relative air velocity, m/s

p_a = Water vapour pressure, Pa

h_c = Convective heat transfer coefficient, W/m^2K

t_{cl} = Surface temperature of clothing, $^{\circ}C$

Similarly, the level of discomfort called PPD (predicted percentage of dissatisfied) is calculated as:

$PPD = 100 - 95 \cdot e^{-(0.03353 \cdot PMV^4 + 0.2179 \cdot PMV^2)}$. Figure 7.4(b) shows the PPD as a function of predicted mean vote. For the optimal value of PMV, i.e. $PMV = 0$ the dissatisfied value is 5%, that is the lowest dissatisfaction value.

The agents in the behaviour model of the co-simulation done in chapter 5 perceive the temperature in the environment and decide their comfort based on the temperature alone. In this chapter however, the comfort of an agent is not solely based on the temperature but a more complex model of thermal comfort i.e. Fanger’s thermal comfort model. Figure 7.5 explains how Fanger’s model is used in the co-simulation and the different input variables required for calculating the PMV value. The agents in the Brahms simulation continuously perceive their comfort. This perception of comfort is provided by the Fanger’s thermal comfort model. Some of the variables i.e. the air velocity and humidity are kept constant in the simulation. The air temperature and mean radiant temperature is calculated by the SIMBAD thermal model, the metabolic rate depends upon the activities of agents and the clothing level depends upon the agents’ choices of clothes. The variations in these variables impact the agents’ comfort who then act on household appliances and objects to maintain the comfort level.

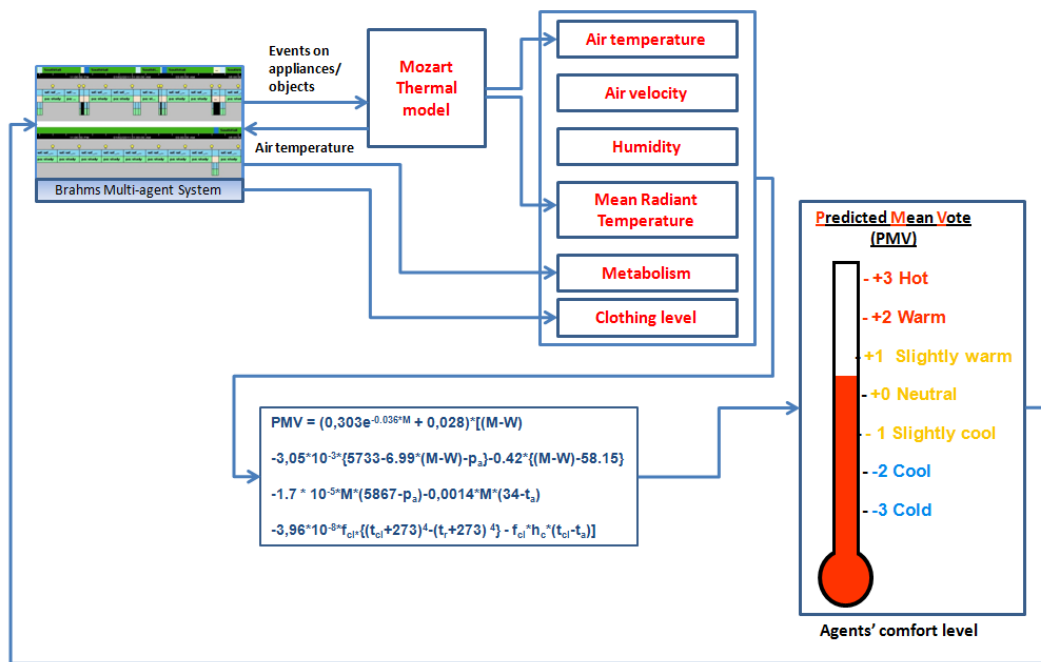

Figure 7.5 Fanger’s model in co-simulation

Figure 7.6 shows how the values for different clothes are calculated. In Brahms, the agents are provided with multiple options for each piece of clothing, e.g. for the choice of shirts, pants and sweaters. The reason for making these choices for each type of clothes randomly is that the clothes impact the thermal comfort levels. Although, the choices of clothes are dependent on the season and weather, however, in order to demonstrate the impact of different clothing combinations on the calculation of PMV, the choices are made randomly by the agents during simulation. Also, at first the agents are allowed to make these choices randomly, however, later with the perception of their thermal comfort they can modify these choices, for example, by putting on and taking off the sweater. The value for the chosen combination of clothes is then sent to the PMV calculator that will use it while calculating the agents’ comfort.

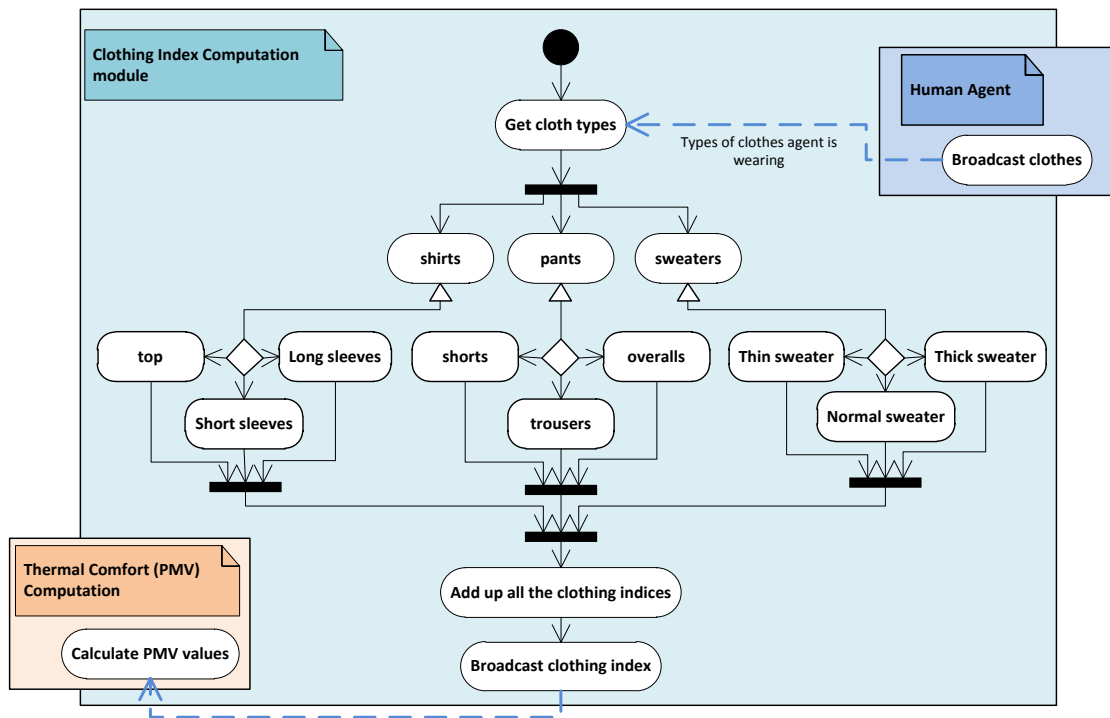

Figure 7.6 Clothing index computation module

Similarly, for the randomly selected activities by the agents, the metabolic rate is assigned and sent to the PMV calculator to use in the comfort calculation. Some of the examples of these activities include watching TV, cleaning, talking etc (Figure 7.7). The more exhausting the activity is, the higher is its metabolic rate, e.g. if the agents are simply sitting relaxing or watching TV, the metabolic rate will be 1.0. However, if they are involved in some activity that needs more energy e.g. cleaning, the metabolic rate will be 2, the metabolic rate can range from 0.8 to 8.0. The notion of dynamic comfort is also taken into account, where the comfort does not necessarily depend upon the PMV but varies dynamically due to the sudden change of thermal environment or body temperature. Here, it is assumed that if the agents are talking about some unpleasant subject, they will start feeling cold, besides of the fact that they were already comfortable, that is why this activity is assigned a lower metabolic rate.

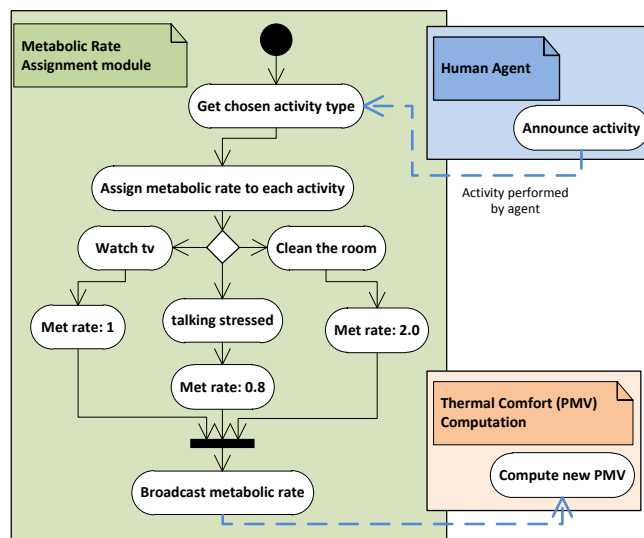

Figure 7.7 Metabolic rate assignment module

Finally, the temperature coming from the SIMBAD thermal model is continuously perceived by the temperature receiver in Brahms. It is then sent to the PMV calculator to calculate the agents' comfort level at each time step, Figure 7.8.

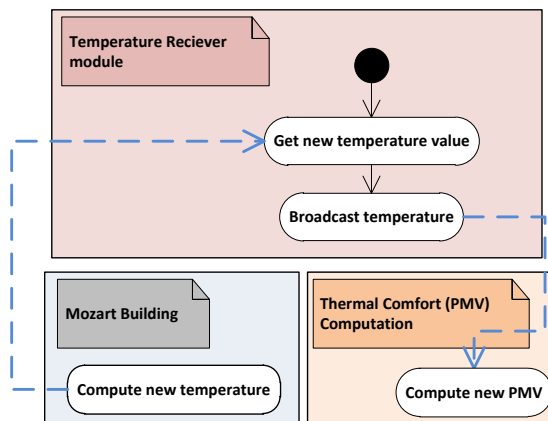

Figure 7.8 Temperature receiver module

Figure 7.9 shows how the PMV value is calculated. The PMV calculator continuously perceives the input variables coming from the “temperature receiver”, “clothing index computation” and “metabolic rate assignment” modules. It then uses Fanger’s model in order to calculate the comfort level for each agent separately and then broadcasts it to them.

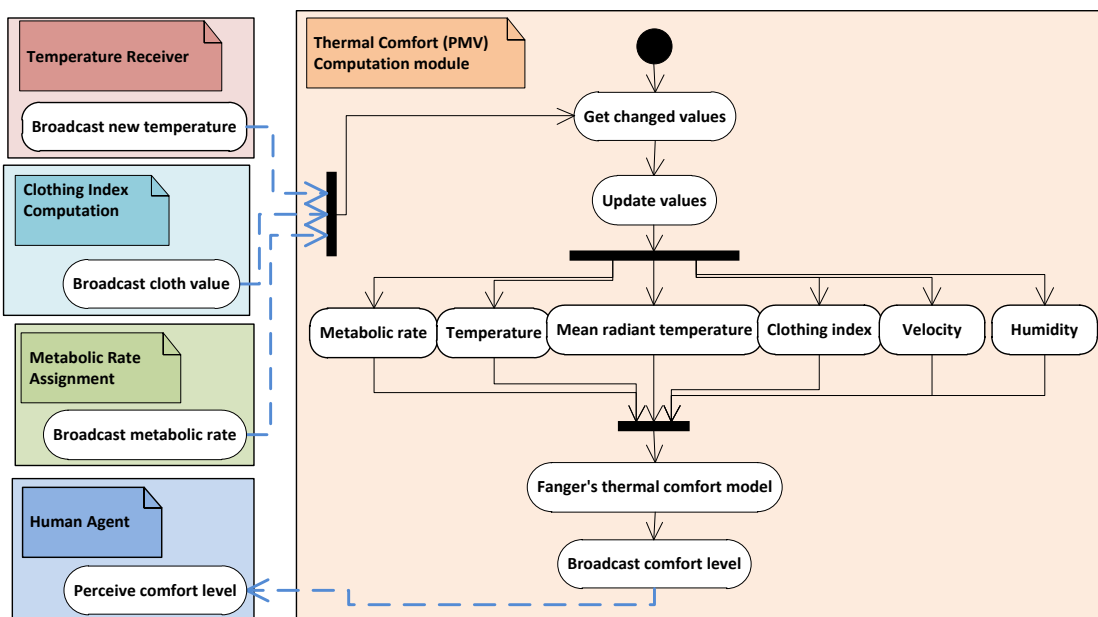

Figure 7.9 Thermal comfort (PMV) computation module

7.3 Co-Simulation Environment

The Brahms-SIMBAD-G-HomeTech⁴ co-simulation environment is shown in figure 7.10. The *Brahms-BEMS-Interface* module provides the interconnection of SIMBAD thermal model with both the BEMS and the Brahms simulation environment. The input that goes to this module from the SIMBAD thermal model is the air temperature and mean radiant temperature. Other inputs include the electric power of appliances, the setpoint temperature and the appliance mode (on/off). The

⁴ G-HomeTech is commercialized by Vesta System. The interconnection of BEMS with the co-simulator is established by Vesta System.

BEMS will use these variables to compute the energy plan and to control the appliances. Conversely, in Brahms these variables are perceived by the agents, who further take certain actions to control their thermal environment.

The output from this interface module either comes from the Brahms simulation environment or the BEMS. The output from Brahms simulation environment consists of occupancy data in each room in the house and the status/modes (on/off, open/closed) of all household appliances or objects. Similarly, the output from the BEMS consists of the setpoints and appliance modes.

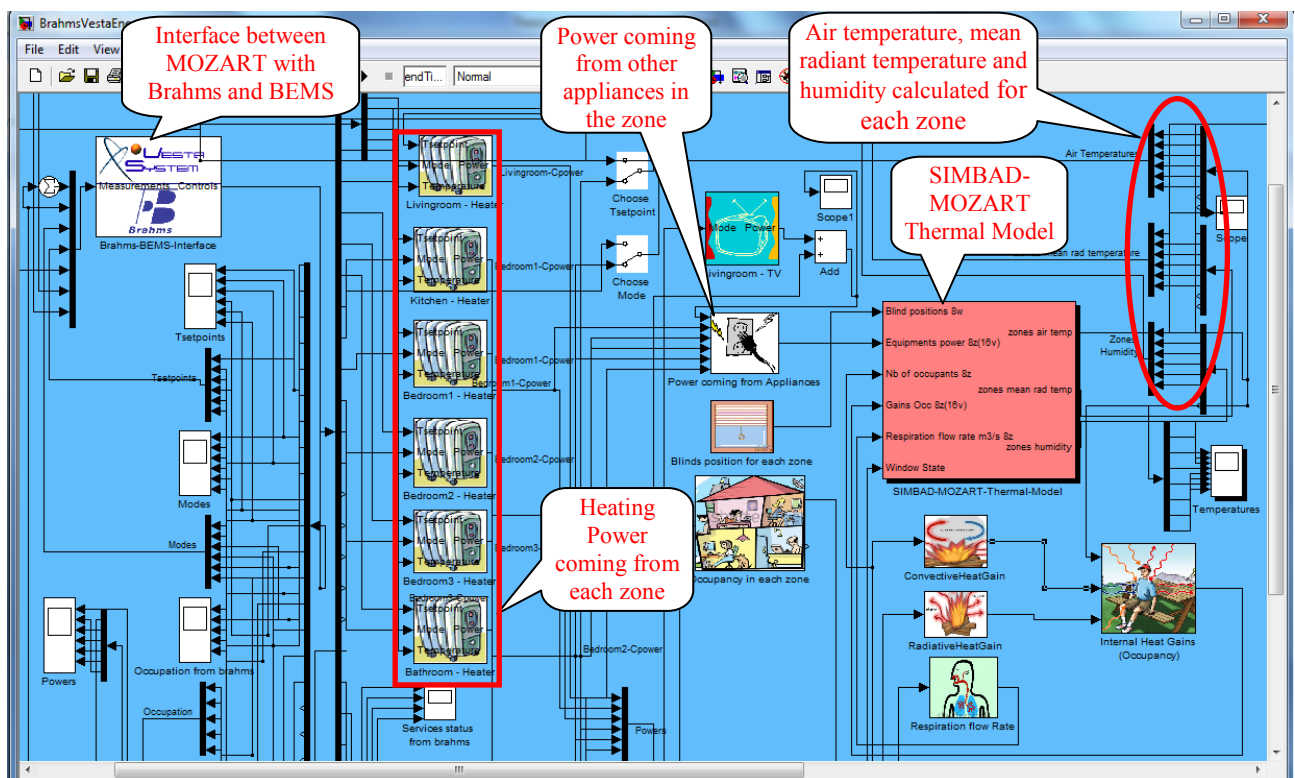

Figure 7.10 Co-simulation environment

The *SIMBAD-MOZART-Thermal-Model* module (Figure 7.10) continuously perceives the values coming from either the BEMS or the Brahms simulation environment and calculates the new temperature at each simulation step.

7.3.1 CO-SIMULATION WITH AND WITHOUT BEMS

In this section the co-simulation without and with the BEMS is performed. The purpose is to see how the inhabitants with different behaviours could possibly control the appliances to achieve a desired level of comfort. The inhabitants are categorized into two different types, inhabitants having “Eco-Behaviour” and others having “Non-Eco Behaviour”. “Eco-Behaviour” means that these inhabitants are always concerned about energy saving and achieve their comfort while not wasting the energy. “Non-Eco-Behaviour”, inhabitants are not concerned with energy savings and take the actions that can quickly make them comfortable. The sections below explain these different categories of people, their actions and the impact on energy consumption.

A scenario has been implemented in Brahms that incorporates the calculation in section 7.2.3. The scenario consists of a 2 person family, husband and wife, where the husband is an “Eco agent”, whereas the wife is a “Non-eco” agent. Figure 7.11 details the scenario, where the agents

have a routine that in the morning they alternatively move to the bathroom, come back to the bedroom and put on their chosen clothes. They, then move to the kitchen, have breakfast and go out to work. In the evening they come back home and perform different activities. Since in the evening the agents are coming back home from outside, when they enter the house, they feel comfortable for a short time, although it is relatively cold in the house. Local field studies have revealed that this is due to the notion of “Dynamic comfort”, meaning that the perception of comfort varies with sudden variations in the thermal environment of the agents. As the house is relatively warmer than outside, the agents will perceive it to be comfortable for a while. However, after a short period they will start perceiving that the actual temperature is very low.

As soon as the agents start perceiving their PMV value, they increase the temperature setpoint to be warmth. Since their perception of comfort does not solely depend on the temperature, but also on other factors, i.e. what activity they are involved in, what clothes they are wearing etc. The time at which they feel comfortable varies. As soon as an agent starts to feel warm it will take an action to be comfortable again. The EcoHusband agent would prefer to decrease the temperature by removing extra clothing and turning off the heater whereas the NonEcoWife agent would like to open the window to quickly become comfortable, without caring that the heater that is still working and that it is wearing too many clothes. The information about the control over the appliance/object is sent to the SIMBAD thermal model, where the new temperature for the room is calculated and sent back to the temperature receiver in Brahms. Based upon the new temperature the PMV values for all the agents are again calculated and broadcasted to them. The SIMBAD thermal model continuously calculates the temperature in the environment and sends this information to the PMV calculator at each simulation time step. Similarly, if the agent put on or takes off some clothes, this information goes to the clothing index calculator, that sends the recalculated value for clothing to the PMV calculator.

The comfort/discomfort of an agent is based on the homeostasis which further depends on the perceived PMV (comfort) values in this scenario. These values and the corresponding level of comfort/discomfort are shown in table 7.1 and figure 7.4. PMV values between -0.5 to 0.5 are considered comfortable for the agents. When the PMV value is between 0.5 and 1 the agent is slightly warm. However, as soon as it starts to feel warm (1 to 2), the agent takes some action to be comfortable again. However, if it does not take any action or if the action does not result the agent being comfortable again it will start feeling hot (2 to 3) or too hot (above 3). Similarly, if the PMV values start decreasing on the negative side, the agent will feel slightly cool (-0.5 to -1), cool (-1 to -2), cold (-2 to -3) or too cold (below -3). In order to depict and differentiate the perception of comfort, the agents will perform their current activity until they feel comfortable. As soon as they will start feeling uncomfortable, they will stop doing whatever they are doing and will take actions to be comfortable again. The agents can also first complete their current activity and then take the action, but in that case they would be continuously feeling uncomfortable during that period of time. Thus it is assumed in the model that when the threshold is reached they immediately react to the environment. Once they take the action they will resume the activity that they were previously doing.

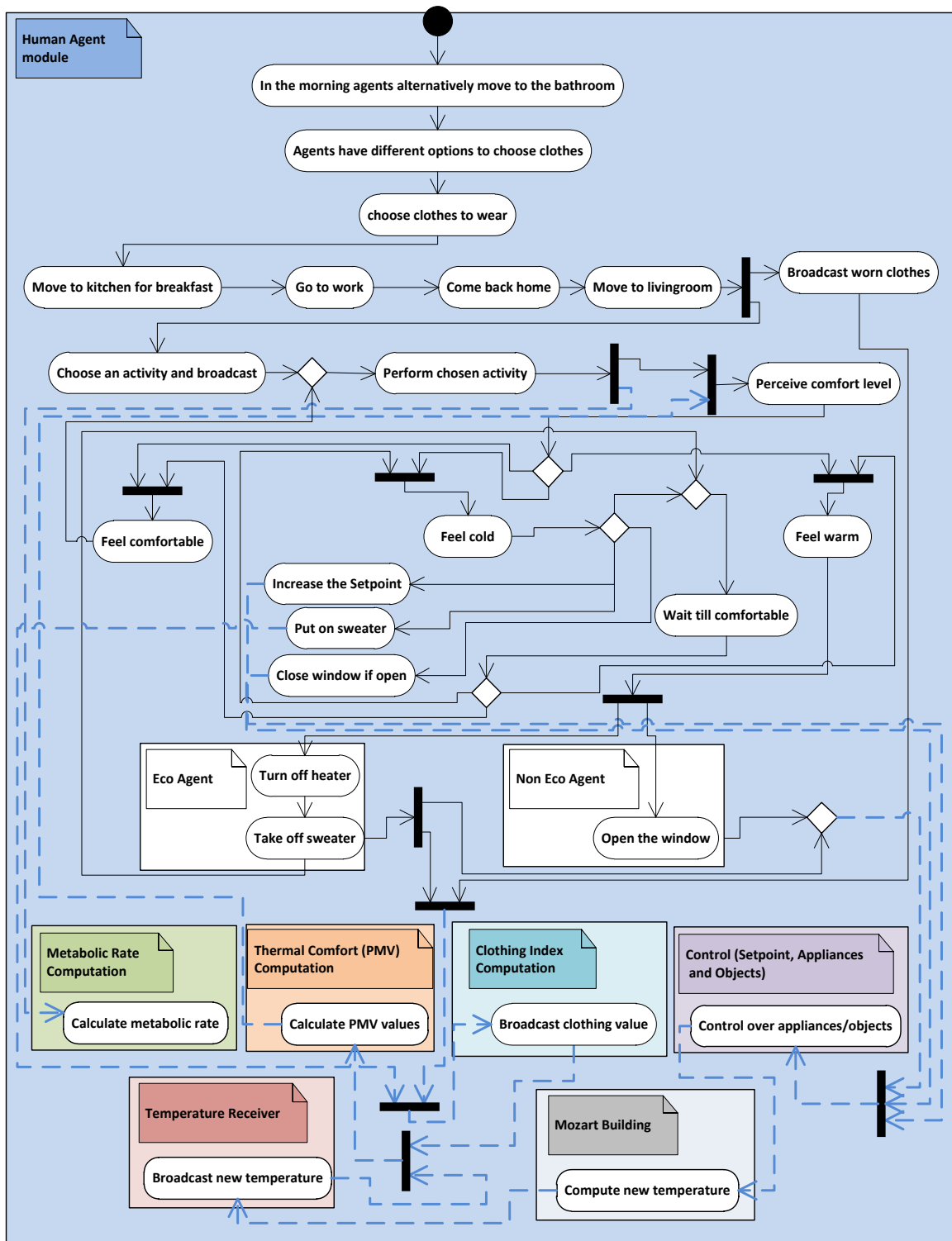

Figure 7.11 Activity diagram: inhabitants' behaviour scenario

7.3.2 ECO VS NON-ECO BEHAVIOURS

In this section the scenario explained in section 7.2.3 is simulated in Brahms simulation environment. Figure 7.12 shows a snapshot of the simulation where the EcoHusband and NonEcoWife agents move from bedroom to the bathroom. The movements are shown with the workframe having move activity. For example the movement of EcoHusband agent from Bedroom1 to Bathroom is shown at around 6:00am with the “move To Bathroom” activity having a time duration of 10 seconds. The agents then come back to the bedroom and choose some clothes to wear (Figure 7.14). For example, EcoHusband agent’s choice of clothes is shown by three workframes at

6:15 am where the tool tips represent what the agent chose to wear in each workframe against the given choices. Then they move to the kitchen, have the breakfast together and go to work (Figure 7.12).

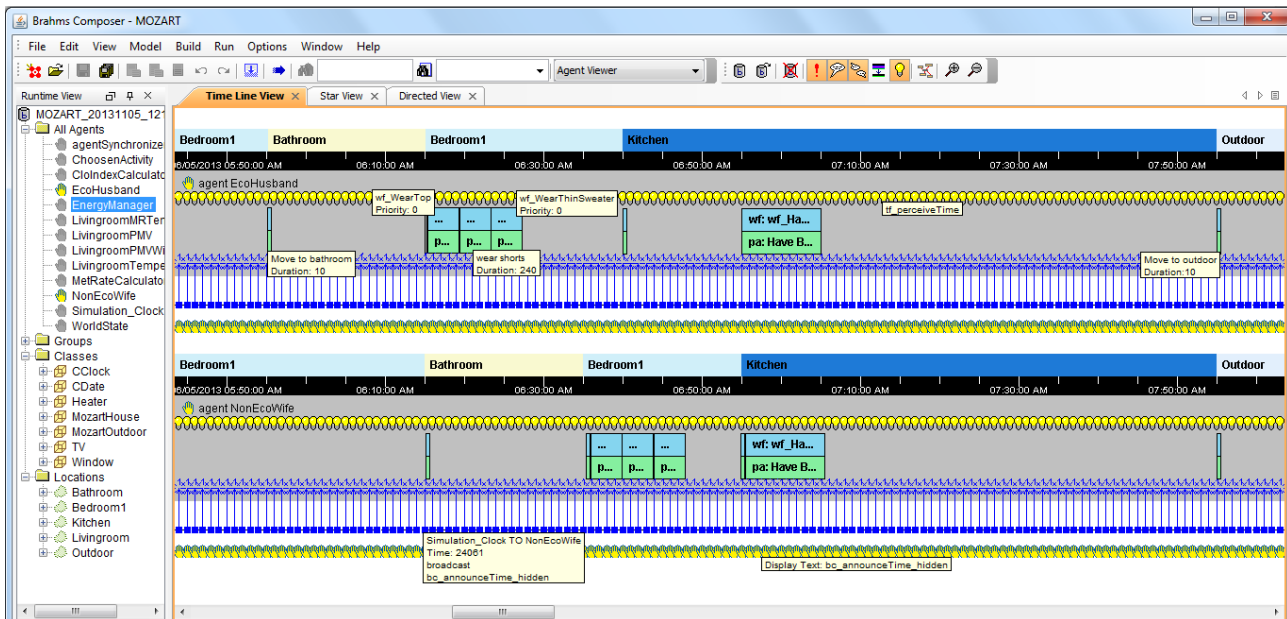

Figure 7.12 Brahms simulation: agents’ movements, activities and perception of environment

Figure 7.13 shows one of the possible situations of agents’ behaviour among many. This figure explains how the different concepts in the model, as explained in chapter 4, section 4.3.1 are implemented inside Brahms. The EcoHusband agent builds its *initial external state beliefs* from the perception of outside environment, as shown in the “Cognitive.Beliefs” block. Similarly, it perceives the thermal comfort level computed by the “ThermalComfortCalculator” function in the “Physical.Homeostasis” block. Based on this perception, the agent will build the *internal state belief* as shown in the “Cognitive.Beliefs” block. The values computed by this function lie in a range of -3 to 3 corresponding to different comfort conditions e.g. comfortable, slightly cool etc. These comfort conditions are realized by the concept of workframes, where there are multiple workframes available at the same time. This is shown in the “Belief Generation” block that defines the agent’s *internal state belief* generation rules through a set of workframes. However, depending upon the output of the “ThermalComfortCalculator” function one of them would be executed.

The agent is already in a state of watching TV as shown in the “AgentActivity” block inside “External (environment)” block which turns into its belief about its activity. If the agent is comfortable, slightly cool or slightly warm it would complete its current activity. For the other comfort conditions it could either continue the activity or abort it. An example of the “Cool” workframe is given in the “Belief Generation” block. This workframe says that if the agent’s comfort level is between -1 and -2, it is cool. This will generate some desires in the agent to be comfortable. The “Desire Generation” block shows the rules that will lead to the generation of these desires. These rules are realized by the thoughtframes where based on the fact that agent’s comfort level is below -1, that agent will conclude some other beliefs. These beliefs will be transformed into agent’s desires based on the “belief certainty” value. The higher value of this variable shows strong chances that the desire will transform into an intention and vice versa. The “Desire” block shows two desires that are generated, i.e. turn on heater and put on sweater. However, the low “belief certainty” becomes a constraint for the desire “wantToPutOnSweater” to be transformed into an

intention. Based on this intention, the agent turned on the heater and adjusted its setpoint as shown in the “Action” block. When the agent will turn on the heater and adjust its setpoint, the object heater will change its state. The changing states of objects will be captured again by the agents. This is done by the objects that broadcast the information about their states as soon as they are changed. The new beliefs of changing states of objects are further captured by the agents through the concept of thoughtframes that replace the old beliefs with the new ones. Now based on the state of the appliance and their impact on the temperature, the agent’s comfort level will change. The agent will remain in the workframe “Cool” and continue watching TV in the state of being cool until its comfort level is changed. As soon as the comfort level is changed, some other workframe, from the available ones, will be executed based on the comfort value as shown in the “Belief Generation” block. The execution of some other workframe can further lead to the generation of some new desires.

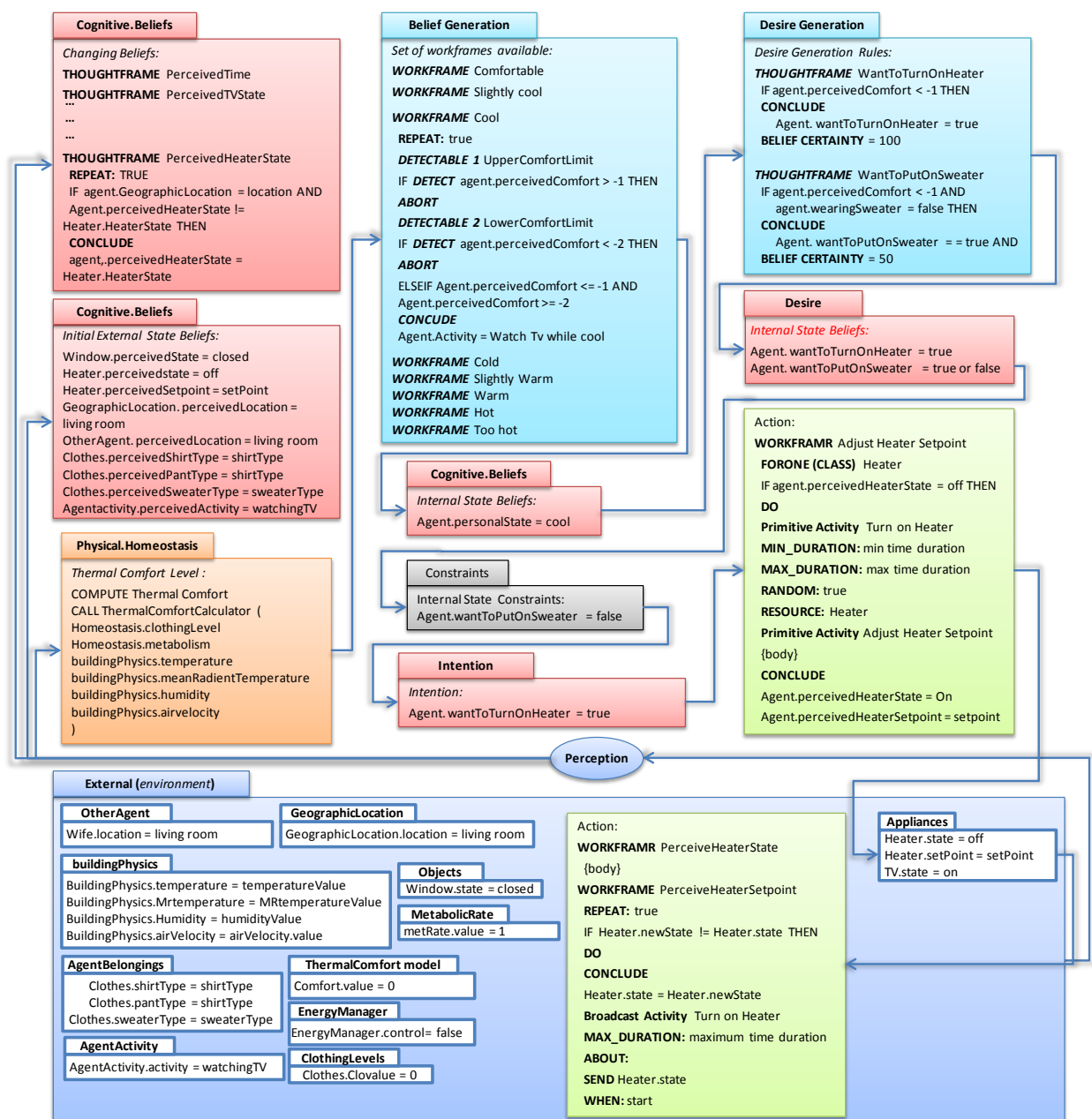

Figure 7.13 A situation modelled in Brahms

In the sections below the effect on environment by both types of agents (Eco and NonEco) and with and without the presence of BEMS are shown. This will help to analyze, how different behaviours with and without the BEMS could result in different energy consumption patterns.

7.3.3 ECO AGENT CONTROLS THE ENVIRONMENT WITHOUT BEMS

Both the eco and non-eco agents can have control over the environment. However, the agent that is uncomfortable first will take the decision to control the environment. Figure 7.16(c) shows the PMV value of the EcoHusband agent while in the living room. At the start the PMV value is low, meaning that the agent is uncomfortable, but the agents are still watching TV comfortably. This is shown by the “watch tv comfortably” tool tip on the white coloured workframe in the EcoHusband agent’s space at the start of the simulation (Figure 7.15). This is due to their dynamic comfort. However, after sometime they start perceiving the real comfort value and being uncomfortable. The EcoHusband agent increases the temperature using the heater’s thermostat to warm up the room. The control over the heating system is shown by yellow coloured workframes. The change in the state of heater by the EcoHusband agent is perceived by the heater, shown by the workframes in LivingroomHeater objects’ space. The blue lines show the connection between the change in heater’s state by the EcoHusband agent and the perception of this state by the heater. The LivingroomHeater object then broadcasts this change in its state to the other agents around, the blue lines show the signals sent to other agents. Figure 7.16(a) shows the state of the appliance as the agent acts upon it. Figure 7.16(b) shows that initially the temperature in living room was set to 18°C, it started increasing due to new thermostat settings of the heater by the EcoHusband agent.

The different levels of comfort of the agents are shown with different colour of workframes in the simulation outputs and PMV charts. The different shades of blue colour from lighter to darker show the PMV values on the negative side (i.e. feeling cold). Similarly different shades of red, from lighter to darker colour, show PMV values on the positive side (i.e. feeling hot). Table 7.1 shows the different colours, the PMV value, and the feeling of comfort.









PMV Value	Feeling of Comfort	Workframe Colour
Above 3	Too hot	
3	Hot	
2	Warm	
1	Slightly warm	
-0.5 to 0 to 0.5	Comfortable	
-1	Slightly cool	
-2	Cool	
-3	Cold	
Below -3	Too cold	

Table 7.1 Colours to represent agents’ comfort/discomfort levels

Figure 7.16(a,b,c,d) show the state/setpoint of the appliance, the temperature in the living room, and the thermal comfort perceived by the agents while watching TV. The state/setpoint and

temperature is taken from Matlab/Simulink output during the co-simulation. The PMV is drawn from the simulation output after parsing the text file generated by Brahms virtual machine. The simulation starts at 12:00am and continues till 12:00am the next day. Figure 7.16(a) shows the control of EcoHusband agent on the heater, its setpoint and the TV while watching TV. The x-axis shows the time in seconds and the y-axis shows the state and setpoint of appliances. In case of appliance state, 0 represents off state and 1 represents on state. The setpoint given under “LivingroomHeater Setpoint”, however, represents the temperature in degrees. The change in the state of heater is shown through up and down signals under “LivingroomHeater state”. Figure 7.16(b) show the temperature while watching TV when the agents enter at 4:00pm. In the simulation run, the EcoHusband agent is wearing the clothes that are warmer compared to NonEcoWife agent (Figure 7.14). Figure 7.16(c) shows the thermal comfort perceived by EcoHusband agent. In the start the agent feels cool (around 16h00, blue curve), but after turning on the heater its PMV value starts increasing, making him slightly cool (around 16h15, light blue curve) and then comfortable (around 16h30, green curve). Figure 7.16(b) shows that the temperature when the agent started feeling comfortable is 20.5°C. NonEcoWife agent however, is cold (around 16h10, dark blue curve) during this period. EcoHusband agent remains comfortable as long as the temperature remains below 24.3°C, but as it increases it starts feeling slightly warm up to 26°C. This is shown in figure 7.16(c) at around 18h30 with the light red coloured curve. As the thermostat settings are changed to a higher temperature by the agent, the heater is continuously working to increase the temperature to the new setpoint. Since, the EcoHusband agent wanted to quickly warm up the room it set the thermostat settings such that it eventually overheated the room, even beyond the agent’s own comfort. This eventually, makes the agent uncomfortable again.

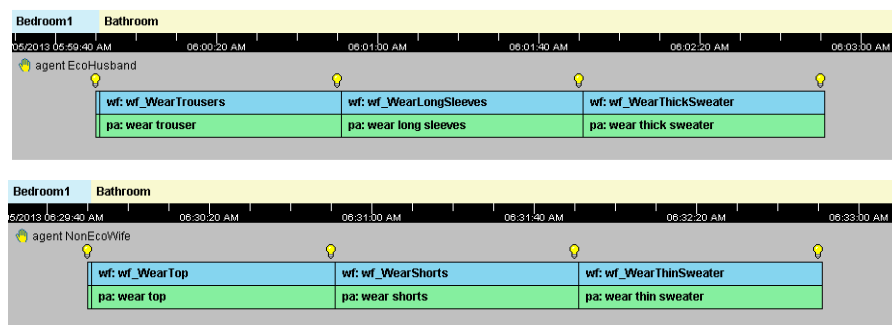

Figure 7.14 Brahms simulation: choice of clothes

Since the agent is an eco person, it would further control the environment by turning off the heater and putting off its extra clothing i.e. sweater. The agent assumes it is an ecological way to save energy and get comfort back. This effort will decrease the temperature after some time, and make him comfortable but will not be an efficient decision in the longer run. The agent starts feeling cold soon and then has to turn on the heater and put on the sweater again. Every time it takes some action i.e. adjusting the thermostat settings, putting on/off extra clothes, it takes some time to get the comfort back. Thus, even the best decisions made by the agent to save energy, are not sufficient in making him comfortable.

Figure 7.15 shows that when the agent is watching TV, it repeatedly controls the heater and its clothes to achieve comfort. The EcoHusband agent puts on the sweater or takes it off which is shown by the yellow coloured workframes with “put off sweater” activity. The first time agent puts off sweater is shown by the “put off sweater” activity tool tip around 6:26 pm. This information is sent to the clothing index calculator, shown by the blue lines between the EcoHusband and

CloIndexCalculator. Removing a thick sweater made its thermal comfort jump from warm to comfortable. This jump is shown by the yellow downward arrow (between 18h30 and 18h45) pointing from the warm to the comfortable direction. Similarly, when the temperature falls below its comfort level it turns on the heater again and puts on the sweater. Putting on the sweater again make the agent feel comfortable quickly. This is shown by the upward arrow (around 19h15) pointing from cool to comfortable. The effort made by EcoHusband agent could help him to save energy, but are not efficient in the longer run in terms of achieving comfort. This shows that the decisions taken by the eco-agent are short term decisions, as they have some fixed control over the environment, i.e. the heating system.

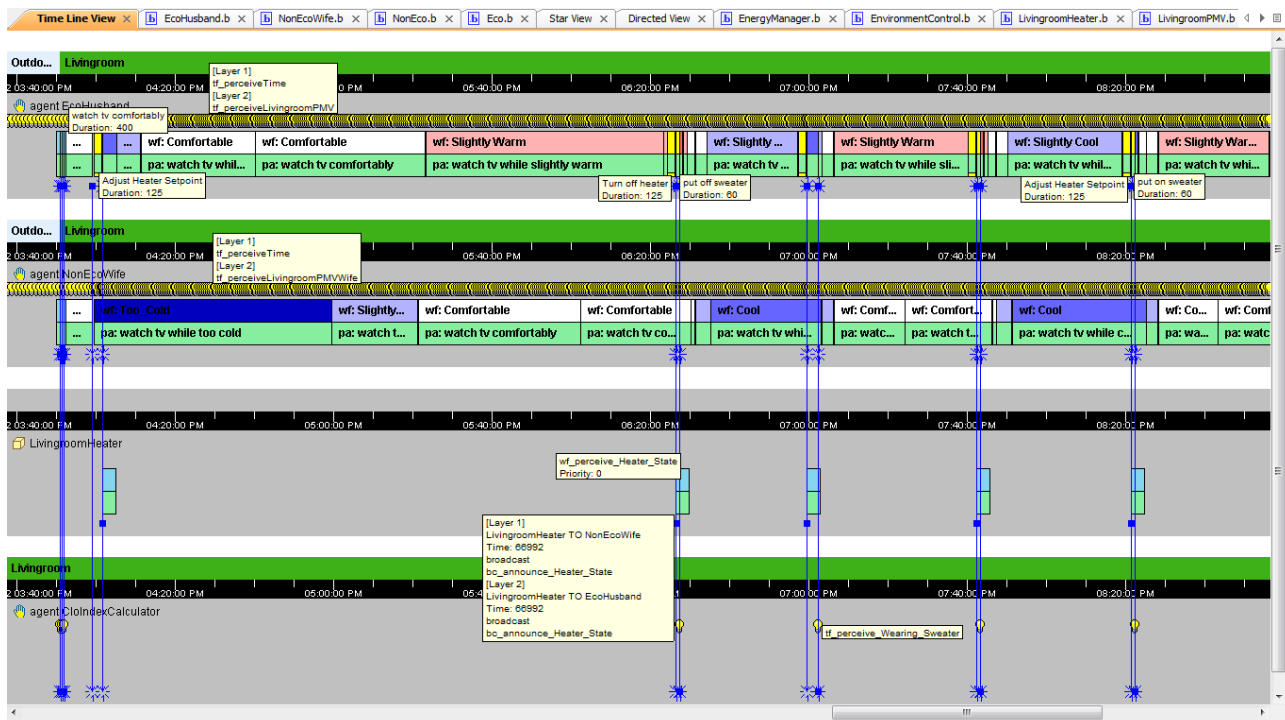
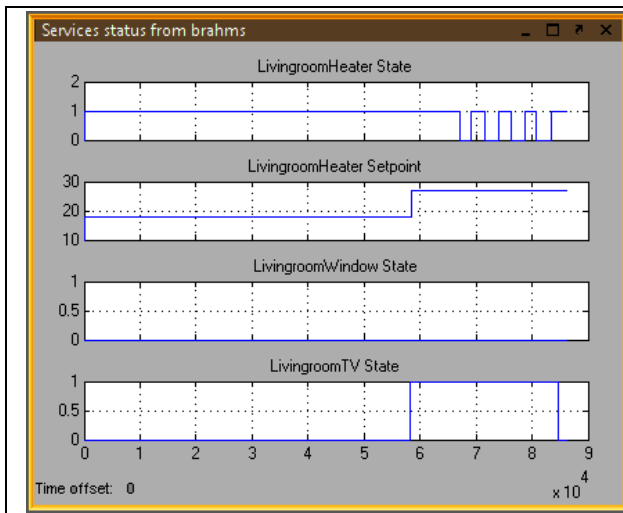
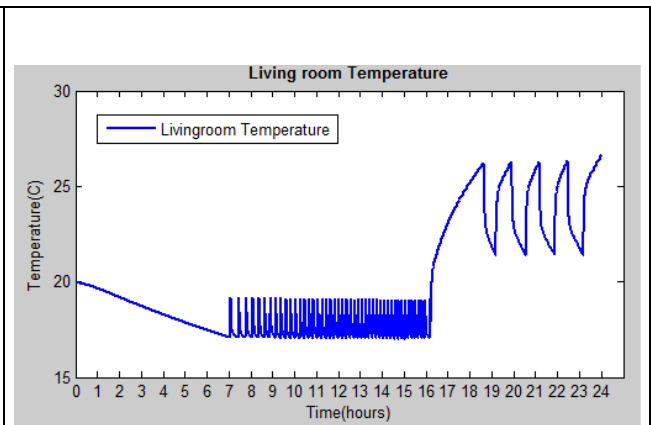

Figure 7.15 Brahms simulation: perception of comfort during watching TV activity

Figure 7.16(c) shows the thermal comfort perceived by NonEcoWife agent during watching TV while EcoHusband agent controls the heater. At the start it feels cold (around 16h10, dark blue curve) but then after the temperature has been increased it just starts to feel cool (around 16h20, blue curve). As the heating system increasingly warms up the room it feels comfortable (between 17h30 and 18h30, green curve) until the EcoHusband agent turns off the heater again. The reason that the agent is cold most of the time, is its clothing is not warm enough, as shown in figure 7.14.



(a) Control over appliance/object by EcoHusband



(b) Temperature as a result of control over environment



(c) PMV EcoHusband while watching TV

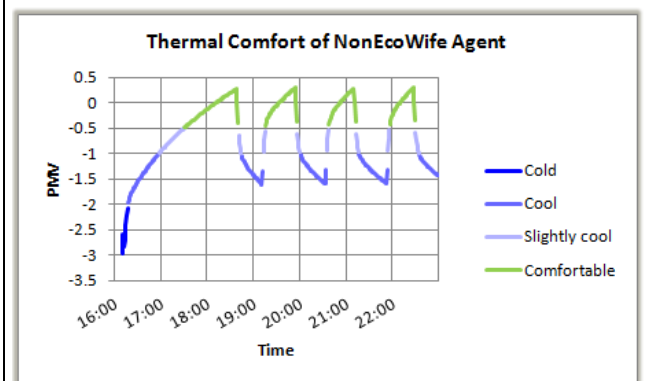

(d) PMV NonEcoWife while watching TV

Figure 7.16 State of the appliance/object, temperature, and PMV perceived while watching TV

Among the other parameters that affect the agents' thermal comfort is the activity being performed. Figure 7.17 shows the simulation when the agents are talking to each other. It is assumed that they are talking stressfully about an unpleasant topic that caused a lower metabolic rate for this activity. The EcoHusband agent increased the thermostat level to a higher temperature than in case of watching TV. This is shown by the yellow coloured workframe with the "Adjust Heater Setpoint" activity tool tip. Figure 7.18(a) shows that although the temperature setpoint is higher i.e 27°C, shown under "LivingroomHeater Setpoint" at around 16:00 pm, it is still feeling cold. The NonEcoWife agent wearing less warm clothes, even feels too cold.

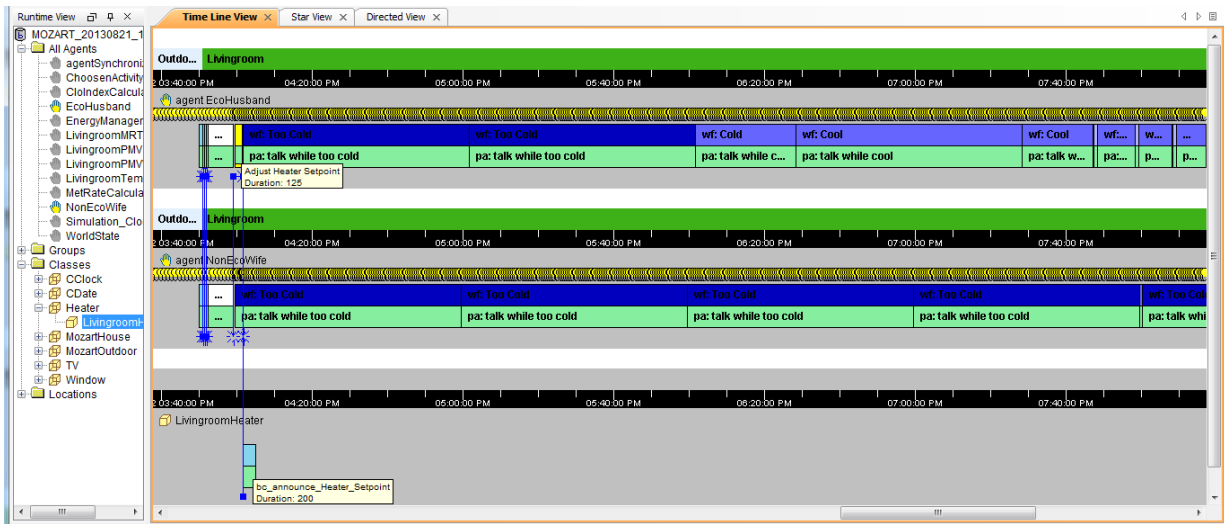

Figure 7.17 Brahms simulation: perception of comfort while talking

The increase in temperature in figure 7.18(b) at a higher setpoint is due to the talking activity where the agents are stressed. Their metabolic rate thus goes down and they need higher temperature to warm them up. Figure 7.18(c,d) shows the thermal comfort perceived by the agents while talking stressfully. Even though the temperature in the room is 27°C, the EcoHusband agent is cool and the NonEcoWife agent is cold most of the time. As the temperature moves up and down by one degree of the setpoint temperature (between 20h00 and 23h00), it affects the PMV value.

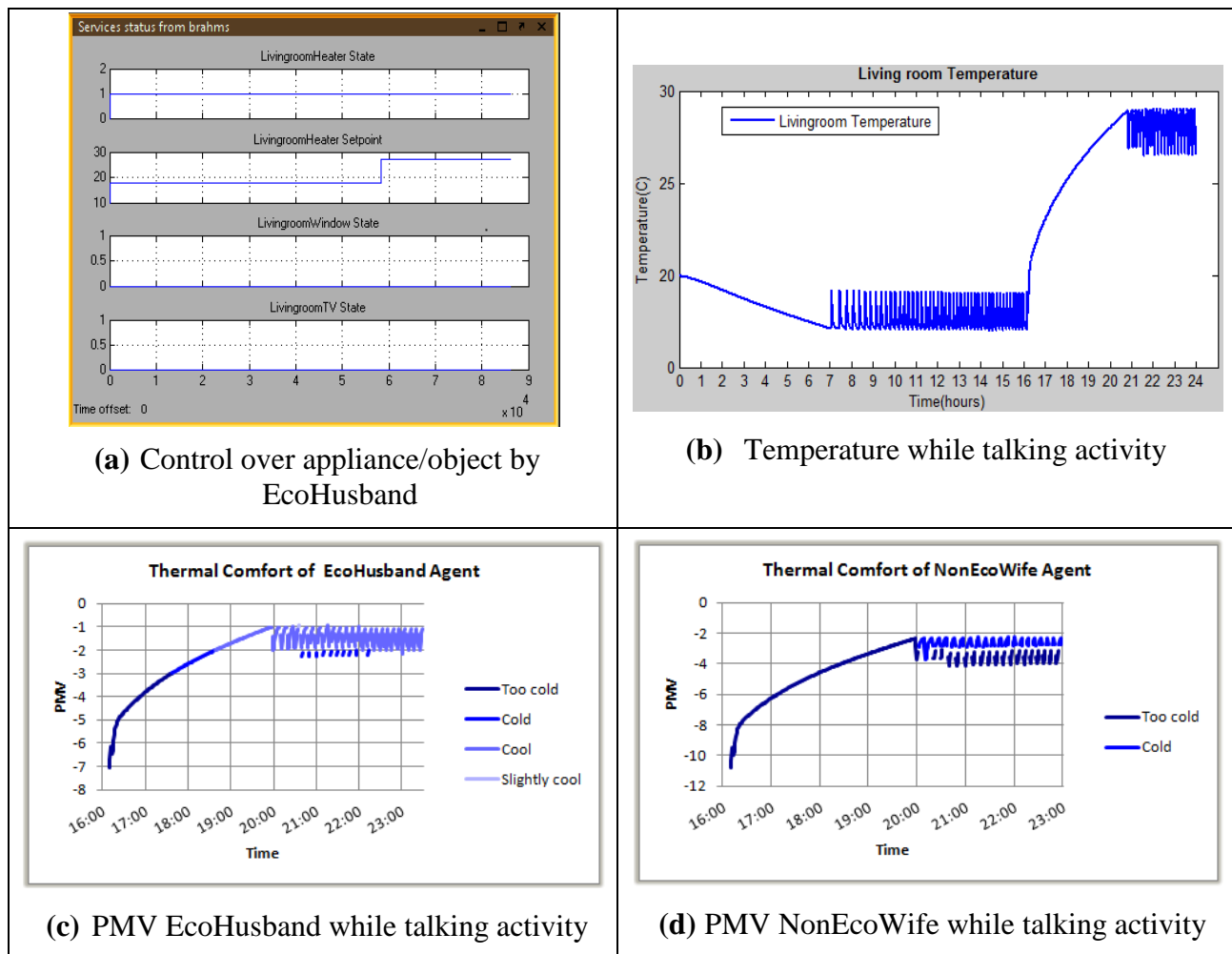

Figure 7.18 State of the appliance/object, temperature, and PMV perceived during talking activity

In case of a cleaning activity, the agent did not increase the thermostat settings. This is shown in Figure 7.19 where there is no yellow coloured workframe after the agents enter the living room in contrast to figures 7.15 and 7.17. This is due to a higher metabolic rate during cleaning that makes the agents comfortable even at a temperature that was not acceptable with other activities i.e. watching TV, and talking stressfully. Since, EcoHusband agent is wearing more clothes than NonEcoWife agent, it sometimes feels slightly warm shown by the pink coloured workframes in the EcoHusband agent's space. NonEcoWife agent, however, remains comfortable due to its less warm clothes, shown by the white coloured workframe in NonEcoWife agent's space.

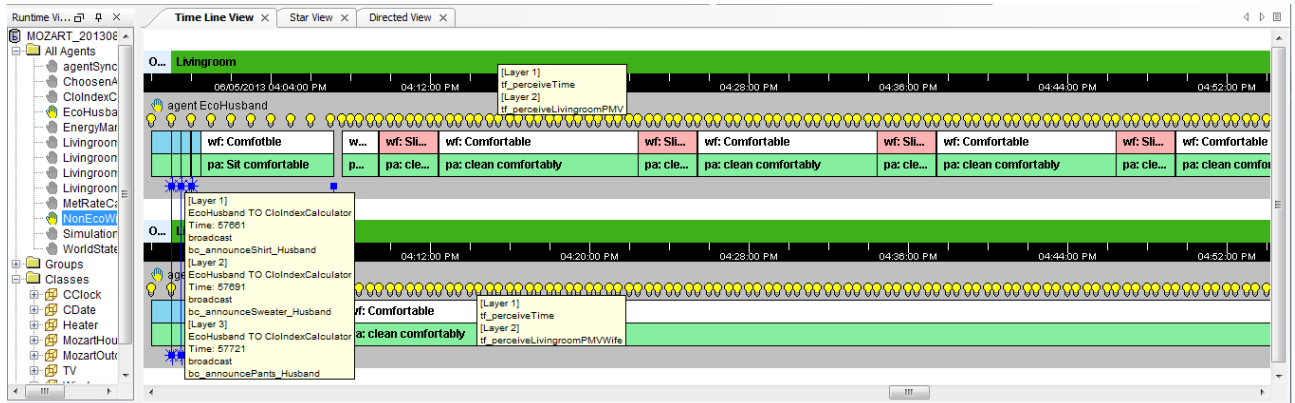
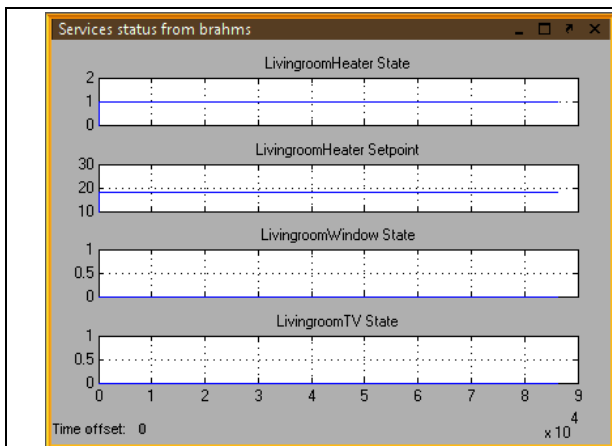
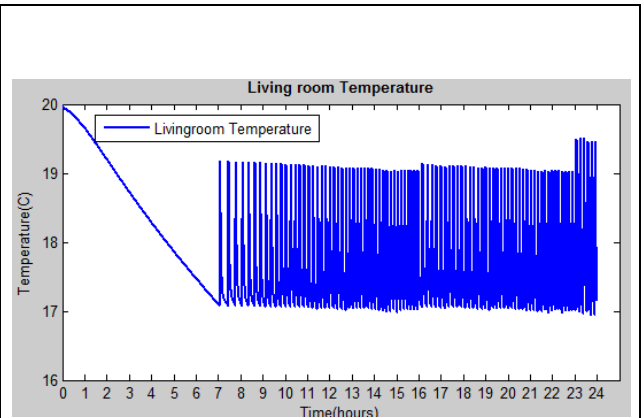

Figure 7.19 Brahms simulation: perception of comfort while cleaning

Figure 7.20 shows appliance state during cleaning activity, where the temperature once set to 18°C, shown under “Livingroom Heater Setpoint”, is never changed later by the agent, due to the high metabolic rate while cleaning activity. In figure 7.20(a,b) the agents are satisfied with the temperature, which was already set at 18°C, since they are involved in cleaning that causes a higher metabolic rate. Figure 7.20(c,d) shows the comfort perceived by agents while cleaning. EcoHusband agent feels comfortable (green curve) when the temperature is around 17°C and slightly warm (pink curve) as the temperature rises to 19°C, figure 7.20(c). NonEcoWife agent however remains comfortable as it is already wearing less warm clothes.



(a) Control over appliance/object by EcoHusband



(b) Temperature while cleaning

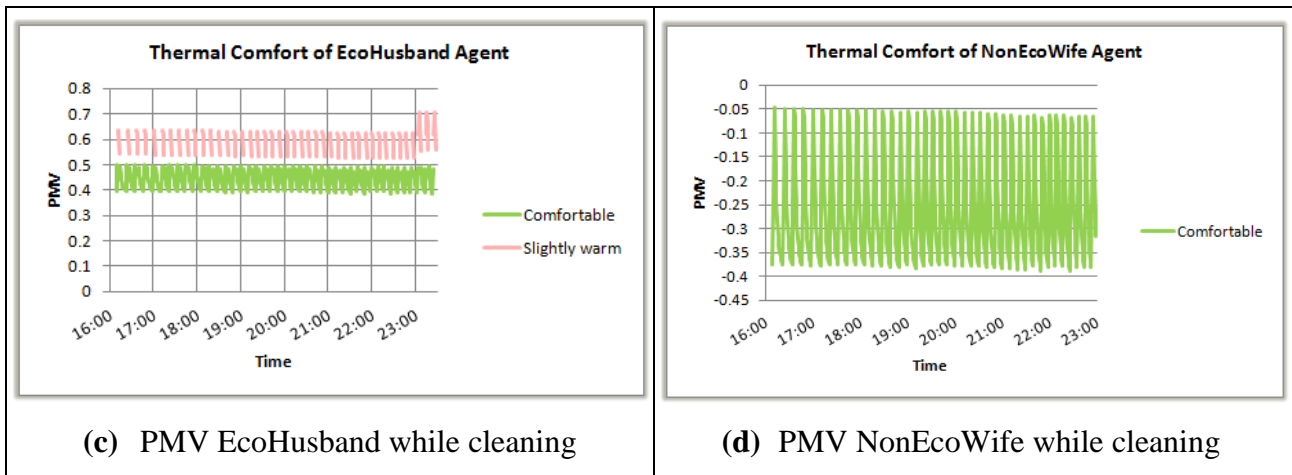

Figure 7.20 State of the appliance/object, temperature, and PMV perceived while cleaning activity

7.3.4 ECO AGENT CONTROLS THE ENVIRONMENT WITH BEMS

In the previous section, the simulation results show that the EcoHusband agent takes actions that appear to be good regarding energy consumption but agent's decisions to achieve a trade-off between cost and comfort may not be relevant. The energy management system cannot only control the environment itself but can also communicate with the inhabitants so that they may make better decisions. In this section, the simulation is run by including the energy management system in the co-simulation environment.

Figure 7.21 shows the interconnection of the energy management system with the other modules of the co-simulation environment. The BEMS can perceive the requests by the agents and also the changes to the appliances/objects states. Agents can express discomfort to the BEMS if they enter the home and are uncomfortable. The BEMS controls the heater by increasing the setpoint to a minimum level where the agents feel comfortable. The new temperature is then calculated by the thermal model and sent back to the temperature receiver in Brahms. The PMV values, when calculated against this temperature could either satisfy the agents with the decision taken by the BEMS or they will be unsatisfied. Their level of satisfaction depends on what type of clothes they are wearing, what activity they are involved in, etc.

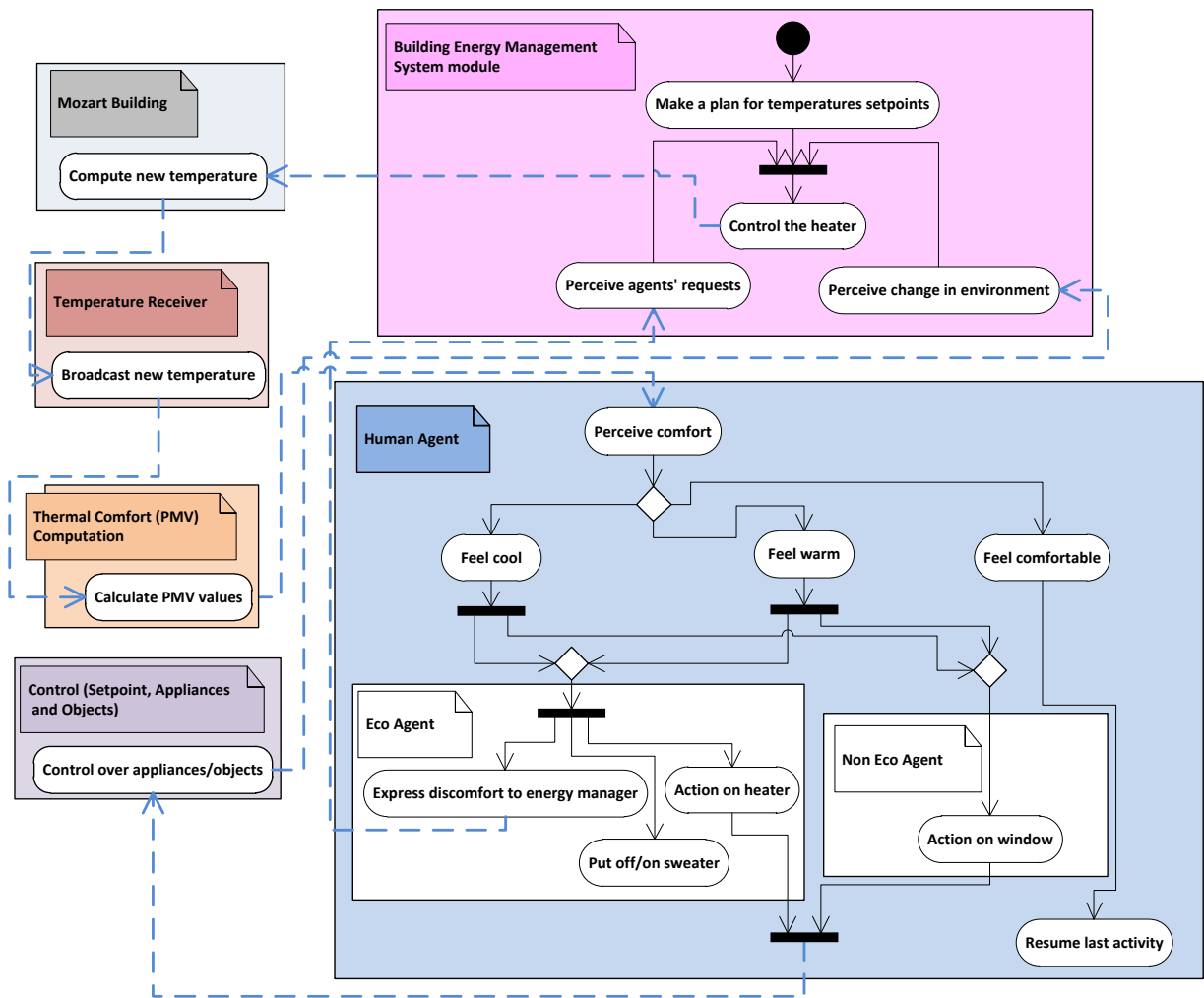

Figure 7.21 How energy management system controls the environment

The agents do not always use the BEMS, they may also control the heater and windows themselves sometimes in order to be comfortable. In this case the BEMS continuously perceives the environment and uses its previous knowledge about agents' comfort to interrupt and control the environment to a better comfort level.

The previous scenario where the EcoHusband agent controls the environment while watching TV is now run with the BEMS. Instead of turning on the heater all the time, the BEMS turns on the heater in the morning for some time and then turns it off. This is shown in figure 7.23(a) by the up and down signals at around 11:00 am. The corresponding change in temperature is shown in figure 7.23(b) between 11h00 and 12h00 where it remains 18°C for some time. However, if the heater has not been turned on and it remained off before agents' arrival, the temperature in the room would decrease faster. Since, the agents are not present in the house there is no need to waste energy. However, in order to make them comfortable when they come home, the room should be warmed up beforehand. The question is why the BEMS chose to warm up the room in the morning and not just before the agents come home. The reason is that the energy tariff varies on different days and at different times. Since, the BEMS has the information about the energy pricing from the grid, it tries to warm up the room when the energy prices are low. It then again turns the heater on as the agents come into the living room, shown by the yellow coloured workframe in EnergyManager's space in figure 7.22. The BEMS increases the setpoint temperature from 18°C in the start to 20°C, before the agents enter the living room. This is shown in figure 7.23(a) under

LivingroomHeater Setpoint at around 16h00. However, the agents still find this temperature uncomfortable and EcoHusband agent communicates its discomfort to the BEMS. This is shown by the yellow coloured workframe in the EcoHusband’s space at around 4:30 pm. The “Express Discomfort to Energy Manager” tool tip on that workframe represents the communication activity executed under this workframe. The blue lines show the transfer of information between the EcoHusband and the EnergyManager. EnergyManager in figure 7.22 represents the BEMS, it captures the signals coming from Matlab/Simulink and communicate them with the agents and objects. The BEMS then sends the request to the heater to further increase the temperature to 23°C. This is shown in figure 7.23(a) under LivingroomHeater Setpoint at around 16h30. The corresponding change in temperature is shown in figure 7.23(b) around 16h30 where the temperature stays at 20°C for some time and then increases up to 23°C. The new PMV values are computed and EcoHusband agent is comfortable after sometime as shown by the white coloured workframes in EcoHusband’s space in figure 7.22. Similarly, in figure 7.23(c) the thermal comfort of EcoHusband is shown to be cool in the start (around 16h10), then it became slightly cool and finally comfortable at around 17h00 (the green curve). NonEcoWife agent is however, feeling cool and then slightly cool due to its light clothing. This is shown by the “Cool” and “Slightly_cool” workframes in NonEcoWife’s space in figure 7.22 and by the blue and light blue coloured curves in figure 7.23(d).

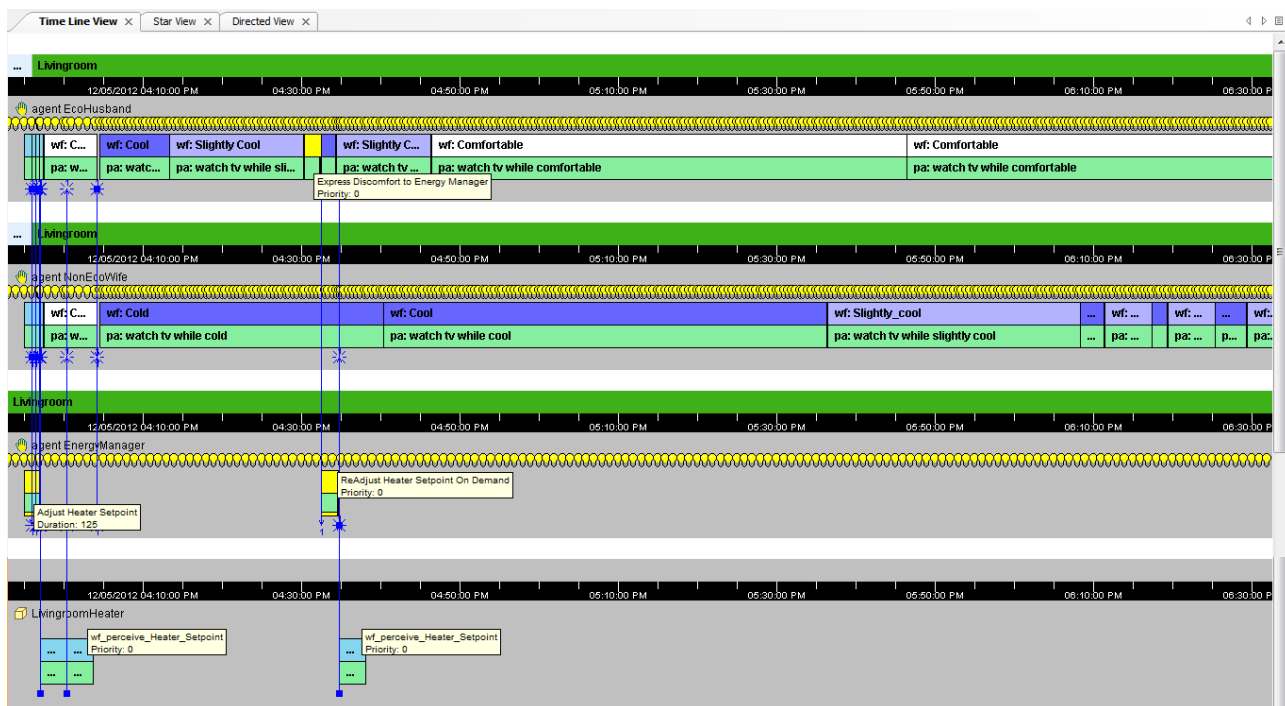
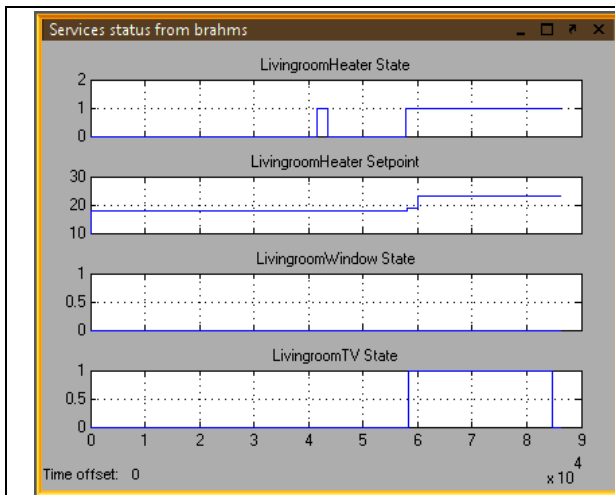
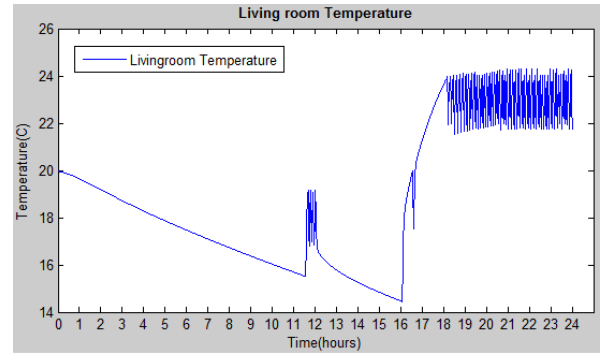

Figure 7.22 Perception of thermal comfort and behaviour during communication with BEMS



(a) Agent demands better comfort from BEMS



(b) Temperature controlled by agent and BEMS

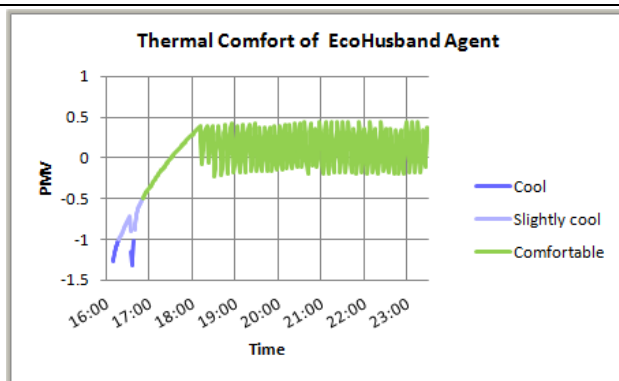

(c) PMV perceived by EcoHusband agent

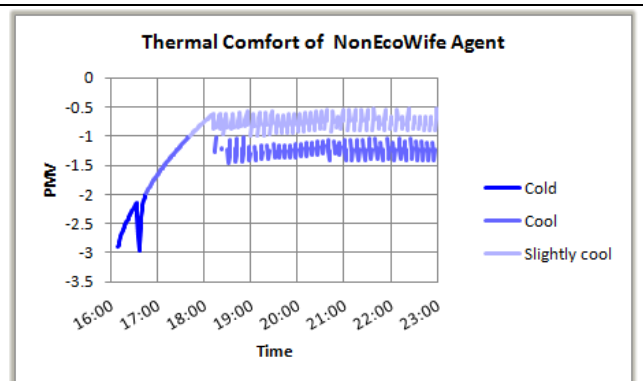

(d) PMV perceived by NonEcoWife agent

Figure 7.23 State of the appliance/object, temperature, and PMV perceived during simulation with BEMS: case 1

Figure 7.24 shows another situation where the BEMS turned on the heater an hour before the agents enter the living room, shown by the yellow coloured workframes at around 3:00 pm in EnergyManager’s space. The reason for this is that energy tariff is low at this hour of this day. The EcoHusband agent expressed discomfort to BEMS and BEMS adjusted the heater to a new value. This communication is shown by the yellow coloured workframes at around 4:20 pm in EcoHusband and EnergyManager’s workspace. This time however, when the BEMS increased the temperature and EcoHusband agent started feeling comfortable, it removed its sweater, shown by “put off sweater” tool tip at this workframe around 5:30 pm. This caused him to be uncomfortable with the setpoint adjusted by the BEMS and it did not communicate to the BEMS. It rather itself increased the setpoint to a higher value and put on the sweater. This is shown by the “Adjust Heater Setpoint” tool tip and “put on sweater” tool tips on these workframes in EcoHusband’s space at around 5:40 pm. The blue line going from this workframe to the workframe in LivingroomHeater’s space show that the EcoHusband agent directly controlled the heater without any intervention by the energy manager. These actions helped the agent become comfortable shown by the yellow coloured upward arrow showing the jump from one thermal condition to another in figure 7.25(c) at around 18:00. The temperature further went up to 26°C, shown in figure 7.25(b) at around 19h30. Now again it starts feeling warm and turns off the heater. At this point when the temperature starts decreasing, the BEMS interrupts the agents’ decisions and does not let the temperature fall below 23°C by controlling the heating system. The state of the heater is shown in figure 7.25(a) under

“LivingroomHeater State” where the signal first goes to zero and then to one due to BEMS interruption. This is shown by the “Set Temperature Intelligently” tool tip in EnergyManager’s workspace at around 07:30 pm. Thus the EcoHusband agent remains comfortable with the decision taken by the BEMS shown by the green curve in figure 7.25(c) between 20h00 and 23h00. The temperature when controlled by the BEMS, also helps NonEcoWife agent to remain in the slightly cool to comfortable condition rather than being cool or cold (Figure 7.25(c,d)). This is shown by the light blue and white workframes in NonEcoWife’s space in figure 7.24 and by the light blue and green curve in figure 7.25(d) between 20h00 and 23h00.

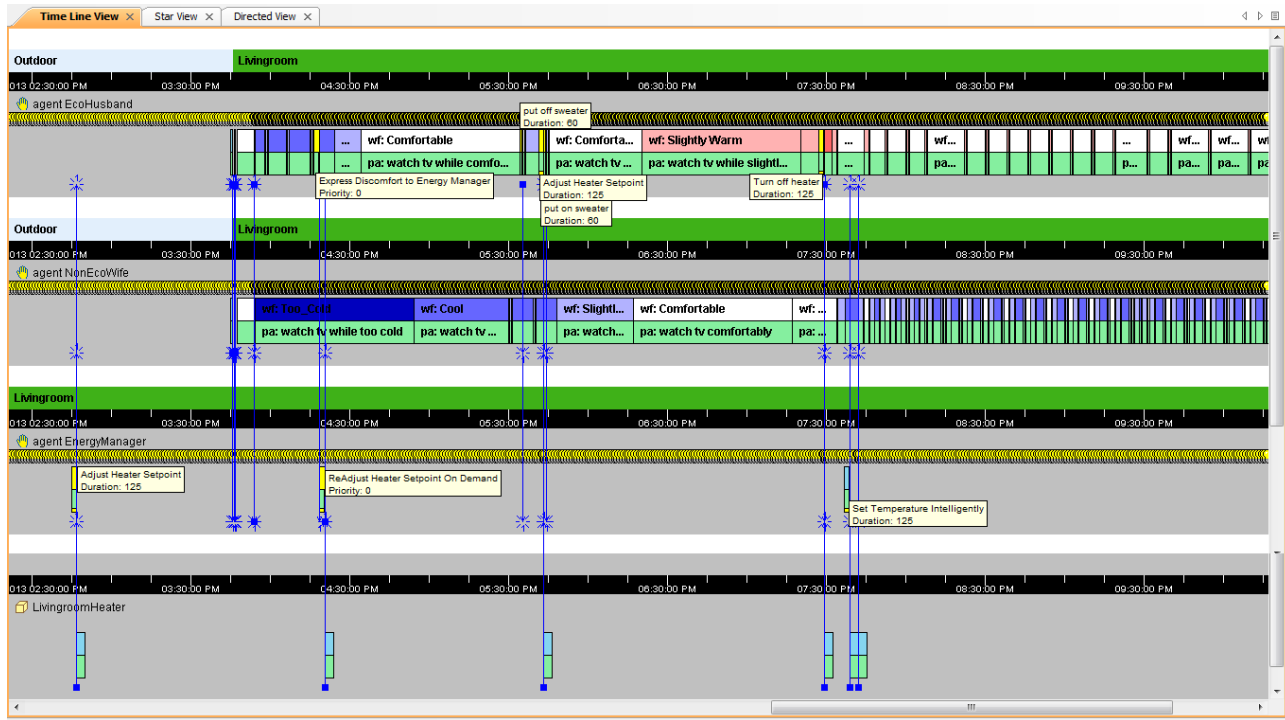
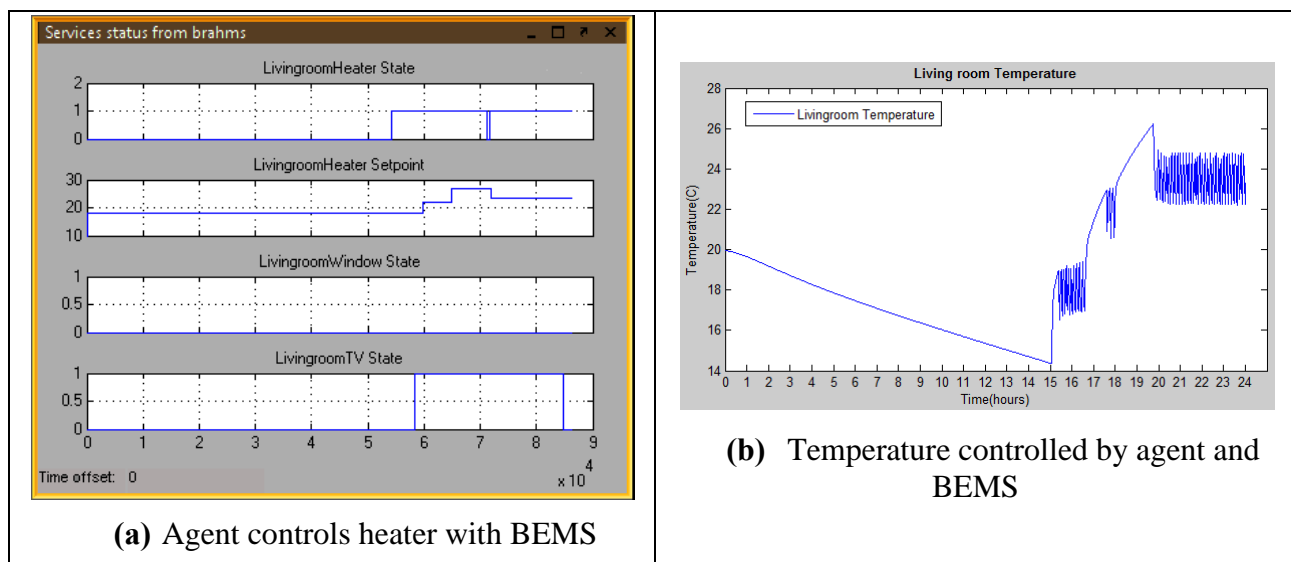

Figure 7.24 Brahms simulation: inhabitant’s behaviour and BEMS’s control over environment



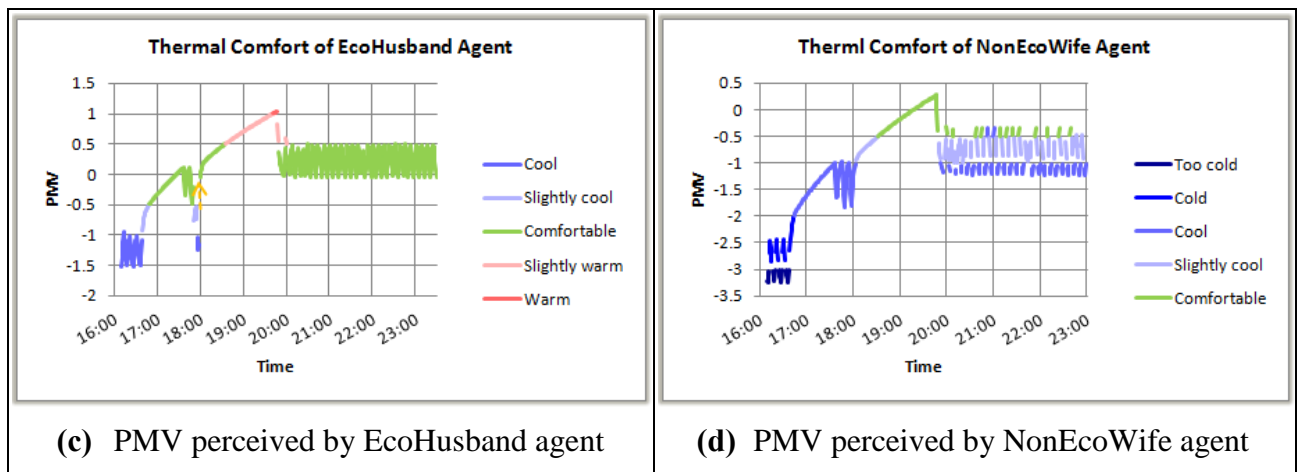

Figure 7.25 State of the appliance/object, temperature, and PMV perceived during simulation with BEMS: case 2

7.3.5 NON-ECO AGENT CONTROLS THE ENVIRONMENT WITHOUT BEMS

Figure 7.26 shows another simulation run where in the beginning when EcoHusband agent turns on the heater. The two agents are feeling cool at the start but as soon as the EcoHusband agent increase the setpoint, they started feeling comfortable. Figure 7.26 shows the “Cool” and “Slightly Cool” workframes for both agents, just after the “Adjust Heater Setpoint” activity at around 04:20 pm. Both figures 7.26 and 7.27 shows that the EcoHusband has become comfortable after NonEcoWife agent due to its less warm clothes. Later when NonEcoWife started feeling warm it decides to lower the temperature to be comfortable. Since, NonEcoWife agent always prefers to be comfortable quickly without caring about energy, it opens the window (Figure 7.26), the yellow coloured workframe with “Open window” activity at around 6:20 pm. It neither lowers down the thermostat settings or turns off the heater, nor removes any extra clothes. As it is cold outside, due to air transfer between the inside and outside of the building, the temperature starts decreasing in the room. This is shown by the decreasing temperature curve at around 18h30 in figure 7.27(b) where the impact of opening and closing the window on living room temperature is calculated by the SIMBAD thermal model. This decrease in temperature takes some time as the heating system is still working to maintain its setpoint temperature initially adjusted by the EcoHusband agent. However, after some time when the room becomes cold, the agents become uncomfortable and NonEcoWife agent closes the window. This is shown in figure 7.26 by the yellow coloured workframe with “Close window” activity at around 7:40 pm and in figure 7.27(b) by the upward temperature curve at around 20h00. Although, NonEcoWife agent has succeeded in maintaining its comfort (Figure 7.26) it had to expend some effort again and again by opening and closing the window as shown in figure 7.27(a) by up and down states of the window under “LivingroomWindow State”. Figure 7.27(a,b) shows the thermal comfort perceived by the agents during watching TV. The NonEcoWife agent is feeling cool at the start shown by the blue curve at around 16h15 (Figure 7.27(c)) but as soon as the EcoHusband agent increased the setpoint, it started feeling comfortable, shown by the green curve. The EcoHusband agent comfort level improved from being cold to cool as shown by the blue curve in figure 7.27(d) between 16h20 and 17h00 but it was not as comfortable as NonEcoWife agent due to its less warm clothes. The agents NonEcoWife after sometime started feeling slightly warm at around 17h30 and then warm. It then opens the window and becomes comfortable quickly.

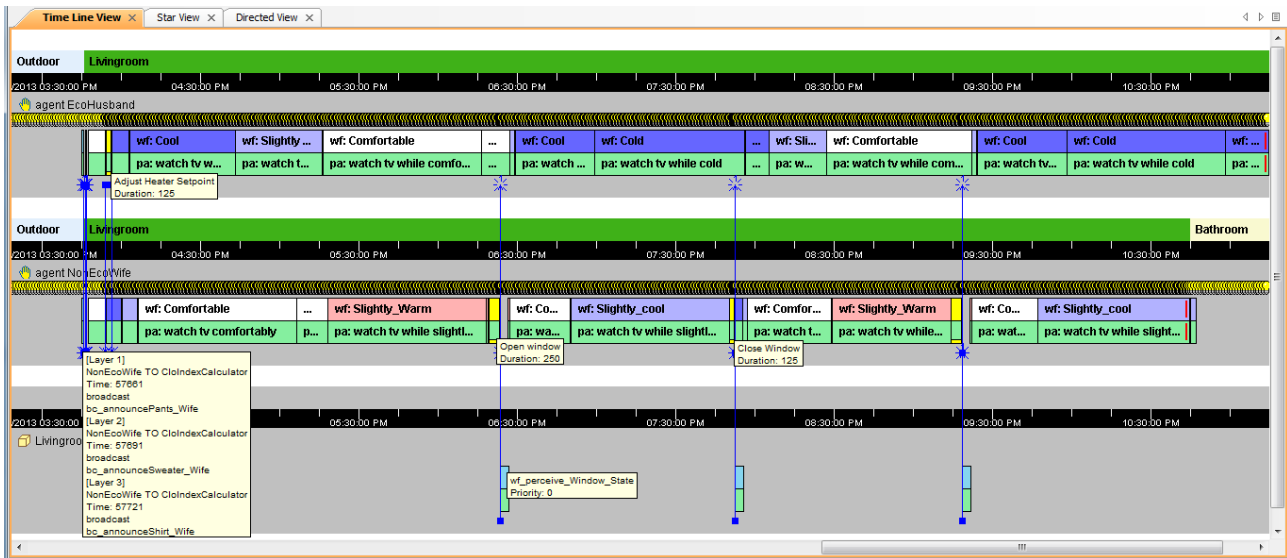

Figure 7.26 Brahms simulation: watching TV and control by the NonEcoWife of the environment

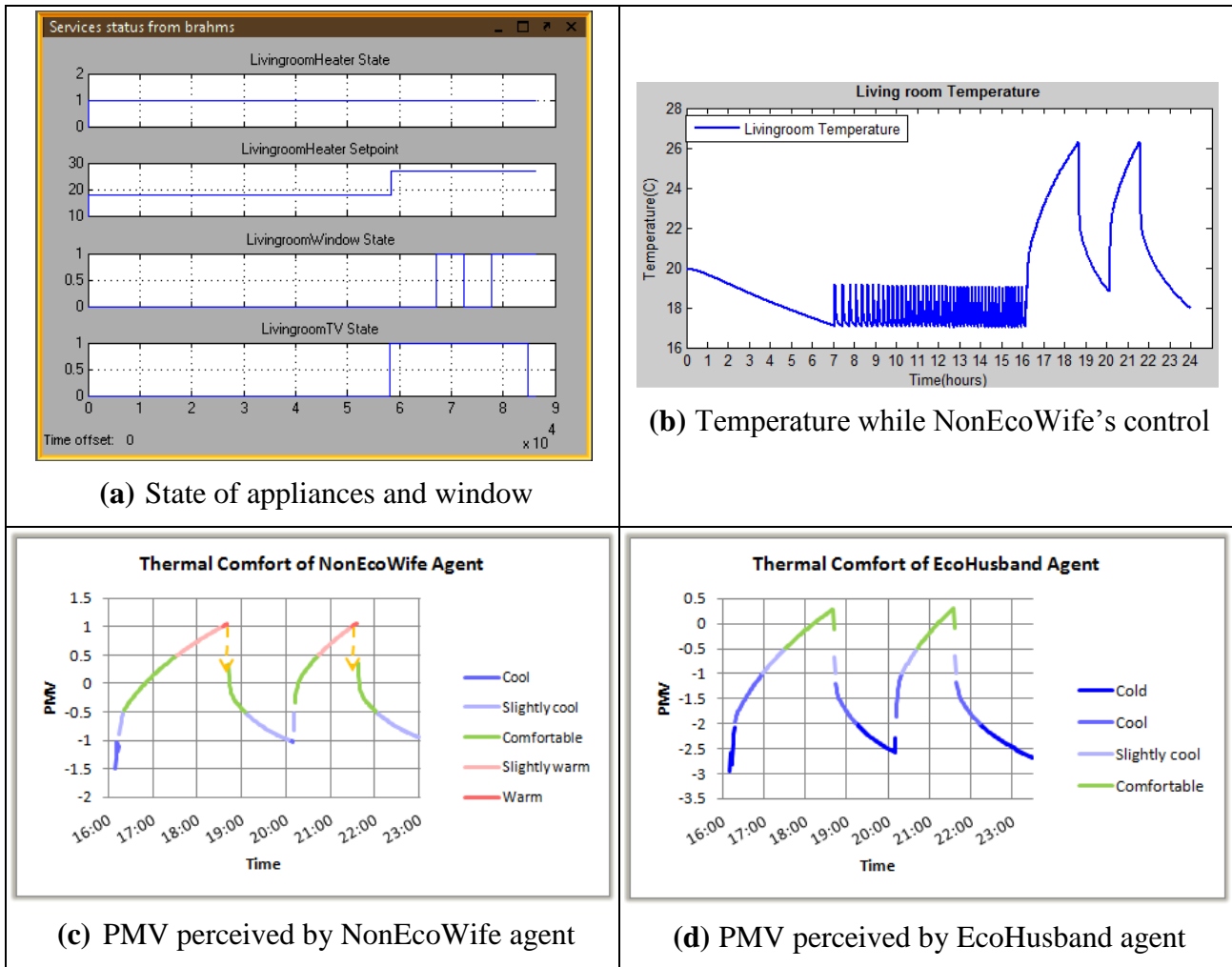

Figure 7.27 State of the appliance/object, temperature, and PMV perceived while NonEcoWife controls the environment without BEMS

7.3.6 NON-ECO AGENT CONTROLS THE ENVIRONMENT WITH BEMS

In the above section the impact on the temperature of the room is analyzed while the NonEcoWife agent who does not care about energy saving, leaves the heater on while opening the window.

Figure 7.29(c,d) shows the thermal comfort perceived by the agents. Figure 7.29(c) shows the thermal comfort of NonEcoWife agent. At the start it is feeling slightly cool (light blue curve at around 16h15) with the temperature set to 18°C. As the agents entered in the room, EcoHusband agent increased the setpoint temperature. This is shown by the yellow coloured workframe with “Adjust Heater Setpoint” activity in figure 7.28 that caused the NonEcoWife agent feel comfortable as shown in figure 7.29(c) with green curve between 16h20 and 17h30. EcoHusband agent however still remains cool (shown by the blue curve) due to its less warm clothes becoming comfortable later at around 17h30 (Figure 7.29(d)). Figure 7.29(b) shows the temperature in the living room. As the temperature reaches above NonEcowife agent’s comfort which is 24°C, it becomes slightly warm, shown by the pink curve in figure 7.29(c), at around 17h30. However, as the temperature reaches 26°C, it becomes warm and then opens the window shown by the yellow coloured workframe with “Open window” activity in NonEcoWife’s space. However the BEMS would perceive that the agent has opened the window, control the heater, and lower down the setpoint temperature. This is shown by the workframe in EnergyManager’s space with “Set Temperature Intelligently” activity. As the temperature in the living room now comes down more quickly to a level where NonEcoWife agent starts feeling slightly cool, it closes the window earlier than in the absence of a BEMS. Figure 7.29(a) shows the status of the window under “Livingroomwindow State” where the window is closed much earlier than without BEMS as shown in figure 7.27(b). Thus there is less energy loss by reducing the time period where the heater is trying to reach a higher setpoint and the window is open. Afterwards, the BEMS maintains the temperature at a setpoint where the agents feel comfortable in the longer run and do not need to control the environment by themselves. Thus the BEMS not only saves energy and makes the agents comfortable over the longer run, but reduces their cognitive workload.

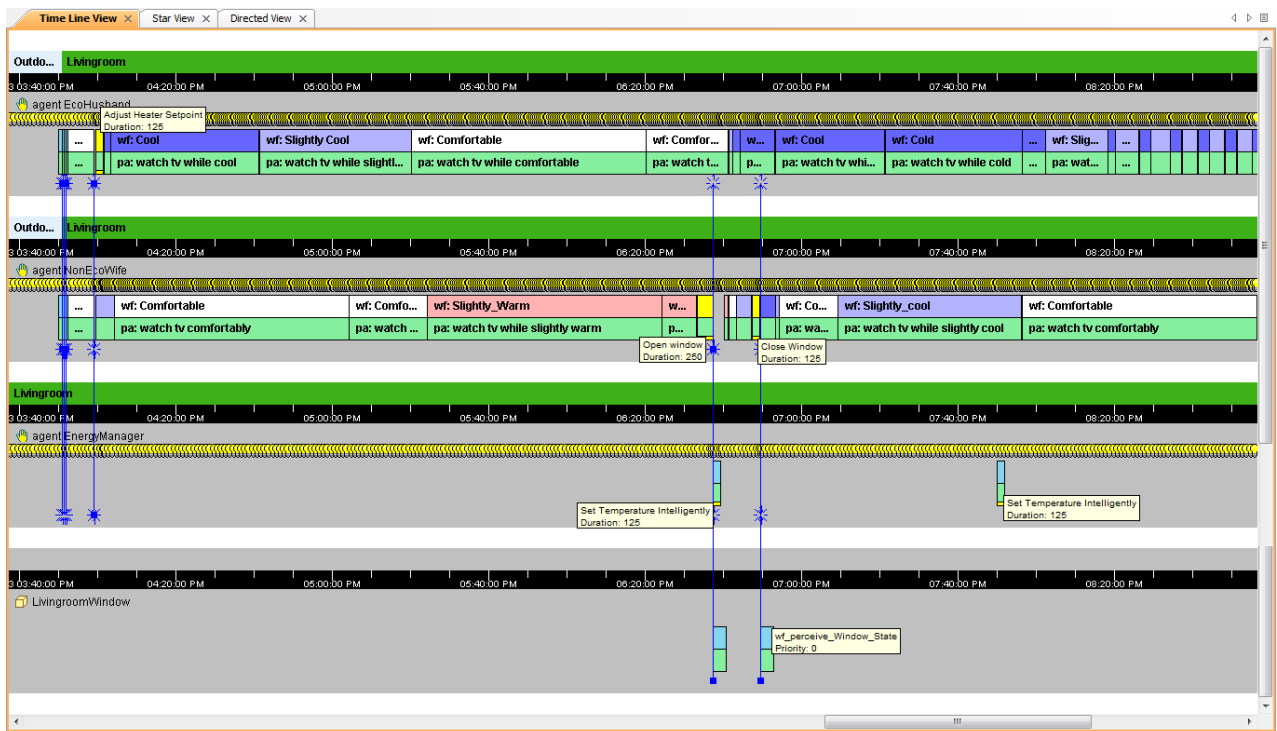

Figure 7.28 Brahms simulation: NonEcoWife and BEMS controls the environment

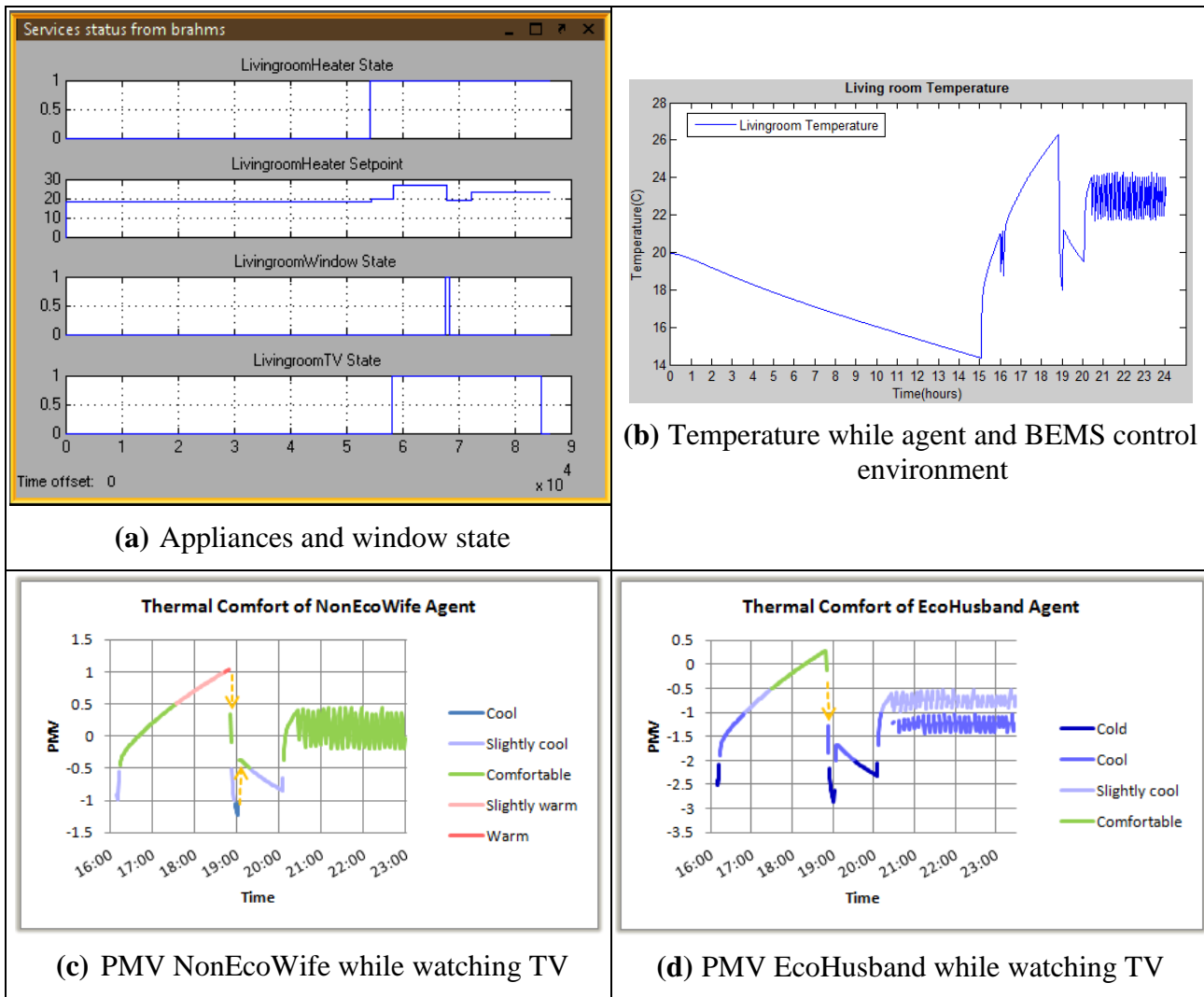

Figure 7.29 State of the appliance/object, temperature, and PMV perceived while NonEcoWife controls the environment with BEMS

7.3.7 ECO VS NON-ECO BEHAVIOURS WITH AND WITHOUT BEMS

In this section an analysis of the cost-comfort tradeoff for the situations with and without the BEMS will be given. Note that the BEMS does not take the decisions alone but the agents are also part of the control. Thus the role of BEMS becomes more challenging as it has to put more effort in order to minimize the cost and maximize the comfort. To quantify the comfort of agents the PMV values obtained after the simulation runs are summed up for different PMV levels (Figure 7.30(a,b)). Since EcoHusband agent is not only concerned by the comfort but also the energy savings and in this effort it remains less comfortable than NonEcoWife agent (Figure 7.30(a)). Mostly, it remains in slightly cool or slightly warm due to having more interactions with the heater to control the temperature. NonEcoWife agent, however, remains more comfortable than EcoHusband agent, as it is not concerned about energy savings and wants to achieve comfort at any cost. Figure 7.30(b) shows the thermal comfort durations of agents with the inclusion of a BEMS in the system. In this case, the divergence of agents' comfort levels is reduced and they converge to the comfortable zone. Also, the agents remain comfortable for a longer time duration as compared to before i.e. without BEMS. In this case EcoHusband agent's comfort is better than NonEcoWife agent. The improvement in the comfort is due to the better decisions taken by the BEMS based on the

knowledge that the BEMS has about the internal and external environmental conditions, weather forecasts, inhabitant's comfort and self learning algorithms.

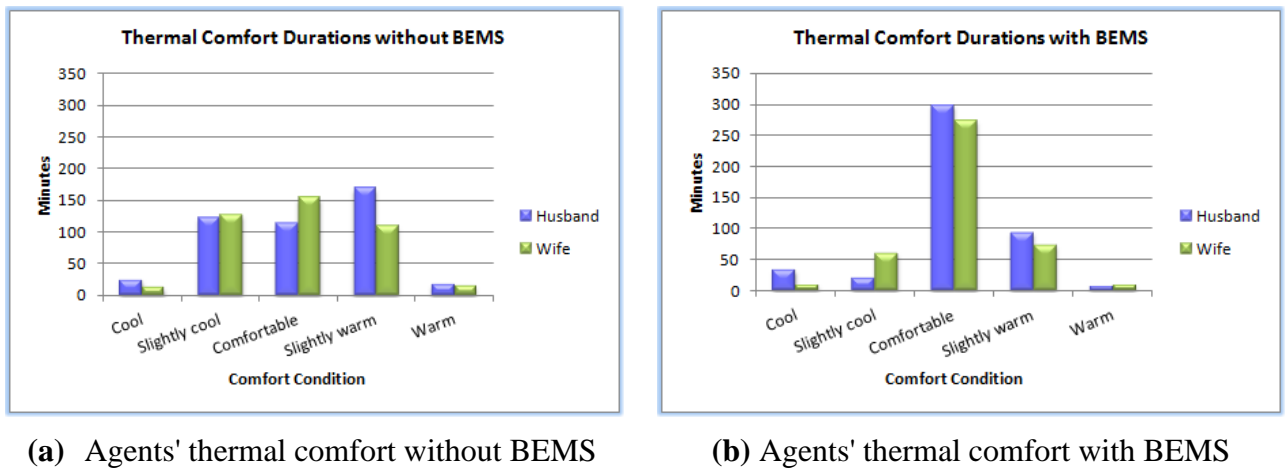

Figure 7.30 Comfort of agents: with and without the control of BEMS

Figure 7.31 shows the power consumption of the electric heater while the environment is controlled by different agents with and without the BEMS. The highest power consumed is due to the behaviour of NonEcoWife agent since it tries to achieve comfort by opening and closing the window. This assessment of BEMS when co-simulated with building system and inhabitants shows that the BEMS is capable of not only saving the inhabitants from cognitive workload but also of providing them with better comfort and energy savings. Figure 7.32(a) shows that after 16h00 when it is in the living room and controlling the window, the heater has to put more effort to warm up the room and the controller never stops. However, the inclusion of BEMS, helps its to achieve comfort earlier by lowering the setpoint when it detects the opening of window, forcing the NonEcoWife to close the window earlier and save energy (Figure 7.32(b)). The EcoHusband agent is however an eco person and tries to behave the way an BEMS do, thus the energy consumption when EcoHusband is controlling the environment is much less as compared to NonEcoWife agent. However, it has to control the heating system multiple times and put extra efforts (Figure 7.32(c)). In case of control by the BEMS, however, it helps him to control the heater and adjust the setpoint such that even if it puts on/off its extra clothing, it remains comfortable most of the time (Figure 7.32(b)) by saving even more energy than it tries to save by its control (Figure 7.32(d))

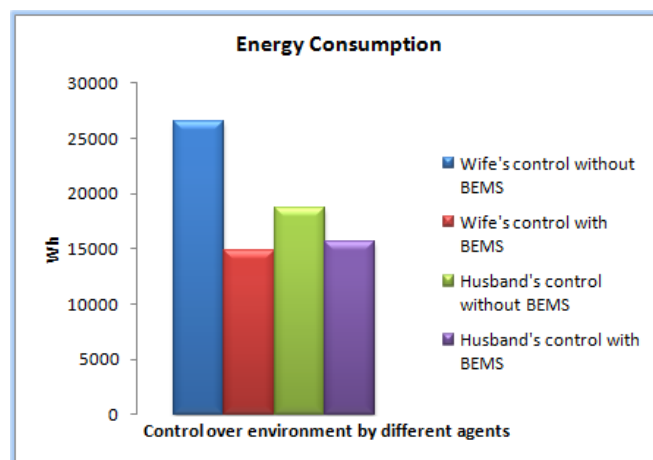
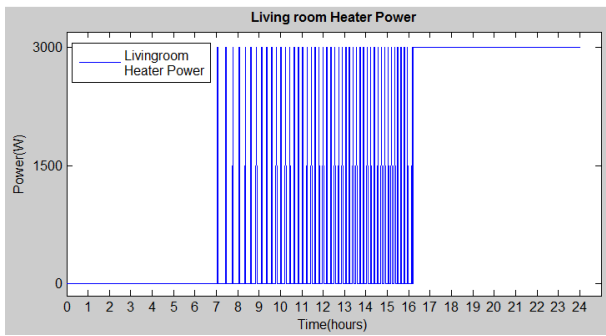
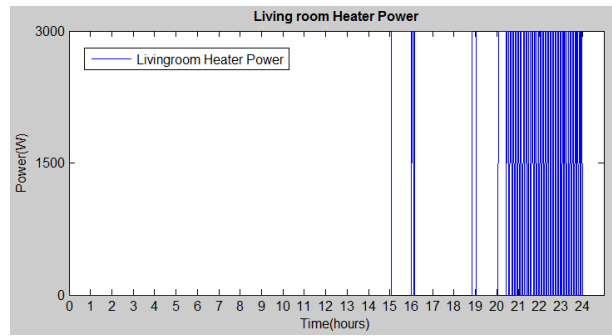

Figure 7.31 Energy consumed during control over environment by different agents with/without BEMS



(a) NonEcoWife controls environment without BEMS



(b) NonEcoWife controls environment with BEMS

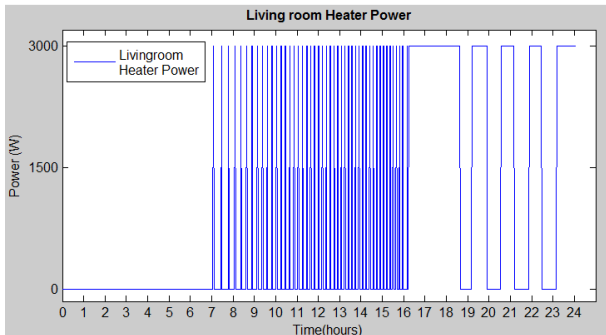

(c) EcoHusband controls environment without BEMS

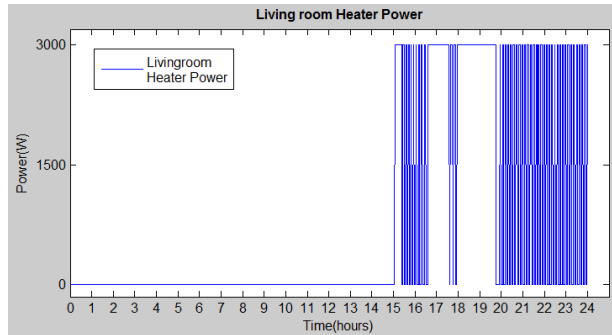

(d) EcoHusband controls environment with BEMS

Figure 7.32 PMV perceived by agents while NonEcoWife and BEMS control the environment

7.4 Summary and Conclusions

The advancements in smart grid technology have led to various advantages. Today, the inhabitants are provided with information that can help them to improve their energy consumption patterns. The information that is provided to the inhabitants consists of availability of energy, tariff details, energy consumption by different household appliances etc. However, the signals coming from smart grid are complex and difficult to be interpreted well by the inhabitants. Thus, there is a need for an intelligent system that translates these signals to the inhabitants in a better way and can communicate back and forth between the inhabitants and the grid. The BEMS is able to advise inhabitants and can take decisions on their behalf to increase comfort and decrease energy consumption and cost. The inhabitants can also communicate with the BEMS and can express their comfort needs, occupancy plans etc. and can also ask for advice.

It is important to include the inhabitants' reactive and dynamic interactions with their environment in building energy simulations. This helps to analyze the control of different behaviours over the environment and the resulting impact on energy consumption patterns. Similarly, the role of an energy management system in the presence of these reactive behaviours is more challenging and must be analyzed for improved functionality and energy efficient decision making.

In this chapter, the co-simulation of inhabitants' dynamic behaviour takes into account the control and advice coming from the BEMS. The perception of the environment in this model is based on Fanger's comfort model. The SIMBAD thermal model used in the co-simulation is from a reference house, MOZART. The Fanger model computes the thermal comfort conditions for

inhabitants based on their clothing, activity, temperature in surroundings etc. The temperature is calculated by the SIMBAD thermal model and sent back to the Fanger's model. The inhabitants based on their perceived comfort levels further control the appliances or objects in the environment. This control over the environment, however, can also be taken by the BEMS that maintains the thermal comfort of inhabitants while taking energy efficient decisions regarding energy consumption.

The inhabitants are categorized into two different types: inhabitants having "Eco-Behaviour" and the others having "Non-Eco Behaviour". "Eco-Behaviour" means that these inhabitants are always concerned about energy saving. Whenever they feel uncomfortable, they adapt the way that could improve their comfort while not wasting the energy. The "Non-Eco-Behaviour" inhabitants, however, are not concerned about energy savings and take the actions to quickly make them comfortable. However, these actions neither help them to save energy nor to be comfortable over the longer run.

The BEMS is able to perceive the actions in its environment, e.g. the requests and actions by the Eco and NonEco inhabitants for better comfort levels over the appliances and objects etc. The BEMS then satisfies them by providing them with desired comfort levels while maintain the setpoints and states of appliances and objects e.g. heating system, windows etc. Comparing the decisions taken by different types of occupants with and without the inclusion of the BEMS, the occupants with eco behaviours are more energy efficient compared to non eco agents. Similarly, whenever the BEMS takes the control of the environment it takes even better decisions than the eco agent both in terms of energy and cost savings and better comfort levels.

The behaviour model in the co-simulator generates the profiles which are random and dynamic. As soon as the environmental variables change, they change agents' beliefs and the system reacts in a different way than before. Thus the profiles generated by the model are adaptive, reactive and consistent. They are not specific to one building; rather they are adaptive to different building areas. If the characters in the model are introduced to some other building, they adapt to that building as well. On the contrary, static profiles are built for some specific building and specific system and need to be changed every time they are introduced to a new system. Similarly, static profiles are generated to be an input to a physical system/model that remains static over time. However, the dynamic profiles by our model first go to the physical system and then come back to the profile generation system with new perceptions from the physical system. These new perceptions change the profiles and this process goes back and forth between the physical system and the profile generation system with randomness, variability and dynamism.

In addition to this dynamism the characters introduced in the model as agents are capable of complex reasoning and decision making capabilities. They are put in an environment that provides them with a real home like situation with the perception of objects, appliances, other agents, time, location, the energy management system, and their belongings e.g. clothing. Similarly, they are able to perceive their internal physical conditions e.g. thermal comfort. Any change in the environment triggers their cognitive capability which leads them to react on the physical system intelligently, perceive its new state continuously while taking care of the other agents around them i.e. the social norms etc.

CHAPTER 8: CONCLUSIONS AND PERSPECTIVES

The work done in this thesis analyzes the impact of inhabitants' behaviour on energy consumption in domestic situations. It has: identified the high energy consuming activities of inhabitants; the reasons behind certain energy impacting behaviours; the extent to which these behaviours have been captured in the past; and given the motivation to improve the energy simulations with new requirements and challenges, specially, with the advancements in smart grid technology. The study has also addressed whether it is important to take into account the complex behaviours, i.e. the reactive, deliberative, social, and reasoning and cognitive elements of inhabitants' behaviour in building energy simulations and how these behaviours could be validated to ensure their representativeness.

This section synthesizes the findings in order to answer the three research questions posed in chapter 1.

1. How to identify the energy impacting behaviours?

The analysis of energy consumption patterns for different household appliances has revealed that these patterns are highly variable. This variability in consumption patterns is found to be linked with inhabitants' behaviour and the activities they perform in their day to day living on appliances. Hence, it is important to analyze both the consumption and behaviour patterns to identify those behaviours that are responsible for high energy consumptions.

The identification of inhabitants' energy impacting behaviours is done through data analysis. In order to perform this task, the availability of both the energy consumption data and the corresponding inhabitants' activities and behaviours data is necessary. Thus the Irise energy consumption data is used and complemented with the inhabitants' behaviour information through field studies.

The behaviours represent not only the simple actions but a complete reasoning process how these actions are reached. They are influenced by certain parameters that ultimately affect the energy consumption. These parameters include the environmental variables (e.g. season, weekdays, weekends etc.), specific interactions with appliances (e.g. turn on/off, put food in fridge etc.), relation between appliance usages (e.g. the impact of the cooking activity on the fridge consumption), and the reasons behind certain actions (e.g. why the cooker is used more on a particular day?). These parameters serve as important inputs to identify inhabitants' representative energy consuming behaviours from Irise database. The identified behaviours are then used in building and validating the model through the co-simulation of inhabitants' and appliances behaviours.

2. How the complex (reactive, deliberative, social and group) behaviours can be co-simulated with the thermal model of the building and physical models of appliances in residential buildings?

The answer to the previous research question revealed that inhabitants' energy impacting behaviours are complex as they are based on intricate reasoning mechanisms. Thus a conceptual, BDI based model is built to capture the complete process of how the inhabitants perceive the outside environment and the internal physical homeostasis. The model describes how these perceptions convert into their beliefs, how these beliefs trigger a cognitive process of building some desires, taking into account various environmental and social constraints, how these desires turn

into an intention and how based on this intention some action on the appliances, objects or building envelope are taken. This behaviour model is implemented in the Brahms agent based modelling and simulation environment. In this environment a complete system consisting of objects, appliances, time, inhabitants and their internal and external state beliefs is constructed. The different elements of this system interact with each other and react to change that occur in the environment. The complexity exhibited by the inhabitants' reasoning and cognitive aspects as well as the social and group behaviours is successfully captured and simulated in Brahms. Similarly, the behaviour of an appliance or object can also be modelled to some extent inside Brahms. However, it is not easy to build the complex physical models of appliances or a thermal model of a building, etc. inside Brahms. Thus, it is better to build the physical systems outside, in an environment that is specifically built for this purpose. For example, the thermal model of the building is constructed in Matlab/Simulink, which computes the temperature in the zone and sends this information to the inhabitants in Brahms environment. The agents in Brahms then act upon the heater, air conditioner or windows, etc. inside Brahms. The information about the changing state of the appliances or objects inside Brahms goes back to the thermal model. This is used to compute the new temperature of the zone, which is then sent back to Brahms. In this way a co-simulator is built through a Java interface between the two systems. Similarly, the complex physical models of appliances can also be built this way in Matlab/Simulink e.g. a fridge freezer and co-simulated with the behaviour model in Brahms. In addition an energy management system is also included in the co-simulator environment. This either controls the appliances on behalf of the inhabitants or gives them advice for improving their energy consuming behaviours. In these co-simulations the randomness and variability is introduced. Firstly, when the human agents goes through the cognitive process and acts on the building system, the variation in the state of the physical systems change their old perceptions about the environment. This will impact their cognitive process and cause them to behave differently in the new situation. Secondly, in each changing situation the agent does not necessarily behave in a single way. Rather, it could behave in multiple ways depending upon the probabilistic values for its different beliefs. These probabilities are assigned to beliefs inside the Brahms environment. Thirdly, the introduction of environmental and social constraints in the system will make the agents behave more like real humans. Fourthly, some random variables, which are difficult to model in Brahms, are also introduced through Java activities. This allows agents to make some decisions depending on the value of the random variable e.g. allowing agents to choose a combination of clothes, etc. The algorithm to compute the values for these random variables are computed in Java and sent back to the agents in Brahms. Thus a combination of all of these different elements of randomness creates interesting situations to analyze different behaviours of agents and their impact on the physical aspects of the building.

3. How can the complex behaviour models be validated to ensure its representativeness?

A methodology is proposed and implemented to validate the inhabitants' behaviour model. In this methodology, the behaviour of the inhabitants in the Irise database is captured by complementing it with additional information. This information actually comprises of the impact of certain parameters on inhabitants' energy consuming behaviour, e.g. seasons, weekdays and weekends, the impact of the usage of one appliance over the other, etc. Then the houses with similar behaviours are clustered to find the representative behaviours. Then the co-simulation of the inhabitants' behaviour model is done with the selected appliance. The different parameters in the model e.g. seasons, weather, weekday/weekend, social behavior, etc. are assigned different probability values or weights to make them tuneable. This co-simulation gives the simulated energy

consumption of the appliance. From the Irise database the actual energy consumption of the appliance is also available. The appliance energy consumption distributions for both the actual and simulated situation are then compared. If the simulated behaviour is realistic the distributions will follow the same trend. If the trends are dissimilar, the parameters are tuned such that their values come closer to the observed behaviour of that cluster and the error is significantly reduced. Similarly, the same simulated behaviour is then compared with another member of the same cluster with the same values of the tuning parameters to analyze how representative is the behaviour model of its cluster.

4. How to validate BEMS with building system and inhabitants?

The BEMS controls the household appliances and objects e.g. lights and shutters etc. and also gives advice to the inhabitants. This advice is given based on the anticipative plan that is computed based on signals coming from the grid. The anticipative plan is updated at every hour, hence the advice is given every hour. However, in order to evaluate that based on different reactions by the inhabitants, how efficiently the BEMS recomputed its strategies, whether they are feasible and whether the inhabitants are saved from cognitive workload and are provided with better comfort and energy savings, a mechanism is required. Thus, the BEMS is co-simulated with the building system and the inhabitants where the inhabitants can either directly control the appliances and objects or through building BEMS. Different stereotypes of inhabitants i.e. having Eco and non-Eco behaviours are also defined and the strategies of BEMS are assessed by putting it in different complex situations.

The work done in this thesis is different from the previous works in several ways. Most of the previous works focus on office buildings where human behaviour is relatively less complex as compared to home situations. In order to capture the behaviour in domestic settings the behaviour needs to be captured in much more detail than simple presence/absence profiles. Similarly, the previous works done for energy management in home situations focus on demand side predictions associated with turning on/off the electrical appliances. The work in this thesis is oriented more towards finding the specific usages or activities behind consumptions that impact energy consumption. These actions are the result of a complete process from perception to cognition and then to action. The introduction of inhabitants' reasoning processes towards their actions on the physical environment will give energy simulation tools more realism. By creating and putting inhabitants' in different situations, it will lead them to reason differently about the situation and solve it in another way than before. Although, it is not easy to capture all different types of reasoning processes behind the different behavioural patterns, some high level categories are identified through field studies. The purpose is to analyze how the introduction of these type of reasoning processes and complex behaviours could help to bring the building energy simulations closer to reality and to reduce the gap between actual and simulated situations. In this thesis we have shown that complex behaviour taking into account BEMS can be managed by the proposed approach. Nevertheless, less complex behaviours, in offices for instance, can also be managed by this approach.

Short term future work

- **Time difference between the change in environment and its perception:**

In the co-simulation of inhabitants' behaviour with the BEMS and SIMBAD thermal model, the inhabitants are able to perceive their thermal comfort at each simulation time step. The thermal

comfort varies with the variation in temperature. As soon as the temperature in the environment is changed, the agents in the simulation perceive it without any time lapse between the change and their perception of that change. It would be more meaningful to analyse and introduce the time difference between the change of temperature and its perception by the inhabitants, through detailed experimentation. This will bring more accuracy in the simulation results and will make them more reliable.

- **Duration of simulation**

The co-simulations performed in this thesis capture inhabitants' dynamic behaviour, with and without the inclusion of a BEMS in the system. In the co-simulation of inhabitants' interactions with the fridge freezer, a period of a month is considered. However, in the co-simulation with the BEMS, the simulation is done for one day. In order to compute the impact of inhabitants' behaviour over a longer run and based on different seasons etc. it would be more meaningful to run the simulation over a longer period of time.

- **Validation in other contexts:**

The work done in this thesis regarding inhabitants' behaviour modelling has to be further validated in different contexts such as different kinds of offices and homes with different types of occupants. For example, how the change in air quality or CO₂ levels impact the office workers' behaviour during a given activity. Validation of the behaviour model in such contexts will lead to more realistic energy simulations and to representative agents.

Long term future work

In this thesis, we have modelled and simulated different aspects of complex human behaviours from perception to cognition and action. This detailed modelling improves the realism of occupants' behaviour towards the household appliances and the physical aspects of the building. Different simulated reference models still have to be developed according to experiments and applications, e.g. to find out the relationship between the CO₂ levels and air quality and the occupants' reactions to them, etc. Many, time use datasets are available. These could be used provided that energy models can be added and complementary field studies conducted in order to find the reasons behind actions. This is a promising direction that has to be investigated. In addition to field studies, occupant behaviours can also be learnt in real time using learning algorithms and a minimum set of sensors to adjust model parameters. Moreover, reasons behind actions can also be collected via a user interface, bringing occupants to analyse their traces.

The introduction of different types of inhabitants with different kinds of behaviours, such as, ecological, non ecological etc., will put BEMS into different situations and allow it to take better decisions in the presence of intelligent agents. This will help to tune and assess the performance of global BEMS, both in control and advice modes, where it acts as a consultant. The inclusion of detailed inhabitants' behaviour will improve learning and prediction inside the BEMS that will react more intelligently to different situations in terms of giving better advice to the inhabitants and more suitable controls.

Some of the work detailed in chapter 7 has revealed that a sudden change in the thermal environment impacts the perception of thermal comfort. For example, in winter the inhabitants while entering the house feel relatively warmer than outside. However, after sometime the inhabitants realize that the house is not actually very warm. They, then increase the thermostat

settings after some time when they start perceiving that the room is actually cold. These types of human sensations and perceptions about the environment can improve the prediction models that take into account only the presence and absence of the occupants to turn on/off some appliance. Thus, in addition to the occupant's presence profiles, the time duration for which the inhabitant feels comfortable due to sudden change in the thermal environment should also be considered. This will make sure that the inhabitants are not provided with extra heat, while saving the energy and providing them with maximum comfort. These types of detailed knowledge about inhabitants' behaviour would also help the building designers to take into account the human impact for better design of buildings, thanks to the building standards that could embed simulation with realistic reference occupants, for instance.

The development of the perceptive, cognitive and action elements of inhabitants as software agents with artificial intelligence could further be used in other applications. For example, in serious games, the simulation of real life events is done to see their impact on the system. The serious games are the applications developed using video games technology. However, beyond the dimension of simple entertainment, the gaming features with teaching, information, communication, and education are combined. This is an innovative way to convey knowledge in a more playful and motivating way. The inhabitants can be introduced in these games as avatars, where each avatar could represent a member of the family. They can interact with their artificial house in the game and can behave in different ways to test certain assumptions and see the result on energy consumption. This will help the inhabitants to realize how certain behaviours are impacting energy consumption and to take better decisions on household appliances or building in terms of cost and comfort.

The introduction of intelligent agents in building energy co-simulations will help to analyze the impact of occupied buildings on the smart grid. The inhabitants' responses to the signals and/or information coming from the grid will then be used to improve the smart grid design. The reactions to these signals could further be diverse and complex depending on different types of inhabitants e.g. based on their family composition, role in the family, economic conditions, knowledge and concerns about energy problem. The realization of all the different kinds of inhabitant behaviours into energy co-simulations with the smart grid will help to improve the smart grid technology and hence provide the inhabitants with better services to save energy and cost while maintaining their comfort levels.

References

[A]

- [Abbas, 2008] Abbas O.A., Comparisons Between Data Clustering Algorithms, *The International Arab Journal of Information Technology*, vol. 5, no. 3, p. 320, 2008
- [Abrás et al., 2010] Abrás S., Ploix S., Pesty S. and Jacomino M., Advantages of MAS for the resolution of a power management problem in smart homes, in *Advances in Intelligent and Soft Computing (Springer, Berlin, Heidelberg)*, p. 269–278, 2010
- [Abushakra and Claridge, 2001] Abushakra B., Claridge D., Accounting for the occupancy variable in inverse building energy baselining models, in: *Proceeding of the International Conference for Enhanced Building Operations (ICEBO), Austin, 2001*
- [Al-Mumin et al., 2003] Al-Mumin A., Khattab O., Sridhar G., Occupants' behavior and activity patterns influencing the energy consumption in the Kuwaiti residences, *Energy and Buildings*, vol. 35(6) p. 549-559, 2003
- [Alpaydin, 2004] Alpaydin E., Introduction to Machine Learning, *MIT Press*: Cambridge, MA, 2004
- [Anderson et al., 2004] Anderson J.R., Bothell D., Byrne M.D. and Lebiere C., An integrated theory of the mind, *Int. Journal of Psychological Review*, 2004
- [Andersen et al., 2009] Andersen R.V., Toftum J., Andersen K.K. and Olesen B.W., Survey of occupant behaviour and control of indoor environment in Danish dwellings, *Energy and Buildings*, vol. 41 p. 11–16, 2009
- [Anthony, 2006] Anthony K.D., Introduction to Causal Modeling, Bayesian Theory and Major Bayesian Modeling Tools for the Intelligence Analyst, *Technical report*, USAF National Air and Space Intelligence Center (NASIC), 2006
- [ASPO, 2009] The Association for the Study Of Peak Oil and Gas “ASPO”, Newsletter No, 100-April 2009, Retrieved on 20th August, 2013 from http://www.energiekrise.de/e/aspo_news/aspo/Newsletter100.pdf
- [Attari et al., 2010] Attari S., Dekay M., Davidson C., Bruine de Bruin W., Public perceptions of energy consumption and savings, *Proceedings of the National Academy of Sciences*, vol. 107(37) p. 16054–16059, 2010
- [Azar and Menassa, 2012b] Azar E. and Menassa C.C., A Comprehensive Analysis of the Impact of Occupancy Parameters in Energy Simulation of office Buildings, *PhD thesis*, Department of Civil and Environmental Engineering, University of Wisconsin-Madison, 2012

[B]

- [Bakhaus and Heiskanen, 2009] Bakhaus J., Heiskanen E., Research Note 2: Rating expert advice on how to change energy behaviour, *European Commission*, 2009
- [Bertoldi et al., 2012] Bertoldi B., Hirtl P., and Labanca N., Energy Efficiency Status Report 2012 – electricity Consumption and Efficiency Trends in the EU-27, European Commission Joint Research Center, Institute for Energy and Transport, Ispra, Italy, 2012
- [Bishop, 2007] Bishop C.M., Pattern Recognition and Machine Learning, *Springer*: New York, 2007
- [Boardman, 2007] Boardman B., Examining the carbon agenda via the 40% house scenario, *Building, research and information*, vol. 35(4) p. 363-378, 2007

[Boergson and Braeger, 2008] Boergson S., and Braeger G., Occupant control of windows: accounting for human behavior in building simulation, *International Report at Center for the built environment (CBE)*, University of California, Berkeley, 2008

[Bonabeau, 2001] Bonabeau E., Agent-based modeling: Methods and techniques for simulating human systems. *Proceedings of the National Academy of Science*, 99(3) p. 7280–7287, 2001

[Bourgeois et al., 2006] Bourgeois D., Reinhart C. and Macdonald I., Adding advanced behavioural models in whole building energy simulation: A study on the total energy impact of manual and automated lighting control, *Energy and Buildings*, vol. 38 p. 814-823, 2006

[Brdiczka et al., 2007] Brdiczka O., Reignier P., Crowley J.L., Detecting Individual Activities from Video in a Smart Home *Knowledge-Based Intelligent Information and Engineering Systems Lecture Notes in Computer Science* vol. 4692, p. 363-370, 2007

[BP, 2013] BP Statistical Review of World Energy, Retrieved on 20th August, 2013 from http://www.bp.com/content/dam/bp/pdf/statistical-review/statistical_review_of_world_energy_2013.pdf, 2013

[C]

[Card et al., 1983] Card S.K., Moran T.P., Newell A., The psychology of human-computer interaction, *Hillsdale, NJ: Lawrence Erlbaum Associates*, 1983

[Capasso et al., 1994] Capasso A., Grattieri W., Lamedica R. and Prudenzi A., A bottom-up approach to residential load modeling, *IEEE Trans, Power Syst.*, vol. 9(2) p. 957–964, doi:10.1109/59.317650, 1994

[Casti, 1997] Casti J., *Would-Be Worlds: How Simulation is Changing the World of Science*, Wiley: New York, 1997

[Claridge et al., 2004] Claridge D.E., Abushakra B. and Haberl J.S., Electricity Diversity Profiles for Energy Simulation of Office Buildings, *ASHRAE Transactions-Research*, vol. 110, Part 1, p. 365-377, 2004

[Clarke et al., 2006] Clarke J., Macdonald I. and Nicol J.F., Predicting adaptive responses-simulating occupied environments, *Proceedings of Windsor conference on Comfort and Energy Use in Buildings-Getting them right*, Cumberland Lodge, Windsor UK, 2006

[Clarke, 2001] Clarke, J.A., *Energy Simulation in Building Design* (2nd edition), 2001

[Clancey et al., 1998] Clancey W.J., Sachs P., Sierhuis M. and Van Hoof R., Brahms: Simulating practice for work systems design, *International Journal of Human-Computer Studies*, vol. 49 p. 831–865, 1998

[Clancey, 1997] Clancey, W., *Situated Cognition: On Human Knowledge and Computer Representations*, Cambridge University Press, Cambridge, 1997

[Cogan et al., 2006] D. Cogan, M. Camilleri, N. Isaacs, L. French National Database of Household Appliances – Understanding Baseload and Standby Power Use. *Energy Efficiency in Domestic Appliances and Lighting (EEDAL) conference*, London, June 2006

[Collier et al., 2010] Collier A., Cotterill A., Everett T., Muckle R., Pike T., Vanstone A., Understanding and influencing behaviours: A review of social research, economics and policy making in Defra, *Defra*, 2010

[Cook and Das, 2007] Cook D.J. and Das S.K., How smart are our environments? an updated look at the state of the art, *Journal of Pervasive and Mobile Computing*, 2007

[Corker and Smith, 1998] Corker K.M. and Smith B.R., An architecture and model for cognitive engineering simulation analysis: Application to advanced aviation automation, *In Proceedings of the AIAA Computing in Aerospace: American Institute of Aeronautics and Astronautics*, 1998

[CSTB, 2012] Méthode de calcul Th-BCE 2012, CSTB, Retrieved on 5th September, 2013 from http://www.bulletin-officiel.developpementdurable.gouv.fr/fiches/BO201114/met_20110014_0100_0007%20annexe.pdf

[D]

[Darby, 2006] Darby S., The effectiveness of feedback on energy consumption, *Oxford: Environmental Change Institute*, 2006

[Das et al., 2002] Das S.K., Cook D.J., Bhattacharya A., Heierman E.O., Lin T.Y., The role of prediction algorithm in the MavHome smart home architecture, *IEEE Wireless Commun.* Vol. 9 (6) p. 77–84, 2002

[Davidsson and Boman, 2005] Davidsson P. and Boman M., Distributed monitoring and control of office buildings by embedded agents, *Inform. Sci.*, vol. 171(4) p. 293–307, 2005

[Degelman, 1999] Degelman L.O., A model for simulation of daylighting and occupancy sensors as an energy control strategy for office buildings p. 571-578, 1999

[Deutsch et al., 1997] Deutsch S.E., Cramer N.L., MacMillan J. and Chopra S., Operability model architecture, *Technical Report by United States Air Force*, 1997

[Dey, 2001] Dey A.K., Understanding and using context, *Personal Ubiquitous Computing* vol. 5 p. 4-7, 2001

[Dong and Andrews, 2009] Dong B., Andrews B., Sensor-based occupancy behavioral pattern recognition for energy and comfort management in intelligent buildings, in: *7th International IBPSA conference*, Glasgow, Scotland, 2009

[Doukas et al., 2007] Doukas H, Patlitzianas K.D., Iatropoulos K, Psarras J. Intelligent building energy management system using rule sets, *Building and Environment* vol. 42(10) p. 3562–9 2007

[Druckman, 2011] Druckman A., Chitnis M., Sorrell S., Jackson T., Missing carbon reductions? Exploring rebound and backfire effects in UK households, *Energy Policy*, vol. 39(6) p. 3572–3581, 2011

[Dutton, 2009] Dutton S., Window opening behaviour and its impact on building simulation: a study in the context of school design, *PhD thesis*, University of Nottingham, UK, 2009

[E]

[Eggleston et al., 2000] Eggleston R.G., Young M.J. and McCreight K.L., Distributed cognition: A new type of human performance model, *In M. Freed (Ed.), Simulating human agents*, AAAI Fall Symposium p. 8-14, 2000

[Energy Technology Perspectives, 2010] International Energy Agency, Energy Technology Perspectives, 2010, Retrieved on 20th August, 2013 from <http://www.iea.org/techno/etp/etp10/English.pdf>

[Engler and Kusiak, 2010] Engler J. and Kusiak A., Agent-based control of thermostatic appliances, in *Green Technologies Conf., IEEE*, p. 1, 2010

[Ellegård and Palm 2011] Ellegård K. and Palm J., Visualizing energy consumption activities as a tool for making everyday life more sustainable, *Applied Energy*, vol. 88 p. 1920–6, 2011

[Elzenga et al., 2010] Elzenga J., Voordijk J., Hartmann T., Salet T., Occupancy based energy simulation for meaningful design decision making, *University of Twente: VISICO Center*, 2010

[Epstein and Axtell, 1996] Epstein J.M. and Axtell R., Growing Artificial Societies: Social Science from the Bottom Up. *MIT Press*: Cambridge, MA, 1996

[EU Commission, 2007] EU Commission, A European Strategic Energy Technology Plan (Set-Plan): Towards a low carbon future, *Brussels: Commission of the European Communities*, Retrieved on 5th September from <http://eur-lex.europa.eu/LexUriServ/LexUriServ.do?uri=COM:2007:0723:fin:en:pdf>, 2007

[EU Commission, 2008] EU Commission, Communication from the Commission: Energy efficiency: delivering the 20% target. *Brussels: Commission of the European Communities*, Retrieved on 5th September, 2013 from <http://eur-lex.europa.eu/LexUriServ/LexUriServ.do?uri=COM:2008:0772:FIN:EN:PDF>, 2008

[EU Commission, 2011] EU Commission, Communication from the commission to the European parliament, the council, the european economic and social committee and the committee of the regions, *Energy Efficiency Plan 2011*, Retrieved on 5th September, 2013 from http://www.ab.gov.tr/files/ardb/evt/1_avrupa_birligi/1_6_raporlar/1_3_diger/energy/communication_energy_efficiency_plan_2011.pdf, 2011

[F]

[Fanger, 1973] Fanger P.O., Assessment of mans thermal comfort in practice. *British Journal of Industrial Medicine*, vol. 30, p. 313-324, 1973

[Fanger, 1970] Fanger P.O., Thermal Comfort, Danish Technical Press, 1970, Republished by *McGraw-Hill*, New York, 1973

[Fabi et al., 2011] Fabi V., Andersen R., Corgnati S., Olesen B., Filippi M., Description of occupant behaviour in building energy simulation: state-of-art and concepts for improvements, *Proceedings of Building Simulation*, Sydney, 2011

[Firby, 1989] Firby R.J., Adaptive execution in complex dynamic worlds, *Doctoral Dissertation*, Yale University, USA, 1989

[Firth et. al, 2008] Firth S.K., Lomas K.J., Wright A.J., Wall R., Identifying trends in the use of domestic appliances from household electricity consumption measurements, *Energy and Buildings*, vol. 40, p. 926-936, 2008

[Fracastaro and Lyberg, 1983] Fracastaro G.V. and Lyberg M.D., Guiding principles concerning design of experiments, instrumentation and measuring techniques (IEA Annex III), *Swedish Council for Building Research* (ISBN 91-540-3955-X), 1983

[Freed, 1998] Freed M.A., Simulating human performance in complex, dynamic environments, *PhD thesis*, Northwestern University, IL USA, 1998.

[Foglar, 2008] Foglar A., Appliances profile specification, *Report*, 2008, Retrieved on 5th September, 2013 from http://www.ict-aim.eu/fileadmin/user_files/deliverables/AIM-D2-3v2-0.pdf

[G]

[Georgeff et al., 1999] Georgeff M., Pell B., Pollack M., Tambe M., Wooldridge M., The Belief-Desire-Intention Model of Agency, *In Proceedings of 5th International Workshop on Intelligent Agents: Agent Theories, Architectures, and Languages*, p. 1-10, Springer-Verlag: Heidelberg Germany, 1999

[Gill et al., 2010] Gill Z., Tierney M., Pegg I., Allan N., Low-energy dwellings: the contribution of behaviours to actual performance, *Building Research and Information*, vol. 38(5) p. 491-508, 2010

[Goldberg, 1989] Goldberg D.E., Genetic Algorithms in Search, Optimization, and Machine Learning, *Addison-Wesley*: Reading, MA, 1989

[Goldstein et al., 2010a] Goldstein R., Tessier A., Khan A., Schedule-calibrated occupant behavior simulation, *In: Proceedings of the Symposium on Simulation for Architecture and Urban*, Orlande, USA, 2010

[Goldstein et al., 2010b] Goldstein R., Tessier A., Khan A., Customizing the behaviour of interacting occupants using personas, *Proceedings of 4th National conference of IBPSA*, New York USA, 2010

[Grandjean, 2013] Grandjean A., Introduction de non linéarités et non stationnarités dans les modèles de représentation de la demande électrique résidentielle, *PhD Thesis*, l'École nationale supérieure des mines de

Paris, Retrieved on 5th September, 2013 from <http://tel.archives-ouvertes.fr/docs/00/81/79/69/PDF/2013ENMP0002.pdf>, 2013

[Griffin, 2008] Griffin J.S., Impact of weather variations on energy consumption efforts at U.S. air force bases, *Master Dissertation*, Air Force Institute of Technology, Air University, 2008 Retrieved on 5th September, 2013 from <http://www.dtic.mil/dtic/tr/fulltext/u2/a482736.pdf>

[H]

[Ha et al., 2006a] Ha D.L., Ploix S., Zamai E., Jacomino M., A home automation system to improve household energy control, *12th IFAC Symposium on Information Control Problems in Manufacturing*, 2006

[Ha et al., 2006b] Ha T.S., Jung J.H., Oh S.Y., Method to analyze user behaviour in home environment, *Personal and Ubiquitous Computing*, vol. 10 p. 110-121, 2006

[Ha et al., 2012] Ha D.L., Joumaa H., Ploix S., Jacomino M., “An optimal approach for electrical management problem in dwellings,” *Energy and Buildings*, vol. 45, no. 0, p. 1–14, 2012

[Hadj et al., 2012] Hadj Y., Ploix S., Pouget J., Berland, C. 2012 Génération dynamique de stratégies de gestion énergétique : Application à une Gare. *Journées AUGC/IBPSA*, 6-8 Juin, Chambéry, France, 2012

[Hadj et al., 2013] Hadj Y., Ploix S., Latremoniere C., Generating global energy management strategies: application to CANOPEA, *Building and Simulation* Chambéry, France, 2013

[Haldi and Robinson, 2009] Haldi F. and Robinson D., Interactions with window openings by office occupants, *Building and Environment*, vol. 44 (12) p. 2378-2395, 2009

[Haldi and Robinson, 2010] Haldi F. and Robinson D., On the Unification of Thermal Perception and Adaptive Actions, *Journal of Building and Environment*, vol. 45 p. 2440-245, 2010

[Hand, 1988] Hand J.W., Removing barriers to the use of simulation in the building design professions, *PhD Thesis*, Glasgow, University of Strathclyde, 1988

[Haradji et al., 2012] Haradji, Y., Poizat, G., Sempé, F., Human activity and social simulation, *Advances in Applied Human Modeling and Simulation*, p. 416–425, 2012

[Haas, 2013] Haas B., The occupant model in COMETH, Centre Scientifique et Technique du B^âtiment, *Technical Report*, 2013

[Husaunndee and Visier, 1997] Husaunndee A. and Visier J.C., SIMBAD: A simulation toolbox for the design and test of HVAC control systems. Proceedings of the 5th international IBPSA conference, Prague, Czech Republic, vol. 2, p. 269-276, 1997

[Hutchins, 1995] Hutchins E., *Cognition in the Wild*. Cambridge: MIT Press, 1995

[Henricksen, 2003] Henricksen K., A Framework for Context-Aware Pervasive Computing Applications, *PhD thesis*, School of Information Technology and Electrical Engineering, University of Queensland, Retrieved on 5th September 2013 from <http://henricksen.id.au/publications/phd-thesis.pdf>, 2003

[Hoes et al., 2009] Hoes P., Hensen J.L.M., Loomans M.G.L.C., de Vries B. and Bourgeois D., User behavior in whole building simulation, *Energy and Buildings* vol. 41(3) p. 295–302, 2009

[Holland, 1995] Holland J., Hidden Order: How Adaptation Builds Complexity, *Addison-Wesley* Reading, MA, 1995

[Holland et al., 2000] Holland J.H., Booker L.B., Colombetti M., Dorigo M., Forrest S., Goldberg D.G., Riolo R.L., Smith R.E., Lanzi P.L., Stolzmann W., and Wilson S.W., What is a Learning Classifier System? In P.L. Lanzi, W.Stolzmann, S.W. Wilson Eds. *Learning Classifier Systems: An Introduction to Contemporary Research* Springer Verlag, p. 3-32, 2000

[Humphreys and Nicol, 1998] Humphreys M.A. and Nicol J.F., Understanding the adaptive approach to thermal comfort, *ASHRAE Transactions*, vol. 104 (1) p. 991-1004, 1998

[Hunt, 1980] Hunt D.R.G., Predicting artificial lighting use - a method based upon observed patterns of behaviour, *Lighting research and technology*, vol. 12, p. 7–14, 1980

[Huovila, 2007] Huovila P., Building and Climate Change Status, Challenges and Opportunities, Ed. United Nations Publications, 2007, ISBN 978-92-807-2795-1

[Van, 2009] Van H.E., Climate and Environment 2009, *The Rockwool Group Denmark*, Retrieved on 20th August, 2013 from http://www.rockwool.com.tr/files/RW-HR%20Slovenia%20files/ER-2009_EN.pdf, 2009

[I]

[Intille, 2002] Intille S.S., Designing a home of the future, *IEEE Pervasive Comput*, vol. 1 (2) p. 76–82 2002

[J]

[Janda, 2011] Janda K., Buildings don't use energy: people do, *Architectural Science Review* vol. 54 p. 15-22, 2011

[Jensen et al., 2009] Jensen O.M., Wittchen K.B., Thomsen K.E., Towards very low energy buildings, *Danish Building Research Institute*, Aalborg University, 2009

[Jennings, 2000] Jennings N.R., On agent-based software engineering. *Artif Intell* 117: p. 277–296, 2000.

[Joumaa et al., 2011] Joumaa H., Ploix S., Abras S., De Oliveira G., A MAS integrated into home automation system, for the resolution of power management problem in smart homes, *Energy Procedia*, vol. 6 p. 786–794, 2011

[Just et al., 1999] Just M.A., Carpenter P.A., Varma S., Computational modelling of high-level cognition and brain function, *Human Brain Mapping*, vol. 8 p. 128-136, 1999

[K]

[Kashif et al., 2011] Kashif A., Le B., Dugdale J., Ploix S., Agent based framework to simulate inhabitants' behaviour in domestic settings for energy management, *Proceedings of the 3rd International Conference on Agents and Artificial Intelligence*, p. 190-199, 2011

[Kashif et al., 2013a] Kashif A., Ploix S., Dugdale J., Le X. H. B., Simulating the dynamics of occupant behaviour for power management in residential buildings, *Energy and Buildings*, vol. 56, p. 85-93, 2013

[Kashif et al., 2013b] Kashif A., Dugdale J., Ploix S., Simulating Occupants' Behaviour for Energy Waste Reduction in Dwellings: A Multi Agent Methodology, *Advances in Complex Systems*, vol. 56, p. 37, 2013

[Kashif et al., 2012] Kashif A., Dugdale J., Ploix S., An agent based approach to find high energy consuming activities, *International Conference on Artificial Intelligence (ICAI)*, Las Vegas, USA, 2012

[Kashif, 2010] Kashif A., Un modèle de l'activité humaine en situation domestique dans un but de gestion de l'énergie (Master Dissertation), Laboratoire des sciences pour la conception, l'optimisation et la production, Institut National Polytechnique de Grenoble (available at ENSGI library, 46, avenue Felix viallet, 38031, Grenoble, France), 2010

[Karjalainen, 2009] Karjalainen S., Thermal comfort and use of thermostats in Finnish homes and offices. *Building and Environment*, vol. 44 (6), p. 1237–1245, 2009

[Kauffman, 1993] Kauffman S.A., The Origins of Order: Self-Organization and Selection in Evolution, *Oxford University Press* Oxford, UK, 1993

[Kieras and Meyer, 1995] Kieras D.E. and Meyer D.E., An overview of the EPIC architecture for cognition and performance with application to human-computer interaction, (*EPIC Report No. 5*), *MI: The University of Michigan*, 1995

[Kintsch, 1988] Kintsch W., The role of knowledge in discourse comprehension: A construction integration model, *Psychological Review*, vol. 95 p. 163–182, 1988

[Kolter and Johnson, 2011] Kolter J.Z., Johnson M.J., REDD: A Public Data Set for Energy Disaggregation Research. In ACM Special Interest Group on Knowledge Discovery and Data Mining, *workshop on Data Mining Applications in Sustainability*, 2011

[Kuehn, 2008] Kuehn S., Energy efficient buildings: the most profitable CO2 saving, Rockwool Scandinavia A/S, 2008, Retrieved on 20th August, 2013 from: http://www.rockwool.com/files/rockwool.com/Energy20Efficiency/PDF%20-20Energy%20efficiency/20081208_COP14_SK.pdf

[L]

[Langton, 1989] Langton C.G., Artificial life. In: Langton CG (ed). *Artificial Life: The Proceedings of an Interdisciplinary Workshop on the Synthesis and Simulation of Living Systems*, Addison-Wesley: Reading, MA, vol. VI p. 1–47, 1989

[Leont'ev, 1979] Leont'ev A.N., The problem of activity in psychology. In *J.V. Wertsch (Ed.), The concept of activity in Soviet psychology*, p. 37–71, Armonk, NY: M.E. Sharpe, 1979

[Le et al., 2010] Le X.H.B., Kashif A., Ploix S., Dugdale J., Mascolo M.D., Abras S., Simulating inhabitant behaviour to manage energy at home, *IBPSA Conference*, France, 2010

[Lee et al., 2011] Lee Y.S., Yi Y.K., Malkawi A., Simulating human behaviour and its impact on energy uses. *Proceedings of the 12th IBPSA Conference*, 2011

[Lehman et al., 1996] Lehman J.F., Laird J.E., Rosenbloom P.S., A gentle introduction to Soar, an architecture for human cognition. Sternberg and Scarborough, editors, *An invitation to Cognitive Science*, vol. 4. MIT Press, 1996

[Liao and Barooah, 2010] Liao C. and Barooah P., An integrated approach to occupancy modeling and estimation in commercial buildings, in *American Control Conf., IEEE*, p. 3130, 2010

[Linden et al., 2006] Linden A., Carlsson-Kanyama A., Eriksson B., Efficient and inefficient aspects of residential energy behaviour: What are the policy instruments for change? *Energy Policy*, vol. 34(14) p. 1918-1927, 2006

[Lutzenhiser, 1987] Lutzenhiser L., Social Variation and Electricity Consumption in san Diego, California: Exploratory Data Analysis and the California Energy Commission's Electricity Demand Forecasting Model. *Technical Report*, UER-196, University of California Energy Research Group, Berkeley, California 1987

[M]

[Macal and North, 2010] Macal C. and North M., Tutorial on agent-based modelling and simulation, *Journal of Simulation*, vol. 4(3) p. 151-162, 2010

[Masoso and Grobler, 2009] Masoso O.T. and Grobler L.J., The dark side of occupants' behaviour on building energy use, *Energy and Buildings*, 2009

[McMakin et al., 2002] McMakin A., Malone E., Lundgren R., Motivating Residents to Conserve Energy without Financial Incentives, *Environment and Behavior*, vol. 34 p. 848, 2002

[Minar et al., 1996] Minar N., Burkhart R., Langton C., Askenazi M., The swarm simulation system, a toolkit for building multi-agent simulations, working paper 96-06-042, Santa Fe Institute, Santa Fe, NM. <http://www.santafe.edu/projects/swarm/overview/overview.html>, 1996

[Morrison, 2003] Morrison J.E., A Review of Computer-Based Human Behavior Representations and Their Relation to Military Simulations, *Technical Repor*, Institute for Defense Analyses, Paper P-3845, 2003

[Matsuda, 2005] Matsuda K., Inverse Gaussian Distribution. Department of Economics, The City University of New York, 2005 Retrieved on 20th August, 2013 from: <http://www.maxmatsuda.com/Papers/Intro/IG%20Distribution.pdf>

[N]

[Newsham, 1994] Newsham G., Manual control of window blinds and electric lighting: Implications for comfort and energy consumption, *Indoor Environment*, vol. 3, p. 135-144, 1994

[Norford et al., 1994] Norford L.K., Socolow R.H., Hsieh E.S., Spadaro G.V., Two-to-one discrepancy between measured and predicted performance of a 'low-energy' office building: insights from a reconciliation based on the DOE-2 model, *Energy and Buildings*, 1994

[Noël, 2008] Noël J., Cas d'exemple CoDyBa à partir de la typologie CSTB des bâtiments. Projet CoDyBa, Retrieved on 20th August, 2013 from: http://www.jnlog.com/pdf/typologie_cstb.pdf

[O]

[Ogilvie, 2009] Ogilvie T., *Environment 2009*, Roxul Inc., Retrieved on 20th August, 2013 from: http://www.roxul.com/files/RX-NA-EN/pdf/ROXC2004_EnviroReport_Singles_LR.pdf

[Ouyang and Hokao, 2009] Ouyang J. and Hokao K., Energy-saving potential by improving occupants' behaviour in urban residential sector in Hangzhou City, China, *Energy and Buildings*, vol. 41 p. 711-720, 2009

[P]

[Page et al., 2008] Page J., Robinson D., Morel N., Scartezzini J.L., A generalized stochastic model for the simulation of occupant presence, *Energy and Buildings*, vol. 40 p. 83–98, 2008

[Pew and Mavor 1998] Pew R.W. and Mavor A.S. (Eds.), Modelling human and organizational behaviour: Applications to military simulations, Washington, DC: *National Academy Press*, 1998

[Pritsker et al., 1974] Pritsker A.B., Wortman D.B., Seum C., Chubb G., Seifert, D.J., SAINT: Systems Analysis of an Integrated Network of Tasks (Aerospace Medical Research Laboratory), 1974

[R]

[Raaij and Verhallen, 1982] Raaij W.F.V. and Verhallen T.M.M., A behavioural model of residential energy use, *Journal of Economic Psychology* vol. 3 p. 39–63, 1982

[Rao and Georgeff, 1995] Rao A.S. and Georgeff M.P., BDI Agents: From Theory to Practice, *Proceedings of the 1st International Conference on Multi-Agent Systems (ICMAS-95)*, p. 312-319, San Francisco USA, 1995

[Railsback et al., 2006] Railsback S., Lytinen S., Jackson S. Agent-based Simulation Platforms: Review and Development Recommendations. *SIMULATION*, vol. 82, p. 609-623.

[Reinhart, 2004] Reinhart C.F., Lightswitch 2002, A model for manual control of electric lighting and blinds, *Solar Energy*, vol. 77(1) p. 15-28, 2004

[Richardson et al., 2008] Richardson I., Thomson M., Infield D., A high-resolution domestic building occupancy model for energy demand simulations, *Energy Buildings*, vol. 40(8) p. 1560–1566, 2008

[Rijal et al., 2007] Rijal H.B., Tuohy P., Humphreys M.A., Nicol J.F., Samuel A., Clarke J., Using results from field surveys to predict the effect of open windows on thermal comfort and energy use in buildings, *Energy and Buildings*, vol. 39 p. 823-836, 2007

[Robinson et al., 2007] Robinson D., Campbell N., Gaiser W., Kabel K., Le-Mouele A., Morel N., Page J., Stankovic S., Stone A. SUNtool – a new modelling paradigm for simulating and optimising urban sustainability, *Solar Energy*, vol. 81(9) p. 1196-1211, 2007

[S]

- [Seryak and Kissock, 2000] Seryak J., Kissock K., Occupancy and behavioural affects on residential energy use, *Proceedings of annual conference on American solar energy society*, 2000
- [Sierhuis et al., 1999] Sierhuis M., Clancey W.J., Van Hoof R., BRAHMS: A multiagent programming language for simulating work practice, Retrieved on August 20th, 2013 from: <http://www.AgentiSolutions.com>, 1999
- [Sierhuis et al., 2007] Sierhuis M., Clancey W.J., van Hoof R., Brahms - a multiagent modeling environment for simulating work practice in organizations, *International Journal of Simulation and Process Modelling*, vol. 3(3) p. 134-152, 2007
- [Sierhuis et al., 2009] Sierhuis M., Clancey W.J., Ron J.J., Hoof V., Brahms: An Agent-Oriented Language for Work Practice Simulation and Multi-Agent Systems Development, *Multi-Agent Programming*, Springer, 2009
- [Sierhuis, 2009] Sierhuis M., Modeling, Simulation and Development of Multi-Agent Systems with Brahms, *Presentation made at Carnegie Mellon University*, 2009, Retrieved on 20th August, 2013 from: ti.arc.nasa.gov/publications/699/download/
- [Shipworth, 2011] Shipworth M., Thermostat settings in English houses No evidence of change between 1984 and 2007. *BUILD ENVIRON*, vol. 46 (3) p. 635 – 642, 2011
- [Sloman, 2001] Sloman A., Varieties of affect and the CogAff architectural scheme, Symposium on Emotion, Cognition, and Affective Computing, *Society for the Study of Artificial Intelligence and Simulation of Behaviour (AISB)*, 2001
- [Spataru and Gillott, 2011] Spataru C., Gillott M., The use of intelligent systems for monitoring energy use and occupancy in existing homes, *Intelligent Buildings International* vol. 3(1) p. 24-31, 2011
- [Stevenson and Leaman, 2010] Stevenson F., Leaman A., Evaluating housing performance in relation to human behaviour: new challenges, *Building research and information*, vol. 38(5) p. 437-441, 2010
- [Stokes et al., 2004] Stokes M., Rylatt M. and Lomas K., A simple model of domestic lighting demand, *Energy Buildings*, vol. 36 p. 103–116, 2004
- [Suchman, 1987] Suchman L.A., Plans and situated actions: The problem of human-machine communication. *Cambridge: Cambridge University Press*, 1987
- [Swan, 2009] Swan L.G., Ismet U.V., Modeling of end-use energy consumption in the residential sector: A review of modeling techniques, *Renewable and Sustainable Energy Reviews*, vol. 13(8) p. 1819-1835, 2009.
- [T]**
- [Thibadeau et al., 1982] Thibadeau R., Just M.A., and Carpenter P.A., A model of the time course and content of reading, *Cognitive Science*, vol. 6 p. 157–203, 1982
- [U]**
- [Ueno et al., 2006] Ueno T., Inada R., Saeki O. and Tsuji K., Effectiveness of an energy-consumption information system for residential buildings, *Applied Energy*, vol. 8 p. 868–883, 2006
- [Uitdenbogerd et al., 2007] Uitdenbogerd D., Egmond C., Jonkers R., Kok G., Energy-related intervention success factors: a literature review, *ECEEE Summer Study Proceedings, France*, 2007
- [V]**
- [Vale and Vale, 2010] Vale B. and Vale R., Domestic energy use, lifestyles and POE: past lessons for current problems, *Building research and information*, vol. 38(5) p. 578-588, 2010
- [Van Dam et al., 2010] Van Dam S, Bakker C, Van Hal J., Home energy monitors: impact over the mediumterm. *Building research and information*, vol. 38(5) p. 458-469, 2010

[VestaEnergy, 2011] VestaEnergy, Solutions logicielles d'énergie management dynamique, Vesta System, *Brochure*, 2011 Retrieved on 20th August, 2013 from: http://www.cades-solutions.com/cades/images/pdf/vestaenergy_fr_bd.pdf

[W]

[Wallace et al., 2002] Wallace L.A., Emmerich S.J., Howard-Reed C., Continuous measurements of air change rates in an occupied house for 1 year: the effect of temperature, wind, fans, and windows, *J Expo Anal Environ Epidemiol*, vol. 12 (4) p. 296-306, 2002

[Weisbuch, 1991] Weisbuch G., Complex Systems Dynamics: An Introduction to Automata Networks (translated from French by S. Ryckebusch), *Addison-Wesley*, Redwood City, CA, 1991

[Wherry, 1976] Wherry R., Monitoring behavior and supervisory control, *Ch. The Human Operator Simulator-HOS*, New York, NY: *Plenum Press*, p. 283-293, 1976

[Widen et al., 2009] Widen J., Lundh M., Vassileva I., Dahlquist E., Ellegard K., Wackelgard E., Constructing load profiles for household electricity and hot water from time-use data—modelling approach and validation, *Energy and Buildings*, vol. 41(7) p. 753–768, 2009

[Wilke et al., 2011] Wilke U., Haldi F., Robinson D., A model of occupants activities based on time user survey data, *Proceedings of Building Simulation, 12th Conference of International Building Performance Simulation Association, Sydney*, 2011

[Wilke et al., 2013] Wilke U., Haldi F., Scartezzini J. L., Robinson D., A bottom-up stochastic model to predict building occupants' time-dependent activities, *Building and Environment*, vol. 60 p. 254-264, 2013

[World Urbanization Prospects, 2007] World Urbanization Prospects, United Nations Department of Economic and Social Affairs/Population Division, 2007

[Y]

[Yamaguchi et al., 2003] Yamaguchi Y., Shimoda Y., Mizuno M., Development of district energy system simulation model based on detailed energy demand model, *8th international IBPSA Conference, Eindhoven, The Netherlands*, 2003

[Yao and Steemers 2005] Yao R. and Steemers K., A method of formulating energy load profile for domestic buildings in the UK, *Energy Buildings*, vol. 37(6) p. 663–671, 2005

[Yun and Steemersm 2011] Yun G.Y. and Steemers K., Behavioural, physical and socio-economic factors in household cooling energy consumption, *Applied Energy*, vol. 88(6) p. 2191-2200, 2011

[Z]

[Zachary et al., 1998] Zachary W.W., Ryder J.M., Hicinbotham J.H., Cognitive task analysis and modelling of decision-making in complex environments, *In J. Canno Cannon-Bowers and E. Salas (Eds.)*, 1998

[Zimmermann et al., 2007] Zimmermann A., Lorenz A., Oppermann R., An Operational Definition of Context, B. Kokinov et al. (Eds.): *Context 2007*, LNAI 4635, p. 558–571, 2007

Appendix A: List of Publications

We have published scientific contributions in the well known international conferences and journals. The count for these publications includes Journal (2), Conference (3) and others (1). In this section we present the list of the articles published/accepted/submitted along with the abstract for the readers' interest.

A.1 Journal Publications:

1. **Ayesha Kashif**, Stephane Ploix, Julie Dugdale, Xuan Hoa Binh Le., *Simulating the dynamics of occupant behaviour for power management in residential buildings*, Energy and Buildings, vol. 56, p. 85-93, 2013

Abstract: Inhabitant's decisions and actions have a strong impact on the energy consumption and are an important factor in reducing energy consumption and in modelling future energy trends. Energy simulations that take into account inhabitants' behaviour are benchmarked at office buildings using controlled activity profiles and predefined scenarios. In this paper we have proposed a co-simulation environment for energy smart homes that takes into account inhabitants' dynamic and social behaviour. Based on this kind of complex behaviour, the setpoints for different controllers are adjusted in the physical simulator. In this platform, human behaviour is modelled using the Brahms environment and the thermal model and controllers for different appliances are modelled as a physical simulator. The thermal model computes the temperature decrease/increase in a room based on the contextual information resulting from the behaviour simulator. This information is then given to the controller to act upon.

Keywords: Human behaviour; Modelling; Simulation; Multiagent system

2. **KASHIF Ayesha**, DUGDALE Julie, PLOIX Stéphane, *Simulating Occupants' Behaviour for Energy Waste Reduction in Dwellings: A Multi Agent Methodology*, Advances in Complex Systems, vol. 56, p. 37 2013

Abstract: Energy waste due to inhabitants' behaviour in residential buildings has emerged as a potential research area due to the increasing worldwide population and growing energy needs. However, existing approaches for simulating energy consumption are mainly limited to office buildings and are based on static profiles. In this paper we propose a 4-step co-simulation methodology to assess how inhabitants' interactions with household appliances affect energy consumption. The approach is validated using a case study showing how human activities influence the energy consumption patterns of a refrigerator. The fridge was specifically chosen because it is a high energy-consuming appliance that is strongly affected by inhabitants' behaviours. In addition, modelling the fridge is nontrivial, and in choosing this appliance we show that it is possible to apply the approach to less complex appliances. A co-simulation approach is adopted with the fridge being physically modelled in Matlab and with human behaviour being modelled in the Brahms language and simulation environment. The consumption distribution from the simulated scenario is compared with the actual distribution (using data from a consumption database), to find optimum values of tuning parameters with less than 10% variation. This methodology enables us to simulate how human behaviours affect energy appliance consumption.

Keywords: Energy waste reduction; agent based dynamic behaviour simulations; behaviour influenced appliance consumption modelling

A.2 International Conference Publications:

1. **Ayesha Kashif**, Xuan Hoa Binh Le, Julie Dugdale, Stéphane Ploix (2011) “*Agent based framework to simulate inhabitants' behaviour in domestic settings for energy management.*” In Proceedings of the 3rd International Conference on Agents and Artificial Intelligence, pages 190-199

Abstract: Inhabitants' behaviour is a significant factor that influences energy consumption and has been previously incorporated as static activity profiles within simulation for energy control & management. In this paper an agent-based approach to simulate reactive/deliberative group behaviour has been proposed and implemented. It takes into account perceptual, psychological (cognitive), social behavioural elements and domestic context to generate reactive/deliberative behavioural profiles. The Brahms language is used to implement the proposed approach to learn behavioural patterns for energy control and management strategies.

Keywords: Multi agent system, Inhabitants' dynamic behaviour, Energy efficiency & management

2. Xuan Hoa Binh Le, **Ayesha Kashif**, Stéphane Ploix, Julie Dugdale, Maria Di Mascolo, Shadi Abras (2010) “*Simulating inhabitant behaviour to manage energy at home*” IBPSA, France

Abstract: This paper presents a causal model of inhabitants behaviour at home that takes into account their reactive behaviour. This model is necessary to develop a new kind of simulation tool for evaluating possible power management solutions, given the diversity and the variation of inhabitants needs.

Keywords: Inhabitants behaviour, modelling, simulation.

3. **A. Kashif**, J. Dugdale, S. Ploix. (2012), *An agent based approach to find high energy consuming activities*. International Conference on Artificial Intelligence (ICAI), Las Vegas, USA, July 2012

Abstract: Inhabitants' behaviour in buildings has a strong impact on the energy consumption patterns resulting in energy waste. The existing multi agent and centralized energy management approaches are focused on consumption optimization and load predictions without taking into account the inhabitants' behaviour. We argue that the consumption optimization without waste reduction is difficult. In this article we focus on the energy waste reduction associated with the inhabitants' behaviour. As an example a physical model for the fridge to predict the energy waste component and an agent based co-simulation methodology to identify high energy consuming activities, are developed. The proposed methodology demonstrates that based on the co-simulation results a library of high energy consuming activities can be built to support energy waste reduction efforts in Smart homes. It shall result in a shift from an energy manager towards an energy wizard to provide agents with the information on their consumption behaviour and alternatives to ensure the energy waste reduction.

Keywords: Multi agent simulation, behaviour, energy consumption, human behavior modelling

A.3 International Poster Publications:

1. Sana Gaaloul, Hoang-Anh Dang, **Ayesha Kashif**, Benoit Delinchant and Frederic Wurtz (2013), *a new co-simulation architecture for mixing dynamic building simulation and agent oriented approach for users behaviour modeling*, Proceedings of BS2013: 13th Conference of International Building Performance Simulation Association, Chambéry, France, August 26-28

Abstract: This paper deals with an interoperability solution based on co-simulation that ensures tools collaborative working for building's global simulation. The proposed solution couples two specialized tools from different domains and characterized by different modelling approaches in

order to simulate a low energy building. A dynamic thermal envelope model in SIMULINK is coupled to a multi-agent based occupants' behaviour model realized in BRAHMS. The co-simulation of these two tools has been established to take advantages of their specific capabilities for a detailed simulation using physical and inhabitants' behaviour (cognitive abilities) models. This work is realized to simulate an efficient building control, taking into account the system's complexity. A co-simulation architecture based on software component standard is also proposed. The use of this technique helps to unify programming interfaces of several BPS tools in order to facilitate and generalize co-simulation use cases.

Keywords: Co-simulation, software component, human behaviour, multi-agent modelling.

