



HAL
open science

Singular KPZ Type Equations

Yvain Bruned

► **To cite this version:**

Yvain Bruned. Singular KPZ Type Equations. General Mathematics [math.GM]. Université Pierre et Marie Curie - Paris VI, 2015. English. NNT : 2015PA066517 . tel-01306427v2

HAL Id: tel-01306427

<https://theses.hal.science/tel-01306427v2>

Submitted on 29 Apr 2016

HAL is a multi-disciplinary open access archive for the deposit and dissemination of scientific research documents, whether they are published or not. The documents may come from teaching and research institutions in France or abroad, or from public or private research centers.

L'archive ouverte pluridisciplinaire **HAL**, est destinée au dépôt et à la diffusion de documents scientifiques de niveau recherche, publiés ou non, émanant des établissements d'enseignement et de recherche français ou étrangers, des laboratoires publics ou privés.



Laboratoire de Probabilités
et Modèles Aléatoires



Université
Pierre et Marie Curie

ÉCOLE DOCTORALE DE SCIENCES MATHÉMATIQUES DE PARIS CENTRE

THÈSE DE DOCTORAT

Discipline : Mathématiques

présentée par

Yvain Bruned

Equations singulières de type KPZ

dirigée par **Lorenzo Zambotti**

Rapportée par :

M. **Ismaël BAILLEUL** Université Rennes 1
M. **Peter FRIZ** Université TU Berlin

Soutenue publiquement le **14 décembre 2015** devant le jury composé de :

M. Ismaël	BAILLEUL	Université Rennes 1	Rapporteur
M. Christian	BROUDER	Université Paris 6	Examineur
M. Massimiliano	GUBINELLI	Université de Bonn	Examineur
M. Martin	HAIRER	Université de Warwick	Examineur
M. Thierry	LEVY	Université Paris 6	Examineur
M. Dominique	MANCHON	Université de Clermont-Ferrand	Examineur
M. Lorenzo	ZAMBOTTI	Université Paris 6	Directeur de Thèse

UPMC
Laboratoire de Probabilités
et Modèles Aléatoires
4 place Jussieu
75252 Paris Cedex 05
Boîte courrier 188

UPMC
Ecole Doctorale de Sciences
Mathématiques de Paris Centre
4 place Jussieu
75252 Paris Cedex 05
Boîte courrier 290

Remerciements

Je ne saurais commencer ce travail sans adresser mes plus vifs remerciements à mes maîtres. Lorenzo Zambotti, mon directeur de thèse, m'a accordé un soutien constant, une disponibilité sereine; et lorsque je tâtonnais et parfois fléchissais devant les problèmes difficiles, il a toujours posé son regard éclairé et bienveillant sur mon entreprise. Nos discussions, nous échangeons et tranquillement, patiemment il me poussait à formuler mes idées, à me tourner vers une réalisation plus théorique. Il me répétait avec un optimisme sans faille que je devais avoir un esprit critique et il m'apprenait à m'éloigner des lectures d'autrui pour chercher par moi-même. Mais surtout Lorenzo Zambotti m'a offert la possibilité de me familiariser avec son domaine de prédilection, les Equations aux dérivées partielles stochastiques, et d'avancer ainsi à grands pas sur le chemin de mon étude. Le savoir mathématique que j'ai acquis grâce à mon directeur de thèse a permis que ce projet aboutisse.

Le cœur de la thèse est aussi le fruit d'une collaboration que nous avons menée, Lorenzo Zambotti et moi-même, avec Martin Hairer. Ce dernier m'a beaucoup appris sur le domaine qu'il a inventé, à savoir les Structures de régularité. Je n'oublierai pas ce stage de M1 en 2011 durant lequel je fis ma première expérience de la recherche en mathématiques. A Warwick pendant huit semaines j'ai découvert comment un chercheur pouvait être entièrement passionné par les mathématiques tout en conservant une grande simplicité, un esprit de motivation capable d'inciter à son tour à la recherche le jeune étudiant que j'étais. De Martin Hairer, outre bien sûr les nombreuses explications qu'il m'a données sur le domaine des Structures de régularité, j'ai d'abord retenu l'envie effrénée de chercher, de comprendre ce qui ne va pas dans certaines preuves, l'énorme travail sans cesse repris avec fièvre et à la fois avec méticulosité. Cette collaboration fructueuse se poursuivra à Warwick l'année prochaine.

Je tiens aussi à remercier Arnaud Debussche, mon directeur de département à l'ENS Rennes, qui m'a introduit auprès de Martin Hairer et de Lorenzo Zambotti lorsque je lui exprimai mon souhait de travailler dans le domaine des Equations aux dérivées partielles stochastiques. De plus, j'ai eu l'opportunité de commencer ma thèse au moment où de nouvelles théories apparaissaient; j'ai ainsi pu discuter avec Massimiliano Gubinelli qui m'a communiqué son intuition sur les diagrammes de Feynman.

On reconnaît un maître à la générosité avec laquelle il transmet son savoir. Merci à vous tous.

Je souhaite également exprimer ma plus profonde gratitude à Ismaël Bailleul et Peter Friz qui ont accepté la responsabilité d'être rapporteurs. Je suis très honoré de la présence dans le jury de : Christian Brouder, Dominique Manchon et Thierry Lévy.

Dans le très beau cadre du LMPA j'ai bénéficié d'un entourage compétent et chaleureux. Merci à Pauline Caron, Florence Deschamps, Maria Pochot et Josette Saman qui m'ont facilité les tâches administratives, à Jacques Portès pour le matériel informatique et à Philippe Macé pour la bibliothèque. Les années de thèse permettent de nouer des liens avec des condisciples qui partagent les mêmes espérances. Je voudrais remercier mes collègues de bureau pour la très bonne ambiance qui règne en 201 : Cécile, Franck, Loic, Max, Miraine, Nikos, Nicolas T., Pierre-Antoine, Vincent. De plus, j'ai beaucoup apprécié les moments passés avec les thésards de Paris 6 au restaurant administratif, notamment les instants privilégiés sur la terrasse où l'on buvait un café ou un thé préparé avec soin par Carole; et l'on se remplissait les yeux de la superbe vue sur la Seine et le jardin des plantes. Merci à Alice, Alexandre B., Alexandre G., Bastien, Cyril, David, Eric, Florian, Franck G., Guillaume, Julien, Liping, Nelo, Nicolas G., Olga, Pablo, Sandro, Sarah, Xan, Xinxin et Wangru. Le groupe de travail des thésards me fut aussi profitable; tour à tour nous assistions à des exposés sur des thématiques variées, nous en donnions nous-mêmes, j'offrais mon aide pour l'organisation, nous recevions nos collègues de Paris 7 : Anna, Aser, Guillaume B., Lorick, Maud, Marc-Antoine, Vu Lan. Et nous avançons tous ensemble.

Enfin, je remercie mes parents et mes deux frères qui m'ont constamment soutenu pendant ces années de thèse. Chantal et José m'ont aidé à me construire et à mettre le cap sur mon devenir. Boris et Vianney, fidèles compagnons de jeux et de rêves, vous hissez toujours les voiles à mes côtés.

Résumé

Dans cette thèse, on s'intéresse à l'existence et à l'unicité d'une solution pour l'équation KPZ généralisée. On utilise la théorie récente des structures de régularité inspirée des chemins rugueux et introduite par Martin Hairer afin de donner sens à ce type d'équations singulières. La procédure de résolution comporte une partie algébrique à travers la définition du groupe de renormalisation et une partie stochastique avec la convergence de processus stochastiques renormalisés. Une des améliorations notoires de ce travail apportée aux structures de régularité est la définition du groupe de renormalisation par le biais d'une algèbre de Hopf sur des arbres labellés. Cette nouvelle construction permet d'obtenir des formules simples pour les processus stochastiques renormalisés. Ensuite, la convergence est obtenue par un traitement efficace de diagrammes de Feynman.

Mots clés Equation KPZ généralisée, Chemins rugueux, Structures de Régularité, Groupe de Renormalisation, Algèbre de Hopf, Diagrammes de Feynman, Equations différentielles partielles stochastiques.

Abstract

In this thesis, we investigate the existence and the uniqueness of the solution of the generalised KPZ equation. We use the recent theory of regularity structures inspired from the rough path and introduced by Martin Hairer in order to give a meaning to this singular equation. The procedure contains an algebraic part through the renormalisation group and a stochastic part with the computation of renormalised stochastic processes. One major improvement in the theory of the regularity structures is the definition of the renormalisation group using a Hopf algebra on some labelled trees. This new construction paves the way to simple formulas very useful for the renormalised stochastic processes. Then the convergence is obtained by an efficient treatment of some Feynman diagrams.

Keywords Generalised KPZ equation, Rough path, Regularity Structures, Renormalisation group, Hopf algebra, Feynman diagrams, Partial stochastic differential equations.

Contents

1	Introduction	11
1.1	Singular SPDEs	13
1.2	Regularity Structures	14
1.3	Renormalisation Group	21
1.3.1	Definitions	22
1.3.2	Hopf algebra on Labelled trees and forests	25
1.3.3	The renormalised model	30
1.3.4	The extended structure	31
1.4	The use of Feynman diagrams	33
1.4.1	Wiener chaos decomposition	33
1.4.2	Renormalised Feynman diagrams	35
1.5	The generalised KPZ	38
2	Hopf Algebras on Labelled trees and forests	41
2.1	Notations	41
2.2	Rooted trees	42
2.2.1	Operations on forests	44
2.2.2	Coproducts on forests	46
2.3	Labelled trees and forests	48
2.4	Positive and negative renormalisations	54
2.4.1	Homogeneity	55
2.4.2	Positive renormalisation	56
2.4.3	Negative renormalisation	59
2.4.4	Groups	59
3	Renormalisation group in SPDEs	65
3.1	Regularity structures on labelled trees	65
3.2	Link with SPDEs and the symbol notation	67
3.3	Computations with $\hat{\Delta}^\circ$	74
3.4	Computation with $\hat{\Delta}$	75
3.5	Composition of renormalisation operations using the symbol notation	76
3.6	Renormalised Models	79
3.6.1	A recursive formulation	80

3.6.2	Renormalised models	83
3.7	Examples of renormalisation groups	88
3.7.1	Hermite polynomials	88
3.7.2	The KPZ equation	90
3.7.3	The stochastic heat equation	92
3.7.4	The generalised KPZ	93
3.7.5	The stochastic quantization	93
4	Extension of the structure	95
4.1	New labelled trees	95
4.2	Renormalised model	101
4.3	Comments	106
5	Convergence of the models	107
5.1	From abstract trees to graphs	107
5.2	Bounds on Labelled Graphs	112
5.2.1	Decomposition of the kernels	116
5.2.2	Partition of the integration domain	117
5.3	Elementary Labelled Graphs	121
5.4	Contractions	127
5.5	Renormalisation Procedure	128
5.5.1	Renormalisation by hand	128
5.5.2	A complete example	131
5.5.3	A general approach	134
5.5.4	Example	144
5.6	Pairing of labelled graphs	146
5.7	Alternative proof	147
5.8	General Theorem	149
5.8.1	Extending the definition	150
5.8.2	A new representation for the subdivergences	153
6	Solving the Generalised KPZ equation	157
6.1	Structure and the model	158
6.1.1	Structure	158
6.1.2	Model	161
6.1.3	Fixed point	165
6.2	The renormalised equation	169
6.3	The Itô model	173
6.4	Renormalisation procedure	174
6.5	Examples	179
6.6	Computation of the constants	182
6.6.1	Methodology	182
6.6.2	Constants for $ \tau _s = -1 - 2\kappa$	184

6.6.3	Constants for $ \tau _s = -2\kappa$	185
6.6.4	Constants for $ \tau _s = -4\kappa$	185
A	Alternative recursive proofs	191
A.1	Structure Group	191
A.2	Renormalised model	194
B	Generalised Taylor formula	201

Chapter 1

Introduction

In this thesis, we study the generalised KPZ equation

$$\partial_t u = \partial_x^2 u + f(u)(\partial_x u)^2 + k(u)\partial_x u + h(u) + g(u)\xi, \quad t \geq 0, x \in \mathbb{R}/2\pi, \quad (1.1)$$

i.e. an extension of the KPZ equation

$$\partial_t u = \partial_x^2 u + (\partial_x u)^2 + \xi, \quad t \geq 0, x \in \mathbb{R}/2\pi, \quad (1.2)$$

where ξ is a space-time white noise. We use the theory of regularity structures introduced by Martin Hairer in [Hai14b] for solving a class of *singular SPDEs*. A singular SPDE is a stochastic partial differential equation which contains some ill-defined term, typically a product of two (or more) Schwartz distributions: for instance in the KPZ equation (1.2) the solution u is not expected to be differentiable in x , so that the partial derivative $\partial_x u$ makes sense only as a distribution and its square $(\partial_x u)^2$ is ill-defined. In the generalised KPZ equation (1.1) the term $g(u)\xi$ is the product of the distribution ξ and the continuous function $g(u)$, which is however not sufficiently regular to give a classical meaning to this product; therefore this term is as difficult as $(\partial_x u)^2$ to treat.

The theory of regularity structures can be considered as a far-reaching extension of the *rough paths* approach to stochastic processes introduced by Terry Lyons in [Lyo91]; in particular the ideas of Massimiliano Gubinelli in [Gub04] have proved to be particularly fruitful. The "rough" point of view can be summarised as follows: if X is solution to a stochastic differential equation driven by a process Y , then the map $Y \mapsto X$ can be factorised into two separate maps

$$Y \mapsto \mathbf{Y} \mapsto X,$$

where $Y \mapsto \mathbf{Y} \in \mathbb{Y}$ is measurable, \mathbb{Y} is a metric space and $\mathbf{Y} \mapsto X$ is continuous in the metric of \mathbb{Y} . The continuity of $\mathbf{Y} \mapsto X$ yields very useful additional information like stability properties of solutions. We call \mathbf{Y} an *enhancement* of Y .

In singular SPDEs we have the same factorisation, but a new phenomenon arises. The natural driving "process" is the space-time white noise ξ ; if we replace ξ by a smooth version ξ_ε , for instance obtained by a convolution with a family of mollifiers, then the

enhancement of ξ_ε does *not* converge in \mathbb{Y} as $\varepsilon \rightarrow 0$ (note that we have not explained yet the structure of \mathbb{Y}). Therefore in general the solution u_ε to our SPDE is not guaranteed to converge either.

In order to solve this problem, the theory of regularity structures includes a *renormalisation* procedure, which consists in a way to appropriately modify the enhancement of ξ_ε , in order for the corresponding modified u_ε to converge. The renormalisation procedure has an algebraic step, by which the appropriate modification of the enhancement of ξ_ε is constructed, and an analytic step, where the actual convergence of the modified enhancement is proved.

Both these steps are rather complex and it is one of the main aims to this thesis to propose a systematic approach to this procedure. Note that several singular SPDEs have already been solved by means of a number of computations concerning the convergence of certain Feynman diagrams. For instance in [Hai14b, ZZ14, HS14, HP14, BK15, FH14, HS15] several important equations, including the stochastic quantization, the Navier-Stokes equation, the dynamical Sine-Gordon equation, the stochastic heat equation with multiplicative noise, the FitzHugh-Nagumo equation and the KPZ equation, have already been proved to be renormalisable in the sense explained above; however in all these papers one has to guess the structure of some linear operators related to the renormalisation group and this makes the approach somewhat *ad hoc* and difficult to apply to very complex equations. Indeed in the above papers the number of terms to be renormalised is sufficiently low to allow a term-by-term study; from this point of view the generalised KPZ equation (1.2) requires a different approach since, with around forty terms to renormalise, it is one of the most difficult examples in the theory.

Therefore, we improve several tools present in [Hai14b], in particular the representation of the renormalisation group by using Hopf algebras on labelled trees. This construction is very similar to the one for the structure group, one of the basic elements in the theory of regularity structures. In order to have a simpler formulation, we also extend the structure space for the SPDEs. By this new algebraic representation, we can treat efficiently the Feynman diagrams and give a proof for the solution of the generalised KPZ equation; moreover we can give a sketch of proof for the general case of locally subcritical equations.

Most of the material of this thesis has been written in collaboration with my advisor Lorenzo Zambotti and with Martin Hairer. I would like to thank them for the numerous discussions we had on the theory of Regularity Structures.

This thesis is divided into two parts: one dedicated to the algebraic representation in chapters 2, 3 and 4 and the other one to the computation of the stochastic terms. These terms appear in the decomposition of our solution in chapters 5 and 6 where we also provide a complete treatment of the generalised KPZ equation.

- In chapter 2, we present two hopf algebras on labelled trees associated to two groups: the structure group and the renormalisation group. This construction is based on the substitution Hopf algebra and the Connes-Kreimer Hopf algebra on labelled trees. We also explain the link between the two constructions.

- Chapter 3 establishes a link between the previous algebraic setting and the regularity structures used for solving singular SPDEs. We present the correspondence with the symbol notation introduced in [Hai14b] and we give a direct construction of the renormalised models, the topology used for proving the convergence of the renormalised solution.
- Chapter 4 gives a way to have a very simple action of the renormalisation group onto the model improving the formulae of the previous chapter. Therefore, we extend the structure space by adding a new label to our labelled trees which keeps track partially of the action of the renormalisation group. This extended structure also simplifies many of the proofs for the renormalised model.
- Chapter 5 uses the renormalisation group in the extended structure in order to prove the convergence of the model. We do not provide a proof of the general case but we give general results for some Feynman diagrams with few divergences. These diagrams include most of the examples which have been treated so far with the regularity structures.
- In chapter 6, we focus mainly on the resolution of the generalised KPZ equation which follows mainly from the methods introduced in the chapter 5.

1.1 Singular SPDEs

Let us recall briefly the main ideas of this theory: one considers a stochastic partial differential equation (SPDE) of the form

$$\partial_t u = \Delta u + F(u, \nabla u, \xi)$$

where $u = u(t, x)$ is a function (or a Schwarz distribution) on $\mathbf{R}_+ \times \mathbf{R}^d$, ξ is a white noise (e.g.) on $\mathbf{R}_+ \times \mathbf{R}^d$ and F is some non-linear function affine in ξ . It has been known for a long time that this kind of equation is ill-posed since the solution is expected to be a genuine Schwarz distribution if $d \geq 2$ and therefore the non-linearity $F(u, \nabla u, \xi)$ is ill-defined; famous examples include the KPZ equation in $d = 1$, where u is a continuous function but ∇u is a distribution, and the stochastic quantization in $d = 2, 3$.

One can regularise the noise ξ , replacing it by the smooth function $\xi_\varepsilon := \varrho_\varepsilon * \xi$ where ϱ_ε is a mollifier, and obtain a well-posed equation

$$\partial_t u_\varepsilon = \Delta u_\varepsilon + F(u_\varepsilon, \nabla u_\varepsilon, \xi_\varepsilon).$$

However, as $\varepsilon \rightarrow 0$ no classical technique allows to control the behavior of u_ε .

The breakthrough has come in the papers [Hai13, Hai14b] where it has been noticed that the solution u_ε can be written as a functional of a finite number of explicit polynomial functions of the noise ξ_ε :

$$u_\varepsilon = \Psi(P_\tau(\xi_\varepsilon), \tau \in T_0),$$

1.2. Regularity Structures

and that the functional Ψ (which is independent of ε) is continuous with respect to suitable topologies. This however does not solve the problem yet, since it turns out that in most cases $P_\tau(\xi_\varepsilon)$ does not converge as $\varepsilon \rightarrow 0$; so we need a renormalisation procedure which acts on the polynomial functions of the noise. We have to define a renormalised solution by

$$\mathcal{R}u_\varepsilon = \Psi(\mathcal{R}P_\tau(\xi_\varepsilon), \tau \in T_0),$$

where \mathcal{R} adds infinite constants in order to obtain the convergence. Several techniques have been used to tackle this problem:

- In [Hai11, HW13, Hai13] rough path techniques allow to deal with a lack of regularity in space. For the first time in [Hai13], the use of Feynman diagrams proves the convergence of the polynomial functions of the noise.
- In [GIP12], [CC13] and [GP15b], the authors used paracontrolled distributions to give a meaning to the ill-defined products in the equation. A good introduction to this approach is given in [GP15c]. The paraproduct has also been recently used in a geometric context for a generalisation of the parabolic Anderson model see [BB15].
- The regularity structure theory has been introduced in [Hai14b] which gives a hope to treat a certain class of singular SPDEs with good properties corresponding to a notion of local subcriticality. In [Hai14b], the main examples are the parabolic Anderson model and the stochastic quantization for $d = 3$.

As all the previous articles, we will consider SPDEs on the torus with space-time white noise. For the whole space, some equations have been solved in [BBF15], [MW15] with the paraproduct and in [HL15] with the regularity structure. Non gaussian noises have been investigated for the KPZ equation in [HS15] and for the quantization stochastic in [Hai15]

The regularity structures systematize the idea of polynomial functions of the noise by introducing an abstract space T of symbols built by using rules depending on the form of the equation. Then we define a model (Π_x, Γ_{xy}) which allows us to interpret any symbol $\tau \in T$ as a polynomial function $P_\tau(\xi_\varepsilon)$ of the noise centered at x . We change the base point thanks to the application Γ which gives the topology of the models for our solution. The theory associates a real number to each symbol called its homogeneity which corresponds to a kind of regularity of the polynomial function of the noise. Short introduction to the theory of regularity structures can be found in [Hai14a], [FH14] and [CW15]. We give the main definitions in the next section.

1.2 Regularity Structures

The main ideas of regularity structures come from the rough theory introduced in [Lyo91] and from control rough path see [Gub04]. The relation between the two theories is treated in [FH14]. The basic idea of regularity structure is to extend the Taylor

expansion by interpreting an abstract set of symbols T with a family of operators Π_x^ε in the case of a regularised SPDEs. We want to obtain a local expansion of the solution u_ε at the order $\gamma > 0$:

$$u_\varepsilon(y) = u_\varepsilon(x) + \sum_{i=1}^N a_i^\varepsilon(x) (\Pi_x^\varepsilon \tau_i)(y) + r_\varepsilon(x, y) \quad (1.3)$$

with $|r_\varepsilon(x, y)| < C\|x - y\|_\mathfrak{s}^\gamma$ and $|(\Pi_x^\varepsilon \tau_i)(y)| < C\|x - y\|_\mathfrak{s}^{\alpha_i}$, where $\alpha_i < \gamma$ and α_i is the homogeneity of τ_i . Moreover for a given scaling $\mathfrak{s} \in \mathbb{N}^d$, we associate a norm $\|\cdot\|_\mathfrak{s}$

$$\|x - y\|_\mathfrak{s} = \sum_{i=1}^d |x_i - y_i|^{1/\mathfrak{s}_i}.$$

The decomposition (1.3) is really close to the classical definition of Hölder function. A function f belongs to \mathcal{C}^γ with $\gamma \in \mathbb{R}_+ \setminus \mathbb{N}$ if there exists a constant $C > 0$ such that

$$f(y) = \sum_{i \leq \gamma} \frac{f^{(i)}(x)}{i!} (y - x)^i + r(x, y), \quad |r(x, y)| \leq C\|y - x\|_\mathfrak{s}^\gamma.$$

The abstract set T of symbols needs to be equipped with a structure if we want to be able to change the point of the Taylor expansion. This is the purpose of a regularity structure.

Definition 1.2.1. The triple $\mathcal{F} = (A, \mathcal{H}, G)$ is called a regularity structure with model space \mathcal{H} and structure group G if

- $A \subset \mathbb{R}$ is bounded from below without accumulation points.
- The vector space $\mathcal{H} = \bigoplus_{\alpha \in A} \mathcal{H}_\alpha$ is graded by A such that each \mathcal{H}_α is a Banach space.
- The group G is a group of continuous operators on \mathcal{H} such that, for every $\alpha \in A$, every $\Gamma \in G$, and every $\tau \in \mathcal{H}_\alpha$, one has $\Gamma\tau - \tau \in \bigoplus_{\beta < \alpha} \mathcal{H}_\beta$.

One simple example of regularity structures is $\bar{\mathcal{H}}$ the linear span of the abstract polynomials. Given $(X_i)_{i=1\dots d}$, the space $\bar{\mathcal{H}}_n$ is defined as the linear span of X^k where $|k|_\mathfrak{s} = \sum_{i=1}^d \mathfrak{s}_i k_i = n$. In that case the structure group is isomorphic to \mathbb{R}^d and it is given by the translation:

$$(\Gamma_h P)(X) = P(X + h).$$

If we want to describe the solution of a SPDE, we need to enlarge the structure space $\bar{\mathcal{H}}$ by adding new symbols. In the case of SPDEs the set \mathcal{H} is given by the linear span of some subset of \mathcal{F} defined recursively as follows:

- $\{1, (X_i)_{i=1\dots d}, \Xi\} \subset \mathcal{F}$

1.2. Regularity Structures

- if $\tau_1, \dots, \tau_n \in \mathcal{F}$ then $\tau_1 \cdots \tau_n \in \mathcal{F}$, where we assume that this product is associative and commutative
- if $\tau \in \mathcal{F} \setminus \{1, X^k : k \in \mathbb{N}^d\}$ then $\{\mathcal{I}(\tau), \mathcal{I}_k(\tau) : k \in \mathbb{N}^d\} \subset \mathcal{F}$.

To the polynomials, we add an abstract integrator $\mathcal{I}(\cdot)$ which represents the convolution with the heat kernel and we add also its derivatives. The construction of that space follows from a perturbative method: we start with the solution $\mathcal{I}(\Xi)$ of the linear equation, the stochastic heat equation and then we plug this solution into the products where the solution of our equation appears. In order to measure the regularity of our terms we define a scalar associated to each symbol its homogeneity. The homogeneity is computed recursively by: $|\Xi|_s = \alpha$, $|X_i|_s = s_i$, $|1|_s = 0$

$$|\tau_1 \cdots \tau_n|_s = |\tau_1|_s + \dots + |\tau_n|_s, \quad \mathcal{I}_k(\tau) = |\tau|_s + \beta - |k|_s.$$

where β is the regularising effect of $\mathcal{I}(\cdot)$ and α is the regularity of the noise. For a space-time white noise on \mathbb{R}^d , α is equal to $-\frac{|s|}{2} - \kappa$ for some $\kappa > 0$ which traduces the fact that $\xi \in \mathcal{C}^\alpha$ see [Hai14b, lemma 10.2]. The parameter β is equal to 2 for the heat kernel. The space \mathcal{H}_η is the linear span of elements with homogeneity η . Under suitable condition introduced in [Hai14b] of local subcriticality discussed also in 3.2, we obtain that the space \mathcal{H}_η is finite. Even if most of the examples converge in this case, it is not a guarantee of convergence. This condition is linked to the products appearing in the right-hand side of an SPDE: we ask that the products have a regularising effect in the sense that we earn some regularity at each step of a perturbative method. The structure group G has several representations, we give the recursive one:

$$\begin{cases} \Gamma_g \mathbf{1} = \mathbf{1}, & \Gamma_g \Xi = \Xi, & \Gamma_g X = X + g(X), & \Gamma_g(\tau\bar{\tau}) = (\Gamma_g \tau)(\Gamma_g \bar{\tau}), \\ \Gamma_g \mathcal{I}_k(\tau) = \mathcal{I}_k(\Gamma_g \tau) + \sum_{\ell} \frac{X^\ell}{\ell!} g(\mathcal{J}_{k+\ell}(\tau)), \end{cases}$$

where

$$\mathcal{J}_k(\tau) := \mathbb{1}_{(\beta - |k|_s + |\tau|_s > 0)} \mathcal{I}_k(\tau).$$

and g is a multiplicative functional on symbols with positive homogeneity. This definition coincides with the one for the polynomial structure. One important fact is the polynomial obtained from the difference $\Gamma_g \mathcal{I}_k(\tau) - \mathcal{I}_k(\Gamma_g \tau)$. If we choose a correct g , we have a Taylor expansion of the original symbol. The algebraic point of view is given in the next section.

Until now, we have presented the abstract point of view and we want to build distributions from these symbols. The idea of regularity structure is to have a local description: we fix a point x in \mathbb{R}^d and as a Taylor expansion, we will know the regularity around this point. Before introducing the operators Π_x , we need some notations. Let $r > 0$, we denote by \mathcal{B}_r the set of functions $\varphi : \mathbb{R}^d \rightarrow \mathbb{R}$ such that $\varphi \in \mathcal{C}^r$, $\|\varphi\|_{\mathcal{C}^r} \leq 1$ and φ is compactly supported in a unit ball around the origin. The parameter r will depend on the equation,

therefore we denote this space by \mathcal{B} . In order to have a local description, we rescale these test functions using the map \mathcal{S}_s^λ associated to a scaling s :

$$\mathcal{S}_s^\lambda(x_1, \dots, x_d) := (\lambda^{-s_1}x_1, \dots, \lambda^{-s_d}x_d).$$

The rescale test functions are given by:

$$\varphi_x^\lambda(y) = \lambda^{-|s|} \varphi(\mathcal{S}_s^\lambda(y - x)). \quad (1.4)$$

We denote by $\mathcal{S}'(\mathbb{R}^d)$ the space of Schwartz distributions on \mathbb{R}^d and by $\mathcal{L}(\mathcal{H}, \mathcal{S}'(\mathbb{R}^d))$ the space of linear maps from \mathcal{H} to $\mathcal{S}'(\mathbb{R}^d)$. Let $\tau \in \mathcal{H}$, we set by $\|\tau\|_\alpha$ the norm of its components in \mathcal{H}_α . We are now able to give the definition of a model:

Definition 1.2.2. Given a regularity structure \mathcal{F} and an integer $d \geq 1$, a model for \mathcal{F} on \mathbb{R}^d consists of maps

$$\begin{aligned} \Pi : \mathbb{R} &\rightarrow \mathcal{L}(\mathcal{H}, \mathcal{S}'(\mathbb{R}^d)) & \Gamma : \mathbb{R}^d \times \mathbb{R}^d &\rightarrow G \\ x &\mapsto \Pi_x & (x, y) &\mapsto \Gamma_{xy} \end{aligned}$$

such that $\Gamma_{xy}\Gamma_{yz} = \Gamma_{xz}$ and $\Pi_x\Gamma_{xy} = \Pi_y$. Moreover, given $r > |\inf A|$, for any compact $K \subset \mathbb{R}^d$ and $\gamma > 0$, there exists a constant C such that the bounds

$$|(\Pi_x\tau)(\varphi_x^\lambda)| \leq C\lambda^{|\tau|}\|\tau\|, \quad \|\Gamma_{xy}\tau\|_\beta \leq C\|x - y\|_s^{\alpha-\beta}\|\tau\|$$

hold uniformly over $\varphi \in \mathcal{B}$, $(x, y) \in K$, $\tau \in \mathcal{H}_\alpha$ with $\alpha \leq \gamma$, and $\beta < \alpha$.

Now when we look at algebraic properties, we write $(\Pi_x\tau)(y)$ instead of $(\Pi_x\tau)(\varphi_x^\lambda)$ because we consider a regularised model in the sense that we convolve the noise ξ with a mollifier. The model depends on ε and for every τ , $\Pi_x\tau$ will be a function. But for the convergence we can obtain distributions in the limit for symbols with negative homogeneity as Ξ . We present the interpretation given in [Hai14b] of the abstract integrator $\mathcal{I}_k(\cdot)$. We first start with a definition of some kernels with nice properties:

Definition 1.2.3. A kernel K is homogeneous of degree $\beta - d$. If $K = \sum_{n \geq 0} K_n$ where $K_n : \mathbb{R}^d \rightarrow \mathbb{R}$ is smooth compactly supported in $B(0, 2^{-n})$ and such that:

$$\sup_x |D^k K_n(x)| \lesssim 2^{n(d-\beta+|k|_s)}. \quad (1.5)$$

Moreover, we have $\int K_n(x)P(x)dx = 0$ for every polynomial of degree N , for some large value of N .

These kernels appear naturally in our equation. Indeed, thanks to the scaling of the heat kernel G it has been proven in [Hai14b] that G can be decomposed into $G = K + R$ where K is homogeneous of degree $2 - d$ and R is smooth. The term K is singular at the origin and this singularity is measured through the bound (1.5).

1.2. Regularity Structures

Definition 1.2.4. Given a kernel of homogeneous of degree $\beta-d$ and a regularity structure \mathcal{H} , we say that a model (Π, Γ) is admissible if the identities

$$(\Pi_x X^k)(y) = (y-x)^k, \quad \Pi_x \mathcal{I}_n \tau = D^{(n)} K * \Pi_x \tau - \Pi_x \mathcal{J}_n(x) \tau,$$

hold for every $\tau \in \mathcal{T}$ with $|\tau|_s \leq N$, where $\mathcal{J}_n(x)$ is given by

$$\mathcal{J}_n(x) \tau = \sum_{|k|_s < |\tau|_s + \beta - |n|_s} \frac{X^k}{k!} \int D^{(k+n)} K(x-y) (\Pi_x \tau)(dy).$$

In an admissible model, we subtract the Taylor expansion of $D^{(n)} K * \Pi_x \tau$ in order to obtain the right decrease around the point x depending on the homogeneity of τ . The proof is based on the theorem given in [Hai14b] and in the appendix B. One can also have another description of the admissible model by using the structure group:

$$\Pi_x \tau = \Pi \Gamma_{g_x} \tau.$$

where g_x is a functional defined recursively from Π_x and Π is the operator which gives the naïve interpretation to a symbol: $\Pi \mathcal{I}_n(\tau) = D^{(n)} K * \Pi \tau$. Moreover, this definition is a consequence of the fact that $\Pi_x(\Gamma_{g_x})^{-1}$ does not depend on x . In this context, the map Γ_{xy} is just described as follows:

$$\Gamma_{xy} = (\Gamma_{g_x})^{-1} \circ \Gamma_{g_y}.$$

Remark 1.2.5. The model defined above is for $\mathcal{H}_{\leq \beta} = \bigoplus_{\alpha \leq \beta} \mathcal{H}_\alpha$ with $\beta < N$. Indeed, we want to annihilate polynomials up to a certain order. In most of the application is sufficient to consider this space for a large value of N . We start with the symbols with negative homogeneity then we can enlarge this family in order to be closed under the action of the structure group see 3.1.8.

We solve our fixed point problem in the abstract space \mathcal{H} . We are looking to functions from \mathbb{R}^d to \mathcal{H} which behave like Hölder functions. We define the space \mathcal{D}^γ by:

Definition 1.2.6. A function $f : \mathbb{R}^d \rightarrow \bigoplus_{\alpha < \gamma} \mathcal{H}_\alpha$, belongs to \mathcal{D}^γ , if for every compact domain K , one has:

$$\|f\|_\gamma = \sup_{z \in K} \sup_{\alpha < \gamma} \|f(z)\|_\alpha + \sup_{(z, \bar{z}) \in K^2} \sup_{\alpha < \gamma} \frac{\|f(z) - \Gamma_{z\bar{z}} f(\bar{z})\|_\alpha}{\|z - \bar{z}\|_s^{\gamma - \alpha}} < \infty. \quad (1.6)$$

Remark 1.2.7. In practice, we add a second parameter η which allows us to deal with singular initial conditions on the line $\{(t, x) : t = 0\}$ see 6.1.3.

Remark 1.2.8. On a classical Hölder space, we look at the difference $f(z) - f(\bar{z})$ which can be expressed as a translation: $f(\bar{z}) = f(z + h)$ where $h = (\bar{z} - z)$. The difference between $f(z)$ and $\Gamma_{z\bar{z}} f(\bar{z})$ is an extension of this fact. We change the base point with the structure group and then we measure how close we are from the new point.

The definition of the previous space depends on the model which is parametrised by ε . We need a way to compare two models and a way to compare two functions in \mathcal{D}^γ but not defined on the same model. Based on [Hai14b], we use a semi distance between two models. Let (Π, Γ) and $(\bar{\Pi}, \bar{\Gamma})$ two admissible models, we consider for a given compact $K \subset \mathbb{R}^2$

$$\|\Pi; \bar{\Pi}\| = \sup_{z \in K} \sup_{\substack{\varphi \in \mathcal{B} \\ \lambda \in (0,1]}} \sup_{\tau \in \mathcal{T}} \frac{|(\Pi_z \tau - \bar{\Pi}_z \tau)(\varphi_z^\lambda)|}{\lambda^{|\tau|}} + \sup_{z, \bar{z} \in K} \sup_{\tau \in \mathcal{T}} \sup_{\alpha < \gamma} \frac{\|\Gamma_{z\bar{z}} \tau - \bar{\Gamma}_{z\bar{z}} \tau\|_\alpha}{\|z - \bar{z}\|^{\gamma-\alpha}}.$$

In our case, this semi distance is a distance because we are working on a compact domain in the space variable and on finite time. The natural distance defined in [Hai14b] between $U \in \mathcal{D}^\gamma$ and $\bar{U} \in \bar{\mathcal{D}}^\gamma$ where $\bar{\mathcal{D}}^\gamma$ is built from $(\bar{\Pi}, \bar{\Gamma})$, is given by

$$\|U; \bar{U}\|_\gamma = \sup_{z \in K} \sup_{\alpha < \gamma} \|U(z) - \bar{U}(z)\|_\alpha + \sup_{(z, \bar{z}) \in K^2} \sup_{\alpha < \gamma} \frac{\|U(z) - \bar{U}(z) - \Gamma_{z\bar{z}} U(\bar{z}) + \bar{\Gamma}_{z\bar{z}} \bar{U}(z)\|_\alpha}{\|z - \bar{z}\|^{\gamma-\alpha}}$$

on a fibred space $\mathcal{M} \times \mathcal{D}^\gamma$ which contains pairs $((\Pi, \Gamma), U)$ such that (Π, Γ) is an admissible model and such that the space \mathcal{D}^γ is constructed from the model (Π, Γ) .

We present the major theorem at the center of all the theory: the reconstruction theorem first introduced in [Hai14b]. It states that from every $f \in \mathcal{D}^\gamma$ with $\gamma > 0$, there exists a unique distribution close to $\Pi_x f(x)$ near x .

Theorem 1.2.9. *With the same hypotheses as above, for every $\gamma > 0$ there exists a unique linear map $\mathcal{R} : \mathcal{D}^\gamma \rightarrow \mathcal{S}'(\mathbb{R}^d)$ such that:*

$$|(\mathcal{R}f - \Pi_x f(x))(\varphi_x^\lambda)| \lesssim \lambda^\gamma,$$

uniformly over $\varphi \in \mathcal{B}$, for every $f \in \mathcal{D}^\gamma$.

Remark 1.2.10. In the case of a parametrised model with ε , for every $\tau \in \mathcal{H}$, $\Pi_x \tau$ happens to be a function. Therefore one has an explicit expression for \mathcal{R} given in [Hai14b] by:

$$(\mathcal{R}f)(x) = (\Pi_x f(x))(x).$$

When we solve a singular SPDEs, we have to give a meaning to ill-defined products. The theory of regularity structure provides a definition for the product. We define some subspaces of \mathcal{H} called sectors which have nice properties. They will be the arrival space for the space of functions \mathcal{D}^γ .

Definition 1.2.11. Let $V \subset \mathcal{H}$, V is a sector of regularity $\alpha \leq 0$ if

- V is invariant under \mathcal{G} .
- $V = \bigoplus_{\beta \geq \alpha} V_\beta$ with $V_\beta \subset \mathcal{H}_\beta$ and there exists a complement of V_β in \mathcal{H}_β .

This definition allows us to give a way of multiplying function in the \mathcal{D}^γ spaces. We consider functions which take values in some specific sectors. We first give a precise definition of what a product is in our structure.

1.2. Regularity Structures

Definition 1.2.12. Let $V, \bar{V} \subset T$ two sectors. A product on (V, \bar{V}) is a bilinear map $\star : V \times \bar{V} \rightarrow T$ such that for any $\tau \in V_\alpha, \bar{\tau} \in \bar{V}_\beta$ and $\Gamma \in G$, we have: $\tau \star \bar{\tau} \in T_{\alpha+\beta}$ and $\Gamma(\tau \star \bar{\tau}) = (\Gamma\tau) \star (\Gamma\bar{\tau})$.

Remark 1.2.13. In the original theorem in [Hai14b], we need the hypothesis of γ regularity for (V_1, V_2) which depends on the choice of the product in our structure. We have chosen the pointwise product and for that product $\Gamma\tau\bar{\tau} = \Gamma\tau\Gamma\bar{\tau}$ which gives the γ regularity for every γ .

The space $\mathcal{D}_\alpha^\gamma$ is the space of functions $f \in \mathcal{D}^\gamma$ such that for every x :

$$f(x) \in T_\alpha^+ = \bigoplus_{\beta \geq \alpha} T_\beta.$$

This space gives a bound of the lowest homogeneity which can appear in the decomposition of $f(x)$.

Theorem 1.2.14. Let $f_1 \in \mathcal{D}_{\alpha_1}^{\gamma_1}(V), f_2 \in \mathcal{D}_{\alpha_2}^{\gamma_2}(\bar{V})$ and let \star a product on (V, \bar{V}) . Then the function f given by $f(x) = \mathcal{Q}_\gamma(f_1(x) \star f_2(x))$ belongs to $\mathcal{D}_\alpha^\gamma$ with

$$\alpha = \alpha_1 + \alpha_2, \quad \gamma = (\gamma_1 + \alpha_2) \wedge (\gamma_2 + \alpha_1),$$

where \mathcal{Q}_γ is the projection on $\bigoplus_{\alpha \leq \gamma} \mathcal{H}_\alpha$.

Remark 1.2.15. This theorem is close to the spirit of the classical result of harmonic analysis which says that the product extends naturally to $\mathcal{C}^{-\alpha} \times \mathcal{C}^\beta$ into $S'(\mathbb{R}^d)$ if and only if $\beta > \alpha$ see [BCD11].

Remark 1.2.16. A sector V is *function-like* if for $\alpha < 0, V_\alpha = 0$ and $V_0 = \langle \mathbf{1} \rangle$. For our fixed point problem, we will not consider the whole space \mathcal{D}^γ but we restrain ourself to the subspace $\mathcal{D}_\mathcal{U}^\gamma$ which are functions in \mathcal{D}^γ taking values in \mathcal{U} given by

$$\mathcal{U} = \mathcal{I}(\mathcal{H}) \oplus \bar{\mathcal{H}}$$

where $\bar{\mathcal{H}}$ are the abstract polynomials. The set \mathcal{U} is an example of a function-like sector. This set is also natural for a SPDE: if we perform a perturbative method all the terms will be convolved with the heat kernel which is equivalent in the abstract space of applying the abstract integrator $\mathcal{I}(\cdot)$.

Given a product $\star : V \times V \rightarrow V$ on that sector, we can define for any smooth function $F : \mathbb{R} \rightarrow \mathbb{R}$, any $U \in \mathcal{D}^\gamma(V)$ and any $\gamma > 0$ the V -valued function $F_\gamma(U)$:

$$(F_\gamma(U))(x) = \sum_{k \geq 0} \frac{F^{(k)}(u(x))}{k!} \mathcal{Q}_\gamma(\tilde{U}(x)^{\star k}) \quad (1.7)$$

where we have set

$$u(x) = \langle \mathbf{1}, U(x) \rangle, \quad \tilde{U}(x) = U(x) - u(x)\mathbf{1}.$$

Proposition 1.2.17. *If $F \in C^k$ for sufficient large k , the map $U \mapsto F_\gamma(U)$ is locally lipschitz continuous from \mathcal{D}^γ into itself.*

Remark 1.2.18. The identity (1.7) can be viewed as a linearisation. This is one of the major strength of the theory compared to the paracontrolled distributions in [GIP12] where the authors introduce a parilinearisation only for the first order. Moreover, this the main reason of the fact that at this moment the generalised KPZ equation can only be solved with the theory of regularity structures.

1.3 Renormalisation Group

For proving the convergence of the solution u_ε of the regularised equation, we use the topology of the model. In [Hai14b], it has been proved that thanks to powerful extension theorems is sufficient to show the convergence of $\Pi_x^\varepsilon \tau$ for $\tau \in T_0$ where T_0 is a finite subset of symbols. This finite set contains the symbols with negative homogeneity. The cardinality of T_0 is 8 for KPZ but 43 for the generalised KPZ. In general, the $\Pi_x^\varepsilon \tau$ do not converge because of ill-defined products. We have to renormalise them which modifies Π_x^ε in $\hat{\Pi}_x^\varepsilon$. For that purpose, we introduce a new group of transformations \mathcal{R} named renormalisation group which act on the symbols. For $M_\varepsilon \in \mathcal{R}$ we can code the transformation $\Pi_x^\varepsilon \rightarrow \hat{\Pi}_x^\varepsilon$. This transformation has to preserve the algebraic structure of the model given in 1.2.2.

For that aim, we define a map:

$$M : T_0 \rightarrow (T_0)^*$$

where $(T_0)^*$ contains T_0 and other terms with positive homogeneity. Indeed, we need an enlarge family of symbols because the map M adds counter terms with better homogeneity which can be positive. Then it is possible under suitable hypothesis on M to define a renormalised model (Π^M, Γ^M) through a factorisation given in [Hai14b] by:

$$\Pi_x^M = (\Pi_x \otimes g_x) \Delta^M$$

where the map g_x is defined from Π_x and the map Δ^M is defined through algebraic equations. The construction of the Δ^M works for any map M but if we want to build a renormalised model we have to check the form of $\Delta^M \tau$ for every $\tau \in T_0$. In many examples, as in [Hai14b], [HP14] we have to guess the form of Δ^M on T_0 and then plug our guess into the equations defining Δ^M which induces a lot of computations. We propose an approach to the construction of the renormalisation group which is simpler than the method proposed in [Hai14b]. Finally, these new objects will be the same. We want to describe a concrete subgroup of the renormalisation group. Elements of this subgroup are given through a coproduct $\hat{\Delta}$ and functionals with a support included in the set of symbols with negative homogeneity:

$$M_\ell = (\ell \otimes 1) \hat{\Delta}.$$

1.3. Renormalisation Group

Moreover, we provide a recursive definition of that group:

$$M_\ell = M_\ell^\circ R_\ell$$

where M_ℓ° and R_ℓ are defined by using different coproducts. The main idea of this recursive definition is that the map R_ℓ computes interactions between some symbols. These interactions can be considered as gaussian correlations. Thanks to the nice properties of R_ℓ , these maps M belong to the renormalisation group and we can define the renormalised model (Π^M, Γ^M) by the same recursive definition:

$$\Pi_x^M \tau = \Pi_x^{M^\circ} R \tau.$$

One main difference is that the renormalised model can be defined directly on the whole structure without using complex extension theorem. By extending the structure space and the maps M , one can obtain a nice definition of the renormalised model given by:

$$\Pi_x^M \tau = \Pi_x M \tau.$$

1.3.1 Definitions

The construction of the renormalisation group is based on the construction of an Hopf algebra as for the structure group. In this section, we provide the reader with basic definitions on Hopf algebra. We also present examples of Hopf algebra which have inspired our construction. For the next definitions and propositions we follow [KRT12].

Definition 1.3.1. (Algebra) A unital associative algebra \mathcal{H} over a field \mathbb{K} is a \mathbb{K} -linear space endowed with two homomorphisms:

- a product $\mathcal{M} : \mathcal{H} \otimes \mathcal{H} \rightarrow \mathcal{H}$ satisfying the associativity condition:

$$\mathcal{M}(\mathcal{M} \otimes id)(\tau_1 \otimes \tau_2 \otimes \tau_3) = \mathcal{M}(id \otimes \mathcal{M})(\tau_1 \otimes \tau_2 \otimes \tau_3), \forall \tau_1, \tau_2, \tau_3 \in \mathcal{H}.$$

- a unit $u : \mathbb{K} \rightarrow \mathcal{H}$ satisfying:

$$\mathcal{M}(u \otimes 1)(1 \otimes \tau) = \tau = \mathcal{M}(1 \otimes u)(\tau \otimes 1), \forall \tau \in \mathcal{H}.$$

Definition 1.3.2. (Algebra) A coalgebra \mathcal{H} over a field \mathbb{K} is a \mathbb{K} -linear space endowed with two homomorphisms:

- a coproduct $\Delta : \mathcal{H} \rightarrow \mathcal{H} \otimes \mathcal{H}$ satisfying the coassociativity condition:

$$\forall \tau \in \mathcal{H}, (\Delta \otimes 1)\Delta \tau = (1 \otimes \Delta)\Delta \tau.$$

- a counit $\mathbf{1}^* : \mathcal{H} \rightarrow \mathbb{K}$ satisfying:

$$\forall \tau \in \mathcal{H}, (\mathbf{1}^* \otimes 1)\Delta \tau = \tau = (1 \otimes \mathbf{1}^*)\Delta \tau.$$

Definition 1.3.3. A **bialgebra** \mathcal{H} over a field \mathbb{K} is a \mathbb{K} -linear space endowed with both an algebra and a coalgebra structure such that the coproduct and the counit are unital algebra homomorphisms:

$$\begin{aligned}\Delta\mathcal{M} &= \mathcal{M}_{\mathcal{H}\otimes\mathcal{H}}(\Delta \otimes \Delta), \Delta 1 = 1 \otimes 1, \\ \mathbf{1}^*\mathcal{M} &= \mathcal{M}_{\mathbb{K}}(\mathbf{1}^* \otimes \mathbf{1}^*), \mathbf{1}^*(1) = 1.\end{aligned}$$

Definition 1.3.4. A **graded bialgebra** is a bialgebra graded as a linear space:

$$\mathcal{H} = \bigoplus_{n=0}^{\infty} \mathcal{H}^{(n)}$$

such that the grading is compatible with the algebra and the coalgebra structures:

$$\mathcal{H}^{(n)}\mathcal{H}^{(m)} \subseteq \mathcal{H}^{(n+m)} \text{ and } \Delta\mathcal{H}^{(n)} \subseteq \bigoplus_{k=0}^n \mathcal{H}^{(k)} \otimes \mathcal{H}^{(n-k)}.$$

Definition 1.3.5. A **connected bialgebra** is a graded bialgebra \mathcal{H} for which $\mathcal{H}^{(0)} = u(\mathbb{K})$.

Definition 1.3.6. A **Hopf algebra** \mathcal{H} over a field \mathbb{K} is a bialgebra over \mathbb{K} equipped with an antipode map $\mathcal{A} : \mathcal{H} \rightarrow \mathcal{H}$ obeying:

$$\mathcal{M}(\mathcal{A} \otimes 1)\Delta = u(\mathbf{1}^*) = \mathcal{M}(1 \otimes \mathcal{A})\Delta.$$

Proposition 1.3.7. Any connected graded bialgebra is a Hopf algebra whose antipode is given by $\mathcal{A}(1) = 1$ and recursively by any of the two following formulas for $\tau \neq 1$:

$$\begin{aligned}\mathcal{A}(\tau) &= -\tau - \sum_{(\tau)} \mathcal{A}(\tau')\tau'', \\ \mathcal{A}(\tau) &= -\tau - \sum_{(\tau)} \tau'\mathcal{A}(\tau'')\end{aligned}$$

where we used Sweedler's notation.

Remark 1.3.8. When we compute $\Delta\tau$ for $\tau \in \mathcal{H}$, we obtain a sum of the form: $\sum_i \tau'_i \otimes \tau''_i$ which can be replaced as a shorthand notation by $\sum_{(\tau)} \tau' \otimes \tau''$. This notation is the Sweedler's notation.

Remark 1.3.9. This proposition is very useful to prove the Hopf algebra structure. We will use it for the renormalisation group. But for the structure group, we have to construct by hand the antipode.

Before giving Hopf algebra on labelled trees, we present briefly some well known Hopf algebra. We first introduce the substitution Hopf algebra used in [CHV05], [CHV07], [CHV10] in the context of Runge-Kunta methods. They can describe the coefficients for the substitution of one B -series into another. This Hopf algebra is defined as follows.

1.3. Renormalisation Group

Given a tree τ , a subforest $\sigma = \{\sigma_1, \dots, \sigma_k\}$ of τ denoted by $\sigma \subset \tau$ is such that each σ_i are subtrees of τ and they are all disjoint. We define τ/σ as the tree obtained from τ by removing all the subtrees σ_i . From these definitions, we can give a coproduct:

$$\Delta_s \tau = \sum_{\sigma \subset \tau} \sigma \otimes (\tau/\sigma).$$

We present a few examples of computation:

$$\begin{aligned} \Delta_s \bullet &= \bullet \otimes \bullet, \\ \Delta_s \begin{array}{c} \bullet \\ | \\ \bullet \end{array} &= \begin{array}{c} \bullet \\ | \\ \bullet \end{array} \otimes \bullet + \bullet \otimes \begin{array}{c} \bullet \\ | \\ \bullet \end{array}, \\ \Delta_s \begin{array}{c} \bullet \\ | \\ \bullet \\ | \\ \bullet \end{array} &= \begin{array}{c} \bullet \\ | \\ \bullet \\ | \\ \bullet \end{array} \otimes \bullet + \bullet \otimes \begin{array}{c} \bullet \\ | \\ \bullet \\ | \\ \bullet \end{array} + 2 \begin{array}{c} \bullet \\ | \\ \bullet \end{array} \otimes \begin{array}{c} \bullet \\ | \\ \bullet \end{array}, \\ \Delta_s \begin{array}{c} \bullet \\ | \\ \bullet \\ | \\ \bullet \\ | \\ \bullet \end{array} &= \begin{array}{c} \bullet \\ | \\ \bullet \\ | \\ \bullet \\ | \\ \bullet \end{array} \otimes \bullet + \bullet \otimes \begin{array}{c} \bullet \\ | \\ \bullet \\ | \\ \bullet \\ | \\ \bullet \end{array} + 2 \begin{array}{c} \bullet \\ | \\ \bullet \end{array} \otimes \begin{array}{c} \bullet \\ | \\ \bullet \\ | \\ \bullet \end{array} + 3 \begin{array}{c} \bullet \\ | \\ \bullet \end{array} \otimes \begin{array}{c} \bullet \\ | \\ \bullet \end{array} + \begin{array}{c} \bullet \\ | \\ \bullet \end{array} \otimes \begin{array}{c} \bullet \\ | \\ \bullet \end{array} \otimes \begin{array}{c} \bullet \\ | \\ \bullet \end{array}. \end{aligned}$$

where we have performed the following identification $\bullet = \emptyset$. If we consider \mathcal{H} the space generated by rooted forests with all connected components containing at least one edge, \mathcal{H} equipped with Δ_s is a hopf algebra because \mathcal{H} is a connected graded bialgebra where the grading is defined in terms of the number of edges. We obtain a nice formula for the antipode given in [CEM11] :

$$\mathcal{A}(\tau) = -\tau + \sum_{r \geq 1} (-1)^{r+1} \sum_{\emptyset \subsetneq \sigma_1 \subsetneq \dots \subsetneq \sigma_r \subsetneq \tau} \sigma_1(\sigma_2/\sigma_1) \dots (\sigma_r/\sigma_{r-1})(\tau/\sigma_r), \quad (1.8)$$

where the σ_i are subforests of τ .

Another well known algebra, is the Connes-Kreimer algebra \mathcal{H}_{CK} of rooted forests originally introduced in [But72] and use in a different context in [CK98]. This algebra is graded by the number of vertices, also used in the rough path theory in [Gub10]. For a brief historical overview see [Bro04]. This algebra is a Hopf algebra equipped with the following coproduct:

$$\Delta_{CK} \tau = \tau \otimes \mathbf{1} + \mathbf{1} \otimes \tau + \sum_{c \in \mathfrak{A}(\tau)} P^c(\tau) \otimes R^c(\tau).$$

$$\begin{aligned} \Delta_{CK} \bullet &= \bullet \otimes \mathbf{1} + \mathbf{1} \otimes \bullet, \\ \Delta_{CK} \begin{array}{c} \bullet \\ | \\ \bullet \end{array} &= \begin{array}{c} \bullet \\ | \\ \bullet \end{array} \otimes \mathbf{1} + \mathbf{1} \otimes \begin{array}{c} \bullet \\ | \\ \bullet \end{array} + \bullet \otimes \bullet, \\ \Delta_{CK} \begin{array}{c} \bullet \\ | \\ \bullet \\ | \\ \bullet \end{array} &= \begin{array}{c} \bullet \\ | \\ \bullet \\ | \\ \bullet \end{array} \otimes \mathbf{1} + \mathbf{1} \otimes \begin{array}{c} \bullet \\ | \\ \bullet \\ | \\ \bullet \end{array} + \begin{array}{c} \bullet \\ | \\ \bullet \end{array} \otimes \bullet + \bullet \otimes \begin{array}{c} \bullet \\ | \\ \bullet \end{array}, \end{aligned}$$

where

- $\mathfrak{A}(\tau)$ is the set of admissible cuts of a forest. An admissible cut is a collection of edges which have the property that only one edge appears in the path between a leaf and the root.

- $P^c(\tau)$ denotes the pruning operation: the subforests formed by the edges above the cut c .
- $R^c(\tau)$ denotes the trunk operation: the subforests formed by the edges under the cut c .

In the next section, we will define two Hopf algebras which are really close in their construction to the previous coproducts. The structure group is encoded by a coproduct similar to those of Connes-Kreimer and the renormalisation group is defined from a substitution coproduct.

1.3.2 Hopf algebra on Labelled trees and forests

In this section, we present the main definitions and the main result of chapter 2. A Hopf algebra has already been given in [Hai14b] in order to describe the structure group with the symbols. We want to repeat this construction for the renormalisation group. But we need to change the formalism if we want to understand better the construction and see the connection between the two groups. For that purpose, we introduce labelled trees and labelled forests which encode the symbols and are closer to the original representation of the Hopf algebra presented in the previous section.

We consider \mathfrak{T} the set of labelled trees. Every $T_\epsilon^n \in \mathfrak{T}$ is described with a triple $(T, \epsilon, \mathfrak{n})$ where T is a rooted tree endowed with an edge-labelling $\epsilon: E_T \rightarrow \mathbf{N}^d$ and a node-labelling $\mathfrak{n}: \mathring{N}_T \rightarrow \mathbf{N}^d$. The sets E_T , L_T and \mathring{N}_T correspond respectively to the edges, the leaves and the inner nodes of T . All the edges and leaves carry a “type” taken from some label set $\mathfrak{L} = \mathfrak{L}_e \sqcup \mathfrak{L}_l$.

Given $T_\epsilon^n, \hat{T}_{\hat{\epsilon}}^{\hat{\mathfrak{n}}} \in \mathfrak{T}$, we have two possible products: $T_\epsilon^n \hat{T}_{\hat{\epsilon}}^{\hat{\mathfrak{n}}} = \bar{T}_{\bar{\epsilon}}^{\bar{\mathfrak{n}}} \in \mathfrak{T}$ corresponds to the graph obtained by identifying the roots and the labels are given by the disjoint sum of the labels: $(\bar{\mathfrak{n}}, \bar{\epsilon}) = (\mathfrak{n} + \hat{\mathfrak{n}}, \epsilon + \hat{\epsilon})$. While $T_\epsilon^n \cdot \hat{T}_{\hat{\epsilon}}^{\hat{\mathfrak{n}}} = F_{\bar{\epsilon}}^{\bar{\mathfrak{n}}}$ corresponds to the disjoint union of the two labelled graphs and belongs to the set of labelled forests \mathfrak{F} . Moreover, \cdot is the natural product on the labelled forests. The operation on the shapes are given in the figure just below:

$$\text{Let } T_1 = \begin{array}{c} \ell_1 \quad \ell_2 \\ \diagdown \quad \diagup \\ \bullet \\ \varrho_{T_1} \end{array} \text{ and } T_2 = \begin{array}{c} \ell_3 \quad \ell_4 \\ \diagdown \quad \diagup \\ \bullet \\ \varrho_{T_2} \end{array}, \text{ then } T_1 \cdot T_2 = \begin{array}{c} \ell_1 \quad \ell_2 \\ \diagdown \quad \diagup \\ \bullet \\ \varrho_{T_1} \end{array} \begin{array}{c} \ell_3 \quad \ell_4 \\ \diagdown \quad \diagup \\ \bullet \\ \varrho_{T_2} \end{array} \text{ and } T_1 T_2 \begin{array}{c} \ell_1 \quad \ell_2 \quad \ell_3 \quad \ell_4 \\ \diagdown \quad \diagup \quad \diagdown \quad \diagup \\ \bullet \\ \varrho \end{array}.$$

We associate to each type $\ell \in \mathfrak{L}$ a “homogeneity” $|\ell|_\mathfrak{s} \in \mathbf{R}$. We also denote by $|F_\epsilon^n|_\mathfrak{s}$ the homogeneity of the labelled forest $F_\epsilon^n \in \mathfrak{F}$, which is given by

$$|F_\epsilon^n|_\mathfrak{s} = \sum_{u \in L_F \sqcup E_F} |l(u)|_\mathfrak{s} + \sum_{x \in \mathring{N}_F} |\mathfrak{n}(x)|_\mathfrak{s} - \sum_{e \in E_F} |\epsilon(e)|_\mathfrak{s},$$

where $|\cdot|_\mathfrak{s}$ denotes the \mathfrak{s} -homogeneity of a multiindex. In particular, one has $|\mathbf{1}|_\mathfrak{s} = 0$ as expected.

Remark 1.3.10. The labelled trees encode the symbols:

1.3. Renormalisation Group

1. Each leaf represents an instance of the noise Ξ . If there is more than one noise, we give the leaf a “type” from a set \mathfrak{L}_l indexing the different types of noise.
2. Each edge with label $k \in \mathbf{N}^d$ represents the operator \mathcal{I}_k . Again, if there is more than one integration map, we give the edge an additional “type” from a set \mathfrak{L}_e indexing the integration maps.
3. Each inner vertex with label $k \in \mathbf{N}^d$ represents a factor X^k .

The homogeneity is the same homogeneity as for the symbols.

Definition 1.3.11. For all $T \in \mathfrak{T}$, we denote by $\mathfrak{A}^+(T) \subset \mathfrak{A}(T)$ the set of all $\mathcal{A} \in \mathfrak{A}(T)$ with either $\mathcal{A} = \emptyset$ or $\mathcal{A} = \{S\}$ with S a rooted subtree of T such that $\varrho_S = \varrho_T$.

Definition 1.3.12. Given a forest $F = T_1 \cdot T_2 \cdots T_k \in \mathfrak{F}$, we denote by $\mathfrak{A}(F)$ the set of all (possibly empty) finite collections $\mathcal{A} = \{S_1, \dots, S_n\}$ of subtrees of F such that the S_i 's are pairwise disjoint and each S_i is admissible in the sense that it satisfies: $L_{S_i} \subseteq L_{T_i}$ and either $\varrho_{S_i} = \varrho_{T_i}$, or there exists at least one leaf $\ell \in L_{T_i} \setminus L_{S_i}$ with $\varrho_{S_i} \leq \ell$.

Any $\mathcal{A} = \{S_1, \dots, S_n\} \in \mathfrak{A}(F)$ induces a natural equivalence relation $\sim_{\mathcal{A}}$ on N_F by postulating that $x \sim_{\mathcal{A}} y$ if and only if either $x = y$ or both x and y belong to the same subtree $S_j \in \mathcal{A}$. This allows us to define for all $F_c^n \in \mathfrak{F}$ another forest

$$\mathcal{R}_{\mathcal{A}}^{\downarrow} F_c^n \in \mathfrak{F},$$

by taking the quotient of the graph (N_F, E_F) with respect to $\sim_{\mathcal{A}}$. In other words, the nodes of $\mathcal{R}_{\mathcal{A}}^{\downarrow} F$ are given by $N_F / \sim_{\mathcal{A}}$ and its edges are given by $E_F \setminus \{(x, y) \in E_F : x \sim_{\mathcal{A}} y\}$, with the obvious identifications. The forest $\mathcal{R}_{\mathcal{A}}^{\downarrow} F_c^n$ inherits the edge-labels from F_c^n by simple restriction, while the node-labels are the sums of the labels over equivalence classes:

$$\mathbf{n}([x]) \stackrel{\text{def}}{=} \sum_{y: y \sim_{\mathcal{A}} x} \mathbf{n}(y). \quad (1.9)$$

We also define

$$\mathcal{R}_{\mathcal{A}}^{\uparrow} F = S_1 \cdot S_2 \cdots S_n \in \mathfrak{F},$$

with the additional natural conventions that $\mathcal{R}_{\emptyset}^{\uparrow} F = \mathbf{1}$ and $\mathcal{R}_{\emptyset}^{\downarrow} F = F$. The forest $\mathcal{R}_{\mathcal{A}}^{\uparrow} F_c^n$ inherits edge- and node-labels from F_c^n by simple restriction.

In the next example, we compute the previous operations on $\mathcal{A} = \{S_1, S_2\} \in \mathfrak{A}(T)$:

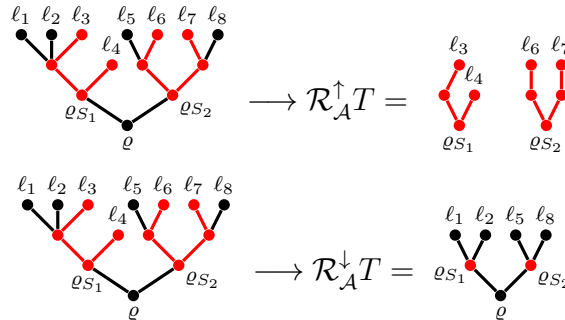

Given a forest $F \in \mathfrak{F}$ and an edge-label $\epsilon: E_F \rightarrow \mathbf{N}^d$, we define the corresponding node-label $\pi\epsilon: N_F \rightarrow \mathbf{N}^d$ by

$$\pi\epsilon(x) = \sum_{e \in E_x} \epsilon(e), \quad E_x = \{(x, y) \in E_F\}.$$

We set $\delta^+ : \langle \mathfrak{F} \rangle \mapsto \langle \mathfrak{F} \rangle \otimes \langle \mathfrak{F} \rangle$, $\delta^- : \langle \mathfrak{F} \rangle \mapsto \langle \mathfrak{F} \rangle \otimes \langle \mathfrak{F} \rangle$

$$\delta^+ F_\epsilon^n := \sum_{\mathcal{A} \in \mathfrak{A}^+(F)} \sum_{\epsilon_{\mathcal{A}}, n_{\mathcal{A}}} \frac{1}{\epsilon_{\mathcal{A}}!} \binom{\mathbf{n}}{\mathbf{n}_{\mathcal{A}}} \mathcal{R}_{\mathcal{A}}^\uparrow F_\epsilon^{n_{\mathcal{A}} + \pi\epsilon_{\mathcal{A}}} \otimes \mathcal{R}_{\mathcal{A}}^\downarrow F_{\epsilon + \epsilon_{\mathcal{A}}}^{n - n_{\mathcal{A}}}, \quad (1.10)$$

$$\delta^- F_\epsilon^n := \sum_{\mathcal{A} \in \mathfrak{A}(F)} \sum_{\epsilon_{\mathcal{A}}, n_{\mathcal{A}}} \frac{1}{\epsilon_{\mathcal{A}}!} \binom{\mathbf{n}}{\mathbf{n}_{\mathcal{A}}} \mathcal{R}_{\mathcal{A}}^\uparrow F_\epsilon^{n_{\mathcal{A}} + \pi\epsilon_{\mathcal{A}}} \otimes \mathcal{R}_{\mathcal{A}}^\downarrow F_{\epsilon + \epsilon_{\mathcal{A}}}^{n - n_{\mathcal{A}}}, \quad (1.11)$$

where we stress that the only difference between the two definitions lies in the choice $\mathcal{A} \in \mathfrak{A}^+(F)$, resp. $\mathcal{A} \in \mathfrak{A}(F)$. The set $\langle \mathfrak{F} \rangle$ is the linear span of \mathfrak{F} . The previous coproducts take values in formal series.

Remark 1.3.13. If we forget the labels, we obtain a finite sum and the coproduct δ^- corresponds to the coproduct defined for the substitution Hopf algebra. The set $\mathfrak{A}(T)$ can be identified with the subforests: the only difference is that we can not remove all the leaves from a branch, it is in strong connection with the annihilation of the polynomials by the abstract integrator $\mathcal{I}(\cdot)$. Just below, we represent an example of subforest:

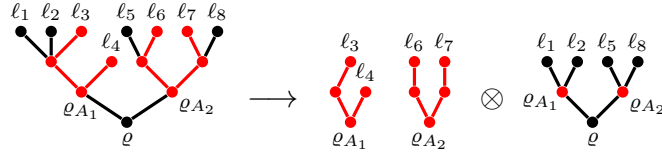

The other coproduct δ^+ is close to the Connes-Kreimer Hopf algebra on labelled trees. Indeed, there are two points of view for the transformation in the figure just below

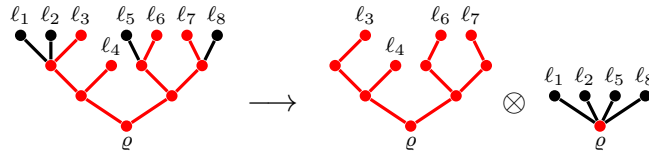

The interpretation given in the definition of the coproduct is: we select a rooted subtree in red, we put it on the left and on the right we keep the remaining branches. The other interpretation is we select an admissible set of cuts which is the black edges, we remove it and we connect them to a root on the right and on the left we consider the remainder. The second vision is closer to the Connes-Kreimer Hopf algebra.

From the previous two coproducts, we are able to define two hopf algebras which give two groups: one for the positive renormalisation and another for the negative renormalisation.

1.3. Renormalisation Group

Positive renormalisation: the structure group

Let $\Pi_+ : \mathfrak{T} \rightarrow \mathfrak{T}_+$ the multiplicative projection on trees with positive homogeneity. We define:

$$\begin{aligned}\Delta : \langle \mathfrak{T} \rangle &\rightarrow \langle \mathfrak{T} \rangle \otimes \langle \mathfrak{T}_+ \rangle, & \Delta &= (1 \otimes \Pi_+) \delta^+ \\ \Delta^+ : \langle \mathfrak{T}_+ \rangle &\rightarrow \langle \mathfrak{T}_+ \rangle \otimes \langle \mathfrak{T}_+ \rangle, & \Delta^+ &= (\Pi_+ \otimes \Pi_+) \delta^+.\end{aligned}$$

The projection Π_+ makes all the sum finite and the next theorem specifies the structure we obtain on the labelled trees:

Theorem 1.3.14. *The algebra $\langle \mathfrak{T}_+ \rangle$ endowed with the product $(\tau, \bar{\tau}) \mapsto \tau \bar{\tau}$ and the coproduct Δ^+ is a Hopf algebra. Moreover Δ turns $\langle \mathfrak{T} \rangle$ into a right comodule over $\langle \mathfrak{T}_+ \rangle$.*

We define \mathcal{H}_+ as $\langle \mathfrak{T}_+ \rangle$. If \mathcal{H}_+^* denotes the dual of \mathcal{H}_+ , then we set

$$G_+ := \{g \in \mathcal{H}_+^* : g(\tau_1 \tau_2) = g(\tau_1)g(\tau_2), \forall \tau_1, \tau_2 \in \mathcal{H}_+\}.$$

Theorem 1.3.15. *Let*

$$\mathcal{R}_+ = \{\Gamma_g : \langle \mathfrak{T} \rangle \rightarrow \langle \mathfrak{T} \rangle, \Gamma_g = (1 \otimes g)\Delta, g \in G_+\}.$$

Then \mathcal{R}_+ is a group for the composition law. Moreover, one has for $f, g \in G_+$:

$$\Gamma_f \Gamma_g = \Gamma_{f \circ g}$$

where $f \circ g$ is defined by

$$f \circ g = (f \otimes g)\Delta^+.$$

Remark 1.3.16. The group G_+ is exactly the structure group defined in [Hai14b]. One can express the coproducts Δ and Δ^+ using the symbol notation see 3.3 and 4.8. It would be slightly different from the coproduct given in [Hai14b] but it is essentially the same in a different basis.

Negative renormalisation: the renormalisation group

Let $\Pi_- : \langle \mathfrak{F} \rangle \mapsto \langle \mathfrak{F}_- \rangle$ be the canonical projection onto $\langle \mathfrak{F}_- \rangle$. Then we define the following maps

$$\begin{aligned}\hat{\Delta} : \langle \mathfrak{F} \rangle &\rightarrow \langle \mathfrak{F}_- \rangle \otimes \langle \mathfrak{F} \rangle, & \hat{\Delta} &= (\Pi_- \otimes 1) \delta^- \\ \Delta^- : \langle \mathfrak{F}_- \rangle &\rightarrow \langle \mathfrak{F}_- \rangle \otimes \langle \mathfrak{F}_- \rangle, & \Delta^- &= (\Pi_- \otimes \Pi_-) \delta^-.\end{aligned}$$

Theorem 1.3.17. *The algebra $\langle \mathfrak{F}_- \rangle$ endowed with the product $(\varphi, \bar{\varphi}) \mapsto \varphi \cdot \bar{\varphi}$ and the coproduct Δ^- is a Hopf algebra. Moreover $\hat{\Delta}$ turns $\langle \mathfrak{F} \rangle$ into a left comodule over $\langle \mathfrak{F}_- \rangle$.*

We define \mathcal{H}_- as $\langle \mathfrak{F}_- \rangle$. If \mathcal{H}_-^* denotes the dual of \mathcal{H}_- , then we set

$$G_- := \{\ell \in \mathcal{H}_-^* : \ell(\varphi_1 \cdot \varphi_2) = \ell(\varphi_1)\ell(\varphi_2), \forall \varphi_1, \varphi_2 \in \mathcal{H}_-\}.$$

Theorem 1.3.18. *Let*

$$\mathcal{R}_- = \{M_\ell : \langle \mathfrak{T} \rangle \rightarrow \langle \mathfrak{T} \rangle, M_\ell = (\ell \otimes 1)\hat{\Delta}, \ell \in G_-\}.$$

Then \mathcal{R}_- is a group for the composition law. Moreover, one has for $f, g \in G_-$:

$$M_f M_g = M_{f \circ g}$$

where $f \circ g$ is defined by

$$f \circ g = (g \otimes f)\Delta^-.$$

Link between the two groups

The previous theorem gives us the renormalisation group for proving the convergence of the symbols. One can also have a nice recursive formulation where M_ℓ is given by:

$$\begin{cases} M^\circ \mathbf{1} = \mathbf{1}, & M^\circ X = X, & M^\circ \Xi = \Xi \\ M^\circ \tau \bar{\tau} = (M^\circ \tau)(M^\circ \bar{\tau}), & M\tau = M^\circ R\tau \\ M^\circ \mathcal{I}_k(\tau) = \mathcal{I}_k(M\tau) & R\mathcal{I}_k(\tau) = \mathcal{I}_k(\tau) \end{cases}$$

The last identity $R\mathcal{I}_k(\tau) = \mathcal{I}_k(\tau)$ is guaranteed by taking the projection Π_- with zero value on terms of the form: $\mathcal{I}_k(\tau)$. For all $\ell \in G_-$, we define

$$M^\circ = M_\ell^\circ = (\ell \otimes 1)\Delta^\circ = (\ell\Pi_- \otimes 1)\delta^\circ$$

for some coproduct δ° defined as δ^+ and δ^- but on a different subset \mathfrak{A}° . We defined

$$R = R_\ell = (\ell \otimes 1)\Delta^R = (\ell\Pi_- \otimes 1)\delta^+.$$

The map R has the nice property of commuting with the structure group which is the key point for building the renormalised model.

Remark 1.3.19. We describe some elements of the subset \mathfrak{A}° in the example just below. On $\mathcal{A} = \{S_1, S_2, S_3\} \in \mathfrak{A}(T)$, we compute:

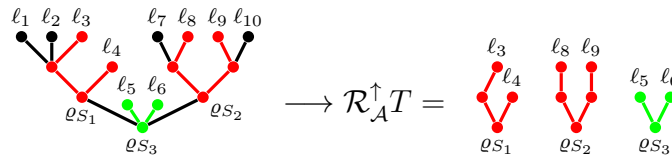

Finally, we obtain $\{S_3\} \in \mathfrak{A}^+(T)$ and $\{S_1, S_2\} \in \mathfrak{A}^\circ(T)$. The set $\mathfrak{A}^\circ(T)$ as to be understood as elements of $\mathfrak{A}(T)$ without rooted subtree.

Remark 1.3.20. This construction of the renormalisation group contains all the examples which have been treated see 3.7. In 3.7.1, we present all the basic ideas of the renormalisation group on the wick renormalisation of the power of a standard gaussian random variable. All the examples belong to the gaussian case, but we can consider non-gaussian noise like in [HS15] and [Hai15]: the main difference is that for the gaussian case the functional ℓ is supported on trees with an even number of leaves whereas we do not have such constraint in the non-gaussian case.

1.3.3 The renormalised model

We can build a model (Π_x^M, Γ_{xy}^M) using the construction of [Hai14b, section 8.3] and we provide a recursive formulation for the map Π_x^M with is really close to the recursive formulation for M in the previous section:

$$\begin{cases} (\Pi_x^{M^\circ} \mathbf{1})(y) = 1, & (\Pi_x^{M^\circ} \Xi)(y) = \xi(y), & (\Pi_x^{M^\circ} X)(y) = y - x, \\ (\Pi_x^{M^\circ} \mathcal{I}_k \tau)(y) = \int D^k K(y - z) (\Pi_x^M \tau)(z) dz - \sum_{\ell} \frac{(y - x)^\ell}{\ell!} f_x^M(\mathcal{J}_{k+l}(\tau)), & (1.12) \\ (\Pi_x^M \tau)(y) = (\Pi_x^{M^\circ} R\tau)(y), & (\Pi_x^{M^\circ} \tau \bar{\tau})(y) = (\Pi_x^{M^\circ} \tau)(y) (\Pi_x^{M^\circ} \bar{\tau})(y) \end{cases}$$

where $f_x^M \in \mathcal{H}_+^*$ is defined by

$$\begin{cases} f_x^M(X) = x, & f_x^M(\tau \bar{\tau}) = f_x^M(\tau) f_x^M(\bar{\tau}) \\ f_x^M(\mathcal{J}_\ell(\tau)) = \mathbb{1}_{(|\mathcal{I}_\ell(\tau)| > 0)} \int D^\ell K(x - z) (\Pi_x^M \tau)(z) dz. \end{cases}$$

In the previous definition, we consider a map $M = M_\ell = (\ell \otimes 1) \hat{\Delta}$ such that R_ℓ is the identity on terms of the form $\mathcal{I}_k(\tau)$, the map $\Pi_x^{M^\circ}$ and Π_x^M coincide on the first two lines of the definition.

Remark 1.3.21. For the definition of $\Pi_x^{M^\circ}$ on the noise, we suppose that we are in the setting of a regularised model where ξ is smooth. If ξ is the space-time white noise, we have to replace y by a rescaled test function φ_x^λ . The definition for abstract integrator guarantees that we obtain an admissible model. We have used the new symbol $\mathcal{J}_k(\tau)$ which is non zero and equal to $\mathcal{I}_k(\tau)$ when this term has positive homogeneity. The third part of the definition describes the behaviour on a product: $\Pi_x^{M^\circ}$ is multiplicative as for M° and we need first to apply R for Π_x^M in order to recover the multiplicativity.

Remark 1.3.22. The main advantage of this definition is the recursive formula for the product which allows us to compute the reconstructor operator \mathcal{R}^M given in the case of smooth functions by

$$(\mathcal{R}^M \tau)(x) = (\Pi_x^M \tau)(x).$$

In most of the examples see 3.7, we even have the property:

$$(\mathcal{R}^M \tau)(x) = (\Pi_x^M \tau)(x) = (\Pi_x M \tau)(x)$$

which is really convenient for computing the renormalised equation.

If we set $F_x^M = \Gamma_{g_x^M}$ where g_x^M is defined from f_x^M in 3.6.2, the transformation Γ_{xy}^M is given by

$$\Gamma_{xy}^M = (F_x^M)^{-1} \circ F_y^M = \Gamma_{\gamma_{xy}^M},$$

where $\gamma_{xy}^M = (g_x^M)^{-1} \circ g_y^M$.

Theorem 1.3.23. *Let (Π_x^M, Γ_{xy}^M) defined as above, then this is a model on some subset of \mathfrak{T} . Moreover, the maps $\Pi_x^{M^\circ} = \Pi^{M^\circ} F_x^M$ and $\Pi_x^M = \Pi^M F_x^M$ are independent of x .*

Remark 1.3.24. The theorem is relatively vague on the subsets from which we obtain the model. In most of the cases, we start from a finite set of labelled trees containing the negative labelled trees and then we enlarge this family in order to be invariant under the structure group. We can also define our model on a bigger space which incorporates all the terms built from the products in our equation see 3.1.

Remark 1.3.25. For proving the previous theorem, we have to check algebraic properties and analytical bounds given in 1.2.2. The algebraic properties follow from the decomposition of M with R commuting with the structure group. The analytical bounds rely on the fact that we define an admissible model. Moreover, the projection Π_- in the definition of the coproduct creates counter-terms with better homogeneity when we remove divergent patterns.

Remark 1.3.26. We provide different proofs of this result. The main one is based on the factorisation given in [Hai14b]:

$$\Pi_x^M = (\Pi_x \otimes g_x) \Delta^M, \quad \gamma_{x,y}^M = (\gamma_{x,y} \otimes g_y) \hat{\Delta}^M.$$

In this proof (see 3.6.2), we have to guess what can be the correct formula for a recursive definition on the abstract integrator. We give an alternative proof in the appendix based on the use of recursive formula and this formulation does not use the coproduct. We also show how the coproduct can be introduced from the recursive definition of Π_x see *A*.

1.3.4 The extended structure

The motivation of the extension of the structure space is to obtain a simpler formula for the renormalised model. We add a new node-label $d : N \rightarrow \mathbb{R}$ which computes a new homogeneity. For a shape T , we denote by $T_\epsilon^{n,d}$ such labelled tree. Let x a node of T , we define T_x where its nodes are identified with $N_x = \{u : x \leq u\}$ and we also define $E^x = \{e = (x, a) \in E\}$ which are the edges above x . The new homogeneity $|\cdot|_{ex}$ of a labelled tree T with root ϱ is given by:

$$|T|_{ex} = |\mathfrak{n}(\varrho)|_s + \sum_{e' \in E^e} |\mathcal{P}_{e'}^\uparrow T|_{ex} + d(\varrho),$$

where

$$|\mathcal{P}_{e'}^\uparrow T|_{ex} = |\mathfrak{l}(e')| - |\mathfrak{e}(e')|_s + |T_u|_{ex}, \quad e' = (\varrho, u).$$

The idea is that when we remove some subtrees, we keep track of some information by changing the label d .

Remark 1.3.27. For the symbol notation, we add a new symbol $\mathbf{1}_\alpha$ with the properties $\mathbf{1}_\alpha \cdot \mathbf{1}_\beta = \mathbf{1}_{\alpha+\beta}$ and $\mathcal{I}(\mathbf{1}_\alpha) = 0$. This symbol encodes the label d .

1.3. Renormalisation Group

We extend the operator $\mathcal{R}_{\mathcal{A}}^{\downarrow}$ as given in the next example.

Example 1.3.28. We select $\mathcal{A} = \{S_1, S_2\}$ in $\mathfrak{A}(T)$, we remove it from the main tree and we leave the homogeneity of the subtrees S_i as labels:

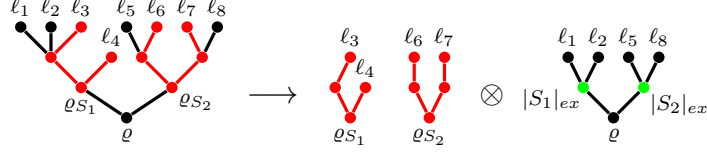

One can extend naturally with this new operator all the coproducts defined in the previous part. This is the case for the coproduct for the renormalisation group. For $\hat{\Delta}$, we obtain a decomposition of the form $\hat{\Delta}T = \sum_i T_i^{(1)} \otimes T_i^{(2)}$ with the nice property $|T|_{ex} = |T_i^{(2)}|_{ex}$. But for the structure group, we need to be cautious. Therefore, we have to use a projector \mathcal{P} which erases the root label d and preserves the property that for every labelled tree T , one has $\Delta T = \sum_i T_i^{(1)} \otimes T_i^{(2)}$ which satisfies $|T|_{ex} = |T_i^{(1)}|_{ex} + |T_i^{(2)}|_{ex}$.

Remark 1.3.29. One natural space of labelled trees which is invariant under the action of the two groups is \mathfrak{T}^n , the labelled trees with d taking values in \mathbb{R}^- . This is also the correct space for defining the model and for having the correct analytical bounds.

As for Π_x , we define a map $\hat{\Pi}_x : \mathfrak{T}^n \rightarrow \mathcal{S}'(\mathbf{R}^d)$ such that $(\hat{\Pi}_x \mathbf{1}_\alpha)(y) = 1$ and where we replace f_x by \hat{f}_x . The definition of \hat{f}_x is exactly the same except for the abstract integrator when we replace the homogeneity $|\cdot|$ by $|\cdot|_{ex}$.

$$\hat{f}_x(\mathcal{I}_k(\tau)) = \mathbb{1}_{(|\mathcal{I}_k(\tau)|_{ex} > 0)} \int D^k K(x - z) (\hat{\Pi}_x \tau)(z) dz.$$

We do the same for \hat{g}_x and we obtain a new $\hat{\gamma}_{xy}$.

Theorem 1.3.30. Let $(\hat{\Pi}^M, \hat{\Gamma}^M)$ extended above, then this is a model on some subset of \mathfrak{T}^n with the homogeneity $|\cdot|_{ex}$. One has the following identities:

$$\hat{\Pi}_x^M = \hat{\Pi}_x M, \quad \hat{\Gamma}_{xy}^M = \hat{\Gamma}_{\hat{\gamma}_{xy}}^M = \hat{\Gamma}_{\hat{\gamma}_{xy} M^\circ}. \quad (1.13)$$

Remark 1.3.31. As for the renormalised model, we do not precise the subset of \mathfrak{T}^n . Its definition can be found in 4.1.14. The main idea is that we have to restraint the value of d if we want to have for each scalar β a finite number of labelled trees with homogeneity below β .

Remark 1.3.32. The identities (1.13) overcome the main difficulties for proving that we obtain a model:

- The map M acts on $\hat{\Pi}_x$ as in the stationary version of this operator which is Π : $\Pi^M = \Pi M$. This action provides a nice formula for the reconstruction operator:

$$(\mathcal{R}^M f(x))(x) = (\hat{\Pi}_x M f(x))(x),$$

where f belongs to \mathcal{D}^γ with $\gamma > 0$. For the convergence of the model, we will use the extended structure because we can have explicit formula for the Feynman diagrams.

- The action of M on the structure group is given by M° acting on $\hat{\gamma}_{xy}$. This is not surprising, because these maps are both multiplicative on the labelled trees. Moreover, the map M° in $\hat{\Gamma}_{\gamma_{xy}M^\circ}$ acts on a labelled tree where we have already removed a rooted subtree. This suggests that the actions of the positive and the negative renormalisation do not overlap.

1.4 The use of Feynman diagrams

Most of the examples of singular SPDEs present a gaussian structure through a space-time white noise. Therefore, for each labelled tree T_ϵ^n we can perform a Wiener chaos decomposition on $\left(\Pi_x^{(\epsilon)} T_\epsilon^n\right)(\varphi)$ where φ is a test function. This one of the main step for proving the convergence of the model. We prove the next theorem for the generalised KPZ equation and we provide tools for the general case of locally subcritical equations in 5.8.1.

Theorem 1.4.1. *Let $(\Pi_x^{M_\epsilon}, \Gamma_{xy}^{M_\epsilon})$ be a renormalised model associated to an SPDEs in the extended structure. Then there exists a random model (Π_x, Γ_{xy}) and a constant C such that for every underlying compact space-time domain*

$$\mathbb{E}\|\Pi^{M_\epsilon}; \Pi\| \leq C\epsilon^{\kappa/2}.$$

In that context, we will use some Feynman diagrams. In our framework, a Feynman diagram would be a labelled graph where each node is a variable integrated on \mathbb{R}^d and the edges are kernels which can depend on a parameter ϵ . Then, we want to obtain uniform bounds in ϵ for proving the convergence of the diagrams. Diverging patterns in a Feynman diagram are subgraphs such that if we freeze the variables outside these subgraphs then the integration of the other variables is not well defined. This property can be expressed in terms of homogeneity where a scalar measure the previous singularity. The main goal of these diagrams is to transpose an analytical problem into a combinatorial one: the convergence is based essentially on checking bounds on the labels of the graph.

1.4.1 Wiener chaos decomposition

In this section, we follow the presentation of the Wiener chaos given in [Nua05]. We consider H a real Hilbert space with the scalar product $\langle \cdot, \cdot \rangle_H$.

Definition 1.4.2. A stochastic process $W = \{W(h), h \in H\}$ defined on a complete probability space (Ω, \mathcal{F}, P) is a isornal Gaussian process if W is a collection of centered Gaussian variables such that the map $h \mapsto W_h$ is an isometry from H to $L^2(\Omega, \mathcal{F})$. We have for every $g, h \in H$:

$$\mathbb{E}(W(g)W(h)) = \langle g, h \rangle_H.$$

1.4. The use of Feynman diagrams

The space-time white noise can be described in this setting by taking H equal to some L^2 space. We denote by \mathcal{G} the σ -field generated by the random variables $\{W(h), h \in H\}$.

For $n \geq 1$, we consider \mathcal{H}_n the closed linear subspace in $L^2(\Omega, \mathcal{F}, P)$ of:

$$\{H_n(W(h)), h \in H, \|h\|_H = 1\}.$$

where the H_n are the Hermite polynomial. We notice that:

- For $n = 1$, \mathcal{H}_1 is the set of the constants.
- For $n \neq m$, \mathcal{H}_n and \mathcal{H}_m are orthogonal.

The space \mathcal{H}_n is called the Wiener chaos of order n .

Theorem 1.4.3. *The space $L^2(\Omega, \mathcal{G}, P)$ can be decomposed into the infinite orthogonal sum of the subspaces \mathcal{H}_n :*

$$L^2(\Omega, \mathcal{G}, P) = \bigoplus_{n=0}^{\infty} \mathcal{H}_n.$$

Let $\{e_i, i \geq 1\}$ an orthonormal basis of H and $H^{\otimes n}$ the n -fold symmetric tensor power of H . If $H = L^2(T)$ then $H^{\otimes n}$ can be identified with the space of symmetric square integrable function in n arguments on T . We have a natural isometry \tilde{I}_n (up to a factor $\sqrt{n!}$) between $H^{\otimes n}$ and the n th Wiener chaos \mathcal{H}_n given by for any sequence a_1, a_2, \dots of positive integer with only finitely many non-zero element such that $|a| = n$:

$$\tilde{I}_n : sym(\bigotimes_{i=1}^{\infty} e_i^{\otimes a_i}) \mapsto a! \prod_{i=1}^{\infty} H_{a_i}(W(e_i))$$

where sym is defined on $f(t_1, \dots, t_m)$ by

$$sym(f)(t_1, \dots, t_m) = \frac{1}{m!} \sum_{\sigma} f(t_{\sigma(1)}, \dots, t_{\sigma(m)}).$$

The map $I_n = \tilde{I}_n \circ sym : H^{\otimes n} \rightarrow L^2(\Omega, P)$ has the following property:

$$\mathbb{E}(I_n(f)^2) = n! \|sym(f)\|^2 \leq n! \|f\|^2.$$

Now, we give one important lemma which is a consequence of Nelson's hypercontractivity:

Lemma 1.4.4. *Let X a L^2 random variable in the k -th inhomogeneous Wiener chaos. Then for every $p \geq 1$, there exists a constant $C_{k,p}$ such that $\mathbb{E}(|X|^{2p}) \leq C_{k,p} \mathbb{E}(|X|^2)$.*

This lemma tells us that for such sequence of processes X_ε depending on a parameter ε , we just need to have uniform bounds on their L^2 norm if we want to prove the convergence of that sequence.

1.4.2 Renormalised Feynman diagrams

It has been noticed in [Hai14b] that for proving the convergence of the model, we just need to have bounds on the covariance of $(\hat{\Pi}_0^\varepsilon \tau)(\varphi_\lambda)$ where φ_λ is a rescaled test function around the origin and τ is a labelled tree with negative homogeneity. In order to compute the covariance of $(\hat{\Pi}_0^\varepsilon \tau)(\varphi_\lambda)$, we decompose this process onto its k -th homogeneous Wiener chaos $(\hat{\Pi}_0^{\varepsilon,k} \tau)(\varphi_\lambda)$:

$$(\hat{\Pi}_0^\varepsilon \tau)(\varphi_\lambda) = \sum_{k \leq \|\tau\|} (\hat{\Pi}_0^{\varepsilon,k} \tau)(\varphi_\lambda).$$

Then by orthogonality of the different chaos, we obtain:

$$\mathbb{E}(|(\hat{\Pi}_0^\varepsilon \tau)(\varphi_\lambda)|^2) = \sum_{k \leq \|\tau\|} \mathbb{E}(|(\hat{\Pi}_0^{\varepsilon,k} \tau)(\varphi_\lambda)|^2).$$

Each term $\hat{\Pi}_0^{\varepsilon,k} \tau$ can be described by a kernel $\hat{W}^{\varepsilon,k} \tau$ in $L^2(\mathbb{R})^{\otimes k}$ through a map $f \mapsto I_k(f)$ which satisfies:

$$\mathbb{E}(I_k(f)^2) \leq k! \|f\|^2 \quad (1.14)$$

where $\|\cdot\|$ is the L^2 norm. Finally, we obtain:

$$\mathbb{E}(|(\hat{\Pi}_0^\varepsilon \tau)(\varphi_\lambda)|^2) \leq \sum_{k \leq \|\tau\|} \langle \hat{W}^{\varepsilon,k} \tau, \hat{W}^{\varepsilon,k} \tau \rangle.$$

where $\|\tau\|$ denotes the number of leaves in τ .

Remark 1.4.5. Given a labelled tree T_ε^n , we use the extended structure in order to have a clear way of computing the kernel $\hat{W}^{\varepsilon,k} T_\varepsilon^n$. Indeed, we have:

$$\begin{aligned} (\hat{\Pi}_0^\varepsilon T_\varepsilon^n)(\varphi_\lambda) &= (\Pi_0^\varepsilon M_\varepsilon T_\varepsilon^n)(\varphi_\lambda) \\ &= \sum_{\mathcal{A} \in \mathfrak{A}(T)} \sum_{\varepsilon_{\mathcal{A}}, n_{\mathcal{A}}} \frac{1}{\varepsilon_{\mathcal{A}}!} \binom{\mathbf{n}}{\mathbf{n}_{\mathcal{A}}} \ell_\varepsilon \left(\Pi_- \mathcal{R}_{\mathcal{A}}^\uparrow T_\varepsilon^{n_{\mathcal{A}} + \pi \varepsilon_{\mathcal{A}}} \right) \left(\Pi_0^\varepsilon \mathcal{R}_{\mathcal{A}}^\downarrow T_{\varepsilon + \varepsilon_{\mathcal{A}}}^{n - n_{\mathcal{A}}, n_{\mathcal{A}} + \pi \varepsilon_{\mathcal{A}}} \right) (\varphi_\lambda). \end{aligned}$$

This explicit expression comes from the simple action of M_ε on Π_0 in the extended structure. Then, we obtain:

$$\hat{W}^{\varepsilon,k} T_\varepsilon^n = \sum_{\mathcal{A} \in \mathfrak{A}(T)} \sum_{\varepsilon_{\mathcal{A}}, n_{\mathcal{A}}} \frac{1}{\varepsilon_{\mathcal{A}}!} \binom{\mathbf{n}}{\mathbf{n}_{\mathcal{A}}} \ell_\varepsilon \left(\Pi_- \mathcal{R}_{\mathcal{A}}^\uparrow T_\varepsilon^{n_{\mathcal{A}} + \pi \varepsilon_{\mathcal{A}}} \right) W^{\varepsilon,k} \left(\mathcal{R}_{\mathcal{A}}^\downarrow T_{\varepsilon + \varepsilon_{\mathcal{A}}}^{n - n_{\mathcal{A}}, n_{\mathcal{A}} + \pi \varepsilon_{\mathcal{A}}} \right) \quad (1.15)$$

where the definition of the kernel $W^{\varepsilon,k}$ is given in 5.1.1. We also provide a recursive definition of ℓ_ε see 5.1.3 in order to treat the subdivergences. This definition can also be expressed in terms of the antipode of the negative renormalisation see 5.8.9.

1.4. The use of Feynman diagrams

Each term $\langle \hat{W}^{\varepsilon, k_\tau}, \hat{W}^{\varepsilon, k_\tau} \rangle$ can be represented by a sum of terms $\mathcal{I}_\lambda(K)$ defined by:

$$\mathcal{I}_\lambda(K) = \int \int \varphi^\lambda(x) \varphi^\lambda(y) K(x, y) dx dy.$$

where K is obtained from generalised convolution of other kernels and $\mathcal{I}_\lambda(K)$ can be rewritten using a direct graph $G = (\mathcal{V}, \mathcal{E})$:

$$\mathcal{I}_\lambda(K) = \int_{(\mathbb{R}^d)^{\mathcal{V}_0}} \prod_{e \in \mathcal{E}} \hat{K}_e(x_{e_+}, x_{e_-}) dx$$

where $e = (e_+, e_-)$ and G has three distinguished vertices $\mathcal{V}_\star = \{v_0, v_{\star,1}, v_{\star,2}\}$. Each edge $e \in \mathcal{E}$ is labelled by $(a_e, r_e, v_e) \in \mathbb{R} \times \mathbb{Z} \times \mathcal{V}$.

By definition, we have for $e \in \mathcal{E}$:

$$\hat{K}_e(x_{e_+}, x_{e_-}) = K_e(x_{e_+} - x_{e_-}) - \sum_{|j|_s < r_e} \frac{(x_{e_+} - x_{v_e})^j}{j!} D^j K_e(x_{v_e} - x_{e_-}).$$

where K_e is compactly supported in a ball of radius 1 around the origin and such that

$$|D^k K_e(x)| \lesssim \|x\|_s^{-a_e - |k|_s}$$

holds uniformly over x with $\|x\|_s \leq 1$ and for multiindices k .

We assume that $v_{\star,1}$ and $v_{\star,2}$ are connected to v_0 by two edges with label $(0, 0)$.

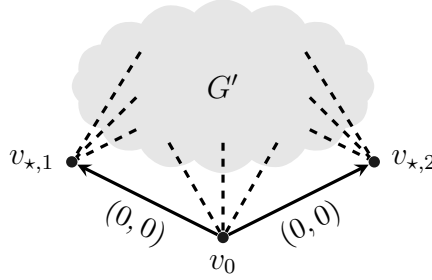

Remark 1.4.6. Given a labelled tree T_ε^n , there exists a direct algorithm for encoding $\hat{W}^{\varepsilon, k} T_\varepsilon^n$ see 5.2. In general, the kernel K_e is associated to an edge of T_ε^n : it could be derivatives of the heat kernels, polynomials or the mollifier ϱ_ε . The distinguished vertices correspond to the rescaled test function.

For any $\bar{\mathcal{V}} \subset \mathcal{V}$, we also define the following subsets of \mathcal{E} :

$$\begin{aligned} \mathcal{E}^\uparrow(\bar{\mathcal{V}}) &= \{e \in \mathcal{E} : e \cap \bar{\mathcal{V}} = e_-\}, & \mathcal{E}^\downarrow(\bar{\mathcal{V}}) &= \{e \in \mathcal{E} : e \cap \bar{\mathcal{V}} = e_+\}, \\ \mathcal{E}_0(\bar{\mathcal{V}}) &= \{e \in \mathcal{E} : e \cap \bar{\mathcal{V}} = e\}, & \mathcal{E}(\bar{\mathcal{V}}) &= \{e \in \mathcal{E} : e \cap \bar{\mathcal{V}} \neq \emptyset\}. \end{aligned}$$

We suppose that our graph G satisfies the following assumptions:

Assumption 1. 1. For every subset $\bar{\mathcal{V}} \subset \mathcal{V}$, one has

$$\sum_{e \in \mathcal{E}_0(\bar{\mathcal{V}})} a_e + \sum_{e \in \mathcal{E}^\uparrow(\bar{\mathcal{V}})} \mathbb{1}_{\{v_e \in \bar{\mathcal{V}} \wedge r_e > 0\}} (a_e + r_e - 1) - \sum_{e \in \mathcal{E}^\downarrow(\bar{\mathcal{V}})} \mathbb{1}_{v_e \in \bar{\mathcal{V}}} r_e < (|\bar{\mathcal{V}}| - 1)|\mathfrak{s}|$$

2. For every non-empty subset $\bar{\mathcal{V}} \subset \mathcal{V} \setminus \mathcal{V}_*$, one has the bound:

$$\begin{aligned} \sum_{e \in \mathcal{E}_0(\bar{\mathcal{V}})} a_e + \sum_{e \in \mathcal{E}^\downarrow(\bar{\mathcal{V}})} (\mathbb{1}_{\{v_e \in \bar{\mathcal{V}} \vee r_e = 0\}} (a_e + r_e - 1) - (r_e - 1)) \\ + \sum_{e \in \mathcal{E}^\uparrow(\bar{\mathcal{V}})} ((a_e + r_e) - \mathbb{1}_{v_e \in \bar{\mathcal{V}}} r_e) > |\bar{\mathcal{V}}||\mathfrak{s}| \end{aligned}$$

Remark 1.4.7. The first assumption is a kind of integrability condition, it gives the convergence. The second one is a guarantee of having the right homogeneity in the limit. We notice that the nodes v_e help the convergence in the first assumption because they appear with a sign minus.

Theorem 1.4.8. Consider a labelled graph G as above satisfying Assumption 3 and a collection of kernels K associated to the graph. Then, there exists a constant C depending only on the cardinality of \mathcal{V} and on the kernels K such that

$$|\mathcal{I}_\lambda(K)| \leq C \lambda^{|\mathcal{G}|_s}, \quad \lambda \in (0, 1],$$

where

$$|\mathcal{G}| = |\mathcal{V} \setminus \mathcal{V}_*||\mathfrak{s}| - \sum_{e \in \mathcal{E}} a_e,$$

is the homogeneity of the graph G .

Remark 1.4.9. This theorem has been introduced in [HQ15] in a simple version: the node v_e is equal to v_0 for every edge e and all the divergent patterns are removed and replaced by a renormalised edges. We will not use these renormalised edges. Indeed, the renormalisation of the diverging patterns is done by a node $v_e \neq v_0$. In fact, we have two renormalisations:

- Positive renormalisation which is given by edges labelled with $v_e = v_0$ and $r_e > 0$. This renormalisation comes from Π_0 and therefore from the structure group.
- Negative renormalisation given by edges labelled with $v_e \neq v_0$. This renormalisation appears when we rewrite the term $\hat{W}^{\varepsilon, k} T_\varepsilon^n$ with the use of telescopic sum.

We summarise how we proceed for proving the convergence:

- For each k , we identify the divergence and the subdivergence in $\hat{W}^{\varepsilon, k} T_\varepsilon^n$.

1.5. The generalised KPZ

- We rewrite by using a telescopic sum the kernels $\hat{W}^{\varepsilon,k}T_\varepsilon^n$ into a sum of graphs where negative renormalisations appear and the divergences identified in the first part are renormalised.
- We finish by just applying the theorem 1.4.8 on each graph.

We use this method for the generalised KPZ. In that case, we do not face overlapping divergence. Moreover, only one term presents a subdivergence and it can be treated by hand.

1.5 The generalised KPZ

In this section, we present our main example on which we apply the previous renormalisation techniques. We want to solve the equation on $\mathbb{R}_+ \times S^1$ given by:

$$\partial_t u = \partial_x^2 u + g(u)(\partial_x u)^2 + k(u)\partial_x u + h(u) + f(u)\xi, \quad (1.16)$$

where ξ is a space-time white noise and x takes value in the circle S^1 . This is an extension of the KPZ equation:

$$\partial_t u = \partial_x^2 u + (\partial_x u)^2 + \xi$$

introduced in [KPZ86]. This equation is ill-posed because solutions to the linear problem the stochastic heat equation are not differentiable. Therefore, the product $(\partial_x u)^2$ is ill-defined. In [BG97], the authors give a meaning to this equation by using the Hopf-Cole transformation, the solution is given by $u = \log(Z)$, where Z solves $dZ = \partial_x^2 Z + Z dW$ in the Itô sense see [PZ14]. Since this trick, the major improvement has come from [Hai13] where the author gives a notion of solution with the use of the rough path theory which coincides with the Hopf-Cole solution and which is unique. We recover also the same solution with the regularity structure. Another interesting approach are the energy solutions where their uniqueness has been recently proved in [GP15a]. The main interest of studying a general version of KPZ is the invariance under change of coordinates which can describe a natural free evolution for loops on manifold generalising the heat equation see [Fun92].

We fix an even, smooth, compactly supported function $\varrho : \mathbb{R}^2 \rightarrow \mathbb{R}$ with $\int \varrho = 1$ and we set

$$\varrho_\varepsilon(t, x) = \varepsilon^{-3} \varrho(\varepsilon^{-2}t, \varepsilon^{-1}x), \quad c_\varrho = \int P(z)(\varrho * \varrho)(z) dz$$

where $*$ means space-time convolution. We regularise the noise as follows

$$\xi_\varepsilon = \varrho_\varepsilon * \xi.$$

The renormalised equation is given by:

$$\partial_t u_\varepsilon = \partial_x^2 u_\varepsilon + g(u_\varepsilon)((\partial_x u_\varepsilon)^2 - C_\varepsilon) + k(u_\varepsilon)\partial_x u_\varepsilon + h(u_\varepsilon) + f(u_\varepsilon)(\xi_\varepsilon - C_\varepsilon f'(u_\varepsilon)). \quad (1.17)$$

Theorem 1.5.1. *Let k , h and g smooth functions. Let u_ε the solution of (6.2) with $C_\varepsilon = \varepsilon^{-1}c_\varrho$ and h replaced by*

$$\begin{aligned}\bar{h}(u) &= h(u) - c_\varrho^{(1)}(f'(u)^3 f(u) + g(u)^3 f(u)^4) \\ &\quad - (3c_\varrho^{(1)} + c_\varrho^{(2)})(g(u)^2 f'(u) f(u)^3 + g(u) f'(u)^2 f(u)^2) \\ &\quad - c_\varrho^{(2)}(g(u) f''(u) f(u)^3 + g'(u) f'(u) f(u)^3 + f''(u) f'(u) f(u)^2 + g'(u) g(u) f(u)^4)\end{aligned}$$

for some constants $c_\varrho^{(i)}$ which can depend on ϱ but not on ε . The initial condition $u_\varepsilon(0, \cdot) = u(0, \cdot)$ is taken in $\mathcal{C}(\mathcal{S}^1)$. for both cases. Then, there exists a choice of $c_\varrho^{(i)}$ such that for some $T > 0$, one has

$$\lim_{\varepsilon \rightarrow 0} \sup_{(t,x) \in [0,T] \times \mathcal{S}^1} |u(t,x) - u_\varepsilon(t,x)| = 0,$$

in probability for some limit u which gives the Itô product for $f(u)\xi$. Moreover for any $\alpha \in (0, \frac{1}{2})$ and $t > 0$, the restriction of u_ε to $[t, T] \times \mathcal{S}^1$ converges to u in probability for the topology of $\mathcal{C}^{\alpha, \alpha/2}$. Finally, if we take a smooth diffeomorphism φ then $\varphi(u_\varepsilon)$ satisfies the same kind of equation with the same constants but with new \tilde{g} , \tilde{h} , \tilde{k} and \tilde{f} depending on g , h , k , f and φ .

Remark 1.5.2. The constants c_ϱ , $c_\varrho^{(1)}$ and $c_\varrho^{(2)}$ are the same as in [HP14] and they have been chosen to obtain the Itô product.

1.5. The generalised KPZ

Chapter 2

Hopf Algebras on Labelled trees and forests

In this chapter, we consider labelled trees and labelled forests and we define two Hopf algebras on their linear span (see Section 2.4 for all relevant definitions). This construction is close to the Connes-Kreimer Hopf algebra on labelled trees. These Hopf algebras are used to construct, respectively, the structure group of a regularity structure (see Definition 1.2.1) and the renormalisation group (see Section 2.4.4). In this way we have an (almost) unified descriptions of these two groups and their algebraic properties.

2.1 Notations

Given a finite set S and a map $\ell: S \rightarrow \mathbf{N}$, we write

$$\ell! \stackrel{\text{def}}{=} \prod_{x \in S} \ell(x)!,$$

and we define the corresponding binomial coefficients accordingly. Note that if ℓ_1 and ℓ_2 have disjoint supports, then $(\ell_1 + \ell_2)! = \ell_1! \ell_2!$. Given a map $\pi: S \rightarrow \bar{S}$, we also define $\pi^* \ell: \bar{S} \rightarrow \mathbf{N}$ by $\pi^* \ell(x) = \sum_{y \in \pi^{-1}(x)} \ell(y)$. With this definition at hand, one has the following slight reformulation of the classical Chu-Vandermonde identity.

For $k, \ell: S \rightarrow \mathbf{N}$ we define

$$\binom{k}{\ell} \stackrel{\text{def}}{=} \prod_{x \in S} \binom{k(x)}{\ell(x)}$$

where we use the convention

$$\binom{k}{\ell} = 0 \quad \text{if} \quad k \not\leq \ell.$$

Lemma 2.1.1 (Chu-Vandermonde). *One has the identity*

$$\sum_{\ell: \pi^* \ell} \binom{k}{\ell} = \binom{\pi^* k}{\pi^* \ell},$$

where the sum runs over all possible choices of ℓ such that $\pi^* \ell$ is fixed.

Proof. We fix a map $f : S \rightarrow \mathbb{N}$ and we have the following identity:

$$\sum_{\ell: \pi^* \ell = \pi^* f} \binom{k}{\ell} = \prod_{x \in \bar{S}} \sum_{\substack{y \in \pi^{-1}(x) \\ \ell(y) = (\pi^* f)(x)}} \prod_{y \in \pi^{-1}(x)} \binom{k(y)}{\ell(y)}.$$

The classical Chu-Vandermonde identity gives for each $x \in \bar{S}$:

$$\sum_{\substack{y \in \pi^{-1}(x) \\ \ell(y) = \pi^* f(x)}} \prod_{y \in \pi^{-1}(x)} \binom{k(y)}{\ell(y)} = \binom{\sum_{y \in \pi^{-1}(x)} k(y)}{\pi^* f(x)} = \binom{\pi^* k(x)}{\pi^* f(x)}$$

which concludes the proof. □

Remark 2.1.2. This statement is also consistent with the case where the maps k and ℓ are multi-index valued under the natural identification of a map $S \rightarrow \mathbf{N}^d$ with a map $S \times \{1, \dots, d\} \rightarrow \mathbf{N}$ given by $\ell(x)_i \leftrightarrow \ell(x, i)$.

2.2 Rooted trees

A rooted tree T is a finite tree (a finite connected graph without simple cycles) with a distinguished vertex, $\rho = \rho_T$, called *the root*, and a function $\iota : L_T \sqcup E_T \rightarrow \mathfrak{L}$, where

1. \mathfrak{L} is a fixed non-empty set of types
2. edges of T are denoted by $E = E_T \subset N \times N$ and nodes by $N = N_T$
3. leaves, denoted by $L = L_T$, are defined as nodes other than the root which have degree equal to one (i.e. which are adjacent to a single edge).

Given a rooted tree T , we endow N with the partial order \leq where $w \leq v$ if and only if w is on the unique path connecting v to the root, and we orient edges in E so that if $(x, y) \in E$, then $x \leq y$. For any two nodes v and w of T (possibly, but not necessarily, leaves), we denote by $v \wedge w$ the maximal node that is less than both v and w . Interior nodes, i.e. nodes which are not leaves, are denoted by $\dot{N} = N \setminus L$.

We allow for the case $L = \emptyset$, in which case $N = \dot{N}$ consists of one element (the root) and E is empty. We do however *not* allow for $N = \emptyset$. We denote by $\mathbf{1}$ the (unique) labelled tree with $L = \emptyset$.

Definition 2.2.1. We write \mathfrak{T}_0 for the set of all rooted trees and $\langle \mathfrak{T}_0 \rangle$ for the linear span of \mathfrak{T}_0 . If $T_1, T_2 \in \mathfrak{T}_0$, then we define $T_1 T_2$, the *product* of T_1 and T_2 , as the tree obtained by identifying the roots ϱ_{T_1} and ϱ_{T_2} ; in other words, $T_1 T_2$ is equal to $(T_1 \sqcup T_2) / \sim$, where $x \sim y$ if $x = y$ or $\{x, y\} = \{\varrho_{T_1}, \varrho_{T_2}\}$. This product is commutative and associative.

Definition 2.2.2. We write \mathfrak{F}_0 for the collection of all multisets with elements in $\mathfrak{T}_0 \setminus \mathbf{1}$. We will denote elements of \mathfrak{F}_0 equivalently either by $\{T_1, \dots, T_k\}$ with $T_i \in \mathfrak{T}_0 \setminus \mathbf{1}$ or by $T_1 \cdot T_2 \cdots T_k$, with the empty set denoted either by \emptyset or by $\mathbf{1}$. Elements of \mathfrak{F}_0 are called *forests* and we have a natural embedding of \mathfrak{T}_0 in \mathfrak{F}_0 .

We then write $\langle \mathfrak{F}_0 \rangle$ for the free vector space generated by \mathfrak{F}_0 , equipped with the product \cdot as above, extended by linearity. Note that this is canonically isomorphic to the free commutative algebra over \mathfrak{T}_0 , quotiented by the ideal generated by $(\mathbf{1} - 1)$. In other words, the special tree $\mathbf{1} \in \mathfrak{T}_0$ is identified with the unit of $\langle \mathfrak{F}_0 \rangle$, so that one has for example $\mathbf{1} \cdot T_1 \cdot T_2 = T_1 \cdot T_2 = T_2 \cdot T_1$ in $\langle \mathfrak{F}_0 \rangle$.

Remark 2.2.3. Given $T_1, T_2 \in \mathfrak{T}_0$, we have two possible products: $T_1 T_2 \in \mathfrak{T}_0$ corresponds to the graph obtained by identifying the roots, while $T_1 \cdot T_2 \in \mathfrak{F}_0$ corresponds to the disjoint union of the two graphs (if both T_1 and T_2 are different from $\mathbf{1}$). In particular, we can identify $T_1 T_2$ with a forest in \mathfrak{F}_0 , which is however different from $T_1 \cdot T_2$.

We illustrate this by the following example:

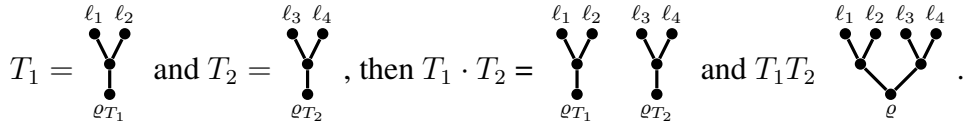

Definition 2.2.4. A forest $F = T_1 \cdot T_2 \cdots T_k \in \mathfrak{F}_0$ is canonically identified with the graph $T_1 \sqcup \cdots \sqcup T_k$, with nodes $N_F = N_{T_1} \sqcup \cdots \sqcup N_{T_k}$ and edges $E_F = E_{T_1} \sqcup \cdots \sqcup E_{T_k}$. We call $L_F = L_{T_1} \sqcup \cdots \sqcup L_{T_k}$ the set of leaves and $\overset{\circ}{N}_F = \overset{\circ}{N}_{T_1} \sqcup \cdots \sqcup \overset{\circ}{N}_{T_k}$ the set of inner nodes of F .

Definition 2.2.5. Given a rooted tree $T \in \mathfrak{T}_0$ and a rooted subtree $S \subseteq T$, we say that S is *admissible in T* if

1. $L_S \subseteq L_T$
2. either $\varrho_S = \varrho_T$, or there exists at least one leaf $\ell \in L_T \setminus L_S$ with $\varrho_S \leq \ell$.

Definition 2.2.6. Given a forest $F = T_1 \cdot T_2 \cdots T_k \in \mathfrak{F}_0$, a *subtree* of F is a rooted tree $S = (N_S, E_S) \subset F = (N_F, E_F)$. Note that necessarily S is a rooted subtree of one of the T_i 's. A subtree S of F is said to be *admissible* if, for some i , $S \subset T_i$ and S is admissible in T_i . We write $\mathfrak{S}(F)$ for the set of admissible subtrees of F .

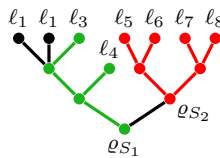

2.2. Rooted trees

In the example just above, the subtree S_1 in green is admissible. However, the subtree S_2 in red is not admissible, even though its leaves are leaves of the original tree, because there is no leaf ℓ not in S_2 such that $\varrho_{S_2} \leq \ell$.

2.2.1 Operations on forests

Definition 2.2.7. Given a forest $F = T_1 \cdot T_2 \cdots T_k \in \mathfrak{F}_0$, we denote by $\mathfrak{A}(F)$ the set of all $\mathcal{A} \subset \mathfrak{S}(F)$ such that any two elements of \mathcal{A} are disjoint. Here, two subtrees $S_1, S_2 \in \mathfrak{S}(F)$ are said to be disjoint if the set of nodes touched by S_1 is disjoint from the set of nodes touched by S_2 . In general, it will be convenient to identify a subtree of F with the corresponding subset of N_F . Given $F \in \mathfrak{F}_0$, we can (and will) view $\mathfrak{A}(F)$ again as a subset of \mathfrak{F}_0 . In particular, we will identify elements in $\mathfrak{A}(F)$ that only differ by a number of trees consisting solely of a root.

Note that $\mathfrak{A}(F)$ is never empty since one does always have $\emptyset \in \mathfrak{A}(F)$.

Definition 2.2.8. Any $\mathcal{A} = \{S_1, \dots, S_n\} \in \mathfrak{A}(F)$ induces a natural equivalence relation $\sim_{\mathcal{A}}$ on N_F by postulating that $x \sim_{\mathcal{A}} y$ if and only if either $x = y$ or both x and y belong to the same subtree $S_j \in \mathcal{A}$. This allows us to define another forest

$$\mathcal{R}_{\mathcal{A}}^{\downarrow} F \in \mathfrak{F}_0,$$

by taking the quotient of the graph (N_F, E_F) with respect to $\sim_{\mathcal{A}}$. In other words, the nodes of $\mathcal{R}_{\mathcal{A}}^{\downarrow} F$ are given by $N_F / \sim_{\mathcal{A}}$ and its edges are given by $E_F \setminus \{(x, y) \in E_F : x \sim_{\mathcal{A}} y\}$, with the obvious identifications. We also define

$$\mathcal{R}_{\mathcal{A}}^{\uparrow} F = S_1 \cdot S_2 \cdots S_n \in \mathfrak{F}_0,$$

with the additional natural conventions that $\mathcal{R}_{\emptyset}^{\uparrow} F = \mathbf{1}$ and $\mathcal{R}_{\emptyset}^{\downarrow} F = F$.

In the next example, we compute the previous operations on $\mathcal{A} = \{S_1, S_2\} \in \mathfrak{A}(T)$:

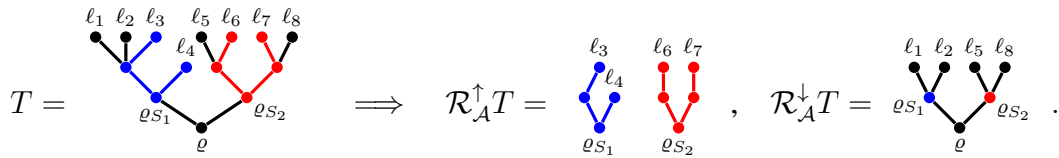

Remark 2.2.9. Definitions 2.2.5 and 2.2.7 guarantee that the set of leaves/edges of both $\mathcal{R}_{\mathcal{A}}^{\downarrow} F$ and $\mathcal{R}_{\mathcal{A}}^{\uparrow} F$ are naturally identified with subsets of the leaves/edges of F for all $\mathcal{A} \in \mathfrak{A}(F)$. In particular the types given to leaves/edges of $\mathcal{R}_{\mathcal{A}}^{\downarrow} F$ are inherited from the corresponding leaves/edges in F . Moreover, one has canonical injections

$$\mathfrak{A}(\mathcal{R}_{\mathcal{A}}^{\uparrow} F) \subset \mathfrak{A}(F), \quad \mathfrak{A}(\mathcal{R}_{\mathcal{A}}^{\downarrow} F) \subset \mathfrak{A}(F),$$

via the obvious identifications of subtrees of $\mathcal{R}_{\mathcal{A}}^{\uparrow} F$ and $\mathcal{R}_{\mathcal{A}}^{\downarrow} F$ with subtrees of F .

Remark 2.2.10. Recall that rooted trees in \mathfrak{T}_0 are canonically identified with a forest in \mathfrak{F}_0 . An important property is that for all $\mathcal{A} \in \mathfrak{A}(T)$ with $T \in \mathfrak{T}_0$, one has $\mathcal{R}_A^\downarrow T \in \mathfrak{T}_0$, while in general $\mathcal{R}_A^\uparrow T \in \mathfrak{F}_0$ but $\mathcal{R}_A^\uparrow T \notin \mathfrak{T}_0$.

Before we proceed, we introduce a number of relations, operations and properties of these collections of rooted subtrees of a forest $F \in \mathfrak{F}_0$. First, given $\mathcal{A}, \mathcal{B} \in \mathfrak{A}(F)$, we say that $\mathcal{A} \Subset \mathcal{B}$ if the following two properties hold:

1. For every $A \in \mathcal{A}$ there exists $B \in \mathcal{B}$ such that $A \subset B$.
2. For every $B \in \mathcal{B}$, writing $\mathcal{A}_B = \{A \in \mathcal{A} : A \subset B\}$, one has $\mathcal{A}_B \in \mathfrak{A}(\mathcal{R}_B^\uparrow F)$.

The following is now immediate.

Lemma 2.2.11. *If $\mathcal{A} \Subset \mathcal{B}$ then $\mathcal{R}_A^\uparrow \mathcal{R}_B^\uparrow F = \mathcal{R}_A^\uparrow F$.* □

Given $\mathcal{A} \in \mathfrak{A}(F)$ and $B \in \mathfrak{G}(F)$ such that for each $A \in \mathcal{A}$ one has either $A \subset B$ or $A \cap B = \emptyset$ (identifying a subtree with the corresponding set of nodes), we write $B \parallel \mathcal{A} \in \mathfrak{G}(\mathcal{R}_A^\downarrow F)$ for the subtree whose set of nodes agrees with that of B , but viewed as a subset of N/\sim_A . This is well-defined since our assumptions precisely guarantee that each equivalence class of \sim_A is either contained in the set of nodes of B , or disjoint from it. Given $\mathcal{A}, \mathcal{B} \in \mathfrak{A}(F)$ with $\mathcal{A} \Subset \mathcal{B}$, we then define $\mathcal{B} \parallel \mathcal{A} \in \mathfrak{A}(\mathcal{R}_A^\downarrow F)$ analogously by setting

$$\mathcal{B} \parallel \mathcal{A} = \{B \parallel \mathcal{A} : B \in \mathcal{B}\}.$$

With this definition, it is straightforward to see that

Lemma 2.2.12. *If $\mathcal{A} \Subset \mathcal{B}$ and $\mathcal{C} := \mathcal{B} \parallel \mathcal{A}$ then*

$$\mathcal{R}_C^\uparrow \mathcal{R}_A^\downarrow F = \mathcal{R}_A^\downarrow \mathcal{R}_B^\uparrow F, \quad \mathcal{R}_C^\downarrow \mathcal{R}_A^\downarrow F = \mathcal{R}_B^\downarrow F. \quad \square$$

Conversely, given $\mathcal{A} \in \mathfrak{A}(F)$ and $\mathcal{C} \in \mathfrak{A}(\mathcal{R}_A^\downarrow F)$, for $C \in \mathcal{C}$ we define $\mathcal{A}^C \in \mathfrak{G}(F)$ as the subtree of F obtained by taking the nodes of C and, instead of viewing them as a subset of $N_{\mathcal{R}_A^\downarrow F} = N_F/\sim_A$, we “expand” the equivalence relation \sim_A and view them again as a subset of N_F . One can verify that \mathcal{A}^C is indeed an admissible subtree of F . Still in the same context, we then define

$$\mathcal{C} \uplus \mathcal{A} = \{\mathcal{A}^C : C \in \mathcal{C}\} \cup \{A \in \mathcal{A} : A \cap \mathcal{A}^C = \emptyset, \forall C \in \mathcal{C}\} \in \mathfrak{A}(F).$$

In the next example, we consider a subtree B and $A \subset B$.

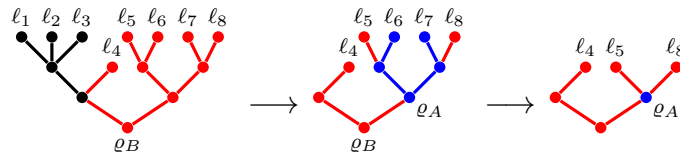

We have first computed $\mathcal{R}_B^\uparrow T$ then $C = \mathcal{R}_A^\downarrow(\mathcal{R}_B^\uparrow T) \in \mathfrak{F}_0$. Using the previous operations, we have: $A \Subset B$, $B \parallel A = C$ and $B = A \uplus C$.

Proposition 2.2.13. *Given $\mathcal{A} \in \mathfrak{A}(F)$ and $\mathcal{C} \in \mathfrak{A}(\mathcal{R}_A^\downarrow F)$, one has $\mathcal{A} \Subset (\mathcal{C} \uplus \mathcal{A})$ and $(\mathcal{C} \uplus \mathcal{A}) \parallel \mathcal{A} = \mathcal{C}$. Conversely, given $\mathcal{A} \Subset \mathcal{B}$, one has $(\mathcal{B} \parallel \mathcal{A}) \uplus \mathcal{A} = \mathcal{B}$.*

Proof. We first show that $\mathcal{A} \Subset (\mathcal{C} \uplus \mathcal{A})$. The first property of \Subset obviously holds, so we only need to check the second one. Writing $\mathcal{B} = \mathcal{C} \uplus \mathcal{A}$, every element $B \in \mathcal{B}$ is, by definition, either of the form $B = \mathcal{A}^C$ for some $C \in \mathcal{C}$, or of the form $B = A$ for some $A \in \mathcal{A}$ disjoint from all the \mathcal{A}^C . In the latter case, one has $\mathcal{A}_B = B \in \mathfrak{A}(\mathcal{R}_B^\uparrow F)$ as required. In the first case, we need to verify that $\{A \in \mathcal{A} : A \subset \mathcal{A}^C\} \in \mathfrak{A}(\mathcal{R}_B^\uparrow F)$. The only way in which this could fail is if one of these subtrees $A \in \mathcal{A}$ is not admissible in B (although it is necessarily admissible in F), namely if there is no $\ell \in L_B \setminus L_A$ with $\varrho_A \leq \ell$. This however would imply that N_A is a leaf of $B \parallel \mathcal{A}$. One has $B \parallel \mathcal{A} = \mathcal{A}^C \parallel \mathcal{A} = C$, since the operation $C \mapsto \mathcal{A}^C$ “undoes” the effect of the equivalence relation $\sim_{\mathcal{A}}$, while the operation $\mathcal{A}^C \mapsto \mathcal{A}^C \parallel \mathcal{A}$ enforces it again. Therefore, N_A would be a leaf of C , but leaves of C are also leaves of $\mathcal{R}_A^\downarrow F$ by definition of \mathfrak{A} , so that N_A would be a leaf of $\mathcal{R}_A^\downarrow F$. This however is ruled out by the fact that A is admissible by assumption.

To show that $\mathcal{B} \parallel \mathcal{A} = \mathcal{C}$, note that for elements $B \in \mathcal{B}$ of the type $B = \mathcal{A}^C$, one has $B \parallel \mathcal{A} = C$ as above. In the case $B = A$ for some $A \in \mathcal{A}$, one has $B \setminus \mathcal{A} = \mathbf{1}$, so that it does not contribute to $\mathcal{B} \parallel \mathcal{A}$, thus showing that indeed $\mathcal{B} \parallel \mathcal{A} = \mathcal{C}$. Finally, the last claim is immediate from the definitions which imply that $\mathcal{A}^{B \setminus \mathcal{A}} = B$. \square

Corollary 2.2.14. *For any shape $T \in \mathfrak{T}_0$, there is a bijection between pairs $(\mathcal{A}, \mathcal{B})$ in $\mathfrak{A}(T)$ with $\mathcal{A} \Subset \mathcal{B}$ and pairs $(\mathcal{A}, \mathcal{C})$ such that $\mathcal{C} \in \mathfrak{A}(\mathcal{R}_A^\downarrow T)$.*

Proof. The map $(\mathcal{A}, \mathcal{B}) \mapsto (\mathcal{A}, \mathcal{C})$ is obtained by setting $\mathcal{C} = \mathcal{B} \parallel \mathcal{A}$ and its inverse by setting $\mathcal{B} = \mathcal{C} \uplus \mathcal{A}$. Proposition 2.2.13 then precisely states that these operations are inverses of each other. \square

2.2.2 Coproducts on forests

We assume that we are given, for each $T \in \mathfrak{T}_0$, a subset $\bar{\mathfrak{A}}(T) \subset \mathfrak{A}(T)$, such that the following properties hold.

Assumption 2. The sets of collections of subtrees $\bar{\mathfrak{A}}(T)$ satisfy the following properties.

1. One has $\mathbf{1} \in \bar{\mathfrak{A}}(T)$ for every $T \in \mathfrak{T}_0$.
2. For every $T \in \mathfrak{T}_0$, $\mathcal{A} \in \bar{\mathfrak{A}}(T)$, and $\mathcal{C} \in \bar{\mathfrak{A}}(\mathcal{R}_A^\downarrow T)$, one has $\mathcal{C} \uplus \mathcal{A} \in \bar{\mathfrak{A}}(T)$.
3. For every $T \in \mathfrak{T}_0$ and $\mathcal{A}, \mathcal{B} \in \bar{\mathfrak{A}}(T)$ with $\mathcal{A} \Subset \mathcal{B}$, one has $\mathcal{B} \parallel \mathcal{A} \in \bar{\mathfrak{A}}(\mathcal{R}_A^\downarrow T)$.

Then we set for $F = T_1 \cdot T_2 \cdots T_k \in \mathfrak{F}_0$

$$\bar{\mathfrak{A}}(F) = \left\{ \bigcup_{i=1}^k \mathcal{A}_i, \mathcal{A}_i \in \bar{\mathfrak{A}}(T_i) \right\},$$

with the natural convention $\bar{\mathfrak{A}}(\emptyset) = \{\emptyset\}$.

Lemma 2.2.15. *Assuming Assumption 2, for any forest $F \in \mathfrak{F}_0$, there is a bijection between pairs $(\mathcal{A}, \mathcal{B})$ with $\mathcal{B} \in \bar{\mathfrak{A}}(F)$ and $\mathcal{A} \Subset \mathcal{B}$, and pairs $(\bar{\mathcal{A}}, \bar{\mathcal{B}})$ with $\bar{\mathcal{A}} \in \bar{\mathfrak{A}}(F)$ and $\bar{\mathcal{B}} \in \mathfrak{A}(\mathcal{R}_A^\downarrow F)$.*

Proof. Identical to that of Corollary 2.2.14, noting that Assumption 2 guarantees that one does indeed have $\mathcal{A} \in \bar{\mathfrak{A}}(F)$, $\bar{\mathcal{B}} \uplus \bar{\mathcal{A}} \in \bar{\mathfrak{A}}(F)$ and $\mathcal{B} \setminus \mathcal{A} \in \mathfrak{A}(\mathcal{R}_A^\downarrow F)$. \square

Theorem 2.2.16. *Let $\bar{\mathfrak{A}}$ satisfy Assumption 2 and define a linear map $\bar{\Delta}: \langle \mathfrak{F}_0 \rangle \rightarrow \langle \mathfrak{F}_0 \rangle \otimes \langle \mathfrak{F}_0 \rangle$ by*

$$\bar{\Delta}F = \sum_{\mathcal{A} \in \bar{\mathfrak{A}}(F)} \mathcal{R}_A^\uparrow F \otimes \mathcal{R}_A^\downarrow F.$$

Then, the identity

$$(1 \otimes \bar{\Delta})\bar{\Delta}F = (\bar{\Delta} \otimes 1)\bar{\Delta}F,$$

holds for every $F \in \mathfrak{F}_0$. Moreover $\bar{\Delta}$ is multiplicative, i.e. for all $F_1, F_2 \in \mathfrak{F}_0$

$$\bar{\Delta}(F_1 \cdot F_2) = (\bar{\Delta}F_1) \cdot (\bar{\Delta}F_2). \quad (2.1)$$

Finally $\bar{\Delta}: \langle \mathfrak{F}_0 \rangle \rightarrow \mathfrak{F}_0 \otimes \langle \mathfrak{T}_0 \rangle$, where $\langle \mathfrak{T}_0 \rangle$ is the linear span of \mathfrak{T}_0 , viewed as a subspace of $\langle \mathfrak{F}_0 \rangle$.

Proof. One has

$$\begin{aligned} (1 \otimes \bar{\Delta})\bar{\Delta}F &= \sum_{\substack{\mathcal{A} \in \bar{\mathfrak{A}}(F) \\ \mathcal{B} \in \bar{\mathfrak{A}}(\mathcal{R}_A^\downarrow F)}} \mathcal{R}_A^\uparrow F \otimes \mathcal{R}_B^\uparrow \mathcal{R}_A^\downarrow F \otimes \mathcal{R}_B^\downarrow \mathcal{R}_A^\downarrow F, \\ (\bar{\Delta} \otimes 1)\bar{\Delta}F &= \sum_{\substack{\mathcal{C} \in \bar{\mathfrak{A}}(F) \\ \mathcal{A} \in \bar{\mathfrak{A}}(\mathcal{R}_C^\uparrow F)}} \mathcal{R}_A^\uparrow \mathcal{R}_C^\uparrow F \otimes \mathcal{R}_A^\downarrow \mathcal{R}_C^\uparrow F \otimes \mathcal{R}_C^\downarrow F. \\ (\bar{\Delta} \otimes 1)\bar{\Delta}F &= \sum_{\substack{\mathcal{C} \in \bar{\mathfrak{A}}(F) \\ \mathcal{A} \in \mathcal{C}}} \mathcal{R}_A^\uparrow \mathcal{R}_C^\uparrow F \otimes \mathcal{R}_A^\downarrow \mathcal{R}_C^\uparrow F \otimes \mathcal{R}_C^\downarrow F. \end{aligned}$$

As a consequence of Lemma 2.2.15, we can put the outer sums in bijection with each other by identifying the collections \mathcal{A} appearing in both expressions, and by identifying \mathcal{B} with $\mathcal{C} \setminus \mathcal{A}$ (or equivalently \mathcal{C} with $\mathcal{B} \uplus \mathcal{A}$).

We are therefore led to compare the two quantities

$$\begin{aligned} &\mathcal{R}_A^\uparrow F \otimes \mathcal{R}_B^\uparrow \mathcal{R}_A^\downarrow F \otimes \mathcal{R}_B^\downarrow \mathcal{R}_A^\downarrow F, \\ &\mathcal{R}_A^\uparrow \mathcal{R}_C^\uparrow F \otimes \mathcal{R}_A^\downarrow \mathcal{R}_C^\uparrow F \otimes \mathcal{R}_C^\downarrow F, \end{aligned}$$

with $\mathcal{A} \Subset \mathcal{C}$ and $\mathcal{B} = \mathcal{C} \setminus \mathcal{A}$ (or equivalently $\mathcal{C} = \mathcal{B} \uplus \mathcal{A}$). Note now that, as a consequence of the definitions of the relation between \mathcal{A} , \mathcal{B} and \mathcal{C} , one has

$$\mathcal{R}_A^\uparrow \mathcal{R}_C^\uparrow = \mathcal{R}_A^\uparrow, \quad \mathcal{R}_B^\uparrow \mathcal{R}_A^\downarrow = \mathcal{R}_A^\downarrow \mathcal{R}_C^\uparrow, \quad \mathcal{R}_B^\downarrow \mathcal{R}_A^\downarrow = \mathcal{R}_C^\downarrow,$$

so that both of these expressions are of the form

$$\mathcal{R}_A^\uparrow F \otimes \mathcal{R}_A^\downarrow \mathcal{R}_C^\uparrow F \otimes \mathcal{R}_C^\downarrow F.$$

In order to show multiplicativity we note that by the definition $\bar{\mathfrak{A}}(F_1 \cdot F_2)$ can be canonically identified with $\bar{\mathfrak{A}}(F_1) \times \bar{\mathfrak{A}}(F_2)$ since $F_1 \cdot F_2$ is the graph $F_1 \sqcup F_2$. \square

2.3 Labelled trees and forests

Definition 2.3.1. A labelled tree is a triple $(T, \epsilon, \mathbf{n})$, where $T \in \mathfrak{T}_0$ is a rooted tree endowed with an edge-labelling $\epsilon: E_T \rightarrow \mathbf{N}^d$ and a node-labelling $\mathbf{n}: \dot{N}_T \rightarrow \mathbf{N}^d$. We denote by \mathfrak{T} the set of such labelled trees and denote a triple $(T, \epsilon, \mathbf{n})$ by $T_\epsilon^\mathbf{n} \in \mathfrak{T}$.

Remark 2.3.2. Note that we have a natural projection $\mathfrak{T} \mapsto \mathfrak{T}_0$ defined by discarding the labels, i.e. $T_\epsilon^\mathbf{n} = (T, \epsilon, \mathbf{n}) \mapsto T$. The product in \mathfrak{T}_0 has a natural extension to a product in \mathfrak{T} , $(T_\epsilon^\mathbf{n}, \hat{T}_\epsilon^{\hat{\mathbf{n}}}) \mapsto \bar{T}_\epsilon^{\bar{\mathbf{n}}}$, where $\bar{T} := T\hat{T}$, the edge-labels $\bar{\epsilon}$ in \bar{T} are obtained by restriction on E_T and $E_{\hat{T}}$, the node-labels $\bar{\mathbf{n}}$ on $N_{\bar{T}} \setminus \{\varrho_{\bar{T}}\}$ are obtained by restriction on $N_T \setminus \{\varrho_T\}$ and $N_{\hat{T}} \setminus \{\varrho_{\hat{T}}\}$, while $\bar{\mathbf{n}}(\varrho_{\bar{T}}) := \mathbf{n}(\varrho_T) + \hat{\mathbf{n}}(\varrho_{\hat{T}})$. This product is commutative and associative.

Definition 2.3.3. A labelled forest is a triple $(F, \epsilon, \mathbf{n})$, where $F \in \mathfrak{F}_0$ is a forest endowed with an edge-labelling $\epsilon: E_F \rightarrow \mathbf{N}^d$ and a node-labelling $\mathbf{n}: \dot{N}_F \rightarrow \mathbf{N}^d$. We denote by \mathfrak{F} the set of such labelled forests and denote a triple $(F, \epsilon, \mathbf{n})$ by $F_\epsilon^\mathbf{n} \in \mathfrak{F}$.

Remark 2.3.4. Note that we have a natural projection $\mathfrak{F} \mapsto \mathfrak{F}_0$ defined by discarding the labels, i.e. $F_\epsilon^\mathbf{n} = (F, \epsilon, \mathbf{n}) \mapsto F$. The product in \mathfrak{F}_0 has a natural extension to a product in \mathfrak{F} , $(F_\epsilon^\mathbf{n}, \hat{F}_\epsilon^{\hat{\mathbf{n}}}) \mapsto \bar{F}_\epsilon^{\bar{\mathbf{n}}}$, where $\bar{F} := F \cdot \hat{F}$, and labels are obtained by restriction on F and \hat{F} . This product is commutative and associative.

Definition 2.3.5. For all $F_\epsilon^\mathbf{n} \in \mathfrak{F}$ and $\mathcal{A} \in \mathfrak{A}(F)$ we can extend canonically the equivalence relation $\sim_{\mathcal{A}}$ on F to $F_\epsilon^\mathbf{n}$. The forest $\mathcal{R}_{\mathcal{A}}^\uparrow F_\epsilon^\mathbf{n}$ inherits edge- and node-labels from $F_\epsilon^\mathbf{n}$ by simple restriction. The forest $\mathcal{R}_{\mathcal{A}}^\downarrow F_\epsilon^\mathbf{n}$ inherits the edge-labels from $F_\epsilon^\mathbf{n}$ by simple restriction, while the node-labels are the sums of the labels over equivalence classes:

$$\mathbf{n}([x]) \stackrel{\text{def}}{=} \sum_{y: y \sim_{\mathcal{A}} x} \mathbf{n}(y). \quad (2.2)$$

Before we proceed, we introduce another structure on \mathfrak{F} . Given $F_\epsilon^\mathbf{n} \in \mathfrak{F}$, we write

$$|F_\epsilon^\mathbf{n}| = |E_F| + |\epsilon| + |\mathbf{n}|,$$

where, for a multiindex \mathbf{n} say, we set $|\mathbf{n}| = \sum_{x \in N_F} \sum_{i=1}^d \mathbf{n}(x)_i$, and similarly for ϵ . Note that we then have the identities

$$|\mathcal{R}_{\mathcal{A}}^\uparrow F_\epsilon^\mathbf{n}| = |E_{\mathcal{A}}| + |\epsilon \upharpoonright E_{\mathcal{A}}| + |\mathbf{n} \upharpoonright N_{\mathcal{A}}|, \quad |\mathcal{R}_{\mathcal{A}}^\downarrow F_\epsilon^\mathbf{n}| = |E_F \setminus E_{\mathcal{A}}| + |\epsilon \upharpoonright E_F \setminus E_{\mathcal{A}}| + |\mathbf{n}|, \quad (2.3)$$

where \upharpoonright denotes the restriction operator.

With this notation, we see that if we furthermore consider a finite set of types \mathfrak{L} , then the set $\{F_\epsilon^\mathbf{n} \in \mathfrak{F} : |F_\epsilon^\mathbf{n}| = N\}$ is finite for every $N \geq 0$. This is because there are only finitely many possible shapes for a forest with a given number of edges (remember that our forests contain no empty trees), and only finitely many ways of labelling them with labels of any fixed total size. We therefore have a natural grading $\langle \mathfrak{F} \rangle = \bigoplus_{N \geq 0} \mathfrak{F}_N$, and similarly for any space of the type $\langle \mathfrak{F} \rangle \otimes \langle \mathfrak{F} \rangle$, etc.

Given a graded vector space of the form $V = \bigoplus_{N \geq 0} V_N$, we then write $[V]$ for the (strictly larger) space of all formal series of the form $\sum_{N \geq 0} v_N$ with $v_N \in V_N$. Given two

graded vector spaces V and \bar{V} , we call a linear map $A: [V] \rightarrow [\bar{V}]$ *infinite triangular* if the projection of $A v_N$ onto \bar{V}_M vanishes for $M < N$. Such linear maps are in bijection with the set of infinite “matrices” of the form $\{A_{MN}\}_{M,N \geq 0}$ with $A_{MN} \in L(V_N, \bar{V}_M)$ and $A_{MN} = 0$ for $M < N$, and composition is given by formal matrix multiplication (this only involves finite sums thanks to the triangular structure of these matrices). Henceforth, we make a slight abuse of language and write again $A: V \rightarrow \bar{V}$ instead of $A: [V] \rightarrow [\bar{V}]$ for such a map, but whenever we do this we will explicitly state that A is infinite triangular.

Given a forest $F \in \mathfrak{F}_0$ and an edge-label $\epsilon: E_F \rightarrow \mathbf{N}^d$, we define the corresponding node-label $\pi\epsilon: N_F \rightarrow \mathbf{N}^d$ by

$$\pi\epsilon(x) = \sum_{e \in E_x} \epsilon(e), \quad E_x = \{(x, y) \in E_F\}.$$

Let $\bar{\mathfrak{A}}$ satisfy Assumption 2 and define an infinite triangular linear map $\bar{\Delta}: \langle \mathfrak{F} \rangle \rightarrow \langle \mathfrak{F} \rangle \otimes \langle \mathfrak{F} \rangle$ by

$$\bar{\Delta} F_\epsilon^n = \sum_{\mathcal{A} \in \bar{\mathfrak{A}}(F)} \sum_{\mathfrak{n}_{\mathcal{A}}, \epsilon_{\mathcal{A}}} \frac{1}{\epsilon_{\mathcal{A}}!} \binom{\mathfrak{n}}{\mathfrak{n}_{\mathcal{A}}} \mathcal{R}_{\mathcal{A}}^\uparrow F_\epsilon^{\mathfrak{n}_{\mathcal{A}} + \pi\epsilon_{\mathcal{A}}} \otimes \mathcal{R}_{\mathcal{A}}^\downarrow F_{\epsilon + \epsilon_{\mathcal{A}}}^{\mathfrak{n} - \mathfrak{n}_{\mathcal{A}}} \quad (2.4)$$

where, for $\mathcal{A} = \{S_1, \dots, S_n\}$,

1. $\epsilon_{\mathcal{A}}$ runs over all \mathbf{N}^d -valued functions on E_F supported by the set of edges $(x_1, x_2) \in E_F \setminus \cup_i E_{S_i}$ such that $x_1 \in \cup_i N_{S_i}$
2. $\mathfrak{n}_{\mathcal{A}}$ runs over the set of all \mathbf{N}^d -valued functions on N_F supported by $\cup_i \mathring{N}_{S_i}$.

Note that, as a consequence of (2.3), one has

$$|\mathcal{R}_{\mathcal{A}}^\uparrow F_\epsilon^{\mathfrak{n}_{\mathcal{A}} + \pi\epsilon_{\mathcal{A}}} \otimes \mathcal{R}_{\mathcal{A}}^\downarrow F_{\epsilon + \epsilon_{\mathcal{A}}}^{\mathfrak{n} - \mathfrak{n}_{\mathcal{A}}}| = |F_\epsilon^n| + 2|\epsilon_{\mathcal{A}}|,$$

so that this map is indeed triangular.

Theorem 2.3.6. *If $\bar{\mathfrak{A}}$ satisfies Assumption 2 then the identity*

$$(1 \otimes \bar{\Delta}) \bar{\Delta} F_\epsilon^n = (\bar{\Delta} \otimes 1) \bar{\Delta} F_\epsilon^n, \quad (2.5)$$

holds for every $F_\epsilon^n \in \mathfrak{F}$. Moreover $\bar{\Delta}$ is multiplicative, i.e. for all $F_1, F_2 \in \mathfrak{F}$

$$\bar{\Delta}(F_1 \cdot F_2) = (\bar{\Delta} F_1) \cdot (\bar{\Delta} F_2). \quad (2.6)$$

Finally $\bar{\Delta}: \langle \mathfrak{T} \rangle \rightarrow \mathfrak{F} \otimes \langle \mathfrak{T} \rangle$, where $\langle \mathfrak{T} \rangle$ is the linear span of \mathfrak{T} .

Proof. We first show the multiplicativity property (2.6). Arguing as in the proof of (2.1) in Theorem 2.3.6 we see that $\mathcal{A} \in \bar{\mathfrak{A}}(F\bar{F})$ if and only if $\mathcal{A} = \mathcal{A} \cup \bar{\mathcal{A}}$ with $\mathcal{A} \in \bar{\mathfrak{A}}(F)$ and $\bar{\mathcal{A}} \in \bar{\mathfrak{A}}(\bar{F})$; moreover $\epsilon_{\mathcal{A}}$ factorises as $\epsilon_{\mathcal{A}} + \epsilon_{\bar{\mathcal{A}}}$, with $\epsilon_{\mathcal{A}}, \epsilon_{\bar{\mathcal{A}}}$ supported by E_F and $E_{\bar{F}}$ respectively, and so does $\mathfrak{n}_{\mathcal{A}}$ on $\mathring{N}_{F\bar{F}}$. Therefore

$$\mathcal{R}_{\mathcal{A}}^\downarrow (F\bar{F})_{\epsilon + \epsilon_{\mathcal{A}}}^{\mathfrak{n} + \bar{\mathfrak{n}} - \mathfrak{n}_{\mathcal{A}}} = (\mathcal{R}_{\mathcal{A}_1}^\downarrow F_{\epsilon + \epsilon_{\mathcal{A}_1}}^{\mathfrak{n} - \mathfrak{n}_{\mathcal{A}_1}}) (\mathcal{R}_{\mathcal{A}_2}^\downarrow \bar{F}_{\epsilon_{\bar{\mathcal{A}}_2}}^{\bar{\mathfrak{n}} - \mathfrak{n}_{\mathcal{A}_2}}),$$

2.3. Labelled trees and forests

as well as

$$\mathcal{R}_A^\uparrow(F\bar{F})_{\epsilon+\bar{\epsilon}}^{n_A+\pi\epsilon_A} = \mathcal{R}_{A_1}^\uparrow F_\epsilon^{n_{A_1}+\pi\epsilon_{A_1}} \mathcal{R}_{A_2}^\uparrow \bar{F}_{\bar{\epsilon}}^{n_{A_2}+\pi\epsilon_{A_2}}.$$

Since factorials factor over functions with disjoint support, so that for example $\epsilon_A! = \epsilon_{A_1}!\epsilon_{A_2}!$, then all coefficients in (2.4) factorise and (2.6) follows.

We prove now (2.5). We first show that the identity (2.5) holds in the special case when F_ϵ^n is a labelled forest with vanishing node-label, namely when $n = 0$; we will see later how the general case can be coerced into this. If $n = 0$, then (2.4) reduces to the somewhat cleaner identity

$$\bar{\Delta}F_\epsilon = \sum_{A \in \bar{\mathfrak{A}}(F)} \sum_{\epsilon_A} \frac{1}{\epsilon_A!} \mathcal{R}_A^\uparrow F_\epsilon^{\pi\epsilon_A} \otimes \mathcal{R}_A^\downarrow F_{\epsilon+\epsilon_A}.$$

One has

$$\begin{aligned} (1 \otimes \bar{\Delta})\bar{\Delta}F_\epsilon &= \sum_{\substack{A \in \bar{\mathfrak{A}}(F) \\ B \in \bar{\mathfrak{A}}(\mathcal{R}_A^\downarrow F)}} \sum_{\epsilon_A, \epsilon_B} \frac{1}{\epsilon_A! \epsilon_B!} \mathcal{R}_A^\uparrow F_\epsilon^{\pi\epsilon_A} \otimes \mathcal{R}_B^\uparrow \mathcal{R}_A^\downarrow F_{\epsilon+\epsilon_A}^{\pi\epsilon_B} \otimes \mathcal{R}_B^\downarrow \mathcal{R}_A^\downarrow F_{\epsilon+\epsilon_A+\epsilon_B}, \\ (\bar{\Delta} \otimes 1)\bar{\Delta}F_\epsilon &= \sum_{\substack{C \in \bar{\mathfrak{A}}(F) \\ A \in C}} \sum_{\epsilon_A^C, \epsilon_C, n_A^C} \frac{1}{\epsilon_C! \epsilon_A^C!} \binom{\pi\epsilon_C}{n_A^C} \mathcal{R}_A^\uparrow \mathcal{R}_C^\uparrow F_\epsilon^{n_A^C + \pi\epsilon_A^C} \otimes \mathcal{R}_A^\downarrow \mathcal{R}_C^\uparrow F_{\epsilon+\epsilon_A^C}^{\pi\epsilon_C - n_A^C} \otimes \mathcal{R}_C^\downarrow F_{\epsilon+\epsilon_C}. \end{aligned}$$

The previous formal series are well-defined. Indeed, if we fix one term appearing in the sum, the edge-labels ϵ_A , ϵ_A^C and ϵ_C are uniquely determined and this implies the same property for ϵ_B and n_A^C .

As a consequence of Lemma 2.2.15, we can put the outer sums in bijection with each other by identifying the collections \mathcal{A} appearing in both expressions, and by identifying \mathcal{B} with $\mathcal{C} \setminus \mathcal{A}$ (or equivalently \mathcal{C} with $\mathcal{B} \cup \mathcal{A}$). We are therefore led to compare the two quantities

$$\frac{1}{\epsilon_A! \epsilon_B!} \mathcal{R}_A^\uparrow F_\epsilon^{\pi\epsilon_A} \otimes \mathcal{R}_B^\uparrow \mathcal{R}_A^\downarrow F_{\epsilon+\epsilon_A}^{\pi\epsilon_B} \otimes \mathcal{R}_B^\downarrow \mathcal{R}_A^\downarrow F_{\epsilon+\epsilon_A+\epsilon_B}, \quad (2.7)$$

$$\frac{1}{\epsilon_C! \epsilon_A^C!} \binom{\pi\epsilon_C}{n_A^C} \mathcal{R}_A^\uparrow \mathcal{R}_C^\uparrow F_\epsilon^{n_A^C + \pi\epsilon_A^C} \otimes \mathcal{R}_A^\downarrow \mathcal{R}_C^\uparrow F_{\epsilon+\epsilon_A^C}^{\pi\epsilon_C - n_A^C} \otimes \mathcal{R}_C^\downarrow F_{\epsilon+\epsilon_C}, \quad (2.8)$$

with summations implied over all of the label functions appearing, and with $\mathcal{A} \subseteq \mathcal{C}$ and $\mathcal{B} = \mathcal{C} \setminus \mathcal{A}$ (or equivalently $\mathcal{C} = \mathcal{B} \cup \mathcal{A}$). Note now that, as a consequence of the definitions of the relation between \mathcal{B} and \mathcal{C} , one has

$$\mathcal{R}_A^\uparrow \mathcal{R}_C^\uparrow = \mathcal{R}_A^\uparrow, \quad \mathcal{R}_B^\uparrow \mathcal{R}_A^\downarrow = \mathcal{R}_A^\downarrow \mathcal{R}_C^\uparrow, \quad \mathcal{R}_B^\downarrow \mathcal{R}_A^\downarrow = \mathcal{R}_C^\downarrow,$$

so that both of these expressions are of the form

$$K(n_{1,2}, \epsilon_{1,2}) \mathcal{R}_A^\uparrow F_\epsilon^{n_2} \otimes \mathcal{R}_A^\downarrow \mathcal{R}_C^\uparrow F_{\epsilon_2}^{n_1} \otimes \mathcal{R}_C^\downarrow F_{\epsilon_1},$$

for some label functions $n_{1,2}$, $\epsilon_{1,2}$ and combinatorial factors K . Furthermore, the label functions have the following properties:

1. One has $\pi \mathbf{e}_2 \leq \mathbf{n}_2 \leq \pi(\mathbf{e}_1 + \mathbf{e}_2)$ and $\mathbf{n}_1 + \pi_{\mathcal{A}} \mathbf{n}_2 - \pi_{\mathcal{A}} \pi(\mathbf{e}_1 + \mathbf{e}_2) = 0$.
2. The edge-label \mathbf{e}_1 is supported on \bar{E}_C , while \mathbf{e}_2 is supported on $E_C \cap \bar{E}_{\mathcal{A}}$.
3. The node-label \mathbf{n}_1 is a function on the quotient set $N / \sim_{\mathcal{A}}$.
4. The node-label \mathbf{n}_2 is supported on $N_{\mathcal{A}}$.

We call any choice of label functions satisfying these properties “acceptable”. Given an acceptable choice of label functions $\mathbf{n}_{1,2}$, $\mathbf{e}_{1,2}$, we say that labels $\mathbf{e}_{\mathcal{A}}$, $\mathbf{e}_{\mathcal{B}}$, \mathbf{e}_C , $\mathbf{e}_{\mathcal{A}}^C$ and $\mathbf{n}_{\mathcal{A}}^C$ are compatible with this choice if the following identities hold:

$$\begin{aligned}
 \pi_{\mathcal{A}}(\pi \mathbf{e}_C - \mathbf{n}_{\mathcal{A}}^C) &= \mathbf{n}_1 = \pi_{\mathcal{A}} \pi \mathbf{e}_{\mathcal{B}}, \\
 \mathbf{n}_{\mathcal{A}}^C + \pi \mathbf{e}_{\mathcal{A}}^C &= \mathbf{n}_2 = \pi \mathbf{e}_{\mathcal{A}}, \\
 \mathbf{e}_C &= \mathbf{e}_1 = \mathbf{e}_{\mathcal{A}}|_{\bar{E}_C} + \mathbf{e}_{\mathcal{B}}, \\
 \mathbf{e}_{\mathcal{A}}^C &= \mathbf{e}_2 = \mathbf{e}_{\mathcal{A}}|_{E_C}.
 \end{aligned} \tag{2.9}$$

Note that the first identity is redundant since it is an automatic consequence of the remaining three identities, combined with the fact that the labelling is acceptable. It thus suffices to show that if we sum the combinatorial factor appearing in (2.7) over all values of $\mathbf{e}_{\mathcal{A}}$ and $\mathbf{e}_{\mathcal{B}}$ compatible with a given acceptable choice of $\mathbf{n}_{1,2}$, $\mathbf{e}_{1,2}$, then we obtain the same value as when we sum the combinatorial factor of (2.8) over all compatible values of \mathbf{e}_C , $\mathbf{e}_{\mathcal{A}}^C$ and $\mathbf{n}_{\mathcal{A}}^C$.

We first consider (2.8), which is the easier case. Indeed, it follows from the last three identities of (2.9) that \mathbf{e}_C , $\mathbf{e}_{\mathcal{A}}^C$ and $\mathbf{n}_{\mathcal{A}}^C$ are uniquely determined by \mathbf{n}_2 , \mathbf{e}_1 and \mathbf{e}_2 , so that the corresponding sum over combinatorial factors contains one single term and is given by

$$\frac{1}{\mathbf{e}_1! \mathbf{e}_2!} \binom{\pi \mathbf{e}_1}{\mathbf{n}_2 - \pi \mathbf{e}_2} = \frac{(\pi \mathbf{e}_1)!}{\mathbf{e}_1! \mathbf{e}_2! (\mathbf{n}_2 - \pi \mathbf{e}_2)! (\pi(\mathbf{e}_1 + \mathbf{e}_2) - \mathbf{n}_2)!} = \frac{1}{\mathbf{e}_1! \mathbf{e}_2!} \binom{\pi \mathbf{e}_1}{\mathbf{n}_2 - \pi \mathbf{e}_2}.$$

(Note that being acceptable automatically implies that the various quantities appearing here are positive.) Regarding (2.7), the situation is a little bit more complicated since the identities (2.9) are not sufficient in general to determine $\mathbf{e}_{\mathcal{A}}$ and $\mathbf{e}_{\mathcal{B}}$ completely. Indeed, the only part of the way in which \mathbf{e}_1 is split between the summands $\mathbf{e}_{\mathcal{A}}|_{\bar{E}_C}$ and $\mathbf{e}_{\mathcal{B}}$ that is determined is its image under π . Since $\pi \mathbf{e}_{\mathcal{B}} = \pi(\mathbf{e}_1 + \mathbf{e}_2) - \mathbf{n}_2$ is determined, we still have the freedom to choose the actual values of $\mathbf{e}_{\mathcal{B}}$ that are consistent with $\pi \mathbf{e}_{\mathcal{B}}$. Once this is chosen, it is easy to see that this also determines $\mathbf{e}_{\mathcal{A}}$.

Combining this with (2.7), we conclude that the sum over the combinatorial factors appearing there is given by

$$\sum_{\mathbf{e}_{\mathcal{B}} | \pi \mathbf{e}_{\mathcal{B}}} \frac{1}{\mathbf{e}_2! (\mathbf{e}_1 - \mathbf{e}_{\mathcal{B}})! \mathbf{e}_{\mathcal{B}}!} = \frac{1}{\mathbf{e}_1! \mathbf{e}_2!} \sum_{\mathbf{e}_{\mathcal{B}}} \binom{\mathbf{e}_1}{\mathbf{e}_{\mathcal{B}}},$$

where the sum runs over all values of $\mathbf{e}_{\mathcal{B}}$ consistent with $\pi \mathbf{e}_{\mathcal{B}} = \pi(\mathbf{e}_1 + \mathbf{e}_2) - \mathbf{n}_2$ and we used the fact that $(f + g)! = f!g!$ for any two label functions f and g with disjoint

2.3. Labelled trees and forests

supports. It now remains to apply the Chu-Vandermonde identity, thus yielding

$$\sum_{\mathbf{e}_B | \pi \mathbf{e}_B} \binom{\mathbf{e}_1}{\mathbf{e}_B} = \binom{\pi \mathbf{e}_1}{\pi \mathbf{e}_B} = \binom{\pi \mathbf{e}_1}{\pi(\mathbf{e}_1 + \mathbf{e}_2) - \mathbf{n}_2} = \binom{\pi \mathbf{e}_1}{\mathbf{n}_2 - \pi \mathbf{e}_2},$$

so that the claim follows at once.

It now remains to show that the required identity also holds if we endow F with a non-zero node-label. For this, we use the following trick: we add additional types to the set \mathcal{L} by setting $\bar{\mathcal{L}} = \mathcal{L} \sqcup \{\star_i\}_{i=1}^d$ and we consider the map ι that takes a forest $F \in \mathfrak{F}^{\mathcal{L}}$ and builds a new forest $\iota F \in \mathfrak{F}^{\bar{\mathcal{L}}}$ obtained by setting the node-labels to 0 and, for any inner node x , adding $\mathbf{n}(x)_i$ new edges with type \star_i and edge label 0. We denote by $(\eta_i)_{i=1, \dots, d}$ the canonical basis of \mathbf{R}^d , i.e. $\eta_i(j) = \mathbb{1}_{(i=j)}$, $j \in \{1, \dots, d\}$.

Given a forest $F \in \mathfrak{F}^{\bar{\mathcal{L}}}$, we call edges of type \star_i for some i “virtual edges” and we call leaves *not* incident to a virtual edge “proper leaves”. We define a map $\Pi: \mathfrak{F}^{\bar{\mathcal{L}}} \rightarrow \langle \mathfrak{F}^{\mathcal{L}} \rangle$ by setting $\Pi F = 0$ if F contains a virtual edge e with $\bar{\epsilon}(e) \not\leq \eta_i$. Otherwise, ΠF is obtained by erasing all virtual edges $e = (x, y)$ and, for each virtual edge of type \star_i with a 0 edge-label, adding η_i to $\mathbf{n}(x)$. In particular, one can convince oneself that Π is a left-inverse for ι .

Setting $\underline{\mathfrak{A}}(F) = \bar{\mathfrak{A}}(\Pi F)$ for all $F \in \mathfrak{F}^{\bar{\mathcal{L}}}$, it is immediate that $\underline{\mathfrak{A}}$ then again satisfies Assumption 2, so that if we define $\underline{\Delta}$ by (2.4) with $\bar{\mathfrak{A}}$ replaced by $\underline{\mathfrak{A}}$, we have

$$(\underline{\Delta} \otimes 1) \underline{\Delta} F = (1 \otimes \underline{\Delta}) \underline{\Delta} F,$$

for every forest $F \in \mathfrak{F}^{\bar{\mathcal{L}}}$ without any node-labels. In particular, one has

$$(\underline{\Delta} \otimes 1) \underline{\Delta} \iota F = (1 \otimes \underline{\Delta}) \underline{\Delta} \iota F, \quad (2.10)$$

for every forest $F \in \mathfrak{F}^{\mathcal{L}}$. We now claim that one has

$$(1 \otimes \Pi) \underline{\Delta} \bar{F} = \bar{\Delta} \Pi \bar{F}, \quad (2.11)$$

for every forest $\bar{F} \in \mathfrak{F}^{\bar{\mathcal{L}}}$ (even those with additional node-labels). We show now that the claim, combined with (2.10), implies (2.5), i.e. co-associativity of $\bar{\Delta}$. Now (2.10) and (2.11) yield

$$(1 \otimes \bar{\Delta}) \bar{\Delta} = (1 \otimes \bar{\Delta})(1 \otimes \Pi) \underline{\Delta} \iota = (1 \otimes 1 \otimes \Pi)(1 \otimes \underline{\Delta}) \underline{\Delta} \iota$$

and

$$\begin{aligned} (\bar{\Delta} \otimes 1) \bar{\Delta} &= ((1 \otimes \Pi) \underline{\Delta} \otimes 1)(1 \otimes \Pi) \underline{\Delta} \iota = (1 \otimes \Pi \otimes \Pi)(\underline{\Delta} \otimes 1) \underline{\Delta} \iota \\ &= (1 \otimes \Pi \otimes \Pi)(1 \otimes \underline{\Delta}) \underline{\Delta} \iota. \end{aligned}$$

In order to conclude we need to show that $(\Pi \otimes \Pi) \underline{\Delta} = (1 \otimes \Pi) \underline{\Delta}$; this is true since $\mathcal{A} \in \underline{\mathfrak{A}}(\bar{F}) = \bar{\mathfrak{A}}(\Pi \bar{F})$ does not contain virtual edges, so that $\Pi \mathcal{R}_{\mathcal{A}}^{\uparrow} \bar{F} = \mathcal{R}_{\mathcal{A}}^{\uparrow} \bar{F}$.

It remains to show that (2.11) holds. We note again that $\mathcal{A} \in \underline{\mathfrak{A}}(\bar{F}) = \bar{\mathfrak{A}}(\Pi \bar{F})$ contains no virtual edge. Then, if $\Pi \bar{F} = 0$, namely if there exists an edge of type \star_i with $\bar{\epsilon}(e) \not\leq \eta_i$,

then the same is true for $\mathcal{R}_A^\downarrow \bar{F}$, i.e. for each of the terms appearing in the right-hand side of (2.4) with $\bar{\mathfrak{A}}$ replaced by \mathfrak{A} , so that one does indeed also have $(1 \otimes \Pi) \Delta \bar{F} = 0$.

We therefore assume that $\Pi \bar{F} \neq 0$ from now on and we set $F = \Pi \bar{F}$. We also define a function $\mathfrak{m}: N_F = N_{\bar{F}} \rightarrow \mathbf{N}^d$ by setting $\mathfrak{m}(x)_i$ to be equal to the number of virtual edges of type \star_i incident to x . In particular, denoting by $\mathfrak{n}, \mathfrak{e}$ the labellings of F and by $\bar{\mathfrak{n}}, \bar{\mathfrak{e}}$ the labellings of \bar{F} , the definition of Π implies that \mathfrak{e} and $\bar{\mathfrak{e}}$ coincide on proper edges, so that one can write

$$\bar{\mathfrak{e}} = \mathfrak{e} + \mathfrak{e}^V,$$

with \mathfrak{e}^V supported on virtual edges only. Furthermore these quantities are related by

$$\mathfrak{n} = \bar{\mathfrak{n}} + \mathfrak{m} - \pi \mathfrak{e}^V. \quad (2.12)$$

Furthermore, the definition of $\Delta \bar{F}$ guarantees that the set of admissible collections appearing in $\Delta \bar{F}$ is the same as the set of admissible collections appearing in $\bar{\Delta} F$, with the obvious identification of the leaves of F as a subset of those of \bar{F} . Since F and \bar{F} have the same nodes, the node-label \mathfrak{n}_A appearing in (2.4) runs in principle over the same set in both cases. However, since the node-labelling $\bar{\mathfrak{n}}$ for \bar{F} is in general smaller than the node-labelling \mathfrak{n} of F , $\bar{\mathfrak{n}}_A$ runs over a smaller set.

On the other hand, \bar{F} has more edges than F (it contains all virtual edges), so that $\bar{\mathfrak{e}}_A$ runs over a larger class in that case. However, any label function $\bar{\mathfrak{e}}_A$ defined on the edges of \bar{F} can be written uniquely as $\bar{\mathfrak{e}}_A = \mathfrak{e}_A + \mathfrak{e}_A^V$, where \mathfrak{e}_A^V is supported on the virtual edges, while \mathfrak{e}_A is supported on the proper edges.

Since the set E_A does not contain any virtual edges, the forest $\mathcal{R}_A^\uparrow \bar{F}_{\bar{\mathfrak{e}}}^{\bar{\mathfrak{n}}_A + \pi \bar{\mathfrak{e}}_A}$ is exactly the same as the forest $\mathcal{R}_A^\uparrow F_{\mathfrak{e}}^{\mathfrak{n}_A + \pi \mathfrak{e}_A}$ for every admissible collection A , provided that one has the identity

$$\bar{\mathfrak{n}}_A + \pi \bar{\mathfrak{e}}_A = \mathfrak{n}_A + \pi \mathfrak{e}_A. \quad (2.13)$$

This is because the identity $F = \Pi \bar{F}$ guarantees that \mathfrak{e} and $\bar{\mathfrak{e}}$ coincide, save for the fact that $\bar{\mathfrak{e}}$ has additional values on the virtual edges which are however discarded by the action of \mathcal{R}_A^\downarrow . Similarly, it is straightforward to verify that one has the identity

$$\Pi \mathcal{R}_A^\downarrow \bar{F}_{\bar{\mathfrak{e}} + \mathfrak{e}_A}^{\bar{\mathfrak{n}} - \bar{\mathfrak{n}}_A} = \mathcal{R}_A^\downarrow F_{\mathfrak{e} + \mathfrak{e}_A}^{\mathfrak{n} - \mathfrak{n}_A},$$

provided that the following holds:

1. On proper edges, one has $\bar{\mathfrak{e}}_A = \mathfrak{e}_A$, so that one does indeed have $\bar{\mathfrak{e}}_A = \mathfrak{e}_A + \mathfrak{e}_A^V$, where \mathfrak{e}_A^V is supported on the virtual edges.
2. For every virtual edge $e \in E \setminus E_A$ of type i , one has $\bar{\mathfrak{e}}(e) + \mathfrak{e}_A^V(e) \leq \eta_i$, since otherwise the left hand side vanishes. In particular, $\bar{\mathfrak{e}}$ and \mathfrak{e}_A^V have disjoint supports.

Indeed, if this is the case, then (2.12) and (2.13) imply that the node-labelling of $\Pi \mathcal{R}_A^\downarrow \bar{F}_{\bar{\mathfrak{e}} + \mathfrak{e}_A}^{\bar{\mathfrak{n}} - \bar{\mathfrak{n}}_A}$ is given by

$$\pi_A(\bar{\mathfrak{n}} - \bar{\mathfrak{n}}_A + \mathfrak{m} - \pi \mathfrak{e}_A^V - \pi \mathfrak{e}^V) = \pi_A(\mathfrak{n} - \bar{\mathfrak{n}}_A - \pi \mathfrak{e}_A^V) = \pi_A(\mathfrak{n} - \mathfrak{n}_A),$$

2.4. Positive and negative renormalisations

which is precisely the node-labelling of the right hand side. The claim thus follows if we can show that

$$\frac{1}{\mathbf{e}_{\mathcal{A}}!} \binom{\mathbf{n}}{\mathbf{n}_{\mathcal{A}}} = \sum_{\mathbf{e}_{\mathcal{A}}^V} \frac{1}{(\mathbf{e}_{\mathcal{A}} + \mathbf{e}_{\mathcal{A}}^V)!} \binom{\mathbf{n} - \mathbf{m} + \pi \mathbf{e}^V}{\mathbf{n}_{\mathcal{A}} - \pi \mathbf{e}_{\mathcal{A}}^V},$$

where $\mathbf{e}_{\mathcal{A}}^V$ is as above. Note first that since $\mathbf{e}_{\mathcal{A}}^V$ has support disjoint from $\mathbf{e}_{\mathcal{A}}$, one has $(\mathbf{e}_{\mathcal{A}} + \mathbf{e}_{\mathcal{A}}^V)! = \mathbf{e}_{\mathcal{A}}! \mathbf{e}_{\mathcal{A}}^V!$. Furthermore, $\mathbf{e}_{\mathcal{A}}^V(e)$ is always either 0 or η_i for some i , so that one actually has $\mathbf{e}_{\mathcal{A}}^V! = 1$. Furthermore, given $\pi \mathbf{e}_{\mathcal{A}}^V$, the number of possible choices for $\mathbf{e}_{\mathcal{A}}^V$ consistent with it is precisely equal to

$$\binom{\mathbf{m} - \pi \mathbf{e}^V}{\pi \mathbf{e}_{\mathcal{A}}^V}.$$

This is because at each node x , there are \mathbf{m} virtual edges incident to x , but only $\mathbf{m} - \pi \mathbf{e}^V$ of these have label 0 and so can be used for $\mathbf{e}_{\mathcal{A}}^V$. It therefore remains to show that

$$\binom{\mathbf{n}}{\mathbf{n}_{\mathcal{A}}} = \sum_{\pi \mathbf{e}_{\mathcal{A}}^V} \binom{\mathbf{m} - \pi \mathbf{e}^V}{\pi \mathbf{e}_{\mathcal{A}}^V} \binom{\mathbf{n} - \mathbf{m} + \pi \mathbf{e}^V}{\mathbf{n}_{\mathcal{A}} - \pi \mathbf{e}_{\mathcal{A}}^V},$$

but this follows immediately from the Chu-Vandermonde identity, thus concluding the proof. \square

2.4 Positive and negative renormalisations

Definition 2.4.1. For all $T \in \mathfrak{T}$, we denote by $\mathfrak{A}^+(T) \subset \mathfrak{A}(T)$ the set of all $\mathcal{A} \in \mathfrak{A}(T)$ with either $\mathcal{A} = \emptyset$ or $\mathcal{A} = \{S\}$ with S a rooted subtree of T such that $\varrho_S = \varrho_T$.

Lemma 2.4.2. *Assumption 2 is satisfied for $\bar{\mathfrak{A}} = \mathfrak{A}$ and $\bar{\mathfrak{A}} = \mathfrak{A}^+$.*

Proof. The first property is part of the definitions and the second one follows from the fact that $\mathcal{R}_{\mathcal{B} \cup \mathcal{A}}^\downarrow F = \mathcal{R}_{\mathcal{B}}^\downarrow \mathcal{R}_{\mathcal{A}}^\downarrow F$. Regarding the last property, the fact that $\mathcal{C} \parallel \mathcal{A} \in \mathfrak{A}(\mathcal{R}_{\mathcal{A}}^\downarrow F)$ similarly follows from the fact that $\mathcal{R}_{\mathcal{C} \setminus \mathcal{A}}^\downarrow \mathcal{R}_{\mathcal{A}}^\downarrow F = \mathcal{R}_{\mathcal{C}}^\downarrow F$. \square

We then define two infinite triangular maps $\delta^+ : \langle \mathfrak{F} \rangle \mapsto \langle \mathfrak{F} \rangle \otimes \langle \mathfrak{F} \rangle$ and $\delta^- : \langle \mathfrak{F} \rangle \mapsto \langle \mathfrak{F} \rangle \otimes \langle \mathfrak{F} \rangle$ exactly as in (2.4), but with $\bar{\mathfrak{A}} = \mathfrak{A}^+$ for δ^+ and $\bar{\mathfrak{A}} = \mathfrak{A}$ for δ^- .

$$\delta^+ F_{\mathbf{e}}^{\mathbf{n}} := \sum_{\mathcal{A} \in \mathfrak{A}^+(F)} \sum_{\mathbf{e}_{\mathcal{A}}, \mathbf{n}_{\mathcal{A}}} \frac{1}{\mathbf{e}_{\mathcal{A}}!} \binom{\mathbf{n}}{\mathbf{n}_{\mathcal{A}}} \mathcal{R}_{\mathcal{A}}^\uparrow F_{\mathbf{e}}^{\mathbf{n}_{\mathcal{A}} + \pi \mathbf{e}_{\mathcal{A}}} \otimes \mathcal{R}_{\mathcal{A}}^\downarrow F_{\mathbf{e} + \mathbf{e}_{\mathcal{A}}}^{\mathbf{n} - \mathbf{n}_{\mathcal{A}}}, \quad (2.14)$$

$$\delta^- F_{\mathbf{e}}^{\mathbf{n}} := \sum_{\mathcal{A} \in \mathfrak{A}(F)} \sum_{\mathbf{e}_{\mathcal{A}}, \mathbf{n}_{\mathcal{A}}} \frac{1}{\mathbf{e}_{\mathcal{A}}!} \binom{\mathbf{n}}{\mathbf{n}_{\mathcal{A}}} \mathcal{R}_{\mathcal{A}}^\uparrow F_{\mathbf{e}}^{\mathbf{n}_{\mathcal{A}} + \pi \mathbf{e}_{\mathcal{A}}} \otimes \mathcal{R}_{\mathcal{A}}^\downarrow F_{\mathbf{e} + \mathbf{e}_{\mathcal{A}}}^{\mathbf{n} - \mathbf{n}_{\mathcal{A}}}. \quad (2.15)$$

Note that δ^+ can also be viewed as a map $\delta^+ : \langle \mathfrak{T} \rangle \mapsto \langle \mathfrak{T} \rangle \otimes \langle \mathfrak{T} \rangle$ since, by Definition 2.4.1, $\mathcal{R}_{\mathcal{A}}^\uparrow T$ is given by a single rooted tree for all $\mathcal{A} \in \mathfrak{A}^+(T)$.

Below, we compute one term given by the coproduct δ^- with $\mathcal{A} = \{A_1, A_2\} \in \mathfrak{A}(T)$ and one term given by δ^+ for $A \in \mathfrak{A}^+(T)$

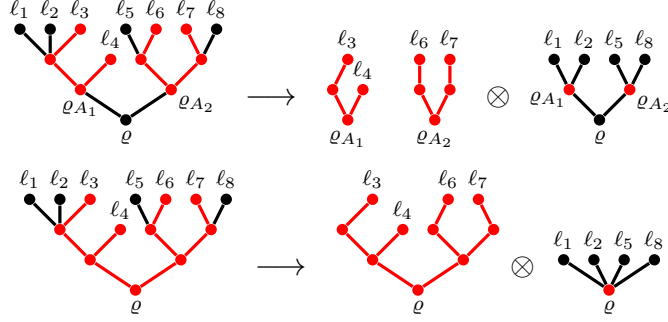

Definition 2.4.3. A rooted tree $T \in \mathfrak{T}_0$ is said to be *elementary* if it either consists only of the root or has only one edge incident to the root. Let $\hat{\mathfrak{T}}_0 \subset \mathfrak{T}_0$ be the set of elementary rooted trees. Let $\hat{\mathfrak{T}}$ be the corresponding set of labelled trees.

2.4.1 Homogeneity

Definition 2.4.4. We associate to each type $\ell \in \mathcal{L}$ a “homogeneity” $|\ell|_{\mathfrak{s}} \in \mathbf{R}$. We also denote by $|F_{\mathfrak{c}}^{\mathfrak{n}}|_{\mathfrak{s}}$ the homogeneity of the labelled forest $F_{\mathfrak{c}}^{\mathfrak{n}} \in \mathfrak{F}$, which is given by

$$|F_{\mathfrak{c}}^{\mathfrak{n}}|_{\mathfrak{s}} = \sum_{u \in L_F \sqcup E_F} |l(u)|_{\mathfrak{s}} + \sum_{x \in \hat{N}_F} |\mathfrak{n}(x)|_{\mathfrak{s}} - \sum_{e \in E_F} |\mathfrak{e}(e)|_{\mathfrak{s}},$$

where $|\cdot|_{\mathfrak{s}}$ denotes the \mathfrak{s} -homogeneity of a multiindex. In particular, one has $|\mathbf{1}| = 0$ as expected.

Remark 2.4.5. For a labelled tree $T_{\mathfrak{c}}^{\mathfrak{n}} \in \mathfrak{T} \subset \mathfrak{F}$ the homogeneity is also well-defined. Moreover the homogeneity has the property

$$\begin{aligned} |\tau\bar{\tau}|_{\mathfrak{s}} &= |\tau|_{\mathfrak{s}} + |\bar{\tau}|_{\mathfrak{s}}, & \forall \tau, \bar{\tau} \in \mathfrak{T}, \\ |\varphi \cdot \bar{\varphi}|_{\mathfrak{s}} &= |\varphi|_{\mathfrak{s}} + |\bar{\varphi}|_{\mathfrak{s}}, & \forall \varphi, \bar{\varphi} \in \mathfrak{T}. \end{aligned}$$

Definition 2.4.6. Let $\mathfrak{F}_- \subset \mathfrak{F}$ be the set of all labelled forests $F_{\mathfrak{c}}^{\mathfrak{n}} = \mathbf{1}$ or $F_{\mathfrak{c}}^{\mathfrak{n}} = (T_1 \cdot T_2 \cdots T_k)_{\mathfrak{c}}^{\mathfrak{n}}$ such that $T_i \notin \hat{\mathfrak{T}}_0$ and $|(T_i)_{\mathfrak{c}}^{\mathfrak{n}}|_{\mathfrak{s}} < 0$ for all $i = 1, \dots, k$, i.e. T_i is non-elementary and $(T_i)_{\mathfrak{c}}^{\mathfrak{n}}$ has negative homogeneity. The set \mathfrak{F}_- is stable under the product inherited from \mathfrak{F} and therefore $\langle \mathfrak{F}_- \rangle$ is an algebra. If we set \mathfrak{T}_- as the set of non-elementary rooted trees with negative homogeneity, then $\langle \mathfrak{F}_- \rangle$ is the algebra generated by \mathfrak{T}_- in $\langle \mathfrak{F} \rangle$.

Definition 2.4.7. Let $\mathfrak{T}_+^0 \subset \hat{\mathfrak{T}}$ be the set of elementary labelled trees with positive homogeneity and zero label at the root; if \mathfrak{n} is a node-labelling of T then $\hat{\mathfrak{n}}(x) := \mathfrak{n}(x)\mathbb{1}_{(x \neq \rho_T)}$ is the node-labelling of T with the label of the root set to 0; then \mathfrak{T}_+ is the set of labelled trees $T_{\mathfrak{c}}^{\mathfrak{n}}$ such that $T_{\mathfrak{c}}^{\hat{\mathfrak{n}}}$ is a product of trees in \mathfrak{T}_+^0 . The set \mathfrak{T}_+ is stable under the product inherited from \mathfrak{T} and therefore $\langle \mathfrak{T}_+ \rangle$ is an algebra.

Let $\Pi_+ : \langle \mathfrak{F} \rangle \mapsto \langle \mathfrak{T}_+ \rangle$ and $\Pi_- : \langle \mathfrak{F} \rangle \mapsto \langle \mathfrak{F}_- \rangle$ be the canonical projection onto $\langle \mathfrak{T}_+ \rangle$, resp. $\langle \mathfrak{F}_- \rangle$. Then we define the following maps

$$\Delta : \langle \mathfrak{T} \rangle \rightarrow \langle \mathfrak{T} \rangle \otimes \langle \mathfrak{T}_+ \rangle, \quad \Delta = (1 \otimes \Pi_+)\delta^+$$

2.4. Positive and negative renormalisations

$$\begin{aligned}\Delta^+ &: \langle \mathfrak{T}_+ \rangle \rightarrow \langle \mathfrak{T}_+ \rangle \otimes \langle \mathfrak{T}_+ \rangle, & \Delta^+ &= (\Pi_+ \otimes \Pi_+) \delta^+ \\ \hat{\Delta} &: \langle \mathfrak{F} \rangle \rightarrow \langle \mathfrak{F}_- \rangle \otimes \langle \mathfrak{F} \rangle, & \hat{\Delta} &= (\Pi_- \otimes 1) \delta^- \\ \Delta^- &: \langle \mathfrak{F}_- \rangle \rightarrow \langle \mathfrak{F}_- \rangle \otimes \langle \mathfrak{F}_- \rangle, & \Delta^- &= (\Pi_- \otimes \Pi_-) \delta^-.\end{aligned}$$

We also set

$$\Delta^R : \langle \mathfrak{T} \rangle \rightarrow \langle \mathfrak{F}_- \rangle \otimes \langle \mathfrak{T} \rangle, \quad \Delta^R = (\Pi_- \otimes 1) \delta^+. \quad (2.16)$$

Remark 2.4.8. While δ^\pm take values in formal (infinite) sums, the projections Π_\pm make all sums defining Δ , Δ^+ , $\hat{\Delta}$, Δ^- and Δ^R finite.

2.4.2 Positive renormalisation

We want to prove the following

Theorem 2.4.9. *The algebra $\langle \mathfrak{T}_+ \rangle$ endowed with the product $(\tau, \bar{\tau}) \mapsto \tau \bar{\tau}$ and the co-product Δ^+ is a Hopf algebra. Moreover Δ turns $\langle \mathfrak{T} \rangle$ into a right comodule over $\langle \mathfrak{T}_+ \rangle$.*

Proof. We claim first that δ^+ , defined in (4.2) and proved to be multiplicative on labelled forests endowed with the product $(\varphi, \bar{\varphi}) \mapsto \varphi \cdot \bar{\varphi}$ in Theorem 2.3.6, is also multiplicative on labelled trees endowed with the product $(T_\epsilon^n, \bar{T}_\epsilon^n) \mapsto T_\epsilon^n \bar{T}_\epsilon^n$. We recall that $\mathfrak{A}^+(T) \subset \mathfrak{A}(T)$ is the set of all $\mathcal{A} = \{S\}$ with S a rooted subtree of T such that $\varrho_S = \varrho_T$; with a slight abuse of notation we denote $\{S\}$ simply by S . We note first that \mathfrak{A}^+ has a nice factorisation property with respect to the product of labelled trees: indeed $\mathfrak{A}^+(T\bar{T})$ is the set of rooted subtrees S of $T\bar{T}$ such that $\varrho_S = \varrho_{T\bar{T}}$ and the map

$$\mathfrak{A}^+(T\bar{T}) \ni \mathcal{A} = S \mapsto (S \cap T, S \cap \bar{T}) = (\mathcal{A}_1, \mathcal{A}_2) \in \mathfrak{A}^+(T) \times \mathfrak{A}^+(\bar{T})$$

is a bijection, with inverse

$$\mathfrak{A}^+(T) \times \mathfrak{A}^+(\bar{T}) \ni (S, \bar{S}) \mapsto S\bar{S} \in \mathfrak{A}^+(T\bar{T}).$$

Now if $\mathcal{A} \in \mathfrak{A}^+(T\bar{T})$ then $\epsilon_{\mathcal{A}}$ factorises as $\epsilon_{\mathcal{A}_1} + \epsilon_{\mathcal{A}_2}$, with $\epsilon_{\mathcal{A}_1}, \epsilon_{\mathcal{A}_2}$ supported by E_T and $E_{\bar{T}}$ respectively, and so does $\mathfrak{n}_{\mathcal{A}}$ on $\mathring{N}_{T\bar{T}} \setminus \{\varrho_{T\bar{T}}\}$. Therefore

$$\mathcal{R}_{\mathcal{A}}^\downarrow (T\bar{T})_{\epsilon+\bar{\epsilon}+\epsilon_{\mathcal{A}}}^{n+\bar{n}-n_{\mathcal{A}}} = (\mathcal{R}_{\mathcal{A}_1}^\downarrow T_{\epsilon+\epsilon_{\mathcal{A}_1}}^{n-n_{\mathcal{A}_1}}) (\mathcal{R}_{\mathcal{A}_2}^\downarrow \bar{T}_{\bar{\epsilon}+\epsilon_{\mathcal{A}_2}}^{\bar{n}-n_{\mathcal{A}_2}}),$$

as well as

$$\mathcal{R}_{\mathcal{A}}^\uparrow (T\bar{T})_{\epsilon+\bar{\epsilon}}^{n_{\mathcal{A}}+\pi\epsilon_{\mathcal{A}}} = \mathcal{R}_{\mathcal{A}_1}^\uparrow T_{\epsilon}^{n_{\mathcal{A}_1}+\pi\epsilon_{\mathcal{A}_1}} \mathcal{R}_{\mathcal{A}_2}^\uparrow \bar{T}_{\bar{\epsilon}}^{n_{\mathcal{A}_2}+\pi\epsilon_{\mathcal{A}_2}}.$$

Since factorials factor over functions with disjoint support, so that for example $\epsilon_{\mathcal{A}}! = \epsilon_{\mathcal{A}_1}! \epsilon_{\mathcal{A}_2}!$, the only part that could potentially prevent (4.2) from factorising when replacing T_ϵ^n by $T_\epsilon^n \bar{T}_\epsilon^n$ is the contribution of the root labels $\mathfrak{n}_{\mathcal{A}}(\varrho)$, where the combinatorial factor in the sum over $\mathfrak{n}_{\mathcal{A}}(\varrho)$ may potentially differ from that of the double sum over $\mathfrak{n}_{\mathcal{A}_1}(\varrho)$ and $\mathfrak{n}_{\mathcal{A}_2}(\varrho)$. However, we note that also in the second case the right hand side only depends on $\mathfrak{n}_{\mathcal{A}_1}(\varrho) + \mathfrak{n}_{\mathcal{A}_2}(\varrho)$ so that the claim follows from the identity

$$\sum_k \binom{n_1 + n_2}{k} F(k) = \sum_{k_1, k_2} \binom{n_1}{k_1} \binom{n_2}{k_2} F(k_1 + k_2),$$

which holds for any expression F as a consequence of the Vandermonde identity.

We note now an important difference between Π_+ and Π_- : indeed, Π_+ is multiplicative on labelled trees while Π_- in general is not (both are trivially multiplicative on labelled forests). In a formula:

$$\Pi_+(\tau\bar{\tau}) = (\Pi_+\tau)(\Pi_+\bar{\tau}), \quad \forall \tau, \bar{\tau} \in \mathfrak{T}.$$

Now, we have to prove that

$$(1 \otimes \Delta^+)\Delta = (\Delta \otimes 1)\Delta, \quad (1 \otimes \Delta^+)\Delta^+ = (\Delta^+ \otimes 1)\Delta^+. \quad (2.17)$$

We claim that the following identity holds:

$$(\Pi_+ \otimes \Pi_+)\delta^+\Pi_+ = (\Pi_+ \otimes \Pi_+)\delta^+.$$

We have to prove that the right-hand side of this identity vanishes for all $\tau \in \mathfrak{T} \setminus \mathfrak{T}_+$. Note that such τ is a product of elementary trees, not all of them with positive homogeneity. Since δ^+ and Π_+ are multiplicative on \mathfrak{T} , then it is enough to check the identity on elementary trees with negative homogeneity. Now for every $\tau \in \mathfrak{T}$, one has $\delta^+\tau = \sum_i \tau_i^{(1)} \otimes \tau_i^{(2)}$ where $|\tau|_s = |\tau_i^{(1)}|_s + |\tau_i^{(2)}|_s$ for all i , so that if $|\tau|_s < 0$ then $|\tau_i^{(1)}|_s \wedge |\tau_i^{(2)}|_s < 0$ and therefore $(\Pi_+ \otimes \Pi_+)\delta^+\tau = 0$.

Now, in order to prove the first equality in (2.17) we notice that

$$\begin{aligned} (1 \otimes \Delta^+)\Delta &= (1 \otimes (\Pi_+ \otimes \Pi_+)\delta^+)(1 \otimes \Pi_+)\delta^+ = (1 \otimes (\Pi_+ \otimes \Pi_+)\delta^+\Pi_+)\delta^+ \\ &= (1 \otimes (\Pi_+ \otimes \Pi_+)\delta^+)\delta^+ = (1 \otimes \Pi_+ \otimes \Pi_+)(1 \otimes \delta^+)\delta^+ \end{aligned}$$

and

$$\begin{aligned} (\Delta \otimes 1)\Delta &= ((1 \otimes \Pi_+)\delta^+ \otimes 1)(1 \otimes \Pi_+)\delta^+ = ((1 \otimes \Pi_+)\delta^+ \otimes \Pi_+)\delta^+ \\ &= (1 \otimes \Pi_+ \otimes \Pi_+)(\delta^+ \otimes 1)\delta^+. \end{aligned}$$

By Theorem 2.3.6, $(1 \otimes \delta^+)\delta^+ = (\delta^+ \otimes 1)\delta^+$ and we obtain the first equality in (2.17). In order to prove the second equality, we have

$$\begin{aligned} (1 \otimes \Delta^+)\Delta^+ &= (1 \otimes (\Pi_+ \otimes \Pi_+)\delta^+)(\Pi_+ \otimes \Pi_+)\delta^+ = (\Pi_+ \otimes (\Pi_+ \otimes \Pi_+)\delta^+\Pi_+)\delta^+ \\ &= (\Pi_+ \otimes (\Pi_+ \otimes \Pi_+)\delta^+)\delta^+ = (\Pi_+ \otimes \Pi_+ \otimes \Pi_+)(1 \otimes \delta^+)\delta^+ \end{aligned}$$

and

$$\begin{aligned} (\Delta^+ \otimes 1)\Delta^+ &= ((\Pi_+ \otimes \Pi_+)\delta^+ \otimes 1)(\Pi_+ \otimes \Pi_+)\delta^+ = ((\Pi_+ \otimes \Pi_+)\delta^+ \otimes \Pi_+)\delta^+ \\ &= (\Pi_+ \otimes \Pi_+ \otimes \Pi_+)(\delta^+ \otimes 1)\delta^+. \end{aligned}$$

Again we conclude by the coassociativity of δ^+ .

Finally, we must prove that $\langle \mathfrak{T}_+ \rangle$ admits an antipode, i.e. a map $A : \langle \mathfrak{T}_+ \rangle \mapsto \langle \mathfrak{T}_+ \rangle$ such that

$$\mathcal{M}(1 \otimes A)\Delta^+\tau = \mathcal{M}(A \otimes 1)\Delta^+\tau = \mathbb{1}_{(\tau=1)}\mathbf{1} = \mathbf{1}^*$$

where $\mathcal{M} : \mathfrak{T} \otimes \mathfrak{T} \mapsto \mathfrak{T}$ is the multiplication map of labelled trees, $\tau \otimes \bar{\tau} \mapsto \tau\bar{\tau}$. We introduce a partial order on \mathfrak{T}_+ : we write $|E_\tau|$ for the number of edges of τ and then we say that $\tau < \bar{\tau}$ if

2.4. Positive and negative renormalisations

- either $|E_\tau| < |E_{\bar{\tau}}|$
- or $|E_\tau| = |E_{\bar{\tau}}|$ and $|\tau|_s < |\bar{\tau}|_s$.

Let $\mathbf{1}^n$ be the labelled tree composed by the root with node label equal to $n \geq 0$. Since

$$\Delta^+ \mathbf{1}^n = \sum_{k=0}^n \binom{n}{k} \mathbf{1}^k \otimes \mathbf{1}^{n-k}$$

we obtain by recurrence on n that $A\mathbf{1}^n = (-\mathbf{1}^1)^n$.

Suppose now that $T_\epsilon^n \in \mathfrak{T}_+ \setminus \{\mathbf{1}^n, n \geq 0\}$. If $|T_\epsilon^n|_s \in [0, 1[$, then for any non-zero $\epsilon_{\mathcal{A}}$ or $\mathfrak{n}_{\mathcal{A}}$ we have $|\mathcal{R}_{\mathcal{A}}^\downarrow T_{\epsilon+\epsilon_{\mathcal{A}}}^{n-\mathfrak{n}_{\mathcal{A}}}|_s < 0$ and therefore

$$\begin{aligned} \Delta^+ T_\epsilon^n &= \sum_{\mathcal{A} \in \mathfrak{A}^+(T)} \Pi_+ \mathcal{R}_{\mathcal{A}}^\uparrow T_\epsilon^n \otimes \Pi_+ \mathcal{R}_{\mathcal{A}}^\downarrow T_\epsilon^n \\ &= \mathbf{1} \otimes T_\epsilon^n + \sum_{\mathcal{A} \in \mathfrak{A}^+(T) \setminus \{\emptyset\}} \Pi_+ \mathcal{R}_{\mathcal{A}}^\uparrow T_\epsilon^n \otimes \Pi_+ \mathcal{R}_{\mathcal{A}}^\downarrow T_\epsilon^n, \end{aligned}$$

so that necessarily

$$AT_\epsilon^n = - \sum_{\mathcal{A} \in \mathfrak{A}^+(T) \setminus \{\emptyset\}} \Pi_+ \mathcal{R}_{\mathcal{A}}^\uparrow T_\epsilon^n \left[A \Pi_+ \mathcal{R}_{\mathcal{A}}^\downarrow T_\epsilon^n \right]$$

and in the right hand side we have $\mathcal{R}_{\mathcal{A}}^\downarrow T_\epsilon^n < T_\epsilon^n$ since the number of edges is decreased by the condition $\mathcal{A} \neq \emptyset$, so that AT_ϵ^n is well-defined by recurrence on the number of edges.

For any $T_\epsilon^n \in \mathfrak{T}_+ \setminus \{\mathbf{1}^n, n \geq 0\}$ with $|T_\epsilon^n|_s \geq 1$ we have analogously

$$\Delta^+ T_\epsilon^n = \mathbf{1} \otimes T_\epsilon^n + \sum_{\mathcal{A} \in \mathfrak{A}^+(T) \setminus \{\emptyset\}} \sum_{\epsilon_{\mathcal{A}}, \mathfrak{n}_{\mathcal{A}}} \frac{1}{\epsilon_{\mathcal{A}}!} \binom{\mathfrak{n}}{\mathfrak{n}_{\mathcal{A}}} \Pi_+ \mathcal{R}_{\mathcal{A}}^\uparrow T_\epsilon^{n_{\mathcal{A}} + \pi \epsilon_{\mathcal{A}}} \otimes \Pi_+ \mathcal{R}_{\mathcal{A}}^\downarrow T_{\epsilon+\epsilon_{\mathcal{A}}}^{n-\mathfrak{n}_{\mathcal{A}}},$$

where the right hand side consists of a finite sum by the effect of the projections Π_+ . Therefore necessarily

$$AT_\epsilon^n = - \sum_{\mathcal{A} \in \mathfrak{A}^+(T) \setminus \{\emptyset\}} \sum_{\epsilon_{\mathcal{A}}, \mathfrak{n}_{\mathcal{A}}} \frac{1}{\epsilon_{\mathcal{A}}!} \binom{\mathfrak{n}}{\mathfrak{n}_{\mathcal{A}}} \Pi_+ \mathcal{R}_{\mathcal{A}}^\uparrow T_\epsilon^{n_{\mathcal{A}} + \pi \epsilon_{\mathcal{A}}} \left[A \Pi_+ \mathcal{R}_{\mathcal{A}}^\downarrow T_{\epsilon+\epsilon_{\mathcal{A}}}^{n-\mathfrak{n}_{\mathcal{A}}} \right],$$

and in the right hand side we have $\mathcal{R}_{\mathcal{A}}^\downarrow T_{\epsilon+\epsilon_{\mathcal{A}}}^{n-\mathfrak{n}_{\mathcal{A}}} < T_\epsilon^n$ so that AT_ϵ^n is well-defined by recurrence on the order $<$.

The fact that $\langle \mathfrak{T} \rangle$ is a right comodule for $\langle \mathfrak{T}_+ \rangle$ is nothing but the first identity in (2.17). \square

Remark 2.4.10. The proof has been done in a different setting in [Hai14b, Theorem 8.16] for $\langle \mathfrak{T}_+ \rangle$. See the section 3.2 for the equivalence between the definitions of Δ and Δ^+ with the labelled trees and the definitions with the symbols.

2.4.3 Negative renormalisation

We want to prove the following

Theorem 2.4.11. *The algebra $\langle \mathfrak{F}_- \rangle$ endowed with the product $(\varphi, \bar{\varphi}) \mapsto \varphi \cdot \bar{\varphi}$ and the coproduct Δ^- is a Hopf algebra. Moreover $\hat{\Delta}$ turns $\langle \mathfrak{F} \rangle$ into a left comodule over $\langle \mathfrak{F}_- \rangle$.*

Proof. By Theorem 2.3.6 we have the coassociativity of δ_- , namely the identity $(1 \otimes \delta^-)\delta^- = (\delta^- \otimes 1)\delta^-$. We claim now that

$$(\Pi_- \otimes \Pi_-)\delta^- \Pi_- = (\Pi_- \otimes \Pi_-)\delta^-.$$

Let us consider $\varphi \in \mathfrak{F} \setminus \mathfrak{F}_-$, i.e. $\varphi = \tau_1 \cdot \tau_2 \cdots \tau_k$ and there is a $\tau \in \{\tau_1, \dots, \tau_k\}$ with $|\tau|_s > 0$ or τ elementary. If we are in the former situation, then we argue as for the analogous formula in the proof of Theorem 2.4.9: indeed, $\delta^- \tau = \sum_i \tau_i^{(1)} \otimes \tau_i^{(2)}$ with $|\tau|_s = |\tau_i^{(1)}|_s + |\tau_i^{(2)}|_s$ for all i , so that if $|\tau|_s > 0$ then $|\tau_i^{(1)}|_s \vee |\tau_i^{(2)}|_s > 0$ and therefore $(\Pi_- \otimes \Pi_-)\delta^- \tau = 0$. Else, if $T \in \hat{\mathfrak{T}}$, the edge e_ρ incident to the root ρ of τ appears for every i in one of the $\tau_i^{(j)}$ for $j \in \{1, 2\}$. If e_ρ belongs to $\tau_i^{(2)}$ then $\tau_i^{(2)} \notin \hat{\mathfrak{T}}$. Else if e_ρ belongs to $\tau_i^{(1)}$, one of the tree in $\{\tau_1, \dots, \tau_k\}$ is not in $\hat{\mathfrak{T}}$. In both cases, $\Pi_- \tau = 0$.

It follows immediately from Theorem 2.3.6, Lemma 2.4.2 and that one has the identities

$$(1 \otimes \hat{\Delta})\hat{\Delta} = (\Delta^- \otimes 1)\hat{\Delta}, \quad (1 \otimes \Delta^-)\Delta^- = (\Delta^- \otimes 1)\Delta^-. \quad (2.18)$$

Furthermore, if we grade $\langle \mathfrak{F}_- \rangle$ by postulating that $\langle \mathfrak{F}_- \rangle_n$ is spanned by those forests with a total of n edges, then it follows immediately from our definitions that $\hat{\Delta}$ and the product of forests are compatible with this grading and that $\langle \mathfrak{F}_- \rangle_0 = \langle \mathbf{1} \rangle \approx \mathbf{R}$. It follows that $\langle \mathfrak{F}_- \rangle$ is a graded and connected bi-algebra, which therefore admits a unique antipode which turns it into a Hopf algebra. The fact that \mathfrak{F} is a left comodule for $\langle \mathfrak{F}_- \rangle$ is nothing but the first identity in (2.18). \square

2.4.4 Groups

We define \mathcal{H}_- as $\langle \mathfrak{F}_- \rangle$. If \mathcal{H}_-^* denotes the dual of \mathcal{H}_- , then we set

$$G_- := \{\ell \in \mathcal{H}_-^* : \ell(\varphi_1 \cdot \varphi_2) = \ell(\varphi_1)\ell(\varphi_2), \forall \varphi_1, \varphi_2 \in \mathcal{H}_-\}.$$

Theorem 2.4.12. *Let*

$$\mathcal{R}_- = \{M_\ell : \langle \mathfrak{T} \rangle \rightarrow \langle \mathfrak{T} \rangle, M_\ell = (\ell \otimes 1)\hat{\Delta}, \ell \in G_-\}.$$

Then \mathcal{R}_- is a group for the composition law. Moreover, one has for $f, g \in G_-$:

$$M_f M_g = M_{f \circ g}$$

where $f \circ g$ is defined by

$$f \circ g = (g \otimes f)\Delta^-.$$

2.4. Positive and negative renormalisations

We define \mathcal{H}_+ as $\langle \mathfrak{T}_+ \rangle$. If \mathcal{H}_+^* denotes the dual of \mathcal{H}_+ , then we set

$$G_+ := \{g \in \mathcal{H}_+^* : g(\tau_1\tau_2) = g(\tau_1)g(\tau_2), \forall \tau_1, \tau_2 \in \mathcal{H}_+\}.$$

Theorem 2.4.13. *Let*

$$\mathcal{R}_+ = \{\Gamma_g : \langle \mathfrak{T} \rangle \rightarrow \langle \mathfrak{T} \rangle, \Gamma_g = (1 \otimes g)\Delta, g \in G_+\}.$$

Then \mathcal{R}_+ is a group for the composition law. Moreover, one has for $f, g \in G_+$:

$$\Gamma_f \Gamma_g = \Gamma_{f \circ g}$$

where $f \circ g$ is defined by

$$f \circ g = (f \otimes g)\Delta^+.$$

We introduce a new coproduct in order to explain the link between the positive and the negative renormalisation.

Definition 2.4.14. For all $T \in \mathfrak{T}_0$ we denote by $\mathfrak{A}^\circ(T)$ the family of all (possibly empty) $\mathcal{A} \in \mathfrak{A}(T)$ such that if $\mathcal{A} = \{S_1, \dots, S_k\}$ then $\varrho_{S_i} \neq \varrho_T$ for all $i = 1, \dots, k$. For all $F \in \mathfrak{F}_0$ with $F = T_1 \cdot T_2 \cdots T_n$ we set

$$\mathfrak{A}^\circ(F) := \{\mathcal{A} \in \mathfrak{A}(F) : \mathcal{A} = \mathcal{A}_1 \cup \dots \cup \mathcal{A}_m, \mathcal{A}_i \in \mathfrak{A}^\circ(T_i), i = 1, \dots, m\},$$

and $\mathfrak{A}^\circ(1) := \emptyset$.

Then we set with the usual notations the map $\delta^\circ : \langle \mathfrak{F} \rangle \mapsto \langle \mathfrak{F} \rangle \otimes \langle \mathfrak{T} \rangle$

$$\delta^\circ F_\epsilon^n := \sum_{\mathcal{A} \in \mathfrak{A}^\circ(F)} \sum_{\epsilon_{\mathcal{A}}, n_{\mathcal{A}}} \frac{1}{\epsilon_{\mathcal{A}}!} \binom{n}{n_{\mathcal{A}}} \mathcal{R}_{\mathcal{A}}^\uparrow F_\epsilon^{n_{\mathcal{A}} + \pi \epsilon_{\mathcal{A}}} \otimes \mathcal{R}_{\mathcal{A}}^\downarrow F_{\epsilon + \epsilon_{\mathcal{A}}}^{n - n_{\mathcal{A}}}, \quad (2.19)$$

and

$$\bar{\Delta}^\circ : \langle \mathfrak{T} \rangle \mapsto \langle \mathfrak{F}_- \rangle \otimes \langle \mathfrak{T} \rangle, \quad \bar{\Delta}^\circ \stackrel{\text{def}}{=} (\Pi_- \otimes 1)\delta^\circ.$$

Remark 2.4.15. While the sum defining δ° is in general infinite, the effect of the projection Π_- is to make the sum defining $\bar{\Delta}^\circ$ finite.

Proposition 2.4.16. *The map $\bar{\Delta}^\circ$ is multiplicative on $\langle \mathfrak{T} \rangle$, i.e. $\bar{\Delta}^\circ(\tau_1\tau_2) = (\bar{\Delta}^\circ\tau_1)(\bar{\Delta}^\circ\tau_2)$ for all $\tau_1, \tau_2 \in \langle \mathfrak{T} \rangle$, where we consider on $\langle \mathfrak{F}_- \rangle \otimes \langle \mathfrak{T} \rangle$ the product*

$$(\varphi_1, \tau_1) \otimes (\varphi_2, \tau_2) \mapsto (\varphi_1 \cdot \varphi_2, \tau_1\tau_2).$$

Proof. We introduce for $n, k \in \mathbf{N}^d$ an operator that we call (for reasons which will be clear later) $X^n \mathcal{I}_k : \mathfrak{T} \mapsto \hat{\mathfrak{T}}$, which takes a labelled tree T_ϵ^n , adds to it a new node that becomes the new root and an edge linking the new root to the old one; the new root gets the label n and the new edge gets the label k ; all other labels are unchanged. We also call $\hat{\Pi} : \hat{\mathfrak{T}} \mapsto \mathfrak{T}$ the map which associates to an elementary labelled tree T_ϵ^n a labelled tree

obtained by erasing the only edge $e = (\varrho, y)$ incident to the root ϱ in T and setting the root to be y .

Since all labelled trees are products of elementary trees, it is enough to prove that for $\tau_1, \dots, \tau_m \in \hat{\mathfrak{T}}$ we have $\bar{\Delta}^\circ(\tau_1 \cdots \tau_m) = (\bar{\Delta}^\circ \tau_1) \cdots (\bar{\Delta}^\circ \tau_m)$. It is easy to see that for all $T_\epsilon^n \in \hat{\mathfrak{T}}$

$$\mathfrak{A}^\circ(T_\epsilon^n) = \mathfrak{A}(\hat{\Pi}T_\epsilon^n), \quad \delta^\circ T_\epsilon^n = (1 \otimes X^{n(\varrho)} \mathcal{I}_{\epsilon(e)}) \delta^- \hat{\Pi}T_\epsilon^n$$

where as above ϱ is the root of T_ϵ^n and $e = (\varrho, y)$ is the only edge incident to ϱ .

Now if $T_\epsilon^n = \tau_1 \cdots \tau_m \in \hat{\mathfrak{T}}$ with $\tau_1, \dots, \tau_m \in \hat{\mathfrak{T}}$, then we have a canonical bijection between $\mathfrak{A}^\circ(T_\epsilon^n)$ and $\mathfrak{A}(\hat{\Pi}\tau_1) \times \cdots \times \mathfrak{A}(\hat{\Pi}\tau_m)$ and the numerical coefficients factorise nicely, so that

$$\begin{aligned} & \delta^\circ(\tau_1 \cdots \tau_m) \\ &= \prod_{i=1}^m \sum_{\mathcal{A}_i \in \mathfrak{A}(\hat{\Pi}\tau_i)} \sum_{\epsilon_{\mathcal{A}_i}, \mathbf{n}_{\mathcal{A}_i}} \frac{1}{\epsilon_{\mathcal{A}_i}!} \binom{\mathbf{n}}{\mathbf{n}_{\mathcal{A}_i}} \mathcal{R}_{\mathcal{A}_i}^\uparrow (\hat{\Pi}\tau_i)_{\epsilon}^{\mathbf{n}_{\mathcal{A}_i} + \pi \epsilon_{\mathcal{A}_i}} \otimes X^{n(\varrho_i)} \mathcal{I}_{\epsilon(e_i)} \mathcal{R}_{\mathcal{A}_i}^\downarrow (\hat{\Pi}\tau_i)_{\epsilon + \epsilon_{\mathcal{A}_i}}^{\mathbf{n} - \mathbf{n}_{\mathcal{A}_i}} \\ &= \prod_{i=1}^m (1 \otimes X^{n(\varrho_i)} \mathcal{I}_{\epsilon(e_i)}) \delta^- \hat{\Pi}\tau_i = \prod_{i=1}^m \delta^\circ \tau_i. \end{aligned}$$

From the multiplicativity of Π_- on labelled forests we obtain the result. \square

For all $\ell \in G_-$, we define

$$M_\ell^\circ = (\ell \otimes 1) \bar{\Delta}^\circ = (\ell \Pi_- \otimes 1) \delta^\circ$$

where δ° is given by (2.19).

Proposition 2.4.17. *Let $\mathcal{M} : \langle \hat{\mathfrak{T}} \rangle \otimes \langle \hat{\mathfrak{T}} \rangle \mapsto \langle \hat{\mathfrak{T}} \rangle$, $\varphi \otimes \bar{\varphi} \mapsto \varphi \cdot \bar{\varphi}$. Then*

$$(\mathcal{M} \otimes 1)(1 \otimes \delta^\circ) \delta^+ = \delta^-.$$

Proof. By multiplicativity on $\langle \hat{\mathfrak{T}} \rangle$, it is enough to prove the equality on all $T_\epsilon^n \in \hat{\mathfrak{T}}$. Note that

$$\begin{aligned} (1 \otimes \delta^\circ) \delta^+ T_\epsilon^n &= \sum_{\mathcal{A} \in \mathfrak{A}^+(T)} \frac{1}{\epsilon_{\mathcal{A}}!} \binom{\mathbf{n}}{\mathbf{n}_{\mathcal{A}}} \sum_{\mathcal{B} \in \mathfrak{A}^\circ(\mathcal{R}_{\mathcal{A}}^\downarrow T)} \frac{1}{\epsilon_{\mathcal{B}}!} \binom{\pi_{\mathcal{A}}(\mathbf{n} - \mathbf{n}_{\mathcal{A}})}{\mathbf{n}_{\mathcal{B}}} \\ &\quad \cdot \mathcal{R}_{\mathcal{A}}^\uparrow T_{\epsilon}^{\mathbf{n}_{\mathcal{A}} + \pi \epsilon_{\mathcal{A}}} \otimes \mathcal{R}_{\mathcal{B}}^\uparrow \mathcal{R}_{\mathcal{A}}^\downarrow T_{\epsilon + \epsilon_{\mathcal{A}}}^{\mathbf{n}_{\mathcal{B}} + \pi \epsilon_{\mathcal{B}}} \otimes \mathcal{R}_{\mathcal{B}}^\downarrow \mathcal{R}_{\mathcal{A}}^\downarrow T_{\epsilon + \epsilon_{\mathcal{A}} + \epsilon_{\mathcal{B}}}^{\mathbf{n} - \mathbf{n}_{\mathcal{A}} - \mathbf{n}_{\mathcal{B}}} \end{aligned}$$

and therefore

$$\begin{aligned} (\mathcal{M} \otimes 1)(1 \otimes \delta^\circ) \delta^+ &= \sum_{\mathcal{A} \in \mathfrak{A}^+(T)} \frac{1}{\epsilon_{\mathcal{A}}!} \binom{\mathbf{n}}{\mathbf{n}_{\mathcal{A}}} \sum_{\mathcal{B} \in \mathfrak{A}^\circ(\mathcal{R}_{\mathcal{A}}^\downarrow T)} \frac{1}{\epsilon_{\mathcal{B}}!} \binom{\pi_{\mathcal{A}}(\mathbf{n} - \mathbf{n}_{\mathcal{A}})}{\mathbf{n}_{\mathcal{B}}} \\ &\quad \cdot \left(\mathcal{R}_{\mathcal{A}}^\uparrow T_{\epsilon}^{\mathbf{n}_{\mathcal{A}} + \pi \epsilon_{\mathcal{A}}} \cdot \mathcal{R}_{\mathcal{B}}^\uparrow \mathcal{R}_{\mathcal{A}}^\downarrow T_{\epsilon + \epsilon_{\mathcal{A}}}^{\mathbf{n}_{\mathcal{B}} + \pi \epsilon_{\mathcal{B}}} \right) \otimes \mathcal{R}_{\mathcal{B}}^\downarrow \mathcal{R}_{\mathcal{A}}^\downarrow T_{\epsilon + \epsilon_{\mathcal{A}} + \epsilon_{\mathcal{B}}}^{\mathbf{n} - \mathbf{n}_{\mathcal{A}} - \mathbf{n}_{\mathcal{B}}}. \end{aligned}$$

2.4. Positive and negative renormalisations

At this point, we note that since $\mathcal{B} \in \mathfrak{A}^\circ(\mathcal{R}_A^\downarrow T)$, ϵ_A and ϵ_B have disjoint support so that $\epsilon_A! \epsilon_B! = (\epsilon_A + \epsilon_B)!$. Similarly, thanks to the fact that \mathbf{n}_B has support away from the root of $\mathcal{R}_A^\downarrow T$, one has

$$\binom{\pi_A(\mathbf{n} - \mathbf{n}_A)}{\mathbf{n}_B} = \binom{\mathbf{n} - \mathbf{n}_A}{\mathbf{n}_B},$$

so that

$$\begin{aligned} \binom{\mathbf{n}}{\mathbf{n}_A} \binom{\pi_A(\mathbf{n} - \mathbf{n}_A)}{\mathbf{n}_B} &= \frac{\mathbf{n}!(\mathbf{n} - \mathbf{n}_A)!}{\mathbf{n}_A!(\mathbf{n} - \mathbf{n}_A)! \mathbf{n}_B!(\mathbf{n} - \mathbf{n}_A - \mathbf{n}_B)!} \\ &= \frac{\mathbf{n}!}{(\mathbf{n}_A + \mathbf{n}_B)!(\mathbf{n} - \mathbf{n}_A - \mathbf{n}_B)!} = \binom{\mathbf{n}}{\mathbf{n}_A + \mathbf{n}_B}. \end{aligned}$$

We note also that the map $(\mathcal{A}, \mathcal{B}) \mapsto \mathcal{C} = \mathcal{A} \cup \mathcal{B}$ is a bijection between $\{(\mathcal{A}, \mathcal{B}) : \mathcal{A} \in \mathfrak{A}^+(T), \mathcal{B} \in \mathfrak{A}^\circ(\mathcal{R}_A^\downarrow T)\}$ and $\mathfrak{A}(T)$, since every $\mathcal{C} \in \mathfrak{A}(T)$ is either in $\mathfrak{A}^\circ(T)$ (if none of the subtrees touches the root of T), or of the form $\{S\} \cup \mathcal{B}$, where $\varrho_S = \varrho_T$ and $\mathcal{B} \in \mathfrak{A}^\circ(\mathcal{R}_A^\downarrow T)$. Moreover setting, $\epsilon_C = \epsilon_A + \epsilon_B$ and $\mathbf{n}_C = \mathbf{n}_A + \mathbf{n}_B$, the above sum can also be rewritten as

$$\sum_{\mathcal{C} \in \mathfrak{A}(T)} \sum_{\mathbf{n}_C, \epsilon_C} \frac{1}{\epsilon_C!} \binom{\mathbf{n}}{\mathbf{n}_C} \mathcal{R}_C^\uparrow T_{\epsilon}^{\mathbf{n}_C + \pi \epsilon_C} \otimes \mathcal{R}_C^\downarrow T_{\epsilon + \epsilon_C}^{\mathbf{n} - \mathbf{n}_C} = \delta^- T_{\epsilon}^{\mathbf{n}}.$$

This concludes the proof. \square

Corollary 2.4.18. *Let $\ell \in G_-$ and $R_\ell \stackrel{\text{def}}{=} (\ell \otimes 1) \Delta^R$ with Δ^R as in (4.4). Then $M_\ell = M_\ell^\circ R_\ell$.*

Proof. Note that

$$M_\ell^\circ R_\ell = (\ell \Pi_- \otimes 1) \delta^\circ (\ell \Pi_- \otimes 1) \delta^+ = (\ell \Pi_- \otimes \ell \Pi_- \otimes 1) (1 \otimes \delta^\circ) \delta^+.$$

Now, since $\ell \Pi_- : \langle \mathfrak{F} \rangle \mapsto \mathbf{R}$ is multiplicative, we obtain

$$M_\ell^\circ R_\ell = (\ell \Pi_- \otimes 1) (\mathcal{M} \otimes 1) (1 \otimes \delta^\circ) \delta^+ = (\ell \Pi_- \otimes 1) \delta^- = M_\ell.$$

This concludes the proof. \square

Example 2.4.19. Through the next subtree, we explain the link between \mathcal{A} , \mathcal{A}^+ and \mathcal{A}° such that we obtain the previous corollary. On $\mathcal{A} = \{S_1, S_2, S_3\} \in \mathfrak{A}(T)$, we compute:

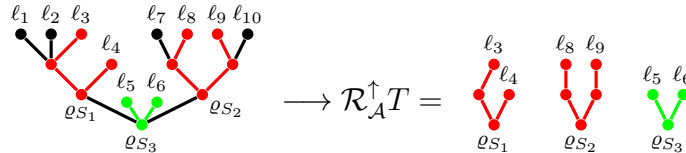

Finally, we obtain $\{S_3\} \in \mathfrak{A}^+(T)$ and $\{S_1, S_2\} \in \mathfrak{A}^\circ(T)$. The set $\mathfrak{A}^\circ(T)$ as to be understood as elements of $\mathfrak{A}(T)$ without rooted subtree.

Proposition 2.4.20. *We have*

$$(1 \otimes \Delta)\Delta^{\mathbf{R}} = (\Delta^{\mathbf{R}} \otimes 1)\Delta.$$

Moreover for all $\ell \in G_-$, R_ℓ commutes with \mathcal{R}_+ .

Proof. Both results follow from the co-associativity of δ^+ . Indeed,

$$(1 \otimes \Delta)\Delta^{\mathbf{R}} = (\Pi_- \otimes 1 \otimes \Pi_+)(1 \otimes \delta^+)\delta^+ = (\Pi_- \otimes 1 \otimes \Pi_+)(\delta^+ \otimes 1)\delta^+ = (\Delta^{\mathbf{R}} \otimes 1)\Delta.$$

Now for all $\ell \in G_-$ and $g \in G_+$

$$R_\ell \Gamma_g = (\ell \Pi_- \otimes g \Pi_+)(\delta^+ \otimes 1)\delta^+ = (\ell \Pi_- \otimes g \Pi_+)(1 \otimes \delta^+)\delta^+ = \Gamma_g R_\ell.$$

□

2.4. Positive and negative renormalisations

Chapter 3

Renormalisation group in SPDEs

We want now to apply the construction of the previous chapter to regularity structures related with subcritical SPDEs. First we have to select subsets of labelled trees (or forests): indeed the set of all labelled trees is far too big and the requirement that the homogeneities be bounded below is violated since we can take arbitrary powers of a tree with negative homogeneity. However on suitable (*admissible*) subspaces we can define regularity structures which satisfy the properties of Definition 1.2.1.

Then we establish a link with the *symbol* notation of [Hai14b] and we show the relationship between our construction and that of [Hai14b]. We note that the original construction of the structure group was already based on a Hopf Algebra description, while the renormalisation group had a different (less transparent) definition.

Throughout this chapter we give, when it is possible, recursive constructions of the object we define. Again, in [Hai14b] one can find a recursive definition for the model before renormalisation, but not the the renormalised model. A recursive description of our Hopf Algebras, groups and (renormalised) models sheds a different light on these objects; moreover it is particularly simple to be coded in a computer programme. Even more recursive computations are collected at the end of this thesis in Appendix A.

3.1 Regularity structures on labelled trees

Definition 3.1.1. A set of labelled trees \mathcal{T} is admissible if for every $T_\epsilon^n \in \mathcal{T}$, every node-labels $\mathbf{n}_1, \mathbf{n}_2$ such that $\mathbf{n} - \mathbf{n}_1 \geq 0$ and every admissible subtree \bar{T} of T , one has

$$\bar{T}_\epsilon^{\mathbf{n}-\mathbf{n}_1} \in \mathcal{T}, \quad \bar{T}_\epsilon^{\mathbf{n}+\mathbf{n}_2} \in \mathcal{T}, \quad |T_\epsilon^n|_s > \max_{\ell \in L_{\bar{T}}} |\ell|_s.$$

We denote by \mathcal{T}_- , the algebra $\langle\langle \Pi_- \mathcal{T} \rangle\rangle$ and by \mathcal{T}_+ the algebra

$$\mathcal{T}_+ = \{ \Pi_+ \mathcal{R}_{\mathcal{A}}^\downarrow T_{\epsilon+\epsilon_{\mathcal{A}}}^{\mathbf{n}-\mathbf{n}_{\mathcal{A}}} : \forall \mathcal{A} \in \mathfrak{A}^+(T), \forall \mathbf{n}_{\mathcal{A}}, \epsilon_{\mathcal{A}} \}.$$

We present a major example of admissible set which is \mathfrak{T}_{ad} given by

$$\mathfrak{T}_{ad} = \{ T_\epsilon^n \in \mathfrak{T} : \forall \mathbf{n}_1, \mathbf{n} - \mathbf{n}_1 \geq 0 \quad \forall \bar{T} \in \mathfrak{A}(T) \quad |T_\epsilon^{\mathbf{n}-\mathbf{n}_1}|_s > \max_{\ell \in L_{\bar{T}}} |\ell|_s \}.$$

3.1. Regularity structures on labelled trees

Remark 3.1.2. The third condition in 3.1.1 used for the definition of \mathfrak{T}_{ad} guarantees that the set of homogeneities is bounded from below.

Definition 3.1.3. Let $T_\epsilon^n \in \mathcal{T}$. We denote by $\mathfrak{A}(E_T)$ the set containing $\mathcal{E} = \{e_1, \dots, e_n\} \subset E_T$ such that $T_{e_i} \cap T_{e_j} = \emptyset$ for $i \neq j$. For an edge e , the notation T_e means the tree above $e = (e_+, e_-)$: its nodes are given by $\mathcal{V}_e = \{v \in \mathcal{V} \setminus \{v_0\} : e_+ \wedge v = e_+\}$.

Definition 3.1.4. A set of labelled trees \mathcal{T} is locally-subcritical if for every $T_\epsilon^n \in \mathcal{T}$ and every $\mathcal{E} = \{e_1, \dots, e_n\} \in \mathfrak{A}(E_T)$ one has $\mathcal{P}_\mathcal{E}^\downarrow T_\epsilon^n$ admissible, where $\mathcal{P}_\mathcal{E}^\downarrow T_\epsilon^n$ means that we replace all the tree T_{e_i} by a leave ℓ with the minimum $|\ell|_s$.

We define the set \mathfrak{T}_{loc} the maximal subset for the inclusion of \mathfrak{T}_{ad} such that \mathfrak{T}_{loc} is locally subcritical. The coproducts Δ , R and $\hat{\Delta}$ are defined on the whole space of labelled trees \mathfrak{T} . The next proposition shows the action of the previous coproducts on a admissible set of labelled trees:

Proposition 3.1.5. *Let \mathcal{T} an admissible set of labelled trees. Then $\Delta : \mathcal{T} \rightarrow \mathcal{T} \otimes \mathcal{T}_+$ and $\hat{\Delta} : \mathcal{T} \rightarrow \mathcal{T}_- \otimes \mathfrak{T}_{ad}$.*

Proof. By definition, the result is obvious for Δ . For $\hat{\Delta}$, let $T_\epsilon^n \in \mathcal{T}$, it follows:

$$\delta^- T_\epsilon^n := \sum_{\mathcal{A} \in \mathfrak{A}(T)} \sum_{\epsilon_{\mathcal{A}}, n_{\mathcal{A}}} \frac{1}{\epsilon_{\mathcal{A}}!} \binom{n}{n_{\mathcal{A}}} \mathcal{R}_{\mathcal{A}}^\uparrow T_\epsilon^{n_{\mathcal{A}} + \pi \epsilon_{\mathcal{A}}} \otimes \mathcal{R}_{\mathcal{A}}^\downarrow T_{\epsilon + \epsilon_{\mathcal{A}}}^{n - n_{\mathcal{A}}}.$$

We have to check that for all $\mathcal{A} \in \mathfrak{A}(T)$, $\epsilon_{\mathcal{A}}$ and $n_{\mathcal{A}}$ such that $|\mathcal{R}_{\mathcal{A}}^\uparrow T_\epsilon^{n_{\mathcal{A}} + \pi \epsilon_{\mathcal{A}}}|_s \leq 0$, one has $\mathcal{R}_{\mathcal{A}}^\downarrow T_{\epsilon + \epsilon_{\mathcal{A}}}^{n - n_{\mathcal{A}}} \in \mathfrak{T}_{ad}$. Let $B \in \mathfrak{A}(T)$:

- If B and \mathcal{A} are independent then $\mathcal{R}_B^\uparrow \mathcal{R}_{\mathcal{A}}^\downarrow T_{\epsilon + \epsilon_{\mathcal{A}}}^{n - n_{\mathcal{A}}} = \mathcal{R}_B^\uparrow T_\epsilon^n$ and we have $|\mathcal{R}_B^\uparrow T_\epsilon^n|_s > \max_{\ell \in L_B} |\ell|_s$ by the admissibility of the set \mathcal{T} .
- Else, let $C \in \mathfrak{A}(T)$ such that $C = B \cup \bigcup \mathcal{A}^B$. It follows:

$$\max_{\ell \in L_B} |\ell|_s < \max_{\ell \in L_C} |\ell|_s < |\mathcal{R}_C^\uparrow T_\epsilon^n|_s = |\mathcal{R}_B^\uparrow \mathcal{R}_{\mathcal{A}}^\downarrow T_{\epsilon + \epsilon_{\mathcal{A}}}^{n - n_{\mathcal{A}}}|_s + |\mathcal{R}_{\mathcal{A}}^\uparrow T_\epsilon^{n_{\mathcal{A}} + \pi \epsilon_{\mathcal{A}}}|_s$$

which implies

$$|\mathcal{R}_B^\uparrow \mathcal{R}_{\mathcal{A}}^\downarrow T_{\epsilon + \epsilon_{\mathcal{A}}}^{n - n_{\mathcal{A}}}|_s > \max_{\ell \in L_B} |\ell|_s$$

because $|\mathcal{R}_{\mathcal{A}}^\uparrow T_\epsilon^{n_{\mathcal{A}} + \pi \epsilon_{\mathcal{A}}}|_s \leq 0$.

□

Proposition 3.1.6. *Let \mathcal{T} a local subcritical set of labelled trees. Then $\Delta : \mathcal{T} \rightarrow \mathcal{T} \otimes \mathcal{T}_+$ and $\hat{\Delta} : \mathcal{T} \rightarrow \mathcal{T}_- \otimes \mathfrak{T}_{loc}$.*

Proof. We have to check that for all $\mathcal{A} \in \mathfrak{A}(T)$, $\epsilon_{\mathcal{A}}$ and $n_{\mathcal{A}}$ such that $|\mathcal{R}_{\mathcal{A}}^{\uparrow} T_{\epsilon}^{n_{\mathcal{A}} + \pi \epsilon_{\mathcal{A}}}|_s \leq 0$ and for all $\mathcal{E} \in \mathfrak{A}(E_T)$, one has $\mathcal{R}_{\mathcal{A}}^{\downarrow} \mathcal{P}_{\mathcal{E}}^{\downarrow} T_{\epsilon + \epsilon_{\mathcal{A}}}^{n - n_{\mathcal{A}}} \in \mathfrak{T}_{ad}$. We notice that

$$\mathcal{R}_{\mathcal{A}}^{\downarrow} \mathcal{P}_{\mathcal{E}}^{\downarrow} T_{\epsilon + \epsilon_{\mathcal{A}}}^{n - n_{\mathcal{A}}} = \mathcal{P}_{\mathcal{E}}^{\downarrow} \mathcal{R}_{\mathcal{A}}^{\downarrow} T_{\epsilon + \epsilon_{\mathcal{A}}}^{n - n_{\mathcal{A}}}.$$

The term $\mathcal{R}_{\mathcal{A}}^{\downarrow} T_{\epsilon + \epsilon_{\mathcal{A}}}^{n - n_{\mathcal{A}}}$ is admissible by definition. Then we use the proposition 3.1.5 to conclude. \square

Proposition 3.1.7. *Let \mathcal{T} a local subcritical set of labelled trees. Then we define a regularity structure $(A_{\mathcal{T}}, \mathcal{H}_{\mathcal{T}}, G_{\mathcal{T}})$ given by:*

- $A_{\mathcal{T}} = \{\alpha : \exists \tau \in \mathcal{T}, |\tau|_s = \alpha\}$.
- $\mathcal{H}_{\mathcal{T}} = \bigoplus_{\alpha \in A_{\mathcal{T}}} \mathcal{H}_{\alpha}$ and \mathcal{H}_{α} is the linear span of $\mathcal{T}_{\alpha} = \{\tau \in \mathcal{T} : |\tau|_s = \alpha\}$.
- $G_{\mathcal{T}}$ is the restriction of G to \mathcal{T} .

Proof. The proof will be done in the next section with the symbol notation. \square

We finish the section by a result on the completion of some finite subset in \mathfrak{T}_{ad} in order to have a subset invariant by Δ and $\hat{\Delta}$.

Proposition 3.1.8. *Let \mathcal{T} a finite subset of \mathfrak{T}_{loc} . There exists a finite set \mathcal{T}^* such that $\mathcal{T} \subset \mathcal{T}^* \subset \mathfrak{T}_{loc}$, $\Delta : \mathcal{T}^* \rightarrow \mathcal{T}^* \otimes \mathcal{T}_+^*$ and $\hat{\Delta} : \mathcal{T}^* \rightarrow \mathcal{T}_-^* \otimes \mathcal{T}^*$.*

Proof. We define recursively the sets $\mathcal{T}_n, \mathcal{A}_n^1, \mathcal{A}_n^2, \mathcal{E}_n^1$ and \mathcal{E}_n^2 by

$$\begin{aligned} \mathcal{T}_0 &= \mathcal{T}, \quad \Delta : \mathcal{T}_n \rightarrow \mathcal{A}_n^1 \otimes \mathcal{A}_n^2, \quad \hat{\Delta} : \mathcal{A}_n^1 \cup \mathcal{A}_n^2 \rightarrow \langle\langle \mathcal{E}_n^1 \rangle\rangle \otimes \mathcal{E}_n^2, \\ \mathcal{T}_{n+1} &= \mathcal{T}_n \cup \mathcal{A}_n^1 \cup \mathcal{A}_n^2 \cup \mathcal{E}_n^1 \cup \mathcal{E}_n^2. \end{aligned}$$

If we look at the sequence of maximum $(\tau_n)_{n \in \mathbb{N}}$ in $\mathcal{T}_{n+1} \setminus \mathcal{T}_n$ regarding the number of edges and then the homogeneity, is strictly decreasing. Indeed, if we take $T \in \mathfrak{T}_{loc}$ then ΔT and $\hat{\Delta} T$ give a decomposition of the form $\sum_i T_i^{(1)} \otimes T_i^{(2)}$ where for each i , the number of edges in $T_i^{(1)}, T_i^{(2)}$ is equal to the number of edges in T . We can add new terms in \mathcal{T}_{n+1} if $T_i^{(1)}$ is of the form X^k , in that case we take derivatives of some edges of the original tree which give a term with lower homogeneity. There exists a N such that $\mathcal{T}_N = \mathcal{T}_{N+1}$. \square

Remark 3.1.9. For the applications, we can start the iteration on a negative set of symbols or on \mathfrak{T}_{loc}^- . This iteration has been done in many examples like in [HP14].

3.2 Link with SPDEs and the symbol notation

The labelled trees can be represented by the use of symbols in the following way:

1. The symbol Ξ encodes the leaves as noises. If there is more than one ‘‘type’’ of leaf from a set \mathcal{L}_l , then we introduce different type of noises $(\Xi_i)_{i \in \mathcal{L}_1}$.

3.2. Link with SPDEs and the symbol notation

2. To each edge with label $k \in \mathbf{N}^d$, we associate an operator \mathcal{I}_k . Again, if there is more than one “type”, the integration maps are indexed with the set \mathfrak{L}_e .
3. A factor X^k encodes each inner vertex with label $k \in \mathbf{N}^d$.

Remark 3.2.1. In the previous coding, the noise Ξ always appears as $\mathcal{I}_k(\Xi)$ and never by itself. In the case of regularity structures generated by stochastic PDEs driven by additive noise, this is automatically the case. In the general case, this can always be enforced “artificially” for example by introducing a new type of edge with label 0. Then to this edge, we associate an abstract integration map \mathcal{I}^* of homogeneity 0 and replace all occurrences of Ξ by $\mathcal{I}^*(\Xi)$ which does not change the algebraic structure.

Now, we consider only one type of noise and one type of edge: this case covers all the examples which have been treated. The set \mathfrak{T} is encoded by the set of symbols \mathcal{F} defined recursively as follows:

- $\{1, (X_i)_{i=1\dots d}, \Xi\} \subset \mathcal{F}$
- if $\tau_1, \dots, \tau_n \in \mathcal{F}$ then $\tau_1 \cdots \tau_n \in \mathcal{F}$, where we assume that this product is associative and commutative
- if $\tau \in \mathcal{F} \setminus \{1, X^k : k \in \mathbf{N}^d\}$ then $\{\mathcal{I}(\tau), \mathcal{I}_k(\tau) : k \in \mathbf{N}^d\} \subset \mathcal{F}$.

In that setting, we can compute the homogeneity recursively: $|\Xi|_{\mathfrak{s}} = \alpha$, $|X_i|_{\mathfrak{s}} = \mathfrak{s}_i$, $|1|_{\mathfrak{s}} = 0$

$$|\tau_1 \dots \tau_n|_{\mathfrak{s}} = |\tau_1|_{\mathfrak{s}} + \dots + |\tau_n|_{\mathfrak{s}}, \quad \mathcal{I}_k(\tau) = |\tau|_{\mathfrak{s}} + \beta - |k|_{\mathfrak{s}}.$$

where β is the edge-type of $\mathcal{I}(\cdot)$.

Remark 3.2.2. The previous homogeneity is the same as the homogeneity introduced in 2.4.4: it is just a recursive way of computing it.

Labelled trees can be associated to parabolic SPDE such as the generalised KPZ equation given in one dimension in space by:

$$\partial_t u = \partial_x^2 u + g(u)(\partial_x u)^2 + h(u)\partial_x u + k(u) + f(u)\xi.$$

and the stochastic quantization given in dimension 3 by:

$$\partial_t u = \Delta u + u^3 + \xi.$$

Indeed, we extract rules from the right hand-side of an SPDE and we perform the following transformations:

$$\xi \mapsto \Xi, \quad x_i \mapsto X_i, \quad u \mapsto \mathcal{I}(\cdot), \quad D^n u \mapsto \mathcal{I}_n(\cdot), \quad u, D^n u \mapsto X^k \quad k \in \mathbf{N}^d.$$

The latest rules mean that u and $D^n u$ can be either replaced by a monomial or the corresponding abstract integrator $\mathcal{I}(\cdot)$ and $\mathcal{I}_n(\cdot)$. Non-linearities of the form $g(u)$ are replaced by polynomials $x^m u^n$ and then we apply the previous transformations. In the generalised KPZ equation the term $g(u)(\partial_x u)^2$ gives the rules $X^k \mathcal{I}(\cdot)^n \mathcal{I}_1(\cdot)^m$ for every $k, n, m \in \mathbb{N} \times \mathbb{N} \times \{0, 1, 2\}$ where $\mathcal{I}_1(\cdot)$ is a shorthand notation for $\mathcal{I}_{(0,1)}(\cdot)$. That means for $X^k \mathcal{I}(\cdot)^n \mathcal{I}_1(\cdot)^2$:

$$\tau_1, \dots, \tau_n, \tau'_1, \tau'_2 \in \mathcal{H} \iff X^k \left(\prod_{i=1}^n \mathcal{I}(\tau_i) \right) \mathcal{I}_1(\tau'_1) \mathcal{I}_1(\tau'_2) \in \mathcal{H}.$$

We obtain a set of rules \mathcal{R}_u associated to the equation of the form:

$$\mathcal{R}_u = \{X^k \mathcal{I}(\cdot)^\ell \mathcal{I}_1(\cdot)^m (\Xi)^n : (k, \ell, m, n) \in B\} \quad (3.1)$$

where B is a subset of $\mathbb{N}^3 \times \{0, 1\}$. We suppose that $\Xi \in \mathcal{R}_u$. In the stochastic quantization, we have

$$\mathcal{R}_{qua} = \{X^k, X^k \mathcal{I}(\cdot), X^k \mathcal{I}(\cdot)^2, \mathcal{I}(\cdot)^3, \Xi, k \in \mathbb{N}^3\}$$

and for the generalised KPZ

$$\mathcal{R}_{gkpz} = \{X^k \mathcal{I}(\cdot)^\ell, X^k \mathcal{I}(\cdot)^\ell \mathcal{I}_1(\cdot), X^k \mathcal{I}(\cdot)^\ell \mathcal{I}_1(\cdot)^2, X^k \mathcal{I}(\cdot)^\ell \Xi, (k, \ell) \in \mathbb{N}^2 \times \mathbb{N}\}.$$

Now we are able to give a recursive definition of some subset of symbols:

$$\mathcal{T} := \{\tau \in \mathcal{F} : \tau = R(\tau_1, \dots, \tau_n), R \in \mathcal{R}_u \text{ and } \tau_1, \dots, \tau_n \in \mathcal{T} \text{ or } \tau = \Xi\}.$$

We associate to each rule an homogeneity as follows:

$$|\Xi|_s = \alpha, \quad |\mathcal{I}_k(\cdot)|_s = \alpha + 2 - |k|_s, \quad \left| \prod_i R_i \right|_s = \sum_i |R_i|_s \quad (3.2)$$

where the R_i are of the form $\Xi, \mathcal{I}_k(\cdot)$ and X^ℓ .

Definition 3.2.3. A set of rules \mathcal{G} is **locally subcritical** if for each $R \in \mathcal{G} \setminus \{\Xi\}$:

$$|R|_s > |\Xi|_s.$$

This definition is a reformulation of the notion of local subcriticality introduced in [Hai14b, Assumption 8.3]. Indeed instead of using rules, the product is described with abstract polynomials:

- the noise ξ is replaced by the dummy variable Ξ with homogeneity α .
- Every occurrence of $D^k u$ such that $\alpha + \beta - |k|_s \leq 0$ is replaced by P_k with homogeneity $\alpha + \beta - |k|_s$.

3.2. Link with SPDEs and the symbol notation

The homogeneity of a monomial is the sum of the homogeneities of each factor. Then the condition of local subcriticality turns out to be: each monomials must have a homogeneity strictly bigger than α . In our settings it likes looking only at rules with negative homogeneity and checking that they have a bigger homogeneity than the noise.

With this assumption on the set of our rule, we can generate a well defined regularity structure which allows us to solve the equation. The idea is that when we apply a perturbative method at each step the regularity of our expansion increases. Given a local subcritical set of rules \mathcal{R}_u , we define $\beta_{\mathcal{R}_u}$ the regularity we earn at each step in \mathcal{R}_u by:

$$\beta_{\mathcal{R}_u} = \min_{R \in \mathcal{R}_u \setminus \{\Xi\}} |R|_s - |\Xi|_s.$$

For the generalized KPZ, $\beta_{\mathcal{R}_{gkpz}} = 1/2$ and for the stochastic quantization, we have $\beta_{\mathcal{R}_{qua}} = 1$. Under the hypothesis of local subcriticality, it has been proven in [Hai14b] that for every $\alpha \in A$, the set \mathcal{T}_α is finite. The key point of the proof is [Hai14b, lemma (8.10)] which strongly uses the parameter $\beta_{\mathcal{R}_u}$.

Remark 3.2.4. The space \mathcal{T} contains all the symbols which can be renormalised and it also contains abstract integrator map $\mathcal{I}_k(\cdot)$ such that $|\mathcal{I}_k(\cdot)|_s > |\Xi|_s$.

Remark 3.2.5. If we face different types of noise (Ξ_i) , for the homogeneity of the rule we take $\alpha = \min_i |\Xi_i|_s$ in (3.2). Then the condition for the local subcriticality is given for every $R \in \mathcal{G} \setminus \{\Xi_i : i\}$ by:

$$|R|_s > \max_i |\Xi_i|_s.$$

Remark 3.2.6. This notion of local subcriticality guarantees the convergence of the model in most of the examples see chapter 5. But in [Hos15], the author puts in evidence a counter-example in the KPZ equation with a fractional derivative equal to $\frac{1}{4}$.

The next proposition establishes a link with [Hai14b, Definition 8.6]

Proposition 3.2.7. *The sets of symbols built from a locally subcritical set of rules \mathcal{R}_u such that for every $X^k \mathcal{I}(\cdot)^m \mathcal{I}_1(\cdot)^n \Xi^\ell \in \mathcal{R}_u$, one has for every $\bar{k}, \bar{m} \leq m, \bar{n} \leq n, \bar{\ell} \leq \ell$, $X^{\bar{k}} \mathcal{I}(\cdot)^{\bar{m}} \mathcal{I}_1(\cdot)^{\bar{n}} \Xi^{\bar{\ell}} \in \mathcal{R}_u$, are in bijection with the local subcritical sets of Labelled trees.*

Proof. Each time, we use a rule we can use any subrule which creates any subtree from the initial labelled tree. That subtree has a homogeneity greater than the homogeneity of the noise from the local subcriticality of the rules. For the reverse, from a local subcritical set of labelled trees F , we obtain the rules by looking at each inner mode u of $T_\epsilon^n \in F$ to the label $n(u)$ which gives $X^{n(u)}|_s$ and to the edges $\mathcal{E}^\downarrow(\{u\})$ defined by

$$\mathcal{E}^\downarrow(\{u\}) = \{(u, v) : e = (e_+, e_-)(u, v) \in E_T\}$$

which yields to the rules used to build the labelled tree T_ϵ^n :

$$X^{n(u)}|_s \prod_{\substack{e \in \mathcal{E}^\downarrow(\{u\}) \\ |l(e)|_s \neq 0}} l(e)_{\epsilon(e)}(\cdot) \prod_{\substack{e \in \mathcal{E}^\downarrow(\{u\}), \ell \in L_T \\ \ell = e_-}} l(\ell).$$

where we have identified $l(e)$ with $\mathcal{I}(\cdot)$ and $l(\ell)$ with Ξ . □

We finish our discussion on the structure space by justifying the universality of the generalised KPZ:

Proposition 3.2.8. *We consider the set of symbols \mathcal{F} generated by the abstract integrator $\mathcal{I}(\cdot)$ and $\mathcal{I}_1(\cdot) = \mathcal{I}_{(0,1)}(\cdot)$ with $|\Xi|_s = -\frac{3}{2} - \kappa$, $|\mathcal{I}(\cdot)|_s = \frac{1}{2} - \kappa$ and $|\mathcal{I}_1(\cdot)|_s = -\frac{1}{2} - \kappa$. Then $\mathfrak{I}_{loc} = \mathcal{T}_{kpz}$ where \mathcal{T}_{kpz} is the structure space associated to the generalised KPZ.*

Proof. In terms of homogeneity, the only abstract integrators which can be used are $\mathcal{I}(\cdot)$ and $\mathcal{I}_1(\cdot)$ because $|\mathcal{I}_k(\cdot)|_s < -\frac{3}{2}$ for $k \notin \{(0,0), (0,1)\}$. Moreover, for $m > 2$ it follows $|\mathcal{I}_1(\cdot)^m|_s < -\frac{3}{2}$. We deduce from these observations that the set of rules \mathcal{R}_{gkpz} given by

$$\mathcal{R}_{gkpz} = \{X^k \mathcal{I}(\cdot)^\ell, X^k \mathcal{I}(\cdot)^\ell \mathcal{I}_1(\cdot), X^k \mathcal{I}(\cdot)^\ell \mathcal{I}_1(\cdot)^2, X^k \mathcal{I}(\cdot)^\ell \Xi, (k, \ell) \in \mathbb{N}^2 \times \mathbb{N}\}$$

generates all the terms in \mathfrak{I}_{loc} . \square

Remark 3.2.9. By definition, $\mathfrak{I}_{loc} \subset \mathfrak{I}_{ad}$ but $\mathfrak{I}_{loc} \neq \mathfrak{I}_{ad}$. Indeed, the following tree $\mathcal{I}_1(\mathcal{I}_1(\Xi)^2)^3$ belongs to \mathfrak{I}_{ad} but not to \mathfrak{I}_{loc} because $|\mathcal{I}_1(\Xi)^3|_s = -\frac{3}{2} - 3\kappa < |\Xi|_s$. In the examples all the terms in \mathfrak{I}_{ad} will converge, but we want to avoid trees built with a non local subcritical rule like $\mathcal{I}_1(\cdot)^3$ for the KPZ equation.

We want to derive recursive versions with the symbols for δ^+ and δ^- . For that purpose, we consider a collection of constants that can conveniently be indexed by expressions of the type $\mathcal{C}(\tau)$ with $\tau \in \mathcal{F}$. Let $\hat{\mathcal{H}}$ denote the vector space spanned by elements of the form $\sigma\tau$ with $\sigma \in \langle\langle \mathcal{C}(\mathcal{F}) \rangle\rangle$ and $\tau \in \mathcal{F}$. Elements of $\hat{\mathcal{H}}$ have a unique decomposition of the form $\sum_{\tau \in \mathcal{F}} \sigma_\tau \tau$ with $\sigma_\tau \in \langle\langle \mathcal{C}(\mathcal{F}) \rangle\rangle$. We then define $\Delta^\circ : \mathcal{H} \rightarrow \mathbf{R}[[\mathcal{H} \otimes \mathcal{H}]]$ and $\hat{\Delta}^\circ : \mathcal{H} \rightarrow \mathbf{R}[[\hat{\mathcal{H}} \otimes \mathcal{H}]]$ by:

$$\begin{cases} \Delta^\circ \mathbf{1} = \mathbf{1} \otimes \mathbf{1}, & \Delta^\circ X_i = X_i \otimes \mathbf{1} + \mathbf{1} \otimes X_i, & \Delta^\circ \Xi = \Xi \otimes \mathbf{1} + \mathbf{1} \otimes \Xi \\ \Delta^\circ(\tau\bar{\tau}) = (\Delta^\circ \tau)(\Delta^\circ \bar{\tau}), & \Delta^\circ \mathcal{I}_k(\tau) = (\mathcal{I}_k \otimes \mathbf{1})\Delta^\circ \tau + \sum_{\ell} \frac{X^\ell}{\ell!} \otimes \mathcal{I}_{k+\ell}(\tau). \end{cases}$$

$$\begin{cases} \hat{\Delta}^\circ \mathbf{1} = \mathbf{1} \otimes \mathbf{1}, & \hat{\Delta}^\circ X_i = X_i \otimes \mathbf{1} + \mathbf{1} \otimes X_i, & \hat{\Delta}^\circ \Xi = \Xi \otimes \mathbf{1} + \mathbf{1} \otimes \Xi \\ \hat{\Delta}^\circ(\tau\bar{\tau}) = (\hat{\Delta}^\circ \tau)(\hat{\Delta}^\circ \bar{\tau}), & \hat{\Delta}^\circ \mathcal{I}_k(\tau) = \left(\mathcal{I}_k \otimes \mathbf{1} + \sum_{\ell} \frac{X^\ell}{\ell!} \mathcal{C} \otimes \mathcal{I}_{k+\ell} \right) \hat{\Delta}^\circ \tau. \end{cases}$$

We extend the previous coproducts on the forests \mathfrak{F} identified with $\langle\langle \mathcal{C}(\mathcal{F}) \rangle\rangle$ by setting:

$$\Delta^\circ \mathcal{C} = (\mathcal{C} \otimes \mathcal{C})\Delta^\circ, \quad \hat{\Delta}^\circ \mathcal{C} = (\mathcal{C} \otimes \mathcal{C})\hat{\Delta}^\circ.$$

The previous recursive construction can be explained graphically using colouring trees. We concentrate ourself on the shape and we omit the decorations given by the infinite sum over ℓ . If we look at one term $\tau_1 \otimes \tau_2$ appearing in the decomposition of $\Delta^\circ \tau$, we obtain the following term for $\mathcal{I}_k \tau$

3.2. Link with SPDEs and the symbol notation

$$(\mathcal{I}_k \otimes 1) \otimes \tau_2 = \mathcal{I}_k(\tau_2) \otimes \tau_2.$$

In the representation of τ_1 , we just look at the shape and we forget the labels. The abstract integrator $\mathcal{I}_k(\cdot)$ adds a new edge to the tree τ_1 drawn in red. We use a different color for τ_1 in order to show that we are building the rooted subtree. The term $(1 \otimes \mathcal{I}_k(\tau))$ indicates that we detach the tree $\mathcal{I}_k(\tau)$ from the red tree.

For $\hat{\Delta}^\circ$, we extract several rooted subtrees simultaneously. We represent subtrees in blue which have been detached. The tree in red is the next subtree we want to erase but it is not yet achieved. At each step, we have two possibilities: we continue the construction of the diverging pattern with $\mathcal{I}_k \otimes 1$ or the construction is over and we just need to color the tree in blue with $(\mathcal{C} \otimes 1)$ (we start to build a new pattern).

$$(\mathcal{I}_k \otimes 1 + \mathcal{C} \otimes \mathcal{I}_k) \otimes \tau_2 = (\mathcal{C} \otimes 1) \otimes \tau_2 + \mathcal{I}_k(\tau_2).$$

Proposition 3.2.10. *By identifying \mathcal{H} and $\langle\langle \mathcal{H} \rangle\rangle$ with subspaces of $\langle \mathfrak{T} \rangle$ and $\langle\langle \mathfrak{T} \rangle\rangle$ respectively, δ^+ and δ^- coincide with the maps Δ° and $(\mathcal{C} \otimes 1)\hat{\Delta}^\circ$.*

Proof. The fact that $\delta^\pm \mathbf{1} = \mathbf{1} \otimes \mathbf{1}$ and $\delta^\pm \Xi = \Xi \otimes \mathbf{1} + \mathbf{1} \otimes \Xi$ follows immediately from the definitions. The element $X^k \in \mathcal{T}$ is encoded by the tree consisting of just a root, but with label k . One then has $A = \emptyset$ and $\epsilon_A = 0$, while \mathfrak{n}_A runs over all possible labels for the root. This shows that (4.2) and (4.3) yield in this case

$$\delta^\pm X^k = \sum_{\ell} \binom{k}{\ell} X^{k-\ell} \otimes X^\ell,$$

which is as required.

It now remains to verify that the recursive identities hold as well. We have seen at the beginning of the proof of Theorem 2.4.9 that δ^+ is multiplicative on labelled trees. It remains to consider $\Delta^\circ \mathcal{I}_k(T_\epsilon^n)$, where \mathcal{I}_k is the operation that grafts a tree onto a new root via a new edge e_\star with edge-label k and type corresponding to the abstract integration map \mathcal{I} . It then follows from the definitions that $\mathfrak{A}^+(\mathcal{I}_k(T))$ is given by $\mathfrak{A}^+(\mathcal{I}_k(T)) = \mathcal{I}_k(\mathfrak{A}^+(T))$. This is because e_\star is the only edge incident to the root, so that every admissible rooted subtree contains e_\star . Given $A \in \mathfrak{A}^+(T)$, since the root-label of $\mathcal{I}_k(T_\epsilon^n)$ is 0, the set of all possible node-labels \mathfrak{n}_A for $\mathcal{I}_k(T)$ appearing in (4.2) for $\delta^+ \mathcal{I}_k(T_\epsilon^n)$ coincides with those

appearing the expression for $\delta^+ T_\epsilon^n$. Furthermore, it follows from the definitions that for any such A one has

$$\mathcal{R}_A^\uparrow \mathcal{I}_k(T_\epsilon^{n_A + \pi \epsilon_A}) = \mathcal{I}_k(\mathcal{R}_A^\uparrow T_\epsilon^{n_A + \pi \epsilon_A}),$$

so that, writing \star as a shortcut for $\emptyset \in \mathfrak{A}^+(\mathcal{I}_k(T))$, we have the identity

$$\begin{aligned} \delta^+ \mathcal{I}_k(T_\epsilon^n) &= (\mathcal{I}_k \otimes 1) \delta^+ T_\epsilon^n + \sum_{\epsilon_\star, n_\star} \frac{1}{\epsilon_\star!} \binom{\mathbf{n}}{\mathbf{n}_\star} \mathcal{R}_\star^\uparrow \mathcal{I}_k(T_\epsilon)^{n_\star + \pi \epsilon_\star} \\ &\quad \otimes X^{\mathbf{n}(\varrho) - \Sigma n_\star} \mathcal{R}_\star^\downarrow \mathcal{I}_{k+\epsilon_\star}(T_\epsilon^n) \\ &= (\mathcal{I}_k \otimes 1) \delta^+ T_\epsilon^n + \sum_{\epsilon_\star} \frac{1}{\epsilon_\star!} X^{\pi \epsilon_\star} \otimes \mathcal{I}_{k+\epsilon_\star}(T_\epsilon^n). \end{aligned}$$

because $\mathbf{n}(\varrho) = 0$ so that \mathbf{n}_\star is a zero ($\mathbf{n}(\varrho) - \Sigma n_\star \geq 0$). Note now that ϵ_\star consists of a single label (say ℓ), supported on e_\star . As a consequence, we can rewrite the above as

$$\delta^+ \mathcal{I}_k(T_\epsilon^n) = (\mathcal{I}_k \otimes 1) \delta^+ T_\epsilon^n + \sum_{\ell} \frac{1}{\ell!} X^\ell \otimes \mathcal{I}_{k+\ell}(T_\epsilon^n).$$

For δ^- , we define $\tilde{\delta}^-$ as δ^- but we distinguish subtrees in $\mathfrak{A}^+(T)$:

$$\tilde{\delta}^- T_\epsilon^n := \sum_{\substack{T_\varrho \in \mathfrak{A}^+(T), \tilde{\mathcal{A}} \in \mathfrak{A}^\circ(T) \\ \mathcal{A} = \tilde{\mathcal{A}} \cup \{T_\varrho\} \in \mathfrak{A}(T)}} \sum_{\epsilon_{\mathcal{A}}, n_{\mathcal{A}}} \frac{1}{\epsilon_{\mathcal{A}}!} \binom{\mathbf{n}}{\mathbf{n}_{\mathcal{A}}} (T_\varrho)_\epsilon^{n_{\mathcal{A}} + \pi \epsilon_{\mathcal{A}}} \star \mathcal{R}_\mathcal{A}^\uparrow T_\epsilon^{n_{\mathcal{A}} + \pi \epsilon_{\mathcal{A}}} \otimes \mathcal{R}_\mathcal{A}^\downarrow T_{\epsilon + \epsilon_{\mathcal{A}}}^{n - n_{\mathcal{A}}}.$$

Then, it is straightforward to notice that $\tilde{\delta}^-$ is multiplicative for the product:

$$((\varphi_1 \star \tau_1) \otimes \tau_3)((\varphi_2 \star \tau_2) \otimes \tau_4) = (\varphi_1 \cdot \varphi_2 \star \tau_1 \tau_2) \otimes \tau_3 \tau_4.$$

We identify the product \star with terms of the form $\tau_1 \mathcal{C}(\tau_2)$. Depending on the value of T_ϱ we obtain two recursive terms appearing in $\tilde{\delta}^-$ given by

$$\tilde{\delta}^- \mathcal{I}_k(T_\epsilon^n) = (\mathcal{I}_k \otimes 1) \tilde{\delta}^- T_\epsilon^n + \left(\sum_{\ell} \frac{1}{\ell!} X^\ell \mathcal{C} \otimes \mathcal{I}_{k+\ell} \right) \tilde{\delta}^- T_\epsilon^n.$$

If we apply $(\mathcal{C} \otimes 1)$ on $\tilde{\delta}^-$, we obtain δ^- . □

By applying the projections, Π_+ and Π_- , we obtain the recursive definition for all the coproducts defined in the first section. The coproducts Δ and Δ^+ have been introduced in [Hai14b, Sec. 8] but in a different form. They are given by

$$\begin{cases} \Delta \mathbf{1} = \mathbf{1} \otimes \mathbf{1}, & \Delta \Xi = \Xi \otimes \mathbf{1}, & \Delta X_i = X_i \otimes \mathbf{1} + \mathbf{1} \otimes X_i, \\ \Delta(\tau \bar{\tau}) = (\Delta \tau)(\Delta \bar{\tau}), & \Delta \mathcal{I}_k(\tau) = (\mathcal{I}_k \otimes 1) \Delta \tau + \sum_{\ell, m} \frac{X^\ell}{\ell!} \otimes \frac{X^m}{m!} \mathcal{J}_{k+\ell+m}(\tau). \end{cases} \quad (3.3)$$

3.3. Computations with $\hat{\Delta}^\circ$

$$\begin{cases} \Delta^+ \mathbf{1} = \mathbf{1} \otimes \mathbf{1}, & \Delta^+ X_i = X_i \otimes \mathbf{1} + \mathbf{1} \otimes X_i, & \Delta^+(\tau\bar{\tau}) = (\Delta^+ \tau)(\Delta^+ \bar{\tau}), \\ \Delta^+ \mathcal{J}_k(\tau) = \mathbf{1} \otimes \mathcal{J}_k \tau + \sum_{\ell} (\mathcal{J}_{k+\ell} \otimes \frac{(-X)^\ell}{\ell!}) \Delta \tau. \end{cases} \quad (3.4)$$

where

$$\mathcal{J}_k(\tau) := \mathbb{1}_{(|\mathcal{I}_k(\tau)|_s > 0)} \mathcal{I}_k(\tau).$$

and the set \mathcal{H}_+ can be described using the symbol notation as the linear span of:

$$\mathcal{F}_+ = \{X^k \prod_i \mathcal{J}_{k_i}(\tau_i) : \tau_i \in \mathcal{F} \text{ and } k, k_i \in \mathbb{N}^d\}.$$

The previous recursive definition is slightly different from those with δ^+ . But if we make a change of basis by defining $\tilde{\mathcal{J}}_k(\tau) = \sum_m \frac{X^m}{m!} \mathcal{J}_{k+m}(\tau)$ (note that the sum is finite since at some point $\mathcal{J}_{k+m}(\tau) = 0$), we obtain the same recursive definition

$$\Delta(\tau\bar{\tau}) = \Delta \tau \cdot \Delta \bar{\tau}, \quad \Delta \mathcal{I}_k(\tau) = (\mathcal{I}_k \otimes \mathbf{1}) \Delta \tau + \sum_{\ell} \frac{X^\ell}{\ell!} \otimes \tilde{\mathcal{J}}_{k+\ell}(\tau).$$

For Δ^+ , it follows that one has the identity

$$\begin{aligned} \Delta^+ \tilde{\mathcal{J}}_k(\tau) &= \sum_{\ell, m, n} \left(\frac{X^m}{m!} \mathcal{J}_{k+\ell+m+n} \otimes \frac{(-X)^\ell X^n}{\ell! n!} \right) \Delta \tau + \sum_{\ell, m} \frac{X^\ell}{\ell!} \otimes \frac{X^m}{m!} \mathcal{J}_{k+\ell+m}(\tau) \\ &= \sum_m \left(\frac{X^m}{m!} \mathcal{J}_{k+m} \otimes \mathbf{1} \right) \Delta \tau + \sum_{\ell, m} \frac{X^\ell}{\ell!} \otimes \frac{X^m}{m!} \mathcal{J}_{k+\ell+m}(\tau) \\ &= (\tilde{\mathcal{J}}_k \otimes \mathbf{1}) \Delta \tau + \sum_{\ell} \frac{X^\ell}{\ell!} \otimes \tilde{\mathcal{J}}_{k+\ell}(\tau). \end{aligned}$$

Finally, we view \mathcal{F}_+ as the free algebra generated by the X_i and all formal expressions of the form $\mathcal{J}_k(\tau)$ where $\mathcal{J}_k(\tau) = 0$ if $|\mathcal{I}_k(\tau)|_s < 0$.

3.3 Computations with $\hat{\Delta}^\circ$

We give examples of computation with $\hat{\Delta}^\circ$ on terms which appear in the stochastic heat equation in [HP14]. The symbols are represented using trees:

$$\Xi \rightarrow \begin{array}{c} \bullet \\ | \\ \bullet \end{array} \quad \mathcal{I}(\Xi) \rightarrow \begin{array}{c} \bullet \\ | \\ \bullet \end{array} \quad \mathcal{I}(\Xi)\Xi \rightarrow \begin{array}{c} \bullet \\ / \quad \backslash \\ \bullet \quad \bullet \end{array} \quad \mathcal{I}(\mathcal{I}(\Xi)\Xi) \rightarrow \begin{array}{c} \bullet \\ | \\ \bullet \end{array} \quad \mathcal{I}(\mathcal{I}(\Xi)\Xi)\Xi \rightarrow \begin{array}{c} \bullet \\ / \quad \backslash \\ \bullet \quad \bullet \end{array}$$

We proceed recursively and we use three colours: the subtrees belonging to the free algebra $\langle\langle \mathcal{F} \rangle\rangle$ are in blue if their construction is over with \mathcal{C} , if it is not they are in red. The remaining tree on the right is in black.

$$\begin{aligned}
 \hat{\Delta}^\circ \text{!} &= \text{!} \otimes 1 + 1 \otimes \text{!} & \hat{\Delta}^\circ \text{!} &= (\mathcal{I} \otimes 1 + \mathcal{C} \otimes \mathcal{I}) \hat{\Delta}^\circ \text{!} = \text{!} \otimes 1 + 1 \otimes \text{!} \\
 \hat{\Delta}^\circ \text{V} &= \left(\hat{\Delta}^\circ \text{!} \right) \left(\hat{\Delta}^\circ \text{!} \right) = \text{V} \otimes 1 + \text{!} \otimes \text{!} + \text{!} \otimes \text{!} + 1 \otimes \text{V} \\
 \hat{\Delta}^\circ \text{Y} &= (\mathcal{I} \otimes 1 + \mathcal{C} \otimes \mathcal{I}) \hat{\Delta}^\circ \left(\text{V} \right) = \text{Y} \otimes 1 + \text{!} \otimes \text{!} + \text{!} \otimes \text{!} + 1 \otimes \text{Y} \\
 \hat{\Delta}^\circ \text{VY} &= \left(\hat{\Delta}^\circ \text{Y} \right) \left(\hat{\Delta}^\circ \text{!} \right) = \text{VY} \otimes 1 + \text{V} \otimes \text{!} + \text{V} \otimes \text{!} + \text{!} \otimes \text{VY} \\
 &\quad + \text{Y} \otimes \text{!} + \text{!} \otimes \text{V} + \text{!} \otimes \text{V} + 1 \otimes \text{VY} \\
 \hat{\Delta}^\circ \text{VYV} &= (\mathcal{I} \otimes 1 + \mathcal{C} \otimes \mathcal{I}) \hat{\Delta}^\circ \left(\text{VY} \right) = \text{VYV} \otimes 1 + \text{V} \otimes \text{!} + \text{V} \otimes \text{!} \\
 &\quad + \text{!} \otimes \text{VY} + \text{Y} \otimes \text{!} + \text{!} \otimes \text{V} + \text{!} \otimes \text{V} + 1 \otimes \text{VYV}
 \end{aligned}$$

Remark 3.3.1. The previous computation creates a lot of terms which end up to be zero when we apply $(\ell\Pi_- \otimes 1)$. In the computation, we omit the decorations in order to have a nicer form.

3.4 Computation with $\hat{\Delta}$

We use the same notation as in the section concerning the computations of $\hat{\Delta}^\circ$ and we represent the abstract integrator map $\mathcal{I}_1(\cdot)$ by a snake edge.

$$\begin{aligned}
 \mathcal{I}_1(\mathcal{I}(\Xi)\Xi)^2 &\rightarrow \begin{array}{c} \ell_1 \quad \ell_2 \quad \ell_3 \quad \ell_4 \\ \text{---} \text{---} \text{---} \text{---} \\ \text{---} \text{---} \text{---} \text{---} \\ \text{---} \text{---} \text{---} \text{---} \end{array} & \mathcal{I}(\mathcal{I}(\mathcal{I}(\Xi)\Xi)\Xi)\Xi &\rightarrow \begin{array}{c} \ell_1 \quad \ell_2 \\ \text{---} \text{---} \\ \text{---} \text{---} \\ \text{---} \text{---} \end{array} \\
 \mathcal{I}_1(X\Xi)\mathcal{I}_1(\Xi) &\rightarrow \begin{array}{c} \ell_1 \quad \ell_2 \\ \text{---} \text{---} \\ \text{---} \text{---} \end{array} & \mathcal{I}(X\Xi)\Xi &\rightarrow \begin{array}{c} \ell_1 \quad \ell_2 \\ \text{---} \text{---} \\ \text{---} \text{---} \end{array}
 \end{aligned}$$

3.5. Composition of renormalisation operations using the symbol notation

$$\begin{aligned}
\hat{\Delta} \begin{array}{c} \ell_1 \ell_2 \ell_3 \ell_4 \\ \diagdown \quad \diagup \\ \bullet \quad \bullet \\ \diagup \quad \diagdown \\ \bullet \quad \bullet \\ \diagdown \quad \diagup \\ \bullet \quad \bullet \\ \diagup \quad \diagdown \\ \bullet \quad \bullet \end{array} &= \begin{array}{c} \ell_1 \ell_2 \ell_3 \ell_4 \\ \diagdown \quad \diagup \\ \bullet \quad \bullet \\ \diagup \quad \diagdown \\ \bullet \quad \bullet \\ \diagdown \quad \diagup \\ \bullet \quad \bullet \\ \diagup \quad \diagdown \\ \bullet \quad \bullet \end{array} \otimes 1 + \begin{array}{c} \ell_2 \ell_3 \\ \diagdown \quad \diagup \\ \bullet \quad \bullet \\ \diagup \quad \diagdown \\ \bullet \quad \bullet \end{array} \otimes \begin{array}{c} \ell_1 \ell_4 \\ \diagdown \quad \diagup \\ \bullet \quad \bullet \\ \diagup \quad \diagdown \\ \bullet \quad \bullet \end{array} + X \begin{array}{c} \ell_2 \ell_3 \\ \diagdown \quad \diagup \\ \bullet \quad \bullet \\ \diagup \quad \diagdown \\ \bullet \quad \bullet \end{array} \otimes \begin{array}{c} \ell_1 \ell_4 \\ \diagdown \quad \diagup \\ \bullet \quad \bullet \\ \diagup \quad \diagdown \\ \bullet \quad \bullet \end{array} \\
+ \begin{array}{c} \ell_2 \ell_3 X \\ \diagdown \quad \diagup \\ \bullet \quad \bullet \\ \diagup \quad \diagdown \\ \bullet \quad \bullet \end{array} \otimes \begin{array}{c} \ell_1 \ell_4 \\ \diagdown \quad \diagup \\ \bullet \quad \bullet \\ \diagup \quad \diagdown \\ \bullet \quad \bullet \end{array} + 1 \otimes \begin{array}{c} \ell_1 \ell_2 \ell_3 \ell_4 \\ \diagdown \quad \diagup \\ \bullet \quad \bullet \\ \diagup \quad \diagdown \\ \bullet \quad \bullet \\ \diagdown \quad \diagup \\ \bullet \quad \bullet \\ \diagup \quad \diagdown \\ \bullet \quad \bullet \end{array}, \\
\hat{\Delta} \begin{array}{c} \ell_1 \ell_2 \\ \diagdown \quad \diagup \\ \bullet \quad \bullet \\ \diagup \quad \diagdown \\ \bullet \quad \bullet \\ \diagdown \quad \diagup \\ \bullet \quad \bullet \\ \diagup \quad \diagdown \\ \bullet \quad \bullet \end{array} &= \begin{array}{c} \ell_1 \ell_2 \\ \diagdown \quad \diagup \\ \bullet \quad \bullet \\ \diagup \quad \diagdown \\ \bullet \quad \bullet \\ \diagdown \quad \diagup \\ \bullet \quad \bullet \\ \diagup \quad \diagdown \\ \bullet \quad \bullet \end{array} \otimes 1 + \begin{array}{c} \ell_2 \ell_3 \\ \diagdown \quad \diagup \\ \bullet \quad \bullet \\ \diagup \quad \diagdown \\ \bullet \quad \bullet \end{array} \otimes \begin{array}{c} \ell_1 \ell_4 \\ \diagdown \quad \diagup \\ \bullet \quad \bullet \\ \diagup \quad \diagdown \\ \bullet \quad \bullet \end{array} + X \begin{array}{c} \ell_2 \ell_3 \\ \diagdown \quad \diagup \\ \bullet \quad \bullet \\ \diagup \quad \diagdown \\ \bullet \quad \bullet \end{array} \otimes \begin{array}{c} \ell_1 \ell_4 \\ \diagdown \quad \diagup \\ \bullet \quad \bullet \\ \diagup \quad \diagdown \\ \bullet \quad \bullet \end{array} \\
\begin{array}{c} \ell_3 \ell_4 \\ \diagdown \quad \diagup \\ \bullet \quad \bullet \\ \diagup \quad \diagdown \\ \bullet \quad \bullet \end{array} \otimes \begin{array}{c} \ell_1 \ell_2 \\ \diagdown \quad \diagup \\ \bullet \quad \bullet \\ \diagup \quad \diagdown \\ \bullet \quad \bullet \end{array} + X \begin{array}{c} \ell_3 \ell_4 \\ \diagdown \quad \diagup \\ \bullet \quad \bullet \\ \diagup \quad \diagdown \\ \bullet \quad \bullet \end{array} \otimes \begin{array}{c} \ell_1 \ell_2 \\ \diagdown \quad \diagup \\ \bullet \quad \bullet \\ \diagup \quad \diagdown \\ \bullet \quad \bullet \end{array} + 1 \otimes \begin{array}{c} \ell_1 \ell_2 \\ \diagdown \quad \diagup \\ \bullet \quad \bullet \\ \diagup \quad \diagdown \\ \bullet \quad \bullet \\ \diagdown \quad \diagup \\ \bullet \quad \bullet \\ \diagup \quad \diagdown \\ \bullet \quad \bullet \end{array}.
\end{aligned}$$

3.5 Composition of renormalisation operations using the symbol notation

We want to derive recursive proofs for δ^+ and δ^- using the symbol notation. We briefly recall the construction with the symbol notation given in 3.2. We consider a collection of constants that can conveniently be indexed by expressions of the type $\mathcal{C}(\tau)$ with $\tau \in \mathcal{F}$. The space $\langle\langle \mathcal{F} \rangle\rangle$ is identified with $\langle\langle \mathcal{C}(\mathcal{F}) \rangle\rangle$. Let $\hat{\mathcal{H}}$ denote the vector space spanned by elements of the form $\sigma\tau$ with $\sigma \in \langle\langle \mathcal{C}(\mathcal{F}) \rangle\rangle$ and $\tau \in \mathcal{F}$. Elements of $\hat{\mathcal{F}}$ have a unique decomposition of the form $\sum_{\tau \in \mathcal{F}} \sigma_\tau \tau$ with $\sigma_\tau \in \langle\langle \mathcal{C}(\mathcal{F}) \rangle\rangle$. We remind the definition of $\Delta^\circ : \mathcal{H} \rightarrow \mathbf{R}[[\mathcal{H} \otimes \mathcal{H}]]$ and $\hat{\Delta}^\circ : \mathcal{H} \rightarrow \mathbf{R}[[\hat{\mathcal{H}} \otimes \mathcal{H}]]$ given by:

$$\left\{ \begin{array}{l} \Delta^\circ \mathbf{1} = \mathbf{1} \otimes \mathbf{1}, \quad \Delta^\circ X_i = X_i \otimes \mathbf{1} + \mathbf{1} \otimes X_i, \quad \Delta^\circ \Xi = \Xi \otimes \mathbf{1} + \mathbf{1} \otimes \Xi \\ \Delta^\circ(\tau\bar{\tau}) = (\Delta^\circ\tau)(\Delta^\circ\bar{\tau}), \quad \Delta^\circ \mathcal{I}_k(\tau) = (\mathcal{I}_k \otimes \mathbf{1})\Delta^\circ\tau + \sum_{\ell} \frac{X^\ell}{\ell!} \otimes \mathcal{I}_{k+\ell}(\tau). \end{array} \right. \quad (3.5)$$

$$\left\{ \begin{array}{l} \hat{\Delta}^\circ \mathbf{1} = \mathbf{1} \otimes \mathbf{1}, \quad \hat{\Delta}^\circ X_i = X_i \otimes \mathbf{1} + \mathbf{1} \otimes X_i, \quad \hat{\Delta}^\circ \Xi = \Xi \otimes \mathbf{1} + \mathbf{1} \otimes \Xi \\ \hat{\Delta}^\circ(\tau\bar{\tau}) = (\hat{\Delta}^\circ\tau)(\hat{\Delta}^\circ\bar{\tau}), \quad \hat{\Delta}^\circ \mathcal{I}_k(\tau) = \left(\mathcal{I}_k \otimes \mathbf{1} + \sum_{\ell} \frac{X^\ell}{\ell!} \mathcal{C} \otimes \mathcal{I}_{k+\ell} \right) \hat{\Delta}^\circ\tau. \end{array} \right. \quad (3.6)$$

We can extend Δ° from $\langle\langle \mathcal{H} \rangle\rangle$ to $\mathbf{R}[[\langle\langle \mathcal{H} \rangle\rangle \otimes \langle\langle \mathcal{H} \rangle\rangle]]$ and $\hat{\Delta}^\circ$ from $\hat{\mathcal{H}}$ to $\mathbf{R}[[\hat{\mathcal{H}} \otimes \hat{\mathcal{H}}]]$ by imposing that for $\tau \in \mathcal{F}$ and $\sigma \in \mathcal{C}(\mathcal{F})$:

$$\Delta^\circ \mathcal{C}(\tau) = (\mathcal{C} \otimes \mathcal{C})\Delta^\circ\tau, \quad \hat{\Delta}^\circ \mathcal{C}(\tau) = (\mathcal{C} \otimes \mathcal{C})\hat{\Delta}^\circ\tau, \quad \hat{\Delta}^\circ \sigma\tau = \hat{\Delta}^\circ\sigma \hat{\Delta}^\circ\tau.$$

Proposition 3.5.1. *One has $(\Delta^\circ \otimes 1)\Delta^\circ = (1 \otimes \Delta^\circ)\Delta^\circ$.*

Proof. We proceed by induction. The proof is obvious for $\mathbf{1}$, X_i and Ξ . By multiplicativity, we just need to look at terms of the form $\mathcal{I}_k(\tau)$. Therefore

$$\begin{aligned} (\Delta^\circ \otimes 1)\Delta^\circ \mathcal{I}_k(\tau) &= (\Delta^\circ \otimes 1)((\mathcal{I}_k \otimes 1)\Delta^\circ \tau + \sum_{\ell} \frac{X^\ell}{\ell!} \otimes \mathcal{I}_{k+\ell}(\tau)) \\ &= (\mathcal{I}_k \otimes 1 \otimes 1)(\Delta^\circ \otimes 1)\Delta^\circ \tau + \sum_{\ell} \frac{X^\ell}{\ell!} \otimes (\mathcal{I}_{k+\ell}(\tau) \otimes 1)\Delta^\circ \\ &\quad + \sum_{\ell, m} \frac{X^\ell}{\ell!} \otimes \frac{X^m}{m!} \otimes \mathcal{I}_{k+\ell+m}(\tau). \end{aligned}$$

On the other hand, it follows:

$$\begin{aligned} (1 \otimes \Delta^\circ)\Delta^\circ \mathcal{I}_k(\tau) &= (1 \otimes \Delta^\circ)((\mathcal{I}_k \otimes 1 \otimes 1)\Delta^\circ \tau + \sum_{\ell} \frac{X^\ell}{\ell!} \otimes \mathcal{I}_{k+\ell}(\tau)) \\ &= (\mathcal{I}_k \otimes 1)(1 \otimes \Delta^\circ)\Delta^\circ \tau + \sum_{\ell} \frac{X^\ell}{\ell!} \otimes (\mathcal{I}_{k+\ell}(\tau) \otimes 1)\Delta^\circ \\ &\quad + \sum_{\ell, m} \frac{X^\ell}{\ell!} \otimes \frac{X^m}{m!} \otimes \mathcal{I}_{k+\ell+m}(\tau). \end{aligned}$$

We conclude by applying the induction hypothesis on τ : $(\Delta^\circ \otimes 1)\Delta^\circ \tau = (1 \otimes \Delta^\circ)\Delta^\circ \tau$. \square

Proposition 3.5.2. *One has $(\hat{\Delta}^\circ \otimes 1)\hat{\Delta}^\circ = (1 \otimes \hat{\Delta}^\circ)\hat{\Delta}^\circ$.*

Proof. Since both maps are multiplicative and the identity obviously holds when applied to $\mathbf{1}$, X_i or Ξ , it suffices to verify that it also holds for elements of the form $\mathcal{I}_k(\tau)$. For this, note first that $\hat{\Delta}^\circ$ has the following properties. For $\sigma\tau \in \hat{\mathcal{F}}$, one has by definition

$$\begin{aligned} \hat{\Delta}^\circ \mathcal{C}(\sigma\tau) &= \hat{\Delta}^\circ \sigma \mathcal{C}(\tau) \mathbf{1} = \hat{\Delta}^\circ(\sigma \mathcal{C}(\tau)) \\ &= (\hat{\Delta}^\circ \sigma)(\mathcal{C} \otimes \mathcal{C})\hat{\Delta}^\circ \tau = (\mathcal{C} \otimes \mathcal{C})\hat{\Delta}^\circ(\sigma\tau). \end{aligned} \tag{3.7}$$

Furthermore, one has the identity

$$\begin{aligned} \hat{\Delta}^\circ \mathcal{I}_k(\sigma\tau) &= \hat{\Delta}^\circ \sigma \mathcal{I}_k(\tau) = (\hat{\Delta}^\circ \sigma)\hat{\Delta}^\circ \mathcal{I}_k(\tau) \\ &= (\hat{\Delta}^\circ \sigma)(\mathcal{I}_k \otimes 1 + \sum_{\ell} \frac{X^\ell}{\ell!} \mathcal{C} \otimes \mathcal{I}_{k+\ell})\hat{\Delta}^\circ \tau \\ &= (\mathcal{I}_k \otimes 1 + \sum_{\ell} \frac{X^\ell}{\ell!} \mathcal{C} \otimes \mathcal{I}_{k+\ell})(\hat{\Delta}^\circ \sigma \hat{\Delta}^\circ \tau) \\ &= (\mathcal{I}_k \otimes 1 + \sum_{\ell} \frac{X^\ell}{\ell!} \mathcal{C} \otimes \mathcal{I}_{k+\ell})(\hat{\Delta}^\circ \sigma\tau). \end{aligned}$$

3.5. Composition of renormalisation operations using the symbol notation

It follows that for any $\tau \in \hat{\mathcal{F}}$ one has the identity

$$\begin{aligned}
(\hat{\Delta}^\circ \otimes 1)\hat{\Delta}^\circ \mathcal{I}_k(\tau) &= (\hat{\Delta}^\circ \mathcal{I}_k \otimes 1 + \hat{\Delta}^- \sum_{\ell} \frac{X^\ell}{\ell!} \mathcal{C} \otimes \mathcal{I}_{k+\ell})\hat{\Delta}^\circ \tau \\
&= ((\mathcal{I}_k \otimes 1 + \sum_{\ell} \frac{X^\ell}{\ell!} \mathcal{C} \otimes \mathcal{I}_{k+\ell})\hat{\Delta}^\circ \otimes 1 \\
&\quad + \sum_{\ell, m} (\frac{X^\ell}{\ell!} \mathcal{C} \otimes \frac{X^m}{m!} \mathcal{C})\hat{\Delta}^\circ \otimes \mathcal{I}_{k+\ell+m})\hat{\Delta}^\circ \tau \\
&= (\mathcal{I}_k \otimes 1 \otimes 1 + \sum_{\ell} \frac{X^\ell}{\ell!} \mathcal{C} \otimes \mathcal{I}_{k+\ell} \otimes 1 \\
&\quad + \sum_{\ell, m} \frac{X^\ell}{\ell!} \mathcal{C} \otimes \frac{X^m}{m!} \mathcal{C} \otimes \mathcal{I}_{k+\ell+m})(\hat{\Delta}^\circ \otimes 1)\hat{\Delta}^\circ \tau .
\end{aligned}$$

On the other hand, we have

$$\begin{aligned}
(1 \otimes \hat{\Delta}^\circ)\hat{\Delta}^\circ \mathcal{I}_k(\tau) &= (\mathcal{I}_k \otimes 1 \otimes 1 + \sum_{\ell} \frac{X^\ell}{\ell!} \mathcal{C} \otimes \mathcal{I}_{k+\ell} \otimes 1 \\
&\quad + \sum_{\ell, m} \frac{X^\ell}{\ell!} \mathcal{C} \otimes \frac{X^m}{m!} \mathcal{C} \otimes \mathcal{I}_k)(1 \otimes \hat{\Delta}^\circ)\hat{\Delta}^\circ \tau ,
\end{aligned}$$

the claim follows by induction. \square

Proposition 3.5.3. *One has:*

$$\begin{aligned}
(\Pi_+ \otimes \Pi_+)\hat{\Delta}^\circ \Pi_+ &= (\Pi_+ \otimes \Pi_+)\hat{\Delta}^\circ, \\
(\Pi_- \mathcal{C} \otimes \Pi_-)\hat{\Delta}^\circ &= (\Pi_- \mathcal{C} \otimes \Pi_-)\hat{\Delta}^\circ \Pi_-.
\end{aligned}$$

Proof. By multiplicativity of Π_+ and $\hat{\Delta}^\circ$, we just need to check the first identity for $\mathcal{I}_k(\tau)$. We have $\hat{\Delta}^\circ \mathcal{I}_k(\tau) = \sum_i \tau_i^{(1)} \otimes \tau_i^{(2)}$ where $|\mathcal{I}_k(\tau)|_s = |\tau_i^{(1)}|_s + |\tau_i^{(2)}|_s$. If $\mathcal{I}_k(\tau)$ has a negative homogeneity then for every i , one of the $\tau_i^{(j)}$, $j \in \{1, 2\}$ is negative. For the other identity, we use the same kind of argument. \square

Given a linear functional $\ell: \langle\langle \mathcal{F} \rangle\rangle \rightarrow \mathbf{R}$, we define a renormalisation map $M = M_\ell$ by:

$$\begin{cases} M_\ell^\circ \mathbf{1} = \mathbf{1}, & M_\ell^\circ X = X, & M_\ell^\circ \Xi = \Xi \\ M_\ell^\circ \tau \bar{\tau} = (M_\ell^\circ \tau)(M_\ell^\circ \bar{\tau}), & M_\ell \tau = M_\ell^\circ R_\ell \tau \\ M_\ell^\circ \mathcal{I}_k(\tau) = \mathcal{I}_k(M_\ell \tau) \end{cases} \quad (3.8)$$

where the map $R = R_\ell$ is defined by

$$R_\ell \tau = (\ell \Pi_- \mathcal{C} \otimes 1)\hat{\Delta}^\circ \tau . \quad (3.9)$$

Proposition 3.5.4. *Let $\ell: \mathcal{T}_- \rightarrow \mathbf{R}$ a multiplicative functional. If M_ℓ and M_ℓ° are given by (3.14) with $R = R_\ell$ as in (3.9), then one has*

$$M_\ell^\circ = (\ell \mathbf{1}^* \otimes 1) \hat{\Delta}^\circ, \quad M_\ell = (\ell \mathcal{C} \otimes 1) \hat{\Delta}^\circ. \quad (3.10)$$

Proof. To show (3.10), we take this as a *definition* for two linear maps M and M° , and we show that these satisfy the identities (3.14). The first three identities are immediate, and it is easy to verify that one has indeed

$$M^\circ \mathcal{I}_k = \mathcal{I}_k M,$$

as required. It is also straightforward to verify that M° as given by (3.10) is multiplicative, so that it only remains to show that $M = M^\circ R$. If we can show that

$$\hat{\Delta}^\circ = (\mathcal{M} \otimes 1)(1 \otimes (\mathbf{1}^* \otimes 1) \hat{\Delta}^\circ) \Delta^\circ, \quad (3.11)$$

Applying the right hand side to $\mathcal{I}_k(\tau)$ we have

$$\begin{aligned} & (\mathcal{M} \otimes 1)(1 \otimes (\mathbf{1}^* \otimes 1) \hat{\Delta}^\circ) \Delta^\circ \mathcal{I}_k(\tau) \\ &= (\mathcal{M} \otimes 1) \left(\mathcal{I}_k \otimes (\mathbf{1}^* \otimes 1) \hat{\Delta}^\circ \right) \Delta^\circ \tau + \left(\sum_m \frac{X^m}{m!} \mathbf{1}^* \otimes 1 \right) \hat{\Delta}^\circ \mathcal{I}_{k+m}(\tau) \\ &= (\mathcal{M} \otimes 1) \left(\mathcal{I}_k \otimes (\mathbf{1}^* \otimes 1) \hat{\Delta}^\circ \right) \Delta^\circ \tau + \left(\sum_m \frac{X^m}{m!} \mathcal{C} \otimes \mathcal{I}_{k+m} \right) \hat{\Delta}^\circ \tau. \end{aligned}$$

At this stage we note that one has the identity

$$\mathcal{M}(\mathcal{I}_k \otimes \mathbf{1}^*) = \mathcal{I}_k \mathcal{M}(1 \otimes \mathbf{1}^*),$$

so that, making use of the induction hypothesis, we have

$$\begin{aligned} & (\mathcal{M} \otimes 1) \left(\mathcal{I}_k \otimes (\mathbf{1}^* \otimes 1) \hat{\Delta}^\circ \right) \Delta^\circ \tau \\ &= \left(\mathcal{I}_k \otimes 1 \right) (\mathcal{M} \otimes 1)(1 \otimes (\mathbf{1}^* \otimes 1) \hat{\Delta}^\circ) \Delta^\circ \tau = \left(\mathcal{I}_k \otimes 1 \right) \hat{\Delta}^\circ \tau. \end{aligned}$$

Combining this with the recursive definition of $\hat{\Delta}^\circ$, we conclude that (3.11) does indeed hold as required to conclude the proof. \square

3.6 Renormalised Models

We start the section by a general recursive formulation of the renormalisation group without coproduct. During this section, we use mainly the symbol notation for the structure space.

3.6.1 A recursive formulation

Before giving the recursive definition of the renormalisation map, we precise some notations. We denote by $\|\tau\|$ the number of times the symbol Ξ appears in τ . We extend the definitions of $|\cdot|_s$ and $\|\cdot\|$ to any linear combination $\tau = \sum_i \alpha_i \tau_i$ of canonical basis vectors τ_i with $\alpha_i \neq 0$ by

$$|\tau|_s := \min_i |\tau_i|_s, \quad \|\tau\| := \max_i \|\tau_i\|, \quad (3.12)$$

which suggests the natural conventions $|0|_s = +\infty$ and $\|0\| = -\infty$. We also define a partial order $<_{\mathcal{T}}$ on \mathcal{T} by setting:

$$\tau_1 <_{\mathcal{T}} \tau_2 \quad \text{if} \quad \|\tau_1\| < \|\tau_2\| \quad \text{or} \quad (\|\tau_1\| = \|\tau_2\| \quad \text{and} \quad |\tau_1|_s < |\tau_2|_s). \quad (3.13)$$

Definition 3.6.1. A symbol τ is an elementary symbol if it has the following form: Ξ , X and $\mathcal{I}_n(\sigma_i)$.

Remark 3.6.2. This is the same definition for the symbols as for the labelled trees given in 2.4.7.

Proposition 3.6.3. Let $\tau = \prod_i \tau_i$ such that the τ_i are elementary symbols and that τ is not an elementary symbol then $\tau_i <_{\mathcal{T}} \tau$.

Proof. We consider $\tau = \prod_i \tau_i$ and let τ_j an elementary symbol appearing in the previous decomposition. We define $\bar{\tau}_j = \prod_{i \neq j} \tau_i$. If the product $\bar{\tau}_j$ contains a term of the form $\mathcal{I}_k(\sigma)$ then $\|\bar{\tau}_j\| > 0$ and $\|\tau_j\| < \|\bar{\tau}_j\| + \|\tau_j\| = \|\tau\|$. Otherwise, $\bar{\tau}_j = X^k$ and $\|\tau_j\| = \|\tau\|$ but $|\bar{\tau}_j|_s > 0$ which gives $|\tau_j|_s < |\tau_j|_s + |\bar{\tau}_j|_s = |\tau|_s$. Finally, we obtain $\tau_i <_{\mathcal{T}} \tau$. \square

Given a regularity structure (A, \mathcal{H}, G) , we consider $\mathcal{L}(\mathcal{H})$ the space of linear maps on \mathcal{H} . For our recursive formulation, we choose a subset of $\mathcal{L}(\mathcal{H})$:

Definition 3.6.4. A map $R \in \mathcal{L}(\mathcal{H})$ is admissible if

1. For every elementary symbol τ , $R\tau = \tau$.
2. For every multiindex k and any symbol τ , $R(X^k \tau) = X^k R\tau$.
3. For each $\tau \in \mathcal{T}$, $\|R\tau - \tau\| < \|\tau\|$.
4. For each $\tau \in \mathcal{T}$, $|R\tau - \tau|_s > |\tau|_s$.
5. It commutes with G : $R\Gamma = \Gamma R$ for every $\Gamma \in G$.

We denote by $\mathcal{L}_{ad}(\mathcal{H})$ the set of admissible maps. For $R \in \mathcal{L}_{ad}(\mathcal{H})$, we define a renormalisation map $M = M_R$ by:

$$\begin{cases} M^\circ \mathbf{1} = \mathbf{1}, & M^\circ X = X, & M^\circ \Xi = \Xi \\ M^\circ \tau \bar{\tau} = (M^\circ \tau)(M^\circ \bar{\tau}), & M\tau = M^\circ R\tau \\ M^\circ \mathcal{I}_k(\tau) = \mathcal{I}_k(M\tau) \end{cases} \quad (3.14)$$

The main idea behind this definition is that R computes the interaction between several elements of the product $\prod_i \tau_i$. In [Hai14b] and [HP14], elements of the renormalisation group are described by an exponential: $M = \exp(C_i \sum_i L_i)$ where $(L_i)_i \subset \mathcal{L}(\mathcal{H})$. The recursive construction is more convenient for several purposes: it gives an explicit and a canonical way of computing the diverging constant we have to subtract. Moreover, the proof of the construction of the renormalised model is simpler than the one given in [Hai14b].

Remark 3.6.5. The definitions (3.12) as well as the convention that follows are designed in such a way that if the third and the fourth conditions of Definition 3.6.4 hold for canonical basis vectors τ , then they automatically hold for every $\tau \in \mathcal{H}$.

Remark 3.6.6. The first two conditions of 3.6.4 guarantee that M commutes with the abstract integrator map. The third condition is crucial for the definition of M and Π^M : the recursion (3.15) stops after a finite number of iterations since it decreases strictly the quantity $\|\cdot\|$ and thus the partial order $<_{\mathcal{T}}$. Moreover, this condition guarantees that $R = 1 + L$ where L is a nilpotent map and therefore R is invertible. The fourth condition allows us to treat the analytical bounds in the definition of the model and the last condition is needed for the algebraic identities.

Remark 3.6.7. Note that $M = M_R$ does not always commute with the structure group G even if R does ; we will see a counterexample in the group of the stochastic heat equation see proposition 3.7.9 .

Proposition 3.6.8. *Let $R \in \mathcal{L}_{ad}(\mathcal{H})$, then M_R is well-defined.*

Proof. We proceed by induction using the order $<_{\mathcal{T}}$. If $\tau \in \{\Xi, X^k, k \in \mathbb{N}\}$ then $M\tau = M^\circ R\tau = M^\circ \tau = \tau$. If $\tau = \mathcal{I}_k(\tau')$ then

$$M\mathcal{I}_k(\tau') = M^\circ R\mathcal{I}_k(\tau') = M^\circ \mathcal{I}_k(\tau') = \mathcal{I}_k(M\tau').$$

We conclude by applying the induction hypothesis on τ' because we have $|\tau'|_s < |\tau|_s$. Let $\tau = \prod_i \tau_i \in \mathcal{T}$ a product of elementary symbols with at least two symbols in the product, we can write

$$M\tau = M^\circ(R\tau - \tau) + M^\circ\tau.$$

We apply the induction hypothesis on $R\tau - \tau <_{\mathcal{T}} \tau$ because $\|R\tau - \tau\| < \|\tau\|$. For $M^\circ\tau$, we have

$$M^\circ\tau = \prod_i M^\circ R\tau_i = \prod_i M\tau_i.$$

We know from 3.13 that for every $i, \tau_i <_{\mathcal{T}} \tau$. Therefore, we apply the induction hypothesis on the τ_i . □

Remark 3.6.9. In the sequel, we use the order $<_{\mathcal{T}}$ for every induction proof on our symbols. It is possible to choose any other order on the symbols for these proofs.

3.6. Renormalised Models

Remark 3.6.10. The properties of the definition of an admissible map R do not guarantee that T is invariant under the action of R . Therefore, the map M_R can create terms which do not belong to the structure space of an SPDE. In the previous case, we need to specify more the admissible map R .

One crucial property for defining a model is the commuting property of $R \in \mathcal{L}(\mathcal{H})$ with the structure group. This property can be rewritten as

Proposition 3.6.11. *Let $R \in \mathcal{L}(\mathcal{H})$ then R commutes with G iff*

$$(R \otimes \mathbf{1})\Delta = \Delta R.$$

Proof. Let $\Gamma_g \in G$ with $g \in \mathcal{H}_+^*$ and $R \in \mathcal{L}(\mathcal{H})$ commuting with G . It follows

$$R\Gamma_g = R(\mathbf{1} \otimes g)\Delta = (\mathbf{1} \otimes g)(R \otimes \mathbf{1})\Delta.$$

On the other hand, we have

$$\Gamma_g R = (\mathbf{1} \otimes g)\Delta R.$$

If the identity $R\Gamma_g = \Gamma_g R$ holds for every $g \in \mathcal{H}_+^*$, we obtain $(R \otimes \mathbf{1})\Delta = \Delta R$. The reverse is obvious. \square

Remark 3.6.12. If we define R through the coproduct Δ° , then it is easy to check that $R \in \mathcal{L}_{ad}(\mathcal{H})$.

We finish the section by an alternative definition of the map M . We denote by M_L the representation of M :

$$\begin{cases} M\mathbf{1} = \mathbf{1}, & MX = X, & M\Xi = \Xi \\ M \prod_i \tau_i = \prod_i M\tau_i - ML \prod_i \tau_i \\ M\mathcal{I}_k(\tau) = \mathcal{I}_k(M\tau) \end{cases} \quad (3.15)$$

where the τ_i are elementary symbols having the following form: Ξ , X and $\mathcal{I}_n(\sigma_i)$ and the map L needs to satisfy the following properties:

1. For every elementary symbol τ , $L\tau = 0$ and for every multiindex k , $LX^k = 0$.
2. For each $\tau \in \mathcal{T}$, $\|L\tau\| < \|\tau\|$ and $|L\tau|_s > |\tau|_s$.
3. It commutes with G : $L\Gamma = \Gamma L$ for every $\Gamma \in G$.

This properties are very similar to those of R . Noticing that the map L is nilpotent, one can check that $R = (1 + L)^{-1}$ and $M^\circ = M(1 + L)$.

3.6.2 Renormalised models

In this section, we consider a renormalisation map $M = M_R$ defined from an admissible map R . We first define two maps Π^{M° and Π^M by

$$\begin{cases} (\Pi^{M^\circ} \mathbf{1})(y) = 1, & (\Pi^{M^\circ} \Xi)(y) = \xi(y), & (\Pi^{M^\circ} X)(y) = y, \\ (\Pi^{M^\circ} \mathcal{I}_k \tau)(y) = \int D^k K(y-z) (\Pi^M \tau)(z) dz, \\ (\Pi^M \tau)(y) = (\Pi^{M^\circ} R \tau)(y), & (\Pi^{M^\circ} \tau \bar{\tau})(y) = (\Pi^{M^\circ} \tau)(y) (\Pi^{M^\circ} \bar{\tau})(y). \end{cases}$$

We prove that we can build a model (Π_x^M, Γ_{xy}^M) using the construction of [Hai14b, section 8.3] and we provide a recursive formulation for the map Π_x^M :

$$\begin{cases} (\Pi_x^{M^\circ} \mathbf{1})(y) = 1, & (\Pi_x^{M^\circ} \Xi)(y) = \xi(y), & (\Pi_x^{M^\circ} X)(y) = y - x, \\ (\Pi_x^{M^\circ} \mathcal{I}_k \tau)(y) = \int D^k K(y-z) (\Pi_x^M \tau)(z) dz - \sum_{\ell} \frac{(y-x)^\ell}{\ell!} f_x^M(\mathcal{J}_{k+\ell}(\tau)), \\ (\Pi_x^M \tau)(y) = (\Pi_x^{M^\circ} R \tau)(y), & (\Pi_x^{M^\circ} \tau \bar{\tau})(y) = (\Pi_x^{M^\circ} \tau)(y) (\Pi_x^{M^\circ} \bar{\tau})(y) \end{cases} \quad (3.16)$$

where $f_x^M \in \mathcal{H}_+^*$ is defined by

$$\begin{cases} f_x^M(X) = x, & f_x^M(\tau \bar{\tau}) = f_x^M(\tau) f_x^M(\bar{\tau}) \\ f_x^M(\mathcal{J}_\ell(\tau)) = \mathbb{1}_{(|\mathcal{I}_\ell(\tau)|_s > 0)} \int D^\ell K(x-z) (\Pi_x^M \tau)(z) dz. \end{cases}$$

Let g_x^M given by

$$\begin{cases} g_x^M(X) = -x, & g_x^M(\tau \bar{\tau}) = g_x^M(\tau) g_x^M(\bar{\tau}) \\ g_x^M(\mathcal{J}_k \tau) = - \sum_{\ell} \frac{(-x)^\ell}{\ell!} f_x^M(\mathcal{J}_{k+\ell} \tau). \end{cases}$$

We consider $F_x^M = \Gamma_{g_x^M}$ and we have

$$\Pi_x^{M^\circ} = \Pi^{M^\circ} F_x^M, \quad \Pi_x^M = \Pi^M F_x^M$$

In that setting, the transformation Γ_{xy}^M is given by

$$\Gamma_{xy}^M = (F_x^M)^{-1} \circ F_y^M.$$

By taking $R = Id$, we obtain $M = M^\circ = Id$ which gives the same definition of Π_x and Γ_{xy} as in [Hai14b, section 8.3].

Reformulation of the conditions

In [Hai14b, (8.34)], the renormalised model (Π_x^M, Γ_{xy}^M) is defined by using a factorisation of the form:

$$\Pi_x^M = (\Pi_x \otimes g_x) \Delta^M, \quad \gamma_{x,y}^M = (\gamma_{x,y} \otimes g_y) \hat{\Delta}^M \quad (3.17)$$

where $\Gamma_{xy}^M = (1 \otimes \gamma_{xy}^M) \Delta$. We have changed the definition by replacing f_x by g_x because we have modified the coproduct Δ and Δ^+ . From [Hai14b, Proposition 8.36], given M there exists a unique choice of linear maps \hat{M} , Δ^M and $\hat{\Delta}^M$ such that

$$\hat{M} \mathcal{J}_k \tau = \mathcal{M}(\mathcal{J}_k \otimes 1) \Delta^M \tau, \quad (3.18a)$$

$$(1 \otimes \mathcal{M})(\Delta \otimes 1) \Delta^M \tau = (M \otimes \hat{M}) \Delta \tau, \quad (3.18b)$$

$$(\mathcal{A} \hat{M} \mathcal{A} \otimes \hat{M}) \Delta^+ = (1 \otimes \mathcal{M})(\Delta^+ \otimes 1) \hat{\Delta}^M$$

$$\hat{M}(\tau_1 \tau_2) = (\hat{M} \tau_1)(\hat{M} \tau_2), \quad \hat{M} X^k = X^k,$$

where \mathcal{M} is the multiplication map given by $\mathcal{M}(\tau \otimes \bar{\tau}) = \tau \bar{\tau}$ and \mathcal{A} denotes the antipode associated to Δ^+ . It is very important to note here that in general the first identity holds only if $|\mathcal{I}_k(\tau)|_s > 0$. Indeed, if $|\mathcal{I}_k(\tau)|_s \leq 0$, then the left hand side vanishes by definition (because $\mathcal{J}_k(\tau) = 0$), while the right hand side may still be non-zero!

If for every τ with $|\tau|_s < 0$, $\Delta^M \tau$ has a certain good form then (Π_x^M, Γ_{xy}^M) is a model and we obtain a renormalisation group.

Definition 3.6.13. The renormalisation group \mathcal{R} consists of the set of linear maps M commuting with \mathcal{I}_k and with multiplication by X^k , such that for $\tau \in \mathcal{H}_\alpha$ one has:

$$\Delta^M \tau \in \mathcal{H}_{\geq \alpha} \otimes \mathcal{H}_+,$$

where $\mathcal{H}_{\geq \alpha} = \bigoplus_{\beta \geq \alpha} \mathcal{H}_\beta$.

Remark 3.6.14. The last property is called "upper triangular" and it is crucial for the analytical bounds needed for a model. The map $\hat{\Delta}^M$ has also to be upper triangular. We omit this fact in the definition because it has been proven in [HQ15, Theorem A.1] that the upper triangularity of Δ^M implies the one of $\hat{\Delta}^M$.

Remark 3.6.15. This construction is really systematic but for most of the examples, one needs to guess the form of Δ^M on each $\tau \in \mathcal{T}$ with negative homogeneity and this can become difficult for very large renormalisation groups.

Let us remind some properties of the antipode:

$$\mathcal{M}(1 \otimes \mathcal{A}) \Delta^+ = \mathbf{1}^* = \mathcal{M}(\mathcal{A} \otimes 1) \Delta^+$$

where $\mathbf{1}^* \in \mathcal{H}_+^*$ is such that $\mathbf{1}^*(\tau) = \mathbb{1}_{\tau=1}$.

Lemma 3.6.16. Let $D : \mathcal{H} \otimes \mathcal{H}_+ \rightarrow \mathcal{H} \otimes \mathcal{H}_+$ given by

$$D = (1 \otimes \mathcal{M})(\Delta \otimes 1)$$

then D is invertible and D^{-1} is given by

$$D^{-1} = (1 \otimes \mathcal{M})(1 \otimes \mathcal{A} \otimes 1)(\Delta \otimes 1).$$

Proof. We have by using the fact that $(\Delta \otimes 1)\Delta = (1 \otimes \Delta^+)\Delta$ and $\mathcal{M}(1 \otimes \mathcal{M}) = \mathcal{M}(\mathcal{M} \otimes 1)$

$$\begin{aligned} D^{-1}D &= (1 \otimes \mathcal{M})(1 \otimes \mathcal{A} \otimes 1)(1 \otimes 1 \otimes \mathcal{M})((\Delta \otimes 1)\Delta \otimes 1) \\ &= (1 \otimes \mathcal{M}(\mathcal{A} \otimes \mathcal{M}))((1 \otimes \Delta^+)\Delta \otimes 1) \\ &= (1 \otimes \mathcal{M})(1 \otimes \mathcal{M}(\mathcal{A} \otimes 1) \otimes 1)((1 \otimes \Delta^+)\Delta \otimes 1) \\ &= (1 \otimes \mathcal{M})((1 \otimes \mathcal{M}(\mathcal{A} \otimes 1)\Delta^+)\Delta \otimes 1). \end{aligned}$$

Now it follows with the identities $\mathcal{M}(\mathcal{A} \otimes 1)\Delta^+ = \mathbf{1}^*$ and $(1 \otimes \mathbf{1}^*)\Delta\tau = (\tau \otimes 1)$

$$D^{-1}D = (1 \otimes \mathcal{M})((1 \otimes \mathbf{1}^*)\Delta \otimes 1) = 1 \otimes 1.$$

Using the same properties, we prove that $DD^{-1} = 1 \otimes 1$. \square

Remark 3.6.17. The previous lemma gives an explicit expression of the inverse of D . It is a refinement of [Hai14b, Proposition 8.38] which proves the fact that D is invertible.

Using explicit expression of the inverse, we change the second identity (3.18b) into

$$\Delta^M = (1 \otimes \mathcal{M})((1 \otimes \mathcal{A})\Delta M \otimes \hat{M})\Delta. \quad (3.19)$$

Alternatively, this can also be written as

$$(1 \otimes \mathcal{A})\Delta^M = (1 \otimes \mathcal{M})(\Delta M \otimes \mathcal{A}\hat{M})\Delta.$$

Remark 3.6.18. The equivalence between (3.19) and (3.18b) is in the strong sense that (3.19) holds for any given symbol τ if and only if (3.18b) holds for the same symbol τ .

Regarding the antipode \mathcal{A} , one has the recursive definition

$$\begin{aligned} \mathcal{A}\mathbf{1} &= \mathbf{1}, \quad \mathcal{A}X_i = -X_i, \quad \mathcal{A}(\tau_1\tau_2) = \mathcal{A}(\tau_1)\mathcal{A}(\tau_2), \\ \mathcal{M}(\mathbf{1} \otimes \mathcal{A})\Delta^+ \mathcal{J}_k\tau &= 0. \end{aligned}$$

which gives

$$\sum_i \frac{X^i}{i!} \mathcal{A}\mathcal{J}_{k+\ell+i}(\tau) = -\mathcal{M}(\mathcal{J}_{k+\ell} \otimes \mathcal{A})\Delta\tau. \quad (3.20)$$

We will use the fact in the next section that, as a consequence of this, one has the identities

$$\sum_\ell \mathcal{M}(\mathcal{A}\mathcal{J}_{k+\ell} \otimes \frac{X^\ell}{\ell!})\Delta\tau = -\mathcal{J}_k(\tau). \quad (3.21)$$

To see this, simply multiply both sides in (3.20) by $\frac{X^\ell}{\ell!}\mathcal{A}$ and make use of the binomial identity: $\mathbf{1} = \sum_{\ell,i} \frac{X^\ell}{\ell!} \frac{(-X)^i}{i!}$.

A recursive approach

We build two linear maps Δ^M and Δ^{M° by setting

$$\Delta^{M^\circ} \mathbf{1} = \mathbf{1} \otimes \mathbf{1}, \quad \Delta^{M^\circ} X_i = X_i \otimes \mathbf{1}, \quad \Delta^{M^\circ} \Xi = \Xi \otimes \mathbf{1},$$

and then recursively

$$\Delta^{M^\circ} \tau \bar{\tau} = (\Delta^{M^\circ} \tau)(\Delta^{M^\circ} \bar{\tau}), \quad \Delta^M \tau = \Delta^{M^\circ} R \tau, \quad (3.22)$$

as well as

$$\Delta^{M^\circ} \mathcal{I}_k(\tau) = (\mathcal{I}_k \otimes 1) \Delta^M \tau - \sum_{|\ell+m|_s \geq |\mathcal{I}_k \tau|_s} \frac{X^\ell}{\ell!} \otimes \frac{(-X)^m}{m!} \mathcal{M}(\mathcal{J}_{k+\ell+m} \otimes 1) \Delta^M \tau. \quad (3.23)$$

We claim that if M and Δ^M are defined in this way, then provided that one defines \hat{M} by (3.18a), the identity (3.18b) holds.

Proposition 3.6.19. *If M , Δ^M and \hat{M} are defined as above, then the identities (3.18) hold and M belongs to \mathfrak{R} .*

Proof. Since (3.18a) holds by definition and it is straightforward to verify that Δ^M is ‘‘upper triangular’’ (just proceed by induction using (3.23) and (3.22)), we only need to verify that (3.18b), or equivalently (3.19), holds. For this, we first note that since $\Delta^M = \Delta^{M^\circ} R$, $M = M^\circ R$, R commutes with Δ , and since R is invertible by assumption, (3.19) is equivalent to the identity

$$\Delta^{M^\circ} = (1 \otimes \mathcal{M})((1 \otimes \mathcal{A}) \Delta^{M^\circ} \otimes \hat{M}) \Delta, \quad (3.24)$$

and it is this identity that we proceed to prove now. Both sides in (3.24) are morphisms so that, by induction, it is sufficient to show that if (3.24) holds for some element τ , then it also holds for $\mathcal{I}_k(\tau)$. (The fact that it holds for $\mathbf{1}$, X_i and Ξ is easy to verify.)

Starting from (3.23), we first use (3.18a) and the fact that Δ^M and Δ^{M° agree on elements of the form $\mathcal{I}_k(\tau)$ to rewrite $\Delta^{M^\circ} \mathcal{I}_k(\tau)$ as

$$\Delta^{M^\circ} \mathcal{I}_k(\tau) = (\mathcal{I}_k \otimes 1) \Delta^M \tau + \sum_{\ell, m} \frac{X^\ell}{\ell!} \otimes \frac{(-X)^m}{m!} (\hat{M} \mathcal{J}_{k+\ell+m}(\tau) - \mathcal{M}(\mathcal{J}_{k+\ell+m} \otimes 1) \Delta^M \tau), \quad (3.25)$$

where the sum runs over all multiindices ℓ (but only finitely many terms in the sum are non-zero). By (3.21), we have

$$\begin{aligned} \mathcal{M}(\mathcal{J}_{k+\ell+m} \otimes 1) \Delta^M \tau &= - \sum_i \frac{X^i}{i!} \mathcal{M}(\mathcal{M}(\mathcal{A} \mathcal{J}_{k+\ell+m+i} \otimes 1) \Delta \otimes 1) \Delta^M \tau \\ &= - \sum_i \frac{X^i}{i!} \mathcal{M}(\mathcal{A} \mathcal{J}_{k+\ell+m+i} \otimes 1) (1 \otimes \mathcal{M})(\Delta \otimes 1) \Delta^M \tau, \end{aligned}$$

Recall that by Remark 3.6.18, the induction hypothesis implies that (3.18b) holds, so that we finally conclude that

$$\mathcal{M}(\mathcal{J}_{k+\ell+m} \otimes 1) \Delta^M \tau = - \sum_i \frac{X^i}{i!} \mathcal{M}(\mathcal{A} \mathcal{J}_{k+\ell+m+i} M \otimes \hat{M}) \Delta \tau .$$

Using again the induction hypothesis, but this time in its form (3.19), we thus obtain from (3.25) the identity

$$\begin{aligned} \Delta^{M^\circ} \mathcal{I}_k(\tau) &= (1 \otimes \mathcal{M})((\mathcal{I}_k \otimes \mathcal{A}) \Delta M \otimes \hat{M}) \Delta \tau + \sum_{\ell, m} \frac{X^\ell}{\ell!} \otimes \frac{(-X)^m}{m!} \hat{M} \mathcal{J}_{k+\ell+m}(\tau) \\ &\quad + \sum_{\ell} \frac{X^\ell}{\ell!} \otimes \mathcal{M}(\mathcal{A} \mathcal{J}_{k+\ell} M \otimes \hat{M}) \Delta \tau . \end{aligned}$$

At this stage, we see that we can use the definition of Δ to combine the first and the last term, yielding

$$\begin{aligned} \Delta^{M^\circ} \mathcal{I}_k(\tau) &= (1 \otimes \mathcal{M})((1 \otimes \mathcal{A}) \Delta \mathcal{I}_k M \otimes \hat{M}) \Delta \tau + \sum_{\ell, m} \frac{X^\ell}{\ell!} \otimes \frac{(-X)^m}{m!} \hat{M} \mathcal{J}_{k+\ell+m}(\tau) \\ &= (1 \otimes \mathcal{M})((1 \otimes \mathcal{A}) \Delta M^\circ \otimes \hat{M})(\mathcal{I}_k \otimes 1) \Delta \tau + \sum_{\ell, m} \frac{X^\ell}{\ell!} \otimes \frac{(-X)^m}{m!} \hat{M} \mathcal{J}_{k+\ell+m}(\tau) . \end{aligned}$$

We now rewrite the last term

$$\begin{aligned} \sum_{\ell, m} \frac{X^\ell}{\ell!} \otimes \frac{(-X)^m}{m!} \hat{M} \mathcal{J}_{k+\ell+m}(\tau) &= \sum_{\ell, m} (1 \otimes \mathcal{M}) \left(\frac{X^\ell}{\ell!} \otimes \frac{(-X)^m}{m!} \otimes \hat{M} \mathcal{J}_{k+\ell+m}(\tau) \right) \\ &= \sum_{\ell} (1 \otimes \mathcal{M}) \left((1 \otimes \mathcal{A}) \Delta M^\circ \frac{X^\ell}{\ell!} \otimes \hat{M} \mathcal{J}_{k+\ell}(\tau) \right) \\ &= \sum_{\ell} (1 \otimes \mathcal{M}) \left((1 \otimes \mathcal{A}) \Delta M^\circ \otimes \hat{M} \right) \left(\frac{X^\ell}{\ell!} \otimes \mathcal{J}_{k+\ell}(\tau) \right) . \end{aligned}$$

Inserting this into the above expression and using the definition of Δ finally yields (3.24) as required, thus concluding the proof. \square

Every $M \in \mathcal{R}_-$ is defined from an admissible map R . Therefore, we can establish from the previous proposition a link between \mathcal{R}_- and \mathcal{R} :

Theorem 3.6.20. *\mathcal{R}_- is a subgroup of \mathcal{R} .*

We finish the section by the proof of the recursive identity for Π_x^M :

Proposition 3.6.21. *Let $\Pi_x^M, \Pi_x^{M^\circ}$ defined from (3.17). Then these maps satisfy (3.16).*

3.7. Examples of renormalisation groups

Proof. The result follows easily for $\tau \in \{\mathbf{1}, \Xi, X\}$. Let $\tau = \prod_i \tau_i$. By multiplicativity of Π_x, g_x and Δ^{M° , we obtain

$$\Pi_x^{M^\circ} \tau = (\Pi_x \otimes g_x) \Delta^{M^\circ} \prod_i \tau_i = \prod_i ((\Pi_x \otimes g_x) \Delta^{M^\circ} \tau_i) = \prod_i \Pi_x^{M^\circ} \tau_i$$

The fact that $\Pi_x^M = \Pi_x^{M^\circ} R$ comes from $\Delta^M = \Delta^{M^\circ} R$. For $\tau' = \mathcal{I}_k(\tau)$, it follows from the fact that we have built an admissible model. \square

3.7 Examples of renormalisation groups

For the examples of this section, we define the renormalisation map M_R by using an admissible map $R = (\ell \otimes I) \Delta^\circ$ where the support of ℓ is contained in the set of symbols with negative homogeneity and without any X in their construction. Moreover for each example, we describe the structure and we look at the following properties which a model could verify or not:

Properties 3.7.1. 1. The map M commutes with G .

2. For every symbol τ , $\Pi_x^M \tau = \Pi_x M \tau$.

3. For every symbol τ , $(\Pi_x^M \tau)(x) = (\Pi_x M \tau)(x)$.

Remark 3.7.2. In this section, we will give examples which do not verify the first two properties. But the last one is verified by all the examples. In the framework of the extended structure, we directly have the second property.

We start with a toy model on the Wick renormalisation then we move on to examples based on the SPDEs regularity structure introduced in section 3.2.

3.7.1 Hermite polynomials

We look at a very simple example: the powers of a standard gaussian r.v. ξ with zero mean and covariance c^2 , which can be interpreted as a white noise on a singleton $\{x\}$. The set \mathcal{T} is given by: $\mathcal{T} = \{\Xi^n : n \in \mathbb{N}\}$ and $G = \{Id\}$. Given the natural definition

$$\Pi \Xi^n = \xi^n,$$

we want to find M such that the renormalised n -th power of ξ is the Wick product:

$$\Pi^M \Xi^n = \xi^{\diamond n} = H_n(\xi, c)$$

where H_n are generalised Hermite polynomials: $H_0 = 1$, $H_{n+1}(x, c) = xH_n(x, c) - c^2 H_n'(x, c)$.

One natural way of defining M is $M = \exp(-R)$ where $R = (\ell \otimes I)\Delta^\circ$ and $\ell(\Xi^n) = c^2 \mathbb{1}_{(n=2)}$. The multiplicative coproduct Δ° is defined by :

$$\Delta^\circ \mathbf{1} = \mathbf{1} \otimes \mathbf{1}, \quad \Delta^\circ \Xi = \Xi \otimes \mathbf{1} + \mathbf{1} \otimes \Xi.$$

On Ξ^n , we obtain the binomial formula

$$\Delta^\circ \Xi^n = \sum_{k=0}^n \binom{n}{k} \Xi^k \otimes \Xi^{n-k}.$$

This coproduct can be expressed in our general setting with the same subset $\mathfrak{A}^+(T)$. But in that case, we do not have any labels. In the next example, we will encode Ξ^n with a set of n leaves. A rooted subtree is identified with a subset of leaves.

Example 3.7.3. We present one term in the decomposition of $\Delta^\circ \Xi^8$ which is in the support of ℓ :

$$\begin{array}{cccccccc} \ell_1 & \ell_2 & \ell_3 & \ell_4 & \ell_5 & \ell_6 & \ell_7 & \ell_8 \\ \bullet & \bullet & \bullet & \bullet & \bullet & \bullet & \bullet & \bullet \end{array} \longrightarrow \begin{array}{cccccccc} \ell_3 & \ell_7 & \otimes & \ell_1 & \ell_2 & \ell_4 & \ell_5 & \ell_6 & \ell_8 \\ \bullet & \bullet & & \bullet & \bullet & \bullet & \bullet & \bullet & \bullet \end{array}.$$

We have removed the set $\{\ell_3, \ell_7\}$ from the term Ξ^8 .

Then Π^M is given by:

$$\Pi^M \Xi^n = \Pi M \Xi^n.$$

By definition, this example verifies all the three properties 3.7.1. We are able to provide a description of ℓ :

Proposition 3.7.4. *The map M is given by:*

$$M = (\ell_{wick} \otimes \mathbf{1}) \hat{\Delta}^\circ$$

where

$$\ell_{wick} = \mathbf{1}^* + \sum_{k \geq 1} (-1)^k \frac{(2k-1)!}{2^{k-1}(k-1)!} c^{2k} \mathbb{1}_{\{\Xi^{2k}\}}.$$

Proof. We use the following lemma:

Lemma 3.7.5. *For every $k \in \mathbb{N}^*$ $\frac{R^k}{k!} = (f_k \otimes I)\Delta^\circ$, where*

$$f_k = \frac{(2k-1)!}{2^{k-1}(k-1)!} c^{2k} \mathbb{1}_{\{\Xi^{2k}\}}.$$

3.7. Examples of renormalisation groups

Proof. We proceed by recurrence. It is obvious for $k = 1$. Let $k \in \mathbb{N}^*$, we suppose the property true for that integer. We have for every $n \in \mathbb{N}$

$$\begin{aligned}
\frac{R^{k+1}}{(k+1)!} \Xi^n &= \frac{1}{k+1} R(f_k \otimes 1) \Delta^\circ \Xi^n \\
&= \frac{1}{k+1} (f_k \otimes \ell \otimes 1) (1 \otimes \Delta^\circ) \sum_{m=0}^n \binom{n}{m} \Xi^m \otimes \Xi^{n-m} \\
&= \frac{1}{k+1} (f_k \otimes \ell \otimes 1) \sum_{m=0}^n \sum_{l=0}^{n-m} \binom{n}{m} \binom{n-m}{l} \Xi^m \otimes \Xi^l \otimes \Xi^{n-m-l} \\
&= \mathbb{1}_{\{n \geq 2k+2\}} \frac{1}{k+1} \frac{(2k-1)!}{2^{k-1}(k-1)!} c^{2k+2} \binom{n}{2k} \binom{n-2k}{2} \\
&= \mathbb{1}_{\{n \geq 2k+2\}} \frac{(2k+1)!}{2^k k!} c^{2k+2}.
\end{aligned}$$

□

From the previous lemma, we deduce that $\ell_{wick} = \mathbf{1}^* + \sum_{k \geq 1} (-1)^k f_k$ which concludes the proof. □

Example 3.7.6. We illustrate the previous proposition by giving one term of the decomposition of $\hat{\Delta}^\circ \Xi^8$. We identify a subforest by a collection of sets of leaves. Let $\mathcal{A} = \{\{\ell_1, \ell_5\}, \{\ell_3, \ell_7\}\}$, we have

$$\begin{array}{cccccccc}
\ell_1 & \ell_2 & \ell_3 & \ell_4 & \ell_5 & \ell_6 & \ell_7 & \ell_8 & \longrightarrow & \ell_1 & \ell_5 & \ell_3 & \ell_7 & \otimes & \ell_2 & \ell_4 & \ell_6 & \ell_8 . \\
\bullet & \bullet & \bullet & \bullet & \bullet & \bullet & \bullet & \bullet & & \bullet & \bullet & \bullet & \bullet & & \bullet & \bullet & \bullet & \bullet
\end{array}$$

The space between $\{\ell_1, \ell_5\}$ and $\{\ell_3, \ell_7\}$ means that we have a product on the forest which is different from the product in Ξ^8 . The functionals f_k and ℓ_{wick} are multiplicative for this product

3.7.2 The KPZ equation

The renormalisation group for the KPZ equation has been introduced in [Hai13] and it has been given in the setting of regularity structure in [Hai14a]. We first present the set of rules \mathcal{R}_{kpz} used for building \mathcal{T}_{kpz} :

$$\mathcal{R}_{kpz} = \{X^k, X^k \mathcal{I}_1(\cdot), X^k \mathcal{I}_1(\cdot)^2, k \in \mathbb{N}\}.$$

The admissible map R_{kpz} associated to KPZ is defined by $R_{kpz} = ((\mathbf{1}^* - \ell_{kpz}) \otimes I) \Delta^\circ$ where ℓ_{kpz} is given by:

$$\begin{aligned}
\ell_{kpz}(\mathcal{I}_1(\Xi)^2) &= C_1, & \ell_{kpz}(\mathcal{I}_1(\mathcal{I}_1(\Xi)^2)^2) &= C', \\
\ell_{kpz}(\mathcal{I}_1(\Xi) \mathcal{I}_1(\mathcal{I}_1(\Xi) \mathcal{I}_1(\mathcal{I}_1(\Xi)^2))) &= C''.
\end{aligned}$$

Otherwise, ℓ_{kpz} is zero.

Proposition 3.7.7. *The map $M = M_{R_{kpz}}$ satisfies the properties 3.7.1.*

Proof. For proving the first two properties, we need the following lemma:

Lemma 3.7.8. *For every symbol τ , $M^\circ\tau = \tau$ and there exists a polynomial P_τ such that: $M\tau = \tau + P_\tau(X)$.*

Proof. We proceed by induction. It is obvious for X and Ξ . For $\tau = \mathcal{I}_1(\tau')$, we apply the induction hypothesis on τ' which gives

$$M^\circ\mathcal{I}_1(\tau') = \mathcal{I}_1(M\tau') = \mathcal{I}_1(\tau' + P_{\tau'}(X)) = \mathcal{I}_1(\tau').$$

Let $\tau = \prod_i \tau_i$ a product of elementary symbols. From the induction hypothesis on the τ_i , it follows

$$M \prod_i \tau_i = M^\circ(R\tau - \tau) + \prod_i M^\circ\tau_i = M^\circ(R\tau - \tau) + \tau.$$

Then $R\tau - \tau$ is non zero if one element in the support of ℓ_{kpz} is a subsymbol of τ . Necessarily, τ should be of the form

- $\tau_1\mathcal{I}_1(\Xi\tau_2)\mathcal{I}_1(\Xi\tau_3)$,
- $\tau_1\mathcal{I}_1(\Xi\tau_2)\mathcal{I}_1(\tau_3\mathcal{I}_1(\Xi\tau_4)\mathcal{I}_1(\tau_5\mathcal{I}_1(\tau_6\Xi)\mathcal{I}_1(\tau_7\Xi)))$,
- $\tau_1\mathcal{I}_1(\tau_2\mathcal{I}_1(\tau_3\Xi)\mathcal{I}_1(\tau_4\Xi))\mathcal{I}_1(\tau_5\mathcal{I}_1(\tau_6\Xi)\mathcal{I}_1(\tau_7\Xi))$,

where the τ_i belong to \mathcal{T}_{kpz} . By looking, at the rule available in \mathcal{R}_{kpz} , we deduce that the τ_i should be monomials of the form X^k . Therefore, $R\tau - \tau$ is a polynomial which allows us to conclude. \square

For the first property, we proceed by induction and we also prove that M° commutes with G . Let $\Gamma \in G$, the proof is obvious for X and Ξ . Let $\tau = \mathcal{I}_1(\tau')$, it happens

$$M\Gamma\mathcal{I}_1(\tau') = M(\Gamma\mathcal{I}_1(\tau') - \mathcal{I}_1(\Gamma\tau') + \mathcal{I}_1(\Gamma\tau')) = \Gamma\mathcal{I}_1(\tau') - \mathcal{I}_1(\Gamma\tau') + \mathcal{I}_1(\Gamma M\tau').$$

On the other hand, we have

$$\Gamma M\mathcal{I}_1(\tau') = \Gamma\mathcal{I}_1(M\tau') - \mathcal{I}_1(\Gamma M\tau') + \mathcal{I}_1(\Gamma M\tau').$$

Using the previous lemma, it follows $\mathcal{I}_1(M\tau') = \mathcal{I}_1(\tau')$ and $\mathcal{I}_1(\Gamma M\tau') = \mathcal{I}_1(\Gamma\tau')$ which give the result. The same proof works for M° .

Let $\tau = \prod_i \tau_i$ a product of elementary symbols, we have

$$\begin{aligned} M\Gamma\tau &= M^\circ R\Gamma\tau = M^\circ\Gamma R\tau = M^\circ\Gamma(R\tau - \tau) + \prod_i M^\circ\Gamma\tau_i \\ &= \Gamma M^\circ(R\tau - \tau) + \prod_i \Gamma M^\circ\tau_i = \Gamma M\tau. \end{aligned}$$

3.7. Examples of renormalisation groups

where we have used the fact that M commutes with Γ on the τ_i and $R\tau$ which comes from the induction hypothesis and the fact that R commutes with G . For the second property, we proceed as the same by induction. The only difficult point is for $\tau = \mathcal{I}_1(\tau')$. We have by applying the induction hypothesis, the previous lemma on τ' and using the fact that K integrates to zero against polynomials

$$\begin{aligned} (\Pi_x^M \mathcal{I}_1 \tau')(y) &= \int D^1 K(y-z) (\Pi_x^M \tau')(z) dz \\ &\quad - \sum_{\ell} \frac{(y-x)^\ell}{\ell!} \mathbb{1}_{|\tau'|_s+1-\ell>0} \int D^{1+\ell} K(x-z) (\Pi_x^M \tau')(z) dz \\ &= \int D^1 K(y-z) (\Pi_x \tau')(z) dz \\ &\quad - \sum_{\ell} \frac{(y-x)^\ell}{\ell!} \mathbb{1}_{|\tau'|_s+1-\ell>0} \int D^{1+\ell} K(x-z) (\Pi_x \tau')(z) dz. \end{aligned}$$

which allows us to conclude. \square

3.7.3 The stochastic heat equation

This equation is given by:

$$\partial_t u = \partial_x^2 u + h(u) + f(u)\xi$$

and has been studied in [HP14] using regularity structures. The set of rules \mathcal{R}_{she} for building \mathcal{T}_{she} is:

$$\mathcal{R}_{she} = \{X^k, X^k \mathcal{I}(\cdot)^\ell \Xi, k, \ell \in \mathbb{N}\}.$$

The admissible map R_{she} associated to the stochastic equation (SHE) is defined by $R_{she} = ((1^* - \ell_{she}) \otimes I) \Delta^\circ$ where ℓ_{she} is given by:

$$\begin{aligned} \ell_{she}(\mathcal{I}(\Xi)\Xi) &= C_1, \\ \ell_{she}(\mathcal{I}(\mathcal{I}(\mathcal{I}(\Xi)\Xi)\Xi)\Xi) &= C_2, \quad \ell_{she}(\mathcal{I}(\Xi)\mathcal{I}(\mathcal{I}(\Xi)\Xi)\Xi) = C_3. \end{aligned}$$

Otherwise, ℓ_{she} is zero.

The map M_{she} is an example of a map which does not commute with the structure group G . More precisely, we have

Proposition 3.7.9. *The map $M = M_{she}$ satisfies only the third property in 3.7.1.*

Proof. One counterexample, for the first two properties is given by: $\tau = \mathcal{I}(\mathcal{I}(\mathcal{I}(\Xi)\Xi)\Xi)$, we have

$$\begin{aligned} \Gamma_g M_{she} \tau &= \Gamma_g \tau - C_1 \Gamma_g \mathcal{I}(\mathcal{I}(\Xi)) \\ M_{she} \Gamma_g \tau &= \Gamma_g \tau - C_1 \mathcal{I}(\Gamma_g \mathcal{I}(\Xi)). \end{aligned}$$

Now $\Gamma_g \mathcal{I}(\mathcal{I}(\Xi)) - \mathcal{I}(\Gamma_g \mathcal{I}(\Xi))$ is a polynomial different from zero. Similarly, one can check that $\Pi_x^M \tau \neq \Pi_x M \tau$. For the third property, we use the proposition A.2.7. We need to check that property on every $\mathcal{I}(\tau) \in \mathcal{T}_{she}$ with negative homogeneity. Such terms do not exist that ends the proof. \square

3.7.4 The generalised KPZ

The equation contains the previous equations and it is given by:

$$\partial_t u = \partial_x^2 u + g(u)(\partial_x u)^2 + h(u)\partial_x u + k(u) + f(u)\xi.$$

The set of rules \mathcal{R}_{gkpz} for building \mathcal{T}_{gkpz} is:

$$\mathcal{R}_{gkpz} = \{X^k \mathcal{I}(\cdot)^\ell, X^k \mathcal{I}(\cdot)^\ell \mathcal{I}_1(\cdot), X^k \mathcal{I}(\cdot)^\ell \mathcal{I}_1(\cdot)^2, X^k \mathcal{I}(\cdot)^\ell \Xi, k, \ell \in \mathbb{N}\}.$$

The admissible map R_{gkpz} associated to the generalised KPZ is defined by $R_{gkpz} = ((\mathbf{1}^* - \ell_{gkpz}) \otimes I)\Delta^\circ$ where ℓ_{gkpz} is given by:

$$\begin{aligned} \ell_{gkpz}(\mathcal{I}_1(\Xi)^2) &= C_1, & \ell_{gkpz}(\mathcal{I}(\Xi)\Xi) &= C_1, \\ \forall \tau, \quad \|\tau\| &= 4 \wedge |\tau|_s < 0, & \ell_{gkpz}(\tau) &= C_\tau. \end{aligned}$$

Otherwise, ℓ_{gkpz} is zero. This renormalisation group is a mix between the renormalisation group of the KPZ equation and the stochastic heat equation. Indeed, ℓ_{gkpz} can be decomposed as:

$$\ell_{gkpz} = \ell_{kpz} + \ell_{she} + \ell_{mix}$$

where the support of ℓ_{mix} are resonant terms between the two equations with four Ξ 's in their decomposition.

Proposition 3.7.10. *The map $M = M_{gkpz}$ satisfies only the third property in 3.7.1.*

Proof. The same counterexample $\tau = \mathcal{I}(\mathcal{I}(\mathcal{I}(\Xi)\Xi)\Xi)$ as in M_{she} works for the first two properties. For the third property,

$$\{\mathcal{I}_1(\tau) \mid \tau \in \mathcal{T}_{gkpz} \text{ and } |\mathcal{I}_1(\tau)|_s < 0\} = \{\mathcal{I}_1(\Xi), \mathcal{I}_1(\mathcal{I}_1(\Xi)^2), \mathcal{I}_1(\mathcal{I}_1(\Xi)\Xi)\}.$$

and $\Pi_x^M \mathcal{I}_1(\tau)(x) = (\Pi_x M \mathcal{I}_1(\tau))(x)$ for $\tau \in \{\Xi, \mathcal{I}_1(\Xi)^2, \mathcal{I}(\Xi)\Xi\}$. \square

3.7.5 The stochastic quantization

The stochastic quantization given in dimension 3 by:

$$\partial_t u = \Delta u + u^3 + \xi.$$

and has been studied in [Hai14b]. The set of rules \mathcal{R}_{qua} for building \mathcal{T}_{qua} is:

$$\mathcal{R}_{qua} = \{X^k, X^k \mathcal{I}(\cdot), X^k \mathcal{I}(\cdot)^2, \mathcal{I}(\cdot)^3, \Xi, k \in \mathbb{N}\}$$

The admissible map R_{qua} associated to the stochastic quantization is defined by $R_{qua} = ((\mathbf{1}^* - \ell_{qua}) \otimes I)\Delta^\circ$ where ℓ_{qua} is given by:

$$\ell_{qua}(\mathcal{I}(\Xi)^2) = C_4, \quad \ell_{qua}(\mathcal{I}(\Xi)^2 \mathcal{I}(\mathcal{I}(\Xi)^2)) = C_5.$$

Otherwise, ℓ_{qua} is zero.

Proposition 3.7.11. *The map $M = M_{qua}$ satisfies only the third property in 3.7.1.*

Proof. For the first two properties, a good counterexample is $\tau = \mathcal{I}(\mathcal{I}(\tau)^3)$. For the third property, $\{\mathcal{I}(\tau) \mid \tau \in \mathcal{T}_{gkpz} \text{ and } |\mathcal{I}(\tau)|_s < 0\} = \{\mathcal{I}(\Xi)\}$. then it is obvious that $\Pi_x^M \mathcal{I}(\Xi) = \Pi_x M \mathcal{I}(\Xi)$. \square

3.7. Examples of renormalisation groups

Chapter 4

Extension of the structure

In this chapter we introduce a different construction of a regularity structure associated with a subcritical SPDE. We start from the same labelled trees as in the previous chapters, but we add to each vertex an additional label which we use to keep track of the action of the renormalisation group: if we "extract" from a tree a negative subtree S rooted at $v \in T$, then we add to this second label in v the homogeneity of S ; this label participates to the computation of the homogeneity, in particular when we construct (renormalised) models.

On this *extended structure* the renormalisation group has a particularly simple form; moreover, simply by forgetting the new label, we recover the original construction and therefore the construction projects onto the old one.

4.1 New labelled trees

In most of the examples in section 3.7, we have $\Pi_x^M \neq \Pi_x M$. Indeed, if we look at a labelled tree of the form $\mathcal{I}(\tau)$. From the previous section, we know that there exist τ_i such that $M\mathcal{I}(\tau) = \mathcal{I}(M\tau) = \mathcal{I}(\tau) + \sum_i \mathcal{I}(\tau_i)$ with $|\tau_i|_s > |\tau|_s$. Then we obtain

$$\begin{aligned} (\Pi_x^M \mathcal{I}(\tau))(y) &= \int K(y-z)(\Pi_x^M \tau)(z) dz - \sum_{\ell < \lceil |\mathcal{I}(\tau)|_s \rceil} \frac{(y-x)^\ell}{\ell!} f_x^M(\mathcal{J}_\ell(\tau)) \\ (\Pi_x M\mathcal{I}(\tau))(y) &= \int K(y-z)(\Pi_x \tau)(z) dz - \sum_{\ell < \lceil |\mathcal{I}(\tau)|_s \rceil} \frac{(y-x)^\ell}{\ell!} f_x^M(\mathcal{J}_\ell(\tau)) \\ &\quad + \sum_i \left(\int K(y-z)(\Pi_x \tau_i)(z) dz - \sum_{\ell < \lceil |\mathcal{I}(\tau_i)|_s \rceil} \frac{(y-x)^\ell}{\ell!} f_x^M(\mathcal{J}_\ell(\tau_i)) \right). \end{aligned}$$

The main difference between the two identities is that we can have longer Taylor expansion in the last line because $|\tau_i|_s > |\tau|_s$. With $\tau = \mathcal{I}(\mathcal{I}(\mathcal{I}(\Xi)\Xi)\Xi)$, we obtain a counterexample to $\Pi_x^M = \Pi_x M$. We extend the structure and the maps M, Π_x in such a way that this identity turns out to be true. The main idea is to guarantee that for every labelled tree

4.1. New labelled trees

τ , one has a decomposition $M\tau = \tau + \sum_i \tau_i$ with $|\tau_i|_{ex} = |\tau|_{ex}$ where $|\cdot|_{ex}$ is a new homogeneity.

For that purpose, we use the same formalism as for \mathfrak{T} and we define \mathfrak{T}_{ex} by:

1. We give the same meaning to the node-labels, the leaves and the edge-labels as for \mathfrak{T} .
2. We add a new node-label $d : N \rightarrow \mathbb{R}$ which computes a new homogeneity. From that label, we obtain the order of the Taylor expansion we need to subtract when we define Π_x .

For a shape T , we denote by $T_{\mathfrak{e}}^{n,d}$ such labelled tree. Let x a node of T , we define T_x where its nodes are identified with $N_x = \{u : x \leq u\}$ and we also define $E^x = \{e = (x, a) \in E\}$ which are the edges above x . The new homogeneity $|\cdot|_{ex}$ of a labelled tree T with root ϱ is given by:

$$|T|_{ex} = |\mathfrak{n}(\varrho)|_{\mathfrak{s}} + \sum_{e' \in E^e} |\mathcal{P}_{e'}^\uparrow T|_{ex} + d(\varrho),$$

where

$$|\mathcal{P}_{e'}^\uparrow T|_{ex} = |\mathfrak{l}(e')| - |\mathfrak{e}(e')|_{\mathfrak{s}} + |T_u|_{ex}, \quad e' = (\varrho, u).$$

Remark 4.1.1. By induction, one can check that $|T|_{ex} = |T| + \sum_{u \in N} d(u)$.

We define one natural injection from \mathfrak{T} to \mathfrak{T}_{ex} , $\iota_{ex} : \mathfrak{T} \rightarrow \mathfrak{T}_{ex}$, which sets all the node-labels of d to zero for $T_{\mathfrak{e}}^n \in \mathfrak{T}$. The previous application can be considered as a map from \mathfrak{T}_{ex} to \mathfrak{T}_{ex} by replacing all the node labels by the new one. We denote by \mathfrak{T}^n the set of labelled trees with $d : N_T \rightarrow \mathbb{R}_-$. We do the same with the forests by setting \mathfrak{F}_{ex} as the extended forest of \mathfrak{F} . The space \mathfrak{F}^n are the forests with negative d .

Given $T_{\mathfrak{e}}^{n,d}, \hat{T}_{\hat{\mathfrak{e}}}^{\hat{n},\hat{d}} \in \mathfrak{T}^n$, we have two possible products: $T_{\mathfrak{e}}^n \hat{T}_{\hat{\mathfrak{e}}}^{\hat{n},\hat{d}} = \bar{T}_{\bar{\mathfrak{e}}}^{\bar{n},\bar{d}} \in \mathfrak{T}$ corresponds to the graph obtained by identifying the roots and the labels are given by the disjoint sum of the labels: $(\bar{n}, \bar{\mathfrak{e}}, \bar{d}) = (n + \hat{n}, \mathfrak{e} + \hat{\mathfrak{e}}, d + \hat{d})$. While $T_{\mathfrak{e}}^{n,d} \cdot \hat{T}_{\hat{\mathfrak{e}}}^{\hat{n},\hat{d}} = F_{\bar{\mathfrak{e}}}^{\bar{n},\bar{d}}$ corresponds to the disjoint union of the two labelled graphs and belongs to the set of labelled forests \mathfrak{F}^n .

Let $\mathcal{A} \in \mathfrak{A}(T)$,

- we extend $\mathcal{R}_{\mathcal{A}}^\uparrow T$ by performing the same computation and the new node-labels is $d_{\mathcal{A}}$ the restriction of d to \mathcal{A} .
- we do the same for $\mathcal{R}_{\mathcal{A}}^\downarrow T$ and for every $A \in \mathcal{A}$, we replace $d(\varrho_A)$ by $|\mathcal{R}_{\mathcal{A}}^\uparrow T|_{ex}$.

In the next example, we compute $\mathcal{R}_{\mathcal{A}}^\downarrow T$ for $\mathcal{A} = \{S_1, S_2\}$. The main difference with the extended structure is that we leave some information about the trees we have removed: their homogeneity.

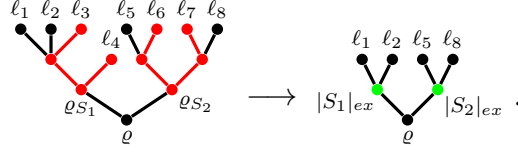

Lemma 4.1.2. For $\mathcal{C} = \mathcal{B} \uplus \mathcal{A}$ with $\mathcal{B} \in \mathfrak{A}(\mathcal{R}_A^\downarrow T)$, one has:

$$\mathcal{R}_B^\uparrow \mathcal{R}_A^\downarrow = \mathcal{R}_A^\downarrow \mathcal{R}_C^\uparrow, \quad \mathcal{R}_B^\downarrow \mathcal{R}_A^\downarrow = \mathcal{R}_C^\downarrow,$$

Proof. Let $\mathcal{A} \in \mathfrak{A}(T)$ and $\mathcal{C} = \mathcal{B} \uplus \mathcal{A}$ with $\mathcal{B} \in \mathfrak{A}(\mathcal{R}_A^\downarrow T)$. Let $A \in \mathcal{A}$, the only difference between \mathcal{R}_A^\downarrow and \mathcal{R}_A^\uparrow is the label of ρ_A the root of $\mathcal{R}_A^\uparrow T$. We have two cases:

1. If for every $B \in \mathcal{B}$, $N_A \cap N_B = \emptyset$ then $A \in \mathcal{C}$ and we obtain the same label.
2. If there exist $B \in \mathcal{B}$ and $C \in \mathcal{C}$ such that $N_A \cap N_B \neq \emptyset$ and such that $\mathcal{R}_B^\downarrow \mathcal{R}_{A^B}^\downarrow = \mathcal{R}_C^\downarrow$. Then the new label $d'(\rho_C)$ in $\mathcal{R}_C^\downarrow T$ is given by:

$$d'(\rho_C) = |\mathcal{R}_C^\uparrow T|_{ex}$$

where

$$|\mathcal{R}_C^\uparrow T|_{ex} = |\mathcal{R}_B^\uparrow \mathcal{R}_{A^B}^\downarrow T|_{ex} + \sum_{A \in \mathcal{A}^B} |\mathcal{R}_A^\uparrow T|_{ex} = |\mathcal{R}_B^\uparrow \mathcal{R}_A^\downarrow T|_{ex},$$

which allows us to conclude. □

We extend the linear map $\bar{\Delta}: \langle \mathfrak{F}_{ex} \rangle \rightarrow \langle \mathfrak{F}_{ex} \rangle \otimes \langle \mathfrak{F}_{ex} \rangle$ defined in (2.4) by

$$\bar{\Delta} F_\epsilon^{n,d} = \sum_{\mathcal{A} \in \mathfrak{A}(F)} \sum_{\mathfrak{n}_A, \epsilon_A} \frac{1}{\epsilon_A!} \binom{\mathfrak{n}}{\mathfrak{n}_A} \mathcal{R}_A^\uparrow F_\epsilon^{n_A + \pi \epsilon_A, d} \otimes \mathcal{R}_A^\downarrow F_{\epsilon + \epsilon_A}^{n - n_A, d + n_A + \pi \epsilon_A} \quad (4.1)$$

where, for $\mathcal{A} = \{S_1, \dots, S_n\}$,

1. ϵ_A runs over all \mathbf{N}^d -valued functions on E_F supported by the set of edges $(x_1, x_2) \in E_F \setminus \cup_i E_{S_i}$ such that $x_1 \in \cup_i N_{S_i}$
2. n_A runs over the set of all \mathbf{N}^d -valued functions on N_F supported by $\cup_i \overset{\circ}{N}_{S_i}$.

Proposition 4.1.3. One has: $(\bar{\Delta} \otimes 1)\bar{\Delta} = (1 \otimes \bar{\Delta})\bar{\Delta}$.

Proof. If $\mathfrak{n} = 0$, then (2.4) reduces to the somewhat cleaner identity

$$\bar{\Delta} F_\epsilon^{0,d} = \sum_{\mathcal{A} \in \mathfrak{A}(F)} \sum_{\epsilon_A} \frac{1}{\epsilon_A!} \mathcal{R}_A^\uparrow F_\epsilon^{\pi \epsilon_A, d} \otimes \mathcal{R}_A^\downarrow F_{\epsilon + \epsilon_A}^{0, d + \pi \epsilon_A}.$$

4.1. New labelled trees

One has

$$\begin{aligned}
(1 \otimes \bar{\Delta}) \bar{\Delta} F_{\epsilon}^{0,d} &= \sum_{\substack{\mathcal{A} \in \bar{\mathfrak{A}}(F) \\ \mathcal{B} \in \bar{\mathfrak{A}}(\mathcal{R}_{\mathcal{A}}^{\downarrow} F)}} \sum_{\epsilon_{\mathcal{A}}, \epsilon_{\mathcal{B}}} \frac{1}{\epsilon_{\mathcal{A}}! \epsilon_{\mathcal{B}}!} \mathcal{R}_{\mathcal{A}}^{\uparrow} F_{\epsilon}^{\pi \epsilon_{\mathcal{A}}, d} \otimes \mathcal{R}_{\mathcal{B}}^{\uparrow} \mathcal{R}_{\mathcal{A}}^{\downarrow} F_{\epsilon + \epsilon_{\mathcal{A}}}^{\pi \epsilon_{\mathcal{B}}, d + \pi \epsilon_{\mathcal{A}}} \\
&\quad \otimes \mathcal{R}_{\mathcal{B}}^{\downarrow} \mathcal{R}_{\mathcal{A}}^{\downarrow} F_{\epsilon + \epsilon_{\mathcal{A}} + \epsilon_{\mathcal{B}}}^{0, d + \pi \epsilon_{\mathcal{A}} + \pi \epsilon_{\mathcal{B}}}, \\
(\bar{\Delta} \otimes 1) \bar{\Delta} F_{\epsilon}^{0,d} &= \sum_{\substack{\mathcal{C} \in \bar{\mathfrak{A}}(F) \\ \mathcal{A} \in \mathcal{C}}} \sum_{\epsilon_{\mathcal{A}}, \epsilon_{\mathcal{C}}, n_{\mathcal{A}}^{\mathcal{C}}} \frac{1}{\epsilon_{\mathcal{C}}! \epsilon_{\mathcal{A}}!} \binom{\pi \epsilon_{\mathcal{C}}}{n_{\mathcal{A}}^{\mathcal{C}}} \mathcal{R}_{\mathcal{A}}^{\uparrow} \mathcal{R}_{\mathcal{C}}^{\uparrow} F_{\epsilon}^{n_{\mathcal{A}}^{\mathcal{C}} + \pi \epsilon_{\mathcal{A}}, d} \\
&\quad \otimes \mathcal{R}_{\mathcal{A}}^{\downarrow} \mathcal{R}_{\mathcal{C}}^{\uparrow} F_{\epsilon + \epsilon_{\mathcal{A}}}^{\pi \epsilon_{\mathcal{C}} - n_{\mathcal{A}}^{\mathcal{C}}, d + n_{\mathcal{A}}^{\mathcal{C}} + \pi \epsilon_{\mathcal{A}}} \otimes \mathcal{R}_{\mathcal{C}}^{\downarrow} F_{\epsilon + \epsilon_{\mathcal{C}}}^{0, d + \pi \epsilon_{\mathcal{C}}}.
\end{aligned}$$

So that both of these expressions are of the form

$$K(\mathbf{n}_{1,2}, \boldsymbol{\epsilon}_{1,2}) \mathcal{R}_{\mathcal{A}}^{\uparrow} F_{\epsilon}^{\mathbf{n}_1, d} \otimes \mathcal{R}_{\mathcal{A}}^{\downarrow} \mathcal{R}_{\mathcal{C}}^{\uparrow} F_{\epsilon_2}^{\mathbf{n}_2, d + \mathbf{n}_2} \otimes \mathcal{R}_{\mathcal{C}}^{\downarrow} F_{\epsilon_1}^{0, d + \epsilon_1 - \epsilon},$$

for some label functions $\mathbf{n}_{1,2}$, $\boldsymbol{\epsilon}_{1,2}$ and combinatorial factors K . At this point, the proof is quite the same as for 2.3.6. \square

We set $\delta^+ : \langle \mathfrak{F}_{ex} \rangle \mapsto \langle \mathfrak{F}_{ex} \rangle \otimes \langle \mathfrak{F}_{ex} \rangle$, $\delta^- : \langle \mathfrak{F}_{ex} \rangle \mapsto \langle \mathfrak{F}_{ex} \rangle \otimes \langle \mathfrak{F}_{ex} \rangle$

$$\delta^+ F_{\epsilon}^{n,d} := \sum_{\mathcal{A} \in \mathfrak{A}^+(F)} \sum_{\epsilon_{\mathcal{A}}, n_{\mathcal{A}}} \frac{1}{\epsilon_{\mathcal{A}}!} \binom{\mathbf{n}}{n_{\mathcal{A}}} \mathcal{R}_{\mathcal{A}}^{\uparrow} F_{\epsilon}^{n_{\mathcal{A}} + \pi \epsilon_{\mathcal{A}}, d} \otimes \mathcal{R}_{\mathcal{A}}^{\downarrow} F_{\epsilon + \epsilon_{\mathcal{A}}}^{n - n_{\mathcal{A}}, d + n_{\mathcal{A}} + \pi \epsilon_{\mathcal{A}}}, \quad (4.2)$$

$$\delta^- F_{\epsilon}^{n,d} := \sum_{\mathcal{A} \in \mathfrak{A}(F)} \sum_{\epsilon_{\mathcal{A}}, n_{\mathcal{A}}} \frac{1}{\epsilon_{\mathcal{A}}!} \binom{\mathbf{n}}{n_{\mathcal{A}}} \mathcal{R}_{\mathcal{A}}^{\uparrow} F_{\epsilon}^{n_{\mathcal{A}} + \pi \epsilon_{\mathcal{A}}, d} \otimes \mathcal{R}_{\mathcal{A}}^{\downarrow} F_{\epsilon + \epsilon_{\mathcal{A}}}^{n - n_{\mathcal{A}}, d + n_{\mathcal{A}} + \pi \epsilon_{\mathcal{A}}}. \quad (4.3)$$

Definition 4.1.4. We define the positive labelled trees \mathfrak{T}_+^n and the negative forests \mathfrak{F}_-^n as the same as for \mathfrak{T}_+ , \mathfrak{F}_- with the new homogeneity $|\cdot|_{ex}$. We consider \mathcal{P} the projection which sets the root label of d to 0:

$$\mathcal{P}T_{\epsilon}^{n,d} = T_{\epsilon}^{n,\bar{d}}, \quad \bar{d} = d - \mathbf{1}_{ex} d.$$

Let $\Pi_+ : \langle \mathfrak{F}^n \rangle \mapsto \langle \mathfrak{T}_+^n \rangle$, $\Pi_- : \langle \mathfrak{F}^n \rangle \mapsto \langle \mathfrak{F}_-^n \rangle$ be the canonical projection onto $\langle \mathfrak{T}_+^n \rangle$, resp. $\langle \mathfrak{F}_-^n \rangle$. Then we define the following maps

$$\begin{aligned}
\Delta : \langle \mathfrak{T}^n \rangle &\rightarrow \langle \mathfrak{T}^n \rangle \otimes \langle \mathfrak{T}_+^n \rangle, & \Delta &= (1 \otimes \Pi_+ \mathcal{P}) \delta^+ \\
\Delta^+ : \langle \mathfrak{T}_+^n \rangle &\rightarrow \langle \mathfrak{T}_+^n \rangle \otimes \langle \mathfrak{T}_+^n \rangle, & \Delta^+ &= (\Pi_+ \mathcal{P} \otimes \Pi_+ \mathcal{P}) \delta^+ \\
\hat{\Delta} : \langle \mathfrak{F}^n \rangle &\rightarrow \langle \mathfrak{F}_-^n \rangle \otimes \langle \mathfrak{F}^n \rangle, & \hat{\Delta} &= (\Pi_- \otimes 1) \delta^- \\
\Delta^- : \langle \mathfrak{F}_-^n \rangle &\rightarrow \langle \mathfrak{F}_-^n \rangle \otimes \langle \mathfrak{F}_-^n \rangle, & \Delta^- &= (\Pi_- \otimes \Pi_-) \delta^-.
\end{aligned}$$

We also set

$$R : \langle \mathfrak{T}^n \rangle \rightarrow \langle \mathfrak{F}_-^n \rangle \otimes \langle \mathfrak{T}^n \rangle, \quad R = (\Pi_- \otimes 1) \delta^+. \quad (4.4)$$

Remark 4.1.5. While δ^\pm take values in formal (infinite) sums, the projections Π_\pm make all sums defining Δ , Δ^+ , $\hat{\Delta}$, Δ^- and R finite.

Remark 4.1.6. By construction for every labelled tree T , one has $\Delta T = \sum_i T_i^{(1)} \otimes T_i^{(2)}$ which satisfies $|T|_{ex} = |T_i^{(1)}|_{ex} + |T_i^{(2)}|_{ex}$ thanks to the projection of \mathcal{P} . The maps R and $\hat{\Delta}$ give a decomposition of the form $\hat{\Delta} T = \sum_i T_i^{(1)} \otimes T_i^{(2)}$ with $|T|_{ex} = |T_i^{(2)}|_{ex}$. All the projections guarantee that trees with negative d are invariant under the previous maps.

From this remark, we have the identities:

Lemma 4.1.7. *One has:*

$$(\Pi_- \otimes \Pi_-)\delta^- \Pi_- = (\Pi_- \otimes \Pi_-)\delta^-, \quad (\Pi_+ \mathcal{P} \otimes \Pi_+ \mathcal{P})\delta^+ \Pi_+ \mathcal{P} = (\Pi_+ \mathcal{P} \otimes \Pi_+ \mathcal{P})\delta^+.$$

This lemma allows to prove in a similar way as in 2.4.9 and 2.4.11 that

Theorem 4.1.8. *The algebra $\langle \mathfrak{T}_+^n \rangle$ endowed with the product $(\tau, \bar{\tau}) \mapsto \tau \bar{\tau}$ and the coproduct Δ^+ is a Hopf algebra. Moreover Δ turns $\langle \mathfrak{T}^n \rangle$ into a right comodule over $\langle \mathfrak{T}_+^n \rangle$. The algebra $\langle \mathfrak{F}_-^n \rangle$ endowed with the product $(\varphi, \bar{\varphi}) \mapsto \varphi \cdot \bar{\varphi}$ and the coproduct Δ^- is a Hopf algebra. Moreover $\hat{\Delta}$ turns $\langle \mathfrak{F}^n \rangle$ into a left comodule over $\langle \mathfrak{F}_-^n \rangle$.*

We obtain the same definition for G_- and \mathcal{R}_- . If $\langle \mathfrak{F}_-^n \rangle^*$ denotes the dual of $\langle \mathfrak{F}_-^n \rangle$, then we set

$$G_- := \{\ell \in \langle \mathfrak{F}_-^n \rangle^* : \ell(\varphi_1 \cdot \varphi_2) = \ell(\varphi_1)\ell(\varphi_2), \forall \varphi_1, \varphi_2 \in \langle \mathfrak{F}_-^n \rangle\}.$$

Theorem 4.1.9. *Let*

$$\mathcal{R}_- = \{M_\ell : \langle \mathfrak{T}^n \rangle \rightarrow \langle \mathfrak{T}^n \rangle, M_\ell = (\ell \otimes 1)\hat{\Delta}, \ell \in G_-\}.$$

Then \mathcal{R}_- is a group for the composition law. Moreover, one has for $f, g \in G_-$:

$$M_f M_g = M_{f \circ g}$$

where $f \circ g$ is defined by

$$f \circ g = (g \otimes f)\Delta^-.$$

If $\langle \mathfrak{T}_+^n \rangle^$ denotes the dual of $\langle \mathfrak{T}_+^n \rangle$, then we set*

$$G_+ := \{g \in \langle \mathfrak{T}_+^n \rangle^* : g(\tau_1 \tau_2) = g(\tau_1)g(\tau_2), \forall \tau_1, \tau_2 \in \langle \mathfrak{T}_+^n \rangle\}.$$

Theorem 4.1.10. *Let*

$$\mathcal{R}_+ = \{\Gamma_g : \langle \mathfrak{T}^n \rangle \rightarrow \langle \mathfrak{T}^n \rangle, \Gamma_g = (1 \otimes g)\Delta, g \in G_+\}.$$

Then \mathcal{R}_+ is a group for the composition law. Moreover, one has for $f, g \in G_+$:

$$\Gamma_f \Gamma_g = \Gamma_{f \circ g}$$

where $f \circ g$ is defined by

$$f \circ g = (f \otimes g)\Delta^+.$$

4.1. New labelled trees

Then we extend the map $\delta^\circ : \langle \mathfrak{T}^n \rangle \mapsto \langle \mathfrak{F}^n \rangle \otimes \langle \mathfrak{T}^n \rangle$

$$\delta^\circ F_\epsilon^{n,d} := \sum_{\mathcal{A} \in \mathfrak{A}^\circ(F)} \sum_{\epsilon_{\mathcal{A}}, n_{\mathcal{A}}} \frac{1}{\epsilon_{\mathcal{A}}!} \binom{\mathbf{n}}{\mathbf{n}_{\mathcal{A}}} \mathcal{R}_{\mathcal{A}}^\uparrow F_\epsilon^{n_{\mathcal{A}} + \pi \epsilon_{\mathcal{A}}, d} \otimes \mathcal{R}_{\mathcal{A}}^\downarrow F_{\epsilon + \epsilon_{\mathcal{A}}}^{n - n_{\mathcal{A}}, d + n_{\mathcal{A}} + \pi \epsilon_{\mathcal{A}}}, \quad (4.5)$$

and

$$\bar{\Delta}^\circ : \langle \mathfrak{T}^n \rangle \mapsto \langle \mathfrak{F}_-^n \rangle \otimes \langle \mathfrak{T}^n \rangle, \quad \bar{\Delta}^\circ \stackrel{\text{def}}{=} (\Pi_- \otimes 1) \delta^\circ.$$

For all $\ell \in G_-$, we define

$$M_\ell^\circ = (\ell \otimes 1) \bar{\Delta}^\circ = (\ell \Pi_- \otimes 1) \delta^\circ.$$

Proposition 4.1.11. *Let $\ell \in G_-$ and $R_\ell \stackrel{\text{def}}{=} (\ell \otimes 1) \Delta^R$ with Δ^R as in (4.4). Then $M_\ell = M_\ell^\circ R_\ell$. Moreover for all $\ell \in G_-$, R_ℓ commutes with \mathcal{R}_+ .*

Let $\alpha \in \mathbb{R}$, we introduce a new symbol $\mathbf{1}_\alpha$ which is the tree with only one node, its root ϱ and $d(\varrho) = \alpha$. We have the following properties:

$$\mathbf{1}_\alpha \cdot \mathbf{1}_\beta = \mathbf{1}_{\alpha+\beta}, \quad \mathcal{I}(\mathbf{1}_\alpha) = 0.$$

Using this notation, we provide a formula for the projection \mathcal{P} :

$$\mathcal{P}(\mathbf{1}_\alpha \tau) = \tau, \quad (4.6)$$

where the labelled tree τ has a root label d equals to zero. We also give recursive formula using this symbol notation for δ^\pm :

$$\left\{ \begin{array}{l} \Delta^\circ \mathbf{1}_\alpha = \mathbf{1}_\alpha \otimes \mathbf{1}_\alpha, \quad \Delta^\circ X_i = X_i \otimes \mathbf{1}_{|X_i|_s} + \mathbf{1} \otimes X_i, \quad \Delta^\circ \Xi = \Xi \otimes \mathbf{1}_{|\Xi|_s} + \mathbf{1} \otimes \Xi \\ \Delta^\circ(\tau\bar{\tau}) = (\Delta^\circ\tau)(\Delta^\circ\bar{\tau}), \quad \Delta^\circ \mathcal{I}_k(\tau) = (\mathcal{I}_k \otimes \mathbf{1}_{|\mathcal{I}_k|_s}) \Delta^\circ \tau + \sum_{\ell} \frac{X^\ell}{\ell!} \otimes \mathbf{1}_{|\ell|_s} \mathcal{I}_{k+\ell}(\tau). \end{array} \right. \quad (4.7)$$

$$\left\{ \begin{array}{l} \hat{\Delta}^\circ \mathbf{1}_\alpha = \mathbf{1}_\alpha \otimes \mathbf{1}_\alpha, \quad \hat{\Delta}^\circ X_i = X_i \otimes \mathbf{1}_{|X_i|_s} + \mathbf{1} \otimes X_i, \quad \hat{\Delta}^\circ \Xi = \Xi \otimes \mathbf{1}_{|\Xi|_s} + \mathbf{1} \otimes \Xi \\ \hat{\Delta}^\circ(\tau\bar{\tau}) = (\hat{\Delta}^\circ\tau)(\hat{\Delta}^\circ\bar{\tau}), \quad \hat{\Delta}^\circ \mathcal{I}_k(\tau) = \left(\mathcal{I}_k \otimes \mathbf{1}_{|\mathcal{I}_k|_s} + \sum_{\ell} \frac{X^\ell}{\ell!} \mathcal{C} \otimes \mathbf{1}_{|\ell|_s} \mathcal{I}_{k+\ell} \right) \hat{\Delta}^\circ \tau. \end{array} \right. \quad (4.8)$$

Remark 4.1.12. If we choose a map $\ell \in G_-$ which is zero on terms of the form $\mathcal{I}_k(\tau)$ then we obtain these nice identities:

$$R_\ell \mathcal{I}_k(\tau) = \mathcal{I}_k(\tau), \quad M_\ell \mathcal{I}_k(\tau) = M_\ell^\circ \mathcal{I}_k(\tau) = \mathcal{I}_k(M\tau).$$

We finish this subsection by given a natural way of extending the definition 3.1.1 of an admissible set of labelled trees:

Definition 4.1.13. A set of labelled trees \mathcal{T}_{ex} is admissible if $\mathcal{T}_{ex} \subset \mathfrak{T}^n$, for every $T_{\mathbf{e}}^{n,d} \in \mathcal{T}_{ex}$, every node-labels $\mathbf{n}_1, \mathbf{n}_2$ such that $\mathbf{n} - \mathbf{n}_1 \geq 0$ and every admissible subtree \bar{T} of T , one has

$$\bar{T}_{\mathbf{e}}^{n-\mathbf{n}_1,d} \in \mathcal{T}_{ex}, \quad \bar{T}_{\mathbf{e}}^{n+\mathbf{n}_2,d} \in \mathcal{T}_{ex}, \quad |\bar{T}_{\mathbf{e}}^{n,d}| > \max_{\ell \in L_{\bar{T}}} |\ell|.$$

We denote by \mathcal{T}_{ex}^- , the algebra $\langle\langle \Pi_- \mathcal{T}_{ex} \rangle\rangle$ and by \mathcal{T}_{ex}^+ the algebra

$$\mathcal{T}_{ex}^+ = \{ \Pi_+ \mathcal{R}_{\mathcal{A}}^\downarrow T_{\mathbf{e}+\mathbf{e}_{\mathcal{A}}}^{n-\mathbf{n}_{\mathcal{A}},d} : \forall \mathcal{A} \in \mathfrak{A}^+(T), \forall \mathbf{n}_{\mathcal{A}}, \mathbf{e}_{\mathcal{A}} \}.$$

We extend as the same the definition of the local subcritical set of labelled trees.

Definition 4.1.14. A set of labelled trees \mathcal{T} is locally subcritical if for every $T_{\mathbf{e}}^n \in \mathcal{T}$ and every $\mathcal{E} = \{e_1, \dots, e_n\} \in \mathfrak{A}(E_T)$ one has $\mathcal{P}_{\mathcal{E}}^\downarrow T_{\mathbf{e}}^n$ admissible. Moreover, for every $T_{\mathbf{e}}^{n,d} \in \mathcal{T}$ one has $\forall \mathcal{A} \in \mathfrak{A}(T), \forall \mathbf{n}_{\mathcal{A}}, \mathbf{e}_{\mathcal{A}}$ such that $|\mathcal{R}_{\mathcal{A}}^\uparrow T_{\mathbf{e}}^{n_{\mathcal{A}}+\pi \mathbf{e}_{\mathcal{A}}}|_s \leq 0$:

$$\mathcal{R}_{\mathcal{A}}^\downarrow T_{\mathbf{e}+\mathbf{e}_{\mathcal{A}}}^{n-\mathbf{n}_{\mathcal{A}}, \mathbf{n}_{\mathcal{A}}+\pi \mathbf{e}_{\mathcal{A}}} \in \mathcal{T}.$$

Finally, every $T_{\mathbf{e}}^{n,d}$ with d different from the zero function is obtained by the previous operation.

We define the extend \mathfrak{T}_{ad}^{ex} as :

$$\mathfrak{T}_{ad}^{ex} = \{ T_{\mathbf{e}}^{n,d} \in \mathfrak{T}^n : \forall \mathbf{n}_1, \mathbf{n} - \mathbf{n}_1 \geq 0 \quad \forall \bar{T} \in \mathfrak{A}(T) \quad |\bar{T}_{\mathbf{e}}^{n-\mathbf{n}_1,d}| > \max_{\ell \in L_{\bar{T}}} |\ell| \}.$$

We define the set \mathfrak{T}_{loc}^{ex} the maximal subset for the inclusion of \mathfrak{T}_{ad}^{ex} such that \mathfrak{T}_{loc}^{ex} is locally subcritical.

4.2 Renormalised model

As for Π_x , we define a map $\hat{\Pi}_x : \mathfrak{T}^n \rightarrow \mathcal{S}'(\mathbf{R}^d)$:

$$\left\{ \begin{array}{l} (\hat{\Pi}_x \mathbf{1}_\alpha)(y) = 1, \quad (\hat{\Pi}_x \Xi)(y) = \xi(y), \quad (\hat{\Pi}_x X)(y) = y - x, \\ (\hat{\Pi}_x \tau \bar{\tau})(y) = (\hat{\Pi}_x \tau)(y) (\hat{\Pi}_x \bar{\tau})(y), \\ (\hat{\Pi}_x \mathcal{I}_k(\tau))(y) = \int D^k K(y-z) (\hat{\Pi}_x \tau)(z) dz - \sum_{\ell} \frac{(y-x)^\ell}{\ell!} \hat{f}_x(\mathcal{I}_{k+\ell}(\tau)), \end{array} \right.$$

where the map \hat{f}_x is defined by

$$\left\{ \begin{array}{l} \hat{f}_x(\mathbf{1}_\alpha) = \mathbf{1}_{\{\alpha \geq 0\}}, \quad \hat{f}_x(X) = x, \quad \hat{f}_x(\tau \bar{\tau}) = \hat{f}_x(\tau) \hat{f}_x(\bar{\tau}), \\ \hat{f}_x(\mathcal{I}_k(\tau)) = \mathbb{1}_{(|\mathcal{I}_k(\tau)|_{ex} > 0)} \int D^k K(x-z) (\hat{\Pi}_x \tau)(z) dz. \end{array} \right.$$

Remark 4.2.1. The difference between f_x and \hat{f}_x comes from the level of the cut off: we replace $|\cdot|_s$ by $|\cdot|_{ex}$. By the property $|\cdot|_{ex} \leq |\cdot|_s$, we obtain shorter Taylor expansion.

4.2. Renormalised model

Remark 4.2.2. In the definition, we consider $(\hat{\Pi}_x \tau)(y)$ instead of $(\hat{\Pi}_x \tau)(\varphi_x^\lambda)$ because the regularisation of the noise transforms all the previous elements into functions. When we have to prove the convergence of that model, we need to look at the definition with a test function.

Proposition 4.2.3. *For every $\tau \in \mathfrak{T}^n$, one has: $(\hat{\Pi}_x \tau)(y) \lesssim \|y - x\|_s^{|\tau|_{ex}}$.*

Proof. We proceed by induction. The proof is obvious for the X_i and Ξ . We apply the induction hypothesis on each τ_i in a product of the form $\tau = \prod_i \tau_i$ with $\tau_i \in \{\Xi, X_i, \mathcal{I}_k(\tau)\}$. Let $\mathcal{I}_k(\tau) \in \mathfrak{T}_{ex}$, we have:

$$\begin{aligned} (\hat{\Pi}_x \mathcal{I}_k(\tau))(y) &= \int D^k K(y - z) (\hat{\Pi}_x \tau)(z) dz - \sum_{\ell} \frac{(y - x)^\ell}{\ell!} \hat{f}_x(\mathcal{I}_{k+\ell}(\tau)) \\ &= \int D^k K(y - z) (\hat{\Pi}_x \tau)(z) dz \\ &\quad - \sum_{\ell < |\mathcal{I}_k(\tau)|_{ex}} \frac{(y - x)^\ell}{\ell!} \int D^{k+\ell} K(-z) (\hat{\Pi}_x \tau)(z) dz \end{aligned}$$

the end of the proof is the same as in [Hai14b] by applying the induction hypothesis on τ and using the theorem B.0.8 with the fact that $|\mathcal{I}_k(\tau)|_{ex} = |\mathcal{I}| - |k|_s + |\tau|_{ex}$. \square

Remark 4.2.4. For $\tau \in \mathfrak{T}$, we obtain $(\hat{\Pi}_x \tau)(y) \lesssim \|y - x\|_s^{|\tau|_s}$ which is the bound needed for a model.

We define $\hat{\Gamma}_{xy}$ by

$$\hat{\Gamma}_{xy} = \hat{\Gamma}_{\hat{g}_x^{-1}} \circ \hat{\Gamma}_{g_y} = \hat{\Gamma}_{\hat{\gamma}_{xy}},$$

where

$$\begin{cases} \hat{g}_x(\alpha) = \mathbf{1}_{\{\alpha \geq 0\}}, & \hat{g}_x(X) = -x, & \hat{g}_x(\tau \bar{\tau}) = \hat{g}_x(\tau) \hat{g}_x(\bar{\tau}), \\ \hat{g}_x(\mathcal{J}_k \tau) = - \sum_{\ell} \frac{(-x)^\ell}{\ell!} \hat{f}_x(\mathcal{J}_{k+\ell} \tau), \end{cases}$$

and

$$\hat{\gamma}_{xy} = (\hat{g}_x \mathcal{A} \otimes \hat{g}_y) \Delta^+.$$

Proposition 4.2.5. *For every $\tau \in \mathfrak{T}_+^n$, one has:*

$$|\hat{\gamma}_{xy} \tau| \leq C \|x - y\|_s^{|\tau|_{ex}},$$

where C is a constant depending only on the model.

Proof. By multiplicativity, one has to check the bound for $\tau' = \mathcal{I}_k(\tau)$:

$$\begin{aligned} \hat{\gamma}_{xy} \mathcal{J}_k(\tau) &= (\hat{g}_x \mathcal{A} \otimes \hat{g}_y) \Delta^+ \mathcal{J}_k(\tau) \\ &= (\hat{g}_x \mathcal{A} \mathcal{J}_k \otimes \hat{g}_y) \Delta \tau + \sum_{\ell} \frac{x^\ell}{\ell!} \hat{g}_y(\mathcal{J}_{k+\ell}(\tau)) \end{aligned}$$

$$\begin{aligned}
 &= \left(\sum_{\ell, m} \frac{x^\ell (-x)^m}{\ell! m!} \mathcal{M}(\hat{f}_x \mathcal{J}_{k+\ell+m} \otimes \hat{g}_x \mathcal{A}) \Delta \right) \otimes \hat{g}_y \Delta \tau \\
 &\quad - \sum_{\ell, m} \frac{x^\ell (-y)^m}{\ell! m!} \hat{f}_y(\mathcal{J}_{k+\ell+m}(\tau)) \\
 &= (\mathcal{M}(\hat{f}_x \mathcal{J}_k \otimes \hat{g}_x \mathcal{A}) \otimes \hat{f}_y)(1 \otimes \Delta^+) \Delta \tau - \sum_{\ell} \frac{(x-y)^\ell}{\ell!} \hat{f}_y(\mathcal{J}_{k+\ell}(\tau)) \\
 &= \hat{f}_x(\mathcal{J}_k \Gamma_{xy} \tau) - \sum_{\ell} \frac{(x-y)^\ell}{\ell!} \hat{f}_y(\mathcal{J}_{k+\ell}(\tau)) \\
 &= (\mathcal{J}_{xy} \tau)_k
 \end{aligned}$$

where for $a \in T_\alpha$

$$\mathcal{J}(x)a = \sum_{|k|_s < \alpha + \beta} \frac{X^k}{k!} \int_{\mathbb{R}^d} D^k K(x-y) (\Pi_x a)(y) dy,$$

and

$$\mathcal{J}_{xy} = \mathcal{J}(x) \Gamma_{xy} - \Gamma_{xy} \mathcal{J}(y).$$

From [Hai14b, lemma 5.21], we have if $|\mathcal{I}_k(\tau)|_{ex} > 0$

$$|(\mathcal{J}_{xy} \tau)_k| \leq C \|x - y\|_s^{|\mathcal{I}_k(\tau)|_{ex}}$$

where C is a constant depending only on the model. \square

Let $\ell \in G_-$ which is zero on terms of the form $\mathcal{I}_k(\tau)$. We define the renormalisation map M_ℓ by

$$M_\ell = (\ell \otimes \mathbf{1}) \hat{\Delta} \tag{4.9}$$

which is also given by $M = M_\ell = M_\ell^\circ R_\ell = M^\circ R$ with $R_\ell = (\Pi_- \otimes \mathbf{1}) \delta^+$.

Remark 4.2.6. Let $\tau \in \mathfrak{T}_{ex}$, then $M_\ell^\circ \tau \in \mathcal{H}_{|\tau|_{ex}}$ which implies $M^\circ \Pi_+ \mathcal{P} = \Pi_+ \mathcal{P} M^\circ$ where \mathcal{P} is defined as in (4.6) because the map M° does not create new root label. Moreover, we have $M^\circ \mathcal{J}_k = \mathcal{J}_k M$.

Proposition 4.2.7. *One has: $(M^\circ \otimes M^\circ) \Delta = \Delta M^\circ$ and $(M \otimes M^\circ) \Delta = \Delta M$.*

Proof. We proceed by induction. We have

$$(M \otimes M^\circ) \Delta = (M^\circ \otimes M^\circ) (R \otimes \mathbf{1}) \Delta = (M^\circ \otimes M^\circ) \Delta R = \Delta M^\circ R = \Delta M.$$

By multiplicativity, we just need to check it for $\mathcal{I}_k(\tau)$. It happens:

$$(M^\circ \otimes M^\circ) \Delta \mathcal{I}_k(\tau) = (M^\circ \otimes M^\circ) \left((\mathcal{I}_k \otimes \mathbf{1}_{|\mathcal{I}_k|_s}) \Delta \tau + \sum_{\ell} \frac{X^\ell}{\ell!} \otimes \mathbf{1}_{|\ell|_s} \mathcal{J}_{k+\ell}(\tau) \right)$$

4.2. Renormalised model

$$= (\mathcal{I}_k \otimes \mathbf{1}_{|\mathcal{I}_k|_s})(M \otimes M^\circ) \Delta \tau + \sum_{\ell} \frac{X^\ell}{\ell!} \otimes \mathbf{1}_{|\ell|_s} \mathcal{J}_{k+\ell}(M\tau).$$

On the other side, we have:

$$\Delta M^\circ \mathcal{I}_k(\tau) = \Delta \mathcal{I}_k(M\tau)$$

which allows us to conclude. \square

Proposition 4.2.8. *One has: $M^\circ \mathcal{A} = \mathcal{A} M^\circ$.*

Proof. We proceed by induction. We have by using the previous proposition:

$$\begin{aligned} M^\circ \mathcal{A} \mathcal{J}_k(\tau) &= - \sum_{\ell} \mathcal{M} \left(M^\circ \mathcal{J}_k \otimes \frac{(-X)^\ell}{\ell!} M^\circ \mathcal{A} \right) \Delta \tau \\ &= - \sum_{\ell} \mathcal{M} \left(\mathcal{J}_k M \otimes \frac{(-X)^\ell}{\ell!} \mathcal{A} M^\circ \right) \Delta \tau \\ &= - \sum_{\ell} \mathcal{M} \left(\mathcal{J}_k \otimes \frac{(-X)^\ell}{\ell!} \mathcal{A} \right) \Delta M \tau = \mathcal{A} M^\circ \mathcal{J}_k(\tau). \end{aligned}$$

\square

Remark 4.2.9. The proposition 4.2.7 tells us that even if the following identities are not true:

$$(\bar{\Delta}^\circ \otimes \bar{\Delta}^\circ) \Delta = (1 \otimes \Delta) \bar{\Delta}^\circ, \quad (\hat{\Delta} \otimes \bar{\Delta}^\circ) \Delta = (1 \otimes \Delta) \hat{\Delta},$$

one has

$$(\ell \otimes 1 \otimes \ell \otimes 1) (\bar{\Delta}^\circ \otimes \bar{\Delta}^\circ) \Delta = (\ell \otimes \Delta) \bar{\Delta}^\circ, \quad (\ell \otimes 1 \otimes \ell \otimes 1) (\hat{\Delta} \otimes \bar{\Delta}^\circ) \Delta = (\ell \otimes \Delta) \hat{\Delta}.$$

which can be replaced by

$$\mathcal{M}^{(13)(2)(4)} (\bar{\Delta}^\circ \otimes \bar{\Delta}^\circ) \Delta = (1 \otimes \Delta) \bar{\Delta}^\circ, \quad (\hat{\Delta} \otimes \bar{\Delta}^\circ) \Delta = \mathcal{M}^{(13)(2)(4)} (1 \otimes \Delta) \hat{\Delta} \quad (4.10)$$

where $\mathcal{M}^{(13)(2)(4)}$ is defined by

$$\mathcal{M}^{(13)(2)(4)} (\tau_1 \otimes \tau_2 \otimes \tau_3 \otimes \tau_4) = (\tau_1 \tau_3 \otimes \tau_2 \otimes \tau_4).$$

The identity (4.10) is similar to the one obtained in [CEM11, theorem 8]. All these properties come from the fact that M° commutes with Π_+ . The proposition presents 4.2.8 a very strong identity: M° commutes with the antipode \mathcal{A} . Finally from these propositions, we derive nice formulas for the renormalised model.

In order to obtain a renormalised model from M , we need to find \hat{M} , Δ^M and $\hat{\Delta}^M$ such that

$$\begin{aligned} (\hat{M} \otimes \mathcal{A}\hat{M}\mathcal{A})\Delta^+ &= (1 \otimes \mathcal{M})(\Delta^+ \otimes 1)\hat{\Delta}^M, \\ (M \otimes \hat{M})\Delta &= (1 \otimes \mathcal{M})(\Delta \otimes 1)\Delta^M, \\ \hat{M}\mathcal{J}_k &= \mathcal{M}(\mathcal{J}_k \otimes 1)\Delta^M \end{aligned} \quad (4.11)$$

as for the renormalised model without the extended structure. Moreover, Δ^M and $\hat{\Delta}^M$ need to be upper triangular in the sense that for every τ , $\Delta^M\tau$ and $\hat{\Delta}^M\tau$ admit a decomposition of the form $\sum_i \tau_i^{(1)} \otimes \tau_i^{(2)}$ such that $|\tau_i^{(1)}|_{ex} = |\tau|_{ex}$.

Proposition 4.2.10. *Let \hat{M} , Δ^M and $\hat{\Delta}^M$ defined by*

$$\hat{M} = M^\circ, \quad \Delta^M = M \otimes 1, \quad \hat{\Delta}^M = \hat{M} \otimes 1,$$

then they satisfy (4.11). The maps Δ^M and $\hat{\Delta}^M$ are also upper triangular.

Proof. The first two identities come from propositions 4.2.8 and 4.2.7. The last one is a consequence of $M^\circ \mathcal{J}_k = \mathcal{J}_k M$. The remark 4.2.6 gives the upper triangularity. \square

We defined the renormalised model by:

$$\hat{\Pi}_x^M = \hat{\Pi}_x M, \quad \hat{\Gamma}_{xy}^M = \hat{\Gamma}_{\hat{\gamma}_{xy}^M} = \hat{\Gamma}_{\hat{\gamma}_{xy} M^\circ}. \quad (4.12)$$

Theorem 4.2.11. *$(\hat{\Pi}_x^M, \hat{\Gamma}^M)$ is a model on every admissible set of labelled trees \mathcal{T}_{ex} with the homogeneity $|\cdot|_{ex}$.*

Proof. The algebraic properties come from the identities (4.11). For the analytical bounds, let $\tau \in \mathfrak{T}^n$, it follows:

$$(\hat{\Pi}_x^M \tau)(y) = (\hat{\Pi}_x M \tau)(y) = \sum_i (\hat{\Pi}_x \tau_i)(y) \lesssim \sum_i \|y - x\|_s^{|\tau_i|_{ex}} \lesssim \|y - x\|_s^{|\tau|_{ex}}.$$

where the τ_i satisfy $|\tau_i|_{ex} = |\tau|_{ex}$. Moreover, one has

$$\hat{\gamma}_{xy}^M \tau = \hat{\gamma}_{xy} M^\circ \tau = \sum_i \hat{\gamma}_{xy} M^\circ \tau_i \lesssim \sum_i \|y - x\|_s^{|\tau_i|_{ex}} \lesssim \|y - x\|_s^{|\tau|_{ex}}.$$

where the τ_i satisfy $|\tau_i|_{ex} = |\tau|_{ex}$. \square

4.3 Comments

The major aim of the extended structure is to provide a simple construction of the renormalised model. In this section, we recap what it has been done in that field and we focus on the major improvements offered by the extended structure. In [Hai14b, (8.34)], the renormalised model (Π_x^M, Γ_{xy}^M) is defined with a factorisation of the form:

$$\Pi_x^M = (\Pi_x \otimes g_x)\Delta^M, \quad \gamma_{x,y}^M = (\gamma_{x,y} \otimes g_y)\hat{\Delta}^M$$

where $\Gamma_{xy}^M = (1 \otimes \gamma_{xy}^M)\Delta$. Then we need to find \hat{M} , Δ^M and $\hat{\Delta}^M$ such that

$$\begin{aligned} (\hat{M} \otimes \mathcal{A}\hat{M}\mathcal{A})\Delta^+ &= (1 \otimes \mathcal{M})(\Delta^+ \otimes 1)\hat{\Delta}^M, \\ (M \otimes \hat{M})\Delta &= (1 \otimes \mathcal{M})(\Delta \otimes 1)\Delta^M, \\ \hat{M}\mathcal{J}_k &= \mathcal{M}(\mathcal{J}_k \otimes 1)\Delta^M \end{aligned}$$

The existence of such maps given a map M has been proved in [Hai14b]. But this proof does not give an explicit formula for the maps Δ^M and $\hat{\Delta}^M$. In order to get a model, we have to check the upper triangularity of Δ^M and $\hat{\Delta}^M$. Therefore, one needs to guess the form of Δ^M and $\hat{\Delta}^M$ on each $\tau \in \mathcal{T}$ with negative homogeneity. This has been done in [Hai14b], [HP14]. One major improvement is the recursive formula for M introduced in 2.4.18 by $M = M^\circ R$ when we are considering a map M given by: $M = M_\ell = (\ell \otimes 1)\hat{\Delta}$ where $\ell \in G_-$. This definition provides a recursive formulation for Δ^M and allows us to have a direct proof. In [HQ15], it has been proved thanks to a complicate recursive formula that the upper triangularity of Δ^M implies the one of $\hat{\Delta}^M$. Finally, the map Π_x^M is given recursively in (3.16) by:

$$\left\{ \begin{array}{l} (\Pi_x^{M^\circ} \mathbf{1})(y) = 1, \quad (\Pi_x^{M^\circ} \Xi)(y) = \xi(y), \quad (\Pi_x^{M^\circ} X)(y) = y - x, \\ (\Pi_x^{M^\circ} \mathcal{I}_k \tau)(y) = \int D^k K(y-z)(\Pi_x^M \tau)(z) dz - \sum_{\ell} \frac{(y-x)^\ell}{\ell!} f_x^M(\mathcal{J}_{k+\ell}(\tau)), \\ (\Pi_x^M \tau)(y) = (\Pi_x^{M^\circ} R\tau)(y), \quad (\Pi_x^{M^\circ} \tau \bar{\tau})(y) = (\Pi_x^{M^\circ} \tau)(y)(\Pi_x^{M^\circ} \bar{\tau})(y) \end{array} \right.$$

The extended structure provides a simpler answer to the definition of the renormalised model. The maps \hat{M} , Δ^M and $\hat{\Delta}^M$ are just given by:

$$\hat{M} = M^\circ, \quad \Delta^M = M \otimes 1, \quad \hat{\Delta}^M = \hat{M} \otimes 1,$$

which provide natural algebraic properties:

$$\Pi_x^M = \Pi_x M, \quad \Gamma_{xy}^M = \Gamma_{\gamma_{xy}^M} = \Gamma_{\gamma_{xy} M^\circ}.$$

We conserve all the Hopf algebra structure and the definition of M does not differ from the one in the normal structure. We will use this formulation in the next chapters.

Chapter 5

Convergence of the models

The construction of the previous chapters gives algebraic formulae for the renormalised model associated with a subcritical SPDE. Now we want to consider the "concrete" random objects $\hat{\Pi}_x^\varepsilon$ and study their convergence as $\varepsilon \rightarrow 0$. To this aim we compute their L^2 norms which are represented as norms of appropriate integral kernels. Therefore to a labelled tree T_ε^n we associate a finite family of integral kernels (the integration variables being indexed by the vertices of T).

These integral kernels have themselves a combinatorial structure, and we code them by graphs which are obtained from the tree T with a class of transformations, which include addition and displacement of edges and modification of the labels. In this chapter, we provide tools for the proof of the convergence of the model in the general case for local subcritical SPDEs with space-time white noise. The next theorem which has been proved in the case of the stochastic heat equation with multiplicative noise in [HP14] will be proved in the next chapter for the generalised KPZ equation.

Theorem 5.0.1. *Let $(\Pi_x^{M_\varepsilon}, \Gamma_{xy}^{M_\varepsilon})$ be the renormalised model described in chapter 4. Then there exist a random model (Π_x, Γ_{xy}) and a constant C such that for every underlying compact space-time domain*

$$\mathbb{E}\|\Pi^{M_\varepsilon}; \Pi\| \leq C\varepsilon^{\kappa/2}.$$

5.1 From abstract trees to graphs

We consider a renormalised model $(\hat{\Pi}_x, \hat{\Gamma}_{xy}) = (\Pi_x^M, \Gamma_{xy}^M)$ on the extended structure where $M_\varepsilon = M_{\ell_\varepsilon}$ is defined as in (4.9) by:

$$M_\varepsilon T_\varepsilon^n = \sum_{A \in \mathfrak{A}(T)} \sum_{\varepsilon_A, n_A} \frac{1}{\varepsilon_A!} \binom{\mathbf{n}}{\mathbf{n}_A} \ell_\varepsilon \left(\Pi_- \mathcal{R}_A^\uparrow T_\varepsilon^{n_A + \pi \varepsilon_A} \right) \mathcal{R}_A^\downarrow T_{\varepsilon + \varepsilon_A}^{n - n_A, n_A + \pi \varepsilon_A}. \quad (5.1)$$

By [Hai14b, thm 10.7], we only need to prove that for every $\tau \in \mathcal{T}$ with $|\tau|_s < 0$, we have

$$\mathbb{E}(|(\hat{\Pi}_x^\varepsilon \tau)(\varphi_x^\lambda)|^2) \lesssim \lambda^{2|\tau| + \kappa}, \quad \mathbb{E}(|(\hat{\Pi}_x^\varepsilon \tau - \hat{\Pi} \tau)(\varphi_x^\lambda)|^2) \lesssim \varepsilon^\kappa \lambda^{2|\tau| + \kappa} \quad (5.2)$$

5.1. From abstract trees to graphs

for some $\kappa > 0$, uniformly over $0 \leq \varepsilon \leq 1$, $\lambda \in (0, 1]$, smooth test function φ and locally uniformly in x . The rescaled function φ_x^λ is defined as in (1.4).

Since the kernels are invariant by translation, it is enough to consider the case $x = 0$. Until the end of the section, we use the shorthand notation φ_λ for φ_0^λ . It has been noticed in [Hai14b] that $\hat{\Pi}_0^\varepsilon \tau$ belongs to the inhomogeneous Wiener chaos of order $\|\tau\|$ where $\|\tau\|$ is the number of Ξ in τ . In order to compute the covariance of $(\hat{\Pi}_0^\varepsilon \tau)(\varphi_\lambda)$, we decompose this process onto its k -th homogeneous Wiener chaos $(\hat{\Pi}_0^{\varepsilon,k} \tau)(\varphi_\lambda)$:

$$(\hat{\Pi}_0^\varepsilon \tau)(\varphi_\lambda) = \sum_{k \leq \|\tau\|} (\hat{\Pi}_0^{\varepsilon,k} \tau)(\varphi_\lambda).$$

Then by orthogonality of the different chaoses, we obtain:

$$\mathbb{E}(|(\hat{\Pi}_0^\varepsilon \tau)(\varphi_\lambda)|^2) = \sum_{k \leq \|\tau\|} \mathbb{E}(|(\hat{\Pi}_0^{\varepsilon,k} \tau)(\varphi_\lambda)|^2).$$

Each term $\hat{\Pi}_0^{\varepsilon,k} \tau$ can be described by a kernel $\hat{W}^{\varepsilon,k} \tau$ in $L^2(\mathbb{R}^d)^{\otimes k}$ through a map $f \mapsto I_k(f)$ which satisfies:

$$\mathbb{E}(I_k(f)^2) \leq k! \|f\|^2 \quad (5.3)$$

where $\|\cdot\|$ is the L^2 norm. Finally, we obtain:

$$\mathbb{E}(|(\hat{\Pi}_0^\varepsilon \tau)(\varphi_\lambda)|^2) \leq \sum_{k \leq \|\tau\|} \langle \hat{W}^{\varepsilon,k} \tau, \hat{W}^{\varepsilon,k} \tau \rangle.$$

It remains to find a nice description of $\hat{W}^{\varepsilon,k} \tau$ in order to compute their L^2 norm. Using the extended structure, we have:

$$\begin{aligned} (\hat{\Pi}_0^\varepsilon T_\varepsilon^n)(\varphi_\lambda) &= (\Pi_0^\varepsilon M_\varepsilon T_\varepsilon^n)(\varphi_\lambda) \\ &= \sum_{\mathcal{A} \in \mathfrak{A}(T)} \sum_{\mathbf{e}_\mathcal{A}, \mathbf{n}_\mathcal{A}} \frac{1}{\mathbf{e}_\mathcal{A}!} \binom{\mathbf{n}}{\mathbf{n}_\mathcal{A}} \ell_\varepsilon \left(\Pi_- \mathcal{R}_\mathcal{A}^\uparrow T_\varepsilon^{\mathbf{n}_\mathcal{A} + \pi \mathbf{e}_\mathcal{A}} \right) \left(\Pi_0^\varepsilon \mathcal{R}_\mathcal{A}^\downarrow T_{\varepsilon + \mathbf{e}_\mathcal{A}}^{\mathbf{n} - \mathbf{n}_\mathcal{A}, \mathbf{n}_\mathcal{A} + \pi \mathbf{e}_\mathcal{A}} \right) (\varphi_\lambda). \end{aligned}$$

Then, we obtain:

$$\hat{W}^{\varepsilon,k} T_\varepsilon^n = \sum_{\mathcal{A} \in \mathfrak{A}(T)} \sum_{\mathbf{e}_\mathcal{A}, \mathbf{n}_\mathcal{A}} \frac{1}{\mathbf{e}_\mathcal{A}!} \binom{\mathbf{n}}{\mathbf{n}_\mathcal{A}} \ell_\varepsilon \left(\Pi_- \mathcal{R}_\mathcal{A}^\uparrow T_\varepsilon^{\mathbf{n}_\mathcal{A} + \pi \mathbf{e}_\mathcal{A}} \right) W^{\varepsilon,k} \left(\mathcal{R}_\mathcal{A}^\downarrow T_{\varepsilon + \mathbf{e}_\mathcal{A}}^{\mathbf{n} - \mathbf{n}_\mathcal{A}, \mathbf{n}_\mathcal{A} + \pi \mathbf{e}_\mathcal{A}} \right)$$

where $W^{\varepsilon,k}$ is defined using the recursive definition of Π_0^ε . Until the rest of this chapter, we denote by x_{v_0} the zero of \mathbb{R}^d .

Definition 5.1.1. Let $T_\varepsilon^{n,d} \in \mathfrak{T}^n$. For $k \geq 0$ we want to define $W^{\varepsilon,k} T_\varepsilon^{n,d} \in (L^2(\mathbb{R}^d))^{\otimes k}$ such that

$$\Pi_0^\varepsilon T_\varepsilon^{n,d}(\varphi_\lambda) = \sum_{k \leq |L_T|} \Pi_0^{\varepsilon,k} T_\varepsilon^{n,d}(\varphi_\lambda) = \sum_{k \leq |L_T|} I_k(W^{\varepsilon,k} T_\varepsilon^{n,d}).$$

If $k + |L_T| \notin 2\mathbb{N}$ or $k > |L_T|$ we set $W^{\varepsilon,k} T_\varepsilon^{n,d} := 0$ and we suppose thereafter that $k + |L_T| \in 2\mathbb{N}$. We fix an arbitrary order of L_T .

- We first set $K_e : (\mathbb{R}^d)^2 \rightarrow \mathbb{R}$ for all $e = (e_+, e_-) \in E_T$

– if $e_- \notin L_T$

$$\hat{K}_e(x_{e_+}, x_{e_-}) := \left(D^{\epsilon(e)} K(x_{e_+} - x_{e_-}) - \sum_{|j|_s < r_e} \frac{(x_{e_+})^j}{j!} D^{\epsilon(e)+j} K(-x_{e_-}) \right)$$

where $r_e := \lceil |T_{e_+}|_{ex} \rceil \vee 0$ and T_{e_+} is the subtree of T above e_+ , namely the nodes of T_{e_+} are $N_{e_+} = \{v \in T : v \wedge e_+ = e_+\}$.

– if $e_- \in L_T$

$$\hat{K}_e(x_{e_+}, x_{e_-}) := \varrho_\varepsilon(x_{e_+} - x_{e_-}).$$

- Now we define $(\mathcal{W}^\varepsilon T_\varepsilon^{n,d}) : (\mathbb{R}^d)^{\{\varrho_T\} \cup L_T} \rightarrow \mathbb{R}$

$$(\mathcal{W}^\varepsilon T_\varepsilon^{n,d})(x_v, v \in \{\varrho_T\} \cup L_T) := \int_{(\mathbb{R}^d)^{|\bar{N}_T|}} \prod_{u \in N_T} (x_u)^{n(u)} \prod_{e \in E_T} \hat{K}_e(x_{e_+}, x_{e_-}) \prod_{v \in \bar{N}_T} dx_v$$

where $\bar{N}_T = N_T \setminus (\{\varrho_T\} \cup L_T)$.

- Now we denote by $L_k(T)$ the set of all $\sigma : \{\varrho_T\} \cup L_T \rightarrow \{0, 1, \dots, (|L_T| + k)/2\}$ such that

– $\sigma(\varrho_T) = 0$

– for all $i \in \{0, 1, \dots, (|L_T| + k)/2\}$, $|\sigma^{-1}(i)| \in \{1, 2\}$

– $|\sigma^{-1}(i)| = 1$ for all $i \in \{0, 1, \dots, k\}$ and $\sigma^{-1} : \{1, \dots, k\} \rightarrow L_T$ is increasing (with respect to the fixed arbitrary order on L_T)

– $|\sigma^{-1}(i)| = 2$ for all $i \in \{k+1, \dots, (|L_T| + k)/2\}$.

- Then we can define $\mathcal{W}^{\varepsilon,k} T_\varepsilon^{n,d} : (\mathbb{R}^d)^{k+1} \rightarrow \mathbb{R}$

$$(\mathcal{W}^{\varepsilon,k} T_\varepsilon^{n,d})(y_0, y_1, \dots, y_k) = \sum_{\sigma \in L_k(T)} \int_{(\mathbb{R}^d)^{\frac{|L_T|+k}{2}}} (\mathcal{W}^\varepsilon T_\varepsilon^{n,d})(y_{\sigma(v)}, v \in \{\varrho_T\} \cup L_T) \prod_{i=k+1}^{\frac{|L_T|+k}{2}} dy_i.$$

- Finally we set $W^{\varepsilon,k} T_\varepsilon^{n,d} : (\mathbb{R}^d)^k \rightarrow \mathbb{R}$

$$(W^{\varepsilon,k} T_\varepsilon^{n,d})(y_1, \dots, y_k) = \int_{\mathbb{R}^d} \varphi_\lambda(y_0) (\mathcal{W}^{\varepsilon,k} T_\varepsilon^{n,d})(y_0, y_1, \dots, y_k) dy_0.$$

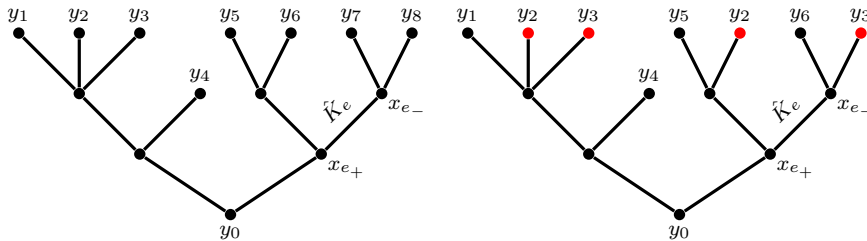

5.1. From abstract trees to graphs

In the figure just above, the first tree represents $\mathcal{W}^\varepsilon T_\varepsilon^{n,d}$ then we give one element of $\mathcal{W}^{\varepsilon,4} T_\varepsilon^{n,d}$. The leaves which are integrated are in red.

Remark 5.1.2. The formula for \hat{K}_ε is given by a Taylor expansion of the form

$$f(y) - \sum_{j < r} \frac{(y-x)^j}{j!} D^j f(x)$$

where $f := D^{\varepsilon(e)} K$, $x = -x_{e_-}$, $y - x = x_{e_+}$, $y = x_{e_+} - x_{e_-}$. This comes from the definition of Π_x and its action on the abstract integration operator.

In the next definition, we give our candidate for ℓ_ε :

Definition 5.1.3. Let $T_\varepsilon^{n,d} \in \mathfrak{T}_-^n$ then ℓ_ε is defined recursively by: $\ell_\varepsilon(\mathbf{1}) = 1$, if $|L_T| \notin 2\mathbb{N}$ then $\ell_\varepsilon(T_\varepsilon^{n,d}) = 0$, otherwise

$$\ell_\varepsilon(T_\varepsilon^{n,d}) = - \sum_{\mathcal{A} \in \mathfrak{A}(T) \setminus \{\{T\}\}} \sum_{\varepsilon_{\mathcal{A}}, n_{\mathcal{A}}} \frac{1}{\varepsilon_{\mathcal{A}}!} \binom{\mathbf{n}}{n_{\mathcal{A}}} \ell_\varepsilon(\Pi_- \mathcal{R}_{\mathcal{A}}^\uparrow T_\varepsilon^{n_{\mathcal{A}} + \pi \varepsilon_{\mathcal{A}}, d}) \tilde{\mathcal{W}}^{\varepsilon,0}(\mathcal{R}_{\mathcal{A}}^\downarrow T_\varepsilon^{n-n_{\mathcal{A}}, d+n_{\mathcal{A}}+\pi \varepsilon_{\mathcal{A}}}),$$

where, using the notations of Definition 5.1.1,

- $\tilde{\mathcal{W}}^\varepsilon T_\varepsilon^{n,d} : (\mathbb{R}^d)^{\{\varrho_T\} \cup L_T} \rightarrow \mathbb{R}$

$$(\tilde{\mathcal{W}}^\varepsilon T_\varepsilon^{n,d})(x_v, v \in \{\varrho_T\} \cup L_T) := \int_{(\mathbb{R}^d)^{|\bar{N}_T|}} \prod_{u \in \bar{N}_T} (x_u - x_{\varrho_T})^{n(u)} \prod_{e \in E_T} K_e(x_{e_+}, x_{e_-}) \prod_{v \in \bar{N}_T} dx_v,$$

where K_e is defined as follows: if $e_- \in L_T$

$$K_e(x_{e_+}, x_{e_-}) := \varrho_\varepsilon(x_{e_+} - x_{e_-})$$

while if $e_- \notin L_T$

$$K_e(x_{e_+}, x_{e_-}) = D^{\varepsilon(e)} K(x_{e_+} - x_{e_-}).$$

- $\tilde{\mathcal{W}}^{\varepsilon,0} T_\varepsilon^{n,d} : \mathbb{R}^d \rightarrow \mathbb{R}$

$$(\tilde{\mathcal{W}}^{\varepsilon,0} T_\varepsilon^{n,d})(y_0) = \sum_{\sigma \in L_0(T)} \int_{(\mathbb{R}^d)^{\frac{|L_T|}{2}}} (\tilde{\mathcal{W}}^\varepsilon T_\varepsilon^{n,d})(y_{\sigma(v)}, v \in \{\varrho_T\} \cup L_T) \prod_{i=1}^{\frac{|L_T|}{2}} dy_i.$$

- By translation invariance, $(\tilde{\mathcal{W}}^{\varepsilon,0} T_\varepsilon^{n,d})(y_0)$ does not depend on y_0 and is therefore equal to a constant that we call $\tilde{W}^{\varepsilon,0} T_\varepsilon^{n,d} \in \mathbb{R}$.

Remark 5.1.4. Let $F_\varepsilon^{n,d} = (T_1)_{\varepsilon_1}^{n_1, d_1} \cdot \dots \cdot (T_n)_{\varepsilon_n}^{n_n, d_n}$ a labelled forest, then we extend the definition of \mathcal{W}^ε , $\tilde{\mathcal{W}}^{\varepsilon,0}$ by setting

$$\mathcal{W}^\varepsilon(F_\varepsilon^{n,d}) = \prod_{i=1}^n \mathcal{W}^\varepsilon((T_i)_{\varepsilon_i}^{n_i, d_i}), \quad \tilde{\mathcal{W}}^{\varepsilon,0}(F_\varepsilon^{n,d}) = \prod_{i=1}^n \tilde{\mathcal{W}}^{\varepsilon,0}((T_i)_{\varepsilon_i}^{n_i, d_i}).$$

Definition 5.1.5. Let $\mathcal{A} = \{T_1, \dots, T_n\} \in \mathfrak{A}(T)$. We set

1. $k(\mathcal{A}) := |L_T| - \|\mathcal{A}\| = |L_T| - \sum_{T_i \in \mathcal{A}} \|T_i\|$, where $\|T_i\|$ is the number of leaves in T_i
2. $L(\mathcal{A})$ is the set of all $\sigma \in L_{k(\mathcal{A})}(T)$ such that for all $i = k(\mathcal{A}) + 1, \dots, \frac{|L_T| + k(\mathcal{A})}{2}$ there exists $j \in \{1, \dots, n\}$ such that $\sigma^{-1}(i) \subset T_j$.

In other words, σ belongs to $L(\mathcal{A})$ if and only if:

- for two leaves $v_1, v_2 \in L(T)$ with $v_1 \neq v_2$, we have $\sigma(v_1) = \sigma(v_2)$ only if v_1 and v_2 belong to the same tree $T_j \in \mathcal{A}$
- for each $T_j \in \mathcal{A}$ and $v_1 \in T_j$ there is one (and only one) $v_2 \in T_j$ such that $\sigma(v_1) = \sigma(v_2)$
- $\sigma(v) \in \{1, \dots, k\}$ for all $v \in L_T \setminus L_{\mathcal{A}}$.

Then we set for $k = k(\mathcal{A})$:

$$(\mathcal{P}_{\mathcal{A}}\mathcal{W}^\varepsilon(T_\varepsilon^n))(y_0, y_1, \dots, y_k) = \sum_{\sigma \in L(\mathcal{A})} \int_{(\mathbb{R}^d)^{\frac{|L_T| - k}{2}}} (\mathcal{W}^\varepsilon T_\varepsilon^{n,d})(y_{\sigma(v)}, v \in \{\varrho_T\} \cup L_T) \prod_{i=k+1}^{\frac{|L_T| + k}{2}} dy_i.$$

Remark 5.1.6. From the previous definition, we obtain another description of the k -th Wiener chaos:

$$\mathcal{W}^{\varepsilon,k}(T_\varepsilon^n) = \sum_{\mathcal{A} \in \mathfrak{A}_k(T)} \mathcal{P}_{\mathcal{A}}\mathcal{W}^\varepsilon(T_\varepsilon^n) + \bar{\mathcal{W}}^{\varepsilon,k}(T_\varepsilon^n) \quad (5.4)$$

where $\mathfrak{A}_k(T) = \{\mathcal{A} \in \mathfrak{A}(T) : \|\mathcal{A}\| = |L_T| - k\}$ and $\bar{\mathcal{W}}^{\varepsilon,k}(T_\varepsilon^n)$ are the other components.

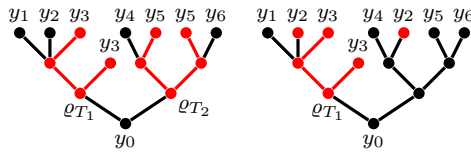

The first tree represents $\mathcal{P}_{\mathcal{A}}\mathcal{W}^\varepsilon(T_\varepsilon^n)$ with $\mathcal{A} = \{T_1, T_2\} \in \mathfrak{A}_4(T)$. The other tree is one of the terms in $\bar{\mathcal{W}}^{\varepsilon,k}(T_\varepsilon^n)$: we have made another contraction in $\mathcal{P}_{\mathcal{A}}\mathcal{W}^\varepsilon(T_\varepsilon^n)$ with $\mathcal{A} = \{T_1\} \in \mathfrak{A}_6(T)$ which does not create a contraction in $\mathfrak{A}_4(T)$.

The strategy of the proof is the following:

- We use a variant of a general theorem for labelled graphs introduced in [HQ15] which covers terms of the form $\langle \hat{W}^{\varepsilon,k}_\tau, \hat{W}^{\varepsilon,k}_\tau \rangle$.

5.2. Bounds on Labelled Graphs

- We start by proving bounds for $W^{\varepsilon, \|\tau\|_\tau}$ which give bounds also for the W^{ε, k_τ} with $k < \|\tau\|$. One crucial argument for these bounds is the admissibility of our trees given in 3.1.1. At this stage, we know exactly which divergent parts in W^{ε, k_τ} have to be renormalised.
- We perform a renormalisation procedure by ‘hand’ in order to treat these divergences. Then we systematize this idea by the use of a telescopic sum which is equal to W^ε_τ . The previous decomposition determines the values of the map ℓ_ε .
- We end the proof by making the pairing (scalar product) of two renormalised graphs (kernels).

5.2 Bounds on Labelled Graphs

In this section, we present a slight modification of the convergence theorem given in [HQ15] which is useful for more complex diverging patterns. Each scalar product $\langle \hat{W}^{\varepsilon, k_\tau}, \hat{W}^{\varepsilon, k_\tau} \rangle$ can be represented by a sum of terms $\mathcal{I}_\lambda(K)$ defined by:

$$\mathcal{I}_\lambda(K) = \int \int \varphi_\lambda(x) \varphi_\lambda(y) J(x, y) dx dy$$

where J is obtained from generalised convolution of other kernels. The integral $\mathcal{I}_\lambda(K)$ can be rewritten using a directed graph $G = (\mathcal{V}, \mathcal{E})$:

$$\mathcal{I}_\lambda(K) = \int_{(\mathbb{R}^d)^{\mathcal{V}_0}} \prod_{e \in \mathcal{E}} \hat{J}_e(x_{e_+}, x_{e_-}) \prod_{v \in \mathcal{V}_0} dx_v$$

where

- every directed edge $e \in \mathcal{E}$ is denoted by $e = (e_+, e_-)$
- G has three distinguished vertices $\mathcal{V}_\star = \{v_0, v_{\star,1}, v_{\star,2}\}$
- \mathcal{V}_0 is the set $\mathcal{V} \setminus \{v_0\}$
- for all $v \in \mathcal{V}_0$, dx_v is the Lebesgue measure on \mathbb{R}^d .

We still have to define the kernels \hat{J}_e . To each edge $e \in \mathcal{E}$ we associate

- a label $(a_e, r_e, v_e) \in \mathbb{R} \times \mathbb{Z} \times \mathcal{V}$
- a kernel $J_e : \mathbb{R}^d \setminus \{0\} \rightarrow \mathbb{R}$ which is compactly supported in a ball of radius 1 around the origin and such that

$$|D^k J_e(x)| \lesssim \|x\|_s^{-a_e - |k|_s}$$

holds uniformly over x with $\|x\|_s \leq 1$ and for multiindices k .

By definition, we have for $e \in \mathcal{E}$:

$$\hat{J}_e(x_{e_+}, x_{e_-}) = J_e(x_{e_+} - x_{e_-}) - \sum_{|j|_{\mathfrak{s}} < r_e} \frac{(x_{e_+} - x_{v_e})^j}{j!} D^j J_e(x_{v_e} - x_{e_-}).$$

Here

- a_e is the order of the singularity of the kernel J_e associated to the edge e .
- the integer r_e gives the order of the Taylor expansion of the edge e and $v_e \in \mathcal{V}$ gives the point $x_{v_e} \in \mathbb{R}^d$ around which we expand our kernel.

For $d > 0$, we define the following semi-norm for the functions J_e given by:

$$\|J_e\|_{a_e, d} = \sup_{|k|_{\mathfrak{s}} < d} \sup_{0 < \|x\|_{\mathfrak{s}} \leq 1} \|x\|_{\mathfrak{s}}^{a_e + |k|_{\mathfrak{s}}} |D^k J_e(x)|.$$

We assume that $v_{\star,1}$ and $v_{\star,2}$ are connected to v_0 by two edges with label $(0, 0, v_0)$.

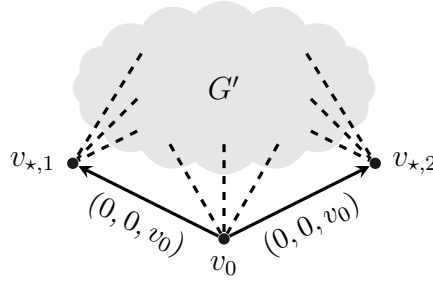

We will often write (a_e, r_e) instead of (a_e, r_e, v_e) when $v_e = v_0$. In fact, $v_e \neq v_0$ implies a negative renormalisation for the convergence. For $v_e = v_0$, this is the positive renormalisation given by the Taylor expansion in $\hat{\Pi}$.

Remark 5.2.1. Let T_ϵ^n a labelled tree, these labelled graphs encode all the kernel coming from the Wiener chaos decomposition of $(\Pi_0^\epsilon T_\epsilon^n)(\varphi_\lambda)$. Indeed, the kernel $W^\epsilon(T_\epsilon^n)$ is obtained by

- the test function φ_λ is encoded by the edge between v_0 and one distinguished edge labelled $(0, 0)$.
- the label $(|\mathfrak{s}| + \kappa, 0)$ with $\kappa > 0$ is for the molifier ϱ_ϵ and is replaced in the limit by a delta function. The molifier is present in the labelled tree as a leaf and is linked to the tree with a zero labelled edge when we face a product of the form $\mathcal{I}(\cdot)\Xi$.
- an edge e such that $0 \leq a_e < |\mathfrak{s}|$ is associated to the same edge in the labelled tree and the kernel J_e is given by $D^{e(e)}K$. For the other labels, we have $v_e = v_0$ and $r_e = \lceil |T_e|_{\mathfrak{s}} \rceil \vee 0$ where T_e is the tree above $e = (e_+, e_-)$ in T_ϵ^n , $T_e = (\mathcal{V}_e, \mathcal{E}_0(\mathcal{V}_e))$ and $\mathcal{V}_e = \{v \in \mathcal{V} \setminus \{v_0\} : e_+ \wedge v = e_+\}$.

5.2. Bounds on Labelled Graphs

- the node label in T_ϵ^n is transformed into edges with label $(a_e, 0)$ between the inner nodes and the node v_0 such that for every inner node u in T , $a_{(u,v_0)} = -|\mathbf{n}(u)|_s$.

Finally, we only integrate the variables corresponding to the inner nodes. Using this matching, we build a labelled graph from a labelled tree but with only two distinguished vertices. Then by merging some leaves, we obtain terms in $W^{\epsilon,k}(T_\epsilon^n)$ and by taking two terms in $W^{\epsilon,k}(T_\epsilon^n)$ as labelled graph we build a term in $\langle \hat{W}^{\epsilon,k}_T, \hat{W}^{\epsilon,k}_T \rangle$.

For any $\bar{\mathcal{V}} \subset \mathcal{V}$, we also define the following subsets of \mathcal{E} :

- $\mathcal{E}^\uparrow(\bar{\mathcal{V}}) := \{e \in \mathcal{E} : e \cap \bar{\mathcal{V}} = e_-\}$, the set of edges which exit $\bar{\mathcal{V}}$
- $\mathcal{E}^\downarrow(\bar{\mathcal{V}}) = \{e \in \mathcal{E} : e \cap \bar{\mathcal{V}} = e_+\}$, the set of edges which enter $\bar{\mathcal{V}}$
- $\mathcal{E}_0(\bar{\mathcal{V}}) = \{e \in \mathcal{E} : e \cap \bar{\mathcal{V}} = e\}$, the set of edges which are contained in $\bar{\mathcal{V}}$
- $\mathcal{E}(\bar{\mathcal{V}}) = \{e \in \mathcal{E} : e \cap \bar{\mathcal{V}} \neq \emptyset\}$, the union of the previous sets.

We suppose that our graph G satisfies the following assumptions:

Assumption 3. 1. For every subset $\bar{\mathcal{V}} \subset \mathcal{V}$, one has

$$\sum_{e \in \mathcal{E}_0(\bar{\mathcal{V}})} a_e + \sum_{e \in \mathcal{E}^\uparrow(\bar{\mathcal{V}})} \mathbb{1}_{\{v_e \in \bar{\mathcal{V}} \wedge r_e > 0\}} (a_e + r_e - 1) - \sum_{e \in \mathcal{E}^\downarrow(\bar{\mathcal{V}})} \mathbb{1}_{\{v_e \in \bar{\mathcal{V}}\}} r_e < (|\bar{\mathcal{V}}| - 1) |\mathfrak{s}| \quad (5.5)$$

2. For every non-empty subset $\bar{\mathcal{V}} \subset \mathcal{V} \setminus \mathcal{V}_*$, one has the bound:

$$\begin{aligned} \sum_{e \in \mathcal{E}_0(\bar{\mathcal{V}})} a_e + \sum_{e \in \mathcal{E}^\downarrow(\bar{\mathcal{V}})} (\mathbb{1}_{\{v_e \in \bar{\mathcal{V}} \vee r_e = 0\}} (a_e + r_e - 1) - (r_e - 1)) \\ + \sum_{e \in \mathcal{E}^\uparrow(\bar{\mathcal{V}})} ((a_e + r_e) - \mathbb{1}_{v_e \in \bar{\mathcal{V}}} r_e) > |\bar{\mathcal{V}}| |\mathfrak{s}| \end{aligned} \quad (5.6)$$

We want to prove that these assumptions are satisfied by a class of graphs constructed with local subcritical rules. One important information on a graph G will be its homogeneity

$$|G|_s = |\mathcal{V} \setminus \mathcal{V}_*| |\mathfrak{s}| - \sum_{e \in \mathcal{E}} a_e.$$

Theorem 5.2.2. *Consider a labelled graph G as above satisfying Assumption 3 and a collection of kernels K associated to the graph. Then, there exist $d > 0$ and a constant C depending only on the cardinality of \mathcal{V} such that*

$$|\mathcal{I}_\lambda(K)| \leq C \lambda^{|\mathcal{G}|_s} \prod_{e \in \mathcal{E}} \|K_e\|_{a_e, d}, \quad \lambda \in (0, 1].$$

Example 5.2.3. We present few examples in the maximum chaos order from KPZ terms where $|\mathfrak{s}| = 3$ and the singularity at the origin of the heat kernel is 1:

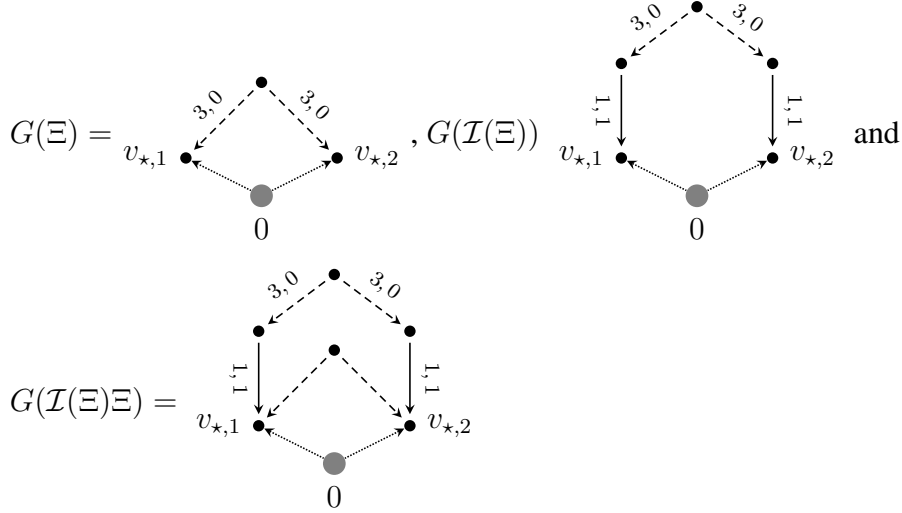

Remark 5.2.4. In most of the examples, the kernel J_e can take few values: K , K' and $\varrho_\varepsilon^{(2)} = \varrho_\varepsilon * \varrho_\varepsilon$ where K is the singular part of the heat kernel around the origin. It has been noticed in [HP14] that for any $d > 0$:

$$\|K\|_{1,d} + \|K'\|_{2,d} < \infty, \quad \sup_{\varepsilon \in (0,1]} \|\varrho_\varepsilon^{(2)}\|_{3,d} < \infty, \quad \sup_{\varepsilon \in (0,1]} \varepsilon^{-\kappa} \|\varrho_\varepsilon^{(2)}\|_{3+\kappa,d} < \infty,$$

for every $\kappa \in (0, 1)$. When we want to prove the convergence of the model, we need to check

$$\mathbb{E}(|(\hat{\Pi}_0^\varepsilon \tau - \hat{\Pi}_0 \tau)(\varphi_\lambda)|^2) \lesssim \varepsilon^\kappa \lambda^{2|\tau|+\kappa}. \quad (5.7)$$

We perform the same Wiener chaos decomposition on $(\hat{\Pi}_0^\varepsilon \tau - \hat{\Pi}_0 \tau)(\varphi_\lambda)$ as for $(\hat{\Pi}_0^\varepsilon \tau)(\varphi_\lambda)$. The kernel associated to each Wiener chaos is slightly different: it can be expressed by a sum of terms similar to those of $(\hat{\Pi}_0^\varepsilon \tau)(\varphi_\lambda)$ but instead of just having ϱ_ε we obtain δ and $\varrho_\varepsilon - \delta$. These terms will check the same bounds as for $(\hat{\Pi}_0^\varepsilon \tau)(\varphi_\lambda)$ and they will contain at least one $\varrho_\varepsilon - \delta$ which gives the bound in (5.7).

Remark 5.2.5. The proof of the theorem 5.2.2 is based on two main ingredients:

- the decomposition of the kernels into a sum of kernels with decreasing compact support.
- a partition of the domain of integration using trees.

For the proof, we follow the main steps given in [HQ15] and we omit the proof of some lemmas which can be found in [HQ15].

5.2.1 Decomposition of the kernels

We will use the following lemma given in [HQ15]

Lemma 5.2.6. *For each $e \in \mathcal{E}$, there exists a sequence of kernels $\{K_e^{(n)}\}_{n \geq 0}$ such that:*

- One has $K_e(x) = \sum_{n \geq 0} K_e^{(n)}(x)$ for all $x \neq 0$.
- The kernel $K_e^{(n)}$ is supported in the annulus $A_n = \{x : \|x\|_s \in [2^{-(n+2)}, 2^{-n}]\}$.
- For all k , the bound

$$|D^k K_e^{(n)}(x)| \lesssim 2^{(a_e + |k|_s)n},$$

holds uniformly in n .

With these properties, we can decompose the kernel $\prod_{e \in \mathcal{E}} \hat{K}_e$. For every $n = (k, p, m) \in \mathbb{N}^3$ and every edge $e \in \mathcal{E}$, if $r_e > 0$ we define a function $\hat{K}_e^{(n)}(y, x)$ by

$$\hat{K}_e^{(n)}(y, x) = \Psi^{(k)}(y - x) \Psi^{(p)}(x_{v_e} - x) \Psi^{(m)}(y - x_{v_e}) \left(K_e(y - x) - \sum_{|j|_s < r_e} \frac{(y - x_{v_e})^j}{j!} D^j K_e(x_{v_e} - x) \right).$$

Else $\hat{K}_e^{(n)}(y, x)$ is just given by

$$\hat{K}_e^{(n)}(y, x) = \Psi^{(k)}(y - x) K_e(y - x),$$

where the function $\Psi^{(n)}$ is defined from $\psi : \mathbb{R} \rightarrow [0, 1]$ a smooth function supported on $[3/8, 1]$ such that $\sum_{n \in \mathbb{Z}} \psi(2^n x) = 1$ for every $x \neq 0$. We set for every $n \in \mathbb{N}$:

$$\Psi^{(n)}(x) = \psi(2^n x).$$

This function gives also the decomposition of the previous lemma, one has $K_e^{(n)}(x) = \Psi^{(n)}(x) K_e(x)$.

In our graph, we have two vertices $v_{1,\star}$ and $v_{2,\star}$ which are connected to the origin through the kernels φ^λ . We obtain

$$\mathcal{I}_\lambda(K) = \sum_{n \in \mathcal{N}_\lambda} \int_{(\mathbb{R}^d)^{\mathcal{V}_0}} \hat{K}^{(n)}(x) dx, \quad \hat{K}^{(n)}(x) = \prod_{e \in \mathcal{E}} \hat{K}_e^{(n_e)}(x_{e_+}, x_{e_-})$$

where \mathcal{N}_λ is the set of functions $n : \mathcal{V}^2 \rightarrow \mathbb{N}^3$ such that $2^{-|n_e|} \leq \lambda$ for the two edges $(v_{\star,i}, 0)$.

5.2.2 Partition of the integration domain

We denote by $\mathcal{B}(\mathcal{V})$ the set of all labelled rooted binary trees which have \mathcal{V} as their set of leaves and we impose a condition on the labelling:

$$\ell_v \geq \ell_w \text{ for } v \geq w$$

where $v \geq w$ means that w belongs to the shortest path connecting v to the root vertex. The following notation will be useful: $u \wedge w$ is the most recent common ancestor of v and w . In the following tree, we have $\ell_{v_1 \wedge v_2} \geq \ell_{v'}$.

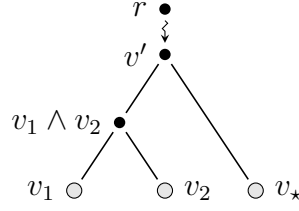

The labelled trees (B, ℓ) make a partition of the domain of integration. The labelling ℓ means that for any $v, w \in \mathcal{V}$, we have:

$$\|v - w\|_s \sim 2^{-\ell_{v \wedge w}}.$$

Definition 5.2.7. Let $(B, \ell) \in \mathcal{B}(\mathcal{V})$ and $c > 0$. The set $\mathcal{N}_c(B, \ell)$ consists of all functions $n : \mathcal{V}^2 \rightarrow \mathbb{N}^3$ such that for every edge $e = (v, w)$:

- If $n_e = (m, 0, 0)$ then

$$|m - \ell_{v \wedge w}| \leq c.$$

- Else $n_e = (k, m, o)$ and:

$$|k - \ell_{v \wedge w}| \leq c, \quad |m - \ell_{v \wedge v_e}| \leq c, \quad |o - \ell_{w \wedge v_e}| \leq c.$$

Lemma 5.2.8. *There exists $c > 0$ such that, for every $n : \mathcal{V}^2 \rightarrow \mathbb{N}^3$ such that $\hat{K}^{(n)}$ as defined as before is non-vanishing, there exists an element $(B, \ell) \in \mathcal{B}(\mathcal{V})$ with $n \in \mathcal{N}_c(B, \ell)$.*

If we denote by $\mathcal{B}_\lambda(\mathcal{V})$ the subset in $\mathcal{B}(\mathcal{V})$ with the property that $2^{-\ell_{v \wedge w}} \leq \lambda$ for $v, w \in \mathcal{V}_*$, then it follows

$$|\mathcal{I}_\lambda(K)| \lesssim \sum_{B \in \mathcal{B}_\lambda(\mathcal{V})} \sum_{n \in \mathcal{N}_c(B, \ell)} \left| \int_{(\mathbb{R}^d)^{\mathcal{V}_0}} \hat{K}^{(n)}(x) dx \right|.$$

We define $\mathcal{D}(B, \ell, C) \subset (\mathbb{R}^d)^{\mathcal{V}_0}$ such that $\|x_v - x_w\|_s \leq C 2^{\ell_{v \wedge w}}$ for $v, w \in \mathcal{V}$.

Lemma 5.2.9. *Let $\mathcal{D}(B, \ell, C)$ as above.*

5.2. Bounds on Labelled Graphs

- There exists \hat{C} such that the support of $\hat{K}^{(n)}$ is contained in $\mathcal{D}(B, \ell, \hat{C})$ for $n \in \mathcal{N}_c(B, \ell)$.
- If we consider B° the set of interior vertices in B , then

$$\mu(\mathcal{D}(B, \ell, \hat{C})) \lesssim \prod_{v \in B^\circ} 2^{-\ell_v |s|}$$

where μ is the lebesgue measure.

As a consequence of the previous lemma, it follows

$$|\mathcal{I}_\lambda(K)| \lesssim \sum_{(B, \ell) \in \mathcal{B}_\lambda(\mathcal{V})} \sum_{n \in \mathcal{N}_c(B, \ell)} \left(\prod_{v \in B^\circ} 2^{-\ell_v |s|} \right) \sup_x |\hat{K}^{(n)}(x)|. \quad (5.8)$$

We notice that

$$\sup_x |\hat{K}^{(n)}(x)| \leq \prod_{e \in \mathcal{E}} \sup_x |\hat{K}_e^{(n_e)}(x_{e_+}, x_{e_-})|.$$

We need to have a bound on $\hat{K}_e^{(n_e)}(x_{e_+}, x_{e_-})$. Let $e \in \mathcal{E}$, $n \in \mathcal{N}_c(B, \ell)$ and $n_e = (k, p, m)$. It follows

$$|k - \ell_{x_{e_+} \wedge x_{e_-}}| \leq c, \quad |p - \ell_{x_{e_-} \wedge x_{v_e}}| \leq c, \quad |m - \ell_{x_{e_+} \wedge x_{v_e}}| \leq c,$$

when $r_e > 0$. The comparison between m and k gives different bounds. Indeed from theorem B.0.8, we have the identity:

$$\begin{aligned} \hat{K}_e^{(n_e)}(x_{e_+}, x_{e_-}) &= \Psi^{(k)}(x_{e_+} - x_{e_-}) \Psi^{(p)}(x_{v_e} - x_{e_-}) \Psi^{(m)}(x_{e_+} - x_{v_e}) \\ &\quad \left(K_e(x_{e_+} - x_{e_-}) - \sum_{|j|_s < r_e} \frac{(x_{e_+} - x_{v_e})^j}{j!} D^j K_e(x_{v_e} - x_{e_-}) \right) \\ &= \Psi^{(k)}(x_{e_+} - x_{e_-}) \Psi^{(p)}(x_{v_e} - x_{e_-}) \Psi^{(m)}(x_{e_+} - x_{v_e}) \sum_{|r|_s = r_e} \int_{\mathbb{R}^d} D^r K_e(y) \mathcal{Q}_e^r(x, dy). \end{aligned}$$

where the kernel \mathcal{Q}_e^r has the property:

$$\mathcal{Q}_e^r(x, \mathbb{R}^d) \lesssim \|x_{e_+} - x_{v_e}\|_s^{r_e}.$$

There exists a constant C_0 such that

1. If $m \geq k + C_0$, then

$$\sup_x |\hat{K}_e^{n_e}(x_{e_+}, x_{e_-})| \lesssim 2^{-r_e m + (a_e + r_e)k} \sim 2^{-r_e \ell_{x_{e_+} \wedge x_{v_e}} + (a_e + r_e) \ell_{x_{e_+} \wedge x_{e_-}}}.$$

2. If $k \geq m + C_0$, then

$$\sup_x |\hat{K}_e^{n_e}(x_{e_+}, x_{e_-})| \lesssim 2^{a_e k} + \sum_{|j|_s < r_e} 2^{-m|j|_s + (a_e + |j|_s)p} \lesssim 2^{a_e k}.$$

3. If $k \sim m$ then

$$\sup_x |\hat{K}_e^{n_e}(x_{e_+}, x_{e_-})| \lesssim 2^{a_e k} + \sum_{|j|_s < r_e} 2^{-m|j|_s + (a_e + |j|_s)p} \lesssim 2^{(a_e + r_e - 1)p - (r_e - 1)m}.$$

We denote by A^+ , A and A^- , the previous configurations. They are represented in the next figure:

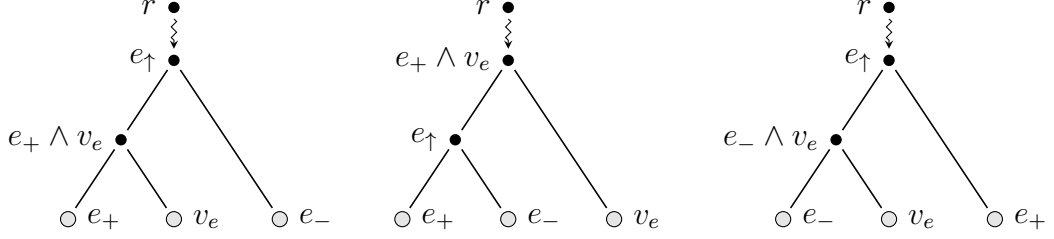

1) 2) 3)

where we have set $e_\uparrow = e_+ \wedge e_-$. When $r_e = 0$, we simply have the following bound:

$$\sup_x |\hat{K}_e^{n_e}(x_{e_+}, x_{e_-})| \lesssim 2^{a_e k}.$$

Denoting by B° the inner nodes of B and by A_0 the set of edges such that $r_e = 0$, we define a function $\eta : B^\circ \rightarrow \mathbb{R}$ by $\eta = \sum_{e \in \mathcal{E}} \eta_e$ where

$$\begin{aligned} \eta_e(v) = & \mathbf{1}_{e \in A} (-a_e \mathbf{1}_{e_\uparrow}(v)) + \mathbf{1}_{e \in A^+} (r_e \mathbf{1}_{e_+ \wedge v_e}(v) - (a_e + r_e) \mathbf{1}_{e_\uparrow}(v)) \\ & - \mathbf{1}_{e \in A^-} ((a_e + r_e - 1) \mathbf{1}_{e_- \wedge v_e}(v) - (r_e - 1) \mathbf{1}_{e_\uparrow}(v)) + \mathbf{1}_{e \in A_0} (-a_e \mathbf{1}_{e_\uparrow}(v)). \end{aligned}$$

We have

$$\sup_x |\hat{K}_e^{(n_e)}(x_{e_+}, x_{e_-})| \lesssim \prod_{v \in B^\circ} 2^{-\ell_v \eta_e(v)}$$

and

$$\sup_x |\hat{K}^{(n)}(x)| \lesssim \prod_{v \in B^\circ} 2^{-\ell_v \eta(v)}.$$

Therefore from the previous inequality and from (5.8):

$$|\mathcal{I}_\lambda(K)| \lesssim \sum_{B \in \mathcal{B}_\lambda(\mathcal{V})} \sum_{n \in \mathcal{N}_\lambda(B)} \prod_{v \in B^\circ} 2^{-\ell_v \tilde{\eta}(v)}$$

where $\tilde{\eta}(v) = |s| + \eta(v)$. We want to prove our theorem for every labelled tree in $\mathcal{B}_\lambda(\mathcal{V})$

For a rooted tree B with a fixed distinguished vertex $v_\star \in B$, we consider a function $\eta : B \rightarrow \mathbb{R}$ and:

$$\mathcal{I}_\lambda(B, \eta) = \sum_{n \in \mathcal{N}_\lambda(B)} \prod_{v \in B} 2^{-n_v \eta_v}.$$

We set $|\eta| = \sum_{v \in B} \eta_v$ and we have the following bound

Theorem 5.2.10. *The function η satisfies the following two properties:*

5.2. Bounds on Labelled Graphs

- For every $v \in B$, one has $\sum_{u \geq v} \eta_u > 0$.
- For every $v \in B$ such that $v_\star \geq v$, one has $\sum_{u \not\geq v} \eta_u < 0$, if this sum contains at least one term.

Then, one has $\mathcal{I}_\lambda(B, \eta) \sim \lambda^{|\eta|}$, uniformly over $\lambda \in (0, 1]$.

We want to check the two conditions of the previous theorem on our map $\tilde{\eta}$. For the first condition, let $v \in B^o$ and we consider $L_v \subset \mathcal{V}$ the leaves attached to v . We need to have

$$\begin{aligned} \sum_{u \geq v} \tilde{\eta}(u) &= |\mathfrak{s}|(|L_v| - 1) + \sum_{u \geq v} \left(\sum_{e \in A} (-a_e \mathbb{1}_{e_\uparrow}(u)) + \sum_{e \in A^+} (r_e \mathbb{1}_{e_+ \wedge v_e}(u) - (a_e + r_e) \mathbb{1}_{e_\uparrow}(u)) \right) \\ &\quad - \sum_{e \in A^-} ((a_e + r_e - 1) \mathbb{1}_{e_- \wedge v_e}(u) - (r_e - 1) \mathbb{1}_{e_\uparrow}(u) - \sum_{e \in A_0} (a_e \mathbb{1}_{e_\uparrow}(u))) \\ &= |\mathfrak{s}|(|L_v| - 1) - \sum_{e \in \mathcal{E}_0(L_v)} a_e - \sum_{e \in \mathcal{E}^\uparrow(L_v)} \mathbb{1}_{v_e \in L_v} (a_e + r_e - 1) + \sum_{e \in \mathcal{E}^\downarrow(L_v)} \mathbb{1}_{v_e \in L_v} r_e > 0 \end{aligned}$$

where we have used the fact that the cardinality of $\{u \in B^o : u \geq v\}$ is equal to $|L_v| - 1$. In the next array, we compute the contribution of the edge e depending on what set, it belongs to:

	$\mathcal{E}_0(L_v)$	$\mathcal{E}^\uparrow(L_v)$	$\mathcal{E}^\downarrow(L_v)$
A^+	a_e	0	$-\mathbb{1}_{v_e \in \bar{\mathcal{V}}} r_e$
A	a_e	0	0
A^-	a_e	$\mathbb{1}_{v_e \in \bar{\mathcal{V}}} (a_e + r_e - 1)$	0
A_0	a_e	0	0

For the second condition, we fix a node $v \in B^o$ such that $v_\star \geq v$. Denoting by $U_v = \{u \in B^o : u \not\geq v\}$ and $\bar{\mathcal{V}}$ the set of leaves attached to U_v . We note that $\bar{\mathcal{V}} \subset \mathcal{V} \setminus \mathcal{V}_\star$ where $\bar{\mathcal{V}}$ is the set of leaves attached to U_v . Moreover, we have $|\bar{\mathcal{V}}| = |U_v|$. It follows

$$\begin{aligned} \sum_{u \in U_v} \tilde{\eta}(u) &= |\mathfrak{s}| |\bar{\mathcal{V}}| - \sum_{u \in U_v} \left(\sum_{e \in A} (-a_e \mathbb{1}_{e_\uparrow}(u)) + \sum_{e \in A^+} (r_e \mathbb{1}_{e_+ \wedge v_e}(u) - (a_e + r_e) \mathbb{1}_{e_\uparrow}(u)) \right) \\ &\quad - \sum_{e \in A^-} ((a_e + r_e - 1) \mathbb{1}_{e_- \wedge v_e}(u) - (r_e - 1) \mathbb{1}_{e_\uparrow}(u) - \sum_{e \in A_0} (a_e \mathbb{1}_{e_\uparrow}(u))). \end{aligned}$$

We compute the different cases:

	$\mathcal{E}_0(\bar{\mathcal{V}})$	$\mathcal{E}^\uparrow(\bar{\mathcal{V}})$	$\mathcal{E}^\downarrow(\bar{\mathcal{V}})$
A^+	a_e	$(a_e + r_e) - \mathbb{1}_{v_e \in \bar{\mathcal{V}}} r_e$	a_e
A	a_e	a_e	a_e
A^-	a_e	a_e	$\mathbb{1}_{v_e \in \bar{\mathcal{V}}} (a_e + r_e - 1) - (r_e - 1)$
A_0	a_e	a_e	a_e

Then

$$\begin{aligned} \sum_{u \in U_v} \tilde{\eta}(u) &\leq |\mathfrak{s}| |\bar{\mathcal{V}}| - \sum_{e \in \mathcal{E}_0(\bar{\mathcal{V}})} a_e - \sum_{e \in \mathcal{E}^\downarrow(\bar{\mathcal{V}})} (\mathbb{1}_{v_e \in \bar{\mathcal{V}}} \mathbb{1}_{v_e \in A_0} (a_e + r_e - 1) - (r_e - 1)) \\ &\quad - \sum_{e \in \mathcal{E}^\uparrow(\bar{\mathcal{V}})} ((a_e + r_e) - \mathbb{1}_{v_e \in \bar{\mathcal{V}}} r_e) < 0. \end{aligned}$$

The conditions of the theorem 5.2.10 are equivalent to the conditions 5.2.2 which concludes the proof.

5.3 Elementary Labelled Graphs

We will not consider general labelled graphs but some graphs built with elementary components. Elementary labelled graphs represent integral kernels and are obtained by some transformations of the original labelled tree. To an elementary graph corresponds a labelled tree T_ϵ^n such that the elementary graph encodes $\Pi_0^\epsilon T_\epsilon^n$. In this section, we present a recursive construction of the elementary graphs and we give some bounds on them by checking the assumptions of the theorem 5.2.2.

Definition 5.3.1. An elementary labelled graph is a graph $G = (\mathcal{V}, \mathcal{E})$ connected with two distinguished vertices $\mathcal{V}_\star = \{v_0, v_\star\}$ with the edge label $(a_e, r_e, v_e) \in \mathbb{R} \times \mathbb{N} \times \mathcal{V}$ such that

- This graph is almost a tree in the sense that $\bar{T} = (\bar{\mathcal{V}}, \bar{\mathcal{E}}) = (\mathcal{V} \setminus \{v_0\}, \mathcal{E} \setminus E_{v_0})$ is a tree where $E_{v_0} = \{(v, v_0) \in \mathcal{E}\}$, all the edges which contain v_0 belong to E_{v_0} and v_\star is its root. Moreover it can be associated to a labelled tree T_ϵ^n such that
 - $E_T = \bar{\mathcal{E}}, N_T = N_{\bar{T}}$ and $L_T = L_{\bar{T}}$
 - for every edge $e \in E_T$, $a_e = |\mathfrak{s}| + |\mathfrak{e}(e)|_\mathfrak{s} - |\mathfrak{l}(e)|_\mathfrak{s}$
 - for every edge $e \in \{e : e_- \in L_T\}$, $a_e = |\mathfrak{s}| + \kappa$, $|\mathfrak{e}(e)|_\mathfrak{s} = |\mathfrak{l}(e)|_\mathfrak{s} = 0$ and $|\mathfrak{l}(e_-)|_\mathfrak{s} = -|\mathfrak{s}|/2 - \kappa = \alpha$ with $\kappa > 0$
 - for every node $v \in N_T$, $(a_{(v, v_0)}, r_{(v, v_0)}, v_{(v, v_0)}) = (-|\mathfrak{n}(v)|_\mathfrak{s}, 0, v_0)$.
- For every edge e of \bar{T} , one has: $r_e = \lceil |T_e|_\mathfrak{s} \rceil \vee 0$ where T_e is the tree above $e = (e_+, e_-)$, $T_e = (\mathcal{V}_e, \mathcal{E}_0(\mathcal{V}_e))$ and $\mathcal{V}_e = \{v \in \mathcal{V} \setminus \{v_0\} : e_+ \wedge v = e_+\}$.

Remark 5.3.2. In practice, we compute the elementary labelled graph from a labelled tree T_ϵ^n . The algorithm has been described in 5.2.1.

We define the homogeneity of an elementary labelled graph T by:

$$|G|_\mathfrak{s} = \left(|\mathring{N}_G| + \frac{|L_G|}{2} - 2 \right) |\mathfrak{s}| - \sum_{e \in \mathcal{E}} a_e.$$

5.3. Elementary Labelled Graphs

In the definition of the homogeneity, the term -2 means that we do not want to count the distinguished vertices.

We denote by $|T_\epsilon^n|_s$ the homogeneity of the labelled tree $T_\epsilon^n \in \mathfrak{T}$, which is given by

$$|T_\epsilon^n|_s = \sum_{u \in L_T \sqcup E_T} |\mathfrak{l}(u)|_s + \sum_{x \in \dot{N}_T} |\mathfrak{n}(x)|_s - \sum_{e \in E_T} |\mathfrak{e}(e)|_s.$$

Proposition 5.3.3. *Let G an elementary labelled graph and \bar{T}_ϵ^n the labelled tree associated to it. Then $|\bar{T}_\epsilon^n|_s = |G|_s$.*

Proof. By definition,

$$\begin{aligned} |G|_s &= \left(|\dot{N}_G| + \frac{|L_G|}{2} - 2 \right) |\mathfrak{s}| - \sum_{e \in \mathcal{E}} a_e = \left(|\dot{N}_G| + \frac{|L_G|}{2} - 2 \right) |\mathfrak{s}| - \sum_{e \in E_{\bar{T}}} a_e - \sum_{e \in E_{v_0}} a_e \\ &= \left(|\dot{N}_G| + \frac{|L_G|}{2} - 2 \right) |\mathfrak{s}| - \sum_{e \in E_{\bar{T}}} (|\mathfrak{s}| + |\mathfrak{e}(e)|_s - |\mathfrak{l}(e)|_s) - \sum_{(v, v_0) \in \mathcal{E}} (-|\mathfrak{n}(v)|_s) - |L_{\bar{T}}| \kappa \\ &= \left(|\dot{N}_G| + \frac{|L_G|}{2} - 2 \right) |\mathfrak{s}| - \sum_{e \in E_{\bar{T}}} |\mathfrak{s}| - \sum_{e \in E_{\bar{T}}} |\mathfrak{e}(e)|_s + \sum_{(v, v_0) \in \mathcal{E}} |\mathfrak{n}(v)|_s + \sum_{e \in E_{\bar{T}}} |\mathfrak{l}(e)|_s - |L_{\bar{T}}| \kappa \end{aligned}$$

We conclude by noticing that

$$\begin{aligned} \left(|\dot{N}_G| + \frac{|L_G|}{2} - 2 \right) |\mathfrak{s}| - \sum_{e \in E_{\bar{T}}} |\mathfrak{s}| - |L_{\bar{T}}| \kappa &= \left(|\dot{N}_{\bar{T}}| + \frac{|L_{\bar{T}}|}{2} - 1 \right) |\mathfrak{s}| - \sum_{e \in E_{\bar{T}}} |\mathfrak{s}| - |L_{\bar{T}}| \kappa \\ &= |L_{\bar{T}}| \alpha = \sum_{u \in L_{\bar{T}}} |\mathfrak{l}(u)|_s. \end{aligned}$$

Moreover, we have $\sum_{(v, v_0) \in \mathcal{E}} |\mathfrak{n}(v)|_s = \sum_{v \in \dot{N}_{\bar{T}}} |\mathfrak{n}(v)|_s$. \square

Remark 5.3.4. In general, we have $\forall u \in L_{\bar{T}}, |\mathfrak{l}(u)|_s = -\frac{|\mathfrak{s}|}{2} - \kappa$ for $\kappa > 0$ like the generalised KPZ. For the rest of the section when $a_e = |\mathfrak{s}|$, it has to be understood as $|\mathfrak{s}| + \kappa$.

Definition 5.3.5. We define the graph $G(\Xi) = (\{v_0, v_\star, v_\ell\}, \mathcal{E}_\Xi)$ and $G(X)$ associated to the symbols Ξ and X :

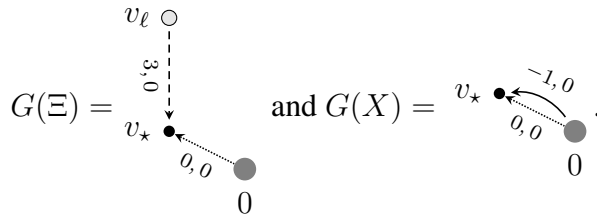

Definition 5.3.6. From two elementary graphs G_1, G_2 , we define a new elementary graph $T = (\mathcal{V}, \mathcal{E}) = T_1 \otimes T_2$ by: $\mathcal{V} = \mathcal{V}_1 \cup \mathcal{V}_2$ and $\mathcal{E} = \mathcal{E}_1 \cup \mathcal{E}_2$. We also make the following identification: $v_\star^1 \sim v_\star^2 \sim v_\star$ and $v_0^1 \sim v_0^2 \sim v_0$. We set $a_{e_\star} = a_{e_\star^1} + a_{e_\star^2}$ and $r_{e_\star} = 0$ for $e_\star = (v_\star, v_0)$ and $e_\star^i = (v_\star^i, v_0^i)$, $i \in \{1, 2\}$.

Definition 5.3.7. The integration of an elementary graph $G = (\mathcal{V}, \mathcal{E})$ is the elementary graph $G' = \mathcal{I}_n(G)$ given by: $(\mathcal{V} \cup \{v'_\star\}, \mathcal{E}')$ where \mathcal{E}' is defined by

- if $a_{e_\star} \neq 0$ then $\mathcal{E}' = \mathcal{E} \cup \{(v'_\star, v_0), (v'_\star, v_\star)\}$ with the label of (v'_\star, v_0) given by $(0, 0)$.
- else $\mathcal{E}' = (\mathcal{E} \setminus \{(v_\star, v_0)\}) \cup \{(v'_\star, v_0), (v'_\star, v_\star)\}$.

where the edge label for (v'_\star, v_0) and $e = (v'_\star, v_\star)$ are respectively $(0, 0)$ and $(|\mathfrak{s}| - |\mathcal{I}(\cdot)|_{\mathfrak{s}} + |n|_{\mathfrak{s}}, 0 \vee [G']_{\mathfrak{s}}, v_0)$.

Example 5.3.8. Just below, we give some examples from the generalised KPZ when $|\mathfrak{s}| = 3$:

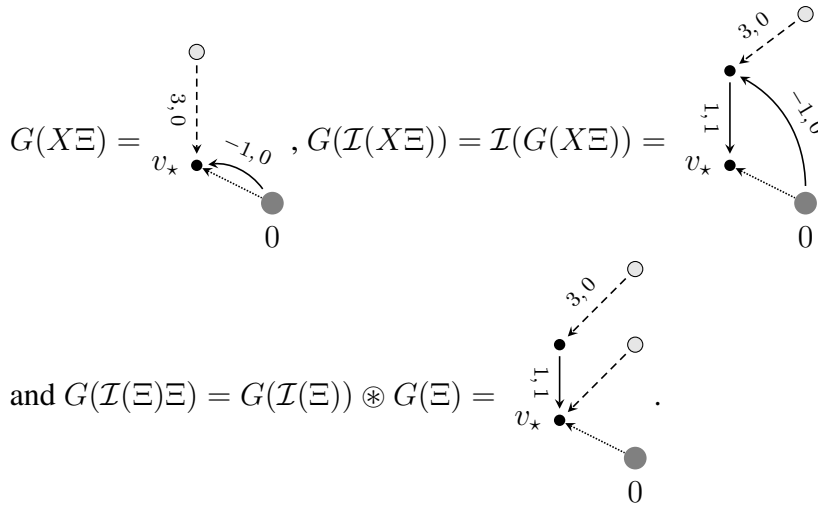

Remark 5.3.9. Elementary graphs represent the kernel $W^{\varepsilon, \|\tau\|_\tau}$ for some symbol τ associated to the maximal Wiener chaos of $\Pi_0^\varepsilon \tau$. Therefore, we suppose that these graphs are built using the same set of rules as for the symbols.

Definition 5.3.10. Let \mathcal{R}_u a set of rules as defined in (3.1), we denote by $\mathcal{G}_{\mathcal{R}_u}$ the set of elementary graphs built from that set and from $G(Ξ)$.

Remark 5.3.11. Let $G = (\mathcal{V}, \mathcal{E}) \in \mathcal{G}_{\mathcal{R}_u}$, one has $v_e = v_0$ for every $e \in \mathcal{E}$. If the set of rules \mathcal{R}_u is locally subcritical then any elementary graph G in $\mathcal{G}_{\mathcal{R}_u}$ satisfies the following property : for every subtree T of G different from $Ξ$, one has $|T|_{\mathfrak{s}} > |Ξ|_{\mathfrak{s}} = \alpha$.

Example 5.3.12. The generalised KPZ terms with negative homogeneity are built with the following rules:

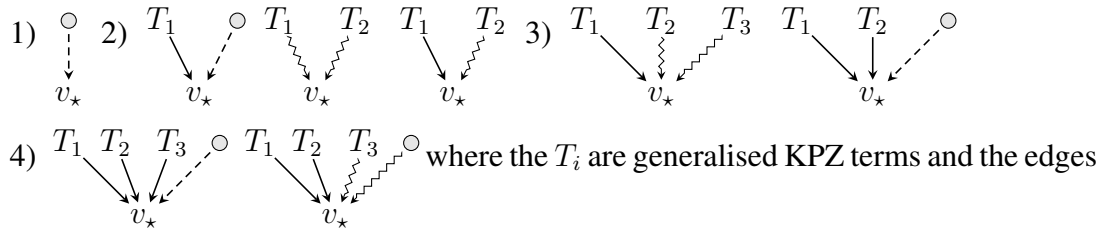

5.3. Elementary Labelled Graphs

$\downarrow\downarrow$, $\downarrow\downarrow\downarrow$ and \downarrow have respectively labelled of the form: $(3, 0)$, $(2, \alpha)$ and $(1, \beta)$. We have also other rules when we multiply these rules with X .

Remark 5.3.13. We obtain a labelled graph with three distinguished vertices by taking two elementary graphs with the same number of leaves and by merging their leaves. This procedure will be described after the renormalisation in 5.6.

We want to prove an analogue of the conditions on the labelled graph for an elementary graph $G = (\mathcal{V}, \mathcal{E})$ generated by a set of rules \mathcal{R}_u . We denote by \mathcal{V}_ℓ the set of its leaves and \mathcal{V}_i the set of its inner nodes.

Assumption 4. 1. For every subset $\bar{\mathcal{V}} \subset \mathcal{V}_0$ one has

$$\sum_{e \in \mathcal{E}_0(\bar{\mathcal{V}})} a_e \leq \left(|\bar{\mathcal{V}}_i| + \frac{|\bar{\mathcal{V}}_\ell|}{2} - \frac{1}{2} \right) |\mathfrak{s}| + \kappa. \quad (5.9)$$

2. For every subset $\bar{\mathcal{V}} \subset \mathcal{V}$, on has for $|\bar{\mathcal{V}}_i| \geq 3$

$$\sum_{e \in \mathcal{E}_0(\bar{\mathcal{V}})} a_e + \sum_{e \in \mathcal{E}^\uparrow(\bar{\mathcal{V}})} \mathbb{1}_{\{v_e \in \bar{\mathcal{V}} \wedge r_e > 0\}} (a_e + r_e - 1) - \sum_{e \in \mathcal{E}^\downarrow(\bar{\mathcal{V}})} \mathbb{1}_{v_e \in \bar{\mathcal{V}}} r_e < \left(|\bar{\mathcal{V}}_i| + \frac{|\bar{\mathcal{V}}_\ell|}{2} - 1 \right) |\mathfrak{s}|. \quad (5.10)$$

We consider the vertex 0 as an inner node.

3. For every non-empty subset $\bar{\mathcal{V}} \subsetneq \mathcal{V}_0$, one has:

$$\begin{aligned} & \sum_{e \in \mathcal{E}_0(\bar{\mathcal{V}})} a_e + \sum_{e \in \mathcal{E}^\downarrow(\bar{\mathcal{V}})} (\mathbb{1}_{\{v_e \in \bar{\mathcal{V}} \vee r_e = 0\}} (a_e + r_e - 1) - (r_e - 1)) \\ & + \sum_{e \in \mathcal{E}^\uparrow(\bar{\mathcal{V}})} ((a_e + r_e) - \mathbb{1}_{v_e \in \bar{\mathcal{V}}} r_e) + \mathbb{1}_{v_* \in \bar{\mathcal{V}}} |G|_{\mathfrak{s}} > \left(|\bar{\mathcal{V}}_i| + \frac{|\bar{\mathcal{V}}_\ell|}{2} - \mathbb{1}_{v_* \in \bar{\mathcal{V}}} \right) |\mathfrak{s}|. \end{aligned} \quad (5.11)$$

If $\bar{\mathcal{V}} = \mathcal{V}_0$, we obtain the equality in the previous bound which is the definition of $|G|_{\mathfrak{s}}$.

Let $G = (\mathcal{V}, \mathcal{E}) \in \mathcal{G}_{\mathcal{R}_u}$ and $\bar{T} = (\bar{\mathcal{V}}, \bar{\mathcal{E}})$ a subtree of G . We define the homogeneity of this subtree as:

$$|\bar{T}|_{\mathfrak{s}} = \left(|\bar{\mathcal{V}}_i| + \frac{|\bar{\mathcal{V}}_\ell|}{2} - \mathbb{1}_{v_* \in \bar{\mathcal{V}}} \right) |\mathfrak{s}| - \sum_{e \in \mathcal{E}_0(\bar{\mathcal{V}})} a_e - \sum_{e \in \mathcal{E}^\uparrow(\bar{\mathcal{V}})} a_e - \sum_{e \in \mathcal{E}^\downarrow(\bar{\mathcal{V}})} \mathbb{1}_{a_e < 0} a_e.$$

Proposition 5.3.14. Let $G = (\mathcal{V}, \mathcal{E}) \in \mathcal{G}_{\mathcal{R}_u}$ and $\bar{T} = (\bar{\mathcal{V}}, \bar{\mathcal{E}})$ a subtree of G such that $\bar{\mathcal{V}} \subsetneq \mathcal{V}_0$, then $\bar{\mathcal{V}}$ satisfies the assumption (5.11).

Proof. Let ϱ the root of \bar{T} , we denote by T_ϱ the tree above ϱ . If $\varrho \neq v_*$, we replace T_ϱ by T_u where $(u, \varrho) \in \mathcal{E}$. To each edge $e = (e_+, e_-) \in \mathcal{E}^\downarrow(\bar{\mathcal{V}})$, we can associate a tree $T_e = T_{e_-}$ and we obtain:

$$T_\varrho = \bar{T} \cup \bigcup_{e \in \mathcal{E}^\downarrow(\bar{\mathcal{V}})} T_e, \quad |T_\varrho|_s = |\bar{T}|_s + \sum_{e \in \mathcal{E}^\downarrow(\bar{\mathcal{V}})} |T_e|_s.$$

Then

$$|T_\varrho|_s = \left(|\bar{\mathcal{V}}_i| + \frac{|\bar{\mathcal{V}}_\ell|}{2} - \mathbb{1}_{v_* \in \bar{\mathcal{V}}} \right) |s| - \sum_{e \in \mathcal{E}_0(\bar{\mathcal{V}})} a_e - \sum_{e \in \mathcal{E}^\uparrow(\bar{\mathcal{V}})} a_e + \sum_{e \in \mathcal{E}^\downarrow(\bar{\mathcal{V}})} |T_e|_s.$$

By definition, we have $\sum_{e \in \mathcal{E}^\uparrow(\bar{\mathcal{V}})} r_e > |T_\varrho|_s$ if $\varrho \neq v_*$ else $|T_\varrho|_s = |G|_s$ and $\mathcal{E}^\uparrow(\bar{\mathcal{V}}) = \emptyset$. Moreover, let $e \in \mathcal{E}^\downarrow(\bar{\mathcal{V}})$, it follows: If $|T_e|_s > 0$ then $|T_e|_s > r_e - 1$, else by local subcriticality of the graph G , we have $|T_e|_s > -\frac{|s|}{2} - \kappa > -a_e$. The previous bounds allow us to conclude and we obtain:

$$\begin{aligned} \sum_{e \in \mathcal{E}_0(\bar{\mathcal{V}})} a_e + \sum_{e \in \mathcal{E}^\uparrow(\bar{\mathcal{V}})} (a_e + r_e) + \sum_{e \in \mathcal{E}^\downarrow(\bar{\mathcal{V}})} (\mathbb{1}_{r_e=0}(a_e + r_e - 1) - (r_e - 1)) + \mathbb{1}_{v_* \in \bar{\mathcal{V}}} |G|_s > \\ \left(|\bar{\mathcal{V}}_i| + \frac{|\bar{\mathcal{V}}_\ell|}{2} - \mathbb{1}_{v_* \in \bar{\mathcal{V}}} \right) |s|. \end{aligned}$$

□

Let $G = (\mathcal{V}, \mathcal{E}) \in \mathcal{G}_{\mathcal{R}_u}$ and $\bar{\mathcal{V}} \subsetneq \mathcal{V}_0$. We consider $\bar{G} = (\bar{\mathcal{V}}, \bar{\mathcal{E}})$ where $\bar{\mathcal{E}} = \mathcal{E}_0(\bar{\mathcal{V}})$. Then the graph \bar{G} admits the following decomposition: $\bar{G} = \bigsqcup_{j \in K} T_j$ where $T_j = (\mathcal{V}_j, \mathcal{E}_j)$ are disjoint subtrees of G and K is a finite set. Using this characterisation, we have:

Proposition 5.3.15. *Let $G = (\mathcal{V}, \mathcal{E}) \in \mathcal{G}_{\mathcal{R}_u}$ and let $\bar{\mathcal{V}} \subset \mathcal{V} \setminus \mathcal{V}_*$. Then $\bar{\mathcal{V}}$ satisfies the assumption (5.11).*

Proof. We decompose $\bar{\mathcal{V}} = \bigsqcup_{j \in K} \mathcal{V}_j$ where the \mathcal{V}_j are disjoint sets and $T_j = (\mathcal{V}_j, \mathcal{E}_0(\mathcal{V}_j))$ is a subtree of G . Then we apply the previous proposition on each \mathcal{V}_j and by summing the bounds, we obtain the required result. □

Proposition 5.3.16. *Let $G = (\mathcal{V}, \mathcal{E})$ a labelled graph and $\bar{\mathcal{V}} \subset \mathcal{V}$ such that $v_0 \in \bar{\mathcal{V}}$ and such that $\tilde{\mathcal{V}} = \mathcal{V} \setminus \bar{\mathcal{V}}$ satisfies (5.11) then $\bar{\mathcal{V}}$ satisfies the assumption (5.10).*

Proof. We suppose that $\bar{\mathcal{V}}$ does not satisfy (5.10) which yields:

$$\sum_{e \in \mathcal{E}_0(\bar{\mathcal{V}})} a_e + \sum_{e \in \mathcal{E}^\uparrow(\bar{\mathcal{V}})} \mathbb{1}_{\{v_e \in \bar{\mathcal{V}} \wedge r_e > 0\}} (a_e + r_e - 1) - \sum_{e \in \mathcal{E}^\downarrow(\bar{\mathcal{V}})} \mathbb{1}_{v_e \in \bar{\mathcal{V}}} r_e \geq \left(|\bar{\mathcal{V}}_i| + \frac{|\bar{\mathcal{V}}_\ell|}{2} - 1 \right) |s|.$$

On the other hand, $\tilde{\mathcal{V}} = \mathcal{V} \setminus \bar{\mathcal{V}}$ satisfies (5.11):

$$\sum_{e \in \mathcal{E}_0(\tilde{\mathcal{V}})} a_e + \sum_{e \in \mathcal{E}^\uparrow(\tilde{\mathcal{V}})} (a_e + r_e - \mathbb{1}_{v_e \in \tilde{\mathcal{V}}} r_e)$$

5.3. Elementary Labelled Graphs

$$+ \sum_{e \in \mathcal{E}^\downarrow(\tilde{\mathcal{V}})} \left(\mathbb{1}_{v_e \in \tilde{\mathcal{V}}} r_e = 0 (a_e + r_e - 1) - (r_e - 1) \right) + \mathbb{1}_{v_* \in \tilde{\mathcal{V}}} |G|_{\mathfrak{s}} > \left(|\tilde{\mathcal{V}}_i| + \frac{|\tilde{\mathcal{V}}_\ell|}{2} - \mathbb{1}_{v_* \in \tilde{\mathcal{V}}} \right) |\mathfrak{s}|.$$

We notice that $\mathcal{E}^\uparrow(\bar{\mathcal{V}}) = \mathcal{E}^\downarrow(\tilde{\mathcal{V}})$ and $\mathcal{E}^\downarrow(\bar{\mathcal{V}}) = \mathcal{E}^\uparrow(\tilde{\mathcal{V}})$ which give by summing the two bounds:

$$\sum_{e \in \mathcal{E}} a_e + \mathbb{1}_{v_* \in \tilde{\mathcal{V}}} |G|_{\mathfrak{s}} > \left(|\mathcal{V}_i| + \frac{|\mathcal{V}_\ell|}{2} - 1 - \mathbb{1}_{v_* \in \tilde{\mathcal{V}}} \right) |\mathfrak{s}|. \quad (5.12)$$

We have:

$$-\frac{|\mathfrak{s}|}{2} - \kappa \leq |G|_{\mathfrak{s}} = \left(|\mathcal{V}_i| + \frac{|\mathcal{V}_\ell|}{2} - 2 \right) |\mathfrak{s}| - \sum_{e \in \mathcal{E}} a_e$$

then

$$\sum_{e \in \mathcal{E}} a_e \leq \left(|\mathcal{V}_i| + \frac{|\mathcal{V}_\ell|}{2} - \frac{3}{2} \right) |\mathfrak{s}| + \kappa.$$

which is in contradiction with (5.12) for $\kappa > 0$ small. We deduce that $\bar{\mathcal{V}}$ satisfies the condition (5.10). \square

Proposition 5.3.17. *Every $G = (\mathcal{V}, \mathcal{E}) \in \mathcal{G}_{\mathcal{R}_u}$ satisfies the condition (5.10) for $\bar{\mathcal{V}} \subset \mathcal{V}$ and $v_0 \in \bar{\mathcal{V}}$.*

Proof. Let $\tilde{\mathcal{V}} = \mathcal{V} \setminus \bar{\mathcal{V}}$. The graph G satisfies the condition (5.11) on $\tilde{\mathcal{V}}$. By the previous proposition, $\bar{\mathcal{V}}$ satisfies (5.10). \square

Proposition 5.3.18. *Let $G = (\mathcal{V}, \mathcal{E}) \in \mathcal{G}_{\mathcal{R}_u}$ and $\bar{T} = (\bar{\mathcal{V}}, \bar{\mathcal{E}}) = \bigsqcup_{j \in K} T_j$ such that $\bar{\mathcal{V}} \subset \mathcal{V}_0$. Then*

- *If $|K| \geq 3$ or $|\bar{T}|_{\mathfrak{s}} > 0$ then the condition (5.10) is satisfied.*
- *If $|K| = 2$ and there exists $j \in K$ such that $|T_j|_{\mathfrak{s}} > -\frac{|\mathfrak{s}|}{2} - \kappa$ then the condition (5.10) is satisfied.*
- *If $|K| = 1$ and $|\bar{T}|_{\mathfrak{s}} < 0$ then the condition (5.9) is satisfied but not (5.10).*

Proof. For every $j \in K$, we denote by $\mathcal{V}_{j,i}$, the inner nodes and by $\mathcal{V}_{j,\ell}$ the leaves of the tree T_j . One has $|T_j|_{\mathfrak{s}} \geq -\frac{|\mathfrak{s}|}{2} - \kappa$, which yields

$$\begin{aligned} \left(|\mathcal{V}_{j,i}| - 1 + \frac{|\mathcal{V}_{j,\ell}|}{2} \right) |\mathfrak{s}| - \sum_{e \in \mathcal{E}_0(V_j)} a_e &\geq |T_j|_{\mathfrak{s}} \geq -\frac{|\mathfrak{s}|}{2} - \kappa \\ \sum_{e \in \mathcal{E}_0(V_j)} a_e &\leq \left(|\mathcal{V}_{j,i}| + \frac{|\mathcal{V}_{j,\ell}|}{2} - \frac{1}{2} \right) |\mathfrak{s}| + \kappa. \end{aligned}$$

By summing the previous bounds, we obtain:

$$\begin{aligned} \sum_{e \in \mathcal{E}_0(\bar{\mathcal{V}})} a_e &= \sum_{j \in K} \sum_{e \in \mathcal{E}_0(\mathcal{V}_j)} a_e \\ &\leq \sum_{j \in K} \left(|\mathcal{V}_{j,i}| + \frac{|\mathcal{V}_{j,\ell}|}{2} - \frac{1}{2} + \frac{\kappa}{|\mathfrak{s}|} \right) |\mathfrak{s}| = \left(|\bar{\mathcal{V}}_i| + \frac{|\bar{\mathcal{V}}_\ell|}{2} - \sum_{j \in K} \left(\frac{1}{2} - \frac{\kappa}{|\mathfrak{s}|} \right) \right) |\mathfrak{s}|. \end{aligned}$$

We distinguish several cases:

- If $|K| \geq 3$, we have $\sum_{j \in K} \left(\frac{1}{2} - \frac{\kappa}{|\mathfrak{s}|} \right) > 1$ which gives the result.
- If $|\bar{T}|_{\mathfrak{s}} > 0$, then $\sum_{j \in K} |T_j|_{\mathfrak{s}} > 0$ which gives the required bound.
- We conclude as the same when $|K| = 2$ and when one of the T_j satisfied $|T_j|_{\mathfrak{s}} > -\frac{|\mathfrak{s}|}{2} - \kappa$.
- For the last assertion when $|K| = 1$ and $|\bar{T}|_{\mathfrak{s}} < 0$, the fact that $|\bar{T}|_{\mathfrak{s}} > -\frac{|\mathfrak{s}|}{2} - \kappa$ proves the condition (5.9) but $|\bar{T}|_{\mathfrak{s}} < 0$ is in contradiction with (5.10).

□

Remark 5.3.19. In the previous proposition, we omit one case when $\bar{T} = T_1 \sqcup T_2$ and $|T_1|_{\mathfrak{s}} = |T_2|_{\mathfrak{s}} = -\frac{|\mathfrak{s}|}{2} - \kappa$. This case will be treated after and needs a renormalisation procedure as for $|\bar{T}|_{\mathfrak{s}} < 0$.

Proposition 5.3.20. Let $G = (\mathcal{V}, \mathcal{E}) \in \mathcal{G}_{\mathcal{R}_u}$ and $\bar{T} = (\bar{\mathcal{V}}, \bar{\mathcal{E}})$ a subtree of G . We suppose that there exists a leaf ℓ in \bar{T} such that $\ell \notin \mathcal{V}_\ell$ then if $|\bar{\mathcal{V}}| > 1$, the condition (5.5) is satisfied.

Proof. We have $|\bar{T}|_{\mathfrak{s}} > -\frac{|\mathfrak{s}|}{2} - \kappa$ and we consider the tree \tilde{T} where we have replaced the node ℓ by a leaf which will count $|\mathfrak{s}|/2$. We always have $|\tilde{T}|_{\mathfrak{s}} > -\frac{|\mathfrak{s}|}{2} - \kappa$ but now $|\bar{T}|_{\mathfrak{s}} = |\tilde{T}|_{\mathfrak{s}} - \frac{|\mathfrak{s}|}{2} > -\frac{|\mathfrak{s}|}{2} - \kappa$ which gives $|\bar{T}|_{\mathfrak{s}} > -\kappa$ and $|T|_{\mathfrak{s}} > 0$. Indeed, the set of homogeneities is a discrete set. Above $-\kappa$, the next homogeneity is 0 which contains only the trivial tree. Finally, the subtree \bar{T} satisfies (5.5). □

5.4 Contractions

If we look at elements in the lower chaos which come from contractions, we start with a graph G in $\mathcal{G}_{\mathcal{R}_u}$ and then we merge some leaves in G .

Definition 5.4.1. Let $G = (\mathcal{V}, \mathcal{E}) \in \mathcal{G}_{\mathcal{R}_u}$ an elementary labelled graph. A graph $\bar{G} = (\bar{\mathcal{V}}, \bar{\mathcal{E}})$ is obtained from G by contractions if there exists an involution map f from \mathcal{V}_ℓ to itself such that $\bar{\mathcal{V}} = \mathcal{V} / \sim_f$ and $\bar{\mathcal{E}} = \mathcal{E} / \sim_f$ where \sim_f means we identify any $v \in \mathcal{V}_\ell$ with its image $f(v)$. The leaves of \bar{G} are given by the $v \in \mathcal{V}_\ell$ such that $f(v) = v$.

5.5. Renormalisation Procedure

Proposition 5.4.2. *Let $G = (\mathcal{V}, \mathcal{E}) \in \mathcal{G}_{\mathcal{R}_u}$ an elementary labelled graph and $\bar{G} = (\bar{\mathcal{V}}, \bar{\mathcal{E}})$ a graph obtained from G by contractions. If G satisfies the conditions (5.11) and (5.10) then \bar{G} satisfies the same conditions.*

Proof. To any subset V of \mathcal{V} , we can associate a subset \tilde{V} of $\bar{\mathcal{V}}$. Indeed, the contractions identify some pairs of leaves in V which become inner nodes in $\bar{\mathcal{V}}$. We have the following identities:

$$\mathcal{E}_0(V) = \mathcal{E}_0(\tilde{V}), \quad \mathcal{E}^\uparrow(V) = \mathcal{E}^\uparrow(\tilde{V}), \quad \mathcal{E}^\downarrow(V) = \mathcal{E}^\downarrow(\tilde{V}), \quad |V_i| + \frac{|V_\ell|}{2} = |\tilde{V}_i| + \frac{|\tilde{V}_\ell|}{2},$$

which give the result. \square

Example 5.4.3. Among the KPZ terms, we face three types of contractions which create new cycles:

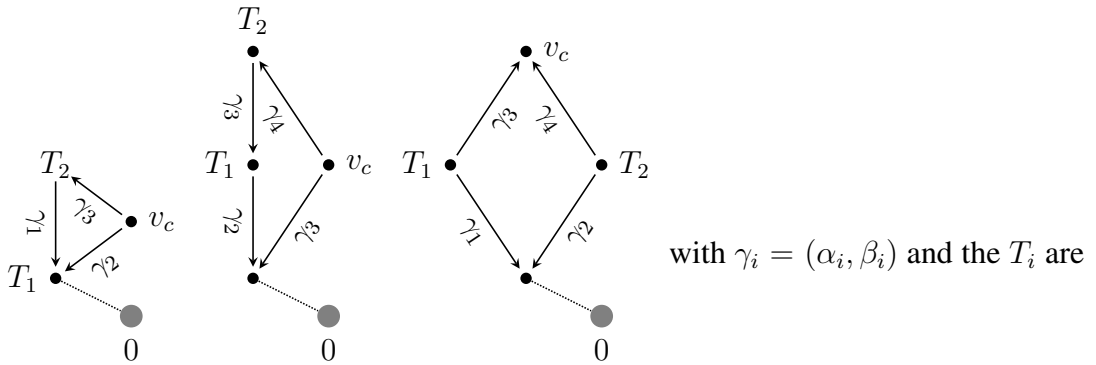

subtrees. From now, we denote by v_c the node coming from the merging of two leaves ℓ_1 and ℓ_2 .

5.5 Renormalisation Procedure

5.5.1 Renormalisation by hand

From the proposition 5.3.18, given $G = (\mathcal{V}, \mathcal{E}) \in \mathcal{G}_{\mathcal{R}_u}$ the diverging patterns are the negative subtrees of T_ϵ^n the labelled tree such that $W^\epsilon T_\epsilon^n$ is encoded by G . Therefore, we have to renormalise them. In this section we treat one negative subtree by performing a local transformation using a telescopic sum.

Let $G = (\mathcal{V}, \mathcal{E}) \in \mathcal{G}_{\mathcal{R}_u}$ and $\bar{T} = (\bar{\mathcal{V}}, \bar{\mathcal{E}})$ a negative subtree of G . In order to treat this divergence, we change the label of some edge $e \in \mathcal{E}^\downarrow(\bar{\mathcal{V}})$ by replacing $v_e = v_0$ by a node of \bar{T} such that this new Taylor expansion point has a renormalisation effect on \bar{T} .

Let $e = (v_1, v_2) \in \mathcal{E}^\downarrow(\bar{\mathcal{V}})$ and $v \in \bar{T}$ such that there exists v' with $(v', v) \in \mathcal{E}^\uparrow(\bar{\mathcal{V}})$.

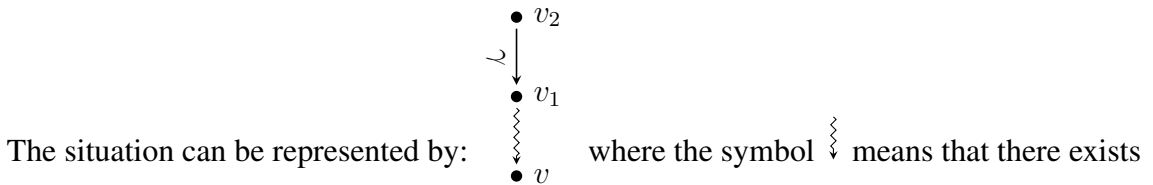

a path between v_1 and v . In most of the examples, this path would be just an edge. The label of e is replaced by $\gamma = (a_e, r'_e, v)$. This transformation and the choice of the level r'_e depend on the subtree \bar{T} . For instance, we take $r'_e = \max(\lceil -|\bar{T}|_s \rceil, r_e)$. The previous renormalised edges appear in a telescopic sum. We start with $v_e = v_0$ on e . We have the

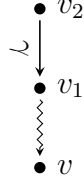

same configuration as before: γ . The label of γ is given by (a_e, r_e, v_0) . We want to rewrite the Taylor expansion in the point v and we proceed as follows:

$$\begin{aligned} \hat{K}_e(x_{v_1} - x_{v_2}) &= K_e(x_{v_1} - x_{v_2}) - \sum_{|j|_s < r_e} \frac{(x_{v_1})^j}{j!} K_e^{(j)}(-x_{v_2}) \\ &= K_e(x_{v_1} - x_{v_2}) - \sum_{|j|_s < r'_e} \frac{(x_{v_1} - x_v)^j}{j!} K_e^{(j)}(x_v - x_{v_2}) \\ &\quad + \sum_{|j|_s < r'_e} \frac{(x_{v_1} - x_v)^j}{j!} K_e^{(j)}(x_v - x_{v_2}) - \sum_{|j+k|_s < r_e} \frac{(x_{v_1} - x_v)^j (x_v)^k}{j!k!} K_e^{(j+k)}(-x_{v_2}) \\ &= K_e(x_{v_1} - x_{v_2}) - \sum_{|j|_s < r'_e} \frac{(x_{v_1} - x_v)^j}{j!} K_e^{(j)}(x_v - x_{v_2}) \\ &\quad + \sum_{|j|_s < r'_e} \frac{(x_{v_1} - x_v)^j}{j!} \left(K_e^{(j)}(x_v - x_{v_2}) - \sum_{|k|_s < r_e - |j|_s} \frac{(x_v)^k}{k!} K_e^{(j+k)}(-x_{v_2}) \right). \end{aligned}$$

This decomposition is general but in the case of the generalised KPZ, we deal only with derivatives in space. Therefore, $j \in \mathbb{N}$. Graphically speaking, we make the following decomposition on our graph G :

$$\text{Diagram} = \text{Diagram} + \sum_{|j|_s < r'_e} \text{Diagram} \quad (5.13)$$

where the labels of γ , γ_e , γ_j and e_j are respectively: (a_e, r_e, v_0) , (a_e, r'_e, v) , $(a_e + |j|_s, \max(r_e - |j|_s, 0), v_0)$ and $(-|j|_s, 0, v_0)$. We prove the next two propositions in the case of the generalised KPZ and they are true for many examples. We will provide a counter-example in the section 5.7 for the general case.

Proposition 5.5.1. *Let G as above, we suppose that G satisfies the conditions (5.6) then the new graph \bar{G} obtained from the transformation of the label of $e = (v_1, v_2)$ satisfies the same condition.*

5.5. Renormalisation Procedure

Proposition 5.5.2. *Let G as above, we suppose that G satisfies the conditions (5.5) for some subsets $V \neq \bar{V}$ then the new graph obtained from the transformation of the label of $e = (v_1, v_2)$ satisfies this condition on the same subsets and on \bar{V} .*

The next two propositions establish that we have the correct bounds for the terms with the labels γ and γ_e then we have the same bounds for the remaining terms depending on j in 5.13.

Proposition 5.5.3. *If the conditions (5.6) is satisfied in 5.13 for the terms with the labels γ and γ_e , then this condition is satisfied on the other terms on $V \subset \mathcal{V}$ such that $V \cap \{v, v_1, v_2\} \neq \{v\}$.*

Proof. The first term has been treated. We have to consider the impact of the new edges e_j and γ_j for the other terms. Let $V \subset \mathcal{V}$, we look at $V_j = V \cap \{v, v_1, v_2\}$:

	γ_j	e_j	γ_e	γ
$\{v\}$	$\mathbb{1}_{(r_e - j _s < 0)}(a_e + j _s) - \mathbb{1}_{r_e - j _s > 0}(r_e - j _s - 1)$	$- j _s$	0	0
$\{v_1\}$	0	$- j _s$	$-(r'_e - 1)$	$-(r_e - 1)$
$\{v_2\}$	$a_e + j _s + \max(r_e - j _s, 0)$	0	$a_e + r'_e$	$a_e + r_e$
$\{v, v_1\}$	$\mathbb{1}_{(r_e - j _s < 0)}(a_e + j _s) - \mathbb{1}_{r_e - j _s > 0}(r_e - j _s - 1)$	$- j _s$	$-(r'_e - 1)$	$-(r_e - 1)$
$\{v, v_2\}$	$a_e + j _s$	$- j _s$	a_e	$a_e + r_e$
$\{v_1, v_2\}$	$a_e + j _s + \max(r_e - j _s, 0)$	$- j _s$	a_e	a_e
$\{v, v_1, v_2\}$	$a_e + j _s$	$- j _s$	a_e	a_e

The sum of the contributions of γ_j and e_j is greater than the minimum between γ_e and γ except for $V_j = \{v\}$: when $r_e - |j|_s > 0$, then $-(r_e - 1) \leq 0$. \square

Proposition 5.5.4. *If the condition (5.10) is satisfied in 5.13 for the terms with the labels γ and γ_e on some subsets \mathcal{V} , then this condition is satisfied for the other terms on the same subsets.*

Proof. The first term has been treated in the previous proposition. We have to consider the impact of the new edges e_j and γ_j for the other terms. Let $V \subset \mathcal{V}$, if $v_0 \in V$ then from the previous proposition the conditions (5.11) are satisfied on $\mathcal{V} \setminus V$. We deduce that the conditions (5.10) are satisfied for V . We suppose that $v_0 \notin V$ and we look at $V_j = V \cap \{v, v_1, v_2\}$:

	γ_j	e_j	γ_e	γ
$\{v\}$	0	0	0	0
$\{v_1\}$	0	0	0	0
$\{v_2\}$	0	0	0	0
$\{v, v_1\}$	0	$- j _s$	$-r'_e$	0
$\{v, v_2\}$	$a_e + j _s$	0	$a_e + r'_e$	a_e
$\{v_1, v_2\}$	0	0	a_e	a_e
$\{v, v_1, v_2\}$	$a_e + j _s$	$- j _s$	a_e	a_e

The sum of the contributions of γ_j and e_j is smaller than the maximum between γ_e and γ .

□

When we obtain a graph with no leaves after the previous transformation, we want to transform those graphs in constants by fixing all the labels (a_e, r_e, v_0) to $(a_e, 0)$. Let $e = (v_1, v_2)$ an edge in \bar{T} with a label (a_e, r_e, v_0) and $r_e > 0$. We can perform the following decomposition:

$$\begin{array}{c} \bullet v_2 \\ \downarrow \\ \bullet v_1 \end{array} = \begin{array}{c} \bullet v_2 \\ \downarrow 0^{+v_0} \\ \bullet v_1 \end{array} - \sum_{|k|_s < r_e} \begin{array}{c} \bullet v_2 \\ \downarrow a_e + |k|_s, 0 \\ \bullet v_1 \\ \searrow -|k|_s, 0 \\ \bullet 0 \end{array} .$$

For the generalised KPZ, we will prove the next proposition:

Proposition 5.5.5. *The previous terms depending on k satisfy the conditions (5.10) and (5.11) on $\mathcal{V}(\bar{T})$.*

5.5.2 A complete example

In the sequel, we present the complete renormalisation of a negative pattern which is created by the contraction of two different trees Ξ .

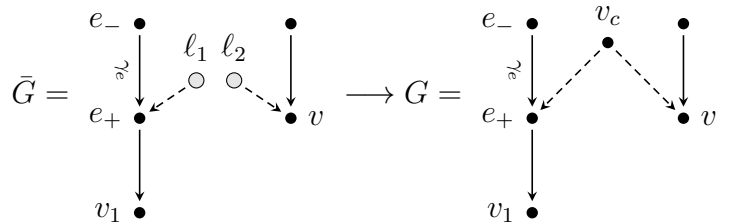

In the previous graph, we go from \bar{G} to G by identifying the two leaves l_1 and l_2 which create the node v_c . The edges (e_+, v_c) and (v, v_c) represent a ϱ_ε and its behaviour around the origin is $\|x\|_s^{-|s|-\kappa}$.

This is the only divergent pattern which is not a tree. We perform our telescopic sum

5.5. Renormalisation Procedure

in the next identity:

$$G = \begin{array}{c} \bullet \\ e_- \\ \downarrow \gamma_e \\ \bullet \\ e_+ \\ \downarrow \\ \bullet \\ v_1 \end{array} \begin{array}{c} \bullet \\ v_c \\ \swarrow \gamma_e \\ \bullet \\ e_+ \\ \downarrow \\ \bullet \\ v_1 \end{array} \begin{array}{c} \bullet \\ \bullet \\ \downarrow \\ \bullet \\ v \end{array} = \begin{array}{c} \bullet \\ e_- \\ \downarrow \gamma_e \\ \bullet \\ e_+ \\ \downarrow \\ \bullet \\ v_1 \end{array} \begin{array}{c} \bullet \\ \bullet \\ \downarrow \\ \bullet \\ v \end{array} = \begin{array}{c} \bullet \\ e_- \\ \downarrow \gamma_e^* \\ \bullet \\ e_+ \\ \downarrow \\ \bullet \\ v_1 \end{array} \begin{array}{c} \bullet \\ \bullet \\ \downarrow \\ \bullet \\ v \end{array} + \sum_{|j|_s < r'_e} \begin{array}{c} \bullet \\ e_- \\ \downarrow \gamma_e \\ \bullet \\ e_+ \\ \downarrow \\ \bullet \\ v_1 \end{array} \begin{array}{c} \bullet \\ \bullet \\ \downarrow \\ \bullet \\ v \end{array} \begin{array}{c} \bullet \\ \bullet \\ \swarrow \gamma_j \\ \bullet \\ e_+ \\ \downarrow \\ \bullet \\ v_1 \end{array} \begin{array}{c} \bullet \\ \bullet \\ \downarrow \\ \bullet \\ v \end{array}.$$

where $\gamma_e = (a_e, r_e, v_0)$, $\gamma_e^* = (a_e, r'_e, v)$, $e_j = (-|j|_s, 0, 0)$ and $\gamma_j = (a_e + |j|_s, \max(r_e - |j|_s, 0), v_0)$. The first identity comes from the fact that a mollifier is invariant by convolution:

$$\hat{\varrho}_\varepsilon = (\varrho_\varepsilon * \varrho_\varepsilon)$$

is also a mollifier if ϱ is. This property allows us to make disappear the node v_c . Then we also have for $j = 0$:

$$\begin{array}{c} \bullet \\ e_- \\ \swarrow \gamma_e \\ \bullet \\ e_+ \\ \downarrow \\ \bullet \\ v_1 \end{array} \begin{array}{c} \bullet \\ \bullet \\ \downarrow \\ \bullet \\ v \end{array} = \begin{array}{c} \bullet \\ e_- \\ \swarrow \gamma_e \\ \bullet \\ e_+ \\ \downarrow \\ \bullet \\ v_1 \end{array} \begin{array}{c} \bullet \\ \bullet \\ \downarrow \\ \bullet \\ v \end{array}$$

which erases the divergence given by $\mathcal{V} = \{e_+, v\}$. Indeed, if we look at the edge $\bar{e} = (v_1, e_+)$, it follows:

$$\hat{K}_{\bar{e}}(x_{v_1} - x_{e_+}) = K_{\bar{e}}(x_{v_1} - x_{e_+}) - \sum_{|j|_s < r_{\bar{e}}} \frac{(x_{v_1})^j}{j!} K_{\bar{e}}^{(j)}(-x_{e_+}).$$

By multiplying by $\varrho_\varepsilon(x_v - x_{e_+})$ and by integrating over x_{e_+} , we obtain:

$$\begin{aligned} \int_{\mathbb{R}^d} \varrho_\varepsilon(x_v - x_{e_+}) \hat{K}_{\bar{e}}(x_{v_1} - x_{e_+}) dx_{e_+} &= \int_{\mathbb{R}^d} \varrho_\varepsilon(x_v - x_{e_+}) D^{\epsilon(\bar{e})} K(x_{v_1} - x_{e_+}) dx_{e_+} \\ &\quad - \sum_{|j|_s < r_{\bar{e}}} \frac{(x_{v_1})^j}{j!} \int_{\mathbb{R}^d} \varrho_\varepsilon(x_v - x_{e_+}) D^{\epsilon(\bar{e})+j} K(-x_{e_+}) dx_{e_+} \\ &= D^{\epsilon(\bar{e})} K_\varepsilon(x_{v_1} - x_{e_+}) - \sum_{|j|_s < r_{\bar{e}}} \frac{(x_{v_1})^j}{j!} D^{\epsilon(\bar{e})+j} K_\varepsilon(-x_{e_+}) \end{aligned}$$

where $K_\varepsilon = \varrho_\varepsilon * K$. From [Hai14b, Lemma 10.17], it follows that the value of a_e is the same for K_ε as for K . Let G_\star and G_j given by:

$$G_\star = \begin{array}{c} \bullet \\ e_- \\ \downarrow \gamma_e^* \\ \bullet \\ e_+ \\ \downarrow \\ \bullet \\ v_1 \end{array} \begin{array}{c} \bullet \\ \bullet \\ \downarrow \\ \bullet \\ v \end{array}, \quad G_j = \begin{array}{c} \bullet \\ e_- \\ \downarrow \gamma_e \\ \bullet \\ e_+ \\ \downarrow \\ \bullet \\ v_1 \end{array} \begin{array}{c} \bullet \\ \bullet \\ \downarrow \\ \bullet \\ v \end{array} \begin{array}{c} \bullet \\ \bullet \\ \swarrow \gamma_j \\ \bullet \\ e_+ \\ \downarrow \\ \bullet \\ v_1 \end{array} \begin{array}{c} \bullet \\ \bullet \\ \downarrow \\ \bullet \\ v \end{array}.$$

Proposition 5.5.6. *The graphs G_\star, G_j satisfy the conditions (5.11), (5.10) on $\bar{\mathcal{V}} = \{e_+, v\}$ and on the same subset as for the original graph.*

Proof. Let $V \subset N_{G_\star}$. We first check the condition (5.11) and we look at $\mathcal{V} = V \cap \{e_+, e_-, v\}$. Comparing the contribution of the edge e in G_\star and G , we obtain:

\mathcal{V}	G_\star	G
$\{v\}$	0	0
$\{e_-\}$	$a_e + r'_e$	$a_e + r_e$
$\{e_+\}$	$-(r'_e - 1) + \mathbb{1}_{r'_e=0}(a_e + r'_e - 1)$	$-(r_e - 1) + \mathbb{1}_{r_e=0}(a_e + r_e - 1)$
$\{e_+, e_-\}$	a_e	a_e
$\{e_+, v\}$	a_e	$-(r_e - 1) + \mathbb{1}_{r_e=0}(a_e + r_e - 1)$
$\{e_-, v\}$	a_e	$a_e + r_e$
$\{e_+, e_-, v\}$	a_e	a_e

Most of the time, the contribution of G_\star is bigger than the one of G . It remains to treat $\bar{\mathcal{V}} = \{e_+\}$ and $\bar{\mathcal{V}} = \{e_-, v\}$. In that case, the edge (e_+, v) gives the contribution $|\mathfrak{s}| + \kappa$. If we look at the graph \bar{G} which is the graph G before the contraction of the two leaves l_1 and l_2 , we can add in V the leaf l_1 (resp. l_2) for $\mathcal{V} = \{e_+\}$ (resp. $\mathcal{V} = \{e_-, v\}$) and we loose $|\mathfrak{s}|/2$ for the bound without these leaves. But we know that the condition (5.11) is satisfied on \bar{G} given by:

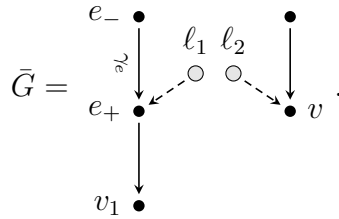

By noticing that $-(r'_e - 1) > -|\mathfrak{s}|/2$ and $\max(|T_e|_{\mathfrak{s}}, 0) < |\mathfrak{s}|/2$, we obtain the same difference between G_\star and G than between \bar{G} and G which allows us to conclude. We have used the fact that when $e \in \mathcal{E}^\uparrow(E_G)$, the label r_e can be replaced by $\max(|T_e|_{\mathfrak{s}}, 0)$ and the condition (5.11) is satisfied for V in G . For the graph G_j , the only problem occurs when $\mathcal{V} = \{v\}$. In that case, we apply the same trick as before by looking at the graph before the contraction.

We proceed as the same for the condition (5.10). Let $V \subset N_{G_\star}$. We look at $\bar{\mathcal{V}} = V \cap \{e_+, e_-, v\}$. Comparing the contribution of the edge e in G_\star and G , we obtain:

\mathcal{V}	G_\star	G
$\{v\}$	0	0
$\{e_-\}$	0	0
$\{e_+\}$	0	0
$\{e_+, e_-\}$	a_e	a_e
$\{e_+, v\}$	$-r'_e$	0
$\{e_-, v\}$	$\mathbb{1}_{r'_e>0}(a_e + r'_e - 1)$	0
$\{e_+, e_-, v\}$	a_e	a_e

5.5. Renormalisation Procedure

When $\mathcal{V} = \{e_+, v\}$, the new contribution $-r'_e$ compensates the divergence of \mathcal{V} .

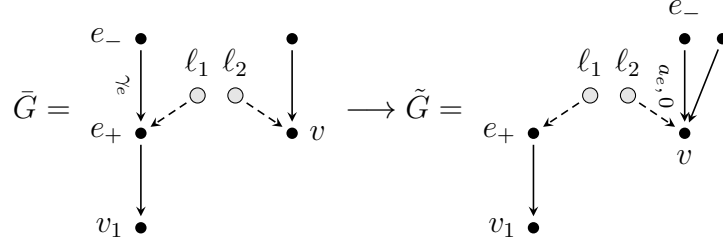

If $\mathcal{V} = \{e_-, v\}$ then we use the graph \bar{G} : by adding the leaf l_2 , we earn $|\mathfrak{s}|/2 + \kappa$ which compensates $r'_e - 1$. The graph \tilde{G} where the label of (v, e_-) is $(a_e, 0)$ satisfies the condition (5.10) because we obtain a graph locally-subcritical. In the sense that the product created by the displacement of the edge e comes from a local-subcritical labelled tree. □

5.5.3 A general approach

Let $T_\epsilon^n \in \mathcal{G}_{\mathcal{R}_u}$ the original labelled tree, to which we associate the graph G representing the integral kernel of the maximal Wiener chaos; by merging some leaves, we obtain graphs G^k 's representing the integral kernels of the lower Wiener chaoses. Negative subtrees of T_ϵ^n correspond to (possibly) diverging subgraphs of the G^k . In the previous section, we have described how to manage such divergence with a telescopic sum. We want to do the same on disjoint negative subgraphs. After that renormalisation, we obtain a finite number of graphs G_1, \dots, G_r which belong to an extension of $\mathcal{G}_{\mathcal{R}_u}$ such that

$$W^\varepsilon(T_\epsilon^n) = \sum_i G_i + \sum_{\bar{\mathcal{A}} \subset \mathcal{A}} (-1)^{|\bar{\mathcal{A}}|+1} \sum_{\epsilon_{\bar{\mathcal{A}}}, n_{\bar{\mathcal{A}}}} \frac{1}{\epsilon_{\bar{\mathcal{A}}}!} \binom{\mathbf{n}}{\mathbf{n}_{\bar{\mathcal{A}}}} W^\varepsilon\left(\Pi_{-} \mathcal{R}_{\bar{\mathcal{A}}}^{\uparrow} T_\epsilon^{n_{\bar{\mathcal{A}}} + \pi \epsilon_{\bar{\mathcal{A}}}}\right) (\varrho_{\bar{\mathcal{A}}}) W^\varepsilon\left(\mathcal{R}_{\bar{\mathcal{A}}}^{\downarrow} T_{\epsilon + \epsilon_{\bar{\mathcal{A}}}}^{n - n_{\bar{\mathcal{A}}}, n_{\bar{\mathcal{A}}} + \pi \epsilon_{\bar{\mathcal{A}}}}\right)$$

where $\mathcal{A} = \{T_1, \dots, T_n\} \in \mathfrak{A}(T)$ and the inclusion $\bar{\mathcal{A}} \subset \mathcal{A}$ means that $T \in \bar{\mathcal{A}}$ implies $T \in \mathcal{A}$. The graph G_i satisfies the conditions (5.9) and (5.11) and the second term is compensated by the renormalisation. For the whole section, we fix $\mathcal{A} \in \mathfrak{A}(T)$.

Remark 5.5.7. We have

$$W^\varepsilon\left(\mathcal{R}_{\mathcal{A}}^{\uparrow} T_\epsilon^{n_{\mathcal{A}} + \pi \epsilon_{\mathcal{A}}}\right) (\varrho_{\mathcal{A}}) = \prod_{i=1}^n W^\varepsilon\left(\mathcal{R}_{T_i}^{\uparrow} T_\epsilon^{n_{\mathcal{A}} + \pi \epsilon_{\mathcal{A}}}\right) (\varrho_{T_i}).$$

where the notation $W^\varepsilon\left(\mathcal{R}_{T_i}^{\uparrow} T_\epsilon^{n_{\mathcal{A}} + \pi \epsilon_{\mathcal{A}}}\right) (\varrho_{T_i})$ means that the tree is rooted in ϱ_{T_i} . Moreover, the variable $x_{\varrho_{T_i}}$ is the same as in the term $W^\varepsilon\left(\mathcal{R}_{\mathcal{A}}^{\downarrow} T_{\epsilon + \epsilon_{\mathcal{A}}}^{n - n_{\mathcal{A}}, n_{\mathcal{A}} + \pi \epsilon_{\mathcal{A}}}\right)$ and it is integrated.

The term $W^\varepsilon \left(\mathcal{R}_{T_i}^\dagger T_\varepsilon^{n_{\mathcal{A}} + \pi \varepsilon_{\mathcal{A}}} \right) (\varrho_{T_i})$ does not contain any test function φ_λ , we have made an abuse of notation by replacing \mathcal{W} by W . Moreover, the previous term should be written with a node label \bar{d} , $W^\varepsilon \left(\mathcal{R}_{T_i}^\dagger T_\varepsilon^{n_{\mathcal{A}} + \pi \varepsilon_{\mathcal{A}}, \bar{d}} \right) (\varrho_{T_i})$ in order to obtain the right length for the Taylor expansion. Indeed, we have to keep track of the trees above T_i in T . For the rest of the section, we omit this label.

In the sequel, we want to give a general formula for the sum of the graphs G_i .

Definition 5.5.8. Let $G = (\mathcal{V}, \mathcal{E})$ an elementary graph with associated tree T as in definition 5.3.1. We suppose that we have ordered the edges of T . Then, for $\mathcal{A} = \{T_1, \dots, T_n\} \in \mathfrak{A}(T)$ we define $\mathcal{E}^\downarrow(\mathcal{A})$ as: $\{\mathcal{E}_1, \dots, \mathcal{E}_n\} \in \mathcal{E}^\downarrow(\mathcal{A})$ if $\mathcal{E}_i \subset_{od} \mathcal{E}^\downarrow(T_i)$ where \subset_{od} means that \mathcal{E}_i is composed of the first $|\mathcal{E}_i|$ th edges toward the order fixed on the edges in $\mathcal{E}^\downarrow(T_i)$.

Definition 5.5.9. Let $\mathcal{A} = \{T_1, \dots, T_n\} \in \mathfrak{A}(T)$, $\mathcal{E} = \{\mathcal{E}_1, \dots, \mathcal{E}_n\} \in \mathcal{E}^\downarrow(\mathcal{A})$, $\varepsilon_{\mathcal{E}} \mathbf{N}^d$ -valued function on E_T supported by the set \mathcal{E} and $n_{\mathcal{A}} \mathbf{N}^d$ -valued function on N_T supported by $\cup_i \dot{N}_{T_i}$. We define $\mathcal{P}_{\mathcal{E}}^{n_{\mathcal{A}}, \varepsilon_{\mathcal{E}}} W^\varepsilon (T_{\varepsilon + \varepsilon_{\mathcal{E}}}^{n - n_{\mathcal{A}}, n_{\mathcal{A}} + \pi \varepsilon_{\mathcal{E}}})$ as the graph G where we make the following transformations:

- Every edge $e_i = (v_1^i, v_2^i) \in \mathcal{E}_i$ such that $r_{e_i} \geq 0$ is removed and is replaced by the edge (ϱ_{T_i}, v_2^i) with the same label. Moreover, we add an edge (ϱ_{T_i}, v_1^i) with the label $(-\pi \varepsilon_{\mathcal{E}}(v_1^i)|_s, 0, 0)$.
- Every edge of the form (v_i, v_0) with $v_i \in T_i$, is replaced by an edge (ϱ_{T_i}, v_0) with the same label and an edge (v_i, ϱ_{T_i}) with label $(-|n_{\mathcal{A}}(v_i)|_s, 0, 0)$.
- the label $(a_{e_i}, r_{e_i}, v_{e_i})$ of the minimum edges e_i in $\mathcal{E}^\downarrow(T_i) \setminus \mathcal{E}_i$

becomes

- $(a_{e_i}, r'_{e_i}, \varrho_{T_i})$ if $|(T_i)_\varepsilon^{n_{\mathcal{A}}}|_s + \sum_{e' \leq_{od} e_i} |\varepsilon_{\mathcal{E}}(e')|_s \leq 0$ then r'_{e_i} is given by

$$r'_{e_i} = \max(r_{e_i}, \lceil -(|(T_i)_\varepsilon^{n_{\mathcal{A}}}|_s + \sum_{e' \leq_{od} e_i} |\varepsilon_{\mathcal{E}}(e')|_s) \rceil).$$

- does not change otherwise.

If we do not perform the third transformation on T_i , we use the notation $\mathcal{P}_{\mathcal{E}, T_i}^{n_{\mathcal{A}}, \varepsilon_{\mathcal{E}}} W^\varepsilon (T_{\varepsilon + \varepsilon_{\mathcal{E}}}^{n - n_{\mathcal{A}}, n_{\mathcal{A}} + \pi \varepsilon_{\mathcal{E}}})$. We denote by $P^{n_{\mathcal{A}}} W^\varepsilon (T_\varepsilon^{n - n_{\mathcal{A}}, n_{\mathcal{A}}})$ the second operation.

Let \mathcal{R}_u , a set of rules. For $\mathcal{A} = \{T_1, \dots, T_n\}$, we define $\tilde{\mathcal{G}}_{\mathcal{R}_u}(\mathcal{A})$ as

$$\tilde{\mathcal{G}}_{\mathcal{R}_u}(\mathcal{A}) = \{ \mathcal{P}_{\mathcal{E}}^{n_{\mathcal{A}}, \varepsilon_{\mathcal{E}}} W^\varepsilon (T_{\varepsilon + \varepsilon_{\mathcal{E}}}^{n - n_{\mathcal{A}}, n_{\mathcal{A}} + \pi \varepsilon_{\mathcal{E}}}) : T_\varepsilon^n \in \mathcal{T}_{\mathcal{R}_u}, \mathcal{E} \in \mathcal{E}^\downarrow(\mathcal{A}), \varepsilon_{\mathcal{E}}, n_{\mathcal{A}} \}.$$

5.5. Renormalisation Procedure

In the next figure, we consider for $T = (\mathcal{V}, \mathcal{E})$: $\mathcal{E}' = \{(v_{r,1}, v_1), (v_{r,1}, v_2), (v_{r,2}, v_3)\}$. The minimum edge in $\mathcal{E} \setminus \mathcal{E}'$ is given by $(v_{r,2}, v_4)$.

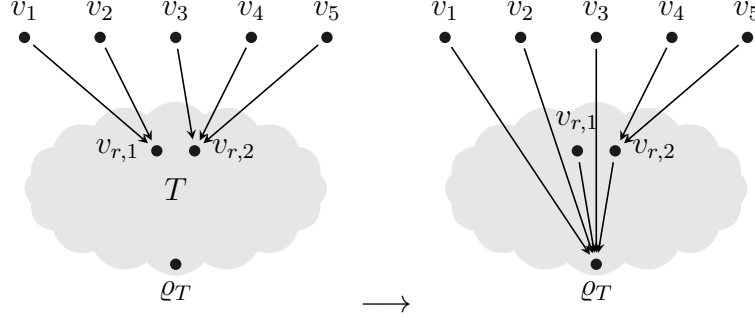

Remark 5.5.10. If one of the \mathcal{E}_i is equal to $\mathcal{E}^\downarrow(T_i)$ then:

$$\mathcal{P}_{\mathcal{E}}^{\mathbf{n}_{\mathcal{A}}, \epsilon_{\mathcal{E}}} W^{\epsilon} (T_{\epsilon + \epsilon_{\mathcal{E}}}^{\mathbf{n} - \mathbf{n}_{\mathcal{A}}, \mathbf{n}_{\mathcal{A}} + \pi \epsilon_{\mathcal{E}}}) = W^{\epsilon} \left(\mathcal{R}_{T_i}^{\uparrow} T_{\epsilon}^{\mathbf{n}_{\mathcal{A}} + \pi \epsilon_{\mathcal{E}}} \right) (\varrho_{T_i}) \mathcal{P}_{\mathcal{E}'}^{\mathbf{n}_{\mathcal{A}}, \epsilon_{\mathcal{E}'}} W^{\epsilon} \left(\mathcal{R}_{T_i}^{\downarrow} T_{\epsilon + \epsilon_{\mathcal{E}}}^{\mathbf{n} - \mathbf{n}_{\mathcal{A}}, \mathbf{n}_{\mathcal{A}} + \pi \epsilon_{\mathcal{E}}} \right)$$

where $\mathcal{E}' = \mathcal{E} \setminus \mathcal{E}_i$ and $\epsilon_{\mathcal{E}'}$ is the restriction of $\epsilon_{\mathcal{E}}$ to \mathcal{E}' . If $\mathcal{E} = \{\mathcal{E}^\downarrow(T_1), \dots, \mathcal{E}^\downarrow(T_n)\}$ then

$$\mathcal{P}_{\mathcal{E}}^{\mathbf{n}_{\mathcal{A}}, \epsilon_{\mathcal{E}}} W^{\epsilon} (T_{\epsilon + \epsilon_{\mathcal{E}}}^{\mathbf{n} - \mathbf{n}_{\mathcal{A}}, \mathbf{n}_{\mathcal{A}} + \pi \epsilon_{\mathcal{E}}}) = W^{\epsilon} \left(\mathcal{R}_{\mathcal{A}}^{\uparrow} T_{\epsilon}^{\mathbf{n}_{\mathcal{A}} + \pi \epsilon_{\mathcal{E}}} \right) (\varrho_{\mathcal{A}}) W^{\epsilon} \left(\mathcal{R}_{\mathcal{A}}^{\downarrow} T_{\epsilon + \epsilon_{\mathcal{E}}}^{\mathbf{n} - \mathbf{n}_{\mathcal{A}}, \mathbf{n}_{\mathcal{A}} + \pi \epsilon_{\mathcal{E}}} \right).$$

Proposition 5.5.11. For every $\mathcal{A} = \{T_1, \dots, T_n\} \in \mathfrak{A}(T)$, one has

$$W^{\epsilon} (T_{\epsilon}^{\mathbf{n}}) = \sum_{\mathcal{E} \in \mathcal{E}^\downarrow(\mathcal{A})} \sum_{\epsilon_{\mathcal{E}}, \mathbf{n}_{\mathcal{A}}} \frac{1}{\epsilon_{\mathcal{E}}!} \binom{\mathbf{n}}{\mathbf{n}_{\mathcal{A}}} \mathcal{P}_{\mathcal{E}}^{\mathbf{n}_{\mathcal{A}}, \epsilon_{\mathcal{E}}} W^{\epsilon} (T_{\epsilon + \epsilon_{\mathcal{E}}}^{\mathbf{n} - \mathbf{n}_{\mathcal{A}}, \mathbf{n}_{\mathcal{A}} + \pi \epsilon_{\mathcal{E}}).$$

where

1. $\epsilon_{\mathcal{E}}$ runs over all \mathbf{N}^d -valued functions on E_T supported by the set \mathcal{E} such that $\forall e \in \mathcal{E}_i$, one has $|(T_i)_{\epsilon}^{\mathbf{n}_{\mathcal{A}}}|_{\mathfrak{s}} + \sum_{e' \leq_{od} e} |\epsilon_{\mathcal{E}}(e')|_{\mathfrak{s}} \leq 0$ for $e \neq e_{\max}^i$ the maximum edge in \mathcal{E}_i and $\epsilon_{\mathcal{E}}(e) < \max(r_e, \lceil -(|(T_i)_{\epsilon}^{\mathbf{n}_{\mathcal{A}}}|_{\mathfrak{s}} + \sum_{e' \leq_{od} e} |\epsilon_{\mathcal{E}}(e')|_{\mathfrak{s}}) \rceil)$.
2. $\mathbf{n}_{\mathcal{A}}$ runs over the set of all \mathbf{N}^d -valued functions on N_T supported by $\cup_i \overset{\circ}{N}_{T_i}$ such that $\mathbf{n}_{\mathcal{A}} \leq \mathbf{n}$.

The only divergent part in the previous sum is given for $\mathcal{E} = \{\mathcal{E}_1, \dots, \mathcal{E}_n\}$ where one of the \mathcal{E}_i is equal to $\mathcal{E}^\downarrow(T_i)$ and the associated tree has a negative homogeneity. Finally, we obtain

$$W^{\epsilon} (T_{\epsilon}^{\mathbf{n}}) = \sum_i G_i + \sum_{\bar{\mathcal{A}} \subset \mathcal{A}} (-1)^{|\bar{\mathcal{A}}|+1} \sum_{\epsilon_{\bar{\mathcal{A}}}, \mathbf{n}_{\bar{\mathcal{A}}}} \frac{1}{\epsilon_{\bar{\mathcal{A}}}!} \binom{\mathbf{n}}{\mathbf{n}_{\bar{\mathcal{A}}}} W^{\epsilon} \left(\prod_{-} \mathcal{R}_{\bar{\mathcal{A}}}^{\uparrow} T_{\epsilon}^{\mathbf{n}_{\bar{\mathcal{A}}} + \pi \epsilon_{\bar{\mathcal{A}}}} \right) (\varrho_{\bar{\mathcal{A}}}) W^{\epsilon} \left(\mathcal{R}_{\bar{\mathcal{A}}}^{\downarrow} T_{\epsilon + \epsilon_{\bar{\mathcal{A}}}}^{\mathbf{n} - \mathbf{n}_{\bar{\mathcal{A}}}, \mathbf{n}_{\bar{\mathcal{A}}} + \pi \epsilon_{\bar{\mathcal{A}}}} \right)$$

where the G_i are terms with renormalisation on \mathcal{A} , in the sense that for each $T_i \in \mathcal{A}$, the label of one edge e in $\mathcal{E}^\downarrow(T_i)$ has been changed as in the first part of the definition 5.5.9.

Proof. We proceed by recurrence on the size of \mathcal{A} and we want to first prove that:

$$\sum_{\mathcal{E} \in \mathcal{E}^\downarrow(\mathcal{A})} \sum_{\mathbf{e}_\mathcal{E}, \mathbf{n}_\mathcal{A}} \frac{1}{\mathbf{e}_\mathcal{E}!} \binom{\mathbf{n}}{\mathbf{n}_\mathcal{A}} \mathcal{P}_{\mathcal{E}}^{\mathbf{n}_\mathcal{A}, \mathbf{e}_\mathcal{E}} W^\mathcal{E}(T_{\mathbf{e}+\mathbf{e}_\mathcal{E}}^{\mathbf{n}-\mathbf{n}_\mathcal{A}, \mathbf{n}_\mathcal{A}+\pi\mathbf{e}_\mathcal{E}}) = \sum_{\mathbf{n}_\mathcal{A}} \binom{\mathbf{n}}{\mathbf{n}_\mathcal{A}} \mathcal{P}^{\mathbf{n}_\mathcal{A}} W^\mathcal{E}(T_{\mathbf{e}}^{\mathbf{n}-\mathbf{n}_\mathcal{A}, \mathbf{n}_\mathcal{A}}).$$

Let $\mathcal{A} = \{T_1, \dots, T_{n+1}\}$ and $\mathcal{E} = \{\mathcal{E}_1, \dots, \mathcal{E}_{n+1}\}$ where $\mathcal{E}_i \subset_{od} \mathcal{E}^\downarrow(T_i)$. We fix some labels $\mathbf{e}_\mathcal{E}, \mathbf{n}_\mathcal{A}$ and we set

$$A_\mathcal{E} = \sum_{\mathbf{e}_\mathcal{E}, \mathbf{n}_\mathcal{A}} \frac{1}{\mathbf{e}_\mathcal{E}!} \binom{\mathbf{n}}{\mathbf{n}_\mathcal{A}} \mathcal{P}_{\mathcal{E}}^{\mathbf{n}_\mathcal{A}, \mathbf{e}_\mathcal{E}} W^\mathcal{E}(T_{\mathbf{e}+\mathbf{e}_\mathcal{E}}^{\mathbf{n}-\mathbf{n}_\mathcal{A}, \mathbf{n}_\mathcal{A}+\pi\mathbf{e}_\mathcal{E}}).$$

Let $e = (e_+, e_-)$ the minimum edge in $\mathcal{E}^\downarrow(T_{n+1}) \setminus \mathcal{E}_{n+1}$, we have

$$\begin{aligned} \hat{K}_e(x_{e_+} - x_{e_-}) &= K_e(x_{e_+} - x_{e_-}) - \sum_{|j|_s < r_e} \frac{(x_{e_+} - x_{v_e})^j}{j!} K_e^{(j)}(x_{v_e} - x_{e_-}) \\ &= K_e(x_{e_+} - x_{e_-}) - \sum_{|j|_s < r'_e} \frac{(x_{e_+} - x_{\varrho_{T_{n+1}}})^j}{j!} K_e^{(j)}(x_{\varrho_{T_{n+1}}} - x_{e_-}) + \sum_{|j|_s < r'_e} \frac{(x_{e_+} - x_{\varrho_{T_{n+1}}})^j}{j!} \\ &\quad \left(K_e^{(j)}(x_{\varrho_{T_{n+1}}} - x_{e_-}) - \sum_{|k|_s < r_e - |j|_s} \frac{(x_{\varrho_{T_{n+1}}} - x_{v_e})^k}{k!} K_e^{(j+k)}(x_{v_e} - x_{e_-}) \right). \end{aligned}$$

where r'_e is defined as in 5.5.9. Then, it follows:

$$A_\mathcal{E} = \sum_{\mathbf{e}_\mathcal{E}, \mathbf{n}_\mathcal{A}} \frac{1}{\mathbf{e}_\mathcal{E}!} \binom{\mathbf{n}}{\mathbf{n}_\mathcal{A}} \mathcal{P}_{\mathcal{E}, T_{n+1}}^{\mathbf{n}_\mathcal{A}, \mathbf{e}_\mathcal{E}} W^\mathcal{E}(T_{\mathbf{e}+\mathbf{e}_\mathcal{E}}^{\mathbf{n}-\mathbf{n}_\mathcal{A}, \mathbf{n}_\mathcal{A}+\pi\mathbf{e}_\mathcal{E}}) - \sum_{\mathbf{e}_{\mathcal{E}'}, \mathbf{n}_\mathcal{A}} \frac{1}{\mathbf{e}_{\mathcal{E}'}!} \binom{\mathbf{n}}{\mathbf{n}_\mathcal{A}} \mathcal{P}_{\mathcal{E}', T_{n+1}}^{\mathbf{n}_\mathcal{A}, \mathbf{e}_{\mathcal{E}'}} W^\mathcal{E}(T_{\mathbf{e}+\mathbf{e}_{\mathcal{E}'}}^{\mathbf{n}-\mathbf{n}_\mathcal{A}, \mathbf{n}_\mathcal{A}+\pi\mathbf{e}_{\mathcal{E}'}}),$$

where $\mathcal{E}' = \{\mathcal{E}'_1, \dots, \mathcal{E}'_{n+1}\}$ and $\mathcal{E}_i = \mathcal{E}'_i$ for $i \neq n+1$, $\mathcal{E}'_{n+1} = \mathcal{E}_{n+1} \cup \{e\}$. If $\mathcal{E}_{n+1} = \mathcal{E}^\downarrow(T_{n+1})$, then

$$A_\mathcal{E} = \sum_{\mathbf{e}_\mathcal{E}, \mathbf{n}_\mathcal{A}} \frac{1}{\mathbf{e}_\mathcal{E}!} \binom{\mathbf{n}}{\mathbf{n}_\mathcal{A}} \mathcal{P}_{\mathcal{E}, T_{n+1}}^{\mathbf{n}_\mathcal{A}, \mathbf{e}_\mathcal{E}} W^\mathcal{E}(T_{\mathbf{e}+\mathbf{e}_\mathcal{E}}^{\mathbf{n}-\mathbf{n}_\mathcal{A}, \mathbf{n}_\mathcal{A}+\pi\mathbf{e}_\mathcal{E}}).$$

By fixing $\mathcal{E}_1, \dots, \mathcal{E}_n$ and making the sum over \mathcal{E}_{n+1} , it remains the term for $\mathcal{E}_{n+1} = \emptyset$:

$$\begin{aligned} \sum_{\mathcal{E}_{n+1} \subset_{od} \mathcal{E}^\downarrow(T_{n+1})} A_\mathcal{E} &= \mathbb{1}_{\mathcal{E}_{n+1} = \emptyset} \sum_{\mathbf{e}_\mathcal{E}, \mathbf{n}_\mathcal{A}} \frac{1}{\mathbf{e}_\mathcal{E}!} \binom{\mathbf{n}}{\mathbf{n}_\mathcal{A}} \mathcal{P}_{\mathcal{E}, T_{n+1}}^{\mathbf{n}_\mathcal{A}, \mathbf{e}_\mathcal{E}} W^\mathcal{E}(T_{\mathbf{e}+\mathbf{e}_\mathcal{E}}^{\mathbf{n}-\mathbf{n}_\mathcal{A}, \mathbf{n}_\mathcal{A}+\pi\mathbf{e}_\mathcal{E}}) \\ &= \mathbb{1}_{\mathcal{E}_{n+1} = \emptyset} \sum_{\mathbf{e}_\mathcal{E}, \mathbf{n}_\mathcal{A}} \frac{1}{\mathbf{e}_\mathcal{E}!} \binom{\mathbf{n}}{\mathbf{n}_\mathcal{A}} \mathcal{P}_{\mathcal{E}}^{\mathbf{n}_\mathcal{A}, \mathbf{e}_\mathcal{E}} W^\mathcal{E}(T_{\mathbf{e}+\mathbf{e}_\mathcal{E}}^{\mathbf{n}-\mathbf{n}_\mathcal{A}, \mathbf{n}_\mathcal{A}+\pi\mathbf{e}_\mathcal{E}}). \end{aligned}$$

Finally, we have

$$\sum_{\mathcal{E} \in \mathcal{E}^\downarrow(\mathcal{A}_{n+1})} A_\mathcal{E} = \sum_{\mathcal{E} \in \mathcal{E}^\downarrow(\mathcal{A}_n)} \sum_{\mathcal{E}_{n+1} \subset_{od} \mathcal{E}^\downarrow(T_{n+1})} A_{\mathcal{E} \cup \{\mathcal{E}_{n+1}\}}$$

5.5. Renormalisation Procedure

$$\begin{aligned}
&= \sum_{\mathcal{E} \in \mathcal{E}^\downarrow(\mathcal{A}_n)} \sum_{\mathfrak{e}_{\mathcal{E}}, \mathfrak{n}_{\mathcal{A}}} \frac{1}{\mathfrak{e}_{\mathcal{E}}!} \binom{\mathfrak{n}}{\mathfrak{n}_{\mathcal{A}}} \mathcal{P}_{\mathcal{E}}^{\mathfrak{n}_{\mathcal{A}}, \mathfrak{e}_{\mathcal{E}}} W^\varepsilon(T_{\mathfrak{e}+\mathfrak{e}_{\mathcal{E}}}^{\mathfrak{n}-\mathfrak{n}_{\mathcal{A}}, \mathfrak{n}_{\mathcal{A}}+\pi\mathfrak{e}_{\mathcal{E}}}) \\
&= \sum_{\mathfrak{n}_{\mathcal{A}}} \binom{\mathfrak{n}}{\mathfrak{n}_{\mathcal{A}}} \mathcal{P}^{\mathfrak{n}_{\mathcal{A}}} W^\varepsilon(T_{\mathfrak{e}}^{\mathfrak{n}-\mathfrak{n}_{\mathcal{A}}, \mathfrak{n}_{\mathcal{A}}}),
\end{aligned}$$

where we have concluded by applying the recurrence hypothesis to \mathcal{A}_n . It remains to prove by recurrence that:

$$W^\varepsilon(T_{\mathfrak{e}}^{\mathfrak{n}}) = \sum_{\mathfrak{n}_{\mathcal{A}}} \binom{\mathfrak{n}}{\mathfrak{n}_{\mathcal{A}}} \mathcal{P}^{\mathfrak{n}_{\mathcal{A}}} W^\varepsilon(T_{\mathfrak{e}}^{\mathfrak{n}-\mathfrak{n}_{\mathcal{A}}, \mathfrak{n}_{\mathcal{A}}}).$$

We proceed as the same as before and we use the binomial identity for every $v_i \in T_i$:

$$(x_{v_i})^{\mathfrak{n}(v_i)} = \sum_{|k|_s \leq |\mathfrak{n}(v_i)|_s} \binom{\mathfrak{n}(v_i)}{k} (x_{v_i} - x_{\varrho_{T_i}})^k (x_{\varrho_{T_i}})^{\mathfrak{n}(v_i)-k}.$$

For the last part of the proposition, we proceed by induction on the size of \mathcal{A} . Let $\mathcal{E} = \{\mathcal{E}_1, \dots, \mathcal{E}_n, \mathcal{E}^\downarrow(T_{n+1})\} \in \mathcal{E}^\downarrow(\mathcal{A})$. By setting $\tilde{\mathcal{A}} = \{T_{n+1}\}$, $\bar{\mathcal{A}} = \mathcal{A}_n = \{T_1, \dots, T_n\}$ and $\bar{\mathcal{E}} = \{\mathcal{E}_1, \dots, \mathcal{E}_n\}$ we obtain

$$\mathcal{P}_{\mathcal{E}}^{\mathfrak{n}_{\mathcal{A}}, \mathfrak{e}_{\mathcal{E}}} W^\varepsilon(T_{\mathfrak{e}+\mathfrak{e}_{\mathcal{E}}}^{\mathfrak{n}-\mathfrak{n}_{\mathcal{A}}, \mathfrak{n}_{\mathcal{A}}+\pi\mathfrak{e}_{\mathcal{E}}}) = W^\varepsilon(\mathcal{R}_{\tilde{\mathcal{A}}}^\uparrow T_{\mathfrak{e}}^{\mathfrak{n}, \tilde{\mathcal{A}}+\pi\mathfrak{e}_{\tilde{\mathcal{A}}}})(\varrho_{\tilde{\mathcal{A}}}) \mathcal{P}_{\bar{\mathcal{E}}}^{\mathfrak{n}_{\bar{\mathcal{A}}}, \mathfrak{e}_{\bar{\mathcal{E}}}} W^\varepsilon(\mathcal{R}_{\bar{\mathcal{A}}}^\downarrow T_{\mathfrak{e}+\mathfrak{e}_{\bar{\mathcal{A}}+\mathfrak{e}_{\bar{\mathcal{E}}}}}^{\mathfrak{n}-\mathfrak{n}_{\bar{\mathcal{A}}}-\mathfrak{n}_{\bar{\mathcal{A}}}, \mathfrak{n}_{\bar{\mathcal{A}}+\pi\mathfrak{e}_{\bar{\mathcal{A}}+\mathfrak{n}_{\bar{\mathcal{A}}+\pi\mathfrak{e}_{\bar{\mathcal{E}}}}})$$

where the labels $\mathfrak{n}_{\bar{\mathcal{A}}}, \mathfrak{e}_{\bar{\mathcal{E}}}$ are the restriction of $\mathfrak{n}_{\mathcal{A}}, \mathfrak{e}_{\mathcal{E}}$ to $\bar{\mathcal{A}}$ and $\bar{\mathcal{E}}$. The labels $\mathfrak{n}_{\tilde{\mathcal{A}}}, \mathfrak{e}_{\tilde{\mathcal{A}}}$ are the restriction of $\mathfrak{n}_{\mathcal{A}}, \mathfrak{e}_{\mathcal{E}}$ to $\tilde{\mathcal{A}}$. It follows

$$\begin{aligned}
W^\varepsilon(T_{\mathfrak{e}}^{\mathfrak{n}}) &= \sum_{\mathcal{E} \in \mathcal{E}^\downarrow(\mathcal{A})} A_{\mathcal{E}} = \sum_{\mathcal{E} \in \mathcal{E}^\downarrow(\mathcal{A})} \sum_{\mathfrak{e}_{\mathcal{E}}, \mathfrak{n}_{\mathcal{A}}} \frac{1}{\mathfrak{e}_{\mathcal{E}}!} \binom{\mathfrak{n}}{\mathfrak{n}_{\mathcal{A}}} \mathcal{P}_{\mathcal{E}}^{\mathfrak{n}_{\mathcal{A}}, \mathfrak{e}_{\mathcal{E}}} W^\varepsilon(T_{\mathfrak{e}+\mathfrak{e}_{\mathcal{E}}}^{\mathfrak{n}-\mathfrak{n}_{\mathcal{A}}, \mathfrak{n}_{\mathcal{A}}+\pi\mathfrak{e}_{\mathcal{E}}}) \\
&= \sum_{\bar{\mathcal{E}} \in \mathcal{E}^\downarrow(\mathcal{A}_n)} A_{\bar{\mathcal{E}} \cup \{\mathcal{E}^\downarrow(T_{n+1})\}} + \sum_{\substack{\bar{\mathcal{E}} \subset_{\text{od}} \mathcal{E}^\downarrow(T_{n+1}) \\ \bar{\mathcal{E}} \neq \mathcal{E}^\downarrow(T_{n+1})}} \sum_{\bar{\mathcal{E}} \in \mathcal{E}^\downarrow(\mathcal{A}_n)} A_{\bar{\mathcal{E}} \cup \bar{\mathcal{E}}}.
\end{aligned}$$

For the first term of the previous identity, we obtain:

$$\begin{aligned}
\sum_{\bar{\mathcal{E}} \in \mathcal{E}^\downarrow(\mathcal{A}_n)} A_{\bar{\mathcal{E}} \cup \{\mathcal{E}^\downarrow(T_{n+1})\}} &= \sum_{\bar{\mathcal{E}} \in \mathcal{E}^\downarrow(\mathcal{A}_n)} \sum_{\mathfrak{e}_{\bar{\mathcal{A}}}, \mathfrak{n}_{\bar{\mathcal{A}}}} \frac{1}{\mathfrak{e}_{\bar{\mathcal{A}}}!} \binom{\mathfrak{n}}{\mathfrak{n}_{\bar{\mathcal{A}}}} \\
&\left(\sum_{\mathfrak{e}_{\bar{\mathcal{E}}}, \mathfrak{n}_{\bar{\mathcal{A}}}} \frac{1}{\mathfrak{e}_{\bar{\mathcal{E}}}!} \binom{\mathfrak{n}}{\mathfrak{n}_{\bar{\mathcal{A}}}} \mathcal{P}_{\bar{\mathcal{E}}}^{\mathfrak{n}_{\bar{\mathcal{A}}}, \mathfrak{e}_{\bar{\mathcal{E}}}} W^\varepsilon(\mathcal{R}_{\bar{\mathcal{A}}}^\downarrow T_{\mathfrak{e}+\mathfrak{e}_{\bar{\mathcal{A}}+\mathfrak{e}_{\bar{\mathcal{E}}}}}^{\mathfrak{n}-\mathfrak{n}_{\bar{\mathcal{A}}}-\mathfrak{n}_{\bar{\mathcal{A}}}, \mathfrak{n}_{\bar{\mathcal{A}}+\pi\mathfrak{e}_{\bar{\mathcal{A}}+\mathfrak{n}_{\bar{\mathcal{A}}+\pi\mathfrak{e}_{\bar{\mathcal{E}}}}}) \right) W^\varepsilon(\mathcal{R}_{\tilde{\mathcal{A}}}^\uparrow T_{\mathfrak{e}}^{\mathfrak{n}, \tilde{\mathcal{A}}+\pi\mathfrak{e}_{\tilde{\mathcal{A}}}})(\varrho_{\tilde{\mathcal{A}}}),
\end{aligned}$$

which yields

$$\begin{aligned}
&\sum_{\bar{\mathcal{E}} \in \mathcal{E}^\downarrow(\mathcal{A}_n)} A_{\bar{\mathcal{E}} \cup \{\mathcal{E}^\downarrow(T_{n+1})\}} \\
&= \sum_{\mathfrak{e}_{\bar{\mathcal{A}}}, \mathfrak{n}_{\bar{\mathcal{A}}}} \frac{1}{\mathfrak{e}_{\bar{\mathcal{A}}}!} \binom{\mathfrak{n}}{\mathfrak{n}_{\bar{\mathcal{A}}}} W^\varepsilon(\mathcal{R}_{\tilde{\mathcal{A}}}^\uparrow T_{\mathfrak{e}}^{\mathfrak{n}, \tilde{\mathcal{A}}+\pi\mathfrak{e}_{\tilde{\mathcal{A}}}})(\varrho_{\tilde{\mathcal{A}}}) W^\varepsilon(\mathcal{R}_{\bar{\mathcal{A}}}^\downarrow T_{\mathfrak{e}+\mathfrak{e}_{\bar{\mathcal{A}}}}^{\mathfrak{n}-\mathfrak{n}_{\bar{\mathcal{A}}}, \mathfrak{n}_{\bar{\mathcal{A}}+\pi\mathfrak{e}_{\bar{\mathcal{A}}}}}). \tag{5.14}
\end{aligned}$$

For the second term, we apply the induction hypothesis on each $A_{\bar{\varepsilon}}$ for \mathcal{A}_n on it and we have the existence of renormalised graph G_i such that:

$$\sum_{\substack{\bar{\varepsilon} \subset \text{od} \mathcal{E} \downarrow (T_{n+1}) \\ \bar{\varepsilon} \neq \mathcal{E} \downarrow (T_{n+1})}} A_{\bar{\varepsilon}} = \sum_i G_i + \sum_{\substack{\bar{\varepsilon} \subset \mathcal{E} \downarrow (T_{n+1}) \\ \bar{\varepsilon} \neq \mathcal{E} \downarrow (T_{n+1})}} \sum_{\substack{\bar{\mathcal{A}} \subset \mathcal{A}_n \\ \bar{\mathcal{A}} \neq \emptyset}} (-1)^{|\bar{\mathcal{A}}|+1} \sum_{\mathbf{e}_{\bar{\mathcal{A}}}, \mathbf{n}_{\bar{\mathcal{A}}}} \frac{1}{\mathbf{e}_{\bar{\mathcal{A}}}!} \binom{\mathbf{n}}{\mathbf{n}_{\bar{\mathcal{A}}}} \quad (5.15)$$

$$\left(\sum_{\mathbf{e}_{\bar{\varepsilon}}, \mathbf{n}_{\bar{\mathcal{A}}}} \frac{1}{\mathbf{e}_{\bar{\varepsilon}}!} \binom{\mathbf{n}}{\mathbf{n}_{\bar{\mathcal{A}}}} \mathcal{P}_{\bar{\varepsilon}}^{\mathbf{n}_{\bar{\mathcal{A}}}, \mathbf{e}_{\bar{\varepsilon}}} W^{\varepsilon} (\mathcal{R}_{\bar{\mathcal{A}}}^{\downarrow} T_{\mathbf{e} + \mathbf{e}_{\bar{\mathcal{A}}} + \mathbf{e}_{\bar{\varepsilon}}}^{\mathbf{n} - \mathbf{n}_{\bar{\mathcal{A}} - \mathbf{n}_{\bar{\mathcal{A}}}, \mathbf{n}_{\bar{\mathcal{A}}} + \pi \mathbf{e}_{\bar{\mathcal{A}}} + \mathbf{n}_{\bar{\varepsilon}} + \pi \mathbf{e}_{\bar{\varepsilon}}}) \right) W^{\varepsilon} \left(\Pi_{-} \mathcal{R}_{\bar{\mathcal{A}}}^{\uparrow} T_{\mathbf{e}}^{\mathbf{n}_{\bar{\mathcal{A}}} + \pi \mathbf{e}_{\bar{\mathcal{A}}}} \right) (\varrho_{\bar{\mathcal{A}}}).$$

The graph G_i are renormalised toward \mathcal{A}_n but also toward \mathcal{A} because each $A_{\bar{\varepsilon}}$ has been renormalised for T_{n+1} . Then the divergent term is given by

$$\sum_{\substack{\bar{\varepsilon} \subset \mathcal{E} \downarrow (T_{n+1}) \\ \bar{\varepsilon} \neq \mathcal{E} \downarrow (T_{n+1})}} \sum_{\substack{\bar{\mathcal{A}} \subset \mathcal{A}_n \\ \bar{\mathcal{A}} \neq \emptyset}} (-1)^{|\bar{\mathcal{A}}|+1} \sum_{\mathbf{e}_{\bar{\mathcal{A}}}, \mathbf{n}_{\bar{\mathcal{A}}}} \frac{1}{\mathbf{e}_{\bar{\mathcal{A}}}!} \binom{\mathbf{n}}{\mathbf{n}_{\bar{\mathcal{A}}}} \quad (5.14)$$

$$\left(\sum_{\mathbf{e}_{\bar{\varepsilon}}, \mathbf{n}_{\bar{\mathcal{A}}}} \frac{1}{\mathbf{e}_{\bar{\varepsilon}}!} \binom{\mathbf{n}}{\mathbf{n}_{\bar{\mathcal{A}}}} \mathcal{P}_{\bar{\varepsilon}}^{\mathbf{n}_{\bar{\mathcal{A}}}, \mathbf{e}_{\bar{\varepsilon}}} W^{\varepsilon} (\mathcal{R}_{\bar{\mathcal{A}}}^{\downarrow} T_{\mathbf{e} + \mathbf{e}_{\bar{\mathcal{A}}} + \mathbf{e}_{\bar{\varepsilon}}}^{\mathbf{n} - \mathbf{n}_{\bar{\mathcal{A}} - \mathbf{n}_{\bar{\mathcal{A}}}, \mathbf{n}_{\bar{\mathcal{A}}} + \pi \mathbf{e}_{\bar{\mathcal{A}}} + \mathbf{n}_{\bar{\varepsilon}} + \pi \mathbf{e}_{\bar{\varepsilon}}}) \right) W^{\varepsilon} \left(\Pi_{-} \mathcal{R}_{\bar{\mathcal{A}}}^{\uparrow} T_{\mathbf{e}}^{\mathbf{n}_{\bar{\mathcal{A}}} + \pi \mathbf{e}_{\bar{\mathcal{A}}}} \right) (\varrho_{\bar{\mathcal{A}}})$$

$$= \sum_{\bar{\mathcal{A}} \subset \mathcal{A}_n} (-1)^{|\bar{\mathcal{A}}|+1} \sum_{\mathbf{e}_{\bar{\mathcal{A}}}, \mathbf{n}_{\bar{\mathcal{A}}}} \frac{1}{\mathbf{e}_{\bar{\mathcal{A}}}!} \binom{\mathbf{n}}{\mathbf{n}_{\bar{\mathcal{A}}}} W^{\varepsilon} \left(\Pi_{-} \mathcal{R}_{\bar{\mathcal{A}}}^{\uparrow} T_{\mathbf{e}}^{\mathbf{n}_{\bar{\mathcal{A}}} + \pi \mathbf{e}_{\bar{\mathcal{A}}}} \right) (\varrho_{\bar{\mathcal{A}}}) W^{\varepsilon} (\mathcal{R}_{\bar{\mathcal{A}}}^{\downarrow} T_{\mathbf{e} + \mathbf{e}_{\bar{\mathcal{A}}}}^{\mathbf{n} - \mathbf{n}_{\bar{\mathcal{A}}}, \mathbf{n}_{\bar{\mathcal{A}}} + \pi \mathbf{e}_{\bar{\mathcal{A}}}})$$

$$- \sum_{\substack{\bar{\mathcal{A}} \subset \mathcal{A} \\ T_{n+1} \in \bar{\mathcal{A}}}} (-1)^{|\bar{\mathcal{A}}|} \sum_{\mathbf{e}_{\bar{\mathcal{A}}}, \mathbf{n}_{\bar{\mathcal{A}}}} \frac{1}{\mathbf{e}_{\bar{\mathcal{A}}}!} \binom{\mathbf{n}}{\mathbf{n}_{\bar{\mathcal{A}}}} W^{\varepsilon} \left(\mathcal{R}_{T_{n+1}}^{\uparrow} T_{\mathbf{e}}^{\mathbf{n}_{\bar{\mathcal{A}}} + \pi \mathbf{e}_{\bar{\mathcal{A}}}} \right) (\varrho_{T_{n+1}})$$

$$W^{\varepsilon} \left(\Pi_{-} \mathcal{R}_{\bar{\mathcal{A}} \setminus T_{n+1}}^{\uparrow} T_{\mathbf{e}}^{\mathbf{n}_{\bar{\mathcal{A}}} + \pi \mathbf{e}_{\bar{\mathcal{A}}}} \right) (\varrho_{\bar{\mathcal{A}} \setminus T_{n+1}}) W^{\varepsilon} (\mathcal{R}_{\bar{\mathcal{A}}}^{\downarrow} T_{\mathbf{e} + \mathbf{e}_{\bar{\mathcal{A}}}}^{\mathbf{n} - \mathbf{n}_{\bar{\mathcal{A}}}, \mathbf{n}_{\bar{\mathcal{A}}} + \pi \mathbf{e}_{\bar{\mathcal{A}}}}).$$

$$= \sum_{\substack{\bar{\mathcal{A}} \subset \mathcal{A}, \bar{\mathcal{A}} \neq \emptyset \\ \bar{\mathcal{A}} \neq \{T_{n+1}\}}} (-1)^{|\bar{\mathcal{A}}|+1} \sum_{\mathbf{e}_{\bar{\mathcal{A}}}, \mathbf{n}_{\bar{\mathcal{A}}}} \frac{1}{\mathbf{e}_{\bar{\mathcal{A}}}!} \binom{\mathbf{n}}{\mathbf{n}_{\bar{\mathcal{A}}}} W^{\varepsilon} \left(\Pi_{-} \mathcal{R}_{\bar{\mathcal{A}}}^{\uparrow} T_{\mathbf{e}}^{\mathbf{n}_{\bar{\mathcal{A}}} + \pi \mathbf{e}_{\bar{\mathcal{A}}}} \right) (\varrho_{\bar{\mathcal{A}}}) W^{\varepsilon} (\mathcal{R}_{\bar{\mathcal{A}}}^{\downarrow} T_{\mathbf{e} + \mathbf{e}_{\bar{\mathcal{A}}}}^{\mathbf{n} - \mathbf{n}_{\bar{\mathcal{A}}}, \mathbf{n}_{\bar{\mathcal{A}}} + \pi \mathbf{e}_{\bar{\mathcal{A}}}})$$

$$- \sum_{\substack{\bar{\mathcal{A}} \subset \mathcal{A} \\ T_{n+1} \in \bar{\mathcal{A}}}} (-1)^{|\bar{\mathcal{A}}|} \sum_{\mathbf{e}_{\bar{\mathcal{A}}}, \mathbf{n}_{\bar{\mathcal{A}}}} \frac{1}{\mathbf{e}_{\bar{\mathcal{A}}}!} \binom{\mathbf{n}}{\mathbf{n}_{\bar{\mathcal{A}}}} W^{\varepsilon} \left(\Pi^{+} \mathcal{R}_{T_{n+1}}^{\uparrow} T_{\mathbf{e}}^{\mathbf{n}_{\bar{\mathcal{A}}} + \pi \mathbf{e}_{\bar{\mathcal{A}}}} \right) (\varrho_{T_{n+1}})$$

$$W^{\varepsilon} \left(\Pi_{-} \mathcal{R}_{\bar{\mathcal{A}} \setminus T_{n+1}}^{\uparrow} T_{\mathbf{e}}^{\mathbf{n}_{\bar{\mathcal{A}}} + \pi \mathbf{e}_{\bar{\mathcal{A}}}} \right) (\varrho_{\bar{\mathcal{A}} \setminus T_{n+1}}) W^{\varepsilon} (\mathcal{R}_{\bar{\mathcal{A}}}^{\downarrow} T_{\mathbf{e} + \mathbf{e}_{\bar{\mathcal{A}}}}^{\mathbf{n} - \mathbf{n}_{\bar{\mathcal{A}}}, \mathbf{n}_{\bar{\mathcal{A}}} + \pi \mathbf{e}_{\bar{\mathcal{A}}}}),$$

where Π^{+} is not multiplicative on the labelled trees and it is the projection onto positive labelled trees. By summing the two expressions (5.14) and (5.15), we get

$$W^{\varepsilon}(T_{\mathbf{e}}^{\mathbf{n}}) = \sum_i \bar{G}_i$$

$$+ \sum_{\substack{\bar{\mathcal{A}} \subset \mathcal{A} \\ \bar{\mathcal{A}} \neq \emptyset}} (-1)^{|\bar{\mathcal{A}}|+1} \sum_{\mathbf{e}_{\bar{\mathcal{A}}}, \mathbf{n}_{\bar{\mathcal{A}}}} \frac{1}{\mathbf{e}_{\bar{\mathcal{A}}}!} \binom{\mathbf{n}}{\mathbf{n}_{\bar{\mathcal{A}}}} W^{\varepsilon} \left(\Pi_{-} \mathcal{R}_{\bar{\mathcal{A}}}^{\uparrow} T_{\mathbf{e}}^{\mathbf{n}_{\bar{\mathcal{A}}} + \pi \mathbf{e}_{\bar{\mathcal{A}}}} \right) (\varrho_{\bar{\mathcal{A}}}) W^{\varepsilon} \left(\mathcal{R}_{\bar{\mathcal{A}}}^{\downarrow} T_{\mathbf{e} + \mathbf{e}_{\bar{\mathcal{A}}}}^{\mathbf{n} - \mathbf{n}_{\bar{\mathcal{A}}}, \mathbf{n}_{\bar{\mathcal{A}}} + \pi \mathbf{e}_{\bar{\mathcal{A}}}} \right).$$

5.5. Renormalisation Procedure

where $\sum \bar{G}_i$ is given by:

$$\begin{aligned} \sum_i \bar{G}_i &= \sum_i G_i - \sum_{\substack{\bar{A} \subset A \\ T_{n+1} \in \bar{A}}} (-1)^{|\bar{A}|} \sum_{\mathbf{e}_{\bar{A}}, \mathbf{n}_{\bar{A}}} \frac{1}{\mathbf{e}_{\bar{A}}!} \binom{\mathbf{n}}{\mathbf{n}_{\bar{A}}} W^\varepsilon \left(\Pi^+ \mathcal{R}_{T_{n+1}}^\uparrow T_\varepsilon^{\mathbf{n}_{\bar{A}} + \pi \mathbf{e}_{\bar{A}}} \right) (\varrho_{T_{n+1}}) \\ &W^\varepsilon \left(\Pi_- \mathcal{R}_{\bar{A} \setminus T_{n+1}}^\uparrow T_\varepsilon^{\mathbf{n}_{\bar{A}} + \pi \mathbf{e}_{\bar{A}}} \right) (\varrho_{\bar{A} \setminus T_{n+1}}) W^\varepsilon \left(\mathcal{R}_{\bar{A}}^\downarrow T_{\varepsilon + \mathbf{e}_{\bar{A}}}^{\mathbf{n} - \mathbf{n}_{\bar{A}}, \mathbf{n}_{\bar{A}} + \pi \mathbf{e}_{\bar{A}}} \right), \end{aligned}$$

Then from the previous sum, we factorise the term $W^\varepsilon \left(\Pi^+ \mathcal{R}_{T_{n+1}}^\uparrow T_\varepsilon^{\mathbf{n}_{\bar{A}} + \pi \mathbf{e}_{\bar{A}}} \right) (\varrho_{T_{n+1}})$ and we perform our telescopic on the remainder which allows us to conclude. \square

Using the previous proposition, we perform a decomposition of $\hat{W}^{\varepsilon, k}(T_\varepsilon^n)$:

$$\begin{aligned} \hat{W}^{\varepsilon, k}(T_\varepsilon^n) &= \sum_{A \in \mathfrak{A}(T)} \sum_{\mathbf{e}_A, \mathbf{n}_A} \frac{1}{\mathbf{e}_A!} \binom{\mathbf{n}}{\mathbf{n}_A} \ell_\varepsilon \left(\Pi_- \mathcal{R}_A^\uparrow T_\varepsilon^{\mathbf{n}_A + \pi \mathbf{e}_A} \right) W^{\varepsilon, k} \left(\mathcal{R}_A^\downarrow T_{\varepsilon + \mathbf{e}_A}^{\mathbf{n} - \mathbf{n}_A, \mathbf{n}_A + \pi \mathbf{e}_A} \right) \\ &= W^{\varepsilon, k}(T_\varepsilon^n) + \sum_{A \in \mathfrak{A}(T), A \neq \emptyset} \sum_{\mathbf{e}_A, \mathbf{n}_A} \frac{1}{\mathbf{e}_A!} \binom{\mathbf{n}}{\mathbf{n}_A} \ell_\varepsilon \left(\Pi_- \mathcal{R}_A^\uparrow T_\varepsilon^{\mathbf{n}_A + \pi \mathbf{e}_A} \right) W^{\varepsilon, k} \left(\mathcal{R}_A^\downarrow T_{\varepsilon + \mathbf{e}_A}^{\mathbf{n} - \mathbf{n}_A, \mathbf{n}_A + \pi \mathbf{e}_A} \right). \end{aligned}$$

Then, it follows from (5.4) and from the second part of (5.5.11):

$$\begin{aligned} W^{\varepsilon, k}(T_\varepsilon^n) &= \bar{W}^{\varepsilon, k}(T_\varepsilon^n) + \sum_{A \in \mathfrak{A}_k(T)} \mathcal{P}_A W^\varepsilon(T_\varepsilon^n) \\ &= \bar{W}^{\varepsilon, k}(T_\varepsilon^n) + \sum_{A \in \mathfrak{A}_k(T)} \mathcal{P}_A \sum_{\mathcal{E} \in \mathcal{E}^\downarrow(A)} \sum_{\mathbf{e}_\mathcal{E}, \mathbf{n}_\mathcal{E}} \frac{1}{\mathbf{e}_\mathcal{E}!} \binom{\mathbf{n}}{\mathbf{n}_\mathcal{E}} \mathcal{P}_\mathcal{E}^{\mathbf{n}_\mathcal{A}, \mathbf{e}_\mathcal{E}} W^\varepsilon(T_{\varepsilon + \mathbf{e}_\mathcal{E}}^{\mathbf{n} - \mathbf{n}_\mathcal{A}, \mathbf{n}_\mathcal{A} + \pi \mathbf{e}_\mathcal{E}}) \\ &= \bar{W}^{\varepsilon, k}(T_\varepsilon^n) + \sum_{A \in \mathfrak{A}_k(T)} \mathcal{P}_A \sum_i G_i \\ &+ \sum_{A' \in \mathfrak{A}_k(T)} \sum_{\substack{A \subset A' \\ A \neq \emptyset}} (-1)^{|\bar{A}|+1} \mathcal{P}_{A'} \sum_{\mathbf{e}_A, \mathbf{n}_A} \frac{1}{\mathbf{e}_A!} \binom{\mathbf{n}}{\mathbf{n}_A} W^\varepsilon \left(\Pi_- \mathcal{R}_A^\uparrow T_\varepsilon^{\mathbf{n}_A + \pi \mathbf{e}_A} \right) W^\varepsilon \left(\mathcal{R}_A^\downarrow T_{\varepsilon + \mathbf{e}_A}^{\mathbf{n} - \mathbf{n}_A, \mathbf{n}_A + \pi \mathbf{e}_A} \right) \\ &= \bar{W}^{\varepsilon, k}(T_\varepsilon^n) + \sum_{A \in \mathfrak{A}_k(T)} \mathcal{P}_A \sum_i G_i \\ &+ \sum_{A' \in \mathfrak{A}_k(T)} \sum_{\substack{A \subset A' \\ A \neq \emptyset}} (-1)^{|\bar{A}|+1} \mathcal{P}_{A' \setminus A} \sum_{\mathbf{e}_A, \mathbf{n}_A} \frac{1}{\mathbf{e}_A!} \binom{\mathbf{n}}{\mathbf{n}_A} W^{\varepsilon, 0} \left(\Pi_- \mathcal{R}_A^\uparrow T_\varepsilon^{\mathbf{n}_A + \pi \mathbf{e}_A} \right) W^\varepsilon \left(\mathcal{R}_A^\downarrow T_{\varepsilon + \mathbf{e}_A}^{\mathbf{n} - \mathbf{n}_A, \mathbf{n}_A + \pi \mathbf{e}_A} \right). \end{aligned}$$

where the G_i are graphs with no divergence. The precise value of the G_i is given in the proposition 5.5.18. We would like to set for every $A \in \mathfrak{A}_k(T)$:

$$\ell_\varepsilon \left(\Pi_- \mathcal{R}_A^\uparrow T_\varepsilon^{\mathbf{n}_A + \pi \mathbf{e}_A} \right) = (-1)^{|\mathcal{A}|} W^{\varepsilon, 0} \left(\Pi_- \mathcal{R}_A^\uparrow T_\varepsilon^{\mathbf{n}_A + \pi \mathbf{e}_A} \right)$$

in order to compensate the divergent term appearing in the previous decomposition. In fact we just subtract the diverging part of the previous term and we define ℓ_ε by:

$$\ell_\varepsilon \left(\Pi_- \mathcal{R}_A^\uparrow T_\varepsilon^{\mathbf{n}_A + \pi \mathbf{e}_A} \right) = (-1)^{|\mathcal{A}|} \tilde{W}^{\varepsilon, 0} \left(\Pi_- \mathcal{R}_A^\uparrow T_\varepsilon^{\mathbf{n}_A + \pi \mathbf{e}_A} \right).$$

where $\tilde{W}^{\varepsilon, 0}$ is given in 5.1.3.

Remark 5.5.12. The definition given here for the map ℓ_ε does not take into account some sub-divergences. We suppose that there does not exist a negative subtree \bar{T} such that \bar{T} is included in one of the element of \mathcal{A} .

Remark 5.5.13. The term $\bar{W}^{\varepsilon,k}(T_\varepsilon^n)$ may contain divergence of the form $\mathcal{A} \in \mathfrak{A}_m(T)$ for $m \geq k$. These divergences appear in a bigger wiener chaos and they are renormalised by:

$$\sum_{\mathcal{A} \in \mathfrak{A}_m(T)} (-1)^{|\mathcal{A}|} \sum_{\varepsilon_{\mathcal{A}}, n_{\mathcal{A}}} \frac{1}{\varepsilon_{\mathcal{A}}!} \binom{\mathbf{n}}{\mathbf{n}_{\mathcal{A}}} W^{\varepsilon,0} \left(\Pi_- \mathcal{R}_{\mathcal{A}}^\uparrow T_\varepsilon^{n_{\mathcal{A}} + \pi \varepsilon_{\mathcal{A}}} \right) W^{\varepsilon,k} \left(\mathcal{R}_{\mathcal{A}}^\downarrow T_{\varepsilon + \varepsilon_{\mathcal{A}}}^{n - n_{\mathcal{A}}, n_{\mathcal{A}} + \pi \varepsilon_{\mathcal{A}}} \right).$$

We will face sub-divergence in the generalised KPZ equation only for the 0th wiener chaos.

Definition 5.5.14. Let $G = (\mathcal{V}, \mathcal{E})$ a labelled graph, we define $\mathfrak{A}(G)$ such that for every $\mathcal{A} = \{G_1, \dots, G_n\} \in \mathfrak{A}(G)$, the G_i are disjoint subgraphs of G with a minimal node given by the orientation of the edges ϱ_{G_i} . Moreover for each $G_i = (\mathcal{V}_i, \mathcal{E}_i)$, one has $\mathcal{E}^\downarrow(\mathcal{V}_i) \not\subseteq \mathcal{E}^\downarrow(\{\varrho_{G_i}\})$.

Definition 5.5.15. Let $G = (\mathcal{V}, \mathcal{E})$ a labelled graph. We consider $\bar{\mathcal{E}} \subset \mathcal{E}_1 \subset \mathcal{E}^+ = \{e \in \mathcal{E} : r_e > 0 \text{ and } v_e = v_0\}$, $\tilde{\mathcal{E}} \subset \mathcal{E}_1 \setminus \bar{\mathcal{E}}$ and $\varepsilon_{\bar{\mathcal{E}}} \mathbf{N}^d$ -valued function on \mathcal{E} supported by the set \mathcal{E} . We define $\mathcal{P}_{\tilde{\mathcal{E}}, \mathcal{E}_1}^{\varepsilon_{\bar{\mathcal{E}}}} G$ as the graphs where we make the following transformations:

- the label (a_e, r_e, v_0) of the edges e in $\tilde{\mathcal{E}}$ becomes $(a_e, 0, v_0)$.
- Every edge $e = (v_1, v_2) \in \bar{\mathcal{E}}$ is removed and is replaced by the edge (v_0, v_2) with the label $(a_e + |\varepsilon_{\bar{\mathcal{E}}}(e)|_s, 0, v_0)$. Moreover, we add an edge (v_0, v_1) with the label $(-|\pi \varepsilon_{\bar{\mathcal{E}}}(v_1)|_s, 0, 0)$.

For $\mathcal{A} = \{G_1, \dots, G_n\} \in \mathfrak{A}(G)$, let $\mathcal{E}(\mathcal{A}) = \{\bigcup_{i=1}^n \mathcal{E}_i : \mathcal{E}_i \subset E_{G_i}\}$. We define $\bar{\mathcal{G}}_{\mathcal{R}_u}(\mathcal{A})$ as

$$\bar{\mathcal{G}}_{\mathcal{R}_u}(\mathcal{A}) = \{\mathcal{P}_{\tilde{\mathcal{E}}, \mathcal{E}_1}^{\varepsilon_{\bar{\mathcal{E}}}} G : G \in \bar{\mathcal{G}}_{\mathcal{R}_u}(\mathcal{A}), \bar{\mathcal{E}} \subset \mathcal{E}_1 \subset \mathcal{E}^+ \in \mathcal{E}(\mathcal{A}), \varepsilon_{\bar{\mathcal{E}}}\}$$

and $\bar{\mathcal{G}}_{\mathcal{R}_u}$ by

$$\bar{\mathcal{G}}_{\mathcal{R}_u} = \bigcup_{\mathcal{A} \in \mathfrak{A}(G)} \bar{\mathcal{G}}_{\mathcal{R}_u}(\mathcal{A}).$$

In the figure below, the set $\bar{\mathcal{E}}$ is given by: $\{(v_{r,1}, v_1), (v_{r,1}, v_2), (v_{r,2}, v_3), (v_{r,2}, v_4)\}$.

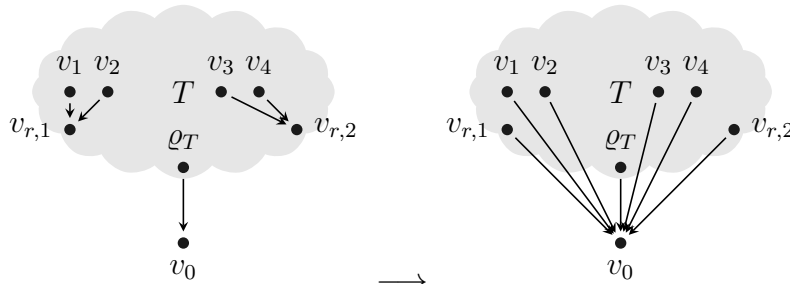

→

5.5. Renormalisation Procedure

Proposition 5.5.16. *Let $G = (\mathcal{V}, \mathcal{E})$ a labelled graph and $\mathcal{E}_1 \subset \mathcal{E}^+$, one has*

$$G = \sum_{\bar{\mathcal{E}} \subset \mathcal{E}_1} \sum_{\mathfrak{e}_{\bar{\mathcal{E}}}} \frac{1}{\mathfrak{e}_{\bar{\mathcal{E}}}!} (-1)^{|\bar{\mathcal{E}}|} \mathcal{P}_{\bar{\mathcal{E}}, \mathcal{E}_1}^{\mathfrak{e}_{\bar{\mathcal{E}}}} G.$$

where $\mathfrak{e}_{\bar{\mathcal{E}}}$ runs over all \mathbf{N}^d -valued functions on E_G supported by the set $\bar{\mathcal{E}}$ such that $\forall e \in \bar{\mathcal{E}}, |\mathfrak{e}_{\mathcal{E}}(e)|_s < r_e$.

Proof. We proceed by recurrence on the size of \mathcal{E}_1 . Let $e = (e_+, e_-) \in \mathcal{E}_1$ and $\bar{\mathcal{E}}$ containing e . We have ,

$$\hat{K}_e(x_{e_+} - x_{e_-}) = K_e(x_{e_+} - x_{e_-}) - \sum_{|j|_s < r_e} \frac{(x_{e_+})^j}{j!} K_e^{(j)}(-x_{e_-}).$$

Therefore,

$$\sum_{\mathfrak{e}_{\bar{\mathcal{E}}'}} \frac{1}{\mathfrak{e}_{\bar{\mathcal{E}}'}!} (-1)^{|\bar{\mathcal{E}}'|} \mathcal{P}_{\bar{\mathcal{E}}', \mathcal{E}_1}^{\mathfrak{e}_{\bar{\mathcal{E}}'}} G + \sum_{\mathfrak{e}_{\bar{\mathcal{E}}}} \frac{1}{\mathfrak{e}_{\bar{\mathcal{E}}}!} (-1)^{|\bar{\mathcal{E}}|} \mathcal{P}_{\bar{\mathcal{E}}, \mathcal{E}_1}^{\mathfrak{e}_{\bar{\mathcal{E}}}} G = \sum_{\mathfrak{e}_{\bar{\mathcal{E}}'}} \frac{1}{\mathfrak{e}_{\bar{\mathcal{E}}'}!} (-1)^{|\bar{\mathcal{E}}'|} \mathcal{P}_{\bar{\mathcal{E}}', \mathcal{E}_1}^{\mathfrak{e}_{\bar{\mathcal{E}}'}} G,$$

where $\mathcal{E}'_1 = \mathcal{E}_1 \setminus \{e\}$ and $\bar{\mathcal{E}}' = \bar{\mathcal{E}} \setminus \{e\}$. It follows by applying the recurrence hypothesis on \mathcal{E}'_1 and the previous identity

$$\begin{aligned} \sum_{\bar{\mathcal{E}} \subset \mathcal{E}_1} \sum_{\mathfrak{e}_{\bar{\mathcal{E}}}} \frac{1}{\mathfrak{e}_{\bar{\mathcal{E}}}!} (-1)^{|\bar{\mathcal{E}}|} \mathcal{P}_{\bar{\mathcal{E}}, \mathcal{E}_1}^{\mathfrak{e}_{\bar{\mathcal{E}}}} G &= \sum_{\substack{\bar{\mathcal{E}}' \subset \mathcal{E}_1 \\ e \notin \bar{\mathcal{E}}'}} \sum_{\mathfrak{e}_{\bar{\mathcal{E}}'}} \frac{1}{\mathfrak{e}_{\bar{\mathcal{E}}'}!} (-1)^{|\bar{\mathcal{E}}'|} \mathcal{P}_{\bar{\mathcal{E}}', \mathcal{E}_1}^{\mathfrak{e}_{\bar{\mathcal{E}}'}} G + \sum_{\substack{\bar{\mathcal{E}}' \subset \mathcal{E}_1 \\ \bar{\mathcal{E}} = \bar{\mathcal{E}}' \cup \{e\}}} \sum_{\mathfrak{e}_{\bar{\mathcal{E}}}} \frac{1}{\mathfrak{e}_{\bar{\mathcal{E}}}!} (-1)^{|\bar{\mathcal{E}}|} \mathcal{P}_{\bar{\mathcal{E}}, \mathcal{E}_1}^{\mathfrak{e}_{\bar{\mathcal{E}}}} G \\ &= \sum_{\bar{\mathcal{E}} \subset \mathcal{E}'_1} \sum_{\mathfrak{e}_{\bar{\mathcal{E}}}} \frac{1}{\mathfrak{e}_{\bar{\mathcal{E}}}!} (-1)^{|\bar{\mathcal{E}}|} \mathcal{P}_{\bar{\mathcal{E}}, \mathcal{E}'_1}^{\mathfrak{e}_{\bar{\mathcal{E}}}} G = G. \end{aligned}$$

□

Remark 5.5.17. Let $T_{\mathfrak{e}}^n$ a labelled tree. We consider the graph $G = (\mathcal{V}, \mathcal{E}) = W^{\varepsilon, 0}(T_{\mathfrak{e}}^n)$. By taking $\mathcal{E}_1 = \mathcal{E}^+$, $\bar{\mathcal{E}} = \emptyset$ and $\mathfrak{e}_{\bar{\mathcal{E}}} = 0$, we obtain:

$$\mathcal{P}_{\bar{\mathcal{E}}, \mathcal{E}_1}^{\mathfrak{e}_{\bar{\mathcal{E}}}} W^{\varepsilon, 0}(T_{\mathfrak{e}}^n) = \tilde{W}^{\varepsilon, 0}(T_{\mathfrak{e}}^n).$$

Proposition 5.5.18. *Let $T_{\mathfrak{e}}^n$ a labelled tree, one has the following decomposition*

$$\begin{aligned} W^{\varepsilon, k}(T_{\mathfrak{e}}^n) &= \bar{W}^{\varepsilon, k}(T_{\mathfrak{e}}^n) + \sum_{A \in \mathfrak{A}_k(T)} \mathcal{P}_A \sum_{\mathcal{E} \in \mathcal{E}_*^{\downarrow}(A)} \sum_{\mathfrak{e}_{\mathcal{E}}, n_A} \frac{1}{\mathfrak{e}_{\mathcal{E}}!} \binom{\mathbf{n}}{\mathbf{n}_A} \mathcal{P}_{\mathcal{E}}^{n_A, \varepsilon_{\mathcal{E}}} W^{\varepsilon}(T_{\mathfrak{e}+\mathfrak{e}_{\mathcal{E}}}^{n-n_A, n_A+\pi\varepsilon_{\mathcal{E}}}) \\ &+ \sum_{A \in \mathfrak{A}_k(T)} \mathcal{P}_A \sum_{\mathcal{E} \in \mathcal{E}_*^{\downarrow}(A)} \sum_{\mathfrak{e}_{\mathcal{E}}, n_A} \frac{1}{\mathfrak{e}_{\mathcal{E}}!} \binom{\mathbf{n}}{\mathbf{n}_A} \left(\prod_{\substack{\mathcal{E}_1 \in \mathcal{E}_o \\ \bar{\mathcal{E}} \subset \mathcal{E}_1 \\ \bar{\mathcal{E}} \neq \emptyset}} \sum_{\mathfrak{e}_{\bar{\mathcal{E}}}} \frac{1}{\mathfrak{e}_{\bar{\mathcal{E}}}!} (-1)^{|\bar{\mathcal{E}}|} \mathcal{P}_{\bar{\mathcal{E}}, \mathcal{E}_1}^{\mathfrak{e}_{\bar{\mathcal{E}}}} \right) \\ &\mathcal{P}_{\mathcal{E}}^{n_A, \varepsilon_{\mathcal{E}}} W^{\varepsilon}(T_{\mathfrak{e}+\mathfrak{e}_{\mathcal{E}}}^{n-n_A, n_A+\pi\varepsilon_{\mathcal{E}}}) \end{aligned}$$

$$+ \sum_{A' \in \mathfrak{A}_k(T)} \sum_{\substack{A \subset A' \\ A \neq \emptyset}} (-1)^{|A|+1} \mathcal{P}_{A' \setminus A} \sum_{\mathbf{e}_{A, n_A}} \frac{1}{\mathbf{e}_A!} \binom{\mathbf{n}}{\mathbf{n}_A} \tilde{W}^{\varepsilon, 0} \left(\mathcal{R}_A^\uparrow T_{\mathbf{e}}^{n_A + \pi \mathbf{e}_A} \right) W^\varepsilon \left(\mathcal{R}_A^\downarrow T_{\mathbf{e} + \mathbf{e}_A}^{n - n_A, n_A + \pi \mathbf{e}_A} \right),$$

where for $\mathcal{A} = \{T_1, \dots, T_n\}$, $\mathcal{E}^\downarrow(\mathcal{A}) = \{\mathcal{E} \in \mathcal{E}^\downarrow(\mathcal{A}) : \exists i \mathcal{E}_i = \mathcal{E}^\downarrow(T_i)\}$, $\mathcal{E}_*^\downarrow(\mathcal{A}) = \mathcal{E}^\downarrow(\mathcal{A}) \setminus \mathcal{E}_-^\downarrow(\mathcal{A})$ and $\mathcal{E}_\circ = \{T_i : \mathcal{E}_i = \mathcal{E}(T_i)\}$. In the previous identities, the graphs G_i are given by the second and the third term in the right-hand side.

Proof. This identity follows from the application of proposition 5.5.11 and 5.5.16. Moreover, we have to perform the same kind of summation as in the second part of 5.5.11. \square

Remark 5.5.19. The identity in 5.5.18 can be rewritten as:

$$\begin{aligned} W^{\varepsilon, k}(T_{\mathbf{e}}^n) &= \bar{W}^{\varepsilon, k}(T_{\mathbf{e}}^n) \\ &+ \sum_{A \in \mathfrak{A}_k(T)} \mathcal{P}_A \sum_{\mathcal{E} \in \mathcal{E}_*^\downarrow(\mathcal{A})} \sum_{\mathbf{e}_{\mathcal{E}, n_{\mathcal{A}}}} \frac{1}{\mathbf{e}_{\mathcal{E}}!} \binom{\mathbf{n}}{\mathbf{n}_{\mathcal{A}}} \mathcal{P}_{\mathcal{E}}^{n_{\mathcal{A}}, \mathbf{e}_{\mathcal{E}}} W^\varepsilon(\mathcal{R}_A^\downarrow T_{\mathbf{e} + \mathbf{e}_{\mathcal{E}}}^{n - n_{\mathcal{A}}, n_{\mathcal{A}} + \pi \mathbf{e}_{\mathcal{E}}}) \tilde{W}^\varepsilon(\mathcal{R}_A^\uparrow T_{\mathbf{e} + \mathbf{e}_{\mathcal{E}}}^{n - n_{\mathcal{A}}, n_{\mathcal{A}} + \pi \mathbf{e}_{\mathcal{E}}}) \\ &+ \sum_{A \in \mathfrak{A}_k(T)} \mathcal{P}_A \prod_{\bar{T} \in \mathcal{A}} \left(W^\varepsilon(\mathcal{R}_{\bar{T}}^\uparrow T_{\mathbf{e}}^n) - \tilde{W}^\varepsilon(\mathcal{R}_{\bar{T}}^\uparrow T_{\mathbf{e}}^n) \right) W^\varepsilon(\mathcal{R}_{\bar{T}}^\downarrow T_{\mathbf{e}}^n) \\ &+ \sum_{A' \in \mathfrak{A}_k(T)} \sum_{\substack{A \subset A' \\ A \neq \emptyset}} (-1)^{|A|+1} \mathcal{P}_{A' \setminus A} \sum_{\mathbf{e}_{A, n_A}} \frac{1}{\mathbf{e}_A!} \binom{\mathbf{n}}{\mathbf{n}_A} \tilde{W}^{\varepsilon, 0} \left(\mathcal{R}_A^\uparrow T_{\mathbf{e}}^{n_A + \pi \mathbf{e}_A} \right) W^\varepsilon \left(\mathcal{R}_A^\downarrow T_{\mathbf{e} + \mathbf{e}_A}^{n - n_A, n_A + \pi \mathbf{e}_A} \right). \end{aligned}$$

This new formulation follows from the summation over the non diverging patterns created by the removal of the Taylor expansion.

Remark 5.5.20. The previous identity is useful when we do not create positive pattern in the sense that $\mathcal{R}_A^\uparrow T_{\mathbf{e}}^{n_A + \pi \mathbf{e}_A}$ has a negative homogeneity.

Proposition 5.5.21. Let $T_{\mathbf{e}}^n \in \mathcal{T}_{\mathcal{R}_u}$ and $k \neq 0$, then the graph $\hat{W}^{\varepsilon, k}(T_{\mathbf{e}}^n)$ admits a decomposition:

$$\hat{W}^{\varepsilon, k}(T_{\mathbf{e}}^n) = \sum_i G_i$$

where the G_i satisfy the conditions (5.10) and (5.11).

Proof. We use the general decomposition in proposition 5.5.18. The only divergent term is the last one:

$$\sum_{A' \in \mathfrak{A}_k(T)} \sum_{\substack{A \subset A' \\ A \neq \emptyset}} (-1)^{|A|+1} \mathcal{P}_{A' \setminus A} \sum_{\mathbf{e}_{A, n_A}} \frac{1}{\mathbf{e}_A!} \binom{\mathbf{n}}{\mathbf{n}_A} \tilde{W}^{\varepsilon, 0} \left(\mathcal{R}_A^\uparrow T_{\mathbf{e}}^{n_A + \pi \mathbf{e}_A} \right) W^\varepsilon \left(\mathcal{R}_A^\downarrow T_{\mathbf{e} + \mathbf{e}_A}^{n - n_A, n_A + \pi \mathbf{e}_A} \right)$$

which is removed by the renormalisation term:

$$\sum_{A' \in \mathfrak{A}_k(T)} \sum_{\substack{A \subset A' \\ A \neq \emptyset}} \mathcal{P}_{A' \setminus A} \sum_{\mathbf{e}_{A, n_A}} \frac{1}{\mathbf{e}_A!} \binom{\mathbf{n}}{\mathbf{n}_A} \ell_\varepsilon \left(\mathcal{R}_A^\uparrow T_{\mathbf{e}}^{n_A + \pi \mathbf{e}_A} \right) W^\varepsilon \left(\mathcal{R}_A^\downarrow T_{\mathbf{e} + \mathbf{e}_A}^{n - n_A, n_A + \pi \mathbf{e}_A} \right)$$

5.5. Renormalisation Procedure

where $\ell_\varepsilon(\mathcal{R}_\mathcal{A}^\uparrow T_\varepsilon^{n_\mathcal{A}+\pi\varepsilon_\mathcal{A}}) = (-1)^{|\mathcal{A}|+1} \tilde{W}^{\varepsilon,0}(\mathcal{R}_\mathcal{A}^\uparrow T_\varepsilon^{n_\mathcal{A}+\pi\varepsilon_\mathcal{A}})$. For the other terms of the decomposition, they contain elementary transformations which renormalise the diverging pattern $\mathcal{A} = \{T_1, \dots, T_n\}$. \square

Remark 5.5.22. In the previous proposition, we have made the following abuse of notation by considering the diverging pattern $\{\Xi, \Xi\}$ as one negative subtree. This divergence is treated in 5.5.6.

If we want the 0th order chaos to be zero, we obtain the following constraint on ℓ_ε :

$$\hat{W}^{\varepsilon,0}(T_\varepsilon^n) = \sum_{\mathcal{A} \in \mathfrak{A}(T)} \sum_{\varepsilon_\mathcal{A}, n_\mathcal{A}} \frac{1}{\varepsilon_\mathcal{A}!} \binom{\mathbf{n}}{\mathbf{n}_\mathcal{A}} \ell_\varepsilon(\mathcal{R}_\mathcal{A}^\uparrow T_\varepsilon^{n_\mathcal{A}+\pi\varepsilon_\mathcal{A}}) W^{\varepsilon,0}(\mathcal{R}_\mathcal{A}^\downarrow T_\varepsilon^{n-n_\mathcal{A}, n_\mathcal{A}+\pi\varepsilon_\mathcal{A}}) = 0$$

$$\ell_\varepsilon(T_\varepsilon^n) = - \sum_{\mathcal{A} \in \mathfrak{A}(T) \setminus \{T\}} \sum_{\varepsilon_\mathcal{A}, n_\mathcal{A}} \frac{1}{\varepsilon_\mathcal{A}!} \binom{\mathbf{n}}{\mathbf{n}_\mathcal{A}} \ell_\varepsilon(\mathcal{R}_\mathcal{A}^\uparrow T_\varepsilon^{n_\mathcal{A}+\pi\varepsilon_\mathcal{A}}) W^{\varepsilon,0}(\mathcal{R}_\mathcal{A}^\downarrow T_\varepsilon^{n-n_\mathcal{A}, n_\mathcal{A}+\pi\varepsilon_\mathcal{A}}).$$

5.5.4 Example

We want to give a complete example for the tree $T_\varepsilon^n = \mathcal{I}(\mathcal{I}(\Xi)^2 \Xi) \Xi$ which has been treated in [HP14]. We consider one component in the second Wiener chaos given by:

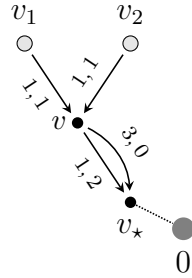

This component is obtained by merging the two leaves l_1 and l_2 in the figure just below. Then we perform the convolution of the mollifier which makes disappear the node v_c :

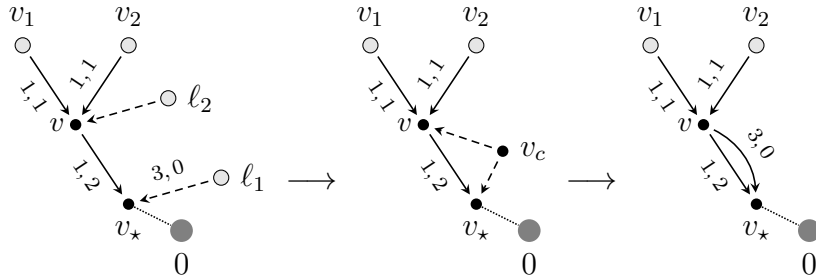

We illustrate the following decomposition for this example:

$$\begin{aligned}
 W^{\varepsilon,k}(T_c^n) &= \bar{W}^{\varepsilon,k}(T_c^n) + \sum_{\mathcal{A} \in \mathfrak{A}_k(T)} \mathcal{P}_{\mathcal{A}} \sum_{\mathcal{E} \in \mathcal{E}_*^\downarrow(\mathcal{A})} \sum_{\varepsilon_{\mathcal{E}}, n_{\mathcal{A}}} \frac{1}{\varepsilon_{\mathcal{E}}!} \binom{\mathbf{n}}{\mathbf{n}_{\mathcal{A}}} \mathcal{P}_{\mathcal{E}}^{n_{\mathcal{A}}, \varepsilon_{\mathcal{E}}} W^{\varepsilon}(T_{c+\varepsilon_{\mathcal{E}}}^{n-n_{\mathcal{A}}, n_{\mathcal{A}}+\pi\varepsilon_{\mathcal{E}}}) \\
 &+ \sum_{\mathcal{A} \in \mathfrak{A}_k(T)} \mathcal{P}_{\mathcal{A}} \sum_{\mathcal{E} \in \mathcal{E}_-^\downarrow(\mathcal{A})} \sum_{\varepsilon_{\mathcal{E}}, n_{\mathcal{A}}} \frac{1}{\varepsilon_{\mathcal{E}}!} \binom{\mathbf{n}}{\mathbf{n}_{\mathcal{A}}} \left(\prod_{\substack{\mathcal{E}_1 \in \mathcal{E}_o \\ \bar{\mathcal{E}} \subset \mathcal{E}_1 \\ \bar{\mathcal{E}} \neq \emptyset}} \sum_{\varepsilon_{\bar{\mathcal{E}}}} \frac{1}{\varepsilon_{\bar{\mathcal{E}}}} (-1)^{|\bar{\mathcal{E}}|} \mathcal{P}_{\bar{\mathcal{E}}, \mathcal{E}_1}^{\varepsilon_{\bar{\mathcal{E}}}} \right) \\
 &\mathcal{P}_{\mathcal{E}}^{n_{\mathcal{A}}, \varepsilon_{\mathcal{E}}} W^{\varepsilon}(T_{c+\varepsilon_{\mathcal{E}}}^{n-n_{\mathcal{A}}, n_{\mathcal{A}}+\pi\varepsilon_{\mathcal{E}}}) \\
 &+ \sum_{\mathcal{A}' \in \mathfrak{A}_k(T)} \sum_{\substack{\mathcal{A} \subset \mathcal{A}' \\ \mathcal{A} \neq \emptyset}} (-1)^{|\mathcal{A}'|+1} \mathcal{P}_{\mathcal{A}' \setminus \mathcal{A}} \sum_{\varepsilon_{\mathcal{A}}, n_{\mathcal{A}}} \frac{1}{\varepsilon_{\mathcal{A}}!} \binom{\mathbf{n}}{\mathbf{n}_{\mathcal{A}}} \tilde{W}^{\varepsilon,0}(\mathcal{R}_{\mathcal{A}}^\uparrow T_c^{n_{\mathcal{A}}+\pi\varepsilon_{\mathcal{A}}}) W^{\varepsilon}(\mathcal{R}_{\mathcal{A}}^\downarrow T_{c+\varepsilon_{\mathcal{A}}}^{n-n_{\mathcal{A}}, n_{\mathcal{A}}+\pi\varepsilon_{\mathcal{A}}}),
 \end{aligned}$$

In the computation just below, we have:

- $\mathfrak{A}_1(T) = \{\{v_*, v\}\}$.
- $\mathcal{E}_*^\downarrow(\mathcal{A}) = \{\emptyset, \{(v, v_1)\}\}$. Then for $\mathcal{E}_1 = \{(v, v_1)\}$, we perform the sum for $\varepsilon_{\mathcal{E}_1}$ and $n_{\mathcal{A}}$ between 0 and 1.
- $\mathcal{E}^\downarrow(\mathcal{A}) = \mathcal{E}_*^\downarrow(\mathcal{A}) \cup \mathcal{E}_-^\downarrow(\mathcal{A})$ with $\mathcal{E}_-^\downarrow(\mathcal{A}) = \{\{(v, v_1), (v, v_2)\}\}$.
- For, $\mathcal{E} = \{\{(v, v_1), (v, v_2)\}\}$, one has $\mathcal{E}_o = \{\{(v_*, v)\}\}$ and $\bar{\mathcal{E}} = \mathcal{E}_1 = \{(v_*, v)\}$ with $|\bar{\mathcal{E}}| = 1$. The label $\varepsilon_{\bar{\mathcal{E}}}$ is just equal to 0.
- For the last part, it follows

$$\begin{aligned}
 \tilde{W}^{\varepsilon,0}(\mathcal{R}_{\mathcal{A}}^\uparrow T_c^{n_{\mathcal{A}}+\pi\varepsilon_{\mathcal{A}}}) &\in \left\{ \begin{array}{c} v \\ \swarrow \quad \searrow \\ v_* \end{array} \begin{array}{l} 2,0 \\ 1,0 \end{array}, \begin{array}{c} v \\ \swarrow \quad \searrow \\ v_* \end{array} \begin{array}{l} 3,0 \\ 1,0 \end{array} \right\} \\
 W^{\varepsilon}(\mathcal{R}_{\mathcal{A}}^\downarrow T_{c+\varepsilon_{\mathcal{A}}}^{n-n_{\mathcal{A}}, n_{\mathcal{A}}+\pi\varepsilon_{\mathcal{A}}}) &\in \left\{ \begin{array}{c} v_1 \quad v_2 \\ \swarrow \quad \searrow \\ v_* \end{array} \begin{array}{l} 1,1 \\ 1,1 \end{array}, \begin{array}{c} v_1 \quad v_2 \\ \swarrow \quad \searrow \\ v_* \end{array} \begin{array}{l} 1,1 \\ 2,0 \end{array} \right\} \\
 \begin{array}{c} v_1 \quad v_2 \\ \swarrow \quad \searrow \\ v \end{array} \begin{array}{l} 1,1 \\ 1,1 \end{array} \begin{array}{c} v \\ \swarrow \quad \searrow \\ v_* \end{array} \begin{array}{l} 3,0 \\ 1,2 \end{array} \\
 = \begin{array}{c} v_1 \quad v_2 \\ \swarrow \quad \searrow \\ v \end{array} \begin{array}{l} 2,1 \\ 1,1 \end{array} \begin{array}{c} v \\ \swarrow \quad \searrow \\ v_* \end{array} \begin{array}{l} 3,0 \\ 1,2 \end{array} + \begin{array}{c} v_1 \quad v_2 \\ \swarrow \quad \searrow \\ v \end{array} \begin{array}{l} 1,1 \\ 1,1 \end{array} \begin{array}{c} v \\ \swarrow \quad \searrow \\ v_* \end{array} \begin{array}{l} 3,0 \\ 1,2 \end{array} + \begin{array}{c} v_1 \quad v_2 \\ \swarrow \quad \searrow \\ v \end{array} \begin{array}{l} 1,1 \\ 1,1 \end{array} \begin{array}{c} v \\ \swarrow \quad \searrow \\ v_* \end{array} \begin{array}{l} 2,0 \\ 2,0 \end{array}
 \end{aligned}$$

5.6. Pairing of labelled graphs

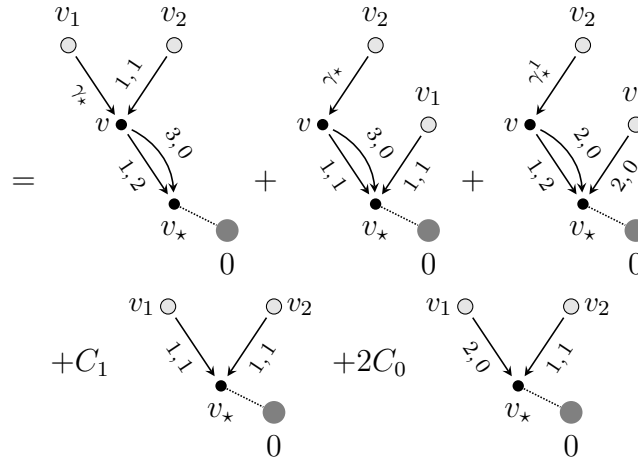

when $\gamma_* = (1, 2, v_*)$ and $\gamma_*^1 = (1, 1, v_*)$ Then

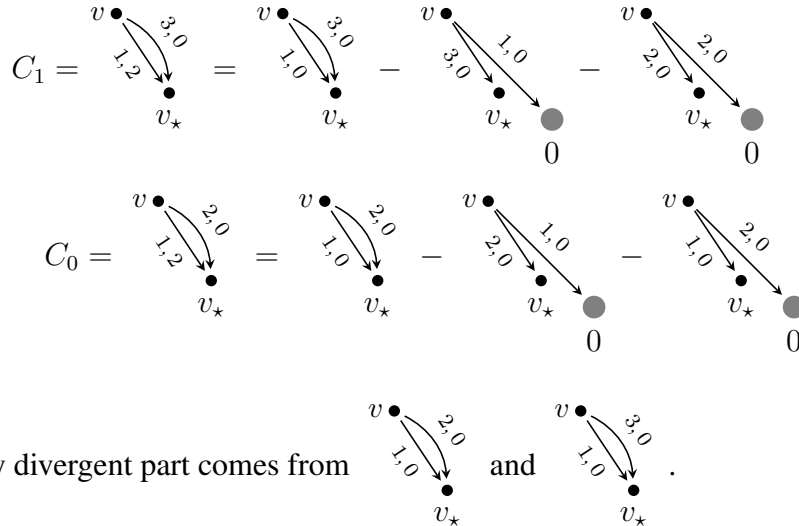

The only divergent part comes from

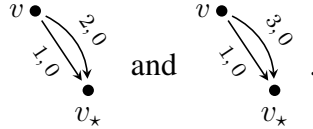

5.6 Pairing of labelled graphs

Definition 5.6.1. A labelled graph $G = (\mathcal{V}, \mathcal{E})$ is obtained from $\bar{\mathcal{G}}_{\mathcal{R}_u}$ if there exist $G_1 = (\mathcal{V}_1, \mathcal{E}_1)$, $G_2 = (\mathcal{V}_2, \mathcal{E}_2)$ such that the G_i belongs to $\bar{\mathcal{G}}_{\mathcal{R}_u}$. The graphs G_i are built from elementary graphs $\bar{G}_i \in \bar{\mathcal{G}}_{\mathcal{R}_u}$ through contractions and the renormalisation procedure. We suppose also the existence of a bijective map f from $\mathcal{V}_{1,\ell}$ to $\mathcal{V}_{2,\ell}$ such that $\mathcal{E} = (\mathcal{E}_1 \cup \mathcal{E}_2) / \sim_f$ and $\mathcal{V} = (\mathcal{V}_1 \cup \mathcal{V}_2) / \sim_f$ where \sim_f means that we identify $f(v)$ with v for every $v \in \mathcal{V}_{1,\ell}$. We do the same identification between v_0^1 and v_0^2 .

Proposition 5.6.2. Every graph $G = (\mathcal{V}, \mathcal{E})$ obtained from $\bar{\mathcal{G}}_{\mathcal{R}_u}$ satisfies the assumptions (5.5) and (5.6).

Proof. We build our graph G with two graphs G_1, G_2 which satisfy (5.9) and (5.11) where we merge their leaves using a bijective map f . Let $\bar{\mathcal{V}} \subset \mathcal{V}$, there exist $\bar{\mathcal{V}}_1 \subset \mathcal{V}_1$ and

$\bar{\mathcal{V}}_2 \subset \mathcal{V}_2$ such that $\bar{\mathcal{V}} = (\bar{\mathcal{V}}_1 \cup \bar{\mathcal{V}}_2) / \sim_f$. The following identities hold:

$$\begin{aligned} \mathcal{E}_0(\mathcal{V}) &= \mathcal{E}_0(\mathcal{V}_1) \sqcup \mathcal{E}_0(\mathcal{V}_2), & \mathcal{E}^\dagger(\mathcal{V}) &= \mathcal{E}^\dagger(\mathcal{V}_1) \sqcup \mathcal{E}^\dagger(\mathcal{V}_2), \\ \mathcal{E}^\downarrow(\mathcal{V}) &= \mathcal{E}^\downarrow(\mathcal{V}_1) \sqcup \mathcal{E}^\downarrow(\mathcal{V}_2), & \mathcal{V} &= \mathcal{V}_{1,i} \sqcup \mathcal{V}_{2,i} \sqcup \mathcal{V}_{1,\ell}. \end{aligned}$$

The T_i satisfy the assumption (5.11) by summing the two bounds and using the previous identities we obtain the bound (5.6) for the graph G . We do the same for the condition (5.5) when $v_0 \in \bar{\mathcal{V}}$. In this case we do not have any constraints on the cardinality of $\bar{\mathcal{V}}$.

We suppose $\bar{\mathcal{V}} \subset \mathcal{V}_0$ such that $|\bar{\mathcal{V}}| \geq 3$. We set $\bar{\mathcal{V}}_\ell = \bar{\mathcal{V}} \cap \mathcal{V}_{1,\ell} = \bar{\mathcal{V}} \cap \mathcal{V}_{2,\ell}$.

- If $\bar{\mathcal{V}}_\ell \neq \emptyset$, then $\bar{\mathcal{V}}_1 \neq \emptyset$ and $\bar{\mathcal{V}}_2 \neq \emptyset$. We obtain the condition (5.9) on each T_i for $\bar{\mathcal{V}}_i$. The summation of the bounds gives the result (5.5).
- If $\bar{\mathcal{V}}_\ell = \emptyset$, there exists $j \in \{1, 2\}$ such that $|\bar{\mathcal{V}} \cap \mathcal{V}_{j,i}| \geq 2$ and there exists a leaf ℓ in $\bar{\mathcal{V}}_j$ such that $\ell \notin \bar{\mathcal{V}}_\ell$. From the proposition 5.3.20, the condition (5.5) is satisfied by $\bar{\mathcal{V}}_j$ which gives the desire bound.

If $|\bar{\mathcal{V}}| = 2$ then we can face the following pattern $\bar{\mathcal{V}} = \{v_1, v_2\}$ created by the pairing

of the leaves: . We apply to this term the renormalisation procedure described in 5.5.2.

□

5.7 Alternative proof

We start the section with a counter-example to the previous method:

Example 5.7.1. Let us consider the following graph:

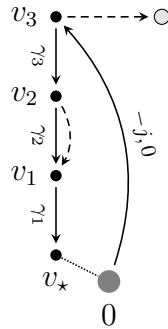

where $\gamma_1 = (1, 2 + j, 0)$, $\gamma_2 = (1, 1 + j, 0)$ and $\gamma_3 = (1, 1 + j, v_1)$. If we look at $\bar{\mathcal{V}} = \{v_3, v_1\}$, we obtain:

$$\sum_{e \in \mathcal{E}_0(\bar{\mathcal{V}})} a_e + \sum_{e \in \mathcal{E}^\downarrow(\bar{\mathcal{V}})} (\mathbb{1}_{\{v_e \in \bar{\mathcal{V}} \vee r_e = 0\}} (a_e + r_e - 1) - (r_e - 1)) + \sum_{e \in \mathcal{E}^\dagger(\bar{\mathcal{V}})} ((a_e + r_e) - \mathbb{1}_{v_e \in \bar{\mathcal{V}}} r_e)$$

5.7. Alternative proof

$$= 3 + j + 3 - (j - 1) + 1 - j + 3 = 11 - j$$

which can be even negative for $j > 11$. Therefore, the condition (5.11) is not satisfied. As the same, we can prove that for $\mathcal{V} = \{v_0, v_2\}$ the condition (5.9) is not satisfied.

In order to treat the previous example, we perform the telescopic sum on a specific domain of integration as described in 5.2.2. Let $G = (\mathcal{V}, \mathcal{E}) \in \mathcal{G}_{\mathcal{R}_u}$ an elementary graph and $\bar{T} = (\bar{\mathcal{V}}, \bar{\mathcal{E}})$ a negative subtree of G . In order to treat this divergence, we change the label of some edge $e \in \mathcal{E}^\downarrow(V)$ by replacing $v_e = v_0$ by a node in $\bar{\mathcal{V}}$ such that this new Taylor expansion point has a renormalisation effect on $\bar{\mathcal{V}}$. Let $e = (v_1, v_2) \in \mathcal{E}^\downarrow(\bar{\mathcal{V}})$ and $v \in \bar{\mathcal{V}}$ such that there exists v' with $(v, v') \in \mathcal{E}^\uparrow(\bar{\mathcal{V}})$. The situation can be represented by:

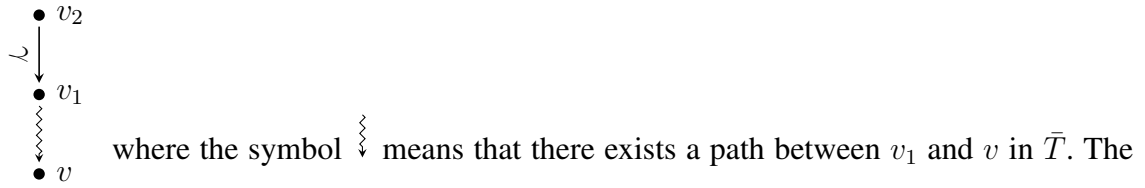

label of e is replaced by $\gamma = (a_e, r'_e, v)$ where $r'_e = \max(\lceil -|\bar{T}|_s, r_e)$.

Definition 5.7.2. We denote by $\mathcal{V}(\bar{T})$, the set such that $V \in \mathcal{V}(\bar{T})$ and:

$$(\exists v_3 \in \bar{\mathcal{V}} \cap V \wedge (\exists v_4 \in V \setminus \bar{\mathcal{V}})) \Rightarrow \bar{\mathcal{V}} \subset V.$$

The previous situation can be summarised by the following trees:

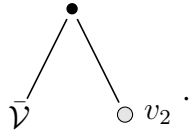

Proposition 5.7.3. Let G as above, we suppose that G satisfies the condition (5.11) then the new graph obtained from the transformation of the label of e satisfies the same condition on $\mathcal{V}(\bar{T})$.

Proof. We have to check that by changing $v_e = v_0$ in G the contribution of the edge e is preserved. Let $V \in \mathcal{V}(\bar{T})$, we distinguish three cases:

- $e \in \mathcal{E}_0(V)$ then we still have the same contribution with a_e .
- $e \in \mathcal{E}^\downarrow(V)$, we have $v_1 \in V$. Then from the properties of $\mathcal{V}(\bar{T})$, $\bar{\mathcal{V}} \subset V$ and $v \in V$. We obtain a better contribution 0 instead of $-r_e$.
- $e \in \mathcal{E}^\uparrow(V)$, we have $v_2 \in V$. If $v \notin V$, we obtain a better contribution $a_e + r'_e$. Else if $v \in V$ then $\bar{\mathcal{V}} \subset V$ and $v_1 \in V$ which is absurd.

□

Proposition 5.7.4. Let T as above, the condition (5.9) is satisfied on $\mathcal{V}(\bar{T})$.

Proof. As before, we have to check that by changing $v_e = v_0$ in G the contribution of the edge e is preserved and it is improved when we choose the set $\bar{\mathcal{V}}$. Let $V \in \mathcal{V}(\bar{T})$, we distinguish three cases:

- $e \in \mathcal{E}_0(V)$ then we still have the same contribution with a_e .
- $e \in \mathcal{E}^\downarrow(V)$, we have $v_1 \in V$. If $v_0 \notin V$ then in the case of $V = \bar{\mathcal{V}}$, we have a new contribution $-r'_e$ which compensates the divergence of $\bar{\mathcal{V}}$. Else $v_0 \in V$, from the properties of $\mathcal{V}(\bar{T})$, we have $v \in V$ and the contribution $-r'_e$ is better than $-r_e$.
- $e \in \mathcal{E}^\uparrow(V)$, we have $v_2 \in V$. If $v \in V$ then $v_1 \in V$ which is absurd. Else we have the same contribution.

□

When we obtain a graph with no leave after the previous transformation, we want to transform those graphs in constants by fixing all the labels (a_e, r_e, v_0) to $(a_e, 0)$. Let $e = (v_1, v_2)$ an edge in \bar{T} with a label (a_e, r_e, v_0) and $r_e > 0$. We can perform the following decomposition:

$$\begin{array}{c} \bullet v_2 \\ \downarrow \\ \bullet v_1 \end{array} = \begin{array}{c} \bullet v_2 \\ \downarrow a_e, 0 \\ \bullet v_1 \end{array} - \sum_{|k|_s < r_e} \begin{array}{c} \bullet v_2 \\ \downarrow a_e + |k|_s, 0 \\ \bullet v_1 \\ \swarrow -|k|_s, 0 \\ \bullet 0 \end{array} .$$

Proposition 5.7.5. *The previous terms depending on k satisfy the conditions (5.10) and (5.11) on $\mathcal{V}(\bar{T})$.*

Proof. Let $V \in \mathcal{V}(\bar{T})$. If $0 \notin V$ then we consider the tree \bar{T} without the edge e . We are able to split \bar{T} into two subtrees of G which satisfy the bound (5.9) and the sum of these two bounds proves the condition (5.10). For (5.11), if v^1 or v^2 does not belong to V then from the definition of $\mathcal{V}(\bar{T})$, we have $\bar{T} \cap V = \emptyset$. □

Remark 5.7.6. We can extend the previous result to $\mathcal{A} \in \mathfrak{A}(T)$ where T is the labelled graph associated to G .

5.8 General Theorem

We want to give some ideas about the following theorem

5.8. General Theorem

Theorem 5.8.1. *Let $(\Pi_x^{M_\varepsilon}, \Gamma_{xy}^{M_\varepsilon})$ be the renormalised model described in chapter 4 associated to a local-subcritical equation. Then there exist a random model $(\Pi_x, \Gamma_{x,y})$ and a constant C such that for every underlying compact space-time domain*

$$\mathbb{E}\|\Pi^{M_\varepsilon}; \Pi\| \leq C\varepsilon^{\kappa/2}.$$

Remark 5.8.2. The notion of local-subcriticality needs to be specify if we look at the counter-example given by [Hos15]. We envisage here the case of a multiplicative (additive depends on the equation) space-time white noise.

5.8.1 Extending the definition

Let T_ε^n , a label tree, we have by applying $M_\varepsilon = M_{\ell_\varepsilon}$ defined as in (4.9):

$$M_\varepsilon T_\varepsilon^n = \sum_{\mathcal{A} \in \mathfrak{A}(T)} \sum_{\varepsilon_{\mathcal{A}}, n_{\mathcal{A}}} \frac{1}{\varepsilon_{\mathcal{A}}!} \binom{\mathbf{n}}{n_{\mathcal{A}}} \ell_\varepsilon \left(\Pi_- \mathcal{R}_{\mathcal{A}}^\uparrow T_\varepsilon^{n_{\mathcal{A}} + \pi \varepsilon_{\mathcal{A}}} \right) \mathcal{R}_{\mathcal{A}}^\downarrow T_{\varepsilon + \varepsilon_{\mathcal{A}}}^{n - n_{\mathcal{A}}, n_{\mathcal{A}} + \pi \varepsilon_{\mathcal{A}}}. \quad (5.16)$$

Then, the kernel associated to k -th Wiener chaos is given by:

$$\hat{W}^{\varepsilon, k} T_\varepsilon^n = \sum_{\mathcal{A} \in \mathfrak{A}(T)} \sum_{\varepsilon_{\mathcal{A}}, n_{\mathcal{A}}} \frac{1}{\varepsilon_{\mathcal{A}}!} \binom{\mathbf{n}}{n_{\mathcal{A}}} \ell_\varepsilon \left(\Pi_- \mathcal{R}_{\mathcal{A}}^\uparrow T_\varepsilon^{n_{\mathcal{A}} + \pi \varepsilon_{\mathcal{A}}} \right) W^{\varepsilon, k} \left(\mathcal{R}_{\mathcal{A}}^\downarrow T_{\varepsilon + \varepsilon_{\mathcal{A}}}^{n - n_{\mathcal{A}}, n_{\mathcal{A}} + \pi \varepsilon_{\mathcal{A}}} \right).$$

Definition 5.8.3. Let $T_\varepsilon^{n,d}$ a labelled tree. We define an integration domain D as a subset of $\mathfrak{A}(\mathcal{R}^\downarrow T)$ given by:

$$\mathfrak{A}(\mathcal{R}^\downarrow T) = \bigcup_{\mathcal{A} \in \mathfrak{A}(T)} \mathfrak{A}(\mathcal{R}_{\mathcal{A}}^\downarrow T).$$

Definition 5.8.4. Given an integration domain D and $\mathcal{A} \in D$, we define $\mathcal{A}(D)$ as:

$$\mathcal{A}(D) = \bigcup_{\substack{\bar{\mathcal{A}} \in D \\ \bar{\mathcal{A}} \subset \mathcal{A}} \bar{\mathcal{A}}.$$

Remark 5.8.5. The set $\mathcal{A}(D)$ contains the main divergence \mathcal{A} and all its subdivergences.

Example 5.8.6. For $\mathcal{A}(D) = \{T_1, T_2, T_3, T_{3,1}, T_{3,2}\}$, the different inclusions are represented by a direct tree just below. An edge of the form (T, \bar{T}) means that $\bar{T} \subset T$.

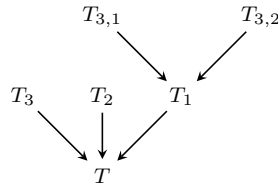

Remark 5.8.7. Given a labelled tree $T_\epsilon^{n,d}$, in the definition of $\mathcal{W}^{\epsilon,k}(T_\epsilon^n)$ for $k \leq |L_T|$ some variables indexed by the inner nodes are integrated. We consider $\mathcal{B}(\mathcal{V})$ the set of all labelled rooted binary trees which have $\mathcal{V}_T = \{x_v : v \in E_T\}$ as their set of leaves and we impose a condition on the labelling:

$$\ell_v \geq \ell_w \text{ for } v \geq w$$

where $v \geq w$ means that w belongs to the shortest path connecting v to the root vertex. We have already introduced these trees in the section 5.2.2.

The labelled trees (B, ℓ) make a partition of the domain of integration. The labelling ℓ means that for any $v, w \in \mathcal{V}$, we have:

$$\|v - w\|_5 \sim 2^{-\ell_{v \wedge w}}.$$

We fix a labelled tree (\tilde{B}, ℓ) in $\mathcal{B}(\mathcal{V}_T)$. Then we define an integration domain D which contains every negative subtree \tilde{T} of T such that the subtree with the leaves $\mathcal{V}_{\tilde{T}}$ is an admissible subtree of \tilde{B} in the sense that there exists no leaf $\ell \in L_B \setminus L_{\tilde{B}}$ such that $\varrho_{\tilde{B}} \leq \ell$. In the next example, we compute one term which appears in $W^{\epsilon,0}(T)$ where $T = \mathcal{I}_1(\mathcal{I}(\Xi)\Xi)^2$.

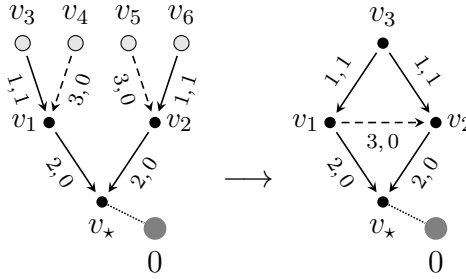

We present two integration domains:

- the first one contains the subtrees $\{v_*, v_1, v_2, v_3, v_4, v_5, v_6\}$ and $\{v_*, v_3\}$ when we remove $\{v_*, v_1, v_2\}$.
- the second one contains the subtrees $\{v_*, v_1, v_2, v_3, v_4, v_5, v_6\}$, $\{v_*, v_1, v_2, v_4, v_5\}$ and $\{v_*, v_3\}$.

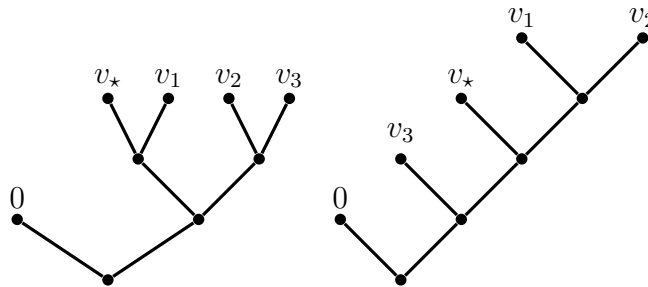

5.8. General Theorem

We can give a more precise formula for the k -th Wiener chaos:

$$\mathcal{W}^{\varepsilon,k}(T_\varepsilon^n) = \sum_{m=k}^{\|T\|} \sum_{\mathcal{A} \in \mathfrak{A}_m(T)} \mathcal{P}_{\mathcal{A}}^k \mathcal{W}^\varepsilon(T_\varepsilon^n)$$

where $\mathcal{P}_{\mathcal{A}}^k$ makes the contraction for \mathcal{A} and then we complete with other contractions in order to be in the k -th Wiener. We avoid contraction that can be done by \mathcal{A}' such that $\mathcal{A} \subset \mathcal{A}'$ where this inclusion means that $T_1 \in \mathcal{A}$ implies the existence of $T_2 \in \mathcal{A}'$ such that $T_1 \subset T_2$. We set by \mathcal{A}_m the bigger element in $D \cap \mathfrak{A}_m(T)$ for the inclusion if this set is not empty. Then the only divergent part in the previous sum is given by:

$$\mathcal{W}_D^{\varepsilon,k}(T_\varepsilon^n) = \sum_{m=k}^{\|T\|} \mathbb{1}_{D \cap \mathfrak{A}_m(T) \neq \emptyset} \mathcal{P}_{\mathcal{A}_m}^k \mathcal{W}^\varepsilon(T_\varepsilon^n).$$

We can rewrite the previous identity as:

$$\mathcal{W}_D^{\varepsilon,k}(T_\varepsilon^n) = \sum_{\mathcal{A} \in D} \mathcal{P}_{\mathcal{A}}^k \mathcal{W}^\varepsilon(T_\varepsilon^n).$$

Definition 5.8.8. Let D an integration domain and $\mathcal{A} \in D$. We define $\mathcal{E}^\downarrow(\mathcal{A}(D))$ as the same as $\mathcal{E}^\downarrow(\mathcal{A})$ but with the constraint that for $\{\mathcal{E}_1, \dots, \mathcal{E}_n\} \in \mathcal{E}^\downarrow(\mathcal{A}(D))$ one has $\mathcal{E}_i \cap \mathcal{E}_j = \emptyset$ where $1 \leq i < j \leq n$.

For $\mathcal{E} \in \mathcal{E}^\downarrow(\mathcal{A}(D))$, we extend the definition of $\mathcal{P}_{\mathcal{E}}^{\mathbf{n}_{\mathcal{A}}, \varepsilon \mathcal{E}} \mathcal{W}^\varepsilon(T_{\varepsilon+\varepsilon \mathcal{E}}^{\mathbf{n}-\mathbf{n}_{\mathcal{A}}, \mathbf{n}_{\mathcal{A}}+\pi \varepsilon \mathcal{E}})$ by starting with the different operations on the maximal trees toward the inclusion order. Then we follow by the other trees respecting this order. In the example 5.8.6, we start with $\{T_1, T_2, T_3\}$ and we finish with $\{T_{3,1}, T_{3,2}\}$.

Now, we use the telescopic sum:

$$\begin{aligned} \mathcal{W}_D^{\varepsilon,k}(T_\varepsilon^n) &= \sum_i G_i \\ &\quad - \sum_{\mathcal{A}' \in D} \sum_{\substack{\mathcal{A} \subset \mathcal{A}' \\ \emptyset}} \mathcal{P}_{\mathcal{A}' \setminus \mathcal{A}}^k \sum_{\varepsilon_{\mathcal{A}}, \mathbf{n}_{\mathcal{A}}} \frac{1}{\varepsilon_{\mathcal{A}}!} \binom{\mathbf{n}}{\mathbf{n}_{\mathcal{A}}} \ell_\varepsilon^D \left(\mathcal{R}_{\mathcal{A}}^\uparrow T_\varepsilon^{\mathbf{n}_{\mathcal{A}}+\pi \varepsilon_{\mathcal{A}}} \right) \mathcal{W}^\varepsilon \left(\mathcal{R}_{\mathcal{A}}^\downarrow T_{\varepsilon+\varepsilon_{\mathcal{A}}}^{\mathbf{n}-\mathbf{n}_{\mathcal{A}}, \mathbf{n}_{\mathcal{A}}+\pi \varepsilon_{\mathcal{A}}} \right), \end{aligned}$$

where the G_i are renormalised on D and ℓ_ε^D is given recursively for $T_\varepsilon^{\mathbf{n},d} \in \mathfrak{T}_-^{\mathbf{n}}$ by: $\ell_\varepsilon^D(\mathbb{1}) = 1$, if $|L_T| \notin 2\mathbb{N}$ then $\ell_\varepsilon^D(T_\varepsilon^{\mathbf{n},d}) = 0$, otherwise

$$\ell_\varepsilon^D(T_\varepsilon^{\mathbf{n},d}) = - \sum_{\mathcal{A} \in D \setminus \{\{T\}\}} \sum_{\varepsilon_{\mathcal{A}}, \mathbf{n}_{\mathcal{A}}} \frac{1}{\varepsilon_{\mathcal{A}}!} \binom{\mathbf{n}}{\mathbf{n}_{\mathcal{A}}} \ell_\varepsilon^D \left(\Pi_- \mathcal{R}_{\mathcal{A}}^\uparrow T_\varepsilon^{\mathbf{n}_{\mathcal{A}}+\pi \varepsilon_{\mathcal{A}}} \right) \tilde{W}^{\varepsilon,0} \left(\mathcal{R}_{\mathcal{A}}^\downarrow T_{\varepsilon+\varepsilon_{\mathcal{A}}}^{\mathbf{n}-\mathbf{n}_{\mathcal{A}}, \mathbf{n}_{\mathcal{A}}+\pi \varepsilon_{\mathcal{A}}} \right),$$

The last terms appear with a sign minus in

$$\sum_{\mathcal{A}' \in D} \sum_{\mathcal{A} \subset \mathcal{A}'} \mathcal{P}_{\mathcal{A}' \setminus \mathcal{A}}^k \sum_{\varepsilon_{\mathcal{A}}, \mathbf{n}_{\mathcal{A}}} \frac{1}{\varepsilon_{\mathcal{A}}!} \binom{\mathbf{n}}{\mathbf{n}_{\mathcal{A}}} \ell_\varepsilon \left(\mathcal{R}_{\mathcal{A}}^\uparrow T_\varepsilon^{\mathbf{n}_{\mathcal{A}}+\pi \varepsilon_{\mathcal{A}}} \right) \mathcal{W}^\varepsilon \left(\mathcal{R}_{\mathcal{A}}^\downarrow T_{\varepsilon+\varepsilon_{\mathcal{A}}}^{\mathbf{n}-\mathbf{n}_{\mathcal{A}}, \mathbf{n}_{\mathcal{A}}+\pi \varepsilon_{\mathcal{A}}} \right).$$

Now, we have to look after the renormalisation term of the form:

$$\ell_\varepsilon \left(\mathcal{R}_B^\uparrow T_\varepsilon^{n_B + \pi \varepsilon_B} \right) W^\varepsilon \left(\mathcal{R}_B^\downarrow T_{\varepsilon + \varepsilon_B}^{n - n_B, n_B + \pi \varepsilon_B} \right).$$

where $B \in \mathfrak{A}(T)$. We also have to look inside the term $\ell_\varepsilon \left(\mathcal{R}_B^\uparrow T_\varepsilon^{n_B + \pi \varepsilon_B} \right)$. For that purpose, we need a new representation of the map ℓ_ε .

5.8.2 A new representation for the subdivergences

Let $T_\varepsilon^n \in \mathfrak{T}_-^n$, then ℓ_ε is defined recursively by: $\ell_\varepsilon(\mathbf{1}) = 1$, if $|L_T| \notin 2\mathbb{N}$ then $\ell_\varepsilon(T_\varepsilon^n) = 0$, otherwise

$$\ell_\varepsilon(T_\varepsilon^n) = - \sum_{A \in \mathfrak{A}(T) \setminus \{\{T\}\}} \sum_{\varepsilon_A, n_A} \frac{1}{\varepsilon_A!} \binom{\mathbf{n}}{\mathbf{n}_A} \ell_\varepsilon \left(\Pi_- \mathcal{R}_A^\uparrow T_\varepsilon^{n_A + \pi \varepsilon_A} \right) \tilde{W}^{\varepsilon, 0} \left(\mathcal{R}_A^\downarrow T_{\varepsilon + \varepsilon_A}^{n - n_A, n_A + \pi \varepsilon_A} \right),$$

This recursive formulation is really close to the formula for the antipode S of the Hopf algebra \mathfrak{T}_-^n in (1.8). Indeed, one has:

Proposition 5.8.9. *Let $T_\varepsilon^{n,d}$ a labelled tree in \mathfrak{T}_-^n then*

$$\ell_\varepsilon(T_\varepsilon^{n,d}) = \tilde{W}^{\varepsilon, 0}(S(T_\varepsilon^{n,d})).$$

Proof. We proceed by induction. By using the recursive expression of ℓ_ε and the formula for the antipode in the proposition 1.3.7, we obtain:

$$\begin{aligned} & \tilde{W}^{\varepsilon, 0}(S(T_\varepsilon^{n,d})) \\ &= \tilde{W}^{\varepsilon, 0} \left(- \sum_{A \in \mathfrak{A}(T) \setminus \{\{T\}\}} \sum_{\varepsilon_A, n_A} \frac{1}{\varepsilon_A!} \binom{\mathbf{n}}{\mathbf{n}_A} S \left(\Pi_- \mathcal{R}_A^\uparrow T_\varepsilon^{n_A + \pi \varepsilon_A, d} \right) \mathcal{R}_A^\downarrow T_{\varepsilon + \varepsilon_A}^{n - n_A, d + n_A + \pi \varepsilon_A} \right) \\ &= - \sum_{A \in \mathfrak{A}(T) \setminus \{\{T\}\}} \sum_{\varepsilon_A, n_A} \frac{1}{\varepsilon_A!} \binom{\mathbf{n}}{\mathbf{n}_A} \tilde{W}^{\varepsilon, 0} \left(S \left(\Pi_- \mathcal{R}_A^\uparrow T_\varepsilon^{n_A + \pi \varepsilon_A, d} \right) \right) \tilde{W}^{\varepsilon, 0} \left(\mathcal{R}_A^\downarrow T_{\varepsilon + \varepsilon_A}^{n - n_A, d + n_A + \pi \varepsilon_A} \right) \\ &= - \sum_{A \in \mathfrak{A}(T) \setminus \{\{T\}\}} \sum_{\varepsilon_A, n_A} \frac{1}{\varepsilon_A!} \binom{\mathbf{n}}{\mathbf{n}_A} \ell_\varepsilon \left(\Pi_- \mathcal{R}_A^\uparrow T_\varepsilon^{n_A + \pi \varepsilon_A} \right) \tilde{W}^{\varepsilon, 0} \left(\mathcal{R}_A^\downarrow T_{\varepsilon + \varepsilon_A}^{n - n_A, n_A + \pi \varepsilon_A} \right) \\ &= \ell_\varepsilon(T_\varepsilon^{n,d}), \end{aligned}$$

where we have apply the induction hypothesis on each term $\Pi_- \mathcal{R}_A^\uparrow T_\varepsilon^{n_A + \pi \varepsilon_A, d}$. This concludes the proof. \square

We can provide a non-recursive formulation of the previous identity by considering new labelled trees. Let $T_\varepsilon^{n,d} \in \mathfrak{T}_-^n$, we associate a finite number of labelled trees built in the following way:

- Each leaf is labelled by a term of the form $\mathcal{R}_A^\downarrow T_{\varepsilon + \varepsilon_A}^{n - n_A, d + n_A + \pi \varepsilon_A}$ and each inner node encodes a term of the form $\Pi_- \mathcal{R}_A^\uparrow T_\varepsilon^{n_A + \pi \varepsilon_A, d}$. The root is labelled by $T_\varepsilon^{n,d}$.

5.8. General Theorem

- From each inner node labelled with $T_\epsilon^{n,d}$, the next branches of the tree are built by using a term of the form:

$$\ell_\epsilon \left(\Pi_- \mathcal{R}_A^\uparrow T_\epsilon^{n,A+\pi\epsilon_A,d} \right) \tilde{W}^{\epsilon,0} \left(\mathcal{R}_A^\downarrow T_{\epsilon+\epsilon_A}^{n-n_A,d+n_A+\pi\epsilon_A} \right).$$

For $\mathcal{A} = \{T_1, \dots, T_n\}$, we have:

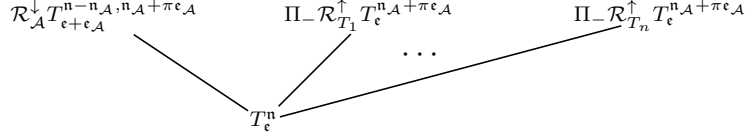

We denote by $\mathcal{T}_{\ell_\epsilon}$ the set of such tree and by $\mathcal{T}_{\ell_\epsilon}(T_\epsilon^n) \subset \mathcal{T}_{\ell_\epsilon}$ trees with T_ϵ^n for the root label. These trees correspond to the point of view of Connes-Kreimer in [CK98] which associates to each Feynman diagram a rooted labelled tree representing the structure of the subdivergences of the graph.

Remark 5.8.10. Using the previous notations, we obtain the following description for $\ell_\epsilon(T_\epsilon^n)$:

$$\ell_\epsilon(T_\epsilon^n) = \sum_{T \in \mathcal{T}_{\ell_\epsilon}(T_\epsilon^n)} (-1)^{|L_T|} c(T) \prod_{u \in L_T} \tilde{W}^{\epsilon,0}(u) \quad (5.17)$$

where $c(T)$ is a combinatorial coefficient depending on T . This non-recursive formulation is similar to the replacement of the iterative Bogoliubov formula by the Zimmermann's Forest Formula see [Zei08].

Example 5.8.11. We give an example of such graph for $T_\epsilon^n = \mathcal{I}(\mathcal{I}(\Xi)^2\Xi)\Xi$:

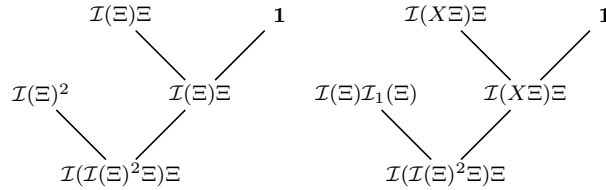

where the previous trees represent:

$$\tilde{W}^{\epsilon,0}(\mathcal{I}(\Xi)\Xi) \tilde{W}^{\epsilon,0}(\mathcal{I}(\Xi)^2), \quad \tilde{W}^{\epsilon,0}(\mathcal{I}(X\Xi)\Xi) \tilde{W}^{\epsilon,0}(\mathcal{I}(\Xi)\mathcal{I}_1(\Xi)).$$

For each leaf u , we compute the integration domain associated to the labelled tree $\tilde{W}^{\epsilon,0}(u)$. Then we perform the telescopic decomposition on each leaf of a tree which does not contain an element of the integration domain as a leaf.

Let \mathcal{B} such that $\mathcal{C} = \mathcal{B} \uplus \mathcal{A}$, One has

$$\mathcal{R}_A^\uparrow \mathcal{R}_C^\uparrow = \mathcal{R}_A^\uparrow, \quad \mathcal{R}_B^\uparrow \mathcal{R}_A^\downarrow = \mathcal{R}_A^\downarrow \mathcal{R}_C^\uparrow.$$

By our telescopic sum, we make the following transformation in the next graph:

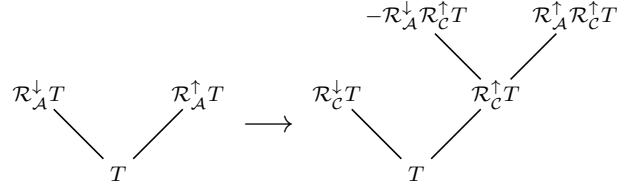

The telescopic sum will induce several local transformations of the previous form. We have described the action on the shape but the same works for the labels. By noticing that $\mathcal{R}_A^\uparrow \mathcal{R}_C^\uparrow T = \mathcal{R}_A^\uparrow T$, we have added two inner nodes and one leaf to the original graph. This term appears with a sign minus in the formula (5.17) and we do not apply a telescopic sum on this term because it contains \mathcal{B} a consequence of the fact that $\mathcal{R}_B^\uparrow \mathcal{R}_A^\downarrow = \mathcal{R}_A^\downarrow \mathcal{R}_C^\uparrow$.

We finish the section by giving the main steps of the proof of the theorem 5.8.1:

- First, we perform some renormalisation on each negative pattern created by the contraction of two Ξ . We do this renormalisation on the counter-terms appearing in MT_ε^n and also inside the tree generated by ℓ_ε .
- Then we decompose the integration domain and we compute its divergent patterns. We renormalise them by starting by the bigger one and then we treat the subdivergence. During this renormalisation, we need to be careful: the contraction of two Ξ creates a diverging edge e which can appear as a subdivergence. In that case, we suppose that we have chosen r'_e large enough to cover the divergence of a bigger pattern.
- It remains to look at each leaf of ℓ_ε and to check the condition (5.6). This condition may not be satisfied if we have a positive subtree in a diverging pattern. But the renormalisation of the negative complementary of this positive subtree helps for the bounds.

Chapter 6

Solving the Generalised KPZ equation

In this chapter, we solve the generalised KPZ equation given on $\mathbb{R}_+ \times \mathcal{S}^1$, where $\mathcal{S}^1 = \mathbb{R}/2\pi$, by:

$$\partial_t u = \partial_x^2 u + g(u)(\partial_x u)^2 + k(u)\partial_x u + h(u) + f(u)\xi. \quad (6.1)$$

where g, k, h and f are smooth. We follow mainly the procedure in [HP14]. The treatment of the Feynman diagrams is based on the chapter 5. Let an even, smooth, compactly supported function $\varrho : \mathbb{R}^2 \rightarrow \mathbb{R}$ with $\int \varrho = 1$ and we set

$$\varrho_\varepsilon(t, x) = \varepsilon^{-3} \varrho(\varepsilon^{-2}t, \varepsilon^{-1}x), \quad c_\varrho = \int P(z)(\varrho * \varrho)(z)dz$$

where $*$ means space-time convolution and P is the heat kernel. We regularise the noise as follows

$$\xi_\varepsilon = \varrho_\varepsilon * \xi.$$

We prove in this chapter the next two theorems:

Theorem 6.0.12. *Let k, h and g smooth functions. Let u_ε the solution of*

$$\partial_t u_\varepsilon = \partial_x^2 u_\varepsilon + g(u_\varepsilon)((\partial_x u_\varepsilon)^2 - C_\varepsilon) + k(u_\varepsilon)\partial_x u_\varepsilon + \bar{h}(u_\varepsilon) + f(u_\varepsilon)(\xi_\varepsilon - C_\varepsilon f'(u_\varepsilon)) \quad (6.2)$$

with $C_\varepsilon = \varepsilon^{-1}c_\varrho$ and \bar{h} given by

$$\begin{aligned} \bar{h}(u) &= h(u) - c_\varrho^{(1)}(f'(u)^3 f(u) + g(u)^3 f(u)^4) \\ &\quad - (3c_\varrho^{(1)} + c_\varrho^{(2)})(g(u)^2 f'(u) f(u)^3 + g(u) f'(u)^2 f(u)^2) \\ &\quad - c_\varrho^{(2)}(g(u) f''(u) f(u)^3 + g'(u) f'(u) f(u)^3 + f''(u) f'(u) f(u)^2 + g'(u) g(u) f(u)^4) \end{aligned}$$

for some constants $c_\varrho^{(i)}$ which can depend on ϱ but not on ε . The initial condition $u_\varepsilon(0, \cdot) = u(0, \cdot)$ is taken in $\mathcal{C}(\mathcal{S}^1)$ for both cases. Then, there exists a choice of $c_\varrho^{(i)}$ such that for some $T > 0$, one has

$$\lim_{\varepsilon \rightarrow 0} \sup_{(t,x) \in [0,T] \times \mathcal{S}^1} |u(t, x) - u_\varepsilon(t, x)| = 0,$$

6.1. Structure and the model

in probability for some limit u which gives the Itô product for $f(u)\xi$. Moreover for any $\alpha \in (0, \frac{1}{2})$ and $t > 0$, the restriction of u_ε to $[t, T] \times \mathcal{S}^1$ converges to u in probability for the topology of $\mathcal{C}^{\alpha, \alpha/2}$.

Theorem 6.0.13. *If we take a smooth diffeomorphism φ then $\varphi(u_\varepsilon)$ satisfies the same kind of equation with the same constants but with new \tilde{g} , \tilde{h} , \tilde{k} and \tilde{f} depending on g, h, k, f and φ given by*

$$\tilde{f} = \frac{f \circ \varphi}{\varphi'}, \quad \tilde{g} = (g \circ \varphi)\varphi' + \frac{\varphi''}{\varphi'}, \quad \tilde{h} = \frac{h \circ \varphi}{\varphi'}, \quad \tilde{k} = k \circ \varphi.$$

6.1 Structure and the model

6.1.1 Structure

In order to prove the existence of our solution, we use the framework of regularity structure introduced in [Hai14b]. We will not give a full description of that theory but we explain how it applies to our example. We first have to build a graded vector space $\mathcal{H} = \bigoplus_{\alpha \in A} \mathcal{H}_\alpha$ where A is a set of real locally finite and bounded and \mathcal{H}_α is finite-dimensional. The space \mathcal{H} comes with a group \mathcal{G} of linear transformation acting on \mathcal{H} such that for every $\tau \in \mathcal{H}_\alpha$ and every $\Gamma \in \mathcal{G}$:

$$\Gamma\tau - \tau \in \bigoplus_{\beta < \alpha} \mathcal{H}_\beta. \quad (6.3)$$

Before giving \mathcal{H} , we remind to the reader the definition of a more general space \mathcal{F} recursively as follows:

- $\{1, X_0, X_1, \Xi\} \subset \mathcal{F}$
- if $\tau_1, \dots, \tau_n \in \mathcal{F}$ then $\tau_1 \cdots \tau_n \in \mathcal{F}$, where we assume that this product is associative and commutative
- if $\tau \in \mathcal{F} \setminus \{1, X^k : k \in \mathbb{N}^2\}$ then $\{\mathcal{I}(\tau), \mathcal{I}_{(0,1)}(\tau)\} \subset \mathcal{F}$.

where (X_0, X_1) corresponds to (T, X) with the parabolic scaling $(2, 1)$. For $k = (k_0, k_1)$, the term X^k is given by $X_0^{2k_0} X_1^{k_1}$. The symbol Ξ corresponds to the noise and $\mathcal{I}_k(\cdot)$ for every $k \in \mathbb{N}^2$ is for the convolution with the heat kernel differentiated k times. From now we use the shorthand notation $\mathcal{I}_1(\cdot)$ instead of $\mathcal{I}_{(0,1)}(\cdot)$.

To each $\tau \in \mathcal{F}$, we associate a real number $|\tau|_s$ called its homogeneity: $|\Xi|_s = -\frac{3}{2} - \kappa$, $|X_0|_s = 2$, $|X_1|_s = 1$, $|1|_s = 0$

$$|\tau_1 \cdots \tau_n|_s = |\tau_1|_s + \dots + |\tau_n|_s, \quad \mathcal{I}_k(\tau) = |\tau|_s + 2 - |k|_s.$$

Remark 6.1.1. The homogeneity corresponds to a kind of regularity. The space time white noise belongs to the Hölder space $\mathcal{C}^{-\frac{3}{2} - \kappa}$ for every $\kappa > 0$.

The abstract symbols of \mathcal{F} appear if we apply a perturbative method on the equation starting with the noise. Of course, the space \mathcal{H} will not contain all the possible products. The licit products come from the equation. Therefore, we extract rules from the right hand-side of the equation as described in 3.2 . We make the following transformations:

$$\xi \mapsto \Xi, \quad x_i \mapsto X_i, \quad u \mapsto \mathcal{I}(\cdot), \quad D^{(0,1)}u \mapsto \mathcal{I}_1(\cdot), \quad u, D^{(0,1)}u \mapsto X^k \quad k \in \mathbb{N}^2.$$

The latest rules mean that u and $D^{(0,1)}u$ can be either replaced by a monomial or the corresponding abstract integrator $\mathcal{I}(\cdot)$ and $\mathcal{I}_1(\cdot)$. Non-linearities of the form $g(u)$ are replaced by polynomials $x^m u^n$ and then we apply the previous transformations. In the generalized KPZ equation the term $g(u)(\partial_x u)^2$ gives the rules $X^k \mathcal{I}(\cdot)^n \mathcal{I}_1(\cdot)^m$ for every $k, n, m \in \mathbb{N} \times \mathbb{N} \times \{0, 1, 2\}$. That means for $X^k \mathcal{I}(\cdot)^n \mathcal{I}_1(\cdot)^2$:

$$\tau_1, \dots, \tau_n, \tau'_1, \tau'_2 \in \mathcal{H} \iff X^k \left(\prod_{i=1}^n \mathcal{I}(\tau_i) \right) \mathcal{I}_1(\tau'_1) \mathcal{I}_1(\tau'_2) \in \mathcal{H}.$$

By applying the previous transformation, the set of rules is given by

$$\mathcal{R}_{gkpz} = \{X^k \mathcal{I}(\cdot)^\ell, X^k \mathcal{I}(\cdot)^\ell \mathcal{I}_1(\cdot), X^k \mathcal{I}(\cdot)^\ell \mathcal{I}_1(\cdot)^2, X^k \mathcal{I}(\cdot)^\ell \Xi, (k, \ell) \in \mathbb{N}^3\}.$$

Now we are able to give the definition of the model set:

$$\mathcal{T} := \{\tau \in \mathcal{F} : \tau = R(\tau_1, \dots, \tau_n) \quad R \in \mathcal{R}_u \text{ and } \tau_1, \dots, \tau_n \in \mathcal{T} \text{ or } \tau = \Xi\},$$

and we let \mathcal{H} be the linear span of \mathcal{T} . If $\mathcal{T}_\alpha := \{\tau \in \mathcal{T} : |\tau|_s = \alpha\}$, then $A := \{\alpha \in \mathbf{R} : \mathcal{T}_\alpha \neq \emptyset\}$ and \mathcal{H}_α is the linear span of \mathcal{T}_α . The set of rules used to build \mathcal{T} is local subcritical which gives the finiteness of the set \mathcal{T}_α . Moreover, we can give the regularity we earn when we apply a rule:

$$\beta_{\mathcal{R}_{gkpz}} = \min_{R \in \mathcal{R}_{gkpz} \setminus \{\Xi\}} |R|_s - |\Xi|_s = \frac{1}{2} > 0.$$

This parameter of the equation will play a major role in the convergence of our solution. Using the labelled trees notation T_ϵ^n , the locally subcriticality implies that: for every \bar{T} subtree of T , one has

$$|\bar{T}_\epsilon^n|_s > |\Xi|_s = -\frac{3}{2} - \kappa.$$

In order to have better properties, we use the extended structure by adding a new symbol $\mathbf{1}_\alpha$ with $\alpha < 0$. For every labelled tree T_ϵ^n , every $\mathcal{A} \in \mathfrak{A}(T)$ and every $\epsilon_{\mathcal{A}}, n_{\mathcal{A}}$ such that $|\mathcal{R}_{\mathcal{A}}^\uparrow T_\epsilon^{n_{\mathcal{A}} + \pi \epsilon_{\mathcal{A}}}|_s < 0$, we add the following term:

$$\mathcal{R}_{\mathcal{A}}^\downarrow T_{\epsilon + \epsilon_{\mathcal{A}}}^{n - n_{\mathcal{A}}, n_{\mathcal{A}} + \pi \epsilon_{\mathcal{A}}}.$$

In order to define the structure group \mathcal{G} , we need more notations. We set

$$\mathcal{T}_+ := \{\tau \in \mathcal{F} : \tau = 1 \text{ or } |\tau|_s > 0, \text{ and } \tau = \tau_1 \tau_2 \implies \tau_1, \tau_2 \in \mathcal{T}_+\},$$

6.1. Structure and the model

and we let \mathcal{H}_+ be the linear span of \mathcal{T}_+ . If \mathcal{H}_+^* denotes the dual of \mathcal{H}_+ , then we define

$$G_+ := \{g \in \mathcal{H}_+^* : g(\tau_1\tau_2) = g(\tau_1)g(\tau_2), \forall \tau_1, \tau_2 \in \mathcal{H}_+\}.$$

For any $g \in \mathcal{H}_+^*$ we define a linear operator $\Gamma_g : \mathcal{H} \mapsto \mathcal{H}$ by

$$\begin{cases} \Gamma_g \mathbf{1}_\alpha = \mathbf{1}_\alpha, & \Gamma_g \Xi = \Xi, & \Gamma_g X = X + g(X), & \Gamma_g(\tau\bar{\tau}) = (\Gamma_g\tau)(\Gamma_g\bar{\tau}), \\ \Gamma_g \mathcal{I}_k(\tau) = \mathcal{I}_k(\Gamma_g\tau) + \sum_{\ell} \frac{X^\ell}{\ell!} g(\mathcal{J}_{k+\ell}(\tau)), \end{cases}$$

where

$$\mathcal{J}_k(\tau) := \mathbb{1}_{(\beta - |k|_s + |\tau|_s > 0)} \mathcal{I}_k(\tau).$$

The structure group \mathcal{G} is given by:

$$\mathcal{G} = \{\Gamma_g, g \in \mathcal{H}_+^*\}$$

It is easy to check the property (6.3) on \mathcal{G} but it is not obvious to prove that this set forms a group under composition.







Remark 6.1.2. The linear map Γ_g is given using the coproduct Δ defined on the extended structure in 4.1 : $\Gamma_g = (1 \otimes g)\Delta$ which is equivalent to the recursive definition.

In order to describe the set \mathcal{T} , we use the same graphical notation as in [HP14]. Therefore all the basis vectors are denoted in blue. We draw a circle for $\Xi = \circ$. The abstract integrators $\mathcal{I}(\cdot)$ and $\mathcal{I}_1(\cdot)$ are represented by a downward facing straight line which is thicker for $\mathcal{I}_1(\cdot)$. Symbols in this representation are multiplied by joining their trees by their roots. For example, we have: $\mathcal{I}(\mathcal{I}_1(\Xi)^2)\Xi = \text{circles joined by lines}$. The multiplication of τ by X is denoted by \otimes if τ contains Ξ else is given by \bullet . Symbols of negative homogeneity will play a major role, therefore we list them:

Homogeneity	Symbol(s)	
$-\frac{3}{2} - \kappa$	\circ	
$-1 - 2\kappa$	$\circ \circ, \text{circles joined by lines}$	
$-\frac{1}{2} - 3\kappa$	$\circ \circ \circ, \text{circles joined by lines}$	
$-\frac{1}{2} - \kappa$	$\otimes, \text{circles joined by lines}$	(6.4)
-4κ	$\text{circles joined by lines}$	
-2κ	$\text{circles joined by lines}$	
0	$\mathbb{1}$	

In order to describe the extended structure \mathcal{T}_{ex} , we represent the symbol $\mathbf{1}_{-1-2\kappa}$ by a green circle: $\mathbf{1}_{-1-2\kappa} = \bullet$. We add the following negative symbols

Homogeneity	Symbol(s)	
-4κ	$\text{circles joined by lines}$	(6.5)

Remark 6.1.3. The symbol $1_{-2\kappa}$ appears also in some labelled trees when we remove the subtrees , , , , ,  and . But all the constants associated to the previous negative trees end up to be zero.

6.1.2 Model

In practice, we do not need to define a model for the whole space \mathcal{H} . We can restrict ourselves to $\mathcal{H}_{\leq \zeta} = \bigoplus_{\alpha \leq \zeta} \mathcal{H}_\alpha$ for some large ζ . We first equip \mathbb{R}^2 with the norm $\|\cdot\|_s$ associated to the parabolic scaling $(2, 1)$, defined by

$$\|(t, x)\|_s = |t|^{1/2} + |x|.$$

We consider a kernel $K : \mathbb{R}^2 \rightarrow \mathbb{R}$ which satisfies:

1. The kernel K is compactly supported in the unique ball $\mathcal{B}(0, 1)$ center at the origin associated to $\|\cdot\|_s$.
2. The kernel is anticipative in the sense that for $t \leq 0$, $K(t, x) = 0$. Moreover, it is symmetric in the space variable: $K(t, x) = K(t, -x)$.
3. For (t, x) , with $(t, x) \in \mathcal{B}(0, 1/2)$ and $t > 0$, then

$$K(t, x) = \frac{1}{\sqrt{4\pi t}} e^{-\frac{x^2}{4t}}$$

and K is smooth on $|t| + x^2 \geq 1/4$.

4. For every polynomial $P : \mathbb{R}^2 \rightarrow \mathbb{R}$ of parabolic scaling less than ζ , one has

$$\int_{\mathbb{R}^2} K(t, x) P(t, x) dt dx = 0.$$

The kernel K is very similar to the heat kernel G . The existence of such kernel is proved in [Hai14b] by using a smooth cutoff function which allows us to split the heat kernel G into two pieces: $G = K + R$ where R is smooth. We will interpret our abstract symbol in the space $\mathcal{S}'(\mathbb{R}^2)$ of Schwartz distributions on \mathbb{R}^2 . In order to have a local description in that space, we denote by \mathcal{B} the set of function $\varphi : \mathbb{R}^2 \rightarrow \mathbb{R}$ such that $\varphi \in \mathcal{C}^2$, $\|\varphi\|_{\mathcal{C}^2} \leq 1$ and φ is compactly supported in a unit ball around the origin. We rescale these test functions using the parabolic scaling:

$$\varphi_{\bar{z}}^\lambda(z) = \lambda^{-3} \varphi(\lambda^{-2}(t - \bar{t}), \lambda^{-1}(x - \bar{x}))$$

where $z = (t, x)$ and $\bar{z} = (\bar{t}, \bar{x})$. We denote by $\mathcal{L}(\mathcal{H}, \mathcal{S}'(\mathbb{R}^2))$ the space of linear maps from \mathcal{H} to $\mathcal{S}'(\mathbb{R}^2)$.

6.1. Structure and the model

We define a sequence of admissible models $(\Pi^{M_\varepsilon}, \Gamma^{M_\varepsilon})$ using a renormalisation map M_ε defined on the extended structure, using a coproduct given in (4.1):

$$M_\varepsilon T_\varepsilon^n = \sum_{\mathcal{A} \in \mathfrak{A}(T)} \sum_{\varepsilon_{\mathcal{A}}, n_{\mathcal{A}}} \frac{1}{\varepsilon_{\mathcal{A}}!} \binom{\mathbf{n}}{\mathbf{n}_{\mathcal{A}}} \ell_\varepsilon \left(\Pi_- \mathcal{R}_{\mathcal{A}}^\uparrow T_\varepsilon^{n_{\mathcal{A}} + \pi \varepsilon_{\mathcal{A}}} \right) \mathcal{R}_{\mathcal{A}}^\downarrow T_\varepsilon^{n - n_{\mathcal{A}}, n_{\mathcal{A}} + \pi \varepsilon_{\mathcal{A}}}. \quad (6.6)$$

Let $\mathcal{A} = \{T_1, \dots, T_n\} \in \mathfrak{A}(T)$ then by multiplicativity of ℓ_ε , we get:

$$\ell_\varepsilon \left(\Pi_- \mathcal{R}_{\mathcal{A}}^\uparrow T_\varepsilon^{n_{\mathcal{A}} + \pi \varepsilon_{\mathcal{A}}} \right) = \prod_{i=1}^n \ell_\varepsilon \left(\Pi_- \mathcal{R}_{T_i}^\uparrow T_\varepsilon^{n_{T_i} + \pi \varepsilon_{T_i}} \right).$$

From the gaussian structure, ℓ_ε must be zero on trees with odd number of leaves. This fact is guaranteed in the recursive definition 5.1.3 of ℓ_ε where we have:

$$\ell_\varepsilon(T_\varepsilon^{n,d}) = - \sum_{\mathcal{A} \in \mathfrak{A}(T) \setminus \{\{T\}\}} \sum_{\varepsilon_{\mathcal{A}}, n_{\mathcal{A}}} \frac{1}{\varepsilon_{\mathcal{A}}!} \binom{\mathbf{n}}{\mathbf{n}_{\mathcal{A}}} \ell_\varepsilon \left(\Pi_- \mathcal{R}_{\mathcal{A}}^\uparrow T_\varepsilon^{n_{\mathcal{A}} + \pi \varepsilon_{\mathcal{A}}, d} \right) \tilde{W}^{\varepsilon,0} \left(\mathcal{R}_{\mathcal{A}}^\downarrow T_\varepsilon^{n - n_{\mathcal{A}}, d + n_{\mathcal{A}} + \pi \varepsilon_{\mathcal{A}}} \right),$$

and $\tilde{W}^{\varepsilon,0}$ is zero on trees with odd number of leaves. From (6.4) and the fact that elementary trees are killed by Π_- , we deduce that we apply ℓ_ε on:

Homogeneity	Symbol(s)
$-1 - 2\kappa$	
-4κ	
-2κ	
0	$\mathbf{1}$

We explain the computation of M_ε on some examples. For \heartsuit , the only subtrees which are non zero in $\mathfrak{A}(T)$ are: $\mathbf{1}$, \heartsuit , \clubsuit and \heartsuit . Therefore, we obtain

$$\begin{aligned} M_\varepsilon \heartsuit &= \ell_\varepsilon(\mathbf{1}) \heartsuit + \ell_\varepsilon(\heartsuit) \heartsuit + \ell_\varepsilon(\clubsuit) \heartsuit + \ell_\varepsilon(\spadesuit) \heartsuit + \ell_\varepsilon(\diamondsuit) \heartsuit + \ell_\varepsilon(\heartsuit) \heartsuit \\ &= \heartsuit + \ell_\varepsilon(\heartsuit) \heartsuit + \ell_\varepsilon(\clubsuit) \heartsuit + \ell_\varepsilon(\heartsuit) \heartsuit. \end{aligned}$$

For \heartsuit , ℓ_ε is non zero on $\mathbf{1}$, \heartsuit , \clubsuit and \heartsuit . Moreover, \clubsuit appears two times in \heartsuit that's why we have a combinatorial factor of 2 in the next identity

$$\begin{aligned} M_\varepsilon \heartsuit &= \ell_\varepsilon(\mathbf{1}) \heartsuit + \ell_\varepsilon(\heartsuit) \heartsuit + 2\ell_\varepsilon(\clubsuit) \heartsuit + 2\ell_\varepsilon(\spadesuit) \heartsuit + 2\ell_\varepsilon(\diamondsuit) \heartsuit + \ell_\varepsilon(\heartsuit) \heartsuit \\ &= \heartsuit + \ell_\varepsilon(\heartsuit) \heartsuit + 2\ell_\varepsilon(\clubsuit) \heartsuit + \ell_\varepsilon(\heartsuit) \heartsuit. \end{aligned}$$

Remark 6.1.4. In the two previous examples, we anticipate the fact that $\ell_\varepsilon(\clubsuit) = \ell_\varepsilon(\spadesuit) = \ell_\varepsilon(\diamondsuit) = 0$ which will be proved in 6.6.3. Moreover, we omit the label -2κ in the counter-terms associated to the previous constants: \heartsuit , \heartsuit and \heartsuit .

If we use the recursive definition of ℓ_ε in the previous computation, we get:

$$\begin{aligned}\ell_\varepsilon\left(\begin{array}{c} \circ \\ \circ \\ \circ \\ \circ \end{array}\right) &= -\tilde{W}^{\varepsilon,0}\left(\begin{array}{c} \circ \\ \circ \\ \circ \\ \circ \end{array}\right) + \tilde{W}^{\varepsilon,0}(\heartsuit) \tilde{W}^{\varepsilon,0}(\spadesuit) + \tilde{W}^{\varepsilon,0}(\circ) \tilde{W}^{\varepsilon,0}(\heartsuit) \\ \ell_\varepsilon(\heartsuit) &= -\tilde{W}^{\varepsilon,0}(\heartsuit) + \tilde{W}^{\varepsilon,0}(\heartsuit) \tilde{W}^{\varepsilon,0}(\spadesuit) + 2\tilde{W}^{\varepsilon,0}(\circ) \tilde{W}^{\varepsilon,0}(\heartsuit).\end{aligned}$$

Finally, the map M_ε has 34 parameters: the value of $\tilde{W}^{\varepsilon,0}$ on each negative tree. If we want just the convergence of the renormalised model the map $\tilde{W}^{\varepsilon,0}$ is uniquely determined as in 5.1.3. There are three constraints which restraint our choice for ℓ_ε and give a map with less parameters:

- the Itô product in 6.3.
- the invariance by smooth diffeomorphism in 6.2.2.
- the convergence of the renormalised model in 6.6 .

In order to obtain the Itô model, we need to annihilate the main components of the 0-th Wiener chaos of $\{\circ, \begin{array}{c} \circ \\ \circ \\ \circ \end{array}, \begin{array}{c} \circ \\ \circ \\ \circ \\ \circ \end{array}, \begin{array}{c} \circ \\ \circ \\ \circ \\ \circ \\ \circ \end{array}, \begin{array}{c} \circ \\ \circ \\ \circ \\ \circ \\ \circ \\ \circ \end{array}, \heartsuit, \spadesuit, \begin{array}{c} \circ \\ \circ \\ \circ \\ \circ \\ \circ \\ \circ \\ \circ \end{array}, \begin{array}{c} \circ \\ \circ \\ \circ \\ \circ \\ \circ \\ \circ \\ \circ \\ \circ \end{array}, \begin{array}{c} \circ \\ \circ \\ \circ \\ \circ \\ \circ \\ \circ \\ \circ \\ \circ \\ \circ \end{array}, \begin{array}{c} \circ \\ \circ \\ \circ \\ \circ \\ \circ \\ \circ \\ \circ \\ \circ \\ \circ \\ \circ \end{array}\}$ which are terms of the form: $\tau\Xi$. Then the map ℓ_ε is given on these terms by:

$$\begin{aligned}\ell_\varepsilon(\circ) &= -C_\varepsilon = -\tilde{W}^{\varepsilon,0}(\circ) \\ \ell_\varepsilon\left(\begin{array}{c} \circ \\ \circ \\ \circ \end{array}\right) &= -c_\rho^{(1)} = -\tilde{W}^{\varepsilon,0}\left(\begin{array}{c} \circ \\ \circ \\ \circ \end{array}\right) + C_\varepsilon \tilde{W}^{\varepsilon,0}(\spadesuit) + C_\varepsilon \tilde{W}^{\varepsilon,0}\left(\begin{array}{c} \circ \\ \circ \end{array}\right) \\ \ell_\varepsilon\left(\begin{array}{c} \circ \\ \circ \\ \circ \\ \circ \end{array}\right) &= -c_\rho^{(2)} = -\tilde{W}^{\varepsilon,0}\left(\begin{array}{c} \circ \\ \circ \\ \circ \\ \circ \end{array}\right) + C_\varepsilon \tilde{W}^{\varepsilon,0}(\heartsuit) + C_\varepsilon \tilde{W}^{\varepsilon,0}(\spadesuit) \\ \ell_\varepsilon\left(\begin{array}{c} \circ \\ \circ \\ \circ \\ \circ \\ \circ \end{array}\right) &= -c_\rho^{(3)} = -\tilde{W}^{\varepsilon,0}\left(\begin{array}{c} \circ \\ \circ \\ \circ \\ \circ \\ \circ \end{array}\right) + C_\varepsilon \tilde{W}^{\varepsilon,0}\left(\begin{array}{c} \circ \\ \circ \\ \circ \end{array}\right) \\ \ell_\varepsilon\left(\begin{array}{c} \circ \\ \circ \\ \circ \\ \circ \\ \circ \\ \circ \end{array}\right) &= -c_\rho^{(4)} = -\tilde{W}^{\varepsilon,0}\left(\begin{array}{c} \circ \\ \circ \\ \circ \\ \circ \\ \circ \\ \circ \end{array}\right) + C_\varepsilon \tilde{W}^{\varepsilon,0}\left(\begin{array}{c} \circ \\ \circ \\ \circ \end{array}\right) \\ \ell_\varepsilon\left(\begin{array}{c} \circ \\ \circ \\ \circ \\ \circ \\ \circ \\ \circ \\ \circ \end{array}\right) &= -c_\rho^{(5)} = -\tilde{W}^{\varepsilon,0}\left(\begin{array}{c} \circ \\ \circ \\ \circ \\ \circ \\ \circ \\ \circ \\ \circ \end{array}\right) \\ \ell_\varepsilon\left(\begin{array}{c} \circ \\ \circ \\ \circ \\ \circ \\ \circ \\ \circ \\ \circ \\ \circ \end{array}\right) &= -c_\rho^{(6)} = -\tilde{W}^{\varepsilon,0}\left(\begin{array}{c} \circ \\ \circ \\ \circ \\ \circ \\ \circ \\ \circ \\ \circ \\ \circ \end{array}\right) + C_\varepsilon \tilde{W}^{\varepsilon,0}\left(\begin{array}{c} \circ \\ \circ \\ \circ \end{array}\right),\end{aligned}$$

where $C_\varepsilon \sim \varepsilon^{-1}$ and the $c_\rho^{(i)}$ are order one. The explanation of why the constants $c_\rho^{(i)}$ end up to be finite can be found in 6.6.4. The invariance by diffeomorphism gives the following constraints:

$$\begin{aligned}\ell_\varepsilon(\circ) &= \ell_\varepsilon(\heartsuit) = -C_\varepsilon \\ 4\ell_\varepsilon\left(\begin{array}{c} \circ \\ \circ \\ \circ \\ \circ \\ \circ \end{array}\right) + \ell_\varepsilon\left(\begin{array}{c} \circ \\ \circ \\ \circ \\ \circ \\ \circ \\ \circ \end{array}\right) &= -c_\rho^{(1)} \\ \ell_\varepsilon\left(\begin{array}{c} \circ \\ \circ \\ \circ \\ \circ \end{array}\right) + \frac{1}{2}\ell_\varepsilon\left(\begin{array}{c} \circ \\ \circ \\ \circ \end{array}\right) &= -c_\rho^{(2)} \\ \ell_\varepsilon\left(\begin{array}{c} \circ \\ \circ \\ \circ \\ \circ \end{array}\right) + \ell_\varepsilon\left(\begin{array}{c} \circ \\ \circ \\ \circ \end{array}\right) &= -c_\rho^{(2)} \\ \ell_\varepsilon\left(\begin{array}{c} \circ \\ \circ \\ \circ \\ \circ \\ \circ \end{array}\right) + 2\ell_\varepsilon\left(\begin{array}{c} \circ \\ \circ \\ \circ \end{array}\right) &= -c_\rho^{(2)} \\ \ell_\varepsilon\left(\begin{array}{c} \circ \\ \circ \\ \circ \\ \circ \end{array}\right) + \ell_\varepsilon\left(\begin{array}{c} \circ \\ \circ \\ \circ \end{array}\right) + 2\ell_\varepsilon\left(\begin{array}{c} \circ \\ \circ \\ \circ \end{array}\right) &= -c_\rho^{(2)}\end{aligned}$$

$$\begin{aligned}
 M_\varepsilon \text{ (diagram)} &= \text{ (diagram)} - C_\varepsilon \text{ (diagram)} - c_\rho^{(2)}, & M_\varepsilon \text{ (diagram)} &= \text{ (diagram)} - C_\varepsilon \text{ (diagram)}, \\
 M_\varepsilon \text{ (diagram)} &= \text{ (diagram)} - C_\varepsilon \text{ (diagram)} - C_\varepsilon \text{ (diagram)} - c_\rho^{(2)}, & M_\varepsilon \text{ (diagram)} &= \text{ (diagram)} - C_\varepsilon \text{ (diagram)} - \frac{1}{2}L_\varepsilon, \\
 M_\varepsilon \text{ (diagram)} &= \text{ (diagram)} - C_\varepsilon \text{ (diagram)} + \frac{1}{4}L_\varepsilon, & M_\varepsilon \text{ (diagram)} &= \text{ (diagram)} + \frac{1}{4}L_\varepsilon, \\
 M_\varepsilon \text{ (diagram)} &= \text{ (diagram)} - C_\varepsilon \text{ (diagram)} - c_\rho^{(6)}, & M_\varepsilon \text{ (diagram)} &= \text{ (diagram)} - C_\varepsilon \text{ (diagram)} - \frac{1}{2}L_\varepsilon - c_\rho^{(2)}, \\
 M_\varepsilon \text{ (diagram)} &= \text{ (diagram)} - C_\varepsilon \text{ (diagram)},
 \end{aligned}$$

Remark 6.1.5. The exact values of the constants are explained in the section 6.6. The divergent part L_ε of the constant is crucial for the convergence of the model. This log divergence compensates and it is not present in the renormalised equation. This fact has been noticed in [Hai13] for the KPZ equation and the terms $4 \text{ (diagram)} + \text{ (diagram)}$.

Remark 6.1.6. The choice for ℓ_ε is not unique. We give one example of map ℓ_ε such that all the constraints explained above are satisfied.

In the framework of the extended structure the maps $\Pi_x^{M_\varepsilon}$ and $\Gamma_{x,y}^{M_\varepsilon}$ have nice identities in (4.12):

$$\Pi_x^{M_\varepsilon} = \Pi_x M_\varepsilon, \quad \Gamma_{xy}^{M_\varepsilon} = \Gamma_{\gamma_{x,y}^{M_\varepsilon}} = \Gamma_{\gamma_{x,y} M_\varepsilon^\circ}.$$

Remark 6.1.7. The expression of $\Pi_x^{M_\varepsilon}$ is useful to obtain the renormalised equation and to explain the convergence of the renormalised model.

6.1.3 Fixed point

We solve our fixed point problem in the abstract space \mathcal{H} . We are looking for functions from \mathbb{R}^2 to \mathcal{H} which behave like Hölder functions. For that purpose, we define the space $\mathcal{D}^{\gamma,\eta}$ by:

Definition 6.1.8. A function $f : \mathbb{R}^2 \rightarrow \oplus_{\alpha < \gamma} \mathcal{H}_\alpha$, belongs to $\mathcal{D}^{\gamma,\eta}$, if for every compact domain K , one has:

$$\|f\|_{\gamma,\eta} = \sup_{z \in K} \sup_{\alpha < \gamma} \frac{\|f(z)\|_\alpha}{|t|^{(\frac{\eta-\alpha}{2}) \wedge 0}} + \sup_{(z,\bar{z}) \in K^2} \sup_{\alpha < \gamma} \frac{\|f(z) - \Gamma_{z\bar{z}} f(\bar{z})\|_\alpha}{(|t| \wedge |\bar{t}|)^{\frac{\eta-\gamma}{2}} \|z - \bar{z}\|_\delta^{\gamma-\alpha}} < \infty. \quad (6.8)$$

In the previous definition, we have denoted by $\|\tau\|_\alpha$ the norm of the component of τ in \mathcal{H}_α .

Remark 6.1.9. If we do not distinguish the time variable t in the definition of $\mathcal{D}^{\gamma,\eta}$ and take $\eta = \gamma$, we obtain an analogue of the Hölder function. Adding the parameter η allows us to deal with singular initial conditions on the line $\{(t, x) : t = 0\}$.

6.1. Structure and the model

The definition of the previous spaces depends on the model which is parametrised by ε . We need a way to compare two models and a way to compare two functions in $\mathcal{D}^{\gamma,\eta}$ with respect to two different models. Based on [Hai14b], we use a semi-distance between two models. Given (Π, Γ) and $(\bar{\Pi}, \bar{\Gamma})$ two admissible models, we consider for a given compact $K \subset \mathbb{R}^2$

$$\|\Pi; \bar{\Pi}\| = \sup_{z \in K} \sup_{\substack{\varphi \in \mathcal{B} \\ \lambda \in (0,1)}} \sup_{\tau \in \mathcal{T}} \frac{|(\Pi_z \tau - \bar{\Pi}_z \tau)(\varphi_z^\lambda)|}{\lambda^{|\tau|_s}} + \sup_{z, \bar{z} \in K} \sup_{\tau \in \mathcal{T}} \sup_{\alpha < \gamma} \frac{\|\Gamma_{z\bar{z}} \tau - \bar{\Gamma}_{z\bar{z}} \tau\|_\alpha}{\|z - \bar{z}\|_s^{\gamma-\alpha}}.$$

In our case, this semi distance is a distance because we are working on a compact domain in the space variable and on finite time. The natural distance defined in [Hai14b] between $U \in \mathcal{D}^{\gamma,\eta}$ and $\bar{U} \in \bar{\mathcal{D}}^{\gamma,\eta}$ where $\bar{\mathcal{D}}^{\gamma,\eta}$ is built from $(\bar{\Pi}, \bar{\Gamma})$, is given by

$$\|U; \bar{U}\|_{\gamma,\eta} = \sup_{z \in K} \sup_{\alpha < \gamma} \frac{\|U(z) - \bar{U}(z)\|_\alpha}{|t|^{(\frac{\eta-\alpha}{2}) \wedge 0}} + \sup_{(z, \bar{z}) \in K^2} \sup_{\alpha < \gamma} \frac{\|U(z) - \bar{U}(z) - \Gamma_{z\bar{z}} U(\bar{z}) + \bar{\Gamma}_{z\bar{z}} \bar{U}(z)\|_\alpha}{(|t| \wedge |\bar{t}|)^{\frac{\eta-\gamma}{2}} |z - \bar{z}|^{\gamma-\alpha}}.$$

on a fibred space $\mathcal{M} \times \mathcal{D}^{\gamma,\eta}$ which contains pairs $((\Pi, \Gamma), U)$ such that (Π, Γ) is an admissible model and such that the space $\mathcal{D}^{\gamma,\eta}$ is constructed from the model (Π, Γ) . For our fixed point problem, we will not consider the whole space $\mathcal{D}^{\gamma,\eta}$ but we restrain ourselves to the subspace $\mathcal{D}_{\mathcal{U}}^{\gamma,\eta}$ of functions in $\mathcal{D}^{\gamma,\eta}$ taking values in \mathcal{U} given by

$$\mathcal{U} = \mathcal{I}(\mathcal{H}) \oplus \bar{\mathcal{H}}$$

where $\bar{\mathcal{H}}$ are the abstract polynomials. The set \mathcal{U} is an example of a sector of \mathcal{H} with 0 regularity. We recall the definition given in [Hai14b] by

Definition 6.1.10. Let $V \subset \mathcal{H}$, V is a sector of regularity $\alpha \leq 0$ if

- V is invariant under the structure group \mathcal{G} .
- $V = \bigoplus_{\beta \geq \alpha} V_\beta$ with $V_\beta \subset \mathcal{H}_\beta$ and there exists a complement of V_β in \mathcal{H}_β .

This definition allows us to give a way of multiplying functions in the $\mathcal{D}^{\gamma,\eta}$ spaces. We consider functions which take values in some specific sectors.

Proposition 6.1.11. Let for $i \in \{1, 2\}$, $U_i \in \mathcal{D}^{\gamma_i, \eta_i}(V_i)$ where V_i is a sector of regularity α_i . Let furthermore, $\gamma = (\gamma_1 + \alpha_2) \wedge (\gamma_2 + \alpha_1)$. Then $U = \mathcal{Q}_\gamma(U_1 U_2) \in \mathcal{D}^{\gamma, \eta}$ where $\eta = (\eta_1 + \alpha_1) \wedge (\eta_2 + \alpha_1) \wedge (\eta_1 + \eta_2)$ and \mathcal{Q}_γ is the projection on $\bigoplus_{\alpha \leq \gamma} \mathcal{H}_\alpha$.

Remark 6.1.12. In the original theorem in [Hai14b], we need the hypothesis of γ regularity for (V_1, V_2) which depends on the choice of the product in our structure. We have chosen the pointwise product for the product $\Gamma \tau \bar{\tau} = \Gamma \tau \Gamma \bar{\tau}$ which gives the γ regularity for every γ .

Now, we want to be able to reconstruct a global distribution from $U \in \mathcal{D}^{\gamma,\eta}$. This action is done by the reconstruction operator \mathcal{R} given in [Hai14b]. In our case, for every

$\tau \in \mathcal{H}$, $\Pi_x \tau$ happens to be a function. Therefore one has an explicit expression for $\mathcal{R} : \mathcal{D}^{\gamma,\eta} \rightarrow \mathcal{C}^{\frac{1}{2}-\kappa}$ given in [Hai14b] by:

$$(\mathcal{R}U)(x) = (\Pi_x U(x))(x).$$

Every element U of $\mathcal{D}^{\gamma,\eta}$ has a unique description:

$$U(z) = u(z)\mathbf{1} + \tilde{U}(z)$$

where \tilde{U} belongs to $\bigoplus_{\alpha \geq \beta} \mathcal{H}_\alpha$ where $\beta = \frac{1}{2} - \kappa$. Indeed the term with the worst homogeneity in $\mathcal{I}(\mathcal{H})$ is $\mathcal{I}(\Xi)$ with $|\mathcal{I}(\Xi)|_s = \frac{1}{2} - \kappa$. For $U \in \mathcal{D}_U^{\gamma,\eta}$, we just have $\mathcal{R}U = u$. It has proved in [Hai14b], that the map $(\Pi, U) \mapsto \mathcal{R}U$ is jointly lipschitz continuous toward the distances defined before.

We need to reformulate the classical fixed point problem into the $\mathcal{D}^{\gamma,\eta}$ spaces. We start with the integral equation:

$$u = G * ((g(u)(\partial_x u)^2 + h(u)\partial_x u + k(u) + f(u)\xi_\varepsilon)\mathbf{1}_{t>0}) + G * u_0,$$

where G denotes the heat kernel. We want to rewrite the previous equation in $\mathcal{D}^{\gamma,\eta}$ and the solution U will be linked to u by the reconstruction operator: $u = \mathcal{R}U$. We first give a meaning to the non-linear operations $g(u)$, $h(u)$, $k(u)$ and $f(u)$. Let $U \in \mathcal{D}_U^{\gamma,\eta}$ and a smooth function $F : \mathbb{R} \rightarrow \mathbb{R}$, we define

$$(\hat{F}(U))(z) = F(u(z))\mathbf{1} + \sum_{k \geq 1} \frac{D^k F(u(z))}{k!} \mathcal{Q}_\gamma \tilde{U}(z)^k.$$

where \mathcal{Q}_γ is the projection on $\bigoplus_{\alpha \leq \gamma} \mathcal{H}_\alpha$. For the partial derivative ∂_x , we associate a linear operator \mathcal{D} on \mathcal{U} defined by:

$$\mathcal{D}\mathcal{I}(\tau) = \mathcal{I}_1(\tau), \quad \mathcal{D}X^k = X^{k-(0,1)}.$$

The action on $\mathcal{D}^{\gamma,\eta}$ of the previous two operators is:

- \hat{F} maps $\mathcal{D}_U^{\gamma,\eta}$ into $\mathcal{D}_V^{\gamma,\eta}$ where V is a sector of regularity 0.
- \mathcal{D} maps $\mathcal{D}_U^{\gamma,\eta}$ into $\mathcal{D}_W^{\gamma-1,\eta-1}$ where W is a sector of regularity $-\frac{1}{2} - \kappa$.

We notice that $z \mapsto \Xi$ belongs to $\mathcal{D}^{\gamma,\eta}$ for every $\gamma > 0$ and takes value in a sector of regularity $\alpha = -\frac{3}{2} - \kappa$. By applying several times the proposition 6.1.11, we obtain:

- $U \mapsto \hat{F}(U)\Xi$ maps $\mathcal{D}_U^{\gamma,\eta}$ into $\mathcal{D}^{\gamma+\alpha,\eta+\alpha}$.
- $U \mapsto \mathcal{Q}_{\gamma-1}(\hat{H}(U)\mathcal{D}U)$ maps $\mathcal{D}_U^{\gamma,\eta}$ into $\mathcal{D}^{\gamma-1,\eta-1}$.
- $U \mapsto \mathcal{Q}_{\gamma+\alpha}(\mathcal{D}U)^2$ maps $\mathcal{D}_U^{\gamma,\eta}$ into $\mathcal{D}_{\bar{W}}^{\gamma+\alpha,2\eta-2}$ where \bar{W} is a sector of regularity $2\alpha + 2$.

6.1. Structure and the model

- $U \mapsto \mathcal{Q}_{\gamma+\alpha} \left(\hat{G}(U) \mathcal{Q}_{\gamma+\alpha} (\mathcal{D}U)^2 \right) = \mathcal{Q}_{\gamma+\alpha} \left(\hat{G}(U) (\mathcal{D}U)^2 \right)$ maps $\mathcal{D}_U^{\gamma,\eta}$ into $\mathcal{D}^{\gamma+\alpha, 2\eta-2}$.

If $U \in \mathcal{D}_{\gamma,\eta}$ then for every $\bar{\gamma} \leq \gamma$ and $\bar{\eta} \leq \eta$, then $\mathcal{Q}_{\bar{\gamma}} U \in \mathcal{D}^{\bar{\gamma}, \bar{\eta}}$. Let F_γ defined for every $\tau \in \mathcal{U}$ by

$$F_\gamma(\tau) = \mathcal{Q}_{\gamma+\alpha} \left(\hat{G}(\tau) (\mathcal{D}\tau)^2 + \hat{H}(\tau) \mathcal{D}\tau + \hat{K}(\tau) + \hat{F}(\tau) \Xi \right)$$

then it happens:

Proposition 6.1.13. *The map $u \mapsto F_\gamma(u)$ is locally lipschitz from $\mathcal{D}_U^{\gamma,\eta}$ to $\mathcal{D}^{\gamma+\alpha, 2\eta-2}$ for every $\gamma > |\alpha|$ and for every $\eta \in (0, \alpha + 2]$.*

Now it remains to give a meaning to the space time convolution with the heat kernel and the initial condition in our abstract space. In [Hai14b], it has been shown that it is possible to construct a linear operator $\mathcal{P} : \mathcal{D}^{\gamma-2+\delta, \eta-2+\delta} \rightarrow \mathcal{D}_U^{\gamma,\eta}$ with $\gamma > 2 + \delta$ and $\delta < \frac{1}{2} - \kappa - \eta$ such that:

1. \mathcal{P} commutes with the reconstruction operator $\mathcal{R} : \mathcal{R}PU = G * \mathcal{R}U$.
2. \mathcal{P} can be decomposed as follows: $\mathcal{P}U = \mathcal{I}U + \bar{\mathcal{P}}U$ where $\bar{\mathcal{P}}U$ takes value in \bar{H} .
3. There exists $\theta > 0$ such that:

$$\|\mathcal{P}\mathbf{1}_{t>0}U\|_{\gamma,\eta} \lesssim T^\theta \|U\|_{\gamma-2+\delta, \eta-2+\delta}$$

over the domain $[0, T] \times \mathbb{R}$.

Given a function $u \in \mathcal{C}^\gamma$, we denote by $\mathfrak{J}_\gamma u$ its taylor expansion of order γ :

$$(\mathfrak{J}_\gamma u)(z) = \sum_{|k|_s < \gamma} \frac{X^k}{k!} (D^k u)(z).$$

After the introduction of the previous objects, we are able to pose our fixed point problem in $\mathcal{D}_U^{\gamma,\eta}$ by looking at solutions U of:

$$U = \mathcal{P}(\hat{F}_\gamma(U)\mathbf{1}_{t>0}) + \mathcal{J}_\gamma(G * u_0). \quad (6.9)$$

Theorem 6.1.14. *Let $\gamma \in (\frac{3}{2} + \kappa, \zeta)$ and f, g, h, k smooth. Then for every initial condition $u_0 \in \mathcal{C}(S^1)$ and every admissible model (Π, Γ) , there exists a time T such that the fixed point map (6.9) admits a unique solution in $\mathcal{D}^{\gamma,0}([0, T] \times S^1)$. The solution is locally lipschitz continuous from $\mathcal{C}(S^1) \times \mathcal{M}$ to $\mathcal{M} \times \mathcal{D}^{\gamma,0}$.*

6.2 The renormalised equation

This section is devoted to the proof of the renormalised equation obtained from M_ε and the proof of the theorem 6.0.13. The proof of the convergence of the renormalised model is delayed to the next chapter.

Proposition 6.2.1. *Let k, h, g, f smooth functions and M_ε defined as in (6.6). Let $u_0 \in \mathcal{C}(\mathcal{S}^1)$ and ξ_ε a smooth function. We denote by U the local solution to (6.9) with model $(\Pi^{M_\varepsilon}, \Gamma^{M_\varepsilon})$. Then the function $u_\varepsilon = \mathcal{R}^{M_\varepsilon}U$ is the classical solution to (6.2) with h replaced by \bar{h} .*

Proof. The function U solves

$$U = \mathcal{P}(\hat{F}_\gamma(U)\mathbf{1}_{t>0}) + \mathcal{J}_\gamma(G * u_0). \quad (6.10)$$

By applying the reconstruction operator $\mathcal{R}^{M_\varepsilon}$ of the model $(\Pi^{M_\varepsilon}, \Gamma^{M_\varepsilon})$, we obtain:

$$u = G * ((k(u) + \mathcal{R}^{M_\varepsilon}(\hat{G}(u)(\mathcal{D}U)^2) + \mathcal{R}^{M_\varepsilon}(\hat{H}(u)\mathcal{D}U) + \mathcal{R}^{M_\varepsilon}(\hat{F}(u)\Xi))\mathbf{1}_{t>0}) + G * u_0$$

If we consider an element of $\mathcal{D}^{\gamma,\eta}$ with $\gamma = \frac{3}{2} + 2\kappa$, for $\kappa > 0$ then U admits the following decomposition:

$$\begin{aligned} U &= u\mathbf{1} + f(u)\circ + f'(u)f(u)\circ\circ + g(u)f(u)^2\circ\circ\circ + u'X + f'(u)^2f(u)\circ\circ\circ \\ &\quad + g(u)f'(u)f(u)^2\left(\circ\circ\circ + \circ\circ\circ\right) + g(u)^2f(u)^2\circ\circ\circ \\ &\quad + \frac{1}{2}f''(u)f(u)^2\circ\circ\circ + g'(u)f(u)^3\circ\circ\circ + f'(u)u'\circ, \end{aligned}$$

for some functions u and u' . By considering the right hand-side of the equation satisfied by U as an element of \mathcal{D}^κ for $\kappa > 0$, we have:

$$\begin{aligned} F_\gamma(U) &= \mathcal{Q}_\kappa\left(\hat{G}(U)(\mathcal{D}U)^2 + \hat{H}(U)\mathcal{D}U + \hat{K}(U) + \hat{F}(U)\Xi\right) \\ &= f(u)\circ + f'(u)f(u)\circ\circ + g(u)f(u)^2\circ\circ\circ + \frac{1}{2}f''(u)f(u)^2\circ\circ\circ \\ &\quad + f'(u)^2f(u)\circ\circ\circ + g(u)f'(u)f(u)^2(2\circ\circ\circ + \circ\circ\circ) + 2g(u)^2f(u)^3\circ\circ\circ \\ &\quad + f'(u)u'\circ + (g(u)u' + k(u))f(u)\circ + f'(u)^3f(u)\circ\circ\circ \\ &\quad + g(u)f'(u)^2f(u)^2\left(2\circ\circ\circ + \circ\circ\circ + 2\circ\circ\circ + \circ\circ\circ\right) \\ &\quad + g(u)^2f'(u)f(u)^3\left(2\circ\circ\circ + 2\circ\circ\circ + 4\circ\circ\circ + 2\circ\circ\circ\right) + g(u)^3f(u)^4\left(4\circ\circ\circ + \circ\circ\circ\right) \\ &\quad + \frac{1}{6}f'''(u)f(u)^3\circ\circ\circ + \frac{1}{2}g''(u)f(u)^4\circ\circ\circ + \frac{1}{2}f''(u)f'(u)f(u)^2\left(\circ\circ\circ + 2\circ\circ\circ\right) \\ &\quad + \frac{1}{2}g(u)f''(u)f(u)^3(2\circ\circ\circ + 2\circ\circ\circ) + g'(u)f'(u)f(u)^3\left(\circ\circ\circ + \circ\circ\circ + 2\circ\circ\circ\right) \\ &\quad + g'(u)g(u)f(u)^4\left(2\circ\circ\circ + \circ\circ\circ + 2\circ\circ\circ\right) + f'(u)^2u'\circ + f''(u)f(u)u'\circ \end{aligned}$$

6.2. The renormalised equation

$$\begin{aligned}
& + 2g(u)f'(u)f(u)u' \circlearrowleft + g'(u)f(u)^2u' \circlearrowright + (g(u)u' + k(u))f'(u)f(u) \circlearrowup \\
& + (g(u)u' + k(u))g(u)f(u)^2 \circlearrowright + (g'(u)u' + k'(u))f(u)^2 \circlearrowleft \\
& + (g(u)u' + k(u))f'(u)f(u) \circlearrowup + (g(u)u' + k(u))g(u)f(u)^2 \circlearrowleft + u \mathbb{1}.
\end{aligned}$$

The coefficients of the trees are easy to compute: they depend on the rules used for their construction. The generalised KPZ terms with negative homogeneity are built with the following rules:

$$\begin{aligned}
\Xi & \rightarrow f(u), & X\Xi & \rightarrow f'(u)u', & \mathcal{I}(\cdot)^n \Xi & \rightarrow f^{(n)}(u), & X\mathcal{I}(\cdot)^n \Xi & \rightarrow f^{(n+1)}(u)u', \\
\mathcal{I}(\cdot)^n \mathcal{I}_1(\cdot)^2 & \rightarrow g^{(n)}(u), & X\mathcal{I}(\cdot)^n \mathcal{I}_1(\cdot)^2 & \rightarrow g^{(n+1)}(u)u', & \mathcal{I}(\cdot)\mathcal{I}_1(\cdot) & \rightarrow (k'(u) + g'(u)u').
\end{aligned}$$

We want to compute the reconstruction operator $\mathcal{R}^{M_\varepsilon}$ on $F_\gamma(U)$. For that purpose, we use the identity:

$$(\mathcal{R}^{M_\varepsilon} \tau)(z) = (\Pi_z^{M_\varepsilon} \tau)(z) = (\Pi_z M_\varepsilon \tau)(z)$$

where $(\Pi^{M_\varepsilon}, \Gamma^{M_\varepsilon})$ is the model defined on the extended structure. For every τ with negative homogeneity, we have:

$$M_\varepsilon \tau = \tau + \sum_i \lambda_i \tau_i$$

where the τ_i belong to $\{\circlearrowleft, \circlearrowright, \circlearrowup, \circlearrowdown, \circlearrowleft, \circlearrowright, \circlearrowup, \circlearrowdown, \mathbb{1}\}$ and $\lambda_i \in \mathbb{R}$. It follows:

$$(\Pi_z \circlearrowleft)(z) = (\Pi_z \circlearrowright)(z) = 0$$

and we have the same identities for $\{\circlearrowleft, \circlearrowright, \circlearrowup, \circlearrowdown, \circlearrowleft, \circlearrowright, \circlearrowup, \circlearrowdown\}$ because the node label d is ignored at the root by Π_x . It remains to compute Π on \circlearrowup and \circlearrowdown :

$$\begin{aligned}
(\Pi_z \circlearrowup)(z) & = (\Pi_z \circlearrowdown)(z) = 0 \\
(\Pi_z \circlearrowdown)(z) & = (\Pi_z \circlearrowup)(z) = 0,
\end{aligned}$$

because $|\circlearrowup|_{ex} > 0$ and $|\circlearrowdown|_{ex} > 0$. Finally, we obtain:

$$(\mathcal{R}^{M_\varepsilon} F_\gamma(U))(z) = g(u)((\partial_x u)^2 - C_\varepsilon f(u)^2) + \bar{h}(u) + f(u)(\xi - C_\varepsilon f'(u)).$$

Indeed, we have:

$$\begin{aligned}
& (\Pi_x \circlearrowup)(x) - (\Pi_x^{M_\varepsilon} \circlearrowup)(x) = c_\rho^{(1)}, \\
& (\Pi_x 2 \circlearrowup + 2 \circlearrowdown + 2 \circlearrowup + 4 \circlearrowdown)(x) - (\Pi_x^{M_\varepsilon} 2 \circlearrowup + 2 \circlearrowdown + 2 \circlearrowup + 4 \circlearrowdown)(x) \\
& = 3c_\rho^{(1)} + c_\rho^{(2)} + 2\left(\frac{1}{4}L_\varepsilon\right) + 4\left(-\frac{1}{8}L_\varepsilon\right) = 3c_\rho^{(1)} + c_\rho^{(2)}, \\
& (\Pi_x 2 \circlearrowup + 2 \circlearrowdown + \circlearrowup + \circlearrowdown)(x) - (\Pi_x^{M_\varepsilon} 2 \circlearrowup + 2 \circlearrowdown + \circlearrowup + \circlearrowdown)(x) = 3c_\rho^{(1)} + c_\rho^{(2)}, \\
& (\Pi_x 4 \circlearrowup + \circlearrowdown)(x) - (\Pi_x^{M_\varepsilon} 4 \circlearrowup + \circlearrowdown)(x) = 4\left(-\frac{1}{8}\right)L_\varepsilon + \frac{1}{2}L_\varepsilon + c_\rho^{(1)} = c_\rho^{(1)}, \\
& (\Pi_x \circlearrowup + \circlearrowdown)(x) - (\Pi_x^{M_\varepsilon} \circlearrowup + \circlearrowdown)(x) = c_\rho^{(2)},
\end{aligned}$$

$$\begin{aligned}
 (\Pi_x \circlearrowleft \circlearrowleft \circlearrowleft + 2 \circlearrowleft \circlearrowleft \circlearrowleft)(x) - (\Pi_x^{M_\varepsilon} \circlearrowleft \circlearrowleft \circlearrowleft + 2 \circlearrowleft \circlearrowleft \circlearrowleft)(x) &= \frac{1}{2}L_\varepsilon + 2\left(-\frac{1}{4}\right)L_\varepsilon = 0, \\
 (\Pi_x \circlearrowleft \circlearrowleft \circlearrowleft)(x) - (\Pi_x^{M_\varepsilon} \circlearrowleft \circlearrowleft \circlearrowleft)(x) &= c_\rho^{(2)}, \\
 (\Pi_x \circlearrowleft \circlearrowleft \circlearrowleft + 2 \circlearrowleft \circlearrowleft \circlearrowleft)(x) - (\Pi_x^{M_\varepsilon} \circlearrowleft \circlearrowleft \circlearrowleft + 2 \circlearrowleft \circlearrowleft \circlearrowleft)(x) &= \frac{1}{2}L_\varepsilon + c_\rho^{(2)} + 2\left(-\frac{1}{4}\right)L_\varepsilon = c_\rho^{(2)}, \\
 (\Pi_x \circlearrowleft \circlearrowleft \circlearrowleft)(x) - (\Pi_x^{M_\varepsilon} \circlearrowleft \circlearrowleft \circlearrowleft)(x) &= C_\varepsilon, \\
 (\Pi_x \circlearrowleft \circlearrowleft \circlearrowleft)(x) - (\Pi_x^{M_\varepsilon} \circlearrowleft \circlearrowleft \circlearrowleft)(x) &= C_\varepsilon.
 \end{aligned}$$

□

Proposition 6.2.2. *Let u_ε the solution of (6.2) with h replaced by \bar{h} . If we take a smooth diffeomorphism φ then $v_\varepsilon = \varphi(u_\varepsilon)$ satisfies the same kind of equation with the same constants but with new \tilde{g} , \tilde{h} , \tilde{k} and f depending on g, h, k, f and φ .*

Proof. We consider the following equation:

$$\partial_t u_\varepsilon = \partial_x^2 u_\varepsilon + g(u_\varepsilon)(\partial_x u_\varepsilon)^2 + k(u_\varepsilon)(\partial_x u_\varepsilon) + h(u_\varepsilon) + f(u_\varepsilon)\xi_\varepsilon.$$

If we set $u_\varepsilon = \varphi(v_\varepsilon)$ where φ is a smooth diffeomorphism, then

$$\partial_t u_\varepsilon = \varphi'(v_\varepsilon)\partial_t v_\varepsilon, \quad \partial_x u_\varepsilon = \varphi'(v_\varepsilon)\partial_x v_\varepsilon, \quad \partial_x^2 u_\varepsilon = \varphi''(v_\varepsilon)(\partial_x v_\varepsilon)^2 + \varphi'(v_\varepsilon)\partial_x^2 v_\varepsilon.$$

Now, v_ε is the solution of the following equation:

$$\begin{aligned}
 \partial_t v_\varepsilon &= \partial_x^2 v_\varepsilon + \left((g \circ \varphi)\varphi' + \frac{\varphi''}{\varphi'} \right)(v_\varepsilon)(\partial_x v_\varepsilon)^2 + (k \circ \varphi)(v_\varepsilon)\partial_x v_\varepsilon + \left(\frac{h \circ \varphi}{\varphi'} \right)(v_\varepsilon) \\
 &+ \left(\frac{f \circ \varphi}{\varphi'} \right)(v_\varepsilon)\xi_\varepsilon.
 \end{aligned}$$

We define the maps V_φ and R_ε by:

$$\begin{aligned}
 V_\varphi : (f, g, h, k) &\mapsto \left(\frac{f \circ \varphi}{\varphi'}, (g \circ \varphi)\varphi' + \frac{\varphi''}{\varphi'}, \frac{h \circ \varphi}{\varphi'}, k \circ \varphi \right) \\
 R_\varepsilon : (f, g, h, k) &\mapsto (f, g, h_1, k)
 \end{aligned}$$

where

$$\begin{aligned}
 h_1(u) &= h(u) - C_1^{(\varepsilon)} f'(u)^3 f(u) - C_2^{(\varepsilon)} g(u)^2 f'(u) f(u)^3 - C_3^{(\varepsilon)} g(u) f'(u)^2 f(u)^2 \\
 &- C_4^{(\varepsilon)} g(u)^3 f(u)^4 - C_5^{(\varepsilon)} g(u) f''(u) f(u)^3 - C_6^{(\varepsilon)} g'(u) f'(u) f(u)^3 \\
 &- C_7^{(\varepsilon)} f''(u) f'(u) f(u)^2 - C_8^{(\varepsilon)} g'(u) g(u) f(u)^4 - C_9^{(\varepsilon)} g(u) f(u)^2 - C_{10}^{(\varepsilon)} f'(u) f(u).
 \end{aligned}$$

The previous constants are of order one (see 6.6) except $C_9^{(\varepsilon)}$ and $C_{10}^{(\varepsilon)}$ which behave as $1/\varepsilon$. We want to prove in order to have the invariance by diffeomorphism that:

$$R_\varepsilon \circ V_\varphi = V_\varphi \circ R_\varepsilon.$$

6.2. The renormalised equation

We first compute $V_\varphi \circ R_\varepsilon$:

$$V_\varphi \circ R_\varepsilon : (f, g, h, k) \mapsto \left(\frac{f \circ \varphi}{\varphi'}, (g \circ \varphi)\varphi' + \frac{\varphi''}{\varphi'}, \frac{h_1 \circ \varphi}{\varphi'}, k \circ \varphi \right)$$

The other term $R_\varepsilon \circ V_\varphi$ is given by

$$R_\varepsilon \circ V_\varphi : (f, g, h, k) \mapsto \left(\frac{f \circ \varphi}{\varphi'}, (g \circ \varphi)\varphi' + \frac{\varphi''}{\varphi'}, h_2, k \circ \varphi \right)$$

where h_2 has the following form:

$$\begin{aligned} h_2 = & \frac{h_1 \circ \varphi}{\varphi'} - \left(-C_1^{(\varepsilon)} - C_2^{(\varepsilon)} + C_3^{(\varepsilon)} + C_4^{(\varepsilon)} + 2C_5^{(\varepsilon)} + C_6^{(\varepsilon)} - 2C_7^{(\varepsilon)} - C_8^{(\varepsilon)} \right) \\ & (f \circ \varphi)^4 (\varphi'')^3 \left(\frac{1}{\varphi'} \right)^7 - \left(-C_5^{(\varepsilon)} - C_6^{(\varepsilon)} + C_7^{(\varepsilon)} + C_8^{(\varepsilon)} \right) (f \circ \varphi)^4 \varphi'' \varphi''' \left(\frac{1}{\varphi'} \right)^6 \\ & - \left((-2C_2^{(\varepsilon)} + C_3^{(\varepsilon)} + 3C_4^{(\varepsilon)} + 2C_5^{(\varepsilon)} - C_6^{(\varepsilon)}) (f \circ \varphi)^4 (g \circ \varphi) (\varphi'')^2 \right. \\ & + (3C_1^{(\varepsilon)} + 3C_7^{(\varepsilon)} + C_2^{(\varepsilon)} - 2C_3^{(\varepsilon)} - C_5^{(\varepsilon)} - C_6^{(\varepsilon)}) (f \circ \varphi)^3 (f' \circ \varphi) (\varphi'')^2 \left. \left(\frac{1}{\varphi'} \right)^5 \right. \\ & - ((C_6^{(\varepsilon)} - C_7^{(\varepsilon)}) (f \circ \varphi)^3 (f' \circ \varphi) \varphi''' + (C_8^{(\varepsilon)} - C_5^{(\varepsilon)}) (f \circ \varphi)^4 (g \circ \varphi) \varphi''') \left. \left(\frac{1}{\varphi'} \right)^4 \right. \\ & - ((C_9^{(\varepsilon)} - C_{10}^{(\varepsilon)}) (f \circ \varphi)^2 + (C_5^{(\varepsilon)} - C_7^{(\varepsilon)}) (f \circ \varphi)^3 (f'' \circ \varphi) \\ & + (C_8^{(\varepsilon)} - C_6^{(\varepsilon)}) (f \circ \varphi)^4 (g' \circ \varphi) + (-3C_1^{(\varepsilon)} + C_3^{(\varepsilon)} - C_7^{(\varepsilon)}) (f \circ \varphi)^2 (f' \circ \varphi)^2 \\ & + (-C_2^{(\varepsilon)} + 3C_4^{(\varepsilon)} + C_8^{(\varepsilon)}) (f \circ \varphi)^4 (g \circ \varphi)^2 \\ & \left. + (C_6^{(\varepsilon)} - C_5^{(\varepsilon)} + 2C_2^{(\varepsilon)} - 2C_3^{(\varepsilon)}) (f \circ \varphi)^3 (f' \circ \varphi) (g \circ \varphi) \right) \varphi'' \left(\frac{1}{\varphi'} \right)^3 \end{aligned}$$

It turns out that if we want the previous identity $R_\varepsilon \circ V_\varphi = V_\varphi \circ R_\varepsilon$, we have to choose:

$$C_1^{(\varepsilon)} = C_4^{(\varepsilon)}, \quad C_3^{(\varepsilon)} = C_2^{(\varepsilon)} = 3C_1^{(\varepsilon)} + C_5^{(\varepsilon)}, \quad C_5^{(\varepsilon)} = C_6^{(\varepsilon)} = C_7^{(\varepsilon)} = C_8^{(\varepsilon)}, \quad C_9^{(\varepsilon)} = C_{10}^{(\varepsilon)}.$$

These constraints are easy to check by fixing the two constants $C_1^{(\varepsilon)} = c_\varrho^{(1)}$ and $C_5^{(\varepsilon)} = c_\varrho^{(2)}$ needed for the Itô model. The constants C_{10} is equal to C_ε . Then, the renormalised equation for u_ε is given by

$$\begin{aligned} \partial_t u_\varepsilon = & \partial_x^2 u_\varepsilon + g(u_\varepsilon) ((\partial_x u_\varepsilon)^2 - C_\varepsilon f(u_\varepsilon)^2) + h(u_\varepsilon) + f(u_\varepsilon) (\xi - f'(u_\varepsilon) C_\varepsilon) \\ & - c_\varrho^{(1)} (f'(u_\varepsilon))^3 f(u_\varepsilon) + g(u_\varepsilon)^3 f(u_\varepsilon)^4 \\ & - (3c_\varrho^{(1)} + c_\varrho^{(2)}) (g(u_\varepsilon)^2 f'(u_\varepsilon) f(u_\varepsilon)^3 + g(u_\varepsilon) f'(u_\varepsilon)^2 f(u_\varepsilon)^2) \\ & - c_\varrho^{(2)} (g(u_\varepsilon) f''(u_\varepsilon) f(u_\varepsilon)^3 + g'(u_\varepsilon) f'(u_\varepsilon) f(u_\varepsilon)^3 \\ & + f''(u_\varepsilon) f'(u_\varepsilon) f(u_\varepsilon)^2 + g'(u_\varepsilon) g(u_\varepsilon) f(u_\varepsilon)^4). \end{aligned}$$

□

6.3 The Itô model

We want to define a random model $(\hat{\Pi}, \hat{\Gamma})$ called the Itô model as in [HP14] which will be the limit of $(\hat{\Pi}^\varepsilon, \hat{\Gamma}^\varepsilon) = (\Pi^{M_\varepsilon}, \Gamma^{M_\varepsilon})$ such that for every $\tau \in \mathcal{U}$

$$(\hat{\Pi}_{(t,x)} \Xi \tau)(\varphi) = \int_t^\infty \langle (\hat{\Pi}_{(t,x)} \tau)(s, \cdot) \varphi(s, \cdot), dW(s) \rangle.$$

If we denote by \mathcal{F} , the filtration generated by the increment of W the underlying cylindrical Wiener process, the support of φ needs to be included in the future $(t, \infty) \times S^1$. From [HP14], we have to prove that for each $\Xi \tau$ with negative homogeneity one has in the limit:

$$(\hat{\Pi}_0 \tau \Xi)(\varphi) = ((\hat{\Pi}_0 \tau) \diamond (\hat{\Pi}_0 \Xi))(\varphi),$$

where \diamond is the wick product.

This identity has been proved for $\{\circlearrowleft, \circlearrowright, \circlearrowleft \circlearrowright, \circlearrowright \circlearrowleft, \circlearrowleft \circlearrowright \circlearrowleft, \circlearrowright \circlearrowleft \circlearrowright, \circlearrowleft \circlearrowright \circlearrowleft \circlearrowright, \circlearrowright \circlearrowleft \circlearrowright \circlearrowleft, \circlearrowleft \circlearrowright \circlearrowleft \circlearrowright \circlearrowleft, \circlearrowright \circlearrowleft \circlearrowright \circlearrowleft \circlearrowright\}$ in [HP14]. It remains to prove the same identity for $\{\circlearrowleft \circlearrowright, \circlearrowright \circlearrowleft, \circlearrowleft \circlearrowright \circlearrowleft, \circlearrowright \circlearrowleft \circlearrowright, \circlearrowleft \circlearrowright \circlearrowleft \circlearrowright, \circlearrowright \circlearrowleft \circlearrowright \circlearrowleft, \circlearrowleft \circlearrowright \circlearrowleft \circlearrowright \circlearrowleft\}$. We first explain the proof for the general case and then we will give a complete example. Let $\tau_1 = \tau \Xi$, we want to avoid the contraction between Ξ and another Ξ in $(\hat{\Pi}_0^{(\varepsilon)} \tau)(\varphi)$ when we pass to the limit in ε . We get two possibilities which are summarised in the next figure:

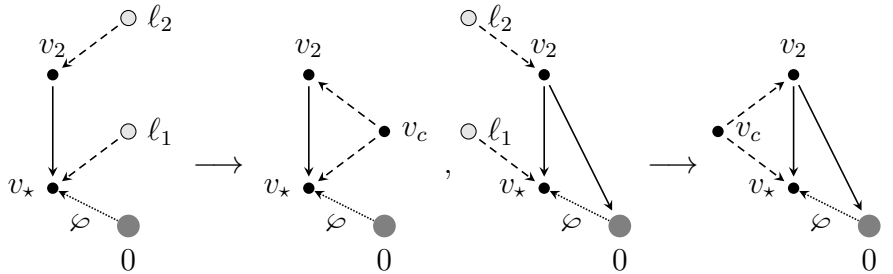

where the edge (v_*, v_2) has to be understood as there exists a path between v_* and v_2 . In the second figure, the path between v_* and v_2 may be empty but there exists a path between v_2 and 0 . We notice that:

- The contraction in the first figure creates a cycle. If (v_*, v_2) is just an edge, the renormalisation of this divergence will annihilate the term in the limit. If (v_*, v_2) is a path with more edges, it starts to become tricky: this cycle is a good help for the convergence thanks to the non-anticipativity of the kernel K . But we are not guaranteed that we obtain a zero constant in the limit that's why we need to remove this kind of terms with the renormalisation group.
- In the second figure, we obtain a cycle with the test function. In that case, all the terms will go to zero in the limit because we have chosen a test function supported in the future.

6.4. Renormalisation procedure

After presenting the main arguments given in [HP14], we present a full example by considering the Wiener chaos decomposition of $\hat{\Pi}_0^{(\varepsilon)}(\varphi)$:

$$(\hat{\Pi}_0^{(\varepsilon)}(\varphi))(\varphi) = \sum_{i=1}^7 A_i =$$

We can make several remarks:

- The renormalisation has killed the following terms:

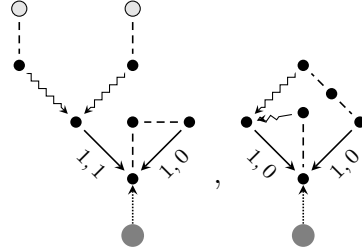

The last one is typically the kind of order one terms in the 0-th Wiener chaos which is not equal to zero.

- The terms A_2 , A_5 , A_6 and A_7 contain a cycle with the test function φ .
- For the term A_4 , the cycle is renormalised but the renormalisation constant $\ell_\varepsilon(\mathbb{1})$ is equal to zero by symmetry.

Finally, all the terms implying a contraction with the rooted Ξ go to zero as ε tends to zero.

6.4 Renormalisation procedure

Let $G = (\mathcal{V}, \mathcal{E}) \in \mathcal{G}_{\mathcal{R}_u}$ the diverging patterns are given by negative subtree of G . We apply here the renormalisation with the telescopic sum introduced in 5.5.1. This method

works because in the case of the generalised KPZ, one can check that on each tree all their negative subtrees are disjoint except for one tree which will require a special treatment in 6.5. Among the generalised KPZ graphs with negative homogeneity, we can list the negative patterns:

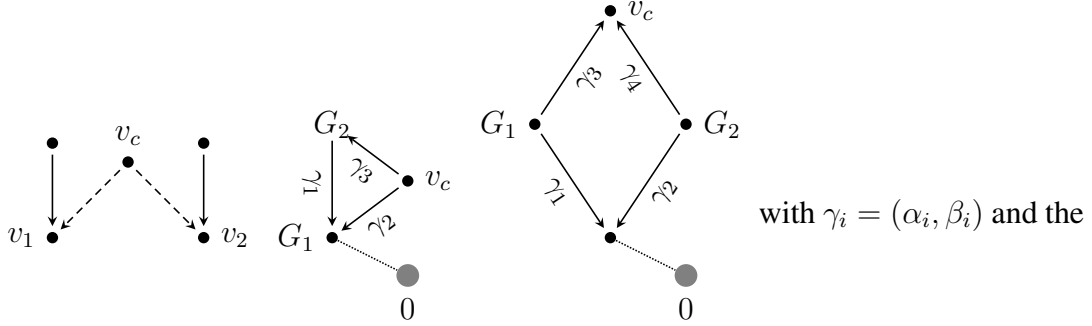

G_i are generalised KPZ graphs. In this section, we consider only terms in the first and second Wiener chaos obtained after one contraction. The 0-th Wiener chaos will be treated in the section 6.6.

Remark 6.4.1. The negative subtrees look simple because the maximum number of leaves is 4. When we perform two contractions, we obtain directly a constant. Moreover, G after one contraction will contain most of the time only one diverging subtree.

Remark 6.4.2. The first example appears also in the maximum chaos order and it has been proved in 5.5.2 that it does not need a renormalisation. This is also the only case when a divergence is created from two subtrees. The third example has to be treated carefully when $\gamma_3 = \gamma_4 = (3, 0)$ because we have a subdivergence in that pattern.

We apply the renormalisation with a telescopic sum explained in 5.5.1. Let $G = (\mathcal{V}, \mathcal{E}) \in \mathcal{G}_{\mathcal{R}_u}$ and $\bar{T} = (\bar{\mathcal{V}}, \bar{\mathcal{E}})$ a negative subtree of T . In order to treat this divergence, we change the label of some edge $e \in \mathcal{E}^\downarrow(\bar{\mathcal{V}})$ by replacing $v_e = v_0$ by a node of \bar{T} such that this new Taylor expansion point has a renormalisation effect on \bar{T} . Let $e = (v_1, v_2) \in \mathcal{E}^\downarrow(\bar{\mathcal{V}})$ and $v \in \bar{T}$ such that there exists v' with $(v', v) \in \mathcal{E}^\uparrow(\bar{\mathcal{V}})$. The situation can be

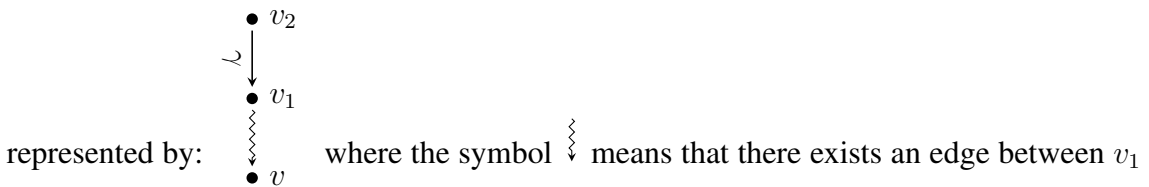

and v . The label of e is replaced by $\gamma = (a_e, r'_e, v)$ where $r'_e = \max(\lceil -|\bar{T}|_s \rceil, r_e)$. For the next theorem, we consider a subtree \bar{T} which gives the graph $\bar{G} = (\bar{\mathcal{V}}, \bar{\mathcal{E}})$ after contracting two leaves creating the node v_c :

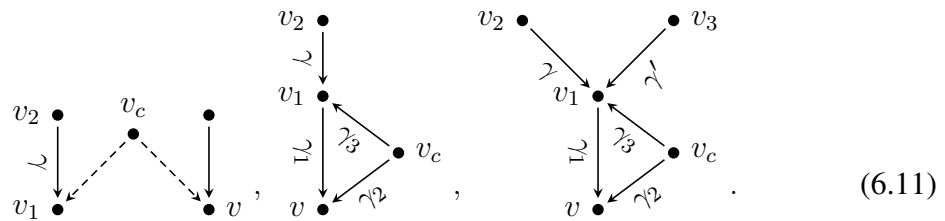

6.4. Renormalisation procedure

For the first case, we have $\bar{\mathcal{V}} = \{v_1, v\}$ and it has been treated in 5.5.6. For the others we get $\bar{\mathcal{V}} = \{v_1, v, v_c\}$.

Proposition 6.4.3. *Let G as above, we suppose that G satisfies the condition (5.6) then the new graph G_\star obtained from the transformation of the label of $e = (v_1, v_2)$ satisfies the same condition.*

Proof. We have to check that by changing $v_e = v_0$ in G the contribution of the edge e is preserved. Let $V \subset \mathcal{V}$, we distinguish three cases:

- $e \in \mathcal{E}_0(V)$ then we still have the same contribution with a_e .
- $e \in \mathcal{E}^\downarrow(V)$, we have $v_1 \in V$:
 - If $v \in \mathcal{V}$ then the new contribution is a_e which is the same when $r_e \leq 0$ and which is better than $-(r_e - 1)$ when $r_e > 0$.
 - If $v \notin \mathcal{V}$, then the new contribution is $-(r'_e - 1)$ which can be more restrictive than $-(r_e - 1)$ when $r'_e > r_e$. This case appears when \bar{T} is a negative subtree. In the practical example, we have $r'_e - r_e \leq 1$ and $\gamma_i = (a_{\gamma_3}, 0)$. It follows for the second case in (6.11):

$$a_{\gamma_1} + a_{\gamma_3} - 3 + \mathbb{1}_{v_c \in V}(a_{\gamma_2} - 3) \geq -|\bar{T}|_s > (r'_e - 1).$$

Then the conditions (5.11) is satisfied for $V = \{v_1\}$ and for $V = \{v_1, v_c\}$. For the third case, if $v_3 \notin V$, the contribution $-(r_{\gamma'} - 1)$ is equal to zero. If $v_3 \in V$, then we use the previous bound for $\{v_1\}$, $\{v_1, v_c\}$ and the fact that $r_{\gamma_1} \geq r_{\gamma'}$ to conclude for $\{v_3\}$.

- $e \in \mathcal{E}^\uparrow(V)$, we have $v_2 \in V$.
 - If $v \notin V$, we have a contribution bigger than $a_e + r_e$ which is $a_e + r'_e$.
 - Otherwise if $v \in V$ then we loose a factor r_e . For the negative tree, we have $r_{\gamma_3} = 0$ and $r_{\gamma_1}, r_{\gamma_2}$ are not both strictly positive. We notice that for $r_{\gamma_1} > 0$

$$a_{\gamma_3} + a_{\gamma_1} + r_{\gamma_1} - 1 \leq 6$$

we obtain the same bound for $r_{\gamma_2} > 0$. It follows that by adding the node v_1 and v_c , the bound becomes sharper to check but in that case we know from G that the bound (5.11) is satisfied.

□

Remark 6.4.4. The previous proof is not general because on two cases, we have to compute the labels to check the bounds. If we want to have a general proof, we need to change our strategy like in 5.7.

Proposition 6.4.5. *Let G as above, we suppose that G satisfies the conditions (5.5) for some subsets $V \neq \bar{\mathcal{V}}$ then the new graph obtained from the transformation of the label of $e = (v_1, v_2)$ satisfies this condition on the same subsets and on $\bar{\mathcal{V}}$.*

Proof. Let $V \subset G$, such that the condition (5.5) is satisfied or such that $V = \bar{\mathcal{V}}$. We have to check that by changing $v_e = v_0$ in G the contribution of the edge e is preserved and it has been improved in the case of $V = G'$. As before we distinguish three cases:

- $e \in \mathcal{E}_0(V)$ then we still have the same contribution with a_e .
- $e \in \mathcal{E}^\downarrow(V)$, we have $v_1 \in V$:
 - If $v \in \mathcal{V}$ then the new contribution is $-r'_e$ which compensates the cycle.
 - If $v \notin V$, then V is not equal to G' and the condition (5.5) is satisfied.
- $e \in \mathcal{E}^\uparrow(V)$, we have $v_2 \in V$.
 - If $v \notin V$, we have the same contribution equal to 0.
 - Otherwise if $v \in V$ then we can have a contribution $a_e + r'_e - 1$ bigger than $a_e + r_e - 1$ in the last two cases. By adding v_c and v_1 in \mathcal{V} and using the fact that:

$$\sum_{i=1}^3 a_{\gamma_i} - 6 + r'_e - 1 > 0,$$

we obtain the desired bound. □

The previous renormalised edges appear in a telescopic sum. Graphically speaking, we make the following decomposition on our graph G :

$$\begin{array}{c} \bullet v_2 \\ \downarrow \gamma \\ \bullet v_1 \\ \downarrow \text{wavy} \\ \bullet v \end{array} = \begin{array}{c} \bullet v_2 \\ \downarrow \gamma_e \\ \bullet v_1 \\ \downarrow \text{wavy} \\ \bullet v \end{array} + \sum_{j < r'_e} \begin{array}{c} v_2 \bullet \\ \downarrow \gamma_j \\ \bullet v \\ \uparrow \text{wavy} \\ \bullet v_1 \end{array} \quad (6.12)$$

where the labels of γ , γ_e , γ_j and e_j are respectively: $(a_e, r_e, 0)$, (a_e, r'_e, v) , $(a_e + j, \max(r_e - j, 0), 0)$ and $(-j, 0, 0)$.

Proposition 6.4.6. *If the conditions (5.6) and (5.10) are satisfied on some subsets \mathcal{V} in 6.12 for the terms with the labels γ and γ_e in the examples given by 6.11, then this condition is satisfied on the other terms for the same subsets.*

6.4. Renormalisation procedure

Proof. For the bound (5.10), the result follows directly from proposition 5.5.4. For the bound (5.6), the proposition gives the result except when we consider a subset V such that $V \cap \{v, v_1, v_2\} = \{v\}$ and $j < r_e$. In that case the node v has a negative contribution $-(r_e - 1)$. But in all the examples $r_e \leq 1$ which gives the result. \square

We iterate the renormalisation procedure on each edge in $\mathcal{E}^\downarrow(\bar{V})$ and we obtain a graph with no leaves which can be divergent. In the generalised KPZ terms, the diverging graph has the following form:

$$\begin{array}{c} v_1 \\ \downarrow e \\ v \end{array} \begin{array}{c} \nearrow \gamma_3 \\ \searrow \gamma_2 \\ v_c \end{array} = \begin{array}{c} v_1 \\ \downarrow e' \\ v \end{array} \begin{array}{c} \nearrow \gamma_3 \\ \searrow \gamma_2 \\ v_c \end{array} - \sum_{k < r_e} \begin{array}{c} v_c \\ \nearrow \gamma_2 \\ v \end{array} \begin{array}{c} \searrow \gamma_3 \\ \downarrow (-k, 0) \\ 0 \end{array} \begin{array}{c} v_1 \\ \downarrow (a_e + k, 0) \\ 0 \end{array} \quad (6.13)$$

where the label of e, e', γ_2 and γ_3 are given respectively by $(a_e, r_e, 0), (a_e, 0, 0), (a_{\gamma_2}, 0, 0), (a_{\gamma_3}, 0, 0)$.

Proposition 6.4.7. *The condition (5.11) is satisfied for all the term of the previous decomposition (6.13).*

Proof. Let V a subset of G . We have for $V' = V \cap \{v, v_1\}$:

	e	e'	$(0, v)$	$(0, v_1)$
$\{v, v_1\}$	a_e	a_e	$-k$	$a_e + k$
$\{v\}$	$-(r_e - 1)$	0	$-k$	0
$\{v_1\}$	$a_e + r_e$	a_e	0	$a_e + k$

For the first two rows of the previous array, the contribution of e' and the sum of $(0, v)$ and $(0, v_1)$ are greater than e . The main difference occurs when $V' = \{v_1\}$ and $r_e > 0$. In that case, we consider that $v_c, v \in V$. The node v gives a contribution bounded by $a_\gamma + r_\gamma \leq |s|$ where $\gamma \in \mathcal{E}^\uparrow(V)$ and the condition (5.11) is satisfied. By removing this node and keeping the other contribution different from γ , we notice that a_e is sufficient for the required bound instead of $a_e + r_e$. \square

Proposition 6.4.8. *The condition (5.10) is satisfied on each term G_k depending on $k < r_e$ of the previous decomposition (6.13) and it is also satisfied for the first term \tilde{G} on subset $V \neq \{v, v_c, v_1\}$.*

Proof. Let $V \subset G$. If $0 \notin V$ then we can split the graph G_k into two KPZ trees by splitting v_c into two leaves and the condition (5.9) is satisfied on each tree which gives (5.10) on V . If $0 \in V$ the previous proposition gives the condition (5.11) on $G_k \setminus V$ which proves (5.10) on V . \square

6.5 Examples

In this section, we give a complete decomposition for some trees. We start with $\mathcal{I}_1(\mathcal{I}(\Xi)\Xi)^2$ where we look at one term appearing in the second Wiener chaos:

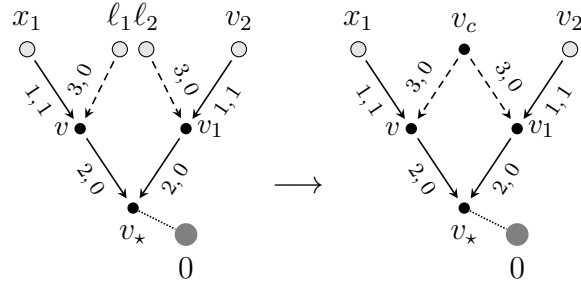

Its telescopic sum is given by:

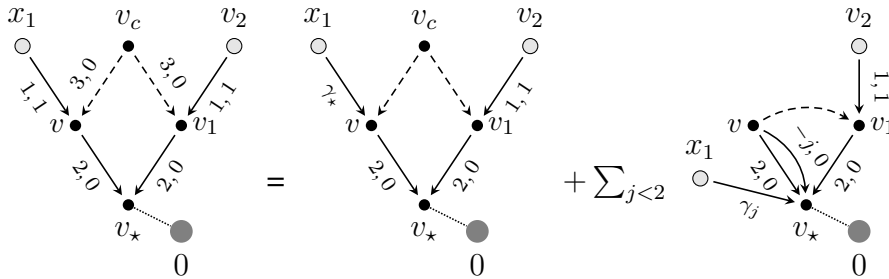

where $\gamma_* = (1, 2, v_*)$ and $\gamma_j = (1+j, 1-j, 0)$. One can show easily like in propositions 6.4.3, 6.4.5 and 6.4.6 that:

- All the terms of the previous decomposition satisfy the condition (5.11).
- For the term with the label γ_* , the condition (5.9) is satisfied for all the subsets except for $\{v, v_1, v_c\}$. We need to renormalise this divergence with another telescopic sum in (6.14).
- For the other terms in the right-hand side, the condition is not satisfied on $\{v, v_1, v_*\}$ whereas the edge (v_1, v) disappears by convolution at the node v . We renormalise these terms in (6.15) and (6.16).

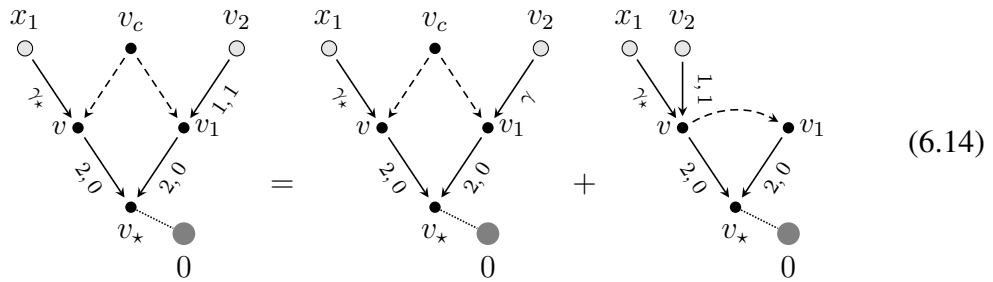

where $\gamma = (1, 1, v)$.

6.5. Examples

$$\text{Diagram} = \text{Diagram} + C_0^1 \text{Diagram} \quad (6.15)$$

where $\gamma_\star = (1, 1, v_\star)$ and $C_0^1 =$

$$\text{Diagram} = \text{Diagram} + C_0^2 \text{Diagram} + C_1 \text{Diagram} \quad (6.16)$$

where $\gamma_\star = (1, 2, v_\star)$, and $C_0^2 =$ and $C_1 =$. By sym-

metry between the nodes v and v_1 , we have $C_0 := C_0^1 = C_0^2$. Finally, the renormalised term is given by:

$$\text{Diagram} - C_1 \text{Diagram} - 2C_0 \text{Diagram}$$

In the previous example, the constant C_0 turns out to be zero because of the antisymmetry of the derivatives of the heat kernel.

We follow with the maximal chaos order for $\tau = \Xi\mathcal{I}(\mathcal{I}(\Xi)\Xi)$ and we first present how we build the scalar product $\langle W^{\varepsilon, \|\tau\|_{\mathcal{T}}}, W^{\varepsilon, \|\tau\|_{\mathcal{T}}} \rangle$:

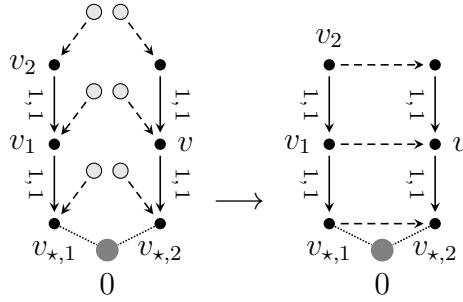

Then we renormalise the edge (v, v_1) in the next identity:

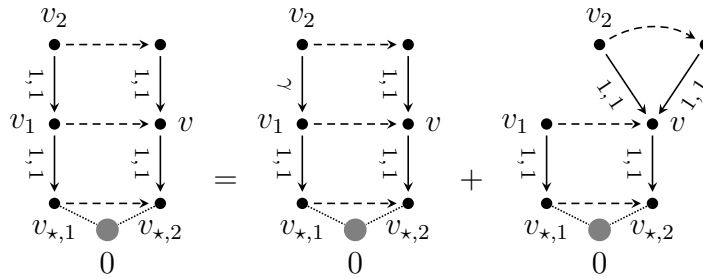

where $\gamma = (1, 1, v)$. After that renormalisation, we renormalise on each term in the right-hand side the edge $(v_{1,*}, v_{2,*})$.

We present an example which needs three renormalisations: the tree $\mathcal{I}(\mathcal{I}(\mathcal{I}(\Xi)\Xi)\Xi)\Xi$ in the second Wiener chaos order:

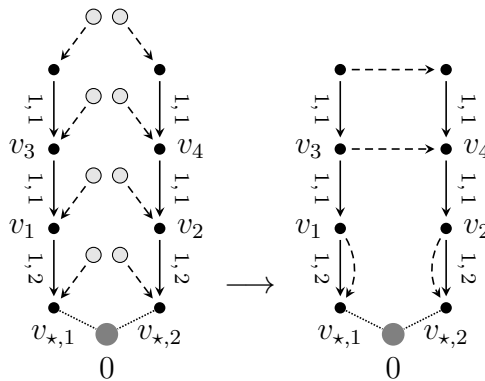

6.6. Computation of the constants

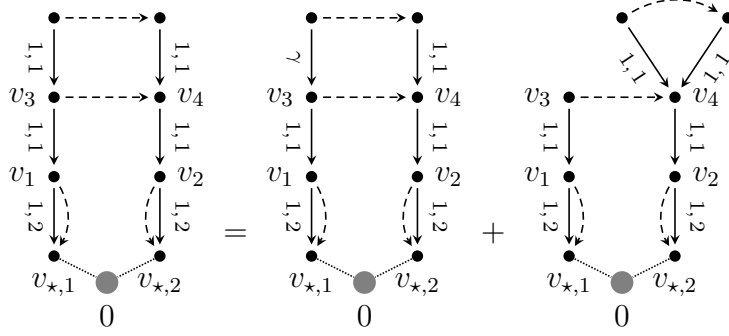

where $\gamma = (1, 1, v_4)$. We have treated $V = \{v_2, v_4\}$ then as in the first example we have to renormalise the sets $V_1 = \{v_1, v_{*,1}\}$ and $V_2 = \{v_2, v_{*,2}\}$.

Remark 6.5.1. All this renormalisation procedure works because the sets V , V_1 and V_2 are disjoint and they are the only possible divergent sets in the previous graph. This is the case for all the generalised KPZ terms.

6.6 Computation of the constants

We treat the constants according to their diverging rate which corresponds roughly to the homogeneity of the term associated with. Indeed, for $|\tau|_s = -1 - 2\kappa$, the constants are of order $1/\varepsilon$. Then for $|\tau|_s = -4\kappa$ and $|\tau|_s = -2\kappa$, some of the constants are of order $\log(\varepsilon)$, others are just of order one. In this section, the constants are computed by using the map ℓ_ε defined recursively in 5.1.3 by:

$$\ell_\varepsilon(T_\varepsilon^{n,d}) = - \sum_{\mathcal{A} \in \mathfrak{A}(T) \setminus \{\{T\}\}} \sum_{\mathfrak{c}_{\mathcal{A}}, n_{\mathcal{A}}} \frac{1}{\mathfrak{c}_{\mathcal{A}}!} \binom{\mathbf{n}}{\mathbf{n}_{\mathcal{A}}} \ell_\varepsilon \left(\Pi_- \mathcal{R}_{\mathcal{A}}^\uparrow T_\varepsilon^{n_{\mathcal{A}} + \pi_{\mathcal{A}}, d} \right) \tilde{W}^{\varepsilon, 0} \left(\mathcal{R}_{\mathcal{A}}^\downarrow T_\varepsilon^{n - n_{\mathcal{A}}, d + n_{\mathcal{A}} + \pi_{\mathcal{A}}} \right).$$

6.6.1 Methodology

We work as in [HQ15] with the rescaled kernel given by

$$K_{\varepsilon, \varrho}(z) = (\varrho * \mathcal{S}_\varepsilon^{(1)} K)(z),$$

where the operator $\mathcal{S}_\varepsilon^{(\alpha)}$ is defined by

$$(\mathcal{S}_\varepsilon^{(\alpha)} K)(t, x) = \varepsilon^\alpha K(\varepsilon^2 t, \varepsilon x).$$

We introduce a family of norms

$$\|F\|_{\alpha, \beta} = \sup_{|z| \leq 1} |z|^\alpha |F(z)| + \sup_{|z| \geq 1} |z|^\beta |F(z)|,$$

and we denote by $\mathcal{B}_{\alpha, \beta}$ the Banach space of the functions $F : \mathbb{R}^d \rightarrow \mathbb{R}$ such that $\|F\|_{\alpha, \beta} < \infty$. The next lemmas and propositions are extracted from [HQ15].

Proposition 6.6.1. *The kernels $K_{\varepsilon,\varrho}$ and $K'_{\varepsilon,\varrho}$ belong to $\mathcal{B}_{0,1}$ and $\mathcal{B}_{0,2}$ respectively. For every $\kappa > 0$, they converge to P_ϱ and P'_ϱ in $\tilde{\mathcal{B}}_{0,1-\kappa}$ and $\mathcal{B}_{0,2-\kappa}$ respectively, where $P_\varrho = P * \varrho$ and P is the heat kernel.*

Lemma 6.6.2. *Let for $j = 1, 2$, F_j functions on \mathbb{R} on \mathbb{R}^{d+1} with parabolic scaling such that $F_i \in \mathcal{B}_{\alpha_i,\beta_i}$ with $\alpha_i < d + 2$ and $\beta_1 + \beta_2 > d + 2$. Then there exists $C > 0$ such that*

$$\|F_1 * F_2\|_{\alpha,\beta} \leq C \|F_1\|_{\alpha_1,\beta_1} \|F_2\|_{\alpha_2,\beta_2},$$

with $\alpha = 0 \vee (\alpha_1 + \alpha_2 - d - 2)$ and $\beta = (\beta_1 + \beta_2 - d - 2) \wedge \beta_1 \wedge \beta_2$.

We define a kernel P_ε by

$$P_\varepsilon(z) = \int K'_{\varepsilon,\varrho}(z - \bar{z}) K'_{\varepsilon,\varrho}(-\bar{z}) d\bar{z}.$$

Lemma 6.6.3. *Let R_ε , $\tilde{R}_\varepsilon^{(1)}$ and $\tilde{R}_\varepsilon^{(2)}$ defined through the identities:*

$$\begin{aligned} 2P_\varepsilon(z) &= K_{\varepsilon,\varrho}(z) + K_{\varepsilon,\varrho}(-z) + R_\varepsilon^{(1)}(z) + (\mathcal{S}_\varepsilon^{(1)} R_\varepsilon^{(2)})(z), \\ \mathcal{S}_\varepsilon^{(1)} K &= K_{\varepsilon,\varrho}(z) + \tilde{R}_\varepsilon^{(1)}, \quad \mathcal{S}_\varepsilon^{(2)} K' = K'_{\varepsilon,\varrho}(z) + \tilde{R}_\varepsilon^{(1)}. \end{aligned}$$

Then, there exists some C independent of $\varepsilon \in (0, 1]$ such that

$$\|R_\varepsilon^{(1)}\|_{0,2} + \|R_\varepsilon^{(2)}\|_{0,4} + \|\tilde{R}_\varepsilon^{(1)}\|_{1,2} + \|\tilde{R}_\varepsilon^{(2)}\|_{2,3} \leq C.$$

For every $\kappa > 0$, the previous kernels converge in $\mathcal{B}_{0,2-\kappa}$, $\mathcal{B}_{0,4}$, $\mathcal{B}_{1,2-\kappa}$ and $\mathcal{B}_{2,3-\kappa}$ as $\varepsilon \rightarrow 0$. The limit of $R_\varepsilon^{(1)}$ is zero and the limits of $\tilde{R}_\varepsilon^{(1)}$ and $\tilde{R}_\varepsilon^{(2)}$ are independent of the choice of K .

The previous lemma is summarised in the next figure where E_ε converges to a limit independent of K .

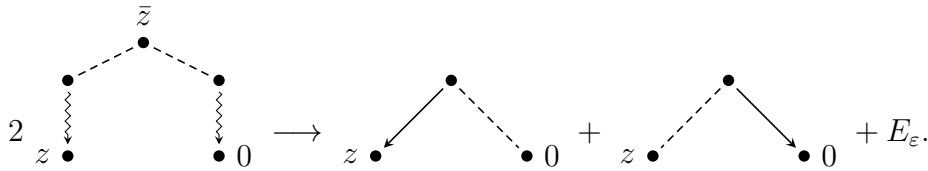

Remark 6.6.4. The transformation of P_ε in lemma 6.6.3 follows from the identity on the heat kernel:

$$2 \int P'(z - \bar{z}) P'(-\bar{z}) d\bar{z} = P(z) + P(-z).$$

The previous lemma is also true by replacing ϱ by $\varrho^{(2)} = \varrho * \varrho$ in the right hand-side of the main identity.

6.6. Computation of the constants

Let $\hat{\mathcal{W}}^{\varepsilon,0} T_c^{n,d}$ the 0-th Wiener chaos of the tree $T_c^{n,d}$ where we have removed all the positive renormalisations. This term is the sum of some constants of the form:

$$\int_{(\mathbb{R}^d)^{N_T \setminus \{v_*\}}} \prod_{u \in N_T} (x_u)^{n(u)} \prod_{e \in E_T} K_e(x_{e_+} - x_{e_-}) dx.$$

In these constants, we perform the following change of variable: $(t', x') = (\varepsilon^2 t, \varepsilon x) \in \mathbb{R}^2$. Finally, we replace every kernels K_e by $\mathcal{S}_\varepsilon^{(a_e)} K_e$ and the constant is multiplied by $\varepsilon^{|G|_s}$. On kernels of the form ϱ_ε , we obtain ϱ after the substitution. Then we can apply the lemma 6.6.2 to the kernels K_e and we obtain different cases:

- If the convergence takes place in $\mathcal{B}_{\alpha,\beta}$ with $\beta > |s|$ and $|s| < \alpha$, we can conclude.
- Else, we will have $\beta > |s|$ and we will notice that the time variable will belong to a compact domain and the kernel will be uniformly integrable.

We will use two main tools:

- The transformation of P_ε into $K_{\varepsilon,\varrho}(z) + K_{\varepsilon,\varrho}(-z)$ which simplifies our graph.
- integration by part in order to create terms of the form P_ε and then we are able to apply the first transformation.

We apply these two rules as an algorithm on the constants we have to treat.

6.6.2 Constants for $|\tau|_s = -1 - 2\kappa$

We prove in this section that the two constants corresponding to the renormalisation of \circ , \heartsuit are exactly equal. For $\Pi_x^{\varepsilon \circ}$, the diverging part of the mean is given by:

$$C_1^{(\varepsilon)} = \int \int \varrho_\varepsilon(t, x) (K * \varrho_\varepsilon)(t, x) dx dt.$$

From the scaling invariance of the heat kernel and the fact that K is compactly supported, we deduce that for sufficient small ε :

$$C_1^{(\varepsilon)} = \frac{c_\varrho}{\varepsilon} = \frac{1}{\varepsilon} \int \int \varrho(t, x) (P * \varrho)(t, x) dx dt = \frac{1}{\varepsilon} \int \int P(t, x) \varrho^{(2)}(t, x) dx dt.$$

The mean of the term $\Pi_x^{\varepsilon \heartsuit}$ is given by:

$$C_2^{(\varepsilon)} = \int K'_{\varrho,\varepsilon}(z)^2 dz = K_{\varrho^{(2)},\varepsilon}(0) + \tilde{C}_2^{(\varepsilon)}$$



where we have used the lemma 6.6.3. In that setting, $K_{\varrho^{(2)},\varepsilon}(0) = c_\varrho$ and $\tilde{C}_2^{(\varepsilon)}$ converge to a limit independent of the choice of K . Finally, we can choose the same renormalisation constant $C_1^{(\varepsilon)}$ for $\Pi_x^{\varepsilon \heartsuit}$.

6.6.3 Constants for $|\tau|_s = -2\kappa$

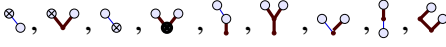
These symbols are given by

Homogeneity	Symbol(s)
-2κ	

We distinguish two cases:

- By antisymmetry, the constants given by  are equal to zero.
- For  and , we obtain a constant integrated against K' and K which ends up to be zero.

6.6.4 Constants for $|\tau|_s = -4\kappa$

We can potentially obtain logarithmic divergencies from the symbols of homogeneity -4κ , i.e. those that are borderline divergent and involve four instances of the noise. Here is a list of these symbols:

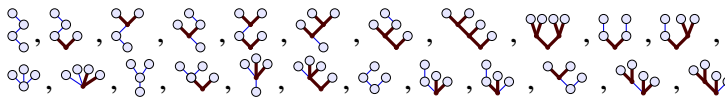
Symbols of homogeneity -4κ

We use the technic introduced in [HP14] and [HQ15]. The terms are more complicated so we need an efficient graphical notation. Therefore, we used the notation introduced in [HP14]. For each integration variable in \mathbb{R}^2 , we draw a node \bullet . The origin is given by a special node \bullet . The edges represent the different kernels evaluated at the difference between the two variables that it connects: an arrow for the heat kernel, a dotted line for $\varrho^{(2)} = \varrho * \varrho$ and a snake line for the derivative of the heat kernel. In order to note the contraction on the trees, we color two leaves in blue if they are paired and we leave the two other leaves in grey.

Constants of order one

Those nice constants of order one are given by:

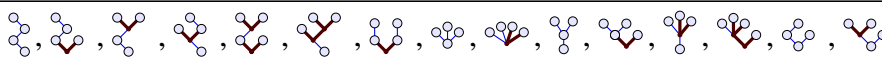
Symbols of homogeneity -4κ and with no divergence

We briefly recall the main arguments used in [HP14]. We look at integrability of the previous kernels at different scales. The small scales are not a problem since $\varrho^{(2)}$ is bounded and the singularity of the heat kernel is mild.





6.6. Computation of the constants





























For the large scales, the time variable belongs to a compact domain because $\varrho^{(2)}$ is compactly supported and we have $K(x, t) = 0$ for $t < 0$. Moreover, the orientation of the graph and the disposition of the edges show that we can earn some integration in time which make the constant to converge:

- If two nodes are connected by $\varrho^{(2)}$ like this $\bullet \text{---} \bullet$, then the corresponding time variables can be separated by at most a fixed finite distance.
- for any configuration of the type $\bullet \longrightarrow \bullet \longrightarrow \bullet$, the time coordinate of the middle variables has to lie between the time coordinates of the other two.

If we find an oriented cycle in the graph, we know that we earn integrations in time. By applying the previous rules and the fact for any fixed time, the heat kernel decays exponentially fast in the space variable, we prove that most the terms converge.

Finally, there are two basic mechanisms that prevent a logarithmic divergency:

1. The contracted graph is not 2-connected. In this case, the divergency has typically already been taken care of by previous renormalisations. This the case for , , ,  and .
2. There is a contraction between one vertex and another vertex that is located on the path joining the first one to the root. Such a contraction causes a “loop”, with the consequence that the integration of the time variables becomes restricted to a small region of width ε^2 .

We draw the different contractions among the terms , , , , , , , , , , , , , , , , , , , , , , , , , , , , . The previous terms allows us to decompose each $\ell_\varepsilon(\tau)$ according to the contractions. We give one example:

$$\ell_\varepsilon \left(\begin{array}{c} \circ \\ \circ \\ \circ \end{array} \right) = -c_\varrho^{(1)} = \begin{array}{c} \circ \\ \bullet \\ \bullet \end{array} + \begin{array}{c} \bullet \\ \bullet \\ \circ \end{array} = -\tilde{W}^{\varepsilon,0} \left(\begin{array}{c} \circ \\ \circ \\ \circ \end{array} \right) + C_\varepsilon \tilde{W}^{\varepsilon,0} \left(\begin{array}{c} \circ \\ \bullet \\ \circ \end{array} \right) + C_\varepsilon \tilde{W}^{\varepsilon,0} \left(\begin{array}{c} \bullet \\ \bullet \\ \circ \end{array} \right).$$

In the next figures, we represent all the constants:

where the symbol \mathcal{R} inside a loop indicates that it was “renormalised” by subtracting a delta-function with weight identical to the integral of the kernel represented by the loop. We have performed a substitution for diagram 1 , diagram 2 and we have replaced $P' * P'$ by $\frac{1}{2}P$ in diagram 3 in order to obtain nice expressions.



The constants used for the Itô product are:

$$\begin{aligned}
 c_\varrho^{(1)} &= \text{diagram 4} + \text{diagram 5}, & c_\varrho^{(2)} &= \text{diagram 6} + \text{diagram 7}, & c_\varrho^{(3)} &= \text{diagram 8} + \text{diagram 9}, \\
 c_\varrho^{(4)} &= \text{diagram 10} + \text{diagram 11}, & c_\varrho^{(5)} &= \text{diagram 12} + \text{diagram 13}, & c_\varrho^{(6)} &= \text{diagram 14} + \text{diagram 15}
 \end{aligned}$$

Now we give the explicit value of the constants which appear in the renormalised equation:

$$\begin{aligned}
 \text{diagram 16} &= \int P(-z_1)P(z_1 - z_2)P(z_2 - z_3)\varrho^{(2)}(-z_2)\varrho^{(2)}(z_1 - z_3) \prod_{i=1}^3 dz_i \\
 &= \int P(z_1)P(z_2)P(z_3)\varrho^{(2)}(z_1 + z_2)\varrho^{(2)}(z_2 + z_3) \prod_{i=1}^3 dz_i, \\
 \text{diagram 17} &= \int P(z_1)P(z_2)(P(z_3)\varrho^{(2)}(z_3) - c_\varrho\delta(z_3))\varrho^{(2)}(z_1 + z_2 + z_3) \prod_{i=1}^3 dz_i, \\
 \text{diagram 18} &= \int P(z_1)P(z_2)P(z_3)\varrho^{(2)}(z_1 + z_2)\varrho^{(2)}(z_2 - z_3) \prod_{i=1}^3 dz_i, \\
 \text{diagram 19} &= \int P(z_1)P(z_2)(P(z_3)\varrho^{(2)}(z_3) - c_\varrho\delta(z_3))\varrho^{(2)}(z_1 - z_2 + z_3) \prod_{i=1}^3 dz_i.
 \end{aligned}$$

6.6. Computation of the constants

Most of the terms contain loops except ,  and . We use the argument developed in [HP14]. If we denote by Q the distributions given by $Q(z) = P(z)\varrho^{(2)}(z) - c_\varrho\delta_0(z)$, we obtain:









$$\begin{aligned} \text{Diagram 1} &= \text{Diagram 2} = \int \varrho^{(2)}(z_1 - z_2)(P * Q)(z_1)P(z_2)dz_1dz_2 \\ \text{Diagram 3} &= \int \varrho^{(2)}(z_1 - z_2)(P * Q)(z_1)P'(z_2)dz_1dz_2. \end{aligned}$$

The formula is really the same for  and we conclude by the next lemma from [HP14]:

Lemma 6.6.5. *There exists a constant C such that the function $P * Q$ is bounded by $C(|z|^{-1} \wedge |z|^{-3})$, uniformly in z .*

Log renormalisation

















The remaining list of symbols that can cause logarithmic divergencies is given by:

Symbols causing logarithmic divergencies							
							

When computing the corresponding expectations, each of them can be contracted in three different ways. However, only two of these contractions yield logarithmic divergencies. We express these divergencies in terms of the basic quantity L_ε given by

$$L_\varepsilon = \int_{B_{1,\varepsilon}} P^3(z) dz = \frac{1}{2\sqrt{3}\pi} \log \varepsilon ,$$

where $B_{1,\varepsilon} = \{(t, x) : t \in [\varepsilon^2, 1]\}$, and P denotes the heat kernel. We then have the following identities:

		$= \frac{1}{4}L_\varepsilon ,$		$= \frac{1}{8}L_\varepsilon ,$
		$= \frac{1}{8}L_\varepsilon ,$		$= \frac{1}{4}L_\varepsilon ,$
		$= -\frac{1}{16}L_\varepsilon ,$		$= -\frac{1}{4}L_\varepsilon ,$
		$= \frac{1}{4}L_\varepsilon ,$		$= -\frac{1}{2}L_\varepsilon ,$
		$= \frac{1}{4}L_\varepsilon ,$		
		$= -\frac{1}{8}L_\varepsilon .$		

We compute the constants by making substitution and replacing $P' * P'$ by P . Using these rules, we obtain:

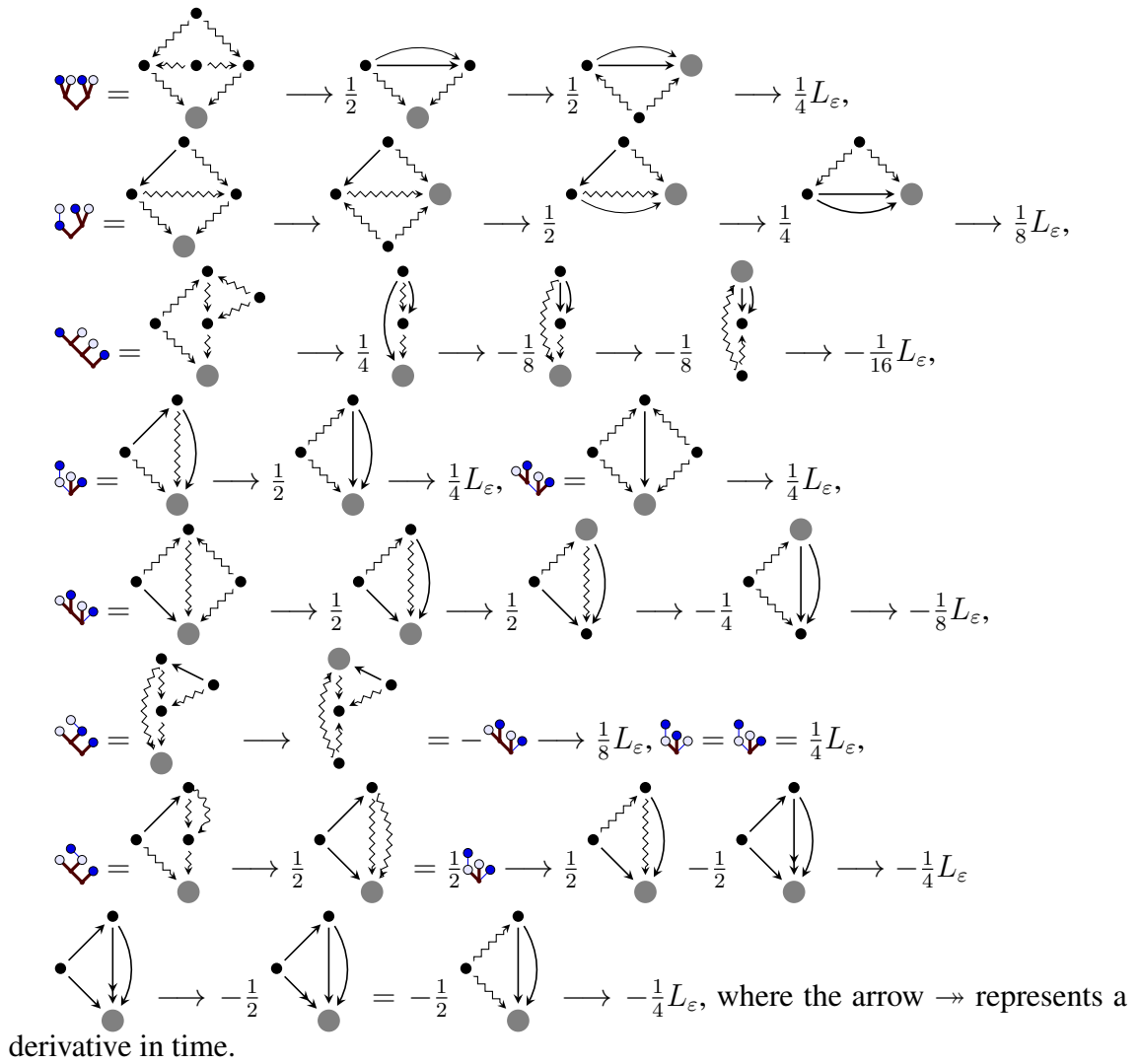

Appendix A

Alternative recursive proofs

In this section, we provide an alternative construction of the structure group and the renormalised model using recursive formulae.

A.1 Structure Group

In order to define the structure group G , we need more notations. We set

$$\mathcal{T}_+ := \{\tau \in \mathcal{F} : \tau = 1 \text{ or } |\tau|_s > 0, \text{ and } \tau = \tau_1\tau_2 \implies \tau_1, \tau_2 \in \mathcal{T}_+\},$$

and we let \mathcal{H}_+ be the linear span of \mathcal{T}_+ . If \mathcal{H}_+^* denotes the dual of \mathcal{H}_+ , then we define

$$G_+ := \{g \in \mathcal{H}_+^* : g(\tau_1\tau_2) = g(\tau_1)g(\tau_2), \forall \tau_1, \tau_2 \in \mathcal{H}_+\}.$$

For any $g \in \mathcal{H}_+^*$ we define a linear operator $\Gamma_g : \mathcal{H} \mapsto \mathcal{H}$ by

$$\begin{cases} \Gamma_g 1 = 1, & \Gamma_g \Xi = \Xi, & \Gamma_g X = X + g(X), & \Gamma_g(\tau\bar{\tau}) = (\Gamma_g\tau)(\Gamma_g\bar{\tau}), \\ \Gamma_g \mathcal{I}_k(\tau) = \mathcal{I}_k(\Gamma_g\tau) + \sum_{\ell} \frac{X^\ell}{\ell!} g(\mathcal{J}_{k+\ell}(\tau)), \end{cases}$$

where

$$\mathcal{J}_k(\tau) := \mathbb{1}_{(\beta - |k|_s + |\tau|_s > 0)} \mathcal{I}_k(\tau).$$

We define the product $\circ : G_+ \times G_+ \mapsto G_+$ recursively by:

$$\begin{cases} (g_1 \circ g_2)(X) = g_1(X) + g_2(X), & (g_1 \circ g_2)(\tau_1\tau_2) = (g_1 \circ g_2)(\tau_1)(g_1 \circ g_2)(\tau_2) \\ (g_1 \circ g_2)(\mathcal{J}_k(\tau)) = g_1(\mathcal{J}_k(\Gamma_{g_2}\tau)) + \sum_{\ell} \frac{(g_1(X))^\ell}{\ell!} g_2(\mathcal{J}_{k+\ell}(\tau)). \end{cases}$$

Proposition A.1.1.

1. For every $g \in G_+$, $\alpha \in A$, $\tau \in \mathcal{H}_\alpha$ and multiindex k , we have $\Gamma_g\tau - \tau \in \bigoplus_{\beta < |\tau|_s} \mathcal{H}_\beta$ and $\Gamma_g \mathcal{I}_k(\tau) - \mathcal{I}_k(\Gamma_g\tau)$ is a polynomial.

A.1. Structure Group

2. The set $(\Gamma_g, g \in G_+)$ forms a group under the composition of linear operators from \mathcal{H} to \mathcal{H} . Moreover, this definition coincides with that of [Hai14b, (8.17)].
3. For all $g, \bar{g} \in G_+$, one has $\Gamma_g \Gamma_{\bar{g}} = \Gamma_{g \circ \bar{g}}$. (G_+, \circ) is a group and each element g has a unique inverse g^{-1} given by the recursive formula

$$\begin{cases} g^{-1}(X) = -g(X), & g^{-1}(\tau_1 \tau_2) = g^{-1}(\tau_1) g^{-1}(\tau_2) \\ g^{-1}(\mathcal{J}_k(\tau)) = -\sum_{\ell} \frac{(-g(X))^\ell}{\ell!} g(\mathcal{J}_{k+\ell}(\Gamma_{g^{-1}} \tau)). \end{cases} \quad (\text{A.1})$$

The product \circ coincides with that defined in [Hai14b, Definition 8.18].

Proof. We prove the first property by induction on the construction of \mathcal{H} . Let $g \in G_+$. The proof is obvious for $\tau \in \{1, X, \Xi\}$. Let $\tau = \tau_1 \tau_2$ then we have

$$\Gamma_g \tau_1 \tau_2 = \Gamma_g \tau_1 (\Gamma_g \tau_2 - \tau_2) + (\Gamma_g \tau_1 - \tau_1) \tau_2 + \tau_1 \tau_2$$

We apply the induction hypothesis on τ_1 and τ_2 . Let $\tau = \mathcal{I}_k(\tau')$ then the recursive definition of Γ_g gives:

$$\Gamma_g \mathcal{I}_k(\tau') = \mathcal{I}_k(\Gamma_g \tau' - \tau') + \mathcal{I}_k(\tau') + \sum_{\ell} \frac{X^\ell}{\ell!} g(\mathcal{J}_{k+\ell}(\tau'))$$

We apply the induction hypothesis on τ' .

Let $g, \bar{g} \in G_+$, $h = g \circ \bar{g} \in G_+$. Simple computations show that

$$\Gamma_h 1 = 1, \quad \Gamma_h \Xi = \Gamma_g \Gamma_{\bar{g}} \Xi, \quad \Gamma_h X = \Gamma_g \Gamma_{\bar{g}} X, \quad \Gamma_h(\tau \bar{\tau}) = \Gamma_g \Gamma_{\bar{g}}(\tau \bar{\tau}).$$

We need to check that $\Gamma_g \Gamma_{\bar{g}} \mathcal{I}_k(\tau) = \Gamma_h \mathcal{I}_k(\tau)$:

$$\begin{aligned} \Gamma_g \Gamma_{\bar{g}} \mathcal{I}_k(\tau) &= \Gamma_g \left(\mathcal{I}_k(\Gamma_{\bar{g}} \tau) + \sum_{\ell} \frac{X^\ell}{\ell!} \bar{g}(\mathcal{J}_{k+\ell}(\tau)) \right) \\ &= \mathcal{I}_k(\Gamma_g \Gamma_{\bar{g}} \tau) + \sum_{\ell} \frac{X^\ell}{\ell!} g(\mathcal{J}_{k+\ell}(\Gamma_{\bar{g}} \tau)) + \sum_{\ell} \frac{(X + g(X))^\ell}{\ell!} \bar{g}(\mathcal{J}_{k+\ell}(\tau)) \end{aligned}$$

while

$$\begin{aligned} \Gamma_h \mathcal{I}_k(\tau) &= \mathcal{I}_k(\Gamma_h \tau) + \sum_{\ell} \frac{X^\ell}{\ell!} h(\mathcal{J}_{k+\ell}(\tau)) \\ &= \mathcal{I}_k(\Gamma_g \Gamma_{\bar{g}} \tau) + \sum_{\ell} \frac{X^\ell}{\ell!} \left(g(\mathcal{J}_{k+\ell}(\Gamma_{\bar{g}} \tau)) + \sum_j \frac{(g(X))^j}{j!} \bar{g}(\mathcal{J}_{k+\ell+j}(\tau)) \right) \\ &= \mathcal{I}_k(\Gamma_g \Gamma_{\bar{g}} \tau) + \sum_{\ell} \frac{X^\ell}{\ell!} g(\mathcal{J}_{k+\ell}(\Gamma_{\bar{g}} \tau)) + \sum_{\ell} \frac{(X + g(X))^\ell}{\ell!} \bar{g}(\mathcal{J}_{k+\ell}(\tau)). \end{aligned}$$

By comparing the two formulae, we obtain that $\Gamma_g \Gamma_{\bar{g}} = \Gamma_{g \circ \bar{g}}$.

Let us show that \circ is associative on G_+ , namely that $g_1 \circ (g_2 \circ g_3) = (g_1 \circ g_2) \circ g_3$; this is obvious if tested on X and on $\tau \bar{\tau}$; it remains to check this formula on $\mathcal{I}_k(\tau)$:

$$\begin{aligned} g_1 \circ (g_2 \circ g_3)(\mathcal{J}_k(\tau)) &= g_1(\mathcal{J}_k(\Gamma_{g_2 \circ g_3} \tau)) + \sum_{\ell} \frac{(g_1(X))^\ell}{\ell!} g_2 \circ g_3(\mathcal{J}_{k+\ell}(\tau)) \\ &= g_1(\mathcal{J}_k(\Gamma_{g_2 \circ g_3} \tau)) + \sum_{\ell} \frac{(g_1(X))^\ell}{\ell!} g_2(\mathcal{J}_{k+\ell}(\Gamma_{g_3} \tau)) + \sum_{\ell} \frac{(g_1(X) + g_2(X))^\ell}{\ell!} g_3(\mathcal{J}_{k+\ell}(\tau)), \end{aligned}$$

while

$$\begin{aligned} (g_1 \circ g_2) \circ g_3(\mathcal{J}_k(\tau)) &= g_1 \circ g_2(\mathcal{J}_k(\Gamma_{g_3} \tau)) + \sum_{\ell} \frac{(g_1 \circ g_2(X))^\ell}{\ell!} g_3(\mathcal{J}_{k+\ell}(\tau)) \\ &= g_1(\mathcal{J}_k(\Gamma_{g_2} \Gamma_{g_3} \tau)) + \sum_{\ell} \frac{(g_1(X))^\ell}{\ell!} g_2(\mathcal{J}_{k+\ell}(\Gamma_{g_3} \tau)) + \sum_{\ell} \frac{(g_1(X) + g_2(X))^\ell}{\ell!} g_3(\mathcal{J}_{k+\ell}(\tau)) \end{aligned}$$

and again by comparing the two formulae we obtain the claim.

Let us show now that (A.1) defines the correct inverse in (G_+, \circ) . First of all, the neutral element in G_+ is clearly $\mathbf{1}^*(\tau) := \mathbb{1}_{(\tau=1)}$. As usual, the only non-trivial property is that $g \circ g^{-1}(\mathcal{I}_k(\tau)) = g^{-1} \circ g(\mathcal{I}_k(\tau)) = \mathbf{1}^*(\mathcal{I}_k(\tau)) = 0$. We have

$$\begin{aligned} g \circ g^{-1}(\mathcal{J}_{k+\ell}(\tau)) &= g(\mathcal{J}_{k+\ell}(\Gamma_{g^{-1}} \tau)) + \sum_m \frac{(g(X))^m}{m!} g^{-1}(\mathcal{J}_{k+\ell+m}(\tau)), \\ &= g(\mathcal{J}_{k+\ell}(\Gamma_{g^{-1}} \tau)) - \sum_{m,\ell} \frac{(g(X))^m}{m!} \frac{(-g(X))^\ell}{\ell!} g(\mathcal{J}_{k+\ell+m}(\Gamma_{g^{-1}} \tau)) = 0 \end{aligned}$$

and

$$\begin{aligned} g^{-1} \circ g(\mathcal{J}_k(\tau)) &= g^{-1}(\mathcal{J}_k(\Gamma_g \tau)) + \sum_{\ell} \frac{(g^{-1}(X))^\ell}{\ell!} g(\mathcal{J}_{k+\ell}(\tau)) \\ &= g^{-1}(\mathcal{J}_k(\Gamma_g \tau)) + \sum_{\ell} \frac{(-g(X))^\ell}{\ell!} g(\mathcal{J}_{k+\ell}(\tau)) \\ &= - \sum_{\ell} \frac{(-g(X))^\ell}{\ell!} g(\mathcal{J}_{k+\ell}(\Gamma_{g^{-1} \circ g} \tau)) + \sum_{\ell} \frac{(-g(X))^\ell}{\ell!} g(\mathcal{J}_{k+\ell}(\tau)), \end{aligned}$$

where we have used a recurrence assumption in the identification $\Gamma_{g^{-1} \circ g} \tau = \tau$. Since $\Gamma_{\mathbf{1}^*}$ is the identity in \mathcal{H} , we obtain that $(\Gamma_g, g \in G_+)$ also forms a group.

We show now that these objects coincide with those defined in [Hai14b, section 8]. In [Hai14b], the action of \mathcal{H}_+^* on \mathcal{H} is defined through the following coproduct $\Delta : \mathcal{H} \mapsto \mathcal{H} \times \mathcal{H}_+$,

$$\begin{cases} \Delta \mathbf{1} = \mathbf{1} \otimes \mathbf{1}, \quad \Delta X = X \otimes \mathbf{1} + \mathbf{1} \otimes X, \\ \Delta \Xi = \Xi \otimes \mathbf{1}, \quad \Delta(\tau \bar{\tau}) = (\Delta \tau)(\Delta \bar{\tau}) \\ \Delta \mathcal{I}_k(\tau) = (\mathcal{I}_k \otimes I) \Delta \tau + \sum_{\ell} \frac{X^\ell}{\ell!} \otimes \mathcal{J}_{k+\ell}(\tau). \end{cases}$$

A.2. Renormalised model

We claim that

$$\Gamma_g \tau = (I \otimes g) \Delta \tau, \quad \forall g \in G_+, \tau \in \mathcal{H}. \quad (\text{A.2})$$

First, (A.2) is easily checked on $1, X, \Xi$ and $\tau \bar{\tau} \in \mathcal{H}$. We check the formula on $\mathcal{I}_k(\tau)$:

$$\begin{aligned} \Gamma_g \mathcal{I}_k(\tau) &= \mathcal{I}_k(\Gamma_g \tau) + \sum_{\ell} \frac{(g(X))^\ell}{\ell!} g(\mathcal{J}_{k+\ell}(\tau)) \\ &= (I \otimes g) \left[(\mathcal{I}_k \otimes I) \Delta \tau + \sum_{\ell} \frac{X^\ell}{\ell!} \otimes \mathcal{J}_{k+\ell}(\tau) \right] = (I \otimes g) \Delta \mathcal{I}_k(\tau). \end{aligned}$$

In [Hai14b], another coproduct $\Delta^+ : \mathcal{H}_+ \times \mathcal{H}_+ \mapsto \mathcal{H}_+$ is defined as follows:

$$\begin{cases} \Delta^+ \mathbf{1} = \mathbf{1} \otimes \mathbf{1}, & \Delta^+ X = X \otimes \mathbf{1} + \mathbf{1} \otimes X, & \Delta^+(\tau \bar{\tau}) = (\Delta^+ \tau)(\Delta^+ \bar{\tau}), \\ \Delta^+ \mathcal{J}_k(\tau) = (\mathcal{J}_k \otimes 1) \Delta \tau + \sum_{\ell} \frac{X^\ell}{\ell!} \otimes \mathcal{J}_{k+\ell}(\tau). \end{cases}$$

In order to prove that the product \circ in \tilde{G} is the same as in [Hai14b], we need to check that for every $g_1, g_2 \in \mathcal{H}_+^*$ we have:

$$g_1 \circ g_2(\tau) = g_1 \otimes g_2(\Delta^+ \tau), \quad \forall \tau \in \mathcal{H}_+.$$

As usual, this formula is easily checked on $1, X$ and on products $\tau \bar{\tau} \in \mathcal{H}_+$. We check the formula on $\mathcal{J}_k(\tau)$:

$$\begin{aligned} (g_1 \circ g_2)(\mathcal{J}_k(\tau)) &= g_1(\mathcal{J}_k(\Gamma_{g_2} \tau)) + \sum_{\ell} \frac{(g_1(X))^\ell}{\ell!} g_2(\mathcal{J}_{k+\ell}(\tau)) \\ &= (g_1 \otimes 1)(\mathcal{J}_k \otimes g_2) \Delta \tau + (g_1 \otimes g_2) \sum_{\ell} \frac{X^\ell}{\ell!} \otimes \mathcal{J}_{k+\ell}(\tau) = g_1 \otimes g_2(\Delta^+ \tau). \end{aligned}$$

□

A.2 Renormalised model

As in [Hai14b], we want a renormalised model (Π_x^M, Γ_{xy}^M) with the following property:

$$\Pi^M \tau = \Pi M \tau. \quad (\text{A.3})$$

We define the linear map Π^M by:

$$\begin{cases} (\Pi^{M^\circ} \mathbf{1})(y) = 1, & (\Pi^{M^\circ} X)(y) = y, & (\Pi^{M^\circ} \Xi)(y) = \xi(y), \\ (\Pi^{M^\circ} \mathcal{I}_k \tau)(y) = \int D^k K(y-z) (\Pi^M \tau)(z) dz \\ (\Pi^{M^\circ} \tau \bar{\tau})(y) = (\Pi^{M^\circ} \tau)(y) (\Pi^{M^\circ} \bar{\tau})(y), & (\Pi^M \tau)(y) = (\Pi^{M^\circ} R \tau)(y) \end{cases} \quad (\text{A.4})$$

where the recursive definition is the same as for M . The kernel K is homogeneous of degree $2 - d$ and it appears in the decomposition of the heat kernel $G = K + R$ where R is smooth in [Hai14b]. The definition of Π^M is really close to the definition of Π . The main difference is that Π^M is no longer multiplicative because we have to renormalize some ill-defined products by subtracting diverging terms which is done by the action of R .

Remark A.2.1. We have chosen the definition (A.2) for Π^M instead of (A.3) because the definition (A.2) contains the definition of Π when $R = Id$. Moreover, the recursive formula for the product is really close to the definition of Π_x^M and this fact is useful for the proofs.

Proposition A.2.2. *We have the following identities: $\Pi^M \tau = \Pi M \tau$ and $\Pi^{M^\circ} \tau = \Pi M^\circ \tau$.*

Proof. We proceed again by induction. It's obvious for $\mathbf{1}$, X and Ξ . For $\tau = \mathcal{I}_k(\tau')$, by the induction hypothesis the claim holds for τ' because $\|\mathcal{I}_k(\tau')\| = \|\tau'\|$ and $|\mathcal{I}_k(\tau')|_s > |\tau'|_s$. We have:

$$\begin{aligned} (\Pi^M \mathcal{I}_k \tau')(y) &= \int D^k K(y-z) (\Pi^M \tau')(z) dz = \int D^k K(y-z) (\Pi M \tau')(z) dz \\ &= (\Pi \mathcal{I}_k M \tau')(y) = (\Pi M \mathcal{I}_k \tau')(y). \end{aligned}$$

For $\tau = \prod_i \tau_i$ product of elementary symbols, we obtain by applying the induction hypothesis on $R\tau - \tau$ and the τ_i :

$$(\Pi^{M^\circ} \tau)(y) = \prod_i (\Pi^{M^\circ} \tau_i)(y) = \prod_i (\Pi M^\circ \tau_i)(y) = (\Pi M^\circ \tau)(y)$$

and

$$\begin{aligned} (\Pi^M \tau)(y) &= (\Pi^{M^\circ} (R\tau - \tau))(y) + (\Pi^{M^\circ} \tau)(y) \\ &= (\Pi M^\circ (R\tau - \tau))(y) + (\Pi M^\circ \tau)(y) = (\Pi M \tau)(y) \end{aligned}$$

which conclude the proof. \square

Until the end of the section, R is an admissible map and M is a renormalisation map built from R .

The renormalised model (Π^M, Γ^M) associated to $M = M_R$ is given by

$$\left\{ \begin{array}{l} (\Pi_x^{M^\circ} \mathbf{1})(y) = 1, \quad (\Pi_x^{M^\circ} \Xi)(y) = \xi(y), \quad (\Pi_x^{M^\circ} X)(y) = y - x. \\ (\Pi_x^{M^\circ} \mathcal{I}_k \tau)(y) = \int D^k K(y-z) \Pi_x^M(\tau)(z) dz - \sum_{\ell} \frac{(y-x)^\ell}{\ell!} f_x^M(\mathcal{J}_{k+\ell}(\tau)) \\ (\Pi_x^M \tau)(y) = (\Pi_x^{M^\circ} R\tau)(y), \quad (\Pi_x^{M^\circ} \tau \bar{\tau})(y) = (\Pi_x^{M^\circ} \tau)(y) (\Pi_x^{M^\circ} \bar{\tau})(y) \end{array} \right.$$

A.2. Renormalised model

where $f_x^M \in \mathcal{H}_+^*$ is defined by

$$\begin{cases} f_x^M(X) = x, & f_x^M(\tau\bar{\tau}) = f_x^M(\tau)f_x^M(\bar{\tau}) \\ f_x^M(\mathcal{J}_k(\tau)) = \mathbb{1}_{(|\mathcal{I}_k(\tau)|_s > 0)} \int D^k K(x-z)(\Pi_x^M \tau)(z) dz. \end{cases}$$

We also define

$$\begin{cases} \Gamma_{xy}^M X = X + (x-y), & \Gamma_{xy}^M \Xi = \Xi, & \Gamma_{xy}^M(\tau\bar{\tau}) = (\Gamma_{xy}^M \tau)(\Gamma_{xy}^M \bar{\tau}) \\ \Gamma_{xy}^M \mathcal{I}_k(\tau) = \mathcal{I}_k(\Gamma_{xy}^M \tau) - \sum_{\ell} \frac{(X+x-y)^\ell}{\ell!} f_y^M(\mathcal{J}_{k+\ell}(\tau)) + \sum_{\ell} \frac{X^\ell}{\ell!} f_x^M(\mathcal{J}_{k+\ell}(\Gamma_{xy}^M \tau)). \end{cases}$$

and

$$\begin{cases} g_x^M(X) = -x, & g_x^M(\tau\bar{\tau}) = g_x^M(\tau)g_x^M(\bar{\tau}) \\ g_x^M(\mathcal{J}_k\tau) = - \sum_{\ell} \frac{(-x)^\ell}{\ell!} f_x^M(\mathcal{J}_{k+\ell}\tau). \end{cases}$$

Proposition A.2.3. *The Γ^M operator is also given by:*

$$\Gamma_{xy}^M = (F_x^M)^{-1} \circ F_y^M$$

where $F_x^M = \Gamma_{g_x^M}$. Moreover, another equivalent recursive definition is:

$$\begin{cases} \Gamma_{xy}^M X = X + (x-y), & \Gamma_{xy}^M \Xi = \Xi, & \Gamma_{xy}^M(\tau\bar{\tau}) = (\Gamma_{xy}^M \tau)(\Gamma_{xy}^M \bar{\tau}) \\ \Gamma_{xy}^M \mathcal{I}_k(\tau) = \mathcal{I}_k(\Gamma_{xy}^M \tau) - \sum_{|\ell|_s < |\tau|_s + \beta - |k|_s} (\Pi_x^M \mathcal{I}_{k+\ell}(\Gamma_{xy}^M \tau))(y) \frac{(X+x-y)^\ell}{\ell!}. \end{cases} \quad (\text{A.5})$$

Proof. We have

$$\begin{aligned} (g_x^M)^{-1}(\mathcal{J}_k(\tau)) &= - \sum_{\ell} \frac{(-g_x^M(X))^\ell}{\ell!} g_x^M(\mathcal{J}_{k+\ell}(\Gamma_{(g_x^M)^{-1}} \tau)) \\ &= - \sum_{m,\ell} \frac{(x)^\ell (-x)^m}{\ell! m!} f_x^M(\mathcal{J}_{k+\ell+m}(\Gamma_{(g_x^M)^{-1}} \tau)) \\ &= - f_x^M(\mathcal{J}_k(\Gamma_{(g_x^M)^{-1}} \tau)). \end{aligned}$$

Since by definition

$$\Gamma_g \mathcal{I}_k(\tau) = \mathcal{I}_k(\Gamma_g \tau) + \sum_{\ell} \frac{X^\ell}{\ell!} g(\mathcal{J}_{k+\ell}(\tau)),$$

then

$$\Gamma_{g_y^M} \mathcal{I}_k(\tau) = \mathcal{I}_k(\Gamma_{g_y^M} \tau) - \sum_{\ell} \frac{(X-y)^\ell}{\ell!} f_y^M(\mathcal{J}_{k+\ell}(\tau))$$

and

$$\begin{aligned}\Gamma_{(g_x^M)^{-1}}\mathcal{I}_k(\tau) &= \mathcal{I}_k(\Gamma_{(g_x^M)^{-1}}\tau) + \sum_{\ell} \frac{X^\ell}{\ell!} (g_x^M)^{-1}(\mathcal{J}_{k+\ell}(\tau)) \\ &= \mathcal{I}_k(\Gamma_{(g_x^M)^{-1}}\tau) - \sum_{\ell} \frac{X^\ell}{\ell!} f_x^M(\mathcal{J}_{k+\ell}(\Gamma_{(g_x^M)^{-1}}\tau)),\end{aligned}$$

so that

$$\begin{aligned}\Gamma_{(g_x^M)^{-1}}\Gamma_{g_y^M}\mathcal{I}_k(\tau) &= \mathcal{I}_k(\Gamma_{(g_x^M)^{-1}}\Gamma_{g_y^M}\tau) - \sum_{\ell} \frac{X^\ell}{\ell!} f_x^M(\mathcal{J}_{k+\ell}(\Gamma_{(g_x^M)^{-1}}\Gamma_{g_y^M}\tau)) \\ &\quad + \sum_{\ell} \frac{(X+x-y)^\ell}{\ell!} f_y^M(\mathcal{J}_{k+\ell}(\tau)).\end{aligned}$$

Therefore, $\Gamma_{(f_x^M)^{-1}}\Gamma_{f_y^M}$ satisfies the same recursive property as Γ_{xy}^M .

Finally, we need to prove (A.5). We have

$$\Gamma_{xy}^M\mathcal{I}_k(\tau) = \mathcal{I}_k(\Gamma_{xy}^M\tau) + \sum_{\ell} \frac{(X+x-y)^\ell}{\ell!} A_{y,x,k,\ell}^M,$$

where

$$A_{y,x,k,\ell}^M = f_y^M(\mathcal{J}_{k+\ell}(\tau)) - \sum_m \frac{(y-x)^m}{m!} f_x^M(\mathcal{J}_{k+\ell+m}(\Gamma_{xy}^M\tau)).$$

We write $\Gamma_{xy}^M\tau = \sum_i \tau_i$ with $|\tau_i|_s \leq |\tau|_s$; note that $\Pi_y^M\tau = \Pi_x^M\Gamma_{xy}^M\tau = \sum_i \Pi_x^M\tau_i$, and $A_{y,x,k,\ell}^M$ is zero unless $\ell < |\tau|_s + \beta - |k|_s$, and if this condition is satisfied then

$$\begin{aligned}A_{x,y,k,\ell}^M &= \int D^{k+\ell} K(y-z)(\Pi_y^M\tau)(z) dz - \sum_{m,i} \frac{(y-x)^m}{m!} f_x^M(\mathcal{J}_{k+\ell+m}(\tau_i)) \\ &= \sum_i \left[\int D^{k+\ell} K(y-z)(\Pi_x^M\tau_i)(z) dz - \sum_m \frac{(y-x)^m}{m!} f_x^M(\mathcal{J}_{k+\ell+m}(\tau_i)) \right] \\ &= \sum_i \Pi_x^M(\mathcal{I}_{k+\ell}(\tau_i))(y) = \Pi_x^M(\mathcal{I}_{k+\ell}(\Gamma_{xy}^M\tau))(y).\end{aligned}$$

This allows to conclude. □

Remark A.2.4. The interest of the previous formula for Γ^M is to show a strong link with the definition of Π_x^M . Moreover it simplifies the proof of the analytical bound of the model. Indeed, analytical bounds on Π_x^M give the bounds for Γ^M .

Proposition A.2.5. *The following identities hold: $\Pi_x^M = \Pi^M F_x^M$ and $\Pi_x^{M^\circ} = \Pi^{M^\circ} F_x^M$.*

A.2. Renormalised model

Proof. We proceed by induction. The proof is obvious for $\tau \in \{\mathbf{1}, \Xi, X\}$. For $\tau = \mathcal{I}_k(\tau')$, we apply the induction hypothesis on τ' , it follows:

$$\begin{aligned} (\Pi_x^{M^\circ} \tau)(y) &= \int D^k K(y-z) (\Pi_x^M \tau')(z) dz - \sum_\ell \frac{(y-x)^\ell}{\ell!} f_x^M(\mathcal{J}_{k+\ell}(\tau')) \\ &= \int D^k K(y-z) (\Pi^M F_x^M \tau')(z) dz - \sum_\ell \frac{(y-x)^\ell}{\ell!} f_x^M(\mathcal{J}_{k+\ell}(\tau')) \\ &= (\Pi^M F_x^M \mathcal{I}_k(\tau'))(y). \end{aligned}$$

It remains to check the identity on a product $\tau = \prod_i \tau_i$ where each τ_i is elementary. We have

$$\Pi^M F_x^M \tau = \Pi^{M^\circ} R F_x^M \tau = \Pi^{M^\circ} F_x^M R \tau$$

since by definition $F_x^M = \Gamma_{f_x^M} \in G$ and R commutes with G . Then by applying the induction hypothesis on $R\tau - \tau$ and the τ_i , we have

$$\Pi^{M^\circ} F_x^M \tau = \prod_i \Pi^{M^\circ} F_x^M \tau_i = \prod_i \Pi_x^{M^\circ} \tau_i = \Pi_x^{M^\circ} \tau.$$

and

$$\begin{aligned} \Pi^{M^\circ} F_x^M R \tau &= \Pi^{M^\circ} F_x^M (R\tau - \tau) + \Pi^{M^\circ} F_x^M \tau \\ &= \Pi_x^{M^\circ} (R\tau - \tau) + \Pi_x^{M^\circ} \tau = \Pi_x^{M^\circ} R\tau = \Pi_x^M \tau. \end{aligned}$$

□

Proposition A.2.6. *If R is an admissible map then (Π^M, Γ^M) is a model.*

Proof. The algebraic relations are given by the previous proposition. It just remains to check the analytical bound. For $\tau = \Xi$ or $\tau = \mathcal{I}_k(\tau')$, the proof is the same as in [Hai14b]. For $\tau = \prod_i \tau_i$ a product of elementary symbols, we have

$$\Pi_x^M \tau = \Pi_x^{M^\circ} (R\tau - \tau) + \Pi_x^{M^\circ} \tau.$$

We apply the induction hypothesis on the τ_i and $R\tau - \tau$:

$$\begin{aligned} |(\Pi_x^{M^\circ} \tau)(y)| &= \prod_i |(\Pi_x^{M^\circ} \tau_i)(y)| \lesssim \prod_i \|x-y\|_s^{|\tau_i|_s} = \|x-y\|_s^{|\tau|_s}, \\ |(\Pi_x^{M^\circ} (R\tau - \tau))(y)| &\lesssim \|x-y\|_s^{|R\tau - \tau|_s} \lesssim \|x-y\|_s^{|\tau|_s}. \end{aligned}$$

It just remains the analytical bound for Γ^M . We proceed by induction. For $\tau = \Xi$ or $\tau = X$, the bound is obvious. Let $\tau = \prod_i \tau_i$ where the τ_i are elementary symbols. For $\beta < |\tau|_s$, we have

$$\begin{aligned} \|\Gamma_{xy}^M \tau\|_\beta &= \sum_{\substack{\sum_i \alpha_{i,j} = \beta \\ \alpha_{i,j} < \|\tau_i\|}} \prod_i \|\Gamma_{xy}^M \tau_i\|_{\alpha_{i,j}} \\ &\leq C \sum_{\substack{\sum_i \alpha_{i,j} = \beta \\ \alpha_{i,j} < \|\tau_i\|}} \prod_i \|x-y\|_s^{|\tau_i|_s - \alpha_{i,j}} \|\tau\| \leq C \|x-y\|_s^{\alpha - \beta}. \end{aligned}$$

For $\tau' = \mathcal{I}_k(\tau)$, the recursive definition (A.5) gives:

$$\Gamma_{xy}^M \mathcal{I}_k(\tau) = \mathcal{I}_k(\Gamma_{xy}^M \tau) - \sum_{\ell < \beta + |\tau|_s - |k|_s} (\Pi_x^M \mathcal{I}_{k+\ell}(\Gamma_{xy}^M \tau))(y) \frac{(X + x - y)^\ell}{\ell!}.$$

Let $\alpha < |\mathcal{I}_k(\tau)|_s$. If $\alpha \in \mathbb{R} \setminus \mathbb{N}$, let us write $\Gamma_{xy}^M \tau = \tau + \sum_i \tau_{xy}^i$ with

$$|\tau_{xy}^i|_s = \alpha_i < |\tau|_s, \quad \|\tau_{xy}^i\|_{\alpha_i} \lesssim \|x - y\|_s^{|\tau|_s - \alpha_i};$$

then if

$$\|\Gamma_{xy}^M \tau'\|_\alpha = \|\mathcal{I}_k(\Gamma_{xy}^M \tau)\|_\alpha \lesssim \sum_i \mathbb{1}_{(\alpha_i + \beta - |k|_s = \alpha)} \|x - y\|_s^{|\tau|_s - \alpha_i} \lesssim \|x - y\|_s^{|\tau|_s + \beta - |k|_s - \alpha}.$$

Now, if $\alpha \in \mathbb{N}$ and $\alpha < |\mathcal{I}_k(\tau)|_s$ then

$$\begin{aligned} \|\Gamma_{xy}^M \mathcal{I}_k(\tau)\|_\alpha &= \left| \sum_{\alpha \leq |\ell|_s < \beta + |\tau|_s - |k|_s} \frac{(X + x - y)^\ell}{\ell!} (\Pi_x^M \mathcal{I}_{k+\ell}(\Gamma_{xy}^M \tau))(y) \right| \\ &\lesssim \sum_{\alpha \leq |\ell|_s < \beta + |\tau|_s - |k|_s} \frac{\|x - y\|_s^{|\ell|_s - \alpha}}{\ell!} \sum_{\gamma \leq |\tau|_s} \|x - y\|_s^{\beta + \gamma - |k|_s - |\ell|_s} \|\Gamma_{xy}^M \tau\|_{\beta + \gamma - |k|_s} \\ &\lesssim \sum_{\alpha \leq |\ell|_s < \beta + |\tau|_s - |k|_s} \frac{\|x - y\|_s^{|\ell|_s - \alpha}}{\ell!} \sum_{\gamma \leq |\tau|_s} \|x - y\|_s^{\beta + \gamma - |k|_s - |\ell|_s} \|x - y\|_s^{|\tau|_s - \beta - \gamma + |k|_s} \\ &\lesssim \|x - y\|_s^{|\tau|_s - \alpha}. \end{aligned}$$

□

Proposition A.2.7. *We suppose that for every $\tau = \mathcal{I}_k(\tau') \in \mathcal{T}$ such that $|\tau|_s < 0$, we have $(\Pi_x^M \tau)(x) = (\Pi_x M \tau)(x)$. Then the following identities hold: $(\Pi_x^M \tau)(x) = (\Pi_x M \tau)(x)$ and $(\Pi_x^{M^\circ} \tau)(x) = (\Pi_x M^\circ \tau)(x)$ for every $\tau \in \mathcal{T}$.*

Proof. We proceed by induction. For $\tau \in \{\mathbf{1}, \Xi, X\}$, we have

$$(\Pi_x^M \tau)(x) = (\Pi_x \tau)(x) = (\Pi_x M \tau)(x).$$

For $\tau = \mathcal{I}_k(\tau')$, if $|\tau'|_s > 0$ then the recursive definition of Π_x^M gives

$$\begin{aligned} (\Pi_x^M \mathcal{I}_k \tau')(x) &= 0 \\ (\Pi_x M \mathcal{I}_k \tau')(x) &= (\Pi_x \mathcal{I}_k M \tau')(x) = 0 \end{aligned}$$

For the second identity, we have used the fact that $|M \tau'|_s \geq |\tau'|_s$. Otherwise, if $|\tau'|_s < 0$ then the hypothesis allows us to conclude. For an elementary product $\tau = \prod_i \tau_i$, it follows by using the induction hypothesis

$$(\Pi_x^{M^\circ} \tau)(x) = \prod_i (\Pi_x^{M^\circ} \tau_i)(x) = \prod_i (\Pi_x M^\circ \tau_i)(x) = (\Pi_x M^\circ \tau)(x)$$

A.2. Renormalised model

$$\begin{aligned}(\Pi_x^M \tau)(x) &= (\Pi_x^{M^\circ}(R\tau - \tau))(x) + (\Pi_x^{M^\circ} \tau)(x) \\ &= (\Pi_x M^\circ(R\tau - \tau))(x) + (\Pi_x M^\circ \tau)(x) = (\Pi_x M \tau)(x).\end{aligned}$$

□

Proposition A.2.7 is crucial for deriving the renormalised equation in many examples. Indeed, the reconstruction map \mathcal{R}^M associated to the model (Π^M, Γ^M) is given for every $\tau \in \mathcal{T}$ by:

$$(\mathcal{R}^M \tau)(x) = (\Pi_x^M \tau)(x) = (\Pi_x M \tau)(x)$$

because for every $\tau \in \mathcal{T}$, $\Pi_x \tau$ is a function. The result of proposition A.2.7 has just been checked on examples [Hai14b], [HP14] and [HQ15] but not in a general setting. In general for $y \neq x$, $(\Pi_x^M \tau)(y)$ is not necessarily equal to $(\Pi_x M \tau)(y)$ as mentioned in [Hai14b].

Appendix B

Generalised Taylor formula

The next generalised Taylor formula is useful for many proofs including the analytic bounds for a model and the convergence of the trees. This formula is taken from [Hai14b, proposition A.1]. We first introduce some notations by defining:

$$\mu_\ell(x, dy) = \mathbb{1}_{[0,x]}(y) \frac{(x-y)^{\ell-1}}{(\ell-1)!} dy, \quad \mu_\star(x, dy) = \delta_0(dy),$$

where for $\ell = 0$, we set $\mu_0(x, dy) = \delta_x(dy)$. For any $k \in \mathbb{N}^d$, we consider the kernel \mathcal{Q}^k given on \mathbb{R}^d by:

$$\mathcal{Q}^k(x, dy) = \prod_{i=1}^d \mu_i^{k_i}(x_i, dy_i),$$

where we defined

$$\mu_i^k(a, \cdot) = \begin{cases} \mu_{k_i}(z, \cdot), & \text{if } i \leq m(k), \\ \frac{z^{k_i}}{k_i!} \mu_\star(z, \cdot). \end{cases}$$

and

$$m(k) = \min\{j : k_j \neq 0\}.$$

One crucial property of these kernels is $\mu_i^k(z, \mathbb{R}) = \frac{z^{k_i}}{k_i!}$ which gives

$$\mathcal{Q}^k(x, \mathbb{R}^d) = \frac{x^k}{k!}.$$

Theorem B.0.8. *Let $A \subset \mathbb{N}^d$ such that for every $k \in A$, one has $k_{<} = \{\ell \neq k : \forall i \ell_i \leq k_i\}$. We define $\partial A = \{k \notin A : k - e_{m(k)} \in A\}$. Then for every smooth functions f on \mathbb{R}^d , it follows*

$$f(x) = \sum_{k \in A} \frac{D^k f(0)}{k!} x^k + \sum_{k \in \partial A} \int_{\mathbb{R}^d} D^k f(y) \mathcal{Q}^k(x, dy).$$

Bibliography

- [BB15] I. Bailleul and F. Bernicot. Heat semigroup and singular PDEs. *ArXiv e-prints*, January 2015.
- [BBF15] I. Bailleul, F. Bernicot, and D. Frey. Higher order paracontrolled calculus and 3d-PAM equation. *ArXiv e-prints*, June 2015.
- [BCD11] H. Bahouri, J.-Y. Chemin, and R. Danchin. *Fourier analysis and nonlinear partial differential equations, vol. 343 of Grundlehren der Mathematischen Wissenschaften [Fundamental Principles of Mathematical Sciences]*. Springer, Heidelberg, 2011.
- [BG97] L. Bertini and G. Giacomin. Stochastic Burgers and KPZ Equations from Particle Systems. *Communications in Mathematical Physics*, 183:571–607, 1997.
- [BK15] N. Berglund and C. Kuehn. Regularity structures and renormalisation of FitzHugh-Nagumo SPDEs in three space dimensions. *ArXiv e-prints*, April 2015.
- [Bro04] Ch. Brouder. Trees, renormalization and differential equations. *BIT Numerical Mathematics*, 44(3):425–438, 2004.
- [But72] J. C. Butcher. An algebraic theory of integration methods. *Math. Comp.*, 26:79–106, 1972.
- [CC13] R. Catellier and K. Chouk. Paracontrolled Distributions and the 3-dimensional Stochastic Quantization Equation. *ArXiv e-prints*, October 2013.
- [CEM11] D. Calaque, K. Ebrahimi-Fard, and D. Manchon. Two interacting Hopf algebras of trees: a Hopf-algebraic approach to composition and substitution of B-series. *Adv. in Appl. Math.*, 47(2):282–308, 2011.
- [CHV05] P. Chartier, E. Hairer, and G. Vilmart. A substitution law for B-series vector fields. *INRIA Report*, 5498:1–24, 2005.
- [CHV07] P. Chartier, E. Hairer, and G. Vilmart. Numerical integrators based on modified differential equations. *Math. Comp.*, 76(260):1941–1953 (electronic), 2007.

Bibliography

- [CHV10] P. Chartier, E. Hairer, and G. Vilmart. Algebraic structures of B-series. *Found. Comput. Math.*, 10(4):407–427, 2010.
- [CK98] A. Connes and D. Kreimer. Hopf algebras, renormalization and noncommutative geometry. *Comm. Math. Phys.*, 199(1):203–242, 1998.
- [CW15] A. Chandra and H. Weber. Stochastic PDEs, Regularity Structures, and Interacting Particle Systems. *ArXiv e-prints*, August 2015.
- [FH14] Peter K. Friz and M. Hairer. *A Course on Rough Paths*. Springer International Publishing, 2014.
- [Fun92] T. Funaki. A stochastic partial differential equation with values in a manifold. *J. Funct. Anal.*, 109:257–288, 1992.
- [GIP12] M. Gubinelli, P. Imkeller, and N. Perkowski. Paracontrolled distributions and singular PDEs. *ArXiv e-prints*, October 2012.
- [GP15a] M. Gubinelli and N. Perkowski. Energy solutions of KPZ are unique. *ArXiv e-prints*, August 2015.
- [GP15b] M. Gubinelli and N. Perkowski. KPZ reloaded. *ArXiv e-prints*, August 2015.
- [GP15c] M. Gubinelli and N. Perkowski. Lectures on singular stochastic PDEs. *ArXiv e-prints*, January 2015.
- [Gub04] M. Gubinelli. Controlling rough paths. *Journal of Functional Analysis*, 216(1):86 – 140, 2004.
- [Gub10] M. Gubinelli. Ramification of rough paths. *Journal of Differential Equations*, 248(4):693 – 721, 2010.
- [Hai11] M. Hairer. Rough stochastic PDEs. *Communications on Pure and Applied Mathematics*, 64(11):1547–1585, 2011.
- [Hai13] M. Hairer. Solving the KPZ equation. *Ann. Math. (2)*, 178(2):559–664, 2013.
- [Hai14a] M. Hairer. Introduction to Regularity Structures. *ArXiv e-prints*, January 2014. to appear in *Braz. J. Prob. Stat.*
- [Hai14b] M. Hairer. A theory of regularity structures. *Inventiones mathematicae*, pages 1–236, 2014.
- [Hai15] M. Hairer. Regularity structures and the dynamical Φ^4_3 model. *ArXiv e-prints*, August 2015.
- [HL15] M. Hairer and C. Labbé. Multiplicative stochastic heat equations on the whole space. *ArXiv e-prints*, April 2015.

-
- [Hos15] M. Hoshino. KPZ equation with fractional derivatives of white noise. *Preprint*, 2015.
- [HP14] M. Hairer and E. Pardoux. A Wong-Zakai theorem for stochastic PDEs. *arXiv:1409.3138*, 2014.
- [HQ15] M. Hairer and J. Quastel. A class of growth models rescaling to KPZ. *Preprint*, 2015.
- [HS14] M. Hairer and H. Shen. The dynamical sine-Gordon model. *ArXiv e-prints*, September 2014.
- [HS15] M. Hairer and H. Shen. A central limit theorem for the KPZ equation. *ArXiv e-prints*, July 2015.
- [HW13] M. Hairer and H. Weber. Rough burgers-like equations with multiplicative noise. *Probability Theory and Related Fields*, 155(1-2):71–126, 2013.
- [KPZ86] M. Kardar, G. Parisi, and Y.-C. Zhang. Dynamic scaling of growing interfaces. *Phys. Rev. Lett.*, 56(9):889–892, 1986.
- [KRT12] T. Krajewski, V. Rivasseau, and A. Tanasa. Combinatorial Hopf algebraic description of the multiscale renormalization in quantum field theory. *ArXiv e-prints*, November 2012.
- [Lyo91] T. Lyons. On the non-existence of path integrals. *Proceedings of the Royal Society of London. Series A: Mathematical and Physical Sciences*, 432(1885):281–290, 1991.
- [MW15] J.-C. Mourrat and H. Weber. Global well-posedness of the dynamic Φ^4 model in the plane. *ArXiv e-prints*, January 2015.
- [Nua05] D. Nualart. *The Malliavin Calculus and Related topics*. Springer-Verlag, 2005.
- [PZ14] G. Da Prato and J. Zabczyk. *Stochastic Equations in Infinite Dimensions*. Cambridge University Press, 2014.
- [Zei08] E. Zeidler. *Quantum Field Theory II: Quantum Electrodynamics: A Bridge between Mathematicians and Physicists*. Quantum Field Theory. Springer Berlin Heidelberg, 2008.
- [ZZ14] R. Zhu and X. Zhu. Three-dimensional Navier-Stokes equations driven by space-time white noise. *ArXiv e-prints*, May 2014.