



HAL
open science

Modelling the logisitcs response to disasters

Wanying Chen

► **To cite this version:**

Wanying Chen. Modelling the logisitcs response to disasters. Business administration. INSA de Lyon, 2015. English. NNT : 2015ISAL0046 . tel-01322876

HAL Id: tel-01322876

<https://theses.hal.science/tel-01322876v1>

Submitted on 28 May 2016

HAL is a multi-disciplinary open access archive for the deposit and dissemination of scientific research documents, whether they are published or not. The documents may come from teaching and research institutions in France or abroad, or from public or private research centers.

L'archive ouverte pluridisciplinaire **HAL**, est destinée au dépôt et à la diffusion de documents scientifiques de niveau recherche, publiés ou non, émanant des établissements d'enseignement et de recherche français ou étrangers, des laboratoires publics ou privés.

Thèse

Modelling the logisitcs of response to disasters

Outils et modèles pour l'organisation de réponses logistiques face
des situations de crises sanitaires

Présentée devant
L'institut national des sciences appliquées de Lyon

Pour obtenir
Le grade de docteur

Spécialité: Informatique
École doctorale : École Doctorale Informatique et Mathématique de
Lyon

Par
Wanying CHEN

Soutenue le 27 Mai 2015 devant le jury composé de:

M. Andrea Matta	Professeur, Shanghai Jiao Tong University	Rapporteur
M. Nico Vandaele	Professeur, KU Leuven	Rapporteur
Mme. Nadine Meskens	Professeur, Louvain School of Management	Examineur
Mme. Caroline Prodhon	Maître de Conférences, UTT de Troyes	Examineur
Mme. Valérie Botta-Genoulaz	Professeur, INSA de Lyon	Examineur
Mme. Annick Terrier	Hospices Civils de Lyon	Membre invité
M. Alain Guinet	Professeur, INSA de Lyon	Directeur
M. Angel Ruiz	Professeur, Université Laval	Co-directeur

Laboratoire Décision et Information pour les Systèmes de Production
INSA de Lyon - Bât. Léonard de Vinci
69621 Villeurbanne cedex - France

Acknowledgements

My deepest gratitude goes first and foremost to my supervisor, Prof. Alain Guinet, whose warm encouragement and considerate support not only benefited my Ph.D study but also helped me overcome one difficulty after another in both my study and my daily life and made me strong when I was far away from my family, studying in France. Without Prof. Alain's constant and thoughtful guidance, this thesis would not have been finished.

I am greatly indebted to my co-supervisor, Prof. Angel Ruiz who guided and helped me, especially when I was in Canada. I was moved by his patience, and enthusiasm. His optimistic attitude and creative thinking in research really inspired me during my PhD study and will certainly benefit my career in the future.

I wish to sincerely acknowledge Prof. Andrea Matta, Prof. Nico Vandaele, Prof. Nadine Meskens, Prof. Valérie Botta-Genoulaz, Dr. Caroline Prodhon and Dr. Annick Terrier for their kindness to become my thesis reviewers and examiners and for their time on constructive and meticulous assessment of this thesis.

My sincere thanks also go to all the members in the laboratories of DISP and CIRRELT. I enjoyed the great experience with them. They were very kind to me and always ready to help.

I would like to thank my parents, my grand-parents and other relatives, for the endless love and support. My thanks are extended to Ruixiao HU and Dr. Mingyuan JIU, who supported me a lot during my Ph.D. life.

Finally, I would like to thank the scholarship support from China Scholarship Council (CSC) and Rhône-Alpes Region.

Résumé

Cette thèse est consacrée à l'optimisation de la logistique sanitaire pour soutenir les plans de gestion de crise afin de réduire les effets des catastrophes naturelles et/ou humaines en termes de santé publique. Après avoir passé en revue la bibliographie existante, deux principales lacunes ont été relevées dans l'état de l'art. La première est que la plupart des recherches ne reposent pas sur des cas réalistes. La seconde est que des caractéristiques fortes des différentes catastrophes sont négligées lorsqu'elles sont étudiées. Par conséquent, sur la base de scénarios de cas réels définis par des praticiens hospitaliers (HCL), cette thèse investit différents types de catastrophes, naturelles et/ou d'origine humaine, séparément en considérant les caractéristiques des celles-ci.

Les catastrophes naturelles peuvent être prédites, mais elles sont difficiles à éviter. Par conséquent, la prise en charge des victimes potentielles et le dimensionnement des moyens logistiques de secours y afférent sont d'une importance cruciale. Une approche analytique en trois étapes est proposée afin d'étudier le dimensionnement des ressources et l'organisation des plans de gestion de crise (plan blanc) d'origine naturelle. La première étape propose un modèle de référence pour concevoir un plan de gestion de crise. La deuxième étape considère un modèle d'optimisation linéaire pour prédire le nombre de ressources nécessaires. La dernière étape présente un modèle dynamique pour simuler l'ensemble de l'organisation de manière fine. L'évacuation d'un hôpital dans le cadre d'un plan blanc étendu à plusieurs hôpitaux pour faire face à un tsunami fluvial a été considérée comme scénario pour évaluer la justesse de notre approche.

Les catastrophes d'origine humaine et la propagation des maladies peuvent donner lieu à des désastres de grande ampleur qui mobilisent de nombreuses ressources humaines et matérielles. Par exemple, un modèle de réponse logistique face à une attaque bioterroriste avec un agent non-contagieux ainsi qu'un modèle pour la réponse logistique aux épidémies ont été proposés. Elles traduisent un problème de gestion d'inventaire multi-échelons et multi-périodes. Ces deux modèles dynamiques de flux requièrent une optimisation linéaire et une optimisation non-linéaire respectivement. Ils intègrent les caractéristiques de la gestion de ces catastrophes : la propagation de l'infection ou de la maladie, les réponses médicales appropriées et le déploiement de la logistique associée. Avec ces deux modèles, le nombre de patients aux différents stades de la maladie et le nombre des ressources médicales nécessaires pour chaque période peuvent être calculés. Les facteurs qui influent sur le nombre de décès et l'efficacité des différentes politiques d'intervention médicale, peuvent également être évalués. Les deux modèles peuvent ainsi aider les décideurs à prévoir les conséquences de la situation en cas de catastrophe ainsi que de connaître les informations d'une réponse pertinente, ceci à un niveau stratégique. Une réponse logistique à une attaque bioterroriste anonyme à l'anthrax dans un centre commercial et une réponse logistique à une pandémie H5N1 sont pris comme scénarios pour tester l'efficacité des modèles correspondants.

Mots-Clés: Gestion de crises, Logistique sanitaires, Modélisation
Mathématique, Simulation, Défense

Abstract

This thesis is devoted to optimize the health care logistics which can support emergency management plans to reduce the impacts of natural and/or man-made disasters. After the review of relevant papers, two main gaps have been found in the current studies. One is that most of the researches are not based on real cases. The other is that some main characteristics of disasters are neglected when disasters are studied. Therefore, based on real case scenarios, the thesis studies different disasters (natural and/or man-made disasters) separately according to the characteristics of disasters.

Natural disasters may be predicted but are difficult to avoid. Therefore, the evacuation of potential victims and the dimensioning of relief resources are crucially important. A three-step approach is proposed to study the resource dimensioning and the organization of emergency management plan (French White Plan) facing natural disasters. In our three-step approach, the first step builds a framework model to get the insights of emergency management plan clearly. The second step establishes a global model (a linear model) to predict the quantity of required resources for evacuation. The third step proposes a detailed simulation model to reflect the real world more precisely. The hospital evacuation under the guidance of a French Extended White Plan in case of a flood has been taken as a real case scenario to test the correctness of our approach.

The man-made disasters and the outbreak of diseases can be large-scale disasters which require a high demand of resources. In this thesis, a model for logistics response to bioterrorist attack with a non-contagious agent and another model for the logistics response to epidemics have been proposed. Multi-period and multi-echelon inventory management problems have been studied. The two models (a linear model and a non linear model respectively) combine the main characteristics of disasters: the propagation of the disease, the relevant medical interventions and the logistics deployment together. The number of patients in different disease stages and the required medical resources for each period can be estimated. The factors affecting the number of deaths and the different medical intervention policies can also be evaluated with the two models. With the help of the models, the decision makers can get an idea of the disaster situation and the relevant medical responses from a strategy level. A logistics response to an anonymous bioterrorist attack with anthrax to a shopping center and the logistics response to the outbreak of H5N1 are taken as real case scenarios to test the effectiveness of the models respectively.

Keyword: Crisis management, Health care logistics, Mathematical modelling, Simulation, Defense

Table of Contents

1. INTRODUCTION	1
1.1 Context	1
1.2 Crisis management	5
1.3 Motivation and objectives.....	14
1.4 Research challenges.....	15
1.5 Contributions	16
2. STATE OF THE ARTS	19
2.1 Literature review of humanitarian logistics	19
2.2 Literature review of disease preventions and medical responses.....	28
2.3 Literature review of emergency management plans.....	40
2.4 Conclusions.....	44
3. NATURAL DISASTERS: MODELING AND SIMULATION OF A HOSPITAL EVACUATION BEFORE A FLOOD.....	47
3.1 Introduction.....	47
3.2 Problem description.....	50
3.3 Three-step approach	51
3.4 Numerical experiments	61
3.5 Conclusions.....	68
4. MAN-MADE DISASTERS: MODELING THE LOGISTICS RESPONSE TO A TERRORIST ATTACK WITH A NON-CONTAGIOUS AGENT	69
4.1 Introduction.....	70
4.2 Problem description.....	72
4.3 The anthrax response model and the mathematical formulations	79
4.4 Numerical experiments	90
4.5 Conclusion	101
5. OUTBREAK OF DISEASES: MODELING THE LOGISTICS RESPONSE TO A GENERAL INFECTIOUS DISEASES	103
5.1 Introduction.....	103
5.2 Problem description.....	105
5.3 The general infectious disease model and the mathematical formulations.....	107
5.4 Numerical experiments	113
5.5 Conclusions.....	118
6. CONCLUSIONS AND FUTURE WORKS.....	119
6.1 Conclusions of study literature reivews	119
6.2 Conclusions of the study of natural disasters	120
6.3 Conclusions of the study of man-made disasters.....	120
6.4 Conclusions of the study of the outbreak of diseases	121
6.5 Future works	122
REFERENCE	125
APPENDIX A: EVACUATION OF PATIENTS IN HOSPITAL LYON SUD	135

APPENDIX B: ARIS MODEL ABOUT A HOSPITAL EVACUATION BEFORE A FLOOD EVACUATION OF PATIENTS IN HOSPITAL LYON SUD.....	137
APPENDIX C: ARIS MODEL OF THE LOGISTICS RESPONSE TO A TERRORIST ATTACK WITH A NON-CONTAGIOUS AGENT.....	151

List of figures

Figure 1.1: Number of reported disasters and victims, 1990-2013	2
Figure 1.2: Number of natural disaster events, 1975-2000.....	4
Figure 1.3: Number of deaths, 1975-2000.....	4
Figure 1.4: Number of affected people, 1975-2000.....	4
Figure 1.5: Natural disasters classification	7
Figure 1.6: Disaster classification and their characteristics.....	8
Figure 1.7: Main activities during the disaster relief	9
Figure 1.8: Disaster management cycle	13
Figure 1.9: Research scope	15
Figure 2.1: Humanitarian logistics classification method	21
Figure 2.2: Humanitarian logistics future directions	27
Figure 2.3: SIR model.....	38
Figure 2.4: The classification method.....	41
Figure 3.1: Process of Hospital Saint-Joseph/Saint-Luc.	52
Figure 3.2: EPC of patient preparing.	53
Figure 3.3: EPC of stretcher control.	54
Figure 3.4: EPC of departure of non-autonomous patients.	55
Figure 3.5: EPC of evacuation of patients by ambulance.....	56
Figure 3.6: Evacuation preparation.....	60
Figure 3.7: Patients evacuation.....	61
Figure 3.8: SMORE plot (Simio LLC. 2006-2012).....	64
Figure 3.9: SMORE plots for each design point.....	66
Figure 4.1: Stages of the anthrax disease.....	73
Figure 4.2: Anthrax progression model with medical interventions.	73
Figure 4.3: The anthrax response phase.....	74
Figure 4.4: The global process of response to bio-terrorist anthrax under the guidance of PCT plan	75
Figure 4.5: Detect attack and start PCT plan.....	76
Figure 4.6: Medical intervention at ADCs.....	78
Figure 4.7: Anthrax progression model with medical interventions (dynamic)...81	
Figure 4.8: Anthrax progression model with medical interventions (with notations).	82
Figure 4.9: Number of patients in different stages.	92
Figure 4.10: The incubation and prodromal stage patients without the medical help or getting the medical help at the beginning of period t.	97
Figure 4.11: Number of the patients who need the oral antibiotics help in the different periods.....	98
Figure 4.12: The impact of the dispensing capacity.	99
Figure 4.13: The impact of the different detection abilities.	100
Figure 5.1: General infectious disease model.....	108
Figure 5.2: The impact of the change of the dispensing capacity and the number of the admission hospitals.	116

Figure 5.3: The impact of the change of the basic reproduction number.	116
Figure 5.4: Number of deaths and economical costs of different scenarios	117

List of tables

Table 1.1: Impacts of Natural Disasters, 2013.....	3
Table 1.2: Natural disaster subgroup definition and classification.....	7
Table 1.3: Comparison of business logistics and humanitarian logistics	9
Table 2.1: Classification of papers on facility location	22
Table 2.2: Classification of papers studying the inventory management	23
Table 2.3: Classification of papers studying the relief distribution	23
Table 2.4: The classification of the papers studying the evacuation	23
Table 2.5: The classification of the papers studying the integrated logistics contribution	25
Table 2.6: Characteristics of infectious diseases	32
Table 2.7: Characteristics of non- infectious diseases	33
Table 2.8: Papers studying mitigation and preparedness.....	41
Table 2.9: Papers studying response and recovery	43
Table 2.10: Integrated-stage Papers	43
Table 3.1: 2^k factorial experiment design.	63
Table 3.2: Sensitivity analysis.	66
Table 4.1: Mean time spent in each stage.....	92
Table 4.2: Number of patients in the different stages from period 1 to period 4. .	93
Table 4.3: The number of patients who have moved into the incubation stage in the different periods (si) and get medical help in the beginning period t (with a uniform recovery rate).	94
Table 4.4: The number of patients who have moved into incubation stage at the different periods (si) and get the medical help at the beginning period t (base case).	97

1. Introduction

This chapter first presents the background of crisis management, and then explains the grave consequence of disasters, the effect of emergency management plans in reducing the impact of disasters, and the important role of humanitarian logistics. Some important characteristics about disasters, humanitarian logistics and the emergency management plans are given in this chapter as well. Last, the problems of emergency management plans and humanitarian logistics, the challenges and the contributions of this thesis are presented. The detail structure of this chapter is as follows:

1.1 Context

- 1.1.1 The aftermath of disasters
- 1.1.2 The importance of emergency management plans
- 1.1.3 The significance role of humanitarian logistics

1.2 Crisis management

- 1.2.1 Disasters
- 1.2.2 Humanitarian logistics
- 1.2.3 Emergency management plan

1.3 Problematic

1.4 Research challenges

1.5 Contributions

1.1 Context

Disasters hit many parts of the world and cause the loss of life, property, and damage the economy and environment. To lessen the impacts of disasters, an emergency management plan should be made. The emergency management plan (disaster management plan) is the creation of plan through which communities reduce vulnerability to hazards and cope with disasters (Drabek, 1991). In most cases, the main objective of emergency management plans is to minimize the number of deaths. A successful disaster management plan depends on the humanitarian logistics (emergency logistics) to deliver necessary supplies and services to the affected area in time. Especially, when the logistics is for the indispensable medical interventions and/or medical supplies, an effective and efficient humanitarian logistics is crucially important to the disaster relief. Therefore, this thesis aims to optimize the logistics, precisely, logistics which delivers the medical resources and services, to decrease the number of the affected people. In the following sections, the backgrounds and characteristics about disasters, emergency management plans and humanitarian logistics will be presented.

1.1.1 The aftermath of disasters

Natural catastrophes and man-made disasters bring about heavy loss of life and property. According to the criteria formulated by Emergency Events Database, an event is regarded as disaster when one of the following criteria is met:

- Ten or more people reported killed
- Hundred or more people reported affected
- Declaration of a state of emergency
- Call for international assistance

Based on this selected criterion, Figure 1.1 (Guha-Sapir et al., 2014) presents the number of reported disasters and the number of victims from 1990 to 2013. From this figure, it can be found that, over 100 disasters happened and the number of victims (sum of deaths and total affected) is more than 60 millions. In 2013, there were 150 natural catastrophes and 158 man-made disasters. Almost 26 000 people died of these catastrophes. Economic losses caused by catastrophes worldwide were 140 billion USD and insurance losses amounted to USD 45 billion. Unfortunately, disaster events continue to generate increasing financial losses with ongoing economic development.

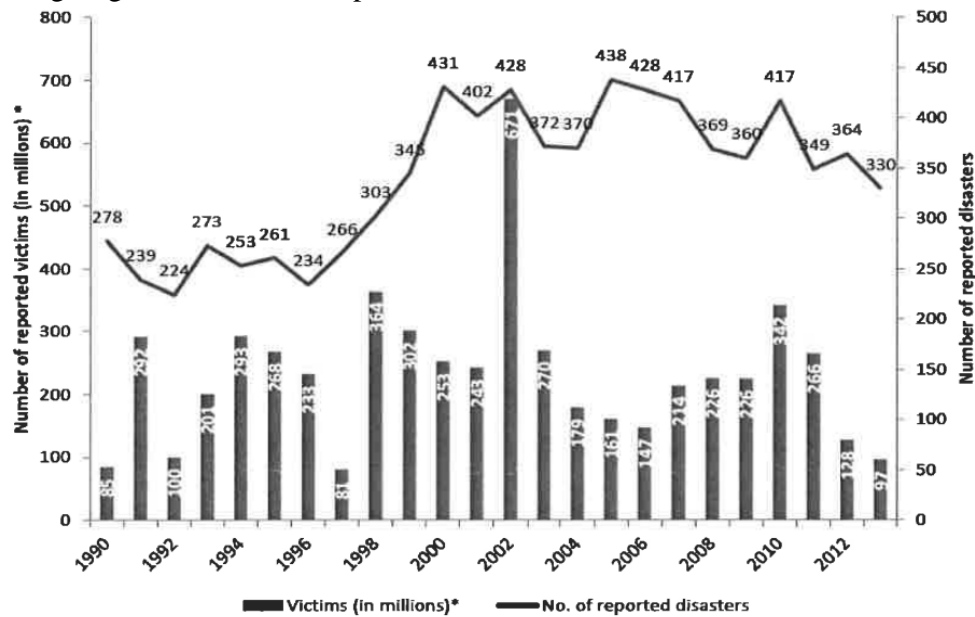

Figure 1.1: Number of reported disasters and victims, 1990-2013

With the development of science and technology, some disasters can be predicted and prevented while a lot of disasters are still inevitable. Table 1.1 (resource from International Disaster Database) provides the impacts of disasters sorted by disaster type. For example, the storm leads to the second largest percentage (39.1%) of deaths and the largest percentage of affected people (49.2%). In most of cases, it is impossible to prevent the storm even though it is possible to predict the storm.

Table 1.1: Impacts of Natural Disasters, 2013

<i>Disaster Type</i>	<i>Impact</i>							
	Occurrence (share in %)		Killed (share in %)		Affected (share in %)		Damage (US\$ million) (share in %)	
Drought	12	(3.3%)		(0.0%)	11,223,522	(11.2%)	2,547	(2.1%)
Earthquake	28	(7.8%)	1,120	(4.8%)	7,031,162	(7.0%)	9,075	(7.6%)
Epidemic	25	(6.9%)	922	(3.9%)	93,438	(0.1%)		(0.0%)
Extreme temperature	17	(4.7%)	2,142	(9.1%)	270,016	(0.3%)	1,000	(0.8%)
Flood	149	(41.3%)	9,823	(41.7%)	32,050,807	(32.1%)	53,175	(44.5%)
Mass movement	12	(3.3%)	281	(1.2%)	1,033	(0.0%)	8	(0.0%)
Storm	105	(29.1%)	9,215	(39.1%)	49,124,353	(49.2%)	52,492	(44.0%)
Volcano	3	(0.8%)		(0.0%)	105,106	(0.1%)		(0.0%)
Wildfire	10	(2.8%)	35	(0.1%)	8,831	(0.0%)	1,072	(0.9%)
Total	361	(100.0%)	23,538	(100.0%)	99,908,268	(100.0%)	119,369	(100.0%)

1.1.2 The importance of emergency management plans

In order to reduce the threats and the consequences of disasters, emergency management plans should be made. A disaster management plan or emergency management plan is the one through which related communities and organizations prevent the occurrence of the disasters or deal with the aftermath of disasters (Drabek, 1991). With the help of emergency management plan, the vulnerability to hazards can be coped with, the economical loss and the number of casualties can be reduced.

For example, based on Figure 1.2, Figure 1.3 and Figure 1.4 (Asian Disaster Reduction Center, 2006), from 1975 to 2000, Europe suffered from 13% of the natural disaster of the world and the number of deaths and affected people accounts for 1% of the deaths and affected people in the world. By contrast, Asia suffered from 38 % of the natural disasters of the world, accounted for 57% of deaths by natural disasters, and 88 % of the affected people in the world. One of the important reasons for this discrepancy is the lack of comprehensive emergency management plans in Asian countries, some of which are developing countries, while Europe consists of, mostly, developed countries and almost each of them has a comprehensive emergency management plans.

But one Asian country, Japan, is an exemplar, which often suffers a wide variety of natural disasters but benefits from comprehensive emergency management plans. According to the Guha-Sapir et al. (2014), in the past few years, Japan has always been on the list of “Top 10 countries by number of reported disaster events”. But, it has not been on the list of “Top 10 countries by number of victims”, the list of “Top 10 countries in terms of disaster mortality” and the list of “Top 10 countries by damages of disasters”. One of the main reasons why Japan, a multi-hazard country, has not been affected by natural disasters too much, is that Japan has comprehensive disaster management plans.

In short, having comprehensive emergency management plans is important and necessary to handle with the impact caused by disasters.

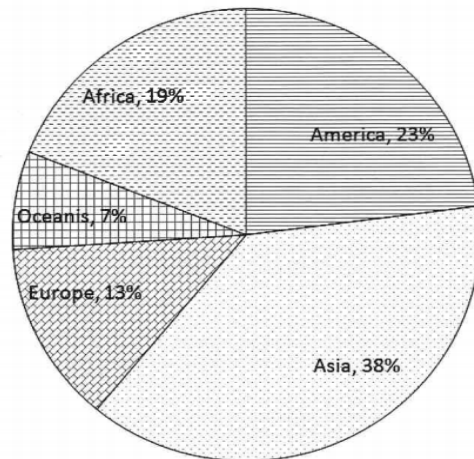

Figure 1.2: Number of natural disaster events, 1975-2000

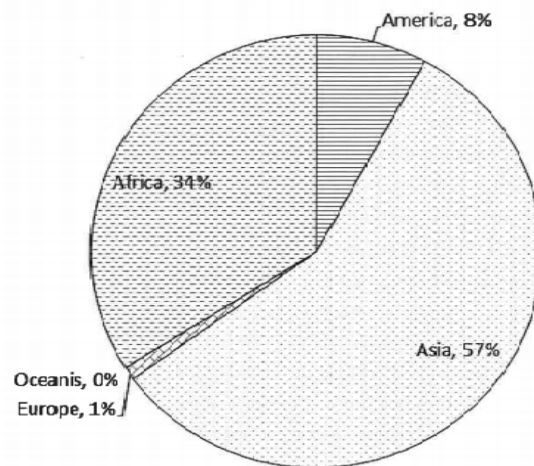

Figure 1.3: Number of deaths, 1975-2000

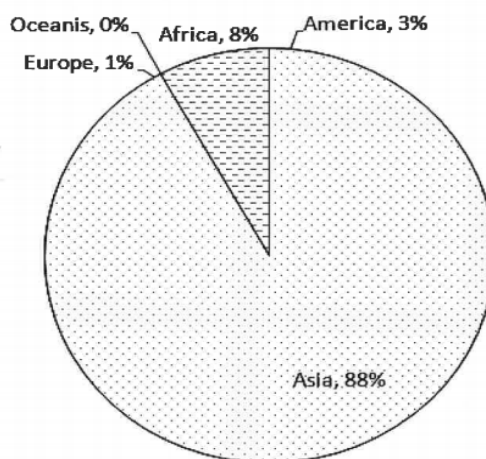

Figure 1.4: Number of affected people, 1975-2000

1.1.3 The significant role of humanitarian logistics

An effective emergency management plan needs the support of logistics. Worded differently, an emergency management plan can work well only when the right amount of material resources can be delivered in the right time, and the related actors cooperate with each other effectively and efficiently. The delivery of material resources and cooperation among actors require the optimization of logistics performance. Precisely, all material resources and the actors should be managed through an integrated approach efficiently and effectively to avoid the redundancy and maximize the efficiency. To sum up, “logistics is a part of any disaster relief that can mean the difference between a successful or failed operation” (Van Wassenhove, 2006). This kind of logistics is known as humanitarian logistics or emergency logistics. Briefly, a prudent and comprehensive humanitarian logistics, which can support the emergency management plan, is necessary and of paramount importance. Humanitarian logistics, as a branch of logistics, specializes in organizing the logistics activities before or after disasters. The Indian Ocean Tsunamis in 2004 increased awareness of the importance of humanitarian logistics because the tsunami provided evidence that the effectiveness of the emergency response plan hinged on logistics speed and efficiency logistics (Cozzolino, 2012).

In the following section, the conceptions about the disasters, humanitarian logistics and emergency management plans will be presented respectively.

1.2 Crisis management

1.2.1 Disasters

1) Definition

To make a definition of disaster is complicated. Though several attempts have been made to define disaster, arguments of these definitions always exist because they are either too general or too specific. A definition of disaster is extremely important because it decides in which case the event needs the guidance of emergency management plans and the support of the humanitarian logistics. Among several definitions, the definition, made by International Federation of Red Cross and Red Crescent Societies (IFRC), acquire the most agreement. IFRC defines that a disaster is a sudden, calamitous event that seriously disrupts the functioning of a community or society and causes human, material, and economic or environmental losses that exceed the community's or society's ability to cope with, using its own resources. In general, a disaster is an event which can bring about bad effects on the human life or economy and need the external assistance. Since the occurrence of one disaster is usually followed by another, namely, secondary disasters, the plural form of disasters is usually used instead of the single form.

2) Characteristics

According to the speed of occurrence, disasters can be classified into quick onset disaster and slow onset disaster. A quick onset disaster means that a disaster occurs suddenly, such as earthquakes. A slow onset disaster refers to a disaster which occurs over a period of time, such as famines. According to causes, the disaster is divided into natural disaster or man-made disaster (human disaster or technological disaster).

Natural disasters are natural events caused either by rapid or slow onset events, which can be geophysical, hydrological, climatological, meteorological or biological (IFRC). Most natural disasters are quick onset disasters. IFRC divided the natural disaster into 5 sub-groups (Table 1.2), which cover more than 30 sub-types (Figure 1.5). At present, it is difficult but possible to predict the occurrence of natural disasters. However, to avoid the happening of natural disasters, such as earthquake, still has a long way to go.

Technological or man-made disasters are events that are caused by human beings and occur in or close to human settlements. Man-made disasters include industrial accidents, such as Halifax explosion (Scanlon, 1998), release of hazardous materials, like Bhopal gas release (Sriramachari, 2004), the collapse of buildings, like Savar building collapse (Manik et al., 2013) and so on. Most of the man-made disasters are unpredictable, such as the anonymous bioterrorist attack.

But it is difficult to know what causes the occurrence of diseases. In other words, it is often difficult to determine if the outbreak of diseases is triggered by man-made reason or natural reason. For example, the cause of the outbreak of swine flu in Northern Ireland in 2009 is controversial. Some researchers believe that it is a man-made disaster because virus of swine flu is a combination of 3 different flu strains from human beings, pigs and birds, which would be highly unlikely to occur in nature. However, the proof of that the swine is a man-made disaster is insufficient. Therefore, the outbreak of diseases is regarded as a kind of special disaster in our thesis.

Figure 1.6 presets the classification of different types of disasters and their characteristics. It should be stressed that the characteristics mentioned in Figure 1.6 are suitable for the general situation but not for all types of disasters. As disasters are of various types, it is necessary to make different disaster management plans for different disasters, taking the different characteristics of every disaster into account.

1.2.2 Humanitarian logistics

1) Definition

In order to explain clearly the important role that the humanitarian logistics plays in the emergency management plan, the conceptions of humanitarian logistics are presented first, and then the characteristics of emergency management plan are given. The logistics accounts for 80 % of disaster relief.

Table 1.2: Natural disaster subgroup definition and classification

Disaster Subgroup	Definition	Disaster Main Types
Geophysical	Events originating from solid earth	Earthquake, Volcano, Mass Movement (dry)
Meteorological	Events caused by short-lived atmospheric processes	Storm
Hydrological	Events caused by deviations in the normal water cycle and/or overflow of water caused by wind set-up	Flood, Mass Movement (wet)
Climatological	Events caused by long-lived processes (in the spectrum from intra-seasonal to multi-decadal climate variability)	Extreme Temperature, Drought, Wildfire
Biological	Disaster caused by the exposure of living, organisms to germs and toxic substances	Epidemic, Insect Infestation, Animal Stampede

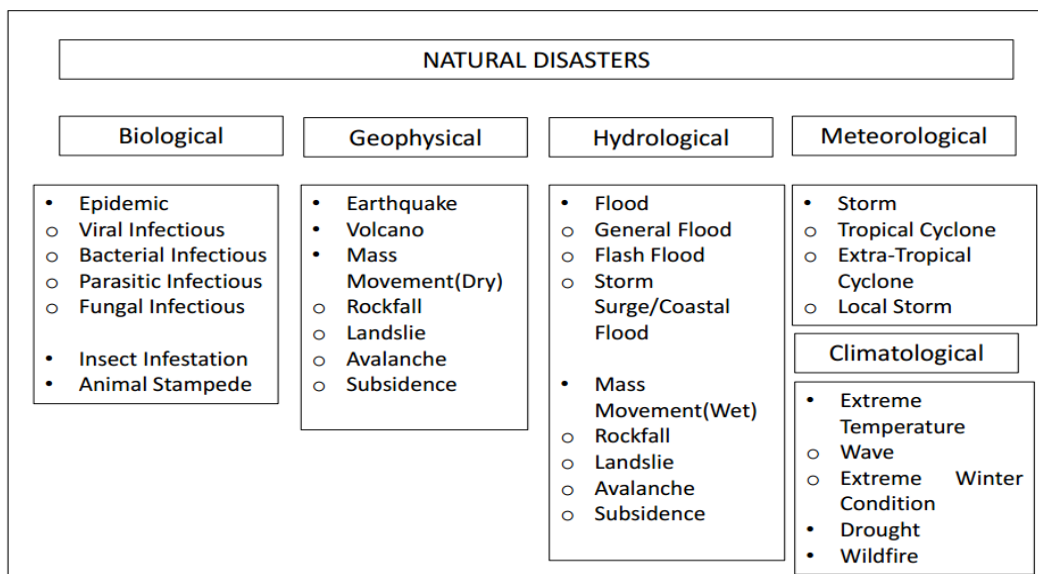
**Figure 1.5:** Natural disasters classification

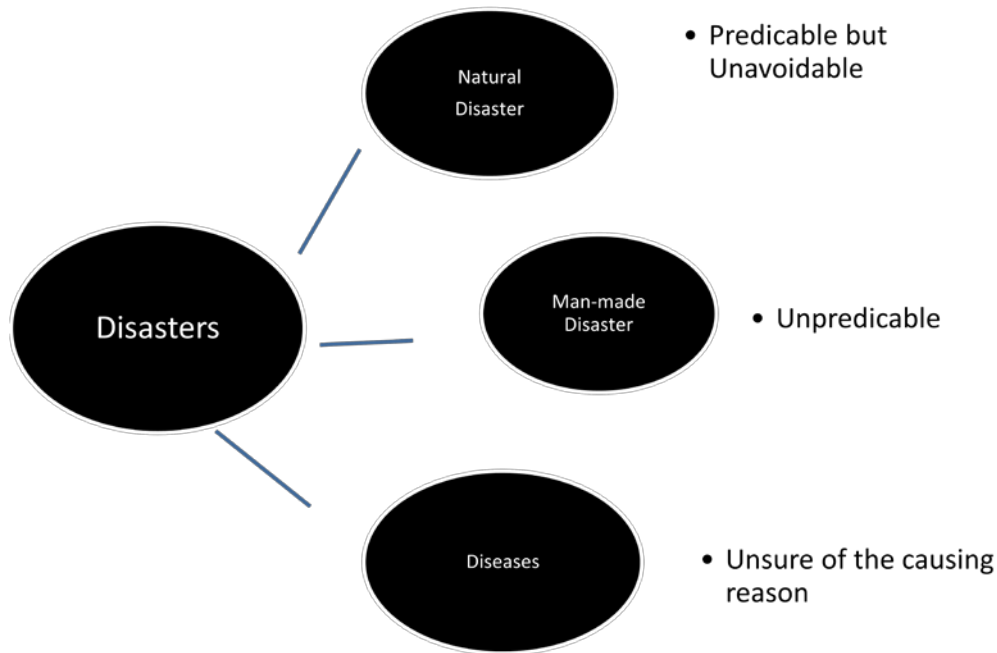

Figure 1.6: Disaster classification and their characteristics

Therefore, the only way to achieve disaster relief is through flexible, efficient and effective logistics operations and more precisely, humanitarian logistics (Van Wassenhove, 2006). A humanitarian logistics is a process of planning, managing and controlling the flows and storages of relief, information and services, from the points of origin to the points of destination for the purpose of alleviating the suffering of people. Van Wassenhove (2006) defines humanitarian logistics as processes and systems to integrate actors and resources to help people affected by disasters.

Before a disaster occurrence, the crisis managers may choose the relief distribution centers and then pre-stock the possible demanded relief in the distribution centers. If the disaster is predictable, the people will be evacuated to the safety places. After the occurrence of disaster, the people should be transported to the safe places and the relief should be dispensed to the affected people as soon as possible. But sometimes, the affected people can go to the distribution center to ask for the relief themselves. For example, after the occurrence of epidemics, the patients can go the distribution centers to ask for the antibiotics. To satisfy the high demands of relief, some makeshift relief distribution centers may be opened. To sum up, the main activities of the humanitarian logistics include facility location, inventory management, relief distribution and affected people evacuation (Figure 1.7). Figure 1.7 presents these main activities. The arrows in Figure 1.7 from the disasters sites to the distribution centers refer that sometimes the affected people can go to the distribution centers to demand the relief.

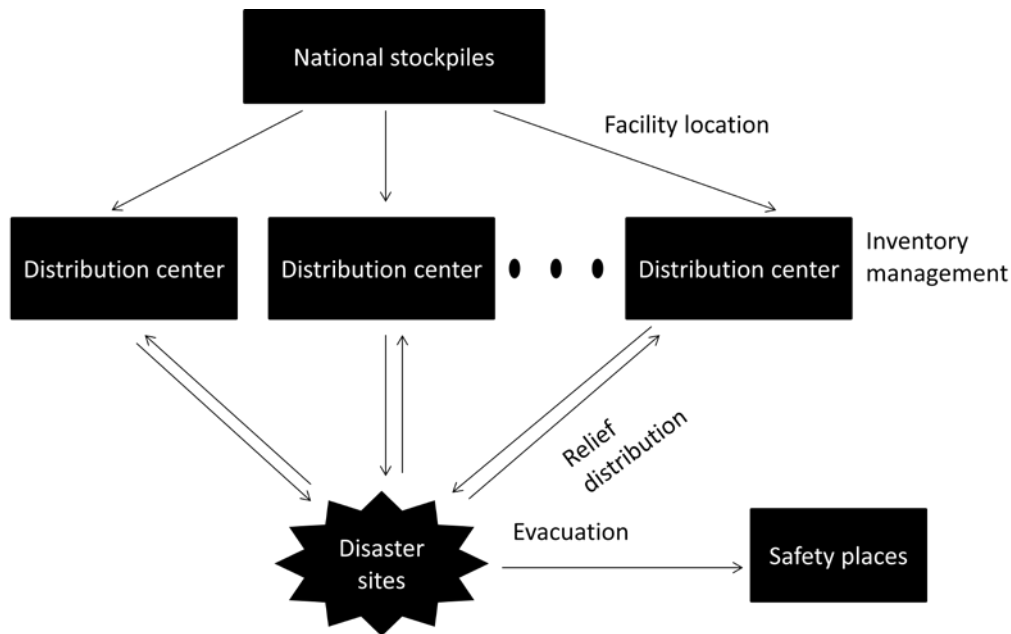

Figure 1.7: Main activities during the disaster relief

2) Characteristics

Since the humanitarian logistics accounts for 80% of disaster relief, it is of course the most expensive part during the disaster relief (Cozzolino, 2012). According to Christopher and Tatham (2011), the overall annual expenditure of aid agencies is about \$20 billion and the logistic spending is around \$15 billion. As a result, it is necessary to optimize the humanitarian logistics with the aim of minimizing the human suffering and economic costs. But if these two objectives conflict, minimizing the human suffering is more important than economical costs in most cases, which is different from most of the business logistics.

The differences between the business logistics and humanitarian logistics have been shown in Table 1.3 (Ertem et al., 2010).

Table 1.3: Comparison of business logistics and humanitarian logistics

Topic	Business Logistics	Humanitarian Logistics
Main objective	Profit maximization	Life rescue
Demand pattern	Fairly stable	Irregular
Supply pattern	Mostly predictable	Unpredictable
Flow type	Commercial products	Resources like vehicles, shelters, food, drugs
Lead time	Mostly predetermined	Unpredictable
Inventory control	Safety stocks	Uncontrolled

From Table 1.3, it can be found that the unpredictability and uncertainty are the most important characteristics of humanitarian logistics. These

characteristics lead to four key challenges of humanitarian logistics (Balcik et a, 2008) (Caunhye et al.,2012):

- Additional uncertainties
The uncertainties include two main parts, stochastic situation and insufficient information.
- Complex communication and coordination
After the disaster, communication systems may be damaged, which will be the barrier of the coordination among the actors and lead to the inaccessibility or inaccuracy of real-time information.
- Hard-to-achieve efficient and timely delivery
The unsafe and unusable transportation after the disaster makes it difficult to deliver the relief to victims even though the stockpile is enough.
- Limited resources often overwhelmed by the scale of the situation
The sudden occurrence of large-scale disasters make it difficult to dispense the resource because the stockpile or the dispensing capacity is not enough.

Therefore, it would be useful to optimize the humanitarian logistics to provide a better support for the emergency management plans taking into account the challenges of humanitarian logistics and characteristics of different disasters.

3) Stakeholders

Humanitarian logistics involves multiple stakeholders, who may have different purposes, interests and capacities (Balcik et al., 2008). Main stakeholders can be categorized as follows: governments, military, aid agencies, donors, non-governmental organizations (NGOs), logistics companies and other companies (Kovács and Spens, 2007; Kaatrud et al., 2003). The functions and responsibilities of each stakeholder are as follows:

- Governments

Governments are activators of humanitarian logistics after disasters since they have the power to authorize operations and mobilize resources. Without the government authorization, no other stakeholders can operate in the disaster relief.

- Military

On many occasions, the military provide primary assistance thanks to their high logistic capabilities.

- Aid agencies

Aid agencies are actors through which governments are able to alleviate the aftermaths caused by disasters.

- Donors

Donors give financial aids to fund relief.

- NGOs

NGOs are organizations which are neither a part of a government nor a conventional for-profit business. They are always influential players and can give local help.

- Logistics companies

Logistics companies play a more and more important role in humanitarian logistics. They provide excellent contributors at each stage of a disaster-relief operation.

- Other companies

Other companies always play a role of donors, collectors and providers at the same time. As a donor, a company can fund humanitarian logistics. As a collector, a company can gather financial aid from its customers and its employees to fund operations. As a provider, a company can offer its goods and services.

1.2.3 Emergency management plan

1) Definition

An emergency management plan (disaster management plan) aims to estimate the risks of disasters, prepare activities which mitigate the consequences of predictable hazards, protect populations and property, and reconstruct the damaged places caused by disasters (IFRC). According to Emergency Management Framework of Canada, the management of emergencies concerns all hazards and risk management measures which can reduce the vulnerability to hazards.

2) Characteristics

Blanchard et al. (2007) proposed eight principles to guide the establishment of emergency management plans. The summary provided below lists the eight principles and a brief description of each principle:

- Comprehensive
All hazards, all phases, all stakeholders and all impacts relevant to disasters should be taken into account.
- Progressive
Emergency managers anticipate future disasters and take preventive and preparatory measures to build disaster-resistant and disaster-resilient communities.
- Risk-driven
Emergency managers use the principles of emergency management plans to decide how the available resources can be used reasonably and effectively.
- Integrated
Emergency managers organize the concerted efforts of different departments and organizations.
- Collaborative
Emergency managers should inspire trust among the team member, build a good team atmosphere, and make the communication easier and so on. All these factors have a positive impact on the effective collaboration.
- Coordinated
To accomplish a common purpose, the activities of all relevant stakeholders should be organized and synchronized by emergency managers effectively.
- Flexible

Emergency managers can deal with difficult problems with different methods according to the specific situation.

- Professional

To evaluate the emergency management plans, several approaches can be used. These approaches should be integrated and consider the following factors, education, training, experience and continuous improvement possibility.

Even though disagreements exist for the division of phases of the disaster management plan, most of the researchers concur the following four phases: mitigation, preparedness, response, and recovery or reconstruction (Altay and Walter, 2006). They constitute the “Disaster management cycle” (Figure 1.8). The activities in the mitigation and preparedness are the pre-disaster activities. And the activities in the response and recovery are the post-disaster activities. The explanation of these four phases and the typical activities involved in each of these four stages are as follows:

- Mitigation

Mitigation phase serves the purpose to minimize the number of casualties and reduce the loss of property when the disaster really occurs. Though the management of national stockpile, the organization of logistics, the resource prediction and so on belong to the mitigation phase. The mitigation phase concerns mostly laws and policies to be taken to prevent the disaster. Therefore, the phase involves the government policies and laws more than the direct participation of logisticians (Cozzolino, 2012).

- Preparedness

Preparedness gets all relevant stakeholders ready for the disaster. The details of the emergency management plans are completed in this phase. The necessary capabilities will be built up in this phase. According to Paul (2008), preparedness measures include: communication plans, maintenance and training of emergency services, development and exercise of emergency population, warning methods combined with emergency shelters and evacuation plans, stockpiling, streamline foods supplies, and other disaster supplies.

- Response

Response includes the arrangement of resources and emergency working procedures according to the emergency management plans to protect the life, property, and environment.

- Recovery or reconstruction

The main objective of this phase is to restore and reconstruct the affected area after disasters. All the efforts which can restore the affected area to its normal state are included in this phase, such as reconstruct of the building and re-employment of the workers.

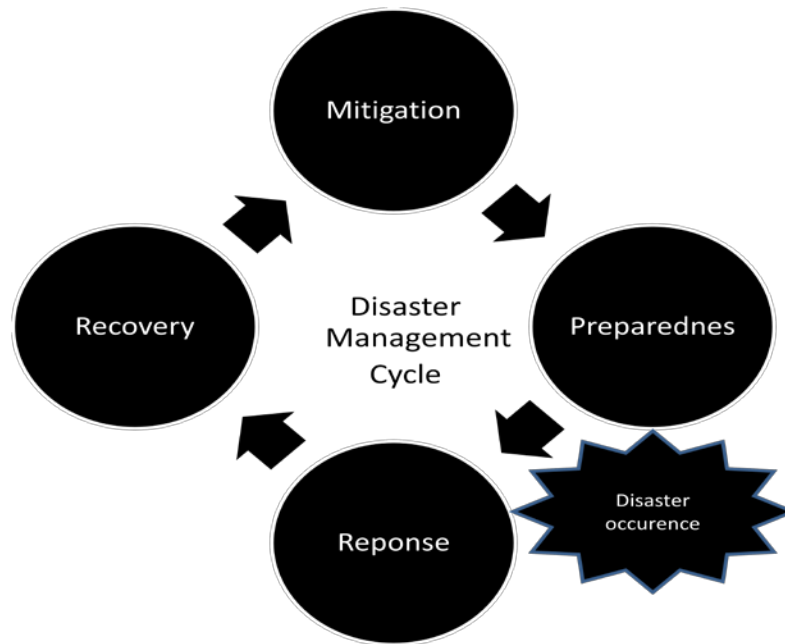

Figure 1.8: Disaster management cycle

Since the mitigation phase does not focus on the humanitarian logistics too much, IFRC proposes another way to divide the disaster management based on the relationship between humanitarian logistics and disasters. In this division method, the emergency management plan is divided into three phases, preparedness, response and recovery. All of these phases need the support of humanitarian logistics to reduce the risk of disaster.

The explanation of these three phases, more from a point of humanitarian logistics, is following:

- Preparedness
Disaster preparedness refers to all the activities which can be conducted to establish an effective supply chain to support the activities during the disaster response.
- Response
The response aims to deliver the goods to the largest possible number of the affected people. In this phase, the coordination and collaboration among all the actors involved in the disaster relief deserve particular attention (Balcik et al., 2008).
- Recovery
Recovery refers to those logistics activities which go beyond the provision of immediate relief to assist those who have suffered from a disaster. This phase aims to rebuild the homes and lives of suffers, reconstruct the services of organizations, and to strengthen the response capacity to cope with future disasters.

Since the mitigation does not focus on the humanitarian logistics too much and the recovery is a long-term activity which does not require a quick humanitarian logistics support, the preparedness and the response will be our main research focus.

1.3 Motivation and objectives

As mentioned before, this thesis aims to optimize the logistics, precisely, logistics which delivers the medical resources and services, to decrease the number of affected people. According to the literature review of the current studies (which will be detailed in Chapter 2), there are two main gaps in the current researches. One is that most of the researches are not based on real cases. The other is that some main characteristics of disasters have not drawn enough attention. Therefore, the scope of our research is limited to the main logistic-related activities based on the types of disasters (Figure 1.9).

Since the natural disaster can be predicted but is difficult to prevent in most of the cases, the evacuation in the event of natural disasters should be studied. Hospital evacuation is different from other kinds of evacuation, which needs cooperation among different departments to take care of the patients. Therefore, hospital evacuation in case of a predictable flood under the guidance of French Extended White Plan (emergency management plan), as a real case scenario, is studied in this thesis.

The main objectives in this part are:

- To present clearly the stakeholders, the processes of evacuation and the cooperation among the different departments so as to help the decision makers to get the insight of current situation.
- To dimension the necessary resources during the evacuation based on the experience of health workers.
- To model the emergency management plan exactly and propose the improvement methods with the model

Besides, the man-made disasters and the outbreak of diseases, which can be of a large scale disasters, have a high demand for resources, especially for medical resources, in a short time. Therefore, taking the logistics response to a bioterrorist attack with anthrax agent and the logistics response to infectious disease, as real case scenarios, this thesis will study the inventory management and relief distribution to target the following objectives:

- To present a model which can help the decision makers to find out the threshold of minimizing the number of deaths among the factors like the dispensing capacity of each distribution center or the stockpile of national stock.
- To dimension a model which can help the decision makers to decide how to distribute the limited resource reasonably to minimize the number of deaths.
- To present a model that can help the decision makers to get an idea how the main characteristics of disasters (the development of diseases) affect the number of deaths.

It should be stressed here that the purpose of this thesis is not to address all the questions related to the design and management of the logistics, but to assess the potential and the generality of the approach proposed by this thesis. Even though specific cases are studied in this thesis, the models proposed by our model can be used in various scenarios..

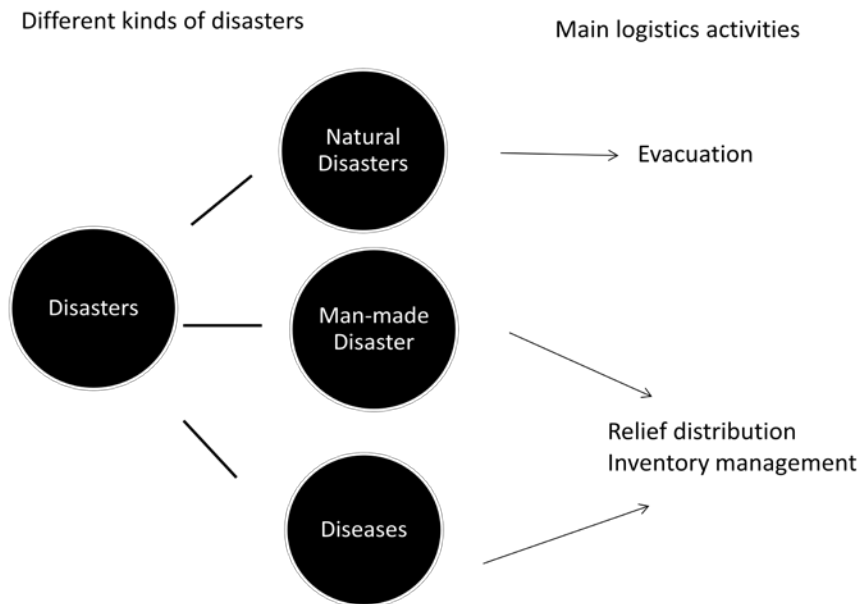

Figure 1.9: Research scope

1.4 Research challenges

The main research challenges of this thesis include the following:

- From a view of disasters
 - ❖ In order to help the decision makers to find out the total quantities of needed resources during the disaster response, it is necessary to know the magnitude of disasters and the number of people who need the help. How to get the information about the magnitude of disasters? How to predict the number of people who need the help? Which method to be used to predict the information precisely?
 - ❖ How can we help the decision makers to find out the amount of resources needed for each period, the development of disaster and the number of people who need the medical help for each period?
 - ❖ Different disasters have different characteristics. How should we present different disasters? Which method is suitable to present which kind of disasters? Which characteristics should be taken into account and which should be neglected when we predict the magnitude of disasters? Which characteristics will affect the number of deaths caused by disasters?
- From a view of emergency management plans
 - ❖ How can the decision makers be helped to get the insight of the current emergency management plans? Which method can be

- used to show the emergency management plans effectively or efficiently?
- ❖ How to present the different processes or activities of the emergency management plans? Is it necessary to present all the processes and activities for the decision makers to make reasonable decisions?
 - ❖ If the emergency management plans involve several actors, how to show clearly the cooperation among the different actors? How to present the information transmission among the different actors?
 - ❖ How should we integrate the development of disasters, the disaster management plans, and the humanitarian logistics together? What factors or parameters should be taken into account when we connect these three parts?
- From a view of data
 - ❖ One of the main characteristics of disasters, emergency management plans or humanitarian logistics is that a lot of information is uncertain or unknown. Therefore, how can we get the real values of these different parameters?
 - ❖ If we cannot get the real values of different data, which method can be used to solve this problem?
 - How to solve the problem?
 - ❖ If it is a large-scale disaster and there are a lot of causalities, how to solve a large-scale problem? Which method or optimizer can be adopted to solve the problem?
 - ❖ If it is modeled as a non-linear problem (disease propagation among people), how to solve the high non-linear problems?

1.5 Contributions

This thesis investigates three base cases. Based on the stage of the art and taking account of the fact that different types of disasters need different emergency management plans, our work first studies the emergency management plans for natural disasters. Second, the logistics response to human-made disasters is researched. Third, logistics response to the outbreak of diseases, which can be caused by nature factors or human-made factors, is studied. One of the reasons why the outbreak of diseases is studied here, is that the propagation of diseases can be presented based on the principle of the SIR model. A special mathematical model integrated this latter. It is hoped that the study of the outbreak of diseases can enlighten the research of other disasters: to respond the different disasters inspired by different mathematical models.

- The state of the art has the following contributions:
 - ❖ A literature review classified the papers in the field of humanitarian logistics, disease prevention and control plans, and emergency management plans respectively.

- ❖ It analyzed the selected papers according to the research contents and the used methodology.
 - ❖ The current research gaps have been found and future directions have been proposed.
 - ❖ The first part of literature review has been published in the ILS 2014, "Information Systems, Logistics and Supply Chain Conference", in Castle of Breda (Netherlands). The second part of literature review will be published in HCSE 2015, "Second International Conference on Health Care System Engineering", in Lyon (France).
- For the natural disaster, with the aim to optimize the resource dimensioning and to minimize the needed evacuation time, we use the hospital evacuation as an exemplar to propose a general approach which can be used to specify the emergency management plans. This part has made the following scientific contributions:
 - ❖ A three-step approach has been proposed to improve the emergency management plans. It consists of three different models, which are used in sequence to define a top-down approach, ensures the reliability of our improvement methods.
 - ❖ The quantitative approach guarantees the reliability of the result and the feasibility of the whole process.
 - ❖ The hospital evacuation is taken as an example to test the correctness of our proposed approach. Since the research of hospital evacuation is limited, it is hoped that this example can inspire other authors.
 - ❖ The model and the simulation are based on a real scenario. Therefore the model is well suited to the hospital's practices.
 - ❖ All the cooperations among different departments during the evacuation are taken into consideration, which is often ignored by other researches.
 - ❖ This part has been published in Operations Research for Health Care. DOI: 10.1016/j.orhc.2015.02.001.
 - For the logistics response to man-made disaster, we proposed a model which studied the bioterrorist attack events with Anthrax. For the outbreak of diseases, a general model which can be used to general communicable diseases has been proposed. The two models have made the following scientific contributions:
 - ❖ To combine the progress of the non-infectious and infectious diseases, the medical response modes, and the logistic deployment choices.
 - ❖ To take into account the different medical responses to people in different disease stages and the different medical response results.
 - ❖ To predict the different antibiotics, antiviral drugs and vaccines inventory requirement in any given period.
 - ❖ To predict the number of the patients in different disease

stages.

- ❖ To optimize the resources for the best response.
- ❖ The paper about the man-made disaster has been submitted for the European Journal of Operational Research and is under review. The study about the outbreak of disease will be published in INCOM 2015, "IFAC Symposium on Information Control in Manufacturing", in Ottawa (Canada).

2. State of the arts

This chapter reviews the relevant papers in humanitarian logistics and emergency management plans, and proposes the directions for future researches. In order to explain clearly how the logistics supports the different phases of an emergency management plan, the articles about the humanitarian logistics are reviewed first, and then the papers about the emergency management plans are analyzed. In Section 2.1, papers about the humanitarian logistics are examined. The outbreak of large-scale diseases is a special disaster because it can be caused both by natural factors and man-made factors. So, Section 2.2 critically reviews literatures focusing on disease prevention and control plans. Since the understanding of articles about diseases prevention and control plans requires some basic but important knowledge about diseases, Section 2.2 first explains the characteristics about diseases, and then reviews and analyzes the selected papers. The articles about the emergency plans are studied in the Section 2.3. Section 2.4 draws the conclusions and gives the research road map based on the review. The detailed structure of this chapter is in the following:

2.1 Literature review of humanitarian logistics

- 2.1.1 Scope of the review and the literature review methodology
- 2.1.2 The literature classification and analysis
- 2.1.3 Discussions and future directions

2.2 Literature review of disease preventions and control plans

- 2.2.1 Introduction
- 2.2.2 Related conceptions
- 2.2.3 Discussions and future directions

2.3 Literature review of emergency management plans

- 2.3.1 Scope of the review and the literature review methodology
- 2.3.2 The literature classification and analysis
- 2.3.3 Discussions and future directions

2.4 Conclusions

2.1 Literature review of humanitarian logistics

Even though the importance of humanitarian logistics has arrested the attention of researchers, not so many review papers have been published yet. But there are still two interesting literature reviews about the humanitarian logistics. Caunhye et al. (2012) reviewed the papers which study the emergency logistics and adopted optimization models. De la Torre et al. (2012) focused on vehicles routing problems within disaster-affected regions. However, until now, no paper has reviewed different methodologies, associated with different disasters and different humanitarian logistics contributions systematically. To fill this gap, this chapter classifies and analyzes existing relevant articles from the three

parts: humanitarian logistics, diseases prevention and control plans and emergency management plans.

2.1.1 Scope of the review and the literature review methodology

The scope of the review to be searched is limited in the sudden-onset disaster, like an earthquake, rather than the slow-onset disaster, such as a famine. Because the logistics in the slow-onset disaster does not need such a quick response as the sudden-onset and the uncertain demands of the slow-onset disaster are not as strong as the sudden-onset disaster, the decision makers can adopt the methodologies which have been used in the business logistics to deal with the problem of the slow-onset disaster. We focus on the publications from 2002 to 2012, while some typical and important articles published before 2002 will be analyzed as well. Two groups of keywords have been chosen to select the articles: Group 1: disaster, catastrophe, emergency, extreme events; Group 2: humanitarian logistics, humanitarian supply chain, emergency logistics, humanitarian aid, humanitarian assistance, humanitarian relief, humanitarian relief logistics, disaster relief, relief chain, relief logistic. As our review covers several disciplines, two multi-disciplinary databases are chosen: Elsevier and Springer. From a view of the engineering, we used the Taylor & Francis, IEEE Xplore.

According to our objective, the articles are classified using three perspectives or levels (Figure 2.1). At the first level, the papers are classified based on their logistics orientation. The detailed information about the different logistics orientations will be given in the following section. At the second level, the papers are classified according to the types of disaster: natural, man-made and integrated. The disaster is said integrated if the authors do not specify the type of disaster in the literature. At the last level, the methodologies for solving the problem are studied. This three-level classification approach can help us synthesize and classify the papers clearly. To analyze the articles, we opted the directed content analysis, which includes two main parts: categorization of research and categorization of literature. The former tries to find the content to be analyzed while the latter is devoted to finding the methodologies and theories to be used in the literature.

2.1.2 The literature classification and analysis

In this section, the papers will be classified and analyzed according to the three-level classification methodology introduced in Section 2.1.1. After a disaster, the relief will be distributed from the national strategic stockpiles to the local distribution centers. Then the relief in the local distribution centers will be dispensed to the beneficiaries. The beneficiaries can also go to the distribution centers themselves to get the relief. The evacuation will be carried out if necessary. So the most important humanitarian logistics subjects are facility location, inventory management, relief distribution and people evacuation. In the following section, the literatures will be classified according to the different

humanitarian logistics contributions embedded with different types of disasters and used methodologies.

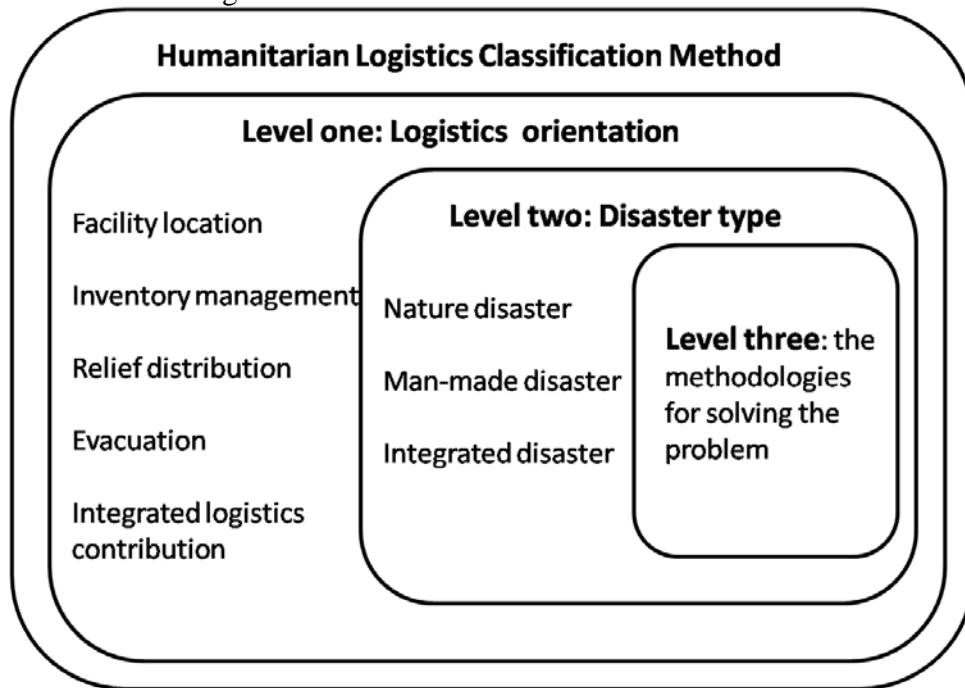

Figure 2.1: Humanitarian logistics classification method

1) Facility location

A facility location problem mainly deals with the choice of a subset of sites, among a set of potential ones, which will act as a depot in the logistic network. Table 2.1 classifies the papers studying the facility location in humanitarian relief. Based on Table 2.1, mathematical programming is the most popular method to deal with the facility location problem. Most of these mathematical models are single-period models and they are used for pre-disaster planning. Moreover, static data are commonly considered since the models are used for the strategy level decision. Jia et al. (2007a) proposed a general facility location model that can be casted as a maximal covering model (Jia et al. (2007b), Dessouky et al. (2006), Murali et al. (2012), Tricoire et al. (2012)), a p-median model (Xi et al. (2013)) or a p-center model (Huang et al (2010)). Among different mathematical models, the maximal covering model is the most widespread optimization model in humanitarian logistics, because its objective function coincides with the main goal of humanitarian logistics. The objective of maximal covering model is to maximize the covered demands with a fixed number of facilities. In most of the cases, the model uses integer programming. A binary location decision variable (Alsalloum and Rand (2006)) is always used in the maximal covering model to decide whether the existing point will be chosen or not. As it is a NP problem, it requires heuristic approach to find a solution efficiently. Doemer et al. (2005) focused on two efficient metaheuristic solution approaches: tabu search and ant colony optimization. Some researchers combined the mathematical model with other methods to capture more realistic

features of the problem. Sorensen and Church (2010) employed simulation to validate the results produced by solving the maximal covering model. Some researchers combined the maximal covering model with queuing theory (Galvao et al., 2005; McLay, L.A., 2009; Takeda et al., 2007). Other methods have also been applied to this field. Berman and Gavious (2002) used game theory to study the relationship between two opponents, the state and the terrorist. Whitworth (2006) used simulation to study the people flow on the facility location.

Table 2.1: Classification of papers on facility location

	Mathematical programming	Game theory	Simulation	Queuing theory
Integrated	Jia et al. (2007a) Sorensen and Church (2010) Galvao et al. (2005) Dessouky et al. (2006), Takeda et al. (2007), Alsalloum and Rand (2006) Doemer et al. (2005) Xi et al. (2013)	—	Sorensen and Church (2010)	Galvao et al. (2005) McLay, L.A. (2009) Takeda et al. (2007)).
Man-made	Jia et al. (2007b) Murali et al. (2012) Huang et al. (2010)	Berman and Gavious (2002)	Whitworth (2006)	—
Natural	Tricoire et al. (2012)	—	—	—

2) Inventory management

Inventory management concerns the stockpiling of resources. Mathematical programming seems to be, again, the researchers' preferred approach (Table 2.2). Taskin and Lodree (2010) and Ozguven and Ozbay (2013) proposed an optimization model with the objective of minimizing the cost. Ozbay and Ozguven (2007) developed a stochastic inventory model that determines optimal order quantities and reorder points for a long-term emergency relief response. Wein et al. (2003) formulated a series of differential equations to estimate the required inventory of antibiotics after a bioterrorist attack. The requirement of the relief after the disaster is dynamic and uncertain, and as a result, some reliefs will be surplus in one distribution center but scarce in another distribution center. These situations require a shared inventory. In this case, game theory, which considers the multi-aid among different actors, seems to suit well. Adida et al. (2011), Delaurentis et al. (2008) and Delaurentis et al. (2009) used game theory to decide the stockpiling of medical supplies by capturing the mutual aid agreement among different actors.

Table 2.2: Classification of papers studying the inventory management

	Mathematical programming	Game theory
Integrated	Ozbay and Ozguven (2007)	Adida et al. (2011), Delaurentis et al. (2008) Delaurentis et al. (2009)
Man-made	Wein et al. (2003)	—
Natural	Ozguven and Ozbay (2013), Taskin and Lodree (2010)	—

Table 2.3: Classification of papers studying the relief distribution

	Mathematical programming	Simulation	Fuzzy theory
Integrated	Campbell et al. (2008) Doerner et al. (2007) Sheu (2006)	Rytilä and Spens (2006)	Azimi et al. (2012)
Man-made	Ke and Zhao(2008) Hu and Zhao (2011) Wang et al. (2009a) Jamrog et al. (2007)	Lee et al. (2006) Ke and Zhao(2008)	—
Natural	Clark et al. (2007) Nolz et al.(2010), Tzeng et al. (2007)	—	Tzeng et al. (2007)

Table 2.4: The classification of the papers studying the evacuation

	Simulation	Graph theory	Mathematical programming
Integrated	Kaup et al. (2002) Filippoupolitis et al. (2008) Filippoupolitis and Gelembe (2009) Shen (2005)	Zhou and Tan (2008) Desmet and Gelenbe (2013)	Bish et al. (2011) Kaiser et al. (2012)
Man-made	Wu et al. (2007)	—	—
Natural	Su et al.(2008) Chen et al. (2012)	—	Chen et al. (2014)

3) Relief distribution

Relief distribution deals with the assignment of reliefs and the selection of the distribution modes. Table 2.3 classifies the papers studying relief distribution. Campbell et al. (2008) modeled the relief distribution as a vehicle routing problem (VRP) with the aim of minimizing the delivering time. Doerner et al. (2007), Clark et al. (2007), Nolz et al.(2010), and Azimi et al. (2012) proposed a model based on the covering tour problem (CTP). As the relief

distribution is a post-disaster activity, uncertainty needs to be taken into account. Ke and Zhao (2008), Ryttilä and Spens (2006) and Lee et al. (2006) used simulation to reflect the uncertainty, dealing with real situations. Hu and Zhao (2011) and Wang et al. (2009a) used differential equations for modeling uncertainty on the demand estimation. Jamrog et al. (2007) used Markov chains to model the uncertainty around the anthrax disease progression. Both Sheu (2007) and Tzeng et al. (2007) proposed to use the fuzzy theory to decrease the uncertainty effect on models. The fuzzy clustering-based approach was used by Sheu (2006) to group the affected areas and to assign to them distribution priorities. Tzeng et al. (2007) built an optimization model based on fuzzy theory with the aim of minimizing the cost and the travel time, and maximizing the satisfaction.

4) Evacuation

Evacuation refers to the immediate and rapid movement of the people from a dangerous place to a safety place. Since simulation can capture the complexity of real-world systems, most of the researchers used simulation to study evacuation situations (Table 2.4). Kaup et al. (2002) used simulation to study the behavior of people being evacuated under both panic and non-panic conditions. Shen (2005), Su et al. (2008), Filippoupolitis et al. (2008) and Filippoupolitis and Gelembé (2009) used simulation to model the building evacuation problem. Wu et al. (2007) combined simulation with a geographic information system (GIS) to simulate the generic evacuation process. Besides simulation, graph theory (Desmet and Gelembé (2013), Zhou and Tan (2008)) has also been used in this field, mostly because of its ability to model routes and paths. Bish et al. (2011) used a mixed integer linear formulation to classify the different kinds of the patients to be evacuated. A linear optimization model was developed by Kaisar et al. (2012) to find the optimum locations for evacuation bus stops. Chen et al. (2014) combined simulation with mathematical programming to study the evacuation of a hospital according to a French extended white plan.

5) Integrated logistics contributions

This part classifies and analyzes the literatures studying the integrated logistics contributions (Table 2.5). Kongsomsaksakul et al. (2005), Rawl and Turnquist (2010) and Chang et al. (2007) adopted Stackeleberg game theory, which can coincide with the policy decision process in the real life. The Stackelberg game is a strategic game theory, in which there is a leader and a follower. The leader will execute an action first and the follower will take appropriate action sequentially. In most of cases, the Stackeleberg game models have been shown as two stage models, which suit different logistics problems. Ekici et al. (2008) developed a mathematical model to estimate the food need and designed a food distribution network model. Some researchers paid more attention to the uncertainty during the response to the disaster. Rottkemper et al. (2011) explored the uncertainty of the disruption during the relief distribution and Rottkemper et al. (2012) considered the uncertainty of the demand. In order to reduce the uncertainty situations during the response to the disaster, Mete and Zabinsky (2010) used different disaster scenarios. Pietz et al. (2009) and Bravata

et al. (2006) used the simulation to study man-made disasters. Yi and Özdamar(2007) treated the evacuees as commodities to simplify the model. Song et al. (2009) seek the minimization of the evacuation time as the objective to study a man-made disaster.

Table 2.5: The classification of the papers studying the integrated logistics contribution

Reference	Disaster Type	Logistics contribution	Methodology
Rottkemper et al. (2011)	Integrated	Inventory management, Relief distribution	Mathematical programming
Ekici et al. (2008)	Integrated	Inventory management, Relief distribution	Mathematical programming
Kongsomsaksakul et al. (2005)	Natural	Facility location, Evacuation	Game theory Mathematical programming
Rawl and Turnquist (2010)	Natural	Facility location, Inventory management, Relief distribution	Game theory Mathematical programming
Mete and Zabinsky (2010)	Integrated	Facility location, Inventory management, Relief distribution	Mathematical programming
Bravata et al. (2006)	Man-made	Inventory management, Relief distribution	Simulation
Chang et al. (2007)	Natural	Facility location, Relief distribution	Game theory Mathematical programming
Yi and Özdamar (2007)	Natural	Relief distribution, Evacuation	Mathematical programming
Rottkemper et al. (2012)	Integrated	Facility location, Relief distribution	Mathematical programming
Pietz et al. (2009)	Man-made	Facility location, Inventory management, Relief distribution	Mathematical programming Simulation
Song et al. (2009)	Man-made	Facility location, Evacuation	Mathematical programming

2.1.3 Discussions and future directions

1) Discussions

Several insights can be extracted based on the three-level classification method with the direct content analysis. From a view of the methods used to study the different kinds of logistics problems, every method has its own advantages and disadvantages. Mathematical programming seems to be the most popular one. However, the mathematical programming is far from being enough to reflect the

real world complexity effectively and needs some other methodologies. For the facility location problem, the queuing theory can quantify the dependency among the different types of servers and the beneficiaries, but the use of the queuing theory is based on a steady situation and the use of specific distribution probabilities is in fact, another limitation. As the relief distribution is a post-disaster action and contains more uncertainty, the fuzzy theory has also been used in this field. But the fuzzy theory increases the difficulty of solving the model in most cases. The game theory has also been used to study inventory management based on the assumption of a good cooperation among the different actors. However, a good cooperation is difficult to achieve under an emergency situation. Simulation is used in most of the cases to address evacuations because the simulation can catch the stochastic nature of real world situations more easily. The disadvantage is that to modify a simulation model is much more difficult than to modify mathematical programs.

Judging from what has been studied in detail, most of the papers do not examine the uncertain situations enough though different kinds of logistics orientation have been researched. In other words, the consequence of the uncertain situations has not captured enough attention. The perspective considering the nature of the disaster has not been explored enough. Natural disasters and the man-made disasters have their own characteristics and should be studied separately. For example, a natural disaster is unavoidable but predictable, such as the flood, so the evacuation should get more attention because we cannot avoid the flood that hits the city but we can evacuate the citizens. Man-made disasters are often unpredictable, such as an anonymous anthrax attack, so the inventory management of the antibiotics should be studied.

2) Future directions

Several future research directions can be proposed according to Section 2.1.2. The main research gaps are illustrated in Figure 2.2 with the connection of the three-level classification methods.

- From the level of the logistics orientation, most of the researches mentioned before were not based on a real scenario, which led to two problems: one is to ignore the details, and the other is to fail to respect the rules and the regulations of the real world. These two problems make it difficult to carry out existing plans and to use improvement methods. Therefore, more studies should be conducted, based on real scenarios to propose more realistic solutions. Moreover, the reverse logistics should catch more attention in the future. The reverse logistics is very common during the response to the disaster. For example, after a medical intervention of an infectious disease, the used medical items could be the source of a second infection and should be treated accordingly. Most of these used medical items should be transported to certain place and dealt with proper methods.
- Natural disasters and man-made disasters should be studied separately with the consideration of their different characteristics, which have attracted little attention so far. No matter what kind of disasters, a secondary disaster following the original one is common. However,

until now, few papers have studied secondary disasters, so it should be a research direction to explore.

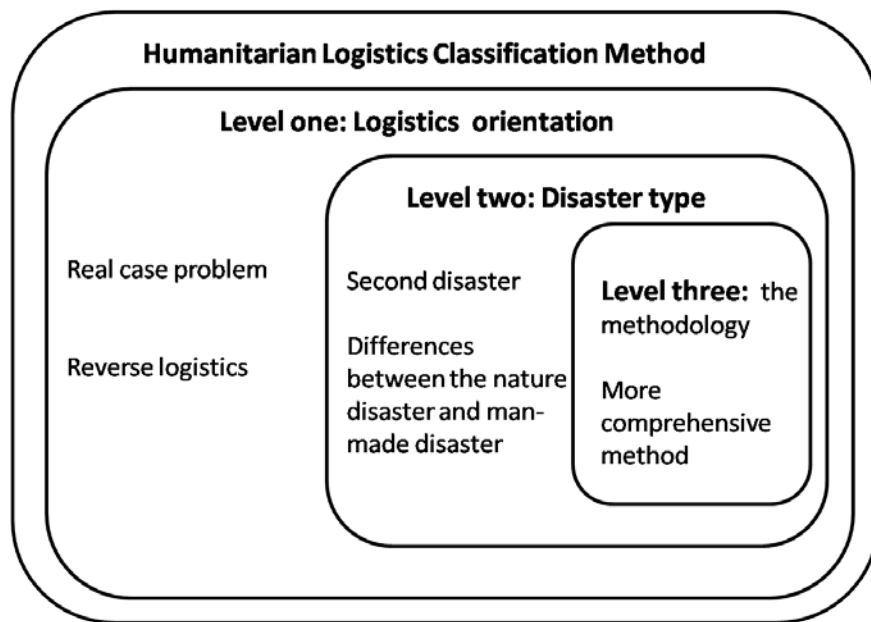

Figure 2.2: Humanitarian logistics future directions

- As for the used methodology, though mathematical programming has numerous advantages, the complexity of the disaster environment renders mathematical programming either ineffective or inefficient. A more comprehensive methodology should be found for two reasons. First, mathematical programming can only present the system in an abstract way and some details will be omitted. Second, the mathematical model is a purely analytical method which will make a problem for the training and education in practice. Some other methodologies can remedy the limitation of mathematical programming to a certain extent, but they have their own disadvantages as well. So a more comprehensive method, which combines different methods, is necessary.
- The uncertainties of disaster require an agility humanitarian logistics. One of the leading studies in this aspect is the thesis of Charles (2010). It proposes an agility maturity model aiming to measure and improve the humanitarian logistics. In the future, the agility of humanitarian logistics should be got more attention of the researchers.
- The situations of disasters are always complicated. Therefore, a comprehensive method to study the humanitarian logistics is necessary. Since the study of humanitarian logistics should be based on the real case, the scenario approach should be got more attention.

2.2 Literature review of disease preventions and medical responses

Outbreaks of the large-scale diseases can pose a great threat to the public health and lead to severe consequences. The outbreaks of diseases can be triggered by:

- The deliberate release of biological spores for the warfare, such as the 1979 aerosol anthrax release in Sverdlovskin (Inglesby et al, 1999a);
- Diseases spreading among animals and then infecting the human beings, such as the avian influenza;
- The aftermath of the nature disasters, such as the large cholera epidemics in West Bengal in 1998, attributed to a flood (Watson et al., 2007).

Now, the pollution, the urbanization and many other reasons increase the possibility of the outbreaks of the diseases. According to the World Health Organization (WHO), the infectious diseases cause almost 25% of deaths each year.

In order to reduce or mitigate the threat and the consequences, an effective and comprehensive disease prevention and control plan is needed. For example, WHO proposed the global influenza preparedness plan in 2005 and Ebola virus disease outbreak response plan in west Africa in 2014. Now, more and more people study the disease prevention and control plans. However, the research papers focusing on this field are still far from being enough. Moreover, to best of our knowledge, until now, no paper has reviewed the articles about the disease prevention and control plan systematically. To fill this gap and shed light on a future research direction, our paper studied the existing relevant articles according to different diseases, related disease prevention and control plans and applied methodologies.

2.2.1 Related conceptions

1) Diseases

According to the infectiousness, diseases can be classified as communicable disease and non-communicable disease. Non-communicable diseases are not passed from person to person. Most of the non-communicable diseases are the chronic diseases. They are of long duration and generally slow progression. Based on the seriousness, non-communicable diseases can be divided into three stages: incubation, prodromal and fulminant. During incubation stage, patients do not have obvious symptoms, but prodromal stage patients show a non specific spectrum of symptoms. In fulminant stage, the patients develop the disease symptoms abruptly. In most cases, the fulminant stage patients need the intensive treatment in hospital. The treatment methods for the incubation stage or prodromal stage patients depend on the diseases.

Communicable diseases can spread from person to person or from an animal to a human being. The spread can happen via viruses or bacteria, through airborne, blood or other bodily fluid. The communicable diseases can be divided into three stages according to the infectiousness, namely, latent, infectious and

isolated. But they can also be divided into incubation, prodromal and fulminant stages according to the seriousness as well. The latent patients are non-infectious. The infectious stage patients can infect the susceptible individuals. When the infectious stage patients develop to the isolated stage, they are not infectious anymore because the infectiousness first increases and then decreases with the time, such as smallpox patients; or the patients are symptomatic and will be isolated, such as H5N1 patients. Some infected patients eventually recover even though they do not get the medical help because they can produce antibody themselves. Susceptible people can be infected by two ways. First, they may inhale or contact with the virus or bacterial dust and become ill. Second, they may get infected by contacting with infectious patients. In epidemiology, the basic reproduction number (R_0), defined as the number of susceptible individuals that can be infected by each patient during the infectious periods, is always used to describe the infection rate of the disease (Diekmann et al., 1990). Generally, two medical treatments are available for the communicable diseases: vaccination and antiviral drugs or antibiotics. The susceptible individuals can become immune by vaccination. But the vaccination can also cause fatalities because of the side-effect. Usually, the antiviral drugs and the antibiotics are used to treat patients infected by the virus and the bacteria respectively. If the susceptible stage and infectious stage individuals who get the medical help cannot become immune or recover, they are still likely to be infected and then infect others in turn.

2) Disease prevention and control plans

Disease prevention and control plans can be considered as strategies to guide the decision makers to adopt the appropriate disease response policy and accelerate the cooperation among the different stakeholders with the reasonable use of broad categories of pharmaceutical and non-pharmaceutical resources to reduce the impacts of diseases (Brebán et al., 2007). The disease prevention consists of three main parts, maintaining certain quantities of necessary resources to assist a prompt response to the outbreak of epidemic, establishing the detection system of any possible outbreak and carrying out the obligatory policy to minimize potential causes which can trigger the disease. The disease control includes different response policies and the related logistics deployments. The response policy consists of several main branches: the individuals' priority policy, the quarantine policy, the isolation policy, the vaccination policy and the medical care coverage policy. Individuals' priority policy refers to a strategy which decides people should get the medical help first. Isolation policy means separating sick from the susceptible. Quarantine policy separates and restricts the movement of those who were exposed to a contagious disease to see if they are infected. Two vaccination policies are popular in academics and practitioners, ring vaccination (traced vaccination) and mass vaccination. Ring vaccination is a strategy by which only direct contacts of confirmed victims are traced and vaccinated. Mass vaccination is to vaccinate everyone in the infected area. Because of the limited stockpiles and the side-effects of vaccines or drugs, medical care coverage policy gives the medical help (vaccines or drugs) to a certain percentage of individuals to control the disease. The logistics

deployment supporting the response policy can be managed both at national and local levels. At the national level, people should decide the time and the amount of medical resources to be delivered from national stockpiles to local distribution centers or hospitals. At the local level, a complex network delivering both services and products should be built. Because different diseases have their own characteristics, different disease response plans are needed to prevent and control the diseases. Therefore, most of the available disease prevention and control plans are for a certain disease instead of a general disease.

3) Scope of review

The papers to be searched for do not include the disease which will not lead to the death in a short time or will not have a high demand for resources, such as diabetes mellitus. We focus on the publications from 2004 to 2014. However, some typical and important articles published earlier will be analyzed as well. Two groups of keywords have been chosen to select the articles; Group 1: disease, epidemic; Group 2: disease prevention, disease control, emergency response. The databases we used are the same as what we used for the humanitarian logistics: Elsevier, Springer, Taylor & Francis, IEEE Xplore.

2.2.2 The literature classification and analysis

Since infectious diseases are almost different from non-infectious diseases, these two kinds of diseases should be studied separately.

1) Infectious diseases

Table 2.6 classifies the papers studying the infectious diseases. Since the number of infected individuals will affect the choice of response strategies, it is important to predict the number of infected individuals to help the decision makers to have a general idea of the current disease situation. In most of the papers, R_0 and the transmission modes are the two important factors which will affect the number of infected people. The value of R_0 decreases after the beginning of medical intervention because the disease can be controlled by an effective medical intervention. In Table 2.6, uniform means the paper supposes that the value of R_0 does not change while nonuniform denotes the value of R_0 changes in the paper. The transmission modes are classified into homogeneity or heterogeneity. Homogeneity transmission mode means that all hosts have identical disease transmission rate while heterogeneity transmission mode means that the disease transmission rate depends on the different people or different infection situations. So the papers studying infectious diseases are classified according to how they present R_0 , how the transmission modes are modeled and which methods are used to solve the problem.

Smallpox is one of the most serious and fatal contagious disease. Influenza is disease which may happen each year. Therefore, most of the papers study the smallpox and influenza.

Kaplan et al. (2002) used the differential equation model to compare the mass vaccination and the ring vaccination after a smallpox bioterrorist attack. The

development of smallpox is divided into four stages according to the symptomatic or asymptomatic, the sensitive or insensitive to the vaccine, the infectious or non-infectious and isolated or not isolated. All these stages are supposed to follow exponential distribution and only one stage, asymptomatic and infectious, can infect susceptible individuals. The side-effect of the vaccine is taken into account. The number of individuals who can be vaccinated depends on the service rate of vaccines. The service rate of the mass vaccination policy is four times higher than the traced vaccination policy. The way proposed by Kaplan et al. (2002) to divide the disease stages is concise and straightforward. Adivar and Selen(2011) proposed an integral equation model and a differential equation model to study how the quarantine policy controls smallpox. The differential equation model assumes exponential distribution function and the integral equation model assumes gamma distribution. There is no vaccination policy in these two models. Different from Kaplan et al. (2002) and Adivar and Selen(2011), the disease transmission mode in Kress (2005) is heterogeneity. The model proposed by Kress (2005) can evaluate the effect of quarantine, public announcement and mass vaccination. The disease is supposed to follow a uniform distribution. The limited quarantine capacity and the limited vaccination capacity are studied by Kress(2005) . Jamrog et al. (2007) studied the effect of mass vaccination, ring vaccination and combined strategy of mass vaccination and ring vaccination by using the Markov chain model. The value of transition probability among the different stages is based on a statistics study. The vaccination capacity and the probability of finding the people who contact with the infected patients are used explicitly to connect the disease transition and the different policies.

Bozzette et al.(2003), Halloran et al. (2002), Porco(2004) and Miller et al (2006) used the event-driven simulation to study the response to smallpox. Bozzette et al. (2003) compared the different vaccine coverage rate polices and the different individuals priority policies under various smallpox attack scenarios. In Bozzette et al. (2003), the value of R_0 decreases after the beginning of the medical intervention. Halloran et al. (2002) used a stochastic simulation model to compare mass and ring vaccination policies in a small community. The value of R_0 in Halloran et al. (2002) varies with different health situations of individuals. The development of disease in Halloran et al. (2002) follows a uniform distribution. Porco et al. (2004) is the only paper which considers the different forms of the smallpox, which will affect the value of R_0 . Porco et al. (2004) compared the mass vaccination and ring vaccination. The vaccination capacity is the most important factor to present the differences between mass vaccination and the target vaccination in Porco et al. (2004). The development of disease in Porco et al. (2004) depends on the age. All these papers suppose the heterogeneity disease transmission mode. Different from other papers, Miller et al (2006) do not compare the different response policies but tries to design the response plan for San Antonio (USA). Two simulation models are proposed in this paper, the casualty prediction model and the health-care complex model. The casualty prediction model predicts the number of infected patients. The health-care complex model uses the number of infected patients predicted by the first simulation model to improve the health-care

delivery activities. The value of R_0 and the transmission mode have not been mentioned in this paper.

Table 2.6: Characteristics of infectious diseases

Reference	Disease	R_0	Transmission mode	Methodology
Kaplan et al. (2002)	Smallpox	Uniform	Homogeneity	Differential equation model
Adivar and Selen (2011)	Smallpox	Uniform	Homogeneity	Differential equation model Integral equation model
Kress (2005)	Smallpox	Uniform	Heterogeneity	Mathematical model
Jamrog et al. (2007)	Smallpox	Uniform	Homogeneity	Markov chain model
Bozzette et al. (2003)	Smallpox	Nonuniform	Heterogeneity	Event-driven simulation
Halloran et al. (2002)	Smallpox	Nonuniform	Heterogeneity	Event-driven simulation
Porco et al. (2004)	Smallpox	Nonuniform	Heterogeneity	Event-driven simulation
Miller et al (2006)	Smallpox	–	–	Event-driven simulation
Arinaminpathy and McLean (2009)	Influenza	Nonuniform	Heterogeneity	Mathematical model
Colizza et al. (2007)	Influenza	Uniform	Heterogeneity	Mathematical model
Roberts et al. (2007)	Influenza	Uniform	Heterogeneity	Mathematical model
Chen and Liao (2008)	Influenza	Uniform	Homogeneity	Mathematical model
Ferguson (2006)	Influenza	Nonuniform	Heterogeneity	Simulation
Germann et al. (2006)	Influenza	Uniform	Heterogeneity	Simulation
Milne et al. (2008)	Influenza	Nonuniform	Homogeneity	Simulation

Arinaminpathy and McLean (2009) used the mathematical model to study how the different drug coverage rates affect the number of deaths, taking into account the limited national stockpiles. The development of disease is uniform distribution. The value of R_0 decreasing after the beginning of medical intervention has been considered by Arinaminpathy and McLean (2009). Colizza et al. (2007) proposed a stochastic epidemic model to investigate how the travel restriction and the antivirus distribution policy affect the pandemic transmission. This model is built on a global scale, taking into account the effect of temporal and spatial characteristics on the evolution of the pandemic. The disease is assumed to follow the exponential distribution and uniform distribution in Colizza et al. (2007). Roberts et al. (2007) studied what response strategy should be adopted according to the different values of R_0 . Chen and Liao (2008) evaluated the effects of enhanced ventilation, use of respiratory mask and vaccination on pandemic influenza transmission in a school in Taiwan.

Ferguson (2006) used simulation to examine the effects of antiviral treatment, vaccination, isolation, household quarantine, school and workplace closure and travel restrictions in the United Kingdom and United States. The basic reproduction number in Ferguson (2006) changes with time and the development of disease is based on the historical data. Germann et al. (2006) used the simulation to evaluate the different factors which may impact the number of infected patients from a strategic level. The transition rates used in Germann et al. (2006) depend on the age. Milne et al. (2008) assessed the effects of isolation, school closure and contact reduction in Australian with an individual-based stochastic simulation model

According to the classification and above analysis, several gaps can be found. From a view of disease, first, for some infectious diseases, such as influenza, people can be infected several times over their lifetime (re-infected). The probabilities for people to be infected or re-infected should be different, which has not captured enough attention. Second, the different values of R_0 will make a big difference on the number of infected individuals. Therefore, different response strategies should be adopted. However, the important impact of R_0 on the response plan is nearly neglected. From a view of disease prevention and control plans, the papers pay more attention to how the vaccination policy prevents the epidemics. But according to WHO, the most likely way in which the virus would be introduced to an isolated geographical area is by an infected traveler. But models taking into consideration the travel restriction are few because considering travel restriction requires a lot of data, which are not easy to get. As a corollary, few papers consider the policy of the travel restriction.

2) Non-infectious diseases

Table 2.7: Characteristics of non- infectious diseases

Reference	HIV	Contribution	Methodology
Kahn et al. (2006)	HIV	Cost-effective analysis	Linear model
Sanders et al. (2005)	HIV	Cost-effective analysis	Markov model
Zaric et al. (2000)	HIV	Cost-effective analysis	Compartmental model
Bertolli et al. (2003)	HIV	Strategies comparison	Decision tree
Bendavid et al. (2005)	HIV	Strategies comparison	Simulation
Paltile et al. (2006)	HIV	Strategies comparison	Simulation
Wein et al. (2003)	Anthrax	Strategies comparison	Mathematical model
Craft et al. (2005)	Anthrax	Response plan analysis	Mathematical model
Wein and Craft (2005)	Anthrax	Strategies comparison	Mathematical model
Houck and Herrmann (2011)	Anthrax	Strategies comparison	Compartmental model
Zaric et al. (2008)	Anthrax	Cost-benefit analysis	Compartmental model
Bravata et al. (2006)	Anthrax	Cost-effectiveness analysis	Compartmental model
Hu and Zhao (2011)	Anthrax	Strategies comparison	System dynamics
Brookmeyer et al. (2008)	Anthrax	Strategies comparison	Markov chains
Whitworth (2006)	Anthrax	Response plan evaluation	Discrete-event simulation

Even though HIV is a kind of infectious diseases, the way of transmission is special and the transmission rate is low. Therefore, in this study, we classify the papers studying the HIV in the non-infectious disease. Table 2.7 classifies the paper studying the non-infectious disease.

Human immunodeficiency virus (HIV) can affect specific cells of the immune system, called CD4 cells, destroy these cells and then lead to acquired immunodeficiency syndrome (AIDS). Hence, the CD4 count, defined as the number of CD4 cells in a sample blood, is an important indicator to test the seriousness of the HIV. The transmission ways of HIV can be divided into four branches: sexual contact with infected patients, sharing needles with infected individuals, transmission via blood and mother-to-child transmission. Until now, no medical intervention can cure the HIV. The treatment can only prolong the

lives of patients and lower their chance of infecting others. Therefore, more attentions have been paid to the HIV prevention policies. The HIV prevention package includes: the provision of HIV screening testing, male circumcision treatment for sexually transmitted infections, the provision of male and female condoms and so on. Since the high cost and the different results of the HIV prevention methods, the choice of different prevention policies is the main topic in this field.

Kahn et al. (2006), Sanders et al. (2005) and Zaric et al. (2000) made the cost-effective analysis with different methods. Kahn et al. (2006) developed a linear model to calculate the costs by using male circumcision to prevent the transmission by sexual contract. This model does not have too many details about the disease transmission but this simple linear model is transparent and efficient. Sanders et al. (2005) developed a Markov model to evaluate the cost effectiveness of HIV screening strategy to control the disease transmission in the United States. The patients' behavioral has been taken into consideration. Zaric et al. (2000) used the compartmental model to estimate the cost effectiveness of using methadone maintenance treatment for injection drug users. Some authors pay more attention to the treatment results rather than the cost of different strategies. Bertolli et al. (2003) studied the strategies which can avoid the transmission from mother-to-child by a decision tree model. The child has the chance to be infected by HIV if the mother breastfeeds. On the other hand, un-mother-breast feeding may lead to the child's death because of the lack of important antibiotics acquired from breast milk. The decision tree model capture the possibility of the HIV transmission from mother to child and the possibility of death if the child does not have the mother breastfeeding. Bendavid et al. (2005) and Paltile et al. (2006) adopted the simulation to evaluate the different strategies. Bendavid et al. (2005) used the CD4 cell count as an indicator to judge the different monitor strategies. Paltile et al. (2006) evaluated how the screening strategies impact the number of the infected patients.

The research gap for HIV is that, though HIV cannot be transmitted by airborne droplet, four ways for HIV transmission should be studied separately since different transmission ways need different prevention plans. From a view of HIV prevention plans, different prevention methodologies exist with different final costs and different prevention results. That is one of the reasons why the cost-effective analysis is popular in this field. In most cases, the cost-effective analysis is made from a strategy level. But the papers making the cost-effective analysis always include a lot of unnecessary details about the disease transmission which increase the computation complexity and do not do any help for the cost-effective analysis. Moreover, the effective of different prevention plans should not be the same for different kinds of individuals. But most of authors assume that the prevention results for all kinds of individuals are the same.

Anthrax is an acute non communicable disease which is caused by bacterium *Bacillus*. Because anthrax spores are easily found in nature, can be produced in a lab, can last for a long time in the environment and can be released quietly without being noticing, anthrax would be one of the biological agents most likely to be used for bioterrorist attack. In most of the papers, the progression of

the anthrax is divided into three stages, incubation, prodromal and fulminant. Two medical treatments are possible available according to the patient's stage. Incubation stage patients can be treated by the prophylaxis antibiotics and the fulminant stage patients should be treated in the hospital with intravenous antibiotics. However, there is no clear treatment recommendation to the individuals in prodromal stage.

A four-paper series constitutes one of the first and most important contributions to the field. Wein et al. (2003) proposed a mathematical model to compare five priority policies after an airborne anthrax attack. This model incorporated an atmospheric dispersion model, an age-dependent dose-infected model, a disease progression model, and an intervention policy model. Craft et al. (2005) simplified the model proposed by Wein et al. (2003) and used the number of deaths as a key criterion to analyze the response to the anthrax bioterrorist attack. Wein and Craft (2005) used the model proposed by Wein et al. (2003) to compare the pre-exposure prophylaxis strategy and post-exposure prophylaxis strategy. Based on the conclusions from the aforementioned papers, Wein and Kaplan (2005) identified the four key elements for an effective anthrax response plan: 1) a quick intervention; 2) immediate distribution of antibiotics; 3) an aggressive education to make sure that infected patients can behave reasonably; 4) an effective management of patients flow. Among these four key points, the last point was the most difficult to achieve.

Both Houck and Herrmann (2011) and Zaric et al. (2008) used the compartmental model. Houck and Herrmann (2011) constructed a homogeneous compartmental model to estimate the number of casualties in the situation where authorities can pre-deploy medications to some people. The compartmental model developed by Zaric et al. (2008) evaluates the costs and benefits of various strategies.

Based on the model proposed by Zaric et al. (2008), Bravata et al. (2006) evaluates the costs and lives saved by four alternative strategies. They concluded that the local dispensing capacity is the most important factor to restraint the mortality rate after anthrax bioterrorist attack. Hu and Zhao (2011) used system dynamics to analyze the different emergency response plans after an anthrax attack. Jamrog et al. (2007) used Markov chains to model the response to the anthrax attack and, again, concluded that the antibiotic distribution capacity is a key factor to reduce casualties. Whitworth (2006) used a discrete-event simulation approach to design and evaluate the response to an anthrax attack. The author's simulation model enables evaluation of dispensing processes, staffing plans, and traffic-management strategies. To the best of our knowledge, this is the only paper using discrete-event simulation to study the response to anthrax attacks.

Another interesting paper in this field is by Brookmeyer et al. (2002). This paper studied anthrax, focusing on the incubation period. Based on the competing risk formulations, several models were developed to number the spores clearance and germination. These models could be used to predict the length of time for which each individual will remain in each of the disease stages.

Anthrax patients are seldom found in the real life, so the medical information about the anthrax is limited. For example, it is difficult to find the information about which kind of distribution functions the development of anthrax follows. Therefore different authors have different hypotheses about anthrax. Since no one knows what will happen after the anthrax eruption, a model with different scenarios will be more useful for decision makers.

2.2.3 Discussions and future directions

In this section, we will first discuss the advantages and disadvantages of used methods from a view of disease, and disease prevention and control plans. Second, the future directions will be given.

1) Discussions

From the classification and above analysis, it can be found that mathematical model is one of the most popular methods. In order to present the propagation of diseases, the compartmental model has been used as a foundation for a lot of mathematical model in this field. The compartmental model can reduce the population diversity to a few key characteristics which can be used to study the progress of an epidemic and the intervention policies easily. The compartmental model stratifies the populations into several stages or compartments. All of these compartments are mutually exclusive. To project the development of different stages over time, most of the compartmental models are dynamic models. At the beginning of 20th century, Kermack and McKendrick (1932) proposed the Susceptible-Infectious-Removed or Susceptible-Infectious-Recovered (SIR) model which is based on the principle of compartmental model. The SIR model divides the people according to the health status. The SIR model is always a nonlinear model and is used to study the communicable diseases. In other words, SIR model is a special kind of compartmental model. In the following paragraphs, the compartmental model and the SIR model will be presented.

1) The compartmental model

The dynamic compartmental model can vary in size and complexity according to the objective of the study. Equation (2-1) is given as an example to show the development of the different stages.

$$X_t^i = X_{t-1}^i + \sum_{k=1}^N X_t^{ki} - \sum_{j=1}^N X_t^{ij} \quad (2-1)$$

X_t^i denotes the number of patients in stage i in period t . X_t^{ki} presents the number of patients who transfer from stage k to stage i in period t . If there are N stages in total, $\sum_{k=1}^N X_t^{ki}$ denotes the total number of patients who get into stage i in period t . X_t^{ij} presents the number of patients who leave stage i and transfer into stage j in period t . $\sum_{j=1}^N X_t^{ij}$ denotes the total number of patients who leave stage i in period t . The model proposed by Zaric et al. (2008) is an exemplar which uses the principle underlying equation (2-1) to study the response to the diseases.

To calculate the number of patients who transfer from the current disease stage to the next stage, most of the papers adopt the multiplication between the number of people in current disease stage and the transition rate. The transition rate can be calculated by three main ways: First, the transition rate is a constant value (Hu and Zhao, 2001); second, the transition rate is the cumulative density function of the mean time of the current stage. For example, Ψ_t^i denotes the transition rate from stage i to the next disease stage in period t . f_x^i is the probability density function of the mean time of stage i . Ψ_t^i can be calculated as $\Psi_t^i = \int_0^t f_x^i dx$; third, the transition rate consists of the cumulative density function (F_x^i) and the probability density function (f_x^i), such as, $\Psi_t^i = \int_0^t \int_0^u f_v^{i-2} f_{u-v}^{i-1} dv F_{u-t}^i du$ (Wein et al., 2003; Craft et al., 2005; Wein and Craft, 2005). In this way, the transition rate of the earlier stages will affect the transition rate of the later stages. The aforementioned three ways could also be combined to present the transition rates in one model. For example, in Houch and Herrmann (2011) and Zaric et al. (2008), the transition rates between different stages are calculated by different ways.

2) The SIR model with differential equations

The SIR model is known as a compartmental model in epidemiology. The SIR model, in the simplest case, stratifies the population into three health status: susceptible to the diseases (denoted by S in Figure 2.3), infected by the diseases (denoted by I in Figure 2.3), and removed from the diseases (denoted by R in Figure 2.3). The basic mathematical formulations are presented in the following:

S_t : The number of susceptible individuals in period t

I_t : The number of infected individuals that can infect susceptible individuals in period t

R_t : The number of people removed from the diseases due to immunization, death or isolation in period t

I_t^v : The number of infected individuals who leave the disease in period t

β : The infection rate

$$\frac{dS}{dt} = -\beta I_t S_t \quad (2-2)$$

$$\frac{dI}{dt} = \beta I_t S_t - I_t^v \quad (2-3)$$

$$\frac{dR}{dt} = I_t^v \quad (2-4)$$

In most cases, the infected people will be divided into several stages, such as latent, infectious and fulminate (Colizza et al., 2007) or several categories (Arinaminpathy and McLean, 2011) such as, young and old. Therefore, I_t consists of $I_t = I_t^1 + I_t^2 + I_t^3 + \dots + I_t^N$. $I_t^1, I_t^2, \dots, I_t^N$ denote the different kinds of infected individuals. Equations (2-5) to (2-8) are given as an example to present this division.

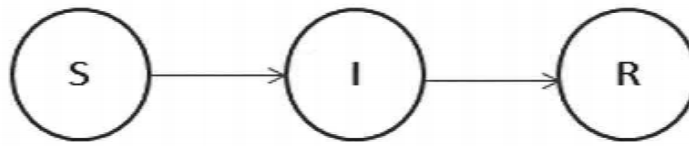

Figure 2.3: SIR model

$$S_t = S_t^1 + S_t^2 \quad (2-5)$$

$$I_t = I_t^1 + I_t^2 \quad (2-6)$$

$$\frac{dS^1}{dt} = -\beta^1 I_t^1 S_t^1 - \beta^2 I_t^2 S_t^1 \quad (2-7)$$

$$\frac{dS^2}{dt} = -\beta^1 I_t^1 S_t^2 - \beta^2 I_t^2 S_t^2 \quad (2-8)$$

Several ways can be used to calculate the infection rate (β) according to the basic reproduction number (R_0). One of the most popular methods is to use the equation $R_0 = \beta S_0 / \gamma$ (Kahn et al., 2002). S_0 stands for the number of susceptible people at the beginning of the occurrence of epidemics while γ is the mean duration of the infectiousness stage. But the infection rate is likely to decrease after the medical intervention. Using a single value of infection rate will lead to the predicted number of infected people more than the reality. But no matter which ways is used to calculate the value of infection rate, when the value of basic reproduction number is smaller than 1, the SIR model will be in an equilibrium situation (Coburn et al., 2009).

If several kinds of patients ask for the same medical help, two ways are always used to decide the number of people in different stages, who can get the medical help. The first method is to use parameters to control the number of patients who can get the medical help. The second way is to use the proportion of different kinds of people to decide the number of patients who can get the medical help, such as using the equation $I_t^{m,v} = Cap \cdot \frac{I_t^m}{\sum_{n=1}^N I_t^n}$. Cap refers to the medical treatment capacity. I_t^m presents the number of stage m patients who ask for the medical help. $I_t^{m,v}$ presents the number of stage m patients who get the medical help. I_t^n means the number of patients who need the medical help.

From a view of the disease, it can be found that SIR model can present the disease development intuitively. The compartmental model is easy to refine or extend when different medical resources are taken into account. For both kinds of mathematical models, the disease development and the medical intervention can be connected by some key important factors of medical intervention, such as the coverage rate of vaccines. This connection can help the decision makers to analyze how these factors affect disease progression easily. However, the mathematical model is difficult in building a complete model which can reflect reality. For example, some mathematical models suppose the homogeneity transition instead of the heterogeneity transmission mode which is not true in the real world. Moreover, an accurate model, which includes many details, needs an effective algorithm and requires enormous computing time. The computation difficulty is another limitation.

Compared with mathematical model, simulation can, easily, reflect the situation in the real world. From a view of disease development, simulation can capture the detail of the real situation, such as the change of R_0 and the heterogeneity transmission mode. From a view of disease prevention, simulation is suitable to handle a large scale problem, such as the disease prevention plans for more than one million individuals. However, the connection between the development of the disease and the medical intervention is not explicit. This inherent connection will become the barrier for the numerical analysis about how the disease prevention affects the disease development.

2) Future research directions

Following the insights provided above, there are a lot of opportunities for future research efforts.

- From a view of disease
 - ❖ Lots of models failed to combine some factors which can impact the number of casualties, such as different periods in which the patients transfer into the current disease stage (length of stay in a disease stage).
 - ❖ Not all the papers studying the response to the diseases are based on real cases and the real emergency management plans. For example, most of the authors assume the recovery rate remains the same for the patients in the same stage while in reality, the recovery rate will decrease when the patients stay in the stage longer. The number of infected individuals will affect the adopted response policy. If the development of the disease follows different disease development probability functions, the number of infected individuals will change. But many authors failed to consider about how disease development probability functions affect the medical interventions.
- From a view of disease prevention and control plans
 - ❖ The side effect of the medical interventions is neglected by most of the authors. For example, the side effect of the mass vaccination of smallpox has often been neglected.
 - ❖ Some key important logistics factors, such as the distribution capacity, are not taken into account. The medical intervention can work well only when the medical resources can be delivered in time with the right amount. Though some papers take, into account, the limitation of the medical treatment capacity, they do not address logistics questions like the number and the size of the antibiotic distribution centers. Moreover, most of the papers consider only one factor, which may affect the medical intervention, such as the vaccination coverage rate, but neglect the national stockpile. However, the sudden occurrence of epidemic may be more transmissible than we predicted and more people will be infected. So the national stockpile may

be exhausted and a lot of individuals cannot get the medical help. In other words, the vaccination coverage policy cannot be executed well without enough medical resources. So, how to dispense medical resources sparingly to avoid exhausting the stockpile, should be studied as well.

- ❖ Some individuals, such as the old and the young, have the high possibilities to be infected and need special help. But most of the authors focus their attention on the general population, and neglected those who need the special help.
- ❖ Most of the papers study the vaccination policy because vaccination is one of the most effective ways to prevent and control disease. But the quarantine policy, isolation policy and so on should also get enough attention.

2.3 Literature review of emergency management plans

The emergency management plan or disaster management plan is the plan through which communities reduce vulnerability to hazards and cope with disasters (Drabek, 1991). Since the importance of the emergency management plan has been stated before, we will not mention here again.

2.3.1 Scope of the review and the literature review methodology

As we mentioned before, with respect to predictability and speed of occurrence, it is possible to classify the disasters into sudden-onset and slow-onset disaster. Since the slow-onset disasters do not require a high effort on the emergency management plan, again, the slow-onset disasters will not be included in our review here. Since the papers studying the emergency management plans are not so many, the time interval of the papers to be searched is enlarged to the last fifteen years, from 1999 to 2014, rather than the last ten years. But, some typical and important articles published earlier will be analyzed as well. Two groups of keywords have been chosen to select the articles: Group 1: disaster, emergency, mass casualty incident; Group 2: emergency management, emergency response and crisis management. The databases we used are same as we used for the review for the humanitarian logistics: Elsevier, Springer, Taylor & Francis, IEEE Xplore.

According to our objectives, the selected articles are classified into three perspectives or levels (Figure 2.4.). Since the mitigation and preparedness are more related to pre-disaster activities and the response and recovery concern more about post-disaster activities, at the first level, the papers are classified according to the problems related to mitigation and preparedness or response and recovery. At the second level, the papers are classified according to the types of disasters: natural, man-made and integrated. The disaster is said integrated if the authors do not specify the type of disaster in the literature, as

the classification method used in Section 2.2. At the last level, the methodologies for solving the problem are studied.

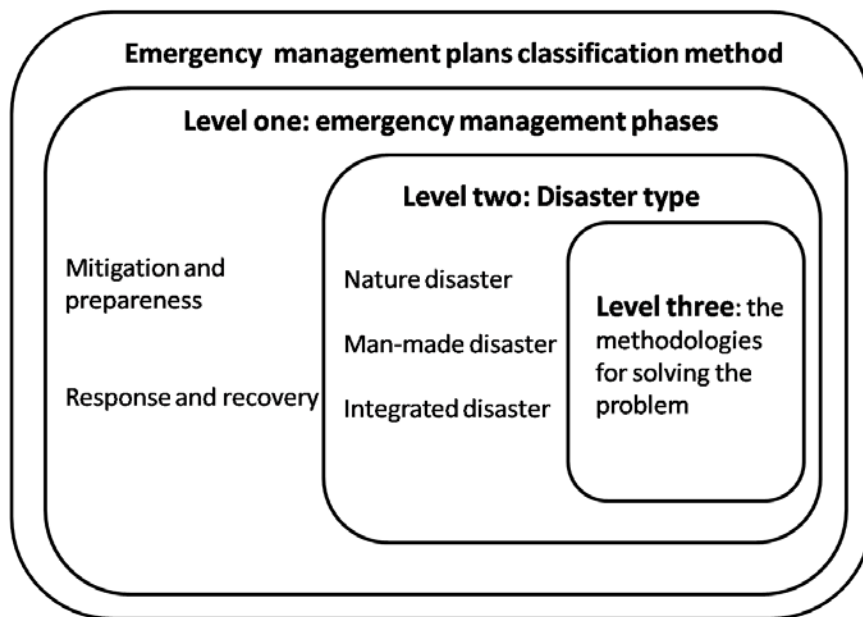

Figure 2.4: The classification method

2.3.2 The literature classification and analysis

In this section, the reviewed articles are classified and analyzed based on the criteria proposed in the Section 2.3.1.

1) Mitigation and preparedness

Table 2.8 studies the papers which deal with the mitigation and preparedness.

Table 2.8: Papers studying mitigation and preparedness

Reference	Disaster	Methodology
Reshetin et Regens (2003)	Man-made	Simulation
Dudin and Semenova (2004)	Integrated	Markov model
Dombroski et al. (2006)	Integrated	Mathematical model
Dombroski and Fischbeck (2006)	Man-made	Simulation
Georgopoulos et al. (2004)	Integrated	Simulation
Inoue et al. (2006)	Man-made	Simulation
Hiroiyuki et al. (2000)	Natural	Simulation
Han et al. (2006)	Integrated	Simulation
Dushmanta et al. (2003)	Nature	Mathematical model

Reshetin et Regens (2003) used the simulation to predict the time interval required for spore dispersion throughout a high-rise building after a terrorist attack. The analysis reveals that an aerosol release of small volume of anthrax spores throughout the building has the potential to have a huge impact on the human health. This simulation model can help the decision makers to measure the potential hazards caused by the release of anthrax spores for a bioterrorist attack. Dudin and Semenova (2004) calculates the possibility of the arrival of integrated disasters by proposing a Markov model. Dombroski et al. (2006) used dispersion model to predict the public compliance to the emergency management plans. Dombroski and Fischbeck (2006) assess the risks of radiological dispersion device events. Georgopoulos et al. (2004) used simulation to evaluate key parameters affecting infection of healthcare workers exposed to the hazardous materials. Inoue et al. (2006) used simulation to evaluate the processes of the patients' evacuation after the large-scale disease with the objective of minimizing the number of deaths. Hiroyuki et al. (2000) used the simulation to assume the hazards of low probability and high consequence nature disasters, such as earthquake. Dushmanta et al. (2003) combined a physically based distributed hydrologic model and a distributed flood loss estimation model to estimate the loss cost by flood. The available evacuation route, after the integrated disaster, has been evaluated by the simulation model proposed by Han et al. (2006).

2) Response and recovery

Papers studying the response and recovery are classified in Table 2.9. Beamon and Kotleba (2006) used optimization model to compare different inventory management strategies during the warfare in south Sudan. Both Feng and Keller (2006) and Papazoglou and Christou (1997) used the multi-objective programming to study the response to the nuclear problem. Papazoglou and Christou (1997) applied multi-objective programming to minimize simultaneously potential adverse effects of an accident and associated socioeconomic impacts. The uncertainty of weather conditions, the multitude of accident scenarios and the probability of occurrence have been taken into consideration. Feng and Keller (2006) presented a multiple-objective decision analysis approach to assess the resources distribution plans qualitatively and quantitatively. These plans try to protect people against potential thyroid cancer resulting from the release of radioactive iodine from nuclear incidents occurring due to terrorism or accidents. Dekle et al. (2005) studied the facility location problem after a large-scale disaster. Kelle et al. (2012) used the stochastic programming to help the decision makers to estimate the average cost of the preparation for the worst case scenario after the hurricane and optimize the utilization of resources during the response. Wang et al. (2011) proposed a two-stage stochastic programming model to solve the region division problem. The first stage is to decide the grouping strategy and the second stage is to find emergency resources delivering strategy within the region when the disaster happened. The second stage decision relies on the first stage decision. Christie and Levary (1998) used simulation to cope with the transportation of injured people to hospital after a man-made disaster in a big city.

Table 2.9: Papers studying response and recovery

Reference	Disaster	Methodology
Beamon and Kotleba (2006)	Man-made	Optimization model
Papazoglou and Christou(1997)	Man-made	Optimization model
Feng and Keller(2006)	Man-made	Optimization model
Dekle et al. (2005)	Integrated	Optimization model
Kelle et al. (2012)	Natural	Stochastic programming
Wang et al. (2011)	Integrated	Stochastic programming
Christie and Levary(1998)	Man-made	Simulation

3) Integrated

Some authors study emergency management plans, taking into account all four stages of the emergency management plan. We called this kind of paper "integrated", which means that all four stages have been taken into account. Table 2.10 classifies this kind of paper.

Ichoua (2010) uses scenario approach to address the problem of facility location and inventory management before disasters with the goal to ensure a fast and effective response when the disaster strikes. Fiedrich et al. (2000) proposes a mathematical model to estimate the related information caused by earthquake. Qin et al. (2012) proposed a single period mathematical model to optimize the emergency management from a strategic level. Ma et al. (2012) study the emergency management with the use of simulation.

Table 2.10: Integrated-stage Papers

Reference	Disaster	Methodology
Ichoua (2010)	Integrated	Scenario approach
Fiedrich et al. (2000)	Natural	Mathematical modelling
Qin et al. (2021)	Integrated	Mathematical modelling
Ma et al. (2012)	Integrated	Simaultion

2.3.3 Discussions and future directions

1) Discussions

Based on the Section 2.3.2, several conclusions can be drawn. From a view of disaster types, despite the frequency and potentially catastrophic health consequences of different types of natural disasters, remarkably, few published models have focused on the different types of natural disasters. Most of the researchers study the earthquake and flood but not other kinds of disasters. The same problem exists for the man-made disasters. Though there are several types of man-made disaster, warfare, bioterrorist attack, aircraft accident, radiologic and chemical accidents and so on, most of the papers study only the bioterrorist attack. Even though the importance of the varied response plans for varied disaster has been strengthened by a lot of researchers again and again, the papers

in this field are far from being enough. Furthermore, the medical resource distribution after bioterrorist attack, and people evacuation after natural disasters have not arrested enough attention, either. To sum up, more attention should be paid to certain kind of disaster.

From a view of used methodology, optimization model and simulation are the most popular. The reasons why the simulations are one of the most popular methodologies are: First, drills can evaluate the validity of the emergency management plans. But drills are expensive and cannot simulate all the possible scenarios. Computer simulation can overcome all aforementioned shortages of drills and can present almost all possible scenarios un-expensively, and it is one of the first choices by the researchers without doubts. Second, one of the main characteristics of disasters is the uncertainty. Computer simulation, which reflects the uncertainty and stochastic situations easier, can capture the uncertainty of disasters. Another popular method is optimization model. Optimization model can analyze the emergency management plan numerically. The response of the disaster always needs a large-scale of resources. But the available material resources are always limited and need the optimization of the utilization. The optimization can support the decision maker to find a strategy to use the materials reasonably.

2) Future directions

After the above analysis, several future guidelines can be proposed.

- The selected papers include a wide variety of outcomes, such as the number of deaths, patient waiting times, the cost-effectiveness analysis. However, the uniform criteria which can judge the model have not been established.
- The mathematical models can provide critical insights into disaster response plans, but are not easy for the decision makers who do not have a strong mathematical background to understand. Therefore, a way to explain the principle under the mathematical model is necessary. In other words, the model should be easier for the people to understand and follow.
- The emergency management plans should be based on the real case. However, a lot of research papers build the models based on assumptions. This gap will lead to the difficulties of the improvements methods to put into practice.

2.4 Conclusions

Based on the above literature review, it can be found that mathematical model (optimization model) and computer simulation (descriptive model) are the two most popular methods. The mathematical model adopts the linear programming, stochastic programming and so on to find the trade-off solutions under the various constraints. The computer simulation tests the different scenarios until the desired solution is found. Since both methods have their own advantages and

disadvantages, a combined approach can be proposed to overcome the shortcomings and benefit from the advantages of the different methods. Three gaps should get attentions.

- Different disasters should be studied separately. However, most of the papers cannot do the research taking into account the different types of disasters.
- A lot of studies are not based on the real case scenario and then a lot of important details which can affect the magnitude of the disasters are neglected.
- Some important logistics factors which may affect the emergency management plans are not taken into consideration.

Therefore, in the following chapters, by using the mathematical model or simulation, different disasters will be studied separately, with the three aforementioned gaps observed.

3. Natural Disasters: Modeling and simulation of a hospital evacuation before a flood

Chapter 3 studies the emergency management plan for natural disasters and proposes a three-step approach to improve the current emergency management plan. The hospital evacuation activities in case of a flood guided by French Extended White Plan are taken as a real life scenario to test the effectiveness of our approach. This study is based on the suggestions and feedback of the health workers of the hospital Saint-Joseph/Saint-Luc. With the help of the three-step approach, the best way to assign the resources has been found and two organizational improvement methods have been proposed. With such improvements, 1 hour and 18 minutes is saved in evacuating the patients and the improvement rate is as high as 23.8%. The detailed structure of this chapter is as follows:

3.1 Introduction

- 3.1.1 Background of the research
- 3.1.2 Gaps of the previous works
- 3.1.3 General information of our approach

3.2 Problem description

- 3.2.1 The situation of disasters
- 3.2.2 The stakeholders

3.3 Three-step approach

- 3.3.1 The framework model
- 3.3.2 The global model
- 3.3.3 The detail model

3.4 Numerical experiments

- 3.4.1 Validation/verification and Experiments design
- 3.4.2 Numerical results
- 3.4.3 Process improvements

3.5 Conclusions

3.1 Introduction

From 2012 to 2013, our research team and the leaders of hospital Saint-Joseph/Saint-Luc held several meetings in the hospital Saint-Joseph/Saint-Luc to design an emergency management plan after natural disasters. Because hospital Saint-Joseph/Saint-Luc is located just by the river, evacuation of hospital Saint-Joseph/Saint-Luc in case of a flood will be used as a real case to design the French emergency management plan. The challenges for the leaders in the hospital Saint-Joseph/Saint-Luc includes how to inform all people in hospital of

what they must do during the evacuation, how to deploy the resources so that all the patients can be evacuated in time, and how to minimize the evacuation time if the resources are limited. All these questions will be solved in Chapter 3.

3.1.1 Background of the research

As we mentioned before, some natural disasters can be predicted. But it is really difficult to avoid the occurrence of natural disasters, such as flood. So, evacuation of people who may suffer from predictable but unavoidable disasters is really important. This chapter takes the hospital evacuation in the event of a predictable natural disaster as a real case scenario, under the guidance of a French Extended White Plan (Ministère de la Santé et des Solidarités 2006), to propose a three-step approach which can be used to improve emergency management plans.

To present French Extended White Plans, French White Plan (Plan Blanc), should be introduced. It is the emergency management plan for the sudden increase of activity in a hospital. If the activity needs several hospitals, this emergency management plan is called French Extended White Plan. In other words, French Extended White Plan provides a legal framework to hospital evacuation, concerning both the hospitals that will be affected by the disasters and that will receive the evacuees.

One of the natural disasters, which may happen in France, is hydrological disasters. Hydrological disasters, triggered by flood or wet mass movement (mudslides), is the most destructive natural hazard in the Mediterranean region (Pegram, 1980). Over the past three decades, hydrological disasters have killed over 100 individuals and caused damages around a billion Euros in France.

The following parts present how to use the proposed three-step approach to design French Extended White Plan in order to satisfy the requirement of the decision workers in the hospital: the resource dimensioning and the evacuation time minimizing.

3.1.2 Gaps of the current research

According to the literature review in Chapter 2, there are the following gaps for the research in this field:

From a view of content, it can be found that papers studying emergency evacuation are abundant, but few of them focuses on the hospital evacuation. It concerns patients, who require intensive and continuous cares which makes challenges different from the traditional emergency evacuation and therefore should be one of the research focuses. However, the research in this field is really limited.

From a view of approach, optimization models and computer simulation are the most suitable methods in this field. But, most of the researches on the evacuation were not based on a real scenario, which led to two problems: one is to fail to respect the hospital's rules and its best practices, and the other is to ignore the detail of the real case. Moreover, most of the models have not been

checked and verified effectively. These problems make it difficult to put the existing plans and the improvement methods into practice

These problems make the existing plans and the improvement methods difficult to put into practice. These gaps have been our main drive .

3.1.3 General information of our approach

Based on our objective and the gaps of the current research, a three-step approach which can improve the emergency management plans is proposed. The first step helps the people understand and model the current situation generally. The second step predicts quantities of required resources during disaster relief because a lot of information before and during the disaster is not clear. The third step is devoted to improve the emergency management plan reasonably by optimizing the usage of limited resources to minimize the evacuation time. General information about this three-step approach is described in the following:

The first step is to establish a framework model to get a holistic view of the current emergency management plan. The model mainly aims to define the stakeholders, describe the processes between actors and present the information transmission abstractly. It can be used as architecture for the following steps.

The second step is to propose a global model to roughly predict the unknown or uncertain information. As mentioned in Chapter 1, one of the main characteristics of natural disasters is unavoidable but partly predictable. Therefore, the preparedness for natural disaster is necessary. However, some information, such as the quantities of the required resources during the response, is usually uncertain or unknown before or even after the disaster happens. With the help of this global model, some uncertain or unknown information can be predicted based on the historical data of natural disasters or the experience of the decision makers.

The third step is to establish a detail model based on the information described by the framework model and the data predicted by the global model. This model can present the processes and activities in detail. With the help of this model, decision makers can discover the problems of the current system intuitively. The improvement methods can be proposed by different scenarios.

It should be stressed here that our approach can not only be used to study the flood and the French Extended White Plan, but also other natural disasters and emergency management plans. For example, Appendix A presents evacuation of patients in Hospital Lyon Sud under the guidance of French Extended White Plan facing a predictable flood and earthquake. The French Extended White Plan and the flood are used here as a real case scenario to test the effectiveness of our approach.

3.2 Problem description

3.2.1 The situation of disaster

The evacuation situation we intend to study is provoked by flood damage to a dam, located in Commune Cernon (Jura, France), which could trigger a disaster if damaged. The dam is about 103m tall and 36 000m long. Its water volume is about 600 million m^3 . After the dam breaks, the speed of the flood is estimated at 20km/h and the height of the water wave is between 1 and 8 m. The Hospital Saint-Joseph/Saint-Luc is located in the passage of the potential flood, which would arrive in Lyon in 5 or 6 hours and at the Hospital Saint-Joseph/Saint-Luc in 8 or 9 hours. Water in the hospital would rise between 6 and 9 meters. The whole situation would last approximately 24 hours and its overall impact is difficult to estimate. The flood would affect telecommunication networks, transportation networks and so on. Therefore, the evacuation of all the patients in the Hospital Saint-Joseph/Saint-Luc to other unaffected hospitals within 5 hours before the flood arrive in Lyon, is necessary. The patients can be classified into non-autonomous patients, who have to be transported by ambulances, and autonomous patients who can be evacuated with public transportation. Since the latter group will not use some special material resources, like the ambulance, they will not be considered in our study. According to the requirement of the Hospital Saint-Joseph/Saint-Luc, 120 non-autonomous patients need to be evacuated.

3.2.2 The stakeholders

There are three main stakeholders or actors in our study, the Hospital Saint-Joseph/Saint-Luc, Hospices Civils de Lyon and SAMU (Service d'Aide Médicale Urgente).

The Hospital Saint-Joseph/Saint-Luc is located beside the river Rhone. This hospital has 1,207 employees and a capacity of 344 beds. In 2012, the number of people who are treated in the emergency department was 37,013. During the holiday, at night, or on Saturday and Sunday, 19 physicians are on duty. These hospital employees take care of autonomous and non-autonomous patients.

Hospices Civils de Lyon (HCL) is a network of hospitals providing expertise in all disciplines – both medical and surgical. The budget for 2014 is 1.6 billion Euros. It has 23,000 professionals and a capacity of more than 5,400 beds.

SAMU is a health care coordinator in France. It controls the response vehicles and ambulances from SMUR (Service Mobile d'Urgence et Reanimation) which is a “mobile intensive care unit” (MICU). SAMU plays a role of coordinating the evacuation activities and its tasks include: to evaluate the patient's needs according to the calls; to find the best care solution for the patient's requirements; to dispatch the most appropriate mobile care resource (MICU, Ambulance...) to move the patients to hospital.

In short, the Hospital Saint-Joseph/Saint-Luc may be hit by the flood and the patients need to be evacuated. For the sake of safety, all the patients must be

evacuated in 5 hours. 120 patients need the extra help during the evacuation. Hospices Civils de Lyon is a network of hospitals and can receive the evacuated patients. In this study, there are two main functions of SAMU: one is to decide the destination of evacuated patients; the other is to assign the suitable medical vehicles to evacuate patients. All the evacuation activities are guided by French Extended White Plan.

3.3 Three-step approach

In this section, the three-step approach will be described in detail.

3.3.1 The framework model

1) The conception with ARIS

To illustrate the French Extended White Plan, several factors should be presented clearly, such as, the processes of evacuation, the information flow among the different stakeholders and so on. To achieve it, a powerful modeling approach is required. Since Architecture of Integrated Information Systems (ARIS) is an approach which can present processes clearly and systematically and takes into account information transmission among the different actors (Wang et al. 2009b), it is used to show the evacuation activities under the guidance of the emergency management plan. ARIS shows the current system in terms of five views: organization, function, data, control and process (Scheer, 1994). A briefly description of these five views is presented in the following.

- Organization

The organization view presents the actors, the hierarchical structure of these actors, relationships among these actors and responsibilities of each actor.

- Function

The function view defines the functions of different actors by representing activities, resources and so on.

- Data

The data view describes the information which is exchanged and stored by actors.

- Control

The control view presents the information transformation.

- Process

The process view provides the linkage among all the views. One of the most important aspects of process view is the Event-driven Process Chain (EPC). An EPC is a flowchart used for describing a business process and workflow. In the figure of EPC, an event which is represented by hexagon describes under what circumstance a function works or which state a function or a process results in. A function which is represented by a rounded rectangle describes transformation from an initial state to a result state.

2) The framework model based on the ARIS conception

To establish this framework model based on the ARIS conception, we adopt the ARIS Toolset. The ARIS Toolset is a software tool for designing, describing and optimizing processes, based on the ARIS conception. With ARIS Toolset, we elaborated a framework model offering a generic view of the current, as-is, system. Moreover, by looking at the model, people can easily get a good idea of the sequence of events and activities. Our framework model is made up of 17 processes and 108 activities. Parts of this framework model are shown in the following figures. More information about ARIS model can be found in the Appendix B.

Figure 3.1 presents the main processes of the Hospital Saint-Joseph/Saint-Luc during the evacuation. The emergency coordination center, as defined in the French Extended White Plan, manages and controls the evacuation activities of the hospital. As mentioned before, this chapter focuses on the evacuation of non-autonomous patients because this kind of patients ask for special help during evacuation. Other main evacuation processes include: hospital activity deprogramming, demobilization of the employees, the evacuation of bio-material and so on. Based on Figure 3.1, the non-autonomous patient evacuation is divided into three main processes: preparing the patients, moving the patients from their care unit to the emergency department (ED) which is the closest access to the ambulance park, and transporting patients to HCL. Every process consists of several activities which will be presented in the following.

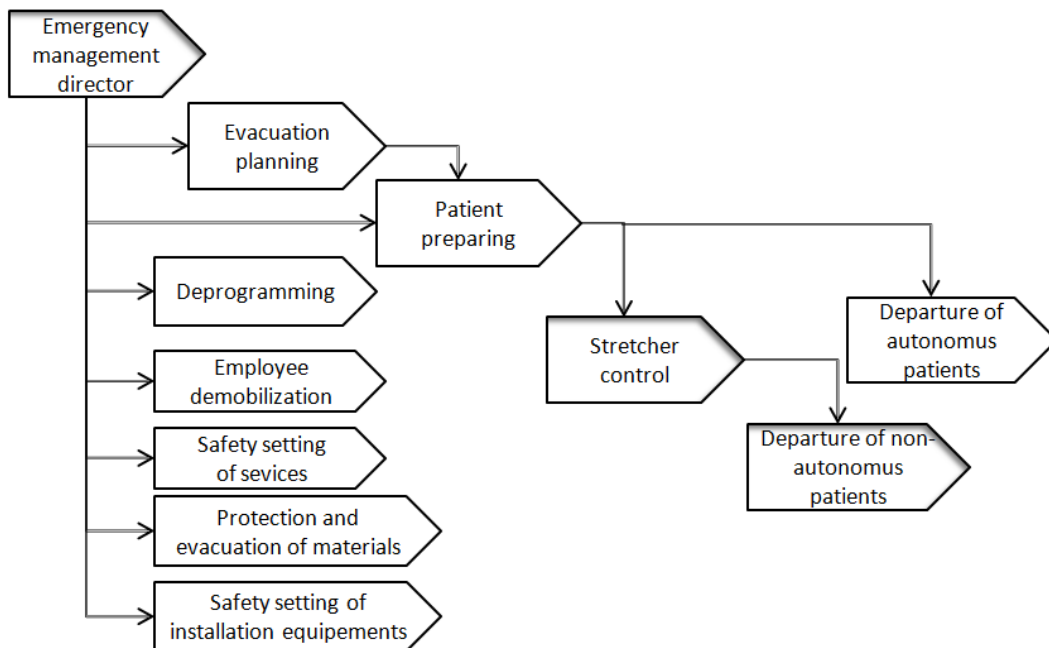

Figure 3.1: Process of Hospital Saint-Joseph/Saint-Luc.

Figure 3.2 presents the EPC of preparing patients in Hospital Saint-Joseph/Saint-Luc. Preparing patients includes following main activities:

preparing name list of non-autonomous patients, assignment of accompanying persons for non-autonomous patients, preparing the special medical resources, such as medicines that patients will need during evacuation, preparing patients' clinical history and so on. After patients are well prepared, they will be transported by stretchers from wards to emergency department where they can wait for ambulance (Figure 3.3). Most of these jobs are done by nurses. According to the information from health workers in Hospital Saint-Joseph/Saint-Luc, it takes about 10 minutes to prepare the name list of non-autonomous patients. Assignment of accompanying persons (attendant) for total non-autonomous patients takes 15 minutes. The mean time to prepare medicines, clinical history and so on for each patient takes 10 minutes. Except name list of non-autonomous patients, another important list is the available bed list in HCL. After the non-autonomous patients list is available, SAMU will ask HCL to prepare the available bed list. Preparation of available bed list takes 15 minutes.

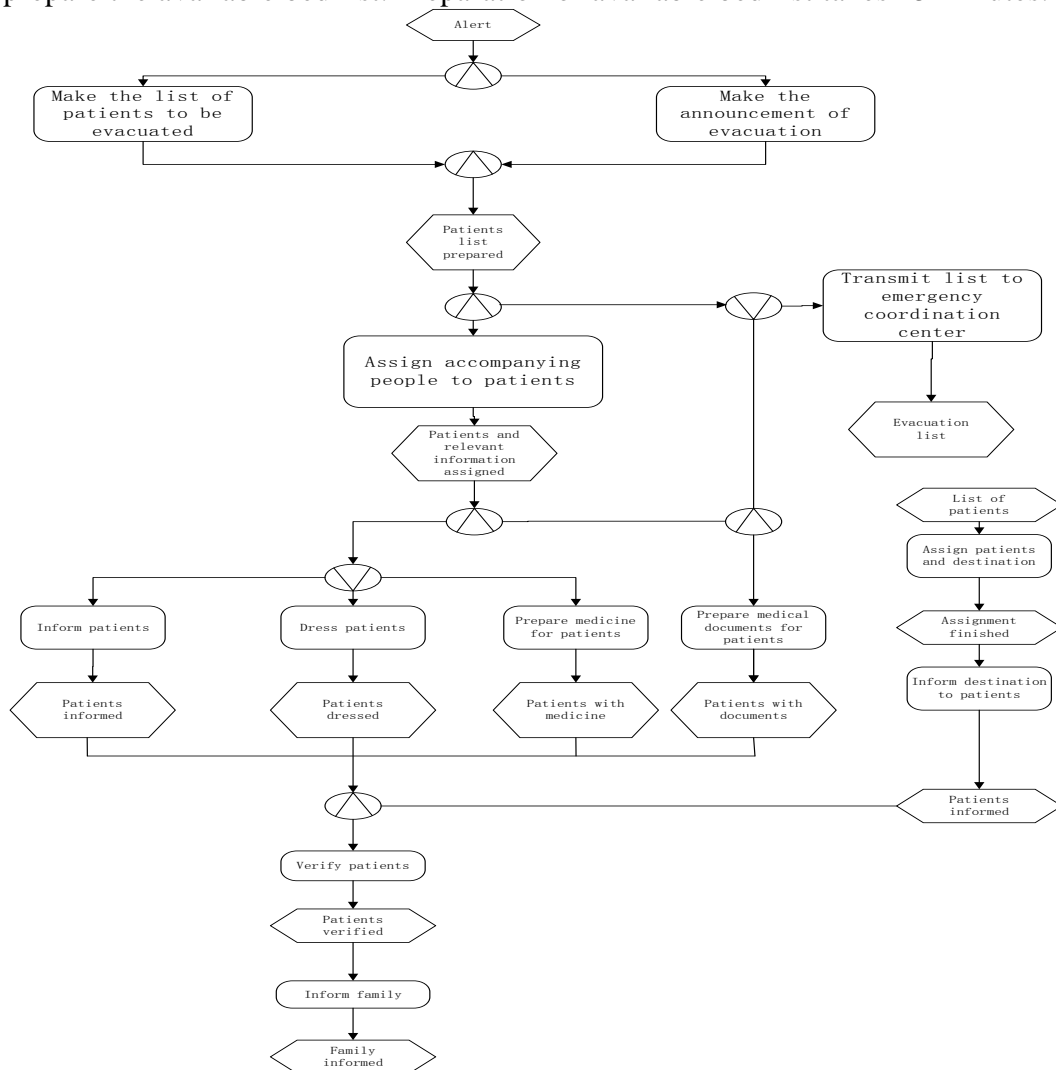

Figure 3.2: EPC of patient preparing.

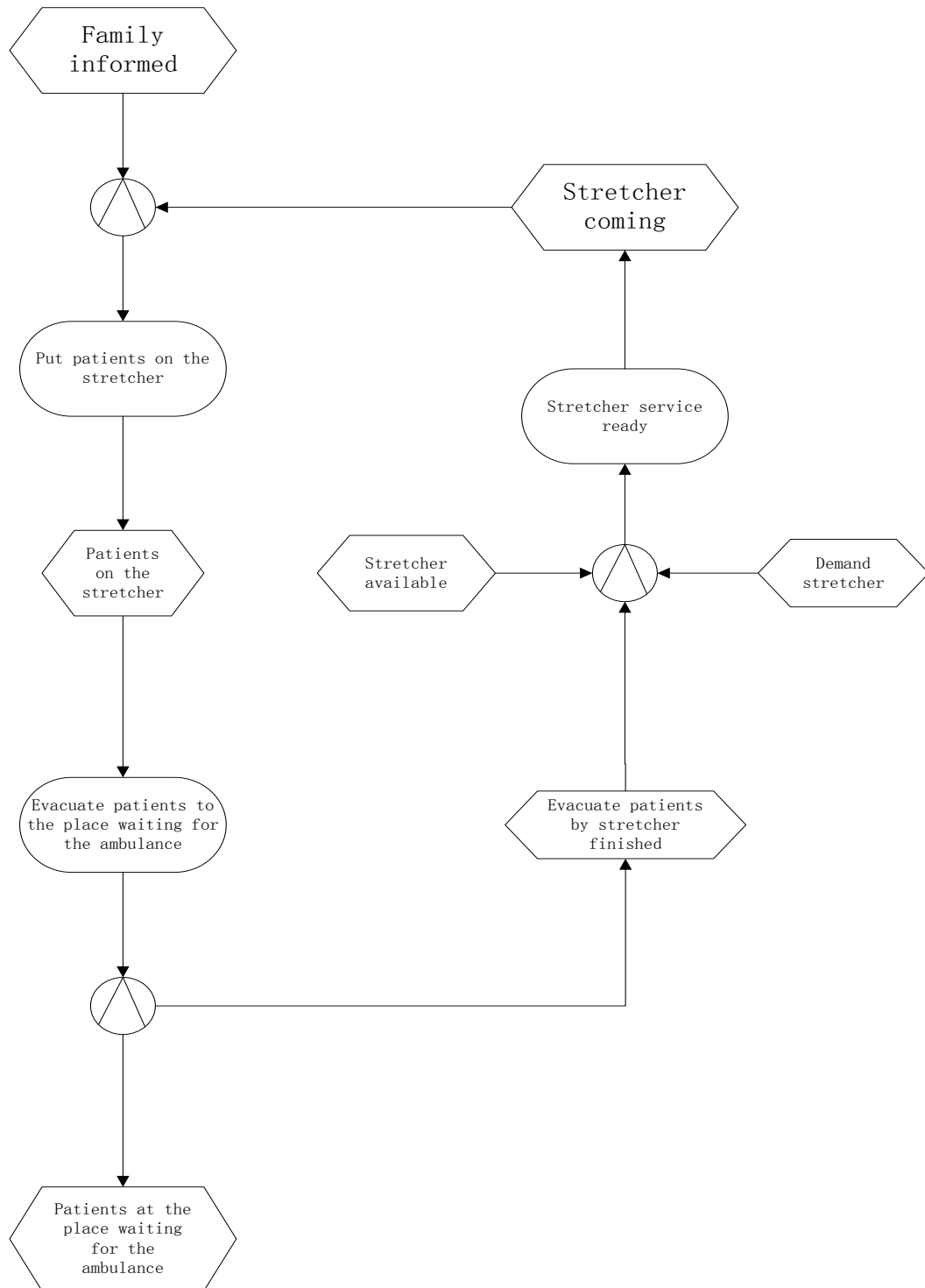

Figure 3.3: EPC of stretcher control.

Figure 3.3 illustrates the evacuation of patients by stretcher. It indicates that evacuation of patients by stretcher can start only after patients are well prepared and there is an available stretcher, precisely, a stretcher team. To be concise, we

use stretcher rather than stretcher team in the following. During the patients evacuation by stretcher, a worker who evacuates a patient with stretcher will move a patient from ward to Emergency department. And then the worker will go back to ward to move next patient. Moving patients from ward to hospital exit takes 6 minutes.

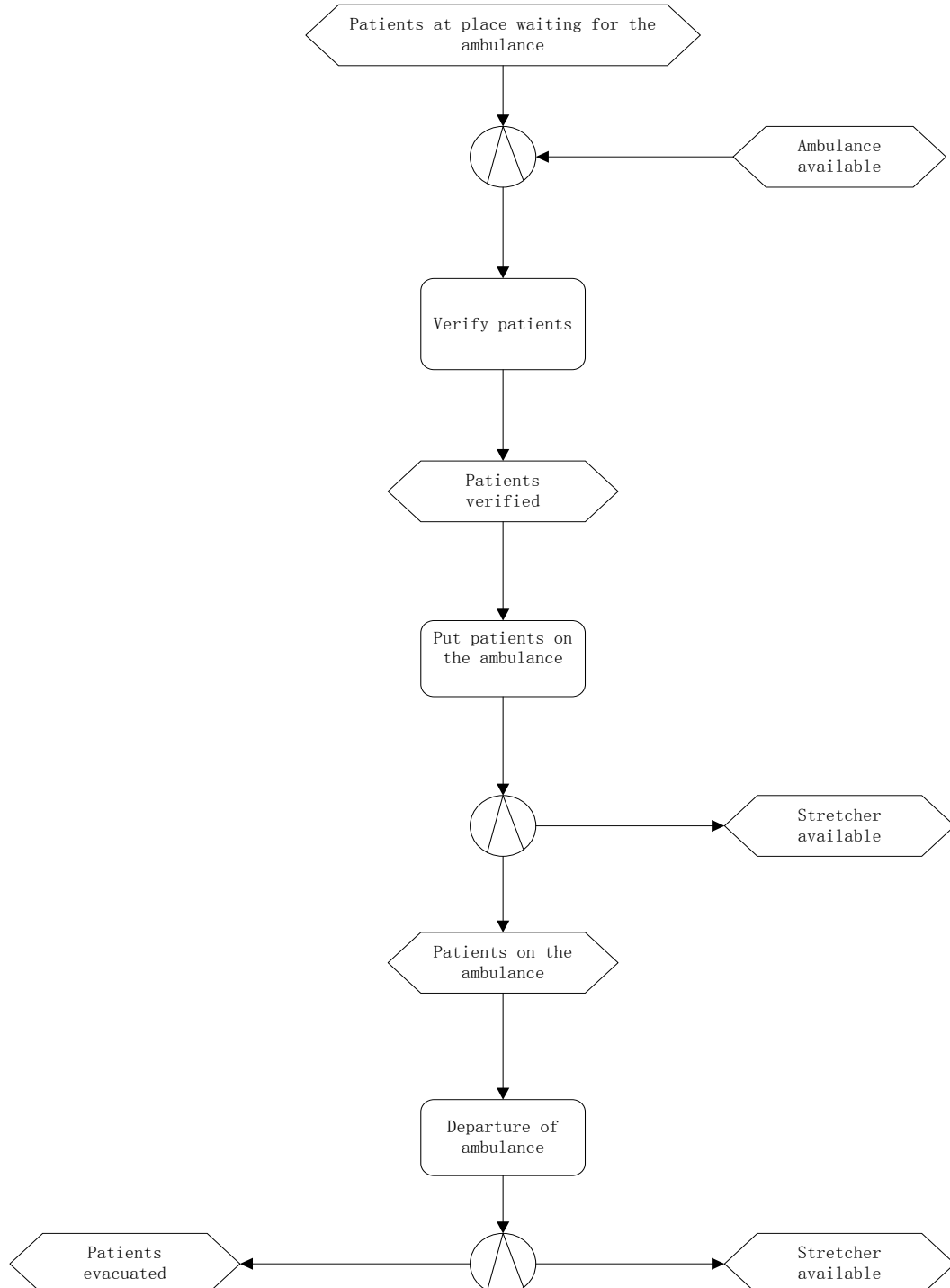

Figure 3.4: EPC of departure of non-autonomous patients.

The departure of patients is shown in Figure 3.4. At the arrival of the ambulance, it will be verified whether the patients will be evacuated to the right hospital. Then, the verified patient and the accompanying person will be moved to the ambulance. After that, the stretcher which is used to transport the patient will be free and the ambulance will move the patient away.

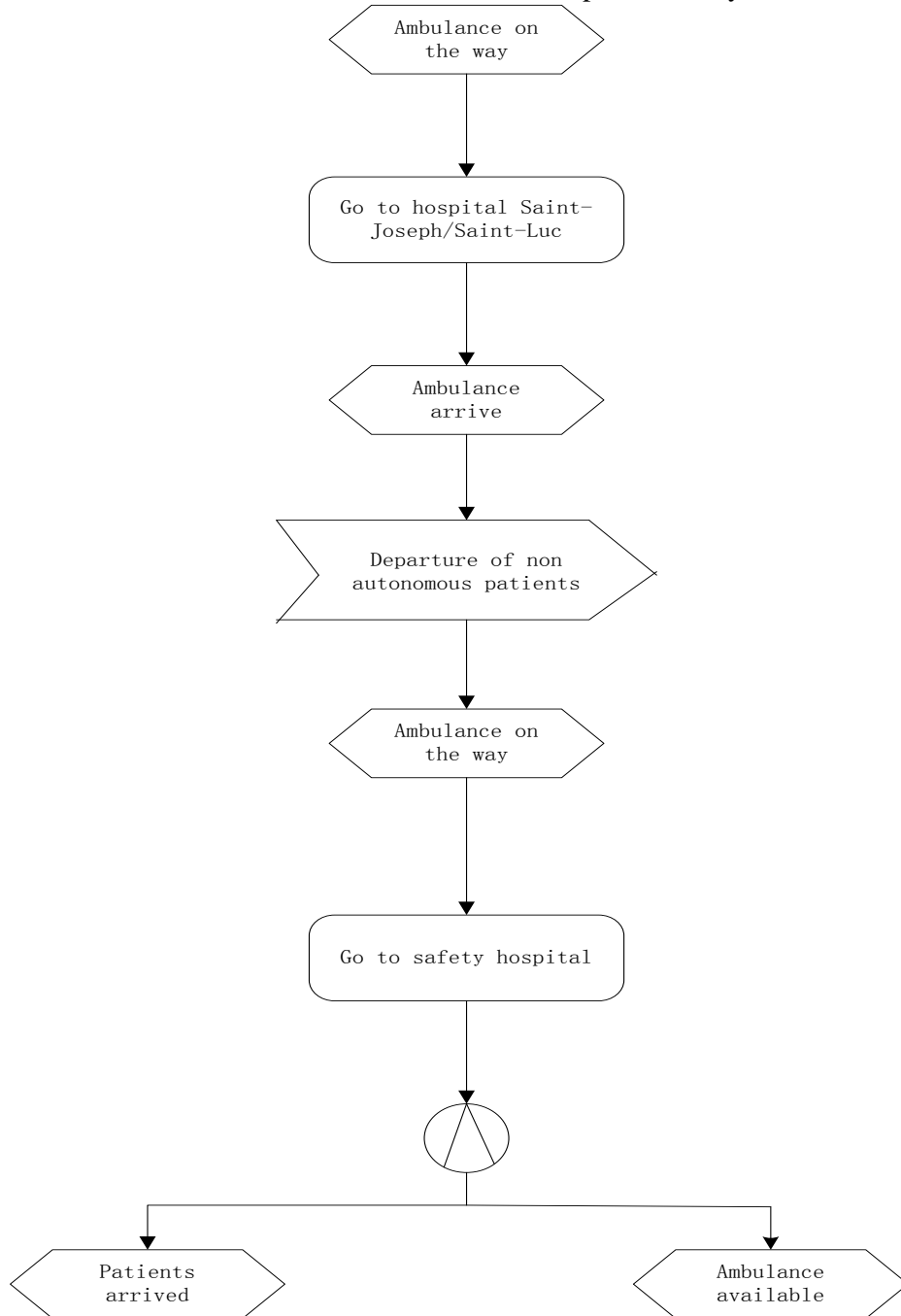

Figure 3.5: EPC of evacuation of patients by ambulance.

Another important evacuation process takes place outside Hospital Saint-Joseph/Saint-Luc: evacuation of patients by ambulance (Figure 3.5). The process

of utilization of ambulance is a little similar to stretcher utilization. The transportation from emergency department to another safety hospital takes 16 minutes. Again, the ambulance refers to ambulance team but we use ambulance for conciseness. The coordination work during these activities are done by coordinators in Hospital Saint-Joseph/Saint-Luc.

Based on the aforementioned main activities during evacuation, it can be found that, nurses who prepare patients, coordinators who are responsible for coordination work, stretchers and ambulances which can be used to transport patients, are main resources.

3.3.2 The global model

In this part, an optimization model is proposed to model the evacuation globally, mainly for resource dimensioning reason.

1) Optimization model

As linear programming technique is an exact method, we adopted this optimization technique to find our resource dimensioning. A linear model has been built according to the aforementioned main processes: Patient preparing (Figure 3.2), stretcher control (Figure 3.3), departure of non-autonomous patients (Figure 3.4) and evacuation of patients by ambulance (Figure 3.5).

The data of this model is:

T: Number of periods t (in hours)

M: Number of activities

Nbpat: Number of non-autonomous patients to be evacuated

Dur (j): Duration of the activity j (by minutes)

Suc (j): Set of successors of the activity j

Cap (j,t) : Capacity of the resource associated to the activity j (by minutes)

The variables are:

X (j,t) : Number of patients who benefit from the activity j during period t

S (j,t) : Number of patients who wait for the next activity during period t

Model:

$$\text{Min} \sum_{t=1}^T X(M, t). t \quad (3-1)$$

Subject to

$$S(j, t - 1) + X(j, t) - S(j, t) \geq X(k, t) \quad \forall k \in \text{Suc} (j) \quad \forall j = 1, \dots, M - 1 \quad (3-2)$$

$$\forall t = 1, \dots, T$$

$$X(j, t) \cdot \text{Dur}(j) \leq \text{Cap}(j, t) \quad \forall j = 1, \dots, M \quad \forall t = 1, \dots, T \quad (3-3)$$

$$\sum_{t=1}^T X(M, t) = \text{Nbpat} \quad (3-4)$$

The objective function endeavors to minimize the sum of two series where each term of same rank in both series is multiplied. To be minimized, the series $X(M, t)$ has to be ranked in decreasing order as the series t is in increasing order. So activities are realized at the earliest. We try to use this dynamic model to find the suitable resource dimensioning. The constraints (3-2) control the patient flow. Constraints (3-3) respect the resource capabilities. Constraint (3-4) defines the number of patients to be evacuated. The managers in Hospital Saint-Joseph/Saint-Luc predicts that 6 nurses, 12 ambulances, 10 stretchers and 2 coordinators may achieve the objective: evacuate 120 patients in 5 hours. With the help of Cplex (version 12.6), the experiment was executed on a computer equipped with an Inter (R) Core(TM) i3-2100 processor running at 2.10 GHz using 5.1 seconds. It is found that, if we want to evacuate 120 non-autonomous patients within 5 hours, at least, 6 nurses, 12 ambulances, 10 stretchers and 2 coordinators should be assigned.

2) Problem complexity

Even though the main processes (patient preparing, stretcher control, departure of non-autonomous patients and evacuation of patients by ambulances) can be modeled via our linear programming, several problem complexities lie in our study and make our linear programming not perfect enough to properly reflect the real world. First, since the evacuation situations are plagued with uncertainties (Aakil et al. 2012), it is better to use stochastic data, which can reflect the situation better. With the stochastic data, however, the solution of the optimization model is difficult to find. Second, the optimization model is an analytical method which can only represent the current emergency management plan in an abstract way and lot of details are omitted. Third, the optimization model cannot achieve the organization improvement objective effectively in practice because it cannot present the emergency management plan intuitively and take into account the detail information of the processes. So, it is necessary to establish a detail model to overcome these gaps.

3.3.3 The detail model

According to our literature review, computer simulation seems to be one of the most suitable approaches in tackling problems related to complex and uncertain real-world situations (Longo 2010). It has, but not limited to, the following advantages: Computer simulation captures explicitly the stochastic nature of data; Computer simulation allows anticipating the system performance under different configurations or parameters settings, making of it a powerful tool in

reengineering processes; Computer simulation can act as a ‘what if’ tool and will be useful to support training exercises (Stewart 2004).

Among the numerous computer simulation packages, we elected SIMIO to build our detail model. SIMIO is designed to support the object modeling paradigm and supports both discrete and continuous systems, along with large scale applications based on agent-based modeling. Moreover, SIMIO’s intuitive and user friendly interface simplifies the modeling tasks, allowing the novice user to develop rather complex models very quickly. The strong 3-D simulation effect is a useful tool for presenting the simulation executions and results.

It is worth to mention that the simulation model is not a straightforward translation of the framework model, but a new representation of their activities, entities and decisional processes. The next paragraphs aim at sketch the main activities related to the patient evacuation and suggest how Simio’s tools were used the model the evacuation process.

Our simulation model is divided into two interacting parts or submodels. The first part (Figure 3.6) models the evacuation preparation, in particular the information flows among the vested interest actors and the decisional processes. The second part (Figure 3.7) emulates the physical evacuation activities. Both submodels are synchronized by specific trigger events.

1) Evacuation preparation

In the simulation model, a server, represented by system block, is used to model capacitated resources with optional input and output. A sever includes a queue where entities are stored before being processed. The processing time may be constant or drawn from a probabilistic distribution chosen by the user. A server may include one or several processors, and may require the presence of external resources to either trigger or accomplish entity’s treatment.

The evacuation preparation submodel consists of a sequence of six servers representing six main activities. The first activity, summoning the Emergency Coordination Center (EC), begins right after the alert is triggered. Once the EC has been constituted, the Medical director requires from each care unit the list of patients to be evacuated as well as their particular requirements, like types of transportation, or specific cares (activity 2). When the patient list is ready, it will be transferred to the SAMU (activity 3). The SAMU analyzes the list of patients. Then it identifies the set of hospitals that could fit the medical needs of the patients to be evacuated and contacts them in order to evaluate their capacity to receive (activity 4). Each hospital verifies its occupancy and informs the SAMU on the number and kind of available hospitalization beds (activity 5). SAMU waits for all the hospitals’ answers and then transfers them to EC at Hospital Saint-Joseph/Saint-Luc (SJSJL). Upon reception, EC assigns patients to available hospitalization beds (activity 6) and identifies attendants that will take care of patients during transportation. And then, the updated patient list, containing the patients to be evacuated as well as their attendants and destinations, is transferred to both the concerned care units at SJSJL and SAMU, which contacts the hospitals that will receive evacuees as well as SMUR in order to coordinate transportation. This process is illustrated by Figure 3.6. Notice that, since our model considers only HCL, it is assumed that it can receive all the patients.

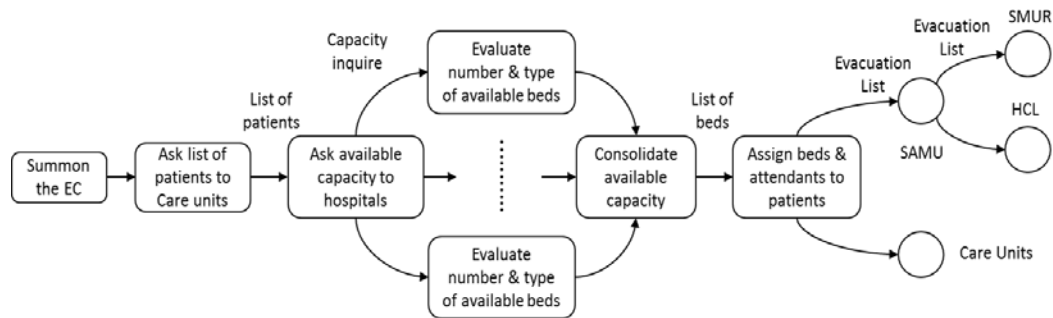

Figure 3.6: Evacuation preparation.

To simulate the execution of the described activities, a system entity is generated when the alert is triggered. This entity flows to the first server (activity). It waits until all the resources required to execute the activity are available (if any), and then the server and the concerned resources are busy during the activity execution. Once the execution completed, the entity moves to the following server and the resources in the server are released to perform other activities. To model the situation where several servers are activated simultaneously, we simply use a separator, a system block which “copies” the alert entity as many times as required, and flows the entities to the servers to be activated.

2) Patient evacuation

Patient evacuation requires a very tight coordination among SJSJL, SMUR and HCL for the safety of each evacuee. The evacuation submodel is divided into two processes: patient preparation and patient transportation.

Patient preparation aims to get the patient ready to be transported, produce a copy of the patients’ clinical history, and ensure that HCL is ready to receive the patient. Patient preparation starts with the end of the Evacuation preparation submodel, more specifically by the reception of the list of patients to evacuate at the SJSJL care unit. At the care unit, a server models the preparation of the patient. This activity includes verification of the patient’s vital signs, patient dressing, preparation of patient medication for at least 24 hours, and other similar tasks. Meanwhile, another server modelling a nurse at the care unit produces the clinical history of all the patients to be evacuated and contacts the person accompanying the patient. Needless to say, patient preparation and clinic records preparation are done after the patient list is made. As soon as a patient is ready along with his/her clinical record and the attendant, the coordinator at HCL is contacted in order to reconfirm the identity of the patient and the availability of an adequate hospitalization bed. Once this final verification is done, the patient is ready to be evacuated so the Patient transportation process is triggered.

From a simulation modelling standpoint, the model creates three entities for each evacuee: an entity of type “patient”, an entity of type “record”, and an entity of type “destination”. Activities synchronization is modelled by a combiner system block. A combiner requires the presence of two or more particular entities before confirming them together within a parent entity. In our

case, a “patient ready” entity is generated when entities “patient”, “record”, and “destination” are all combined.

The Patient transportation process starts by moving the patient from his/her room at the care unit towards the emergency department (the ambulances arrival points). This activity is represented in the model by a server which requires, to execute the action, the presence of an external resource (a team of stretchers). The first available team of stretchers will walk from their position (the emergency department) to the care unit which requires the patient transportation. Travelling time is modelled by a Timepath, a system tool used to connect two blocks and which requires a given time (fixed by the user) to be crossed. Stretcher requests follow a first come first served basis. Meanwhile, a request for an ambulance is sent to SMUR, which assigns an ambulance to the patient or put the request in a waiting list if no vehicle is available.

When the ambulance arrives at SJSL, the health workers on the ambulance contacts the coordinator at the emergency department in order to identify the patient whose name appears in the request. If the patient is already at the emergency department, he or she will be installed in the vehicle. The health workers inform SMUR that the patient departs and validates, again, the destination. Meanwhile, the coordinator at the emergency department confirms to the Emergency Committee the departure of the patient and its attendant. Notice that stretchers stay with the patient until he/she has been installed in the ambulance. The reason for this practice is to guarantee the patient’s safety during the installation process. We will discuss the impact of this practice on the total evacuation time.

Finally, ambulances, which are represented as resources in our model, travel (go and back) from SJSL to HCL on a network of Timepath connectors with probabilistic travelling times. When an ambulance arrives at HCL, patients will be transported to the hospitalization beds and the relevant information will be transferred from HCL to SMUR. Then, SMUR confirms to SJSL’s EC the completion of the patient evacuation and assigns another mission (if available) to the ambulance. This whole process is depicted in Figure 3.7.

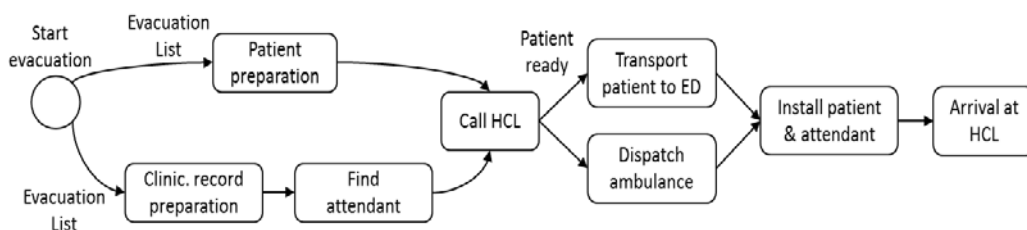

Figure 3.7: Patients evacuation.

3.4 Numerical experiments

The purpose of this section is to assess the time required to evacuate all the non-autonomous patients at SJSL, but more broadly, to find out how the evacuation

time evolves according to potential changes in some model parameters or system settings. In particular, we would like to anticipate the behavior of the variation of the evacuation time when resources related to evacuation activities (eg, the number of ambulances or the number of stretchers) change. In this way, crisis managers will be able to make better strategic choices about the design of resources to be deployed to cope with a situation as the one studied in this article.

The common steps in simulation experiments include (Banks et al. 2004): (1) problem formulation, (2) setting of objectives and overall project plan, (3) model conceptualization, (4) data collection, (5) model translation, (6) verification and validation, (7) experimental design, (8) execution and results analysis, and (9) documenting and reporting. Steps 1 to 3 and step 5 have already been discussed in previous sections. The next subsection elaborates on steps 4, 6 and 7. Then numerical results will be presented and analyzed. Finally, we suggest and assess the impact of two process improvements on the evacuation time.

3.4.1 Validation/verification and Experiments design

Data collection is one of the most important, yet difficult steps in a simulation project. In our case, there were not historical data or precise measures allowing estimating values and distributions for activities execution times. We just have the mean time of each activities estimated by manager in SJSL and HCL. To overcome this difficulty, we validate some of these estimates by observing of a crisis management exercise at SJSL, but in the context of an exercise simulating the massive arrival of patients after a biochemical terrorist attack in the Lyon area. Although we found consistency between our observations and the estimates, a specific data collection activity needs to be performed. Since we just know the mean time of each activity, we assume that time used by each activity obey normal distribution. Verification allows ensuring that the computer translation (the Simio simulation model) represents adequately the logic and the structure of the conceptual model. Validation refers to the adequacy of the proposed model to represent the studied situation. After a thorough debugging of the Simio model, we proceed to validate our model by presenting the framework model, as well as the numerical results produced by the simulation model, to SJSL and HCL managers. Experts found the logic and the numerical results close to what they expected. So we did not see any reason to reconsider our model and simulator.

As mentioned before, the main goal of this study was to evaluate the evacuation time for non-autonomous patients at SJSL and to assess the system sensibility to the amount of resources deployed (i.e., number of nurses or ambulances) as well as other parameters like travelling or task execution times. A brain storming session was conducted with managers from both SJSL and HCL. Unfortunately, despite of our solicitation, SMUR and SAMU did not participate in this exercise. Following this meeting, we selected as independent variables the number of nurses at the unit care, the number of coordinators at the emergency department, the number of ambulances and the number of stretchers'

teams. Although some other variables were mentioned during the brainstorming, we agreed to limit ourselves to these variables because they seemed a priori the most significant.

Table 3.1: 2^k factorial experiment design.

Design point	N	C	A	S
1	3	2	12	10
2	6	2	12	10
3	3	1	12	10
4	6	1	12	10
5	3	2	6	10
6	6	2	6	10
7	3	1	6	10
8	6	1	6	10
9	3	2	12	5
10	6	2	12	5
11	3	1	12	5
12	6	1	12	5
13	3	2	6	5
14	6	2	6	5
15	3	1	6	5
16	6	1	6	5

Using these factors, we designed a 2^k factorial experiment (Barton 2002; Barton 2003; Klaus and Kempthorne 2008). The 2^k factorial design is an experiment which considers k factors (independent variables). Only two levels (or values) are considered for each factor: a low level and a high level. The choice of levels should be done in such a way that: (1) they are feasible, (2) they are far enough as to provoke differences in the system output, and (3) they are close enough as to assume that the system response is approximately linear over the range of the factor. The output performance measures called responses (dependent variables) will vary with the change of the levels of each factor. Therefore, this experiment allows studying the effect of each independent variable on the dependent variables, as well as the effects of interactions between the independent variables. The experimental design includes all possible combinations of the different levels across all factors. The proposed 2^k factorial design had 4 factors: the number of nurses (N), the number of coordinators (C), the number of ambulances (A), and the number of stretchers teams (S), which leads to 16 ($2^k = 2^4$) different combinations (also called design-points) to be simulated. High and low values for each factor were selected after discussions with the crisis managers at SJSL and HCL. Table 3.1 lists the 16 different design points and the particular value taken by each factor in each design point.

3.4.2 Numerical results

We executed 20 terminating replications of our Simio model for each design point in Table 3.1, for a total number of 320 runs. All our experiments were executed on a computer equipped with an Inter (R) Core(TM) i3-2100 processor running at 2.10 GHz. We decided to execute only 20 replications because the obtained confidence intervals around the mean for each design point were tight enough (around 10 minutes). Each replication consists in the evacuation of 120 non-autonomous patients. These results are presented by means of Simio boxplots called SMORE (Simio Measure Of Risk and Error). Given a system performance measure, a SMORE indicates the mean, maximum and minimum values across a set of replications. Moreover, it computes a confidence interval on the mean. Finally, it shows also the upper and lower percentile values as well as confidence intervals around them. In our simulation experiments we set the mean's confidence interval to 95%. Figure 3.8 illustrates a SMORE plot.

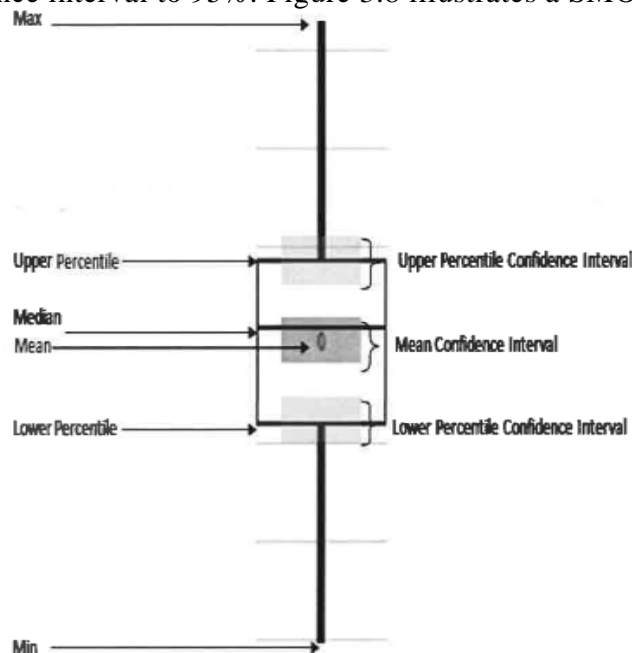

Figure 3.8: SMORE plot (Simio LLC. 2006-2012).

The results produced for design points 1 to 16 are shown in Figure 3.9, where each scenario corresponds to one design point. Since the observed measure is the evacuation time, scenarios (design points) showing lower evacuation times are preferred. Taking this into account, scenarios 1 and 2 (corresponding to design points 1 and 2) clearly outperform the others. Figure 3.9 clearly shows that the evacuation times produced for scenario 1 are in all the cases lower than those produced by the other scenarios. Moreover, the confidence intervals on the mean for scenarios 1 and 2 do not overlap. Therefore, we can conclude that scenario 1 is preferred. This result is not unexpected, because in design point 1 all the factors but N (the number of nurses) take their higher value. Figure 3.9 shows also that there is little or no difference between the other scenarios (confidence

intervals overlap). Since only one scenario fulfills the threshold of 5 hours, it can be concluded that if all patients need to be evacuated within 5 hours, at least 6 nurses, 2 coordinators, 12 ambulances and 10 stretchers should be deployed. However, even though for scenario 1, in the worst case, the used time will be more than 5 hours. So, in order that all patients can be evacuated in 5 hours, more resources should be deployed.

But choosing the best among a given set of scenarios helps managers only partly. Making strategic decisions needs to anticipate the impact of increasing or decreasing the amount of resources on the evacuation time or, in other words, to perform a sensibility analysis. With the results obtained by our simulation experiments, we computed the mean effect of every factor i , denoted E_i and defined as the average change in the response due to moving factor i from its low to its high level, the interaction between every two factors (E_{ij}) defined as the half of the difference between the average effect of factor i when factor j takes its high level (and all the others factors are held constant) and the average effect of factor i when factor j takes its low level.

We also computed variation on the evacuation time (in percentage) associated to these effects. Results, sorted by relevance, are given in Table 3.2. Notice that higher order interactions (interactions between three or more factors) were not considered. Finally, we also computed confidence intervals for each effect, but since there are very tight, we decided not to show them.

According to Table 3.2, the most effective factor (i.e. the one provoking the highest decrease in the evacuation time when it moves from its low to its high value, the other factors being unchanged) is the number of ambulances. On the other hand, it can be observed that having one or two coordinators affects the evacuation time in a rather negligible manner. We also observe important interaction values, mostly between S and A , N and S and N and A . Since all the interactions show a “-“ sign, we can conclude that the best performance is obtained when S and A both take the same level, N and S take the same level, and N and A take the same level. Finally, we can also observe that number of ambulances explains around 19% of the variation of the evacuation time. Around 16% and 13% of the variation of the evacuation time is due to the number of stretchers and nurses. The number of coordinators account for only a fraction of the variation.

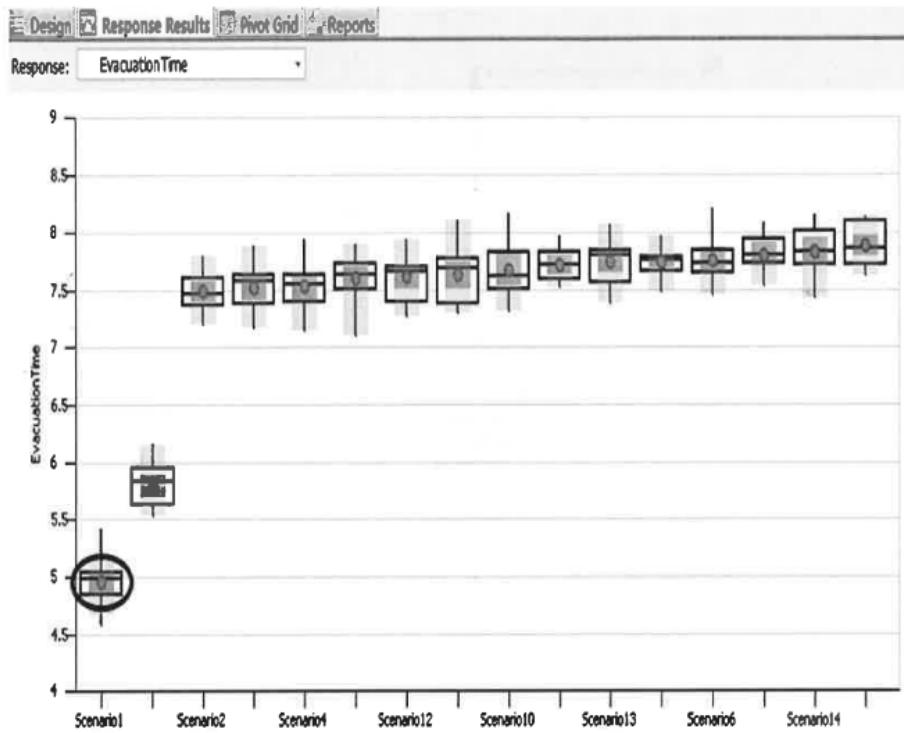

Figure 3.9: SMORE plots for each design point.

Table 3.2: Sensitivity analysis.

Factor(s)	Effect	Variation (%)
E_A	-0.69	19.5%
E_S	-0.63	16.3%
E_N	-0.57	13.3%
E_{SA}	-0.57	13.3%
E_{NS}	-0.53	11.5%
E_{NA}	-0.48	9.4%
E_{NC}	-0.14	0.9%
E_{CS}	-0.12	0.6%
E_C	-0.09	0.3%
E_{CA}	-0.05	0.1%

All in one, we conclude that the number of ambulances and the number of stretchers are bottlenecks of the current system, any increase in their number should lead to reduction in the evacuation time. As can be seen in Figure 3.9, scenarios 1 and 2 differ only in the number of coordinators. Average evacuation time for the best scenario is 4.95 hours, which confirms the most likely evacuation time suggested by the hospitals managers. For 20 cases of scenario 1, the upper percentile and the lower percentile are set to 75% and 25% respectively. The confidence interval for the upper percentile is from 5.00 hours to 5.13 hours. The confidence interval for the lower percentile is from

4.67 hours to 4.97 hours. The best case is 4.59 hours and the worst case is 5.42 hours.

Structuring process activities into a formal model allows improving the process. During the modeling phase, we observed certain inefficiencies in the evacuation process. This subsection proposes two improvements to the current as-is process and evaluates the potential reductions in the total evacuation time achieved by the implementation of the suggested changes.

Our first improvement concerns the evacuation preparation process. We observed that an important time is elapsed until the evacuation of the first patient, or in other words, the evacuation preparation time. In particular, even for the best proposed scenario (6 nurses, 2 coordinators, 12 ambulances and 10 stretchers teams) the evacuation preparation time takes 1.4 hours. Increasing the number of nurses, stretchers and ambulances do not affect the evacuation preparation time, but every minute saved during the evacuation preparation becomes a minute saved to the total evacuation time. After the analysis, we found that information gathering tasks consume a lot of time. To be exact, it takes too much time to dress the patient list and the available beds list. We think that an appropriate information system should reduce the time required to produce these list. The Regional Health Agency in Rhône-Alpes (France) is beginning to build a web site called SPIRAL where each private or public hospital is required to provide their number of available beds twice a day (Combes 2008). In the current situation, it takes in average 10 minutes to assemble the patient list and 15 minutes to build the available beds list. We assume that using an adequate information system, the time used for these activities could be reduced to only 1 and 5 minutes, respectively. We simulated our model but using the shorter execution times for the mentioned tasks. The results show that the average evacuation time reduces from 4.95 to only 4.04 hours (a confidence interval of ± 0.05 hours), an improvement of almost 1 hour!

The second process improvement concerns the stretchers behavior. In the as-is system, stretchers transport the patient to the emergency department and they stay with the patient until he/she is installed in the ambulance. Only then they will be available to transport another patient. We propose that, instead of waiting for the ambulance arrival, stretchers leave the patient at the emergency department and then go back to the care unit to continue the transportation of other patients, using a free stretcher. As a consequence, the number of available stretches must be increased. Installation of the patient in the ambulance would be done by the ambulance crew. By means of simulation, we are able to quantify the potential reduction on the evacuation time of this process improvement. Using the configuration called scenario 1, evacuation time for 120 patients is in average of 4.95 hours while, implementing the new stretchers behavior lead to an average evacuation time of only 4.27 hours (a confidence interval of ± 0.09 hours), a reduction of almost half an hour!

We finally wonder what will happen if we combine the two process improvements together. Simulation results indicate that evacuation of 120 patients should only take 3.77 hours in average (a confidence interval of ± 0.06 hours), an improvement of 1.18 hours! Even though for the worst case of

scenario 1, with our improvement method, the evacuation time is less than 5 hours.

From a practical standpoint, we think that these improvements can be easily deployed. Although SPIRAL is still in an early implementation phase, such a real-time database is not only useful for emergency situations as the one here described, but also to better detect and control pandemics and diseases' outbreaks. As per the change in the stretchers behavior, we agreed with SJSJL managers that assigning a team of stretchers permanently to the emergency department will allow implementing the improved transportation process. This team, who will ensure the installation of the patient in the ambulance, will also increase patients' safety and improve the patients' vigil during the time they wait for ambulances. However, this practice will probably increase the number of patients at the emergency department and, eventually, make more difficult operations at this service.

3.5 Conclusions

This chapter proposes a general three-step approach to studying the emergency response plan to deal with natural disasters. Three models have been made based on a real life scenario in the context where the hospital suffers from a threatening flood and all the patients must be evacuated. In our three-step approach, the first step builds a framework model to present the processes and activities during the evacuation clearly. With the help of this framework model, the health workers can get a clear and general idea of the emergency management plan quickly. They will know what to do in every stage, to evacuate patients and what kind of resources should be used. Patients can also get an idea of what they must do in every stage to be evacuated safely and quickly. The second step establishes a global model, a linear model in this chapter, to predict the required resources during evacuation. This linear model can be used to predict roughly the required resources when all patients need to be evacuated in time. The third step proposes a detailed simulation model to reflect the real world precisely. This simulation model can be used to find the ways to minimize the evacuation time when resources are limited. Through our experiment, the best way to assign the resources and improvements has been proposed. The results of the experiments confirm the effectiveness of our three-step approach.

4. Man-made Disasters: Modeling the logistics response to a terrorist attack with a non-contagious agent

This chapter is devoted to studying the humanitarian logistics response to a man-made disaster under the guidance of emergency management plan. This study is proposed by the zonal coordinator, Dr. Annick, according to the real need for health crisis. Taking the anonymous bio-terrorist attack to a shopping center in a large city with anthrax agent as a real case scenario, this chapter proposes a model which links the disease progression, the related medical intervention actions and the logistics deployment together to help crisis managers to extract crucial insights on humanitarian logistics management from a strategic level. This model is a multi-period one with the consideration of the period when the patients transfer into the different disease stages, the period when the medical intervention begins and the change of the recovery rate because of the time lag between the two aforementioned periods. Our model can support the decision making process in case of a real bioterrorist attack caused by non-contagious agent and evaluate the important factors, which can have a great impact on the number of casualties. The detail structure of this chapter is as follows:

4.1 Introduction

- 4.1.1 Background of the research
- 4.1.2 Gaps of previous works
- 4.1.3 General information of our approach

4.2 Problem description

- 4.2.1 Anthrax's progress and its stages
- 4.2.2 Response to anthrax bioterrorist attack
- 4.2.3 Logistics decisions

4.3 The anthrax response model and the mathematical formulations

- 4.3.1 Transitions in the anthrax progression
- 4.3.2 The anthrax response
- 4.3.3 The detailed model

4.4 Numerical experiments

- 4.4.1 The choice of the parameters
- 4.4.2 Base case experiments
- 4.4.3 Sensitive analysis

4.5 Conclusions

4.1 Introduction

Man-made disasters, like bioterrorist attacks, are more likely to happen today. We had several meetings with the zonal coordinator, Dr. Annick, to find out the current challenges and problems during the response to man-made disasters. The information we got during the meetings shows that one of the biggest challenges to health workers is how to distribute the limited medical resources reasonably to minimize the number of deaths. Moreover, the decision makers are also interested in how different logistics capacities affect the number of affected people since it is trade-off between the number of deaths and the final costs. Therefore, Chapter 4 studies the logistics questions about the man-made disaster, to be exact, bioterrorist attacks.

4.1.1 Background of the research

As mentioned before, man-made disasters and natural disasters should be studied separately because they have different characteristics. Among different man-made disasters, anonymous bioterrorism, is a kind of man-made disasters which can cause the most serious consequences. A biological attack, or bioterrorism, is the intentional release of viruses, bacteria, or other germs that can sicken or kill people (Inglesby et al., 1999b). Being organized and being premeditated are two main characteristics of the anonymous bio-terrorist attack. The two characteristics can lead to a large-scale disaster which causes a sudden peak demand of health care resources. This sudden demand makes a big challenge to the humanitarian logistics. Therefore, this chapter focuses on the study of man-made disaster caused by anonymous bioterrorism.

Anthrax is classified by The Centres for Disease Control and Prevention of America (CDC) as the agent which can pose the greatest possible threat to the public health. According to CDC, Anthrax is one of the biological agents most likely to be used by bioterrorism because anthrax has the following characteristics:

- Anthrax spores are easily found in nature, can be produced cheaply in a lab, and can last for a long time in the environment.
- Anthrax can be released quietly without being noticed.
- Anthrax has been used as a weapon before.

The autumn 2001 Anthrax Attack on the United States Postal Service (Day, 2003) captured more attention on the study of the emergency response to the anthrax attack. And this chapter will use the anonymous bioterrorism with anthrax agent as a real case scenario to study the relevant logistics questions.

4.1.2 Gaps of the previous works

Based on the literature review in Chapter 2, anthrax may spread across a large area and needs a great deal of planning for the protection of the people's health. An effective emergency management plan can obviously reduce the number of casualties and the serious consequences of an anthrax attack. Even though several

studies have been made about the emergency response to the anthrax attack from different perspectives, some crucial questions are still unanswered and, in particular, those concerning the suitable dispensing capacity of the antibiotics distribution centers (ADC), the utilization of sensors to improve the anthrax detection ability and the patients who should get the medical help first. All these questions need to be addressed in the design of the most effective post-attack response. Moreover, even though papers studying the emergency response to an anthrax attack made great contributions to this field, the following gaps still need to be filled:

- Lots of models failed to combine some factors which can impact the number of casualties, such as different periods in which the patients transfer into the current disease stage, the treatment results, and the limitation of logistics capacity.
- Not all papers studying the response to the anthrax were based on real cases and emergency management plans. For example, most of the authors assume the recovery rate remained the same for all the patients in the same stage. However, in reality, the recovery rate will decrease when the patients stay in any stage longer.
- Most of the papers tried to compare the different response modes but did not pay attention to what the crisis manager can do under the current situation. In other words, the question of how to optimize the utilization of the resources based on the current situation, such as which is the best way to distribute the antibiotics effectively, did not get enough attention.

These drawbacks make it difficult to put into practice the existing emergency management plans, which motivate us to propose the use of a multi-period model, taking into consideration, all the important factors which can influence the number of casualties, and to study the strategic logistics questions after the anthrax attack based on a real case.

4.1.3 General information of our approach

The original modelling approach proposed in this chapter solves all the questions mentioned in Chapter 1. All these questions will be explained in detail in Section 4.2.3.

The original modelling approach proposed in this chapter has the following contributions:

- This modelling approach combines the progress of the disease, the medical response modes, and the logistic deployment choices together.
- The approach takes into account the important factors: the different medical responses to patients in different stages, the time gap between the period when the patients transfer into the current disease stage and the period when the patients get medical treatment. To the best of our knowledge, the length of time between the period of evolving to the different disease stages and the period of receiving medical treatment has never been taken into consideration by other authors. However,

this will have effect on the recovery rate, the survival rate and the number of deaths. It will therefore further affect the crisis manager's decision about how to respond to the anthrax attack.

- By using this model, crisis managers could estimate the number of individuals infected in different periods and the number of patients in different disease stages for each period, and therefore optimize the resources for the best response.
- The model is flexible and can be adapted to specific situations and various resource deployment scenarios.

Moreover, in the experimental part, the survival rate of the patients in the different stages is calculated to obey two kinds of probability distribution functions, exponential and lognormal to check how the disease distribution affects the number of deaths.

4.2 Problem description

In order to give the reader a general view of the situation that we intend to address, this section describes firstly, the progression of the anthrax and the transitions between the different stages of the disease, secondly the three phases of a response to an anonymous bioterrorist attack, and thirdly, the decisions concerning the logistics of medical help delivery.

4.2.1 Anthrax's progression and its stages

The progression of anthrax is divided into three stages (Figure 4.1), namely, incubation (I), prodromal (P), and fulminant (U) stages. During stage I, people infected by anthrax spores have no symptoms, but patients in stage P show a spectrum of non-specific symptoms, such as fever, chill, cough and vomiting. In stage U the patients develop the symptoms abruptly, with high fever, dyspnoea, diaphoresis and shocks, or more specific and severe symptoms. We assume that all the infected individuals become symptomatic if they are not treated, and they move progressively through the prodromal and fulminant stages. Craft et al. (2005) reported that 90% of infected individuals can recover if they are treated with prophylaxis during stage I, 40% of patients that are in stage P can recover with prophylaxis, and all patients that have reached stage U would die. However, according to the last data from Zaric et al. (2008), the prophylaxis may recover 20% of the patients in P stage, and, in the best case, 3.2% of stage U patients may recover. Fowler et al. (2005) denoted that, taking into account that some patients may not be adherent with the prophylaxis, only 80% of patients in stage I may recover after taking the prophylaxis. The disease is brought under control when all the infected people have either fully recovered or died after a full treatment (60 days of antibiotics called a full regime dose).



Figure 4.1: Stages of the anthrax disease.

Two medical treatments are possible according to the patient’s stage. Patients in stage I should receive prophylaxis antibiotics (oral antibiotics treatment) consisting of single oral antibiotic doses, either ciprofloxacin or doxycycline (Inglesby et al, 2002; Bartlett et al., 2002). Patients in stage U are admitted in intensive care unit with ventilators, and are treated with intravenous antibiotics. However, there is no clear treatment recommendation to the individuals in stage P. We therefore assumed, like in Jamrog et al. (2007), that since the hospital admission capacity for anthrax patients is very limited, individuals in stages I and P will refer to patient centres to get oral antibiotics.

Antibiotics’ efficiency decreases as the disease progresses. Therefore, if the treatment does not help the patient at an earlier stage, we assume that the disease will progress unless a more effective in-hospital treatment is provided. However, even if antibiotics can be ineffective for some patients, they modify the disease progression and, in particular, its speed. According to Holty et al. (2006), treatment with antibiotics may toward an association of prolonged mean stage duration compared with untreated patients. This point has been taken into account by our model. Figure 4.2 proposes a new anthrax progression model which considers medical interventions. In Figure 4.2, disease stages are presented by nodes which are connected by arcs representing the possible transitions between stages which will be discussed in the following section. Stages are noted by $^B A$, where A denotes the current stage of the individual, and B indicates the stage in which the patient started to receive medical treatment (if applies). Stages when the infected patients recovered or died are represented by nodes R and D respectively.

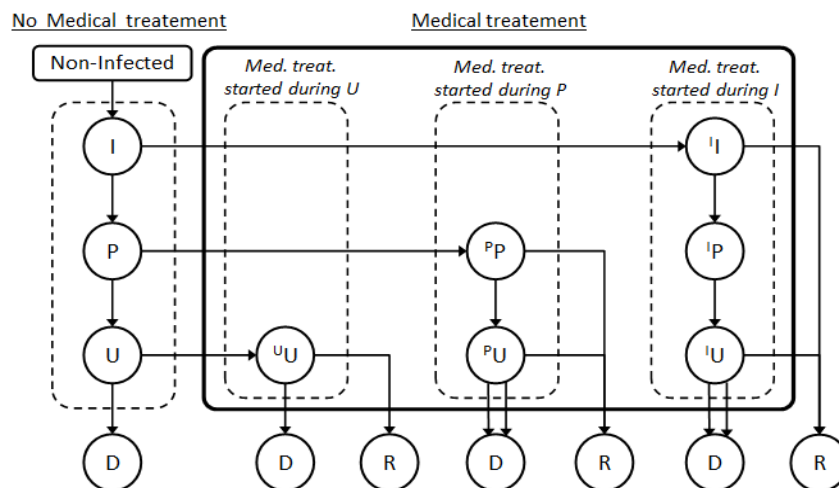

Figure 4.2: Anthrax progression model with medical interventions.

4.2.2 Response to an anthrax bioterrorist attack

In France, PCT Plan (Peste, Charbon, Tularemie) or BIOTOX plan (Guide Peste Charbon Tularémie, 2007) is the emergency response plan to the threat of aggression by plague, anthrax and tularemia. However, to the best of our knowledge, no scientific paper has studied the application or suitability of the recommendations in the French PCT plan to organize the response to an anthrax attack. Therefore, all our following studies are based on PCT plan. According to PCT plan, bioterrorist attacks can be separated into two types: attacks declared by the terrorists in advance and anonymous attacks where the authorities are not informed of the attack. Our work is devoted to the latter case, but our models can be easily adapted to deal with the former changing values of parameters. An anonymous, airborne anthrax attack will lead to a time gap between the attack and the authorities' intervention. During this time lag, people will continue their daily activities as usual until the disease causes several deaths. Once the attack is detected, identifying and cordoning off the attack area as soon as possible will be of paramount importance. Authorities response to an anthrax bioterrorist attack can therefore be separated into three consecutive phases (Figure 4.3: phase 0, phase 1 and phase 2), each phase lasts several time periods (days). Phase 0 covers the time from the period in which the attack is launched to the period in which the authorities realize it. During phase 0, no medical help is delivered and more and more people come to the seat of the attack and get infected. In period t_d , authorities become aware of the anthrax outbreak and phase 1 begins. During phase 1 (since period t_d), infected patients are diagnosed and medical help can be provided. However, the anthrax attack site has not been identified yet, so as a corollary more people become infected. Phase 2 begins at period t_c , where the authorities identify and isolate the seat of anthrax attack. Therefore, one of the most important response activities is to organize the logistics to support optimal antibiotics delivery to the population.

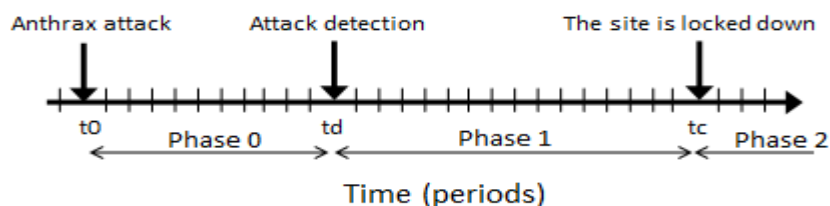

Figure 4.3: The anthrax response phase.

4.2.3 Logistics decisions

In order to precise logistics decisions related to PCT plan, we used ARIS to present response activities under the guidance of PCT plan. Figure 4.4 shows the global process of response to anthrax attack. After the detection of anthrax

attack, PCT plan will be triggered as soon as possible (Detect attack and start PCT plan in Figure 4.4).

Figure 4.5 presents Event-driven Process Chain (EPC) of the "Detect attack and start PCT plan". In the figure of EPC, an event which is represented by hexagon describes under what circumstance a function works or which state a function or a process results in. A function which is represented by a rounded rectangle describe transformation from an initial state to a result state. A process owner is responsible for a function. It is represented by a square with a vertical line. An organization unit determines which organization is responsible a specific function. It is represented by an ellipse with a vertical line. From Figure 4.5, it can be found that after the disease detected by physicians and the situation analyzed by Agence Regionale de Sante (ARS), the PCT plan will be triggered. Before attacked place are closed, people will continue to visit attacked place and get infected, which corresponds to Phase 0 and Phase 1. Before the attacked place are closed, more and more people will be infected. Therefore,

- How will the early response action affect the number of the deaths? How will the early action of cordoning off the anthrax attack site early affect the number of the deaths?
- If we cannot use a sensor to detect the anthrax attack early, can we try to close off the anthrax attack site early to reduce the delay between the attack detection and the site closure?

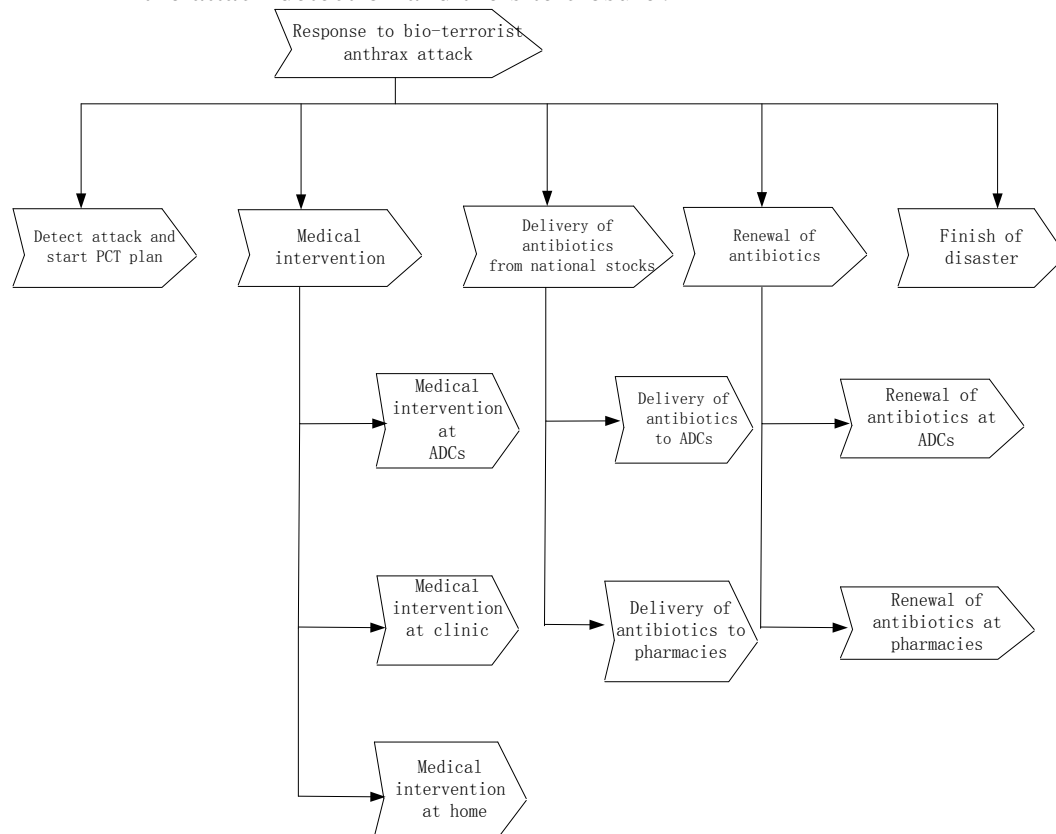

Figure 4.4: The global process of response to bio-terrorist anthrax under the guidance of PCT plan

Based on Figure 4.4, it can be found that the distribution of antibiotics is managed both at national level (Delivery of antibiotics from national stocks in Figure 4.4) and local level (such as Medical intervention at clinic in Figure 4.4). At the national level, national strategic stocks are supposed to provide the antibiotics distributions centers (ADCs) and relevant medical departments with the necessary amount of oral antibiotics and intravenous antibiotics. Before the antibiotics are delivered from the national stocks, each ADC and/or regular pharmacies may have some antibiotics in stock. So, medical interventions at local level may start before the delivery of antibiotics from national stocks to

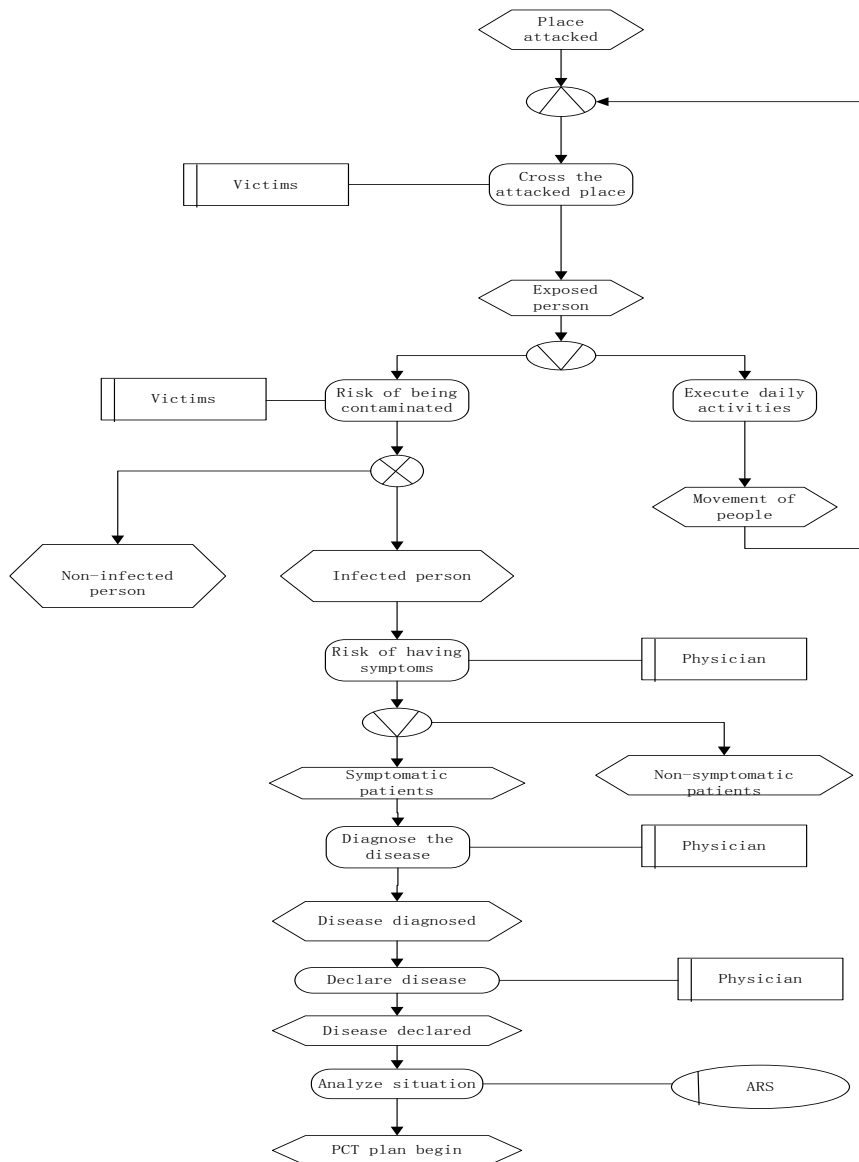

Figure 4.5: Detect attack and start PCT plan.

local distribution centers or relevant medical departments. Usually, the pre-stock of antibiotics at local level are insufficient for the full-regime dose quantities. Therefore, a renewal of antibiotics is necessary after the delivery of antibiotics from national stocks to ADCs and relevant medical departments (Renewal of antibiotics in Figure 4.4). Although very little information is available concerning oral strategic stock quantities and locations, France claim that every potentially infected area in the French metropolitan area is assured to have antibiotics delivered to the relevant ADCs, pharmacies and hospitals within 24 hours.

We will therefore focus on the decisions concerning the local level decision in the infected region. At the local level, a complex network delivering both services (diagnose) and products (antibiotics) needs to be deployed as soon as possible. Some people, such as old people, who cannot go to ADCs or pharmacies can get the medicine at home (Medical intervention at home in Figure 4.4). But this kind of people just take a very small percentage of patients who need medical help. Therefore, this kind of patients are not taken into account in the following. Other people can be diagnosed by their general practitioners and then be referred to a pharmacy where the treatment will be delivered (Medical intervention at pharmacies in Figure 4.4). But we should not rely on the capacity of pharmacies because their priority is to ensure the maintenance of their usual activities. Moreover, pharmacies could be modeled as a particular ADC. Therefore, because physicians will be available at ADCs to confirm the diagnosis, they seem to be the preferred option to provide the anthrax medical response for oral antibiotics. Figure 4.6 presents the medical intervention processes at ADCs. From this figure, it can be found the importance of antibiotics. Without antibiotics, the medical intervention cannot continue. The related logistics questions are:

- How to distribute the antibiotics?
Since both incubation stage and prodromal stage patients will need antibiotics, who should get medical help first?
If several patients transfer into the same disease stage in different periods, who should get the medical help first?
- What is the reasonable dispensing capacity for ADCs?
Can the pre-stock of some antibiotics in each ADC reduce the number of deaths?
How will the dispensing capacity impact the number of the deaths?
- How much inventory of antibiotics for anthrax response is to be held at the national level?
If the ADCs increase the dispensing capacity, is the strategic national stockpile enough?

Moreover,

- How do the different disease probability distributions affect the logistics decisions? Until now, no scientific document can prove that the development of the anthrax follows a certain distribution. Most

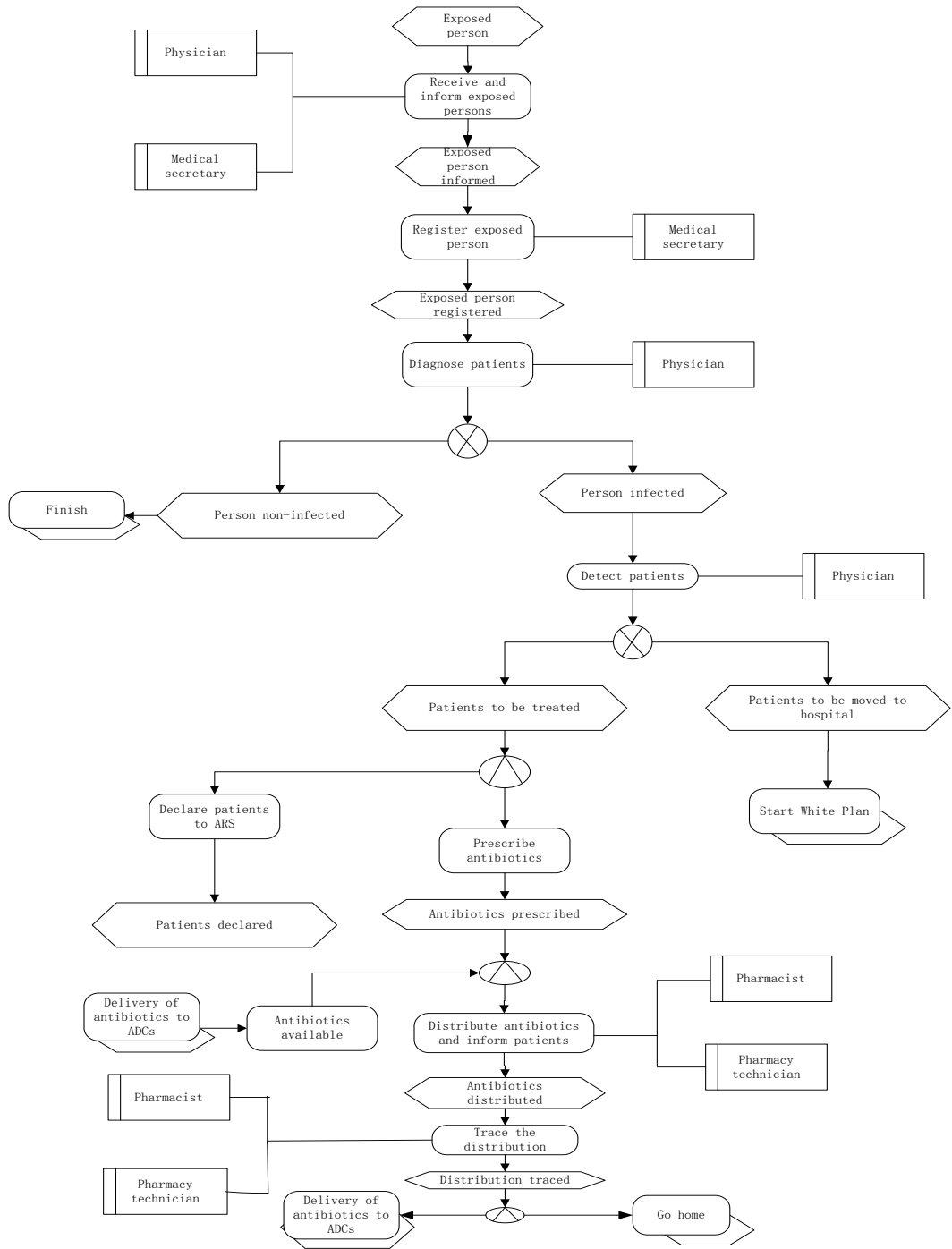

Figure 4.6: Medical intervention at ADCs.

authors use the lognormal distribution or the exponential distribution to simulate the development of the anthrax. Will the different probability distributions affect the aforementioned logistic decisions? If yes, how?

More information about the processes of logistics response can be found in appendix C. It should be stressed here that the purpose of our model was not to

address all the questions related to the design and management of an antibiotics distribution network, but to assess the potential and the generality of our approach.

4.3 The anthrax response model and the mathematical formulations

This section presents the anthrax response model and the related mathematical formulations. Given the network of stages reflecting the disease's progress, we first discuss the transitions between stages and the anthrax response. Then, a mathematical formulation aiming at minimizing the number of deaths caused by an airborne anthrax bioterrorist attack under limited medical resources is presented. We assume that the airborne anthrax bioterrorist attack takes place in a closed area, such as a commercial centre or a railway station where the anthrax spores are difficult to disperse, and so, the daily infection rate is uniform before the attack site is detected and closed (but this hypothesis can be removed).

4.3.1 Transitions in the anthrax progression

The proposed model for the anthrax response (Figure 4.2) takes into account potential medical interventions. The model consists of a set of nodes (the disease stages under different medical treatment situations) and oriented arcs (possible transitions between the stages). The length of stay of an individual in a given stage is a random variable, modelled by a probability distribution function which will be approximated by transition rates. We assume that the development of the disease (with or without medical intervention) is a stochastic Markov process, meaning that the transition probability between two stages depends on the time that the patient has spent in the current stage. Moreover, we assume the patients cannot pass two disease stages during one period. The process (in Section 4.2) is approximated by a flow model with period-dependant parameters based on the computation of probabilities with lognormal or exponential distribution function (see Figure 4.7). Thanks to these period-dependant parameters, we can model and compute the problem more easily.

The model (Figure 4.2) applies to the three response phases (Figure 4.3) by doing slight modifications on the probability approximations affecting the transition arcs. During response phase 0, only stages in the left part of the model (under title No medical treatment) are allowed. Other transitions between these stages and those in the right part of the model (under title Medical treatment) are forbidden so they have a probability approximation equal to zero. The model in Figure 4.2 also applies to response phase 2 by forbidding the arc between the arrival of newly infected people and stage I.

4.3.2 The anthrax response

The model assumes that transfers between adjacent disease stages are done at the end of discrete periods. It also assumes that logistics decisions (delivery of antibiotics) are done at the beginning of periods. The individuals who are in the current stage at the beginning of period t may evolve to the following stage at the beginning of period $t+1$ (at the end of period t) according to the medical decisions taken at the beginning of period t . For the same reason, our model assumes the medical interventions (administration of antibiotics) are done at the beginning of periods. Since our model assumes the patients cannot pass two disease phases during one period, the earlier periods when the patients get into I, P and U stages are the first, the second and the third periods respectively. The first patient who may die is in period three. This assumption corresponds to the Thomas (1999), who says that the first dying patient is at the third period after the bioterrorist event. Our model ignores the time lag between the periods when the patients get the medical help and when the medical treatment result appears because this time lag will not affect our decisions. The model assumes a dispensing of a full regime dose antibiotics, but the result study can remove this assumption. We denote the individuals in different stages by $A = \{I, P, U, I^I, I^P, I^U, P^P, P^U, U^U\}$. All of these elements correspond to the nodes shown in Figure 4.2. The elements I, P and U denote the individuals who are in the different disease stages without medical help. For the element I^I, I^P, I^U, P^P, P^U and U^U , the superscript indicates the stage in which the patients started to receive medical treatment and the normal letter denotes the current disease stage of the individual. The letters D and R stand for the dead and recovered individuals respectively. In short, in our model, from a view of the disease, there are three disease stages (I, P and U); from a view of the current disease stage the patients are in and the disease stage in which the patients start the medical help, there are eleven stages (I, P, U, $I^I, I^P, I^U, P^P, P^U, U^U, R, D$). The individual in stage I or P may have the chance to get the oral antibiotics and then transfer into the I^I or P^P stage respectively (Figure 4.2). If they cannot recover, they will develop to the I^P, I^U , and P^U respectively. The arc between U and D denotes the patients who die of the lack of the medical help in time. The arc between U^U , and D means the death of the stage U patients who get the hospital treatment without receiving any oral antibiotics before. There are two arcs between P^U or I^U , and D. P^U and I^U , denote the patients who have got the oral antibiotics in stage P or I but cannot recover and continue to develop to stage U. One arc presents stage P^U or I^U patients who do not get the further hospital treatment before they die. The other arc presents stage P^U or I^U patients who get the further hospital treatment but cannot recover and then die. The arcs between I^I or P^P and R show the patients who get the oral antibiotics when they are in stage I or P respectively and recover. The arc between P^U and R denotes the patients who receive no oral antibiotics before and begin hospital treatment in

stage U and recover. The arc between ${}^P U$ or ${}^U U$ and R denotes the patients who received oral antibiotics during stage P or U but did not recover and begin hospital treatment in stage U and recover. There is no arc between ${}^I P$ and R because we assume if the patients cannot recover when the medical treatment begins at the earlier stage, they cannot recover unless more effective medical intervention is available. Figure 4.7 presents the flow transitions among stages ${}^I I$, ${}^I P$ and ${}^I U$ from period 1 to period 4 as an example to explain the anthrax progression model with medical interventions dynamically. This figure allows us to represent the different approximated values of the transition probability between stages. The dash line arrows present the transition between the different stages. The solid line arrows denote the individuals who stay in the same stage between two adjacent time periods. The stage transitions of individuals who get into the stage ${}^I P$ at the beginning of period 3 are used as an example to introduce the flows of the mathematical model. The number of patients who get into the stage ${}^I P$ at the beginning of period 3 can be calculated as the number of patients who get into stage ${}^I I$ at the beginning of periods 1 or 2 and transfer into stage ${}^I P$ at the beginning of period 3. At the beginning of period 4, some of the individuals who get into the stage ${}^I P$ at the beginning of period 3 still stay in the stage ${}^I P$. Others from period 3 transfer into the stage ${}^I U$ at period 4. The transitions between other stages obey the same hypotheses.

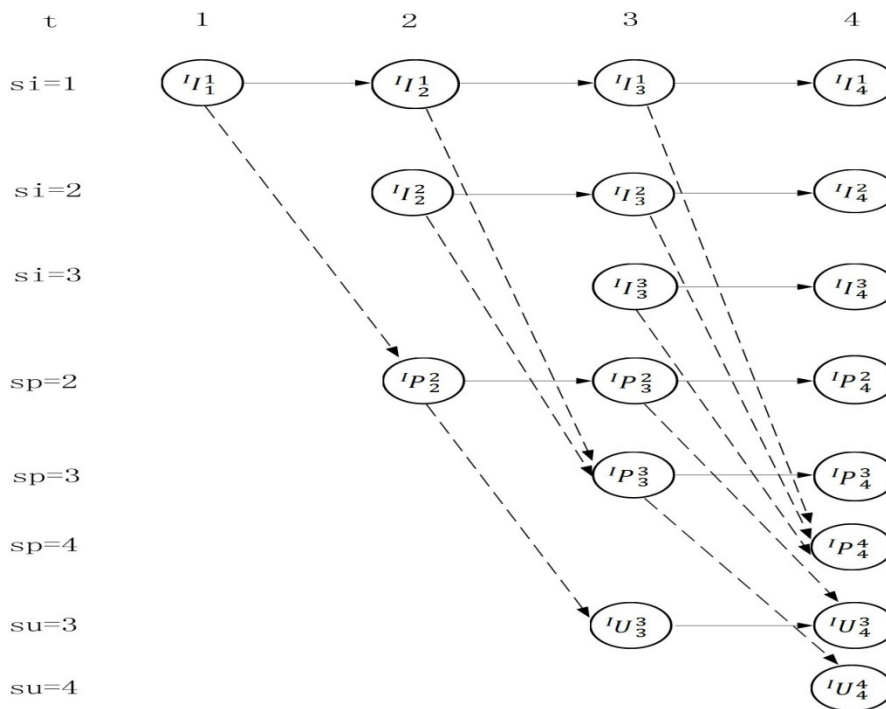

Figure 4.7: Anthrax progression model with medical interventions (dynamic).

4.3.3 The mathematical formulation

We propose a discrete time mathematical formulation of the anthrax progression model with medical interventions. Figure 4.8 presents our model denoted by all important notations without an index of the time period. Figure 4.8 corresponds to the Figure 4.2. In Figure 4.8, the notations on the arcs present the quantities of transitions between different stages, which correspond to the formulations in the following. A^X presents the number of the individuals in stage A and A^Y gives the number of the individuals in stage A who get the medical help and then evolve to another stage. The notations with square outlines present the patients who get the medical help. The notations with dotted square outlines denote the patients who recover after getting the medical help. The notations with single underlines show the transitions from stage I to the stage P. The notations with dotted lines explain the transitions from stage P to stage U. The other notations on the arcs present the patients who transfer from stage U to die.

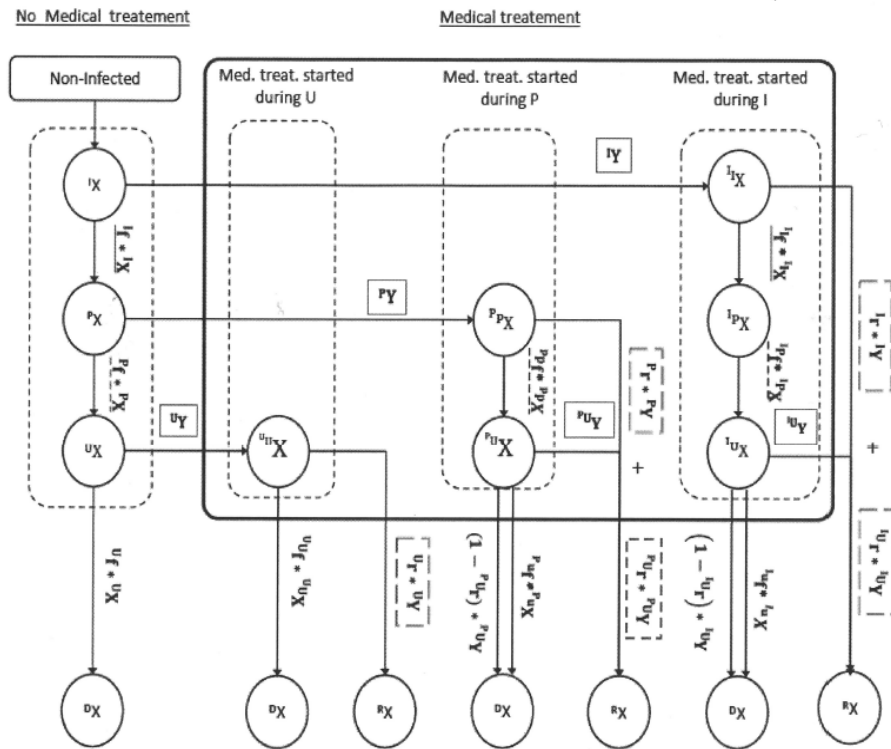

Figure 4.8: Anthrax progression model with medical interventions (with notations).

The mathematical formulation is shown as follows:

Indices and parameters of time period

T Number of time periods, $t = \{1, \dots, T\}$

sa	Periods in which the patients transfer into the current disease stages I,P and U , $sa = \{si, sp, su\}, si = \{1, \dots, T\}, sp = \{2, \dots, T\}, su = \{3, \dots, T\};$
----	--

td,tc	Periods in which the attack is detected and the site is locked off, respectively
-------	--

Indices and parameters of resources

H	Number of hospitals, $h = \{1, \dots, H\}$
---	--

D	Number of distribution centers, $d = \{1, \dots, D\}$
---	---

inh	The initial available intravenous antibiotics (number of doses) per hospital at the beginning of the horizon
-----	--

ind	The initial available oral antibiotics (number of doses) per distribution center at the beginning of the horizon
-----	--

ch	Daily treatment capacity (expressed in number of intravenous antibiotics doses) per hospital
----	--

cd	Daily distribution capacity (expressed in number of oral antibiotics doses) per distribution center
----	---

sh	Stock capacity (number of intravenous antibiotics doses) per hospital
----	---

sd	Stock capacity (number of oral antibiotics doses) per distribution center
----	---

sth	Number of available intravenous antibiotics (number of doses) from strategic stock
-----	--

std	Number of available oral antibiotics (number of doses) from strategic stock
-----	---

Parameter of newly infected individuals

η_t	The number of newly-infected individuals at the beginning of period t (
----------	---

$$\eta_t = 0, \forall t \geq t_c$$

Parameter of transition probabilities

A_t^{sa} Probability estimation that an individual who has got into the stage A at the beginning of period s_a and evolves to the next stage at the end of period t . This one can be calculated with exponential distribution or log-normal distribution

$$(s_a \leq t, s_a = \{s_i, s_p, s_u\}, A = \{I, P, U, {}^I I, {}^I P, {}^I U, {}^P P, {}^P U, {}^U U\})$$

Parameters of recovery rate

A_t^{sa} Recovery rate that an individual who has got into stage A at the beginning of period s_a and who gets the medical help, recovers at the beginning of period t ($s_a \leq t, s_a = \{s_i, s_p, s_u\}, A = \{I, P, U, {}^I U, {}^P U\}$)

Variables of individuals

A_t^{sa} Number of individuals in stage A who has got into stage A at the beginning of period s_a , and who may evolve to the following stage at the end of period t according to the medical decisions at the beginning of period t

$$(s_a \leq t, s_a = \{s_i, s_p, s_u\}, A = \{I, P, U, {}^I I, {}^I P, {}^I U, {}^P P, {}^P U, {}^U U, R, D\})$$

A_t^{sa} Number of individuals who has got into stage A at the beginning of period s_a and who received medical treatment at the beginning of period t ($s_a \leq t, s_a = \{s_i, s_p, s_u\}, A = \{I, P, U, {}^I P, {}^I U, {}^P U\}$)

Variables of resources

Q_{ht} Number of intravenous antibiotics doses sent to hospital h by strategic stockpiles at the beginning of period t

Q_{dt} Number of oral antibiotics doses sent to distribution center d by strategic stockpiles at the beginning of period t

I_{ht} Number of available intravenous antibiotics doses at hospital h at the beginning of period t

I_{dt}	Number of available oral antibiotics doses at distribution center d at the beginning of period t
G_{ht}	Number of infected individuals getting the intravenous antibiotics help at hospital h at the beginning of period t
G_{dt}	Number of infected individuals getting the oral antibiotics help at distribution center d at the beginning of period t

The linear model is formulated as follows

$$\text{Min}(\sum_{t=1}^T D X_t) \quad (4-1)$$

No medical treatment

$$I_{X_t}^{si} + I_{Y_t}^{si} = \eta_t \quad t = \{1, \dots, T\}, si=t \quad (4-2)$$

$$I_{X_t}^{si} + I_{Y_t}^{si} = I_{X_{t-1}}^{si} - I_{f_{t-1}}^{si} \times I_{X_{t-1}}^{si} \quad t = \{2, \dots, T\}, si < t \quad (4-3)$$

$$P_{X_t}^{sp} + P_{Y_t}^{sp} = \sum_{si=1}^{t-1} I_{f_{t-1}}^{si} \times I_{X_{t-1}}^{si} \quad t = \{2, \dots, T\}, sp=t \quad (4-4)$$

$$P_{X_t}^{sp} + P_{Y_t}^{sp} = P_{X_{t-1}}^{sp} - P_{f_{t-1}}^{sp} \times P_{X_{t-1}}^{sp} \quad t = \{3, \dots, T\}, sp < t \quad (4-5)$$

$$U_{X_t}^{su} + U_{Y_t}^{su} = \sum_{sp=2}^{t-1} P_{f_{t-1}}^{sp} \times P_{X_{t-1}}^{sp} \quad t = \{3, \dots, T\}, su=t \quad (4-6)$$

$$U_{X_t}^{su} + U_{Y_t}^{su} = U_{X_{t-1}}^{su} - U_{f_{t-1}}^{su} \times U_{X_{t-1}}^{su} \quad t = \{4, \dots, T\}, su < t \quad (4-7)$$

Medical treatment started during the I stage

$$I_{X_t}^{si} = (1 - I_{r_t}^{si}) \times I_{Y_t}^{si} \quad t = \{1, \dots, T\}, si=t \quad (4-8)$$

$$I_{X_t}^{si} = I_{X_{t-1}}^{si} - I_{f_{t-1}}^{si} \times I_{X_{t-1}}^{si} + (1 - I_{r_t}^{si}) \times I_{Y_t}^{si} \quad t = \{2, \dots, T\}, si < t \quad (4-9)$$

$$I_{P_{X_t}^{sp}} + I_{P_{Y_t}^{sp}} = \sum_{si=1}^{t-1} I_{f_{t-1}}^{si} \times I_{X_{t-1}}^{si} \quad t = \{2, \dots, T\}, sp=t \quad (4-10)$$

$$I_{P_{X_t}^{sp}} + I_{P_{Y_t}^{sp}} = I_{P_{X_{t-1}}^{sp}} - I_{f_{t-1}}^{sp} \times I_{P_{X_{t-1}}^{sp}} \quad t = \{3, \dots, T\}, sp < t; \quad (4-11)$$

$${}^I U_{X_t^{su}} + {}^I U_{Y_t^{su}} = \sum_{sp=2}^{t-1} {}^I P_{f_{t-1}^{sp}} \times {}^I P_{X_{t-1}^{sp}} \quad t = \{3, \dots, T\}, su=t \quad (4-12)$$

$${}^I U_{X_t^{su}} + {}^I U_{Y_t^{su}} = {}^I U_{X_{t-1}^{su}} - {}^I U_{f_{t-1}^{su}} \times {}^I U_{X_{t-1}^{su}} \quad t = \{4, \dots, T\}, su < t \quad (4-13)$$

Medical treatment started during the P stage

$${}^P P_{X_t^{sp}} = (1 - {}^P P_{r_t^{sp}}) \times {}^P P_{Y_t^{sp}} \quad t = \{2, \dots, T\}, sp=t \quad (4-14)$$

$${}^P P_{X_t^{sp}} = {}^P P_{X_{t-1}^{sp}} - {}^P P_{f_{t-1}^{sp}} \times {}^P P_{X_{t-1}^{sp}} + (1 - {}^P P_{r_t^{sp}}) \times {}^P P_{Y_t^{sp}} \quad t = \{3, \dots, T\}, sp < t \quad (4-15)$$

$${}^P U_{X_t^{su}} + {}^P U_{Y_t^{su}} = \sum_{sp=2}^{t-1} {}^P P_{f_{t-1}^{sp}} \times {}^P P_{X_{t-1}^{sp}} \quad t = \{3, \dots, T\}, su=t \quad (4-16)$$

$${}^P U_{X_t^{su}} + {}^P U_{Y_t^{su}} = {}^P U_{X_{t-1}^{su}} - {}^P U_{f_{t-1}^{su}} \times {}^P U_{X_{t-1}^{su}} \quad t = \{4, \dots, T\}, su < t \quad (4-17)$$

Medical treatment started during the U stage

$${}^U U_{X_t^{su}} = (1 - {}^U U_{r_t^{su}}) \times {}^U U_{Y_t^{su}} \quad t = \{3, \dots, T\}, su=t \quad (4-18)$$

$${}^U U_{X_t^{su}} = {}^U U_{X_{t-1}^{su}} - {}^U U_{f_{t-1}^{su}} \times {}^U U_{X_{t-1}^{su}} + (1 - {}^U U_{r_t^{su}}) \times {}^U U_{Y_t^{su}} \quad t = \{4, \dots, T\}, su < t \quad (4-19)$$

Dead individuals

$$D_{X_t} = \sum_{su=3}^{t-1} {}^U U_{f_{t-1}^{su}} \times {}^U U_{X_{t-1}^{su}} + \sum_{su=3}^{t-1} {}^I U_{f_{t-1}^{su}} \times {}^I U_{X_{t-1}^{su}} \\ + \sum_{su=3}^{t-1} {}^P U_{f_{t-1}^{su}} \times {}^P U_{X_{t-1}^{su}} + \sum_{su=3}^{t-1} {}^U U_{f_{t-1}^{su}} \times {}^U U_{X_{t-1}^{su}} \quad t = \{3, \dots, T\} \quad (4-20)$$

$$+ \sum_{su=3}^t (1 - {}^I U_{r_t^{su}}) \times {}^I U_{Y_t^{su}} + \sum_{su=3}^t (1 - {}^P U_{r_t^{su}}) \times {}^P U_{Y_t^{su}}$$

Recover individuals

$$\begin{aligned}
R_{X_t} = & \sum_{si=1}^t I_{I_t^{si}} \times I_{Y_t^{si}} + \sum_{sp=2}^t P_{I_t^{sp}} \times P_{Y_t^{sp}} \\
& + \sum_{su=3}^t U_{I_t^{su}} \times U_{Y_t^{su}} \\
& + \sum_{su=3}^t I_{I_t^{su}} \times I_{Y_t^{su}} \\
& + \sum_{su=3}^t P_{I_t^{su}} \times P_{Y_t^{su}}
\end{aligned} \quad t = \{1, \dots, T\}, \quad (4-21)$$

Oral antibiotics deployment

$$G_{dt} \leq cd \quad d = \{1, \dots, D\}, t = \{td, \dots, T\} \quad (4-22)$$

$$I_{d,td} = ind \quad d = \{1, \dots, D\} \quad (4-23)$$

$$I_{dt} + Q_{dt} \leq sd \quad d = \{1, \dots, D\}, t = \{td, \dots, T\} \quad (4-24)$$

$$I_{d,t+1} = I_{dt} - G_{dt} + Q_{dt} \quad d = \{1, \dots, D\}, t = \{td, \dots, T-1\} \quad (4-25)$$

$$\sum_{si=1}^t I_{Y_t^{si}} + \sum_{sp=2}^t P_{Y_t^{sp}} = \sum_{d=1}^D G_{dt} \quad t = \{td, \dots, T\} \quad (4-26)$$

$$\sum_{d=1}^D \sum_{t=td}^T Q_{dt} \leq std \quad (4-27)$$

Intravenous antibiotics deployment

$$G_{ht} \leq ch \quad h = \{1, \dots, H\}, t = \{td, \dots, T\} \quad (4-28)$$

$$I_{h,td} = inh \quad h = \{1, \dots, H\} \quad (4-29)$$

$$I_{ht} + Q_{ht} \leq sh \quad h = \{1, \dots, H\}, t = \{td, \dots, T\} \quad (4-30)$$

$$I_{h,t+1} = I_{ht} - G_{ht} + Q_{ht} \quad h = \{1, \dots, H\}, t = \{td, \dots, T-1\} \quad (4-31)$$

$$\sum_{su=3}^t U_{Y_t^{su}} + \sum_{su=3}^t I_{Y_t^{su}} + \sum_{su=3}^t P_{Y_t^{su}} = \sum_{h=1}^H G_{ht} \quad t = \{td, \dots, T\} \quad (4-32)$$

$$\sum_{h=1}^H \sum_{t=td}^T Q_{ht} \leq sth \quad (4-33)$$

$$\begin{aligned}
& t = \{1, \dots, td - 1\}, sa = \{si, sp, su\}, \\
& A_{Y_t^{sa}}, Q_{dt}, Q_{ht} = 0 \qquad h = \{1, \dots, H\}, d = \{1, \dots, D\},
\end{aligned} \tag{4-34}$$

$$A = \{I, P, U, {}^I I, {}^I P, {}^I U, {}^P P, {}^P U, {}^U U\}$$

$${}^I P_{Y_t^{sp}} = 0 \qquad t = \{1, \dots, T\} \tag{4-35}$$

$$\begin{aligned}
& t = \{1, \dots, T\}, sa = \{si, sp, su\}, \\
& A_{X_t^{sa}}, A_{Y_t^{sa}}, I_{dt}, Q_{dt}, I_{ht}, Q_{ht} \geq 0 \qquad h = \{1, \dots, H\}, d = \{1, \dots, D\},
\end{aligned} \tag{4-36}$$

$$A = \{I, P, U, {}^I I, {}^I P, {}^I U, {}^P P, {}^P U, {}^U U, R, D\}$$

Equation (4-1) aims at minimizing the number of deaths caused by anthrax. Equations (4-2) to (4-36) consist of the constraints of our model. There are three sets of constraints that form the mathematical formulation in a broad sense.

Equations (4-2) to (4-19) concern individuals at differing stages. Since our model assumes that the patients cannot pass two disease stages during one period, equations (4-2) to (4-19) can be divided into two sets: the first period when the patient develop to the current disease stage ($sa=t$) and the following periods when the patients remain in the current disease stage ($sa<t$) according to Figure 4. Equations (4-2) to (4-7) present patients in different stages without medical assistance. Equations (4-2), (4-4) and (4-6) give the number of stages I, P and U patients without medical help at the first period when individuals develop into the current disease stage, respectively. In equations (4-2), at the first period when individuals develop to stage I ($si=t$), the number of stage I patients who do not get the medical help (${}^I X_t^{si}$) plus the number of stage I patients who get the oral antibiotics (${}^I Y_t^{si}$), is equal to the number of newly infected individuals (η_t). In equations (4-4), in the first period when patients develop to stage P ($sp=t$), the number of stage P patients who do not receive medical help (${}^P X_t^{sp}$), plus the number of stage P patients who get the oral antibiotics (${}^P Y_t^{sp}$), is equal to the sum of the number of individuals who develop into stage I in different periods si and evolve to stage P at the end of period $t-1$ ($\sum_{si=1}^{t-1} I_{t-1}^{si} \times I X_{t-1}^{si}$). Equations (4-6) are similar to equations (4-4). Equations (4-3), (4-5) and (4-7) calculate the number of stages I, P and U patients who remain in the current disease stages for more than one period without medical treatment, respectively. In equations (4-3), the number of stage I patients who develop to stage I at period si and who remain in stage I in period t without medical help (${}^I X_t^{si}$), plus the number of patients who develop to stage I in period si and who get the medical help in period t (${}^I Y_t^{si}$), is equal to the number of stage I patients

who develop to stage I in period s_i and remain in stage I in period $t-1$ without medical help (${}^I X_{t-1}^{s_i}$), minus the number of patients who develop to stage I in period s_i and who evolve to stage P at the end of period $t-1$ (${}^I f_{t-1}^{s_i} \times {}^I X_{t-1}^{s_i}$). Equations (4-5) and (4-7) are similar to equations (4-3).

Equations (4-8) to (4-19) concern the individuals that received oral antibiotics but for whom they were not efficient. Equations (4-8), (4-14) and (4-18) present the non-recovered patients who get the medical help at the first period when they develop to the current disease stage. Equations (4-9) calculate that the number of patients who develop to the incubation stage in period s_i and remain in ${}^I I$ stage in period t (${}^I X_t^{s_i}$, $s_i < t$). This number of patients can be calculated as the number of ${}^I I$ stage patients in period $t-1$ (${}^I X_{t-1}^{s_i}$), minus the number of ${}^I I$ stage patients who develop to the next disease stage at the end of period $t-1$ (${}^I f_{t-1}^{s_i} \times {}^I X_{t-1}^{s_i}$), plus the number of patients who develop to the incubation stage at period s_i and who get the medical help but do not recover in period t ($(1 - {}^I r_t^{s_i}) \times {}^I Y_t^{s_i}$). Equations (4-15) and (4-19) follow the same rule of equations (4-9). In equations (4-10), in the first period when the ${}^I I$ stage patients develop to prodromal stage ($sp=t$), the number of ${}^I P$ stage patients without medical help (${}^I X_t^{sp}$), plus the number of ${}^I P$ stage patients who get the further treatment (${}^I Y_t^{sp}$), is equal to the sum of the number of ${}^I I$ stage patients who develop to the incubation stage in different periods s_i and who evolve to ${}^I P$ at the end of period $t-1$ ($\sum_{s_i=1}^{t-1} {}^I f_{t-1}^{s_i} \times {}^I X_{t-1}^{s_i}$). Equations (4-12) and (4-16) obey the same rules of equations (4-10). In equations (4-11), in the period when the ${}^I P$ stage patients who develop to the prodromal stage which is earlier than the current period ($sp < t$), the number of ${}^I P$ stage patients without medical help (${}^I X_t^{sp}$), plus the number of ${}^I P$ stage patients who get the further medical treatment (${}^I Y_t^{sp}$), is equal to the number of ${}^I P$ stage patients without further medical help at period $t-1$ (${}^I X_{t-1}^{sp}$), minus the number of ${}^I P$ stage patients who develop to the next disease stage at the end of period $t-1$ (${}^I f_{t-1}^{sp} \times {}^I X_{t-1}^{sp}$). Equations (4-13) and (4-17) are similar to equations (4-11).

Equations (4-20) and (4-21) calculate the number of dead and recovered people respectively. Equations (4-22) to (4-33) concern the antibiotics' stocks and limitations. Equations (4-22) and (4-28) ensure that the number of patients who can get the oral or intravenous antibiotics is less than the distribution capacity or treatment capacity at each ADC or hospital, respectively. Equations (4-23) and (4-29) set the quantity of pre-stocked oral and intravenous antibiotics at each ADC and hospital. Equations (4-24) and (4-30) limit that, at each ADC and hospital, the quantity of oral and intravenous antibiotics that can be received from the strategic stockpiles plus current available antibiotics is less than the

storage capacity. Equations (4-25) and (4-31) state inventory flow conservation for oral and intravenous antibiotics, respectively. More precisely, equations (4-25) and (4-31) say that the antibiotics inventory at the beginning of period t minus the number of antibiotics delivered in period t plus the quantity received from the strategic stockpiles at the beginning of period t equals the remaining inventory at the beginning of the next period $t+1$. Equations (4-26) and (4-33) ensure that the sum of patients in different stages who get the oral or intravenous antibiotics is equal to the total number of individuals who can get the oral or intravenous antibiotics in each period, respectively. Equations (4-27) and (4-33) present that the number of oral or intravenous treatments delivered on the horizon are lower than or equal to the national stockpile respectively. Equations (4-34) explain that no patients can get the medical help before the beginning of medical intervention. We want to stress again that we assume only fulminant stage patients can get the hospital treatment. So equation (4-35) forces the value of ${}^1P Y_t^{sp}$ to zero. In other words, we use equations (4-35) to ensure that those P stage patients who get the oral antibiotics since I stage and cannot recover will not recover in 1P stage (see Figure 4.8). That is the reason why we do not take into account the effect caused by ${}^1P Y_t^{sp}$ in other constraints. But we want to use ${}^1P Y_t^{sp}$ to show that our model can be easily extended to other hypothesis. Finally, Equations (4-36) make the variables to be positive or null.

Our mathematical formulations can be easily extended to cope with other resources, for example, hospitalization beds. It can also be adapted to represent a situation where oral antibiotics are prescribed by pharmacies instead of ADCs. The logistics costs are not taken into the consideration in the model, but financial indicators can be easily calculated.

4.4 Numerical experiments

This section not only shows how to use our model to solve the aforementioned logistics questions, but also presents how to gain insight into deployment logistics with the help of our model. The base case experiment was done after collecting the data by reviewing the related literatures and discussions with physicians and pharmacists in French hospitals. If the data cannot be found in any related official documents, we will use the different scenarios to evaluate how the different values of these data affect the number of deaths. A sensitivity analysis, comparing the number of deaths, was made to evaluate the important elements which may affect the number of deaths. In the sensitivity analysis, all the experiments are done under two kinds of scenarios: the disease obeys the exponential distribution or the lognormal distribution. All our experiments are coded in OPL language and solved by CPLEX 12.6 with the simplex method.

4.4.1 The choice of the parameters

Table 4.1 (resource from Zaric et al. (2008) and Holty et al. (2006)) shows the mean duration of each stage and we assume that the disease stages obey the exponential distribution in our base case experiments. Since the mean period of each disease stage is accounted by day and a full-regime (dose) of the oral antibiotics is a 60-day regime, we set the horizon of our model at 70 days. Because the first person infected dies in period 3, we selected $t_d=5$ days and $t_c=7$ days in our base case experiment. After discussion with physicians and pharmacists, we assume that there are four ADCs, which should be able to receive around 1600 individuals per day. Each of the 3 hospitals can admit on average 50 individuals affected by anthrax per period. The stock capacity for the ADC or the hospital is twice as much as the current distribution capacity or treatment capacity. We did not find any official information concerning the size of oral and intravenous antibiotics from national strategic stockpiles. Usually, the oral antibiotics and intravenous antibiotics strategic stockpiles are always available and enough to support the treatments in the ADCs and hospitals. Therefore, we fixed the number of oral antibiotics and intravenous antibiotics strategic stockpiles to 150000 and 4000 doses arbitrarily for the whole horizon respectively. Two scenarios are done to evaluate how the different values of the oral antibiotics strategic stockpile affect the number of deaths. With the rate of the adherence to the oral antibiotics taken into account, the recovery rate of the oral antibiotics given at the beginning of the incubation stage is 0.8 (Fowler et al., 2005). We assume all prodromal and fulminant patients will be adherent to the medical treatment. The recovery rate is 20% when the antibiotics are given at the beginning of the prodromal stage and the recovery rate for the fulminant stage patients with the intensive help in the hospital is 3.2% (Zaric et al., 2008). In the real life, the recovery rate decreases with the increasing of stage duration. However, a lot of authors assume that the recovery rate is uniform for the patients in the same stages and we cannot find any information about how the recovery rate decreases. So, two scenarios are done to evaluate how the recovery rate affects the decision making processes. One scenario assumes the recovery rate is uniform for the same stage patients and the other scenario assumes that the recovery rate decreases with increasing of stage duration. According to the data from a shopping center, with an underground station and a railway station nearby, located in a big French city, 100000 people may go through the shopping center per day. If the infection rate is 35% (Inglesby, 1999), 35000 exposed people are infected per day. Because of the high population flow through the railway stations, we ignore the number of people, who may go through the shopping center more than once. So in our base experiments, the number of infected patients is 210000.

Table 4.1: Mean time spent in each stage.

Different stages	Mean time (day)
I	10.95
P	3.8
U	1.10
I_I	10.95
I_P	5.1
I_U	1.00
P_P	5.0
P_U	1.00
U_U	1.60

4.4.2 Base case experiments

Three scenarios are done in our base case experiments. In the first scenario, we suppose that there is no oral antibiotics strategic stockpile during the medical intervention. In the second scenario, the recovery rates for the patients in the same stage are assumed to be uniform and the oral antibiotics strategic stockpile is available. The third scenario supposes that the recovery rate of those using oral antibiotics decreases with the increasing of stage duration and the oral antibiotics strategic stockpile is available. Several insights can be drawn from our base case experiments. These include but are not limited to:

- After a large-scale anonymous anthrax attack, why is the death rate of infected individuals so high even though the national stockpile is enough?
- Which patients should get the oral antibiotics help first? How do the different priority policies affect the number of deaths?
- If the logistics capacity is limited and then the full regime antibiotics should be dispensed by several times, how many days of antibiotic doses should be prescribed for the first time?
- How should our model be used to optimize the deployment of logistics?

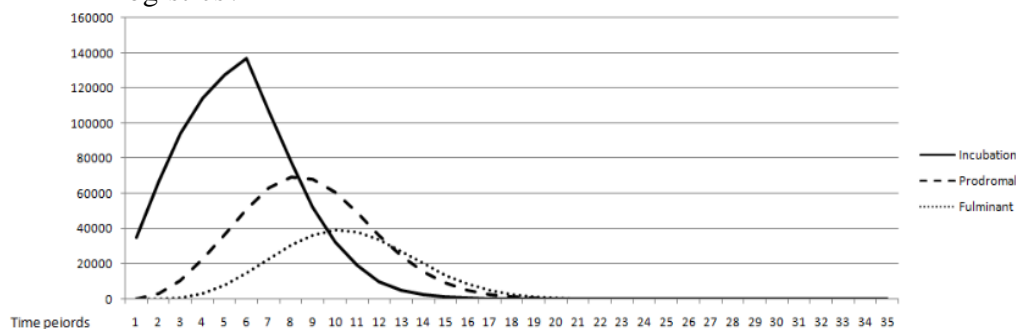
**Figure 4.9:** Number of patients in different stages.

4.4.2.1 Scenario one: medical intervention without oral antibiotics strategic stockpile

After a large-scale anonymous bioterrorist attack, it is possible that the incubation and prodromal stage patients cannot get the oral antibiotics because there is no available oral antibiotics strategic stockpile. So, the first scenario in our base case experiments is done without oral antibiotics strategic stockpile. In this scenario, the number of deaths is 209914. Figure 4.9 presents the evolution of patients in different stages in this scenario. From this figure, it can be found that there is a hospital surge in period 10. From period 6 to period 21, the number of fulminant stage patients is larger than the total available admission capacity in the hospital (the admission capacity of each hospital multiplied by the number of the hospitals, 150) and so 150 fulminant stage patients are treated in the hospital per period. From period 22, the number of fulminant patients is less than total available admission capacity in the hospitals and the number of fulminant stage patients who are treated in the hospital depends on the number of fulminant patients in the current period. At the end of the medical intervention, 2676 patients have been admitted into hospital and 86 patients recover after the hospital treatment.

Table 4.2: Number of patients in the different stages from period 1 to period 4.

t	1		2		3			4			
s	1	2	1	2	1	2	3	1	2	3	4
I	35000	31945	35000	26612	31945	35000	20235	26612	31945	35000	
P	0	0	3055	0	2348	8388	0	1387	6447	14765	
U	0	0	0	0	0	707	0	0	285	2902	
D	0	0		0				422			

To present how our model simulates the evolution of patients in different stages dynamically, Table 4.2 is given as an example to show the number of individuals in different stages from period 1 to period 4 (before the beginning of the medical intervention), and the transitions between the different stages are described in the following. At the beginning of the first period, 35000 individuals are infected. At the beginning of the second period, 3055 (8.7%) patients infected in the first period transfer into the prodromal stage and 31945 patients (35000-3055=31945) infected in the first period still stay in the incubation stage. At the beginning of the third period, 5333 (16.7%) and 3055 (8.7%) patients infected in the first period and second period transfer into the prodromal stage respectively. Therefore, 8388 (5333+3055=8388) patients have got into the prodromal stage at the beginning of the third period. 26612 (31945-5333=26612) and 31945 (35000-3055=31945) patients infected in the first period and second period stay in the incubation stage respectively. 707 (23.1%) patients who get into the prodromal stage at the beginning of the second period transfer into the fulminant stage. 2348 (3055-707=2348) patients who get into the prodromal stage at the beginning of second period are still in the prodromal

stage. At the beginning of the fourth period, 6377 (23.96%), 5333 (16.7%) and 3055 (8.7%) patients infected in the first, second and third period respectively get into the prodromal stage. And so, 14765 ($6377+5333+3055=14765$) people get into the prodromal stage at the beginning of fourth period. 20235 ($26612-6377=20235$), 26612 ($31945-5333=26612$) and 31945 ($35000-3055=31945$) patients infected in the first, second and third period respectively still stay in the incubation stage. 961 (40.9%) and 1941 (23.1%) patients who get into the prodromal stage in the second and the third periods respectively transfer into the fulminant stage. So, 2902 ($961+1941=2902$) patients get into the fulminant stage in the beginning of third period. 1387 ($2348-961=1387$) and 6447 ($8388-1941=6447$) patients who get into the prodromal stage in the second and the third period still stay in the prodromal stage. 422 (59.7%) patients who get into the fulminant stage in the third period die. 285 ($707-285=422$) patients who get into the fulminant stage in the third period remain the fulminant stage.

4.4.2.2 Scenario two: medical intervention under uniform recovery rate

Scenario two investigates the decision making processes under the uniform recover rate assumption. If the recovery rate is uniform for the same disease stage patients, the number of deaths is 169362. 52545 oral antibiotics and 2899 intravenous antibiotics are distributed to the patients. 40638 patients recover after the treatment. The values of ${}^I Y_t^{si}$ (the number of patients who have got into incubation stage at the beginning of period s_i and get the medical help at the beginning period t) are shown in Table 4.3 which investigates the patients' priority policies. Because period 6 is the last period in which the exposed people can be infected and most of incubation stage patients get the medical help after period 10, we present the value of ${}^I Y_t^{si}$ from periods 6 to 10. The values of ${}^I Y_t^{si}$ which are equal to 0 are not presented in the table.

From Table 4.3, it can be found that before all the patients who are infected earlier get medical help, the patients infected later cannot get the medical help. It is because the earlier infected patients have higher possibility to transfer into the next disease stage in which it is more difficult to recover. So, if the recovery rate is uniform for the same disease stage patients, it is the patients who get into the current disease stage earlier that should get the medical help first.

Table 4.3: The number of patients who have moved into the incubation stage in the different periods (s_i) and get medical help in the beginning period t (with a uniform recovery rate).

t	6		7	8		9		10	
s_i	1	2	2	2	3	3	4	4	5
${}^I Y_t^{si}$	4841	1559	6400	872	5528	1946	4454	2568	3832

4.4.2.3 Scenario three: medical under non-uniform recovery rate

In this scenario, the strategic stockpile of the oral antibiotics and the intravenous antibiotics are 150000 and 4000 respectively for the whole horizon. We assume that the oral antibiotics recovery rates for I and P stage patients decrease linearly with the increasing duration in each disease stage. The recovery rate for later incoming patients is always higher than the earlier incoming stage patients (the recovery rate for I stage patients is higher than P stage patients and the recovery rate for P stage patients is higher than U stage patients). The recovery rate for I and P stage patients decrease by the rate of 0.05 and 0.04 per day until they reach 0.25 ($0.20+0.5$) and 0.04 ($0.04+0$) respectively ($(0.8-0.2)/10.95 \approx 0.05$ and $(0.2-0.032)/3.8 \approx 0.04$). Since the recovery rate, 0.032, for the U stage patients is too small, we assume this recovery rate is uniform. This scenario has 37773272 constraints and 55792 decision variables. The solver takes 2.45 hours to search for the optimal solution. The number of deaths is 178920. 49360 oral antibiotics and 2550 intravenous antibiotics are distributed to the patients. 31080 patients recover after the treatment. The reason of the high death rate, the medical priority policy, the dispensing strategy and the deployment logistics, will be analyzed in the following.

1) Main reasons of the high death rate

The high death rate exists for two main reasons. First, the dispensing capacity of the ADCs is too limited. The total available dispensing capacity is 6400 (the dispensing capacity of each ADC multiplied by the number of the ADCs). At the beginning of medical intervention (period 5), the number of infected patients is 175000. Only about 3.7% of the patients can get the oral antibiotics ($6400/175000 \approx 0.037$). Second, the length of this disease stage is short and the patients cannot get the medical help in time. For example, the patients infected at the beginning of the first period get the medical help at the beginning of the ninth period when they are still in the incubation stage. Their recovery rate has already decreased to 0.4 and some patients infected at the beginning of the first period have already developed to the prodromal stage or fulminant stage in which it is more difficult for them to recover.

The death rate given in other papers may be lower than ours because : first, the value of the medical resources dispensing capacity they use is too high, which is not true in the real life; second, they do not take into account the fact that some patients (antibiotics resistance) may not be adherent to the antibiotics and they assume the recovery rate for the patients who take the oral antibiotics during stage I is 100%; third, the decrease of the recovery rate with the increasing of the stage duration when the patient stays in the current disease stage has not been taken into consideration.

Note that all recovery is possible if detection is instantaneous and no antibiotics resistance is considered, the antibiotics efficiency is 100%, and antibiotics can be dispensed to all patients immediately. For example, if the attack site can be found immediately after the anthrax attack, on the hypothesis that people stock the antibiotics (Medkits, (Houck and Herrmann, 2011)) prior to

the attack and people can start taking antibiotics as soon as they know there is an anthrax attack. In other words, the main reason of the high death rate is that patients cannot get the medical help in time because of the limited logistics capacity and the short disease period.

2) Medical help priority policy

Figure 4.10 presents the number of incubation and prodromal stage patients who get the medical help at the beginning period t ($\sum_{s_i=1}^t I_t^{s_i}$ and $\sum_{s_p=2}^t P_t^{s_p}$) and the number of incubation and prodromal stage patients who do not get the medical help at the beginning of period t ($\sum_{s_i=1}^t I_t^{s_i}$ and $\sum_{s_p=2}^t P_t^{s_p}$).

The hypothesis of a full dispensing antibiotics regime is retained. From the beginning of period 5 (when the medical intervention starts) to the beginning of period 11, the number of incubation stage patients who get medical help is equal to the total available dispensing capacity. At the beginning of period 11, the number of remaining incubation stage patients without medical help is 259. At the end of period 11, 163 incubation stage patients get into the prodromal stage. At the beginning of period 12, 96 incubation stage patients and 6304 prodromal stage patients get the oral antibiotics help respectively. No incubation stage patients need the oral antibiotics help any more after period 12 and no prodromal stage patients get the oral antibiotics help before period 12. This result shows that for the patients in different stages who ask for the same medical help, if the gap of the recovery rate between these different disease stages is high, the patients in the earlier disease stage should be given medical help first (incubation stage first and then the prodromal stage patient) because the recovery rate of the patients in the earlier stage is much higher than that of patients in the later stage.

Like the analysis we did in section 5.2.3, in order to decide the medical help priority for the same disease stage patients who move into the current disease stage in the different periods, the number of patients who have moved into the incubation stage at the beginning of period s_i and get the medical help at the beginning period t ($I_t^{s_i}$) is analyzed (Table 4.4). Because all the incubation stage patients infected at the beginning of period 6 get medical help before period 11, we just present the value of $I_t^{s_i}$ from the period 6 to the period 10. Table 4.4 does not present the values of $I_t^{s_i}$ which are equal to 0. From period 6 to period 9, the number of patients who are infected at the beginning of period 6 and get medical help is equal to the total available dispensing capacity. At the beginning of period 9, 1215 patients infected at the beginning of period 6 do not get medical help. 372 patients infected at the beginning of period 6 get into the prodromal stage at the end of period 9. At the beginning of period 10, 843 remaining patients infected at the beginning of period 6 and 5557 patients infected at the beginning of period 5 get the medical help respectively. No patients infected at the beginning of period 6 need medical help after period 10. If the recovery rate decreases, this experiment shows that the patients who get infected later should receive medical help earlier because the longer patients stay in the current disease stage, the lower the recovery rate is. In the real life, incubation stage patients can go to ADCs

easier than prodromal stage patients because incubation stage patients have better health situations. Therefore, the priority policy proposed in our paper can be logically put into practice.

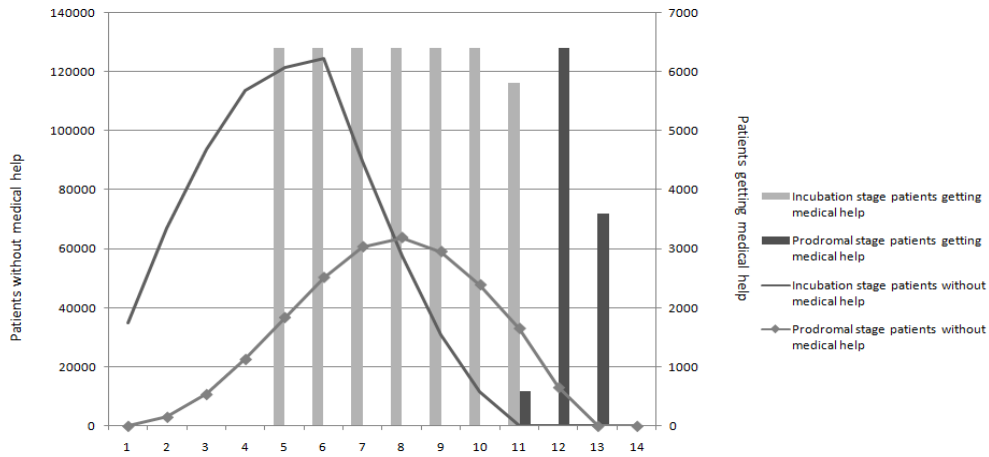

Figure 4.10: The incubation and prodromal stage patients without the medical help or getting the medical help at the beginning of period t.

Table 4.4: The number of patients who have moved into incubation stage at the different periods (s_i) and get the medical help at the beginning period t (base case).

t	6	7	8	9	10	
s_i	6	6	6	6	5	6
$I_{Y_t}^{s_i}$	6400	6400	6400	6400	5557	843

3) Antibiotics dispensing strategy

The antibiotics dispensing strategy should solve the problem: How many days of antibiotics should be prescribed at the first time if the logistics capacity is limited and should the full regime antibiotics be dispensed over several times. Figure 4.11 shows the number of the incubation stage patients and the prodromal stage patients who do not receive medical help at the beginning of the different periods and the required medical resources at each period. It can be found that after period 13, no patients need the oral antibiotics help any more. Our experiment results enlighten us that if the national level of the antibiotics inventory is limited, or the antibiotics cannot be sent to each ADC from strategic stockpile in time, the patients can be given a 13-day dose of antibiotics first to control the disease progression and then given the following doses of antibiotics later. Figure 4.8 shows us the information about the number of patients waiting for the oral antibiotics in the different periods. An extreme demand for the oral antibiotics will happen in period 6. And then, there will be an aggressive demand for the hospital treatment around period 10. This aggressive demand can lead to a high patient flow in hospitals. The bottleneck resources are for more physicians and pharmacists (ADC capacity) than antibiotics.

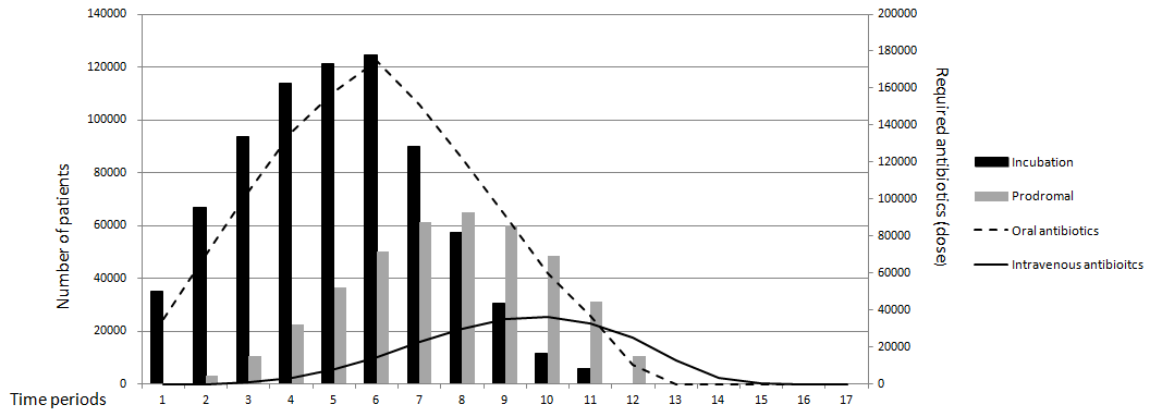

Figure 4.11: Number of the patients who need the oral antibiotics help in the different periods.

4) Deployment logistics

This part will explain how to use our model to help the decision makers for the deployment of logistics. For the delivery of antibiotics from national stockpile, we observed the number of antibiotics sent to each ADC or hospital per period by national stockpile (Q_{dt} and Q_{ht}). Since each ADC pre-stocks full regime antibiotics for 800 individuals, in the first period when the anthrax attack response begins, the national stockpile sends 800 doses of oral antibiotics to each ADC to make sure that the oral antibiotics available in each ADC are no less than the dispensing capacity. From period 6 to period 13, 1600 antibiotics will be sent to each ADC for each period. From period 5 to period 21, 50 intravenous antibiotics are sent to each hospital per period. After period 24, how many doses of intravenous antibiotics to be sent to each hospital depends on the number of patients in stage U because not so many patients transfer into stage U after period 21. So, after period 13, the number of oral antibiotics sent to each ADC can be decreased and, after period 21, the number of intravenous to be sent to each hospital can be decided according to the demand.

4.4.3 Sensitive analysis

Because the recovery rates decreasing with the increasing of stage duration is closer to the real situation, all the following experiments are done, taking into account, the decreasing of the recovery rate with the increase of the stage duration. Since how the recovery rate decrease is not clearly, we assume the recovery rate may decrease linearly or exponentially. The oral antibiotics strategic stocks are fixed to 150000 in the following experiments to see how other factors may impact the number of deaths. 33 new experiments are presented in this section to address other logistics questions, assuming that the disease development can follow an exponential distribution or a lognormal distribution for us to check how the different disease distributions affect the number of deaths (see the sixth logistics question in Section 3.3). In the

lognormal distribution, the dispersion factor of patients in I, P and U stages are $e^{0.713}$, $\sqrt{2}$ and $\sqrt{2}$ respectively (Wein et al., 2003; Zaric et al., 2008).

1) Dispensing capacity of ADCs

It is difficult to evaluate the optimum dispensing capacity because the optimum dispensing capacity depends on several factors, such as the national stockpile and the transition rates among the different stages, which are hard to decide. However, the mean periods of incubation and prodromal stage of the anthrax are short, and hence, it is necessary to decide a reasonable dispensing capacity to minimize the number of deaths. Figure 4.12 shows the number of deaths with the change of the dispensing capacity of each ADC.

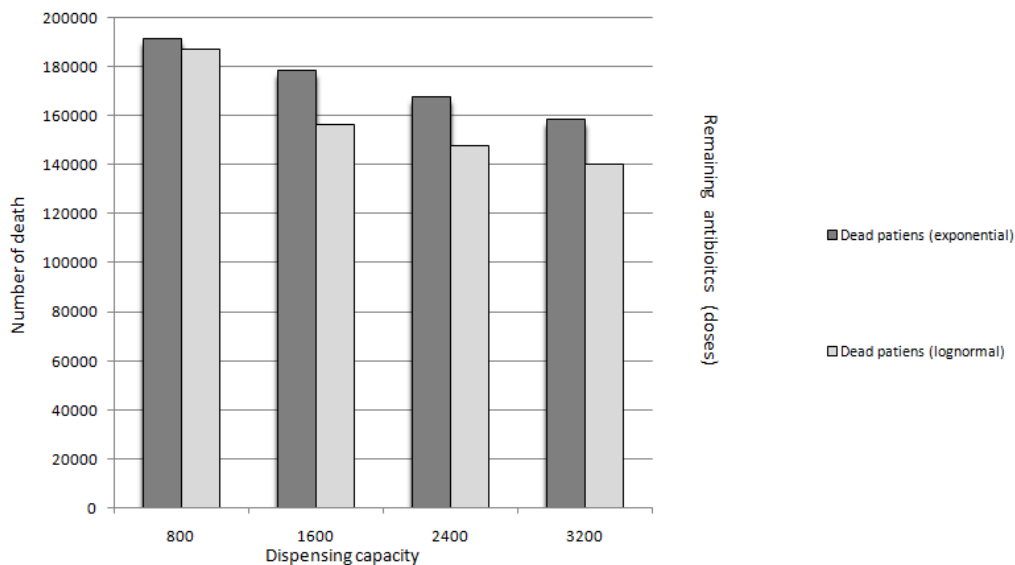

Figure 4.12: The impact of the dispensing capacity.

Based on Figure 4.12, the number of dead patients decreases significantly with the increase of distribution capacity because the increase of dispensing capacity of ADCs can ensure that more incubation stage patients get the oral antibiotics earlier. In our experiments, the national strategic stockpile is always enough in our experiments. So, the dispensing capacity is the threshold of minimizing the death of individuals. Compared with the exponential distribution, the number of deaths is more sensible to the dispensing capacity under the lognormal distribution. The number of deaths will not change if each ADC does not pre-stock some antibiotics because the national stockpile can deliver the antibiotics in time. Hence, if the national stockpile can support each ADC in time, the pre-stock of the antibiotics in each ADC will not affect the number of dead individuals.

2) Detection ability

The detection ability includes two parts: one is the anthrax attack detection ability and the other is the anthrax attack site detection ability. Figure 4.13

shows that the number of dead patients decreases when the detection ability increases. This experiment can help the decision makers to decide if it is necessary to install sensors to critical infrastructures to detect anthrax attacks. Under the exponential distribution, if the anthrax attack is detected at the beginning of period 3 and the attack site is closed at the beginning of period 7, the total number of deaths is 164047. If the anthrax attack is detected at the beginning of period 4 and the attack site is cordoned off at the beginning of period 6, the total number of deaths is 148587. If the anthrax attack cannot be found earlier, we can try to find the anthrax attack site and seal it off as soon as possible to reduce the casualties. Compared with the dispensing capacity, the number of deaths is more sensible to the detection ability because our experiment is made under a large-scale anthrax attack in an enclosed area. An earlier anthrax attack detection ability can enable more infected patients to get the medical help in time and the earlier site detection ability can reduce the number of infected individual effectively. Compared between lognormal and exponential distributions, the detection ability has a bigger impact on the number of deaths if the disease follows the lognormal distribution.

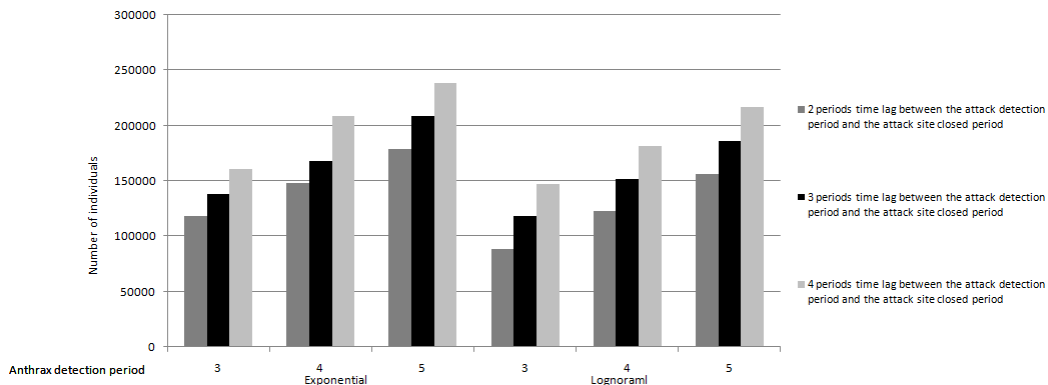

Figure 4.13: The impact of the different detection abilities.

3) Discussion between two kinds of distributions

Based on our experiments, the number of deaths is always higher under the exponential distribution, because, for transition rate of the incubation stage, the fatter left tail of the exponential distribution transition rate ($A_{f_t}^{sa}$) makes the transition rate higher than the lognormal distribution transition rate before the medical intervention begins (most of the recovery patients are the patients who get the medical help during the incubation stage). Because of the thinner left tail of the lognormal distribution, under the lognormal distribution, the number of deaths is more sensible to dispensing capacity and detection ability. In other words, the thinner left tail of the lognormal distribution makes the development of anthrax slower. Therefore more patients can get the timely medical help under the lognormal distribution. The large scale attack leads to the impact of the detection ability is bigger than the dispensing capacity no matter what course the disease follows.

If it is a large-scale anthrax attack, the sensitive analysis presents that the use of sensors (the increasing of the detection ability) will be the first-order improvement method to reduce the number of deaths. The second-order improvement method is the increasing of the dispensing capacity of each ADC. Most of the conclusions gained by our experiments are consistent with the conclusions established by Craft et al. (2005).

4.5 Conclusion

This chapter studies the logistic response to man-made disaster. Using anthrax attack as real situation, this chapter first proposes an ARIS model to inform people with what they must do during the response to the bioterrorist attack. Second, a mathematical model, which can help the decision makers to predict the different antibiotics requirements on any given day, is established. This model can help the decision makers to decide how to distribute the medical resource reasonably, and tell the decision makers how different logistics capacities affect the number of deaths. Based on numerical experiments, two factors which can decrease the number of deaths effectively are found: increasing the detection ability and increasing the dispensing capacity of each ADC. In case of a large-scale attack, the first factor is more important. This model can be extended to several situations easily, and can be applied to tackle some other non-communicable biological agents, such as legionella pneumophila, and can take different resources into consideration if needed.

5. Outbreak of diseases: modeling the logistics response to a general infectious diseases

Chapter 5 studies the logistics response to the outbreak of diseases, and proposes a model which links the disease progression, the related medical intervention actions and the logistics deployment together to support the decision making process in case of the logistics response to an infectious disease from a strategic level. The model can be used not only for the communicable diseases, but also for the non-communicable diseases. The number of patients in different disease stages and the required medical resources for each period can be estimated by our model. The impacts of factors on the number of deaths and the different medical intervention policies can also be evaluated by this model. Numerical results take the H5N1 as an example to assess the potential contribution of our model. The detail structure of this chapter is in the following:

5.1 Introduction

- 5.1.1 Background of the research
- 5.1.2 Gaps of the previous works
- 5.1.3 General information of our approach

5.2 Problem description

- 5.2.1 General situation of infectious diseases
- 5.2.2 Logistics decisions

5.3 The general infectious disease model and the mathematical formulation

- 5.3.1 The general infectious disease model
- 5.3.2 The mathematical formulation

5.4 Numerical Experiments

- 5.4.1 The choice of data
- 5.4.2 The base case analysis
- 5.4.3 Sensitive analysis

5.5 Conclusions and future directions

5.1 Introduction

More and more epidemics occur today. Therefore, a comprehensive strategy should be proposed to prevent and/or control the occurrence of epidemics. During the response to epidemics, one of the challenges is to help the susceptible and the infected with limited medical resources. This chapter uses a mathematical model to study how different strategies affect the number of affected people and how different logistics capacities affect the development of epidemics. The model proposed in this chapter can help decision makers to optimize the use of resources to response to the outbreak of disease effectively.

5.1.1 Background of the research

As what has been presented in Chapter 1, it is often difficult to find the cause triggering the outbreak of diseases. Both human beings and nature can cause the outbreak of communicable diseases. The uncertain causes of the outbreak of diseases render the prevention of diseases disasters more difficult. The urbanization, the pollutions, the increase of the population and many other factors make the occurrence of infectious diseases more possible than before.

Moreover, from a view of the used methodology, the propagation of the communicable disease can be presented by a non-linear model, the SIR model. But, finding a solution of the non-linear model is not easy, especially for the large-scale problem. So, this chapter is devoted to the study of logistics response to the outbreak of infectious diseases. But the model proposed in this chapter can be used to the logistics response to the non-infectious diseases as well.

5.1.2 Gaps of the current research

Based on the literature review of Chapter 2, it can be found that papers studying the logistics response to the infectious disease are far from being enough. The main gaps of the research in this field are:

- In the models, too many details have been taken into account. These details make the mathematical models more difficult to be understood and to be solved. But some of these details cannot help the decision makers to optimize the logistics deployments or the emergency management plans.
- Most of the papers neglect the logistics capacities which will have a big impact on the response capacities. For example, a lot of papers make an assumption that the national stockpile of the vaccines is always enough during the response, which is not true in the real world.
- To the best of our knowledge, until now, no paper has proposed a logistics response model which can be adapted to the response to a general infectious disease other than a certain infectious disease. Today, there are so many new epidemics which have never been known before these epidemics break out. Therefore, a general model, which can be used to the logistics response to the most kinds of infectious diseases, should be proposed.

These gaps motivate us to propose a conscious logistics response model for general infectious diseases which takes into account all necessary details.

5.1.3 General information of our approach

The model proposed in this chapter solve all the questions mentioned in Chapter 1. All these question will be presented in detail in Section 5.2.2. Our approach has the following characteristics:

- The model proposed in this chapter connects the disease progression,

the medical intervention methods and the logistics deployment together.

- By using this model, crisis managers can estimate the number of patients in different stages for each period and then optimize the usage of resources for the best response.
- This model can help the crisis managers to organize an efficient logistic response to a general infectious disease from a strategic level.
- The information which is taken into account in this model is the detail which will impact the response capacity or the number of affected people. The unnecessary information has not been taken into account to make the model to be conscious.
- The model is a generous model. In other words, it can adapt to several situations, such as the outbreak of the diseases caused by human reasons or the natural reasons.

5.2 Problem description

In order to give the reader a general view of the situation that we intend to address, this section describes the general situation of an infectious disease and the decisions concerning the logistics problems of medical interventions.

5.2.1 General situation of infectious diseases

Since some knowledge of infectious diseases has been presented in the Chapter 2, this section just briefly repeats the points which will be used as the foundation knowledge in our model. The progression of a general infectious disease can be divided into three stages according to the infectiousness, namely, latent (L), infectious (A) and isolated (I) stages. The patients in L stage are non-infectious. The A stage patients can infect the susceptible (S) individuals. When the A stage patients develop to the I stage, they are not infectious anymore because the infectiousness first increases and then decreases with the time, such as smallpox patients; or the patients are symptomatic and will be isolated, such as H5N1 patients. Some infected patients eventually recover even though they do not get the medical help because they can produce antibody themselves. The infected patients who cannot produce antibody themselves will pass through these stages and die (D) if untreated. Susceptible people can be infected by two ways. First, they may inhale or contact with the virus or bacterial dust and become ill. Second, they may get infected by contacting with infectious patients. In epidemiology, the basic reproduction number, defined as the number of susceptible individuals that can be infected by each infected patient during the infectious periods, is always used to describe the infection rate of the disease.

Generally, two medical intervention methods are available: vaccination (V) and antiviral drugs or antibiotics (D). The susceptible individuals can become immune by vaccination. But the vaccination can also cause fatalities because of the side-effect. As long as susceptible people are infected, vaccination will not be

useful anymore. It is, usually, the antiviral drug and antibiotics that can be used to treat patients infected by virus and bacterias respectively. If the S stage and I stage individuals who take the medical help cannot become immune or recover, they still have the possibilities to be infected and infect others respectively.

5.2.2 Logistics decisions

Some logistics decisions are similar to the logistics decisions that have been presented in Chapter 4. Therefore, in this section, the similar logistics decisions which are presented in Chapter 4 will be presented briefly and the logistics decisions which are different from the logistics decisions in Chapter 3 will be introduced in detail.

The logistics deployment of drugs and vaccines is managed both at national and local levels. At the national level, national strategic stocks are supposed to supply the necessary amount of drugs to the Antiviral drug Distributions Centres or Antibiotics Distributions Centres (ADC), as well as the vaccines used by the hospitals. Usually, vaccines are only available in the hospital that is appointed or related. In most cases, the national stock is available round the clock every day and can deliver the available medical resources to the local ADCs in time. We will therefore focus on the local level decisions in the infected region. At the local level, a complex network delivering both services (diagnose or injection) and products (antiviral drugs or antibiotics and vaccines) needs to be deployed as soon as possible.

According to the WHO, the antiviral drugs or antibiotics and the vaccines should be stored in advance to response to the occurrence of an infectious disease. However, it is difficult to prepare the stockpiles of vaccines in advance for two reasons: first, there are too many types of viruses and so it is hard to store the vaccines for every infectious disease; second, the production and conservation costs of the vaccines are too high. Though it is difficult, but it is not impossible. To deal with different epidemics, different drugs should be dispensed in time. But, the logistic capacity is always limited. All these problems make a big challenge for the logistics organization to support the high demand of the scare medical resources after the sudden occurrence of an infectious disease

Therefore, this chapter proposes a general model, which can support the following logistics decisions after the occurrence of an epidemic.

- How should the antiviral drugs or antibiotics be prescribed? Since the infected patients in the different stages ask for the same antiviral drugs or antibiotics, who should get the most part of the antiviral drugs or antibiotics?
- Should certain kinds of vaccines be stored in advance? If yes, how many hospitals should be deployed to inject the vaccines?
- How does the change of the dispensing capacity of ADCs affect the number of deaths? Is the national stockpile always enough to support the local ADCs?
- The different infectious diseases have different basic reproduction

numbers, how will different basic reproduction numbers affect the number of deaths and the use of medical resources?

5.3 The general infectious disease model and the mathematical formulations

This section first discusses our general infectious disease model. Then the mathematical formulation aiming at minimizing the number of deaths caused by a general infectious disease under limited medical resources is presented.

5.3.1 The general infectious disease model

The proposed model (Figure 5.1) takes into account of the different disease stages and the potential medical intervention methods. The notations used in Figure 5.1 are defined in Table 5.1. This model consists of a set of nodes (the disease stages under different medical treatment situations) and oriented arcs (possible transitions between the stages). The individuals are divided into 10 stages according to the different disease stages and different medical treatment statuses which they are in. These stages are denoted by $m = \{S, L, A, I, S^V, L^D, A^D, I^D, R, D\}$. The normal letter presents the disease stages: susceptible (S), latent (L), infectious (A), isolated (I), immune or recover (R) and dead (D). The superscript indicates the medical treatment that the patients receive (if applies): receiving antiviral drugs or antibiotics (D) and receiving the vaccines (V). If there is no superscript, that means the patients do not receive the medical help. Transition between the different stages is based on different disease stages, different medical treatment statuses and the results of different medical interventions. The model assumes that logistics decisions (delivery of medical resources) are made at the beginning of periods. The individuals who are in the current stage at the beginning period t may evolve to the following stage at the beginning of period $t+1$ (at the end of period t) according to the medical decisions taken at the beginning of period t . Hence, our model assumes the medical interventions (administration of the medical treatment) are done at the beginning of periods

In Figure 5.1, the arcs between the second line nodes and the third line nodes present the transitions between the individuals without medical help and individuals getting the medical help. After getting the medical help, some infected patients may recover (the arcs between the third line nodes and the node “Recovery” on the fourth line) and some will not. The non-recovered patients will continue to develop to the next disease stage, which is presented by the arcs between the third line nodes. The two arcs between the node “Susceptible Vaccine” and the node “Immune” or “Death” show the susceptible individuals who are immune after vaccination or die of the side-effect of the vaccination respectively. The arcs between the first line node and the second line nodes mean that some infected patients can recover without medical treatment because of production of antibody themselves. In our model, we assume the recovered or

immune people will be immune to this kind of disease and will not be infected by this disease again. The two infection methods, breathing or contacting with the virus or bacterial dust and contacting with the A stage patients, are represented by arcs between the nodes “Susceptible No Treatment” and “Latent No Treatment” or “Susceptible Vaccine” and “Latent Drug”. The number of new infected patients caused by contacting with the infectious patients can be calculated as a nonlinear function, which is denoted by the function f .

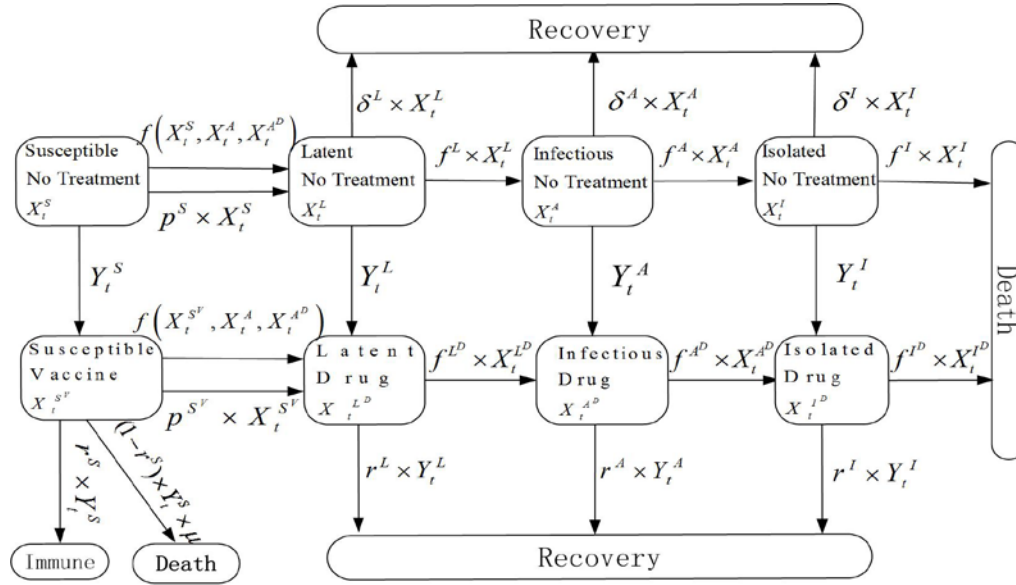

Figure 5.1: General infectious disease model

5.3.2 The mathematical formulation

We propose a discrete time mathematical formulation of the logistics response to a general infectious disease model. In most cases, it is difficult to know when the epidemic takes place. But it is possible to know the number of patients in different stages when the epidemic is detected. Therefore, our model supposes that the medical intervention starts from the beginning of period 2 and the number of individuals in the different stages at the beginning of the first period is known. The notations and the mathematical formulations are shown in the followings.

Indices and parameters	
m	Index for different stages, $m=\{S, L, A, I, S^V, L^D, A^D, I^D, R, D\}$
m^S	Index for individuals in the susceptible stage, $m^S=\{S, S^V\}$
m^A	Index for individuals in the infectious stage, $m^A=\{A, A^D\}$
T	Number of periods, $t = \{1, \dots, T\}$
H	Number of available hospitals, $h = \{1, \dots, H\}$
D	Number of distribution centers, $d = \{1, \dots, D\}$
p^{m^S}	Rate of infection due to the breathing or contacting with the virus

	dust, $m=\{S, S^V\}$
$b_{m^A}^{m^S}$	Rate of infection due to the contact between the individuals in stage m^S and m^A $m^S = \{S, S^V\}$; $m^A = \{A, A^D\}$
f^m	Rate of transition from the current disease stage m to the next disease stage $m=\{L, A, I, L^D, A^D, I^D\}$
r^m	Rate of recovery or immune of individuals in disease stage m with medical help, $m=\{S, L, A, I\}$
δ^m	Rate of recovery for individuals without medical help in stage m because of producing antibody, $m=\{L, A, I\}$
μ	Rate of death because of the side effect of the vaccination
sth, std	Number of available vaccines or antiviral drugs from strategic stocks respectively (number of doses)
ch, cd	Daily treatment capacity per hospital or daily distribution capacity per distribution center respectively (number of doses)
sh, sd	Stock capacity per hospital or per distribution center (number of doses)
initd, inith	Number of available antiviral drugs per distribution center or number of available vaccines per hospital at the beginning of the horizon (number of doses)
num^m	Number of individuals in stage m at the beginning of the first period; $m=\{S, L, A, I, S^V, L^D, A^D, I^D, R, D\}$
Variables	
X_t^m	Number of individuals in stage m at the beginning of period t ; $m=\{S, L, A, I, S^V, L^D, A^D, I^D, R, D\}$
Y_t^m	Number of individuals who are in stage m and get the medical help at the beginning of period t , $m=\{S, L, A, I\}$
Q_{ht}	Number of vaccines sent to hospital h by strategic stockpile at the beginning of period t
Q_{dt}	Number of drug doses sent to distribution center d by strategic stockpile at the beginning of period t
I_{ht}	Number of available vaccines at hospital h at the beginning of period t
I_{dt}	Number of available drug doses at distribution center d at the beginning of period t
G_{ht}	Number of infected individuals being vaccinated at hospital h at the beginning of period t
G_{dt}	Number of infected individuals getting the drug help at distribution center d at the beginning of period t ;

$$\text{Min}(\sum_{t=1}^T X_t^D) \quad (5-1)$$

$$X_{t+1}^S = X_t^S - Y_t^S - p^S \times X_t^S - b_A^S \times X_t^S \times X_t^A - b_{A^D}^S \times X_t^S \times X_t^{A^D} \quad t = \{1, \dots, T-1\} \quad (5-2)$$

$$X_{t+1}^L = X_t^L - \delta^L \times X_t^L + p^S \times X_t^S + b_A^S \times X_t^S \times X_t^A + b_{A^D}^S \times X_t^S \times X_t^{A^D} - Y_t^L - f^L \times X_t^L \quad t = \{1, \dots, T-1\} \quad (5-3)$$

$$X_{t+1}^A = X_t^A - \delta^A \times X_t^A + f^L \times X_t^L - Y_t^A - f^A \times X_t^A \quad t = \{1, \dots, T-1\} \quad (5-4)$$

$$X_{t+1}^I = X_t^I - \delta^I \times X_t^I + f^A \times X_t^A - Y_t^I - f^I \times X_t^I \quad t = \{1, \dots, T-1\} \quad (5-5)$$

$$X_{t+1}^{S^V} = X_t^{S^V} + Y_t^S - r^S \times Y_t^S - (1 - r^S) \times Y_t^S \times \mu - p^{S^V} \times X_t^{S^V} - b_A^{S^V} \times X_t^{S^V} \times X_t^A - b_{A^D}^{S^V} \times X_t^{S^V} \times X_t^{A^D} \quad t = \{1, \dots, T-1\} \quad (5-6)$$

$X_{t+1}^{L^D} = X_t^{L^D} + Y_t^{L^D} + p^{S^V} \times X_t^{S^V} + b_A^{S^V} \times X_t^{S^V} \times X_t^A + b_{A^D}^{S^V} \times X_t^{S^V} \times X_t^{A^D} - r^L \times Y_t^L - f^{L^D} \times X_t^{L^D}$	$t = \{1, \dots, T-1\}$	(5-7)
$X_{t+1}^{A^D} = X_t^{A^D} + Y_t^A + f^{L^D} \times X_t^{L^D} - r^A \times Y_t^A - f^{A^D} \times X_t^{A^D}$	$t = \{1, \dots, T-1\}$	(5-8)
$X_{t+1}^{I^D} = X_t^{I^D} + Y_t^I + f^{A^D} \times X_t^{A^D} - r^I \times Y_t^I - f^{I^D} \times X_t^{I^D}$	$t = \{1, \dots, T-1\}$	(5-9)
$X_{t+1}^D = (1 - r^S) \times Y_t^S \times \mu + f^{I^D} \times X_t^{I^D} + f^I \times X_t^I$	$t = \{1, \dots, T-1\}$	(5-10)
$X_{t+1}^R = r^L \times Y_t^L + r^A \times Y_t^A + r^I \times Y_t^I + r^S \times Y_t^S + \delta^L \times X_t^L + \delta^A \times X_t^A + \delta^I \times X_t^I$	$t = \{1, \dots, T-1\}$	(5-11)
$G_{dt} \leq cd$	$\forall t = \{2, \dots, T\}$ $\forall d = \{1, \dots, D\}$	(5-12)
$I_{d,1} = \text{initd}$	$\forall d = \{1, \dots, D\}$	(5-13)
$I_{dt} + Q_{dt} \leq sd$	$\forall t = \{2, \dots, T\}$ $\forall d = \{1, \dots, D\}$	(5-14)
$I_{d,t+1} = I_{dt} - G_{dt} + Q_{dt}$	$\forall t = \{2, \dots, T-1\}$ $\forall d = \{1, \dots, D\}$	(5-15)
$Y_t^L + Y_t^A + Y_t^I = \sum_{d=1}^D G_{dt}$	$\forall t = \{2, \dots, T\}$	(5-16)
$\sum_{d=1}^C \sum_{t=2}^T Q_{dt} \leq \text{std}$		(5-17)
$G_{ht} \leq ch$	$\forall t = \{2, \dots, T\}$ $\forall h = \{1, \dots, H\}$	(5-18)
$I_{h,1} = \text{inith}$	$\forall h = \{1, \dots, H\}$	(5-19)
$I_{ht} + Q_{ht} \leq sh$	$\forall t = \{2, \dots, T\}$ $\forall h = \{1, \dots, H\}$	(5-20)
$I_{h,t+1} = I_{ht} - G_{ht} + Q_{ht}$	$\forall t = \{2, \dots, T-1\}$ $\forall h = \{1, \dots, H\}$	(5-21)
$Y_t^S = \sum_{h=1}^H G_{ht}$	$\forall t = \{2, \dots, T\}$	(5-22)
$\sum_{h=1}^H \sum_{t=2}^T Q_{ht} \leq \text{sth}$		(5-23)
$X_1^m = \text{num}^m$	$m = \{S, L, A, I, S^V, L^D, A^D, I^D, D, R\}$	(5-24)
$Y_1^m, Q_{d,1}, Q_{h,1}, I_{h,1} = 0$	$\forall h = \{1, \dots, H\}$ $\forall d = \{1, \dots, D\}$ $m = \{S, L, A, I\}$	(5-25)
$X_t^m, Y_t^m, I_{dt}, Q_{dt}, I_{ht}, Q_{ht} \geq 0$	$t = \{1, \dots, T\}$ $m = \{S, L, A, I, S^V, L^D, A^D, I^D\}$ $\forall h = \{1, \dots, H\}$ $\forall d = \{1, \dots, D\}$	(5-26)

Equation (5-1) aims at minimizing the number of deaths. Equations (5-2) to Equations (5-11) concern individuals in different stages. Equations (5-2) to Equations (5-5) present individuals who cannot get medical assistance in different stages. Equations (5-2) present susceptible individuals who cannot get no medical help. In equations (5-2), the number of susceptible individuals who cannot get medical help in period $t+1$ (X_{t+1}^S), is equal to the number of

susceptible individuals without medical help in period t (X_t^S), minus the number of susceptible individuals who get medical help in period t (Y_t^S), minus the number of people who get infected because of breathing or contacting with virus dust ($p^S \times X_t^S$), minus the number of susceptible people who get infected because of contacting with infectious individuals who did not get medical help ($b_A^S \times X_t^S \times X_t^A$), minus the number of people who get infected because of contacting with infectious individuals who have got medical help but did not recover ($b_{A^D}^S \times X_t^S \times X_t^{A^D}$). Equations (5-3), (5-4) and (5-5) give the numbers of patients in stages L, A and I patients without medical help, respectively. In equations (5-3), the number of patients in L stage without antiviral drugs in period $t+1$ (X_{t+1}^L), is equal to the number of patients in L stage without antiviral drugs in period t (X_t^L), minus the number of the L stage patients who become immune without medical help because of production of antibody themselves ($\delta^L \times X_t^L$), plus the number of susceptible people without medical help who get infected because of breathing or contacting with virus dust in period t ($p^S \times X_t^S$), plus the number of susceptible individuals without medical help who get infected because of contacting with infectious individuals who do not get medical help ($b_A^S \times X_t^S \times X_t^A$), plus the number of susceptible individuals without medical help who get infected because of contacting with infectious individuals who got medical help but cannot recover ($b_{A^D}^S \times X_t^S \times X_t^{A^D}$), minus the number of L stage patients who got antiviral drugs in period t (Y_t^L), minus the number of L stage patients who transfer to next stage in period t ($f^L \times X_t^L$).

In equations (5-4), the number of patients in A stage without antiviral drugs in period $t+1$ (X_{t+1}^A), is equal to the number of patients in A stage without antiviral drugs in period t (X_t^A), minus the number of A stage patients who recover without medical help because of production of antibody themselves ($\delta^A \times X_t^A$), plus the number of patients in L stage without medical help who transfer to A stage in period t ($f^L \times X_t^L$), minus the number of the A stage patients who get the medical help in period t (Y_t^A), minus the number of the A stage patients without medical help who transfer to the next stage in period t ($f^A \times X_t^A$). The principle of equations (5-5) is similar to equations (5-4). Equations (5-6) to (5-9) present individuals in different stages with medical assistance but cannot become immune or recover. In equations (5-6), the number of susceptible people who get medical help but cannot get immune in period $t+1$ ($X_{t+1}^{S^V}$), is equal to the number of the susceptible people who get medical help but cannot become immune in period t ($X_t^{S^V}$), plus the number of susceptible people who get vaccines in period t (Y_t^S), minus the number of susceptible individuals who get vaccines and are immune ($r^S \times Y_t^S$), minus the number of susceptible individuals who get vaccines, cannot become immune and die of the side-effect of vaccines ($(1 - r^S) \times Y_t^S \times \mu$), minus the number of susceptible individuals who get vaccination but cannot become immune and get infected by

contacting or breathing the virus dust ($p^{S^V} \times X_t^{S^V}$), minus the number of susceptible individuals who get vaccination, cannot become immune and get infected by contacting with infectious individuals without medical help ($b_A^{S^V} \times X_t^{S^V} \times X_t^A$), minus the number of susceptible individuals who get vaccination help, cannot be immune and get infected by contacting with infectious patients who get medical help but cannot recover ($b_{A^D}^{S^V} \times X_t^{S^V} \times X_t^{A^D}$). Equations (5-7) present patients in L stage who get antiviral drugs but cannot recover. In equations (5-7), the number of L stage patients who get antiviral drugs but cannot recover in period t+1 ($X_{t+1}^{L^D}$), is equal to the number of L stage patients who get antiviral drugs but cannot recover in period t ($X_t^{L^D}$), plus the number of the L stage patients who get medical help in period t (Y_t^L), plus the number of susceptible individuals who get vaccination but cannot recover and get infected because of touching or breathing the virus dust ($p^{S^V} \times X_t^{S^V}$), plus the number of susceptible individuals who get vaccination but fail to get immune and then get infected by contacting with infectious individuals without medical help ($b_A^{S^V} \times X_t^{S^V} \times X_t^A$), plus the number of susceptible individuals who get vaccination, but cannot get immune and thus get infected by contacting with infectious patients who get medical help but cannot recover ($b_{A^D}^{S^V} \times X_t^{S^V} \times X_t^{A^D}$), minus the number of L stage patients who get medical help and recover ($r^L \times Y_t^L$), minus the number of L stage patients who get medical help, cannot recover, and transfer to next disease stage in period t ($f^{L^D} \times X_t^{L^D}$). In equations (5-8), the number of patients in A stage who get medical help and cannot recover in period t+1 ($X_{t+1}^{A^D}$), is equal to the number of A stage patients who get medical help and cannot recover in period t ($X_t^{A^D}$), plus the number of A stage patients getting medical help in period t (Y_t^A), plus the number of L stage patients who get medical help, fail to recover, and transfer to A stage in period t ($f^{L^D} \times X_t^{L^D}$), minus the number of A stage patients who get medical help and recover in period t ($r^A \times Y_t^A$), minus the number of A stage patients who get medical help but cannot recover, and transfer to next disease stage in period t ($f^{A^D} \times X_t^{A^D}$). Equations (5-9) is similar to equations (5-8). Equations (5-10) and equations (5-11) calculate the number of deaths and the number of recovered people respectively.

Equations (5-12) to (5-23) concern the antiviral drugs' and vaccines' stocks and limitation. Equations (5-12) and (5-18) ensure that the number of patients who can get the antiviral drugs or vaccines is less than the distribution capacity or treatment capacity at each ADC or hospital, respectively. Equations (5-13) and (5-19) set the quantity of pre-stocked antiviral drugs or vaccines at each ADC and hospital. Equations (5-14) and (5-20) limit that, at each ADC and hospital, the quantity of antiviral drugs or vaccines that can be received from the

strategic stockpiles plus current available antibiotics is less than the storage capacity. Equations (5-15) and (5-21) state inventory flow conservation for antiviral drugs or vaccines, respectively. Equations (5-16) and (5-22) ensure that the sum of the numbers of patients in different stages who get the antiviral drugs or vaccines is equal to the total number of individuals who can get the antiviral drugs or vaccines in each period, respectively. Equations (5-17) and (5-23) present that the number of antiviral drugs or vaccines treatments delivered on the horizon are lower than or equal to the national stockpile respectively. Constraints (5-24) and (5-25) are the initial status constraints. The non-negativity conditions on the variables are enforced by constraints (5-25).

5.4 Numerical experiments

This section shows how to use our model to solve the logistics questions raised in Section 5.2 and gives insight into logistics deployment with the help of our model. The following experiments take H5N1 as an example to assess the performance of our model. It should be stressed here that, H5N1 are used as an example to test the correctness of our model and the model proposed in this chapter can be used in many other diseases as well.

Since our model is a large and high nonlinear model, the barrier approach with a big initial value of barrier parameter is adopted, which can ensure that the search of the feasible solution can converge to the feasible field quickly. The principle of barrier approach is the following:

The original problem is

$$\min f(x), \text{ subject to } h(x) = 0 \text{ and } g(x) \leq 0 \quad (5-27)$$

The barrier approach tries to transform the original model (5-27) to (5-28)

$$\min f(x) - \mu \sum_i \ln(s_i), \text{ subject to } h(x) = 0 \text{ and } g(x) + s = 0 \quad (5-28)$$

We assign μ a big initial value to make sure the search of the feasible solution can converge to the feasible field quickly.

The Lagrangian relaxation is used to find the lower bound of the base case experiment. Because the MATLAB can solve a large-scale problem, our model is coded in MATLAB R2010b. All experiments were executed on a machine equipped with an Inter (R) Core(TM) i3-2100 processor running at 2.10GHz with 2.00 GB of RAM.

5.4.1 The choice of data

Data used in the model were collected from a variety of works. According to Colizza et al. (2007) and the report from Centers for Disease Control and Prevention in America (CDC), the ranges of transition rates of patients in L and

I stages are from 0.3 to 0.5 and from 0.2 to 0.33 respectively. The transition rate of A stage patients is 0.5 (f^A, f^{A^D}). Since we cannot find any official data about how medical interventions affect the transition rate, we assume that the medical interventions can reduce the transition rate. Therefore, the transition rates of the L, I, L^D and I^D stage patients are assumed to be 0.5 (f^L), 0.33 (f^I), 0.3 (f^{L^D}) and 0.2 (f^{I^D}) respectively. It is assumed that the transition rates of the A and AD stage patients do not change because we cannot find any data about it. CDC presents that vaccine effectiveness is about 60% (r^S). The antiviral medical effectiveness is approximately from 70% to 90%. We assume the medical effectiveness decreases as the disease gets serious. Hence, the recovery rate of the L, A and I stage patients are 0.9 (r^L), 0.8 (r^A) and 0.7 (r^I) respectively. Based on CDC, patients can seldom produce the antibodies themselves for H5N1 without medical help and the side effects of vaccination are mild and short-lasting. So, both the values of the recovery rate of those who get no medical interventions because they produce antibody themselves (δ^m) and the rate of death from the side effects of the vaccination (μ) are zero. Most experts think that flu viruses are spread mainly by droplets from the infected patients. A person rarely might get flu by touching a surface or object with flu virus. So, the value of the rate of infection because of breathing or contacting with the flu virus (p^{m^S}) is zero. The basic reproduction number of H5N1 is 2 (R_0 , Colizza et al., 2007). The infection rate can be calculated by the basic reproduction number multiplied by the mean period of the infectious stage divided by the number of the susceptible individuals at the beginning (Edward et al., 2002). We assume the total number of people is 10000. At the beginning of the first period, the number of the S, L, A and I stage patients are 8920 (num^S), 270 (num^L), 405 (num^A), and 405 (num^I) respectively (Colizza et al., 2007). Since the mean time of the infectious stage is 2 days, the infection rate is 0.0004 ($2 * 2 / 8920 \approx 0.0004$, $b_{m^A}^{m^S}$). Values of all logistics parameters were collected after discussion with local health workers. In our base case experiment, we selected 3 ADCs, which could distribute 200 antiviral drugs to patients per day and do not pre-stock drugs. The national stockpile antiviral drugs are 10000. 3 hospitals can inject 200 people with vaccines per day and do not pre-stock vaccines. The national stockpile vaccines are 5000. The total horizon periods is 20 days.

5.4.2 The base case analysis

Our base case result illustrates how our model helps the decision makers to minimize the number of deaths by optimizing the using of medical resources. The spent time to find the solution is 27.8 minutes. Under the base case, the total number of deaths is 4842. The optimality gap to the lower bound is 7.8%. 75%, 15%, and 10% of antiviral drugs are dispensed to the A, I and L stage patients respectively. A stage patients get the most of the antiviral drugs mainly because

they can infect the susceptible individuals, and if we cannot reduce the number of A stage patients, more susceptible individuals will be infected. The I stage patients are the second largest part of patients who get the medical help because I stage is the last stage of disease, and if they cannot get the timely help, they will die. To sum up, in order to reduce the number of the total infected people and minimize the number of deaths, we should, in dispensing drugs, give priority to the A stage patients above other patients. And then, the I stage patients should take the priority. From period 2 to period 6, the number of patients who go to ADCs is equal to the total dispensing capacity of ADC because the number of patients who need the drugs is greater than the full dispensing capacity. From period 7 to period 20, the number of patients who need the drug is less than the full dispensing capacity and so the number of patients who go to ADCs is equal to the number of patients who need the medical help in the current period.

5.4.3 Sensitive analysis

This section is made of two parts. The first part is made to evaluate the different factors, which may affect the number of deaths and is addressed to the remaining logistics questions mentioned in Section 5.2. The second part is made to evaluate the effect and the final cost of different medical intervention policies.

1) Evaluation of different logistics factors

The impact of the change of dispensing capacity is shown in Figure 5.2. It is assumed that the dispensing capacity of each ADC can be increased from 200 to 400. And the national stockpile is always enough to support the local ADCs. The number of deaths decreases with the increase of distribution capacity because the increase of dispensing capacity of ADCs can give infectious patients the medical help early, and then the total number of infected patients can be better controlled. When we do the experiment with the assumption that, each ADC pre-stocks some drugs before the medical intervention, the number of deaths does not change because the national stockpile can deliver the drugs in time. So, if the national stockpile can support each ADC in time, the pre-stock of drugs in each ADC will not affect the number of deaths.

During the epidemics, people will try to self-isolate to avoid being infected and the government will also discourage the people from going to public place. The crisis managers always increase the number of available hospitals, which can admit the infected patients, so that the patients can go to the nearest hospital instead of increasing the admission capacity of each hospital to satisfy the demand. Hence, we assume that the treatment capacity of each hospital is the same. Every hospital can admit, on an average, 200 patients per day. The impact of the increasing of the number of admission hospitals, from 3 to 9, is presented in Figure 5.2. Under the assumption that the national stockpile of vaccines is 5000, the increase of the number of available hospitals reduces the number of deaths. Since the susceptible individuals can get vaccines and become immune,

the number of infected people can be controlled by increasing number of admission hospitals.

Figure 5.3 shows the impact of basic reproduction number (infection rate=the basic reproduction number * the mean duration of infectious period/the number of susceptible people). From Figure 5.2 and Figure 5.3, it can be found that it is the dispensing capacity of antiviral drugs has the biggest impact on the number of deaths.

The sensitive analysis presents that, if the logistics capacity is limited during the response to H5N1, the increase of the dispensing capacity of each ADC will be first-order improvement method to reduce the number of deaths. The second-order improvement method is to increase the number of the admission hospitals to vaccinate the susceptible individuals

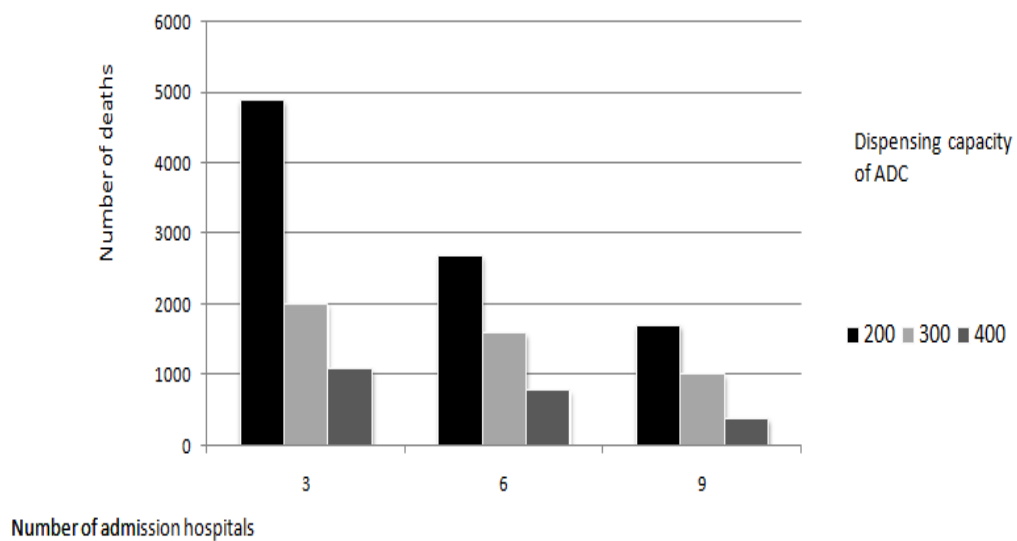

Figure 5.2: The impact of the change of the dispensing capacity and the number of the admission hospitals.

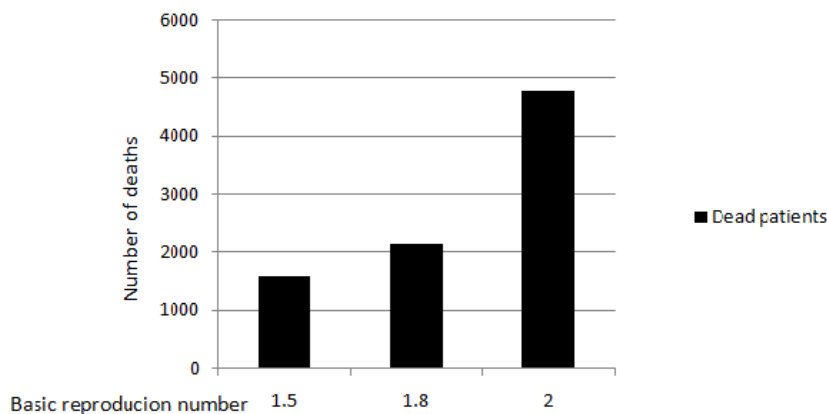

Figure 5.3: The impact of the change of the basic reproduction number.

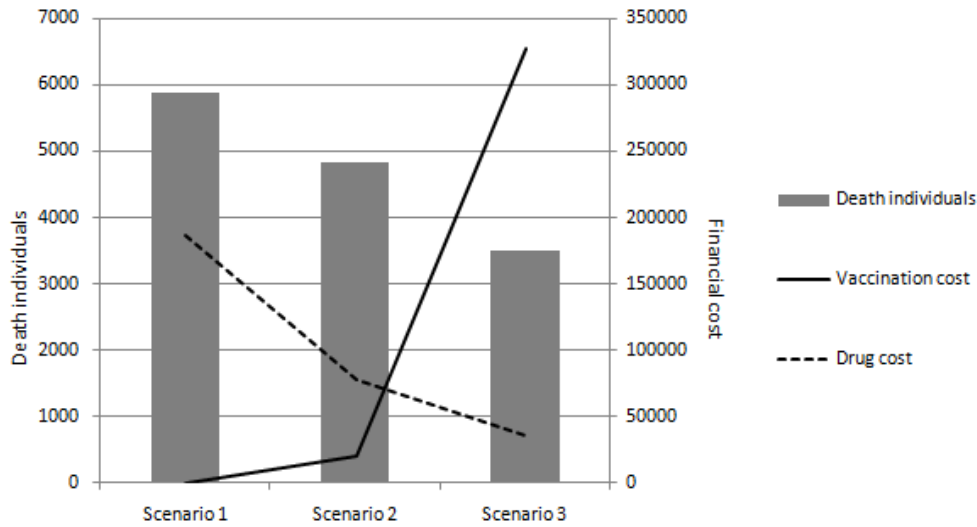

Figure 5.4: Number of deaths and economical costs of different scenarios

2) Evaluation of different medical intervention policies

The price for pharmaceuticals is \$12 per vaccine dose and \$32 per antiviral course (Newall et al., 2010). Vaccination usually requires 2 doses of vaccines and the cost of administration is \$6.6. Therefore, the total cost of vaccination is \$30.6.

Three medical interventions are considered here:

Scenario 1: Antiviral drugs for infected patients during the outbreak of epidemic.

Scenario 2: Antiviral drugs for infected patients and vaccination for susceptible individuals during the outbreak of epidemic.

Scenario 3: Vaccination for susceptible individuals before the outbreak of epidemic and antiviral drugs for infected patients during the outbreak of epidemic.

Figure 5.4 presents the number of deaths and economic costs of vaccination and drugs of different scenarios. The number of deaths of scenario 3 is far less than the others. One of the most important reasons is that pre-epidemic vaccination policy can reduce the number of infected patients and susceptible people effectively. Therefore, the value of R_0 decreases. However, the financial cost of vaccination of scenario 3 is much more than others. The vaccination cost of scenario 3 is much more than the total financial cost (vaccination cost + drug cost) of scenario 1 or 2. The total financial cost of scenario 1 is the least while the number of deaths is the largest.

It should be specified here that we just want to test the effectiveness of our approach. In the reality, the cost of vaccination policy and antiviral drug policy may require many other fees, such as the inventory costs. And the vaccination may lead to side effect for old people.

5.5 Conclusions

This chapter proposed a logistic response model to a general infectious disease which combines the progress of the disease, the medical response methods, and the logistic deployment together. This model can, but is not limited to, estimate the number of patients in different stages for any given day, decide the amount of medical resources that should be delivered to the ADCs or to the hospitals per day, find the factors which may affect the number of deaths and predict the patients who should get most part of the medical resources. The effects of different medical intervention policies can be evaluated by the model as well. This model can be extended to several situations easily and applied to some other non-infectious disease as well, and take the different resources into consideration.

6. Conclusions and future works

Disasters, as a serious disruption of the normal function of a society, causing heavy losses of human lives, economy and environment, make it necessary to work out comprehensive emergency management plans, which can reduce the grave consequences of disasters. The plans need the support of humanitarian logistics, the most important and expensive part of disaster relief, which plays a role in making differences between a successful or a failed disaster relief. Different types of disasters have different characteristics and need different emergency management plans. Therefore, a reasonable emergency management plan with high performance of humanitarian logistics should be studied according to the different types of disasters.

This thesis focuses on the study of humanitarian logistics which can support emergency management plans to minimize the consequences of disasters. We classified the disasters according to the cause of the disasters: natural disasters which are caused by nature, man-made disasters which are caused by human beings, and the disease outbreaks, whose causes are difficult to know. In the following, a brief conclusion will be presented.

6.1 Conclusions of study literature reviews

This thesis reviews the relevant literatures from different aspects: the humanitarian logistics, the disease prevention and control plans and the emergency management plans. Different disasters have different characteristics. To investigate the methods suitable for the disasters, all the selected papers are classified according to the types of disasters and the used research methodologies.

The literature review of humanitarian logistics classifies the selected papers according to the types of disasters, the humanitarian logistics contributions and the used methodologies. The literature review of disease prevention and control plans classifies the papers according to the types of diseases, the characteristic of diseases and the used methodologies. The literature review of emergency management plans classifies the selected papers according to the contributions of the emergency management plans, the types of disasters and the used methodologies. Mathematical programming and computer simulation are the most popular methods in this field. It seems that computer simulation has been used more frequently to predict the magnitude of disasters or get insight of the processes of disaster relief. Mathematical programming is more popular in the research of the facility location and the inventory management. From our literature review, two main gaps can be found. One is that the research of the emergency management plans does not take into account different characteristics of different types of disasters. The other is that some studies are not based on the real case but on academic assumptions.

Therefore, this thesis studies the humanitarian logistics and emergency management plans taking, into account, the different characteristics of the

different types of disasters, and tries to propose a general approach which can be applied in different situations easily based on the real case scenario.

6.2 Conclusions of the study of natural disasters

To study the natural disasters, a three-step approach which consists of a framework model, a global model and a detail model has been proposed to improve the current emergency management plans for natural disasters. Since some natural disasters are predictable but unavoidable, the evacuation of victims who may suffer from natural disasters is one of the most important activities of emergency management plans. Hospital evacuation under the guidance of a French Extended White Plan in case of a flood has been taken as a real case scenario to test the correctness of our approach.

In the three-step approach, the framework model can help the decision makers to get the insight of current emergency management plan. This framework model can also be used as architecture for the following steps. The global model can predict some uncertain or unknown information of the disaster relief activities and check the correctness of the detail model. The detail model presents the whole evacuation activities based on the knowledge presented by the framework model and the information predicted by the global model. We use ARIS to build the framework model. This model presents the main processes of evacuation activities under the guidance of a French Extended White Plan. A linear model has been proposed to estimate the required resources to evacuate 120 patients in 5 hours and to verify the correctness of the detail of the model. With the help of the software SIMIO, a computer simulation model has been proposed to present the detailed information of all evacuation activities. The information transmission among the different stakeholders has also been taken into account.

2^k factorial analysis has been done to find the impacts of different factors on the evacuation time. After numerical experiments, two improvement solutions have been proposed. With such improvements, 1 hour and 18 minutes is saved in evacuating all the patients and the improvement rate is as high as 23.8%. Our model proves effective.

This three-step approach can not only be applied in the evacuation activities in the event of a flood. It can also be used to improve other processes or plans.

6.3 Conclusions of the study of man-made disasters

The anonymous bioterrorist attack is one branch of man-made disasters which can cause very serious consequences. An anonymous bioterrorist attack is a premeditated disaster and can bring about a grave social problem. So, a high performance of humanitarian logistics is necessary. This thesis studies the logistics response to the man-made disaster caused by anonymous bioterrorist attack with Anthrax.

The mathematical model proposed to study the man-made disaster combines the propagation of Anthrax disease, the related medical interventions and the logistics deployment together. This connection can help the decision makers to know the disaster situation and the relevant response information from a strategy level, such as the required quantities of medical resources for different types of victims in different periods, the impacts of the different logistics capacities on the number of deaths, the strategy to dispense the limited medical resources to minimize the number of deaths and so on. In this model, all the factors, which can impact the number of deaths, have been taken into account, such as the period when the patients transfer into the different disease stages, the period when the medical intervention begins and the change of the recovery rate because of the time lag between the two aforementioned periods.

Because it is difficult to know which kind of probability distribution the survival length of the patients in the different stages obey, all the experiments are made under two kinds of probability distribution function – exponential and lognormal to check how the disease distribution affects the number of deaths. In the base case experiments, two scenarios, the medical intervention without oral antibiotics strategic stockpile and the medical intervention with oral antibiotics strategic stockpile, have been done to test how the oral antibiotics strategic stockpile affects the number of deaths. Another scenario, medical intervention under uniform recovery rate, has also been done to test how the recovery rate affects the number of death. Medical help priority policy and the antibiotics dispensing strategy have been obtained based on our base case experiments. In the sensitive analysis, the impact of different factors which may affect the number of deaths have been checked.

The model proposed in this chapter can be extended to several situations easily and applied to some other non-communicable biological agents, and take into account different resources .

6.4 Conclusions of the study of the outbreak of diseases

The causes triggering the outbreak of diseases is difficult to identify. Every year, some new epidemics break out. Therefore, a general model which can be used to optimize the logistics response to the outbreak of diseases is important and useful. Moreover, the propagation of diseases can be presented by SIR model. We hope the study of the outbreak of diseases can enlighten the research of other disasters with other models.

This thesis proposes a model for logistics response to the general infectious diseases and links the disease progression, the related medical intervention actions and the logistics deployment together to support the decision making process in case of the outbreak of an infectious disease from a strategic level. The details which will not impact the number of infected people are ignored to make the model concise. This problem is presented as a high non-linear model to present the disease transmission. To solve this high non-linear model, the barrier approach is adopted. A big initial value of barrier parameter is used to ensure that the search of the feasible solution can converge to the feasible field quickly.

Then, the Lagrangean relaxation is used to find the lower bound of the base case experiment.

In the experiment parts, H5N1 is taken as a real case scenario to test the correctness of our model. Based on the base case scenario, the strategy to dispense limited medical resources with the objective of minimizing the number of deaths has been found. In the sensitive experiment, the impact on the number of deaths, and following factors, have been tested: the dispensing capacity of antivirus drugs distribution centers, the number of admission hospitals for vaccines and the basic reproduction number of the infectious diseases.

6.5 Future works

Our future works include, but are not limited to the following directions:

- Secondary disasters are disasters triggered by a primary disaster, such as the fire caused by an earthquake. Secondary disasters often cause much more damage than the primary disaster. Therefore, the study of secondary disasters will be our next step. We will try to propose an approach which can improve the emergency management plan to minimize consequences of the first disaster and prevent the occurrence of the secondary disasters.
- For the three-step approach proposed for the study of natural disasters, the possibility of an interruption was not taken into account during the evacuation such as transportation congestion. In the present study, the hospital managers suppose that the evacuation way (tramway) will be protected by the army. In the future, an extended simulation model which could consider various disruptions will be proposed.
- For the model proposed for the logistics response to the man-made disaster caused by bioterrorist attack with anthrax, several-antibiotics therapy or combination antiserum–antibiotic therapy will be taken into account. Besides, the future model will consider the characteristics of the infected patients, such as their ages and genders.
- For the model proposed for the logistics response to the outbreak of diseases, the model of the propagation of the infectious disease, SIR model, is a non-linear model. Is it possible to use some heuristic algorithm to solve this non-linear problem more effectively? In short, how to solve the non-linear model more effectively will be our next step.
- One of the limitations of our research is the reliability and availability of the data. Most of the data we obtained is solely based on the experience of the health workers in the hospital. And the uncertainty of parameters has not been taken into account. In the future, our models will be extended to a stochastic programming model, taking into account the uncertainty of parameters. More data will be tested.
- The objective of our model is to minimize the number of deaths or

minimize the evacuation time. Once the possible strategies are found, it will be useful to evaluate the different strategies from other aspects, for example the financial cost.

- A user-friendly software can be proposed to integrate different models to help the health workers make the decision easily. For example, for the response to the man-made disaster, the health workers just need to enter the value of logistics capacities and the number of current infected patients. The needed resources will be predicted automatically.
- We will try also to investigate the protection of hospitals against terrorist attack (www.threatsproject.eu).

Reference

- Aakil M., NieX., Shaligram P.(2012) Optimization models in emergency logistics: A literature review. *Socio-Economic Planning Sciences* 46: 4-13.
- Adida, E., DeLaurentis, P. C. C., & Lawley, M. A. (2011). Hospital stockpiling for disaster planning. *IIE Transactions*, 43(5), 348-362.
- Adivar, B., Selen E. S. (2011): Compartment disease transmission models for smallpox. *Discrete and Continuous Dynamical Systems*, 13-21.
- Allen, L.J.S. and Burgin, A.M. (2000). Comparison of deterministic and stochastic SIS and SIR models in discrete time. *Mathematical Biosciences*, 163, 1-33.
- Alsalloum, O.I., Rand, G.K. (2006). Extensions to emergency vehicle location models. *Computers & Operations Research*, 33(9):2725–2743.
- Altay, N., Green, W.G. (2006). OR/MS research in disaster operations management. *European Journal of Operational Research* . 175(1): 475–493.
- Arinaminpathy, N., McLean, R. (2009). Logistics of control for an influenza pandemic. *Epidemics*, 1(2), 83–88.
- Asian Disaster Reduction Center (2012). *Natural Disasters Data Book 2012-An Analytical Overview*.
- Azimi, N., Renaud, J., Ruiz, A., Salari, M. (2012). Covering tour approach to the location of satellite distribution centers to supply humanitarian aid. *European Journal of Operational Research* , 222: 596-605.
- Balcik, B., Caroline, C., Krejci, K., Muramatsu, M. (2008). Coordination in humanitarian relief chains: Practices, challenges and opportunities. *International Journal of Production Economics*. 126 (1), 22-34.
- Banks J., Carson, J.S., Nelson, B.L., Nicol, D. (2004) *Discrete-Event System Simulation*, 4th Edition, Prentice Hall, New Jersey, USA.
- Barton R.R. (2002) *Designing simulation experiments*. Proceedings of the 2002 Winter Simulation Conference , New Jersey, USA.
- Barton R.R. (2003) *Experimental design for simulation*. Proceedings of the 2003 Winter Simulation Conference, New Orleans, Louisiana, USA.
- Bartlett, J. G., Inglesby Jr, T. V., & Borio, L. (2002). Management of anthrax. *Clinical infectious diseases*, 851-858.
- Benneyan, J. C. (1997). An introduction to using computer simulation in healthcare: patient wait case study. *Journal of the Society for Health Systems*, 5(3), 1-15.
- Bendavid, E., Young, S. D., Katzenstein, D. A., Bayoumi, A. M., Sanders, G. D., Owens, D. K.: Cost-effectiveness of HIV monitoring strategies in resource-limited settings: A southern African analysis. *Archives of Internal Medicine* 168(17):1910–1918 (2008).
- Berman, O., Gavius, A. (2002) . Location of terror response facilities: A game between state and terrorist. *European Journal of Operational Research* . 177(2):1113–1133.

- Bertolli, J., Hu, D. J., Nieburg, P., Macalalad, A., Simonds, R. J. (2003). Decision analysis to guide choice of interventions to reduce mother-to-child transmission of HIV. *AIDS*, 17(14), 2089–2098.
- Bish, D. R., Agca, E., Glick, R. (2011). Decision support for hospital evacuation and emergency response. *Annals of Operations Research*. August.
- Blanchard, B. W., Canton, L. G., Cwiak, C. L., Goss, K. C., McEntire, D. A., Newsome, L., ... & West, D. (2007). Principles of emergency management supplement. Emergency Management Public Safety, Public Trust, 4.
- Bozzette, S., Boer, R., Bhatnagar, V., Brower, J. L., Keeler, E. B., Morton, S. C., Stoto, M. (2003). A model for a smallpox-vaccination policy. *The New England Journal of Medicine*, 348(5), 416–425.
- Breban, R., Vardavas, R., Blower, S. (2007). Theory versus data: how to calculate R_0 ? *PloS One*, 2(3), e282 .
- Bravata, D. M., Zaric, G. S., Holty, J. E. C., Brandeau, M. L., Wilhelm, E. R., McDonald, K. M., & Owens, D. K. (2006). Reducing mortality from anthrax bioterrorism: strategies for stockpiling and dispensing medical and pharmaceutical supplies. *Biosecurity and bioterrorism: biodefense strategy, practice, and science*, 4(3), 244-262.
- Brookmeyer, R., Johnson, E., & Barry, S. (2002). Modelling the incubation period of anthrax. *Statistics in medicine*, 24(4), 531-542.
- Campbell, A. M., Vandenbussche, D., & Hermann, W. (2008). Routing for relief efforts. *Transportation Science*, 42(2), 127-145.
- Caunhye, A.M., Nie, X., Pokharel, S. (2012) Optimization models in emergency logistics: A literature review. *Socio-Economic Planning Sciences* . 46(1): 4–13.
- Chang, M. S., Tseng, Y. L., & Chen, J. W. (2007). A scenario planning approach for the flood emergency logistics preparation problem under uncertainty. *Transportation Research Part E: Logistics and Transportation Review*, 43(6), 737-754.
- Charles, A. (2010). Improving the design and management of agile supply chains: feedback and application in the context of humanitarian aid.
- Chen, W., Guinet, A., Ruiz, A. (2014) Modeling and Simulation of a French Extended White Plan: A hospital evacuation before a forecasted flood. *Proceedings of the International Conference on Health Care Systems Engineering*, A. Matta and al. editors, Springer Proceedings in Mathematics & Statistics, 61, 277-288.
- Chen, S. C., & Liao, C. M. (2008). Modelling control measures to reduce the impact of pandemic influenza among schoolchildren. *Epidemiology and infection*, 136(08), 1035-1045.
- Christie, P. M. J., & Levary, R. R. (1998). The use of simulation in planning the transportation of patients to hospitals following a disaster. *Journal of medical systems*, 22(5), 289-300.
- Christopher, M., & Tatham, P. (2014). *Humanitarian logistics: Meeting the challenge of preparing for and responding to disasters*. Kogan Page Publishers.

Clark, A., Culkin, B. (2007). A network transshipment model for planning humanitarian relief operations after a Natural Disaster. 22nd EURO 8-11 July, Prague, Czech Republic.

Coburn, B. J., Wagner, B. G., & Blower, S. (2009). Modeling influenza epidemics and pandemics: insights into the future of swine flu (H1N1). *BMC medicine*, 7(1), 30.

Colizza, V., Barrat, A., Barthelemy, M., Valleron, A.-J., Vespignani, A. (2007). Modeling the worldwide spread of pandemic influenza: baseline case and containment interventions. *PLoS Medicine*, 4(1), e13.

Combes E.(2008) SPIRAL, la plate-forme d'échange de l'urgence en Rhône-Alpes , Colloque européen inter-régional l'e-Santé au service du patient, 18-19 Novembre 2008,Charbonnières-les-Bains(France).

Cozzolino A. (2012). Humanitarian Logistics and Supply Chain Management. In *Humanitarian Logistics*, Springer Berlin, Heidelberg .

Craft, D.L., Wein, L.M., Wilkins, A.H.(2005). Analyzing Bioterror Response Logistics: the Case of Anthrax. *Management Science*, 51, 679–694 .

Day, T. G. (2003). The autumn 2001 anthrax attack on the United States Postal Service: the consequences and response. *Journal of contingencies and crisis management*, 11(3), 110-117.

De la Torre, L.E., Dolinskaya, I.S., Smilowitz K.R. (2012). Disaster relief routing: Integrating research and practice. *Socio-Economic Planning Sciences*; 46(1):88–97.

Dekle, J., Lavieri, M. S., Martin, E., Emir-Farinas, H., & Francis, R. L. (2005). A Florida county locates disaster recovery centers. *Interfaces*, 35(2), 133-139.

Desmet, A., Gelenbe, E. (2013). Graph and analytical models for emergency evacuation. *Future Internet*, 5:46-55.

Dessouky, M., Ordonez, F., Jia, H., & Shen, Z. (2006). Rapid distribution of medical supplies. In *Patient Flow: Reducing Delay in Healthcare Delivery* (pp. 309-338). Springer US.

Delaurentis, P., Lawley, M. (2008). A game theoretical approach for hospital stockpile in preparation for pandemics. IERC May 17, British Columbia, Canada.

Delaurentis, P., Lawley, M. (2009).Hospital stockpile for influenza pandemics with pre-determined response levels. IERC May 2009, British Columbia, Canada.

Diekmann, O., Heesterbeek, J. A. P., & Metz, J. A. (1990). On the definition and the computation of the basic reproduction ratio R_0 in models for infectious diseases in heterogeneous populations. *Journal of mathematical biology*, 28(4), 365-382.

Doerner, K. F., Gutjahr, W. J., Hartl, R. F., Karall, M., & Reimann, M. (2005). Heuristic solution of an extended double-coverage ambulance location problem for Austria. *Central European Journal of Operations Research*, 13(4), 325-340.

Doerner, K. F., Gutjahr, W. J., & Nolz, P. C. (2007). Multi-criteria location planning for public facilities in tsunami-prone coastal areas. *Or Spectrum*, 31(3), 651-678.

Dombroski, M., Fischhoff, B., & Fischbeck, P. (2006). Predicting emergency evacuation and sheltering behavior: A structured analytical approach. *Risk Analysis*, 26(6), 1675-1688.

Dombroski, M. J., & Fischbeck, P. S. (2006). An integrated physical dispersion and behavioral response model for risk assessment of radiological dispersion device (RDD) events. *Risk Analysis*, 26(2), 501-514.

Drabek, T. (1991). *Emergency Management: Principles and Practice for Local Government*. Washington D.C.. International City Management Association, xvii.

Dudin, A., & Semenova, O. (2004). A stable algorithm for stationary distribution calculation for a BMAP/SM/1 queueing system with Markovian arrival input of disasters. *Journal of Applied Probability*, 41(2), 547-556.

Dutta, D., Herath, S., & Musiak, K. (2003). A mathematical model for flood loss estimation. *Journal of hydrology*, 277(1), 24-49.

Ekici, A., Keskinocak, P., Swann, J.L. (2008). Pandemic influenza response. WSC 8-11 December , Miami USA.

Ertem, M. A., Buyurgan, N., & Rossetti, M. D. (2010). Multiple-buyer procurement auctions framework for humanitarian supply chain management. *International Journal of Physical Distribution & Logistics Management*. 40 (3), 202-227.

Feng, T., & Keller, L. R. (2006). A multiple-objective decision analysis for terrorism protection: Potassium iodide distribution in nuclear incidents. *Decision Analysis*, 3(2), 76-93.

Ferguson, N. M., Cummings, D. A., Fraser, C., Cajka, J. C., Cooley, P. C., & Burke, D. S. (2006). Strategies for mitigating an influenza pandemic. *Nature*, 442(7101), 448-452.

Fowler, R. A., Sanders, G. D., Bravata, D. M., Nouri, B., Gastwirth, J. M., Peterson, D., ... & Owens, D. K. (2005). Cost-effectiveness of defending against bioterrorism: a comparison of vaccination and antibiotic prophylaxis against anthrax. *Annals of internal medicine*, 142(8), 601-610.

Filippopolitis, A., Gelenbe, E., Gianni, D., Hey, L., Loukas, G., Timotheou, S. (2008). Distributed agent-based building evacuation simulator. SCSC Edinburgh Scotland, June .

Filippopolitis, A., Gelenbe, E. (2009). A decision support system for disaster management in buildings. SCSC July, Istanbul Turkey.

Galvao, R., Chiyoshi, F., Morabito, R. (2005). Towards unified formulations and extensions of two classical probabilistic location models. *Computers & Operations Research*, 32, 15-33.

Georgopoulos, P. G., Fedele, P., Shade, P., Liroy, P. J., Hodgson, M., Longmire, A., ... & Brown, M. A. (2004). Hospital response to chemical terrorism: personal protective equipment, training, and operations planning. *American journal of industrial medicine*, 46(5), 432-445.

Germann, T. C., Kadau, K., Longini, I. M., Macken, C. (2006). Mitigation strategies for pandemic influenza in the United States. *Proceedings of the National Academy of Sciences of the United States of America*, 103 (15), 5935–5940.

Gupta, J. P. (2002). The Bhopal gas tragedy: could it have happened in a developed country?. *Journal of Loss Prevention in the process Industries*, 15(1), 1-4.

Guha-Sapir, D., Hoyois, Ph. , Below, R. (2014). *Annual Disaster Statistical Review 2013: The Numbers and Trends*. Brussels: Centre for Research on the Epidemiology of Disasters.

Halloran, M. E., Longini, I. M., Nizam, A., Yang, Y. (2002): Containing bioterrorist smallpox. *Science*, 298(5597), 1428–1432.

Han, L. D., Yuan, F., Chin, S. M., & Hwang, H. (2006). Global optimization of emergency evacuation assignments. *Interfaces*, 36(6), 502-513.

Harrington, J. E., Hsu, E. B. (2010). Stockpiling anti-viral drugs for a pandemic: the role of Manufacturer Reserve Programs. *Journal of Health Economics*, 29(3), 438–544.

Hashikura, M., Kizu, J.(2009). Stockpile of personal protective equipment in hospital settings: preparedness for influenza pandemics. *American Journal of Infection Control* 37, 703–707 .

Henderson, D.A. (1999). Biological terrorism—the looming threat of bioterrorism. *Science* 283, 1279–1282.

Hessel, L. (2009). Pandemic influenza vaccines: meeting the supply, distribution and deployment challenges. *Influenza and Other Respiratory Viruses*, 3(4), 165–70.

Hiroyuki., T., Yamamoto, K., Tomiyama, S., & Hatono, I. (2000). Modeling and analysis of decision making problem for mitigating natural disaster risks. *European Journal of Operational Research*, 122(2), 461-468.

Holty, J. E. C., Bravata, D. M., Liu, H., Olshen, R. A., McDonald, K. M., & Owens, D. K. (2006). Systematic review: a century of inhalational anthrax cases from 1900 to 2005. *Annals of Internal Medicine*, 144(4), 270-280.

Houck, M.L., Herrmann, J.W. (2011). Preparing for an Anthrax Attack: the Impact of Distributing MedKits. *Proceedings of the 2011 Industrial Engineering Research Conference*, Arkansas, USA .

Hu, J., & Zhao, L. (2011). Emergency logistics strategy in response to anthrax attacks based on system dynamics. *International Journal of Mathematics in Operational Research*, 3(5), 490-509.

Huang, R., Kim, S., Menezes, M.B.C. (2010). Facility location for large-scale emergencies. *Annals of Operations Research*, 181(1), 271-286.

Inglesby, T. V. (1999a). Anthrax: A possible case history. *Emerging infectious diseases*, 5(4), 556.

Inglesby, T. V., Henderson, D. A., Bartlett, J. G., Ascher, M. S., Eitzen, E., Friedlander, A. M., ... & Tonat, K. (1999). Anthrax as a biological weapon: medical and public health management. *Jama*, 281(18), 1735-1745.

Inglesby, T. V., O'Toole, T., Henderson, D. A., Bartlett, J.G., Ascher, M. S., Eitzen, E., ... & Tonat, K. (2002). Anthrax as a biological weapon, 2002:

updated recommendations for management. *Journal of the American Medical Association*, 287(17), 2236-2252.

Inoue, H., Yanagisawa, S., & Kamae, I. (2006). Computer-simulated assessment of methods of transporting severely injured individuals in disaster—Case study of an airport accident. *Computer methods and programs in biomedicine*, 81(3), 256-265.

Jamrog, D. C., Shatz, M. P., Smith, C. (2007). Modeling Responses to Anthrax and Smallpox Attacks, 17(1), 115–129 .

Jia, H., Ordóñez, F., & Dessouky, M. M. (2007a). Solution approaches for facility location of medical supplies for large-scale emergencies. *Computers & Industrial Engineering*, 52(2), 257-276.

Jia, H., Ordóñez, F., & Dessouky, M. (2007b). A modeling framework for facility location of medical services for large-scale emergencies. *IIE transactions*, 39(1), 41-55.

Kahn, J. G., Marseille, E., Auvert, B. (2006). Cost-effectiveness of male circumcision for HIV prevention in a South African setting. *PLoS Medicine*, 3(12), e517.

Kaisar, E.I., Hess, L., Palomo, A.B.P. (2012). An emergency evacuation planning model for special needs populations. *Journal of Public Transportation* , 15 (2):45-70.

Kaplan, E. H., Craft, D. L., Wein, L. M. (2002). Emergency response to a smallpox attack: the case for mass vaccination. *Proceedings of the National Academy of Sciences of the United States of America*, 99(16), 10935–40 .

Kaup, D.J., Clarke, T.L., Malone, L, Olosn, R. (2002). Crowd dynamics simulation research. SCSC San Diego USA, 14-18 July .

Ke, Y., Zhao, L. (2008). Optimization of emergency logistics delivery model based on anti-bioterrorism. *IEEM December 8-11, 2008, Singapore* .

Kelle, P., Schneider, H., Yi. H.,(2012)." Decision alternatives between expected cost minimization and worst case scenario in emergency supply – Second revision", *International Journal of Production Economics*, 157, P 250–260.

Kermack, W. O., & McKendrick, A. G. (1932). Contributions to the mathematical theory of epidemics. III. Further studies of the problem of endemicity. *Proceedings of the Royal Society of London. Series A, Containing Papers of a Mathematical and Physical Character*, 94-122.

Klaus H., Kempthorne O. (2008). *Design and Analysis of Experiments*. Wiley. Hoboken, USA.

Kongsomsaksakul, S., Yang, C., Chen, A. (2005). Shelter location-allocation model for flood evacuation planning. *Journal of the Eastern Asia Society for Transportation Studies* , 6:4237-4252.

Kress, M. (2005). The Effect of Social Mixing Controls on the Spread of Smallpox—A Two-Level Model. *Health Care Management Science*, 8(4), 277–289 .

Longo, F. (2010). Emergency simulation: state of the art and future research guidelines. *SCS M&S Magazine*, 1(4), 2010-04.

- Lee, E.K., Maheshwary, S., Mason, J., Glisson, W. (2006). Decision support system for mass dispensing of medications for infectious disease outbreaks and bioterrorist attacks. *Annals of Operations Research* , 148(1): 25–53.
- Lee, V. J., Tok, M. Y., Chow, V. T., Phua, K. H., Ooi, E. E., Tambyah, P. A., & Chen, M. I. (2009). Economic analysis of pandemic influenza vaccination strategies in Singapore. *PLoS One*, 4(9), e7108.
- Manik, J. A., & Yardley, J. (2013). Building Collapse in Bangladesh Leaves Scores Dead. *NY TIMES* , 2013.
- McLay, L.A. (2009). A maximum expected covering location model with two types of servers. *IIE Transportation*. 41(8), 730-741.
- Mete, H. O., & Zabinsky, Z. B. (2010). Stochastic optimization of medical supply location and distribution in disaster management. *International Journal of Production Economics*, 126(1), 76-84.
- Miller, G., Randolph, S., Patterson, J. E. (2006). Responding to Bioterrorist Smallpox in San Antonio. *Interfaces*, 36(6), 580–590.
- Milne, G. J., Kelso, J. K. , Kelly, H. A., Huband, S. T., McVernon, J. (2008). A small community model for the transmission of infectious diseases: comparison of school closure as an intervention in individual based models of an influenza pandemic. *PLoS One*, 3:e4005.
- Murali, P., Ordóñez, F., Dessouky, M. (2012). Facility location under demand uncertainty: response to a large-scale bio-terror attack. *Socio-Economic Planning Sciences* , 46:78–87.
- Newall, A. T., Wood, J. G., Oudin, N., & MacIntyre, C. R. (2010). Cost-effectiveness of pharmaceutical-based pandemic influenza mitigation strategies. *Emerging infectious diseases*, 16(2), 224.
- Nolz, P., Doerner, K., Gutjahr, W., Hartl, R. (2010). A bi-objective metaheuristic for disaster relief operation planning. *Advances in Multi-Objective Nature Inspired Computing Studies in Computational Intelligence* , 272: 167-187.
- Ozbay, K., & Ozguven, E. E. (2007). Stochastic humanitarian inventory control model for disaster planning. *Transportation Research Record: Journal of the Transportation Research Board*, 2022(1), 63-75.
- Beamon, B., Kotleba, S. (2006). Inventory modelling for complex emergencies in humanitarian relief operations. *International Journal of Logistics* . 9(1):1–18.
- Ozguven, E., Ozbay, K. (2013). A secure and efficient inventory management system for disasters. *Transportation Research Part C*, 29:171-196.
- Özdamar, L. & Yi, W., (2007). A dynamic logistics coordination model for evacuation and support in disaster response activities. *European Journal of Operational Research*, 179(3), 1177-1193.
- Papazoglou, I. A., & Christou, M. D. (1997). A decision support system for emergency response to major nuclear accidents. *Nuclear technology*, 118(2), 97-122.
- Paltiel, D., Weinstein, M. C., Kimmel, A. D., Seage, G. R., Losina, E., Zhang, H., Walensky, R. P. (2006): Expanded screening for HIV in the United States-an analysis of cost-effectiveness. *The New England Journal of Medicine*, 352 .

- Paul, J. M. (2008). Modeling critical vaccine supply location: protecting critical infrastructure and population in central Florida. Florida State University.
- Pegram, G. G. S. (1980). A continuous streamflow model. *Journal of Hydrology*, 47(1), 65-89.
- Pietz, F Lee, E. K., Chen, C. H. & Benecke, B. (2009). Modeling and optimizing the public-health infrastructure for emergency response. *Interfaces*, 39(5), 476-490.
- Porco, T.C., Holbrook, K.A., Fernyak, S.E., Portnoy, D.L., Reiter, R., Aragón, T.J. (2004). Logistics of community smallpox control through contact tracing and ring vaccination: a stochastic network model :*BMC Public Health*, 4, 1-34.
- Rawls, C.G., Turnquist, M.A. (2010). Pre-positioning of emergency supplies for disaster response. *Transportation Research Part B: Methodological*, 44(4): 521-34.
- Reshetin, V. P., & Regens, J. L. (2003). Simulation modeling of anthrax spore dispersion in a bioterrorism incident. *Risk Analysis*, 23(6), 1135-1145.
- Roberts, M. G., Baker, M., Jennings, L. C., Sertsou, G., Wilson, N. (2007). A model for the spread and control of pandemic influenza in an isolated geographical region. *Journal of the Royal Society, Interface / the Royal Society*, 4(13), 325–30 .
- Rottkemper, B., Fischer, K., Blecken, A., & Danne, C. (2011). Inventory relocation for overlapping disaster settings in humanitarian operations. *OR spectrum*, 33(3), 721-749.
- Rottkemper, B., Fischer, K., & Blecken, A. (2012). A transshipment model for distribution and inventory relocation under uncertainty in humanitarian operations. *Socio-Economic Planning Sciences*, 46(1), 98-109.
- Ryttilä, J.S., Spens, K.M. (2006). Using simulation to increase efficiency in blood supply chains. *Management Research News*, 29(12): 801–819
- Sanders, G. D., Bayoumi, A. M., Sundaram, V., Bilir, S. P., Neukermans, C. P., Rydzak, C. E., Douglass, L. R. (2005). Cost-effectiveness of screening for HIV in the era of highly active antiretroviral therapy. *New England Journal of Medicine* 352(6):570–585.
- Scanlon, J. (1998). Dealing with mass death after a community catastrophe: handling bodies after the 1917 Halifax explosion. *Disaster Prevention and Management*, 7(4), 288-304.
- Scheer, A. W. (1994). *Architecture of integrated information systems: foundations of enterprise modelling*. Springer-Verlag New York, Inc..
- Shen, T. (2005). A building evacuation simulation model. *Building and Environment*, 40 (5): 671–680.
- Sheu, J.B. (2007). An emergency logistics distribution approach for quick response to urgent relief demand in disasters. *Transportation Research Part E: Logistics and Transportation Review*, 43(6): 687–709.
- Sheu, J.-B. (2006). Challenges of emergency logistics management. *Transportation Research Part E: Logistics and Transportation Review*, 43(6), 655–659.

- Song R, He S, Zhang L (2009). Optimum transit operations during the emergency evacuations. *Journal of Transportation Systems Engineering and Information Technology* ; 9(6):154-60.
- Sorensen, P., & Church, R. (2010). Integrating expected coverage and local reliability for emergency medical services location problems. *Socio-Economic Planning Sciences*, 44(1), 8-18.
- Sriramachari, S. (2004). The Bhopal gas tragedy: an environmental disaster. *Current Science*, 86(7), 905-920.
- Stewart R. (2004) *Simulation - The practice of model development and use*. John Wiley & Sons.
- Su, S., Tsai, S. T., Shih, C. L., Kuo, R. J., Wang, H. C., Chen, J. C. (2008). Use of computer simulation in the evacuation system for hospitals. SCSC Edinburgh Scotland, June .
- Takeda, R., Widmer, J., Morabito, R. (2007). Analysis of ambulance decentralization in an urban emergency medical service using the hypercube queueing model. *Computers & Operations Research* . 34,727-741.
- Taskin, S., & Lodree, E. J. (2010). Inventory decisions for emergency supplies based on hurricane count predictions. *International Journal of Production Economics*, 126(1), 66-75.
- Tricoire, F., Graf, A., Gutjahr, W.J. (2012). The bi-objective stochastic covering tour problem. *Computers & Operations Research* , 39(7), 1582–1592.
- Tzeng, G.H., Cheng, H.J., Huang, T.D.. (2007). Multi-objective optimal planning for designing relief delivery systems. *Transportation Research Part E: Logistics and Transportation Review*, 43(6):673-686.
- Wang, H., Wang, X., Zeng, A. (2009a). Optimal material distribution decisions based on epidemic diffusion rule and stochastic latent period for emergency rescue. *International Journal of Mathematics in Operational Research* , 1, 76–96.
- Wang, T., Guinet, A., Belaidi, A., & Besombes, B. (2009b). Modelling and simulation of emergency services with ARIS and Arena. Case study: the Emergency Department of Saint Joseph and Saint Luc Hospital. *Production Planning and Control*, 20(6), 484-495.
- Wang, J. , Yang, H., Zhu, J.. (2011) A Two-stage Stochastic Programming Model for Emergency Resources Storage Region Division. *Systems Engineering Procedia* 5 (2012) 125 – 130.
- Watson, J. T., Gayer, M., & Connolly, M. A. (2007). Epidemics after natural disasters. *Emerging infectious diseases*, 13(1), 1.
- Wein, L.M., Craft, D.L., Kaplan, E.H. (2003). Emergency response to an anthrax attack. *Proceedings of the National Academy of Sciences of the United States of America* , 100(7): 4346–51.
- Wein, L.M., and Craft, D.L. (2005). Evaluation of Public Health Interventions for Anthrax: A Report to the Secretary’s Council on Public Health Preparedness. *Biosecurity and Bioterrorism: Biodefense Strategy, Practice, and Science*, 3, 348-356 .

Wein, L.M., Kaplan, E.,H..(2003) Unready for Anthrax. The Washington Post, July 28, 2003.

Whitworth, M.H. (2006). Designing the Response to an Anthrax Attack. *Interface*. 36(6):562–568.

Wu, S., Shuman, L., Bidanda, B., Kelly, M., Sochats, K., Balahan, C. (2007). Embedding GIS in disaster simulation. Esri San Diego USA , July 15–18.

Van Wassenhove , L. N. (2006). Humanitarian aid logistics: supply chain management in high gear. *The Journal of the Operational Research Society*. 57(5):475-89.

Xi, M., Ye, F., Yao, Z., Zhao, Q. (2013). A modified-median model for emergency facilities location problem and its variable neighborhood search-based algorithm. *Journal of Applied Mathematics* ,1-10.

Zaric, G. S., Barnett, P. G., Brandeau, M. L. (2000). Methadone maintenance and HIV prevention: A cost-effectiveness analysis. *Management Science* 46(8):1013–1031.

Zaric, G.S., Bravata, D.M., Cleophas, H. J. E., McDonald, K.M., Owens, D.K., Brandeau, M.L. (2008). Modeling the Logistics of Response to Anthrax Bioterrorism. *Medical Decision Making*, 28, 332-350.

Zhou, F., Tan, Av, Jiao J. (2008) Emergency logistics using graph theory and abstraction hierarchy. 4th ICMIT 21-24 September, Bangkok Thailand.

Appendix A: Evacuation of patients in Hospital Lyon Sud

Appendix A presents the three-step approach proposed in Chapter 3 to model the evacuation of patients in a building of Hospital Lyon Sud (maternity), in case of an earthquake, under the guidance of an Extended White Plan. The steps and models used here are almost the same as the models used in Chapter 3. 25 non-autonomous patients need to be evacuated. Because of the special location of the Hospital Lyon Sud and the road state, a patient evacuation will take more time than from the Hospital Saint-Joseph/Saint-Luc. According to health workers in Hospital Lyon Sud, it will take at least 20 to 30 minutes to evacuate one patient if this hospital is hit by an earthquake. If there is an earthquake in Lyon, the patients must be evacuated to hospitals which are farther. The time used here to evacuate a single patient will be between 30 to 60 minutes. Preparing patient list takes 10 to 15 minutes. Preparing medicines, medical history and so on takes 5 to 10 minutes. Transportation from care unit to hospital exit takes 5 to 10 minutes. As the input data we got for this model is an interval, the uniform distribution is used here to simulate.

The number of coordinators in Hospital Lyon Sud is always 1 person. But the number of nurses can be 3 or 8. The number of ambulance can be 2 or 3. The number of stretchers is 3 or 5. So there are three independent variables in total. The variable values have been suggested by a leader of the hospital according to the actual situation. Table A.1 gives the time used to evacuate the patients because of the earthquake.

Table A.1: Time used to evacuate patients in Hospital Lyon Sud

Nurse number	Stretcher number	Ambulance number	Used time (hours)
8	3	5	9.07266
8	2	5	9.08262
3	2	5	9.08451
3	3	5	9.11784
8	2	3	14.195
3	2	3	14.1989
3	3	3	14.225
8	3	3	14.2379

From Table A.1, it can be found that our model can be extended to and applied to different situations.

Appendix B: ARIS model about a hospital evacuation before a flood Evacuation of patients in Hospital Lyon Sud

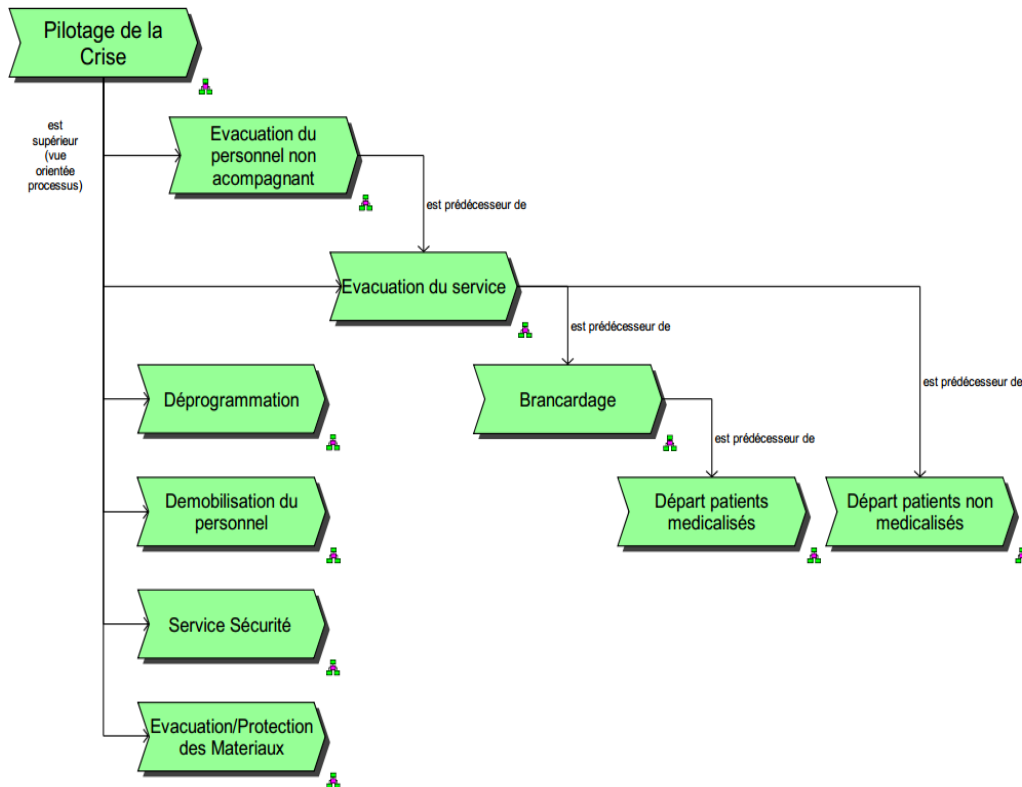

Figure B.1 : Process of Hospital Saint-Joseph/Saint-Luc.

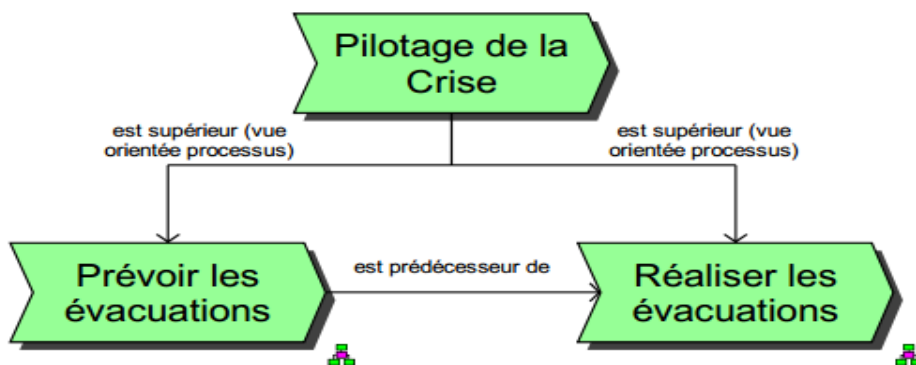

Figure B.2: Pilotage de la Crise.

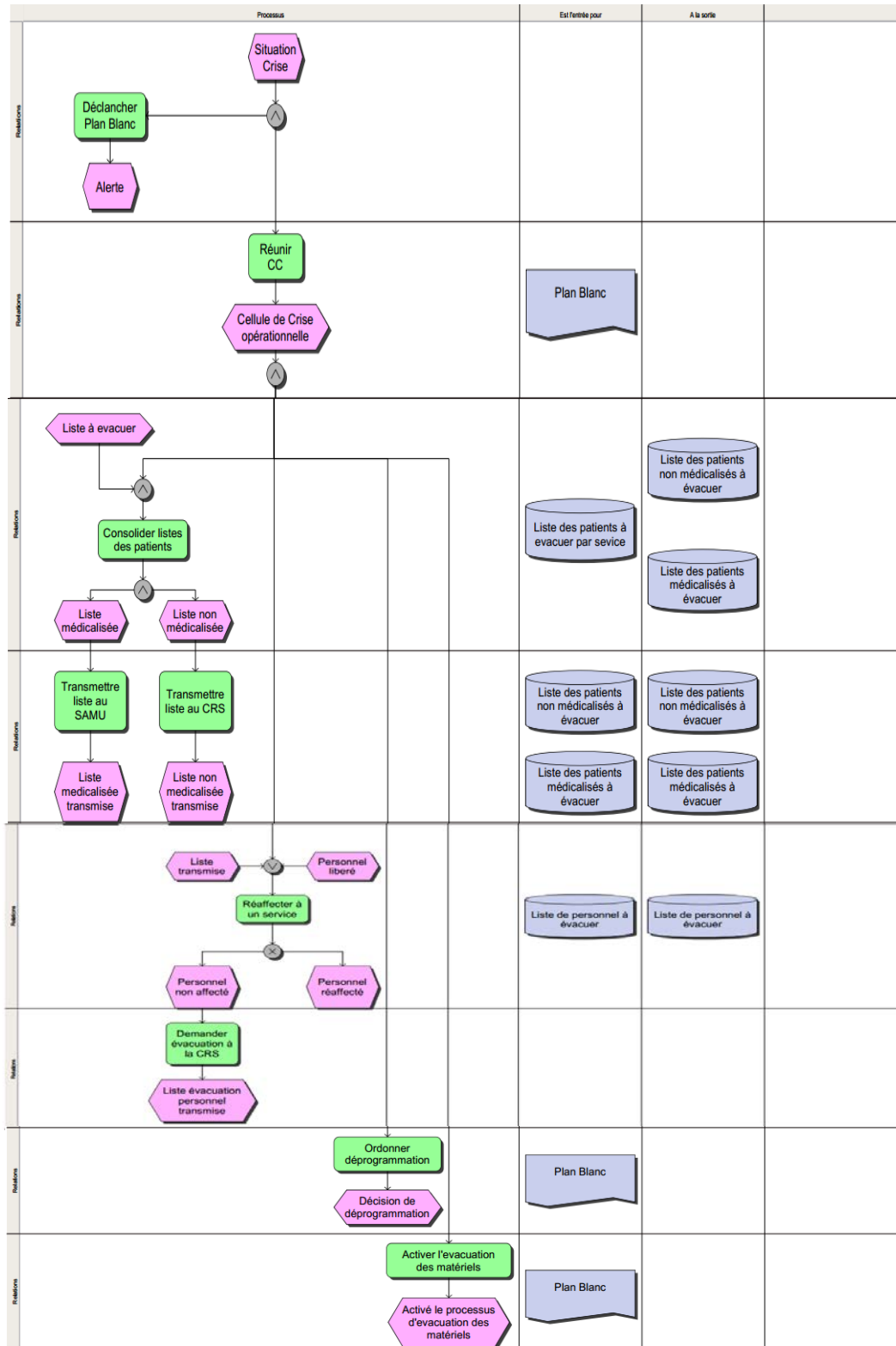

Figure B.3: Prévoir les évacuations.

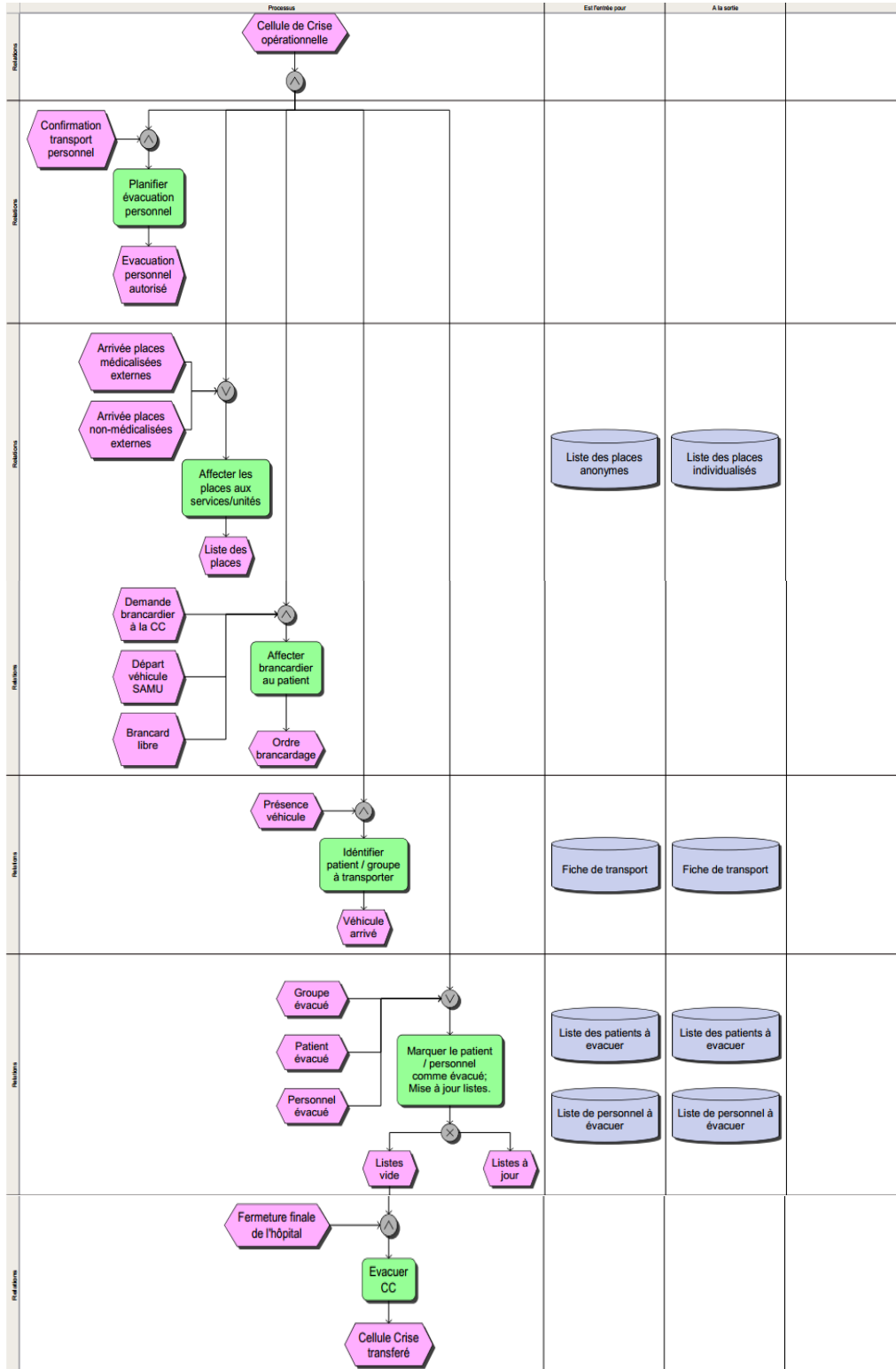

Figure B.4: Réaliser les évacuations.

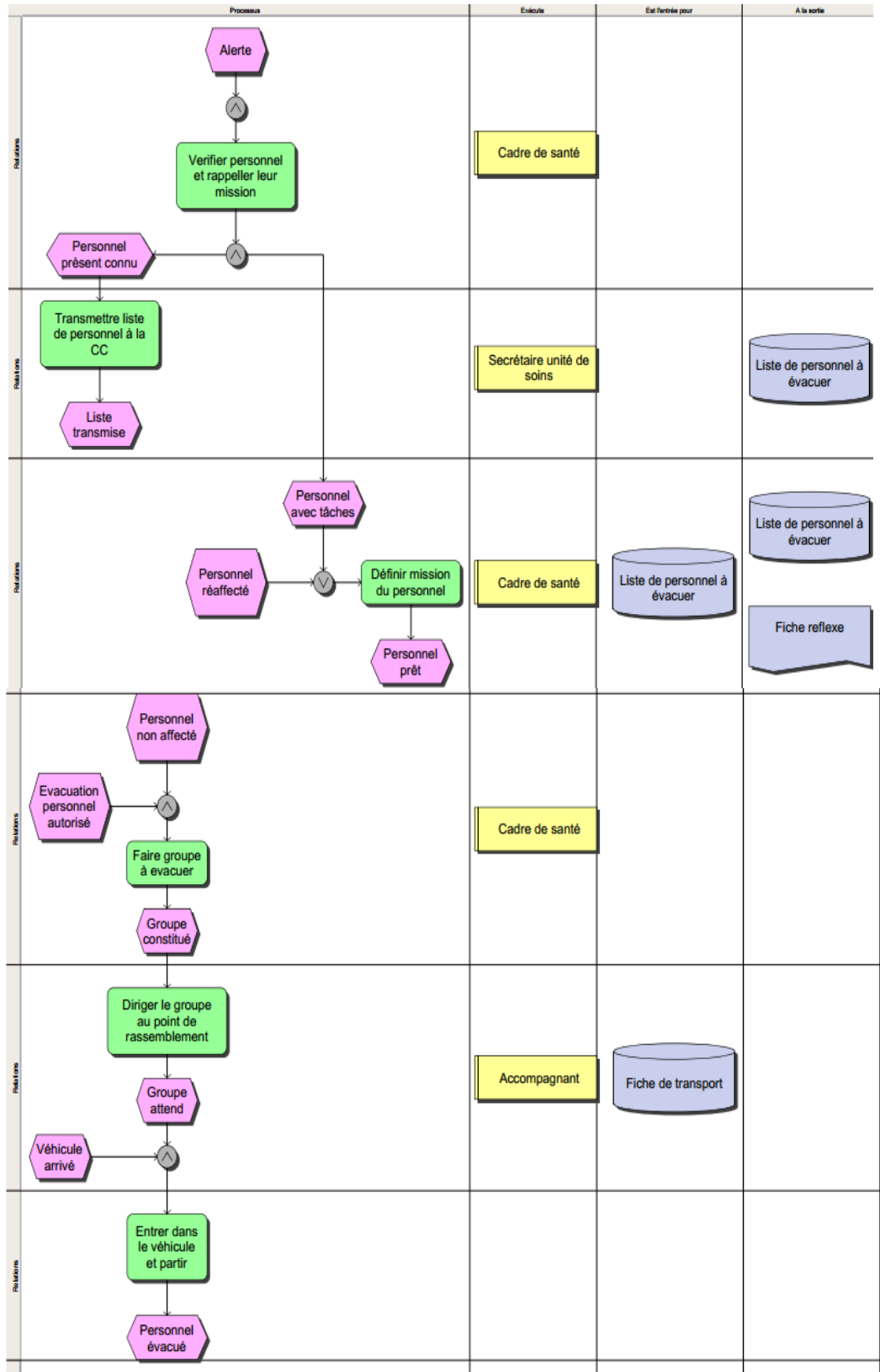

Figure B.5: Evacuation personnel non accompagnant.

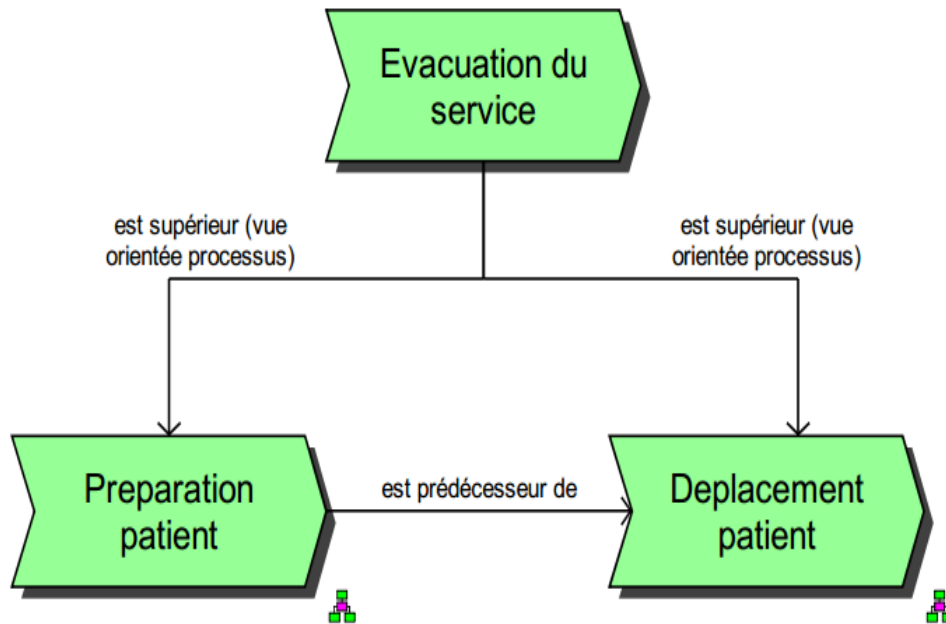

Figure B.6: Evacuation du service.

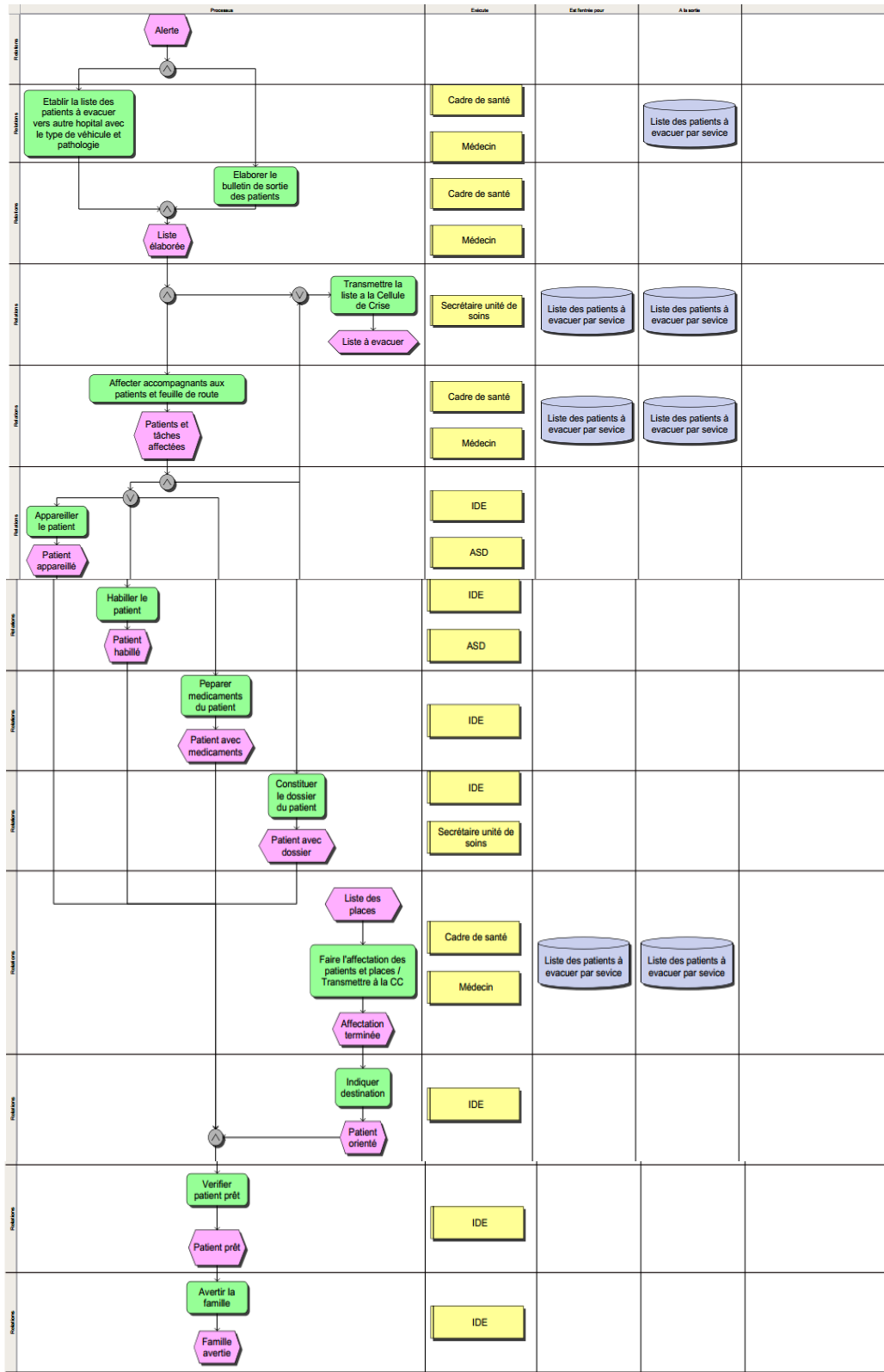

Figure B.7: Preparation patient.

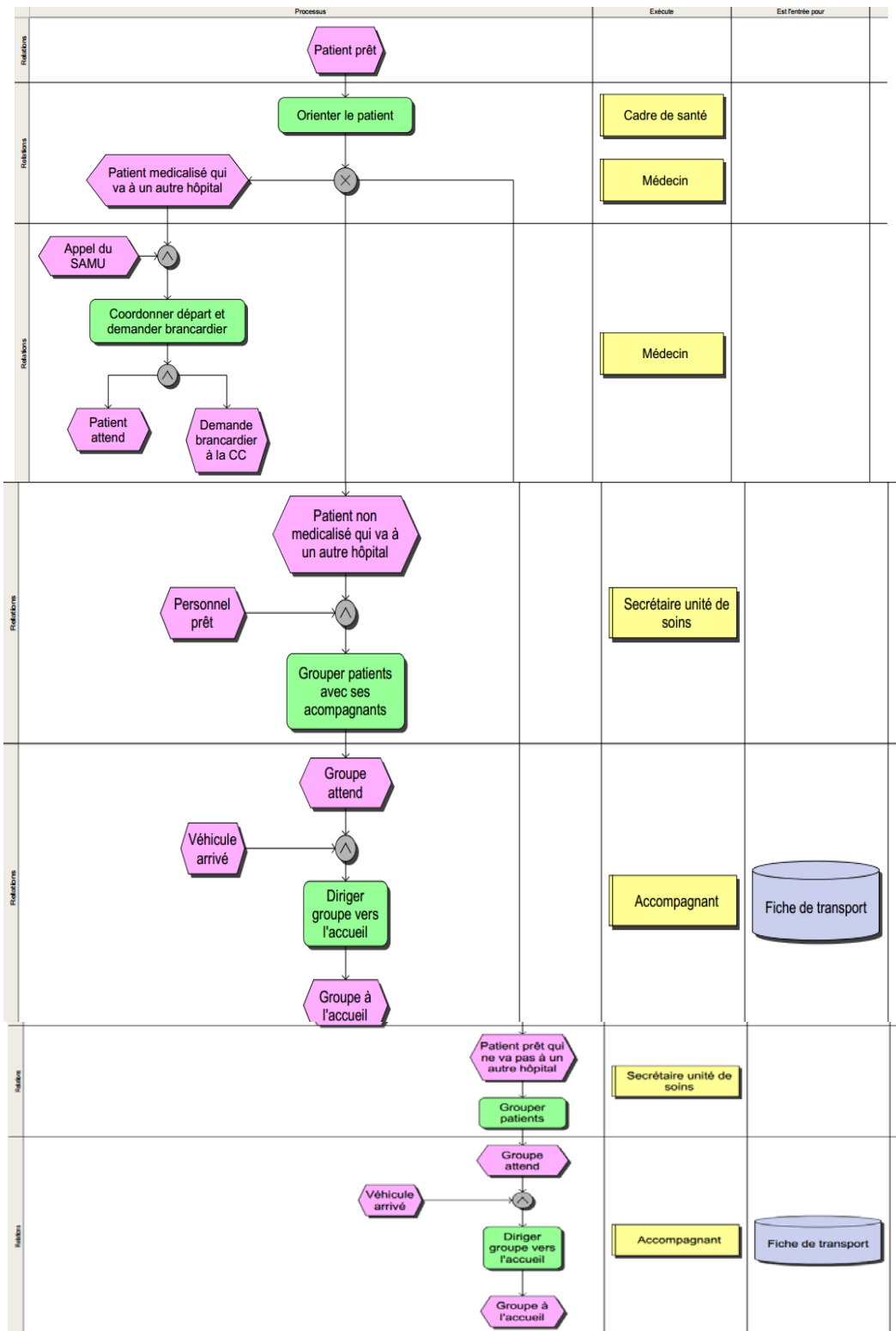

Figure B.8: Déplacement patient.

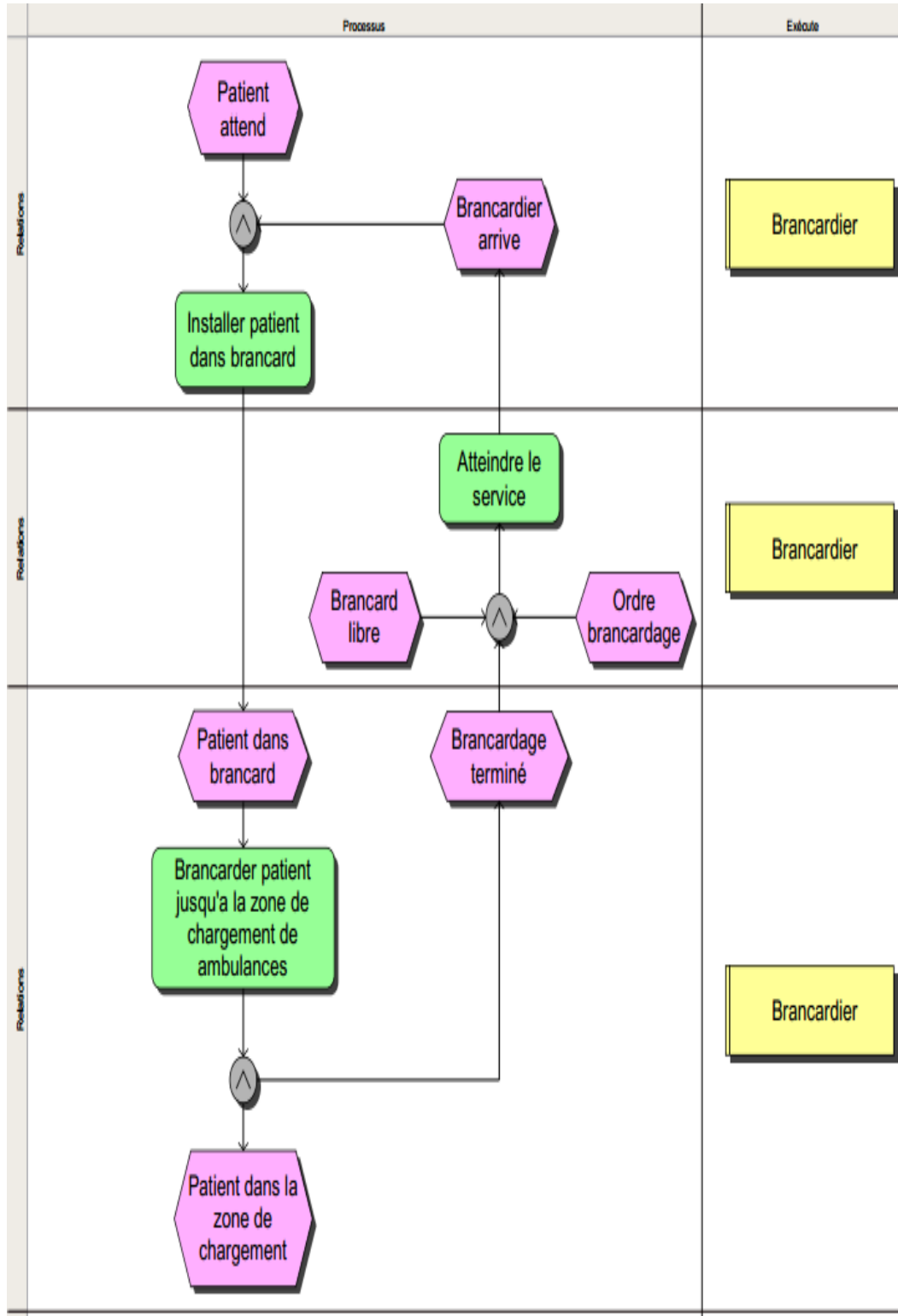

Figure B.9: Brancardage.

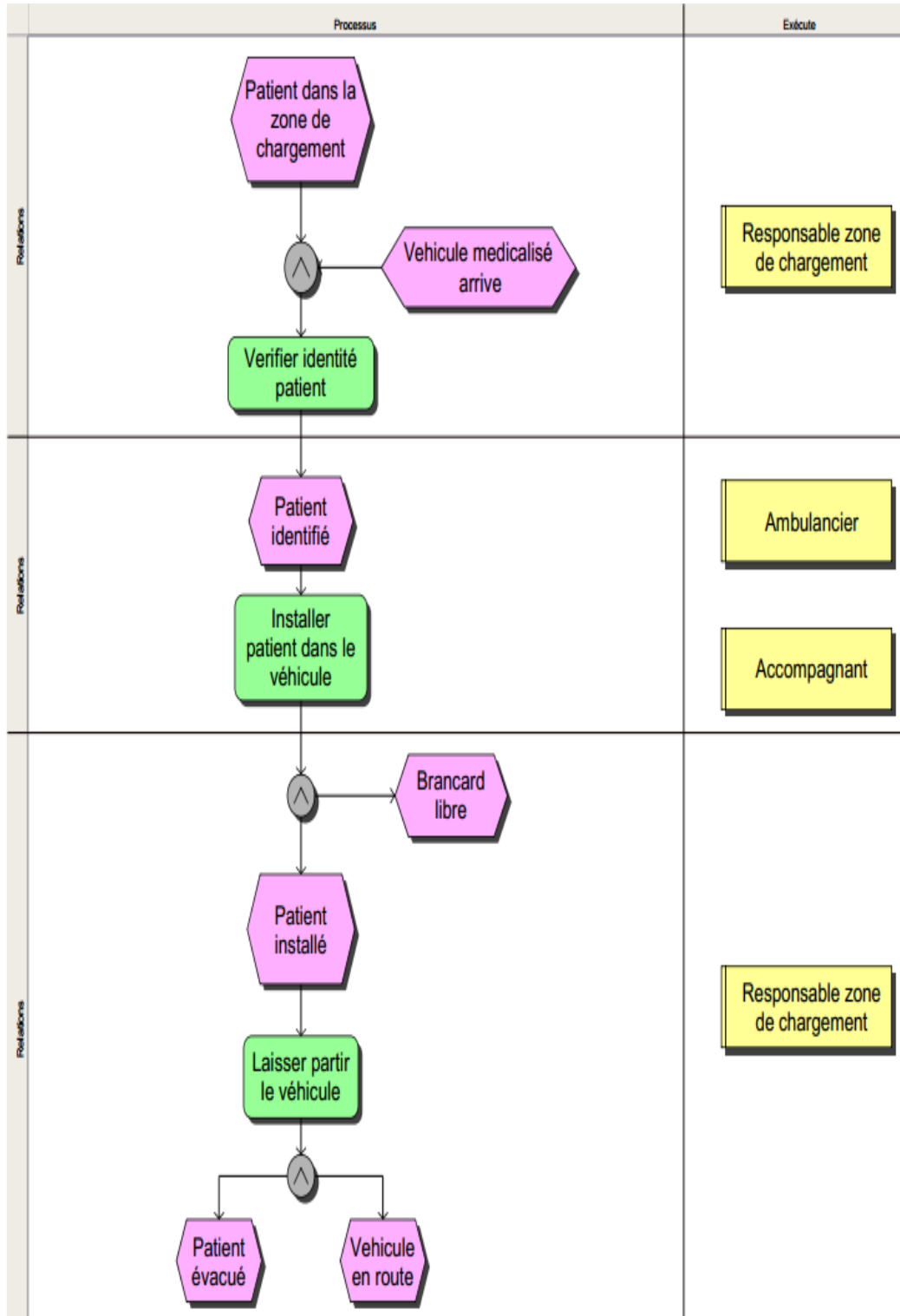

Figure B.10: Départ patients medicalisés

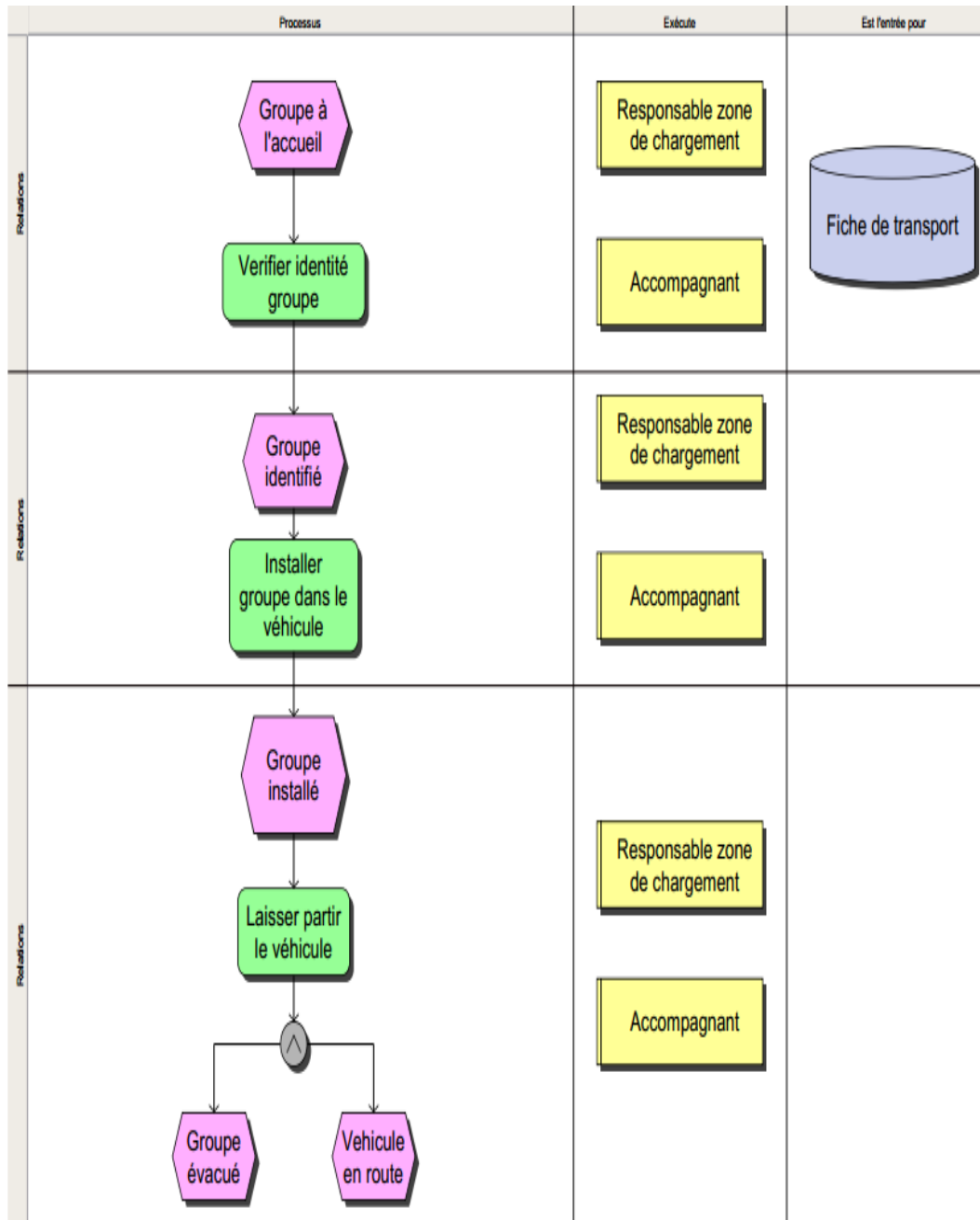

Figure B.11: Départ patients non medicalisés

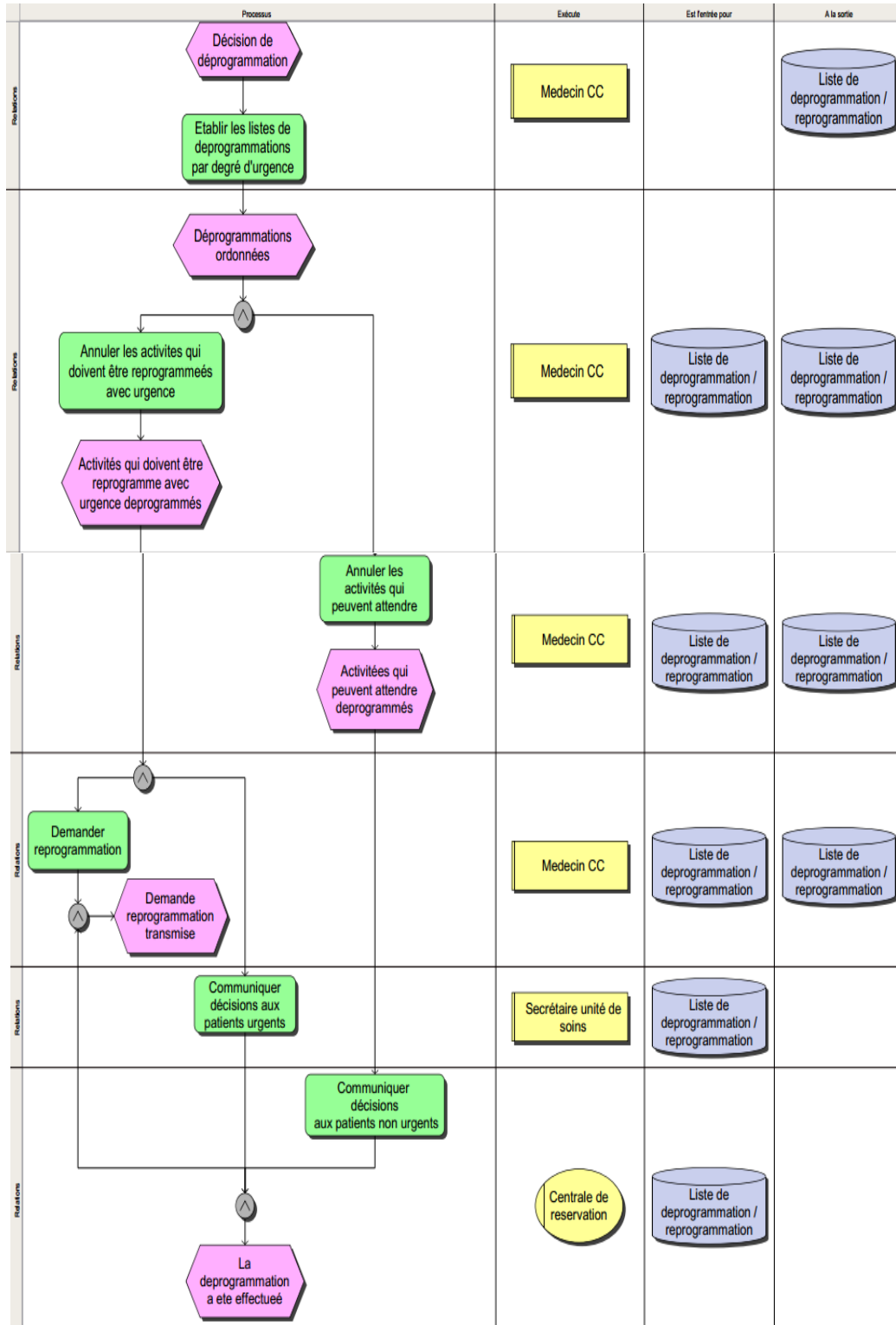

Figure B.12: Déprogrammation.

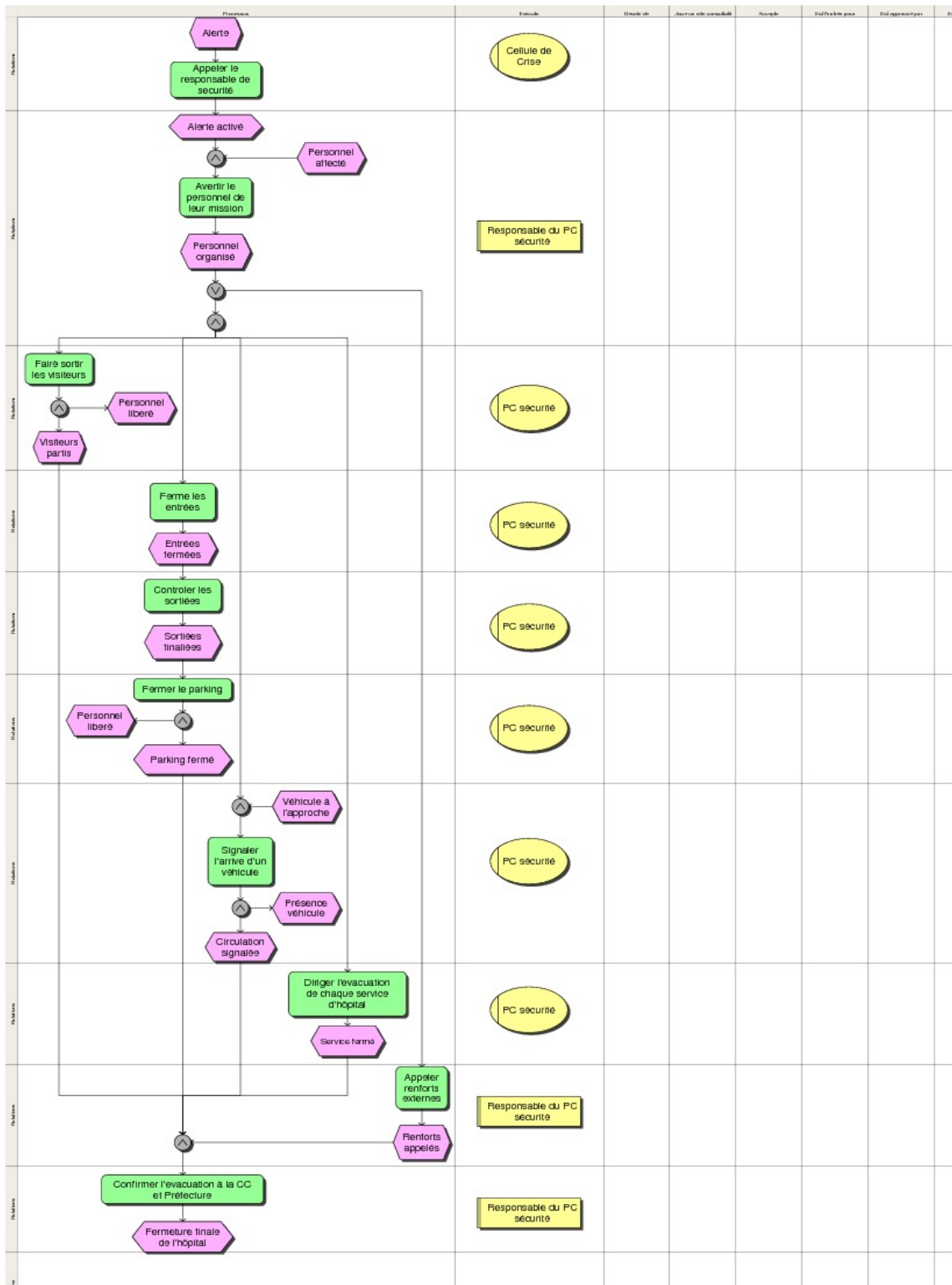

Figure B.13: Service Sécurité.

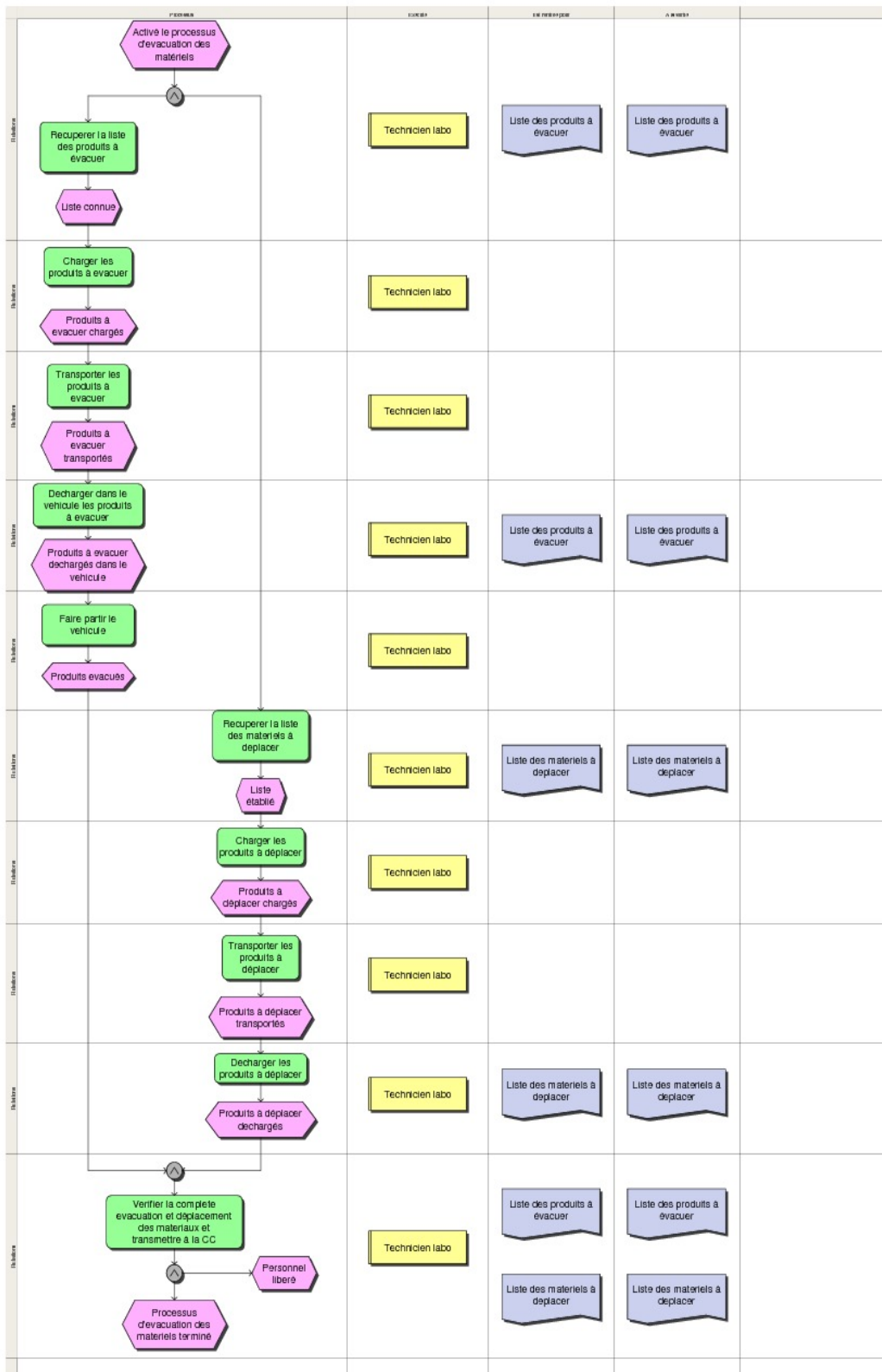

Figure B.14: Evacuation/ Protection des Matériels.

Appendix C: ARIS model of the logistics response to a terrorist attack with a non-contagious agent

Figure C.1 presents the processes of logistics response to anthrax. Figure C.2 to Figure C.10 present EPC of processes in Figure C.1.

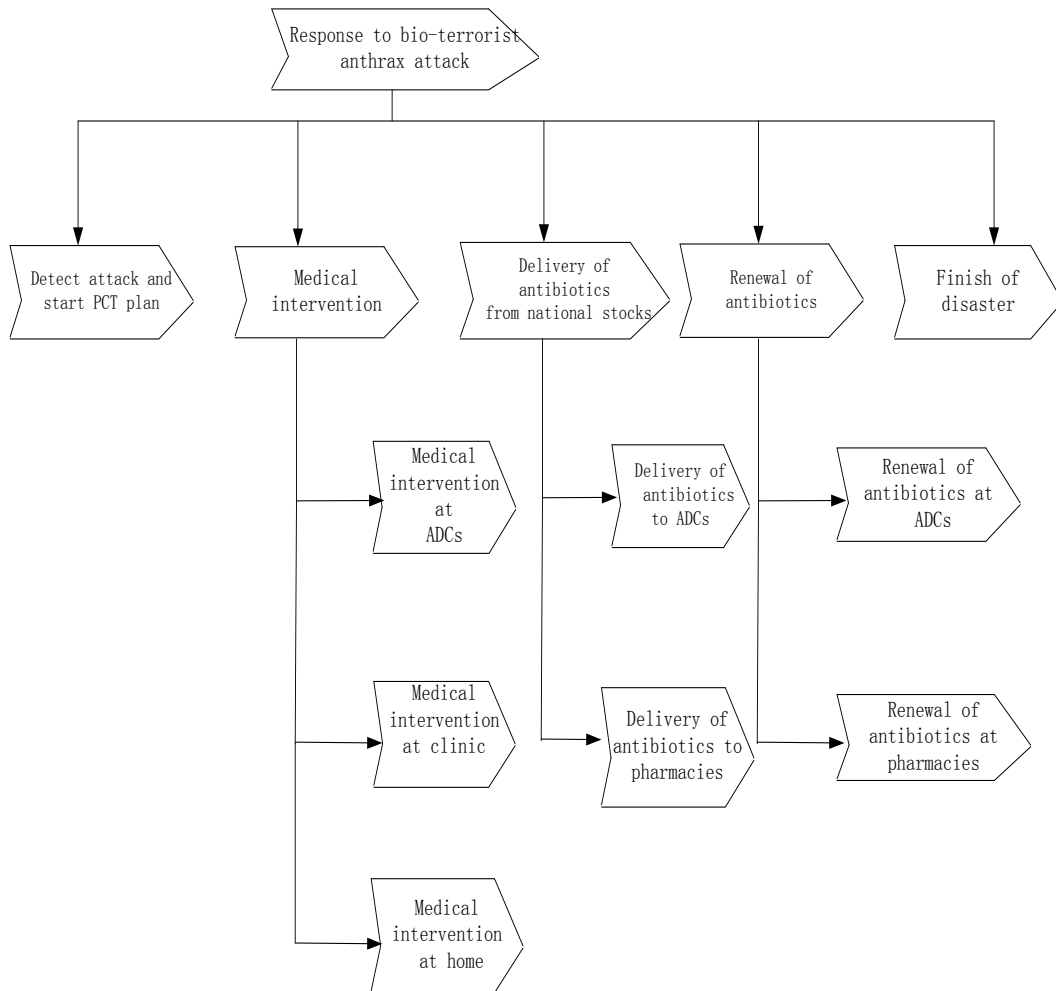

Figure C.1: The global process of response to bio-terrorist anthrax under the guidance of PCT plan.

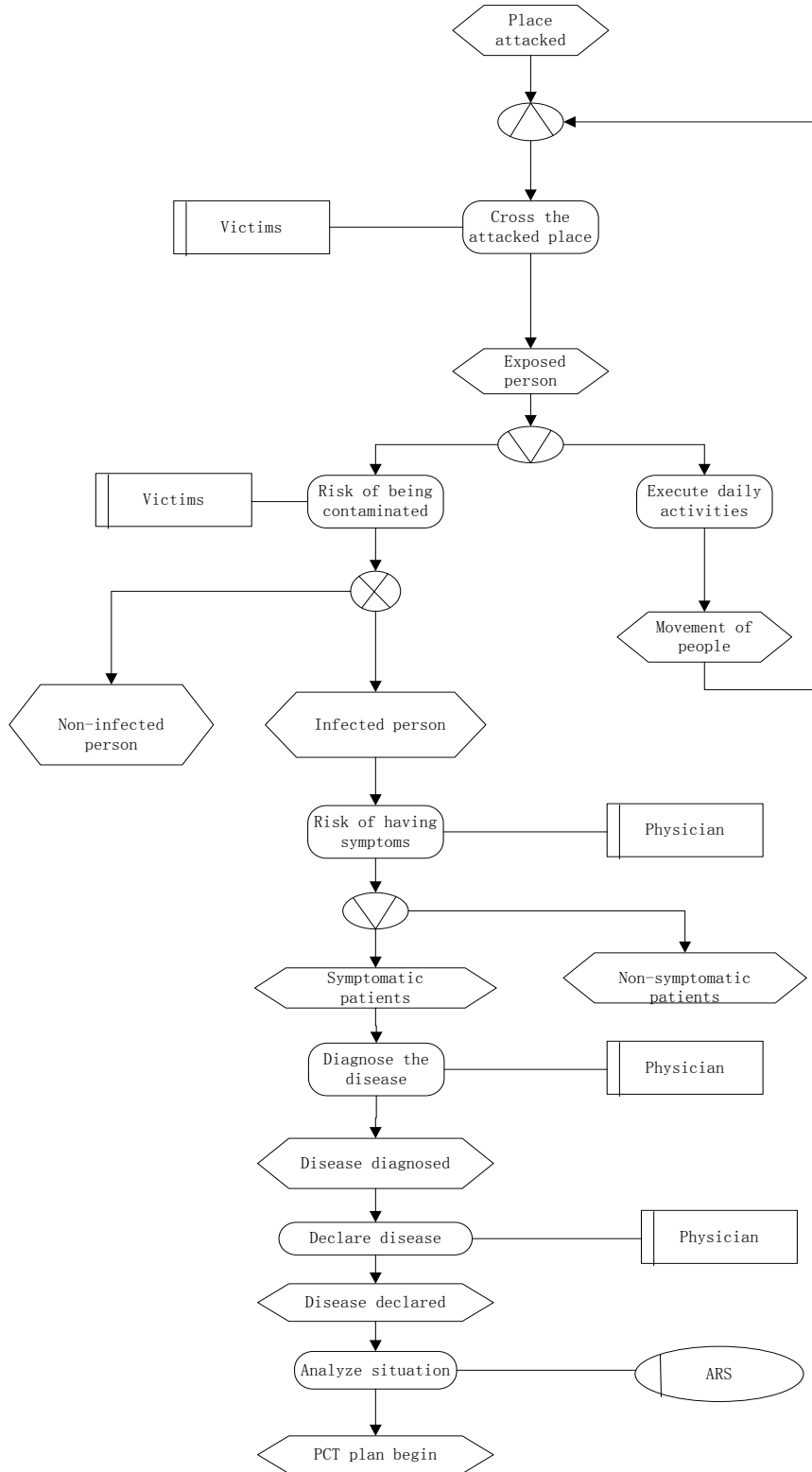

Figure C.2: Detect attack and start PCT plan.

Figure C.2 presents the detection of Anthrax attack and begin of PCT plan.

Figure C.3, Figure C.4 and Figure C.5 present medical intervention at the local level. Figure C.3 presents medical intervention at ADCs. It can be found that a physician at ADC will identify if exposed individuals are infected. If exposed individuals are infected, physicians will divide patients according to the disease stage in which patients are. If patients are in fulminant stage, patients will be transported to hospitals and White Plan will be triggered. Otherwise, patients can take oral antibiotics at ADCs. Figure C.4 presents medical intervention at clinic. People who visit clinic can be diagnosed by their general practitioners. If people are infected, they will be referred to a pharmacy where oral antibiotics will be delivered or transported to hospital because they are in the fulmiant stage. Figure C.5 presents the possible infected people who cannot go to ADCs or clinics and can get medical help at home.

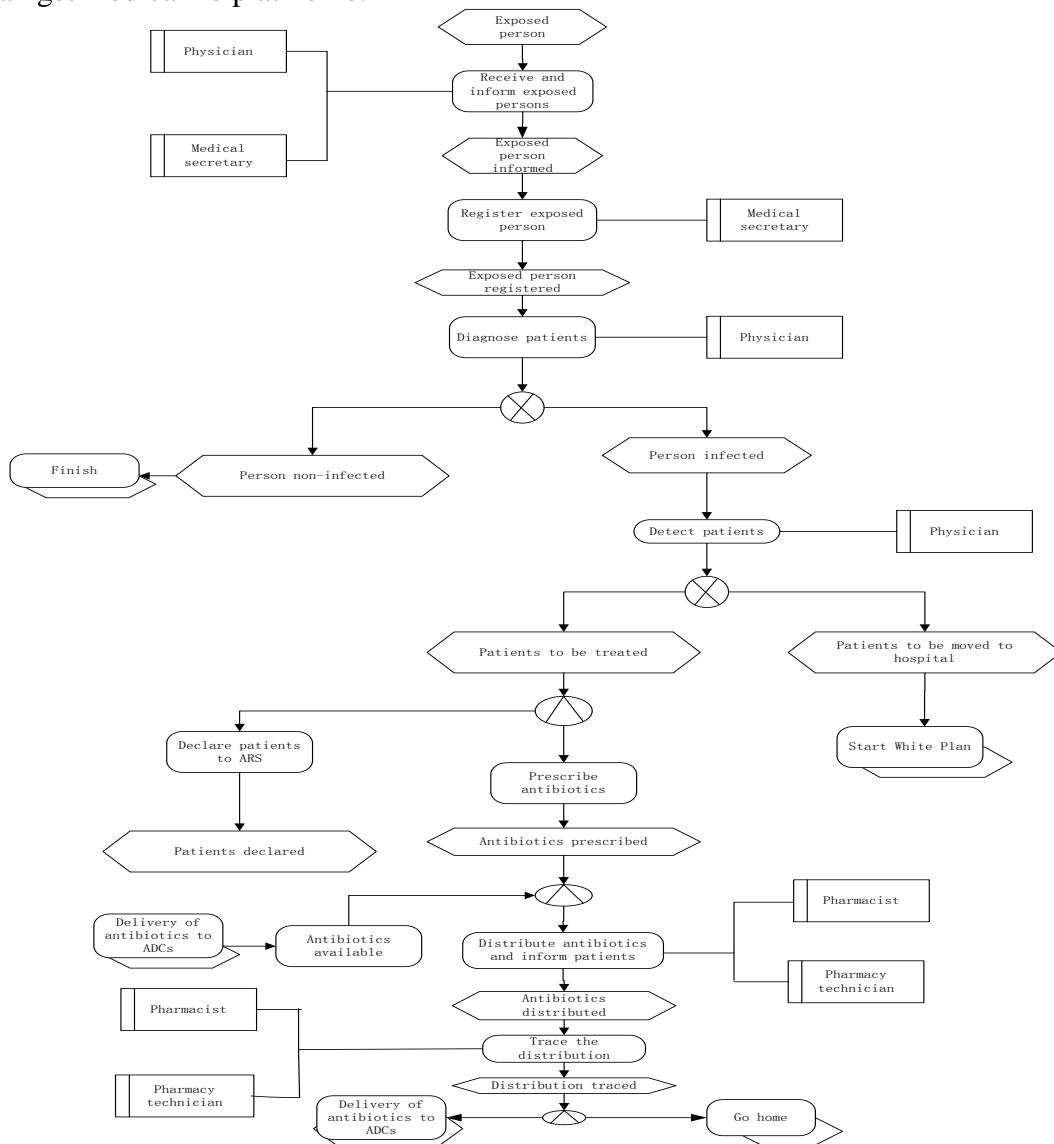

Figure C.3: Medical intervention at ADCs.

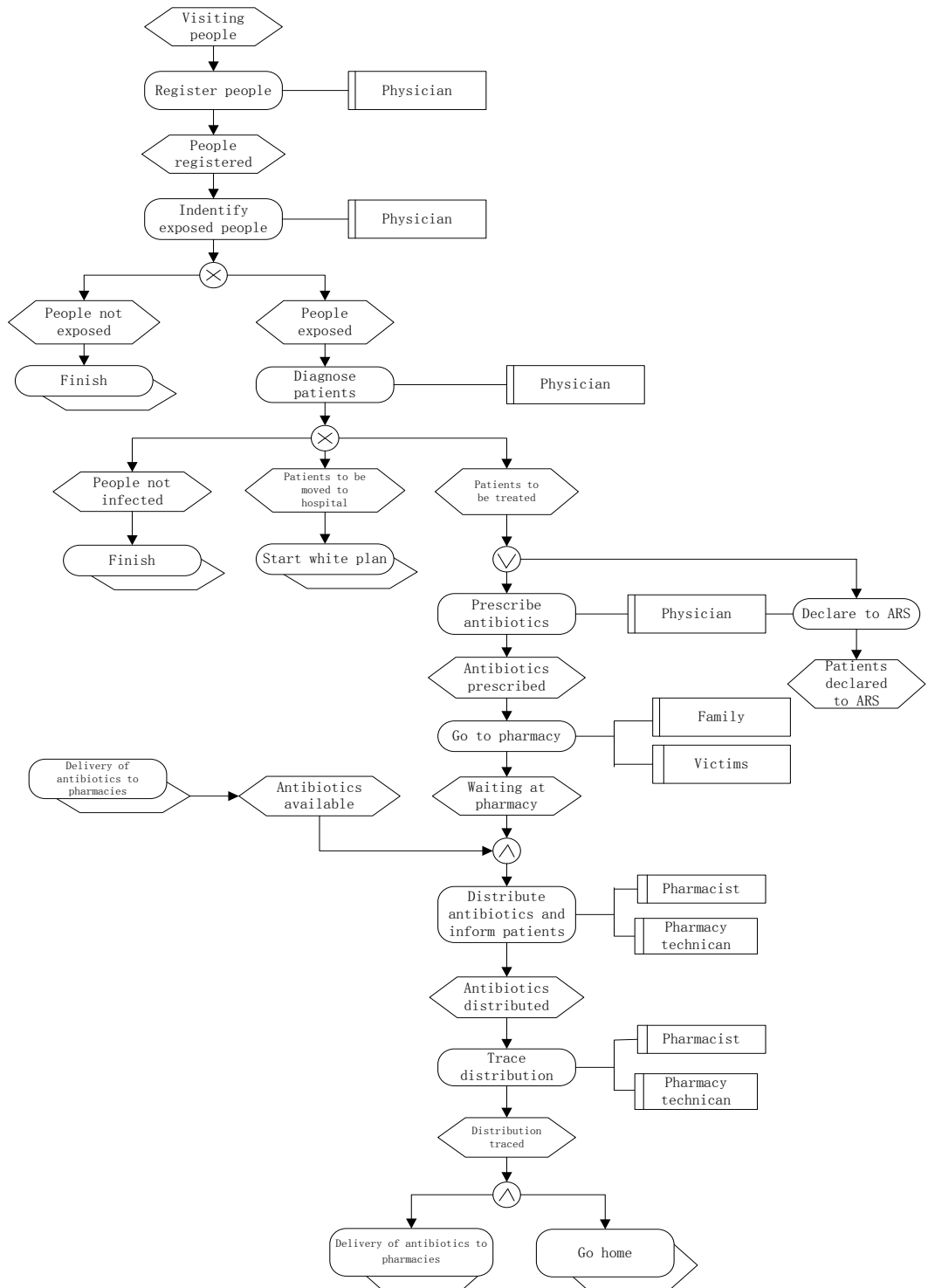

Figure C.4: Medical intervention at clinic.

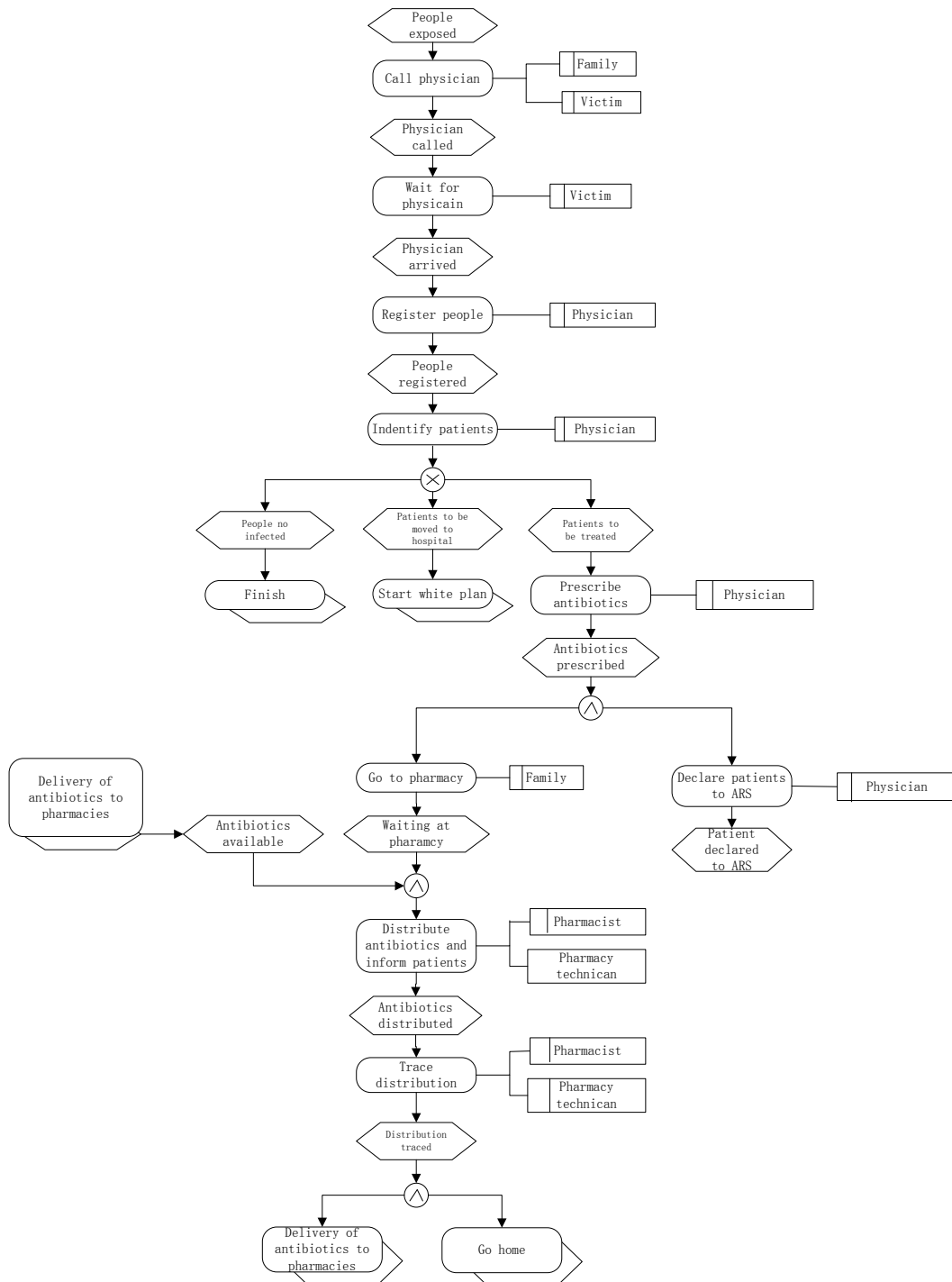

Figure C.5: Medical intervention at home.

Figure C.6 and Figure C.7 show the delivery of antibiotics from national stockpiles to local ADCs and pharmacies respectively.

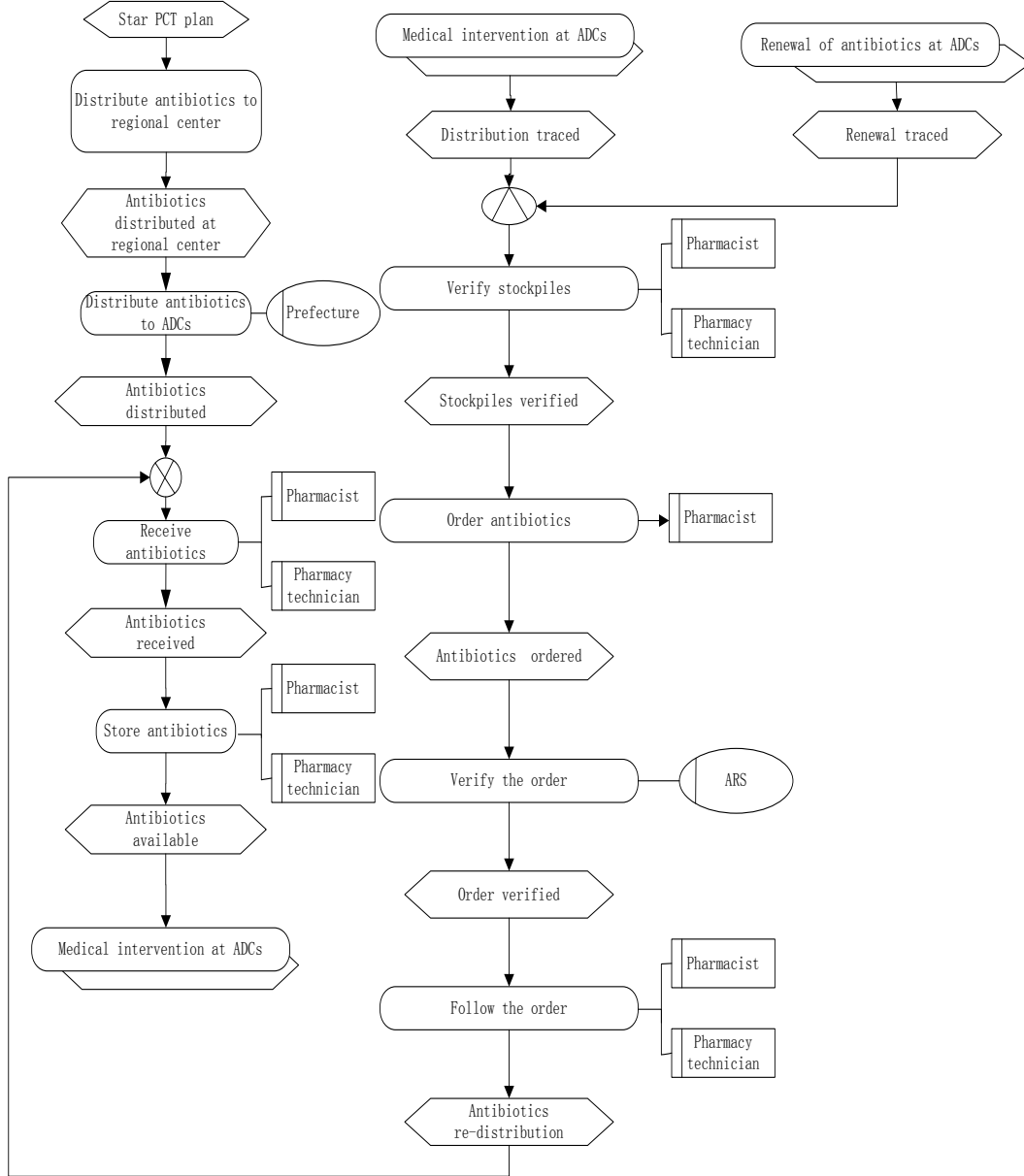

Figure C.6: Delivery of antibiotics to ADCs.

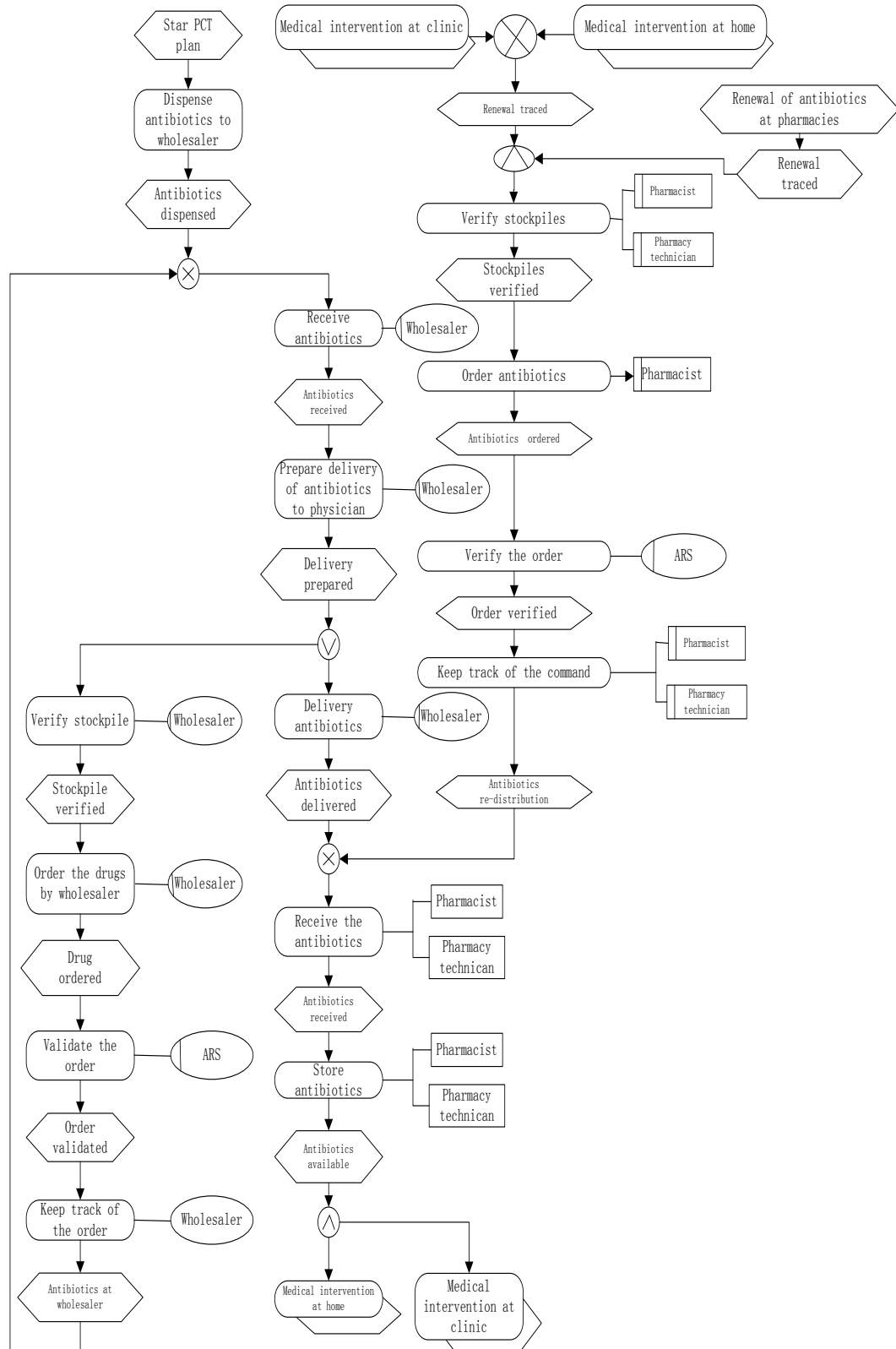

Figure C.7: Delivery of antibiotics to pharmacies.

Since the distribution of antibiotics to patients at first time may not enough to support the full-regime treatment. A renewal of antibiotics may be done. Figure C.8 and Figure C.9 present renewal of antibiotics.

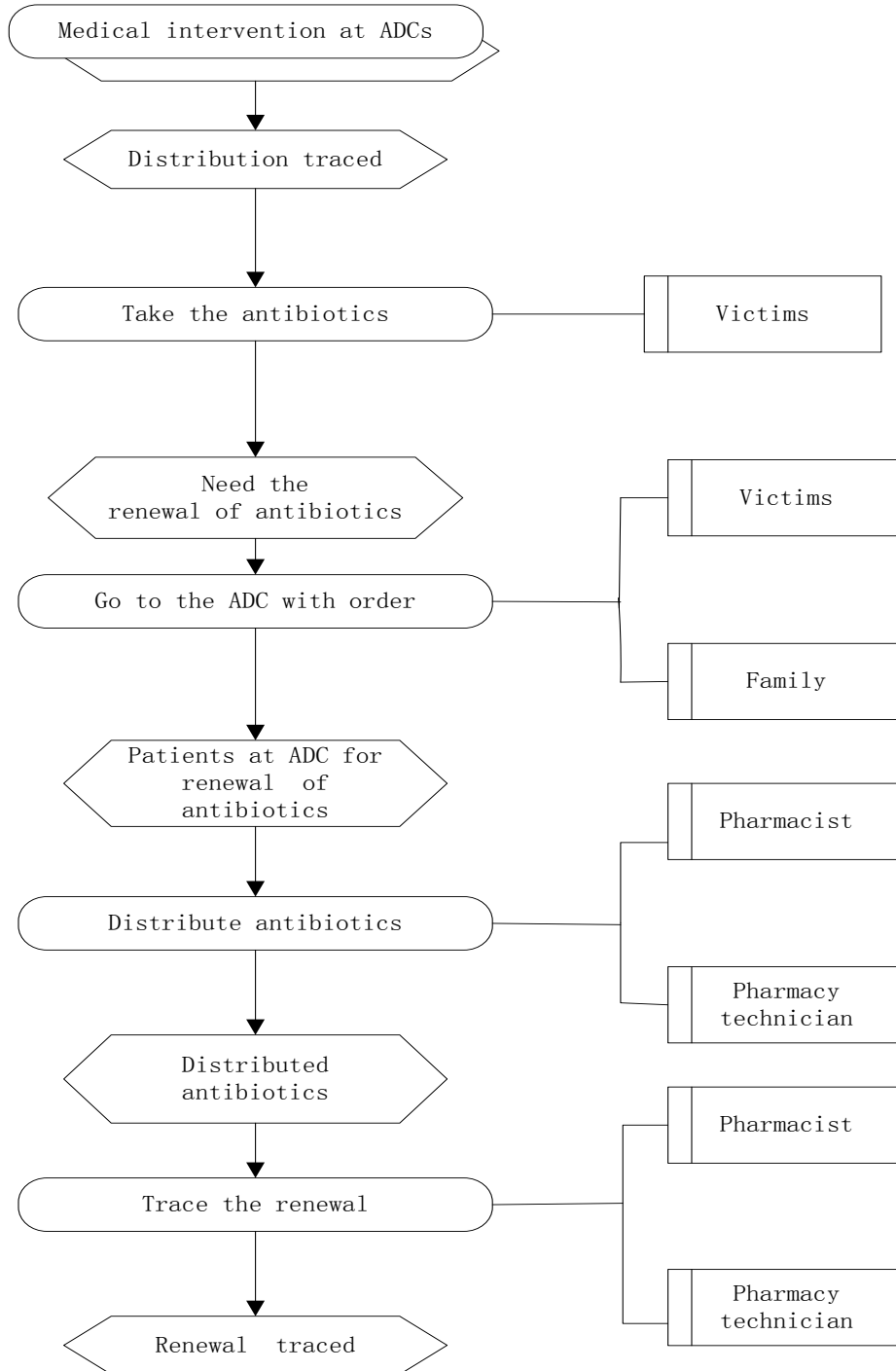

Figure C.8: Renewal of antibiotics at ADCs.

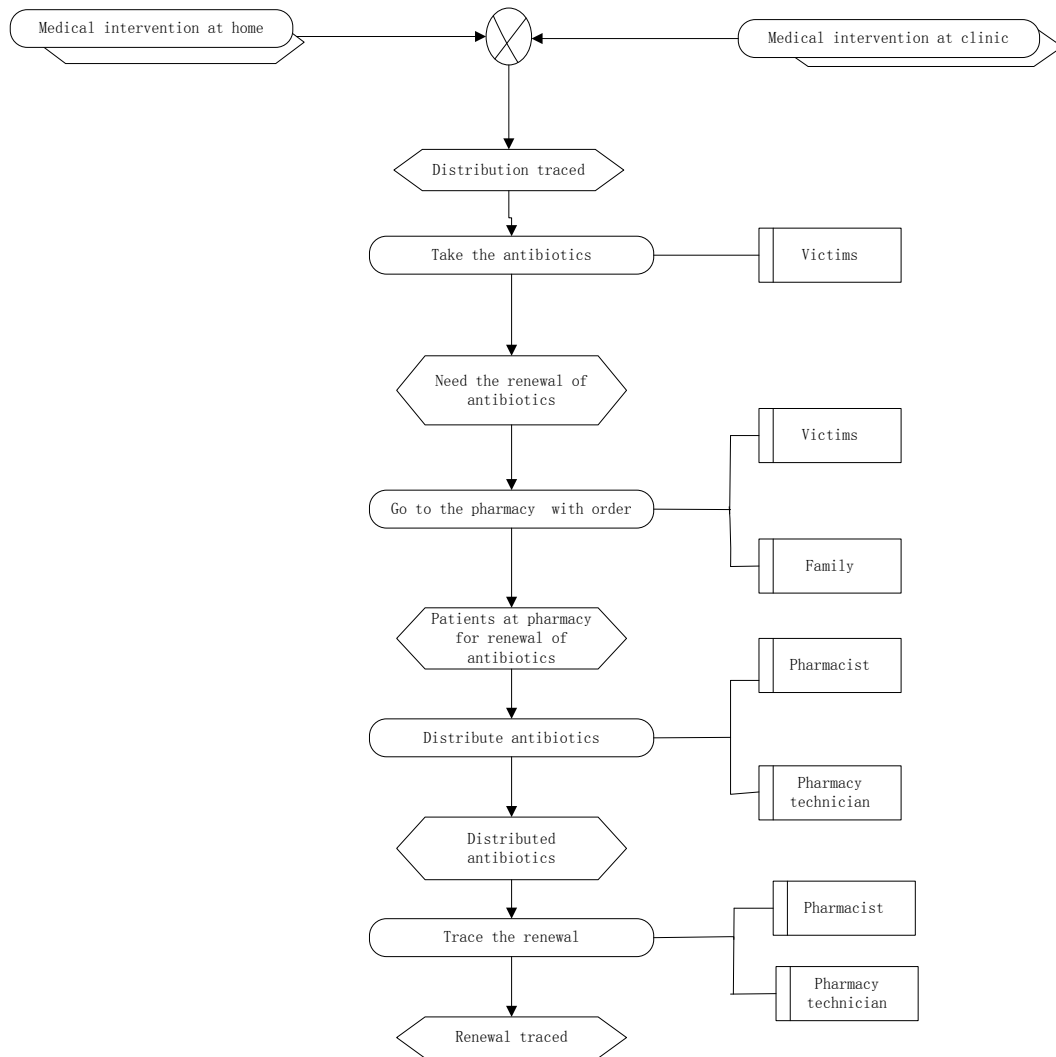

Figure C.9: Renewal of antibiotics at pharmacies.

The process of finishing of PCT plan has been shown in Figure C.10.

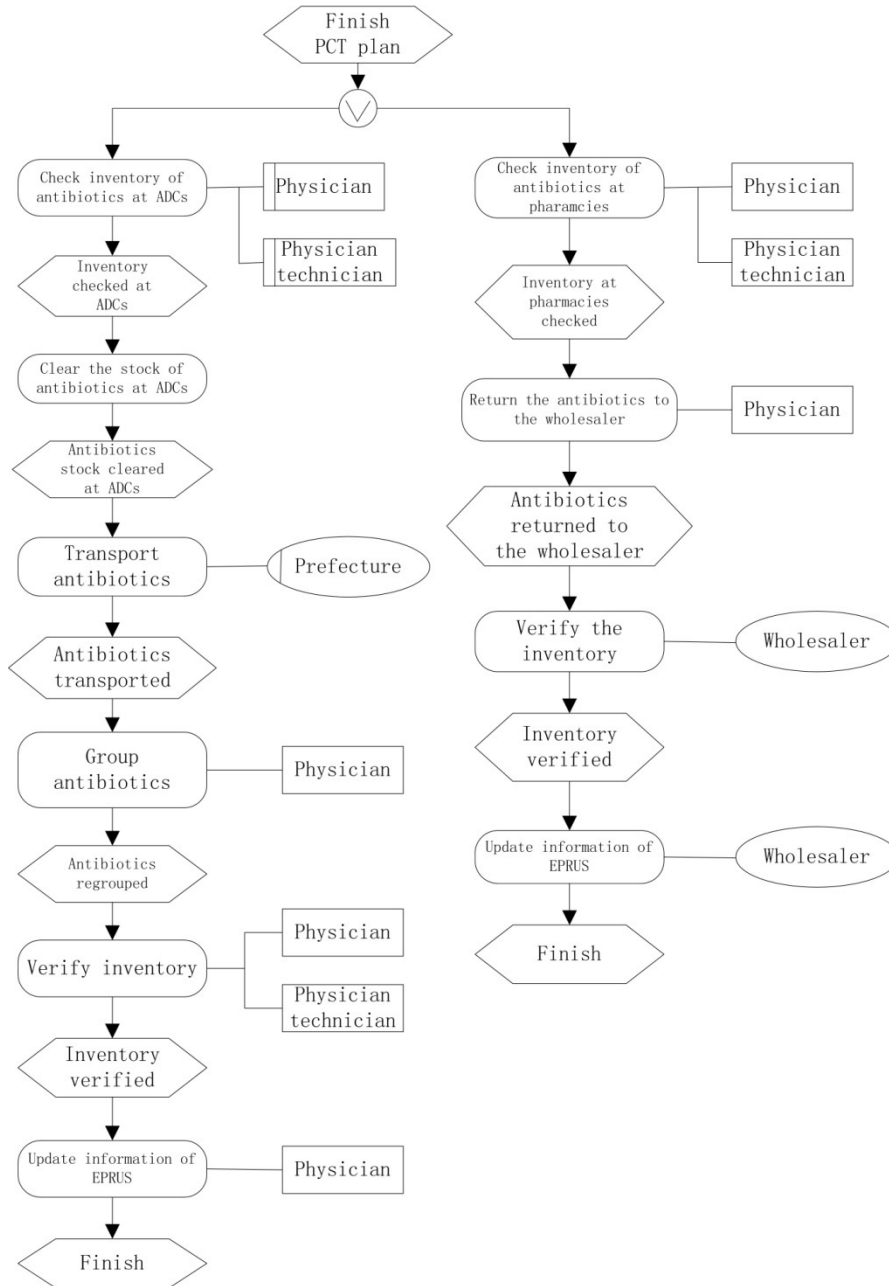

Figure C.10: Finish of disaster.