



**HAL**  
open science

# Modeling and analysis of propagation risks in complex projects: application to the development of new vehicles

Hadi Jaber

## ► To cite this version:

Hadi Jaber. Modeling and analysis of propagation risks in complex projects: application to the development of new vehicles. Chemical and Process Engineering. Université Paris Saclay (COMUE), 2016. English. NNT: 2016SACLCO22 . tel-01327936

**HAL Id: tel-01327936**

**<https://theses.hal.science/tel-01327936>**

Submitted on 7 Jun 2016

**HAL** is a multi-disciplinary open access archive for the deposit and dissemination of scientific research documents, whether they are published or not. The documents may come from teaching and research institutions in France or abroad, or from public or private research centers.

L'archive ouverte pluridisciplinaire **HAL**, est destinée au dépôt et à la diffusion de documents scientifiques de niveau recherche, publiés ou non, émanant des établissements d'enseignement et de recherche français ou étrangers, des laboratoires publics ou privés.

NNT : 2016SACLCO22

THESE DE DOCTORAT  
DE  
L'UNIVERSITE PARIS-SACLAY  
PREPAREE A  
CENTRALESUPELEC

ECOLE DOCTORALE N° 573

Interfaces : approches interdisciplinaires / fondements, applications et innovation  
Spécialité de doctorat : Sciences et technologies industrielles

Par

**M. Hadi Kamal JABER**

Modeling and analysis of propagation risks in complex projects:  
Application to the development of new vehicles

Modéliser et Analyser les risques de propagations dans les projets complexes:  
Application au développement de nouveaux véhicules

**Thèse présentée et soutenue à Châtenay-Malabry, le 11 Mars 2016 :**

**Composition du Jury :**

M. BONJOUR, Éric	Professeur, Université de Lorraine	Président
M. CAILLAUD, Emmanuel	Professeur, Université de Strasbourg	Rapporteur
M. MARMIER, François	Professeur, Ecole des Mines d'Albi-Carmaux	Rapporteur
M. MARLE, Franck	Professeur, CentraleSupélec	Directeur de thèse
M. DIDIEZ Lionel	Chef de Service Ingénierie, Renault S.A.	Examineur
Mme. JANKOVIC, Marija	Professeur, CentraleSupélec	Examinatrice
M. VIDAL, Ludovic-Alexandre	Docteur, CentraleSupélec	Co-encadrant

## Abstract

**Title: Modeling and analysis of propagation risks in complex projects:  
Application to the development of new vehicles.**

**Keywords:** Project risk management, Project complexity, Complex Systems Modeling, Graph theory, Propagation analysis, Topological analysis, Clustering, Decision-making.

Abstract: The management of complex projects requires orchestrating the cooperation of hundreds of individuals from various companies, professions and backgrounds, working on thousands of activities, deliverables, and risks. As well, these numerous project elements are more and more interconnected, and no decision or action is independent. This growing complexity is one of the greatest challenges of project management and one of the causes for project failure in terms of cost overruns and time delays. For instance, in the automotive industry, increasing market orientation and growing complexity of automotive product has changed the management structure of the vehicle development projects from a hierarchical to a networked structure, including the manufacturer but also numerous suppliers. Dependencies between project elements increase risks, since problems in one element may propagate to other directly or indirectly dependent elements. Complexity generates a number of phenomena, positive or negative, isolated or in chains, local or global, that will more or less interfere with the convergence of the project towards its goals. The thesis aim is thus to reduce the risks associated with the complexity of the vehicle development projects by increasing the understanding of this complexity and the coordination of project actors. To do so, a first research question is to prioritize actions to mitigate complexity-related risks. Then, a second research question is to propose a way to organize and coordinate actors in order to cope efficiently with the previously identified complexity-related phenomena.

The first question will be addressed by modeling project complexity and by analyzing complexity-related phenomena within the project, at two levels. First, a high-level factor-based descriptive modeling is proposed. It permits to measure and prioritize project areas where complexity may have the most impact.

Second, a low-level graph-based modeling is proposed, based on the finer modeling of project elements and interdependencies. Contributions have been made on the complete modeling process, including the automation of some data-gathering steps, in order to increase performance and decrease effort and error risk. These two models can be used consequently; a first high-level measure can permit to focus on some areas of the project, where the low-level modeling will be applied, with a gain of global efficiency and impact. Based on these models, some contributions are made to anticipate potential behavior of the project. Topological and propagation analyses are proposed to detect and prioritize critical elements and critical interdependencies, while enlarging the sense of the polysemous word "critical."

The second research question will be addressed by introducing a clustering methodology to propose groups of actors in new product development projects, especially for the actors involved in many deliverable-related interdependencies in different phases of the project life cycle. This permits to increase coordination between interdependent actors who are not always formally connected via the hierarchical structure of the project organization. This allows the project organization to be actually closer to what a networked structure should be. The automotive-based industrial application has shown promising results for the contributions to both research questions. Finally, the proposed methodology is discussed in terms of genericity and seems to be applicable to a wide set of complex projects for decision support.

## Résumé

### **Titre : Modéliser et Analyser les risques de propagations dans les projets complexes: Application au développement de nouveaux véhicules.**

**Mots clés :** Gestion de risques projet, Complexité projet, Modélisation de systèmes complexes, Théorie des graphes, analyse de la propagation, analyse topologique, Clustering, prise de décision.

**Résumé :** La gestion de projets complexes nécessite d'orchestrer la coopération de centaines de personnes provenant de diverses entreprises, professions et compétences, de travailler sur des milliers d'activités, livrables, objectifs, actions, décisions et risques. En outre, ces nombreux éléments du projet sont de plus en plus interconnectés, et aucune décision ou action n'est indépendante. Cette complexité croissante est l'un des plus grands défis de la gestion de projet et l'une des causes de l'échec du projet en termes de dépassements de coûts et des retards. Par exemple, dans l'industrie automobile, l'augmentation de l'orientation du marché et de la complexité croissante des véhicules a changé la structure de gestion des projets de développement de nouveaux véhicules à partir d'une structure hiérarchique à une structure en réseau, y compris le constructeur, mais aussi de nombreux fournisseurs. Les dépendances entre les éléments du projet augmentent les risques, car les problèmes dans un élément peuvent se propager à d'autres éléments qui en dépendent directement ou indirectement. La complexité génère un certain nombre de phénomènes, positifs ou négatifs, isolés ou en chaînes, locaux ou globaux, qui vont plus ou moins interférer avec la convergence du projet vers ses objectifs. L'objectif de la thèse est donc de réduire les risques associés à la complexité des projets véhicules en augmentant la compréhension de cette complexité et de la coordination des acteurs du projet. Pour ce faire, une première question de recherche est de prioriser les actions pour atténuer les risques liés à la complexité. Puis, une seconde question de recherche est de proposer un moyen d'organiser et de coordonner les acteurs afin de faire face efficacement aux phénomènes liés à la complexité identifiés précédemment.

La première question sera abordée par la modélisation de complexité du projet en analysant les phénomènes liés à la complexité dans le projet, à deux niveaux. Tout d'abord, une modélisation descriptive de haut niveau basée

facteurs est proposé. Elle permet de mesurer et de prioriser les zones de projet où la complexité peut avoir le plus d'impact. Deuxièmement, une modélisation de bas niveau basée sur les graphes est proposée. Elle permet de modéliser plus finement les éléments du projet et leurs interdépendances. Des contributions ont été faites sur le processus complet de modélisation, y compris l'automatisation de certaines étapes de collecte de données, afin d'augmenter les performances et la diminution de l'effort et le risque d'erreur. Ces deux modèles peuvent être utilisés en conséquence; une première mesure de haut niveau peut permettre de se concentrer sur certains aspects du projet, où la modélisation de bas niveau sera appliquée, avec un gain global d'efficacité et d'impact. Basé sur ces modèles, certaines contributions sont faites pour anticiper le comportement potentiel du projet. Des analyses topologiques et de propagation sont proposées pour détecter et hiérarchiser les éléments essentiels et les interdépendances critiques, tout en élargissant le sens du mot polysémique "critique".

La deuxième question de recherche sera traitée en introduisant une méthodologie de « Clustering » pour proposer des groupes d'acteurs dans les projets de développement de nouveaux produits, en particulier pour les acteurs impliqués dans de nombreuses interdépendances liées aux livrables à différentes phases du cycle de vie du projet. Cela permet d'accroître la coordination entre les acteurs interdépendants qui ne sont pas toujours formellement reliés par la structure hiérarchique de l'organisation du projet. Cela permet à l'organisation du projet d'être effectivement plus proche de la structure en « réseau » qu'elle devrait avoir. L'application industrielle aux projets de développement de nouveaux véhicules a montré des résultats prometteurs pour les contributions aux deux questions de recherche. Enfin, la méthodologie proposée est discutée en termes de généralité et semble être applicable à un large éventail de projets complexes pour l'aide à la décision.



## **Extended summary: Modeling and analysis of propagation risks in complex projects: Application to the development of new vehicles**

---

The management of complex projects requires orchestrating the cooperation of hundreds of individuals from various companies, professions and backgrounds, working on thousands of activities, deliverables and risks. As well, these numerous project elements are more and more interconnected, and no decision or action is independent. The aim is to optimize and achieve numerous economic and technical objectives within a high competitive environment in each market segment. Moreover, the complexity of the final deliverable, the vehicle, makes the project far more complex since each decision, whether on product or project parameters, may influence other dimensions (respectively project or product). This growing complexity is one of the greatest challenges of project management and one of the causes for project failure in terms of cost overruns and time delays. For instance, in the automotive industry, increasing market orientation and growing complexity of automotive product has changed the management structure of these vehicle development projects from a hierarchical to a networked structure, including the manufacturer but also numerous suppliers. These multiple dependencies between project elements increase risks since problems in one element may propagate to other directly or indirectly dependent elements. Complexity generates a number of phenomena, positive or negative, isolated or in chains, local or global, that will more or less interfere with the convergence of the project towards its goals. In particular, Renault's vehicles projects are based on phases structured within the development logic. The transition from one phase to another is marked by a project milestone. The crossing of a project milestone is delivered based on the analysis of the project's progress against expected results. The milestones and synchronization points structure the process of automotive product development into phases that permit the assessment of the current project status at each gate. This structure gives measurements indicating if deliverables are achieved or if additional actions have to be undertaken. It also supports the coordination between manufacturers, suppliers and development partners. Unceasing monitoring and control of milestones, cost, project objectives, and tasks characterize these projects. Theoretically, this structure of vehicle projects with many milestones reduces the transmission of risks and the domino effects. Nevertheless, in practice, there may be propagation from one « upstream » risk to numerous « downstream » risks, which may be in different phases (“trans-milestones”) and through numerous interfaces within the organization (“trans-organization”). The main industrial challenge is to improve continuously the economic performance of projects and meet the deadlines set. The feedback of past projects revealed some examples of impacts propagation about some purchasing choices of mono-sourcing, and some choices about technical process of some pieces, that generate an impact propagation chain that amplify the charges and increase the logistics costs due to accumulated events. Renault seeks to know better the impact of the choices made and ensure that the decisions taken subsequently will not generate adverse or unanticipated effects. This will be developed in Chap. 1.

The thesis aim is thus to reduce the risks associated with the complexity of the vehicle development projects by increasing the understanding and anticipation of complexity-related phenomena and coordination of actors. Chap. 2 will introduce the two research questions arising from the industrial challenge and the limits of existing work.

First, the performance of a project is related to its complexity. More complex projects may require an additional level of control. This complexity needs to be managed properly and understanding its specific aspects at an early stage can aid in reducing risks and assisting a project in reaching its objectives. More specifically, multiple dependencies between project elements related to product, process and organization dimensions increase risks since problems in one element may propagate to other directly or indirectly dependent elements. The way interdependencies are modeled and treated is crucial for the capacity of analysis and decision (Eppinger and Browning, 2012); (Mane et al., 2011). Complexity needs then to be described and modeled, in order to be able to identify and prioritize mitigation actions that will reduce it, or at least keep its consequences under control. **A first research question is thus to prioritize actions to mitigate complexity-related risks.**

Second, the managerial issues potentially associated to the monitoring and control of impact propagation in a complex project are mainly related to its inability to be broken down into independent parts. This is true for all types of systems, whether natural, technical or human. The consequence is that, whatever the way the system is broken down, there will always be interdependencies between the parts, here the organizational boundaries of the project decomposition. Projects can be decomposed into either Activities- or Deliverables-related elements, phases or organizational entities, but there will always be numerous interdependencies between actors who do not belong to the same part. This implies risk of bad communication, bad coordination or locally optimal decisions. The way that project members are organized is crucial to determine how they will be able to cope collectively with nontrivial problems and risks. Current project organizations are generally based on single-criterion decompositions, whether product- or process- or organizational entity-based. The organizational literature recognizes the challenge faced by organizations when attempting to coordinate the links between the components of the system they develop (Sanchez and Mahoney, 1996); (Terwiesch et al., 2002). Due to the number of interactions outside the official project structures, the danger is that the communication and coordination between actors may not be correctly done. **Then, a second research question is to propose a way to organize and coordinate actors in order to cope efficiently with the previously identified complexity-related phenomena.**

We started by analyzing the observed phenomenon (the industrial need), in addition to studying the knowledge base in literature in order to establish the knowledge gap. Our methodology encompasses distinct phases of audit and diagnostic, formulation of encountered scientific issues, data collection and analysis, proposition of new models and methods to end up with industrial implementations. It consists of four distinct

contributions, the first three addressing the first research question (corresponding to Chap. 3 to 5), and the fourth one addressing the second question (corresponding to Chap. 6).

The first question will be addressed by modeling and measuring project complexity and by analyzing complexity-related phenomena within the project. This is based on an analysis at 2 levels. First, a high-level factor-based descriptive modeling is proposed in Chap. 3. It permits to measure and prioritize areas and domains where complexity may have the highest impact. This thesis explores the complexity modelling theory, including existing and emergent theories, and develops a framework and a score sheet to measure project complexity. Project complexity literature is analyzed and used in conjunction with project practitioners' interviews to identify and classify related factors, while highlighting benefits in pertaining. This work presents original identification and classification of project complexity factors while simultaneously highlighting the potential benefits of project complexity indicators. These benefits are recognized from current applications of this framework in an automotive manufacturer. A framework comprising ninety factors is presented and divided into seven categories: Stakeholders, Project Team, Project Governance, Product, Project Characteristics, Resources and Environment. Current application on vehicle development projects highlights the potential benefits of complexity evaluation. This framework tries to be exhaustive and generic, even though it is likely to be adapted to specific contexts. For the project complexity assessment grid, a brainstorming procedure was applied to prioritize and weight its factors. The score sheet is designed to be practical in order to customize easily the factors and the weights of each category, and the weights of factors. We then propose a multi-criteria approach to project complexity evaluation, underlining the benefits of such an approach. In order to solve properly this multi-criteria problem, we first conduct a critical state of the art on multi-criteria methodologies. We then argue for the use of the TOPSIS method. It also has a visual reporting mechanism designed to provide early-warning signs with the possibility of comparing its findings with other projects. Practical applications on vehicle development projects highlight the benefits of such an approach for managers, in order to detect, anticipate and keep under control complex situations before they have negative consequences. Establishing an objective and standardized measure permits a retrospective analysis of previous projects. This is needed to assess the impact of the complexity sources on the achievement of the project goals and their influence on the cost and the staffing level. Moreover, its application in the upstream stage permits to highlight areas which have a high complexity, in order to: 1) anticipate their impact by comparing to other projects; and 2) plan mitigation actions to reduce risks associated with complexity, for example, adopting a simpler process, choosing a more stable supplier or increasing communication frequencies between actors.

Second, a low-level graph-based modeling is proposed in Chap. 4, based on the finer modeling of project elements and interdependencies. Contributions have been made on the complete modeling process, including the automation of some data gathering steps, in order to increase performance and decrease effort and error risk. This thesis explored the systems modeling theory, including existing and emergent theories,

like hierarchical representation of complex systems (Gomez et al. 2011) or Dependency and Structure Modeling approach (DSM) developed by Steward, Eppinger and Browning... One scientific issue of this thesis is the number of elements and the number of interactions between these elements that does not always enable to use classical methods, which have proven their usefulness on smaller systems. This thesis proposes a modeling approach of complex projects using weighted directed graph (matrix-based modeling) which takes into account the huge number of project elements that will be manipulated. We introduce interactions in some domains which may still consider elements as if they were independent. This approach models the interdependencies between risks, deliverables, processes, systems, actors, and organizational entities. To run this modeling in an efficient and ergonomic way, we propose a framework that allows the user to enter, calculate and operate efficiently and ergonomically the input data. The input data are analyzed in a simple and non-matrix format in Excel, and an automated process creates the corresponding graph (Design Structure Matrix). This framework allows to extract the global network of project elements from local interactions data, as well as the extraction of the exhaustive list of interactions between two elements via other elements. Furthermore, it contains an algorithm for bidirectional transformation frame between the global network and its corresponding local data to update continuously the input and the output data. To increase the reliability of interactions-based models used for further analyses, we propose a reciprocal enrichment procedure to complete these models and reduce the gap between the reality and the models by providing more complete, consistent and stable information on the interactions between project elements. From a practical perspective, the information captured in one domain is used for mutual enrichment of both models, with the aim of better understanding and thus better anticipation of the propagation phenomena in order to control more effectively the project evolution. The industrial application has shown concrete results by improving the initial project model within the organization with both detecting (automatic reporting) and correcting initial anomalies. In addition, some tasks and deliverables were re-organized using the benefits of the global view of deliverables network. In brief, the quality of documents associated to the new vehicle development logic has been improved.

The two models presented respectively in Chapters 3 and 4 can be used independently or consequently. Namely, a first high-level measure can permit to focus on some project areas where the low-level modeling will be applied, with a gain of global efficiency and impact.

Based on these models, some contributions are made in Chap. 5 to anticipate potential behavior of the project. Topological and propagation analyses are made to detect and prioritize critical elements and critical interdependencies, while enlarging the sense of the polysemous word “critical”. After a literature review on the topological indicators of nodes and arcs of weighted directed graphs, their applications and interpretations, we propose a set of indicators suitable for project elements, which mainly allow us to discuss “What is the impact of an element to other elements within the network? What is the collective influence of this element?”. These indicators permit to prioritize project elements and their connections according to their importance

within the network (the most influential elements and interactions taking into account the entire pattern of the network). For example, they permit to evaluate the collective criticality of project deliverables and to re-evaluate the priority of the project risks by coupling the traditional features of individual risks with the highest topological indicators of the risk network. Furthermore, some algorithms are applied to extract and visualize the propagation path between two elements within the network. For example, this allows to provide a vision of impact propagation between the project deliverables, with an option to focus on the chain that connects two deliverables associated with two milestones or on the chain that connects two critical deliverables. The industrial application on vehicle development projects is performed to build up and analyze the interactions-based project network. Firstly, this work was on the direct analysis of risks in vehicle projects, but it has been cancelled because of incomplete or poorly documented data. The initial investigation field was therefore limited to focusing on indirect risk analysis in vehicle projects via the analysis of propagation risks between deliverables, either on milestones or between two milestones. The obtained results demonstrate that the topological network analysis adds value to the classical project risk analysis, in identifying both the influential elements and the important interactions with respect to their role in the network behavior. Furthermore, the proposed analysis gives additional information for the decision-making in monitoring and controlling the impact propagation, since risks or deliverables may be considered influential for criticality and/or topological reasons. That is to say, a deliverable taken individually may be non-critical, but through interactions could become the source of impact propagation to some critical ones. The same analysis was done on the relationships between deliverables to evaluate the most crucial edges in the network structure. Overall, these reduce project complexity by mastering better the phenomenon of propagation. Based on the analysis outcomes, we demonstrate the effectiveness of using network theory for project elements topological analysis. The proposed method is generic and could be applicable to a wide set of engineering projects for decision support.

The second research question is addressed in Chap. 6 by introducing a clustering methodology to propose groups of actors in new product development projects, especially for the actors involved in many deliverable-related interdependencies in different phases of the project life cycle. This permits to increase coordination between interdependent actors who are not always formally connected via the hierarchical structure of the project organization. We propose an approach to form complementary teams of actors according to the relationships they have due to their deliverable exchanges. This enables potential issues due to complexity, like bad communication and coordination, to be dealt with actors who are not initially put together. Therefore, we propose a “mastering of impact propagation” organization with the objective of taking into account interdependencies between actors to mitigate risks due to the project complex structure. As underlined by Morel, the organization is an adaptive and evolving system which has to correspond to the complexity of the situation it has to manage (Morel and Ramanujam, 1999). To do this, clustering aims at maximizing the amount of interactions within clusters. A desired consequence is an increase in organizational

capacity, in terms of communication and coordination between potentially interacting actors, and a reduction of potential propagation of the occurrence of one or several risks. Clustering is thus an appropriate action to improve project members and managers' risk attitude (Van Bossuyt et al., 2013), which means an improvement of how individual members will respond to risk in their activities once they are grouped with interconnected people, and a higher level of coordination between multi-domain and multi-timeframe decisions. Similar clustering-related works exist, either about risks (Marle and Vidal, 2014), or more often about other elements in order to indirectly assess and mitigate risks. These elements are generally related to one of the main project domains, product, process or organization. Our contribution is a three-stage process for clustering a network of project elements. The first stage is information gathering, about input data and parameters definition. The second stage consists in running each algorithm many times with several problem configurations. Afterwards, we obtain a number of clustered solutions, with quality indicators for each solution and for each cluster in the solution. In addition, a frequency analysis is done to indicate the number of times that each couple of elements (actors in our case study) were put together in a clustered solution. The idea is that the more often pairs of actors are proposed together in the different configurations, then the more robust the decision of putting them together in the final solution is. The third stage is the post processing of the obtained results. This is done by combining extractions of particular clusters or pieces of clusters from different solutions. This combination is based on the quality indicators and the frequency analysis on the results (the number of times the couple of actors were put together). A hybrid solution, that meets at best the needs of the decision maker, is built using a mix of best clusters from all configurations. This approach has been illustrated through actual data in a new product development project in the automotive industry, more precisely. The industrial application has shown promising results by grouping people according to interdependencies, changing more or less the way that actors were initially organized.

New vehicle development projects are very complex projects with innovative technology and a dynamic organization that changes continuously to improve economic performance. The complexity of vehicle development projects cannot be solved and must be managed because the performance results from the projects are related to its complexity. Modeling and analyzing the interactions between risks, deliverables, process, product architecture and actors contribute in understanding the complexity aspects in order to reduce them in making decisions. This allows to understand and thus anticipate better the propagation phenomena in order to act more effectively to control the project evolution. The automotive-based industrial application has shown promising results for the contributions to both research questions. Finally, the proposed methodology is discussed in terms of genericity and seems to be applicable to a wide set of complex projects for decision support.

**Keywords:** Project risk management, Project complexity, Complex Systems Modeling, Graph theory, Propagation analysis, Topological analysis, Clustering, Decision-making.

# Résumé étendu: Modélisation et analyse des risques de propagations dans les projets complexes: Application au développement de nouveaux véhicules

---

La gestion de projets complexes nécessite d'orchestrer la coopération de centaines de personnes provenant de diverses entreprises, professions et compétences, de travailler sur des milliers d'activités, livrables, objectifs, actions, décisions et risques. En outre, ces nombreux éléments du projet sont de plus en plus interconnectés, et aucune décision ou action n'est indépendante. Cette complexité croissante est l'un des plus grands défis de la gestion de projet et l'une des causes de l'échec du projet en termes de dépassements de coûts et des retards. Par exemple, dans l'industrie automobile, l'augmentation de la segmentation du marché et la complexité croissante des véhicules ont changé la structure de gestion des projets de développement de nouveaux véhicules. On constate une évolution d'une structure hiérarchique vers une structure en réseau, pour le constructeur, mais aussi pour de nombreux fournisseurs. Les dépendances entre les éléments du projet augmentent les risques, car les problèmes dans un élément peuvent se propager à d'autres éléments qui en dépendent directement ou indirectement. La complexité génère un certain nombre de phénomènes, positifs ou négatifs, isolés ou en chaînes, locaux ou globaux, qui vont plus ou moins interférer avec la convergence du projet vers ses objectifs.

En particulier, les projets véhicules chez Renault sont basés sur des phases structurées en dizaines de jalons dans la logique de développement (Amont, Développement, Industrialisation...). Le passage d'une phase à une autre est marqué par un jalon projet. Le jalonnement qualité des projets véhicules a trois fonctions d'assistance principales: Synchroniser tous les acteurs du projet ; Garantir en continu la tenue de la trajectoire de convergence du projet ; Autoriser l'engagement des étapes ultérieures. Le franchissement du jalon projet est prononcé sur la base de l'analyse de l'état d'avancement du projet par rapport aux résultats décisifs attendus. Cette structure en jalons prend également en charge la coordination entre le constructeur, les fournisseurs et les partenaires au développement. La surveillance et le contrôle continus des tâches, des jalons, des coûts, et des objectifs caractérisent ces projets. Théoriquement, cette structure de projets véhicule avec de nombreux jalons réduit la transmission des risques et les effets domino. Néanmoins, dans la pratique, il peut y avoir propagation d'un risque «en amont» vers de nombreux risques «en aval». Ces propagations peuvent être entre différentes phases «Trans-jalons», et par le biais de nombreuses interfaces entre les entités structurelles de l'organisation ("Trans-organisation"). Le principal défi industriel est d'améliorer continuellement la performance économique des projets et de respecter les échéances fixées. Les retours d'expérience de projets antérieurs ont révélé quelques exemples de propagations d'impacts à propos de certains choix d'achat de logistique « mono-sourcing », et certains choix sur le processus technique de quelques pièces, qui génèrent une chaîne de propagation d'impacts amplifiant les charges et les coûts logistiques en raison d'événements accumulés. Renault cherche à mieux connaître l'impact des choix opérés et à s'assurer que les



décisions prises par la suite ne généreront pas d'effets indésirables ou imprévus. Ceci sera développé dans le chapitre. 1.

L'objectif de la thèse est donc de réduire les risques associés à la complexité des projets véhicules en augmentant la compréhension de cette complexité et la coordination des acteurs du projet. Le chapitre 2 présentera les deux questions de recherche provenant de l'enjeu industriel et les limites de travaux existants.

Tout d'abord, la performance du projet est liée à sa complexité. Les projets les plus complexes peuvent exiger un niveau de contrôle supplémentaire. Cette complexité doit être gérée correctement et la compréhension de ses aspects spécifiques à un stade précoce peut aider à réduire les risques et à atteindre les objectifs du projet. Plus précisément, des dépendances multiples entre les éléments du projet liés au produit, processus et organisation augmentent les risques. La façon dont les interdépendances sont modélisées et traitées est cruciale pour la capacité d'analyse et de décision (Eppinger and Browning, 2012; Mane et al., 2011). La complexité doit ensuite être décrite et modélisée, afin d'être en mesure d'identifier et de prioriser les actions d'atténuation qui permettront de réduire, ou au moins garder ses conséquences sous contrôle. Pour ce faire, **une première question de recherche est de prioriser les actions pour atténuer les risques liés à la complexité.**

Deuxièmement, les problèmes de gestion potentiellement associés à la surveillance et le contrôle de la propagation des impacts dans un projet complexe sont principalement liés à son incapacité à être décomposé en parties indépendantes. Cela est vrai pour tous les types de systèmes, qu'ils soient naturels, techniques ou humains. La conséquence est que, quelle que soit la façon dont le système est décomposé, il y aura toujours des interdépendances entre les parties. Dans le contexte de cette thèse, les limites de l'organisation correspondent à la décomposition du projet. Les projets peuvent être décomposés en éléments liés aux activités, livrables, phases ou entités organisationnelles, mais il y aura toujours de nombreuses interdépendances entre les acteurs qui n'appartiennent pas à la même entité. Cela implique des risques de mauvaise communication, mauvaise coordination ou de décisions optimisées localement mais négligeant le reste du projet. La façon dont les membres du projet sont organisés est cruciale pour déterminer comment ils vont être en mesure de faire face collectivement à des problèmes et des risques non triviaux. Les organisations actuelles du projet sont généralement basés sur des décompositions monocritère, à base des entités du produit ou processus ou organisationnelles. La littérature organisationnelle reconnaît le défi à relever par les organisations lors de la tentative de coordonner les liens entre les éléments du système qu'ils développent (Sanchez and Mahoney, 1996; Terwiesch et al., 2002). En raison du nombre élevé d'interactions en dehors des structures officielles du projet, le danger est que la communication et la coordination entre les acteurs ne puissent pas être faites correctement. De cela découle **une seconde question de recherche qui consiste à proposer un moyen d'organiser et de coordonner les acteurs afin de faire face efficacement aux phénomènes liés à la complexité identifiés précédemment.**

Nous avons commencé par analyser le phénomène observé (le besoin industriel), en plus d'étudier la base de connaissances dans la littérature afin d'établir l'écart des connaissances. Notre méthodologie englobe des phases distinctes de l'audit et de diagnostic, la formulation des questions scientifiques rencontrées, la collecte et l'analyse de données et la proposition de nouveaux modèles et méthodes pour aboutir à des réalisations industrielles. Notre approche se compose de quatre contributions distinctes, les trois premières pour répondre à la première question de recherche (correspondant au chap. 3 à 5), et la quatrième abordant la deuxième question (correspondant au chap. 6).

La première question sera abordée par la modélisation de complexité du projet en analysant les phénomènes liés à la complexité dans le projet, à deux niveaux. Tout d'abord, une modélisation descriptive de haut niveau orientée facteurs de complexité est proposée dans le chapitre 3. Elle permet de mesurer et de prioriser les zones et les domaines de projet où la complexité peut avoir le plus d'impact. Cette thèse explore la théorie de la modélisation de la complexité, y compris les théories existantes et émergentes, et développe un référentiel et une feuille de pointage pour mesurer la complexité du projet. La littérature de la complexité du projet est analysée et utilisée en conjonction avec des interviews de praticiens de projet pour identifier et classer les facteurs de complexité, tout en soulignant les avantages rapportés par le diagnostic de cette complexité. Ce travail présente une identification et classification originales des facteurs de complexité projet tout en soulignant en même temps les avantages potentiels des indicateurs de complexité du projet. Ces avantages sont reconnus à partir des applications actuelles de ce référentiel au sein du constructeur automobile. Ce référentiel comprenant quatre-vingt-dix facteurs est présenté et divisé en sept catégories: les parties prenantes, l'équipe projet, la gouvernance du projet, le produit, les caractéristiques du projet, les ressources et l'environnement. L'application actuelle sur les projets de développement du véhicule met en évidence les avantages potentiels de l'évaluation de la complexité. Ce référentiel essaye d'être exhaustif et générique, même si il est susceptible d'être adapté à des contextes spécifiques. Pour la grille d'évaluation de la complexité projet, une procédure de Brainstorming a été appliquée pour prioriser et pondérer ses facteurs. La feuille de pointage est conçue pour être pratique afin de personnaliser et pondérer facilement les facteurs de chaque catégorie, et pondérer chaque catégorie. Nous proposons ensuite une approche d'évaluation multicritère de complexité projet en soulignant les avantages d'une telle approche. Afin de résoudre correctement ce problème multicritères, nous effectuons d'abord un état de l'art critique sur les méthodes multicritères. Nous faisons le choix d'utiliser la méthode TOPSIS. La feuille de pointage dispose également d'un mécanisme de rapport visuel conçu pour fournir des signes d'alerte précoces avec la possibilité de comparer ses résultats avec d'autres projets. Les applications pratiques sur des projets de développement de véhicules soulignent les avantages d'une telle approche pour les gestionnaires, afin de détecter, anticiper et garder sous contrôle des situations complexes avant qu'elles n'aient des conséquences négatives. L'établissement d'une mesure objective et standardisée permet une analyse rétrospective des projets précédents. Cela est nécessaire pour évaluer l'impact des sources de complexité sur la réalisation des objectifs du projet et leur influence sur le coût et le niveau des

effectifs. En outre, son application en phase amont, permet de mettre en évidence les zones qui ont une grande complexité, afin de: 1) anticiper leur impact en comparant à d'autres projets; et 2) mettre en place des plans d'actions pour atténuer les risques associés à la complexité. Par exemple, on peut se tourner vers l'adoption d'un processus plus simple, le choix d'un fournisseur plus stable ou l'augmentation des fréquences de communication entre les acteurs.

Deuxièmement, une modélisation de bas niveau basée sur les graphes est proposée dans le chapitre 4. Elle permet de modéliser plus finement les éléments du projet et leurs interdépendances. Des contributions ont été faites sur le processus complet de modélisation, y compris l'automatisation de certaines étapes de collecte de données, afin d'augmenter les performances et la diminution de l'effort et le risque d'erreur. Cette thèse explore la théorie de la modélisation des systèmes complexes, y compris les théories existantes et émergentes, comme la représentation hiérarchique de systèmes complexes (Gomez et al., 2011) ou l'approche de modélisation de la structure et les dépendances (DSM) développée par Steward, Eppinger et Browning (Steward, 1981), (Eppinger and Browning, 2012)... Un défi scientifique de cette thèse est le nombre élevé d'éléments et leurs nombreuses interactions qui ne permettent pas toujours d'utiliser les méthodes classiques qui ont prouvé leur utilité sur les petits systèmes. Cette thèse propose une approche de modélisation de projets complexes à l'aide de graphes orientés pondérés (modélisation matricielle) qui prend en compte le grand nombre d'éléments du projet qui seront manipulés. Nous introduisons des interactions entre certains éléments qui étaient auparavant considérés comme indépendants. Nous modélisons les interdépendances entre les risques, les livrables, les processus, les systèmes, les acteurs et les entités organisationnelles. Pour exécuter cette modélisation d'une manière efficace et ergonomique, nous proposons un Framework qui permet à l'utilisateur d'entrer, de calculer et de traiter efficacement et ergonomiquement les données d'entrée. Les données d'entrée sont analysées dans un format simple non-matriciel dans des fichiers Excel, et un processus automatisé crée le graphe correspondant (Design Structure Matrix). Ce Framework permet d'extraire le réseau global des éléments du projet à partir de données d'interactions locales, ainsi que l'extraction de la liste exhaustive des interactions entre deux éléments précis via d'autres éléments de différents types. En outre, ce Framework contient un algorithme pour une transformation bidirectionnelle entre le réseau global et ses données locales correspondantes, afin de mettre à jour en permanence les données d'entrée d'analyse et les résultats associés. Pour augmenter la fiabilité des modèles basés sur les interactions, qui seront utilisés pour d'autres analyses, nous proposons une procédure d'enrichissement réciproque. Ceci permet de finaliser ces modèles et réduire l'écart entre la réalité et ces modèles en fournissant des informations plus complètes, cohérentes et stables sur les interactions entre les éléments du projet. D'un point de vue pratique, l'information saisie dans un domaine est utilisée pour l'enrichissement mutuel des deux modèles, dans le but de mieux comprendre et donc mieux anticiper les phénomènes de propagation afin de contrôler plus efficacement l'évolution du projet. L'application industrielle a montré des résultats concrets en améliorant le modèle initial

du projet au sein de l'organisation ; à la fois par la détection des anomalies (reporting automatique) et leurs corrections. En outre, certaines tâches et certains livrables ont été réorganisés en utilisant les avantages de la vision globale du réseau de livrables. En bref, la qualité des documents associés à la nouvelle logique de développement de nouveaux véhicules a été améliorée.

Les deux modèles sont présentés respectivement dans les chapitres 3 et 4. Ces deux modèles peuvent être utilisés conjointement; une première mesure de haut niveau peut permettre de se concentrer sur certains aspects du projet, où la modélisation de bas niveau sera appliquée, avec un gain global d'efficacité et d'impact.

Basé sur ces modèles, certaines contributions sont faites dans le chapitre 5 pour anticiper le comportement potentiel du projet. Des analyses topologiques et de propagation sont proposées pour détecter et hiérarchiser les éléments essentiels et les interdépendances critiques, tout en élargissant le sens du mot polysémique "critique". Après une revue de la littérature poussée sur les indicateurs topologiques des nœuds et des arcs au sein de graphes orientés pondérés, leurs applications et leurs interprétations, nous proposons un ensemble d'indicateurs adaptés aux éléments du projet. Ces indicateurs nous permettent de répondre aux questions: "Quel est l'impact d'un élément à d'autres éléments au sein du réseau? Quelle est l'influence collective de cet élément?". Ces indicateurs permettent de hiérarchiser les éléments du projet et leurs connexions en fonction de leur importance au sein du réseau (les éléments et les interactions les plus influents en tenant compte de la structure globale du réseau). Par exemple, ils permettent d'évaluer la criticité collective des livrables du projet et de réévaluer la priorité des risques projet en couplant leurs caractéristiques traditionnelles avec les indicateurs topologiques de réseau des risques. En outre, certains algorithmes sont appliqués pour extraire et visualiser les chemins de propagation entre deux éléments du réseau. Par exemple, cela permet de donner une vision de la propagation de l'impact entre les livrables du projet, en laissant l'option de se concentrer sur la chaîne qui relie deux livrables associés à deux jalons ou sur la chaîne qui relie deux livrables critiques. L'application industrielle aux projets de développement de nouveaux véhicules est effectuée pour construire et analyser le réseau d'interactions du projet. Tout d'abord, ce travail a commencé sur l'analyse des interactions directes entre les risques dans les projets de véhicules mais il a été contrecarré par des données terrain incomplètes ou mal documentées. Le champ d'investigation initial a donc été limité pour se concentrer sur l'analyse indirecte des risques par l'intermédiaire de l'analyse des risques de propagation entre les livrables que ce soit aux jalons ou entre deux jalons. Les résultats obtenus démontrent que l'analyse de réseau topologique ajoute de la valeur à l'analyse classique des risques du projet, en identifiant à la fois les éléments critiques et les interactions importantes selon leurs rôles dans le comportement du réseau. De plus, l'analyse proposée donne des informations supplémentaires pour la prise de décision en matière de surveillance et de contrôle de la propagation de l'impact, car les risques ou livrables peuvent être considérés comme critiques pour des raisons de criticité individuelle ou collective (pour des raisons topologiques). En d'autres termes, un livrable considéré individuellement peut être non-critique, mais peut devenir la source de propagation de l'impact vers d'autres livrables critiques eu égard à ses interactions. La même analyse a été

faite sur les relations entre les livrables pour évaluer les interactions dans la structure du réseau. A partir des résultats de l'analyse, nous démontrons l'efficacité de l'application de la modélisation des éléments projet en graphes et l'analyse topologique associée. La méthode proposée est générique et peut être applicable à un large éventail de projets complexes pour l'aide à la décision.

La deuxième question de recherche sera traitée dans le chapitre 6 en introduisant une méthodologie de « Clustering » pour proposer des groupes d'acteurs dans les projets de développement de nouveaux produits, en particulier pour les acteurs impliqués dans de nombreuses interdépendances liées aux livrables à différentes phases du cycle de vie du projet. Cela permet d'accroître la coordination entre les acteurs interdépendants qui ne sont pas toujours formellement reliés par la structure hiérarchique de l'organisation du projet. Cela permet à l'organisation du projet d'être effectivement plus proche de la structure en « réseau » qu'elle devrait avoir. Nous proposons une approche pour former des équipes complémentaires d'acteurs selon les relations qu'ils ont, via leurs échanges de livrables. Cela permet d'éviter des problèmes potentiels engendrés par la complexité projet, comme la mauvaise communication et coordination ; qui nécessitent d'être traités entre des acteurs qui ne sont pas initialement mis ensemble. Par conséquent, nous proposons une organisation pour maîtriser la propagation des impacts, qui prend en compte les interdépendances entre les acteurs pour atténuer les risques engendrés par la structure complexe du projet. Comme souligné par Morel et Ramanujam, l'organisation est un système adaptatif et évolutif, qui doit correspondre à la complexité de la situation qui doit être gérée (Morel and Ramanujam, 1999). Pour ce faire, le regroupement (Clustering) vise à maximiser la quantité d'interactions au sein des clusters. Une conséquence souhaitée est une augmentation de la capacité organisationnelle, en termes de communication et de coordination entre les acteurs potentiellement en interaction, et une réduction de la propagation potentielle de l'occurrence d'un ou plusieurs risques. Le Clustering est donc une action appropriée pour améliorer la conduite de gestionnaires des risques et les acteurs du projet (Van Bossuyt et al., 2013), ce qui signifie une amélioration de la façon dont les membres individuels réagissent aux risques dans leurs activités, une fois qu'ils sont regroupés avec les gens interconnectés, avec un niveau supérieur de coordination pour les décisions inter-domaines et inter-jalons. Des travaux similaires de regroupement existent, que ce soit sur les risques (Marle and Vidal, 2014), ou plus souvent sur d'autres éléments afin d'évaluer et atténuer les risques indirectement. Ces éléments sont généralement liés à l'un des principaux domaines de projet : les processus, le produit, et l'organisation. La solution optimale pour le Clustering d'un graphe orienté pondéré n'existe pas. L'objectif est de trouver la meilleure solution possible. Notre contribution est de proposer un processus de Clustering en trois étapes pour regrouper les éléments de projet modélisés en réseau. La première étape est la collecte d'informations sur les données d'entrée et de définition des paramètres. La deuxième étape consiste en l'exécution répétée de plusieurs algorithmes avec plusieurs configurations et paramètres. Ensuite, nous obtenons un certain nombre de solutions de Clustering, avec des indicateurs de qualité pour chaque solution et pour chaque cluster de la solution. De plus, une analyse

fréquentielle est faite pour indiquer le nombre de fois que chaque couple d'éléments (« acteurs » dans notre étude de cas) a été mis en place en cluster dans une solution. L'idée est que les paires d'acteurs qui sont proposés ensemble le plus souvent dans les différentes configurations rendent la décision de les mettre ensemble dans la solution finale plus robuste. La troisième étape est le post-traitement des résultats obtenus. Ceci est fait en combinant les extractions des clusters ou des morceaux de différents clusters parmi des solutions originales. Cette combinaison est basée sur des indicateurs de qualité et l'analyse fréquentielle sur les résultats (le nombre de fois que le couple d'acteurs a été mis ensemble). Une solution hybride, qui répond au mieux aux besoins du décideur, est construite en utilisant un mélange des meilleurs clusters de toutes les configurations. Cette approche a été illustrée par des données réelles dans un projet de développement de nouveaux produits, plus précisément dans l'industrie automobile chez Renault. L'application industrielle montre des résultats prometteurs en regroupant les personnes selon les interdépendances, et permet de changer plus ou moins la façon dont les acteurs ont été organisés initialement.

Les projets de développement de nouveaux véhicules sont des projets très complexes avec des technologies innovantes et une organisation dynamique qui change constamment pour améliorer les performances économiques. La complexité des projets véhicules ne peut être résolue et doit être gérée parce que les résultats et la performance du projet sont liés à sa complexité. La modélisation et l'analyse des interactions entre les risques, les livrables, les processus, l'architecture du produit, et les acteurs contribuent à comprendre les aspects de la complexité afin de les réduire et prendre des décisions de simplification et de protection. Cela permet de comprendre et donc de mieux anticiper les phénomènes de propagation afin d'agir plus efficacement pour contrôler l'évolution du projet. L'application industrielle aux projets de développement de nouveaux véhicules a montré des résultats prometteurs pour les contributions aux deux questions de recherche. Enfin, la méthodologie proposée est discutée en termes de généricité et semble être applicable à un large éventail de projets complexes pour l'aide à la décision.

**Mots-clés:** Gestion de risques projet, Complexité projet, Modélisation de systèmes complexes, Théorie de graphes, analyse de la propagation, analyse topologique, Clustering, prise de décision.

## Acknowledgements

---

It would not have been possible to write this doctoral thesis without the help and support of a number of persons around me, to only some of whom it is possible to give particular mention here.

First, I would like to express my very great appreciation to my principal supervisor Franck MARLE for his help, guidance and patience throughout the three years of my PhD. Thank you Franck for your professionalism and for the efficacy of your supervision. I would like also my sincere gratitude to my academic supervisor Ludovic-Alexandre VIDAL, for his contribution to my work, as well as their valuable advices and help.

I am also grateful for my supervisors at Renault S.A., who were always here for providing me with their professional advices and for guiding my research work. Thank you Jacques HUR, Lionel DIDIEZ, François BUCHER for your collaboration. I wish also to acknowledge the help and guidance provided by Philippe MARQUEZ and Paul LABARERE.

I would like to offer my special thanks to Emmanuel CAILLAUD and François MARMIER for accepting to review this dissertation. I would like to thank also the other members of the jury: Eric BONJOUR and Marija JANKOVIC for their interest in my research work. Thank you all for your constructive comments, questions, and remarks.

Above all, I would like to express my deepest gratitude and love for my father Kamal-Mohamad JABER and my mother Nada-JABER JABER. My brothers: Mohamad, Nizar & Houssam who will stay alive in my heart forever, and sisters: Mariam, Sarah, & Hiba, my nephews: Houssam-Kamal & Kamal and all my friends who gave me always and still their unequivocal love and support.

I would like to thank all my colleagues at LGI: Karim, Hakim, Maxime, Toufic, Denis, Julien, Ronay, Goknur, Massinissa, and Mathieu. Thank you for your support and friendship. It has been really a great pleasure for me to share these three years with you. Special thanks to the very kind secretaries Corrine, Delphine, and Sylvie.

Great thanks to my friends: Georges, Rani, Nehmé, Youssef and Elise whom always there, and still, cheering me up and standing by me through the good and bad times.



# Table of Contents

---

<b>Abstract</b> .....	<b>2</b>
<b>Résumé</b> .....	<b>3</b>
<b>Extended summary: Modeling and analysis of propagation risks in complex projects: Application to the development of new vehicles</b> .....	<b>4</b>
<b>Résumé étendu: Modélisation et analyse des risques de propagations dans les projets complexes: Application au développement de nouveaux véhicules</b> .....	<b>10</b>
<b>Acknowledgements</b> .....	<b>17</b>
<b>Table of Contents</b> .....	<b>18</b>
<b>List of Figures</b> .....	<b>23</b>
<b>List of Tables</b> .....	<b>27</b>
<b>Foreword</b> .....	<b>29</b>
<b>Chapter 1: Introduction</b> .....	<b>30</b>
1.1 Thesis Context.....	30
1.2 Groupe Renault .....	30
1.3 Quality and Customer Satisfaction Division within Renault .....	31
1.3.1 Total Quality Management (TQM) .....	32
1.3.2 Renault Design System .....	32
1.4 Structure of vehicle development projects.....	33
1.4.1 Process approach.....	34
1.4.2 Product Decomposition.....	36
1.4.3 Organization perspective.....	36
1.5 Industrial challenges, motivations and objectives.....	38
1.5.1 Challenges related to complexity .....	38
1.5.2 Objectives.....	40
1.6 References.....	41
<b>Chapter 2: Background and Research Questions</b> .....	<b>43</b>
2.1 Project, Risks & Complexity .....	43
2.1.1 Project Management .....	43

2.1.2 Project success .....	44
2.1.3 Project Risk Management .....	45
2.1.4 Complexity in project management .....	51
2.1.5 Are Basic project Management techniques always able to reach project success while coping complexity?55	
2.2 Decision making strategies to cope with project complexity-induced risks .....	56
2.2.1 Existing Actions to mitigate complexity-related risks .....	56
2.2.2 Research gap in prioritizing mitigation actions of complexity-induced risks.....	60
2.3 Project organization to collectively cope with complexity-related phenomena.....	60
2.3.1 Project Organization & Coordination .....	60
2.3.2 Limits of these methods to cope efficiently with the complexity-related phenomena.....	63
2.4 Research purposes.....	65
2.5 Research methodology.....	65
2.6 Organization of the rest of the dissertation .....	66
2.7 References.....	67

**Chapter 3: A Framework & Score Sheet to Evaluate Project Complexity Using the TOPSIS Method**

..... 72

3.1 Introduction.....	72
3.2 Problem setting .....	73
3.2.1 Project system .....	73
3.2.2 Research Questions.....	74
3.2.3 Related Work.....	74
3.3 Framework proposal .....	76
3.3.1 Research methodology.....	76
3.3.2 A 7-category framework.....	76
3.4 Using the Technique for Order Preference by Similarity to Ideal Solution (TOPSIS) to assess project complexity .....	78
3.4.1 Multi-criteria decision methodologies .....	78
3.4.2 Using (the technique for Order Preference by Similarity to Ideal Solution) TOPSIS .....	81
3.5 Findings: The project complexity framework.....	82
3.5.1 Stakeholders.....	82
3.5.2 Project Team / Actors .....	84
3.5.3 Project Governance.....	85

3.5.4 Project Characteristics.....	87
3.5.5 Product.....	88
3.5.6 Resources.....	89
3.5.7 Environment.....	91
3.6 Application to the Vehicle development projects.....	93
3.6.1 Features of vehicle development projects.....	93
3.6.2 Applying the complexity framework to analyze and compare vehicle development projects.....	95
3.6.3 Project complexity score sheet.....	95
3.6.4 Applying TOPSIS Method to vehicle projects.....	97
3.6.5 Current & future work.....	100
3.7 Conclusions & Perspectives.....	100
3.8 References.....	101

**Chapter 4: Modeling a complex project in order to analyze its behavior & improve coordination between its actors.....104**

4.1 Introduction & Motivation.....	104
4.2 Graph-based modeling to manage project complexity.....	105
4.2.1 Elements of complex projects.....	105
4.2.2 Types of interdependencies.....	106
4.2.3 Related Work.....	109
4.2.4 Challenges of modeling interdependencies in complex projects.....	112
4.3 Modeling framework.....	113
4.3.1 Stages of complex projects modelling.....	113
4.3.2 Automation of data-gathering steps, in order to increase performance and decrease effort and error risk.....	117
4.3.3 Strength, reliability & accuracy of interdependencies modeling.....	121
4.4 Case Study: Modeling the new-vehicle development projects.....	123
4.4.1 Reciprocal enrichment of the RR model and the APP model.....	124
4.4.2 Analysis of the development logic of new vehicles.....	127
4.5 Conclusion.....	131
4.6 References.....	132

**Chapter 5: Propagation analysis of impacts between project deliverables .....134**

5.1 Introduction.....	134
-----------------------	-----

5.2 Impacts' propagation between project deliverables .....	135
5.2.1 Decomposing and Organizing Work .....	135
5.2.2 Propagation phenomena between deliverables .....	137
5.2.3 Gaps in Criticality Analysis of Project Elements.....	139
5.3 Criticality, Topological and Propagation analysis within the network of project deliverables .....	140
5.3.1 Using Topological Network Theory-Based Indicators to Highlight Elements Due to Their Position in the Network.....	141
5.3.2 Propagation behavior within the Project Deliverables Network.....	145
5.3.3 Criticality Analysis and Monitoring of Project Deliverables .....	148
5.3.4 Acting on Nodes.....	151
5.3.5 Acting on Edges and Chains in the Network .....	151
5.4 Application to vehicle development projects .....	152
5.4.1 Data collection of project deliverables network.....	152
5.4.2 Prioritizing the risks of non-completeness of Deliverables with respect to their importance in terms of influence in the network.....	156
5.4.3 Results: Monitoring of project critical deliverables.....	157
5.5 Conclusions.....	159
5.6 References.....	160

**Chapter 6: Improving coordination between actors in new product development projects using clustering algorithms .....162**

6.1 Introduction.....	162
6.2 Solving strategies for reshuffling project organization to improve coordination between its actors .....	163
6.2.1 Clustering of Project actors.....	163
6.2.2 First Strategy based on modeling direct relationships between actors.....	164
6.2.3 Second strategy based on modeling indirectly relationships between actors.....	165
6.2.4 Problem formulation for the actors clustering considering interdependencies between elements.....	166
6.3 A three-stage Clustering process for network of project elements.....	169
6.3.1 First Stage: Information gathering, about input data and parameters definition.....	170
6.3.2 Second Stage: Running multi-algorithms many times with several problem configurations .....	171
6.3.3 Third Stage: Cluster validity & post-processing of the obtained results.....	175
6.4 The automotive project case study.....	179
6.4.1 The network of project actors .....	179

6.4.2 Results: Aligning the project organization to its complexity .....	183
6.5 Conclusions.....	188
6.6 References.....	189
<b>Overall conclusion &amp; Perspectives.....</b>	<b>193</b>
<b>List of publications .....</b>	<b>198</b>

# List of Figures

---

Figure 1 Renault Captur (in black) & Renault Clio (in red) .....	31
Figure 2 Vehicle Project Structure .....	34
Figure 3 Vehicle decomposition into thirty groups of elementary functions .....	36
Figure 4 Permanent changes in vehicle projects organization .....	37
Figure 5 Risk propagation within vehicle development projects .....	40
Figure 6 Gap between actual and initial estimated project trajectory. ....	41
Figure 7 Project Risk Management Cycle .....	47
Figure 8 Dissertation Structure .....	66
Figure 9 Benefits of measuring project complexity .....	73
Figure 10 Dynamic relationships between the dimensions of the project system .....	77
Figure 11 Summary of Project complexity .....	78
Figure 12 Stepwise procedure performing TOPSIS methodology .....	82
Figure 13 The Key features of vehicle development projects .....	94
Figure 14 Project complexity comparison <i>example</i> .....	95
Figure 15 The assessment grid of project complexity .....	96
Figure 16 Pooled Interdependence .....	107
Figure 17 Sequential Interdependence .....	107
Figure 18 Reciprocal Interdependence .....	107
Figure 19 Team interdependence .....	108
Figure 20 The weighted DSM (with inputs in columns and outputs in rows) and its equivalent in weighted directed graph .....	111
Figure 21 A DMM relates the elements of one DSM domain (process activities) to elements of another DSM domain (organizational units) .....	112

Figure 22 Modeling RR from interactions identification.....	115
Figure 23 Reducing the gap between the project risks' model and the project real behavior .....	115
Figure 24 Building RR MDM directly.....	116
Figure 25 Building APP MDM by combination of DSMs and DMMs.....	117
Figure 26 Example of constructing the global interactions' network and updating inputs' data of a small risk network .....	118
Figure 27 Extracting the global network of project elements from local interactions' data.....	119
Figure 28 Algorithm for Bidirectional transformation frame between the global network and its corresponding local data.....	120
Figure 29 Example of interactions between actors (Y) via the exchange of deliverables (X).....	121
Figure 30 Example of number of deliverables exchanged between two actors .....	121
Figure 31 Mutual enrichment of both models.....	122
Figure 32 An example of focus on Actor A12 that may help enriching RR matrix .....	123
Figure 33 The APP matrix of a vehicle development project .....	125
Figure 34 Risks identification .....	126
Figure 35 Using APP to improve RR .....	127
Figure 36 Using RR to improve APP .....	127
Figure 37 Local data of interactions between elements of the development logic of new vehicles .....	128
Figure 38 The weighted directed network of 93 actors within the vehicle project .....	129
Figure 39 Presumption of dependencies between deliverables.....	129
Figure 40 DSM of process interactions via the exchange between deliverables .....	130
Figure 41 Extraction of the exhaustive list of deliverables exchanged between processes .....	130
Figure 42 Automatic treating of the process flowchart modeling.....	131
Figure 43 The purpose of project deliverables.....	135



Figure 44 Consequences of propagation of deliverables' non-completeness.....	138
Figure 45 Projects deliverables monitoring: At each milestone a quality check is made .....	141
Figure 46 Illustration of a network of project elements with topological indicators. ....	142
Figure 47 Navigation from Deliverable X-centered to Y-centered interdependency diagram.....	146
Figure 48 Find the neighbors (with path of length k at a minimum) for every node .....	147
Figure 49 Displaying the path between source and target .....	147
Figure 50 Dijkstra which also returns the shortest paths (Dijkstra 1971).....	148
Figure 51 Some Causes of non-completeness of deliverables .....	149
Figure 52 Some consequences of non-completeness of project deliverables .....	150
Figure 53 Illustration of the additional information brought by the collective criticality analysis.....	151
Figure 54 Initial data in the development logic of new vehicle .....	153
Figure 55 Presumption of interactions between project deliverables .....	153
Figure 56 Zoom on a small zone of the network of project deliverables.....	154
Figure 57 Zoom on the interactions between 254 deliverables (verified dependencies).....	155
Figure 58 Prioritizing the project critical deliverables.....	156
Figure 59 Deliverables classification.....	157
Figure 60 Impacts propagation between project deliverables throw milestones & organizational units. ....	158
Figure 61 Implementation of monitoring of project critical deliverables .....	159
Figure 62 The project organization should practically be closer to the real network structure of project actors.....	163
Figure 63 Clustering is an appropriate action to increase organizational capacity in terms of communication and coordination between actors.....	164
Figure 64 Cooperation link .....	165
Figure 65 Maximization of intra-cluster interactions.....	167
Figure 66 Obtaining actors groups AC through the clustering of XX matrix and the use of affiliation matrix AX .....	168

Figure 67 A three-stage Clustering process for network of project elements .....	170
Figure 68 Global and local quality indicators examples .....	177
Figure 69 The frequency matrix.....	178
Figure 70 Initial AA matrix.....	181
Figure 71 The network of direct relationships between project actors (AA).....	182
Figure 72 Local vision on Project Planning Engineer .....	183
Figure 73 Proposing seven new groups of interrelated actors .....	185
Figure 74 Illustration of cluster <i>C2</i> .....	186
Figure 75 Contributions: Prioritize actions to mitigate complexity-related risks .....	196
Figure 76 Organize and coordinate actors in order to cope efficiently with the complexity-related phenomena.....	197

## List of Tables

---

Table 1 Examples of project risks .....	48
Table 2 Complexity regulation strategies (adapted from (Grussenmeyer and Blecker, 2013); (Kontogiannis and Malakis, 2013)).....	59
Table 3 The five coordinating mechanisms.....	61
Table 4 Comparison of AHP, ELECTRE, SAW and TOPSIS.....	80
Table 5 Complexity factors related to the stakeholders .....	82
Table 6 Complexity factors related to the project team .....	84
<b>Table 7 Complexity factors related to the project governance.....</b>	<b>85</b>
Table 8 Complexity factors related to the project characteristics .....	87
Table 9 Complexity factors related to the product .....	88
Table 10 Complexity factors related to the project resources .....	89
Table 11 Complexity factors related to the environment .....	91
Table 12 The collected data of complexity of the various projects.....	97
Table 13 Criteria weighting.....	98
Table 14 The normalized matrix of three projects with seven evaluation criteria .....	98
Table 15 The weighted normalized decision matrix. Positive ideal and negative ideal solutions are represented in red and green respectively.....	99
Table 16 Measures of separation of each alternative solution .....	99
Table 17 Results of closeness coefficient and rank.....	99
Table 18 Organizational Structure of Product Development (adapted from Prasad 1996).....	105
Table 19 Elements of complex projects .....	106
Table 20 Seven types of interactions (from (Marle 2002)) .....	108
Table 21 Clustering parameters.....	171

Table 22 Algorithms' Selection .....	174
Table 23 The seven clusters and their quality indicators.....	184
Table 24 The twelve actors' types in cluster <i>C4</i> .....	187

## Foreword

---

The present PhD was conducted in collaboration between Renault S.A. and the Industrial Engineering Laboratory (LGI) of Ecole Centrale Paris under a CIFRE contract (Convention Industrielle de Formation par la REcherche) between February 2013 and January 2016.

**GROUPE RENAULT**



# Chapter 1: Introduction

---

The management of complex projects requires orchestrating the cooperation of hundreds of individuals from various companies, professions and backgrounds, working on thousands of activities, deliverables and risks. As well, these numerous project elements are more and more interconnected, and no decision or action is independent. The aim is to optimize and achieve numerous economic and technical objectives within a highly competitive environment in each market segment in order to bring innovation to the market quickly and efficiently. In this chapter, we will present the thesis context, the Groupe Renault, its Quality Management System, the vehicle development projects, their challenges and the industrial motivations and objectives of this thesis.

## 1.1 Thesis Context

This thesis took place within the “Skills Service (Design Methods and Standards)”, a unit of the “Quality-Engineering Management” (QEM) department. The latter is attached to the organizational division “Quality and Customer Satisfaction”. The present research work is conducted in collaboration between the QEM Department of GROUPE RENAULT and the Industrial Engineering Laboratory (Laboratoire Génie Industriel) at CentraleSupélec. Thus, our research objectives were defined in a way to comply with both industrial and academic perspectives. This PhD thesis dissertation results from this collaboration under a CIFRE (Conventions Industrielles de Formation par la REcherche) contract between February 2013 and January 2016. The thesis subject is: “Modeling and analysis of propagation risks in complex projects: Application to the development of new vehicles”.

## 1.2 Groupe Renault

Automotive industry has known major developments during recent years, with a continuous increase in sales around the world and rapid technological progresses. Automakers are in constant competition to gain market segments in the conquered countries, and for responding to emerging markets. For this, they have different levers: design, innovation, price, strategy, partnerships, branding, advertising, and quality of products and services. According to International Organization of Motor Vehicle Manufacturers in 2013, Renault was the eleventh biggest automaker in the world by production volume (OICA, 2013).

Present in over 128 countries, Groupe Renault designs, manufactures and sells vehicles under its three brands: Renault, Dacia and Renault Samsung Motors. It also has a sales finance business through its subsidiary RCI Banque. It is represented by four types of structures: commercial subsidiary, factory, design center or engineering center. Present in 118 countries with 38 manufacturing sites and 13 300 outlets, Renault offers a wide range of innovative vehicles, safer and more environmentally friendly. In 2014, the Renault group sales

rose 3.2%, in other words 2.7 million units (Groupe Renault, 2014), driven by the success of Clio, Captur, Duster and Sandero (see Figure 1). The Renault Group is organized into five regions: Europe, Eurasia, Euromed, Americas and Asia-Africa.



**Figure 1 Renault Captur (in black) & Renault Clio (in red)**

In the automotive changing environment, with increased competitiveness between different actors, shifting markets, and customers demanding ever more innovative services, all manufacturers are required to review periodically their product development policy to meet at best market requirements. For Groupe Renault, this corresponds to three major areas:

- Reducing new project development costs,
- Reducing development time to offer the customer the right product at the right time and deliver as soon as possible the latest innovations,
- Optimizing cost/value of services offered in the vehicle.

In the following section, we will present the Quality and Customer Satisfaction division, its Total Quality Management approach, and the Renault Design System used to develop the new vehicles.

### **1.3 Quality and Customer Satisfaction Division within Renault**

The design of new vehicles should take into account customers' behavior, expectations, and perceptions, in order to anticipate their needs. Renault' customer satisfaction plan has identified numerous areas for improvement that summarize the customer requirements: compliance, perceived quality, durability, quality of service, responsiveness and finally communication. On the other hand, in terms of customer loyalty, Renault tries to improve the quality / price ratio, progressing product quality while reducing costs, notably through standardization (which is result of the implementation of the alliance with Nissan). Renault reduced the gap with its competitors, in terms of design and perceived quality, thanks to its competitive intelligence system. It



always starts in the customer satisfaction plan, to design more appealing cars with more modern design, and more subtle and attractive finish. The Quality and Customer Satisfaction division supports this through two main systems: the Total Quality Management and the Renault Design System, presented in the following paragraphs.

### **1.3.1 Total Quality Management (TQM)**

The application of TQM within Renault is based on a problem-solving approach. This reasoning is divided into several steps: 1) Analysis of the organization initial situation; 2) Identifying opportunities for improvement; 3) Choice of solutions to be applied according to their efficiency; 4) Establishment of changes and modern standards; 5) Verification that the new situation can satisfy the expectations; 6) Find more improvement opportunities; 7) Restart. The aim of this approach is to optimize costs, improve communication and working conditions, anticipate and control risks, increase in turnover and annual margin, improve processes and business deals. In other words, the objective of TQM is to have an effective and efficient organization in all its areas.

The Quality Management System (QMS) within Renault is based on eight principles: customer listening, leadership, involvement of personnel, process-based approach, a management based on a system approach, continuous improvement, factual approach to decision making and mutually beneficial relations with suppliers. We can find different QMS in several organizational departments but they always respect these principles. The QMS allows to:

- Decline homogeneous standards and facilitate assimilation by all Renault actors,
- Promote the internal benchmarking and sharing of best practices,
- Ensure a consistent level everywhere on control and quality assurance with the guarantee of being compliant with ISO 9001.

### **1.3.2 Renault Design System**

The Renault Design System includes the development logic of new vehicles and associated processes, unifying processes, tools and methods of vehicle engineering and mechanical engineering. Since 2010, the project steering within Renault follows a new development logic named **V3P** (Value up Product, Process, and Program). It includes activities to be undertaken by stakeholders and actors in the project to develop mechanical parts and vehicles. This new logic reduced the costs in projects around 30%, and improved the “Time To Market”, between four and six months depending on the type of projects. Finally, it optimized the balance cost / value.

The V3P logic comprises three phases:

- **Upstream Framing:** the purpose of this phase is to confirm the innovations and novelties that Renault wants to integrate in the new concepts. It is a robust scoping phase, rhythmmed to achieve the optimum cost / customer value.
- **Development:** this phase aims at controlling the Product/Process risks. During this phase, Renault wants to integrate suppliers of structural components for the project and also the providers of innovation in order to use their skills very early in development tasks. It relies on numerical simulation.
- **Industrialization:** The objective of this phase is to validate and implement the industrial system. It must be perfectly synchronized with all actors and suppliers of the vehicle project. It is a phase based on parts compliance and as soon as possible systems validation.

The entire company is organized around this logic. The timing and synchronization of the activities of all stakeholders must be respected for each phase. Each phase incorporates successive loops of convergence. Each loop aims a good result at the first attempt. The common references are shared before the loop start. Problems are treated within each loop. The final milestone is a ratchet without turning back.

This thesis took place in the Quality-Engineering Department, which is an entity within the Quality and Customer Satisfaction division. It is responsible for:

- Defining policy of quality-assurance and modes of operation, and related management methods and tools,
- Guaranteeing the respect of project milestones and quality development, especially by implementing of monitoring plans, and providing project teams and engineering professions its capacity of warning and anticipation,
- Conducting the Quality Management System and improving engineering performance by optimization of development logic (V3P) and associated processes.

In the next section, we will present the structure of vehicle development projects, based on three perspectives: Process Management, Product, and Organization.

## 1.4 Structure of vehicle development projects

The strategic management within Renault defines the permanent organization and instantiates vehicle projects. A vehicle project federates actors and means mobilized by professions. The permanent organization nominates the project team and defines the structure of professions and their interfaces. Each vehicle project

applies the development logic (V3P) based on processes to organize the set of activities required to develop the vehicle. Each activity produces one or more deliverables that will be validated by the project team. These activities define the vehicle decomposition into systems and sub-systems, and develop the vehicle components. The project team is also responsible for refereeing the technical-economical compromises. Figure 2 illustrates the systemic structure of vehicle projects described above.

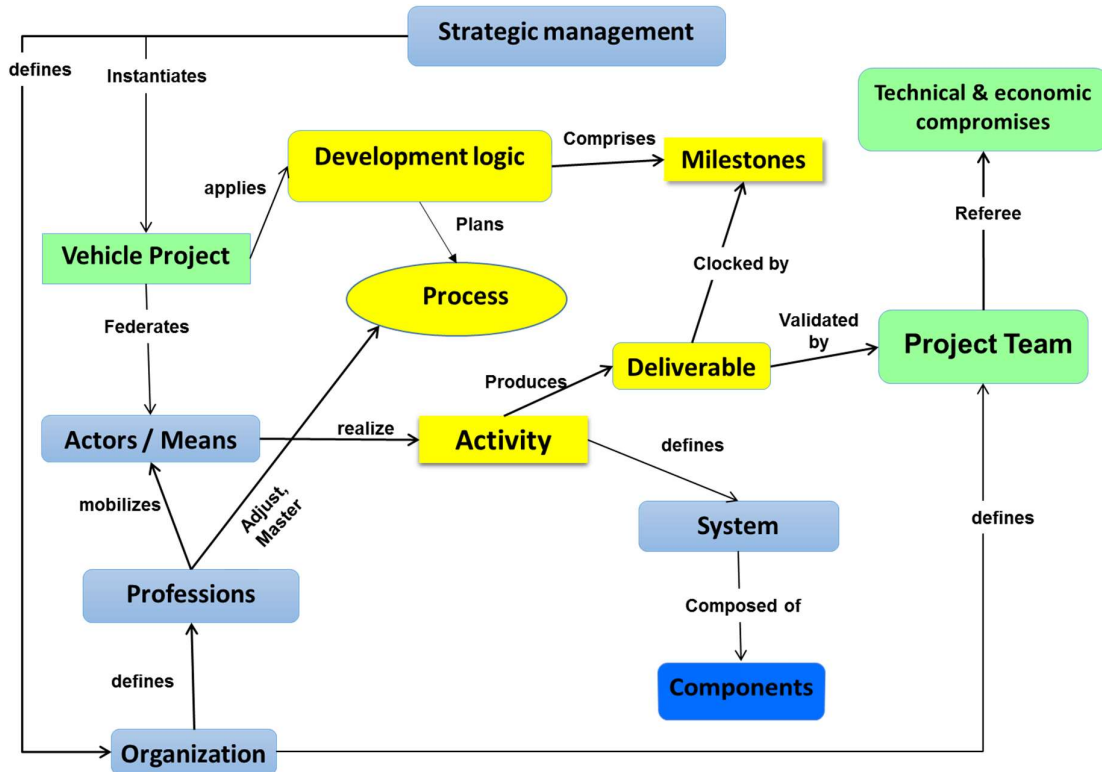

Figure 2 Vehicle Project Structure

We describe now the three perspectives of vehicle projects: Process Management, Product, and Organization.

### 1.4.1 Process approach

The process approach for vehicle development projects is taking sets of activities, which use resources to transform inputs into outputs. Process mapping provides a macroscopic description of the relationships between different processes. Their typology (Management, Operational or Support) clarifies the nature of the interactions (which can be physical, document-based, decision-based ...) Indeed, the management processes are guiding the strategy of operational processes based on their performance and results. As for the support processes, they are services of operational processes based on guidelines set by the management process. The processes of the development logic of new vehicles are the operational processes of the Quality Management System. The families of these processes are:

- Project Steering, benefit, regulations;
- Design Product (mechanics, vehicle);
- System and industrial product design;
- Strategic Plans, innovation and technology policies.

An example of V3P process is: "Pilot project, benefit, regulation", which includes four sub-processes:

- Manage projects in development;
- Manage the project quality assurance;
- Manage the project schedules;
- Manage economic convergence within vehicle development projects.

The transition from one phase to another is marked by a project milestone. The crossing of a milestone is accepted based on the analysis of the progress against expected results. This structure supports the coordination between manufacturers, suppliers and development partners. Continuous monitoring and control of milestones, cost, project objectives, and tasks characterize these projects.

## 1.4.2 Product Decomposition

The automotive design, requires integration and coordination among multiple functional areas. Vehicle may be portioned into thirty groups of Elementary Functions as seen in Figure 3.

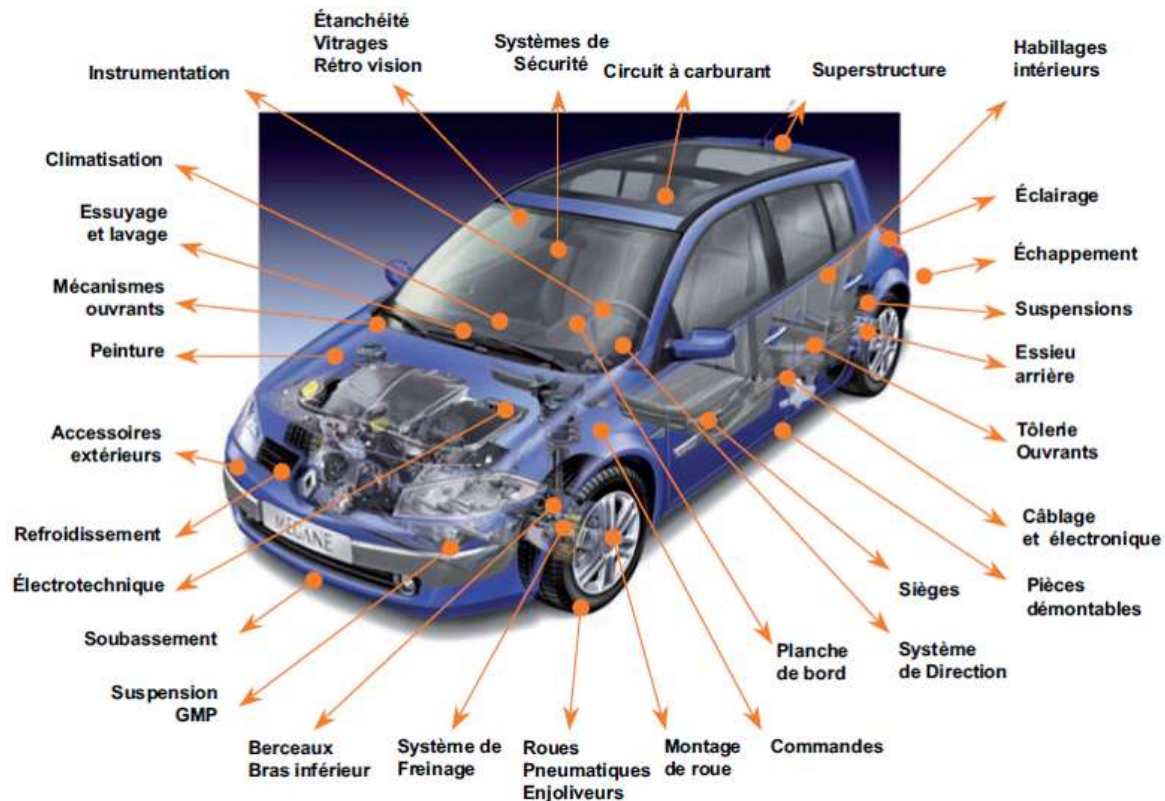

Figure 3 Vehicle decomposition into thirty groups of elementary functions

Recently, architecture decomposition changed to forty sub-systems. High-level functions are hierarchically decomposed into functions for subsystems; these sub-functions are then mapped to physical components that are, in turn, recomposed into a complete system. This decomposition defines the interfaces between these subsystems in terms of information, energy, and logical control flows. The vehicles are comprised of systems and sometimes specific parts. Many parts are reused on multiple vehicles. These elements are linked by numerous dependencies. Any modification on one of them can therefore undermine the coherence of other components. Subsequently, considering and managing all interfaces in a consistent way is challenging for project actors. This is the object of the next paragraph.

## 1.4.3 Organization perspective

Project-based organization is regularly used for industrial development of motorized vehicles (Weber, 2009). There are great varieties in required efforts driven by technical specifications, fixed budget and duration. This effort is notably driven by the number of models and options, and the degree of innovation.

Many evolutions in project organizations have been made in recent years. These are permanent changes to optimize earnings and the sharing of knowledge within the company. As shown in Figure 4 below, the project becomes a client of automotive professions, and there are changes in the role of vehicle architecture, product engineering and automotive process engineering. Furthermore, there is a rise of importance of the process approach for managing vehicle projects.

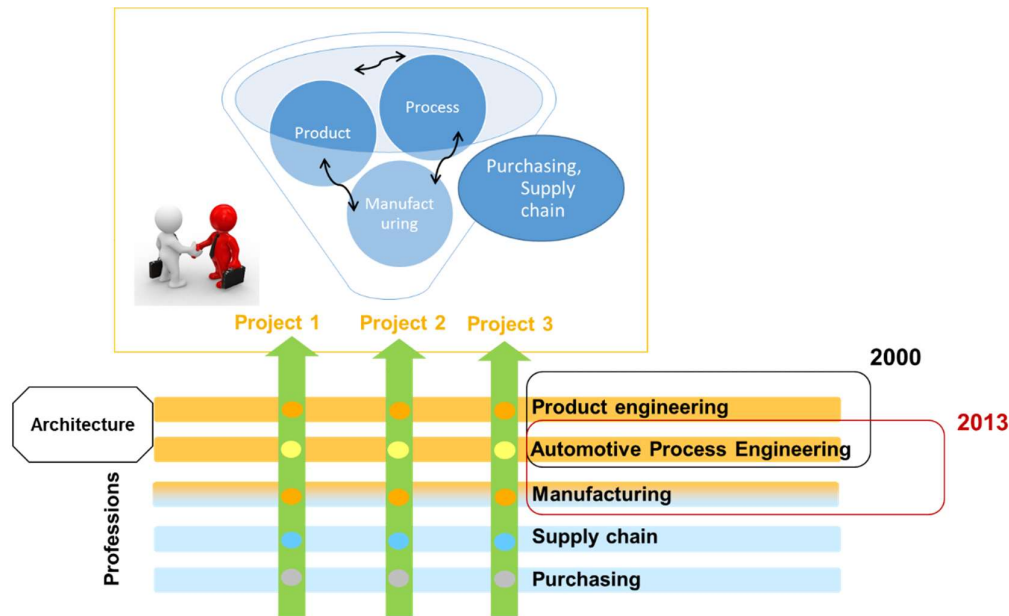

**Figure 4 Permanent changes in vehicle projects organization**

The vehicle project manager is responsible for the achievement of program objectives (Quality, Costs, Time, functionality...) on his economic scope covering engineering costs, cost of sales, cost of use, and investments. He coordinates technical departments (purchasing, manufacturing, logistics...) to carry out all activities necessary for the execution of projects. These englobe design and product definition with precise objectives on quality, cost, deadlines and volumes, which were contracted by the professions and business divisions with the Program Director. Finally, we will give an example of project actor within Renault organization, who is leading the implantation of issues treatments: the Project-Quality Engineer (PQE) is responsible for piloting quality assurance within the projects. The main tasks are:

- Develop the Project Quality Plan and ensure its deployment,
- Ensure convergence of quality requirements at milestones,
- Formalize an opinion on crossing milestones,
- Ensure the progress of action plans formalized when crossing milestones,
- Complete the project quality reporting.

After introducing the structure of vehicle development projects, the next section will demonstrate the industrial challenges, motivations and objectives of this thesis.

## **1.5 Industrial challenges, motivations and objectives**

New vehicle development projects are complex because of the structure of the product, and the process and organization to deliver this product. Moreover, the project evolves in a complex and changing context, with several constraints, risks and opportunities that may influence either its objectives or its means, or both. This gives a lot of challenges to manage simultaneously. Some of them are the object of the motivation and objectives of this work.

### **1.5.1 Challenges related to complexity**

The vehicle is a complex product, and is less and less isolated, because of the existence of families or platforms and the customization of some elements. There is thus an increasing variety of vehicle models and innovations: Electrical, hybrid, Family, Sport, low-emission, luxury, economic, fuel-efficient, etc.... A vehicle solution is a complex tradeoff between numerous and conflicting performances such as comfort, safety, consumption, environmental impacts, perceived quality, space and cost. The typical car contains about 2000 functional components, 30000 parts, and 10 million lines of software code (MacDuffie and Fujimoto, 2010). Thus, to achieve the development of a new vehicle, designers and engineers must choose between a variety of product components, interior and exterior trim levels, engine-body combinations, innovation degrees of parts and in the process of manufacturing of each part, the role of suppliers (Make – Buy decisions), and carryover parts from predecessor models. These decisions must be made quickly while still adhering to certain factors, such as milestones, profitability and customer's quality expectations. As a consequence, they have a major impact on project performance and product complexity. Furthermore, the level of suppliers' involvement and the use of carry-over parts influence the volume of engineering work to be done internally, then project complexity. As a result, this influences profitability, lead time and total product quality (Clark and Fujimoto, 1991). Vehicle development projects are very long and complex, with the participation of 1500 to 2000 project members, 320 milestones during 26 months of development, and the release of about 4000 deliverables. The automotive market imposes freezing technical definition at the latest and commercializing the vehicle as soon as possible. Several studies stress that faster product development leads to superior performance (Midler, 1993); (Griffin, 1997); (Afonso et al., 2008). The project coordinates tens of processes like: innovation integration process, manufacturing and supply chain feasibility and scheduling, design style, economic optimization, and purchasing. Besides that, about 75% of vehicle components are manufactured outside the company by more than 600 suppliers with a high geographic dispersion around the world.

This growing complexity is one of the greatest challenges of project management and one of the causes for project failure in terms of cost overruns and time delays. For instance, in the automotive industry, increasing market orientation and growing complexity of automotive product has changed the management structure of these vehicle development projects from a hierarchical to a networked structure, including the manufacturer but also numerous suppliers. These multiple dependencies between project elements increase risks, since problems in one element may propagate to other directly or indirectly dependent elements. Complexity generates a number of phenomena, positive or negative, isolated or in chains, local or global, that will more or less interfere with the convergence of the project towards its goals.

These risks may be either existing risks, but with occurrence parameters which were underestimated through the classical analysis, or emergent risks, like loops, chain reactions (or domino effect), threshold effects (or nonlinear amplification). These risks are all the more dangerous since they are generally not identified, and thus not managed. These risk drivers must be studied. Risks in vehicle development projects are grouped in eight categories: technical performance, safety and reliability, production volume, schedule, brand image, partnership, cost, and industrialization-related risks (See Figure 7).

We list below some additional extreme conditions that make the project riskier and highlight the need to prioritize and apply preventive actions:

- The vehicle is developed for a segment from which Renault is absent.
- The vehicle is to be produced in a Greenfield or a non-Renault plant.
- New inbound supply or outbound distribution flows must be established.
- The project is based on a new organization model that has not been proven on a previous project, or involves a Partner Original Equipment Manufacturer (OEM).
- The project is developed according to new methods and guidelines that have not been proven on a previous project.
- The project is based on a new master schedule timeline that has not been proven on a previous project.
- The technical content of the vehicle or its architecture includes innovations.
- A majority of functions of the project is performed by actors without prior project experience.

These challenges must be taken into account, and the anticipation strategy of project risks must be adapted to its complexity. Each project actor is responsible seamlessly of risk management and problem solving in his



area of authority. However, sometimes when the barriers fail, the consequences can be devastating (See Figure 5).

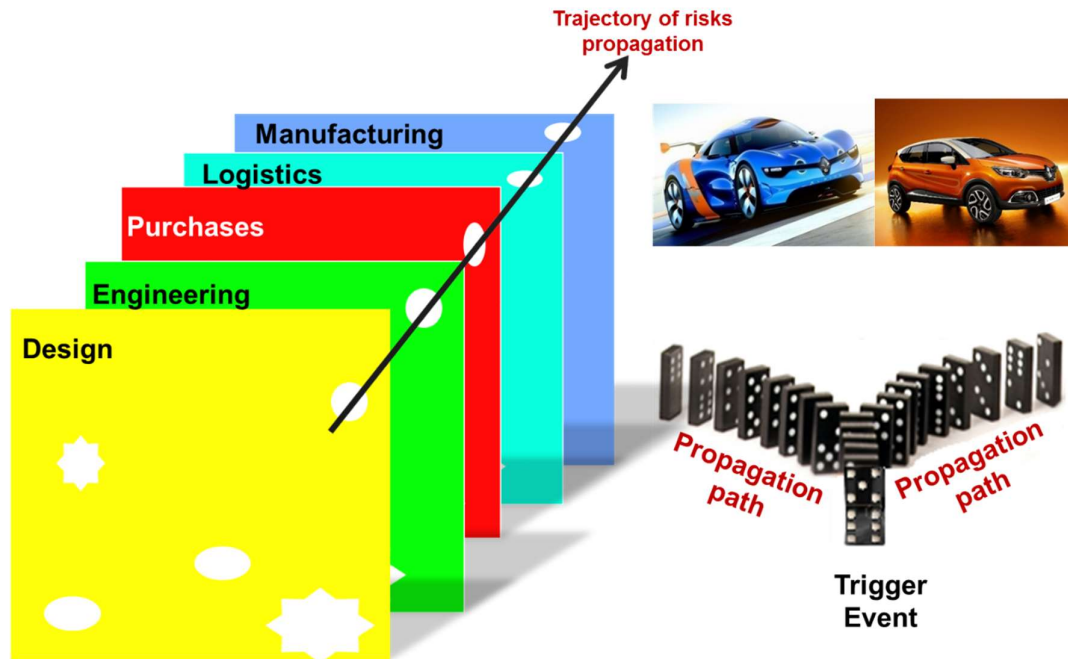

**Figure 5 Risk propagation within vehicle development projects**

Theoretically, the structure of vehicle projects with many milestones reduces the transmission of risks and the domino effects. Nevertheless, in practice, there may be propagation from one « upstream » risk to numerous « downstream » risks, which may be in different phases (“trans-milestones”) and through numerous interfaces within the organization (“trans-organization”). Renault seeks to know better the impact of the choices made and ensure that the decisions taken subsequently will not generate adverse or unanticipated effects. Project stakeholders must then recognize, analyze, and understand these risks for making decisions which can keep the project on the way to its objectives.

## **1.5.2 Objectives**

Renault is very effective in treating problems, with registration and control of vehicle design issues detected during complete vehicle integration. This efficiency is based on reactivity experience of the concerned actors and also on the collective gratitude for actors who solve problems. As against, actors who anticipate risks will not have the same gratefulness. Most of the critical problems are tied to organizational interfaces, then there will be an accumulation of impacts, and an increasing difficulty to solve these problems in the required time.

Subsequently, the objective is to promote the culture of anticipation, in a complementary way with the existing effectiveness in processing problems. There must be a balance between problem-solving strategy and risk anticipation strategy (see Figure 6). However, it is generally accepted that prevention is more efficient

than correction. This work aims at facilitating the early detection of potential problems and to evidence their consequences and treatment strategies.

In the projects, managerial risks are underestimated in relation to technical risks. The interest manifested by the industrial partner into this research can be placed in the scope of decision aid for project actors to make decisions with the best possible knowledge about the generated consequences. The thesis objectives are improving coordination between project actors and the process control system, anticipating the risks, planning for effective actions, and thus reducing the gap between initial estimated and actual project trajectory. The industrial need is preventing risk propagation phenomena within the vehicle project in order to reduce this gap.

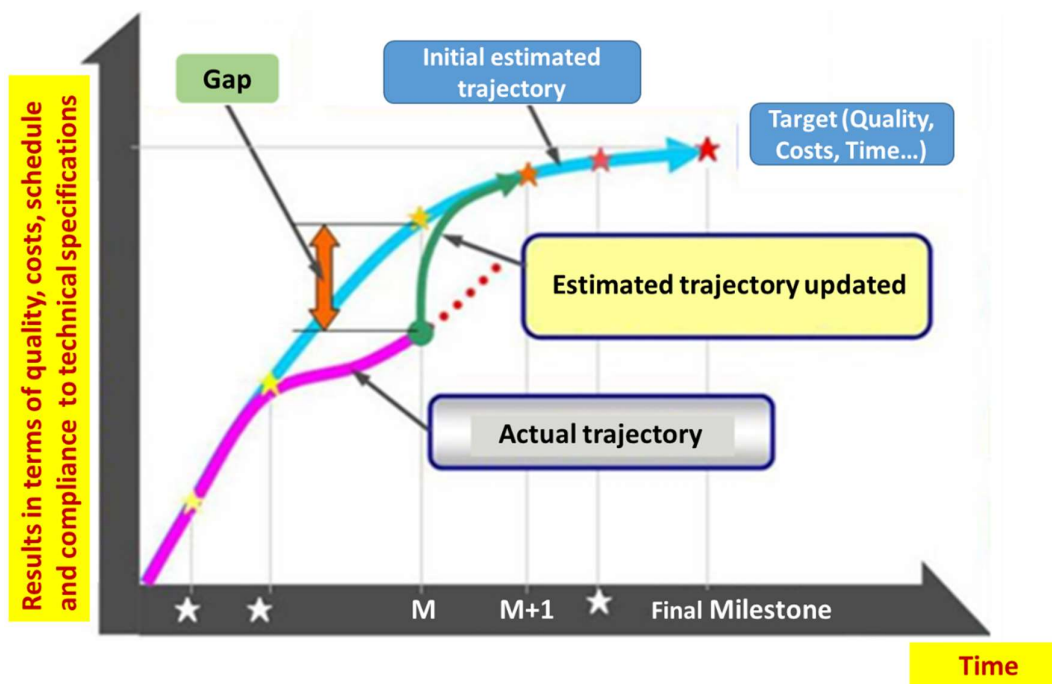

Figure 6 Gap between actual and initial estimated project trajectory.

The thesis aim is thus to reduce the risks associated with the complexity of the vehicle development projects by increasing the understanding and anticipation of complexity-related phenomena and coordination of actors.

## 1.6 References

Afonso, P., Nunes, M., Paisana, A., Braga, A., 2008. The influence of time-to-market and target costing in the new product development success. *International Journal of Production Economics* 115, 559–568. doi:10.1016/j.ijpe.2008.07.003

- Clark, K.B., Fujimoto, T., 1991. *Product Development Performance: Strategy, Organization, and Management in the World Auto Industry*. Harvard Business School Press, Cambridge, MA.
- Griffin, A., 1997. The effect of project and process characteristics on product development cycle time. *Journal of Marketing Research* XXXIV, 24–35.
- Groupe Renault, 2014. Renault en bref, <https://group.renault.com/groupe/>.
- MacDuffie, J.P., Fujimoto, T., 2010. Why dinosaurs will keep ruling the auto industry. *Harvard Business Review* 88, 23–25.
- Midler, C., 1993. *L'auto qui n'existait pas: management des projets et transformation de l'entreprise*, InterEditions. ed.
- OICA, 2013. World motor vehicle production correspondents survey. World ranking of manufacturers year 2013.
- Unger, D.W., Eppinger, S.D., 2009. Comparing product development processes and managing risk. *International Journal of Product Development* 8, 382. doi:10.1504/IJPD.2009.025253
- Weber, J., 2009. *Automotive development processes: Processes for successful customer oriented vehicle development*. Springer.

## Chapter 2: Background and Research Questions

---

This chapter will introduce the two research questions arising from industrial challenges and limits of existing work. Then it will present research purposes and methodology to answer these research questions.

### 2.1 Project, Risks & Complexity

In this section, we will first present the basics of project management and the notion of project success. Second, the project risk management process will be introduced with its key characteristics and associated challenges. Third, we will present complexity in project management, and related phenomena called complexity-induced risks. Finally, we will present the limits of current project management techniques to reach project success while coping with complexity-related phenomena and induced risks.

#### 2.1.1 Project Management

“A project is a unique process that consists of a set of coordinated and controlled activities with start and end dates undertaken to achieve an objective conforming to specific requirements, including the constraints of time, costs and resources” (AFITEP, 2010). According to the Project Management Institute (PMI), a project is “a temporary endeavor undertaken to create a unique product, service or result” (PMI, 2013). In this thesis we will retain the PMI definition. The activity within an organization (firm, association, government, or non-profit agency) is traditionally divided into operations and projects. The operations involve rather repetitive and continuous activities, while projects are inherently unique and temporary initiatives. As highlighted by (Shenhar and Dvir, 2007), “the high demand for growth and innovation that the share of transactions in most organizations is decreasing in favor of increasing the share of project activities.” They explain this trend by the fact that the transformation of organizations, whether their products, modes of work or competitive, is mostly done through projects. There are many similarities between projects and operations. Indeed, the works done by companies (operations or projects) are made by people, are programmed and sequenced, and are subject to constraints, particularly the limitation of resources (human, material and financial). The PMBOK (Project Management Body of Knowledge) explains the differences between projects and operations: “operations and projects differ primarily because the operations are ongoing and repetitive, while projects are temporary and unique.” The temporary nature of projects indicates that it has a definite beginning and a definite ending; therefore, it also has a defined scope and resources (PMI, 2013).

Project elements (activities, deliverables, objectives and resources) are organized by phases. The life cycle of a project contains several phases, like design, development, or implementation; more precisely: feasibility study, conceptual design, revision of the concept, project definition, call for tenders, organization, etc.

(Pluchart and Jablon, 2001). Phases may be sequential or executed in parallel, and require transfer of information between them. Each step is subject to a deliverable and a validation from a specific document. This allows to control the compliance of deliverables with the definition of requirements and to ensure the adequacy to project objectives (Quality, Costs Time, Product features...). Project management, then, “is the application of knowledge, skills, tools, and techniques to project activities to meet the project requirements” (PMI, 2013), which justifies to present in the following paragraph the key aspects of project success.

### **2.1.2 Project success**

The success of a project depends on the ability of the project to meet or exceed customer expectations in terms of cost, time and performance (Gray and Larson, 2007). There are some conditions to consider the project as a success in complex organizations (Poulin, 1999):

- The project must satisfy its key stakeholders. The project stakeholders are actors and organizations actively involved in the project, or the interests of which potentially being impacted by the execution or completion of the project. They notably include: the project manager, the customer / end user, contractors, the company and members of the project team.
- The project deliverable must have been accepted by the client, beneficiaries or users, and must have been produced in accordance with technical specifications, deadline and budget.

According to Morris and Hugh, project success is dependent on having: a realistic goal; competition; client satisfaction; a definite goal; profitability; third parties; market availability; the implementation process; and the perceived value of the project (Morris and Hugh, 1986). Project management and many other factors outside the direct control of the project manager play a role in project success. Projects can succeed or fail independently of the project management process (Munns and Bjeirmi, 1996). These factors can be related directly to the project management process or to project complexity (Prabhakar, 2008).

Avots enumerates some factors that may cause project management to fail to meet its goals, including the obvious indicators of completion to budget, adequate quality standards and satisfying the project schedule (Avots, 1969): a wrong person as project manager; unsupportive top management; inadequate basis for the project; inadequately defined tasks; lack of project management techniques; management techniques miss-used; project closedown not planned; and lack of commitment to project. (Belassi and Tukel, 1996) grouped the success factors listed in the literature and described the impact of these factors on project performance. They grouped the factors into four areas: factors related to the project; factors related to the project manager and team members; factors related to the organization; factors related to the external environment. This classification will allow us to place the thesis contributions on improving project success factors in these categories (See the last chapter "Overall Conclusion").

Project success consists of two separate components, namely project management success and project product success (Baccarini, 1999). Project management success focuses on the project management process and in particular on the successful accomplishment of the project with regards to cost, time and quality. Product success focuses on the effects of the project end-product. However, the literature reflects the inability to agree over a list of success criteria that would apply to all projects (Vidal, 2005).

According to (Cambridge Dictionary, 2015), success is “the achieving of the results wanted or hoped” and risk is “ the possibility of something bad happening.”

In the thesis context, project success is the achievement of project objectives and project risks are the possibility that its objectives will not be achieved. As seen in chapter 1, this thesis seeks to increase chances of project success.

Through project execution over time, uncertainty is reduced, but the risks are still present within the project. In this way, means must be provided, on the one hand, in order to anticipate the appearance of these risks, and on the other hand, to provide remedial action where appropriate. According to (Schroeder et al., 2011), project success centers on good management of project risks. More precisely, holding a risk identification session early in a project, as part of the front-end development process, will improve chances of having a successful project. (Teller and Kock, 2013) suggest that risk transparency and risk coping capacity have a direct impact on project success. In addition, project complexity is strongly and negatively associated with project success outcomes: product unit cost, time-to-market, and performance (Tatikonda and Rosenthal, 2000). So, in the following paragraph, we will present the project risk management process and the key characteristics of successful risk management.

### **2.1.3 Project Risk Management**

Risk management is mandatory and should always be performed in all projects, at least intuitively. However, projects where risks are managed intuitively or in which little importance is granted to them, are more likely to encounter difficulties. Moreover, it is much less likely that the objectives of timeliness, quality and performance are achieved.

#### **2.1.3.1 Project Risk**

Project risk management is a crucial process, for two reasons. First, it enables to anticipate potential events that could affect project results or project activities, with a prevention cost which is very often far lower than the correction cost (Marmier et al., 2013). Second, it helps capturing experience of previous projects to reuse it as potential risks for a new project, in order to identify and possibly avoid repeating the same problems

(Marle and Gidel, 2012). Although risks are objects which can be manipulated in day-to-day life, they are not so simple to define. There are numerous ways to define risk and more specifically project risk:

- a) A risk is the possibility that the objectives of a system for a specific purpose will not be achieved (Haller, 1976);
- b) A risk is the realization of a feared event, with negative consequences induced (Rowe, 1977);
- c) A project risk is the possibility that a project is not carried out in accordance with the forecast delivery date, budget and requirements. These gaps between forecasts and reality can be considered acceptable or not (Giard, 1991);
- d) A project risk is the possibility of an event occurring, impacting positively or negatively the project (Gourc et al., 2001);
- e) The risk is the “effect of uncertainty on objectives” (ISO 31000, 2009).

We will retain the definition of PMBOK (PMI, 2013) because it compiles all the aspects discussed above. Thus, a project risk is an event which, may it occur, will generate a positive or negative impact on the project. From a formal standpoint, the risk is the measure of the occurrence of an uncertain situation (beneficial or harmful) or event (expected or feared).

This measure is a two-dimensional real random variable composed of two components:

- The probability or likelihood of occurrence of the situation or event considered (since a risk might occur in the future)
- The impact (the resulting consequences): a risk may have one or more effects on project objectives. It may even have positive effect on one side and negative effect on the other side. It is recognized that risk, when properly managed, can offer opportunities.

### **2.1.3.2 Process of Project Risk Management (PRM)**

PRM is one of the most essential activities in project management in order to ensure project success. The aim of a risk management approach in a project is helping to secure the achievement of its objectives. It is a proactive approach to react as soon as possible. This is to:

- Identify risks that may hinder the achievement of project objectives;
- Assess the risks according to their severity and likelihood;
- Assess the level of control of these risks;
- Arbitrate the need to implement additional treatment plans.

Risks should be ranked in order of importance. It is necessary to determine the potential consequences of these risks in terms of cost, delay and quality impacts. In the eventuality that important concerns during the project endanger the project, a backup plan can be applied. This plan should be established during the preliminary study and when the major risks have been identified. Figure 7 illustrates the five steps of Project Risk Management (PRM) process.

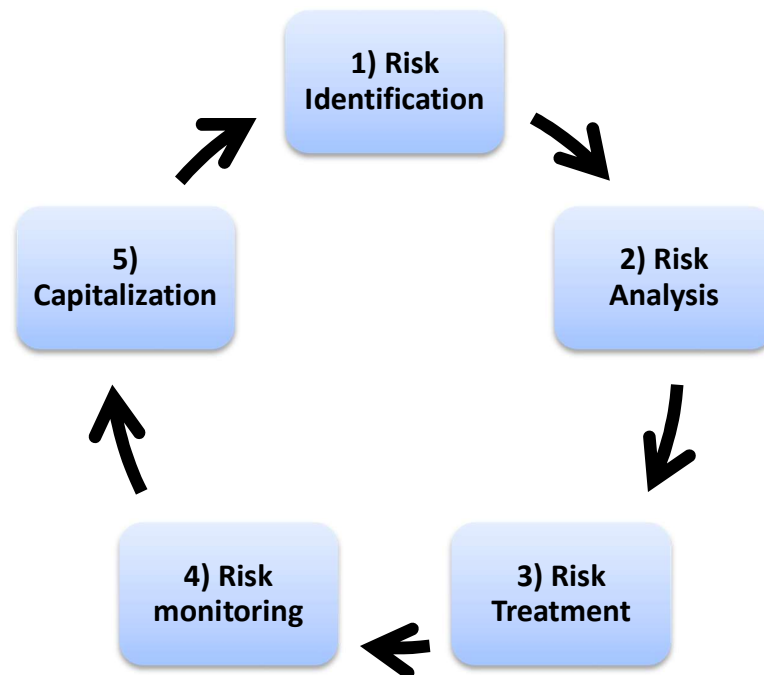

Figure 7 Project Risk Management Cycle

- 1) Risk Identification:** The first step in the risk management process is the identification of risks. It is important since an unidentified risk can never be managed and / or controlled. It starts with the identification and classification of risks and probable dangers according to their typologies, using risk identification tools: analysis of the feedbacks of past projects, assessments of the current situation and creativity techniques such as brainstorming procedures. This step involves the identification of risk factors associated with each task and their classification: those that could cause slight delays in the planning or those which block the continuation of the project as belonging to the critical path. It is important to introduce in the planning process the risks and uncertainties associated with each task and to deduce duration of the project together with a probability level. Different types of risk can be identified: human (absence or loss of a prominent resource on the project), hidden costs (discovery of costs during the project incurred in the budget dedicated to the project), delay in the supply of essential materials to the project (risk of change in the total duration of the project), delay in the delivery of



deliverables, technological (development of the project pending technology), lack of communication and coordination, inadequate development to expressed needs. Table 1 presents some examples of project risks.

**Table 1 Examples of project risks**

<b>Project risk</b>
New or modified regulatory texts
Changing standards or technical regulations
Appearance of a competing product
Misperception of the need (qualitative approach)
Overestimated volume market; Overestimation of market prices
Erroneous forecast
Failure of a key supplier
Unrealistic goal; Insufficient time; Insufficient budget; Too ambitious Specifications
Poor design choices
Choosing an inadequate or non-performance solution/process
Non-availability of certain technologies
Inadequate steering
Poor quality of control, communication
Lack of visibility and / or inappropriate decision
Undervaluation of human and / or technical investment
Underestimation of the complexity
Increase in purchase price

- 2) Risk Analysis:** A risk analysis consists of an answer to the following three questions (Kaplan and Garrick, 1981): (i) What can happen? (i.e., what can go wrong), (ii) How likely is it that that will happen? (iii) If it does happen, what are the consequences? The output of classical risk analysis is the risk matrix which could be formalized in this way: the abscissa is the degree of the risk severity and along the ordinate axe we find the probability of occurrence of the risk. This matrix should be updated during the project. A risk can be much more dangerous if it occurs later in the project. Therefore, tools are often used to prioritize actions to be taken (such as the Farmer chart based on tolerance and acceptability of risk).

- 3) Risk treatment:** The risk response plan takes into account the risks by establishing, for each risk, an intervention strategy. In other words, it is for each risk to answer the following questions: a) what can we do to reduce that risk? ; b) who will be responsible for preventive action relating to such risk?

The main treatment strategies are:

- i. Acceptance: decision not to change the project plans to deal with the risk;
  - ii. Monitoring: risk monitoring without mitigation action;
  - iii. Mitigation: reducing to an acceptable threshold;
  - iv. Transfer: the transfer principle is based on the logic of subcontracting, outsourcing, contractual approaches in general;
  - v. Elimination or avoidance: project plan modification to eliminate the risk.
- 4) Risk monitoring:** As the project is advanced, the portfolio of potential risks should be adjusted to reflect newly gathered information. Some risks may disappear; others appear or others, initially considered to be not critical, can quickly become unacceptable to the company as they could not be controlled. It is important to conduct periodic monitoring and control of risks because the level of risk exposure of the project is changing continuously. The purpose of this fourth step is to update the original list of identified risks, to refine data about already known risks characteristic, to reassess their criticality, to control the application of control measures, to assess the effectiveness of the actions, and to monitor the occurrence of dreaded events and their consequences.
- 5) Capitalization:** PRM requires capitalization of know-how and experience by establishing a rigorous documentation of project risks. This should enable to enrich the knowledge of the potential risks to increase reactivity at each level of intervention, to facilitate decision making and to improve the effectiveness of control actions. This step makes it possible to ensure traceability of encountered risks, of action and results. Moreover, it is appropriate to organize and plan the collection and storage of useful information. This capitalization and documentation of risks must be made periodically to give

the overall state of risks incurred and yet to assess the progress of control actions implemented. This can be used in the risk identification step for future projects.

### **2.1.3.3 Challenges and key characteristics of successful PRM**

One of the main difficulties of risk management is that it is not "an exact science" (Giner, 2007). Furthermore, it is impossible to predict in the long term without admitting some uncertainty. Risks are present at all stages of a project and can take many forms with internal and / or external origins. We can reduce project risks, but cannot totally eliminate them. Due to the diversity of risks and their treatments, especially depending on the project size; the resources mobilized; and the industry concerned; there is a difficulty to highlight the invariants of PRM.

There are many success factors of the project risk management processes such as:

- Integrating risk management into the project;
- Identifying risk at the earliest;
- Considering risk management as a value-creating process (Boyer et al., 2003);
- Communicating about risk : ability to escalate rapidly (Hopkin, 2014);
- Considering both the threats and opportunities;
- Clarifying responsibilities;
- Assessing risks and determining their order of priority;
- Planning and implementing the risk response;
- Documenting and tracking project risks and the related tasks;
- Update, improving and constantly strength the procedure.

As well, post-project analysis permits to do a long term improvement of PRM, by assessing project results and making recommendations for more (or different) actions devoted to risk management and project planning, execution, and control (Kendrick, 2015).

Finally, project complexity is one of the biggest challenges for PRM and is increasing the risk exposure for their organizations. The following paragraph will develop the project complexity-induced phenomena and particular risks that may arise from poor consideration of complexity in projects.

## **2.1.4 Complexity in project management**

Complexity is among the real challenges of project management (Crawford, 2006). It has changed our view of the world of science in all fields, including social sciences. Projects have always been complex (Frame, 2002) and their complexity increases (Williams, 2002). Project Complexity is an important criterion in the selection of an appropriate project organizational form; it influences the selection of project inputs, e.g. the expertise and experience requirements of management staff; and it affects the project objectives of time, cost and quality. Generally, it influences project outcomes, the higher the complexity of the project, the greater the time and cost (Baccarini, 1996), (Tatikonda and Rosenthal, 2000).

### ***2.1.4.1 Description of complexity and complex systems***

A complex system is composed of a large number of elements; these elements are of several types and have an internal structure that cannot be overlooked; these elements are connected by non-linear interactions, often of distinct types. The system is subject to external influences at different scales. Le Moigne and Morin had helped to develop a theory or a "systems science" which first wants to be interdisciplinary and second aims to cope with complex phenomena (Morin, 1990);(Le Moigne, 1994). Morin also presents the concepts of uncertainty and un-decidability as concepts closely linked to the complex thought. Thus, complexity revolves around the relationship between the four principles that characterize this thought are: order, disorder, organization and interaction. The increasing complexity of systems raises the question of their control and, more generally, the competitiveness of enterprises in terms of capacity to analyze the architecture with the means of "systems engineering". Complexity in "systems science" is divided into three types: first, the complexity of the systems themselves; second, the complexity of contractual frameworks in which the systems are finally realized; third, the complexity of organizations involved in the definition phase, construction and operation. Such complexity requires to develop the engineering and information systems processes to manage, share and leverage engineering data during all project phases.

A system is defined as something that pursues objectives in a dynamic and evolving environment, exerting activity, organizing and evolving without losing its identity (Le Moigne, 1994). A system is an arrangement of interacting elements organized to achieve one or more defined objectives (ISO/IEC 15288, 2002). In this thesis, we consider a system as the following aggregated definition: a system is an object, which, in a given environment, aims at reaching some objectives (teleological aspect) by doing an activity (functional aspect) while its internal structure (ontological aspect) evolves through time (genetic aspect) without losing its own identity (Le Moigne, 1994), (Simon, 1996), (Vidal and Marle, 2008).

### ***2.1.4.2 Projects as Complex systems***

A project is complex (which does not necessarily mean complicated). It makes use of resources, means, skills that are placed usually under different authorities (organizational units). These resources, means and

skills must be coordinated to achieve project objectives. Project complexity is not just related to technical complications. It is also a matter of organizing and motivating actors in order to make diverse resources, that sometimes have highly divergent interests, work together.

Projects can be considered as systems. Indeed, a project exists within a specific environment and aims at reaching objectives given this context (teleological aspect). It has goals in a dynamic environment and evolutionary context. These goals are engaged and organized around actors that change and evolve over time without losing the project identity. A project has to accomplish a network of activities using some methods and methodologies functional aspect. A project has an internal structure composed of resources, deliverables, tools, workers, etc.... (ontological aspect). Finally, a project evolves through time, via resource consumption, product delivery, members' changes and gain of experience, without losing its own identity (genetic aspect). Furthermore, Simon mentioned that "Complex systems will evolve from simple systems much more rapidly if there are stable intermediate forms" (Simon, 1996). The behavior of a project is difficult to predict, control and understand at every moment; the reality of perception is, in essence, uncertain, unfinished and incomplete. Projects appear to be complex systems, which encourages us to focus on the notion of project complexity, and their dynamic aspects since their elements can react / interact with each other in different ways.

#### ***2.1.4.3 Complexity-related phenomena and induced risks***

One major current problem with project complexity is that it generates a number of phenomena beyond the management capacity of decision-makers. This causes a number of surprises, generally bad for decision-makers. Helping them to identify better these complex phenomena and anticipating better impact propagation through time and through the organization would help them making more accurate decisions. This is manifested at different times, either for detection or anticipation of adverse events, or for the prevention or protection or repair of the project system upon to face these events. This results in failures, losses and time waste, both on project performance (delays, additional costs, etc.), and on the performance of the system resulting from the project (quality, cost, reliability, etc.). Project performance is one shot; product performance will be multiplied by the number of manufactured products, undergoing many times the impact on the selling price, the reliability or destruction of cost. For example, a mechanical problem on a product component may cause a delay on the associated task, so supplemental costs of this task, a shift in the next task, then restricting the space available for other components after solving the initial technical problem, and so on. In addition, there is a potential accumulation of delays, additional costs to the product and the project, and quality and human related problems. All these phenomena are a major source of unpredictability and therefore, it is difficult to decide and control the project system. Increasing project complexity leads to an increase in internal conflicts within the project, so management methods and style must be adapted to cope with such conflicts (Jones and Deckro, 1993).

Perrow sees that complexity in itself is the source of unpredictability and that such complex systems are inherently beyond control. Further, it is side-effects and their propagation and interaction that cause accidents (Perrow, 1984). Project complexity depends on both complexity of the relationships between actors and technical or technological issues (Cicmil et al., 2009). Success factors and measurement of risks are related to one or the other of these two aspects of complexity. For example: if the problem is technological, do we have the assets, patents, human skills to deal or not? Any lack in the device gives rise to the extent of the associated risk.

Complexity can thus have both a negative aspect (in terms of difficulty to be understood or controlled) and a positive influence on the project system (thanks to the emergence of opportunities). A project is complex if you do not understand it and master it in its entirety. The complexity manifests itself at three levels: 1) The reality itself is presumed complex; 2) The phenomena are complex if a viewer perceives them as such - the representation of a complex reality is presumed as complex; 3) Our representations of reality determines our behavior - the complexity of reality is, to some extent, built from our performances.

The behavior of a project is difficult to predict, control and understand in each moment and its reality of perception is often unfinished and incomplete. As part of a project, a change, whether desired or not, may more or less affect the rest of the project, at different times and on distinctive types of objects. The propagation phenomena will be even more difficult to anticipate and manage as the project is complex, with many varieties of objects interactions. Turbulent phenomena, even chaotic, may occur during the project. It is of course sensitive to initial conditions, but even during the project an event seemingly insignificant or with a small impact can cause a chain reaction that leads to disaster. Chaos is a situation where the evolutions of the system in the short term are not predictable, particularly because of the coexistence of interdependence and variability in parameters. All these phenomena are a major source of unpredictability and make it therefore, difficult to decide, control the project system.

Various complexity-related phenomena are discussed in the literature (Vidal, 2009), (Mowles, 2015). For example, the complexity of new product development projects processes and the limited information, knowledge and experience to identify characteristics of these processes, cause ambiguity and uncertainty (Yang et al., 2014). In this thesis, we will focus on the following four phenomena: Project Uncertainty, Project Ambiguity, Propagation phenomena and Chaos.

- 1) Uncertainty:** There are several types of uncertainty: The first one is related to the project purpose. This uncertainty is related to the complexity of what is to be performed. Uncertainty means also that we will have to implement the technical problems that we need to master - the uncertainty of the social, economic, environmental in which we find ourselves and may affect the problem. (The uncertainty of complex legal, fiscal devices). Caron defined Uncertainty as “the gap between the knowledge ideally

required to successfully deal with a project and the knowledge actually available”. So, exploiting all of the available knowledge can improve project predictability (Caron, 2013). Vidal defined project uncertainty as “the inability to pre-evaluate project objectives and characteristics of the project elements as well as the impact of actions and decisions”. In this way, uncertainty appears as one of the main possible negative consequences of project complexity (Vidal, 2009) although sometimes cited as project complexity sources in the literature (Lebcir, 2006).

- 2) **Propagation phenomena:** It corresponds to the fact that any change in the parameters of the project system is to propagate through the entire project system due to its numerous and varied interdependencies. Interdependencies between constituent systems of a project increase risk since problems in one subsystem may propagate to other directly or indirectly dependent subsystems. This is notably the case for anticipating the potential behavior of the project, with or without corrective decisions. System complexity is often defined as the potential for a system to exhibit unexpected behavior (Allaire et al., 2012). Potential events may be seen as potential changes in the project. Each change is accompanied by intended and unintended impacts both of which might propagate. Such risk propagation causes uncertainty in project parameters cost, time, and quality and thus needs to be predicted and controlled.
- 3) **Ambiguity:** Schrader explains project ambiguity as a lack of awareness of the project team about certain states of the project or causal relationships between coupled activities in the process structure (Schrader et al., 1993). Ambiguity may result from inadequacy of information caused either by events or causality being unknown (Pich et al., 2002). There are two aspects of project ambiguity. The first one is the lack of awareness of elements, events and their characteristics (due to the overall lack of understandability of the project system), particularly when evaluating them. The second one is the differences in the perception of the project system by team members, notably because of their different cultures (Vidal, 2009).
- 4) **Chaos:** Chaos and turbulence phenomena may appear in a project due to complexity. Chaos refers to a situation, where the short-term developments cannot be accurately predicted, notably because of the joint impact of interdependence and variability (Tavistock Institute, 1966), which were identified as complexity drivers. Project chaos refers to the ability of project elements to fluctuate randomly and unpredictably in the context of the project system itself (Radu et al., 2014). Chaotic phenomena are sometimes hard to separate from ambiguity, and propagation phenomena.

### **2.1.5 Are Basic project Management techniques always able to reach project success while coping complexity?**

Dalchar said that “Contemporary project management practice is characterized by: late delivery, exceeded budgets, reduced functionality and questioned quality. As the complexity and scale of attempted projects increases, the ability to bring these projects to a successful completion dramatically decreases” (Dalcher, 1993). Williams stresses that traditional project management techniques are ineffective in dealing with complex projects, but that beyond purely quantitative data, we need to incorporate softer ideas (Williams, 1999). The vast majority of documents, methods and tools used in project management or risk management are based on trees representing a single interaction or even simple lists that don't manage any interaction. This is extremely far from the real complexity of the project and therefore, very insufficient to manage this complexity (Marle, 2002).

**Ambiguity** implies difficulty when carrying out the project risk monitoring and control step (for the same reasons as in the risk identification step), making the process also subjective. In the end, project systems try to reduce subjectivity by expressing, monitoring and controlling the impact of risks on few limited scales (and especially the financial one). This does not permit to encompass the multi-criteria nature of project risks (Gourc 2006). Even though people and organizations tend to be more and more risk averse, risk management methodologies are still not so efficiently and effectively implemented, notably because of ambiguity and the lack of implication of management teams.

**Uncertainty:** When monitoring and controlling projects, traditional approaches like Earned Value Management do not take into account project uncertainty and variability, since they use deterministic values. However, a few extensions of such methods were developed. In terms of project schedule monitoring and control, decisions are sometimes difficult to make and control due to project complexity-driven uncertainty. For instance, “crashing decisions become much more complex [...] when task times are uncertain,” notably since “uncertain task times may be correlated” in complex environments (Hall 2012).

**Propagation** When executing a project, very few approaches permit to facilitate the coordination of project organizations, and notably the interconnection of actors and activities. Actors do not generally realize that their decisions might have dramatic consequences on actors who are in their direct or indirect environment (Vidal 2009). Finally, in terms of monitoring and control and notably the use of earned value methods, “a related weakness is that Earned Value Analysis assumes that tasks are independent, whereas in practice they are often dependent, and consequently variance in one task affects the performance of another” (Hall 2012).

**Chaos** mostly influences the efficiency of the project response plans and decisions, whether addressing risks, schedules, etc. Indeed, for instance, if some errors are made in the analysis and planning processes, it may



have dramatic consequences during the decision process. For instance, the sensitive dependence on initial conditions implies that even little differences in the decisions made during the risk response planning step may imply important difficulties (Quinn 1985; Kiel 1995; Smith 2003). Other approaches even claim to change paradigm and manage project by paradoxes (Riis and Pedersen 2003).

However, conventional methods have limitations in modeling the real complexity of project elements. For example, certain events such as chain reactions and loops are not properly taken into account. Visibility is limited, consequences are hidden, and “what-if” analysis requires impressive efforts. Cooke-Davies et al. claim that complex projects can rarely be managed by applying a standard methodology that has been designed to be used unvaryingly in all contexts. Because most standard project management methodologies carry the implicit assumption that the practitioner will use a particular set of tools in a defined order, and that all or most of the tools in the methodology will apply (Cooke-Davies et al., 2011). We understand here that traditional project management tools are not enough to carry out projects whose complexity increases. This encourages us to discuss the strategies to cope with complexity-induced risks in the following section.

## **2.2 Decision making strategies to cope with project complexity-induced risks**

Decision making in complex environments is neither easy nor reliable. “The complex environment in which we live requires a new logic, a new way to deal with the multitude of factors involved in the realization of our objectives and the coherence of our assessments to draw valuable conclusions” (Saaty, 1984). Whitney expresses that “the root cause of failure in complex projects is complexity itself” (Whitney and Daniels, 2013). It is never possible to have at its disposal all the necessary information to make the best choice, nor to assess the consequences of that decision. There is uncertainty both on the decision to make and on what will happen once the decision is made. The higher the complexity of a project, the higher the potential for risk and the greater the need for a high level of project management maturity or capacity (Treasury Board of Canada Secretariat, 2015). Many project practitioners are unable to get the right information at the right time to effectively recognize the present risky situation in order to deal with undesirable events and/or communicate potential opportunities.

### **2.2.1 Existing Actions to mitigate complexity-related risks**

Many sources in the literature mentioned that efficient leadership, open communication, vision, strong values and strong organizational beliefs, are actions to cope with complexity-related risks (Radu et al., 2014). The monitoring of project complexity-induced risks with the goal of surveillance, is to anticipate the phenomenon and to alert the project actors who could deal with the phenomenon and those who are its victims. This requires the use of analytical and measuring devices integrated with a warning system to alert actors of the danger. It will be important to identify difficult to predict phenomena in time (minor events conjunctions that appear

gradually). There are many strategies that reduce complexity and make decisions quickly and efficiently, such as the models of “Bounded Rationality” and “Subjective Expected Utility” (Hanseth and Ciborra, 2007). According to (Jones, 1999), bounded rationality asserts that “decision makers are intendedly rational; that is, they are goal-oriented and adaptive, but because of human cognitive and emotional architecture, they sometimes fail, occasionally in important decisions. Limits on rational adaptation are of two types: procedural limits, which limit how we go about making decisions, and substantive limits, which affect particular choices directly”. In decision theory, subjective expected utility is the attractiveness of an economic opportunity as perceived by a decision-maker in the presence of risk (Park et al., 2014). This method makes a tradeoff between measures of expected utility and uncertainty, in order to maximize an expected return with minimal risk exposures. The limit is that it doesn’t analyze the project elements and their connections and is too mathematics-based to be applied in real projects. While the classic decision theorists believe that the Subjective Expected Utility model can produce optimal results (Hanseth and Ciborra, 2007), several psychologists have another approach to deal with complexity. Morel studied absurd decisions, defined as radical and persistent errors, whose decision-makers act consistently and intensively against the goal they have set themselves, and in a variety of areas: incomprehensible errors of airline pilots or boat pilots, managerial actions totally contrary to the objective, meaningless decisions.... He analyzed these cases in three ways: 1) The cognitive interpretation that highlights basic errors of reasoning; 2) The collective explanation revealing interaction systems that enclose the protagonists in an absurd solution; 3) the teleological explanation that shows the loss of meaning in different stages of the action (Morel, 2014). Taking absurd decision can finally be explained by the loss of meaning in relation to the original intent of an action. To investigate the loss of meaning, Morel uses the ideal processes that relate between goal and action, represented by the Deming wheel (Deming, 1982) which includes four stages for action:

- The definition of objectives (PLAN);
- The implementation of the objectives (DO);
- Monitoring compliance with the objectives (CHECK);
- The correction (ACT), after which begins a new cycle.

This is an interesting approach to analyze different stages of action. It is a sociologic approach and can be applied on large types of activities due to its extensive vision. However, it was applied after the occurrence of events and it still needs a complementary approach to prioritize actions to mitigate complexity-induced risks. These risks have an effect on the relationship between control and performance. In a recent study, Liu argues that in the presence of a high complexity risk, the effects of behavior and self-control on performance are low whereas the effectiveness of outcome and clan control increase. He claims that “each control mode exhibits

different characteristics and effectiveness under high complexity risk” (Liu, 2015). So there is a research gap on how to prioritize actions to cope with complexity-induced risks. There is a lack of understanding the impact of a mitigation action against the risk of non-coordination and non-communication due to this complexity level. Renn argued that in view of uncertainty, complexity and ambiguity, it is important to explore various sources of information and to identify various perspectives. The challenge is to organize productive and meaningful communication with all risk-related actors who have complementary role and sometime diverging interests (Renn et al., 2011).

Next, we will detail the complexity management methods. Many complexity mitigation strategies exist in the literature. Kontogiannis and Malakis tried to explore the way that practitioners adapt their strategies to complexity. They classified the strategies in four categories (Kontogiannis and Malakis, 2013): 1) Adjusting monitoring and anticipation; 2) Re-planning and managing uncertainty; 3) Restructuring tasks over time and sector; 4) Communication and coordination.

Wildemann and other authors recommend regulating strategies such as “complexity reduction”, “complexity control” and “complexity avoidance” for complex but stable system structure (Wildemann, 1999), (Müller-Stewens and Lechner, 2005). Paetow and Schmitt stress that instable system structures can be handled only by self-organization (Paetow and Schmitt, 2003). In a more recent work, a classification of complexity regulation strategies in five categories to handle project complexity is proposed: avoidance, reduction, transfer, division, and self-charge as seen in Table 2 (Grussenmeyer and Blecker, 2013). According to this classification, avoiding systems complexity takes place in product and process development on a long-term view. Reduction refers to the already existing complexity. Transfer and division as regulation strategies are closely related to each other. By transferring complexity, the company attempts to outsource its. If this is impossible, methods to divide complexity to two or more companies can be applied. The last regulation strategy – self-charge – is used if no other method can be applied and the company itself has to cope with the complexity.

**Table 2 Complexity regulation strategies** (adapted from (Grussenmeyer and Blecker, 2013); (Kontogiannis and Malakis, 2013))

Type of Strategy		Complexity regulation strategy name	Strategy description	References
<b>Measures related to causes</b>	<b>Avoidance</b>	<b>Platform strategy, Substitution</b>	Different products are built on one strategy by assembling various add-ons. Examination, if a product or service can be replaced by a substitute.	(Wildemann, 1999)
	<b>Avoidance</b>	<b>Six Sigma</b>	Discovering of the cause roots, not resolving the symptoms	(Anderson et al., 2006);
	<b>Reduction</b>	<b>Process communality, product bundling, multiple usage of material, avoid redundancies</b>	Few components or processes should be used in as many products as possible, as long as it is economically reasonable. This is stressed during NPD. Furthermore, certain products are bundled; they can only be sold in combination with each other. Revising processes or supporting items whether they hold redundancies.	(Wildemann, 1999); (Jagersma, 2008);(Blecker and Abdelkafi, 2006);(Anderson et al., 2006);
	<b>Reduction</b>	<b>Modularization of logistics, processes, products, including module / system procurement</b>	Central logistics, processes or products get clearly defined interfaces in order to create the possibility of individual combination. So all activities can be performed in a standardized way. The procurement of entire modules or systems is strived for; single components should not be bought.	(Wildemann, 1999); (Blecker and Abdelkafi, 2006); (Anderson et al., 2006);
	<b>Reduction</b>	<b>Standardization</b>	Products / data transfer / business processes are standardized (industry wide). Packages should be consolidated and send by standard transport means (pallet, container)	(Wildemann, 1999); (Hoole, 2005); (Anderson et al., 2006);
	<b>Transfer</b>	<b>Sub-contracting development/logistics services or assignment of organizational tasks to supplier</b>	Defined R&D and design tasks are transferred to a design engineering service provider, maintenance of stocks, or just in time / just in sequence supply are required, contracting service providers, etc.	(Wildemann, 1999); (Schulte, 2009)
<b>Measures related to actions</b>	<b>Division</b>	<b>Activities sharing</b>	Decomposition of business activities in several part activities with exact interface definition.	(Schulte, 2009) (Kontogiannis and Malakis, 2013):
	<b>Self-charge</b>	<b>Definition of interfaces and facts</b>	Exact definition helps to avoid overlapping tasks and to clarify the targets of the tasks.	(Franke, 1998) (Paetow and Schmitt, 2003)

Nevertheless, this work doesn't offer an analysis to guide project practitioners to know when and which specific strategy or action is to be applied. In the following paragraph, we will present the research gap in prioritizing mitigation actions of complexity-induced risks.

## **2.2.2 Research gap in prioritizing mitigation actions of complexity-induced risks**

Actions to mitigate complexity-induced risks, which are used in practice, mostly just refer to one specific topic within projects, e.g. the complexity of the developed products. Therefore, it is crucial to develop a global approach, which is able to cover all complexity-related factors. Different actions to mitigate complexity-induced risks have been elaborated, but nothing is known about their relevance and their importance. For all practical purposes, lots of studies have focused on local optimization and local impact of project elements, and do not take into account the global vision of interdependencies between elements and decisions. Their conclusion is that current methods have shown their limits, since they cannot face anymore the stakes of ever growing project complexity. Limits and lacks have indeed been detected in research as well as in industry about the project predictability, since usual parameters (time, cost and quality) are clearly not sufficient to describe properly the complete situation at a given time (Williams, 1999), (Meijer, 2002), (Jaafari, 2003). The performance of a project is related to its complexity. More complex projects may require an additional level of control. This complexity needs to be managed properly and understanding its specific aspects at an early stage can aid in reducing risks and assisting a project in reaching its objectives. More specifically, multiple dependencies between project elements related to product, process and organization dimensions increase risks since problems in one element may propagate to other directly or indirectly dependent elements. The way interdependencies are modeled and treated is crucial for the capacity of analysis and decision (Eppinger & Browning, 2012; Mane, DeLaurentis, & Frazho, 2011). However, single-domain change propagation methods miss out most dependencies from other domains and suffer from hidden dependencies. Complexity needs then to be described and modeled, in order to be able to identify and prioritize mitigation actions that will reduce it, or at least keep its consequences under control. Finally, there is a lack in the prioritization of actions for complexity mitigations: for example, we don't know which project area requires a special focusing, what are the critical elements that necessitate an exceptional monitoring, what are the vital interactions in the project network structure to be controlled to anticipate propagation phenomena.

A first research question is thus formulated as follows:

### **Question 1**

**How can one prioritize actions to mitigate complexity-related risks?**

The next section introduces the second way to deal with complexity, which is the project organization. The second research question will be then introduced.

## **2.3 Project organization to collectively cope with complexity-related phenomena**

In this section, we present a literature review on coordination mechanisms, the structure types of project organization and the limits of these methods to cope efficiently with the complexity-related phenomena.

### **2.3.1 Project Organization & Coordination**

Coordination is a major concern within organizations, since the tasks to be accomplished are divided between many individuals (Mintzberg, 1982). The first organizational theorists (Fayol, 1916; Gulick, 1937; Mooney

and Reiley, 1939) tended to regard the hierarchy as the excellent way to coordinate the various activities taking place within the company. Subsequently, from the 1950s, researchers began to point to other devices and mechanisms to coordinate efforts: the plan, timetable (Simon, 1947), (March and Simon, 1958), standardization of processes, rules, procedures (Thompson, 1967), mutual adjustment, direct contacts, meetings (Lawrence and Lorsch, 1967), (Van De Ven et al., 1976), the integrators positions, liaison roles (Lawrence and Lorsch, 1967), the project teams (Galbraith, 1973), steering committees (Lawrence and Lorsch, 1967), the objectives, standardization of results (Galbraith, 1973; Mintzberg, 1982), the matrix structure (Galbraith, 1973) and, finally, the standardization of qualifications (Mintzberg, 1982). The organization structure can be simply defined as the total sum of the means used to: 1) divide the work between different tasks; and 2) ensure the necessary coordination between these tasks. In the following paragraph, we will present the different coordination mechanisms.

### 2.3.1.1 *The coordination mechanisms*

Table 3 shows below the five coordinating mechanisms synthesized by Mintzberg to explain the fundamental ways in which organization coordinate their work: mutual adjustment, direct supervision, standardization of work processes, standardization of work outputs, and standardization of worker skills (Mintzberg, 1992). According to him, these should be considered as the basic elements of organizational structure, the glue that holds organizations together.

**Table 3 The five coordinating mechanisms**

<b>Mechanism name</b>	<b>Description</b>
<b>1) Mutual adjustment</b>	Achieves the coordination of work by the simple process of informal communication.
<b>2) Direct supervision</b>	Achieves coordination by having one person take responsibility for" the work of others, issuing instructions to them and monitoring their actions.
<b>3) Standardization of work processes</b>	Work processes are standardized when the contents of the work are specified, or programmed.
<b>4) Standardization of work outputs</b>	Outputs are standardized when the results of the work are specified.
<b>5) Standardization of worker skills</b>	Skills (and knowledge) are standardized when the kind of training required to perform the work is specified.

These mechanisms give a stereotyped apprehension of who is coordinating and being coordinated in organizations. There is a need to be more specific as to who is coordinating, being coordinated, and what actions are performed when taking part in coordination situations, especially when we are facing the complexity-related phenomena. Mintzberg's mechanisms don't deal with communication related to actions that should be coordinating or coordinated, for example, information before action (e.g. announcements) or after action (e.g. feedback) (Melin and Axelsson, 2005). Additionally, there is a lack on the analysis of the global network of actors to be coordinated.

### 2.3.1.2 *Structure types*

Many complexity theorists and researchers are occupied with the study of how complex projects are organized (Antoniadis et al., 2011; Hanisch and Wald, 2013; Mowles, 2015). In complex system design, management of collaborative decision making is characterized by many decisions impacting numerous product- and project-related parameters. Multi-domain nature of these processes needs involvement of a wide range of actors, like project manager, system engineer, technical engineers, purchasers, architect engineers, product planners, supply chain managers and quality engineers. During early complex system design stage, decision owners need to manage decision-making process and establish temporary decision teams, identifying relevant experts in the project. In many cases, these teams are not properly established; hence, many actors participate in a large number of meetings but fail to be efficiently related to the decision-making outcome and impact. This may involve loss of efficiency and additional risks in communication and coordination between actors (Browning and Eppinger, 2002), (Browning, 2013).

Projects require special and temporary organizations, since they have a beginning and an end. Most project actors belong to the permanent structure of the company which is set up to respond to the vocation of the company. Project structure is the way the project organization crosses the permanent structure of the company. The project management experts admit that there are three types of organizational structures:

- 1) **The hierarchical structure or anti-structure:** it is a system with no specific project structure. Persons required to work on the project are still coherent, wherever they are, in their hierarchy that they continue to receive their work instructions. The project manager must systematically address the hierarchy when he has a task to be executed by an actor. The anti-structure is the usual pattern of the company which is not structured by projects. In this case, the project manager is at best a project coordinator.

There are many limits of this project organization. Firstly, due to the strong influence of department heads on their staff, there are little possibility of action in terms of project management strategy. Secondly, there is a low motivation of the project team because each actor is depending primarily to its hierarchy. Thirdly, it is difficult to know what happens, since each department head commands his staff to do what he thinks is "good" for the project. In addition, this structure may cause some extension of deadlines, because it is hard or impossible to mobilize all actors on a problem before it becomes crucial. Besides, direct management of interfaces between services (and therefore, the project lots) done directly by the project manager. Finally, there exists a significant risk of having an over-quality compared to the initial objectives.

- 2) **The task force structure (commando):** specialists who will work on the project will be detached from their departments and attached to the project manager for the duration of their work on the project.

**3) The matrix structure (cross or transverse):** the specialists assigned to the project by their department head stay attached hierarchically to him. However, they form together a real project team, led by the project manager. It is a logic of dual dependency, both hierarchical and operational.

### **2.3.2 Limits of these methods to cope efficiently with the complexity-related phenomena**

There are some limits of these classical structures. For example, they do not take into account the global network structure of interdependencies between actors, especially between actors who are not put together in same entity, in order to enable coping with complexity-induced issues like bad communication and coordination. According to (Hobday, 2000), the Project-Based Organization (PBO) assists in managing risk and uncertainty, but is inherently weak in coordinating processes, resources and capabilities across the organization as a whole. PBOs derive their performance from the structural position they occupy within their project-organizing networks (Sedita and Apa, 2015). Social network analysis and gap analysis were used to study project network gaps and project success. The combined use of both was found to be a powerful tool to examine inter- and intra-network projects for effective project governance (El-Sheikh and Pryke, 2010). But the proposed work doesn't allow to propose a complementary organization to decrease ambiguity, assist interface management and subsequently reduce risks of propagation, then it doesn't cope collectively with the complexity-related phenomena.

However, as seen previously, the amount and uncertain nature of interdependencies between actors involved in management processes makes it difficult to propose an appropriate organization generally based on breakdown structures. Whatever the criterion for breaking the list down, there will always be a huge amount of interdependencies between elements and actors which will remain outside official organizational boundaries. Moreover, the organizational dimension may be analyzed through the communication patterns between connected teams or through the resource allocation problem and its associated risks and indirect consequences (Mehr and Tumer, 2006). As underlined by Morel, the organization is an adaptive and evolving system which has to correspond to the complexity of the situation it has to manage (Morel and Ramanujam, 1999). Clustering is thus an appropriate action to improve project members and managers' risk attitude (Van Bossuyt et al., 2013), which means an improvement of how individual members will respond to risk in their activities once they are grouped with interconnected people, and a higher level of coordination between multi-domain and multi-timeframe decisions. Similar clustering-related works exist, either about risks (Marle and Vidal, 2014), or more often about other elements in order to indirectly assess and mitigate risks. These elements are generally related to one of the main project domains, product, process or organization.

Morris claims that "the project organization must change according to the needs of the project's size, speed, and complexity" (Morris, 1983). The managerial issues potentially associated with the monitoring and control of impact propagation in a complex project are mainly related to its inability to be broken down into



independent parts. This is true for all types of systems, whether natural, technical or human. The consequence is that, whatever the way the system is broken down, there will always be interdependencies between the parts, here the organizational boundaries of the project decomposition. The decomposition of the project system into smaller objects is a problem that a project is systematically confronted to. The decomposition decision is critical and often made without really knowing the necessary information, without using an effective method, and with only one proposal. The result of this decomposition presents risk of oversights and errors with multiple consequences:

- A poorly done decomposition can lead to problems of defining boundaries and interfaces between two sub-items: loss of time due to poor visibility of the work contours, rework, and work done in duplicate.
- The decomposition of the project may be inconsistent with the existing breakdown of the organization: loss of time due to organizational conflicts.
- Achieving sub-objects may not restore the complete object.

Projects can be decomposed into either Activities- (or Deliverables)-related elements, phases or organizational entities, but there will always be numerous interdependencies between actors who do not belong to the same part. This implies risk of bad communication, bad coordination or locally optimal decisions. When facing complex situations, the way that project members are organized is crucial to determine how they will be able to cope collectively with nontrivial problems and risks. Current project organizations are generally based on single-criterion decompositions, whether product- or process- or organizational entity-based. The organizational literature recognizes the challenge faced by organizations when attempting to coordinate the links between the components of the system they develop (Sanchez and Mahoney, 1996; Terwiesch et al., 2002). Due to the number of interactions outside the official project structures, the danger is that the communication and coordination between actors may not be correctly done.

Current approaches form teams without considering the interdependencies between project elements and thus without considering project complexity. These approaches are based on classical criteria, either based on similarity or diversity. There is an opportunity to forming alternative teams based on interdependencies between project elements, which is complimentary to the classical project breakdown structure organization. This is an emerging and vital topic to the performance of projects either for mitigating communication risks or for seizing creativity opportunities (Rushton et al., 2002); (Carroll et al., 2006); (Millhiser et al., 2011); (Sosa and Marle, 2013). This can create an increase in organizational capacity, in terms of communication and coordination between potentially interacting actors, and a reduction of potential propagation of the occurrence of one or several risks.

**Then, a second research question is formulated as follows:**

## **Question 2**

**How can one propose a way to organize and coordinate actors in order to cope efficiently with the complexity-related phenomena?**

### **2.4 Research purposes**

To sum up, the main purposes of this thesis are to:

- Increase the chances of project success through better understanding and identification of complexity-induced risks leading to a better definition of actions to protect the project convergence.
- Contribute to the improvement of communication and facilitate cooperation between the project actors on prioritization decisions and actions.
- Contribute to a relevant management of project deliverables by improving the quality of information in order to control the project better by adjusting its steering and organizing responsiveness to events that could disrupt its delivery progress.

### **2.5 Research methodology**

We started by analyzing the observed phenomenon (the industrial need), in addition to studying the knowledge base in literature in order to establish the knowledge gap. Our methodology encompasses distinct phases of audit and diagnostic, formulation of encountered scientific issues, data collection and analysis, proposition of new models and methods to end up with industrial implementations.

The literature review conducted in this second chapter and the above analysis of research gaps were used as a basis for constructing our research approach. We divided identified questions into several items. Then, we used a mixture of both quantitative and qualitative research methodologies. The qualitative research methods include interviews with key actors in the vehicle development project organization and brainstorming procedures to analyze complexity factors of vehicle projects. The quantitative research methods include questionnaires to evaluate project complexity and interactions between project elements. We conducted this thesis by switching back and forth between the observations and theoretical knowledge. However, during the collection and analysis of data, a sufficient degree of convergence quickly emerged, which enabled stabilizing conceptual and methodological frameworks. The full research approach is to be presented in the next chapters in details, where four distinct contributions will be exposed and treated. The first three address the first research question (corresponding to Chap. 3 to 5). It starts with a global complexity measurement technique

in Chap. 3, followed by a local, graph-based complexity assessment and analysis technique in Chap. 4. Finally, prioritization techniques based on previous analyses are presented in Chap. 5. The fourth contribution addresses the second research question and corresponds to the development of a specific clustering methodology designed to improve coordination between actors (corresponding to Chap. 6).

## 2.6 Organization of the rest of the dissertation

In this section we will introduce the organization of the four chapters which contribute to the resolution of the research questions as illustrated in Figure 8.

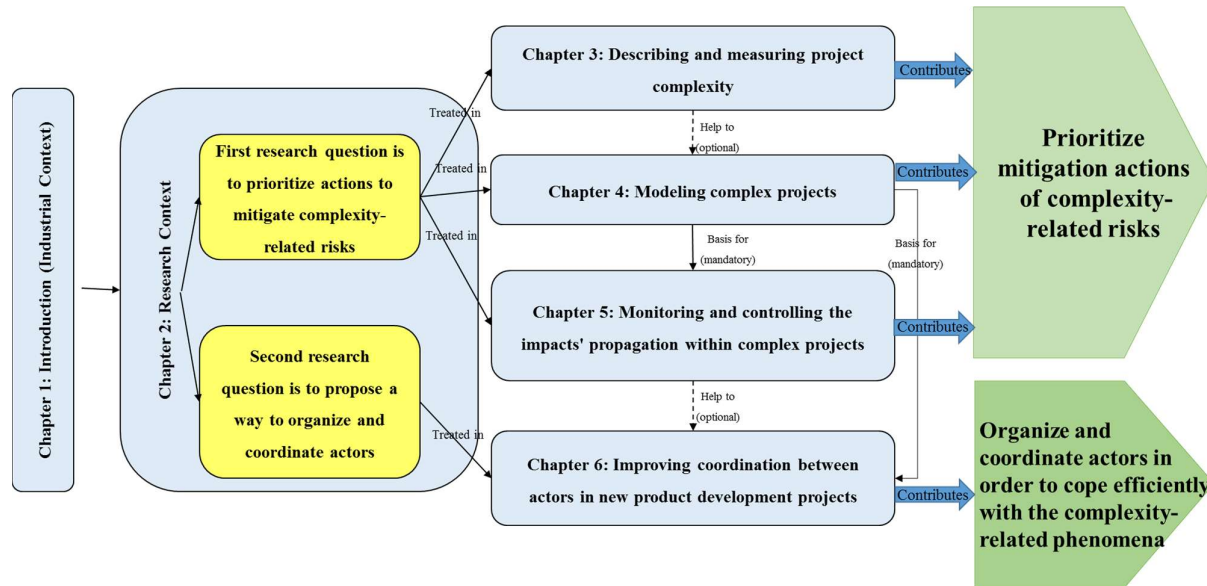

Figure 8 Dissertation Structure

**Chapter 3:** A framework & Score Sheet to evaluate Project Complexity using the TOPSIS method: this chapter introduces a high-level factor-based descriptive modeling of project complexity. It permits to measure and prioritize areas and domains where complexity may have the most impact. The first research question is addressed in this chapter.

**Chapter 4:** Modeling a complex project in order to analyze its behavior & improve coordination between its actors: this chapter proposes a low-level graph-based modeling, based on the finer modeling of project elements and interdependencies. Contributions have been made on the complete modeling process, including the automation of some data-gathering steps, in order to increase performance and decrease effort and error risk. In addition, it gives a synopsis of chapters 5 and 6, as well as industrial achievements. The first research question is addressed in this chapter.

**Chapter 5:** Propagation analysis of impacts between project deliverables: this chapter is based on previous project models; it includes some contributions to anticipate potential behavior of the project. Topological and propagation analyses are made to detect and prioritize critical elements and critical interdependencies, while enlarging the sense of the polysemous word “critical”. The first research question is addressed in this chapter.

**Chapter 6:** Improving coordination between actors in new product development projects using clustering algorithms: this chapter addresses the second research question by introducing a clustering methodology to propose groups of actors in new product development projects, especially for the actors involved in many deliverable-related interdependencies in different phases of the project life cycle. This permits to increase coordination between interdependent actors who are not always formally connected via the hierarchical structure of the project organization.

**General Conclusions** — it sums up the contributions and limitations of the thesis and describes possible starting points for future research.

## 2.7 References

- AFITEP, 2010. Dictionnaire de management de projet: Plus de 1 400 termes français définis et analysés, avec leur équivalent en anglais ; table de correspondance Français, Anglais, Allemand; Espagnol; Portugais, Ukrainien, Russe ; 15 graphes d’enchaînement des termes, 5e éd. ed. AFNOR, Saint Denis-La Plaine.
- Allaire, D., He, Q., Willcox, K., 2012. An Information-Theoretic Metric of System Complexity with Application to Engineering System Design. American Institute of Aeronautics and Astronautics.
- Anderson, B., Hagen, C., Reifel, J., Stettler, E., 2006. Complexity: customization’s evil twin. *Strategy & Leadership* 34, 19–27.
- Antoniadis, D.N., Edum-Fotwe, F.T., Thorpe, A., 2011. Socio-organo complexity and project performance. *International Journal of Project Management* 29, 808–816. doi:10.1016/j.ijproman.2011.02.006
- Avots, I., 1969. Why does project management fail? *California Management Review*.
- Baccarini, D., 1999. The Logical Framework Method for Defining Project Success. *Project Management Journal* 30.
- Baccarini, D., 1996. The concept of project complexity a review. *International Journal of Project Management* 14, 201 – 204.
- Belassi, W., Tukel, O.I., 1996. A new framework for determining critical success/failure factors in projects. *International journal of project management* 14, 141–151.
- Blecker, T., Abdelkafi, N., 2006. Complexity and variety in mass customization systems: analysis and recommendations. *Management Decision* 44, 908–929.
- Boyer, M., Christoffersen, P., Lasserre, P., Pavlov, A., 2003. Value creation, risk management and real options. CIRANO, Université de Montréal, McGill University, UQÀM, Simon Fraser University.
- Browning, T.R., 2013. Managing complex project process models with a process architecture framework. *International Journal of Project Management*. doi:10.1016/j.ijproman.2013.05.008
- Browning, T.R., Eppinger, S.D., 2002. Modeling impacts of process architecture on cost and schedule risk in product development. *IEEE Transactions on Engineering Management* 49, 428–442. doi:10.1109/TEM.2002.806709
- Cambridge Dictionary, 2015. . Cambridge Dictionary.
- Caron, F., 2013. Managing the Continuum: Certainty, Uncertainty, Unpredictability in Large Engineering Projects, SpringerBriefs in Applied Sciences and Technology. Springer Milan, Milano.
- Carroll, T.N., Gormley, T.J., Bilardo, V.J., Burton, R.M., Woodman, K.L., 2006. Designing a New Organization at NASA: An Organization Design Process Using Simulation. *Organization Science* 17, 202–214.
- Cicmil, S., Cooke-Davies, T., Crawford, L., Richardson, K., 2009. Exploring the Complexity of Projects: Implications of Complexity Theory for Project Management Practice. Project Management Institute, Inc.

- Cooke-Davies, T., Crawford, L., Patton, J.R., Stevens, C., Williams, T., 2011. Aspects of complexity: managing projects in a complex world. Project Management Institute, Newtown Square, Pa.
- Crawford, L., 2006. Developing organizational project management capability: Theory and practice. *Project management journal* 37, 74–97.
- Dalcher, D., 1993. The new project management mindset for the 21st century, in: 1st British Project Management Colloquium. Henley-on-Thames, UK.
- Deming, W.E., 1982. Quality, productivity, and competitive position, Massachusetts Institute of Technology Center for Advanced En. ed.
- El-Sheikh, A., Pryke, S.D., 2010. Network gaps and project success. *Construction Management and Economics* 28, 1205–1217. doi:10.1080/01446193.2010.506643
- Fayol, H., 1916. Administration industrielle et générale: prévoyance, organisation, commandement, coordination, contrôle. Dunod, 1999, Paris.
- Frame, J.D., 2002. The new project management: tools for an age of rapid change, complexity, and other business realities, 2nd ed. ed, The Jossey-Bass business & management series. Jossey-Bass, San Francisco, CA.
- Franke, H., 1998. Effektive Entwicklung und Auftragsabwicklung variantenreicher Produkte. *Produkt-Variantenvielfalt - Ursachen und Methoden zu ihrer Bewältigung.*, Düsseldorf 1424, 1–13.
- Galbraith, J.R., 1973. Designing Complex Organizations, Addison-Wesley Longman Publishing Co. ed. Boston, MA.
- Giard, V., 1991. Pilotage de projets et d'entreprise.
- Giner, J., 2007. Revues De Projet IN2P3, Maitrise Des Risques. Institut national de physique nucléaire et de physique des particules.
- Gourc, D., Vacher, B., Pingaud, H., 2001. Manager les risques en projets: de la prise de conscience à la mise en confiance. *Communication et organisation*.
- Gray, C.F., Larson, E.W., 2007. Management de projet, Adapté par Y. Langevin. Dunod.
- Grussenmeyer, R., Blecker, T., 2013. Requirements for the design of a complexity management method in new product development of integral and modular products. *International Journal of Engineering, Science and Technology* 5. doi:10.4314/ijest.v5i2.10S
- Gulick, L., 1937. Notes on the theory of organization, Institute of Public Administration - Columbia University. ed. New York.
- Haller, M., 1976. The aim of risk management. *Foresight*, Jun.
- Hanisch, B., Wald, A., 2013. Effects of complexity on the success of temporary organizations: Relationship quality and transparency as substitutes for formal coordination mechanisms. *Scandinavian Journal of Management*. doi:10.1016/j.scaman.2013.08.005
- Hanseth, O., Ciborra, C. (Eds.), 2007. Risk, complexity and ICT. E. Elgar, Cheltenham, UK ; Northampton, MA.
- Hobday, M., 2000. The project-based organisation: an ideal form for managing complex products and systems? *Research Policy* 29, 871–893.
- Hoole, R., 2005. Five ways to simplify your supply chain. *Supply Chain Management: An International Journal* 10, 3–6.
- Hopkin, P., 2014. Fundamentals of risk management: understanding, evaluating, and implementing effective risk management. Kogan Page, London ; Philadelphia.
- ISO 31000, 2009. Risk management - Principles and guidelines. International Organization for Standardization, Geneva.
- ISO/IEC 15288, 2002. Systems engineering – System lifecycle processes. International Standardization Organization / International Electrotechnical Commission, Geneva, Switzerland.
- Jaber, H., Marle, F., Jankovic, M., 2015. Improving Collaborative Decision Making in New Product Development Projects Using Clustering Algorithms. *IEEE Transactions on Engineering Management* 1–9. doi:10.1109/TEM.2015.2458332
- Jagersma, P.K., 2008. The hidden cost of doing business. *Business Strategy Series* 9, 238–242.
- Jones, B.D., 1999. Bounded rationality. *Annual review of political science* 2, 297–321.
- Jones, R., Deckro, R., 1993. The social psychology of project management conflict. *European Journal of Operational Research* 64, 216–228.
- Kaplan, S., Garrick, B.J., 1981. On the quantitative definition of risk. *Risk analysis* 1, 11–27.
- Kendrick, T., 2015. Identifying and managing project risk: essential tools for failure-proofing your project, Third edition. ed. American Management Association, New York.

- Kontogiannis, T., Malakis, S., 2013. Strategies in coping with complexity: Development of a behavioural marker system for air traffic controllers. *Safety Science* 57, 27–34. doi:10.1016/j.ssci.2013.01.014
- Lawrence, P.R., Lorsch, J.W., 1967. Adapter les structures de l'entreprise : intégration ou différenciation, Éditions d'Organisation. ed. Paris.
- Lebcir, M., 2006. A framework for project complexity in new product development (NPD) projects.
- Le Moigne, J.L., 1994. La théorie du système général: théorie de la modélisation.
- Liu, S., 2015. Effects of control on the performance of information systems projects: The moderating role of complexity risk. *Journal of Operations Management* 36, 46–62. doi:10.1016/j.jom.2015.03.003
- March, J.G., Simon, H.A., 1958. Les Organisations : problèmes psycho-sociologiques, Dunod. ed. Paris.
- Marle, F., 2002. Modèles d'information et méthodes pour aider à la prise de décision en management de projets. Ecole Centrale Paris.
- Marle, F., Gidel, T., 2012. Assisting project risk management method selection. *Int. J. Project Organisation and Management* 2, 189–223.
- Marle, F., Pointurier, C., Jaber, H., 2015. Managing a complex project using a Risk-Risk Multiple Domain Matrix. *The Journal of Modern Project Management* 3.
- Marle, F., Vidal, L.-A., 2014. Forming risk clusters in projects to improve coordination between risk owners. *Journal of Management in Engineering* 30.
- Marmier, F., Gourc, D., Laarz, F., 2013. A risk oriented model to assess strategic decisions in new product development projects. *Decision Support Systems* 56, 74–82.
- Mehr, A.F., Tumer, I.Y., 2006. Risk-Based Decision-Making for Managing Resources during the Design of Complex Aerospace Systems. *Journal of Mechanical Design* 128.
- Melin, U., Axelsson, K., 2005. Understanding Organizational Coordination and Information Systems: Mintzberg's Coordination Mechanisms Revisited and Evaluated, in: *Proceedings of the 13th European Conference on Information Systems*. Institute for Management of Information Systems, Regensburg.
- Millhiser, W.P., Coen, C.A., Solow, D., 2011. Understanding the Role of Worker Interdependence in Team Selection. *Organization Science* 22, 772–787.
- Mintzberg, H., 1992. *Structure in Fives: Designing Effective Organizations*. Prentice-Hall, New Jersey.
- Mintzberg, H., 1982. *Structure et dynamique des organisations*, Éd. d'Organisation. ed. Paris.
- Mooney, J.D., Reiley, A.C., 1939. *The Principles of Organization*, Harper & Brothers. ed. New York.
- Morel, B., Ramanujam, R., 1999. Through the Looking Glass of Complexity: The Dynamics of Organizations as Adaptive and Evolving Systems. *Organization Science* 10, 278–293.
- Morel, C., 2014. *Les décisions absurdes*, Gallimard. ed, Vol. 1.
- Morin, E., 1990. *Introduction à la pensée complexe*, Esf. ed. Paris.
- Morris, P.W.G., 1983. Managing project interfaces: key points for project success. *Project management handbook* 2, 16–55.
- Morris, P.W.G., Hugh, G.H., 1986. *Preconditions of Success and Failure in Major Projects*.
- Mowles, C., 2015. *Managing in uncertainty: complexity, ambiguity and the paradoxes of everyday organizational life*. Routledge, Taylor & Francis Group, London ; New York.
- Müller-Stewens, G., Lechner, C., 2005. *Strategisches Management* 3rd ed., Stuttgart: Schäffer-Poeschel.
- Munns, A.K., Bjeirmi, B.F., 1996. The role of project management in achieving project success. *International Journal of Project Management* 14, 81–87.
- Paetow, K., Schmitt, M., 2003. *Komplexitätsmanagement durch systemische Selbstskalierung*. Hamburg.
- Park, C., Ahn, S., Lee, S., 2014. A Bayesian decision model based on expected utility and uncertainty risk. *Applied Mathematics and Computation* 242, 643–648. doi:10.1016/j.amc.2014.06.005
- Perrow, C., 1984. *Normal accidents: living with high-risk technologies*, Basic Books. ed. New York.
- Pich, M.T., Loch, C.H., De Meyer, A., 2002. On uncertainty, ambiguity, and complexity in project management. *Management Science* 48, 1008–1023.
- Pinto, J.K., Morris, P.W.G. (Eds.), 2004. *The Wiley guide to managing projects*. John Wiley & Sons, Hoboken, N.J.
- Pluchart, J.-J., Jablon, P., 2001. *L'ingénierie de projet créatrice de valeur*. Editions d'organisation.
- PMI, 2013. *A Guide to the Project Management Body of Knowledge: PMBOK Guide*. Project Management Institute.
- Poulin, Y., 1999. *Gestion de projets*. L'informateur.
- Prabhakar, G.P., 2008. What is Project Success: A Literature Review. *International Journal of Business and Management*.

- Radu, B.Ş., Liviu, M., Cristian, G., 2014. Aspects Regarding the Positive and Negative Sides of Chaos Applied to the Management Science in Projects of Organizational Change. *Procedia Economics and Finance* 15, 1543–1548. doi:10.1016/S2212-5671(14)00623-6
- Renn, O., Klinke, A., van Asselt, M., 2011. Coping with Complexity, Uncertainty and Ambiguity in Risk Governance: A Synthesis. *AMBIO* 40, 231–246. doi:10.1007/s13280-010-0134-0
- Rowe, W.D., 1977. *An Anatomy of Risk*. John Wiley & Sons, New York.
- Rushton, G., Zakarian, A., Grigoryan, T., 2002. Systems Engineering Approach for Modeling an Organizational Structure. Presented at the 12th Annual International Symposium of INCOSE “Engineering 21st Century Systems: Problem Solving Through Structured Thinking,” INCOSE, Seattle, Las Vegas, NV.
- Saaty, T.L., 1984. *Décider face à la complexité. Une approche analytique multicritère d’aide à la décision*, Les Éditions ESF. ed.
- Sanchez, R., Mahoney, J.T., 1996. Modularity, flexibility, and knowledge management in product and organization design. *Strategic management journal* 17, 63–76.
- Schrader, S., Riggs, W.M., Smith, R., 1993. Choice over uncertainty and ambiguity in technical problem solving. *Journal of Engineering and Technology Management* 10, 13–99.
- Schroeder, B., Alkemade, J., Lawrence, G., 2011. Risk Management—A Key Requirement for Project Success. *Pharmaceutical Engineering*.
- Schulte, C., 2009. *Logistik. Wege zur Optimierung der Supply Chain*, 5th ed. München: Franz Vahlen.
- Sedita, S.R., Apa, R., 2015. The impact of inter-organizational relationships on contractors’ success in winning public procurement projects: The case of the construction industry in the Veneto region. *International Journal of Project Management* 33, 1548–1562. doi:10.1016/j.ijproman.2015.05.001
- Shenhar, A., Dvir, D., 2007. *Reinventing project management: the diamond approach to successful growth and innovation*. Harvard Business School Press, Boston, Mass.
- Simon, H.A., 1996. *The sciences of the artificial*. MIT Press, Cambridge, Mass.
- Simon, H.A., 1947. *Administration et processus de décision*, Économica. ed. Paris.
- Sosa, M.E., Marle, F., 2013. Assembling Creative Teams in NPD Using Creative Team Familiarity. *Journal of Mechanical Design* 135.
- Tatikonda, M.V., Rosenthal, S.R., 2000. Technology novelty, project complexity, and product development project execution success: a deeper look at task uncertainty in product innovation. *Engineering Management, IEEE Transactions on* 47, 74–87.
- Tavistock Institute, 1966. *Interdependence and uncertainty*.
- Teller, J., Kock, A., 2013. An empirical investigation on how portfolio risk management influences project portfolio success. *International Journal of Project Management* 31, 817–829. doi:10.1016/j.ijproman.2012.11.012
- Terwiesch, C., Loch, C.H., Meyer, A.D., 2002. Exchanging preliminary information in concurrent engineering: Alternative coordination strategies. *Organization Science* 13, 402–419.
- Thompson, J.D., 1967. *Organizations in action: social science bases of administrative theory*, Classics in organization and management. Mc Graw-Hill, New York.
- Treasury Board of Canada Secretariat, 2015. *Project Complexity and Risk Assessment Tool [WWW Document]*. URL <http://www.tbs-sct.gc.ca/pm-gp/doc/pcra-ecrp/pcra-ecrp-eng.asp>
- Van Bossuyt, D.L., Dong, A., Tumer, I.Y., Carvalho, L., 2013. On Measuring Engineering Risk Attitudes. *Journal of Mechanical Design* 135, 121001.
- Van De Ven, A.H., Delbecq, A.L., Koenig, R., 1976. Determinants of coordination modes within organizations. *American Sociological Review* 41, 322–338.
- Vidal, L.-A., 2009. *Thinking Project Management In The Age Of Complexity. Particular Implications On Project Risk Management*. École Centrale Paris.
- Vidal, L.-A., 2005. *Succès d’un projet, succès d’un portefeuille de projets, succès du management de projet, succès de l’entreprise, succès de l’individu (Master)*. Ecole Centrale Paris.
- Vidal, L., Marle, F., 2008. Understanding project complexity: implications on project management. *Kybernetes* 37, 1094–1110. doi:10.1108/03684920810884928
- Whitney, K.M., Daniels, C.B., 2013. The Root Cause of Failure in Complex IT Projects: Complexity Itself. *Procedia Computer Science* 20, 325–330. doi:10.1016/j.procs.2013.09.280
- Wildemann, H., 1999. *Komplexität: Vermeiden oder beherrschen lernen*. Harvard Business Manager 30–42.
- Williams, T., 2002. *Modelling Complex Projects*. Wiley, Sydney; New York.

- Williams, T., 1999. The need for new paradigms for complex projects. *International Journal of Project Management* 17, 269 – 273.
- Yang, Q., Yao, T., Lu, T., Zhang, B., 2014. An Overlapping-Based Design Structure Matrix for Measuring Interaction Strength and Clustering Analysis in Product Development Project. *IEEE Transactions on Engineering Management* 61, 159–170.



## **Chapter 3: A Framework & Score Sheet to Evaluate Project Complexity Using the TOPSIS Method**

---

The first research question will be addressed by modeling and measuring project complexity and by analyzing complexity-related phenomena within the project. This is based on an analysis at two levels. First, a high-level factor-based descriptive modeling is proposed in this chapter. It permits to measure and prioritize areas and domains where complexity may have the highest impact. This thesis explores the complexity modelling theory, including existing and emergent theories, and develops a framework and a score sheet to measure project complexity. Project complexity literature is analyzed and used in conjunction with project practitioners' interviews to identify and classify related factors, while highlighting benefits in pertaining. This work presents original identification and classification of project complexity factors while simultaneously highlighting potential benefits of project complexity indicators. These benefits are recognized from current applications of this framework in an automotive manufacturer. A framework comprising ninety factors is presented and divided into seven categories: Stakeholders, Project Team, Project Governance, Product, Project Characteristics, Resources and Environment. Current application on vehicle development projects highlights the potential benefits of complexity evaluation. This framework tries to be exhaustive and generic, even though it is likely to be adapted to specific contexts. For the project complexity assessment grid, a brainstorming procedure was applied to prioritize and weight its factors. The score sheet is designed to be practical in order to easily customize the factors and the weights of each category, and the weights of factors. We then propose a multi-criteria approach to project complexity evaluation, underlining the benefits of such an approach. In order to solve properly this multi-criteria problem, we first conduct a critical state of the art on multi-criteria methodologies. We then argue for the use of the TOPSIS method. It also has a visual reporting mechanism designed to provide early-warning signs with the possibility of comparing its findings with other projects. Practical applications on vehicle development projects highlight the benefits of such an approach for managers, in order to detect, anticipate and keep under control complex situations before they have negative consequences.

### **3.1 Introduction**

The overall ambition of this chapter is to define a measure of project complexity, which will be applied within the organization of a car manufacturer in order to assist decision-making, notably when analyzing and comparing several projects. Establishing an objective and standardized measure permits a retrospective analysis of previous projects. This is needed to assess the impact of the complexity sources on the achievement of the project goals and their influence at the cost and the staffing level. Moreover, its application in the upstream stage permits to highlight areas which have a high complexity, in order to: 1) anticipate their impact

by comparing to other internal projects; and 2) plan mitigation actions to reduce risks associated with complexity, for example, adopting simpler process or choosing a more stable supplier.

Project practitioners noticed a great correspondence between the project complexity level, and the cost and staffing level needed in the project. The literature review confirms this observation, that is to say, development effort increases with project complexity (Griffin, 1997), and there is a strong relation between complexity level and overall production cost (Schleich et al., 2007). Figure 9 shows the proposed complexity evaluation process with its associated benefits.

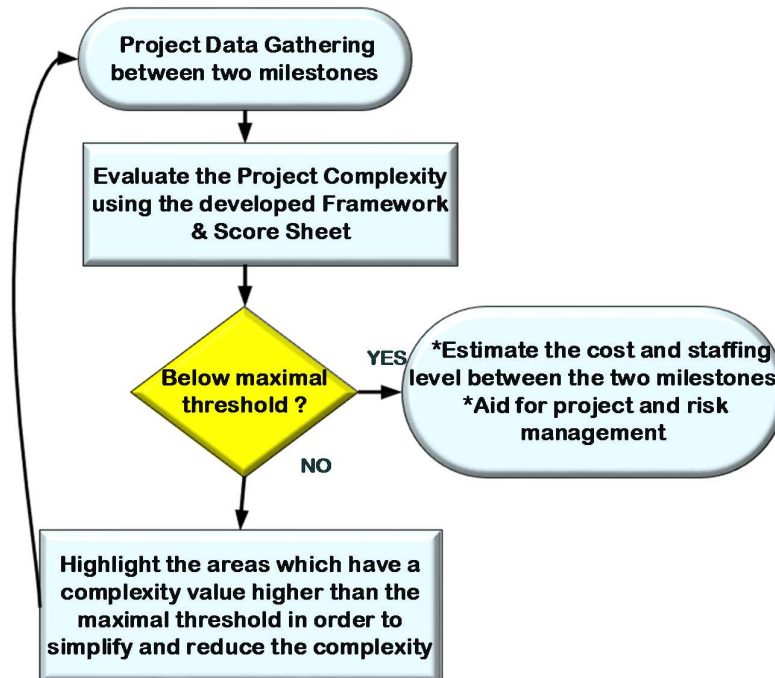

Figure 9 Benefits of measuring project complexity

## 3.2 Problem setting

### 3.2.1 Project system

A project has goals in a dynamic environment and evolutionary context. These goals are engaged and organized around actors that change and evolve over time without losing the project identity. The behavior of a project is difficult to predict, control and understand in each moment and its reality of perception is often unfinished and incomplete. As seen in chapter 2, projects appear to be complex systems, which encourages us to focus on the notion of project complexity, and its dynamic aspect where its elements can react / interact with each other in different ways.

### 3.2.2 Research Questions

Project Complexity is an important criterion in the selection of an appropriate project organizational form; it influences the selection of project inputs, e.g. the expertise and experience requirements of management personnel; and it affects the project objectives of time, cost and quality. Generally, the higher the complexity of a project, the greater the time and cost (Baccarini, 1996). In order to develop the framework and the score sheet to evaluate project complexity, this chapter aims at answering these research questions: Which factors make a project more complex? Which classification of these factors is more valuable for industry applications? What could be the benefits of an assessment of project complexity? How to run this assessment?

### 3.2.3 Related Work

Baccarini defines project complexity as several interrelated diverse parts that can be operationalized in terms of differentiation and interdependence. "It is proposed that project complexity be defined as consisting of many varied interrelated parts and can be operationalized in terms of differentiation and interdependency" (Baccarini 1996). Differentiation is the number of different items such as tasks, resources, components, their interdependence and connectivity and the degree of interrelationships between these elements. For Baccarini, it is important to qualify the type of complexity which one speaks; he distinguishes as such organizational complexity of technological complexity. Within the organizational complexity, we can find complexity related to the differentiation and complexity associated with interdependence. A complex organization is made up of separate parts. The more interdependencies between its parts, the more important organizational complexity is. Two dimensions are defined: Vertical differentiation relative to the depth of hierarchical structure of the organization, units, departments, etc. Horizontal differentiation is defined in two ways, 1) the organizational units (the number of units, departments, etc.) and 2) the structure tasks that take the division of labor and individual specializations. Organizational complexity by specialization will be measured by the number of specializations and their interdependencies necessary for the performance of work. Baccarini then describes the technological complexity as the transformation process that converts inputs into outputs through the use of material goods, skills, knowledge and abilities. As for the organizational complexity, distinction is made between differentiation and interdependence.

The technological complexity of differentiation relates to the variety of aspects of the job, such as the number and diversity of inputs or outputs and the number of separate actions and various tasks for the production of the project result, the number of specialties involved in a project. Technological complexity of interdependence takes into account the interdependencies between tasks in a network of tasks between teams, between different technologies and between inputs. According to Baccarini's paradigm, complexity is essentially characterized by the differentiation and interdependencies, i.e. by the presence of multiple interconnected parts. It offers the conclusion "to manage complexity" by the integration, coordination,

communication and control. If the multiplicity of parties and their interrelationships are characteristic of the complexity, other components must be considered. Otherwise, the difference between complicated and complex is in the nature of relations between the parties (Maylor et al., 2008). Thus Williams added to the differentiation (number of items) and interdependence (between elements) grouped under the name of structural complexity, volatility assumptions on which the tasks are based, related to the notion of uncertainty (Williams, 1999). He suggested two types, the uncertainty on targets and uncertainty of method. Concept of uncertainty is raised by Baccarini but dismissed as a separate concept of complexity. Even so, the uncertainty on targets may result in changes that once made themselves increase the structural complexity and then the complexity of the product so the global project complexity (Williams, 1999).

In this thesis, we define project complexity as “the property of a project which makes it difficult to understand, foresee and keep under control its overall behavior, even when given reasonably complete information about the project system” (Vidal et al., 2011a). Several researchers proposed a useful description of the landscape of “complexity theory” and illuminates its high relevance to project management and project performance (Cicmil et al., 2009). Also, literature on project complexity contains several classifications of project complexity factors, as size, variety, interdependency and context-dependence classification (Vidal et al., 2011a) which, thanks to Baccarini’s traditional dichotomy (Baccarini, 1996) can be categorized into technological and organizational aspects of project complexity. This framework has the ability to highlight project complexity sources, is reliable and is independent of the project models. However, this classification of project complexity factors is non intuitive for the final users and thus its benefits are difficult to communicate in an industrial context. Otherwise, the Technical, Organizational and Environmental framework (Bosch-Rekveldt et al., 2011) categorizes the project complexity into large engineering projects. In total, 50 elements contributing to project complexity were identified, but only a few elements pertaining to product complexity; therefore, it is still adapting to the new product development projects. Another project complexity model which tries to identify factors that make a project difficult to manage is given by (Maylor et al., 2008), and is divided into five categories: mission, organization, delivery, stakeholders and team. However, this model has limitations, as it does not contain any context nor environment category. This article aims at developing a framework that regroups project complexity factors based on findings from literature with conjunction with results obtained via project practitioners’ interviews and brainstorming procedures. This is applied within an automotive manufacturer company in order to classify better these factors in a way that permits to highlight benefits of the project complexity assessment.

### 3.3 Framework proposal

This section contributes to the literature about project complexity by synthesizing the existing theoretical and empirical work in a new detailed framework taking into account a classification with denominations that are widely shared between project practitioners.

#### 3.3.1 Research methodology

In the early stages of the research, large-scale interviews were conducted in order to investigate factors, which may make a project more complex. In addition, a brainstorming procedure listing the participation of project practitioners with the same topic was applied in order to increase the quantity of identified project complexity factors. All the identified factors were merged into one large idea map, and a first analysis was done in order to classify these factors. Alongside gathering this research, we regrouped the project complexity factors after an extensive literature review. Thanks to the modeling of dynamic relationships between elements of the project system, we proposed a framework to evaluate overall project complexity factors regrouped into seven different categories: Stakeholders, Project Team, Project Governance, Product Complexity, Project Characteristics, Resources and Environment. Besides, to give a quantification of our measure, another brainstorming session was organized in order to prioritize the complexity categories and give weight to each factor inside each category. Afterwards, the first version of the framework was tested on several vehicle development projects, which allowed highlighting the benefits of this framework.

#### 3.3.2 A 7-category framework

Figure 10 shows how project complexity factors are divided into seven categories:

- a) Stakeholders: The multi-type and networked relationships between project stakeholders are critical elements of the project challenges and opportunities. Project stakeholders are considered the most important factor in communication complexity (Damasiotis et al., 2012). This is due to the increasing number of potential communication channels that equal to  $N*(N-1)/2$  where “N” represents the number of project’s stakeholders (Project Management Institute, 2013).
- b) Project Team: Project actors must develop products by applying processes, allocating resources, choosing suppliers and cooperating with subcontractors. Moreover, their organizational configurations directly impact the time it takes to develop a product. Due to this, more cooperation and communication are necessary among the project team, between projects, and across stakeholders in order to better manage complexity-induced risks.

- c) Project Governance: This is seen as a set of managerial and process complexities. Increasing complexity of products requires implementing a complex process organization to their developments. Project governance is a critical step within any project, especially when dealing with complex and risky ones.
- d) Project Characteristics: Project characteristics refer to uniqueness, temporary and short life of projects teams that set up to achieve specific objectives in a unique scope;

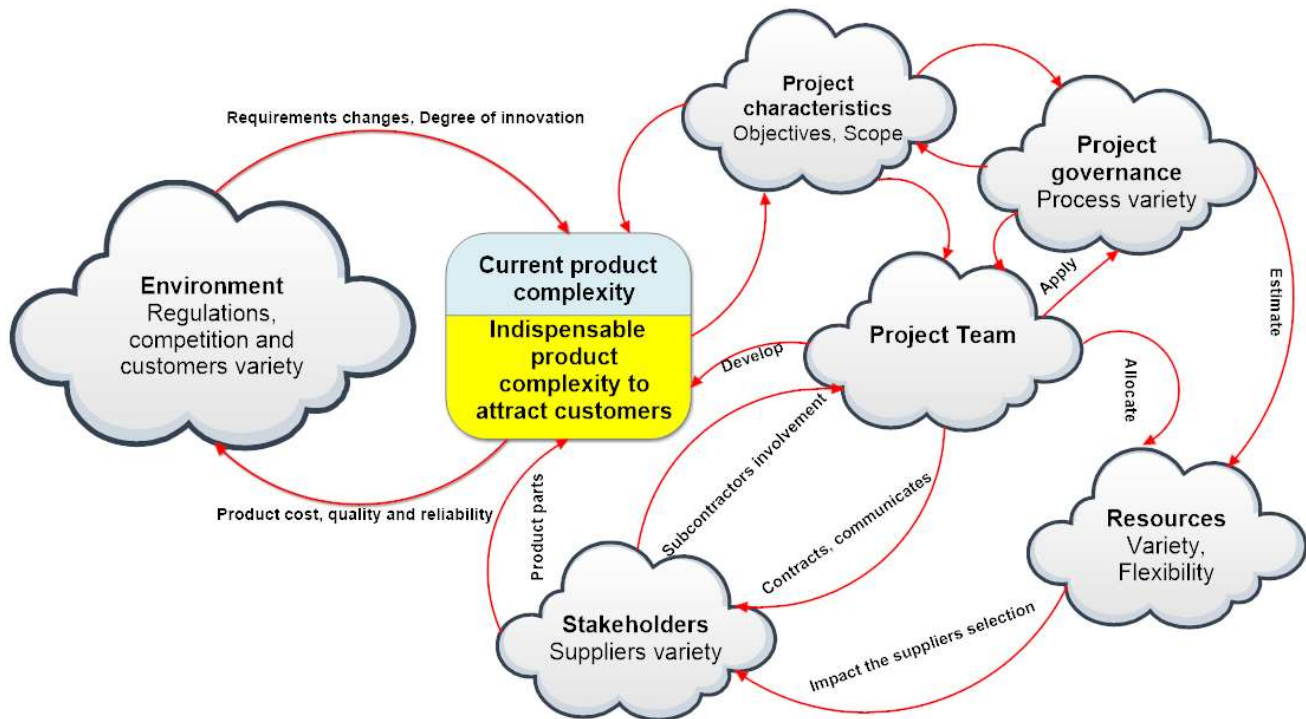

**Figure 10 Dynamic relationships between the dimensions of the project system**

- e) Product: The variety of functions within the new product increases the design, evaluation and validation efforts and may assist in changing a product architecture and/or the development process. In addition, requirement changes and a necessary degree of innovation do not only impact the product and its parts but may also lead to overhead costs and impact the coordination between project actors and suppliers. Product complexity is considered the first major source of complexity in the design and manufacture or design and construction projects (Gerald and Adlbrecht, 2007). It has three main elements: Size (Number of product components to specify), Interactions (parts integration), and Novelty. Product (structural) complexity is the number of sub-systems in a product and their inter-relationships, where an inter-relationship can mean, for example, that changes in the design of one sub-system make cross-impacts and affect the design of other systems (Vidal et al., 2011b).

- f) **Resources:** The analysis of the project resources must be done in the upstream phase. Furthermore, resource adjustments are used to address emerging and unexpected issues and for reducing allocated resources to areas that no longer need attention. These resources contribute efficiently to successful project management. Projects having a greater degree of resource flexibility have higher levels of project execution success (Tatikonda and Rosenthal, 2000).
- g) **Environment:** Projects delivered in complex environments are often late, over-budget and provide fewer benefits than originally expected. Furthermore, increasing environment complexity (competitiveness, regulations, requirements, and customers' satisfaction) requires an attractiveness level of the project delivery, e.g. a necessary level of customization and complexity. These elements evolve during the project and trigger changes in requirements.

This specific collection of identified project complexity factors allows for in-depth understanding of the complexity propagation since these denominations have been widely used between project practitioners. Figure 11 shows the summary of sources, factors classification and consequences of project complexity.



Figure 11 Summary of Project complexity

### 3.4 Using the Technique for Order Preference by Similarity to Ideal Solution (TOPSIS) to assess project complexity

#### 3.4.1 Multi-criteria decision methodologies

Multi-criteria decision methodologies (MCDM) involve finding the best opinion from all feasible alternatives in the presence of multiple, usually conflicting, decision criteria. Priority-based, outranking, distance based, and mixed methods are the primary approaches (Pomerol and Romero, 2000). One of the most widely used MCDM approaches is the Analytic Hierarchy Process (AHP) (Ngai and Chan, 2005; Saaty, 2003,

1986), which finds the relative weights of the factors and the total value of each alternative based on these weights. The AHP has widely been used in multicriteria decision-making and has been successfully applied to many practical problems (Tavana and Hatami-Marbini, 2011; Vidal et al., 2010). In spite of its popularity, it is often criticized because of its inability to handle uncertain decision-making problems (Cheng, 1999).

ELECTRE, was expressed by (Roy, 1991) and his colleagues at SEMA Consultancy Company and then evolved into ELECTRE I, ELECTRE II, ELECTRE III, ELECTRE IV, ELECTRE IS and ELECTRE TRI (Del Vasto-Terrientes et al., 2015). This method consists of two sets of parameters: the importance coefficient and the veto thresholds.

Simple Additive Weighting (SAW) is another method of Multi criteria Decision was developed by (MacCrimmon, 1968), SAW is also known as the weighted linear combination, scoring method, or weighted sums (Stanujkic et al., 2012). SAW uses the principle of weighted average (Chen, 2012) .

TOPSIS, another MCDM method, is based on choosing the alternative that has the shortest distance from the positive ideal alternative and the longest distance from the negative-ideal alternative (Boran et al., 2009; Hwang and Yoon, 1981). Technique for Order Preference by Similarity to Ideal Solution (TOPSIS) is a method whose aim is to rank in order of choice a number of alternatives on the basis of a set of positive or negative criteria. This method is part of the techniques used within the field of MCDM. It was developed by (Hwang and Yoon, 1981). Its principle consists in determining for each alternative a coefficient between 0 and 1 on the basis of the Euclidean distances between each alternative, on the one hand, and the favorable and unfavorable ideal solutions on the other hand. We will see below in detail the step by step procedure. An alternative is so-called ideal favorable if it is farther from the worst alternative and closest to the best alternative. An alternative is so-called ideal unfavorable if it is closer to the worst alternative and further away from the best alternative (Dymova et al., 2013).

A comparison of four popular MCDM techniques in maintenance decision making is shown in **Table 4** (Thor et al., 2013). This comparison is performed in terms of consistency, core process, problem structure, concept and final results.



	AHP	ELECTRE	SAW	TOPSIS
Consistency	Yes	Yes	No	No
Core process	Hierarchy principle	Pairwise comparison principle	Weighted average principle	Distance principle
Problem structure	Few criteria and alternatives	Many criteria	Many criteria and alternatives	Many criteria and alternatives
Concept	Scoring model	Concordance model	Scoring model	Compromising model
Final results	Global, net ordering	Partial pre-order	Global, net ordering	Global, net ordering

**Table 4 Comparison of AHP, ELECTRE, SAW and TOPSIS**

As seen in **Table 4**, SAW and TOPSIS are not able to show a controlled consistency like that of AHP and ELECTRE. Nevertheless, TOPSIS uses a compromising idea that takes the optimum among all of its attributes and picks the best solution. This concept causes TOPSIS to not be inferior to AHP or ELECTRE due to its lack of control consistency. Therefore, one cannot argue that one of the four methods is better than the others solely based on its control consistency due to the fact that every alternative within the method is compared with its ideal solution. In terms of problem structure, AHP is noticeably inferior because numerous criteria and alternatives cannot be integrated into the algorithm. ELECTRE provides only partial pre-ordering which calls for further investigation of the results in order to obtain the final ranking for every alternative. TOPSIS is a simple algorithm that can be run for a vast amount of data and is therefore, useful when numerous alternatives and criteria are involved, which is also due to its directness and lack of calculation complication, even when faced with the large amount of data. In other words, performing calculations by means of TOPSIS principle is not difficult to perform and implement. Also, TOPSIS will yield to a final result in a net ordering format, which is extremely close to the ideal solution. In terms of final ranking, a comparison between the final scores of each alternative calculated in TOPIS is performed so that decision making can be more flexible. As well, TOPSIS can simultaneously consider various criteria of the alternatives with the different units (Ekmekçioğlu et al., 2010) and therefore can be used without regard of the unit of the criteria as long as the given data are provided as crisp numbers. TOPSIS as well satisfies the requirements to be used for project complexity evaluation. It is able to handle qualitative criteria in addition to quantitative ones. It is able as well to prioritize criteria, evaluate a discrete set of alternatives and rank alternatives according to a cardinal scale. Moreover, it is reliable, computable and adapted to project environment.

### 3.4.2 Using (the technique for Order Preference by Similarity to Ideal Solution) TOPSIS

The MCDM method TOPSIS is a method with appeals as simplicity (easy to apply) and hypotheses based approach of a problem (the best and the worst situations). TOPSIS applies a simple concept of maximizing distance from the negative-ideal solution and minimizing the distance from the positive ideal solution (Özcan et al., 2011). The chosen alternative must be as close as possible to the ideal solution and as far as possible from the negative-ideal solution. The ideal solution represents the maximal benefit solution determined from a composite of best performance values shown in the matrix. The negative-ideal solution represents the minimal benefit solution, which is also the composite of the worst values in the matrix. TOPSIS selects the alternative that is the closest to the ideal solution and farthest from negative ideal alternative.

Figure 12 describes the stepwise procedure of Hwang and Yoon (Boran et al., 2009) for implementing TOPSIS. After forming an initial decision matrix, the procedure starts by normalizing it. This is followed by building the weighted normalized decision matrix in step 2, determining the positive and negative ideal solutions in step 3, and calculating the separation measures for each alternative in step 4. The procedure ends by computing the relative closeness coefficient. The set of alternatives (or candidates) can be ranked according to the descending order of the closeness coefficient.

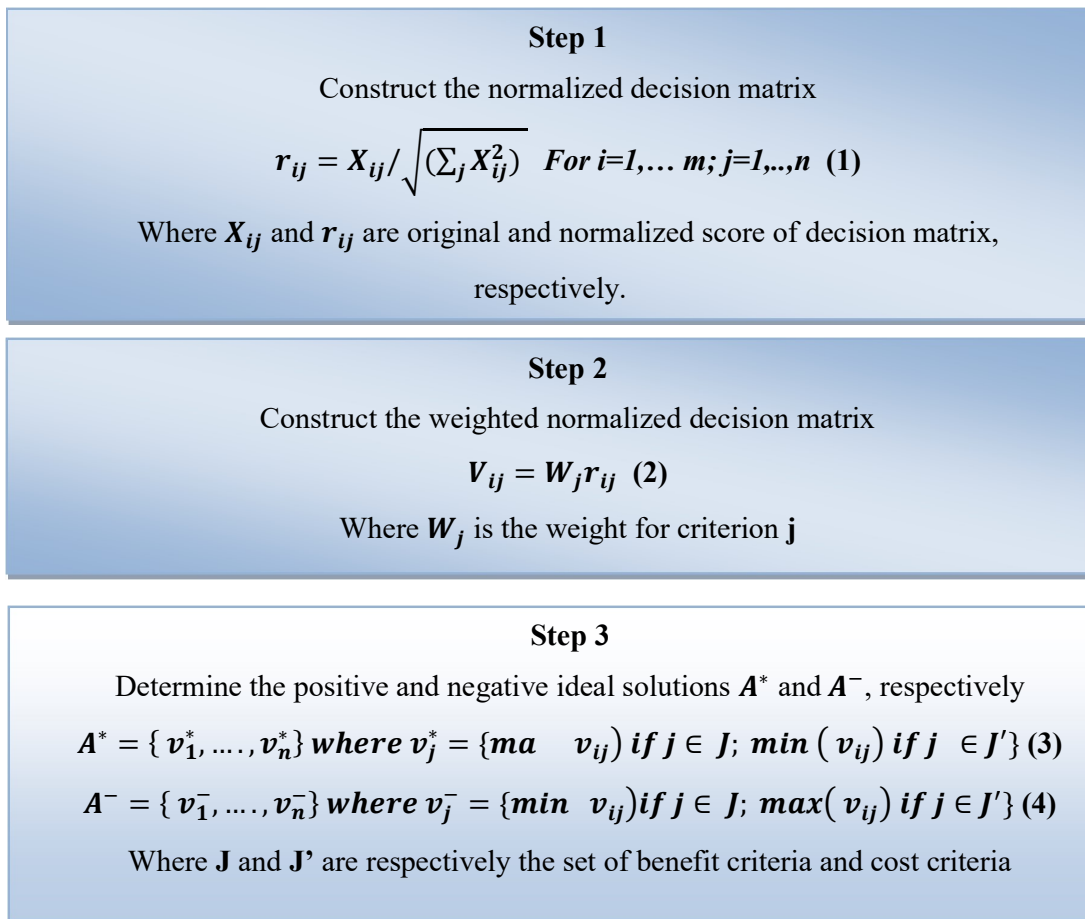

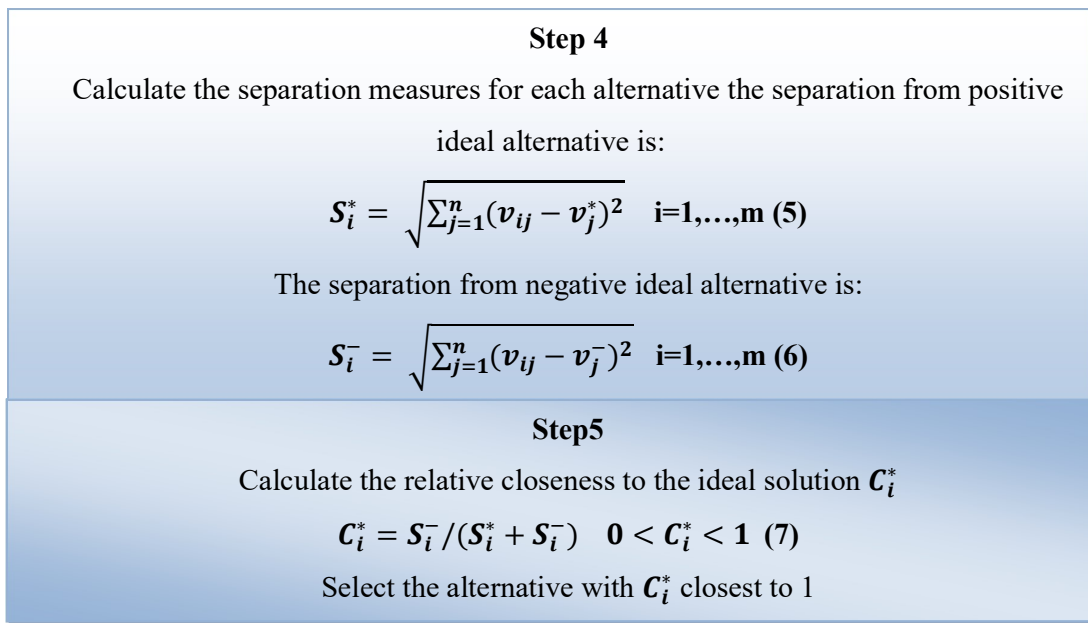

**Figure 12 Stepwise procedure performing TOPSIS methodology**

### 3.5 Findings: The project complexity framework

This section presents the framework which regroups the project complexity factors into seven categories corresponding to the **Figure 10.** : Stakeholders in **Table 5**, Project Team/Actors in **Table 6**, Project Governance in **Table 7**, Project Characteristics in **Table 8**, Product in **Table 9**, Resources in **Table 10**, Environment in **Table 11**.

#### 3.5.1 Stakeholders

**Table 5 Complexity factors related to the stakeholders**

<b>Stakeholders</b>	<b>Evaluate the contribution of each factor from 1 (Very Weak) to 5 (Very Strong).</b>	<b>Assistance in assessing : you can think of :</b>	<b>Sources</b>
Number of stakeholders	To what extent does the number of stakeholders contributes to project complexity?	How many stakeholders are there?	(Vidal et al., 2011a) ; (Project Management Institute, 2013);(Maylor et al., 2008); (Nguyen et al., 2015)
Number of investors	To what extent does the number of investors contributes to project complexity?	How many investors are there?	(Vidal et al., 2013);(Qureshi and Kang, 2015)

Variety of the stakeholders' status	To what extent does the variety of the stakeholders' status contributes to project complexity?	Suppliers 'status Variety	(Vidal et al., 2011a); (Qureshi and Kang, 2015)
Variety of the interests of the stakeholders	To what extent does the variety of the interests of the stakeholders contributes to project complexity?	Are there competing priorities of stakeholders?	(Vidal et al., 2011a); (Qureshi and Kang, 2015)
Geographic location of stakeholders (and their mutual disaffection)	To what extent does the geographic location of stakeholders contributes to project complexity?		(Hass and Rothman, 2008; Qureshi and Kang, 2015; Vidal et al., 2011a) (Qureshi and Kang, 2015)
Interdependence between sites, departments and companies	To what extent does the interdependence between sites, departments and companies contribute to project complexity?		(Vidal et al., 2011a);
Stakeholders interrelations	To what extent do the stakeholders interrelations contribute to project complexity?	What is the number and nature of dependencies on other stakeholders?	(Hass and Rothman, 2008; Qureshi and Kang, 2015; Vidal et al., 2011a)
Political influence	To what extent does the political influence contributes to project complexity?		(Bosch-Rekvelde et al., 2011);(Nguyen et al., 2015)
Trust level between Stakeholders	To what extent does the trust level between stakeholders contributes to project complexity?		(Bosch-Rekvelde et al., 2011)
Subcontractors involvement in the project	To what extent does the subcontractors' involvement in the project contributes to project complexity?	What is percentage of the project' work done	(Clark and Fujimoto, 1991)

		by the subcontractors?	
Manufacturer-Supplier relationship	To what extent does the Manufacturer-Supplier relationship contributes to project complexity?		Brainstorming

### 3.5.2 Project Team / Actors

**Table 6 Complexity factors related to the project team**

<b>Project Team</b>	<b>Evaluate the contribution of each factor from 1 (Very Weak) to 5 (Very Strong).</b>	<b>Assistance in assessing : you can think of :</b>	<b>Sources</b>
Staff quantity	To what extent does the staff quantity contributes to project complexity?	Number of actors involved in the project	(Hass and Rothman, 2008); (Vidal et al., 2011a)
Number of interfaces in the project organization	To what extent does the number of interfaces in the project organization contributes to project complexity?		(Ireland, 2007); (Vidal et al., 2011a)
Number of hierarchical levels	To what extent does the number of hierarchical levels contributes to project complexity?		(Qureshi and Kang, 2015); (Vidal et al., 2011a)
Number of departments involved	To what extent does the number of departments involved contributes to project complexity?		(Qureshi and Kang, 2015); (Vidal et al., 2011a)
Number of structures / groups / teams to be coordinated	To what extent does the number of structures / groups / teams to be coordinated contributes to project complexity?		(Ireland, 2007); (Qureshi and Kang, 2015); (Vidal et al., 2011a)
Team cooperation and communication	To what extent do the cooperation and communication inside the team contribute to project complexity?	Is a communication plan existed in the project? Is the project manager an effective communicator?	(Hass and Rothman, 2008; Qureshi and Kang, 2015; Vidal et al., 2011a)
Variety of organizational interdependencies	To what extent does the variety of organizational interdependencies contributes to project complexity?		(Ireland, 2007; Vidal et al., 2011a)
Variety of hierarchical levels within the organization	To what extent does the variety of hierarchical levels within the organization contributes to project complexity?	How does the variety of the hierarchical levels	(Ireland, 2007; Vidal et al., 2011a)

		influence the project?	
Diversity of staff (experience, social background, etc...)	To what extent does the diversity of staff contributes to project complexity?	Differences between the people involved in the project that may lead to conflicts and misunderstandings?	(Ireland, 2007; Vidal et al., 2011a)
Variety of skills needed	To what extent does the variety of skills needed contributes to project complexity?	Does the project involve multiple technical disciplines?	(Vidal et al., 2011a);(Maylor et al., 2008)
Interdependencies between actors	To what extent do the interdependencies between actors contribute to project complexity?	Number and nature of interdependencies between actors	(Qureshi and Kang, 2015; Vidal et al., 2011a)
Dynamic and evolving team structure	To what extent does the dynamic and evolving team structure contribute to project complexity?	Is the team structure changing during the project?	(Vidal et al., 2011a)
Relations with permanent organizations	To what extent do the relations with permanent organizations contribute to project complexity?		(Ireland, 2007; Vidal et al., 2011a)
Level of trust between actors of the project team	To what extent does the level of trust between actors of the project team contributes to project complexity?	Do you trust the project team members?	(Bosch-Rekvelde et al., 2011)
Experience and skills of team members	To what extent do the experience and skills of team members contribute to project complexity?		(Maylor et al., 2008); (Azim, 2010)
Leadership, authority, technical / managerial expertise of the project manager	To what extent do the leadership, authority, and technical / managerial expertise of the project manager contribute to project complexity?	Does the project manager have leadership, Technical and managerial expertise?	(Maylor et al., 2008), (Azim, 2010)
Overlapping office hours	To what extent do the overlapping office hours contribute to project complexity?	How many overlapping office hours does the project have because of different time zones involved?	(Bosch-Rekvelde et al., 2011)

### 3.5.3 Project Governance

**Table 7 Complexity factors related to the project governance**

<b>Project Governance</b>	<b>Evaluate the contribution of each factor from 1 (Very Weak) to 5 (Very Strong).</b>	<b>Assistance in assessing : you can think of :</b>	<b>Sources</b>
Processes interdependence	To what extent does the processes' interdependence contributes to project complexity?	Number and nature of dependencies between processes?	(Vidal et al., 2011a)
Organizational degree of innovation	To what extent does the organizational degree of innovation contributes to project complexity?	Are there organizational innovations?	(Vidal et al., 2011a)
Number of deliverables	To what extent does the number of deliverables contributes to project complexity?		(Vidal et al., 2011a)
Number of activities	To what extent does the number of activities contributes to project complexity?		(Vidal et al., 2011a)
Variety of project management methods and tools applied	To what extent does the variety of project management methods and tools applied contributes to project complexity?		(Vidal et al., 2011a); (Treasury Board of Canada Secretariat, 2015)
Number of decisions to be made	To what extent does the number of decisions to be made contributes to project complexity?		(Qureshi and Kang, 2015; Vidal et al., 2011a)
Level of interrelations between phases	To what extent does the level of interrelations between phases contributes to project complexity?		(Qureshi and Kang, 2015; Vidal et al., 2011a)
Dependencies with the environment	To what extent do the dependencies with the environment contribute to project complexity?	Is the project depended and highly influenced by the environmental factors?	(Qureshi and Kang, 2015; Vidal et al., 2011a)
Interconnectivity and feedback loops in the task and project networks	To what extent do the interconnectivity and feedback loops in the task and project networks contribute to project complexity?		(Qureshi and Kang, 2015; Vidal et al., 2011a)

### 3.5.4 Project Characteristics

**Table 8 Complexity factors related to the project characteristics**

<b>Project Characteristics</b>	<b>Evaluate the contribution of each factor from 1 (Very Weak) to 5 (Very Strong).</b>	<b>Assistance in assessing : you can think of :</b>	<b>Sources</b>
Number of objectives	To what extent does the number of objectives contributes to project complexity?		(Qureshi and Kang, 2015; Vidal et al., 2011a)
Alignment of objectives	To what extent does the alignment of objectives contributes to project complexity?	Are the project objectives aligned?	(Vidal et al., 2011a)
Interdependence of objectives	To what extent does the interdependence of objectives contributes to project complexity?	How many dependencies between projects are there?	(Vidal et al., 2013)
Scope largeness	To what extent does the scope largeness contributes to project complexity?	What is the largeness of the scope?	(Gerald and Adlbrecht, 2007; Vidal et al., 2011a)
Duration of the project	To what extent does the project duration contributes to project complexity?	What is the expected duration of the project?	(Hass and Rothman, 2008; Vidal et al., 2011a)
Dependencies between schedules	To what extent do the dependencies between schedules contribute to project complexity?	How many interdependencies between the schedules are there?	(Cicmil et al., 2009)
Largeness of capital investment	To what extent does the largeness of capital investment contributes to project complexity?	What is the total capital investment?	(Cicmil et al., 2009)
Support and priority level of the project in the company	To what extent does the support and priority level to the project within the company contributes to project complexity?	Is the project of high priority and elevated support level within the organization?	(Treasury Board of Canada Secretariat, 2015)



### 3.5.5 Product

**Table 9 Complexity factors related to the product**

<b>Product</b>	<b>Evaluate the contribution of each factor from 1 (Very Weak) to 5 (Very Strong).</b>	<b>Assistance in assessing : you can think of :</b>	<b>Sources</b>
Number of functions to be designed	To what extent does the number of functions to be designed contributes to project complexity?		(Griffin, 1997)
Number of components and number of new component	To what extent does the number of components and number of new component contributes to project complexity?	Number of new components = Expected number of parts - the number of carry over parts.	(Vidal et al., 2011a)
Number of subsystems / Integration Complexity	To what extent does the number of subsystems contributes to project complexity?	Number of technical systems requiring integration and the nature of the interfaces	(Helmsman Institute Pty Ltd, 2012); (Azim, 2010)
Variety of the product components	To what extent does the variety of the product components contributes to project complexity?		(Vidal et al., 2011a);[23]
Interdependence between the components of the product	To what extent does the interdependence between the product components contributes to project complexity?		(Novak and Eppinger, 2001); (Vidal et al., 2011a)
Technology maturity	To what extent does the technology maturity contributes to project complexity?	Are new technologies such as unproven technologies used in the project?	(Ireland, 2007; Vidal et al., 2011a)
Variety of the technologies used during the project	To what extent does the variety of the technologies used during the project contributes to project complexity?		(Ireland, 2007; Nguyen et al., 2015; Vidal et al., 2011a)

Technological degree of innovation	To what extent does the technological degree of innovation contributes to project complexity?	Number of innovations applicable to the product' parts	(Nguyen et al., 2015; Vidal et al., 2011a)
Technological process dependencies	To what extent do the technological process dependencies contribute to project complexity?		(Vidal et al., 2011a)
Variety of technological dependencies	To what extent does the variety of technological dependencies contributes to project complexity?	Number of heterogeneity dependencies	(Vidal et al., 2011a)
Change of Specifications	To what extent does the change of Specifications contributes to project complexity?	Do you expect a change in specifications during the project?	(Azim, 2010)
Specifications interdependence	To what extent does the specifications' interdependence contributes to project complexity?		Brainstorming
Feasibility and technical difficulty of the Design	To what extent do the feasibility and technical difficulty of the Design contribute to project complexity?		Brainstorming
Time to Market	To what extent does the time to market contributes to project complexity?		(Azim, 2010)
Variety of manufacturing processes between factories	To what extent does the variety of manufacturing processes between factories contributes to project complexity?		Brainstorming
Customization degree, Option variability	To what extent does the customization degree of the product contributes to project complexity?		Brainstorming
Number of iterations to refine the product	To what extent does the number of iterations to refine the product contributes to project complexity?		(Azim, 2010)

### 3.5.6 Resources

**Table 10 Complexity factors related to the project resources**

<b>Resources</b>	<b>Evaluate the contribution of each factor from 1 (Very Weak) to 5 (Very Strong).</b>	<b>Assistance in assessing : you can think of :</b>	<b>Sources</b>
Number and quantity of resources	To what extent do the number and quantity of resources contribute to project complexity?		(Qureshi and Kang, 2015; Vidal et al., 2011a)
Number of companies / projects sharing their resources	To what extent does the number of companies / projects sharing their resources contributes to project complexity?		(Qureshi and Kang, 2015; Vidal et al., 2011a)
Number of information systems	To what extent does the number of information systems contributes to project complexity?		(Qureshi and Kang, 2015; Vidal et al., 2011a)
Variety of information systems to be combined	To what extent does the variety of information systems to be combined contributes to project complexity?		(Qureshi and Kang, 2015; Vidal et al., 2011a)
Interdependence of Information systems	To what extent does the interdependence of Information systems contributes to project complexity?		(Qureshi and Kang, 2015; Vidal et al., 2011a)
Variety of financial resources	To what extent does the variety of financial resources contributes to project complexity?		(Qureshi and Kang, 2015; Vidal et al., 2011a)
Computational capacity	To what extent does the computational capacity contributes to project complexity?	Does the project have the suitable computational capacity?	Brainstorming
Availability of people, material and of any resources due to sharing	To what extent does the availability of people, material and of any resources due to sharing contributes to project complexity?	Are human resources and materials shared across projects? What is the availability of key experts?	(Vidal et al., 2011a)
Variety of technical resources to be manipulated	To what extent does the variety of technical resources to be manipulated contributes to project complexity?		(Vidal et al., 2011a)

Resource and raw material interdependencies	To what extent do the resource and raw material interdependencies contribute to project complexity?		(Vidal et al., 2011a)
Flexibility of project budgets/financial resources	To what extent does the Flexibility of project budgets/financial resources contributes to project complexity?	How flexible are project budgets/financial resources?	(Hass and Rothman, 2008; Maylor et al., 2008)
Project manager control over resource selection	To what extent does the project manager control over resource selection contributes to project complexity?	Does the project manager have control over resource selection?	(Maylor et al., 2008)
Combined transportation (Supply / Shipping)	To what extent does the combined transportation contributes to project complexity?		(Vidal et al., 2011a)

### 3.5.7 Environment

**Table 11 Complexity factors related to the environment**

<b>Environment</b>	<b>Evaluate the contribution of each factor from 1 (Very Weak) to 5 (Very Strong).</b>	<b>Assistance in assessing : you can think of :</b>	<b>Sources</b>
Level of competition	To what extent does the level of competition contributes to project complexity?	What is the level of competition (e.g. related to market conditions)?	(Nguyen et al., 2015; Vidal et al., 2011a)
Partnership and multi-firm alliances	To what extent do the partnership and multi-firm alliances contribute to project complexity?	Do you cooperate with others partners in the project?	Brainstorming
Technological / organizational complexity of the environment	To what extent does the technological / organizational complexity of the environment contributes to project complexity?		(Vidal et al., 2011a)
Contract types	To what extent does the contract types contributes to project complexity?	Are there different main contract types involved?	(Nguyen et al., 2015; Vidal et al., 2011a)

Local standards, laws and regulations	To what extent do the local standards, laws and regulations contribute to project complexity?		(Nguyen et al., 2015; Vidal et al., 2011a)
New standards, laws and regulations	To what extent do the new standards, laws and regulations contribute to project complexity?		(Vidal et al., 2011a)
Demand of creativity	To what extent does the demand of creativity contributes to project complexity?		(Vidal et al., 2011a)
Institutional configuration	To what extent does the institutional configuration contributes to project complexity?	How well and how clearly does the project align with the Institutional configuration?	(Vidal et al., 2011a)
Culture configuration and variety	To what extent do the culture configuration and variety contribute to project complexity?	Number of different languages, Number of different nationalities	(Bosch-Rekvelde et al., 2011; Lu et al., 2015; Nguyen et al., 2015; Vidal et al., 2011a)
Significance on public agenda	To what extent does the significance on a public agenda contributes to project complexity?	Is the project related to a public agenda?	(Vidal et al., 2011a)
Variety of standards between development and industrialization, and between sites	To what extent does the variety of standards between development and industrialization, and between sites contribute to project complexity?		Brainstorming
HSSE awareness	To what extent does the HSSE awareness contributes to project complexity?	Are involved parties aware of health, safety, security and environment (HSSE) importance?	(Bosch-Rekvelde et al., 2011)
Weather Conditions	To what extent does the weather Conditions contribute to project complexity?	Do you expect unstable and/or extreme weather	(Bosch-Rekvelde et al., 2011; Nguyen et al., 2015)

		conditions; could they potentially influence the project progress?	
Influence of the public perception on the project	To what extent does the influence of the public perception on the project contributes to project complexity?		(Treasury Board of Canada Secretariat, 2015)

### 3.6 Application to the Vehicle development projects

Automotive development is both challenging and fascinating, technically and organizationally as well. This development is achieved by integrating separate components into a complete vehicle, as well as orchestrating the cooperation of thousands of individuals from various companies, professions and cultural and social backgrounds, in order to optimize and achieve economic and technical objectives. This section presents key features in the vehicle development projects, current applications of the project complexity framework and its benefits in the industrial context.

#### 3.6.1 Features of vehicle development projects

A new vehicle development project is a complex system composed of hundreds of interrelated activities, deliverables, actors and risks (years of development, budgets of tens to hundreds millions of euros). Moreover, the complexity of the final deliverable, the vehicle, makes the project far more complex since each decision, whether on the product or project parameters, may influence other dimensions (respectively project or product). This kind of heterogeneous interrelation is increasingly difficult to anticipate and to manage (Marle, 2002).

Figure 13 shows the key features of vehicle development projects divided into four classes that drive forward the required effort and the development time: the Design level, the Design content, the innovation level and the amount of options and versions.

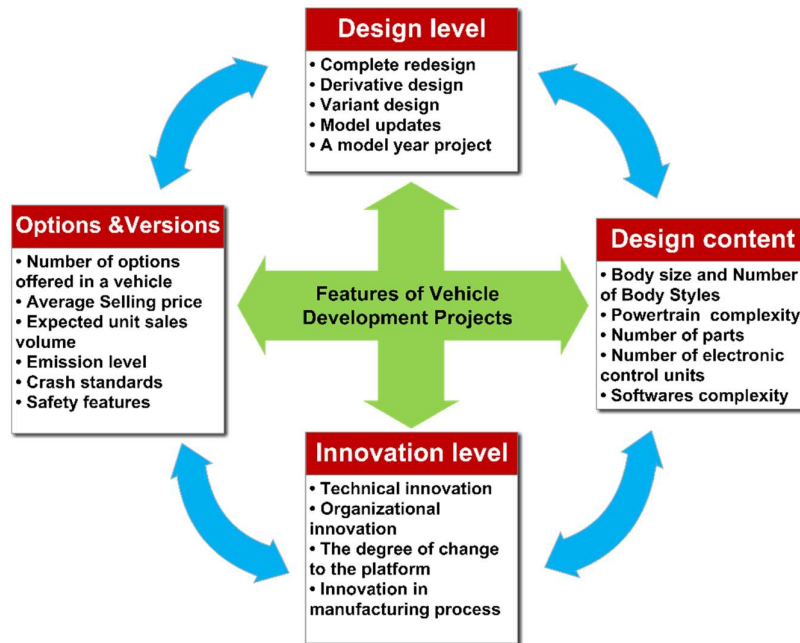

**Figure 13 The Key features of vehicle development projects**

The typical car contains about 2000 functional components, 30000 parts, and 10 million lines of software code (MacDuffie and Fujimoto, 2010), thus, to achieve the development of a new vehicle, designers and engineers must choose between a variety of product components, interior and exterior trim levels, engine-body combinations, innovation degrees of parts and in the process of manufacturing of each part, the role of suppliers (Make – Buy decisions), and carryover parts from predecessor models. These decisions must be made quickly while still adhering to certain factors, such as keeping milestones, maintaining profitability and respecting the customer's quality expectations. As a consequence, they have a major impact on project performance and product complexity. Furthermore, the level of suppliers' involvement and the use of carry over parts influence the volume of engineering work to be done internally, then the project complexity. As a result, this influences profitability, lead time and total product quality (Clark and Fujimoto, 1991) .

### 3.6.2 Applying the complexity framework to analyze and compare vehicle development projects

The increase of complexity in the vehicle development projects has changed the project structure from hierarchical to network structured. This framework was tested on several vehicle development projects within the auto manufacturer.

**Figure 14** shows an example of complexity comparison between two projects. Project X developed an electric vehicle, and project Y developed a new designed thermal car. An example of product complexity factor is the technological innovation with cost constraints which requires a greater level of engineering skills. In the electric vehicle project, more than sixty innovation patents were deposited. The interdependence of components made the implementation of the electrical technology more challenging because on a sub-system or

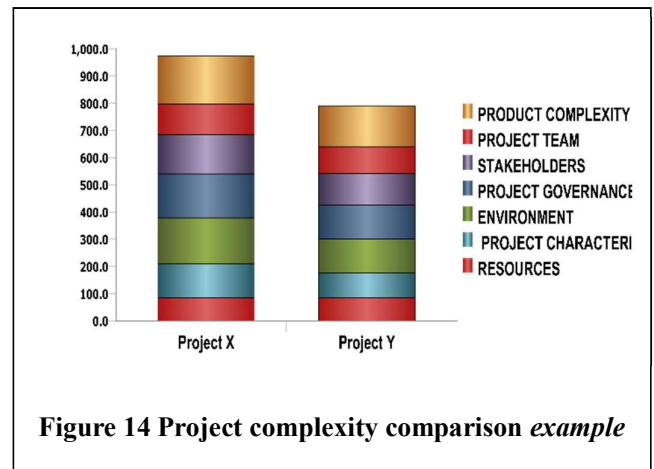

**Figure 14 Project complexity comparison example**

vehicle level, the parts handling, joining, and fastenings were very exigent. For the thermal car, the new design features and increased degree of customization have increased the demand for creativity during the project.

An example of environmental complexity factor: offering more environmentally friendly vehicles like the zero emission electrical cars and reduced emission thermal cars with the constraints imposed by the recharge infrastructure of electric vehicles that trigger rigorous technical requirements on the developed vehicles. An example of stakeholders' factors: the challenges and opportunities for the vehicle development projects are associated with multi-type and networked relationships between these projects and their various stakeholders. In addition, the international dimension of the projects (developed and industrialized in different countries) increases the complexity of project coordination. The manufacturer-supplier relation and the geographical localization of suppliers must be anticipated because they directly impact the project delay.

### 3.6.3 Project complexity score sheet

Several authors in the literature tried to define complexity measures in order to explain project failures, to identify intricate situations, to understand better project complex phenomena and to help decision-making. Indeed, such a measure is notably meant to assist decision-makers before engaging their projects / portfolios into too difficult situations since too early decisions when facing complex and uncertain situations often fail to deliver the targeted performance. There exist six important criteria to determine the complexity measure quality, according to (Latva-Koivisto, 2001). These criteria are: validity, reliability, computability, ease of implementation, independence, and intuitiveness. Generally, the survey research scales may vary from two to ten points or more. Two or three-point scales are infrequently utilized because they offer an insufficient choice. Furthermore, seven to ten-point scales, while they offer a finer degree of discrimination, are rarely used



because it is questionable as to whether respondents are actually able to differentiate enough to make them valuable. Therefore, researchers have generally settled using four or five-point scales for satisfaction research. Using a four-point scale can be effectively discriminate between satisfied and unsatisfied respondents because there is no neutral or middle option. However, some researchers (Monrad, 2013) argue that such a clear division may cause hesitation for respondents who are neither satisfied nor dissatisfied in regard to survey item. Moreover, without midpoint option, the respondents often choose a positive response, which affects the accuracy and creates positively skewed data. For these reasons, the five-point scale is utilized in this article. The score sheet is designed to be a practical way of customizing the factors and their weights. It also has a visual reporting mechanism using a spider diagramming (see Figure 15 The assessment grid of project complexity). Spider diagramming is widely used within the project management domain, especially in the work of (Gareis and Huemann, 2007) with project maturity where he develops similar profile models using different categories. This score sheet is designed to provide early-warning signs of factors with high contribution in the complexity of the project, along with the possibility of comparing and contrasting other projects. A customized version with criteria related to the specificities of a vehicle development project of an auto manufacturer was used; a brainstorming procedure was applied in order to weigh each framework and factor inside each category. In the evaluation process, experts could evaluate the contribution of each factor on project complexity from 1 (Very Weak) to 5 (Very Strong). Figure 15 shows an evaluation example in the synthesis page of the project complexity assessment grid.

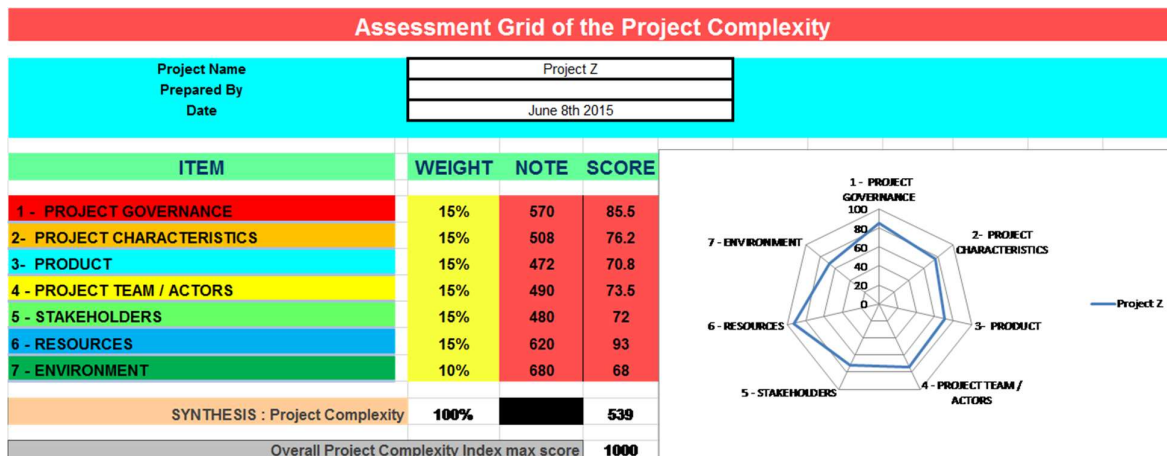

Figure 15 The assessment grid of project complexity

The tool for project complexity evaluation is divided into eight Excel sheets. The first sheet is for results reporting. The seven remaining sheets correspond to the categories in the Framework. The finale score for each project complexity category  $c$  ( $S_c$ ) is calculated using the followed equation: Score of the category  $C$  :

$$S_c = \sum_{i=1}^n W_i * N_i$$

Where  $n$ =the number of complexity factors inside  $C$ ,  $W_i$ =the weight of the complexity factor  $i$ , and  $N_i$  is the 1-5 rating of the complexity factor  $i$ . The following condition is respected on the overall

weights of complexity factors inside a category:  $\sum_{i=1}^n W_i = 1$ . In the Excel tool,  $S_c$  is normalized to zero-1000 scale, and in the Table 12 the  $S_c$  is normalized to zero-100 scale.

### 3.6.4 Applying TOPSIS Method to vehicle projects

In this section, the TOPSIS method is used to sort some vehicle projects based on their complexity. The criteria in this case are the complexities of the project in terms of environment, product, stakeholders, project team, project governance, project characteristics and resources. The alternatives in this case are project *A*, project *B* and project *C*. In this case, the number of alternatives is three and the number of criteria is seven. The matrix  $X = (X_{ij}) (3, 7)$  is the score matrix where  $X_{ij}$  is the score of the option  $i$  with respect to the criterion  $j$ .  $J$  is the set of benefit attributes complexity of the project in terms of environment, product, stakeholders, project team, project governance, project characteristics and resources. For a benefit attribute, higher value means better values. The problem is illustrated in **Table 12**.

Each project will be evaluated and given a score with respect to each criterion. These scores should be chosen with high accuracy in order to make an accurate decision.

<b>Complexity of the project in terms of :</b>	Environment	Product	Stakeholders	Project Team	Project Governance	Project Characteristics	Resources
Project <i>A</i> $X_{ij}$	93	89.7	84	61.5	74.1	75.9	50
Project <i>B</i> $X_{ij}$	92	90	87	60	75	74	55
Project <i>C</i> $X_{ij}$	94	91	86	65	73	77	48

**Table 12 The collected data of complexity of the various projects**

The criteria have different weights as seen in **Table 13**. These weights are highly dependent on the type of the project. These weights show the importance of each criterion in the decision making procedure. In real applications, these weights should be determined based on discussions with many project managers to get an idea of how much each criterion affects the complexity of the project. The choice of these weights is critical in the making decision procedure as it is possible to get different inputs from the various project managers.

<b>Complexity of the project in terms of :</b>	Environment	Product	Stakeholders	Project Team	Project Governance	Project Characteristics	Resources
--	-------------	---------	--------------	--------------	--------------------	-------------------------	-----------

Weight	0.1	0.15	0.15	0.15	0.15	0.15	0.15
--------	-----	------	------	------	------	------	------

**Table 13 Criteria weighting**

After collecting the data concerning the various projects candidates and the weights of the different criteria, the next step will be to construct the normalized decision matrix. This step transforms various attribute dimensions into non-dimensional attributes, which allows comparisons across criteria. The scores and data can be normalized by using Equation 1 (See Figure 12 in section 3.3.2) .The normalized decision matrix is presented in **Table 14**.

<b>Complexity of the project in terms of :</b>	Environment	Product	Stakeholders	Project Team	Project Governance	Project Characteristics	Resources
Project <i>A</i> $r_{ij}$	0.262630 587	0.25 3311437	0.237214 724	0.17 3675065	0.209257 274	0.21434044 7	0.14119 924
Project <i>B</i> $r_{ij}$	0.259806 602	0.25 4158632	0.245686 678	0.16 9439088	0.211798 86	0.20897487 6	0.15531 9164
Project <i>C</i> $r_{ij}$	0.265454 572	0.25 6982617	0.242862 693	0.18 3559012	0.206150 891	0.21744683	0.13555 1271

**Table 14 The normalized matrix of three projects with seven evaluation criteria**

The second step will be to construct the weighted normalized decision matrix using Equation 2 (See Figure 12), and presented in **Table 15**.

The third step will be to determine the positive ideal (the more complex) and negative ideal solutions (the less complex) using Equations 3 and 4 (See Figure 12). In this example  $A^*$  is illustrated in red and  $A^-$  is illustrated in brown in **Table 15**.

<b>Complexity of the project in terms of :</b>	Environment	Product	Stakeholders	Project Team	Project Governance	Project Characteristics	Resources
Project <i>A</i> $V_{ij}$	<b>0.026263</b> 05	<b>0.03</b> 799671	<b>0.035582</b> 20	<b>0.02</b> 605125	<b>0.031388</b> 59	<b>0.03215107</b>	<b>0.02117</b> 988
Project <i>B</i> $V_{ij}$	<b>0.025980</b> 66	<b>0.03</b> 812379	<b>0.036853</b> 00	<b>0.02</b> 541586	<b>0.031769</b> 82	<b>0.03134623</b>	<b>0.02329</b> 787

Project <b>C</b>	<b>0.026545</b>	<b>0.03</b>	<b>0.036429</b>	<b>0.02</b>	<b>0.030922</b>	<b>0.03261702</b>	<b>0.02033</b>
$V_{ij}$	<b>45</b>	<b>854739</b>	40	<b>753385</b>	<b>63</b>		<b>269</b>

**Table 15** The weighted normalized decision matrix. Positive ideal and negative ideal solutions are represented in red and green respectively

The fourth step will be to calculate the separation measures for each alternative using the dimensional Euclidean distance.

The separation from the ideal alternative is calculated using Equation 5 (See Figure 12), and the separation from the negative ideal alternative using Equation 6 (See Figure 12). The measures of separation of each alternative solution are presented in **Table 16**.

$S_{ij}^*$	Separation from the ideal solution	$S_{ij}^-$	Separation from the ideal negative solution
Project <b>A</b>	0.0030	Project <b>A</b>	0.0014
Project <b>B</b>	0.0026	Project <b>B</b>	0.0033
Project <b>C</b>	0.0031	Project <b>C</b>	0.0027

**Table 16** Measures of separation of each alternative solution

And the last step is to calculate the relative closeness to the ideal solution using Equation 7 (See Figure 12).

The results of closeness coefficient and rank are presented in **Table 17**.

$C_i^*$	Relative closeness to the ideal solution
Project <b>A</b>	0.3234
Project <b>B</b>	0.5651
Project <b>C</b>	0.4670

**Table 17** Results of closeness coefficient and rank

Finally, the conclusion of this problem is that project **B** is the most complex project between the three projects and project **A** is the project with the smallest global complexity. Measuring the complexity of a project permits to understand what its principal areas of complexity are. These final results permit to realize a ranking of projects according to a complexity scale / index (from 0 to 1), as shown on Table 17.

The existence of a numerical relative evaluation of project complexity within a project portfolio appears to be promising since it permits to know which projects are to be the most complex ones, but also how complex projects are. As project complexity increases, higher communication frequencies will be needed to achieve optimal performance, such as email occurs at the lowest communication frequency, phone communication next, and face-to-face (personally) communication at the highest (Kennedy et al., 2011). This method requires a very accurate design of the score matrix of the various candidates with respect to the various criteria. Also, accurate information of the weights assigned to each criterion plays a crucial role.

### **3.6.5 Current & future work**

The framework presented in this chapter shows how the theory of project complexity assessment can be applied to real vehicle development projects. The testing was done retrospectively on completed projects, and testing on a significant number of ongoing projects is essential to ensure that the framework functions properly. Due to the dynamic aspects of each project, real time testing and analysis would be required, using the framework in the upstream phase of the project and following between the milestones to ensure the score sheet could be used effectively and reported interesting indicators to projects practitioners.

## **3.7 Conclusions & Perspectives**

The performance of a project is related to its complexity. More complex projects may require an additional level of control. We emphasize that the main goal of this chapter has been to give the project complexity a framework to describe and measure it better. In terms of practicality, the findings provide a framework that gives relevant indicators for key actors to anticipate and make better decisions based on its impact on the evolution of the project complexity. This chapter proposed a framework of identified and classified project complexity factors that may be integrated into the exploratory phase of a complexity impact analysis. It may also be used to capture and structure its possible consequences; also, to ensure that these are managed appropriately. Due to the dynamic aspect of the project complexity, repeated use during the different phases

of a project is expected. Establishing an objective and standardized measure permits a retrospective analysis of previous projects. This is needed to assess the impact of the complexity sources on the achievement of the project goals and their influence on the cost and the staffing level. Moreover, its application in the upstream stage permits to highlight areas which have a high complexity, in order to: 1) anticipate their impact by comparing to other projects; and 2) plan mitigation actions to reduce risks associated with complexity, for example, adopting a simpler process, choosing a more stable supplier or increasing communication frequencies between actors. A key improvement of the proposed framework would be to introduce more precise evaluation scale by enumerating more accurate criteria for each factor, as well as developing a common database of results that improve and grow with every use. To conclude, a high-level factor-based descriptive modeling was proposed in this chapter. It permits to measure and prioritize areas and domains where complexity may have the highest impact.

### 3.8 References

- Azim, S.W., 2010. *Understanding and Managing Project Complexity*. University of Manchester.
- Baccarini, D., 1996. The concept of project complexity a review. *International Journal of Project Management* 14, 201 – 204.
- Boran, F.E., Genç, S., Kurt, M., Akay, D., 2009. A multi-criteria intuitionistic fuzzy group decision making for supplier selection with TOPSIS method. *Expert Systems with Applications* 36, 11363–11368.
- Bosch-Rekveltdt, M., Jongkind, Y., Mooi, H., Bakker, H., Verbraeck, A., 2011. Grasping project complexity in large engineering projects: The TOE (Technical, Organizational and Environmental) framework. *International Journal of Project Management* 29, 728–739. doi:10.1016/j.ijproman.2010.07.008
- Cheng, C.-H., 1999. Evaluating weapon systems using ranking fuzzy numbers. *Fuzzy Sets and Systems* 107, 25–35.
- Chen, T.-Y., 2012. Comparative analysis of SAW and TOPSIS based on interval-valued fuzzy sets: Discussions on score functions and weight constraints. *Expert Systems with Applications* 39, 1848–1861. doi:10.1016/j.eswa.2011.08.065
- Cicmil, S., Cooke-Davies, T., Crawford, L., Richardson, K., 2009. *Exploring the Complexity of Projects: Implications of Complexity Theory for Project Management Practice*. Project Management Institute, Inc.
- Clark, K.B., Fujimoto, T., 1991. *Product Development Performance: Strategy, Organization, and Management in the World Auto Industry*. Harvard Business School Press, Cambridge, MA.
- Damasiotis, V., Fitsilis, P., O’Kane, J.F., 2012. Measuring communication complexity in projects, in: 8th Annual MIBES International Conference 8th Annual MIBES International Conference.
- Del Vasto-Terrientes, L., Valls, A., Slowinski, R., Zielniewicz, P., 2015. ELECTRE-III-H: An outranking-based decision aiding method for hierarchically structured criteria. *Expert Systems with Applications* 42, 4910–4926.
- Dymova, L., Sevastjanov, P., Tikhonenko, A., 2013. A direct interval extension of TOPSIS method. *Expert Systems with Applications* 40, 4841–4847. doi:10.1016/j.eswa.2013.02.022
- Ekmekçioğlu, M., Kaya, T., Kahraman, C., 2010. Fuzzy multicriteria disposal method and site selection for municipal solid waste. *Waste Management* 30, 1729–1736.
- Gareis, R., Huemann, M., 2007. Maturity Models for the project-oriented Company. *The Gower Handbook of Project Management*, Turner JR (ed), Gower, Aldershot 187–213.
- Geraldi, J.G., Adlbrecht, G., 2007. On faith, fact, and interaction in projects. *Project Management Journal* 38, 32 – 43.
- Griffin, A., 1997. The effect of project and process characteristics on product development cycle time. *Journal of Marketing Research* XXXIV, 24–35.
- Hass, K.B., Rothman, J., 2008. *Introducing the New Project Complexity Model*. Projects and Profits Case Studies in Management.
- Helmsman Institute Pty Ltd, 2012. *Why Project Complexity Matters*.
- Hwang, C.-L., Yoon, K., 1981. *Multiple attribute decision making: methods and applications ; a state-of-the-art-survey*, Lecture notes in economics and mathematical systems. Springer, Berlin.

- Ireland, L., 2007. Project Complexity: A Brief Exposure To Difficult Situations.
- Kennedy, D.M., McComb, S.A., Vozdolska, R.R., 2011. An investigation of project complexity's influence on team communication using Monte Carlo simulation. *Journal of Engineering and Technology Management* 28, 109–127. doi:10.1016/j.jengtecman.2011.03.001
- Latva-Koivisto, A.M., 2001. Finding a complexity measure for business process models. Helsinki University of Technology, Systems Analysis Laboratory.
- Le Moigne, J.L., 1994. *La théorie du système général: théorie de la modélisation*.
- Lu, Y., Luo, L., Wang, H., Le, Y., Shi, Q., 2015. Measurement model of project complexity for large-scale projects from task and organization perspective. *International Journal of Project Management* 33, 610–622.
- MacCrimmon, K.R., 1968. Decision Making Among Multiple-Attribute Alternatives: A Survey and Consolidated Approach. RAND Memorandum, RM-4823-ARPA.
- MacDuffie, J.P., Fujimoto, T., 2010. Why dinosaurs will keep ruling the auto industry. *Harvard Business Review* 88, 23–25.
- Marle, F., 2002. *Modèles d'information et méthodes pour aider à la prise de décision en management de projets*. Ecole Centrale Paris.
- Maylor, H., Vidgen, R., Carver, S., 2008. Managerial complexity in project-based operations: A grounded model and its implications for practice. *Project Management Journal* 39, S15–S26.
- Monrad, M., 2013. On a scale of one to five, who are you? Mixed methods in identity research. *Acta Sociologica* 56, 347–360.
- Ngai, E.W.T., Chan, E.W.C., 2005. Evaluation of knowledge management tools using AHP. *Expert Systems with Applications* 29, 889–899. doi:10.1016/j.eswa.2005.06.025
- Nguyen, A.T., Nguyen, L.D., Le-Hoai, L., Dang, C.N., 2015. Quantifying the complexity of transportation projects using the fuzzy analytic hierarchy process. *International Journal of Project Management* 33, 1364–1376.
- Novak, S., Eppinger, S.D., 2001. Sourcing by design: product complexity and the supply chain. *Management science* 47, 189–204.
- Özcan, T., Çelebi, N., Esnaf, Ş., 2011. Comparative analysis of multi-criteria decision making methodologies and implementation of a warehouse location selection problem. *Expert Systems with Applications* 38, 9773–9779.
- PMI, 2013. *A Guide to the Project Management Body of Knowledge: PMBOK Guide*. Project Management Institute.
- Pomerol, J.C., Romero, S.B., 2000. *Multicriterion Decision in Management - Principles and Practice*, 1st Edition. (Translation by Claude James from French). ed. Kluwer Academic Publishers, Norwell.
- Qureshi, S.M., Kang, C., 2015. Analysing the organizational factors of project complexity using structural equation modelling. *International Journal of Project Management* 33, 165–176.
- Roy, B., 1991. The outranking approach and the foundations of ELECTRE methods. *Theory and decision* 31, 49–73.
- Saaty, T.L., 2003. Decision-making with the AHP: Why is the principal eigenvector necessary. *European journal of operational research* 145, 85–91.
- Saaty, T.L., 1986. Axiomatic foundations of the analytic hierarchy process. *Management Science* 32, 841–855.
- Schleich, H., Schaffer, J., Scavarda, L.F., 2007. Managing complexity in automotive production, in: 19th International Conference on Production Research.
- Simon, H.A., 1996. *The sciences of the artificial*. MIT Press, Cambridge, Mass.
- Stanujkic, D., Magdalinovic, N., Jovanovic, R., Stojanovic, S., 2012. An objective multi-criteria approach to optimization using MOORA method and interval grey numbers. *Technological and Economic Development of Economy* 18, 331–363.
- Tatikonda, M.V., Rosenthal, S.R., 2000. Successful execution of product development projects: Balancing firmness and flexibility in the innovation process. *Journal of Operations Management* 18, 401–425.
- Tavana, M., Hatami-Marbini, A., 2011. A group AHP-TOPSIS framework for human spaceflight mission planning at NASA. *Expert Systems with Applications*.
- Thor, J., Ding, S.-H., Kamaruddin, S., 2013. Comparison of Multi Criteria Decision Making Methods From The Maintenance Alternative Selection Perspective. *The International Journal of Engineering And Science (IJES)* 2, 27–34.
- Treasury Board of Canada Secretariat, 2015. Project Complexity and Risk Assessment Tool [WWW Document]. URL <http://www.tbs-sct.gc.ca/pm-gp/doc/pcra-ecrp/pcra-ecrp-eng.asp>
- Vidal, L.-A., Marle, F., Bocquet, J.-C., 2013. Building up a project complexity framework using an international Delphi study. *International Journal of Technology Management* 62, 251–283.

- Vidal, L.-A., Marle, F., Bocquet, J.-C., 2011a. Measuring project complexity using the Analytic Hierarchy Process. *International Journal of Project Management* 29, 718–727.
- Vidal, L.-A., Marle, F., Bocquet, J.-C., 2011b. Using a Delphi process and the Analytic Hierarchy Process (AHP) to evaluate the complexity of projects. *Expert Systems with Applications* 38, 5388–5405.
- Vidal, L.-A., Sahin, E., Martelli, N., Berhoune, M., Bonan, B., 2010. Applying AHP to select drugs to be produced by anticipation in a chemotherapy compounding unit. *Expert Systems with Applications* 37, 1528–1534.



## **Chapter 4: Modeling a complex project in order to analyze its behavior & improve coordination between its actors**

---

This chapter proposes a modeling approach of complex projects using weighted directed graph (matrix-based modeling) which takes into account the number and diversity of project elements. Modeling and analyzing the interactions between risks, processes, product elements and actors contribute in understanding the project complexity aspects in order to reduce them when making decisions. We propose a framework which allows the user to enter, calculate and operate efficiently and ergonomically the input data. The input data are analyzed in a simple and non-matrix format in Excel, and an automated process creates the corresponding graph and associated Design Structure Matrix. This framework allows to assembly the global network of project elements interactions from local data. Furthermore, it contains an algorithm for bidirectional updates between the global network and the local data, in order to keep both models continuously refreshed. A reciprocal enrichment procedure is proposed in to complete the different models used, and reduce the gap between the reality and the models by providing more complete, consistent and stable information on the interactions between project elements. Application of this proposed modeling approach on vehicle development projects within Renault is performed and presented in the last Section.

### **4.1 Introduction & Motivation**

Our aim is to model a complex project in order to analyze its behavior and improve coordination between its actors. Modeling is the act of representing our concepts and objects of our material or immaterial reality. It is impossible to describe absolutely the reality but we can build models for specified descriptive or predictive purposes: a model is therefore necessarily limited and is only a focused description of reality according to one vision and angle. Box said: "All models are wrong but some are useful" (Box and Draper, 1987), which illustrates that a model is not designed to be true and perfectly representative of reality, but to fulfill a purpose. As a consequence, a model is valid if and only if it is a simplified representation of a problem in order to develop a solution to this problem, making it suitable for use. In this chapter we will retain the definition of Boccara: "A model of a system is a simplified mathematical representation of this system, which should be as simple as possible but, however, being able to capture the key elements of the system allowing to elicit highly relevant questions" (Boccara, 2010). Modeling work is, in essence, a way to reduce the perceived complexity of the system to understand it better. Models that are not complex enough are not sufficiently realistic to give good results. Conversely, human capacity of complexity management has a limit, and overly difficult models, will no longer be usable.

## 4.2 Graph-based modeling to manage project complexity

Decision-making in a project is done at all levels of detail and with all kinds of objects. Decision-making in a highly inter-connected system is all the more difficult that the number of objects in interaction with the subject is large. This means that any project and any object within the project is very likely to have to be decomposed. However, the interactions between subsystems should be treated with as much importance as the interactions within each sub-system. The WBS and Gantt chart are challenged by their inability to manage the entire problem of complexity and interaction in and around a project. They manage one or two interactions at a time, while there are many others. In this section, we present the types of elements in complex projects, types of interdependencies between these elements, and the modeling of local interactions.

### 4.2.1 Elements of complex projects

A project is composed of numerous and diverse elements  $X$ , owned by actors  $A(X)$  with numerous and diverse interactions  $I(X, Y)$ . This complex structure may cause the emergence of some local or global unexpected phenomena. Classical decisions are made about project's elements, including hierarchical links between these elements, often modeled through breakdown structures and organization charts. The Project Management Institute defines a project as "a temporary endeavor undertaken to create a unique product, service or result". This definition introduces some elements: 1) The words "product or service" introduce the concept of implementation, materialization of the result  $\Rightarrow$  object "Deliverable" and family "Product" or "System"; 2) The word "temporary" introduces the concept of limited duration for the effort to be made, that is to say a number of activities to be implemented using the resources  $\Rightarrow$  object "Activity" and family "Process"; 3) The word "endeavor" introduces the concept of resources to be used. The search is restricted in terms of resources to human resources  $\Rightarrow$  object "Actor" and family "Organization". They are also found in following Table 18.

**Table 18 Organizational Structure of Product Development (adapted from Prasad 1996)**

Hierarchy Levels (top-down)	Organization		Product	Process
	Business Unit	Tasks		Modeling element
	Strategic business Unit	Project vision and Mission	System	Process
	Sub unit	Strategies, values, objectives	Sub system	Sub process
	Product development team	Project initiatives and tasks	Components	Activities, functional chain (sub-sub process)
	Work group	Project teams	Parts	Work procedures, sub functions
	Experts	Time plans	Attribute	Activities, methods

Finally, several elements are included in Table 19, based on previously introduced definitions and literature.

**Table 19 Elements of complex projects**

<b>Object Type</b>	<b>Definition</b>
<b>Actor</b>	This is a person or a human structure that is used to fill a need.
<b>Activity</b>	This is a set of actions achievable by resources, with a certain duration, and producing results.
<b>Deliverable</b>	This is a tangible object produced as a result of the project that is intended to be delivered to a customer (either internal or external). A deliverable could be a report, a document, a permit or any other building block of an overall project.
<b>Decision</b>	This is a choice made by one or more human beings among several alternatives. Each decision is based on choice criteria, and requires certain information. It has consequences, positive or negative, on the object in which it is related to, or to other external objects.
<b>Objective</b>	This is the end to which turns the efforts. Expected Result. Measurement criteria of a performance (Ward, 1997).
<b>Other project within the firm</b>	This is a temporary endeavor undertaken to create a unique product, service or result.
<b>Product related elements</b>	These can be components or systems used in product design.
<b>Risk ( Potential event)</b>	This is an event which, if it occurs, will generate a positive or negative impact on the project.

#### 4.2.2 Types of interdependencies

Thompson stressed that the study of interdependence helps business owners understand how the different departments or units within their organization depend on the performance of others (Thompson, 1967). The way interdependencies are modeled and treated is crucial for the capacity of analysis and decision (Mane et al., 2011); (Eppinger and Browning, 2012).

There are two types of interactions in a system (Simon, 1965): 1) Interactions between subsystems; 2) Interactions within a subsystem. Thompson defined three types of interdependence to describe the intensity of interactions and behaviors within an organizational structure (Thompson, 1967): pooled, sequential, and reciprocal, to which (Van De Ven et al., 1976) added a fourth, team interdependence.

Figure 16 shows an example of pooled interdependence between four project elements. This type of independence exists between activities and organizational units, where work and activities are performed independently by immediate subordinates and do not interact.

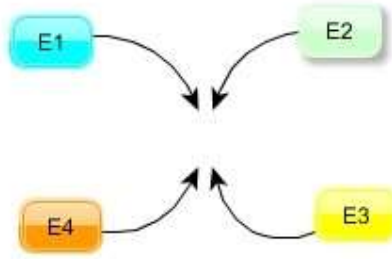

**Figure 16 Pooled Interdependence**

Figure 17 shows sequential interdependence between project elements. In this type of interdependence, work and activities flow between project elements only in one direction.

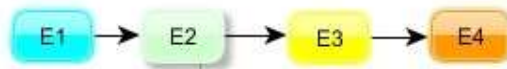

**Figure 17 Sequential Interdependence**

Figure 18 shows reciprocal interdependence between project elements, where work and activities flow between project elements in a reciprocal "back and forth" manner over a period of time.

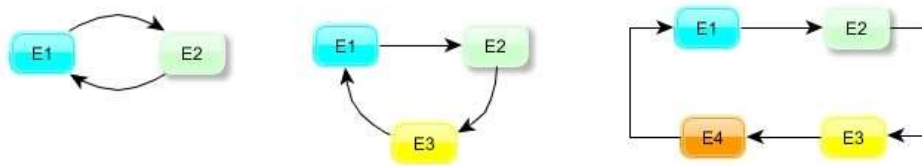

**Figure 18 Reciprocal Interdependence**

Figure 19 shows team interdependence, defined by (Van De Ven et al., 1976) as Team Work Flow Case, where work and activities come into a business unit and actors subordinates diagnose, problem-solve and collaborate as a group at the same time to deal with the work.

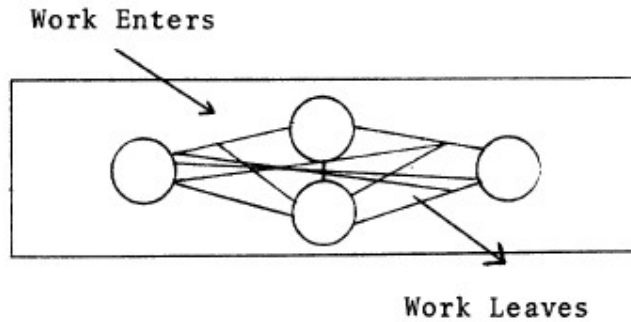

**Figure 19 Team interdependence**

In a more recent work, Marle characterized interactions between project objects into seven types as described in Table 20 below. However, he doesn't precise the mathematical structure used to collect information about these interactions. Furthermore, this work offers a vision centered on one object, without building the global network and running the associated analysis

**Table 20 Seven types of interactions (from (Marle 2002))**

<b>Link Type</b>	<b>Definition</b>
<b>Hierarchical link</b>	This is the classic link in all project decomposition. It indicates "subsidiary" dependence of two objects. The first object is sometimes called the father, and the second object called the son. It indicates that the second object is part of the first object. It entails the consequence that the responsible of the first object has the authority over the son object.
<b>Sequential link</b>	This is the classic link in any project schedule, which marks the sequence in time of two objects. Often, they are end-start links; the object "B" can only start when the object "A" is completed. The object "A" is called the predecessor and object "B" the successor.
<b>Link of Contribution</b>	This shows how the object "A" contributes to the achievement of the object "B." There is no hierarchical relationship between the two objects, but a result of the first object advances the work of the second object.
<b>Link of Influence</b>	This shows the influence of the object "A" to the object "B", which can be of two types: · 1) Object "A" may alter or challenge the conduct of the object "B"; 2) The result of the object "A" can impact the object "B"
<b>Resources Link</b>	This indicates a common point between the two objects to which is assigned the same material resource. Ultimately, the resource may be material (people, machines, equipment, tools) or immaterial (competence, technology).
<b>Link of Exchange</b>	This indicates an exchange of information and data between two objects, without hierarchical or contribution or influence or sequential relationship.
<b>Resemblance link</b>	This indicates a resemblance between two objects, which shows a possibility to re-use a tool or a good practice between these objects.

Two categories of relationships are particularly important in system modeling: hierarchical (vertical) and lateral (horizontal). Hierarchical relationships stem from the decomposition or breakdown of a system. They are often modeled with breakdown structure diagrams. Lateral relationships stem from interactions between elements at the same level.

We need a global vision for two reasons: to prioritize the elements of the project which require more surveillance and monitoring, but also to have an exhaustive list of input and output interactions of each element, to establish local coordination actions. For example, having the global vision of interactions between project risks permits to re-evaluate their criticality by taking into account their overall influence in the network, but also gives us an exhaustive list of causes and consequences of a risk, which permits to manage local coordination actions better.

### **4.2.3 Related Work**

As seen in the previous chapter, project complexity has three main drivers: Size, Variety and Interdependence. To deal with finer modeling of project complexity, we need a mathematical structure which can deal with a huge number of elements, of interdependencies, and also various types of project elements and interactions. As seen in the previous section, links between project elements can have a direction: a change in the direction can inverse the meaning and the interpretation of the link. Consequently, an additional requirement to the mathematical structure which should be used for modeling is that it should take into account the direction of links and their weights. The existing and emergent theories of systems modeling like hierarchical representation of complex systems are based on weighted directed graph (Gunawan, 2009) (Gomez et al. 2011). Therefore, the most adaptable structure to respect these requirements is the weighted directed graph. This structure can be presented in a matrix format. Complexity management by matrix-based modeling has come a long way. Matrix has become a widely used modeling framework across many areas of research and practice. A whole community was developed around the research on the Design Structure Matrix (DSM) originated by (Browning, 2001; S. Eppinger et al., 1994; D. Steward, 1981).

A DSM is a square matrix, representing interactions between its elements, with the rows and columns identically labeled and ordered, and where the off-diagonal elements indicate relationships between the elements. The literature contains two conventions for DSM orientation:

- An element's inputs appear in its matrix row and its outputs appear in its column.
- An element's inputs appear in its matrix columns and outputs in rows. In this thesis, we choose this convention to be closer to the adjacency matrix in graph theory.

Depending on the number and location of identified relationships, elements may be (Browning, 2001; Thompson, 1967):

- Dependent (sequential if temporality is a parameter of the relationship),
- Independent (or parallel),
- Coupled,
- Conditionally connected (contingent relationship).

A DSM may be binary or numerical, with qualitative or quantitative assessment. DSMs are used in systems engineering and project management to model the structure of complex systems or processes, in order to perform system analysis, project planning and organization design (Danilovic and Browning, 2007). For example, a significant reduction of the number of design iterations involved in a Petroleum Oil Field Development project was done using DSM techniques (Gunawan, 2009). A DSM is mainly used to represent the lateral relationships between elements at a particular level of decomposition and of one single domain, for example product pieces to analyze the global change impacts and the possible change propagations (Clarkson et al., 2004); (Giffin et al., 2009).

The Dependency Structure Modeling approach has proven to be a practical tool for representing and analyzing relations and dependencies among system components. The DSM approach has several advantages, such as the calculations inherent to the matrix format to get the benefits of different types of analyses. It avoids issues associated with the visual display of complex networks, especially in the case of structures including lots of interactions and even loops (Steward, 1981), (Eppinger et al., 1994), (Eppinger and Browning, 2012). It is a highly compact, easily scalable, and intuitively readable representation to navigate across dependencies between elements. Graphic representation is more intuitive but cannot be totally understandable when the number of nodes and edges grow. DSMs can be very efficient to represent large and complex graphs. Figure 20 shows a weighted DSM model of a system with eight elements, along with its equivalent weighted directed graph representation.

Element	A	B	C	D	E	F	G	H
A	A		3					
B		B		6	5		2	
C			C			3		
D	2			D				
E		4			E		1	8
F						F		
G	4		7				G	
H						4		H

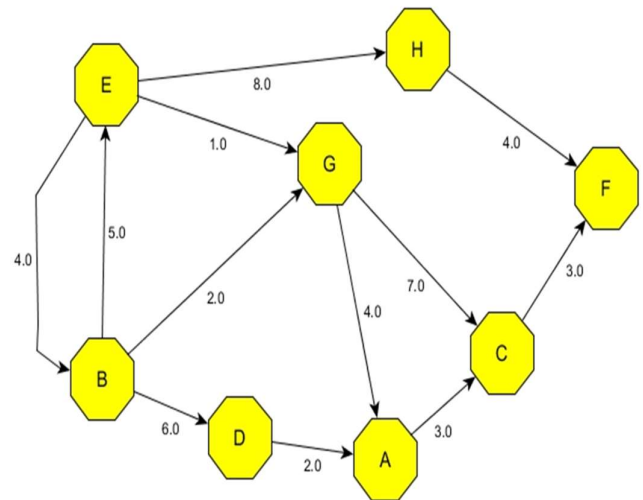

**Figure 20 The weighted DSM (with inputs in columns and outputs in rows) and its equivalent in weighted directed graph**

Many applications have been done for modeling project elements, like:

- Product-related elements (components, sub systems or functions),
- Process-related elements (tasks, activities or processes)
- Organization-related elements (actors or entities).

DSM approach has also been used to model interactions between project risks with numerous benefits in a number of industrial applications (Marle et al., 2008), (Marle and Vidal, 2011), (Fang and Marle, 2012).

Domain Mapping Matrix (**DMM**) is a rectangular matrix mapping elements of a certain domain to elements of another domain (Akao, 1990; Danilovic and Browning, 2007), see Figure 21 below.



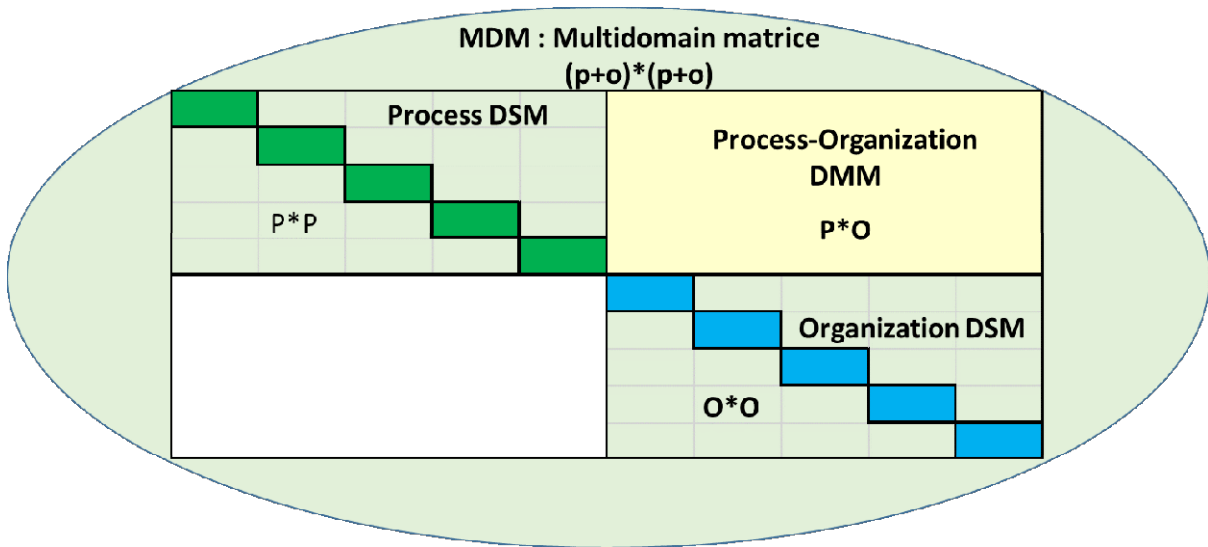

**Figure 21 A DMM relates the elements of one DSM domain (process activities) to elements of another DSM domain (organizational units)**

Multi-Domain Matrix (**MDM**) is an extension of DSM modeling in which two or more DSM models in different domains are represented simultaneously (Lindemann et al., 2009), (Maurer, 2007). Each single-domain DSM is on the diagonal of the MDM, and the off-diagonal blocks are DMMs. This combination of multiple domains in a single big matrix has been called periodic table of DSMs and DMMs (Danilovic and Browning, 2007). Multi-Domain Matrices provide a promising way for modeling complex, multi-domain systems such as projects. The MDM is a powerful tool to analyze and manage complex situations and problems. It holds great potential for applications that require organizing, managing, and analyzing large amounts of information about product, process, organization, and other elements and their intra- and inter domain relationships.

#### 4.2.4 Challenges of modeling interdependencies in complex projects.

One scientific issue of this thesis is the number of elements and interactions between these elements which do not always enable classical methods to be used. In a recent survey, which studied 553 papers about DSM applications and its opportunities and challenges, Browning stressed that the fundamental challenges of DSM methodology are: 1) the large amount of new data required to build a rich, structural model of some systems; and 2) the absence of a versatile and user-friendly software toolset for DSM/DMM/MDM modeling, manipulation, and analysis. As for the data challenge, this is not a DSM problem but rather a general problem for any system model: “gathering new data is a tedious and error-prone process” (Browning, 2015). We can resume literature review about DSM into two main research streams:

- 1) Automation of data-gathering steps, in order to increase performance and decrease effort and error risk.

2) Strength, reliability & accuracy of interdependencies modeling.

This chapter will address both streams. It is a basis for chapters 5 and 6. From these observations, we underline the following research question:

❖ How can one model complex projects in order to prevent, predict and control the propagation of impacts within the project?

1) How can we increase confidence on project models by introducing interactions in domains which may still consider elements as if they were independent?

2) How can one run this modeling in an efficient and ergonomic way?

3) How can we increase the reliability of interactions-based models used for further analyses?

In the next section, we propose a modeling framework to answer these research questions.

### **4.3 Modeling framework**

This section presents the stages which should be followed when modeling complex projects and proposes a framework which allows the user to enter, calculate and operate efficiently and ergonomically the input data. This modelling framework is based on weighted directed graphs.

In mathematics, a graph is an abstract representation of a set of objects (called vertices), where some pairs of the objects are connected by links (called edges). The input data are analyzed in a simple and non-matrix format in Excel, and an automated process creates the corresponding graph. This framework allows to extract the global network of project elements from local interactions data, as well as the extraction of the exhaustive list of interactions between two elements via other elements. Furthermore, it contains an algorithm for bidirectional update between the global network and its corresponding local data. To increase the reliability of interactions-based models used for further analyses, we propose a reciprocal enrichment procedure to complete these models and reduce the gap between the reality and the models by providing more complete, consistent and stable information on the interactions between project elements.

#### **4.3.1 Stages of complex projects modelling**

Several project elements can be considered for such studies, like product components, functions, activities, deliverables, decisions, goals or actors. In this section, we describe the steps of modeling complex projects by modeling interdependencies between their elements, we propose two models of project elements: the first one is the Risk-Risk (RR) interdependency model with the purpose of anticipating project risk propagation through actors and time within the project. The second one is the APP (Actors-Process-Product) model classically used to anticipate the propagation of desired changes and of unintended disruptive events from one project element to another. Then, we present the automation of data gathering steps, in order to increase

performance and decrease effort and error risk, and we propose a methodology to establish complete, consistent and stable information on the interactions between project elements with a mutual exchange of information between the APP model and the RR model. The first step is about modeling interactions between elements of product, process, and actors of the project. The second step is about modeling risk interdependencies. The third step represents the mutual enrichment of both models using information from one side to another.

#### 4.3.1.1 The risk network

The existing methods in project risk management are not able to represent appropriately and model the real complexity of a project and its underlying risks. The modeling of the interrelationships between project risks in the network structure permits us to conduct subsequent risk network analyses for studying the risk propagation behavior. The results can thus improve the project manager's insights for making decisions concerning risk management. Here, we are manipulating risks, which may be grouped into different levels of categories (or families), depending on their domain, their assessed values or ownership. The purpose of modeling project risks in a network is to provide project managers with improved insights into risks considering complexity and help them to design more effective response actions by calculating risk propagation, re-evaluating risks' characteristics such as probability and criticality, and prioritizing risks with respect to their importance in terms of influence in the network. In addition, this modeling of project risks permits to organize the relationships between the actors who own these risks (who are accountable for their management). Chapter 6 develops a method to reshuffle project risk organization in order to put together (as much as possible) interconnected risks, and thus actors.

Determine and establish the possible cause-effect relationship between risks is the first step of identification of risk interaction (see Figure 22). The procedure is as follows:

- For each risk  $R_i$  which belongs to the original list  $L_0$  with dimension equal to  $n_0$ , we identify all of its direct causes and potential consequences DCPC  $\{(i)\}$ .
- For each  $k$ , if  $DCPC_k(i)$  element belongs to  $L_0$ , then there exists an index  $j$  such that  $DCPC_k(i) = R_j$ .
- Then we fill the corresponding  $(i,j)$  cell in the RR matrix. This is  $RR_{ij}$  if  $R_j$  is a potential cause of  $R_i$ , and  $RR_{ji}$  if  $R_j$  is a consequence of  $R_i$ . So we may have either  $RR_{ij}$  or  $RR_{ji}$  equal to 1, or both if risks are reciprocally interrelated.
- Instead, if the  $DCPC_k(i)$  element does not belong to the original list, we add it as the  $(n_0+1)^{th}$  risk. We update the list which becomes  $L_1 = L_0 + R_{n_0+1}$ .

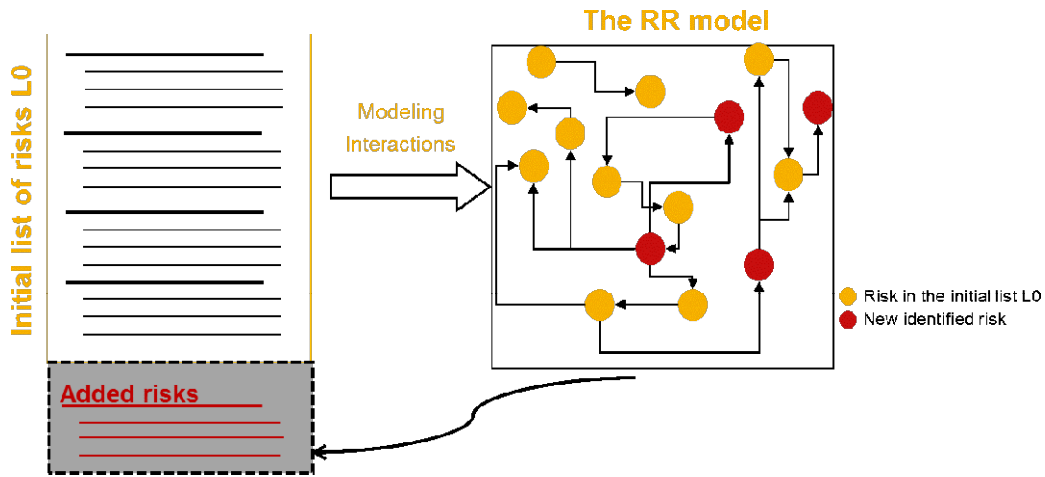

**Figure 22 Modeling RR from interactions identification**

- This operation is repeated for each  $k$  and for each  $i$  until the list become stable, i.e. there are not new risks identified from interactions to existing risks or from them.
- At the end, we get the RR matrix of dimension  $n_1 * n_1$ , with  $n_1 \geq n_0$ . This is a first result of interdependency modeling, which is to get a refined list of risks.

The two reasons that may involve the formalization of a new risk in the list are shown in Figure 23, where risks  $R_i$ ,  $R_j$  &  $R_k$  are already included in the list, and the newly identified risk will be added. We insist on the fact that risks are not created, but formalized, since they exist independently of the human limited capacity to model them.

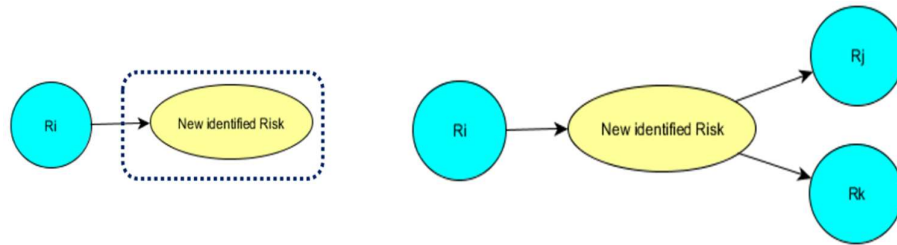

**Figure 23 Reducing the gap between the project risks' model and the project real behavior**

In the end, **RR** is also a MDM. Namely risks are by construction heterogeneous, meaning that they are of different natures. On the contrary to APP, this MDM is built directly from the analysis of relationships between heterogeneous elements (Figure 24).

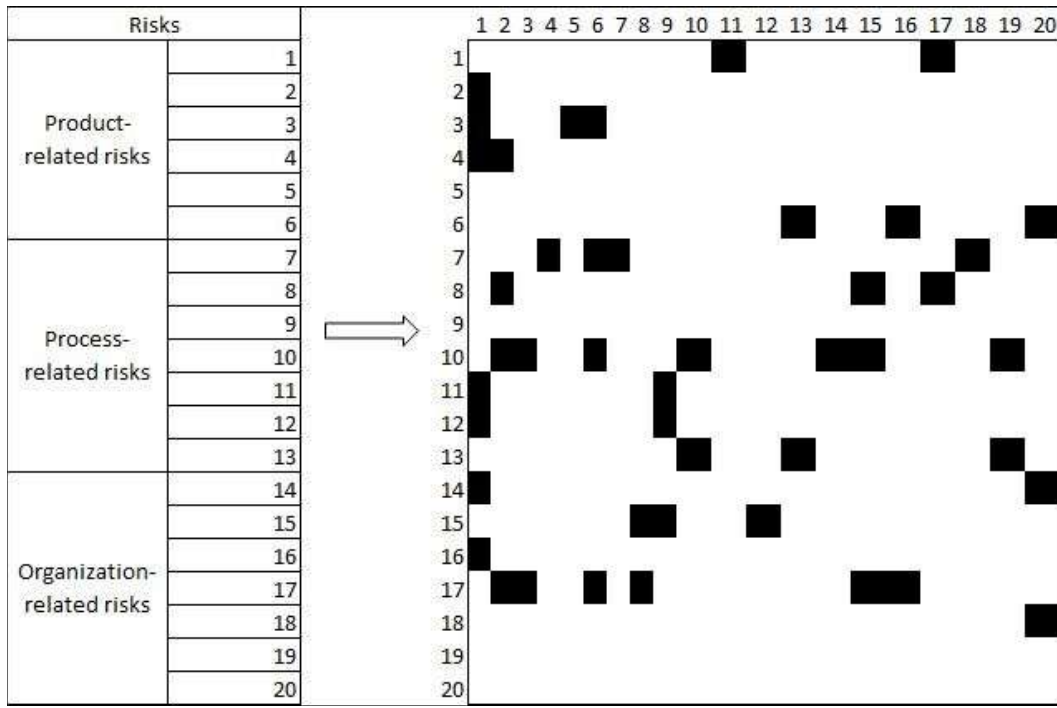
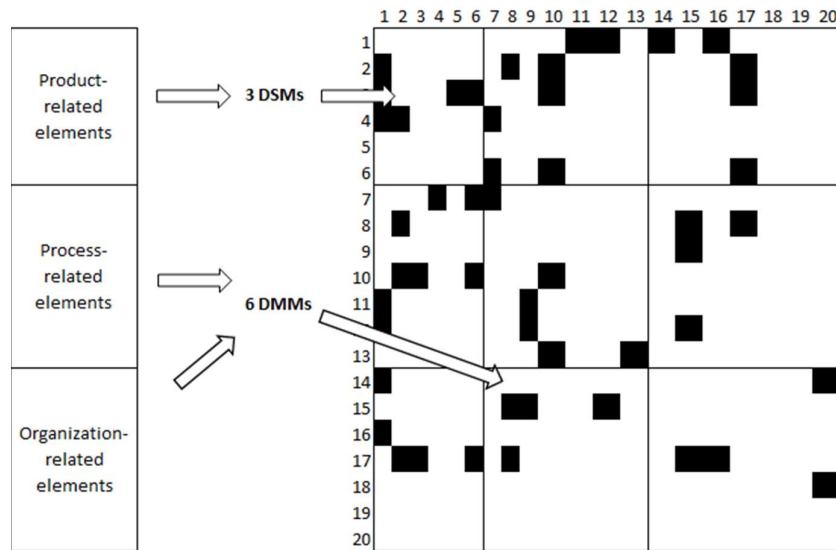

Figure 24 Building RR MDM directly

#### 4.3.1.2 The APP (Actors-Process-Product) model

To build the APP model, the existing lists of project team members, processes and product sub-systems are used. Interactions between elements are identified. An interaction defines an exchange between the elements. This exchange can be physical, documentary, decisional, etc. 3 DSM and 6 DMM are built, modeling respectively homogeneous and heterogeneous interactions.

There are several interests and advantages by analyzing separately each matrix and also by building one single multi domain matrix, the APP (Ali A. Yassine, 2010; Clarkson et al., 2004; Danilovic and Browning, 2007). This is a classical MDM, built from the assembly of homogeneous matrices, respectively DSMs and DMMs (Figure 25).



**Figure 25 Building APP MDM by combination of DSMs and DMMs**

The RR and the APP matrices have a similar nature but different sizes. The size of the APP matrix is equal to  $N_{Act} + N_P + N_S$ , where  $N_{Act}$  is the number of actors,  $N_P$  is the number of process and  $N_S$  is the number of subsystems. But RR does not have any reason to have the same size, or even a size close to this. Namely, several attributes are characterizing a given project element, meaning if there are  $N_A$  attributes, it is possible to define at least  $N_A$  risks for 1 element.

### 4.3.2 Automation of data-gathering steps, in order to increase performance and decrease effort and error risk.

The efficiency of the data gathering process is crucial, particularly the sequence of the several pieces of analysis which need to be done. The combinatory explosion of number of potential interdependencies between  $N$  elements is a major issue in such complex systems. There are  $N*(N-1)$  cells to fill or not, but each cell  $(i,j)$  has to be analyzed twice, once from  $E_i$  to  $E_j$  as an effect, and once from  $E_j$  to  $E_i$  as a cause. So, in reality, for  $N$  elements,  $2*N*(N-1)$  questions are to be answered.

#### 4.3.2.1 Bidirectional transformation frame between the global network and its corresponding local data

In prior works dealing with the construction of DSMs, a direct manual assessment is used to fill the cells within the matrix, which might require certain time efforts from the modeller and may trigger risk of error when a mistake is made while filling the matrix. For example, if the risk  $R_2$  is cited as a cause of risks  $R_5$  and  $R_6$  in the original, manually, locally filled data, that does not mean necessarily that  $R_5$  and  $R_6$  are cited as consequences of  $R_2$ . Figure 26 shows this example and represents on the right hand side the updated local

interactions data and more especially in red, the updated information that wasn't cited explicitly in the initial input data at the left.

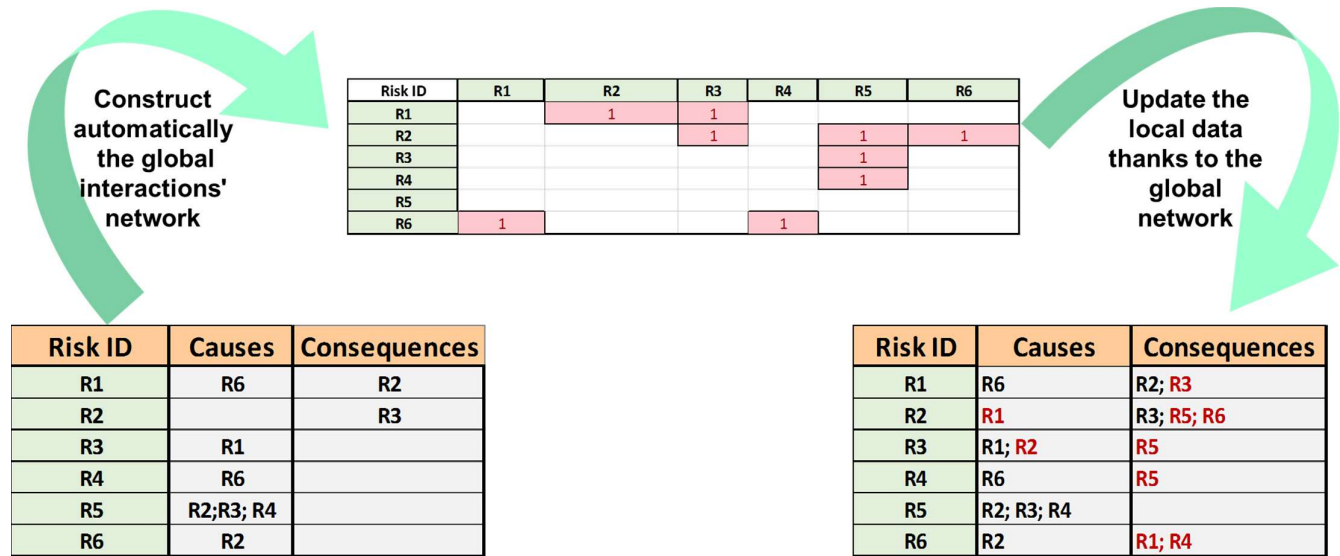

**Figure 26 Example of constructing the global interactions' network and updating inputs' data of a small risk network**

Updated and exhaustive representations of local interactions data are important to understand network data and document relationships between elements. So we need an algorithm which can update automatically and continuously the input data and output data in order to increase performance and decrease effort and error risk.

The automatic DSM building process is represented in Figure 27. It has been implemented using java under Eclipse Modelling Framework (EMF) and includes a set of tools for DSM building and analysis.

```

1 Initialize List of project elements L
2 Read Excel File (Parsing initial data)
3 Begin
4 for each line in the File
5     E = Element, In = Inputs Elements, Out = OutputsElements
6     If L doesn't contain E
7         E.inputs.add(In); E.outputs.add(Out);
8         L.add (E);
9     Else
10        L.get(E).getInputs().add(In); L.getOutputs.add(Out);
11 End
12
13 Initialize DSM a matrix of (L.size()*L.size()) to zeros
14 int i=0;
15 for each Element E in L
16     for each input in E.getInputs()
17         DSM(getIndex(L,input), i)=1;
18     End
19     for each output in E.getOutputs()
20         DSM (i, getIndex(L, output) =1;
21     End
22     i++;
23 End
24 End

```

**Figure 27 Extracting the global network of project elements from local interactions' data**

The automatic process and associated tool includes several steps. First, a local interaction data is gathered in a simple format. An automated process creates the corresponding graph and associated matrix. This framework allows to build the global network of project elements from local interactions data. Then, local interactions data are updated to reflect the exhaustive list of interactions built at the global level (See Figure 28). The same logic is used to obtain global DMM from local interactions data between two different types of elements. The main advantage of this automatic treatment is that the information is captured in one place, then it is compiled to give the exhaustive list from different points of views.



```

1 Transform a DSM to local interactions' data
2 L = List of project elements with the same order of DSM elements,
3 This pseudo code is implemented in Java and uses for each project element,
4 a HashSet of inputs (a list of elements that doesn't allow to contain the same element twice)
5 and a HashSet of outputs.
6 For (i=0, i< DSM.Size(); i++)
7     For (j=0; j<DSM.Size(); j++)
8         if (DSM(i,j) !=0)
9             L.get(i).getOutputs().add(L.get(j)); // Outputs in rows
10            L.get(j).getInputs().add (L.get(i)); // Inputs in columns
11        End if
12    End For
13 End For
14 //Write the local interactions' data in an Excel sheet
15 //----- Write the titles in the First Line of the Excel sheet-----
16 Excel sheet = workbook.createSheet("Inputs&Outputs of ... ");
17     Row row = sheet.createRow(rownum++);
18     Cell cell = row.createCell(cellnum++);
19     cell.setCellValue("Type of the project element");
20     cell = row.createCell(cellnum++);
21     cell.setCellValue("Name of the project element");
22     cell = row.createCell(cellnum++);
23     cell.setCellValue("Inputs Elements");
24     cell = row.createCell(cellnum++);
25     cell.setCellValue("Outputs Elements");
26 //-----
27 For each element in L
28     For each element in L.getInputs();
29         Write as inputs...
30     For each element in L.getOutputs(),
31         Write as outputs...
32 ////////////////////////////////////////////////////////////////////////////////////////////////////////////////////////////////////
33 Local data --> DSM
34     Use the algorithm of extraction DSM from local data
35 End

```

**Figure 28 Algorithm for Bidirectional transformation frame between the global network and its corresponding local data**

The DSM approach has to be repeated as interdependencies change over time since the product development is a dynamic process. In order to support practitioners, we developed a framework that helps practitioners to do DSM studies in a simple way. In order to make DSM results more representative, we visualize the diagram of local interactions of each element thanks to the use of the graph editor yED. Visualization is often used as an additional or standalone data analysis method. With respect to visualization, network analysis tools are used to change the layout, colors, size and other properties of the network representation. yED is a graphical editor of the adjacency matrix of a graph, but it doesn't contain the feature of updating local interactions and integrating them in the global network. To deal with this issue, we have implemented an algorithm for bidirectional update between the global network and its corresponding local data.

#### 4.3.2.2 Extraction of the exhaustive list of interactions via other elements $YX^*XY$

There are many examples about interactions between project elements via other elements: for example, when two actors are exchanging many deliverables in two directions, there is a need to communicate the exhaustive

list of these deliverables, and not just the number of deliverables exchanged. This kind of data (See Figure 29) is formalized with a two interactions data: the first one is the Actor(s) Transmitter(s) → Deliverable, the second one is the Deliverable → Actor(s) Receiver(s). In this case, we need to build two DMM (Domain Mapping Matrices) and one DSM for interactions between actors. This will be detailed in the “Case study” section.



**Figure 29 Example of interactions between actors (Y) via the exchange of deliverables (X)**

Figure 30 shows the number of deliverables exchanged between two actors, the need in this case is the reporting of exhaustive list of deliverables exchanged in two directions, not just the number but also the names of deliverables exchanged.

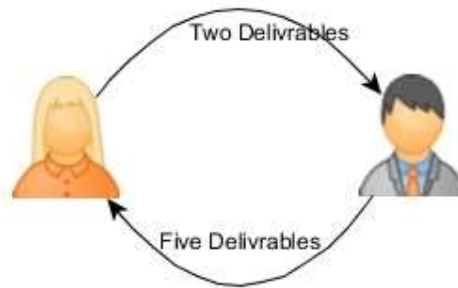

**Figure 30 Example of number of deliverables exchanged between two actors**

The developed modeling framework permits to build automatically the two DMMs, and the DSM which can be calculated by multiplying the two DMMs and also to report the exhaustive list of deliverables exchanged between two actors. Here we give an example on deliverables exchanged between actors, but the same principle is applied to report explicitly the deliverables exchanged between processes. Many other examples of interactions between project elements via other elements exist, when we added this feature of reporting to our framework for communication purposes.

### 4.3.3 Strength, reliability & accuracy of interdependencies modeling

The reliability of the data which are related to project elements and moreover, elements interdependencies, is a challenge and an essential factor to reliability of further analyses and decisions. In this section, we propose a reciprocal enrichment between two Multi-Domain Matrices (the RR and APP) of elements interdependencies

and a procedure for detecting and reporting modeling anomalies. This improves the accuracy of models and then the reliability of decisions made based on these models. The application on new-vehicle development projects in an automotive manufacturer is presented in the section 4.4 “Case Study”.

#### 4.3.3.1 Reciprocal enrichment of RR and APP models

We present here a procedure for enriching both models as illustrated in **Figure 31**, in order to improve their completeness and robustness. This permits to improve accuracy of the vehicle development project interdependencies modeling and analysis.

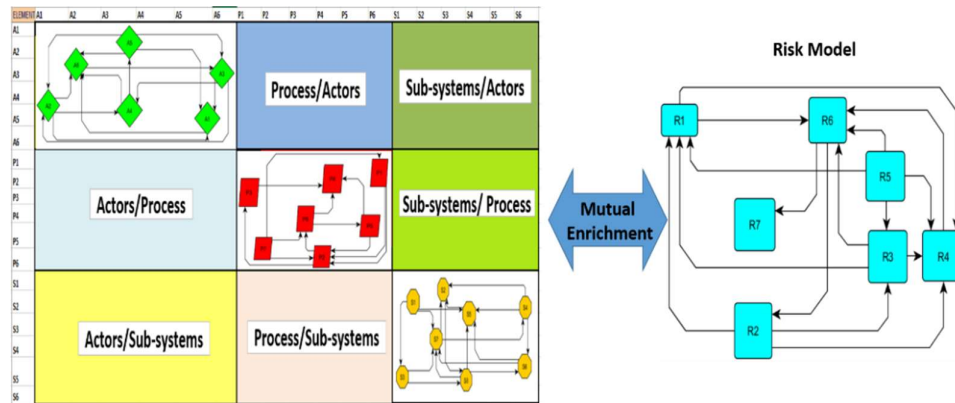

**Figure 31 Mutual enrichment of both models**

The procedure to enrich the other model is as follows:

- FOR each non-empty cell  $M_{ij}$  in one of the two matrices, SEARCH if there is a corresponding non-empty cell in the other matrix (of course, the indices are not the same).
- If an interaction exists between two risks related respectively to  $E_i$  and  $E_j$  ( $E$  being an element of APP, whether product, process or organization-related), that means that the element  $E_i$  might be interacting with  $E_j$  for a specific reason (depending on the nature of risks, which may be related to one or more attributes of the element, time or cost for instance).

Reciprocally, Figure 32 presents an example of improving the risk model using extraction of data from the APP model corresponding to the actor number 12. The procedure is as follows:

- If an element  $E_1$  is related to element  $E_2$  within the APP model, the risks related to  $E_1$  could be on relationship with the risks related to  $E_2$ . There is still a possibility to identify new risks as causes and new risks as consequences.
- For each cell  $RR_{ij}$ , if the element related to  $R_i$  are on relationship with elements related to  $R_j$ , this implies that  $R_i$  could interact with  $R_j$ .

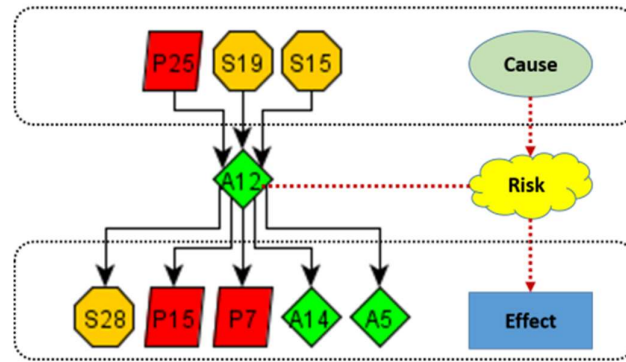

**Figure 32** An example of focus on Actor A12 that may help enriching RR matrix

We get an **RR** matrix of dimension  $n_2 * n_2$ , with  $n_2 \geq n_1$  with new risks and new risk interdependencies (non-empty cells). The cardinality of both matrices is not the same, for several reasons: first, several risks may be related to a single element (due to the presence of multiple attributes to describe an element). Second, not all the risks related to all elements are considered in the risk model. It may be an issue, but practically it is a necessity, in order to avoid having to model at least  $N_E * N_A$  risks, where  $N_E$  is the number of Elements and  $N_A$  the number of Attributes per element.

Finally, even if the number of **APP** elements is known, the size of a complete risk model remains unknown. It is impossible and not desirable to identify and model all risks. There is a limit in the detail level or in the scope considered as potentially influenced by risk mitigation actions. Even if the size of the refined **RR** matrix is higher, it is not possible to know how good this model is, in terms of absolute assessment. An improvement is done, but it is relative. For **APP**, the number of empty cells in the improved **APP** model is lower than in the initial one since new interactions between projects elements were identified thanks to the risk model.

#### 4.3.3.2 Detection of anomalies

In every modeling process, we must define the rules to respect, and we must also ensure that our modeling has complied with defined rules. As part of this thesis, we create a plugin permitting to categorize project elements and automatically report modeling anomalies in excel files to correct, update and share data between modelers. This gives a more reliable model, for communication and synchronization between project stakeholders are improved, which will be useful for further analysis.

### 4.4 Case Study: Modeling the new-vehicle development projects

In this section, we apply the modeling approach and associated framework to the new vehicle development projects.

#### **4.4.1 Reciprocal enrichment of the RR model and the APP model**

This section presents two Multi-Domain Matrix-based models of propagation analysis within a vehicle development project. The aim is to reduce the gap between these models and the reality of propagation behavior within the project, notably by reciprocal enrichment of these models. In order to reduce the complexity of vehicle projects, the vehicle architecture was decomposed into 40 smaller systems. These systems must be integrated to work together in order to achieve the performance of the vehicle as a whole. First, we used the formalized lists of the actors of the project team, the process used in the logic of the vehicle development, and the list of the subsystems formalized and officially used in design within the auto manufacturer.

Then we started with the identification of interactions between processes of the vehicle development project. An interaction defines an exchange between the elements. This exchange can be physical, documentary, decisional, etc. Each process has an identity document which we can analyze the inputs and the outputs it in order to identify the interactions with the other process. After analyzing the documents and building the DSM of the process, we mapped interactions between processes and actors and built two DMM matrices using an existed document about relations between actors and process. In order to analyze interactions between actors, hierarchical dependencies and dependencies between their business units were identified. For the rest of matrices, they are either built using existing information, or under construction using interviews. The multi-domain matrix of Actors, Process Product model is presented in Figure 33.

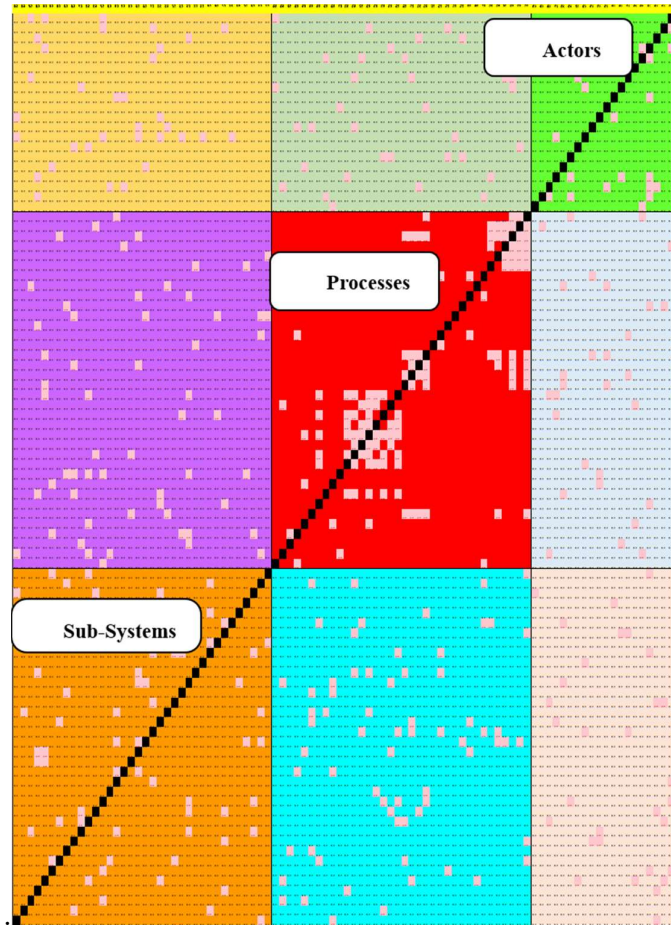

**Figure 33 The APP matrix of a vehicle development project**

For the risk model, we started by combining different lists of project risks identified from feedback and audit of past projects, risks related to the process, technical risks, etc. (See Figure 34).



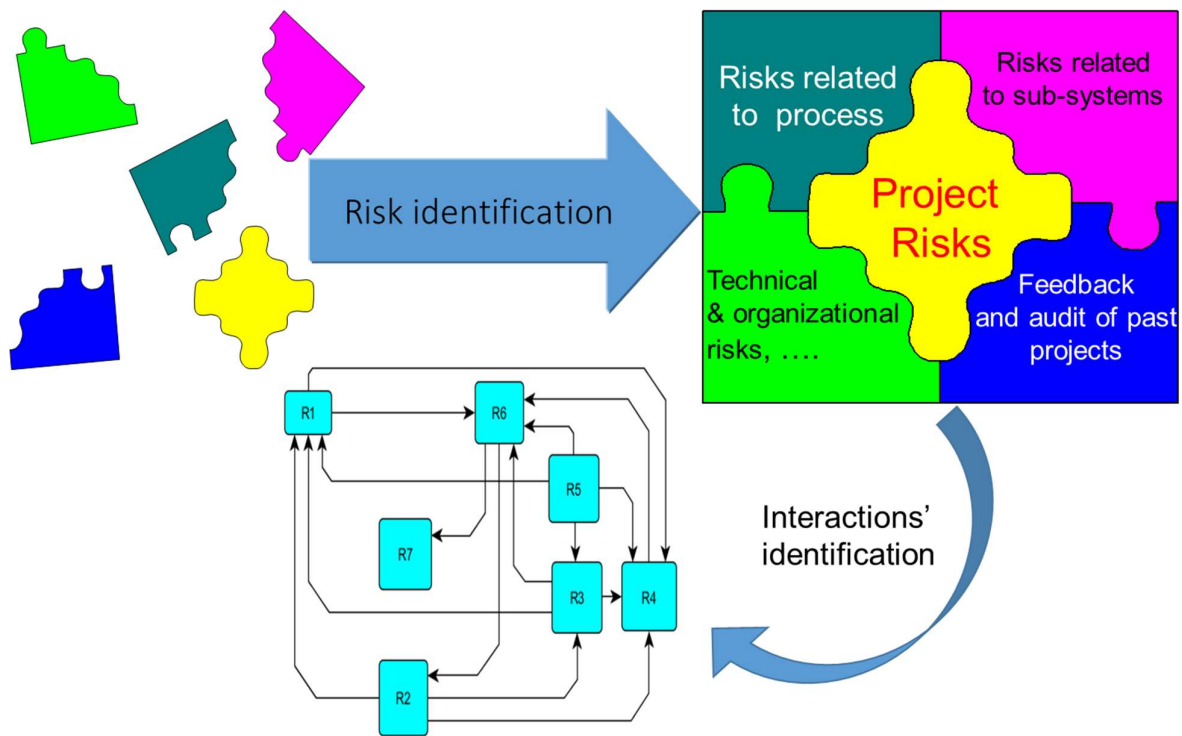

**Figure 34 Risks identification**

So a first list of project risks  $L_0$  was constructed. Then we started modeling the interactions between risks and as described in the section 4.3.1, we get an intermediary RR matrix of dimension  $n_1 * n_1$ , with  $n_1 \geq n_0$ . The knowledge of the interrelationships between project objects facilitates the identification of the interrelationships between risks because they are connected to one or more objects via one or more attributes. For example, the project schedule provides information on sequential interactions between tasks. This allows the identification of possible relationships between the risk of delay associated with these tasks. A relationship between product components, whether functional, structural or physical, permits to connect potentially risks related to product attributes (function, quality, cost) or project (cost, delay). So, we can use the relationships between project elements, whether of the same nature or not, to identify relationships between risks. Afterwards, we started the procedure of analyzing the empty cells in the RR, and after treatment of several local analyses focusing on related elements as described in the section 4.3.4, we identified more interactions between risks, a final RR of size  $n_2 * n_2$ , with  $n_2 > n_1$  (See Figure 35).

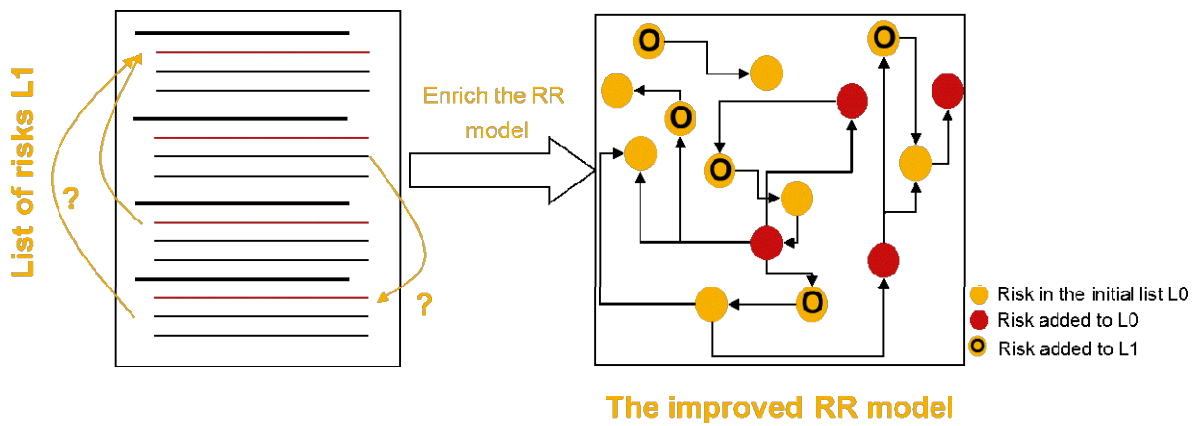

**Figure 35 Using APP to improve RR**

The work of mutual enrichment with APP is still ongoing, since data about project risks come from different sources and take more time to be validated (especially risk interdependencies), as shown in Figure 36.

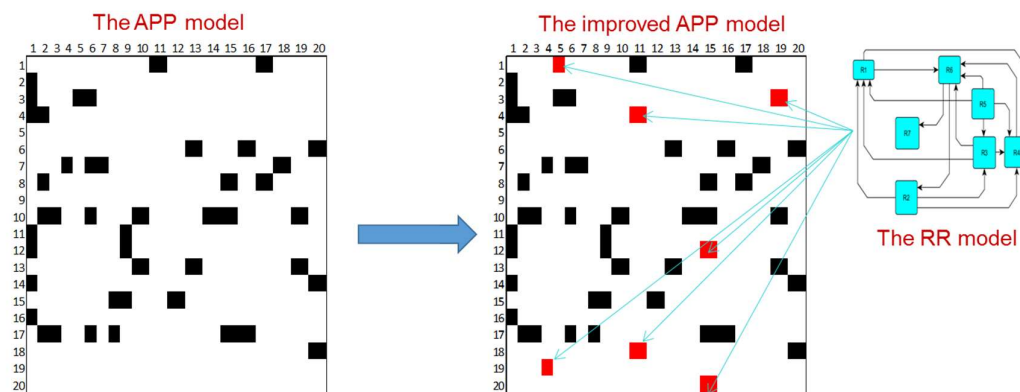

**Figure 36 Using RR to improve APP**

The current application on several vehicle development projects within an automotive manufacturer is giving first intermediary but promising results, since first mismatches have already been identified (mainly from **RR** to **APP**). The result of this procedure, which is the first modeling step before analyzing and making decisions, is mainly to improve model reliability by analysis of mismatches between two parallel ways of modeling project complexity. It aims at improving anticipation, coordination and then management of this project.

#### **4.4.2 Analysis of the development logic of new vehicles**

The Renault Design System includes the development logic of new vehicles and associated processes, unifying processes, tools and methods of vehicle engineering and mechanical engineering. Since 2010, the project steering within Renault follows a new development logic named V3P (Value up Product, Process, and Program). It includes activities to be undertaken by stakeholders and actors in the project to develop the



mechanical parts and new vehicles. This new logic reduced the costs in projects around 30%, and improved the “Time To Market”, between four and six months depending on the type of projects. Finally, it optimized the balance cost / value.

The entire company is organized around this logic. The timing and synchronization of the activities of all stakeholders must be respected for each phase. Each phase incorporates successive loops of convergence. Each loop aims a good result at the first attempt. The common references are shared before the loop start. Problems are treated within each loop. The final milestone is a ratchet without turning back. We will employ the proposed modeling framework in order to analyze & improve the development logic of new vehicles, which its initial data are formalized locally as explained in Figure 37 below. This is the input data to create networks of project elements.

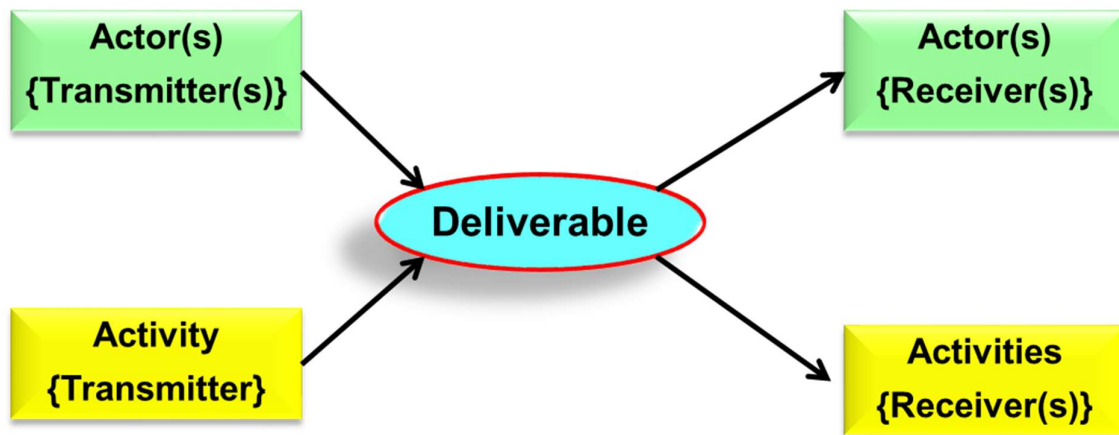

Figure 37 Local data of interactions between elements of the development logic of new vehicles

### The network of project Actors, Deliverables, processes

In this section, we present 3 DSMs and 8 DMMs, which are defined and used in the following chapters:

For instance, the  $Actor_{Transmitter}Deliverable$  matrix called **AD**, is built by modeling affiliation relationships between actors (**transmitters**) and deliverables. The  $DeliverableActor_{Receiver}$  matrix called **DA**, is built by modeling affiliation relationships between deliverables and actors (**receivers**). The **AD** and **DA** Matrices, usually known as Responsibility Assignment or Affiliation Matrix, defined as a DMM. These two matrices are obtained using the algorithm of global interactions data from local interactions data.

The Actor-Actor Matrix, called **AA**. It represents the relationships between actors, on which clustering will be applied in order to improve coordination between its actors. It is an organization-related DSM, which has been the object of several works (Lorsch and Lawrence, 1972; McCord and Eppinger, 1993; Sosa et al., 2004). AA

is obtained thanks to the following formula. How to obtain **AA** and associated analysis and interpretations is detailed in chapter six.

$$Actor_{Actor} = Ac_{Transmitter} Deliverable * Deliverable_{Actor} Receiver$$

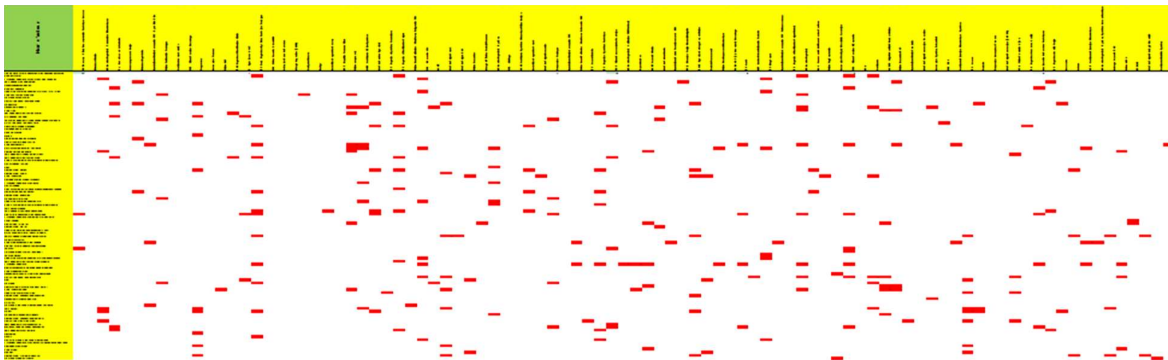

**Figure 38** The weighted directed network of 93 actors within the vehicle project

Figure 38 presents the weighted directed network of 93 actors within the vehicle development project. The case in this matrix represent numbers of deliverables exchanged between actors (emitted deliverables in rows and received deliverables in columns). In addition, we have identified potential interactions between deliverables through the paths of connections via activities, as presented in the following Figure 39. Also, we detect and delete the false links related to temporal shift. This will be a basis to study the impacts' propagation between project deliverables.

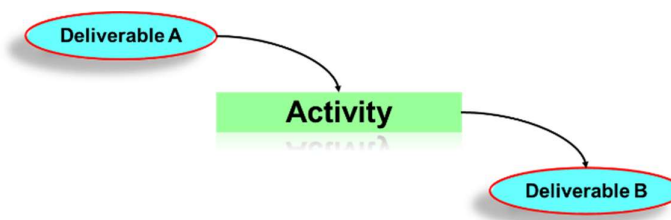

**Figure 39** Presumption of dependencies between deliverables

For instance, the **Activity<sub>Transmitter</sub>-Deliverable** matrix, is built by modeling affiliation relationships between activities (transmitters) and deliverables. The **Deliverable-Activity<sub>Receiver</sub>** matrix, is built by modeling affiliation relationships between deliverables and activities (receivers). These matrices are defined as DMMs. Both matrices are obtained using the algorithm of global interactions data from local interactions data. The **Deliverable-Deliverable** Matrix, called DD. It represents the relationships between deliverables, on which several improvements and analyses will be applied in order to understand and control the project behavior, more precisely the impacts' propagation analysis between its deliverables. How to obtain DD and associated analysis and interpretations is detailed in Chapter 5.

In order to identify process flow disconnects and to improve process architecture, we study the interaction between processes via the deliverables by providing a comprehensive vision of the deliverables exchanged between customers and suppliers-related processes (Figure 40).

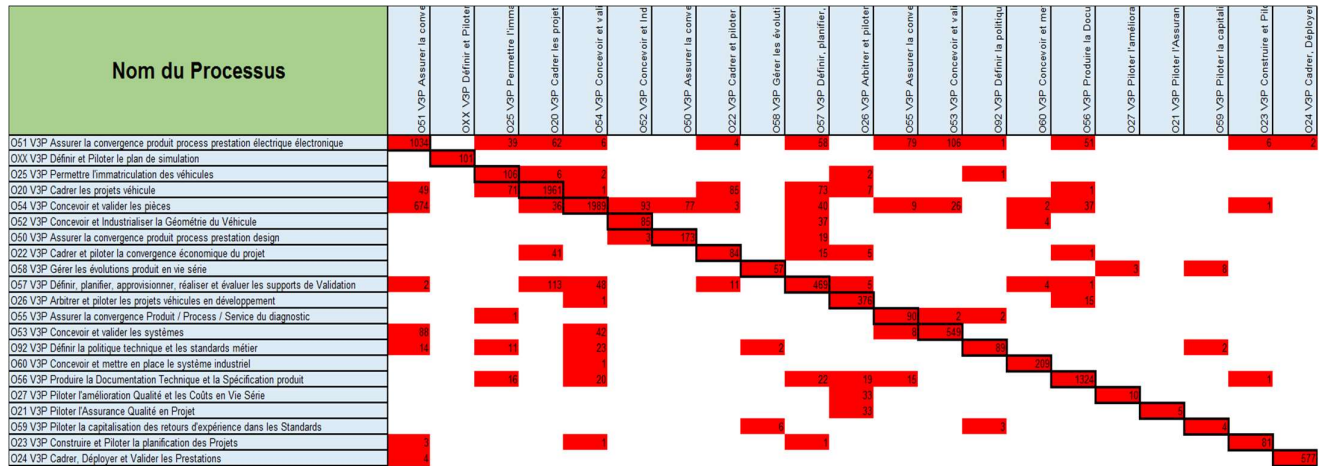

**Figure 40 DSM of process interactions via the exchange between deliverables**

Figure 40 shows the DSM of a subgroup of the vehicle development project related processes. We can see the number of deliverables produced by each process in order to be used by the connected process (Convention: inputs in columns and outputs in rows See Figure 41).

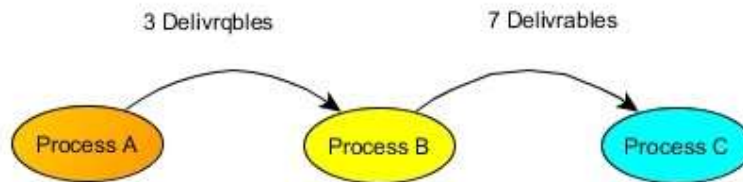

**Figure 41 Extraction of the exhaustive list of deliverables exchanged between processes**

Furthermore, we report the exhaustive list of deliverables exchanged between processes in two directions, not just the number but the names of deliverables exchanged.

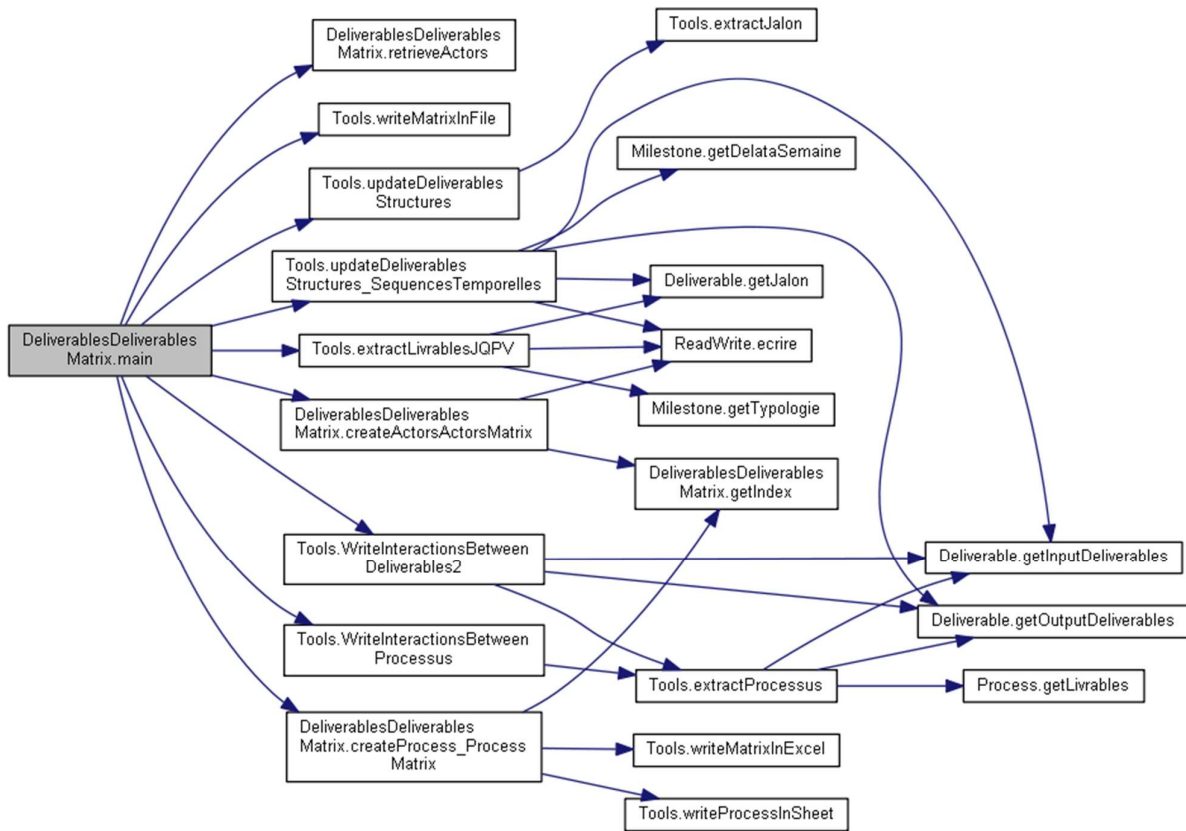

**Figure 42 Automatic treating of the process flowchart modeling**

To ensure a shared and coherent vision with all process modelers who must meet the same modeling rules, we propose an automatic treatment of the process flowchart modeling (See Figure 42) and we build the global networks of interactions between project elements with their associated updated local vision. Furthermore, we improve the quality of existing modeling by detecting and reporting of anomalies with proposals for improving the documentary quality of the development of logic.

## 4.5 Conclusion

In this chapter, we proposed a low-level graph-based modeling approach of complex projects. It is established on the finer modeling of project elements and interdependencies. Network analysis of project elements is proposed to identify, represent, analyze, visualize, or simulate nodes (e.g. agents, risks, actors, deliverables...) and edges (relationships) from various types of input data (relational and non-relational) including the process diagram of development logic of new vehicles. The output data can be saved in external files. Different input and output file formats exist. Network analysis tools allow us to investigate representations of networks of distinctive size - from small (e.g. Project team) to very large (e.g. network of thousands of deliverables). The various tools provide further analyses and will be discussed in the two following chapters. Contributions have been made on the complete modeling process, including the automation of some data gathering steps, in order

to increase performance and decrease effort and error risk. From a practical perspective, the information captured in one model is used for mutual enrichment of both models, with the aim of better understanding and thus better anticipation of the propagation phenomena in order to control more effectively the project evolution. Modeling and analyzing the interactions between risks, process, product architecture and actors using the DSM approach contribute in understanding the complexity aspects in order to reduce their impact in making decisions. Overall, these models reduce project complexity because they decrease ambiguity by sharing the same concepts among the actors, and reduce uncertainty by sharing a comprehensive and complete view of interactions between project elements. The industrial application has shown concrete results by improving the original project model within the organization with both detecting (automatic reporting) and correcting existing anomalies. In addition, some tasks and deliverables were re-organized using the benefits of the global view of deliverables network. In brief, the quality of documents associated to the new-vehicle development logic has been improved.

Finally, the two models presented respectively in Chapters 3 and 4 can be used independently or consequently. Namely, a first high-level measure can permit to focus on some project areas where the low-level modeling proposed in this chapter will be applied, with a gain of global efficiency and impact.

## 4.6 References

- Akao, Y., 1990. *Quality Function Deployment*. Productivity Press, Cambridge, MA.
- Ali A. Yassine, 2010. Multi-Domain DSM: Simultaneous Optimization of Product, Process & People DSMs, in: *Proceedings of the 12th International DSM Conference—Managing Complexity by Modelling Dependencies*.
- Boccaro, N., 2010. *Modeling Complex Systems*, Graduate Texts in Physics. Springer New York, New York, NY.
- Box, G.E.P., Draper, N.R., 1987. *Empirical Model Building and Response Surfaces*, John Wiley & Sons. ed. New York, NY.
- Browning, T.R., 2015. *Design Structure Matrix Extensions and Innovations: A Survey and New Opportunities*. IEEE Transactions on Engineering Management.
- Browning, T.R., 2001. Applying the design structure matrix to system decomposition and integration problems: a review and new directions. *IEEE Transactions on Engineering Management* 48, 292–306. doi:10.1109/17.946528
- Clarkson, J., Simons, C., Eckert, C., 2004. Predicting change propagation in complex design. *Journal of Mechanical Design* 126. doi:doi:10.1115/1.1765117
- Danilovic, M., Browning, T.R.T.R., 2007. Managing complex product development projects with Design structure matrices and domain mapping matrices. *International Journal of Project Management* 25, 300–314.
- Eppinger, S.D., Browning, T.R., 2012. *Design structure matrix methods and applications*. MIT Press, Cambridge, Mass.
- Eppinger, S.D., Whitney, D.E., Smith, R.P., Gebala, D.A., 1994. A model-based method for organizing tasks in product development. *Research in Engineering Design* 6, 1–13.
- Eppinger, S., Whitney, D., Smith, R., Gebala, D., 1994. A Model-Based Method for Organizing Tasks in Product Development. *Research in Engineering Design* 6, 1–13. doi:10.1007/BF01588087
- Eybpoosh, M., Dikmen, I., Talat Birgonul, M., 2011. Identification of Risk Paths in International Construction Projects Using Structural Equation Modeling. *Journal of Construction Engineering and Management* 137, 1164–1175. doi:10.1061/(ASCE)CO.1943-7862.0000382
- Fang, C., Marle, F., 2012. A simulation-based risk network model for decision support in project risk management. *Decision Support Systems* 52, 635–644.
- Giffin, M., de Weck, O., Bounova, G., Keller, R., Eckert, C., Clarkson, P.J., 2009. Change Propagation Analysis in Complex Technical Systems. *Journal of Mechanical Design* 131, 081001. doi:10.1115/1.3149847

- Gunawan, I., 2009. Application of Numerical Design Structure Matrix Method in Engineering Projects Management. *Operations and Supply Chain Management* 2, 1–10.
- Hepperle, C., Maier, A.M., Kreimeyer, M., Lindemann, U., Clarkson, J., 2007. Analyzing communication dependencies in product development using the design structure matrix., in: 9th International Design Structure Matrix Conference, DSM'07. Munich, Germany.
- Jankovic, M., Stal-Le Cardinal, J., Bocquet, J.-C., 2010. Collaborative Decision in design project management : a particular focus on automotive industry. *Journal of Decision Systems* 9, 93–117.
- Lindemann, U., Maurer, M., Braun, T., 2009. *Structural complexity management an approach for the field of product design*. Springer, Berlin.
- Lorsch, J., Lawrence, P., 1972. *Managing Group and Intergroup Relations*. Richard D. Irwin, Homewood, IL.
- Mane, M., DeLaurentis, D., Frazho, A., 2011. A Markov Perspective on Development Interdependencies in Networks of Systems. *Journal of Mechanical Design* 133.
- Marle, F., 2002. *Modèle d'information et méthodes pour aider à la décision en management de projet*. PhD thesis. Ecole Centrale Paris.
- Marle, F., Vidal, L.-A., 2011. Project risk management processes: improving coordination using a clustering approach. *Research in Engineering Design* 22, 189–206.
- Marle, F., Vidal, L., others, 2008. Potential applications of DSM principles in project risk management, in: *DSM 2008: Proceedings of the 10th International DSM Conference*, Stockholm, Sweden, 11.-12.11. 2008.
- Maurer, M.S., 2007. *Structural awareness in complex product design*.
- McCord, K., Eppinger, S., 1993. *Managing the Integration Problem in Concurrent Engineering*, MIT Sloan Working Paper.
- Simon, H.A., 1965. The architecture of complexity. *General systems* 10, 63–76.
- Sosa, M.E., Eppinger, S.D., Rowles, C.M., 2004. The Misalignment of Product and Organizational Structures in Complex Product Development. *Management Science* 50, 1674–1689.
- Steward, D., 1981. The Design Structure System: A Method for Managing the Design of Complex Systems. *IEEE Transaction on Engineering Management* 28, 79–83.
- Steward, D.V., 1981. The design structure system: a method for managing the design of complex systems. *Engineering Management, IEEE Transactions on* 71–74.
- Thompson, J., 1967. *Organizations in action*. McGraw-Hill, New York.
- Van De Ven, A.H., Delbecq, A.L., Koenig, R., 1976. Determinants of coordination modes within organizations. *American Sociological Review* 41, 322–338.

## Chapter 5: Propagation analysis of impacts between project deliverables

---

Based on models presented in the previous chapter, some contributions are made in this chapter to anticipate potential behavior of the project. Topological and propagation analyses are made to detect and prioritize critical elements and critical interdependencies, while enlarging the sense of the polysemous word “critical”. After a literature review on the topological indicators of nodes and arcs of weighted directed graphs, their applications and interpretations, we propose a set of indicators suitable for project elements, which mainly allow us to discuss “What is the impact of an element to other elements within the network? What is the collective influence of this element?”. These indicators permit to prioritize project elements and their connections according to their importance within the network (the most influential elements and interactions taking into account the entire pattern of the network). For example, they permit to evaluate the collective criticality of project deliverables and to re-evaluate the priority of the project risks by coupling the traditional features of individual risks with the highest topological indicators of the risk network. Furthermore, some algorithms are applied to extract and visualize the propagation path between two elements within the network. For example, this allows to provide a vision of impact propagation between the project deliverables, with an option to focus on the chain which connects two deliverables associated with two milestones or on the chain which connects two critical deliverables.

### 5.1 Introduction

In a world of growing competition between firms, the time for the provision of new innovative products and services to market is becoming an essential part of the performance and success of an organization. The control of project delays requires expertise in strategy and organization, and the adoption of behaviors that permit anticipation and stakeholder involvement. This must go far beyond simple mastery of planning and management techniques/tools.

The implementation of a management by deliverables and deadlines, based on detailed planning and strict control of deliverables is a strategic decision that reports to the project manager. It is a key element of the success of complex projects. Management by deliverables is to find the match between the needs of the project, the correct expression of these needs by appropriate specifications that pass through attentive listening to the customer, and a realization that meets the needs expressed. Describing the deliverables of the project in terms of precise specifications and requirements is an input to identify more accurately the work which will have to be done during the execution. The definition of good quality and stable requirements is even an important success factor of projects (Yang et al. 2015). This is particularly true for instance for new product development projects.

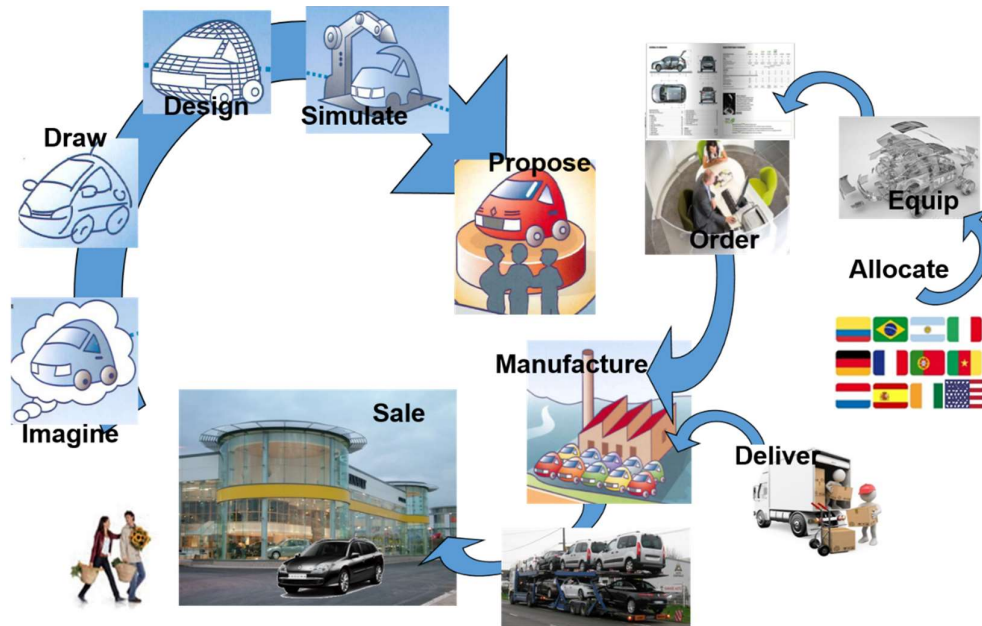

**Figure 43 The purpose of project deliverables**

The purpose of project decomposition into documented deliverables is to provide a vehicle that meets the expectations of the end customer. To achieve this, the company's actors are encouraged to imagine that vehicle, to draw it, design, simulate its production, start to offer the concessions in order that the customer can order it, which will launch its manufacture to sell him (see Figure 43). Project deliverables are used to manufacture a vehicle that will be sold to a customer, and share information across the company between transmitters and receivers.

## **5.2 Impacts' propagation between project deliverables**

This section presents the project planning techniques, the propagation phenomena between project deliverables and the gaps of criticality analysis of project elements.

### **5.2.1 Decomposing and Organizing Work**

Many methodologies do exist to define the specifications and requirements of a project. As underlined in (Cano and Lidón, 2011), such specification definition process is the logical continuation of the stakeholders' expectations and constraints identification, presented before. A proper and robust approach to identify requirements is all the more needed that the later a change of requirement occurs during a project, the more important its impact is, in terms of over cost, rework, etc. Some of these methodologies can be considered as "internal," meaning that the deliverables of the project and their components are studied a priori so that their specifications are correctly defined. Functional needs and solutions analysis is one of these methodologies. It permits to define the specifications of a system by studying its interactions with its environment in all the



phases of its lifecycle (Yannou, 1998). Other methodologies are, on the other hand, considered as “external,” meaning that the requirements are defined without studying the deliverables themselves, but asking clients and stakeholders how they would specify the deliverable. Customer listening methods are for instance a group of methodologies which permit to define the specifications of a system in order to meet the needs of their users, clients, and market (Garver, 2003), (Gannon-Leary and Mccarthy, 2010). As a whole, the conjoint use of such internal and external methods provides the best results in practice.

The construction of the schedule involves modeling graphically the dependency network between tasks. This is a structured decomposition of work. We must break down the project into smaller subsets (OT or WBS). Many representations exist at the base of any planning construction. If the project is really a quasi-decomposable tree system, there must be a way to describe it as the interaction between subsystems is negligible compared to the interaction within each subsystem. Today it does not exist. The decomposition is done according to deliverables called Work Breakdown Structure (WBS), and following the activities (in a calendar called Gantt chart), but there are always interactions between these elements not displayable on conventional regimens. In addition, each interaction can be strongly and suddenly act on another subsystem. Therefore, it is not globally a comprehensible long-term behavior. The properties of project quasi-decomposability are not met, because the interactions between sub-systems are not all negligible.

Project scope and work planning includes the process of decomposing and organizing the entire project work into smaller units and thus more manageable packages of work (Tiner 1985). Such an organizational structure permits to manage more efficiently the execution of the project and measure its performance, given the fact that smaller units of work are in essence more easily accountable. The traditional tool which permits to decompose and organize work in a project is the WBS. It consists in a hierarchical structure which decomposes units of work into smaller units of work. Several rules should be kept in mind when the WBS of the project is built.

- The WBS should be a bijection of the project scope: what is inside the WBS must be done during the project, what should be done during the project must be inside the WBS (Stal-Le Cardinal and Marle, 2006).
- Each parent unit of work, when decomposed into smaller units, should be decomposed into 3–7 children. By doing so, the decomposition is useful and still easily understandable and manageable, the children units of work being sufficient enough to completely describe the parent unit of work (bijection) (Marle, 2002).

- Each parent unit of work, when decomposed into smaller units, should be decomposed into homogeneous children units of work (for instance according to project phases, geographical locations, customers/users/stakeholders, product components, etc.).
- Each elementary unit of work should be possibly measured in terms of cost, time, and performance (quality, project values, etc.).

The WBS theoretically includes the project deliverables and its tangible results. Some mistakes come from approximations in the formulation and individual perceptions of the same formulation; thus, design a car engine can be interpreted by people as a goal: "the engine must be designed", as an activity "design an engine car" or as a deliverable "plans for the car engine." Not only several people can interpret differently blurred formulation, but more everyone can use a different formulation depending on the time. The ideal diagram recommended by PMI (PMI, 2013) should only contain deliverables, objectives being apart in a separate tree, and even for activities.

## **5.2.2 Propagation phenomena between deliverables**

Management by deliverables or control by results, is a newer method of project management. This is an alternative to traditional project management techniques, historically oriented resource management: that is the purpose of such curves EVA (Earned Value Added) which compares the budget to the work performed. Indeed, this traditional approach is dated: Alain Fernandez stressed "We could not pilot the project by only following the schedule and budget. These are two fundamental concerns, but we should ensure the compliance delivered features such as quality of technical implementation. Management by deliverables focuses on operational monitoring of the project; it focuses on results and allows the anticipation" (Fernandez, 2011).

A task is performing an action to achieve a result. Each outlined task must involve: a precise and measurable objective; appropriate human, material and financial resources; a workload expressed in the number of resources / day; a specified period with clarified start and an end date. In a schedule, tasks are interconnected by dependency relationships. Project milestones are defined as the key events within the project, showing important progress in significant dates with concrete realizations (deliverables production). Project milestones can be for instance "Project Definition Complete"; "Begin Preliminary Engineering" etc... A project consists of deliverables that meet objectives that are realized through activities. These deliverables are themselves broken down into sub-deliverables and activities. A deliverable is a term used in project management to describe a tangible object produced as a result of the project that is intended to be delivered to a customer (either internal or external). For example, requirements' specification and feasibility study are deliverables within a project. A deliverable could be a report, a document, a permit or any other building block of an overall project. A deliverable may be composed of multiple smaller deliverables. It may be either an outcome to be

achieved or a product to be provided (Browning and Ramasesh, 2009). These deliverables are updated according to the changes and developments that occur throughout the project life cycle. They are archived at the end of the project and provide a practical basis for future projects within the company. For example, the final deliverables of development projects are documents for manufacturing vehicles in factories.

The managerial issues potentially associated to the mastering of impacts' propagation in a complex project are mainly related to its inability to be broken down into independent parts. This is true for all types of systems, whether natural, technical or human. The consequence is that, whatever the way the system is broken down into, there will always be interdependencies between the parts, here the organizational boundaries of the project decomposition. Project can be decomposed into either Activities- (or Deliverables)-related elements, phases or organizational entities, but there will always be numerous interdependencies between actors who do not belong to the same part. This implies risk of bad communication, bad coordination or locally optimal decisions. Due to the number of interactions outside the official project structures, the danger is that the communication and coordination between actors may not be correctly done. Despite the events that disrupt the progress through the project, the propagation of impacts should be managed in order to ensure the continued achievement of targets in terms of quality, costs, lead time, product' technical performance, its industrialization and production volume, the image of the brand and the associated partnership. The problems of impacts' propagation encountered in projects are usually due to inadequate anticipation. The aim is to master and anticipate potential cascading effects and their dynamics.

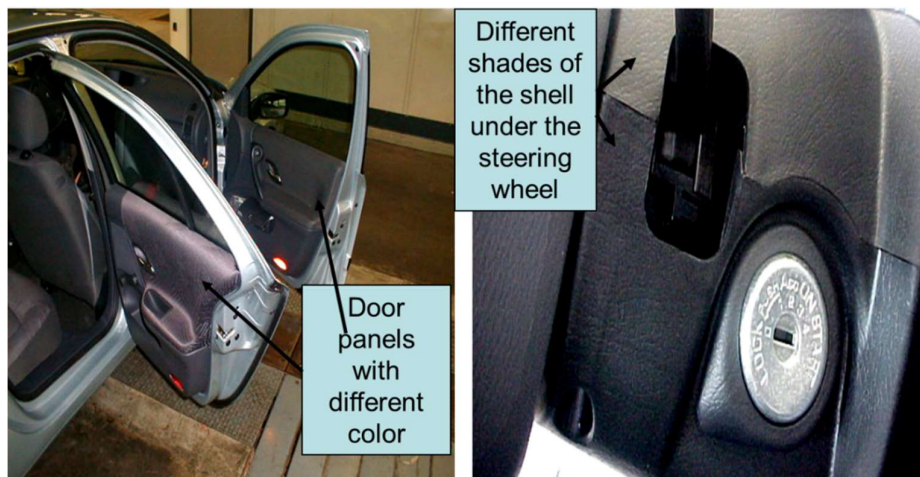

**Figure 44 Consequences of propagation of deliverables' non-completeness**

Some propagation of deliverables' non-completeness errors can have significant consequences for the company, involving vehicles retouching: For example, door panels of a different color, or different shades of the shell under the steering wheel (See Figure 44).

If the project is a quasi-decomposable tree system, there must be a way to describe it as the interaction between subsystems is negligible compared to the interaction within each subsystem. Today it does not exist. The decomposition is done according to deliverables called Work Breakdown Structure (WBS), and following the activities (in a calendar called Gantt chart), but there are always interactions between these elements not displayable on conventional regimens.

### **5.2.3 Gaps in Criticality Analysis of Project Elements**

The estimation of task duration and thus the theoretical scheduling is uncertain. Some tools permit to cope with such uncertainty. For instance, advanced methodologies permit to determine the most likely critical path within a probabilistic project network (Soroush, 1994). Other models have been developed to propose solutions to the project scheduling problems with uncertain durations: based on sensitivity analyses (Samikoglu et al., 1998), Markov chain-based models (Hao et al., 2014), fuzzy logic (Shi and Blomquist, 2012); (Masmoudi and Haït, 2013), stochastic models, and associated heuristics (Bruni et al., 2011). The Critical Path is a mathematical analysis that identifying the sequence of activities that add up to the longest overall duration. In other words, this is the quickest way the project can be done. Any delay affecting a task on the critical path is fully reflected in the project duration and therefore, the end date. However, this analysis does not take into consideration the criticality of the deliverables. It only identifies the longest (duration) sequence of activities, regardless of their importance. We should not focus only on the critical path when we are evaluating which deliverables to monitor closely. Also we should focus on critical deliverables. A critical deliverable is a deliverable with a lot of risk, either because of its impact, its likelihood or a combination of both. Some of these may or may not be on the critical path yet they may be more important for staying on schedule.

Managing risk is not an isolated activity. It is a part of many project activities, including schedule management. There are other factors to consider when identifying items for which a timely delivery is critical. Existing modeling approaches have limitations when it comes to modeling the complexity of project deliverables. Hence, some propagation phenomena like chain reactions and loops are not properly taken into account. This chapter aims at analyzing behaviors like impacts propagation in the built deliverables network and helps project managers to make more reliable decisions. This enables us to re-evaluate the priority of the project deliverables in terms of different characteristics, to update the deliverables criticality measure.

In practice, some project actors estimate that they have enough time and resources; and wait for the critical moment to hurry performing their tasks. They hope that nothing will be a problem, it's a bit like the story of "The Tortoise and the Hare": Nothing is gained by running if you do not start on time (La Fontaine 1668). Project planning is done by developing a 'Gantt' or PERT. Then we can identify the critical path without margins where we must avoid daily any activity that drifts on this path. And regularly, the conscientious

project manager updates the "have to do" to each activity, planning and recalculate the critical path. However, one "project actor" who has the syndrome of the "Hare" will disturb the functioning of this beautiful mechanism. For example, this "project actor" has to conduct an activity, a result to produce, and should take four days of work from his availability. The product of this activity is on a parallel path, however, determines the result of the project. Even so, this "project actor" has fortunately or unfortunately, a margin of some weeks, and he says that "I have all the time, and I can do something else; I can also forget for some time." Finally, five days before the deadline, he says it's time to put it (he even took one day of security margin). Then he discovers later that he lacks a lot of information, tools, materials from other deliverables and other actors, and it will take several days. And the path of tasks of this project actor, which was far from being critical, becomes a path under stress. The end date is exceeded. And the project, which was mastered, will become a little chaotic! In brief, depending on the behavior of project actors and interdependencies between deliverables, as we have shown in the example above, any path can quickly become critical and expose a risk. The industrial need is to prioritize and master critical deliverables and critical interdependencies within the project, while enlarging the sense of the polysemous word critical. This must begin by a definition and measurement of deliverable criticality that takes into account collective criticality of deliverables, because the risk of not taking into account some important deliverables that they are not in the critical chain exists. Current methods and associated tools deal mainly with quantitative estimation of time and costs, and are transcribed in the tools. But what helps to create and define the parameters of activities, deliverables, objectives and affected actors? What helps to identify for each deliverable responsible, with whom he has ties, what type, and how to manage them? How can we understand better the far-reaching impacts of late deliverables?

From these observations, we underline the following research question:

**How can one monitor and control the impacts' propagation within complex projects and make decisions to keep propagation phenomena under control?**

### **5.3 Criticality, Topological and Propagation analysis within the network of project deliverables**

Our goal is to prioritize actions to mitigate the complexity-induced risks (for example: risks of propagation). This is done through the monitoring of deliverables that are the origin or the transmitters of these risks. This requires identifying possible dependencies between deliverables (e.g., a deliverable that is necessary to achieve the following deliverables); define actions to secure critical deliverables (e.g., formally communicate to the transmitter the date at the latest which you need his deliverable before impacting the project); and provide the paths of propagation, and identify the critical deliverables that should be strictly monitored (See Figure 45).

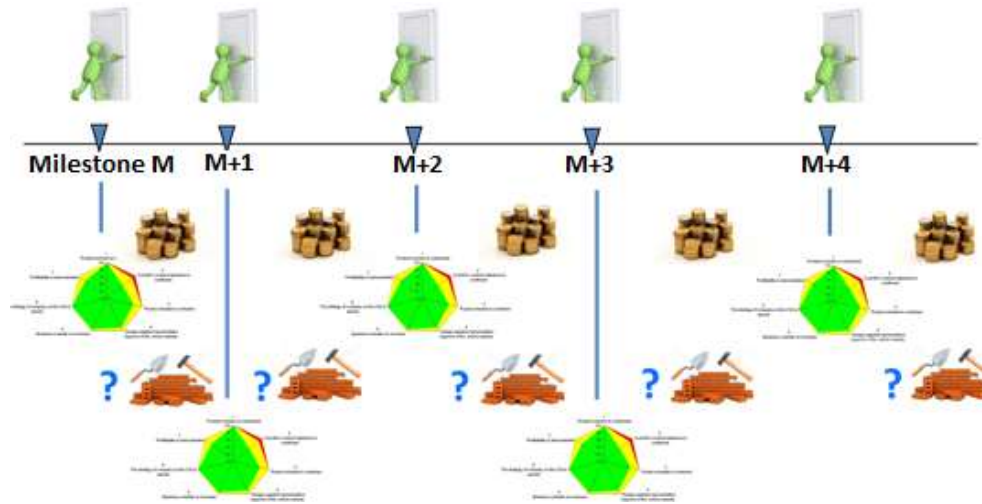
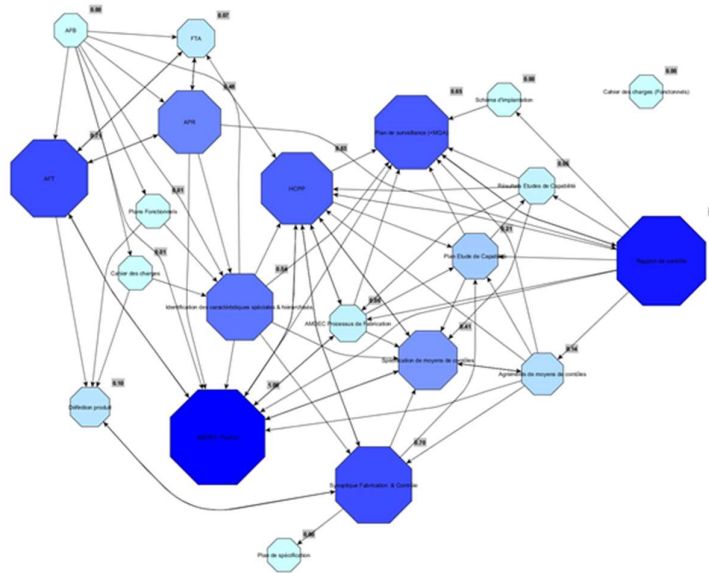

Figure 45 Projects deliverables monitoring: At each milestone a quality check is made

### 5.3.1 Using Topological Network Theory-Based Indicators to Highlight Elements Due to Their Position in the Network

This paragraph presents a literature review on the topological indicators of nodes and arcs of weighted directed graphs, their applications and interpretations, we propose a set of the most adaptable to project elements that mainly allow us to discuss “What is the impact of an element to other elements within the network? What is the collective influence of this element?” These indicators permit to prioritize project elements and their connections according to their importance within the network (the most influential elements and interactions taking into account the entire pattern of the network). Figure 46 shows an example of a small network of project element with illustration of topological indicators. The size of the node (and its color) is proportional to the centrality indicators detailed in the following paragraphs, the darkest and the biggest node corresponding to the actor who has the highest value of centrality.



**Figure 46 Illustration of a network of project elements with topological indicators.**

### 5.3.1.1 Centrality

Centrality is the relative importance of a node within a graph. There are various measures to determine this ranking, such as "Betweenness", "Closeness", and "Degree" are all measures of centrality. This measure gives a rough indication of the social power of a node based on how well they "connect" the network. Centrality is the degree functions that allows determining nodes with a large number of connections. It is also defined as the relative importance of a node within a graph. While degree centrality of a group, is the number of actors outside the group that are connected to the member of that group. It is regarded as one of the most important and commonly used conceptual tools for exploring actor roles in social networks. A node's degree centrality is defined as the number of nodes that are connected to that node in a graph. Freeman imposed categorized centrality measures into three basic categories degree, closeness and betweenness along with the eigenvector-based measure proposed by Bonacich (Bonacich, 1972); (Freeman, 1977);

### 5.3.1.2 Betweenness centrality

Betweenness centrality denotes the number of pairs of nodes they lie between, or the number of paths that contain them (Freeman, 1977; Guimera and Amaral, 2004). It serves as an assistance to identify hubs in the network, particular nodes or interactions, which play the role of key passages for potential propagation. It is defined as the fraction of all shortest paths in the network that contain a given node. In other words, is the sum of the fraction of all-pairs shortest paths that pass through a given node. Nodes with high values of Betweenness centrality participate in a large number of shortest paths. Betweenness centrality measures were applied in high-power grid selection and demonstrate very useful results in biological networks, road networks and web crawler...

### **5.3.1.3 Closeness centrality**

Closeness is based on the length of the average shortest path from one node to another. It focuses on how close a node is to all the other nodes in a network. It also describes the extent of influence of a node on the network. The degree a node is near all other nodes in a network (directly or indirectly). It reflects the ability to access information through the "grapevine" of network members. Thus, closeness is the inverse of the sum of the shortest distances between each individual and every other person in the network. The shortest path may also be known as the "geodesic distance".

### **5.3.1.4 Eigenvector centrality**

According to eigenstructure analysis, the importance of a node is proportional to the importance of its connected nodes. Once again, such indicators permit to confirm previous results or to highlight surprising elements, elements that had not been seen as important, either by individual importance or by other topological indicators. Eigenvector centrality is a measure of the importance of a node in a network (Katz, 1953); (Bonacich, 1972); (Page et al., 1999). The idea is that even if a node influences directly only one other node, which subsequently influences many other nodes, then the first node in that chain is highly influential (Borgatti, 2005). It assigns scores to the nodes based on the three following principles: (1) connections to more nodes contribute to the score; (2) connections to important nodes contribute to the score; (3) strong connections contribute to the score (Fang and Marle, 2012), (Spizzirri, 2011). This measure is used by sociologists to measure connection between players in social groups, and is implemented in Google's page rank, that is the system by which the search engine ranks the pages in its search results.

### **5.3.1.5 Core/Periphery centrality**

It is the centrality concept to examine the core/periphery structure of a network. The mixture of these concepts is the notion of a core/periphery structure, which is simultaneously a model of graph structure and a generalized measure of centrality. Here, all nodes can be regarded as belonging to a single group, either as core members or peripheral members. A common characteristic of core/periphery structures is that they have fairly short trail distances between pairs of nodes, which enable information to flow rapidly (Borgatti et al., 2013).

### **5.3.1.6 Direct and indirect Reachability indicators (Marle and Vidal, 2016)**

Properties of a network can be highlighted by reachability indicators. The degree of nodes provides information on the local potential connectivity of a node X (Kreimeyer, 2009). The number of outgoing/incoming edges is called the activity/passivity degree of a node:



$$AD_i = \sum_j XX_{ij}$$

$$PD_i = \sum_j XX_{ji}$$

The reachability matrix (RM) is built using the Floyd's sequential shortest path iterative algorithm, with  $RM_{ij} = 1$  if there exists at least one path from  $X_i$  to  $X_j$  (Floyd, 1962). This reachability parameter has been used in several studies in the field of product development and project organization analysis (Feng et al., 2010); (Braha and Bar-Yam, 2004). The powers of the adjacency matrix give information about potential paths of different lengths and about potential loops in the network (Warfield, 1973; West, 2001). The number of reachable nodes for a given  $X_i$ , called  $NRN_i$ , indicates the number of other nodes that  $X_i$  can impact directly and indirectly:

$$NRN_i = \sum_j RM_{ij}$$

Similarly, the number of possible sources for  $X_i$ , called  $NPS_i$ , counts the other nodes that are connected or potentially connected to  $X_i$ :

$$NPS_i = \sum_j RM_{ji}$$

These indicators on direct and indirect reachability degrees help understanding the global potential causes and effects of a node. The gap between the local potential impact and the global potential impact of a node expresses the potential events that might not be detected with classical direct cause-effect analysis. The existence of a potential path between nodes is useful for potential undesired reaction chain detection, even without any information about either the likelihood of the occurrence of the path, or its impact. Reachability degree helps us understand the global consequences and sources of a risk of propagation, and enable us to classify them into different categories. Finally, the degree of nodes provides an indication of the local connectivity characteristics of the risk (Fang, 2011). The number of reachable nodes indicates the number of other risks that a given risk can impact indirectly or directly. For arcs, the number of outgoing arcs signifies the activity degree of a risk and the incoming arcs give the passivity degree of the risk (Fang, 2011).

#### 5.3.1.7 Interfaces

Interfaces are one key factor of potential success or failure of complexity management. This paragraph briefly introduces indicators linked to direct and indirect interfaces between elements. These indicators help project managers identifying the interconnections between different actors. It may notably improve the

communication between these actors to enhance coordinated decision-making. The same kind of indicator can be calculated for interfaces between element domains (Fang et al., 2012). A local indicator is calculated as the total number of non-null cells of the XX matrix in the area delimited by ownership. We call this indicator  $NDI_{kl}$ , for number of direct interfaces between Actors  $A_k$  and  $A_l$ :

$$NDI_{kl} = \sum_{i,j} XX_{ij} + XX_{ji}$$

Similarly, a global indicator, called  $NII_{kl}$  for number of indirect interfaces between Actors  $A_k$  and  $A_l$ , is calculated as the total number of non-null cells of the reachability matrix RM previously introduced:

$$NII_{kl} = \sum_{i,j} RM_{ij} + RM_{ji}$$

### 5.3.1.8 Group Centrality

It generalizes the different centralities concepts from a single node to that of a group of nodes within the network. In addition, it is possible to evaluate the relative centrality of different teams or departments within an organization. Group centrality measure is a measure of the centrality of the whole group with respect to the individuals in the rest of the network, rather than to other groups. In group centrality normalization is important because different groups will have different size in the same network as compare to individual centrality where normalization will be negligible (Everett and Borgatti, 2012).

## 5.3.2 Propagation behavior within the Project Deliverables Network

In this paragraph, we propose an application of some algorithms to extract and visualize the propagation path between two elements within the network of project deliverables. For example, this allows to provide a vision of impact propagation between the project deliverables, with an option to focus on the chain that connects two deliverables associated with two milestones or on the chain that connects two critical deliverables.

We propose three types of propagation-based analyses:

- A local, step-by-step web-like navigation without specific tools, but with a complete description of the direct environment of each element,
- An identification of the existence of potential paths between nodes and associated lengths,
- Display the chains that relate two nodes.

a) Step-by-Step Propagation Analysis: The first way to deal with potential propagation is to focus on a single element, showing all its interdependencies, but at a local level only. The idea is to give to the actor who will own or contribute to this central element the information about all its direct relationships. It is then possible to focus on one of these directly connected elements, which becomes the center of the diagram, and so on. This is similar to website navigation and enables direct and indirect relationships to be displayed on a user-friendly, complete (locally) and standard vision (Marle, 2002).

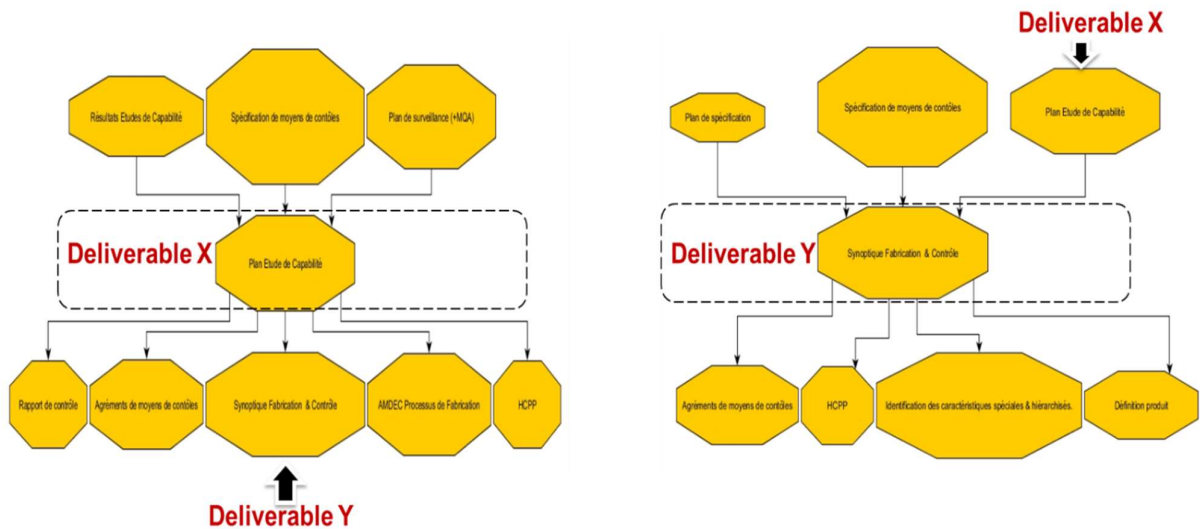

**Figure 47 Navigation from Deliverable X-centered to Y-centered interdependency diagram**

For instance, Figure 47 illustrates the case of complete representation of deliverables connected to **X**. One can see the classical interdependency of composition, its inputs and its outputs. It is then possible to focus on **Y**. The right part of Figure 47 shows that the sequential link between **X** and **X** is still displayed, but now the rest of the information is about direct interdependencies with **Y**. Behind the deliverables, there are actors. This means that this navigation from deliverable to deliverable permits simultaneously to build communication paths between actors. This is illustrated in Figure 47 for direct connections, but the principle is the same for longer chains.

b) An algorithm to identify the existence and the length of a potential path between two elements

We propose the use of a known algorithm in graph theory presented in Figure 48 and allows:

- The identification of indirect consequences of an initial (un)desired event.
- The identification of indirect causes of a final (un)desired event.

- The detection of loops, which are characterized by the identification of a path which has the same initial and final nodes.

```

1  % INPUTS: adjacency matrix, node index, k - number of links
2  % OUTPUTS: vector of "kmin"-neighbors indices
3  function kneigh = kmin_neighbors(adj,ind,k)
4  close_neighbors=[];
5  adjk = adj;
6  for i=1:k-1
7      close_neighbors = [close_neighbors find(adjk(ind,*)>0)];
8      adjk = adjk*adj;
9  end
10 kneigh = setdiff(find(adjk(ind,*)>0),[close_neighbors ind])

```

**Figure 48 Find the neighbors (with path of length k at a minimum) for every node**

This algorithm is implemented in Matlab, and permit to give in an ergonomic way, for each node, the connected neighbors with associated length of paths.

- c) Display the chain that connects two deliverables:

In this analysis, we propose the use of the known Dijkstra algorithm (Dijkstra 1971) with an additional option that allows to remember the path which relates two nodes within the network, after that we report and visualize this propagation path between two elements (See Figure 49).

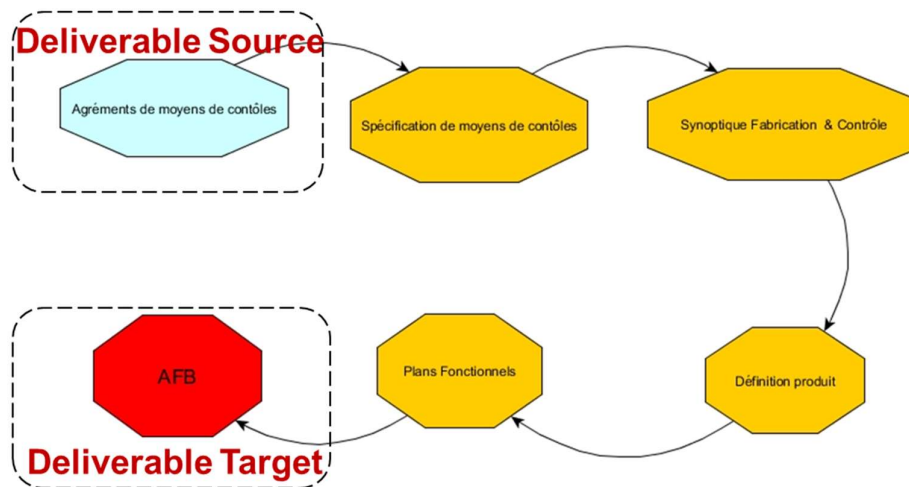

**Figure 49 Displaying the path between source and target**

```

1  % INPUTS: adj - adjacency matrix, s - source node, target - target node
2  % OUTPUTS: distance, d and path, P (from s to target)
3  % Note: if target==[], then dist and P include all distances and paths from s
4  function [dist,P]=dijkstra(adj,s,target)
5  % initialize distances =====
6  n=length(adj);          % number of nodes
7  adjL=adj2adjL(adj);    % list of neighbors
8  dist=inf(1,n); dist(s)=0;
9  previous=[1:n; inf(1,n)]'; % {i: inf}, i=1:n, inf -> not assigned
10 S=cell(1,n); % shortest path sequence
11 Q=[1:n]; % all unvisited vertices, entire graph
12 while length(Q)>0 % while not empty
13     % get min dist member among unvisited vertices
14     [mindist,min_ind]=min(dist(Q)); u=Q(min_ind);
15     % termination condition - save source-u path
16     S{u}=[]; t=u;
17     while not isempty(find(previous(:,1)==t)) % t in previous.keys():
18         % insert u at the beginning of S
19         S{u}=[t S{u}]; t=previous(t,2);
20     end
21     if length(target)>0 & u==target
22         dist=dist(u); P=S{u};
23         return
24     end
25     Q=purge(Q,u); % remove u from Q
26     for v=1:length(adjL{u}) % across all neighbors of u
27         v=adjL{u}(v); alt=dist(u)+adj(u,v);
28         if alt < dist(v)
29             dist(v)=alt;
30             previous(v,2)=u;
31         end
32     end
33 end
34 P=S;

```

Figure 50 Dijkstra which also returns the shortest paths (Dijkstra 1971)

The input of the algorithm in Figure 50 are the matrix of the interactions between elements (the adjacency matrix of weighted directed graph), the source node and the target node. The output of this algorithm is the explicit shortest path between these two nodes. If we don't specify the target node, we obtain all distances and paths from the node source.

In brief, we proposed a methodology of propagation analysis between elements strongly inter-linked and treat several cases and scenarios with an ergonomic and efficient way.

### 5.3.3 Criticality Analysis and Monitoring of Project Deliverables

As seen in Section 5.2.3, there is actually a lack of consensus on what deliverable criticality is. In this section we propose a measure of deliverables criticality that take into account the individual and the collective criticality.

### 5.3.3.1 Individual criticality

The risk assessment of each deliverable should be made during the initial planning. It determines the probability that the deliverable of a task can be produced. There are three levels of risk to the project deliverables:

- The first level means that no high risk is linked to this task, similar deliverables were previously produced without particular problems.
- The second level means unexpected difficulties may delay the delivery of the result. The exact result that the task is supposed to deliver has not been developed by the project team. It corresponds to the current state of knowledge, and the risk that the problem will not be solved is low.
- The third level means it is not sure that the necessary knowledge will be produced with the resources allocated to the project. It is even possible that there are scientific or technical boundaries' conditions that prevent a positive response to the question about the task.

The allocation to these levels of risks can identify critical deliverables, the preparation of which is recommended as early as possible in the project. The temporal involvement may be less important if the deliverable can be reproduced in case of confirmed risk. In any case, the objective of risk levels is to anticipate optimally the possible dysfunctions in order to detect them as they emerge, communicate and treat them spontaneously.

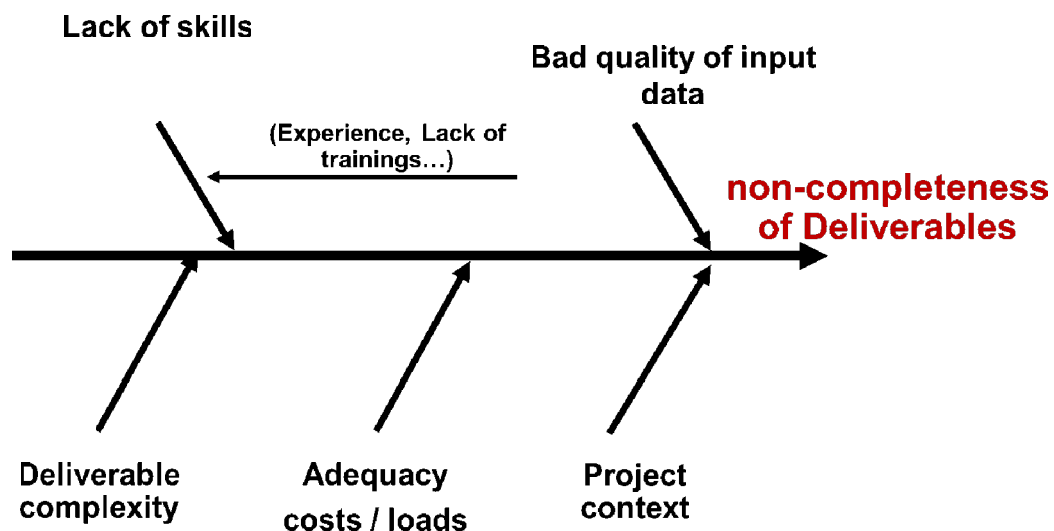
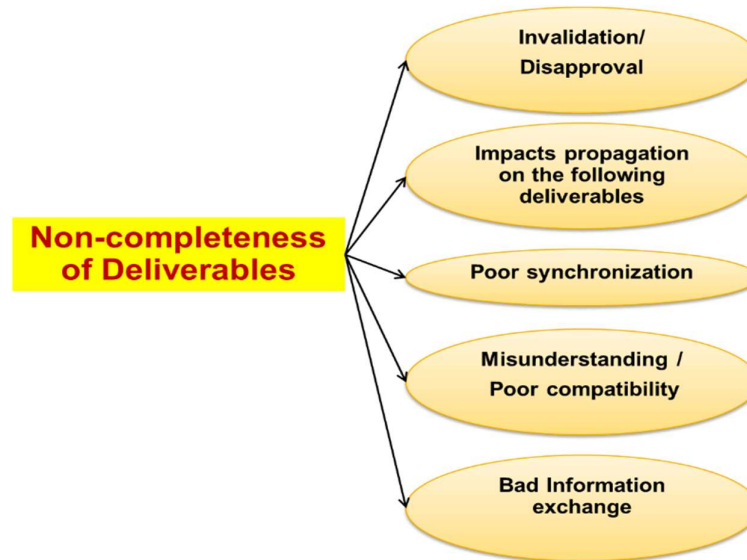

Figure 51 Some Causes of non-completeness of deliverables

The quality of project deliverables encompasses four areas: Correctness; Timeliness; Completeness; and Flexibility of providing (Yang, 2009). We define the concept of individual criticality of a deliverable as the

assessment of its risk of bad quality (For example non-completeness, See Figure 51 that represent some causes of deliverables' non-completeness).



**Figure 52 Some consequences of non-completeness of project deliverables**

Figure 52 shows some consequences of non-completeness of project deliverables. The criticality level is normally divided into three degrees; Simple, Moderate and Complex (or respectively: green, orange and red). We used a brainstorming or to identify the individual critical features such as the major deliverables to meet customer satisfaction; the deliverables associated to the critical path; and the identified late/non-complete deliverables from the feedbacks of past projects... Finally the individual criticality is assessed using the following formula associated to the risk of Deliverable' non-completeness:

$$Criticality = Probability * Gravity * Detectability$$

### 5.3.3.2 Collective criticality of a deliverable

Many engineers interviewed within the automotive manufacturer Renault, cited several factors of collective criticality of project deliverables such as: The deliverable is the result of many other deliverables; The deliverable is consumed by many receivers....Collective criticality analysis help understanding the global importance of a deliverable, the global sources of impacts, and the global hubs influenced by many other deliverables, that might not be detected with the classical direct cause–effect analysis. This analysis will show how one can deal with the difficulty to anticipate and control the consequences of complexity by proposing complementary complex-oriented mitigation actions. These actions may suggest to act on deliverables (e.g., to modify X to get X'), but sometimes on other elements or on other attributes than classical analysis output. Moreover, complementary indicators may involve different strategies like acting on an interaction (e.g., to get

I'(X1, X2) less influent on the system behavior) or on an actor who manages an element (e.g., to assign a more appropriate A' to X).

Figure 53 illustrate the additional information brought by the collective criticality analysis. The topological indicators represented in section 5.3.1 permit to evaluate the collective criticality of project deliverables and to re-evaluate the priority of the project risks by coupling the traditional features of individual risks with the highest topological indicators of the risk network

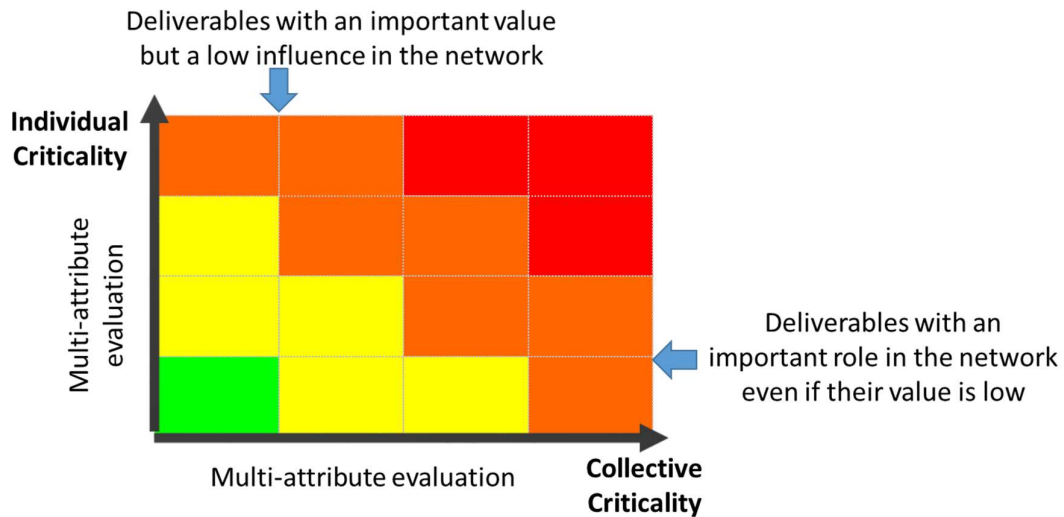

**Figure 53 Illustration of the additional information brought by the collective criticality analysis**

### 5.3.4 Acting on Nodes

During the project, the occurrence of risks can induce changes in the planning and therefore on the project time and cost (Marmier et al., 2014). In order to reduce the risk level in a project, it is necessary to define and apply a treatment strategy of the risk. The main idea is to combine several types of actions on specific nodes, these nodes being highlighted by classical or non-classical indicators (previous sections). Acting on project elements and their maturity consists in improving maturity to reduce the main internal weaknesses of the project (Gonzalez Ramirez, 2009), but the basic short-term actions are to implement correctly what is provided by the project office, or to simultaneously develop and implement something which was missing or immature. This gap between current and required maturity levels will have more or less consequences depending on the level of exposure to potential dangers. The more dangers there are, the higher the required maturity is.

### 5.3.5 Acting on Edges and Chains in the Network

In classical methods, actions are decided on elements, like for instance risks having the highest criticality or gravity. These actions correspond to the classical categories, which are avoidance, acceptance, mitigation,



prevention, protection, etc. Based on refined evaluations and priorities, an updated response plan is developed, combining classical and innovative actions (Figure 53).

Innovative actions include: (1) mitigation actions based on classical strategies but applied to new elements, depending on their refined values and rankings; (2) non classical mitigation actions, which mitigate propagation occurrence instead of mitigating local problem occurrence. A complementary preventive action for accumulation or transition elements is to cut off their input links or at least to reduce the transition probability values. Instead of acting on an element, the action focuses on its sources. Blocking the output links can be regarded as the action of confining the further propagation in the network. This is well adapted to source and transition elements. Instead of acting on the element, the action focuses on its consequences. This does not avoid the local problem, but its propagation and amplification to the rest of the project.

## **5.4 Application to vehicle development projects**

Modeling, prototyping and validating a new vehicle design entails dozens of subassemblies and hundreds of unique parts, all of which have complex engineering cross-dependencies. Some design and engineering work can proceed in parallel; other tasks must be executed in sequence. These complexities must be modeled and factored into monthly, weekly and daily planning buckets. At each milestone, a quality check is made. Between the milestones the cost control monitoring is well organized at Renault, but the deliverables monitoring is partially made and not unified from one project to another.

Our aim is to develop action strategies to prevent critical deliverables associated risks by providing decision support to improve the anticipation of shifting milestones. Even so, provide decision support for Quality-Assurance Engineers (who are responsible for milestones crossing agreements). The industrial need is to prioritize the most critical project deliverables.

### **5.4.1 Data collection of project deliverables network**

The first step of our analysis is the data collection about dependencies between project deliverables. Based on analysis of the processes' flow charts within the development logic of new vehicles (See Figure 54), we made a presumption of interactions between deliverables by studying the paths of connections between deliverables via the activities' emitters and receivers (See Figure 55 and section 4.4.2 in chapter 4). We took into account during this assumption the time shift between emitting and receiving in order to delete fake links.

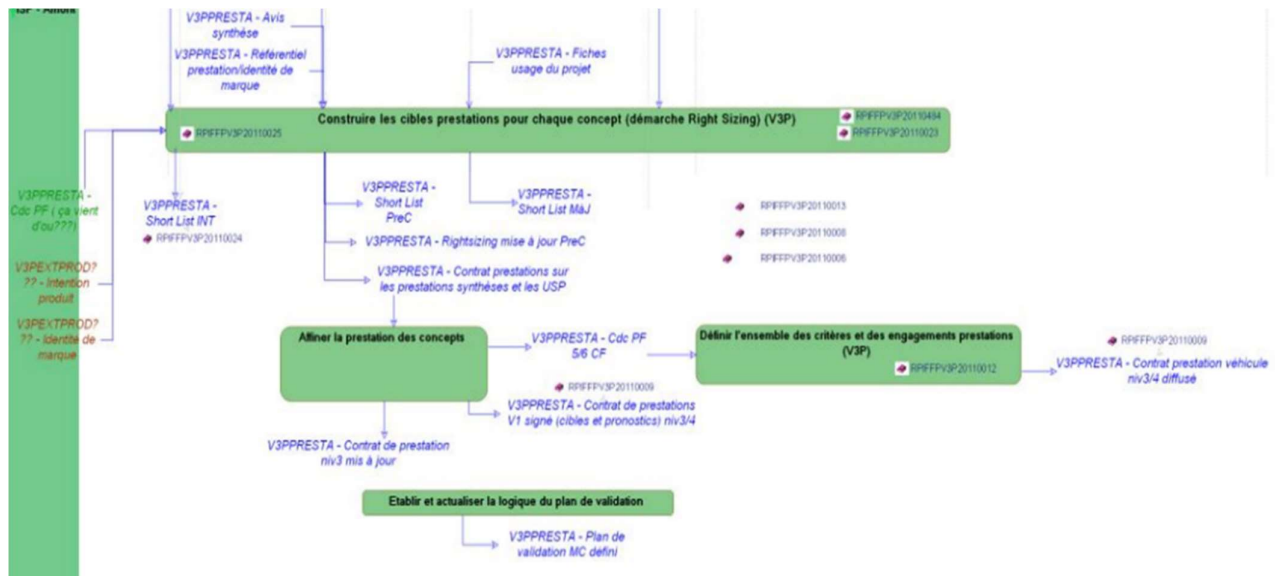

Figure 54 Initial data in the development logic of new vehicle

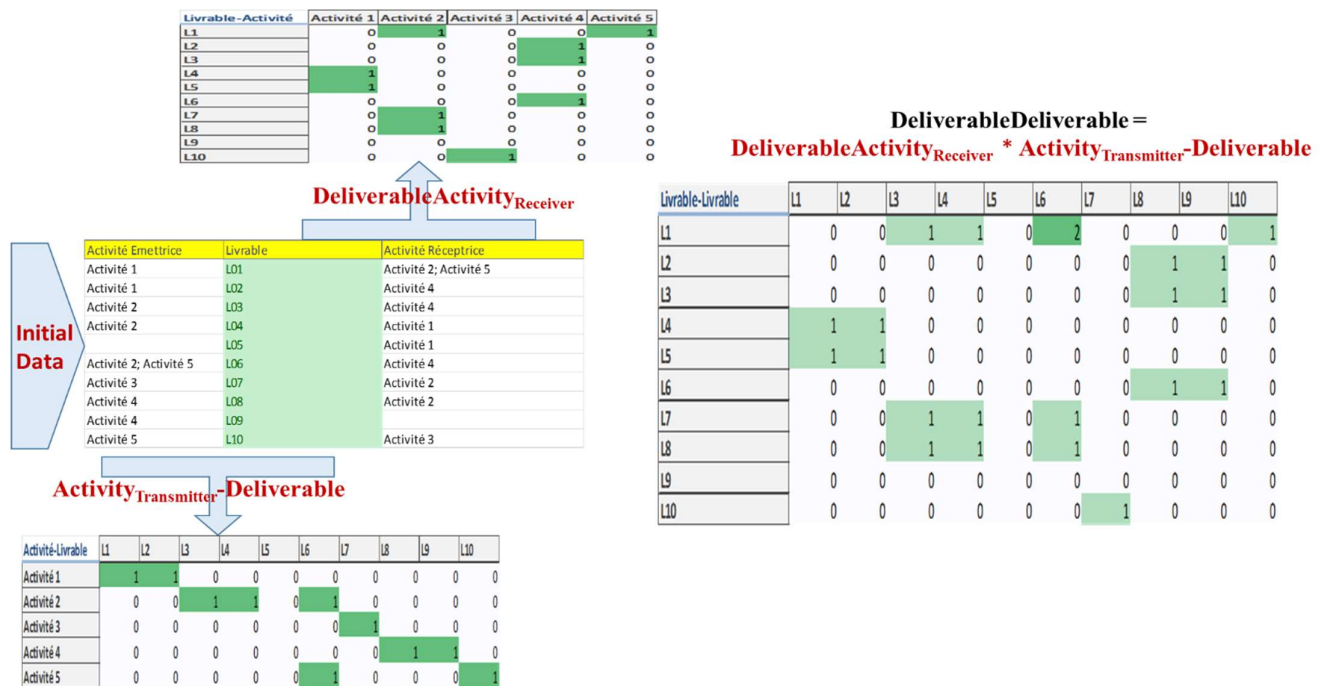

Figure 55 Presumption of interactions between project deliverables

After presumption, we enriched our model of spreading impacts between deliverables by interviews with deliverables' owners and their emitting responsible. Then we obtain a validate network of project deliverables. Figure 56 presents a zoom on small zone of this network. Figure 57 shows the matrix of interactions between 254 deliverables. The total size of the verified matrix is about 2200\*2200 deliverables.

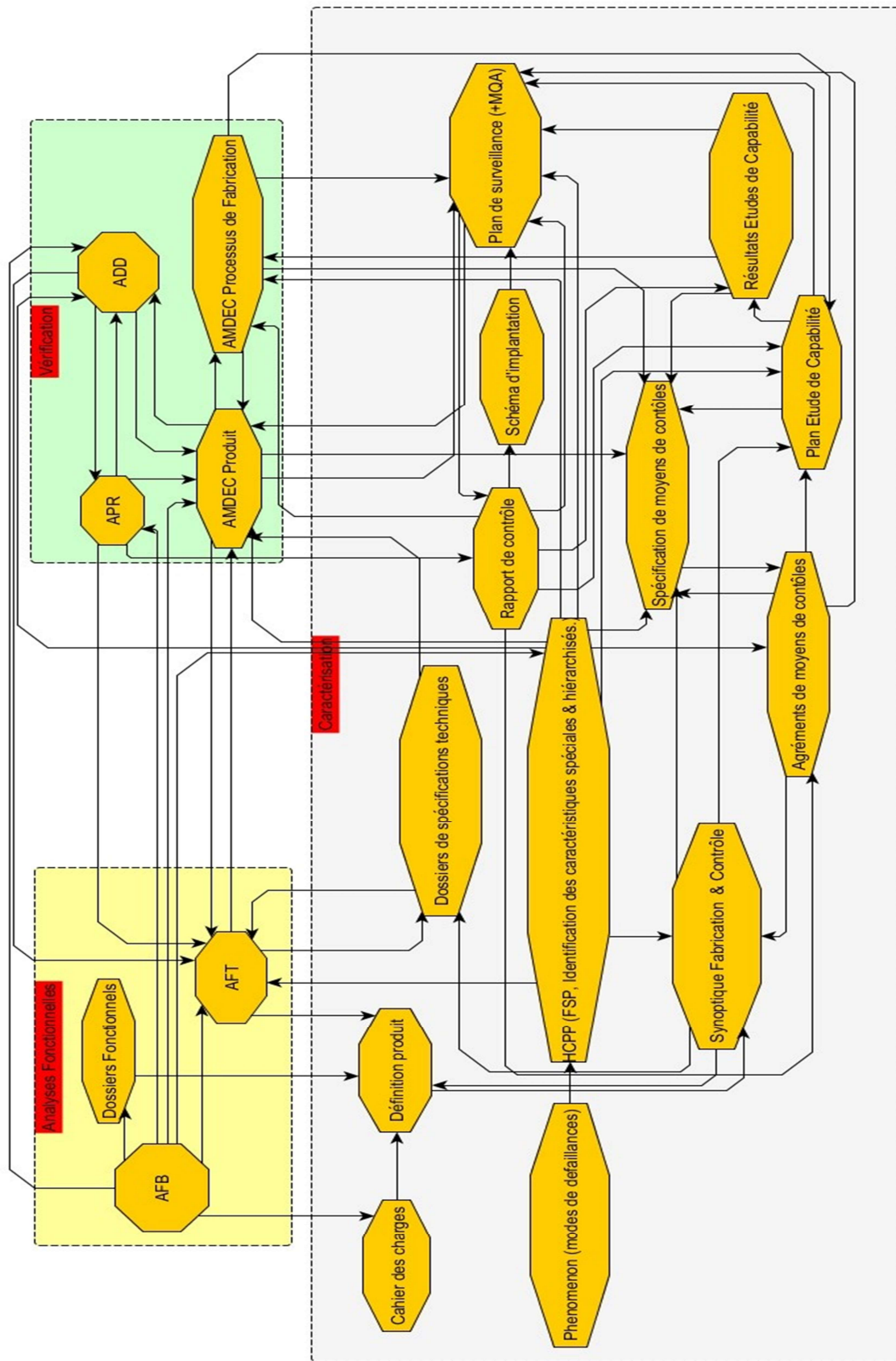
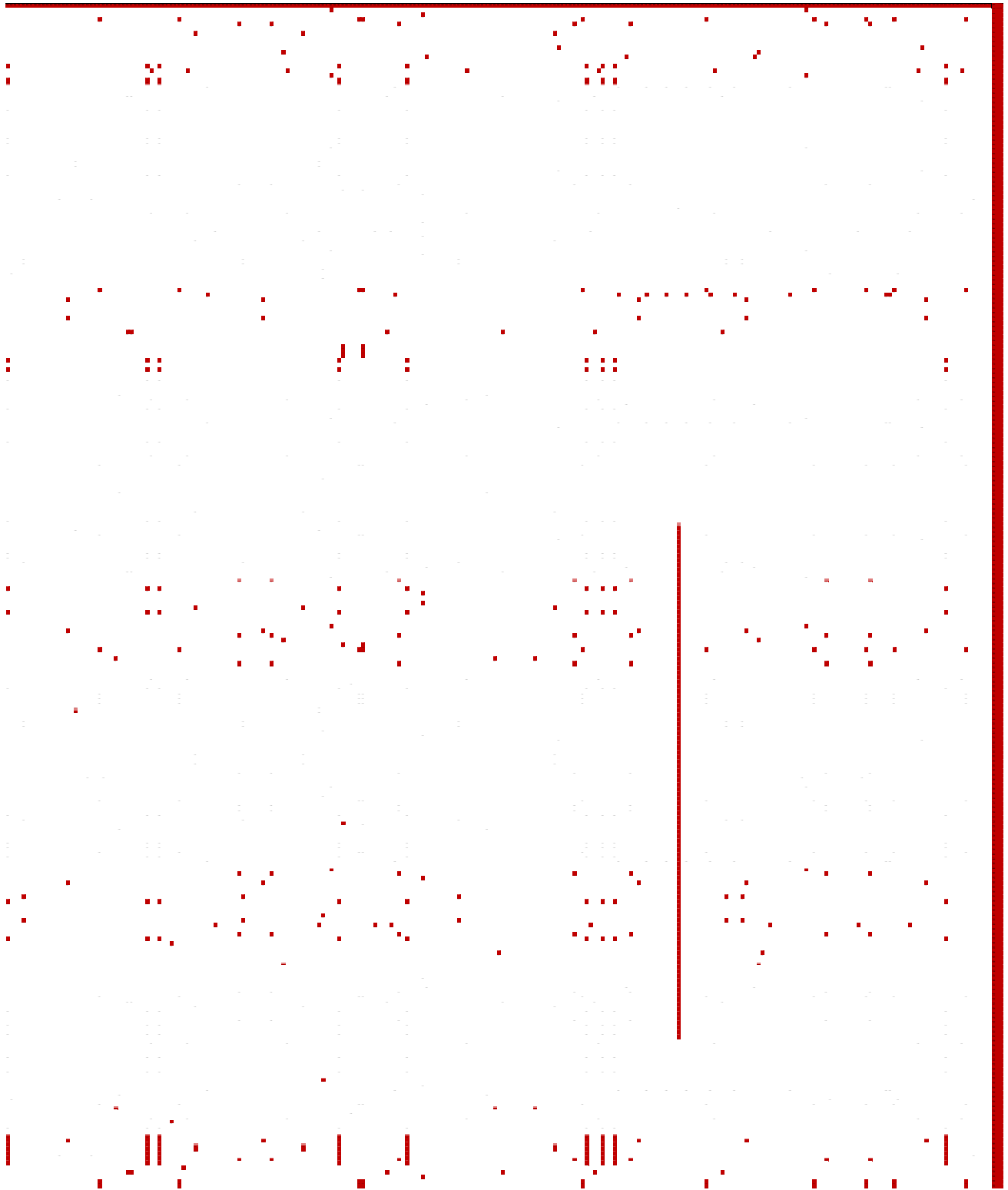

Figure 56 Zoom on a small zone of the network of project deliverables



**Figure 57 Zoom on the interactions between 254 deliverables (verified dependencies)**

## 5.4.2 Prioritizing the risks of non-completeness of Deliverables with respect to their importance in terms of influence in the network

We defined a notion of deliverable individual criticality which is consistent and compatible with the different exploitations that are already made within Renault, for example: the frequency (percentage) of "green" validation of deliverables posterior to analyzing the feedbacks of 57 previous project.

The assessments of this criticality were made by the risk assessment of deliverables' non-completeness. The collective criticality analysis is done through the identification and analysis of impacts' propagation channels in the network of deliverables as soon as possible in the project life cycle, in conjunction with the centrality indicators represented in section 5.3.1. An example of the obtained results is given in Figure 58.

Deliverable Name	Individual Criticality	Deliverable Inputs	Deliverable Outputs	Collective Criticality
V3PREGL - Confirmation du cadrage réglementaire sur la base des pays décidés	57.1%	3	62	70769
V3PEXTPROG - INT VRB signé	73.8%	16	8	51331
V3PIS - STR Comp	60.3%	5	57	50120
V3PCADRER - INT VRB DGT	30.0%	37	5	45280
V3PPART - Bilan RTGFE VPC	100.0%	3	20	42830
V3PCADRER - Intentions Techniques	59.7%	17	34	30654
V3PREGL - DER officialisés dans BMIR	66.6%	6	13	26060
V3PIS - DAS V1 une hypothèse de référence	79.0%	11	25	25452
V3PIS - DAS V2	74.8%	11	30	25404
V3PPART - 100% Nums validées par fournisseurs/outilleurs pour engagement faisabilité (Cp)	40.3%	15	5	22107
V3PIS - DAS V0 plusieurs hypothèses	71.7%	11	23	15316
V3PCADRER - Liste des Innovations Projet	73.6%	17	23	13547
V3PCADRER - Liste potentielle Projet Innovations	75.8%	17	23	13547
V3PCADRER - Liste innovations Projet (Draft)	70.2%	17	23	13547
V3PPRESTA - Cdc PF 5/6 CF	79.6%	1	19	12868
V3PCADRER - VPC VRB DGT	57.1%	37	21	12302
TA - Contrat prestations sur les prestations synthèses	71.8%	9	3	12188
V3PPART - DT Contrat	76.1%	15	28	11956
V3PIS - STR V2 quantifié	66.1%	23	22	11613
V3PIS - STR V1 Fonctions adaptées	63.2%	23	17	11556
V3PIS - STR V0	66.8%	23	15	11480
V3PPART - FDR2 (VPCRef)	45.7%	11	18	11346
V3PPART - FDR1 (CFRef)	71.4%	11	18	11346
PPOLTEC - Propositions de pièces et modules standa	67.3%	12	5	11153
V3PPART - DR confirmée (CFRef -3s)	40.0%	8	7	11124
V3PPART - 100% représentativité pièces PIE C	66.7%	15	39	11078
V3PCONVECO - Budget (TEI, Investissement)	42.3%	11	35	10894
V3PCADRER - CF VRB DGT	50.0%	37	5	10434
V3PCADRER - PreC VRB DGT	25.0%	37	5	10276
V3PPROJETS - Liste d'acteurs par projet contextualisé	50.0%	15	28	10171
V3PPART - Définition connectique figée	92.3%	15	36	10160
V3PEXTPROG - Qui Fait Quoi VRB	67.5%	16	21	9989

Figure 58 Prioritizing the project critical deliverables

After assessing individual and collective criticality, we classify project deliverables in four main categories (See Figure 59). The first one is for deliverables with a significant role in the network and important individual criticality value. This category includes, for instance “Perceiving quality convergence”, “Product General Safety status”... The second one is for deliverables with an important role in the network even if their value is

low, this includes, for example: “PFE's checklist inputs”. The third one is for deliverable with ignoble individual criticality value and without a significant role in the network. The fourth one is for deliverables with an important individual criticality value but a low influence in the network such as “Project Team Training status”.

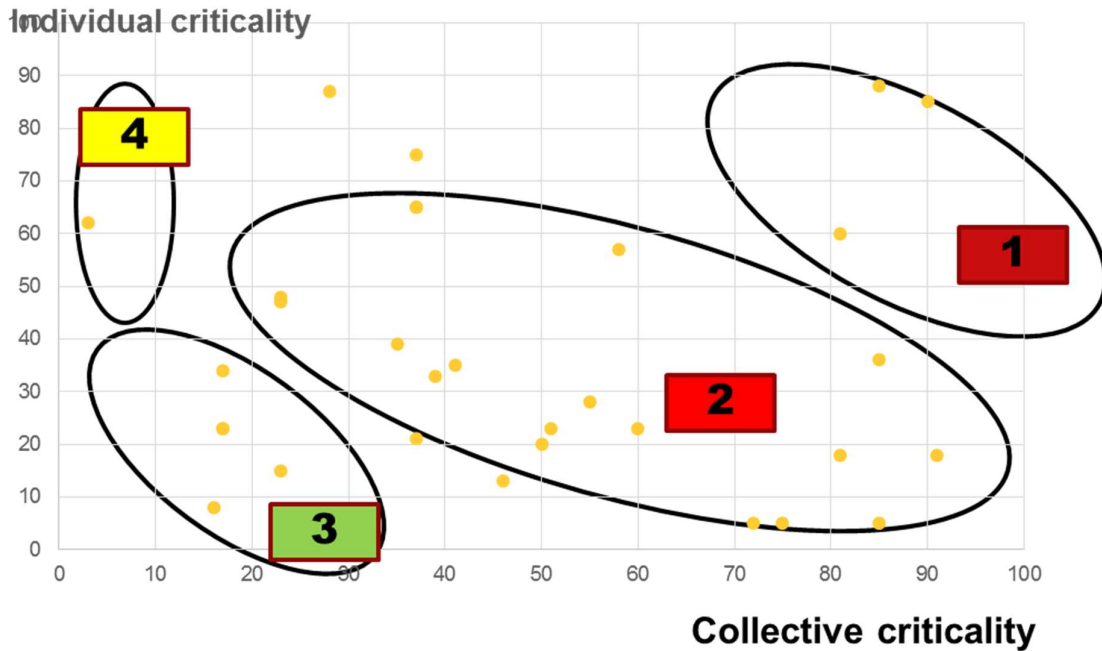
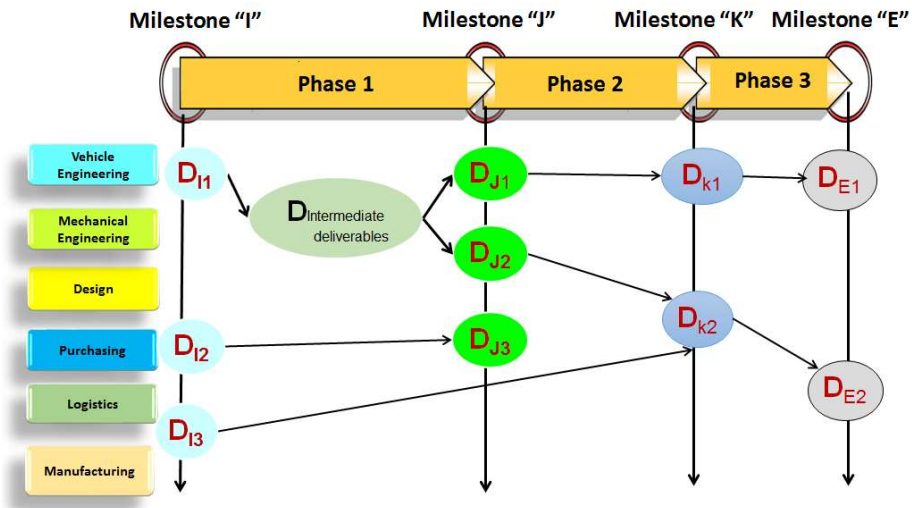

Figure 59 Deliverables classification

### 5.4.3 Results: Monitoring of project critical deliverables

Finally, we provided an anticipatory vision of impacts' propagation between the deliverables, with an option to zoom in on the "chain" that connects two deliverables associated to different milestones (See Figure 60) or the path between two critical deliverables. To do this, we used the proposed propagation analysis techniques in section 5.3.2.

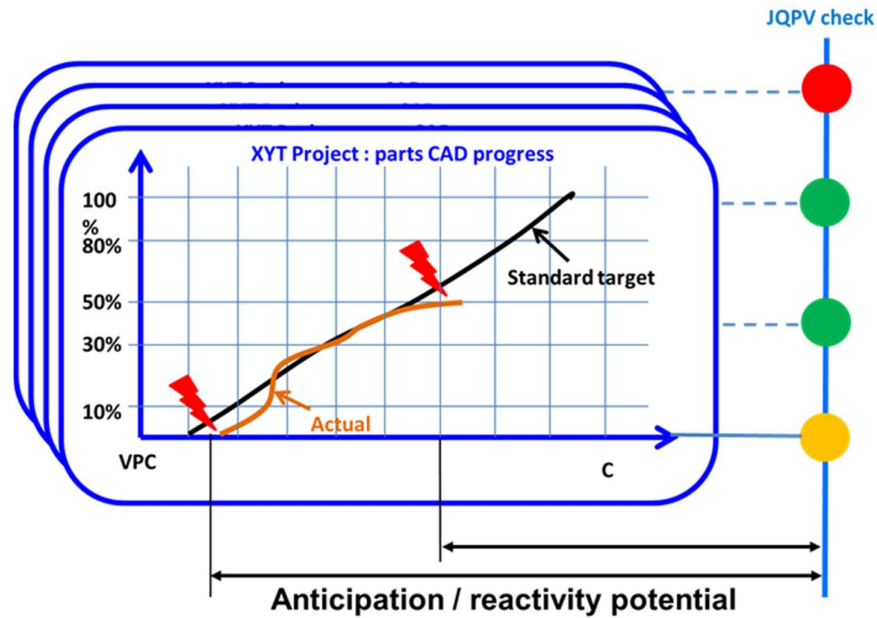

**Figure 60 Impacts propagation between project deliverables through milestones & organizational units.**

This helps on daily proactive management by deliverables. After the identification of critical deliverables and implementation of monitoring plans (See Figure 61), we can get the right information to build the steering dashboard.

To conclude, mastering the critical deliverables is based on:

- Estimation of the remainder to make, and analysis of the deviations from the project target path (See Figure 61);
- Make the right decisions and manage corrective actions;
- Ensure the quality of deliverables.



**Figure 61 Implementation of monitoring of project critical deliverables**

Risk management applied by the company integrates the anticipation of foreseeable risks and planning for possible solutions. However, the company does not control the management of unpredictable risks. Only the active planning with its decentralized and bilateral control system can compensate for this failure. Late deliverables continue to be a major impediment to project success (Barry et al., 2015). We should apply the prevention recommendations for the most common late deliverables (Top 100 selected) and lessons learned in managing late deliverables and mitigating their impacts. The implemented monitoring (See Figure 61) improves cost, schedule, safety, quality, and organizational performance through a greater understanding of risks associated with late deliverables.

## 5.5 Conclusions

The industrial application on vehicle development projects is performed to build up and analyze the interactions-based project network. Firstly, this work was on the direct analysis of risks in vehicle projects, but it has been cancelled because of incomplete or poorly documented data. The initial investigation field was therefore limited to focusing on indirect risk analysis in vehicle projects via the analysis of propagation risks between deliverables, either on milestones or between two milestones. The obtained results demonstrate that the topological network analysis adds value to the classical project risk analysis, in identifying both the influential elements and the important interactions with respect to their role in the network behavior. Furthermore, the proposed analysis gives additional information for the decision-making in monitoring and controlling the impact propagation, since risks or deliverables may be considered influential for criticality and/or topological reasons. That is to say, a deliverable taken individually may be non-critical, but through



interactions could become the source of impact propagation to some critical ones. The same analysis was done on the relationships between deliverables to evaluate the most crucial edges in the network structure. Overall, these reduce project complexity by mastering better the phenomenon of propagation. Based on the analysis outcomes, we demonstrate the effectiveness of using network theory for project elements topological analysis. The proposed method is generic and could be applicable to a wide set of engineering projects for decision support.

## 5.6 References

- Barry, W., Leite, F., O'Brien, W.J., 2015. Late Deliverable Risk Catalog: Evaluating the Impacts and Risks of Late Deliverables to Construction Sites. *Journal of Construction Engineering and Management* 141, 04014087. doi:10.1061/(ASCE)CO.1943-7862.0000950
- Bonacich, P., 1972. Factoring and weighting approaches to status scores and clique identification. *Journal of Mathematical Sociology* 2, 113–120.
- Borgatti, S.P., 2005. Centrality and network flow. *Social Networks* 27, 55–71.
- Borgatti, S.P., Everett, M.G., Johnson, J.C., 2013. *Analyzing Social Networks*, 1st Edition. ed. SAGE Publications Limited.
- Braha, D., Bar-Yam, Y., 2004. Information flow structure in large-scale product development organizational networks. *Journal of Information Technology* 19, 244–253.
- Browning, T.R., Ramasesh, R.V., 2009. A Survey of Activity Network-Based Process Models for Managing Product Development Projects. *Production and Operations Management* 16, 217–240. doi:10.1111/j.1937-5956.2007.tb00177.x
- Bruni, M.E. et al., 2011. A heuristic approach for resource constrained project scheduling with uncertain activity durations. *Computers & Operations Research* 38, 1305–1318.
- Cano, J.L., Lidón, I., 2011. Guided reflection on project definition. *International journal of project management* 29, 525–536.
- Dijkstra, Edsger W., 1971. *A short introduction to the art of programming*.
- Everett, M.G., Borgatti, S.P., 2012. Categorical attribute based centrality: E-I and G-F centrality. *Social Networks* 34, 562–569.
- Fang, C., 2011. *Modeling and Analyzing Propagation Behavior in Complex Risk Network: A Decision Support System for Project Risk Management*.
- Fang, C., Marle, F., 2012. A simulation-based risk network model for decision support in project risk management. *Decision Support Systems* 52, 635–644.
- Fang, C., Marle, F., Zio, E., Bocquet, J.-C., 2012. Network theory-based analysis of risk interactions in large engineering projects. *Reliability Engineering & System Safety* 106, 1–10.
- Feng, W. et al., 2010. Dependency structure matrix modelling for stakeholder value networks, in: *The 12th International DSM Conference*. Cambridge, UK.
- Fernandez, A., 2011. *Les nouveaux tableaux de bords des managers*, Editions d'organisation. ed.
- Floyd, R., 1962. Algorithm 97: shortest path. *Communications of the ACM* 5.
- Freeman, L., 1977. Set of measures of centrality based on betweenness. *Sociometry* 40, 35–41.
- Gannon-Leary, P., McCarthy, M.D., 2010. *Customer care*, Elsevier. ed. Philadelphia.
- Garver, M.S., 2003. Best practices in identifying customer-driven improvement opportunities. *Industrial Marketing Management* 32, 455–466.
- Gonzalez Ramirez, N., 2009. *Mesure de la maturité des projets :une approche pour améliorer le pilotage des projets automobiles*. Ecole Centrale Paris.
- Guimera, R., Amaral, L., 2004. Modeling the world-wide airport network. *The European Physical Journal B-Condensed Matter and Complex Systems* 38.
- Hao, X., Lin, L., Gen, M., 2014. An effective multi-objective EDA for robust resource constrained project scheduling with uncertain durations. *Procedia Computer Science* 36, 571–578.
- Katz, L., 1953. A new status index derived from sociometric analysis. *Psychometrika* 18, 39– 43.
- Kreimeyer, M.F., 2009. *A Structural Measurement System for Engineering Design Processes*.

- Marle, F., 2002. Modèles d'information et méthodes pour aider à la prise de décision en management de projets. Ecole Centrale Paris.
- Marle, F., Vidal, L.-A., 2016. Managing Complex, High Risk Projects. A Guide to Basic and Advanced Project Management, Springer-Verlag. ed. London.
- Marmier, F., Cheikhrouhou, N., Gourc, D., 2014. Improvement of the planning reliability by the integration of human skills in project risk management, in: Logistics and Operations Management (GOL), 2014 International Conference on. IEEE, pp. 125–132.
- Masmoudi, M., Hait, A., 2013. Project scheduling under uncertainty using fuzzy modelling and solving techniques. Engineering Applications of Artificial Intelligence 26, 135–149.
- Page, L. et al., 1999. The pagerank citation ranking: Bringing order to the web.
- PMI, 2013. A Guide to the Project Management Body of Knowledge: PMBOK Guide. Project Management Institute.
- Samikoglu et al., 1998. Sensitivity analysis for project planning and scheduling under uncertain completions. Computers & Chemical Engineering 22, 871–874.
- Shi, Q., Blomquist, T., 2012. A new approach for project scheduling using fuzzy dependency structure matrix. International Journal of Project Management 34, 503–510.
- Soroush, H.M., 1994. The most critical path in a PERT network: A heuristic approach. European Journal of Operational Research 78, 93–105.
- Spizzirri, L., 2011. Justification and application of eigenvector centrality. Algebra in Geography: Eigenvectors of Network.
- Stal-Le Cardinal, J., Marle, F., 2006. Project: The just necessary structure to reach your goals. International Journal of Project Management 24, 226–233.
- Warfield, J., 1973. Binary matrices in system modeling. IEEE Transactions on Systems, Man and Cybernetics 3, 441–449.
- West, D., 2001. Introduction to graph theory., Upper Saddle River. ed. NJ: Prentice Hall.
- Yang, L.R., 2009. Impacts of automation technology on quality of project deliverables in the Taiwanese construction industry. Canadian Journal of Civil Engineering 36, 402–414.
- Yannou, B., 1998. Analyse fonctionnelle et analyse de la valeur. In Conception de produits mécaniques, méthodes, modèles et outils., M. Tollenaere & Hermes, eds. ed.

## **Chapter 6: Improving coordination between actors in new product development projects using clustering algorithms**

---

Our second research question is addressed in this chapter by introducing a clustering methodology to propose groups of actors in new product development projects. The focus is on actors who are involved in many deliverable-related and inter-phase interdependencies. We propose an approach to form complementary teams or working groups according to the relationships they have due to their deliverable exchanges. This permits to increase coordination between actors who are interdependent, albeit not always formally connected via the hierarchical structure of the project organization. This enables potential issues due to complexity, like bad communication and coordination, to be dealt by actors who are not initially put together. Therefore, we propose a “mastering of impact propagation” organization with the objective of taking into account interdependencies between actors to mitigate risks due to the complex structure of the project.

### **6.1 Introduction**

Project complexity has several potential consequences, like: project uncertainty, project ambiguity, propagation and chaos. They trigger gaps between initially estimated and actual project trajectories. To deal with project complexity, we use in this Chapter a second strategy, which is to organize project actors in a manner adaptable to its complexity. This does not automatically imply that complexity is analyzed and mitigated with actions developed in previous Chapters. Both strategies can be combined but this is not mandatory. This re-organization of project actors should foster communication and afterwards decrease project ambiguity, assist interface management and subsequently reduce risks of propagation. Finally, it may help reducing project uncertainty by increasing ability to pre-evaluate project objectives and characteristics of the project elements as well as the impact of actions and decisions.

When facing complex situations, the way that project members are organized is crucial to determine how they will be able to collectively cope with nontrivial problems and risks. Current project organizations are generally based on single-criterion decompositions, whether product- or process- or organizational entity-based. The managerial issues potentially associated to the management of a complex project are mainly related to its inability to be broken down into independent parts. This is true for all types of systems, whether natural, technical or human. The consequence is that, whatever the way the system is broken down into, there will always be interdependencies between the parts, here the organizational boundaries of the project decomposition. Project can be decomposed into either Product- (or System)-related elements, phases or organizational entities, but there will always be numerous interdependencies between actors who do not belong to the same part. This implies risk of bad communication, bad coordination or locally optimal decisions. Due to the number of interactions outside the official project structures, the danger is that the

communication and coordination between actors may not be correctly done. Figure 62 shows the problematic treated in this chapter with the objective to propose a complementary project organization to be practically closer to the real network structure of project actors in order to cope efficiently and collectively with project complexity-related phenomena. This organizational reshuffling will be done using clustering methodology, based on actor-actor interdependency matrices.



Figure 62 The project organization should practically be closer to the real network structure of project actors.

## 6.2 Solving strategies for reshuffling project organization to improve coordination between its actors

This section presents a literature review on clustering project actors for reshuffling project organization. It divides strategies of clustering project actors into two categories. The first strategy is based on modeling direct relationships between actors. The second one is based on modeling indirectly relationships between actors, by modeling interdependencies between project elements and thus between their owners. This section proposes thus a problem formulation for the actors clustering considering or not interdependencies between elements.

### 6.2.1 Clustering of Project actors

As underlined by Morel and Ramanujam, the organization is an adaptive and evolving system which has to correspond to the complexity of the situation it has to manage (Morel and Ramanujam, 1999). To do this, clustering aims at maximizing the amount of interactions between project actors within clusters, and minimize interactions inter-clusters. A desired consequence is an increase in organizational capacity, in terms of

communication and coordination between potentially interacting actors, and a reduction of potential propagation of the occurrence of one or several risks (see Figure 63).



**Figure 63 Clustering is an appropriate action to increase organizational capacity in terms of communication and coordination between actors.**

In this thesis we define community (or cluster of actors) as “a subset of actors among whom there are relatively strong, direct, intense, frequent or positive ties” (Wasserman and Faust, 1994). Clustering is thus an appropriate action to improve project members and managers’ risk attitude (Van Bossuyt et al., 2013), which means an improvement of how individual members will respond to risk in their activities once they are grouped with interconnected people, and to get a higher level of coordination between multi-domain and multi-timeframe decisions. Organizational clustering has also been studied in several works, either for mitigating communication risks or for seizing creativity opportunities (Rushton et al., 2002); (Carroll et al., 2006); (Millhiser et al., 2011); (Sosa and Marle, 2013). This clustering is based either on modeling direct relationships between actors or modeling indirect relationships between project elements owners by modeling interdependencies between these elements.

### **6.2.2 First Strategy based on modeling direct relationships between actors**

Actor relationships or dependencies are important because they affect the efficiency of team communication, thus directly influencing design process outcomes. Rondeau et al. applied the concept of cooperation graph to design process. A cooperative group is composed of agents which are organized according to the relationships between the actors of this group. The structure of cooperation is represented by a directed graph called cooperation graph, based on cooperation links as shown on Figure 64. Vertices represent the agents, edges represent the relations between them. An edge from agent  $A_j$  to  $A_i$  means that  $A_j$  needs information transfer from  $A_i$ . Agent  $A_i$  cooperates with agent  $A_j$  if  $A_i$  gives or shares some of its information with  $A_j$  (Rondeau et al., 1999). Three categories of relations between actors are proposed: **a)** Actors who can be sequenced so that each one can work only after receiving the required information from his predecessors (Series Actors); **b)**

Actors who do not depend on other actors (Parallel Actors); **c)** Actors who are interdependent and must work simultaneously (Coupled Actors).

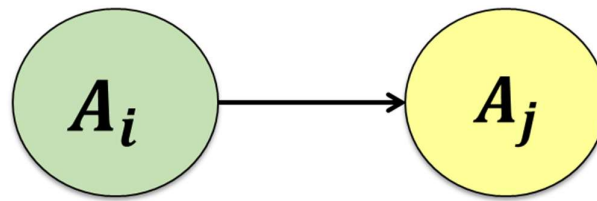

**Figure 64 Cooperation link**

Hepperle et al. use DSM principles to analyze communication dependencies between actors in product development (Hepperle et al., 2007). They propose a Communication Grid Method based on the identification of the network structure underlying the communication relationships between these actors. Sosa & Marle propose an approach based on the concept of creative interaction, which recognizes that people generate creative ideas when they interact with other people as part of their duties. He formed clusters whose creativity potential is maximized based on the measurement of creative interactions, those in which the receiver of information is likely to generate new useful ideas after receiving this information from the transmitter (Sosa and Marle, 2013). In other cases, actors are directly grouped together because of the decisions they are contributing to. This permits to propose groups of actors involved in numerous collaborative decisions (Jaber et al., 2015). For instance, direct interactions in the US Senate have been analyzed by (Bartolomei et al., 2012) by identifying organizational structure of interactions between members, inferred from joint committee assignments.

### **6.2.3 Second strategy based on modeling indirectly relationships between actors**

In this case, actors groups are formed indirectly due to the fact that they own elements within the same cluster, but clustering is applied to element interdependency modeling matrices. These elements are generally related to one of the main project domains, product, process or organization, or to multi-domain elements, like risks, decisions or deliverables. For instance, Leung and colleagues present a method to identify and to quantify the system-level work share risk based on the couplings of system components and the work assignments of the distributed teams (Leung et al., 2008). Sosa has introduced an approach to identify technical modularity of the product and its influence on the design teams (Sosa et al., 2003); (Sosa et al., 2007). Product clustering is generally done to determine and possibly increase product modularity, since modular architectures are supposed to have many advantages (Robert Helmer et al., 2010); (Sarkar et al., 2014); (T.-L. Yu et al., 2007); (Yu et al., 2009).

In the field of project organization, DSM applications concern either the scheduling of design tasks and the identification of iteration in design (Eppinger et al. 1994; Browning, 2001; Whitfield et al. 2005) or the decomposition and integration of large design projects into different teams (Mc Cord and Eppinger, 1993; Sosa et al., 2003). Particularly, Chen and Lin propose a method to decompose a large interdependent task group into smaller and manageable sub-groups (Chen and Lin, 2003). The authors use DSM, analytic hierarchy process and cluster analysis to represent task relationships, quantify task couplings and decompose large size of task groups. Chen (2005) develops a methodological framework for project task coordination and team organization, in order to assign the right team members to the right tasks. In terms of process clustering, many works have tried to cluster activities, knowing that they may be coupled or not; (Efatmaneshnik et al., 2010); (Kusiak, 2002); (Liang, 2009). An example of the applications of clustering DSM is the clustering of organizational units performing overlapped activities in order to reduce complexity of coordination in a product development project (Yang et al., 2014). Finally, the organizational dimension may be analyzed through the resource allocation problem and its associated risks and indirect consequences (Mehr and Tumer, 2006).

We note that all studies of direct relationships between actors, and circuitous relationships between actors via other project elements can be modeled in weighted directed graphs. Clustering techniques can thus be applied directly to actor-actor matrices in the first case, but we need a problem formulation for the second case, developed in next paragraph.

#### **6.2.4 Problem formulation for the actors clustering considering interdependencies between elements.**

The existing organization, called **AG**, represents the assignment of actors  $A$  to organizational groups  $G$ . It always serves as a comparison point with proposed clusters. The aim is to propose an improved version of **AG**, called **AC**.

The first parameters which seems important to analyze an existing organization or to propose an alternative organization are the rates of interdependencies that are respectively within and outside boundaries, called *INTRA* (for intra-cluster interdependencies) and *INTER* (for inter-clusters interdependencies). Intuitively, the more interdependencies within the cluster, the better the coordination is likely to be. This maximization of *INTRA* value or minimization of *INTER* value could then be an objective for the organization reshuffling.

The generic notation **XX** will be used in the rest of the Section, knowing that  $X$  could be equal or not to  $A$ .  $NX$  is the number of elements  $\{X_j\}$  and  $NC$  is the number of clusters  $\{C_k\}$ .  $NX$  is fixed and  $NC$  is a variable. **XC** is a  $NX \times NC$  variable matrix with each of its elements  $XC_{j,k}$  ( $1 \leq j \leq NX$ ,  $1 \leq k \leq NC$ ) being a Boolean variable. For each element, the variable  $XC_{j,k}$  being 1 means the presence of element  $X_j$  in cluster  $C_k$ , while being zero

means its absence.  $\mathbf{XC}$  is our decision variable. For the record,  $\mathbf{XX}$  is a  $NX \times NX$  matrix with its elements  $\mathbf{XX}_{j_1,j_2}$  ( $1 \leq j_1, j_2 \leq NX$ ) representing the interaction value between elements  $X_{j_1}$  and  $X_{j_2}$ , already introduced before.

The objective function of the problem is defined by the sum of the values of all interactions between elements which belong to a same cluster. It is a quadratic integer problem, described in Eq. 1:

$$\max(\text{INTRA}(\mathbf{XC})) = \max \sum_{1 \leq k \leq NC} \sum_{1 \leq j, j_2 \leq NX} \mathbf{XC}_{j,1,k} * \mathbf{XC}_{j_2,k} * \mathbf{XX}_{j_1,j_2} \quad (1)$$

As shown in Figure 65, elements interactions are counted if and only if both elements belong to the same cluster (bold lines). Dotted lines show inter-cluster interactions and are not counted.

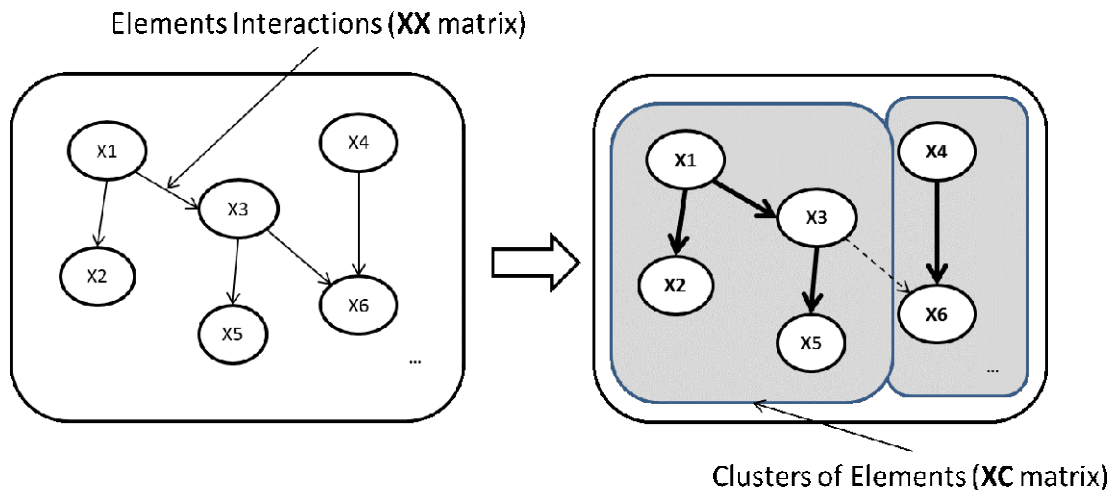
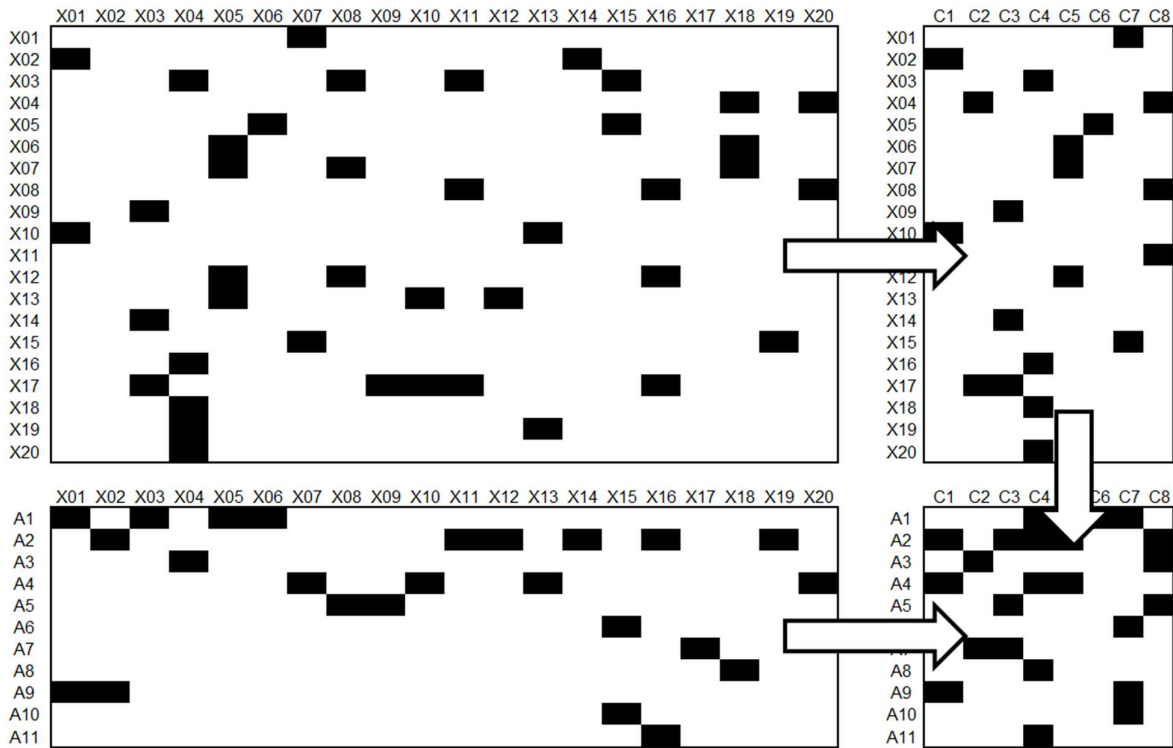

**Figure 65 Maximization of intra-cluster interactions**

Our strategy consists in clustering interdependent elements  $\{X\}$  to obtain a refined organization of these elements  $\mathbf{XC}$ . Then, the affiliation of actors to clusters is obtained knowing the affiliation of actors to elements (when  $X$  is not equal to  $A$ , otherwise  $\mathbf{AC}$  is directly obtained by the clustering of  $\mathbf{AA}$ ). This strategy is applicable when interdependencies are between elements. This strategy requires two types of data: the connections between elements  $\{X\}$ ,  $\mathbf{XX}$  (or  $\mathbf{bXX}$  if the existence of interdependencies is enough with binary values and does not need to be more precisely assessed) and the affiliation matrix  $\mathbf{AX}$ . Clustering the  $\mathbf{XX}$  matrix, called  $C(\mathbf{XX})$ , enables clusters of  $X$  to be proposed,  $\mathbf{XC}$ .

Figure 66 illustrates this with the obtaining of actors clusters knowing affiliation relationships between elements and actors and the elements clusters. The affiliation of actors to clusters is obtained by multiplying  $\mathbf{AX}$  and  $\mathbf{XC}$ . Multiple applications of this strategy exist, using homogeneous or heterogeneous elements.





**Figure 66 Obtaining actors groups AC through the clustering of XX matrix and the use of affiliation matrix AX**

However, this problem formulation means that the optimal solution is to have only 1 group composed of every element and every actor, which is often not manageable due to size issue. Constraints shall then be added to keep under control different parameters related to the number of elements to be included within the clusters (for the managers of the clusters), to the number of clusters to manage (for the manager of the whole) and to the number of clusters in which a single element can be included. Moreover, the implication of actors who are behind the elements (as managers, owners or contributors) has also to be controlled, by limiting the number of assignments for a single actor (for workload and scheduling issues) and the number of actors involved in a cluster (for meeting effectiveness and collective decision-making issues). Individual assessments of clusters in terms of elements and actors have to be made and kept under control (under a maximal limit or in a certain interval).

Constraints related to the inclusion of elements in clusters are described in this paragraph. First, the number of elements may be limited for a given cluster:

$$\forall k \in [1..NC], NX(C_k) = \sum_{1 \leq j \leq NX} XC_{j,k} \leq \text{Max}(X|C_k) \quad (4)$$

Where  $NX(C_k)$  is equal to the number of elements in cluster  $C_k$  and  $\text{Max}(X|C)$  is a vector of size  $NC$  with its  $k^{\text{th}}$  value being the maximum number of elements the  $k^{\text{th}}$  cluster can contain. This constraint may be specific to each cluster  $C_k$  or generic and can then be reformulated using a single value. The clustering operation is mainly a trade-off between two conflicting parameters, the minimization of interactions outside clusters, and

the size of clusters. This may be considered whether as a bi-objective optimization or a single-objective optimization under constraint. We chose the second solution, because we think that going for maximization of intra-cluster interactions is more important, albeit cluster size should of course be kept under control, since the optimal solution of 1 cluster is obvious but practically unmanageable. Similar constraints may be put to have a minimal number of elements  $Min(X|C_k)$ , or an exact number of elements in a cluster  $NX|C_k$ .

Eq. 5 represents the maximum number of clusters that an element can belong to:

$$\forall j \in [1..NX], NC(X_j) = \sum_{1 \leq k < N} XC_{jk} \leq Max(C|X) \quad (5)$$

Where  $NC(X_j)$  is the number of clusters the  $j^{\text{th}}$  element is included in. Classically, clusters are disjoint, meaning that  $Max(C|X)$  is equal to 1 (an element may belong to at most one cluster). This is mainly to keep under control the number of assignments for actors who own the elements in the clusters. But it is possible to specify a higher value for  $Max(C|X)$ , knowing that this must be done carefully, since the main consequence is to multiply the assignments for the actors who own these multi-cluster elements.

The total number of clusters may also be a decision variable. Algorithms are supervised or unsupervised, and as for  $Max(X|C)$ , the decision-maker may require a maximal number of clusters, or an interval, or an exact number of clusters:

$$NC_{\min} \leq NC \leq NC_{\max} \text{ or } NC = NC_{\text{req}} \quad (6)$$

Once the problem is formulated with its objective function and associated constraints, the solving strategy is described in following paragraph.

### 6.3 A three-stage Clustering process for network of project elements

This Section introduces the clustering strategy used to group elements (or actors) taking into account the number, direction and strength of their interdependencies. The solving approach consists in running in parallel several complementary algorithms with several parameters configurations. This approach (see Figure 67) may propose the best possible solution adaptable to the needs of the decision maker.

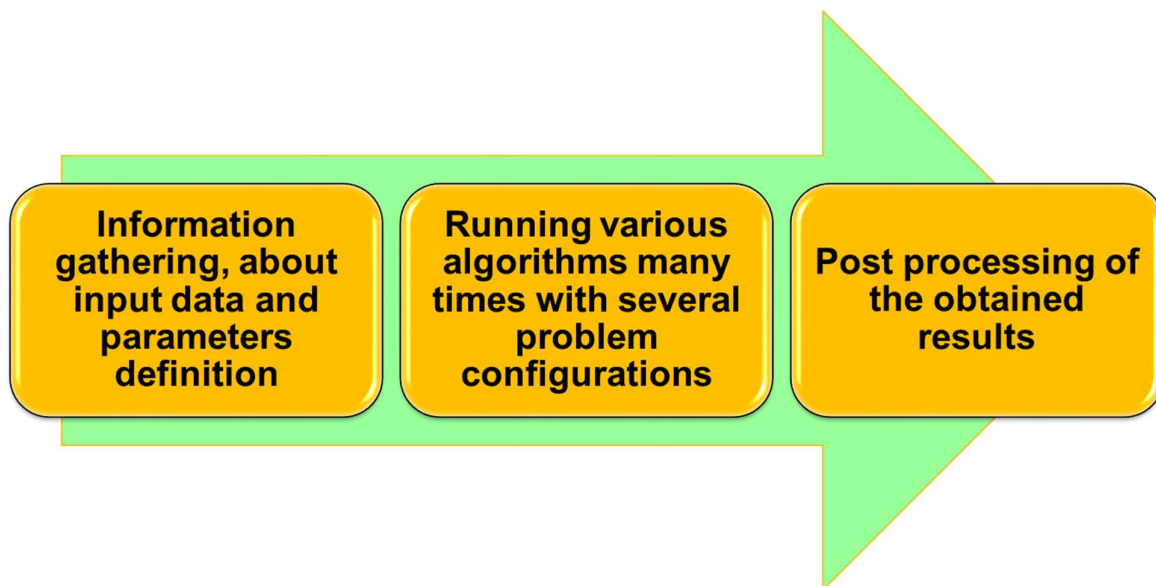

**Figure 67** A three-stage Clustering process for network of project elements

### **6.3.1 First Stage: Information gathering, about input data and parameters definition**

Chapter 4 proposed an approach to model interactions between project elements. Here we consider that the network of project elements is an input data but we need to define parameters of the desired clustering solution. Furthermore, in this thesis we created an interface that allows to enter clustering parameters, calculate and operate efficiently and ergonomically the input data with a given clustering configuration. We achieved automatic processing to the solutions provided by these algorithms, which will give quality indicators: local and global, but also helps to build the final solution from part of one or more proposed solutions to assemble the best solution corresponding to the expectations of the decision maker. Clustering algorithms can be either parameterized or unsupervised, if no prior knowledge is provided. Such parameters can be the number of the desired clusters, for example, the maximal size of the clusters, allowing clusters to overlap (to produce non-disjoint clusters).

Table 21 shows six parameters that can be usually demanded by the decision maker.

**Table 21 Clustering parameters**

---

<b>Parameters definition of the desired solution</b>
Number of desired groups (clusters).
Maximal number of actors in each cluster.
Number of actors in each cluster.
Disjoint or non-disjoint groups.
Number of project elements interchanged between actors within a cluster.
Constraints: actors who need to be put together or actors who are not to be put conjointly.

---

The next paragraph introduces the second stage of the proposed methodology including related work on clustering techniques.

### **6.3.2 Second Stage: Running multi-algorithms many times with several problem configurations**

We introduce classical literature on clustering and graph partitioning. Clustering is known as the identification of patterns around which communities of elements can be grouped (Gomez et al., 2011), which is a key issue in many engineering and design problems (Alfaris et al., 2010; Li, 2010). A clustering approach is based on a solving technique (to obtain clusters) and a cluster validation technique (to check if they fit with the targets and constraints of the problem). Numerous methods are suitable for quantitative evaluation of the results of a clustering algorithm, known under the term cluster validity.

We note  $G(V, E)$  a graph where  $V$  is the list of nodes, and  $E$  is the list of edges in the graph. Lines that connect two nodes and thus define a relationship between them are called edges. We also note partition of the graph  $P = (C_1, \dots, C_k)$ . In our case, vertices are related to particular project elements, the actors. Actors  $A_i$  will be assigned to clusters  $C_j$ , forming the matrix  $AC$ . The most common approach to this problem in the literature has been to ignore edge direction and apply methods developed for community discovery in undirected networks, but they discard potentially useful information contained in the edge directions. In this thesis, we selected algorithms while extending clustering objective function and methodology to directed graph. Measures are extended by considering edge directionality as inherent network characteristics, like the directed version of modularity (clustering objective function) used by Leicht and Newman (Leicht and Newman, 2008a)

Methods are based on approximate heuristics or optimization algorithms. They may use algorithms to identify a globally optimal solution (Borjesson and Holtta-Otto, 2014; R. Helmer et al., 2010; Sherali and Desai, 2005) or propose heuristics for identifying clusters (Day et al., 2009; Fortunato, 2010; Stone et al.,

2000). For instance, genetic algorithms have been used for clustering, even if the convergence speed is slow due to the required chromosome length (Jung and Simpson, 2014; Kamrani and Gonzalez, 2003; Whitfield et al., 2002; T. L. Yu et al., 2007).

Two approaches for constructing clusters exist (Jain and Dubes, 1988): they can be progressively built from singletons (often called hierarchical), or broken down from the initial graph into smaller clusters (often called partitioning). Our choice is to work on the assembly of individual vertices into clusters which are evaluated.

First, the vertex similarity-based criteria and methodologies are based on a simple assumption: the higher the vertex similarity, the stronger the need to cluster the vertices together. A cluster can contain identical or similar elements, with a particular element called centroid and representative of the group (Filippone et al., 2008). These measures are based on a similarity matrix built from characteristics of the vertices. Rather than defining similarity measures, dissimilarity measures such as distance measures are usually defined (Ben-Arieh and Sreenivasan, 1999; Dong et al., 2006; Everitt et al., 2011; Gusfield, 1997; Hennig and Hausdorf, 2006; Jaccard, 1901; Kuntsche, 2003). Some works thus focus on edges that are least central or most “between” clusters, and remove them from the original graph in order to build the strongest clusters with the remaining edges (Clauset et al., 2004; Freeman, 1977; Girvan and Newman, 2002; Leicht and Newman, 2008a; Newman and Web, 2003).

The modularity is an important measure utilized by many clustering algorithms (Blondel et al., 2008; Clauset et al., 2004). Different modularity measures exist and have been developed and applied in different contexts, like the SMI (Singular Modularity Index), the WI (Whitney Index) or the information-theoretic measure (Guo and Gershenson, 2004; Hölttä-otto and De Weck, 2007; Van Eikema Hommes, 2008; Wang and Antonsson, 2004). For instance, modularity is defined in (Leicht and Newman, 2008a) as  $Q = \frac{1}{m} \sum_{i,j} \left[ A_{ij} - \frac{K_i^{in} K_j^{out}}{m} \right] \delta_{C_i, C_j}$ , where  $m$  is the total number of edges in the network,  $A_{ij}$  is defined as 1 if there is an edge from  $j$  to  $i$  and zero otherwise,  $K_i^{in}$  and  $K_j^{out}$  are the in- and out-degrees of the vertices,  $\delta_{C_i, C_j}$  is the Kronecker delta symbol, and  $C_i$  is the label of the community to which vertex  $i$  is assigned.  $\frac{K_i^{in} K_j^{out}}{m}$  is the probability that an edge  $(i,j)$  does exist from node  $i$  to node  $j$ . Other modularity measures exist, like the total coordination cost developed in several works (Borjesson and Holtta-Otto, 2014; Gutierrez-Fernandez, 1998; Thebeau, 2001), or the minimum description length principle (R. Helmer et al., 2010; T. L. Yu et al., 2007).

Vertex similarity measures are often defined by the structural characteristics of the graph. Spectral clustering infers relations between the spectral properties and the structure of the graph by analyzing eigenvalues and eigenvectors of the associated matrix (Biggs, 1994; Bühler and Hein, 2009; Cvetkovic et al., 1995). Numerous works exist on spectral clustering (De Aguiar and Bar-Yam, 2005; Farkas et al., 2001; Ng et al., 2001), some

of them having recently showed that network spectra are like fingerprints of the network, linking for instance linearly independent eigenvectors to the number of clusters (Newman, 2013; Peixoto, 2013; Platanitis et al., 2012; Sarkar et al., 2013). The concepts of adjacency, interdependency or proximity can be used to assess the importance of the relationship between two vertices that could justify to include them in the same cluster.

Second, the cluster fitness measure-based criteria and methodologies assess the overall quality and relevance of a given cluster or of a given global clustering solution. The global objective of these methodologies is to identify clustering solutions which directly fulfill a certain property. The partitioning can be done without knowing the number of clusters  $k$  in advance, or requires this information like in the  $k$ -means method (McQuenn, 1967; Tan et al., 2007).

For instance, methodologies based on graph density measures have been developed in order to partition the initial graph into sub graphs, the density of which should be inferior and/or superior to chosen values (Aliguliyev, 2009; Karp, 1976; Kim, 2003; Zotteri et al., 2005). But other cluster fitness measures are used as a criterion for graph partitioning. Cut size-based measures permit to quantify the relative independence of a sub graph to the rest of the graph and have been used in many clustering processes (Kannan et al., 2001; Shi and Malik, 2000).

The Dunn index is related to the ratio between the maximum distance within a cluster and the minimum distance between two clusters (Dunn, 1973). Similarly, the Davies–Bouldin index proposed measures the validity of the cluster as the average ratio between within-cluster scatter and between-cluster separation (Davies and Bouldin, 1979). Xie and Beni have defined a validity index for fuzzy clustering schemes, based on the normalized ratio between the compactness of a partition and its separation (Xie and Beni, 1991). Bezdek introduced two indices called the partition's coefficient and the partition entropy (Bezdek, 1981; Bezdek and Nikhil, 1998).

A cluster may contain similar elements, with a particular element called centroid (Filippone et al., 2008). On the opposite, some works focus on edges that are least central or most “between” clusters, and remove them from the original graph in order to build the strongest clusters with the remaining edges (Girvan and Newman, 2002);(Blondel et al., 2008). Newman et al. are co-authors of numerous works in the field of finding community structures in complex networks (Clauset et al., 2007, 2008; Leicht and Newman, 2008b). Specific DSM-related clustering techniques have been developed and implemented in industrial applications like IGTA (Idicula-Gutierrez-Thebeau Algorithm) for clustering Component-DSM (Idicula, 1995); (Thebeau, 2001), or the DSM-based algorithm of Borjesson and Holttä-Otto (Borjesson and Holttä-Otto, 2014).

We argue that no algorithm fits every context, and that the solution is to use a flexible combination of several algorithms developed in and for different contexts. We have tested a wide spectrum of clustering algorithms, and we decided to use the most adaptable four algorithms (See Table 22).

**Table 22 Algorithms' Selection**

Algorithm	Input	Output	Reference
Community structure in directed networks	Adjacency matrix	Clusters and modularity metric of directed network	Q - (Leicht & Newman, 2008)
Fast unfolding of community hierarchies in large networks	Adjacency matrix	Clusters and modularity metric of directed network	Q - (Blondel et al., 2008)
Idicula-Gutierrez-Thebeau Algorithm for clustering Component-DSM	DSM, Maximal Size of clusters	Clusters with the required maximal size	(Fredrik Borjesson & Katja Holtt-Otto, 2012)
1-Spectral Clustering	Symmetric Adjacency Matrix, Number of desired clusters [K], constraints on the desired solution	[k] clusters	(Bühler & Hein, 2009)

Instead of selecting a single algorithm and optimizing in the space of possibilities, our resolution strategy will be based on 4 well-known algorithms, developed in different contexts (Blondel et al., 2008; Leicht and Newman, 2008b; Bühler and Hein, 2009; Borjesson and Holtt-Otto, 2014). This provides the benefits of each of these algorithms, which may offer either large or dense or balanced clusters, etc. Many authors and algorithms exist, as introduced in the previous Section. The choice has been done to promote complementary and relatively robust algorithms. Indeed, since the structure of the data set is not known in advance, some algorithms developed in a very particular context may not be relevant at all in another configuration (dense matrix versus sparse matrix, presence of loops...). Some algorithms are unsupervised and serve as an initial treatment. Then, the others can be applied with more precise parameters and a more accurate idea of the problem configuration.

To conclude, the second stage consists in running each algorithm many times with several problem configurations. Afterwards, we obtain a number of clustered solutions that we will treat in the third stage of our clustering process.

### 6.3.3 Third Stage: Cluster validity & post-processing of the obtained results

This section introduces the third stage of the clustering process. First, it presents the global and quality indicators to validate clusters and compare solutions; second it presents the frequency analysis, and finally the methodology to assemble the final solution.

#### 6.3.3.1 Cluster validity: Global and Local Indicators

Schaeffer made an extensive overview of clustering methodologies, in which two approaches are introduced: vertex similarity-based methodologies and cluster fitness measure-based methodologies (Schaeffer, 2007). They are based on either similarity between elements (called here vertices) or performance of groups of elements. Whatever the chosen approach, the final partition of a data set requires some sort of evaluation called cluster validity, either absolute or relative. Indeed, algorithms take as input some parameters (e.g. number of clusters, density of clusters) and attempt to define the best partitioning of a data set for these parameters.

Cluster validation is a major issue in cluster analysis; in fact, much more attention has to be paid to cluster validity issues (checking the quality of clustering results). However, it must be emphasized that the results obtained by these methods are only tools at the disposal of the expert in order to evaluate the resulting clustering. For these reasons we define two types of indicators. The first type is global and permit to compare the quality of two clustering solutions; the second one is local and permit to compare two clusters either within the same solution or from different solution.

We define INTRA ( $C_i$ ) in Eq. (7) as the sum of edges included in cluster  $C_i$  (noted  $W_i$ ), divided by the total sum of edges in the matrix AA, denoted TW (for Total Weight).

$$\text{INTRA}(C_i) = W_i / \text{TW} \quad (7)$$

The term INTRA has been chosen to reflect the notion of intra-cluster interdependencies, obtained as the sum of intra-cluster edges. To obtain the  $W_i$ , we create the matrix CC as the following product using Eq. (8):

$$\text{CC} = \text{CA} * \text{AA} * \text{AC} \quad (8)$$

This is obtained in two steps following Eq. (2) as the product of CA by the product of AA and AC:

$$\text{CC} = \text{CA} * (\text{AA} * \text{AC}) \quad (9)$$

The  $W_i$  are the diagonal cells of CC.



However, the implementation of the  $i$ -th cluster  $C_i$  requires the use of a certain number of actors. This is why we moderate the raw performance of the clustering algorithm by the managerial efficiency, counting the Number of Actors involved in  $C_i$ , called  $NA(C_i)$ , as described in Eq. (10):

$$P(C_i) = INTRA(C_i) / NA(C_i) \quad (10)$$

Moreover, we also consider the interdependency value between two clusters  $C_i$  and  $C_j$ , called  $INTER(C_i, C_j)$ . It is defined as the sum of edges for the couples of nodes where one belongs to  $C_i$  and the other one belongs to  $C_j$ . This represents the amount of inter-clusters interactions.

It corresponds to the non-diagonal cells of the matrix  $CA*AA*AC$  previously introduced in Eq. (7). For a given  $C_i$ , we define the  $INTER(C_i)$  as the total  $INTER(C_i, C_j)$  values for all the  $C_j$ . The meaning of  $INTER$  is to compare relatively  $INTER$  and  $INTRA$  in order to determine whether actors in the cluster should be leaders (if  $INTRA \gg INTER$ ) or guests (if  $INTRA \ll INTER$ ).

The final performance index is then calculated as in Eq. (11):

$$P'(C_i) = INTRA(C_i) / (NA(C_i)*INTER(C_i)) \quad (11)$$

These indicators permit the comparison between proposed clustered configurations against each other, and afterwards against initial configuration **AG**, both in terms of organizational efficiency ( $P$  index) and in terms of role given to the actors ( $P'$  index). For instance, if a cluster is always proposed whatever the algorithm and whatever the configuration, then one can be confident to put it in the final proposed configuration. Complementary performance parameters could then be introduced, considering for instance the efficiency of clusters, meaning their *INTRA* value divided by the number of actors (or elements). This could help comparing relatively clusters, distinguishing big but inefficient clusters and lower in terms of *INTRA* but very dense clusters. Figure 68 shows an example of automatically reported result for a clustering configuration.

Results for the clustered Configuration N° 7			
Quality Global Indicators			
INTRA global:		741	
Global Interactions:		917	
Percentage:		80.80697928	
Quality Local Indicators			
Cluster ID	Cluster size	INTRA within the cluster	Density of the cluster
1	13	125	0.73964497
2	11	62	0.512396694
3	8	34	0.53125
4	4	20	1.25
5	9	100	1.234567901
6	12	89	0.618055556
7	2	19	4.75
8	14	172	0.87755102
9	11	119	0.983471074

Figure 68 Global and local quality indicators examples

### 6.3.3.2 Frequency analysis

We define  $N_{\text{Config}}$  as the number of different tested problem configurations. We introduce a new index which calculates the percentage of times where two actors are put in the same cluster (Common Cluster Frequency Index), and we introduce the variable  $l$  as the number of the tested configuration ( $l$  varies between 1 and  $N_{\text{Config}}$ ). An associated complementary index gives the percentage of times where an actor is included in a cluster (Clustered Frequency Index). For different configurations  $C_l$ , we have different Clustered Organization matrices  $CO_l$ , and we define the Frequency Matrix as the sum of the  $CO_l$  matrices. The non-diagonal terms of the Frequency Matrix of Figure 69 give the Common Cluster Frequency Index for a couple of actors, and the diagonal terms give the Clustered Frequency Index for an actor:

$$CCFI(i, j) = \frac{\sum_l^{N_{\text{Config}}} CO(i, j)}{N_{\text{Conf}}} \quad CFI(i) = \frac{\sum_l^{N_{\text{Config}}} CO(i, i)}{N_{\text{Config}}}$$

The interesting values are 0% and 100%.  $CCFI = 0$  means that the actors are never clustered together and 100% means that they are always in the same cluster.

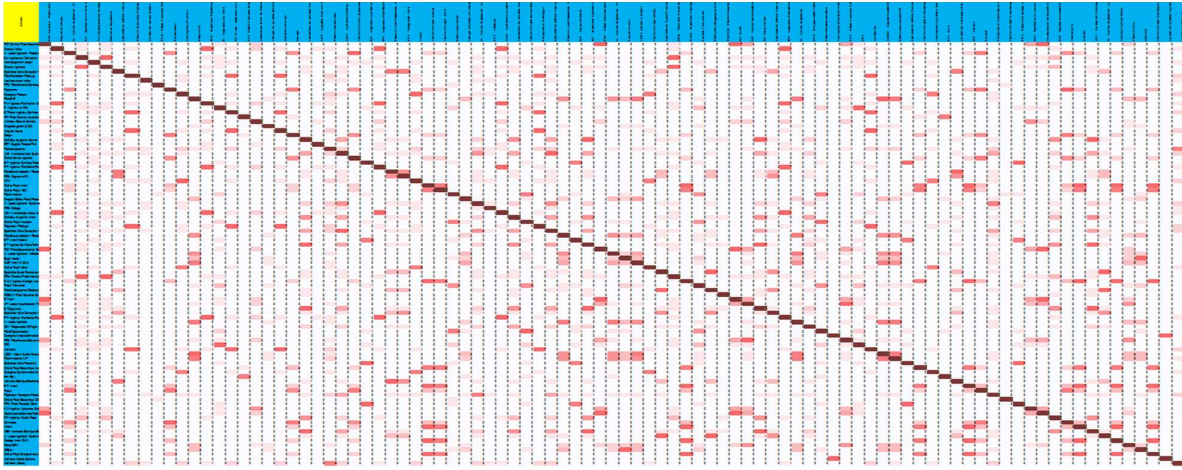

**Figure 69 The frequency matrix**

We define the frequency matrix FM (see Figure 69) as the sum of  $CO_i$  divided by  $N_{Config}$ . There is then the non-diagonal cells  $FM_{i,j}$  are equal to that  $CCFI(i, j)$  and the diagonal cells  $FM_{i,i}$  are equal to  $CFI(i)$ . Both index and therefore the FM matrix are between 0 and 1 (or 0% and 100%).

We introduced a frequency matrix which indicates, for its non-diagonal elements the percentage of times where two actors  $A_i$  and  $A_j$  are assigned to the same cluster, and for its diagonal elements the percentage of times where one actor is assigned to a cluster. These information give an indication for pre-assigning some variables to 0 or 1, expressing that two actors cannot be together or must be together. Moreover, it gives an idea of the robustness of the final clustering decision, since we are more confident with an index of 1 (or close to 1) than an index of 0.5. To conclude, it should be noted that the frequency indicator is a decision aid, not an automatic assignment rule.

### 6.3.3.3 Assembly of the final solution

The last stage is the combination of particular clusters or pieces of clusters from different solutions. This combination is based on the quality indicators and the frequency analysis of the results. An innovation of this work is thus to assembly a solution from pieces of solutions obtained in different ways and using different problem configurations. There is no universally optimal configuration of clusters, but it depends on the judgment of the decision maker. Clustering then aims at defining the best data set partitioning for given parameters. The solution is strongly dependent upon the decision-maker.

Afterwards, one obtains a number of clustered solutions, with quality indicators for each solution and for each cluster in the solution. In addition, a frequency analysis is done to indicate the number of times that each couple of elements (actors in our case study) were put together in a clustered solution. The idea is that the more often pairs of actors are proposed together in the different configurations, then the more robust the

decision of putting them together in the final solution is. To conclude, a hybrid solution, that meets best the needs of the decision maker, is built using a mix of clusters from all configurations.

## 6.4 The automotive project case study

This section aims at facilitating the collaborative decision-making process by grouping actors according to the relationships they have due to their deliverable exchanges. Clusters of actors are proposed in order to provide decision-makers with a temporary and complementary organization designed for making efficiently simultaneous cooperative decisions in order to prevent impacts' propagation between project deliverables. This approach has been illustrated through actual data in new-product development projects within the automotive manufacturer Renault.

### 6.4.1 The network of project actors

Vehicle development projects are very long and complex, with the participation of 1500 to 2000 project members. Usually, this type of project can take between two to four years when concurrent engineering is used as a basic organizational hypothesis. Early design stages can be long as 8 to 10 months. The data gathering process represents a result of several working groups integrating cross-domain project members. Some of these processes are: innovation integration process, manufacturing and supply chain feasibility and scheduling, design style, economic optimization, and purchasing. Collaborative decisions integrate members from different domains. There are in total 93 different types of actors participating in the development phase of the vehicle project.

Numerous deliverables exchanges take place during the development phase of vehicle project. They often involve many actors, with the difficulty that they are shared across numerous parallel collaborative groups, for coordination and meeting scheduling reasons.

The initial organization is made of 93 types of actors, called  $G_k$ . The 2200 deliverables  $D_j$  are affiliated to one or multiple actors. The **Actor**<sub>Transmitter</sub> – **Deliverable** matrix called **AD**, is built by modeling affiliation relationships between actors (**transmitters**) and deliverables. The **Deliverable** – **Actor**<sub>Receiver</sub> matrix called **DA**, is built by modeling affiliation relationships between deliverables and actors (**receivers**). The **AD** and **DA** Matrices, usually known as Responsibility Assignment or Affiliation Matrix, are defined as DMM (Domain Mapping Matrices). These two matrices are obtained using the algorithm of assembling global interactions data from the gathering of local interactions data.

The Actor-Actor Matrix is called **AA**. It represents the relationships between actors, on which clustering will be applied in order to improve coordination between its actors (see Figure 70). **AA** is obtained using the following formula:

$$\mathbf{ActorActor} = \mathbf{Actor}_{\text{Transmitter}} \mathbf{Deliverable} * \mathbf{DeliverableActor}_{\text{Receiver}}$$

Where  $N_A$  = number of actors,

$N_D$  = number of deliverables,

$N_G$  = number of groups

The existing organization  $\mathbf{AG}$  serves as a comparison point with proposed clusters  $\mathbf{AC}$ .  $\mathbf{AC}$  is the result of the clustering of the  $\mathbf{AA}$  matrix.

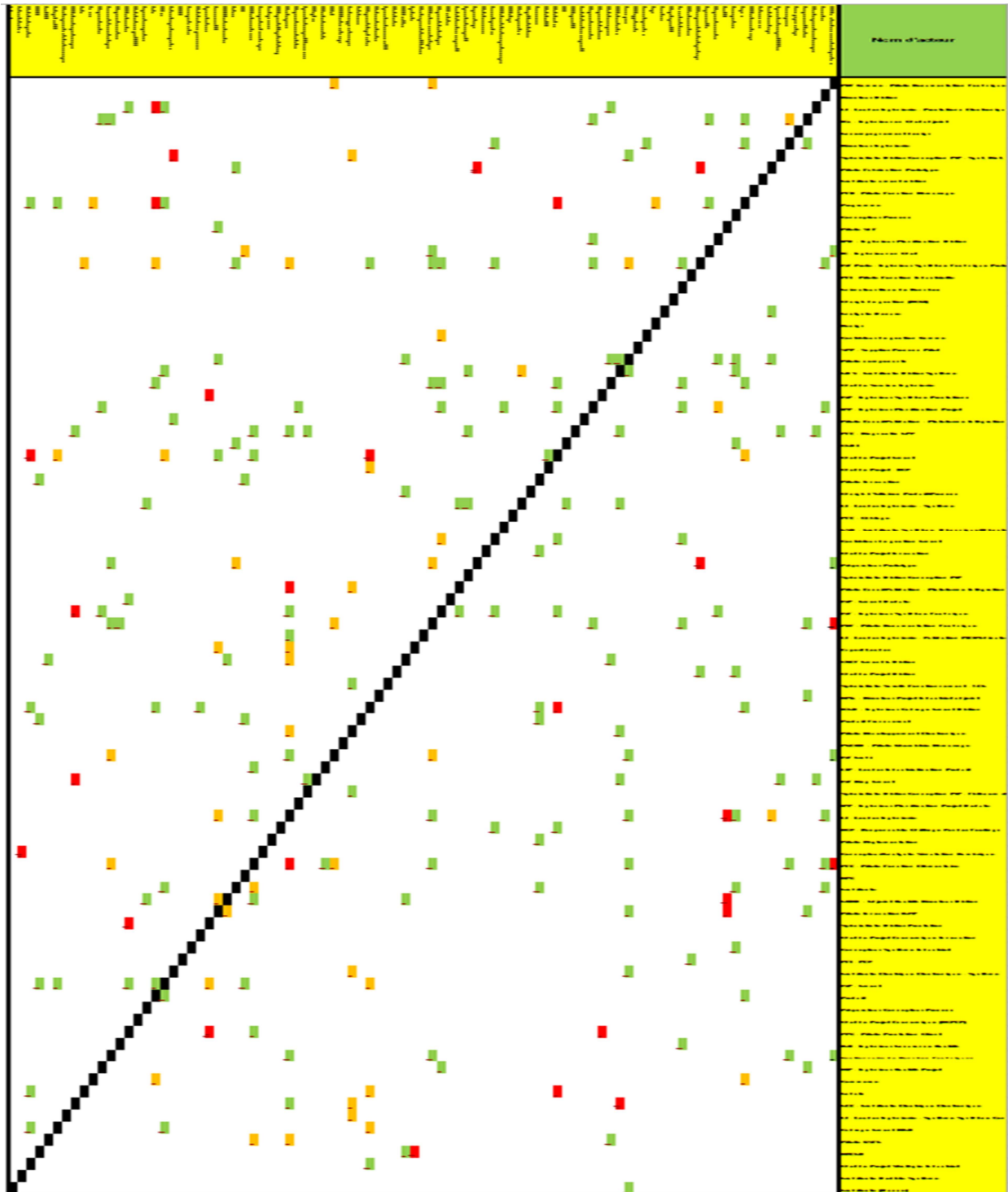

**Figure 70 Initial AA matrix**

This matrix AA enables direct interactions between actors to be analyzed. It's shown in Figure 70. If  $0 < AA(i,j) < 4$ , then the cell is represented in green. If  $4 \leq AA(i,j) < 7$ , then cell is represented in orange. If  $AA(i,j) \geq 7$ , then cell is represented in red (See Figure 70). The network of direct connections between project actors due to their assignment to their exchanged deliverables, is shown hereafter in Figure 71.

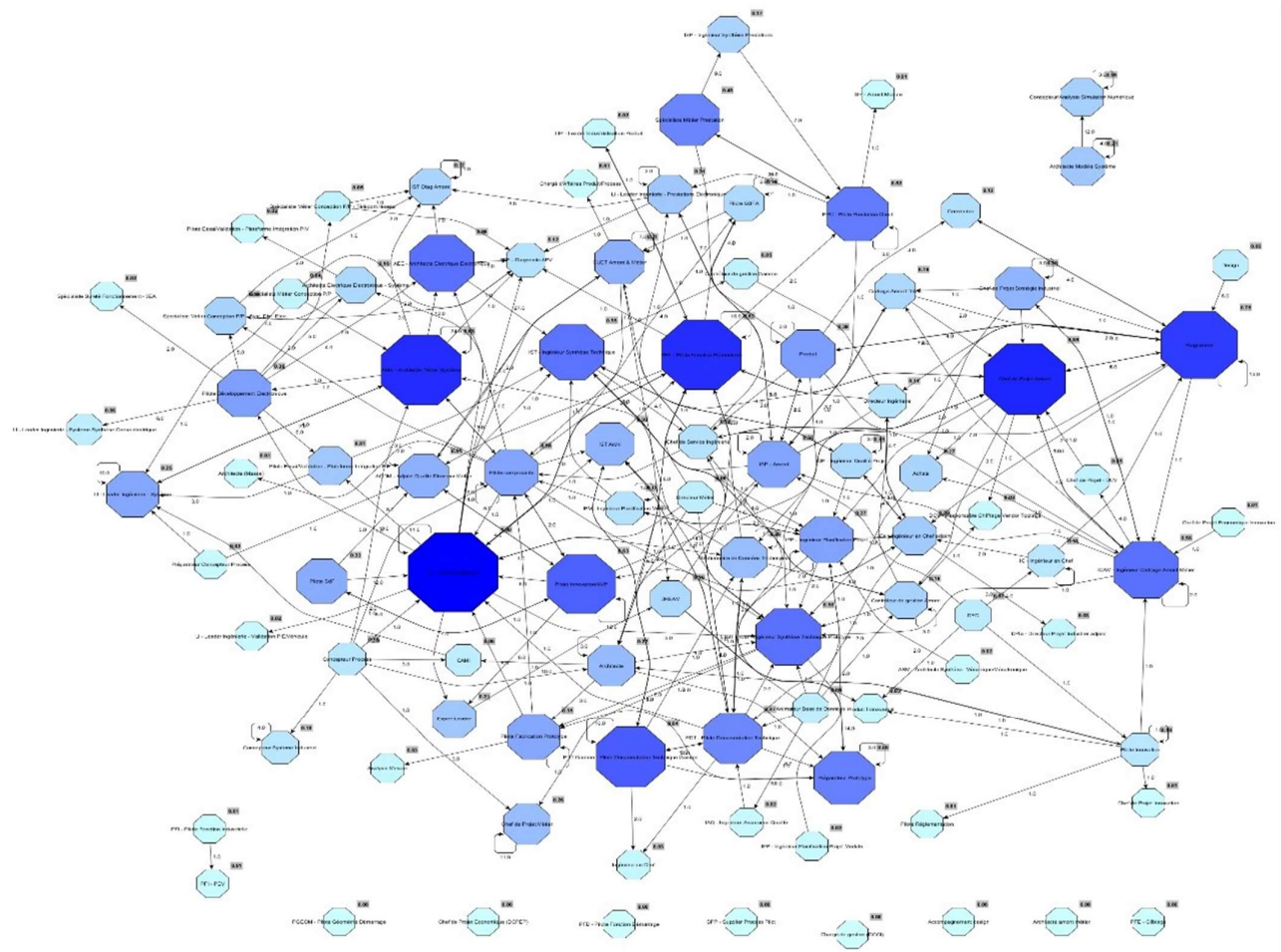
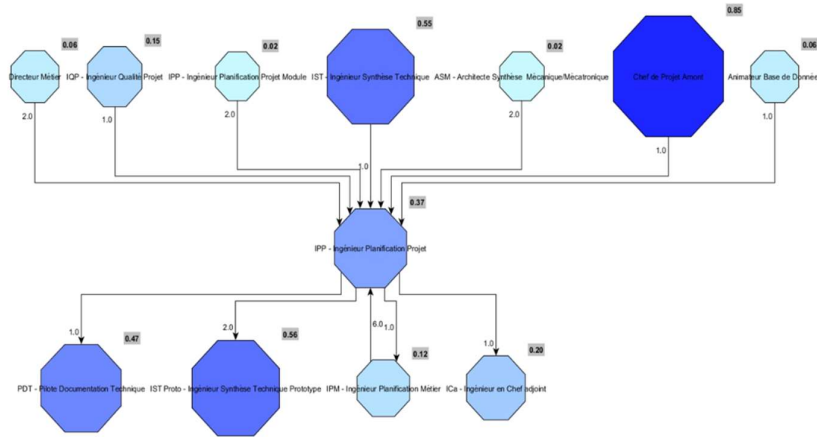

**Figure 71 The network of direct relationships between project actors (AA)**

Figure 71 is a graph representation of the matrix AA. The weight on the edge between two actors represents the number of exchanged deliverables between these two actors. The size of the node (and its color) is proportional to the number and the weight of its direct edges, the darkest and the biggest node corresponding to the actor who has the highest value of connected weighted edges.

Gathering information in a global network of exchanged deliverable between types of actors, provide an updated and exhaustive description for local interaction. Figure 72 shows a local vision on the actor type: Project Planning Engineer, as we can see, for example, he receives two deliverables from Module Planning Engineer, six deliverables from Functional Planning Engineer and send two deliverable to IST-proto and one deliverable to Technical Documentation Leader, etc.





**Figure 72 Local vision on Project Planning Engineer**

Additionally we report explicitly the deliverables exchanged (not only the number but also the names of these deliverables) as explained in section 4.3.2.2 in Chapter 4.

### 6.4.2 Results: Aligning the project organization to its complexity

Defining the groups can be difficult to decide and to implement. There are two main parameters that need to be discussed: 1) the size of the group, i.e. the number of actors one wants to put in one group, and 2) the number of groups, i.e. the total number of groups that one wants to coordinate in one project. Indeed, it is very time-consuming for people, with intertwined meetings and decisions and potential issues like meeting sequence.

The network is composed of very interrelated parts, difficult to cut into disjunctive clusters. This requires the application of our proposed strategy to define an adequate process to propose clusters tailored to decision-makers' requirements and constraints.

Several proposals are obtained for AC, running simultaneously several algorithms with 15 configurations: by imposing groups of 14, and smaller groups (down to 8). The final recommendation is made considering the relevance of clusters (within-clusters total value, cluster size, cluster density, number of clusters), in order to keep the algorithmic solution applicable to real-life project.

It seemed interesting, in the exploitation of proposed configurations, to allow some actors to be straddling two clusters, because the algorithms proposed both opportunities (an actor within a cluster or another). A few actors in high interactivity with the overall organization as "Systems Engineering Leader" or "Integration



responsible," were assigned as transverse actors. They are out of the clusters but in interface with (almost) everyone. Finally, there are some actors who are not interactive with the rest.

This generation of several alternatives enables comparisons and sensitivity analysis. Finally, the most relevant complementary organizational configuration **AC** is compared to the existing one **AG**, and implemented if judged better and applicable. Table 23 shows the quality indicators and the size of the proposed clusters.

**Table 23 The seven clusters and their quality indicators**

Cluster	Size	INTRA	P
C1	13	84	6.461538
C2	14	147	10.5
C3	9	71	7.888889
C4	12	69	5.75
C5	11	87	7.909091
C6	11	57	5.181818
C7	8	34	4.25

Figure 73 shows the final clustering results for AA by proposing seven new groups of interrelated actors. As we can see, all red cells are put within the proposed clusters.

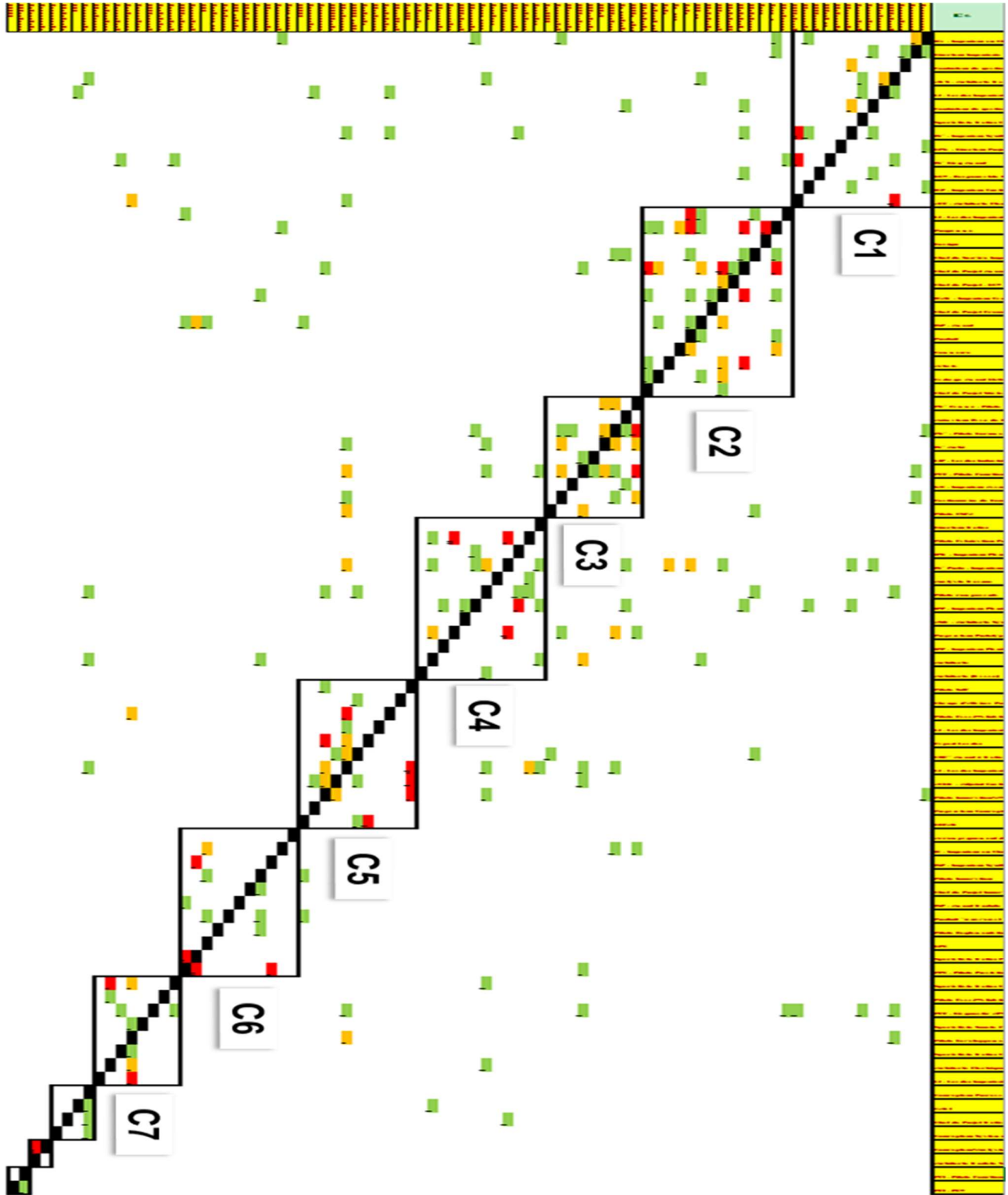

Figure 73 Proposing seven new groups of interrelated actors

The permanent organization of the company and the applied project organization are adjusted in a continuous manner due to the partnership with Nissan. The company promotes coordination between its actors based on standardization of deliverables and standardization of skills (type of actors). Hence, this justifies the need of this kind of analysis which provides a stable and complementary organization based on standardized skills and exchanged deliverables. The percentage of interactions put within the seven clusters is **81.56%**. This value is by far higher than the value of the initial organization **59.77%**. This increased percentage permits: 1) to improve communication between connected actors and afterwards decrease project ambiguity; 2) to promote management of interfaces and subsequently reduce risks of propagation; 3) to diminish project uncertainty by increasing ability to pre-evaluate characteristics of the project deliverables as well as the impact of actions and decisions. Particularly, a strong cluster **C2** of 14 actors has been identified (See Figure 74). **C2** contains 147 deliverables exchanged between 14 types of actors during the development phase of the project.

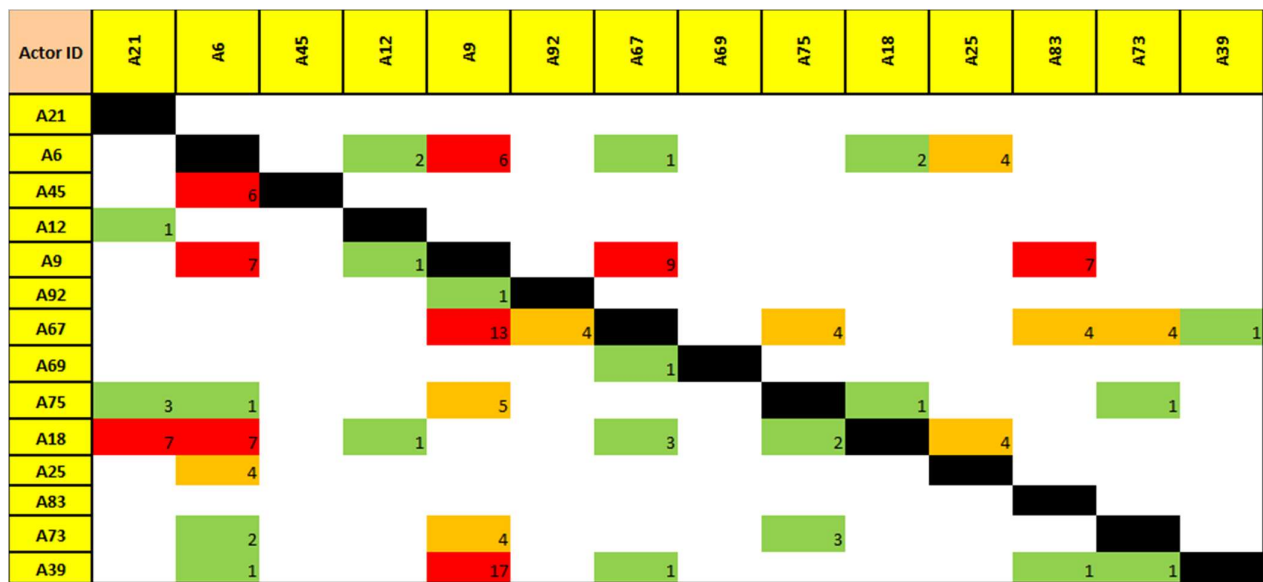

Figure 74 Illustration of cluster C2

In this section, we applied our three-stage clustering process to propose groups of actors involved in numerous deliverables exchanges. These groups are formed using and combining results of several clustering algorithms with different parameters. The first results show different reasons to group actors and different roles of these actors in the network structure and behavior. Table 24 lists the twelve actors proposed in *C4*. This illustrates an example on investigated types of actors within this thesis.

**Table 24 The twelve actors' types in cluster *C4***

<b>Actors types</b>
Range Technical Documentation Leader
Database coordinator
Technical Documentation Leader
IST Architecture
LIP - Leader Industrialization of Product
PFE - Elementary Function Leader
IAQ - Quality Assurance Engineer
Technical Data Manager
Safety & Reliability Pilot
Product/Process Contract Manager
Test/Validation Leader - EIPF
Systems Engineering Leader - EIPF/Vehicle Validation

Finally, we have proposed additional communication groups within the Renault organization, to avoid propagation of impacts between deliverables. A perspective is to integrate deliverable criticality measurement in the study (deliverable weight, resulting also from analysis of feedbacks of past projects). Future works will be done to test such strategies and their impact on the organizational capacity to deal with the structural complexity.

## 6.5 Conclusions

Our contribution is a three-stage process for clustering a network of project elements. The first stage is information gathering, about input data and parameters definition. The second stage consists in running each algorithm many times with several problem configurations. Afterwards, we obtain a number of clustered solutions, with quality indicators for each solution and for each cluster in the solution. In addition, a frequency analysis is done to indicate the number of times that each couple of elements (actors in our case study) were put together in a clustered solution. The idea is that the more often pairs of actors are proposed together in the different configurations, then the more robust the decision of putting them together in the final solution is. The third stage is the post processing of the obtained results. This is done by combining extractions of particular clusters or pieces of clusters from different solutions. This combination is based on the quality indicators and the frequency analysis on the results (the number of times the couple of actors were put together). A hybrid solution, that meets at best the needs of the decision maker, is built using a mix of best clusters from all configurations. This approach has been illustrated through actual data in a new product development project in the automotive industry. The industrial application has shown promising results by grouping people according to interdependencies, changing more or less the way that actors were initially organized. Forming alternative teams based on interdependencies between project elements, which is complementary to the classical project breakdown structure organization, is an emerging and vital topic to the performance of projects. We argue that the approach presented here has a theoretical and practical importance, albeit some insights remain to be improved or discovered.

## 6.6 References

- Alfaris, A., Svetinovic, D., Siddiqi, A., Rizk, C., De Weck, O., 2010. Hierarchical Decomposition and Multidomain Formulation for the Design of Complex Sustainable Systems. *J. Mech. Design* 132.
- Aliguliyev, R., 2009. Performance evaluation of density-based clustering methods. *Information Sciences* 179, 3583–3602.
- Bartolomei, J.E., Hastings, D.E., de Neufville, R., Rhodes, D.H., 2012. Engineering Systems Multiple-Domain Matrix: An organizing framework for modeling large-scale complex systems. *Systems Engineering* 15, 41–61. doi:10.1002/sys.20193
- Ben-Arieh, D., Sreenivasan, R., 1999. Information Analysis in a Distributed Dynamic Group Technology Method. *International Journal of Production Economics* 60-61, 427–432.
- Bezdek, J., 1981. *Pattern Recognition with Fuzzy Objective Function Algorithms*. Plenum Press.
- Bezdek, J., Nikhil, R., 1998. Some New Indexes of Cluster Validity. *IEEE Transactions on Systems Management Cybernetics - Part A* 28.
- Biggs, N., 1994. *Algebraic Graph Theory*. Cambridge University Press, Cambridge.
- Blondel, V., Guillaume, J.-L., Lambiotte, R., Lefebvre, E., 2008. Fast unfolding of communities in large networks. *Journal of Statistical Mechanics: Theory and Experiment* P10008.
- Borgatti, S., Cross, R., 2003. A Relational View of Information Seeking and Learning in Social Networks. *Management Science* 49, 432–445.
- Borjesson, F., Holtta-Otto, K., 2014. A Module Generation Algorithm for Product Architecture based on Component Interactions and Strategic Drivers. *Research in Engineering Design* 25, 31–51.
- Bühler, T., Hein, M., 2009. Spectral clustering based on the graph p-Laplacian, in: *Proceedings of the 26th Annual International Conference on Machine Learning*. ACM, pp. 81–88.
- Carroll, T., Gormley, T., Bilardo, V., Burton, R., Woodman, K., 2006. Designing a New Organization at NASA: An Organization Design Process using Simulation. *Organization Science* 17, 202–214.
- Carroll, T.N., Gormley, T.J., Bilardo, V.J., Burton, R.M., Woodman, K.L., 2006. Designing a New Organization at NASA: An Organization Design Process Using Simulation. *Organization Science* 17, 202–214.
- Chen, S.-J.G., Lin, L., 2003. Decomposition of interdependent task group for concurrent engineering☆. *Computers & Industrial Engineering* 44, 435–459.
- Clauset, A., Moore, C., Newman, M.E., 2007. Structural inference of hierarchies in networks, in: *Statistical Network Analysis: Models, Issues, and New Directions*. Springer, pp. 1–13.
- Clauset, A., Moore, C., Newman, M.E.J., 2008. Hierarchical structure and the prediction of missing links in networks. *Nature* 453, 98–101. doi:10.1038/nature06830
- Clauset, A., Newman, M.E.J., Moore, C., 2004. Finding community structure in very large networks. *Phys. Rev. E* 70, 1–6.
- Cvetkovic, D., Doob, M., Sachs, H., 1995. *Spectra of Graphs: Theory and Applications*. Johann Ambrosius Barth Verlag, Heidelberg.
- Davies, D.L., Bouldin, D.W., 1979. A cluster separation measure. *IEEE Transactions on Pattern Analysis and Machine Intelligence* 1, 224–227.
- Day, R., Stone, R., Lough, K.G., 2009. Validating Module Heuristics on Large Scale Products, in: *ASME International Design Engineering Technical Conference IDETC*. pp. 1079–1087.
- De Aguiar, M., Bar-Yam, Y., 2005. Spectral Analysis and the Dynamic Response of Complex Networks. *Phys. Rev. E* 71.
- Dong, Y., Zhuang, Y., Chen, K., Tai, X., 2006. A hierarchical clustering algorithm based on fuzzy graph connectedness. *Fuzzy Sets and Systems* 157, 1760–1774.
- Dunn, J., 1973. A fuzzy relative of the ISODATA process and its use in detecting compact well-separated clusters. *Journal of Cybernetics*.
- Efatmaneshnik, M., Reidsema, C., Marczyk, J., Balaei, A.T., 2010. Immune decomposition and decomposability analysis of complex design problems with a graph theoretic complexity measure, in: *Smart Information and Knowledge Management*. Springer, pp. 27–52.
- Eppinger, S.D., Browning, T.R., 2012. *Design structure matrix methods and applications*. MIT Press (MA).
- Everitt, B., Landau, S., Leese, M., Stahl, D., 2011. *Cluster Analysis*. Chichester: Wiley.
- Farkas, I., Derényi, I., Barabasi, A., Vicsek, T., 2001. Spectra of “Real-World” Graphs: Beyond the Semicircle Law. *Phys. Rev. E* 64.

- Filippone, M., Camastra, F., Masulli, F., Rovetta, S., 2008. A survey of kernel and spectral methods for clustering. *Pattern recognition* 41.
- Fortunato, S., 2010. Community Detection in Graphs. *Physics Reports* 75–174.
- Freeman, L., 1977. Set of measures of centrality based on betweenness. *Sociometry* 40, 35–41.
- Gargiulo, M., Benassi, M., 2000. Trapped in your own net ? Network Cohesion, Structural Holes, and the Adaption of Social Capital. *Organization Science* 11, 183–196.
- Girvan, M., Newman, M., 2002. Community structure in social and biological networks. *Proceedings of National Academy of Science (PNAS)* 99, 7821– 7826. doi:doi:10.1073/pnas.122653799
- Gomez, C., Sanchez-Silva, M., Duenas-Osorio, L., 2011. Clustering methods for risk assessment of infrastructure network systems. *Applications of Statistics and Probability in Civil Engineering* 1389–1397.
- Grant, R.M., 1996. Toward a knowledge-based theory of the firm. *Strategic management journal* 17, 109–122.
- Guo, F., Gershenson, J., 2004. A Comparison of Modular Product Design Methods based on Improvement and Iteration, in: *ASME International Design Engineering Technical Conference IDETC*. pp. 261–269.
- Gusfield, D., 1997. *Algorithms on Strings, Trees and Sequences*. Cambridge University Press.
- Gutierrez-Fernandez, C.I., 1998. *Integration Analysis of Product Architecture to Support Effective Team Co-Location*. Massachusetts Institute of Technology.
- Helmer, R., Yassine, A., Meier, C., 2010. Systematic module and interface definition using component design structure matrix. *Journal of Engineering Design* 21, 647–675.
- Helmer, R., Yassine, A., Meier, C., 2010. Systematic Module and Interface Definition using Component Design Structure Matrix. *Journal of Engineering Design* 21, 647–675.
- Hennig, C., Hausdorf, B., 2006. A Robust Distance Coefficient Between Distribution Areas Incorporating Geographic Distances. *Systematic Biology* 55, 170–175.
- Hepperle, C., Maier, A.M., Kreimeyer, M., Lindemann, U., Clarkson, P.J., 2007. Analyzing Communication Dependencies In Product Development Using The Design Structure Matrix, in: *9TH INTERNATIONAL DESIGN STRUCTURE MATRIX CONFERENCE, DSM'07. MUNICH, GERMANY*.
- Hölttä-otto, K., De Weck, O., 2007. Degree of Modularity in Engineering Systems and Products with Technical and Business Constraints. *Concurrent Engineering* 15, 113–126.
- Idicula, J., 1995. *Planning for Concurrent Engineering*, Gintic Inst. ed. Singapore.
- Jaber, H., Marle, F., Jankovic, M., 2015. Improving Collaborative Decision Making in New Product Development Projects Using Clustering Algorithms. *IEEE Transactions on Engineering Management* 1–9. doi:10.1109/TEM.2015.2458332
- Jaccard, P., 1901. Étude comparative de la distribution florale dans une portion des Alpes et du Jura. *Bulletin de la Société Vaudoise des Sciences Naturelles* 37, 547–579.
- Jain, A., Dubes, R., 1988. *Algorithms for Clustering Data*. Prentice Hall, New Jersey.
- Jung, S., Simpson, T., 2014. A Clustering Method Using New Modularity Indices and Genetic Algorithm with Extended Chromosomes, in: *16th International Dependency and Structure Modeling Conference DSM*. pp. 167–176.
- Kamrani, A.K., Gonzalez, R., 2003. A genetic algorithm-based solution methodology for modular design. *Journal of Intelligent Manufacturing* 14, 599–616.
- Kannan, R., Vempala, S., Vetta, A., 2001. On Clusterings : Good, Bad and Spectral. Working paper.
- Karp, R.M., 1976. Probabilistic analysis of partitioning algorithms for the travelling salesman problem in the plane. *Mathematics of operations research* 2, 209–224.
- Kim, S., 2003. Graph theoretic sequence clustering algorithms and their applications to genome comparison, in: Wu, C.H., Wang, P., Wang, J.T.L. (Ed.), *Chapter 4 in Computational Biology and Genome In-Formatics*. World Scientific, Singapore.
- Kuntsche, E., 2003. *Cluster Analysis.*, *Swiss Journal of Psychology*. Chichester: Wiley. doi:10.1024//1421-0185.62.3.202h
- Kusiak, A., 2002. Integrated product and process design: A modularity perspective. *Journal of Engineering Design* 13, 223–231.
- Leicht, E.A., Newman, M.E., 2008a. Community structure in directed networks. *Physical review letters* 100, 118703.
- Leicht, E.A., Newman, M.E., 2008b. Community structure in directed networks. *Physical review letters* 100, 118703.
- Leung, P., Ishii, K., Abell, J., Benson, J., 2008. Distributed System Development Risk Analysis. *Journal of Mechanical Design* 130, 051403.
- Liang, L.Y., 2009. Grouping Decomposition under Constraints for Design/Build Life Cycle in Project Delivery System. *International Journal of Technology Management* 48.

- Li, S., 2010. Methodical Extensions for Decomposition of Matrix-Based Design Problems. *J. Mech. Design* 132, 061003. doi:10.1115/1.4001534
- Mane, M., DeLaurentis, D., Frazho, A., 2011. A Markov Perspective on Development Interdependencies in Networks of Systems. *Journal of Mechanical Design* 133, 101009. doi:10.1115/1.4004975
- Marle, F., Vidal, L.-A., 2014. Forming risk clusters in projects to improve coordination between risk owners. *Journal of Management in Engineering* 30.
- McQuenn, J., 1967. Some methods for classification and analysis of multivariate observations. *Computers and Chemistry* 4, 257–272.
- Mehr, A.F., Tumer, I.Y., 2006. Risk-Based Decision-Making for Managing Resources during the Design of Complex Aerospace Systems. *Journal of Mechanical Design* 128.
- Millhiser, W.P., Coen, C.A., Solow, D., 2011. Understanding the Role of Worker Interdependence in Team Selection. *Organization Science* 22, 772–787.
- Morel, B., Ramanujam, R., 1999. Through the Looking Glass of Complexity: The Dynamics of Organizations as Adaptive and Evolving Systems. *Organization Science* 10, 278–293.
- Newman, M.E., 2013. Spectral Methods for Community Detection and Graph Partitioning. *Phys. Rev. E* 88.
- Newman, M.E.J., Web, W., 2003. Properties of highly clustered networks 1–7.
- Ng, A., Jordan, M., Weiss, Y., 2001. On spectral clustering, analysis and an algorithm. *Advances in Neural Information processing systems* 14.
- Peixoto, T., 2013. Eigenvalue Spectra of Modular Networks. *Physical Review Letters* 111.
- Platanitis, G., Pop-iliiev, R., Barari, A., 2012. Development of a DSM-based Methodology in an Academic Setting. *J. Mech. Design* 134.
- Rondeau, E., Idelmerfaa, Z., Richard, J., 1999. Identification of group organization during a design process by means of cooperation graphs. *Concurrent Engineering* 7, 191–199.
- Rushton, G., Zakarian, A., Grigoryan, T., 2002. Systems Engineering Approach for Modeling an Organizational Structure. Presented at the 12th Annual International Symposium of INCOSE “Engineering 21st Century Systems: Problem Solving Through Structured Thinking,” INCOSE, Seattle, Las Vegas, NV.
- Sanchez, R., Mahoney, J.T., 1996. Modularity, Flexibility, and Knowledge Management in Product and Organization Design. *Strategic Management Journal* 17, 63–76.
- Sarkar, S., Dong, A., Henderson, J.A., Robinson, P.A., 2014. Spectral characterization of hierarchical modularity in product architectures. *Journal of Mechanical Design* 136, 011006.
- Sarkar, S., Dong, A., Henderson, J., Robinson, P., 2013. Spectral Characterization of Hierarchical Modularity in Product Architectures. *J. Mech. Design* 136.
- Schaeffer, S.E., 2007. Graph clustering. *Computer Science Review* 1, 27–64.
- Sherali, H., Desai, J., 2005. A global optimization RLT-based approach for solving the hard clustering problem. *Journal of Global Optimization* 32, 281–306.
- Shi, J., Malik, J., 2000. Normalized cuts and image segmentation. *IEEE Transactions on Pattern Analysis and Machine Intelligence* 22, 888–905.
- Sosa, M.E., Eppinger, S.D., Rowles, C.M., 2007. A Network Approach to Define Modularity of Components in Complex Products. *Journal of Mechanical Design* 129, 1118.
- Sosa, M.E., Eppinger, S.D., Rowles, C.M., 2003. Identifying Modular and Integrative Systems and Their Impact on Design Team Interactions. *Journal of Mechanical Design* 125, 240.
- Sosa, M.E., Marle, F., 2013. Assembling Creative Teams in NPD Using Creative Team Familiarity. *Journal of Mechanical Design* 135.
- Stone, R., Wood, K.L., Crawford, R.H., 2000. A Heuristic Method for Identifying Modules for Product Architecture. *Design Studies* 21, 5–31.
- Tan, M.P.M., Broach, J.R.J., Floudas, C. a. C., 2007. A novel clustering approach and prediction of optimal number of clusters: global optimum search with enhanced positioning. *Journal of Global Optimization* 39, 323–346. doi:10.1007/s10898-007-9140-6
- Terwiesch, C., Loch, C.H., Meyer, A.D., 2002. Exchanging preliminary information in concurrent engineering: Alternative coordination strategies. *Organization Science* 13, 402–419.
- Thebeau, R.E., 2001. Knowledge Management of System Interfaces and Interactions for Product Development Process. Massachusetts Institute of Technology.
- Thompson, J.D., 1967. Organizations in action: social science bases of administrative theory, Classics in organization and management. Mc Graw-Hill, New York.



- Van Bossuyt, D.L., Dong, A., Tumer, I.Y., Carvalho, L., 2013. On Measuring Engineering Risk Attitudes. *Journal of Mechanical Design* 135, 121001.
- Van De Ven, A.H., Delbecq, A.L., Koenig, R., 1976. Determinants of coordination modes within organizations. *American Sociological Review* 41, 322–338.
- Van Eikema Hommes, Q., 2008. Comparison and Application of Metrics that Define the Components Modularity in Complex Products, in: *ASME International Design Engineering Technical Conference IDETC*. pp. 287–296.
- Wang, B., Antonsson, E.K., 2004. Information Measure for Modularity in Engineering Design, in: *ASME International Design Engineering Technical Conference IDETC*. pp. 449–458.
- Wasserman, S., Faust, K., 1994. *Social Network Analysis: Methods and Applications*, Cambridge university press. ed.
- Whitfield, R., Smith, J., Duffy, A., 2002. Identifying Component Modules, in: *Proceedings of the 7th International Conference on Artificial Intelligence in Design AID'02*. pp. 571–592.
- Xie, X.L., Beni, G., 1991. A validity measure for fuzzy clustering. *IEEE Transactions on Pattern Analysis and Machine Intelligence* 13, 841–847.
- Yang, Q., Yao, T., Lu, T., Zhang, B., 2014. An Overlapping-Based Design Structure Matrix for Measuring Interaction Strength and Clustering Analysis in Product Development Project. *IEEE Transactions on Engineering Management* 61, 159–170.
- Yu, T.-L., Goldberg, D.E., Sastry, K., Lima, C.F., Pelikan, M., 2009. Dependency structure matrix, genetic algorithms, and effective recombination. *Evolutionary computation* 17, 595–626.
- Yu, T.-L., Yassine, A.A., Goldberg, D.E., 2007. An information theoretic method for developing modular architectures using genetic algorithms. *Research in Engineering Design* 18, 91–109. doi:10.1007/s00163-007-0030-1
- Yu, T.L., Yassine, A., Goldberg, D., 2007. An Information Theoretic Method for Developing Modular Architectures using Genetic Algorithms. *Research in Engineering Design* 18, 91–109.
- Zotteri, G., Kalchschmidt, M., Caniato, F., 2005. The Impact of Aggregation Level on Forecasting Performance. *International Journal of Production Economics* 93-94, 479–491.

## Overall conclusion & Perspectives

---

The performance of a project is related to its complexity. More complex projects may require an additional level of control. We emphasize that the main goal of chapter 3 has been to give project complexity a framework to describe and measure it better. In terms of practicality, the findings provide a framework that gives relevant indicator for key actors to anticipate and make better decisions based on its impact on the evolution of the complexity of a given project. We proposed a framework of identified and classified project complexity factors that may be integrated into the exploratory phase of a complexity impact analysis. It may also be used to capture and structure its possible consequences; also, to ensure that these are managed appropriately. Due to the dynamic aspect of project complexity, repeated use during the different phases of a project is expected. Establishing an objective and standardized measure permits a retrospective analysis of previous projects. This is needed to assess the impact of the complexity sources on the achievement of the project goals and their influence on the cost and the staffing level. Moreover, its application in the upstream stage permits to highlight areas which have a high complexity, in order to: 1) anticipate their impact by comparing to other projects; and 2) plan mitigation actions to reduce risks associated with complexity, for example, adopting a simpler process, choosing a more stable supplier or increasing communication frequencies between actors. A key improvement of the proposed framework would be to introduce more precise evaluation scale by enumerating more accurate criteria for each factor, as well as developing a common database of results that improve and grow with every use. A high-level factor-based descriptive modeling was proposed. It permits to measure and prioritize areas and domains where complexity may have the highest impact.

In chapter 4, we proposed a low-level graph-based modeling approach of complex projects. It is established on the finer modeling of project elements and interdependencies. Network analysis of project elements is proposed to identify, represent, analyze, visualize, or simulate nodes (e.g. agents, risks, actors, deliverables...) and edges (relationships) from various types of input data (relational and non-relational) including the process diagram of development logic of new vehicles. The output data can be saved in external files. Different input and output file formats exist. Network analysis tools allow us to investigate representations of networks of distinctive size - from small (e.g. Project team) to very large (e.g. network of thousands of deliverables). The various tools provide further analyses and will be discussed in the two following chapters. Contributions have been made on the complete modeling process, including the automation of some data gathering steps, in order to increase performance and decrease effort and error risk. From a practical perspective, the information captured in one model is used for mutual enrichment of both models, with the aim of better understanding and thus better anticipation of the propagation phenomena in order to control more effectively the project evolution. Modeling and analyzing the interactions between risks, process, product architecture and actors using the DSM approach contribute in understanding the complexity

aspects in order to reduce their impact in making decisions. Overall, these models reduce project complexity because they decrease ambiguity by sharing the same concepts among the actors, and reduce uncertainty by sharing a comprehensive and complete view of interactions between project elements. The industrial application has shown concrete results by improving the original project model within the organization with both detecting (automatic reporting) and correcting existing anomalies. In addition, some tasks and deliverables were re-organized using the benefits of the global view of deliverables network. In brief, the quality of documents associated to the new-vehicle development logic has been improved.

The two models presented respectively in Chapters 3 and 4 can be used independently or consequently. Namely, a first high-level measure can permit to focus on some project areas where the low-level modeling proposed in this chapter will be applied, with a gain of global efficiency and impact.

The industrial application on vehicle development projects is performed to build up and analyze the interactions-based project network. Firstly, this work was on the direct analysis of risks in vehicle projects, but it has been cancelled because of incomplete or poorly documented data. The initial investigation field was therefore limited to focusing on indirect risk analysis in vehicle projects via the analysis of propagation risks between deliverables, either on milestones or between two milestones. The obtained results demonstrate that the topological network analysis adds value to the classical project risk analysis, in identifying both the influential elements and the important interactions with respect to their role in the network behavior. Furthermore, the proposed analysis gives additional information for decision-making in monitoring and controlling the impact propagation, since risks or deliverables may be considered influential for criticality and/or topological reasons. That is to say, a deliverable taken individually may be non-critical, but through interactions could become the source of impact propagation to some critical ones. The same analysis was done on the relationships between deliverables to evaluate the most crucial edges in the network structure. Overall, these reduce project complexity by mastering better the phenomenon of propagation. Based on the analysis outcomes, we demonstrate the effectiveness of using network theory for project elements topological analysis. The proposed method is generic and could be applicable to a wide set of engineering projects for decision support.

In chapter 6, our contribution is a three-stage process for clustering a network of project elements. The first stage is information gathering, about input data and parameters definition. The second stage consists in running each algorithm many times with several problem configurations. Afterwards, we obtain a number of clustered solutions, with quality indicators for each solution and for each cluster in the solution. In addition, a frequency analysis is done to indicate the number of times that each couple of elements (actors in our case study) were put together in a clustered solution. The idea is that the more often pairs of actors are proposed together in the different configurations, then the more robust the decision of putting them together in the final

solution is. The third stage is the post processing of the obtained results. This is done by combining extractions of particular clusters or pieces of clusters from different solutions. This combination is based on the quality indicators and the frequency analysis on the results (the number of times the couple of actors were put together). A hybrid solution, that meets at best the needs of the decision maker, is built using a mix of best clusters from all configurations. This approach has been illustrated through actual data in a new product development project in the automotive industry. The industrial application has shown promising results by grouping people according to interdependencies, changing more or less the way that actors were initially organized. Forming alternative teams based on interdependencies between project elements, which is complementary to the classical project breakdown structure organization, is an emerging and vital topic to the performance of projects. We argue that the approach presented here has a theoretical and practical importance, albeit some insights remain to be improved or discovered.

### **Perspectives:**

- Modeling the productivity link between actors in new product development projects that integrate information exchange and creativity
- Creating an efficient multi-objective evolutionary algorithm for community detection in the network of project actors based on the mix of similitude, productivity link, loops detection and social network analysis.
- Incorporating all the features developed into one tool that allows and facilitates the modeling of complex projects based on weighted directed graphs (i.e., design structure matrix), the associated topological and propagation analysis, and the developed clustering framework.

My longer term goals focus on studying the extent to which efficiency and robustness are maximal if the project organization is aligned on the structure and architecture of the product, the structure and architecture of the processes, or a mixture of these. Particularly, modeling a complex project system with multi-dimensional elements may be promising since it would permit me to align, naturally, the project's organization based on the global and multidimensional complexity of this project; this cannot be achieved with mono-dimensional models. Future versions of models and tools will consider the dynamics of the network by integrating updates to the project and its environment. Values on the attributes and interactions of elements may change, and events may appear or disappear. Another parameter that was not considered yet is the propagation time, meaning that the interaction between two elements is not supposed to be immediate but has a certain time of occurrence duration.

To conclude, our responses to the research questions are summarized in the two figures below: **Figure 75 Contributions: Prioritize actions to mitigate complexity-related risks; and Figure 76 Organize and coordinate actors in order to cope efficiently with the complexity-related phenomenon.**

## High-level factor-based descriptive modeling

- It permits to measure and prioritize areas and domains where complexity may have the highest impact

Framework & Scoresheet

TOPSIS

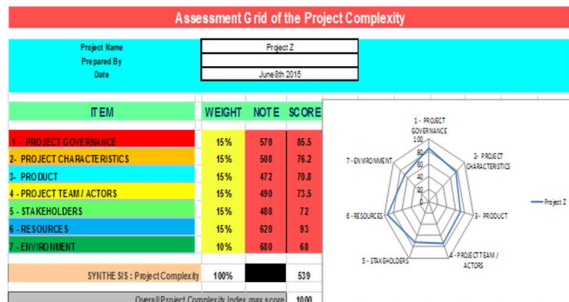

## Low-level modeling based on weighted directed graphs

- Modeling more accurately the project elements and their interdependencies

Automation

Enhancements

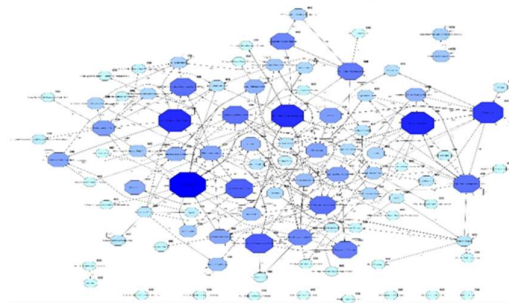

## Anticipating the potential behavior of the project

- Identify and prioritize the essential elements and critical interdependencies
- Acting on Nodes, Edges and Chains in the Network

Topological & Propagation analysis

Criticality Analysis

ITEM ID	ITEM NAME	TYPE	WEIGHT	SCORE	CRITICALITY	IMPACT	DEPENDENCY	STATUS
1	Project Governance	Task	15%	57.0	High	Medium	Low	Completed
2	Project Characteristics	Task	15%	50.0	Medium	Medium	Medium	In Progress
3	Product	Task	15%	47.2	Low	High	High	Not Started
4	Project Team / Actors	Task	15%	49.9	Medium	Medium	Medium	In Progress
5	Stakeholders	Task	15%	40.0	Low	Low	Low	Not Started
6	Resources	Task	15%	52.0	Medium	Medium	Medium	In Progress
7	Environment	Task	15%	68.0	High	Low	Low	Completed

Figure 75 Contributions: Prioritize actions to mitigate complexity-related risks

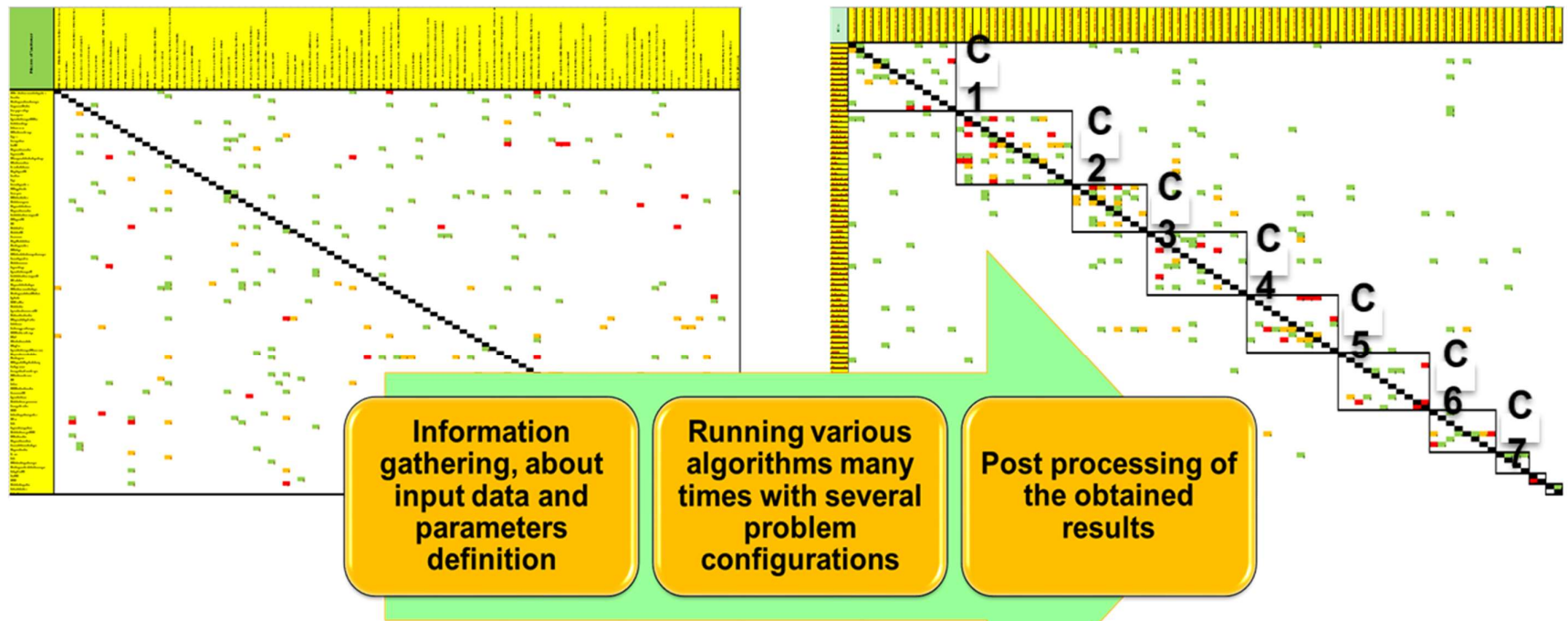

Figure 76 Organize and coordinate actors in order to cope efficiently with the complexity-related phenomena

## List of publications

---

### Journals Articles

- 1) **Improving Collaborative Decision Making in New Product Development Projects Using Clustering Algorithms.** *IEEE Transactions on Engineering Management* vol.62(4) pp. 475 - 4839, 2015. Hadi Jaber, Franck Marle, Marija Jankovic.
- 2) **Managing a Complex Project Using a Risk-Risk Multiple Domain Matrix,** *Journal of Modern Project Management*, vol. 3, pp. 32-37, 2015. Pointurier, C., F. Marle, and H. Jaber.
- 3) **Organizing Project Actors for Coordinating Interdependent Risk Management.** Franck Marle, Hadi Jaber, Catherine Pointurier. Accepted to *Journal of Mechanical Design*.
- 4) **A Framework & Score Sheet to Evaluate Project Complexity Using the TOPSIS Method.** Submitted to *Project Management Journal*. Hadi Jaber, Ludovic-Alexandre Vidal, Franck Marle, and Lionel Didiez.
- 5) **Criticality and Propagation Analysis of Impacts between Project Deliverables.** Hadi Jaber, Franck Marle, Ludovic-Alexandre Vidal and Lionel Didiez. Submitted to *Journal of Research in Engineering Design*.

### Conferences Articles

- 1) **A framework & Score Sheet to evaluate Project Complexity - Application to the automotive industry.** Hadi Jaber, Ludovic-Alexandre Vidal, Franck Marle, and Lionel Didiez. *The 2014 Project Management Institute Research and Education Conference*, Portland, Oregon, USA.
- 2) **Reciprocal enrichment of two Multi-Domain Matrices to improve accuracy of vehicle development project interdependencies modeling and analysis.** Hadi Jaber, Franck Marle, Ludovic-Alexandre Vidal and Lionel Didiez. *16th International Dependency and Structure Modeling Conference*, DSM'14, Paris, France.
- 3) **Reshuffling collaborative decision-making organization using a Decision-Decision MDM.** Franck Marle, Marija Jankovic and Hadi Jaber. *16th International Dependency and Structure Modeling Conference*, DSM'14, Paris, France.
- 4) **Managing a complex project using a Risk-Risk Multiple Domain Matrix.** Catherine Pointurier, Franck Marle and Hadi Jaber. *16th International Dependency and Structure Modeling Conference*, DSM'14, Paris, France.
- 5) **Pilotage d'un projet complexe par ses risques : construction et exploitation d'une matrice d'affinité.** Catherine Pointurier, Franck Marle and Hadi Jaber. *Congrès de maîtrise des risques, LambdaMu'19*, Dijon, France.