



HAL
open science

Key performance indicators of inventive activities for characterizing technological design in R&D : application in automotive industries

Ali Taheri

► **To cite this version:**

Ali Taheri. Key performance indicators of inventive activities for characterizing technological design in R&D : application in automotive industries. Other. Université de Strasbourg, 2015. English. NNT : 2015STRAD025 . tel-01330762

HAL Id: tel-01330762

<https://theses.hal.science/tel-01330762v1>

Submitted on 13 Jun 2016

HAL is a multi-disciplinary open access archive for the deposit and dissemination of scientific research documents, whether they are published or not. The documents may come from teaching and research institutions in France or abroad, or from public or private research centers.

L'archive ouverte pluridisciplinaire **HAL**, est destinée au dépôt et à la diffusion de documents scientifiques de niveau recherche, publiés ou non, émanant des établissements d'enseignement et de recherche français ou étrangers, des laboratoires publics ou privés.

École doctorale Mathématique, Sciences de l'Ingénieur et de l'information - ED 269

THESE

Pour obtenir le grade de
DOCTEUR DE L'UNIVERSITE DE STRASBOURG
Discipline: Génie Industriel

Présenté par :

Ali TAHERI

**Définition des indicateurs de l'efficience inventive pour
caractériser les activités inventives en R&D ;
Application au domaine de l'automobile**

Soutenue à l'INSA de Strasbourg le 26 Août 2015

Membres du Jury

Vincent Boly	Professeur, INP de Lorraine	Rapporteur externe
Jean-Marc Le Lann	Professeur, INP de Toulouse	Rapporteur externe
Denis Cavallucci	Professeur, INSA de Strasbourg	Directeur de Thèse
Samuel Gomes	Professeur, Université de Belfort Montbéliard	Examineur externe
Cecilia Zanni-Merk	Maître de conférences HDR, INSA de Strasbourg	Examineur
David Oget	Maître de conférences, INSA de Strasbourg	Examineur

Laboratoire de Génie de la Conception (LGéCo) - INSA de Strasbourg

EA 3938

THESIS

By

Ali Taheri

in partial fulfillment of the requirements for
the Degree of Doctor of Philosophy of

UNIVERSITY OF STRASBOURG

Discipline: Industrial Engineering

Doctoral School of Mathematics, Information Sciences and Engineering - ED 269

prepared in

Design Engineering Laboratory - EA 3938

INSA national graduate school of science and technology of Strasbourg

Key performance indicators of inventive activities for characterizing technological design in R&D; Application in automotive industries

Defended at INSA of Strasbourg, August 26th, 2015

in front of a jury consist of:

Vincent Boly	Professor, INP of Lorraine	External reporter
Jean-Marc Le Lann	Professor, INP of Toulouse	External reporter
Denis Cavallucci	Professor, INSA of Strasbourg	Thesis director
Samuel Gomes	Professor, University of Belfort Montbéliard	External examiner
Cecilia Zanni-Merk	Associate Professor HDR, INSA of Strasbourg	Examiner
David Oget	Associate Professor, INSA of Strasbourg	Examiner

à mes parents et mes amis,
à qui je reste attaché et en attente pour mon plus grand bonheur.

Remerciements / Acknowledgements

Je tiens, tout d'abord, à remercier Monsieur Denis Cavallucci, Professeur des Universités et l'INSA de Strasbourg, de m'avoir accepté et encouragé à faire cette thèse sous sa direction. Je le remercie pour ses suggestions et son assistance tout au long de mes travaux de recherche. Tous mes remerciements pour sa patience pendant la rédaction des articles et de mon mémoire de thèse.

Je tiens ensuite à remercier Monsieur David Oget, Maître de Conférences à l'INSA de Strasbourg, pour son encadrement au quotidien dans l'exploration et les discussions tout au long de mes travaux.

Je remercie Monsieur Vincent Boly, Professeur, à Ecole Nationale Supérieure de Génie des Systèmes Industriels de Nancy (ENSGSI, INP de Lorraine), et Monsieur Jean-Marc Le Lann, Professeur, à Ecole Nationale Supérieure des Ingénieurs en Arts Chimiques et Technologiques (ENSIACET, INP de Toulouse), d'avoir accepté d'être rapporteurs de ma thèse.

Je tiens à remercier Monsieur Jean Renaud, le Directeur du Laboratoire de Génie de la Conception (LGéCo) et mes collègues au LGéCo pour leurs accueils pendant cette thèse.

Je remercie en particulier Monsieur Rémy Houssin, Maître de Conférences HDR à l'Université de Strasbourg, pour ses discussions heuristiques et son assistance pour améliorer mes points de vue.

Je remercie « le pôle véhicule de futur » en tant qu'organisme de labélisation, la région Alsace, le FEDER (Fond européen de développement régional) pour le financement de cette thèse et nos partenaires industriels, pour leurs soutiens et leur participation dans ce succès. Parmi eux: Faurecia, CoolTech Application, MarkIV Automotive.

I would like to express my sincere gratitude to my supervisor, Prof. Denis Cavallucci, for his continuous support of my research, and also for his motivation, enthusiasm, immense knowledge, and patient. His admonitions, and relevant guidances helped me during all this time. My sincere thanks also goes to my assistant supervisor, Prof. David Oget, for his continues engagement, invaluable insights and careful inspection for every detail during this work.

I would like to appreciate Prof. Remy Houssein, for his fruitful discussions that provides training on how to think carefully and present logically. I would like to express my appreciation to Prof. Jean Renaud, the director of LGeCO and all members and stuff of the laboratory, and also my colleagues, for their support, understanding, and kindness through the process. I would like to thank the Pôle Véhicule du Futur Alsace Franche-Comté, who has labeled this research, and also the Région Alsace and the FEDER, who have supported financially this research.

I wish to thank our partner companies during this thesis, notably MarkIV Automotive, Faurecia, and CoolTech Application, for their support to approach more applicable results.

Abstract

Today a number of industries resent the lack of sustainable growth through innovation. Although most of the aspects of innovation have been analyzed and studied, the upstream phase of its process poses a major cause for concern, since this phase imposes a significant fall on the total performance index. This problem derives from the nature of activities in the earlier steps of innovation process which are known as the fuzzy front end phase including problem-solving, creative activities, and idea generation. In this regard, the performance measurement of R&D departments has often been the subject of research activities, particularly in the economy and management sector. So the answers are therefore mostly of financial and managerial levels that lead toward monitoring profitability with significant recommendations for the attention of managers. In this context, the absence of a system that measures and monitors the performance of inventive activities in engineering level is obvious. Indeed defining inventive performance metrics allows managers to take the best strategy during problem-solving, and adopt corrective technics. A preliminary state of the art revealed that a few researches have already contributed to this problem for the financial, managerial and organizational dimensions but with mixed results. However, the contribution of this research provides a methodological and technical answer for engineers and design practices to enhance creativity and/or obviously inventions. Just because of this new research perspective, the project DEFI (definition of inventive efficiency) was defined and targeted in 2008, to establish the metrics of inventive-design efficiency by which the earlier stages of innovation process exit from their absolute uncertainty for being a relative uncertain phase.

This thesis was defined in the DEFI project to characterize the notion of efficiency in Inventive Design, and develop the metrics of inventive-design. The objective of this proposal is to define inventive performance indicators to enhance the creative capacity in the automotive industry. The research is focused on the NPD projects of R&D department, which are known as the responsible of technological evolutions. In this respect, the main elements of design performance, and the main criteria of inventiveness are studied and merged together. The inventive performance of a R&D team is concerned with the efficiency of their activities to create inventive designs when they apply existing knowledge, and/or use creative resources. This analyzes the relationship between what is received and what is applied or consumed to achieve higher inventiveness degree. The measures of inventiveness are based on the evaluation of novelty, resourcefulness, and usefulness of what comes out from design activities. All the evaluation methods developed in this work are integrated into a concrete system as IDPMS (Inventive Design Performance Measurement System), and an initial version of the IDPMS application is developed, by which R&D and project managers can observe the inventive performance of their NPD projects. So this work is categorized in Engineering Science for specifying performance indicators of inventive design activities.

In recent years, our laboratory (LGeCo) focused on developing theoretical methods, then appropriate tools to accompany the industrial changes from the era of quality to the era of innovation. In this regard, this thesis provides the missing link of this effort by evaluating the main characteristics of inventions in engineering level to help companies enter into a logic performance along their innovation projects.

Keywords: inventive-design performance, inventive-design efficiency, inventive design effectiveness, R&D assessment, product data representation, design resourcefulness, ideality evaluation, novelty evaluation, usefulness evaluation, technological evolution;

Résumé

De nos jours, un grand nombre d'industries n'ont pas mis en place des processus fiables associés à l'innovation, s'exposant ainsi à de grands risques quant à leur croissance et leur pérennité. Bien que la plupart des étapes et des aspects du processus d'innovation soient objet d'études, les phases amont de ce dernier sont souvent mise en cause et sont rendues responsables de la chute de sa performance globale. Ce problème provient de la nature des étapes amont du processus d'innovation car elles présentent une grande incertitude, notamment concernant les activités créatives, la résolution de problèmes, et la génération d'idées. Pourtant, la mesure de la performance en R&D a souvent fait l'objet d'activités de recherche, notamment en économie et en gestion. Les réponses apportées sont donc, pour la plupart, d'ordre financières et managériales. Elles aboutissent souvent, suite à la mise en place d'éléments de veille et d'audit, à un contrôle de rentabilité pouvant se traduire, après rédaction d'un rapport d'étonnement, par des recommandations à l'attention des dirigeants. Dans ce contexte, on constate l'absence évidente de systèmes de mesure quantitative et de robustesse des décisions qui incombent aux managers. Ces dernières sont souvent aléatoires et intuitives et peinent à améliorer les performances inventives de l'entreprise. Un état de l'art préliminaire nous a révélé que de nombreuses recherches ont déjà contribué à cette problématique mais avec des résultats mitigés. Dans les travaux de recherche présentés dans ce mémoire, nos contributions apportent des réponses méthodologiques et technologiques aux décideurs quant à leurs performances associées à leurs pratiques en conception inventive. Nos métriques concernent essentiellement les ingénieurs en R&D et leurs pratiques car ils sont souvent au cœur de la naissance d'innovations lorsqu'ils inventent de nouveaux produits. C'est sous cet angle nouveau qu'est né le projet DEFI (Définition de l'EFFcience Inventive) qui se propose de contribuer à la métrique de l'efficience inventive en Conception.

Le sujet de cette thèse intervient dans le cadre du projet DEFI et vise à caractériser la notion d'Efficience Inventive en Conception afin d'élaborer des moyens de mesure de cette dernière. L'objectif étant à terme d'aboutir à l'adoption d'indicateurs aidant les entreprises à situer leurs capacités inventives en R&D. Par la suite, les entreprises ayant adopté ces indicateurs pourront, le cas échéant, entamer des actions d'évolution de leurs pratiques afin que la valeur de ces indicateurs évolue dans le sens recherché. Aux vues de la diversité des typologies d'entreprises et l'ampleur d'un tel sujet, notre recherche est focalisée sur les projets de conception de produits au sein des départements R&D de l'industrie automobile. Afin de mener cette recherche et définir les indicateurs de l'efficience inventive, nous avons étudié dans un premier temps les critères inhérents à la conception inventive. Selon nos travaux, la mesure de la performance inventive est corrélée à l'efficience inventive et doit considérer son efficacité par des caractéristiques ciblées, l'étude des connaissances impliquées et des ressources consommées. Notre mesure de l'efficience inventive est aussi basée sur l'analyse des flux des connaissances en jeu tout au long du processus d'innovation technologique, et particulièrement dans la phase de pré-développement. Elle analyse la relation entre ce qui est reçu et ce qui est appliqué ou consommé par rapport à l'inventivité. La mesure de l'inventivité est alors basée sur l'évaluation de l'idéalité, la nouveauté et l'utilité de ce qui sort du processus de conception de produit. L'ensemble des méthodes d'évaluation développées dans ce travail pour chaque critère d'inventivité, et l'efficience inventive, sont intégrés dans un système d'évaluation concret nommé IDPMS (Inventive Design Performance Measurement System) destiné à aider les directeurs des projets de la conception de produit et R&D à observer la performance inventive des équipes projet, et tenter d'améliorer les activités inventives. Donc, ce travail se catégorise dans le domaine des sciences de l'ingénieur. Depuis plus de deux décennies, notre laboratoire (le LGéCo) travaille à la construction, d'abord théorique, puis déclinée en méthodes et outils, de nouvelles approches destinées à accompagner les mutations industrielles de l'ère de la qualité vers l'ère de l'innovation. A cet égard, cette thèse fournira un chaînon manquant : celui qui concerne l'évaluation, et la mesure de ce qui caractérise l'amont de l'innovation afin d'aider les entreprises à entrer, par rapport à ces dernières, en logique de performance.

Table of Contents

Acknowledgement/Remerciements	4
Abstract/Résumé	6
Table of Contents	9
List of Tables	13
List of Figures	16
List of Equations	19
Acronyms and Symbols	20
Chapter I. Introduction	25
1. Research Background and Motivation	25
1. 1. Innovation as Sustainable Competitive Advantage	29
1. 2. Innovation Management and Standardization	30
2. Objective, Overall Problem, and Research Questions	32
3. Research Area and Assumption	32
4. Research Audience	34
5. Research Methodology	35
6. Thesis Structure	36
Chapter II. State of the Art	39
1. The Nature of Inventive-Design Performance	39
1.1. Performance Analysis	40
1.2. Uncertainty and Risk Management	42
1.3. Inventive Performance Metrics	44
2. Dissection of the Innovation in Search of Inventive Activities	46
2. 1. Innovation	46
2. 1. 1. Innovation Modes	48
2. 1. 2. Innovation Typology	50
2. 2. Technological Innovation Management	50
2. 2. 1. R&D Management	54
2. 2. 1. 1. R&D Activities	54
2. 2. 1. 2. R&D Management Models	54

2. 2. 2. Technology Management	56
2. 3. Technological Innovation Process	57
2. 3. 1. Fuzzy Front End Phase	67
2. 4. Engineering Design	68
2. 4. 1. Instructive Design Models	67
2. 4. 2. Descriptive Design Models	71
2. 4. 3. Organization of Design Activities	75
2. 4. 4. Design Activity	76
2. 4. 4. 1. Generation in the FFE	77
2. 4. 4. 1. 1. Creativity as a Principle	77
2. 4. 4. 1. 2. Invention and Inventive Activity	80
2. 4. 4. 2. Assessment in the FFE	81
2. 4. 4. 2. 1. Patent Registration	82
Chapter III. Theoretical Modeling and Propositions	84
1. Inventive-Design Performance Metrics	84
1. 1. Development of Performance Metrics	84
1. 2. Modeling Inventive-Design Activities	86
2. Measuring Inventive-Design Performance	92
2. 1. Modeling Inventive-Design Effectiveness	92
2. 1. 1. Technological Novelty	99
2. 1. 1. 1. An Overview of Novelty Measurement Methods	99
2. 1. 1. 2. A New Framework for Measuring Novelty	101
2. 1. 1. 2. 1. Technological Evolution and Novelty	101
2. 1. 1. 2. 2. Technical Characterization of a System	102
2. 1. 1. 2. 2. 1. System Function	104
2. 1. 1. 2. 2. 2. System Structure	109
2. 1. 1. 2. 2. 3. System Behavior	111
2. 1. 1. 2. 2. 4. System Environment	115
2. 1. 1. 2. 2. 5. A Model of Technological Systems	116
2. 1. 1. 2. 3. Detection, Identification and Valorization of New Changes	117
2. 1. 1. 2. 3. 1. Definition of Novelty References	117
2. 1. 1. 2. 3. 2. Formulation of Technical Characteristics	119
2. 1. 1. 2. 3. 3. Valorization of New Changes	124

2. 1. 1. 2. 3. 4. Calculation of TND	132
2. 1. 1. 2. 4. Procedure of TND Measurement	134
2. 1. 1. 2. 5. Case Study of TND Measurement	136
2. 1. 1. 2. 6. Technological Novelty Indicators	138
2. 1. 2. Technological Resourcefulness	139
2. 1. 2. 1. An Overview of Ideality in Engineering Design	139
2. 1. 2. 2. A New Framework for Measuring Resourcefulness	142
2. 1. 2. 2. 1. Parameters of a Technological System	143
2. 1. 2. 2. 2. Ideality of System Parameters	146
2. 1. 2. 2. 3. Calculation of TRD	150
2. 1. 2. 2. 4. Procedure of TRD Measurement	153
2. 1. 2. 2. 5. Case Study of TRD Measurement	154
2. 1. 2. 2. 6. Technological Resourcefulness Indicators	156
2. 1. 3. Technological Usefulness	157
2. 1. 3. 1. An Overview of Usefulness in Technological Design	157
2. 1. 3. 2. Usefulness Measurement	158
2. 1. 3. 3. Technological Usefulness Indicators	159
2. 1. 4. Technological Inventiveness Degree (TID)	160
2. 2. Modeling Inventive-Design Efficiency	160
2. 2. 1. Material Gain by Inventive-Design Projects	161
2. 2. 2. Resources Used by Inventive-Design Projects	162
2. 2. 3. Inventiveness-based Efficiency (IBE)	162
2. 2. 4. Inventiveness-based Efficiency Indicators	163
3. A Platform for Measuring Inventive-Design Performance	163
Chapter IV. An Initial Prototype of IDPMS	167
1. Product Evolution Exploring Model (PEEM)	167
1. 1. An Overview of Product Models in Engineering Design	167
1. 2. PEEM; A Product Model for Exploring Technological Evolution	168
1. 2. 1. Environmental Characteristics	169
1. 2. 2. Functional Characteristics	170
1. 2. 3. Behavioral Characteristics	171
1. 2. 4. Structural Characteristics	172
2. IDPMS Application Platform	174

Chapter V. Conclusion	177
1. Discussion	177
2. Conclusion	178
3. Contributions	179
4. Perspective	179
References	182
Appendix	206
Appendix A	206
Appendix B	208
Appendix C	213
Appendix D	224
Résumé Complet	227

List of Tables

Tab. 1.	Some considerable inventions during the first and the second industrial revolutions	26
Tab. 2.	Some considerable studies on the production and operation management	27
Tab. 3.	Some considerable works on the quality management	28
Tab. 4.	The specified audience of the work	34
Tab. 5.	The signification of Assessment, Evaluation, Measurement in performance management . . .	41
Tab. 6.	Different definitions of performance in literature	45
Tab. 7.	The definitions of innovation in different perspectives	47
Tab. 8.	Innovation modes according to Edquist et al.	49
Tab. 9.	The strategic criteria of innovation management.	52
Tab. 10.	The categorization of R&D management models in five generation types by Rothwell 1994.	56
Tab. 11.	Different models of NPD process	58
Tab. 12.	The characteristics of the FFE phase and the development phase	67
Tab. 13.	Design models based on the nature of activities	70
Tab. 14.	Descriptive design models based on designing technical characteristics of a solution	71
Tab. 15.	Interactive characteristics of design activities in group	76
Tab. 16.	Different activities mentioned in design studies regarding the cognitive science	76
Tab. 17.	Some definitions of creative-product	78
Tab. 18.	Different data types can be used for representing the magnitude of an object	85
Tab. 19.	The constituent elements of the dimensions in measurement systems	86
Tab. 20.	The consequences of choosing each organizational level for design performance analysis . .	89
Tab. 21.	The characteristics of inventiveness-based effectiveness in the literature	94
Tab. 22.	The evolution laws of technological systems by Altshuller et al.	95
Tab. 23.	The patentability criteria of industrial properties in different IP offices.	97
Tab. 24.	The four aspects of system characterization	103
Tab. 25.	Example of MUF within a system	105
Tab. 26.	Example of MCF within a system	106
Tab. 27.	Example of LDF within a system	106
Tab. 28.	Example of ECF within a system	107
Tab. 29.	Example of ICF within a system	108
Tab. 30.	Example of CCF within a system	108
Tab. 31.	Example of DSF within a system	109

Tab. 32.	Example of SEP and SEA within a system	110
Tab. 33.	The phenomenal actions of energy flow across structural entities	111
Tab. 34.	Different energy types	112
Tab. 35.	Different states of matter	113
Tab. 36.	Some scientific phenomena through receptions, transitions and transmissions of energy . . .	113
Tab. 37.	Reasons of choosing energy, scientific effects, and the state of matters of a mechanism	114
Tab. 38.	Example of SSE and OPA within a system	114
Tab. 39.	The characterization layers on the product pedigree chart (PPC)	118
Tab. 40.	The main criteria of arranging the characterization layers on the y-axis of PPC	119
Tab. 41.	The standard formulas of defining/identifying a MUF	120
Tab. 42.	The standard formulas of the environmental characterization layers	120
Tab. 43.	The standard formula of functional characterization layers	121
Tab. 44.	The standard formulas of behavioral characterization layers	122
Tab. 45.	The standard formulas of structural characterization layers	123
Tab. 46.	The importance of changes occurring in each major-layer to intensify TND	124
Tab. 47.	The classification of new solutions according to the applied knowledge	125
Tab. 48.	The classification of new changes occurring at the major layers in a familial scope	126
Tab. 49.	The ranking of different conditions that emerge by new changes occurring in a fbs-chain . .	128
Tab. 50.	The classification of function types according to their general importance within a system .	128
Tab. 51.	The change of SPA with affecting system behavior	129
Tab. 52.	The classification of the behavioral elements according to their influence on novelty	130
Tab. 53.	New structural characteristics without affecting system behavior	131
Tab. 54.	The importance of changing structural attributes regarding their influence on novelty	131
Tab. 55.	The statistical data of measuring the TND of 300 samples by a numerical simulation	134
Tab. 56.	Some case studies of TND measurement	136
Tab. 57.	The key indicators of novelty in a mono-functional system with monolithic structure	138
Tab. 58.	Technical interaction between substances through energy flows and scientific phenomena .	144
Tab. 59.	The definitions of AP and EP in IDM-TRIZ	145
Tab. 60.	Technical characteristics of the specified systems for TRD measurement	154
Tab. 61.	The key indicators of resourcefulness in engineering design	156
Tab. 62.	The related items to the <i>perceived usefulness</i> from a technological system	157
Tab. 63.	The classification of function types regarding usefulness	159
Tab. 64.	An example of successive steps of measuring technical performance in a guideline	159
Tab. 65.	The principal criteria of resources used for performing activities during design projects. . . .	162

Tab. 66.	The measures of inventiveness-based efficiency regarding different resource criteria.	163
Tab. 67.	The key indicators of inventiveness-based efficiency in engineering design	163
Tab. 68.	The supplied measures by the IDPMS	165

List of Figures

Fig. 1.	The position of innovation on the pyramid of the sustainable competitive advantages	30
Fig. 2.	The number of papers and books about innovation management in Science Direct	31
Fig. 3.	The research areas of the thesis	33
Fig. 4.	The relationships of a R&D department in a company	34
Fig. 5.	Research strategy	35
Fig. 6.	Global research plan	36
Fig. 7.	The structure of the dissertation	37
Fig. 8.	The succeed rate of each step along the innovation projects	40
Fig. 9.	Assessment, Evaluation, and Measurement in performance management cycle.	42
Fig. 10.	The relationship between uncertainty, performance measurement, and risk management.	43
Fig. 11.	Triangle of performance	45
Fig. 12.	The innovation typology on technological growth trajectories	50
Fig. 13.	Innovation management in three perspectives from external to internal layers	51
Fig. 14.	The operational funnel of innovation for implementing normative and strategic objectives	53
Fig. 15.	Innovation, technology, research and development management	53
Fig. 16.	The S-curve of technology forecasting as for market demand, and performance	57
Fig. 17.	Phase-review-process model for NPD	58
Fig. 18.	Typical 2 nd generation of the Stage-gate process	61
Fig. 19.	Total influence, the cost of changes, and the volume of information along NPD process	65
Fig. 20.	New ideas mortality curve along NPD projects	65
Fig. 21.	New ideas mortality curves along NPD projects: the best versus the rest practices	66
Fig. 22.	The fuzziness level along NPD process	67
Fig. 23.	Typical FFE activities along the instructive design models	69
Fig. 24.	The TRIZ process	70
Fig. 25.	Substance-Field formalization for modeling physical interactions by TRIZ	70
Fig. 26.	The design process in the Axiomatic Design	72
Fig. 27.	The original and the situated FBS framework with designer's world	74
Fig. 28.	C-K operators	75

Fig. 29.	The sequential and the integrated design models	76
Fig. 30.	The invention phase along NPD process	79
Fig. 31.	The organizational levels of analyzing design performance in the literature	87
Fig. 32.	The analysis area of design performance at the project level	88
Fig. 33.	The five operations of any design activity	89
Fig. 34.	The design square or the design loop according C-K theory	90
Fig. 35.	A set of design activities at the project level and their operations	92
Fig. 36.	The constituent elements of measuring design performance	92
Fig. 37.	The comparative relationship between goals and outputs for measuring effectiveness	93
Fig. 38.	Dissecting a set of outputs by a design team on the genealogy tree of Shah et al.	101
Fig. 39.	The principal dimensions of technological novelty measurement	102
Fig. 40.	A schema of functional, behavioral, structural, and environmental aspects within a system	103
Fig. 41.	The characterization of technical aspects within any system	104
Fig. 42.	The behavioral condition of a structural entity within a system	112
Fig. 43.	Tracing energy-flow path along the chain of structural entities within a system	112
Fig. 44.	Reception, transition and transmission of energy by a structural entity	112
Fig. 45.	The relationships between a system and its environmental objects (SSO)	116
Fig. 46.	A set of integrated fbs-chains within a system	117
Fig. 47.	The related fbs-chain of the function 2 in the figure 41	117
Fig. 48.	The dissection of a new system on the product pedigree chart (PPC)	118
Fig. 49.	The range of variation of TND totally and at each major characterization layer	133
Fig. 50.	The procedure of measuring TND of a system	135
Fig. 51.	The ideality of familial systems should be improved by inventive design	141
Fig. 52.	The design parameters as the principal factor of measuring technological resourcefulness . .	143
Fig. 53.	The formalization of conflicts between the interactions of a substance by Cavallucci et al .	145
Fig. 54.	Consistent and inconstant tendencies of EPs regarding the opposite orientations of an AP .	148
Fig. 55.	Typology of evaluation parameters and their features regarding technological evolutions . .	149
Fig. 56.	The cumulative growth traces out an S-curve	151
Fig. 57.	The S-curve jumping by the continuous succession of idea generation	151

Fig. 58.	A simple logistic S-curve	152
Fig. 59.	The procedure of measuring TRD of a system	153
Fig. 60.	The relationships for measuring efficiency at the project level	161
Fig. 61.	IDPMS as a neural integrated system for presenting inventive performance of a company .	164
Fig. 62.	The main characterization areas in PEEM	168
Fig. 63.	The abstract classes in PEEM	169
Fig. 64.	Environmental object classes in PEEM	169
Fig. 65.	Functional object classes in PEEM	170
Fig. 66.	Functional property classes in PEEM	171
Fig. 67.	Behavioral object classes in PEEM	172
Fig. 68.	Behavioral property classes in PEEM	172
Fig. 69.	Structural object classes in PEEM	173
Fig. 70.	Structural property classes in PEEM	174
Fig. 71.	The general use case diagram of the IDPMS application	174
Fig. 72.	The dashboard of the IDPMS application	175

List of Equations

Equ. 1.	Knowledge processing of a design activity	90
Equ. 2.	Inputs and outputs of a design activity	91
Equ. 3.	Goals or intentions of carrying out a design activity	91
Equ. 4.	Resources used for carrying out a design activity	91
Equ. 5.	The effectiveness value of a design activity	93
Equ. 6.	Generic calculation formulas of novelty measurement by Shah et al.	100
Equ. 7.	Assigned score of considering a new function in universal scope	129
Equ. 8.	The calculation formula of the creativity roughness indexes	132
Equ. 9.	The calculation formula of measuring technological novelty degree.	133
Equ. 10.	The matrix model of design formalization in axiomatic design	140
Equ. 11.	The generic formula of ideality in engineering	141
Equ. 12.	The quality of implementing a technical interaction or technological system	147
Equ. 13.	The calculation formulas of earned and unearned values	150
Equ. 14.	The formulas of measuring the ideality degree of an EP	150
Equ. 15.	The formula of measuring technological resourcefulness degree	150
Equ. 16.	Technological forecasting of an EP.	152
Equ. 17.	Technological resourcefulness degrees of four DVD models	154
Equ. 18.	The relationship between technical performance and technological usefulness	158
Equ. 19.	The formula of measuring technological usefulness degree.	159
Equ. 20.	The formula of measuring technological inventiveness degree of a system	160
Equ. 21.	The formula of measuring technological inventiveness degree of a project.	160
Equ. 22.	The generic formula of efficiency in design	161
Equ. 23.	The knowledge gain by a design project	161
Equ. 24.	The relationship between knowledge gain and technological inventiveness	161
Equ. 25.	The generic formula of measuring inventiveness-based efficiency	163

Acronyms and Symbols

Π	Effectiveness Value
AFNOR	Association Française de Normalisation
AP	Action Parameter
AV	Actual Value of an EP
BMI	Business Model Innovation
c	Cost
CAD	Computer-Aided Design
CAM	Computer-Aided Manufacturing
CCF	Control-Command Function
CCS	Cartesian Coordination System
CEN	Comité Européen de Normalisation/European Committee for Standardization
C-K	The Theory of Concept and Knowledge
CRI	Creativity Roughness Index
DSF	Discrete Supplementary Function
E	Energy Type
ECF	Environmental Constraint Function
eEP	Earned Value By an EP
EOU	Easy to Use/Ease of Use
EP	Evaluation Parameter
fbs-chain	The chain of a function and the behavior of its related structural entities
FFE	Fuzzy Front End Phase of Innovation Process
f_i	Function i of system j
FSM	Fundamental State of Matter
G_i	Goals or intentions of carrying out design activity i
HF	Harmful Function
hr	The Number of Human Resource
IBE	Inventiveness-Based Efficiency
IC	Inventive Creativity
ICF	Indicating Complementary Function
IDM-TRIZ	Inventive Design Method Based on TRIZ
IE	Inventive Efficiency

IF	Inventive Frequency
IFR	Ideal Final Result
I_i	Inputs or imported knowledge of design activity i
IP	Intellectual/Industrial Property
IP	Inventive Productivity
IPC	International Patent Classification
ISO	International Organization for Standardization
IV	Initial Value of an EP
JIT	Just-In-Time
KBE	Knowledge-Based Engineering
K_n⁺	Knowledge Gain by a Design Project
LDF	Loading/Discharging Function
M⁺	Material gain by a knowledge processing
Max-ideal	an EP type that are targeted to be increased toward infinity by idealization activities
MC	Main Criteria
MCF	Main Complementary Function
mh	Man-Hour
mhc	Man-Hour Cost
Min-ideal	an EP Type that are targeted to be increased toward zero by idealization activities
MSC	Main Specific Consumer
MSO	Main Specific Operator
MUC	Main Useful Criteria
MUF	Main Useful Function
MUO	Main Useful Object
N(t)	Growing variable at time t
NASA	National Aeronautics and Space Administration in the USA
NIP	Net Inventive Productivity
NPD	New Product Development
O_i	Outputs or exported knowledge of design activity i
OPA	Operational Property Attributes
PDM/ED	Produktdatenmanagement/Engineering Data Management
PEEM	Product Evolution Exploring Model
P_i	The average of registered patents in the related section of sector i

p_i	The registered patents in sector i according to the IPC
POM	Production and Operations Management
PPC	Product Pedigree Chart
R&D	Research and Development
R_i	Resources used for carrying out design activity i
S	Substance
ScPh.	Scientific phenomenon/Physical effect
SPA	Structural Property Attributes
SPC	Statistical Process Control
SSE	System Structural Entities
SSO	Super-System Objects
SSP	System Structural Properties
t	Time
TET	Technological Evolution Theory
TID	Technological Inventiveness Degree
TIM	Total Innovation Management
t_m	Midpoint time when the curve reaches $\kappa / 2$
TND	Technological Novelty Degree
TP/P	Technological Products and Processes
TPM	Technical Performance Measure
TQC	Total Quality Control
TQM	Total Quality Management
TRD	Technological Resourcefulness Degree
TRIZ	Theory of Inventive Problem-Solving
TUD	Technological Usefulness Degree
uEP	Unearned Value by an EP
UF	Useful Function
UIV	Ultimate Ideal Value of an EP
UO	Useful Object
V_a^-	The Negative Orientation of an EP
V_a^+	The Positive Orientation of an EP
x_i	The creativity roughness of activity sector i before normalization
α	Growth rate parameter

β	Location parameter; (tm) when the curve reaches $\kappa / 2$
β_b	The generic value of new changes in the behavioral characteristics in a familial scope
β_f	The generic value of new changes in the functional characteristics in a familial scope
β_s	The generic value of new changes in the structural characteristics in a familial scope
Δt	Duration of evolution growth with evolution wave
η	Efficiency Value
θ_k	Assigned score to the attribute of structural property k
κ	Asymptotic limit of growth (carry capacity)
λ_f	Assigned score to behavioral elements in a familial scope
λ_{f1}	Assigned score to E in a familial scope
λ_{f1}	Assigned score to FSM in a familial scope
λ_{f1}	Assigned score to ScPh. in a familial scope
λ_{f1}	Assigned score to SPA in a familial scope
μ_1	Assigned score to a MUF in a familial scope
μ_2	Assigned score to a MCF in a familial scope
μ_3	Assigned score to a ECF in a familial scope
μ_4	Assigned score to a LDF in a familial scope
μ_5	Assigned score to a ICF in a familial scope
μ_6	Assigned score to a CCF in a familial scope
μ_7	Assigned score to a DSF in a familial scope
μ_f	Assigned score to different function types in a familial scope
μ_g	Assigned weight to different function types for TUD measurement
μ_u	Assigned score to different function types in a universal scope
τ_i	The Creativity Roughness Index (CRI) of activity sector i
Ψ_i	Knowledge processing of design activity i

Chapter I: Introduction

The chapter I introduces the research background, motivation, objective, problem, areas, questions, audience, methodology, and the structure of the dissertation. This research is a contribution to construct total innovation management through defining the key performance indicators of inventive design. The research seeks to find those indicators that monitor and enhance inventive performance of design activities at the fuzzy front-end phase of innovation process. The research objective is summarized in two research questions, and followed by a literature review, a survey of R&D managers, modeling, and developments. This work is especially significant for R&D managers who are the responsible of innovation management in their companies.

1. Research Background and Motivation
 2. Objective, Overall Problem, and Research Question
 3. Research Area and Assumption of Research Questions
 4. Research Audience
 5. Research Methodology
 6. Thesis Structure
-

I. 1. Research Background and Motivation

During the industrial revolutions from the 18th to 20th centuries, manufacturing shifted from homes to the factories with special-purpose machineries and the emergence of mass production. The first industrial revolution (1790s-1840) started with the mechanization of the textile industries and the development of iron-making. It was a period with a profound effect on socioeconomic and cultural condition [Mokyr 1985] [Deane 1979]. The period between 1850 and 1914 is known as the second industrial revolution [Mokyr 1998]. It started in 1860 when a patent on cheaply mass-produce steel called the Bessemer steel process (1856) emerged and was developed [Bugayev 2001]. Although a number of technological inventions are registered before the 1850s – such as spinning jenny (1764 by James Hargreaves), steam engine (1776 by James Watt), art lamp (1802 by Humphry Davy), railway steam locomotive (1804 by Richard Trevithick), principle of electromagnetic generators (1832 by Michael Faraday), Morse code (1838 by Samuel Morse) – a considerable number of them occurred in the second industrial

revolution. This is why Mowery and Rosenberg [Mowery 1991] characterize the second period as one of the most fruitful and dense during the innovation history. This period was marked by the development of railways and the growth of chemical and electrical industries [Tab.1]. Joel Mokyr [Mokyr 1998] describes the second industrial revolution as a great breakthrough that emerged from human genius having not only a huge impact on production, but also increasing the effectiveness of research and development in inventive activities. In fact, engineering, medical technology and agriculture until 1850 were pragmatic bodies of applied knowledge without clear theoretical understanding behind them. And this wasted enormous amount of energy and ingenuity [Mokyr 1998].

Tab. 1. Some considerable inventions during the first and the second industrial revolutions. Source [Roy 2005];

Date	Inventor	Process or Machine
1764	James Hargreaves	Spinning jenny
1776	James Watt	Steam engine
1802	Humphry Davy	Arc lamp
1804	Richard Trevithinck	Railway steam locomotive
1822	Thomas Blanchard	Pattern tracing lathe
1826	John Walker	Friction match
1838	Samuel Morse	Morse code
1839	James Nasmyth	Steam hammer
1855	Henry Bessemer & William Kelly	Bessemer steel process
1853	Elisha Otis	Mechanized passenger elevator
1856	James Harrison	Refrigeration
1868	George Westinghouse	Compressed-air brake
1876	Alexander Graham Bell	Telephone
1877	Thomas Edison	Phonograph
1878	Henry Fleuss	Rebreather
1879	Thomas Edison (and Joseph Swan)	Light bulb
1886	Charles Martin Hall	Producing aluminum economically
1886	George Westinghouse and Nikola Tesla	High voltage alternating electric current
1888	Charles F. Brush	Wind turbines for grid electricity

1893	Charles and Frank Duryea	First practical gasoline-powered motorcar
1903	Orville and Wilbur Wright	First motorized aircraft
1915	Ernest Swinton	The tank

Before the industrial revolutions most productions were done in small workshops with employing a few skilled labors [Chandler 1977]. By changing the production technologies, most important economies turned to the manufacturing and this changed the nature of production and industrial organization [Mokyr 1998]. The management of manufacturing was established in the second half of the 18th century when Adam Smith in his book “The Wealth of Nations” [Smith 1776] proposed the specialization of labors according to their tasks for enhancing efficiency. Some other scholars, such as Eli Whitney (1799) and Charles Babbage [Babbage 1832] took some new steps in this direction [Roy 2005] by proposing the concept of cost accounting, division of labors, skills-based job allocation, and time study [Tab.2]. Frederick. W. Taylor in the early 20th century (1911) was the first one who based the principles of scientific time management, planning and industrial efficiency improvement on his efficiency technics [Taylor 1911]. The importance of these studies – between 1930s to 1980s – was to reduce cost and time as the prosperity factors of production units. And nowadays, *the production and operation management* (POM) is known as the key science to enhance the flow work efficiency and productivity [Roy 2005].

Tab. 2. Some considerable studies on the production and operation management. Source: [Roy 2005];

Date	Author	Method
1776	Adam Smith	Specialization of labors and jobs breaking down
1799	Eli Whitney and others	Interchangeable parts, cost accounting
1832	Charles Babbage	Division of labor and assignment of jobs by skill, basic of time study
1900	Frederick W. Taylor	Scientific management of time and tasks
1900	Frank B. Gilbreth	Motion study in manufacturing
1901	Henry L. Gantt	Scheduling technics of production line
1915	F. W. Harris	Inventory control and lot sizes
1927	Elton Mayo	Human relations and Hawthorne studies
1940	P. M. Blacker and others	Operations research applications in World War II
1946	J. Maucly & J. P. Eckert	Digital computer

1947	G. B. Dantzing, Williams and others	Linear programming
1950	A. Charnes, W.W. Cooper and others	Mathematical programming, on-linear and stochastic processes
1951	S. Univac	Commercial digital computer: large-scale computations available.
1960	L. Cummings, L. Porter	Organizational behavior: continued study of people at work
1970	W. Skinner J. Orlicky and G. Wright	Integrating operations into overall strategy and policy, W. Skinner J. Orlicky and Computer applications to manufacturing, Scheduling G. Wright and control, Material requirement planning (MRP)
1980	W.E. Deming and J. M. Juran	Quality and productivity applications, Robotics, CAD-CAM

In the meantime of developing the POM, the quality became a new critical component for reducing time and cost. Walter Shewhart in 1920s [Shewhart 1926] proposed the quality control and inspection based on a statistical process control of products. Later Joseph M. Juran, W. Edwards Deming, Armand V. Feigenbaum, and some Japanese practitioners with some other researchers developed the quality control. They focused on the improvement of organizational processes to achieve quality assurance, quality improvement system, total quality control, and total quality management (TQM). The results of all these studies prepared the quality revolution in 1984 [Brocka 1992]. These studies emphasized not only on the statistical analyses but also on the approaches that embraced an entire organization. By the last decade of the 20th century new quality systems evolved from the foundations of the TQM and were proposed [Tab.3].

Tab. 3. Some considerable works on the quality management. Source: [Roy 2005];

Date	Author	Method
1920s	W. Shewhart	Statistical process control (SPC), Quality control charts
1926	J. M. Juran	Top management and quality, Projects improvement, Pareto principle
1935	H. F. Dodge & H. G. Roming	Sampling plans for quality control inspection
1947	W. E. Deming	Management responsibility and variations
1949	T. Ohno	Toyota production quality, Kaizen team, JIT inventory, cycle time reduction
1950	G. Taguchi	Robust design

1951	A. V. Figenbaum	Total quality control (TQC)
1962	K. Ishikawa	Quality control circles
1979	Ph. B. Crosby	Quality and pay of the cost
1984	U.S. Navy	Total quality management (TQM)
1986	Bill Smith	Six sigma
1988	J. Krafcik	Lean; triumph of the lean production system
2002	M. George, P. Vincent	Lean Six Sigma

Increasing the use of the term *globalization* – since 1985 –, and defining its basis by the international monetary fund (IMF), 2000, [IMF 2000], drew the attention of industries to business competitions [O’Regan 2006]. The promotion of economic efficiency became a rivalry among companies to increase profit, market share, and sales volume. In this regard, the capability of industries to benefit from each one of the POM (Production and Operations Management), the TQM (Total Quality Management), and the NPD (New Product Development) were known as the strategic advantage of industries [Ward 1998] [Powell 1995] [Kessler 2000] to stay ahead of their competitors. However, the advancement of industries regarding each of these sciences (POM, TQM, and/or PDM) makes the competition more difficult. J. Mick-lethwait and A. Wooldridge in their book “The Witch Doctors”, 1997, expressed that the greatest source of competitive advantages is creativity but no longer cost or quality [Micklethwait 1997]. Bellon et al. 1994 [Bellon 1994], and Copper 1999 [Copper 1999] affirmed that companies without developing new products and innovation disappear inevitably. Zahra and Covin 1993, [Zahra 1993] found that the competitive marketing intensity is positively correlated with the NPD. Also Griffin and Page 1996, [Griffin 1996] observed a positive relationship between innovativeness and differentiation. In this regard, gradually, new product development (NPD) and innovation became the main competitive advantage and grew into an important aspect of differentiation [Vázquez 2001]. Thus, companies needed to accelerate the pace and the rhythm of developing new products and services to remain competitive. From the 20th century onward, innovation began to be valorized. However, innovation was not a new topic, Schumpeter, 1934, was the first economist who emphasized the importance of NPD more than marginal changes in the price of existing products for economic growth [Schumpeter 1939] [Schumpeter 1934] [Schumpeter 1955].

I. 1. 1. Innovation as a Sustainable Competitive Advantage

At the beginning of the 21st century, innovation as the key challenge became an indispensable condition of survival [Benghozi 2000], or the key driver to achieve sustainable competitive

advantage of companies [O'Regan 2006]. The role of technology and innovation was explicitly recognized in the most prevalent business strategy frameworks as the manner in which a firm decides to compete [Vázquez 2001] [Walker 1987]. Dert 1997 [Dert 1997], and Lundin and Midler 1998 [Midler 1998] were the first who considered innovation as a substantial factor of competitive management to enhance economic efficiency. Indeed, the sustainable advantage of innovation appears when it passes the competition frontiers by unveiling a new successful idea implementation [Dert 1997] [Midler 1998]. The term *successful* in this definition refers to the generation of profits, the improvement of competitiveness, and overall, the increase of benefits for firms [Martins 2011]. Innovation as a competitive advantage allows companies to obtain their private rate of returns [Arrow 1962] with higher sales, firm growth, and indirect financial and non-financial spillover effects, [Avlonitis 2001] [Pauwels 2004] e.g. on brand, image and reputation, and transform their capabilities [Bayus 2003]. The advantages of the innovation put it besides the triptych of time, cost, and quality, as the fourth necessary competitive element to conduct business, keep market position, and create wealth [Ben Rejeb 2008]. The figure 1 illustrates innovation as the strategic factor at the top of the pyramid of the sustainable competitive advantages in companies [Fig.1].

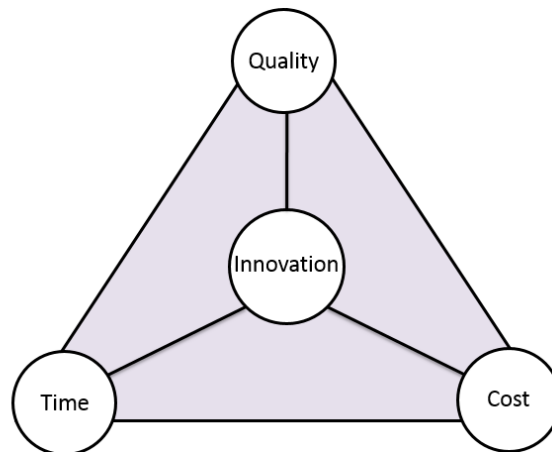

Fig. 1. The position of innovation on the pyramid of the sustainable competitive advantages in companies [Crubleau 2002].

I. 1. 2. Innovation Management and Standardization

Recognizing innovation as a sustainable competitive advantage stimulated companies to enhance their innovation capabilities. In the last decades of 1900s, the innovation management became an increasingly covered topic in scientific and management literature [Fig.2].

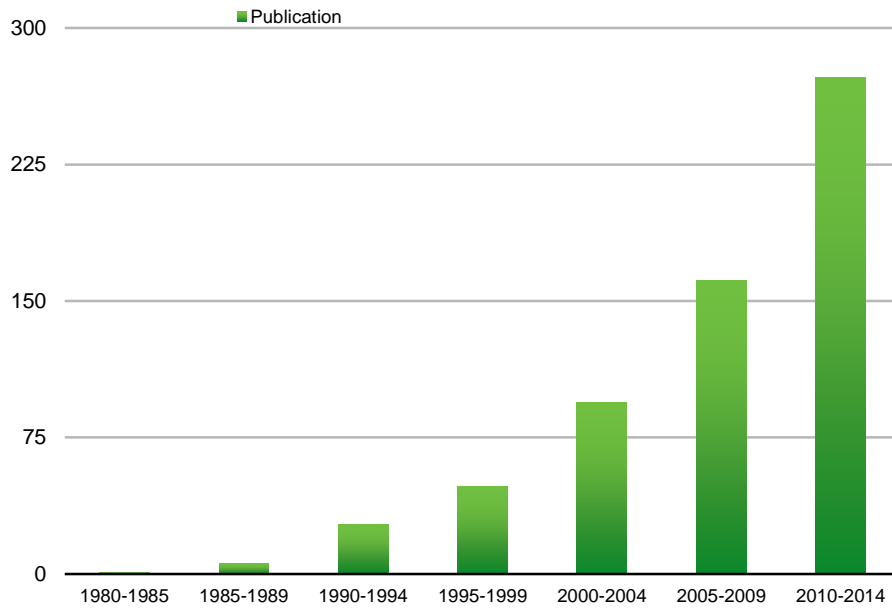

Fig. 2. The number of papers and books about innovation management over the years in Science Direct.

Companies nurtured and invested in innovation capabilities from which they execute and lead effective innovation processes with superior business performance results [Lawson 2001]. However, generating innovative results and be the leader of sector is not easy. Even huge companies that once were the forerunners and creators of whole markets have failed to stay competitive when changes occurred [Utterback 1994] [Hamel 1994] [Christensen 2003]. In this regard, over the time, the focus of many innovation researches shifted from macro to micro analysis, i.e. understanding innovation management and contributing to the success of the firms in various aspects of innovation [Xu 2007]. Up until the 21st century, the theory of innovation management has developed through four stages: individual innovation 1940s-1950s, organization-driven innovation 1960s-1970s, external-source based innovation and outsider involvements 1970s, innovation portfolio, integrated and systematic innovation 1980s-1990s [Von Hippel 2007] [Qingrui 2000] [Xu 2007]. With the beginning of 21st century, it had been admitted that innovation management needs a totally new paradigm to improve innovation performance [Xu 2007]. Something like the destiny of the total quality management (TQM) that is led to ISO series quality standards in the last decades of 1900s, but so different from the quality management standards that always use the existing situation of organizations as the departure point, and assume to manage everything from within firms [Griffin 1997]. In November 2009, the European Committee for Standardization (CEN), which consists of 31 countries, launched a project named “CEN/TC389 Innovation Management” to encourage a pervasive standard for supporting innovation culture in Europe. CEN/TC389 project consisted of five workgroup, as; Collaboration and Creativity Management, Innovation Management System, Innovation Management Assessment, Intellectual Property Management, and Strategic Intelligence Management. In fact, the *total innovation management* as a catalyst supports companies to be not out of line too far from the early adopters of new ideas. Nowadays, although several surveys rank innovative companies by their own assessment

methods, at the same time, rarely the business world agrees unanimously on a company as the most innovative company. Thus, the lack of a standard to assess innovations is the major barrier for future efforts by industries regarding sustainable business strategy. In this regard, the following sections of this chapter describe the research objective, problem statement, research question, research areas, research methodology, and the structure of this dissertation.

I. 2. Objective, Overall problem, and Research Questions

Although Schumpeter in 1911 [Schumpeter 1934] described the characteristics and the influence of innovation on economic development, there is not yet any admitted standard to say what the creativity should produce when the innovation is a priority. In sync with the CEN/TC389 project, – in the context of the workgroup 5 (Innovation Management Assessment) –, this research was defined in the perspective of taking inventive activities in a logic performance. A Ph.D thesis to define the "key performance indicators of inventive activities for characterizing technological design in R&D departments". The objective was gathering a set of performance indicators regarding inventive activities to characterize inventive-design. This research direction was held to characterize design activities in perspective of enhancing inventive activities and contributing toward *total innovation management* (TIM). Thus, we look for the performance indicators of inventive capability in the midst of innovation process. Since the R&D (Research and Development) departments are the responsible of innovation management in companies, the research is focused on R&D activities. So this project is more specifically directed to the attention of R&D managers whose concerns include decision makings during inventive-design projects. The study is adapted to automotive industries that possess a remarkable diversity of technological products on both constructor and subcontractor levels. The overall research problem is to define inventive performance indicators to be adapted for evolving inventive approaches and even conventional optimization approaches. This refers to equip the engineering level of innovation processes with a practicable method. In this regard, in order to achieve the research objective, the overall research questions were defined as:

1. What are the limitations of existing approaches/guidelines regarding creative performance?
2. What are the key performance indicators of inventive-design activities in R&D departments?

I. 3. Research Areas and Assumptions

This research is involved in several research areas including Technological Design, Design Performance, Innovation Management, Knowledge-Based Engineering (KBE), and Standard practices of R&D department [Fig.3].

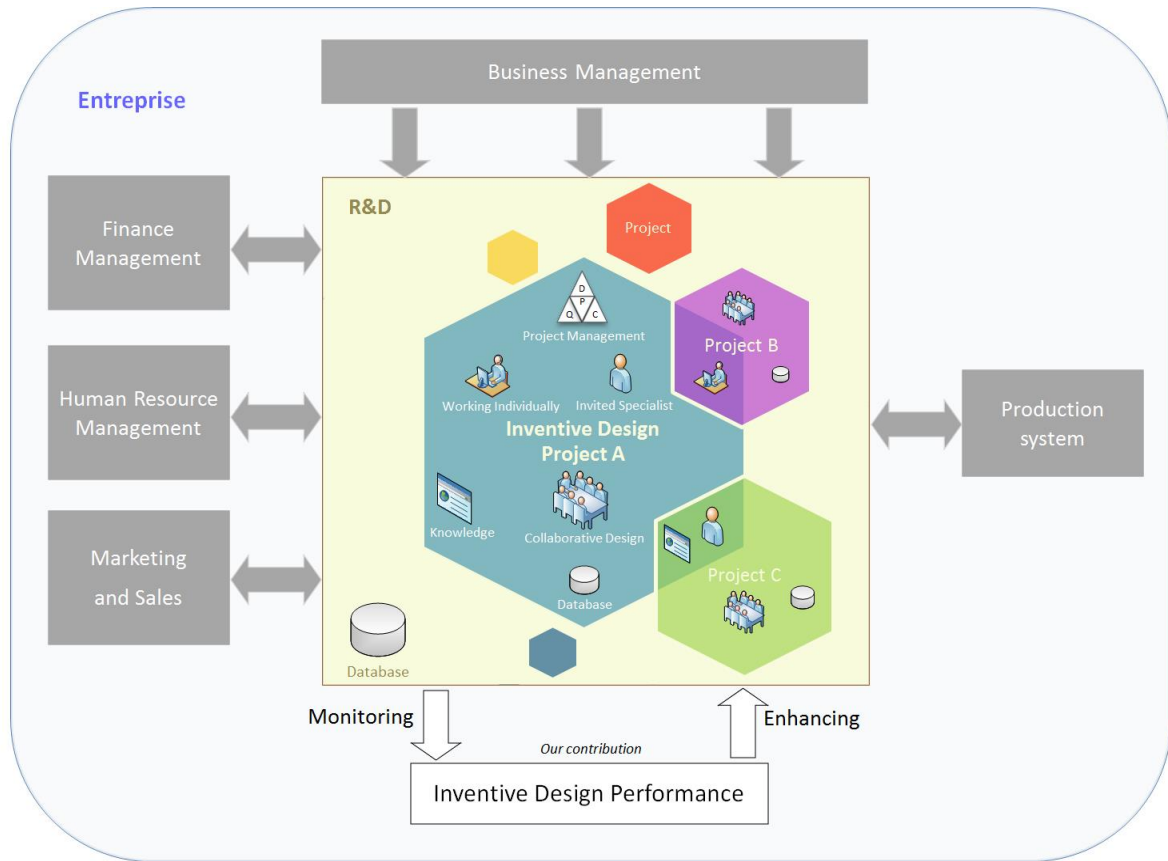

Fig. 4. The relationships of a R&D department in a company.

I. 4. Research Audience

The result of this research is significant to four active groups in engineering design and innovation management [Tab.4]. Firstly, to managers of R&D departments and consultants – specifically in automotive industries – whose task is involved in monitoring and enhancing inventive design performance and innovation. Because the study supplies a package of inventive performance indicators with an integrated measurement system for monitoring the activities in fuzzy front-end phase along new product development process. Secondly, to the intellectual property offices and/or the standard organizations that scheduled constructing a comprehensive protocol for R&D departments and inventive activities for standardizing innovation assessment and classifying companies by more appropriate metrics. Thirdly, the research is significant to academic researchers on innovation management and our colleagues in design engineering laboratories, since it expands existing perception of inventive-design performance, and contributes to the enrichment of *total innovation management*. Fourthly, to the practitioners in the midst of inventive-design projects, who has to know how to enhance inventive activities and needs a new viewpoint on their job.

Tab. 4. The specified audience of this work;

Research Audience

Managers of R&D department and Innovative projects	Intellectual property offices and Standard Organizations	Academic researcher on engineering design and innovation management	Practitioners in the midst of design projects
--	--	---	---

I. 5. Research Methodology

Taking an appropriate research strategy is one of the first challenges faced in any research. In this case, nine major tasks have been considered within four phases [Fig.5] [Fig.6]:

- First phase: Literature reviewing;
- Second phase: Collecting information from industries;
- Third phase: Development and proposition;
- Fourth phase: Development of application;

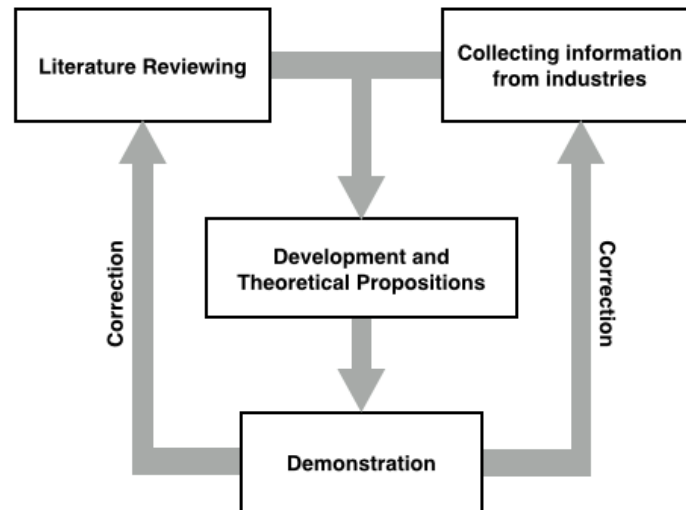

Fig. 5. Research strategy.

The research starts by seeking and reviewing existing guidelines/standards regarding innovation, R&D department, and inventive activities. The second step includes a large literature review on the research areas. The third step is concerned with clarifying research objectives, constructing problem graph, and posing research questions. The fourth step aims to build a survey for R&D departments in order to collect real data about their activities, perceptions and the meaning of current issues. The fifth step is dedicated to decomposition and adaptation of theoretical definitions, and the sixth step looks for developing and proposing solutions. The seventh step is concerned with the demonstration of propositions. The step eight shares result (demonstrator) with research partners and industries, and collects feedbacks. And the ninth step implements received feedback and improves propositions.

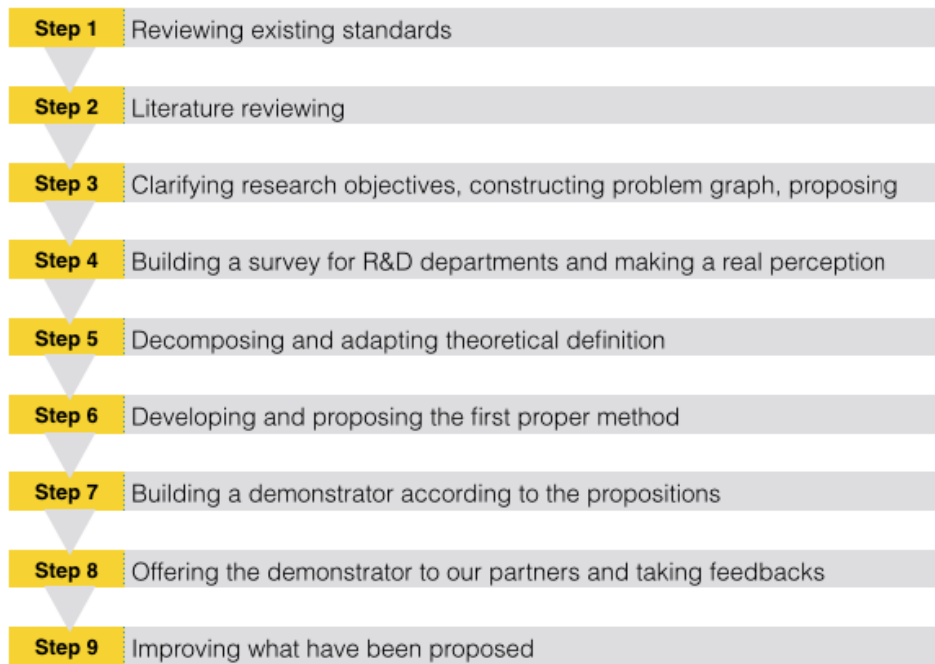

Fig. 6. Global research plan.

I. 6. Thesis Structure

This dissertation is structured in four chapters and a complete conclusion in chapter 5 [Fig.7]. Chapter 1 is the departure point by giving an introduction about research background, motivation, and objective. Chapter 2 presents a literature review and the state of the art as the basis of research development looking for clarifying research problematic. Chapter 3 presents theoretical modeling, developments, and propositions including indicators and definitive results of the research. Chapter 4 presents an initial application (demonstration) of theoretical method proposed in chapter 3. Chapter 4 includes the specification of product model, data collection, and the data bases of proposal method. Chapter 5 presents a complete conclusion including a discussion about proposed methods, the contributions of this work, and the perspectives of future researches based on this work. The survey that was built for studying design project within R&Ds, according to the task 4 of this research [Fig.6], is given in Appendix C [Appendix.C].

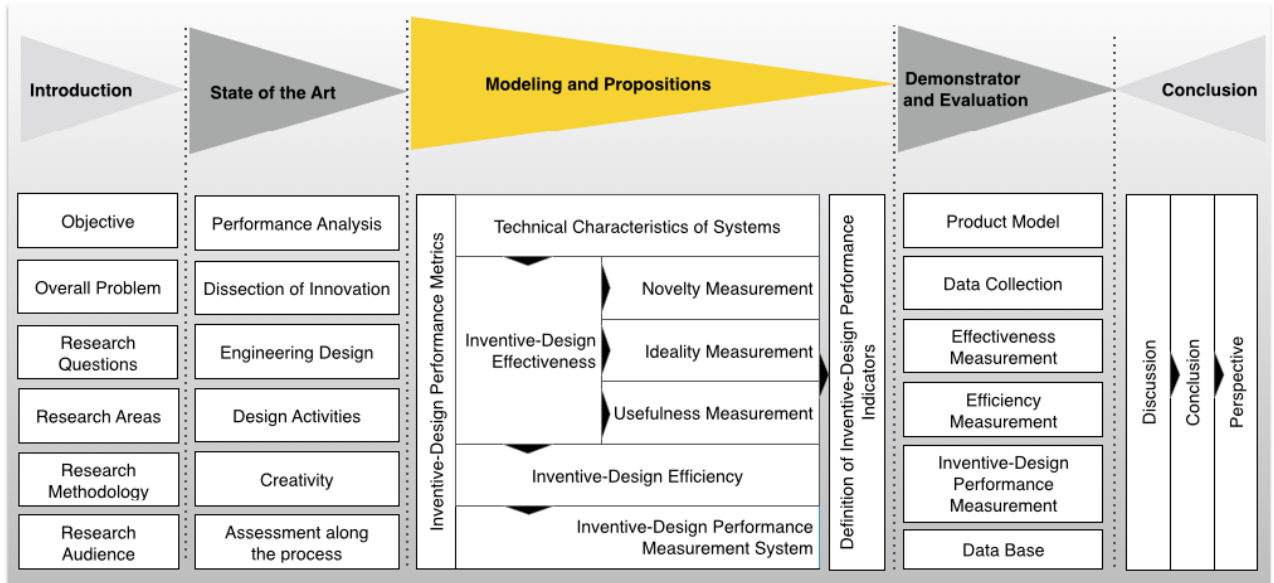

Fig. 7. The structure of the dissertation.

Chapter II: State of the Art

This chapter provides an insight into the design performance and inventive activities along the innovation processes by dissecting the concepts of research areas. It highlights the problematic of research by identifying the key issues for defining inventive-design performance indicators. Moreover, it illustrates the position of inventive-design activities within innovation management by a literature review including the acquisition, analysis and synthesis of related sciences. The contents are taken from more disposal adequate works of the scientific databases. This chapter is considered as the basis or the key requirement of what has been proposed in the next chapter for modeling and defining the performance indicators of inventive design.

1. The Nature of Inventive-Design Performance
 2. Dissection of the Innovation in Search of Inventive Activity
 2. 2. Technological Innovation Management
 2. 3. Technological Innovation Process
 2. 4. Engineering Design
-

II. 1. The Nature of Inventive-Design Performance

From the perspective of innovation, a high rate of new ideas fails while the development phase imposes a heavy burden of cost upon the firms [Weitz 2002]. For every seven new ideas at the beginning of innovation projects, four are sent to development phase, and one and a half are launched to the markets. Furthermore, only one-seventh of generated ideas is known as *innovation* [Jaruzelski 2006] [Kumar 2013] [Fig.8].

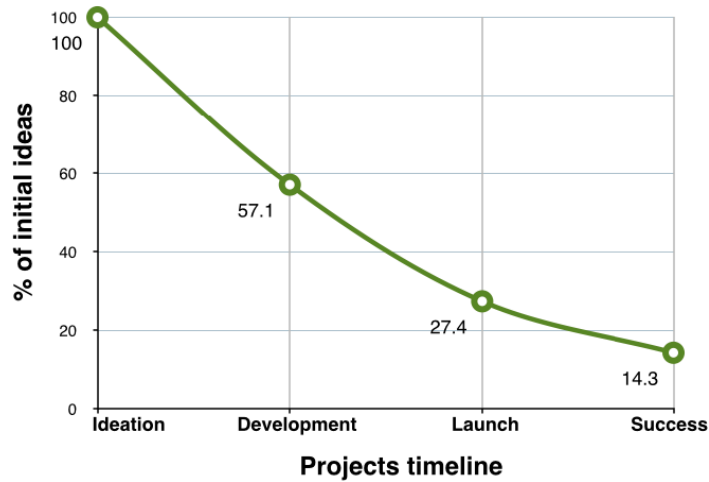

Fig. 8. The succeed rate of each step along the innovation projects. Source: [Kumar 2013].

The proof of this fact is when Henry Ford and the Ford Motor as a known leader in the automobile market, in 1950s, lost more than \$100 million, despite introducing the *Edsel* (an automobile marque) as a new smart car for the younger executives and professional families [Weitz 2002] [McCarthy 2007]. Another example is an automatic seat belt for the cars that was developed in 1990s. Although the idea passed the development phase and had been launched on the market, it is known risky by governors' safety associations in some particular situations and so was not allowed to be used. Just slightly later, the development of the airbags finished the moot points of automatic seat belts. In another case, in 1962, Chrysler made the first gas-turbine-powered car that idled at 22000 rpm, sounded like a jet engine, and required no warm-up time. But when Chrysler decided to introduce its new idea on the market by producing fifty-five samples of this car, the project failed because of destroying about forty-six samples after usage, and the company lost about \$350,000 [Huebner 1964] [Lehto 2010] [Chrysler 1963]. These examples and hundreds of others confirm this understanding that the pre-development phase suffer from a sharp drop of the performance rate. However, it is a fact that the failure rates are substantial, and depend on projects' goals.

II. 1. 1. Performance Analysis

The innovation performance is one of the hottest and most interested topics for managers of companies (from highest to lowest organizational hierarchy). They look for identifying how much is the performance rate of their innovation projects to manage and improve the weaknesses along the process. The performance management needs both assessment and improvement activities to eliminate the flaws, and also to strengthen the effective factors properly [Neely 1999] [Pritchard 1990] [Kaplan 1996] [Mehra 1998] [Sinclair 1995]. Performance assessment, as the first step, encompasses measurement and evaluation tasks in order to recognize critical points, analyses, and remedial actions for an existing condition. The sequence of executing each of these tasks of performance management arises from the signification of the

terms *assessment*, *evaluation* and *measurement*, their capabilities, and their prerequisites [Tab.5].

Tab. 5. The signification of the terms *Assessment*, *Evaluation*, *Measurement* in performance management;

Signification, Capability and Prerequisites of the terms <i>Assessment</i> , <i>Evaluation</i> , <i>Measurement</i>
<ul style="list-style-type: none">• <i>Assessment</i> is achieved through a systematic process for collecting, analyzing and interpreting information. It is realized in a macro-view decision-making and used to guide toward an appropriate decision for improving actions or planning the future. Assessment gives a global judgement using evaluations of qualitative and quantitative measurements. It is a judgement with considering what was spent, what was intended, and what was obtained. The tests are a form of assessments that made under contrived circumstances [Kizlik 2011]. A test enlists the whole process – i.e. <i>measurement</i> and <i>evaluation</i> – for assessing some known objectives or goals.
<ul style="list-style-type: none">• <i>Evaluation</i> is the definition of value by gathering the information of measurements for judgment in micro-level [Bachman 1990] [Weiss 1972] [Lynch 2001]. It is a superordinate term regarding to <i>measurement</i> and sometimes used interchangeably for assessment [Bachman 1990] [Lynch 2001]. Evaluation is the classification of measurement results in relation with people, objects, methods or conditions (according to defined criteria of quality) [Kizlik 2011]. Any evaluation is based on the results of an accurate and relevant measurement.
<ul style="list-style-type: none">• <i>Measurement</i> is the process of determining attributes or dimensions of physical objects [Kizlik 2011]. It needs the standard instruments to determine how degree is a property of an object – such as weight, length, volume, temperature, or speed – according to a conventional metric.

Assessment as the outermost layer of a performance management provides a baseline from which an innovation manager needs for analyzing, planning and implementing to improve performance [Lynch 2001] [Fig.9]. However, this work at the first step prepares a technical evaluation, and consequently raises the awareness of designers about inventive performance and technological evolution road map.

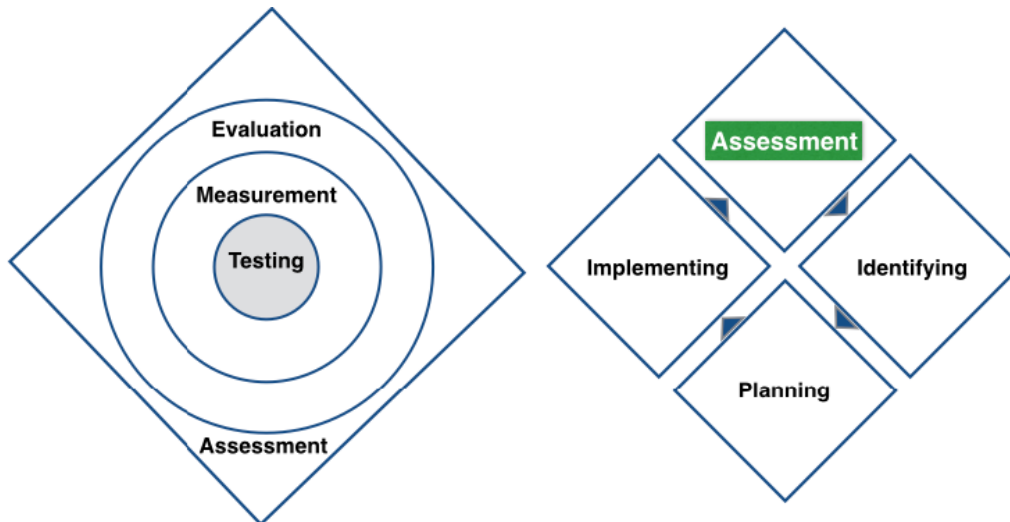

Fig. 9. The relationships between *Assessment*, *Evaluation*, and *Measurement* in performance management cycle.

Innovative performance analyses are done with various purposes. An empirical research summarizes the interest of firms to measure innovation performance as [Pritchard 1990] [Chiesa 1999] [Kerssens-van 1999] [Kald 2000]:

- Motivating experts – researcher, designers, and engineers – in order to improve the individual performance during innovative projects;
- Monitoring the progress of innovation projects with respecting resource consumption, quality targets, and technical requirements;
- Evaluating the economic value and profitability of innovation projects;
- Supporting the selection, planning, controlling, and decision-making to initiate, continue, or discontinue a project;

Considering the benefits of assessment reliability [Pritchard 1990] [Chiesa 1999] [Kerssens-van 1999] [Kald 2000], turned innovation performance measurement into an important concern of the firms in the last decades [Kerssens-van 2000] [Bilderbeek 1999]. Although the measurement of innovation performance as a fundamental task could not still be entirely committed to the innovation management [Brown 1998], the interest of researchers and practitioners has been raised for all should be hindered by proper metrics of the creative capability [Brown 1998] [Pappas 1985] [Sivathanu 1996] [Hauser 1998] [Driva 1999] [Driva 2000] [Poh 2001] [Loch 2002] [Godener 2004] [Ojanen 2006].

II. 1. 2. Uncertainty and Risk Management

Scientific researches and several experiences have proven that innovation is an uncertain and risky process. Managers in order to bypass these features allocate considerable time and money. Technological innovation is not exempt from this condition when there is no guarantee for an idea to become commercially viable [Weitz 2002]. The sensitivity about the innovation

performance refers to the uncertainty feature of innovative activities [Dosi 1988] [Funtowicz 1994]. The uncertainty feature of the innovation beside considering the crucial role of innovation for the viability of companies compels them to a large investment for performing their innovation projects [Tsai 2009]. Although several methods have been developed and used to increase the business performance of innovation, most of them stress on the financial dimension [Hauschildt 2011] [Zahra 1993] [Cooper 1987]. Griffin 1996, and Hauschild 2004 confirmed that the innovation is a multidimensional process and its performance should be measured in different senses [Griffin 1996] [Hauschildt 2011]. Furthermore, reducing the risk and the uncertainty is an urgent matter for any organization. In this endeavor, all admit that among the different factors that foment uncertainty within the innovation projects (creative uncertainty, technological uncertainty, market uncertainty, regulatory uncertainty, social and political uncertainty, acceptance and legitimacy uncertainty, managerial uncertainty, timing uncertainty, consequence uncertainty), the greatest role belongs to the creativity and inventive activities [Jalonen 2011]. Moenart et al. 1995 conclusively expressed that the prosperity of innovation projects in the midst of R&D departments are based on the ability of reducing uncertainty during planning phase, i.e., the early stages of projects [Moenart 1995]. *Uncertainty* belongs to the risky cases in which there are not ability to assign the probability value to occurrences [Knight 1921]. This argues that [Fig.10]:

- Firstly, innovation managers need to eliminate *uncertainty* before setting the management of *risk* [Matthews 2009];
- Secondly, the elimination of uncertainty needs the ability of measuring the probability value of occurrences during innovation projects.
- Thirdly, the measurement and the evaluation of occurrences leads to calculate the probability values and to identify the indicators as the leverages in the hands of managers for decreasing risks.

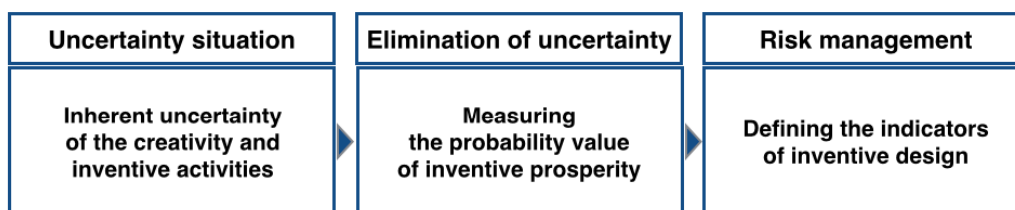

Fig. 10. The relationships between uncertainty, performance measurement, and risk management.

In this regard, 1) for knowing the inherent uncertainty of the creativity in inventive design, 2) in order to step toward eliminating the uncertainty in technological innovation, 3) and moreover to remove the indigence of the innovation management to identify and rank the innovation products, innovation projects, and innovation companies – in a national or international scope –, this research is consecrated to measure the performance of inventive design activities, and to define relevant indicators.

62% of respondents to our survey declared that they evaluate their design projects (c.f. Appendix C.).

II. 1. 3. Inventive Performance Metrics

Nowadays “performance metrics” is a scientific concept used for process improvements. “The performance of organizations”, is a well-known research topic since the 20th century [Neely 1999] [Kaplan 1996]. In this regard, performance, per se, had been defined differently according to what is used, as a generic term depending on the context of use [Pritchard 1990]. In the folk culture, performance signifies the action or process of performing a task or function [Oxford 2014]. In business management, the performance is about the current share value, and in the production management, the performance refers to the number of products that are produced in a given time and an expected quality. Despite numerous publications on *performance* issue – as keyword or in titles [Neely 1995] [Meyer 1994] [De Haas 1999] [Eccles 1991] [Bititci 2000] [Dixon 1966] [Lockamy 1998] [Montoya-Weiss 1994] [Shafer 2000] [Peters 2008] [Schmeisser 2010] [Suomala 2003] [Behn 2003], – the clear definitions of performance do not exceed more than the fingers of one hand [Cordero 1990] [Dwight 1999] [Neely 1996]. By these definitions, authors have studied and burnished the dimensions of performance and its related terms [Clark 1991] [Doz 1996] [Moseng 1993] such as efficiency, effectiveness, quality, productivity, adaptability, flexibility, and profitability [Doz 1996] [McDonough 1997]. However, the existing performance metrics are varied and mostly concentrated on economic dimension and financial elements [Chiesa 1998]. *Efficiency* and *effectiveness* are the common points of most definitions or characterization of *performance* in literature [Tab.6]. In some cases, they have been considered as the necessary and sufficient components of investigating *performance* [Mentzer 1991] [Grimshaw 2004] [Ostroff 1993]. In general, efficiency depends on the use of resources, and effectiveness is the attainment of objectives or goals [O’Donnell 2005]. Whereas the definitions of both terms – *efficiency* and *effectiveness* – may have various meaning in various disciplines [Pritchard 1990], here there – in design – their definitions are clarified. Gilbert 1980 [Gibert 1980], is the one who considered the *pertinence* as the third factor of the performance. In his definition, the performance is a core concept of the *efficiency*, the *effectiveness*, and the *pertinence* which describes the relationships between *goals*, *methods*, and *results* [Fig.11] [Gibert 1980] [O’Donnell 2005].

- *Effectiveness* is the degree to which the obtained results meet a desired goal (objective);
- *Efficiency* is the relationship between material gain and resources used;
- *Pertinence* verifies the appropriateness of tools, methods and other resources used to attain the goals;



Fig. 11. Triangle of performance. Source: [Gibert 1980].

Tab. 6. Different definitions of performance in literature;

Definitions of performance	Authors	Scientific context
Effectiveness (measuring output to determine if they help accomplish objectives) and efficiency (measuring resources to determine whether minimum amounts are used in the production of these outputs).	Cordero, 1989	R&D organization
The level to which a goal is attained.	Dwight, 1999	General
Efficiency and effectiveness of purposeful action.	Neely et al., 1996	Business
A complex interrelationship between seven performance criteria; effectiveness, efficiency, quality, productivity, quality, productivity, quality of work life, innovation, profitability and budget ability.	Rolstadas, 1998	Organizational system
Total product quality, Lead time and productivity (level of resources used).	Clark et al., 1991	Product development
Focus in development, speed of development and R&D efficiency.	Doz, 1996	Product development
Measuring; Development time, development productivity (use of resources) and total design quality.	Emmanuelides, 1993	Product development
Performance cossets of efficiency, effectiveness, and adaptability.	Moseng et al., 1993	Manufacturing
Performance is consists of time, cost, quality, and flexibility.	Neely et al., 1995	Manufacturing
The acquisition and analysis of information about the actual arraignment of company objectives and plans, and about factors that may influence this attainment.	Van Drongelen, 1997	General

The process of determining how successful organizations or individuals have been in attaining their objectives.	Sinclair et al., 1995	Organization
Ratio of clarification, risk reduction, detail, and documentation to costs.	Andeasen et al., 1987	Product development
A measure of how well resources are combined and used to accomplish specific, desirable results.	Griffin et al. 1982	General
A combination of efficiency and effectiveness.	Duffy, 1998	Engineering design
A combination of efficiency and effectiveness.	Goldschmit, 1983	Engineering design
Measuring the influence of all that contributes to achieve the objective.	Lorino, Demeestere et al. 1997	Management
Efficiency, effectiveness, and pertinence.	Gilbert, 1980	Engineering

The investigation on the performance metrics of inventive design is the aim of this contribution. Performance metrics generally derive from a process model for analyzing what has been done through process activities [O'Donnell 2005]. Thus, modeling inventive performance along design process, needs to investigate the creative and inventive activities. These activities are realized from an initial expression of needs to reach a solution model by which can support initial requirements [O'Donnell 2005]. Therefore, this study focus on what happens during inventive activities.

- What is inventive design activity? What is its nature? How can measure them?

Among the definitions of *performance*, Andreasen et al. [Andreasen 1987] are the only ones who explicitly linked design performance to the knowledge-based characteristics of design activities. Concerning the necessity for an alignment between design performance and the overall performance of innovation process, the following sections provide an overview of innovation, its concepts, inventive design, the relationships, and inventive activities, in order to give an understanding of research area, and pave the way for developing a method to measure inventive activities.

II. 2. Dissection of Innovation in Search of Inventive Activity

In this section, innovation is dissected with the aim of clarifying the characteristics of inventive design and activities along innovation process. This section highlights research problematic by providing an image of innovation management, product development, design and creativity, with their structure, applied systems, and methods in literature.

II. 2. 1. Innovation

In the present days, innovation is known as a competitive success key of high-technology firms [Lengnick-Hall 1992] [Brown 1995]. It is considered as the central core of the economic growth [OECD, 2005], or as a powerful weapon to ensure sustainable survival of any firm against high-frequency market changes and the short fast-cycle markets [Damanpour 1991] [Dougherty 1992] [Eisenhardt 1995]. The term *innovation* stems from the latin *innovatus* with the meaning of renewing and changing [OED 2015]. According to Schumpeter 1934, innovation is the implementation of new combinations with the sense of creating a new to be distinguishable from previous ones, or to break a monopoly position [Schumpeter 1934] [Hauschildt 2004]. It is the success of a challenge to put a different idea against the older ones in place [Van de Ven 1986]. The successful challenge means the successful exploitation of a new idea [Pryce 2005]. With the passage of time, the term *innovation* used in different sectors and turned into a catchall term for different activities in economy, technology, biology, policy, administration, art, etc. [Barnett 1953] [Damanpour 1991] [Dewar 1986] [Von Hippel 1995] [Piller 2004] [Utterback 2006] [Van de Ven 1986]. This widespread usage causes various definitions, interpretations and assessment methods depending on the contexts and the nature of activities [Garcia 2002] [Tab.7]. Perhaps this can explain why the related concepts to innovation were never defined in a standard way precisely [Eris 2006].

Tab. 7. The definitions of innovation in different perspectives;

Definition of innovation	Authors / Protocol	Context
Innovation is to do things differently in the realm of economic life.	Schumpeter, 1934	Business
An innovation is accompanied with the first commercial transaction involving the new product, process, system or device, although the word is used to describe the whole process.	Freeman, 1982	Business
Innovation involves the creation and marketing of the new technologies singly and in combination with a high uncertain process.	Kline and Rosenberg, 1986	Business
Innovation is the generation of creative ideas within a process for successfully implementing ideas.	Amabile, 1996	Product development
Innovation is a new way of doing things that is commercialized.	Porter, 1990	Business
Innovation is the generation of new combinations from existing knowledge.	Kogut and Zander, 1992	Business
Innovation is something that is new or improved done by an enterprise to create significantly added value either directly for the enterprise or directly for its customer.	Carnegie and Butlin, 1993	Product development
Innovation is the application of knowledge to produce new knowledge.	Drucker, 1993	Business

Innovation is an activity geared towards the generation and application of new knowledge.	Kalthoff et al., 1997	Product development
Innovation is new products or processes that increase value, including anything from patents and newly developed products to creative uses of information and effective human resource management systems.	Livingstone et al., 1998	Product development
Organizational innovation has been described as an idea, practice or object that is perceived as new.	Rogers, 2003	Organizational management
Innovation is the process of finding, making, and commercializing something new.	Tidd et al. 2005	Product development
Innovation is the implementation of a new or significantly improved product (good or service), or process, a new marketing method, or a new organizational method in business practices, workplace organization or external relations.	OECD, 2005	Business
Innovation is not a single action but a total process of interrelated sub-processes.	Trott, 2005	Product development
Innovation is a complex problem due to the incomplete information, diversity of required expertise, complexity of technologies and customer interfaces.	Chapman and Magnusson, 2006	Product development
Innovation is the creation of new products, processes, knowledge or services by using new or existing scientific or technological knowledge, which provides a degree of novelty either to the developer, the industrial sector, the nation or the world and succeed in the marketplace.	Galanakis, 2006	Product development

II. 2. 1. 1. Innovation Modes

Schumpeter 1934, divided innovations into five groups – new goods, new production methods, new markets, new resources, new organizations –, and consequently some others began to recognize innovation modes. Evan 1966, distinguished and defined *technological* and *administrative* innovations [Evan 1966], and further Utterback 1978, defined innovation as a *product* or *process* [Utterback 1978]. Edquist et al 2001, integrated these viewpoints and defined four modes for innovations [Tab.8]. They putted *technological* innovation of *products* and *processes* vis-a-vis the *administrative* innovation in *services* and *organizations* [Edquist 2001] [Edquist 2006]. The *Administrative* innovations are concerned with non-technological innovations for organizing social systems including services and organizational processes such as recruitment, tasks structuring, resources allocation, authority and rewards. Indeed the *administrative* innovations are about the coordination of human resources in services and organizational processes, without considering the technological components [Meeus 2006].

Tab. 8. Innovation modes according to Edquist et al., [Edquist 2001] [Edquist 2006];

Innovation Modes		Typology of Evan, 1966	
		Technological	Administrative
Typology of Utterback, 1978 [Utterback 1978]	Product	Product innovation	Service innovation
	Process	Process innovation	Organizational innovation

On the other hand, *technological* innovations for products and processes are defined as:

- “A technological product innovation is the implementation and commercialization of a product with improved performance characteristics such as to deliver objectively new or improved services to the consumers” [OECD 2005].
- “A technological process innovation is the implementation and adoption of new or significantly improve production or delivery methods. It may involve changes in equipment, human resources, working methods or a combination of these” [OECD 2005].

Boly 2004, described innovations with different visions as for economist, operating, knowledge engineering (cogniticien), systemic, sociologist, and biologist [Boly 2004]:

- Innovation in the *economist* vision is the introduction of a new product, process or service on markets successfully. The success in this definition is the sustainability in the economy of a company where the value creation is the capital, and the notion of market is to be used by client. New products should present a difference – more or less – in relation to existing products in term of price, functionality, usage, security, ergonomic, estimated value, etc. perceptible by user.
- Innovation with the *operative* vision is a transformation process of an idea to a new object. This transformation is realized along a linear or iterative (nonlinear) succession of stages.
- Innovation in the *knowledge engineering* is an integrated process of value creation when the determining factor is the restructuring of cognitive dimension of the individuals during the process. Here innovation is a rupture in production methods, mode of reasoning, or organizations for adopting a new practice.
- Innovation by the *systemic* vision is considered as a complex object. This vision is based on the systemic theory [Le Moigne 1990] that defines a complex object as a structure which is composed of several elements in multiple categories hierarchically. All these elements are in relation with different interaction types, and multiple variables of these interactions. By this innovation appears complex.
- Innovation with the *sociologist* vision implies inducing new – less or more – conflicted interrelationship between the concerned individuals of an innovation process in a company.
- Innovation in the *biologist* vision is an analogy between the alive world and the innovation world within industrial systems, economic activities, and environment.

What takes place in the scope of this research is the innovation of *technological products and processes* (TP/P) at the individual firms, with taking into account the *economist, operative* and *systemic* visions.

II. 2. 1. 2. Innovation Typology

The innovation typology is concerned with the qualification of innovation outputs. In most literature innovations have been identified in two major classes; *incremental*, and *radical* (disruptive) innovations [Fig.12] [Dewar 1986] [Freeman 1991] [Chakrabarti 1999] [Schilling 2005]. The *incremental* innovation is achieved through the modest improvement of an existing product or process (existing TP/P). This improvement includes a minor change of existing TP/P about their applied technology, performance, and price [subramaniam 2005]. An *incremental* innovation possesses a narrow technological progress on the same growth trajectory of existing technologies [Fig.12]. The *radical* or *disruptive* innovation signifies a major technological advancement of TP/P [Tushman 1986] [Ettlie 2006]. A *radical* innovation refers to those outputs that cause a major change on usage behavior [Boly 2004] [Leifer 2000] [Green 1995] [Dewar 1986]. A *radical* innovation appears by one or some design changes that differ largely a TP/P from the existing (older) TP/Ps (on a technological growth trajectory) [Fig.12]. A *radical* innovation may be a *breakthrough* in accordance to the change occurring in technical characteristics, and appears on a new growth trajectory (new generation). Identifying the *breakthrough* innovations are not clear in literature. However, the both innovation types are based on inventive activities but in different levels.

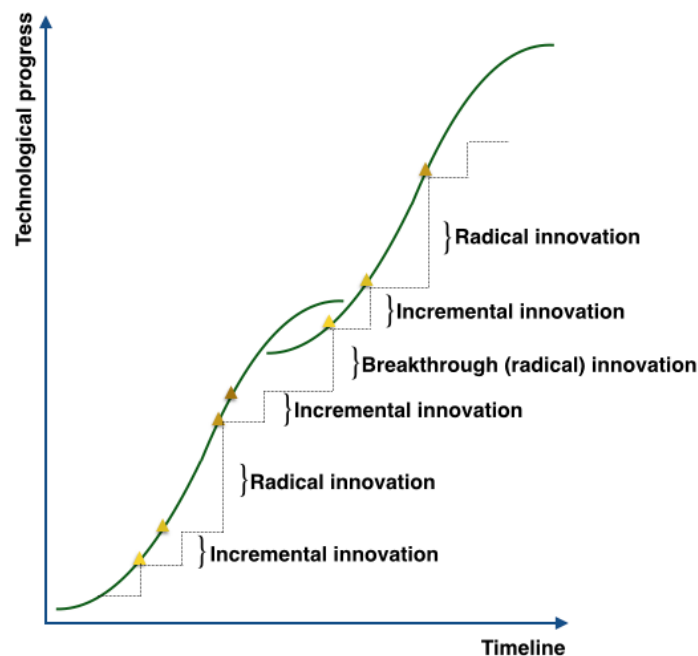

Fig. 12. The innovation typology on technological growth trajectories. Source: [Ait-El-Hadj 1989].

II. 2. 2. Technological Innovation Management

Schumpeter in 1930s was one of the first researchers who developed innovation management as a key factor of economic growth [Carroll 2006]. The innovation management has been developed to capacitate a firm for creating, inventing, and introducing new ideas industriously

[Kelly 1978]. Innovation management commonly refers to the planning and the organization of innovation process from idea to market launch [Bullinger 2008]. It includes the attempts of an organization to control and execute proper activities that lead to have innovation [Birkinshaw 2007] [Hamidizadeh 2013]. The management of technological innovation endeavors to reinforce and deploy creative capabilities in the organizations for promoting new TP/Ps [Clark 1980]. The mission of technological innovation management is also to cultivate a suitable environment for encouraging innovation through inventive activities [Godin 2008] [Boutellier 2008]. An effective management of innovation appears as competitive advantage in the markets [Tuominen 1999]. Innovation management in the literature is discussed within *strategic*, *normative*, and *operational* perspectives [Bullinger 2008] [Fig.13].

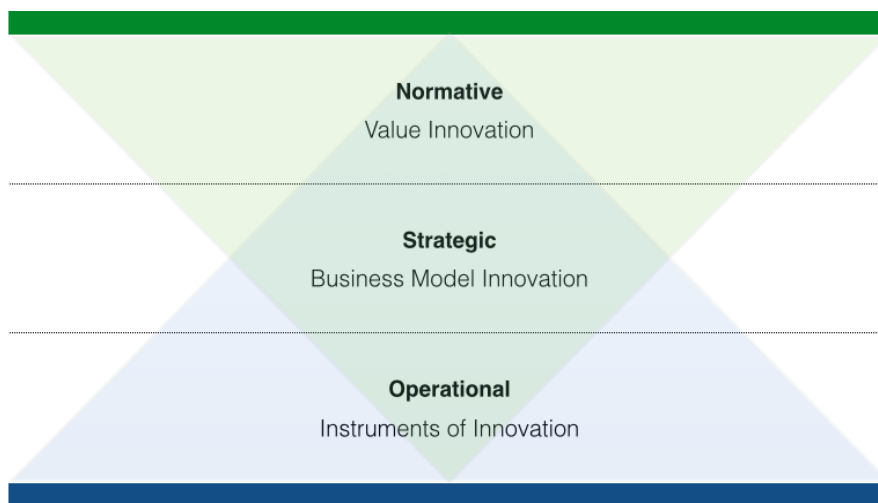

Fig. 13. Innovation management in three perspectives from external (on top) to internal (at bottom) layers.

- The *normative* aspect of innovation management is “to ensure the surviving of a firm through the preservation of its identity” [Bleicher 1994]. It helps a firm to explain its value, vision, mission, and strategic goals to communicate and stabilize firm’s identity [Breuer 2014]. The normative level of an innovative company is concerned with the mission statement, principles and the values assessment of the innovations or innovation projects [Bleicher 1994]. It functions as the foundation of activities [Bleicher 1994]. The installation of a corporate policy, a proper leadership style (governance), and an innovative culture are the central issues of this level that helps to promote a positive influence on the innovative activities and results [Getz 2003] [Breuer 2014]. This enhances the creativity and consequently the innovation capability particularly [Leonard-Barton 1998] [Takeuchi 1996]. The normative management tends to establish an organization for innovation through supplying a suitable standard for innovative, creative, and inventive activities, behaviors, communications, and interactions.
- Innovation *strategy* is the foundation of the innovation management [Van der Panne 2003]. It provides a global guidance for innovation projects, which has a strong relationship with the *business model innovation* (BMI) [Casadesus 2010]. The strategic level of innovation management is concerned with future orientation of companies about what should be

developed as new TP/P, seize market share, and compete with rivals [Khurana 1998]. It aims to direct inventive activities in accordance with the normative level by providing a suitable integration of target-market with an original (new) TP/P [Chesbrough 2003]. Organizational structures, strategic programs, problem-solving, and learning capability are developed in this level [Breuer 2014]. The strategic perspective deals with three management criteria [Tab.9] [Bullinger 2008]:

- Market orientation: Market orientation is the fundamental strategic criteria of innovation management. The success of an innovation project depends on the added value to what has been done by projects.
- Resource orientation: The strategic innovation considers new TP/P development as the departure point of the innovation processes. It is fed by knowledge, staff capabilities, methods and tools through an innovative organization.
- Integration: The success of innovation projects depends on the integration of resource-based with market-based viewpoints. The integration of these perspectives gives a holistic and strategic innovation management to the firms.

Tab. 9. The strategic criteria of innovation management;

Strategic criteria of the innovation management	Elements of the strategic innovation management
Market orientation	<ul style="list-style-type: none"> • Customers (target market) • Suppliers • Partners • Competitors
Resource orientation	<ul style="list-style-type: none"> • New Technological Products/Processes • Core competences: Methods, Tools, Techniques, Know how to do • Knowledge and Capabilities of human resources:
Integration	<ul style="list-style-type: none"> • Market-based • Resource-based

- *Operational* perspective of innovation management includes planning, organizing and controlling innovation process in the lowest layers [Bullinger 2008]. In this level of management, the objectives of normative and strategic perspectives are implemented through the innovation funnel from the idea generation until the concept development during the pre-development phase [Abernathy 1978] [Clark 1992] [Fig.14].

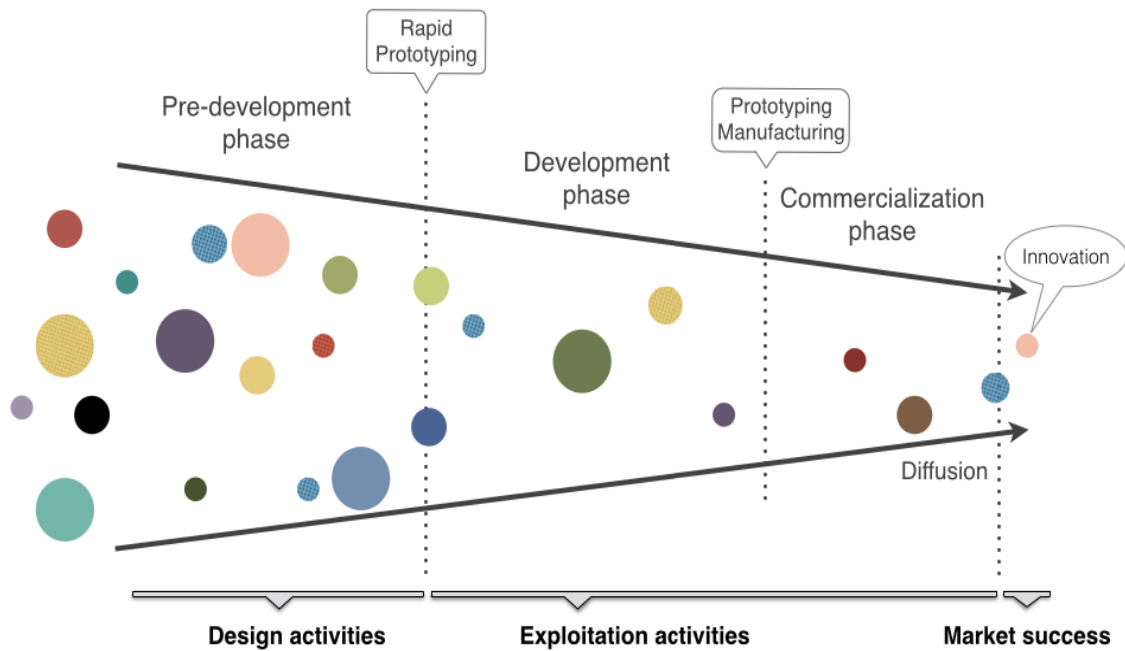

Fig. 14. The operational funnel of innovation for implementing normative and strategic objectives. Source: [Clark 1992].

This research is an effort to enrich the normative perspective of innovation management to provide the performance metrics of inventive activities along innovation projects.

The management of technological innovation is involved with research and development activities. Thus, it has been delimited with R&D management and technology management. Although recognizing the boundaries between them are blurred, Brockhoff 1999, discussed and illustrated the relationship and their common borders in his book [Brockhoff 1999] [Fig.15]. Technology management consists of *storage, acquisition* (external and internal), and *creation* of knowledge to dynamize the firsts stages of innovation process including research and development activities.

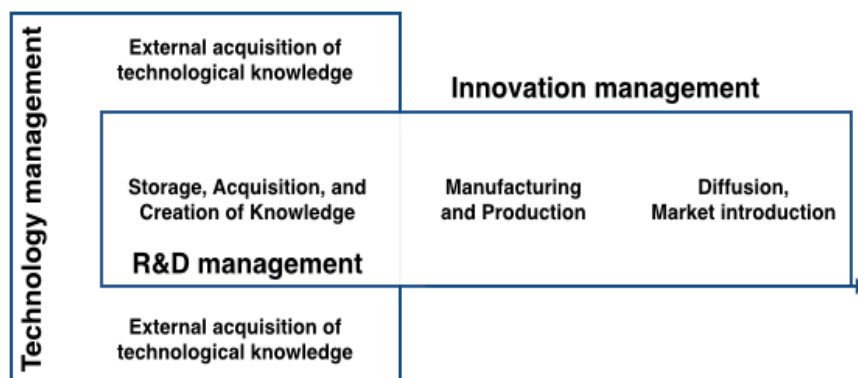

Fig. 15. Innovation management is involved with technology, research and development management. Source: [Brockoff, 1999].

57% of respondents to our survey have a specific department for R&D and others declared a technical office (c.f. Appendix C).

II. 2. 2. 1. R&D Management

The dynamism of business needs a continuous research and development (R&D) to renew and refresh technological competencies [Chiesa, 2001]. In the present-day, R&D is known as a key source of the innovation [Gupta 2007]. The importance of R&D management is caused by the increase of competition intensity for changing and creating rapidly [Rosenbloom 1996]. The dependency of companies' cost to R&D expenditures is another reason of highlighting R&D management. As a result, in general, R&D management is compelled to achieve innovations in a high-performance way. It aims to maintain and extend technological competitiveness of the firms [Bullinger 2008]. Historically, R&D management emerged 50 years after establishing the first R&D centers around 1900 [Brockhoff 1997]. An R&D is a specific unit, department, or center, belonging to a firm or an external organization – e.g. universities or consultants – that have to implement and manage the research and the development activities. R&D departments are on duty to drive business growth through performing innovative activities and develop new TP/P [Ettlie 2006].

II. 2. 2. 1. 1. R&D Activities

The R&D departments comprise any technologically related activities for extending present businesses or generating new ones, including competency development, and innovation [Matheson 1998]. R&D management is the responsible point of planning, designing and leading the innovation processes, where the tasks of innovation management meet the tasks of technology management [Chiesa 2001]. The R&D management in the technological firms includes a specific group of activities for developing new TP/P (new product developments). In the purpose of developing new TP/P, R&D is occupied by discovering and the creation activities to produce new scientific or technological knowledge. Planning, scheduling, research, execution, management, control, invention, and development are the R&D activities. According to Ettlie 2006, the term *research and development*, per se, includes three *uncertain* activity types [Ettlie 2006]:

- Basic research that signifies the investigation on scientific knowledge without commercial objectives;
- Applied research that signifies the investigation on scientific knowledge with commercial objectives;
- Development that signifies product development based on existing knowledge;

Brockhoff 1999, summarized the joint activities between R&D management and technology management in the storage, acquisition, and creation of knowledge [Brockhoff 1999]. In different industries, although the emphasis on the development activities is more than research activities (an estimated 70 to 90% of the R&D budget), there is not a hierarchic importance regarding their contributions to innovations [Jaruzelski 2005]. In fact, they are seen as one unit to facilitate the access of the whole R&D process to data and information [Roussel 1991].

II. 2. 2. 1. 2. R&D Management Models

Numerous researches has been done on the R&D departments – between 1950 and 1990 – to find best practices of R&D and innovation management [Hamidizadeh 2013]. Although the models derived from these efforts gradually have become more complex, more interdisciplinary and more integrated [Eveleens 2010], none of them could claim as the perfect model with considering all the aspect of innovation management. Since the relative importance of these models have been varied over different periods of time [Miller 2000] (due to the difference of business needs over the time), Rothwell 1994, categorized all the suggested practice in five generation types [Rothwell 1994] [Tab.10]:

- First generation is *technology-push* mode with the assumption that technology is the propellant of innovation [Rothwell 1994]. Here, the innovation projects focus on scientific discoveries and inventions. Thus, technology expansion has become the first priority of these models. Models of the first generation are based on this ideology that “coming more research and development in” results “more successful new TP/P out”. The models are a simple linear sequential process including research, engineering, manufacturing, and marketing [Rothwell 1992] [Rothwell 1993].
- Second generation is *market-pull* mode with the orientation for market needs [Nobelius 2004]. These models include a simple linear sequential process that emphasizes on market investigation. In other word, market is the motivation of new idea generations, which directs R&D trajectory. They need to a market research continuously for identifying market demand based on customer needs, and competitors [Rothwell 1992] [Rothwell 1993].
- Third generation is a *coupling* mode through the combination of *market-pull* and *technology-push* modes, which includes the advantages of both the first generation models. This signifies *research*, *development*, and *marketing* are more in balance. These models are sequential with considering feedback loops from later to earlier stages. They need the interfaces to integrate research, development, and marketing well. What is new in the third generation unlike the previous generations is the decision-making, which was tacit in the previous models [Rosenberg 1979] [Rothwell 1992] [Rothwell 1993].
- Fourth generation as *interactive* mode, considers the integration of R&D activities with organizational innovation. The models are equipped with an interactive approach for considering innovation process as parallel activity across organizational function [Nobelius 2004]. In fact, the emphasis is on the integration of R&D activities and manufacturing. These models attempt to capture high degree of cross-functional integration within R&D departments. The integrated or parallel models are used firstly in Japanese automobile companies [Rothwell 1992] [Rothwell 1993].
- Fifth generation as *network* mode, includes those models that characterize a network R&D. The models of this generation emphasize on the influence of external environment to ensure an effective communication. Indeed, innovation occurs within a network of internal and external stakeholders’ activities. The horizontal linkages in these models are joint venture, collaborative research groupings, collaborative marketing arrangements, and etc. So what is important is the flexibility and the speed of development activities [Cooper 2001] [Nobelius 2004] [Davenport 2013].

Tab. 10. The categorization of R&D management models in five generation types by Rothwell 1994 [Rothwell 1994];

R&D Management Mode	Prevalent throughout	Related context	Characteristic
First generation	1950 to Mid-1960s	Black hole demand	Technology-push oriented
Second generation	Mid-1960s to Early-1970s	Market shares battle	Market-pull oriented
Third generation	Mid-1970s to Mid-1980s	Rationalization efforts	Coupling technology and market orientation
Fourth generation	Early-1980s to Mid-1990s	Time-based struggle	Interactive with organizational innovation
Fifth generation	Mid-1990 onward	Systems integration	Involving in a network

II. 2. 2. 2. Technology Management

Technology management is to understand the value of a certain technology for organizations [Phaal 2004]. Technology comes from τέχνη – *techne* – in Greek, that means art, skill, or cunning of hand [EIEG 1986]. In 19th century the term *technology* is referred to the description or the study of the useful arts, i.e. technical education [Constable 2003] [George 1948]. By the second industrial revolution 1950s, it was not only used for learning industrial arts, but also used for developing TP/P [Crabb 1833]. Despite existing numerous definitions for *technology* in literature, all agree that the technology is a specific type of knowledge. The key characteristic of this specific knowledge is applied regarding to the *know-how* in the organizations [Phaal 2004]. With this perception, technology refers to the tools or the machines that use for solving real-world problems. Technology is the knowledge of how to combine resources to produce – virtual or physical – desired TP/P, for fulfilling needs, solving problems, and satisfying human wants. According to these definitions, technology management is defined as the effective identification, selection, acquisition, development, exploitation and protection of technologies [EITM 2014]. The technology management is relevant to strategy development, innovation, new product development (NPD), and operation management [Phaal 2004]. The emergence of a new technology (TP/P, innovation, or knowledge) is managed by R&D activities along the innovation processes [Brockhoff 1999]. Thus, it can be expressed that R&D management is a part of technology management. Typical concepts of technology management are technology strategy, technology forecasting, and technology roadmap;

- *Technology strategy* is about the identification, selection and application of technological resources into business strategy [Matthews 1992]. It should be considered as an integral part of business planning [Manning 1997] [Dussauge 1992].
- *Technology forecasting* is for studying 1) the changes occurring in new technologies, and 2) technology market demand. In other words, as the first function it helps to present the value of – incremental or radical – changes appearing in new technologies. As the second function, it helps to verify the value of investment and innovation level according to market

potential [Bower 1996]. Studying the technology forecasting gives an evolutionary reconfiguration analysis in three socio-technical views [Rip 1998] [Rip 2001]:

- Macro: evolving socio-technical landscapes;
- Meso: a patchwork of regimes;
- Micro: novel configurations;

These studies are illustrated and presented in term of the technology S-curves. Top of the S-curves represents the technologies compete in a turbulent environment until emerging a new dominant design [Fig.16].

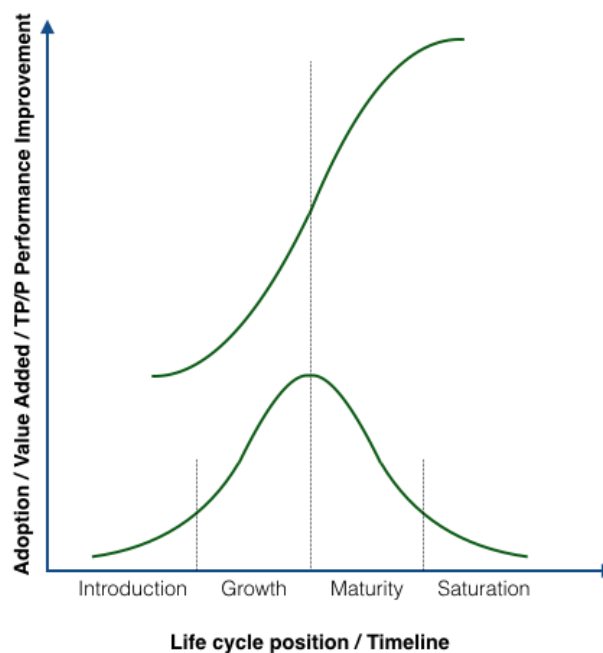

Fig. 16. The S-curve of technology forecasting as for market demand, and performance improvement of a TP/P.

- *Technology road-mapping* explores the relationship and dynamism of linkages between resources, objectives, and the changes of environment for supporting technology management [Phaal 2004]. A technology roadmap plans R&D vision on a time-based chart [Martinich 2008].

II. 2. 3. Technological Innovation Process

Innovation process is the main element of innovation management. It is used to expatiate activities, and to standardize their sequential ordering [Verworn 2002]. The process of technological innovation, in literature, is often illustrated as a transition funnel for transforming new ideas into marketable TP/P at the end of the process [Draghici 2000] [David 2004] [Fig.14]. The innovation process commonly depends on different expertise workgroup because of including various activities; market research, industrial design, R&D, engineering, manufacturing, production, marketing and sale [Cooper 1983]. Technological innovations are realized along a linear or iterative process with a succession of activities. The main limit of innovation processes is time [Loilier 1999] [Perrin 2001] [Le Masson 2006] [Boly 2004] [Utterback 1975]. The OECD 1991 defined the technological innovation as “an iterative process

initiated by the perception of a new market and/or new service opportunity for a technology-based intervention which leads to development, production, and marketing tasks striving for the commercial success of the invention” [OECD 1991]. This definition implies the exigency of invention along innovation process. Freeman 1973, described innovation process through technical, industrial, and commercial phases [Freeman 1971]. The technological innovation is interpreted as the new product development (NPD) projects for mentioning design and development activities along the process. Accordingly, it can be said that a successful technological innovation is based on the capability of NPD to bring rapidly a new TP/P to the market and satisfy user expectations [Clark 1992]. Kahn et al., 2005 defined the NPD as “a disciplined and defined set of tasks and steps that describes the normal means by which a company repetitively converts embryonic ideas into salable products or services.” [Kahn 2005]. However, it’s true that NPD succeeding depends on the achievement of predetermined goals successfully by introducing and adopting a new TP/P in the marketplaces (c.f. II.2.1.1). In order to improve a process, it is wise to break the whole process into smaller stage of activities. This gives a focus on activities to conduct well by ensuring an effective control on time and cost wasting and achieving an expected quality [Du Preez 2008] [Hamilton 1982]. The quality of technological innovations strongly depends on the quality of NPD process and how to order the process stages for developing ideas [Du Preez 2008]. NASA in the 1960s developed “Phase-review-processes” as the first multi-stage process model for NPD [Hughes 1996]. In this process model, marketing activities were neglected and the objective was based to ensure task accomplishment, and to reduce uncertainty during the process [Verworn 2002] [Fig.17].

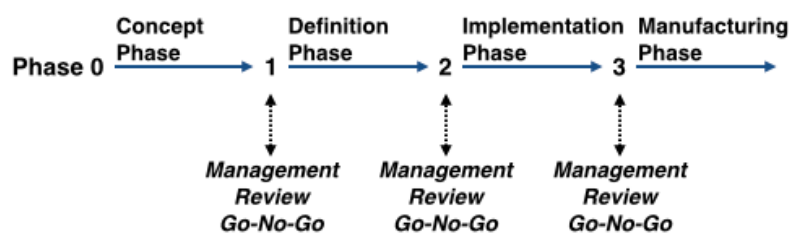

Fig. 17. The Phase-review-process model for NPD. Source: [Hughes 1996].

Later Myers et al. 1969, Rothwell et al 1974, and Cooper 1979, continued the NPD multi-stage characterization except that for describing the process they focused on the success factors of the NPD process and so completed the process statement up to the commercialization phase [Myers 1969] [Rothwell 1974] [Cooper 1979] [Cooper 1983] [Tab.11]. Although several models with a various number of stages had been developed and proposed to prepare a best practice along NPD process [Kuczmarski 1992] [Rosenau 1996] [Ulrich 2003] [Crawford 1994] [Hughes 1996], the logic of all of them were similar according to the nature and the progression of activities over the course of the process [Urban 1993] [Crawford 1994] [Veryzer 1998] [Tab.11].

Tab. 11. Different models of NPD process;

Author / Institution	NPD Process Model
Booz et al., 1968	New product strategy —» Idea generation —» Screening evaluation —» Business analysis —» Development —» Testing —» Commercialization

Meyers et al., 1969	Recognition —» Idea formulation —» Problem-solving —» Solution (Invention) —» Utilization and diffusion
RIBA, 1973	Inception —» Feasibility —» Outline proposals —» Scheme design —» Detail design production information
Urban and Hauser, 1980	Opportunity identification —» Design —» Testing —» Launch —» Life cycle management
Hubka and Eder, 1982	Elaboration of assigned problem —» Conceptual design —» Layout design —» Detailed design
Cooper, 1983	Idea —» Preliminary assessment —» Concept —» Development —» Testing —» Trial —» Launch
Freeman, 1983	Need —» Analysis of problem —» Conceptual design —» Embodiment design —» Detailing
Crawford, 1984	Strategic planning —» Conceptual design —» Pre-technical evaluation —» Technical development —» Commercialization
Cooper, 1986	Ideation —» Preliminary investigation —» Detailed investigation —» Development —» Testing and validation —» Full production and market launch
Andeasen and Hein, 1987	Recognition of need —» Investigation of need —» Product principle —» Product design —» Product preparation —» Execution
Cooper et al, 1990	Idea —» Gate1 —» Preliminary assessment —» Gate2 —» Definition —» Gate3 —» Development —» Gate4 —» Validation —» Gate5 —» Commercialization
Pugh, 1990	Market —» Specification —» Concept design —» Detail design —» Manufacture
Henry & Walker, 1991	Conception —» Invention —» Exploitation
Thom, 1992	Idea generation —» Idea acceptance —» Idea implementation
Elbert et al., 1992	Problem analysis —» Idea generation —» Idea assessment and selection —» Development —» Transfer and launch
Hales, 1993	Idea —» Need —» Proposa —» Brief —» Task clarification —» Concept design —» Embodiment design —» Detailed design
Fox, 1993	Pre-concept —» Concept —» Design —» Demonstration —» Production
Clausing, 1994	Concept —» Design —» Prepare —» Produce
Rozenburg and Eekels, 1995	Analysis —» Concept —» Materialization

Baxter, 1995	Assess innovation opportunity —» Possible products —» Possible concepts —» Possible embodiments —» Possible details —» New product
Ulrich et al., 1995	Concept development —» System-level design —» Detail design —» Testing and Refinement —» Product ramp-up
Ford, GM, Chrysler, 1995	Plan with program definition —» Product design & development —» Process design & development —» Validation —» Launch
BAA plc, 1995	Inception —» Feasibility —» Concept design —» Co-ordinated design —» Production information
Pahl and Beitz, 1996	Clarification of task —» Conceptual design —» Embodiment design —» Detail design
Pleschak et al., 1996	Idea generation —» Idea assessment —» Development —» Rollout to production —» Launch
McGrath, 1996	Concept evaluation —» Planning and specification —» Development —» Test —» Release
Hugher et al., 1996	Concept phase —» Definition phase —» Implementation phase —» Manufacturing phase
Ullman, 2002	Identify needs —» Plan for design process —» Develop engineering specifications —» Develop concept —» Develop product
Blanchard, 2004	Detailed design and development —» Construction —» Production
Cooper, 2005	Scoping —» Build business case —» Development —» Testing and validation —» Launch
Calantone, 1988	Theoretical design —» Technical innovation —» Commercial exploitation
Industrial innovation process, 2006	Mission statement —» Market research —» Idea phase —» Concept phase —» Feasibility phase —» Pre-production
Design council, 2007	Discover —» Define —» Develop —» Deliver
Cross, 2008	Clarifying objectives —» Establishing functions —» setting requirements —» determining characteristics —» Evaluating and generating alternative —» Improving detail

In 1990, Cooper promoted his primary NPD process model and proposed the *stage-gate* model with considering practical conditions – called “*game plan*” – unlike the existing conceptual models at that time [Cooper 1990] [Fig.18]. Considering the evaluation gates between process stages in the *stage-gate* model convinced some others to accept the *stage-gate* as a generic model for describing NPD process [Rosenau 1996] [Connor 1994] [Fig.18].

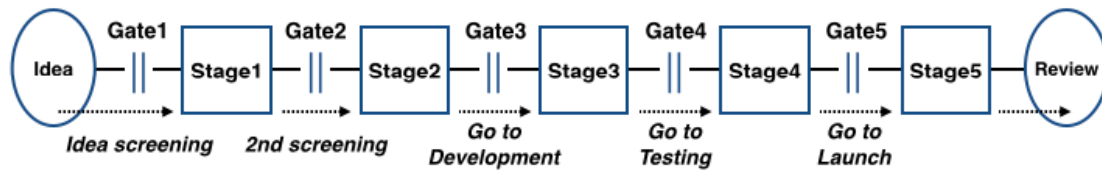

Fig. 18. Typical 2nd generation of the Stage-gate process. Source: [Cooper 1990].

The *stage-gate* model was considered as a standard to model innovative activities for facilitating the analysis and organizing project interactions as a robust ideas-to-launch system. An empirical study in the industries illustrates that the implementation of the *stage-gate* based models helps to systematize, clarify and define all functions that are involved with technological innovation processes [Verworn 2002] [Cooper 2014]. The *stage-gate* model as a conceptual-operational map describes the process in a multi-stage form with the evaluation gates [Cooper 2014] [Fig.18]. Cooper explains the *stage-gate* model as a tool for managing and improving the efficiency and the effectiveness of innovation process [Cooper 2014]. Generally, the stage-gate framework helps to ensure the quality of innovation by enforcing decision-making in its reviewer gates [Du Preez 2008]. The *stages* are composed of a set of required or recommended – best-practice – activities needed to progress a project to a next gate. A *stage* is where project team undertakes the work, obtains needed information, does a data analysis and integration, and prepares deliverables for sending to the related *gates* [Cooper 2014]. In following each *stage*, there is a *gate* that behaves as a go/kill decision point. The *gates* make decision to continue the process advancement or sending back delivered results. Also they can decide to kill projects. The *gates* serve quality-check, and prioritize decisions. A *gate* is the examination point with a composition of pre-defined quality criteria waiting to be fulfilled [Du Preez 2008]. All gates' structures are similar that consist of [Cooper 2014]:

- *Deliverables*: What a *gate* receives from the last stage – as the result of a set of completed activities – for decision-making. The deliverables should be in accordance with the predetermined menu of project gates.
- *Criteria*: What a *gate* considers to judge the deliverables for decision-making. Cooper categorized the gate criteria in *Must-Meet* – those that the lack of them weeds out misfit deliverables (project) quickly – and *Should-Meet* – those that as desirable factors prioritizes deliverables (projects) – types.
- *Outputs*: What a *gate* decides – to Go, Kill, Hold, or Replace – for deliverables with an approved action-plan to the next stage (forward or backward sequentially).

Equally, a NPD model starts by concept generation, continues through pre-technical and technical developments, and be finished by commercialization [Crawford 1994] [Griffin 1996]. Common definitions of different stages and gates along a NPD process are [Cooper 2011] [Fig.18]:

- Stage zero: or the *ideation* stage is the main feedstock of NPD process [Cooper 2011]. The idea generation is the trigger source of blowing new ideas along the process. It undertakes the generation through inventive methods with considering strategic plan, user needs, and opportunities. Sometimes it is called *discovery* stage because of its uncovering and revelation features [Cooper 2011]. New ideas are generated by internal (project team) or external (customer or supplier in open innovations) sources. In some cases, new ideas are generated by chance without considerable concentrated research, and in some others they occur by the allocation of a certain creative (inventive) thinking times, problem-solving activities, and brainstorming [Du Preez 2008]. This signifies that the *ideation* strongly relies on team's knowledge that needs a formalized knowledge supply chain to support this stage. Some crucial knowledge groups for the idea generation are [Du Preez 2008]:
 - Understanding current problem and problem area in business;
 - Competitor analysis;
 - Recognition of user, consumer, client;
 - Information about new technologies;
 - Knowing project strategy;
- Gate 1: or the *idea screening* gate is the first decision point that includes the criteria for verifying strategic alignment, idea advantage, project feasibility, market attractiveness (magnitude of opportunity), market growth forecasts, available resources, and company policies. Removing unsound concepts before devoting firm's resources is the first purpose of the screening gates. Financial criteria are not verified in this evaluation point [Cooper 2011].
- Stage 1: or the *concept definition* stage aims to prepare a quick scope definition of new ideas. The focus is to transform generated ideas into a workable concept [Du Preez 2008]. The stage1 includes primary activities for ideas assessment with technical, marketing and business criteria. Here, technical feasibility analysis of selected ideas in gate1 are more important than financial feasibility analysis. Normally it is the first stage of the process that needs to spend more [Cooper 2011].
- Gate 2: the *concept screening* gate is a repeat of gate1 except that gate2 considers technical and financial criteria briefly – e.g. technical feasibility and payback period – for removing unsound concepts before starting the next expensive stages. This gate makes a more precise decision in compare of the analysis of the deliverable information in gate1 [Cooper 2011].
- Stage 2: or *building the business case* or *concept testing* stage is the step before the *development* stage. It concentrates to prepare activities on a detailed investigation in which the final TP/Ps are clearly defined. This stage justifies projects through a feasibility study and a detailed planning. Because of the final analysis by this stage, it has also been known

as the *concept feasibility and refinement* stage [Du Preez 2008]. The keyword of this stage is taking additional information before starting the development phase. The key activities of this stage are [Cooper 2011]:

- A detailed technical appraisal on the technical feasibility of concepts;
 - A concept testing to give an elementary validation on the product concept;
 - A manufacturing appraisal including resources and operations estimation;
 - A market research with a competitive or strategic analysis, and target market definition;
 - A business and financial analysis with the sensitivity on possible downside risks;
- Gate 3: This gate is the last decision point before *going to development* or production stage. The gate3 repeats the evaluation by the criteria of gate2, much more rigor, and according to more solid information. The *development* stage normally is the most expensive stage of the process and this highlights the importance of gate3. Development, manufacturing, production, and marketing are what will start by the permission of gate3 to *Go* [Cooper 2011].
 - Stage 3: or the *development* stage is where the development plan is implemented. It includes the actual detailed design and development of new concepts. Generally development stage is the most expensive stage of NPD process. It can be comprised of numerous milestones or periodic sub-projects [Cooper 2011].
 - Gate 4: or *Go to testing* gate as a post-development reviewer checks the deliverables, the progress and the attractiveness to continue NPD projects. The deliverable is internally-tested prototype of a selected concept after the development and engineering. Logically the criteria of gate4 are consistent with the definitions that specified at gate3. The decision-making in this gate is for going to verification and validation in the next step that commands immediately for the industrialization and launch to the marketplaces [Cooper 2011].
 - Stage 4: or *testing and validation* stage includes the tests and trials in lab, industry, plant or marketplace, to verify what has been developed in the development stage. The verification should lead to validation of new TP/P for exploitation (industrialization), and marketing [Cooper 2011].
 - Gate 5: or *Go to launch* gate is the final gate of NPD process, which permits for full commercialization process. It is the last point to kill project before starting the industrialization, marketing, and selling the developed concepts. According to the focus of stage4 on the quality of verification and validation, the gate5 focuses on the expected financial return and appropriateness for starting next stage [Cooper 2011].

- Stage 5: or *launch* stage is the commercialization step of the process. This stage considers full operation of exploitation (industrial), production (industrialization that may be implemented as a one-off, batch or mass production), operational marketing, and selling. It is executed by a well throughout plan of action.

After the commercialization (*launch*) stage, NPD projects are deemed to be terminated, and R&D management is involved with the *post-launch review* step for verifying project performance by taking the latest project data such as revenues, costs, expenditures, profits, timing, consumed resources, and human resources. These data are compared with project goals, firms strategy, and the criteria of the gates 2 and 3 [Cooper 2011] [Fig.18].

Nowadays, a number of firms benefit from such NPD models adapted to their activities' nature. In this circumstance what has preoccupied firms' managers is around two interdependent questions:

- How to measure the performance of NPD projects?
- How to enhance the performance of NPD project?

Since TP/P life cycles has been shortened and competitive markets are changing fast, the technology-based companies have to convert new technologies into innovative TP/P as quickly as possible [Verworn 2001]. In most studies, time reduction, cost reduction, and increasing quality have been introduced as the advantages of adopting NPD models [Hamilton 1982] [Cooper 1986]. However, the lack of focus on the quality, and a detailed market study, has been diagnosed as the main issues that suffer innovation projects. Some studies on innovation, inappropriately, tried to implement the operational management and/or the quality management methods – such as the *six-sigma* or the *lean manufacturing* – for innovation process, however they were bootless for such idea fertilization process [Hindo 2007]. On the other hand, some others tried to conduct problem-solving activities. The most significant weakness of these studies is the failure to observe NPD process as a robust *idea-to-launch* process. They had been developed to take a problem and converge upon a solution, regardless of the fact that problem-solving activities are divergent based on the right brain behavior and the creativity [Hindo 2007].

By the time, the early stages of innovation process obviously were found to be of a great particular importance compared with the next stages. The influence of early stages – including all the early stuffs before development – is not negligible at all on all the rest steps of NPD process [Bullinger 2008] [Cooper 2014] [Fig.19].

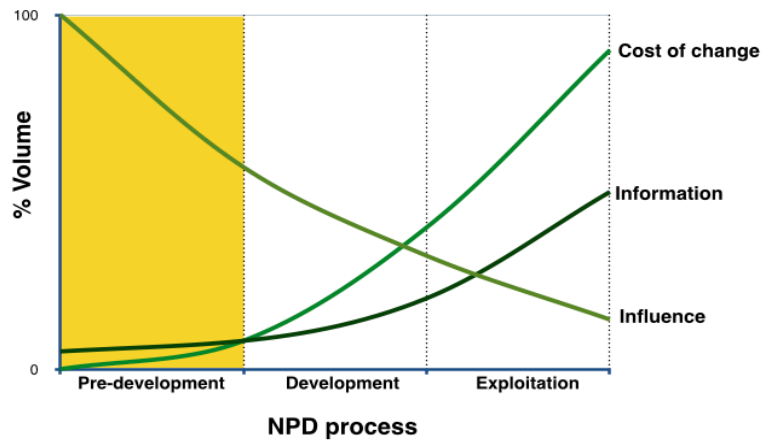

Fig. 19. Total influence, the cost of changes, and the volume of information along NPD process. Source: [Bullinger 2008].

Several researchers unanimously acclaimed the importance of the early stages of innovation process. High failure rate of innovation projects is referred to insufficient managerial attention, low performance, and poor financial support during the early stages of innovation process [Cooper 1988] [Verworn 2001]. 80 percent of total project costs are influenced by the early stages or the first 20 percent of the NPD processes [Bullinger 2008]. The lack of a reliable assessment to make proper decisions during the early stages also is a dilemma facing to risk reduction of the whole project [Koen 2001] [Fig.20] [Fig.21]. It's why the early stages are known as *pre-development* stages [Cooper 1993], *pre-project* [Verganti 1997], and/or *pre-phase* [Khurana 1997] [Khurana 1998] along NPD process.

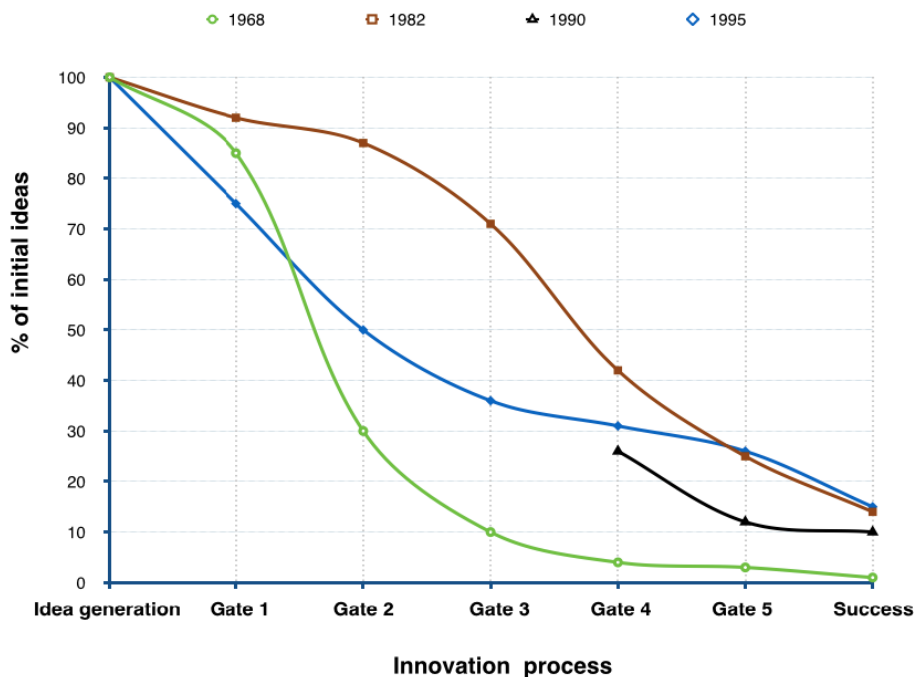

Fig. 20. New ideas mortality curve along NPD projects. Source: [Griffin 1997].

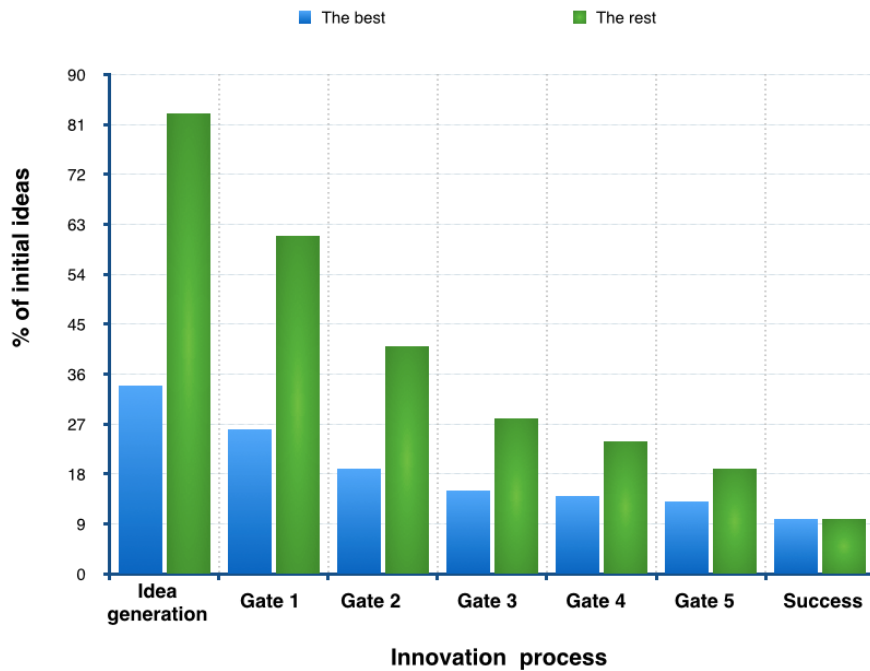

Fig. 21. New ideas mortality curves along NPD projects: the best versus the rest practices. Source: [Griffin 1997].

For maximizing the performance of NPD process, scientific efforts should concentrate on the early stages [Cooper 2001]. In this regard, Wheelwright and Clark (1992) expressed that more successful innovative companies in a universal and dynamic competition are those that [Clark 1992]:

1. profit from a structured NPD process;
2. emphasize on the early stages of NPD process;

Systematically structuring the earlier stages is one of the success factors of industries [Cooper 1992] [Montoya-Weiss 1994]. Enhancing the performance at the early stages allows better allocation of resources which consequently reduces project costs [Cooper, 2001]. In recognition of this fact, an extensive empirical study by Cooper et al. 1994, shows that the greatest differences between winners and losers is the execution quality of pre-development phase [Cooper 1993]. In other words, having more proper ideas promises more successful future for companies. In this regard, although several efforts tried to prepare a sustainable flow of ideas along the early stages [Boeddrich 2004], the low performance still is the greatest weakness of pre-development phase [Khurana 1997].

A technological innovation process is fed by ideas, scientific discoveries and inventions that are the results of creative, inventive or rational thinking process [Ferney-Walch 2006] [Gartiser 1999]. Dealing with the creativity, cognition, thinking and generally psychological sciences causes a limited scientific attention on the early stages. This leads to have an unstructured phase at the beginning of NPD models. Despite the exigency of a good idea generation for making successful projects, the pre-development phase including *ideation*, *concept definition* and *selection* lacks a well-defined structure, reliable information, and proven decision-rules [Schulze 2008] [Goldenberg 1999]. Smith et al 1991, used the term *fuzzy front end* for the pre-development phase, which emphasizes on the *fuzziness* feature of this phase [Smith 1991] [Dahl 2002].

II. 2. 3. 1. Fuzzy Front End Phase

The *fuzzy front end* (FFE) phase is the messy period at the beginning of innovation process. A pre-phase for planning the development phase [Koen 2001] [Verworn 2001]. It's where new ideas are generated and new concepts are formulated as the inventions [Moenaert 1995] [Wilemon 2002]. The term *fuzziness* illustrates the uncertainty feature of this phase that implies an ambiguity about the performance, required resources, the quality of activities, and idea generation. Whatever the subsequent phases of NPD process are structured, predictable, and formal, with a prescribed set of activities, the FFE activities are often chaotic, unpredictable, and unstructured [Kahn 2005] [Boeddrich 2004] [Tab.12]. By taking approval decisions at the end of FFE phase and starting development phase, the fuzziness level of activities descend significantly [Fig.22]. The fuzziness of earlier stages refers to the nature of their activities.

Tab. 12. The characteristics of the FFE phase and the development phase. Source: [Wilemon 2002];

NPD factors	Characteristic	
	at the FFE phase	at the development phase
State of an idea	probable, fuzzy, ease to change	clear, specific, difficult to change
Feature of information for decision-making	qualitative, informal and approximate	quantitative, formal and precise
Outcome	blueprint	technological product or process
Width and depth of the focus	broad but thin	narrow but detailed
Ease of rejecting an idea	easy	more difficult
Degree of formalization	low	high
Personnel involvement	individual or small project team	a full development team
Budget	small/none	large designated
Management methods	unstructured, experimental, creativity needed	structured, systematic
Visible damage if abandoned	usually small	substantial
Commitment of the CEO	none or small	usually high

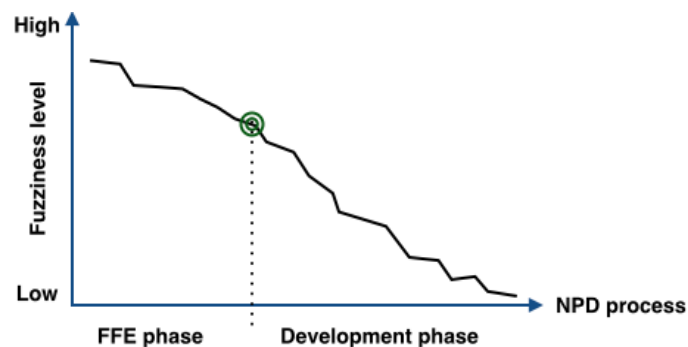

Fig. 22. The fuzziness level along NPD process. Source: [Wilemon 2002];

II. 2. 4. Engineering Design

The *engineering design* is one of the historical phrase to differentiate *technological* design from design in art, architecture, or briefly *non-technological* design. The word *design* per se, is not a very clear term in meaning and its contents. In the American heritage dictionary it has defined as “to conceive of fashion in the mind; invent” or “to formulate a plan” [AHD 2014]. The juxtaposition of this translation and the term *engineering* – as “the application of scientific and mathematical principles to practical ends such as the design, manufacturing, and operation of efficient and commercial structures, machines, processes, and systems” [AHD 2014] – may complete the definition of *engineering design*. In many definitions, the engineering design is considered as a set of sequential activities within one or a set of processes. A design is done by design activities based on the knowledge of actors. Design activities are realized by designers from a preliminary definition of TP/P toward a detailed definition step by step [AFNOR 2002]. In design studies, various models has been developed with different purpose to precise what are design activities. Some models propose a classification of activities in an organizational process. Some of them focus on the nature of activities. And some others explain the design thinking with considering technical characteristics of TP/P in a minor way [Lonchamp 2004]. Overall, the approach of design models can be categorized as *descriptive* and/or *instructive* models.

II. 2. 4. 1. Instructive Design Models

Pahl and Beitz 1996, Ulrich an Eppinger 2000, Ullman 2002, Pugh 1990 have described and modeled design process through multiple successive stages [Pahl 2013] [Ulrich 2000] [Ullman 1992] [Pugh 1990]. These models are known as the organizational models to carry forward design projects. Although the instructive models are different in relation to their structure and terminology, their logic are very similar. In general, a design process consists of four instructive stages as; the clarification of the tasks, conceptual design, embodiment design, and detailed design. Among these four stages, two front end stages belong to the FFE phase and two back end stages belong to the development phase [Fig.23]. The FFE stages are:

- *Planning and clarifying the task* consists of a market analysis, firm situation analysis, finding and selecting ideas, formulating generated ideas, clarifying the task, and elaborating a requirement list (design specification) as the output of the stage. It gives a definition of idea for establishing technical and economic specifications of project.
- *Conceptual design* is a stage for developing the principle solution. The formulation of a solution concept from an idea is carried out in this stage. The activities consist of identifying essential problems, establishing functional structures, search for working principles and working structures, combination and firm up into concept variants, and evaluation against technical and economic criteria. This stage uses problem-solving, functional analysis, and other sub-processes to define an idea as a solution concept. The output of this stage is the concept or principal solution.

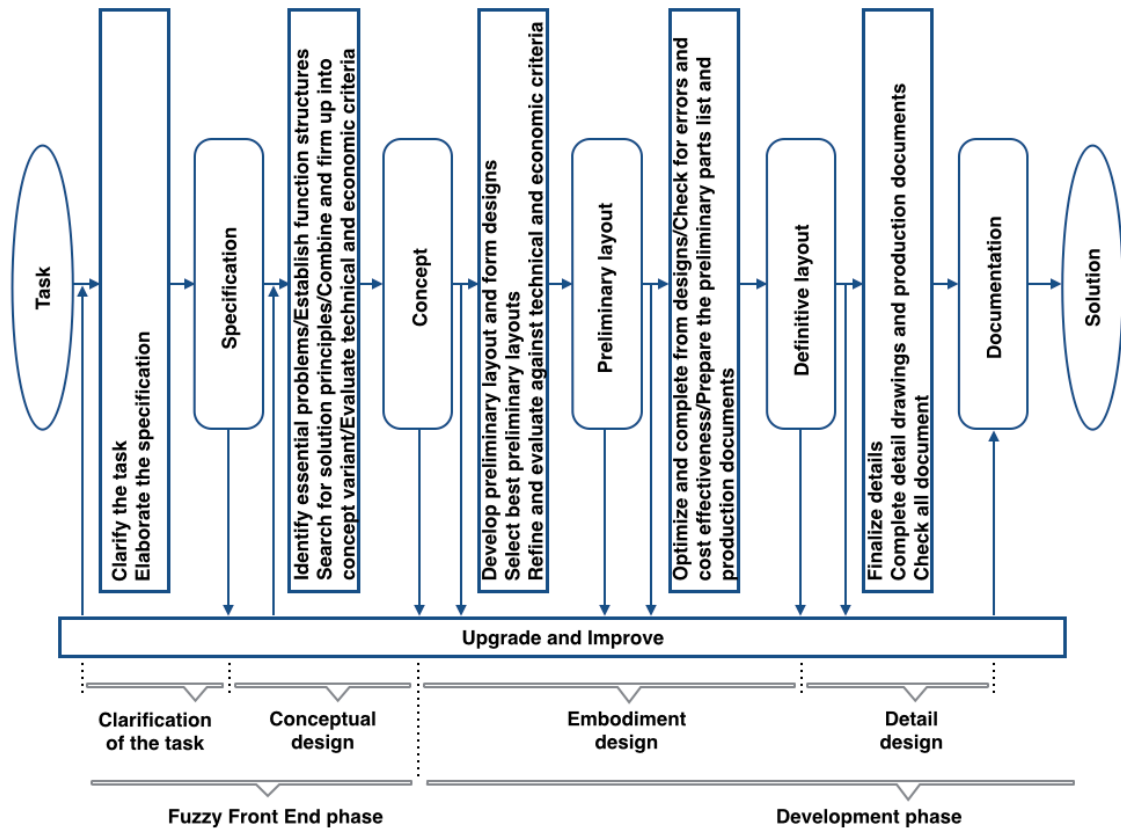

Fig. 23. Typical FFE activities along the instructive design models. Source: [Pahl 2013].

However, Altshuller 1988, Purcell 1994, Girod 2000, and some others developed their models in accordance with the nature of design activities [Purcell 1994] [Girod 2000]. These models are also known more instructive than a descriptive formalization for guiding design teams [Tab.13]. Altshuller among them is who focused especially on the art of inventive problem-solving and on the criteria of creativity in his method or theory under the name of TRIZ (theory of inventive problem-solving).

- *TRIZ* is a method that aims to guid problem-solvers to gain a good solution. This solution in TRIZ is defined as ideal final result (IFR). TRIZ encapsulates a set of principles and standards for good inventive practices into a generic problem-solving framework [Fig.27]. TRIZ is based on the fact that any problem derives from a contradiction and accordingly prepared different tools to help designers. In this regard, the most commonly applied tool is the Contradiction Matrix – a 39 x 39 matrix – including three or four most likely strategies for solving similar design problems. During solving contradictions, TRIZ suggests nine engineering evolution laws to designer for deciding about global strategy of technological evolution (system completeness, conductivity, harmonization, ideality, irregularity of evolution, integration with super-systems, integration with micro-level, dynamization, and substance-field interaction) [Altsuller 1999] [Salamatove 1999]. Among these laws, ideality is the basis when designers look for IFR. The simple definition of IFR is that “the solution contains all of the benefits and none of the costs or harms

(environmental impacts, adverse side-effects, etc.)” [Mann 2001]. Concerning the functionality, TRIZ states that any idea as a system possesses a main useful function (MUF), and that any system component which does not contribute to achieve of this function is ultimately harmful [Mann 2001]. In TRIZ, the resources used for designing a system are energy and substance by which system operates. Thus, technical analysis in the physical level is based on analyzing the relationships between substances by defining (or identifying) energy type (energy field) [Altsuller 1999] [Salamatove 1999]. Accordingly, Altshuller et al. have defined a modeling way and 76 standard solutions of substance-field interactions [Fig. 28] [Altsuller 1999] [Salamatove 1999].

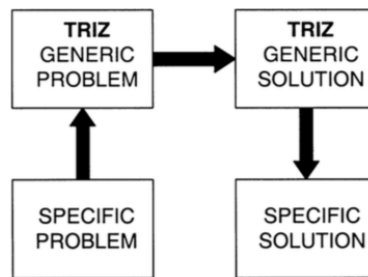

Fig. 24. The TRIZ process. Source: [Mann 2001].

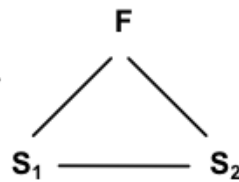

Fig. 25. Substance-Field formalization for modeling physical interactions by TRIZ. Source: [Salamatove 1999].

Nowadays, in addition of these models and on the basis of them, certain protocols and guidelines have been prepared and used for enhancing creative activities, innovation, and the management of R&D departments [Appendix.A].

Tab. 13. Design models based on the nature of activities;

Process models based on the nature of design activities	Author
Programming —» Collection —» Analysis —» Synthesis —» Development —» Communication	Archer, 1965
Analysis —» Synthesis —» Evaluation —» Dissemination	Markus et al., 1973
Recognize and formalize —» Functional requirements’ constrains —» Ideate and create —» Analyze and test —» Prototyping —» Producing	Wilson, 1980
Observation —» Reflection —» Action —» Re-observation	Schon, 1983

Recognize problem —» Elaboration of problem —» Define problem —» Search for alternative proposals —» Predict outcome —» Test feasible alternatives —» Judge feasible alternatives —» Specify solution —» Implement	Ray, 1985
Initial situation —» Problem modeling —» Ideal solution —» Physical solution —» Engineering solution	Altshuller, 1988
Analyzing problem —» Proposing solution —» Analyzing solution —» Explicit strategies	Purcell 1994,
Define problem —» Understand problem —» Think about problem —» Ideation and enrichment —» Idea screening —» Concept definition —» Concept assessment	Cooper et al., 1995
Decomposition —» Analysis of an existing solution —» Problem formulation —» Decoupling —» Concept generation and selection —» Trade-off —» Implementation	Tate et al., 1996
Analysis —» Synthesis —» Evaluation	Lawson, 1997
Concept —» Review of state of art —» Synthesis —» Inspiration —» Experimentation —» Analysis/Reflect —» Synthesis —» Decisions to constraints —» Output	Black, 1999
Exploration —» Generation —» Evaluation —» Communication	Cross, 2000
Divergence —» Transformation —» Convergence	Hsiao et al., 2004

II. 2. 4. 2. Descriptive Design Models

On the other hand, Suh 1990, 2001, Gero 1990, Hubka and Eder 1988, 1992, and Hatchuel 2003, proposed their models to describe design process [Suh 1990] [Suh 2001] [Gero 1994] [Hubka 2012] [Eder 2012] [Hatchuel 2010]. Their models are the more famous descriptive design models that try to explain what happens between designer, problem, and solution, during carrying out design tasks [Fig.14]. However, step by step, these models include some prescriptions for design teams. In general, the descriptive models verify user requirements (problem), and design process in regard with what are the sequential activities of creating a solution. These models help to understand designers, how they think, and how they act for generating a new idea during FFE phase. In other words, *design activity* is the main object of their contribution, which needs to be understood and recognized well.

Tab. 14. Descriptive design models based on designing technical characteristics of a solution;

Design methodology	Authors	Description
Axiomatic design	Suh, 1990	Zig-Zag among the functional, Structural, and behavioral characteristics
FBS framework	Gero et al., 2004	Function —» Expected behavior —» Structure —» Behavior derived from structure —» Structure —» Design description

C-K theory	Hatchuel et al, 2003	K-C disjunction —» C-C expansion —» K-K expansion —» C-K Conjunction
------------	----------------------	---

• *Axiomatic Design* is known as a general design framework that can describe all design activities. The intention of providing this method was to identify a set of fundamental principles for engineering design. Axiomatic design describes design as a process with different steps in generating design concepts [Suh 1990] [Suh 2001] [Fig.24].

- Consumer attributes (CAs): Variables that characterize the design in the consumer domain. CAs are the consumer needs that must be fulfilled by new design;
- Functional requirements (FRs): Variables that characterize new design in the functional space. These variables describe the behavior of new design;
- Design parameters (DPs): Variables that describe new design in the physical solution space;
- Process variables (PVs): Variables that characterize new design in the process domain (manufacturing);

Suh based his model on two conceptually design axioms; 1) the *independence* that can be stated in number of ways, but the most important are a) an optimal design always maintains the independence of the FRs, and b) in an acceptable design the DPs and FRs are related in such a way that a specific DP can be adjusted to satisfy its corresponding FR without affecting other functional requirements. 2) the *information* that says the best design is a functionally uncoupled design that has the minimum information content.

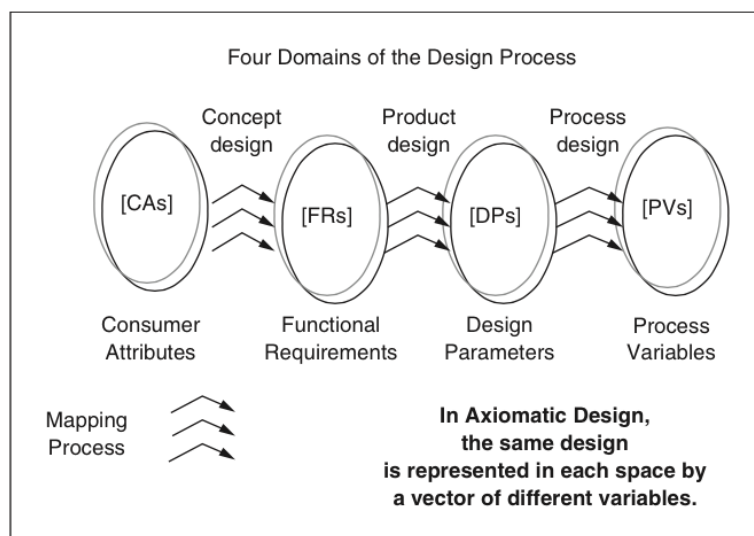

Fig. 26. The design process in the Axiomatic Design. Source: [Suh 2001].

• *FBS framework* is proposed as a basis for developing an agent-based design system in artificial intelligence (AI). FBS framework gives a dynamic view of design process when all the requirements are not known at the outset of a design task, and design activities involve finding what is needed again for modifying in a repetitive cycle [Gero 2004]. The basis of this framework is formed by classes of variables is a design object as function (for describing the teleology of the object), behavior (for describing the attributes that derived from the structure of design object), and structure (for describing the components of the object and their relationships). In this respect, it has been supposed that “a designer constructs connections between the function, behavior and structure of a design object through experience” [Gero 2004]. According to this perception, Gero et al. defined a set of processes linking function, behavior, and structure together. These processes are supposed as the different states of designing an object, and claimed as the fundamentals of design process [Gero 1996] [Gero 2004] [Fig.25]. The eight principal processes that by defining different worlds of designer regarding design activities is expanded to twenty processes as [Fig.25] (where, X^e means external representation, X^i means interpreted representation, and X_e^i means expected representation):

- Process 1: uses R to produce F^i variables;
- Process 2: uses R to produce B^i variables;
- Process 3: uses R to produce S^i variables;
- Process 4: uses constructive memory to produce further F^i variables. The F^i variables result from the history of all F^i variables that have been constructed in current and previous design experiences;
- Process 5: uses constructive memory to produce further B^i variables. The B^i variables result from the history of all B^i variables that have been constructed in current and previous design experiences;
- Process 6: uses constructive memory to produce further S^i variables. The S^i variables result from the history of all S^i variables that have been constructed in current and previous design experiences;
- Process 7: focuses on a subset ($F_e^i \subseteq F^i$) of F^i to produce an initial function state space;
- Process 8: focuses on a subset ($B_e^i \subseteq B^i$) of B^i to produce an initial behavior state space;
- Process 9: focuses on a subset ($S_e^i \subseteq S^i$) of S^i to produce an initial structure state space;
- Process 10: transforms F_e^i into B_e^i ;
- Process 11: transforms B_e^i into S_e^i ;
- Process 12: transforms S_e^i into S^e ;
- Process 13: uses S^e as well as the current analysis goals to produce S^i ;

- Process 14: transforms S^i into B^i ;
- Process 15: compares the interpreted and the expected value of a particular behaviour variable;
- Process 16: ascribes new F^i to B^i ;
- Process 17: transforms Be^i into B^e to be added in the design description produced by process12;
- Process 18: transforms Fe^i into F^e to be added in the design description produced by process12;
- Process 19: constructs new B^i from B^e ;
- Process 20: constructs new F^i from F^e ;

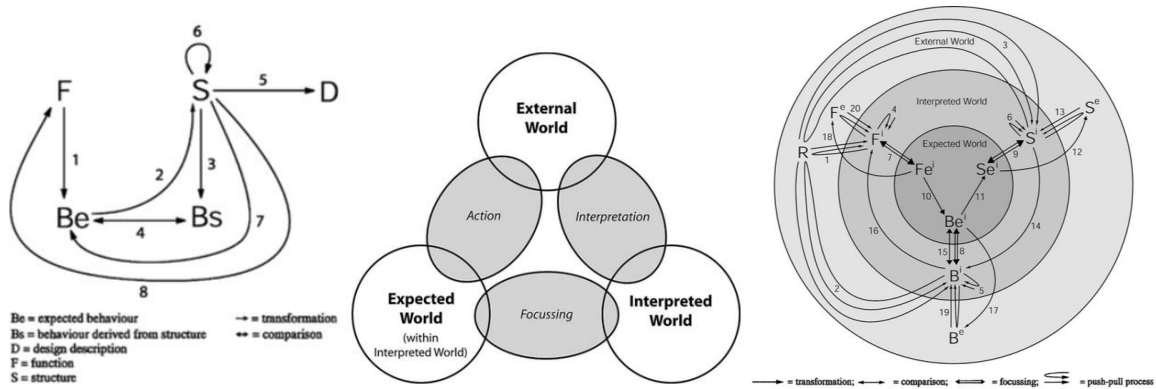

Fig. 27. The original and the situated FBS framework by considering the interactions between designer's worlds.

Source: [Gero 2004].

- *C-K theory* models design activities as an interplay between two independent spaces; the space of concept (C), and the space of knowledge (K). C-K theory explains the generation of new objects and new knowledge as the distinctive feature of design. It has been proposed with the aim of providing a rigorous, unified formal framework for design [Hatchuel 2010]. In the right hand [Fig.26], the knowledge space includes a set of propositions with a logical status, according to the available knowledge for designer. The knowledge space describes all objects and truths that are established from the point of view of designer. Then K-Space is expandable as new truths that may appear by research and this imposes a major influence on design process [Hatchuel 2010]. In the other hand [Fig.26], a concept presents a proposition without logical status in the K-Space. Concepts can be partitioned or included, but not searched nor explored [Hatchuel 2010]. In this regard, all design activities are defined by four operators as: $C \rightarrow C$, $C \rightarrow K$, $K \rightarrow C$, and $K \rightarrow K$ [Fig.26].

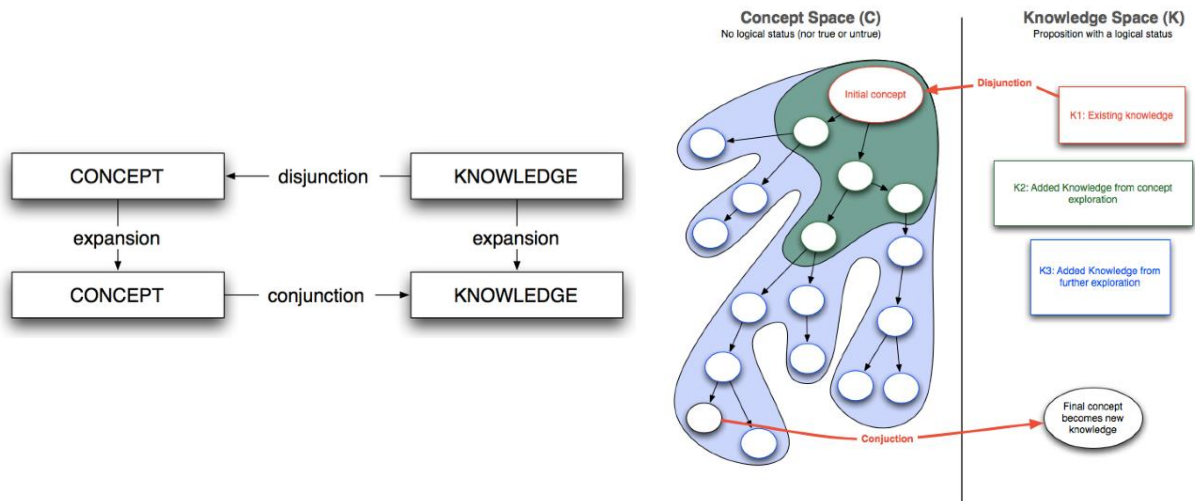

Fig. 28. C-K operators. Source: [Hatchuel 2010].

Based on our survey (c.f. Appendix C.), about 16% of respondents use TRIZ, 2% Axiomatic Design, 4% C-K theory, 18% Engineering/Systematic Design, and 13% nothing in particular during their design projects (c.f. Appendix C.).

II. 2. 4. 3. Organization of Design Activities

Design activities within design projects are carried out individually and collaboratively. The organization of design activities in groups seems more critical than working individually. The critical point is to build a proper flow of information between designers, or regarding an extended study, between internal and external stakeholders. In this perspective, such terms as sequential design, integrated design (concurrent engineering) [Fig.24], communication, coordination, cooperation, and collaborative design are considered, studied, modeled and discussed by different authors [Lonchamp 2004] [Darses 1997] [Prasad 1996] [Sohlenius 1992] [Larsson 2002] [Tab.15].

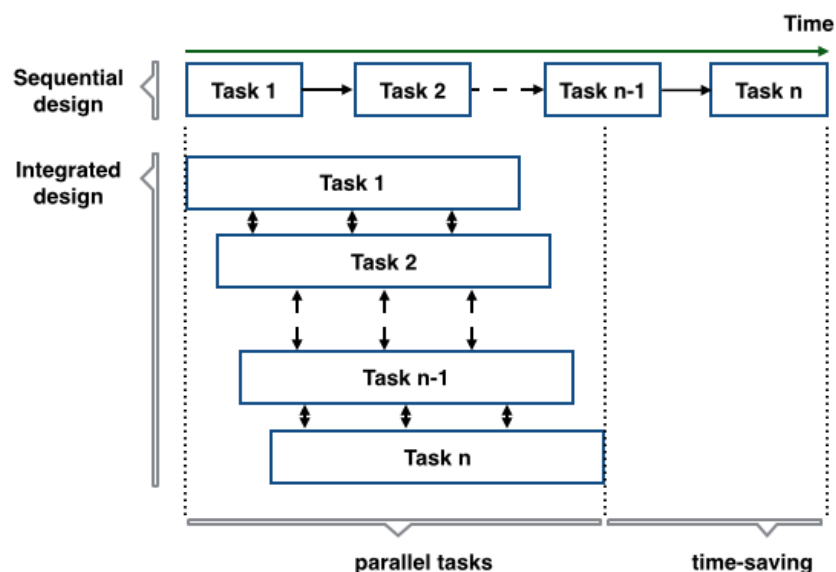

Fig. 29. The sequential and the integrated design models. Source: [Lonchamp 2004].

Tab. 15. Interactive characteristics of design activities in group;

Design activities in group	
Interactive characteristic	Description
Communication	Communication is an interaction between stakeholders in order to exchange ideas and combine different perspectives. In this interaction there is knowledge acquisition and sequentially knowledge creation [Bouzon 2003]. It can be done in various forms by writing (note), drawing (sketch), gesturing (gestures), posturing (postures), to express unambiguously knowledge [Soubie 1996] [Eckert 2001].
Coordination	Coordination is a set of rules or procedures in order to function effectively. As a concept in the task management, it defines the orders and structures to maximize the efficiency of group work [Dameron 2003]. The task management and functioning of group are two dimension of coordination.
Cooperation	Cooperation is the contribution or the participation in a public action. The public action signifies a collective action by which stakeholders contribute for a same goal [De Terssac 1996]. Often it's used for the contribution between at least two design groups belonged to different projects or enterprises [Huet 2004] [Froehlicher 2000].
Collaboration	Collaboration in design is providing a community with the maximum adherence by a strong commitment to increase trust between participants (stakeholders) [Kvan 2000]. In collaboration, as for solving a problem, the participants have one or some specific spaces to store and share information, and exchange knowledge [Caillaud 2004].

II. 2. 4. 4. Design Activities

Design activities derive from the cognitive science. Cognition includes all mental abilities and processes related to knowledge by attention, memorizing, judgement, evaluation, reasoning, problem-solving, decision-making, comprehension, learning and etc. Design activities as a specific cognitive process aims to generate new knowledge [Blomberg 2011]. Newell 1982 [Newell 1982] defined design activities as problem solving in knowledge level that delimits design studies in cognitive science [Lester 2009]. Verifying design studies including design process models and all the concepts involved in technological design, illustrate that all design activities at the cognition level can be categorized into the generation and the assessment activities [Tab.16]. However, design activities regarding the cognitive science can be presented in different terms or different forms.

Tab. 16. Different activities mentioned in design studies regarding the cognitive science;

Principal design activities in the FFE			
Knowledge forms	related activities to Generation		related activities to Assessment
- Problem	- Definition	- Observation	- Screening
- Need/Requirement	- Problem-solving	- Invention	- Analyzing
- Existing solution	- Understanding	- Decomposition	- Decision-making
- Idea/Pre-concept	- Thinking	- Identification	- Evaluation
- Solution	- Analyzing	- Specification	- Testing
- Concept	- Formulation	- Conception	- Selection
	- Recognition	- Expansion	- Collection
	- Decoupling	- Conjunction	- Experimentation
	- Modeling	- Disjunction	- Judge
	- Elaboration	- Exploration	
	- Enrichment	- Divergence	
	- Analyzing	- Synthesizing	
	- Ideation	- Designing	
	- Creation	- Discovering	
	- Formulation	- Establishment	
	- Prediction	- Inspiration	
	- Proposition	- Determination	
	- Searching	- Clarification	
	- Programming	- Action	
	- Modeling	- Reflection	

II. 2. 4. 4. 1. Generation in the FFE

In design, the idea generation activities are summarized in problem analysis, problem modeling, solution modeling, idea generation, research and development. Thus, the appearance of an idea depends on thought when it can be expressed explicitly in a visual, concert, or abstract way [Gänshirt 2007] [Jonson 2005]. The idea generation or the ideation in the FFE is based on the *creativity* as the indispensable notion of design [Amabile 1996] [Thompson 2003] [Roozenburg 1995] [Eppinger 1995]. On other words, design is a thinking act that is powered by the creativity to generate new ideas [Jungpyo 2007].

II. 2. 4. 4. 1. 1. Creativity as the Principle

It is long time that the creativity has been as an interesting topic in scientific researches. Consequently, it has been adopted in different domains, sectors and approaches. During these researches, the creativity has been studied from different perspectives – such as psychoanalytic, psychometric, cognitive, other social-psychological, and neurobiological – and obtained a wide range of definitions [Batey 2012]. In general, creativity is considered as the power of creation that emerges through divergent thinking and such behaviors and defies existing norms [Sternberg 2006]. Creativity is the ability to produce a valuable new form or combination of elements [Amabile 1988] through a dynamic intuitive anticipation, imagination and unconscious [Cortes Robles 2006]. Encyclopedia of Creativity defines it as a creative ability, artistic or intellectual inventiveness [Balon 1999], and Wallisch 2003, defined it as giving a new meaning to the facts which are already known [Wallisch 2003]. The main factors for configuring

the creativity are thus the intelligence, knowledge, thinking style, personality, motivation, and context [Sternberg 2006] [Amabile 1996]. However, the creative leaps occur with retrospection [Dorst 1997] [Cross 2008]. The definitions of creativity in literature essentially refer to the personal thinking (inspiration) (cognitive process in a person), and moreover it has also used for the environmental press (environmental influence), process (methodological processes to achieve creative products), and products (results of creative activities) [Rhodes 1987] [Batey 2012] [Mayer 1992] [Csikszentmihalyi 1997].

- *Creative-thinking*: The creative-thinking comes from Eastern view as personal truth or self-growth [Sternberg 1999]. Creativity, little by little, was interpreted as the ability and the disposition of individuals, and studied as the heredity genius [Batey 2012]. Nowadays, individual creativity is investigated as intellectual trait with considering other individual traits such as personality, motivation, values, and interests [Batey 2012].

Based on our survey (c.f. Appendix C.), more than 89% of design teams are composed of less than 10 experts and 42% of design activities are collaborative (c.f. Appendix C.).

- *Creative-product*: The earliest perception of creativity was the creation in *Genesis*. It was exactly where the concept of creation originally was affected the interpretation of creating TP/Ps. This viewpoint almost exclusively defined the creativity as the *novelty* and the *utility* properties of outputs by an individual [Mumford 2003]. Most authors have adopted the definitions of “new” and “useful” for creative results [Mumford 2003] [Batey 2012] [Tab.17].

Tab. 17. Some definitions of *creative-product*. Source: [Batey 2012];

Definition of <i>Creative-product</i>	Author
“Creativity is the interaction among aptitude, process and environment by which an individual or group produces a perceptible product that is both novel and useful as defined within a social context.”	Plucker, Beghetto, and Dow 2004
“Over the course of the last decade, however, we seem to have reached a general agreement that creativity involves the production of novel, useful products”	Mumford 2003
“Creativity is the ability to produce work that is both novel (i.e., original, unexpected) and appropriate (i.e., useful, adaptive concerning task constraints)”	Sternberg and Lubart 1999
“Creativity must entail the following two separate components. First a creative idea or product must be original . . . However, to provide a meaningful criterion, originality must be defined with respect to a particular sociocultural group. What may be original with respect to one culture may be old news to the members of some other culture . . . Second, the original idea or product must prove adaptive in some sense. The exact nature of this criterion depends on the type of creativity being displayed”	Simonton 1999
“Creative thought or behavior must be both novel-original and useful-adaptive”	Feist 1998

“Bringing something into being that is Original (new, unusual, novel, unexpected) and also Valuable (useful, good, adaptive, appropriate)”	Ochse 1990
“Creativity refers to as the production of new or novel ideas that are useful”	Amabile 1988
“The word creativity is a noun naming the phenomenon in which a person communicates a new concept (which is the product)”	Rhodes 1961
“If a response is to be called original . . . it must be to some extent adaptive to reality”	Barron 1955

- *Creative-process*: The creative-process refers to this viewpoint that the creativity is an applied art, and acquired by teaching and learning. This includes those methods that cause individuals to strive for original answers despite having the routine ones. The term *creative-process* applies to inspiration, preparation, learning, or problem-solving methods that motivate or stimulate individuals to be creative [Rhodes 1987] [Mayer 1992].
- *Creative-environment*: The creative-environment – or creative-press – is based on this principle that a person receives sensations and perceptions from both external and internal sources [Rhodes 1987]. The information of these two source area is applied by memorizing and synthesizing intellectual functions for proposing ideas. A creative-environment seeks to construct a sufficient advanced stage of creativity culture to foster idea generation for inventions [Rhodes 1987] [Csikszentmihalyi 1997] [Moss 2002] [Dodds 2002].

These four concepts of creativity cover all factors involved in a design process through inputs, outputs, treatments, and environment, to ensure the existence of creativity and accomplish design activities. In inventive design, the creativity is considered as the departure point to generate inventions [Amabile 1996] [Cropley 2012]. Accordingly, some authors such as Modesto 1980, Roberts 1988, Schulz 2001, Henry & Walker 1991, and Cavallucci et al. 2009, named the FFE as the invention phase [Schulze 2001] [Modesto 1980] [Coates 2014] [Henry 1991] [Cavallucci 2009] [Cropley 2012] [Bledow 2009]. Indeed for them, *invention* is a definition for describing design activities and design outputs (design goals) [Fig. 25].

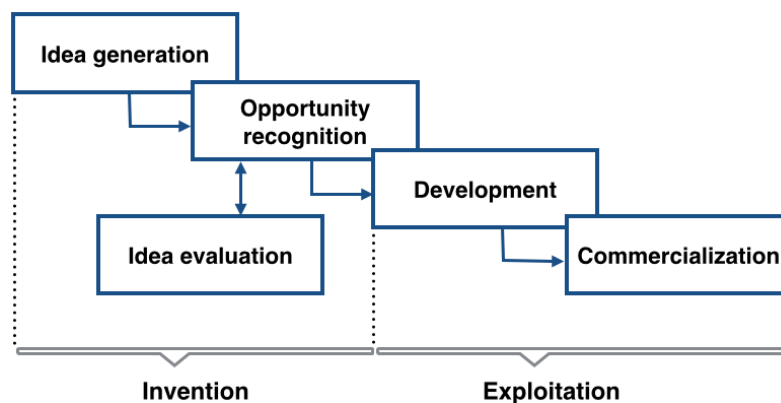

Fig. 30. The invention phase along NPD process. Source: [Luecke 2003].

63% of respondents to our survey declared that they specify those NPD projects that have been determined to obtain an invention (c.f. Appendix C.).

II. 2. 4. 4. 1. 2. Invention and Inventive Activities

Design is the process of identifying problems – of incompleteness, inconsistency, imprecision, ambiguity and impossibility in requirement statements – for modifying and refining in a well-formed problem statement and from which generating solution [Logan 1993]. Design in literature is defined as a problem-solving process that occurs in knowledge level of inventors [Duffy 2003]. Simon 1969, said that “anyone who attempts to transform an existing situation into a desired new situation performs a design activity” [Simon 1996]. All these descriptions are consistent with the definition of design activities as a knowledge process by Hubka and Eder [Hubka 2012], and Gero [Gero 2004], where they interpret design activities as the rational actions of designer to achieve design goals [Logan 1993] [Hubka 2012]. On the other hand, design is on a continuum with *invention*. It occurs in a joint effort with art, science, and inventive activities [Weber 1992]. Here, the term *invention* refers to the action of creating or designing something new (original) that has not existed before (virtually and physically) [Oxford 2014], contrary to the *discovery* that signifies finding something existent [Perrin 2001] [Orloff 2003]. An invention emerges from inventive design activities [Luecke 2003] [Perrin 2001] during FFE phase. Weber 1992, defined *invention* as the applied knowledge with dash of art added [Weber 1992]. Moreover, Micaelli 2003, and Simon 2004, considered the term *invention* equivalent to the artifact which points out a designed entity by human in order to satisfy requirements [Micaelli 2003] [Simon 1996]. These statements mean that inventive activities can include scientific researches and art, because they look for the solutions that apply new technics to support specified problems. Indeed, they emerge from an imagination to construct a material or immaterial object [Perrin 2001]. Inventive activities look for combining available knowledge in a new way from a mental performance beyond the average [Kuznets 1962] (“a new combination of available knowledge concerning properties of the material universe”). Having an invention is much simpler than expanding science [Weber 1992]. Now it is more intelligible why invention is younger than art, and art has a much longer appearance and history than science [Weber 1992]. The science expansion starts with complexity [Weber 1992]. The complexity during inventive design derive from the complexity of expanding science. It appears when the process goes deeper for understanding scientific phenomena, and interfere with the basic research. However, invention consists of efforts to do – required functions – with fewer parts and less resources [Weber 1992]. An invention must be useful, and be produced through a mental effort [Kuznets 1962]. So inventors deal with the complications of real world, where the current sciences ruling on it. Likewise, scientists often deal with the conceptualizations in ideal conditions. And artists try to communicate with customer by a sensible form.

Since the distance between an invention to an innovation is the passage from an idea to a profitable TP/P [Dal Pont 2007], inventions are known as the basic structure of innovation [Salamatov 1999] [Byrd 2003]. An invention can be introduced by idea sketches, concept models, concept definition, and/or concept specification, for being patented and/or starting the development phase [Rosenberg 1986] [Freeman 1982]. According to Altshuller 1999, an invention is a partial or total passage from some contradictions [Altshuller 1999]. Here, the term *contradiction* is equivalent to *problem* [Savransky 2000] [Piaget 2012], and means that an

invention is the first (the latest) different technical solution for a problem [Brockhoff, 1999] [Bullinger 2008].

II. 2. 4. 4. 2. Assessment in the FFE

The assessments along FFE phase is a readiness control for convincing process gates (c.f. II.2.3). The assessment activities include measurement, evaluation, and decision-making for idea selection at the gates 1, 2, and 3 (c.f. II.2.3). Although decision-making in the FFE is an “uncertain fumble at minimal sight” [Bullinger 2008], it has a strong impact on the performance of the whole innovation process [Bullinger 2008]. The idea selection still is an intuitive and unreliable activity of the FFE phase. Moreover, although some approaches such as the *stage-gate* model or TRL (technology readiness level) [Mankins 1995] have been made and proposed to ensure task accomplishments, verifying the inventiveness level of results is not their main objective.

Assessing design projects needs to recognize their typology. In general, all design projects are categorized by four major characteristics [Deneux 2002] [Micaëlli 2003]:

- *Routine design* refers to use the same concept (specification) that has been designed before without any change.
- *Re-design* is when the design processes try to modify, improve, or optimize an existing TP/P for satisfying a requirement or increasing the TP/P performance. Re-designs occur in two types; variant design, and adaptive design [Pahl 2013].
 - *Variant design* includes the changes of existing TP/P concerning variants (attributes of properties) such as color, size, volume, and etc.
 - *Adaptive design* includes the changes of existing TP/P concerning adaptivity of the embodiment according to requirements and constraints. These changes don't include principal solutions.
- *Creative or inventive design* is when the design process is activated to propose a new concept. It establishes a new principal solution without any similarity to existing ones.
- *Innovative design* is when a design emerges by synthesizing existing concepts or solutions [Gero 1990].

More than 70% of respondents to our survey (c.f. Appendix.C) differentiate inventive design projects from routine projects by measuring the volume of consumption of time, cost and human-resource.

The difficulties of measuring the rate of inventive though have been discussed by Kuznets 1962 [Kuznets 1962]. Kuznets et al. [Kuznets 1962], at the first step, emphasized on *patentability* as the basis of inventive distinction and focused on patent statistics as a possible measure of inventiveness. They considered patents as invention units that are accepted by Patent Law of United States. However, today, intellectual property offices do not distinguish the level of

inventions. In this respect, patentability is considered as a useful point for continuing this research.

II. 2. 4. 4. 2. 1. Patent registration

The term *patent* comes from the Latin *litterae patentes*, meaning open letters [Nard 2008]. Historically, the letter patents were specific grants of privilege by the monarchs to manufacturers and traders [Nard 2008]. These letter patents including patents for inventions, enabled recipient to exercise monopolies – such as soap, saltpeter, alum, leather, salt, glass, lives, sailcloth, sulphur, starch, iron and paper –, manufacture, and sale particular goods or particular services [Nard 2008]. Later, the issued patents for particular commodities became the subject to abuse and revoked, while the issued patents on inventions were strengthened, valued, and developed through the work of lawyers and judges in the courts [Nard 2008]. The patents on inventions were to provide legal protection of new inventions against potential infringers [Deazley 2010]. Nowadays, industrial patents are considered as a category of intellectual properties to protect all creations of human mind legally. The intellectual property is defined as the “rights related to all intellectual activities in the industrial, scientific, literary, or artistic fields” [WIPO 2004]:

- Literary, artistic and scientific works;
- Performances of performing artists, phonograms and broadcasts, inventions in all fields of human endeavor;
- Scientific discoveries;
- Industrial designs;
- Trademarks, service marks and commercial names and designations, protection against unfair competition;

Today in law, the term *industrial property* covers related rights about inventions, industrial design and trademarks [WIPO 2004]. Patent laws, in general, grants inventors the right to exclude their works for a limited period of time (usually 20 years) from making, selling, offering to sell, and importing by anyone else in exchange for the public disclosure. A patent gives inventors the right to sue any useful act without their permission on their invention. In return of the protection law, the patentee must reveal his invention in writing. Inventors describe and ascertain the nature of the invention, and moreover the manner in which the invention will be performed or applied. This document is known as *specification* [Nard 2008]. The intellectual property offices in countries define and control; the requirements of patentability, how inventors’ descriptions should be implemented, what degree of description required, and how the exclusive right protects inventions. However, among them, the requirements of patentability is the concern of this work.

At last, by defining research zone and boundaries, difficulties, and limits, it can be said that this research looks for:

The generic metrics of inventiveness in order to find the global aptitude of inventive activities during the fuzzy front end phase of technological innovation process.

Chapter 3: Theoretical Modeling and Propositions

The third chapter presents theoretical contributions of this work. It has been devoted to report our propositions, modeling, and the related developments for establishing invention metrics. The chapter is comprised of studying the fundamental principles of performance measurement, defining the equivalents in inventive design, developing related measurement systems, and defining the key performance indicators. In addition, all the obtained measures of inventive performance will be presented as an integrated measurement system that allows classifying design projects and inventive companies. The implementation of the propositions is clarified by a number of examples.

1. Inventive-Design Performance Metrics

1. 1. Development of Performance Metrics

1. 2. Modeling Inventive-Design Activities

2. Measuring Inventive-Design Performance

2. 1. Modeling Inventive-Design Effectiveness

2. 2. Modeling Inventive-Design Efficiency

3. A Platform for Measuring Inventive-Design Performance

III. 1. Inventive-Design Performance Metrics

As mentioned in the previous chapters, the lack of an effective measurement regarding inventive-design performance is the missing link in the chain of innovation management. Developing the metrics of inventive-design performance can demonstrate the value of NPD projects from the perspective of innovation. Having the metrics of inventive-design performance makes managers capable of analyzing and improving the weaknesses. In general, any measurement system is based on a set of appropriate metrics in relation to the criteria and the characteristics of their objects. Concerning inventive-design performance, *creativity* and *inventiveness* are the particular criteria that need to be considered and studied.

III. 1.1. Development of Performance Metrics

Any metric is developed to express the attributes of entities in numerical terms [Fenton 2014]. They found disciplines to facilitate measurements, comparisons, and predictions of objects or events [Bashir1999]. The development of a measurement system at the first step, generally,

needs to define the *level of measurement, dimensions, and uncertainty*. Hence, any measurement system can be judged through these meta-measurement criteria [VIM 2004];

- *Level or scale of measurement* refers to the types of data for representing the magnitude of an object. In inventive design, the term *idea* (invention) is placed instead of *object*, same as the United States Supreme Court for naming inventive results [Schulze 2008]. Steven 1946 [Stevens 1946] classified all the variables in four data types as *nominal, ordinal, interval, and ratio* [Tab.18]. All these four scale types are used in this work, however the final measures of inventive-design performance are expressed in terms of *ratio* and *interval* scales. Different scales are used according to the nature of objects and the objectives of measurement methods. Selecting the scale of measurements requires a particular attention regarding the kind of values and their heterogeneity.

Tab. 18. Different data types can be used for representing the magnitude of an object;

Scales of measurement	Description
Nominal	It includes the qualitative scales of measurements for differentiating between items (subjects) by classifying their characteristics, categories, and what they belong to. The nominal scale type constructs a classification with the aim of explaining sensory measurements. Regarding this scale type, a nominal measurement is based on the modeling of the qualitative data. [Schofield 2007] [Crotty 1998].
Ordinal	In an ordinal scale of measurement, the data can be sorted in a rank order without giving a relative degree of difference between them. e.g. in particular, IQ scores reflect an ordinal scale in which all score are meaningful and a 10-point difference may carry different meaning at different points of the scale [Sheskin 2003] [Bartholomew 2004]. The ordinal types can include both dichotomous as truth values (sick vs. healthy) and non-dichotomous data as opinion (completely agree, mostly disagree, and completely disagree).
Interval	The interval scales allow measuring the degree of difference between subjects, but not the ratio between them; e.g. the Celsius temperature scale possesses an arbitrary-defined zero point.
Ratio	In a ratio scale, the measurement is carried out by estimation of the relationship between a continuous numerical magnitude and a unit numerical magnitude of the same kind [Wentworth 1922]. The ratio scales possess a non-arbitrary zero point; e.g. the Kelvin temperature scale is a ratio scale. Most measurement in the physical sciences and engineering is done on ratio scales.

- *Dimension* of a measurement system refers to the units of measurement. A unit of measurement is the definite magnitude of a property that is used for measuring object with the same property. Indeed units of measurements are the standards for expressing measures in the term of units (one and/or multiple units) [VIM 2004]. A unit of measurement consists

of three elements; its related *property*, its *standard magnitude* and its *symbol* [Tab.19] [VIM 2004].

Tab. 19. The constituent elements of the *dimensions* in measurement systems;

Dimension of measurement	Description
Property	Property is what belongs to the objects of measurement. Any property possesses an attribute that is expressed as a relative value of the chosen unit for measurement; e.g. considering length as a physical property.
Unit	Units are the standard magnitudes for measuring properties. The unit in a measurement system is defined as a constant value that allows expressing different quantity of measurements, i.e. multiple-values of the unit value; e.g. in the SI (the international system of units) the unit of measuring <i>length</i> is one ten-millionth of the distance from the earth's equator to the North Pole (at sea level), which is known as <i>meter</i> (unit symbol).
Unit symbol	The unit is what a measurement use for expressing the value of a property; e.g. <i>meter</i> (<i>m</i>) that expresses SI based measurements of <i>length</i> .

- *Uncertainty* refers to the consequences of measurement. Measurements cause reducing uncertainty by expressing the certain value of properties. It gives the possibility to manage, forecast and control risks (c.f. II.1.2).

III. 1. 2. Modeling Inventive-Design Activities

The performance of design activities can be measured in different organizational levels. In literature, four levels have been considered as the focal points for analyzing the performance of NPD projects; *activity level*, *process level*, *project level*, and *firm level* [Schainblatt 1982] [Cooper 1995] [Wilson 1994] [Loch 1996] [Werner 1997] [Cordero 1990] [Kim 2002] [Fig.26]. But the question is:

- Which organizational level is more appropriate for analyzing design performance?

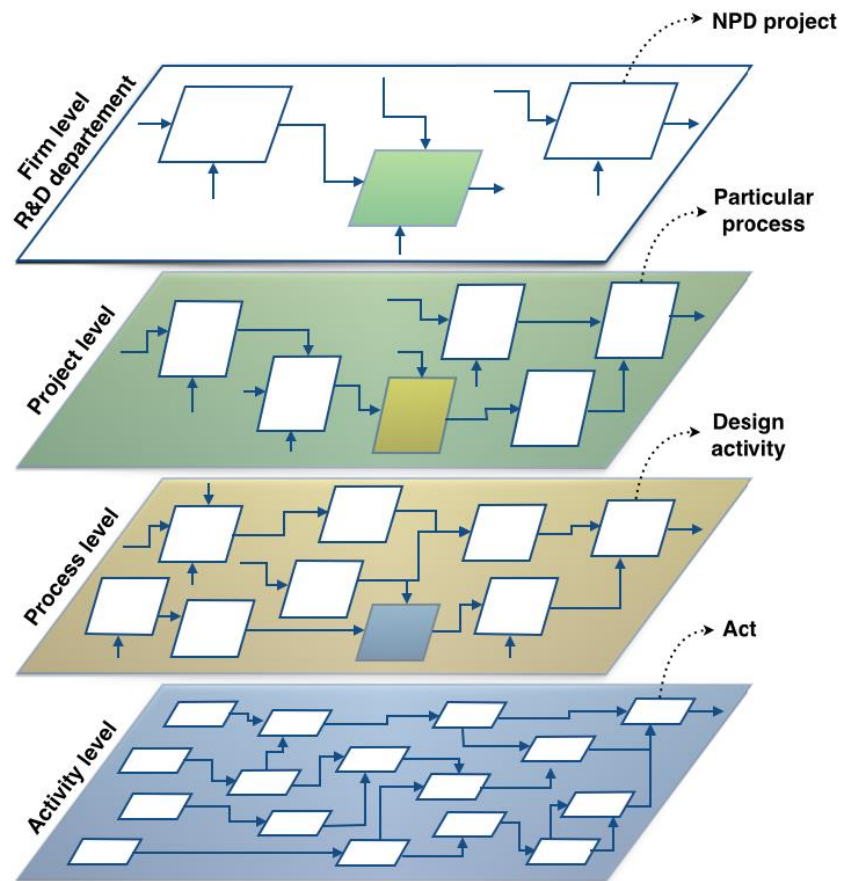

Fig. 31. The organizational levels of analyzing design performance in the literature (a hierarchical view in SADT).

- *Activity level* is the fundamental level of design projects. An inventive-design activity is associated with the cognition and the creative acts of a person to accomplish design tasks [Nijstad 2006]. Although Duffy et al. [O'Donnell 2005], based their performance analysis on this level, they have not clarified the definition and the boundaries of a design activity, let alone specifying the boundaries of an individual's act.
- *Process level* presents particular processes that are defined, scheduled and executed along a design project. Any process includes a certain number of activities to be carried out, individually or collaboratively. Using the term *particular* for processes [Fig.26] refers to the methods and/or the technics of enhancing the cognition during design projects. Considering the process level as an intermediate analysis level of design performance imposes less complexity rather than the activity level.
- *Project level* as the upper level of particular processes incorporates activities and processes for a same purpose. The performance analysis at this level covers analyzing all the activities, processes, entries and exits (tools, resources, knowledge, results), and their relationships. Thus, since the project level ensures both detailed and comprehensive analyses, it is the most prevalent level for analyzing organizational performance.

- *Firm level* refers to the performance analysis in a global view. In technological companies, the R&D departments are the official responsible of launching NPD projects. The R&D departments aside from design activities include several other activities such as planning, research and development for supporting the sustainability in different competitive advantages. This diversity of activities makes hard inventive performance analysis.

Observing the advantages and disadvantages of each organizational level confirms that the *project* level is the most appropriate level for analyzing inventive-design performance. So in this work, the *project* level have been chosen as the focal point for developing inventive-design performance measurement. However Duffy et al. used the *activity* level for developing their method of design performance measurement [O'Donnell 2005]. Considering the *activity* level by Duffy et al. [O'Donnell 2005] emanated from the fact that design activities are fed by individuals' creativity. Although focusing on the *activity* level – as a micro-analysis – gives a well recognition on the nature of activities and their relationships, it leads to a large difficulty with identifying the performance metrics of different activities [Tab.20]. The diversity of activities raises a large amount of information that complicates performance measurement. The impracticability of design performance measurement method by Duffy et al. [O'Donnell 2005] is proven when they never gave a practical example for their model. Analyzing design performance at the *process* level is also complicated as well as the *activity* level. Contrariwise, choosing the *project* level not only increases the accuracy of measurement, but even ensures that a detailed consideration are taken into account. This means that the performance analysis based on the overall resultant of entries and exits at the *project* level, considers all actions and performances in the lower levels (the *activity* and the *process* levels). Choosing the *project* level as the focal point of performance analysis, decreases the complexity of measurement. Moreover, focusing on the *project* level limits the performance analysis to the projects' goal as a clear entry. This causes disregarding most of partial goals in the lower levels (the *activity* and the *process* levels), and reducing the intricacy of performance analysis. On the other hand, projects' goals derive from specifying strategic goals at the *firm* level. They are the precise and detailed definitions of global objectives.

Furthermore, according to the literature on psychology and creativity, the germination and the growing period of an idea are not the proper moments for analyzing performance. Along the NPD process, design activities commonly are finished by the *stage2* [Fig.27] and the admitted ideas appear in the *gate3* before starting the *development* phase [Hindo 2007] [Fig.27].

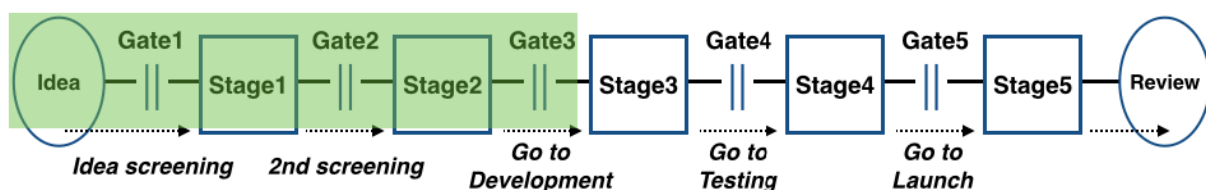

Fig. 32. The analysis area of design performance at the project level.

Tab. 20. The consequences of choosing each organizational level for design performance analysis;

Advantages (+) and disadvantages (-) of considering each level as the focal point of performance analysis;		
Activity level	Project level	Firm level
- Lack of the definition of activity boundaries;	+ Avoid to make a complex analysis;	- So far to observe the interactions of lower levels;
- Taking into account all partial interactions;	+ Avoid to an ambiguous analysis by considering strategic objectives;	- Difficulties of detecting inventive activities among other activities;
- Inability to provide a practicable measurement;	+ Taking into account the resultants of all interactions in the lower levels;	- Inventive performance analyses are based on the project levels;
- Emerging an immense data base for analyzing, measuring and integrating;	+ Comprising all the factors' influences in deal with activities;	+ Providing a practicable measurement is possible;
+ Make a detailed analysis, but not necessarily accurate;	+ Provide a practicable and accurate measurement;	- The measurement is less accurate than analysis of the project level;

As the departure point of performance analysis in the *project* level there needs to be understood what happens in the *activity* level as the elementary component. Analyzing design activities individually helps to perceive the nature of activities, and trace the relationships up to the project level with a reasonable accuracy. Apart from the modality of *inventive-design*, a design activity is described through its five operations; processing, importation, exportation, entitling, and supporting [Fig.28]. These operations are applied for transferring entries and exits during design projects.

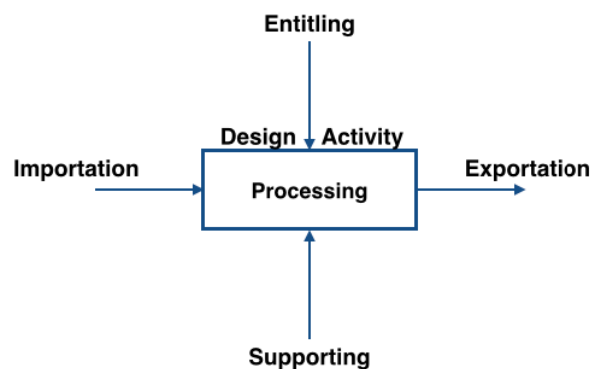

Fig. 33. The five operations of any design activity.

III. 1. 2. 1. Processing (Ψ)

In literature, design activities are considered as the rational cognitive activities that occur in the knowledge level [Newell 1982] [Hubka 2012]. From this perspective, a design activity is a knowledge processing for knowledge creation [O'Donnell 2005] [Popadiuk 2006] [Helfat 2000] [Pitt 1999] [McAdam 2006] [Von Krogh 2006]. According to the cognitive science, design is known as a cognitive process for generating new knowledge [Blomberg 2011]. So design activity is categorized as an interdisciplinary science of the mind and its processes [Blomberg 2011] [Fig.29]. The literature on how knowledge processing and knowledge creation (idea generation) are carried out during a design activity is extremely limited [Nonaka 1994]. C-K theory is the only description that gives a comprehensive portrayal of what actually happens during design activities [Hatchuel 2009] [Fig.29]. Indeed, design as the knowledge processing implies an imputation process to attribute a combination of knowledge without logical status (concept) for possessing logical status. During this imputation process – that is known as the knowledge creation, – activities are supported by knowledge acquisition and scientific researches [McAdam 2006].

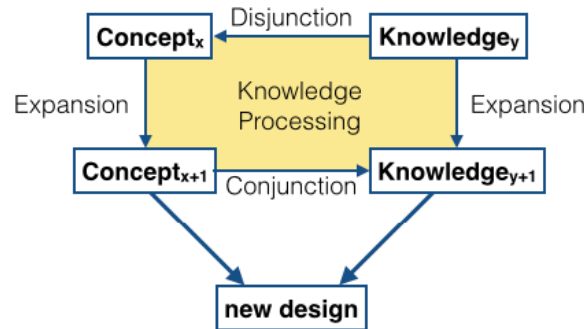

Fig. 34. The design square or the design loop according C-K theory.

Normally, both tacit and explicit kinds of knowledge deal with design activities. Furthermore, the knowledge processing can occur by one or a set of activities. This signifies that each unit of knowledge processing (design activity) can be enlarged to the process or the project levels [Equ.1]. Hence, the resultants of all entries and exits – of all activities – appear at the upper levels (the process and/or the project levels) [O'Donnell 2005] [Fig.26].

$$\Psi_i : \text{Knowledge processing of design activity } i, \{ \forall i : \text{May be a set of activities} \};$$

Equ. 1.

III. 1. 2. 2. Importation and Exportation

The importation and the exportation of a design activity refer respectively to the inputs and the outputs of the activity. Since the task of a design activity is knowledge processing, the nature of inputs and outputs is knowledge that may appear in various forms [Tab.16]. The inputs and the outputs respectively present the initial and the final states of knowledge before and after processing between the concept space and the knowledge space [Fig.29]. However, both the inputs and the outputs of design activities are in explicit knowledge form [Equ.2].

$$\begin{aligned} I_i &: \text{Inputs or imported knowledge of design activity } i, \{ \forall i : \text{May be a set of activities} \}; \\ O_i &: \text{Outputs or exported knowledge of design activity } i, \{ \forall i : \text{May be a set of activities} \} \end{aligned}$$

Equ. 2.

Since design projects look for generating new solutions and presenting them at the output of the process, the lack of admitted solutions at the *gate3* signifies the failure of projects. The resultant of all inputs and outputs at the project level derives from inputs and outputs at the activity level without mentioning partial solutions and partial problems in detail [Fig.30].

III. 1. 2. 3. Entitling an Activity (G)

Entitling design activities refers to the intention of fulfilling them. Indeed, any activity of a design project possesses a set of goals that derive from overall project goal (original goals). In other words, a project goal is distributed over the lower levels among activities when the project management defines and schedules the tasks of activities along particular processes. This implies the preference of the project level for measuring the performance of design activities [Fig.30] [Equ.3].

G_i : Goals or intentions of carrying out design activity i , $\{\forall i$: May be a set of activities $\}$;

Equ. 3.

The goals of design projects make up the specification of final results (outputs). The goals are a knowledge-entry of the knowledge processing. They direct the knowledge processing to be implemented for generating what has been expected as the output [O'Donnell 2005].

III. 1. 2. 4. Supporting an Activity (R)

Supporting design activities refers to what the knowledge processing utilizes as resource to be carried out. Human-resources, methods, particular processes, tools, environment, and all munition used for carrying out design tasks are considered as the usable resources of knowledge processing [Equ.4].

R_i : Resources used for carrying out design activity i , $\{\forall i$: May be a set of activities $\}$

Equ. 4.

However, the human-resource is known as the main resource of design activities and its absence cripples whole knowledge processing [Frankenberger 2012]. In addition, all resources used for carrying out design activities can appear and be taken into account at the project levels [Fig.30].

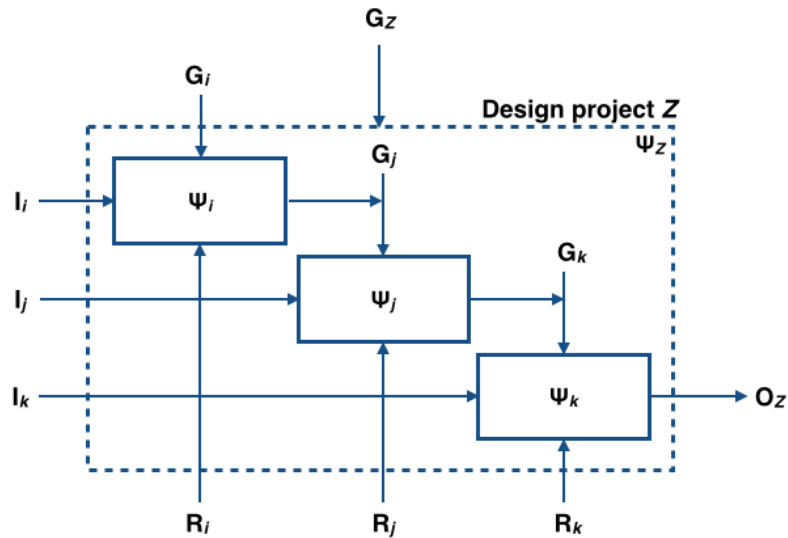

Fig. 35. A set of design activities at the project level and their operations.

III. 2. Measuring Inventive-Design Performance

Reviewing existing researches reveals that measuring design performance depends on the constituent elements of performance; the efficiency of activities, the effectiveness of carrying out design tasks, and the pertinence of entries. Although the performance of design activities takes great effects from the pertinence of their entries (Goals, Inputs, and Resources), the effectiveness and the efficiency are sufficient to approximate the size of design performance [Fig.31]. Indeed, the pertinence looks for the influence of entries on the effectiveness and the efficiency of design activities. It leads to recommend and/or recognize pertinent entries. Thus, studying the pertinence of entries is not done in this work because of the prerequisite role of metrics development. Furthermore, studying pertinent entries needs empirical researches to confirm the pertinence or the competency level of entries. The effectiveness and the efficiency are the main indicators of performance [Goldschmidt 1995] [Duffy 2012] [Wilemon 2002], which cover different aspects of performance measurement and give a comprehensive analysis.



Fig. 36. The constituent elements of measuring design performance.

The next sections of this chapter give an adaptive understanding of effectiveness and efficiency according to inventive-design performance. Moreover they present metrics development.

III. 2. 1. Modeling Inventive-Design Effectiveness

In general, effectiveness is defined as the capability of producing desired results [O'Donnell 2005] [LLC 2011]. Effectiveness is the capability of implementing (realizing) an intention exactly as it is imagined or specified. The intention is interpreted as what has been expected to be achieved in a deep and vivid impression [LLC 2011]. The effectiveness in design signifies “the degree to which design result (output) meets project goals” [O'Donnell 2005]. Design

effectiveness focuses on the quality aspect of design outputs [Shah 2003]. In other words, design effectiveness expresses how much an output has been conformed to project goals. Thus, the measures of a design effectiveness determine how far has the outputs in real world been approached to the expected or worthy output. Although attaining a full effectiveness is not possible now, the value of effectiveness can be measured through comparing outputs and goals [Equ.5] [Fig.32].

$\Pi (\Psi_i) : O_i == G_i$
$\Pi (\Psi_i)$: The effectiveness value (Π) of design activity i
Ψ_i : Knowledge processing by design activity i
$O_i == G_i$: Comparison between the outputs and the goals of design activity i
G_i : Goals of design activity i
O_i : Outputs of design activity i

Equ. 5.

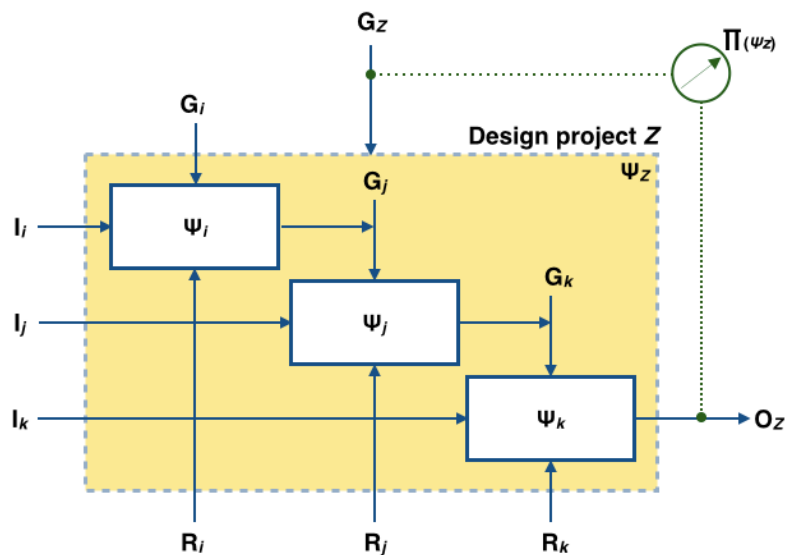

Fig. 37. The comparative relationship between goals and outputs for measuring effectiveness.

The goals of design activities are the references of comparison while outputs must tend toward them. Concerning inventive-design, although the project goals are apparently different from one another, they all seek to generate and put out inventive results. The term *inventive* as an adjective that adds up to design introduces *inventiveness* as the common goal of all projects (activities) with *inventive* prefix. Subjoining the term *inventiveness* to the specification of design goals poses the following question regarding the effectiveness metrics:

- What are the criteria of inventiveness-based effectiveness?

Regardless of considering client-user satisfaction or economic competitive advantage in the markets, the inventiveness is a subjective goal to obtain by the activities of design projects. The emphasis of inventiveness-based effectiveness is on the accomplishment of design activities in a creative manner, however it is demonstrated by evaluating the quality of outputs. In the

literature on issues of design measurement, commonly, the inventiveness is used with the same meaning of the creativity [Wunsch-Vincent 2011] [Demirkan 2012] [Shah 2003] [Sarkar 2011] [Dean 2006] [Shah 2000]. Among the characteristics of inventiveness discussed in literature [Tab.21], *novelty* and *usefulness* seem as the essential characteristics required for admitting an inventive output [Sarkar 2011]. Although the signification of most related characteristics to the inventiveness [Tab.21] – such as the *appropriateness*, *valuable*, *adaptivity*, or *unexpected* – are covered by *novelty* and *usefulness*, some of them – such as *fluency*, and *elaboration* – remain ambiguous even by defining them again.

Tab. 21. The characteristics of inventiveness-based effectiveness in the literature;

Criteria of inventive effectiveness in the literature	Author
Originality;	Stein, 1953
Novelty;	Guilford, 1950
Originality, Usefulness, Valuable;	Barron, 1955
Novelty, Solution, Elaboration and Synthesis;	Bessemer and Treffinger, 1981
Novelty, Appropriateness,	Amabile, 1983
Originality, Utility;	Runco, 1988, 2012
Originality;	Redmond et al., 1993
Originality, Usefulness;	Woodman et al., 1993
Novel, Valuable;	Weisberg, 1993
Rarity;	Eisenberger and Selbst, 1994
Novelty, Non-obviousness, Relevance, Workability, Thoroughness;	MacCrimmon and Wagner, 1994
Originality, Purpose, Implementation;	Wagner, 1996
Novel (Unexpected, Original), Appropriate (Useful, Adaptive);	Sternberg and Lubart, 1999
Originality, Appropriateness (Usefulness)	Reiter-Palmon & Illies, 2004
Novelty, Non-obviousness, Relevance, Workability, Specificity;	Dean et al., 2006
Novel, Valuable (Technical, Engineered), Utility (Usefulness);	Sarkar and Chakrabarti, 2008
Originality, Fluency, Flexibility, Elaboration;	Torrance, 2010
Novelty, Utility;	Batey, 2012

In addition of *novelty* and *usefulness*, Altshuller et al. [Altshuller 1984] [Altshuller 1988], in TRIZ (Theory of inventive problem-solving), discussed the evolution of technological systems (TP/P) and defined nine engineering laws for conducting technological evolutions [Tab.22].

Among these laws, *ideality* is the most significant notion. The importance of *ideality* is emanated from the fact that ideality is the extract of implementing the other technological evolution laws. In other words, it seems that all the other evolution laws are defined to lead design activities toward generating ideal outputs (c.f. the definition of ideality and usefulness in III.2.1.2 and III.2.1.3 respectively). The laws 2, 3, and 8, directly, and the laws 1, 5, 6, 7, and 9, indirectly affect the ideality improvement of technological systems [Tab.22] [Cavallucci 2009]. The influence of TRIZ evolution laws for enhancing *ideality* is so obvious that the theory of inventive problem-solving (TRIZ) [Altshuller 1988] is known as a holistic method for generating the portrait of ideal systems [Cavallucci 2011] [Cavallucci 2010]. According to this perception, *ideality* alongside *novelty* and *usefulness* has been considered as the principal criteria of inventiveness.

Tab. 22. The evolution laws of technological systems by Altshuller et al. [Altshuller 1988];

TRIZ evolution laws of engineering design	Description
1. Completeness of systems	This law defines a minimum required of a technological system. Accordingly, a working system must have four parts (i.e. engine, transmission, worker, and control) which the lack of each one destroys the signification of systems. Hence, these parts are necessary for birth of a technological system.
2. Energy conductivity	This law is about the energy flow that must pass through all of the main parts (components) of a system. i.e. the completeness of a system is verified by optimizing the flow of energy through different parts in order to maximize the ratio between transmitted energy and consumed energy.
3. Harmonization	This law looks for maximizing the performance of technological systems regarding the coordination of the main parts.
4. Ideality	This law is concerned with the ideality value of technological systems. During technological evolutions, systems tend to improve the ratio between the system performance and the system cost required to perform jobs. The ideality of a system refers to the consumption of energy and substance along system operation.
5. Irregularity of evolution	This law describes that the main parts (components) of a technological system evolve irregularly.
6. Integration with super-systems	This law implies the tendency of new designs to be integrated with their super systems. i.e. technological systems tend to merge with their super-systems.
7. Integration with micro-level	This law describes the transitions from macro-level to micro-level. This law refers to the advantage of using properties of dispersed martial (e.g. tools) and particles of physical fields within a technological system.

8. Dynamization	This law describes the dynamic growth by technological evolution, when technological systems in order to obtain more performance tends to be more flexible, adaptable (regarding to change working conditions and requirements), and rapidly changing structure.
9. Substance-field interactions	This law is concerned with the improvement of technical performance of systems by using the elementary rules (including physical effects) of <i>inventive standards</i> (70 standards of TRIZ). Considering physical effects (substance-field interactions) helps a system be more controllable.

Furthermore, inventiveness is analyzed by the intellectual property (IP) offices officially. The IP offices undertake the evaluation and the registration of inventive outputs without ranking them. However, it is evident that the quality of outputs are not same regarding inventiveness [Griliches 1990] [Nuvolari 2006]. Moreover, all the outputs of inventive projects are not patentable, neither are patented. As mentioned before (c.f. III.2), although the IP offices are established nationally, multi-nationally, and internationally, the criteria of evaluating industrial properties to grant patent agreements are almost similar [Tab.23]. In most industrial patent laws, the patentability refers on the substantive conditions with certain criteria that must be met by the outputs [Robertson 2009] [Mishra 2014] [Kunets 1962]. The link between the patent laws [Tab.23] and inventive activities provide a basis for developing inventiveness metrics [Nuvolari 2006]. In general, the criteria of patentability in different laws are based on verifying *novelty*, *usefulness* and *non-obviousness* [Tab.23].

- *Novelty*: An invention (patent) must be novel (new);
- *Usefulness* (Utility): An invention (patent) must be capable of being used for performing industrial jobs that can be extended to personal and social jobs;
- *Non-obviousness*: An invention (patent) must be different from what a skilled-user might expect since hearing the story;

Among these three criteria, *non-obviousness* seems a little ambiguous and needs to be clarified. The term *non-obviousness* as a patenting criterion refers to the consideration of an inventive step during design phase. The interpretations of *non-obviousness* are not evident in the literature because of its non-clear definitions in the law. This ambiguity poses difficulties to recognize *non-obviousness* within design projects. In general, non-obviousness implies the idea generation with a level beyond the expectation of skilled users [CFT 2003]. The question that arises here is:

- What is the expectation of skilled user regarding the evolution of technology?

User expectations are not the same as decision-makers' anticipations for a hedonic future [Kahneman 1990]. The expectations of a skilled user are in relation with the term *expected world* by Gero et al. [Gero 2004] in order to predict what has been expected to be generated. Indeed, the *expected world* of Gero [Gero 2004] encompasses the predicted outputs by skilled users. The intuitive predictions are typically non-regressive, i.e. an expert with both singular or distributional information often makes the extreme predictions on the basis of information whose reliability and predictive validity are known to be low [Kahneman 1977]. The lack of reliability or predictive validity in the *expected world* refers to the generation of concepts without logical status, in C-K theory. C-K theory [Hatchuel 2010] explains that the credibility gap between the *expected world* and the *real world* fills with associating existing knowledge even after knowledge expansion (generating new science by research) [Fig.29]. Since using the term *non-obviousness* aims to highlight non-obvious visions of outputs in the real world, the credibility gap must fill by knowledge expansion and the achievement of new knowledge (research and/or discovery). However, existing knowledge (the knowledge of skilled use) may be limited to certain science or sectors of industry. Furthermore, *non-obviousness* refers to obtain an inventive step (activity) during design phase [Barton 2003]. This means that *non-obviousness* can be defined as a different manner of problem-solving same as the definition of inventive problem-solving in TRIZ [Altshuller 1984] [Altshuller 1988] [Altshuller 1999] [Denis]. According to Altshuller et al. [Altshuller 1984], the inventive step occurs by considering technical contradictions during problem-solving [Salamatov 1999]. The existence of a contradiction despite reviewing existing solutions during a problem-solving proves the necessity of knowledge expansion at least by the combination.

Taking into account all these viewpoints let us define *non-obviousness* as the generation of a solution beyond existing solutions (the generation of a new solution) for an unresolved contradiction. Here, considering an unresolved contradiction is the necessary condition, and generating a new solution is the sufficient condition of *non-obviousness*. Hence, the consideration of unresolved contradictions implies obtaining inventive steps or inventive activities during design phase (inventive problem-solving), and the generation of new solutions implies generating a level beyond existing solutions (the knowledge of skilled user). Indeed, *non-obviousness* is the principal characteristic of inventive-design projects that eventuates in inventiveness-based evolution (i.e. for achieving *novelty*, *usefulness*, and *ideality* within new systems). Defining *non-obviousness* as a manner of problem-solving that looks for generating new solutions eliminates the risk of ignoring small changes occurring by design project. Ignoring the small changes runs the risk of missing the entire value chain of inventive-design performance during evaluation [Nuvolari 2006].

Tab. 23. The patentability criteria of industrial properties in different IP offices;

Intellectual property office	Prescribed criteria (tests) for validity of the patentability
------------------------------	---

Europe	<ul style="list-style-type: none"> = <u>Novelty</u>: inventions must be new strictly. They must not be found at a previous date in any matter (TP/P); = <u>Inventiveness</u>: inventions must involve an inventive step, i.e. an ordinary brain with experiences in the art should not be able to derive the claims; = <u>Industrial application</u>: inventions must have an industrial application, or be susceptible of industrial application;
USA	<ul style="list-style-type: none"> = <u>Novelty</u>: inventions must be new; = <u>Utility</u>: inventions should be useful; = <u>Non-obviousness</u>: inventions must not be obvious to anybody having ordinary intelligence and knowledge on the subject matter;
Japan	<ul style="list-style-type: none"> = <u>Novelty</u>: inventions must not be publicly known, publicly used, and publicly available through an electric telecommunication line; = <u>Inventive step</u>: inventions at the time of the application should not have been easy make for a person ordinarily skilled in the field of art to which the invention belongs; = <u>Industrial application</u>: inventions must be specified for a concrete application use;
India	<ul style="list-style-type: none"> = <u>Novelty</u>: inventions must be new TP/Ps during the examination procedure, i.e. inventions are disqualified by any indication of prior use; = <u>Non-obvious</u>: inventions as new TP/Ps involve an inventive step; = <u>Useful</u>: inventions even though obtaining novelty and non-obvious features cannot be patented unless and until have some use to the mankind;
WIPO	<ul style="list-style-type: none"> = <u>Novelty</u>: inventions must be new (novel); = <u>Inventive step (be non-obvious)</u>: inventions should not have been obvious to a person skilled in the art at the time the patent application was filed; = <u>Industrial application</u>: inventions must be useful;

According to these studies and arguments, the value of inventiveness-based effectiveness in the engineering design is based on an association of *novelty*, *ideality*, and *usefulness* values. By recognizing the principal criteria of inventiveness, the development of inventiveness metrics goes to a next step that needs to:

1. Understand the basic criteria of inventiveness-based effectiveness (*novelty*, *ideality*, and *usefulness*);

2. Develop an integrated measurement system for evaluating the inventiveness-based effectiveness;
3. Define the evaluation methods and the indicators;

In this manuscript, the term ‘system’ is used for any technological product or process (TP/P) that is designed as a complete system (c.f. Tab.22; Completeness of system) to support one or some functions for satisfying user requirements.

III. 2. 1. 1. Technological Novelty

Novelty is one of the key metrics to evaluate the inventiveness of design outputs. Novelty measurement is the step before defining novelty indicators and characterizing inventive activities. In the literature on creativity, *novelty* is considered as the first fact of the creativity [Sternberg 1999] [MacCrimmon 1994]. It is known as the minimum required characteristic of technological innovations [OECD 2005] that come from inventions [Schumpeter 1934]. Novelty derives from Latin words “novus” and defined as the quality or state of being new, striking, different, original or unusual [Merriam-Webster 2014]. Novelty attaches a design to the newness, i.e. the design has not been experienced before, because it has been created recently [Cambridge 2008]. MacCrimmon et al, [MacCrimmon 1994] defined novelty as the unique ideas that had not been previously expressed. The uniqueness is the main characteristic of novel ideas that tend to migrate from the most unique idea to the most usual idea over time, i.e. becoming common, frequent or prevalent [MacCrimmon 1994].

III. 2. 1. 1. 1. An Overview of Novelty Measurement Methods

The industrial property laws do not determine how can evaluate novelty degree [Sarkar 2011]. Although the IP offices are interested to evaluate or identify novel systems, their evaluations are relied on the text mining of *claims* and *descriptions* [Sarkar 2011] [Schlicher 2003]. On other hand, there are a few researches that have been devoted to understand and evaluate cognitive activities during the idea generation [Jansson 1991] [Gero 1996] [Finke 1992] [Ward 1994] [Dugosh 2000] [Nelson 2009], [Shah 2000]. However, most of the existing methods verify *novelty* quantitatively and not qualitatively [Chakrabarti 2003] [Saunders 2002] [Shah 2003]. Shah et al. 2000 [Shah 2000] introduced the engineering design metrics through *four separate effectiveness measures* as *novelty*, *variety*, *quantity*, and *quality*. Further, these four measures are discussed and completed by some recent works with the perspective of providing comprehensive design metrics [Dean 2006] [Nelson 2009] [Verhaegen 2013]. Despite an obvious inconsistency between the terms and the definitions of this categorization, Verhaegen et al. [Verhaegen 2013] considered it as a high-level guideline for mapping design metrics. In fact, Shah et al.’s categorization presents a tangled relationship, in which different metrics interfere with each other. In the words of Shah et al., *novelty* is a measure of unexpected ideas or counting the number of unique concepts. A concept is known unique when a different designer (an individual or a design team) apply a different solution to support the function of existing

solutions [Shah 2003]. Here, the term *novelty* is used for detecting the differences regarding physical principles. Accordingly, they defined *variety* as the degree to which the concepts (solutions) that come from a designer are dissimilar from his other concepts (solutions) [Nelson 2009]. *Variety* is for quantifying the differences at the *detail* level of an idea when it has only slight differences from existing ideas [Shah 2003] [Verhaegen 2013] [Dean 2006]. The term *quantity* is for stating the total number of different concepts generated by a designer. The term *quality* is the verification of the feasibility, and the achievement of design specifications. The measurement of novelty, variety, and quantity by Shah et al. is based on this assumption that generating more improves the quality of concepts [Osborn 1963] [MacCrimmon 1994] [Shah 2003]. So, different procedures have been developed for quantifying the number of unique concepts [Verhaegen 2013]. In the meantime, Shah et al. 2000 [Shah 2000], proposed two approaches for estimating the novelty degree of new concepts. First, by considering a universal comparison including all preconceived ideas generated by all participant from different teams. And second, by considering a comparison with the set of all ideas generated by the same team [Shah 2003] [Equ.6]. Although the first approach seems impracticable because of the need to aggregate a big data, the second approach might be practicable by the method for dissecting (encoding) ideas on a genealogy tree [Fig.33] [Shah 2003].

$$M_1 = \sum f_j \sum S_{1jk} p_k : \{j = [1, m], k = [1, n]\}$$

M_1 : Overall novelty score of system1 with m functions (j);

f_j : Assigned weight according to the importance of function j of system1;

p_k : Assigned weight according to the importance of level k on the genealogy tree;

S_{1jk} : Assigned weight according to the chosen approach of comparing the applied solution of function j at level k ;

If the comparison is done according to the first approach:

$$S_{1jk} = ((T_{1jk} - C_{1jk})/T_{1jk}) 10$$

T_{1jk} : Total number of ideas produced for function j at level k ;

C_{1jk} : The count of current solution for function j at level k ;

If the comparison is done according to the second approach:

A novelty score (S_1) is assigned to each idea according to the function and levels of the genealogy tree [Fig.33]. A closest match is found on the tree and the score S_1 noted (S_1 of a prior knowledge).

Equ. 6. The generic calculation formulas of novelty measurement by Shah et al. Source: [Shah 2003].

The genealogical characterization by Shah et al. consists of four levels including *physical principles* at the highest level, *working principles* at the second level, *embodiment* at the third level, and *detail* characteristics at the lowest level. Each characterization level on their tree has been weighted [Fig.33]. The nodes in each level illustrate different solutions applied for supporting functions of that level [Shah 2003]. The number of branches on the genealogy tree of Shah et al. is considered as the indicator of *variety* [Shah 2003] [Fig.33].

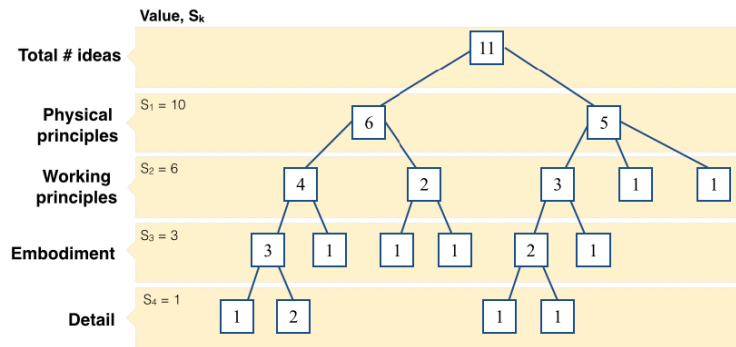

Fig. 38. Dissecting a set of outputs by a design team on the genealogy tree of Shah et al. Source: [Shah 2003].

Saunders 2002 [Saunders 2002] based his novelty measurement method on three questions; first, how often similar patterns have been experienced? Second, how similar these patterns have been? And three, how recently these patterns have been experienced? Further, Chakarbarti and Khadikar 2003 [Chakarbarti 2003] for assessing novelty defined two axes as; *vertical criteria* including the need, task, sub-system structure, technology, sub-technology, and implementation levels, and *horizontal criteria* including the main supplementary and additional levels. This novelty measurement was done in four steps respectively by; comparing new system with references, identifying differences at each level, calculating novelty value of any difference – with considering assigned weights on the horizontal axis –, and then aggregating the novelty values. Lopez-Mesa and Vidal 2006 [Vidal 2006] proposed almost the same method. The main difference of their method was that they did not consider the sequence of idea generation over the timeline and this had caused a high novelty value for the systems with more unusual solutions. Function, structure, and detail structure are the vertical levels of system characterization by this method. Verhaegen 2012 [Verhaegen 2013], after an overview on the existing methods of novelty measurement concluded that the main shortcoming of existing methods is the assignment of weights to the characterization levels arbitrarily. The weakness that is confirmed by Chakarbarti et al. [Sarkar 2011].

III. 2. 1. 1. 2. A New Framework for Measuring Novelty

The development of a new framework for measuring novelty values is an effort to complete existing methods, and eliminate their weaknesses. The new framework by this work measures technological novelty degree (TND) of the outputs in an abstract way. So the development started by asking two questions:

- What is the relation between novelty and technological evolution?
- How can estimate the novelty degree of a technological system?

III. 2. 1. 1. 2. 1. Technological Evolution and Novelty

The main feature of detecting design creativity is novelty (newness) [Batey 2012] [Fryer 2012] [Runco 2012]. Technological design (engineering design) obeys a technological evolution theory (TET) similar to Darwin's theory of evolution in biological population. Since the technology is defined as the practical application of existing knowledge [Merriam-Webster 2014], technological evolution is concerned with the process by which the changes happen in new

designs over time [Merriam-Webster 2014], i.e. technological evolutions are based on the changes occurring in technical characteristics of existing systems. With this perception, although technological evolutions are done by different projects for different targets, the *novelty* appears as the first categorical, pervasive dimension of technological evolutions. Technological novelty should be evaluated in an abstract way, without considering the positivity or the negativity of evolutions. According to the definitions of *novelty* in the literature (c.f. III.2.1.1), and by considering *novelty* as a criterion of inventive effectiveness, it is understood that novelty evaluation is comprised of the comparisons between outputs and goals of a design project. In regard with the proposed definition of *non-obviousness* (c.f. III.2.1), novelty comparisons are made between outputs in the real world and the expectations based on the knowledge of skilled users. So new systems (solutions) must be different (dissimilar) from existing systems (solutions) that are known as the references of novelty comparisons. In this work, creating dissimilarity from existing solutions during design projects by design activities are known as the changes occurring in technical characteristics of systems.

The measurement of technological novelty consists of three dimensions (properties) [Fig.34]:

- Time of occurrence of the changes occurring in technical characteristics of systems;
- Amplitude of the changes occurring in technical characteristics of systems;
- Magnitude of the changes occurring in technical characteristics of systems;

In this regard, technical characteristics of technological systems are the first and prominent issue to be studied in construing the changes through the three principal dimensions of novelty.

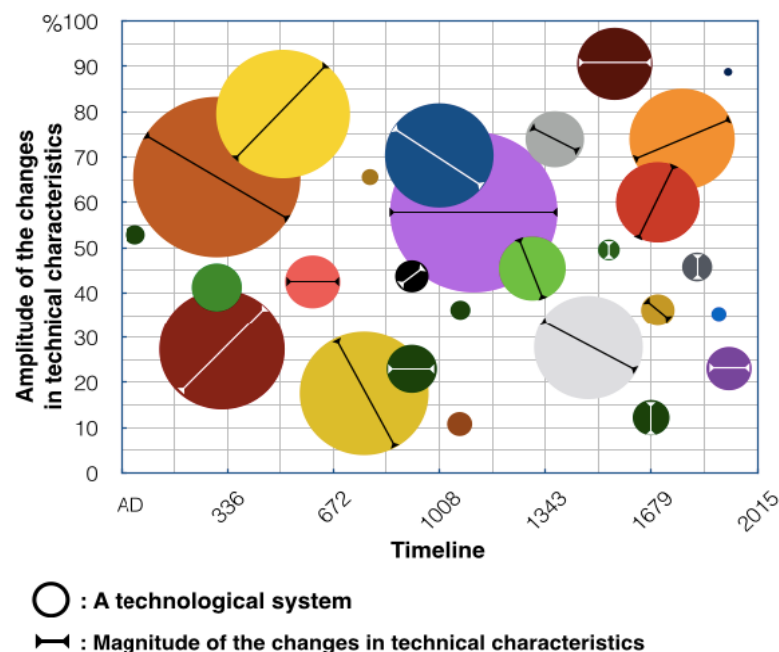

Fig. 39. The principal dimensions of technological novelty measurement.

III. 2. 1. 1. 2. 2. Technical Characteristics of a System

Technical characteristics of a system is defined by the applied knowledge during design phase. Bobrow 1984 [Bobrow 1984], is one of the first authors who studied technical characteristics of technological systems. He described technical characteristics by three viewpoints including

functional, behavioral, and structural characteristics. Later, some other authors such as Gero [Gero 2004], Suh [Suh 2001], Hatchuel [Hatchuel 2010], developed their own models based on Bobrow’s technical characterization that allowed them to establish some systematic analyses (c.f. II.2.1.1) for verifying systems at the macro and the micro layers. Arthur 2007 [Arthur 2007] also expressed that any technological system is made for a particular purpose. He said any system is an architectural combination of its components through embedding scientific principles and phenomena [Arthur 2007]. A system during its operation exhibits its own behaviors by a set of entities that are connected in a meaningful way [Zhang 2011]. System operations are done by transferring certain input objects and/or energies into certain output objects and/or energies by which the specified functions are carried out [Fig.35]. In addition of considering functional, behavioral, and structural aspects for characterizing technological systems, in this work, some information of operational environment (super-system/environment of technological systems) are also taken into account as the fourth aspect of the characterization [Tab.24].

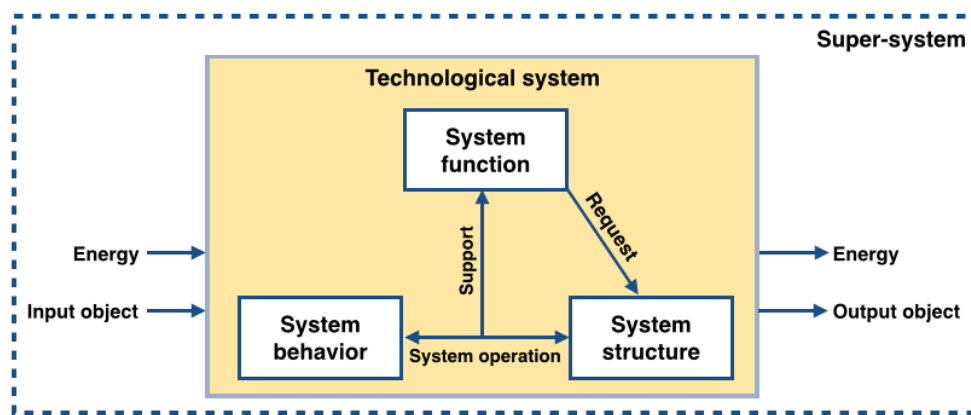

Fig. 40. A schema of the relationship between functional, behavioral, structural, and environmental aspects within a system.

Tab. 24. The four aspects of system characterization;

No.	The characterization aspects of a technological system
1	Functional characteristics
2	Behavioral characteristics
3	Structural characteristics
4	Environmental characteristics

As mentioned above, at the first, for characterizing each aspect of a technological system, we need to identify related properties (property objects) and their values (property attributes) [Fig.36]. Studying technical characteristics of technological systems allows identifying the changes occurring by new designs, and consequently developing novelty metrics.

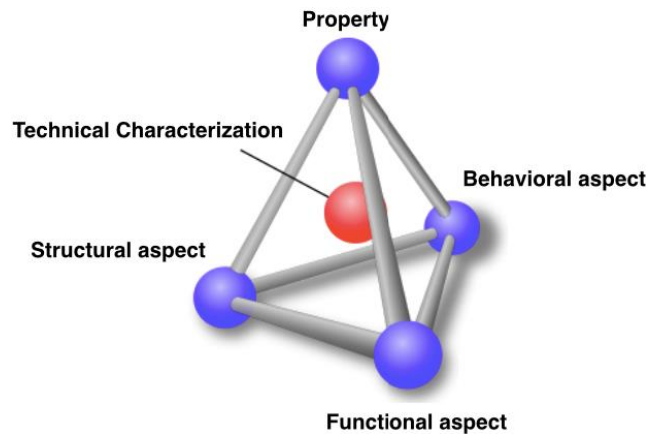

Fig. 41. The characterization of technical aspects within any system is involved with identifying related properties.

From this section of the manuscript, the term 'system' is used for addressing mono-functional systems, i.e. the systems with only one function for delivering. Hence, the systems with more than one function are covered by the term 'multi-functional systems'. The difference between both system types are clarified in the next section; 'System Function'.

III. 2. 1. 1. 2. 2. 1. System Function

Any system exists for supporting its specified function through the behavior of its structure. A system function is the interface between the system behaviors and the system usages (in relation with user requirements) [Bobrow 1984]. In other words, a system function is what has been designed for satisfying a user requirement. Among different typologies for describing system functions, the typology of Tassinari 1997 [Tassinari 1992] has been one of the most authentic and popular categorizations. Tassinari in his method [Tassinari 1992] – *functional analysis* – categorized all system functions into *principal*, *constraint*, and *complementary* types. The *principals* cover those functions of a system that are designed to satisfy user requirements. The *constraint* functions are those that limit designers to design according to a given condition. So the *constraint* functions deal with operational conditions of systems that must be strictly considered during problem-solving. The operational conditions can be related to operational environment, technology, company's strategy or the markets. The *complementarie* functions are those that facilitate, improve, or complete principal functions [Tassinari 1992]. On this basis, in order to accurate the measurement of novelty (TND), in this work, all functionality within a system – from technical to physical layers – are defined in seven categories:

1. Main Useful Function (MUF);
2. Main Complementary Function (MCF);

3. Loading/Discharging Function (LDF);
4. Environmental Constraint Function (ECF);
5. Control-Command Function (CCF);
6. Indicating Complementary Function (ICF);
7. Discrete Supplementary Function (DSF);

- **Main Useful Function (MUF):** this function type is the basic function of a system. All other function types within a system are in relation with the MUF, and/or exist for supporting this function type directly or indirectly. Eliminating the MUF of a system frustrates the main objective of its design, and the other function types (except DSF). Indeed, the MUF justifies the existence of the other function types on a system. The systems with more than one MUF are defined as *multi-functional system*. Two MUFs within a system (multi-functional system) work separately without interfering each other like their relationships with other function types. Identifying any function within a system is done by verifying three elements; its main function (MF), its useful objects (UO), and its main criteria (MC). Concerning the MUF, the two latest elements (UO and MC) are named as the main useful objects (MUO), and the main useful criteria (MUC). Identifying the MUF within technological systems allows regrouping systems into different product families [Tab.25].

- *Main Useful Function (MUF)* is the related task to the main useful function (MUF).
- *Main Useful Object (MUO)* refers to the objects of a MUF. A MUO appears as the specified input/output of a system. MUOs are not the components of a system. A MUO can be a substance (water), an energy (electricity), a feature of substances or energies (heavy water/extra-low voltage), space, or time that is received and delivered by technological systems.
- *Main Useful Criteria (MUC)* refers to the related criteria that deal directly with the main useful functions (MUF).

Tab. 25. Example of the MUF within a system;

Example: Main Useful Function (MUF)	Case study: Tumbler stainless steel cup for car
<ul style="list-style-type: none"> - Main Useful Function (MUF): Containing edible liquid; - Main Useful Object (MUO): Edible liquid as the input and the output; - Main Useful Criteria (MUC): Volume; <p>Description: Containing edible liquid is the main function of the system. This means that without containing edible liquid, the system is useless. The elimination of <i>containing</i> function frustrates other function types within the system, even those functions that don't need edible liquid for operating (constraint functions). Because</p>	

the system is a mono-functional system. The *volume* is the main criterion (MUC) of containing.

- **Main Complementary Function (MCF):** this function type includes the complementary functions regarding the MUF. It refers to those functions of a system that interact directly with the main useful objects (MUO) in order to enrich the main useful function (MUF). A MCF becomes useless without its MUF [Tab.26]. The main object (UO) of a MCF is same as the MUO of its MUF. A MCF also may be a feature of its MUO which is considered for system operation.

Tab. 26. Example of the MCF within a system;

Example: Main Complementary Function (MCF)	Case study: Tumbler stainless steel cup for car
<ul style="list-style-type: none"> - MCF₁: Maintaining initial temperature of edible liquid; - MCF₂: Securing liquid transfer via cup lid and its valve; - UO of MCF₁: Liquid temperature; - UO of MCF₂: Liquid transfer; - MC of MCF₁: Temperature, Pressure, Time; - MC of MCF₂: Gravity, Pressure; <p>Description: Maintaining initial temperature of liquid (MCF) makes sense if the system can contain some liquid (MUF). In addition, maintaining temperature (MCF) has a direct interaction with <i>liquid</i> as the MUO of the MUF. i.e. the main object of the MCF is liquid temperature (Liquid temperature is a feature of liquid). The main criteria of this function are the external temperature, pressure and time.</p>	

- **Loading/Discharging Function (LDF):** this function type refers to those functions that are defined to put MUO (or its features) in (loading) or out (discharging) of a system [Tab.27]. This may include the UO of MCF.

Tab. 27. Example of the LDF within a system;

Example: Loading/Discharging Function (LDF)	Case study: Tumbler stainless steel cup for car
<ul style="list-style-type: none"> - LDF₁: Transferring edible liquid in the cup via the mouth of cup; - LDF₂: Transferring edible liquid out of the cup via the mouth of cup; - LDF₃: Transferring edible liquid out of the cup via the mouthpieces on the cup lid; - UO of LDF_{1,2,3}: Edible liquid; - MC of LDF_{1,2,3}: Flow rate, Gravity; <p>Description: Loading and discharging are done via the mouth of the cup when taking liquid position up. However, a cap – with different mouthpieces – is designed to manage the</p>	

LDF. In this case, edible liquid is the UO of the LDF. Also the main criterion (MC) is the flow rate.

- Environmental Constraint Function (ECF):** this function type refers to those functions of a system that undertake unavoidable interactions with system environment (the super-system of systems). The ECFs are the functions that derive from the environmental condition when a system is in use. An ECF prepares the necessary condition according to system environment for carrying out other functions within a system. Hence, designers are usually obliged to consider this function type within systems to obtain MUFs, MCFs, LDFs, and the others (ICFs and CCFs). Indeed, the ECFs are the ancillaries of the other function types for obtaining them by preparing adaptive actions. In this manuscript, the objects of system environments – including substances, phenomena, and energies – are named *Super-System Objects* (SSO) [Tab.28]. The identification of an ECF is done by verifying the indispensability of considering it to achieve other functions, and its ancillary role regarding other functions.

Tab. 28. Example of the ECF within a system;

Example: Environmental Constraint Function (ECF)	Case study: Tumbler stainless steel cup for car
<ul style="list-style-type: none"> - ECF₁: Holding cup via the cup's handle; - ECF₂: Holding cup via the seating area at bottom of body-shell; - ECF₃: Holding cup via the wrapped area around the body-shell; - UO of ECF_{1,2,3}: The mass and the position of tumbler and liquid; - MC of ECF_{1,2,3}: Wight, gravity, dimension of seating area; <p>Description: Holding cup is an unavoidable function for providing the system operation or using the MUF of the tumbler cup. Holding the tumbler cup in a static position is an ancillary role to benefit from <i>containing edible liquid</i> (MUF). In this case, <i>holding</i> function has been supported by three sub-systems as for three <i>holding</i> ways. In fact, the need to consider some operational conditions for exploiting the MUF (<i>containing edible liquid</i>) imposed holding cup. However specifying car as the system environment limits system interactions with environmental objects (SSO) including cup car tray, deriver's hand claws (human hand claws), and the shakes of taking ride in car. The main criteria (MC) of this case are; weight, gravity or the center of mass, dimension of seating area, and etc.</p>	 <p>The image on the right is a composite of three parts. At the top is a stainless steel tumbler cup with a black handle and a black lid. Below it is a hand holding the cup from the bottom. At the bottom is a photograph of the interior of a car, showing the dashboard, steering wheel, and center console.</p>

- Indicating Complementary Function (ICF):** this function type refers to those functions of a system that are considered to indicate its behavioral and/or structural states. An ICF has a duty to express the operational state of related components regarding energy

flows and/or input objects (MUO/UO). Any sub-system – related to MUF, MCF, LDF, ECF, CCF, and even ICF – within a system may be equipped with the indicating instruments (ICF) [Tab.29]. So the identification of an ICF is done by verifying the specified indicators of systems, the objects of indicators (its UO), and the criteria of indicators (its MC).

Tab. 29. Example of the ICF within a system;

Example: Indicating Complementary Function (ICF)	Case study: Tumbler stainless steel cup for car
<ul style="list-style-type: none"> - ICF₁: Digital liquid-level indicator via the LED screen; - ICF₂: Digital temperature indicator via the LED screen; - UO of ICF₁: Liquid-level within the tumbler cup; - UO of ICF₂: Liquid temperature within the tumbler cup; - MC of ICF₁: The sensitivity of sensor to detect an upper free surface and repose to a peak; - MC of ICF₂: The sensitivity of sensor to exhibit temperature and alarm a large; <p>Description: The indication of liquid-level and/or liquid-temperature via the LED screen imply the ICF type embedded on the tumbler cup. However, the temperature indicator is for the MCF (maintaining initial temperature), and the liquid-level indicator is concerned with the MUF (containing) of the system. The UO of both indicators are liquid-level and liquid-temperature. Also, the MC of the both indicators are the sensitivity of related sensors to detect and repose to a peak.</p>	

- **Control-Command Function (CCF):** this function type refers to those functions of a system that allow signaling and/or commanding actions along system operation by a foreign agent. Commonly this function type is known as *control-command* interfaces that are designed for *operators* and/or *consumers*. A CCF within a technological system is used for controlling system operation according to user decisions [Tab.30]. Any sub-system – related to MUF, MCF, LDF, ECF, ICF, and even CCF – within a system may be equipped with the control-command interfaces (CCF) [Tab.30]. So the identification of a CCF is done by verifying the specified control-command interfaces of systems, the objects of control-command interfaces (its UO), and the criteria of control-command interfaces (its MC).

Tab. 30. Example of the CCF within a system;

Example: Control-Command Function (CCF)	Case study: Tumbler stainless steel cup for car

- CCF: The buttons of turning on/off heating system on the tumbler cup;
- UO of CCF: Turning on/off heating system;
- MC of CCF: Electronic signal, Signal transmission, Current, Voltage;

Description: In this case, heating system of the tumbler cup is under control via a button on the control-command box (below the indicating instruments). However, the heating system embedded on the tumbler cup is a MCF type. The button of turning on/off on the black box imply the CCF embedded within the tumbler cup. The UO of controlling-commanding is turning on/off heating system. The MC of controlling-commanding are the current and the voltage of signals.



- **Discrete Supplementary Function (DSF):** this function type refers to those functions that don't have any relation with the other function types embedded within a system. Detecting a DSF within a system means that the system is a multi-functional system. However, a DSF is less important than the MUF for user and/or designer. A DSF is a foreign function that has been attached to a system and turned it into a multi-functional system. In other words, a DSF is another MUF that serves users separately out of the specified scenarios for the premier MUF and its related function types. A DSF may have its own users, because the manipulation of a DSF is independent without taking the premier MUF into operation. So a DSF can be used by anyone including user, consumer, operator and even those who has no deal with the other system functions [Tab.31].

Tab. 31. Example of the DSF within a system;

Example: Discrete Supplementary Function (DSF)	Case study: Tumbler stainless steel cup for car
<ul style="list-style-type: none"> - DSF: Embedded watch on the shell body; - UO of DSF: Time; - MC of DSF: Battery life, Voltage; <p>Description: The LED watch on the body-shell of a mug can serve any user who reads it (make interaction with it). In this case, it is sufficient to be located in the same environment for using the LED watch (reading clock or the LED lighted branches).</p>	

III. 2. 1. 1. 2. 2. System Structure

Any complete system for supporting its function uses substances (matter) and energies, however some energy types don't need any substance for transferring. The structural aspect of technological systems refers to the physical and also the architectural properties of these matters that are known as system components. So characterizing the system structure is involved with the properties such as *assembled piece*, *connection type*, *chemical element*,

material structure, formation, dimension, size, color, density and etc. Since the term *component* is used for both *monolith* and *assembled* parts in some literature [Brimble 2000] [Fenves 2008] [Labrousse 2008], in this work, any *monolith* part is known as *entity*. Hence, the term *system structure* refers to a set of integrated entities. The changes occurring in this characterization-level (structural) have been known by different authors as *variety* [Shah 2003] [Shah 2000] [Verhaegen 2013], because the novelty comparison needs the systems (references) with same mechanism (same functions and same behavior). The characterization of structural entities is based on the identification of physical-architectural properties and their values [Fig.36] [Tab.32]:

- **System Structural Properties (SSP):** the physical-architectural properties of a structural entity within a system.
- **Structural Property Attributes (SPA):** the values (attributes) of physical-architectural (structural) properties within a system.

Tab. 32. Example of the SSP and the SPA within a system;

Example: Body-shell as an structural entity		Case study: Tumbler stainless steel cup for car	
System Structural Properties (SSP)	Structural Property Attribute (SPA)		
Material	Stainless steel, SST-304		
Chemical element	The alloy of:		
	Carbon	0.08 max.	0.03 max.
	Manganese	2.00 max.	2.00 max.
	Phosphorus	0.045 max.	0.045 max.
	Sulfur	0.030 max.	0.030
	max.		
	Silicon	0.75 max.	0.75 max.
	Chromium	18.00-20.00	18.0-20.0
	Nickel	8.00-12.00	8.0-12.0
	Nitrogen	0.10 max.	0.10 max.
	Iron	Balance	Balance
Geometry	Code CAD according to ISO 10303-203 (AP203)		
Dimension	63.5mm high by 44.5mm diameter		
Weight	approximately 130 grams		
Color	Silver gray body		
Assembled pieces	<ul style="list-style-type: none"> • Top edge as the provider for Mouthpiece • Bottom edge as provider for Heater body-shell 		



	<ul style="list-style-type: none"> • Height 58.3mm to 53.2mm as consumer for Knob • Height 58.3mm to 49.5mm, as provider for Control-command box 	
--	--	--

III. 2. 1. 1. 2. 2. 3. System Behavior

The behavior of a technological system refers to the mechanism of supporting its function through its structural components [Zhang 2011]. Any system consists of certain entities by which it illustrates its behaviors to achieve its functions. Each structural entity within a technological system has its own specific behavioral role during system operation [Zhang 2011] [Bobrow 1984]. So the characterization of behavioral aspects of any technological system is based on identifying the structural entities and verifying their operational mechanism:

- **System Structural Entities (SSE):** the structural entities that are involved with accomplishing a system function.
- **Operational Property Attributes (OPA):** the values (attributes) of operational properties along system operation.

The behavioral characteristics within a system derives from the state-changing of structural entities during system operations. Since just the passage of energy across structural entities causes their state-changing physically, chemically, and geometrically [Bobrow 1984] [Altshuller 1988], characterizing system behaviors lies on verifying the determinant moments of this passage. Any structural entity of technological systems exposes its behavior – or takes a different state – when receives, conducts, and/or transmits energy flows [Tab.33] [Fig.37]. Receiving energy, transiting (conducting) energy, and transmitting energy to another contiguous entity are the three phenomenal actions that occur for any structural entity during system operation. Indeed, this process with a certain repetition accomplishes system operation and consequently system function [Fig.38]. In this regard, if the existence of energy and entity (substance) is considered as the necessary condition of system behaviors by the energy *reception*, *transition*, and *transmission*, it can be said that scientific and engineering phenomena (physical effects) are the sufficient condition of these actions [Fig.39].

Tab. 33. The phenomenal actions of energy flow across structural entities;

No.	Phenomenal action between substance and energy	Description
1	Reception	When a structural entity receives a flow of energy from the outside;
2	Transition	When a structural entity conducts a flow of energy access itself as an energy-carrier;
3	Transmission	When a structural entity transmits a flow of energy outside of itself;

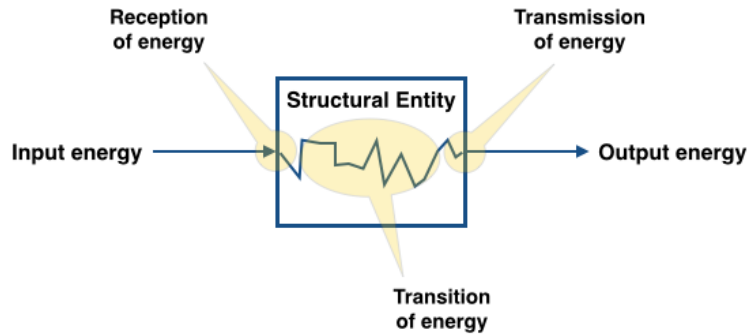

Fig. 42. The behavioral condition of a structural entity within a system.

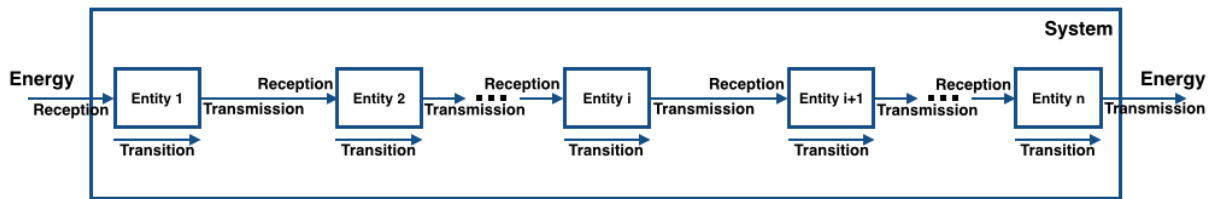

Fig. 43. Tracing energy-flow path along the chain of structural entities within a system.

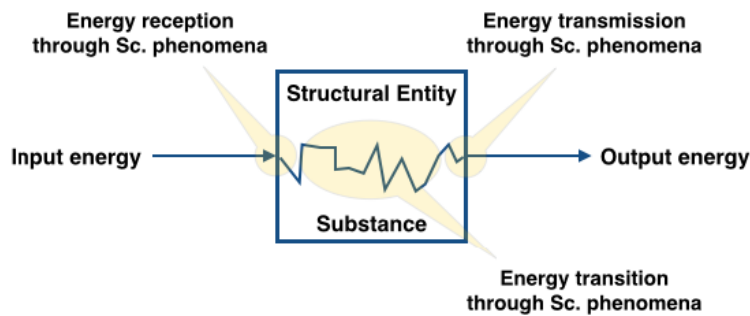

Fig. 44. The reception, the transition and the transmission of energy by a structural entity through scientific phenomena.

Therefore, the awareness about establishing scientific effects helps to identify the mechanism (solutions) applied for ensuring system behaviors. Accordingly, identifying the reception-transition-transmission of energy across any structural entity is based on verifying three elements:

1. Type of energy (input and output): Verifying the type of input/output energy of a structural entity during system operation. Different forms of energy are categorized in seven main types [Tab.34] [Tab.38].

Tab. 34. Different energy types;

No.	Type of energy
1	Mechanical (Kinematic/Potential/Gravitational)
2	Electrical

3	Electromagnetic (Radiation/Light)
4	Electrochemical
5	Thermal
6	Acoustic
7	Nuclear

2. Fundamental State of Matter (FSM): Verifying the fundamental state of the structural entities during system operation. All structural entities (substances) can be regrouped in four fundamental states [Tab.35] [Tab.38].

Tab. 35. Different states of matter;

No.	Fundamental States of Matter (FSM)
1	Solid
2	Liquid
3	Gas
4	Plasma

3. Scientific phenomenon (Physical effects): Verifying the scientific phenomena that cause the *receptions*, the *transitions* and the *transmissions of energies* analog system entities during system operations [Tab.36] [Tab.38].

Tab. 36. Some scientific phenomena occurring through receptions, transitions and transmissions of energy;

Scientific phenomena	Description
Convection	The movement caused within a fluid by the tendency of hotter and therefore less dense material to rise, and colder, denser material to sink under the influence of gravity, which consequently results in transfer of heat. [Oxford 2014] [Bergman 2011].
Condensation	Condensation is the change of physical state of matter from gas phase to liquid phase and is the reverse of evaporation [Calvert 1990].
Nuclear fusion	Nuclear fusion is a nuclear reaction in which two or more atomic nuclei collide at a very high speed and join to form a new type of atomic nucleus. During this process, matter is not conserved because some of the matter of the fusing nuclei is

	converted to photons (energy). Fusion is the process that powers active or "main sequence" stars [Shultis 2002].
Ionization	Ionization is the process by which an atom or a molecule acquires a negative or positive charge by gaining or losing electrons to form ions, often in conjunction with other chemical changes [McNaught 1997].



Verifying these three elements of behavioral characteristics within technological systems gives a comprehensive identification of applied mechanisms, as well as facilitating the inspection of system behaviors in a common level [Tab.37].

Tab. 37. The reasons of choosing *energy*, *scientific effects*, and the *state of matters* for identifying the mechanism applied in a system;

No.	The reasons for choosing Energy, Scientific phenomena, and FSM
1	To reduce the complexity of the identification.
2	To avoid from a complicate verification.
3	To decrease the verification level to a common level regarding the diversity of auto equipment (auto parts).
4	To make a comprehensive verification. These three elements are the basis of all combinations (solutions).

Tab. 38. Example of the SSE and the OPA within a system;

Example: Behavior of the related structure to hold cup (function) via the cup's handle	Case study: Holding tumbler cup via its handle	
System Structural Entities (SSE)	Operational Property Attributes (OPA)	
SSE1: Handle of cup as a monolith piece	Input energy: Mechanical-Kinematic by human	
	Output energy: Mechanical-Gravitational-Potential	
	FSM: Solid	
	Physical effect: Mechanical torque/force transmission	
SSE2: Bolt and nut	Input energy: Mechanical-Kinematic by handle	

	Output energy: Mechanical-Gravitational-Potential	
	FSM: Solid	
	Physical effect: Mechanical torque/force transmission	
SSE ₃ : Main body-shell	Input energy: Mechanical-Kinematic by bolt and nut	
	Output energy: Mechanical-Gravitational-Potential	
	Physical effect: Mechanical torque/force transmission	

III. 2. 1. 1. 2. 2. 4. System Environment

Any technological system becomes operational in a specific condition. The term *system environment* refers to the operational condition beyond system boundaries. Generally, the environmental conditions required for system operation are defined during design phase about what should be considered or supported to operate a system. Thus, characterizing system environments depends on identifying the environmental objects that deal with system entities during system operation. The characterization of system environments is based on verifying [Fig.40]:

- **Main Specific Consumer (MSC):** The MSC refers to the systems or the persons that/who are specifically defined to be directly served by the output objects and/or behavior of a system.
- **Main Specific Operator (MSO):** The MSO refers to the systems or the persons that/who are specifically defined to provide directly a system to operate.
- **Super-System Objects (SSO):** The SSO refers to environmental objects that interact with system entities. Reciprocally, a system needs to interact with the environmental objects – beyond its entities – for carrying out well its function. In this study, the MUOs and the UOs (useful objects of different function types), the MSC (main specific consumers), and the MSO (main specific operators) have not been considered as the environmental objects of systems.

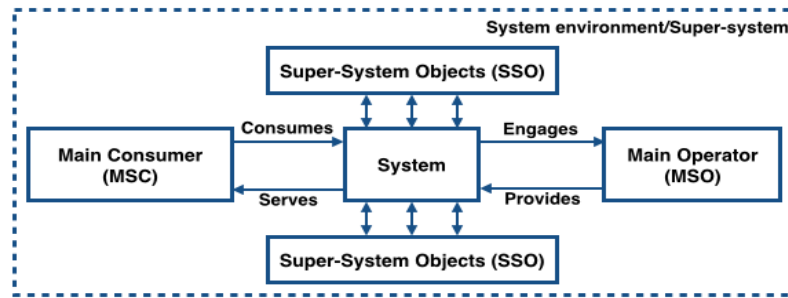

Fig. 45. The relationships between a system and its environmental objects (SSO), its MSC, and its MSO.

III. 2. 1. 1. 2. 2. 5. A Model of Technological Systems

As mentioned above, any technological system exists for supporting one or some functions by which user requirements are satisfied. Different studies on this issue [Suh 2001] [Gero 2004] [Altshuller 1988] [Kaplan 1996] [Kerssens-van 1999] imply that the response to a user requirement needs to design a system by functional, behavioral, and structural engineering. Indeed, designing a system of supporting a requirement needs to design at least a functionality, a behavioral support (energy flows), and an appropriate structural support. The chain of designing a function, and its mechanism within a system, in this work, is named *fbs-chain*. In construing the term *fbs-chain*, can say that any technological system is made of one or several *fbs-chains* (according to the number of integrated functions within a system). Each *fbs-chain* within a system is identified by only one function. Each of them utilizes one, some, or the whole structural entities of system to achieved required (designed) behaviors (energy flows) in a given specified condition (environment). The *fbs-chains* within a system are detectable [Fig.41]. However, an entity may belongs to different *fbs-chains* and be shared during their operations [Fig.42].

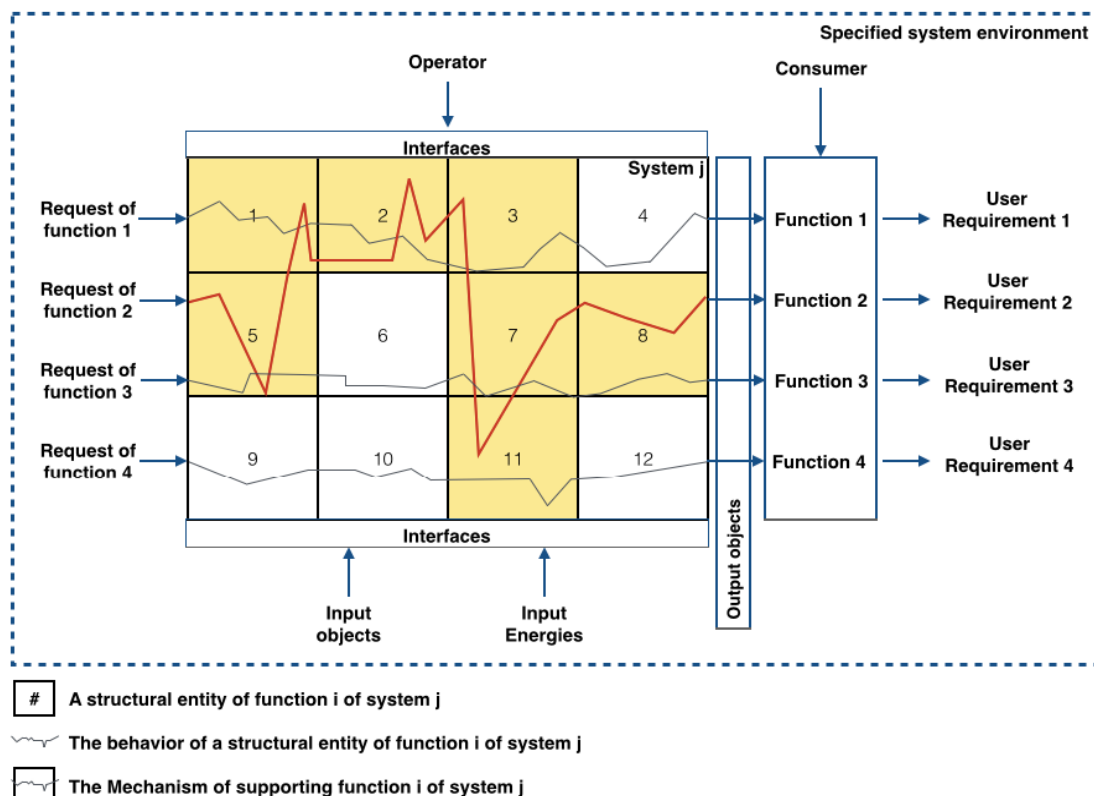

Fig. 46. A set of integrated fbs-chains within a system.

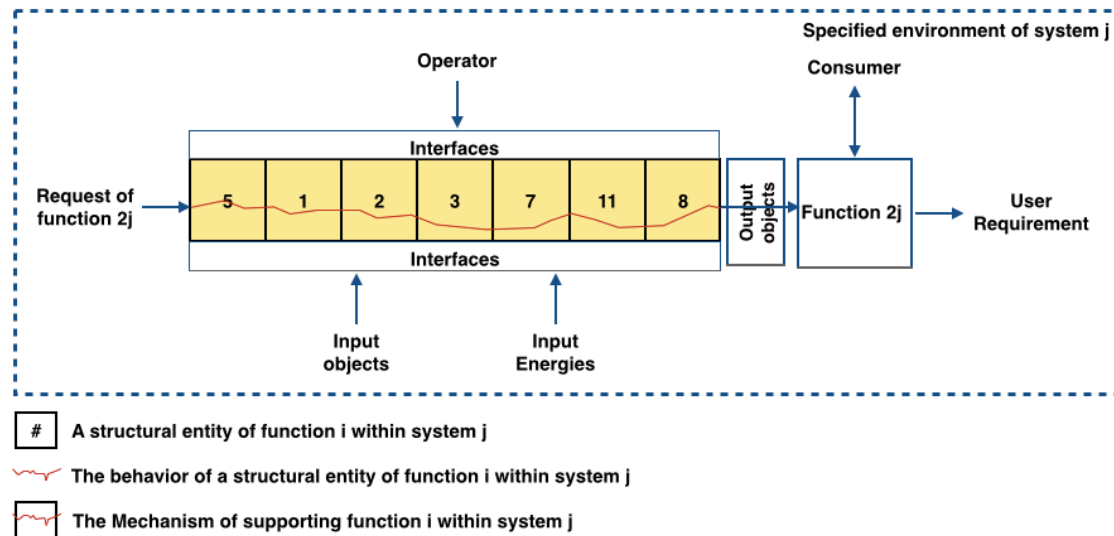

Fig. 47. The related fbs-chain of the function 2 in the figure 41.

III. 2. 1. 1. 2. 3. Detection, Identification and Valorization of New Changes

Basically, measuring the TND of any system needs to respectively detect, identify, and valorize new outputs of inventive-design projects. So the development of novelty evaluation system depends on clarifying how to detect, identify, and valorize new changes occurring in technical characteristics. So dissecting technological systems on a pedigree chart as well as formulating technical characteristics is the proposed method for evaluation technological novelty. Valorization is the next step that allows taking into account the intensity of originalities within new systems.

III. 2. 1. 1. 2. 3. 1. Definition of Novelty References

Boden 1999 [Boden 1999] described the dependence of novelty on the references. He stated that the novelty of a system has a strong relationship with psychological and historical creativity [Boden 1999]. This relates the notion of *novelty* to a number of references through comparison. Since here novelty is dedicated to technological systems, the measurement refers to compare technical characteristics of different systems. Any existing system that is generated before the system under study, may be considered as the reference of novelty comparison. However, considering a large number of references to compare is not easy and moreover is not rational. Thus, identifying appropriate references limits the scope of comparisons. This guarantees the practicability of evaluations as well as the logic of comparison. Therefore, the question is:

- What are the appropriate references for measuring novelty?

In this work, the term *novelty references* includes the appropriate references of a novelty comparison. The novelty references are identified through the inspection of technical characteristics. Focusing more on the technical characteristics implies that functional characteristics are the critical points for selecting novelty references. Indeed, the semblance of

functionalities is the necessary and sufficient condition of comparing two systems. In other words, the semblance of functional characteristics is the basis of comparing behavioral characteristics, and the semblance of behavioral characteristics is the basis of comparing structural characteristics. Thus, the novelty references, at the first step, are limited to those existing systems that are designed for supporting the same function of a new system. According to the technical characterization of technological systems (c.f. III.2.1.1.2.2), although all functional, behavioral, structural, and environmental aspects are considered for comparing two systems, the MUF as the point of departure allows us clustering technological systems into product families. The product family of a new system is the first scope of the comparisons for evaluating novelty. Among the population of all existing systems, more appropriate references are those that possess the same or compatible MUF of new system (system under evaluation). Considering the MUF as the stem of defining product families leads to identify existing systems as familial and non-familial [Fig.43]. Consequently, the dissection and the comparison of familial systems are done by establishing a product pedigree chart (PPC) with consistent formulation at each characterization layer [Fig.43]. A PPC, on the vertical axis, consists of four major-layers and their sub-layers, and on the horizontal axis, demonstrates time (c.f. III.2.1.1.2.2) [Tab.39] [Fig.43].

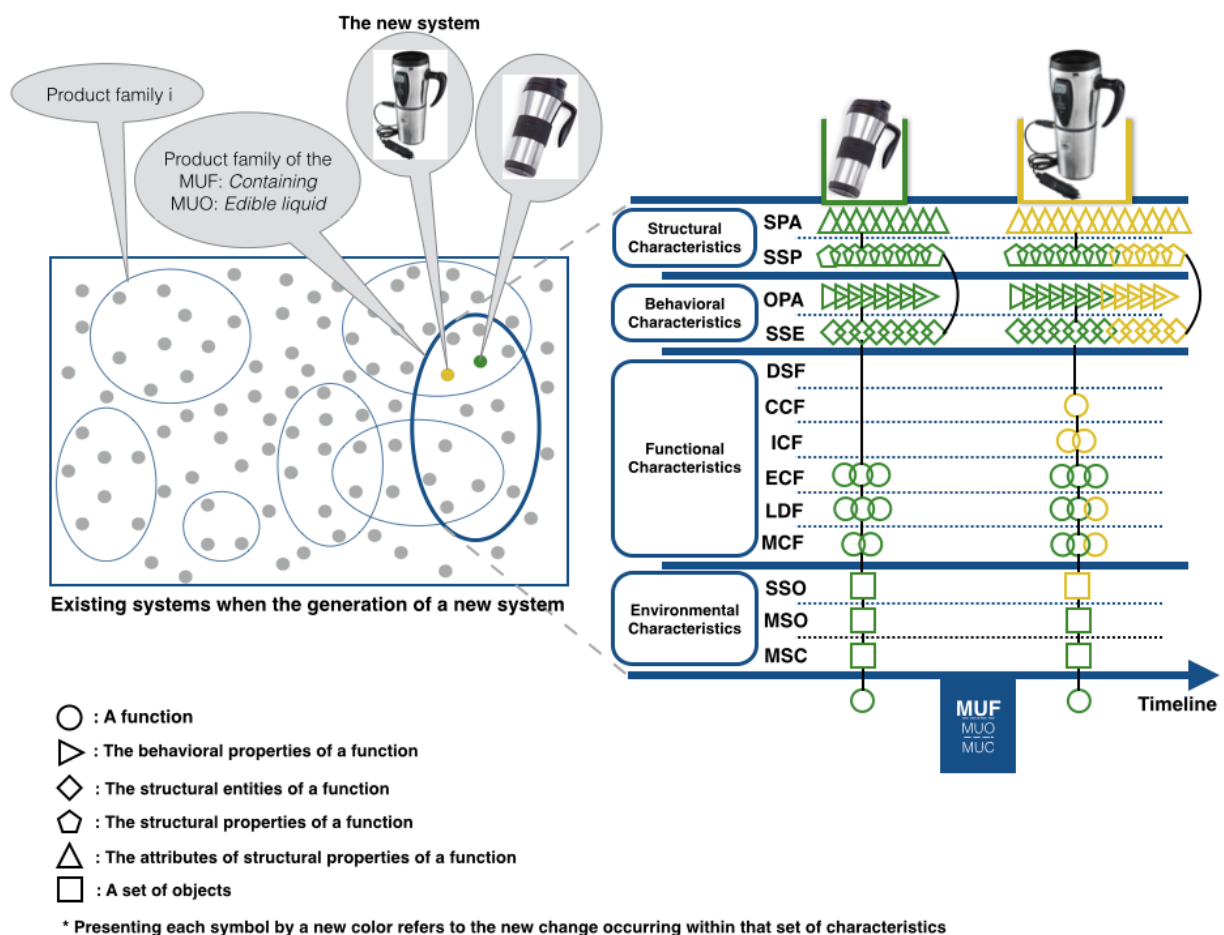

Fig. 48. The dissection of a new system on the product pedigree chart (PPC).

Tab. 39. The characterization layers on the product pedigree chart (PPC);

Product Pedigree Chart (PPC)		
Major-Layer	Sub-Layer	Description
Main identity of product family	MUF	This layer is assigned to verify the main function of a TP/P, by which other functions find meaning;
		MUO: The main useful objects of the main useful function;
		MUC: The main useful criteria of the main useful function;
Environmental characteristics	MSC	This layer is assigned to verify the main specific consumers that have been defined to consume system outputs;
	MSO	This layer is assigned to verify the main specific operators that have been defined to provide system operation;
	SSO	This layer is assigned to verify the environmental objects required to system operation;
Functional characteristics	MCF	This layer is assigned to verify the main complementary functions of a MUF;
	ECF	This layer is assigned to verify the constraint functions that are imposed to other functions by environment;
	LDF	This layer is assigned to verify the loading and discharging functions of transferring objects in/out a TP/P;
	ICF	This layer is assigned to verify the indicating functions of operating other functions;
	CCF	This layer is assigned to verify the control-command functions of operating other functions;
	DSF	This layer is assigned to verify the discrete functions from a MUF;
Behavioral characteristics	OPA	This layer is assigned to verify the operational properties by function;
	SSE	This layer is assigned to verify all the structural entities by function;
Structural characteristics	SSP	This layer is assigned to verify the structural properties by entity;
	SPA	This layer is assigned to verify the attributes of structural properties by entity;

III. 2. 1. 1. 2. 3. 2. Formulation of Technical Characteristics

The product pedigree chart (PPC) verifies technical characteristics of a TP/P through fourteen layers on its y-axis. The arrangement of characterization layers on the y-axis is based on certain criteria such as the importance of layers for a mutual recognition, the frequency and the amplitude of new changes, and the contingency of new changes in each layer [Tab.40]. Since

the functional layers are the critical points of comparing system mechanisms, they are verified before behavioral and structural characteristics [Fig.43]. The x-axis of PPC is assigned to the timeline, which gives a historical view of generating systems, emerging and/or considering functions, and applying solutions within a family.

Tab. 40. The main criteria of arranging the characterization layers on the y-axis of PPC;

The criteria of ordering the characterization layers of PPC:
To identify a system or the purpose of a solution;
The frequency of changes occurring in each layer;
The amplitude of changes occurring in each layer;
The possible contingency in each layer;
The requisite relationship

Dissecting technical characteristics into each layer of PPC needs to follow a standard for formulating data and presenting information. In fact, having a syntactic standard helps to make more precise comparisons and ensure measurement accuracy. Therefore, a proper formula with a generic syntax rule is defined for each characterization layer of PPC [Tab.41] [Tab.42] [Tab.43] [Tab.44] [Tab.45].

Tab. 41. The standard formulas of defining/identifying a MUF;

Main identity of product family	Formula
Main Useful Function (MUF)	<i><verb to be></i>
Main Useful Criteria (MUC)	<i>{ criterion; unit; (max, min)}</i>
Main Useful Object (MUO)	<i><input object>+<output object></i>
Example of defining a product family: MUF: <to contain> MUC: {volume; liter; (5 , 0.2)} MUO: <edible liquid>	A product family includes all the systems in the range of its defined MUF.

Tab. 42. The standard formulas of the environmental characterization layers;

Environmental characterization layers	Formula
---------------------------------------	---------

Main Specific Consumer (MSC)	$\forall TP/P_j: \{ \langle consumers\ type \rangle + \langle particular\ name\ of\ consumer \rangle \}$
Main Specific Operator (MSO)	$\forall TP/P_j: \{ \langle operator\ type \rangle + \langle particular\ name\ of\ operator \rangle \}$
Super-System Object (SSO)	$\forall TP/P_j: \langle environmental\ objects\ or/and\ phenomenon \rangle$
Description:	
<ul style="list-style-type: none"> At the SSO layer; the set of environmental objects of system j will be compared with the set of environmental objects of others systems. 	
Example: System A	<p>MSC: {<human, driver and co-driver>}</p> <p>MSO: {<human, driver and co-driver>}</p> <p>SSO: <the air pressure/temperature inside couch-builder, car cup tray, cigar lighter socket></p>
	

Tab. 43. The standard formula of functional characterization layers;

Functional characterization layers	Formula
<ul style="list-style-type: none"> Main Useful Function (MUF) Main Complementary Function (MCF) Environmental Constraint Function (ECF) Loading/Discharging Function (LDF) Indicating Complementary Function (ICF) Control-Command Function (CCF) Discrete Supplementary Function (DSF) 	$\forall f_{ij}: \{ \langle verb\ to\ be \rangle + \langle object \rangle + [preposition + \langle engaging\ piece/part \rangle], \{ criteria; unit; (max, min) \}, \{ \langle input\ objects \rangle \}, \{ \langle output\ objects \rangle \} \}$
Description:	
<ul style="list-style-type: none"> The brackets ([]) within formulas will be used only if there were more than one function with a same means, for a same function type, e.g. transferring and holding the tumbler cup. 	
Example: System A	<p>MUF:</p> <p>$f_{1A} \langle to\ contain\ edible\ liquid \rangle, \{ volume; cm^3; (350, 0) \};$</p>



MCF:

f_{2A} <to heat up edible liquid via heating element>,{temperature; Celsius; (29,4 , 71)},{electric current; $V=IR$; (12v , -)};

f_{3A} <to maintain liquid temperature via double-wall>,{temperature; Celsius; (100 , -4)};

ECF:

f_{4A} <to hold tumbler cup via cup-handle>,{weight; kg; (0.55 , 0.2)};

f_{5A} <to hold tumbler cup via the exterior bottom side of main body>,{weight; kg; (0.55 , 0.2)};

f_{6A} <to plug-in/out heating system to electricity via cigar lighter plug> , {volt; V; (12)}, {cord length; cm; (50)};

LDF:

f_{7A} <to transfer edible liquid into the container>,{volumetric flow rate; cm^3/s ; (56 , 5)};

f_{8A} <to transfer edible liquid from container via mouthpiece>,{volumetric flow rate; cm^3/s ; (56 , 5)};

f_{9A} <to transfer edible liquid from container via the hole of cap>,{volumetric flow rate; cm^3/s ; (12 , 1)};

ICF:

f_{10A} <to indicate liquid temperature via LED>,{power; W; (1.6 , 1.1)}, {volt; V; (4.5,1.6)};

f_{11A} <to indicate operation mode via LED>,{power; W; (0.9 , 0.5)}, {volt; V; (4.5,1.6)};

CCF:

f_{12A} <to turn-on/off heating system via manual system>,{power; W; (1.6 , 1.1)}, {volt; V; (5,2)};

f_{13A} <to turn-on/off heating system via automatic system>,{power; W; (2.5 , 1.8)}, {volt; V; (5,2)};

f_{14A} <to adjust operation mode>,{power; W; (0.9 , 0.5)}, {volt; V; (5,2)};

DSF:

f_{15A} <to show time via a LED watch>,{power; W; (7 , 0.5)}, {volt; V; (21,16)};

Tab. 44. The standard formulas of behavioral characterization layers;

Behavioral characterization layers	Formula
System Structural Entities (SSE)	$\forall f_{ij}: \{ \langle entity_{a\ f_{ij}} \rangle_{1..n} \}$ or $\forall f_{ij}: \langle engine_{f_{ij}} \rangle + \langle transmitter_{f_{ij}} \rangle + \langle worker_{f_{ij}} \rangle$
Operational Property Attributes (OPA)	$\forall f_{ij}: \{ (\langle input\ energy \rangle + \langle reception\ scientific\ phenomena \rangle) +$ $(\langle transition\ scientific\ phenomena \rangle + \langle fundamental\ state\ of$ $matter \rangle) + (\langle output\ energy \rangle + \langle transmission\ scientific$ $phenomena \rangle) \}$
Description: <ul style="list-style-type: none"> • At the SSE layer; there are two methods for listing structural entities. 1) listing all monolithic entities that support function i of system j, 2) listing the name of parts/pieces that play the roles of <engine>, <transmitter>, and <worker>. • At the OPA layer; the chain of operational properties will be presented in order of listed entities at the SSE layer. 	
Example: System A 	f_{1A} : SSE: <interior wall>, <mouth part>, <exterior wall>, <ring>, <heater body-shell> OPA $\langle interior\ wall, mouth\ part, exterior\ wall, ring, heater\ body-shell \rangle$: <mechanical, gravity>, <pressure>, <solid>, <intermolecular force>, <mechanical, gravity>, <pressure> f_{2A} : SSE: <plug-in fiche>, <electricity cord>, <heating element>; OPA $\langle plug-in, cord \rangle$: <electricity>, <conductivity>, <solid>, <conductivity>, <electricity>, <conductivity>; OPA $\langle heating\ element \rangle$: <electricity>, <conductivity>, <solid>, <electrical resistance>, <thermal>, <convection>;

Tab. 45. The standard formulas of structural characterization layers;

Structural layers	Formula
System Entity Properties (SEP)	$\{ \langle related\ structural\ properties\ to\ entity_{a\ f_{ij}} \rangle_{1..n}, \langle attributes\ (values)$ $of\ structural\ properties \rangle \}$
System Entity Attributes (SEA)	

Example: System A



f_{2A} :

{SEP, SEA}_{plug-in fiche}: {geometrical dimension, AP203-STEP}, {material, ABS}, {color, black};

{SEP, SEA}_{cord}: {length, 0.9m}, {material, copper+PLA}, {color, black}, {dimeter wire, 3mm}, {geometry of section, AP203-STEP}, {conductivity level, 5.96×10^7 S/m at 20° };

{SEP, SEA}_{heating element}: {length, 0.5m}, {material, aluminum}, {color, silvern}, {dimeter, 9mm}, {geometry of section, AP203-STEP}, {conductivity level, 3.50×10^7 S/m at 20° };

During the characterization of a new technological system on its related PPC, emerging any new node in each characterization layer signifies the dissimilarity – or difference – at that layer vis-a-vis existing familial systems. Generalizing the comparison to a universal scope including all existing systems means comparing new systems with all existing systems even beyond their familial systems.

III. 2. 1. 1. 2. 3. 3. Valorization of New Changes

Among the existing measurement methods of novelty, few ones have considered the importance of new changes occurring by a new design [Shah 2003] [Howard 2008] [Sarkar 2011]. The common point of all these methods is that they assigned different scores (weights) to the different layers of technical characterization layers qualitatively or quantitatively. Shah et al. [Shah 2003] assigned the scores 10, 7, 3, 1 respectively to *physical*, *working*, *embodiment* and *detail* layers, and some others like Howard et al. [Howard 2008] used the terms *original*, *adaptive*, *variant* to indicate respectively the importance of changes in behavioral, functional, and structural characteristics. By the way, it is obvious that the value of changes regarding different characterization layers is not same, and raises this issue:

- What is the impact of changes occurring at each characterization layer on the intensity of novelty?

According to the studies of Howard et al. [Howard 2008] and Sarkar 2011 [Sarkar 2011], who considered the changes occurring in behavioral characteristics more important than the changes occurring in functional and structural characteristics, in this work, the behavioral, functional, and structural changes are evaluated respectively as *high*, *medium*, and *low* factors for affecting novelty magnitude [Tab.46].

Tab. 46. The importance of changes occurring in each major-layer to intensify TND;

New changes occurring in technical characteristics	Affecting TND
Functional characteristics	Medium
Behavioral characteristics	High

Structural characteristics	Low
----------------------------	-----

In addition of Howard’s classification, Sarkar et al. [Sarkar 2011] argued that functional changes may be evaluated more important than behavioral changes if a new system is designed to fulfill a new function. In fact, this situation emerge when a new system proposes a new function to industrial processes or social/personal lives for the first time, e.g. watching television in 1928. On the other hand, Althsuller et al. 1999 [Altshuller 1999], classified new systems according to the applied knowledge for designing them. This classification was based on the field and the history of solutions that are used to fulfill functions. Accordingly, reusing those knowledge that have been used already to design a system – or solution – intensifies novelty degree less than using new scientific discoveries [Tab.47].

Tab. 47. The classification of new solutions according to the applied knowledge. Source: [Altshuller 1999];

New changes (solution) occurring within a new system	Classification
The applied change (solution) is well known within the specialty	Level one (non-significant)
The applied change (solution) is well known within the industry, i.e. new solution was applied already in the same technology.	Level two
The applied change (solution) is well known outside the industry, i.e. new solution was applied already in other sectors (technologies).	Level three
The applied change (solution) is well known as a new principle (science) that not used within any system, i.e. new solution emerge for the first time by applying new science.	Level four
The applied change (solution) comes from a recent scientific discovery, i.e. new solution is based on a recent scientific (principle) discovery.	Level five (most significant)

By studying these classification methods, a combination of them was considered and developed for valorizing different changes occurring within technological systems. Looking in more detail at these classification methods gives three conceptions for developing the valorization of new changes:

1. The impact factor of each characterization layer can be defined in relation to the other layers;
2. The impact factor of technical changes can be defined differently in familial and non-familial scope of the comparison;
3. The impact factor of technical changes can be defined differently in different industrial technology sectors, e.g. electronic, chemical, metallurgic, petrochemical, leathery, medical, and etc.;

In this regard, according to the generic classification [Tab.48] – as mentioned above – the changes occurring in behavioral characteristics of systems intensify technological novelty more than the changes occurring in functional and structural characteristics respectively. Remembering the argument of Sarkar et al. [Sarkar 2011] about the creation of new functions limits this generic classification to the comparisons in familial scope. The assigned scores to this generic/major classification (β) respectively are defined as $|1.x10^{-1}|$, $|1.x10^{-2}|$, and $|1.x10^{-3}|$.

- β_f : The generic value of new changes occurring in the functional characteristics of a new system in a familial scope;
- β_b : The generic value of new changes occurring in the behavioral characteristics of a new system in a familial scope;
- β_s : The generic value of new changes occurring in the structural characteristics of a new system in a familial scope;
- *Familial scope*: the scope of novelty comparison when the comparison is limited to the familial products of a new system, i.e. there are similarities in universal scope and not in familial scope;
- *Universal scope*: the scope of novelty comparison when the comparison is extended to the existing systems beyond product family, i.e. there is not any similarity in familial scope, nor in universal scope;

Tab. 48. The classification of new changes occurring at the major layers in a familial scope;

New changes occurring in technical characteristics	Generic classification in familial scope	The assigned score to the generic values of new changes (β)
Functional characteristics	Medium	$\beta_f = 1.x10^{-3}$
Behavioral characteristics	High	$\beta_b = 1.x10^{-1}$
Structural characteristics	Low	$\beta_s = 1.x10^{-5}$

The generic classification is considered as the basis of classifying different conditions that emerge by taking into account both; the changes occurring in different aspects (functional, behavioral, structural), and the scopes of novelty comparison. These conditions are defined for a *fbs-chain*, and listed in ascending order of importance to intensify novelty [Tab.49]:

1. New fbs-chain is designed to fulfill a function that has already been considered in familial scope, by applying a mechanism that has already been applied in familial scope, and by changing a structural attribute that does not influence system mechanism;

2. New fbs-chain is designed to fulfill a new function in familial scope, by applying a mechanism that has already been applied in familial scope, without changing any structural attributes;
3. New fbs-chain is designed to fulfill a new function in universal scope, by applying a mechanism that has already been applied in familial scope, without changing any structural attributes;
4. New fbs-chain is designed to fulfill a new function in familial scope, by applying a mechanism that has already been applied in familial scope, and by changing a structural attribute that does not influence system mechanism;
5. New fbs-chain is designed to fulfill a new function in universal scope, by applying a mechanism that has already been applied in familial scope, and by changing a structural attribute that does not influence system mechanism;
6. New fbs-chain is designed to fulfill a function that has already been considered in familial scope, by applying a new mechanism in familial scope, without changing any structural attributes;
7. New fbs-chain is designed to fulfill a new function in familial scope, by applying a new mechanism in familial scope, without changing any structural attributes;
8. New fbs-chain is designed to fulfill a new function in universal scope, by applying a new mechanism in familial scope, without changing any structural attributes;
9. New fbs-chain is designed to fulfill a function that has already been considered in familial scope, by applying a new mechanism in familial scope, and by changing a structural attribute that does not influence system mechanism;
10. New fbs-chain is designed to fulfill a new function in familial scope, by applying a new mechanism in familial scope, and by changing a structural attribute that does not influence system mechanism;
11. New fbs-chain is designed to fulfill a new function in universal scope, by applying a new mechanism in familial scope, and by changing a structural attribute that does not influence system mechanism;
12. New fbs-chain is designed to fulfill a function that has already been considered in familial scope, by applying a new mechanism in universal scope;
13. New fbs-chain is designed to fulfill a new function in familial scope, by applying a new mechanism in universal scope;

14. New fbs-chain is designed to fulfill a new function in universal scope, by applying a new mechanism in universal scope;

Tab. 49. The ranking of different conditions that emerge by new changes occurring in a fbs-chain;

The ranking of different conditions regarding novelty of a fbs-chain	Function is not new in familial scope	Function is new in familial scope	Function is new in universal scope	
Mechanism is not new in familial scope	-	2	3	Structure is not changed
	1	4	5	Structure is changed without influencing mechanism
Mechanism is new in familial scope	6	7	8	Structure is not changed
	9	10	11	Structure is changed without influencing mechanism
Mechanism is new in universal scope	12	13	14	

Assigning the scores to the major-layers, and classifying different conditions that emerge by the changes occurring in new systems, facilitate the classification of sub-layers.

Concerning the functional aspect of technological systems, the function types are classified among each other in a generic way. However each one may be evaluated differently in accordance with the purpose of their usage within a system. Since the MUF is defined as the identity of systems or the blazon of families, it is known as the high important function type that intensifies novelty (with a score of $\mu_{f1} = 1597$). Further, the MCF because of its special relationships with the MUF is ranked as the second high important function type to intensify novelty (with a score of $\mu_{f2} = 8$). The ECF (with a score of $\mu_{f3} = 7$) is placed after the MCF, and the LDF (with a score of $\mu_{f4} = 5$) is ranked as the fourth booster of novelty value. The ICF (with a score of $\mu_{f5} = 3$) and the CCF (with a score of $\mu_{f6} = 3$) are ranked in the fifth place together. The DSF (with a score of $\mu_{f7} = 1.5$) is known as the lowest important function type within technological systems [Tab.50].

Tab. 50. The classification of the function types according to their general importance within a system;

The ranking of function type (μ)		Assigned score in familial scope (μ_f)	Assigned score in universal scope (μ_u)
Functional characteristics	1 Main Useful Function (MUF)	$\mu_1 = 1597$	$\mu_u = \mu_f \cdot 10^2$
	2 Main Complementary Function (MCF)	$\mu_2 = 8$	
	3 Environmental Constraint Function (ECF)	$\mu_3 = 7$	

4	Loading/Discharging Function (LDF)	$\mu_4 = 5$
5	Indication Complementary Function (ICF)	$\mu_5 = 3$
6	Control-Command Function (CCF)	$\mu_6 = 3$
7	Discrete Supplementary Function (DSF)	$\mu_7 = 1.5$

By extending the scope of comparison from familial (μ_f) to universal (μ_u), the score of each function type increases a hundred times ($\mu_u = \mu_f \cdot 100$) [Tab.50] [Equ.7].

$\mu_u = \mu_f \cdot 100$ <p>μ_u : The value of considering/defining a new function in universal scope;</p> <p>μ_f : The value of considering/defining a new function in familial scope;</p>
--

Equ. 7.

Concerning the behavioral characteristics, since they makes sense with tracing energy flow along physical components, the changes occurring in behavioral characteristics are valorized by verifying the applied solution for *receiving*, *transiting*, and *transmitting* energy by each physical part (the smallest physical part is named structural entities, i.e. monolithic parts) (c.f. III.2.1.1.2.2) (c.f. . III.2.1.1.2.2.2). In this regard, the behavioral elements (E, FMS, ScPh.) (c.f. III.2.1.1.2.2.3) are the first objects of classifying new mechanisms (solutions). The change of one of the behavioral elements often is sufficient to say that the method of flowing energy is changed, i.e. a new mechanism has been applied for transferring energy. However, in most cases, changing one of these behavioral elements changes the other behavioral elements. In addition, in some cases, changing structural properties and their attributes (SPA) affects energy flows, without changing any behavioral elements [Tab.51]. So the comparison of behavioral newness needs to count how many changes are applied for proposing a new mechanism regarding the energy type (E), the states of matter (FSM), the scientific phenomena (physical effects) (ScPh.), and the structural properties/attributes (SSP and SPA) (c.f. III.2.1.1.2.2.3).

Tab. 51. The change occurring in structural property (SPA) affects system behavior without changing any of the other behavioral elements (E, FMS, ScPh.);

Example: Changing structural properties with affecting energy flow along system operation	Case study: Windshield wiper blade
---	------------------------------------

Description:

The change occurring in the number and the 3D shapes (dimension) of entities affects the flow of energy. This causes a difference in regard to the distribution of energy on the blade and consequently on the windshield. Concerning the winter blades, the beam structure distributes the arm pressure to an infinitive number of points to optimize the windshield contact and pressure, while for the summer blades, excessive potential is being exerted to specific pressure points.

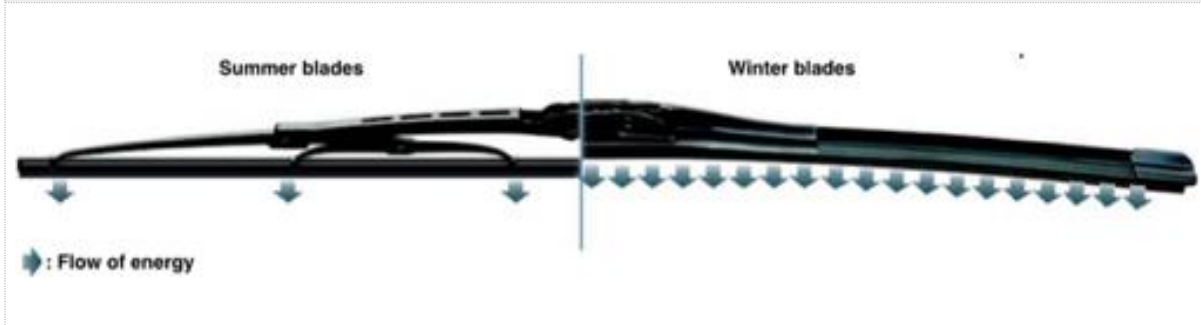

The classification of the behavioral elements among each other in relation to their influence on novelty is not evident. Therefore, the values of changing each behavioral element (E, FMS, ScPh.) is considered equal (with a score of $\lambda_f = 2$), and the value of changing structural properties and their attributes (SPA) is considered lower than the behavioral elements (with a score of $\lambda_f = 1.5$) [Tab.52]. Moreover, according to Althsuller et al. 1999 [Altshuller 1999], the proposed mechanisms (solution) for supporting a function are evaluated in three scopes:

1. New mechanism is the same of a dissimilar function;
2. New mechanism is an application of existing sciences (existing knowledge);
3. New mechanism is an application of existing sciences that are discovered and developed by same design team (project, enterprise).

Tab. 52. The classification of the behavioral elements according to their influence on novelty;

Applying new mechanism		There is a new solution to use instead of an existing solution for supporting a function	New solution has already been applied for supporting another function	New solution is obtained by developing non-applied but existing sciences	New solution is obtained by discovering and developing non-applied and non-existing sciences
		Score in familial scope ($\Sigma\lambda_f$)	Score in universal scope (λ_u)		
E	$\lambda_{f1} = 2$	$\lambda_{u5} = \Sigma\lambda_f . 2$	$\lambda_{u6} = \Sigma\lambda_f . 4$	$\lambda_{u7} = \Sigma\lambda_f . 6$	
FMS	$\lambda_{f2} = 2$				

Behavioral characteristics	ScPh.	$\lambda_B = 2$		
	SPA	$\lambda_M = 1.5$		
For each entity within a system	$\Sigma\lambda = (\langle \text{input E} \rangle + \langle \text{reception ScPh} \rangle + \langle \text{transition ScPh} \rangle + \langle \text{FSM} \rangle + \langle \text{SPA} \rangle)$			

Concerning the structural characteristics, since changing them refers to the changes occurring in the structural properties and their attributes without affecting mechanism [Tab.53], we need to count how many changes have been applied in a new design regarding the SPA and the SPP (c.f. III.2.1.1.2.2.2) of an existing mechanism. This definition includes all the changes about physical properties without affecting system behavior. In most cases, the structural changes include changing the attributes (values) of structural properties, because changing a structural property often results a new mechanism. The assigned scores to a structural change is defined in relation to the scores of functional and behavioral characteristics regarding the influence on novelty (with a score of $\theta = 2$) [Tab.54]. Changing structural attributes is known *variety* in this work.

Tab. 53. New structural characteristics refers to those changes occurring in structural properties (SPA) without affecting system behavior;

Example: Changing structural properties without affecting energy flow along system operation	Case study: Steering column switch
Description: The changes occurring in 3D shape (dimension and geometry) of the entity A (as new design) vis-a-vis B (as existing design), and/or the entity C (as new design) vis-a-vis D (as existing design) do not affect the flow of energies and consequently their system operations. In both cases, the ascii code (attribute of geometry), and the size (attribute of dimension) are changed.	

Tab. 54. The importance of changing structural attributes regarding their influence on novelty;

Applying new structure		A structural property of an existing system (existing fbs-chain) has taken a new attribute (value). (θ)
Structural characteristics	SPA	$\theta = 2$

Furthermore, since the required effort to generate new ideas in different technology sectors are not same, the novelty value (TND) of new systems regarding their technology sectors should be normalized. The coefficient of normalizing each novelty score, in this work, is named *creativity roughness index* (CRI) (τ) and its calculation is based on the number of the registered patents in different well-known technology sectors [Equ.8] [Appendix.B].

- *Creativity Roughness Index* (CRI) indicates the difficulty or the speed of idea generation in an industrial technology sector. This coefficient is different for different sectors and depends on the average probability of the idea generation (inventing) in each technology sector. Since the research advancement and discoveries are used to invent, the nature of the major science used in a technology sector is one of the main factors for determining its CRI. On this subject, the international, multinational, and/or national standards – such as ISO, CEN, NF – are the secondary factor for determining the CRI of each technology sector.

$$x_i = (P_i / p_i)$$

$$\tau_i = (x_i - x_{\min}) / (x_{\max} - x_{\min})$$

τ_i : The creativity roughness index (CRI) of *sector* i;
 x_i : The creativity roughness of *sector* i before normalization;
 P_i : The average of registered patents in the related *section* of sector i;
 p_i : The registered patents in *sector* i according to the international patent classification (IPC);
Section : A *section* in the international patent classification (IPC), e.g. A;
Sector : A *group* in the international patent classification (IPC), e.g. B60 that refers to vehicles in general;

Equ. 8

Clarifying the classification of changes occurring in different characterization layers allows estimating the novelty value of new designs. The scores given to each technical characteristic are based on deductive reasoning. In addition, they have been chosen so that they can visualize the variations at the major layers relative to each other more specifically [Tab.48].

III. 2. 1. 1. 2. 4. Calculation of Technological Novelty Degree (TND)

The calculation formula of measuring TND takes into account respectively the score of functional novelty, the score of behavioral novelty, and the score of structural novelty [Equ.9].

$$\text{TND}_a = \tau_a ((\beta_f \sum_i^1 \mu_i) + (\beta_b \sum_j^m \lambda_{ij} \cdot \mu_{ij}) + (\beta_s \sum_k^n \theta_k))$$

TND_a : Technological novelty degree of system a;

τ_a : Creativity roughness index of the related technology sector to design system a;

β_f : The assigned score to any new change occurring in the functional characteristics;

β_b : The assigned score to any new change occurring in the behavioral characteristics;

β_s : The assigned score to any new change occurring in the structural characteristics;

μ_i : The assigned score to a new function (i) applied in system a, {new functions : [i , l]};

$\lambda_{ij} \cdot \mu_{ij}$: The assigned score to a new behavior applied for supporting a function (j) of system a, {functions with new mechanism : [j , m]};

θ_k : The assigned score to a new attribute of structural property k applied in system a, {structural properties with new attributes : [k , n]};

Equ. 9. Technological novelty degree of system a.

Consequently, the outputs of TND calculation formula [Equ.9] is studied by a numerical simulation. The TND of 300 exemplars (systems) (repetition) has been simulated by considering the possibility of maximum 10 new changes for each functional and behavioral characteristic, and 1000 new changes in structural aspect of a system [Fig.44] (each exemplar is a repetition of the simulation code). This numerical study illustrates that according to the scores given to different characteristics, the novelty value at each major layer varies total TND in accordance with deductive reasoning between them [Fig.44].

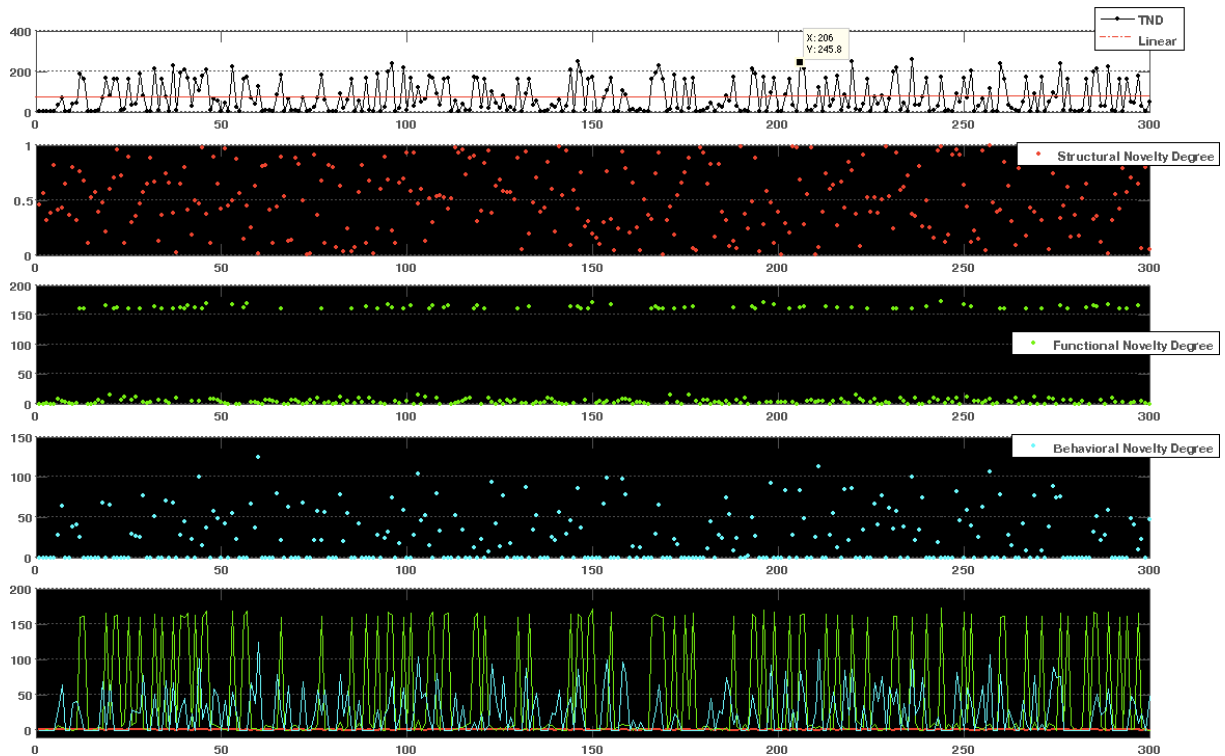

Fig. 49. The range of variation of TND at each major characterization layer and totally obtained from a numerical simulation with 300 repetitions.

For example, by considering a new principal function (MUF) in universal scope within system i, the TND records a jump of 159.7 degrees. The TND of 300 cases with a new MUF in universal scope has varied between [159.79, 259.973] units [Tab.55]. The changes occurring in the

behavioral aspect of system i is changed between [2.4, 125.1], and the changes occurring in the structural aspect of system i is changed between [0.001, 0.993] [Fig.44] [Tab.55].

Tab. 55. The statistical data of measuring the TND of 300 samples by a numerical simulation;

Statistical data	TND at functional aspect	TND at behavioral aspect	TND at structural aspect	TND total	TND of systems with a new MUF in universal scope
Min (new system)	0.3	2.4	0.001	0.108	159.702
Max	172.5	125.1	0.993	259.973	259.973
Mean	47.182	23.276	0.503	70.961	184.913
Variance	5066.618	909.466	0.085	5833.849	749.612
Standard deviation	71.1802	30.1573	0.2921	76.3796	27.379

The means and the standard deviations of novelty values in each technical aspect show well the novelty ranking by assigned scores according to the mentioned deductive reasoning of technical change in each technical aspect [Fig.44] [Tab.55].

III. 2. 1. 1. 3. Procedure of TND Measurement

The technological novelty degree (TND) of a system is evaluated in five steps [Fig.45]:

1. Data collection;
2. Reference selection;
3. Comparison;
4. Scoring;
5. Calculation;
6. Ranking regarding other systems;

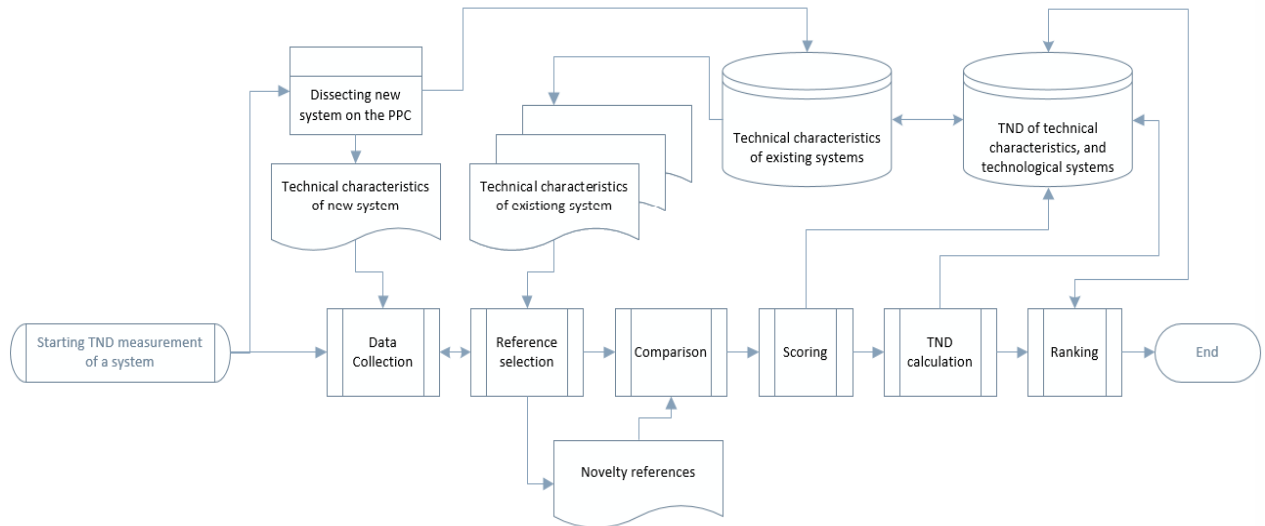

Fig. 50. The procedure of measuring the TND of a system.

- **Data Collection:** At the first step, the technical data applied on the system under evaluation (new system) must be collected. According to the classic approach, these data are collected by dissecting new systems on a PPC, in accordance with the characterization layers and their syntax rules, layer by layer (c.f. III.2.1.1.2.2). According to the second approach, instead of verifying comprehensively all technical characteristics of a new system and collecting data, the data collection is limited to the claims of changes occurring in a new systems. However, the classic approach is more appropriate to make a reference database of technical characteristics of existing systems, the second approach shortens the length of evaluation as well.
- **Reference Selection:** Reference selection as the second step of the procedure looks for identifying comparable systems with the system under evaluation. The comparable systems with a new system, in this work, is named *novelty references* that are selected on the basis of their similarities with with the new system. Detecting functional similarity between systems is the main issue of *reference selection*. Accordingly, comparing structural characteristics needs to the similarity of functional and behavioral characteristics. The main activities of this step are respectively:
 - Defining the MUF of product family (the MUF of PPC);
 - Detecting the novelty references of each characterization layer;
- **Comparison:** Detecting and identifying any similarity between two systems needs to compare and highlight their differences. The lack of similarity with novelty references in each characterization layer is the desire condition of novelty comparison.

- **Scoring:** By identifying technical differences of a new system with its novelty references, new changes occurring in each layer should be scored [Tab.48] [Tab.50] [Tab.52] [Tab.54] and putted into the calculation formula [Equ.9].
- **Calculation:** Applying the calculation formula [Equ.9] to estimate the total novelty value of a new system is the last step of TND measurement procedure. Since the calculation formula is an accumulation of defined scores according the changes occurring by new designs, the final scores builds up strong credibility for ranking familial systems against each others.
- **Ranking:** The calculation formula of the TND gives the possibility of ranking familial systems against each other regarding their novelty degrees. Since the MUF is considered as the identity of a product family, defining the MUF of a family have a strong impact on the TND measurement. Thus, ranking of a system against others in the universal scope is not always credible. The incredibility of universal ranking can be eliminated by standardizing the definition of product families.

III. 2. 1. 1. 4. Case Study of TND Measurement

For clarifying the measurement method of TND, this section provides some examples of different changes occurring within technological systems. For facilitating the measurement, the structural entities are analyzed through considering the three generic parts of any complete system (*engine*, *transmitter*, and *worker*) by Altshuller [Altshuller 1988].

Tab. 56. Two case studies of the TND measurement;

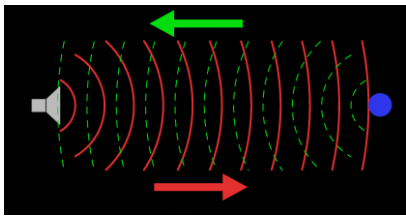
No.	Case study of TND measurement	MUF of related PPC	Functional characteristics	Behavioral characteristics	Structural characteristics	CRI (τ)	TND
1	Parking sensor on bumper car <small>(US 4855736 A, 1989)</small>	to detect distance	a ICF in car	same as proximity sensors (electronic)	There is not any familial reference to measure <i>variety</i>	B62	9606.10 ⁻⁵
	Novelty References	proximity sensors	new in familial scope	new in familial scope	-	0.02	
	TND	-	10 ⁻³ . (μ_6)	10 ⁻¹ . (16). (μ_6)	-	-	
Description:							
Since the distance detection has been considered already by existing systems from other product families, the car							

parking sensor is known as a new function in familial scope.

- $TND_f = 10^{-3} \cdot (\mu_6) = 0.003$

Since the parking function already was carried out by driver him/herself, there is a behavioral novelty at least in familial scope. In addition, since the distance detection by electronic signal is used by some other existing system in universal scope, the behavioral novelty is considered in category: λ_{u5}

1. The engine part: Transferring data to driver's senses;

$$\Sigma\lambda_f = (2+2+2+0+0) = 6$$
2. The transmitter part: Transferring data from bumper car to the automatic announcing device;

$$\Sigma\lambda_f = (0+0+2+0+0) = 2$$
3. The worker part: Verifying the distance of bumper to obstacle;

$$\Sigma\lambda_f = (2+2+2+0+0) = 6$$

- $TND_b = 10^{-1} \cdot (8) \cdot (2) \cdot (\mu_6) = 4.8$

Since the system mechanism is new, there is not any reference to verify structural changes.

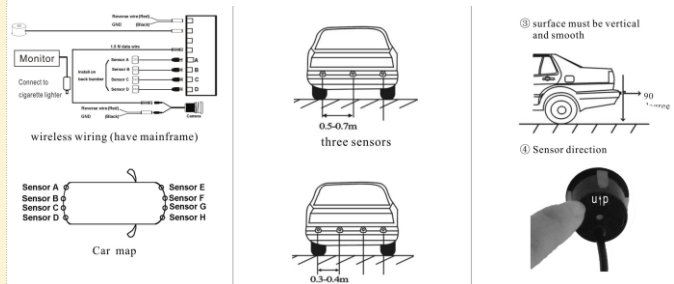

Pneumatic tire (US 5104 A, 1847)	to move comfortable	a MCF in a car	same as air-supported structure (1970)	There is not any familial reference to measure <i>variety</i>	B60	88.10 ⁻³
Novelty References	Rubber tire on wooden rim	not new	new in universal scope	-	0.005	
TND	-	0	10 ⁻¹ · (22) · (μ ₂)	-		

2 Description:

Since the comfortable movement has been considered already by existing systems in familial scope (by rubber tire), the system function is not new.

- $TND_f = 0$

Since the comfortable movement already was supported by rubber tires, but through a different mechanism, the system mechanism is new. In addition, since the pneumatic tire was developed for the first time through using the pneumatic science



and air pressure by Robert William Thomason himself, during this inventive project, the behavioral novelty is considered in category: λ_{u6}

1. The engine part: Connection point between tire and wooden rim;

$$\Sigma\lambda_r = (0+0+0+0+0) = 0$$

2. The transmitter part: Transition of force to the tread area;

$$\Sigma\lambda_r = (0+0+2+2+1.5) = 5.5$$

3. The worker part: Connection point between tire and ground;

$$\Sigma\lambda_r = (0+0+0+0+0) = 0$$

- $TND_b = 10^{-1} \cdot (5.5) \cdot (4) \cdot (\mu_2) = 17.6$

Since the system mechanism is new, there is not any reference to verify structural changes or *variety*.



III. 2. 1. 1. 5. Technological Novelty Indicators

On the basis of all the studies, modeling, and developments for measuring technological novelty degree, eighteen indicators have been defined to be considered by design teams in order to enhance their creative activities, and so intensify the TND of outputs [Tab.57].

Tab. 57. The key indicators of novelty in a mono-functional system with monolithic structure;

No.	Design's Indicators of Novelty	Impact level (degree)
1	Supplying a new function in familial scope	Principal (MUF)
2		Complementary (MCF)
3		Constrain (ECF)
4		Load/Discharge (LDF)
5		Indicating (ICF)
6		Control-command (CCF)
7		Discrete (DSF)
8	Supplying a new function in universal scope multiplies functional novelty by 100	x100
9	Applying a new mechanism,	Through changing energy type
10		Through changing FMS

11	i.e. changing the amount, pattern, or transfer method of energy flow	Through changing structural property/attribute	0.2
12		Through changing the scientific phenomenon of energy flow	0.15
13	Applying a mechanism that is used for supporting another function multiplies behavioral novelty by 2		x2
14	Manipulating an existing science that is developed by another team (project) multiplies behavioral novelty by 4		x4
15	Manipulating an existing science that is developed by same team (project) multiplies behavioral novelty by 6		x6
17	Varying a structural attribute	Through changing the value of a structural property	2×10^{-5}
18	Technological field of design activity		[3 , 100] % Depends on technology sector

III. 2. 1. 2. Technological Resourcefulness

Technological resourcefulness, in this work, refers to the concept of *ideality* in the engineering design. The term *resourcefulness* expresses the perception of ideality as a principal criterion of inventiveness-based effectiveness (c.f. III.2.1). The resourcefulness of a technological system depends on the ideality of the mechanism (solution) applied for supporting system function (problem/function) during problem-solving/design phase.

III. 2. 1. 2. 1. An Overview of Ideality in Technological Design

Ideality in design is a concept derived from idealization in philosophy, which possesses a serious argument in natural sciences. Philosophers since 1980s recognized the importance of idealization in science [Weisberg 2007]. N. Cartwright, E. McMullin, L. Nowak, Immanuel Kant, S. A. Kierkegaard, E. A. Singer, Jr., W. Wimsatt and M. Weisberg are those who largely contributed to this argument. M. Weisberg 2007 [Weisberg 2007], discussed that during this long quest, despite the enormously disparate characterizations and the lack of convergence, idealization activities can be clustered around three idealization types; *Galilean*, *Minimalist*, and *Multiple-models* [Weisberg 2007]. The *Galilean* idealization describes grasping the real world from which the idealization takes its origin [McMullin 1985]. The *minimalist* idealization includes only the core casual factors that make a difference between the occurrence and the essential characters of a phenomenon and give rise to the phenomenon. The *multiple-models* idealization represents the efforts for idealizing highly complex models that consist of several *minimalist* idealizations with different phenomena [Weisberg 2007]. In design, G. Altshuller 1984 [Altshuller 1984], concerning inventive activities and the engineering design, argued that

all existing technological systems evolve toward ideal systems. He mentioned ideality as one of the fundamental concepts of his theory of inventive problem-solving (TRIZ). TRIZ model starts problem-solving through a problem analysis in which the problem-solver should define the ideal final result (IFR) as the most desirable solution for a given condition. Later, Suh. N. P. 1990 [Suh 1990], in his method; *Axiomatic Design*, tried to establish a mathematical foundation of systematic design which is based on matrices [Equ.10]. The objective was to improve the ideality of systems through analyzing their parameters. In this regard, he defined two axioms to identify a good design from bad ones. The *first axiom* states that within a system, each fbs-chain (c.f. III.2.1.1.2.2.5) should satisfy its related function without affecting other fbs-chains. The *second axiom* is about minimizing the information content of design. So, in axiomatic design, an ideal design occurs when the number of design parameters is equal to the number of functional requirements, i.e. when [A] turn into a unit matrix [Suh 1990] [Equ.10].

$[\text{FR}] = [\text{A}].[\text{DP}]$ <p>[FR]: The matrix of functional requirements which are specified for a system; [A]: The matrix of design elements matrix; [DP]: The matrix of design parameters including physical characteristics;</p> $[\text{DP}] = [\text{B}].[\text{PV}]$ <p>[B]: The matrix of behavioral characteristics; [PV]: The matrix of process variables;</p>

Equ. 10. The matrix model of design formalization in axiomatic design. Source: [Suh 2001]

Overall, in view of these perceptions, it can be concluded that in the engineering design, firstly, the idealization means reducing the gap between a current system and the ideal expectations [Haag 2007]. Secondly, the idealization activities are involved with all three idealization types in natural sciences. And thirdly, design parameters are the main factors of technological evolution toward ideal systems. In order to get deeper into this issue, three questions are raised:

- What does ideality signify in technological design?
- What does design parameter mean?
- What is the role of design parameters to evaluate ideality?

Clarifying these questions paves the way of developing ideality metrics. Since the inventiveness is interpreted as the significant evolution toward ideal ones, inventive design is inferred by an *ideal selection*. The *ideal selection* is the main dominant law of the *stages* and the *gates* during design phase (c.f. II.2.3). It implies the tendency of technological evolution to emerge inventive systems. The *ideal selection* helps to understand and guide idea generations and further idea selections at the invention phase. It justifies new designs and illuminates the path of technological evolution. Equipping the *ideal selection* with the forecasting methods makes it easier to find the right direction for evolutions. Technological evolutions emerge gradually by the changes – encompassing both *incremental* and *radical* improvements – in order to approach ideal systems. Logically, the ideality values of familial systems (different solutions of a same problem/function) should be increased over the timeline [Fig.46]. Therefore, measuring ideality ensures relevant evolutions of new systems.

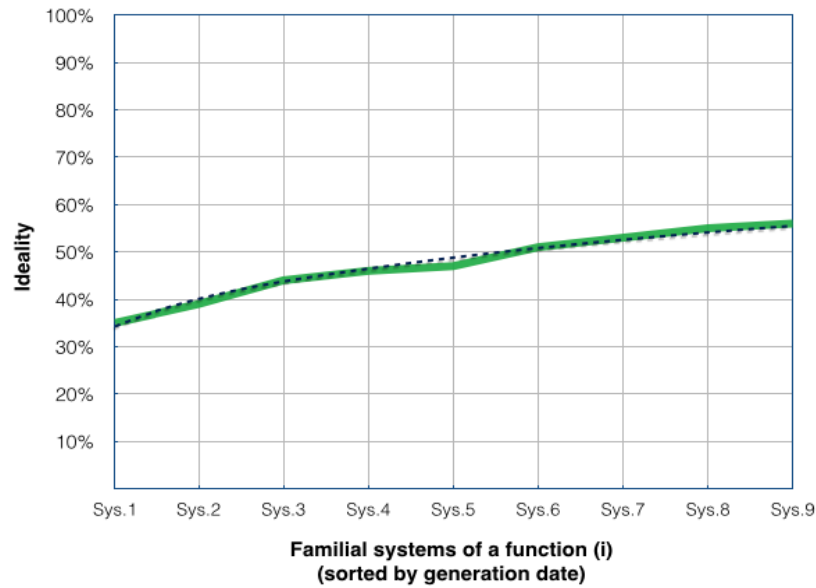

Fig. 51. The ideality of familial systems should be improved by inventive design.

In the literature, an ideal system is defined as an ultimate objective or the aim of performance arisen from a mental image that exists only in a fantasy world or imagination [Blosiu 2000]. An ideal system fulfills its specified functions at the right time and at the right place without applying any substance and/or consuming energy [Petrov 2005]. In real world, the idealization activities seek to fulfill requirements with the least dependency on materials and energy. This effort focuses on decreasing the dependency of existing systems for approaching ideal ones. So the ideality of a system is perceived as the success rate of idealization activities during design phase. Furthermore, ideality measurement in the engineering literature is based on a generic formula; the ratio of *useful functions* to *harmful functions* [Equ.11] [Altshuller 1984] [Petrov 2005].

$$\text{Ideality} = \frac{\sum \text{UF}}{\sum \text{HF}}$$

Ideality: The success rate of idealization activities during design phase {Ideality $\rightarrow \infty$ };

UF: The useful function of a system, { $\sum \text{UF} \rightarrow$ the maximum possible};

HF: The harmful function of a system, { $\sum \text{HF} \rightarrow 0$ };

Equ. 11. The generic formula of evaluating ideality in engineering.

This signification of ideality in engineering aligns *ideality* with the concept of ‘*easy to use*’ or ‘*ease of use*’ (EOU). Davis 1989 [Davis 1989], defined EOU as the degree to which a person believes that using a particular system would be free from efforts. The tendency of ideality for increasing useful functions versus decreasing harmful functions illustrates well the willingness to supply functional requirements freely, i.e. a new system without any harmful effect or resource consumption. Here, the term *harmful function* (HF) includes all expenditures and losses by the existence of a system to accomplish specified requirements. In contrast, the term *useful function* (UF) signifies all the acquirable benefits from a system. Despite the same perception in the literature on ideality, there are few methods that allow measuring ideality in a practicable way [Regazzoni 2008] [Shephard 1990] [Petrov 2005] [Blosiu 2000] [Ionescu 2008] [Adams 2009] [Livotov 2008]. Blosiu et al. 2000 [Blosiu 2000], by the same definition of ideality suggested an approach to quantify and measure evolution level. According to their method,

the degree of approaching an imaginary ideal system is estimated by dividing the sum of all useful functions by the sum of energy, the sum of weight, the sum of resources – including incurred cost –, the sum of volume, the sum of time, and the sum of effects [Blosiu 2000]. However, Blosiu et al. did not describe the denominator elements, it is evident that their selection brings some bugs, especially regarding volume, weight, and time. One of the good points of their method is the suggestion to establish a road map from the current states – of a system for supporting a function – to the art and the imaginary ideal states (systems). This proposition leads to develop technologies' road map by forecasting the characteristics of future systems.

Adams et al. 2009 [Adams 2009], discussed a computer-aided approach which was based on text mining for extracting patent data. Their computer-aided approach had been prepared to generate hierarchical, functional and physical models of patents with an estimation of ideality degree. The remarkable thing about their novelty evaluation is that they used the number of functions and structural components within a patent to estimate ideality degree, i.e. dividing the number of functions by the number of components at each functional and physical hierarchical level [Adams 2009].

Petrov et al. 2005 [Petrov 2005] enumerated the ways of increasing ideality by a logical argument regarding the numerators and the denominators of the ideality formula. Their objective was to ensure approaching the ideal *objects* (ideal *substance*, ideal *form*, and ideal *process*) that do not exist physically, but their functionalities are carried out completely. The functionality in their argument refers to the physical properties such as solidity, density, impenetrability, elasticity, corrosion, electro-conductivity, and chemical resistance, that all were highlighted for the *substances*, without giving some other examples in relation to the *forms* and/or the *processes*.

III. 2. 1. 2. 2. A New Framework for Measuring Resourcefulness

Based on the existing researches and the meaning of ideality in engineering design, a new measurement framework is developed by this work. This effort aims to clarify the measurement of ideality, put in place a practicable method, and adapt the metrics of resourcefulness to the other measurement frameworks of this work (novelty, usefulness). The measurement of resourcefulness relies on the analysis of design parameters, and uses the generic formula of ideality in engineering [Equ.11]. The *design parameters* in this argument refers to the technical and physical parameters that have arisen from the interactions between substances and energies. Since inventive design is concerned with improving ideality (resourcefulness level) of new systems, design activities endeavor to approximate design parameters to their ideal values [Fig.47].

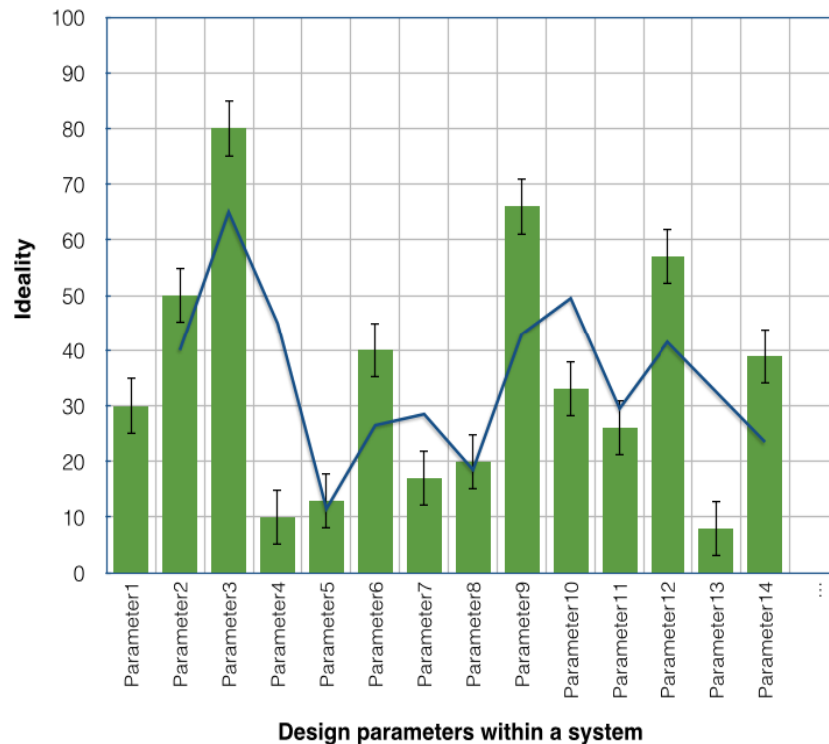

Fig. 52. The design parameters as the principal factor of measuring technological resourcefulness.

III. 2. 1. 2. 2. 1. Parameters of a Technological System

The request of a function flows energy and starts the operation of related fbs-chain within a system (c.f. III.2.1.1.2.2.5) [Fig.41]. The flow of energy within a system causes the *interactions* between structural entities (substances) to each other and to system environment (environmental objects) [Tab.58]. Although a designed interaction within a technological system (interior and exterior) will be useful to achieve a specified function, it may be harmful simultaneously for achieving some other system functions. For example, the friction as an interaction of pneumatic tires with asphalt plays a useful role for decelerating cars, however it has a harmful effect on fuel consumption and/or acceleration. Furthermore, a technical interaction in real world does not operate with the highest efficiency as well as the expectations in ideal conditions, e.g. the standard conditions for temperature and pressure. Thus, the implication of a technical interaction is far from free (ideal) operation in real world. According to this feature, Cavallucci et al. 2007 [Cavallucci 2007] used the concept of *partial solution* in their *problem-graph analysis* to consider both *useful* and *harmful* sides of existing mechanisms [Tab.59]. They also, in their inventive design method which is based on TRIZ (IDM-TRIZ), described technical interactions by defining two parameter types; *action parameters* (AP) and *evaluation parameters* (EP) [Cavallucci 2007].

- *Action parameters* (AP) derive from functional requirements and includes the acts that designers desire to support them.
- *Evaluation parameters* (EP) derive from the action parameters and covers all physical-chemical and/or even phenomenal parameters that are in relation to action parameters. EPs disclose physical characteristics and the measurement unit of an AP [Cavallucci 2007].

Tab. 58. Technical interactions between substances by energy flows and scientific phenomena;

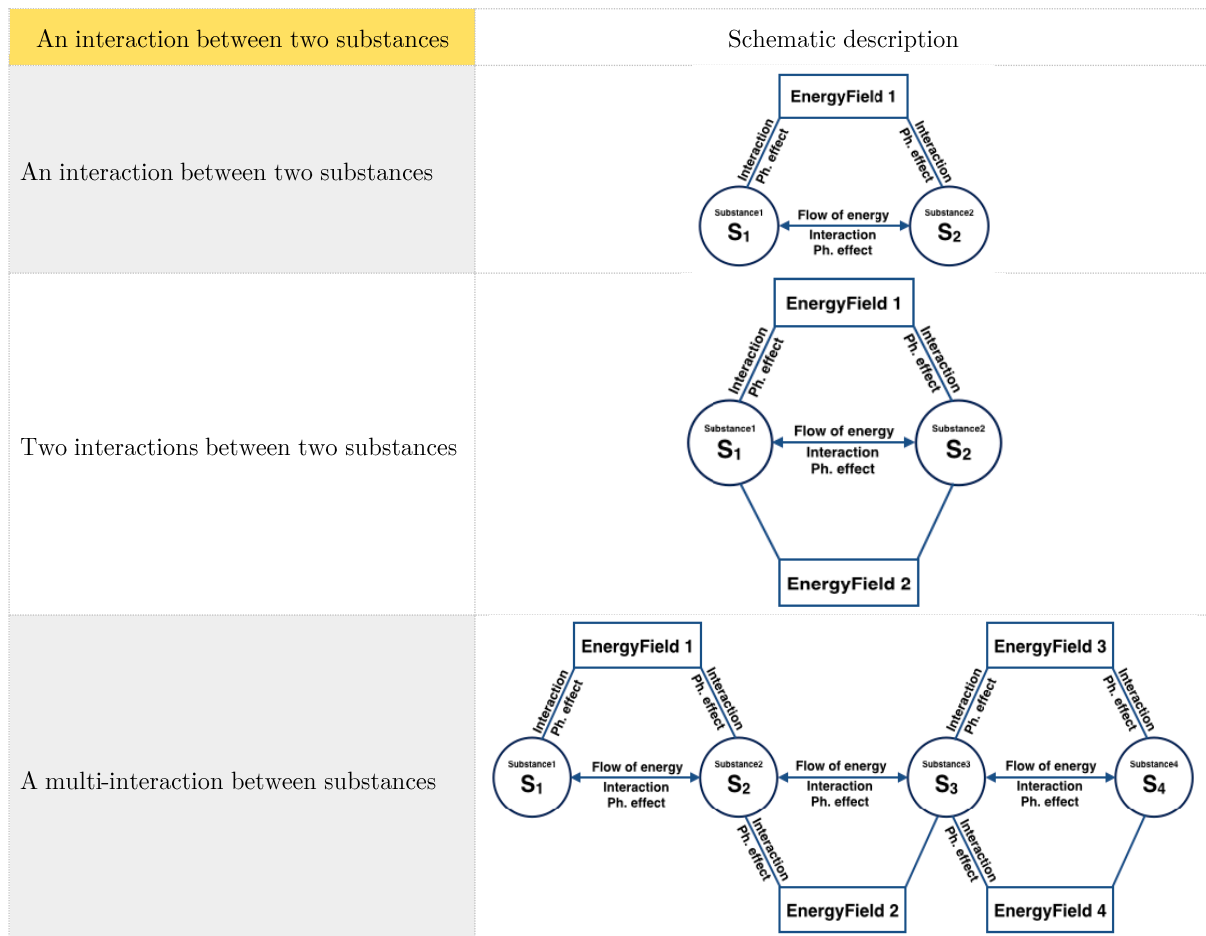

Cavallucci et al. in IDM-TRIZ [Cavallucci 2007] tried to formalize both *useful* and *harmful* effects of an AP. They proposed multi-contradictions – based on the contradiction matrix of Altshuller [Altshuller 1999] [Altshuller 1984] – and illustrated the paradoxical condition of all related EPs to each value orientation (Va^+ / Va^-) of an AP within a system [Fig.47] [Tab.59]. Indeed, taking each orientation of an AP into account may affect certain physical parameters, physical effects/phenomena and/or some other interactions positively or negatively [Fig.47]. Since detecting the ideal orientation of an EP is the first step of measuring resourcefulness, this formalization was considered as the basis of our evaluation method. In this regard, it can be concluded that the satisfaction of an EP at each value orientation (Va^+ / Va^-) of an AP implies the ideal orientation of the EP regarding the AP.

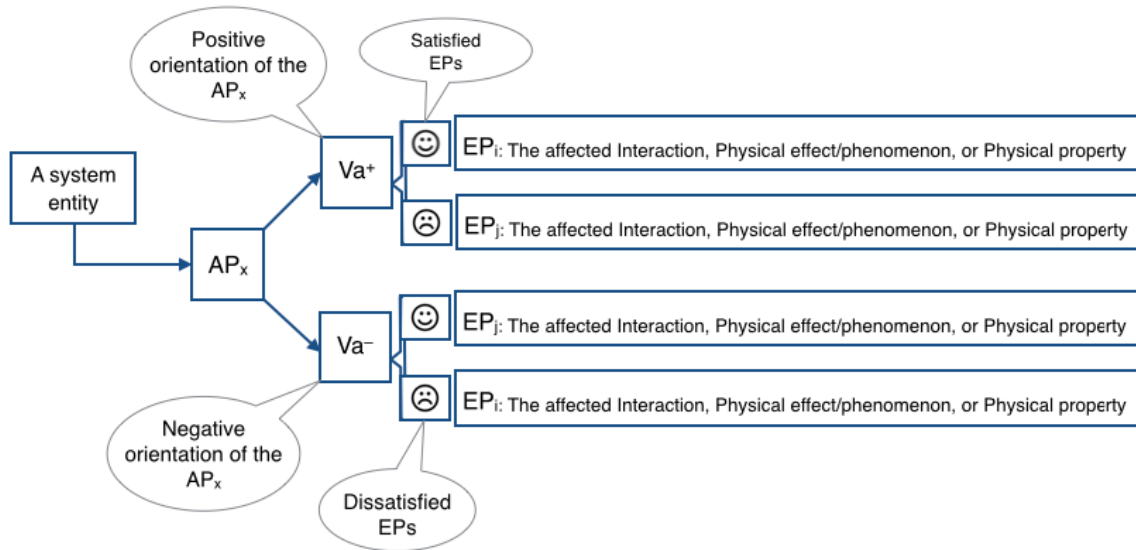
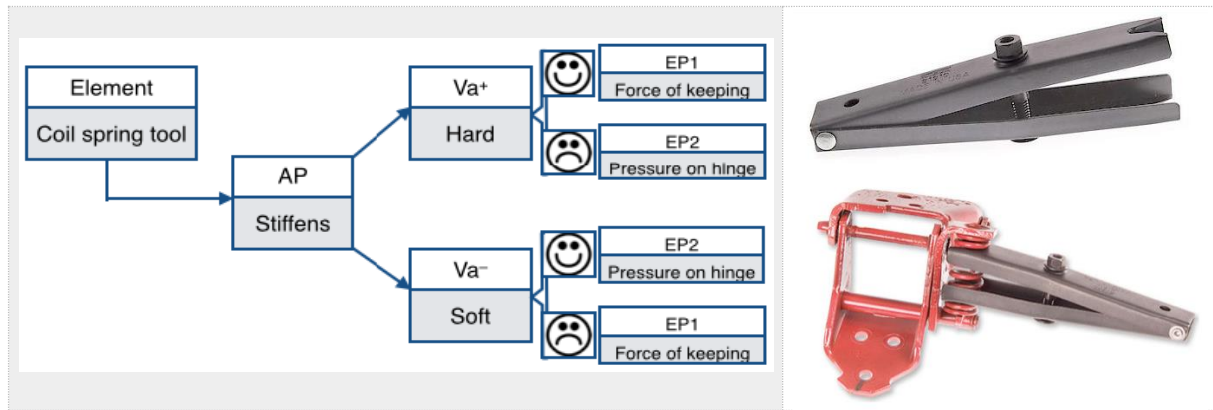

Fig. 53. The formalization of conflicts between the interactions of a substance by Cavallucci et al [Cavallucci 2011].

Tab. 59. The definitions of AP and EP in IDM-TRIZ. Source: [Cavallucci 2007];

Technical-Physical Parameters	Description	Example: Coil spring tool for GM cars and light truck doors (It is used to remove and install door hinge springs)
Action Parameter (AP)	The functional requirements and/or the partial solutions that are considered for designing a fbs-chain within a system. The action parameters can take two opposite orientations (Va ⁺ and Va ⁻) that affect other interactions, physical phenomena, and physical parameters.	Changing the stiffness of the spring is considered as an action parameter (AP) that can take two opposite orientations as being soft (Va ⁺) or hard (Va ⁻).
Evaluation Parameter (EP)	All the interactions, physical phenomena, and physical parameters that are affected by an AP are known as EP in the related contradiction. The EPs derive from APs. They are related to the opposite orientations of APs due to their satisfaction and/or dissatisfaction.	The physical parameters of keeping the hinge of doors are known as the evaluation parameters (EPs) for changing the stiffness of spring including the <i>force</i> and the <i>pressure</i> of spring. The force of keeping the hinge ensures installation and uninstallation, and the pressure on the hinge should not damage the hinge spring by deep claw marks.



III. 2. 1. 2. 2. 2. Ideality of System Parameters

After clarifying the definition of system parameters, it is necessary to detect and measure beneficial and detrimental aspects of technical interactions in accordance with the classical formula of ideality measurement [Equ.11]. Any interaction within a generated system could have been an AP of IDM-TRIZ during design phase. Thus, in general, being a beneficial or detrimental interaction depends on three factors:

- Quality of interactions;
- Amount of benefits from interactions;
- Amount of resources used or expenditures by interactions;

The quality of an interaction refers to the validation level of a designed interaction. However, the verification and the validation of a new design is possible only by implementing conceptual specification. Indeed, the validation level indicates the degree of compliance after implementing conceptual design in real world. Therefore, the validation level depends on:

- The implementation of design specification;
- The achievement of specified function/task completely;
- The satisfaction of designer's expectation/imagination;

Although the verification and the validation of the two first criteria (the implementation of conceptual design, and the achievement of specified function) are possible, the tacit aspect and the variety of imagination (expectation) from one designer to another one impedes the validation of the third criterion (designer's imaginations). In order to overcome this problem, the quality of an interaction is limited to the validation of implementation and task achievement. So the quality of an interaction is defined in a Boolean logic with two-elements; 0 and 1 (incomplete and complete) (or false and true) [Equ.12] that express respectively *non-operational* and *operational* states after implementing design specification.

$$W = w_1 \wedge w_2 \wedge \dots \wedge w_n$$

w_i		w_j	W
0	\wedge	0	0
1		0	0
0		1	0
1		1	1

- A designed interaction/system W have quality ($W=1$) if all n sub-interactions/systems of system operation (w_i and w_j) are accomplished completely ($w_i=1$) and ($w_j=1$), $\{1 < i < n\}$, $\{1 < j < n\}$;
- A designed interaction/system W does not have quality ($W=0$) if one of n sub-interactions/systems of system operation (w_i or w_j) is accomplished incompletely ($w_i=0$) or ($w_j=0$) $\{1 < i < n\}$, $\{1 < j < n\}$;
- *Complete accomplishment* means a system/interaction in the operational state, i.e. system can be operated and accomplishe specified function without any disruption;
- *Incomplete accomplishment* means a system/interaction in the non-operational state, i.e. system cannot be operated and accomplish specified function;

Equ. 12. The quality of implementing a technical interaction/technological system in this work.

The amount of benefits from an interaction is defined as all the benefits of a fbs-chain from an interaction. On the other hand, the amount of resources used and/or expenditures incurred by an interaction is defined as its detriments to related fbs-chains. Measuring these amounts lies on analyzing the ideal figures of EPs. Moreover, the satisfaction and the dissatisfaction of an EP in relation to each contradictory orientation of an AP is defined respectively as the *consistent* and *inconsistent* tendencies of EPs [Fig.49].

- *Consistent tendency* of an EP leads to a positive evolution on technology roadmap, which amplifies the ideality of accomplishing an AP;
- *Inconstant tendency* of an EP leads to a negative evolution on technology roadmap, which weakens the ideality of accomplishing an AP;

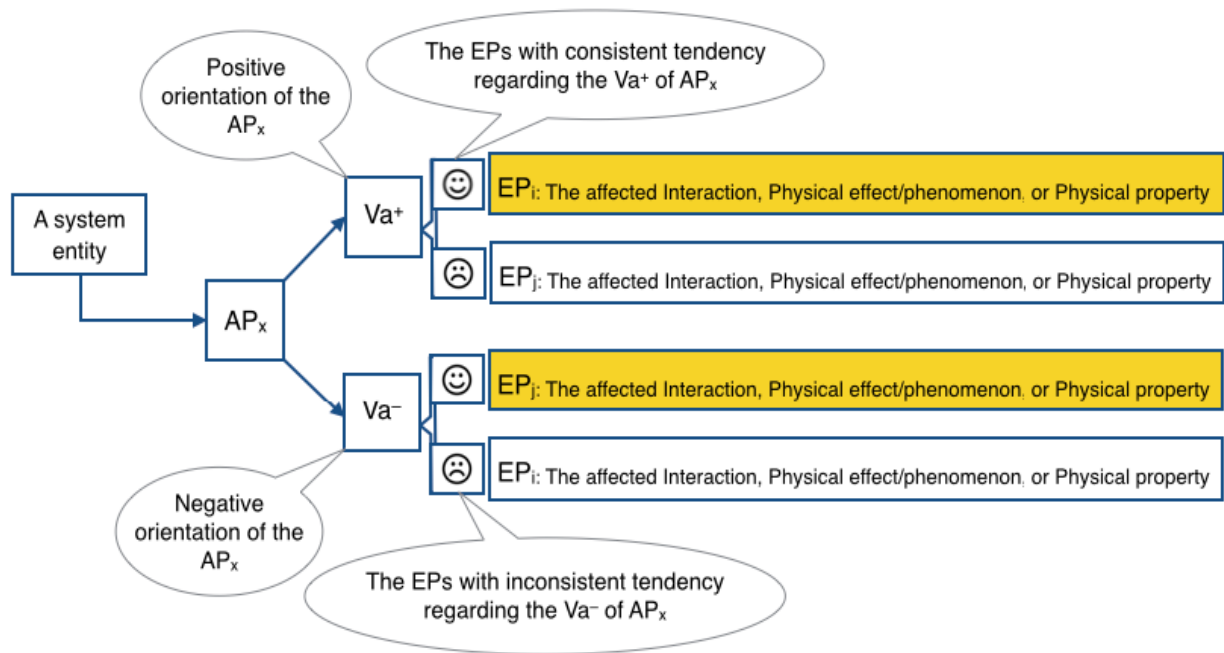

Fig. 54. The consistent and inconstant tendencies of EPs regarding the opposite orientations of an AP.

So, as mentioned before, the ideal figures of EPs are defined according to their *consistent tendency* with an AP. Accordingly, the ideal figure of different EPs is presented in two categories; *max-ideal* and *min-ideal* [Fig.50].

- *Max-ideal* category refers to those EPs that are targeted to be increased ($\rightarrow \infty$) by idealization activities, and evolve toward a more profitable (less costly) EPs for their related APs.
- *Min-ideal* category refers to those EPs that are targeted to be decreased ($\rightarrow 0$) by idealization activities, and evolve toward a more profitable (less costly) EPs for their related APs.

Indeed, both *max-ideal* and *min-ideal* EPs tend to their *ultimate ideal value* (UIV). The UIV of an EP is known as the roadmap of technological evolution. The UIVs of several EPs in a fantasy world tend to infinity and/or zero. However, applying these values are not possible in real world and seem as an oversimplification to attribute technological evolution roadmap. In this regard, the estimation of UIVs in real world is based on the technological forecasting. Learning about the *ultimate ideal value* (UIV), the *actual value* (AV), and the *initial value* (IV) of an EP allows calculating beneficial and detrimental amounts regarding an AP [Fig.50].

- *Ultimate ideal value* (UIV): the ultimate value of an EP is its ultimate ideal figure that can be imagined (estimated) by forecasting methods for new next evolutions. The UIV is the less costly value of an EP during evolution trajectory;

- *Actual value (AV)*: the actual value of an EP is a factual value that derive from the most inventive solutions applied for an AP (an existing EP);
- *Initial value (IV)*: the initial value of an EP is the introductory value of an EP that derive from the earliest (first) solution applied for an AP (an existing EP). The IV is the most costly value of an EP during evolution trajectory;

According to these definitions, the *benefit amount* from an EP is equal to what has been obtained toward its UIV [Fig.50]. Also, the resource used and/or the expenditures incurred by an EP is equal to what has not been obtained rather than its UIV [Fig.50]. This approach looks for measuring how far is the distance from the AV of an EP to its IV and its UIV. The difference between AV and UIV imposes costs on APs and/or declines the accomplishment of APs. In other words, the distance between AV and UIV demonstrates the disability of solution to avoid resource consumptions (substances, energies) and/or harmful effects (failures/declines) for accomplishing an AP. Whilst the difference between AV and IV demonstrates the capability of a new solution to avoid resource consumptions (substances, energies) and/or harmful effects (failures/declines) for accomplishing an AP. In fact, the difference between AV and IV is what idealization activities have obtained during problem-solving regarding the elimination of expenditures to the extent possible. In this argument, despite the distance of IV-AV causes resource consumptions and expenditures (dissatisfaction side), simultaneously it supports related APs (satisfaction side). However, applying energy and substances are crucial to carry out APs, their absence get rid of costs. The failure of proposing solutions with ideal EPs (failure to reach UIV) (distance of AV-UIV) is considered as *detriment amounts*. The *benefit* and the *detriment* amounts of an EP are named respectively *earned* and *unearned* values in this work [Fig.50]:

- *Earned value (eEP)*: the earned value is the distance or difference between IV and AV of an EP,
- *Unearned value (uEP)*: the unearned value is the distance or difference between AV and UIV of an EP;

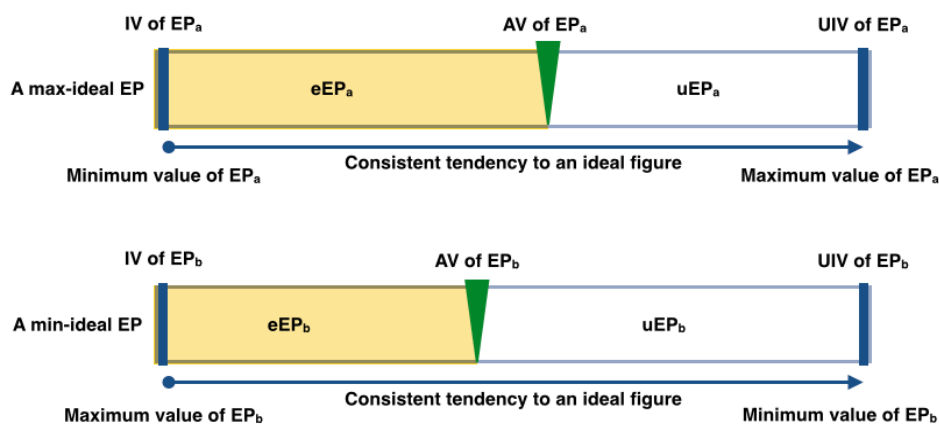

Fig. 55. The typology of evaluation parameters (EPs) and their features regarding technological evolutions.

III. 2. 1. 2. 2. 3. Calculation of Technological Resourcefulness Degree (TRD)

On the basis of the definitions given above for useful function, harmful function, and design parameters, the calculation formula of technological resourcefulness degree (TRD) is developed. Calculating the TRD of a system starts by learning about the IVs and the AVs of system EPs. This allows forecasting the UIVs of EPs. Since the EP values possess different units, the uEP and the eEP values must be normalized. The calculation of the *earned value* and the *unearned value* of EPs is the step before calculating TRD [Equ.13].

<p>For max-ideal EPs:</p> $uEP_i = 1 - \left(\frac{ AV }{ UIV } \right)$
<p>For a min-ideal EPs:</p> $uEP_i = \left(\frac{ AV }{ UIV - IV } \right)$
<p>uEP_i: The unearned value of evaluation parameter i (EP_i)</p>
<p>For both max-ideal and min-ideal EPs:</p> $eEP_i = 1 - uEP_i$
<p>eEP_i: The earned value of evaluation parameter i (EP_i)</p>

Equ. 13.

The ideality of an EP is calculated by dividing its earned value by its unearned value [Equ.14].

$\text{Ideality degree of EP}_i = eEP_i / uEP_i$
--

Equ. 14.

Dividing the sum of all *earned values* by the sum of all *unearned values* within a system figures out the TRD of the system [Equ.15].

$TRD_a = (\sum eEP_{ij} / \sum uEP_{ij}).100$
<p>TRD_a: Technological resourcefulness degree of system a;</p> <p>EP_{ij}: EP_i of function j within system a, {i: [1, m]}, {j: [1, n]};</p> <p>eEP_{ij}: Earned ideality by EP_{ij};</p> <p>uEP_{ij}: Unearned ideality by EP_{ij};</p>

Equ. 15. Technological resourcefulness degree of system a.

In the meantime, forecasting UIV is the critical point of TRD measurement. Forecasting UIV plays an important role to have a credible resourcefulness evaluation. Moreover, it helps to describe relevant growth discipline of variables (logistic growth curves) for studying further evolutions [Marchetti 1979] [Modis 2007] [Fig.51]. From the early 1960s, S-curves and develop-curves have been employed for technological forecasting [Ayres 1969] [Kucharavy 2011] [Kucharavy 2009]. A technological logistic S-curve represents the growth trajectory of future systems in a product family according to their evolution of performance index [Fig.51]. The

logistic law of a growth shows that technological evolutions grow exponentially. The growth trajectory of a product family starts at the moment of launching the earliest system of family, however the first system may be a continuous succession of other close families (S-Curve jumping/genetic mutation) according to their MUFs (c.f. III.2.1.1.2.2.1) [Fig.52]. Concerning the idealization of familial systems, EPs proceed toward their UIVs by successive generations. Forecasting the UIV of EPs within an existing system means defining the ultimate range of EPs that may appear in a most ideal system through redesigning, i.e. defining the EPs of a most ideal system in familial scope.

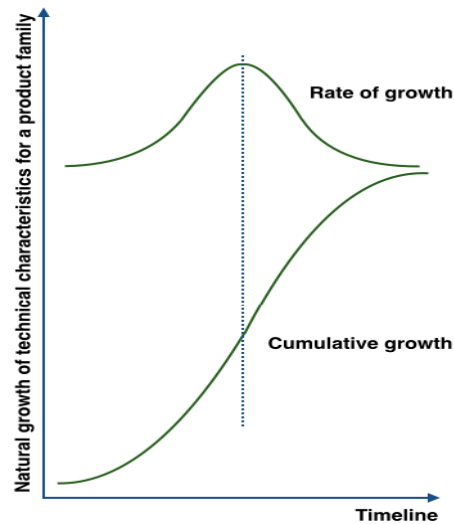

Fig. 56. The rate of growth shows a normal distribution and the cumulative growth traces out an S-curve. Source: [Modis 2007].

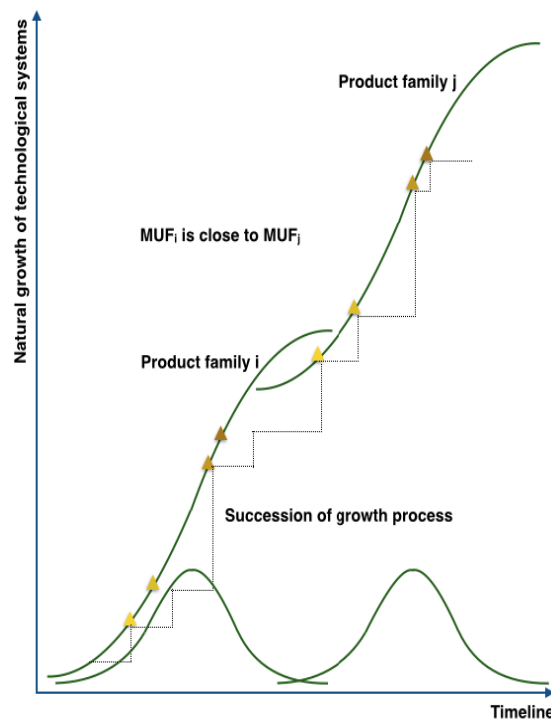

Fig. 57. The S-curve jumping by the continuous succession of idea generation in technological evolution. Source: [Modis 2007].

In logistic models, the forecasting formula consists of certain variables [Equ.16] [Fig.53].

$$N(t) = \frac{\kappa}{2} \left\{ \frac{t - t_m}{|t - t_m|} \cdot \left[1 - \exp\left(\frac{\ln(0.04)}{\Delta t} \cdot |t - t_m|\right) \right] + 1 \right\}$$

In a simple form:

$$N(t) = \frac{\kappa}{(1 + e^{-\alpha t - \beta})}$$

For $N(t) \ll \kappa$:

$$N(t) = e^{\alpha t + \beta}$$

$N(t)$: Growing variable at time t ;

κ : Asymptotic limit of growth (carry capacity);

Δt : Duration of evolution growth with evolution wave;

t_m : Midpoint time when the curve reaches $\kappa/2$;

e : A numerical value of approximately 2.71828;

α : Growth rate parameter;

β : Location parameter; (t_m) when the curve reaches $\kappa/2$;

Equ. 16.

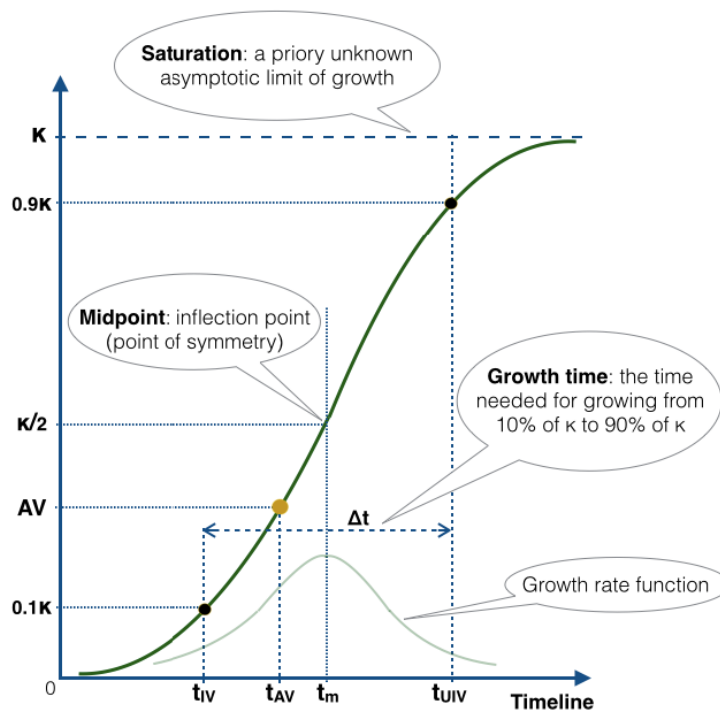

Fig. 58. A simple logistic S-curve. Source: [Kucharavy 2011].

$N(t)$ and κ respectively refer to the AV and the UIV. Δt presents the evolution period that since it is not same for different technology sectors, there needs to be adapted according to the growth period in related technology sector. For example, the length of technical revolution in chemistry, electrotechnical, and machinery according to the study of Scaron is sixty years [Scaron 2010]. t indicates the date of new generation or AV. t_{iv} and t_{uiv} are respectively related to the date of initial generation, and the date of ideal generation on the growth trajectory of a

product family. In this work, since it was confirmed by different studies that the major growth of a technological S-curve emerges from 10% to 90% of κ , IV and UIV are respectively considered equal to 0.1κ to 0.9κ . In a simple form of the forecasting formula, α specifies the width or the steepness of S-curves [Equ.16]. (e.g., $\alpha = 0.15$ means approximately 15% growth per time fraction). So α is frequently replaced with a variable that qualifies the time required for growing from 10% to 90% of limit (0.1κ to 0.9κ) [Lynch 2001] [Fig.53]. And β specifies the time (t_m) when the curve reaches the midpoint of growth trajectory [Lynch 2001].

III. 2. 1. 2. 2. 4. Procedure of TRD Measurement

The technological resourcefulness degree of a system is estimated in five steps [Fig.54]:

1. Detection of the fbs-chains within system;
2. Identification of APs and related EPs;
3. Learning about the AV and the IV of EPs;
4. Forecasting the UIV of EPs;
5. Normalization and calculation;
6. Ranking;

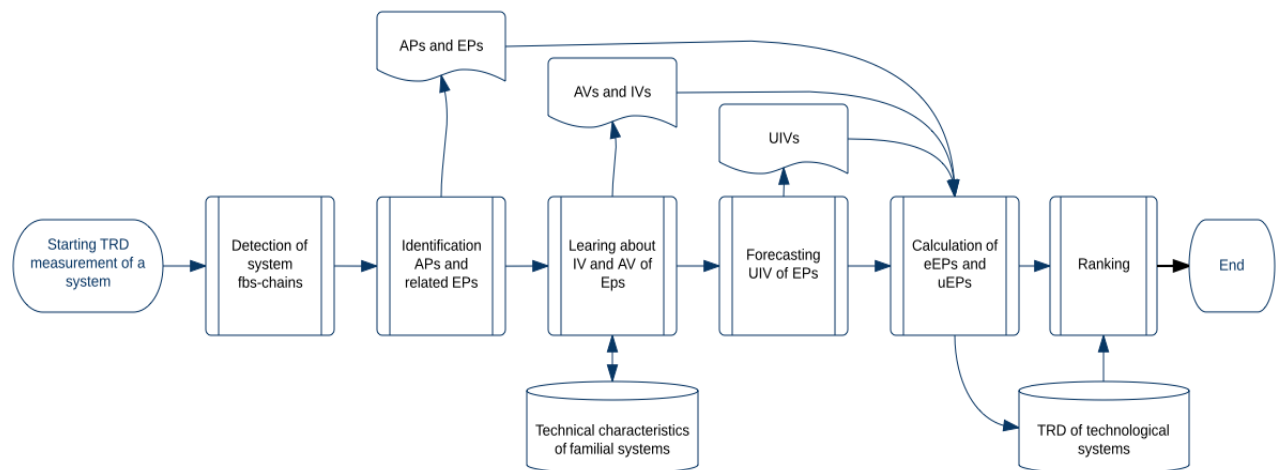

Fig. 59. The procedure of measuring TRD of a system.

- **Detection of the fbs-chains within system:** At the first step, the sub-systems of a system should be detected. Detecting the fbs-chains of a system facilitates identifying APs and EPs.
- **Learning about AV and IV of EPs:** AV and IV are the raw materials of TRD measurement. Although learning about AV is available immediately by verifying the specification of a system under study, learning about the IV of an EP may take time. The IV of an EP is the value of a similar EP in the primitive familial system. The term *primitive* refers to the earliest system (solution) of on the growth trajectory of related product family.
- **Forecasting UIVs of EPs:** Forecasting UIVs needs to develop its S-curve model in four steps; a) defining growing variable, b) selecting time series data such as the length of technological revolution and the time of midpoint on the S-curve, c) learning about IVs, AV and α , and d) estimating the upper limit (ceiling) for growing variable.

- **Calculation:** The earned and the unearned values of EPs (eEP and uEP) are calculated at this step [Equ.13]. This leads the measurement toward final calculation for presenting TRD [Equ.15].
- **Ranking:** Ranking is the tailing act after measurement. It makes sense with the TRD of other systems on a same growth trajectory (product family). Then, it is said that the familial systems with higher TRD have been designed in a higher resourcefulness capability.

III. 2. 1. 2. 2. 5. Case Study of TRD Measurement

For clarifying the measurement method of TRD, certain systems of a product family have been chosen:

- Four models from DVD product family (DVD-5-R, DVD-5-RW, DVD-10-RW, and DVD-18-R);
- Product family identification: the MUF of DVDs is: <to store binary data (bits)>,{capacity, GiB, (1.36 , 17.8)}, {read speed, MB/s, (0.83 , 1.39)};
- Other close product families: all digital storage devices including magnetic tapes, hard disc drives, RAM, flush memories, and above all Compact Disks (CDs).

The DVD-1 is the earliest system of the product family (on the growth trajectory) that causes an S-curve jumping from *Compact Disk* family (CDs). In this case, since the major growth of a technological evolution emerges between 10% and 90% of κ during Δt , the EP values of DVD-1 (AV) are considered as 0.1κ that tend toward an ideal value equal to 0.9κ as the UIV of the product family [Tab.60]. The TRD of each DVD demonstrates the ideality and/or resourcefulness capability of that DVD, and moreover the consistency of each generation with the inventive evolution road map [Equ.17] [Tab.60]. Considering a same EP for different AP (function) ensures taking into account the impact of each EP on the resourcefulness of a system, and the credibility of TRD measurement [Tab.60].

- $\text{TRD}_{\text{DVD-5-R SS SL}} = (1.08/8.41).10^2 = 13$
- $\text{TRD}_{\text{DVD-5-RW SS SL}} = (1.20/9.30).10^2 = 13$
- $\text{TRD}_{\text{DVD-10-RW DS SL}} = (1.56/8.94).10^2 = 17$
- $\text{TRD}_{\text{DVD-18-R SS SL}} = (2.03/7.46).10^2 = 27$

Equ. 17.

The TRD of the *DVD-5-R SS SL* and the *DVD-5-RW SS SL* are the same value, despite the *DVD-5-RW SS SL* possesses two functions more than the *DVD-5-R SS SL* (rewriting and erasing). The *DVD-10-RW DS SL* with the same functions as the *DVD-5-R SS SL* obtains a higher TRD because of a good evolution on storage, and reading speed. Concerning the *DVD-18-R DS DL*, despite the removal of rewriting function, it obtains a higher TRD vis-a-vis the *DVD-5-RW SS SL* and the *DVD-10-RW DS SL* [Equ.17].

Tab. 60. Technical characteristics of the specified systems for TRD measurement;

Example: TRD measurement	Case study: Four DVD models
--------------------------	-----------------------------

DVD	System function (AP)	Interact with	EP type	EP	AV	IV	UIV	uEP _f	eEP _f
DVD-5-R SS SL	to store	digital files	maxideal	capacity	4.37 GiB	1.36 GiB	12.24 GiB	0.64	0.36
	to mobilize	digital files	minideal	weight	13 g	15 g	1.6 g	0.97	0.03
			minideal	surface	10935.88 mm ²	10935.88 mm ²	1215 mm ²	1.12	0.12
			minideal	thickness	1.2 mm	1.2 mm	0.13 mm	1.12	0.12
	to write	digital files	maxideal	speed in 1x	77 MB/min	46 MB/min	414 MB/min	0.81	0.19
	to read	digital files	maxideal	speed in 1x	79 MB/min	50 MB/min	450 MB/min	0.82	0.18
	to put in	driver	minideal	weight	13 g	15 g	1.6 g	0.97	0.03
	to rotate in	driver	minideal	weight	13 g	15 g	1.6 g	0.97	0.03
	to bring out from	driver	minideal	weight	13 g	15 g	1.6 g	0.97	0.03
	DVD-5-RW SS SL	to store	digital files	maxideal	capacity	4.37 GiB	1.36 GiB	12.24 GiB	0.68
to mobilize		digital files	minideal	weight	13 g	15 g	1.6 g	0.97	0.03
			minideal	surface	10935.88 mm ²	10935.88 mm ²	1215 mm ²	1.12	0.12
			minideal	thickness	1.2 mm	1.2 mm	0.13 mm	1.12	0.12
to write and rewrite		digital files	maxideal	speed in 1x	77 MB/min	46 MB/min	414 MB/min	0.81	0.19
to read		digital files	maxideal	speed in 1x	79 MB/min	50 MB/min	450 MB/min	0.89	0.11
to erase		digital files	maxideal	speed in 1x	1792 MB/min	1792 MB/min	16128 MB/min	0.97	0.03
to put in		driver	minideal	weight	13 g	15 g	1.6 g	0.97	0.03
to rotate in		driver	minideal	weight	13 g	15 g	1.6 g	0.97	0.03
to bring out from		driver	minideal	weight	13 g	15 g	1.6 g	0.96	0.04
DVD-10-RW DS SL	to store	digital files	maxideal	capacity	8.75 GiB	1.36 GiB	12.24 GiB	0.29	0.71
	to mobilize	digital files	minideal	weight	13 g	15 g	1.6 g	0.97	0.03
			minideal	surface	10935.88 mm ²	10935.88 mm ²	1215 mm ²	1.12	0.12
			minideal	thickness	1.2 mm	1.2 mm	0.13 mm	1.12	0.12

	to write and rewrite	digital files	maxideal	speed in 1x	77 MB/min	46 MB/min	414 MB/min	0.81	0.19
	to read	digital files	maxideal	speed in 1x	80 MB/min	50 MB/min	450 MB/min	0.89	0.11
	to erase	digital files	maxideal	speed in 1x	1792 MB/min	1792 MB/min	16128 MB/min	0.89	0.11
	to put in	driver	minideal	weight	13 g	15 g	1.6 g	0.97	0.03
	to rotate in	driver	minideal	weight	13 g	15 g	1.6 g	0.97	0.03
	to bring out from	driver	minideal	weight	13 g	15 g	1.6 g	0.97	0.03
DVD-18+R DS DL	to store	digital files	maxideal	capacity	15.9 GiB	1.36 GiB	12.24 GiB	-0.30	1.30
			minideal	weight	13 g	15 g	1.6 g	0.97	0.03
	to mobilize	digital files	minideal	surface	10935.88 mm ²	10935.88 mm ²	1215 mm ²	1.12	0.12
			minideal	thickness	1.2 mm	1.2 mm	0.13 mm	1.12	0.12
	to write	digital files	maxideal	speed in 1x	77 MB/min	46 MB/min	414 MB/min	0.81	0.19
	to read	digital files	maxideal	speed in 1x	81 min/layer	50 MB/min	450 MB/min	0.82	0.18
	to put in	driver	minideal	weight	13 g	15 g	1.6 g	0.97	0.03
	to rotate in	driver	minideal	weight	13 g	15 g	1.6 g	0.97	0.03
	to bring out from	driver	minideal	weight	13 g	15 g	1.6 g	0.97	0.03

III. 2. 1. 2. 2. 6. Technological Resourcefulness Indicators

On the basis of the studies and the propositions for evaluating technological resourcefulness degree, six indicators have been defined to be considered by design teams (NPD projects) in order to enhance idealization activities and intensify the TRD of design outputs [Tab.61].

Tab. 61. The key indicators of resourcefulness in engineering design;

No.	Design's Indicators of Resourcefulness
1	The elimination of a technical contradiction between the related EPs of an AP;
2	The improvement of an evaluation parameter (EP) toward its ideal value ($AV_t - AV_{t+1}$);
3	The forecasted ideal value (UIV) of an evaluation parameter (EP);
4	The actual position (AV) of an evaluation parameter (EP) on the growth trajectory of product family;
5	The initial position (IV) of an evaluation parameter (EP) on the growth trajectory of product family;

III. 2. 1. 3. Technological Usefulness

Usefulness is one of the key metrics for evaluating inventiveness (c.f. III.2.1). Describing *usefulness* through the terms *utility*, *useful*, *industrial application*, *industrial exploitation*, *relevance*, and *purpose* by different authors [Tab.21] [Tab.23] (c.f. III.2.1) makes easier the interpretation of usefulness. In the literature, *usefulness* is discussed as an adjective for predicting and/or explaining the usage of a system [Davis 1989] [Keil 1995]. Davis 1989, supposed that a system is used when user believes the system will help him/her to perform his/her job better [Davis 1989]. He named this condition as the *perceived usefulness* from a system. The *perceived usefulness* is defined as “the degree to which a person believes that using a particular system would enhance his or her job performance” [Davis 1989]. In other words, the *perceived usefulness* refers to a positive use-performance relationship [Davis 1989]. Davis by verifying 37 published researches prepared a list of items that deal with the *perceived usefulness* [Tab.62]. However, some items overlap and interfere with each other. He ranked these items regarding their impact on *perceived usefulness* [Tab.62], and proposed an evaluation approach based on users’ opinions. However, each detected item can be analyzed as a technical feature of use-performance relationship [Tab.62].

Tab. 62. The related items to the *perceived usefulness* from a technological system;

	Useful features of a system	Positive use-performance item	Rank
1	Useful to facilitate difficulties of performing specified job;	Less complication	13
2	Useful for controlling job;	Greater control on job	9
3	Useful for improving job-performance;	Higher job-performance	2
4	Useful for addressing job-related needs;	Less job-performance risk	12
5	Useful for saving time;	Faster job-performance	11
6	Useful for accomplishing job quickly;	Faster job-performance	7
7	Useful for supporting critical aspects of job;	Less job-performance risk	5
8	Useful for accomplishing more jobs;	Higher efficiency	6
9	Useful for reducing unproductive time;	Higher productivity	10
10	Useful for enhancing the effectiveness of job;	Higher effectiveness	1
11	Useful for improving the quality of job;	Greater quality	3
12	Useful for increasing productivity;	Higher productivity	4
13	Useful for making job easier;	Less complication	8

III. 2. 1. 3. 1. An Overview of Usefulness in Technological Design

The same perception of Davis [Davis 1989] about *usefulness* has been taken into account by several literature for analyzing the usage of a technological system [Adams 1992] [Sarkar 2011] [Yannou 2013] [Wang 2013] [Yannou 2015]. Concerning the evaluation of *usefulness*, there are few methods that can be employed. Aside from some authors like Shah and Vargas-Hernandez [Shah 2003] [Shah 2001], who proposed a quality measurement of product regarding design goals (weighted objective method), most authors focused on an evaluation from user side. In this respect, the popularity, usage importance, usage scenario coverage, usage segmentation, usage frequency, usage duration, widespread usage issue, expected performance of a system, system reliability, failure rate, probability of usage fails, are considered as the key indicators for assessing *usefulness*, which in addition of measuring system's performance, need to test system usage for an appropriate sample size [Sarkar 2011] [Yannou 2013]. For example, in a recent work by Yannou et al. [Yannou 2015], although it seems the proposition is notable and practicable by taking into account different usage scenarios, the method is based on measuring the technical performance of technological systems. Moreover for measuring the usefulness rate, there needs a usage survey after manufacturing and diffusion. This means their model is incapable to measure the usefulness of invention claims or patents at least before prototyping. Among the few *usefulness* evaluation methods, Sarkar et al. [Sarkar 2011] did not consider the technical performance of systems, and their measurement is based on three factors; the rate (the ratio of the number of user to the total population), the frequency, and the duration of usage.

III. 2. 1. 3. 2. Usefulness Measurement

Since analyzing technical performance of a system has a high consistency of evaluation and contents in dealing with the usefulness evaluation concepts, in this work, the technical performance measure (TPM) are considered as the main indicator of technological usefulness degree (TUD) [Eue.18]. This strategy is based on the fact that in general, the TPM is defined as “the continuing prediction and demonstration of the degree of anticipated or actual achievement of selected technical objectives“[Sears 1984]. The technical performance of a system refers to key technical goals that needed to be met during system operation for supporting system functions in given condition (system environment). The technical performance of a system is based on analyzing the technical attributes of system operation to determine how well it satisfies the specified requirements, functions, or goals [Roedler 2005]. This is a measurement of compliance of the performance required to accomplish specified functions by system mechanism. However, TPMs can provide the assessments of technological systems through design, implementation, and test (usage).

$$TPM_a = TUD_a$$

TPM_a : Technical Performance Measure of system a (in percent);

TUD_a : Technological Usefulness Degree of system a;

Equ.18.

Measuring technical performance starts by identifying the fbs-chains within a system. For each fbs-chain within a system, the related technical performance criteria should be identified and measured, and finally presented by a single normalized number (in percent). In this respect,

with considering the relative importance of system functions [Tab.63], the average of all technical performance measures within a system presents the technological usefulness degree (TUD) of system [Eq.19]. The study of technical performance measurement is not considered in the scope of this work and, furthermore, there are an extensive research with several guidelines on this issue [Garvey 2005] [Sears 1984] [Roedler 2005] [Tab.64].

Tab. 63. The classification of function types regarding usefulness;

No.	Function type	General assigned weight (μ_{gi})
1	Main Useful Function (MUF)	7
2	Main Complementary Function (MCF)	6
3	Loading/Discharging Function (LDF)	5
4	Environmental Constraint Function (ECF)	4
5	Control-Command Function (CCF)	3
6	Indicating Complementary Function (ICF)	2
7	Discrete Supplementary Function (DSF)	1

$$TUD_a = \frac{\sum_1^n (TPM_i \cdot \mu_{gi})}{\sum_1^n \mu_{gi}}$$

TPM_i : Technical performance of function i in system a, {function i: [1 , n]};

μ_{gi} : The relative importance (weight) of function a in system a, {function i: [1 , n]};

TUD_a : Technological Usefulness Degree of system a;

Equ.19.

Tab. 64. An example of successive steps of measuring technical performance in a guideline. Source: [Sears 1984];

No.	The steps of measuring technical performance
1	Identifying key performance requirement of system. These are candidate of measurement;
2	Specifying requirements with properties and attributes of different fbs-chains;
3	Identifying critical technical parameters;
4	Performing risk analysis;
5	Detecting and establishing upper and lower limits and performance growth values of each mechanism regarding key performance requirements;
6	Measuring performance values of key interactions;
7	Normalizing and integrating performance values of key interactions;

III. 2. 1. 3. 3. Technological Usefulness Indicators

On the basis of the proposed model for measuring inventiveness-based efficacy, the indicators of usefulness are the same as the indicators of technical performance. Thus, a system with a high technical performance regarding specified jobs (system functions) possesses a high usefulness.

III. 2. 1. 4. Technological Inventiveness Degree (TID)

The technological inventiveness degree (TID) of a system is obtained by integrating its technological novelty, resourcefulness, and usefulness degree (TND, TRD, and TUD) [Equ.20].

$$TID_a = TND_a + TRD_a + TUD_a$$

TID_a : The technological inventiveness degree of system a;

TND_a : The technological novelty degree of system a;

TRD_a : The technological resourcefulness degree of system a;

TUD_a : The technological usefulness degree of system a;

Equ. 20. Technological inventiveness degree of design (system) a.

Accordingly, the TID of a design project is obtained by integrating the TND, the TRD, and the TUD of all validated designs (systems) at the gate3 of NPD process (c.f. II.2.3) [Equ.21].

$$TID_j = \sum_i TID_{ij}, \{i: [1, n]\}$$

TID_j : The technological inventiveness degree of project j;

TID_{ij} : The technological inventiveness degree of system i by project j, $\{i: [1, n]\}$;

Equ. 21. Technological inventiveness degree of project j.

III. 2. 2. Modeling Inventive-Design Efficiency

In general, efficiency refers to the productivity rate of processes [Chiou 1999]. Efficiency presents the extent to which time, cost, efforts, and in general, all resources are used well for achieving specified goals, purposes, and functions [Merriam-Webster 2014]. So the efficiency of any system, process, operation, and organization is defined as “the ratio of useful work performed to the total resources expended” [Duffy 2003]. According to O’Donnell et al. [O’Donnell 2005], useful works along design processes appear as material gain (M^+) through performing design activities. Thus, the efficiency of design projects depends on the material gain (M^+) and the resources used (R) by design activities [Equ.22] [O’Donnell 2005]. Generalizing efficiency measurement from an activity to a project takes into account all materials gain (M^+) and resources used (R) [Fig.55].

$$\eta(\Psi_i) = M_i^+ / R_i$$

$\eta(\Psi_i)$: The efficiency ratio (η) of knowledge processing (design activity) i;

M_i^+ / R_i : The ratio of material gain to resources used during knowledge processing (design activity) i;

M_i^+ : Material gain by knowledge processing (design activity) i;

R_i : Resources used by knowledge processing (design activity) i;

Equ. 22.

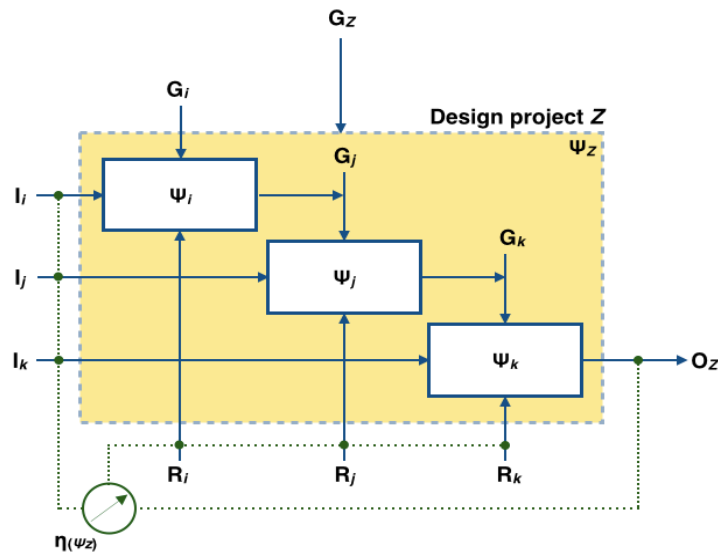

Fig. 60. The relationships for measuring efficiency at the project level.

III. 2. 2. 1. Material Gain by Inventive-Design Projects

In inventive design, the efficiency refers to the efficiency of inventive activities. As mentioned above (c.f. section III.1.2.1), design projects have been considered as the units of knowledge processing that are putted in place to generate new knowledge [Fig.54]. According to Hatchuel et al. [Hatchuel 2010] a new idea is designed when it is transformed into knowledge or takes logical status [Hatchuel 2003]. So, the input and the output materials of knowledge processing are introduced as the knowledge that their possibility or feasibility are proven (with logic status). Accordingly, an inventive-design project looks for a new combination of knowledge with inventive characteristics at output. Thus, the knowledge gain (Kn^+) by an inventive project refers to the evolution rate of outputs regarding inventiveness [Equ.23].

$$Kn_j^+ = O_j - I_j$$

Kn_j^+ : Knowledge gain by design project j including certain activity i ($\sum \Psi_i$), {i: (1, n)};

I_j : The inputs of design project j including certain activity i ($\sum \Psi_i$), {i: (1, n)};

O_j : The outputs of design project j including certain activity i ($\sum \Psi_i$), {i: (1, n)};

Eau. 23. Knowledge gain as the evolution rate of input knowledge.

Since the inventiveness-based effectiveness has been studied and its measures have been developed at the section 2.1 of this chapter (c.f. III.2), for obtaining the knowledge gain (Kn^+) by an inventive-design project, it is sufficient to measure or learn about the TID of project [Equ.24].

$$Kn_j^+ = TID_j$$

Kn_j^+ : Knowledge gain by design project j;

TID_{ij} : Technological inventiveness degree of design project j;

Equ. 24.

III. 2. 2. 2. Resources Used by Inventive-Design Projects

The resources used by design projects refers to the consumption level of resources used for performing design activities [Duffy 2012]. In this work, all the resources used within a design project, are summarized into the three principal criteria of resources used, i.e. *time*, *cost*, and *human-resource* [Tab.64]. As *human-resource* is the engine of design activities, all other resources are in service to human-resources. In this regard, the combinations of *human-resource* with *time* and *cost* are also considered for measuring efficiency [Tab.64]. The consideration of *man-hour* and *man-hour cost* for measuring inventive-design efficiency highlights the cerebrate level of design projects. Measuring inventive-design efficiency takes into account the resources used at the FFE phase before starting development stage along NPD projects.

Time, Cost and Human-Resource are the main criteria of all respondents to our survey (c.f. Appendix.C).

Tab. 65. The principal criteria of resources used (R) for performing activities during design projects;

Resources used at FFE phase		Sign	Unit	Description
in detail	in general			
<ul style="list-style-type: none"> • Duration of using methods • Duration of using materials • Duration of using tools • Duration of using minds 	Time	t	Hour	How much time has been spent for accomplishing inventive-design activities at FFE phase?
<ul style="list-style-type: none"> • Cost of methods used • Cost of materials used • Cost of tools used • Cost of team • Cost of environment 	Cost	c	Euro	How much cost has been spent for accomplishing inventive-design activities at FFE phase?
<ul style="list-style-type: none"> • Salary of designers 	Human-Resource	hr	Brain (minding)	How many brain has been engaged for inventive minding at FFE phase?
<ul style="list-style-type: none"> • Duration of using minds 	Man-Hour	mh	Man-Hour	How much work has been performed by a designer in one hour?
<ul style="list-style-type: none"> • Cost of using minds per hour 	Man-Hour Cost	mhc	Euro	How much cost has been spent for a man-hour?

III. 2. 2. 3. Inventiveness-based Efficiency (IBE)

The value of inventiveness-based efficiency (IBE) is obtained by calculating the ratio of TID as knowledge gain to resources used at FFE phase [Equ.25]. The IBE can be presented differently on the basis of the type of resources used in the denominator [Tab.65].

$$IBE_j = TID_j / R_j$$

IBE_j : Inventiveness-based efficiency of design project j;

TID_j : Technological inventiveness degree of design project j;

R_j : Resources used at the FFE phase of design project j;

Equ. 25. The generic calculation formula of measuring inventiveness-based efficiency.

Tab. 66. The measures of inventiveness-based efficiency (IBE) regarding different resource criteria;

Inventiveness-based efficiency of project j		
Resource used (R_j)	IBE_j	Measures of inventiveness-based efficiency (IBE)
Time	$= \frac{TID_j}{t_j}$	Inventive efficiency by project j (IE_j)
Cost	$= \frac{TID_j}{c_j}$	Inventive productivity by project j (IP_j)
Human-Resource	$= \frac{TID_j}{hr_j}$	Inventive creativity by project j (IC_j)
Man-Hour	$= \frac{TID_j}{mh_j}$	Inventive frequency by project j (IF_j)
Man-Hour Cost	$= \frac{TID_j}{mhc_j}$	Net inventive productivity by project j (NIP_j)

Although all the measures of IBE are important as the indicators that help to interpret and improve inventive-design processes, the NIP (net inventive productivity) is considered as the main index for presenting IBE of a design project [Tab.65].

III. 2. 2. 4. Inventiveness-based Efficiency indicators

On the basis of measuring inventiveness-based efficacy, five indicators have been defined to be considered by design teams (NPD projects). Since having a high IBE needs to use pertinent materials and resources during design phase, the indicators of IBE are summarized by three strategies; firstly, using creative resources, secondly, using pertinent method and tools for interchanging knowledge, and thirdly, concentrating the attention of design activities to the related indicators of the inventiveness-based effectiveness and enhancing technological inventiveness degree [Tab.66].

Tab. 67. The key indicators of inventiveness-based efficiency in engineering design;

No.	Indicators of inventiveness-based efficiency
1	Using pertinent resources during design phase regarding inventiveness and creativity;
2	Using pertinent methods and tools during design phase for enhancing collaborative design, interchange of knowledge, and knowledge-based engineering;
3	Concentrating the attention of design activities to the technological inventiveness indicators and enhancing TID;

III. 3. A Platform for Measuring Inventive-Design Performance

All the proposed models in this chapter are integrated in a framework as IDPMS (inventive-design performance measurement system) in order to provide a coherent system of monitoring inventive performance for managers. Since the project level is preferred for measuring design activities (c.f. III.1.2), the IDPMS requires the development of a neural system for collecting required data, and providing a data base from the design phases of all NPD projects within a R&D. The IDPMS consists of two major parts that undertake inventive performance analysis [Fig.56];

1. Part 1: The measurement of inventiveness-based effectiveness including the detail measures of inventiveness;
 - Technological Novelty Degree (TND);
 - Technological Resourcefulness Degree (TRD);
 - Technological Usefulness Degree (TUD);
 - Technological Inventiveness Degree (TID);

2. Part 2: The measurement of inventiveness-based efficiency including the detail measures of different resources used;
 - Inventive Efficiency (IE);
 - Inventive Productivity (IP);
 - Inventive Creativity (IC);
 - Inventive Frequency (IF);
 - Net Inventive Productivity (NIP);

Among the different indicators of the IDPMS (TND, TRD, TUD, TID, IE, IP, IC, IF, NIP), NIP (Net Inventive Performance) is introduced as the main gage of inventive-design performance [Fig.56] [Tab.67].

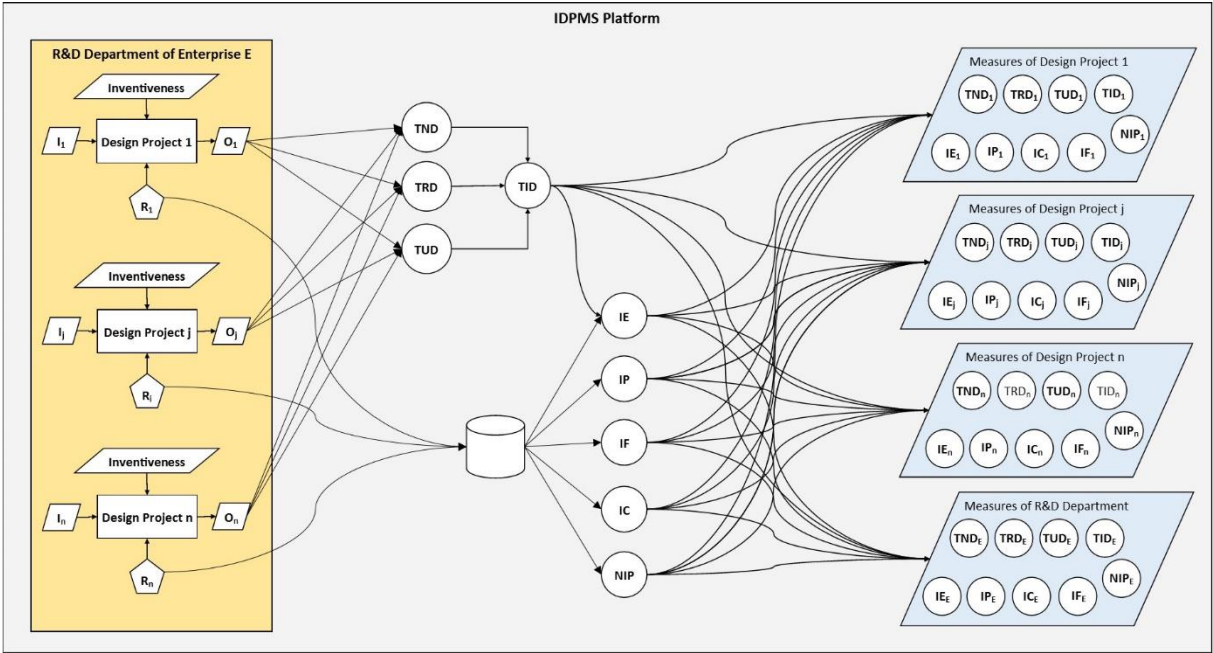

Fig. 61. IDPMS as a neural integrated system for presenting inventive performance of a company.

Tab. 68. The supplied measures by the IDPMS;

Supplied measures by IDPMS	required data	Sub-measurement system
TND: Technological Novelty Degree	I: Input knowledge; O: Output knowledge; The importance of change;	Inventiveness-based effectiveness
TRD: Technological Resourcefulness Degree	AP: Action Parameter; EP: Evaluation Parameter; Technological forecasting of EP;	Inventiveness-based effectiveness
TUD: Technological Usefulness Degree	TP: Technical performance; The importance of functionality;	Inventiveness-based effectiveness
TID: Technological Inventiveness Degree	TND: Technological novelty degree; TRD: Technological resourcefulness degree; TUD: Technological usefulness degree;	Inventiveness-based effectiveness
IE: Inventive Efficiency	TID: Technological inventiveness degree; t: Duration of the FFE phase;	Inventiveness-based efficiency
IP: Inventive Productivity	TID: Technological inventiveness degree; c: Cost of the FFE phase;	Inventiveness-based efficiency
IC: Inventive Creativity	TID: Technological inventiveness degree; hr: Number of designers at the FFE phase;	Inventiveness-based efficiency
IF: Inventive Frequency	TID: Technological inventiveness degree; mh: Man-hour of the FFE phase;	Inventiveness-based efficiency
NIP: Net Inventive Productivity or Net Inventive Performance	TID: Technological inventiveness degree; mhc: Man-hour cost of the FFE phase;	Inventiveness-based efficiency

Chapter IV: An Initial Prototype of IDPMS

Keeping in mind that this research aims to help managers for monitoring and enhancing inventive performance of NPD projects, it is necessary to translate the theoretical propositions into an applicable tool. In this regard, and in order to demonstrate the results of this work in a tangible way, and moreover testing our method with industries, the development of a web application have been considered in the agenda of the thesis. This chapter describes the implementation of IDPMS (c.f. III.3) as a web application available for R&D and NPD managers. The basis of the IDPMS application is what have been proposed in chapter 3. This chapter presents the representation model of the IDPMS application that provide a solid database for realizing the evaluation system. The initial prototype of IDPMS has been programed in Ruby.

1. Product Evolution Exploring Model (PEEM)

1. 1. An Overview of Product Models in Engineering Design

1. 2. PEEM; A Product Model for Exploring Technological Evolution

2. IDPMS Application Platform

IV. 1. Product Evolution Exploring Model (PEEM)

The product evolution exploring model (PEEM) is a product model that allows capturing the information of technological systems according to the criteria of chapter 3. The PEEM is a generic model to discern technological evolutions during NPD projects. An initial version of the PEEM was developed in 2014 to support the TND measurement, and now this version is more complete from the ancient version. The primary objective of PEEM is to provide a data base of required information for the IDPMS application.

IV. 1. 1. An Overview of Product Models in Engineering Design

The recognition of new exigencies in design puts in place new research orientations, new tools, and new adaptations. Nowadays, the product models are the key tools of design engineering [Cavallucci 2013]. In general, the product models are on a mission to provide product data regarding specified objectives, creation, erection, operation, structure, manufacturing or construction, usage, storage and/or recycling. In simpler words, the product models are created in order to capture the information of different stages of product life cycles. After a large work in engineering design and manufacturing from 1984 to 2002, the ISO 10303 is accepted as a standard for product data representation and exchange (STEP). The initial version of the

STEP applications were considered to use the outcomes of design activities (geometrical design information) [Kemmerer 1999] [STEP 1994], and the more recent STEP applications have been developed to support some types of non-geometrical information [Fenves 2008]. In 1999 R. Brimble et al. [Brimble 2000] proposed the MOKA modeling language (MML) by considering all product lifecycle data within five viewpoints based on function, behavior, structure, technical solution, and representation [Brimble 2000]. Further, in October 2002, despite the emergence of the system modeling language (SysML) in July 2002 to model the earlier stages of design processes, S. J. Fenves et al. proposed the core product model (CPM) to support the full range of product lifecycle management (PLM) [Fenves 2001]. They revised CPM in 2004 and 2008 [Fenves 2008]. Later, M. Labrousse et al. 2008 [Labrousse 2008], proposed FBS-PPRE model to improve and complete the PLM effectiveness. Although MML, CPM and FBS-PPRE were dedicated to knowledge based engineering (KBE) in order to extract and model the applied knowledge in technological systems, none of them meet a complete data list in perspective of detecting the inventive worth of systems. Le Lann et al., 2004, [Le Lann 2004] proposed a model for capitalizing knowledge based on TRIZ, however their model is not consider as a product representation model. PEEM is a new product model which has been developed to supply the related information to technological evolution regarding inventiveness. It provides a data base for supporting the framework of IDPMS. PEEM can be integrated in STEP AP 203 (or some other AP of STEP) or uses the complementary models as the open assembly model (OAM) [Rachuri 2006].

IV. 1. 2. PEEM; A Product Model for Exploring Technological Evolution

PEEM is a generic model that aims to acquire the required data for the IDPMS. The PEEM is presented as an abstract model that use a generic semantic policy for gathering product information. The PEEM explores the required characteristics of technological systems according to the four major aspect on the PPC (product pedigree chart) (c.f. III.2.1.1.2.3.1) [Fig.57].

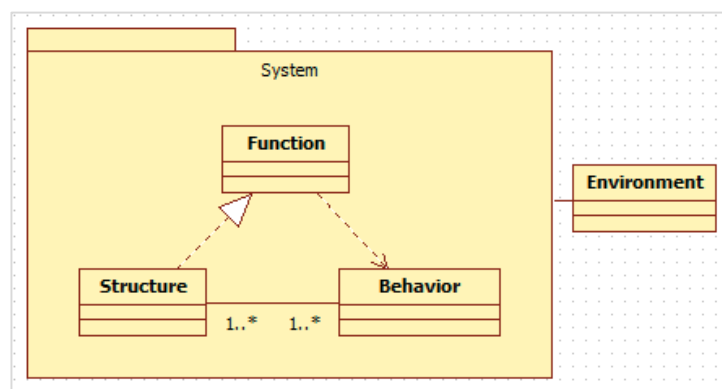

Fig. 62. The main characterization areas in PEEM.

Each major characterization area consists of two abstract classes for verifying related objects and related properties [Fig.58].

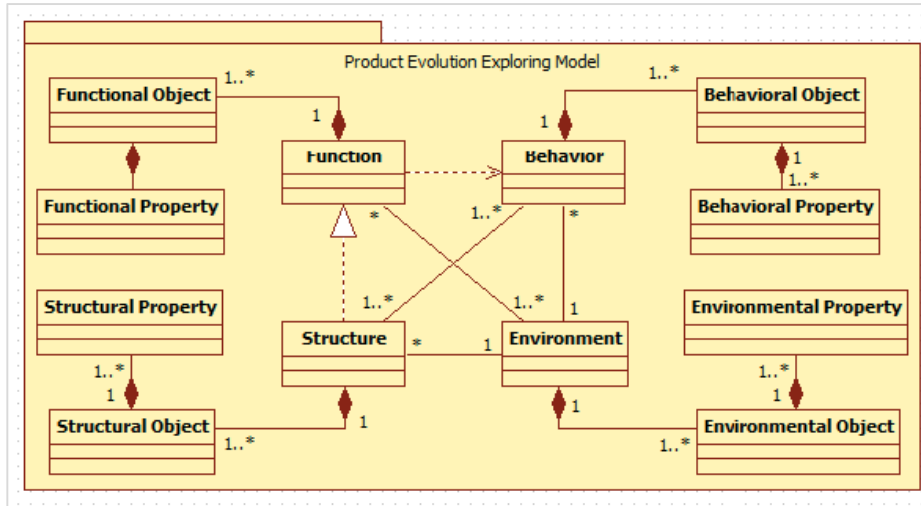

Fig. 63. The abstract classes in PEEM.

IV. 1. 2. 1. Environmental Characteristics

According to the section 2. 1. 1. 2. 2. 4 of chapter 3, the environmental objects of a system is modeled for verifying following classes [Fig. 59]:

- Useful Object: that represents the object of a system function;
- Main Useful Object: that represents the object of the main useful function within a system;
- Actor: that represents the environmental objects for providing system operation, and/or consume useful objects;
 - Main Specific Consumer;
 - Main Specific Operator;
- Super-System Object: that represents the environmental objects of supporting the environmental constraint functions (ECF).

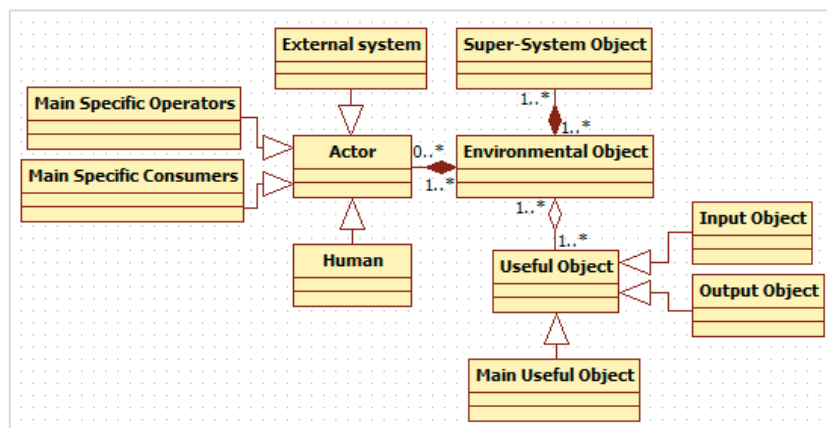

Fig. 64. Environmental object classes in PEEM.

IV. 1. 2. 2. Functional Characteristics

According to the section 2. 1. 1. 2. 2. 1. of chapter 3, the functional objects within a system is modeled for verifying following classes [Fig. 60]:

- Main Useful Function (MUF): that represents the primary function of a system;
- Main Complementary Function (MCF): that represents the complementary functions of the MUF within a system;
- Environmental Constraint Function (ECF): that represents the specified functions for supporting environmental constraints (conditions);
- Loading/Discharging Function (LDF): that represents the functions of loading and discharging useful objects in/out a system;
- Control-Command Function (CCF): that represents the specified functions for control-command system operation;
- Indicating Complementary Function (ICF): that represents the specified functions for indicating system operation states;
- Discrete Supplementary Function (DSF): that represents those system functions that don't have any interaction with the useful objects and the main useful function within a system;

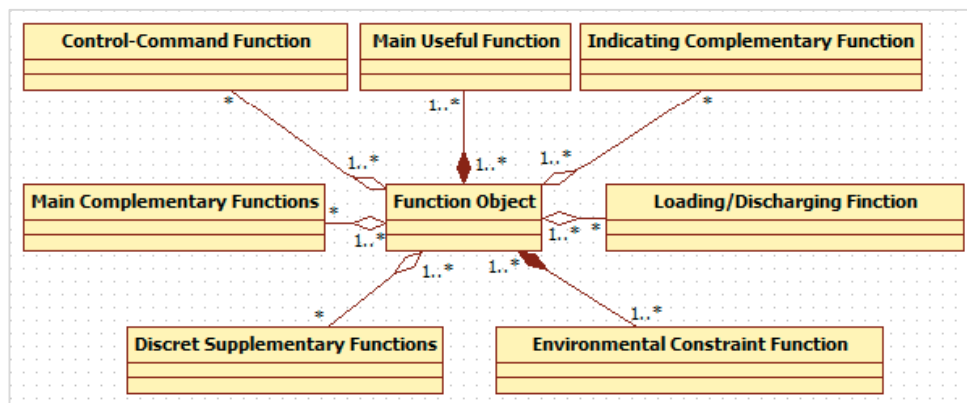

Fig. 65. Functional object classes in PEEM.

Accordingly, the functional properties within a system is modeled for verifying following classes [Fig.61]:

- Action: that represents a system function by using related verb in infinitive form;
- Criterion: that represents related criteria to an action;
- Unit: that represents the measurement unit of criteria;

- Constraint value: that represents the limit or constraint values of a criterion;
- Useful Object: that represents the input/output object in/out a fbs-chain;
 - Main Useful Object: that represents the useful objects of the MUF within a system;
 - Input Object: that represents the input objects of a system function;
 - Output Object: that represents the output objects of a system function;

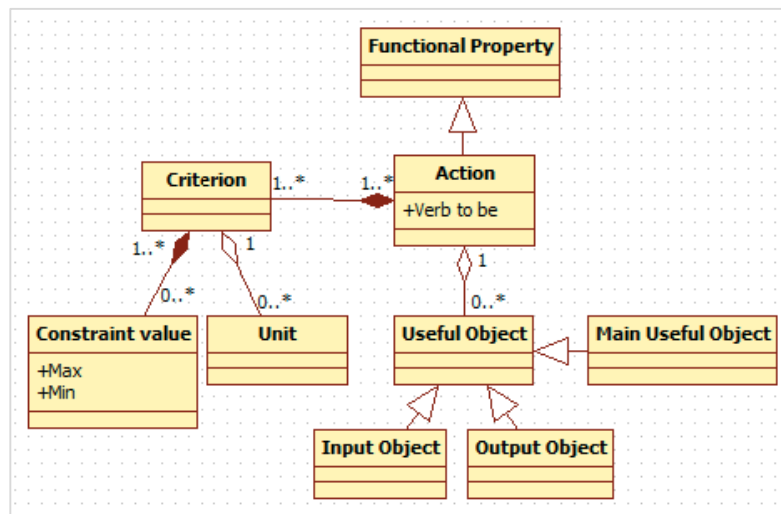

Fig. 66. Functional property classes in PEEM.

IV. 1. 2. 3. Behavioral Characteristics

According to the section 2. 1. 1. 2. 2. 3 of chapter 3, the behavioral objects of a system is modeled for verifying following classes regarding energy flow [Fig. 62]:

- Reception: that represents energy importation to a structural entity or a component (substance);
- Transition: that represents the passage of energy inside a structural entity or a component;
- Transmission: that represents the energy exportation from a structural entity or a component;

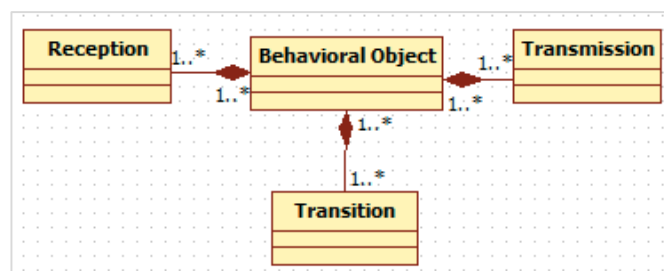

Fig. 67. Behavioral object classes in PEEM.

The behavioral properties of a system consists of following classes [Fig.63]:

- Entity: that represents a monolithic structural part;
- Energy: for representing an energy that is received, transited, and transmitted by an entity;
 - Input energy;
 - Output energy;
- Scientific phenomenon: that represents the physical effects occurring by any reception, transition, and transmission of energy within a system;
- Fundamental State of Matter (FSM): that represents the fundamental state of an entity (solid, liquid, gas, and plasma) during system operation;
- Geometry (ascii point data): that represents the geometrical dimension of an entity in ascii point data.
- Position in CCS: that represents the local position of an entity according to its initial position on the Cartesian Coordination System (CCS).
- Substance: that represents the physical-chemical element of an entity within a system;

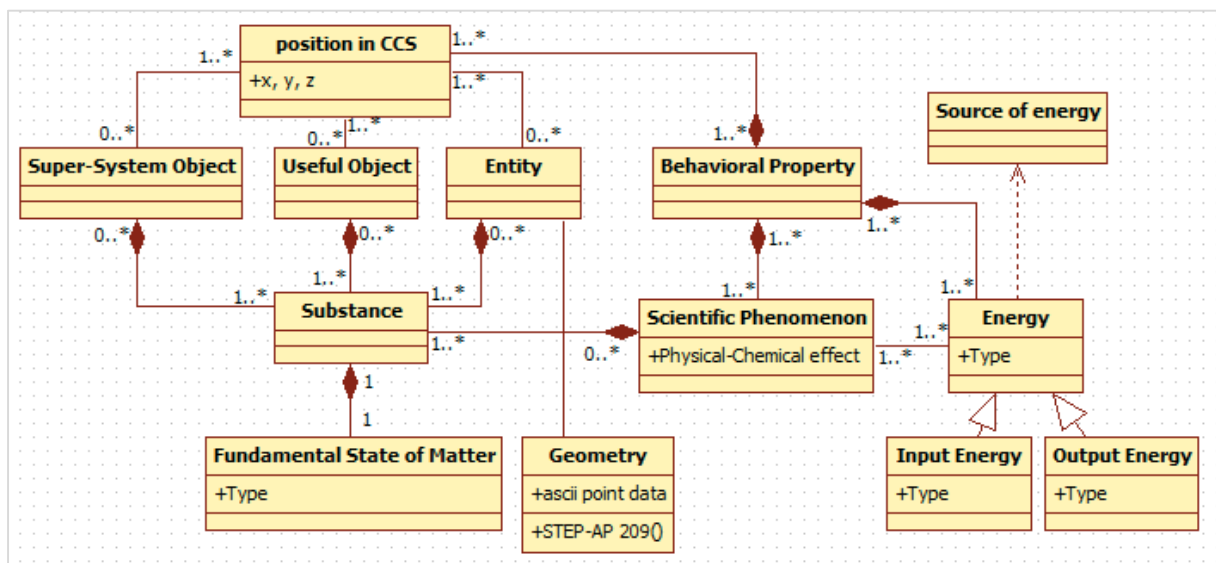

Fig. 68. Behavioral property classes in PEEM.

IV. 1. 2. 4. Structural Characteristics

According to the section 2. 1. 1. 2. 2. 2. of chapter 3, the structural objects of a system is modeled for verifying following classes [Fig. 64]:

- Entity: that represents a monolithic structural part. A component can be consists of several entities;
- Component/Part: that represents a specified structural area of system structure including one or several entities, e.g. Alshuller [Alshuller 1988] defined a technological system in three parts as *engine*, *transmitter*, and *worker*;
- Piece: that represents a specified area of an entity, e.g. the bottom side of a body-shell;
 - Server: represents those pieces in a connection that serve energy;
 - Client: represents those pieces in a connection that receive energy;
- Assembly: that represents the assembling solution of two structural entities within a system;
- Connection: that represents the conductivity of energy between structural entities or components;

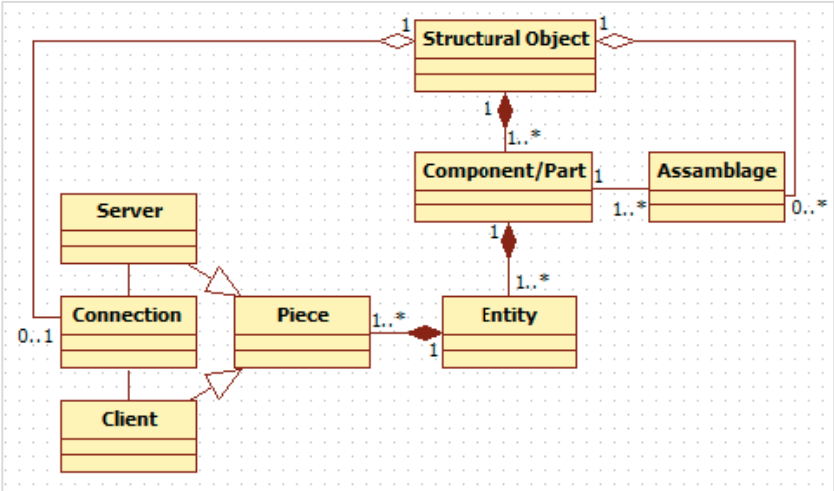

Fig. 69. Structural object classes in PEEM.

The structural properties of a system vary from an entity to another one. Some of them are [Fig.65]:

- Weight;
- Color;
- Geometry;
- Material;

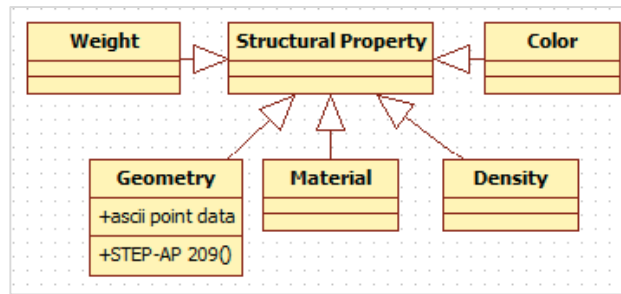

Fig. 70. Structural property classes in PEEM.

IV. 2. IDPMS Application Platform

The IDPMS application is designed as a self-arbitrage tool for NPD project managers and/or R&D managers that allows them to evaluate inventive performance of their design projects. The IDPMS application is designed to measure with minimum information by asking required data from an informed person about a new design. In this implementation, any new design (new system) is registered as a new project belonging to a registered company [Fig.66] [Fig.67] [Appndix.D]. Today, the IDPMS application is available for any manager who want to know the inventive performance measures of his team through the address; <http://idpms.ideaslab.fr/>. However, it is not still up to dated according to the latest version of IDPMS and covers only the first segment of this system (novelty evaluation).

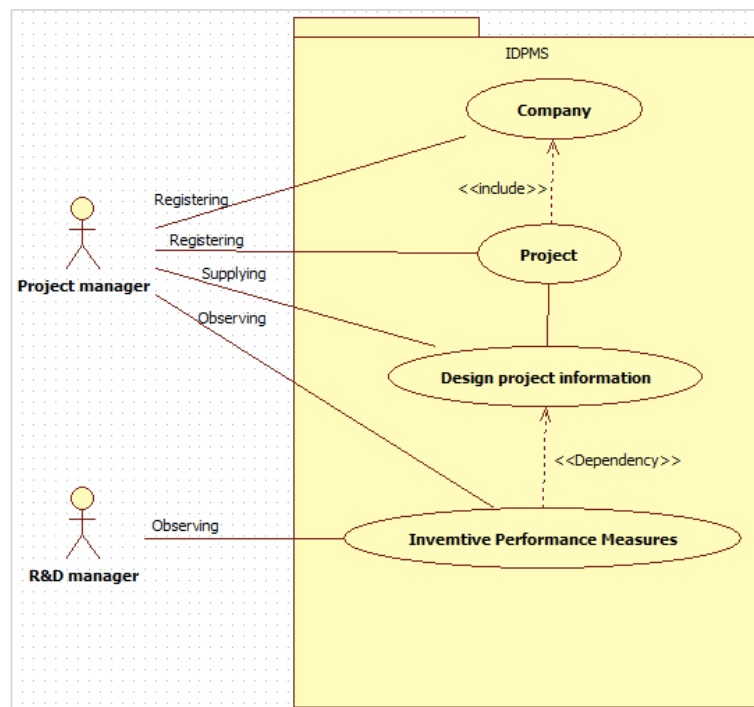

Fig. 71. The general use case diagram of the IDPMS application.

After signing up and in the application, user has a private dashboard for registering any company and related design projects [Fig.67]. A project in this application means a new system that you want to evaluate with the information of its related project. According to the answers

or data by which user feeds the application, at last he/she finds related degrees of his/her evaluation.

Inventive Design Performance Measurement System

User panel

- Home
- My companies
- My projects
- My account
- Log-out

Dashboard

Welcome to Ideas Metric Online.
Chose a company and browse existing projects, or create a new one.

My companies

Name	Activity	Country	Options
G12	Sectors	Luxembourg	Related projects + New creative project

DEFI project / IDPMS - based upon Ali Taheri's PhD - INSA Strasbourg

Fig. 72. Private dashboard of the IDPMS application.

Chapter V: Conclusion

The fifth chapter discusses the critical points of this work, presents a global view of the research, and gives a summary of contributions. At last, it highlights the perspective of the research direction.

1. Discussion
 2. Conclusion
 3. Contributions
 4. Perspective
-

V. 1. Discussion

Based on the findings, definitions, and proposed methods for evaluating different aspects of inventive-design performance, we argue that the IDPMS (Inventive Design Performance Measurement System) including all proposal evaluation metrics, at first, provides a set of indicators to raise the awareness of designers about the inventiveness level of possible solutions. It improves designers' intuition during problem solving about the elements that intensify the inventive performance of design. The IDPMS was proposed by considering the limitations of existing evaluation methods, standards, and guidelines in order to reduce uncertainty and risky condition in the earlier stages of innovation process. The evaluation metrics of the IDPMS were defined and developed in the technical level that relates this work to engineering science. Evaluating design projects through IDPMS increases the credibility of decision making and idea selection regarding technological evolution and inventiveness before passing on the development phase and the expensive phases of NPD projects. In this respect, it can be said that considering the defined indicators of this work improves the uncertainty condition in the earlier stages of innovation process regarding making proper decisions about technological evolution and road mapping.

As the second advantage, the IDPMS has the potential to acquaint R&D managers, and particularly NPD project managers about the creativity level of their teams and organization. The different measures of inventiveness-based efficiency (IBE) give important information about the performance of applying different resources along design phase, and help managers to test and know the aptitude of different resources to improve and/or change with pertinent ones.

The main features of the IDPMS, in comparison with existing evaluation methods of creativity, are comprehensiveness, data integrity, practicable, and executable method. It considers all the aspects discussed in the literatures of evaluating creativity and inventive activities. It is backed

by a logic evaluation, and based on a generic analysis of technical characteristics of systems. This enable us to introduce the IDPMS as a generic method for evaluating any output by design activities.

Concerning the numerical studies and validation of the IDPMS, since the technological inventiveness degree (TID) is an accumulative degree of TND, TRD, and TUD, it may take any degree because of the variety of applying different design with several combinations. However, TRD and TUD tend toward 100. Accordingly, providing a precise interpretation on the values obtained by a design project is not possible and needs the comparisons. The comparison of TID and IBEs of different projects is based on the similarity of product families. In this regard, although the basis of identifying and/or defining a product family is described and formalized by this work, defining product families needs a global standardization. So, our proposition before having a universal standard for identifying product families, is based on this fact that any result of evaluation by the IDPMS should be interpreted with the evaluation results of same product family. Since supplying the required data of evaluation by the IDPMS needs to have a same perception for characterizing technological systems, a specific syntax has been prepared and proposed in order to help evaluator (data supplier) for collecting correct information. So the evaluation by the IDPMS needs a big data-base;

V. 2. Conclusion

In Chapter 1, the interests and the motivations of starting this thesis have been studied. This work is realized in order to help managers to enhance inventive activities regarding technological innovations. Since R&D departments are the responsible of innovation projects and creativity in automotive industries, this work is addressed to R&D managers including NPD project managers and design teams. In contrast of many researches in engineering design about innovation assessment, this research focused on the evaluation of fuzzy front end phase along innovation process, in which inventive activities appear during problem analyses, idea generations, and conceptual developments. The ultimate goal of this work was to prepare a monitoring panel of inventive performance, and introduce related indicators of enhancing inventive activities.

Chapter 2, has presented a literature review on the research areas and existing science. It includes an investigation about different concepts involved in the research area with a focus on technological innovation and inventive activities. This section aims to clarify the research problematic in detail. Moreover, it paves the way for presenting the propositions in the next chapters.

Chapter 3 presents the methods and theoretical propositions of this work to achieve specified goals in chapters 1, and 2. It started by studying the basis of performance analysis in design, and continues by developing and adapting inventive performance metrics. The development of inventive performance metrics was based on verifying two integrated elements of performance analysis; effectiveness, and efficiency. Thus, the main criteria of inventiveness have been studied and the measures of inventiveness-based effectiveness, and consequently inventiveness-based efficiency have been developed. On the basis of these evaluations, the key performance indicators of inventive-design activities have been defined.

Chapter 4 presents the development of a demonstrator of what have been proposed in chapter 3. In order to verify and improve the proposal methods in chapter 3, the IDPMS application as an initial prototype of this work has been developed. Chapter 4 presents this web application through some UML diagrams including the presentation of a product representation model as PEEM (the product evolution exploring model) to support the IDPMS application data-base.

V. 3. Contributions

Firstly, this work tries to reduce the uncertainty and risky condition in the earlier stages of innovation process by defining the key indicators of inventive performance.

Secondly, the performance metrics of inventive-design activities have been defined and developed by this work. This contribution includes the development of a new method for evaluating technological novelty (TND), the development of a new method for evaluating technological resourcefulness (TRD), studying the evaluation of technological usefulness (TUD), the development of the efficiency evaluation of inventive activities, and the definition of key indicators of inventive-design performance.

Thirdly, the identity elements of the product families in engineering design have been defined, and accordingly, a product pedigree chart (PPC) with 4 major layers and 14 detailed layers has been modeled to facilitate the dissection of technological systems regarding technical characteristics.

Fourthly, characterizing technical characteristics of technological system has been described by the fbs-chain model. This model proposes a generic and comprehensive definition for detecting and identifying different aspects of a technological system.

For industries, this thesis presents an evaluation method for monitoring and enhancing inventive design-activities in the earlier stages of their innovation projects. The inventive indicators spread out a guideline for designers to consider during design activities. Moreover, the IDPMS methods helps to monitor inventive performance of design teams and NPD projects.

For industrial consultants and intellectual property offices, this thesis provides a new discourse to guide and classify companies for innovation. This work proposes the evaluation of technological evolution as one complementary segment of innovation evaluation aside from financial and management evaluations.

For researchers and our colleagues in the design engineering laboratories, this thesis provides a preliminary evaluation method of technological evolution. It highlights the departure points for achieving total innovation management in a creative condition.

V. 4. Perspective

The first perspective of this work is referred to the pertinence as the third side of the performance triangle [Fig.11]. According to Andreasen et al. 1998 [Andreasen 1998], the considerable efforts during design processes are those that use the right resources at the right time to carry out the right activities for the right reasons. Although this thesis listed the

indicators of inventive performance, it needs to prepare a list of the entries that should be used along design phase. The inventiveness-based efficiency of a design project depends significantly on the pertinent choice regarding project goals, resources, input knowledge, and output knowledge. Identifying inventive characteristics and inventive performance metrics are the basis of defining pertinent entries. Defining inventive indicators permits to recognize pertinent entries into design processes.

A second perspective of this work is referred to the standardization of product families. Although there is a protocol that classifies products for the intellectual property offices, it seems insufficient to identify any product on its familial pedigree chart and its position on the growth trajectory of family.

This work needs to be verified through several practices, and applies the feedbacks to improve itself for being more appropriate regarding the definitions, criteria, technical characterization, calculation, and evaluation.

Reference

- [Abernathy 1978] Abernathy, William J., and James M. Utterback. 1978. "Patterns of Industrial Innovation". *Technology Review* 64: 254–228.
- [Adams 1992] Adams, Dennis A., R. Ryan Nelson, and Peter A. Todd. 1992. "Perceived Usefulness, Ease of Use, and Usage of Information Technology: A Replication." *MIS Quarterly*, 227–47.
- [Adams 2009] Adams, Christopher, and Derrick Tate. 2009. "Computer-Aided TRIZ Ideality and Level of Invention Estimation Using Natural Language Processing and Machine Learning." In *Growth and Development of Computer-Aided Innovation*, 27–37. Springer.
- [AFNOR 2002] AFNOR (NF X 50-170), 2nd version.
- [AHD 2014] The American Heritage Dictionary of the English Language, Fourth Edition. Retrieved August 11, 2014.
- [Aït-El-Hadj 1989] Aït-El-Hadj, Smaïl. 1989. *L'entreprise face à la mutation technologique*. Les Ed. d'organisation Paris.
- [Altshuller 1984] Altshuller, Genrikh Saulovich. 1984. *Creativity as an Exact Science*. Gordon and Breach. <http://cds.cern.ch/record/450367>.
- [Altshuller 1988] Altshuller, G. 1988. *The Innovation Algorithm: TRIZ, Systematic Innovation and Technical Creativity*. Amabile, T. 1996. *Creativity in Context*. Colorado, Westview Press.
- [Altshuller 1999] Altshuller, Genrich. 1999. "The Innovation Algorithm." *Technical Innovation Center* 312.
- [Amabile 1988] Amabile, Teresa M. 1988. "A Model of Creativity and Innovation in Organizations." *Research in Organizational Behavior* 10 (1): 123–67.
- [Amabile 1996] Amabile, Teresa M., Regina Conti, Heather Coon, Jeffrey Lazenby, and Michael Herron. 1996. "Assessing the Work Environment for Creativity." *Academy of Management Journal* 39 (5): 1154–84.
- [Andreasen 1987] Andreasen, M. M., and L. Hein. n.d. "Integrated Product Development. 1987." Bedford, UK: IFS Publications Ltd.
- [Andreasen 1998] Andreasen, Mogens Myrup, A. H. B. Duffy, K. J. MacCallum, J. Bowen, and T. Storm. 1998. "The Design Co-Ordination Framework: Key Elements for Effective Product Development." In *The Design Productivity Debate*, 151–72. Springer.
- [Arrow 1962] Arrow, K., 1962. Economic welfare and the allocation of resources for invention, in: *The Rate and Direction of Inventive Activity: Economic and Social Factors*. Nber, pp. 609–626.
- [Arthur 2007] Arthur, W. Brian. 2007. "The Structure of Invention." *Research Policy* 36 (2): 274–87.
- [Avlonitis 2001] Avlonitis, G.J., Papastathopoulou, P.G., Gounaris, S.P., 2001. An empirically-based typology of product innovativeness for new financial services: Success and failure scenarios. *Journal of Product Innovation Management* 18, 324–342.
- [Ayres 1969] Ayres, Robert U. 1969. "Technological Forecasting and Long-Range Planning." <http://documents.irevues.inist.fr/handle/2042/30317>.
- [BAA 1995] BAA Plc. 1995. *The Project Process: A guide to the BAA project process*". London, Internal publication, BAA Plc.
- [Babbage 1832] Babbage, Charles. *On the Economy of Machinery and Manufactures*. Charles Knight, Pall Mall East, 1832.

- [Bachman 1990] Bachman, Lyle F., and Sandra J. Savignon. *Fundamental Considerations in Language Testing*. Vol. 107. Oxford University Press Oxford, 1990.
- [Balon 1999] Balon, R. 1999. *Encyclopedia of Creativity*. Pritzker, M.A.R.a.S. San Diego, USA, Academic Press: 1663
- [Barnett 1953] Barnett, Homer Garner. 1953. "Innovation: The Basis of Cultural Change".
- [Barron 1955] Barron, Frank. 1955. "The Disposition toward Originality." *The Journal of Abnormal and Social Psychology* 51 (3): 478.
- [Bartholomew 2004] Bartholomew, David J. 2004. *Measuring Intelligence: Facts and Fallacies*. Cambridge University Press.
- [Barton 2003] Barton, John H. 2003. "Non-Obviousness." *Idea* 43: 475.
- [Bashir1999] Bashir, Hamdi A., and Vince Thomson. 1999. "Metrics for Design Projects: A Review." *Design Studies* 20 (3): 263–77.
- [Batey 2012] Batey, Mark. 2012. "The Measurement of Creativity: From Definitional Consensus to the Introduction of a New Heuristic Framework." *Creativity Research Journal* 24 (1): 55–65.
- [Baxter 1995] Baxter, M. 1995. *Product Design: a Practical Guide to Systematic Methods of New Product Development* New York, Chapman & Hall.
- [Bayus 2003] Bayus, B.L., Erickson, G., Jacobson, R., 2003. The financial rewards of new product introductions in the personal computer industry. *Management Science* 49, 197–210.
- [Behn 2003] Behn, Robert D. 2003. "Why Measure Performance? Different Purposes Require Different Measures." *Public Administration Review* 63 (5): 586–606.
- [Bellon 1994] Bellon, B., Cecchini, A., 1994. *Innover ou disparaître*. Économica, Paris.
- [Ben Rejeb 2008] Ben Rejeb, Helmi. *Phases Amont de L'innovation: Proposition D'une Démarche D'analyse de Besoin et D'évaluation de L'acceptabilité D'un Produit*. Vandoeuvre-les-Nancy, INPL, 2008.
- [Benghozi 2000] Benghozi, P.-J., Charue-Duboc, F., Midler, C., 2000. *Innovation Based Competition & Design Systems Dynamics: Lessons from French Innovative Firms and Organizational Issues for the Next Decade*. Editions L'Harmattan.
- [Bergman 2011] Bergman, Theodore L., and Frank P. Incropera. 2011. *Introduction to Heat Transfer*. John Wiley & Sons.
- [Besemer 1998] Besemer, Susan P. 1998. "Creative Product Analysis Matrix: Testing the Model Structure and a Comparison among Products—three Novel Chairs." *Creativity Research Journal* 11 (4): 333–46.
- [Bilderbeek 1999] Bilderbeek, Jan, and others. "R&D Performance Measurement: More than Choosing a Set of Metrics." *R&D Management* 29, no. 1 (1999): 35–46.
- [Birkinshaw 2007] Birkinshaw, J., and M. Hansen. 2007. "The Innovation Value Chain." *Harvard Business Review* (June).
- [Birkinshaw 2008] Birkinshaw, J., Hamel, G., Mol, M.J., 2008. Management innovation. *Academy of management Review* 33, 825–845.
- [Bititci 2000] Bititci, Umit S., Utrevor Turner, and Carsten Begemann. 2000. Dynamics of Performance Measurement Systems. *International Journal of Operations & Production Management* 20(6): 692–704.
- [Bledow 2009] Bledow, Ronald, Michael Frese, Neil Anderson, Miriam Erez, and James Farr. 2009. "A Dialectic Perspective on Innovation: Conflicting Demands, Multiple Pathways, and Ambidexterity." *Industrial and Organizational Psychology* 2 (3): 305–37.
- [Bleicher 1994] Bleicher, Knut. 1994. "Integrative Management in a Time of Transformation." *Long Range Planning* 27 (5): 136–44.
- [Blomberg 2011] Blomberg, Olle. 2011. "Conceptions of Cognition for Cognitive Engineering." *The International Journal of Aviation Psychology* 21 (1): 85–104.

- [Blosiu 2000] Blosiu, Julian O., and Codrin J. Blosiu. 2000. "Perfection, Ideality, and Technology Road Map as Measured by a Sliding Scale (technology Creativity Metrics)." In *Management of Innovation and Technology, 2000. ICMIT 2000. Proceedings of the 2000 IEEE International Conference on*, 1:321–26. IEEE.
- [Boeddrich 2004] Boeddrich, Heinz-Juergen. 2004. "Ideas in the Workplace: A New Approach towards Organizing the Fuzzy Front End of the Innovation Process." *Creativity and Innovation Management* 13 (4): 274–85.
- [Bobrow 1984] Bobrow, Daniel G. 1984. "Qualitative Reasoning about Physical Systems: An Introduction." *Qualitative Reasoning about Physical Systems*, 1–5.
- [Boden 1999] Boden, M.A., 1999. *Computer Models of Creativity*. Handbook of creativity 351.
- [Boly 2004] Boly, Vincent. 2004. "Ingénierie de L'innovation." *Organisation et Méthodologies Des Entreprises*. Lavoisier, Paris, France.
- [Booz 1968] Booz, E., Allen, J. and Hamilton, C. 1968. *Management of New Products*. New York, USA, Booz, Allen & Hamilton Inc.
- [Boutellier 2008] Boutellier, Roman, Oliver Gassmann, and Maximilian Von Zedtwitz. 2008. *Managing Global Innovation: Uncovering the Secrets of Future Competitiveness*. Springer Science & Business Media.
- [Bouzon 2003] Bouzon, Arlette. 2003. "Coopération et Communication Dans Les Projets de Conception Collective." In *Conférence Internationale Francophone Des Sciences de l'Information et de La Communication (CIFSIK)-Bucarest-28 Juin, 2 Juillet 2003*. 30 Juin 2003. Publié Ou En Cours de Publication.
- [Bower 1996] Bower, Joseph L., and Clayton M. Christensen. 1996. "Disruptive Technologies: Catching the Wave." *The Journal of Product Innovation Management* 1 (13): 75–76.
- [Breuer 2014] Breuer, Henning, and Florian Lüdeke-Freund. 2014. "Normative Innovation for Sustainable Business Models in Value Networks." In *The Proceedings of XXV ISPIM Conference-Innovation for Sustainable Economy and Society*, 8–11.
- [Brimble 2000] Brimble, Richard, and Florence Sellini. 2000. "The Moka Modelling Language." In *Knowledge Engineering and Knowledge Management Methods, Models, and Tools*, 49–56. Springer.
- [Brocka 1992] Brocka, Bruce, and M. Suzanne Brocka. *Quality Management: Implementing the Best Ideas of the Masters*. Business One Irwin Homewood, IL, USA, 1992.
- [Brockhoff 1997] Brockhoff, Klaus K., Grit Koch, and Alan W. Pearson. 1997. "Business Process Re-engineering: Experiences in R&D." *Technology Analysis & Strategic Management* 9 (2): 163–78.
- [Brockhoff 1999] Brockhoff, Klaus. 1999. "Forschung Und Entwicklung."
- [Brown 1995] Brown, Shona L., and Kathleen M. Eisenhardt. 1995. "Product Development: Past Research, Present Findings, and Future Directions." *Academy of Management Review* 20 (2): 343–78.
- [Brown 1998] Brown, Mark G., and Raynold A. Svenson. "Measuring R&D Productivity." *Research-Technology Management* 41, no. 6 (1998): 30–35.
- [Bugayev 2001] Bugayev, K., Y. Konovalov, and Y. Bychkov. *Iron and Steel Production*. New York: Books for Business, 2001.
- [Bullinger 2008] Bullinger, Angelika, and others. 2008. *Innovation and Ontologies: Structuring the Early Stages of Innovation Management*. Springer.
- [Burns 1961] Burns, Tom E., and G. M. Stalker. *The Management of Innovation*. SSRN Scholarly Paper. Rochester, NY: Social Science Research Network, 1961.
- [Byrd 2003] Byrd, Jacqueline, and Paul Lockwood Brown. 2003. *The Innovation Equation: Building Creativity and Risk Taking in Your Organization*. Jossey-Bass/Pfeiffer.

- [Caillaud 2004] Hadj-Hamou, K., and E. Caillaud. 2004. "Cooperative Design: A Framework for a Competency-Based Approach." In 5th International Conference on Integrated Design and Manufacturing in Mechanical Engineering (IDMME), Bath, UK. Vol. 15.
- [Calantone 1988] Calantone, Roger J., and C. Anthony Benedetto. 1988. "An Integrative Model of the New Product Development Process." *Journal of Product Innovation Management* 5 (3): 201–15.
- [Calvert 1990] Calvert, Jack George. 1990. "Glossary of Atmospheric Chemistry Terms (Recommendations 1990)." *Pure and Applied Chemistry* 62 (11): 2167–2219.
- [Cambridge 2008] Dictionary, Cambridge. 2008. Cambridge Advanced Learner's Dictionary. PONS-Worterbucher, Klett Ernst Verlag GmbH.
- [Carroll 2006] Carroll, P. E., and E. Pol. 2006. "An Introduction to Economics with Emphasis on Innovation." Australia: Thomson Learning.
- [Casadesus 2010] Casadesus-Masanell, Ramon, and Joan Enric Ricart. 2010. "From Strategy to Business Models and onto Tactics." *Long Range Planning* 43 (2): 195–215.
- [Cavallucci 2007] Cavallucci, Denis, and Thomas Eltzer. 2007. "Parameter Network as a Means for Driving Problem Solving Process." *International Journal of Computer Applications in Technology* 30 (1-2): 125–36.
- [Cavallucci 2009] Zanni-Merk, Cecilia, Denis Cavallucci, and François Rousselot. 2009. "An Ontological Basis for Computer Aided Innovation." *Computers in Industry* 60 (8): 563–74.
- [Cavallucci 2010] Zanni-Merk, C., D. Cavallucci, and F. Rousselot. 2010. "Using Patents to Populate Inventive Design Ontology." In *Proceedings of the TRIZ Future Conference*, 52–62.
- [Cavallucci 2011] Cavallucci, Denis, and Thomas Eltzer. 2011. "Structuring Knowledge in Inventive Design of Complex Problems." *Procedia Engineering* 9: 694–701.
- [Cavallucci 2013] Yan, Wei, Cecilia Zanni-Merk, Francois Rousselot, and Denis Cavallucci. 2013. "Ontology Matching for Facilitating Inventive Design Based on Semantic Similarity and Case-Based Reasoning." *KES Journal* 17 (3): 243–56.
- [CFT 2003] Commission, Federal Trade, others. 2003. *To Promote Innovation: The Proper Balance of Competition and Patent Law and Policy*.
- [Chakrabarti 1999] Kessler, Eric H., and Alok K. Chakrabarti. 1999. "Speeding up the Pace of New Product Development." *Journal of Product Innovation Management* 16 (3): 231–47.
- [Chakrabarti 2003] Chakrabarti, Amaresh, and Pramod Khadilkar, others. 2003. "A Measure for Assessing Product Novelty." In *DS 31: Proceedings of ICED 03, the 14th International Conference on Engineering Design*, Stockholm.
- [Chandler 1977] Chandler, Jr., Alfred D. *The Visible Hand*. Harvard University Press, 1977.
- [Chen 2007] Xu, Q., Chen, J., Xie, Z., Liu, J., Zheng, G., Wang, Y., 2007. *Total Innovation Management: a novel paradigm of innovation management in the 21st century*. *J Technol Transfer* 32, 9–25.
- [Chesbrough 2003] Chesbrough, Henry W. 2003. "A Better Way to Innovate." *Harvard Business Review* 81 (7): 12–13.
- [Chiesa 1998] Chiesa, Vittorio, Paul Coughlan, and Chris A. Voss. 1998. "Development of a Technical Innovation Audit." *IEEE ENG MANAGE REV* 26 (2): 64–91.
- [Chiesa 1999] Chiesa, Vittorio, Federico Frattini, Valentina Lazzarotti, and Raffaella Manzini. "Performance Measurement in R&D: Exploring the Interplay between Measurement Objectives, Dimensions of Performance and Contextual Factors." *R&d Management* 39, no. 5 (2009): 487–519.
- [Chiesa 2001] Chiesa, Vittorio. 2001. "R&D Strategy and Organization." London (UK): Imperi.

- [Chiou 1999] Chiou, Wen-Chih, Hsiu-Wei Kuo, and Iuan-Yuan Lu. 1999. "A Technology Oriented Productivity Measurement Model." *International Journal of Production Economics* 60: 69–77.
- [Christensen 2003] Christensen, C.M., Raynor, M.E., 2003. *The innovators solution: Creating and sustaining successful growth*. Harvard Business Press.
- [Clark 1980] Clark, Charles Hutchison. 1980. *Idea Management: How to Motivate Creativity and Innovation*. New York, NY: AMACOM.
- [Clark 1991] Clark, Kim B., and Takahiro Fujimoto. 1991. *Product Development Performance: Strategy, Organization, and Management in the World Auto Industry*. Harvard Business Press.
- [Clark 1992] Clark, Kim B., and Steven C. Wheelwright. 1992. "Revolutionizing Product Development: Quantum Leaps in Speed, Efficiency, and Quality." New York: NY.
- [Coates 2015] Coates, Donald. 2015. "Improving the Fuzzy Front End of Product Development for Continuous Innovation Incorporating TRIZ." Accessed July 2.
- [Constable 2003] Constable, George, and Bob Somerville. 2003. *A Century of Innovation: Twenty Engineering Achievements That Transformed Our Lives*. Joseph Henry Press.
- [Cooper 1979] Cooper, Robert G. 1979. "The Dimensions of Industrial New Product Success and Failure." *The Journal of Marketing*, 93–103.
- [Cooper 1983] Cooper, Robert G. 1983. "A Process Model for Industrial New Product Development." *Engineering Management, IEEE Transactions on*, no. 1: 2–11.
- [Cooper 1986] Cooper, Robert G., and Elko J. Kleinschmidt. 1986. "An Investigation into the New Product Process: Steps, Deficiencies, and Impact." *Journal of Product Innovation Management* 3 (2): 71–85.
- [Cooper 1987] Cooper, Robert G., and Elko J. Kleinschmidt. 1987. "Success Factors in Product Innovation." *Industrial Marketing Management* 16 (3): 215–23.
- [Cooper 1988] Cooper, Robert G. 1988. "Predevelopment Activities Determine New Product Success." *Industrial Marketing Management* 17 (3): 237–47.
- [Cooper 1992] Cooper, Robert G. 1992. "The NewProd System: The Industry Experience." *Journal of Product Innovation Management* 9 (2): 113–27.
- [Cooper 1993] Cooper, Robert G., and Elko J. Kleinschmidt. 1993. "Screening New Products for Potential Winners." *Long Range Planning* 26 (6): 74–81.
- [Cooper 1995] Cooper, Robert G., and Elko J. Kleinschmidt. 1995. "Benchmarking the Firm's Critical Success Factors in New Product Development." *Journal of Product Innovation Management* 12 (5): 374–91.
- [Cooper 1999] Cooper, R.G., 1999. *Product Leadership: Creating and Launching Superior New Products*. Perseus Books.
- [Cooper 2001] Cooper, Robert Gravlin. 2001. *Winning at New Products: Accelerating the Process from Idea to Launch*. Basic Books.
- [Cooper 2011] Cooper, Robert G. 2011. "Stage-Gate Idea to Launch System," in *Wiley International Encyclopedia of Marketing: Product Innovation & Management*, Volume 5, B.L. Bayus (ed.), West Sussex, UK: Wiley.
- [Cooper 2014] Cooper, R. G. 2014. *The Stage-Gate® Idea-to-Launch Process—Update, What's New, and NexGen*. Peržiūrėta.
- [Cordero 1990] Cordero, Rene. 1990. "The Measurement of Innovation Performance in the Firm: An Overview." *Research Policy* 19 (2): 185–92.
- [Cordero 1990] Cordero, Rene. 1990. "The Measurement of Innovation Performance in the Firm: An Overview." *Research Policy* 19 (2): 185–92.
- [Crabb 1833] Crabb, George. 1833. *Universal Technological Dictionary, Or Familiar Explanation of the Terms Used in All Arts and Sciences, Containing Definitions Drawn from the*

- Original Writers and Illustrated by Plates, Epigrams, Cuts, &c. by George Crabb: AF. Vol. 1. Baldwin and Cradock.
- [Chrysler 1963] Chrysler Corporation Engineering Office Technical Information. History of Chrysler Corporation Gas Turbine Vehicles: March 1954-May 1963: A Review of Gas Turbine-Powered Vehicles Shown Publicly by Chrysler Corporation. Chrysler Corporation, Engineering Staff, Technical Information Section, 1963.
- [Crawford 1994] Crawford, Charles Merle. 1994. *New Products Management*. 4th Edition. Boston. Richard D. Irwin, Inc.
- [Cropley 2012] Cropley, David, and Arthur Cropley. 2012. "A Psychological Taxonomy of Organizational Innovation: Resolving the Paradoxes." *Creativity Research Journal* 24 (1): 29–40.
- [Cross 2008] Cross, N. 2008. *Engineering Design Methods: Strategies for Product Design*. London, John Wiley & Sons.
- [Crotty 1998] Crotty, Michael. 1998. *The Foundations of Social Research: Meaning and Perspective in the Research Process*. Sage.
- [Cortes Robles 2006] Cortes Robles, Guillermo. 2006. "Management de L'innovation Technologique et Des Connaissances: Synergie Entre La Théorie TRIZ et Le Raisonnement À Partir de Cas. Application En Génie Des Procédés et Systèmes Industriels".
- [Crubleau 2002] Crubleau, P. 2002. "L'identification Des Futures Générations de Produits Industriels." Proposition D'une Demarche Utilisant Les Lois D'évolution de TRIZ. France, Université d'Angers.
- [Csikszentmihalyi 1997] Csikszentmihalyi, Mihaly. 1997. "Flow and the Psychology of Discovery and Invention." HarperPerennial, New York 39.
- [Dahl 2002] Dahl, Darren W., and Page Moreau. 2002. "The Influence and Value of Analogical Thinking during New Product Ideation." *Journal of Marketing Research* 39 (1): 47–60.
- [Dal Pont 2007] Dal Pont, Jean-Pierre. 2007. "L'entreprise Industrielle." *Techniques de L'ingénieur. L'Entreprise Industrielle*, no. AG10v2.
- [Damanpour 1991] Damanpour, Fariborz. 1991. "Organizational Innovation: A Meta-Analysis of Effects of Determinants and Moderators." *Academy of Management Journal* 34 (3): 555–90.
- [Dameron 2003] Dameron, Stéphanie. 2003. "Structuration de La Coopération Au Sein D'équipes Projet." <http://basepub.dauphine.fr/handle/123456789/2290>.
- [Mann 2001] Mann, Darrell. 2001. "An Introduction to TRIZ: The Theory of Inventive Problem Solving." *Creativity and Innovation Management* 10 (2): 123–25.
- [Darses 1997] Darses, Françoise. 1997. "L'ingénierie Concourante: Un Modèle En Meilleure Adéquation Avec Les Processus Cognitifs de Conception." *Ingénierie Concourante: De La Technique Au Social*, 39–55.
- [Davenport 2013] Davenport, Thomas H. 2013. *Process Innovation: Reengineering Work through Information Technology*. Harvard Business Press.
- [David 2004] David, Michaël. 2004. "Définition D'un Cadre Pour L'organisation et L'évaluation Des Activités Du Travail Coopératif." Université Henri Poincaré-Nancy I.
- [Davis 1989] Davis, Fred D. 1989. "Perceived Usefulness, Perceived Ease of Use, and User Acceptance of Information Technology." *MIS Quarterly*, 319–40.
- [De Haas 1999] De Haas, Marco, and Ad Kleingeld 1999. Multilevel Design of Performance Measurement Systems: Enhancing Strategic Dialogue throughout the Organization. *Management Accounting Research* 10(3): 233–261.
- [De Terssac 1996] De Terssac, G., and B. Maggi. 1996. "Autonomie et Conception." *Coopération et Conception*. Octaves Edition, ISBN, 2–906769.

- [Dean 2006] Dean, Douglas L., Jillian M. Hender, Thomas L. Rodgers, and Eric L. Santanen. 2006. "Identifying Quality, Novel, and Creative Ideas: Constructs and Scales for Idea Evaluation." *Journal of the Association for Information Systems* 7 (1): 30.
- [Deane 1979] Deane, P. M. *The First Industrial Revolution*. Cambridge University Press, 1979.
- [Deazley 2010] Deazley, Ronan, Martin Kretschmer, and Lionel Bently. 2010. *Privilege and Property: Essays on the History of Copyright*. Open Book Publishers.
- [Deneux 2002] Deneux, Dominique. 2002. "Méthodes et Modèles Pour La Conception Concourante." *Habilitation À Diriger Des Recherches, Université de Valenciennes et Du Hainaut Cambrésis*.
- [Demirkan 2012] Demirkan, Halime, and Yasemin Afacan. 2012. "Assessing Creativity in Design Education: Analysis of Creativity Factors in the First-Year Design Studio." *Design Studies* 33 (3): 262–78.
- [Dert 1997] Dert, F., Solving International, 1997. *L'Art d'innover, ou, La conquête de l'incertain*. Maxima, Paris.
- [Design Council 2007] Design Council. 2007. *Eleven Lessons: Managing Design in Eleven Global Companies - Desk research report London, Design Council*.
- [Dewar 1986] Dewar, Robert D., and Jane E. Dutton. 1986. "The Adoption of Radical and Incremental Innovations: An Empirical Analysis." *Management Science* 32 (11): 1422–33.
- [Dixon 1966] Dixon, John R. 1966. *Design Engineering: Inventiveness, Analysis, and Decision Making*. McGraw-Hill New York. accessed June 03, 2014.
- [Dodds 2002] Dodds, Rebecca A., Steven M. Smith, and Thomas B. Ward. 2002. "The Use of Environmental Clues during Incubation." *Creativity Research Journal* 14 (3-4): 287–304.
- [Dorst 1997] Dorst, Cornelis Hans. 1997. *Describing Design-A Comparison of Paradigms*. TU Delft, Delft University of Technology.
- [Dosi 1988] Dosi, Giovanni, others. 1988. "The Nature of the Innovative Process." *Technical Change and Economic Theory* 2: 590–607.
- [Dougherty 1992] Dougherty, Deborah. 1992. "Interpretive Barriers to Successful Product Innovation in Large Firms." *Organization Science* 3 (2): 179–202.
- [Doz 1996] Doz, Yves. 1996. *New Product Development Effectiveness: A Triadic Comparison in the Information Technology Industry*. Oxford University Press, New York.
- [Draghici 2000] Choulier, Denis, and George Draghici. 2000. "TRIZ: Une Approche de Résolution Des Problèmes D'innovation Dans La Conception de Produits." *Modélisation de La Connaissance Pour La Conception et La Fabrication Intégrées, Drăghici G. & Brissaud D. (Ed.)*, 31–59.
- [Driva 1999] Pawar, Kulwant S., and Helen Driva. "Performance Measurement for Product Design and Development in a Manufacturing Environment." *International Journal of Production Economics* 60 (1999): 61–68.
- [Driva 2000] Driva, H., K. S. Pawar, and U. Menon. "Measuring Product Development Performance in Manufacturing Organisations." *International Journal of Production Economics* 63, no. 2 (2000): 147–59.
- [Du Preez 2008] Du Preez, Niek D., and Louis Louw. 2008. "A Framework for Managing the Innovation Process." In *Management of Engineering & Technology, 2008. PICMET 2008. Portland International Conference on*, 546–58. IEEE.
- [Duffy 2003] Sim, Siang Kok, and Alex HB Duffy. 2003. "Towards an Ontology of Generic Engineering Design Activities." *Research in Engineering Design* 14 (4): 200–223.
- [Duffy 2012] Duffy, Alex HB. 2012. *The Design Productivity Debate*. Springer Science & Business Media.

- [Dugosh 2000] Dugosh, Karen Leggett, Paul B. Paulus, Evelyn J. Roland, and Huei-Chuan Yang. 2000. "Cognitive Stimulation in Brainstorming." *Journal of Personality and Social Psychology* 79 (5): 722.
- [Dussauge 1992] Dussauge, Pierre, Stuart Hart, and Bernard Ramanantsoa. 1992. "Strategic Technology Management." <https://hal.archives-ouvertes.fr/hal-00708987/>.
- [Dwight 1999] Dwight, Richard. 1999. "Searching for Real Maintenance Performance Measures." *Journal of Quality in Maintenance Engineering* 5 (3): 258–75.
- [Eccles 1991] Eccles, R. 1991. The Performance Measurement Manifesto. *Harvard Business Review*, January-February: 131–137.
- [Eckert 2001] Eckert, Claudia, and Martin Stacey. 2001. "Dimensions of Communication in Design." In *13th International Conference on Engineering Design (ICED 01)*, 473–80.
- [Eder 2012] Hubka, Vladimir, and W. Ernst Eder. 2012. *Theory of Technical Systems: A Total Concept Theory for Engineering Design*. Springer Science & Business Media.
- [Edquist 2001] Edquist, Charles, Leif Hommen, and Maureen D. McKelvey. 2001. *Innovation and Employment: Process versus Product Innovation*. Edward Elgar Publishing.
- [Edquist 2006] Edquist Charles, and Meeus Marius. 2006. "Introduction to Part I. Product and Process Innovation." *Innovation, Science and Institutional Change. A Research Handbook*, 23–37.
- [EIEG 1986] Electricity in Economic Growth. 1986. Washington, DC: National Academy Press. pp. 16, 40. Accessed June 1, 2014. <http://www.nap.edu/catalog/900/electricity-in-economic-growth>.
- [Eisenberger 1994] Eisenberger, Robert, and Michael Selbst. 1994. "Does Reward Increase or Decrease Creativity?" *Journal of Personality and Social Psychology* 66 (6): 1116.
- [Eisenhardt 1995] Eisenhardt, Kathleen M., and Behnam N. Tabrizi. 1995. "Accelerating Adaptive Processes: Product Innovation in the Global Computer Industry." *Administrative Science Quarterly*, 84–110.
- [EITM 2014] European Institute of Technology and Innovation Management (EITM), <http://www-eitm.eng.cam.ac.uk/index.html>. Accessed 2 May 2014.
- [Elko 2011] Cooper, Robert G., and Elko J. Kleinschmidt. 2011. *New Products: The Key Factors in Success*. Marketing Classics Press.
- [Emmanuelides 1993] Emmanuelides, Paul A. 1993. "Towards an Integrative Framework of Performance in Product Development Projects." *Journal of Engineering and Technology Management* 10 (4): 363–92.
- [Eppinger 1995] Eppinger, Steven D., and Karl T. Ulrich. 1995. "Product Design and Development." 1995.
- [Eris 2006] Eris, Engin Deniz, and Omur Yasar Saatcioglu. 2006. "A System Look for Technological Innovation: Firm Based Perspective." In *European and Mediterranean Conference on Information Systems (EMCIS)*, July, 6–7.
- [Ettlie 2006] Ettlie, John E. 2006. *Managing Innovation: New Technology*. Elsevier Science & Technology.
- [Evan 1966] Evan, William. 1966. "Organizational Lag." *Human Organization* 25 (1): 51–53.
- [Eveleens 2010] Eveleens, Chris. 2010. "Innovation Management; a Literature Review of Innovation Process Models and Their Implications." *Science* 800 (2010): 900.
- [Feist 1998] Feist, Gregory J. 1998. "A Meta-Analysis of Personality in Scientific and Artistic Creativity." *Personality and Social Psychology Review* 2 (4): 290–309.
- [Fenton 2014] Fenton, Norman, and James Bieman. 2014. *Software Metrics: A Rigorous and Practical Approach*. CRC Press.
- [Fenves 2001] Fenves, Steven Joseph. 2001. *Core Product Model for Representing Design Information*. Citeseer.

- [Fenves 2008] Fenves, Steven J., Sebti Foufou, Conrad Bock, and Ram D. Sriram. 2008. "CPM2: A Core Model for Product Data." *Journal of Computing and Information Science in Engineering* 8 (1): 014501.
- [Fernez-Walch 2006] Fernez-Walch, Sandrine, François Romon, Vincent COUSIN, and TABLE RONDE. 2006. "Management de L'innovation." *De La Stratégie Aux Projets*.
- [Ferraro 2002] Ferraro, Mike. 2002. "Technical Performance Measurement-A Program Manager's Barometer." *Program Manager* 31 (6): 14-35.
- [Finke 1992] Finke, Ronald A., Thomas B. Ward, and Steven M. Smith. 1992. "Creative Cognition: Theory, Research, and Applications".
- [Frankenberger 2012] Frankenberger, Eckart, Petra Badke-Schaub, and Herbert Birkhofer. 2012. *Designers: The Key to Successful Product Development*. Springer Science & Business Media.
- [Fryer 2012] Fryer, Marilyn. 2012. "Some Key Issues in Creativity Research and Evaluation as Seen from a Psychological Perspective." *Creativity Research Journal* 24 (1): 21-28.
- [Freeman 1971] Freeman, Christopher. 1971. *A Study of Success and Failure in Industrial Innovation*. JEA.
- [Freeman 1989] Freeman, Christopher. 1989. *The Nature of Innovation and the Evolution of the Productive System*. MERIT.
- [Froehlicher 2000] Froehlicher, Thomas. 2000. "R & D En Coopération: Une Synthèse Des Thèses Françaises."
- [Funtowicz 1994] Funtowicz, Silvio O., and Jerome R. Ravetz. 1994. "Uncertainty, Complexity and Post-Normal Science." *Environmental Toxicology and Chemistry* 13 (12): 1881-85.
- [Gänshirt 2007] Gänshirt, Christian. 2007. *Tools for Ideas: Introduction to Architectural Design*. Walter de Gruyter.
- [Garcia 2002] Garcia, Rosanna, and Roger Calantone. 2002. "A Critical Look at Technological Innovation Typology and Innovativeness Terminology: A Literature Review." *Journal of Product Innovation Management* 19 (2): 110-32.
- [Gartiser 1999] Gartiser, N. 1999. "Analyse Contingente Du Processus d'innovation-Application Aux Établissements Industriels de La Région Alsace." *Strasbourg, Université Louis Pasteur* 544.
- [Garvey 2005] Garvey, Paul R., and Chien-Ching Cho. 2005. "An Index to Measure and Monitor a System-of-Systems' Performance Risk." *MITRE Technical Paper*.
- [George 1948] George, Liddell Henry, Robert Scott, Henry Stuart Jones, and others. 1948. *A Greek-English Lexicon*. United Kingdom: Oxford University Press. ISBN 0-19-910207-4.
- [Gero 1990] Gero, John S. 1990. "Design Prototypes: A Knowledge Representation Schema for Design." *AI Magazine* 11 (4): 26.
- [Gero 1994] Purcell, A. T., J. S. Gero, H. M. Edwards, and E. Matka. 1994. "Design Fixation and Intelligent Design Aids." In *Artificial Intelligence in Design'94*, 483-95. Springer.
- [Gero 1996] Purcell, A. Terry, and John S. Gero. 1996. "Design and Other Types of Fixation." *Design Studies* 17 (4): 363-83.
- [Gero 2004] Gero, John S., and Udo Kannengiesser. 2004. "The Situated Function-behaviour-structure Framework." *Design Studies* 25 (4): 373-91.
- [Getz 2003] Getz, Isaac, and Alan G. Robinson. 2003. "Innovate or Die: Is That a Fact?" *Creativity and Innovation Management* 12 (3): 130-36.
- [Gibert 1980] Gibert, Patrick. 1980. *Le Contrôle de Gestion Dans Les Organisations Publiques*. Editions d'Organisation.
- [Girod 2000] Girod, Maurice, A. Elliott, I. Wright, and N. Burns. 2000. "Activities in Collaborative Concept Selection Processes for Engineering Design." In *Proc. ASME Design Theory and Methodology Conference, DETC2000/DTM-14548*.

- [Godener 2004] Godener, Armelle, and Klas Eric Söderquist. "Use and Impact of Performance Measurement Results in R&D and NPD: An Exploratory Study." *R&D Management* 34, no. 2 (2004): 191–219.
- [Godin 2008] Godin, Benoît. 2008. "Innovation: The History of a Category." Project on the Intellectual History of Innovation Working Paper, no. 1.
- [Goldenberg 1999] Goldenberg, Jacob, David Mazursky, and Sorin Solomon. 1999. "Toward Identifying the Inventive Templates of New Products: A Channeled Ideation Approach." *Journal of Marketing Research*, 200–210.
- [Goldschmidt 1995] Goldschmidt, Gabriela. 1995. "The Designer as a Team of One." *Design Studies* 16 (2): 189–209.
- [Green 1995] Green, Stephen G., Mark B. Gavin, and Lynda Aiman-Smith. 1995. "Assessing a Multidimensional Measure of Radical Technological Innovation." *Engineering Management, IEEE Transactions on* 42 (3): 203–14.
- [Griffin 1996] Griffin, Abbie, and Albert L. Page. "PDMA Success Measurement Project: Recommended Measures for Product Development Success and Failure." *Journal of Product Innovation Management* 13, no. 6 (1996): 478–96.
- [Griffin 1997] Griffin, Abbie. 1997. "PDMA Research on New Product Development Practices: Updating Trends and Benchmarking Best Practices." *Journal of Product Innovation Management* 14 (6): 429–58.
- [Griliches 1990] Griliches, Zvi. 1990. "Patent Statistics as Economic Indicators: A Survey." National Bureau of Economic Research. <http://www.nber.org/papers/w3301>.
- [Grimshaw 2004] Grimshaw, Jeremy, R. Thomas, G. MacLennan, CRRC Fraser, C. R. Ramsay, L. et al Vale, P. Whitty, M. P. Eccles, L. Matowe, and L. Shirran, others. 2004. "Effectiveness and Efficiency of Guideline Dissemination and Implementation Strategies."
- [Gupta 2007] Gupta, Anil K., Paul E. Tesluk, and M. Susan Taylor. 2007. "Innovation at and across Multiple Levels of Analysis." *Organization Science* 18 (6): 885–97.
- [Haag 2007] Schuh, Günther, Christoph Haag, and Jennifer Kreysa. 2011. "TRIZ-Based Technology Know-How Protection-How to Find Protective Mechanisms against Product Piracy with TRIZ." *Procedia Engineering* 9: 611–19.
- [Hagedoorn 2003] Hagedoorn, J., & Cloudt, M. (2003). Measuring innovative performance: is there an advantage in using multiple indicators? *Research Policy*, 32(8), 1365–1379.
- [Hales 1993] Hales, C. 1993. *Managing engineering design* Harlow, England, Longman Scientific and Technical.
- [Hamel 1994] Hamel, G., Prahalad, C.K., 1994. *Competing for the Future*, 1994. Harvard Business School Press, Boston.
- [Hamidzadeh 2013] Hajikarimi, Abbasali, Mohammad Reza Hamidzadeh, Nasrin Jazani, and Sayed Mahdi Golestan Hashemi. 2013. "A Comprehensive Systemic Model of Innovation Management: Total Innovation Management (TIM)." *Interdisciplinary Journal of Contemporary Research in Business* 4 (9): 1078.
- [Hamilton 1982] Booz, and Allen & Hamilton. 1982. *New Products Management for the 1980s*. Booz, Allen & Hamilton.
- [Hatchuel 1994] Hatchuel, Armand. 1994. *Apprentissages Collectifs et Activités de Conception*.
- [Hatchuel 2003] Hatchuel, Armand, and Benoit Weil, others. 2003. "A New Approach of Innovative Design: An Introduction to CK Theory." In *DS 31: Proceedings of ICED 03, the 14th International Conference on Engineering Design*, Stockholm.
- [Hatchuel 2009] Hatchuel, Armand, and Benoit Weil. 2009. "CK Design Theory: An Advanced Formulation." *Research in Engineering Design* 19 (4): 181–92.
- [Hatchuel 2010] Masson, Pascal Le, Benoît Weil, and Armand Hatchuel. 2010. *Strategic Management of Innovation and Design*. Cambridge University Press.

- [Hauschildt 2004] Hauschildt, Jürgen. 2004. "Innovationsmanagement, 3., Völlig Überarbeitete Und Erweiterte Aufl." München: Franz Vahlen.
- [Hauschildt 2011] Hauschildt, Jürgen, and Sören Salomo. Innovationsmanagement. Vahlen, 2011.
- [Hauser 1996] Griffin, Abbie, and John R. Hauser. 1996. "Integrating R&D and Marketing: A Review and Analysis of the Literature." *Journal of Product Innovation Management* 13 (3): 191–215.
- [Hauser 1998] Hauser, John R. "Research, Development, and Engineering Metrics." *Management Science* 44, no. 12-part-1 (1998): 1670–89.
- [Helfat 2000] Helfat, Constance E., and Ruth Raubitschek. 2000. "Product Sequencing: Co-Evolution of Knowledge, Capabilities and Products." In Tuck-JFE Contemporary Corporate Governance Conference.
- [Henry 1991] Henry, Jane, and David Walker. 1991. *Managing Innovation*. Sage Pubns.
- [Hindo 2007] Hindo, Brian, and Brian Grow. 2007. "Six Sigma: So Yesterday? In an Innovation Economy, It's No Longer a Cure-All." *Business Week* 11.
- [Howard 2008] Howard, Thomas J., Stephen J. Culley, and Elies Dekoninck. 2008. "Describing the Creative Design Process by the Integration of Engineering Design and Cognitive Psychology Literature." *Design Studies* 29 (2): 160–80.
- [Hubka 1982] Hubka, V. and Eder, W.E. 1982. *Principles of Engineering Design*. London, Butterworth Scientific.
- [Hubka 2012] Hubka, Vladimir, and W. Ernst Eder. 2012. *Design Science: Introduction to the Needs, Scope and Organization of Engineering Design Knowledge*. Springer Science & Business Media.
- [Huebner 1964] Huebner, George J. *The Chrysler Regenerative Turbine-Powered Passenger Car*. SAE Technical Paper, 1964. <http://papers.sae.org/640414/>.
- [Huet 2004] Huet, Frédéric. 2004. "Apprentissage Collectif et Dynamique Coopérative: Une Étude Empirique Des PME Françaises." Compiègne. <http://www.theses.fr/2004COMP1541>.
- [Hughes 1996] Hughes, G. David, and Don C. Chafin. 1996. "Turning New Product Development into a Continuous Learning Process." *Journal of Product Innovation Management* 13 (2): 89–104.
- [IMF 2000] Team, I. M. F., and others. *Globalization: Threats or Opportunity*. IMF Publications, 2000.
- [Ionescu 2008] Hincu, Daniela, Marin Andreica, Gabriela Ionescu, Nicolae Ionescu, Aurelian Visan, and Angela Andreica. 2008. "Managing the Ideality Concept and the Evaluation of the Innovation Level." In *Proceedings of the 9th WSEAS International Conference on Mathematics & Computers In Business and Economics*, 146–51. World Scientific and Engineering Academy and Society (WSEAS).
- [ISA 2000] ANSI, ISA. ISA-95.00. 01-2000 (2000) *Enterprise Control System Integration*. Part1, n.d.
- [Jalonen 2011] Jalonen, Harri. "The Uncertainty of Innovation: A Systematic Review of the Literature." *Journal of Management Research* 4, no. 1 (2011).
- [Jansson 1991] Jansson, David G., and Steven M. Smith. 1991. "Design Fixation." *Design Studies* 12 (1): 3–11.
- [Jaruzelski 2005] Jaruzelski, B. 2005. "The Global Innovation 1000. Money Isn't Everything." *Strategy+ Business*.—spring.
- [Jaruzelski 2006] Jaruzelski, Barry, Kevin Dehoff, and Rakesh Bordia. "Smart Spenders: Once Again, Booz Allen Hamilton's Annual Study of the World's 1,000 Largest Corporate R&D Budgets Shows That High Investment Can't Buy Success." *Strategy and Business* 45 (2006): 46.

- [Jonson 2005] Jonson, Ben. 2005. "Design Ideation: The Conceptual Sketch in the Digital Age." *Design Studies* 26 (6): 613–24.
- [Jungpyo 2007] Jungpyo, Hong, Jeong Sukyoung, and Cho Dongmin. 2007. "Idea Generation Methodology for Creative Design Thinking."
- [Kahn 2005] Kahn, K., Castellion, G., and Griffin, A. (eds) *The PDMA Handbook of New Product Development* 2nd Ed., John Wiley & Sons, Hoboken, NJ, 2005, p. 601.
- [Kahneman 1977] Kahneman, Daniel, and Amos Tversky. 1977. "Intuitive Prediction: Biases and Corrective Procedures." DTIC Document.
- [Kahneman 1990] Kahneman, Daniel, and Jackie Snell. 1990. "Predicting Utility." <http://psycnet.apa.org/psycinfo/1990-97854-017>.
- [Kald 2000] Kald, Magnus, and Fredrik Nilsson. "Performance Measurement at Nordic Companies." *European Management Journal* 18, no. 1 (2000): 113–27.
- [Kaplan 1996] Kaplan, Robert S., and David P. Norton. "Using the Balanced Scorecard as a Strategic Management System." *Harvard Business Review* 74, no. 1 (1996): 75–85.
- [Keil 1995] Keil, Mark, Peggy M. Beranek, and Benn R. Konsynski. 1995. "Usefulness and Ease of Use: Field Study Evidence Regarding Task Considerations." *Decision Support Systems* 13 (1): 75–91. doi:10.1016/0167-9236(94)E0032-M.
- [Kelly 1978] Kelly, Patrick, Melvin Kranzberg, and others. 1978. "Technological Innovation: A Critical Review of Current Knowledge."
- [Kemmerer 1999] Kemmerer, Sharon J. 1999. *STEP: The Grand Experience*. US Department of Commerce, Technology Administration, National Institute of Standards and Technology.
- [Kerssens-van 1999] Kerssens-van Drongelen, Inge C. *Systematic Design of R & D Performance Measurement Systems*. Print Partners Ipskamp, 1999.
- [Kerssens-van 2000] Kerssens-van Drongelen, Inge, Bill Nixon, and Alan Pearson. "Performance Measurement in Industrial R&D." *International Journal of Management Reviews* 2, no. 2 (2000): 111–43.
- [Kessler 2000] Kessler, E.H., Bierly, P.E., Gopalakrishnan, S., 2000. Internal vs. external learning in new product development: effects on speed, costs and competitive advantage. *R&D Management* 30, 213–224.
- [Khurana 1997] Khurana, Anil, and Stephen R. Rosenthal. 1997. "Integrating the Fuzzy Front End of New Product Development." *Sloan Management Review* 38: 103–20.
- [Khurana 1998] Khurana, Anil, and Stephen R. Rosenthal. 1998. "Towards Holistic 'front Ends' in New Product Development." *Journal of Product Innovation Management* 15 (1): 57–74.
- [Kim 2002] Kim, Bowon, and Heungshik Oh. 2002. "An Effective R&D Performance Measurement System: Survey of Korean R&D Researchers." *Omega* 30 (1): 19–31.
- [Kizlik 2011] Kizlik, Bob. "Measurement, Assessment, and Evaluation in Education." Retrieved 9, no. 16 (2011): 2011.
- [Kleinschmidt 2001] Cooper, R., S. Edgett, and E. Kleinschmidt. 2001. "Portfolio Management for New Product Development." *r&D Management* 31 (4): 361–80.
- [Knight 1921] Knight Frank, H. "Risk, Uncertainty and Profit." *Книга*, 1921.
- [Koen 2001] Koen, Peter, Greg Ajamian, Robert Burkart, Allen Clamen, Jeffrey Davidson, Robb D'Amore, Claudia Elkins, et al. 2001. "Providing Clarity and a Common Language to the." *Research-Technology Management* 44 (2): 46–55.
- [Kucharavy 2009] Kucharavy, Dmitry, Eric Schenk, and Roland De Guio. 2009. "Long-Run Forecasting of Emerging Technologies with Logistic Models and Growth of Knowledge." In *Proceedings of the 19th CIRP Design Conference—Competitive Design*. Cranfield University Press.

- [Kucharavy 2011] Kucharavy, Dmitry, and Roland De Guio. 2011. "Logistic Substitution Model and Technological Forecasting." *Procedia Engineering* 9: 402–16.
- [Kuczumarski 1992] Kuczumarski, Thomas. 1992. "Managing New Products." p. 163.
- [Kumar 2013] Kumar, Vijaya. "PDMA - Product Development and Management Association : Blogs : Improving the Success Rate of New Product Introduction through Digital Social Media," August 27, 2013.
- [Kuznets 1962] Kuznets, Simon. 1962. "Inventive Activity: Problems of Definition and Measurement." In *The Rate and Direction of Inventive Activity: Economic and Social Factors*, 19–52. Princeton University Press. <http://www.nber.org/chapters/c2112.pdf>.
- [Kvan 2000] Kvan, Thomas. 2000. "Collaborative Design: What Is It?" *Automation in Construction* 9 (4): 409–15.
- [Labrousse 2008] Labrousse, M., and Alain Bernard. 2008. "FBS-PPRE, an Enterprise Knowledge Lifecycle Model." In *Methods and Tools for Effective Knowledge Life-Cycle-Management*, edited by Alain Bernard and Serge Tichkiewitch, 285–305. Springer Berlin Heidelberg.
- [Larsson 2002] Larsson, Staffan. 2002. *Issue-Based Dialogue Management*. Department of Linguistics, Göteborg University. <http://www.ling.gu.se/~sl/Thesis/thesis.pdf>.
- [Lawson 2001] Lawson, B., Samson, D., 2001. Developing innovation capability in organisations: a dynamic capabilities approach. *International Journal of Innovation Management* 5, 377–400.
- [Le Masson 2006] Le Masson, Pascal, Benoit Weil, and Armand Hatchuel. 2006. *Les Processus D'innovation: Conception Innovante et Croissance Des Entreprises*. Hermes science publ.
- [Le Moigne 1990] Le Moigne, Jean-Louis. 1990. "La Modélisation Des Systèmes Complexes." Paris: Bordas, Dunot, 1990 1.
- [Leifer 2000] Leifer, Richard. 2000. *Radical Innovation: How Mature Companies Can Outsmart Upstarts*. Harvard Business Press.
- [Lehto 2010] Lehto, Steve. *Chrysler's Turbine Car: The Rise and Fall of Detroit's Coolest Creation*. Chicago Review Press, 2010.
- [Le Lann 2004] Cortes Robles, G., S. Negny, and J. Le Lann. 2004. "Knowledge Management and TRIZ: A Model for Knowledge Capitalization and Innovation". In *World Conference: TRIZ Future*.
- [Lengnick-Hall 1992] Lengnick-Hall, Cynthia A. 1992. "Innovation and Competitive Advantage: What We Know and What We Need to Learn." *Journal of Management* 18 (2): 399–429.
- [Leonard-Barton 1998] Leonard-Barton, Dorothy. 1998. *Wellsprings of Knowledge: Building and Sustaining the Sources of Innovation*. Harvard Business Press.
- [Lester 2009] Lester, Richard K., and Michael J. Piore. 2009. *Innovation—the Missing Dimension*. Harvard University Press.
- [Liberatore 1995] Liberatore, M.J., Stylianou, A.C., 1995. Expert support systems for new product development decision making: a modeling framework and applications. *Management science* 41, 1296–1316.
- [Livotov 2008] Livotov, Pavel. 2008. "Method for Quantitative Evaluation of Innovation Tasks for Technical Systems, Products and Processes." In , 197–99.
- [LLC 2011] Dictionary.com, LLC. "Effectiveness | Define Effectiveness at Dictionary.com." *Dictionary.com | Find the Meanings and Definitions of Words at Dictionary.com*. 2011. Web. 28 Sept. 2011.
- [Loch 1996] Loch, Christoph, Lothar Stein, and Christian Terwiesch. 1996. "Measuring Development Performance in the Electronics Industry." *Journal of Product Innovation Management* 13 (1): 3–20.

- [Loch 2002] Loch, Christoph H., and U. A. Tapper. "Implementing a Strategy-Driven Performance Measurement System for an Applied Research Group." *Journal of Product Innovation Management* 19, no. 3 (2002): 185–98.
- [Lockamy 1998] Lockamy III, Archie 1998. *Quality-Focused Performance Measurement Systems: A Normative Model*. *International Journal of Operations & Production Management* 18(8): 740–766.
- [Logan 1993] Logan, Brian, and Tim Smithers. 1993. "Creativity and Design as Exploration." *Modeling Creativity and Knowledge-Based Creative Design*, 139–73.
- [Loilier 1999] Loilier, Thomas, and Albéric Tellier. 1999. *Gestion de L'innovation: Décider, Mettre En Oeuvre, Diffuser*. Ed. Management et société.
- [Lonchamp 2004] Lonchamp, Pierre. 2004. "Co-Évolution et Processus de Conception Intégrée de Produits: Modèle et Support de L'activité de Conception." Institut National Polytechnique de Grenoble-INPG. <https://tel.archives-ouvertes.fr/tel-00007313/>.
- [Lorino 1997] Demeestère, René, Philippe Lorino, and Nicolas Mottis. 2006. *Contrôle de Gestion et Pilotage de L'entreprise*. Dunod.
- [Luecke 2003] Luecke, Richard, and Ralph Katz. 2003. *Harvard Business Essentials: Managing Creativity and Innovation*. Harvard Business School Press.
- [Lundin 1998] Lundin, Rolf A., and Christophe Midler. *Projects as Arenas for Renewal and Learning Processes*. 1998 edition. Boston: Springer, 1998.
- [Lynch 2001] Lynch, Brian K. "Rethinking Assessment from a Critical Perspective." *Language Testing* 18, no. 4 (2001): 351–72.
- [MacCrimmon 1994] MacCrimmon, Kenneth R., and Christian Wagner. 1994. "Stimulating Ideas through Creative Software." *Management Science* 40 (11): 1514–32.
- [Mankins 1995] Mankins, John C. 1995. "Technology Readiness Levels." White Paper, April 6.
- [Manning 1997] Manning, Heather. 1997. "The Management of Technology: Perception and Opportunities." *Journal of Manufacturing Systems* 16 (3): 232.
- [Marchetti 1979] Marchetti, Cesare, and Nebojsa Nakicenovic. 1979. "The Dynamics of Energy Systems and the Logistic Substitution Model." PRE-24360.
- [Martinich 2008] Martinich, Joseph S. 2008. *Production and Operations Management: An Applied Modern Approach*. John Wiley & Sons.
- [Martins 2011] Martins, Paula S., Ferraz, Thais C. P., Alves, Luiz H. D., 2011. *Competitive advantage gained through the establishment of innovation*. POMS 23rd, Chicago, Illinois, USA.
- [Matheson 1998] Matheson, David, and James E. Matheson. 1998. *The Smart Organization: Creating Value through Strategic R&D*. Harvard Business Press.
- [Matthews 1992] Matthews, William H. 1992. "Conceptual Framework for Integrating Technology into Business Strategy." *International Journal of Vehicle Design* 13 (5-6): 524–32.
- [Matthews 2009] Matthews, Mark. "6. Fostering Creativity and Innovation in Cooperative Federalism—the Uncertainty and Risk Dimensions." *Critical Reflections on Australian Public Policy: Selected Essays*, 2009, 59.
- [Mayer 1992] Mayer, Richard E. 1992. *Thinking, Problem Solving, Cognition*. WH Freeman/Times Books/Henry Holt & Co.
- [McAdam 2006] McAdam, Rodney, Renee Reid, and William Keogh. 2006. "Technology and Market Knowledge Creation and Idea Generation: An Integrated Quality Approach." *International Journal of Technology Management* 34 (3-4): 340–59.
- [McCarthy 2007] McCarthy, Tom. *Auto Mania: Cars, Consumers, and the Environment*. Yale University Press, 2007.

- [McDonough 1997] McDonough, E. R., and Abbie Griffin. 1997. "The Impact of Organizational Tools on New Product Development Efficiency and Effectiveness." In Proceedings of the International PDMA Conference, Monterey (CA).
- [McMullin 1985] McMullin, Ernan. 1985. "Galilean Idealization." *Studies in History and Philosophy of Science Part A* 16 (3): 247–73.
- [McNaught 1997] McNaught, Alan D., and Alan D. McNaught. 1997. *Compendium of Chemical Terminology*. Vol. 1669. Blackwell Science Oxford..
- [Meeus 2006] Meeus, Marius TH, and Jerald Hage. 2006. "Product and Process Innovation, Scientific Research, Knowledge Dynamics and Institutional Change: An Introduction." *Innovation, Science, and Institutional Change: A Research Handbook*, 1–22.
- [Mehra 1998] Mehra, Satish. "Perpetual Analysis and Continuous Improvements: A Must for Organizational Competitiveness." *Managerial Finance* 24, no. 1 (1998): 19–27.
- [Mentzer 1991] Mentzer, John T., and Brenda Ponsford Konrad. 1991. "An Efficiency/effectiveness Approach to Logistics Performance Analysis." *Journal of Business Logistics* 12 (1): 33.
- [Merriam-Webster 2014] Inc, Merriam-Webster. 2004. *Merriam-Webster's Collegiate Dictionary*. Merriam-Webster.
- [Meyer 1994] Meyer, Marshall W., and Vipin Gupta 1994. *The Performance Paradox. Research in Organizational Behaviour* 16: 309–369.
- [Micaëlli 2003] Micaëlli, Jean-Pierre, and Joëlle Forest. 2003. *Artificialisme: Introduction À Une Théorie de La Conception*. PPUR presses polytechniques.
- [Micklethwait 1997] Micklethwait, J., Wooldridge, A., 1997. *The witch doctors: making sense of the management gurus*. Times Business, New York.
- [Miller 2000] Miller, Douglas J. 2000. "Corporate Diversification, Relatedness, and Performance." The Ohio State University.
- [Mishra 2014] Mishra, Umakant. 2014. "Patentability Criteria in Different Countries." Available at SSRN 2430768.
- [Modesto 1980] Maidique, Modesto A. 1980. "Entrepreneurs, Champions, and Technological Innovation." *Sloan Management Review* 21 (2): 59–76.
- [Modis 2007] Modis, Theodore. 2007. "Strengths and Weaknesses of S-Curves." *Technological Forecasting and Social Change* 74 (6): 866–72.
- [Moenaert 1995] Moenaert, Rudy K., Amoud De Meyer, William E. Souder, and Dirk Deschoolmeester. 1995. "R&D/marketing Communication during the Fuzzy Front-End." *Engineering Management, IEEE Transactions on* 42 (3): 243–58.
- [Moenaert 1995] Moenaert, Rudy K., Arnoud De Meyer, William E. Souder, and Dirk Deschoolmeester. "R&D/marketing Communication during the Fuzzy Front-End." *Engineering Management, IEEE Transactions on* 42, no. 3 (1995): 243–58.
- [Mokyr 1985] Mokyr, Joel. *The Economics of the Industrial Revolution*. Government Institutes, 1985.
- [Mokyr 1998] Mokyr, Joel. "The Second Industrial Revolution, 1870-1914." *Storia Dell'economia Mondiale*, 1998, 219–45.
- [Montoya-Weiss 1994] Montoya-Weiss, Mitzi M., and Roger Calantone 1994. "Determinants of New Product Performance: A Review and Meta-Analysis." *Journal of Product Innovation Management* 11(5): 397–417.
- [Montoya-Weiss 1994] Montoya-Weiss, Mitzi M., and Roger Calantone. 1994. "Determinants of New Product Performance: A Review and Meta-Analysis." *Journal of Product Innovation Management* 11 (5): 397–417.
- [Moseng 1993] Moseng, Bojorn, and Harald Bredrup. 1993. "A Methodology for Industrial Studies of Productivity Performance". *Production Planning & Control* 4 (3): 198–206.

- [Moss 2002] Moss, Simon A. 2002. "The Impact of Environmental Clues in Problem Solving and Incubation: The Moderating Effect of Ability." *Creativity Research Journal* 14 (2): 207–11.
- [Mowery 1991] Mowery, David C., and Nathan Rosenberg. *Technology and the Pursuit of Economic Growth*. Cambridge University Press, 1991.
- [Mumford 2003] Mumford, Michael D. 2003. "Taking Stock in Taking Stock." *Creativity Research Journal* 15 (2-3): 147–51.
- [Myers 1969] Myers, Summwe, and Donald G. Marquis. 1969. *Successful Industrial Innovation*. Institute of Public Administration.
- [Nard 2008] Nard, Craig Allen, and others. 2008. *The Law of Patents*. Aspen Publishers.
- [Neely 1995] Andy Neely, Mike Gregory, and Ken Platts. "Performance Measurement System Design." *International Journal of Operations & Production Management* 15, no. 4 (April 1, 1995): 80–116. Doi: 10.1108/01443579510083622.
- [Neely 1996] Neely, A., J. Mills, M. Gregory, H. Richards, K. Platts, and M. Bourne. 1996. "Getting the Measure of Your Business, University of Cambridge." *Manufacturing Engineering Group, Mill Lane, Cambridge*.
- [Neely 1999] Neely, Andy. "The Performance Measurement Revolution: Why Now and What Next?" *International Journal of Operations & Production Management* 19, no. 2 (1999): 205–28.
- [Nelson 2009] Nelson, Brent A., Jamal O. Wilson, David Rosen, and Jeannette Yen. 2009. "Refined Metrics for Measuring Ideation Effectiveness." *Design Studies* 30 (6): 737–43.
- [Newell 1982] Newell, Allen. 1982. "The Knowledge Level." *Artificial Intelligence* 18 (1): 87–127.
- [Nijstad 2006] Nijstad, Bernard A., and Wolfgang Stroebe. 2006. "How the Group Affects the Mind: A Cognitive Model of Idea Generation in Groups." *Personality and Social Psychology Review* 10 (3): 186–213.
- [Nobelius 2004] Nobelius, Dennis. 2004. "Towards the Sixth Generation of R&D Management." *International Journal of Project Management* 22 (5): 369–75.
- [Nonaka 1994] Nonaka, Ikujiro. 1994. "A Dynamic Theory of Organizational Knowledge Creation." *Organization Science* 5 (1): 14–37.
- [Norton 1996] Kaplan, Robert S., and David P. Norton. *The Balanced Scorecard: Translating Strategy into Action*. Harvard Business Press, 1996.
- [Nuvolari 2006] MacLeod, Christine, and Alessandro Nuvolari. 2006. "Inventive Activities, Patents and Early Industrialization. A Synthesis of Research Issues." *DRUID Wp*, no. 06-28. 2009 Bloomberg Finance
- [O'Connor 1994] O'Connor, Paul. 1994. "Implementing a Stage-Gate Process: A Multi-Company Perspective." *Journal of Product Innovation Management* 11 (3): 183–200.
- [O'Donnell 2005] O'Donnell, Francis J., and Alexander HB Duffy. 2005. *Design Performance*. Springer Science & Business Media.
- [O'Regan 2006] O'Regan, N., Ghobadian, A., Sims, M., 2006. Fast tracking innovation in manufacturing SMEs. *Technovation* 26, 251–261.
- [OCDE 1991] OCDE (1991). *The nature of innovation and the evolution of the productive system. Technology and productivity-the challenge for economic policy*. Paris: OCDE, p. 303-314.
- [Ochse 1990] Ochse, Richard. 1990. *Before the Gates of Excellence: The Determinants of Creative Genius*. CUP Archive.
- [OECD 2005] Manual, Oslo. 2005. "The Measurement of Scientific and Technological Activities." *Proposed Guidelines for Collecting and Interpreting Innovation Data*.
- [OED 2015] "Online Etymology Dictionary." 2015. Accessed May 30. <http://www.etymonline.com/>.

- [Ojanen 2006] Ojanen, Ville, and Olli Vuola. "Coping with the Multiple Dimensions of R&D Performance Analysis." *International Journal of Technology Management* 33, no. 2 (2006): 279–90.
- [Orloff 2003] Orloff, Michael A. 2003. "TRIZ." Springer.
- [Osborn 1963] Osborn, Alex Faickney. 1963. *Applied Imagination; Principles and Procedures of Creative Problem-Solving: Principles and Procedures of Creative Problem-Solving*. Scribner.
- [Ostroff 1993] Ostroff, Cheri, and Neal Schmitt. 1993. "Configurations of Organizational Effectiveness and Efficiency." *Academy of Management Journal* 36 (6): 1345–61.
- [Oxford 2014] Oxford Dictionary (British & World English)." Accessed October 17, 2014. [http://www.oxforddictionaries.com/definition/english/"](http://www.oxforddictionaries.com/definition/english/)term".
- [Pahl 2013] Pahl, Gerhard, and Wolfgang Beitz. 2013. *Engineering Design: A Systematic Approach*. Springer Science & Business Media.
- [Pappas 1985] Pappas, Richard A., and Donald S. Remer. "Measuring R and D Productivity," 1985.
- [Pauwels 2004] Pauwels, K., Silva-Risso, J., Srinivasan, S., Hanssens, D.M., 2004. New products, sales promotions, and firm value: The case of the automobile industry. *Journal of marketing* 142–156.
- [Perrin 2001] Perrin, Jacques. 2001. *Concevoir L'innovation Industrielle: Méthodologie de Conception de L'innovation*. CNRS.
- [Peters 2008] Peters, Bettina 2008. *Innovation and Firm Performance: An Empirical Investigation for German Firms*, vol.38. Springer Science & Business Media, accessed June 30, 2015.
- [Petrov 2005] Petrov, Vladimir, and Avraam Seredinski. 2005. "Progress and Ideality." In *TRIZ Future Conference*. Citeseer.
- [Phaal 2004] Phaal, Robert, Clare JP Farrukh, and David R. Probert. 2004. "Technology Roadmapping—a Planning Framework for Evolution and Revolution." *Technological Forecasting and Social Change* 71 (1): 5–26.
- [Piaget 2012] Piaget, Jean. 2012. *La Psychologie de L'intelligence*. Armand Colin.
- [Piller 2004] Piller, F. T. 2004. "Innovation and Co-Creation: Habilitation Treatise of the Technische Universitaet Muenchen: Revised Book Publication in Preparation."
- [Pitt 1999] Pitt, Martyn, and Ken Clarke. 1999. "Competing on Competence: A Knowledge Perspective on the Management of Strategic Innovation." *Technology Analysis & Strategic Management* 11 (3): 301–16.
- [Plucker 2004] Plucker, Jonathan A., Ronald A. Beghetto, and Gayle T. Dow. 2004. "Why Isn't Creativity More Important to Educational Psychologists? Potentials, Pitfalls, and Future Directions in Creativity Research." *Educational Psychologist* 39 (2): 83–96.
- [Poh 2001] Poh, K. L., B. W. Ang, and F. Bai. "A Comparative Analysis of R&D Project Evaluation Methods." *R&D Management* 31, no. 1 (2001): 63–75.
- [Popadiuk 2006] Popadiuk, Silvio, and Chun Wei Choo. 2006. "Innovation and Knowledge Creation: How Are These Concepts Related?" *International Journal of Information Management* 26 (4): 302–12.
- [Powell 1995] Powell, T.C., 1995. Total quality management as competitive advantage: A review and empirical study. *Strategic Management Journal* 16, 15–37.
- [Prasad 1996] Prasad, Biren. 1996. *Concurrent Engineering Fundamentals*. Vol. 1. Prentice Hall Englewood Cliffs, NJ.
- [Pritchard 1990] Pritchard, Robert D. 1990. *Measuring and Improving Organizational Productivity: A Practical Guide*. Greenwood Publishing Group.
- [Pritchard 1990] Pritchard, Robert D. *Measuring and Improving Organizational Productivity: A Practical Guide*. Greenwood Publishing Group, 1990.

- [Pryce 2005] Pryce, V. 2005. "Creativity, Design and Business Performance." DTI Economics Paper, no. 15.
- [Pugh 1990] Hollins, Bill, and Stuart Pugh. 1990. *Successful Product Design: What to Do and When*. Butterworth-Heinemann.
- [Purcell 1994] Purcell, A. T., J. S. Gero, H. M. Edwards, and E. Matka. 1994. "Design Fixation and Intelligent Design Aids." In *Artificial Intelligence in Design'94*, 483–95. Springer.
- [Qing-rui 2000] Qing-rui, B.X., GUO, B., WANG, Y., 2000. Development of Technological Innovation in China: Core Competence-based Innovation Portfolio [J]. *Journal of Industrial Engineering and Engineering Management* 5 1.
- [Rachuri 2006] Rachuri, Sudarsan, Young-Hyun Han, Sebti Foufou, Shaw C. Feng, Utpal Roy, Fujun Wang, Ram D. Sriram, and Kevin W. Lyons. 2006. "A Model for Capturing Product Assembly Information." *Journal of Computing and Information Science in Engineering* 6 (1): 11–21.
- [Redmond 1993] Redmond, Matthew R., Michael D. Mumford, and Richard Teach. 1993. "Putting Creativity to Work: Effects of Leader Behavior on Subordinate Creativity." *Organizational Behavior and Human Decision Processes* 55 (1): 120–51.
- [Reiter-Palmon 2004] Reiter-Palmon, Roni, and Jody J. Illies. 2004. "Leadership and Creativity: Understanding Leadership from a Creative Problem-Solving Perspective." *The Leadership Quarterly* 15 (1): 55–77.
- [Regazzoni 2008] Regazzoni, Daniele, and Roberto Nani. 2008. "TRIZ-Based Patent Investigation by Evaluating Inventiveness." In *Computer-Aided Innovation (CAI)*, 247–58. Springer.
- [Rhodes 1987] Rhodes, Mel. 1987. "An Analysis of Creativity." *Frontiers of Creativity Research: Beyond the Basics*, 216–22.
- [RIBA 1973] RIBA.1973. *RIBA Handbook - RIBA: Plan of Work for Design Team Operation*. London, Royal Institute of British Architects.
- [Rip 1998] Rip, Arie, and René Kemp. 1998. *Technological Change*. Battelle Press.
- [Rip 2001] Kemp, R. P. M., Arie Rip, and J. W. Schot. 2001. "Constructing Transition Paths through the Management of Niches."
- [Robertson 2009] Shann Kerner, Andrej Barbic, Kyle Robertson. "Examples Requirements for Patentability of Inventions in U.S. and Foreign Jurisdictions - Recherche Google." 2009. Bloomberg Finance.
- [Roedler 2005] Roedler, G. J., and C. Jones. 2005. "Technical Measurement: A Collaborative Project of PSM, INCOSE, and Industry, Ver. 1." INCOSE-TP-2003-020-01, San Diego, CA.
- [Rolstadås 1998] Rolstadås as, Asbjørn. 1998. "Enterprise Performance Measurement." *International Journal of Operations & Production Management* 18 (9/10): 989–99.
- [Roozenburg 1995] Roozenburg, Norbert FM, and Johannes Eekels. 1995. *Product Design: Fundamentals and Methods*. Vol. 2. Wiley Chichester.
- [Rosenau 1996] Rosenau Jr, Milton D. 1996. "Choosing a Development Process That's Right for Your Company." *The PDMA Handbook of New Product Development*, New York et Al, 77–92, p. 79.
- [Rosenberg 1979] Mowery, David, and Nathan Rosenberg. 1979. "The Influence of Market Demand upon Innovation: A Critical Review of Some Recent Empirical Studies." *Research Policy* 8 (2): 102–53.
- [Rosenberg 1986] Kline, Stephen J., and Nathan Rosenberg. 1986. *An Overview of Innovation-The Positive Sum Strategy: Harnessing Technology for Economic Growth (1986)*. National Academy of Sciences. The National Academy Press.

- [Rosenbloom 1996] Myers, Mark B., and Richard S. Rosenbloom. 1996. "Rethinking the Role of Industrial Research." *Engines of Innovation: US Industrial Research at the End of an Era*, 209–28.
- [Rothwell 1974] Rothwell, Roy, Christopher Freeman, Anthony Horlsey, V. T. P. Jervis, A. B. Robertson, and James Townsend. 1974. "SAPPHO Updated-Project SAPPHO Phase II." *Research Policy* 3 (3): 258–91.
- [Rothwell 1992] Rothwell, Roy. 1992. "Successful Industrial Innovation: Critical Factors for the 1990s." *R&D Management* 22 (3): 221–40.
- [Rothwell 1993] Rothwell, R. 1993. "Systems Integration and Networking: The Fifth Generation Innovation Process." In *Chair Hydro—Quebec Conference En Gestion de AI Technologie*, Montreal, Canada. Vol. 28.
- [Rothwell 1994] Rothwell, Roy. 1994. "Towards the Fifth-Generation Innovation Process." *International Marketing Review* 11 (1): 7–31.
- [Roussel 1991] Roussel, Philip A., Kamal N. Saad, and Tamara J. Erickson. 1991. *Third Generation R&D: Managing the Link to Corporate Strategy*. Harvard Business Press.
- [Roy 2005] Roy, Ram Naresh. *A Modern Approach to Operations Management*. New Age International, 2005.
- [Runco 1988] Runco, Mark A. 1988. "Creativity Research: Originality, Utility, and Integration."
- [Runco 2012] Runco, Mark A., and Selcuk Acar. 2012. "Divergent Thinking as an Indicator of Creative Potential." *Creativity Research Journal* 24 (1): 66–75.
- [Salamatov 1999] Salamatov, Yuri, Valeri Souchkov, Maria Strogaia, and Sergei Yakovlev. 1999. *TRIZ: The Right Solution at the Right Time: A Guide to Innovative Problem Solving*. Insytec Hattem.
- [Sarkar 2008] Sarkar, P., & Chakrabarti, A. (2008). Studying engineering design creativity e developing a common definition and associated measures. In J. Gero (Ed.), *Studying design creativity*. Springer Verlag.
- [Sarkar 2011] Sarkar, Prabir, and Amaresh Chakrabarti. 2011. "Assessing Design Creativity." *Design Studies* 32 (4): 348–83.
- [Saunders 2002] Saunders, Rob. 2002. "Curious Design Agents and Artificial Creativity-A Synthetic Approach to the Study of Creative Behaviour." <http://cumincad.scix.net/cgi-bin/works/Show?8461>.
- [Savransky 2000] Savransky, Semyon D. 2000. *Engineering of Creativity: Introduction to TRIZ Methodology of Inventive Problem Solving*. CRC Press.
- [Scaron 2010] Scaron, Daniel, others. 2010. "Waves of Technological Innovations and the End of the Information Revolution." *Journal of Economics and International Finance* 2 (4): 58–67.
- [Schainblatt 1982] Schainblatt, Alfred H. 1982. "How Companies Measure the Productivity of Engineers and Scientists." *Research Management* 25 (3): 10–18.
- [Schilling 2005] Schilling, Melissa A. 2005. *Strategic Management of Technological Innovation*. Tata McGraw-Hill Education.
- [Schlicher 2003] Schlicher, John W. 2003. *Patent Law: Legal and Economic Principles*. Vol. 2. Thomson/West.
- [Schmeisser 2010] Schmeisser, Wilhelm, Hermann Mohnkopf, Matthias Hartmann, and Gerhard Metze 2010. *Innovation Performance Accounting: Financing Decisions and Risk Assessment of Innovation Processes*. Springer Science & Business Media.
- [Schofield 2007] Schofield Clark, Lynn. 2007. "Critical Theory and Constructivism: Theory and Methods for the Teens and the New Media@ Home Project." Retrieved Oct 11: 2007.
- [Schulze 2001] Schulze, Anja. 2001. "Applied Knowledge Management in Innovation Processes." In *Management of Engineering and Technology*, 2001. PICMET'01. Portland International Conference on, 1:63 – vol. IEEE.

- [Schulze 2008] Schulze, Anja, and Martin Hoegl. 2008. "Organizational Knowledge Creation and the Generation of New Product Ideas: A Behavioral Approach." *Research Policy* 37 (10): 1742–50.
- [Schumpeter 1934] Schumpeter, J. (1934), *The Theory of Economic Development* (Cambridge, Mass: Harvard University Press).
- [Schumpeter 1939] Schumpeter, J.A., 1939. *Business cycles: a theoretical, historical, and statistical analysis of the capitalist process*. Martino Pub.
- [Schumpeter 1955] Schumpeter, J.A., *Capitalism, S., 1955. Democracy* (New York, 1942). Part II'Can Capitalism Survive.
- [Sears 1984] Sears, T. B., and E. P. Taylor. 1984. "Technical Performance Measurement Handbook." DTIC Document.
- [Shafer 2000] Shafer, Scott M., and Terry A. Byrd 2000. *A Framework for Measuring the Efficiency of Organizational Investments in Information Technology Using Data Envelopment Analysis*. *Omega* 28(2): 125–141.
- [Shah 2000] Shah, Jami J., Santosh V. Kulkarni, and Noe Vargas-Hernandez. 2000. "Evaluation of Idea Generation Methods for Conceptual Design: Effectiveness Metrics and Design of Experiments." *Journal of Mechanical Design* 122 (4): 377–84.
- [Shah 2003] Shah, Jami J., Steve M. Smith, and Noe Vargas-Hernandez. 2003. "Metrics for Measuring Ideation Effectiveness." *Design Studies* 24 (2): 111–34.
- [Shephard 1990] Shephard, Mark S. 1990. "Idealization in Engineering Modeling and Design." *Research in Engineering Design* 1 (3-4): 229–38.
- [Sheskin 2003] Sheskin, David J. 2003. *Handbook of Parametric and Nonparametric Statistical Procedures*. crc Press.
- [Shewhart 1926] Shewhart, W. A. "Quality Control Charts1." *Bell System Technical Journal* 5, no. 4 (October 1, 1926): 593–603. doi:10.1002/j.1538-7305.1926.tb00125.x.
- [Shultis 2002] Shultis, J. Kenneth, and Richard E. Faw. 2002. *Fundamentals of Nuclear Science and Engineering*. Taylor & Francis.
- [Simon 1996] Simon, Herbert A. 1996. *The Sciences of the Artificial*. Vol. 136. MIT press.
- [Simonton 1999] Simonton, Dean Keith. 1999. *Origins of Genius: Darwinian Perspectives on Creativity*. Oxford University Press.
- [Sinclair 1995] Sinclair, David, and Mohamed Zairi. "Effective Process Management through Performance Measurement: Part III-an Integrated Model of Total Quality-Based Performance Measurement." *Business Process Re-Engineering & Management Journal* 1, no. 3 (1995): 50–65.
- [Sivathanu 1996] Pillai, A. Sivathanu, and K. Srinivasa Rao. "Performance Monitoring in R&D Projects." *R&D Management* 26, no. 1 (1996): 57–65.
- [Smith 1937] Smith, Adam. "The Wealth of Nations. Modern Library." New York 1937 (1776).
- [Smith 1991] Reinertsen, Donald, and Preston Smith. 1991. "Developing Products in Half the Time." *New York* 13.
- [Sohlenius 1992] Sohlenius, Gunnar. 1992. "Concurrent Engineering." *CIRP Annals-Manufacturing Technology* 41 (2): 645–55.
- [Soubie 1996] Soubie, Jean-Luc, Florence Buratto, and Corinne Chabaud. 1996. "La Conception de La Coopération et La Coopération Dans La Conception." *Coopération et Conception*, 187–206.
- [STEP 1994] "ISO 10303-1:1994 - Industrial Automation Systems and Integration -- Product Data Representation and Exchange -- Part 1: Overview and Fundamental Principles." Geneva, Switzerland.
- [Sternberg 1999] Sternberg, Robert J., and Todd I. Lubart. 1999. "The Concept of Creativity: Prospects and Paradigms." *Handbook of Creativity* 1: 3–15.

- [Sternberg 2006] Sternberg, Robert J. 2006. "Creating a Vision of Creativity: The First 25 Years." *Psychology of Aesthetics, Creativity, and the Arts*, no. 1: 2.
- [Stevens 1946] Stevens, Stanley Smith. 1946. *On the Theory of Scales of Measurement*. Bobbs-Merrill, College Division.
- [Subramaniam 2005] Subramaniam, Mohan, and Mark A. Youndt. 2005. "The Influence of Intellectual Capital on the Types of Innovative Capabilities." *Academy of Management Journal* 48 (3): 450–63.
- [Suh 1990] Suh, Nam P. 1990. *The Principles of Design*. Vol. 990. Oxford University Press New York. http://www.maelabs.ucsd.edu/mae156/A_New/Resources/Design-Process/Axiomatic_Design/Axiomatic_Text_Excerpts.pdf.
- [Suh 2001] Nam, Pyo Suh. 2001. *Axiomatic Design: Advances and Applications*. Oxford University Press, New York.
- [Suomala 2003] Suomala, Petri, and Miikka Jamsen. 2003. "Performance Measurement in Finnish Industrial R&D Management." *LTA* 4: 0–3.
- [Takeuchi 1996] Nonaka, Ikujiro, and Hirotaka Takeuchi. 1996. "The Knowledge-Creating Company: How Japanese Companies Create the Dynamics of Innovation." *Long Range Planning* 29 (4): 592.
- [Tan 2006] Tan, Adrian Ronald, and Timothy Charles McAloone, others. 2006. "Understanding and Developing Innovative Products and Services: The Essential Elements." In *DS 36: Proceedings DESIGN 2006, the 9th International Design Conference, Dubrovnik, Croatia*.
- [Tassinari 1992] Tassinari, Robert. 1992. *Pratique de L'analyse Fonctionnelle*. Dunod. <http://cds.cern.ch/record/1994409>.
- [Taylor 1911] Taylor, Frederick Winslow. "The Principles of Scientific Management." New York 202 (1911).
- [Thompson 2003] Thompson, Leigh. 2003. "Improving the Creativity of Organizational Work Groups." *The Academy of Management Executive* 17 (1): 96–109.
- [Tsai 2009] Tsai, Yingyi, Justin Yifu Lin, and Lucia Kurekova. 2009. "Innovative R&D and Optimal Investment under Uncertainty in High-Tech Industries: An Implication for Emerging Economies." *Research Policy* 38 (8): 1388–95.
- [Tuominen 1999] Tuominen, Markku, Petteri Piippo, Takaya Ichimura, and Yoshio Matsumoto. 1999. "An Analysis of Innovation Management Systems' Characteristics." *International Journal of Production Economics* 60: 135–43.
- [Tushman 1986] Tushman, Michael L., and Philip Anderson. 1986. "Technological Discontinuities and Organizational Environments." *Administrative Science Quarterly*, 439–65.
- [Ullman 1992] Ullman, David G. 1992. *The Mechanical Design Process*. Vol. 2. McGraw-Hill New York.
- [Ulrich 2000] Ulrich, Karl T. 2000. *Eppinger, SD: Product Design and Development*. New York: McGraw-Hill.
- [Ulrich 2003] Ulrich, Karl T. 2003. *Product Design and Development*. Tata McGraw-Hill Education. p. 14.
- [Urban 1993] Urban, Glen L., John R. Hauser, and Glen L. Urban. 1993. *Design and Marketing of New Products*. Vol. 2. Prentice Hall Englewood Cliffs, NJ.
- [Utterback 1975] Utterback, James M., and William J. Abernathy. 1975. "A Dynamic Model of Process and Product Innovation." *Omega* 3 (6): 639–56.
- [Utterback 1978] Utterback, James M. 1978. *The Dynamics of Product and Process Innovation in Industry*. Center for Policy Alternatives, Massachusetts Institute of Technology.
- [Utterback 1994] Utterback, J.M., 1994. *Mastering the Dynamics of Innovation* (Boston, MA: Harvard Business School Press).

- [Utterback 2006] Utterback, James M. 1996. *Mastering the Dynamics of Innovation*. Harvard Business Press.
- [Van de Ven 1986] Van de Ven, Andrew H. 1986. "Central Problems in the Management of Innovation." *Management Science* 32 (5): 590–607.
- [Van der Panne 2003] Van der Panne, Gerben, Cees Van Beers, and Alfred Kleinknecht. 2003. "Success and Failure of Innovation: A Literature Review." *International Journal of Innovation Management* 7 (03): 309–38.
- [Vázquez 2001] Vázquez, R., Santos, M.L., Álvarez, L.I., 2001. Market orientation, innovation and competitive strategies in industrial firms. *Journal of strategic marketing* 9, 69–90.
- [Verganti 1997] Verganti, Roberto. 1997. "Leveraging on Systemic Learning to Manage the Early Phases of Product Innovation Projects." *R&D Management* 27 (4): 377–92.
- [Verhaegen 2013] Verhaegen, Paul-Armand, Dennis Vandevenne, Jef Peeters, and Joost R. Duflou. 2013. "Refinements to the Variety Metric for Idea Evaluation." *Design Studies* 34 (2): 243–63.
- [Verworn 2001] Herstatt, Cornelius, and Birgit Verworn. 2001. "The 'Fuzzy Front End' of Innovation." Technische Universität Hamburg-Harburg.
- [Verworn 2002] Verworn, Birgit, and Cornelius Herstatt. 2002. "The Innovation Process: An Introduction to Process Models." Working Papers/Technologie-und Innovationsmanagement, Technische Universität Hamburg-Harburg.
- [Veryzer 1998] Veryzer, Robert W. 1998. "Discontinuous Innovation and the New Product Development Process." *Journal of Product Innovation Management* 15 (4): 304–21.
- [Vidal 2006] Lopez-Mesa, B., and R. Vidal, others. 2006. "Novelty Metrics in Engineering Design Experiments." In *DS 36: Proceedings DESIGN 2006*, the 9th International Design Conference, Dubrovnik, Croatia.
- [VIM 2004] VIM, ISO. 2004. "International Vocabulary of Basic and General Terms in Metrology (VIM)." International Organization 2004: 09–14.
- [Von Hippel 2007] Von Hippel, E., 2007. *The sources of innovation*. Springer.
- [Von Krogh 2006] Nonaka, Ikujiro, Georg Von Krogh, and Sven Voelpel. 2006. "Organizational Knowledge Creation Theory: Evolutionary Paths and Future Advances." *Organization Studies* 27 (8): 1179–1208.
- [Walker 1987] Walker Jr, O.C., Ruekert, R.W., 1987. Marketing's role in the implementation of business strategies: a critical review and conceptual framework. *The Journal of Marketing* 15–33.
- [Wallisch 2003] Wallisch, Pascal. 2003. "Artificial Creativity." University of Chicago.
- [Wang 2013] Wang, Jiliang, Bernard Yannou, Fabrice Alizon, and Pierre-Alain Yvars. 2013. "A Usage Coverage-Based Approach for Assessing Product Family Design." *Engineering With Computers* 29 (4): 449–65.
- [Ward 1994] Ward, Thomas B. 1994. "Structured Imagination: The Role of Category Structure in Exemplar Generation." *Cognitive Psychology* 27 (1): 1–40.
- [Ward 1998] Ward, P.T., McCreery, J.K., Ritzman, L.P., Sharma, D., 1998. Competitive Priorities in Operations Management. *Decision Sciences* 29, 1035–1046.
- [Weber 1992] Weber, Robert John, and David N. Perkins. 1992. *Inventive Minds: Creativity in Technology*. Oxford University Press. p.317.
- [Weisberg 2007] Weisberg, Michael. 2007. "Three Kinds of Idealization." *The Journal of Philosophy*, 639–59.
- [Weiss 1972] Weiss, Carol H. "Methods for Assessing Program Effectiveness." Englewood Cliffs, 1972.
- [Weitz 2002] Weitz, Barton A., and Robin Wensley. *Handbook of Marketing*. Sage, 2002.
- [Wentworth 1922] Wentworth, Chester K. 1922. "A Scale of Grade and Class Terms for Clastic Sediments." *The Journal of Geology*, 377–92.

- [Werner 1997] Werner, Bjorn M., and William E. Souder. 1997. "Measuring R&D Performance—state of the Art." *Research Technology Management* 40 (2): 34.
- [Wilemon 2002] Kim, Jongbae, and David Wilemon. 2002. "Focusing the Fuzzy Front-End in New Product Development." *R&D Management* 32: 269–79.
- [Wilson 1994] Wilson, Donald K., Roland Mueser, and Joseph A. Raelin. 1994. "New Look at Performance Appraisal for Scientists and Engineers." *Research Technology Management* 37 (4): 51.
- [WIPO 2004] World Intellectual Property. 2004. *WIPO Intellectual Property Handbook: Policy, Law and Use*. 489. World Intellectual Property Organization.
- [Woodman 1993] Woodman, Richard W., John E. Sawyer, and Ricky W. Griffin. 1993. "Toward a Theory of Organizational Creativity." *Academy of Management Review* 18 (2): 293–321.
- [Wunsch-Vincent 2011] Wunsch-Vincent. Sacha. 2011. "Accounting for Creativity in Innovation: Measuring Ambitions and Related Challenges." *The Global Innovation Index 2011*, 107.
- [Xu 2000] Xu, Q., 2000. *Management of research, development and technology-based innovation*. Beijing: Higher Education Press.
- [Xu 2007] Xu, Q., Ling Zhu, Gang Zheng, and Fangrui Wang. "Haier's Tao of Innovation: A Case Study of the Emerging Total Innovation Management Model." *The Journal of Technology Transfer* 32, no. 1–2 (2007): 27–47.
- [Yannou 2013] Yannou, Bernard, Pierre-Alain Yvars, Chris Hoyle, and Wei Chen. 2013. "Set-Based Design by Simulation of Usage Scenario Coverage." *Journal of Engineering Design* 24 (8): 575–603.
- [Yannou 2015] Bekhradi, Alborz, Bernard Yannou, Romain Farel, Benjamin Zimmer, and Jeya Chandra. 2015. "Usefulness Simulation of Design Concepts." *Journal of Mechanical Design* 137 (7): 071414.
- [Zahra 1993] Zahra, S.A., Covin, J.G., 1993. Business strategy, technology policy and firm performance. *Strategic Management Journal* 14, 451–478.
- [Zahra 1994] Zahra, Shaker A., and Sidhartha R. Das. 1994. "Innovation Strategy and Financial Performance in Manufacturing Companies: An Empirical Study." *Production and Operations Management* 2 (1): 15–37.
- [Zanni 2009] Cavallucci, D., F. Rousselot, and C. Zanni. 2009. "Procedures and Models for Organizing and Analysing Problems in Inventive Design." In *Proceedings of the 19th CIRP Design Conference—Competitive Design*. Cranfield University Press.
- [Zhang 2011] Zhang, W. J., Y. Lin, and Niraj Sinha. 2011. "On the Function-Behavior-Structure Model for Design." *Proceedings of the Canadian Engineering Education Association*.

Appendix

Appendix A. The list of existing standards for implementing the creativity, inventive activity, and/or innovation management;

	ISO			CEN			AFNOR		
	Qn.	Name	Price	Qn.	Name	Price	Qn.	Name	Price
Innovation	0	-	-	2	CWA 15899:2008 Standardization of an Innovation Capability Rating for SMEs	-	7	FD X50-146 Décembre 2010 Management de l'innovation - Management de la propriété intellectuelle	54,70 €
								CWA 15899 Décembre 2008 - Standardization of an Innovation Capability Rating for SMEs	64,45 €
								NF EN 12973 Juin 2000 - Management par la valeur	104,55 €
								FD X50-158 Février 2007 Management par la Valeur - Apports du Management par la valeur aux processus de l'entreprise	62,60 €
								FD X50-550 Octobre 2001 Démarche qualité en recherche - Principes généraux et recommandations	62,60 €
								FD X50-190 Septembre 2000 Outils de management - Capitalisation d'expérience	62,60 €
								BS 7000-1:2008 Avril 2008 Design management systems. Guide to managing innovation - Systeme de gestion de la conception. Guide de gestion d'innovation	245,00 €
Invention	0	-	-	-	-	-	0	-	-
Performance de la conception/Design performance	1	ISO 9699:1994 Performance standards in building -- Checklist for briefing -- Contents of brief for building design	86 \$	1	EN 12811-1:2003 Temporary works equipment - Part 1: Scaffolds - Performance requirements and general design	-		NF E60-182 Mai 2002 Moyens de production - Indicateurs de performances - Taux de rendement synthétique (TRS) - Taux de rendement global (TRG) - Taux de rendement économique (TRE)	54,70 €
	4	ISO 16818:2008	128 \$	0	-		0	-	-

Efficiency inventive/inventive Efficiency		Building environment design -- Energy efficiency -- Terminology						
		ISO 14045:2012 Environmental management -- Eco-efficiency assessment of product systems -- Principles, requirements and guidelines	140 \$					
		ISO 16813:2006 Building environment design -- Indoor environment -- General principles	86 \$					
		ISO/IEC 8326:1996/Amd 1:1998 Efficiency enhancements	16 \$					
Creativity/Créativité	0	-	-	0	-	-	0	-
Brevet/Patent	1	ISO/IEC 10918-1:1994/Cor 1:2005 Patent information update	0 \$	1	CEN/CLC Guide 8:2011 CEN-CENELEC Guidelines for Implementation of the Common IPR Policy on Patent (and other statutory intellectual property rights based on inventions)	-	0	-
Efficiency de la conception/Design efficiency	0	-	-	0	-	-	0	-
Inventivité/ Inventiveness	0	-	-	0	-	-	0	-
Nouveauté/Novelty	0	-	-	0	-	-	0	-
Métriques de la conception/Design metrics	1	ISO 26262-5:2011 Road vehicles -- Functional safety -- Part 5: Product development at the hardware level	184 \$		-	-	0	-
Conception inventive/Inventive design	0	-	-	0	-	-	1	NF EN 61160 Mai 2006 - Revue de conception 87,00 €

Appendix B. The creativity roughness index (CRI) of each IPC;

International Patent Class	Creativity roughness index (τ)	IPC section	
A01	0.033	A: HUMAN NECESSITIES	
A21	0.411		
A22	0.672		
A23	0.071		
A24	0.421		
A41	0.251		
A42	1.000		
A43	0.301		
A44	0.385		
A45	0.166		
A46	0.550		
A47	0.038		
A61	0.007		
A62	0.317		
A63	0.061		
B01	0.008		B: PERFORMING OPERATIONS; TRANSPORTING
B02	0.148		
B03	0.142		
B04	0.236		
B05	0.032		
B06	0.351		
B07	0.096		
B08	0.103		

B09	0.270	
B21	0.028	
B22	0.038	
B23	0.014	
B24	0.053	
B25	0.035	
B26	0.069	
B27	0.093	
B28	0.095	
B29	0.011	
B30	0.125	
B31	0.143	
B32	0.028	
B41	0.015	
B42	0.093	
B43	0.196	
B44	0.124	
B60	0.005	
B61	0.078	
B62	0.020	
B63	0.048	
B64	0.047	
B65	0.007	
B66	0.050	
B67	0.109	
B68	1.000	

B81	0.224	C: CHEMISTRY; METALLURGY	
B82	0.033		
C01	0.039		
C02	0.065		
C03	0.055		
C04	0.046		
C05	0.328		
C06	0.549		
C07	0.005		
C08	0.010		
C09	0.017		
C10	0.041		
C11	0.062		
C12	0.014		
C13	1.000		
C14	0.871		
C21	0.085		
C22	0.054		
C23	0.034		
C25	0.093		
C30	0.168		
C40	0.425		
D01	0.113		D: TEXTILES; PAPER
D02	0.448		
D03	0.272		
D04	0.139		

D05	0.367		
D06	0.063		
D07	1.000		
D21	0.720		
E01	0.664	E: FIXED CONSTRUCTIONS	
E02	0.548		
E03	1.000		
E04	0.216		
E05	0.356		
E06	0.650		
E21	0.316		
F01	0.106		F: MECHANICAL ENGINEERING; LIGHTING; HEATING; WEAPONS; BLASTING ENGINES OR PUMPS
F02	0.070		
F03	0.467		
F04	0.162		
F15	0.303		
F16	0.540		
F17	0.031		
F21	0.967		
F22	0.259		
F23	1.228		
F24	0.250		
F25	0.157		
F26	0.220		
F27	1.000		
F28	0.685		

F41	0.276	
F42	0.431	
G01	0.001	G: PHYSICS
G02	0.004	
G03	0.004	
G04	0.042	
G05	0.009	
G06	0.001	
G07	0.011	
G08	0.016	
G09	0.007	
G10	0.017	
G11	0.004	
G12	1.000	
G21	0.030	
H01	0.171	
H02	0.780	
H03	1.000	
H04	0.195	
H05	0.824	

QUESTIONNAIRE SUR LA PERFORMANCE DES ACTIVITES INVENTIVES EN R&D

Depuis deux ans, le laboratoire de Génie de la Conception de l'INSA (le LGéCo) a débuté un travail de recherche sur l'efficience inventive en conception. La finalité étant d'élaborer (dans un premier temps de façon théorique) un indicateur d'efficience qui caractériserait l'aptitude à l'invention d'un service R&D. Après avoir fait un état de l'art de la situation et compris les modèles existants et leurs limites, nous entrons maintenant dans une phase de construction du portrait théorique d'un tel indicateur. Mais pour que ce portrait soit fondé sur des réalités industrielles, nous avons besoin de recueillir un certain nombre de données. Pour cela, nous sollicitons votre participation.

Objectives:

- 1. Capturer l'essentiel des perceptions concernant les activités inventives**
- 2. Elaborer un indicateur de l'efficience inventive des équipes de R&D**

Durée de réponse :

environ 20 minutes

Public concerné :

responsables R&D et bureaux d'études

Confidentialité :

**aucune information individuelle ne sera communiquée à des tiers externes à l'INSA de
Strasbourg, sauf accord express de votre part**

Résultats du questionnaire :

**toute entreprise qui aura répondu à toutes les questions et qui en fera
la demande pourra bénéficier des fruits de l'exploitation des données.**

Il y a 37 questions dans ce questionnaire.

Questions administratives

1 [1]

1. Quels sont vos nom et prénoms ?

Veillez écrire votre (vos) réponse(s) ici :

Nom

Prénoms

2 [2]

2. Quelle est votre fonction dans l'entreprise (service/activité) ?

Veillez écrire votre réponse ici :

3 [3]

3. Depuis combien de temps occupez-vous cette fonction ?

Veillez écrire votre réponse ici :

Réponse attendue en nombre d'années. Pour les valeurs inférieures à une année, veuillez indiquer le chiffre 1.

4 [4]

4. Quel est le nom de votre entreprise ?

Veillez écrire votre réponse ici :

5 [5]

5. Où se situe votre entreprise ?

Veillez écrire votre (vos) réponse(s) ici :

* Ville :

* Pays :

* Code postal / Zip code :

6 [6]

6. Dans quels secteurs d'activité votre entreprise est-elle référencée ?

Veillez écrire votre réponse ici :

7 [7]

7. Combien de salarié-e-s compte votre entreprise (équivalent temps plein) ?

Veillez écrire votre réponse ici :

8 [8]

8. Votre site dispose-t-il d'un département R&D ?

Veillez sélectionner *une seule* des propositions suivantes :

* Oui

* Non

Un département R&D peut comporter des bureaux d'études spécialisés.

9 [9]

9. Combien de salarié-e-s font partie de votre département R&D ?

Veillez écrire votre réponse ici :

10 [10]

10. Quelle est la répartition par type des salarié-e-s de votre département R&D ?

Veuillez saisir un nombre compris entre 0 et 200 pour chaque élément :

	Nombre d'expert-e-s salarié-e-s
Docteur-e	
Ingénieur-e	
Docteur-e-Ingénieur-e	

Questions sur le Projet Inventif

11 [11]

11. Existe-t-il une distinction au sein des activités de votre R&D entre des projets dits « inventifs » et des projets dits « routiniers » ou « classiques » (cf. ci-dessous) ?

« Projets inventifs » (PI) :

- pouvant impliquer des activités de recherche inédites pour votre entreprise ;
- pouvant déboucher sur une invention ou une innovation ;
- mobilisant parfois une réflexion préalable face à un problème paraissant insoluble.

« Projets routiniers » ou « classiques » (PR) :

- mobilisant, exclusivement ou presque, des activités bien rodées ;
- dont les méthodes sont connues ;
- dont les résultats sont essentiellement le fruit d'un raisonnement d'optimisation.

Veuillez sélectionner *une seule* des propositions suivantes :

- * Oui, cette distinction existe et porte le nom suivant :
- * Oui, cette distinction existe mais ne porte pas de nom spécifique.
- * Non, on ne distingue pas les projets car : Non, on ne distingue pas les projets car :

Faites le commentaire de votre choix ici :

12 [12]

12. En général quels éléments de comparaison permettent de différencier les projets inventifs (PI) des projets routiniers (PR) ?

Choisissez la réponse appropriée pour chaque élément :

	Tout à fait d'accord	D'accord	Plutôt d'accord	Plutôt pas d'accord	Pas d'accord	Pas du tout d'accord
Le budget du projet						
La durée accordée au projet						
L'équipe du projet (taille ou périmètre)						
L'équipe du projet (composition)						
Les priorités affichées par le management stratégique						

Le potentiel économique du projet (parts de marché, bénéfices escomptés)						
--	--	--	--	--	--	--

13 [13]

13. Si vous estimez que le budget d'un projet inventif est supérieur à celui d'un projet routinier, quelles raisons peuvent expliquer ce surcoût ?

Choisissez la réponse appropriée pour chaque élément :

	Tout à fait d'accord	D'accord	Plutôt d'accord	Plutôt pas d'accord	Pas d'accord	Pas du tout d'accord
L'augmentation de la taille de l'équipe du projet						
La gestion des divers modes d'organisation et de fonctionnement de l'équipe du projet						
L'équipe du projet (taille ou périmètre)						
L'équipe du projet (composition)						
La nécessité d'entretenir un environnement/climat créatif						
L'emploi d'une méthode d'aide à la créativité						
La formation du personnel aux méthodes de créativité						
Le matériel et la technologie au service du fonctionnement de l'équipe du projet						
L'augmentation des travaux de prototypages, calculs, validations ou simulations						
La nécessité d'effectuer des recherches supplémentaires durant le projet						
Le dépassement des délais fixés en début de projet						
Le déploiement d'un marketing différent associé au lancement d'un produit						
La mise sur le marché des résultats						

14 [14]

14. Qu'est-ce qu'une invention pour votre entreprise ?

Choisissez la réponse appropriée pour chaque élément :

	Tout à fait d'accord	D'accord	Plutôt d'accord	Plutôt pas d'accord	Pas d'accord	Pas du tout d'accord
Un croquis amélioré d'une nouvelle idée techniquement envisageable						
Une solution nouvelle spécifiée dans un cahier des charges						
Un brevet						
L'utilisation et l'application concrète d'un nouvel effet scientifique/technologique						
Un produit/service nouveau mis sur le marché						

15 [15]

15. Pourriez-vous dire qu'un projet inventif produit :

Choisissez la réponse appropriée pour chaque élément :

	Tout à fait d'accord	D'accord	Plutôt d'accord	Plutôt pas d'accord	Pas d'accord	Pas du tout d'accord
Un concept radicalement nouveau						
Un ou plusieurs brevets						
Une nouvelle application technique						
La mise sur le marché d'un nouveau produit/service						
Un succès commercial						
Un nouveau comportement d'usage						

16 [16]

16. Comment caractérisez-vous la dimension inventive et la gestion d'un « Projet Inventif » (PI) ?

Choisissez la réponse appropriée pour chaque élément :

	Tout à fait d'accord	D'accord	Plutôt d'accord	Plutôt pas d'accord	Pas d'accord	Pas du tout d'accord
La dimension inventive du projet se révèle durant la phase de définition du projet						
La dimension inventive du projet se révèle au fil du						

déroulement du projet						
La dimension inventive du projet se révèle à la fin du projet						
Le PI implique un processus spécifique de gestion de projet						
Le PI est pris en charge par une équipe spécifique						

Questions sur le processus d'un Projet Inventif

17 [17]

17. Est-ce qu'il y a des règles de fonctionnement spécifiques aux projets inventifs (PI) ?

Choisissez *toutes* les réponses qui conviennent :

- * Non, les règles sont les mêmes que pour les projets routiniers.
 - * Oui, les règles sont établies par le/la chef-fe de projet.
 - * Oui, les règles de fonctionnement sont spécifiques aux séances créatives.
 - * Oui, les PI ont moins de contraintes de temps que les projets routiniers.
 - * Oui, les PI ont moins de contraintes de résultats que les projets routiniers.
-

18 [18]

18. Quelle(s) méthode(s) de conception utilisez-vous ?

Choisissez *toutes* les réponses qui conviennent :

- * Axiomatic Design Axiomatic Design
 - * Engineering Design / Systematic Design Engineering Design / Systematic Design
 - * Quality Function Development (QFD) Quality Function Development (QFD)
 - * Conception à l'écoute du client & méthode Kano Conception à l'écoute du client & méthode Kano
 - * Robust Design Robust Design
 - * Stage – Gate process Stage – Gate process
 - * Méthode basée sur la théorie C-K Méthode basée sur la théorie C-K
 - * Méthode basée sur la théorie TRIZ Méthode basée sur la théorie TRIZ
 - * Analyse de la valeur – Analyse fonctionnelle Analyse de la valeur – Analyse fonctionnelle
 - * Aucune en particulier
 - * Autre:
-

19 [19]

19. Parmi les méthodes de conception utilisées, quelles sont celles (ou en citer d'autres) spécifiques aux activités inventives ou reliées aux projets inventifs ?

Veuillez écrire votre réponse ici :

20 [20]

20. Quelles dispositions méthodologiques particulières avez-vous mises en place pour servir de cadre aux projets inventifs (gestion des idées : énumération, catégorisation, comptabilisation...), et pour vous aider à organiser vos activités de R&D ?

Veillez écrire votre réponse ici :

21 [21]

21. Si vous avez des dispositions méthodologiques particulières servant de cadre aux projets inventifs, quelle influence ont-elles sur l'efficacité de ces projets (PI) ?

Choisissez la réponse appropriée pour chaque élément :

	Tout à fait positive	Positive	Plutôt positive	Nulle	Plutôt négative	Négative	Tout à fait négative
Une influence :							

Questions sur les acteurs d'un Projet Inventif

22 [22]

22. En général, combien d'équipes travaillent en parallèle sur un projet inventif poursuivant les mêmes objectifs ?

Veillez écrire votre réponse ici :

23 [23]

23. Sur les cinq derniers projets inventifs, quel était le nombre moyen d personnes d'une équipe travaillant sur un projet ?

Veillez saisir un nombre compris entre 0 et 200 pour chaque élément :

Projet inventif 1	
Projet inventif 2	
Projet inventif 3	
Projet inventif 4	
Projet inventif 5	

Si vous avez moins de cinq PI, veuillez indiquer le chiffre 0.

24 [24]

24. Dans l'investissement d'une personne dans un projet inventif, quelle est la proportion de travail individuel (indiv.) et collaboratif (collab.) (en %) ?

Choisissez la réponse appropriée pour chaque élément :

	100% indiv.	80% indiv. - 20% collab.	60% indiv. - 40% collab.	50% - 50%	40% indiv. - 60% collab.	20% indiv. - 80% collab.	100% collab.
Proportion de travail							

Une proportion de travail 100 % indiv. correspond à une personne ne travaillant que seule et en autonomie.

Une proportion de travail 100 % collab. correspond à une personne ne travaillant qu'en situation de groupe.

25 [25]

25. D'après vous, une personne impliquée dans un projet inventif a les caractéristiques personnelles suivantes :

Choisissez la réponse appropriée pour chaque élément :

	Tout à fait d'accord	D'accord	Pas d'accord	Pas du tout d'accord
A la plus grande maîtrise, dans l'entreprise, du domaine concerné				
A un haut niveau de connaissances scientifiques (Master, Doctorat)				
A un haut niveau d'expertise technique (reconnaissance internationale, responsabilité de grands projets)				
Est impliquée de façon récurrente dans ce type de projets				
A des aptitudes évidentes à la créativité ("Géo Trouvetout")				
A une ouverture d'esprit				
Est spontanée				
Remet souvent en question les normes établies				
Est tenace, voire pugnace				
Est résiliente				
Est remplie de certitudes				
A une attirance forte pour l'exercice de responsabilités hiérarchiques				
A une nette préférence pour le travail en équipe				
Aime planifier, contrôler les activités				
Est économe de son temps				

Questions sur les résultats d'un Projet Inventif

26 [26]

26. La réussite d'un projet inventif est caractérisée par :

Choisissez la réponse appropriée pour chaque élément :

	Tout à fait d'accord	D'accord	Plutôt d'accord	Plutôt pas d'accord	Pas d'accord	Pas du tout d'accord
Une validation technique						
Une optimisation de la qualité technique du produit						
Une réduction des délais de fabrication du nouveau produit						

Une réduction des coûts de fabrication du nouveau produit						
Un dépôt de brevet						
Un nouveau produit/service sur le marché						
Une augmentation des parts de marché						
La commercialisation d'un nouveau produit						
La satisfaction des attentes des client-e-s						

27 [27]

27. Évaluez-vous la qualité des résultats d'un projet inventif ? (Merci de préciser)

Veuillez sélectionner *une seule* des propositions suivantes :

* Oui

* Non, précisez pour quelle(s) raison(s) :

Faites le commentaire de votre choix ici :

28 [28]

28. Si oui, comment évaluez-vous la réussite d'un projet inventif

Veuillez choisir toutes les réponses qui conviennent et laissez un commentaire :

- * Par une règle particulière à l'entreprise (méthode interne formalisée)
 - * Par une règle particulière à l'entreprise (méthode externe formalisée)
 - * Par des échanges informels internes à la R&D
 - * Par des échanges informels entre la R&D et les autres services de l'entreprise
 - * Par les avis d'expert-e-s indépendant-e-s
 - * Par le conseil en recrutement de sociétés d'ingénierie
 - * Autre(s) méthode(s)
-

29 [29.1]

29.1 Au sein de votre R&D, sur la totalité des projets finis (A) (/cf./ schéma ci-dessous) :



* Combien sont routiniers (B) ?

* Combien sont inventifs et non réussis (C) ?

- * Combien sont inventifs et réussis (D) (selon les critères de la question précédente) ?
- * Combien n'ont pas aboutis (E) ?

Veuillez saisir un nombre compris entre 0 et 100 pour chaque élément :

	En moyenne ou approximativement pour une année
Total des projets (A)	
Projets routiniers (B)	
Projets inventifs (C)	
Projets inventifs réussis (D)	
Projets non aboutis (E)	

30 [29.2]

29.2. Au sein de votre R&D, au cours de ces quatre dernières années, sur la totalité des projets finis (A) (cf. schéma ci-dessus) :

- * Combien sont routiniers (B) ?
- * Combien sont inventifs et non réussis (C) ?
- * Combien sont inventifs et réussis (D) (selon les critères de la question précédente) ?
- * Combien n'ont pas aboutis (E) ?

Veuillez saisir un nombre compris entre 0 et 100 pour chaque élément :

	2008	2009	2010	2011
Total des projets (A)				
Projets routiniers (B)				
Projets inventifs (C)				
Projets inventifs réussis (D)				
Projets non aboutis (E)				

31 [30.1]

30.1 En matière de performance, pouvez-vous estimer les résultats chiffrés des projets inventifs ?

Veuillez saisir un nombre compris entre 0 et 2000 pour chaque élément :

	En moyenne ou approximativement
Nombre d'idées obtenues en séance créative (brainstorming ou autre) après filtrage	
Nombre de concepts de solutions validés pour être prototypés	
Nombre de brevets déposés	
Nombre de produits (ou services) nouveaux lancés sur le marché	

32 [30.2]

30.2 En matière de performance, sur les quatre dernières années, pouvez-vous estimer les résultats chiffrés des projets inventifs ?

Veuillez saisir un nombre compris entre 0 et 2000 pour chaque élément :

	2008	2009	2010	2011
Nombre d'idées obtenues en séance créative (brainstorming ou autre) après filtrage				
Nombre de concepts de solutions validés pour être prototypés				
Nombre de brevets déposés				
Nombre de produits (ou services) nouveaux lancés sur le marché				

33 [31]

31. Sur les quatre dernières années, quel est le nombre moyen de brevets déposés par votre département R&D (par année) ?

Veillez saisir un nombre compris entre 0 et 100 pour chaque élément :

	En moyenne ou approximativement
Nombre d'idées obtenues en séance créative (brainstorming ou autre) après filtrage	
Nombre moyen de brevets déposés	

34 [32]

32. Quelle est la part (en %) de votre R&D dans le chiffre d'affaires de votre entreprise ?

Veillez saisir un nombre compris entre 0 et 100 pour chaque élément :

	2008	2009	2010	2011	En moyenne ou approximativement pour une année
Part annuelle de votre R&D					

Questions de confidentialité

35 [33]

33. Nous autorisez-vous à citer votre nom ?

Veillez sélectionner *une seule* des propositions suivantes :

* Oui

* Non

36 [34]

34. Nous autorisez-vous à citer le nom de votre entreprise ?

Veillez sélectionner *une seule* des propositions suivantes :

* Oui

* Non

37 [35]

35. Pouvez-vous nous renvoyer un fichier présentant l'organisation de votre département R&D ?

Kindly attach the aforementioned documents along with the survey

Fin du questionnaire
Merci pour votre participation
***- 02 juillet 2012 -**

Appendix. D. The flowchart of the initial version of the IDPMS application;

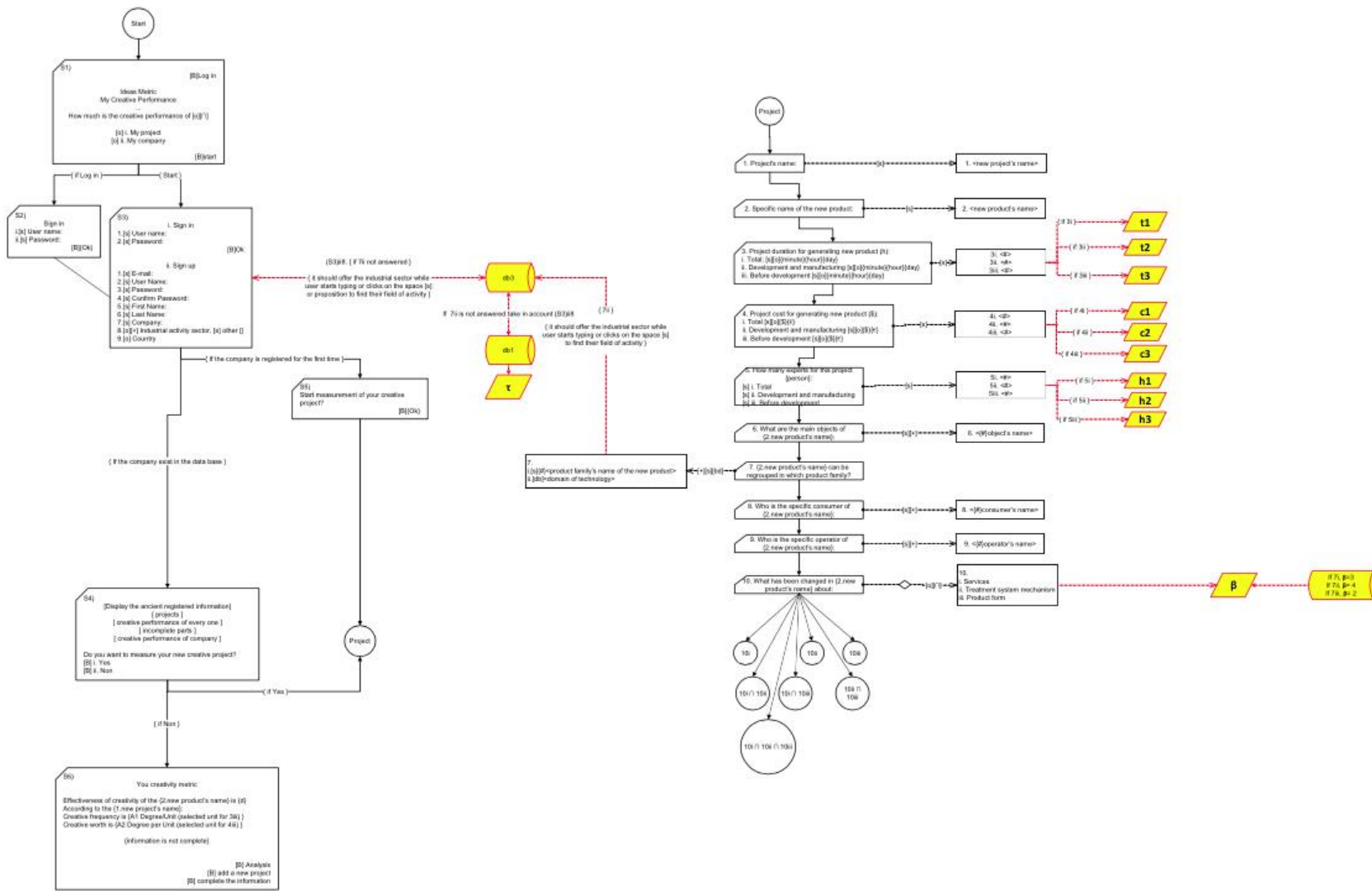

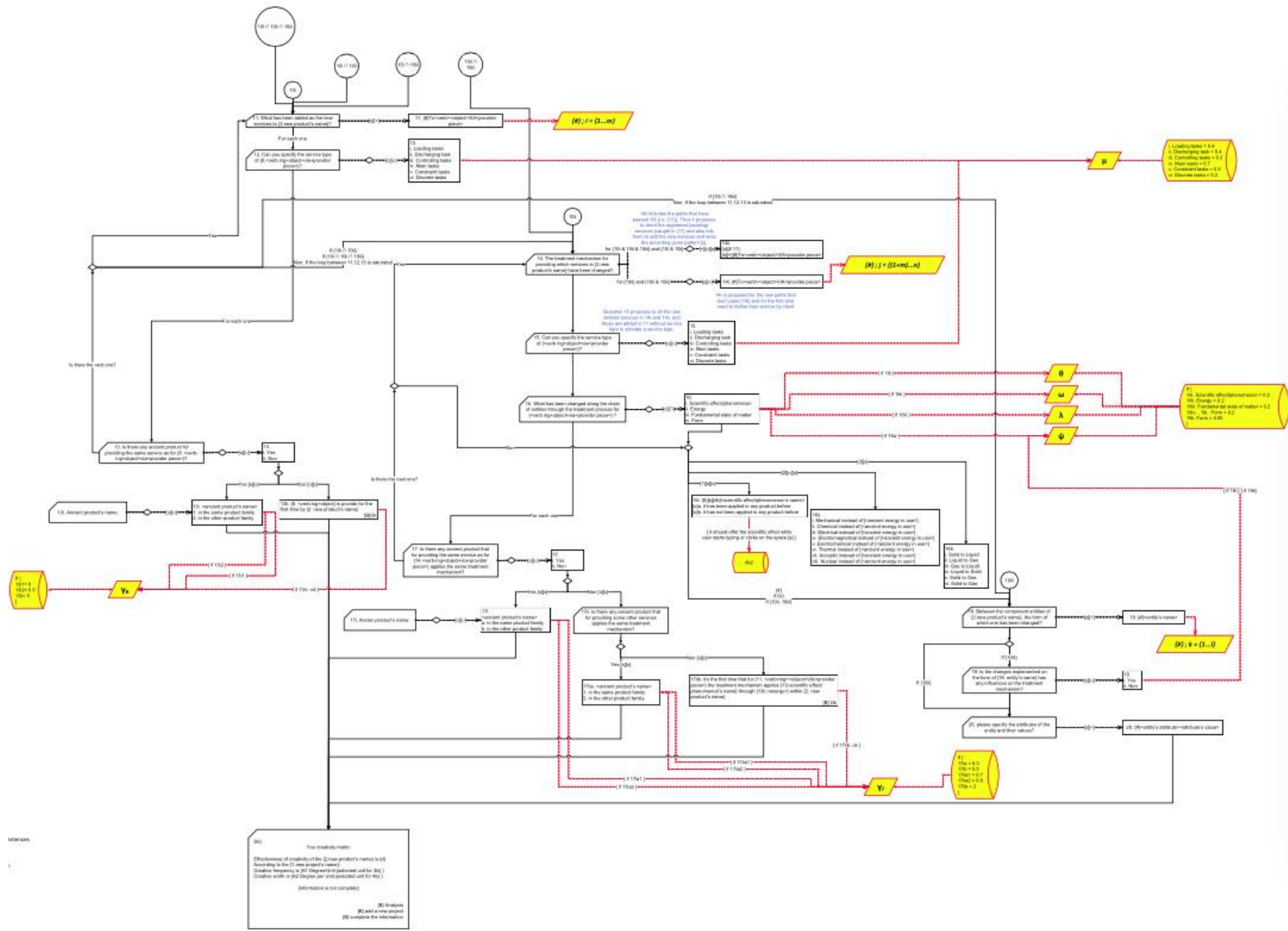

network

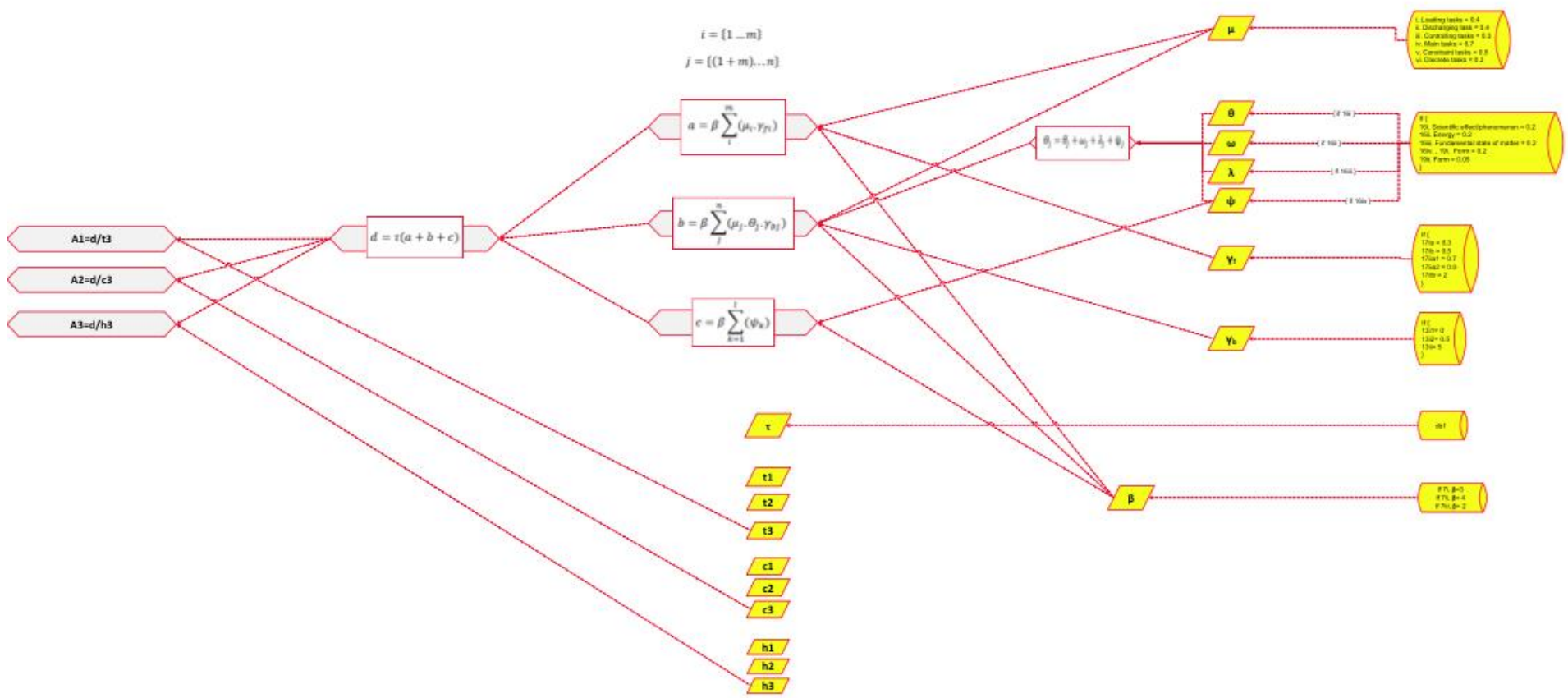

Résumé du mémoire de thèse de doctorat

**Définition des indicateurs de l'efficiency
inventive pour caractériser les activités
inventive en R&D; Application au domaine
de l'automobile**

Thésard: Ali TAHERI
Directeur: Denis CAVALLUCCI
Co-encadrant: David OGET

Table des matières

1. Introduction.....	227
2. Propositions	228
2.1. Efficacité Inventive.....	230
2.1.1. Nouveauté	231
2.1.2. Idéauté.....	236
2.1.3. Utilité	238
2.2. Efficiency Inventive	240
3. Conclusion.....	241
4. Perspectives	243

1. Introduction

Au début du 21ème siècle, l'innovation est devenue une condition indispensable à la survie des entreprises [Benghozi 2000]. Elle a été présentée comme un défi clé pour obtenir un avantage concurrentiel durable [O'Regan 2006]. Au cours de cette dernière décennie, le management de l'innovation est devenu un sujet de plus en plus couvert par la littérature scientifique et de gestion pour aider les entreprises à accélérer le rythme de développement de nouveaux produits et de nouveaux services. Cette

accélération requiert la recherche d'un nouveau paradigme. L'absence d'une norme admise a été identifiée comme la raison pour laquelle un grand nombre d'industries n'ont pas mis en place des processus fiables associés à l'innovation, s'exposant ainsi à des risques quant à leur croissance et leur pérennité. Bien que la plupart des étapes et des aspects du processus d'innovation soient l'objet d'études, les phases amont de ce dernier sont souvent mises en cause et sont rendues responsables de la chute de sa performance globale. Les étapes amont du processus d'innovation présentent une grande incertitude, notamment celles relatives aux activités créatives, à la résolution de problèmes et la génération d'idées. La présence de ces risques nous a conduit à considérer les activités de la conception inventive dans une logique de performance. L'objectif de notre recherche est la définition d'un ensemble d'indicateurs de performance des activités inventives. La finalité recherchée est la réduction du risque de contre-performance. Car le département R&D (Recherche et Développement) est responsable de la gestion de l'innovation dans l'entreprise. L'étude que nous avons réalisée interroge les entreprises industrielles du secteur de l'automobile ayant une diversité de génération des idées technologiques. Notre recherche commence par l'examen des normes existantes sur l'innovation, le département R&D et les activités créatives. Dans un deuxième temps, elle comprend une revue de littérature dans les domaines concernés nous conduisant à poser la problématique et les questions détaillées de la recherche. Enfin, nous proposons un instrument de mesure de la performance des activités de conception inventive intégrées au processus d'innovation en partant des concepts reliés aux domaines concernés.

2. Propositions

En général, tout système de mesure est basé sur un ensemble de mesures appropriées en ce qui concerne les critères et les caractéristiques de leurs objets. En ce qui concerne

la performance inventive, la créativité et l'inventivité sont les critères particuliers qui doivent être pris en compte et étudiés. La performance des activités de la conception inventive peut être évaluée selon le niveau hiérarchique organisationnel. Dans la littérature, quatre niveaux ont été considérés comme les points focaux d'analyse de la performance des projets de conception de nouveaux produits (NPD); le niveau de l'activité, le niveau du processus, le niveau du projet et le niveau de l'entreprise [Schainblatt 1,982] [Cooper 1,995] [Wilson 1,994] [Loch 1996] [Werner 1997] [Cordero 1990] [Kim 2002].

Après en avoir examiné les avantages et les inconvénients, le niveau de projet a été reconnu comme le niveau le plus approprié pour analyser la performance de la conception inventive. Cependant Duffy et al. ont utilisé le niveau de l'activité pour l'évaluation de la performance inventive [O'Donnell 2005]. Le choix du niveau de l'activité par Duffy et al. [O'Donnell 2005] émanait du fait que les activités de conception sont alimentées par la créativité des individus. Bien que le choix du niveau de l'activité donne une reconnaissance à la nature des activités et à leurs relations, il conduit à une grande difficulté à identifier les indicateurs de performance d'une série d'activités. En effet, la diversité des activités pendant un projet de conception mobilise un grand nombre d'informations qui ne peuvent être toutes mobilisées pour la mesure du rendement. L'analyse de la performance au niveau du projet est basée sur la résultante globale des entrées et sorties, en considérant toutes les ressources consommées et toutes les actions réalisées aux niveaux de l'activité et du processus.

En dehors de la modalité de l'inventivité, une activité de conception est décrite à travers cinq opérations : les opérations de traitement, d'importation, d'exportation, d'obtention des autorisations juridiques et de soutien matériel et humain. Ces opérations sont appliquées au cours d'un projet de conception pour transformer les intrants en extrants.

Par ailleurs, les recherches effectuées révèlent que la mesure de la performance en science de la conception est basée sur trois éléments constitutifs : l'efficacité, l'efficacit , et la pertinence. Bien que la performance des activit s de la conception d pende de la pertinence des intrants, l'analyse de l'efficacit  et de l'efficacit  est suffisante pour estimer le niveau de la performance d'un projet de conception. En effet, la pertinence cherche   prendre en compte l'influence des intrants sur l'efficacit  et l'efficacit  des activit s de la conception. L' tude de la pertinence des intrants ne se fait pas dans ce travail qui vise   d finir les m triques de la performance comme une condition pr alable.

2.1. Efficacit  Inventive

L'efficacit  de la conception signifie "la mesure dans laquelle la suite de conception (sortie) r pond aux objectifs du projet" [O'Donnell 2005]. L'efficacit  de la conception se concentre sur l'aspect qualitatif des sorties du processus la conception [Shah 2003]. En d'autres termes, l'efficacit  de la conception exprime combien une sortie a  t  conforme aux objectifs pr vus. Ainsi, le niveau de l'efficacit  peut  tre mesur  en comparant les sorties et les objectifs. Ici, le terme *inventive* qui, comme l'adjectif, est impos  aux activit s de la conception pour avoir les sorties inventives, induit la question suivante : Quels sont les crit res de l'inventivit  d'efficacit  ? Dans la litt rature en science de la cr ativit , commun ment, l'inventivit  a  t  utilis e dans le m me sens que la cr ativit  [Wunsh Vincent 2011] [Demirkan 2012] [Shah 2003, p] [Sarkar 2011] [Dean 2006] [Shah 2000]. Parmi les caract ristiques de l'inventivit  discut e dans la litt rature, la *nouveaut * et l'*utilit * sont les caract ristiques essentielles requises pour l'admission d'une sortie inventive [Sarkar 2011]. En plus de la nouveaut  et de l'utilit , Altshuller et al. [Altshuller 1984] [Altshuller 1988], dans la TRIZ (la th orie de r solution inventive des probl mes), ont d fini neuf lois d'ing nierie pour expliquer les

évolutions technologiques. L'une d'elles, l'*idéalité* est considérée comme un critère d'évaluation de l'inventivité. L'importance de l'idéalité émane du fait que l'idéalité est le ferment de la mise en œuvre des autres lois d'Altshuller. L'influence des autres lois d'évolution pour améliorer l'idéalité est tellement évidente que TRIZ est connu comme une méthode holistique pour générer le portrait des systèmes idéaux [Cavallucci 2011] [Cavallucci 2010]. Selon cette approche, l'idéalité a été considérée comme un indicateur clé de l'inventivité à côté de la nouveauté et de l'utilité.

Dans la plupart des pays, les droits de la propriété intellectuelle et de la brevetabilité se rapportent aux conditions de fond avec certains critères qui doivent être respectés par les sorties [Robertson 2009] [Mishra 2014] [Kunets 1,962]. Le lien entre les lois sur les brevets et les activités inventives fournit une base d'élaboration des paramètres de l'inventivité [2006] Nuvolari. En général, les critères principaux de brevetabilité sont fondés sur la vérification de la *nouveauté*, l'*utilité*, et la *non-évidence* [Tab.23]. La non-évidence est la caractéristique principale de de la conception inventive qui considère les contradictions au moment de la résolution.

- **Nouveauté:** Une invention (un brevet) doit être nouvelle (nouveau);
- **Utilité (Utility):** Une invention (brevet) doit pouvoir être utilisée dans les activités industrielles, personnelles et sociales;
- **Non-évidence:** Une invention (brevet) doit être différente de ce qu'un homme-utilisateur peut attendre.

2.1.1. Nouveauté

La nouveauté est une dérivation du mot latin «novus» pour exprimer la qualité ou l'état d'être nouvelle, différent, original ou inhabituel [Merriam-Webster 2014]. Elle

signifie qu'il y a des changements qui n'auraient pas été connus auparavant, parce qu'ils ont été créés récemment [Cambridge 2008]. L'unicité est la caractéristique principale de la nouveauté [MacCrimmon 1,994].

La mesure de la nouveauté technologique se compose de trois dimensions (propriétés) :

- Le temps d'apparition des changements;
- L'amplitude des changements;
- L'ampleur des changements;

Bobrow 1984 [Bobrow 1984] est l'un des premiers auteurs qui ont étudié les caractéristiques techniques des systèmes technologiques. Il décrit les caractéristiques techniques des systèmes technologiques selon trois points de vue, y compris fonctionnels, comportementaux, et structurels. Dans ce travail, en plus de considérer les aspects fonctionnels, comportementaux et structurels, certaines données de l'environnement opérationnel (super-système/environnement des systèmes technologiques) sont également prises en compte pour caractériser les systèmes technologiques.

Toutes les fonctionnalités qui s'appliquent à un système technologique sont définies dans sept catégories :

- La *Main Useful Function* (MUF) sert à vérifier la fonction principale d'un système, par laquelle d'autres fonctions trouvent un sens ;
- La *Main Complementary Function* (MCF) vérifie les fonctionnalités qui complètent la fonction principale (MUF) ;

- La *Loading/Discharging Function* (LDF) vérifie les fonctionnalités qui s'appliquent aux chargements/déchargements des objets extérieurs dans/en dehors d'un système;
- La *Environmental Constraint Function* (ECF) vérifie les fonctionnalités contraintes par l'environnement ;
- La *Control-Command Function* (CCF) vérifie les fonctionnalités qui s'appliquent pour indiquer l'exploitation d'autres fonctions ;
- La *Indicating Complementary Function* (ICF) vérifie les fonctionnalités qui s'appliquent pour contrôler l'exploitation d'autres fonctions ;
- Discrete Supplementary Function (DSF) vérifie les fonctionnalités qui s'appliquent pour faire des fonctions discrètes de la fonctionnalité principale (MUF) ;

La caractérisation des entités structurelles est basée sur l'identification des propriétés physico-architecturales et leurs valeurs :

- Le *System Structural Properties* (SSP) : les propriétés physiques et d'architecture d'une entité structurelle dans un système.
- Le *Structural Property Attributes* (SPA) : les valeurs des propriétés physiques et d'architecture d'une entité structurelle dans un système.

Le comportement d'un système technologique se réfère au mécanisme de soutenir sa fonction à travers ses composantes physiques (structurelles) [Zhang 2011]. Tout système se compose de certaines entités structurelles par laquelle il illustre ses comportements pour atteindre ses fonctions. Chaque entité structurelle dans un système technologique a son propre rôle comportemental spécifique pendant le fonctionnement du système [Zhang 2011] [Bobrow 1984]. Donc, la caractérisation des

aspects comportementaux de tout système technologique est basée sur l'identification des entités structurelles et la vérification de leur mécanisme opérationnel:

- Le *System Structural Entities* (SSE) : les entités structurelles qui sont impliquées pour réaliser une fonction d'un système technologique.
- Le *Operational Property Attributes* (OPA) : les valeurs des propriétés opérationnelles au long du fonctionnement d'un système technologique.

Toute entité structurelle des systèmes technologiques expose son comportement - ou prend un état différent - quand reçoit, mène, et/ou transmet les flux d'énergie. Recevoir de l'énergie, transférer (conduire) de l'énergie, et transmettre de l'énergie à une autre entité contiguë, sont les trois actions phénoménales qui se produisent pendant le fonctionnement d'un système pour toute entité structurelle reliée à la fonctionnalité. En effet, ce procédé avec une certaine répétition accomplit le fonctionnement d'un système.. À cet égard, l'énergie et l'entité (substance) sont considérées comme la condition nécessaire et les phénomènes scientifiques pendant la réception, la transition, et la transmission d'énergie, sont la condition suffisante du fonctionnement d'un système technologique. Ainsi, l'identification du mécanisme de servir une fonctionnalité dans un système technologique est basée sur la vérification de trois éléments :

- Type d'énergie (entrée et sortie): les sept formes d'énergie.
- État fondamental de la matière (FSM): l'état gazeux, l'état liquide, l'état solide, l'état plasma (gaz ionisé).
- Phénomène scientifique (effets physiques) : les phénomènes scientifiques qui causent les réceptions, les transitions et les transmissions d'énergies au cours de fonctionnement d'un système.

Chaque système technologique est conçu pour fonctionner dans une condition spécifique (l'environnement de système). Ainsi, la caractérisation des environnements opérationnels repose sur l'identification des objets de l'environnement qui traitent avec des entités structurelles des systèmes pendant le fonctionnement [Fig.40]:

- *Main Specific Consumer* (MSC): Le MSC se réfère aux systèmes ou aux personnes qui sont spécifiés pour être desservi par les objets de sortie et/ou le comportement de système.
- *Main Specific Operator* (MSO): L'MSO se réfère aux systèmes ou aux personnes qui sont spécifiés pour prévoir directement le fonctionnement du système.
- *Super-System Objects* (SSO): Le SSO se réfère aux objets environnementaux qui interagissent avec des entités structurelles de système.

Boden [Boden 1999] a déclaré que la nouveauté d'un système a une relation forte avec la créativité psychologique et historique [Boden 1999]. La notion de la nouveauté a un certain nombre de références pour faire des comparaisons.

Selon la méthode proposée dans ce travail, le degré de la nouveauté technologique (TND) d'un système technologique est estimé en cinq étapes [Fig.45]:

1. Collection des données : la première étape reçoit les données techniques appliquées sur les systèmes technologiques (un nouveau système en cours de mesure ou un système qui est la référence de la comparaison). Comme une approche classique, ces données sont obtenues en décomposant les systèmes technologiques sur le PPC (l'arbre généalogique proposé). Cette approche fournit une base de données des caractéristiques techniques appliquées aux systèmes technologiques. Cette étape

peut être utilisée à plusieurs reprises comme l'étape suivante (sélection des références). En effet, elle alimente les données nécessaires à l'étape de comparaison.

2. Sélection des références : Cette étape est doit identifier les systèmes comparables (référentiels) avec le nouveau système. Les principales activités de cette étape sont respectivement :
 - Définition de la fonctionnalité principale pour définir la famille de produit (MUF et la famille en PPC) ;
 - Détection des références dans chaque couche de PPC ;
3. Comparaison : Cette étape sert à identifier toute similitude et dissimilitude familiale et non-familiale. L'absence de similitude entre le nouveau système et les références de la nouveauté, dans chaque couche de caractérisation, est la condition de désir de cette comparaison.
4. Notation : En identifiant les différences techniques d'un nouveau système vis-à-vis ses références de la nouveauté, chaque changement prend un poids spécifique selon son importance et se met dans la formule de calcul proposé.
5. Calcul : L'application de la formule de calcul proposée aide à estimer le score total de la nouveauté d'un nouveau système (TND).

2.1.2. Idéauté

La conception inventive est un support à l'évolution technologique des systèmes techniques en recherche d'idéauté. Ce postulat relie l'inventivité à l'idéauté. En effet, la poursuite de l'idéal est un principe de base de la conception inventive qui guide la génération d'idées. Il justifie les directions de conceptions entreprises, et balise le

chemin de l'évolution technologique. Les évolutions technologiques émergent progressivement par des changements - des améliorations radicales et/ou incrémentales de caractéristiques techniques - afin de se rapprocher de systèmes idéaux. A cet égard, l'évaluation de l'idéalité de nouveaux systèmes nous assure un choix idéal et sous-tend une évolution légitime. Dans la littérature, un système idéal est défini comme un objectif ultime où le but de la performance qui y est envisagée intervient dans un monde de fantaisiste [Blosiu 2000]. Un système idéal remplit ses fonctions spécifiées au bon moment et au bon endroit sans implication de substances et sans consommation d'énergie [Petrov 2005]. Dans le monde réel, l'idéalisation cherche à remplir des exigences fonctionnelles en minimisant les dépendances aux matériaux et à l'énergie. En résumé, l'idéalité d'un système doit être perçue comme son taux de rapprochement de l'idéal durant la phase de conception. L'évaluation de l'idéalité dans la littérature en sciences de l'ingénieur est basé sur une formule générique; le ratio des fonctions utiles aux fonctions nuisibles [Altshuller 1984] [Petrov 2005]. Ici, la fonction nuisible (HF) comprend toutes les dépenses et les pertes induites par l'existence du système pour accomplir les exigences spécifiées. En revanche, le terme de fonction utile (UF) signifie tous les aspects fonctionnels accomplis par le système. Les paramètres d'action (AP) découlent de besoins fonctionnels et impliquent des décisions que les concepteurs souhaitent entreprendre.

La mesure du degré d'ingéniosité technologique d'un système est réalisée en cinq étapes:

1. Détection de la chaîne FBS du système (FBS- chaîne);
2. Identification des leviers d'action et EPs connexes;
3. Enregistrer les valeurs actuelles (AV) et les valeurs initiales (IV) des EPs;

4. Prédiction des valeurs ultimes (UIV) des EPs;

5. Calcul;

2.1.3. Utilité

L'utilité est l'un des indicateurs clés de l'évaluation de l'inventivité. Dans la littérature, l'utilité est discutée comme un adjectif pour prédire et/ou expliquer l'utilisation d'un système [Davis 1989] [Keil, 1995]. Davis 1989, a supposé qu'un système est utile lorsque l'utilisateur croit que le système va l'aider à mieux accomplir son travail [Davis 1989]. Il a nommé cette condition comme l'utilité perçue d'un système. La perception de l'utilité est définie comme «la mesure dans laquelle une personne croit que l'utilisation d'un système particulier serait d'améliorer son rendement au travail" [Davis 1989]. En d'autres termes, l'utilité perçue réfère à la relation d'usage et sa performance positive [Davis 1989]. Davis, en vérifiant 37 recherches publiées, a préparé une liste des articles qui traitent de l'utilité perçue. Cependant, certains éléments se chevauchent et interfèrent les uns avec les autres. Il a classé ces éléments en ce qui concerne leur impact sur l'utilité perçue [Tab.62], et a proposé une approche d'évaluation fondée sur les opinions des utilisateurs. Cependant, chaque élément détecté peut être analysé comme une caractéristique technique de relation d'usage et sa performance.

La même perception de Davis [Davis 1989] à propos de l'utilité a été prise en compte par plusieurs littératures pour analyser l'usage associée à un système technique [Adams 1992] [Sarkar 2011] [Yannou 2013] [Wang 2013] [Yannou 2015]. En ce qui concerne l'évaluation de l'utilité, il existe peu de méthodes de calcul. Hormis certains auteurs comme Shah et Vargas-Hernandez [Shah 2003, p] [Shah 2001] qui proposent une mesure de la qualité du produit en ce qui concerne les objectifs de conception (méthode objective pondérée), la plupart des auteurs se sont concentrés sur l'évaluation côté

utilisateur. À cet égard, la popularité, l'utilisation d'importance, la couverture de scénario d'utilisation, la segmentation d'utilisation, la fréquence d'utilisation, la durée d'utilisation, la question de l'usage répandu, la performance attendue d'un système, la fiabilité du système, le taux d'échec, la probabilité que l'utilisation échoue, sont considérés comme les principaux indicateurs pour évaluer l'utilité, qui, en plus de mesurer la performance de système, nécessite de tester l'utilisation du système pour une taille d'échantillon appropriée [Sarkar 2011] [Yannou 2013]. Par exemple, dans un ouvrage récent [Yannou 2015], propose une méthode réaliste qui prend en compte les différents scénarios d'utilisation. Cette méthode est basée sur la mesure de la performance technique des systèmes techniques. En outre, pour mesurer le taux d'utilité, il faut une enquête d'usage après la fabrication et la diffusion. Cela a pour conséquence notamment de rendre délicat la mesure de l'utilité des revendications de brevets d'invention voire tout ce qui a lieu avant les phases de prototypage. Parmi les quelques méthodes d'évaluation de l'utilité, Sarkar et al. [Sarkar 2011] ne tient pas compte de la performance technique des systèmes. Leur évaluation est basée sur trois facteurs; le taux (le rapport entre le nombre d'utilisateurs de la population totale), la fréquence et la durée d'utilisation.

Une telle analyse de la performance technique d'un système évalue avec précision le concept d'utilité. Dans ce travail, la mesure de la performance technique (TPM) est considérée comme le principal indicateur de l'utilité technologique (TUD). La performance technique d'un système se réfère aux objectifs techniques clés qui devaient être respectés pendant le fonctionnement du système pour supporter les fonctions du système dans un état donné (système d'exploitation). La performance technique d'un système est basée sur l'analyse des caractéristiques techniques du fonctionnement de ce système afin de déterminer comment il satisfait aux exigences spécifiées [Roedler

2005]. Ceci est une mesure de la conformité de la performance requise pour accomplir les fonctions spécifiées des systèmes technologiques.

Sur la base du modèle proposé pour la mesure de l'efficacité inventive, les indicateurs de l'utilité sont les mêmes que les indicateurs de la performance technique. Ainsi, un système avec une haute performance technique possède une grande utilité aux vues des travaux susmentionnés.

2.2. Efficience Inventive

Le degré d'inventivité technologique (TID) d'un système est obtenu en intégrant le degré de la nouveauté technologique, le degré d'idéalité, et le degré d'utilité (TND, TRD, et TUD) du système [Equ.20].

En conséquence, le TID d'un projet de conception est obtenue en intégrant TND, TRD, et TUD de tous les modèles validés (systèmes) à la porte 3 du processus d'innovation.

En général, l'efficacité se réfère à la productivité des procédés [Chiou 1999]. L'efficacité présente la mesure dans laquelle le temps, le coût, les efforts, et en général, toutes les ressources sont bien utilisées pour atteindre les objectifs, les finalités précises et les fonctions [Merriam-Webster 2014]. Donc, l'efficacité de tout système, processus, ou fonctionnement est défini comme «le rapport de travail utile effectué au total des ressources dépensées" [Duffy 2003]. Selon O'Donnell et al. [O'Donnell 2005], des œuvres utiles au long du processus de conception semble les matières gagnées (M+) en effectuant des activités de la conception. Ainsi, l'efficacité des projets de conception dépend des matières gagnées (M+) et des ressources utilisées (R) par les activités de conception [Equ.22] [O'Donnell 2005].

Dans la conception inventive, l'efficacité se réfère à l'efficacité des activités inventives. Comme mentionné ci-dessus, les projets de conception ont été considérés comme les

unités de traitement des connaissances qui sont en place pour générer de nouvelles connaissances. Selon Hatchuel et al. [Hatchuel 2010] une nouvelle idée est conçue quand il se transforme en connaissance ou prend un statut logique [Hatchuel 2003]. Ainsi, l'entrée et la sortie des matériaux de traitement sont introduits comme une connaissance dès lors que leur possibilité ou la faisabilité sont prouvés. En conséquence, un projet de la conception inventive ressemble à une nouvelle combinaison de connaissances avec des caractéristiques inventives en sortie. Ainsi, les connaissances gagnées (K_{n+}) par un projet inventif se réfèrent au taux d'évolution des résultats en ce qui concerne l'inventivité.

Depuis, l'efficacité inventive a été étudiée et ses mesures ont été développées, pour obtenir les connaissances gagnées (K_{n+}) par un projet inventif. Il suffit de mesurer ou d'apprendre davantage sur le TID du projet. Dans ce travail, toutes les ressources utilisées dans un projet de conception, sont résumées dans les trois principaux critères de ressources utilisées; le temps, le coût, et les ressources humaines. Comme les ressources humaines sont le moteur des activités inventives, toutes les autres ressources sont au service des ressources humaines. La valeur de l'efficacité inventive (IBE) est obtenue en calculant le rapport des TID comme une connaissance gagnée aux ressources utilisées lors des phases amont.

3. Conclusion

Tous les modèles proposés dans ce chapitre sont intégrés dans un cadre comme IDPMS (*Inventive Design Performance Measurement System*) afin de fournir un système cohérent de suivi de la performance inventive. Le niveau « projet » est préférable pour mesurer les activités de conception. L'IDPMS nécessite le développement d'un système neuronal pour la collecte des données et de fournir une base de données à partir des phases amont du processus d'innovation. L'IDPMS se compose de deux grandes parties

relatives à la mesure de la performance inventive. La première partie mesure l'efficacité inventive et la seconde mesure l'efficacité inventive.

Ce travail tente de réduire l'incertitude dans les premières étapes du processus d'innovation en définissant les indicateurs clés de la performance inventive.

Les indicateurs de la performance des activités inventives ont été définis et mis au point par ce travail. Notre contribution comprend le développement d'une nouvelle méthode d'évaluation de la nouveauté technologique, le développement d'une nouvelle méthode pour évaluer l'ingéniosité technologique (l'idéalité), l'étude de l'évaluation de l'utilité technologique, le développement d'une nouvelle méthode pour évaluer l'efficacité des activités inventives, et la définition des indicateurs clés de la performance inventive.

Pour les industries, cette thèse présente une méthode d'évaluation pour le suivi et l'amélioration des activités de conception inventive dans les premiers stades de leurs projets d'innovation. Les indicateurs inventifs étalent une ligne directrice pour les concepteurs à prendre en considération au cours des activités de conception. Pour les consultants industriels et les bureaux de la propriété intellectuelle, cette thèse fournit un nouvel indicateur pour guider et classer les entreprises en matière d'innovation. Notre travail propose l'évaluation de l'évolution technologique comme un segment complémentaire de l'évaluation de l'innovation. Pour les chercheurs et nos collègues dans les laboratoires d'ingénierie de la conception, cette thèse propose une méthode d'évaluation préliminaire de l'évolution technologique. Elle met en évidence les points de départ pour parvenir à une gestion totale de l'innovation dans un état créatif.

4. Perspectives

La première perspective de ce travail nous renvoie à la pertinence pour la mesure de la performance du système de conception. , Les processus de conception nécessitent des efforts considérables [Andreasen 1998] pour sélectionner les ressources dans un temps donné afin de réaliser de façon efficace, efficiente et pertinente les activités. Bien que cette thèse ait énuméré les indicateurs de performance inventive, il faut préparer une liste des entrées qui devrait être utilisée tout au long de la phase de conception. La valeur de l'efficacité d'un projet inventif dépend de manière significative du choix pertinent des objectifs du projet, des ressources, des connaissances des entrées et des sorties. L'identification des caractéristiques de l'invention et des indicateurs de la performance inventive sont la base de la définition des entrées pertinentes. Définir des indicateurs de l'inventivité permet de reconnaître les entrées pertinentes dans les processus de conception.

Ce travail doit être éprouvé au travers de plusieurs expériences. Il doit aussi tenir compte des évaluations externes afin d'améliorer les définitions, les critères, la caractérisation technique, le calcul et l'évaluation.

