



HAL
open science

Application de la détente instantanée contrôlée pour l'eco-extraction des produits naturels : intensification & combinaison

Tamara Allaf

► **To cite this version:**

Tamara Allaf. Application de la détente instantanée contrôlée pour l'eco-extraction des produits naturels : intensification & combinaison. Autre. Université d'Avignon, 2013. Français. NNT : 2013AVIG0249 . tel-01337322

HAL Id: tel-01337322

<https://theses.hal.science/tel-01337322>

Submitted on 25 Jun 2016

HAL is a multi-disciplinary open access archive for the deposit and dissemination of scientific research documents, whether they are published or not. The documents may come from teaching and research institutions in France or abroad, or from public or private research centers.

L'archive ouverte pluridisciplinaire **HAL**, est destinée au dépôt et à la diffusion de documents scientifiques de niveau recherche, publiés ou non, émanant des établissements d'enseignement et de recherche français ou étrangers, des laboratoires publics ou privés.

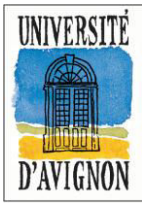

Thèse

Présentée pour obtenir le grade de Docteur en Sciences
de l'Université d'Avignon et des pays de Vaucluse

Spécialité : CHIMIE

**Application de la Détente Instantanée Contrôlée pour
l'Eco-Extraction des Produits Naturels :
Intensification & Combinaison**

par

Tamara ALLAF

Thèse Soutenue le 24 juin 2013 devant le jury composé de :

Olivier DANGLES	Professeur Université d'Avignon et des Pays de Vaucluse	<i>Président du Jury</i>
Eugène VOROBIEV	Professeur Université de Technologie de Compiègne	<i>Rapporteur</i>
Jean-Louis LANOISELLE	Professeur Université de Bretagne-Sud	<i>Rapporteur</i>
Antoine BILY	Directeur R&D Naturex, Avignon	<i>Invité</i>
Alexei LAPKIN	Professeur Université de Cambridge, GB	<i>Invité</i>
Laurent LEFEVRE	Directeur Technique ABCAR-DIC Process, La Rochelle	<i>Suiveur de Thèse</i>
Valérie TOMAO	Maitre de Conférences HDR Université d'Avignon et des Pays de Vaucluse	<i>Co-Directrice de Thèse</i>
Farid CHEMAT	Professeur Université d'Avignon et des Pays de Vaucluse	<i>Directeur de Thèse</i>



Thèse

Présentée pour obtenir le grade de Docteur en Sciences
de l'Université d'Avignon et des pays de Vaucluse

Spécialité : CHIMIE

**Application de la Détente Instantanée Contrôlée pour
l'Eco-Extraction des Produits Naturels :
Intensification & Combinaison**

**Instant Controlled Pressure Drop for
Green Extraction of Natural Products:
Intensification & Combination**

par

Tamara ALLAF

Thèse Soutenue le 24 juin 2013 devant le jury composé de :

Olivier DANGLES	Professeur Université d'Avignon et des Pays de Vaucluse	Président du Jury
Eugène VOROBIEV	Professeur Université de Technologie de Compiègne	Rapporteur
Jean-Louis LANOISELLE	Professeur Université de Bretagne-Sud	Rapporteur
Antoine BILY	Directeur R&D Naturex, Avignon	Invité
Alexei LAPKIN	Professeur Université de Cambridge, GB	Invité
Laurent LEFEVRE	Directeur Technique ABCAR-DIC Process, La Rochelle	Responsable scientifique
Valérie TOMAO	Maître de Conférences HDR Université d'Avignon et des Pays de Vaucluse	Co-Directrice de Thèse
Farid CHEMAT	Professeur Université d'Avignon et des Pays de Vaucluse	Directeur de Thèse

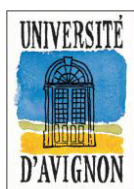

A mis queridos padres,

REMERCIEMENTS

Il est difficile de savoir comment commencer ces remerciements... étant donné qu'il y a eu autour de moi beaucoup de personnes qui m'ont soutenue que ce soit par leur sourire, leur présence, leur amour. Je sais bien que je ne serai pas évaluée sur cette partie, ce qui me permet d'exprimer ma reconnaissance à ma manière.

*Je tiens donc tout d'abord à remercier très sincèrement mes directeurs de thèse : **Farid Chemat** qui a su être un véritable mentor. Si nous regardons la définition de mentor, nous y trouverons les mots qui le définissent très bien : guide, conseiller avisé et expérimenté, personne influente, de confiance et de soutien ; **Valérie Tomao** pour son soutien et son aide, surtout lorsque ma saturation était au plus haut.*

*Je remercie chaleureusement **Laurent Lefèvre** qui a su me faire confiance et me donner la possibilité d'apprendre sur le terrain tout en n'hésitant pas à me donner des responsabilités au sein d'ABCAR-DIC Process.*

*J'exprime toute ma gratitude et tout mon respect aux professeurs **Eugène Vorobiev** et **Jean-Louis Lanoisellé** pour avoir accepté d'être les rapporteurs de mon travail. Je tiens également à remercier **Alexei Lapkin**, **Antoine Bily** et **Olivier Dangles** pour avoir accepté d'examiner ma thèse.*

*J'adresse mes sincères remerciements à mes collègues et amis de l'équipe GREEN : **Céline Tanzi**, **Ying Li**, **Daniella Pingret**, **Loïc Petigny**, **Magali Jacotet**, **Dima Mnayer**, **Aurore Filly**, **Jean-Thomas Pierson**, **Julien Matois**, **Karine Ruiz**, **Emmanuel Petitcolas**, **Anne-Sylvie Fabiano Tixier**, **Maryline Abert Vian** et **Sandrine Périno** ; sans oublier ceux qui sont passés par notre équipe, **Shiraz Bitar** (et sa famille), **Doriane Ferreira**, **Sabiha Achat** et ceux qui sont juste en face et qui ont été d'un soutien plus qu'agréable, **Céline**, **Carole** et ce cher **Simon**.*

*Je tiens également à remercier ceux qui ont fait ou font partie de la société ABCAR : **Ismail**, **Marwan**, **Philippe**, et tous ceux qui ont contribué à ce que les travaux sur l'instantanéité avancent.*

*J'adresse également mes remerciements à mes collègues et amis de l'équipe du laboratoire LaSIE de l'Université de La Rochelle : **Sabah Mounir, Colette Besombes, Carmen Tellez, Martiza Alonzo-Macias, Baya Berka, et Antony Gélicus.***

*Mes remerciements vont également à mes très chers amis qui m'ont soutenue chacun à leur manière : **Claire Blanchier**, de par nos fous-rires et nos plans « foireux », **Lucie Astoul**, de par sa bonne humeur et nos délires, **Patricia Minguez Blasco**, de par sa joie de vivre et sa si belle personne, **Amra Aksamija**, de par ses bras toujours grand-ouverts,*

***Nassim Arabi**, qui est toujours présent même loin, **Nadya Zounaki** pour nos moments furtifs mais si agréables, **Cécile et Raphaël** pour leur soutiens et leur bonne humeur, **Aurélia Reynaud** pour avoir été aussi folle que moi pendant nos moments d'étude autour de la table.*

*Je remercie très chaleureusement **Michelle Hébert** qui a vu en moi un potentiel que je pensais inexistant.*

*Je remercie tout particulièrement mon **Victor** pour son amour et toute cette douceur qu'il a installée lorsque les temps étaient stressants.*

*Je tiens à remercier immensément mes deux grands frères **Nabil et Raoul** (et sa merveilleuse petite famille) et tiens également à insister sur la chance que j'ai de les avoir. Ce sont de loin et en toute objectivité les meilleurs frères qu'une personne puisse rêver d'avoir.*

*J'exprime tout mon amour à mes parents, **Vicenta et Karim** qui sont à eux seuls un mélange de passion, force, énergie, réconfort, bonheur, douceur et joie de vivre.*

*Comment finalement omettre de citer **ma grande famille** du Liban et d'Espagne, d'Australie, d'Autriche, de la République Tchèque et de France. Je dédie mes très affectueux remerciements à chacune et chacun de mes tantes, oncles, cousins, cousines,...ils ont chacun, à leur manière, contribué à la bonne humeur et l'optimisme durant cette thèse.*

SCIENTIFIC PUBLICATIONS

Publications

- ◆ Allaf, T., Tomao, V., Ruiz, K., Bachari, K., ElMaataoui, M., Chemat, F. Deodorization by instant controlled pressure drop autovaporization of rosemary leaves prior to solvent extraction of antioxidants. *LWT – Food Science and Technology* 51(1), 111-119. (2013)
- ◆ Allaf, T., Tomao, V., Ruiz, K., Chemat, F. Instant controlled pressure drop technology and ultrasound assisted extraction for sequential extraction of essential oil and antioxidants. *Ultrasonics Sonochemistry* 20(1), 239-246. (2013)
- ◆ Allaf, T., Tomao, V., Besombes, C., Chemat, F. Thermal and mechanical intensification of essential oil extraction from orange peel via instant autovaporization. *Chemical Engineering and Processing: Process Intensification.* , (Submitted)
- ◆ Allaf, T., Tomao, V., Nguyen, C., Ginies, C., Fine, F. Chemat, F. Kinetic modeling of canola oil extraction – Impact of instant controlled pressure drop parameters. *Journal of Food Engineering.* (Submitted)

Communications

- ◆ Tamara ALLAF, Valérie TOMAO, Farid CHEMAT. *Innovative extraction process combination.* Eighth International Conference on Renewable Resources and Biorefineries (RRB8), 4-6 Juin, 2012, Toulouse – France. (Oral communication)
- ◆ Tamara ALLAF, Valérie TOMAO, Farid CHEMAT. *Instant controlled pressure drop and Ultrasound – Innovative extraction process combination.* 3rd International Congress on Green Process Engineering, 5-8 Dec, 2011, Kuala Lumpur – Malaysia (Oral communication)
- ◆ Tamara ALLAF, Laurent LEFEVRE, Valérie TOMAO, Farid CHEMAT. *DIC assisted extraction of natural products “take an instantaneous break”.* Mediterranean Conference on Natural product, Oct 2011, Blida – Algeria (Oral communication)
- ◆ Tamara ALLAF, Laurent LEFEVRE, Valérie TOMAO, Farid CHEMAT. *Extraction enhanced by DIC treatment.* Food and Veg’ processing, 20-21-22 Dec, 2010, Muscat – Oman (Oral communication)

- ◆ Tamara ALLAF, Valérie TOMAO, Farid CHEMAT. *Instant controlled pressure drop assisted extraction of natural products.* 6^{èmes} Journées Franco-Italiennes de Chimie, April 16-17, 2012, Marseille – France (Poster communication)
- ◆ Tamara ALLAF, Valérie TOMAO, Farid CHEMAT. *DIC – US : combinaison de procédés d’extraction.* 22^{ème} Journée de la Chimie SCF-PACA, Mars 11, 2011, Toulon – France (Poster communication)

Table of Content

Table of Content

INTRODUCTION GENERALE	2
1. <i>Contexte</i>	3
2. <i>Les six principes de l'éco-extraction</i>	6
3. <i>Axe de recherche de la thèse.....</i>	7
4. <i>Plan d'étude de la thèse.....</i>	9
5. <i>References.....</i>	21
CHAPITRE I – FUNDAMENTAL OF SOLID FLUID INTERACTION FOR EXTRACTION UNIT OPERATION	23
I. INTRODUCTION	24
II. POROUS MATERIALS.....	25
1. <i>Structure characteristics of porous material.....</i>	25
2. <i>Functional properties of porous materials</i>	26
2.1. Thermal characteristics.....	26
2.2. Mass transfers	29
III. VOLATILE COMPOUNDS – PROCESS INTENSIFICATION	30
1. <i>Volatility.....</i>	30
1.1. Vapor Pressure and Boiling.....	30
1.2. Impact in terms of distillation and steam-distillation processes:	31
1.3. Relative Volatility.....	31
2. <i>Issues regarding standard essential oil Extraction.....</i>	32
2.1. Surface/Superficial secretion zone of essential oils.....	33
2.2. Deep secretion zones of essential oils.....	35
3. <i>Intensification of essential oil extraction</i>	40
3.1. Microwave technology	41
3.2. Instant controlled pressure drop technology	47
IV. NON-VOLATILE COMPOUNDS IN NATURAL PRODUCTS	56
1. <i>Solvent extraction process</i>	56
1.1. General aspects	56
1.2. Principle	57
1.3. Conclusion: Intensification – How to intensify?.....	65
2. <i>Instant controlled pressure drop (DIC)</i>	67
2.1. DIC – Texturing	67
2.2. Fundamental and modeling.....	68
3. <i>Ultrasounds.....</i>	71
3.1. Principle – Fundamental aspects	71
3.2. Physical Effects of Ultrasound and Cavitation.	73

4. <i>Microwaves</i>	76
V. CONCLUSION.....	80
VI. REFERENCES.....	81
CHAPITRE II – DEODORIZATION OF ROSEMARY LEAVES BY INSTANT AUTOVAPORIZATION	87
I. INTRODUCTION.....	88
II. MATERIALS AND METHODS.....	90
1. <i>Plant material</i>	90
2. <i>Protocol treatment</i>	91
3. <i>Hydrodistillation (HD) apparatus and protocol</i>	91
4. <i>DIC apparatus and treatment</i>	92
5. <i>Solvent extraction after deodorization</i>	93
6. <i>Microwave Assisted Extraction</i>	93
6.1. Microwave Soxhlet apparatus.....	93
6.2. Treatment.....	95
7. <i>Assessment protocol</i>	95
7.1. Statistical and experimental design protocol.....	95
7.2. Gas Chromatography – Mass spectrometry identification.....	97
7.3. High Performance Liquid Chromatography (HPLC) analysis.....	98
7.4. Scanning electron microscopy (SEM).....	98
7.5. Histochemistry.....	98
7.6. Nitrogen adsorption: specific surface area calculation.....	99
III. RESULTS AND DISCUSSION.....	100
1. <i>Optimization of instant controlled pressure drop deodorization</i>	100
2. <i>Essential oil composition</i>	102
3. <i>Antioxidant extraction after deodorization</i>	104
3.1. Ultraturrax extraction.....	104
3.2. Microwave soxhlet extraction.....	105
4. <i>Scanning electron microscopy (SEM)</i>	106
5. <i>Histochemistry</i>	108
6. <i>Nitrogen adsorption: specific surface area</i>	109
7. <i>Operational costs</i>	111
IV. CONCLUSION.....	112
V. REFERENCES.....	113
CHAPITRE III – COUPLING DIC AND ULTRASOUND FOR ORANGE PEEL EXTRACTION.....	116
I. INTRODUCTION.....	117
II. MATERIALS AND METHODS.....	121
1. <i>Plant material</i>	121
2. <i>Chemicals</i>	121

3.	<i>Protocol</i>	122
4.	<i>Hydrodistillation apparatus and protocol</i>	122
5.	<i>Instant controlled pressure drop apparatus and protocol</i>	123
6.	<i>Ultrasound Assisted Extraction (UAE)</i>	125
7.	<i>Solvent Extraction (SE)</i>	125
8.	<i>Assessment</i>	126
8.1.	Kinetics modeling: diffusivity and starting accessibility.....	126
8.2.	Statistical and experimental design protocol.....	126
8.3.	Gas chromatography analysis.....	128
8.4.	HPLC analysis.....	129
8.5.	Measurement of antioxidant activity.....	129
8.6.	Scanning Electron Microscope SEM.....	130
III.	RESULTS AND DISCUSSION.....	131
1.	<i>Hydrodistillation</i>	131
2.	<i>DIC optimization Statistical and experimental design protocol</i>	132
3.	<i>Essential oil Gas chromatography analysis</i>	136
4.	<i>Comparative extraction yields and kinetics of SE and UAE</i>	138
5.	<i>Antioxidant activity</i>	142
6.	<i>Impact of treatments on microstructure</i>	142
IV.	CONCLUSION.....	144
V.	REFERENCES.....	145
CHAPITRE IV – KINETIC MODELING OF CANOLA OIL EXTRACTION		149
I.	INTRODUCTION.....	150
II.	MATERIALS AND METHODS.....	153
1.	<i>Plant and Chemicals</i>	153
2.	<i>Experimental Protocol</i>	153
3.	<i>Instant controlled pressure drop reactor and protocol</i>	154
4.	<i>Soxhlet extraction apparatus and procedure</i>	154
5.	<i>Analytical Procedures and Assessments</i>	155
5.1.	Sieving instrument.....	155
5.2.	Statistical and experimental design protocol.....	155
5.3.	Gas chromatography.....	156
III.	CALCULATION: KINETIC MODELING – DIFFUSIVITY AND STARTING ACCESSIBILITY.....	157
IV.	RESULTS AND DISCUSSION.....	158
1.	<i>Extraction kinetics: Study and Modeling</i>	158
2.	<i>Starting accessibility</i>	159
3.	<i>Effective diffusivity</i>	160
4.	<i>Oil analysis via Gas chromatography</i>	163

5.	<i>Correlation between oil yield obtained via weighing and via gas chromatography</i>	164
6.	<i>Impact of DIC parameters on oil extraction yields</i>	164
7.	<i>Fatty acid composition (percentage level)</i>	166
V.	CONCLUSION	170
VI.	REFERENCES	171
	CONCLUSION GENERALE & PERSPECTIVES	176

Nomenclature

Symbol	Definition	Units
$ \mathbf{E}(\mathbf{r}) $: amplitude of electric field intensity	V.m^{-1}
$\langle \mathbf{D} \rangle$: average granule size	m
A	: effective exchange area at the solid-plant surface between the solid-plant surface and the condenser surface	m^2
c_p	: specific heat at constant pressure	$\text{J kg}^{-1} \text{K}^{-1}$
D_{eff}	: effective diffusivity	$\text{m}^2 \text{s}^{-1}$
d_p	: penetration depth	m
r_d	: average radius	m
e	: half of thickness	m
ESA	: exchange surface area between solvent and the product	m^2
$f_{\text{expulsion}}$: density of the expulsion force	N/m^3 or $\text{kg m}^{-2} \text{s}^{-2}$
f_k	: volume fraction of the system	
f_s	: density of the friction force acting on the fluid at its contact surface with the solid	N/m^3 or $\text{kg m}^{-2} \text{s}^{-2}$
g	: gravitational acceleration	m.s^{-2}
H	: heat exchange coefficient by global convection/condensation processes	
h	: Convection coefficient	$\text{W m}^{-2} \text{K}^{-1}$
k	: exchange coefficient of mass transfer by diffusion/convection in the surrounding medium	$\text{m}^{-1} \text{s}$ or $\text{kg s}^{-1} \text{m}^{-2} \text{Pa}^{-1}$
k_f	: friction coefficient between the two bodies	$\text{kg m}^{-1} \text{s}^{-3}$
K	: permeability	m^2
k_{cond}	: coefficient of condensation	$\text{kg m}^{-2} \text{s}^{-1} \text{K}^{-1}$
k_e	: is the coefficient of dissolution of solute by the solvent	$\text{kg of solvent m}^{-2} \text{s}^{-1}$
L	: is the latent heat of evaporation	J kg^{-1} or $\text{m}^2 \text{s}^{-2}$
l_p	: heated material thickness	m
m_d	: sample dry material weight	g
M	: molar mass	kg.mol^{-1}
m_s	: mass of solute extracted by interaction between the solvent and the superficial part of the product	kg of solute
m_v	: mass of vapor generated by expansion of the treatment pressure (initial pressure), to the final pressure	g
$m_{v,EO}$: essential oil vapor mass	kg
$\dot{m}_{v,EO}$: essential oil vapor rate	kg s^{-1}
$m_{v,W}$: water vapor mass	kg
$\dot{m}_{v,W}$: water vapor rate	kg s^{-1}
p	: vapor pressure	Pa
P_f	: final pressure (surrounding pressure) just after pressure drops	Pa
\dot{Q}	: total heat flow rate	W
\dot{q}	: heat generation	W.m^{-3}
R	: radius of the pore	m

R_{GP}	: is the ideal gas constant	J.mol ⁻¹ .K ⁻¹
s	: density of expulsiing section depending on the structure of the plant organ	m ² /m ³
S	: smooth surface	m ²
S_{eff}	: efficient exchange surface	m ²
SESA	: is the specific exchange surface area between the solvent and the product per unit of dry basis	m ² kg ⁻¹
T	: Temperature	°C or K
t	: time	s
T_{cond}	: temperatures at the condenser surface	°C or K
T_e	: temperature at equilibrium level (quasi-static transformation)	°C or K
T_t	: temperatures of treatment	°C or K
T_{g,m}	: glass transition temperature of the dry material	°C or K
T_{g,w}	: glass transition temperature of the pure water	°C or K
T_p	: temperature reached by the product just after the pressure drops	°C or K
T_s	: temperature at the exchange surface evolving from T _i to T _t	°C or K
T_{steam}	: temperatures of steam	°C or K
t_v	: time of the vacuum stage	s
T_{X-S}	: temperatures at the exchange surface	°C
v	: velocity of the solid dry material	m.s ⁻¹
W	: Water content dry basis	%
W'	: Water content dry basis after pressure drop	%
W_i	: initial moisture of the treated product	% of dry matter.
X	: amount of solute extracted at time t	g.g ⁻¹ dry material
X_∞	: initial amount of solute within the matrix=amount of solute extract at t ==> infinite	g.g ⁻¹ dry material
X_s	: density of solute per unit of dry matter extracted by interaction between the solvent and the superficial part of the product	kg of solute/kg of dry matter or % db
α_{eff}	: effective thermal diffusivity	m ² s ⁻¹
δ	: pore diameter	m
δX_s	: Starting accessibility	kg of solute/kg of dry matter
ε'	: dielectric constant	
ε''	: loss factor	
ε*	: complex relative permittivity	
ε_a	: absolute expansion ratio	
λ₀	: wave length	m
λ_a	: intrinsic thermal conductivity of the air	W.m ⁻¹ .K ⁻¹
λ_{app}	: apparent thermal conductivity	W.m ⁻¹ .K ⁻¹
λ_d	: intrinsic thermal conductivity of the dry matter	W.m ⁻¹ .K ⁻¹
λ_{eff}	: effective conductivity normally including evaporation/condensation phenomenon within the porous material	W m ⁻¹ K ⁻¹

λ_{pm}	: thermal conductivities of the matrix on parallel	$W \cdot m^{-1} \cdot K^{-1}$
λ_{sm}	: thermal conductivities of the series structures	$W \cdot m^{-1} \cdot K^{-1}$
$\lambda_{w/s}$: intrinsic thermal conductivities of the water/solvent	$W \cdot m^{-1} \cdot K^{-1}$
μ	: dynamic viscosity	Pa.s
μ^*	: complex relative permeability	
ν	: kinematic viscosity	$m^2 \cdot s^{-1}$
ξ	: expansion ratio	
ξ_{abs}	: absolute expansion ratio	
$\rho_{bulk} = \rho_d$: apparent density of the dry material	$kg \cdot m^{-3}$
ρ_{EO}	: apparent density of liquid essential oils in the material	$kg \cdot m^{-3}$
$\rho_{intrinsic}$: intrinsic (or true) solid density	$kg \cdot m^{-3}$
ρ_d	: apparent density of dry material	$kg \cdot m^{-3}$
ρ_{solute}	: apparent density of the solute within the solid matrix	$kg \cdot m^{-3}$
ρ_w	: apparent density of water in the material	$kg \cdot m^{-3}$
ϕ	: heat flow within the porous material	$W \cdot m^{-2}$
Ψ	: porosity ratio	
ω_e	: dissolving coefficient at equilibrium	kg of solute kg^{-1} of solvent
$\omega_{solvent}$: solute dissolved in solvent	kg of solute kg^{-1} of solvent
\mathbb{H}	: electrical energy stored per unit volume	$J \cdot m^{-3}$

Introduction Générale

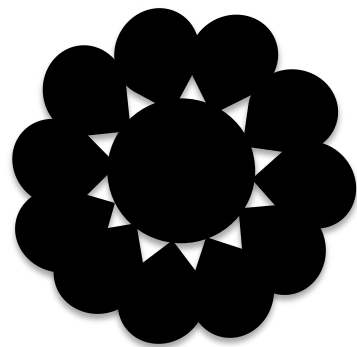

INTRODUCTION GENERALE

1. Contexte

De nos jours, la quasi-totalité des procédés de fabrication dans les secteurs industriels cosmétique, pharmaceutique, agroalimentaire et de la parfumerie fait directement ou indirectement appel à l'extraction des ingrédients issus des plantes. Afin de réagir à ces demandes, les divers milieux industriels cherchent à adopter des procédés pertinents pour l'extraction des composés à base de plantes. De larges gammes de molécules naturelles sont ainsi destinées à remplacer les composés de synthèse dans les différents secteurs concernés. Les opérations recherchées concernent aussi bien les composés volatils que les non volatils.

Les huiles essentielles forment souvent la plus grande partie des molécules volatiles présentes dans les plantes. Pendant longtemps elles n'ont concerné que l'industrie de la parfumerie, mais aujourd'hui, elles sont de plus en plus utilisées dans d'autres domaines, comme l'alimentation ou la cosmétique. Parmi les composés non-volatils, présents dans les végétaux, les antioxydants ou les huiles végétales font partie des composés d'intérêts à haute, voire très haute valeur ajoutée. Ils sont cependant caractérisés par une faible disponibilité et restent coûteux à extraire. Les plantes concernées sont extrêmement ciblées en termes d'origine géographique ou de mode de culture. Les marchés concernés sont versatiles et exigent des entreprises en extraction d'être capables de rapidement mettre en œuvre de nouveaux produits aux différentes échelles de production (essais de faisabilité, production de lots pour tests et caractérisation, premiers lots de fabrication pour essais du client final avant d'entamer une réelle production de lots).

Les industries intéressées par ces types de molécules ont besoin de définir des procédés d'extraction plus efficaces et/ou d'intensifier les procédés conventionnels d'extraction en vue de les rendre plus rentables, plus pertinents et plus adaptés aux contraintes de l'environnement. En effet, les procédés conventionnels ne sont pas ou plus adaptés:

1. Longue durée d'extraction
2. Faible rendement
3. Utilisation importante de solvants et d'énergie
4. Importants rejets (solides et liquides)
5. Procédés fonctionnant généralement par batch

Les enjeux politiques, économiques, sociétaux ou encore environnementaux imposent désormais des innovations technologiques que l'on peut qualifier de rupture et non plus seulement incrémentales.

La commission européenne à travers la consigne REACH (Registration, Evaluation, Authorisation and Restriction of CHemicals) s'est focalisée sur l'enregistrement, l'évaluation, l'autorisation et les restrictions des substances chimiques en tant que telles ou intervenant dans les produits ou les objets manufacturés. Quant à la directive européenne dite IPPC (Integrated Pollution Prevention Control), elle vise à prévenir et réduire la contribution de l'industrie au développement non durable à l'échelle européenne, puis mondiale. L'objectif est de définir au niveau européen une approche intégrée de la prévention et de la réduction des pollutions émises par les installations industrielles et agricoles entrant dans son champ d'application. Un de ses principes directeurs est le recours aux MTD (Meilleure Technologie Disponible) afin de prévenir les pollutions de toutes natures.

L'objectif de cette directive est de définir le stade de développement le plus efficace et le plus avancé des activités et de leurs modes d'exploitation. Les MTD doivent démontrer leur aptitude pratique à constituer la base des valeurs limites d'émission visant à éviter et, lorsque cela s'avère impossible, à réduire de manière générale les émissions et l'impact sur l'environnement dans son ensemble.

Dans ce contexte, les opérations unitaires du génie chimique et les technologies séparatives associées occupent une place primordiale au cœur du développement de procédés respectueux de l'environnement, à titre curatif ou à titre préventif. C'est pourquoi, on note une politique de R&D toujours active dans ce domaine, même sur des procédés dits historiques comme l'extraction solide-liquide.

La mise en œuvre de différentes méthodes d'extraction des molécules issues de plantes soulève des questions spécifiques, notamment sur la base des interactions, solide/vapeur, liquide/vapeur et solide/liquide. Les deux premières sont étroitement liées à la capacité d'évaporation / volatilité ; la dernière à la capacité de solubilisation. Dans le cas de ce dernier (extraction par solvant) après le choix d'un solvant adéquat on peut supposer que

la solubilisation du soluté recherché s'effectue d'une façon très rapide. Quatre mécanismes de transfert de masse sont impliqués:

- 1) Interaction entre le solvant et la surface du produit
- 2) Diffusion du solvant dans le produit
- 3) Diffusion du soluté dans le solvant
- 4) Transport du soluté en dehors de la surface du produit vers le solvant environnant

La structure de nombreux matériaux naturels, principalement biologiques, joue un rôle essentiel dans la cinétique et dans la progression des opérations d'extraction de molécules non-volatiles (principes actifs...) ou volatiles (huiles essentielles, arômes,...). Quand le choix du solvant a assuré un potentiel de solubilisation élevé et que les processus de transfert externes de matière et de chaleur sont assez intenses ou ont été assez intensifiés pour ne plus être les facteurs limitant l'opération, la structure propre de la matière limite le processus, traduisant ainsi la mauvaise aptitude technologique naturelle de la matière.

Dans les opérations d'extraction par solvant, en particulier des composés non volatils à partir des produits solides, le choix du solvant et de ses propriétés vis-à-vis des molécules visées (capacité de mise en solution, polarité, sélectivité) est un élément essentiel. Cependant, une fois les transferts externes suffisamment intensifiés, la structure naturelle forme, là également, une grande résistance au transfert du solvant liquide strictement dépendante de la viscosité (transfert interstitiel). D'autre part, les parois cellulaires interviennent comme une barrière supplémentaire (transfert intracellulaire).

En pratique, l'opération d'extraction solide-liquide ne peut être dissociée des étapes amont (préparation du solide, conditionnement, séchage, broyage...) et aval (séparation du solide et du liquide, récupération et purification du soluté, éventuellement régénération du solvant par évaporation, distillation ou extraction liquide-liquide). La mise en œuvre à l'échelle laboratoire ou industrielle fait appel à de nombreuses opérations unitaires.

De plus, l'utilisation du solide implique de nombreuses contraintes, au niveau de la manipulation, du choix d'appareillage robuste ou des règles de sécurité. Cette spécificité laisse, à côté des outils théoriques classiques du Génie des Procédés, une grande part à un savoir-faire que l'on ne peut facilement mettre en équation.

Une grande diversité de technologies et d'appareils ont ainsi été mis au point et sont utilisés dans le domaine de l'extraction solide-liquide.

2. Les six principes de l'éco-extraction

En janvier 2010, plus de 60 chercheurs et professionnels travaillant dans le domaine de l'extraction des produits naturels se sont réunis à Grasse, sous l'impulsion de « France Eco-Extraction », pour définir l'éco-extraction et ses principes. Une définition très générale a été adoptée : « l'éco-extraction est basée sur la découverte et la conception de procédés d'extraction permettant de réduire la consommation énergétique, mais aussi l'utilisation de solvants alternatifs et des ressources végétales renouvelables, tout en garantissant un produit/extrait sûr et de qualité ».

Plusieurs ateliers de réflexion ont permis de lister les attentes mais aussi d'envisager les visions futures, dans un contexte de développement durable, aussi bien au niveau des producteurs de matières premières végétales, que des industriels transformateurs, des formulateurs de produits finis, des chercheurs académiques et des institutionnels. Une des conclusions de ces groupes de travail a été la nécessité de la notion d'« éco-extrait » qui touche directement les consommateurs bien au-delà de l'éco-extraction. Des travaux sont menés sur la réflexion d'un label spécifique d'« éco-extrait » mais également sur l'évaluation de l'impact environnemental de cet extrait, à l'aide de l'Analyse de Cycle de Vie (ACV).

Voici les principes tels qu'énoncés (Vian et al., 2011) :

PRINCIPE 1 : Favoriser l'innovation par la sélection variétale et l'utilisation de ressources végétales renouvelables.

PRINCIPE 2 : Privilégier les solvants alternatifs et principalement ceux issus des agro-ressources.

PRINCIPE 3 : Réduire la consommation énergétique par l'assistance des technologies innovantes et favoriser la récupération d'énergie.

PRINCIPE 4 : Favoriser la création de coproduits au lieu de déchets pour intégrer la voie de la bio- ou agro-raffinerie.

PRINCIPE 5 : Réduire les opérations unitaires grâce à l'innovation technologique et favoriser les procédés sûrs, robustes et contrôlés.

PRINCIPE 6 : Privilégier un produit non dénaturé, biodégradable, sans contaminants et surtout porteur de valeurs : « éco-extrait ».

Trois voies majeures ont été identifiées pour parvenir à imaginer, concevoir et faire la démonstration à l'échelle industrielle de ces principes :

- L'amélioration des procédés existants, en proposant des ruptures technologiques et de mise en œuvre ;
- Le détournement d'appareils non dédiés pour parvenir au plus proche d'un optimal de consommation de matière première et d'énergie ;
- L'innovation méthodologique et technologique.

3. Axe de recherche de la thèse

Dans le travail présenté, nous avons focalisé notre effort de recherche sur l'étude des procédés d'extraction dans le but de les intensifier, en vue d'atteindre la meilleure qualité d'extrait, les plus hauts taux de rendement et les meilleures performances du procédé.

Comme point de départ, nous avons décidé d'examiner les méthodes classiques, d'en analyser la performance, d'en identifier les inconvénients en termes de processus, de qualité du produit ou encore d'impact environnemental, et de formuler les améliorations possibles à ces différents points de vue. Nous avons tout naturellement cherché à ne pas limiter notre approche à une simple modification technique. Notre objectif n'a nullement visé l'invocation d'arguments en tant qu'un jugement de valeur capable de justifier l'adoption ou le rejet de solutions techniques spécifiques. L'analyse des processus innovants a suivi un cheminement intellectuel et une approche philosophique similaires. Dans les deux cas, il s'agit de s'interroger aux niveaux fondamental et technologique. Nous avons essayé de commencer avec une analyse aussi exhaustive et aussi pertinente que possible des lois de transfert. L'identification du phénomène limitant sera l'élément de

base, c'est-à-dire le point de départ pour la sélection d'une technologie. Chaque technologie candidate a systématiquement été analysée, évaluée et éventuellement adoptée en fonction de sa capacité à remédier à la situation « limitante » ainsi identifiée sans perdre de vue la nécessité de mise en œuvre industrielle du procédé.

Toute opération d'extraction est un pari sur la possibilité d'identifier un comportement physique généralement sélectif, distinctif et différent selon le composé.

Un solvant est non-seulement choisi à partir de sa capacité à solubiliser sélectivement les molécules recherchées. Les contraintes de plus en plus fortes qu'exercent la législation et l'augmentation des coûts, ont accentuées la tendance des solvants alternatifs et principalement ceux issus des agro-ressources. En effet, l'utilisation des solvants pétrochimiques est aujourd'hui très réglementée. Chaque producteur ou importateur d'extrait devra désormais apporter la preuve de l'innocuité du solvant utilisé lors de l'extraction mais également la non-nocivité des résidus éventuels des extraits finaux.

En ce qui concerne les procédés, ils sont adoptés de par leur action sur le végétal et l'effet qu'ils auront sur l'extraction. Il est approprié de donner ici une idée sur les différents procédés innovants mis en avant dans le contexte d'Eco-Extraction du végétal et qui ont été étudiés dans nos travaux.

- **La Détente Instantanée Contrôlée (DIC)**

Issue des études théoriques concernant l'expansion lors de l'extrusion, la technologie DIC est fondée sur la thermodynamique de l'instantanéité et des processus d'autovaporisation couplés à l'évolution hydro-thermo-mécanique de nombreux composés à usages alimentaires, cosmétiques ou encore pharmaceutiques. Cette technologie est capable de coupler, presque systématiquement, la maîtrise de l'aptitude technologique, pour un produit de haute qualité, avec la réduction du coût énergétique. Ce procédé innovant a été étudié, développé, optimisé et utilisé à l'échelle industrielle pour des applications diverses telles que le séchage (Mounir et al., 2012), la décontamination (Debs-Louka, 2000), l'extraction directe de composés volatils (Besombes et al., 2007), la texturation (Delgado-Rosas et al., 2006) et le pré-traitement pour l'extraction de molécules non volatiles telles que les flavonoïdes (Ben Amor and Allaf, 2009).

- **Les Micro-Ondes**

Ce sont des ondes électromagnétiques résultantes d'un champ électrique \vec{E} et d'un champ magnétique \vec{H} perpendiculaires entre eux et à la direction de propagation. Les applications de ces ondes ont pu être mises en évidence dans des domaines variés tels que : la synthèse organique (Loupy, 2004), l'environnement (Pérez-Cid et al., 1999), l'agroalimentaire (Lau and Tang, 2002), la médecine (Battocletti, 1995), l'extraction (Camel, 2000), etc. Ainsi les procédés d'extraction par micro-ondes sont implantés aujourd'hui dans le domaine de l'agroalimentaire, de la cosmétologie et de la pharmacie.

- **Les Ultrasons de puissance** (intensité ultrasonore $> 1 \text{ W.cm}^{-2}$ et fréquence de 20 kHz à 1 MHz)

Ils peuvent entraîner des modifications de type mécanique, thermique ou chimique. Actuellement, les ultrasons sont utilisés dans des domaines de production et de recherche très variés. Ces applications touchent différents secteurs et domaines allant de la cristallisation (Louhi-Kultanen et al., 2006) au nettoyage des surfaces (Farmer et al., 2000) en passant par l'atomisation (Avvaru et al., 2006), le découpage/tranchage (Eggers et al., 2004), le traitement antibactérien (Rehorek et al., 2004), l'extraction (Vilkhu et al., 2008), etc. L'extraction assistée par ultrasons est de plus en plus répandue dans le monde industriel. En effet, dans la grande majorité des cas, les rendements, la quantité de solvant et les temps de manipulation sont améliorés par cette technologie.

4. Plan d'étude de la thèse

L'éco-extraction tend donc à favoriser les procédés innovants, continus ou semi-continus, à grand rendement, avec optimisation des quantités de solvants et d'énergie utilisées. Le domaine de l'extraction du végétal a aujourd'hui, tout comme le monde industriel, un besoin et une obligation de produire de façon plus propre, plus sûre et plus respectueuse de l'environnement. Cette tendance est plus connue sous le terme d'intensification des procédés de production. Aujourd'hui, l'enjeu est de développer de nouvelles techniques apportant une/des amélioration(s) significative(s) de manière générale et spécifiques par rapport aux modes de production actuels. Il est cependant important d'éviter un mauvais usage de l'idée d'intensification souvent due à une interprétation erronée focalisant l'effort

sur le procédé proprement dit. En effet, afin d'intensifier un processus ou un procédé il faut non seulement établir les données théoriques, agir sur le contexte environnant mais également étudier le végétal, sa structure, ses propriétés physiques et fonctionnelles...

Un processus d'intensification débute, au plan intellectuel, par une détermination indispensable du processus limitant du procédé utilisé. Il est alors possible d'aboutir à la proposition d'une solution adéquate, externe ou interne, éventuellement capable de générer un nouveau processus limitant et donc une nouvelle solution. Le tout doit, souvent, nous amener à opter pour un dépassement du procédé proprement dit. De nouveaux procédés peuvent ainsi être développés de manière adéquate. L'innovation en terme de procédés éco-conçus permet d'obtenir des réponses adaptées aux problèmes rencontrés. En effet aujourd'hui, de nombreuses techniques émergentes appliquées au domaine de l'extraction ont l'avantage de réduire le nombre d'étapes, de diminuer le temps d'extraction et la quantité de solvant afin de devenir moins énergivores.

Notons par ailleurs que les contraintes environnementales et éventuellement économiques imposent le plus souvent une valorisation successive des coproduits. Il est alors nécessaire d'optimiser la valeur tirée des matières premières. Un produit, après une première extraction, peut être récupéré et réutilisé pour d'autres applications, produisant ainsi plusieurs produits d'une même source.

Pour contribuer à l'étude de ces problématiques, cette thèse s'articule autour de quatre chapitres :

Chapitre 1 :

Les aspects fondamentaux des procédés d'extraction ont été défini afin de déterminer les limites potentielles de chaque procédé étudié et d'assigner les intensifications en conséquences.

Chapitre 2 :

Une étude sur la désodorisation des feuilles de romarin a été effectuée par Détente Instantanée Contrôlée, suivie par une extraction par solvants de ses molécules antioxydantes non-volatiles.

Chapitre 3 :

Une extraction séquentielle des huiles essentielles et des flavanones des écorces d'orange à travers la Détente Instantanée Contrôlée et les Ultrasons a été étudiée.

Chapitre 4 :

La cinétique d'extraction d'huile de colza a été étudiée par modélisation, en insistant sur l'impact des paramètres de la Détente Instantanée Contrôlée.

Chapitre 1

Dans un premier chapitre, nous avons défini les caractéristiques fondamentales en mettant en avant les aspects paradoxaux ou limitants. Ce chapitre sera structuré autour de deux axes capables d'être identifiés sous le vocable de : extraction de composés volatiles et de composés non-volatiles. Dans la première partie nous avons procédé à la définition de la notion de volatilité, en donnant quelques exemples de volatilité relative de composés présents dans l'huile essentielle de romarin ou écorces d'agrumes. Ceci nous a permis d'expliquer et d'illustrer les procédés classiques (entraînement à la vapeur, hydrodistillation) d'un point de vue fondamental (voir Figure I-1). Il est indispensable de préciser qu'en ce qui concerne l'extraction, les problèmes rencontrés peuvent concerner plusieurs aspects tels que la structure centrale ou encore les transferts de chaleur et de masse (liquide et vapeur).

Dans la première partie, concernant les molécules volatiles, nous avons surtout mis l'accent sur l'extraction de l'huile essentielle. Celles-ci sont généralement extraites via hydrodistillation (extraction solide-liquide) ou entraînement à la vapeur (extraction solide-gaz). Les cinétiques de l'étape d'extraction de ces techniques sont connues pour être particulièrement lente (temps de traitement allant jusqu'à 24 heures, voire plus), impliquant une grande consommation d'énergie et une possible dégradation des molécules thermo-sensibles.

Le procédé d'entraînement à la vapeur dépend de la différence entre les pressions partielles de vapeur des composants individuels à la température considérée. Les pressions de vapeur sont, à première approximation, normalement indépendantes des concentrations des différents composés ; elles évoluent strictement en fonction de la température et ne suivent que par épuisement, l'évolution du mélange liquide et la concentration liquide/solide. Par conséquent, l'entraînement à la vapeur dépend des caractéristiques de pression de vapeur du liquide ou du mélange de liquides, et des interactions éventuelles des composés solides et liquides considérés et de leur évolution.

L'entraînement à la vapeur génère un paradoxe. En effet, ce procédé entraîne un transfert de chaleur allant de la surface vers l'intérieur (par conduction effective). Le transfert de matière sous forme de vapeur ne dépendant que de la pression partielle suit, de toute évidence, le même sens. Autrement dit, cette situation implique un transfert des composés volatils sous forme de vapeur vers le centre du milieu poreux considérés. Pour résoudre cette situation paradoxale, un seul moyen : instaurer un transfert de vapeur par gradient de pression totale (Loi de Darcy) au lieu du transfert diffusionnel usuel (similaire à la loi de Fick) ; deux propositions ont ainsi été envisagées:

1. Le chauffage par micro-ondes dont le processus de chauffage principal n'implique pas un gradient de température entre la surface et le cœur de la matière. La situation paradoxale est alors réduite, voire supprimée.
2. L'autovaporisation instantanée par DIC (Détente Instantanée Contrôlée) qui implique un transfert de type Darcy volatile de l'intérieur du matériau vers le milieu sous vide environnant.

Dans la deuxième partie nous nous sommes concentrés sur les molécules non-volatiles, en nous focalisant principalement sur l'extraction des molécules antioxydantes et de l'huile végétale.

Dans toutes les méthodes d'extraction des composés non-volatils, le transfert de masse que nous avons considéré pendant l'extraction par solvant est entravé et limité par la structure de la matrice et celle de la paroi cellulaire. L'extraction classique par solvant a été illustrée au niveau fondamental via une modélisation de la cinétique d'extraction, en montrant l'accessibilité initiale (étape de "lavage") et la diffusivité effective. Nous concluons qu'il est possible d'intensifier l'extraction par solvant sur ces deux niveaux. L'accessibilité initiale peut être intensifiée par une plus grande surface spécifique et la diffusivité par une meilleure interaction entre le solvant et la surface d'échange.

1. L'expansion de la matrice par DIC, génère une augmentation de la surface spécifique du végétal, ce qui entraîne une augmentation de l'accessibilité initiale.
2. Les Ultrasons permettent, tout particulièrement dans les pores expansés, de produire une convection interne, intensifiant ainsi le transfert des composés vers le solvant lui-même présent dans les pores du végétal.
3. Les Micro-Ondes générant de la chaleur en divers points du volume du produit peuvent induire, si la puissance est assez élevée, une quantité de vapeur permettant de briser les parois cellulaires et rendre la résistance de la structure face au transfert du solvant, pur ou chargé de soluté, considérablement plus réduite.

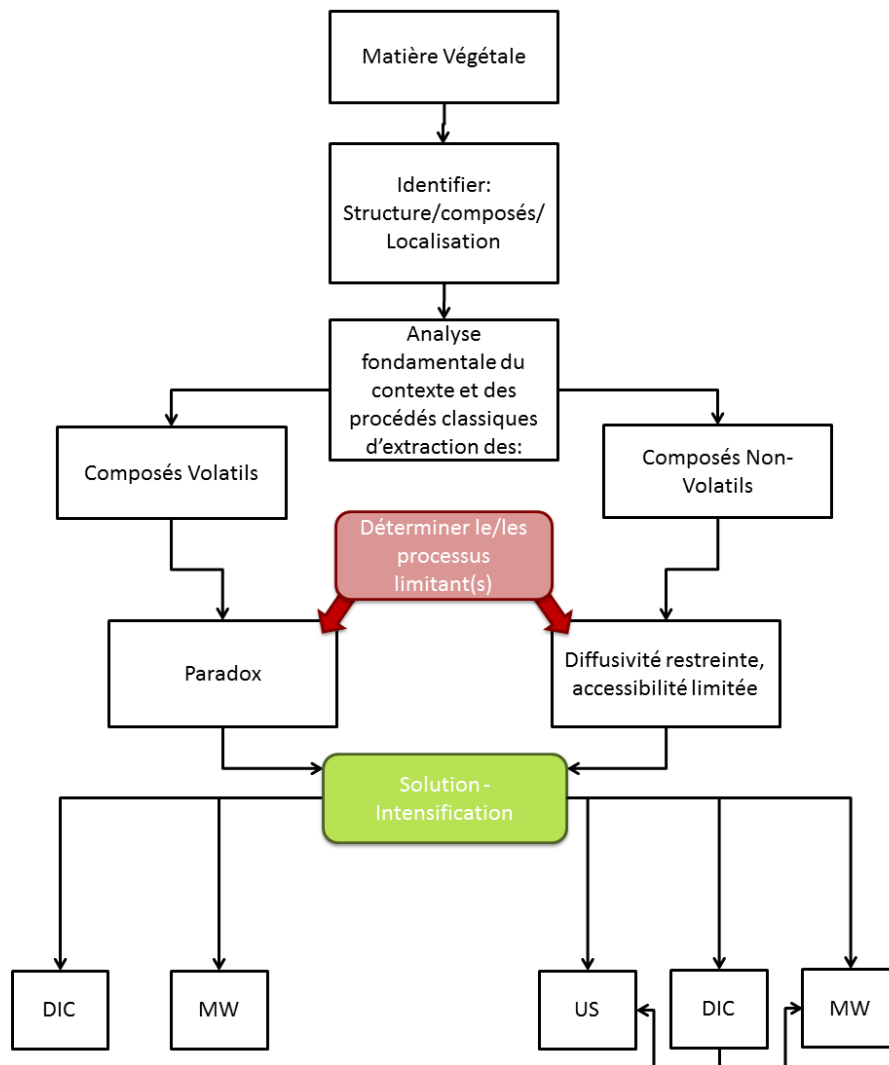

Figure I-1 : Principe et philosophie d'intensification

Chapitre 2

Ce second chapitre est consacré à la désodorisation du romarin avant l'extraction de ses molécules antioxydantes non-volatiles (Figure I-2).

Il est important de préciser que la prise de conscience croissante des consommateurs et leur préoccupation en matière de santé, a encouragé les entreprises agro-industrielles à chercher à substituer des antioxydants synthétiques, tels que le butylhydroxyanisole (BHA) et l'hydroxytoluène butylé (BHT), par des antioxydants naturels.

Les feuilles de Romarin (*Rosmarinus officinalis*), connues pour avoir une forte activité antioxydante, sont de plus en plus valorisées et de plus en plus utilisées. Les principales substances liées à cette activité sont les diterpènes phénoliques, tels le carnosol, le rosmanol, l'acide carnosique et les acides phénoliques, tel l'acide rosmarinique. Cependant, les feuilles de romarin contiennent entre 0,7 et 3% d'huiles essentielles (sur base fraîche) selon la variété, le mode de récolte, leur situation géographique...

Les procédés d'obtention d'antioxydants devraient préserver une forte activité antioxydante tout en réduisant voire éliminant complètement l'aspect odorant.

Une première étude sur les feuilles de romarin a montré une amélioration relative de l'extraction de composés volatiles assistée par DIC par rapport à d'autres procédés d'extraction classiques. D'autres études ont fourni des éléments nouveaux par rapport aux phénomènes d'autovaporisation à travers la DIC. Ceci a été observé et expliqué aux deux niveaux fondamental et expérimental. Ces résultats ont montré l'intérêt qu'il y a d'étudier la désodorisation par DIC avant d'effectuer l'extraction d'antioxydants par solvant.

Dans ce chapitre, nous avons mis en avant non seulement l'étape d'extraction des huiles essentielles, mais également les résultats de l'extraction par solvant post désodorisation. Nous avons donc procédé à une comparaison entre les méthodes de « déodorisation » (hydrodistillation et DIC) et à une comparaison en termes d'antioxydants extraits des feuilles de romarin après ces traitements. Des études de microscopie électronique optique et à balayage ont été réalisées afin de comprendre, à l'échelle structurale, les effets spécifiques de l'hydrodistillation et de la DIC sur les tissus foliaires du romarin.

De plus, la surface spécifique a été calculée afin de mieux interpréter le comportement de chaque matrice.

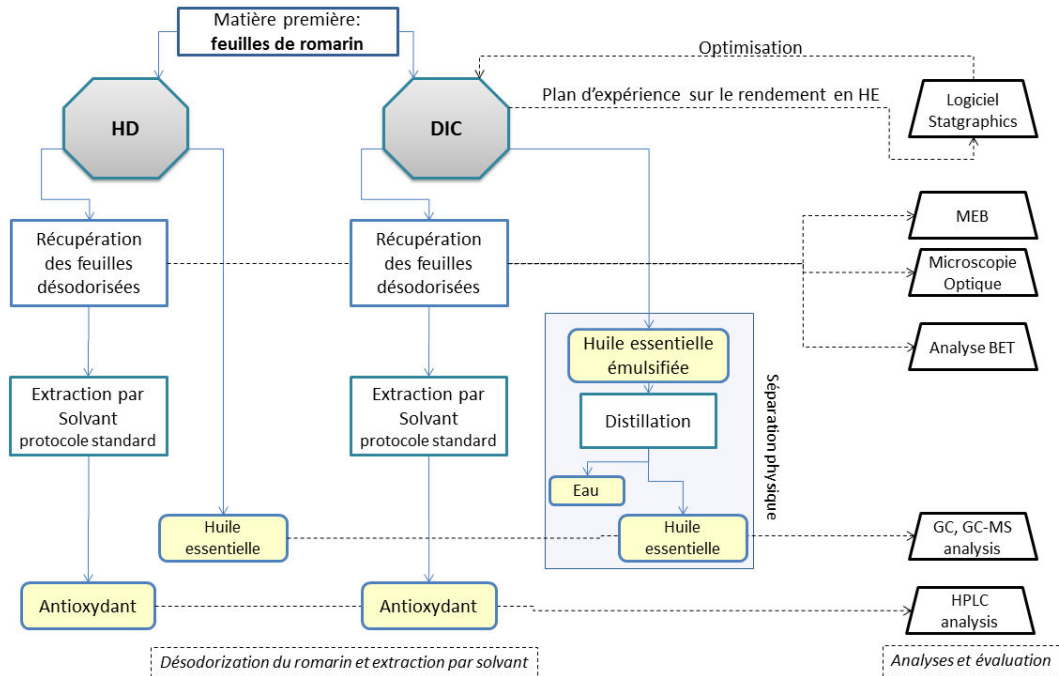

Figure I-2: Protocol d'extraction des feuilles de romarin

Chapitre 3

Le troisième chapitre est consacré à la valorisation des peaux d'agrumes et plus particulièrement des peaux d'oranges. Les industries sont aujourd'hui plus que jamais disposées à valoriser les « déchets », appelés préférentiellement « co-produits », en produits commerciaux à haute valeur ajoutée. La production annuelle d'agrumes dans le monde a doublé au cours des 5 dernières années et est aujourd'hui estimée à plus de 100 millions de tonnes. Près de 50% des agrumes sont utilisées pour produire du jus. La quantité colossale de déchets entraîne une situation inquiétante pour le respect de l'environnement.

L'écorce d'orange contient de l'huile essentielle, que l'on trouve dans des petites glandes situées dans la partie nommée « flavedo », et des molécules antioxydantes (principalement naringine et hespéridine) présentes dans l'« albedo ».

Le produit nécessite un broyage avant la distillation, faute de quoi une grande partie de l'huile essentielle reste dans la matrice solide. De nombreuses technologies d'extraction telles les micro-ondes ou le CO₂ supercritique, ont été envisagées et étudiées afin d'améliorer l'extraction de l'huile essentielle. Cependant, toutes ces techniques nécessitent également un broyage, afin de palier à la structure même des glandes, qui empêche une extraction facilitée des huiles essentielles.

La Détente Instantanée Contrôlée est un procédé qui combine effets thermique et mécanique. Ainsi un cycle de traitement DIC entraîne simultanément l'autovaporisation des composés volatils, une expansion du végétal et un refroidissement instantané du produit. En ce qui concerne les composés volatils, des éléments de ces phénomènes d'autovaporisation (illustrant les effets mécaniques) ont été étudiés de manière fondamentale dans le chapitre précédent. Ici, nous mettons en avant les aspects expérimentaux (Figure I-3).

Par conséquent, il a été proposé d'étudier, tout d'abord à travers une analyse cinétique, la « résistance » des parois des glandes contenant les huiles essentielles, en mettant en évidence les aspects thermiques et mécaniques de l'extraction de l'écorce d'orange. Le procédé d'hydrodistillation a été comparé sur les écorces d'orange, broyées et en morceaux, à travers une modélisation cinétique et en termes de rendements. Par la suite, nous avons analysé les effets thermo-mécaniques de la DIC par une étude statistique. Cette dernière nous permettra de déterminer les prédominances des paramètres de temps de traitement à haute température et du nombre de chutes de pression vers le vide, de façon à mettre en évidence les impacts relatifs de l'autovaporisation face à l'évaporation.

En réalisant une microscopie électronique à balayage, nous avons analysé la structure des produits post-DIC, post-HD et non-traités et les avons comparés. Nous avons ainsi la possibilité de confirmer nos hypothèses fondamentales et expérimentales par des aspects visuels (structures microscopiques).

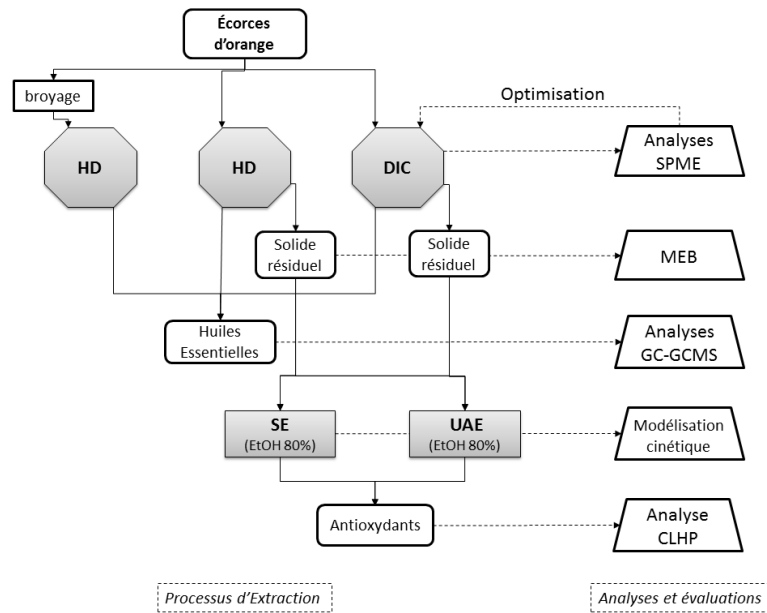

Figure I-3: Protocol d'extraction des écorces d'oranges

L'extraction des composés bioactifs, tels les molécules antioxydantes non-volatiles, est classiquement effectuée à l'aide d'un solvant. Cependant la diffusion du solvant dans une matrice solide est souvent un processus très lent, en particulier si celle-ci est compacte. L'expansion générée par DIC permettrait de la sorte d'améliorer l'extraction par solvant.

L'extraction assistée par ultrasons offre une reproductibilité élevée tout en réduisant le temps de traitement, la température, la consommation de solvants et la consommation d'énergie. Les ultrasons entraînent une agitation réalisant un mouvement de convection interne du solvant présent à l'intérieur des pores. Par ailleurs, la cavitation génère des micro-jets à la surface de la matière alimentaire, ce qui peut augmenter la surface d'échange. Les deux effets peuvent ainsi augmenter les transferts de masse de solvant à l'intérieur du solide et du soluté dans le solvant.

Afin de valoriser au mieux les peaux d'orange, dans cette étude, nous avons procédé tout d'abord à l'extraction des huiles essentielles (via HD et DIC). Les solides résiduels seront récupérés afin d'en extraire les flavonoïdes. Nous réaliserons l'extraction des flavonoïdes (naringine et hespéridine) de manière standard et à l'aide des ultrasons, afin de les comparer quantitativement et qualitativement (activité anti-oxydante). Nous avons effectué une utilisation séquentielle de l'extraction assistée par ultrasons UAE et de la DIC pour visualiser les impacts de cette « combinaison ».

Chapitre 4

Le dernier chapitre est consacré à l'étude de la cinétique d'extraction de l'huile de colza.

La production mondiale de colza est d'environ 5 millions de tonnes par an, ce qui la classe au 5^{ème} rang parmi les cultures d'oléagineux. Les graines de colza contiennent 40 à 55% d'huile. L'huile de colza contient 97 à 99% de triglycérides, 0,5 - 2% d'acides gras libre et de 0,5 à 1% de lipides mineurs (Przybylski et al., 2005). L'huile de colza est source de grandes quantités d'acides gras insaturés. La composition en acides gras est la suivante : 61-63% d'acide oléique C18:1 ; 20-22% d'acide linoléique C18:2 ; 8,5-10% d'acide linoléique C18:3 ; 3,5-4% d'acide palmitique C16:0 ; 1,5-1,8% d'acide stéarique C18:0 ; ~3% d'autres acides gras.

L'extraction d'huile de colza est généralement réalisée par voie mécanique (pressage) ou par solvant. Les deux méthodes d'extraction peuvent être également combinées (extraction par pressage d'une partie de l'huile puis extraction à l'hexane des tourteaux). Certains facteurs, qui influent sur le processus d'extraction, ont déjà été étudiés: la nature du solvant, la taille des particules, les conditions d'extraction (température, pression ...).

L'extraction de l'huile de colza par solvant peut être décrite par deux étapes : l'accessibilité initiale et la diffusivité. L'huile située à la surface est en principe facilement et rapidement retirée au début du processus d'extraction par simple « lavage » au solvant. L'extraction se poursuit par un processus de diffusion caractérisé par une « consommation temporelle » importante. Ce processus diffusionnel semble être contrôlé par deux mécanismes:

- L'un lent, de diffusion sans entrave de l'huile contenue dans les cellules qui sont rompues dans la graine
- L'autre très lent, entravé par les cellules non rompues dans la graine

L'intensification globale d'extraction consiste d'abord à identifier le principal phénomène limitant et ainsi, agir afin d'améliorer la cinétique globale de l'opération.

Dans le présent travail, nous effectuerons une première approche de la modélisation de la cinétique d'extraction par solvant (combiné au traitement DIC), pour des graines de colza grossièrement et finement broyées (Figure I-4).

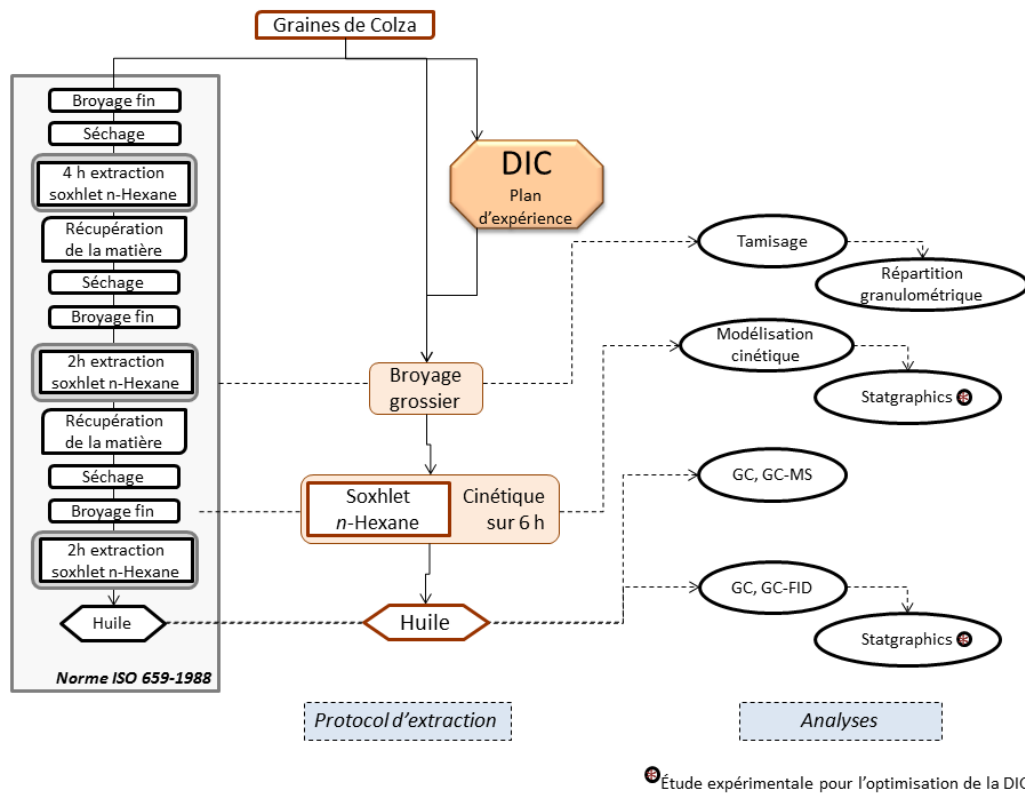

Figure I-4: Protocol d'extraction de l'huile de colza

L'objectif est d'améliorer la performance des processus (dans notre cas cinétique d'extraction) sans modifier le profil en acides gras. L'impact du traitement DIC sur le canola pour l'extraction de l'huile a été étudié et discuté afin d'optimiser les paramètres de prétraitement DIC pour l'intensification.

5. References

- Avvaru, B., Patil, M.N., Gogate, P.R., Pandit, A.B., (2006). Ultrasonic atomization: Effect of liquid phase properties. *Ultrasonics* 44(2), 146-158.
- Battocletti, J.H., (1995). Biomedical Applications of Microwave Engineering, in: Ishii, T.K. (Ed.), *Handbook of Microwave Technology*. Academic Press, Inc., USA.
- Ben Amor, B., Allaf, K., (2009). Impact of texturing using instant pressure drop treatment prior to solvent extraction of anthocyanins from Malaysian Roselle (*Hibiscus sabdariffa*). *Food Chemistry* 115(3), 820-825.
- Besombes, C., Albitar, N., Allaf, K., Barkat, O., (2007). The Instantaneous Controlled Pressure Drop (DIC) for the Extraction of Essential Oils from: Oregano and Jasmine, Graz (Autriche), pp. 44-44.
- Camel, V., (2000). Microwave-assisted solvent extraction of environmental samples. *TrAC Trends in Analytical Chemistry* 19(4), 229-248.
- Debs-Louka, E., (2000). Destruction des microorganismes par voie thermo-mécanique contrôlée dans des produits solides en morceaux ou en poudre. Application aux épices et aromates. Université de La Rochelle, La Rochelle - France.
- Delgado-Rosas, M., Sobolik, V., Allaf, K., (2006). Texturation de la poudre de maltodextrine par détente instantanée contrôlée (Texturing of Maltodextrin powder by instant controlled pressure drop. *Sciences des Aliments*). *Sciences des Aliments* 26(1), 103-111.
- Eggers, G., Klein, J., Blank, J., Hassfeld, S., (2004). Piezosurgery®: an ultrasound device for cutting bone and its use and limitations in maxillofacial surgery. *British Journal of Oral and Maxillofacial Surgery* 42(5), 451-453.
- Farmer, A.D., Collings, A.F., Jameson, G.J., (2000). The application of power ultrasound to the surface cleaning of silica and heavy mineral sands. *Ultrasonics Sonochemistry* 7(4), 243-247.
- Lau, M.H., Tang, J., (2002). Pasteurization of pickled asparagus using 915 MHz microwaves. *Journal of Food Engineering* 51(4), 283-290.
- Louhi-Kultanen, M., Karjalainen, M., Rantanen, J., Huhtanen, M., Kallas, J., (2006). Crystallization of glycine with ultrasound. *International Journal of Pharmaceutics* 320(1-2), 23-29.
- Loupy, A., (2004). *Microwaves in Organic Synthesis*. Wiley-VCH Verlag GmbH & Co. KGaA, Weinheim.
- Mounir, S., Allaf, T., Mujumdar, A.S., Allaf, K., (2012). Swell Drying: Coupling Instant Controlled Pressure Drop DIC to standard convection drying processes to intensify transfer phenomena and improve quality- an overview. *Drying Technology* 30(14), 1508-1531.
- Pérez-Cid, B., Lavilla, I., Bendicho, C., (1999). Application of microwave extraction for partitioning of heavy metals in sewage sludge. *Analytica Chimica Acta* 378(1-3), 201-210.
- Przybylski, R., Mag, T., Eskin, N.A.M., McDonald, B.E., (2005). *Canola Oil, Bailey's Industrial Oil and Fat Products*. John Wiley & Sons, Inc.
- Rehorek, A., Tauber, M., Gübitz, G., (2004). Application of power ultrasound for azo dye degradation. *Ultrasonics Sonochemistry* 11(3-4), 177-182.
- Vian, M.A., Chemat, F., Prat, L., Gourdon, C., (2011). Eco-extraction - Contexte et Innovation, in: Chemat, F. (Ed.), *Eco-Extraction du Végétal*. Dunod, Paris, pp. 1-26.
- Vilkhu, K., Mawson, R., Simons, L., Bates, D., (2008). Applications and opportunities for ultrasound assisted extraction in the food industry — A review. *Innovative Food Science & Emerging Technologies* 9(2), 161-169.
-

Chapter 1

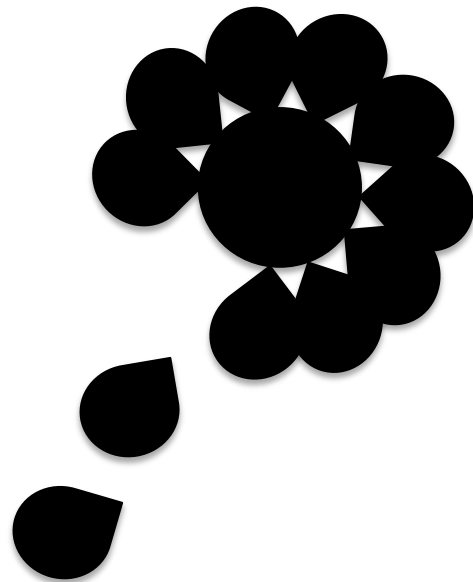

**Chapitre I - FUNDAMENTAL OF SOLID-FLUID
INTERACTION FOR EXTRACTION UNIT
OPERATION**

Paradox leads to insanity...unless you identify it

I. INTRODUCTION

Whatever the applications and uses, the main industry sectors are more and more focusing a main part of their effort to replace large ranges of synthetic compounds by natural plant-based molecules. The operation of extraction has normally to be defined depending on their physical behavior, more especially either volatile or non-volatile compounds.

- Essential oils are complex mixtures of volatile organic compounds. Every single essential oil normally has more than a hundred components, depending on the oil in question. They can have all the great family of organic chemistry: alcohols, carbonyl compounds (mainly aldehydes and ketones), esters, phenols, and to a lesser extent, nitrogen and sulfur derivatives. However, terpenes (hydrocarbons C₁₀ or C₁₅) and terpenoids (terpenes functionalized) are by far the most abundant (Fernandez and Chemat, 2012). They have been produced in the main part for the perfume industry (98%) but are more and more used in different other fields such as food, cosmetic, etc.

Other ingredients present in the plants such as antioxidants, vegetable oils (fatty acids), etc. are mostly non-volatile:

- Natural antioxidants are undergoing nowadays an arising demand thanks to growing consciousness of consumers regarding human health. Hence agro-industrial firms are encouraged to substitute synthetic antioxidants, such as butylated hydroxyanisole (BHA) and butylated hydroxytoluene (BHT) by natural antioxidants (Sebranek et al., 2005; Yanishlieva et al., 2006). Phenolic compounds are classified as simple phenols or polyphenols based on the number of phenol units in the molecule (Soto-Vaca et al., 2012).
 - Naturally occurring fats and oils are essentially triglycerides. Triglycerides consist of three fatty acids bound to a glycerol backbone. All fats and oils have three types of fatty acids (Nettleton, 1995): Saturated Fatty Acids (SFAs) have no double bonds between the individual carbon atoms of the fatty acid chain, MonoUnsaturated Fatty Acids (MUFAs) are unsaturated fatty acids whose carbon chain has one double or triple valence bond per molecule and PolyUnsaturated Fatty Acids (PUFAs) are fatty acids that contain more than one double bond in their backbone.
-

These kinds of molecules require to relevantly define more effective extraction processes and/or intensify different other conventional types of solvent extraction processes.

It is hence important to first characterize the extraction of such natural molecules, adopting a first categorization of the extraction processes fundamentally based on volatility of molecules. Porous materials

1. Structure characteristics of porous material

One of the most important characteristics of porous material is the specific bulk density ρ_{bulk} . It reflects the apparent volume normally obtained through the bouncy force (Archimedes method) or, for the water-reacted/absorbed materials, using fine mineral powder such as Fontainebleau sand or cracking powder (80 μm diameter), as indicated by Louka and Allaf (2002, 2004b); Louka et al. (2004). The specific bulk density ρ_{bulk} is expressed in kg m^{-3} .

The solid density $\rho_{intrinsic}$ (intrinsic density or true density), is used to identify the ‘porosity’ and the absolute expansion ratio. The solid density $\rho_{intrinsic}$ is measured using the Pycnometer method, which employs Archimedes' principle of fluid (usually helium) displacement and Boyle's Law to determine the volume and solid density. The absolute expansion ratio can be quantified by determining the ratio between the intrinsic and the bulk (specific) densities; it can be expressed as:

Absolute expansion ratio:	$\xi_{abs} = \frac{\text{Apparent volume}}{\text{Intrinsic volume}} = \frac{\rho_{intrinsic}}{\rho_{bulk}} = \frac{\rho_{intr}}{\rho_d}$	Eq. I-1
Porosity:	$\text{Porosity ratio } \psi = \frac{\text{Apparent volume} - \text{Intrinsic volume}}{\text{Apparent volume}}$	Eq. I-2
	$\text{Porosity ratio } \psi = \frac{\xi_{abs} - 1}{\xi_{abs}} = 1 - \frac{\rho_d}{\rho_{intr}}$	Eq. I-3

In the case of presence of gas (air...) and liquid (water, solvent...) in a porous matrix, it is possible to define gas volume fraction ε_{gas} , liquid volume fraction ε_W , and dry solid volume fraction ε_d . They can be determined from the liquid content dry basis ($W_{w/s}$) and density ($\rho_{w/s}$), the apparent density of the product ($\rho_{bulk}=\rho_d$) and the dry matter intrinsic density (ρ_{intr}):

Gas volume ration:	$\varepsilon_{gas} = 1 - \frac{\rho_d}{\rho_{intr}} - \frac{W\rho_d}{\rho_w}$	Eq. I-4
Liquid volume ratio	$\varepsilon_w = \frac{W\rho_d}{\rho_w}$	Eq. I-5
Dry solid volume ratio:	$\varepsilon_d = \frac{\rho_d}{\rho_{intr}}$	Eq. I-6

Another important porous material parameter has normally to be defined; it is the average size of pores expressed in m as the mean pore-diameter δ :

$\delta = \langle \text{pore diameter} \rangle$	Eq. I-7
---	---------

The pore diameter may play a very important role in terms of heat flow because of the fluid present in the pore (air, water...) by intensifying the heat flow combining conduction to a phenomenon of evaporation-condensation. The buoyancy and thermal forces of such fluids should normally imply them to move, getting close contact with the solid matrix at the pore wall.

This phenomenon enables an intensification of heat flow through natural convection, sometimes combined with evaporation/condensation, especially when concerned fluid is a volatile substance.

When high porosity material is completely dried, it is considered as isolated-behavior material with very low conductivity. However, by the presence of volatile fluid, the possible evaporation/condensation process in the pores, a similar conduction process is carried out during heat transfer. Such intensification can be revealed as a similar conduction heat transfer with higher effective conductivity.

2. Functional properties of porous materials

2.1. Thermal characteristics

Thermal conductivity is one of very important physical properties in many process engineering and unit operations (Becker and Fricke, 1999; Saravacos and Kostaropoulos, 1996).

To predict the thermal conductivity of aggroresources during processing models have been proposed in the literature (Kostaropoulos and Saravacos, 1997; Rahman et al., 1997). These models take into account the porosity ratio, the density, the air, water, and solvent contents and, the product temperature.

2.1.1. Dry materials

When high porous material is completely dried, it is considered as isolated-behavior material with very low conductivity.

The intrinsic thermal conductivity of initially dry porous plant-based materials increases with increasing water or other solvent content. The presence of air cells within the product involved a reduction of conductivity. A linear approach is typically used to determine the thermal conductivity as a function of the humidity of the product, the correlation parameters depend on the nature of the product. However, to cover a wide range of composition (from 0 to 100%) a nonlinear correlation is usually required.

A generalized model has been developed by Rahman et al. (1997) to predict the variation of the thermal conductivity of fruit vegetables throughout their drying. This model is based on taking into account the structure of each product. The model assumes that porous medium is formed by the juxtaposition of alternating layers of solid, air and water/solvent. The apparent thermal conductivity λ_{app} of the porous medium is given by the relationship:

Apparent thermal conductivity	$\lambda_{app} = \frac{1}{\left(\frac{1-f_k}{\lambda_{pm}} + \frac{f_k}{\lambda_{sm}}\right)}$	Eq. I-8
-------------------------------	--	---------

where f_k is the volume fraction of the system (between 0 and 1) arranged perpendicularly to the direction of heat flow, and thus $(1 - f_k)$ is the complementary fraction, parallel to the flow. λ_{pm} and λ_{sm} are the conductivities of the matrix on parallel and series structures, respectively (Figure I-1).

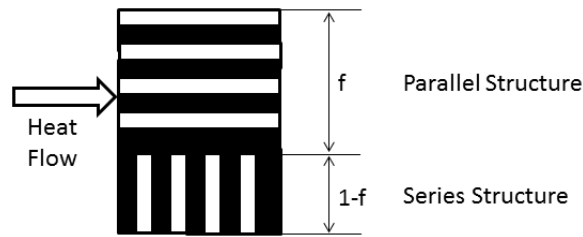

Figure I-1. Mixed model of thermal conductivity

The conductivity of the parallel structure is:

$\lambda_{pm} = \varepsilon_d \lambda_d + \varepsilon_{W/s} \lambda_{W/s} + \varepsilon_a \lambda_a$	Eq. I-9
--	---------

While the conductivity of the series structure is:

$\lambda_{sm} = \frac{1}{\left(\frac{\varepsilon_d}{\lambda_d} + \frac{\varepsilon_{W/s}}{\lambda_{W/s}} + \frac{\varepsilon_a}{\lambda_a} \right)}$	Eq. I-10
---	----------

Where λ_d , $\lambda_{w/s}$, and λ_a are the intrinsic thermal conductivities of the dry matter, water/solvent, and air, respectively. These intrinsic thermal conductivities of pure substances are usually given in the literature as a function of temperature.

2.1.2. Partially moist porous material

Water and equally solvents play a key role in determining the effective thermal conductivity in organic products as porous matter. This is not only due to the higher intrinsic conductivities of the water and solvent relative to the dry matter; it is also due to other dynamic behavior of vapor. The presence of vapor in pores intensifies the transfer of heat within the porous material. The buoyancy and thermal forces of such fluids should normally imply them to move getting some friction and close contact with the pore wall. This enables an intensification of heat flow through natural convection. Then, the pore diameter may play a vital role in terms of heat flow transferred within the pore.

Nevertheless, the heat energy able to be transferred can dramatically increase through the phenomenon of evaporation/condensation in the pores (Figure I-2). This directly depends on the pore diameter and depends greatly on the wall temperature.

However, such a global transfer may be considered as a similar conduction process carried out with higher effective conductivity λ_{eff} (sometimes 10 times higher “static conditions”).

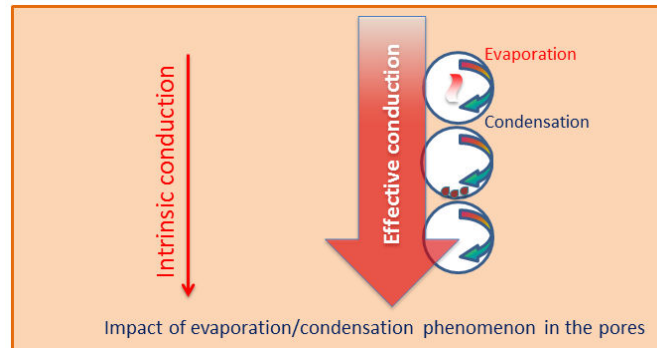

Figure I-2. Evaporation/condensation phenomenon in the pores

2.2. Mass transfers

Plant and many other agro-materials are poly-phase, locally heterogenic matrix. Normally, they are porous.

During rehydration process (soaking) and during the first stage of numerous solvent extraction processes, liquid migrates from surrounding medium to fill a main part even all the pores. Opposite liquid flows can take place during other unit operations. For such rich-in-liquid porous materials, capillary transfer is one of the main parallel transport phenomena and mechanisms (Chen et al., 2002). Molecular diffusion equally takes place. It concerns liquid/vapor phase with the concentration gradient as the driving force. A main part of such transfer phenomena within the porous material can then be expressed as a Fick-type similar-diffusion with the gradient of concentration ratio as a driving force. Such a relationship is used to globally illustrate these mass transfer phenomena without a real phenomenological consideration. One can take into account of an effective diffusivity D_{eff} ($\text{m}^2 \text{s}^{-1}$) for the whole of the considered transport operation. D_{eff} depends on structure, liquid content, and temperature.

In various plant materials, effective diffusivity D_{eff} varies between 10^{-13} and $10^{-7} \text{ m}^2 \text{ s}^{-1}$ while effective thermal diffusivity is usually much higher (10^{-7} and $10^{-5} \text{ m}^2 \text{ s}^{-1}$). Both normally imply experimental data to be measured; their values are different for the same materials depending of authors and the experiences used for such empirical studies.

II. VOLATILE COMPOUNDS - PROCESS INTENSIFICATION

1. Volatility

1.1. Vapor Pressure and Boiling

Temperature reveals the mean of fluctuation kinetic energy of molecules forming a thermodynamic system (Allaf, 1982). The repartition of the kinetic energy of each molecule present in both liquid and vapor systems allows equilibrium between molecules leaving and entering the liquid surface. The vapor pressure of a liquid at a particular temperature reveals the equilibrium number of the concerned molecules present in the surrounding medium.

To distinguish the technological ability of compounds, vapor pressure has to be studied. Volatility describes the tendency of a substance to be present as vapor phase. Indeed, at a given temperature, a dynamic equilibrium between liquid and vapor phases reveals the mean of fluctuation kinetic energy. As a thermodynamic characteristic, volatility is strictly linked to the composition, and the density of fluctuation kinetic energy revealing the temperature. However one can assume the vapor pressure to be independent on liquid concentration of mixture. The vapor pressure of any substance only depends on the temperature independently of the total external pressure. The higher the temperature, the higher the “concentration of vapor-phase molecules”.

“Boiling temperature” of a substance is thermodynamically defined as the temperature allowing the vapor pressure to be identical to the surrounding atmospheric pressure. Substance volatility has normally to be defined versus temperature; it is as higher as its vapor pressure is higher (Beychok, 2012; Jespersen, 2012; Mortimer, 2008). In other words, at a given temperature, the higher the substance vapor pressure, the more volatile the substance. The definition of a compound volatility should not and cannot be limited to consider the only boiling temperature.

1.2. Impact in terms of distillation and steam-distillation processes:

Hydrodistillation is used to separate volatile compounds from a liquid mixture; it is a solid-liquid followed by a liquid-vapor interactions. Steam distillation is usually carried out by establishing an interaction between the solid matrix containing volatile compounds and the steam as heating system. It is hence a solid-vapor interaction. Both distillation processes depend on the differences in vapor pressures of the individual components at considered temperature. Relative concentration in the vapor phase is almost independent of the liquid phase concentration.

1.3. Relative Volatility

Relative volatility is a measure of the ratio of volatilities of two compounds at a given temperature:

When relative volatility is very close to one, it indicates that they have very similar vapor pressure values. This means that it is not possible to separate the two components via distillation at the considered temperature.

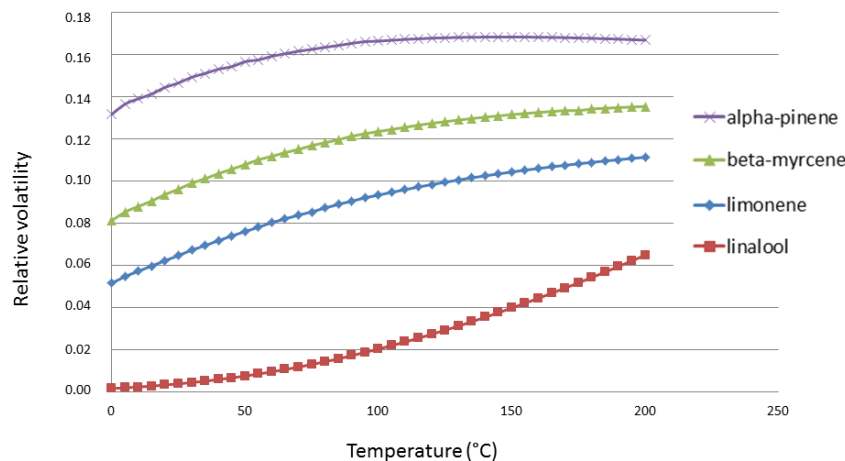

Figure I-3. Relative volatility of orange peel volatile compounds vs water.

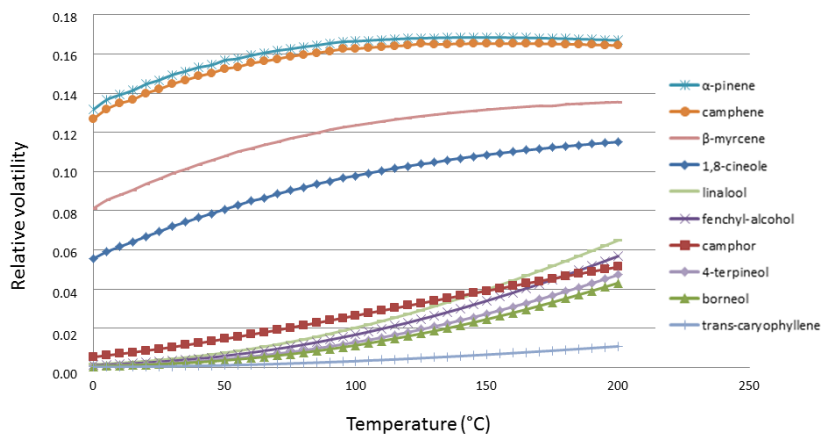

Figure I-4. Relative volatility of Rosemary volatile compounds vs water.

Here relative volatility is defined against water vapor pressure.

$\text{Relative volatility} = p_v(\text{substance})/p_v(\text{water})$	Eq. I-11
--	----------

With $p_v(\text{substance})$ and $p_v(\text{water})$ are the vapor pressure values of substance and water, respectively.

By using high temperature and subsequently low temperature, for a time period, a main part of the most volatile liquid will be evaporated to be converted back into a liquid.

2. Issues regarding standard essential oil extraction

Essential oil extraction is a direct application of separation of differently volatile molecules. Extraction issues can concern several aspects linked to the plant structure, the heat and mass (liquid and vapor) transfers, the thermal degradation.

Essential oils are usually extracted using hydrodistillation (HD) or steam-distillation (SD). These techniques provide heat from steam or boiling water by both convection and condensation processes.

- Steam distillation includes a solid–gas interaction stage,
- Whereas HD involves a solid–liquid followed by a liquid vapor interaction.

At operational level, in both techniques, vapors (water and volatile molecules such as essential oils) generated at high temperature, have to be condensed on an adequate low temperature condenser, which is followed by a decantation stage in which water is separated from the other condensed liquid. Kinetics of the evaporation stage of these techniques is known to be particularly slow (a long processing time of up to 24 h and sometimes longer), involving a large consumption of energy and degradation of sensitive molecules (Bendahou et al., 2008; Bocchio, 1985; Cassel et al., 2009; Chemat and Lucchesi, 2006; Ferhat et al., 2006; Gámiz-Gracia and Luque de Castro, 2000; Lucchesi et al., 2004).

2.1. Surface/Superficial secretion zone of essential oils

The process of essential oil extraction should depend on the way the plant stores oil and the type of secretion zones. There are special zones involved in the secretion of essential oils located on the surface of the plant or within plant tissues (deep structures).

2.1.1. Heat and Fluid surface interaction

Whatever the heating sources (boiling water, saturated steam, microwaves...), since the concerned zone is located on the surface, the time of essential oil extraction is short. It does not need a real internal diffusion stage and strictly depends on the gradient of vapor pressure of essential oils between the exchange-surface between steam and plant, and the low temperature condenser surface. This aspect may be intensified through forced convection instead of the simple gravitational buoyancy.

Washing process: Essential oil (EO) vapor flow:	$\dot{m}_{v,EO} = \frac{dm_{v,EO}}{dt} = k_{EO} \langle A \rangle [p_{EO,X-s} - p_{EO,cond}]$	Eq. I-12
Water vapor flow generation:	$\dot{m}_{v,W} = \frac{dm_{v,W}}{dt} = k_W \langle A \rangle [p_{W,X-s} - p_{W,cond}]$	Eq. I-13
Convection/condensation heat flow generation:	$\dot{Q} = h A [T_{steam} - T_{X-s}]$	Eq. I-14
Heat flow balance:	$\dot{Q} = \dot{m}_{v,EO} L_{v,EO} + \dot{m}_{v,W} L_{v,W}$	Eq. I-15

Eq. I-15 explains that the main part of heat Q is absorbed and used for evaporating water and essential oils (with a ratio which normally is the relative volatility as calculated here above).

Whatever the “volatile” compound, since the vapor pressure strictly depends on the temperature, the external mass transport within the surrounding environment takes place from the surface of the plant organ toward the condenser; it concerns vapors of water and the other volatile molecules (EO). In the case of simple diffusion, the essential oil vapor pressure gradient is the driving force.

When the secretion zones of essential oils are distributed on the superface, the process would usually be **intensified** by increasing the difference in temperature and by reducing the distance between the material exchange surface and the condenser surface; and, much more by establishing an agitation allowing the vapor mass transfer to be carried out by mass convection.

2.1.2. Secretion wall role

The membrane and walls of the secretion organ (peltate glandular trichome structures) may be watertight to liquid and vapor, they are as impenetrable barrier. The vapor pressures of essential oils and water at the external wall of the exchange surface $p_{EO}(T_{X-s})$ and $p_W(T_{X-s})$, respectively depend on the difference of the total force between the internal zone and the surrounding medium. $p_{EO}(T_{X-s})$ of the Eq. I-13 must normally depend on temperature but this dependence is normally very weak.

The mass transfer through these membranes and walls becomes the limiting process. Direct mechanical breaking of such gland wall can be used as the only way to recover the concerned essential oils.

2.2. Deep secretion zones of essential oils

In the case of a homogeneous repartition of essential oil secretion zones in deep structure, one can carry out phenomenological modeling of steam extraction by considering both heat and mass transfers within the matrix; coupled to the external transfers (Allaf, 2009; Besombes et al., 2010). This type of plants was assumed as a porous material in which coupled heat and mass transfer processes occur successively (Allaf et al., 2011).

2.2.1. Internal transfers

Since the external mass transport from the surface to the surrounding environment is adequately intensified, whatever the “volatile” compound, various types of internal heat and mass transfers may take place within the plant as the possible limiting processes.

2.2.1.A Internal heat transfer

Heat flow is used in part to increase the product temperature, but in the main part it ensures a phase change (liquid–vapor). In steam extraction, the external saturated steam ensures heat transfer on the external surface of the solid matrix; thus heat transfer is normally carried out by convection but mostly by condensation.

After quickly rising to the highest temperature level (very close to the saturated steam temperature) the exchange surface can ensure a gradual spread of heat within the solid.

Subsequently, an internal heat transfer occurs through a similar conduction phenomenon. The presence of air, water, and other volatile molecules within the porous structure should imply a phenomenon of **convection-vaporization/condensation in the pores**. This generates a heat transfer phenomenon where the temperature gradient is the driving force.

This process is specific to the porous materials presenting some concentration of volatile molecules such as liquid and vapor, water and essential oil compounds. It normally greatly intensifies the heat transfer, which can be reflected as a conduction-type transfer with an effective conductivity value much higher than the standard conductivity values.

Heat flow used for convection, evaporating and condensing water and essential oils within the holes in the product should depend on both the expansion ratio ξ and the mean size of pores δ . Such heat flow should normally be depending on the gradient of temperature, allowing the global heat transfer within such porous material to be similar to Fourier model with much higher effective conductivity.

2.2.1.B Internal Liquid and Vapor Mass Transfer

Usually internal mass transfer is assumed to be the limiting process since the effective heat diffusivity is much higher than the effective mass diffusivity. The effective conductivity normally increases thanks to convection/condensation-evaporation fluid phenomenon inside the pores. This reinforces much more this situation and leads systematically to identify internal liquid and vapor mass transfers as the limiting phenomenon.

Since the secretion zones of essential oils are uniformly (homogeneously), deeply distributed in the considered organ of considered plant, it normally would be assumed that during steam extraction of volatile compounds, the transfer of liquid essential oil is negligible whereas most mass transfer is a gas diffusion phenomenon, obeying a Fick-type law with the vapor pressure gradient of each volatile compound as the driving force.

2.2.2. Paradox of Coupled Heat and Vapor Transfers

From paragraph 1. it is possible to underline that the vapor pressure of each substance, either water or other volatile compounds, depends only on temperature. Thermodynamic data on the liquid-vapor equilibrium of each molecule at different temperatures could be found via ilab software.

Mass transfer processes, which usually occur with liquids and vapors, depend on the nature and localization of the molecules and the porosity of the medium. These processes may be driven by capillary forces and by diffusion when it is a liquid/solid interaction. The gas phase (gas/solid interaction) mass transfer occurs through diffusion within the pores. It also depends on several factors including temperature, structure, and the morphological state of the matter (porosity ratio and mean pore size and repartition, specific surface area, permeability of the secretion element walls, etc.) (Allaf, 2009).

In steam extraction, it can be assumed that the transfer of essential oils in the form of a liquid within the solid matrix is negligible. The main transfer phenomenon is a gas diffusion phase, which can be shown to be a Fick-type law related to the vapor pressure gradient of each volatile compound through an effective diffusivity (D_{eff}). However, the involvement of the structure, the presence of secretion element walls as barriers, and more generally the porosity of the material contribute to a macroscopic mass transfer inside the material.

In similar cases, it is assumed that essential oil extraction necessarily implies an amount of heat capable of transforming the liquid phase into the gas phase within the porous material (Besombes et al., 2010). Since the external vapor pressure is normally saturated, one can postulate:

$\vec{\nabla} \cdot \vec{\varphi} + (\rho_d c_{pd} + \rho_{EO} c_{pEO} + \rho_w c_{pw}) \frac{\partial T}{\partial t} + \frac{\partial}{\partial t} \left[\frac{\psi}{R_{GP} T} (p_{EO} M_{EO} L_{EO} + p_w M_w L_w) \right] = 0$	Eq. I-16
--	----------

As the internal transfer is carried out by conduction:

$\vec{\nabla} \cdot (-\lambda_{eff} \vec{\nabla} T) + (\rho_d c_{pd} + \rho_{EO} c_{pEO} + \rho_w c_{pw}) \frac{\partial T}{\partial t} + \frac{\partial}{\partial t} \left[\frac{\psi}{R_{GP} T} (p_{EO} M_{EO} L_{EO} + p_w M_w L_w) \right] = 0$	Eq. I-17
--	----------

The temperature distribution is assumed to be stationary during most of the operation since most of the heat transfer is “only” used to evaporate essential oils and water (Allaf, 2009):

$\vec{\nabla} \cdot (-\lambda_{eff} \vec{\nabla} T) + \frac{\partial}{\partial t} \left[\frac{\psi}{R_{GP} T} (p_{EO} M_{EO} L_{EO} + p_w M_w L_w) \right] = 0$	Eq. I-18
--	----------

As the mass transfers of vapor of different essential oil compounds and water would be governed by a Fick-type law, the formulations of (Allaf, 1982) can be used separately:

$\frac{(p_{EO}/T)}{\rho_d} (\vec{v}_{EO} - \vec{v}_d) = -D_{effEO} \vec{\nabla} \left(\frac{p_{EO}/T}{\rho_d} \right)$	Eq. I-19
$\frac{(p_w/T)}{\rho_d} (\vec{v}_w - \vec{v}_d) = -D_{effw} \vec{\nabla} \left(\frac{p_w/T}{\rho_d} \right)$	Eq. I-20

By neglecting possible shrinkage phenomena, one can assume that $\rho_d = \text{constant}$ and $\vec{v}_d = 0$, Eq. I-19 and Eq. I-20 may be transformed into:

$(p_{EO}/T)\vec{v}_{EO} = -D_{effEO}\vec{\nabla}(p_{EO}/T)$	Eq. I-21
$(p_w/T)\vec{v}_w = -D_{effw}\vec{\nabla}p_w/T$	Eq. I-22

Since the external vapor pressure is saturated, one can assume that the internal water vapor pressure p_w in the porous material is approximately constant, and so Eq. I-18 can be postulated as:

$-\lambda_{eff}\vec{\nabla}\cdot(\vec{\nabla}T) + \psi M_{EO}L_{EO}\frac{\partial}{\partial t}\left[\frac{p_{EO}}{R_{GP}T}\right] = 0$	Eq. I-23
--	----------

By assuming that each “particle” of the plant is spherical, homogeneous, and isotropic, Eq. I-22 and Eq. I-23 can be transformed at one dimension (r) respectively into:

$(p_{EO}/T)v_{EO} = -D_{effEO}\left(\frac{\partial(p_{EO}/T)}{\partial r}\right)$	Eq. I-24
$-\lambda\frac{\partial^2 T}{\partial r^2} + \psi M_{EO}L_{EO}\frac{\partial}{\partial t}\left[\frac{p_{EO}}{R_{GP}T}\right] = 0$	Eq. I-25

To achieve such diffusion operation, the essential oil vapor should flow to be directed from $r = 0$ towards $r = R$ (Figure I-5):

$v_{EO} > 0$	Eq. I-26
$\frac{\partial(p_{EO}/T)}{\partial r} < 0$	Eq. I-27

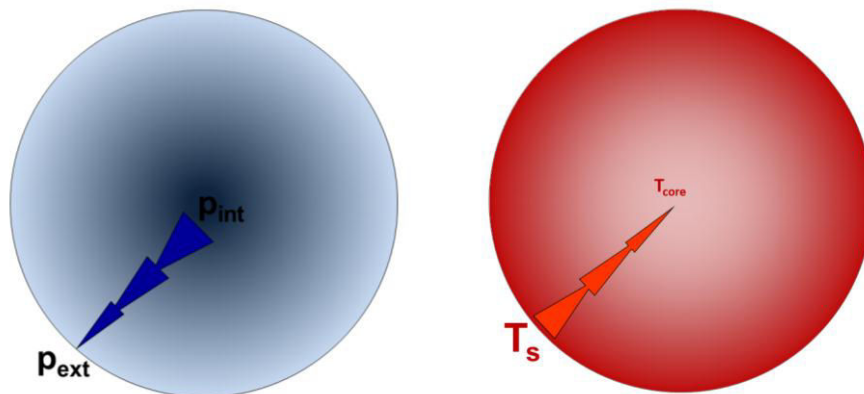

Figure I-5. Essential oil (left) and heat (right) transfers as supposed to be carried out during an extraction.

However, as the exchange surface defined by $r = R$ has the highest temperature value, and as the value of p_{EO}/T is as high as the temperature is higher, p_{EO}/T has similarly the highest value at $r = R$ (Figure I-6):

$\frac{\partial(p_{EO}/T)}{\partial r} > 0$	Eq. I-28
---	----------

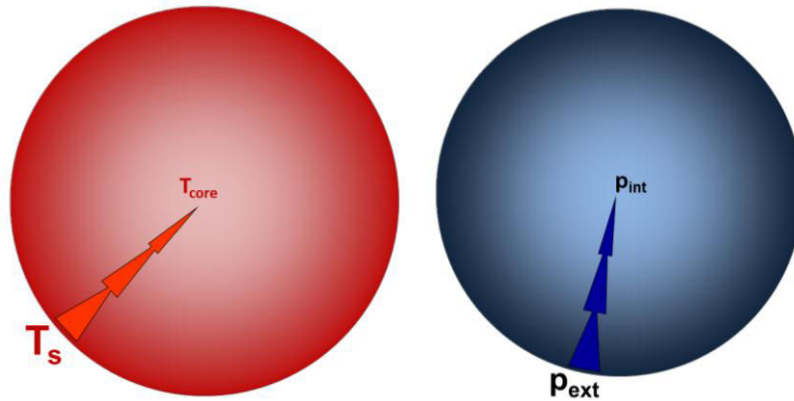

Figure I-6. The paradoxical situation of the extraction of volatile compounds during steam distillation; impact in terms of progressive front kinetics

As long as the porous matrix is full of essential oils and water, the values of essential oil vapor pressure p_{EO} are thus higher at the exchange surface than in the granule core in one side, and in the surrounding medium. This result is a paradox, inducing a double motion of these vapors (Figure I-6).

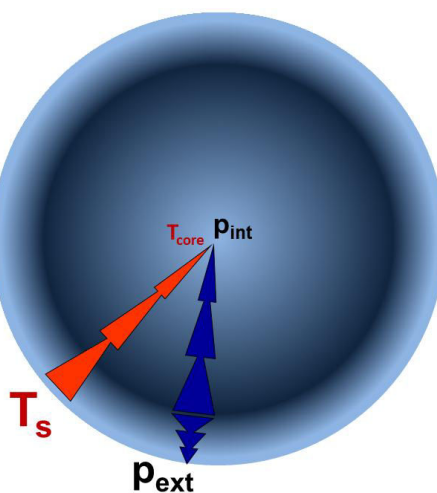

Figure I-7. "Front progression" kinetics of the extraction of volatile compounds during steam distillation; impact in terms of progressive front kinetics

Some part of the vapor has to be transferred towards the surrounding medium, but another part should be transferred towards the material core. This last is completely opposite to what is required for an extraction operation (Al Haddad, 2007; Al Haddad et al., 2008). Then, in the standard steam extraction of essential oils, the operation is achieved using successive layers with “front progression” kinetics.

This may further explain why a pretreatment step of grinding is often required in steam extraction to reduce the granule size. However, it would be possible to remedy this situation and make a notable improvement in kinetics by adopting other methods for heating and/or moving such molecules by a mass transfer achieved through the total pressure gradient process (DIC process).

Thermal degradation of matrix might allow the transfer to decrease because of the structure shrinkage and hardness increasing.

3. Intensification of essential oil extraction

Main issue in standard steam distillation of volatiles, as mentioned above could be identified as the paradoxical situation. It implies a partial transfer of vapor towards the core of the porous material (plant). To solve this situation, two main proposals were considered: microwave heating and instant autovaporization by instant controlled pressure drop technology DIC (Détente Instantanée Contrôlée) (Allaf, 1982). The main heating process carried out by the first should not imply a temperature gradient between the surface and the core of the material; the main reason of the paradoxical situation is reduced even deleted. The second proposal should imply a Darcy-type transfer of volatile from inside the material towards the under-vacuum surrounding medium.

3.1. Microwave technology

Regarding solvent free extraction, microwave technology gathers in the main part two types of “processes” that slightly differ: Solvent-free Microwave Hydrodistillation (SFME) and Microwave Hydrodiffusion and Gravity (MHG).

For both techniques, the internal heating of the in situ water within the plant material distends the plant cells and leads to the rupture of glands and oleiferous receptacles. The heating action of microwaves thus releases essential oil and in situ water, which are transferred from the inside to the outside of the plant material.

SFME is a recent method of extraction, patented in 2004, with the specific objective of obtaining essential oil from plant material (Lucchesi et al., 2004; Lucchesi et al., 2007). Without adding solvent or water, SFME is a combination of microwave heating and distillation. It is performed at atmospheric pressure and operates via evaporating the volatile compounds.

MHG (Virot et al., 2007) is a new and green extraction technique that combines microwave heating and gravity driven flow at atmospheric pressure. This method also does not require solvent or water and allows the extract (water and essential oils, as well as some non-volatile compounds) to migrate by gravity out of the microwave reactor.

3.1.1. Microwave Heat Transfer

Microwaves (MWs) are electromagnetic waves consisting of an electric field and a magnetic field normal to one another (propagating electromagnetic energy). The electromagnetic spectrum for microwave is located between far infrared light and radio frequencies with a frequency range from 300 MHz to 300 GHz. Four specific frequencies (915 ± 25 , 2450 ± 13 , 5800 ± 75 , $22\,125 \pm 125$ MHz) are used for industrial and scientific microwave heating. This energy acts as a non-ionizing radiation that causes molecular motions of ions and rotation of the dipoles, but does not affect molecular structure.

When dielectric materials containing either permanent or induced dipoles are placed in electrical field, the dipoles will try to follow the same electrical field direction.

Microwaves induce a very high variation of electrical field (normally about or much more than 10^6 modifications per ms). The random motions of dipoles should dramatically increase thanks to the high variation of electrical field. More precisely, the applied microwave field enables the molecules, on average, to spend slightly more time orienting themselves in the direction of the electric field rather than in other directions. Hence, the electric fields of microwaves imply higher disordered agitation with isotropic arbitrary direction. Fluctuation energy thus generated can macroscopically be considered as microwave heating resulting from dissipation of electromagnetic waves in the irradiated medium. The dissipated power in the medium depends on the complex permittivity of the material and the local time-averaged electric field strength.

In conventional heating, heat is transferred from the highest temperature (superficial) zone progressively to the interior of the sample. It is a propagation of the random motions of particles normally from the highest level towards the lowest level of the density of fluctuation kinetic energy (which means from the highest temperature zone towards the lowest temperature zone). However, in microwave heating, heat is dissipated volumetrically inside the irradiated depth of the medium. In this zone, MWs are volumetrically distributed heating. This causes an important difference between conventional and microwave heating. In conventional heating, heat transfer time is completely limited, for solids, by the product thermal conductivity, depending on the temperature difference across the sample, and, for fluids, on convection currents. As a result, the temperature increase is often rather slow. By contrast, in microwave heating, due to the volumetric heating effect, much faster temperature increases can be obtained, depending on the microwave power and the dielectric loss factor of the material being irradiated (Chemat et al., 2009).

Although microwaves heat volumetrically, it is well known that the electromagnetic field distribution is not even in the irradiated material, thus the energy is not homogeneously dissipated. The electric field distribution depends on the geometry of the heated object and the dielectric properties.

For media which readily absorb microwaves, i.e. for which the loss factor is > 5 , the penetration depth d_p at which the dissipated power is reduced to $1/e$ of surface value might be a limiting factor:

$d_p \approx \frac{\lambda_o}{2\pi} \frac{\sqrt{\epsilon'}}{\epsilon''}$	Eq. I-29
--	----------

If this dimension is much smaller than the dimension of the object being heated, localized surface heating will occur. For more transparent media, e.g. with a loss factor < 0.01 , penetration depth will not be problematical but dissipating enough power will. In addition, the occurrence of standing wave patterns will result in “hot spots” if the power dissipation is faster than the heat transfer to surrounding colder areas. Hot spots have been observed in poorly conductive materials (solids or highly viscous media) and at the surface of boiling liquids by IR measurements (Semenov and Zharova, 2006).

Microwave ovens can have monomode or multimode cavity. The monomode cavity can generate a frequency, which excites only one mode of resonance. The multimode cavity is large and the incident wave is able to affect several modes of resonance.

Microwave is a heating mechanism as a coupled heat generation based primarily on the dipole behavior of the polar molecules in interaction with microwaves, and the heat conduction within the material. In the absence of electric fields, polar molecules are randomly oriented. They rapidly change their orientations in reaction to the changing electric fields. Heat is generated as a result of the rotation of the molecules. Microwave heating closely depends on the physical state and electromagnetic properties of the material, which are characterized by the complex relative permittivity ϵ^* and the complex relative permeability μ^* , where:

$\epsilon^* = \epsilon' - i\epsilon'' \text{ and } \mu^* = \mu' - i\mu''$	Eq. I-30
---	----------

The real permittivity, or dielectric constant ϵ' , characterizes the penetration of microwaves into the material while ϵ'' , which is the loss factor, indicates the material's ability to store the electrical potential energy, and the loss tangent $\tan \delta$ designates the ability of the material to convert absorbed energy into heat. ϵ' significantly depends on microwave frequency and material temperature.

For optimum coupling, a balanced combination of moderate ϵ' , to permit adequate penetration, and high loss (maximum ϵ'' and $\tan \delta$) is required. In a microwave essential oil extraction operation, heat generation and transfer within a plant as a porous medium is described by the following Equation:

$\dot{q} - \vec{\nabla} \cdot \vec{\varphi} = \rho_d (c_{pd} + E c_{pEO} + W c_{pw}) \frac{\partial T}{\partial t} + \psi \frac{\partial \left(\frac{M_{EO} L_{EO} p_{EO} + M_w L_w p_w}{R_{GP} T} \right)}{\partial t}$	Eq. I-31
---	----------

where the second term in LHS stands for heat transfer, which normally is performed through the conduction law. The first term in RHS stands for the sensitive heat accumulation and the second term for the heat dissipated for evaporation.

The first term in LHS \dot{Q} stands for the microwave volumique absorbed power or, in other words, the heat produced per unit volume per unit time; it is also called absorption rate density (ARD) and can be expressed by the following relation:

$\dot{q}(\vec{r}) = \pi f \epsilon_o \epsilon''(\vec{r}) E(\vec{r}) ^2$	Eq. I-32
--	----------

where $|E(r)|$ is the amplitude of electric field intensity, which varies depending on the point defined by the vector (\vec{r}). If the thickness l_p of the heated material is sufficiently large and the loss factor is constant, power distribution can follow Lambert's law:

$\dot{q}(x) = \pi f \epsilon_o \epsilon'' E_o ^2 \exp\left(-\frac{x}{d_p}\right)$	Eq. I-33
--	----------

where $|E_o|$ stands for the amplitude of electric field intensity at the material surface ($x = 0$), and d_p for the penetration depth (Kitchen, 2001):

$d_p = \frac{c}{2\pi f \sqrt{2\epsilon''}} \left(\sqrt{1 + \left(\frac{\epsilon''}{\epsilon'}\right)^2} - 1 \right)^{-1/2}$	Eq. I-34
--	----------

At the penetration depth d_p from the surface ($x = 0$), the power density is equal to 36.788% of the power density on the surface.

As microwave heating is distributed versus the position within the wet porous material through Eq. I-33, temperature can reach a level so high that the induced vapor pressure highly exceeds the external pressure.

During this stage, a main part of mass transfer of both water and essential oil vapors is performed through a Darcy law type with the total pressure gradient as driving force. Usually, essential oil compounds have vapor pressures much lower than water; at atmospheric pressure, their boiling point is known to be more than 160°C even reaching over 270°C. The presence of water inside the plant during microwave extraction of volatile molecules is important because water molecules are normally the main polar molecules. It is also because the contribution of water vapor to the total internal pressure is indispensable for assuring a Darcy's type transfer. Thus, the paradoxical stage is absent. Thanks to its much higher extraction rate and because of the absence of hydrolysis degradation and as the high temperature is reached in a short time, SFME presents numerous advantages compared with hydrodistillation, in terms of both process performance such as faster kinetics, higher efficiency, lower costs, lower environmental impact, and better extract quality.

3.1.2. Mass Transfer under microwave irradiation

Internal pressure is the sum of initial air pressure, essential oil, and water vapor pressures. Once it increases by microwave heating, the gradient between internal and external total pressures would allow to establishing a Darcy-type transfer (Eq. I-35).

Keeping in mind that vapor pressure of essential oils at any temperature is dramatically lower than water vapor pressure.

To allow an effective Darcy-type transfer, MW energy must be conceded to the material as abruptly (instantaneously) as possible. The presence of water is then very important as both functional roles of the main heated-heating material and the main responsible of high-pressure (internal) gas.

Indeed, since the water molecules are bipolar molecules, they are the main molecules sensitive to microwave (contrary to essential oil molecules). Water is the main MW-heated/heating medium. On the other hand, the contribution of essential oils to total pressure is normally very weak compared to water vapor (less than 16% as it is shown in Figure I-3 and Figure I-4). This aspect is very important since internal mass transfer process is mainly Darcy's.

Hence dried products are not adequate to a MW-assisted essential oil extraction because of the absence of both heating medium and gradient of total pressure i.e. Darcy's transfer.

Regarding the MW-assisted essential oil extraction MHG technique, the liquid essential oils are forced out from the structure cells and/or secretion zone. By heating the internal mixture of water and essential oils of such units, the total internal pressure increases (mainly thanks to water vapor). Indeed, the higher the difference of pressures between the two sides, the greater the possible motion of fluid (vapor but even liquid) through this wall. Since the internal and external total pressures greatly depend on temperature, the larger the pressure difference between the two-side fluids, the larger the expulsion forces.

Darcy liquid flow transfer through the cell or secretion unit wall:	$\rho_{mix(liq)}v = \frac{K}{\nu_{mix(liq)}} \left(\frac{p_{mix(vapor)} - P_{atm}}{e} \right)$	Eq. I-35
---	---	----------

However, since the permeation of cell wall and membrane is normally very weak, and the viscosity of liquids is too high, the liquid motion rate should stay negligible. Only by breaking such barriers, the liquid may move more freely within the plant:

“Whenever two bodies in contact move relative to each other, a friction force develops at the contact surface in the direction opposite to that of the motion to be, at low value proportional to their relative velocity”:

Friction force acting on a fluid in contact with a solid at their contact surface:	$\vec{f}_s = -k(\vec{v}_{liq} - \vec{v}_s)$	Eq. I-36
--	---	----------

Under conditions assumed to be steady, the liquid flow rate driven by the total forces (frictional force, gravity force, and expulsing force from the difference of the internal and the external pressures) is established:

$\vec{f}_s + \rho_{(liq)}\vec{g} + \vec{f}_{expulsing} = -k\vec{v}_{liq} + \rho_{(liq)}\vec{g} + (p_{mix(vapor)} - P_{atm})s\vec{u}_r = 0$	Eq. I-37
--	----------

Such a phenomenon indicates how important the rupture of cell wall and the expulsing force in generating a liquid flow; will be. The energy issued from MW should then be delivered as quickly as possible. High power-MW should be needed for this operation. For all these reasons, Microwave Liquid-Permeation and Gravity (MHG) operation needs energy to be conceded to the material as abruptly (instantaneously) as possible.

3.2. Instant controlled pressure drop technology

3.2.1. General principle

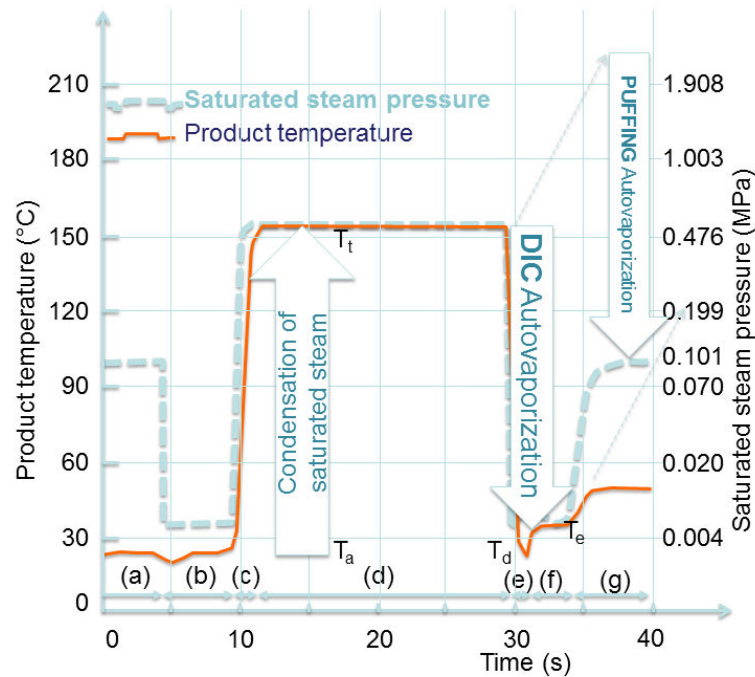

Figure I-8. History of temperature and pressure during a saturated steam pressure DIC treatment: b, c and d are the steps of the heating stage and e is the one-step pressure drop stage: (a) atmospheric pressure; (b) initial vacuum; (c) injection of saturated steam; (d) keeping constant steam pressure and ambient temperature; (e) abrupt pressure drop towards a vacuum; (f) keeping the vacuum; (g) releasing to atmospheric pressure (Allaf, 2002)

DIC treatment is based on two main stages of heating and pressure drop. The first stage is a High-Temperature/High-Pressure-Short-Time effect. It is induced by exposing the raw material to a short period of time at high temperature/high pressure that can be achieved through one of various ways: saturated steam pressure, high temperature compressed air, high pressure microwave, etc. Pressure usually is between 0.1 up to 0.6 MPa or even 1 MPa depending on the product, i.e. a temperature from 100 to 159°C or even 180°C (in the case of saturated steam: Figure I-8). Hence, the vapor pressure of each essential oil compound is higher than the one of the standard steam distillation, which is carried out at 100°C (boiling temperature of water at atmospheric pressure).

The high temperature-short time stage is followed by an abrupt pressure-drop towards a vacuum at about 5 kPa. Such a pressure-drop, whose rate ($\Delta P/\Delta t$) is higher than 0.5 MPa/s, simultaneously triggers:

- an autovaporization of volatile compounds,
- the instantaneous cooling of the product, which stops thermal degradation,
- a swelling or even rupture of the cell and the secretion element walls.

The porous structure thus created enhances mass transfer, intensifying the effective diffusivity as well as the overall operation kinetics. However, the major impact of the DIC process is that it provides a solution for the paradox of essential oil mass/heat transfers by allowing a mass transfer as a gradient of total pressure (Darcy-type law with the Total Pressure Gradient as the driving force of mass transfer), flowing from the core of the material at high total pressure of vapor to its surface under a vacuum.

The temperature and pressure levels during one DIC cycle are shown in Figure I-8. After an initial atmospheric pressure stage (a), a vacuum of about 4.5 kPa is established in the autoclave (b) and, just after saturated steam is injected into the autoclave (c) to be maintained at a fixed pressure level for a predetermined time (d). The initial vacuum (a) state allows closer contact between the steam, which is the heating fluid, and the exchange surface of the plant. The vacuum allows the exchange surface to be much higher than the situation of atmospheric air pressure where the normal surface inserts air globules inducing very weak both thermal conductivity and water condensed contact. Thus, the vacuum step allows the heat transfer towards the plant exchange surface to be enhanced, and the product to immediately reach saturated steam temperature. After this thermal treatment, the steam is cut off and the spherical valve is opened rapidly (in less than 50 ms), which results in an abrupt pressure-drop within the vessel (e). The vacuum period (f) is followed by a final release in order to attain atmospheric pressure (g), or by stage (c) of a new DIC cycle for a Multi Cycle-DIC treatment. Multi Cycle-DIC contains n repetitions of stages (c), (d), (e) and (f), with a total heating time which is the heating time of all these cycles.

3.2.2. Heat and Mass transfer

3.2.2.A Heating steps (b, c, and d)

The first DIC-stage is the heating stage. It aims at establishing from the initial product temperature T_i , a uniform treatment temperature T_t practically equal to the boiling temperature of water at the treatment pressure. Heating by pressured saturated steam injection is a specific process starting by quickly getting the product surface (exchange surface) at the steam temperature level T_t by convection and mainly more by condensation. It is followed by a conduction process within the product. Inside any porous wet material, the possibility to get evaporating/condensation process usually allows the effective conductivity λ_{eff} to be much higher than the calculated or measured static value λ .

To evaluate the quantity of water issued from steam condensation, one has to evaluate the heat energy needed to modify the temperature from initial T_i level till the treatment temperature value T_t . When the initial porous wet material is defined as a dry material m_d with an initial water content W (% dry basis), it would be possible to consider the specific heat of the material as a linear combination of both compounds. At a constant treatment pressure value P_t , the enthalpy variation (or heat absorbed by the product) should be following (Choi and Okos, 1986):

Specific heat at constant pressure, correlated to sensible heat Q at constant pressure	$c_p = \sum_{i=1}^n (C_i c_{p,i})$	Eq. I-38
	$c_p = \left. \frac{1}{m} \frac{\partial Q}{\partial T} \right]_p$	Eq. I-39

In our case, this situation becomes:

Sensible heat Q at constant pressure:	$\Delta H = Q = m_d (c_{p,d} + W c_{p,w}) (T_t - T_i)$	Eq. I-40
---	--	----------

The amount of water obtained by condensation of steam at the product exchange surface becomes:

$m_v = m_d \frac{(c_{p,d} + W c_{p,w}) (T_t - T_i)}{L}$	Eq. I-41
---	----------

Just before dropping the pressure, product has an increasing of water content (% , dry basis), which is:

$\Delta W = \frac{(c_{p,d} + W c_{p,w})(T_t - T_i)}{L}$	Eq. I-42
---	----------

Since the heating fluid is a saturated steam, the kinetics of the operation is strictly linked to the condensation, which is a very rapid phenomenon:

Condensation kinetics:	$\frac{dm_v}{dt} = k S(T_t - T_s)$	Eq. I-43
------------------------	------------------------------------	----------

By assuming the part of convection is negligible in the heating process, the heat flow from the saturated steam towards the surface is supposed to be:

Heating of surface kinetics:	$\frac{dQ}{dt} = \dot{Q} = \phi = \varphi S = k L S(T_t - T_s)$	Eq. I-44
------------------------------	---	----------

When steam is injected from an initial atmospheric air pressure, the open and dead-end pores are kept normally filled with air acting as an isolated medium. Thus, the effective exchange surface between the condensed steam and the product has to be only limited to the geometrical smooth surface. At the opposite, after an initial vacuum step, the steam injected almost completely fills the open superficial and dead-end pores, leading to a close contact between both mediums. Thus, the effective exchange surface S_{eff} between the condensed steam and the product becomes much higher than the smooth surface S:

After vacuum step condensation kinetics:	$\frac{dm_v}{dt} = k_{cond} S_{eff}(T_t - T_s)$	Eq. I-45
--	---	----------

The kinetics of condensation phenomenon is much quicker while establishing such initial vacuum step prior to the properly said heating step. However, as the specific heat c_p of air is negligible, the amount of condensed steam m_v has the same value in both cases.

After this first washing step assuring the superficial interaction between condensed steam strictly correlated with the temperature T_t , water and heat diffusion transfers within the material are carried out from the surface at the highest values of water content and temperature towards the core which is at the lowest water content and temperature values.

Since the superficial temperature is established quickly at the steam pressure level T_t , thanks mainly to the saturated steam condensation, the heat transfer within the product immediately starts. The initial vacuum state enables a closer contact between the external product surface and the steam, with much higher value of S_{eff} than the smooth surface S , the intensification is strictly located at this superficial process. Heat and mass transfers occur separately within the product. The first occurs through conduction according to a Fourier-type law:

$\vec{\varphi} = -\lambda_{eff} \cdot \vec{\nabla} T$	Eq. I-46
---	----------

The second is a normal Fick-type water diffusion mass transfer (Allaf et al., 2011):

1 st Fick's Law	$\frac{\rho_w}{\rho_d} (\vec{v}_w - \vec{v}_d) = -D_{eff} \vec{\nabla} \left(\frac{\rho_w}{\rho_d} \right)$	Eq. I-47
Absence of expansion or shrinkage: $\vec{v}_d = 0$ and $\rho_d = constant$	$\rho_w \vec{v}_w = -D_{eff} \vec{\nabla} \rho_w$	Eq. I-48
By adding the continuity:	$\frac{\partial \rho_w}{\partial t} = -\vec{\nabla} \cdot (D_{eff} \vec{\nabla} \rho_w)$	Eq. I-49
	$\frac{\partial T}{\partial t} = -\vec{\nabla} \cdot (\alpha_{eff} \vec{\nabla} T)$	Eq. I-50

The values of both effective diffusivities α_{eff} and D_{eff} expressed in $m^2 s^{-1}$ depend on water content W (dry basis). We usually use the Dickerson approximation:

Estimation of effective thermal diffusivity α ($m^2 s^{-1}$):	$\alpha_{eff} = \frac{8.8 \cdot 10^{-8} + W \alpha_w}{1 + W}$	Eq. I-51
---	---	----------

Effective thermal diffusivity α_{eff} also slightly depends on the temperature T , the porosity ratio and the average size of pores. Although the water effective diffusivity within the product D_{eff} considerably varies versus the porosity and temperature of the granule, its values (about $10^{-10} m^2 s^{-1}$) are usually assumed to be much lower than the heat diffusivity α_{eff} (about $10^{-7} m^2 s^{-1}$).

Since the temperature within the product can reach its equilibrium level in very short time compared to time needed to obtain such water content equilibrium, it is possible to consider D_{eff} value to be constant once the hypothesis of both structural and thermal homogeneities is assumed.

A general quantification of physical processes and adequate experiments normally confirm this hypothesis, allowing Eq. I-49 to become the second Fick's law:

Similar second Fick's law:	$\frac{\partial \rho_w}{\partial t} = D_{eff} \vec{\nabla} [\vec{\nabla} \rho_w] = D_{eff} \nabla^2 \rho_w$	Eq. I-52
----------------------------	---	----------

And, by assuming a unidirectional flow, Eq. I-52 becomes:

One-r-direction second Fick's law:	$\frac{\partial \rho_w}{\partial t} = D_{eff} \frac{\partial^2 \rho_w}{\partial r^2}$	Eq. I-53
------------------------------------	---	----------

The duration (t_c) of the high-temperature stage of DIC must generally be defined so that both the temperature (T) and moisture content (W) are uniform within the product. Since the first parameter is much more quickly achieved; this high-temperature time frame is calculated to allow the amount of added moisture absorbed by the product from the surrounding saturated steam (Eq. I-41) to be uniformly and homogeneously distributed in the material.

3.2.2.B Pressure drop stage

Pressure-drop stage has to be defined and studied at several levels: autovaporization, expansion, cooling, and glass transition processes.

By abruptly dropping the pressure, an adiabatic autovaporization of the overheated water and volatile compounds occurs, pore inducing an instant cooling of the residual material.

The vapor hence generated engenders mechanical stresses and constraints within the plant, swelling cells and the structure. General behavior and structure evolution greatly depend on the plant's viscoelastic characteristics, which is a function of temperature and water content. However, the preservation of the swelled new structure depends greatly on the glass transition, which is carried out at low temperature and water content. This aspect is very important to explain why the pressure has to drop towards a vacuum allowing the equilibrium temperature to reach such a glass transition temperature level.

The amount of water removed from the product by autovaporization through the exchange surface becomes:

m_v :	$m_v = m_d \frac{(c_{p,d} + W'c_{p,w})(T_p - T_t)}{L}$	Eq. I-54
---------	--	----------

Where T_p is the temperature reached by the product just after the pressure drops.

Depending on the pressure-drop time, T_p can be the equilibrium level T_e (quasi-static transformation):

For long pressure-drop time (quasi-static transformation):	$T_p = T_e$	Eq. I-55
--	-------------	----------

T_p can also be at much lower level than the equilibrium temperature T_e when the pressure is dropped instantaneously (instantaneous transformation):

For instant pressure-drop (instantaneous transformation):	$T_m \leq T_p \leq T_e$	Eq. I-56
---	-------------------------	----------

Thus, just after dropping the pressure, product has a decreasing of water content (% dry basis), which is:

Modification of water content (%dry basis)	$\Delta W = \frac{(c_{p,d} + W'c_{p,w})(T_p - T_t)}{L} < 0$	Eq. I-57
--	---	----------

After the instant pressure-drop step (e) and during the vacuum step (f), the internal total pressure is mainly due to water vapor (and other volatile molecules) in the porous medium. Under DIC conditions, the total pressure of the volatile mixture vapor in the porous material just after the pressure-drop was assumed to be much higher than the external pressure (Allaf, 2009).

3.2.2.C Mass transfer by permeability

In various cases where there is a zone of total pressure gradient (membrane transfer, permeability of porous material...), mass transfer takes place by Darcy permeability type, the total pressure gradient is the "driving force":

General Darcy law:	$\rho_v(\vec{v}_v - \vec{v}_d) = -\frac{K}{\nu_v} \vec{\nabla} P$	Eq. I-58
--------------------	---	----------

Where the permeability K expressed in (m^2) mainly depends on the structure, porosity, tortuosity of solid matrix. The kinematic viscosity ν_v expressed in ($m^2 s^{-1}$) depends on the nature of transferred fluid (density, molecular size...). It was assumed an instantaneous expansion phenomenon, possibly due to the autovaporization itself just after the pressure drops (Allaf, 2009). The expansion time was measured to be between 20 and 200 ms, depending on the material and the autovaporization conditions. By assuming that $\vec{v}_d = 0$, and the transfer to be one-dimension radial within a spherical shape material, Eq. I-58 becomes:

$\rho_v \vec{v}_v = -\frac{K}{\nu_m} \frac{\partial P}{\partial r} \vec{u}_r$	Eq. I-59
---	----------

Therefore, the transfer of volatile molecule vapor such as water and essential oils within the expanded granule is assumed to be from the core towards the surrounding medium through the gradient of total pressures. By using the 1st Darcy-type law describing this transfer, coupled to mass conservation and continuity, and by integrating between the pore (whose radius is R_o) and the external radius (R_s) of the spherical shape, Eq. I-59 becomes:

$\dot{m}_v = \frac{4\pi K (P_{globule} - P_{ext})}{\nu_m \left(\frac{1}{R_o} - \frac{1}{R_s}\right)}$	Eq. I-60
---	----------

The value of the total pressure ($P_{globule}$) in the hole decreases versus the time (t), depending on the flow (\dot{m}_m). The globule radius (R_o) is assumed to be constant (absence of expansion) as is the temperature, which would appear to remain constant at the value reached just after the pressure-drop, defined by the level of water-vapor temperature-pressure equilibrium. Eq. I-60 becomes:

$\frac{dP_{globule}}{dt} \frac{\langle M \rangle V_{hole}}{R_{GP}T} = - \frac{4\pi K (P_{globule} - P_{ext})}{v_v \left(\frac{1}{R_o} - \frac{1}{R_s} \right)}$		Eq. I-61
$(P_{globule} - P_{ext}) = (P_{globule,o} - P_{ext}) \exp \left(- \frac{3KR_{GP}T}{v_v \langle M \rangle R_o^3 \left(\frac{1}{R_o} - \frac{1}{R_s} \right)} t \right)$		Eq. I-62
The evolution of the amount of vapor versus time is:	$\dot{m}_v = \dot{m}_{v,o} \exp \left(- \frac{3KR_{GP}T}{v_m \langle M \rangle R_o^3 \left(\frac{1}{R_o} - \frac{1}{R_s} \right)} t \right)$	Eq. I-63
Characteristic time of Darcy's mass transfer	$\tau = \frac{\langle M \rangle R_o^3 \left(\frac{1}{R_o} - \frac{1}{R_s} \right) v_m}{3KR_{GP}T}$	Eq. I-64

Usually, the time t_v of the vacuum stage (f) allows the vapor mixture to be transported towards the surrounding medium and then collected.

DIC process provides an appropriate solution to the disadvantages of the paradoxical phenomenon and greatly intensifies essential oil extraction. It uses the autovaporization instead of (or coupled to) the evaporation process, and Total Pressure Gradient instead of the normal diffusion phenomenon. Here too, the water vapor pressure takes a very important role in the driving force because it is normally 10 times greater than other natural volatile molecules. Another point has to be highlighted. By grinding the material and reducing the granule size, the characteristic time τ of Darcy's mass transfer can dramatically decrease (mainly evolving as a function of R_o^2).

III. NON-VOLATILE COMPOUNDS IN NATURAL PRODUCTS

1. Solvent extraction process

1.1. General aspects

Solvent extraction is usually used to recover compounds from either a solid or a liquid. It is a very important operation in industries such as the chemical and biochemical industries, together with the food, cosmetics and pharmaceutical industries (Allaf et al., 2011). As a unit operation, extraction is used to remove some compounds from plants to be used as beverages or ingredients in food, medicines and drugs in pharmaceuticals and fragrances or perfumes.

The sample is placed in contact with a solvent that will dissolve the desired solutes. Solvents used in the separation processes of plant products are usually water, organic and petrochemical solvents, super- or sub- critical fluids...

Standard extraction techniques include several methods that all consist in the liquid solvent interacting with the solid material in order to dissolve the desired components (Leybros and Frémeaux, 1990).

They can be listed as follows:

- Percolation: usually a very hot solvent is flushed onto a bed of finely divided solids. This method is used in the preparation of coffee.
- Decoction: the solid is immersed in a boiling liquid solvent. This is a brutal operation that should be reserved for the extraction of non-thermolabile active ingredients. However, this process is very fast and is sometimes necessary.
- Infusion: the solid is immersed in a heated solvent without boiling, followed by cooling the mixture. The preparation of tea is a typical example.

- **Maceration:** the solid is immersed in a cold solvent. The operation is usually long and with poor results; however it is the only method used in the case of a set of fragile molecules. To be effective, maceration can last 4 to 10 days, which may present problems in terms of fermentation or bacterial contamination, particularly if the solvent used is water. These phenomena can cause rapid degradation of active molecules. In order to avoid or limit these drawbacks, the maceration can be carried out in a covered container and, in some cases, in a refrigerator.
- **Digestion:** especially used in perfumery and pharmacy, digestion is a hot maceration. As it is faster, it generally does not involve any degradation or bacterial contamination problems.

In all these methods, the mass transfer that occurs during solvent extraction is hindered and limited by the structure and the cell wall of the matrix. To avoid this difficulty and to improve such conventional solvent extraction operations, several solutions have been proposed as pretreatments: reducing the size of particles by crushing, breaking cell walls by enzyme treatment... or using ultrasound, microwaves, accelerated solvent extraction... or a special solvent such as sub- or supercritical fluids. These options have not definitively resolved the main issues.

1.2. Principle

Solvent extraction and separation process is, from a technological point of view, an operation based on the diffusion of a carrier fluid (liquid) within a solid in order to bring out specific molecules. It is frequently presented as a solid-liquid interaction. A solvent capable of "dissolving" one or more components from a solid or a liquid generates an extract solution (solvent + solute).

The transfer of these active molecules to the surroundings occurs through a diffusion which is mainly the result of a concentration gradient of solute between the inner solution near the solid phase (more concentrated) and the liquid phase. At the end of the operation, the system tends towards equilibrium and the diffusion is near zero. In contrast, if the liquid phase is continuously renewed, the diffusion continues until the complete exhaustion of the solid phase, at least from what is available.

1.2.1. Identification of limiting process and intensification of unit operation

The solid/liquid interaction is achieved by close contact between the solid and the solvent. During the extraction, the concentration of solute in the solid varies continuously, which explains the non-stationary mass transfer.

The operation starts with a superficial solute dissolution in solvent. This occurs at the surface (external process of washing) and is immediately transported within the surrounding solvent medium.

After this first stage, a series of successive processes takes place, reflecting the interaction between the solid initially containing the solute and the solvent provoking the separation. These successive processes include:

1. Solvent diffusion within the solid matrix,
2. Internal solute dissolution in the solvent: this occurs within the solvent, which has diffused within the porous solid plant matrix (internal process),
3. Solute diffusion in the solvent within the solid matrix towards the surface. This can also be considered as the diffusion of external solvent within the internal mixture of solute/solvent; the specific transport of the solute within the filled-in-solvent pores must be carried out as a Fick-type diffusion process.
4. External diffusion and/or convection transfer of the solute from the surface of the solid to the external environment.

The extraction often studied on a phenomenological basis or on an empirical model as a unit operation, should be analyzed in terms of kinetics and total yields.

Kinetics is usually expressed in terms of solute concentration in the solid per unit time (dX/dt). Since these four processes are successive, the operation rate should follow the slowest process, which is then defined as the limiting process.

To identify the limiting process and intensify the whole operation, we propose, first, to analyze these various processes involved in the operation.

1.2.1.A Dissolution of the molecule to be extracted in the liquid solvent

Dissolution is the operation of dissolving a substance in a solvent. Dissolution tends toward thermodynamic equilibrium in terms of concentration and is described through the distribution, or equilibrium partitioning constant or coefficient ϖ_e , which is a function of the maximum dissolution (saturation level), thereby leading to an equilibrium concentration between the extract and the dry matter (Schwartzberg and Chao, 1982).

The higher the value of " ϖ_e ", the more easily the solvent dissolves the indicated compound. The value of " ϖ_e " depends on the characteristics of the solvent, the compound to be extracted and the temperature. Usually, dissolution of hydrophobic (non-polar) molecules is performed using organic solvent.

Dissolution of the molecules to be extracted (solute) is the limiting process in the extraction operation only if, for instance, an unsuitable solvent and a low temperature are chosen. Normally the extraction process would be entirely driven by the dissolution of the solute in the solvent.

To intensify such a situation, one has to perform the operation by simply using "suitable" solvents with the desired solutes. Often, the appropriate temperature should be as high as possible up to the boiling temperature although below the degradation level of the molecules. The choice of extraction solvent and temperature is usually made according to the desired solutes, the nature and the variety of the plant.

So, it is normally easy to avoid having dissolution as the limiting process. On the contrary, it may often be considered in practice as a very quick and even instantaneous process.

1.2.1.B Transport from the surface toward the outside

Since the dissolution is assumed to be fast, solute close to the exchange surface is transferred to the surrounding medium, via either diffusion and/or convection.

In the absence of any agitation phenomenon, it is possible that the limiting process of the extraction operation is the transfer of solute from the solid surface toward the external solvent.

To obtain a proper intensification of this external transfer, one has to establish a convective instead of a diffusional transfer. This has to be realized through adequate agitation of the outside “solvent medium”. The external transfer resistance becomes negligible. A quantification of the impact of agitation is represented by the Biot number whose value gives an idea of the homogeneity of the system:

$Bi = \frac{kl}{D_s}$	Eq. I-65
-----------------------	----------

In practice, the Biot number is usually greater than 200. One can thus neglect the mass transfer resistance at the interface compared to that inside the solid. It is for this reason that agitation is often included in the extraction process (Schwartzberg and Chao 1982).

Since the adequate solvent instantaneously dissolves the solute, the extraction operation starts by solvent washing the surface, which is a very rapid phenomenon:

Extraction rate of solute from surface:	$\frac{dm_s}{dt} = k_e ESA (\varpi_e - \varpi_{solvent})$	Eq. I-66
Density of extraction rate of solute from surface by unit of dry matter:	$\frac{dX_s}{dt} = k_e SESA (\varpi_e - \varpi_{solvent})$	Eq. I-67

By intensifying the convection via an adequate high agitation of solvent, the dissolution coefficient value of solute by the solvent (k_e) is increased. This amplifies kinetic processes compared to a simple diffusion process. An adequate ultrasound treatment can also contribute to increasing the internal fluctuation motion of the particles and the solute flows from the surface towards the outside.

Extraction processes can be enhanced by a grinding of the raw material - the smaller the granule average size, the higher the specific surface exchange area SESA.

Another effective intensification way can be carried out by assuring the injection of solvent after an initial vacuum step. Hence, instead of getting at initial atmospheric air pressure the open and dead-end pores normally filled with air acting as an isolated medium, the solvent would almost completely fill the open superficial and dead-end pores.

Thanks to initial vacuum step we can have a close contact and exchange between the “total surface” and the solvent, thus avoiding the limitation of the geometrical smooth surface. The effective exchange surface area between the solvent and the product becomes much higher:

After vacuum step, the density of extraction rate of solute from surface by unit of dry matter:	$dX_s = k_e SESE_{eff}(\varpi_e - \varpi_{solvent})dt$	Eq. I-68
---	--	----------

"External" intensification processes are usually easy to be carried out. They are great agitation processes possibly combined with US treatment. Grinding can also lead to high Specific Exchange Surface Area. Initial vacuum step can also increase this exchange surface value $SESE_{eff}$, normally higher than the smooth surface $SESA$.

Once the external transfer phenomena are perfectly intensified, they are no longer the limiting processes. Solute extraction kinetics from the surface then reaches its highest level (Allaf et al., 2011).

Their total effect can be revealed through the “Starting Accessibility” parameter:

Starting Accessibility	$\delta X_s = k_e SESE_{eff}(\varpi_e - \varpi_{solvent})\delta t$	Eq. I-69
------------------------	--	----------

Usually, in kinetic study, the Starting Accessibility δX_s does not imply any diffusion source or effect; it is the density of solute per unit of dry matter extracted by the initial interaction between the solvent and the superficial part of the product; and is expressed as kg of solute per kg of dry matter or % db.

1.2.1.C Internal transfer by diffusion

After this first washing step establishing the solvent superficial interaction, solvent diffusion transfer towards the material is carried out from the surface with the highest solvent concentration towards the core which has the lowest concentration.

Since the superficial extraction is achieved very quickly with a value revealed through the Starting Accessibility δX_s level, the diffusional solvent transfer within the product immediately occurs through a normal Fick-type solvent diffusion mass transfer.

Hence, once the external transfer is adequately intensified the diffusion step can be considered as the limiting process. Indeed, whatever the pore size, internal convection in the pore is assumed to be negligible. The diffusion process is achieved on two levels. The first internal transfer is the solvent transfer within the plant structure (solid/liquid interaction) - the driving force of solvent transfer is the gradient of apparent densities ratio of solvent to solid. The second type of diffusional transfer is the diffusion transfer of the solute within the solvent solution (liquid/liquid interaction) - the solute transfer is carried out through the gradient of the apparent density ratio of solute to solvent.

As the first usually is much quicker, the main part of kinetics appears as solute-in-solvent transfer in the pores of the solid matrix, closely depending on the porosity of the material.

Thus, during this operation, the random movement of molecules guarantees a diffusion transfer with the concentration gradient as the driving force. We can then explain why diffusion (Fick type) appears to be the major transport phenomenon occurring within the solid matrix (Aguilera and Stanley, 1999) and the mass transfer process cannot be intensified through any external mechanical or thermal changes. Only a modification of shape (by grinding), an expansion improving the porosity, and/or an Ultra-sonic treatment increasing the apparent agitation of molecules in the pores may improve such an operation.

1.2.2. Kinetic modeling

As mentioned just above, a certain amount of the solute is immediately accessible on the surface and can be immediately dissolved in the external solvent, usually removed from the plant by convection (Amor et al., 2008; Ben Amor, 2008; Ben Amor and Allaf, 2009).

Indeed, in any solvent extraction achieved on plants (porous solid material), a first solvent-exchange surface interaction (washing (Fernández et al., 2012)) takes place for a short time-frame. Thus, starting accessibility δX_s (expressed in g of extract per g of dry material) reveals the amount of extract obtained in very short time-frame (t near 0) through the convection of solvent interacting with the exchange surface. Afterward, the main part of the operation is controlled through various penetration processes of the solvent within the material (capillarity, molecular diffusivity...).

In such conditions, formulation (Allaf, 1982) of the first Fick law can be used. The driving force of solvent transfer is the gradient of apparent densities ratio of solvent to solid:

$\frac{\rho_{solvent}}{\rho_d} (\vec{v}_{solvent} - \vec{v}_d) = -D_{eff,solvent-d} \vec{\nabla} \left(\frac{\rho_{solvent}}{\rho_d} \right)$	Eq. I-70
--	----------

While the solute transfer is carried out through the gradient of the apparent density ratio of solute to solvent, the driving force of global operation is the gradient of concentration:

$\frac{\rho_{solute}}{\rho_{solvent}} (\vec{v}_{solute} - \vec{v}_{solvent}) = -D_{eff,solute-solvent} \vec{\nabla} \left(\frac{\rho_{solute}}{\rho_{solvent}} \right)$	Eq. I-71
--	----------

Fick-type global diffusion model were considered with an effective diffusivity D_{eff} ($m^2 s^{-1}$) as the process coefficient:

(Allaf et al., 2011; Allaf et al., 2012)	$\frac{\rho_{solute}}{\rho_d} (\vec{v}_{solute} - \vec{v}_d) = -D_{eff} \vec{\nabla} \left(\frac{\rho_{solute}}{\rho_d} \right)$	Eq. I-72
--	---	----------

However, if it is possible to assume that the operation does not involve any swelling or shrinkage, it would be easy to simplify such a transfer law assuming that it occurs in a presumably motionless solid matrix. This also suggests that the change with time of solid porous medium density is negligible, despite the extraction phenomenon that still occurs. It is then possible to assume that ρ_m is constant:

Motionless solid matrix: $\vec{v}_d = 0$ and $\rho_d = constant$	$\rho_{solute} \vec{v}_{solute} = -D_{eff} \vec{\nabla} \rho_{solute}$	Eq. I-73
--	--	----------

Using the balance mass, it is possible to obtain:

By adding the continuity:	$\frac{\partial \rho_{solute}}{\partial t} = -\vec{\nabla} \cdot (D_{eff} \vec{\nabla} \rho_{solute})$	Eq. I-74
---------------------------	--	----------

Where t is the time starting just after the solvent-surface interaction.

Although the effective diffusivity (D_{eff}) varies considerably with the system temperature and porosity, it can be considered constant in the hypothesis of both structural and thermal homogeneities, that allows the equation to become (Mounir and Allaf, 2008):

Structure and temperature homogeneity $\rightarrow D_{eff} = Constant$:	$\frac{\partial \rho_{solute}}{\partial t} = -D_{eff} \nabla^2 \rho_{solute}$	Eq. I-75
--	---	----------

And, for one-direction radial flow, it becomes:

$\frac{\partial \rho_{solute}}{\partial t} = -D_{eff} \frac{\partial^2 \rho_{solute}}{\partial r^2}$	Eq. I-76
--	----------

The solutions required for this diffusion equation closely depend on the initial and boundary solvent conditions. The classical Crank's solutions according to the granule geometry may be adopted (Crank 1975) by inserting the time t_0 , which corresponds to a time when the extraction process is in the pure diffusion area:

Crank's solution Infinite plate with $r_d = \text{thickness}/2$	$\frac{X_\infty - X}{X_\infty - X_{t_0}} = \sum_{i=1}^{\infty} \frac{8}{(2i-1)^2 \pi^2} \exp\left(-\frac{(2i-1)^2 \pi^2 D_{eff}}{4r_d^2} (t - t_0)\right)$	Eq. I-77
$\frac{X_\infty - X}{X_\infty - X_{t_0}} = \frac{8}{\pi^2} \exp\left(-\frac{\pi^2 D_{eff}}{4r_d^2} (t - t_0)\right) + \frac{8}{9\pi^2} \exp\left(-\frac{9\pi^2 D_{eff}}{4r_d^2} (t - t_0)\right) + \frac{8}{25\pi^2} \exp\left(-\frac{25\pi^2 D_{eff}}{4r_d^2} (t - t_0)\right) + \dots$		
Crank's solution : Sphere $d_p = \text{radius}$	$\frac{X_\infty - X}{X_\infty - X_{t_0}} = \sum_{i=1}^{\infty} \frac{6}{i^2 \pi^2} \exp\left(-\frac{i^2 \pi^2 D_{eff}}{r_d^2} (t - t_0)\right)$	Eq. I-78
$\frac{X_\infty - X}{X_\infty - X_{t_0}} = \frac{6}{\pi^2} \exp\left(-\frac{\pi^2 D_{eff}}{r_d^2} (t - t_0)\right) + \frac{6}{4\pi^2} \exp\left(-\frac{4\pi^2 D_{eff}}{r_d^2} (t - t_0)\right) + \frac{6}{9\pi^2} \exp\left(-\frac{9\pi^2 D_{eff}}{r_d^2} (t - t_0)\right) + \dots$		
Crank calculation to determine D_{eff} (1 st term approach)	$\frac{X_\infty - X}{X_\infty - X_{t_0}} = A \exp(-k(t - t_0))$	Eq. I-79
1 st term approach	$\ln\left(\frac{X_\infty - X}{X_\infty - X_{t_0}}\right) = -k(t - t_0)$	Eq. I-80
Infinite plate:	$D_{eff} = k \frac{4r_d^2}{\pi^2}$	Eq. I-81
Sphere	$D_{eff} = k \frac{r_d^2}{\pi^2}$	Eq. I-82
Calculated value by extrapolating diffusion model to $t=0$: $X_o \neq (X_i = 0)$	$X_o - X_i = X_o = \delta X_s$ Starting accessibility (amount of solute directly extraction by solvent/superficie interaction)	Eq. I-83

1.2.3. Mass and heat diffusivities

A bibliographic analysis showed that the effective diffusivity (D_{eff}) of the entire extraction operation of liquids in plant matrices have a magnitude that is generally close to 10^{-11} to $10^{-10} \text{ m}^2 \text{ s}^{-1}$, while heat diffusivity is usually between 10^{-8} to $10^{-6} \text{ m}^2 \text{ s}^{-1}$, depending on water content and porosity.

This confirms, in a way, that the solvent diffusion into a solid matrix must often be the slowest process and appears to be the "main" limiting process throughout the operation. The intensification operation lies in the expansion of this natural structure as a real method for improving the processing ability of the plant regarding solvent extraction.

To study the kinetics and use the experimental data to make a model of the diffusion process, the value $X = 0$ was excluded measured at the starting point (at $t \rightarrow 0$) (Mounir and Allaf, 2009). The experimental data used for such a diffusion model excludes the points close to $t = 0$; the extrapolation of the model thus obtained showed that δX_s is in general non-zero. δX_s represents the amount of solute accessible on the surface that is quickly removed and extracted from the surface, independently from diffusion process. Its value is then calculated by extrapolating the diffusion model towards $t=0$.

Solvent extraction kinetics is then defined through the yield values X_∞ , the starting accessibility δX_s , and the effective diffusivity D_{eff} .

1.3. Conclusion: Intensification – How to intensify?

Kinetics model of solvent extraction leads to the determination of the impacts of the different intensification treatments via the yields (X_∞), the starting accessibility (δX_s) and the effective diffusivity (D_{eff}). The values of X_∞ , δX_s , and D_{eff} have to reflect the main response parameters characterizing the plant "technological aptitudes" regarding solvent extraction technology.

Four procedures capable of intensifying the solvent extraction operation were listed (Mounir and Allaf, 2008):

1. Agitation of the surrounding solvent, which normally allows the solute transport from the product surface to the outside by convection.
2. Grinding: which normally reduces the depth of diffusion of a liquid within the granule. It also increases the exchange surface area and makes the solute on the surface more accessible. Thus, generally, since granules are assumed to be spherical and compact (see point 3.), external exchange surface evolves to be as high as $1/\langle D \rangle$ where $\langle D \rangle$ is the average granule size.

These two intensification ways should increase the starting accessibility (δX_s).

3. Texturing: it aims at reducing mass transfer resistance. Indeed, the natural plant structure and more specifically the cytoplasmic membrane and cell walls would constrain the liquid transfer processes. Hence, by breaking these membranes whether via enzymatic treatments, DIC swelling etc., mass transfer kinetics can significantly increase.
4. The Ultrasonic assistance: it takes place at both:
 - a. External exchange surface (increasing the starting accessibility δX_s) where it may imply a higher value of effective coefficient of mass convection,
 - b. Internal pore solvent (increasing the effective diffusivity D_{eff}) where it may induce mass convection instead of solute-in-solvent diffusion. Here it worth noting that the pore size distribution plays a significant role.

It is important to highlights that in all these possibilities, the place of instant controlled pressure drop DIC technology is strategic. Indeed in all the solvent extraction operations and whatever the part of plant, it is possible to intensify the operation through expansion, which increases the porosity, the specific surface area and the availability of the desired compounds.

Moreover regarding grinding and powders since granules are often compact, an adequate expansion can be used to completely modify the internal ability/skills of the material vis-à-vis the diffusion. Likewise, texturing will increase the porosity and the volume of the pores, improving solute transfer in the solvent within the product.

2. Instant controlled pressure drop (DIC)

2.1. DIC - Texturing

Instant controlled pressure drop DIC consists in establishing a short time frame (from 10 s⁻¹ min) high-temperature/high-pressure steam (0.05-1 MPa) step, followed by an instant pressure drop towards a vacuum (up to 1.5 kPa involving decompression ratio $\frac{\Delta P}{\Delta t} > 0.2 \text{ MPa s}^{-1}$). This operation involves an autovaporization of the volatile molecules (present in the solid matrix), thus inducing a cooling effect and texturing. In addition, the decompression towards the vacuum provides a greater temperature difference between the two states just before and after decompression. The amount of vapor produced is largely sufficient to develop the mechanical constraints without reaching a too high processing temperature (Iguedjtal et al., 2008; Louka and Allaf, 2004a), with a greater likelihood of achieving the glass transition.

Following theoretical work on the thermomechanical expansion of organic polymers (Allaf, 1988) and studies on the instantaneity transformations (Allaf, 2002), the DIC has got many applications (Allaf et al., 1998; Allaf et al., 1993; Allaf and Vidal, 1989) and several PhD works on drying (Sahyoun, 1996), drying/texturing, steaming (Habba, 1997), drying fish (Juhel, 2000), decontamination (Debs-Louka, 2000), treatment of archaeological wood (Sanya, 2000), drying of pharmaceutical products, sputtering (Delgado-Rosas, 2002), treatment of vegetables and leguminous (Haddad, 2002), rice processing, and the new concept of expanded granule powders (Mounir, 2007). Various industrial applications have shown the ability of the DIC to control both high product quality and relevant process performance thus saving energy consumption, and preserving environment (green process).

Gas pressure Texturing

Recent research on the DIC showed the possibility of using gases such as air, carbon dioxide and nitrous oxide at high pressures from 0.1 to 10 MPa. Changes in texture could be observed, with other mechanisms (micromechanical, chemical ...), yet underdeveloped but only used in the particular case of heat-sensitive materials such as dairy powders.

2.2. Fundamental and modeling

2.2.1. Autovaporization

The product, initially at a temperature much higher than the final thermal equilibrium level, undergoes just by instant pressure drop, an abrupt release of a certain amount of vapor. The volume of "vapor" is capable of inducing high amplitude internal constraints:

Evolution of water content dry basis by autovaporization:	$\Delta W = \frac{m_v}{m_d} = \frac{(c_{p,d} + W_i c_{p,w})(T_e - T_t)}{L} < 0$	Eq. I-84
Normal volume of generated vapor:	$V_v = \frac{m_s \Delta W T_e}{M_W P_f} = \frac{m_s R_{GP} T_e (c_{p,d} + W_i c_{p,w})(T_t - T_e)}{M_W P_f L}$	Eq. I-85

Assuming that the volume occupied by the vapor just when it is generated is determined by V_a , which is the difference between the specific volume and the intrinsic volume of the material, we can write:

Volume initially occupied by water:	$V_a = m_s \left(\frac{1}{\rho_{specific}} - \frac{1}{\rho_{intrinsic}} \right)$	Eq. I-86
-------------------------------------	---	----------

Constraints coming from the vapor thus generated should be correlated with the difference between internal and external pressures:

$\Delta P_{max} = \frac{m_s \Delta W R_{GP} T_e}{M_W V_a} - P_f = \frac{R_{GP} T_e (c_{p,s} + W_i c_{p,w})(T_t - T_e)}{M_W \left(\frac{1}{\rho_{spécifique}} - \frac{1}{\rho_{intrinsèque}} \right) L} - P_f$	Eq. I-87
--	----------

The maximum pressure difference ΔP_{\max} between the pore and the external environment is a very important parameter in the texturing operations either they are extrusion-cooking, steam-explosion, puffing and DIC. Indeed, the pressure difference ΔP is the driving force in the evolution of the pore size vs time:

Temporal evolution of the radius of the pore:	$\mu 2\pi R \frac{dR}{dt} = \frac{1}{2} \pi R^2 \Delta P$	Eq. I-88
---	---	----------

The change rate of the pore is thus proportional to the pressure difference ΔP between inside the pore and the external medium, and inversely proportional to viscosity. However, as this pressure difference depends on the initial value and evolves according to the pore size, we can write a relation similar to that used by Arhaliass et al. (2009).

The rheological behavior of the material during the expansion is very important. Indeed, by coupling the autovaporized water (responsible for internal constraints ΔP) and a viscoelastic behavior (here revealed by the viscosity μ) one can establish the expansion ratio. When the heating process is mainly carried out by high-pressure saturated steam (in the case of DIC), the increase of temperature is closely related to an increase of the moisture of the material:

Increase in water content during saturated steam heating:	$\Delta W_{cond} = \frac{m_v}{m_s} = \frac{(c_{p,s} + W_o c_{p,w})(T_t - T_i)}{L} > 0$	Eq. I-89
---	--	----------

Where:

m_v is the mass of steam condensed on the surface of the product capable of ensuring the passage of the initial temperature T_i at the treatment temperature T_t .

m_s is the mass of dry matter of the product treated

W_o is the initial moisture of the product to be treated in % of dry matter:

The material moisture just before pressure drops:	$W_t = W_o + \Delta W_{condensation}$	Eq. I-90
---	---------------------------------------	----------

2.2.2. Glass transition

High levels of humidity and temperature just before the instant pressure drop often increase the possibility of a viscoelastic behavior of the material. Preservation of the new honeycomb expanded structure is closely related to the glass transition of the material; instant pressure-drop responsible for the decrease in both humidity and temperature of the material can often increase the likelihood of the glass transition of the material. Indeed, experimental measurements of the glass transition temperature obtained at each moisture content can be correlated with the Gordon-Taylor relationship (Gordon and Taylor, 1952), formulated according to Allaf (1982):

Glass transition: Gordon-Taylor correlation model:	$T_g(W) = \frac{T_{g,m} + kW T_{g,w}}{1 + kW}$	Eq. I-91
--	--	----------

W is the moisture content (dry basis), $T_{g,m}$ and $T_{g,w}$ are the glass transition temperatures of the dry material and pure water, respectively. Note that $T_{g,w}$ is suggested by Orford et al. (1990) to be: $T_{g,w} = -139$ °C. Finally, k is the correlation Gordon-Taylor parameter, depending on the material. For $k=1$, the glass transition can be obtained as followed:

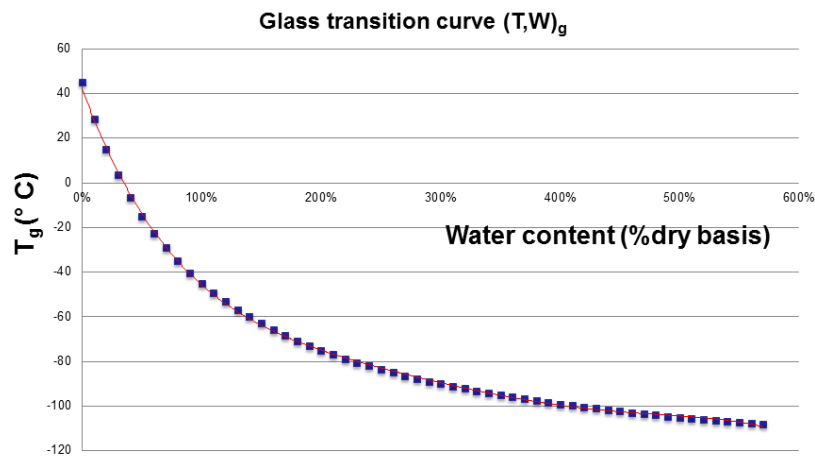

Figure I-9. Evolution of glass transition vs water content dry basis W (Allaf, 1982)

3. Ultrasound

3.1. Principle - Fundamental aspects

Ultrasound is mechanical waves that require an elastic medium to spread. Ultrasound frequencies are above human hearing (from 16 Hz to 16-20 kHz) and below microwaves frequency (20 kHz to 10 MHz). Ultrasound can be divided into two groups with regard to their frequencies:

- **diagnostic ultrasounds:** these ultrasounds are also called low power or high frequency ultrasounds which range from 5 to 10 MHz and are used in several fields such as medical imaging (med scan) or even for defect detection (bond inspection for plastics). Diagnostic ultrasounds, low-power ultrasounds permit measure without alteration of the medium unlike power ultrasounds.
- **power ultrasounds or low frequency ultrasounds** were used to produce physical or chemical effects into the medium. These are used in sonochemistry (facilitate or accelerate chemical reactions), agriculture (water dispersion) or in industry (cutting, plastic welding).

In order to visualize ultrasound effect, its action can be described as a piston on the surface of the medium (McClements, 1995) (Figure I-10). This results in a succession of compression and rarefaction phases into the medium. When the piston is in its opened position it induces a compression into the medium and when the piston is in its contracted (pull) position it creates a rarefaction phase.

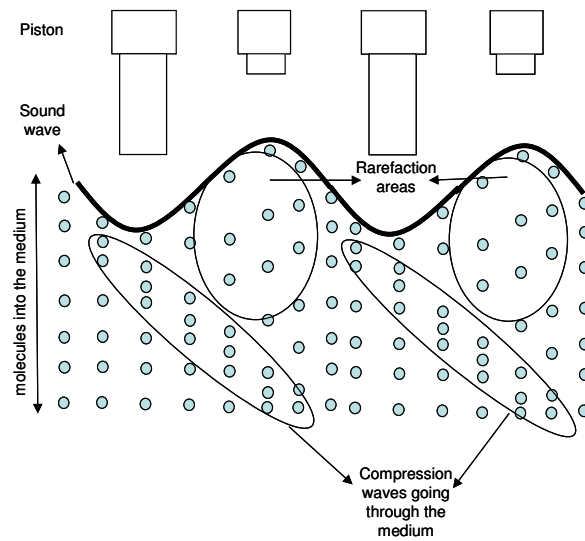

Figure I-10: Compression and rarefaction cycles induced by a sound wave (Pingret et al., 2013)

On a molecular scale, as the sound wave passes through the medium, the molecules are temporarily dislodged from their original position and may collide with the surrounding molecules (Figure I-11). Then, during the rarefaction phase the first group of molecules will be pulled back towards their original position and the kinetic energy involved will pull them further back than this position. This will create rarefaction regions into the medium but due to its elastic properties all the molecules will go back to their original location as the sound wave has fully pass through the medium (Mason et al., 2005).

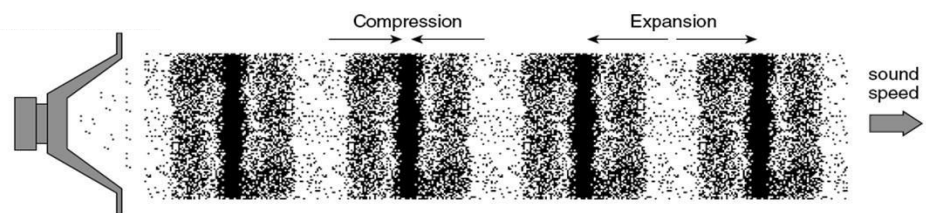

Figure I-11: Sound wave Compression and Expansion (Mason et al., 2005)

In acoustic cavitation, a sound wave imposes a sinusoidally varying pressure upon existing cavities in solution (Kentish and Ashokkumar, 2011) (Figure I-12). During the negative pressure cycle, the liquid is pulled apart at sites containing such a gaseous impurity, which are known as “weak spots” in the fluid. The number of bubbles that are produced during this rarefaction cycle is proportional to the density of such weak spots present in the fluid (Leong et al., 2011).

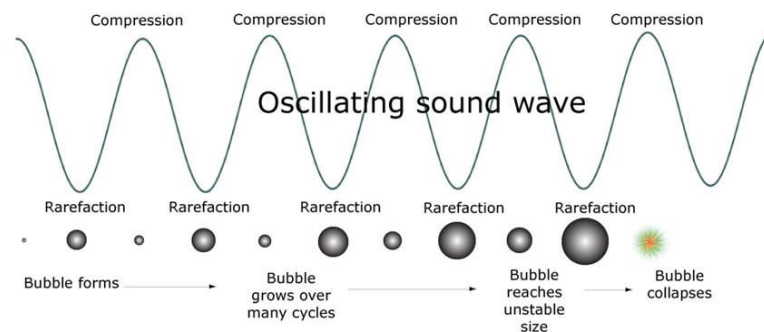

Figure I-12: Graphical summary of the event of bubble formation, bubble growth and subsequent collapse over several acoustic cycles (Leong et al., 2011)

Mass transfer characteristics of a system (indicated by the mass transfer coefficient) depend on the convection in the medium, i.e. mass transfer can be enhanced by making the system turbulent. Ultrasound, and its secondary effect, cavitation (which is nucleation, growth and transient collapse of tiny gas bubbles driven by ultrasound wave) can enhance convection in the medium through various physical phenomena such as micro-streaming, micro-turbulence, acoustic (or shock) waves and microjets.

3.2. Physical Effects of Ultrasound and Cavitation

Prior to the main components of this study, we briefly describe various physical effects of ultrasound and cavitation, which could create convection in the medium that could be beneficial to the adsorption process (Leighton, 1994; Mason and Lorimer, 2002). Ultrasound passes through the medium in the form of compression and rarefaction cycles, creating sinusoidal variation in the bulk pressure. Passage of ultrasound gives rise to the cavitation phenomenon in the medium (Louisnard and González-García, 2011). The nuclei for cavitation events are gas pockets trapped in the walls and crevices of the reactor wall, or they could be freely floating small bubbles in the medium. In some cases cavitation bubbles grow from these nuclei during the rarefaction half-cycle of ultrasound, when the bulk pressure in the medium falls sufficiently below ambient or static pressure.

During the compression half-cycle of ultrasound, the bubble contracts. The expansion of the bubble is accompanied by evaporation of the liquid medium into the bubble. During the compression phase, the radial motion of the bubble becomes extremely fast, and not all of the vapor evaporated into the bubble can escape by condensation into the bulk medium.

This causes entrapment of the vapor molecules in the bubble. The spherical convergence of fluid elements in the ensuing compression phase imparts high energy to the bubble that results in energy concentration during collapse. The transient bubble collapse results in generation of very high temperatures (~ 5000 K) and pressures (~ 500 bar) inside the bubble, making the bubble a local hot spot. The extreme temperature and pressure conditions in the bubble result in generation of radicals due to dissociation of entrapped vapor molecules (Colussi et al., 1998; Storey and Szeri, 2000).

With fragmentation of the bubble at the point of maximum compression, these radicals are released into the medium where they induce and accelerate chemical reactions, which are well-known as sonochemical reactions.

The physical effects of ultrasound and cavitation, which give rise to strong convection in the medium through various physical phenomena, are as follows.

3.2.1. Microstreaming

During propagation of ultrasound waves through a liquid medium, the fluid elements undergo small-amplitude oscillatory motion around a mean position. This phenomenon is called microstreaming. The amplitude of this oscillatory motion varies directly with the pressure amplitude of the acoustic wave.

3.2.2. Microturbulence

During radial motion of the bubble, the fluid in the vicinity of the bubble is set into oscillatory motion, which is called microturbulence. The velocity of the microturbulence varies directly with the amplitude of the oscillations of the bubble. For large-amplitude bubble oscillations, the collapse is transient (with the bubble wall velocity reaching or even exceeding the sonic velocity), and accordingly, the velocity of the microturbulence generated is also quite intense. It should, however, be noted that the phenomenon of microturbulence is restricted only in the close vicinity of the bubble. The velocity of the microturbulence decreases very rapidly away from the bubble.

3.2.3. Acoustic Waves (or Shock Waves)

During the transient collapse of the bubble, the fluid elements in the vicinity of the bubble wall spherically converge toward the bubble wall. If the bubble contains non-condensable gas, the pressure inside the bubble rises rapidly during the transient collapse. At the point of minimum radius during transient collapse, the bubble wall comes to a sudden halt and the converging fluid elements are reflected back. This reflection creates a high-pressure acoustic (or shock) wave that propagates through the medium.

3.2.4. Microjets

If the cavitation bubble is located close to a phase boundary, the motion of the liquid in its vicinity is hindered, which results in development of a pressure gradient around the bubble. The portion of the bubble exposed to higher pressure collapses faster than the rest of the bubble, which gives rise to formation of a high-speed liquid jet. The velocity of these microjets has been estimated in the range of 120-150 m/s (Philipp and Lauterborn, 1998; Vogel et al., 1989).

In the case of rigid boundaries, these jets can cause erosion at the point of impact. These jets can also cause particle size reduction. The microjet formation, however, also depends on the relative sizes of the solid boundary and the cavitation bubble.

Hence, with regards to extraction via solvent such an agitation realizes an internal convection motion of solute within the solvent inside pores of porous material. Moreover, possible cavitation produces micro-jets at the surface of the material that may improve the exchange surfaces which has to be revealed globally through a high starting accessibility. Both effects can increase mass transfers of both, solvent within the solid and solute within the solvent (Mason, 2000; Toma et al., 2001).

In other words, ultrasonic treatment implies an internal motion/agitation of the liquid within the pores, leading the solute transfer to be achieved by convection instead of or coupled to diffusion (Toma et al., 2001).

When there is a lack of agitation in the surrounding medium, transport of solute from the surface of solid within the external solvent should be done by diffusion from the highest solute concentration (close contact with the solid exchange surface) towards the lowest concentration zone with the gradient of solute concentration as the driving force.

Similar behavior occurs with the solute transfer within the solvent situated inside the pores of porous materials. It is usually achieved by diffusion from the highest value towards the lowest value of solute concentration zones. The driving force is the gradient of solute/solvent concentration ratio with D as the standard solute-solvent diffusivity:

$\frac{\rho_{solute}}{\rho_{solvent}} (\vec{v}_{solute} - \vec{v}_{solvent}) = -D_{solute-solvent} \vec{\nabla} \left(\frac{\rho_{solute}}{\rho_{solvent}} \right)$	Eq. I-92
--	----------

To ensure a solute-in-solvent **micro-convection** inside the pores instead the **natural diffusion**: US realizes such a micro-convection in the internal solvent and the operation can be postulated by a similar diffusion-model within the porous solid with an effective diffusivity D_{US} normally much higher than standard solute-solvent diffusivity D :

$\frac{\rho_{solute}}{\rho_{solid}} (\vec{v}_{solute} - \vec{v}_{solid}) = -D_{US} \vec{\nabla} \left(\frac{\rho_{solute}}{\rho_{solid}} \right)$	Eq. I-93
--	----------

Thus the advantages of ultrasonic extraction are as follow: reducing extraction time; decreasing solvent quantity; and improving solute extraction yield. Oscillatory particle motion produced by high-intensity ultrasonic waves can also induce secondary flows, known as acoustic streaming. Such an agitation should realize an internal convection motion of solute within the solvent inside pores of porous material. It has to be revealed globally through a higher effective diffusivity D_{US} .

4. **Microwaves**

Microwaves fit into a continuum, electromagnetic spectrum, which extends from the low-frequency alternating currents to the cosmic rays. They occupy the electromagnetic spectrum in a three-decade band of (300 MHz to 300 GHz) between the radiofrequency range VHF, and the far infrared range.

Microwave applications can be divided into two categories, depending on whether the microwave is information-carrier (telecommunications...) or mere-energy carrier.

This last is characterized by the implementation of continuous high power and lack of carrier modulation. The usual electromagnetic radiation (infrared, visible light) has a very limited penetration into the material (due to their short wavelengths). The microwave-wavelengths are from centimeters to decimeters, so as the penetration depths of bodies to be heated.

4.1.1. Microwave treatment

The main specificity of microwaves as a heat source is its penetrating power in materials normally independently of the conductivity of processed materials. A number of factors may be taken into account to adapt or not the use of microwaves:

- Geometry such as sizes of products to be processed, and the difficulty of using other heating methods...
- Thermal sensitivity...
- Cost: products have to be high-added value to tolerate treatment with microwaves.

An important element in the development of microwave and design systems is the ability to model the interactions between matter and electromagnetic wave.

The correlations between dielectric properties (usually linked with humidity and/or solvent presence) and temperature is important for simulation and modeling process.

The most important parameter in the microwave treatment is $\tan\delta$. It indicates the product ability to transform the absorbed energy into heat. So it must be a combination of a moderated ϵ' to good penetration and high loss (maximum of ϵ'').

Products to be processed by microwave must be dipolar, which, fortunately, is the case of many natural plant products. However, since the thermal conductivity of materials is low, the heat is not dissipated quickly in the surrounding zone.

The microwave heating process can be illustrated by considering the product electronic conduction σ_e , ionic conduction σ_i and a complex permittivity $\epsilon' - i\epsilon''$. In the presence of an electric field, E , in the product stream must flow.

$$E = e^{i\omega t}$$

Eq. I-94

According to Maxwell's equations, the current density j is:

$$j = [\sigma_e + \sigma_i + i\omega\epsilon_o(\epsilon' - i\epsilon'')]E = i\omega\epsilon_o\epsilon'E + \omega\epsilon_o\epsilon'tan\delta E \quad \text{Eq. I-95}$$

The phase angle, δ , is connected to the delay involved in the polarizing product. $tan\delta$ is the amount loss tangent, which is the most important parameter in the microwave treatment.

Returning to the equation, the first term on the right side of the equation is the current component, which is in phase opposition with the electric field.

This is the displacement current which stores electric energy in the material. The electrical energy stored per unit volume average is:

$$W = 1/2 \epsilon_o\epsilon'E^2 \quad \text{Eq. I-96}$$

Through this term, the microwave energy is converted into heat. The average value of the energy converted to heat per unit volume is:

$$P = 1/2 \epsilon_o\epsilon'tan\delta E^2 \quad \text{Eq. I-97}$$

Thus, the loss tangent characterizes the ability of the material to convert the microwave power absorbed into heat. This conversion depends on the electric field strength, frequency, the loss factor and the dielectric constant.

The higher the material $tan\delta$ and ϵ'' , the more effective the microwave heating.

4.1.2. Water and aqueous dielectrics

Because of its asymmetric configuration, the water molecule has an exceptional polarity, which makes the material ideal for microwave heating.

The two positively charged hydrogen atoms form an angle of 105° whose apex is the negatively charged oxygen atom. O-H distance is 0.096 nm. The dipole moment resulting directed along the bisector of the angle HOH, is estimated at $0.62 \cdot 10^{-29}$ C m.

Other polar volatile solvent used in some "conventional solvent extraction" can be adequate for MW heating.

In a microwave-assisted unit operations, heat generation and transfer within a plant as a porous medium is described by the following equation:

$\dot{q} - \vec{\nabla} \cdot \vec{\varphi} = \rho_s (c_{ps} + W c_{pw}) \frac{\partial T}{\partial t} + \psi \frac{\partial \left(\frac{M_w L_w p_w}{R_{GP} T} \right)}{\partial t}$	Eq. I-98
--	----------

where the second term in LHS stands for heat transfer, which normally is performed through the conduction law. The first term in RHS stands for the sensitive heat accumulation and the second term for the heat dissipated for evaporation.

The first term in LHS \dot{q} stands for the microwave volumique absorbed power or, in other words, the heat produced per unit volume per unit time; it is also called absorption rate density (ARD) and can be expressed by the following relation:

$\dot{q}(\vec{r}) = \pi f \varepsilon_o \varepsilon''(\vec{r}) E(\vec{r}) ^2$	Eq. I-99
--	----------

where $|E(r)|$ is the amplitude of electric field intensity, which varies depending on the point defined by the vector (\vec{r}). If the thickness l_p of the heated material is sufficiently large and the loss factor is constant, power distribution can follow Lambert's law:

$\dot{q}(x) = \pi f \varepsilon_o \varepsilon'' E_o ^2 \exp\left(-\frac{x}{d_p}\right)$	Eq. I-100
--	-----------

where $|E_o|$ stands for the amplitude of electric field intensity at the material surface ($x = 0$), and d_p for the penetration depth (Kitchen, 2001):

$d_p = \frac{c}{2\pi f \sqrt{2\varepsilon''}} \left(\sqrt{1 + \left(\frac{\varepsilon''}{\varepsilon'}\right)^2} - 1 \right)^{-1/2}$	Eq. I-101
---	-----------

At the penetration depth d_p from the surface ($x = 0$), the power density is equal to 36.788% of the power density on the surface.

IV. CONCLUSION

It is worth concluding that in order to intensify the extraction unit operations we should seek to partially improve, completely reformed or fully challenge the "traditional" methods of extraction. After having analyzed the successive transfer processes, identified the slowest phenomenon, we could propose adequate solution referred to increasing kinetics, and improving quality.

After this first fundamental approach, some specific cases were studied. We selected three specific vegetal: rosemary leaves, orange peels and canola seeds.

We have conducted a study on the deodorizing rosemary leaves by instant controlled pressure drop followed by solvent extraction of its antioxidant molecules. The antioxidants were also extracted by microwave-assisted solvent extraction as a very brief test.

We have then realized the sequential extraction of essential oils and antioxidants of orange peel via instant controlled pressure drop and ultrasound.

We have finally modeled the extraction kinetics of rapeseed oil with emphasis on the impact of the parameters of instant controlled pressure drop.

V. REFERENCES

- Aguilera, J.M., Stanley, D.W., (1999). *Microstructural principles of food processing and engineering*. Aspen Publication, USA.
- Al Haddad, M., (2007). Contribution théorique et modélisation des phénomènes instantanée dans les opérations d'autovaporisation et de déshydratation. Université de La Rochelle, La Rochelle - France.
- Al Haddad, M., Mounir, S., Sobolik, V., Allaf, K., (2008). Fruits & Vegetables Drying Combining Hot Air, DIC Technology and Microwaves. *International Journal of Food Engineering* 4(6).
- Allaf, K., (1982). Transfer phenomena and industrial applications, *Lebanese University Faculty of Science*, Beirut, p. 182.
- Allaf, K., (1988). Approche à l'analyse fondamentale de l'expansion par alvéolation selon différents procédés (puffing, cuisson-extrusion...). Université de Technologie de Compiègne, Compiègne - France.
- Allaf, K. (2002). Analysis of instantaneity in thermodynamic processes; Fundamental laws In *Proceedings of the Conference Namel*, Conference Locationl.
- Allaf, K., (2009). The New instant controlled pressure – drop DIC technology, *Essential Oils and Aromas: Green Extraction and Application*. Chemat F., New Delhi, pp. 85-121.
- Allaf, K., Besombes, C., Berka-Zougali, B., Kristiawan, M., Sobolik, V., Allaf, T., (2011). Instant Controlled Pressure Drop Technology in Plant Extraction Processes, in: Lebovka, N., Vorobiev, E., Chemat, F. (Eds.), *Enhancing Extraction Processes in the Food Industry*. CRC Press Taylor & Francis Group, Dublin, Ireland, pp. 255-302.
- Allaf, K., Debs-Louka, E., Louka, N., Abraham, G., (1998). Procédé de réduction ou d'élimination d'organismes, de microorganismes, de pasteurisation et de stérilisation des produits solides en morceaux ou pulvérulents et installation pour la mise en œuvre d'un tel procédé, *Procédé de réduction ou d'élimination d'organismes, de microorganismes, de pasteurisation et de stérilisation des produits solides en morceaux ou pulvérulents et installation pour la mise en œuvre d'un tel procédé*.
- Allaf, K., Louka, N., Bouvier, J.M., Parent, F., Forget, M., (1993). Procédé de traitement de produits biologiques en vue de la modification de leur texture, installations pour la mise en oeuvre d'un tel procédé et produits ainsi réalisés, *Procédé de traitement de produits biologiques en vue de la modification de leur texture, installations pour la mise en oeuvre d'un tel procédé et produits ainsi réalisés*.
- Allaf, K., Vidal, P., (1989). Feasibility study of a new process of drying/swelling by instantaneous decompression towards vaccum, *Chemical Engineering Department*. University of Technology of Compiègne, France.
- Allaf, T., Mounir, S., Tomao, V., Chemat, F., (2012). Instant Controlled Pressure Drop Combined to Ultrasounds as Innovative Extraction Process Combination: Fundamental Aspects. *Procedia Engineering* 42, 1164-1181.
- Amor, B.B., Lamy, C., Andre, P., Allaf, K., (2008). Effect of instant controlled pressure drop treatments on the oligosaccharides extractability and microstructure of *Tephrosia purpurea* seeds. *Journal of Chromatography A* 1213(2), 118-124.
- Arhaliass, A., Legrand, J., Vauchel, P., Fodil-Pacha, F., Lamer, T., Bouvier, J.M., (2009). The effect of wheat and maize flours properties on the expansion mechanism during extrusion cooking. *Food and Bioprocess Technology* 2(2), 186-193.

- Becker, B.R., Fricke, B.A., (1999). Food thermophysical property models. *International Communications in Heat and Mass Transfer* 26(5), 627-636.
- Ben Amor, B., (2008). Maîtrise de l'aptitude technologique de la matière végétale dans les opérations d'extraction de principes actifs; texturation par Détente Instantanée Contrôlée DIC. Université de La Rochelle, France.
- Ben Amor, B., Allaf, K., (2009). Impact of texturing using instant pressure drop treatment prior to solvent extraction of anthocyanins from Malaysian Roselle (*Hibiscus sabdariffa*). *Food Chemistry* 115(3), 820-825.
- Bendahou, M., Muselli, A., Grignon-Dubois, M., Benyoucef, M., Desjobert, J.-M., Bernardini, A.-F., Costa, J., (2008). Antimicrobial activity and chemical composition of *Origanum glandulosum* Desf. essential oil and extract obtained by microwave extraction: Comparison with hydrodistillation. *Food Chemistry* 106(1), 132-139.
- Besombes, C., Berka-Zougali, B., Allaf, K., (2010). Instant controlled pressure drop extraction of lavender essential oils: fundamentals and experimental studies. *Journal of Chromatography A* 1217(44), 6807-6815.
- Beychok, M., (2012). Vapor pressure. *The Encyclopedia of Earth*.
- Bocchio, E., (1985). *Hydrodistillation of essential oils: theory and applications*. Société d'expansion technique et économique, Paris.
- Cassel, E., Vargas, R.M.F., Martinez, N., Lorenzo, D., Dellacassa, E., (2009). Steam distillation modeling for essential oil extraction process. *Industrial Crops and Products* 29(1), 171-176.
- Chemat, F., Abert-Vian, M., Huma, Z., (2009). Microwave-assisted separations: green chemistry in action, *Green chemistry research trends*. J.T. Pearlman, New York, p. Chapt. 1.
- Chemat, F., Lucchesi, M.E., (2006). Microwave assisted extraction of essential oils, *Microwaves in Organic Synthesis*. A. Loupy Wiley, Weinheim, p. Chapt. 22.
- Chen, R.-H., Chow, L.C., Navedo, J.E., (2002). Effects of spray characteristics on critical heat flux in subcooled water spray cooling. *International Journal of Heat and Mass Transfer* 45(19), 4033-4043.
- Choi, Y., Okos, M., (1986). *Effects of Temperature and Composition on the Thermal Properties of Food*. Elsevier Applied Science, London.
- Colussi, A.J., Weavers, L.K., Hoffmann, M.R., (1998). Chemical Bubble Dynamics and Quantitative Sonochemistry. *The Journal of Physical Chemistry A* 102, 6927-6934.
- Debs-Louka, E., (2000). Destruction des microorganismes par voie thermo-mécanique contrôlée dans des produits solides en morceaux ou en poudre. Application aux épices et aromates. Université de La Rochelle, La Rochelle - France.
- Delgado-Rosas, M., (2002). Analyse et conception d'un réacteur à pulvérisation contrôlée sous vide (VCS). Université de La Rochelle, La Rochelle - France.
- Ferhat, M.A., Meklati, B.Y., Smadja, J., Chemat, F., (2006). An improved microwave Clevenger apparatus for distillation of essential oils from orange peel. *Journal of Chromatography A* 1112(1-2), 121-126.
- Fernández, M.B., Perez, E.E., Crapiste, G.H., Nolasco, S.M., (2012). Kinetic study of canola oil and tocopherol extraction: Parameter comparison of nonlinear models. *Journal of Food Engineering* 111(4), 682-689.
- Fernandez, X., Chemat, F., (2012). *La chimie des huiles essentielles - Tradition et innovation*. Vuibert, Paris.
- Gámiz-Gracia, L., Luque de Castro, M.D., (2000). Continuous subcritical water extraction of medicinal plant essential oil: comparison with conventional techniques. *Talanta* 51(6), 1179-1185.

- Gordon, M., Taylor, J.S., (1952). Ideal copolymers and the second-order transitions of synthetic rubbers. i. non-crystalline copolymers. *Journal of Applied Chemistry* 2(9), 493-500.
- Habba, A., (1997). Nouveaux procédés de précuisson et d'étuvage du riz par détente instantanée contrôlée (DIC) : analyse des opérations, optimisation des procédés et approche à l'industrialisation. Université de Technologie de Compiègne, Compiègne - France.
- Haddad, J., (2002). Impacts des procédés hydro-thermo-mécaniques dans la valorisation des graines oléoprotéagineuses. Université de La Rochelle, La Rochelle - France.
- Iguedjal, T., Louka, N., Allaf, K., (2008). Sorption isotherms of potato slices dried and texturized by controlled sudden decompression. *Journal of Food Engineering* 85(2), 180-190.
- Jespersen, N.D., (2012). *Barron's Educational Series* (6th ed). Barron's Educational Series.
- Juhel, F., (2000). Etude de l'application de deux nouvelles opérations de séchage/texturation du poisson; analyse comparative du procédé et du produit. Université de La Rochelle, La Rochelle - France.
- Kentish, S., Ashokkumar, M., (2011). The physical and Chemical Effects of Ultrasound, in: Feng, H., Barbosa-Cánovas, G.V., Weiss, J. (Eds.), *Ultrasound Technologies for Food and Bioprocessing*. Springer, New York, USA, pp. 13-57.
- Kitchen, R., (2001). *Radio Frequency RF & Microwave Radiation Security*. Reed Elsevier Group, Oxford.
- Kostaropoulos, A.E., Saravacos, G.D., (1997). Thermal diffusivity of granular and porous foods at low moisture content. *Journal of Food Engineering* 33(1-2), 101-109.
- Leighton, T.G., (1994). The Acoustic Bubble. *Journal of Fluid Mechanics* 272, 407-409.
- Leong, T., Ashokkumar, M., Kentish, S., (2011). The fundamentals of power ultrasound: a review. *Acoustics Australia* 39, 54-63.
- Leybros, J., Frémeaux, P., (1990). Extraction solide-liquide. Aspects théoriques. *Techniques de l'Ingénieur J1 077 06*.
- Louisnard, O., González-García, J., (2011). Acoustic Cavitation, in: Feng, H., Barbosa-Cánovas, G.V., Weiss, J. (Eds.), *Ultrasound Technologies for Food and Bioprocessing*. Springer, New York, USA, pp. 1-12.
- Louka, N., Allaf, K., (2002). New Process for Texturizing Partially Dehydrated Biological Products Using Controlled Sudden Decompression to the Vacuum: Application on Potatoes. *Journal of Food Science* 67(8), 3033-3038.
- Louka, N., Allaf, K., (2004a). Expansion ratio and color improvement of dried vegetables texturized by a new process "Controlled Sudden Decompression to the vacuum": Application to potatoes, carrots and onions. *Journal of Food Engineering* 65(2), 233-243.
- Louka, N., Allaf, K., (2004b). Expansion ratio and color improvement of dried vegetables texturized by a new process "Controlled Sudden Decompression to the vacuum": Application to potatoes, carrots and onions. *Journal of Food Engineering* 65(2), 233-243.
- Louka, N., Juhel, F., Allaf, K., (2004). Quality studies on various types of partially dried vegetables texturized by Controlled Sudden Decompression: General patterns for the variation of the expansion ratio. *Journal of Food Engineering* 65(2), 245-253.
- Lucchesi, M.E., Chemat, F., Smadja, J., (2004). Solvent-free microwave extraction of essential oil from aromatic herbs: comparison with conventional hydro-distillation. *Journal of Chromatography A* 1043(2), 323-327.

- Lucchesi, M.E., Smadja, J., Bradshaw, S., Louw, W., Chemat, F., (2007). Solvent free microwave extraction of *Elletaria cardamomum* L.: A multivariate study of a new technique for the extraction of essential oil. *Journal of Food Engineering* 79(3), 1079-1086.
- Mason, T.J., (2000). Large scale sonochemical processing: aspiration and actuality. *Ultrasonics Sonochemistry* 7(4), 145-149.
- Mason, T.J., Lorimer, J.P., (2002). *Applied sonochemistry: the uses of power ultrasound in chemistry and processing*. Wiley-VCH.
- Mason, T.J., Riera, E., Vercet, A., Lopez-Buesa, P., (2005). Application of Ultrasound, in: Da-Wen, S. (Ed.), *Emerging Technologies for Food Processing*. Academic Press, London, pp. 323-351.
- McClements, D.J., (1995). Advances in the application of ultrasound in food analysis and processing. *Trends in Food Science & Technology* 6(9), 293-299.
- Mortimer, R.G., (2008). *Physical Chemistry* (3rd Edition ed). Elsevier Academic Press, Canada.
- Mounir, S., (2007). Studies of new manufacturing process of powders by inserting the instant controlled pressure drop DIC within spray-drying, swell-drying and controlled vacuum atomization of dairy products. Université de La Rochelle, La Rochelle - France.
- Mounir, S., Allaf, K., (2008). Three-Stage Spray Drying: New Process Involving Instant Controlled Pressure Drop. *Drying Technology* 26(4), 452-463.
- Mounir, S., Allaf, K., (2009). Study and modelling of dehydration and rehydration kinetics within porous medium, Lyon - France.
- Nettleton, J., (1995). Introduction to Fatty Acids, *Omega-3 Fatty Acids and Health*. Springer US, pp. 1-63.
- Orford, P.D., Parker, R., Ring, S.G., (1990). Aspects of the glass transition behaviour of mixtures of carbohydrates of low molecular weight. *Carbohydrate Research* 196(0), 11-18.
- Philipp, A., Lauterborn, W., (1998). Cavitation erosion by single laser-produced bubbles. *Journal of Fluid Mechanics* 361, 75-116.
- Pingret, D., Fabiano-Tixier, A.-S., Chemat, F., (2013). Ultrasound-assisted Extraction, in: Rostagno, M.A., Prado, J.M. (Eds.), *Natural Product Extraction: Principles and Applications*. Royal Society of Chemistry, London (UK), pp. 89-112.
- Rahman, M.S., Chen, X.D., Perera, C.O., (1997). An improved thermal conductivity prediction model for fruits and vegetables as a function of temperature, water content and porosity. *Journal of Food Engineering* 31(2), 163-170.
- Sahyoun, W., (1996). Maîtrise de l'aptitude de matériaux agro-alimentaires aux procédés de séchage. Etude de l'adéquation entre les états structuraux, biochimiques, physiques et comportementaux sur les processus de déshydratation = Mastering the aptitude of food products to drying processes. Study of the adequacy between structural, biochemical, physical, and behavioural states on the dehydration process. Université de Technologie de Compiègne, France.
- Sanya, E., (2000). Analyse du traitement hydro-amido-thermique de bois gorgé d'eau; application à la restauration-préservation du bois archéologique. Université de La Rochelle, La Rochelle - France.
- Saravacos, G.D., Kostaropoulos, A.E., (1996). Engineering properties in food processing simulation. *Computers & Chemical Engineering* 20, Supplement 1(0), S461-S466.
- Schwartzberg, H.G., Chao, R.Y., (1982). Solute diffusivities in leaching processes. *Food Technology* 2, 73-86.
- Sebranek, J.G., Sewalt, V.J.H., Robbins, K.L., Houser, T.A., (2005). Comparison of a natural rosemary extract and BHA/BHT for relative antioxidant effectiveness in pork sausage. *Meat Science* 69(2), 289-296.

-
- Semenov, V.E., Zharova, N.A., (2006). Thermal Runaway and Hot Spots under Controlled Microwave Heating, in: Willert-Porada, M. (Ed.), *Advances in Microwave and Radio Frequency Processing*. Springer Berlin Heidelberg, pp. 482-490.
- Soto-Vaca, A., Gutierrez, A., Losso, J.N., Xu, Z., Finley, J.W., (2012). Evolution of Phenolic Compounds from Color and Flavor Problems to Health Benefits. *J Agric Food Chem*.
- Storey, B.D., Szeri, A.J., (2000). Water vapour, sonoluminescence and sonochemistry. *Proceedings of the Royal Society of London. Series A: Mathematical, Physical and Engineering Sciences* 456(1999), 1685-1709.
- Toma, M., Vinatoru, M., Paniwnyk, L., Mason, T.J., (2001). Investigation of the effects of ultrasound on vegetal tissues during solvent extraction. *Ultrasonics Sonochemistry* 8(2), 137-142.
- Virost, M., Tomao, V., Colnagui, G., Visinoni, F., Chemat, F., (2007). New microwave-integrated Soxhlet extraction. An advantageous tool for the extraction of lipids from food products. *Journal of Chromatography A* 1174(1-2), 138-144.
- Vogel, A., Lauterborn, W., Timm, R., (1989). Optical and acoustic investigations of the dynamics of laser-produced cavitation bubbles near a solid boundary. *Journal of Fluid Mechanics* 206, 299-338.
- Yanishlieva, N.V., Marinova, E., Pokorný, J., (2006). Natural antioxidants from herbs and spices. *European Journal of Lipid Science and Technology* 108(9), 776-793.

Chapter 2

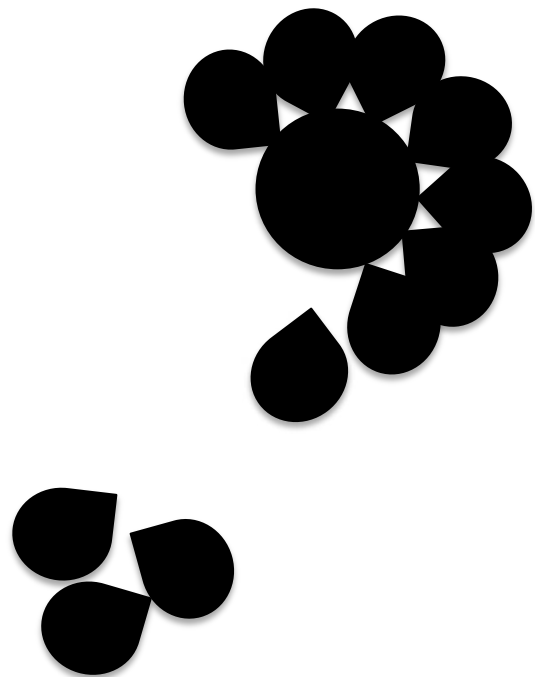

Chapitre II - **DEODORIZATION OF ROSEMARY LEAVES BY INSTANT AUTOVAPORIZATION**

Deodorization by instant controlled pressure drop autovaporization of rosemary leaves prior to solvent extraction of antioxidants

- ◆ Allaf, T., Tomao, V., Ruiz, K., Bachari, K., ElMaataoui, M., Chemat, F. Deodorization by instant controlled pressure drop autovaporization of rosemary leaves prior to solvent extraction of antioxidants. *LWT - Food Science and Technology* 51(1), 111-119. (2013)

I. INTRODUCTION

Growing consciousness of consumers regarding human health has encouraged agro-industrial firms to substitute synthetic antioxidants, such as butylated hydroxyanisole (BHA) and butylated hydroxytoluene (BHT) by natural antioxidants (Sebranek et al., 2005; Yanishlieva et al., 2006). Antioxidants are compounds capable of scavenging free radicals and consequently delaying or even preventing auto-oxidation. One of the most important phenomena involved in food deterioration is oxidation (Pérez-Fons et al., 2009). Antioxidant molecules must be potent with low quantity taking into account that changes in foodstuff aromas should be minimal (Pokorny et al., 2001). Indeed antioxidant compounds cannot be added to foodstuff when still containing aromas (Ares et al., 2009).

Rosemary (*Rosmarinus officinalis*) is known to have great antioxidant activity (Erkan et al., 2008). The main substances related to antioxidant activity are phenolic diterpenes (Schwarz and Ternes, 1992a, b; Schwarz et al., 1992) such as carnosol, rosmanol, carnosic acid, methyl carnosate, and phenolic acids such as rosmarinic acid (Petersen and Simmonds, 2003). However, rosemary leaves contains between 0.7 to 3 % fresh weight material of essential oils depending on the variety, the way of harvesting, their location, etc. (Bousbia et al., 2009; Singh and Guleria, 2013; Sui et al., 2012; Szumny et al., 2010).

As a consequence, processes for obtaining antioxidants should preserve high antioxidant activity, reducing or even completely removing aroma. López-Sebastián et al. (1998) tested at laboratory scale deodorization of rosemary leaves through supercritical fluids. Although this operation was coupled with enzymatic pretreatment, the process itself was quite complicated, making it inconvenient at industrial scale.

DIC (Détente Instantanée Contrôlée) standing for instant controlled pressure drop was defined in 1988 (Allaf, 1988). DIC is a thermo-mechanical process generated by subjecting the raw material for a short period of time to high saturated steam pressure followed by an abrupt pressure drop towards a vacuum. It triggers autovaporization of volatile compounds, which results in an expansion of the sample.

An initial study on rosemary leaves showed a relative improvement of DIC treatment compared to other classic volatile compound extraction processes (Rezzoug et al., 2005). Further studies provided new elements with respect to autovaporization phenomena through instant controlled pressure drop technology. This was observed and explained in terms of fundamental and experimental aspects. Indeed studies were reported for Kananga flowers (Kristiawan et al., 2008), lavandin (Besombes et al., 2010), myrtle leaves (Berka-Zougali et al., 2010), orange peel (Allaf et al., 2012), etc. providing very relevant results in terms of essential oil extraction. Such results indicated that further studies should be carried out in terms of the feasibility of the instant controlled pressure drop technology as a method of deodorization through autovaporization before solvent extraction of antioxidants. DIC extraction process through autovaporization phenomenon provides essential oil in a stable oil-in-water emulsion.

In this report, a study carried out on the extraction of essential oils of rosemary leaves performed with standard hydrodistillation and DIC technique was described. Scanning electron microscopy and light microscopy were performed in order to understand, at structural scale, the specific effects of HD and DIC treatments on rosemary leaf tissues. In addition specific surface area was calculated to better interpret each matrix behavior.

II. MATERIALS AND METHODS

1. Plant material

In this study 10 kg of dry leaves of Rosemary (*Rosmarinus officinalis* L.) were purchased from the firm Herbiere du Diois (Châtillon-en-Diois, France) and have an initial water content of 6.83 ± 0.06 % dry basis.

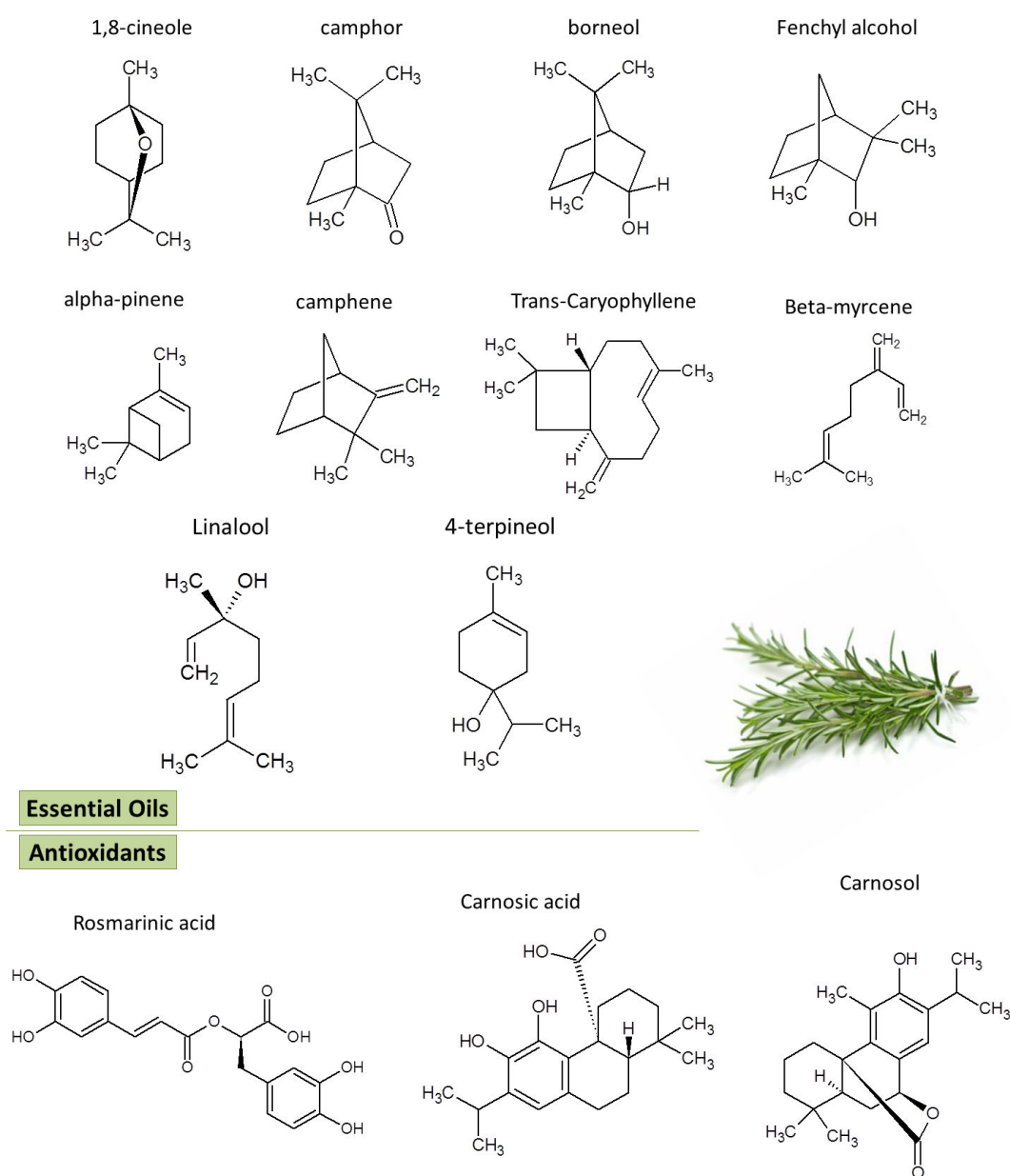

Figure II-1: Rosemary compounds

2. Protocol treatment

After a first stage of deodorization carried out by hydrodistillation or by DIC-autovaporization, rosemary sample “residue” was treated by ethanol:water (80:20) to extract the antioxidants. Solvent extracts were then analyzed by HPLC. The amount of essential oils was determined and used in order to optimize DIC operating parameters. The performed protocol is shown in Figure 1.

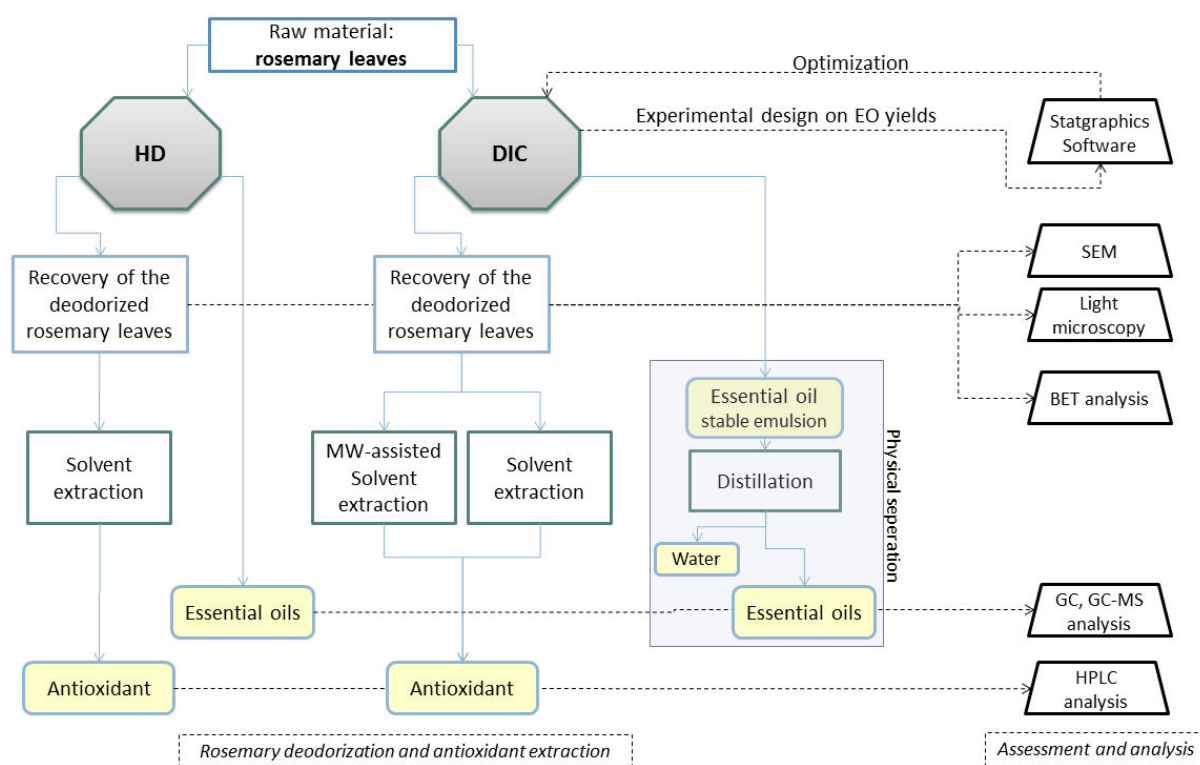

Figure II-2: Protocol treatment of rosemary leaves.

3. Hydrodistillation (HD) apparatus and protocol

Hydrodistillation equipment used in the present study was a 6-liter modified stainless steel Clevenger apparatus from REUS Company (Contes, France).

200 g of dried rosemary leaves were immersed in 2 liters of distilled water. The extraction of essential oils was achieved during 4 h, from the first drop of distillate until the quantity of extracted essential oils was stabilized. Afterwards the rosemary leaves were recovered and dried at room temperature to be stored for antioxidant extraction and determination.

4. DIC apparatus and treatment

DIC reactor used Figure II-3 was from ABCAR-DIC Process Company (La Rochelle, France). A 7-liter processing vessel with a heating jacket was utilized; thermal treatment in this vessel is achieved using saturated steam. A vacuum tank with cooling water jacket is connected with a water ring vacuum pump allowing the vacuum chamber to be maintained at 5 kPa.

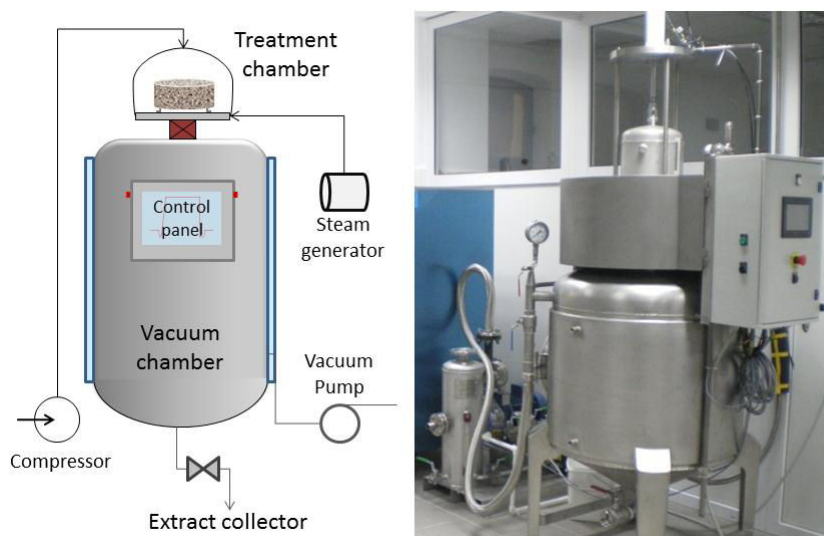

Figure II-3: Instant controlled pressure drop (DIC) apparatus.

DIC cycle can be split into five steps:

1. the sample was put at an initial vacuum;
2. saturated steam was injected in the treatment chamber to reach the selected pressure and kept constant;
3. the pressure was then dropped towards a vacuum instantaneously;
4. the vacuum was maintained for a short moment;
5. the pressure level was then released towards the atmospheric level.

Multi DIC cycles contain several repetitions of stages (2), (3) and (4).

5. Solvent extraction after deodorization

50 grams of dried rosemary leaves, both deodorized and raw material were milled during 2 min using an electrical mill, Ultraturrax (Janke and Kunkel, Osterode, Germany) in 50 mL of ethanol:water (80:20). Activated charcoal was added to absorb the chlorophyll. The homogenized sample suspension was subsequently filtered with a filter paper and then concentrated in a rotary evaporator. The precipitate thus obtained is dissolved in a precise volume of 50 mL of ethanol:water (80:20). The solution was filtered through a 0.45 μm Wattman filter.

6. Microwave Assisted Extraction

6.1. Microwave Soxhlet apparatus

The basic principle of the Microwave Soxhlet extraction assisted by microwaves is illustrated in Figure II-4 (Virot et al., 2007; Virot et al., 2008). Microwave integrated Soxhlet extraction was performed in a Milestone ETHOS microwave oven. The multi-mode microwave reactor having a twin magnetron (2 x 800 W, 2.45 GHz) with a maximum delivered power of 1000 W variable in 10 W increments.

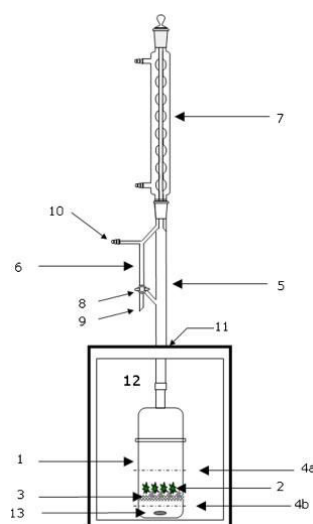

Figure II-4: The basic principle of the new process of Soxhlet extraction assisted by microwaves. 1: base vessel; 2: solid material; 3: support; 4a: solvent level immersing the sample; 4b: n-hexane level below the sample; 5: extraction tube; 6: side arm; 7: condenser; 8: 3-way valve; 9: side arm opening to collect n-hexane; 10: side arm opening to pull a vacuum in the system; 11: opening on upper surface of the microwave oven; 12: microwave oven; 13: Weflon magnetic stirrer.

Temperature was monitored by a shielded thermocouple (ATC-300) inserted directly into the sample container and by an infrared sensor outside the reactor. The base vessel is a traditional glass round-bottom flask. The flask (1) for containing the solid material is a flask suited for microwave reactions. The base vessel (1) forming part of the device contains a polytetrafluoroethylene/graphite stir bar capable of absorbing microwaves at the bottom of the vessel. The use of such a stir bar allows diffusion of heat created by the microwaves to the surroundings and is particularly useful in the case when solvents which are transparent to microwave radiations, i.e. which are not able to absorb microwaves. The base vessel contains an inner support (3) for placing the solid material (2) to be extracted. The inner support is a porous support made out of material which absorbs or not microwave radiation. Preferably, the support made of polytetrafluoroethylene (PTFE) is placed at a defined distance above the bottom of the base vessel. This presents the advantage that, after the method has been performed, the solid material (2) placed on said support can easily be separated from the residual solvent which is collected at the bottom of the vessel.

The device for carrying out the extraction further comprises an extraction tube (5) which is placed on top of the base vessel. The extraction tube is typically a glass tube. Thus, the microwave oven (12) is provided with an opening on its upper surface (11) such that the extraction tube (5) which is fitted on top of the base vessel may extend from inside the microwave oven (12) to outside. The extraction tube (5) comprises a side arm (6) which is provided with at least one valve and one opening (9). Depending on how the valve is adjusted, the solvent may reflux down the side arm (6) back into the extraction tube (5) and eventually back into the base vessel (1) or when the valve is adjusted accordingly, the refluxing solvent may be collected from the opening (9). Additionally, the side arm provided with another opening (10) which, depending on the application, may be used to pull a vacuum in the system. A condenser (7) is placed on top of the extraction tube (5) in order to allow the solvent present in the base vessel to reflux upon microwave irradiation. Refluxing allows the sample to be extracted to be repeatedly percolated, thus increasing the extraction yield. The solid material is extracted by immersing the sample into vessel containing the solvent under reflux and repeated percolation with the same organic solvent. AWeflon magnetic stirrer (Soriso, Bergamo, Italy) is placed in the base vessel (1) and a PTFE filter support (3) is added.

6.2. Treatment

An amount of 30 g of rosemary leaves (2) is loaded onto the support (3) and 500 mL of ethanol:water 80:20 is added in order to immerse the sample (4a). Then, the base vessel is placed in the microwave oven (12) and screwed together with the extraction tube (5). The condenser (7) is placed on the extraction tube and the system is started. The four steps are as follows. First, the solvent is heated up to the boiling point by microwaves and stirred with the Weflon magnetic stirrer (13). The solvent vapors penetrate through the sample and the condensation takes place on the condenser. Then, the condensate drips down onto the sample by adjusting the 3-way valve (8). The extraction is performed during 8 min. Second, the level of the solvent is lowered below the sample (4b) by adjusting the 3-way valve accordingly during 3.5 min.

Then, the leaching with only clean fresh solvent follows during 3.5 min, with the valve adjusted in a way that the condensate goes back into the extraction tube.

7. Assessment protocol

7.1. Statistical and experimental design protocol

In DIC essential oil extraction, preliminary trials allowed us to define an adequate experimental design with relevant operating parameters with well-defined ranges. Main DIC operating parameters used as independent variables were the number of cycles and the thermal treatment time per cycle. The other parameters such as saturated steam pressure P , and initial water content were kept constant. The amount of essential oil extracted was used as the main response.

An adequate statistical treatment of the data issued from the experimental work was used to study, analyze and optimize DIC extraction of essential oils. Response surface methodology (RSM) with a two-factor five level $(-\alpha; -1; 0; 1; 0)$ central composite rotatable experimental design method was defined with:

- Factorial points: 4 points $(-1/-1; -1/+1; +1/-1; +1/+1)$
- Star points: 4 points $(-\alpha/0; 0/-\alpha; +\alpha/0; 0/+\alpha)$
- 3 repetitions: $(0/0)$

In the present study, the saturated steam pressure used kept constant at 0.6 ± 0.02 MPa and the two DIC operating studied parameters were ranged as: (1) 6 ± 2 to 40 ± 2 s for the treatment time per cycle t , and (2) 1 to 11 cycles for the number of cycles C . This resulted in 11 experimental trials, run at random. Statistical treatment of results was executed using the analysis design procedure of Statgraphics Plus software for Windows (1994, version 4.1, Levallois-Perret, France). Variance (ANOVA) was performed to determine significant differences between independent variables ($P \leq 0.05$) and Pareto charts were introduced as well as the general trends, response surface, empirical model coefficients, and R^2 were determined. The dependent variables had concerned process performances (in terms of efficiency) as well as the final extracted attributes: the response was expressed with a second order polynomial empirical model of independent variables:

$$Y = \beta_0 + \sum_{i=1}^n \beta_i x_i + \sum_{i=1}^n \beta_{ii} x_i^2 + \sum_{i=1}^n \beta_{ij} x_i x_j + \varepsilon \quad \text{Eq. II-1}$$

where Y was the response, β_0 , β_i , β_{ii} and β_{ij} stand for the regression coefficients, x_i stand for the independent variables, ε stands for the random error, and i and j for the indices of the factors. Response surface methodology could be used to optimize the operating parameters by coupling various studied responses (Benoist et al., 1994).

$$\alpha(\text{axial distance}) = \sqrt[4]{2^N} \quad \text{Eq. II-2}$$

In the present case $N = 2$ and $\alpha = 1.4142$

7.2. Gas Chromatography – Mass spectrometry identification

Essential oils were analyzed by gas chromatography using a Hewlett–Packard 6890N gas chromatograph equipped with a flame ionization detector (FID). The gas vector was helium; the injector and detector temperatures were at 250°C; the injected volume was 1 µl with split mode 1/20; fused-silica capillary column HP5MS™ (30 m × 0.25 mm I.D., film thickness 0.25 µm with constant flow at 0.3 ml/min) and Carbowax™ poly(ethylene glycol) (60 m × 0.20 mm I.D., film thickness 0.25 µm); the oven temperature program was 40°C for 8 min increased at 2°C/min to 250°C and held at 250°C for 30 min. Retention indices were determined with C₅–C₂₆ alkane standards as reference. Relative amount of individual components are based on peak areas obtained without FID response factor correction.

Gas chromatography coupled to mass spectrometry (GC–MS) analysis (Hewlett-Packard computerized system, comprising a 6890 gas chromatograph coupled to a 5973A mass spectrometer) were carried out using two fused-silica-capillary columns with different stationary phases. The non-polar column was HP5MS (30 m x 0.25 mm i.d., 0.25 µm film thickness) and the polar column was a Stabilwax consisting of Carbowax–PEG (60 m x 0.2 mm i.d., 0.25 µm film thickness). GC–MS spectra were obtained using the following conditions: the gas vector was helium; flow rate of 1 ml/min; the injection volume was 1 µl with split mode 1/20; injection temperature at 250°C; oven temperature program of 40°C for 8 min, then increased with 2°C/min to 250°C and held at 250°C for 15 min; the ionization mode used was electronic impact at 70 eV.

Most components were tentatively identified by comparison of their GC retention indices (RI) calculated with the help of a series of linear alkanes C₆–C₂₆ on apolar and polar columns (HP5MS™ and Carbowax™). RIs were determined with reference to a homologous series of C₅–C₂₈ n-alkanes and with those of authentic standards available in the authors' laboratory. Identification was confirmed when possible by comparison of their mass spectral fragmentation patterns with those stored in the MS database (National Institute of Standards and Technology and Wiley libraries) and with mass spectra literature data (Adams, 2001). Component relative concentrations were obtained directly from GC peak areas.

7.3. High Performance Liquid Chromatography (HPLC) analysis

HPLC analyses were performed using a Waters (Milford, MA) HPLC system consisting of a Waters 600E pump, a Waters 717 autosampler, a Waters 2996 photodiode array detector. HPLC pumps, autosampler, column temperature, and diode array system were monitored and controlled by using Waters Empower 2 Chromatography Data software program. The wavelengths used for the identification of the phenol (rosmarinic acid) and of phenolic diterpenes (carnosol and carnosic acid) with the diode detector were 329 nm and 284 nm, respectively. The chromatographic separation was carried out on a Purospher Star RP-18_e column (250 mm × 4 mm I.D.; 5 μm particle size), with a RP18_e guard column (4 mm × 4mm I.D.; 5 μm particle size). The end-capped column and guard column were held at 27°C and the flow rate was set at 1.5 mL/min. The mobile phase consisted of two solvents: 0.5 % formic acid (A) and 100 % acetonitrile (B). The solvent gradient in volume ratios was as follows: 90% A and 10 % B over 35 min. The solvent gradient was increased to 100 % B for 10 min and then at 45 min the solvent ratios go back to 10 % B for 15 min. The injection volume was 20 μL. Analyses were triplicated and only mean values were reported. Quantification was carried out by using the external standard method and the final concentrations were calculated in mg/g dm (dry material).

7.4. Scanning electron microscopy (SEM)

Micro-structures were observed using an environmental type JEOL 5410LV FEI Quanta 200F Scanning Electronic Microscope (SEM) (Philips Croissy-sur-Seine; France). Leaf samples were collected after each treatment placed on a covered stud using carbon adhesive-and scanned under a partial vacuum (7 Pa) with an acceleration tension of 20 kV.

7.5. Histochemistry

Leaf fragments (5 mm length) were excised from leaves after HD and DIC treatments and from control. They were fixed for 48 h in formalin-acetic acid-ethanol (FAA: 5:5:90, V/V/V). To improve fixation, samples were subjected to vacuum during 20 minutes. After fixation, the material was rinsed overnight in tap water, dehydrated in an ethanol series (70%-100%), and embedded in 2-hydroxyethyl methacrylate resin.

After resin polymerization at room temperature, the blocks were transversally sectioned at 3 μm thickness using an automatic retracting microtome (Supercut 2065; Reichert-Jung, Leica Instruments, Nussloch, Germany) equipped with disposable knives (Histoknife H; Heraeus-Kulzer). The sections were stained using periodic acid-Schiff's reagent (PAS) in combination with naphthol blue black to specifically reveal insoluble polysaccharides (in pink) and proteins (in dark blue), respectively (El Maataoui and Pichot, 1999). Observations were performed using Leica DMR light microscope (Leica Microsystems GmbH, Wetzlar, Germany). Images were captured using Leica DFC 300 FX digital camera and analyzed using LAS software (Leica).

7.6. Nitrogen adsorption: specific surface area calculation

The specific surface area represents the total effective area accessible to exchange atoms and molecules per external unit mass of product. The entire outer surface of the solid is considered, including open porosity. The physical principle, universally recognized for the determination of specific surface area, is based on measuring the amount of gas adsorbed in a monolayer, at low temperature. It enables both, measurement without modification of the geometric texture of the sample and determination of the area of the entire surface of the powder particles (including surface of open pores or cracks in cul-de-sac, accessible to external gas molecules). This adsorption phenomenon is carried out by forces called weak or secondary (Van der Waals forces) on the surface of the powder or solid. These forces act outwards, including gas molecules that, in the atmosphere surround the sample. They are always present at low temperature, regardless of chemical nature of the body presence.

Adsorption-desorption study of nitrogen was performed on a NOVA2000e analytical system made by Quantachrome instrument at 77K. A sample was degassed in vacuum at 373K for 12 h before measurement. The surface area was calculated based on the BET (Brunner-Emmett-Teller) method, while pore size distribution was computed using the BJH (Barrett-Joyner-Halenda).

III. RESULTS AND DISCUSSION

1. Optimization of instant controlled pressure drop deodorization

Essential oil yields obtained for different trials of the experimental design protocol are shown in Table II-1. These results were analyzed statistically through Statgraphics software in order to obtain the optimal DIC parameters.

Table II-1. DIC extraction trials carried out with the response surface methodology RSM at a fixed steam pressure value (0.6 MPa) in the cases of dried rosemary leaves.

DIC treatment n°	1	2	3	4	5	6	7	8	9	10	11
Number of cycles	11	6	6	10	10	6	2	2	1	6	6
Treatment time per cycle (s)	23	40	23	35	11	23	11	35	23	6	23
Total treatment time (s)	253	240	138	334	105	138	27	86	23	36	138
EO yield (g/100 g dm)	1.4	0.9	0.9	1.0	1.3	0.8	0.04	0.1	0.0	0.6	0.9

A Pareto chart of standardized effects (Figure II-5) was calculated in order to show significant effects of all variables (linear, quadratic and interactions between variables). The vertical line represents the limit between the significant and insignificant effects regarding the response. The length of each parameter characterizes the absolute importance of the estimated effects. It is interesting to note that Pareto chart enabled us to provide the data to determine the relevance of each parameter (number of cycles C and treatment time per cycle t).

On the one hand, thermal effects are represented by the total treatment time (summed period in which the product was put at high temperature). On the other hand, autovaporization aspects, illustrated by the pressure drop, were characterized by the number of cycles (numbers of pressure drops). General trends showed that autovaporization effects (illustrated by the number of cycle) are significant whereas thermal effects (illustrated by the treatment time) do not have a major influence.

The response surfaces enabled the representation of the total effect of operative parameters. RSM optimization was used to show the impact of the operative factors in terms of extraction yields (Figure II-5). It was hence possible to optimize DIC deodorization for rosemary leaves. Here, via the Standardized Pareto Chart it was clear that the number of cycles (revealing the impact of the pressure drops) was the only factor to have a significant effect.

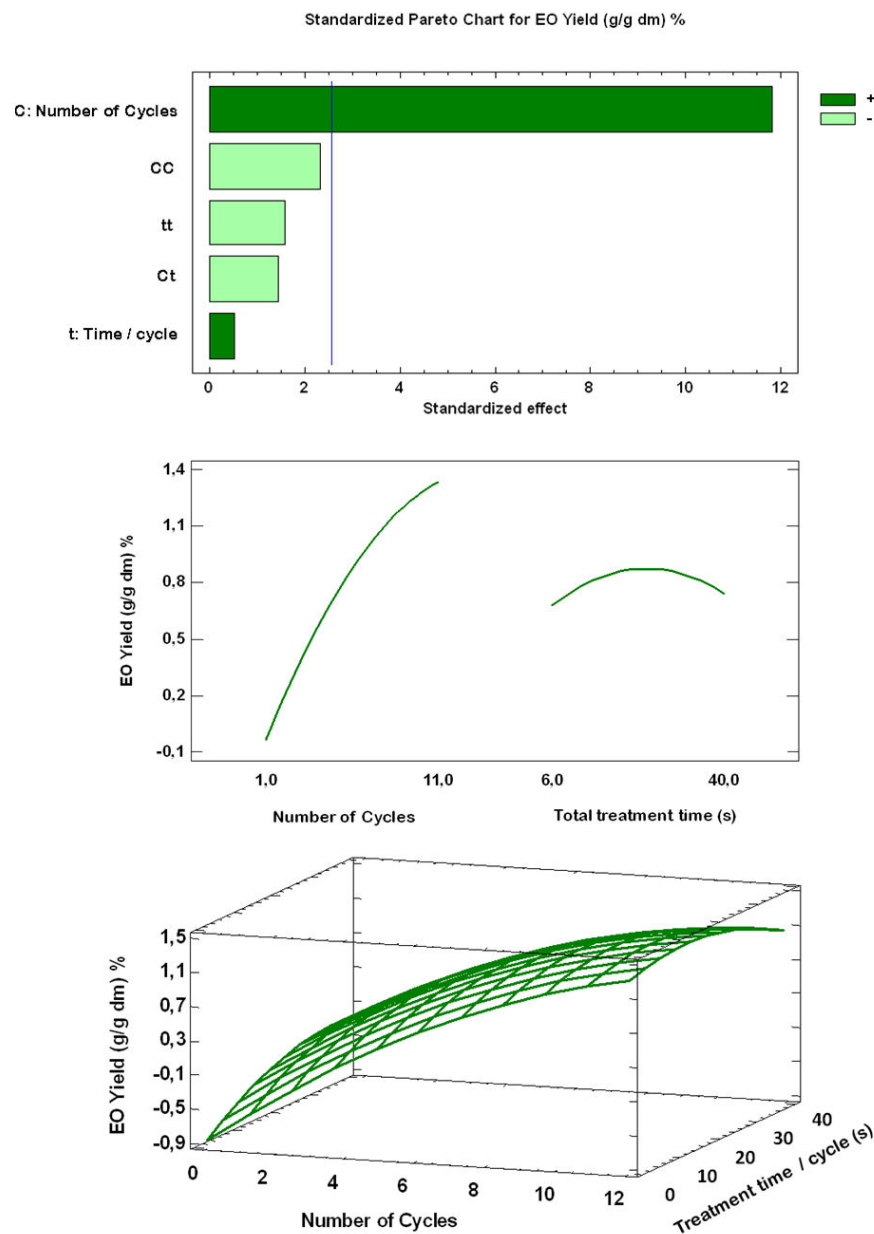

Figure II-5. Rosemary leaf essential oil yields standardized Pareto Chart, main effects plot and estimated response surface of depending on two independent parameters: number of DIC cycles and time per cycle in seconds

The mathematical relationship obtained with the statistical software Statgraphics was a polynomial equation representing the quantitative effect of process variables and their interactions on the measured response. The values of the coefficients of C and t were related to the effect of these variables on the response i.e. essential oil yields. A positive value represented an effect that favors the operation, while a negative value indicated an antagonistic effect. The second-order polynomial equation of the response surface obtained is as follows:

$Yield_{EO}(\%) = 0.2879C + 0.0391t - 0.00897C^2 - 0.001875Ct - 0.00056t^2 - 0.873$	Eq. II-3
With $R^2 = 96.74 \%$	

Taking into account that only the number of cycle C had a significant influence one can assume that:

$Yield_{EO}(\%) = 0.1372C - 0.1013$	Eq. II-4
With $R^2 = 90.91 \%$	

The most adequate conditions, with the goal to maximize the extraction yield, were achieved for 16 s as a treatment time per cycle t, and 11 cycles C. Optimized DIC gave the same complete deodorization as the hydrodistillation, however with 3 min as against 4 h, respectively.

2. Essential oil composition

In order to recover and value the rosemary EO obtained by Hydrodistillation (HD) and DIC, gas chromatography analyses were performed. Essential oil extracted yields were 1.28 ± 0.04 g EO/100 g dry material (dm) with HD and 1.36 ± 0.08 g EO/100g dm with DIC. In this analysis, for HD 20 compounds were identified representing 99.62% of the EO total chemical composition and for DIC 24 compounds were identified representing 98.41% of the EO total chemical composition. Oxygenated monoterpene were the major component for both DIC-EO and HD-EO with 1,8-cineole as the main compound (37.35% and 35.70% respectively).

They were compared in terms of essential oil quality, enumerating their compounds. Comparisons of isolation times and detailed composition for each extract are reported in Table II-2. It also shows the grouped components of the essential oil: oxygenated and non-oxygenated fractions and composition of chemical families of rosemary leaf essential oils obtained by these methods. Monoterpene hydrocarbons are less valuable than oxygenated compounds in terms of their contribution to the fragrance of the essential oil. Conversely, the oxygenated compounds are highly odoriferous and, hence, the most valuable. Essential oils obtained by DIC had a quality slightly superior. Indeed the quantity of oxygenated compounds is 72.13% for HD and 80.57% for DIC.

Table II-2. Hydrodistillation and instant controlled pressure drop essential oil composition identified by GC-FID, GC-MS

n°	Compounds ^a	R.I. ^b	R.I. ^c	HD ^d (%)	DIC ^e (%)
Monoterpenes					
1	Tricyclene	921	1009	0.27	0.1
2	Pinene <Alpha->	937	1031	13.1	6.07
3	Camphene	949	1065	8.03	3.65
4	Verbenene	953	1121	0.26	0.12
5	Pinene <Beta->	972	1105	0.33	0.53
6	Myrcene <Beta->	989	1163	4.1	2.28
7	I-phellandrene	1000	1166	0.23	Tr
8	Carene <Delta-3->	1005	1145	0.65	0.44
9	Terpinene <Alpha->	1012	1181	0.3	Tr
10	Terpinene <Gamma->	1052	1247	tr	0.16
11	Terpinolene <Alpha->	1080	1287	tr	0.12
Oxygenated Monoterpenes					
12	1,8-Cineole	1029	1210	37.35	35.7
13	Linalool	1105	1520	1.09	2.11
14	Fenchyl Alcohol	1114	1571	tr	6.9
15	Camphor	1146	1506	21.21	23.05
16	Pinocarvone	1160	1548	0.17	0.2
17	Borneol	1166	1682	6.11	8.55
18	Terpineol <4->	1177	1574	0.99	1.91
19	Terpineol <Alpha->	1189	1677	2.72	Tr
20	Verbenone	1201	1696	2.1	1.48
21	Myrtenol	1205	1851	tr	0.18
22	Borneol Acetate	1281	1558	0.2	0.27

n ^o	Compounds ^a	R.I. ^b	R.I. ^c	HD ^d (%)	DIC ^e (%)
Sesquiterpenes					
23	Copaene <Alpha->	1363	-	tr	0.15
24	Caryophyllene <Trans->	1408	1577	0.22	3.31
25	Humulene <Alpha->	1442	1651	tr	0.61
26	Cadinene <Delta->	1525	-	tr	0.3
Other oxygenated compounds					
27	1-Octen-3 ol	977	1411	0.19	0.22
Grouped compound					
Total oxygenated compounds				72.13	80.57
Total non-oxygenated compounds				27.49	17.84
Extraction time (min.)				240	3
Yield (%)				1.28±0.04 10 ⁻²	1.36±0.08 10 ⁻²

^a Essential oil compounds sorted by chemical families and percentages

^b Retention indices relative to C5–C28 n-alkanes calculated on non-polar HP5MS capillary column.

^c Retention indices relative to C5–C28 n-alkanes calculated on polar Carbowax-PEG capillary column.

^d Hydrodistillation

^e Instant controlled pressure drop

3. Antioxidant extraction after deodorization

3.1. Ultraturrax extraction

In terms of antioxidant extraction, HD and DIC could be presented as specific pretreatments. Indeed, rosemary leaves were recovered after these pretreatment to be extracted with ethanol:water (80:20) following the standard protocol described above. HPLC analyses of antioxidant extraction are shown in Table II-3. These two treated matrices were compared to untreated rosemary leaves in order to analyze whether degradation or loss is induced. DIC treatment triggers an expansion of the whole structure and cells and hence a higher availability of extracts; thus DIC-treated leaves led to twice as much Rosmarinic Acid than the untreated raw material RM.

However, HD solid residue allowed a very low amount of rosmarinic acid; this fact should be correlated to the long-time/high temperature solid-liquid interaction between water and the solid knowing that usually rosmarinic acid is extracted using water as solvent.

Table II-3. Antioxidant extraction after deodorization through HD and DIC process compared to RM

		Rosmarinic Acid (mg/g dm)	Carnosol (mg/g dm)	Dry extract (g/100g dm)
	RM	6.74±0.20	3.25±0.31	19.75 ± 1.01
Deodorized rosemary leaves	HD	1.92±0.29	1.38±0.08	15.89 ± 0.15
	DIC	12.76±0.22	2.91±0.07	26.32 ± 0.16

Because of the natural structure of plants, which resists to penetration by any liquid, solvent extraction is very slow. The availability of certain compounds is very low because of a compact structure. Rosmarinic acid is usually extracted with water which could explain the low values of this compound in the residual solid that has underwent HD.

Dry extract yields of the different matrices (RM: raw material, HD: hydrodistilled material, DIC: treated product) followed by solvent extraction were determined to be 19.75 ± 1.01%, 15.89 ± 0.15%, and 26.32 ± 0.16 % respectively. DIC as an expansion pre-treatment could dramatically improve extraction yields through a better availability of compounds.

3.2. Microwave soxhlet extraction

Using microwave soxhlet extraction we performed an extraction with untreated and DIC-treated leaves. Microwaves enable a faster heating than conventional heating (Table II-4).

Table II-4. Antioxidant MW assisted extraction after DIC-deodorization and untreated rosemary leaves

MW-Soxhlet	Untreated Rosemary Leaves	DIC treated Rosemary Leaves
Rosmarinic Acid (mg / g dm)	4.03 ± 0.13	7.37 ± 0.17
Canosol (mg / g dm)	1.59 ± 0.21	1.35 ± 0.26

The extraction performed in 15 min highlighted the fact that it is unavoidable to have a modification of the structure in order to enhance the diffusivity of the solvent regarding the solid vegetal.

4. Scanning electron microscopy (SEM)

SEM analyses of essential oil trichomes, before and after the performed treatments are summarized in Figure II-6. Large differences in the morphology of the essential oil-containing glands are evident. Raw material leaves exhibited normal glandular trichomes (Figure II-6, A-B). In contrast, HD and DIC treated leaves showed apparently empty glands (Figure II-6, D-F). This indicated that both processes induced the extraction of essential oils.

It is well known that the DIC treatment can modify the structure of plant at various and controlled levels, this being highly dependent on the operating parameters. Such modifications from interstitial zone to broken cell walls can greatly modify structural characteristics. It would be then possible to control functional and technological capacities that help to greatly intensify mass transfer phenomena by improving diffusivity and permeability within the matrix. In the case of rosemary leaves, the SEM images revealed structural differences between raw material, DIC treated samples and HD treated samples.

Before DIC treatment, the product had a slightly compact and relatively well organized cell structure. On the one hand, the impact of DIC treatment was clearly noticeable with an evident expansion of the product. On the other hand, HD shrinkage is visible, which disables an easy diffusivity and hence should hold back the extraction of antioxidant after deodorization.

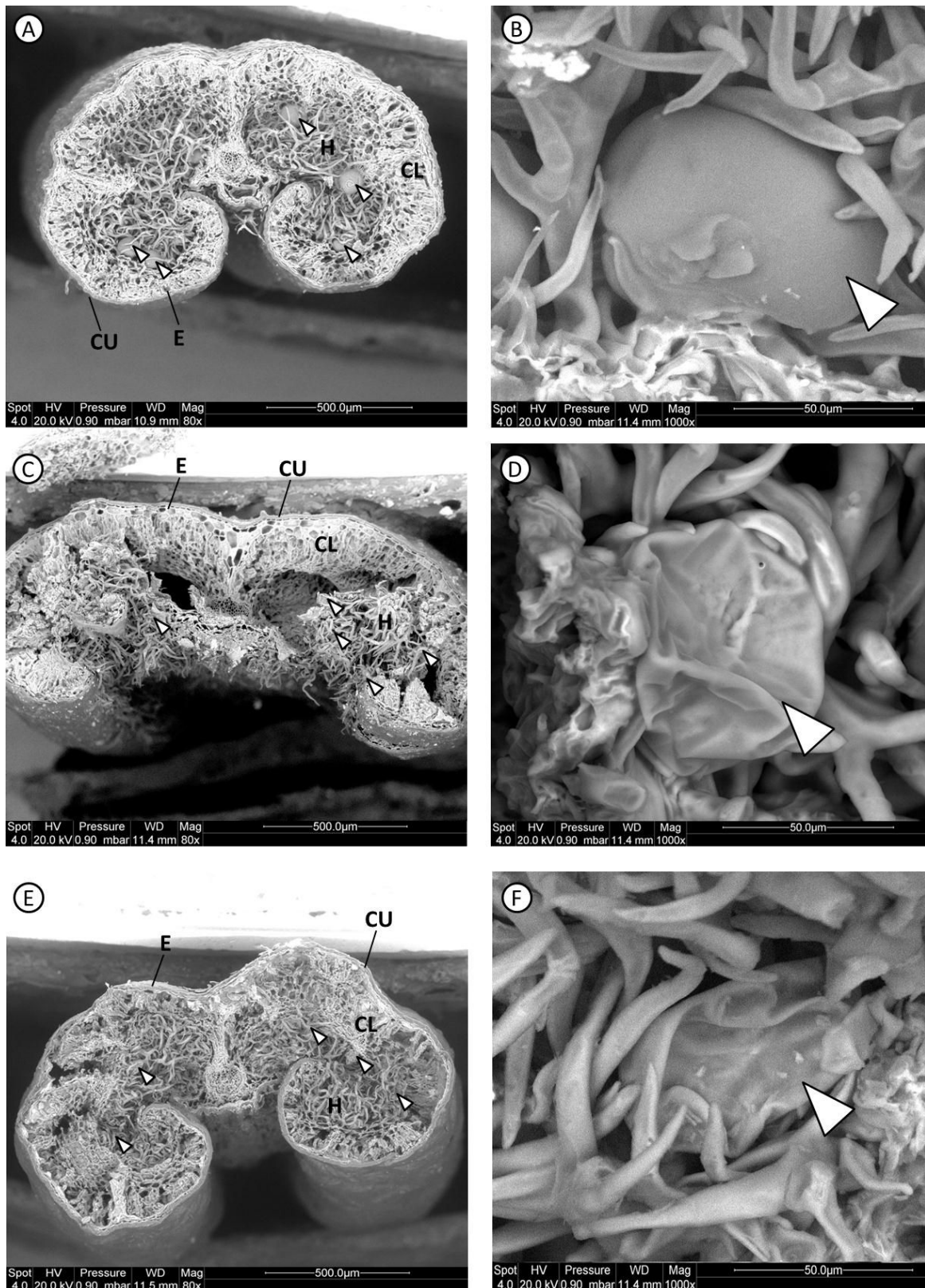

Figure II-6. Scanning Electron Micrographs of untreated rosemary leaf (A - B); DIC-treated rosemary leaf (C - D); HD-treated rosemary leaf (E - F) zoomed 80 and 1000 times. CU: cuticle; E: epidermis; H: hairs; CL: collenchyma; \blacktriangleright : glandular trichomes.

5. Histochemistry

Sections of leaf fragments from raw material showed that the structure of Rosemary leaf is typical of a drought-adapted species (Figure II-7) characterized by the presence of a thick cuticle and a dense abaxial indumentum. This structure showed a continuous organization in which the leaf parenchyma (mesophyll) is maintained in association with epidermal layers, and vascular tissues.

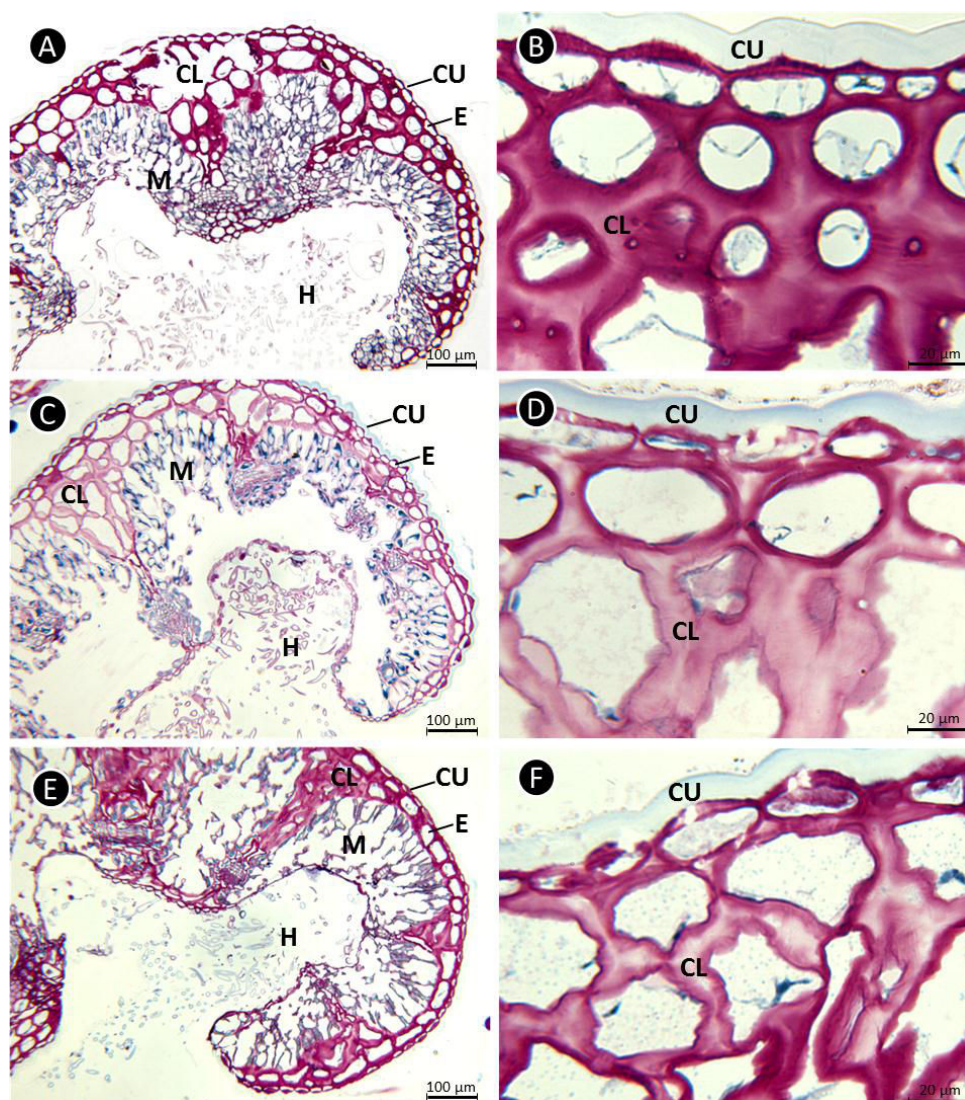

Figure II-7. Cytological impacts via light microscopy of untreated rosemary leaf (A - B); DIC-treated rosemary leaf (C - D); HD-treated rosemary leaf (E - F). CU: cuticle; E: epidermis; H: hairs; CL: collenchyma; LM: lacunar mesophyll. Scanning Electron Micrographs of zoomed 80 and 1000 times

Another characteristic of rosemary leaf is the presence of a massive collenchyma composed of voluminous cells with thick, polysaccharidic wall as revealed by the observed intensive response to PAS test (Figure II-7 B).

Observation of sections from leaves subjected to DIC treatments revealed profound alterations affecting both tissue cohesion and cell structure (Figure II-7, C and D). Indeed, this treatment resulted in the opening of leaf structure by disconnecting the abaxial epidermis (Figure II-7, C). At cytological scale, DIC triggered cell destructuration in all tissues mainly in regard to cell wall architecture. This was particularly evident with collenchymatous cell that exhibited an important loosening of their wall polysaccharides (compare Figure II-7, D and Figure II-7, B). Cross sections from leaves subjected to HD displayed similar alteration regarding cell structure but to a lesser extent (Figure II-7, E and F). By HD treatment, the product was submitted to high temperature during 4 hours which obviously realized some damages regarding the cells. In addition, with this method the tissular integrity of leaves remained unchanged in comparison to DIC technology (Figure II-7, E).

6. Nitrogen adsorption: specific surface area

The different methods for calculating the surface area using physical adsorption of gases at low temperatures are based on the work of Brunauer, Emmett and Teller, more generally known under the initials BET. Specific surface area calculation is based on the analytical treatment of the adsorption isotherm determined experimentally; it is thus possible to define the amount of gas adsorbed in a complete monolayer, and then to calculate the area of this layer, so the specific surface area of the powder or solid.

Specific surface areas, pore size distributions and pore volumes calculated by BET and BJH methods are summarized in Table II-5. The measurement of specific surface area, average value of pore volume and diameter were performed on the three different samples: raw material, product after HD, and product treated by DIC.

Table II-5. Textual properties of Rosemary leaves

Rosemary leaves	S_{BET} ($\text{m}^2 \cdot \text{g}^{-1}$)	Pore volume ($\text{cm}^3 \cdot \text{g}^{-1}$)	Pore diameter (nm)
RM	2.13	0.27	7.79
HD	2.26	0.28	7.79
DIC	2.52	0.35	7.74

Table II-5 showed that the specific surface of the untreated and differently treated rosemary leaves (HD and DIC treatments) varied between 2.13-2.52 $\text{m}^2\cdot\text{g}^{-1}$ and pore volume between 0.27-0.35 $\text{cm}^3\cdot\text{g}^{-1}$. However, the pore size is in the range of 7.79-7.74 nm.

Specific surface areas were improved after DIC treatment. Indeed, Specific surface area of DIC treated sample underwent an increase of 20% compared to RM

DIC average pore diameter value is slightly lower than that of RM. This can be explained by the fact that DIC treatment triggered new small pores generating such an average pore diameter value. HD matrix had an intermediate position regarding all these parameters. The porosity of the samples was evaluated by N_2 adsorption isotherms. Figure II-8 shows N_2 adsorption-desorption isotherms of the three samples.

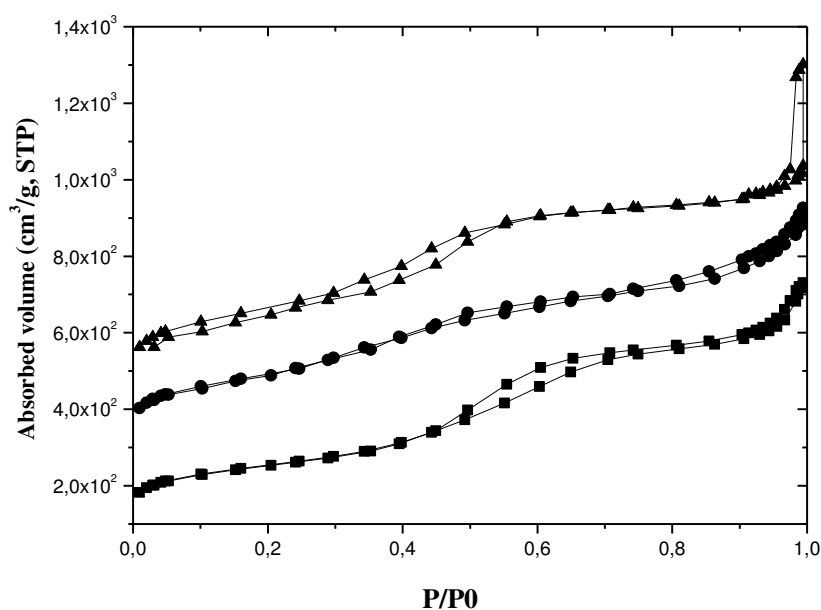

Figure II-8. N_2 physical adsorption-desorption isotherms of the rosemary leaves: (■) untreated, (●) HD-treated, (▲) DIC-treated; absorbed volume versus relative pressure (P/P_0)

According to this figure, the N_2 adsorption-desorption isotherms of the three samples exhibit typical type IV isotherms with hysteresis loop caused by capillary condensation in mesopores, manifesting that the three samples possess probably the mesoporous structure.

There are three well-defined stages in the isotherms of the two samples that may be identified: the isotherms show a step at the relative pressure (p/p_0) of ca. 0.3-0.5, characteristic of capillary condensation of uniform porous materials, showing that the three samples have uniform average pore size distribution. The isotherms corresponding to $p/p_0 < 0.3$ are due to a monolayer adsorption of nitrogen on the walls of the mesopore.

The near horizontal section beyond $p/p_0 > 0.5$ represents the multilayer adsorption on the outer surface of the particles.

The adsorption and desorption graph of HD treated, DIC treated and untreated rosemary leaves showed significant differences, confirming the values of specific surface area. Adsorption-desorption isotherms closely depend on exchange surface between condensed matter and surrounding gas. It was then obvious that the higher the specific surface area, the higher the value of surrounding gas pressure.

7. Operational costs

Deodorization times were 4 hours with hydrodistillation and 3 minutes with DIC. In a previous article, Besombes et al. (2010) calculated operational costs for DIC treatment. In the case of rosemary leaf deodorization, energy expenses were more than 3 kWh/kg dm for HD and less than 1.4 kWh/kg dm with DIC treatment.

IV. CONCLUSION

This study describes the thermo-mechanical treatment of rosemary leaves using the instantaneous controlled pressure drop (DIC) method as both deodorization and expansion process. This expansion dramatically increased the plant technological abilities in terms of solvent extraction of antioxidants. Compared to hydrodistillation, DIC could reach the same level of deodorization in 3 min instead of 4 h. Furthermore, rosmarinic acid being soluble in water, the amount of this compound in the recovered leaves after hydrodistillation was obviously low. The structure expansion triggered by DIC and denoted with SEM illustrated the readiness of solvent penetration going along with a higher availability. Structural alterations eased secondary metabolite extraction. BET and BJH calculation also showed that specific surface area improved after DIC treatment. Taken together, the results indicated that DIC was both, an efficient deodorizing process and a powerful pre-treatment improving antioxidant extraction from rosemary leaves.

Some heating issues are correlated with conventional ways implying conduction method. Thus generation of heating by microwave can provide an efficient path for almost uniform deep temperature.

V. REFERENCES

- Adams, R.P., (2001). *Identification of essential oil components by gas chromatography/quadrupole mass spectroscopy*. Allured Publishing Corporation, Illinois, USA.
- Allaf, K., (1988). Approche à l'analyse fondamentale de l'expansion par alvéolation selon différents procédés (puffing, cuisson-extrusion...). Université de Technologie de Compiègne, Compiègne - France.
- Allaf, T., Tomao, V., Ruiz, K., Chemat, F., (2012). Instant controlled pressure drop technology and ultrasound assisted extraction for sequential extraction of essential oil and antioxidants. *Ultrasonics Sonochemistry*(In Press).
- Ares, G., Barreiro, C., Deliza, R., Gámbaro, A., (2009). Alternatives to reduce the bitterness, astringency and characteristic flavour of antioxidant extracts. *Food Research International* 42(7), 871-878.
- Benoist, D., Tourbier, Y., Germain-Tourb, S., (1994). *Plans d'expériences: construction et analyse*. Lavoisier, London.
- Berka-Zougali, B., Hassani, A., Besombes, C., Allaf, K., (2010). Extraction of essential oils from Algerian myrtle leaves using instant controlled pressure drop technology. *Journal of Chromatography A* 1217(40), 6134-6142.
- Besombes, C., Berka-Zougali, B., Allaf, K., (2010). Instant controlled pressure drop extraction of lavandin essential oils: fundamentals and experimental studies. *Journal of Chromatography A* 1217(44), 6807-6815.
- Bousbia, N., Abert Vian, M., Ferhat, M.A., Petitcolas, E., Meklati, B.Y., Chemat, F., (2009). Comparison of two isolation methods for essential oil from rosemary leaves: Hydrodistillation and microwave hydrodiffusion and gravity. *Food Chemistry* 114(1), 355-362.
- El Maataoui, M., Pichot, C., (1999). Nuclear and cell fusion cause polyploidy in the megagametophyte of common cypress, *Cupressus sempervirens* L. *Planta* 208(3), 345-351.
- Erkan, N., Ayranci, G., Ayranci, E., (2008). Antioxidant activities of rosemary (*Rosmarinus Officinalis* L.) extract, blackseed (*Nigella sativa* L.) essential oil, carnolic acid, rosmarinic acid and sesamol. *Food Chemistry* 110(1), 76-82.
- Kristiawan, M., Sobolik, V., Allaf, K., (2008). Isolation of Indonesian cananga oil using multi-cycle pressure drop process. *Journal of Chromatography A* 1192(2), 306-318.
- López-Sebastián, S., Ramos, E., Ibáñez, E., Bueno, J.M., Ballester, L., Tabera, J., Reglero, G., (1998). Dearomatization of Antioxidant Rosemary Extracts by Treatment with Supercritical Carbon Dioxide. *Journal of Agricultural and Food Chemistry* 46(1), 13-19.
- Pérez-Fons, L., Garzón, M.a.T., Micol, V., (2009). Relationship between the Antioxidant Capacity and Effect of Rosemary (*Rosmarinus officinalis* L.) Polyphenols on
-

- Membrane Phospholipid Order. *Journal of Agricultural and Food Chemistry* 58(1), 161-171.
- Petersen, M., Simmonds, M.S.J., (2003). Rosmarinic acid. *Phytochemistry* 62(2), 121-125.
- Pokorny, J., Yanishlieva, N., Gordon, M., (2001). *Antioxidants in Foods: Practical Applications*. Woodhead Publishing Ltd, England.
- Rezzoug, S.A., Boutekedjiret, C., Allaf, K., (2005). Optimization of operating conditions of rosemary essential oil extraction by a fast controlled pressure drop process using response surface methodology. *Journal of Food Engineering* 71(1), 9-17.
- Schwarz, K., Ternes, W., (1992a). Antioxidative constituents of *Rosmarinus officinalis* and *Salvia officinalis*. I. Determination of phenolic diterpenes with antioxidative activity amongst tocochromanols using HPLC. *Zeitschrift für LebensmittelUntersuchung und Forschung* 195(2), 95-98.
- Schwarz, K., Ternes, W., (1992b). Antioxidative constituents of *Rosmarinus officinalis* and *Salvia officinalis*. II. Isolation of carnosic acid and formation of other phenolic diterpenes. *Zeitschrift für LebensmittelUntersuchung und Forschung* 195(2), 99-103.
- Schwarz, K., Ternes, W., Schmauderer, E., (1992). Antioxidative constituents of *Rosmarinus officinalis* and *Salvia officinalis*. III. Stability of phenolic diterpenes of rosemary extracts under thermal stress as required for technological processes. *Zeitschrift für LebensmittelUntersuchung und Forschung* 195(2), 104-107.
- Sebranek, J.G., Sewalt, V.J.H., Robbins, K.L., Houser, T.A., (2005). Comparison of a natural rosemary extract and BHA/BHT for relative antioxidant effectiveness in pork sausage. *Meat Science* 69(2), 289-296.
- Singh, M., Guleria, N., (2013). Influence of harvesting stage and inorganic and organic fertilizers on yield and oil composition of rosemary (*Rosmarinus officinalis* L.) in a semi-arid tropical climate. *Industrial Crops and Products* 42(0), 37-40.
- Sui, X., Liu, T., Ma, C., Yang, L., Zu, Y., Zhang, L., Wang, H., (2012). Microwave irradiation to pretreat rosemary (*Rosmarinus officinalis* L.) for maintaining antioxidant content during storage and to extract essential oil simultaneously. *Food Chemistry* 131(4), 1399-1405.
- Szumny, A., Figiel, A., Gutiérrez-Ortíz, A., Carbonell-Barrachina, Á.A., (2010). Composition of rosemary essential oil (*Rosmarinus officinalis*) as affected by drying method. *Journal of Food Engineering* 97(2), 253-260.
- Virost, M., Tomao, V., Colnagui, G., Visinoni, F., Chemat, F., (2007). New microwave-integrated Soxhlet extraction. An advantageous tool for the extraction of lipids from food products. *Journal of Chromatography A* 1174(1-2), 138-144.
- Virost, M., Tomao, V., Ginies, C., Visinoni, F., Chemat, F., (2008). Green procedure with a green solvent for fats and oils' determination: Microwave-integrated Soxhlet using limonene followed by microwave Clevenger distillation. *Journal of Chromatography A* 1196-1197(0), 147-152.
- Yanishlieva, N.V., Marinova, E., Pokorný, J., (2006). Natural antioxidants from herbs and spices. *European Journal of Lipid Science and Technology* 108(9), 776-793.

Chapter 3

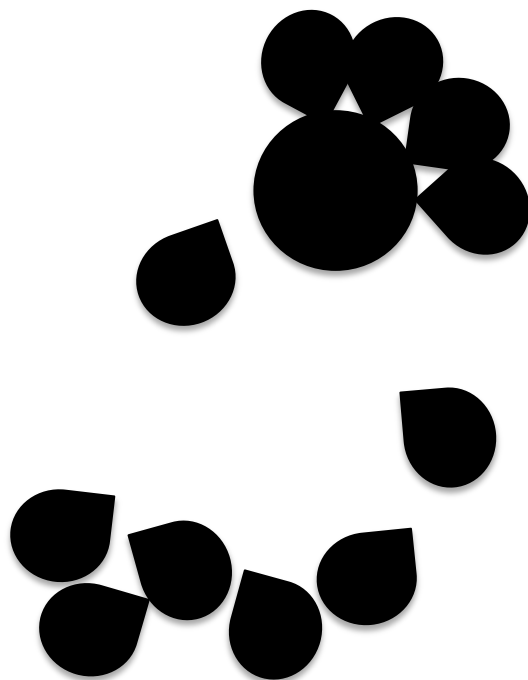

Chapitre III - COUPLING DIC AND ULTRASOUND FOR ORANGE PEEL EXTRACTION

Instant controlled pressure drop technology and ultrasound assisted extraction for sequential extraction of essential oil and antioxidants

- ◆ Allaf, T., Tomao, V., Ruiz, K., Chemat, F. Instant controlled pressure drop technology and ultrasound assisted extraction for sequential extraction of essential oil and antioxidants. *Ultrasonics Sonochemistry* 20(1), 239-246. (2013)
- ◆ Allaf, T., Tomao, V., Besombes, C., Chemat, F. Thermal and mechanical intensification of essential oil extraction from orange peel via instant autovaporization. *Chemical Engineering and Processing: Process Intensification.* , (Submitted)

I. INTRODUCTION

For the last decades, the demand for appropriate nutritional and health standards has considerably increased taking into account environmental pollution. Therefore there is a considerable emphasis on the recovery, recycling and upgrading of wastes (Garau et al., 2007). This is particularly valid for food and food processing industry in which waste, effluents, residues, and by-products can be recovered and often upgraded to higher value and useful products (Reddy and Yang, 2005).

Within the past century, industries have been willing to convert citrus wastes into high added-value commercial products. Current annual worldwide citrus production has doubled over the last 5 years and is now estimated at over 100 million tons (FAO, 2003). Almost 50% of citrus fruit are used for processing (FAO, 2010). Obviously citrus juice processing triggers high amount of by-products, mostly peel, which creates a serious environmental pollution issue (Manthey and Grohmann, 2001).

Over the last two decades recovering of such waste has become a research area of great interest and with huge impacts either for the production of flavonoids (Khan et al., 2010; Leuzzi et al., 2000; Li et al., 2006), pectin (Bocco et al., 1998; El-Nawawi and Heikal, 1995; Graham and Shepherd, 1953) or essential oils (Berna et al., 2000; Bousbia et al., 2009; Ferhat et al., 2006). These products have interested several fields (agro-industry, cosmetics, flavoring, pharmaceutical, etc.) in which their uses are diverse such as essence and fragrances (Shahidi and Zhong, 2005), aromatherapy (Kumagai et al., 2010) and food flavoring (Ashurst, 1999).

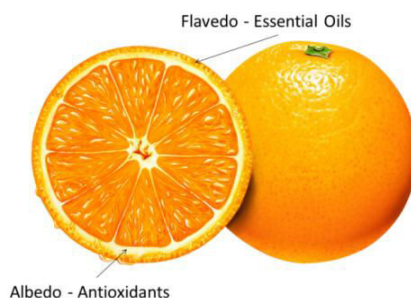

Figure III-1: Flavedo and Albedo of the Orange peel

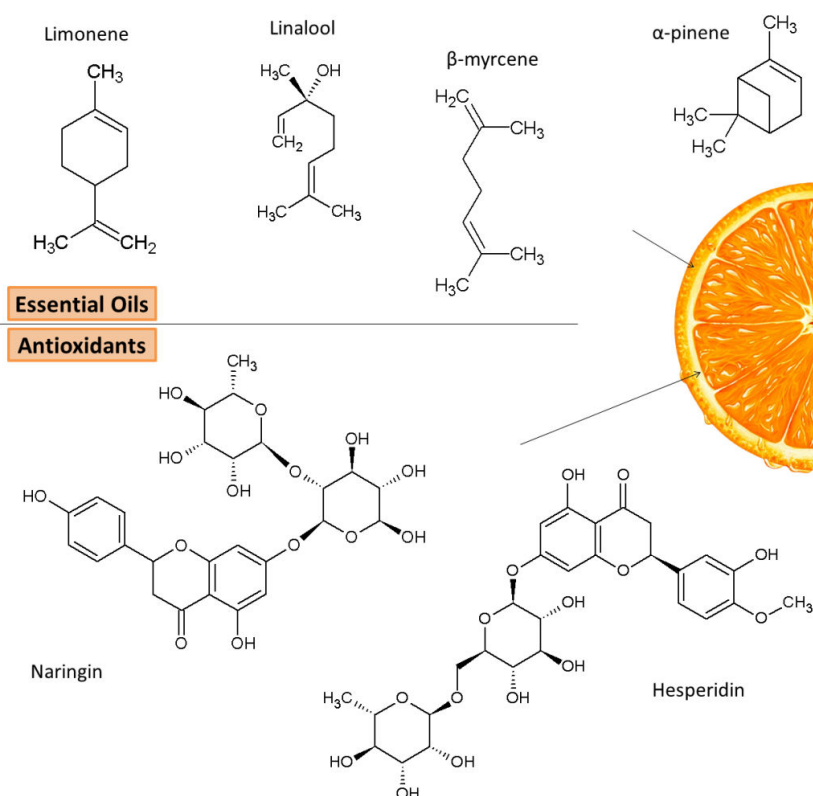

Figure III-2: Orange peel compounds

On the one hand, citrus outer peel, known as flavedo (Figure III-1, has a large number of very small glands, each containing a minute drop of essential oils (Figure III-2). The common commercial technique to produce essential oils from citrus peels is via cold-press. However through this extraction method, citrus essential oils contain more or less high amounts of furocoumarins (Frérot and Decorzant, 2004). The European Cosmetics Directive 76/768/EEC (SCCP, 2005) recently introduced a limit on the presence and use of the photosensitizing furocoumarins in cosmetics since they are recognized to be photomutagenic and photocarcinogenic. As a consequence hydrodistillation (HD) is increasingly used for extraction of citrus peel essential oil. HD is often combined with grinding, otherwise the main part of the essential oils remain in the solid matrix. Many extraction technologies such as Microwaves (Ferhat et al., 2006; Sahraoui et al., 2011), supercritical CO_2 (Atti-Santos et al., 2005) were considered and studied in order to improve essential oil extraction. However, all these techniques also require grinding (Atti-Santos et al., 2005) because of high structure permeability preventing an easy essential oil removal.

On the other hand, citrus processing byproducts represent a rich and growing source of natural target molecules, such as phenolic compounds (Rouseff et al., 1987). Phenolics, especially flavonoids, have gained much attention due to their antioxidant activities and free radical scavenging abilities, which potentially have beneficial implications in human health (Imeh and Khokhar, 2002). These properties embrace anticancer, antiviral and anti-inflammatory activities (Benavente-García et al., 1997). DIC is a thermo-mechanical process generated by subjecting the raw material for a short period of time to high saturated steam pressure followed by an abrupt pressure drop towards a vacuum. It triggers autovaporization of volatile compounds, which results in an expansion of the sample.

Regarding volatile compounds new elements with respect to autovaporization phenomena (illustrating mechanical effects) have been studied in terms of fundamental and experimental aspects. Indeed studies were reported for Kananga flowers (Kristiawan et al., 2008), lavandin (Besombes et al., 2010), myrtle leaves (Berka-Zougali et al., 2010), rosemary leaves (Allaf et al., 2013), providing very relevant results when analyzing thermal and mechanical aspects. In this context, it was proposed to study thermal and mechanical aspects on orange peel flavedo. First, we compared HD performed on orange peel in pieces (HD-P) and ground (HD-G) in terms of yields and kinetic modeling. Second, we analyzed DIC thermo-mechanical effects via statistical study. And finally scanning electron microscopy was performed on the orange peel as raw material, after HD and after DIC treatment in order to determine whether structure modification was notable.

Regarding bioactive compounds, such as antioxidants, solvent extraction is usually performed. However, solvent diffusion into a solid matrix is often a quite slow process, hence appearing as the “main” limiting process throughout the operation (Allaf et al., 2011).

Ultrasound irradiation (20–100 kHz) (Ma et al., 2009; Ma et al., 2008; Sun et al., 2011) is one of the upcoming extraction techniques that can offer high yields in shorter time, lower temperature, reduced solvent consumption and less energy input (Chemat et al., 2008). Oscillatory particle motion produced by high-intensity ultrasonic waves can also induce secondary flows, known as acoustic streaming. Such an agitation should realize an internal convection motion of solute within the solvent inside pores of porous material.

Moreover, cavitation produces micro-jets at the surface of the food material that may improve the exchange surfaces which has to be revealed globally through a high starting accessibility. Both effects can increase mass transfers of solvent within the solid and solute within the solvent (Mason, 2000; Toma et al., 2001).

In this context, in order to entirely recover and value orange byproduct (peels), peels were recovered after removing the essential oils (via HD and DIC) to perform the extraction of flavonoids. The flavanones (naringin and hesperidin) extracted afterwards by ultrasound assisted extraction and standard solvent extraction were determined in order to compare them quantitatively and qualitatively (antioxidant activity).

UAE for orange peel antioxidant extraction was formerly optimized by Khan and colleagues (Khan et al., 2010) in terms of extraction temperature, ultrasound power and ethanol:water ratio.

We therefore decided to proceed to a sequential use of DIC and UAE processes to determine whether each process effects can suit and supplement one another (Chemat and Cravotto, 2011).

II. MATERIALS AND METHODS

1. Plant material

Sun-dried orange peel (*Citrus sinensis*) in pieces (Figure III-3) was purchased from the company Herbier du Diois (Châtillon-en-Diois, France). The orange peel was originally from Burkina Faso harvested in December 2010. The initial water content was 6.91 ± 0.09 % dry basis (db). They were in pieces of $5 \times 2 \times 5$ mm³.



Figure III-3: Dried Orange peels – Raw material

2. Chemicals

The solvents used for HPLC analyses were analytical grade acetonitrile and acetic acid supplied by VWR International (Darmstadt, Germany). Flavanone glycosides (naringin, hesperidin) were purchased from Extrasynthese (Genay, France). DPPH (2,2-diphenyl-1-picrylhydrazyl) from Sigma–Aldrich (Steinhaus, Germany) was used for the determination of the antioxidant activity.

3. Protocol

The dried orange peel undergone two main steps (Figure III-4): first the extraction of essential oils and the extraction of antioxidants from solid residue. Both of these steps were performed by standard extraction apparatus and innovative processes in order to achieve a thorough comparison.

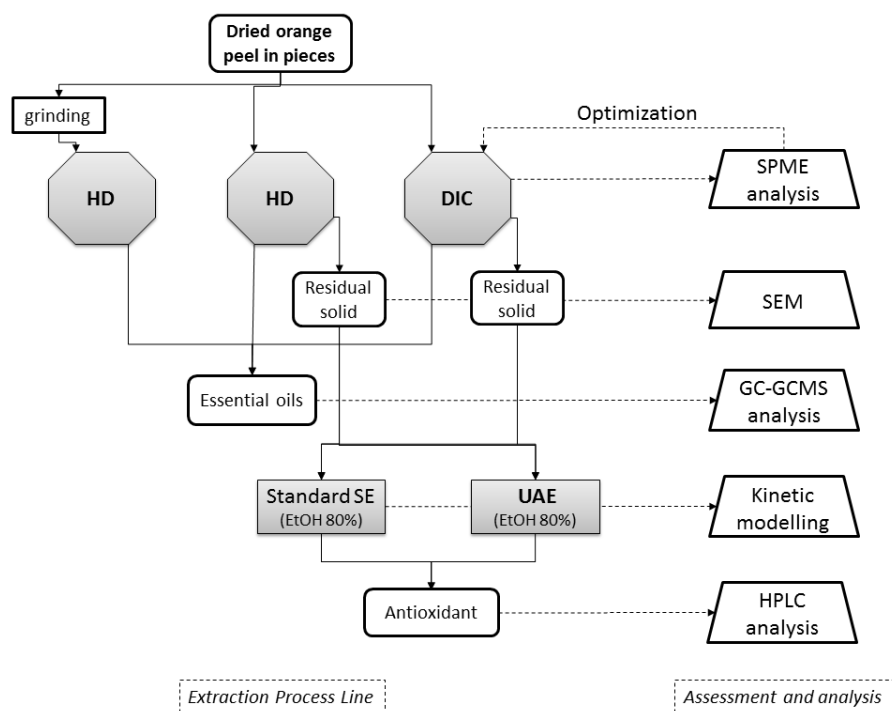

Figure III-4: Protocol treatment of orange peel extraction

4. Hydrodistillation apparatus and protocol

The hydrodistillation equipment (Figure III-5) used was a 6-liter modified stainless steel Clevenger apparatus (REUS Company, Contes - France).

200 g of dried orange peel were immersed in 2 L of distilled water. The extraction of essential oils, from ground (HD-G) and in pieces orange peels (HD-P), was carried out during 3 h and 4 h respectively, from the first drop of distillate until the quantity of essential oils stabilized. Afterwards the orange peels were recovered and dried at room temperature in order to be stored for antioxidant extraction and measurement.

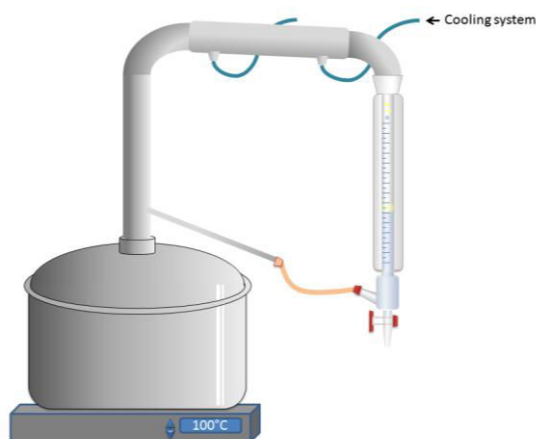

Figure III-5: Hydrodistillation apparatus

5. Instant controlled pressure drop apparatus and protocol

DIC lab-scale equipment was from the company ABCAR-DIC Process (La Rochelle, France).

The reactor we used was a 7 L processing vessel with a heating jacket; thermal treatment in this vessel is achieved using saturated steam with pressure varying from 5 kPa up to 1 MPa (Figure III-6). A pneumatic valve ensures an “instant” connection between the vacuum tank (maintained at 5 kPa) and the processing vessel.

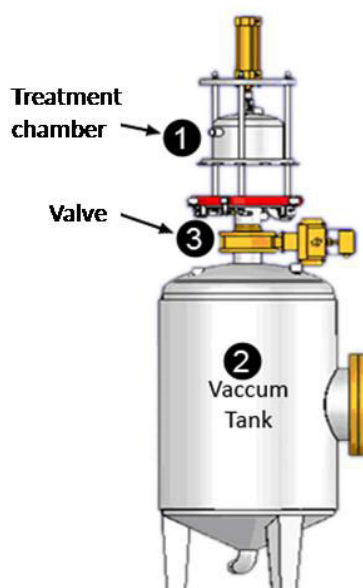

Figure III-6: Instant controlled pressure drop (DIC) apparatus

After placing 200 g of dried orange peel in the treatment vessel and closing it, a first vacuum stage was established just before the steam was injected (Figure III-7, phase b and c). High pressure saturated steam used in our case was 0.6 MPa. This stage lasted few seconds (phase d) and ended by an abrupt pressure drop towards a vacuum (phase e) by opening the pneumatic valve between the treatment and vacuum chamber. In our case, several DIC-cycles were carried out. Figure III-7 gives the flow-sheet of this treatment. Multi Cycle-DIC contains n repetitions of stages (c), (d), (e), and (f), with a total heating time that is the sum up of heating time of all cycles.

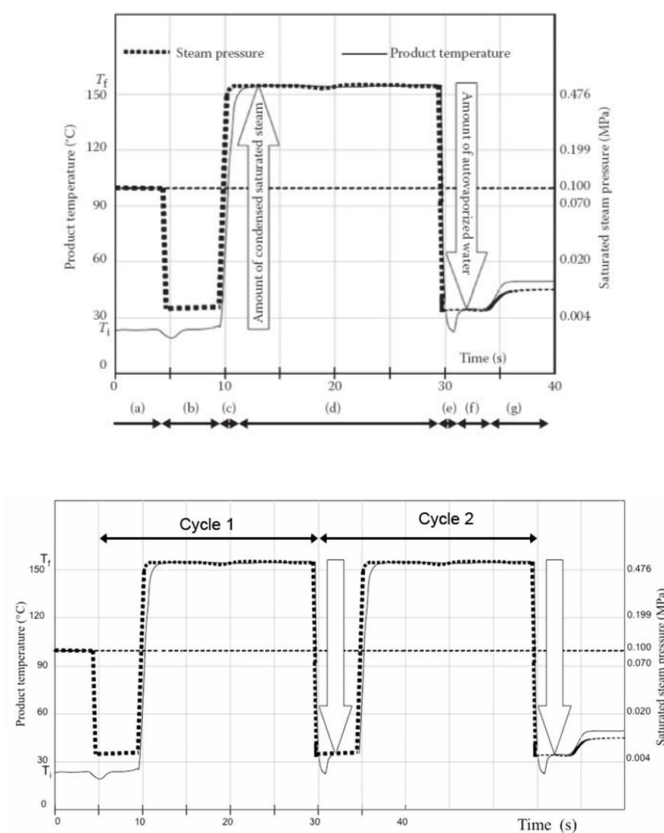

Figure III-7: Instant controlled pressure drop (DIC) cycle.

The essential oils are recovered as stable oil in water emulsion. Afterwards the orange peels were recovered and dried at room temperature in order to be stored for antioxidant extraction and measurement. DIC cycle can be divided into seven steps as shown in Figure III-7.

6. Ultrasound Assisted Extraction (UAE)

UAE was performed with a PEX 3 Sonifier (R.E.U.S., Contes, France) shown in Figure III-8, composed of a stainless steel container of 10 cm diameter and 14 cm high (internal dimensions) with a maximal capacity of 1 L, and a transducer at the bottom, operating at a frequency of 25 kHz with maximum input power of 150 W. The double layered mantle enables the control of the temperature of the medium. The output power of the 150 Watts generator was measured by calorimetry.

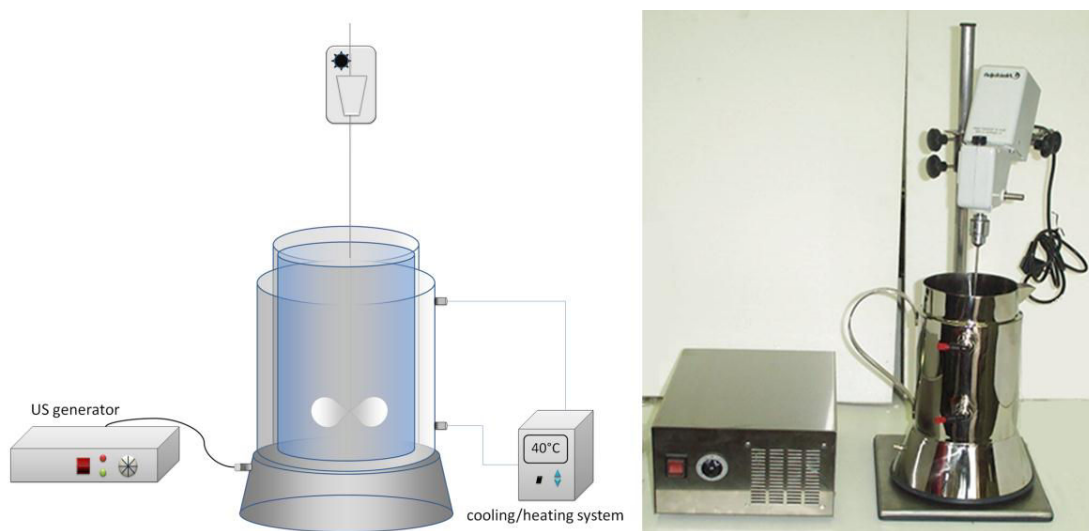

Figure III-8: Ultrasound apparatus

Orange peels, either raw material or after DIC treatment or after hydrodistillation, were sonicated in ethanol:water ratio 4:1 (v/v) at 40 °C for 60 min with a solvent:orange peel (dry basis) ratio of 20:1. The optimal parameters were taken from former studies (Khan et al., 2010). In order to perform kinetic study, 0.5 mL was withdrawn from the extraction vessels after 5, 10, 20, 30, 40, 50 and 60 minutes for each extraction treatment.

7. Solvent Extraction (SE)

Solvent extraction was achieved with the same conditions and same material without ultrasound assistance.

8. Assessment

8.1. Kinetics modeling: diffusivity and starting accessibility

In any solvent extraction achieved on plants (porous solid material), the main part of the operation is controlled through various penetration processes of the solvent within the material (capillarity, molecular diffusivity, etc.). The driving force global operation is the gradient of concentration and the model can be similar to Fick's Law with an effective diffusivity D_{eff} as the process coefficient.

However, before starting this "diffusion stage" there is the interaction between the solvent and the exchange surface of the porous solid. This first stage, which is not part of the diffusion mode and must be excluded from the total diffusion model, must reveal the starting accessibility δX_s .

8.2. Statistical and experimental design protocol

An adequate statistical treatment of the data issued from the experimental work carried out in the present article allowed us to empirically study, analyze, optimize and model the DIC extraction of essential oils. This investigation was achieved according to the design protocol shown in Table III-1. In order to achieve relevantly such experimental studies, the Response Surface Methodology (RSM) with a central composite rotatable experimental design is normally adopted. In the present study, the various DIC operating parameters and their most relevant ranges were identified through preliminary experiments. Thus, the moisture content just before DIC treatment as well as the saturated steam pressure used kept constant at 6.91 ± 0.09 % db and 0.6 MPa, respectively. Two DIC operating parameters the total heating time t and the number of cycles C were used as independent variables and ranged as: 30 ± 2 to 210 ± 2 s and 1 to 11 cycles, respectively. This experimental design led to 11 experiments to carry out. An adequate statistical treatment of the data issued from the experimental work was used to study, analyze and optimize DIC extraction of essential oils.

Response surface methodology (RSM) with a two-factor five-level $(-\alpha; -1; 0; 1; 0)$ central composite rotatable experimental design method was defined with star points defined through α (axial distance) $= \sqrt[4]{2^N}$. In the present case $k = 2$ and $\alpha = 2^{0.25k} = 1.4142$. The number of trials was:

- $2^k = 2^2 = 4$ factorial points: $(-1/-1; -1/+1; +1/-1; +1/+1)$
- $2 * k = 2 * 2 = 4$ star points: $(-\alpha / 0; 0 / -\alpha; +\alpha / 0; 0 / +\alpha)$
- 3 central points: $(0/0)$

Table III-1: DIC trials - experimental design

	Number of cycles	Total treatment time (s)
DIC 1	11	120
DIC 2	6	210
DIC 3	6	120
DIC 4	9	184
DIC 5	9	56
DIC 6	6	120
DIC 7	2	56
DIC 8	2	184
DIC 9	1	120
DIC 10	6	30
DIC 11	6	120

The trials were run at random to minimize the effects of unexpected variability of responses due to unrelated factors.

The statistical treatment of results was executed using the analysis design procedure of Statgraphics Plus software for Windows (1994, version 4.1, Levallois-Perret, France). Variance (ANOVA) was performed to determine significant differences between independent variables ($P \leq 0.05$) and Pareto charts were introduced as well as general trends, response surface, empirical model coefficients, and R^2 were determined.

The dependent variables had concerned process performance (in terms of efficiency) as well as the final extracted attributes: the response was expressed with a second order polynomial model of independent variables. Response surface methodology could be used to optimize the operating parameters by coupling various studied responses.

The extraction efficiency EE considered as the main response parameter (dependent variable) was calculated from GC–MS analysis by summing the areas, carried out on untreated orange peels (raw material) and residual solid after DIC treatments, as:

$EE = \frac{\text{Essential oils in raw material} - \text{Essential oils in DIC solid residue}}{\text{Essential oils in raw material}}$	Eq. III-1
---	-----------

8.3. Gas chromatography analysis

The essential oils were analyzed by gas chromatography coupled to mass spectrometry (GC–MS) (Hewlett-Packard computerized system, comprising a 6890 gas chromatograph coupled to a 5973A mass spectrometer), using two fused-silica-capillary columns with different stationary phases. The non-polar column was HP5MS (30 m x 0.25 mm i.d., 0.25 µm film thickness) and the polar column was a Stabilwax consisting of Carbowax–PEG (60 m x 0.2 mm i.d., 0.25 mm film thickness). GC–MS spectra were obtained using the following conditions: carrier gas, He; flow rate, 1 ml/min; split mode 1/20; injection volume, 1 µl; injection temperature, 250°C; oven temperature program, 60°C for 8 min, then increased at 2 °C/min to 250°C and held at 250°C for 15 min; ionization mode, electronic impact at 70 eV.

The relative percentages of the components were calculated from GC–FID peak areas. A Hewlett-Packard 6890 GC–FID system was used for gas chromatography analysis, fitted with a fused-silica-capillary column with an apolar stationary phase HP5MS (30 m x 0.25 mm i.d., 0.25 µm film thickness). Column temperature program, 60°C for 8 min, then increased at 2 °C/min to 250°C and held at 250°C for 15 min; injection, performed at 250°C in the split mode 1/20; injection volume, 1 µl; carrier gas, nitrogen at a flow rate of 1 ml/min; FID temperature, 320 °C. Most constituents were tentatively identified by comparison of their GC retention indices (RIs), determined with reference to a homologous series of C₅–C₂₈ n-alkanes and with those of authentic standards available in the authors' laboratory.

Identification was confirmed when possible by comparison of their mass spectral fragmentation patterns with those stored in the MS database (National Institute of Standards and Technology (NIST) and Wiley libraries) and with mass spectra literature data (Adams, 2001).

8.4. HPLC analysis

HPLC analyses were performed using a Waters (Milford, MA) HPLC system consisting of a Waters 600E pump, a Waters 717 autosampler, a Waters 2996 photodiode array detector. The HPLC pumps, autosampler, column temperature, and diode array system were monitored and controlled using Waters Empower 2 Chromatography Data software program. The wavelength used for the quantification of the flavanone glycosides with the diode detector was 280 nm. The chromatographic separation was carried out on a Purospher Star RP-18 end-capped column (250 mm × 4 mm I.D.; 5 µm particle size from VWR), with a RP18_e guard column (4 mm × 4mm I.D.; 5 µm particle size also from VWR). The end-capped column and guard column were held at 37 °C and the flow rate was set at 1mL/min. The mobile phase consisted of two solvents: 0.5% acetic acid (A) and 100% acetonitrile (B). The solvent gradient in volume ratios was as follows: 10–30% B over 20 min. The solvent gradient was increased to 35% B at 25 min and it was maintained at 35% B for 5 min. The injection volume was 20 µL. Identification of naringin and hesperidin was achieved by comparing their retention times and UV spectra with standards. Quantification was carried out using the external standard method and the final concentrations were calculated in g/g dm (dry material).

8.5. Measurement of antioxidant activity

A solution of DPPH (0.1 mM) in methanol was prepared as well as a series of extract solutions in methanol with 8 different dilutions (from 1/500 to 1/20). 2 mL of DPPH was added to 1 ml of the extracts. The mixtures were left for 30 min at room temperature in a dark location. Mixture assay was then put into a quartz cuvette and carefully closed. Maximum absorption of the radical DPPH was identified at 517 nm in methanol.

Absorbance measurements were carried out on a Spectronic GENESYS 5 UV-Visible spectrophotometer (wavelength range: 200-1100 nm) equipped with an eight-position multicell holder. The antioxidant activity of each sample was expressed in terms of IC₅₀ (micromolar concentration required to inhibit DPPH radical formation by 50%) (Mimica-Dukic et al., 2004).

8.6. Scanning Electron Microscope SEM

Micro-structures were observed using an environmental type JEOL 5410LV FEI Quanta 200F Scanning Electronic Microscope (SEM) (Philips Croissy-sur-Seine; France). The samples were placed on a covered support using carbon adhesive; the samples were scanned in a partial vacuum (7 Pa) with an acceleration tension of 20 kV.

III. RESULTS AND DISCUSSION

1. Hydrodistillation

In order to materialize the structure permeability of orange peel flavedo we compared essential oil extraction using HD, orange peel left in pieces and ground orange peels.

Regarding grinding, we obtained a powder granulometry repartition of 36% between 600 and 800 μm , 20% between 400 to 600 μm and 40% lower than 280 μm .

After 4h of hydrodistillation of orange peel in pieces essential oil yields reached $0.2 \cdot 10^{-2} \pm 1.3 \cdot 10^{-4}$ g/g dry material (dm) while hydrodistillation on ground orange peels generated a yield of essential oil of $1.6 \cdot 10^{-2} \pm 5.2 \cdot 10^{-4}$ g/g dm.

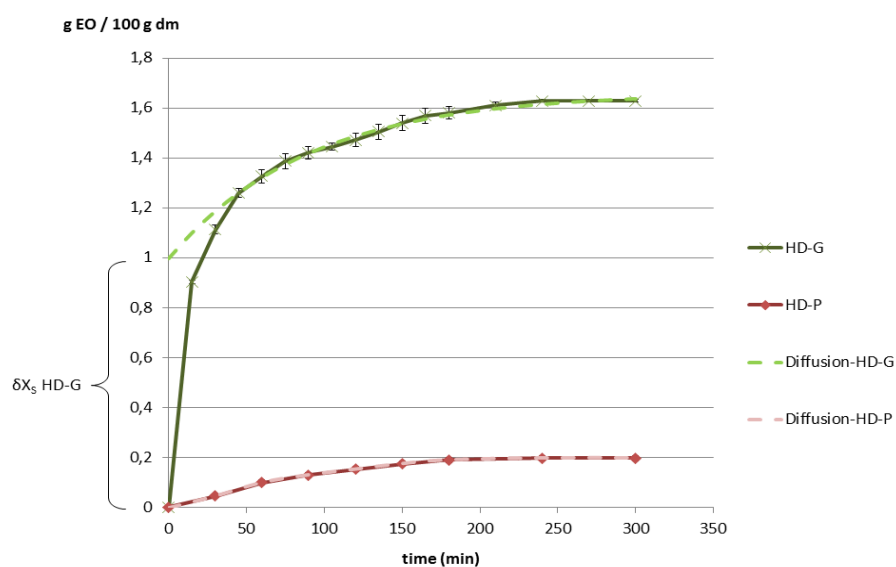

Figure III-9: Dried orange peel essential oil kinetics; comparison between hydrodistillation for two different matrices: in pieces and ground into powder.

HD-G: hydrodistillation performed on ground matrix and HD-P: hydrodistillation performed on matrix in pieces

It was possible to observe (Figure III-9) important differences in terms of kinetics of extraction depending on whether the product was ground or in pieces. Indeed in Table III-2, we gathered the effective diffusivity D_{eff} and starting accessibility δX_S of each matrix.

Table III-2: Comparison of diffusivity and starting accessibility of essential oil extraction through hydrodistillation of ground and in pieces orange peels.

Hydrodistillation	Starting accessibility δX_s (g/100g dry material)	D_{eff} (10^{-12} m²/s)
In pieces HD-P	2.044±0.642 10^{-2}	0.4265±0.0003
After grinding HD-G	1.013±0.084	0.6633±0.0013

Hydrodistillation on ground and in pieces orange peels revealed a dramatic difference in terms of essential oil yield. There is a dramatic rise of starting accessibility of 50 times when the orange peels are ground.

The matrix required a mechanical effect that will break the cells before enabling the essential oil diffusivity toward the water, which evaporated and condensed.

2. DIC optimization Statistical and experimental design protocol

We performed a central composite experimental design with the number of DIC cycles (C) and the total heating time (t) as independent parameters. The essential oil extraction yields were considered as the main response parameter. Points 5 and 10 had a high temperature treatment time per cycle too short to be able to be done with the DIC lab-scale device. Results gathered in Table III-3 and analyzed with Statgraphics software enabled the optimization of DIC parameters.

Table III-3: DIC extraction trials with essential oil extraction efficiency (EE%)

	Number of cycles	Total treatment time (s)	Extraction Efficiency EE (%)
DIC 1	11	120	98.7
DIC 2	6	210	97.4
DIC 3	6	120	97.7
DIC 4	9	184	98.3
DIC 5	9	56	97.8
DIC 6	6	120	97.8
DIC 7	2	56	94.8
DIC 8	2	184	95.7
DIC 9	1	120	93.7
DIC 10	6	30	94.2
DIC 11	6	120	97.3

As shown in Table III-3, we performed a central composite experimental design in order to analyze and determine the importance of mechanical and thermal effects. The number of DIC cycles and total heating time were taken as independent parameters. These parameters were appropriate to represent respectively mechanical and thermal aspects of DIC process. The extraction efficiency EE% determined on each solid residue after DIC experimental design by SPME was considered as the main response parameter.

Some studies already defined DIC extraction of essential oil as autovaporization process and many of these studies identified and quantified the relative impacts of this phenomenon with the evaporation (Berka-Zougali et al., 2010; Besombes et al., 2010; Kristiawan et al., 2008).

A Pareto chart of standardized effects (Figure III-10) was calculated in order to show significant effects of all variables (linear, quadratic and interactions between variables). The vertical line represents the limit between the significant and insignificant effects regarding the response.

The length of the bars of Pareto chart of each parameter (C: number of cycles, t: total treatment time, C^2 , t^2 , Ct) reveals the importance of the estimated effect. It is interesting to note that Pareto chart provided the data to settle importance and priorities and hence determine the relevance of each parameter (number of cycles C and treatment time per cycle t). On the one hand, thermal effects are represented by the total treatment time (summed period in which the product was put at high temperature). On the other hand, mechanical aspects, illustrated by the pressure drop, were characterized by the number of cycles (numbers of pressure drops).

Pareto charts revealed that mechanical effect (pressure drop impact) had significant influence regarding essential oil extraction. Total heating time is slightly below the vertical line, which indicated that thermal effect has, though not highly significant, a certain task. Indeed heating time is an important step since it is involved in the condensed water to deeply diffuse within the material. Regarding mechanical effect, it was clear from Table III-3 that the more DIC cycles, the higher the extraction efficiency.

The response surfaces enabled the representation of the total effect of operative parameters. RSM optimization was used to show the impact of the operative factors in terms of extraction efficiency EE (Figure III-10).

It was therefore possible to identify the highest and the quickest DIC extraction process through the operation efficiency.

The mathematical relationship obtained with the statistical software Statgraphics was a polynomial equation representing the quantitative effect of process variables and their interactions on the measured response EE (%). The values of the coefficients of C and t were related to the effect of these variables on the response EE (%). A positive value represented an effect that favors the operation, while a negative value indicated an antagonistic effect. This established mathematical relationship is indicated hereafter:

$EE (\%) = 0.89846 + 0.008704C + 0.000522t - 0.00035C^2 - 1.9467 \cdot 10^{-6}Ct - 1.6468 \cdot 10^{-6}t^2$	
with $R^2 = 88.95 \%$	Eq. III-2

The optimized operative conditions were determined with the goal to maximize the extraction efficiency (EE). They were hence calculated as an optimum value of EE (%) = 98.97%, with the highest value (11) of DIC cycles C ; and a total heating time t equal to 152 s. Higher values of heating time slightly reduced the value of EE as indicated in the graph of Figure III-10. EE was attenuated after a peak as function of the total heating time. One can assume that exceeding certain duration (here 152s at 159°C), structural change might be generated, reducing transfers of matter. In other words thermal overstepping might imply at times a decreasing of the transfer of the volatile (and fluid) molecules within the structure.

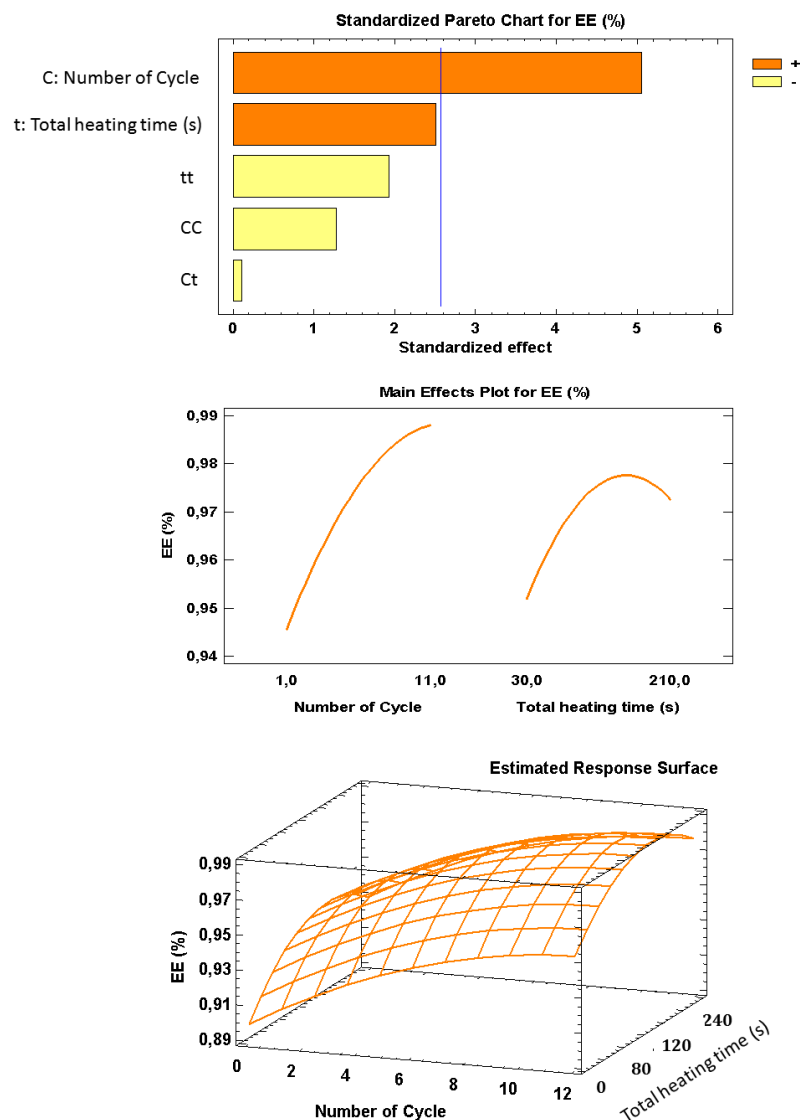

Figure III-10: Standardized Pareto chart for EE (%); Main effects plot for EE (%) regarding each parameter (number of cycle and total heating time); Response surfaces to represent the total effect of operative parameters (C : number of cycles and t : total heating time).

3. Essential oil Gas chromatography analysis

Both processes, hydrodistillation with ground orange peels and in pieces, and DIC (optimized parameters), were compared in terms of essential oil composition. Comparisons of isolation times and detailed composition for each extract are reported in Table III-4. It also gathers the grouped components of the essential oil: oxygenated and non-oxygenated fractions and composition of chemical families of orange peels essential oils obtained by these methods. Monoterpene hydrocarbons are less valuable than oxygenated compounds in terms of their contribution to the fragrance of the essential oil. Conversely, the oxygenated compounds are highly odoriferous and, hence, the most valuable. Essential oils obtained whether by hydrodistillation of ground orange peel or DIC had a quality quite close. Indeed, the quantity of oxygenated compounds is 0.228 mg/g dm for HD-P, 0.551 mg/g dm for HD-G and 0.616 mg/g dm for DIC.

Limonene is the major component with a percentage of 82.57%, 91.94% and 92.33% respectively for HD-P, HD-G and DIC essential oils.

Table III-4: HD and DIC essential oil composition by GC-MS, GC-FID

n° Compound ^a	RI ^b	RI ^c	HD-P ^d		HD-G ^e		DIC ^f	
			(%)	mg/g dm	(%)	mg/g dm	(%)	mg/g dm
Monoterpenes								
1 Pinene<Alpha->	926	1023	0.66	0.013	0.95	0.151	0.66	0.110
2 Camphene	942	1103	0.03	0.001	0.02	0.003	0	0.000
3 Myrcene<Beta->	988	1165	1.53	0.031	2.44	0.389	2.53	0.420
4 Limonene	1030	1206	82.57	1.688	91.94	14.646	92.33	15.330
5 Carene<Delta-3->	1101	1290	0	0	0.12	0.019	0.12	0.020
Oxygenated Monoterpenes								
6 Sabinene hydrate<Cis->	1112	-	0.16	0.003	0.37	0.059	0.3	0.050
7 Linalool	1125	1538	8.52	0.174	2.62	0.417	2.87	0.477
8 Camphor	1158	1514	0.82	0.017	0.08	0.013	0.04	0.007
9 Borneol	1176	1679	0.17	0.003	0	0.000	0	0.000
10 Terpin-4-ol	1191	1590	0.33	0.007	0.08	0.013	0.09	0.015
11 Terpineol<Alpha->	1203	1677	0.91	0.019	0.18	0.029	0.28	0.046

n° Compound ^a	RI ^b	RI ^c	HD-P ^d		HD-G ^e		DIC ^f		
			(%)	mg/g dm	(%)	mg/g dm	(%)	mg/g dm	
Sesquiterpenes									
12	Copaene<Alpha->	1372	-	0.07	0.001	0.19	0.030	0.16	0.027
13	Cubebene<Beta->	1382	-	0	0.000	0.07	0.011	0.06	0.010
14	Cubebene<Beta->	1386	-	0	0.000	0.02	0.003	0.02	0.003
15	Caryophellene<E->	1418	1594	0.14	0.003	0.14	0.022	0.09	0.015
16	Humulene<Alpha->	1450	1657	0.04	0.001	0	0.000	0	0.000
17	Muurolene<Alpha->	1493	1706	0.07	0.001	0.16	0.025	0.1	0.017
18	Cadinene<Delta->	1517	1746	0.13	0.003	0.3	0.048	0.2	0.033
Oxygenated Sesquiterpenes									
19	Germacrene D-4-ol	1567	2041	0.05	0.001	0.1	0.016	0.08	0.013
Other oxygenated compounds									
20	Decanal	1211	1497	0.18	0.004	0	0.000	0	0.000
21	Linalyl Acetate	1239	1549	0	0.000	0.03	0.005	0.05	0.008
Grouped compound									
Total oxygenated compounds				11.14	0.228	3.46	0.551	3.71	0.616
Total non-oxygenated compounds				85.24	1.742	96.35	15.349	96.27	15.984
EO Yield mg/g dm				1.97		15.9		16.6	

^aEssential oil compounds sorted by chemical families and percentages calculated by GC–FID on non-polar HP5MS capillary column

^bRetention indices relative to C5–C28 n-alkanes calculated on non-polar HP5MS capillary column.

^cRetention indices relative to C5–C28 n-alkanes calculated on polar Carbowax-PEG capillary column.

^dHydrodistillation of orange peel in pieces

^eHydrodistillation of ground orange peels

^fInstant controlled pressure drop

While monoterpene hydrocarbons are less valuable than oxygenated compounds in terms of their contribution to the fragrance of the essential oil, oxygenated compounds are highly odoriferous and, hence, the most valuable. Here the most important point was the fact that the EO yields were dramatically different giving in terms of total oxygenated compounds 0.22 mg/g dm for HD and 0.61 mg/g dm for DIC treatment.

4. Comparative extraction yields and kinetics of SE and UAE

According to HPLC analyses (Figure III-11), yields and kinetics of naringin and hesperidin extracted from the three products (RM, HD and DIC treated materials) during 1 hour of SE or UAE were compared.

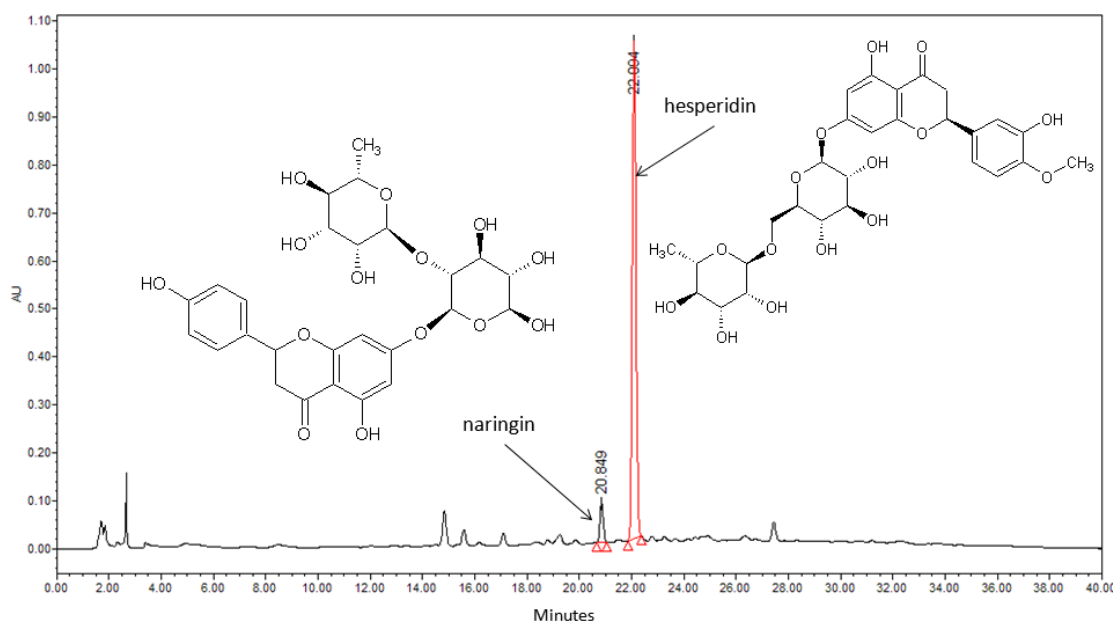

Figure III-11: Naringin and Hesperidin HPLC chromatogram

Each flavanone kinetic was gathered in Figure III-11. Extraction kinetics of naringin and hesperidin mostly show the same trends which gave the possibility to perceive and deduce the action of each process used. It is however interesting to note that regarding hesperidin extraction, DIC-SE and RM-UAE have the same trends, yet combining them gave a complementary effect. Indeed, both effects were acting on two different sides of the extraction enhancement. DIC opened the cells enabling an easy diffusion, ultrasound, through its agitation, generated an internal convection motion of solute within the solvent.

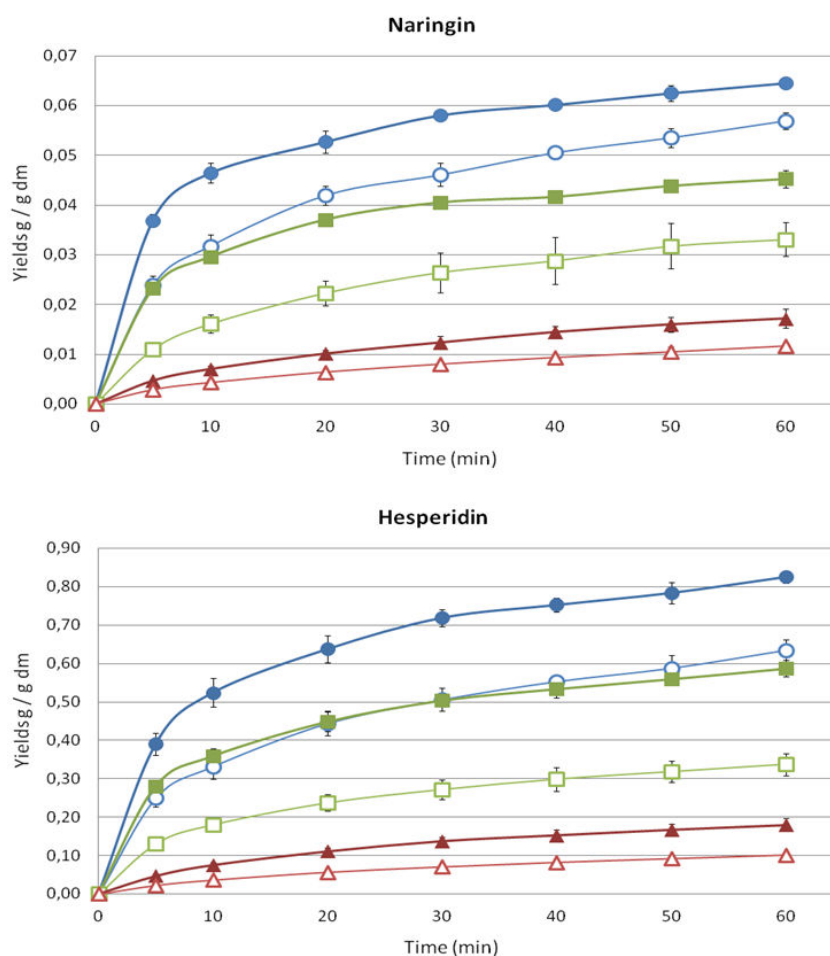

Figure III-12 Naringin and hesperidin extraction kinetics achieved by HPLC analysis

—●— DIC-UAE; —○— DIC-SE; —■— RM-UAE; —□— RM-SE; —▲— HD-UAE; —△— HD-SE

In addition to these elements we noticed that mass transfer from a matrix that has undergone hydrodistillation is reduced in terms of kinetics; HD treated product kinetics, whether extracted by UAE or SE, are below RM kinetics and dramatically below DIC treated product kinetics. After 60 min of extraction, it was possible to observe important differences in terms of yields and extraction rate.

With hydrodistilled solid samples, one hour standard SE generated a yield of $1.2 \cdot 10^{-2} \pm 6.7 \cdot 10^{-4}$ g of naringin /g dm and $0.11 \pm 5.5 \cdot 10^{-3}$ g of hesperidin /g dm. By coupling hydrodistilled solid samples to UAE treatment, this solvent extraction became intensified to $1.7 \cdot 10^{-2} \pm 1.9 \cdot 10^{-3}$ g of naringin /g dm and $0.18 \pm 1.7 \cdot 10^{-2}$ g of hesperidin /g dm.

With raw material, one hour standard SE generated a yield of $3.3 \cdot 10^{-2} \pm 3.4 \cdot 10^{-3}$ g of naringin /g dm and $0.34 \pm 2.8 \cdot 10^{-2}$ g of hesperidin /g dm. By using UAE treatment for raw material, this solvent extraction became intensified to $4.5 \cdot 10^{-2} \pm 1.8 \cdot 10^{-3}$ g of naringin /g dm and $0.18 \pm 1.7 \cdot 10^{-2}$ g of hesperidin /g dm.

With DIC treated solid samples, one hour standard SE generated a yield of $5.7 \cdot 10^{-2} \pm 1.6 \cdot 10^{-3}$ g of naringin /g dm and $0.64 \pm 2.7 \cdot 10^{-2}$ g of hesperidin /g dm. By coupling DIC treated solid samples to UAE treatment, this solvent extraction became intensified to $6.5 \cdot 10^{-2} \pm 2.3 \cdot 10^{-4}$ g of naringin /g dm and $0.83 \pm 1.6 \cdot 10^{-2}$ g of hesperidin /g dm.

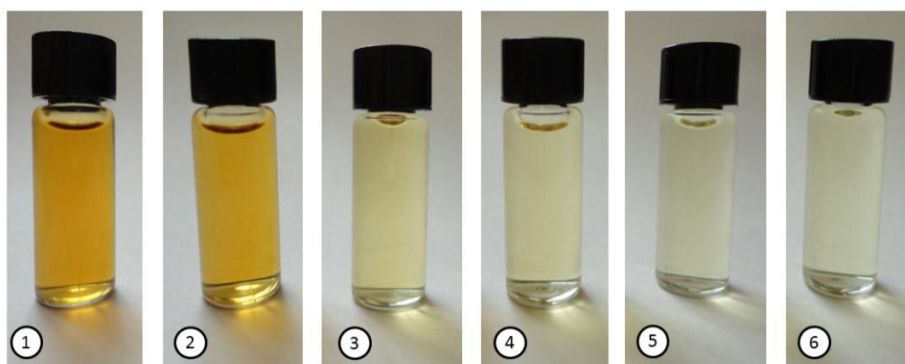

Figure III-13: Obtained extract: 1. DIC-UAE / 2. DIC-SE / 3. MP-UAE / 4. MP-SE / 5. HD-UAE / 6. HD-SE

Consequently, combining DIC to UAE enabled to highly improve the antioxidant extraction yields with trends in terms of kinetics dramatically improved compared to standard processes.

To obtain a thorough kinetics analyses, diffusivity and starting accessibility calculation was undergone. The results of modeling analysis of extraction kinetics based on the surface exchanging and internal diffusion revealed respectively by starting accessibility and effective diffusivity are shown in Table III-5.

Table III-5: Diffusivity and starting accessibility of solvent within different matrices

	Effective diffusivity (10^{-11} m ² /s) D_{eff}	Improvement of effective diffusivity	Starting accessibility δX_s (mg /g dM)	Starting accessibility ratio (%)	Improvement of starting accessibility	Time (min) for getting 95% of final extraction $t_{95\%}$
Naringin						
RM-SE	4.23	100%	10.46	16	100%	310
RM-UAE	5.71	135%	20.95	32	201%	211
HD-SE	0.73	17%	3.05	5	29%	1103
HD-UAE	1.12	27%	4.81	7	46%	715
DIC-SE	13.11	310%	26.62	40	256%	100
DIC-UAE	25.22	597%	43.13	66	414%	47
Hesperidin						
RM-SE	2.74	100%	121.66	14	100%	479
RM-UAE	6.31	231%	269.91	32	222%	193
HD-SE	0.49	18%	22.99	3	19%	1659
HD-UAE	0.88	32%	42.05	5	35%	916
DIC-SE	8.91	326%	266.37	32	219%	150
DIC-UAE	26.10	954%	506.02	60	416%	49

RM-SE: raw material extracted by solvent extraction

RM-UAE: raw material extracted by ultrasound assisted extraction;

HD-SE: hydrodistilled matrix extracted by solvent extraction;

HD-UAE: hydrodistilled matrix extracted by ultrasound assisted extraction;

DIC-SE: DIC treated material extracted by solvent extraction;

DIC-UAE: DIC treated material extracted by ultrasound assisted extraction

The raw material extracted with standard SE (RM-SE) was taken as the comparison basis. Regarding naringin extraction, the effective diffusivity and starting accessibility of DIC-UAE are respectively 6 and 4 times higher than that of RM-SE. With regards to hesperidin extraction, the effective diffusivity and starting accessibility of DIC-UAE are respectively 9.5 and 4 times higher than that of RM-SE.

The time for getting 95% of the final extraction of naringin (assuming that the availability is the same for all the samples) resulted in dramatic differences between the different materials. Indeed, when $t_{95\%}$ is around 5 hours for RM-SE and 3 hours and 30 minutes for RM-UAE, it skyrocketed to 18 hours for HD-SE and 15 hours for HD-UAE. DIC treatment decreases $t_{95\%}$ for naringin to an hour and a half with SE and less than an hour with UAE.

5. Antioxidant activity

Phenol antioxidants are able to more or less rapidly reduce reactive oxygen species including free radicals. Antioxidant activities indicated that extracts had an anti-radical activity in compliance with the higher antioxidant concentration.

We compared a 60 minute SE and UAE on the raw material itself; ultrasound enabled increasing the antioxidant activity of the extract by approximately 13% (IC_{50} was 1.20 ± 0.07 % for the raw material with SE and 1.06 ± 0.03 % with UAE). Moreover, DIC pre-treatment generated a rise of antioxidant activity twice as high as untreated material regarding both SE and UAE; indeed IC_{50} was 0.62 ± 0.02 % with SE and 0.52 ± 0.01 % with UAE. HD, however, induced an important decrease of the antioxidant activity; IC_{50} was 1.46 ± 0.02 % with SE and 1.46 ± 0.04 % with UAE.

6. Impact of treatments on microstructure

Essential oils are present in the pores shown in Figure III-14 SEM images of dried orange peels before and after DIC treatment revealed considerable structural differences. Indeed, after DIC treatment the opening of these cells are well pronounced highlighting the fact that essential oils were removed. On the contrary, after HD it was noticeable that the main part of EOs was detained in the collapsed structure. In terms of micro-structure, the raw material had a compact and relatively homogeneous internal structure (Figure III-14). As expected, DIC treatment radically changed the ultra-structure of orange peels while SEM images of orange peels after HD treatment illustrated the difficult essential oil extraction. Indeed the structure of the product after HD showed a shrunk and flat structure.

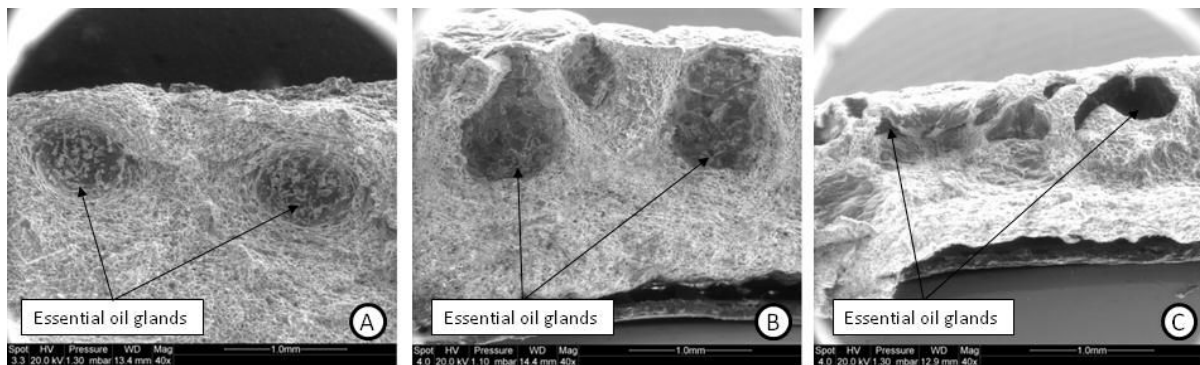

Figure III-14: Micrographs zoomed 40 times of untreated dried orange peel (left); DIC-treated dried orange peel (middle); HD-treated dried orange peel (right)

It is well known that the DIC treatment can modify the structure of plant at various and controlled levels although this is highly dependent on the operating parameters (Amor et al., 2008; Ben Amor and Allaf, 2009). Such modifications from interstitial zone to broken cell walls can greatly modify structural characteristics. It would be then possible to control functional and technological capacities that help to greatly intensify mass transfer phenomena by improving diffusivity and permeability within the matrix. In the case of orange peel, the SEM images revealed structural differences between raw material, DIC treated samples and HD treated samples. Before DIC treatment (Figure III-15), the product had a slightly compact and relatively well organized cell structure. On the one hand, the impact of DIC treatment, which led to an evident expansion of the structure, has kept the main part of the cells intact thus proving the great structural stability of the peels. On the other hand, HD shrinkage is clearly noticeable, which weakened diffusivity and hence prevented good extraction kinetics.

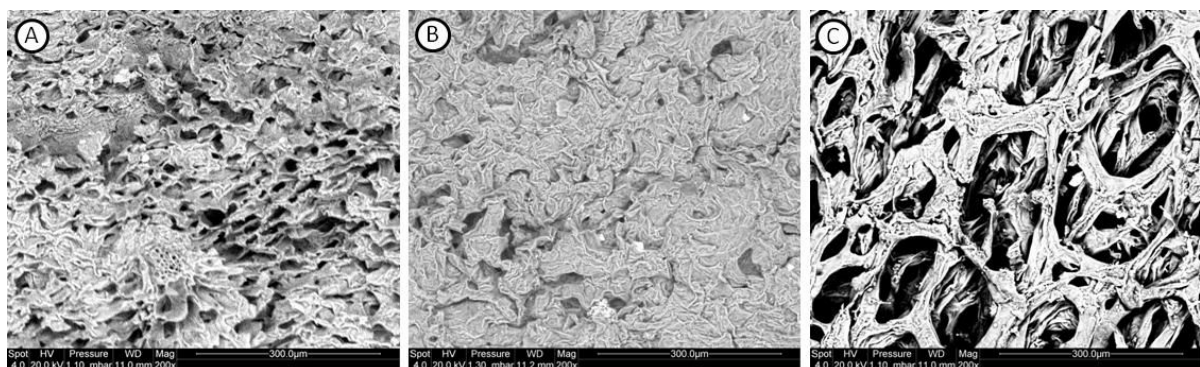

Figure III-15 Scanning Electron Micrographs of untreated dried orange peel (A); HD-treated dried orange peel (B); DIC-treated dried orange peel (C) zoomed 200 times

IV. CONCLUSION

In order to recover and recycle wastes from citrus processing, a thorough study was performed on sweet dried orange peels. The latter has undergone two main steps. We first extracted the essential oils and after recovering the solid residue we conducted the extraction of antioxidants. Both of these steps were performed by standard and innovative extraction processes in order to obtain a quite complete comparison.

It is important to note that the natural structure of some plants such as citrus peels prevents an easy essential oil extraction. The extraction performed by hydrodistillation (HD) showed that mechanical process, in this case grinding, was necessary. Therefore, in the case of instant controlled pressure drop (DIC) mechanical (illustrated by the number of cycle C) and thermal (illustrated by the heating time t) processes can be combined for this particular material. DIC as a thermo-mechanical treatment enabled the extraction of essential oil through autovaporization phenomenon.

We could also compare the effect of Ultrasound Assisted Extraction (UAE) to standard Solvent Extraction (SE) both achieved on dried orange peels as raw material, material after hydrodistillation (HD) and instant controlled pressure drop (DIC) treated material.

Pre-treatment by DIC can improve antioxidant extraction yields and kinetics as well as UAE. The highest yield with best kinetics is obtained by coupling both treatments. We also noted that UAE treatment generated a higher antioxidant activity than standard SE and even higher when UAE is undergone on DIC treated matrix. The impact of DIC on microstructure delivered a reliable explanation regarding our results. The swelling of the cells enabled a better kinetic extraction in terms of diffusivity and starting accessibility.

Investigations with a DIC and ultrasonic at industrial scale equipment could be realized for industry tests. DIC treatment enables to directly extract essential oils preparing the matrix for solvent extraction and ultrasound appears to be a viable option for extraction of antioxidants from orange peels. This combined process can be considered as a sustainable alternative for the industry since it allows entirely recovering and valuing citrus by-products.

V. REFERENCES

- Adams, R.P., (2001). *Identification of essential oil components by gas chromatography/quadrupole mass spectroscopy*. Allured Publishing Corporation, Illinois, USA.
- Allaf, K., Besombes, C., Berka-Zougali, B., Kristiawan, M., Sobolik, V., Allaf, T., (2011). Instant Controlled Pressure Drop Technology in Plant Extraction Processes, in: Lebovka, N., Vorobiev, E., Chemat, F. (Eds.), *Enhancing Extraction Processes in the Food Industry*. CRC Press Taylor & Francis Group, Dublin, Ireland, pp. 255-302.
- Allaf, T., Tomao, V., Ruiz, K., Bachari, K., ElMaataoui, M., Chemat, F., (2013). Deodorization by instant controlled pressure drop autovaporization of rosemary leaves prior to solvent extraction of antioxidants. *LWT - Food Science and Technology* 51(1), 111-119.
- Amor, B.B., Lamy, C., Andre, P., Allaf, K., (2008). Effect of instant controlled pressure drop treatments on the oligosaccharides extractability and microstructure of *Tephrosia purpurea* seeds. *Journal of Chromatography A* 1213(2), 118-124.
- Ashurst, P.R., (1999). *Food Flavorings*. Aspen Publisher Inc., United Kingdom.
- Atti-Santos, A.C., Rossato, M., Serafini, L.A., Cassel, E., Moyna, P., (2005). Extraction of essential oils from lime (*Citrus latifolia* Tanaka) by hydrodistillation and supercritical carbon dioxide. *Brazilian archives of biology and technology* 48(1), 155-160.
- Ben Amor, B., Allaf, K., (2009). Impact of texturing using instant pressure drop treatment prior to solvent extraction of anthocyanins from Malaysian Roselle (*Hibiscus sabdariffa*). *Food Chemistry* 115(3), 820-825.
- Benavente-García, O., Castillo, J., Marin, F.R., Ortuño, A., Del Río, J.A., (1997). Uses and Properties of Citrus Flavonoids. *Journal of Agricultural and Food Chemistry* 45(12), 4505-4515.
- Berka-Zougali, B., Hassani, A., Besombes, C., Allaf, K., (2010). Extraction of essential oils from Algerian myrtle leaves using instant controlled pressure drop technology. *Journal of Chromatography A* 1217(40), 6134-6142.
- Berna, A., Tárrega, A., Blasco, M., Subirats, S., (2000). Supercritical CO₂ extraction of essential oil from orange peel; effect of the height of the bed. *The Journal of Supercritical Fluids* 18(3), 227-237.
- Besombes, C., Berka-Zougali, B., Allaf, K., (2010). Instant controlled pressure drop extraction of lavender essential oils: fundamentals and experimental studies. *Journal of Chromatography A* 1217(44), 6807-6815.
- Bocco, A., Cuvelier, M.-E., Richard, H., Berset, C., (1998). Antioxidant Activity and Phenolic Composition of Citrus Peel and Seed Extracts. *Journal of Agricultural and Food Chemistry* 46(6), 2123-2129.
- Bousbia, N., Abert Vian, M., Ferhat, M.A., Petitcolas, E., Meklati, B.Y., Chemat, F., (2009). Comparison of two isolation methods for essential oil from rosemary leaves: Hydrodistillation and microwave hydrodiffusion and gravity. *Food Chemistry* 114(1), 355-362.
- Chemat, F., Cravotto, G., (2011). Combined Extraction Techniques, in: Lebovka, N., Vorobiev, E., Chemat, F. (Eds.), *Enhancing Extraction Processes in the Food Industry*. CRC Press Taylor & Francis Group, Dublin, Ireland, pp. 173-194.
- Chemat, F., Tomao, V., Virot, M., (2008). Ultrasound-assisted extraction in food analysis, *Handbook of food analysis instruments*. Ötleş S., USA.
-

- El-Nawawi, S.A., Heikal, Y.A., (1995). Production of a low ester pectin by de-esterification of high ester citrus pectin. *Carbohydrate Polymers* 27(3), 191-195.
- FAO, (2003). Medium-term prospects for agricultural commodities, in: FAO (Ed.). food and agriculture organization of the united nations, US.
- FAO, (2010). Citrus Fruit: Fresh and Processed - Annual Statistics, in: FAO (Ed.). food and agriculture organization of the united nations, US.
- Ferhat, M.A., Meklati, B.Y., Smadja, J., Chemat, F., (2006). An improved microwave Clevenger apparatus for distillation of essential oils from orange peel. *Journal of Chromatography A* 1112(1-2), 121-126.
- Frérot, E., Decorzant, E., (2004). Quantification of Total Furocoumarins in Citrus Oils by HPLC Coupled with UV, Fluorescence, and Mass Detection. *Journal of Agricultural and Food Chemistry* 52(23), 6879-6886.
- Garau, M., Simal, S., Rossello, C., Femenia, A., (2007). Effect of air-drying temperature on physico-chemical properties of dietary fibre and antioxidant capacity of orange (*Citrus aurantium* v. *Canoneta*) by-products. *Food Chemistry* 104(3), 1014-1024.
- Graham, R.P., Shepherd, A.D., (1953). Pectin Production, Pilot Plant Production of Low-Methoxyl Pectin from Citrus Peel. *Journal of Agricultural and Food Chemistry* 1(16), 993-1001.
- Imeh, U., Khokhar, S., (2002). Distribution of Conjugated and Free Phenols in Fruits: Antioxidant Activity and Cultivar Variations. *Journal of Agricultural and Food Chemistry* 50(22), 6301-6306.
- Khan, M.K., Abert-Vian, M., Fabiano-Tixier, A.-S., Dangles, O., Chemat, F., (2010). Ultrasound-assisted extraction of polyphenols (flavanone glycosides) from orange (*Citrus sinensis* L.) peel. *Food Chemistry* 119(2), 851-858.
- Kristiawan, M., Sobolik, V., Allaf, K., (2008). Isolation of Indonesian cananga oil using multi-cycle pressure drop process. *Journal of Chromatography A* 1192(2), 306-318.
- Kumagai, C., Sawamura, M., Son, U.S., (2010). Aromatherapy, *Citrus Essential Oils*. John Wiley & Sons, Inc., pp. 297-341.
- Leuzzi, U., Caristi, C., Panzera, V., Licandro, G., (2000). Flavonoids in pigmented orange juice and second-pressure extracts. *Journal of Agricultural and Food Chemistry* 48(11), 5501-5506.
- Li, B., Smith, B., Hossain, M., (2006). Extraction of phenolics from citrus peels I. Solvent extraction method. *Separation and Purification Technology* 48(2), 182-188.
- Ma, Y.-Q., Chen, J.-C., Liu, D.-H., Ye, X.-Q., (2009). Simultaneous extraction of phenolic compounds of citrus peel extracts: Effect of ultrasound. *Ultrasonics Sonochemistry* 16(1), 57-62.
- Ma, Y., Ye, X., Hao, Y., Xu, G., Xu, G., Liu, D., (2008). Ultrasound-assisted extraction of hesperidin from Penggan (*Citrus reticulata*) peel. *Ultrasonics Sonochemistry* 15(3), 227-232.
- Manthey, J.A., Grohmann, K., (2001). Phenols in Citrus Peel Byproducts. Concentrations of Hydroxycinnamates and Polymethoxylated Flavones in Citrus Peel Molasses. *Journal of Agricultural and Food Chemistry* 49(7), 3268-3273.
- Mason, T.J., (2000). Large scale sonochemical processing: aspiration and actuality. *Ultrasonics Sonochemistry* 7(4), 145-149.
- Mimica-Dukic, N., Bozin, B., Sokovic, M., Simin, N., (2004). Antimicrobial and antioxidant activities of *Melissa officinalis* L. (Lamiaceae) essential oil. *Journal of Agricultural and Food Chemistry* 52(9), 2485-2489.
- Reddy, N., Yang, Y., (2005). Biofibers from agricultural byproducts for industrial applications. *Trends in Biotechnology* 23(1), 22-27.

-
- Rouseff, R.L., Martin, S.F., Youtsey, C.O., (1987). Quantitative survey of narirutin, naringin, hesperidin, and neohesperidin in citrus. *Journal of Agricultural and Food Chemistry* 35(6), 1027-1030.
- Sahraoui, N., Vian, M.A., El Maataoui, M., Boutekdjiret, C., Chemat, F., (2011). Valorization of citrus by-products using Microwave Steam Distillation (MSD). *Innovative Food Science & Emerging Technologies* 12(2), 163-170.
- SCCP, (2005). Opinion on Furocoumarins in cosmetic products, in: Assessment, P.H.a.R. (Ed.). European Commission, Europe.
- Shahidi, F., Zhong, Y., (2005). Citrus Oils and Essences, *Bailey's Industrial Oil and Fat Products*. John Wiley & Sons, Inc.
- Sun, Y., Liu, D., Chen, J., Ye, X., Yu, D., (2011). Effects of different factors of ultrasound treatment on the extraction yield of the all-trans- β -carotene from citrus peels. *Ultrasonics Sonochemistry* 18(1), 243-249.
- Toma, M., Vinatoru, M., Paniwnyk, L., Mason, T.J., (2001). Investigation of the effects of ultrasound on vegetal tissues during solvent extraction. *Ultrasonics Sonochemistry* 8(2), 137-142.

Chapter 4

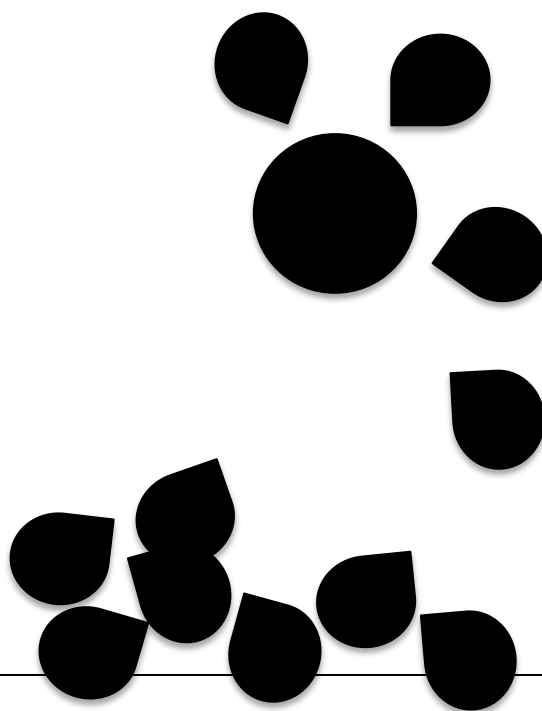

Chapitre IV - KINETIC MODELING OF CANOLA OIL EXTRACTION

Kinetic modeling of canola oil extraction - Impact of instant controlled pressure drop parameters

- ◆ Allaf, T., Tomao, V., Nguyen, C., Ginies, C., Fine, F. Chemat, F. Kinetic modeling of canola oil extraction – Impact of instant controlled pressure drop parameters. *Journal of Food Engineering*. (*Submitted*)

I. INTRODUCTION

The production of canola oil has been highly developed over many years for food use. Canola seeds carry a quantity between 40 to 55 % oil weight (wt%) which contains triglycerides 97 - 99 wt%, fatty acids 0.5 - 2wt% and minor lipids 0.5 - 1 wt% (Olivier and Elisabeth, 2009). Canola oil is known for its high amounts of unsaturated fatty acids. The main fatty acid composition is approximately oleic acid C18:1 (61.6%), linoleic acid C18:2 (21.7%), linolenic acid C18:3 (9.6%), palmitic acid C16:0 (3.6%), stearic acid C18:0 (1.5%), and other fatty acids (3%) (Przybylski et al., 2005). These fatty acids are described in Table IV-1.

Table IV-1: Main Fatty Acids present in Canola oil

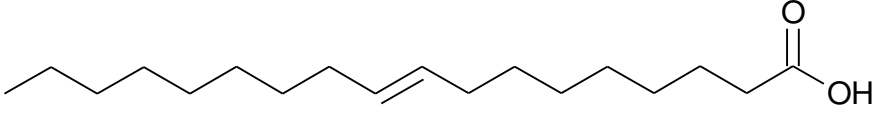
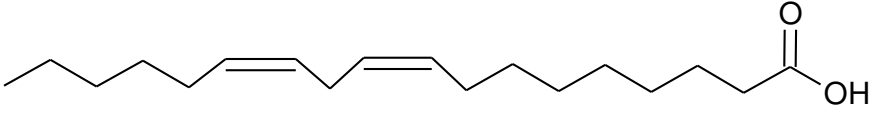
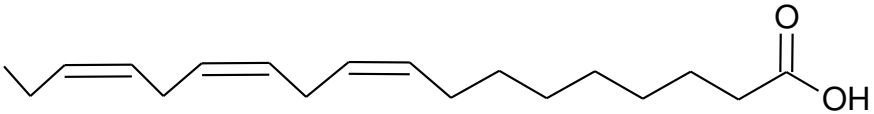
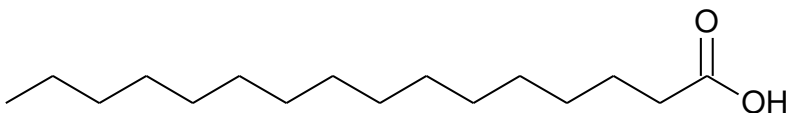
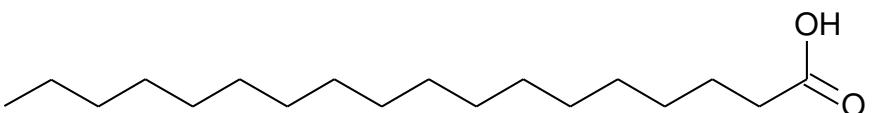
Oleic Acid	C18:1n9	MUFA
		
Linoleic Acid	C18:2n6	PUFA
		
Linolenic Acid	C18:3n3	PUFA
		
Palmitic Acid	C16:0	SFA
		
Stearic Acid	C18:0	SFA
		

SFA: Saturated Fatty Acids

MUFA: Mono-Unsaturated Fatty Acid

PUFA: Poly-Unsaturated Fatty Acid

World production of canola seed amounts to about 5 million tons/year, taking the 5th place among oilseed crop (USDA, 2013). For canola oil extraction, industries employ and even combine both, mechanical (pre-press) and solvent extraction methods.

Some factors influencing the extraction process were previously studied: the nature of the solvent (Hensarling and Jacks, 1983; Kmiecik et al., 1991), the particle size (Meziane et al., 2006; So and Macdonald, 1986), and the extraction conditions (temperature, pressure, etc.) (Fernández et al., 2012). Oil seeds were also submitted to high pressure methanol extraction (Brühl et al., 1999; Eggers, 1985; Olivier and Elisabeth, 2009). The different factors acting on hexane extraction kinetics have been researched in the case of rapeseed (So and Macdonald, 1986) and optimal conditions for oil extraction of canola and some other seeds were also tested (Tulbentci, 1986).

The extraction of oil from canola using hexane as a solvent can be described via two stages: starting accessibility and diffusion model. Superficial oil is normally easily and quickly removed at the beginning of the extraction process through a simple “solvent washing” of the surface (So and Macdonald, 1986). This is followed by a slow extraction of the oil from the seed by a diffusion process. This latter process appears to be controlled by two mechanisms: slow, unhindered diffusion of oil held in the ruptured cells in the seed; and very slow, hindered diffusion of oil held within un-ruptured cells in the seed.

Global intensification methodology consists in first, defining the limiting phenomena and determine what to intensify in order to improve global kinetics of the operation (Allaf et al., 2011a; So and Macdonald, 1986).

In the case of solvent extraction, it is well known that four mass transfer mechanisms should take place (Allaf, 1982):

- Solvent transfer in the product; carried out in liquid form by various processes including capillarity, molecular diffusivity; the solvent content gradient is the driving force.
- Solute transfer in the solvent within the product; it is carried out by molecular diffusivity with the gradient of solute concentration in the solvent as the main driving force.

- Solvent interaction between the material exchange surface and the contacting solvent.
- Solute transport outside the product surface to external solvent; when no external agitation is done, this transport takes place by diffusion with the gradient of solute concentration in the solvent as the driving force.

In order to overcome limiting processes, there has been an increasing demand for new extraction techniques for getting shorter extraction time, higher yields with lower consumption of organic solvent.

The application of the instant controlled pressure drop (DIC) as a texturing pretreatment prior to solvent extraction has been a relevant mean to improve the technological abilities of material; it has allowed solvent extraction to be undertaken very efficiently in a shorter time using less solvent (Besombes et al., 2010). Instant controlled pressure drop (DIC) technology was defined in 1988 (Allaf, 1988). This innovative process has been studied, developed, optimized and used at industrial scale for various applications like drying (Mounir et al., 2011), decontamination (Allaf et al., 2011b), direct extraction of volatile compounds (Berka-Zougali et al., 2010; Besombes et al., 2010), texturing (Allaf et al., 2013; Mounir et al., 2011) and pre-treatment for extraction of non-volatile molecules such as flavonoids (Allaf et al., 2012b; Ben Amor and Allaf, 2009). DIC is a thermo-mechanical process generated by subjecting the raw material for a short time-frame to high-pressure saturated steam followed by an abrupt pressure drop towards a vacuum. This generates an autovaporization of volatile molecules, implying instant cooling and expansion of the sample.

In this present work, we carried out a first approach of modeling of solvent extraction kinetics of untreated and expanded canola seeds via DIC. The main objective is to improve process performance (in our case extraction kinetics) without modifying the fatty acid profile. In addition, the impact of DIC treatment on canola oil extraction was carried out and discussed in order to optimize DIC pretreatment parameters for intensifying solvent extraction process of canola oil.

II. MATERIALS AND METHODS

1. Plant and Chemicals

In this study, Astrid variety of canola seeds, with 8.69 % dry basis moisture content were treated. Analytical grade n-hexane used as solvent; methanol, sulfuric acid and NaCl used for the preparation of fatty acid derivatives were all purchased from VWR International (Darmstadt, Germany).

2. Experimental Protocol

Samples of untreated and DIC-treated material were coarsely ground and then extracted via n-hexane Soxhlet. In each case, kinetic modeling and gas chromatography analysis were used as means to characterize canola seed extraction in terms of functional behavior and fatty acid determination. The ISO 659-1988 norm was also performed on the raw material to have a baseline of the extraction process. The performed protocol is shown in Figure IV-1.

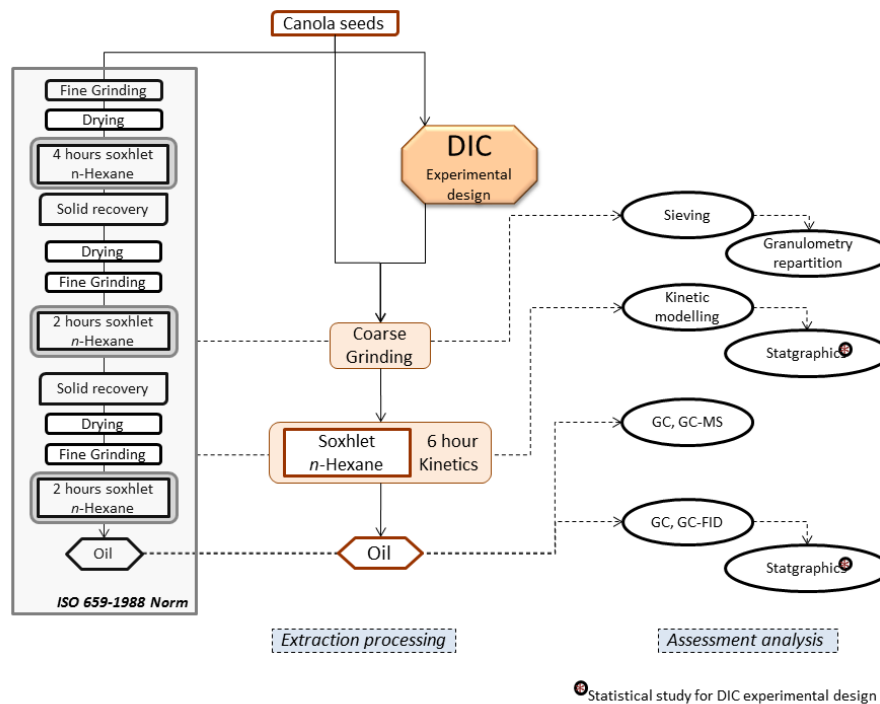

Figure IV-1. Experimental Protocol

3. Instant controlled pressure drop reactor and protocol

DIC lab-scale equipment from ABCAR-DIC Process company (La Rochelle, France), is a reactor with 7-l processing vessel. Thermal treatment in this vessel is achieved using saturated steam with pressure varying from 5 kPa up to 1 MPa. An “instant” valve ensures a connection between the vacuum tank (maintained at 5 kPa) and the processing vessel. DIC equipment and treatment is described in several papers (Allaf et al., 2012b; Berka-Zougali et al., 2010; Kristiawan et al., 2008).

For each treatment of the experimental design, 100g of canola seeds were processed by DIC; i.e. canola seeds undergone 2 stages: high temperature/high pressure and an instant pressure drop towards a vacuum.

4. Soxhlet extraction apparatus and procedure

Soxhlet extractions were performed on DIC-treated and untreated rapeseeds using 15 g of coarsely ground samples. The amount was transferred in a 30 × 80 mm cellulose thimble and placed in the 200-mL extraction chamber of a Soxhlet apparatus. The Soxhlet apparatus, fitted with a condenser, was placed on a 500 mL distillation flask containing 300 mL of hexane. Sample oil was thus extracted under n-hexane reflux for 6 h (60 siphoning). For conventional Soxhlet extraction of canola oil the ISO 659-1988 Norm (Standardization, 1998) procedure was carried out. The norm involved a very fine grinding.

In order to perform kinetic study, 1 mL was withdrawn after the first, second, third and fourth siphoning then every 30 minutes until 3 hours of extraction and then each hour. After evaporating the n-hexane, the samples were weighted in order to follow the extraction kinetics. Results obtained for total extraction kinetics were expressed as described hereafter:

$\%Extract (dm) = \frac{\text{Weight of extract obtained after extraction}}{\text{Weight of canola (dry material)}}$	Eq. IV-1
--	----------

Extractions were performed at least three times; the mean values were reported and obtained extract were analyzed via gas chromatography.

5. Analytical Procedures and Assessments

5.1. Sieving instrument

The sieving instrument was a vibratory sieve shaker Analysette 3 Pro from C2M technology (Florange, France). Sieving was performed for the coarse and the fine grinding with sieves of 2000 - 1400 - 1000 - 800 - 600 - 200 - 71 μm and of 800 - 600 - 560 - 400 - 280 - 200 - 140 - 100 - 71 μm respectively. The amplitude of the instrument was fixed at 1.2.

5.2. Statistical and experimental design protocol

Preliminary investigation allowed to defining a response surface methodology (RSM) with a two-factor five level $(-\alpha; -1; 0; 1; \alpha)$ central composite rotatable experimental design. This method was defined with: 4 factorial points $(-1/-1; -1/+1; +1/-1; +1/+1)$, 4 star points $(-\alpha/0; 0/-\alpha; +\alpha/0; 0/+\alpha)$ and 3 repetitions: $(0/0)$. Responses were expressed with a second order polynomial empirical model of independent variables:

$$Y = \beta_0 + \sum_{i=1}^n \beta_i x_i + \sum_{i=1}^n \beta_{ii} x_i^2 + \sum_{i=1}^n \beta_{ij} x_i x_j + \varepsilon$$

Eq. IV-2

where Y was the response, β_0 , β_i , β_{ii} and β_{ij} stand for the regression coefficients, x_i stand for DIC operating parameters as independent variables, ε stands for the random error, and i and j for the indices of the factors. RSM can be used to optimize the operating parameters by coupling various studied responses (Benoist et al., 1994).

$\alpha(\text{axial distance}) = \sqrt[4]{2^N}$. In the present case $N = 2$ and $\alpha = 1.4142$

In the present study DIC operating parameters were: saturated steam pressure (P) ranged from 0.2 MPa to 0.7 MPa and treatment time (t) ranged from 20 to 120 seconds. The responses regarding extraction kinetics and extraction yields were analyzed. Statistical treatment of obtained results was executed using the analysis design procedure of Statgraphics Plus software for Windows (version 16.0, Levallois-Perret, France).

5.3. Gas chromatography

5.3.1. Preparation of fatty acids methyl ester derivatives

Fatty acid methyl esters (FAMES) were prepared according to AOCS Official method Ce 2–66 (AOCS, 1989). Samples were then filtered through a 0.2 μm cellulose regenerated filter (Alltech associates, Deerfield, IL, USA) before injection.

5.3.2. Gas chromatography analysis

GC-MS analyses were performed by using an Agilent (Kyoto, Japan) gas chromatography. The instrument was equipped with a BD-EN14103 capillary column 30 m x 320 μm x 0.25 μm (Agilent). The velocity of the carrier gas (He) was at 33 cm s^{-1} . Injection of 2 μl of the various samples was carried out with a split mode (ratio 1:20) and the injector temperature was set at 250°C. The oven temperature increased from 50°C (1 min) to 180°C at a rate of 20°C.min⁻¹, increased from 180°C to 220°C at a rate of 2°C/min⁻¹, and then held at 230°C for 10 min. The mass spectra were recorded at 3 scan/s between 50 to 400 amu. The ionization mode was electron impact (EI) at 70 eV. Identification of common fatty acids was performed using the NIST'98 [US National Institute of Standards and Technology (NIST), Gaithersburg, MD, USA] mass spectral database.

GC-FID analyses were performed on an Agilent (Kyoto, Japan) gas chromatography (GC) equipped with a Flame Ionization Detector (FID). The detector temperature was 300°C. The other analytic conditions including the column type and column temperature, the injection temperature, split ratio, carrier gas and the linear velocity were the same as those of GC-MS analysis. FAMES were identified by retention time and comparison with purified FAME standards (Sigma Co., USA).

III. CALCULATION: KINETIC MODELING - DIFFUSIVITY AND STARTING ACCESSIBILITY

In any solvent extraction achieved on plants (porous solid material), a first solvent-exchange surface interaction (washing (Fernández et al., 2012)) takes place for a short time-frame. Thus, starting accessibility δX_s (expressed in g of extract per g of dry material) reveals the amount of extract obtained in very short time-frame (t near 0) through the convection of solvent interacting with the exchange surface. Afterward, the main part of the operation is controlled through various penetration processes of the solvent within the material (capillarity, molecular diffusivity...). The driving force of global operation is the gradient of concentration and the model can be similar to Fick's law with an effective diffusivity D_{eff} ($m^2 s^{-1}$) as the process coefficient (Allaf et al., 2011a; Allaf et al., 2012a).

1st Fick's Law (Allaf, 1982):

$\frac{\rho_s}{\rho_d} (\vec{v}_s - \vec{v}_d) = -D_{eff} \vec{\nabla} \left(\frac{\rho_s}{\rho_d} \right)$	Eq. IV-3
--	----------

One can assume the absence of expansion or shrinkage, i.e. $\vec{v}_d = 0$ and $\rho_d = constant$

$\rho_s \vec{v}_s = -D_{eff} \vec{\nabla} \rho_s$	Eq. IV-4
---	----------

Crank's solution for a sphere

$\frac{X_\infty - X}{X_\infty - X_{t_0}} = \sum_{i=1}^{\infty} \frac{6}{i^2 \pi^2} \exp \left(-\frac{i^2 \pi^2 D_{eff}}{r_d^2} (t - t_0) \right)$	Eq. IV-5
--	----------

$\frac{X_\infty - X}{X_\infty - X_{t_0}} = A \exp(-k(t - t_0))$	Eq. IV-6
---	----------

$\ln \left(\frac{X_\infty - X}{X_\infty - X_{t_0}} \right) = -k(t - t_0)$	Eq. IV-7
--	----------

$D_{eff} = k \frac{r_d^2}{\pi^2}$	Eq. IV-8
-----------------------------------	----------

Starting accessibility: value obtained by extrapolating diffusion model to $t=0$: $X_0 \neq (X_i = 0)$

$X_\infty - X_i = X_\infty - X_0 = \delta X_s$	Eq. IV-9
--	----------

IV. RESULTS AND DISCUSSION

1. Extraction kinetics: Study and Modeling

To identify the extraction kinetics, measurements of extracts were carried out for the different samples (untreated seeds and DIC treated). Figure IV-2 presents the untreated sample and two DIC pre-treated sample extract kinetics. Whatever the DIC treatment conditions, obtained kinetics during the extraction are always better than that obtained with untreated sample. Indeed, with regards to the carried out experimental design, DIC 3 and DIC 5 are the treatment inducing the weakest and the highest kinetics, respectively. Even after only 2-h extraction it was possible to obtain better extract yields with DIC treatment than untreated products for untreated seeds after 6-h extraction.

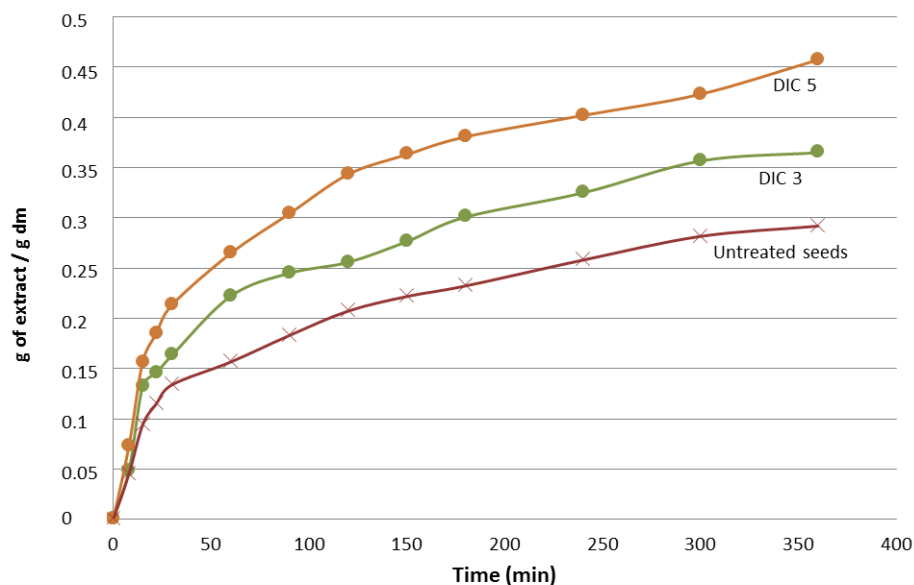

Figure IV-2. Extract yield kinetics of canola oil extraction treated and untreated seeds

To identify the impact of DIC parameters on the extraction oil, the starting accessibility δX_S , and the effective diffusivity D_{eff} were used as response variables. The same parameters were related to that of the untreated seeds and to the Norm in order to get baseline comparisons (Table IV-2).

Table IV-2: Starting accessibility, Effective Diffusivity and Oil Yield

	Pressure	Time	Starting accessibility		Effective Diffusivity	Oil Yield
	(MPa)	(s)	Value (g/100g dm)	Ratio (%)	(10^{-12} m ² /s)	(g/100g dm)
DIC1	0.45	70	12.40	23.70	2.051	36.71
DIC2	0.7	70	10.87	20.76	1.179	30.92
DIC3	0.45	120	12.41	23.71	1.075	28.39
DIC4	0.63	105	12.92	24.68	1.067	31.56
DIC5	0.63	35	15.01	28.69	1.879	37.28
DIC6	0.45	70	14.06	26.87	1.737	35.58
DIC7	0.27	35	14.75	28.19	1.435	31.94
DIC8	0.27	105	13.48	25.75	1.037	31.17
DIC9	0.2	70	14.44	27.59	1.536	32.15
DIC10	0.45	20	13.92	26.59	1.786	33.77
DIC11	0.45	70	14.49	27.68	1.826	35.16
RM	-	-	9.96±0.10	19.03±1.63	0.706±0.02	24.72±0.1
ISO-Norm	-	-	32.90±0.08	62.87±1.40	0.713±0.01	45.02±0.06

2. Starting accessibility

The starting accessibility depends on the specific surface area (SSA) of the product, which is function of granule diameter. SSA for such compact granules is related to $1/D$ (D being the diameter of the particles).

As shown in Table IV-2, DIC treatment systematically allowed increasing the starting accessibility δX_s whose ratio reveals the percentage that is removed within the first step extraction, i.e. the “washing” stage (Fernández et al., 2012). DIC pre-treatment systematically induced an increase of starting accessibility from 109% to 151% compared to the untreated matrix RM. We can suppose that the increase of δX_s via DIC was caused by the enhancement of the SSA. This supposition was based on studies regarding SSA before and after DIC treatment on several products (Ben Amor and Allaf, 2009; Iguedjtal et al., 2008; Kamal et al., 2008).

It was very interesting to note that for the Norm sample, the δX_s was very significant compared to usual untreated seeds (62.87% instead 19.03%, respectively). By comparing the mean diameter (Fig. 3) to the starting accessibility of raw material finely ground for Norm at 360 μm ; and coarsely ground at 1 mm for the usual raw material, δX_s became 32.90 instead of 9.96 g/100g dm, respectively.

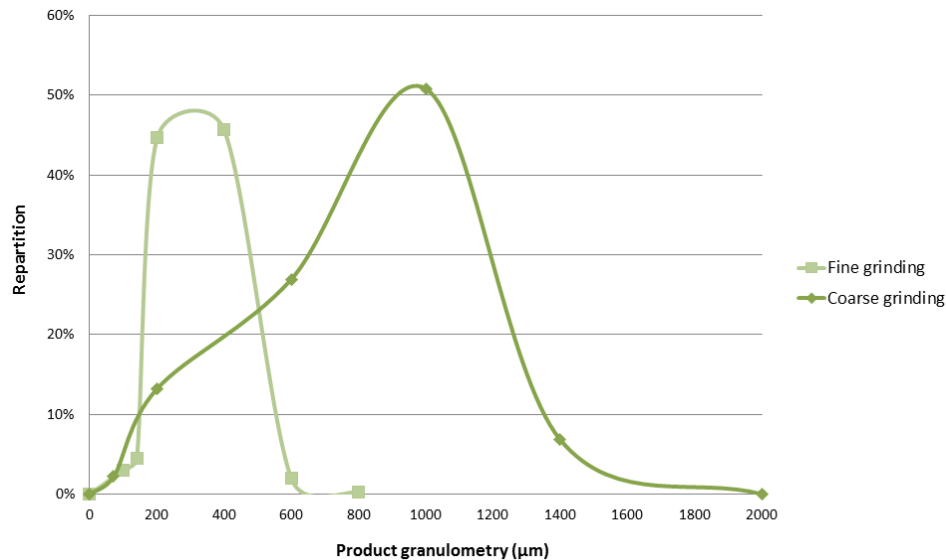

Figure IV-3. Granulometry repartition of seeds ground coarsely and finely

The ISO-Norm for the extraction of canola oil enables a better extraction via a higher starting accessibility thanks to a very fine grinding. This norm can easily be performed at laboratory scale. However it is important to highlight that fine grinding generates real issues in industries. Hence SSA has to be enhanced via other ways than intensive grinding.

3. Effective diffusivity

To study and even optimize DIC operating parameters vis-à-vis the effective diffusivity D_{eff} , experimental results were analyzed using a central composite design. The mathematical relationship obtained was a polynomial empirical model representing the quantitative effect of process variables and their interactions on the measured response. The values of the coefficients of P and t were related to the effect of these variables on the response.

Pareto chart of standardized effects (Figure IV-4) was calculated in order to show significant effects of all variables (linear, quadratic and interactions between variables). The vertical line represents the limit between the significant and insignificant effects regarding the response. The length of each parameter characterizes the absolute importance of the estimated effects. Pareto charts revealed that the longer the treatment, the less the effective diffusivity.

It also shows that squared t and squared P are significant. Indeed as one can see in the main effect plot, we had an optimal point for both pressure and time. Indeed as we can see in Figure IV-4, if we apart from these “optimal” points we obtain a lower D_{eff} .

The response surfaces enabled the representation of the total effect of operative parameters. RSM optimization was used to show the impact of the operative factors in terms of effective diffusivity (Figure IV-4). Saturated steam pressure injected in the treatment chamber showed an optimum when its value is average.

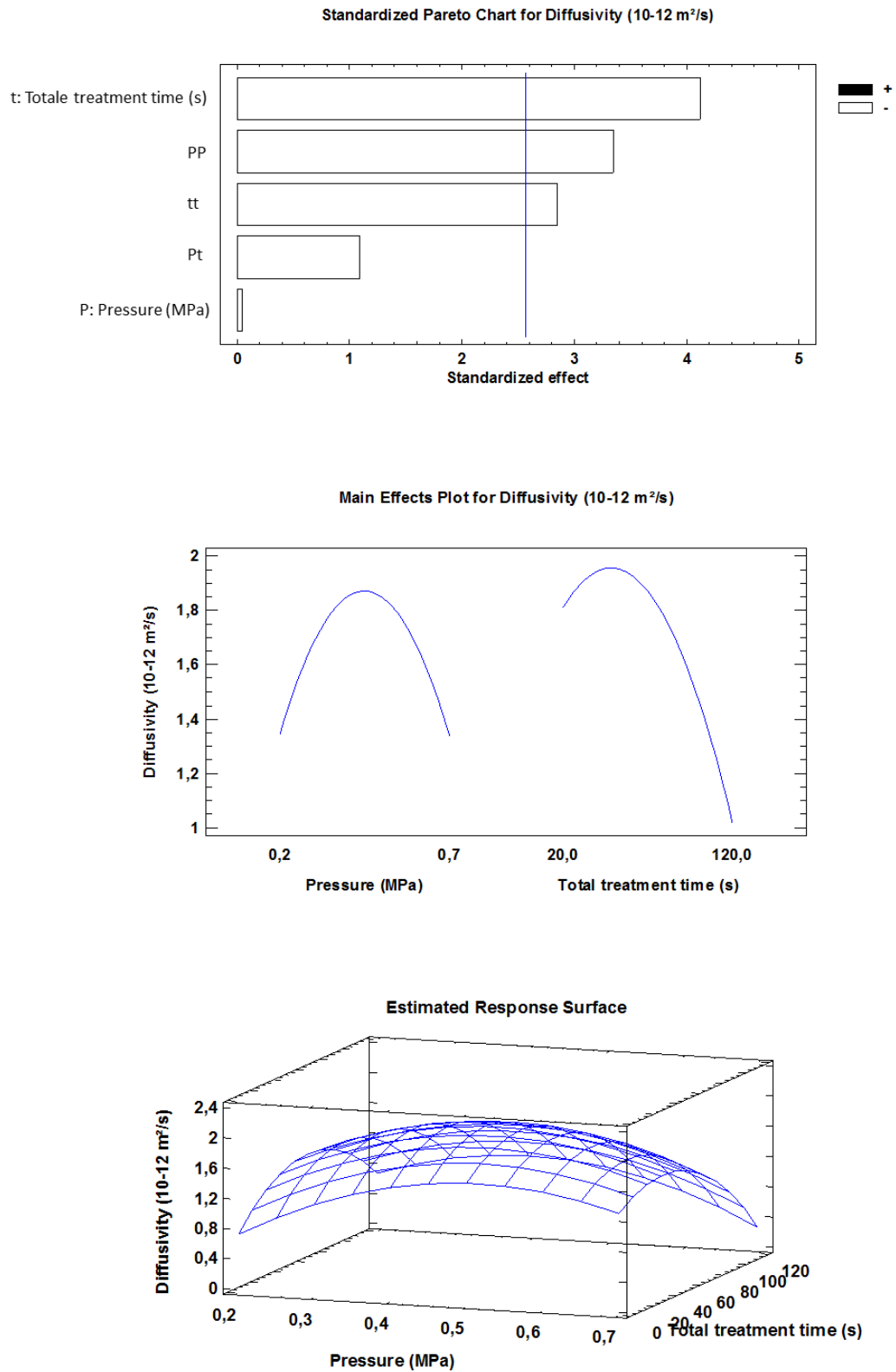

Figure IV-4. Statistical modeling of canola seed oil extraction kinetics: Standard Pareto Chart, main effects plot and estimated response surface of effective diffusivity De_{ff}

It was therefore possible to identify the highest and the quickest DIC extraction process through the operation efficiency. The optimized DIC operating conditions determined with the goal to maximize effective diffusivity was obtained with the following parameters: 0.47 MPa and 48 s with D_{eff} of $1.96 \cdot 10^{-12} \text{ m}^2 \text{ s}^{-1}$ versus $0.706 \cdot 10^{-12} \text{ m}^2 \text{ s}^{-1}$ for the usual raw material.

This established mathematical empirical model indicated hereafter:

$D_{\text{eff}} = (-0.70736 + 8.7907P + 0.025145t - 8.502P^2 - 0.0165Pt - 0.0001828t^2) \cdot 10^{-12} \text{ m}^2 \text{ s}^{-1}$	
with $R^2 = 86.90 \%$	Eq. IV-10

In this study effective diffusivity of the extractions performed on the different material (RM, DIC1-11 and ISO-Norm) were compared.

DIC treatment systematically increased the effective diffusivity D_{eff} . It is very interesting here to note that both finely ground Norm sample and usual coarsely ground sample, had similar values of the effective diffusivity (0.706 and $0.713 \cdot 10^{-12} \text{ m}^2/\text{s}$, respectively), independently on the mean diameter ($300 \mu\text{m}$ and 1 mm , respectively). D_{eff} of DIC-treated samples were significantly higher. Indeed their values depending on the applied parameters were up to $1.960 \cdot 10^{-12} \text{ m}^2/\text{s}$. The effective diffusivity, unlike starting accessibility does not depend on the grinding of the matrix. Canola seeds without pre-treatment coarsely and fine grinding had averagely the same effective diffusivity.

4. Oil analysis via Gas chromatography

After establishing the extraction kinetics through weighing method, the analysis of extracts carried out by GC-MS and GC-FID using FAME method, allowed to identifying their fatty acid composition revealing the profile and total amount of extracted oil in each sample (Table IV-2).

The analysis of the FAMES by GC-FID showed that the availability of oil yields can increase from 126% to 151% for samples treated by DIC in comparison with the availability of oil yields of untreated material (RM).

5. Correlation between oil yield obtained via weighing and via gas chromatography

Kinetics results were obtained via weighing 1 mL samples withdrawn from the extraction vessel. Final lipid yields were determined via gas chromatography which gave very precise results. It was hence important to establish the correlation between these two elements. We hence linked final extract weights with lipid yield. The linear correlation between the total extracts and the lipid extracts was calculated and found to be very interesting:

Correlation equation	$y = 1.3467x + 0.0082$	Eq. IV-11
with $R^2 = 97.53\%$		

6. Impact of DIC parameters on oil extraction yields

To determine and optimize DIC operating parameters this time vis-à-vis the final extracted lipid yield, experimental results were analyzed using Statgraphics software. The mathematical relationship obtained was a polynomial empirical model representing the quantitative effect of process variables and their interactions on the measured response. The values of the coefficients of P and t were related to the effect of these variables on the response. Statgraphics software tested the statistical significance of each effect by comparing the mean square against an estimate of the experimental error. In this case, 2 effects have P-values less than 0.05, indicating that they are significantly different from zero at the 95% confidence level.

Pareto chart of standardized effects (Figure IV-5) was calculated in order to show significant effects of all variables (linear, quadratic and interactions between variables). As said earlier, the vertical line represents the limit between the significant and insignificant effects regarding the response. Pareto charts revealed that the longer the treatment, the less the lipid extracted. The response surfaces enabled the representation of the total effect of each operative parameter. RSM optimization was used to show the impact of the operative factors in terms of effective diffusivity (Figure IV-5).

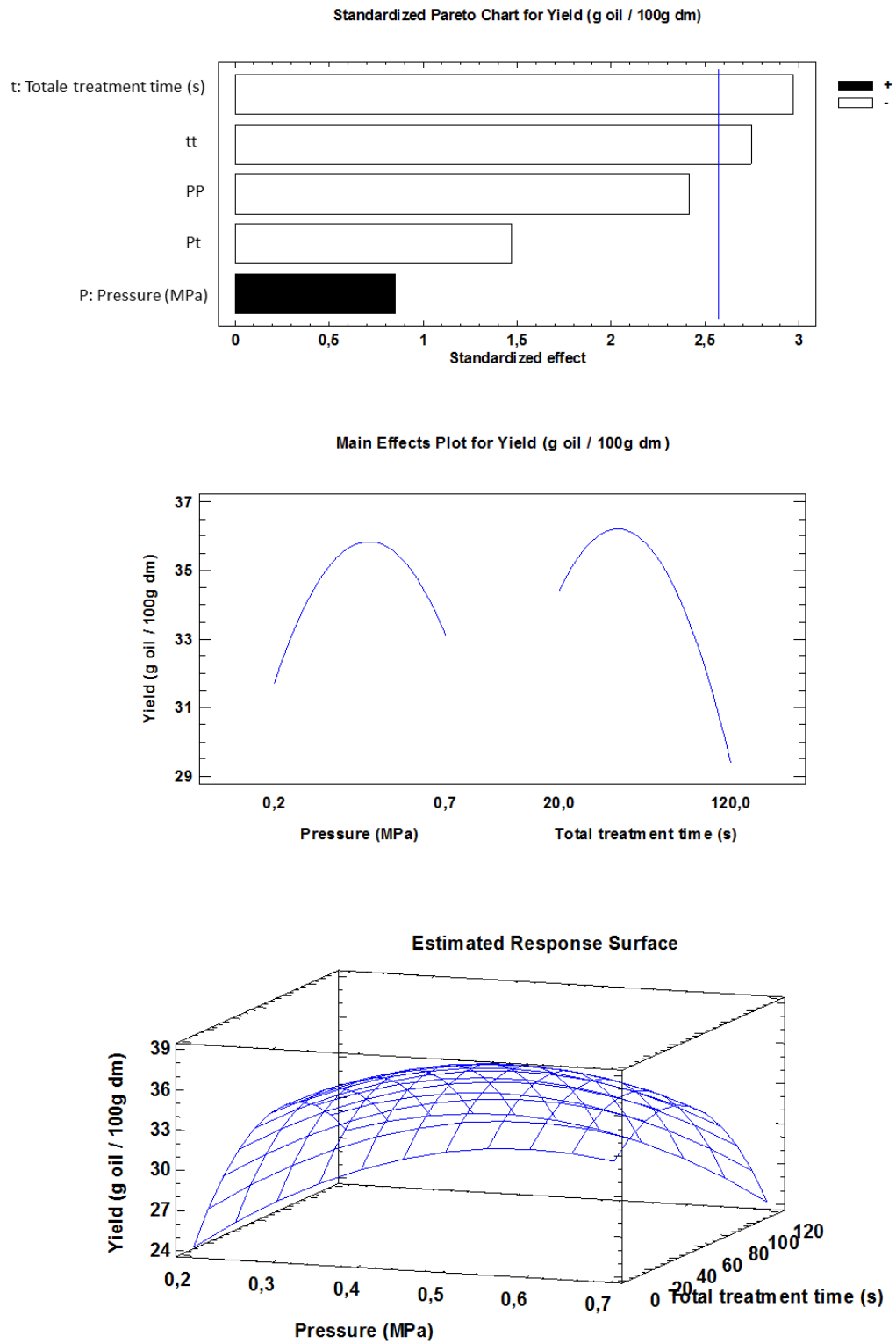

Figure IV-5. Statistical modeling of canola seed oil extraction: Standard Pareto Chart, main effects plot and estimated response surface of final oil yield

It was therefore possible to identify the highest and the quickest DIC extraction process through the operation efficiency. The optimized DIC operating conditions determined with the goal to maximize effective diffusivity was obtained with the following parameters: 0.51 MPa – 50 s with 36.39 g/100 g dm of lipid extracted yield versus 24.72 g/100 g dm for the usual raw material.

The equation of the fitted model is:

$Yield_{oil} = 13.2196 + 65.4494 P + 0.025645 t - 54.2845 P^2 - 0.196429 Pt - 0.00155838 t^2$	
with $R^2 = 81.55\%$	Eq. IV-12

The R-Squared statistic indicates that the model as fitted explains 81.55% of the variability in oil extraction yields. Since the P-value is greater than 5%, there is no indication of serial autocorrelation in the residuals at the 5% significance level.

7. Fatty acid composition (percentage level)

Extracts were analyzed by GC-MS and GC-FID in order to identify their fatty acid composition and to compare pre-treated and untreated rapeseeds. These analyses allowed a qualitative and quantitative comparison between the different samples. The total contents of fatty acids were determined using a modified fatty acid methyl ester (FAME) method (Morrison and Smith, 1964).

Fatty acid can be divided in 3 groups: Saturated Fatty Acids (SFA), MUFA (Mono-Unsaturated Fatty Acid) and PUFA (Poly-Unsaturated Fatty Acid). The fatty acid composition of extracted oils is presented in Table IV-3 and Figure IV-6. Extracted canola oils contain all around 60% of MUFA, 30% of PUFA and 6% of SFA.

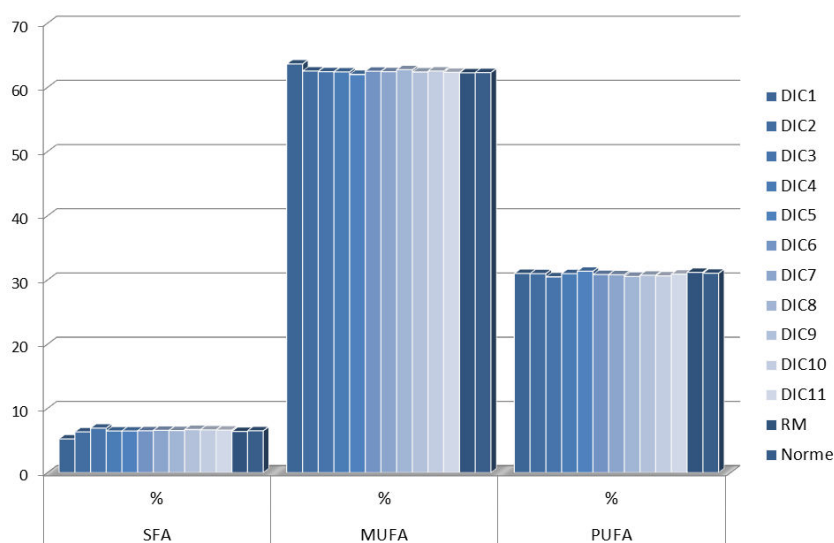

Figure IV-6: Fatty acid group of canola oils

In all the extraction of canola oils we have found that there are 3 fatty acids that are predominantly present; with oleic acid (C18:1n9) ranged from 57.58 to 59.03%, linoleic acid (C18:2n6) ranged from 21.23 to 21.89%, and linolenic acid (C18:3n3) ranged from 9.11 to 9.45%.

Regarding fatty acid profile, DIC treatment did not generate degradation as shown in Table IV-3 and Figure IV-7.

Table IV-3: Fatty acid profile (relative proportion %) obtained via Gas chromatography

Table IV-3: Fatty acid profile (relative proportion %) obtained via Gas chromatography

%	DIC1	DIC2	DIC3	DIC4	DIC5	DIC6	DIC7	DIC8	DIC9	DIC10	DIC11	RM	ISO-Norm
C₁₆	3.35	4.21	4.67	4.28	4.32	4.27	4.29	4.29	4.40	4.30	4.33	4.16±0.06	4.31±0.01
C_{16:1n9}	0.15	0.17	0.20	0.18	0.19	0.18	0.18	0.18	0.19	0.19	0.19	0.18±0.01	0.19±0.00
C₁₈	1.19	1.39	1.51	1.44	1.43	1.47	1.49	1.48	1.54	1.55	1.51	1.44±0.04	1.44±0.02
C_{18:1n9}	58.87	58.12	58.04	58.09	57.58	58.02	58.56	58.38	57.96	57.62	58.23	57.99±0.07	59.03±0.07
C_{18:2n6}	21.60	21.67	21.23	21.66	21.79	21.50	21.55	21.34	21.48	21.34	21.54	21.89±0.00	21.76±0.00
C_{18:3n3}	9.32	9.23	9.16	9.22	9.45	9.23	9.17	9.11	9.17	9.19	9.26	9.19±0.04	9.20±0.02
C₂₀	0.49	0.50	0.50	0.51	0.51	0.52	0.53	0.52	0.50	0.53	0.51	0.53±0.00	0.51±0.00
C_{20:1n9}	2.18	2.04	2.12	2.10	2.10	2.11	1.92	2.12	2.15	2.23	2.04	2.02±0.01	1.76±0.01
C_{20:2n6}	0.11	0.11	0.11	0.12	0.13	0.13	0.12	0.12	0.12	0.13	0.12	0.12±0.00	0.10±0.00
C₂₂	0.25	0.26	0.27	0.27	0.25	0.27	0.29	0.28	0.27	0.29	0.28	0.29±0.00	0.27±0.00
C_{22:1n9}	2.46	2.23	2.12	2.05	2.16	2.21	1.81	2.09	2.11	2.52	1.89	2.10±0.01	1.34±0.00
SFA	5.27	6.36	6.94	6.50	6.51	6.52	6.60	6.57	6.72	6.68	6.62	6.42±0.10	6.53±0.04
MUFA	63.66	62.55	62.47	62.42	62.03	62.53	62.47	62.76	62.41	62.56	62.35	62.29±0.17	62.33±0.08
PUFA	31.02	31.01	30.50	31.00	31.37	30.85	30.83	30.57	30.76	30.66	30.92	31.21±0.04	31.06±0.03
Yield_{Oil}	36.71	30.92	28.39	31.56	37.28	35.58	31.94	31.17	32.15	33.77	35.16	24.72±0.10	45.02±0.06

RM: Raw Material

DIC: seeds treated by DIC following the experimental design

Norm: ISO 659-1988 norm

SFA: Saturated Fatty Acid; MUFA: Mono-Unsaturated Fatty Acid; PUFA: Poly-Unsaturated Fatty Acid;

Yieldoil: Extracted oil yield in g / 100 g dm)

If there were considerable and accurate differences we would have concluded to thermal degradation when using DIC. As shown in Figure IV-7 relative fatty acid proportion are alike. DIC treatment do not generates modifications regarding the fatty acid profile.

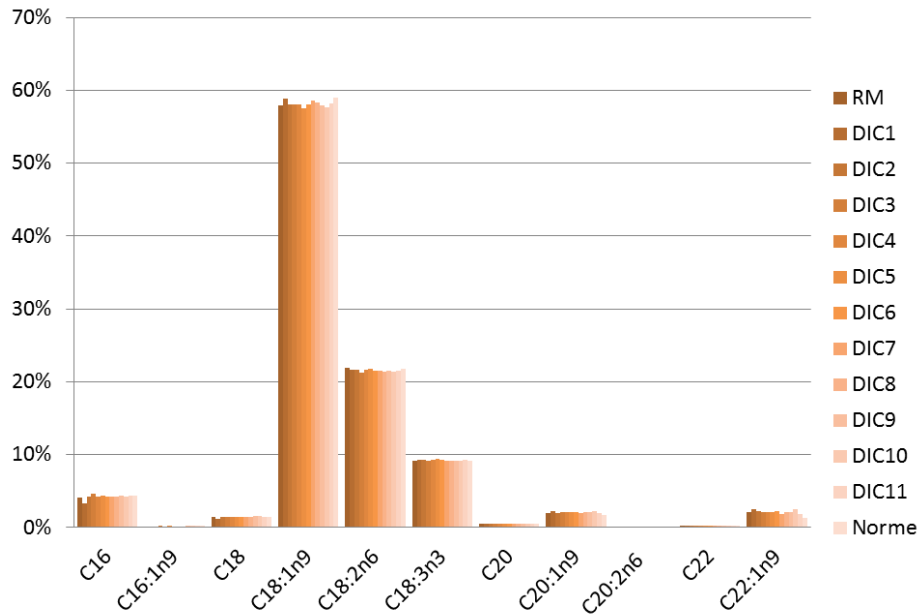

Figure IV-7: Relative lipid percentage

V. CONCLUSION

Canola seeds were treated by instant controlled pressure-drop (DIC) at different operative parameters, as a pretreatment for solvent extraction (n-hexane). Via RSM response surface methodology, the impact of DIC pre-treatment to solvent extraction on the oil extraction process showed considerable enhancement. Indeed whatever the DIC treatment conditions, oil yield and effective diffusivity, after 6 hours of extraction, were higher than that of the untreated raw material (RM). It was clearly noted that, whatever the operative conditions, the DIC treatment had a strong influence on the yields and the rate of extraction process. For modeling kinetics, it was assumed the process to start by a convection stage between the solvent and the exchange surface and a second stage of diffusion within the porous solid. The first process had to be revealed through the starting accessibility, when the effective diffusivity as well as the yields could explain the second stage.

Regarding oils quality, predominant fatty acids in all extracted canola oils are oleic acid (C18:1n9), linoleic acid (C18:2n6) and linolenic acid (C18:3n3). None of DIC treatment produced a modification of the fatty acid relative proportion.

VI. REFERENCES

- Allaf, K., (1982). Transfer phenomena and industrial applications, *Lebanese University Faculty of Science*, Beirut, p. 182.
- Allaf, K., (1988). Approche à l'analyse fondamentale de l'expansion par alvéolation selon différents procédés (puffing, cuisson-extrusion...). Université de Technologie de Compiègne, Compiègne - France.
- Allaf, K., Besombes, C., Berka-Zougali, B., Kristiawan, M., Sobolik, V., Allaf, T., (2011a). Instant Controlled Pressure Drop Technology in Plant Extraction Processes, in: Lebovka, N., Vorobiev, E., Chemat, F. (Eds.), *Enhancing Extraction Processes in the Food Industry*. CRC Press Taylor & Francis Group, Dublin, Ireland, pp. 255-302.
- Allaf, T., Besombes, C., Mih, I., Lefevre, L., Allaf, K., (2011b). Decontamination of Solid and Powder Foodstuffs using DIC Technology, in: InTech (Ed.), *Advances in Computer Science and Engineering*. Matthias Schmidt, Croatia.
- Allaf, T., Mounir, S., Tomao, V., Chemat, F., (2012a). Instant Controlled Pressure Drop Combined to Ultrasounds as Innovative Extraction Process Combination: Fundamental Aspects. *Procedia Engineering* 42, 1164-1181.
- Allaf, T., Tomao, V., Ruiz, K., Chemat, F., (2012b). Instant controlled pressure drop technology and ultrasound assisted extraction for sequential extraction of essential oil and antioxidants. *Ultrasonics Sonochemistry* (In Press).
- Allaf, T., Tomao, V., Ruiz, K., Chemat, F., (2013). Instant controlled pressure drop technology and ultrasound assisted extraction for sequential extraction of essential oil and antioxidants. *Ultrasonics Sonochemistry* 20(1), 239-246.
- AOCS, A.O.C.s.S., (1989). *Official Method Ce 2-66*. American Oil Chemist's Society, Champaign.
- Ben Amor, B., Allaf, K., (2009). Impact of texturing using instant pressure drop treatment prior to solvent extraction of anthocyanins from Malaysian Roselle (*Hibiscus sabdariffa*). *Food Chemistry* 115(3), 820-825.
- Benoist, D., Tourbier, Y., Germain-Tourb, S., (1994). *Plans d'expériences: construction et analyse*. Lavoisier, London.
- Berka-Zougali, B., Hassani, A., Besombes, C., Allaf, K., (2010). Extraction of essential oils from Algerian myrtle leaves using instant controlled pressure drop technology. *Journal of Chromatography A* 1217(40), 6134-6142.
- Besombes, C., Berka-Zougali, B., Allaf, K., (2010). Instant controlled pressure drop extraction of lavender essential oils: fundamentals and experimental studies. *Journal of Chromatography A* 1217(44), 6807-6815.
- Brühl, L., Matthäus, B., Bernd, W., (1999). Extraction of oilseeds by SFE : a comparison with other methods for the determination of the oil content. *Fresenius' journal of analytical chemistry* 364(7), 631-634.
-

- Eggers, R., (1985). High pressure extraction of oil seed. *Journal of the American Oil Chemists' Society* 62(8), 1222-1230.
- Fernández, M.B., Perez, E.E., Crapiste, G.H., Nolasco, S.M., (2012). Kinetic study of canola oil and tocopherol extraction: Parameter comparison of nonlinear models. *Journal of Food Engineering* 111(4), 682-689.
- Hensarling, T.P., Jacks, T.J., (1983). Solvent extraction of lipids from soybeans with acidic hexane. *Journal of the American Oil Chemists' Society* 60(4), 783-784.
- Iguedjal, T., Louka, N., Allaf, K., (2008). Sorption isotherms of potato slices dried and texturized by controlled sudden decompression. *Journal of Food Engineering* 85(2), 180-190.
- Kamal, I.M., Sobolik, V., Kristiawan, M., Mounir, S.M., Allaf, K., (2008). Structure expansion of green coffee beans using instantaneous controlled pressure drop process. *Innovative Food Science & Emerging Technologies* 9(4), 534-541.
- Kmiecik, S., Meziane, S., Kadi, H., Moussaoui, R., (1991). Oil extraction from olive foot cake with acidic hexane. *Grasas y aceites* 42(1), 46-50.
- Kristiawan, M., Sobolik, V., Allaf, K., (2008). Isolation of Indonesian cananga oil using multi-cycle pressure drop process. *Journal of Chromatography A* 1192(2), 306-318.
- Meziane, S., Kadl, H., Lamrous, O., (2006). Kinetic study of oil extraction from olive foot cake. *Grasas y aceites* 57(2), 175-179.
- Morrison, W.R., Smith, L.M., (1964). Preparation of fatty acid methyl esters and dimethylacetals from lipids with boron fluoride-methanol. *Journal of Lipid Research* 5(4), 600-608.
- Mounir, S., Besombes, C., Al-Bitar, N., Allaf, K., (2011). Study of Instant Controlled Pressure Drop DIC - Treatment in Manufacturing Snack and Expanded Granule Powder of Apple and Onion. *Drying Technology* 29(3), 331-331.
- Olivier, B., Elisabeth, B., (2009). Extraction from oleaginous seeds using supercritical CO₂ : Experimental design and products quality. *Journal of Food Engineering* 92(4), 396-402.
- Przybylski, R., Mag, T., Eskin, N.A.M., McDonald, B.E., (2005). *Canola Oil, Bailey's Industrial Oil and Fat Products*. John Wiley & Sons, Inc.
- So, G.C., Macdonald, D.G., (1986). Kinetics of oil extraction from canola (rapeseed). *Canadian Journal of Chemical Engineering* 64(1), 80-86.
- Standardization, I.O.f., (1998). Oilseeds — Determination of oil content (Reference method), in: Standard, I. (Ed.), Geneva, Switzerland.
- Tulbentci, H.S.G., (1986). Extraction of rapeseed, linseed, safflowerseed and tobaccoseed with a new laboratory extractor. *Journal of the American Oil Chemists' Society* 63(11), 1465-1469.
- USDA, (2013). Soybeans & Oil Crops: Canola. United States Department of Agriculture Economic Research Service.
- Allaf, K., (1982). Transfer phenomena and industrial applications, *Lebanese University Faculty of Science*, Beirut, p. 182.

- Allaf, K., (1988). Approche à l'analyse fondamentale de l'expansion par alvéolation selon différents procédés (puffing, cuisson-extrusion...). Université de Technologie de Compiègne, Compiègne - France.
- Allaf, K., Besombes, C., Berka-Zougali, B., Kristiawan, M., Sobolik, V., Allaf, T., (2011a). Instant Controlled Pressure Drop Technology in Plant Extraction Processes, in: Lebovka, N., Vorobiev, E., Chemat, F. (Eds.), *Enhancing Extraction Processes in the Food Industry*. CRC Press Taylor & Francis Group, Dublin, Ireland, pp. 255-302.
- Allaf, T., Besombes, C., Mih, I., Lefevre, L., Allaf, K., (2011b). Decontamination of Solid and Powder Foodstuffs using DIC Technology, in: InTech (Ed.), *Advances in Computer Science and Engineering*. Matthias Schmidt, Croatia.
- Allaf, T., Mounir, S., Tomao, V., Chemat, F., (2012a). Instant Controlled Pressure Drop Combined to Ultrasounds as Innovative Extraction Process Combination: Fundamental Aspects. *Procedia Engineering* 42, 1164-1181.
- Allaf, T., Tomao, V., Ruiz, K., Chemat, F., (2012b). Instant controlled pressure drop technology and ultrasound assisted extraction for sequential extraction of essential oil and antioxidants. *Ultrasonics Sonochemistry* (In Press).
- Allaf, T., Tomao, V., Ruiz, K., Chemat, F., (2013). Instant controlled pressure drop technology and ultrasound assisted extraction for sequential extraction of essential oil and antioxidants. *Ultrasonics Sonochemistry* 20(1), 239-246.
- AOCS, A.O.C.s.S., (1989). *Official Method Ce 2-66*. American Oil Chemist's Society, Champaign.
- Ben Amor, B., Allaf, K., (2009). Impact of texturing using instant pressure drop treatment prior to solvent extraction of anthocyanins from Malaysian Roselle (*Hibiscus sabdariffa*). *Food Chemistry* 115(3), 820-825.
- Benoist, D., Tourbier, Y., Germain-Tourb, S., (1994). *Plans d'expériences: construction et analyse*. Lavoisier, London.
- Berka-Zougali, B., Hassani, A., Besombes, C., Allaf, K., (2010). Extraction of essential oils from Algerian myrtle leaves using instant controlled pressure drop technology. *Journal of Chromatography A* 1217(40), 6134-6142.
- Besombes, C., Berka-Zougali, B., Allaf, K., (2010). Instant controlled pressure drop extraction of lavandin essential oils: fundamentals and experimental studies. *Journal of Chromatography A* 1217(44), 6807-6815.
- Brühl, L., Matthäus, B., Bernd, W., (1999). Extraction of oilseeds by SFE : a comparison with other methods for the determination of the oil content. *Fresenius' journal of analytical chemistry* 364(7), 631-634.
- Eggers, R., (1985). High pressure extraction of oil seed. *Journal of the American Oil Chemists' Society* 62(8), 1222-1230.
- Fernández, M.B., Perez, E.E., Crapiste, G.H., Nolasco, S.M., (2012). Kinetic study of canola oil and tocopherol extraction: Parameter comparison of nonlinear models. *Journal of Food Engineering* 111(4), 682-689.
- Hensarling, T.P., Jacks, T.J., (1983). Solvent extraction of lipids from soybeans with acidic hexane. *Journal of the American Oil Chemists' Society* 60(4), 783-784.
- Iguedjtal, T., Louka, N., Allaf, K., (2008). Sorption isotherms of potato slices dried and texturized by controlled sudden decompression. *Journal of Food Engineering* 85(2), 180-190.
- Kamal, I.M., Sobolik, V., Kristiawan, M., Mounir, S.M., Allaf, K., (2008). Structure expansion of green coffee beans using instantaneous controlled pressure drop process. *Innovative Food Science & Emerging Technologies* 9(4), 534-541.

-
- Kmieciak, S., Meziane, S., Kadi, H., Moussaoui, R., (1991). Oil extraction from olive foot cake with acidic hexane. *Grasas y aceites* 42(1), 46-50.
- Kristiawan, M., Sobolik, V., Allaf, K., (2008). Isolation of Indonesian cananga oil using multi-cycle pressure drop process. *Journal of Chromatography A* 1192(2), 306-318.
- Meziane, S., Kadl, H., Lamrous, O., (2006). Kinetic study of oil extraction from olive foot cake. *Grasas y aceites* 57(2), 175-179.
- Morrison, W.R., Smith, L.M., (1964). Preparation of fatty acid methyl esters and dimethylacetals from lipids with boron fluoride–methanol. *Journal of Lipid Research* 5(4), 600-608.
- Mounir, S., Besombes, C., Al-Bitar, N., Allaf, K., (2011). Study of Instant Controlled Pressure Drop DIC - Treatment in Manufacturing Snack and Expanded Granule Powder of Apple and Onion. *Drying Technology* 29(3), 331-331.
- Olivier, B., Elisabeth, B., (2009). Extraction from oleaginous seeds using supercritical CO₂ : Experimental design and products quality. *Journal of Food Engineering* 92(4), 396-402.
- Przybylski, R., Mag, T., Eskin, N.A.M., McDonald, B.E., (2005). *Canola Oil, Bailey's Industrial Oil and Fat Products*. John Wiley & Sons, Inc.
- So, G.C., Macdonald, D.G., (1986). Kinetics of oil extraction from canola (rapeseed). *Canadian Journal of Chemical Engineering* 64(1), 80-86.
- Standardization, I.O.f., (1998). Oilseeds — Determination of oil content (Reference method), in: Standard, I. (Ed.), Geneva, Switzerland.
- Tulbentci, H.S.G., (1986). Extraction of rapeseed, linseed, safflowerseed and tobaccoseed with a new laboratory extractor. *Journal of the American Oil Chemists' Society* 63(11), 1465-1469.
- USDA, (2013). *Soybeans & Oil Crops: Canola*. United States Department of Agriculture Economic Research Service.

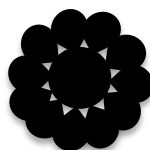
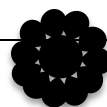
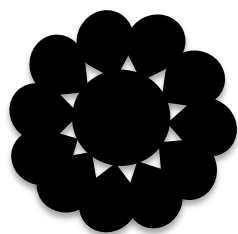

Conclusion Générale et Perspectives

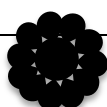
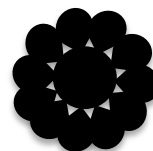
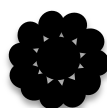
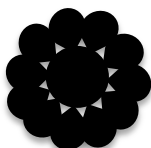

CONCLUSION GENERALE & PERSPECTIVES

Le domaine de l'extraction des substances naturelles à partir du végétal souffre d'un manque d'analyse fondamentale des processus et de l'absence de modèles capables de présenter des corrélations générales et pertinentes entre les données structurales du végétal et les performances fonctionnelles des procédés.

L'objet de la présente étude concerne l'intensification de l'opération unitaire d'extraction des composés naturels. Un processus d'intensification doit suivre une philosophie, un scénario souvent laissé pour compte ou abordé d'une façon purement empirique voire approximative.

Afin d'intensifier les opérations d'extraction, il faut chercher à améliorer ou remettre en question les méthodes « conventionnelles » d'extraction. Il ne s'agit pas d'un choix subjectif, mais du fruit d'un processus d'analyse théorique et expérimentale des divers phénomènes intervenant au cours de l'extraction.

Pour ce qui est de l'extraction, il faut tout d'abord procéder à l'étude du végétal visant à déterminer la localisation des composés convoités. Cet aspect est très souvent négligé, le végétal étant abordé en tant que matrice amorphe, homogène, sans aucune particularité. Les biologistes font bien de nous rappeler que dans un végétal, chaque composé ou groupe de composés est localisé de manière spécifique. Un « bon » processus d'extraction doit donc tenir compte de l'anatomie de la plante.

Un autre aspect est à prendre en considération : les propriétés physico-chimiques des composés visés. Nous avons ainsi eu à classer les composés recherchés selon leur volatilité, en deux catégories : volatile et non-volatile. Un composé volatil est extrait par distillation, alors qu'un composé non-volatile nécessite généralement une extraction par solvant.

Pour l'extraction des composés volatils (huiles essentielles...), l'entraînement à la vapeur est ralenti voire bloqué par « le processus paradoxal ». Ce dernier est dû au couplage du transfert de la vapeur avec celui de la chaleur ; les deux sont alors dirigés de la surface d'échange vers l'intérieur. Seul un processus de transfert partiel de la vapeur par front progressif assure l'évolution du processus ; la cinétique est ainsi inévitablement lente,

généralisant un niveau élevé de consommation d'énergie et induisant une dégradation potentielle de la matière extraite.

Pour faire face à cette situation paradoxale, la modification de la nature du transfert est essentielle. Nous avons pu envisager le gradient de la pression totale au lieu du gradient de la pression partielle comme « driving force ». Nous avons ainsi choisi l'autovaporisation instantanée par DIC (Détente Instantanée Contrôlée) qui implique, suite à la détente, un transfert de type Darcy des vapeurs de l'intérieur du matériau vers le milieu environnant sous vide.

Les divers produits étudiés ont été considérés en vue de vérifier les analyses fondamentales déjà abordées, tout en préservant au sens expérimental, leur entière particularité sur le plan des problématiques qui leur sont spécifiques.

L'huile essentielle de feuilles de romarin a été extraite par DIC et par hydrodistillation (HD). Ces feuilles ont été récupérées puis extraites par solvant. Les feuilles ont été observées par microscopie optique et par microscopie électronique à balayage, avant et après traitement, à l'issue des deux opérations DIC et HD. L'intérêt des huiles essentielles des feuilles de romarin est évident. Leur extraction est souvent considérée comme un objectif propre, de par leur forte valeur économique. De nouvelles problématiques industrielles situent l'intérêt du romarin plutôt pour ses composés bioactifs non-volatils, en tant qu'antioxydants naturels. L'objectif que nous nous sommes fixé avec les industriels concernés est de recueillir des antioxydants « désodorisés ».

La « désodorisation » par DIC a été obtenue en 3 min comparée à 4h par HD. Loin de présenter une difficulté pénalisante, l'étape de désodorisation par DIC présente, tout au contraire, une amélioration intrinsèque du processus d'extraction par solvant. Les observations par microscopies nous ont poussés à opter pour une modification structurelle. Nous avons ainsi mis en évidence une meilleure disponibilité des composés non-volatils et un taux de composés antioxydants non-seulement considérablement supérieurs comparés aux feuilles désodorisées par hydrodistillation, mais également supérieurs comparés aux feuilles non-désodorisées.

Un autre matériau à portée économique et environnemental est l'écorce d'agrumes. L'intérêt est ici accordé aux huiles essentielles et aux composés antioxydants non-

volatils ; d'autres travaux ont, d'ores et déjà signalé la possibilité d'utilisation de ces « déchets » comme sources d'extraction de pectine.

Nous avons donc procédé à l'extraction des huiles essentielles par DIC. Une fois optimisée, l'opération est réalisée en 3 min contre 4 h par HD. La DIC ne nécessite pas de broyage préliminaire contrairement à l'HD. Afin de valoriser au mieux ce coproduit, nous l'avons récupéré et avons réalisé une extraction des molécules antioxydantes par solvant (éthanol:eau 80:20). La microscopie à balayage a montré de considérables différences en termes de structures entre DIC et HD. Ainsi, l'obstruction que génère l'HD lors de l'extraction des huiles essentielles induit un affaissement de la matrice et, par conséquence, une diminution notable de la diffusivité des flavonones au sein de la structure. En revanche, l'autovaporisation des volatils par DIC induit une structure aérée et stable, ce qui rend possible une surface d'échange plus importante, un contact plus intime entre le solvant et une matrice de plus grande accessibilité initiale (lavage) ainsi qu'une bien plus grande diffusivité effective.

D'autre part, quand l'extraction par solvant (éthanol:eau 80:20) est assistée par ultrasons, le rendement en naringine et hespéridine est clairement supérieur. Et plus nette est cette augmentation quand l'écorce d'orange a préalablement été traitée par DIC. La micro-agitation que génèrent les Ultrasons au sein des pores remplis de solvant, font que le transfert des composés de la paroi des pores vers le solvant (présent dans les pores du végétal) est de type convectif et non simplement diffusionnel ; autrement dit, les ultrasons vont permettre une nette augmentation de la diffusivité effective.

Dans nos travaux sur les graines de colza, nous nous sommes limités à une étude préliminaire visant à modéliser la cinétique d'extraction de l'huile de colza et à optimiser les paramètres de la DIC permettant une meilleure intensification. Il serait par la suite essentiel de réaliser un travail en accord avec les méthodes d'extraction industrielles. En outre, un souci majeur est soulevé en ce qui concerne la désolvation. En effet, après une extraction par solvant, les tourteaux de colza sont généralement utilisés pour l'alimentation du bétail. Ceux-ci doivent donc contenir une quantité de solvant minimale. La désolvation pourra avantageusement s'effectuer par autovaporisation instantanée.

Par ailleurs, l'extraction d'huile de colza par pressage est fréquemment laissée de côté vu le faible rendement que celui-ci produit. La DIC a déjà été utilisée pour l'amélioration de l'extraction par presse de l'huile de poisson permettant à celle-ci d'être hautement efficace.

Il serait dans ce cas plus qu'intéressant d'analyser les rendements d'huile de colza par une combinaison d'une extraction mécanique (pressage à froid, double-vis...) assistée par DIC. L'extension des principales tendances déjà établies vers d'autres sources oléagineuses serait un objectif immédiat de prochaines études d'un grand intérêt industriel.

D'autres études comparatives fondées sur un effort d'analyse en physique théorique et de physique semi-quantitative (thermodynamiques), chimiques... pourront guider la recherche de couplages adéquats entre les différentes technologies de Détente Instantanée Contrôlée DIC, microondes, ultrasons, et d'autres ; cela pourrait contribuer à la maîtrise des propriétés fonctionnelles pour répondre, de manières judicieuses, aux divers besoins industriels.

L'établissement de corrélations plus précises et plus générales entre les trois catégories des données cyto-histologiques, des caractéristiques structurelles et des spécificités fonctionnelles seraient également importantes à définir :

- données cyto-histologiques (localisation des composés, zones actives, catégorie cellulaire, caractéristiques des parois cellulaires, perméabilité des membranes...),
- caractéristiques structurelles issues principalement des modifications contrôlées (degré d'expansion absolue, porosité, surface spécifique, distribution des tailles de pores...),
- spécificités fonctionnelles (accessibilité initiale, diffusivité effective, perméabilité, rendement effectif...).

*“Caminante, no hay camino,
se hace camino al andar.
Al andar se hace el camino,
y al volver la vista atrás
se ve la senda que nunca
se ha de volver a pisar.”*

Antonio Machado

RÉSUMÉ

Cette étude porte sur l'analyse fondamentale et expérimentale des processus d'extraction des procédés conventionnels et innovants. L'intensification de ces techniques s'est tout d'abord basée sur des approches théoriques. D'une part, nous nous sommes focalisés sur « le paradoxe » généré par l'extraction conventionnelle des huiles essentielles et les issues et solutions que la Détente Instantanée Contrôlée (DIC) ou les Micro-Ondes (MO) peuvent apporter. D'autre part, nous nous sommes intéressés à la problématique d'intensification des opérations d'extraction par solvant des composés non-volatils à partir de végétaux. La spécificité des processus diffusionnels leur donne une importance particulière en raison de la structure propre de la matière, traduisant ainsi une mauvaise aptitude technologique intrinsèque. L'amélioration de l'extraction par l'action de la DIC sur la structure de la matrice, des MO sur le chauffage et des UltraSons (US) sur la micro-agitation, permet d'envisager un couplage, de conduire à une intensification après optimisation souvent multicritères (cinétique, qualité et énergie). La DIC a été appliquée sur des feuilles de romarin et des écorces d'orange afin d'en extraire les huiles essentielles. Ce traitement a permis d'accéder à une expansion et de parvenir à une intensification de l'extraction des molécules antioxydantes. Nous avons donc procédé à une combinaison DIC/MO pour le romarin et DIC/US pour les écorces d'orange. Enfin, la cinétique de l'extraction d'huiles de colza a été intensifiée par un prétraitement DIC et étudiée à travers une modélisation dont l'un des aspects a été une diffusion de type Fick couplée à une solution de Crank.

Mots-Clés : Extraction, diffusion, accessibilité initiale, intensification, Détente Instantanée Contrôlée (DIC), autovaporisation, ultrason

ABSTRACT

This study focuses on fundamental analysis and experimental work carried out on extraction via conventional and innovative processes. The intensification of these techniques is first based on theoretical approaches. On the one hand, we focused our meditation on examining the "paradox" generated by conventional steam-distillation of essential oils, and suggested solutions from Instant Controlled Pressure Drop (DIC) or Microwave (MW). On the other hand, we were interested in the problematic of solvent extraction operations of plant-based non-volatile compounds. The specificity of the diffusional process gives them a special importance because of the specific structure of the material, reflecting poor intrinsic technological ability. Improving extraction by letting DIC act on the structure of the matrix, MW on heating, and UltraSound (US) on the micro-agitation, allows to coupling technologies leading to a perfect intensification and thus multi-criteria optimization (kinetics, quality and energy). DIC was applied to the leaves of rosemary and orange peel to extract essential oils. This treatment has access to expansion and to achieve increased extraction of antioxidant molecules. We therefore conducted a combination DIC/MW for rosemary and DIC/US for orange peel. Finally, the extraction kinetics of rapeseed oil has been intensified by DIC pretreatment. This kinetics was identified through modeling including Fick diffusion coupled to a Crank solution.

Keywords: Extraction, diffusivity, starting accessibility, intensification, instant controlled pressure drop (DIC), autovaporization, ultrasound